



NAVAL AIR TRAINING COMMAND

NAS CORPUS CHRISTI, TEXAS

CNATRA P-303 (Rev 03-03)

**AVIATION WEATHER
STUDENT GUIDE**



PREFLIGHT

2003



DEPARTMENT OF THE NAVY

CHIEF OF NAVAL AIR TRAINING
CNATRA
250 LEXINGTON BLVD SUITE 102
CORPUS CHRISTI TX 78419-5041

1542

N317

31 MAR 2003

CNATRA P-303 (REV 03-03) PAT

Subj: AVIATION WEATHER STUDENT GUIDE

1. CNATRA P-303 (Rev 03-03) PAT, Aviation Weather Student Guide is issued for information, standardization of instruction, and guidance to instructors and students in the Naval Air Training Command.
2. This publication will be used to supplement the Preflight Syllabus in the Academic Department of Naval Aviation Schools Command.
3. Recommendations for changes shall be submitted to the Commanding Officer, Naval Aviation Schools Command, Code 031, via the TIP process. Questions concerning Preflight academics should be referred to CNATRA Naval Aviation Schools Command Academics Officer, Code N317. POC is Mr. Larry R. Wardle, DSN 861-3824, COMM (361) 961-3824. CNATRA FAX is DSN 861-3398. CNATRA POC E-Mail is wardle.l.r@nrs.navy.mil.
4. CNATRA P-303 (REV 09-98) is hereby cancelled and superseded.

A handwritten signature in dark ink, appearing to read "R. E. Bird".

R. E. BIRD
Assistant Chief of Staff for
Training and Operations

Distribution:

CNATRA (05)
CNATRA N62 (01)
NAVAVSCOLSCOM (500)

STUDENT GUIDE
FOR PREFLIGHT AVIATION WEATHER

Q-9B-0020

UNIT 2

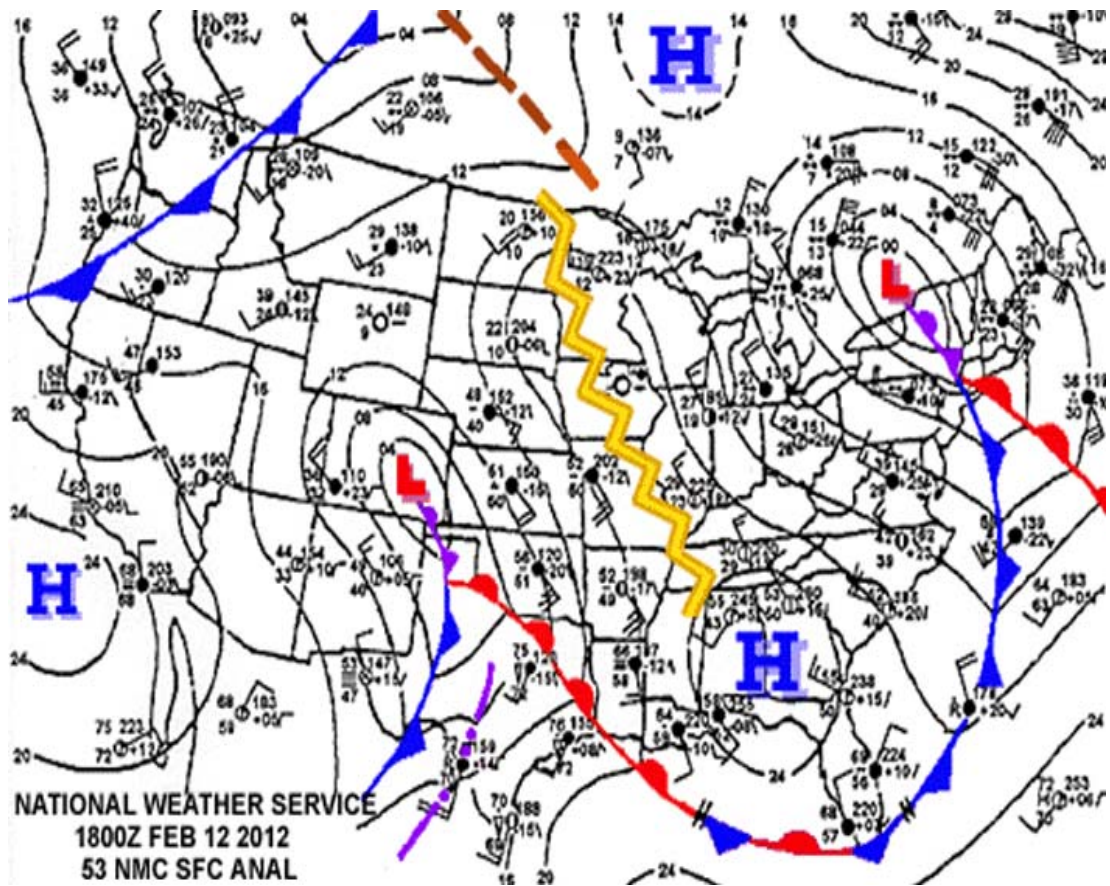

SECURITY AWARENESS NOTICE

This course does not contain any classified material.

SAFETY NOTICE

All personnel must be reminded personal injury, death, or equipment damage can result from carelessness, failure to comply with approved procedures, or violations of warnings, cautions, and safety regulations.

SAFETY/HAZARD AWARENESS NOTICE

- a. Safe training is the number one goal. Each year at training commands, lives are lost and thousands of man-hours and millions of dollars are wasted as the result of accidents. Most of these accidents could have been prevented. They are the result of actions performed incorrectly, either knowingly or unknowingly, by people who fail to exercise sufficient foresight, lack the requisite training, knowledge, or motivation, or who fail to recognize and report hazards.
- b. A mishap is any unplanned or unexpected event causing personnel injury, occupational illness, death, material loss or damage, or an explosion whether damage occurs or not.
- c. A near miss or hazardous condition is any situation where, if allowed to go unchecked or uncorrected, has the potential to cause a mishap.
- d. It is the responsibility of all Department of Defense personnel to report all mishaps and near misses. If a mishap, hazardous condition or near miss occurs let your instructor know immediately.
- e. Students will report all hazardous conditions and near misses to the command high-risk safety officer via their divisional/departmental high-risk safety officer. Reports can be hand written on the appropriate form. Injuries shall be reported on the appropriate form.

HOW TO USE THIS WORKBOOK

1. Read and become familiar with the objectives of each chapter. These objectives state the purpose of the chapter in terms of what you will be able to do as you complete the chapter. Most importantly, your end-of-course examination is developed directly from these objectives. Therefore, it is to your benefit to know all information the objectives are asking you to comprehend.
2. Before the class presentation, read the information in each chapter using the objectives as a guide. Develop a list of questions about material that is unclear to you at this point. This practice will allow you to ask questions when the topic is covered during the classroom presentation, or at a later time with the instructor in a one-on-one setting.
3. After the class presentation, re-read each chapter to ensure your comprehension of the subject material. If you desire further information, explanation, or clarification, consult the other resources available to you such as your Weather for Aircrews book, Internet web sites provided in Appendix D, and your instructor.
4. Answer the questions provided in the “Study Questions” sections. These questions will help you recall the information presented in each chapter and serve as a practice for the examination. Check your answers to the Study Questions with those provided in Appendix E. If your answer to a question is incorrect, review the objective and information covering that subject area prior to continuing to the next chapter. “Good Luck.”

CLASS SCHEDULE

| Topic No. | Type | Hours | Topic |
|---------------|--------|-------|--|
| Chapter One | Class | 2.0 | General Structure of the Atmosphere, Atmospheric Temperature and Pressure |
| Chapter Two | Class | 2.0 | Winds, Clouds and Moisture, and Atmospheric Stability |
| Chapter Three | Class | 2.0 | Frontal Systems |
| Chapter Four | Class | 1.0 | Thunderstorms |
| Chapter Five | Class | 3.0 | Weather Hazards of Turbulence, Icing, Ceilings, Visibility, and Ash Clouds |
| | Review | 1.0 | In Class Review |
| | Exam | 1.0 | Final Examination |

LIST OF EFFECTIVE PAGES

Dates of issue for original and changed pages are:

Original...0...31 Mar 03(this will be the date issued)

TOTAL NUMBER OF PAGES IN THIS PUBLICATION IS 158 CONSISTING OF THE FOLLOWING:

| Page no. | Page no. |
|-----------------|-----------------|
| COVER | 5-1 –5-33 |
| LETTER | 5-34 (blank) |
| iii - xiii | A-1 – A-10 |
| xiv (blank) | B-1 – B-5 |
| 1-1 – 1-17 | B-6 (blank) |
| 1-18 (blank) | C-1 – C-3 |
| 2-1 – 2-27 | C-4 (blank) |
| 2-18 (blank) | D- 1 |
| 3-1 – 3-22 | D-2 (blank) |
| 4-1 – 4-18 | E-1 – E-2 |
| | |
| | |
| | |

INTERIM CHANGE SUMMARY

The following Changes have been previously incorporated in this manual:

| CHANGE NUMBER | REMARKS/PURPOSE |
|------------------|-----------------|
| | |
| | |
| | |
| | |

The following interim Changes have been incorporated in this Change/Revision:

| INTERIM CHANGE NUMBER | REMARKS/PURPOSE | ENTERED BY | DATE |
|-----------------------------|-----------------|------------|------|
| | | | |
| | | | |
| | | | |
| | | | |
| | | | |
| | | | |
| | | | |

TABLE OF CONTENTS

| | |
|--------------------------------------|-------------|
| LIST OF EFFECTIVE PAGES | vii |
| INTERIM CHANGE SUMMARY | viii |
| TABLE OF CONTENTS | ix |
| TABLE OF FIGURES | xi |

CHAPTER ONE – General Structure of the Atmosphere, and Atmospheric Temperature and Pressure **1-1**

| | |
|---|-------------|
| 100. INTRODUCTION | 1-1 |
| 101. LESSON TOPIC LEARNING OBJECTIVES | 1-1 |
| 102. REFERENCES | 1-2 |
| 103. STUDY ASSIGNMENT | 1-2 |
| 104. THE ATMOSPHERE | 1-2 |
| 105. ATMOSPHERIC LAYERS..... | 1-2 |
| 106. COMPOSITION | 1-4 |
| 107. LAPSE RATES – TEMPERATURE AND PRESSURE | 1-4 |
| 108. UNITS OF MEASUREMENT | 1-6 |
| 109. THE STANDARD ATMOSPHERE | 1-7 |
| 110. STATION AND SEA LEVEL PRESSURE..... | 1-7 |
| 111. PRESSURE CHARTS..... | 1-8 |
| 112. ALTITUDE MEASUREMENT | 1-9 |
| 113. ALTIMETER ERRORS | 1-12 |
| STUDY QUESTIONS | 1-14 |

CHAPTER TWO – Atmospheric Mechanics of Winds, Clouds, and Moisture, and Atmospheric Stability **2-1**

| | |
|---|-------------|
| 200. INTRODUCTION | 2-1 |
| 201. LESSON TOPIC LEARNING OBJECTIVES | 2-1 |
| 202. REFERENCES | 2-2 |
| 203. STUDY ASSIGNMENT | 2-2 |
| 204. WINDS | 2-2 |
| 205. STATION MODELS | 2-3 |
| 206. LARGE SCALE WIND PATTERNS | 2-5 |
| 207. CHARACTERISTICS AND TYPES OF PRECIPITATION | 2-14 |
| 208. TYPES OF CLOUDS | 2-16 |
| 209. ATMOSPHERIC STABILITY..... | 2-20 |
| 210. METHODS OF LIFTING..... | 2-22 |
| 211. STABILITY AND FLIGHT CONDITIONS..... | 2-22 |
| STUDY QUESTIONS | 2-24 |

CHAPTER THREE – Mechanics of Frontal Systems..... **3-1**

| | |
|---|-----|
| 300. INTRODUCTION | 3-1 |
| 301. LESSON TOPIC LEARNING OBJECTIVES | 3-1 |
| 302. REFERENCES | 3-2 |
| 303. STUDY ASSIGNMENT | 3-2 |

| | | |
|---|--|-------------|
| 304. | AIR MASSES | 3-2 |
| 305. | FRONTAL SYSTEMS | 3-3 |
| 306. | FRONTAL DISCONTINUITIES | 3-8 |
| 307. | FACTORS INFLUENCING FRONTAL WEATHER | 3-10 |
| 308. | COLD FRONTS | 3-11 |
| 309. | WARM FRONTS | 3-14 |
| 310. | STATIONARY FRONTS | 3-16 |
| 311. | INACTIVE FRONTS | 3-18 |
| STUDY QUESTIONS..... | | 3-20 |
| CHAPTER FOUR - Thunderstorms..... | | 4-1 |
| 400. | INTRODUCTION | 4-1 |
| 401. | LESSON TOPIC LEARNING OBJECTIVES | 4-1 |
| 402. | REFERENCES | 4-2 |
| 403. | STUDY ASSIGNMENT | 4-2 |
| 404. | THUNDERSTORM DEVELOPMENT | 4-2 |
| 405. | THE LIFE CYCLE OF A THUNDERSTORM CELL | 4-2 |
| 406. | THUNDERSTORM WEATHER HAZARDS | 4-3 |
| 407. | RADAR THUNDERSTORM INFORMATION..... | 4-10 |
| 408. | FLIGHT TECHNIQUES IN THE VICINITY OF THUNDERSTORMS | 4-12 |
| STUDY QUESTIONS..... | | 4-17 |
| CHAPTER FIVE – Weather Hazards of Turbulence, Icing, Ceilings, Visibility, and Ash | | |
| Clouds..... | | 5-1 |
| 500. | INTRODUCTION | 5-1 |
| 501. | LESSON TOPIC LEARNING OBJECTIVES | 5-1 |
| 502. | REFERENCES | 5-3 |
| 503. | STUDY ASSIGNMENT | 5-3 |
| 504. | TURBULENCE DEFINED AND CLASSIFIED..... | 5-3 |
| 505. | AIRCRAFT ICING..... | 5-12 |
| 506. | EFFECTS AND HAZARDS OF STRUCTURAL ICING..... | 5-14 |
| 507. | OTHER TYPES OF AIRCRAFT ICING | 5-16 |
| 508. | MINIMIZING OR AVOIDING ICING HAZARDS | 5-17 |
| 509. | VISIBILITY DEFINITIONS..... | 5-20 |
| 510. | SKY COVERAGE AND CEILINGS..... | 5-22 |
| 511. | FOG VS STRATUS..... | 5-24 |
| 512. | FOG FORMATION..... | 5-24 |
| 513. | TYPES OF FOG | 5-26 |
| 514. | VOLCANIC ASH CLOUDS | 5-28 |
| STUDY QUESTIONS..... | | 5-30 |
| APPENDIX A – Glossary of Selected Meteorological Terms..... | | A-1 |
| APPENDIX B – Common Weather Contractions | | B-1 |
| APPENDIX C – Location Identifiers | | C-1 |
| APPENDIX D – Selected Weather Information Resources..... | | D-1 |
| APPENDIX E – Answers to Study Questions | | E-1 |

TABLE OF FIGURES

| | | |
|--------------------|--|-------------|
| Figure 1-1 | Thickness of the Earth's Atmosphere..... | 1-2 |
| Figure 1-2 | Two Lowest Atmospheric Layers and Lapse Rates..... | 1-3 |
| Figure 1-3 | Path of Aircraft Flying A Constant Indicated Altitude with Decreasing Temperture..... | 1-5 |
| Figure 1-4 | Temperature Deviation vs Indicated and MSL Altitude..... | 1-5 |
| Figure 1-5 | Temperature Deviation vs Indicated and MSL Altitude..... | 1-6 |
| Figure 1-6 | Pressure Systems..... | 1-8 |
| Figure 1-7 | Barometric Altimeter (aka Pressure Altimeter) | 1-9 |
| Figure 1-8 | Altitudes..... | 1-11 |
| Figure 1-9 | Density Altitude Effects on Aircraft Performance | 1-12 |
| Figure 1-10 | Path of Aircraft Flying a Constant Indicated Altitude with Decreasing Surface Pressure..... | 1-12 |
| Figure 1-11 | Pressure Change vs Indicated and MSL Altitude..... | 1-13 |
| Figure 2-1 | Station Model Explanation..... | 2-3 |
| Figure 2-2 | Major Station Model Symbols | 2-4 |
| Figure 2-3 | Typical Surface Analysis Chart..... | 2-6 |
| Figure 2-4 | Pressure Gradient Force | 2-7 |
| Figure 2-5 | Pressure Gradient Force | 2-7 |
| Figure 2-6 | Gradient Winds Flow Parallel to Isobars (Found Aloft)..... | 2-8 |
| Figure 2-7 | Surface Winds are Deflected Across Isobars Towards Lower Pressure | 2-9 |
| Figure 2-8 | Surface Winds Relates to Gradient Wind Above It..... | 2-9 |
| Figure 2-9 | Jet Stream..... | 2-10 |
| Figure 2-10 | Sea Breeze | 2-11 |
| Figure 2-11 | Land Breeze..... | 2-12 |
| Figure 2-12 | Mountain and Valley Winds | 2-12 |
| Figure 2-13 | Dots Illustrate the Increased Water Vapor Capacity of Warmer Air | 2-13 |
| Figure 2-14 | Stratus | 2-17 |
| Figure 2-15 | AltoCumulus Clouds..... | 2-18 |
| Figure 2-16 | Cirrus Clouds | 2-19 |
| Figure 2-17 | Cumulonimbus Clouds | 2-19 |
| Figure 2-18 | Cloud Families..... | 2-20 |
| Figure 2-19 | Stable..... | 2-20 |
| Figure 2-20 | Neutrally Stable..... | 2-21 |
| Figure 2-21 | Unstable | 2-21 |
| Figure 2-22 | Stable, Unstable, and Neutral Stability..... | 2-22 |
| Figure 2-23 | The Four Lifting Methods..... | 2-22 |
| Figure 2-24 | Clouds in Stable and Unstable Air | 2-23 |
| Figure 2-25 | Atmospheric Stability and Flight Conditions..... | 2-23 |
| Figure 3-1 | Northern Hemisphere Air Mass Source Regions..... | 3-2 |
| Figure 3-2 | Source Region Surface..... | 3-3 |
| Figure 3-3 | Air Mass Symbology | 3-3 |
| Figure 3-4 | Frontal Symbols | 3-4 |

| | | |
|-------------|--|------|
| Figure 3-5 | Uniform Temperature and Moisture of Air Masses..... | 3-6 |
| Figure 3-6 | Frontal Zone Structure..... | 3-7 |
| Figure 3-7 | General Model of a Frontal System | 3-8 |
| Figure 3-8 | Pressure Changes Across a Front..... | 3-9 |
| Figure 3-9 | Wind Shift Across a Cold Front | 3-10 |
| Figure 3-10 | Frontal Slope | 3-11 |
| Figure 3-11 | Cold Front..... | 3-12 |
| Figure 3-12 | Cold Front Cloud Formation..... | 3-13 |
| Figure 3-13 | Squall Line Formation..... | 3-14 |
| Figure 3-14 | Warm Front..... | 3-15 |
| Figure 3-15 | Warm Front Cloud Formation | 3-15 |
| Figure 3-16 | Stationary Front..... | 3-17 |
| Figure 3-17 | Occluded Front..... | 3-18 |
| Figure 3-18 | Occluded Wave..... | 3-18 |
| Figure 3-19 | Summary of Frontal Movement and Wind Shift..... | 3-19 |
| | | |
| Figure 4-1 | Summary of Thunderstorm Stage Characteristics..... | 4-3 |
| Figure 4-2 | Gust Front..... | 4-4 |
| Figure 4-3 | Roll Cloud | 4-4 |
| Figure 4-4 | Hailstones..... | 4-5 |
| Figure 4-5 | Lightning Hazards | 4-6 |
| Figure 4-6 | Vortex Ring of a Microburst..... | 4-8 |
| Figure 4-7 | Cross Section of a Microburst | 4-8 |
| Figure 4-8 | Attitude Changes with Microburst Penetration..... | 4-9 |
| Figure 4-9 | NEXRAD Doppler Radar Composite | 4-11 |
| Figure 4-10 | Around a Thunderstorm | 4-13 |
| Figure 4-11 | Over the Top..... | 4-14 |
| Figure 4-12 | Under the Thunderstorm | 4-14 |
| Figure 4-13 | Through the Thunderstorm..... | 4-15 |
| Figure 4-14 | Thunderstorm Penetration | 4-15 |
| | | |
| Figure 5-1 | PIREP Turbulence Reporting | 5-4 |
| Figure 5-2 | Strength of Convective Currents Vary with Composition of Surface | 5-5 |
| Figure 5-3 | Airflow Over Irregular Terrain | 5-6 |
| Figure 5-4 | Mountain Wave Turbulence | 5-7 |
| Figure 5-5 | Lenticular Clouds..... | 5-8 |
| Figure 5-6 | Frontal Turbulence..... | 5-9 |
| Figure 5-7 | Jet Stream Diagram..... | 5-10 |
| Figure 5-8 | Wind Shear Associated With a Temperature Inversion | 5-11 |
| Figure 5-9 | Air Florida Mishap Abstract | 5-12 |
| Figure 5-10 | Cumulative Effects of Icing..... | 5-15 |
| Figure 5-11 | Pitot Tube Icing..... | 5-16 |
| Figure 5-12 | Options to Escape Icing..... | 5-17 |
| Figure 5-13 | Icing Reporting Criteria..... | 5-19 |
| Figure 5-14 | Prevailing Visibility Determination..... | 5-20 |
| Figure 5-15 | Surface vs Flight Visibility | 5-21 |

| | | |
|--------------------|---|-------------|
| Figure 5-16 | Sky Coverage Contractions..... | 5-23 |
| Figure 5-17 | Wind Causing Eddy Currents, Cooling Air to Saturation..... | 5-25 |
| Figure 5-18 | Radiation Fog..... | 5-26 |
| Figure 5-19 | Dissipation of Radiation Fog..... | 5-27 |
| Figure 5-20 | Advection Fog..... | 5-27 |

THIS PAGE INTENTIONALLY LEFT BLANK

CHAPTER ONE

General Structure of the Atmosphere, and Atmospheric Temperature and Pressure

100. INTRODUCTION

The purpose of this assignment sheet is to introduce the student to the general composition and structure of the atmosphere, the properties of temperature and atmospheric pressure, and their effect on aircraft altimeters.

This lesson will discuss the basic building blocks of the atmosphere, beginning with the lower layers in which most flight activity occurs. These layers have particular temperature characteristics affecting many aspects of weather and are important to the understanding of later chapters. Pressure is another characteristic of the atmosphere, which enables meteorologists to track weather phenomena as they move across the surface of the Earth. Additionally, pressure is important to the aviation community since one of the most basic flight instruments, the barometric altimeter, operates from the action of atmospheric pressure upon its sensors. Additionally, in order to gain a complete understanding of the altimeter, the effects of temperature and pressure variations on altimeter readings will be discussed.

101. LESSON TOPIC LEARNING OBJECTIVES

Terminal Objective: Completely supported by this lesson topic:

2.0 Upon completion of this unit of instruction, student aviators and flight officers will demonstrate knowledge of meteorological theory enabling them to make intelligent decisions when confronted with various weather phenomena and hazards.

Enabling Objectives: Completely supported by this lesson topic:

- 2.1 Describe the characteristics of the troposphere, tropopause, and stratosphere.
- 2.2 Describe the flight conditions associated with the troposphere, tropopause, and stratosphere.
- 2.3 Define a lapse rate.
- 2.4 State the average lapse rate in degrees Celsius.
- 2.5 Define atmospheric pressure.
- 2.6 State the standard units of pressure measurement.
- 2.7 Define the standard atmosphere to include temperature and pressure.
- 2.8 Differentiate between sea level pressure and station pressure.

2.9 Define indicated altitude, calibrated altitude, Mean Sea Level (MSL) altitude, Above Ground Level (AGL) altitude, pressure altitude, and density altitude.

2.10 Describe the effects of pressure changes on aircraft altimeters.

2.11 State the effects of temperature deviations from the standard lapse rate on aircraft altimeters.

102. REFERENCES

1. Weather for Aircrews, AFH 11-203, Volume 1, Chapters 1, 3, and 4.
2. Aviation Weather for Pilots and Flight Operations Personnel, Chapters 1-3.

103. STUDY ASSIGNMENT

Review Chapter One and answer the study questions.

104. THE ATMOSPHERE

The atmosphere is the gaseous covering of the Earth. This envelope of air rotates with the Earth but also has a continuous motion relative to the Earth's surface, called circulation. It is created primarily by the large temperature difference between the tropics and polar regions, and is complicated by uneven heating of land and water areas by the Sun.

105. ATMOSPHERIC LAYERS

If the Earth were compared to a baseball, the gaseous covering would be about as thick as the baseball's cover (Figure 1-1).

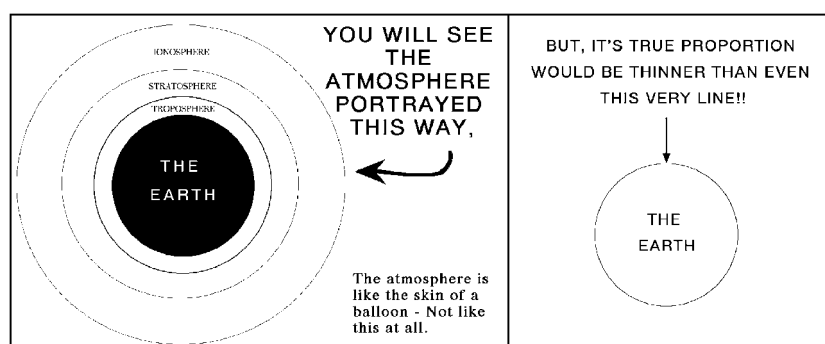

Figure 1-1 Thickness of the Earth's Atmosphere

It is divided into layers that have certain properties and characteristics (Figure 1-2). The lowest two layers are the troposphere and stratosphere, with the tropopause being a region between these two. The **troposphere** is the layer adjacent to the Earth's surface. It varies in height from an average 55,000 feet over the equator to 28,000 feet over the poles.

1-2 General Structure of the Atmosphere, and Atmospheric Temperature and Pressure

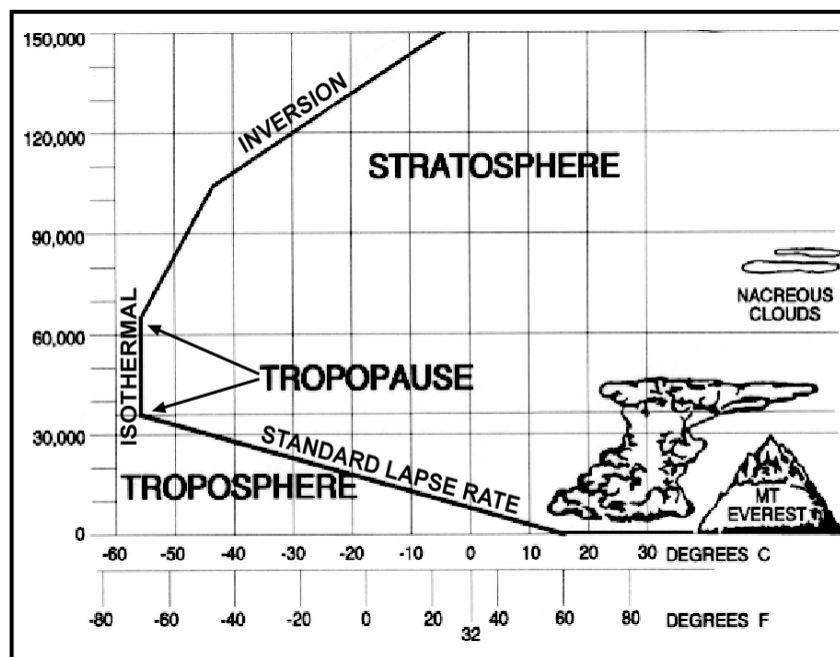

Figure 1-2 Two Lowest Atmospheric Layers and Lapse Rates

The average height of the troposphere over the United States is 36,000 feet mean sea level (MSL), but pressure systems and seasonal differences cause a variance in the height. Due to heating, the troposphere extends to a greater height in summer than in winter. The atmosphere becomes less dense with altitude, and roughly 50% of it, by weight, lies below 18,000 feet and 90% within 53,000 feet. Within the troposphere, the temperature normally decreases with increasing altitude. Large amounts of moisture and condensation nuclei are found in the troposphere because of its closeness to the Earth's surface, and nearly all weather occurs here. Winds are generally light near the Earth's surface and increase with altitude. Wind speeds over 200 knots may occur near the top of the troposphere. An abrupt change in the rate of temperature decrease with increasing altitude marks the boundary, called the tropopause.

The tropopause is a transition zone between the troposphere and the stratosphere. The temperature in this layer is isothermal with altitude. As you can see from Figure 1-2 above, there is an abrupt change in the rate of temperature decrease with increasing altitude. The tropopause is important to aviators for several reasons. The strongest winds, those of the jet stream, occur just below the tropopause. Moderate to severe turbulence is sometimes associated with the wind shear caused by the jet stream. Contrails frequently form and persist near the tropopause since it is normally the coldest area within the lower atmosphere. While clouds and weather are generally confined to the troposphere, severe thunderstorm tops may penetrate the tropopause into the stratosphere. You can sometimes identify the tropopause while in-flight by the following characteristics: the average height of the tropopause over the US is 36,000 feet MSL, anvil tops of thunderstorms will spread out at the base of the tropopause, and a haze layer with a definite top frequently exists at the tropopause.

The stratosphere is the layer characterized by increasing temperature with increasing altitude. This increase in temperature is due to the gas ozone, which plays a major part in heating the air at this altitude. Flying in the stratosphere is generally smooth with excellent visibility. The air is thin and offers very little resistance to the aircraft. The general lack of weather in this layer makes for outstanding flying.

106. COMPOSITION

Air is a mixture of gases having weight, elasticity, and compressibility. Pure, dry air contains 78% nitrogen, 21% oxygen, a 1% mixture of ten other gases. The atmosphere also contains water vapor ranging from 0% to 5% by volume. Water vapor (for ordinary considerations) acts as an independent gas mixed with air.

The atmosphere appears clear, but it contains many nongaseous substances such as dust and salt particles, pollen, which are referred to as condensation nuclei. When these particles are relatively numerous, they appear as haze and reduce visibility.

107. LAPSE RATES – TEMPERATURE AND PRESSURE

The decrease in atmospheric temperature with increasing altitude is called the temperature lapse rate. In order to determine how temperature changes with increasing altitude, meteorologists send up a weather balloon to take the temperature (among other readings) at different altitudes. The resulting temperature profile is known as the environmental lapse rate (a.k.a. the existing lapse rate (ELR)). The average or standard lapse rate is 2°C (3.5°F) per 1000 feet. Even though this is the average lapse rate of the troposphere, close to the surface of the Earth the ELR may indicate an increase, decrease, or a constant temperature when measured at increasing altitudes. These different ELRs give meteorologists a clue to the type of weather that exists, and there are names for these various types of ELRs, as well. The standard lapse rate is actually a shallow lapse rate (between 1.5 and 3.0°C/1000 feet). Any lapse rate greater than 3° Celsius/1,000 feet is called a steep lapse rate. An isothermal lapse rate indicates the temperature is the same at different altitudes, and an inversion is a lapse rate where the temperature increases with increasing altitude, such as occurs in the stratosphere. Inversions can be anywhere from a few hundred to a few thousand feet thick, and stable conditions are generally found within them. These three major types of lapse rates (the standard, isothermal, and inverted) are shown in Figure 1-2 as a graph of temperature vs altitude overlaid on a profile of the atmosphere.

Example of using standard lapse rates: If the temperature is -2°C at 8000 feet and the existing lapse rate is standard, at what altitude is the temperature +4°C?

$$\frac{\text{Algebraic difference of } -2^{\circ}\text{C and } +4^{\circ}\text{C}}{2^{\circ}\text{C}/1000 \text{ feet}} = \frac{6^{\circ}\text{C}}{2^{\circ}/1000 \text{ feet}} = 3000 \text{ feet}$$

$$8000 \text{ feet} - 3000 \text{ feet} = 5000 \text{ feet}$$

Temperature

Aircraft altimeters are calibrated for a standard lapse rate. An incorrect altitude indication will result if the temperature deviates from the standard. For every 11°C that the temperature varies from the standard, the altimeter will be in error by 4%. If the air is colder than the standard atmosphere, the aircraft will be lower than the altimeter indicates. If the air is warmer than standard, the aircraft will be higher than the altimeter indicates (Figures 1-3, 1-4, and 1-5). You may notice the rules presented in the pressure section, above, also apply to temperature deviations.

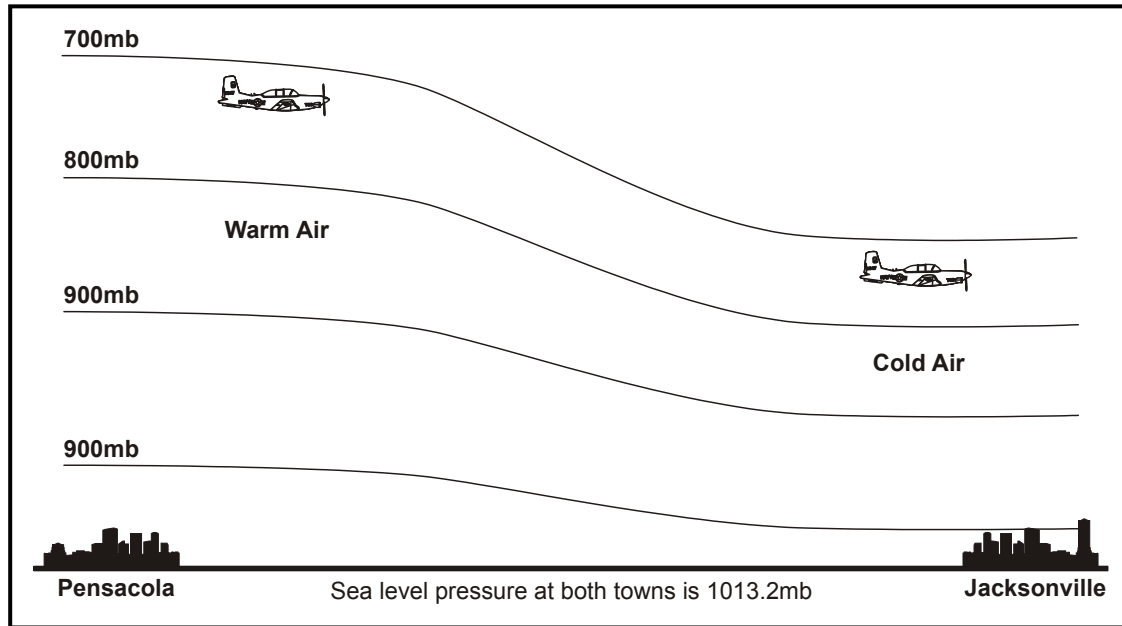

Figure 1-3 Path of Aircraft Flying A Constant Indicated Altitude with Decreasing Temperature

| TEMPERATURE CHANGE | ALTIMETER | ACTUAL MSL ALTITUDE |
|--|------------------------------|-----------------------|
| Flying from standard temp. toward lower temp. | Indicates higher than actual | Lower than indicated |
| Flying from standard temp. toward higher temp. | Indicates lower than actual | Higher than indicated |

Figure 1-4 Temperature Deviation vs Indicated and MSL Altitude

Figures 1-3 and 1-5 show that as you fly from warm to cold air, an altimeter will read too high and the aircraft is lower than the altimeter indicates. Over flat terrain, this lower true reading is no great problem; other aircraft in the vicinity are also flying indicated altitudes resulting from the same temperature and pressure conditions, and the altimeter readings are compatible because the errors result from the same conditions.

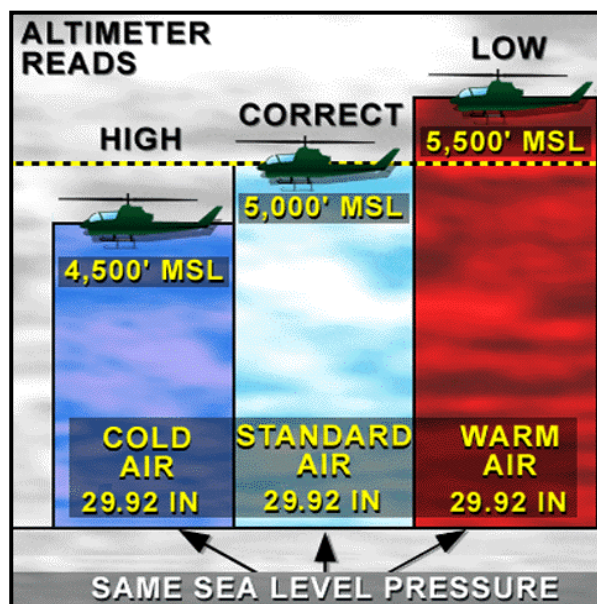

Figure 1-5 Temperature Deviation vs Indicated and MSL Altitude

Since these deviations due to temperature are usually relatively small, these errors are often ignored in the early stages of flight training, and calibrated altitude is often treated directly as true altitude. However, toward the advanced stages, tactical accuracy becomes paramount, and temperature effects cannot be ignored. For example, when flying in cold weather over mountainous terrain, you must take this difference between indicated and true altitude into account by calculating a correction to the indicated altitude.

Atmospheric Pressure

Pressure is force per unit area. Atmospheric (barometric) pressure is the pressure exerted on a surface by the atmosphere due to the weight of the column of air directly above that surface. The average weight of air on a square inch of the Earth's surface at sea level under standard conditions is 14.7 pounds. Pressure, unlike temperature, always decreases with altitude. In the lower layers of the atmosphere pressure decreases much more rapidly than it does at higher altitudes because density decreases as altitude increases.

108. UNITS OF MEASUREMENT

In the U.S., two units are used to measure and report atmospheric pressure: inches of mercury (in-Hg) and millibars (mb). Inches of mercury is a measure of the height of a column of mercury supported by atmospheric pressure. The millibar is a direct representation of pressure, which is defined as force per unit area. Normal sea level pressures in the atmosphere vary from as low as 28 in-Hg (about 960 mb) to as high as 31 in-Hg (about 1060 mb).

Some countries, particularly those using the metric system, use millibars for altimeter settings. However, in the United States and Canada altimeter settings are reported in inches of mercury.

1-6 General Structure of the Atmosphere, and Atmospheric Temperature and Pressure

109. THE STANDARD ATMOSPHERE

For a standard reference, a concept called a standard day is used. In aviation, everything is related to standard day conditions at sea level, which are 29.92 in-Hg (1013.2 mb) and 15°C (59°F). In the lower atmosphere, and thus for most aviation applications, a 1000 foot increase in altitude will result in a pressure decrease of approximately 1 in-Hg (34 mb) and a temperature decrease of 2°C (3.5 °F). These values are the standard day pressure and temperature lapse rates.

110. STATION AND SEA LEVEL PRESSURE

Station pressure is the atmospheric pressure measured directly at an airfield or other weather station. Sea level pressure (or Reported Altimeter Setting) is the pressure measured from the existing weather if the station were at MSL. This can be measured directly at sea level, or calculated if the station is not at sea level using the standard pressure lapse rate.

Surface analysis charts, such as the one in Figure 1-6, use MSL as the reference level for the depicted isobars (to provide a common reference), even though the pressure was first measured at a weather station. This is done so that daily pressure variations associated with weather systems can be tracked as they move across the country, as mentioned above. If, instead, station pressures were used, the pressure charts would depict the inverse of the land topography, reflecting the contour lines of a map. Mountain tops would always have lows over them, and valleys would have highs. In other words, high altitude stations such as Denver would always reflect lower pressure than surrounding stations at lower altitudes regardless of the day-to-day pressure variations that occur with passing weather systems. Thus, for pressure to be meaningful, all stations (even those far from the ocean) will report sea level pressure.

To calculate sea level pressure use the formula: $SLP = SP + \text{Terrain correction (2 in-Hg/1000 feet)}$.

Example: Barometer reads 28.95 and elevation at the station is 1050 feet.

$$SLP = 28.95 + 1.05$$

$$SLP = 30.00$$

Set 30.00 in your altimeter (Figure 1-7)

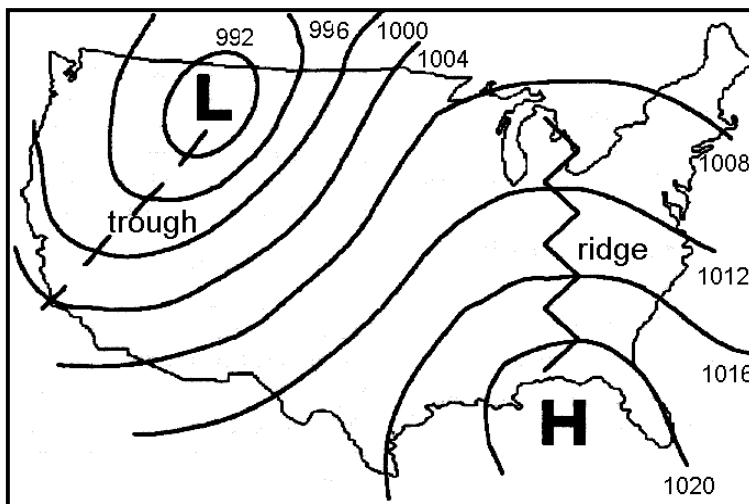

Figure 1-6 Pressure Systems

111. PRESSURE CHARTS

The pressure at the Earth's surface changes for several reasons. The most noted reason is the movements of high and low pressure systems. The temperature and moisture content of air also affect surface pressures.

Meteorologists track these different weather systems by noting the pressure each time a weather observation is made and then forwarding all observations to the National Weather Service (NWS). The NWS then plots the weather on various charts. The resulting horizontal distribution of pressure across the Earth's surface is depicted on weather charts by isobars, or lines of equal barometric pressure (Figure 1-6).

There are several standard types of pressure distribution patterns found on weather charts (Figure 1-6). A high-pressure area (or high), where the pressure in the center is higher than the surrounding areas, may be thought of as a mountain on a surface pressure chart. Similarly, a low-pressure area, where the pressure in the center is lower than the surrounding areas, may be thought of as a basin or valley. A ridge is an extension of a high-pressure area and a trough is an extension of a low-pressure area. There are certain characteristic winds and weather systems associated with these pressure systems. For example, poor weather such as found with fronts and squall lines are generally associated with troughs and lows, while good weather is associated with highs and ridges.

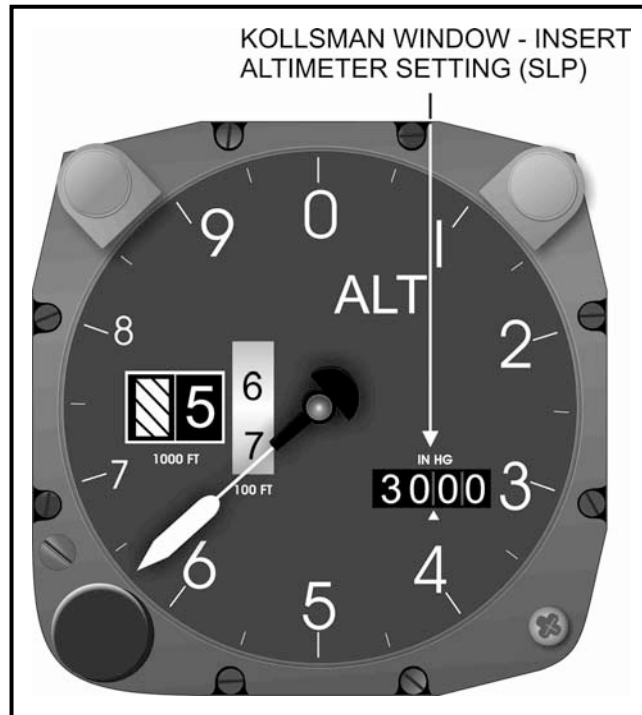

Figure 1-7 Barometric Altimeter (aka Pressure Altimeter)

112. ALTITUDE MEASUREMENT

Altitude is defined as the height above a given reference. The instrument displaying altitude in the cockpit is called an altimeter. The barometric altimeter is an aneroid barometer calibrated to display altitude in feet, as opposed to pressure in inches of mercury (Figure 1-7). Since an altitude includes not only the height number, but also the reference, altimeters have a Kollsman window that shows the reference pressure, known as the altimeter setting. The altimeter setting is the value to which the scale of the pressure altimeter is set so the altimeter indicates true altitude at field elevation. It is very nearly equal to the station pressure corrected to MSL pressure (not exact, but close enough for instructional purposes). An adjustment knob allows the altimeter setting to be changed. If the local altimeter setting is dialed in to the Kollsman window, the altimeter will indicate the altitude in feet above MSL. If 29.92 is set, the altimeter will indicate the altitude above the standard datum plane. MSL and pressure altitudes are the two altitudes most often displayed on the altimeter and are discussed in the next section.

Altitudes

Indicated altitude is the altitude read directly from the altimeter. Since altimeters need no power (except for lighting, they operate by measuring the outside pressure), they will always indicate some value. Figure 1-7 shows an indicated altitude of 5635 feet. For an indicated altitude to be useful, however, the altimeter needs to have the correct reference for the situation by dialing either the local altimeter setting or 29.92 in to the Kollsman window. This way, the indicated altitude will be equal to either the MSL or pressure altitude (still to be discussed).

To illustrate, if an aircraft is parked at Sherman Field with the local altimeter setting in the Kollsman window, the indicated altitude should be the same as the airfield elevation, and the indicated altitude will be an MSL altitude. Therefore, the altimeter should indicate approximately 30 feet MSL since Sherman Field is 30 feet above mean sea level.

Altimeters are subject to mechanical errors caused by installation, misalignment, and positioning of the static ports that measure the pressure. Collectively, these errors are referred to as instrument error. Instrument error is determined prior to takeoff by noting the difference between field elevation and indicated altitude. For example, an aircraft taking off from Sherman Field (elevation +30 feet MSL) with an indicated altitude of 70 feet would have an instrument error of +40 feet. If the instrument error is in excess of 75 feet, the aircraft is considered unsafe for instrument flight. Calibrated altitude is indicated altitude corrected for instrument error.

True altitude is the actual height above mean sea level. It is found by correcting calibrated altitude for temperature deviations from the standard atmosphere. On a standard day, MSL/true altitude is equal to calibrated altitude. If there is no instrument error, true altitude would also be equal to indicated altitude. MSL altitude is very important since airfields, hazards, and terrain elevations are stated in feet above mean sea level.

Above ground level (AGL) or absolute altitude is the aircraft's height above the terrain directly beneath the aircraft and is measured in feet AGL. Absolute altitude is not normally displayed on a barometric altimeter, but it can be calculated by subtracting the terrain elevation from the true altitude. Additionally, it can be displayed directly on a radar altimeter.

Pressure altitude is the height above the standard datum plane. The standard datum plane is the actual elevation above or below the Earth's surface at which the barometric pressure is 29.92 in-Hg. Federal Aviation Rules (FAR) require all aircraft operating above 18,000 feet MSL set 29.92 into the altimeter to ensure consistent altitude separation. Since most mountains in the U.S. are well below 18,000 feet MSL, there is less concern with terrain avoidance than with aircraft separation above that altitude. Thus, a pilot flying a pressure altitude will have an altimeter setting of 29.92 instead of the local altimeter setting. In short, a pressure altitude is the height above the place in the atmosphere where the pressure is 29.92 in-Hg. Whether this place is above, below, or coincides with sea level is of little concern.

When aircraft fly pressure altitudes, they are assigned a flight level (FL) of three digits, representing hundreds of feet above 29.92. As an example, an aircraft assigned FL250 (pronounced "flight level two five zero") would be flying a pressure altitude, and the pilot would fly the aircraft so that the altimeter reads 25,000 feet with 29.92 in the Kollsman window. These above altitude definitions are illustrated in Figure 1-8.

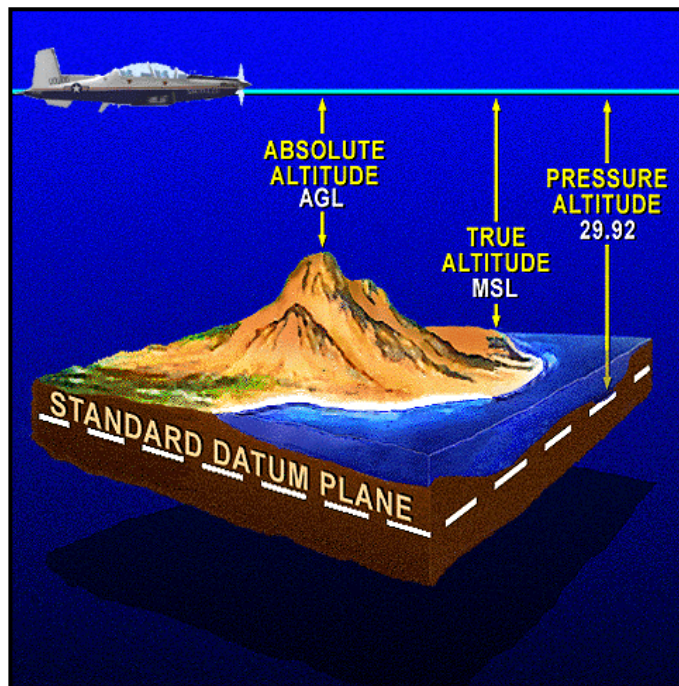

Figure 1-8 Altitudes

Density altitude (DA) is pressure altitude corrected for nonstandard temperature deviations. On a hot day, air molecules are farther apart, decreasing the air density and increasing the density altitude. In this situation, the DA of an airfield would be higher than both the published field elevation and the pressure altitude. The opposite is true on a colder day: Increased air density causes a decreased density altitude and a DA lower than the published field elevation and the pressure altitude.

DA is not a height reference; rather, it is an index to aircraft performance. It affects airfoil, engine, propeller, and rotor performance. Thrust is reduced because a jet engine has less mass (air) to compress. Lift is also reduced due to thinner air. Additionally, higher density altitudes result in longer takeoff and landing distances and a reduced rate of climb. Takeoff distances are longer since reduced thrust requires a longer distance to accelerate to takeoff speed. Landing distances are longer since a higher true airspeed is required to land at the same indicated airspeed. Climb rate is decreased because of reduced available thrust. At certain high density altitudes, takeoffs and/or single-engine flight (loss of one engine after becoming airborne) are not possible due to limitations of thrust, lift, and runway length. Figure 1-9 summarizes the effects of temperature on aircraft performance. Moisture affects aircraft performance in the same manner as temperature, but to a lesser degree. No instrument in the cockpit displays density altitude, it needs to be calculated.

| HIGH TEMPERATURE OR MOISTURE | LOW TEMPERATURE OR MOISTURE |
|------------------------------|-------------------------------|
| Lower Air Density | Higher Air Density |
| Higher Density Altitude | Lower Density Altitude |
| Decreased Thrust and Lift | Increased Thrust and Lift |
| Longer Takeoffs and Landings | Shorter Takeoffs and Landings |

Figure 1-9 Density Altitude Effects on Aircraft Performance

113. ALTIMETER ERRORS

Pressure

When an aircraft flies from one place to another at a constant indicated altitude (by referencing the barometric altimeter), it is flying along a surface of constant pressure. Figure 1-10 shows the path of an aircraft as it follows such a constant pressure surface, done by flying a constant indicated altitude. As the sea level pressure on the surface decreases (all other conditions remaining the same), the whole column of air aloft is lowered, causing an aircraft flying at an assigned MSL altitude to descend to a lower AGL altitude. Only by updating the reference of the altimeter setting can this potential problem be eliminated, and a more constant AGL altitude can be maintained.

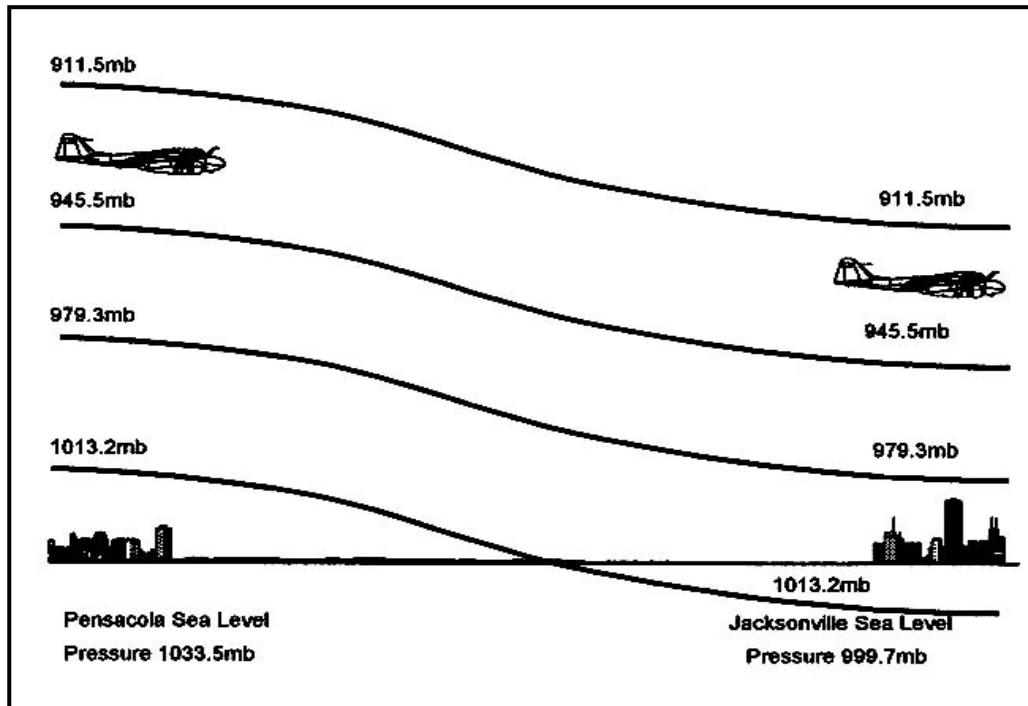

Figure 1-10 Path of Aircraft Flying a Constant Indicated Altitude with Decreasing Surface Pressure

1-12 General Structure of the Atmosphere, and Atmospheric Temperature and Pressure

This updating is accomplished via radio throughout the flight. Usually, when switching to a different air traffic controller, about every 50 - 100 miles, an updated altimeter setting will also be passed to the aircrew. This ensures all aircraft in a given area are flying at the correct altitudes (up to FL180). A change in pressure of 0.10 in-Hg will change the altimeter reading 100 feet. Therefore, it is imperative to receive a current altimeter setting at your destination prior to landing. If the altimeter is not adjusted and your flight path takes you into an area of lower MSL pressure the aircraft will be lower than the altimeter indicates. Conversely, if your flight path takes you into an area of higher MSL pressure, the aircraft will be higher than the altimeter indicates. These events are summarized by a set of rhymes, as well as by Figure 1-11.

| PRESSURE CHANGE | ALTIMETER | ACTUAL MSL ALTITUDE |
|-----------------------------------|------------------------------|--|
| Flying toward lower MSL pressure | Indicates higher than actual | Lower than indicated by the altimeter |
| Flying toward higher MSL pressure | Indicates lower than actual | Higher than indicated by the altimeter |

Figure 1-11 Pressure Change vs Indicated and MSL Altitude

RULE: High to Low, look out below

The aircraft is lower than indicated, thus the indicated altitude is higher than the aircraft.

RULE: Low to High, plenty of sky

The aircraft is higher than indicated, thus the indicated altitude is lower than the aircraft.

It is quite common to confuse these two concepts. Remember, if you have a one inch decrease in barometric pressure your altimeter (i.e., indicated) will read 1000 feet higher. If this difference occurred gradually between two points you would fly to a 1000 foot lower true/MSL altitude because of your altimeter error.

Temperature

Pressure changes have a far greater effect on an altimeter error than temperature. Nevertheless, when the margin for error is low (extreme low altitude flight), temperature change needs to be taken into account.

When accounting for altimeter error attributed to temperature use the rules shown for pressure above (High to Low). For example, when traveling from point A with a temperature of 70°F to point B with a temperature of 90°F, without updating the altimeter setting, you can expect to be higher than your altimeter is showing ("low to high, plenty of sky").

STUDY QUESTIONS

General Structure of the Atmosphere, and Atmospheric Temperature and Pressure

1. At the top of the troposphere, there is a transition zone called the _____.
 - a. tropopause
 - b. ozone layer
 - c. atmospheric layer
 - d. stratosphere

2. The two lower layers of the atmosphere are the _____.
 - a. tropopause and mesosphere
 - b. troposphere and stratosphere
 - c. tropopause and stratopause
 - d. mesosphere and thermosphere

3. Which one of the following best describes the flight conditions found in the stratosphere?
 - a. The strongest winds occur in the stratosphere.
 - b. Contrails frequently form and persist in this part of the atmosphere.
 - c. 50% of the atmosphere, by weight, is found in the stratosphere.
 - d. Flying in the stratosphere is generally smooth with excellent visibility.

4. What is the standard temperature lapse rate of the atmosphere in degrees Celsius per 1000 feet?
 - a. 1.5
 - b. 2.0
 - c. 3.0
 - d. 3.5

5. Using the standard lapse rate, a pilot flying at 10,000 feet MSL and at a temperature of -8°C should do what to find an altitude at which the temperature is +4 °C?
 - a. Descend to approximately 2000 feet MSL.
 - b. Descend to approximately 4000 feet MSL.
 - c. Descend to approximately 6000 feet MSL.
 - d. Climb to 15,000 feet MSL.

6. A condition where the air temperature aloft is higher than that of the lower atmosphere is generally referred to as _____.
- a low-pressure area
 - turbulence
 - a temperature inversion
 - convection currents
7. Which one of the following best describes the change in atmospheric pressure with increasing altitude?
- Increases
 - Decreases
 - May increase or decrease, depending on weather conditions
 - Remains constant
8. Which one of the following correctly lists the standard day conditions of sea level pressure, temperature, pressure lapse rate, and temperature lapse rate?
- 30.00 in-Hg, 15°C, 1.5 in-Hg/1000 feet, 3.0°C/1000 feet
 - 29.92 in-Hg, 59°C, 34 in-Hg/100 feet, 5°C/100 feet
 - 29.92 in-Hg, 15°C, 1 in-Hg/1000 feet, 2°C/1000 feet
 - 30.02 in-Hg, 20°C, 2 in-Hg/1000 feet, 1°C/1000 feet
9. The horizontal distribution of pressure on the Earth's surface is depicted on weather charts by _____.
- isotherms
 - isotachs
 - isogonic lines
 - isobars
10. The weight of the air mass over any point on the Earth's surface defines _____.
- density altitude
 - atmospheric pressure
 - pressure altitude
 - true weight
11. The quantities 1013.2 mb and 29.92 in-Hg are two different expressions for the _____.
- atmospheric density at a standard air temperature of 15°C
 - atmospheric pressure at sea level at an air temperature of 0°C
 - standard atmospheric pressure at mean sea level and at a standard air temperature of 15°C
 - weight of the atmosphere at the surface of the Earth

12. In the lower 5000 feet of the atmosphere, a decrease of one inch of mercury in atmospheric pressure would cause a change in an altimeter reading of approximately _____ feet (assuming constant elevation and altimeter setting).
- minus 100
 - plus 100
 - minus 1000
 - plus 1000
13. Which one of the following correctly describes the meteorological feature of a trough?
- An elongated area of relatively low pressure.
 - An elongated area of relatively high pressure that extends from the center of a high pressure area.
 - An area where the pressure in the center is higher than the surrounding areas.
 - A long shallow often V-shaped receptacle for the drinking water or feed of domestic animals.
14. Which one of the following items would have a value closest to that used as a Kollsman window setting for an altimeter in the U.S. (assuming an airfield above sea level)?
- Station pressure
 - Station temperature
 - AGL pressure
 - Sea level pressure
15. The height of an aircraft above the ground is known as _____.
- MSL/True altitude
 - AGL/absolute altitude
 - indicated altitude (IA)
 - pressure altitude (PA)
16. Which one of the following types of altitudes would be assigned in the U.S. above 18,000 feet MSL?
- MSL/True altitude
 - AGL/absolute altitude
 - Indicated altitude (IA)
 - Pressure altitude (PA)
17. Density altitude is _____.
- the same as an MSL/True altitude
 - pressure altitude corrected for nonstandard field elevations
 - an indicator of aircraft performance
 - the height above the standard datum plane

Situation for items 18-20:

The altimeter setting at Randolph AFB is 29.85 in-Hg, and at Vance AFB it is 30.15 in-Hg. A pilot sets the altimeter correctly at Randolph and flies to Vance at an indicated altitude of 5000 feet without changing the altimeter setting.

18. Assuming a standard lapse rate, what is the MSL/true altitude when flying over Vance at the assigned indicated altitude?

- a. 4700 feet
- b. 5000 feet
- c. 5030 feet
- d. 5300 feet

19. If Vance's elevation is 1307 feet MSL, what is the AGL/absolute altitude over Vance?

- a. 3393 feet
- b. 3693 feet
- c. 3723 feet
- d. 3993 feet

20. If the pilot lands successfully at Vance (elevation 1307 feet MSL) without resetting the altimeter, what altitude will the altimeter indicate?

- a. 0 feet
- b. 1007 feet
- c. 1307 feet
- d. 1607 feet

21. When flying a constant indicated altitude of 4000 feet from an area where the outside air temperature is 10°C to an area that is 15°C, the aircraft would be at_____.

- a. a lower altitude than indicated
- b. the altitude indicated
- c. a higher altitude than indicated
- d. the absolute altitude

THIS PAGE INTENTIONALLY LEFT BLANK

CHAPTER TWO

Atmospheric Mechanics of Winds, Clouds and Moisture, and Atmospheric Stability

200. INTRODUCTION

This chapter introduces the student to the concepts associated with large- and small-scale wind systems, the relationship between atmospheric temperature, moisture content, major cloud types, and their effects on flight, as well as the various terms and requirements used to describe atmospheric stability and instability.

Additionally, it covers a wide range of topics basic to the understanding of weather phenomena. After an introduction to the meteorological station model, used in this chapter mainly to show wind direction in diagrams, we build upon the pressure basics presented in Chapter One to determine why winds blow in the particular direction that they do. To keep our analysis as simple as possible, we will focus only on winds in the Northern Hemisphere. Since winds and some forces in the Southern Hemisphere are a mirror image, discussing both patterns at this stage would unnecessarily complicate things for a first-time introduction to weather.

The next topic covered is atmospheric moisture. Since most weather hazards have something to do with moisture, it is important to understand how air becomes saturated, and how this will affect the formation of clouds, fog, and precipitation. In fact, the two main types of precipitation match up with two types of clouds. Clouds are classified according to the altitude of their bases, and this chapter covers four major types of cloud. Eventually (and usually more often than desired) all aviators will fly into clouds and thus an understanding of cloud composition and activity will be essential to this course.

Cloud types can be a visual signal of atmospheric stability or instability. These two conditions can be a further indication to meteorologists as well as to aircrew regarding the various weather and flight conditions that may be encountered. There can be great differences in the expected weather found between stable and unstable conditions, each with their own particular hazards to flight. Consequently, knowing the relationships between atmospheric stability and flight conditions could prove invaluable to an aviator.

201. LESSON TOPIC LEARNING OBJECTIVES

Terminal Objective: Partially supported by this lesson topic:

- 2.0 Upon completion of this unit of instruction, student aviators and flight officers will demonstrate knowledge of meteorological theory enabling them to make intelligent decisions when confronted with various weather phenomena and hazards.

Enabling Objectives: Completely supported by this lesson topic:

- 2.12 Explain the term pressure gradient.
- 2.13 Explain Coriolis force and its apparent effect on wind.

- 2.14 Explain and identify gradient winds with respect to the isobars around high and low pressure systems in the Northern Hemisphere.
- 2.15 Define Buys Ballot's Law.
- 2.16 Explain and identify the surface wind direction with respect to the gradient winds in a high and low-pressure system in the Northern Hemisphere.
- 2.17 Describe the jet stream.
- 2.18 Describe sea breezes and land breezes.
- 2.19 Describe valley and mountain winds.
- 2.20 Define saturation, dew point temperature, dew point depression, and relative humidity.
- 2.21 State the relationships between saturation, air temperature, dew point temperature, and dew point depression necessary for the formation of clouds, fog, and precipitation.
- 2.22 Describe the three characteristics of precipitation.
- 2.23 Describe the types of precipitation.
- 2.24 Identify the four principal cloud groups.
- 2.25 Identify the weather conditions associated with various clouds and types of precipitation.
- 2.26 Describe atmospheric stability, instability, and neutral stability.
- 2.27 Describe the four types of lifting.
- 2.28 Identify the flight conditions associated with a stable and unstable atmosphere including cloud type, turbulence, precipitation, visibility, winds, and icing.

202. REFERENCES

Weather for Air Crews, AFH 11-203, Volume 1, Chapters 2, 5, 6, and 9

203. STUDY ASSIGNMENT

Review Chapter Two and answer the Study Questions.

204. WINDS

Understanding the causes of wind and wind direction is essential to the safe operation of an aircraft. Takeoffs and landings are best performed into a headwind, whereas landing with a

strong crosswind can be dangerous, to say the least. Additionally, the circulation of air brings about changes in weather by transporting water vapor. Therefore, wind plays an important role in the formation of fog, clouds, and precipitation.

So how does one determine the wind direction? Wind direction is always expressed in terms of the direction from which it is blowing. This convention holds throughout the world-- civilian or military, weather or navigation, aviation or sailing -- wind always blows from a particular direction. Thus, it would be best for a student to master this particular concept as early as possible in a career where wind is an everyday concern.

There are many different ways weather phenomenon, such as wind, are annotated on charts or in print. One of these methods is the use of a station model.

205. STATION MODELS

Some weather charts display the information gathered from individual weather stations through the use of the station model, shown in Figure 2-1. This model begins with a circle (or a square for automated stations) at the center to represent the location of the station that issued the weather report. Around the station symbol, data describing wind, temperatures, weather, and pressures are displayed in a pictorial shorthand (Figure 2-2) to provide the maximum amount of data in a minimum of space.

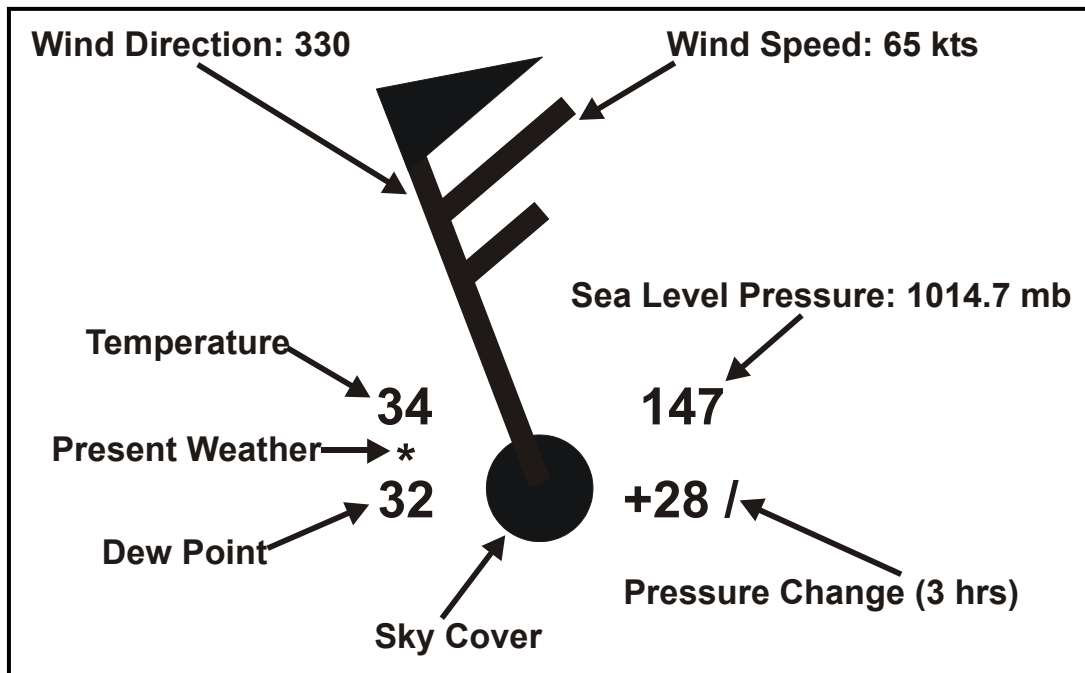

Figure 2-1 Station Model Explanation

Another noticeable feature of the station model is a line coming out of the circle indicating the wind direction. Since the station models are aligned for ease of reading, north is at the top of the

page. Therefore, in Figure 2-1, the winds are from the northwest. At the end of this stick are any numbers of barbs, which come in three shapes, to indicate the wind speed. A long barb represents 10 knots, short barbs are 5 knots, and pennants are 50 knots.

The numbers to the left of the station symbol indicate the temperature (top left) and dew point (bottom left). In between the temperature and dew point, there may be a symbol from Figure 2-2 representing the present weather at the station. Additionally, the circle (or square) may be filled in to represent the amount of sky covered by clouds, in eighths. An empty circle means clear skies, while a fully darkened circle indicates a completely overcast sky (also from Figure 2-2).

































| AUTOMATED SKY CONDITION | MANUAL SKY CONDITION | PRESENT WEATHER | PRESENT TENDENCY |
|--|--|---|--|
|  OR |  CLEAR |  RAIN |  RAIN SHOWERS |
| | |  DRIZZLE |  HURRICANE |
|  OR |  1/8 TO 4/8 INCLUSIVE (SCATTERED) |  SNOW |  SQUALL |
|  OR |  5/8 TO 7/8 INCLUSIVE (BROKEN) |  ICE PELLETS |  FUNNEL CLOUD |
|  OR |  8/8 (OVERCAST) |  HAIL |  BLOWING SNOW |
| | |  THUNDERSTORM |  FOG |
|  OR |  SKY OBSCURED OR PARTIALLY OBSCURED |  FREEZING DRIZZLE |  BLOWING DUST OR SAND |
| | |  FREEZING RAIN |  DUST DEVIL |
|  OR |  DATA MISSING |  SNOW SHOWERS |  SMOKE |
| | |  THUNDERSTORM AND RAIN |  HAZE |
| | | | (+) HIGHER THAN 3 HOURS AGO (-) LOWER THAN 3 HOURS AGO |

Figure 2-2 Major Station Model Symbols

The right-hand side of the station model describes the pressure at the station. On the top right, there will be three digits to represent the sea level pressure (SLP) in millibars and tenths. Since SLP will always be somewhere around 1000 millibars, the hundreds digit (and thousands, if present) is dropped, and the decimal point is also omitted. Thus, depicted pressures beginning with large numbers (such as a 9) really start with a hidden “9” and pressures beginning with small numbers (such as a 1) actually have a “10” in front of them. Below the current SLP is the pressure tendency over the last three hours, beginning with a (+) or (-) sign to denote an overall rise or fall, and then the value of that total pressure change. After this notation is a set of two

connected line segments graphically showing the pressure change over those three hours, as indicated on the right-hand side of Figure 2-2.

206. LARGE SCALE WIND PATTERNS

Now that we have discussed station models, it may be easier to understand how pressure and wind fit together by imagining how a surface analysis chart is constructed (Figure 2-3). While most of these are built automatically by computer, picture a meteorologist at the National Weather Service starting with a U.S. map covered only with station models. The first thing he/she would do is to start playing “connect the dots” by finding stations with the same pressures, and drawing isobars between them (as discussed in Chapter One). These isobars are drawn, as a standard, with four millibars of space between each line, and they are labeled accordingly. At this point, it would become clear where the low and high-pressure systems are located, and he/she could draw either a big red “L” or a blue “H” to signify these locations. Finally, he/she could draw other symbols, such as fronts and troughs, as needed, depending on the chart type. We now have enough of a picture to move onward in the discussion of winds.

Notice the winds in Figure 2-3 are moving in generally the same direction in the areas between each of the pressure systems. If you look closely, you may even notice the winds are moving almost parallel to the isobars, in most situations. After enough observation, you may also recognize a pattern of air circulation around high- and low-pressure systems. In fact, each of these characteristics is a result of pressure differences causing the air to circulate in a consistent pattern: parallel (or almost parallel) to isobars, clockwise around high pressure, and counterclockwise around low pressure. Next, we will discuss why winds blow in this fashion.

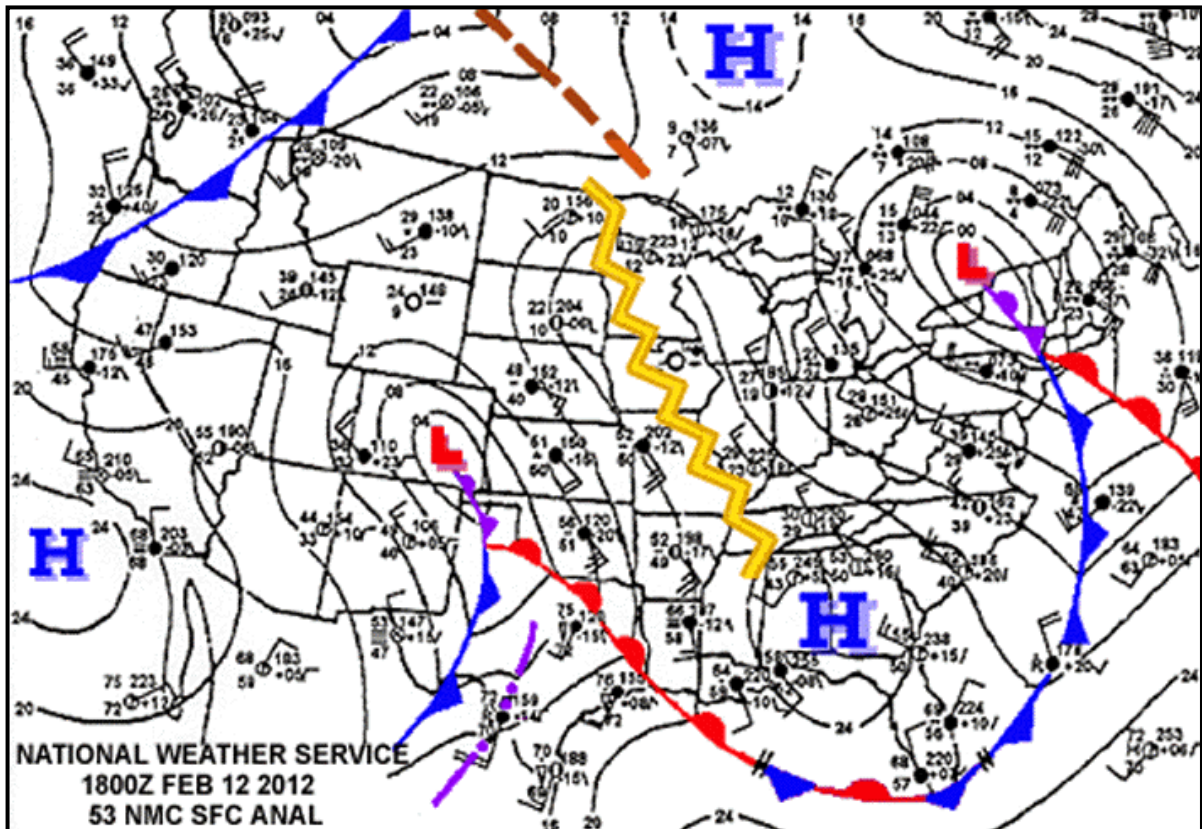

Figure 2-3 Typical Surface Analysis Chart

Pressure Gradients

The spacing of isobars indicates the rate of pressure change over a horizontal distance. In Figure 2-4, the isobars are more closely spaced to the east than they are to the west, indicating that pressure changes more rapidly on the eastern side. The rate of pressure change in a direction perpendicular to the isobars (horizontal distance) is called the pressure gradient and this isobar spacing represents the size of the pressure gradient force (PGF). The PGF is steep or strong, when isobars are close together and is shallow or weak, when the isobars are far apart; the steeper the gradient, the stronger the winds. The PGF is the initial movement of air from high pressure to low pressure, thus it is the initiating force for wind.

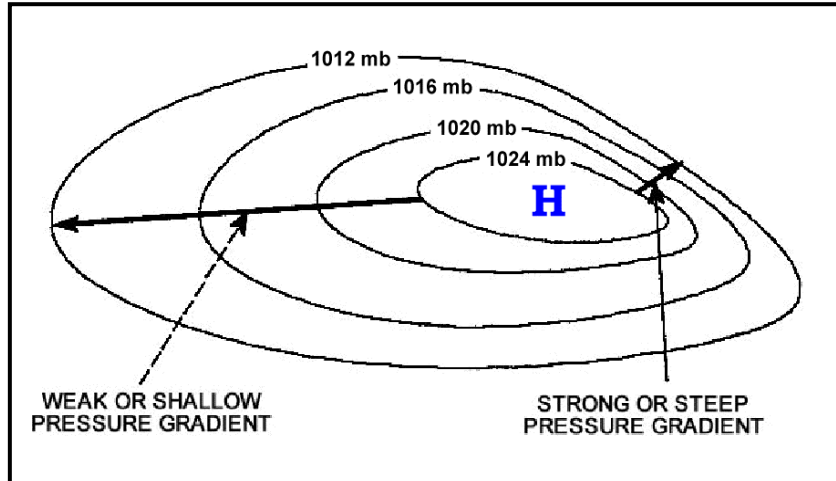

Figure 2-4 Pressure Gradient Force

Atmospheric circulation moves air in mainly two ways: ascending and descending currents. When the air descends, the downward force against the Earth creates a high-pressure system on the surface. The air then can only spread out and diverge, moving across the surface of the Earth, producing the horizontal flow of air known as wind. Likewise, air moving upward away from the Earth, results in a low at the surface and tries to converge toward the center of the low, also producing wind.

However, the wind cannot and does not blow straight out of a high into a low. These motions are the result of the pressure gradient force (Figure 2-5).

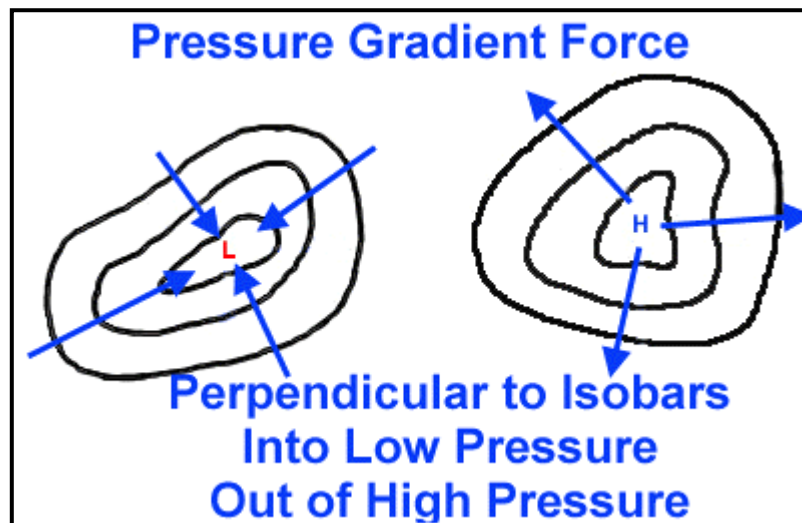

Figure 2-5 Pressure Gradient Force

Gradient Winds

While the pressure gradient force causes air to flow from high- to low-pressure across the isobar pattern, another force acts upon the wind to determine its direction. The Coriolis force, created by the Earth's rotation, diverts the air to the right—with respect to its initial direction of motion—regardless of whether the air is near a high- or low-pressure system. The result of these two forces is the gradient winds, which flow perpendicular to the pressure gradient force. This means gradient winds flow parallel to the isobars (Figure 2-6) and results in circulation flowing clockwise around highs and counterclockwise around lows. Finally, gradient winds are found above 2000 feet AGL.

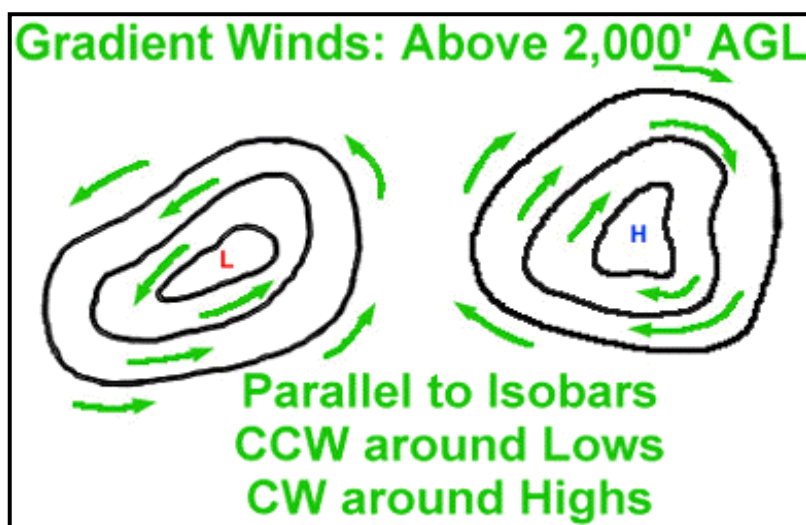

Figure 2-6 Gradient Winds Flow Parallel to Isobars (Found Aloft)

Surface Winds

When we consider winds below 2000 feet AGL, we cannot ignore the role of surface friction in the analysis of wind direction. Surface friction reduces the speed of the wind, which causes a reduction in the Coriolis force. This results in a different set of forces that must be balanced: the PGF, Coriolis force, and friction. When the new balance of forces is reached, the air blows at an angle across the isobars from high pressure to low pressure. This angle varies as a result of the type of terrain, but for our purposes, we will assume a 45° angle (Figure 2-7). Another way to think of this effect is that the Coriolis force still tries to turn the wind to the right, from its initial intended direction of the PGF, but it does not turn to the right quite as much as with gradient winds. Thus, surface winds still move clockwise around highs, and counterclockwise around lows, but since they blow across the isobars at a 45° angle, they also have a component of motion that moves air out of the high pressure and into the low. Thus, given a gradient wind we can calculate the appropriate surface winds as shown in Figure 2-8.

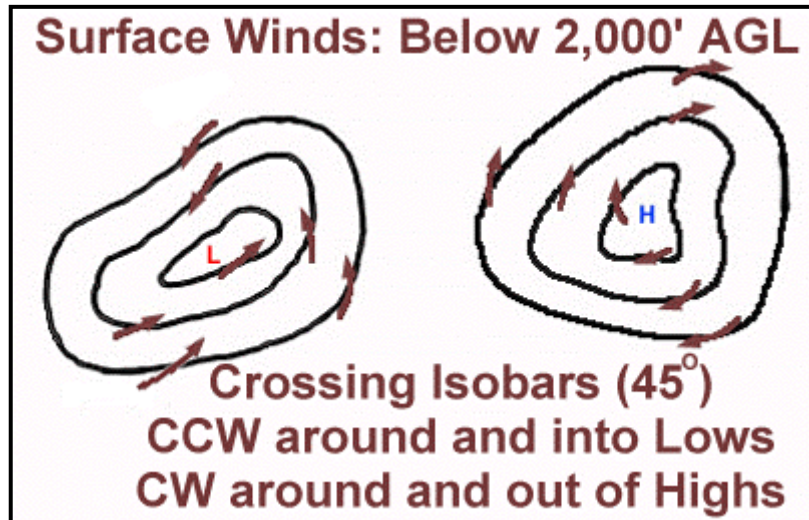

Figure 2-7 Surface Winds are Deflected Across Isobars Towards Lower Pressure

| | | | | |
|------------------|----|----|----|----|
| Gradient: | N | E | S | W |
| Surface: | NW | NE | SE | SW |

Figure 2-8 Surface Winds Relates to Gradient Wind Above It

Buys Ballot's Law, A Rule Of Thumb

A rule of thumb to help remember the direction of the wind in relation to a pressure system is Buys Ballot's Law. This law states that if the wind is at your back, the area of lower pressure will be to your left. When standing on the Earth's surface, the low will be slightly forward or directly left because the winds flow across the isobars.

Movement of Pressure Systems and Large Scale Wind Patterns

Weather in the Temperate Zone (which includes the U.S.) and farther north changes almost constantly with the passage of highs and lows. These migrating systems move from west to east with the prevailing westerly winds. They are accompanied by wind shifts, and with some exceptions, large and rapid changes in temperature and broad areas of precipitation. These systems furnish the most significant means of heat transfer between high and low latitudes.

The Jet Stream

Wind speeds generally increase with height through the troposphere, reaching a maximum near the tropopause, and often culminating in the jet stream. The jet stream is a narrow band of strong winds of 50 knots or more that meanders vertically and horizontally around the hemisphere in wave-like patterns. The jet streams (polar and subtropical) have a profound influence on weather patterns.

These winds average about 100 to 150 knots but may reach speeds in excess of 250 knots (Figure 2-9). Since the jet stream is stronger in some places than in others, it rarely encircles the entire hemisphere as a continuous river of wind. More frequently, it is found in segments from 1000 to 3000 miles in length, 100 to 400 miles in width, and 3000 to 7000 feet in depth.

The average height of jet stream winds is about 30,000 feet MSL, but they can be above or below this level depending on the latitude and the season. During the winter, the position of the jet stream is further south, the core rises to higher altitudes, and its speed is faster than in the summer.

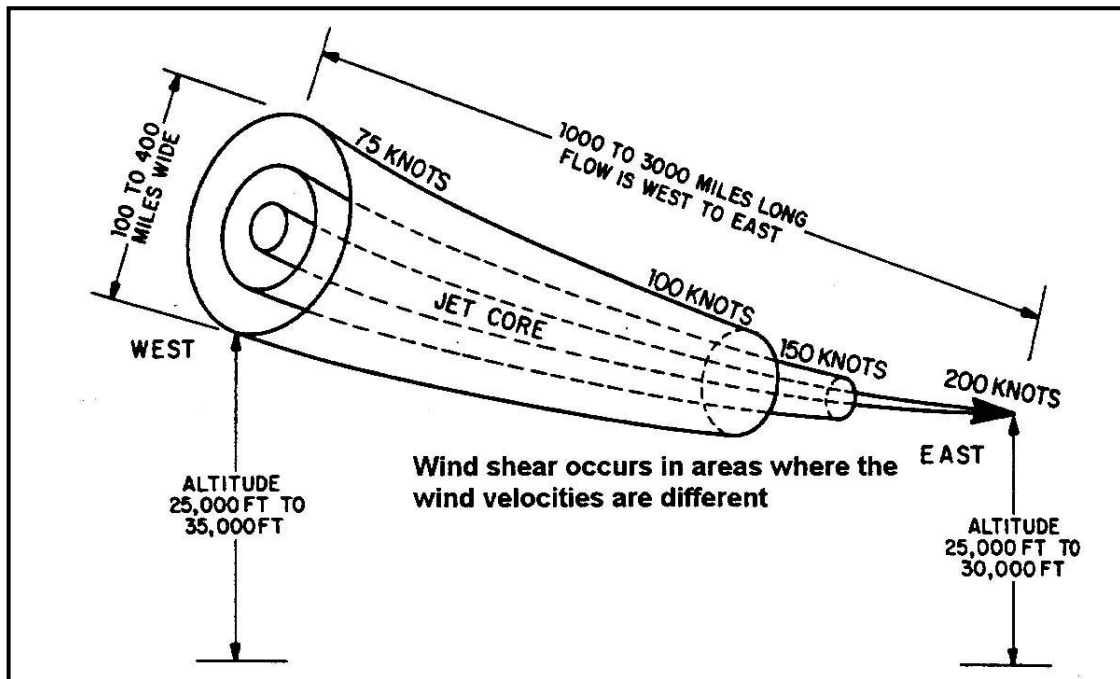

Figure 2-9 Jet Stream

The existence of jet streams at operational altitudes requires additional aircrew flight planning consideration. The greater headwind component for westbound aircraft will increase fuel consumption and may require additional alternate landing fields along the route. Wind shear associated with the jet stream may also cause turbulence, forcing the aircrew to change altitude or course.

Local Winds

The term “local,” in the case of wind systems, applies to areas whose sizes range from tens of miles across, to long, geographically thin areas. The local wind systems created by mountains, valleys, and water masses are superimposed on the general wind systems and may cause significant changes in the weather.

Sea and Land Breezes

The differences in the specific heat of land and water cause land surfaces to warm and cool more rapidly than water surfaces through insolation and terrestrial radiation. Therefore, land is normally warmer than the ocean during the day and colder at night. This difference in temperature is more noticeable during the summer and when there is little horizontal transport of air in the lower levels of the atmosphere. In coastal areas, this difference of temperature creates a tendency for the warmer, less dense air to rise, and the cooler, denser air to sink, which produces a pressure gradient. During the day, the pressure over the warm land becomes lower than over the colder water. The cool air over the water moves toward the lower pressure, replacing the warm air over the land that moved upward. The resulting onshore wind, blowing from the sea, is called a sea breeze, with speeds sometimes reaching 15 to 20 knots (Figure 2-10).

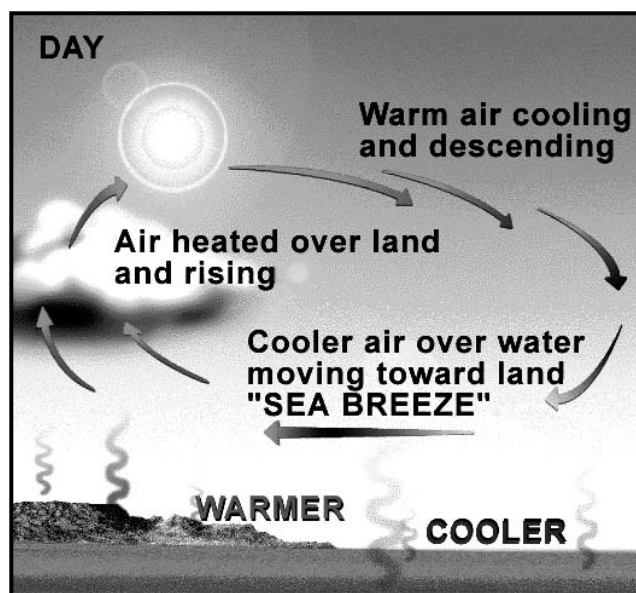

Figure 2-10 Sea Breeze

At night, the circulation is reversed so that the air movement is from land to sea, producing an offshore wind called the land breeze (Figure 2-10). The sea breezes are usually stronger than the land breezes, but they seldom penetrate far inland. Land and sea breezes are shallow in depth, and should be considered during takeoff and landing near large lakes and oceans.

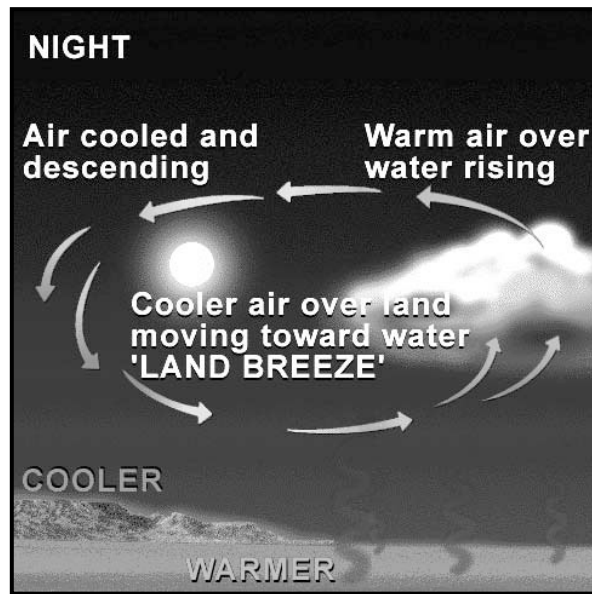

Figure 2-11 Land Breeze

Mountain and Valley Winds

In the daytime, mountain slopes are heated by the Sun's radiation, and in turn, they heat the adjacent air through conduction. This air usually becomes warmer than air farther away from the slope at the same altitude and, since warmer air is less dense, it begins to rise (Figure 2-10). It cools while moving away from the warm ground, increasing its density. It then settles downward, towards the valley floor, completing a pattern of circulation. This downward motion forces the warmer air near the ground up the mountain and since it is then flowing from the valley, it is called a valley wind.

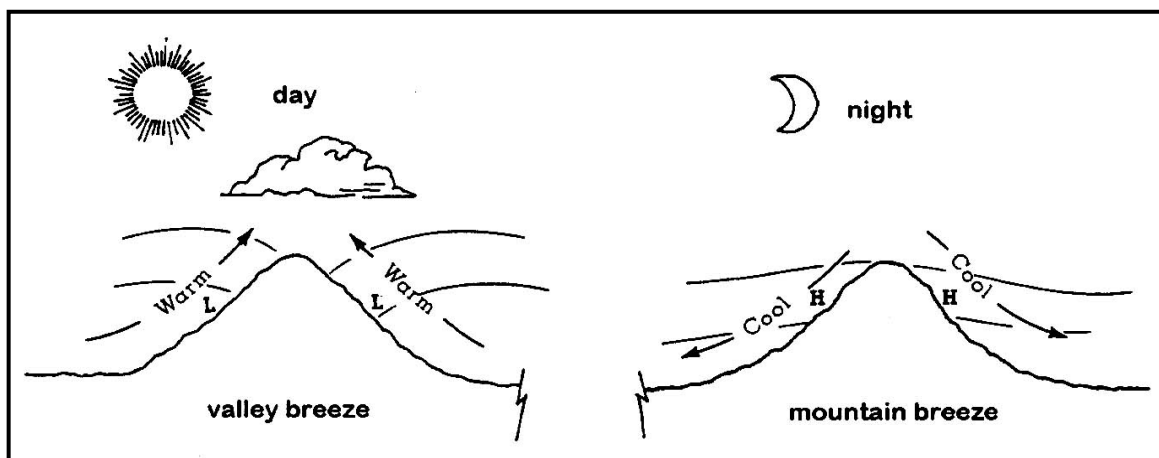

Figure 2-12 Mountain and Valley Winds

At night, the air in contact with the mountain slope is cooled by outgoing terrestrial radiation and becomes more dense than the surrounding air. As the denser air flows downhill, from the top of the mountain, it is called the mountain wind, and a circulation opposite to the daytime pattern forms.

These winds are of particular importance for light aircraft, helicopter, and low-level operations. In mountainous areas where the performance of some fixed-wing aircraft or helicopters is marginal, the location of mountain and valley winds can be critical.

Atmospheric Moisture

Moisture is water in any of its three states: solid, liquid, or gas. As water changes from one state to another, it releases (or absorbs) heat to (or from) the atmosphere. For example, when water in the atmosphere freezes, it releases heat into the air, and the air becomes warmer. Air can hold only a certain amount of water depending on the air temperature. The higher the temperature, the more water vapor the air can hold (Figure 2-13). The air reaches saturation when it contains the maximum amount of water vapor for that temperature.

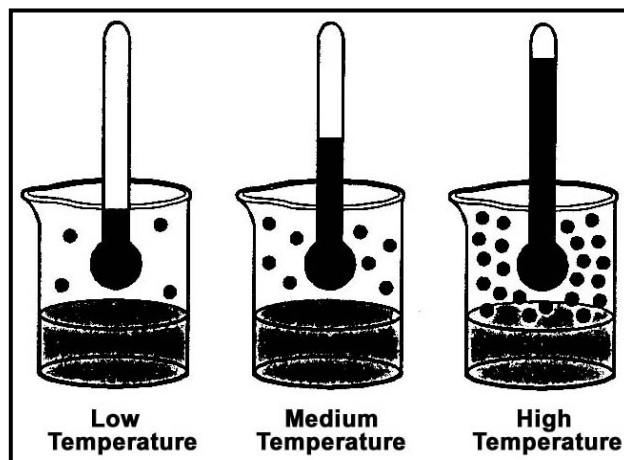

Figure 2-13 Dots Illustrate the Increased Water Vapor Capacity of Warmer Air

The dew point temperature (T_D) is the temperature at which saturation occurs. The dew point is a direct indication of the amount of moisture present in the air. The higher the dew point, the greater chances for clouds, fog, or precipitation.

If there is a difference between the air temperature and the dew point temperature, this is known as the dew point depression or dew point spread, and the dew point will always be the lower of the two. The dew point can never be higher than the air temperature, only equal to or less than. This spread provides a good indication of how close the atmosphere is to the point of saturation. When the dew point depression reaches about 4°F, the air is holding close to the maximum amount of water vapor possible. If this spread continues to decrease, moisture will begin to condense from the vapor state to the liquid or solid state and become visible. This visible moisture can form dew or frost on exposed surfaces, fog near the ground, or clouds higher in the

atmosphere. Saturation occurs when the dew point and the air temperature are equal. This can occur either by raising the dew point (evaporation) or lowering the air temperature (cooling).

Another measure of atmospheric moisture is the relative humidity (RH), which is the percent of saturation of the air. The air can become saturated (RH = 100%) by one of two ways. If the air is cooled, the falling air temperature decreases the dew point spread closer to zero, while the RH rises closer to 100%. If evaporation occurs, this adds moisture to the atmosphere, increasing the dew point, which again lowers the dew point spread and increases the RH. Once the dew point spread reaches 4°F, the RH will be 90%, and the water vapor will begin to condense into fog or clouds. Any further cooling or evaporation will produce precipitation, as there will be more water present in the air than it can hold.

207. CHARACTERISTICS AND TYPES OF PRECIPITATION

The characteristics and types of precipitation reveal information about various atmospheric processes. The nature of precipitation may give a clue about a cloud's vertical and horizontal structure or indicate the presence of another cloud deck aloft. The three characteristics of precipitation are:

1. Showers - Characterized by a sudden beginning and ending, and abruptly changing intensity and/or sky conditions. Showers are associated with cumuliform clouds.
2. Continuous - Also known as steady (not showery). Intensity changes gradually, if at all. Continuous or steady precipitation is associated with stratiform clouds.
3. Intermittent - Stops and restarts at least once during the hour. Intermittent precipitation may be showery or steady, and therefore may be associated with cumuliform or stratiform clouds.

Precipitation takes many forms. A few of the more common types of precipitation are mentioned here.

1. Drizzle – Very small droplets of water that appear to float in the atmosphere.
2. Freezing drizzle – Drizzle that freezes on impact with objects.
3. Rain – Precipitation in the form of water droplets that are larger than drizzle and fall to the ground.
4. Freezing rain – Rain that freezes on impact with objects.
5. Hail or graupel – A form of precipitation composed of irregular lumps of ice that develop in severe thunderstorms, consisting of alternate opaque and clear layers of ice in most cases. Water drops, which are carried upward by vertical currents, freeze into ice pellets, start falling, accumulate a coating of water, and are carried upward again, causing the water to freeze. A

repetition of this process increases the size of the hailstone. It does not lead to the formation of structural ice, but it can cause structural damage to aircraft.

6. Ice pellets or sleet – Small translucent and irregularly shaped particles of ice. They form when rain falls through air with temperatures below freezing. They usually bounce when hitting hard ground and make a noise on impact. Ice pellets do not produce structural icing unless mixed with super-cooled water.

7. Snow – White or translucent ice crystals, usually of branched hexagonal or star-like form that connect to one another forming snowflakes. When condensation takes place at temperatures below freezing, water vapor changes directly into minute ice crystals. A number of these crystals unite to form a single snowflake. Partially melted, or “wet” snow, can lead to structural icing.

8. Snow grains – Very small white, opaque grains of ice. When the grains hit the ground, they do not bounce or shatter. They usually fall in small quantities from stratus-type clouds, never as showers.

Precipitation, depending on the type and intensity, affects aviation in many ways:

Visibility in light rain or drizzle is somewhat restricted. In heavy rain or drizzle, it may drop to a few hundred feet. Rain or drizzle streaming across a windscreen further restricts forward visibility. Snow can greatly reduce visibility and can lead to a total lack of forward vision.

Very heavy rain falling on a runway may cause hydroplaning. During hydroplaning, the tires are completely separated from the runway surface by a thin film of water. Tire traction becomes negligible and the wheels may stop rotating. The tires now provide no braking capability and do not contribute to directional control of the aircraft. Loss of control may result.

If there is enough wet snow on the runway, it tends to pile up ahead of the tires during takeoff. This creates sufficient friction to keep the aircraft from reaching rotation speed and becoming airborne.

Heavy rain ingested into the engines of a jet or turboprop aircraft in flight can cause power loss or even flameout.

Hail can cause serious damage to any aircraft, but so can rain if it is penetrated at very high speed.

Clouds

Clouds may be defined as the visible manifestation of weather. With some knowledge of the weather conditions that cause clouds to develop, a pilot can get an excellent picture of the weather environment and can make a reasonable forecast of the weather conditions to follow. The most important element in the formation of clouds is water vapor.

General Theory of Clouds

Clouds are condensed water vapor, consisting of water droplets or ice crystals. They form when the air becomes saturated either by being cooled to the dew point or through the addition of moisture. Most clouds are the result of cooling from some lifting process, such as surface heating. The excess moisture condenses on minute particles in the atmosphere, thus forming droplets.

Condensation Nuclei

Water vapor requires a surface on which to condense. An abundance of microscopic solid particles, called condensation nuclei, are suspended in the air and provide condensation surfaces. Condensation nuclei consist of dust, salt crystals from the sea, acid salts from industrial waste, ash and soot from volcanoes and forest fires, rock particles from wind erosion, and organic matter from forests and grass lands. The most effective condensation nuclei are the various salts since they can induce condensation even when air is almost, but not completely, saturated.

208. TYPES OF CLOUDS

Clouds provide visible evidence of the atmosphere's motions, water content, and degree of stability and are therefore weather signposts in the sky. They can be numerous, widespread, form at very low levels, or show extensive vertical development.

Knowledge of principal cloud types helps the aircrew member when being briefed to visualize expected weather conditions. Additionally, knowledge of cloud types helps the pilot recognize potential weather hazards in flight. Clouds are classified according to their appearance, form, and altitude of their bases, and may be divided into four groups:

1. Low clouds, ranging from just above the surface to 6500 feet AGL.
2. Middle clouds with bases between 6500 and 20,000 feet AGL.
3. High clouds with bases usually above 16,000 feet AGL.
4. Special clouds with extensive vertical development.

The height of the cloud base, not the top, determines the classification. A cloud with a base at 5000 feet AGL and a top at 8000 feet AGL is classified as a low cloud. Each group is subdivided by appearance. There are two principal cloud forms:

1. Cumuliform – A lumpy, billowy cloud with a base showing a definite pattern or structure.
2. Stratiform – A cloud with a uniform base, formed in horizontal, sheet-like layers.

Low Clouds

Cloud bases in this category range from just above the surface to 6500 feet AGL (Figure 2-14). Low clouds are mainly composed of water droplets. The low clouds have no special prefix attached to their name. However, if the word nimbo or nimbus appears, beware, these clouds are producing violent or heavy precipitation.

Nimbostratus, a stratiform cloud, produces heavy steady precipitation.

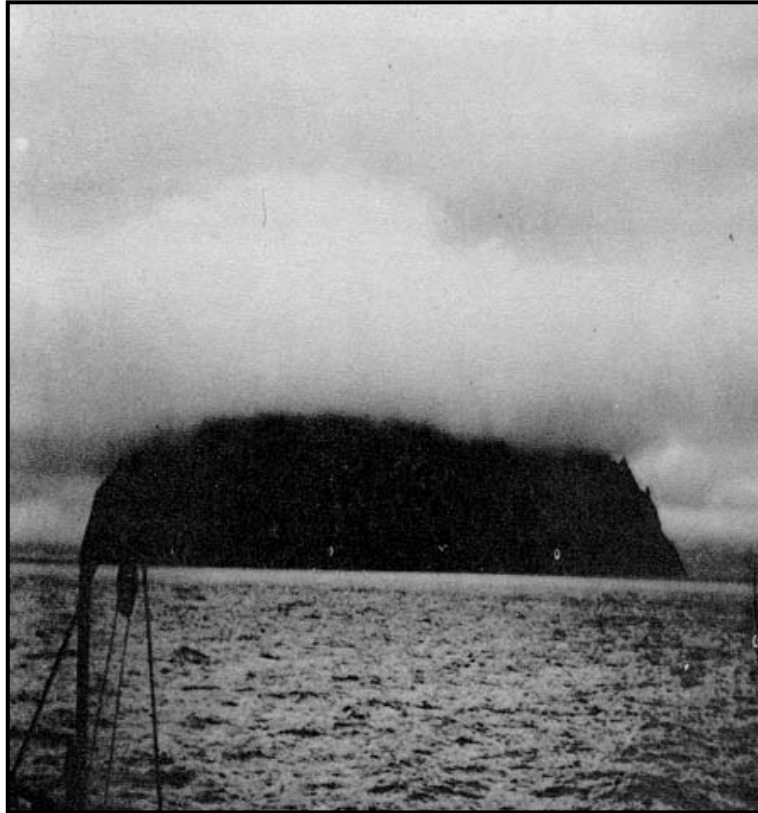

Figure 2-14 Stratus

Low clouds frequently present serious hazards to flying. The most serious hazard is the proximity of the cloud base to the surface of the Earth. Some of the low cloud types hide hills, making a collision with the terrain a very real danger, and visibility within low clouds is very poor. Low clouds may also hide thunderstorms. If the clouds are at or below freezing temperatures, icing may result. Icing accumulates faster in low clouds since they are generally denser than middle and high clouds. Turbulence varies from none to moderate. Expect turbulence in and below the clouds. Precipitation from low clouds is generally light rain or drizzle.

Middle Clouds

In this category, cloud bases form between 6500 and 20,000 feet AGL. The names of the middle clouds will contain the prefix alto- (Figure 2-15). They are composed of ice crystals, water droplets, or a mixture of the two.

A special cloud, altocumulus, produces continuous rain, snow, or ice pellets. The cloud base will extend down to about 1000 feet AGL and fog is often present. Expect poor visibility and low ceilings with very slow clearing.



Figure 2-15 Altocumulus Clouds

Visibility in middle clouds varies depending on cloud density from 1/2 mile to a few feet. Turbulence may be encountered in middle clouds. Frequently these clouds are dark and turbulent enough to make formation flying difficult. Icing is common due to the presence of super-cooled water droplets. Rain, rain and snow mixed, or snow can be encountered in thick middle clouds.

Virga is rain or snow that evaporates before reaching the ground and may be encountered below these clouds.

High Clouds

In this category, cloud bases average 20,000 to 40,000 feet AGL. The names of the high clouds will contain the prefix cirro- or the word cirrus (Figure 2-16).

High clouds have little effect on flying except for moderate turbulence and limited visibility associated with dense jet stream cirrus. Since high clouds are composed mostly of ice crystals,

they have no precipitation and do not constitute an icing hazard. Severe or extreme turbulence is often found in the anvil cirrus of thunderstorms.



Figure 2-16 Cirrus Clouds

Special Clouds with Extensive Vertical Development

This category consists of towering cumulus and cumulonimbus clouds. The base of these clouds is found at the low to middle cloud heights and their tops extend through the high cloud category. Figure 2-17 shows cumulonimbus clouds.



Figure 2-17 Cumulonimbus Clouds

Towering cumulus are clouds nearing the thunderstorm stage. They can produce heavy rain showers and moderate turbulence in and near the cloud. Icing is common above the freezing level.

Cumulonimbus clouds are thunderstorm clouds. A cumulonimbus cloud is sometimes referred to as a "CB." Cumulonimbus is an exceedingly dangerous cloud, with numerous hazards to flight such as severe to extreme turbulence, hail, icing, lightning, and other hazards discussed in Chapter Four. Figure 2-18 summarizes the weather conditions found in the various types of clouds.

| Cloud Groups | | | | |
|--------------|---------------|------------------------|------------------|--|
| | High Clouds | Middle Clouds | Low Clouds | Clouds with Extensive Vertical Development |
| Visibility | Good to Fair | 1/2 mile to a few feet | A few feet | A few feet |
| Icing | None to Light | None to Moderate | None to Moderate | Severe |
| Turbulence | None to Light | None to Moderate | None to Moderate | Severe |

Figure 2-18 Cloud Families

209. ATMOSPHERIC STABILITY

One of the most important meteorological considerations to a pilot is stability. Atmospheric stability is one of the primary determinants of weather encountered in flight. In some cases, a pilot may be able to determine if stable or unstable conditions exist along the route of flight.

There are three conditions of stability: stable, neutral stable, and unstable. We will consider each of these individually by observing a ball inside a bowl. If the ball is displaced, and tends to return to its original position, the ball is said to be stable (Figure 2-19).

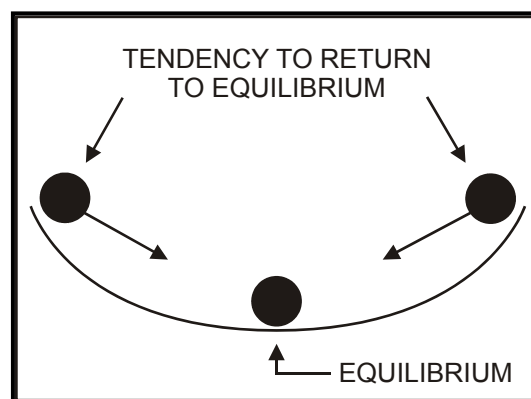

Figure 2-19 Stable

If a ball on a flat table is displaced, it will tend to remain in its new position and is said to be neutrally stable (Figure 2-20). It will not have a tendency to return to its original position or move away from its final position.

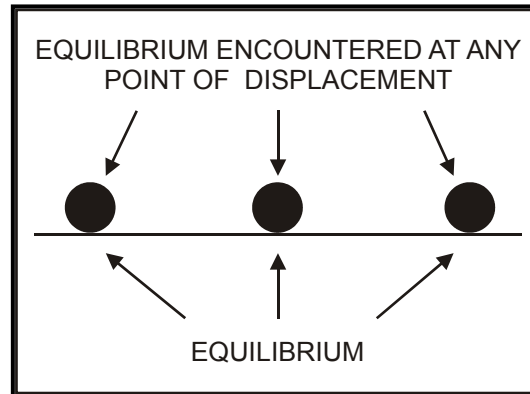

Figure 2-20 Neutrally Stable

Now, consider an inverted bowl with a ball balanced on top. Once the ball is displaced, it will tend to move away from its original position, never to return, and the ball is said to be in an unstable condition (Figure 2-21).

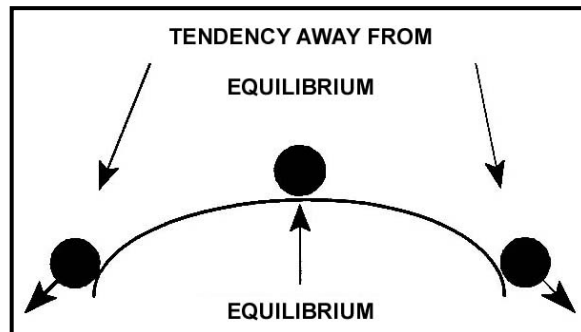

Figure 2-21 Unstable

In weather, parts or parcels of an air mass become displaced through one of four lifting methods. The temperature of the surrounding air determines the stability of a quantity of air after it is lifted. Lifted air that is colder than the surrounding air settles when the lifting action is removed, since it is denser. This indicates a stable condition. Lifted air that is warmer than the surrounding air continues to rise when the lifting action is removed because it is less dense. This indicates an unstable condition. This lifted air that continues to rise has reached the point of free convection, which occurs when the lifted air rises with no external lifting force, due only to the parcel's warmer temperature. Lifted air having the same temperature as the surrounding air after it is lifted will simply remain at the point where the lifting action was removed. This is an example of a neutrally stable atmosphere. If the air behaves in one of these three ways, then we can say the atmosphere has the same condition of stability (Figure 2-22).

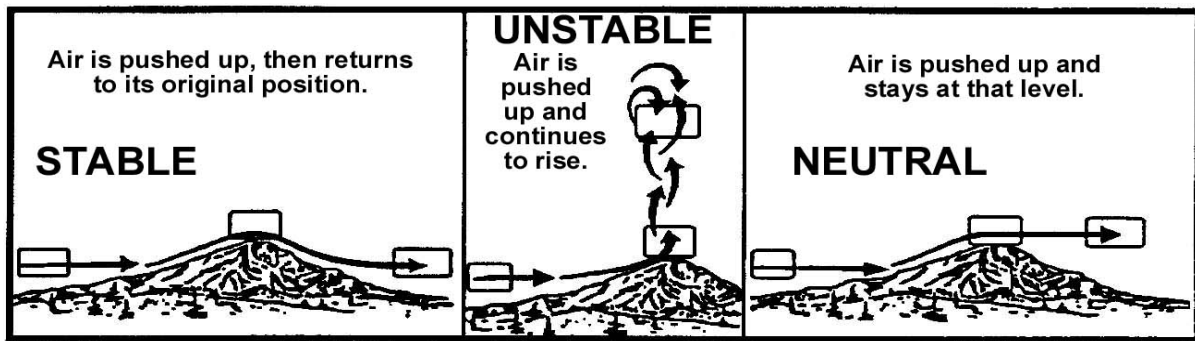

Figure 2-22 Stable, Unstable, and Neutral Stability

210. METHODS OF LIFTING

The four methods of lifting are convergence, frontal, orographic, and thermal (Figure 2-23). Convergence of two air masses, or parts of a single air mass, force the air upward because it has nowhere else to go. Because of the shape of cold fronts, as they move through an area, they will lift the air ahead of the cold air mass. Orographic lifting is a term indicating the force of the wind against a mountainside pushes the air upward. Thermal lifting, also known as convective lifting, is caused when cool air is over a warm surface and it is heightened by intense solar heating on a clear day.

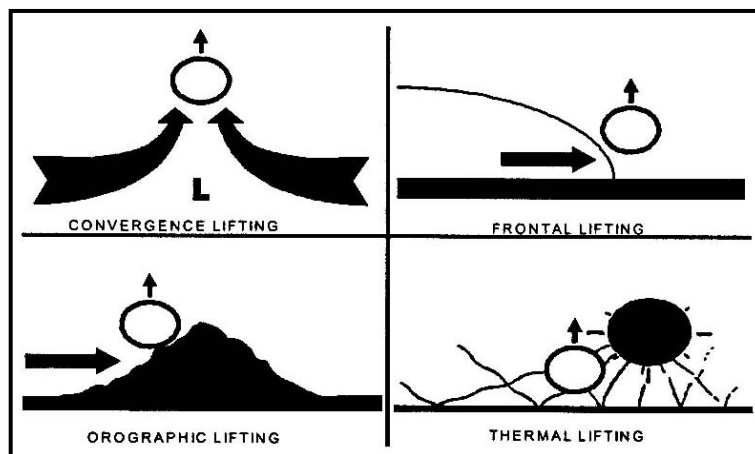

Figure 2-23 The Four Lifting Methods

211. STABILITY AND FLIGHT CONDITIONS

Cloud types are helpful in identifying conditions of stability or instability. Cumuliform clouds develop with unstable conditions and stratiform clouds develop with stable conditions (Figure 2-24), assuming sufficient moisture exists for cloud development.

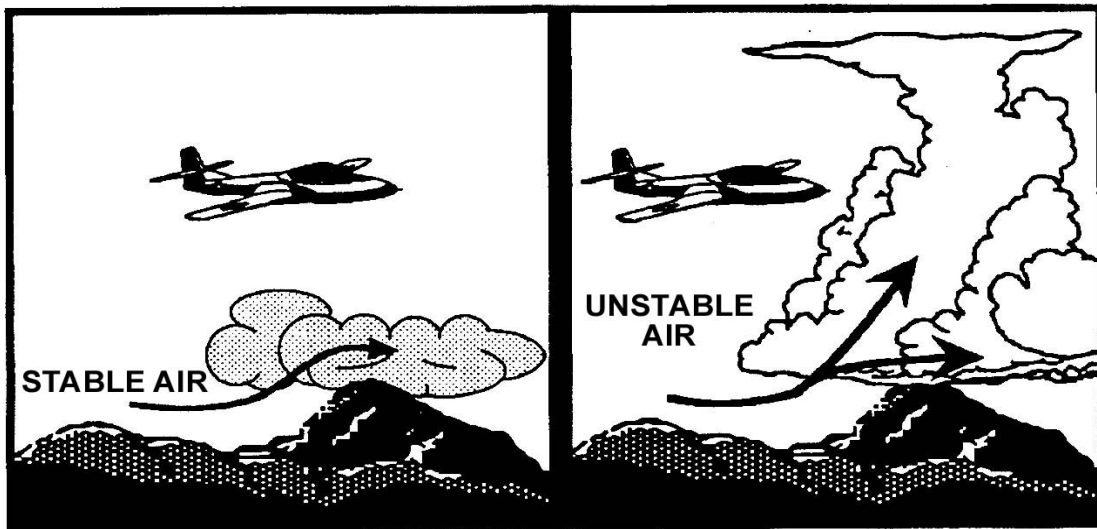

Figure 2-24 Clouds in Stable and Unstable Air

There are a significant number of flight conditions associated with atmospheric stability, as depicted in Figure 2-25. If one or more of these conditions is encountered, the stability of the atmosphere can be easily determined, and other flight conditions can be predicted. Thus, understanding the relationships among stability and flight conditions provides aircrew with a key that unlocks many of the mysteries of weather phenomena.

| Flight Conditions | Stable Atmosphere | Unstable Atmosphere |
|--------------------------|--------------------------|----------------------------|
| Cloud type | Stratus | Cumulus |
| Turbulence | Smooth | Rough |
| Visibility | Poor | Good (outside clouds) |
| Winds | Steady | Gusty |
| Precipitation | Steady | Showery |
| Icing | Rime | Clear |
| Air mass | Warm | Cold |
| Front | Warm | Cold |

Figure 2-25 Atmospheric Stability and Flight Conditions

Being able to recognize the stability of the air while flying will help prepare you for the various flight conditions you are experiencing. When encountering a change in weather conditions—apart from what was briefed—the relationships in Figure 2-25 can also be a guide to understanding the different options available and to making better decisions for avoiding weather hazards. Here are some additional “signs in the sky” that indicate stable air: temperature inversions, low fog and stratus, and rising air temperature while climbing. Thunderstorms, showers, towering clouds, dust devils, and rapidly decreasing air temperature while climbing all indicate unstable atmospheric conditions.

STUDY QUESTIONS

1. Which one of the following types of isobar spacing would indicate a weak pressure gradient force?
 - a. Narrow
 - b. Deep
 - c. Wide
 - d. Tight

2. Which one of the following types of pressure gradients would indicate the presence of strong winds?
 - a. Steep
 - b. Low pressure
 - c. Weak
 - d. Shallow

3. The initial movement of air toward a low-pressure area is caused by the _____.
 - a. pressure gradient force
 - b. Coriolis force
 - c. centrifugal force
 - d. force of friction

4. Coriolis force directs air _____, with respect to its initial direction of motion.
 - a. vertically
 - b. to the left
 - c. horizontally
 - d. to the right

5. According to Buys Ballot's law, if I have a head wind the area of lower pressure is _____.
 - a. to my right
 - b. to my left
 - c. straight ahead
 - d. aft

6. The forces that determine the wind direction in the atmosphere are weakened at the Earth's surface by the _____.
 - a. pressure gradient force
 - b. Coriolis force
 - c. centrifugal force
 - d. force of friction

7. Gradient winds move parallel to the isobars above 2000 feet AGL because they are not affected by the _____.
- pressure gradient force
 - Coriolis force
 - centrifugal force
 - force of friction
8. The surface wind, when compared with the gradient wind, is of _____.
- lesser speed and blows parallel to the isobars
 - lesser speed and blows across the isobars toward low pressure
 - greater speed and blows across the isobars toward high pressure
 - greater speed and blows across the isobars toward low pressure
9. In the Northern Hemisphere, the wind blows _____.
- from low to high pressure
 - clockwise around a low
 - counterclockwise around a low
 - perpendicular to the isobars
10. Gradient winds blow parallel to the isobars because of the _____.
- Coriolis force
 - frictional force
 - centrifugal force
 - wind force
11. The sea breeze blows from the _____ to the _____ during the _____, and the land breeze blows from the _____ to the _____ during the _____.
- water, land, day; water, land, night
 - land, water, day; land, water, night
 - land, water, day; water, land, night
 - water, land, day; land, water, night
12. _____ and water vapor must be present in the atmosphere for precipitation to occur.
- Carbon dioxide
 - Condensation nuclei
 - Wind
 - Nitrogen

13. When air contains the maximum moisture possible for a given temperature, the air is _____.
14. The temperature to which air must be cooled to become saturated is called the _____.
15. Which one of the following conditions could produce fog, clouds, or precipitation?
- Dew point spread of 5°C
 - Warm air over cold water.
 - RH of 0%
 - RH of 100%
16. Stratiform clouds are associated with (stable/unstable) flight conditions.
17. At which altitude could an altostratus cloud be found?
- 5000 feet MSL
 - 5000 feet AGL
 - 10,000 feet AGL
 - 25,000 feet AGL
18. Cumulonimbus clouds typically produce which type of precipitation?
- Drizzle
 - Light steady
 - Heavy showers
 - Fog
19. Nimbostratus clouds will produce _____ precipitation.
- heavy showery
 - light showery
 - heavy steady
 - light steady
20. _____ defines air with the same temperature as the surrounding air.
- Unstable
 - Neutrally stable
 - Stable
 - Displaced

21. Which one of the following correctly lists the four methods of lifting?
- Convergence, frontal, orographic, and thermal
 - Convergence, subsidence, orographic, and thermal
 - Convergence, convection, adiabatic, and katabatic
 - Divergence, subsidence, frontal, and convective
22. If lifted air is warmer than the surrounding air, then _____ clouds will form resulting in _____ flight conditions.
23. If stratus clouds are present, which of the following flight conditions could be expected?
- Rough turbulence, good visibility, showery precipitation, and clear icing
 - Smooth flight, good visibility, steady winds, and no precipitation
 - Poor visibility, steady winds, continuous precipitation, and rime icing
 - Smooth flight, turbulent flight, good visibility, and showery precipitation
24. Which one of the following types of clouds could be produced by unstable conditions?
- Cirrus
 - Cumulonimbus
 - Stratus
 - Nimbostratus

THIS PAGE INTENTIONALLY LEFT BLANK

CHAPTER THREE

Mechanics of Frontal Systems

300. INTRODUCTION

The purpose of this chapter is to introduce the student to various frontal systems, including their formation, flight conditions, and associated weather patterns, since most of the active weather is concentrated along fronts. The goal of this chapter is to present a broad description of each of the frontal types, along with the general flight conditions associated with each. With this knowledge, an aviator will carry on a conversation about flight conditions with the meteorologist during the weather brief, as opposed to having a one-way conversation. Because only the flight crew understands the details and ramifications of the mission, it would be impossible to expect a meteorologist to foresee all the possibilities and to brief the weather accordingly.

301. LESSON TOPIC LEARNING OBJECTIVES

Terminal Objective: Partially supported by this lesson topic:

2.0 Upon completion of this unit of instruction, student aviators and flight officers will demonstrate knowledge of meteorological theory enabling them to make intelligent decisions when confronted with various weather phenomena and hazards.

Enabling Objectives: Completely supported by this lesson topic:

2.29 Define the terms air mass and front.

2.30 Describe the air mass classification system, including moisture content, temperature, and source region with respect to latitudes.

2.31 Describe the relationship between air mass temperature and stability.

2.32 Describe the structure of a front.

2.33 Describe the discontinuities used to locate and classify fronts.

2.34 Describe the factors that influence frontal weather.

2.35 Describe the conditions associated with a cold front.

2.36 Describe the characteristics of a squall line.

2.37 Describe the conditions associated with a warm front.

2.38 Describe the conditions associated with a stationary front.

2.39 Describe the conditions associated with occluded fronts.

2.40 Describe the conditions associated with an inactive front.

302. REFERENCE

Weather for Aircrews, AFH 11-203, Volume 1, Chapter 8

303. STUDY ASSIGNMENT

Review Chapter Three and answer the Study Questions.

304. AIR MASSES

No discussion of fronts would be complete without considering the air masses in vicinity of the fronts. The various characteristics of a front are highly dependent on the contrasts of the air masses separated by the front. If these characteristics are not large differences between the air masses, the front will be weak or non-existent.

An air mass is a large body of air that has essentially uniform temperature and moisture conditions in a horizontal plane, meaning there are no abrupt temperature or dew point changes within the air mass at a given altitude. It may vary in size from several hundred to more than several thousand square miles.

Air masses are named according to their moisture content, location, and temperature (Figure 3-1). The location of an air mass has a large influence over the other two properties.

| Symbol | Source Region | Latitudes |
|---------------|----------------------|------------------|
| A | Arctic | 60° - 90° N |
| P | Polar | 40° - 60° N |
| T | Tropical | South of 30° N |
| E | Equatorial | ± 10° of equator |

Figure 3-1 Northern Hemisphere Air Mass Source Regions

NOTES

1. Source region never changes. Example: an arctic air mass that moves South of 30° N latitude is still considered arctic.
2. Arctic air masses form around the North Pole. Polar air masses do not form at the North Pole.

3-2 Mechanics of Frontal Systems

Naturally, moist air masses will have a greater potential for producing clouds and precipitation than dry air masses. Most importantly, though, its temperature indicates the stability of the air mass. Warm air masses bring stable conditions, while cold air masses are inherently unstable. This temperature classification is relative to the surface beneath it. An air mass with a temperature of 90°F over a surface with a temperature 100°F is classified as cold.

A maritime air mass would be reclassified to continental when precipitation over land occurs. A continental air mass would be reclassified to maritime if evaporation over water occurs (Figure 3-2).

| Symbol | Surface | Moisture Content (Related to Dew point Temperature) |
|--------|-------------|--|
| m | Maritime | High |
| c | Continental | Low |

Figure 3-2 Source Region Surface

These symbols are combined to describe air masses as follows (Figure 3-3)

| Symbol | Source Region and Surface |
|--------|---------------------------|
| cA | Continental Arctic |
| cP | Continental Polar |
| mP | Maritime Polar |
| mT | Maritime Tropical |
| cT | Continental Tropical |
| E | Equatorial |

Figure 3-3 Air Mass Symbology

Air masses are also classified by temperature. An air mass leaving its source region will generally be warmer than the surface over which it is flowing if it is moving north, or colder than the surface over which it is flowing if it is moving south. If the air mass is warmer than the surface, it is cooled by contact with the cold ground, becomes more stable, and is called a warm air mass (Figure 3-3). If the air mass is colder than the surface over which it is moving, it is heated from below, resulting in convective currents and instability and is called a cold air mass.

305. FRONTAL SYSTEMS

A front is an area of discontinuity that forms between two contrasting air masses when they are adjacent to each other. A front can be thought of as a border, boundary, or line between the air masses. These air masses must have sufficiently different temperature and moisture properties, the defining characteristics of an air mass, otherwise there would be little reason to distinguish between them. Since air masses cover many thousands of square miles, the boundary between

them can be hundreds of miles long. Air masses and fronts are three-dimensional. The point where a front comes in contact with the ground is called the surface front.

The surface front is the line plotted on surface analysis charts with different colors and shapes representing each type of front, as pictured in Figure 3-4.







| Type of Front | Color Scheme | SYMBOL |
|------------------|-----------------|--|
| Cold front | Blue |  |
| Warm front | Red |  |
| Occluded front | Purple |  |
| Stationary front | Blue and Red |  |
| Trough | Brown or Black |  |
| Ridge | Yellow or Black |  |
| Squall line | Purple |  |

Figure 3-4 Frontal Symbols

The frontal zone is the area encompasses the weather located on either side of the front. The depth of this frontal zone depends on the properties of the two air masses. When the properties differ greatly, the resulting narrow frontal zone can include sudden and severe weather changes. It is often impossible to determine the exact outer boundaries of a frontal zone. Most active weather is focused along and on either side of the surface front and frontal zone. Likewise, most aviation weather hazards are also found in the vicinity of fronts. In the mid-latitudes, fronts usually form between the warmer, tropical air to the south and the cooler, polar air to the north. When a pilot passes through a front or a front moves past a station, the atmospheric conditions change from one air mass to those of the other. Abrupt changes indicate the frontal zone is narrow and in some cases, the zone can be less than a mile wide. On the other hand, gradual changes indicate the frontal zone is broad and diffuse, often over 200 miles in width. Abrupt changes will bring more severe weather than gradual changes.

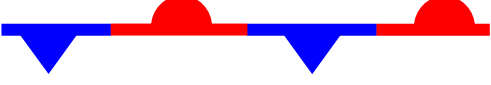
Aviation weather hazards are not limited to the area of frontal zones. Some fronts do not produce clouds or precipitation. Additionally, weather associated with one section of a front is frequently different from the weather in other sections of the same front. Do not conclude all

3-4 Mechanics of Frontal Systems

adverse weather occurs along fronts. In some cases, very large areas of low ceilings and poor visibility occur in areas far removed from a front.

Air Masses And Fronts

Having introduced the basics of both air masses and fronts, an analysis of a real-world situation can help explain how these pieces fit together. Figure 3-5 shows the weather across the U.S. at the same time from three different points of view. From the frontal systems shown on the Current Surface chart, we can see there are three major air masses over the nation: one over the West, one over the Midwest and the East, and one over the Deep South. For simplicity, we will compare only the Midwest/East and Deep South air masses.

Looking at the Current Temperatures chart, the Midwest air mass (centered approximately on the “H” of the high pressure) has temperatures in the 50s, give or take a few degrees. So far, this shows a relatively uniform temperature across the air mass, matching with what we would expect from the discussion above. The southern air mass, on the other hand, has much warmer temperatures, generally in the 70s and 80s. Even so, these temperatures are still relatively uniform throughout the air mass.

The dew points are also different between the two air masses. Even though the Dew Point chart only indicates dew points above 50° F, it is clear the southern air mass contains much more moisture than the air mass to its north. Thus, these charts indeed show two air masses over the eastern U.S., each with temperature and moisture properties different from the other. Accordingly, a front has been drawn between the two. From the “L” to just south of the “H” there is a warm front and to the east of that position, all the way to the next “L” over New England, there is a cold front.

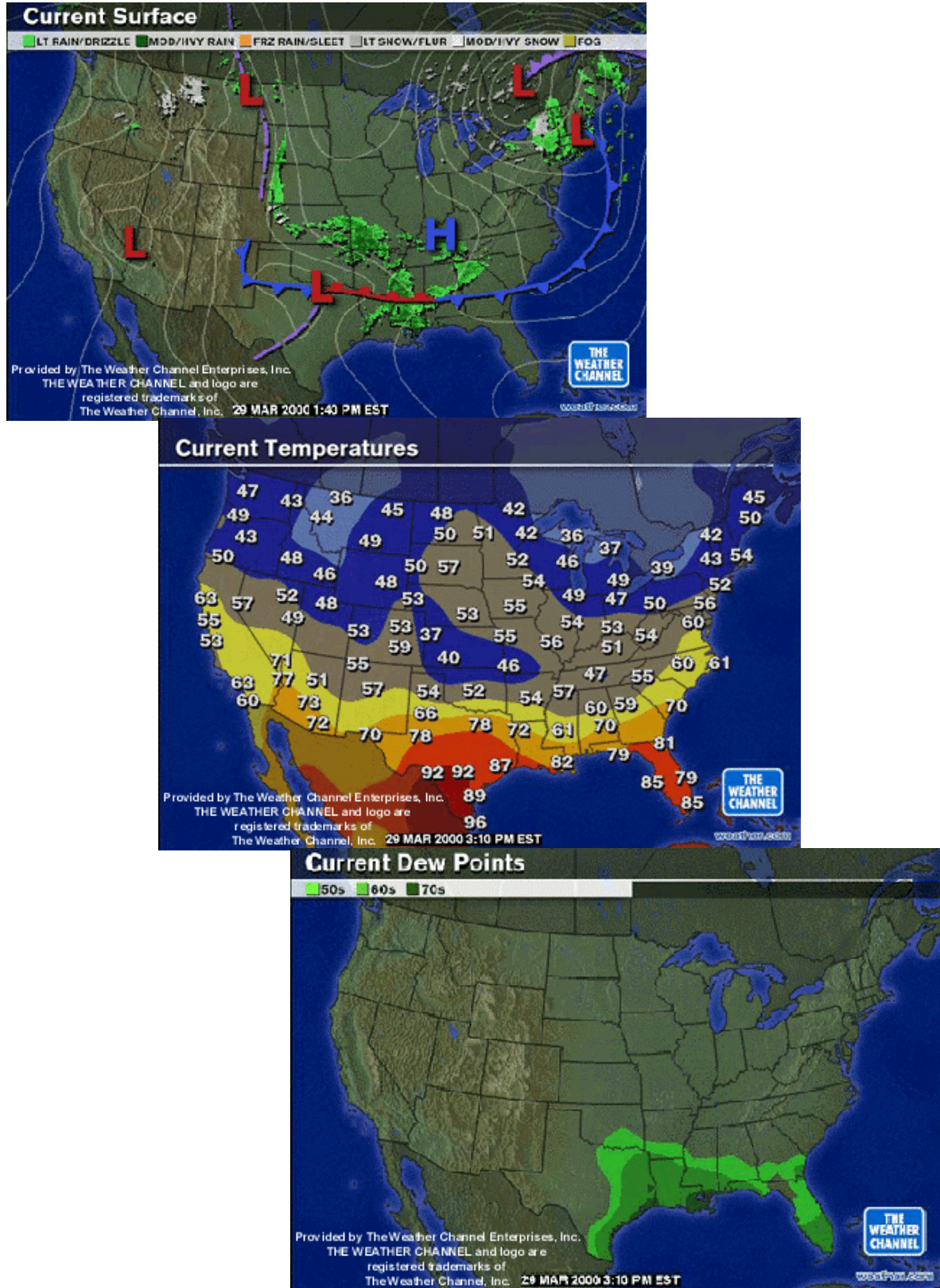

Figure 3-5 Uniform Temperature and Moisture of Air Masses

3-6 Mechanics of Frontal Systems

General Frontal Structure

The characteristics of each air mass on either side of the front diminish with increasing altitude. At some level above the surface, usually above 15,000 to 20,000 feet, the differences between the two air masses forming the front become negligible and the cloud and precipitation patterns in the upper frontal zone are not easily attributable to one frontal type or another (Figure 3-6). Therefore, the most significant frontal weather occurs in the lower layers of the atmosphere. However, the temperature contrast between the air masses can sometimes extend as high as the tropopause.

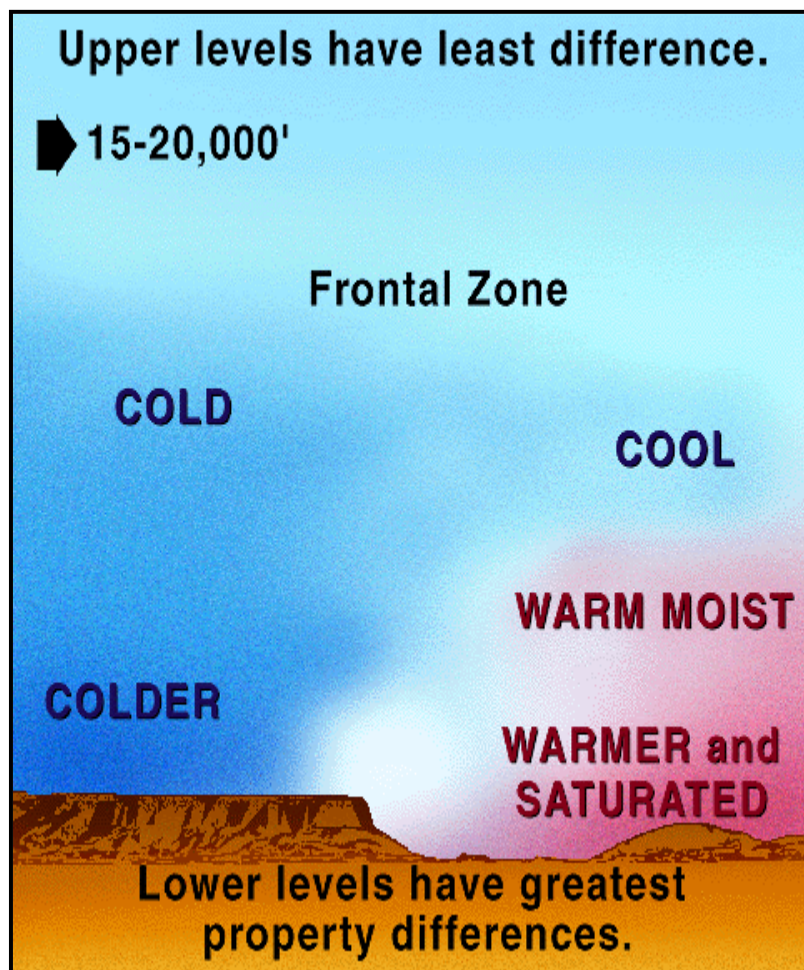

Figure 3-6 Frontal Zone Structure

Most fronts, regardless of type, have some common characteristics. First, fronts are named according to the temperature change they bring. For example, if the temperature will become warmer after the front passes, it is named a warm front. Second, fronts move across the country with their attached low-pressure system and isobars, as the corresponding air masses move. As they move, we are only concerned with any movement perpendicular to the line representing the front; thus, fronts are considered to move perpendicular to the way they are drawn. Also, cold

fronts move faster than warm fronts, in general. Next, we usually see a 90° wind shift from one side of the front to the other, with the two exceptions explained below. Finally, every front is located in a trough of low pressure.

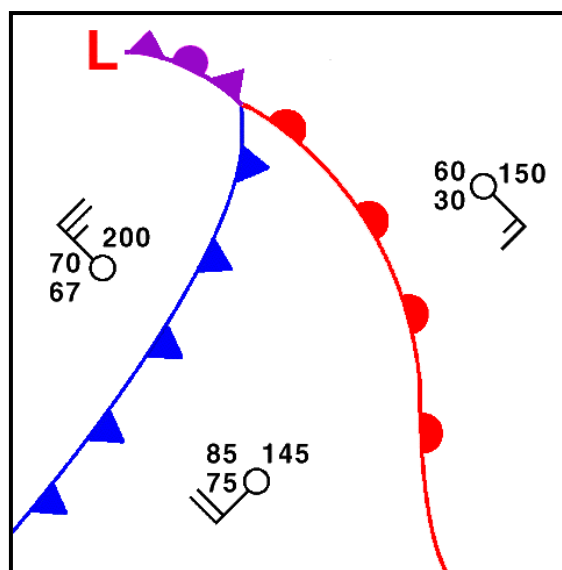

Figure 3-7 General Model of a Frontal System

This course will use the general frontal model presented in Figure 3-7 to illustrate the different characteristics of the various fronts. Remembering the basics of this model can aid in the comprehension of how the various fronts usually move, as well as the characteristic changes in weather from one side of a front to the other. Once this model is understood, it can easily be modified to fit the appropriate real-world situation by rotating the system, by changing the angle between the fronts or considering a curvature to any of the frontal lines. As we discuss each frontal type, imagine zooming in on this model to study the particular characteristics of that front. These frontal characteristics will be discussed in depth for each type of front, and as a group in the next section, which explains how meteorologists determine where to place fronts on weather charts.

306. FRONTAL DISCONTINUITIES

Differences in the various properties of adjacent air masses, such as their temperature, moisture (indicated by the dew point), winds, and pressure, are used to locate and classify fronts. For example, when comparing two dissimilar air masses, one will be colder than the other. Because of this, the colder one will be denser and drier (it must have a lower dew point). Cloud types are useful indicators of the type of front and will be discussed in connection with each individual front.

Temperatures

Temperature is one of the most easily recognizable differences across a front. In the lower layers of the atmosphere a greater temperature change will be noticed with frontal passage or when

3-8 Mechanics of Frontal Systems

flying through a front. The amount and rate of change partially indicates the front's intensity. Strong and weak fronts are accompanied by abrupt and gradual changes in temperature respectively.

Dew Points

The dew point temperatures reported from weather observing stations are helpful in locating the position of a front. The dew point temperature and air temperature give an indication of the relative humidity of the air. Cold air masses will usually have lower dew point temperatures than warm air masses. Higher dew points indicate a greater amount of moisture available to produce clouds, fog, or precipitation.

Pressures

All fronts are located in troughs of low pressure. The arrows in Figure 3-8 indicate the trough (where low pressure extends outward from the center of the low), as well as the direction of movement of the low-pressure system. Therefore, when a front approaches a station or a pilot flies toward a front, the pressure decreases. Pressure then rises immediately following frontal passage. Figure 3-8 illustrates this pressure fall and rise with the time sequence of the weather at station NSE. The earliest time is pictured in the upper right, when the pressure is 1011 mb, and the last point in time is at the lower left, with a pressure of 1007 mb. Because of this pressure change, it is extremely important to obtain a new altimeter setting when flying in the vicinity of a front.

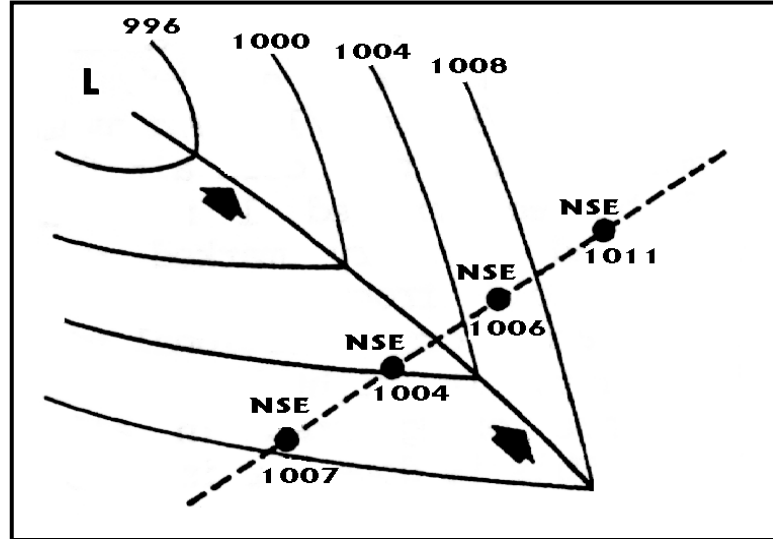

Figure 3-8 Pressure Changes Across a Front

Winds

Near the Earth's surface, the wind changes direction across a front. In the Northern Hemisphere, as the front approaches and passes a station, the wind changes direction in a clockwise rotation. When flying across a front, because of this wind shift you must adjust heading to the right to

maintain your original ground track (Figure 3-9). This wind shift often creates a hazardous wind shear when departing or approaching an airfield. For example, winds at 220° at 10 knots ahead of the front can rapidly change to 330° at 20 knots gusting to 30 knots immediately after the front.

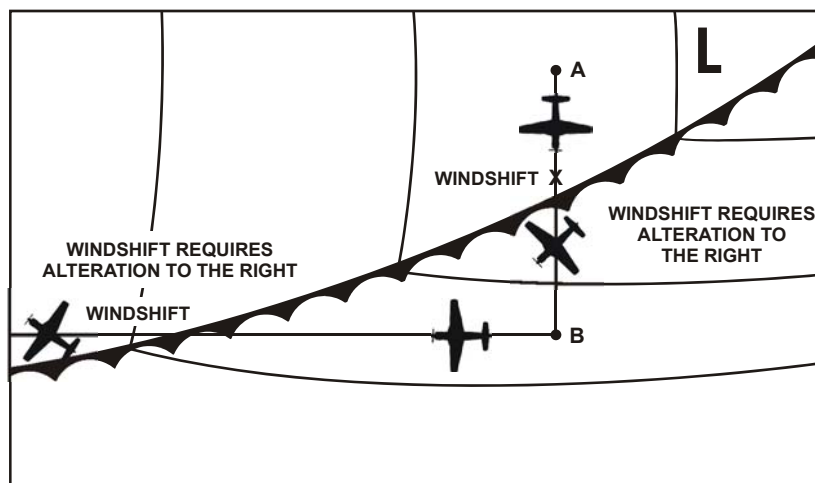

Figure 3-9 Wind Shift Across a Cold Front

307. FACTORS INFLUENCING FRONTAL WEATHER

The weather along fronts is not always severe. Flying conditions can vary from insignificant weather to extremely hazardous situations. The hazardous situations can include thunderstorms, turbulence, icing, low ceilings, and poor visibility. The severity of the clouds and precipitation occurring along a front are dependent on the following factors:

1. The amount of moisture available (shown by the dew point),
2. The degree of stability of the lifted air,
3. The slope of the front,
4. The speed of the frontal movement, and
5. The contrast in the amounts of temperature and moisture between the two air masses.

The amount of moisture available, as indicated by the dew point, greatly determines the amount of weather associated with a front. Often little or no significant weather is associated with a front or a portion of a front because of a lack of moisture, despite the presence of all other factors.

The degree of stability of the air lifted determines whether cloudiness will be predominantly stratiform or cumuliform. With stratiform clouds, there is usually steady precipitation and little

3-10 Mechanics of Frontal Systems

or no turbulence. Precipitation from cumuliform clouds is showery and the clouds indicate turbulence.

The slope is the ratio of the vertical rise to horizontal distance. The slope of a warm front is generally shallow, while the slope of a cold front can be quite steep (Figure 3-10). Shallow frontal slopes tend to produce extensive cloudiness with large areas of steady precipitation, while steep frontal slopes tend to move rapidly producing narrow bands of cloudiness and showery precipitation. Steep frontal slopes normally separate air masses of vastly different properties, indicating the potential for more severe weather.

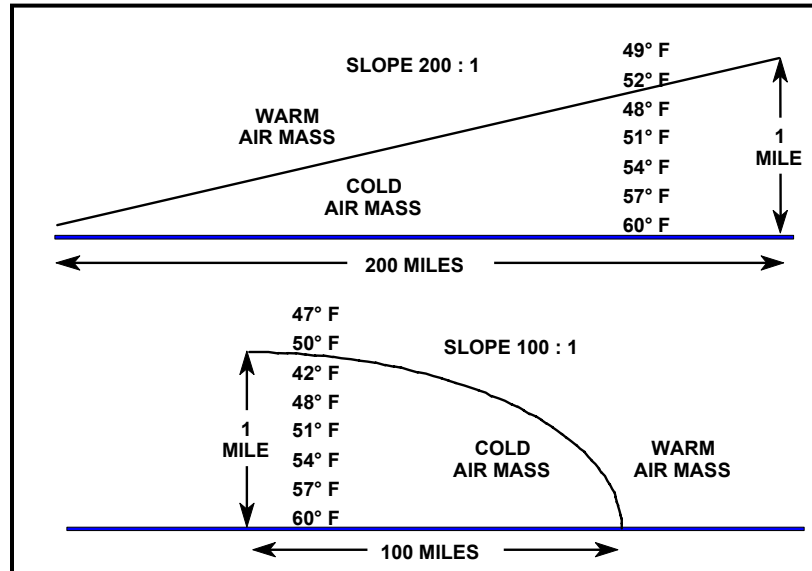

Figure 3-10 Frontal Slope

The speed of the frontal movement affects the weather associated with it. A narrow band of more severe weather generally accompanies faster moving fronts. On the other hand, slower moving fronts have less severe weather, but the frontal zone is more extensive.

The greater the contrast in temperature and moisture between the colliding air masses, the greater the possibility of weather associated with a front, particularly severe weather. For example, most tornadoes occur in the spring due to very cold, dry air from Canada colliding with very warm, moist air from the Gulf of Mexico.

308. COLD FRONTS

A cold front is the leading edge of an advancing cold air mass. In this case, the colder (more dense) air mass is overtaking and wedging underneath a relatively warmer (less dense) air mass. As the cold air pushes the warm air upward, this motion sometimes produces very violent and unstable conditions, to include strong thunderstorms (cumulonimbus clouds) and severe turbulence. Figure 3-11 shows the manner in which a cold front is depicted on a surface weather chart. Cold fronts move toward the SE at 20 knots, on average, and the wind shift is from the SW to the NW.

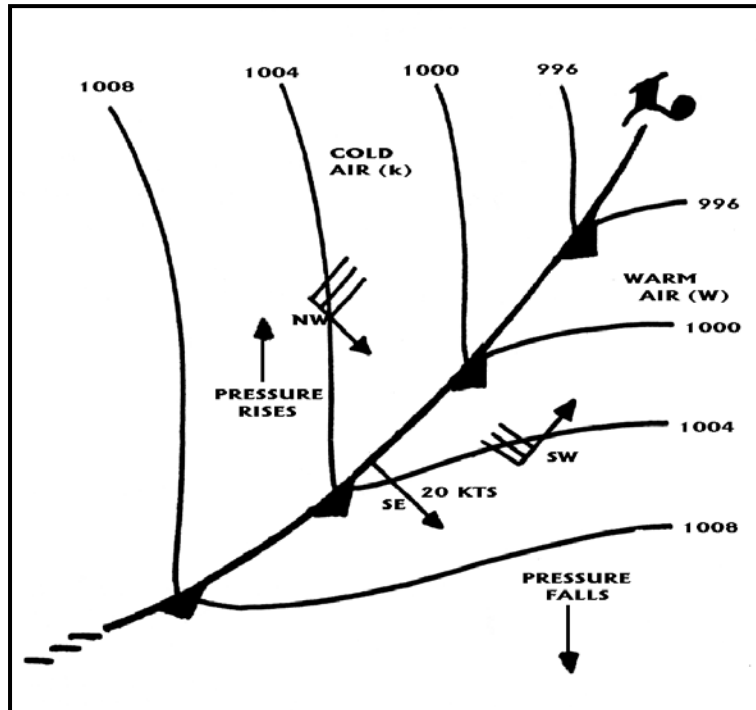

Figure 3-11 Cold Front

Cold front weather can vary greatly depending on the speed of the front and the characteristics of the air masses. Usually, though, as the cold front approaches, the southwesterly winds in the warm air mass ahead of the front begin to increase in speed. Meanwhile, the barometric pressure decreases, and altocumulus clouds appear on the horizon. Next, the cloud bases lower, and rain or snow showers begin as the cumulonimbus clouds move into the area. The precipitation increases in intensity and may persist as the front nears the station. As the front passes, the pressure rises sharply and the wind shifts approximately 90° from SW to NW. The postfrontal weather includes rapidly clearing skies, fair weather cumulus clouds, and decreasing temperature and dew point. The extent of postfrontal cloudiness depends on the degree of stability and moisture content of the cold air mass. In some cases, the sequence of events described here may be considerably different, depending on the specific atmospheric conditions (Figure 3-12).

Weather with fast-moving cold fronts occurs in a narrow band, is usually severe, and clears rapidly behind the front. Cumuliform clouds, showers, or thunderstorms may form near the front position. Lines of fast-moving thunderstorms, or squall lines, can form well ahead of the front. Weather with slow-moving cold fronts (usually from late fall through early spring) occurs over a large area, is less severe, but may persist for hours, even after the front has passed.

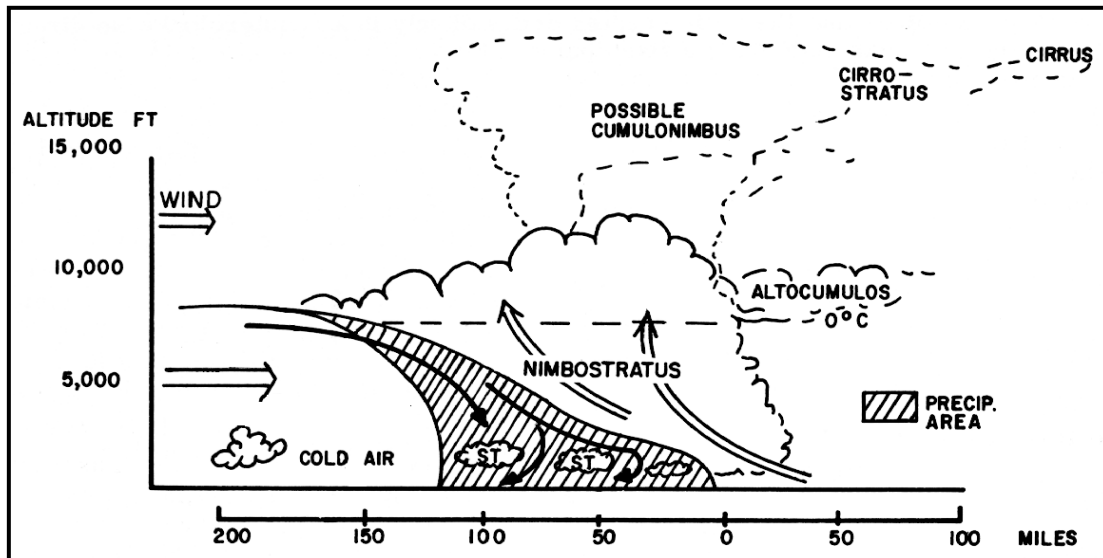

Figure 3-12 Cold Front Cloud Formation

Recognizing Cold Fronts During Flight

During a flight over flat terrain, you may see a long line of cumuliform clouds on the horizon. These clouds may indicate you are flying toward an approaching active cold front. When flying above an altocumulus layer extending ahead of the front, the lower frontal clouds are often hidden. Stratus or stratocumulus decks extending many miles ahead of a front may conceal the main clouds from a low flying aircraft.

Cold Front Flight Problems

Wind shifts: expect an abrupt wind shift when passing through a frontal zone, especially when flying at lower altitudes. Turbulence is often associated with the wind shift. The wind generally shifts from SW to NW with greater speeds behind the front.

Ceiling and visibility: if an active cold front moves at a moderate or rapid speed (15-30 knots), its weather zone is generally less than 50 miles wide. If the front moves slower, its weather zone may be broad enough to seriously affect flight operations for many hours. Ceilings and visibilities are generally visual meteorological conditions (VMC), but isolated instrument meteorological conditions (IMC) exist in heavy precipitation and near thunderstorms. Wider areas of IMC conditions can exist in winter due to snow showers.

Turbulence: many active cold fronts have turbulent cloud systems associated with them, but thunderstorms may not always be present. Even when there are no clouds, turbulence may still be a problem. As a rule, expect a rough flight in the vicinity of an active cold front, even when flying at a considerable altitude.

Precipitation and icing conditions: active cold fronts usually have a relatively narrow belt of precipitation, especially if the precipitation is showery. Icing may be severe in cumuliform clouds. Slow-moving cold fronts may have a broader area of precipitation and greater threat of remaining in icing conditions for a longer period.

Thunderstorms and squall lines: severe weather is implied to exist in areas of reported thunderstorms. Chapter Four will detail the hazards associated with thunderstorms.

Squall Lines

A squall line is a line of violent thunderstorms. They are indicated on surface charts by a dashed, double-dotted purple line. They develop 50 to 300 miles ahead of the cold front and roughly parallel to it. They form when cold air downdrafts flowing ahead of a cold front lift additional warm, unstable air. The uplifted air develops its own updrafts and downdrafts and starts the thunderstorm development cycle (Figure 3-13). Sometimes, however, squall lines can be located nowhere near a cold front, possibly from the convergence of air flows at one location. Squall lines are usually the most intense during the late afternoon and early evening hours, just after maximum daytime heating.

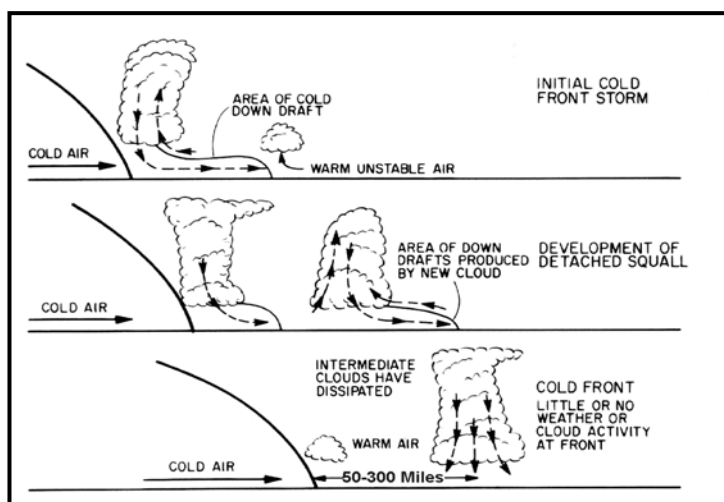

Figure 3-13 Squall Line Formation

It is often impossible to fly through squall lines, even with radar, since the storms are extremely close to one another. Similar to cold fronts, squall lines will also have a 90° wind shift from the SW to the NW.

309. WARM FRONTS

A warm front is the boundary of the advancing warm air mass overtaking and replacing a colder air mass. To do so, the warmer, less dense air must ride up and over the top of the cold air mass. Figure 3-14 shows the manner in which a warm front is depicted on a surface weather chart. The warm air mass gradually moves up over the frontal surface creating a broad area of cloudiness.

3-14 Mechanics of Frontal Systems

This cloud system extends from the front's surface position to about 500 to 700 miles in advance of it (Figure 3-15).

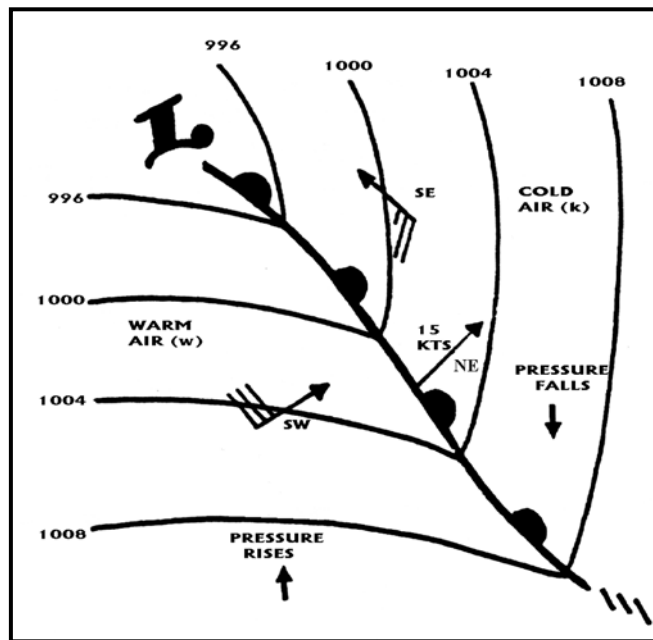

Figure 3-14 Warm Front

A warm front typically moves at a slower speed than a cold front, 15 knots on average, and produces a more gradual frontal slope, as well as sloping forward, ahead of the surface front. Because of this slower speed and gradual slope, warm fronts are not as well defined as cold fronts. The winds shift across a warm front from the SE to the SW.

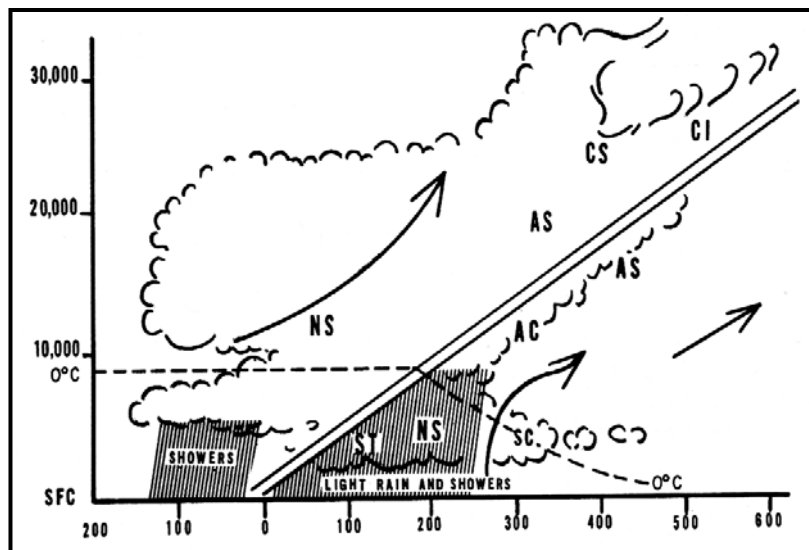

Figure 3-15 Warm Front Cloud Formation

Recognizing Warm Fronts During Flight

The most common cloud found along a warm front is the stratiform cloud. If one were to approach the front from the east, the sequence of clouds would be cirrus, cirrostratus, altostratus, nimbostratus, and stratus, rain and fog (Figure 3-15). Steady precipitation gradually increases with the approach of this type of warm front and usually continues until the front passes.

Warm Front Flight Problems

Wind Shift: warm front wind shifts are not as sudden as those of a cold front, and therefore, turbulence isn't likely. The wind generally shifts from SE to SW.

Ceiling and Visibility: the widespread precipitation ahead of a warm front is often accompanied by low stratus and fog. In this case, the precipitation raises the moisture content of the cold air until saturation is reached. This produces low ceilings and poor visibility covering thousands of square miles. Ceilings are often in the 300 to 900 foot range during steady, warm frontal rain situations. Just before the warm front passes the station, ceilings and visibilities can drop to zero with drizzle and fog. The worst conditions often occur in the winter when the ground is cold and the air is warm; the best scenario for dense fog and low ceilings.

Turbulence and Thunderstorms: if the advancing warm air is moist and unstable, altocumulus and cumulonimbus clouds can be embedded in the cloud masses normally accompanying the warm front. These embedded thunderstorms are quite dangerous, because their presence is often unknown to aircrews until encountered. Even with airborne radar, it can be difficult to distinguish between the widespread areas of precipitation normally found with a warm front and the severe showers from the embedded thunderstorms. The only turbulence along a warm front would be found in such embedded thunderstorms. Otherwise, little to no turbulence exists in warm front systems.

Precipitation and Icing: approaching an active warm front from the cold air side (from the east), precipitation will begin where the middle cloud deck is from 8000 to 12,000 feet AGL. Often, this precipitation will not reach the ground; a phenomenon called virga. As you near the front, precipitation gradually increases in intensity and becomes steadier. Occasional heavy showers in the cold air beneath the frontal surface indicate thunderstorms exist in the warm air aloft. Drizzle, freezing drizzle, rain, freezing rain, ice pellets (sleet), and snow are all possible in a warm front, depending on the temperature. The shallow slope and widespread thick stratiform clouds lead to large areas of icing. It may take a long time to climb out of the icing area and you may need to descend into warmer air to avoid the icing.

310. STATIONARY FRONTS

Sometimes the frontal border between the air masses shows little or no movement. Since neither air mass is replacing the other, the front is called a stationary front (Figure 3-16). Stationary fronts are indicated on surface charts by an alternating warm and cold front symbols, retaining their original red and blue colors, but pointing in opposite directions. Even though the front may not be moving, winds can still be blowing. Surface winds tend to blow parallel on both sides of

the front rather than against and/or away from it. Therefore, a stationary front has a 180° wind shift. The wind shift may be from any one direction to the opposite direction, as stationary fronts are less likely to be aligned in any one particular direction.

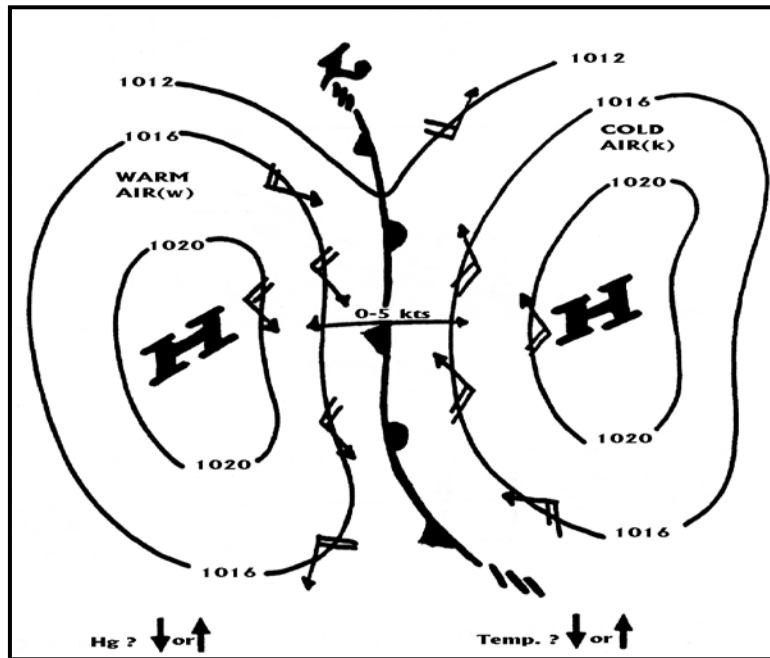

Figure 3-16 Stationary Front

The weather conditions occurring with a stationary front are similar to those found with the warm front, but are usually less intense. The weather pattern of a stationary front may persist in one area for several days, until other, stronger weather systems are able to push the stationary front weather along its way.

OCCLUDED FRONTS

Occluded fronts form when a faster moving cold front overtakes a slower moving warm front. There are two types of occluded fronts, cold and warm. The type of occlusion that forms depends on which front remains in contact with the ground. For example, if the cold front remains in contact with the ground, then it is named a cold front occlusion.

Occlusions are shown on surface charts with both cold and warm frontal symbols pointing in the same direction, but colored purple. Both types of occlusions tend to be aligned from NW to SE, and hence move toward the NE at the speed of the front that remains on the ground. The wind shift across either type of occlusion will be a 180° shift, as there are actually two fronts in the same location. Therefore, ahead of the occlusion, the winds will be the same as those ahead of the warm front, and behind the occlusion, the wind will be from the same direction as behind the cold front: the wind shift is SE to NW. Because the occluded front is the result of the meeting of both a cold front and a warm front, the weather associated with the occlusion will be a combination of both types of frontal weather.

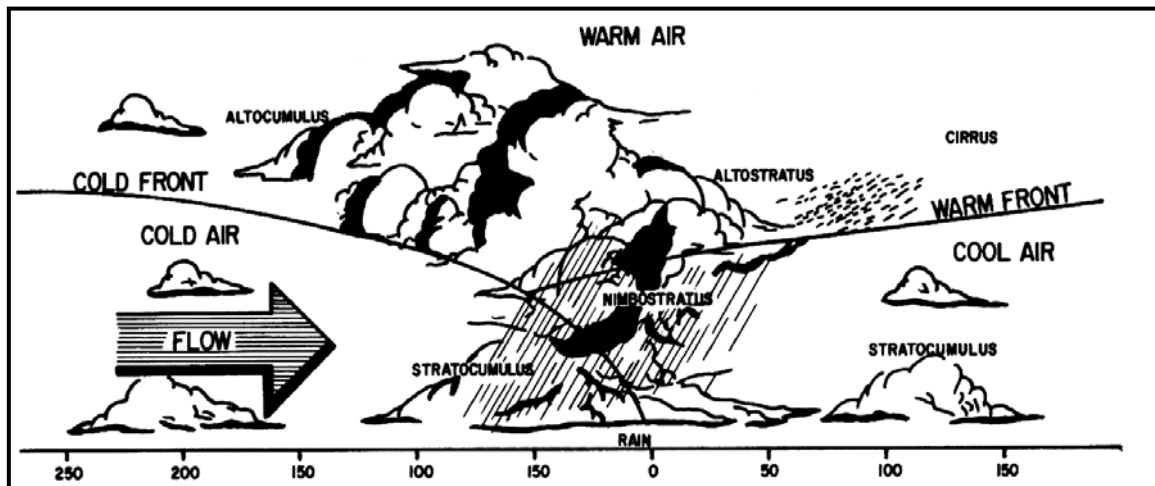

Figure 3-17 Occluded Front

Figure 3-17 depicts a profile of an occluded front. If either type of occlusion is arrived at from the east, you would first encounter warm front type weather which may extend for several hundred miles to the east of the surface front. On the other hand, if it were arrived at from the west you would first encounter cold front type weather. The location of the occluded front is significant to aircrews because the most severe weather, including ceilings and visibilities, is generally located in an area 100 NM South to 300 NM North of the frontal intersection. Figure 3-18 illustrates an overhead view of an occlusion.

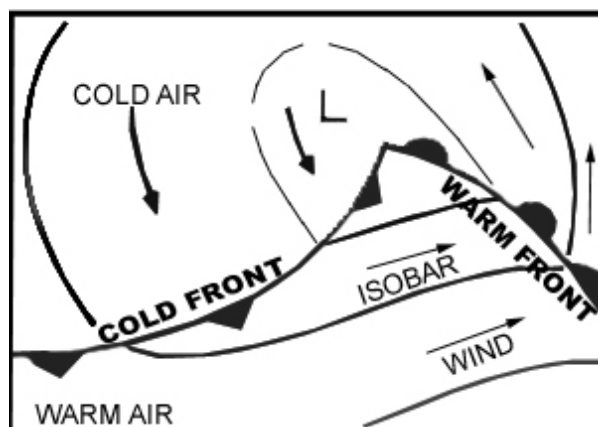

Figure 3-18 Occluded Wave

311. INACTIVE FRONTS

Clouds and precipitation do not accompany inactive fronts. Sometimes the warm air mass is too dry for clouds to form even after the air is lifted and cooled. Inactive fronts may also be referred to as dry fronts.

The reason for showing an inactive front on the weather chart is to indicate the boundary of the opposing air masses. Additionally, it displays the location of potentially unfavorable flying weather. The warm air mass may gradually become more moist and lead to the formation of clouds and precipitation in the frontal zone. In many cases the inactive front only has a shift in the wind direction and a change in the temperature and pressure. Figure 3-19 is a summary of frontal movements and wind shifts.

| Front | Direction of Movement | Speed | Wind Shift |
|--|-----------------------|-------|------------|
| Cold | SE | 20 | SW – NW |
| Warm | NE | 15 | SE – SW |
| Stationary * | - | - | 180° |
| Cold Front Occlusion | NE | 20 | SE – NW |
| Warm Front Occlusion | NE | 15 | SE - NW |
| * Stationary Fronts – Same general flight conditions as warm front (less intense). | | | |

Figure 3-19 Summary of Frontal Movement and Wind Shift

STUDY QUESTIONS

Mechanics of Frontal Systems

1. Which one of the following parameters of an air mass is generally uniform when measured across any horizontal direction?
 - a. Pressure and stability
 - b. Pressure and moisture
 - c. Temperature and pressure
 - d. Temperature and moisture

2. An airmass with a temperature of 100° F over a surface with a temperature of 110° F is classified _____.
 - a. maritime
 - b. continental
 - c. cold
 - d. warm

3. Why would an airmass be reclassified from maritime to continental? From continental to maritime?
 - a. Precipitation over water; precipitation over land.
 - b. Precipitation over land; evaporation over water.
 - c. Precipitation over water; evaporation over water.
 - d. This classification never changes.

4. Which one of the following correctly indicates the four frontal discontinuities used to locate and classify fronts?
 - a. Pressure, wind, stability, and slope
 - b. Pressure, temperature, dew point, and wind
 - c. Pressure, temperature, dew point, and slope
 - d. Pressure, wind, dew point, and stability

5. Which one of the following indicates two of the five factors that influence frontal weather?
 - a. Slope and stability
 - b. Slope and pressure change
 - c. Stability and winds
 - d. Stability and pressure change

6. With frontal passage, the winds of a cold front will shift from the _____ to the _____, and the winds of a warm front will shift from the _____ to the _____.
- southeast to the northwest; southeast to the northwest
 - southeast to the southwest; southwest to the northwest
 - southwest to the northwest; southeast to the southwest
 - northwest to the southwest; southwest to the southeast
7. In one respect, embedded warm-front thunderstorms present a greater flying hazard than cold-front thunderstorms because the warm-front cumulonimbus clouds _____.
- may be hidden in stratus type clouds
 - generally contain a great amount of cloud-to-ground lightning
 - have lower bases and lie closer to the Earth's surface
 - are much more violent and turbulent
8. Which one of the following would indicate a cold front has passed?
- Wind shifts
 - Pressure falls
 - Humidity increases
 - Temperature rises
9. If you are flying from east to west and you encounter cirrus, cirrostratus, alto-stratus, nimbostratus and then stratus clouds, you are most likely approaching a _____.
- stationary front
 - warm front
 - either a or b
 - neither a nor b

CHAPTER THREE

AVIATION WEATHER

10. In each cell of the table below, circle the correct characteristics of each of the types of fronts. This is similar to a multiple-choice question where matching a column heading with a row heading forms the question and the alternatives are listed in the intersecting cell.

| Type of Front | Wind Shift | Temperature Change | Pressure Change | Direction of Movement | Speed of Movement (kts) | Cloud Types | Turbulence Conditions | Color Code |
|-----------------------------|------------|--------------------|------------------|-----------------------|-------------------------|-------------|-----------------------|------------|
| Warm Front | SE to SW | Warmer | Rises then Falls | SE | 0 to 5 | Stratiform | Smooth | Red |
| | SW to NW | Colder | Falls then Rises | NE | 15 | Cumuliform | Rough | Blue |
| | SE to NW | Either | Falls then Rises | NW | 20 | Combination | Combination | Purple |
| | 180° | | | None | 25 | | | R & B |
| Cold Front | SE to SW | Warmer | Rises then Falls | SE | 0 to 5 | Stratiform | Smooth | Red |
| | SW to NW | Colder | Falls then rises | NE | 15 | Cumuliform | Rough | Blue |
| | SE to NW | Either | Falls then rises | NW | 20 | Combination | Combination | Purple |
| | 180° | | | None | 25 | | | R & B |
| Warm Front Occlusion | SE to SW | Warmer | Rises then Falls | SE | 0 to 5 | Stratiform | Smooth | Red |
| | SW to NW | Colder | Falls then rises | NE | 15 | Cumuliform | Rough | Blue |
| | SE to NW | Either | Falls then rises | NW | 20 | Combination | Combination | Purple |
| | 180° | | | None | 25 | | | R & B |
| Cold Front Occlusion | SE to SW | Warmer | Rises then Falls | SE | 0 to 5 | Stratiform | Smooth | Red |
| | SW to NW | Colder | Falls then rises | NE | 15 | Cumuliform | Rough | Blue |
| | SE to NW | Either | Falls then rises | NW | 20 | Combination | Combination | Purple |
| | 180° | | | None | 25 | | | R & B |
| Stationary Front | SE to SW | Warmer | Rises then Falls | SE | 0 to 5 | Stratiform | Smooth | Red |
| | SW to NW | Colder | Falls then rises | NE | 15 | Cumuliform | Rough | Blue |
| | SE to NW | Either | Falls then rises | NW | 20 | Combination | Combination | Purple |
| | 180° | | | None | 25 | | | R & B |

CHAPTER FOUR

Thunderstorms

400. INTRODUCTION

The purpose of this chapter is to introduce the student to the fundamentals of thunderstorm hazards and the proper techniques for safe flight in their vicinity.

Thunderstorms contain many of the most severe weather hazards. They are often accompanied by strong wind gusts, severe turbulence, lightning, heavy rain showers, severe icing, and possibly hail and tornadoes. As a result, avoid thunderstorms if possible.

Additionally, this chapter presents hazards a pilot must consider when flying in the vicinity of or actually entering a thunderstorm. About 44,000 thunderstorms occur daily over the Earth and pilots can expect to encounter one occasionally. In some tropical regions, thunderstorms occur year round. In the mid-latitudes, they develop most frequently in spring, summer, and fall. Being familiar with these factors will help you better understand what is going on both inside and outside the cockpit. Knowledge of thunderstorm characteristics and the application of tested procedures will help aircrews operate safely near thunderstorms.

401. LESSON TOPIC LEARNING OBJECTIVES

Terminal Objective: Partially supported by this lesson topic:

2.0 Upon completion of this unit of instruction, student aviators and flight officers will demonstrate knowledge of meteorological theory enabling them to make intelligent decisions when confronted with various weather phenomena and hazards.

Enabling Objectives: Completely supported by this lesson topic:

- 2.41 Describe the requirements for thunderstorm formation.
- 2.42 Describe the thunderstorm life cycle and the characteristics of each stage, including pressure variations.
- 2.43 Identify the hazards associated with thunderstorms.
- 2.44 Define a microburst.
- 2.45 Identify the characteristics of a microburst.
- 2.46 Explain how radar can aid a pilot when flying in the vicinity of thunderstorms.
- 2.47 Describe the recommended techniques for avoiding thunderstorm hazards.

402. REFERENCES

Weather for Aircrews, AFH 11-203, Volume 1, Chapters 10 and 13

403. STUDY ASSIGNMENT

Review Chapter Four and answer the Study Questions.

404. THUNDERSTORM DEVELOPMENT

The basic requirements for thunderstorm formation are moisture, unstable air, and some type of lifting action. Lifted air does not always result in thunderstorm activity. Air may be lifted to a point where the moisture condenses and clouds form, but these clouds may not grow significantly unless the air parcel reaches a point where it will continue to rise freely (recall the point of free convection from Chapter Two). The higher the moisture content the easier the point of free convection is reached. One of the four lifting methods (from Chapter Two) is necessary to force warmer air from its lower level to the point of free convection, which is the trigger to starting the cumulus cloud through the thunderstorm life cycle. Once moist air is lifted in an unstable environment, the rapidly rising unstable air quickly forms towering cumulus and eventual cumulonimbus clouds. The degree of vertical cloud growth often indicates the potential severity of the thunderstorm.

405. THE LIFE CYCLE OF A THUNDERSTORM CELL

Thunderstorm cells progress through three stages during their life cycle: the cumulus, mature, and dissipating stages. A thunderstorm cell is simply an individual cumulonimbus cloud. It is virtually impossible to visually detect the transition from one stage to another. A thunderstorm often consists of a cluster of cells in different stages. The life cycle of each thunderstorm cell ranges from 20 minutes to 1-1/2 hours with a few lasting up to three hours. The life span of a line of thunderstorms depends on the number of cells contained in the line and their stage of development.

Cumulus Stage

Most cumulus clouds do not become thunderstorms. However, the initial stage of a thunderstorm is always a cumulus cloud. The main feature of the cumulus stage is the updraft which may extend from near the Earth's surface to several thousand feet above the visible cloud top. The strongest updrafts occur at higher altitudes late in the stage and may be greater than 3000 feet per minute. No precipitation is associated with this stage, however significant turbulence exists.

Mature Stage

The mature stage is reached when the raindrops and ice particles in the cloud have grown too large to be supported by the updrafts and begin to fall. Rain and/or hail falling from the cloud base indicates a downdraft has developed and the cell has entered the mature stages. The

average cell grows to a height of 25,000 feet during this stage. At higher latitudes, tops may be as low as 12,000 feet.

Dissipating Stage

Downdrafts continue to develop while the updrafts continue to weaken during the mature stage. As a result, the entire thunderstorm cell becomes an area of downdrafts with precipitation in the dissipating stage (Figure 4-1). Thunderstorms begin to dissipate when the updrafts, which are necessary to produce condensation and the resulting release of heat, are no longer present. During this stage the strong winds aloft may carry the upper section of the cloud into the familiar anvil form. However, the appearance of an anvil does not indicate the thunderstorm is free of hazards. Severe weather is present in many storms with a well-developed anvil.

| | Updrafts | Downdrafts | Hazards |
|--------------------|-----------------|-------------------|----------------|
| Cumulus | √ | | |
| Mature | √ | √ | √ |
| Dissipating | | √ | √ |

Figure 4-1 Summary of Thunderstorm Stage Characteristics

406. THUNDERSTORM WEATHER HAZARDS

Some or all of the following hazards accompany thunderstorms: extreme turbulence, hail, microbursts, severe icing, lightning, and tornadoes. Turbulence is the worst hazard and hail is the second worst.

Turbulence

Severe turbulence is present in all thunderstorms. One of the major characteristics of every thunderstorm is updrafts and downdrafts that can occur near each other creating strong, vertical shear and turbulence. This turbulence can extend over 5000 feet above the cloud tops and down to the ground beneath the cloud base. It can damage an airframe and cause serious injury to passengers and crew.

The first gust or gust front, a low level turbulent area between the cold downdrafts of a thunderstorm and the surrounding air of an approaching thunderstorm, is another form of turbulence that can cause a rapid and drastic change in the surface wind (Figure 4-2). An attempt to takeoff or land with an approaching thunderstorm nearby could have disastrous results. Gust fronts can travel 5 to 20 miles from the thunderstorm.

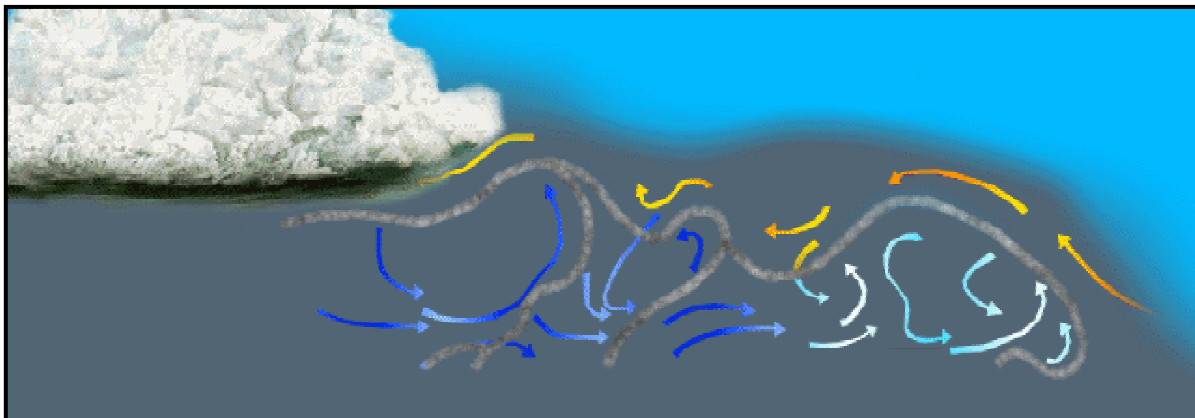

Figure 4-2 Gust Front

A roll cloud on the lower leading edge of a cumulonimbus cloud marks an area of strong eddy currents and identifies the location of wind shear and severe turbulence occurring with the onset of the gust front (Figure 4-3).



Figure 4-3 Roll Cloud

Large pressure changes can accompany thunderstorm formation due to the turbulence of updrafts and downdrafts. Therefore, if the altimeter setting is not updated, the indicated altitude might be in error by over 200 feet. The pressure variations associated with thunderstorms follow a common pattern:

1. A rapid fall in pressure as the storm approaches,
2. An abrupt rise in pressure with the onset of the first gust and arrival of rain showers, and
3. A gradual return to normal pressure as the storm passes and the rain ceases

4-4 Thunderstorms

Hail

As a rule, the larger the storm, the more likely it is to produce hail. Hail has been encountered as high as 45,000 feet in completely clear air and may be carried up to 30 miles downwind from the storm core. Aircrews should anticipate possible hail with any thunderstorm, especially beneath the anvil of a large thunderstorm. Hailstones larger than 1/2 to 3/4 of an inch (Figure 4-4) can cause significant aircraft damage in a few seconds. Give yourself a clearance of at least 20 miles around a thunderstorm.



Figure 4-4 Hailstones

Lightning and Electrostatic Discharge

Lightning occurs at all levels in a thunderstorm. The majority of lightning bolts never strike the ground, but occur between clouds or within the same cloud. Lightning also occurs in the clear air around the tops, sides, and bottoms of storms. Aircrews flying several miles from a thunderstorm can still be struck by the proverbial "bolt out of the blue." Lightning strikes can also occur in the anvil of a well-developed or dissipated thunderstorm. Additionally, lightning strikes in the anvil have occurred up to three hours after the thunderstorm has dissipated.

An electrostatic discharge (ESD) is similar to a lightning strike, but caused by the aircraft itself. The larger and faster the aircraft, the more particles it impacts, generating a greater static electricity charge on the airframe. The electrical field of the aircraft may interact with the cloud and an ESD may then occur. Aircraft have reported damage from ESD occurring in cirrus clouds downwind of previous thunderstorm activity, in cumulus clouds around a thunderstorm's periphery, and even in stratiform clouds and light rain or showers. This release of static electricity is frequently called Saint Elmo's fire.

Aircraft Lightning or Electrostatic Discharge Encounters

Lightning strikes and ESD are the most reported weather-related aviation incidents. All types of aircraft are susceptible to lightning strikes and ESD. Aircraft have been struck by lightning or experienced ESD at altitudes ranging from the surface to at least 43,000 feet.

Most lightning strikes occur when aircraft are operating in one or more of the following conditions:

1. Within 8°C of the freezing level.
2. Within approximately 5000 feet of the freezing level.
3. In precipitation, including snow.
4. In clouds.
5. In some turbulence.

Note

Not all these conditions need to occur for a lightning strike or an ESD to take place.

Lightning strikes have varied effects on aircraft and aircrews (Figure 4-5). Usually the structural damage is minor, but it has the potential to be severe. Normally, it will only interrupt electrical circuits, causing damage to aircraft electrical systems, instruments, avionics, or radar.



Figure 4-5 Lightning Hazards

Catastrophic fuel ignition can occur under certain conditions. In non-pressurized fuel tanks, a mixture of vaporized fuel and air fills the space above the liquid fuel. The proper ratio of fuel

4-6 Thunderstorms

vapor to air can form a highly explosive mixture. For this reason, as well as for battle survivability, most military aircraft fuel tanks are pressurized.

Pilots are not immune to the effects of lightning strikes, either. Temporary night vision degradation can occur due to flash blinding, but turning cockpit lighting to maximum intensity can minimize this effect. Additionally, some pilots have experienced mild electric shock and minor burns.

Tornadoes

A tornado is a violent, intense, rotating column of air that descends from cumulonimbus clouds in funnel-like or tube-like shapes. If the circulation does not reach the surface, it is called a funnel cloud. If it touches down over the water, it is called a waterspout. A tornado vortex is normally several hundred yards wide, but some have been measured up to 2 1/2 miles wide. Within the tornado's funnel-shaped circulation, winds have been measured at speeds over 300 miles per hour, while the forward speed of tornadoes averages 30 to 40 knots.

Observed as appendages of the main cloud, tornadoes often form in groups or families of funnel clouds, some as far as 20 miles from the lightning and precipitation areas. Innocent looking cumulus clouds trailing a thunderstorm may mask tornadic activity, and the vortex may not be visible to warn unwary aircrews. The invisible vortices may be revealed only by swirls in the cloud base or dust whirls boiling along the ground, but may be strong enough to cause severe damage to aircraft.

Tornadoes form only with severe thunderstorms. The hazards they present have been chronicled often by news reports and television documentaries. To avoid tornadoes, avoid areas of severe thunderstorm activity.

MICROBURSTS

A microburst is an intense, highly localized downward atmospheric flow with velocities of 2000 to over 6000 feet per minute. This downward flow diverges outward, producing a vortex ring of wind that can produce differential velocities ranging from 20 to 200 knots in an area only 1/4 to 2 1/2 miles in diameter (Figures 4-6 and 4-7). Microbursts may emanate from any convective cloud, not just cumulonimbus clouds. Another unique aspect of a microburst is its short life span, usually only five to ten minutes after reaching the ground, which makes the study, and hence the prediction, of microbursts a difficult task. They are more likely to occur in mid-afternoons during summer months.

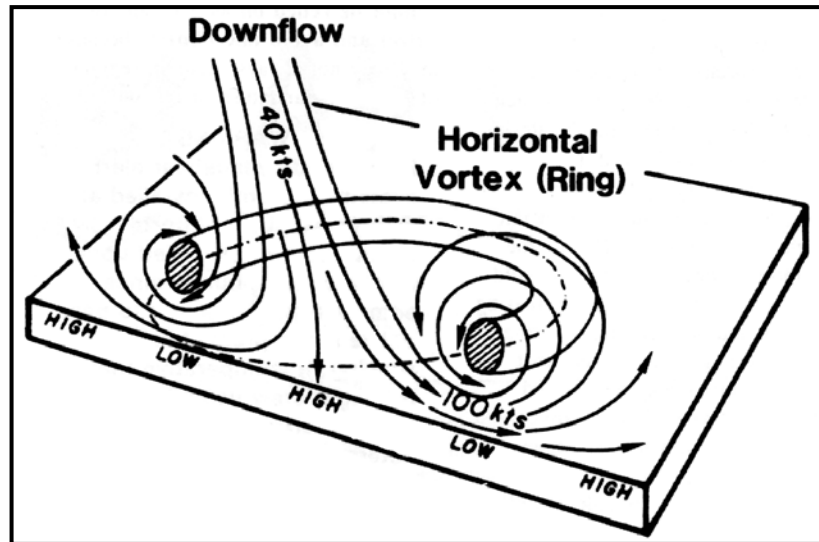

Figure 4-6 Vortex Ring of a Microburst

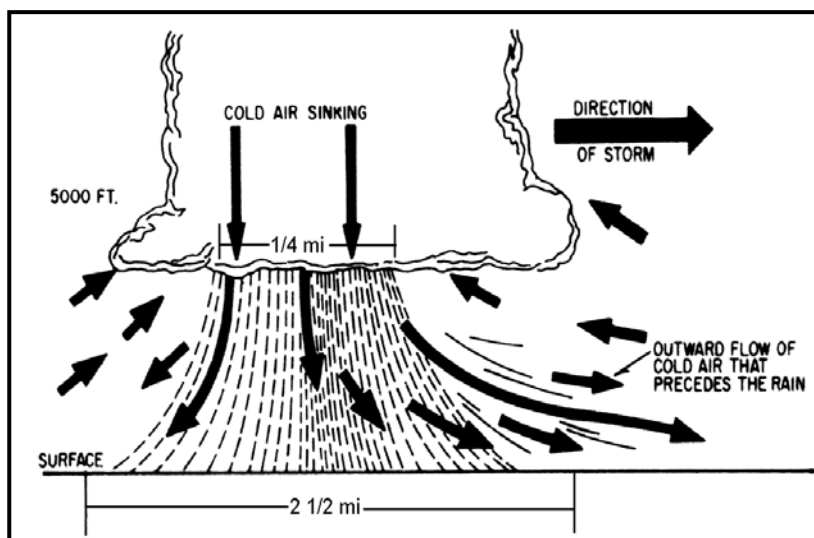

Figure 4-7 Cross Section of a Microburst

The wind shear created by microbursts is extremely dangerous to aircraft during the takeoff, approach, and go-around phases of flight. Not all microbursts are associated with thunderstorms. Microbursts are possible with any rain shower, even if the rain isn't reaching the ground (virga).

In Figure 4-8, the aircraft at position 1 has entered a microburst. At this point, the crew may notice an increased angle of attack as the aircraft enters the upward flow of the vortex ring. Once inside the microburst, the aircraft will experience a strong increase in headwind, with a resulting increase in indicated airspeed and lift, which will cause the aircraft to pitch up (position 2). A natural reaction of the pilot would be to reduce power and apply nose down stick force. This would correct the situation if the aircraft was not in a microburst, and would appear to work

4-8 Thunderstorms

here until the reaching position 3. At this point, the aircraft will be in a severe downdraft, and a transition from a strong headwind to a strong tailwind will occur (position 4). The resulting loss of indicated airspeed and lift will cause the aircraft to pitch down and lose altitude. At this point (or earlier), the correct reaction would be to add maximum power and establish a climbing attitude on the vertical gyro. Chances of successful recovery depend on reaction time, aircraft performance capabilities, and the altitude of the aircraft.

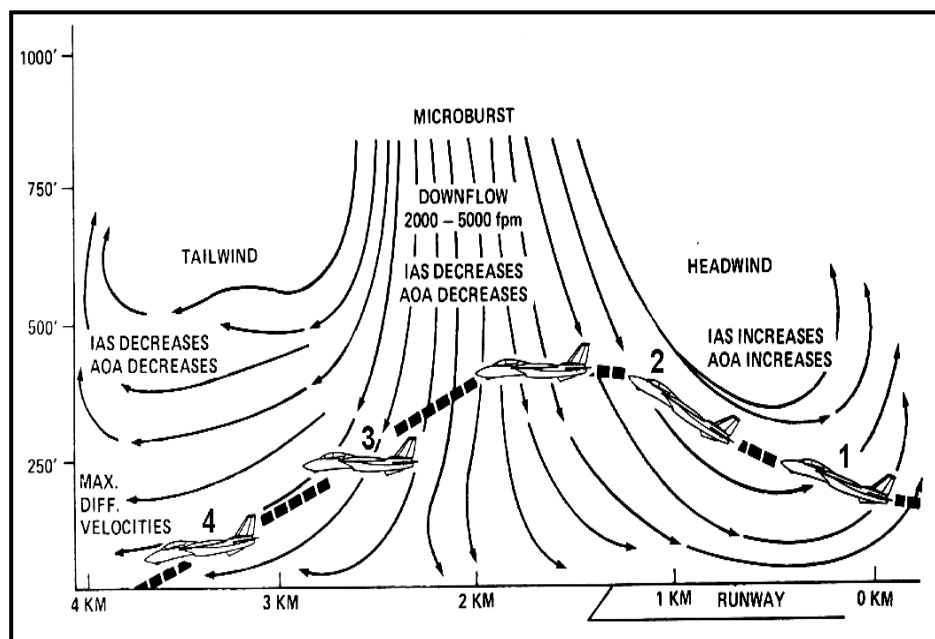

Figure 4-8 Attitude Changes with Microburst Penetration

If you encounter a microburst on final approach or on takeoff, the results could be disastrous. The best course of action is to avoid microbursts at all costs. This point cannot be over emphasized. You must always be alert for the warning signs of a microburst. Remember, avoid, avoid, avoid. You may only get one chance to make a life or death decision.

Methods of Microburst Detection

Microbursts are such a dangerous phenomenon, early detection is vital to mishap prevention. In most microburst accidents warning signs have been ignored, misinterpreted, or misunderstood. You must evaluate the warning signs and make a decision quickly and decisively. Here are some very important clues indicating the presence of microburst.

Ground-based Doppler radar now has the capability to accurately detect hazards that can take the form of microbursts, tornadoes, and other low-level wind shear activity. Therefore, when weather observations or recordings mention low-level wind shear, or call for gusty winds, heavy rain, or severe thunderstorms, be aware the potential for microburst activity exists.

Visual cues are also very important in detecting microbursts. In fact, in many fatal wind shear mishaps the pilot continued the approach or takeoff in visible and known thunderstorm conditions. Visual cues include virga, localized blowing dust (especially in circular or elliptical patterns), rain shafts with rain diverging away from the core of the cell, roll clouds, and experiencing vivid lightning or tornado-like activity.

If you suspect the potential for wind shear conditions prior to takeoff or landing, get additional information from the tower or base weather station to include the latest radar report and pilot reports (PIREPs). Some airfields even have a wind shear warning system to help you. These sources will not identify every microburst situation, so if in doubt, wait it out! If you do encounter a wind shear condition, you must make a PIREP to warn fellow aviators about the dangerous situation. Your PIREP should include the location where the activity was encountered, an estimate of its magnitude and, most importantly, a description of what was experienced, such as turbulence, airspeed gain or loss, glidepath problems, etc.

Icing

Expect severe icing in thunderstorms where the free-air temperature is at or below freezing. Since heavy rainfall and turbulence most frequently occur at the freezing level, this particular altitude appears to be the most hazardous. Most of the icing, however, occurs in the top 2/3 of the thunderstorm cell. Note that the actual altitude of the freezing level will fluctuate with the up and downdrafts, and be lower in the area of downdrafts. Due to the heavy amounts of moisture and large water droplets, the icing in thunderstorms is mostly clear icing, accumulating rapidly on the airfoils and other aircraft surfaces. Other aspects of icing will be covered in more detail in Chapter Five.

407. RADAR THUNDERSTORM INFORMATION

Ground-based weather radar is the most accurate means of tracking thunderstorms. In addition to the locating and tracking of cumulonimbus cells, their intensities can also be determined. The large drops of water and hail, if present, within thunderstorms yield the strongest return signals. Smaller droplets result in dimmer areas on the scope and snow produces the faintest echo.

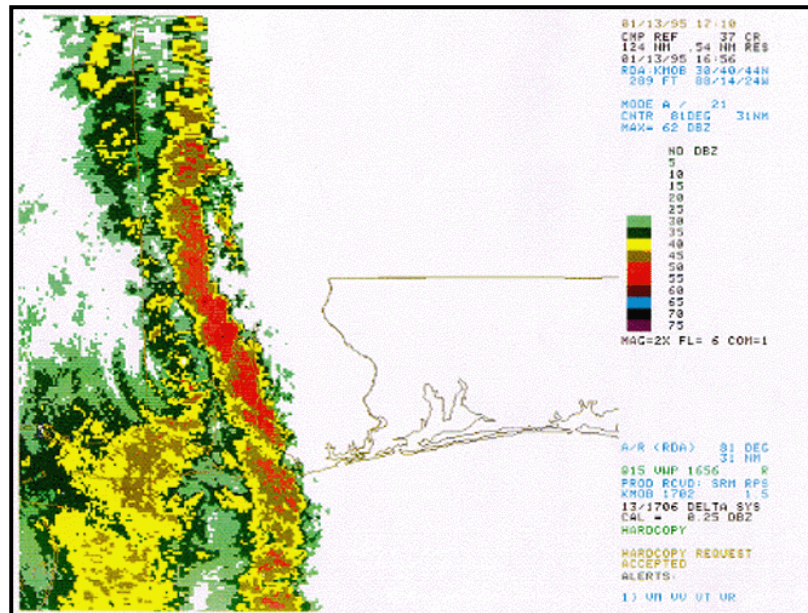

Figure 4-9 NEXRAD Doppler Radar Composite

Detection and warnings are more accurate with the modern NEXRAD Doppler radar systems (Figure 4-9). This is particularly true for microbursts and wind shear alerts.

A direct relationship exists among the strength of the radar echoes, the presence of aircraft icing, and the intensity of turbulence. Stronger radar echoes are associated with more severe thunderstorms.

The following weather radar information is of particular interest to pilots:

1. A thunderstorm with radar echo tops indicated above 35,000 feet often contains extreme turbulence and hail.
2. Hazardous weather associated with scattered echoes can usually be circumnavigated. However, if the lines or areas are reported as broken or solid and are of moderate to strong intensity, hazardous weather can be avoided only if the aircraft is radar equipped.
3. Severe clear air turbulence and hail may be experienced between thunderstorms if the separation between echoes is less than 30 miles.

Ground-based weather radar is most valuable to a pilot when there are numerous thunderstorms obscured by multiple cloud layers. However, echoes can change shape, character, and intensity in a matter of minutes when updrafts reach velocities of over 6000 feet per minute. Therefore, radar information received before takeoff may be worthless by the time thunderstorms are encountered.

A pilot with airborne weather radar should remember that radar does not eliminate the hazards of the thunderstorm. It merely helps to locate the most severe conditions. Since the radarscope indicates only precipitation areas within thunderstorms, hazards can be encountered even in soft spots. Thunderstorms having frequent, vivid lightning discharges are especially dangerous.

Airborne weather radar should be used as an avoidance rather than penetration tool. The pilot should take time to properly evaluate scope indications and watch for trends in order to avoid the most intense echo patterns. The pilot without airborne weather radar should make no attempt to find soft spots on the basis of radar information not current up-to-the-minute.

408. FLIGHT TECHNIQUES IN THE VICINITY OF THUNDERSTORMS

Since thunderstorms have so many potential hazards, it is appropriate to list some recommended practices for pilots who must cope with these “uninvited guests.” As far as flying is concerned, there is no such thing as a small thunderstorm, so some common sense recommendations are provided below:

1. If at all possible, avoid thunderstorms.
2. Do not venture closer than 20 miles to any storm cloud with overhanging anvils because of the possibility of encountering hail.
3. Do not attempt to fly under thunderstorms in mountainous regions even if the area on the other side of the mountains can be seen. Strong enough winds providing the lifting action to produce the thunderstorms can also create extreme turbulence between mountain peaks.
4. If at all possible, avoid flying under thunderstorms because updrafts and downdrafts can exceed the performance of the aircraft.
5. Do not take off or land if a thunderstorm is approaching. Sudden wind shifts or microbursts can cause control problems.
6. Do not fly into a cloud mass containing scattered embedded thunderstorm without airborne radar. Radar is necessary to “see” storms in the cloud mass. Scattered thunderstorms can be circumnavigated visually unless they are embedded.
7. To avoid lightning do not penetrate a thunderstorm or fly through the cirrus anvil of a well-developed or dissipated thunderstorm. Aircraft should also avoid clouds downwind of thunderstorms.
8. The brighter and more frequent the lightning, the more severe the thunderstorm.
9. Regard any thunderstorm with tops 35,000 feet or higher as severe.

Avoid thunderstorms if at all possible using the following recommendations, listed in order of priority:

1. Fly around (circumnavigate) the storm.
2. Fly over the top of the storm.

3. Fly under the storm.
4. If it is not possible to avoid the storm(s), fly through the lower 1/3 of the storm.

When thunderstorms are isolated, they are easily circumnavigated provided the surrounding area is clear of masking clouds. If lines of thunderstorms are present or if masking clouds obscure the area around the storm, other techniques must be employed.

Circumnavigation

Circumnavigation presents no special flight problems. When the aircrew determines circumnavigation is possible, they merely alter course to take them around the storm (Figure 4-10). Since most individual thunderstorm cells are about five to ten miles in diameter, detouring to one side or another would not appreciably add to either the time or distance of the flight. In case of a line of thunderstorms, it is sometimes possible to circumnavigate them by flying through thin spots of precipitation between the storms. Exercise care in this procedure because another thunderstorm may lie on the other side of a thin spot.

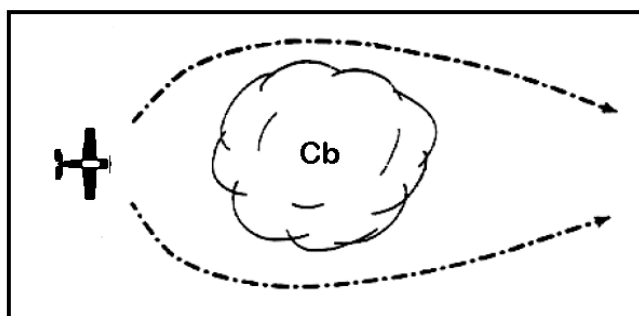

Figure 4-10 Around a Thunderstorm

Over the Top

When circumnavigation of thunderstorms is not possible, the next best course of action is to go over the top (Figure 4-11). Realize, thunderstorms build to great heights and this procedure is restricted to aircraft with the capability and fuel to climb to these altitudes. Some turbulence may be encountered in the clear air above the cloud. Additionally, hail can be thrown out the top of the cumulonimbus cloud. Thus, allow a margin of safety by choosing an altitude separation from the top of the thunderstorm of 1000 feet for every ten knots of wind speed at the altitude of the tops. Oftentimes, aircraft cannot climb over the top of the cloud, but it will still be possible to fly over the saddlebacks between the build-ups.

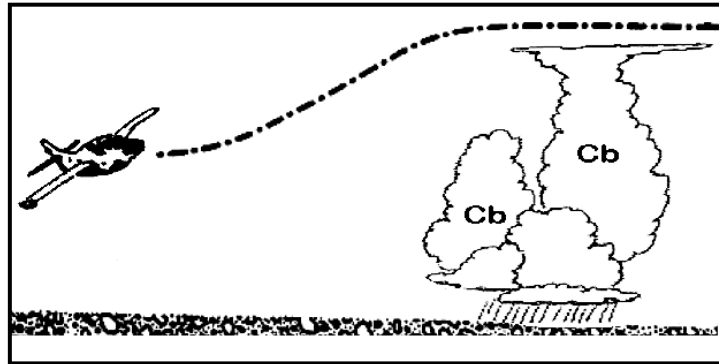

Figure 4-11 Over the Top

Underneath

If you are unable to circumnavigate the thunderstorms in your area and the ceiling capabilities of your aircraft will not permit an over-the-top flight, you should consider flying below the base of the cloud. The speed of downdrafts usually decreases closer to the surface (Unless a microburst is present!). Therefore, an altitude should be selected which will keep you as far away from the cloud base as possible and still enable you to maintain adequate terrain clearance. Here you can use the 1/3 rule which specifies selecting an altitude 1/3 the distance from the surface to the base of the cloud (Figure 4-12). This procedure is not recommended for areas of mountainous terrain. Below the storm, expect a low ceiling, poor visibility, and moderate turbulence. Perhaps the most dangerous threat to flight below a thunderstorm is the downburst or microburst, which can be deadly to the unsuspecting pilot.

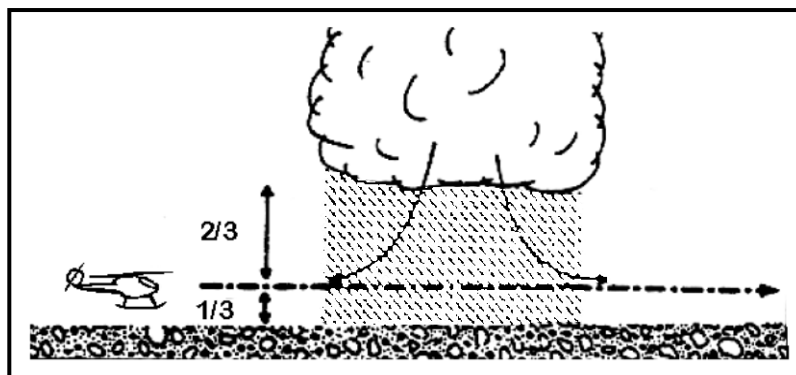

Figure 4-12 Under the Thunderstorm

Penetration

Mission urgency or fuel state dictates whether thunderstorm penetration is required when avoidance is not possible. The lower in the storm the penetration is made, the less the chance of encountering hail, structural icing, or being struck by lightning. Therefore, another version of the 1/3 rule applies: penetrate through the lower 1/3 of the storm, since most hazards are more

severe in top 2/3 of the cell (Figure 4-13). However, with the strong updrafts and downdrafts, adequate terrain clearance should also be considered in the selection of a penetration level. When crossing a line of thunderstorms (a squall line for example), attempt to determine the orientation of the line and penetrate the line at right angles (Figure 4-14). During the penetration of a thunderstorm, do not attempt to turn back once you are inside the storm. Remember, single-cell thunderstorms are only about one to five miles in diameter, and turning around will only increase your time in the storm. Turning around can also result in a pilot becoming disoriented and flying in the storm for a considerably longer period of time than continuing directly through the storm in the first place. With no other information to make a decision, a penetration altitude between 4000 and 6000 feet AGL should be adequate.

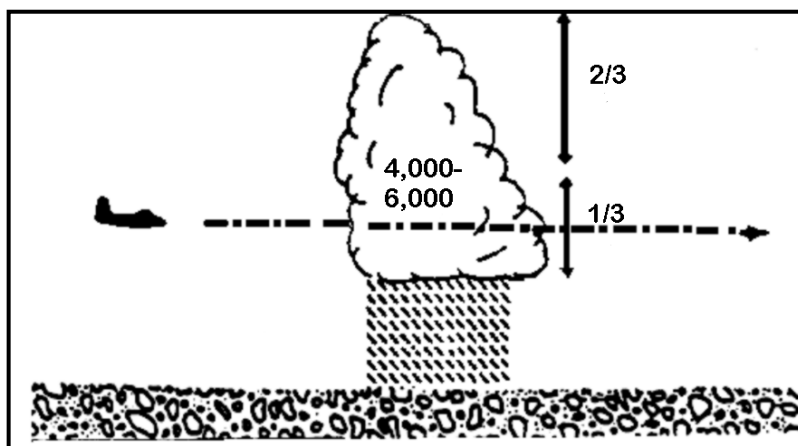

Figure 4-13 Through the Thunderstorm

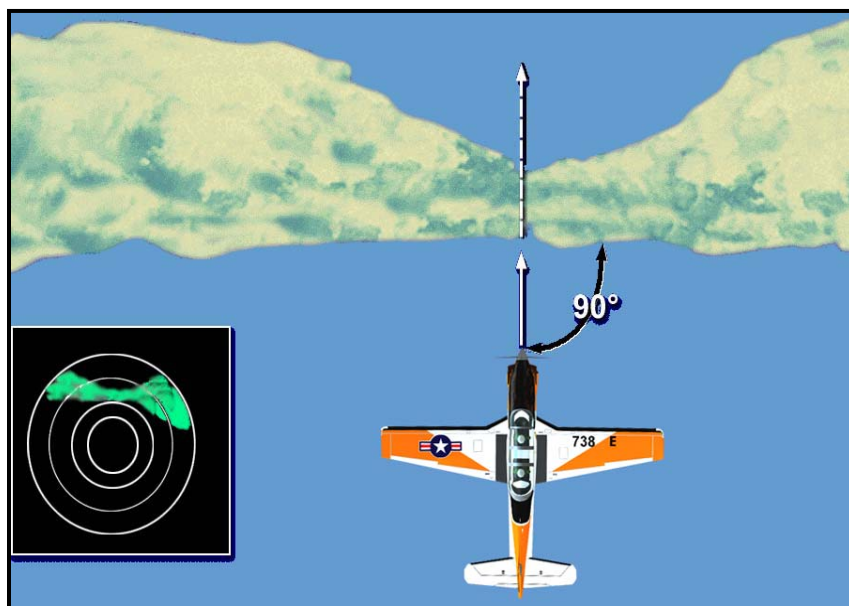

Figure 4-14 Thunderstorm Penetration

Penetration Procedures

The faster a plane is going when it strikes an updraft or downdraft, the greater the shock. Refer to your flight manual for the recommended turbulent air penetration speed.

Once inside the storm, the pilot should let the plane ride out the updrafts and downdrafts and concentrate on maintaining a level attitude. With power set to maintain the proper airspeed, maintaining the same attitude will result in only minor airspeed variations. However, the aircraft's altitude may vary by thousands of feet. The rapidly changing pressure conditions within the storm will result in unreliable indications and erratic variations in altitude, airspeed, and rate of climb instruments. Since the attitude gyro is independent of the pitot-static system, its indications should be considered reliable.

If thunderstorm penetration is unavoidable or you inadvertently fly into a thunderstorm, follow these procedures:

1. Secure all loose objects, tighten your lap belt and lock your shoulder harness. Turn cockpit lights up to highest intensity.
2. Turn on pitot heat. (If the aircraft is equipped with engine anti-ice, turn it on. Neither the T-34 nor the T-6 has engine anti-ice.)
3. If able, plan your course to take you through the storm in minimum time, penetrating below the freezing level or above -20°C to avoid the most critical icing areas.
4. Establish the recommended turbulent air penetration speed and disengage the autopilot to minimize control inputs that could increase structural stresses.
5. Don't chase the airspeed and minimize power changes. Expect significant deviations in attitude and altitude. Keep your eyes on your instruments.
6. Don't turn back once in the thunderstorm.

Experience in severe weather flying is gained by necessity more often than by design and planning. Your first flight experience near a severe thunderstorm will make the dangers listed in this chapter all too real. Pilots should not knowingly fly into severe weather if the mission does not demand it. In making a "go/no-go" decision, consider it better to arrive at the destination late than not at all.

STUDY QUESTIONS

Thunderstorms

1. The atmospheric conditions necessary for the formation of a thunderstorm include a combination of _____.
 - a. stable air or relatively low humidity and some type of lifting action
 - b. stable air of relatively high humidity and some type of subsiding action
 - c. unstable air of relatively low humidity and some type of subsiding action
 - d. unstable air of relatively high humidity and some type of lifting action

2. Select the best match of a thunderstorm's life cycle with the appropriate characteristics.
 - a. Cumulus – updrafts
 - b. Mature – updrafts, downdrafts and hazards
 - c. Dissipating – updrafts
 - d. Both a and b

3. Which one of the following hazards to flight are associated with thunderstorms?
 - a. Hail, turbulence, and lightning
 - b. Hail, icing, and microbursts
 - c. Hail, turbulence, and icing
 - d. All of the above are correct

4. Which one of the following is an indication of turbulence found in thunderstorms?
 - a. Cirrus clouds
 - b. The gust front
 - c. Orographic lifting
 - d. Severe icing

5. Which one of the following type clouds could indicate the possibility of microburst activity?
 - a. Convective only
 - b. Cumulonimbus only
 - c. Both a and b
 - d. Nimbostratus

6. Which one of the following telltale signs in the vicinity of thunderstorms should alert you to the possibility of microburst activity?
 - a. Roll clouds
 - b. Blowing dust
 - c. Gusty conditions
 - d. All of the above

7. Which one of the following is/are correct concerning thunderstorm recommended flight techniques?
- a. Penetration of a thunderstorm should be at an altitude of 4000 to 6000 feet AGL.
 - b. When flying under a thunderstorm, select an altitude 1/3 the distance from the surface to the base of the cloud.
 - c. Both a and b above are correct.
 - d. Neither a or b above are correct.
8. When flying through a thunderstorm a pilot should concentrate on maintaining a level attitude.
- a. True
 - b. False

CHAPTER FIVE

Weather Hazards of Turbulence, Icing, Ceilings, Visibility, and Ash Clouds

500. INTRODUCTION

This chapter will cover the causes of turbulence, classification of the various categories of turbulence, conditions under which turbulence exists, and recommend flying procedures used when turbulence is encountered. Additionally, it covers the requirements for icing formation, types of icing, and their effects on aircraft flight and aircraft components, including techniques that should be followed for safe flight. Finally, this chapter introduces the student to ceilings and visibility, sky coverage terminology, and the requirements for fog formation and dissipation, plus a synopsis of the aviation hazards of volcanic ash clouds.

Turbulence is one of the most unexpected aviation hazards to fly through and also one of the most difficult hazards to forecast. Severe and extreme turbulence has been known to cause extensive structural damage to military aircraft, with lesser intensities resulting in compressor stalls, flameouts, and injury to crewmembers and passengers. From minor bumps to severe mountain wave turbulence, turbulence comes in many forms and is usually worst during the winter months. Turbulence causes an estimated \$30 million in annual aviation assets damage.

Aircraft icing is another aviation weather hazard. Many aircraft accidents and incidents have been attributed to aircraft icing. In fact, many ice-related mishaps have occurred when the aircraft was not deiced before attempting takeoff. Most of the time, ground deicing and anti-icing procedures adequately handle icing formation. However, there are times when pilots are caught unaware of dangerous ice buildup.

Historically, low ceilings and poor visibilities have contributed to many aircraft accidents. Fog, heavy snow, heavy rain, blowing sand, and blowing dust all restrict visibility and can result in low ceilings. Adverse weather conditions causing widespread low ceilings and visibilities can restrict flying operations for days. Since ceiling and visibility is so important to operational flying, it is imperative a pilot understands the strict meanings of the two terms. There are many different kinds of “visibility,” but pilots are usually more concerned with “prevailing visibility.”

Ash clouds from volcanic eruptions present a unique hazard to aviation. Though most prudent aviators would choose to keep well clear of any active volcano, certain situations such as evacuations may require the military to operate in close proximity to ash clouds. The corresponding causes of aircraft damage are discussed in the last portion of the chapter.

501. LESSON TOPIC LEARNING OBJECTIVES

Terminal Objective: Partially supported by this lesson topic:

- 2.0 Upon completion of this unit of instruction, student aviators and flight officers will demonstrate knowledge of meteorological theory enabling them to make intelligent decisions when confronted with various weather phenomena and hazards.

Enabling Objectives: Completely supported by this lesson topic:

- 2.48 List the types and intensities of turbulence used in Pilot Reports (PIREPs).
- 2.49 Define the terms used to report turbulence with respect to time.
- 2.50 Describe how thermal turbulence develops.
- 2.51 Describe cloud formations associated with thermal turbulences.
- 2.52 Describe how mechanical turbulence develops.
- 2.53 Describe the cloud formations associated with mountain wave turbulence.
- 2.54 Describe techniques for flight in the vicinity of mountain waves.
- 2.55 Describe how frontal lifting creates turbulence.
- 2.56 Describe how jet streams and temperature inversions are examples of wind shear turbulence.
- 2.57 Describe the recommended procedures for flying through turbulence.
- 2.58 Describe super cooled water.
- 2.59 Describe the types of structural icing.
- 2.60 State the requirements for the formation of structural icing.
- 2.61 State the temperature range most conducive to structural icing.
- 2.62 Identify icing conditions associated with fronts.
- 2.63 Identify the effects and hazards of aircraft icing.
- 2.64 Describe induction icing and compressor icing.
- 2.65 Describe ground icing hazards.
- 2.66 Identify the procedures to minimize or avoid the effects of icing.
- 2.67 List the types and intensities of icing used in Pilot Reports (PIREPs).
- 2.68 Define the following terms: visibility, flight visibility, prevailing visibility, slant range visibility, and runway visual range.

5-2 Weather Hazards of Turbulence, Icing, Ceilings, Visibility, and Ash Clouds

- 2.69 Define and identify obscuring phenomena.
- 2.70 List the sky coverage terms that define a ceiling.
- 2.71 Identify the parameters that define fog.
- 2.72 Identify the requirements for fog formation.
- 2.73 Identify the two main types of fog and how they form and dissipate.
- 2.74 Describe the aviation hazards of ash clouds.

502. REFERENCES

1. Weather for Aircrews, AFH 11-203, Volume 1, Chapters 9, 10, 11, 12, and 16
2. DOD Flight Information Publication (En route) Flight Information Handbook, Section C

503. STUDY ASSIGNMENT

Review Chapter Five and answer the Study Questions.

504. TURBULENCE DEFINED AND CLASSIFIED

Turbulence is any irregular or disturbed flow in the atmosphere producing gusts and/or eddies. Occurrences of turbulence are local in extent and transient in character. Although general forecasts of turbulence are quite good, forecasting precise locations is difficult.

Turbulence intensity is classified using a subjective scale. Figure 5-1 contains the four intensity levels and the three time descriptors used by aircrews when giving a Pilot Report (PIREP), which details the in-flight weather. You can see how individual crewmembers of the same aircraft might disagree on the degree of turbulence they encountered. Realize moderate turbulence for a B-52 could be severe or extreme for a T-34.

| Intensity | Aircraft Reaction | Reaction Inside Aircraft |
|-----------------|---|---|
| Light | Turbulence that momentarily causes slight, erratic changes in altitude and/or attitude (pitch, roll, yaw). Report as Light Turbulence; ¹ or Turbulence that causes slight, rapid, and somewhat rhythmic bumpiness without appreciable changes in altitude or attitude. Report as Light Chop. | Occupants may feel a slight strain against seat belts or shoulder straps. Unsecured objects may be displaced slightly. Food service may be conducted and little or no difficulty is encountered in walking. |
| Moderate | Turbulence that is similar to Light Turbulence but of greater intensity. Changes in altitude and/or attitude occur but the aircraft remains in positive control at all times. It usually causes variations in indicated airspeed. Report as Moderate Turbulence; ¹ or Turbulence that is similar to Light Chop but of greater intensity. It causes rapid bumps or jolts without appreciable changes in aircraft altitude or attitude. Report as Moderate Chop. | Occupants feel definite strains against seat belts or shoulder straps. Unsecured objects are dislodged. Food service and walking are difficult. |
| Severe | Turbulence that causes large, abrupt changes in altitude and/or attitude. It usually causes large variations in indicated airspeed. Aircraft may be momentarily out of control. Report as Severe Turbulence; ¹ | Occupants are forced violently against seat belts or shoulder straps. Unsecured objects are tossed about. Food service and walking are impossible. |
| Extreme | Turbulence in which the aircraft is violently tossed about and is practically impossible to control. It may cause structural damage. Report as Extreme Turbulence. | |

¹High level turbulence (normally above 15,000 feet MSL) not associated with cumuliform cloudiness, including thunderstorms, should be reported as CAT (clear air turbulence) preceded by the appropriate intensity, or light or moderate chop.

NOTE:

| <u>Reporting Term</u> | <u>Definition</u> |
|-----------------------|---------------------------|
| Occasional | Less than 1/3 of the time |
| Intermittent | 1/3 to 2/3 of the time |
| Continuous | More than 2/3 of the time |

Figure 5-1 PIREP Turbulence Reporting

The different types of turbulence can be divided according to their causative factors: thermal, mechanical, frontal, and large-scale wind shear.

Two or more of these causative factors often work together. Any of the four types of turbulence may occur without the visual warning associated with clouds. Turbulence in the absence of or outside of clouds is referred to as clear air turbulence (CAT).

5-4 Weather Hazards of Turbulence, Icing, Ceilings, Visibility, and Ash Clouds

Clear Air Turbulence

CAT normally occurs outside of clouds and usually occurs at altitudes above 15,000 feet MSL, due to strong wind shears in the jet stream. CAT is not limited to jet streams, in fact CAT can be found in each of the four categories of turbulence, but the most severe CAT is associated with jet streams. You may also notice the Wind Shear category of turbulence is only CAT.

Thermal Turbulence

The thermal or convective turbulence forms as a result of heating from below. Localized vertical convective currents resulting from surface heating or cold air moving over warmer ground cause thermal turbulence. Strong solar heating of the Earth's surface can result in localized vertical air movements, both ascending and descending. For every rising current, there is a compensating downward current usually slower in speed since it covers a broader area. Such vertical air movements can also result from cooler air being heated through contact with a warm surface.

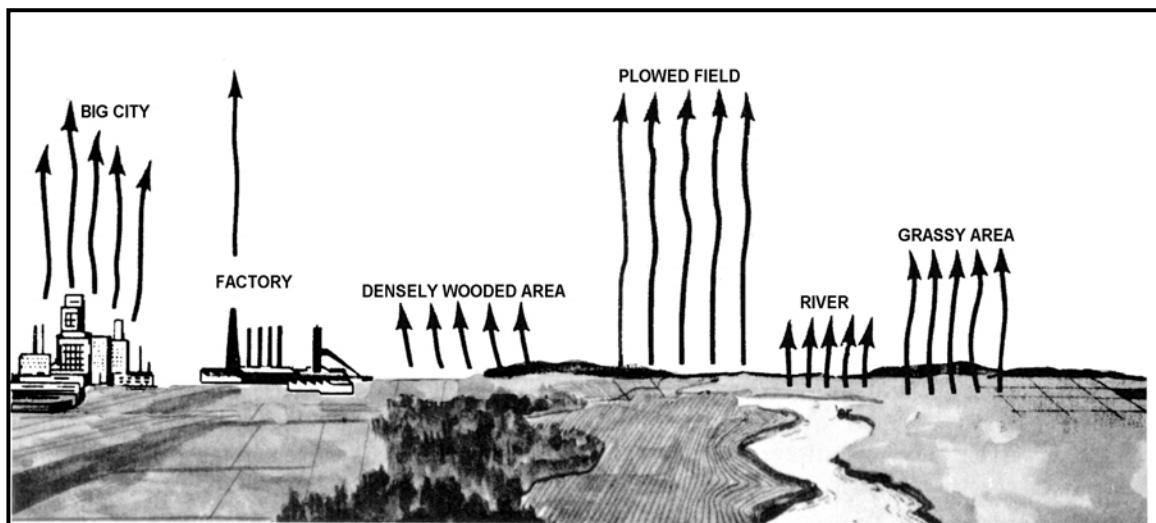

Figure 5-2 Strength of Thermal Currents Vary with Composition of Surface

The strength of thermal currents depends in part on the extent to which the Earth's surface has been heated, which in turn, depends upon the nature of the surface (Figure 5-2). Notice in the illustration, dry- barren surfaces such as sandy or rocky wasteland and plowed fields absorb heat more readily than surfaces covered with grass or other vegetation, which tend to contain more moisture. Thus, barren surfaces generally cause stronger convective currents. In comparison, water surfaces are heated more slowly. The difference in surface heating between land and water masses is responsible for the turbulence experienced by aircrews when crossing shorelines on hot summer days.

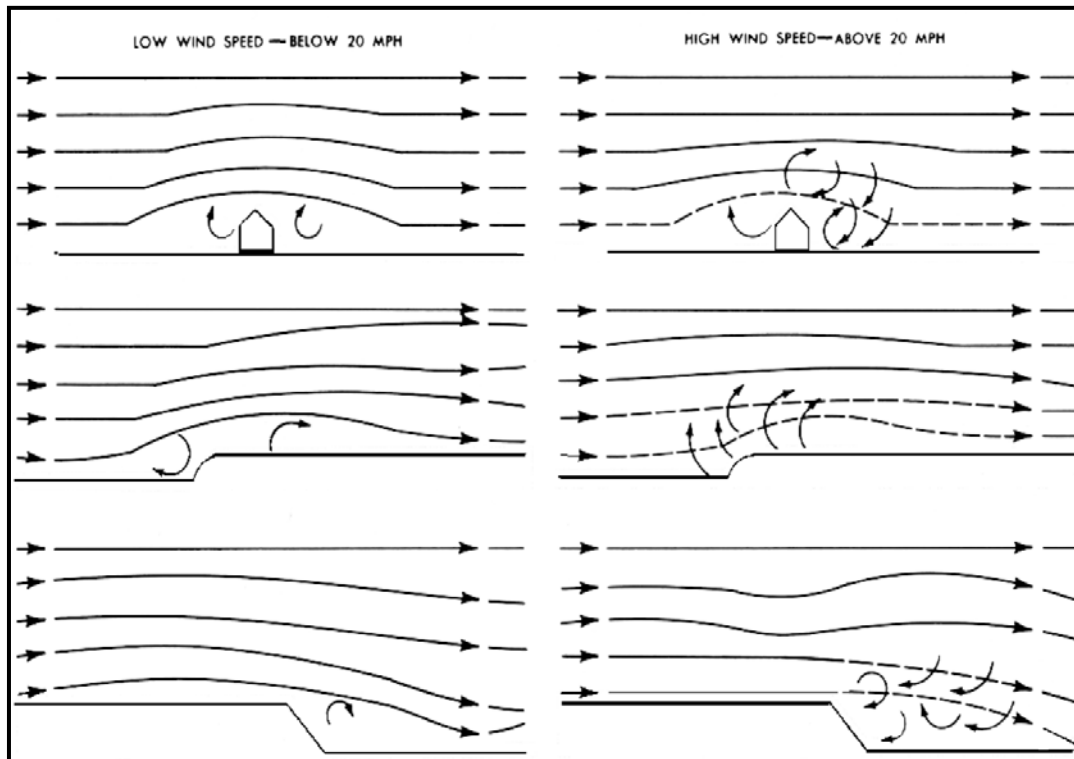

Figure 5-3 Airflow Over Irregular Terrain

When air is very dry, convective currents may be present even though convective-type clouds (cumulus) are absent. The upper limits of the convective currents are often marked by haze lines or by the tops of cumulus clouds that form when the air is moist. Varying surfaces often affect the amount of turbulence experienced in the landing pattern and on final approach.

Mechanical Turbulence

Mechanical turbulence results from wind flowing over or around irregular terrain or man-made obstructions. When the air near the surface of the Earth flows over obstructions, such as bluffs, hills, mountains, or buildings, the normal horizontal wind flow is disturbed and transformed into a complicated pattern of eddies and other irregular air movements (Figure 5-3). An eddy current is a current of air (or water) moving contrary to the main current, forming swirls or whirlpools. One example of mechanical turbulence may result from the buildings or other obstructions near an airfield.

The strength and magnitude of mechanical turbulence depends on the speed of the wind, the roughness of the terrain (or nature of the obstruction), and the stability of the air. Stability seems to be the most important factor in determining the strength and vertical extent of the mechanical turbulence. When a light wind blows over irregular terrain, the resulting mechanical turbulence has only minor significance. When the wind blows faster and the obstructions are larger, the turbulence intensity increases and extends to higher levels.

5-6 Weather Hazards of Turbulence, Icing, Ceilings, Visibility, and Ash Clouds

Mountain Wave Turbulence

When strong winds blow approximately perpendicular to a mountain range, the resulting turbulence can be severe. Associated areas of steady updrafts and downdrafts may extend to heights from 2 to 20 times the height of the mountain peaks. When the air is stable, large waves tend to form on the lee side of the mountains and extend up to the lower stratosphere for a distance of up to 300 miles or more downwind.

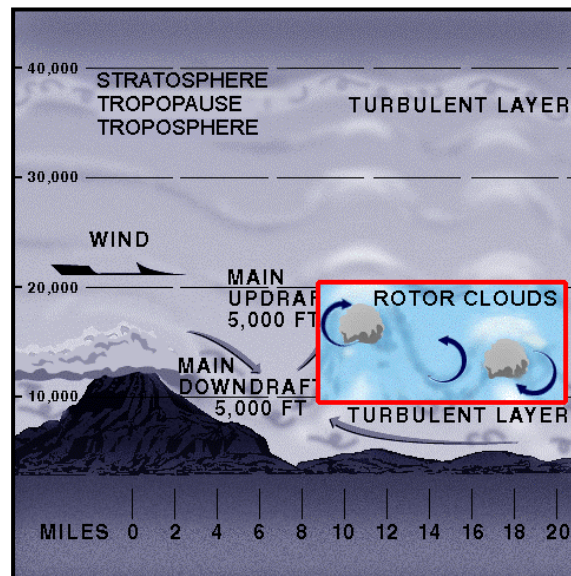

Figure 5-4 Mountain Wave Turbulence

These are referred to as standing waves or mountain waves, and may or may not be accompanied by turbulence (Figure 5-4). Pilots, especially glider pilots, have reported the flow in these waves is often remarkably smooth. Others have reported severe turbulence.

Even though mountain wave turbulence may be present, when the airflow begins to move up the windward side of the mountain, it is usually fairly smooth as the orographic lifting imparts the vertical component to the motion of the air. The wind speed gradually increases, reaching a maximum near the peak of the mountain. Past the peak, the air naturally flows down the leeward side, completing one cycle of oscillation and setting up the standing wave pattern of the mountain wave turbulence. Downwind, perhaps five to ten miles from the peak, the airflow begins to ascend again, where the rotor or lenticular clouds may appear. Additional waves, generally less intense than the primary wave, may form farther downwind. Note in Figures 5-4 and 5-5 the mountains are on the left and the wind is flowing from left to right.

While lenticular, cap, and rotor clouds are usually present to warn aircrews of mountain wave activity, it is possible for wave action to take place when the air is too dry to form clouds, producing CAT. Still, cloud forms particular to wave action provide the best means of identifying possible turbulence, aside from weather forecasts and PIREPs. Although the lenticular clouds in Figure 5-5 are smooth in contour, they may be quite ragged when the airflow

at that level is turbulent. These clouds may occur singularly or in layers at heights usually above 20,000 feet. The rotor cloud forms at a lower level and is generally found at about the same height as the mountain ridge. The cap cloud usually obscures both sides of the mountain peak. The lenticular clouds (Figure 5-5), like the rotor and cap clouds, are stationary in position, even though the wind flows through them.



Figure 5-5 Lenticular Clouds

The pilot is concerned, for the most part, with the first wave because of its more intense activity and proximity to the high mountainous terrain. Extreme turbulence is usually found at low levels on the leeward side of the mountain in or near the rotor and cap clouds when the winds are 50 knots or greater at the mountaintop. With these wind conditions, severe turbulence can frequently be found to exist from the surface to the tropopause and 150 miles downwind. Moderate turbulence can be experienced often as far as 300 miles downwind under those same conditions. When the winds are less than 50 knots at mountain peak level, a lesser degree of turbulence may be experienced.

Mountain wave turbulence is dangerous in the vicinity of the rotor clouds and to the leeward side of the mountain peaks. The cap cloud must always be avoided because of the turbulence and the concealed mountain peaks.

Apply the following techniques when mountain wave turbulence has been forecasted:

1. Avoid the turbulence, if possible, by flying around the areas where wave conditions exist. If this is not feasible, fly at a level at least 50% higher than the height of the mountain range. This procedure will not keep the aircraft out of turbulence, but provides a margin of safety if a strong downdraft is encountered.

5-8 Weather Hazards of Turbulence, Icing, Ceilings, Visibility, and Ash Clouds

2. Avoid the rotor, lenticular, and the cap clouds since they contain intense turbulence and strong updrafts and downdrafts.
3. Approach the mountain range at a 45° angle, so a quick turn can be made away from the ridge if a severe downdraft is encountered.
4. Avoid the leeward side of mountain ranges, where strong downdrafts may exist, until certain turbulence is not a factor.
5. Do not place too much confidence in pressure altimeter readings near mountain peaks. They may indicate altitudes more than 2500 feet higher than the true altitude.
6. Slow to the turbulence penetration airspeed recommend in your aircraft NATOPS or Dash-One Technical Order.

Frontal Turbulence

Frontal turbulence is caused by lifting of warm air, a frontal surface leading to instability, or the abrupt wind shift between the warm and cold air masses. The vertical currents in the warm air are the strongest when the warm air is moist and unstable. The most severe cases of frontal turbulence are generally associated with fast-moving cold fronts. In these cases, mixing between the two air masses, as well as the differences in windspeed and or direction (wind shear), add to the intensity of the turbulence.

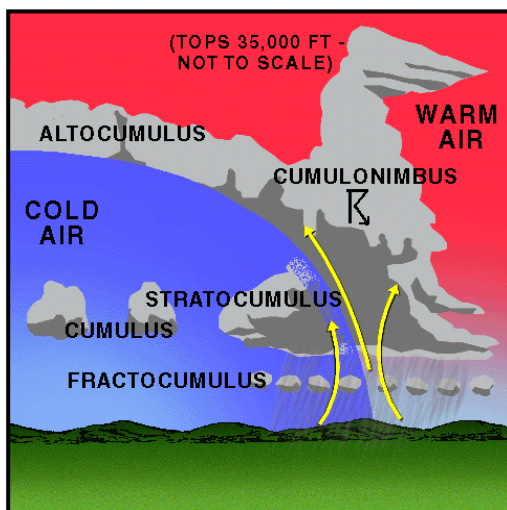

Figure 5-6 Frontal Turbulence

Ignoring the turbulence resulting from any thunderstorm along the front, Figure 5-6 illustrates the wind shift contributing to the formation of turbulence across a typical cold front. The wind speeds are normally greater in the cold air mass.

Wind Shear Turbulence

Large-scale wind shear turbulence results from a relatively steep gradient in wind velocity or direction producing eddy currents that result in turbulence. Wind shear is defined as a sudden

change in windspeed or direction over a short distance in the atmosphere. The greater the change in windspeed and/or direction in a given area, the more severe the turbulence will be. These turbulent wind shear flight conditions are frequently encountered in the vicinity of the jet stream, where large shears in both the horizontal and vertical planes are found, as well as in association with land and sea breezes, fronts, inversions, and thunderstorms. Strong wind shear can abruptly distort the smooth flow of wind, creating rapid changes in aircraft performance.

Jet stream turbulence is described in Chapter Two as one of the major sources of wind shear turbulence, which can sometime reach speeds of over 250 knots (Figure 5-7). The highest wind speeds and probable associated turbulence is found about 5000 feet below the tropical tropopause and closer to the tropopause in the polar regions. The rapid change of wind speed within a short distance of the jet core is particularly significant. The vertical shear is generally close to the same intensity both above and below the core, and it may be many times stronger than the horizontal shear. The horizontal shear on the cold air side of the core is stronger than on the warm air side. Thus, if it is desired to exit jet stream turbulence, a turn to the south should result in smoother air. Additionally, a climb or descent to a different flight level should help, as jet stream turbulence often occurs in patches averaging 2000 feet deep, 20 miles wide, and 50 miles long. If changing altitude, watch the outside air temperature for a minute or two to determine the best way to exit the CAT quickly. If the temperature is rising, climb; if the temperature is falling, descend. This maneuver will prevent following the sloping tropopause or frontal surface and thereby staying in the turbulent area. If the temperature remains the same, either climb or descend.

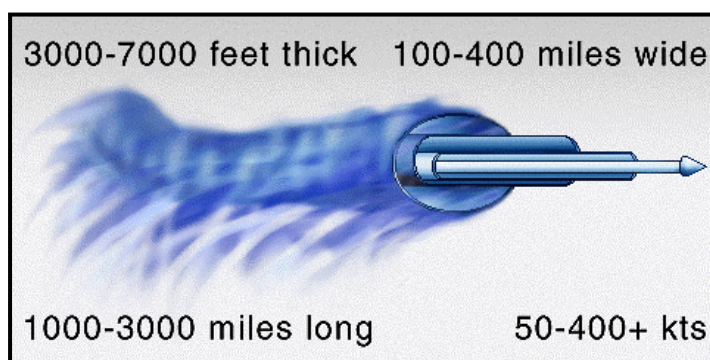

Figure 5-7 Jet Stream Diagram

Temperature Inversions

Recall from Chapter One the lapse rate where temperature increases with altitude, there is a temperature inversion. Even though this produces a stable atmosphere, inversions can cause turbulence at the boundary between the inversion layer and the surrounding atmosphere. The resulting turbulence can often cause a loss of lift and airspeed near the ground, such as when a headwind becomes a tailwind, creating a decreasing-performance wind shear. It is important to know how to recognize and anticipate an inversion in flight so you can prepare and take precautions to minimize the effects. If you are caught unaware, the loss of lift can be catastrophic because of your proximity to the ground. Inversions often develop near the ground

5-10 Weather Hazards of Turbulence, Icing, Ceilings, Visibility, and Ash Clouds

on clear, cool nights when the winds are light and the air is stable. If the winds just above the inversion grow relatively strong, wind shear turbulence can result.

Figure 5-7 shows a wind shear zone and the turbulence that developed between the calm air and stronger winds above the inversion. When taking off or landing in near-calm surface winds under clear skies within a few hours of sunrise, watch for a temperature inversion near the surface. If the wind at 2000 to 4000 feet AGL is 25 knots or more, expect a shear zone at the inversion. To prepare yourself, allow a margin of airspeed above normal climb or approach speed if turbulence or a sudden change in wind speed occurs in order to counteract the effects of a diminished headwind or increased tailwind at and below the inversion.

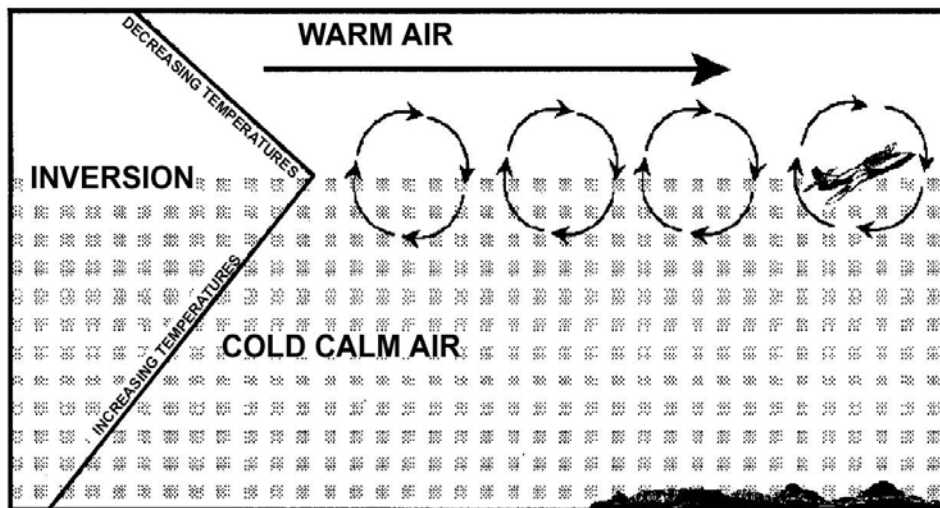

Figure 5-8 Wind Shear Associated With a Temperature Inversion

Turbulence Associated with Thunderstorms

The strongest turbulence within cumulonimbus clouds occurs with the shear between the updrafts and downdrafts. Outside the clouds, wind shear turbulence has been encountered several thousand feet above and 20 miles laterally from a severe storm. Severe turbulence can be encountered in the anvil 15 to 30 miles downwind. The storm cloud is only the visible portion of a turbulent system whose updrafts and downdrafts often extend outside the storm.

Flight Techniques For Turbulence

If you cannot avoid flying in turbulence, recommend the following procedures:

1. Establish and maintain thrust settings consistent with turbulent air penetration airspeed and aircraft attitude. Severe turbulence may cause large and rapid variations in indicated airspeed. Do not chase airspeed.
2. Trim the aircraft for level flight at the recommended turbulent air penetration airspeed. Do not change trim after the proper attitude has been established.

3. The key to flying through turbulence is proper attitude control. Both pitch and bank should be controlled by reference to the attitude gyro indicator. Extreme gusts may cause large changes in pitch or bank. To avoid overstressing the aircraft, do not make abrupt control inputs. Use moderate control inputs to reestablish the desired attitude.
4. Severe vertical gusts may cause appreciable altitude deviations. Allow altitude to vary. Sacrifice altitude to maintain desired attitude. Do not chase the altimeter.

505. AIRCRAFT ICING

Summary of Air Florida Mishap

On January 13, 1982, Air Florida Flight 90, a Boeing 727-222 (N62AF), was a scheduled flight to Fort Lauderdale, Florida, from Washington National Airport, Washington D.C. There were 74 passengers, including 3 infants, and 5 crewmembers on board. The flight's scheduled departure time was delayed about 1 hour 45 minutes because of moderate to heavy snowfall, which necessitated the temporary closing of the airport.

Following takeoff from runway 36, which was made with snow and/or ice adhering to the aircraft, the aircraft at 1:31 EST crashed into the barrier wall of the northbound span of the 14th Street Bridge, which connects the District of Columbia with Arlington County, Virginia, and plunged into the ice-covered Potomac River. It came to rest on the west side of the bridge 0.75 nm from the departure end of runway 36. Four passengers and one crewmember survived the crash.

When the aircraft hit the bridge, it struck seven occupied vehicles and then tore away a section of the bridge barrier wall and bridge railing. Four persons in the vehicles were killed; four were injured.

The National Transportation Safety Board determined that the probable cause of this accident was the flight crew's failure to use engine anti-ice during ground operation and takeoff, their decision to takeoff with snow/ice on the airfoil surfaces of the aircraft, and the captain's failure to reject the takeoff during the early stage when his attention was called to anomalous engine instrument readings. Contributing to the accident were the prolonged ground delay between deicing and the receipt of ATC takeoff clearance during which the airplane was exposed to continual precipitation, the known inherent pitch up characteristics of the B-727 aircraft when the leading edge is contaminated with even small amounts of snow or ice, and the limited experience of the flight crew in jet transport winter operations.

Figure 5-9 Air Florida Mishap Abstract

Figure 5-9 graphically demonstrates that icing poses a serious threat to aviation. No matter which part of the world home base is located, icing can become a hazard to any phase of flight, not just the takeoff or landing phase. Aircraft icing is classified into two main groups: structural and engine icing.

Structural icing forms on the external structure of an aircraft. Structural ice forms on the wings, fuselage, antennas, pitot tubes, rotor blades, and propellers. Significant structural icing on an aircraft can cause control problems and dangerous performance degradation. The types of structural icing are clear, rime, mixed, and frost.

Engine icing occurs when ice forms on the induction or compressor sections of an engine, reducing its performance.

Icing Requirements

There are two requirements for the formation of aircraft icing. First, the atmosphere must have super-cooled visible water droplets. Second, the free air temperature and the aircraft's surface temperature must be below freezing.

Clouds are the most common form of visible liquid water and super-cooled water is liquid water found at air temperatures below freezing. When super-cooled droplets strike an exposed object, such as a wing, the impact induces freezing and results in aircraft icing. Therefore, when penetrating a cloud at subzero temperatures, icing should be expected. Frozen precipitation in solid form (hail, snow grains, ice pellets) does not cause structural icing.

Super-cooled water forms because, unlike bulk water, water droplets in the free air do not freeze at 0°C. Instead, their freezing temperature varies from -10 to -40 degrees C: the smaller the droplets, the lower the freezing point. As a general rule, serious icing is rare in clouds with temperatures below -20°C since these clouds are almost completely composed of ice crystals. However, icing is possible in any cloud when the temperature is 0°C or below.

Structural Icing Conditions

Clear icing normally occurs at temperatures between 0 and -10 degrees C, where water droplets are large because of unstable air, such as in cumulus clouds and in areas of freezing rain or drizzle. Instead of freezing instantly upon contact with the aircraft's surface, these large water droplets move along with the airflow, freeze gradually, and form a solid layer of ice. This layer of clear ice can cover a large portion of the wing surface and is difficult to break off. Clear icing is the most severe form of icing because it builds up fast, can freeze the flight controls, and disrupts airflow over the wings.

Rime icing is rough, opaque, milky white in appearance and most likely to occur at temperatures of -10 to -20 °C. It is more dense and harder than frost, but lighter, softer, and less transparent than clear ice. Rime ice occurs in stable conditions, clouds where the water droplets are small and freeze instantaneously, such as stratiform clouds and the upper portions of cumulus clouds. It is brittle and fairly easy to break off. Rime ice does not normally spread over an aircraft surface, but protrudes forward into the air stream along the leading edges of airfoils.

Mixed icing is a combination of clear ice and rime ice, occurring where both large and small water droplets are present, normally at temperatures of -8 to -15 degrees C. Because mixed icing is a combination of large and small water droplets, it takes on the appearance of both rime

and clear icing. It is lumpy, like rime ice, but also hard and dense, like clear ice. The most frequent type of icing encountered is usually a form of mixed icing.

Frost is a thin layer of crystalline ice that forms on exposed surfaces. It normally occurs on clear, calm wind nights when the air temperature and dew point are below freezing. Frost also forms in flight when a cold aircraft descends from a zone of freezing temperatures into high relative humidity. The moist air is chilled suddenly to below freezing temperatures by contact with the cold surfaces of the aircraft, and deposition occurs. Frost, like other forms of icing, disrupts the smooth boundary layer flow over airfoils, and thus increases drag, causes a loss of lift, and increases stall speed. Though it is unlikely to add considerable weight to an aircraft, any amount of frost is hazardous and must be removed prior to takeoff.

Aircrews should anticipate and plan for some type of icing on every flight conducted in below freezing temperatures and should be familiar with the icing generally associated with different atmospheric conditions, as discussed in the next section.

Frontal Icing Conditions

Cold fronts and squall lines generally have a narrow band of both weather and icing. The associated clouds will be cumuliform. The icing zone will be about 10,000 feet thick, 100 miles wide, and the icing will be predominantly clear, accumulating rapidly.

Warm fronts and stationary fronts generally have a much wider band of weather and icing, reflecting the size of the warm frontal zone. The icing will be found mainly inside stratiform clouds, accumulating at a relatively low rate, due to the smaller size of the super-cooled water droplets. The vertical depth of the icing zone will generally be about 3000 to 4000 feet thick, possibly up to 10,000 feet. The type of icing will be predominantly rime, but may also contain mixed icing.

The most critical icing (rain or drizzle) area is where water is falling from warm air above to a flight level temperature below freezing. In this case, severe clear ice would be encountered below the cloud layer and the evasive action is to climb to an altitude where the temperature is above freezing.

Occluded fronts often produce icing covering a very widespread area, containing both stratiform and cumuliform type clouds. The depth of the icing zone will often be 20,000 feet, approximately double the depth of icing zones with other type fronts. The types of icing will be clear, mixed, and rime, with a very rapid and heavy rate of accumulation.

506. EFFECTS AND HAZARDS OF STRUCTURAL ICING

The most hazardous aspect of structural icing is its aerodynamic effects. The presence of ice on an aircraft decreases lift, thrust, and range, and increases drag, weight, fuel consumption, and stall speed. The added weight with reduced lift and thrust can be a dangerous combination (Figure 5-10). Ice can alter the shape of an airfoil, changing the angle of attack at which the aircraft stalls and therefore increasing the stall speed. Ice reduces lift and increases drag on an

airfoil. Ice thickness is not the only factor determining the effect of icing. Location, roughness, and shape are important, too. For example, a half-inch high ridge of ice on the upper surface of the airfoil at 4% chord reduces maximum lift by over 50%. Yet, the same ridge of ice at 50% chord decreases maximum lift by only 15%. On another airfoil, a distributed sandpaper-like roughness on the leading edge of the wing may decrease lift by 35%. Along with this decrease in lift, it is obvious parasite drag will significantly increase. The buildup of ice on various structural parts of the aircraft can result in vibration, causing added stress to those parts. This is especially true in the case of propellers and rotors, which are delicately balanced. Even a small amount of ice, if not distributed evenly, can cause great stress on the propeller and engine mounts.

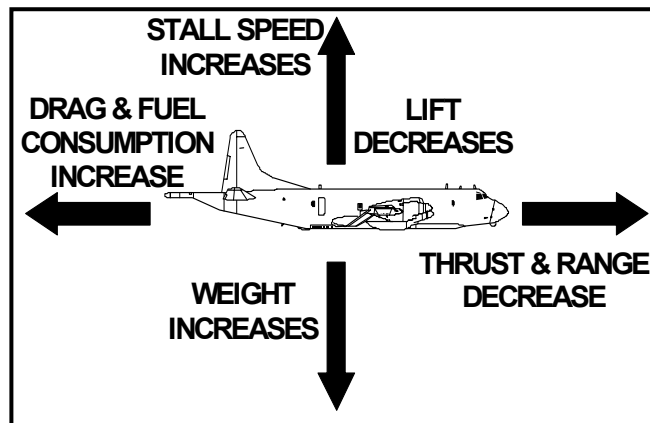

Figure 5-10 Cumulative Effects of Icing

Icing is not restricted to airfoils and other external structure. Engines, fuel, and instruments may also be affected by ice formation.

Ice associated with freezing rain or drizzle can accumulate beyond the limits of an ice protection system. If you encounter any type of freezing rain or drizzle, the best course of action is to leave the area.

Structural icing can block the pitot tube (Figure 5-11) and static ports. This can cause a pilot to either lose or receive erroneous indications from various instruments such as the airspeed indicator, VSI, and altimeter. For example, if the pitot tube becomes blocked with ice, the “total pressure” input to the system remains constant. Therefore, during a descent, as the “static pressure” input to the system increases, the airspeed indicator gives an erroneous indication of decreasing airspeed. The opposite would be true during a climb.

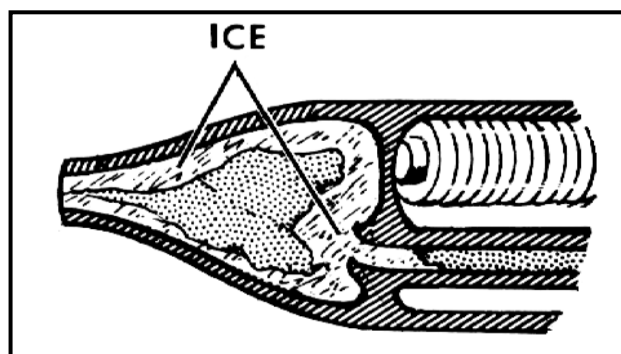

Figure 5-11 Pitot Tube Icing

During flight, it can be difficult to detect ice on areas such as the empennage that may be impossible to see. Cues that signal the potential for icing include the following:

1. Ice on windshield wiper arms or projections such as engine drain tubes, pitot tubes, engine inlet lips, or propeller spinners,
2. decreasing airspeed with constant power and altitude, and
3. ice detector annunciation.

Icing on rotary wing aircraft is related to those involving wings and propellers. Ice formation on the helicopter main rotor system or antitorque rotor system may produce serious vibration, loss of efficiency or control, and can significantly deteriorate the available RPM to a level where safe landing cannot be assured. In fact, a 3/16-inch (4.8-mm) coating of ice is sufficient to prevent some helicopters from maintaining flight in a hover.

507. OTHER TYPES OF AIRCRAFT ICING

Induction icing – in flights through clouds containing super-cooled water droplets, air intake duct icing is similar to wing icing. However, the ducts may ice when skies are clear and temperatures are above freezing. The reduced pressure that exists at the intake lowers the temperature to the point that condensation and/or deposition take place, resulting in the formation of ice. The degree of temperature decrease varies considerably with different types of engines. However, if the free air temperature is 10°C or less (especially near the freezing point) and the relative humidity is high, the possibility of induction icing exists. Ingestion of ice shed ahead of the compressor inlet may cause severe foreign object damage to the engine.

Compressor icing – ice forming on compressor inlet screens and compressor inlet guide vanes will restrict the flow of inlet air, eventually causing engine flameout. The reduction in airflow is noticeable through a loss of thrust and a rapid rise in exhaust gas temperature. As the airflow decreases, the fuel-air ratio increases, which in turn raises the temperature of the gases going to the turbine. The fuel control attempts to correct any loss in engine RPM by adding more fuel, which merely aggravates the condition. Ice build-up on inlet screens sufficient to cause turbine failure can occur in less than one minute under severe conditions.

Ground icing hazards – we have already stressed the importance of removing all icing and frost from an aircraft prior to takeoff. De-icing itself, however, can also be a hazard. De-icing fluids (discussed in the next section) are highly corrosive to internal aircraft and engine parts. Thus, it is imperative de-icing crews understand the particular requirements for your type of aircraft. Additionally, taxiing through mud, water or slush on ramps and runways can create a covering of ice that can hamper the movement of flaps, control surfaces, and the landing gear mechanism. Ice and snow on runways are conditions that affect braking action of aircraft. Braking action varies widely with aircraft type and weight. Therefore, pilots must be aware of the limits to their aircraft's braking capabilities.

508. MINIMIZING OR AVOIDING ICING HAZARDS

Flight Path Options

In coping with an icing hazard in flight, a pilot usually has two alternatives. First, the pilot can climb to the colder temperatures where the precipitation will be frozen and therefore not an icing hazard. Second, the pilot can descend to an altitude where the air temperatures are well above freezing (Figure 5-12). However, if encountering clear icing in the freezing precipitation below the clouds of a warm front, the aircraft is most likely in the cold air ahead of the warm front. In this case, the best alternative may be to climb to warmer temperatures, across the frontal boundary, as the freezing precipitation may extend all the way to ground level.

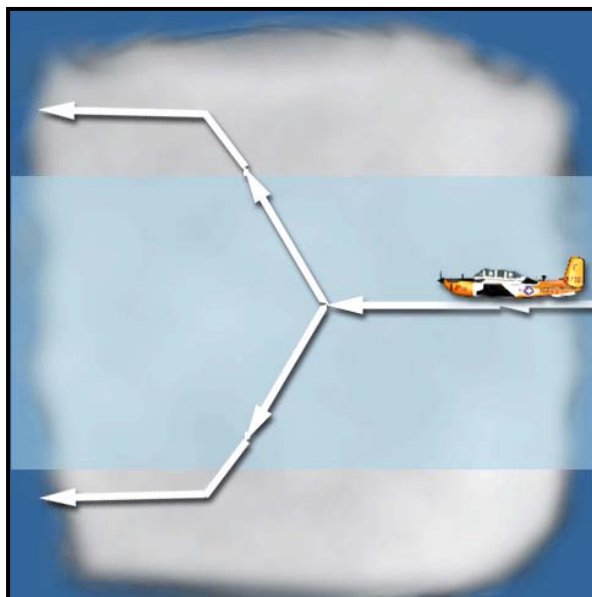

Figure 5-12 Options to Escape Icing

Anti-Icing and Deicing Equipment

Deicing equipment eliminates or removes ice already accumulated on the aircraft. Anti-icing equipment prevents the accumulation of ice on specific aircraft surfaces. Most military aircraft

are equipped with anti-icing and/or deicing equipment. There are three common methods for preventing and/or eliminating ice buildup: mechanical, fluids, and heat.

The mechanical method uses deicing boots, which are rubber bladders installed on the leading edges of lift producing surfaces. Compressed air cycles through these rubber boots causing them to alternately inflate and deflate, thus cracking accumulated ice and allowing the air stream to peel it away.

Anti-icing fluids are freezing point depressants and are pumped through small holes in the wing's leading edge. This fluid coats the wing, preventing ice from forming on the wing's surface. Additionally, ground crews use deicing fluids to remove and prevent ice buildup before takeoff.

Heat application capability to wings, props, tail surfaces, or engine intakes is installed in most aircraft. Systems of this nature can be designed for either anti-icing or deicing purposes. Critical areas can be heated electrically or by hot air bled from the engine's compressor section.

Recommended Precautions

Keep these precautions in mind when flying in the vicinity of icing conditions:

1. Do not fly into areas of known or forecast icing conditions.
2. Avoid flying in clouds with temperatures from 0 to -20 degrees C.
3. Do not fly through rain showers or wet snow with temperatures near freezing.
4. Avoid low clouds above mountain ridges or crests. Expect the heaviest icing in clouds around 5000 feet above the mountaintops.
5. Do not make steep turns with ice on the airplane due to increased stall speeds.
6. Avoid high angles of attack when ice has formed on the aircraft since the aircraft is closer to stall speed in these maneuvers.
7. Under icing conditions, increased drag and additional power required increases fuel consumption.
8. Change altitude to temperatures above freezing or colder than -20 °C. An altitude change also may take you out of clouds.
9. In freezing rain, climb to temperatures above freezing, since it will always be warmer at some higher altitude. Do not delay your climb; ice can accumulate quickly. If you are going to descend, you must know the temperature and terrain below.
10. Do not fly parallel to a front while encountering icing conditions.
11. Avoid icing conditions as much as possible in the terminal phase of flight due to reduced airspeeds.
12. Expect to use more power on final approach when experiencing structural icing.
13. Always remove ice or frost from airfoils before attempting takeoff.

Icing Intensities And PIREPS

Weather personnel cannot generally observe icing; they must rely on PIREPs. When flying during icing conditions, pilots should report these conditions as indicated in Figure 5-13. However, forecasters attempt to forecast the maximum intensity of icing that may be encountered during a flight, not necessarily the intensity of icing encountered by a particular aircraft. It becomes the pilot's responsibility to make certain a complete weather briefing is obtained, to include the information for safe completion of the flight.

| Intensity | Airframe Ice Accumulation | Pilot Report |
|---|--|---|
| Trace | Ice becomes perceptible. Rate of accumulation slightly greater than rate of sublimation. It is not hazardous even though deicing/anti-icing equipment is not used, unless encountered for an extended period of time--over one hour. | Aircraft identification, location, time (GMT), altitude (MSL), type aircraft, sky cover, visibility & weather, temperature, wind, turbulence, icing, remarks. Example of PIREP transmission: "Pensacola METRO, Rocket 501, holding 20 miles south of Navy Pensacola, at 2100Z and one-six thousand feet, single T-39 Sabreliner, we're IFR in stratus clouds, temperature -15°C , winds 330 at 25, no turbulence, Light Rime Icing, flying 200 knots indicated. |
| Light | The rate of accumulation may create a problem if flight is prolonged in this environment (over one hour). Occasional use of deicing/anti-icing equipment removes/prevents accumulation. It does not present a problem if the deicing/anti-icing equipment is used. | |
| Moderate | The rate of accumulation is such that even short encounters become potentially hazardous and use of deicing/anti-icing equipment or diversion is necessary. | |
| Severe | The rate of accumulation is such that deicing/anti-icing equipment fails to reduce or control the hazard. Immediate diversion is necessary. | |
| <p>Icing may be rime, clear, or mixed:</p> <p>Rime ice – Rough milky opaque ice formed by the instantaneous freezing of small super-cooled water droplets.</p> <p>Clear ice – A glossy, clear or translucent ice formed by the relatively slow freezing of large super-cooled water droplets.</p> <p>Mixed ice – A combination of rime and clear ice.</p> | | |

Figure 5-13 Icing Reporting Criteria

509. VISIBILITY DEFINITIONS

Visibility is important to all aviators since it plays an essential role in takeoffs, approaches, and landings. Visibility is defined as the ability to see and identify prominent unlighted objects by day and prominent lighted objects at night, and is expressed in statute miles, hundreds of feet, or meters. There are several particular methods of reporting visibility, some of which are defined below.

Flight visibility is the average forward horizontal distance, measured in statute miles from the cockpit of an aircraft in flight, at which a pilot can see and identify prominent unlighted objects by day and prominent lighted objects at night.

Prevailing visibility is the greatest horizontal visibility, measured in statute miles, equaled or exceeded throughout at least half the horizon circle, which need not be continuous. Figure 5-14 illustrates how prevailing visibility is determined. The center of the circles depict the observation point and the edge of the circles represent a distance of three miles, the furthest that prominent objects may be seen and identified. In the left depiction, the maximum visibility common to half or more of the horizon circle is three miles, so the prevailing visibility is three miles. If a bank of fog were to roll in to the airfield, as in the right depiction, visibility toward the east would be reduced. However, the observer can still see three miles throughout at least 180° of view, so the prevailing visibility is still three miles. Look at the visibility for each of the runways, and notice how the actual visibility may vary significantly from the prevailing visibility.

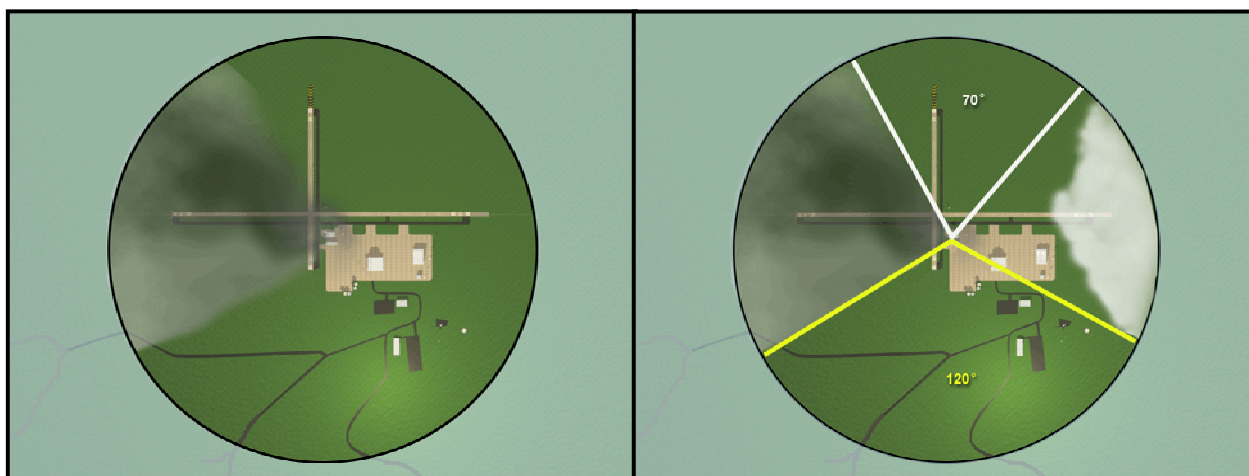

Figure 5-14 Prevailing Visibility Determination

Slant Range Visibility is the distance on final approach when the runway environment is in sight. This is probably the most vital weather information needed during a final approach in questionable weather. Unfortunately, slant range visibility is not often provided because of great difficulty in estimating or measuring it from the ground. Runway Visual Range (RVR) provides the best indication of the slant range visibility. However, other weather information such as precipitation and prevailing visibility help indicate slant range visibility.

RVR is the horizontal distance, expressed in hundreds of feet or meters, a pilot will see by looking down the runway from the approach end. For takeoff and landing under IFR, prevailing visibility is not as important as the visibility within the runway environment.

Surface vs Flight Visibility

RVR and prevailing visibility are horizontal visibilities near the Earth's surface. They may be quite different from the vertical visibility when looking down at the ground from an aircraft in flight. For example, surface visibility may be seriously reduced by fog or blowing snow, yet only a slight reduction in visibility is apparent when viewed from above the field. In Figure 5-15, the airfield may be seen relatively clearly from above the fog. When descending to the level of the fog, however, the airfield may disappear from sight. In another situation, flying into the setting sun on a hazy day may reduce flight visibility to values less than the surface visibility. When given the surface visibility, learn to anticipate what your flight visibility is likely to be. It may vary, depending on other weather conditions present.

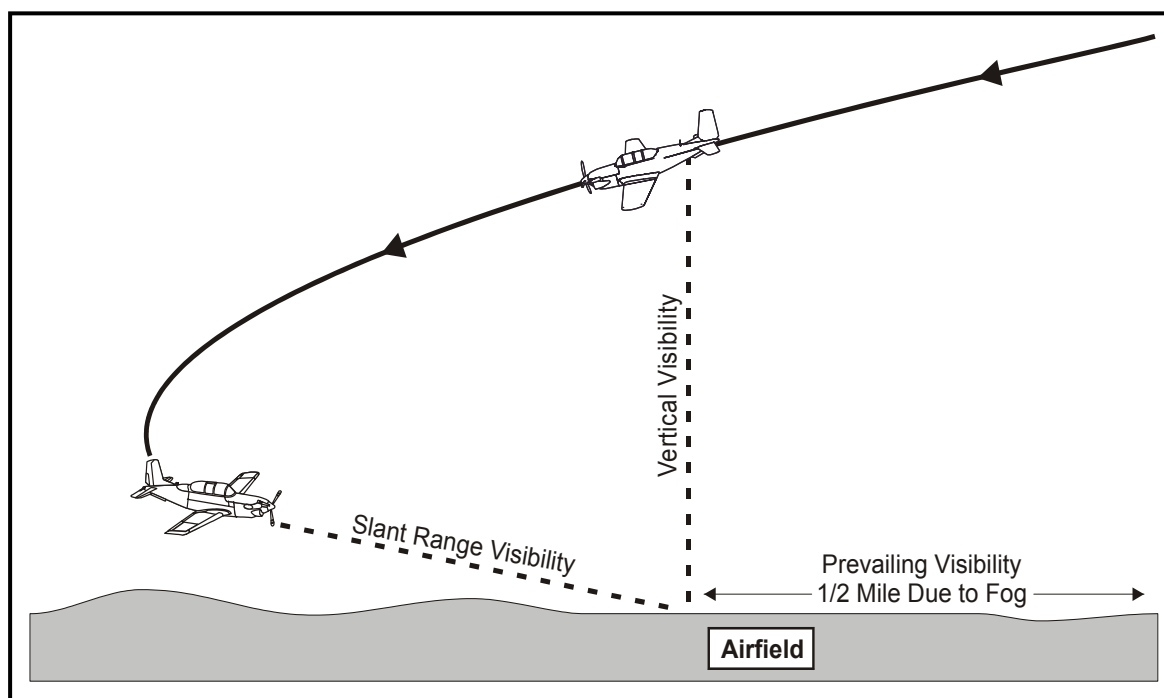

Figure 5-15 Surface vs Flight Visibility

Obscuring Phenomena

Obscuring phenomena are any collection of particles reducing horizontal visibility to less than six miles. They may be either surface based or aloft. Examples include fog, haze, smoke, volcanic ash, and blowing spray, to name a few.

Haze produces a bluish color when viewed against the ground. Although haze may occur at any level in the troposphere, it is more common in the lower few thousand feet. Haze is associated

with a stable atmosphere. The top of a haze layer, which is usually confined by a low level inversion, has the appearance of a horizon when viewed from above the layer. In this case, the haze may completely obscure the ground in all directions except the vertical. Dense haze may reduce visibility to less than three miles, with slant range visibility generally less than surface visibility. Visibility in haze is lower when looking toward the Sun than away from it.

Smoke causes the sunrise and sunset to appear very red. Smoke reduces visibility in a manner similar to haze. Smoke from forest fires is often concentrated in layers aloft with good visibility beneath. Smoke may be a major concern near industrial areas. Smoke from forest fires has been carried great distances at high altitudes. Aircrews flying at these altitudes may encounter dense smoke, although the lower altitudes are clear.

Rain and drizzle are precipitation in liquid form that can reduce visibility. Precipitation also reduces visibility as it streams across a windshield or canopy. Drizzle is a feature of stable air with the likely presence of fog or smog. Therefore, drizzle may result in extremely poor visibility. Approaches and the ensuing transition to visual flight can be very hazardous since moderate to heavy rain conditions can seriously affect the recognition of visual cues. Night approaches in these conditions can be even more critical as you may be distracted by the aircraft's flashing strobes or sequenced flashing runway lights.

Snow affects visibility much more than rain or drizzle and can easily reduce visibility to less than one mile. It is often difficult to see snow falling ahead of you; you may enter the snow unexpectedly.

Blowing snow is fine dry snow easily lifted by the wind up to 300 feet AGL, depending on wind strength and air stability. During or after a fresh snowfall with brisk winds, surface visibility may be reduced to less than 1/2 mile. Blowing snow is accompanied by many of the same hazards as rain, such as turbulence (creating difficulties in reading flight instruments) and obscured visual cues (a lack of visual cues for runway identification during the visual portion of the approach). The approach and runway lights will provide some identification of the runway environment; however, runway markings may be lost in the whiteness. Therefore, depth perception will be difficult, requiring more emphasis on instruments.

Dust and sand form when strong winds combined with unstable air and loose dry soil can blow dust or sand into the air. Dust is finer than sand and strong winds may lift the dust to considerable heights. Sand will usually be limited in altitude to 50 or 100 feet. In severe conditions, visibility can be near zero. Blowing dust is common behind cold fronts moving rapidly across prairies in early spring before a cover of vegetation has appeared. This effect may cause blowing dust conditions and reduced visibilities over a wide area.

510. SKY COVERAGE AND CEILINGS

For determining the amount of sky covered by clouds, the celestial dome is divided into eighths. The terms contained in Figure 5-16 are used to report the percentage of sky coverage as well as any obstructions to visibility. These coverages apply to a given altitude; therefore, more than one is normally reported. For example, the sky may be reported as follows: SCT at 2000 feet,

BKN at 5000 feet, OVC at 10,000 feet, where the altitudes refer to the bases of the cloud layers in feet AGL.

| Reportable Contractions | Meaning | Amount of Sky Cover |
|---|-----------------------|---------------------|
| SKC or CLR ¹ | Sky Clear | 0/8 |
| FEW ² | Few | > 0/8 - 2/8 |
| SCT | Scattered | 3/8 - 4/8 |
| BKN | Broken | 5/8 - 7/8 |
| OVC | Overcast | 8/8 |
| VV | Obscured ³ | 8/8 (surface based) |
| <p>1. The abbreviation CLR is used at automated stations when no clouds at or below 12,000 feet are reported; the abbreviation SKC is used at manual stations when no clouds are reported</p> <p>2. Any amount less than 1/8 is reported as FEW.</p> <p>3. The last 3 digits report the height of the vertical visibility into an indefinite ceiling.</p> | | |

Figure 5-16 Sky Coverage Contractions

A ceiling is the height AGL ascribed to the lowest broken or overcast layer or the vertical visibility into an obscuring phenomenon (total obscuration).

Vertical visibility is the distance seen directly upward from the ground into a surface-based obscuring phenomenon. This term is used when the celestial dome is totally hidden from view (8/8ths) by some surface based obscuration, and the reported ceiling is determined by measuring the vertical visibility upward as seen from the ground. In this type of situation, the base of the obscuration is less well defined, but it may still be possible to see upwards into the moisture (or other obstruction) for a short distance. While this does constitute a ceiling, it is sometimes referred to as an “indefinite” ceiling, and the distance seen upward into the phenomenon is then given as the vertical visibility. For example, if the sky were totally hidden by fog which touched the ground, but a ground observer could see a weather balloon ascend upward into the fog for 200 feet, he/she would report a vertical visibility of 200 feet.

It is important to realize the vertical visibility of 200 feet in the foregoing example is very different from a cloud ceiling of 200 feet. With a low cloud ceiling, a pilot normally can expect to see the ground and the runway once the aircraft descends below the cloud base. However, in the case of vertical visibility, the obscuring phenomenon also reduces the slant range visibility. Therefore, a pilot will have difficulty seeing the runway or approach lights clearly even after descending below the level of the reported vertical visibility.

If the weather observer on the ground is able to see part of the celestial dome or some clouds through an obscuring phenomenon (a partial obscuration) it is reported as few, scattered, or broken as appropriate, and assigned a height of 000 to indicate it is a surface based phenomenon. If clouds are present, their bases and amount or coverage are also reported.

Surface based obscuring phenomena classified as few, scattered, or broken also present a slant range visibility problem for pilots on approach for a landing but normally to a lesser degree than when the celestial dome is completely hidden. Thus, partial obscurations are not considered ceilings.

511. FOG VS STRATUS

Fog-related low ceilings and reduced visibility are among the most common and persistent weather hazards encountered in aviation. Since fog occurs at the surface, it is primarily a hazard during takeoff and landing.

Fog is a visible aggregate of minute water droplets that is based at or within 50 feet of the surface, is greater than 20 feet in depth, and reduces the prevailing visibility to less than 5/8 of a statute mile. Fog reduces horizontal and vertical visibility and may extend over a large area.

Fog extending no more than 200 feet in height is considered shallow fog and is normally reported as a partial obscuration. Since the fog may be patchy, it is possible visibility will vary considerably during the approach and rollout. RVR may not be representative of actual conditions in this situation if the measuring equipment is located in an area of good visibility.

One of the most serious problems with shallow fog stems from the abundance of cues available at the start of the approach. You may see the approach lighting system and possibly even some of the runway during the early stages of the approach. However, as the fog level is entered, loss of visual cues may cause confusion or disorientation. In these conditions, you should not rely entirely on visual cues for guidance. Bring visual cues into your instrument cross-check to confirm position, but maintain instrument flight until visual cues can provide sufficient references for landing.

Dense fog normally causes a total obscuration. You will not normally see visual cues during the early portion of an approach. Strobe lights and landing lights may cause a blinding effect at night. Transitioning to land in a total obscuration involves the integration of visual cues with the instrument cross-check during the latter portion of the approach.

A layer of low clouds forming a ceiling is usually formed from stratus clouds. Stratus, like fog, is composed of extremely small water droplets or ice crystals suspended in the air. The main distinction between fog and stratus is that a stratus layer is not surface based. Stratus is above the ground (greater than 50 feet AGL) and does not reduce the horizontal visibility at the surface. An observer on a mountain enveloped in the layer would call it fog, while one farther down the slope would call it stratus. In fact, the requirements for formation of fog contain many of the same items listed in the requirements for cloud formation.

512. FOG FORMATION

The formation of fog or cloudiness of any type is dependent on the air becoming temporarily supersaturated (contains more moisture than the air can hold at that temperature). Once the air reaches a supersaturated state, the excess moisture in the air condenses out of solution into

minute water droplets light enough to remain suspended in the air. If the condensed water particles form in sufficient amounts near the surface, the resulting condition is fog. For fog to form, three conditions must be satisfied:

1. Condensation nuclei must be present in the air,
2. the air must have a high water content (a low dew point spread), and
3. light surface winds must be present.

Recall from Chapter Two, when the air temperature is equal or nearly equal to the dew point temperature, there is a low dew point spread, and the air is close to saturation. Once saturation is achieved, either through the cooling of the air or through the evaporation of water into the atmosphere, water will condense from the vapor state into water droplets or ice crystal.

Wind velocity is an important consideration in the formation of fog. As will be discussed shortly, the radiational cooling of the Earth's surface is one of the main causes of fog formation. When light surface winds are present, on the order of one to ten knots, the speed differential resulting from friction slowing the air directly next to the surface causes the air to tumble in a mild eddy current (Figure 5-17). This brings more air in contact with the surface, enabling more air to be cooled, producing a thicker layer of condensed moisture. If the winds become too fast, however, this layer lifts away from the ground, lifting the bases higher with increasing speeds.

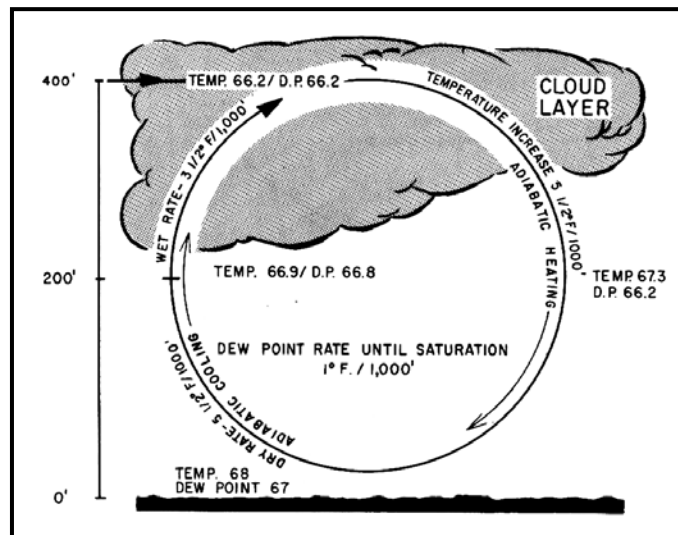

Figure 5-17 Wind Causing Eddy Currents, Cooling Air to Saturation

513. TYPES OF FOG

The two main types of fog are radiation and advection.

Radiation Fog

Radiation fog (Figure 5-18) occurs due to nocturnal cooling, usually on clear nights, when the Earth releases relatively large amounts of radiation into the atmosphere, cooling the surface. Cloudy nights, on the other hand, reflect most terrestrial radiation back to the Earth, reducing the amount of cooling through a “blanket” effect. Radiation cooling actually begins after the maximum daily temperature is reached, usually between 1530 and 1600 local time. Cooling continues until sunrise or shortly after sunrise and it affects only the lower limits of the atmosphere. If nocturnal cooling reduces the air temperature to the dew point temperature, fog or low ceiling clouds will develop in the area. Winds play an important factor in fog formation. Winds less than five knots usually results in shallow fog. Winds of five to ten knots will usually cause dense fog. Winds of greater than ten knots will usually dissipate the fog and cause low stratus or stratocumulus clouds to form. The other way radiation fog can dissipate is through solar heating.



Figure 5-18 Radiation Fog

The rate at which the ground temperature can increase after sunrise affects the dissipation of fog and low clouds. Vertically thick fog or multiple cloud layers in the area will slow down the morning heating of the ground. Only the heating of the ground can increase the temperature of the air overlying the ground. Once the surface air temperature rises, the ability of the air to hold more water vapor increases and the fog particles tend to evaporate (Figure 5-19).

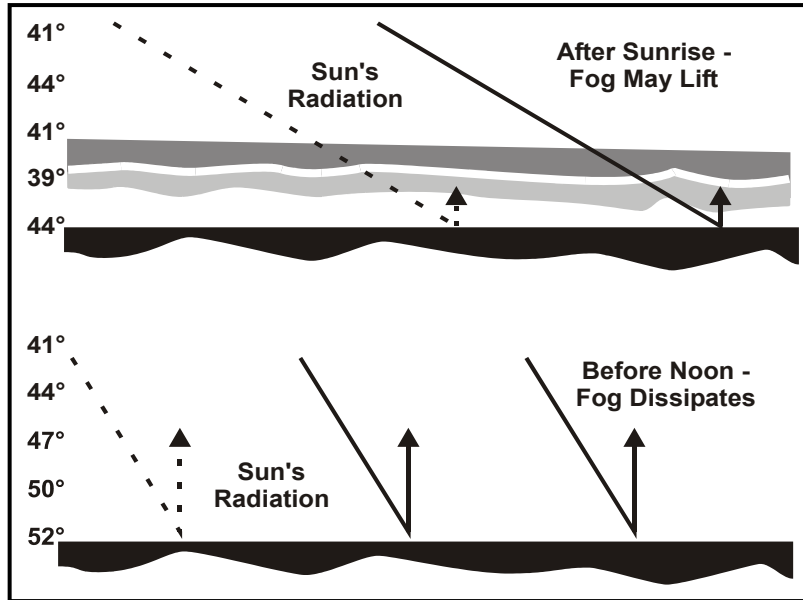

Figure 5-19 Dissipation of Radiation Fog

Advection Fog

Advection fog occurs when warm, moist air moves over a cold surface and the air is cooled to below its dew point. Common in coastal areas, it is often referred to as sea fog when observed to come from the sea. Fog of this type becomes thicker and denser as the wind speed increases, up to about 15 knots. Winds much stronger than this lift the fog into a layer of low stratus. However, in some oceanic areas, sea fog has been known to persist with winds as high as 40 knots. Advection fog can stay over the water for weeks, moving over the land late in the day and moving back over the water the next morning.



Figure 5-20 Advection Fog

The west coast of the United States is quite vulnerable to sea fog (Figure 5-20). This frequently occurring fog forms offshore, largely as a result of very cold water from the ocean depths rising to the surface, cooling the moist air above it, and is carried inland by the wind. Advection fog over the southeastern United States and along the Gulf Coast results from moist tropical air moving over cold ground. It is, therefore, more frequent in winter than in summer.

Advection fog dissipates only with a wind shift, blowing the fog away, usually back out over the sea. Incoming solar radiation will seldom cause the dissipation of advection fog because its thickness generally prevents enough radiation to warm the Earth sufficiently. The high specific heat of water and resulting stable temperature also prevents any solar heating from causing the dissipation of sea fog. Only a change in wind direction moving the air from a colder surface to a warmer surface, reversing the saturation process, can cause advection fog to dissipate.

514. VOLCANIC ASH CLOUDS

Volcanic eruptions are rare, but the severe effects ash clouds have on an aircraft make it important to understand the hazards in order to minimize or avoid them.

Volcanic ash clouds create an extreme hazard to aircraft operating near (especially downwind) of active volcanoes. Aircraft flying through volcanic ash clouds have experienced a significant loss of engine thrust and/or multiple engine flameouts along with wing leading edges and windshields being sandblasted.

Avoid flight into an area of known volcanic activity. Avoiding volcanic ash clouds is particularly difficult during hours of darkness or in daytime instrument meteorological conditions when the flight crew may not detect the volcanic ash cloud. Volcanic ash clouds are not displayed on airborne or Air Traffic Control (ATC) radar, as the radar reflectivity of volcanic ash is roughly a million times less than that of a cumuliform cloud.

A volcanic ash cloud is not necessarily visible, either. Aircrews have reported smelling an acrid odor similar to electrical smoke and smoke or dust appearing in the aircraft, but not seeing the ash cloud. Expect minor eye irritation if odors become noticeable (i.e., eyes watering). Remove contact lenses if this occurs. Consider using oxygen when odors or eye irritation occurs.

If volcanic activity is reported, the planned flight should remain at least 20 NM from the area and, if possible, stay on the upwind side of the volcano even when flying outside of the 20 NM limitation. Volcanic ash clouds may extend downwind for several hundred miles and thousands of feet in altitude. Volcanic ash can cause rapid erosion and damage to the internal components of engines with loss of thrust within 50 seconds.

Since airborne radar cannot detect volcanic ash clouds, weather forecasts are occasionally wrong, and other clouds may hide ash clouds, inadvertent flight through an ash cloud may occur. It may be difficult to determine if you are in an ash cloud when flying through other clouds or at night. The following conditions may indicate you have inadvertently flown into an ash cloud:

1. Airspeed indications may fluctuate greatly or appear unusually high or low due to volcanic dust blocking the pitot-static system. Establish the proper pitch and power settings required by the Dash One or the NATOPS Flight Manual for flying with an unreliable airspeed indicator.
2. An acrid odor similar to electrical smoke may be present.
3. A rise in oil temperature could indicate dust-plugged oil cooler(s).
4. Torching (flames) from the engine tailpipe(s) may occur.
5. Volcanic ash/dust may be blown into the cockpit through the aircraft air conditioning system.
6. Windshields become severely pitted that results in translucence. In addition, the abrasive cloud particles will sandblast the aircraft's leading edges.
7. St. Elmo's fire and static discharges around the windshield are often visible at night. A bright orange glow in engine inlets frequently occurs.
8. At night or in dark clouds, landing lights cast dark distinct shadows in ash clouds (unlike the fuzzy, indistinct shadows cast against moisture clouds).
9. Multiple engine malfunctions such as power surges, loss of thrust, high EGT, or compressor stalls. These result from ash buildup and blockage of the high-pressure turbine guide vanes and high-pressure turbine cooling ports.
10. More than one or all engines may flameout, since all engines are exposed to the same ash cloud.

If you encounter volcanic ash in flight, the best procedure is to perform a 180° turn immediately and leave the area. Additionally, consider a reduction in altitude, as hot ash has most likely ascended in convective currents before forming the cloud. Reduce thrust to the minimum practical and monitor your engine instruments for indications of a possible flameout. If engines flameout, continue attempting restart procedures, as exiting the ash cloud may improve the probability of light off. Declare an in-flight emergency as soon as practicable, and land at the nearest suitable airfield. Transmit PIREPs to military weather stations to report the location of the volcanic ash cloud (to warn other aircrews). As soon as safely possible, record the altitude, location, duration of exposure, and any related malfunctions observed, since special aircraft cleanup procedures are required after flight through volcanic ash.

STUDY QUESTIONS**Weather Hazards of Turbulence, Icing, Ceilings, Visibility, and Ash Clouds**

1. Which one of the following is not one of the classifications used to describe turbulence?
 - a. Trace
 - b. Light
 - c. Moderate
 - d. Extreme

2. Which one of the following may cause mechanical turbulence when air is flowing over it?
 - a. Irregular terrain
 - b. Buildings
 - c. Mountains
 - d. All of the above

3. Which one of the following is not one of the cloud formations associated with mountain wave turbulence?
 - a. Lenticular cloud
 - b. Roll cloud
 - c. Rotor cloud
 - d. Cap cloud

4. Frontal turbulence would be the most severe when associated with a _____.
 - a. fast-moving warm front
 - b. fast-moving cold front
 - c. slow-moving warm front
 - d. slow-moving cold front

5. Which one of the following is not one of the recommended procedures for flying through turbulence?
 - a. Establish and maintain thrust settings consistent with cruise airspeeds.
 - b. Control attitude by referencing the attitude gyro indicator.
 - c. To avoid overstressing the aircraft, do not make abrupt control inputs.
 - d. Allow airspeed and altitude to vary; do not chase the altimeter.

6. Which precipitation best characterizes super cooled water?
- Hail
 - Wet snow
 - Heavy showers
 - Freezing drizzle
7. In addition to freezing temperatures, what other conditions are necessary for the formation of ice on aircraft?
- Invisible moisture, and rain
 - Visible moisture, and aircraft skin temperature below freezing
 - Humidity above 75 percent, and aircraft skin temperature below freezing
 - Strong head winds and clear skies
8. An aviation hazard associated with structural icing is that it results in_____.
- a reduction of lift by changing the airfoil characteristics
 - a decrease in airspeed
 - a decrease in drag
 - both a and c are correct
9. Clear icing will generally be encountered between a temperature range of_____.
- 2 °C and -10 °C
 - 0 °C and -10 °C
 - 0 °C and -20 °C
 - +2 °C and -20 °C

In questions 10 through 13, match the types of structural ice in column B with the correct descriptions in column A.

- | <u>A</u> | <u>B</u> |
|--|----------------|
| 10. Formed from small super-cooled water droplets in stratiform clouds of stable air | |
| 11. Consists of ice crystals formed by deposition. | a. Clear icing |
| 12. Formed by large individual water droplets freezing as they strike the aircraft surface | b. Rime icing |
| 13. Considered to be the most frequently encountered type of icing | c. Mixed icing |
| | d. Frost |

14. What happens to stall speed when ice forms on the wings of an aircraft?
- It will increase.
 - It will decrease.
 - It will remain the same.
 - All of the above.
15. Engine failure due to icing conditions encountered by a jet aircraft is generally the result of _____.
- carburetor icing
 - a rapid drop in exhaust gas temperature
 - a decrease in the fuel-air ratio
 - induction icing
16. Ice in the pitot tube or static ports could affect instruments, depending on the type of aircraft and its system hookup.
- True
 - False
17. Which one of the following would be correct if an aircraft attempted to takeoff without removing frost formed during the night?
- Increase in the stall speed
 - Lift and drag/ratios will be affected
 - Extensive weight increase
 - All of the above are correct
 - Only a and b are correct
18. Which one of the following types of clouds would you most likely fly through if encountering clear icing?
- Nimbostratus
 - Cumulus
 - Cirrocumulus
 - Both b and c are correct
19. Which one of the following states a correct evasive tactic used when wet snow or freezing rain is encountered?
- Climb or descend to colder air in either case.
 - Climb or descend to warmer air in either case.
 - Climb to colder air with wet snow and climb to warmer air with freezing rain.
 - Climb to warmer air with wet snow and climb to colder air with freezing rain.

20. Which one of the following is not a of the classification used to describe icing?
- Light
 - Moderate
 - Severe
 - Extreme
21. Which one of the following conditions would most likely result in frost on an aircraft?
- Cloudy nights, 5 knots of wind, dew point 28° F
 - Clear nights, no wind, dew point of 28° F
 - Clear nights, 5 knots of wind, dew point of 32° F
 - Cloudy nights, no wind, dew point of 37° F
22. Which one of the following describes a basic type of fog classification?
- Air mass
 - Advection
 - Adiabatic
 - All of the above are correct
23. Which one of the following will result in the saturation of an air mass?
- Rising dew point
 - Lowering humidity
 - Lowering dew point
 - Rising temperature
24. A layer of condensed water vapor is considered to be fog if its base is at or below 20 feet above terrain elevation and greater than 50 feet in thickness.
- True
 - False
25. Radiation fog could be expected in areas characterized by_____.
- low wind speed, and clear skies
 - low wind speed, and cloudy skies
 - high wind speed, and cloudy skies
 - high wind speed, and clear skies

26. What phenomenon would your aircraft be flying through if experiencing a rise in oil temperatures, acrid odor (possibly from an electrical fire), airspeed fluctuations, pitted windscreens, and a bright orange glow around the engine inlets?

- a. Advection fog
- b. Microburst
- c. Volcanic ash cloud
- d. Mountain wave turbulence

APPENDIX A

GLOSSARY OF SELECTED METEOROLOGICAL TERMS

ACTUAL TIME OF OBSERVATION – For METAR reports, it is the time the last element of the report is observed or evaluated. For SPECI reports, it is the time the criteria for a SPECI were met or noted.

ADIABATIC – The word applied in the science of thermodynamics to a process during which no heat is communicated to or withdrawn from the body or system concerned. Adiabatic changes of atmospheric temperatures are those that occur only in consequence of compression or expansion accompanying an increase or a decrease of atmospheric pressure.

AIRCRAFT MISHAP – An inclusive term to denote the occurrence of an aircraft accident or incident.

ALTIMETER SETTING – Pressure of the reporting station converted in order to produce a reading on altimeters of field elevation at ten feet above the runway (normal installation height of the altimeter). Altimeter settings are given in inches of mercury and represent sea level pressure.

ATMOSPHERIC PRESSURE – The force exerted by the weight of the atmosphere from the level of measurement to its outer limits.

AUGMENTED REPORT – A meteorological report prepared by an automated surface weather observing system for transmission with certified weather observers signed on to the system to add information to the report.

AUTOMATED REPORT – A meteorological report prepared by an automated surface weather observing system for transmission, and with no certified weather observers signed on to the system.

BLOWING DUST – Dust raised by the wind to moderate heights above the ground and restricting horizontal visibility to less than seven miles. If visibility is reduced to between 5/8 and 5/16 then it is a duststorm; if less than 5/16, it is a severe duststorm.

BLOWING SAND – Sand raised by the wind to moderate heights above the ground and restricting horizontal visibility to less than seven miles. If visibility is reduced to between 5/8 and 5/16 then its a sandstorm; if less than 5/16, its a severe sandstorm.

BLOWING SNOW – Snow particles raised and stirred violently by the wind to moderate or great heights. Visibility is poor (six miles or less) and the sky may become obscured when the particles are raised to great heights.

BLOWING SPRAY – Spray raised in such quantities as to reduce the visibility at eye level (six feet on shore, 33 feet at sea) to six miles or less.

BROKEN LAYER – A cloud layer covering whose summation amount of sky cover is 5/8 through 7/8.

CALM – A condition when no motion of the air is detected.

CEILING – The height above the Earth's surface (field elevation or ground elevation) of the lowest non-surface based layer that is reported as broken or overcast, or the vertical visibility into an indefinite ceiling.

CEILOMETER – A device used to evaluate the height of clouds or the vertical visibility into a surface-based obscuration.

CELSIUS – The ninth General Conference of Weights and Measures, held in October 1948, adopted the name Celsius in place of centigrade in honor of its originator, Anders Celsius (1704-1744), a Swedish astronomer who devised the scale.

CLEAR-AIR TURBULENCE (CAT) – Turbulence encountered when flying through air devoid of clouds, produced primarily by thermals and wind shear, including proximity to the jet stream.

CLEAR SKY (SKC) – The state of the sky when it is cloudless.

CLOUD-AIR LIGHTNING (CA) – Streaks of lightning which pass from a cloud to the air, but do not strike the ground.

CLOUD-CLOUD LIGHTNING (CC) – Streaks of lightning reaching from one cloud to another.

CLOUD-GROUND LIGHTNING (CG) – Lightning occurring between cloud and ground.

CLOUD HEIGHT – The height of the base of a cloud or cloud layer above the surface of the Earth.

CONTOUR LINE – A line connecting points of equal (constant) height on a Constant-Pressure Chart.

COORDINATED UNIVERSAL TIME (UTC) – The time in the zero meridian time zone.

CUMULUS – A principal cloud type in the form of individual, detached elements that are generally dense and possess sharp non-fibrous outlines.

CUMULONIMBUS – An exceptionally dense and vertically developed cloud, occurring either isolated or as a line or wall of clouds with separated upper portions. These clouds appear as mountains or huge towers, at least a part of the upper portions of which are usually smooth, fibrous, or striated, and almost flattened.

DESIGNATED RVR RUNWAY – A runway at civilian airports designated by the FAA for reporting RVR in long-line transmissions.

DEW POINT – The temperature to which a given parcel of air must be cooled at constant pressure and constant water-vapor content in order for saturation to occur.

DISPATCH VISUAL RANGE – A visual range value derived from an automated visibility sensor.

DRIZZLE – Fairly uniform precipitation composed exclusively of fine drops (diameter less than 0.02 inch or 0.5 mm) very close together. Drizzle appears to float while following air current, although unlike fog droplets, it falls to the ground.

DRY ADIABATIC LAPSE RATE – The rate of decrease of temperature with height, approximately equal to 3°C per 1000 feet. This is close to the rate at which an ascending body of unsaturated air will cool by adiabatic expansion.

DUSTSTORM – An unusual weather condition, frequently severe, characterized by strong winds and dust-filled air over an extensive area.

FEW – A layer whose summation amount of sky cover is 1/8 through 2/8.

FIELD ELEVATION – The elevation above sea level of the highest point on any of the runways of the airport.

FOG – A visible aggregate of minute water particles (droplets) which are based at the Earth's surface and reduce horizontal visibility to less than 5/8 statute mile and, unlike drizzle, it does not fall to the ground.

FREEZING – A descriptor, FZ, used to describe drizzle and/or rain that freezes on contact with the ground or exposed objects, and used also to describe fog that is composed of minute ice crystals.

FREEZING DRIZZLE – Drizzle that freezes upon impact with the ground, or other exposed objects.

FREEZING FOG – A suspension of numerous minute ice crystals in the air or water droplets at temperatures below 0°Celsius based at the Earth's surface, which reduces horizontal visibility. It is also called ice fog.

FREEZING PRECIPITATION – Any form of precipitation freezing on impact and forming a glaze on the ground or exposed objects.

FREEZING RAIN – Rain freezing on impact and forming a glaze on the ground or exposed objects.

FROZEN PRECIPITATION – Any form of precipitation that reaches the ground in solid form (snow, small hail and/or snow pellets, snow grains, hail, ice pellets, and ice crystals).

FUNNEL CLOUD – A violent, rotating column of air, which does not touch the ground and usually appended to a cumulonimbus cloud (see tornado and waterspout).

GLAZE – Ice formed by freezing precipitation covering the ground or exposed objects.

GRAUPEL – Granular snow pellets, also called soft hail.

GUST – Rapid fluctuations in wind speed with a variation of ten knots or more between peaks and lulls.

HAIL – Precipitation in the form of small balls or other pieces of ice falling separately or frozen together in irregular lumps.

HAZE – A suspension in the air of extremely small, dry particles invisible to the naked eye and sufficiently numerous to give the air an opalescent appearance.

HECTOPASCAL – A unit of measure of atmospheric pressure equal to 100 newtons per square meter, abbreviated hPa.

ICE CRYSTALS (DIAMOND DUST) – A fall of unbranched (snow crystals) are branched ice crystals in the form of needles, columns, or plates.

ICE PELLETS (PL) – Precipitation of transparent or translucent pellets of ice, which are round or irregular, rarely conical, and which have a diameter of 0.2 inch (5 mm), or less. There are two main types:

1. Hard grains of ice consisting of frozen raindrops, or largely melted and refrozen snowflakes.
2. Pellets of snow encased in a thin layer of ice which have formed from the freezing of either droplets intercepted by the pellets or of water resulting from the partial melting of the pellets.

IN-CLOUD LIGHTNING (IC) – Lightning which takes place within the thunder-cloud.

INDEFINITE CEILING – The ceiling classification applied when the reported ceiling value represents the vertical visibility upward into surface-based obscuration.

INSOLATION – INcoming SOLar radiATION. The total amount of Sun radiated energy reaching the Earth's surface. Insolation is the primary source for all weather phenomena on the Earth.

INTENSITY QUALIFIER – Intensity qualifiers are used to describe whether a phenomena is light (–), moderate (no symbol used), or heavy (+).

ISOBAR – A line on a chart or diagram drawn through places or points having the same barometric pressure. (Isobars are customarily drawn on weather charts to show the horizontal

distribution of atmospheric pressure reduced to sea level or the pressure at some specified altitude.)

ISOTACH – A line joining points of equal wind speed.

ISOTHERM – A line on a chart or diagram drawn through places or points having equal temperature.

LOW DRIFTING – A descriptor, DR, used to describe snow, sand, or dust raised to a height of less than six feet above the ground.

LOW DRIFTING DUST – Dust raised by the wind to less than six feet above the ground; visibility is not reduced below seven statute miles at eye level, although objects below this level may be veiled or hidden by the particles moving nearly horizontal to the ground.

LOW DRIFTING SAND – Sand raised by the wind to less than six feet above the ground; visibility is not reduced below seven statute miles at eye level, although objects below this level may be veiled or hidden by the particles moving nearly horizontal to the ground.

LOW DRIFTING SNOW – Snow raised by the wind to less than six feet above the ground; visibility is not reduced below seven statute miles at eye level, although objects below this level may be veiled or hidden by the particles moving nearly horizontal to the ground.

MANUAL STATION – A station, with or without an automated surface weather observing system, where the certified observers are totally responsible for all transmitted meteorological reports.

METAR/SPECI – An evaluation of select weather elements from a point or points on or near the ground according to a set of procedures. It may include type of report, station identifier, date and time of report, a report modifier, wind, visibility, runway visual range, weather and obstructions to vision, sky condition, temperature and dew point, altimeter setting, and remarks.

MILLIBAR – (Bar – a unit of pressure equal to 1,000,000 dynes per square centimeter.) A millibar is equal to 1/1,000 of a bar.

MIST – A hydrometer consisting of an aggregate of microscopic and more-or-less hygroscopic water droplets or ice crystals suspended in the atmosphere that reduces visibility to less than six statute miles but greater than or equal to 5/8 statute mile.

MOIST ADIABATIC LAPSE RATE – See Saturated Adiabatic Lapse Rate.

NON-UNIFORM SKY CONDITION – A localized sky condition varying from that reported in the body of the report.

NON-UNIFORM VISIBILITY – A localized visibility varying from that reported in the body of the report.

OBSCURED SKY – The condition when the entire sky is hidden by a surface-based obscuration.

OBSCURATION – Any aggregate of particles in contact with the Earth's surface that is dense enough to be detected from the surface of the Earth. Also, any phenomenon in the atmosphere, other than precipitation reducing the horizontal visibility.

OVERCAST – A layer of clouds whose summation amount of sky cover is 8/8.

PARTIAL – A descriptor, PR, used only to report fog that covers part of the airport.

PARTIAL FOG – Fog covering part of the station and which extends to at least six feet above the ground and apparent visibility in the fog is less than 5/8 SM. Visibility over parts of the station is less than or equal to 5/8 SM.

PARTIAL OBSCURATION – The portion of the sky cover (including higher clouds, the moon, or stars) hidden by weather phenomena in contact with the surface.

PATCHES – A descriptor, BC, used only to report fog that occurs in patches at the airport.

PATCHES (OF) FOG – Fog covering part of the station which extends to at least six feet above the ground and the apparent visibility in the fog patch or bank is less than 5/8 SM. Visibility in parts of the observing area is greater than or equal to 5/8 SM, when the fog is close to the point of observation, the minimum visibility reported will be less than 5/8 SM.

PEAK WIND SPEED – The maximum instantaneous wind speed since the last METAR that exceeded 25 knots.

PRECIPITATION DISCRIMINATOR – A sensor, or array of sensors, that differentiates between different types of precipitation (liquid, freezing, frozen).

PRESSURE FALLING RAPIDLY – A decrease in station pressure at a rate of 0.06 inch of mercury or more per hour which totals 0.02 inch or more.

PRESSURE RISING RAPIDLY – An increase in station pressure at a rate of 0.06 inch of mercury or more per hour which totals 0.02 inch or more.

RADIOSONDE – A balloon-borne instrument used to measure the temperature, pressure and humidity aloft.

RAIN – Precipitation of liquid water particles, either in the form of drops larger than .02 inch (0.5 mm) or smaller drops which, in contrast to drizzle, are widely separated.

PREVAILING VISIBILITY – The visibility considered representative of conditions at the station; the greatest distance seen throughout at least half the horizon circle, not necessarily continuous.

ROTOR CLOUD – A turbulent cloud formation found in the lee of some large mountain barriers. The air in the cloud rotates around an axis parallel to the mountain range.

RUNWAY VISUAL RANGE – An instrument-derived value, based on standard calibrations, representing the horizontal distance a pilot may see down the runway from the approach end.

SANDSTORM – Particles of sand ranging in diameter from 0.008 to 1 mm carried aloft by a strong wind. The sand particles are mostly confined to the lowest ten feet, and rarely rise more than 50 feet above the ground.

SATURATED ADIABATIC LAPSE RATE – A rate of decrease of temperature with height equal to the rate at which an ascending body of saturated air will cool during adiabatic expansion. This value will vary, but is considered to average about 1.5°C. per 1000 feet.

SCATTERED – A layer whose summation amount of sky cover is 3/8 through 4/8.

SCHEDULED TIME OF REPORT – The time a scheduled report is required to be available for transmission.

SEA-LEVEL PRESSURE – The pressure value obtained by the theoretical reduction or increase of barometric pressure to sea-level; measured in hectopascals (millibars).

SECTOR VISIBILITY – The visibility in a specified direction that represents at least a 45° arc of the horizon circle.

SHALLOW – A descriptor, MI, used only to describe fog when the visibility at six feet above the ground is 5/8 statute mile or more and the apparent visibility in the fog layer is less than 5/8 statute mile.

SHALLOW FOG – Fog in which the visibility at six feet above ground level is 5/8 statute mile or more and the apparent visibility in the fog layer is less than 5/8 statute mile.

SHOWER(S) – A descriptor, SH, used to qualify precipitation characterized by the suddenness with which they start and stop, by the rapid changes of intensity, and usually by rapid changes in the appearance of the sky.

SIGNIFICANT CLOUDS – Cumulonimbus, cumulonimbus mammatus, towering cumulus, altocumulus castellanus, and standing lenticular or rotor clouds.

SKY CONDITION – The state of the sky in terms of such parameters as sky cover, layers and associated heights, ceiling, and cloud types.

SKY COVER – The amount of the sky covered by clouds or partial obscurations in contact with the surface.

SMOKE – A suspension in the air of small particles produced by combustion. A transition to haze may occur when smoke particles have traveled great distances (25 to 100 statute miles or more) and when the larger particles have settled out and the remaining particles have become widely scattered through the atmosphere.

SNOW – Precipitation of snow crystals, mostly branched in the form of six-pointed stars; for automated stations, any form of frozen precipitation other than hail.

SNOW GRAINS – Precipitation of very small, white opaque grains of ice; the solid equivalent of drizzle.

SNOW PELLETS – Precipitation of white, opaque grains of ice. The grains are round or sometimes conical. Diameters range from about 0.08 to 0.2 inch (2 to 5 mm).

SPRAY – An ensemble of water droplets torn by the wind from an extensive body of water, generally from the crests of waves, and carried up into the air in such quantities that it reduces the horizontal visibility.

SPECI – A surface weather report taken to record a change in weather conditions meeting specified criteria or is otherwise considered to be significant.

SQUALL – A strong wind characterized by a sudden onset in which wind speeds increase to at least 16 knots and are sustained at 22 knots or more for at least one minute.

STANDARD ATMOSPHERE – A hypothetical vertical distribution of the atmospheric temperature, pressure, and density, which by international agreement is considered to be representative of the atmosphere for pressure-altimeter calibrations and other purposes (29.92 in-Hg or 1013 Pa).

STANDING LENTICULAR CLOUD – A more or less isolated cloud with sharp outlines generally in the form of a smooth lens or almond. These clouds often form on the lee side of and generally parallel to mountain ranges. Depending on their height above the surface, they may be reported as stratocumulus standing lenticular cloud (SCSL), altocumulus standing lenticular (ACSL), or cirrocumulus standing lenticular cloud (CCSL).

STATION ELEVATION – The officially designated height above sea level to which station pressure pertains. It is generally the same as field elevation at an airport station.

STATION IDENTIFIER – A four-alphabetic-character code group used to identify the observing location.

STATION PRESSURE – Atmospheric pressure computed for the level of the station elevation.

SUMMATION LAYER AMOUNT – A categorization of the amount of sky cover at and below each reported layer of cloud.

SUMMATION PRINCIPLE – This principle states the sky cover at any level is equal to the summation of the sky cover of the lowest layer, plus the additional sky cover present at all successively higher layers up to and including the layer being considered.

SURFACE VISIBILITY – The prevailing visibility determined from the usual point of observation.

SYNOPTIC CHART – A chart, such as the ordinary weather map, which shows the distribution of meteorological conditions over an area at a given moment.

THUNDERSTORM – A descriptor, TS, used to qualify precipitation produced by a cumulonimbus cloud accompanied by lightning and thunder, or for automated systems, a storm detected by lightning detection systems.

TIME OF OCCURRENCE – A report of the time weather begins and ends.

TORNADIC ACTIVITY – The occurrence or disappearance of tornadoes, funnel clouds, or waterspouts.

TORNADO – A violent, rotating column of air touching the ground or funnel cloud touching the ground (see funnel cloud and water spout).

TOWER VISIBILITY – The prevailing visibility determined from the airport traffic control tower when the surface visibility is determined from another location.

TOWERING CUMULUS – A descriptive term for a cloud with generally sharp outlines and with moderate to great vertical development, characterized by its cauliflower or tower appearance.

UNKNOWN PRECIPITATION – Precipitation type reported if the automated station detects the occurrence of light precipitation but the precipitation discriminator cannot recognize the type.

VARIABLE CEILING – A ceiling of less than 3000 feet, which rapidly increases or decreases in height by established criteria during the period of observation.

VARIABLE LAYER AMOUNTS – A condition when the reportable amount of a layer varies by one or more reportable values during the period it is being evaluated (variable sky condition).

VARIABLE PREVAILING VISIBILITY – A condition when the prevailing visibility is less than three statute miles and rapidly increases and decreases by 1/2 mile or more during the period of observation.

VARIABLE WIND DIRECTION – A condition when:

1. The wind direction fluctuates by 60° or more during the two minute evaluation period and wind speed is greater than six knots; or

2. The direction is variable and wind speed is six knots or less.

VERTICAL VISIBILITY – A subjective or instrumental evaluation of the vertical distance into a surface-based obscuration that an observer would be able to see.

VICINITY – A proximity qualifier, VC, used to indicate weather phenomena observed between five and ten statute miles of the usual point of observation but not at the station.

VIRGA – Visible wisps or strands of precipitation falling from clouds and evaporating before reaching the surface.

VISIBILITY – The greatest horizontal distance at which selected objects can be seen and identified or its equivalent derived from instrumental measurements.

VOLCANIC ASH – Fine particles of rock powder that originate blown out from a volcano and that may remain suspended in the atmosphere for long periods. The ash is a potential hazard to aircraft operations and may be an obscuration.

VOLCANIC ERUPTION – An explosion caused by the intense heating of subterranean rock which expels lava, steam, ashes, etc., through vents in the Earth's crust.

WATERSPOUT – A violent, rotating column of air forming over a body of water, and touching the water surface; tornado or funnel cloud touching a body of water (see funnel cloud and tornado).

WELL-DEVELOPED DUST/SAND WHIRL – An ensemble of particles of dust or sand, sometimes accompanied by small litter, raised from the ground in the form of a whirling column of varying height with a small diameter and an approximately vertical axis.

WIDESPREAD DUST – Fine particles of Earth or other matter raised or suspended in the air by the wind that may have occurred at or far away from the station.

WIND SHIFT – A change in the wind direction of 45° or more in less than 15 minutes with sustained wind speeds of ten knots or more throughout the wind shift.

APPENDIX B
COMMON WEATHER CONTRACTIONS

| | |
|------------------------------------|--|
| A | |
| ABT..... about | BYD..... beyond |
| ABV.....above | |
| AC.....altocumulus | C |
| ACS..... across | C..... ceiling |
| ACFT.....aircraft | CA.....clear above |
| ACRS..... across | CAT..... clear air turbulence |
| ACTVTY/ACT..... activity | CBS/CB..... cumulonimbus |
| ADJ..... adjacent | CDFNT/CFP.....cold front |
| ADVY..... advisory | CDT..... Central Daylight Time |
| AFT..... after | CHC..... chance |
| AGL.....above ground level | CI..... cirrus |
| AHD..... ahead | CIG..... ceiling |
| ALF..... aloft | CIGS.....ceilings |
| ALG..... along | CLD..... cold |
| ALQDS.....all quadrants | CLDS.....clouds |
| AMS..... air mass | CLR.....clear (used at automated stations) |
| AOB..... at or below | CLSD..... closed |
| APRNT..... apparent | CNCL..... cancel |
| AR..... Arkansas | CNTRD/CNTR.....centered |
| ARPT.....airport | CNTRL/CTRL..... central |
| ATLC..... Atlantic | CNSDBLY.....considerably |
| AUTO..... automated weather report | CNVGNC..... convergence |
| | CNVTV.....convective |
| B | CO..... Colorado |
| B.....began | CONDS.....conditions |
| BA..... breaking action | CON/CONTD..... continue |
| BC..... patches | CONS.....continuous |
| BCM.....become | CONTG..... continuing |
| BCMG..... becoming | COR..... correction |
| BGNG..... beginning | CST..... Central Standard Time |
| BHND..... behind | CSTL..... coastal |
| BINOVC..... breaks in overcast | CTC.....contact |
| BKN..... broken | CU.....cumulus |
| BL..... blowing | CUFA..... cumulofractus |
| BLDPS..... buildups | |
| BLO/BLW..... below | D |
| BNDRY..... boundary | D..... dust |
| BR..... mist | DCRG..... decreasing |
| BRFLY.....briefly | DEP..... depth |
| BTWN..... between | DMSHG..... diminishing |

APPENDIX B**AVIATION WEATHER**

| | |
|--|--|
| DR.....dropping rapidly | FRZLVL.....freezing level |
| DR.....low drifting | FT.....feet |
| DRFTG.....drifting | FU.....smoke |
| DS.....dust storm | FXD.....fixed |
| DSIPTG.....dissipating | FVRBL.....favorable |
| DSNT.....distant | FZ.....freezing |
| DU.....(widespread) dust | FZRNO.....freezing rain sensor not available |
| DURG.....during | |
| DURCG.....during climb | G |
| DURGD.....during descent | G.....gust/gusting |
| DVLP/DVLPG.....develop/developing | GA.....Georgia |
| DVR.....dispatch visual range | GND.....ground |
| DZ.....drizzle | GR.....hail (graupel) |
| | GRT/GTR.....greater |
| E | GS.....small hail/snow pellets |
| E.....ended/east | GULFMEX/GLF.....Gulf of Mexico |
| EBND.....eastbound | |
| ELSW.....elsewhere | H |
| ELY.....easterly | H/HZ.....haze |
| EMBDD.....embedded | HALF.....haze aloft |
| ERN.....eastern | HGTS.....heights |
| EST.....estimated | HI.....high |
| EWD.....eastward | HLSTO/GR/GS.....hailstone |
| EXCP/EXC.....except | HZ.....haze |
| EXPCD/EXPCTD/EXPTD/EXP.....expected | |
| EXTM/EXTRM.....extreme | I |
| EXTDS.....extends | IA.....Iowa |
| | IC.....icing/ice crystals |
| F | ICGIC.....icing in clouds |
| FAP.....final approach | ICGICIP.....icing in clouds & in precipitation |
| FEW.....few clouds | ID.....Idaho |
| FC.....funnel cloud(s) | IFR.....Instrument Flight Rules |
| FCST.....forecast | IL.....Illinois |
| FG.....fog | IMPVG/IPVG.....improving |
| FIBI.....filed but impractical to transmit | INC.....in clouds |
| FL.....flight level/Florida | IN.....inch/Indiana |
| FLT.....flight | INCRG.....increasing |
| FM.....from | INTMT.....intermittent |
| FNT.....front | INTSFYG.....intensifying |
| FNTL.....frontal | INSTBY.....instability |
| FRQ.....frequent | INVOF.....in vicinity of |
| FQTLY.....frequently | ISLTD/ISOLD.....isolated |
| FRMG.....for | |
| FROPA.....frontal passage | J |
| FRTHR.....further | JSTR.....jet stream |

AVIATION WEATHER**APPENDIX B**

| | | |
|--|---|--|
| K | | |
| K/FU smoke | MS Mississippi | |
| KALF smoke aloft | MSL mean sea level | |
| KOCTY smoke over city | MST most | |
| KS Kansas | MSTLY mostly | |
| KT knot | MSTR moisture | |
| KTS knots | MT mountains/Montana | |
| | MTN/MTNS mountain/mountains | |
| L | | |
| LCL local | MULTILYRD multi layered | |
| LCLY locally | MVFR Marginal Visual Flight Rules | |
| LE Lake Erie | MXD mixed | |
| LGT light | N | |
| LI lifted index | N north | |
| LLWS low level wind shear | ND North Dakota | |
| LN line | NE Nebraska or northeast | |
| LOC location identifier | NEG negative | |
| LO low | NEWD northeastward | |
| LRG large | NJ New Jersey | |
| LTG lightning | NMRS numerous | |
| LTGCA lightning cloud to air | NNEWD north-northeastward | |
| LTGCCG lightning cloud to cloud and cloud to ground | NR near | |
| LTGCG lightning cloud to ground | NRN northern | |
| LTGIC lightning in cloud | NW northwest | |
| LTL little | NWD northward | |
| LTLCHG little change | NWLY northwesterly | |
| LVL level | | |
| LWR lower | O | |
| LWRG lowering | OBSCD obscured | |
| LYR/LYRD layer/laye | OBSCG obscuring | |
| | OBSCN obscuration | |
| M | | |
| M minus; less than | OCNL occasional | |
| MALSR medium intensity approach lighting system | OCNLY occasionally | |
| MAX maximum | OMTS over mountains | |
| MDT/MOD moderate | OR Oregon | |
| MEGG merging | OTLK outlook | |
| MI Michigan/miles/shallow | OTRW otherwise | |
| MO Missouri | OTS out of service | |
| MOGR moderate or greater | OVC overcast | |
| MOV move | OVHD overhead | |
| MOVD moved | OVR over | |
| MOVG\MVG moving | | |

APPENDIX B**AVIATION WEATHER**

| | |
|---|---|
| P | SFC..... surface |
| P..... plus; greater than | SG..... snow grains |
| PCPN..... precipitation | SGFNT/SIG..... significant |
| PE..... ice pellets | SH..... shower(s) |
| PNHDL..... panhandle | SHD/SHLD..... should |
| PK..... peak | SHFTG..... shifting |
| PK WND..... peak wind | SHLW..... shallow |
| PO..... well-developed dust/sand whirls | SHWRS..... showers |
| PR..... partial | SIG CLD..... significant cloud |
| PRCTN..... precautions | SKC..... sky clear |
| PRD..... period | SLD..... solid |
| PRES..... pressure | SLGT..... slight |
| PRESFR..... pressure falling rapidly | SLP..... sea level pressure |
| PRESRR..... pressure rising rapidly | SLPG..... sloping |
| PSBL/POSS..... possible | SLPNO..... sea level pressure not available |
| PTN/PTNS..... portion/portions | SLY..... southerly |
| PY..... spray | SM..... statute miles |
| | SMTH..... smooth |
| R | SN..... snow |
| R..... runway | SPECI..... a special observation |
| RA..... rain | SPRDG..... spreading |
| RDG..... reading | SQ..... squalls |
| REPTD/RPRTD/RPTD..... reported | SQLN..... squall line |
| RGD..... ragged | SRN..... southern |
| RMN..... remain | SS..... sand storm |
| RMNDR..... remainder | ST..... stratus |
| RQR..... require | STFRA..... stratofractus |
| RTD..... routine delayed observation | STG..... strong |
| RVR..... runway visual range | STN..... station |
| RVRNO..... RVR not available | STNRY..... stationary |
| RWU..... rain shower intensity unknown | SVRL..... several |
| RWY/RYS..... runway | SWD/SWRD/SWWD..... southwestward |
| | SW..... snow showers or southwest |
| S | SYNS..... synopsis |
| S..... South | T |
| SA..... sand | TAF..... terminal aerodrome forecast |
| SCSL..... stratocumulus standing lenticular cloud | TE..... thunder ended |
| | TEMPS..... temperatures |
| SCT..... scattered | THN..... thin |
| SD..... South Dakota | THRU..... through |
| SE..... southeast | THSD..... thousand |
| SECS..... sections | TIL..... until |
| SERN..... southeastern | TS/TSTMS..... thunderstorms |
| SEV/SVR..... severe | TWR..... tower |
| SEWD..... southeastward | TURB..... turbulence |

B-4 Common Weather Contractions

AVIATION WEATHER**APPENDIX B**

| U | WIND DIRECTIONS (8 POINTS) |
|--|---|
| UP unknown precipitation | |
| UPR upper | N –NORTH–000° or 360° |
| UTC Coordinated Universal Time | NE –NORTHEAST–045° |
| UDDF updrafts and downdrafts | E –EAST–090° |
| UNK/UNKN unknown | SE –SOUTHEAST–135° |
| UNSTBL unstable | S –SOUTH–180° |
| UP unknown precipitation | SW –SOUTHWEST–225° |
| | W –WEST–270° |
| V | NW –NORTHWEST–315° |
| V variable | For additional contractions, acronyms, and |
| VA volcanic ash | locations not found in this Appendix, consult |
| VC/VCNTY vicinity | Section 14 of the AC 00-45E, Aviation |
| VFR Visual Flight Rules | Weather Services, available at the following |
| VIS visibility | location: http://www.faa.gov/avr/afs/afs400 |
| VLYS valleys | |
| VOR Very high frequency/ Omni-directional Range | |
| VR visual range | |
| VRB/VRBL variable | |
| VRY very | |
| VSBYDR visibility decreasing rapidly | |
| VV vertical visibility | |
| | |
| W | |
| W West | |
| WA Washington | |
| WBND westbound | |
| WDLY widely | |
| WS wind shear | |
| WSCONDS wind shear conditions | |
| WSHFT wind shif | |
| WTRS waters | |
| WX weather | |
| | |
| X | |
| XCP/XCPT except | |
| XTNDG extending | |
| | |
| Z | |
| Z Zulu Time (UTC) | |
| | |

THIS PAGE INTENTIONALLY LEFT BLANK

APPENDIX C

LOCATION IDENTIFIERS

| | | | |
|-----------|---------------------|-----------|--------------------------|
| KABI..... | Abilene, TX | KCTY..... | Cross City, FL |
| KABQ..... | Albuquerque, NM | KCVG..... | Cincinnati, OH |
| KABR..... | Aberdeen, SD | KDAB..... | Daytona Beach, FL |
| KABY..... | Albany, GA | KDAL..... | Dallas, TX |
| KACT..... | Waco, TX | KDCA..... | Washington, DC |
| KACY..... | Atlantic City, NJ | KDDC..... | Dodge City, KS |
| KADM..... | Ardmore, OK | KDFW..... | Fort Worth, TX |
| KAEX..... | England AFB, LA | KDHN..... | Dothan, AL |
| KAGS..... | Augusta, GA | KDLF..... | Loughlin AFB, TX |
| KALO..... | Waterloo, IA | KDOV..... | Dover AFB, DE |
| KAMA..... | Amarillo, TX | KDRT..... | Del Rio, TX |
| KANB..... | Anniston, AL | KDUA..... | Durant, OK |
| KAND..... | Anderson, SC | KDYR..... | Dyersburg, TN |
| KAQQ..... | Apalachicola, FL | KDYS..... | Dyess AFB, TX |
| KARG..... | Walnut Ridge, AR | KEFD..... | Ellington AFB, TX |
| KART..... | Watertown, NY | KELP..... | El Paso, TX |
| KATL..... | Atlanta, GA | KEND..... | Enid, OK |
| KAUG..... | Augusta, GA | KEUG..... | Eugene, OR |
| KAUS..... | Austin, TX | KFAT..... | Fresno, CA |
| KAVL..... | Asheville, NC | KFBG..... | Fort Bragg, NC |
| KBAD..... | Barksdale AFB LA | KFDY..... | Findley, OH |
| KBAL..... | Baltimore, MD | KFFO..... | Wright Patterson AFB, OH |
| KBFM..... | Brookley VOR, AL | KFLO..... | Florence, SC |
| KBGS..... | Big Springs, TX | KFMN..... | Farmington, NM |
| KBHM..... | Birmingham, AL | KFMY..... | Fort Myers, FL |
| KBIS..... | Bismarck, ND | KFOD..... | Fort Dodge, IA |
| KBIX..... | Biloxi, MS | KFSI..... | Fort Sill, OK |
| KBLD..... | Boulder City, NV | KFSM..... | Fort Smith, AR |
| KBLH..... | Blythe, CA | KFTY..... | Fulton County VOR, GA |
| KBNA..... | Nashville, TN | KFWH..... | Carswell AFB, TX |
| KBOI..... | Boise, ID | KFYV..... | Fayetteville, AR |
| KBOS..... | Boston, MA | KGAG..... | Gage, OK |
| KBPT..... | Beaumont, TX | KGCK..... | Garden City, KS |
| KBRO..... | Brownsville, TX | KGFA..... | Great Falls, MT |
| KBSM..... | Bergstrom AFB, TX | KGFK..... | Grand Forks, ND |
| KBTR..... | Baton Rouge, LA | KGGG..... | Longview, TX |
| KBWG..... | Bowling Green KY | KGLS..... | Galveston, TX |
| KCAE..... | Columbia, SC | KGPT..... | Gulfport, MS |
| KCBM..... | Columbus, MS | KGRI..... | Grand Island, NE |
| KCDW..... | Caldwell, NJ | KGRK..... | Gray AAF, TX |
| KCDS..... | Childress, TX | KGSO..... | Greensboro, NC |
| KCEW..... | Crestview, FL | KGUS..... | Grissom AFB, IN |
| KCHA..... | Chattanooga, TN | KGUY..... | Guymon, OK |
| KCHI..... | Chicago, IL | KGWO..... | Greenwood, MS |
| KCHS..... | Charleston, SC | KHAR..... | Harrisburg, PA |
| KCID..... | Cedar Rapids, IA | KHAT..... | Cape Hatteras, NC |
| KCLL..... | College Station, TX | KHLR..... | Fort Hood AAF, TX |
| KCLT..... | Charlotte, NC | KHNN..... | Henderson, WV |
| KCNU..... | Chanute, KS | KHOT..... | Hot Springs, AR |
| KCOT..... | Cotulla, TX | KHOU..... | Houston, TX |
| KCOU..... | Columbia, MO | KHQM..... | Hoquiam, WA |
| KCRP..... | Corpus Christi, TX | KIAH..... | Houston, TX |
| KCSV..... | Crossville, TN | KICT..... | Wichita, KS |

APPENDIX C

AVIATION WEATHER

| | | | |
|------|-------------------------|------|------------------------|
| KIGB | Columbus, MS | KORF | Norfolk, VA |
| KILM | Wilmington, NC | KORL | Orlando, FL |
| KINK | Wink, TX | KOUN | Norman, OK |
| KINL | International Falls, MN | KOZR | Cairns AFB, AL |
| KJAN | Jackson, MS | KPAH | Paducah, KY |
| KJAX | Jacksonville, FL | KPAM | Tyndall AFB, FL |
| KLBE | Latrobe, PA | KPBI | Palm Beach, FL |
| KLBF | North Platte, NE | KPDX | Portland, OR |
| KLBL | Liberal, KS | KPIE | St. Petersburg, FL |
| KLCH | Lake Charles, LA | KPHL | Philadelphia, PA |
| KLEX | Lexington, KY | KPHX | Phoenix, AZ |
| KLFK | Lufkin, TX | KPIT | Pittsburgh, PA |
| KLIT | Little Rock, AR | KPKB | Parkersburg, WV |
| KLRD | Laredo, TX | KPNS | Pensacola, FL |
| KLRF | Little Rock, AR | KPOE | Fort Polk, LA |
| KLTS | Altus, OK | KPRC | Prescott, AZ |
| KLUF | Luke AFB, AZ | KPRX | Paris, TX |
| KMCB | McComb, MS | KPSB | Philipsburg, PA |
| KMEI | Meridian, MS | KPUB | Pueblo, CO |
| KMEM | Memphis, TN | KPWM | Portland, ME |
| KMGM | Montgomery, AL | KRAP | Rapid City, SD |
| KMIA | Miami, FL | KRDR | Grand Forks, ND |
| KMKC | Kansas City, MO | KRDU | Raleigh, NC |
| KMLB | Melbourne, FL | KRIV | March AFB, CA |
| KMLU | Monroe, LA | KRND | Randolph AFB, TX |
| KMOB | Mobile, AL | KRNO | Reno, NV |
| KMOT | Minot, ND | KRWI | Rocky Mount, NC |
| KMRB | Martinsburg, WV | KSAN | San Diego, Ca |
| KMSP | Minneapolis, MN | KSAT | San Antonio, TX |
| KMSY | New Orleans, LA | KSBA | Santa Barbara, CA |
| KMXF | Maxwell AFB, AL | KSDF | Louisville, KY |
| KNBE | Navy Dallas, TX | KSEA | Seattle, WA |
| KNBU | Navy Glenview, IL | KSEM | Craig AFB, AL |
| KNBG | New Orleans, LA | KSFO | San Francisco, CA |
| KNFB | Navy Detroit, MI | KSGF | Springfield, MO |
| KNFL | NAS Fallon, NV | KSHV | Shreveport, LA |
| KNGZ | NAS Alameda, CA | KSJT | San Angelo, TX |
| KNID | NAF China Lake, CA | KSKF | Kelly AFB, CA |
| KNIP | Navy Jacksonville, FL | KSLC | Salt Lake City, UT |
| KNKT | MCAS Cherry Point, NC | KSLN | Salina, KS |
| KNKX | NAS Miramar, CA | KSPS | Sheppard AFB, TX |
| KNMM | Navy Meridian, MS | KSTL | St. Louis, MO |
| KNPA | Navy Pensacola, FL | KSUU | Travis AFB, CA |
| KNQA | Navy Memphis, TN | KSVN | Hunter AFB, GA |
| KNSE | Navy Whiting Field, FL | KTLH | Tallahassee, FL |
| KNSU | NALF Monterey, CA | KTIK | Tinker AFB, OK |
| KNTD | NAS Pt Mugu, CA | KTOL | Toledo, OH |
| KNTU | Navy Oceana, VA | KTOP | Topeka, KS |
| KNUN | NAS Saufley Field, FL | KTPL | Temple, TX |
| KNUW | NAS Whidbey Island, WA | KTRI | Bristol, TN |
| KNXX | Navy Willow Grove, PA | KTUL | Tulsa, OK |
| KNZY | NAS North Island, CA | KTUS | Tucson, AZ |
| KOFF | Offutt AFB, NE | KVAD | Moody AFB, GA |
| KOKC | Oklahoma City, OK | KVPS | Eglin AFB, FL |
| KOKM | Okmulgee, OK | KVRB | Vero Beach, FL |
| KOMA | Omaha, Ne | KWRB | Warner-Robbins AFB, GA |
| KONP | Newport, OR | KWRI | McGuire AFB, NJ |

INTERNATIONAL IDENTIFIERS

EGLL Gatwick, England
 PGUA Andersen AFB, Guam, Mariana Islands
 LEMD Madrid, Spain
 EDAH Amsterdam, Holland

STATE ABBREVIATIONS

| | | | |
|----------------------------|----|------------------------------|----|
| Alabama | AL | Nebraska | NE |
| Alaska | AK | Nevada | NV |
| Arizona..... | AZ | New Hampshire | NH |
| Arkansas..... | AR | New Jersey | NJ |
| American Samoa..... | AS | New Mexico..... | NM |
| California | CA | New York..... | NY |
| Colorado..... | CO | North Carolina | NC |
| Connecticut..... | CT | North Dakota..... | ND |
| Delaware | DE | Northern Mariana Island..... | CM |
| District of Columbia | DC | Ohio..... | OH |
| Florida..... | FL | Oklahoma..... | OK |
| Georgia..... | GA | Oregon..... | OR |
| Guam..... | GU | Pennsylvania | PA |
| Hawaii..... | HI | Puerto Rico..... | PR |
| Idaho | ID | Rhode Island | RI |
| Illinois | IL | South Carolina | SC |
| Indiana..... | IN | South Dakota..... | SD |
| Iowa..... | IA | Tennessee..... | TN |
| Kansas | KS | Trust Territory..... | TT |
| Kentucky..... | KY | Texas | TX |
| Louisiana..... | LA | Utah..... | UT |
| Maine | ME | Vermont | VT |
| Maryland..... | MD | Virginia | VA |
| Massachusetts | MA | Virgin Islands..... | VI |
| Michigan | MI | Washington | WA |
| Minnesota..... | MN | West Virginia..... | WV |
| Mississippi | MS | Wisconsin..... | WI |
| Missouri | MO | Wyoming..... | WY |
| Montana | MT | | |

THIS PAGE INTENTIONALLY LEFT BLANK

APPENDIX D

SELECTED WEATHER INFORMATION RESOURCES

Current as of October 2002

Aviation Weather Center

Homepage: <http://www.awc-kc.noaa.gov/index.html>

Frequently Asked Questions: <http://www.awc-kc.noaa.gov/info/faq.html>

Contractions frequently used in National Weather Service products:

http://www.awc-kc.noaa.gov/info/domestic_contractions.html

Direct User Access Terminal Service – Free access to GTE DUATS is available to U.S. pilots and student pilots who hold current medical certificates, flight instructors without current medicals, aviation ground instructors, glider/balloon pilots, and other approved users in the U.S. aviation community.

<http://www1.duats.com/>

Landings.com Aviation Weather Information

http://www.landings.com/_landings/pages/wthr/av_weather.html

National Hurricane Center/Tropical Prediction Center

<http://www.nhc.noaa.gov>

National Oceanographic and Atmospheric Administration – Home Page

<http://www.noaa.gov/>

National Weather Service

Home Page: <http://www.nws.noaa.gov/>

Storm Prediction Center

<http://www.spc.noaa.gov/>

USA Today Aviation Weather links

<http://www.usatoday.com/weather/wpilots0.htm>

The Weather Channel – Home Page

<http://www.weather.com>

THIS PAGE INTENTIONALLY LEFT BLANK

APPENDIX E

ANSWERS TO STUDY QUESTIONS

CHAPTER 1

- | | | | |
|------|-------|-------|-------|
| 1. A | 7. B | 13. A | 19. D |
| 2. B | 8. C | 14. D | 20. B |
| 3. D | 9. D | 15. B | 21. C |
| 4. B | 10. B | 16. D | |
| 5. B | 11. C | 17. C | |
| 6. C | 12. D | 18. D | |

CHAPTER 2

- | | | | |
|------|---------------|---------------|-----------------|
| 1. C | 8. B | 14. dew point | 20. B |
| 2. A | 9. C | temperature | 21. A |
| 3. A | 10. A | 15. D | 22. cumuliform, |
| 4. D | 11. D | 16. stable | unstable |
| 5. A | 12. B | 17. C | 23. C |
| 6. D | 13. saturated | 18. C | 24. B |
| 7. D | | 19. C | |

CHAPTER 3

- | | | | |
|------|------|------|------|
| 1. D | 3. B | 5. A | 7. A |
| 2. C | 4. B | 6. C | 8. A |
| | | | 9. C |
| 10. | | | |

| Type of Front | Wind Shift | Temperature Change | Pressure Change | Direction of Movement | Speed of Movement (kts) | Cloud Types | Turbulence Conditions | Color Code |
|----------------------|------------|--------------------|------------------|-----------------------|-------------------------|-------------|-----------------------|------------|
| Warm Front | SE to SW | Warmer | Falls then rises | NE | 15 | Stratiform | Smooth | Red |
| Cold Front | SW to NW | Colder | Falls then rises | SE | 20 | Cumuliform | Rough | Blue |
| Warm Front Occlusion | SE to NW | Warmer | Falls then rises | NE | 15 | Combination | Combination | Purple |
| Cold Front Occlusion | SE to NW | Colder | Falls then rises | NE | 20 | Combination | Combination | Purple |
| Stationary Front | 180° | Either | Falls then rises | None | 0 to 5 | Stratiform | Smooth | R & B |

CHAPTER 4

- | | | | |
|------|------|------|------|
| 1. D | 3. D | 5. C | 7. C |
| 2. D | 4. B | 6. D | 8. A |

CHAPTER 5

- | | | | | | | | | | |
|----|---|-----|---|-----|---|-----|---|-----|---|
| 1. | A | 7. | B | 13. | C | 19. | C | 25. | A |
| 2. | D | 8. | A | 14. | A | 20. | D | 26. | C |
| 3. | B | 9. | B | 15. | D | 21. | B | | |
| 4. | B | 10. | B | 16. | A | 22. | B | | |
| 5. | A | 11. | D | 17. | E | 23. | A | | |
| 6. | D | 12. | A | 18. | B | 24. | B | | |