



**NONRESIDENT
TRAINING
COURSE**



April 1993

Seabee Combat Handbook, Volume 1

NAVEDTRA 14234

Although the words “he,” “him,” and “his” are used sparingly in this course to enhance communication, they are not intended to be gender driven or to affront or discriminate against anyone.

COMMANDING OFFICER
NETPTDC
6490 SAUFLEY FIELD ROAD
PENSACOLA, FL 32509-5237

Errata #1

Mar 1996

Specific Instructions and Errata for
Training Manual (TRAMAN)

SEABEE COMBAT HANDBOOK, VOLUME 1

1. No attempt has been made to issue corrections for errors in typing, punctuation, etc., that do not affect your ability to answer the question or questions.

2. Change the following items in the training manual:

a. Delete the caption under figure 3-26, page 3-11, and replace with "5.56-mm ammunition for the M16A1."

b. Add under figure 3-26, page 3-11, "Warning: Ammunition for the M16A1 and the M16A1E3 are not interchangeable."

c. Delete paragraph 1, page 3-9, under header "Malfunction, Stoppage, and Immediate Action." Replace with "Malfunction is an unplanned cessation of fire. A malfunction occurs because of a stoppage caused by a mechanical failure of the weapon, magazine, or ammunition."

d. Under the header "Malfunction, Stoppage, and Immediate Action" page 3-9 numbers 1 through 4. Replace with

- Slap up on bottom of the magazine
- Pull charging handle to rear
- Observe for an ejection of the round
- Release the charging handle
- Tap the forward assist
- Aim on target
- Squeeze the trigger again

NOTE: "Apply immediate action only one time for a given stoppage. If the weapon still fails to fire, inspect it to determine the cause of the stoppage and take appropriate action."

e. Delete paragraph 2, page 3-3, "unless specifically..."

f. Delete bullet #4 on page 3-3 that begins with the statement "The new model no longer..."

g. Delete the note on page 3-7 that begins with the statement "Disengage the takedown..."

h. Replace all references of "M16A2" with "M16A2E3"

COMMANDING OFFICER
NETPTDC
6490 SAUFLEY FIELD ROAD
PENSACOLA, FL 32509-5237

Errata #3

7 May 2001

Specific Instruction and Errata for
Nonresident Training Course

SEABEE COMBAT HANDBOOK, VOLUME 1

1. This errata supersedes all previous errata. No attempt has been made to issue corrections for errors in typing, punctuation, etc., that do not affect your ability to answer the question or questions.

2. To receive credit for deleted questions, show this errata to your local course administrator (ESO/scorer). The local course administrator is directed to correct the course and the answer key by indicating the questions deleted.

3. Assignments

Delete the following questions and leave the corresponding spaces blank on the answer sheets:

Question

2-20
3-28
5-67

Make the following changes:

Question	Changes
2-71	Change the responses as follows: 1. low 2. high
3-45	Change the responses as follows: 3. maximum firepower to the right and to the front 4. minimum firepower to the front and maximum to the right
5-65	Add a response to Column B as follows: 4. Blood
6-7	Change the stem as follows: "You are the first person to learn of a chemical attack. You immediately stop breathing. Which of the following actions should you take next?"
6-7	Change the response as follows: 4. Wait for instruction from your squad leader
8-32	Change the stem as follows: "When clearing an M60 machine gun, you should place the safety on SAFE after which of the following procedures?"

PREFACE

By enrolling in this self-study course, you have demonstrated a desire to improve yourself and the Navy. Remember, however, this self-study course is only one part of the total Navy training program. Practical experience, schools, selected reading, and your desire to succeed are also necessary to successfully round out a fully meaningful training program.

COURSE OVERVIEW: In completing this nonresident training course, you will demonstrate a knowledge of the subject matter by correctly answering questions on the following: History and Organization of the Seabees and Laws of War; Special Clothing and Equipment; Service Rifle and Pistol Marksmanship; Combat Maneuvers, Formations, Patrols, and Ambushes; Land Navigation; Evasion, Survival, and Escape; Individual Protective Measures; Entanglements; Chemical, Biological, and Radiological (CBR) Defense; First Aid and Field Sanitation; Grenades, Land Mines, and Booby Traps; Organic Support Weapons: M203 and Machine Guns; and Organic Support Weapons: 60-mm Mortar and AT4.

THE COURSE: This self-study course is organized into subject matter areas, each containing learning objectives to help you determine what you should learn along with text and illustrations to help you understand the information. The subject matter reflects day-to-day requirements and experiences of personnel in the rating or skill area. It also reflects guidance provided by Enlisted Community Managers (ECMs) and other senior personnel, technical references, instructions, etc., and either the occupational or naval standards, which are listed in the *Manual of Navy Enlisted Manpower Personnel Classifications and Occupational Standards*, NAVPERS 18068.

THE QUESTIONS: The questions that appear in this course are designed to help you understand the material in the text.

VALUE: In completing this course, you will improve your military and professional knowledge. Importantly, it can also help you study for the Navy-wide advancement in rate examination. If you are studying and discover a reference in the text to another publication for further information, look it up.

*1993 Edition Prepared by
UCCM(SCW) R. C. Blackmon*

Published by
NAVAL EDUCATION AND TRAINING
PROFESSIONAL DEVELOPMENT
AND TECHNOLOGY CENTER

**NAVSUP Logistics Tracking Number
0504-LP-026-8720**

Sailor's Creed

“I am a United States Sailor.

I will support and defend the Constitution of the United States of America and I will obey the orders of those appointed over me.

I represent the fighting spirit of the Navy and those who have gone before me to defend freedom and democracy around the world.

I proudly serve my country's Navy combat team with honor, courage and commitment.

I am committed to excellence and the fair treatment of all.”

CONTENTS

CHAPTER	PAGE
1. History and Organization of the Seabees and Laws of War	1-1
2. Special Clothing and Equipment	2-1
3. Service Rifle and Pistol and Marksmanship	3-1
4. Combat Maneuvers, Formations, Patrols, and Ambushes	4-1
5. Land Navigation	5-1
6. Evasion, Survival, Escape	6-1
7. Individual Protective Measures	7-1
8. Entanglements	8-1
9. Chemical, Biological, and Radiological (CBR) Defense	9-1
10. First Aid and Field Sanitation	10-1
11. Organic Communications Equipment	11-1
12. Hand Grenades, Land Mines, and Booby Traps	12-1
13. Organic Support Weapons: M203 and Machine Guns	13-1
14. Organic Support Weapons: 60-mm Mortar and AT4	14-1
APPENDIX	
I. Glossary of Common Military Terms	AI-1
II. References used to develop the TRAMAN	AII-1
INDEX	INDEX-1

SUMMARY OF SEABEE COMBAT HANDBOOK TRAINING MANUALS

VOLUME 1

Seabee Combat Handbook Volume 1, NAVEDTRA 14234 consists of chapters on the History and Organization of the Seabees and Laws of War; Special Clothing and Equipment; Service Rifle and Pistol Marksmanship; Combat Maneuvers, Formations, Patrols, and Ambushes; Land Navigation; Evasion, Survival, and Escape; Individual Protective Measures; Entanglements; Chemical, Biological, and Radiological (CBR) Defense; First Aid and Field Sanitation; Organic Communications Equipment; Hand Grenades, Land Mines, and Booby Traps; Organic Support Weapons: M203 and Machine Guns; and Organic Support Weapons: 60-mm Mortar and AT4.

VOLUME 2

Seabee Combat Handbook Volume 2, NAVEDTRA 14235 consists of chapters on Setup and Operation of the Command Post; Organization and Operation of the Combat Operation Center; Application of the Laws of Armed Conflict; Setup and Control of Medical Evacuation (MEDEVAC); Planning and Development of Defensive Tactics; Planning and Deployment of Patrols; Deployment and Control of Heavy Weapons; and Deployment and Control of CBR and NBC Teams.

REGULATIONS ON ENVIRONMENTAL POLLUTION AND HAZARDOUS MATERIALS

Environmental Pollution and Hazardous Waste Handling and Disposal programs have been enacted and are United States law. These programs are of immense importance and should be taken into consideration during the planning stages before beginning any new construction or rehabilitation project.

As a member of the Naval Construction Forces, United States law requires you to be constantly aware of potential environmental pollution hazards or hazardous material spills and to report them to your immediate supervisor or other senior personnel at the earliest possible time.

The following list of directives contains information on the cognizant government departments and the procedures for preventing, reporting, and correcting environmental pollution hazards and hazardous materials disposal worldwide:

- Naval Occupational Safety and Health Program Manual, OPNAVINST 5100.23B
- Environmental and Natural Resources Protection Manual, OPNAVINST 5090.1
- Domestic Wastewater Control, MIL-HDBK 1005/8

INSTRUCTIONS FOR TAKING THE COURSE

ASSIGNMENTS

The text pages that you are to study are listed at the beginning of each assignment. Study these pages carefully before attempting to answer the questions. Pay close attention to tables and illustrations and read the learning objectives. The learning objectives state what you should be able to do after studying the material. Answering the questions correctly helps you accomplish the objectives.

SELECTING YOUR ANSWERS

Read each question carefully, then select the BEST answer. You may refer freely to the text. The answers must be the result of your own work and decisions. You are prohibited from referring to or copying the answers of others and from giving answers to anyone else taking the course.

SUBMITTING YOUR ASSIGNMENTS

To have your assignments graded, you must be enrolled in the course with the Nonresident Training Course Administration Branch at the Naval Education and Training Professional Development and Technology Center (NETPDTC). Following enrollment, there are two ways of having your assignments graded: (1) use the Internet to submit your assignments as you complete them, or (2) send all the assignments at one time by mail to NETPDTC.

Grading on the Internet: Advantages to Internet grading are:

- you may submit your answers as soon as you complete an assignment, and
- you get your results faster; usually by the next working day (approximately 24 hours).

In addition to receiving grade results for each assignment, you will receive course completion confirmation once you have completed all the

assignments. To submit your assignment answers via the Internet, go to:

<https://courses.cnet.navy.mil>

Grading by Mail: When you submit answer sheets by mail, send all of your assignments at one time. Do NOT submit individual answer sheets for grading. Mail all of your assignments in an envelope, which you either provide yourself or obtain from your nearest Educational Services Officer (ESO). Submit answer sheets to:

COMMANDING OFFICER
NETPDTC N331
6490 SAUFLEY FIELD ROAD
PENSACOLA FL 32559-5000

Answer Sheets: All courses include one “scannable” answer sheet for each assignment. These answer sheets are preprinted with your SSN, name, assignment number, and course number. Explanations for completing the answer sheets are on the answer sheet.

Do not use answer sheet reproductions: Use only the original answer sheets that we provide—reproductions will not work with our scanning equipment and cannot be processed.

Follow the instructions for marking your answers on the answer sheet. Be sure that blocks 1, 2, and 3 are filled in correctly. This information is necessary for your course to be properly processed and for you to receive credit for your work.

COMPLETION TIME

Courses must be completed within 12 months from the date of enrollment. This includes time required to resubmit failed assignments.

PASS/FAIL ASSIGNMENT PROCEDURES

If your overall course score is 3.2 or higher, you will pass the course and will not be required to resubmit assignments. Once your assignments have been graded you will receive course completion confirmation.

If you receive less than a 3.2 on any assignment and your overall course score is below 3.2, you will be given the opportunity to resubmit failed assignments. **You may resubmit failed assignments only once.** Internet students will receive notification when they have failed an assignment--they may then resubmit failed assignments on the web site. Internet students may view and print results for failed assignments from the web site. Students who submit by mail will receive a failing result letter and a new answer sheet for resubmission of each failed assignment.

COMPLETION CONFIRMATION

After successfully completing this course, you will receive a letter of completion.

ERRATA

Errata are used to correct minor errors or delete obsolete information in a course. Errata may also be used to provide instructions to the student. If a course has an errata, it will be included as the first page(s) after the front cover. Errata for all courses can be accessed and viewed/downloaded at:

<https://www.advancement.cnet.navy.mil>

STUDENT FEEDBACK QUESTIONS

We value your suggestions, questions, and criticisms on our courses. If you would like to communicate with us regarding this course, we encourage you, if possible, to use e-mail. If you write or fax, please use a copy of the Student Comment form that follows this page.

For subject matter questions:

E-mail: n314.products@cnet.navy.mil
Phone: Comm: (850) 452-1001, Ext. 1826
DSN: 922-1001, Ext. 1826
FAX: (850) 452-1370
(Do not fax answer sheets.)
Address: COMMANDING OFFICER
NETPDTC N314
6490 SAUFLEY FIELD ROAD
PENSACOLA FL 32509-5237

For enrollment, shipping, grading, or completion letter questions

E-mail: fleetservices@cnet.navy.mil
Phone: Toll Free: 877-264-8583
Comm: (850) 452-1511/1181/1859
DSN: 922-1511/1181/1859
FAX: (850) 452-1370
(Do not fax answer sheets.)
Address: COMMANDING OFFICER
NETPDTC N331
6490 SAUFLEY FIELD ROAD
PENSACOLA FL 32559-5000

NAVAL RESERVE RETIREMENT CREDIT

If you are a member of the Naval Reserve, you may earn retirement points for successfully completing this course, if authorized under current directives governing retirement of Naval Reserve personnel. For Naval Reserve retirement, this course is evaluated at 18 points. These points will be credited as follows:

Unit 1 – 12 points upon satisfactory completion of Assignments 1 through 6

Unit 2 – 6 points upon satisfactory completion of Assignments 7 through 9

(Refer to *Administrative Procedures for Naval Reservists on Inactive Duty*, BUPERSINST 1001.39, for more information about retirement points.)

Student Comments

Course Title: Seabee Combat Handbook, Volume 1

NAVEDTRA: 14234 **Date:** _____

We need some information about you:

Rate/Rank and Name: _____ SSN: _____ Command/Unit _____

Street Address: _____ City: _____ State/FPO: _____ Zip _____

Your comments, suggestions, etc.:

<p>Privacy Act Statement: Under authority of Title 5, USC 301, information regarding your military status is requested in processing your comments and in preparing a reply. This information will not be divulged without written authorization to anyone other than those within DOD for official use in determining performance.</p>
--

NETPDTC 1550/41 (Rev 4-00)

CHAPTER 1

HISTORY AND ORGANIZATION OF THE SEABEES AND LAWS OF WAR

The Seabees are the Navy's construction forces; and few select teams, if any, enjoy a finer reputation among America's fighting men. During their short history, the Seabees have won fame, honor, and distinction as an organization that "Can Do," even when faced with practically insurmountable obstacles. A brief discussion on the history of the Seabees is given below.

THE CIVIL ENGINEER CORPS

No discussion on the history of the Seabees is complete without first explaining the origin and purpose of the Civil Engineer Corps (CEC). The CEC is composed of dedicated staff corps officers who are specialists in the field of civil engineering. A CIVIL ENGINEER is a professional engineer who performs a variety of engineering work in planning, designing, and overseeing construction and maintenance of structures and facilities, such as roads, airports, bridges, harbors, pipelines, power plants, and water and sewage systems.

Civil engineers have been an integral part of the Navy since its very beginning. Our first "fleet" consisted of less than 10 ships. However, our forefathers realized that to survive as a nation, the United States must have a Navy powerful enough to counter the naval threat from pirates and other great powers, such as England, France, and Spain. To meet this threat, Congress authorized the hiring, purchasing, and building of several additional vessels. Suitable land for use as navy yards had to be located, surveyed, and purchased. Logically, civil engineers were delegated to perform these tasks.

By the time Thomas Jefferson became President, the Secretary of the Navy, Mr. Stoddert, had established six Navy Yards. All were managed by civil engineers, although they were not yet known as Civil Engineer Corps officers. In the following years, the number of ships increased sharply as well as the need for more dry docks and repair facilities. The United States was emerging as a great sea power and governmental functions were becoming more complex. As a result, on 31 August 1842, Congress established the "Bureau" system. The Bureau of Yards and Docks (BUDOCKS)—known now as the Naval Facilities Engineering Command (NAVFAC)—was created, and

the chief of this bureau was a civil engineer. It was not until 25 years later, however, that the Civil Engineer Corps was officially named and authorized. At that time, the officers in the corps were the forerunners of the CEC officers who lead the variety of Seabee units today.

As naval technology advanced in the modern era, the navies of the world ranged far over the great oceans. Ships grew more and more dependent upon an ever-increasing chain of sophisticated shore bases for their support, both at home and abroad. The construction of these bases necessitated a new and large organization of seafaring fighter-builders.

Before 1941, the Civil Engineer Corps used private contractors to accomplish all overseas construction. The contractors, in turn, hired steelworkers, electricians, carpenters, draftsmen, and mechanics from private industry. However, the Navy realized that, in the event of war, civilian contractors and construction workers could not be used very well outside our own country. If they were attacked and attempted to defend themselves, these civilians could be regarded as guerrillas. Also, since most of them had never received any type of combat training, there was reason to believe that they could not adequately defend themselves, even if their lives depended on it. These fears soon became realities.

As World War II drew near, there was an urgent need for more overseas bases. Airfields and landing strips had to be rushed into existence on far away islands. Clearly, we needed a combat MILITARY ORGANIZATION trained to construct these advance bases. Even before the outbreak of hostilities, the Bureau of Yards and Docks had conceived the idea of naval construction battalions. The first construction units were organized early in January 1942. Highly skilled construction workers were recruited, and whole construction companies volunteered men and equipment.

THE FIRST SEABEES

The name Seabees is derived from these first construction units, or construction battalions (CBS) as they were called. Officially, permission to use the name "Seabee" was granted on 5 March 1942. Each year March 5th is observed as the anniversary of the Seabees.

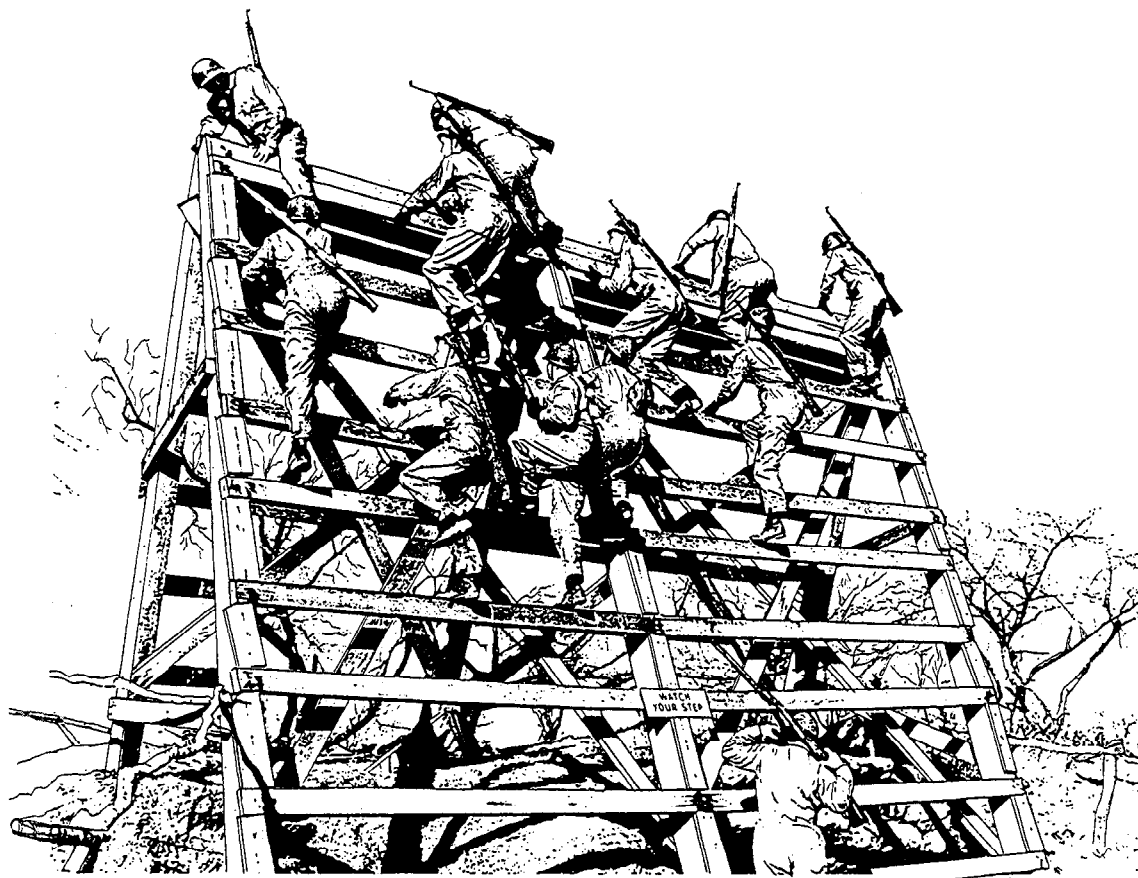

Figure 1-1.—Seabees going over one of the obstacle courses during combat training at Camp Endicott, Davisville, Rhode Island, during World War II.

Because of the urgent need for these men, the first Seabees had no time for military training. They were given medical shots, handed equipment, and sent off to pick up where the civilian contractors left off. One month after the first units were organized, Seabees were at work constructing roads on Bora Bora, one of the Society Islands, thousands of miles out in the Pacific Ocean.

Little time was given to training the next group of recruits, who were old hands in the construction trades, averaging 31 years of age. Since they were experienced in their respective skills, they needed and received mostly military training. Some additional instruction in technical matters peculiar to the Navy, such as pontoon assembly, was also given these men.

Throughout World War II the Seabees were without construction ratings as we know them now. They were given the most appropriate existing Regular Navy rating on the basis of their civilian vocation and experience; for example, an experienced steelworker or plumber who had achieved a position of responsibility—perhaps as a foreman or owner of a small business—was rated first class or chief Shipfitter. Seabees who held this and

other ratings, such as Boatswain's Mate, Machinist's Mate, and Electrician's Mate, were easily distinguished from those who held corresponding shipboard ratings by the Seabee insignia shoulder patch. This now famous insignia consists of a flying bee—fighting mad—with a “white hat” on his head, a spitting “tommy gun” in his front hands, a wrench in his middle hand, and a carpenter's hammer in his rear hand.

Soon the Seabees had grown enough to have their own stations, such as Camp Endicott, Camp Allen, and Camp Bradford. Camp Peary, near Williamsburg, Virginia, became the receiving and training station for the Seabees. At these camps, they learned such things as combat formations, combat signals, fire control, combat orders, first aid, use of various weapons, and military courtesy. Instruction was also given in trail cutting and jungle warfare.

After boot training, the new Seabees were assigned to construction battalions and advanced training began. They learned air raid protection, earthmoving, Quonset hut erection, and dry refrigeration. Crosscountry marches, sleeping in the open, obstacle courses (fig. 1-1), and simulated combat exercises toughened them up.

After this advanced training, battalions were ordered to an advanced base depot, such as Port Hueneme, California, or Davisville, Rhode Island, to await transportation overseas. Again, training continued while they were being outfitted with the tools, construction equipment, and materials needed to build advanced bases and facilities. In addition, they took on stores of ammunition, food, and medical supplies; in fact, everything necessary to make them self-sufficient.

By 1943, the training period for Seabees had expanded to about 3 months. However, in the spring of 1945, a major change in their training took place. Training of organized construction battalions was halted, and emphasis was placed on training individuals to replace the battle-weary veterans due for discharge or rotation back to the States. Even then, time did not permit extensive trade school training for the younger, unskilled Selective Service inductees. As a result, experienced personnel in the field had to augment meager stateside training with a lot of on-the-job training.

Seabees served with the assault forces in almost every major invasion in World War II, going ashore, in most cases, with or directly behind the first wave of troops. Such names as Guadalcanal, Los Negros, Tarawa, Munda, Saipan, Tinian, Attu, Iwo Jima, Guam, Samar, Okinawa, Salerno, Sicily, and Normandy will forever be associated with the Seabees, just as Montezuma and the Shores of Tripoli are symbolic of the traditions associated with the Marine Corps.

Looking back, some of the jobs accomplished by the Seabees in World War II seemed almost impossible. But they were done—efficiently, effectively, and quickly!

Undoubtedly, these accomplishments provided the basis for the Seabees' famous quotation:

“The difficult task we accomplish right away, the impossible may take a little longer!”

The Seabees' official motto is “Construimus-Batuimus.” Literally this means “We Build—We Fight.” Even engineers who were used to visualizing large construction projects were amazed at the Seabees' ability to improvise and build. In the first 2 years of the war, more than 300 advanced bases of various sizes and kinds were constructed by the Seabees.

In addition to earning the Navy's traditional “Well done!” for construction work and defensive combat, the Seabees also earned well-deserved recognition in other capacities. The now famous Underwater Demolition

Teams (UDTs) were composed largely of Seabees. One large group of Seabees, called Naval Construction Battalions, Special, functioned as stevedores, loading and off-loading cargo ships. Other groups included automotive repair detachments, pontoon assembly detachments, pontoon operating battalions, and construction maintenance units. The latter maintained existing bases, releasing full battalions for building new ones.

POST WORLD WAR II SEABEES

Since World War II, Seabees have participated in all kinds of training exercises. They have been part of the naval Antarctic expeditions, and they participated in the atomic bomb tests on the Pacific Islands. Seabees have engaged in constructing overseas bases, such as those at Subic Bay, Philippines, and the Marine Corps Air Facility at Futema, Okinawa. They have manned Arctic test stations, and they have been associated with resupply expeditions to Alaska.

SEABEES IN KOREA

In Korea, the Seabees rose to the challenge of the Cold War in the tradition of their “Can Do” predecessors. At the Inchon landing in September 1950, Seabees positioned pontoon causeways within hours of the first beach assault under continuous enemy fire and in the face of enormous and strong tides.

In addition to amphibious operations, the Seabees were broken up into numerous detachments to service the K-fields of the various Marine air groups. Each airfield of the Marine air groups was designated with a “K” number, such as K-3 at Pohang, K-18 at Kimpo, Seoul, and K-2 at Teagan. As the war continued, the need arose for an advance airfield to retrieve damaged aircraft unable to reach home bases or carriers after raiding the North Korean interior.

The project was code named Operation “Crippled Chick,” and a detachment of Seabees was sent to Yo Do in the Bay of Wonson to build an airstrip. The Seabees were given 35 days to complete the job—the strip was ready in 16 days. While building the strip, the Seabees were under constant artillery bombardment from enemy forces on neighboring islands.

The rapid demobilization that followed World War II was not repeated after the signing of the Korean Armistice in July 1953. The Cold War had created a necessity to maintain military strength and preparedness. Crises in Berlin, Cuba, Africa, South

America, and especially in Southeast Asia kept the Seabees strong and active.

Just before the outbreak of the Korean War, a basic reorganization was substantially completed. Two distinct types of battalions were established to gain specialization and mobility. The amphibious construction battalions (PHIBCBs) are landing and docking units. The PHIBCBs have the mission of planning causeways, constructing pontoon docks, and performing other functions necessary for landing personnel and equipment in the shortest possible time. The naval mobile construction battalions (NMCBs) are responsible for land construction of a wide variety that includes military camps, roads, bridges, tank farms, airstrips, and docking facilities.

BETWEEN KOREA AND VIETNAM

After the Korean War, the Seabees' efforts were directed toward more building and less fighting. Their peacetime achievements were no less impressive than their wartime achievements. In Okinawa, for example, the Seabees built a Marine Corps air facility using concrete precasting methods that drew the admiration of contractors throughout the Pacific area. At Holy Lock, Scotland, Seabees assembled a floating dry dock for the Polaris submarine facility. In far off Antarctica, a group of Seabees earned a round of tributes for their installation of the first nuclear reactor power plant at McMurdo Station, despite weather conditions that are laughingly called "summer" in the forbidding region. Elsewhere, while Ecuadorians were building a new naval academy, a small detachment of Seabees supervised and instructed them in modern construction methods.

By far the largest and most impressive peacetime project was the construction of Cubi Point Naval Air Station in the Philippines, the largest single construction job ever tackled by the Seabees. At Cubi, Seabees cut a mountain in half to make way for the nearly 2-mile-long runway, blasted coral, and filled in a section of Subic Bay that is almost a mile wide and nearly 2 miles long. The Seabees took nearly 5 years and 20 million man-hours to construct the air station and its adjacent aircraft carrier pier that is capable of docking the Navy's biggest aircraft carriers. The amount of coral and fill required for the job—some 20 million cubic yards—was equal to the task of building the Panama Canal.

During this period, Seabees could be found everywhere. They participated in building missile ranges both in the Atlantic and the Pacific and housing

complexes at naval bases and stations all over the world. During the Cuban Missile Crisis in 1962, Seabees hastily erected and helped man a strong defensive perimeter of fortifications at Guantanamo Bay.

Disaster relief became more than just another mission. When the island of Guam was devastated by Typhoon Karen in 1962, Seabees restored power and rebuilt damaged structures. Another team of Seabees helped the Chilean Navy repair the earthquake-damaged waterfront of their principal shipyard. Later in 1964, Seabees were on the scene restoring utilities and rebuilding roads in a matter of hours after Alaska was stricken by a devastating earthquake and tidal wave.

SEABEES IN VIETNAM

In South Vietnam, the Seabees built and fought and established a new reputation for their deeds of construction while under fire. From the Demilitarized Zone (DMZ) in the north to the delta region in the south, they supported combat operations and sometimes fought side-by-side with the United States Marines and Army troops in guerrilla-infested areas.

The first full Seabee battalion arrived in Vietnam on 7 May 1965 to build an expeditionary airfield for the Marines at Chu Lai. Others soon followed. From 1965 until 1969, the Seabee commitment in Southeast Asia rapidly increased. This necessitated, first, the transfer of Atlantic Fleet battalions to the Pacific through a change of home port; then, the deployment to the Republic of Vietnam (RVN) of Atlantic Fleet NMCBs; and later the reactivation of nine additional battalions. This was culminated by the call to active duty of two Reserve NMCBs in May of 1968, bringing to 21 the number of battalions deploying to RVN. In addition, there were two amphibious construction battalions lending support to the RVN effort. In the same time period, a requirement for Seabees to support in-country activities, such as naval support activities at Da Nang and Saigon, two construction battalion maintenance units, two deployed naval construction regiments, and the deployed Third Naval Construction Brigade rapidly increased. To support these various requirements, the total Seabee community grew from 9,400 in mid-1965; to 14,000 in mid-1966; to 20,000 in mid-1967; to more than 29,000 in 1968 and 1969.

Seabee accomplishments in Vietnam were impressive, just as they were in World War II, Korea, and during peacetime. All 21 active battalions deployed to Vietnam—some several times—to build the roads, airfields, cantonments, warehouses, hospitals, storage

facilities, bunkers, and other facilities needed to continue the struggle. In accordance with the “mobile” concept of the Naval Construction Force, Seabee units supported Marine, Navy, Army, and Air Force operations at camps and landing zones throughout RVN and at such outposts as Con Thien, Khe Sanh, and Gio Linh.

For their efforts in Vietnam, Seabee units and individual Seabees received formal recognition in the form of numerous commendations and medals.

In Vietnam, a Seabee, CM3 Marvin E. Shields, a member of Seabee Team 1104, was posthumously awarded the Medal of Honor. This nation’s highest recognition was awarded to CM3 Shields for his heroic efforts in the defense of a Special Forces camp and Vietnamese District Headquarters at Dong Xoai.

When de-escalation of U.S. activity in Southeast Asia got under way, Seabee strength was once more reduced. By September 1970, NMCBs were down to the planned post-RVN level of 10 full-size battalions. Once more, Seabees were being called upon to undertake major peacetime projects that had been deferred or neglected because of wartime priorities.

POST VIETNAM

Today’s Seabees are involved in new and far-reaching construction frontiers, the Indian Ocean, the Trust Territories of the Pacific Islands, and on the ocean floor.

One of the major peacetime projects ever undertaken by the Seabees is the complete development, construction, and operation of the United States communications station on Diego Garcia in the Indian Ocean. Construction was started in early 1971.

Prior to 1971, Diego Garcia was a jungle-covered atoll devoid of activity except for a small meteorological station and a copra plantation. Today, it is a busy naval support activity, all due to the largest peacetime construction effort ever accomplished by the Seabees. This tremendous effort ultimately involved some 14 naval construction force (NCF) commands, 17 battalion deployments, and over 60 individual detachment deployments. The Seabees completed over 200 Navy and Air Force projects, valued at over \$200 million.

NMCB 40, the first detachment of Seabees involved in this effort, was deployed by amphibious ship to Diego Garcia in March 1971. They landed on the beach and quickly cleared temporary camp areas. Next, they cleared 15 acres of jungle, which was later used for more

permanent structures. They also completed a 3,500-foot-long, C-130 capable airstrip and carved a 4-mile road network out of the jungle.

Those early years presented many challenges—remote location, difficult on-site conditions, adverse weather, extreme heat, material delivery delays, numerous design changes, and problems establishing a 13,000-mile logistic pipeline. Despite these hardships Seabees completed 85 percent of construction on nine major industrial and support buildings. They cleared 210 acres; and during the preparation of a permanent runway base, they removed 200,000 cubic yards of unsuitable material and placed 300,000 cubic yards of coral. All tested the Seabee “Can Do” motto.

Priorities and world situations changed however, and what had originally been a 3-year mission for the Seabees was extended. After building an austere communications station, the Seabees were now tasked with building Diego Garcia to provide broader support for U.S. ships and aircraft in the Indian Ocean.

By mid-1975, the Seabees completed an entire Naval Construction Force camp that included berthing, messing, shops, storage, utilities, and recreation facilities. Diego Garcia had become a minor naval activity with a permanent airfield; air operations buildings; navigational aides; additional communications facilities; harbor operation facilities; a large port with petroleum, oil, and lubricating (POL) facilities; telephone systems; water distribution; power and electrical distribution; sewage systems; five BEQs, three BOQs, public works facilities, administrative, and other support facilities.

Today, Diego Garcia encompasses a busy support facility with a communications station, a naval air facility, a major fuel storage facility, a permanent pier, and other support structures. Naval Support Facility, Diego Garcia, hosts over 15 tenant activities, including a weather service unit, a Navy broadcasting unit, and fleet air reconnaissance and patrol squadrons. The runway at Diego Garcia has been lengthened from 8,000 feet to 12,000 feet. The extension permits operation of larger cargo aircraft as well as high-performance, tactical aircraft under a variety of circumstances in the tropical climate. Other airfield improvements include additional parking aprons and arresting gear for emergency use and limited aircraft maintenance facilities.

At the time Chief of Civil Engineers and Commander, Naval Facilities Engineering Command, Rear Admiral William M. Zobel praised the Seabee

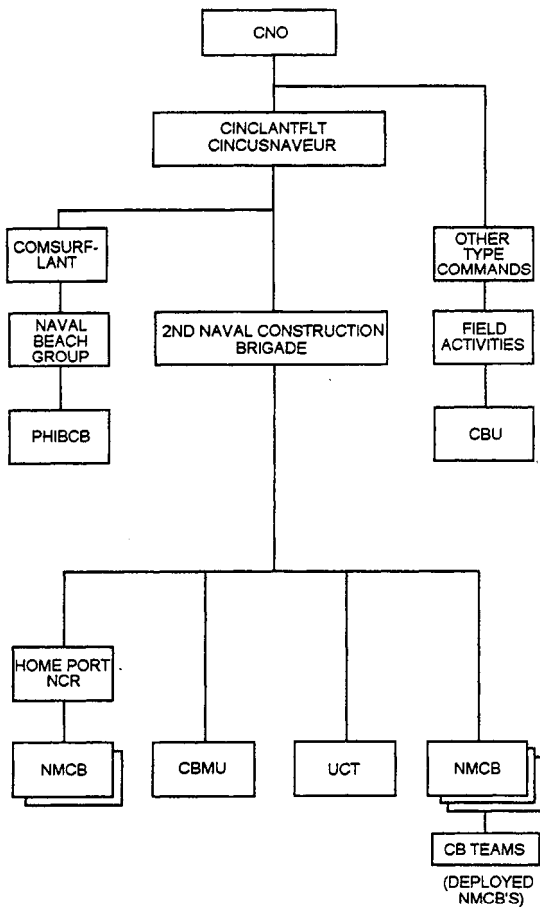

Figure 1-2.—Chain of command for LANTFLT NCF units.

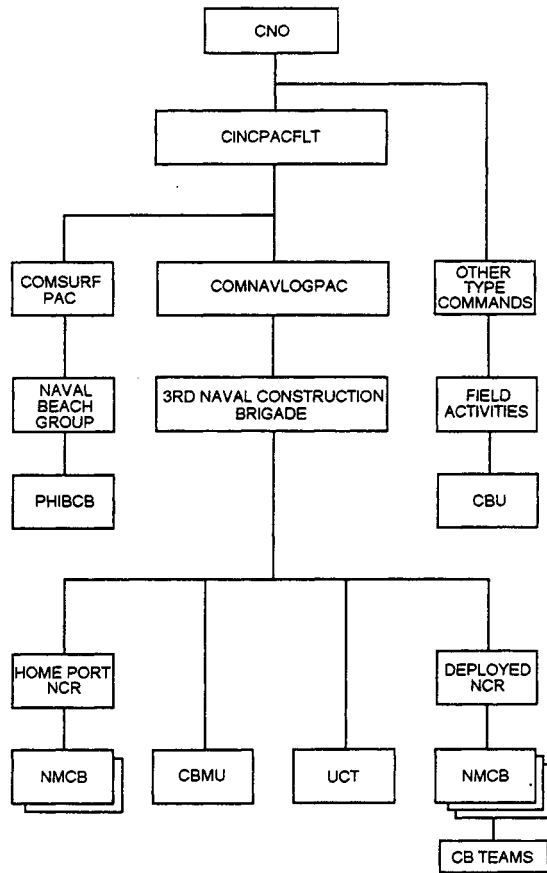

Figure 1-3.—Chain of command for PACFLT NCF units.

efforts on Diego Garcia and said, "With the departure of NMCB 62 from Diego Garcia on July 14, 1982, we closed another illustrious chapter in our Seabee history."

UNITS OF THE NAVAL CONSTRUCTION FORCE

The Naval Construction Force (NCF) consists of commissioned units of the Navy operating forces that are under the control of the Chief of Naval Operations (CNO), as shown in figures 1-2 and 1-3. The CNO commissions naval construction force units, assigns them to the fleet, and approves their deployment. He also defines the general mission, approves personnel allowance lists, establishes detachment sites, and approves the NMCB table of allowance (TOA), except for small arms, weapons, and landing party equipment allowances, which are approved by the Chief of Naval Material.

The Commanders in Chief of the Atlantic and Pacific Fleets are charged with ensuring that NMCB deployments and assigned projects follow CNO policies. They exercise command or operational and administrative control of the units of the NCF assigned to their command. Command or operational control is the authority to assign tasks, to designate objectives, to give any specific directions necessary to accomplish the mission, and by a specified date, when required. Command control and operational control go together; if you have one, you automatically have the other.

Under the Commanders in Chief of the Fleets, various Type Commanders command all the ships or units of a certain type; for example, all surface units of the Pacific Fleet (COMNAVSURFPAC); the commander of the submarine forces in the Atlantic Fleet is COMSUBLANT.

Commander, Second Naval Construction Brigade (Norfolk) and Commander, Third Naval Construction

Brigade (Pearl Harbor) have been established as representatives of the Commander in Chief, U.S. Atlantic Fleet and the Commander in Chief, U.S. Pacific Fleet, respectively, to exercise command and administrative control over assigned NMCBs. Much of this control is exercised through the home port Naval Construction Regiment (NCR). The home port NCR performs the routine functions related to coordination of administration, training, project selection, and logistic support for assigned units. Logistic support by the home port NCR consists of planning and carrying out the movement of personnel and equipment, and furnishing of services, supplies, and materials.

When a battalion is deployed overseas, it is under the command and control of a separate NCF commander. Operational command of the NMCB is exercised, in all cases, through a designated NCF commander.

The Chief of Naval Operations may establish Naval Construction Regiments (NCRs) and Brigades (NCBs) to meet certain command requirements in particular geographic areas or situations. Operational regiments consist of two or more NMCBs under one commander; a brigade is made up of two or more regiments under one commander. The mission of the operational brigades and regiments is different from the mission of the home port regiments. Operational regiments and brigades are primary planning groups and exist as subdivisions of the military command, exercising the administrative and operational control to meet specific operational requirements. The home port regiments have broad administrative and logistic duties that are discussed in this chapter.

CONSTRUCTION BATTALION UNITS (CBUs)

Construction Battalion Units (CBUs) are separate activities of the Naval Shore Establishment and are components of the Naval Construction Force. The CBU mission is to be prepared to mobilize either as contingency augment for active NMCBs or as Fleet Hospital public works support units; to conduct individual military and technical skill training essential to maintain the required readiness posture; and to perform construction assignments or other such functions as may be directed to further that intent.

CONSTRUCTION BATTALION MAINTENANCE UNITS (CBMUs)

The Construction Battalion Maintenance Units (CBMUs) operate, maintain, and repair public works and utilities at an already established advance base or at a recently constructed base after the departure of the NMCB or NMCBs that built it. In addition, the CBMU maintains security against unfriendly acts and is capable of conducting its own defenses. The CBMU also provides limited construction support for the base, for civic action programs, and for self-help projects. It also participates in disaster recovery operations.

Functions usually performed by a CBMU are maintenance, repair, and minor construction of buildings and grounds, existing roads within the base, and waterfront and airfield facilities. The CBMU operates and maintains automotive, construction, weight-handling, and materials-handling equipment, except for equipment assigned to combat units.

AMPHIBIOUS CONSTRUCTION BATTALIONS (PHIBCBs)

The Amphibious Construction Battalions (PHIBCBs) are commissioned naval units whose main function is to provide military and amphibious construction support to the armed forces in military operations. In addition to providing the means for moving troops and equipment from ship to shore, the PHIBCB may

1. install and operate tanker-to-shore bulk fuel delivery systems;
2. develop and improve beach facilities;
3. undertake special construction projects, especially those requiring surf, open sea, and heavy rigging experience, including work with pontoons and other floating equipment.

In some instances, there may be Underwater Demolition Team (UDT) personnel working to remove underwater obstacles that may jeopardize landing operations.

The PHIBCB is organized administratively into a headquarters company, an equipment company, two waterfront companies, and a single construction company. The size and composition of a PHIBCB is based on providing support for landing a reinforced infantry division over four battalion-size beaches,

normally considered to be 4400 meters wide. The PHIBCB is not intended for prolonged use in the field and is finished when the mission of the naval beach group is accomplished. This group assists the landing force in ship-to-shore movement by providing a uniform flow of material and services required by the landing force. To carry out this task, the PHIBCB provides causeway piers, barge units, fuel systems, and construction in support of the landing party.

At present there are two PHIBCBs: Amphibious Construction Battalion ONE, operating from Coronado, California, and Amphibious Construction Battalion TWO, operating from Little Creek, Virginia.

UNDERWATER CONSTRUCTION TEAMS (UCTs)

The Underwater Construction Teams (UCTs) are specially trained units that construct, maintain, and repair underwater facilities. Each UCT is capable of performing underwater construction tasks and surveying the sea bottom to select the site for an underwater facility.

The two UCTs are assigned to the 31st NCR and the Third Naval Construction Brigade, home ported at Naval Construction Battalion Center (NCBC), Port Hueneme, California, and Naval Amphibious Base, Little Creek Virginia, respectively.

SEABEE TEAM (CIVIC ACTION TEAM)

A Seabee team is a small, highly mobile, air transportable construction unit that can be tailored to accomplish a variety of construction tasks. The standard composition of a Seabee team is one CEC officer and 12 petty officers; however, when necessary, the standard personnel allowance can be increased to allow the undertaking of a specific deployment task. Although Seabee team allowances are normally associated with an NMCB, the responsibility for the operation of the team in a foreign country lies with the appropriate United States and host country agencies.

The tasks usually assigned to a team call for experience in operating equipment needed for the following tasks:

1. Constructing roads, dams, and bridges
2. Clearing forests and jungles to reclaim land for new hamlets, croplands, and refugee centers
3. Drilling water wells
4. Digging irrigation canals

5. Building schools, and erecting, repairing, and improving public buildings

Teams carry enough food, toolkits, and automotive and construction equipment to be Self-sufficient in the field while performing their construction tasks. Seabee teams also provide medical and dental care to the local villagers and conduct on-the-job training and classroom instruction for host country workmen.

These teams receive extensive training at their parent NMCBs' home port. After completion of this training, they may be deployed to any part of the world—generally to an underdeveloped area. These teams are actually the Seabees' "Peace Corps," and their work in Vietnam won the admiration of the Vietnamese. Seabee teams have also been deployed as engineers for the Army's Special Forces, technical instructors for the Agency for International Development, and construction advisors under various military assistance programs.

ORGANIZATIONS SUPPORTING THE NAVAL CONSTRUCTION FORCE

Many elements of the national defense organization provide support to the NCF, some directly and some indirectly. In this section we will cover only the Naval Facilities Engineering Command (NAVFAC), Naval Construction Battalion Centers (NCBCs), home port Naval Construction Regiments (NCRs), and Naval Construction Force Support Units (NCFSUs).

NAVFAC

NAVFAC provides support for the NCF in the general area of shore facilities and related material and equipment. The commander of NAVFAC serves as technical advisor to the CNO on all matters relating to the NCF and also as technical advisor to the Chief of Naval Personnel (CNP) on all matters pertaining to CEC officers and Seabee personnel.

NAVAL CONSTRUCTION BATTALION CENTERS (NCBCs)

The Naval Construction battalion Centers (NCBCs) are permanent shore stations equipped and staffed to support the NCF. Each NCBC has a supply and fiscal department and a construction equipment department (CED) that furnishes depot level maintenance for units of automotive and construction equipment. This type of maintenance involves major overhaul, using facilities that are not readily available at the battalion level. Naval

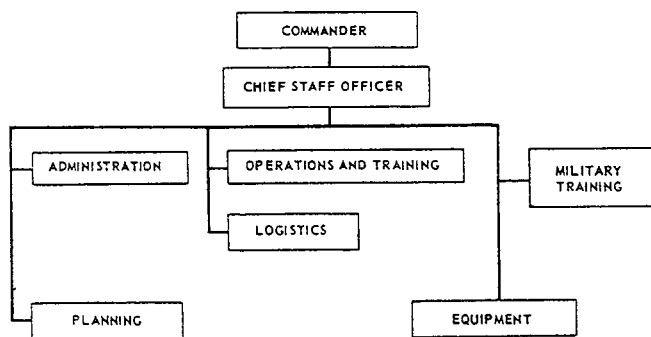

Figure 1-4.—Staff/function home port Naval Construction Regiment.

Construction Training Centers (NCTCs) are tenant commands at the NCBCs and provide training schools for NMCB personnel. A tenant command is one that occupies buildings and uses facilities provided as direct support by the NCBC. The NCBC receives, preserves, stores, accounts for, and issues advanced base material and equipment. Newly commissioned NMCBs are usually outfitted at the NCBC, which also provides home port facilities. The NCBC is under the management and technical control of NAVFAC. At present there are two NCBCs: one at Port Hueneme, California, and one at Gulfport, Mississippi.

HOME PORT NAVAL CONSTRUCTION REGIMENTS (NCRs)

Home port NCRs are located at both of the NCBCs. Under the direction of the Second NCB/Third NCB, the mission of the home port NCR is to ensure maximum effectiveness of all units of the NCR, while at home port, in achieving the highest possible state of readiness to meet their disaster recovery, contingency, and wartime missions of military construction support of the armed forces. As a secondary mission, the home port NCR acts as a receiving and separating activity for Seabee personnel.

The home port NCRs exercise operational control and, as specifically designated by the Second NCB/Third NCB, various elements of administrative control over all units of the NCF at the home port. The home port NCRs

- conduct and coordinate military, technical, and specialized training;
- administer the details of the automotive and equipment program;

- provide liaison with CBC on storage, preservation, and shipping of advance base and mobilization stocks;
- provide management guidance and evaluate the effectiveness of military, operational, and material readiness of all home port units of the NCFs;
- monitor personnel distribution among the NCF units;
- make recommendations to the Enlisted Personnel Distribution Office.

The basic organization and functions of a typical home port NCR's staff are shown in figure 1-4.

NAVAL CONSTRUCTION FORCE SUPPORT UNITS (NCFSUs)

The Naval Construction Force Support Units (NCFSUs) provide logistical support for an NCR and other supported NCF units. NCFSU equipment is maintained both in the active force and in the Reserve (PWRMs). The NCFSUs

- perform inventory management of construction materials, including requisitioning, expediting, receipt, control, issue, delivery, and other supply support functions;
- maintain inventory control;
- operate and perform maintenance, repair, and upkeep of NCF auxiliary construction and transportation equipment;
- perform specialized repair and overhaul of equipment components (such as transmissions, electric motors, and fuel injectors) when conditions warrant a centralized operation;
- provide the operation and maintenance capability for plants, such as rock crushers and asphalt and concrete batch plants, large paving machines, long-haul transportation, and other equipment of this type.

NAVAL MOBILE CONSTRUCTION BATTALIONS

The Naval Mobile Construction Battalions (NMCBs) are primarily designed for construction and military support operations to build advance base

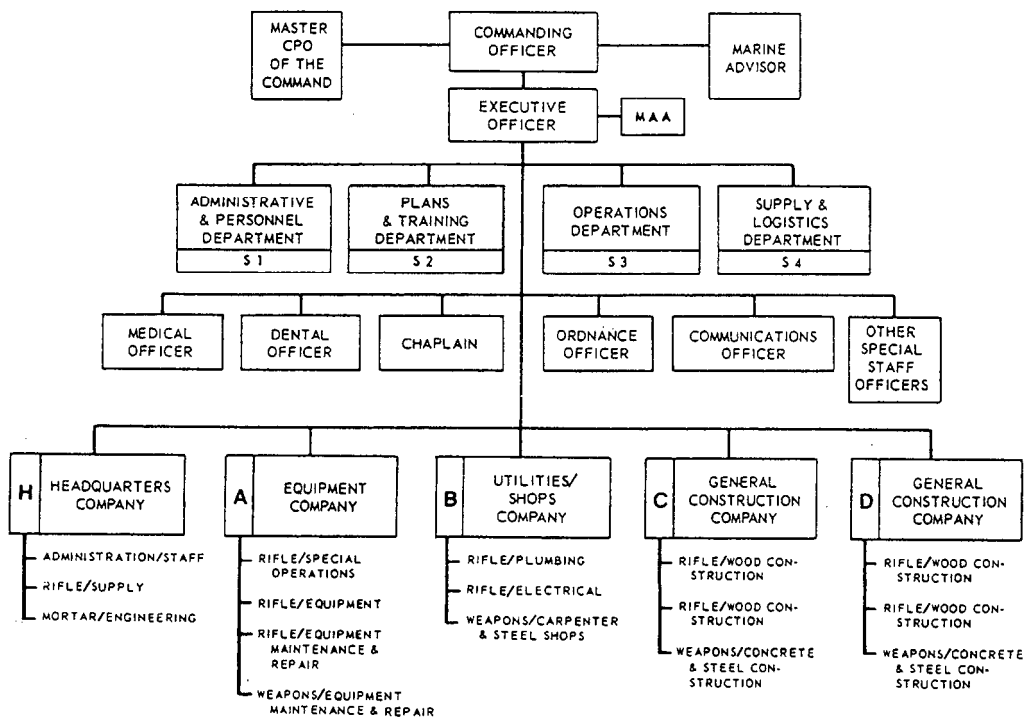

Figure 1-5.—The basic NMCB organization.

facilities in support of the armed forces. Figure 1-5 shows the basic NMCB organization. The function of an NMCB also includes projects of repair and operation of facilities and lines of communications during emergencies or under conditions that demand immediate action. When fully outfitted, NMCBs are self-sufficient units for 90 days and require

replenishment of consumable items only. They can defend themselves for a limited time; communicate internally; provide messing and billeting facilities; and perform the necessary administrative, personnel, medical, dental supply, and chaplain functions. The NMCBs also participate in disaster recovery operations during both natural and man-made disasters.

Each battalion subdivision has a construction and military support assignment, and every officer and enlisted man fills a construction and military billet. Command channels are the same for both construction and military support, permitting rapid transition from one to the other.

The battalion is organized into one headquarters and four construction/rifle companies: A, B, C, and D, as shown in figure 1-6.

The construction/rifle companies each have a weapons platoon containing M60 machine guns and lightweight antitank weapons.

The headquarters company has a weapons platoon containing the 60-mm mortars. (See fig. 1-7.) All platoons are organized into work squads that correspond to the weapons/rifle squad organization. Work crews and work squads of construction platoons are also trained as disaster control teams. Each battalion may organize the squads of each platoon to meet its particular

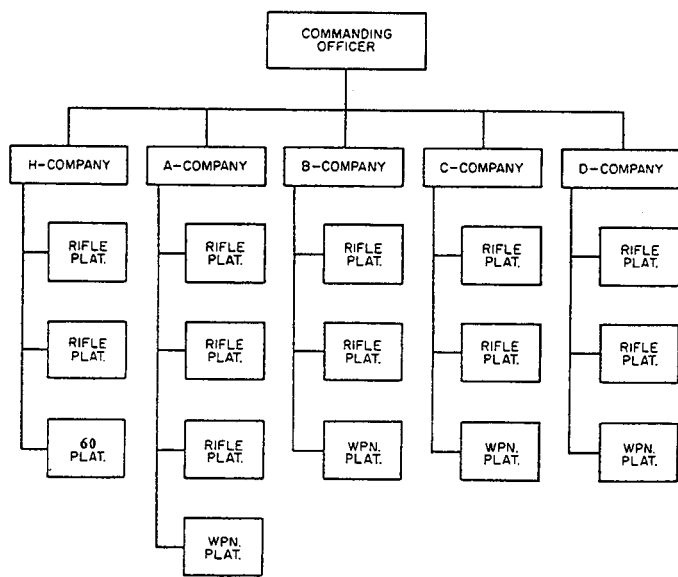

Figure 1-6.—The NMCB military organization.

1-11

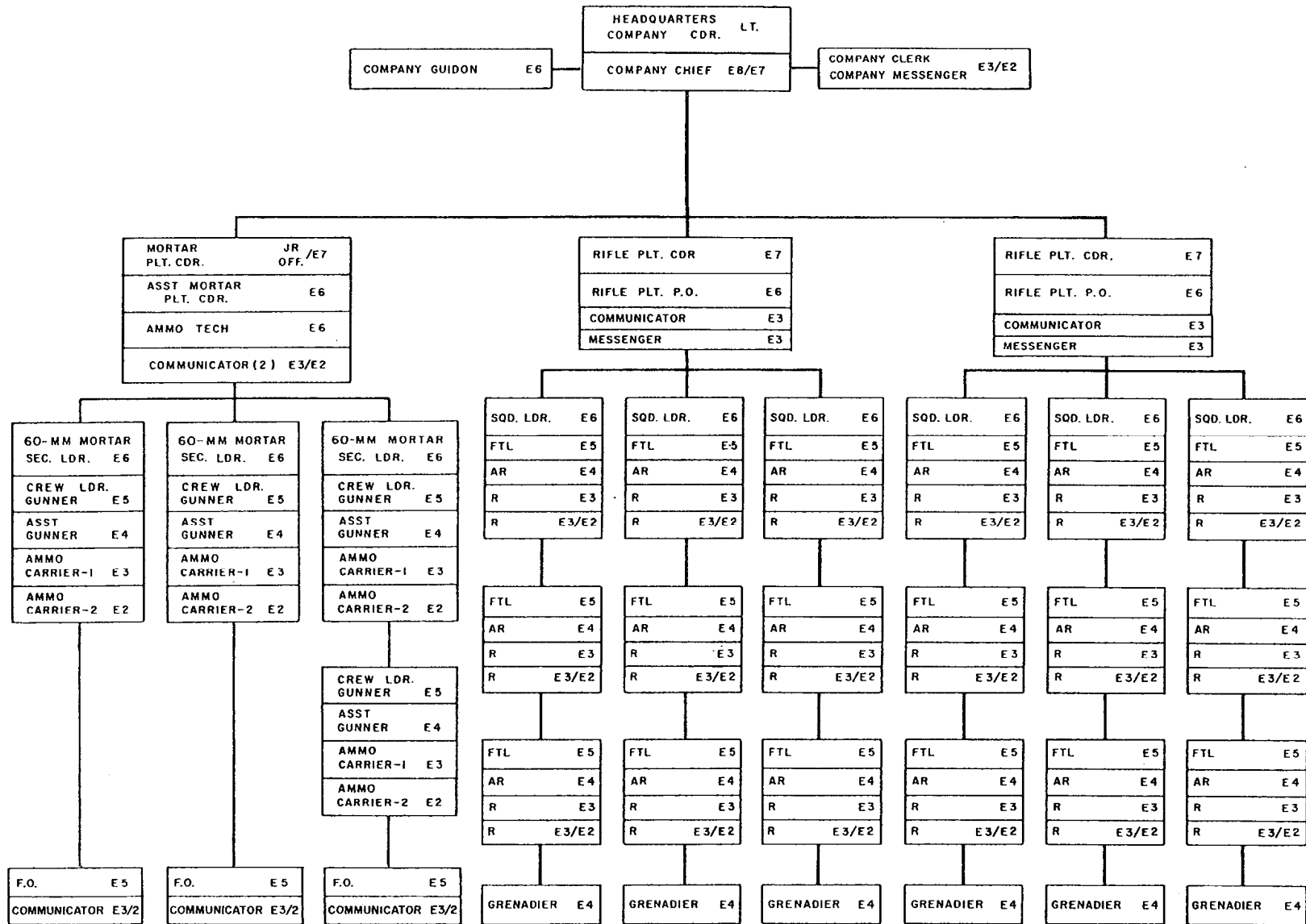

Figure 1-7.—Organization of military support in the headquarters company.

needs. The construction/military companies retain their normal letter designation, and the platoons retain their letter-number designation to facilitate reference, planning, and scheduling.

THE HEADQUARTERS COMPANY

The headquarters company of a Seabee battalion serves as the military and administrative organization for the personnel assigned to the executive and special staffs of an NMCB. Headquarters company has the capability of providing defense in a combat situation as a company unit and, in addition, acts as a reserve force for the battalion. The headquarters company's staff, when participating in a defensive situation, consists of the company commander, platoon commanders, a company chief petty officer, and other administrative assistants as required to organize it into two rifle platoons and one weapons (mortar) platoon, as shown in figure 1-7.

Headquarters Company Commander

Normally assigned to additional duty on the battalion staff, the headquarters company commander is responsible for the following:

1. Command of the company in all military formations and operations
2. Assignment of personnel on the watch, quarter, and station bill
3. Personnel muster
4. Supervision and coordination of military and leadership training
5. Administration and guidance in professional and technical training
6. Berthing, messing, mail distribution, and physical fitness
7. Division officer responsibilities, unless separate division officers are assigned

He is also responsible for the security and defense of the battalion's command post and acts as the reserve force commander for the battalion in the defense. He is armed with the .45-caliber pistol.

Platoon Commanders

All personnel assigned to the battalion's executive and special staffs are administratively assigned to headquarters company. Therefore, the headquarters

platoon commanders are normally officers of the administration and personnel department, the operations department, and the supply and logistics department. However, most battalions generally use a chief petty officer (E-7) from each department to act in the capacity of platoon commander.

The platoon commander is responsible for training, discipline, control, and tactical deployment of his platoon. He carries out the orders of the company commander and controls his platoon through his squad leaders. In combat, the platoon commander positions himself where he can readily control his squad leaders. At the same time, he remains in contact with his company commander. He is generally linked with the company commander by radio and field telephone or both, and is armed with the service pistol.

Headquarters Company Chief Petty Officer

The headquarters company chief petty officer can be a chief petty officer (E-7) or a senior chief petty officer (E-8), and serves as an assistant to the headquarters company commander in a staff capacity. The headquarters company CPO is directly responsible to the company commander for the administration and efficient operation of the company. He is also responsible for the discipline, training, and performance of the men assigned to the company and is armed with the service pistol.

THE RIFLE COMPANY HEADQUARTERS

The company headquarters of a Seabee company consists of the company commander, an assistant company commander when assigned, the company chief, a company guidon, a company clerk a company messenger, and other administrative assistants as required. The company headquarters varies somewhat in each company, depending on its construction/combat missions. Figure 1-8 shows the organization of military support in the construction/rifle companies.

Rifle Company Commander

The rifle company commander is usually a lieutenant in the Civil Engineer Corps who is responsible for commanding his company by following the policies of the commanding officer.

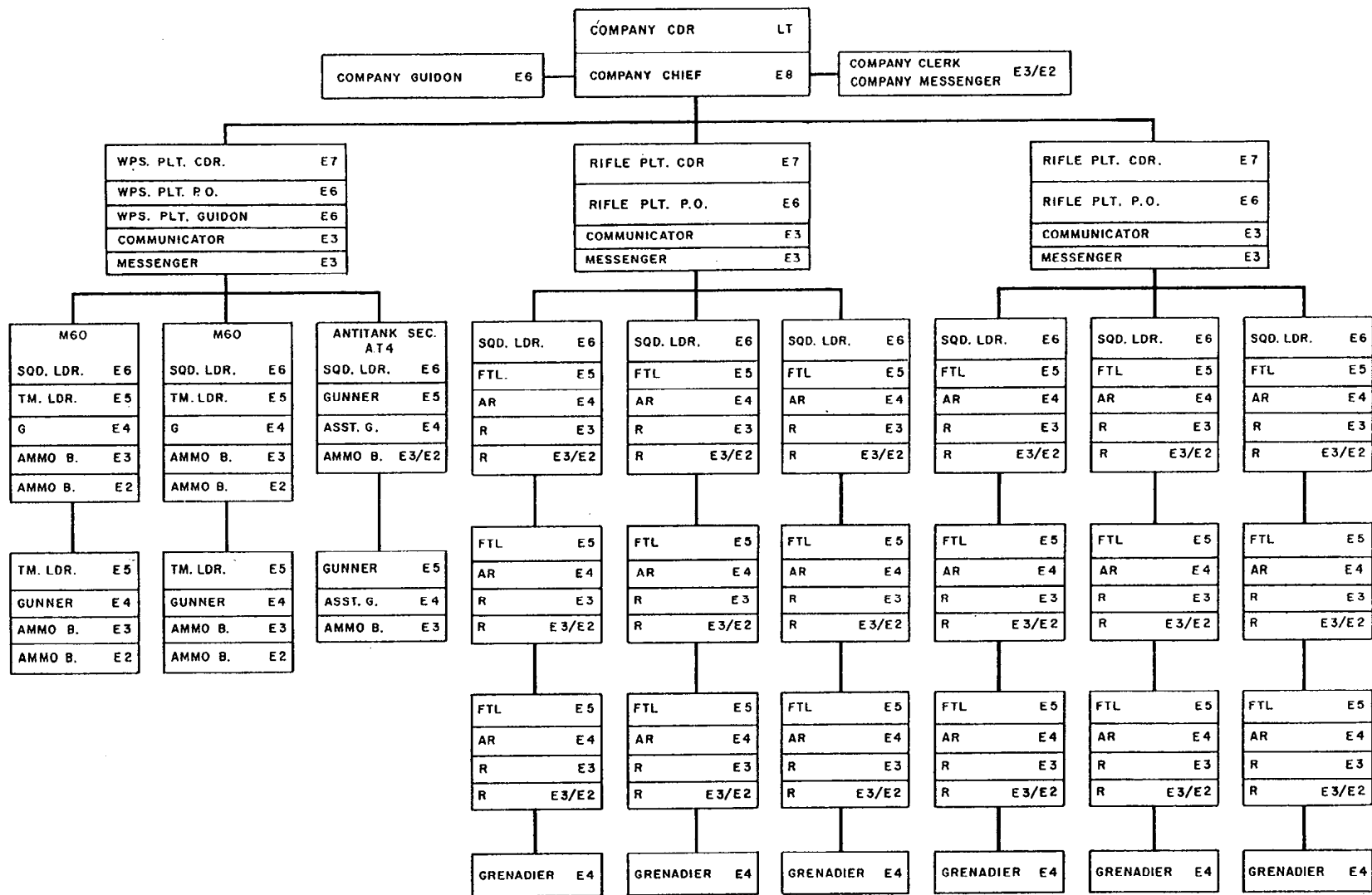

Figure 1-8.—Organization of military support in the construction rifle companies.

Assistant Rifle Company Commander

The assistant rifle company commander, when assigned, may be a junior CEC officer or a senior enlisted man. He is normally placed in a position of line authority and responsibility between the company commander and the platoon commanders. As a personnel and material manager within the company, he concerns himself with executing and enforcing the policies of the company commander and the commanding officer. The assistant rifle company commander supervises the administration of the company; plans and gives technical support to the platoon commanders about their crew assignments, project planning and scheduling, safety, and training. He is armed with the service pistol.

Rifle Company Chief

The rifle company chief is the senior enlisted man assigned to the company, usually a senior chief petty officer (E-8) or a master chief petty officer (E-9). He is the primary administrative assistant and technical advisor to the company commander. The rifle company chief is directly responsible to the company commander for the administration and efficient operation of the company and for the discipline, training, and the performance of the men assigned to the company. He is armed with the service pistol.

Rifle Company Guidon

The rifle company guidon, generally a petty officer first class (E-6), acts as a construction expeditor and supply coordinator for the company. During combat, he is stationed near the company commander and is responsible for the distribution of ammunition to the platoon guides. He coordinates the ammunition counts following combat to ensure appropriate redistribution. He is armed with the service pistol.

Rifle Company Clerk

The rifle company clerk is normally a constructionman (E-3) with clerical experience. His duties consist of preparing company memorandums, typing, filing, and many other administrative tasks. He is also the company mail orderly. During military operations, he becomes the company staff communicator and must be familiar with the operation and care of the company communications equipment. In addition, he is trained in proper procedures for

transmitting reports and messages. The rifle company clerk also may serve as guidon (company banner) bearer during parade formation. He is armed with the M16 service rifle.

Rifle Company Messenger

Generally, a constructionman (E-3) is assigned to the company headquarters as a rifle company messenger. He primarily performs in this capacity only during military operations. For work purposes, he is assigned to a work crew/rifle fire team. Although he delivers most of his messages on foot, he is also trained in the operation of communications equipment so he can take over should the rifle company clerk become a casualty. When the company administrative tasks increase, as they do during home port training periods, the rifle company messenger may assist the rifle company clerk with his duties. He is armed with the service rifle.

THE RIFLE PLATOON HEADQUARTERS

The maneuvering elements of a rifle company are the rifle platoons. A Seabee rifle platoon consists of a platoon headquarters and three or more rifle squads. Each rifle squad is composed of three or more work crew/rifle fire teams. The primary combat mission of the rifle company, as well as the rifle platoon, is to repel the enemy assault by fire and close combat.

Each rifle platoon headquarters consists of a platoon commander, platoon petty officer, platoon guide, communicator, and a messenger.

Rifle Platoon Commander

The rifle platoon commander is generally a chief petty officer (E-7). Normally, he is the project supervisor. He is responsible for the training, discipline, control, and tactical deployment of his platoon. The rifle platoon commander carries out the orders of the company commander and controls his platoon through his squad leaders. In combat, the rifle platoon commander positions himself where he can readily control his squad leaders and, at the same time, remain in contact with his company commander. The rifle platoon commander is generally linked with the company commander by either radio or field telephone or both. He is armed with the service pistol.

Rifle Platoon Petty Officer

The rifle platoon petty officer, generally a first class petty officer (E-6), is the next senior man in the platoon and is second in command. As such, he performs all duties assigned by the rifle platoon commander and stands ready to assume command in his absence. On the job, he will assist in project supervision. In combat, he assists in all aspects of supervision and control of the platoon. The rifle platoon petty officer positions himself where he can hear the commands of the rifle platoon commander but far enough away to avoid becoming a casualty should the rifle platoon commander be hit. The rifle platoon petty officer is also armed with the service pistol.

Rifle Platoon Guide

The rifle platoon guide is generally a first class petty officer (E-6) who performs the administrative functions the rifle platoon commander may direct. He is directly responsible to the rifle platoon commander for the supply and timely resupply of the platoon in combat and often performs a similar task on the jobsite. He also maintains the platoon casualty record. While the platoon is moving in training or in combat operations, the rifle platoon guide helps prevent straggling. He is armed with the service rifle.

Rifle Platoon Communicator and Messenger

These men are generally constructionmen (E-3); and during normal construction, they are assigned to work a crew/rifle fire team. The rifle platoon communicator and messenger, in combat, provide communications between the rifle company headquarters and the rifle platoon commander and also between the rifle platoon, its squads, and attached units. The rifle platoon communicator uses radio or telephone communication methods, while the rifle platoon messenger generally travels on foot. Both are armed with service rifles.

THE RIFLE SQUAD

The Seabee rifle squad is composed of a squad leader, three fire teams and a grenadier. Ideally, the rifle squad will contain three fire teams of four men each, a grenadier, and the squad leader for a total of 14 men.

Squad Leader

The squad leader is generally a first class petty officer (E-6). He carries out the orders of the platoon commander and is responsible to him for the discipline, appearance, training, control, and conduct of his squad at all times. He must pay particular attention to the care and maintenance of the weapons and equipment of the squad. In combat, he has the important responsibilities of fire discipline, fire control, and maneuvering his squad. He takes a position where he can best observe and control his squad and carry out the orders of the platoon commander. He controls his squad by voice and visual commands. The squad leader is primarily a leader; therefore, he only fires his own weapon in critical situations. He is armed with the service rifle.

Grenadier

The grenadier, generally a third class petty officer (E-4), carries out the orders of the squad leader and is responsible to him for the effective care, maintenance, and employment of his weapon-the M203 grenade launcher. In combat, the grenadier always moves with or is close to the squad leader. Usually, another E-4 in the squad is trained to replace the grenadier should he become a casualty. On the jobsite, the grenadier has no special authority unless specifically designated.

THE RIFLE FIRE TEAM

The rifle fire team is the basic combat unit of the rifle squad and is formed around the automatic rifle, which is an M16 service rifle, with the selector lever always turned to frilly automatic. The fire team normally consists of four men, although it may contain as few as three and as many as seven men. All members are armed with the M16 service rifle. The four basic members are the following:

1. Fire team leader
2. Automatic rifleman
3. Rifleman number 1
4. Rifleman number 2

Fire Team Leader

The fire team leader, generally a second class petty officer (E-5), carries out the orders of his squad leader and is responsible to him for the effective employment of his fire team. His primary responsibility is to control his fire team in combat. In addition, he is responsible for

the care and condition of the weapons and equipment of the fire team. The fire team leader stations himself where he can best control the fire of the automatic rifles of the team. He usually controls his men through real and visual communications, since there are normally no radio or telephone communications below the platoon commander's level. Although he is armed with the service rifle, his primary duty as a leader comes first; and he serves as a rifleman only when absolutely necessary. The senior fire team leader serves as assistant squad leader and is prepared to take over the squad in the event that the squad leader becomes a casualty.

Automatic Rifleman

The automatic rifleman, generally a third class petty officer (E-4), provides heavy firepower and is the backbone of the fire team. He is responsible to the fire team leader for the effective employment of his automatic rifle as well as its condition and care. The automatic rifleman acts as the fire team leader's assistant and takes over in his absence.

Rifleman Number 1

Rifleman number 1, generally a constructionman (E-3), carries extra ammunition for the automatic rifleman. The automatic rifle must be kept in action at all times; if the automatic rifleman becomes a casualty, rifleman number 1 moves up and replaces him. In addition, rifleman number 1 is armed with the service rifle and acts as a rifleman and a scout. He assists rifleman number 2 in protecting the flank (exposed side) of the fire team.

Rifleman Number 2

Rifleman number 2, a constructionman (E-3) or an apprentice (E-2), serves as a rifleman and protects the flank of the fire team. He is point man for all team formations and may also serve as a scout. If more than four men are assigned to the fire team, the additional men have the same general duties as rifleman number 2. All are armed with the service rifle.

FIRE SUPPORT ELEMENTS

The fire support elements of the rifle companies are the weapons platoons, the 60-mm mortar platoon of the headquarters company, and the weapons platoons furnished by the construction/rifle companies. Their purpose is to provide the companies organic machine

gun and mortar fire support and an antitank defense with the antitank weapon (AT4).

THE WEAPONS PLATOONS

Alfa, Bravo, Charlie, and Delta companies each have a weapons platoon composed of a platoon headquarters, two machine gun squads, and an antitank squad.

Weapons Platoon Headquarters

The weapons platoon headquarters consists of the platoon commander, platoon petty officer, ammunition technician/guide, a communicator and a messenger.

WEAPONS PLATOON COMMANDER.— The weapons platoon commander is generally a chief petty officer (E-7). He is responsible for the training, combat efficiency, discipline, administration, and welfare of his platoon. He also sees to it that his platoon members proceed correctly when carrying out preventive maintenance on their weapons. The weapons platoon commander makes sure they use their weapons and equipment economically. All of his other responsibilities are similar to those discussed for the rifle platoon commander. He is armed with the service pistol.

WEAPONS PLATOON PETTY OFFICER.— The weapons platoon petty officer is usually a first class petty officer (E-6). His responsibilities and duties are identical to those of the rifle platoon petty officer. He is armed with the service pistol.

AMMUNITION TECHNICIAN/GUIDE.— The ammunition technician/guide is also a first class petty officer (E-6). He not only has the responsibility of supplying the platoon and keeping the casualty list but he also must be highly skilled in the operation and maintenance of the machine guns used by his platoon. He must be familiar with the many types of ammunition used by the machine guns, its safe use, and its effect upon the enemy. The ammunition technician/guide's other duties are similar to those of the rifle platoon guide. He is armed with the service rifle.

COMMUNICATOR AND MESSENGER.— The communicator and the messenger, both usually constructionmen (E-3), perform the same basic duties as their counterparts in the rifle platoon. They are armed with the service rifle.

Machine Gun Squad

The machine gun squad consists of a machine gun squad leader and two four-man machine gun teams. They work together under the supervision of the crew/squad leader.

MACHINE GUN SQUAD LEADER.— The machine gun squad leader, generally a first class petty officer (E-6), has the same basic duties as the rifle squad leader. In addition, he selects and assigns exact positions and targets for his machine guns within the area designated by his platoon commander. The machine gun squad leader is armed with the service rifle and also carries binoculars and a compass.

MACHINE GUN TEAM.— The machine gun team consists of a team leader, a gunner, and two ammunition carriers. This team operates and services the machine gun.

Machine Gun Team Leader.— The machine gun team leader, generally a second class petty officer (E-5), is responsible to the squad leader for the effective employment (fire power) of the machine gun for his team. He carries and places the machine gun tripod for action. He also carries one bandolier (belt with pockets to carry machine gun ammunition). During combat, the machine gun team leader is responsible for changing the machine gun barrel, so he carries a kit that contains an extra gun barrel and a combination wrench. He is armed with a service pistol.

Gunner.— The gunner does the actual firing of the machine gun in combat as directed by the team leader. He carries the machine gun, one bandolier of machine gun ammunition, and is armed with a service pistol. Also, he must be able to maintain his machine gun. Generally, the gunner is a third class petty officer (E-4).

Ammunition Carrier Number 1.— The ammunition carrier number 1, generally a constructionman (E-3), acts as the supply man for the team. He carries one box of machine gun ammunition (200 rounds) and the spare barrel case with the traversing and elevating (T&E) mechanism. Ammunition carrier number 1 is armed with the service rifle. When not actually engaged in carrying machine gun ammunition, he protects the flank of the machine gun team.

Ammunition Carrier Number 2.— Ammunition carrier number 2, generally a construction apprentice (E-2), carries two boxes of machine gun ammunition (400 rounds). He is armed with the service rifle and also protects the machine gun team.

Antitank (AT4) Squad

The antitank squad consists of two three-man teams whose principle mission is defense against armored vehicles (tanks).

ANTITANK SQUAD LEADER.— The antitank squad leader, generally a first class petty officer (E-6), has the same basic duties as any other squad leader. In addition, he selects and assigns the exact positions and targets for his antitank weapons within the areas defined by his platoon commander. He is armed with the service rifle, and he carries binoculars and a compass.

ANTITANK TEAM.— The antitank team consists of three men carrying five AT4s each. These men are also armed with service rifles.

THE 60-MM MORTAR PLATOON

The NMCBs 60-mm mortar platoons can provide fire support during an assault or during defense. It is extremely effective in defending an established campsite against attacking ground forces and is often used to provide illumination during night operations. Since the mortar is a relatively heavy weapon, it is not often carried about during normal work operations. Permanent positions are generally set up in the base camp area near the battalion administrative area. As the major portion of the headquarters company personnel remain in camp during normal working hours, they are always available to man the mortars. This is the reason that the mortar platoon is normally assigned to headquarters company.

The standard mortar platoon consists of a platoon headquarters and four mortar squads of two crews each. At present, however, the NMCBs are only authorized four 60-mm mortars in the weapons allowance. Therefore, the mortar platoons of an NMCB at the present time have two squads of two crews each.

Mortar Platoon Headquarters

The mortar platoon headquarters consists of the platoon commander, assistant platoon commander, ammunition technician, and a minimum of two communicators.

MORTAR PLATOON COMMANDER.— The mortar platoon commander may be either a junior officer or a chief petty officer (E-7), preferably from the engineering department. He has the same general duties as any other platoon commander. However, during actual combat operations, he takes up a position in the

fire direction center (FDC). The FDC can be a separate bunker, generally located in the battalion command post. In the FDC, he receives fire missions from his forward observers (FOs) or from other commands. He then plots the targets on the plotting board to check their accuracy and determine the exact coordinates. After receiving permission to fire from the commanding officer, he issues fire commands to his squad leaders. The platoon commander is armed with the service pistol.

ASSISTANT MORTAR PLATOON COMMANDER.— The assistant mortar platoon commander, normally a first class petty officer (E-6), must always be prepared to assume command of the platoon. During combat, he takes up a position in the alternate command post and stands ready to take command of the platoon should the battalion command post be destroyed. He is armed with the service pistol.

MORTAR PLATOON AMMUNITION TECHNICIAN.— The mortar platoon ammunition technician, usually a first class petty officer (E-6), has the same responsibilities of supply, weapons maintenance, and casualty reporting as the weapons platoon ammunition technician. He is armed with the service rifle.

MORTAR PLATOON COMMUNICATORS.— The mortar platoon communicators, generally constructionmen (E-3), are trained as a team and must be completely familiar with fire commands and procedures. Whenever possible, one communicator is stationed with each forward observer. He passes target information back to another communicator in the FDC by radio. After the fire missions are assigned by the platoon commander, the FDC communicator passes the proper fire commands to the respective squad leaders by field telephone. All communicators are armed with service rifles.

Mortar Section

The mortar section consists of 11 men, a section leader, and 2 mortar crews of 4 men each, a forward observer, and a communicator.

MORTAR SECTION LEADER.— The mortar section leader is usually a first class petty officer (E-6). He is responsible to the platoon commander for the effective employment of his two gun crews. The section leader selects the exact position for placement of the mortar tubes. He supervises their placement and zeroing in. He is armed with the service rifle. The mortars are generally placed about 50 yards apart to help reduce casualties. The section leader normally takes up a position midway between and to the rear of the mortar

positions. If possible, he is connected by telephone to his mortar gun crews and to the platoon commander in the FDC.

FORWARD OBSERVER.— The forward observer is usually a second class petty officer (E-5). He is normally the second senior man in the mortar squad. He is the eyes of the mortar team and has the primary mission of locating suitable targets, and calling for and adjusting fire on these targets. He is armed with the service rifle.

MORTAR GUN CREWS.— Each mortar gun crew consists of four men. These men are called the crew leader/gunner, assistant gunner, ammunition carrier number 1, and ammunition carrier number 2.

Crew Leader/Gunner.— The crew leader/gunner, usually a second class petty officer (E-5), is responsible for the correct sighting of the weapon. He receives the target coordinates from the squad leader and makes the necessary safety checks and adjustment to the weapon. He is armed with the service pistol.

Assistant Gunner.— The assistant gunner, generally a third class petty officer (E-4), checks the mortar barrel for cleanliness, assists the gunner in positioning the barrel, and loads the weapon on command. The weapon automatically fires upon loading. He is also armed with the service pistol.

Ammunition Carrier Number 1.— Ammunition carrier number 1, generally a constructionman (E-3), prepares the ammunition for firing and passes it to the assistant gunner. In addition, he realigns the aiming stakes under the direction of the gunner. He is armed with the service rifle.

Ammunition Carrier Number 2.— Ammunition carrier number 2, also a nonrated man (E-3 or E-2) assists in placing the mortar and helps prepare the rounds for firing. He is also armed with the service rifle.

LAWS OF WAR

The laws of armed conflict are the concern of every member of the armed forces: soldiers, sailors, airmen, marines, and yes, even Seabees. Because of the important sound of the term *laws of armed conflict*, you may think that only people, such as the Chief of Naval Operations, the Secretary of the Navy, the Secretary of Defense, and the President, concern themselves with the rules of war. While individuals such as these from many countries have, over the years, drafted the basic documents governing man's treatment of his fellowman

in wartime, the laws of armed conflict remain the direct concern of every serviceman.

The principles behind the laws of armed conflict can be stated in the following question: How should you, an individual Seabee, conduct yourself in wartime operations to accomplish your mission while still respecting the rights of civilians, your enemies, and your allies? This chapter provides you with some basic information on what to do and, just as important, what not to do in wartime situations.

WHY WE NEED LAWS IN WAR

Unfortunately, war is as old as man himself. People cause wars; weapons do not. Man creates the weapons that are merely the instruments that a nation uses to carry out its war objectives. Genghis Khan, the ancient Asian warlord, killed or maimed a greater percentage of people than any other leader in history. He did it with bows and arrows and other similar primitive weapons. During Genghis Khan's era, there were no rules of war. Although man continues today to be the force behind the weapons, there exists now a certain orderliness to which people of most countries who find themselves on a battlefield subscribe.

The positive side of mankind has managed to improve the conditions under which war is conducted since the era of Genghis Khan. As newer weapons of warfare have made it easier for man to kill his fellowman, nations have sensed a need to eliminate unnecessary death, destruction, and suffering. This need has been reflected in the moral values of civilized man and also in his military policies.

Binding customs and formal laws of war, presented in the Geneva conventions and The Hague regulations, have evolved. They legally bind most nations to the practices set down at Geneva and The Hague. The United States has agreed to these rules. Any violation of them is the same as a violation of the laws of the United States itself. The United States has led the world in adopting rules for its military forces. These rules recognize that enemies are also human beings and that captured or detained people are entitled to retain their fundamental rights as humans regardless of their past conduct or beliefs. Every Seabee has the duty, therefore, to know and obey the laws of armed conflict.

History shows that discipline and high morale led our military forces to victory in battle after battle. These same characteristics apply to obedience to the laws of armed conflict. Although you will be in uniform and be an instrument of a nation state (the United States) in an

armed conflict, this does not give you license to do anything you wish to do. There are limits on what you can do when waging war, and those limits are established by the laws of armed conflict. This chapter explains what you can and cannot do.

GENERAL PRECEPTS OF THE LAWS OF ARMED CONFLICT

When you enter into armed conflict in another country, you should be aware of many of the characteristics of the country. Knowledge of these characteristics will better prepare you to follow the tenets of the laws of armed conflict.

Geography

A general understanding of the geography of a nation will help you to know where the population of the country is concentrated. That knowledge should prepare you to deal with civilians and the enemy as you encounter them. In addition, you should know the general area of the country in which you are operating and the nations that border it. This knowledge may help you in understanding any trends that may have an effect on carrying out the laws of armed conflict. You should know the capital city and the other major cities, the characteristics of the land (mountains, deserts, plains, etc.), and the climate. Knowledge of all these features will help you to deal with rules of war situations that might arise during your time in the country. You should receive information about the general characteristics of the geography of a nation as part of instructional briefings given in operational deployments.

People

Knowledge of the people in a country can be invaluable to you in how to conduct yourself under the rules of war. Since nearly all offenses under the laws of armed conflict involve people, the more you know about the civilian populace of a country and of your enemy, the better off you will be. Know their ethnic backgrounds, their language, the educational level of the people, the important cultural characteristics (particularly if they are different than the culture of the United States), the religions of the country, and the social customs of the people.

Knowledge of the people is probably the most important thing for you to know about the country. Without it, you cannot begin to understand the way the people think and act. Accordingly, the chances of doing something in violation of the rules of war increase. If

the enemy and the people are one and the same, then the questions posed above will serve for both. If not, you need to ask the same questions about the enemy. You must know both the military and nonmilitary characteristics of the enemy.

History

There is no need for you to know the long and detailed history of a country, except as it relates to why you are there. Historical circumstances involving politics, religion, or cultural values may have led to your being in the country. You need to have knowledge of, and be sensitive to, the historical circumstances dictating U.S. Armed Forces involvement in the country. Pay attention when you receive briefings on these matters. Read what you can find on the subject (newspapers, periodicals, etc.). Knowing the history of the country as it relates to your involvement may serve you well if a situation exists where you have to decide what action(s) to take in a wartime situation under the laws of armed conflict.

Economy

Is the country poor or wealthy? Does it have wealth concentrated in a few people and enormous pockets of poverty among the general populace? You need answers to these questions because such conditions may contribute to the way you deal with the people and the enemy of the country. Current economic conditions are also important. (These conditions include growth, inflation, deflation, unemployment, poverty, etc.). Knowledge of the economic condition of a country can lead to an understanding of how the people and the enemy of the country might behave toward you. It might also assist you in preventing a violation of the rules of war.

Foreign Relations

Knowing the alliances, Allies, traditional enemies (if any), and the role of the country in international organizations (for example, the United Nations) can provide you with an understanding of what to expect. Will the country comply with the laws of armed conflict that you fight under, or can you expect behavior contrary to your training?

Government

Knowing something about the nature of the national government in a country may better prepare you to

understand the nature and conduct of your enemy as well as the civilian populace, Is the government of the country bound by the Geneva conventions and The Hague resolutions? Will the government prosecute you for a crime against civilians or against the enemy for a violation of the rules of war? Even if the government does not comply with the rules of war in any way, your obligation as a Seabee is to conduct yourself under the laws of armed conflict that you are taught.

RELATIONS OF THE UNITED STATES WITH THE COUNTRY

The relations of the United States' with the country that you are entering may be good, bad, or somewhere between these two extremes. The government of the country may want the Seabees to be there, but some of its people may not. You may encounter situations or actions from the enemy, from the government, or from the general population that will try your patience. They may treat you as "Yankee, Go Home!" If so, you must maintain your self-control and not violate the principles you have learned under the laws of armed conflict. You should be familiar with our relations with the country you are entering. This knowledge can serve you well in preventing the creation of a situation where you might violate the rules of war.

Basically, what you have just read can be summed up in eight words: Know the country into which you are going. That is as important as knowing terrain features and enemy tactics.

Along with knowledge of the country in which you are operating, make sure you understand your mission fully. Because while conducting your mission, a situation may develop where you will have an opportunity to succeed or fail in your practice of the laws of armed conflict.

When you complete this chapter, you should have sufficient knowledge of what to do and what not to do under most combat situations. This knowledge protects you from violating the laws of armed conflict. When you encounter a situation where you are unsure of what action(s) to take in carrying out your mission, get clearance from the next higher authority before continuing. For example, when military action by you might endanger the lives of some local civilians and you are not sure how to proceed, be certain to get approval for your next action from the next higher authority.

YOUR CONDUCT UNDER THE LAWS OF ARMED CONFLICT

The laws of armed conflict tell you what you can and cannot do in combat situations. With the training you receive, you will have the necessary discipline to do the right thing. But if you do not learn how to conduct yourself in combat, you will be punished for mistakes.

All persons in uniform, carrying a weapon or participating in any way in military operations or activities, are known as combatants. Under the laws of armed conflict, only combatants are considered proper targets and may be fired upon. All others are called noncombatants. Noncombatants include civilians, medical personnel, and chaplains. Knowing the difference between combatants and noncombatants in guerrilla war situations may sometimes be difficult and require great care. Humane treatment of noncombatants may help you in obtaining valuable intelligence to better pursue your mission. If you are in doubt about the differences between combatants and noncombatants, consult your superior before pursuing a course of action.

Enemy Combatants

Never attack enemy soldiers who surrender or enemy soldiers who are captured, sick, or wounded. When you have prisoners of war (POWs), you should follow the six Ss: search, secure, silence, segregate, safeguard, and speed the prisoners to the rear. You must never kill, torture, or mistreat a prisoner because such actions are a violation of the law. Besides, prisoners may provide you with vital information about the enemy. Treating a prisoner badly also discourages other enemy soldiers from surrendering, and it strengthens their will to resist. But if you treat prisoners well, your fairness encourages the enemy to treat their prisoners (your buddies) well. Humane treatment of POWs is right, honorable, and required under the laws of armed conflict. Improper treatment of prisoners by you is punishable by court-martial.

Let enemy soldiers surrender. The enemy may use different signals to convey they are surrendering, but all of the signals should be noticeable. It is illegal to fire on an enemy that has thrown down their weapons and offered to surrender.

You should also provide medical care to the wounded whether friend or foe. You are required under the laws of armed conflict to provide the same medical care to the sick and wounded as you would provide for your own personnel.

When someone is captured, you may not be certain whether the person is an enemy. That determination is made by specifically trained personnel at a higher headquarters. You may question captives about military information of immediate value to your mission, but you may never use threats, torture, or other forms of coercion to obtain information.

You may not take personal property from a prisoner, except those items that are clearly of a military or intelligence value (weapons, maps, or military documents). You do this only after the prisoner has been secured, silenced, and segregated. You take nothing that is not of military value. Only an officer may take custody of the personal effects of a prisoner.

Captives may perform some types of work but the work must not relate to assisting your war effort. The acceptable work performed must be limited to allowing captives to dig foxholes or build bunkers only for their own protection. Under the laws of armed conflict, you may never use captives as a shield for your attack or defense against the enemy; to search for, clear, or place mines or booby traps; or to carry your ammunition or heavy gear.

Under the rules of armed conflict, you are not permitted to attack villages, towns, or cities. But you are allowed to engage the enemy that is in a village, town, or city and to destroy any equipment or supplies that the enemy has there when it is mission essential. In all cases, you must not create more destruction than is necessary to accomplish the mission. When using firepower in a populated area, you must attack only military targets.

You may not attack **PROTECTED PROPERTY**. While some protected property may mean little to you, the property in question maybe of cultural importance to the people of the country. Examples of protected property include buildings dedicated to religion, art, science, or charitable purposes; historical monuments; hospitals and places where the sick and wounded are collected and cared for; and schools and orphanages for children. When the enemy uses these places for refuge or for offensive purposes, your commander may order an attack. It is common sense to destroy no more than the minimum amount of protected property consistent with carrying out the mission. To do more may undermine your mission.

Civilians

Earlier in this chapter, the reasons for knowing as much as possible about the country in which you are operating was discussed. Once there, you need to treat

civilians humanely and private property as though it were your own.

Do not violate the rights of civilians in war zones. When you know something about the culture and practices of the people, you should have little trouble recognizing the rights of civilians. Make sure civilians are protected from acts of violence, threats, and insults both from the enemy and from your fellow Seabees.

On occasion, it may be necessary to move or resettle civilians because such action is urgently required for military activities. Under no circumstance should you burn civilian property without approval of higher authority. Similarly, you should never steal from civilians. Failure to obey these rules is a violation of the laws of armed conflict and punishable by court-martial.

Under no circumstances should you fire upon medical personnel or equipment used for the welfare of the people or the enemy. Most medical personnel and facilities are marked with a red cross on a white background. However, a few countries use a different symbol. This is one of the reasons you should be familiar with the customs of the country in which you are operating. Similarly, never pose as a Red Cross representative when you are not. Your life may depend on proper use of the Red Cross symbol.

Parachutists are considered helpless until they reach the ground. Under the rules of war, you may not fire at parachutists while they are in the air. If they resist with weapons upon landing or do not surrender, you may fire at them. Paratroopers, on the other hand, are always considered combatants and may be fired on while they are still in the air.

Under the laws of armed conflict, you may not use poison or poisoned weapons. However, you may use nonpoisoning weapons to destroy the food and water of the enemy.

You may not alter weapons to cause unnecessary suffering by the enemy. You cannot use altered rounds to inflict greater destruction on the enemy. These alterations are forbidden under the laws of armed conflict.

WHAT HAPPENS WHEN RULES ARE VIOLATED

You have been provided some basic rules to show what you can and cannot do in a wartime situation, as they relate to the laws of armed conflict. This section provides instructions on what action to take if the rules are violated by other personnel.

You must prevent violations of the laws of armed conflict by others because they are criminal acts. When you see a criminal act about to happen, you should try to prevent it by

- arguing against it.
- threatening to report the criminal act.
- repeating the orders of your superiors.
- stating your personal disagreement, or
- asking a senior individual present to intervene.

You should be able to do this when you are totally familiar with the country in which you are operating and are knowledgeable about the rules of war. In the event the criminal act immediately endangers your life or the lives of others, you may use the exact amount of force needed to prevent the crime, but do this only as a last resort. You should immediately report the criminal act through your chain of command. When the criminal act is committed or about to be committed by your immediate superior, report the act to his immediate superior. You are required to do this by the laws of armed conflict. Conversely, you are not required to commit a crime under the laws of conflict. If you are ordered to commit a crime under the rules of war, you must refuse to follow the order and report your refusal to the next higher authority. You can be prosecuted for carrying out an unlawful act under the laws of war, so you must know what is legal and act by following the rules of armed conflict.

CODE OF THE U.S. FIGHTING FORCE

The Code was prescribed by the President of the United States in 1955 as a simple, written creed applying to all members of the armed forces of the United States. The words of the Code, presented in six articles, state the principles that Americans have honored in all the wars this country has fought since 1776.

The Code is not intended to provide guidance on every aspect of military life. For that purpose there are military regulations, rules of military courtesy, and established customs and traditions. The Code is in no way connected with the Uniform Code of Military Justice (UCMJ). The UCMJ has punitive powers; the Code does not.

The six articles of the Code can be divided into three categories. Articles I and VI are general statements of dedication to country and freedom. Conduct on the

battlefield is the subject of Article II. Articles III, IV, and V concern conduct as a prisoner of war.

Article I

- I am an American, fighting in the forces which guard my country and our way of life. I am prepared to give my life in their defense.

It is a long-standing tradition of American citizens to answer the call to arms willingly when the peace and security of this nation are threatened. Patrick Henry stated it best in the early days of our country when he said, “. . . give me liberty or give me death.” Nathan Hale, captured by the British during the revolutionary war and charged with spying, personified the spirit of an American fighting for freedom, when he spoke the immortal words, “I only regret that I have but one life to lose for my country,” just before his execution by hanging.

More recently, the threat to America has been less obvious as small countries, such as South Korea and South Vietnam, have borne the brunt of attacks by the enemy. Nevertheless, Americans have risen to the challenge and have proven their dedication and willingness to make the supreme sacrifice as much as in any of the wars in our history.

In June 1965, Construction Mechanic Third Class David G. Shields served with U.S. Navy Seabee Team 1104 at Dong Koai, supporting 5th Special Forces Group (Airborne), 1st Special Forces. Although wounded when a reinforced Viet Cong regiment using a machine gun, heavy weapons, and small arms placed intensive fire on the unit, CM3 Shields continued to resupply his fellow Americans with needed ammunition to return the enemy fire for a period of approximately 3 hours. Wounded a second time during this attack, CM3 Shields assisted in carrying a more critically wounded man to safety. Then, he resumed firing at the enemy for 4 more hours. CM3 Shields unhesitatingly volunteered to accompany the commander and knock out an enemy machine gun emplacement that was endangering the lives of all personnel in the compound because of the accuracy of the enemy fire. Advancing toward the objective with a 3.5-inch rocket launcher, the two men succeeded in destroying the enemy machine gun emplacement, undoubtedly saving the lives of many of their fellow servicemen.

CM3 Shields fell mortally wounded by hostile fire while returning to his position. He was later awarded the Medal of Honor for his courageous actions. His bold

initiative and fearless devotion to duty are perfect examples of the meaning of the words of Article I of the Code.

Article II

- I will never surrender of my own free will. If in command, I will never surrender the members of my command while they still have the means to resist.

This is an American tradition that dates back to the revolutionary war. An individual may never voluntarily surrender himself. If isolated and unable to fight the enemy, he is obligated to evade capture and rejoin friendly forces at the earliest possible time.

John Paul Jones always comes to mind when one reads Article II of the Code. In 1779 the captain of the *Bonhomme Richard* challenged two British ships of war, the *Serapis* and the *Countess of Scarborough*. Old, slow, and hopelessly outclassed the *Bonhomme Richard* was being badly battered, repeatedly set on fire, and rapidly falling with water when the captain of the *Serapis* called, “Do you ask for quarter?”

“I have not yet begun to fight,” replied John Paul Jones. Hours later, the *Serapis* struck her flag; and Jones and his crew boarded and captured the British ship as they watched their own ship sink

When a unit is involved, the officer in command may never surrender that unit to the enemy while it has the power to resist or evade. A unit that is cut off or surrounded must continue to fight until it is relieved by, or able to, rejoin friendly forces.

Article III

- If I am captured, I will continue to resist by all means available. I will make every effort to escape and aid others to escape. I will accept neither parole nor special favors from the enemy.

Article IV

- If I become a prisoner of war, I will keep faith with my fellow prisoners. I will give no information or take part in any action which might be harmful to my comrades. If I am senior, I will take command. If not, I will obey the lawful orders of those appointed over me and will back them up in every way.

Article V

- When questioned, should I become a prisoner of war, I am required to give name, rank, service number, and date of birth. I will evade answering further questions to the utmost of my ability. I will make no oral or written statements disloyal to my country and its Allies or harmful to their cause.

The misfortune of being captured by the enemy does not end a Seabee's usefulness to his country. His duty is to continue to resist the enemy by all possible means and to escape and assist others to escape. A Seabee may not accept parole from the enemy or special favors, such as more food, warm clothes, less physical restrictions, and so forth, in return for promises not to escape or for informing or providing information to the enemy.

Informing, or any other action endangering the well-being of a fellow prisoner, is forbidden. Prisoners of war must not help the enemy by identifying fellow prisoners who may have knowledge of particular value to the enemy and who may, therefore, be made to suffer brutal interrogation.

Strong leadership is essential to discipline. Organization, resistance, and even survival may be extremely difficult without discipline. Personal hygiene, sanitation, and care of the sick and wounded prisoners of war are an absolute "must." All United States officers and noncommissioned officers must continue to carry out their responsibilities and exercise their authority if captured.

The senior line officer or noncommissioned officer within a prisoner of war camp, or a group of prisoners, must assume command according to rank or date of rank, without regard to branch of service. He is the lawful superior of all lower ranking personnel.

If the senior officer or noncommissioned officer is incapacitated or unable to command for any reason, command must be assumed by the next senior man. This responsibility cannot be avoided.

Article VI

- I will never forget that I am an American, fighting for freedom, responsible for my actions, and dedicated to the principles which made my country free. I will trust in my God and in the United States of America.

Article VI and Article I of the Code are quite similar. The repeated words *I am an American, fighting for*

freedom, are perhaps the most important words of the Code, because they signify each American's faith and confidence in his God, his country, and his service. Since John Paul Jones made his defiant reply, "I have not yet begun to fight," to the present, Americans have traditionally fought the enemy wherever they were found and with whatever weapons were available. When captured, the American, fighting for freedom, has continued the battle in a new arena. When facing a Communist interrogator, they have been under fire just as though bullets and shell fragments were flying about them. Disarmed, the POW has fought back with mind and spirit, remaining faithful to their fellow POWs, yielding no military information, and resisting every attempt of indoctrination. Every Seabee has the responsibility to honor these traditions by carefully adhering to the meaning of each article of the Code. The many Americans who have accepted this responsibility are heroes in the finest sense of the word.

In February 1966, Lieutenant (jg) Dieter Dengler, USNR, was on a bombing mission over North Vietnam when his aircraft was badly damaged by ground fire. LTJG Dengler crash-landed his aircraft in nearby Laos and attempted to evade capture. After successfully evading the enemy for 1 day, he was captured and led to a village where he was interrogated and told to sign a Communist propaganda statement condemning the United States. LTJG Dengler's repeated refusal to give more than his name, rank, service number, date of birth, or to sign any statements, resulted in severe beatings. When he continued to refuse to answer questions, he was tied behind a water buffalo that dragged him through the brush. The interrogations and beatings continued for 3 days, but LTJG Dengler refused to give in. Later, he escaped from his guards but was recaptured and again severely beaten. After 6 months in captivity, LTJG Dengler successfully escaped, killing several enemy guards in the process. On the seventeenth day, a pilot who escaped with him was killed, and LTJG Dengler had to continue alone. Although suffering from malnutrition, jaundice, fatigue, and badly cut and swollen feet, LTJG Dengler refused to give up. Finally, on the twenty-second day after his escape, he managed to lay out a crude SOS on a bed of rocks and attract the attention of a United States Air Force aircraft. Later, a rescue helicopter plucked him to safety and ended his ordeal.

The stories of Americans, fighting for freedom, have steadfastly followed both the spirit and letter of Articles III, IV and V of the Code are numerous.

CONCLUSION

We all recognize that full compliance with the laws of armed conflict is not always easy, especially in the

confusion and passion of battle. For instance, you might be extremely angry and upset because your unit has taken a lot of casualties from enemy booby traps or hit-and-run tactics. But you must NEVER engage in reprisals or acts of revenge that violate the laws of armed conflict.

CHAPTER 2

SPECIAL CLOTHING AND EQUIPMENT

This chapter is intended as a guide for the individual Seabee on the proper use and care of special clothing and equipment issued to him while serving with the Naval Construction Force (NCF).

The utility uniform is known as special clothing. Special equipment is needed by an individual under field conditions whether in combat or in training. This special equipment is commonly called 782 gear, the number of the custody card originated in the Marine Corps Supply System years ago. This gear is also known as field or bivouac equipment.

General instructions for wearing, cleaning, pressing, storing, and mending items of the uniform are included in this chapter. Uses of the poncho, sleeping bag, and other bivouac equipment are discussed as well as methods of assembling, packing, and using load-carrying equipment. Instructions for the display of individual clothing and equipment are given where applicable.

You are responsible for the use and care of clothing and equipment issued to you. It is your duty to ensure these items are available and in a serviceable condition when they are needed. A torn sleeping bag cannot provide the protection required on cold nights. Neither can your cold weather coat if it does not have buttons or a zipper. Under certain circumstances, you may be charged for the replacement or repair of items lost or damaged through carelessness. Under other circumstances, neglect may cost you your life.

SPECIAL CLOTHING (STANDARD ISSUE)

The initial allowance of utility uniforms will be issued to you when you check into your unit. These items remain the property of the government; however, you are responsible for their proper upkeep. When an item wears out through normal use, it will be replaced at no cost to you by the supply section of the unit. Always ensure that your clothing is in good condition before deploying to an overseas destination where the supply of these items maybe limited.

Current instructions recommend that the standard MINIMUM OUTFIT issued to each person consist of the following:

1. Six utility shirts
2. Six pairs of utility trousers
3. Three caps
4. A cold weather coat (field jacket)
5. Two pairs of combination combat/safety boots

All items of clothing are to be marked in the following manner:

1. Utility shirts. When these shirts are issued, a 1-inch-wide green tape must be sewn above each pocket flush with the pocket seam. These tapes are the full width of the pocket, except that some personnel with long surnames may require tapes wider than the pocket. In addition, an iron-on type of Seabee insignia must be applied to the center of the left breast pocket (fig. 2-1).

Your last name must be stenciled in black stencil ink or black paint in 3/4-inch block letters on the tape above your right breast pocket.

The tape above your left breast pocket must be stenciled in the same manner with the words U.S. NAVY centered above the pocket. As an alternative to stenciling, block letters may be embroidered with black thread. The Seabee insignia may also be embroidered on the pocket, but the sew-on patch is not authorized.

2. Utility trousers. A name tape similar to that sewn above your right breast pocket must be sewn over the rear right pocket.

3. Caps. Utility caps should be stenciled with your initials only on the sweatband.

4. Boots. Each boot should be stenciled with your initials on the inside near the top.

5. Belt. The black web belt should be stenciled in white ink with your last name and initials on the end nearest the buckle.

6. Cold weather coat. This coat, commonly called a field jacket, is issued to you. The field jacket is to be stenciled in the same manner as the green shirt.

COLLAR DEVICES

SPREAD EAGLE AND CHEVRONS
WORN BY E-4 THROUGH E-6.

**NAME TAPE**

1" WIDE GREEN TAPE FLUSH WITH
TOP OF POCKET.

NAME

3/4" BLOCK LETTERS, STENCILED
IN BLACK INK OR EMBROIDERED
WITH BLACK THREAD, CENTERED
ABOVE ROCKET.

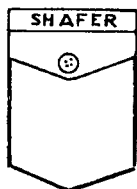
**BLOUSING**

TROUSERS SHALL COVER TOP ROW
OF HOOKS OR EYELETS. BLOUSING
GARTERS OR SPRINGS SHALL BE USED,
RATHER THAN TUCKING TROUSERS IN
BOOT TOPS.

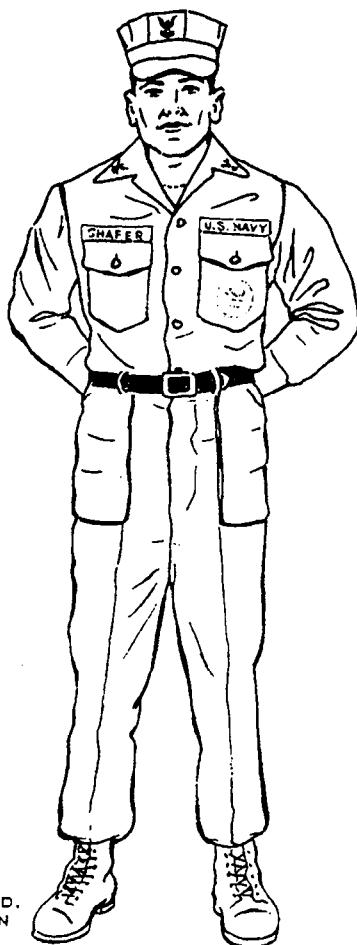
**CAP**

WORN SQUARELY ON HEAD. CAP
DEVICE SHALL BE WORN 1-1/4"
ABOVE THE VISOR.

U.S. NAVY TAPE

1" WIDE GREEN TAPE FLUSH
WITH TOP OF POCKET.

U.S. NAVY

3/4" BLOCK LETTERS, STENCILED
IN BLACK INK OR EMBROIDERED
WITH BLACK THREAD, CENTERED
ABOVE POCKET.

SEABEE INSIGNIA

APPLIED TO LEFT BREAST POCKET;
IRON ON TYPE OR EMBROIDERED
WITH BLACK THREAD. IF EMBROI-
DERED INSIGNIA IS USED, NAMES
ON SHIRT OR TROUSERS MUST ALSO
BE EMBROIDERED.

BELT

RIGHT EDGE OF BUCKLE ALIGNED
WITH CENTER OF TROUSERS. TIP
END SHALL PASS THROUGH BUCKLE
RIGHT TO LEFT, AND SHALL EX-
TEND 2" TO 4" PAST LEFT EDGE OF
BUCKLE. BUCKLE AND TIP END
SHALL BE KEPT SHINED.

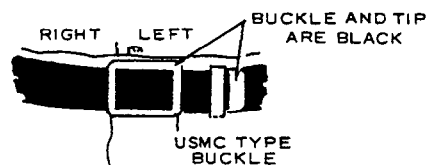
**COMBAT OR COMBINATION
COMBAT/SAFETY BOOTS**

APPEARANCE - SHINED OR OILED
AS PRESCRIBED BY APPROPRIATE
AUTHORITY.

Figure 2-1.—Olive green utility uniform.

All petty officers (E-4 to E-9) are required to wear the cap and collar devices on the green utility uniform.

Cap devices are located 1 1/4 inches above the visor in the center of the cap. Chief through third class petty officer must wear the appropriate black cap devices.

Chief petty officers wear the appropriate black CPO rank, collar devices centered 1 inch from each edge of the collar wings. Other petty officers wear a spread eagle and a series of black chevrons according to the rate of the individual. These are worn 1 inch from the point of the collar wing along the axis of a line bisecting the angle of the collar point with the eagle of the chevron facing inboard (fig. 2-1). Nonrated personnel do not wear collar or cap devices.

The utility uniform is worn as described below (fig. 2-1). Clothing may be tailored slightly to ensure proper fit, but formfitting tailoring, such as "pegging" or narrowing of the trousers, is not permitted

1. Cap. The cap should be worn squarely on your head, so the visor is in line and just above eye level.

2. Utility shirt. The shirt should be worn with the tail tucked in and all buttons, except the collar button, buttoned. Sleeves may be rolled up at the option of appropriate authority. When authorized, utility sleeves should be rolled with the inside out, forming a roll about 3 inches wide and terminating at a point about 3 inches above the elbow.

3. Utility trousers. The utility trousers should be worn with the rear edge of the trouser legs hemmed 2 inches above the deck. When worn with combination combat/safety boots, the trouser legs must be bloused with springs, so the blouse covers the top row of hooks or eyelets on the boot. The trouser legs are not to be tucked in the top of your boots instead of using blousing springs.

4. Footwear. The combination combat/safety boots are worn with the utility uniform. They are black in color and must be kept clean and in good repair. They may be shined or oiled, as prescribed by appropriate authority.

5. Belt/buckle. The 1 1/4-inch black web belt with Marine Corps type of buckle is worn by members of the

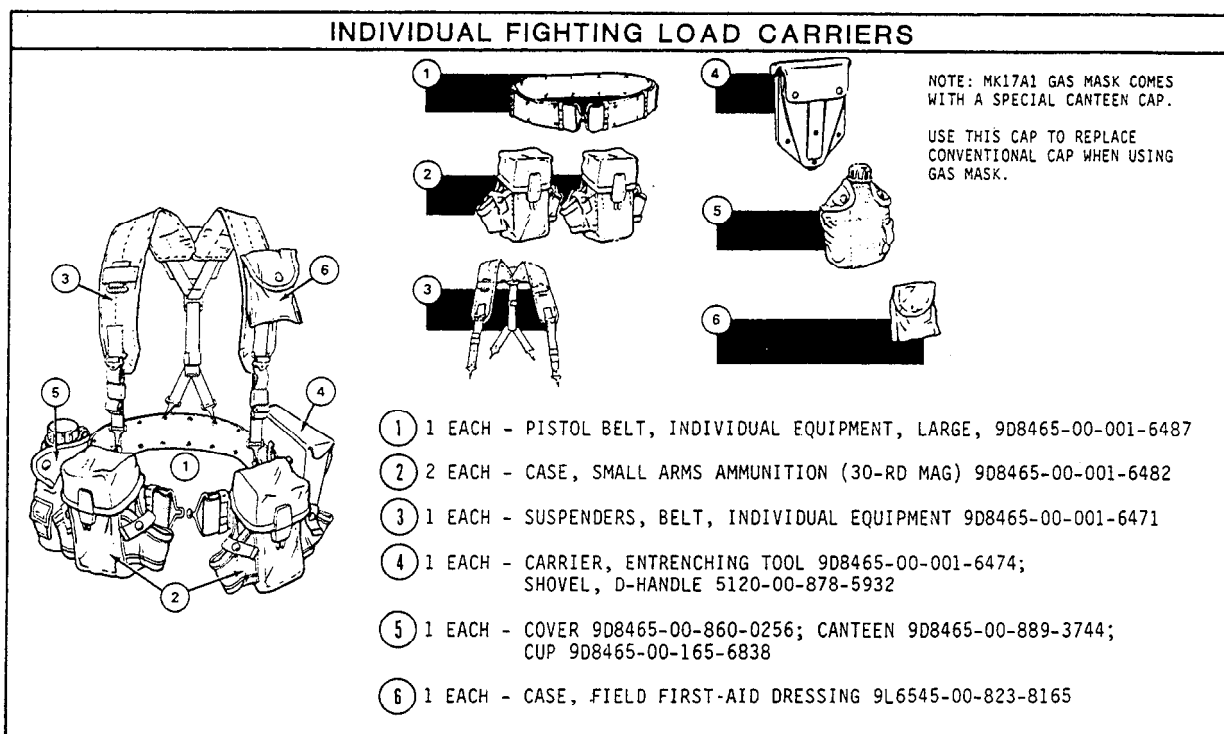

Figure 2-2.—Load-carrying equipment.

Construction Ratings (Seabeds) and non-occupational field 13 personnel serving with the NCF. The belt should be worn with the right edge of the buckle aligned with the center of the trousers and with the metal-tipped end passing through the buckle to your left, approximately 2 to 4 inches (fig. 2-1). The metal-tip and buckle are black.

6. Cold weather coat. When the coat (field jacket) is worn with the green utility uniform, all of the buttons except the top or collar button must be buttoned.

7. Changes in regulation. Relations concerning the wearing of the olive green uniform change from time to time. Changes are published in NAVFACINST 1020.1 and are incorporated into the battalion or unit instructions. You should also review the corresponding section in the *United States Navy Uniform Regulations*. All of these publications should be available in the personnel office of your unit.

STANDARD ISSUE (782 GEAR)

The standard issue of 782 gear is divided into three categories: fighting load-carrying equipment, bivouac equipment, and protective equipment. Normally, this equipment is issued to you on a full-time basis whether you are in a combat area or in the United States for training.

The standard issue of 782 gear items is listed below.

1. Pistol belt
2. Pack combat medium
3. Suspenders
4. Two ammo pouches
5. Canteen cover, canteen, and canteen cup
6. First-aid packet*
7. Entrenching tool and cover
8. Poncho
9. Shelter half with one tent pole, five tent pins, and guy line
10. Mess kit with knife, fork and spoon
11. Bayonet or K-Bar*
12. Kevlar helmet
13. Camouflage cover
14. Hat and mosquito net

*These items may or may not be issued.

FIGHTING LOAD EQUIPMENT

Fighting load equipment consists of the items shown in figure 2-2 and described below. Each item has

been designed to make the job of carrying the equipment you need easier and more comfortable. There are certain rules, however, that must be followed when the equipment is to do the job for which it is intended. When the rules listed below are followed, individual loads can be carried with more ease and comfort.

Rules for carrying equipment.

- Keep your load as light as possible.
- Know your equipment.
- Assemble the equipment correctly.
- Keep every item in its proper place.

1. Pistol belt (item 1 of fig. 2-2). The olive drab webbed pistol belt, M-1956, has a special ball type of fastener that makes the belt easier to put on and take off. The belt uses eyelets for attachment purposes and has sliding keepers to prevent the belt hooks from becoming unfastened after adjustment to the waist of the wearer. The pistol belt helps to carry the entrenching tool and carrier, the ammunition pouches, the canteen and cover, and the first-aid or compass case. It is issued in two sizes: medium and large. Medium is the size for waist measurements under 30 inches; large is the size for waist measurements of 30 inches or more. The proper-size belt can be adjusted to fit over all layers of outer clothing, including the armored vest.

2. Ammunition pouches (item 2 of fig. 2-2). Each small-arms ammunition pouch is 4 1/4 inches wide, 6 1/4 inches high, and 2 1/2 inches deep. Plastic stiffeners are provided in the back of each pouch, so the clips of ammunition can be easily inserted and removed. There are two attaching clips and supporting straps on the back of the pouch, so they can be fastened to the pistol belt and to the suspenders. (See fig. 2-5.) Both sides of each ammunition pouch have attachments for carrying hand grenades. The pouches are designed to carry any of the basic loads of ammunition; however, with special weapons it may be necessary to carry more ammunition than the pouches can hold. When extra ammunition is needed, bandoleers of ammo may be carried in a cross-chest manner. To place bandoleers in pouches, make a neat bundle by folding the bandoleers accordion fashion and placing them in the pouches with the bandoleer strap on the top. This method permits the bandoleer to be inserted and removed easily.

3. Suspenders (item 3 of fig. 2-2). The olive drab webbed suspenders, with the pistol belt, make up the basic individual fighting load equipment, as the remaining components are suspended from them. The suspenders can be adjusted by means of the clamp type of buckle. Suspenders are issued in three sizes: regular, long, and extra long. If you are under 68 inches tall without shoes, wear the regular size. If over 68 inches, wear the large size. If you are tall or broad chested or intend wearing them over outer garments or the armored vest or both, wear the extra large size. When you have the time, you should try them on first.

4. Entrenching tool carrier (item 4 of fig. 2-2). The entrenching tool carrier is olive drab in color and is attached to the pistol belt by means of two clips located on the back.

5. Canteen cover (item 5 of fig. 2-2). The olive drab canteen cover has either a pile or felt lining and is attached to the pistol belt by means of two clips located on the back of the cover. The canteen cover accommodates the canteen and canteen cup. During warm weather, the lining should be kept wet to help keep the water cool. The cover should be kept dry during cold weather, as the lining helps to protect the water inside from freezing.

6. First-aid case (item 6 of fig. 2-2). The olive drab first-aid case is attached to the pistol belt by means of a clip located on the back. The case is closed by means of a flap that is secured by a glove type of fastener. The first-aid case is used either to carry a field dressing or an unmounted magnetic compass.

The method for assembling the individual fighting load equipment is described below in the sequence normally followed.

Adjusting the Pistol Belt

First, try on the belt for size. It should be comfortable y snug—not tight. The following six steps in adjusting the pistol belt correspond to the six actions shown in figure 2-3:

1. Push the two metal keepers between the adjusting clamp and the belt buckle toward the buckle.

2. Unlock the adjusting clamp by spreading the looped webbing apart.

3. Slide the clamp toward the belt buckle to loosen or away from the buckle to tighten.

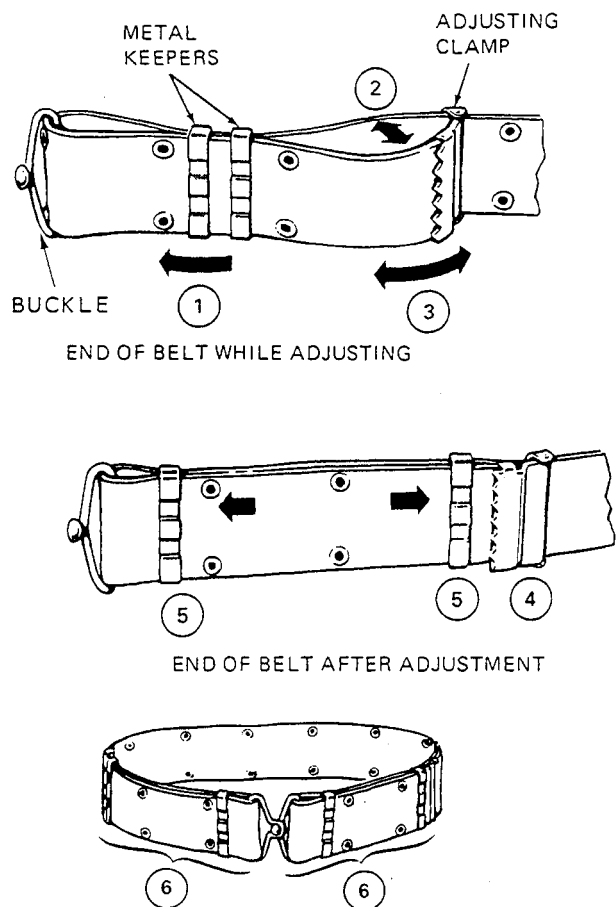

Figure 2-3.—Adjusting the belt.

4. Squeeze the adjusting clamp to lock it in place.
5. Move the metal keepers so one is next to the adjusting clamp and the other is next to the buckle.
6. Adjust the other end of the belt the same way. Both clamps should be about the same distance from the buckle.

Your belt is now ready for attaching equipment.

Attaching the Ammunition Pouch to Your Belt

The following four steps used in attaching the ammunition pouch to your belt correspond to the four actions shown in figure 2-4:

1. Pull each keeper up to its open position and slide it over only one thickness of webbing. Make sure the

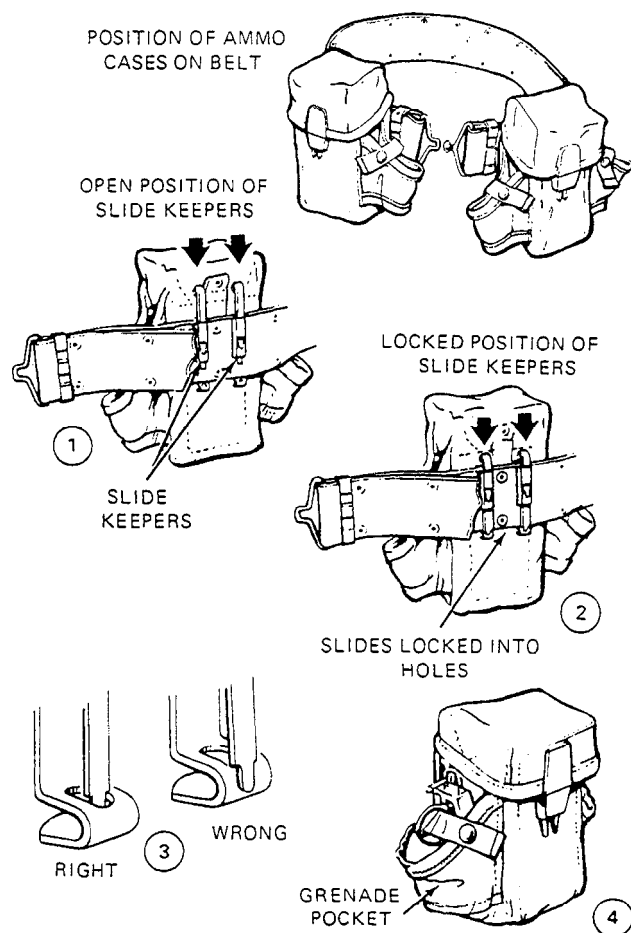

Figure 2-4.—Attaching ammo pouch to belt.

keepers are vertical and the bottoms are out beyond the webbing.

2. Push the slides of the keepers down and into the bottom holes.

3. Make sure you push the slides firmly into the holes; otherwise, the slide is in the **WRONG** position, as shown in the sketch, and the equipment could fall off.

4. Use the pockets on each side of the ammo pouch for carrying fragmentation hand grenades. Be sure, tier putting them in, that the nylon strap goes through the ring and is snap fastened, as shown in the sketch.

NOTE: If you have a 20-round magazine pouch for the M-16 rifle, refer to Step 6 of the following procedure to attach them.

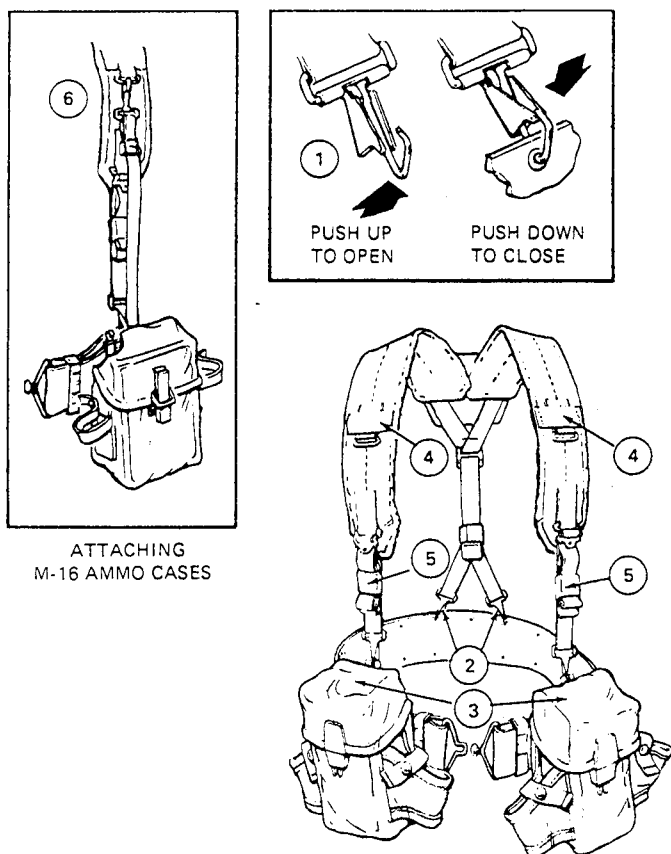

Figure 2-5.—Attaching the suspenders to the ammo pouches and pistol belt.

Attaching Suspenders to the Ammunition Pouches and Belt

The following six steps used in attaching suspenders to the ammunition pouch and belt correspond to the six actions shown in figure 2-5:

1. Open the snap hooks for attaching the suspenders to the belts by pushing the hookup and out of the side retaining closure. When the hook is engaged into the eyelets, snap it back into its closed position.
2. Attach the back suspender strap hooks into the eyelets (top row of belt) located to the right and left of the eyelet centrally located on the back of the equipment belt.
3. Attach the front suspender strap hooks to the strap support eyelet located on the top row on the back of the ammunition pouch.
4. Attach the small items (first-aid/compass case, flashlight) to the web and metal loops on each shoulder strap.
5. Use the elastic loops on each of the adjustment straps to secure the loose ends of the straps after adjustment.

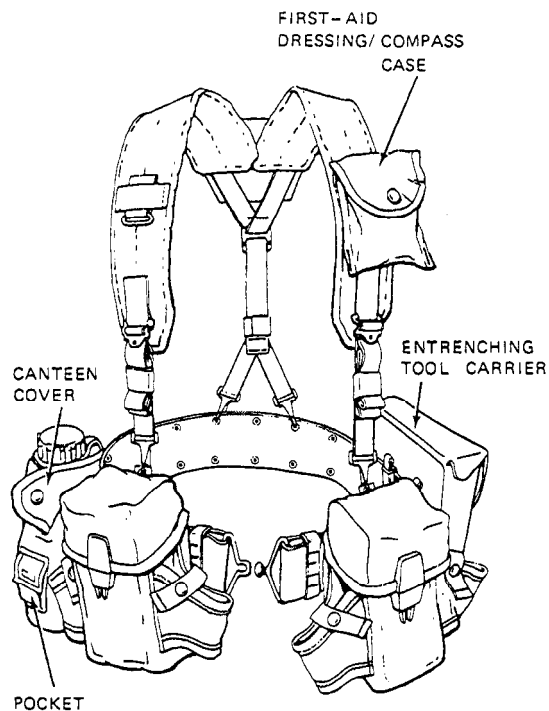

Figure 2-6.—Attaching entrenching tool carrier, canteen cover, and first aid dressing/compass case.

6. Attach the front suspender straps to the eyelets on either side of the belt buckle when the ammo pouches are not used. When M-16 ammo pouches are used, attach them to the suspenders, as shown in the sketch.

Attaching the Entrenching Tool Carrier

Attach the carrier to the belt on the left side by means of the two slide keepers on the back of the carrier as close as possible to the ammunition pouch. (See fig. 2-6.)

NOTE: Place the entrenching tool in the carrier so the handle faces toward the front and the shovel blade is to the back of the carrier.

Attaching the Canteen Cover

- Attach the cover onto the right side of the belt by means of the two slide keepers on the back. Attach it as close as possible to the ammunition pouch (See fig. 2-6.)
- Carry water purification tablets in the small pocket on the canteen cover. A touch-and-close fastener is provided for securing the pocket flap.

Attaching the First-Aid Dressing/Compass Case

This case can be attached by means of the slide keeper on the back of the case in either of the following positions: (See fig. 2-6.)

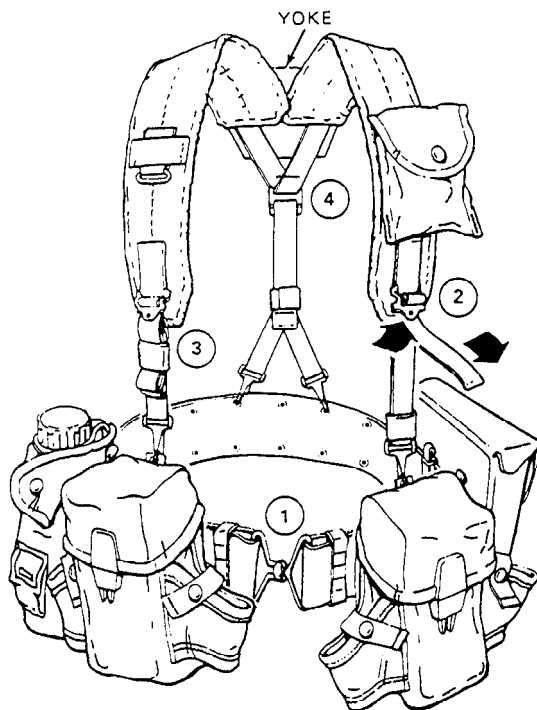

Figure 2-7.—Adjusting suspender straps.

- To the belt on the right side next to the ammunition pouch. This is the preferred position.
- Onto the webbing loop on the front of the suspenders.

Attaching the Bayonet Scabbard

Attach the bayonet scabbard by its hooks to the lower eyelets of the belt between the ammunition pouch and the entrenching tool carrier.

Adjusting the Front and Back Suspender Straps

After the equipment is attached to the belt and suspenders, put it on. The following four steps in adjusting the front and back suspender straps correspond to the four actions shown in figure 2-7:

1. Fasten the belt buckle.
2. Adjust the length of the back and front straps, so the belt hangs evenly in the desired position at the waist by pulling down on the loose end of the strap to tighten or by lifting the end of the buckle to loosen the strap.
3. Position the belt around your waist by securing the loose ends of the straps with the elastic loops.
4. Adjust the back strap the same way, but it is best done with the help of another person to make the adjustment.

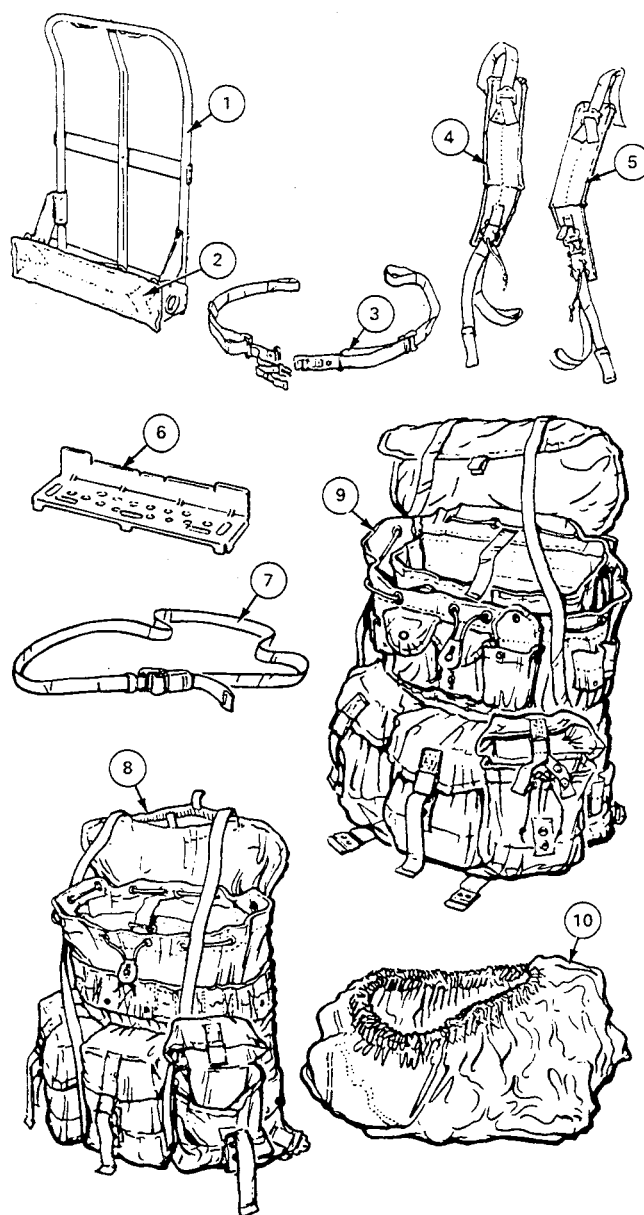

Figure 2-8.—Individual existence load carriers.

Care should be taken in adjusting the back and front straps so the belt hangs at the proper waist level, and the yoke is positioned for your maximum comfort.

NOTE: You may be required by different Seabee units to wear more or less equipment than stated in this text. This is also true in reference to the position of the equipment.

Your Individual Existence Load

The following 10 items of the existence load are identified, numerically, in figure 2-8:

1. 1 each frame, pack ground troops

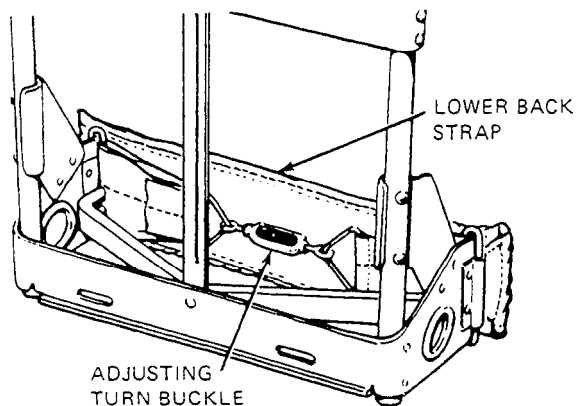

Figure 2-9.—Lower part of pack frame.

2. 1 each strap, lower back
3. 1 each strap, waist
4. 1 each strap, shoulder, without quick release
5. 1 each strap, shoulder, with quick release
6. 1 each shelf, cargo support
7. 2 each strap, cargo tie-down
8. 1 each pack, combat, medium
9. 1 each pack, combat, large
10. 1 each cover, field pack, camouflage (for either medium or large pack)

ADJUSTING THE PACK FRAME LOWER BACK STRAP.— Your pack frame is used to carry cargo or the large pack. Sometimes it can be used to carry the medium pack, but not under normal circumstances.

For your maximum comfort in load carrying, the frame is built with an adjustable lower back strap to keep the load away from your back and to allow air circulation between your back and the load (fig. 2-9). When the turnbuckle is screwed tight, the strap is almost flat. If your waist is small, the turnbuckle should be loosened enough to allow the back strap to curve in and fit against your lower back.

ATTACHING YOUR EXISTENCE LOAD SHOULDER AND WAIST STRAP.— The shoulder straps are used with the following carriers:

- Frame when used to carry a load with the cargo shelf attached to it
- Frame with the large pack attached to it
- Medium pack without the frame

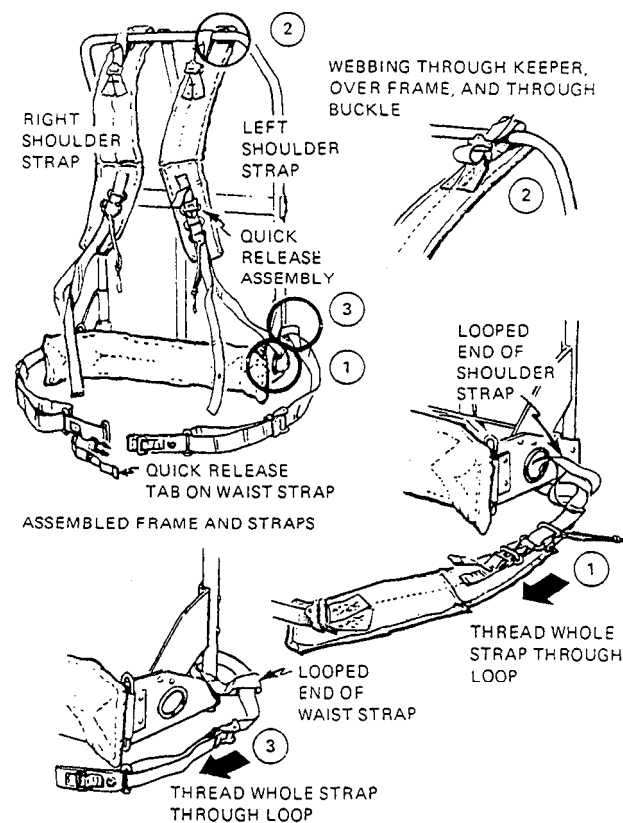

Figure 2-10.—Attaching shoulder and waist straps to pack frame.

- Frame with the medium pack attached to it (fig. 2-10)

ATTACHING THE SHOULDER STRAPS.— One strap is for your right shoulder, and the other, with the quick-release assembly, is for your left shoulder. The quick-release assembly is described later in this chapter.

The following three steps for attaching the existence load shoulder and waist straps correspond to the three actions shown in figure 2-10:

1. Insert the looped end of the strap from the **INSIDE** of the frame through the nylon ring at the bottom side, thread the strap through the loop, and pull tight.

2. Insert the webbing at the top of the strap through the metal keeper on the top of the frame, through the buckle, and pull tight. The padded end of the strap should normally be under the frame bar.

Like the shoulder straps, the waist straps also are made with a quick-release assembly. The pull tab is shown on the strap assembled to the frame. Attach the strap with the pull tab, either on the left or right of the frame, depending on which hand you use to pull it open.

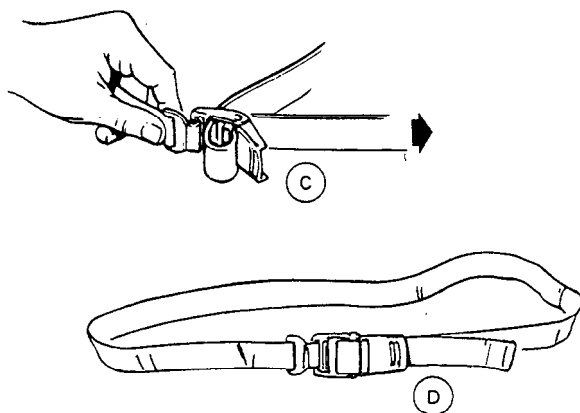
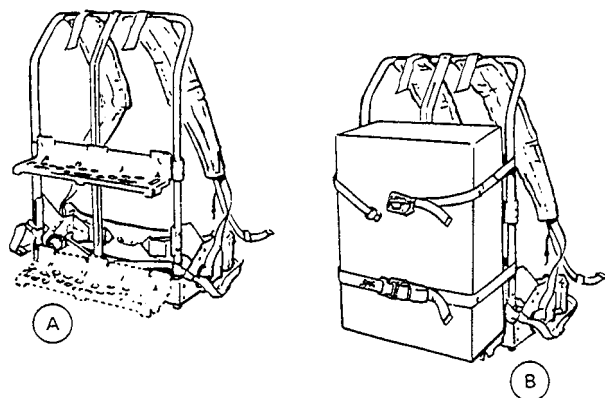

Figure 2-11.—Attaching cargo shelf and load.

3. Insert the looped end of the waist strap around the lower part of the frame, as shown, and pull tight.

ATTACHING THE CARGO SHELF AND CARGO TO THE FRAME.—

The cargo shelf is simply slipped onto either the middle or bottom of the back of the frame, as shown in figure 2-11, view A. It is used to support such loads as 5-gallon water or gas cans, cases of ammunition, field rations, radio, or other bulky items.

A load is shown partially tied to the frame with the cargo tiedown straps (fig. 2-11, view B). Two are furnished with each issue.

The tie-down strap buckle is made for a secure hold of the load to the frame. Proper adjustment, however, is important. The top strap, as shown in figure 2-11, view B, is wrapped around the load and frame but not pulled tight. To secure the load, insert the hooked end in the buckle, as shown in view C, and the loose end pulled in the direction of the arrow for a fairly tight hold, but leaving some slack. The fastener is then pushed into the closed position, as shown in view D, which takes up the remaining slack. If enough slack is not left before closing the fastener, closing it puts too much tension on the strap and it does not fully close; or if the load is

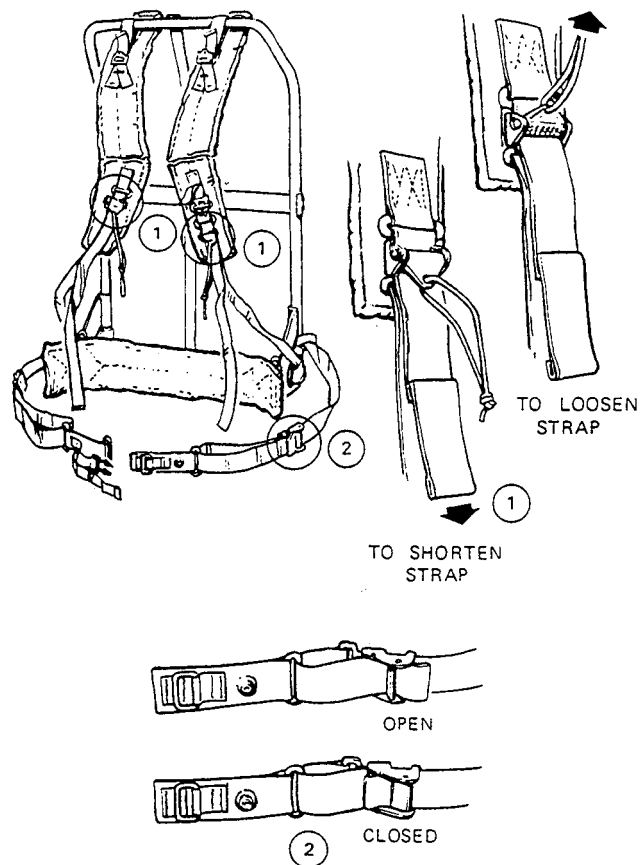

Figure 2-12.—Adjusting shoulder and waist straps.

contained in a soft container, the closed strap may crush the contents.

To release, pull upon the end of the strap to open the fastener.

ADJUSTING THE SHOULDER AND WAIST STRAPS.—

The shoulder and waist straps have adjustment buckles that are used after the straps are attached to the load and you have the straps and load over your shoulder.

The following two steps for adjusting the shoulder and waist straps correspond to the two actions shown in figure 2-12:

1. Shoulder straps. Pull down on the loose end of the webbing to shorten the strap. To lengthen it or to loosen it for slipping off the load easily, pull up on the cords.

2. Waist straps. Open the buckle and slide it either away from or toward the front. Sliding it away from the front tightens the strap; sliding it toward the front loosens the strap. Close the buckle to hold the adjustment.

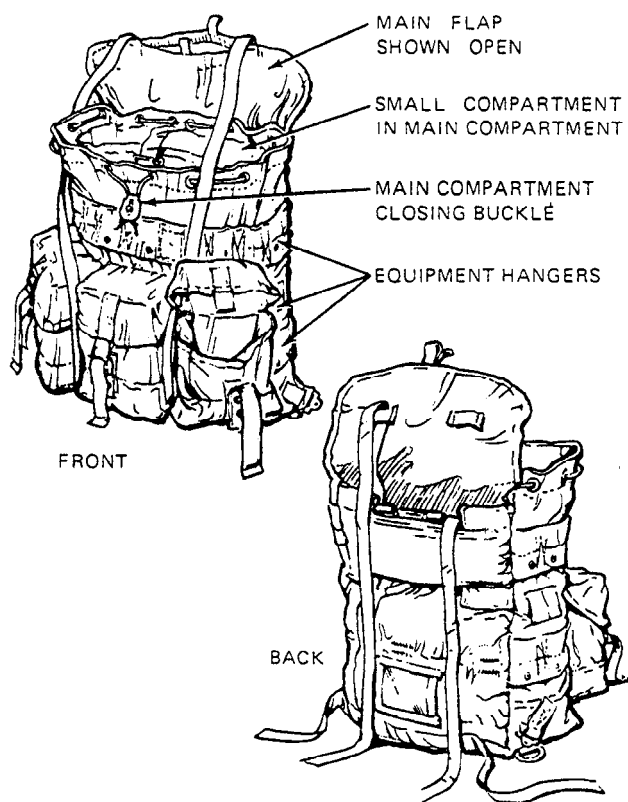

Figure 2-13.—Front and back views of medium pack.

MEDIUM PACK

The medium pack designed to carry up to 50 pounds of various existence load items, is the one generally used by most combat troops. Figure 2-13 shows front and back views. The pack is water repellent but not waterproof. Four waterproof liners are issued with each pack one large one for the main compartment and three small ones for each of the three pockets. Equipment to be carried should first be inserted in the waterproof liners, then into the main compartment and pockets. Instructions for making a watertight closure are printed on the outside of each liner.

The small pocket in the main compartment can be used to carry the AN/PRC-25 or AN/PRC-77 radio.

The main flap for covering the loaded pack can be opened by pulling apart the two tabs. The camouflage cover or other small, flat objects may be stored in it. Simply pressing the flap together seals it.

Equipment hangers (webbed loops and webbing with eyelets) for use with slide keepers and/or hooks are provided on the sides of the pack and above the pockets for carrying equipment on the outside of the pack

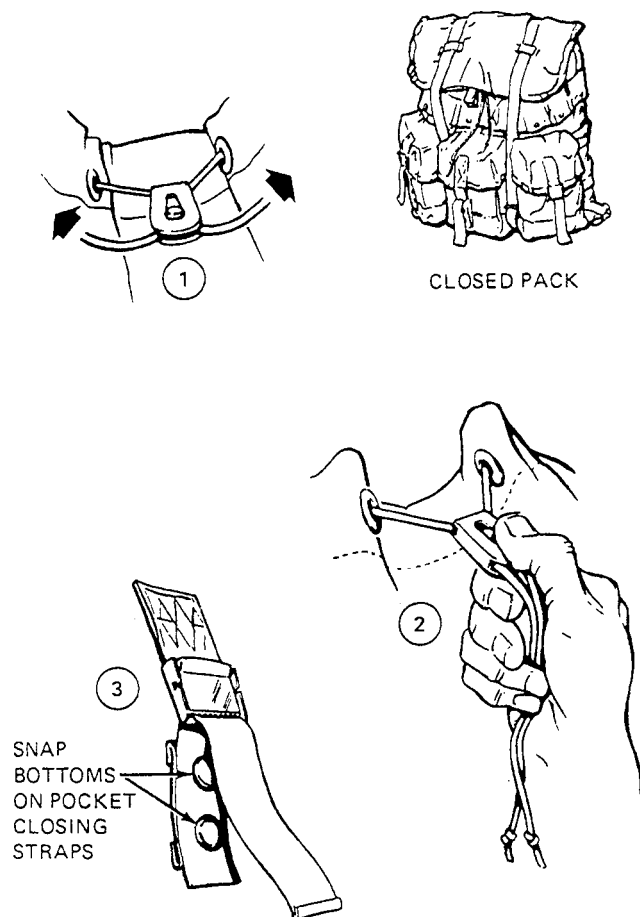

Figure 2-14.—Buckles for closing and opening pocket flaps and main compartments.

For carrying equipment, such as a bayonet scabbard or machete sheath, the pockets are tunneled between the pockets and the main compartment. By sliding the piece down through the tunnel, it can be fastened to the hanger above it with slide keepers or hooks.

The medium pack is most commonly carried using the shoulder straps without the frame. When required, the pack can be attached to the frame and shoulder straps in the same way as is shown later for attaching the large pack to the frame.

Closing the Loaded Medium Pack

Once your pack is loaded, close and tighten it. The following three steps for closing the loaded medium pack correspond to the three actions shown in figure 2-14:

1. Close the top of the pack by using the drawstring buckle. Pull the two cord ends, as shown, to gather the top into a tight closure.

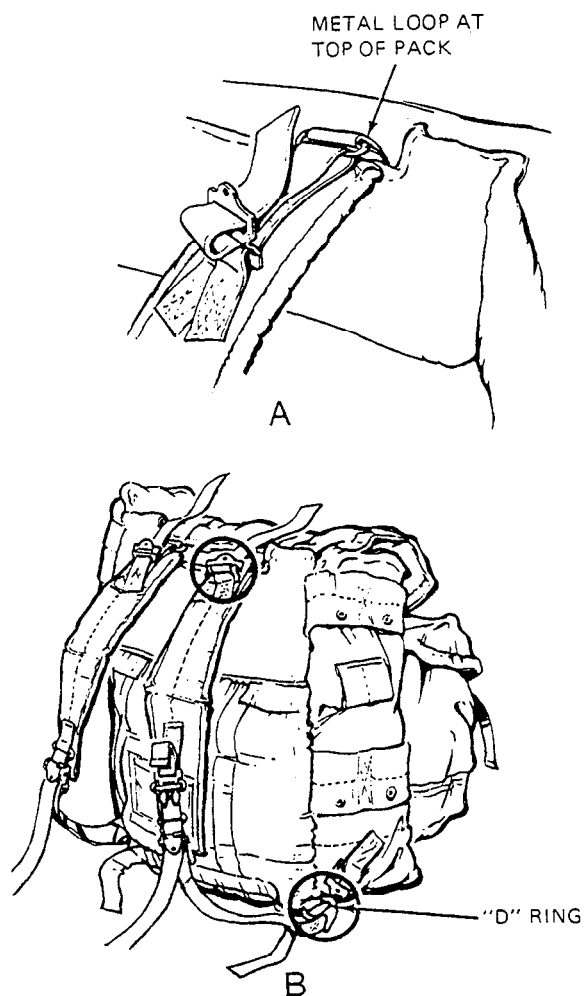

Figure 2-15.—Attaching shoulder straps to medium pack.

2. To loosen the drawstring, push the button on the buckle up with your thumb and pull down.

3. Each pocket is closed by threading the webbing through the buckle and pulling tight. For ease of opening a pocket, unsnap the lower end of the tie-down. This allows you to close the pocket again without threading the webbing through the buckle.

Insert the main flap tie-down straps through the webbed loops on top of the main flap, pull them down over the pack through the bottom buckles, and pull them tight

Attaching the Shoulder Straps to the Medium Pack

The medium pack is often carried using the shoulder straps without the pack frame, as shown in figure 2-15.

To attach the straps to the pack, follow the same procedure as used in attaching the straps to the frame.



Figure 2-16.—Ground mat attached to medium pack.

- Insert the webbing at the top of the strap through the metal loop on the top of the pack and pull it tight. (See fig. 2-15, view A.)

- Insert the looped end of the strap through the D ring at the bottom of the pack through the strap loop and pull it tight. (See fig. 2-15, view B.)

Be sure the strap with the quick release is over your left shoulder.

CAUTION:

When the medium pack is to be worn in extreme cold climates, it must be worn on the frame. See figure 2-18 for the manner of attachment. Using the frame prevents accumulation of perspiration in the area where the pack makes contact with the back of the individual, which could cause rapid cooling of the individual.

Attaching the Ground Mat

The ground mat can be carried inside the pack or attached to the outside. Figure 2-16 shows one way of carrying it by attaching it to the bottom of the medium pack with two cargo straps pulled through the loops on the bottom of the pack.

LARGE PACK

The large pack is a special-purpose pack used to carry excessively large loads (up to 70 pounds) that would be required for Arctic or other special missions. It is much the same as the medium pack except for its



Figure 2-17.—Front and back views of large pack.

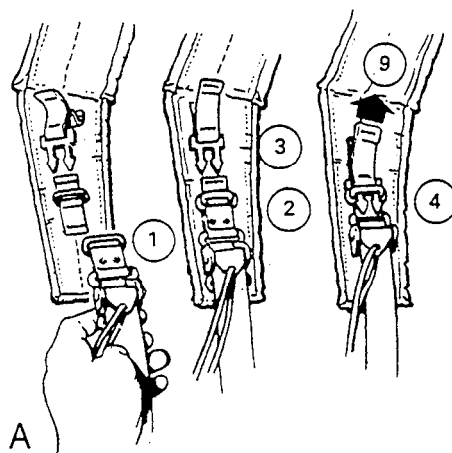

SHOULDER STRAP QUICK RELEASES

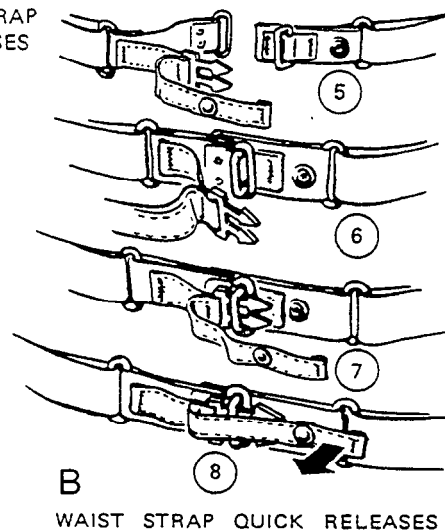

WAIST STRAP QUICK RELEASES

Figure 2-19.—Shoulder strap and waist strap quick releases.

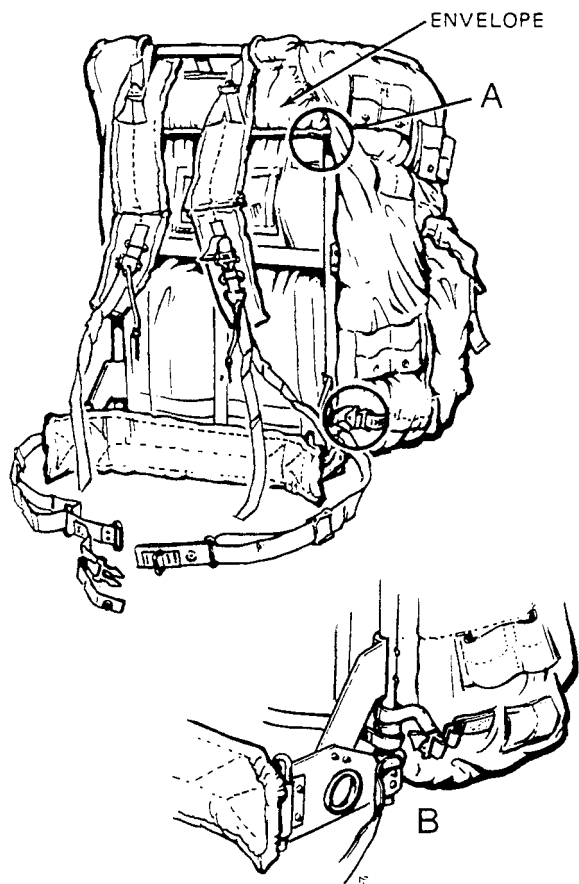

Figure 2-18.—Attaching the large pack to the frame.

larger size and three more small pockets at the top. (See fig. 2-17.) There are tie-down cords and D rings inside the main compartment to shorten the pack when it is not filled to capacity. The three lower pockets are tunneled to allow for carrying of skis and other equipment, and they have cords at the top for better sealing of the pocket before closing the flap. The large pack should always be carried on the frame.

Attaching the Large Pack to the Frame

Figure 2-18 shows the large pack on the pack frame. To attach it to the frame, complete the following steps:

1. Insert the bare frame into the envelope on the back of the pack. (See fig. 2-18, view A.)
2. Secure the bottom of the pack to the frame, as shown. Note that the webbing is looped around the frame TWICE before buckling. Attach the shoulder straps and waist straps as previously described. (See fig. 2-18, view B.)

Quick Releases

In emergency situations when sudden removal of your backpack is required, quick releases are provided on the left shoulder strap and the waist strap.

Items 1 through 4 in view A of figure 2-19 show how the shoulder strap quick release is assembled. The metal

loop at the top of the lower end of the strap (item 1) is hooked over the metal loop (item 2). The plastic prongs (item 3) are pushed down through the locked assembly (item 4) as shown.

Items 5 through 8 in view B of figure 2-19 and item 9 in view A show how to assemble the quick release on the waist strap.

For sudden release, first pull the tab on the waist strap (item 8). Follow immediately by pulling up on the tab on the shoulder strap. (See item 9, view A.) Shift the load to your right and let it slip off your right shoulder.

CLEANING AND MAINTENANCE

Water repellent treated nylon duck and webbing was used to fabricate all of the fabric items of equipment. The entrenching tool carrier is molded of ethylene-vinyl acetate. The pack frame and cargo shelf are fabricated from aluminum with solid steel rivets in certain high-stress areas.

The equipment can be cleaned by removing mud or other foreign matter with a brush, damp or dry cloth, or by scrubbing the exceedingly dirty areas using the following procedure:

1. Scrape dirt or mud from the equipment with a flat stick or dull instrument that will not cut the fabric or webbing.

2. Remove loose dirt from soiled surfaces with a cloth or soft brush.

3. Wet the surface and apply a warm solution of detergent, laundry, powdered, MIL-D-12182, Type II (FSN 7930-252-6797). Scrub with a soft brush, cloth, or sponge.

4. Flush the item thoroughly with clean, warm water until all of the cleaning solution has been rinsed away.

5. Dry the item or equipment away from direct sunlight, direct heat, and open flames.

EXISTENCE/BIVOUAC EQUIPMENT

Existence/bivouac equipment is designed to provide you with the minimum necessities while living in the field. It is carried in or on the load-carrying equipment as explained below. Take care of your equipment and it will take care of you. This equipment consists of the following items:

- Poncho and liner

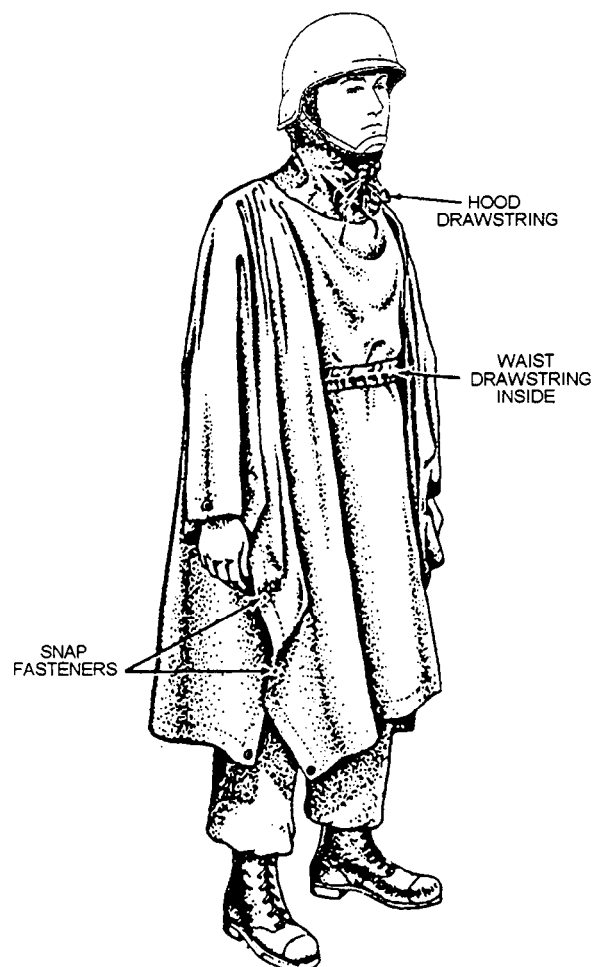

Figure 2-20.—Poncho worn as raincape.

- Shelter half
- Entrenching tool
- Canteen and cup
- Mess kit

Poncho and Liner

The poncho, with hood, is made of waterproof nylon cloth. It is roughly rectangular in shape with the long side parallel and the short side slightly curved. The hood and the opening for the neck are located in the center. Drawstrings are located at the neck and waist.

You can use the poncho as a rain garment, shelter, ground cloth, or sleeping bag.

The poncho may be worn as a rain cape with the arms inside, or it may be worn with the arms outside for freedom of movement (fig. 2-20). To put the poncho on, slip it over your head. If the poncho is to be worn, adjust

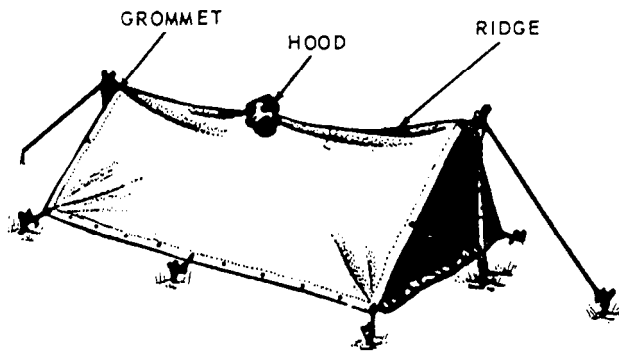
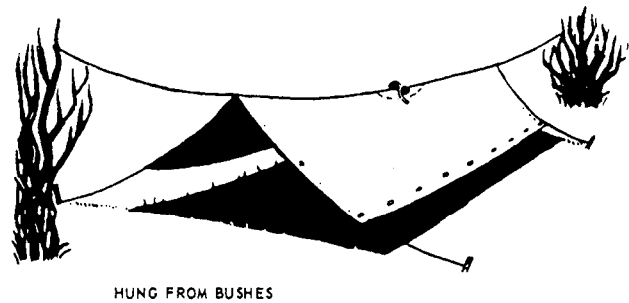

Figure 2-21.—One poncho used as one-man shelter.



HUNG FROM BUSHES

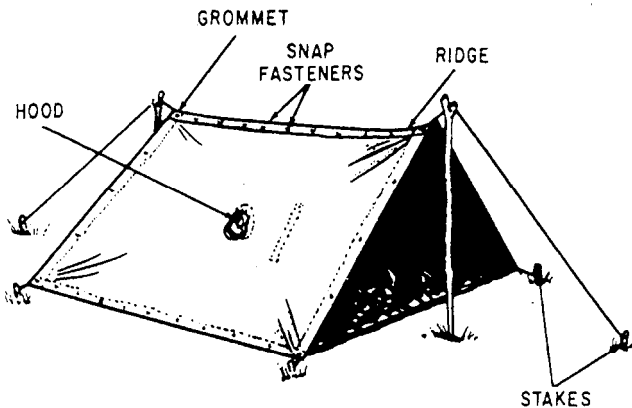
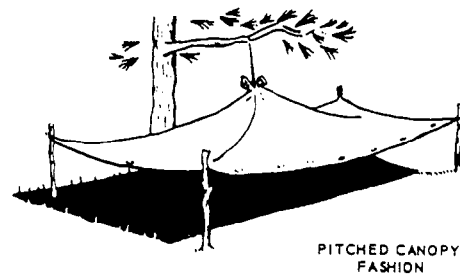
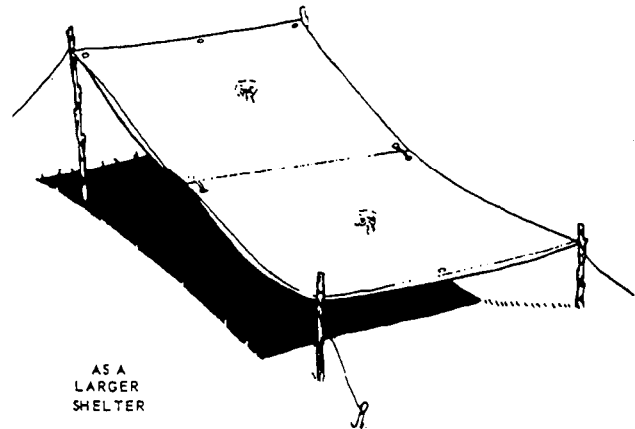

Figure 2-22.—Two ponchos for two-man tent.



PITCHED CANOPY FASHION



AS A LARGER SHELTER

Figure 2-23.—Several ways ponchos can be used for shelter.

the hood drawstring to fit. The helmet is worn over the hood. Fasten the snap fasteners on the sides to prevent the poncho from flapping in high winds.

Various types of shelters and lean-tos can be made by attaching ponchos to trees, tree branches, bushes, sticks or poles. Always dig a ditch around the edge to help drain off the rainwater. (See figs. 2-21, 2-22, and 2-23.) The poncho may be used as a ground cover for shelters and as a waterproof barrier between the ground and sleeping bag.

The poncho may be used as a sleeping bag either by itself or in conjunction with a poncho liner (fig. 2-24). Spread the poncho flat on the ground, making sure the hood opening is tightly closed. If a liner is used, place it on top of the poncho, fold the poncho and liner in half lengthwise, and fasten the snaps together. If the poncho is being used without a liner, snap the sides together along its entire length and tuck the foot end under to keep the feet from sticking out.

When the poncho is being used as a sleeping bag in a combat area, **DO NOT FASTEN THE SNAP FASTENERS TOGETHER; THEY CANNOT BE OPENED QUICKLY.**

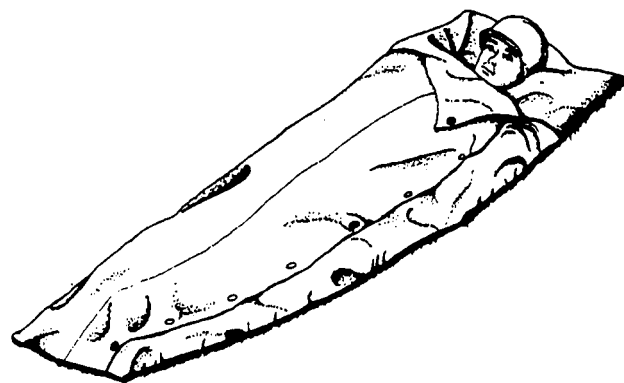

Figure 2-24.—Poncho used as sleeping bag.

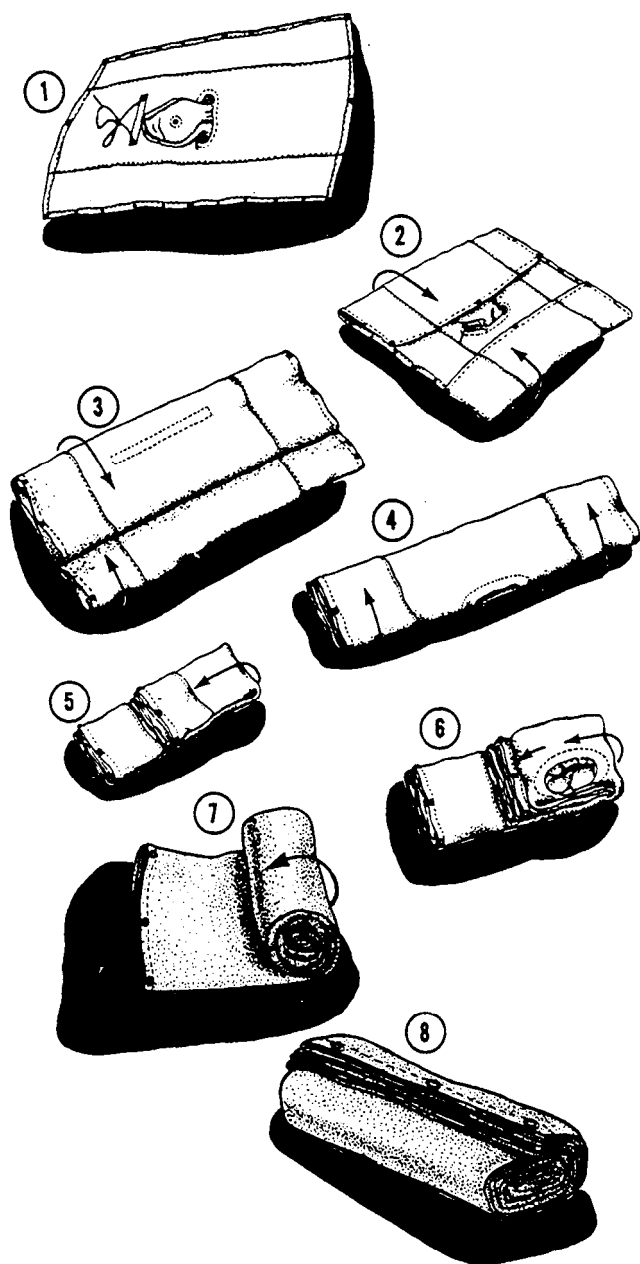

Figure 2-25.—Folding poncho for carry with load-carrying equipment

The poncho can be folded and packed for carrying with your individual load-carrying equipment or for carrying over your pistol belt. It can be carried in a duffel bag or inside the field pack, if space permits. See figures 2-25 and 2-26 for steps in folding the poncho.

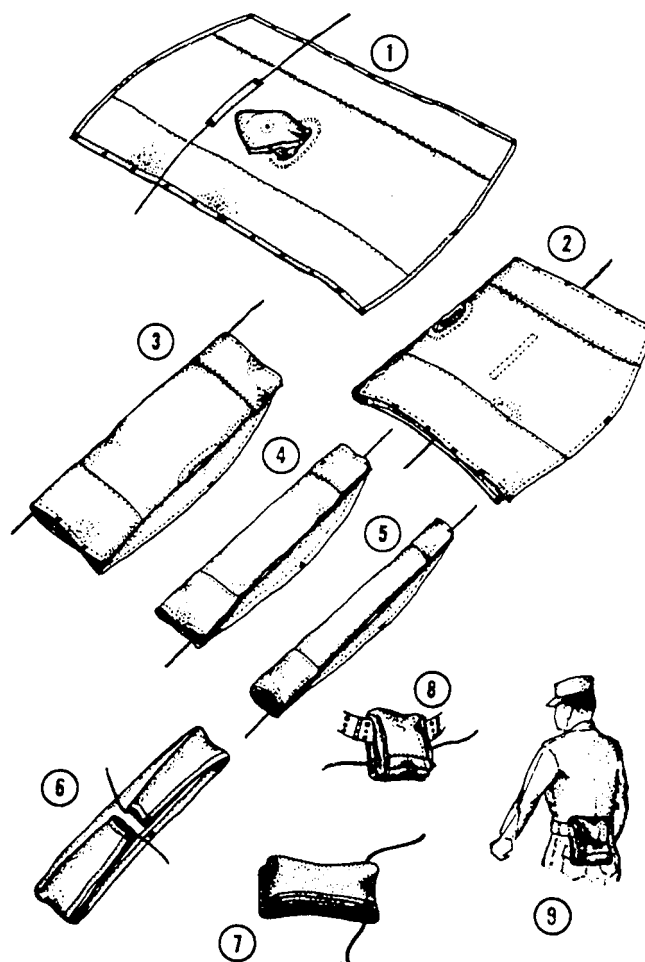

Figure 2-26.—Folding poncho for carry over pistol belt only.

Shelter Half

The shelter half is made of water-repellent and mildew-resistant cotton duck. It is 154 1/4 inches long and has a triangular fly at each end. It is issued to you with five tent pins, a guy line, and a three-section tent pole. The shelter half, when joined to another shelter half by buttons or snap fasteners, forms a shelter for two persons. Be sure when you are issued your gear that your friend has

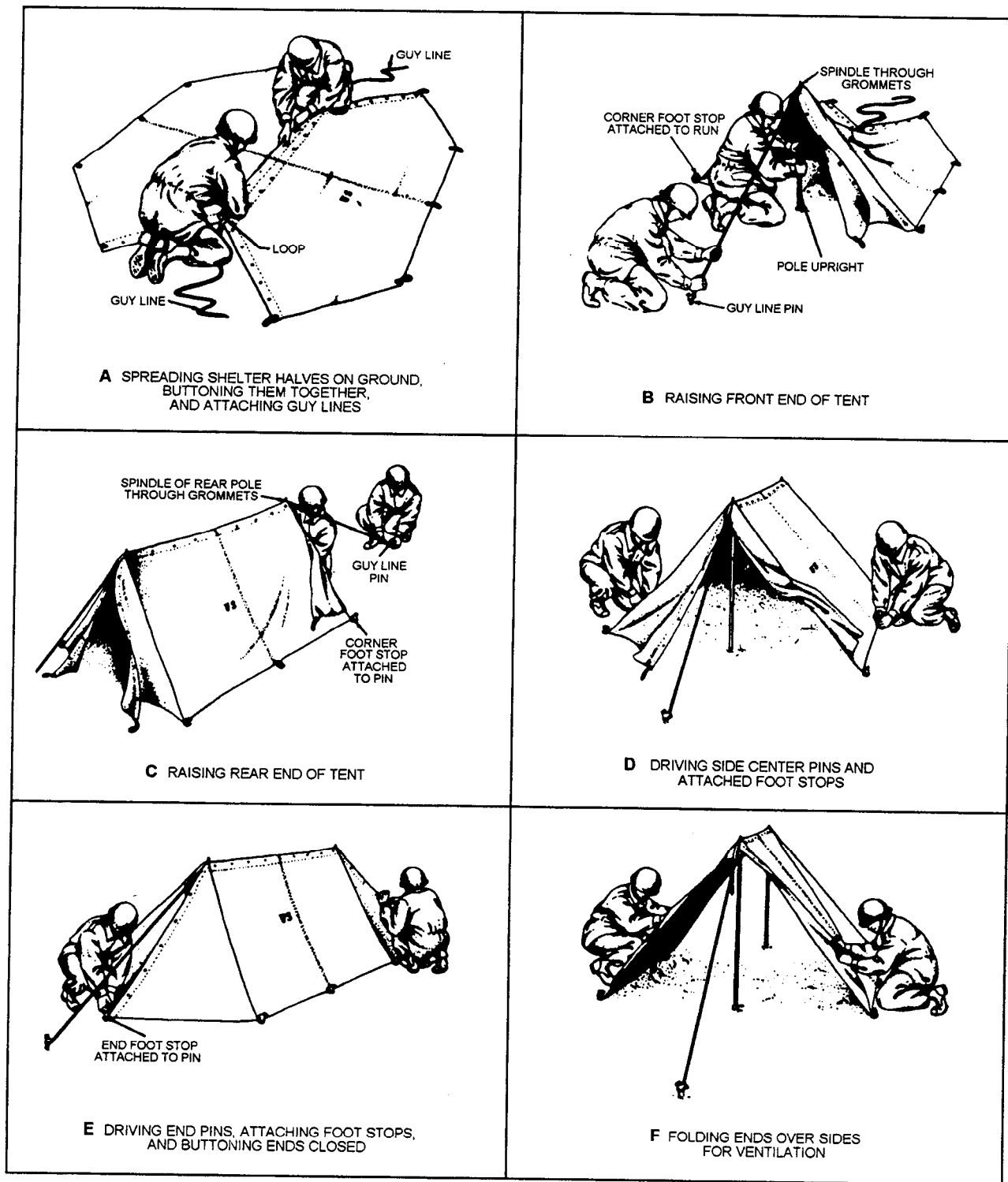

Figure 2-27.—Procedures in pitching shelter half tent.

the same type of fasteners that you do. (See fig. 2-27 for the proper procedures to follow in pitching the two-man shelter tent.) Six shelter halves can be joined together to make a six-man tent (fig. 2-28). You can also use the shelter half by itself for shade or shelter.

To fold the shelter half, spread it out flat with the button side down. Next, place the tent-pole sections, pins, and guy lines in the center and follow the procedures in figure 2-29. Carry the rolled shelter half under the expandable flap of the field pack or attach it to the bottom of the field pack.

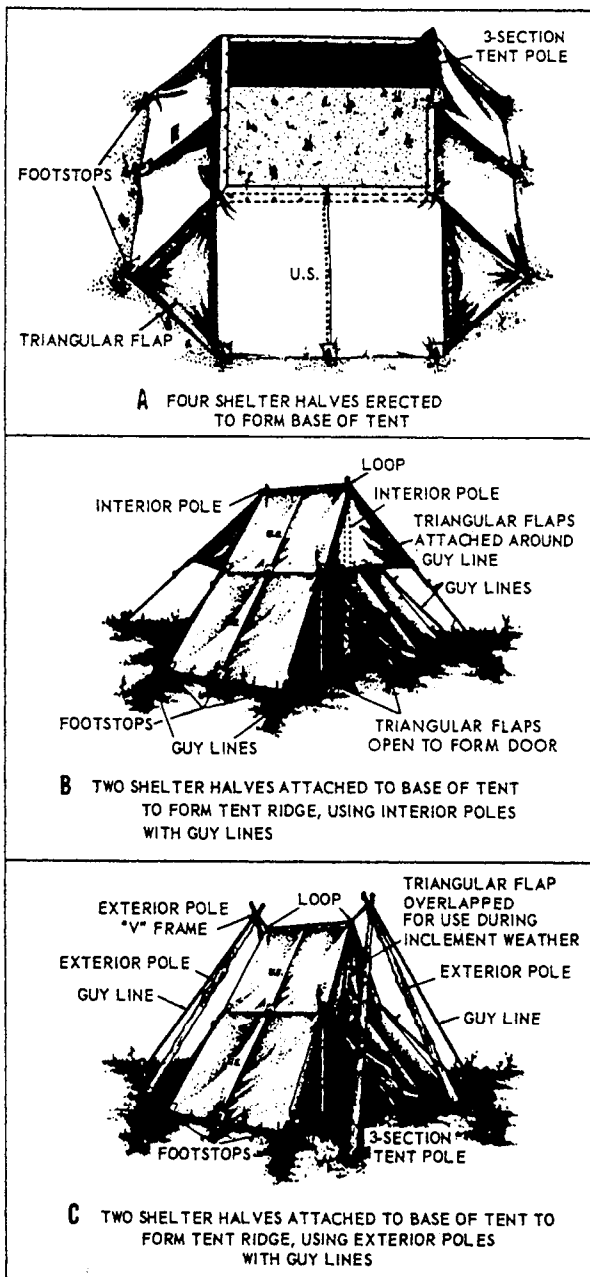

Figure 2-28.—Procedures for pitching six-man tent.

Entrenching Tool

The combination entrenching tool has a pick blade and a shovel blade. Each blade can be moved to any of three positions by loosening the locking nut at the blade end of the handle, adjusting the blade to the desired position, and tightening the nut again. The new entrenching tool has only one blade. Both tools can be used for digging fighting holes, breaking hard ground, and clearing brush or undergrowth. Do not use it for cutting large-size timber. After using the tool, you

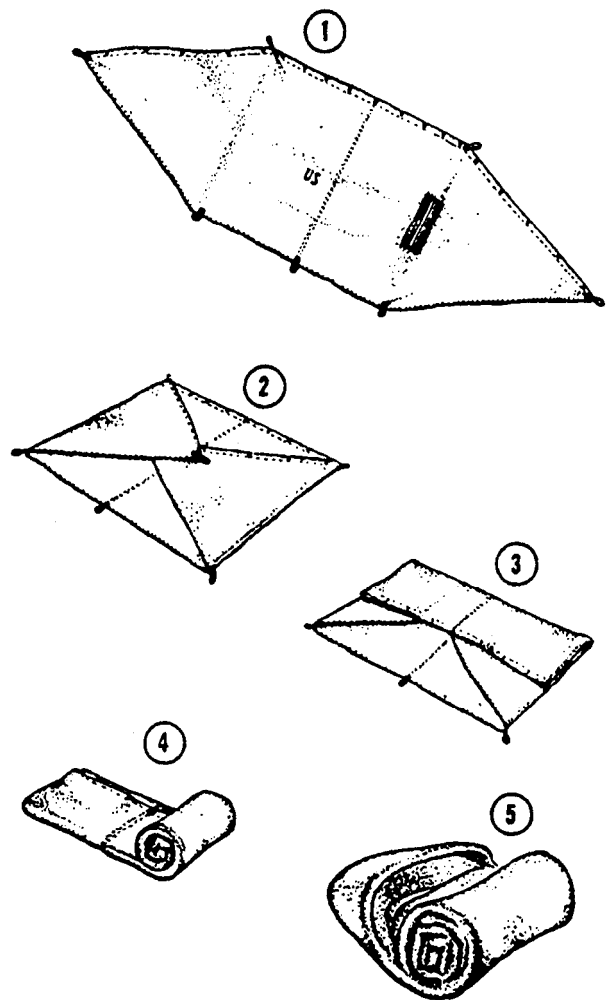

Figure 2-29.—Folding shelter half.

should clean it and oil the threads of the locking nut. When carrying the entrenching tool, turn each blade so it is parallel with and against the handle.

Canteen and Cup

Keep the canteen and cup drained and dry when they are not in use. Even a small amount of water left inside the canteen may discolor or cause the contents to have an unpleasant taste or odor. Never use the canteen for anything except water; carbonated drinks or other beverages with an acid content may discolor it. Never put the canteen in an open flame or on a burner plate.

Mess Kit

Your mess kit consists of a knife, fork spoon, meat tray, and vegetable tray. The two trays are placed together to form a container for the knife, fork and spoon. The kit is carried in the field pack

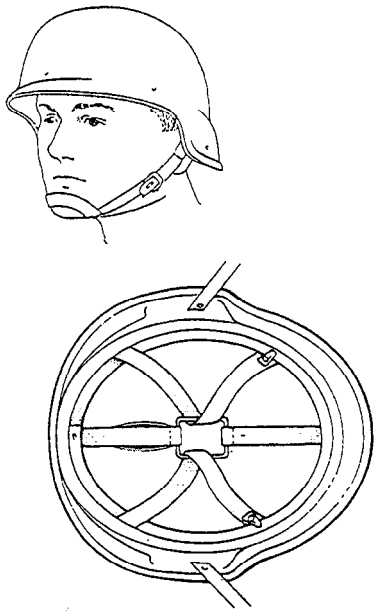
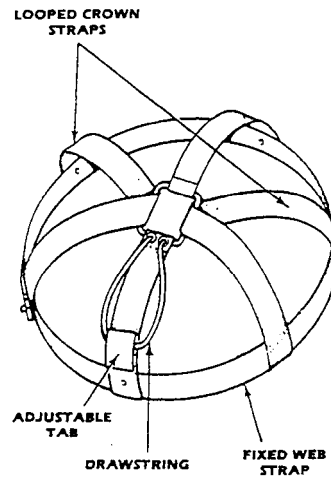

Figure 2-30.—Kevlar helmet.

IT COMES WITH

SUSPENSION BAND
AND CHIN STRAP
INSTALLED

ALL YOU HAVE TO DO
IS ADJUST AND INSERT
THE HEADBAND



SUSPENSION BAND

YOUR SUSPENSION BAND
CONSISTS OF THE
FOLLOWING:

1. Two looped and one front and rear crown straps.
2. A fixed web strap to which the ends of the crown straps are attached.
3. Crown drawstring and adjustable tab with hook and pile closure.

Figure 2-31.—Suspension band.

- Headband
- Chin strap

HELMET SHELL.— The helmet shell (fig. 2-30) comes with suspension band and chin strap installed. It is worn for protection against fragmentation from artillery fire, grenades, and ricocheting bullets. The helmet may be worn over the watch cap or over/under the poncho hood. Although the helmet is a sturdy item and can withstand rough treatment, the following safety procedures should be observed:

- Do not use the helmet to heat water for cooking or for hygienic purposes.
- Do not use the helmet as a shovel, hammer, or any other kind of tool.
- Do not place heavy objects on or sit on the helmet.

SUSPENSION BAND.— The suspension band (fig. 2-31) consists of the following:

- Two looped and one front and rear crown straps
- A fixed web strap to which the ends of the crown straps are attached
- Crown drawstring and adjustable tab with hook and pile closure

HEADBAND.— The headband (fig. 2-32) is a padded, leather-lined web strap. Fitted around it are six metal clips and at its rear a buckle for adjusting the band

PROTECTIVE EQUIPMENT

Protective equipment includes items designed primarily to protect you from injury, either from the enemy or from nature, and consists of the following:

- Kevlar helmet
- Camouflage cover
- Hat and mosquito net

Helmet

The helmet has four simple parts as follows:

- Helmet shell
- Suspension band

HEADBAND

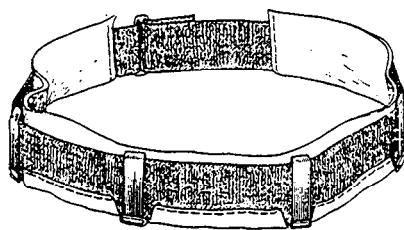

THE HEADBAND IS A PADDED LEATHER-LINED WEB STRAP. FITTED AROUND IT ARE SIX METAL CLIPS AND AT ITS REAR A BUCKLE FOR ADJUSTING TO THE FIT OF YOUR HEAD SIZE.

THE CLIPS ARE USED TO ATTACH THE HEADBAND TO THE FIXED WEB STRAP IN THE HELMET.

Figure 2-32.—Headband.

TO REMOVE AND REPLACE THE SUSPENSION IS SIMPLE...

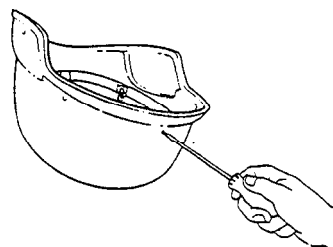

Using a screwdriver or small coin...

Remove the six mounting screws and A nuts.

To replace—line up the holes in the suspension with the holes of the helmet, making sure the drawstring pull tab is at the rear of the helmet...

Now insert the A nut (peak of the A toward the rim) through the holes and replace the six screws.

Figure 2-34.—Remove/replace suspension.

CHIN STRAP

The chin strap consists of the following:

1. Web straps with open cup.
2. Two adjusting buckles and tabs.
3. One Lift-The-Dot snap fastener and tab.

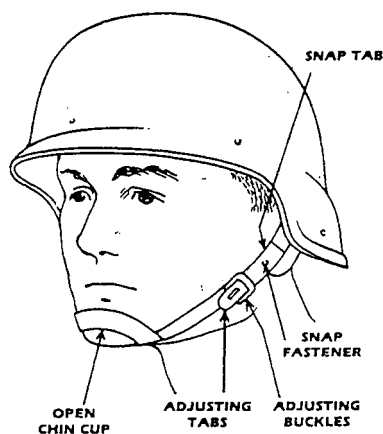

Figure 2-33.—Chin strap.

to your head size. The clips are used to attach the headband to the fixed web strap in the helmet as follows:

- Thread the webbing end through the headband buckle. Make the headband larger than your head size.
- Put the headband on your head, making sure the leather portion is against your forehead, the buckle is at the back and the clip closures are facedown.
- Adjust the headband to a snug fit, then remove and insert it into the helmet so the clip closures are toward the rim of the helmet. Make sure the buckle is to the rear.

- Open the headband clips one at a time. Slip the clips under the fixed web strap, centering the two front clips. Close all the clips with a small screwdriver or penknife.

- Now, put the helmet on your head. If it is too high, adjust the drawstring tab toward the crown of the helmet. If it is too low, adjust the drawstring tab toward the rim of the helmet.

CHIN STRAP.— The chin strap (fig. 2-33) consists of the following:

- Web strap with open cup
- Two adjustable buckles and tabs
- One lift-the-dot snap fastener and tab

When the helmet is on your head and properly adjusted, fasten the snap closure of the chin strap, making sure the small strap on the chin cup is in front of the chin. Now grasp the adjustment tabs at each buckle and pull evenly until the chin cup is snug and comfortable.

To remove and replace the suspension, use a screwdriver or small coin. Remove the six mounting screws and A nuts. To replace, lineup the holes in the suspension (fig. 2-34) with holes of the helmet, making sure the drawstring pull tab is at the rear of the helmet. Now replace the A nut (peak of the A toward the rim) through the holes and replace the six screws.

MOUNTING THE CAMOUFLAGE COVER

1. Put cover over helmet so that the end marked 'front' covers the bill of the helmet.
2. Pull cover over back and sides of helmet and thread each end of chin strap through slits on the sides of the cover.
3. Extend the six cover retaining tabs down and around the fixed web strap of the suspension system (not the headband); fasten the tab onto itself using the hook and pile closure.
4. Now place the elastic helmet band over the helmet and cover.

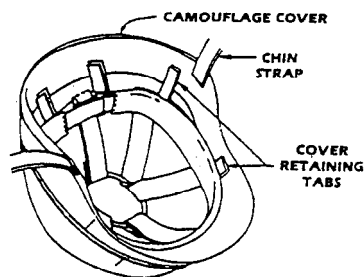

Figure 2-35.—Camouflage cover.

Mounting the Camouflage Cover

1. Put the cover (fig. 2-35) over the helmet so the end marked "front" covers the bill of the helmet.
2. Pull the cover over the back and sides of the helmet and thread each end of the chin strap through the slits on the sides of the helmet.
3. Extend the six cover retaining tabs down and around the fixed web strap of the suspension system (not the headband). Fasten the tab onto itself with the hook and pile closure.
4. Now, place the elastic helmet band over the helmet and cover.

Hat and Mosquito Net

Wear the hat and mosquito net for protection against mosquitoes and other insects (fig. 2-36). The cloth toppiece has an elastic suspension that fits over the head or helmet. Metal rings hold the net away from the face and neck even when you are sleeping. The hat and mosquito net fit over the collar in back and are held in place in front by two elastic loops that can be attached to the pocket buttons of the shirt. An elastic draw tape at the bottom may be drawn tight when the head net is not fastened to the pocket buttons.



Figure 2-36.—Mosquito hat and net over helmet.

SPECIAL ISSUE

Special issue items are items not listed in the standard issue. These items are designed to increase your comfort, capability, and personal safety. Though the following list of items is not complete, it includes the most significant items that you will be issued.

- Armor vest
- Mountain sleeping bag
- Sleeping mat
- Canvas cot and insect bar frame
- Insect bar
- Camouflage band

ARMOR VEST

The armor vest (armor, body, fragmentation protective) is more commonly called a "flack jacket." There are many types in use, but they are all designed to provide protection against low-weight, high-velocity shell, mortar, and grenade fragments. These fragments cause the major portion of combat casualties. For best results from the armored vest, observe the following instructions:

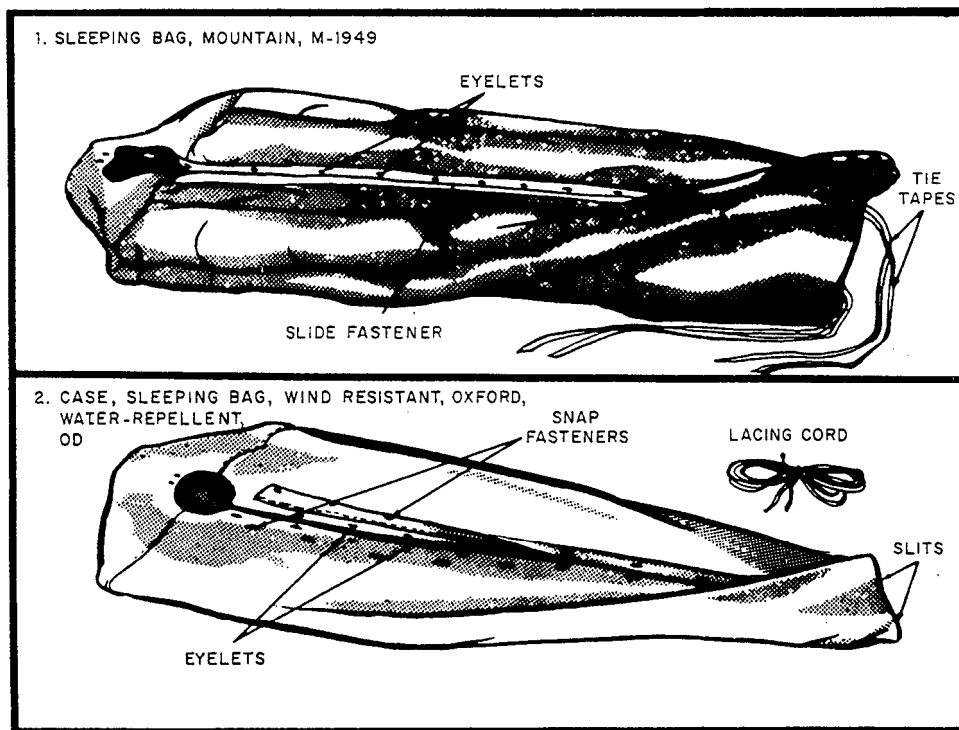

Figure 2-37.—Mountain sleeping bag and sleeping bag case.

- Wear the vest over your utility shirt but under additional outside layers of clothing if possible.

- Adjust the side laces to make the armor vest fit the body, leaving enough room for air to circulate; above all, do not fit it too tightly.

- Use the protective side flaps to cover the opening under the side laces, and protect the slide fasteners by fastening the snap closure.

MOUNTAIN SLEEPING BAG

The mountain sleeping bag (fig. 2-37) is a mummy-shaped bag with a quick-release slide fastener at the front opening. The bag has quilted construction and is filled with a mixture of down and feathers. The shape of the bag gives maximum warmth with minimum weight. A waterproof clothing bag is provided for carrying and storing. The bag is laced to an outer sleeping bag case, also shown in figure 2-37. The tie tapes at the bottom of the bag are used to fasten the bag at the bottom of the sleeping bag case and to secure the bag for packing after folding and rolling. The mountain sleeping bag is intended

for use in locations where the temperatures range from 14°F to 45°F.

Here are some useful hints on the care and use of the sleeping bag.

- Always use the sleeping bag case to protect the bag and to provide extra warmth.

- Keep the sleeping bag dry. Breathe through the face opening to keep your breath from wetting the bag.

- Fluff the bag after unrolling.

- Put padding under the bag for warmth and comfort. Use the pneumatic mattress, packboard, clothes, or fir boughs for padding.

- Do not wear too many clothes when in the bag. Put some of them under the bag.

- If your face is too cold, cover it with a towel or muffler.

The bag is provided with a slide fastener. There are two methods of releasing this slide fastener. Under ordinary circumstances, pull the slide fastener down to release it. In an emergency, pull

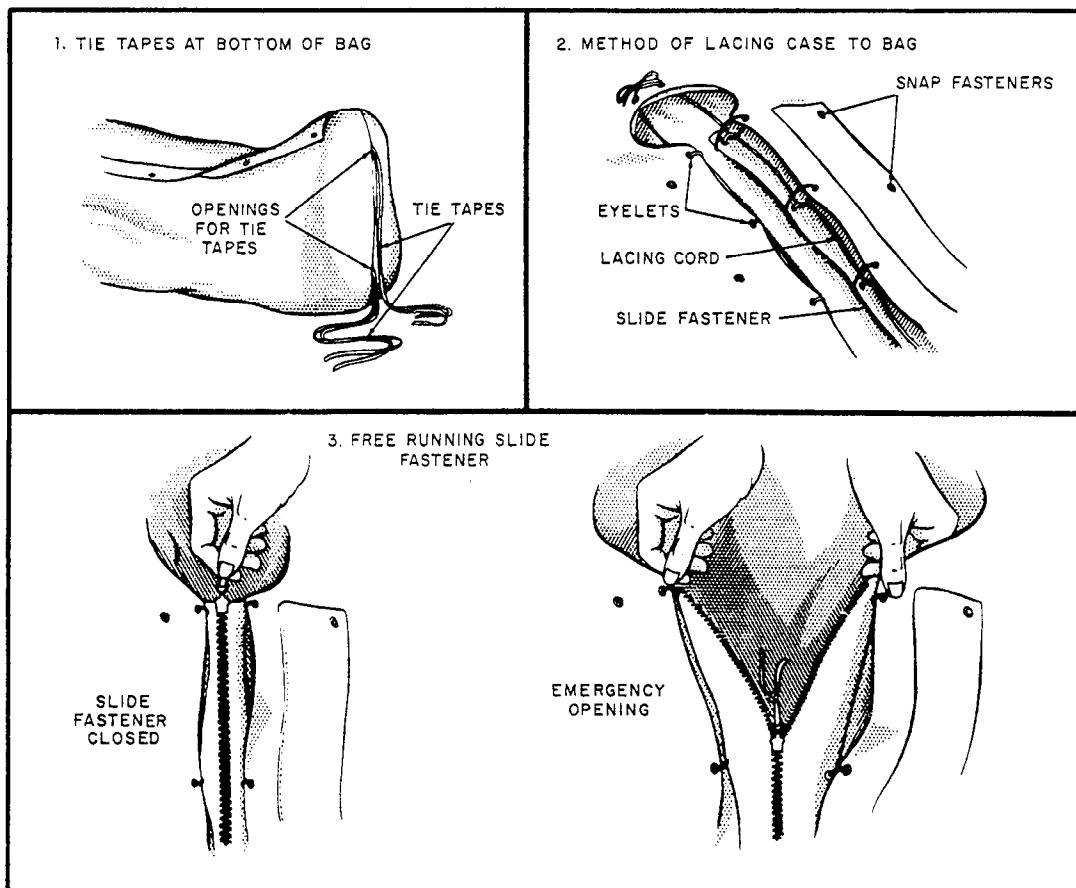

Figure 2-38.—Adjustments to sleeping bag and sleeping bag case.

the slider up to the very top. (See fig. 2-38.) This releases the slide fastener immediately along its entire length. To close the slide fastener after opening it in this manner, run the slider down to the bottom of the track, thread it into the other side, and pull it up again. Be sure both sides of the track are close together before closing. Use the side fastener quick-release feature only in an emergency. Rethreading the fastener requires time, and it is difficult to do with cold fingers.

To pack the sleeping bag, place it directly into the waterproof clothing bag, then roll it from the top to the bottom into a small bundle, and tie it with the tie tapes provided at the bottom. Always carry the sleeping bag inside its waterproof case.

SLEEPING MAT

The sleeping mat (fig. 2-39) is made of a rubber-coated foam material and shaped to conform to the sleeping bag. You should use the mat under the

sleeping equipment for added warmth and comfort and to keep your equipment clean and dry.

When possible, air-dry the mat before packing it away. Place the mat on the sleeping equipment, and roll them together or roll the mat separately and put it in or attach it to your field pack.

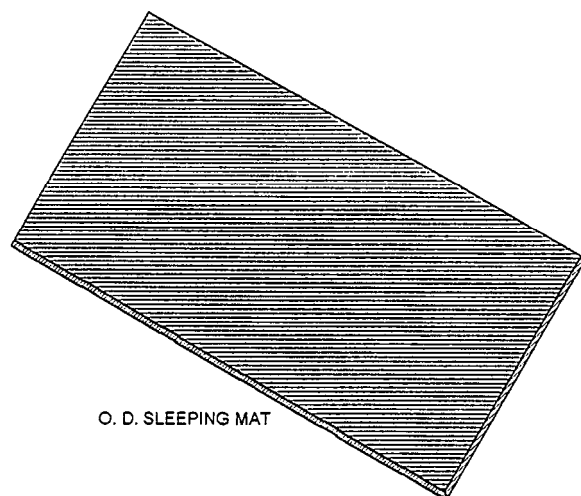

Figure 2-39.—Sleeping mat.

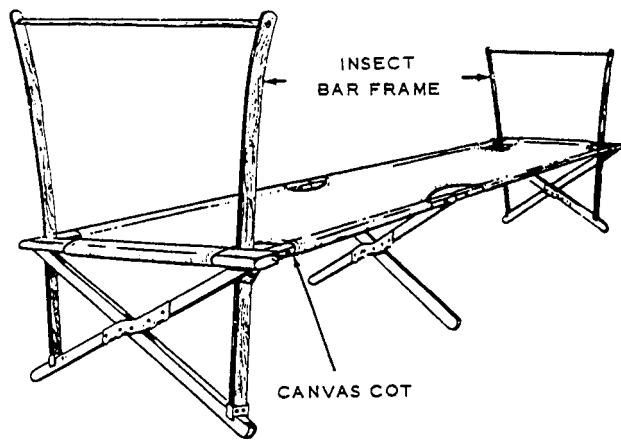

Figure 2-40.—Canvas cot and insect bar frame.

CANVAS COT AND INSECT BAR FRAME

The collapsible canvas cot has three sets of fold nets. The insect bar frame is made of wood and consists of four upright members fitted to the bottom of the end cot legs by steel clips (fig. 2-40).

INSECT BAR

The field type of insect bar is a canopy made from netting of small nylon mesh. It protects you against mosquitoes, sandflies, and other small insects. The bar may be used with the canvas cot by attaching a wooden insect bar frame to each end of the cot and tying the tie tapes of the net to the top corners of each frame. The net may also be used with the shelter half tent, as shown in figure 2-41, or it may be suspended from trees or bushes. The insect net may be folded in a small bundle and carried in the field pack.

CAMOUFLAGE BAND

The camouflage helmet band is an elastic band that may be fitted around the helmet at the base above the rim. The band is used to hold a camouflage head net or other camouflage material, such as foliage, in place.

GENERAL CARE AND MAINTENANCE OF CLOTHING AND EQUIPMENT

You are responsible for the care and maintenance of the clothing and equipment issued or sold to you. It is your duty to see that these items are available and in serviceable condition when they are needed.

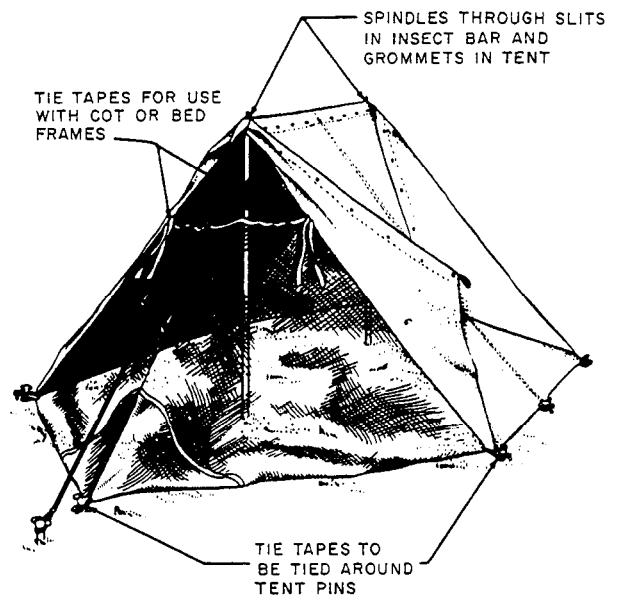

Figure 2-41.—Using field type of insect bar with shelter half tent.

General instructions for cleaning, pressing, storing, mending, and maintaining items of your uniform and equipment are provided in the following sections.

CLEANING CLOTHING

Brush clothing frequently and, whenever possible, outdoors in the sunlight. Always brush and sun clothing before it is stored and when it is unpacked after storage. Clean clothing regularly when it is not in use. Dirty clothing wears out rapidly because the dirt cuts textile fibers and retains moisture from perspiration. Observe the following instructions:

- Wash cotton clothing, such as shirts, trousers, and socks, with soap or synthetic detergent in hot water.
- Wash untailored wool clothing, such as socks and glove inserts, in mild soap or synthetic detergent with lukewarm or cool water. Never use hot or boiling water. Stretch them into shape while they are drying.
- Dry-clean all tailored wool clothing, such as wool jackets and blues. Washing affects their tailored features.
- Remove stains or soil as soon as possible because the longer they remain the harder it is to get them out.
- Wipe coated clothing, such as ponchos and raincoats, with a clean cloth and wash with water and mild soap or synthetic detergent. Do NOT use cleaning fluid on coated fabrics.

- Wash synthetic fabrics, such as stretch-type socks, in mild soap or synthetic detergent, using lukewarm or cool water.

PRESSING CLOTHING

Press clothing after it has been cleaned and all spots removed. Never press dirty clothing. Observe the following instructions when pressing:

- Make certain the iron is not too hot. Use the temperature settings on the iron as required for the type of clothing being pressed.

- Use a damp cloth between the iron and the fabric when pressing wool clothing.

- Dampen the surface of cotton clothing and apply the iron directly to it; when a steam iron is used, dampening is not required.

STORING CLOTHING

Observe the following instructions when storing clothing:

- Make certain the clothing is clean.

- Brush, sun, and air-dry all wool and cotton clothing before storing to avoid mildew in humid weather. Do not fold clothing when wet or place wet clothing in a bag or pack. Use naphthalene or mothballs to protect wool clothing from insects.

- Make certain that coated clothing is cool and dry before folding it for storage. When possible, fold it so a coated side is against an uncoated side to avoid sticking. When possible, dust-coat clothing with talcum before storing.

REPLACING BUTTONS

Observe the following procedures when replacing buttons:

1. First, thread the needle and tie the two ends of the thread together.

2. Put the needle through the cloth and stitch several times to anchor the end of the thread.

3. Next, put the needle through the button and allow it to slide down the thread.

4. Stitch through the cloth and the holes, first on one side then on the other. Hold the button away from the cloth, just a little, to help prevent straining the cloth.

5. After sewing, wrap a few turns of thread around the stitches between the button and the cloth. Finish up by stitching through the wrapped thread a number of times and locking the stitches with a knot.

REPAIRING RIPS AND TEARS

To mend a ripped seam, place the two edges together and sew, keeping the stitches small and in line with those already made. To mend a tear, place the two edges on the wrong (or inside) side and sew together. To mend a frayed edge, turn the edge under and sew.

BOOTS AND SHOES

A new pair of boots or shoes should not be fitted too snugly with the expectation that they will stretch. They should fit properly when new. Whenever possible, wear one pair one day and another pair the next to allow them to dry between wearings. In cleaning boots, scrape dirt or mud away with a flat stick, brush, or anything dull that will not cut the leather. Using a small hand brush, wash them with mild soap and very little water. Remove all the soapsuds, and wipe the inside dry with a clean cloth. Stuff paper in the toes while the boots or shoes are still wet to keep the leather from shrinking out of shape. Dry the boots or shoes slowly in a warm, dry place. Do not dry by exposing them to hot sun, fire, or other strong heat, because it may injure the rubber or leather. Be sure that boots or shoes are replaced or repaired when they show signs of excessive wear. Do not wait. A pair of shoes that is not in good repair can cause severe discomfort and lessen your effectiveness, so take care of them.

CANVAS EQUIPMENT

Clean canvas equipment, such as bags and packs, by dipping them vigorously in a pail of water containing mild soap or detergent. Do not scrub them with a stiff brush because it damages the material. Dry canvas items in the shade or indoors. Never wash or dry canvas items in automatic machines. Always repair small rips and tears as soon as possible.

WEB EQUIPMENT

Clean web equipment in the same manner as canvas. Never use chlorine, yellow issue soap, cleaning fluids, or dyes. Do not attempt to dye or repair web equipment. When web equipment is old or damaged, turn it in for replacement.

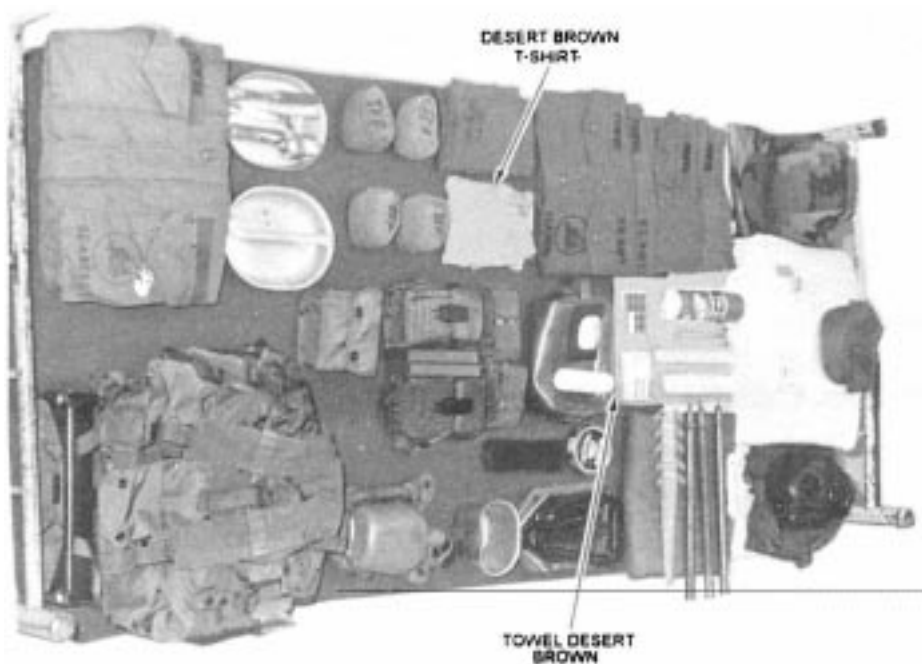

187.1

Figure 2-42.—Bunk layout-rifleman.

NETTING

Wash netting with a warm solution of mild soap or detergent. Repair small holes or tears by placing pieces of adhesive tape or waterproof tape over both sides of the hole. In an emergency, draw the edges together and tie them with string.

FASTENERS

Always use care in opening a snap fastener. To open, place your thumb and forefinger between the two layers of cloth close to the fastener and pry it apart. Do not tug at the cloth.

A slide fastener, even of sturdy construction, must be used carefully. When it snags, check it to see what is wrong. Do not try to force it. Usually by backing it up, smoothing it out, and trying again, it will work. If it works stiffly, rub a thin coating of wax or graphite from a lead pencil on each side of the track and then work it back and forth a few times.

COATED ITEMS

Wipe soiled items with a clean cloth, wash them with water and a mild soap or detergent, and rinse thoroughly. Dry the items as quickly as possible, but

do not use direct heat because the material will dry out and crack. Take special care to see that such substances as grease, oil, acid, or insect repellent are washed off as soon as possible.

ARMOR VEST

General instructions for taking care of the armor vest are usually sewn inside it near the collar. Observe these instructions carefully. Never dry the armor vest over or near an open flame.

SEABAG AND 782 GEAR LAYOUT

COMSECONDNCB and COMTHIRDNCB have agreed on a 782 gear layout for the NCF. A standard layout consists of the items shown in table 2-1 and table 2-2. Requirements may change with the mission of your command. Also, an environmental condition may require a modification to the layout. When changes occur, local commands will direct the 782 gear layout procedures.

For a rifleman, the standard bunk layout is displayed in figure 2-42 and the poncho layout in

Table 2-1.—782 Gear Layout Items.

Poncho
Camouflaged Helmet Cover/Mounted on Helmet
Utility Cover
Identification Tags
Identification Card
Field Protective Mask Carrier
Field Protective Mask
Trousers (Display two)
Towel Desert Brown
Soap/toothbrush/Toothpaste/Razor/Razor Blades/Shaving Leather (Displayed on towel)
Shelter Half
Tent Pole (Three sections)
Tent Pins (Display five)
Guy Line
Shirts (Display two)
Shaving Kit Bag
Sewing Kit
Foot Powder
Boot Polish
Brush
Entrenching Tool Cover
Entrenching Tool
Undershirts Desert Brown (Display two) Stenciled
Undershorts White or Desert Brown (Display two) Stenciled
Web Belt
*M-16 Magazine Pouch
*M-16 Magazine (Display two)
*M-16 Magazine Pouch
Canteen Cup
Canteen Cover
Canteen
Socks Stenciled (Display four)
First-Aid Kit
Mess Gear (Display knife, fork spoon)
Field Jacket
Alice Pack
Suspenders
*When authorized to wear .45 cal pistol, display .45 cal magazine pouch, two magazines, and pistol holster.

Table 2-2.—Deployed NMCB Uniform Requirements for Personnel E-1 through E6

I T E M	Q U A N T I T Y
Bag, Duffel	1
Belt, Web, Black w/Silver Clip	2
Belt, Web, White, w/Silver Clip	1
Belt, Web, Black, w/Gold (Brass) Clip	1
Boots, Combat	2 pr
Buckle, Web Belt, Silver	2
Buckle, Web Belt, USMC	1
Cap, Utility, OG	3
Coat, Field	1
Liner, Field Coat	1
Drawers, White and Desert Brown	6
Group Rate Mark, Black	3
Group Rate Mark, White	4
Hat, Hard Construction	1
Hat, White	2
Jumper, Blue Dress	1
Jumper, White Dress	1
Neckerchief	1
Necktie, Black	1
Shirt (Winter Blue)	1
Shirt, White, Short Sleeves	1
Shirt, Utility, OG	6
Shoes, Dress Black	1 pr
Socks, OG	6 pr
Socks, Cotton/Nylon Black	2 pr
Towel, Bath	4
Trousers, OG	6
Trousers, Broadfall Blue	1 pr
Trousers, (Dress Blue)	1 pr
Trousers, (White)	1 pr
Trousers, White Jumper (Polyester)	1 pr
Undershirts White and Desert Brown	6
NOTE: The above seabag is the minimum requirement established by COMSECONDNCB/COMTHIRDNCB for deployed units. Commanding officers may require additional items commensurate with environmental conditions at deployed sites.	

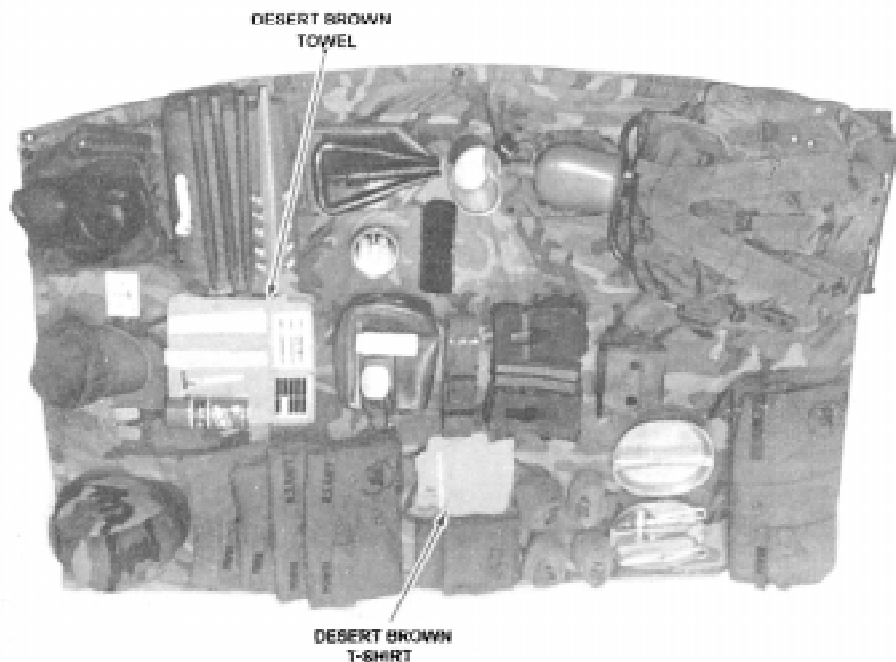

Figure 2-43.—Poncho layout-rifleman.

187.A

figure 2-43. Personnel assigned a service pistol will use the bunk layout displayed in figure 2-44 and the poncho layout shown in figure 2-45.

The seabag layout is standard according to COMSECONDCB/COIVIIIRDNCBINST 1020.2A.

A home-port layout (fig. 2-46) and a deployed layout (fig. 2-47) are covered by the same instruction. Table 2-2 is a listing of deployed NMCB minimum uniform requirements for personnel in paygrades E-1 through E-6. Your command may require additional uniform items that are not on this list.

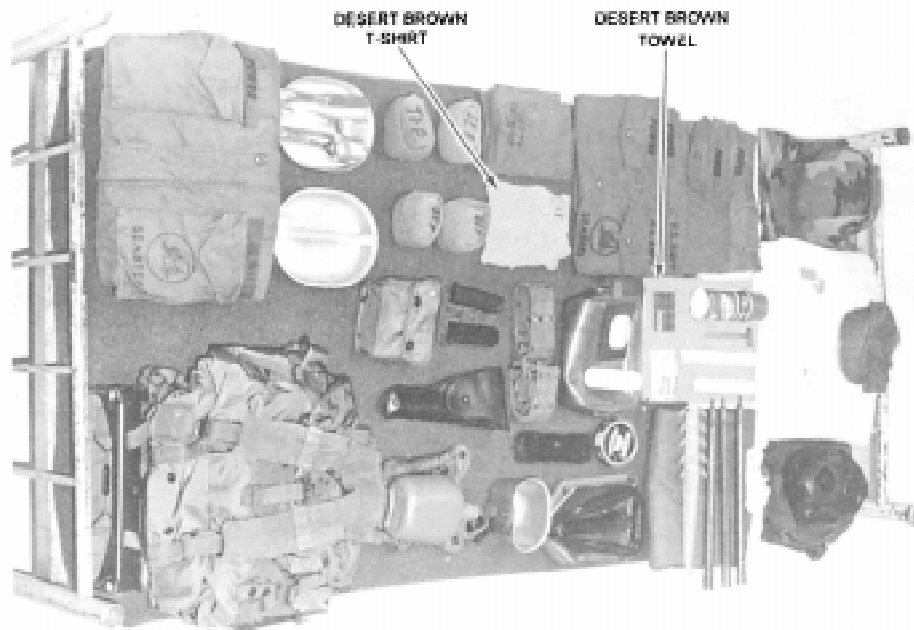

187.B

Figure 2-44.—Bunk layout with service pistol.

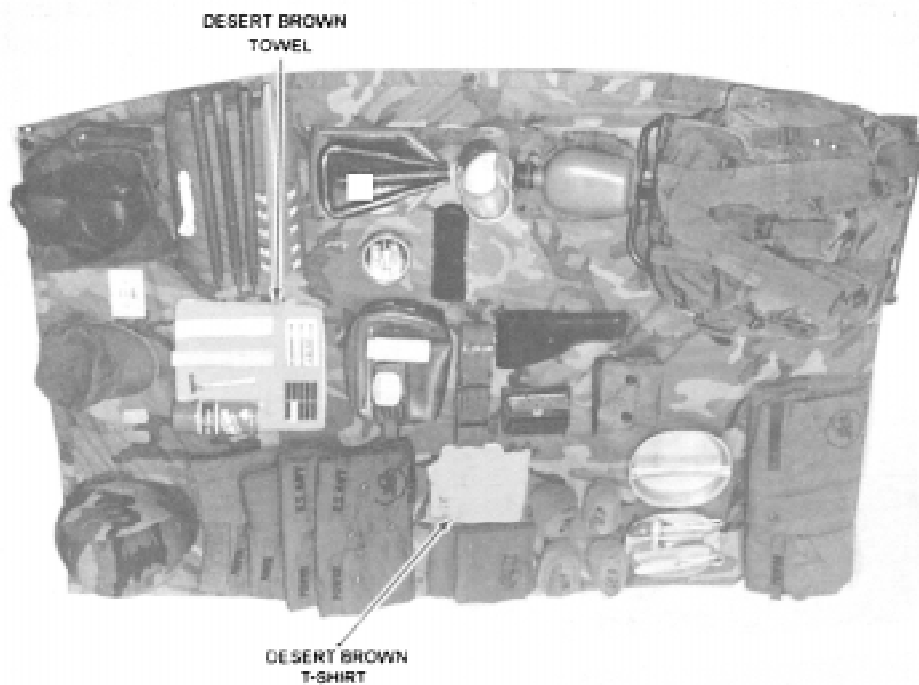

187.C

Figure 2-45.—Poncho layout with service pistol.

SIDE OF BUNK NEXT TO WALL OR PARTITION

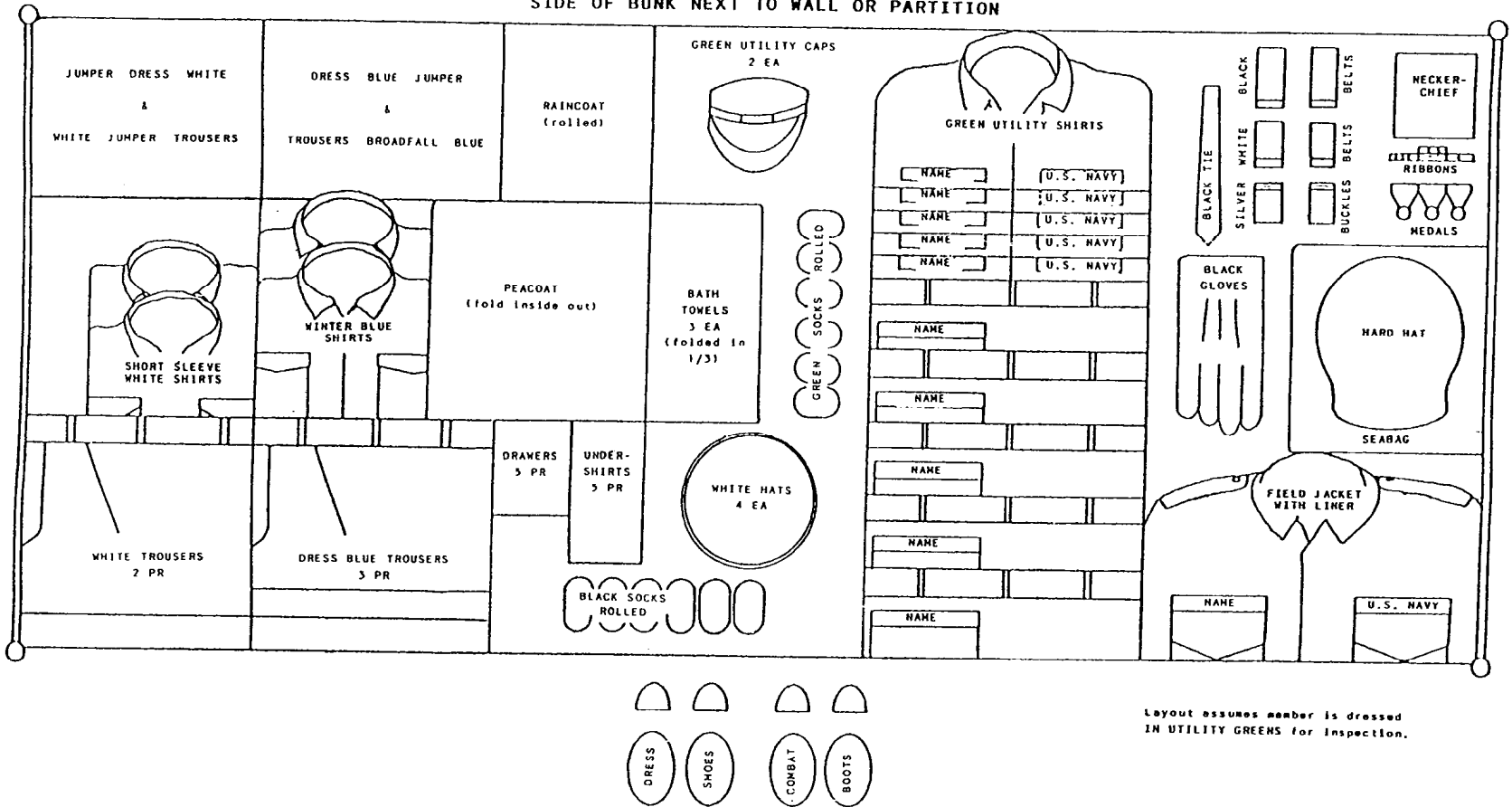

2-30

Figure 2-46.—Seabee seabag layout (home port).

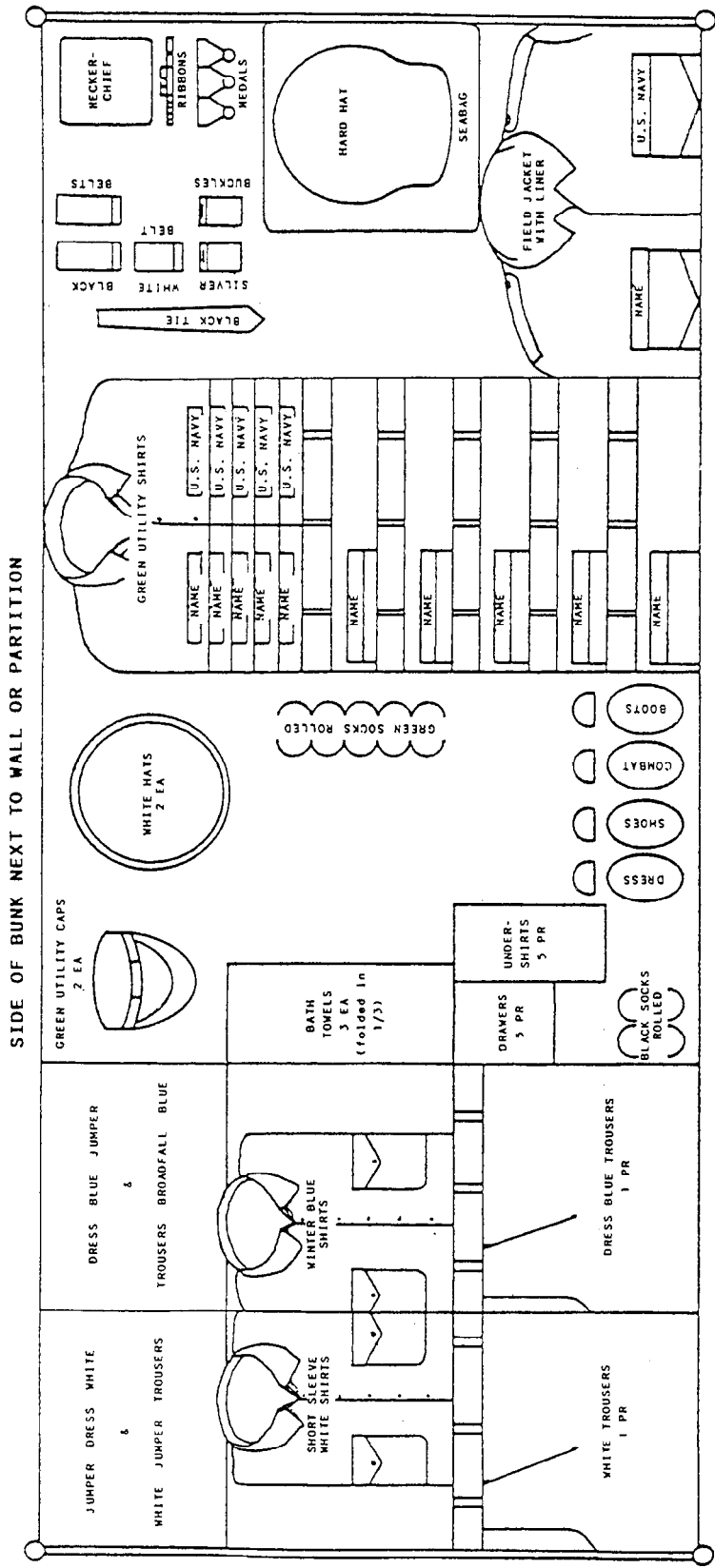

Layout assumes member is dressed
IN UTILITY GREENS for inspection.

Figure 2-47.—Seabee seabag layout (deployed).

CHAPTER 3

SERVICE RIFLE AND PISTOL AND MARKSMANSHIP

As a Seabee, you make important contributions to the Naval Construction Force (NCF) activities. You are important as an individual as well as a Seabee. The NCF is made up of individuals like you, working together as a team. The ultimate goal of the NCF is success in its construction projects as well as the defense of these projects when needed. Your job is to help achieve that success and to help provide that defense. You may have to fight alone; but most of the time, you will work and help defend a site with other Seabees under a unit or team leader. You can prepare yourself for defense by acquiring the knowledge and skills needed for using both individual and crew-served weapons. You, as a Seabee, are likely to be required to use them; therefore, they are discussed in the next two chapters.

Basic and introductory information about Seabee weapons is given so you can load, fire, field strip, and clean the service rifle, service pistol, light machine gun, light antitank weapon, grenade launcher, and mortar.

This chapter covers functioning, mechanical training, assembly and disassembly, loading and firing, ammunition, safety precautions, and marksmanship techniques for both the M16A1 and M16A2 service rifles and the .45 caliber pistol.

THE M16A1 AND M16A2 RIFLES

The M16A1 and the M16A2 service rifles (figs. 3-1 and 3-2) are 5.56-mm, magazine-fed, gas-operated shoulder weapons. Their design provides for either semiautomatic or automatic fire by means of a selector lever.

The M16A1 is equipped with a flash suppressor, but the M16A2 has a flash compensator to hold the muzzle down during rapid and automatic firing.

The barrel of the M16A1 is covered by two aluminum-lined fiber glass handguards (fig. 3-3). These handguards have notches to permit air to circulate around the barrel and to serve further as protection for the gas tube. On the M16A2, the handguards are round and ridged (fig. 3-2), making them stronger and easier to grip. The handguards are interchangeable; the handguard retaining ring is also specially contoured and easier to grip.

A “clothespin” biped is issued to, and used by, the automatic rifleman. The biped attaches to the barrel directly beneath the front sling swivel (fig. 3-4).

A forward assist assembly (fig. 3-1), located on the right rear of the upper receiver, permits closing of the bolt when the force of the action spring does not.

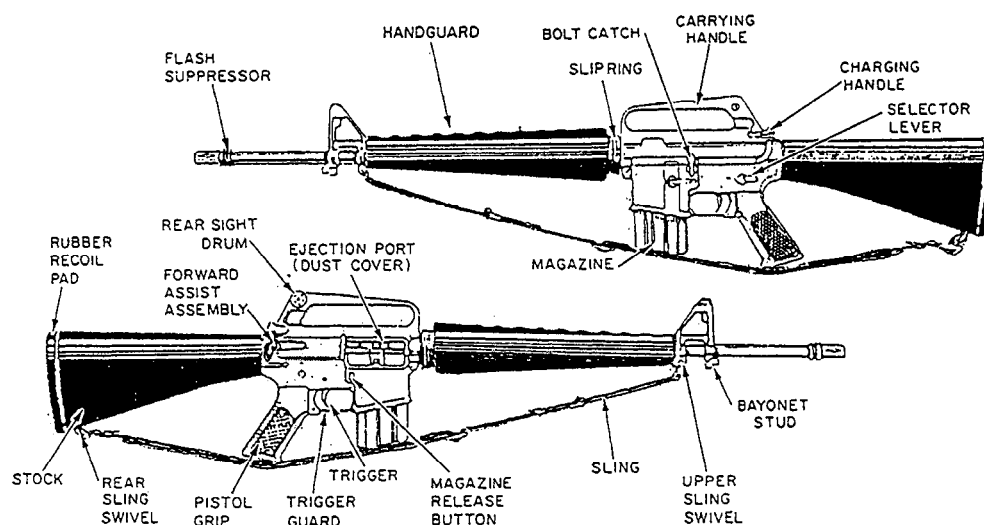

Figure 3-1.—M16A1 service rifle, 5.56 mm, left and right side views.

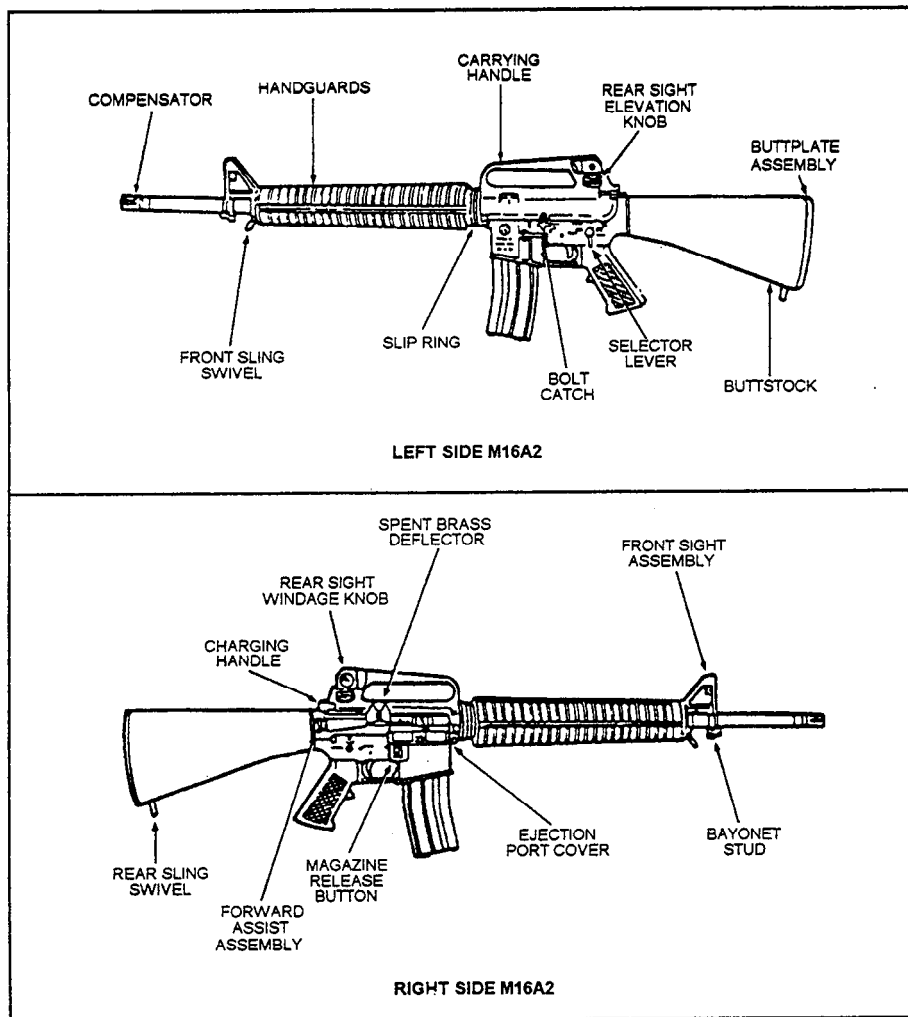

Figure 3-2.—M16A2 service rifle, 5.56 mm.

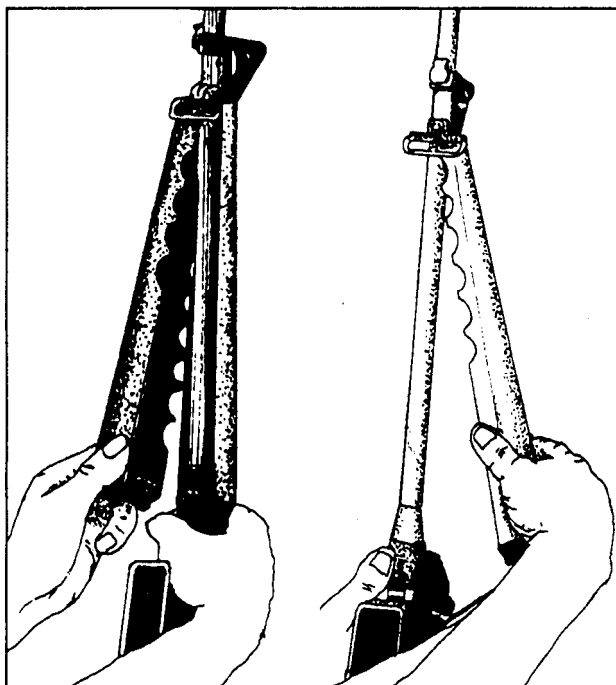

Figure 3-3.—Fiber glass handguard.

The trigger guard adapts easily for use in winter operations. A spring-loaded retaining pin is depressed so the trigger guard swings down along the pistol grip, allowing ready access to the trigger when cold weather mittens are being worn.

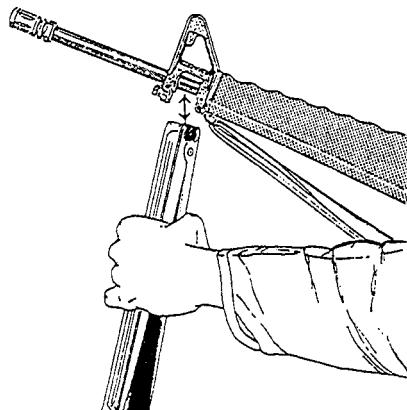

Figure 3-4.—Attaching "clothespin" bipod to M16 rifle.

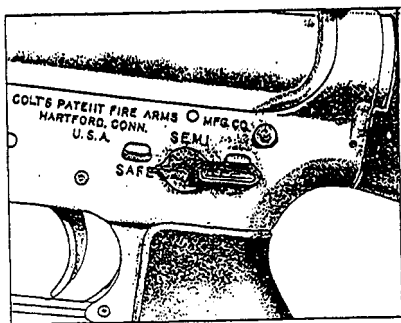

Figure 3-5.—Selector lever pointing to SAFE.

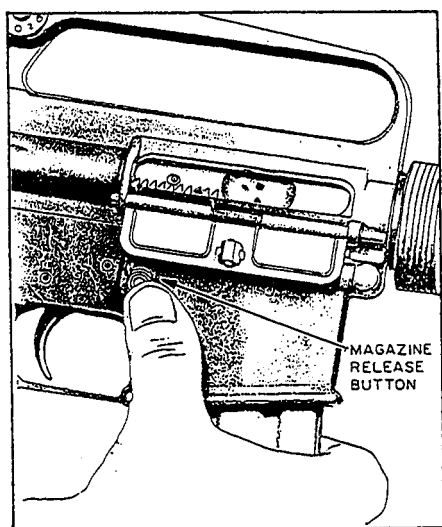

Figure 3-6.—Removing the magazine.

An ejection port cover prevents sand and dirt from getting into the ejection port. It should be closed during periods when firing is NOT anticipated and will open by either forward or rearward movement of the bolt carrier.

The M16A2 is an improvement over the M16A1 in the following ways:

- The barrel is 3 to 4 ounces heavier. The new barrel spins the bullet one turn in 7 inches, compared to one turn in 12 inches by the M16A1.
- The M16A2 has a maximum effective range of 800 meters, compared to 500 meters for the M16A1.
- The front sight post is now square instead of round, making it easier to see.
- The new model no longer fires fully automatic; it fires three rounds only per burst in the automatic setting.
- Left-handed shooters have some protection from injury with a built-in brass deflector located at the rear

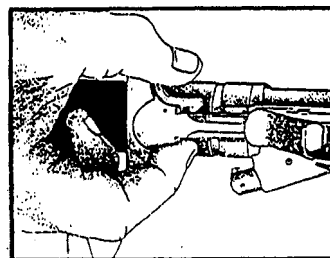

Figure 3-7.—Pulling the charging handle rearward.

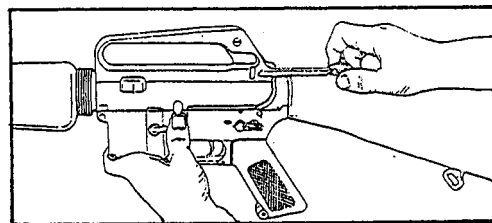

Figure 3-8.—Locking the bolt open.

of the ejection port. The stock of the rifle is 5/8 inch longer, making it more comfortable and easier to handle.

Unless specifically stated otherwise, the following discussion of the M16 rifle applies equally to both the M16A1 and M16A2.

For economy in communication, the following maintenance procedures (clearing, field-stripping, assembling, etc.) for the M16 service rifles are written for the right-handed Seabee. The left-handed Seabee can reverse hand directions for these procedures if it improves their efficiency.

CLEARING THE RIFLE

The first precaution to take in handling any weapon is to make it safe by clearing it. To clear the M16 rifle, place the butt against the right thigh and proceed as follows:

1. Attempt to point the selector lever toward SAFE, the position shown in figure 3-5. If the weapon is not cocked, the selector lever cannot be pointed toward SAFE. If that is the case, do not cock the weapon at this time; instead, go on to the next step in clearing.
2. Remove the magazine, as shown in figure 3-6. Grasp it with the right hand (fingers curled around the front of the magazine, thumb placed on the magazine catch button). Apply pressure on the magazine catch button with the thumb, and pull the magazine straight out of the weapon.
3. Lock the bolt open, as shown in figures 3-7 and 3-8. Grasp the charging handle with the thumb and

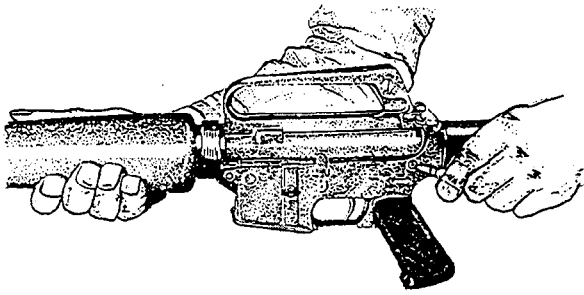

Figure 3-9.—Pressing takedown pin to the right.

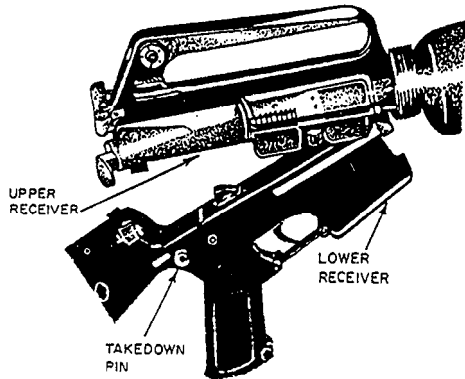

Figure 3-10.—Breaking upper receiver away from lower receiver.

forefinger of the right hand, depress the charging handle, latch it with the right thumb, and pull to the rear (fig. 3-7). When the bolt is fully rearward, press the bottom of the bolt catch with the thumb or forefinger of the left hand (fig. 3-8). Allow the bolt to move slowly forward until it engages the bolt catch, and return the charging handle to its forward position.

4. Inspect the receiver and chamber of the weapon, by looking through the ejection port, to ensure these spaces contain no ammunition.

5. Check the selector lever to ensure it points toward SAFE; then allow the bolt to go forward by depressing the upper portion of the bolt catch.

CAUTION

The selector must be on SAFE to prevent damage to the automatic sear during assembly and disassembly.

FIELD-STRIPPING THE RIFLE

The individual Seabee is authorized to disassemble the M16 to the extent termed *field-stripping*. Field-stripping is done without supervision and is adequate for normal maintenance. As the weapon is disassembled, lay out the parts on a table or other clean

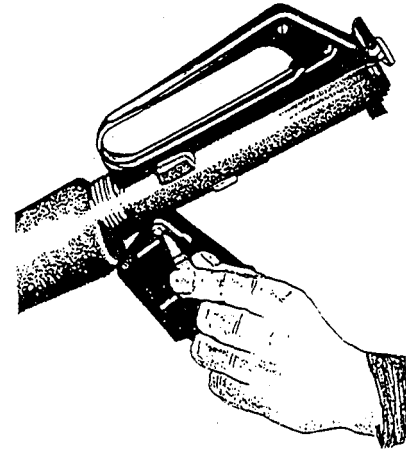

Figure 3-11.—Pressing out receiver pivot pin.

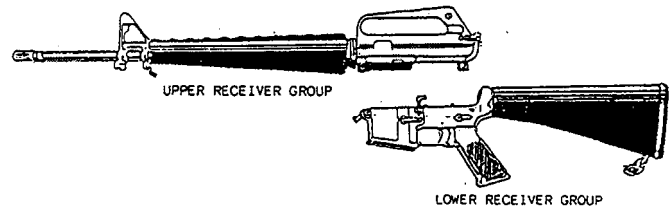

Figure 3-12.—Upper and lower receiver groups.

surface in the order of removal from left to right. This makes reassembly easier because you can assemble the parts in the reverse order of disassembly.

The steps infield-stripping are as follows:

1. Remove the sling, and place the rifle on a table or flat surface, muzzle to the left.

2. Turn the weapon on its right side, keeping the muzzle to the left. Press the takedown pin to the right (fig. 3-9) until the upper receiver swings free of the lower receiver (fig. 3-10).

CAUTION

The takedown pin does not come out of the receiver.

3. Press out the receiver pivot pin (fig. 3-11). Separate the upper and lower receiver groups (fig. 3-12), and place the lower receiver group on the table.

CAUTION

The receiver pivot pin does not come out of the receiver.

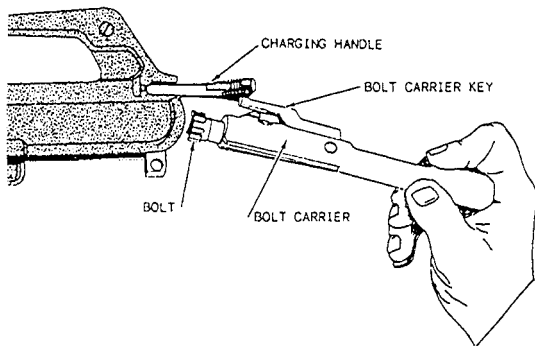

Figure 3-13.—Removing bolt carrier from receiver.

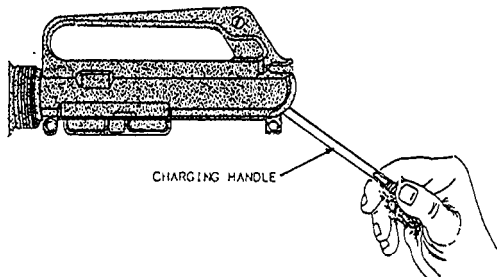

Figure 3-14.—Removing the charging handle.

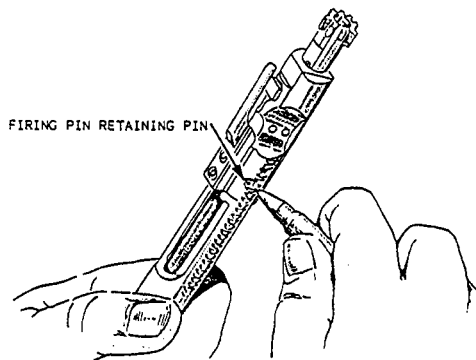

Figure 3-15.—Pressing out the firing pin retaining pin with the tip of a cartridge.

4. Pickup the upper receiver group, keeping the muzzle to the left. Grasp the charging handle; press in on the latch and pull it to the rear (fig. 3-7) to remove the bolt carrier from the receiver. Grasp the bolt carrier and pull it from the receiver (fig. 3-13). When the bolt carrier is removed, the charging handle frills free of its groove in the receiver (fig. 3-14). Place the receiver on the table.

5. Press out the firing pin retaining pin (fig. 3-15) to disassemble the bolt carrier group. Elevate the front of the bolt carrier, and allow the firing pinto drop from its well in the bolt (fig. 3-16). Rotate the bolt until the cam pin is clear of the bolt carrier key. Remove the cam pin by rotating it 90 degrees (one-quarter turn) and

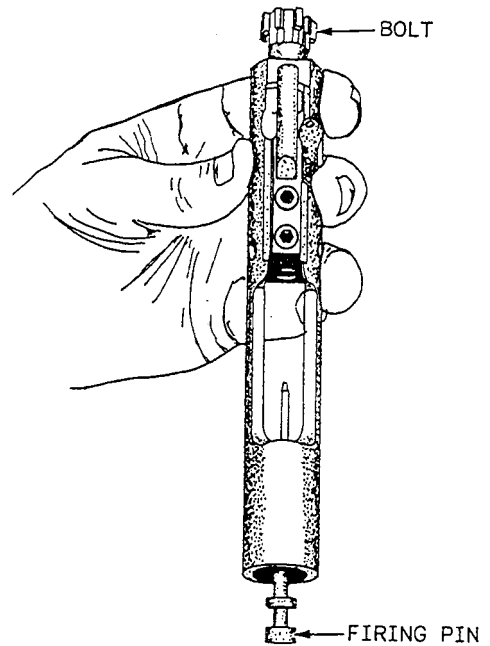

Figure 3-16.—Removing the firing pin.

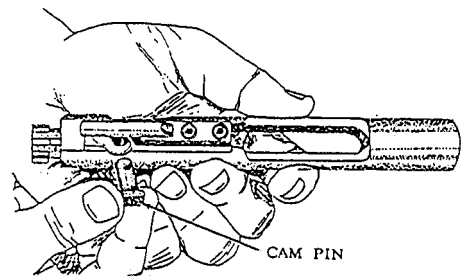

Figure 3-17.—Removing the cam pin.

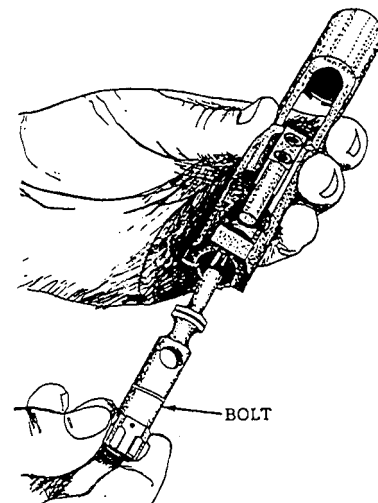
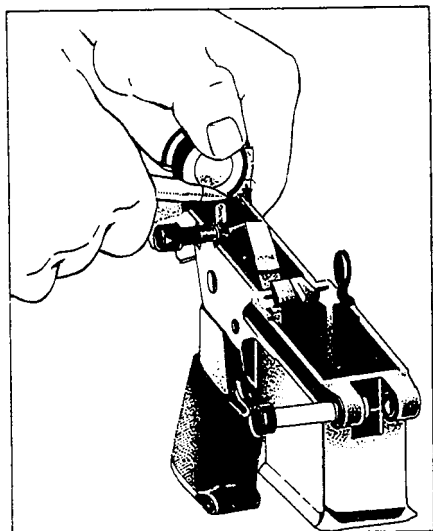

Figure 3-18.—Removing the bolt from the bolt carrier.

lifting it out of the well in the bolt and bolt carrier (fig. 3-17). After the cam pin is removed, the bolt can be easily removed from its recess in the bolt carrier (fig. 3-18).



A. DEPRESSING THE BUFFER RETAINER.

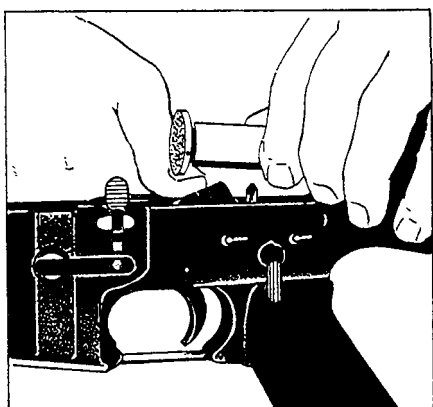

Figure 3-19.—Removing the buffer assembly and action spring.

the body of the buffer assembly has cleared the hammer, you can withdraw the action spring from the lower receiver (fig. 3-19, view B).

NOTE: The action spring is under pressure; therefore, take care when you are removing it. Step 6 should be performed only when absolutely necessary for care and cleaning.

Figure 3-20 shows the M16A1 service rifle field-stripped after you complete the above steps.

ASSEMBLY OF THE RIFLE

To assemble the rifle, reverse the procedures of disassembly.

1. Insert the end of the assembly spring into the lower receiver extension; depress the cocked hammer to allow passage of the buffer assembly; depress the buffer retainer with the nose of a cartridge or the tip of the firing pin; seat the buffer assembly; and then release the buffer retainer.

2. Assemble the bolt carrier group by grasping the bolt and the extractor with the action spring. Seat the extractor in the extractor recess; apply pressure on the extractor to align the pinhole; and then insert the extractor pin. Pickup the bolt carrier with the carrier key up and to the front; insert the bolt into the front of the bolt carrier, ensuring that the ejector is down and to the left. Replace the cam pin into its well, and rotate the cam pin 90 degrees (one-quarter turn) to align the holes for the firing pin in the bolt and the cam pin. Grasp the lugged rim of the bolt, and turn it until the cam pin is directly under the bolt carrier key. Insert the firing pin through the open end of the bolt carrier and seat it fully. Insert the firing pin retaining pin (if you encounter resistance, rotate the pin while inserting it).

CAUTION

Do NOT attempt to spread the slotted end of the firing pin retaining pin. Check for proper assembly by elevating the front of the bolt. If the firing pin drops out, the firing pin retaining pin is not between the front and rear spool. The bolt carrier group is improperly assembled.

3. Grasp the upper receiver with the carrying handle up. Place the charging handle into the groove in the top of the upper receiver. The lugs on the charging handle must be seated in their grooves in the receiver. Place the bolt carrier group into the open end of the receiver, ensuring that the bolt carrier key is in the slot

Remove the extractor by first pushing the extractor pin out with the firing pin. Then, while maintaining pressure on the rear portion of the extractor with your index finger, withdraw the firing pin from the extractor pinhole. Release the pressure from the extractor and remove. The extractor should be disassembled only when necessary for cleaning. Disassembly of the extractor should be supervised. Since the extractor pin is quite small, handle it with care to prevent loss or damage.

NOTE: Do not remove the extractor spring from the extractor. If the spring falls out of its recess, the battalion armorer should replace it.

6. Push in on the buffer assembly, using the index finger of the left hand. With the nose of a cartridge or some similar object, push down on the buffer retainer (fig. 3-19, view A). To remove the buffer assembly, press the hammer downward past the cocked position. After

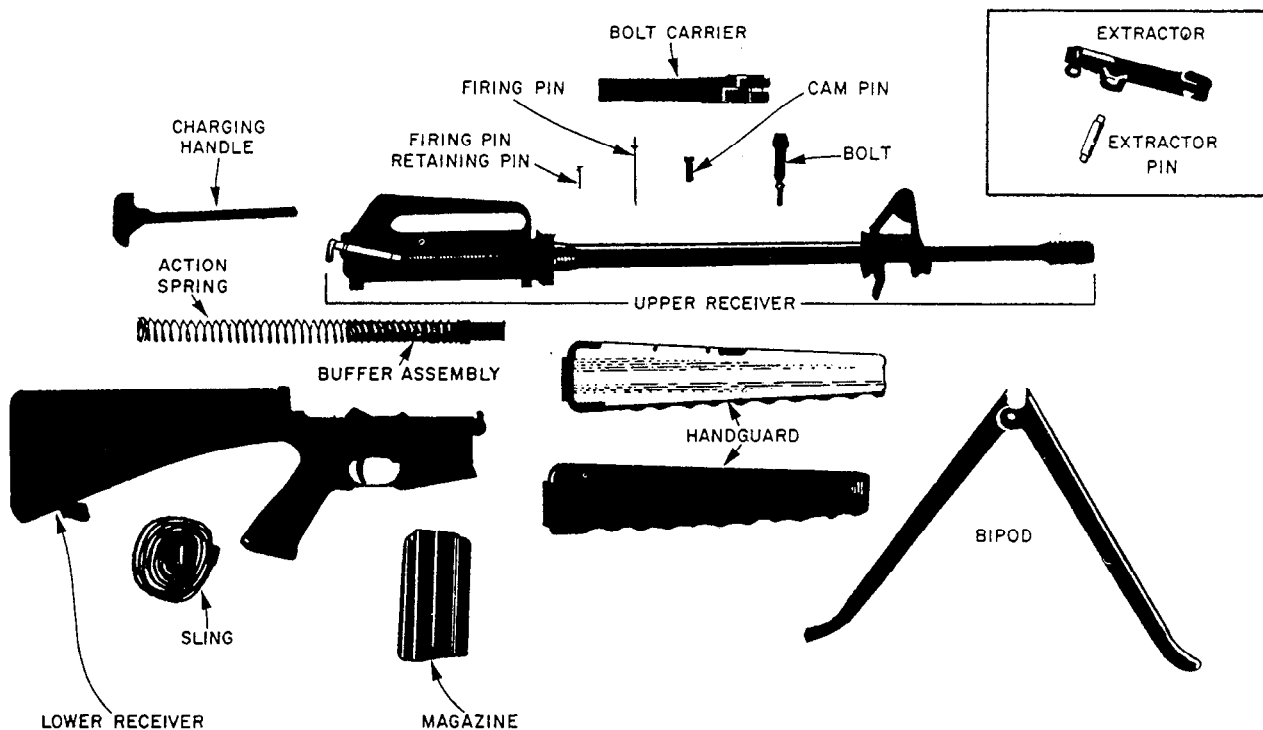

Figure 3-20.—The M16A1 service rifle field-stripped.

on the underside of the charging handle and the bolt is forward in the unlock position. Push forward on the bolt carrier group and charging handle until it is fully seated.

4. Place the upper receiver group and lower receiver group together, and reseal the receiver pivot pin.

5. With the hammer cocked and the selector lever on SAFE, close the weapon and seat the takedown pin.

6. Replace the handguards, and be sure that the slip ring is fully seated on the lower lip of both sections of the handguards. Take care to prevent damage to the upper and lower lips and to ensure proper seating.

7. A complete fictional check of the rifle consists of checking the operation of the weapon while the selector is in the SAFE, SEMI, and AUTO positions. Use the following sequence for a rapid, complete check. You may use any portion of the check alone to determine the operational condition of any specific fire selection.

NOTE: Disengage the takedown pin and open receivers. The hammer must be in the cocked position.

a. SAFE position. Pull the trigger; the hammer should not fall.

b. SEMI position. Pull the trigger; the hammer should fall. Hold the trigger to the rear, recock the hammer, and release the trigger. The hammer should

transfer from hammer hooks and disconnect to the hammer and sear engagement.

c. AUTO position. Pull the trigger; the hammer should fall. Hold the trigger to the rear, and recock the hammer. The hammer is now under the automatic sear. Still holding the trigger to the rear, push forward on the automatic sear. The hammer should frill. Still holding the trigger to the rear, recock the hammer, release the trigger, and push forward on the automatic sear. The hammer should transfer to the sear engagement. Move the selector lever to SAFE or SEMI position. Close the receivers and engage the takedown pin.

CAUTION

If the selector lever is not moved to the SAFE or SEMI position before you close the receivers, you can damage the automatic sear.

d. SEMI position. Pull the charging handle to the rear. Make certain the chamber is clear; then release the charging handle. Pull the trigger. The hammer should fall.

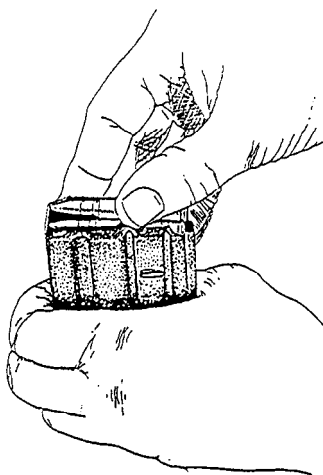

Figure 3-21.—Loading cartridges into the magazine, 20 rounds capacity.

LOADING THE MAGAZINE

The magazine has a capacity of 20 rounds and may be loaded with any amount up to that capacity. The magazine follower has a raised portion generally resembling the outline of a cartridge. Cartridges are loaded into the magazine so the tips of the bullets point in the same direction as the raised portion of the follower (fig. 3-21).

CAUTION

Do not load or attempt to load more than 20 rounds in the magazine. Overloading deforms the lips of the magazine and causes malfunctions.

UNLOADING THE MAGAZINE

To prevent damage to the lips of the magazine, remove the ammunition in the following manner:

1. Hold the magazine in your left hand with the open end away from your body and with the nose of the cartridge down (fig. 3-22, view A).

2. Depress the center of the second round in the magazine using the nose of the cartridge, allowing the first round to drop out of the magazine (fig. 3-22, view B). Repeat this procedure until you remove all the rounds from the magazine except the last one.

3. Use the nose of the cartridge to depress the follower to remove the last round, allowing the last round to drop out of the magazine (fig. 3-22, view C).

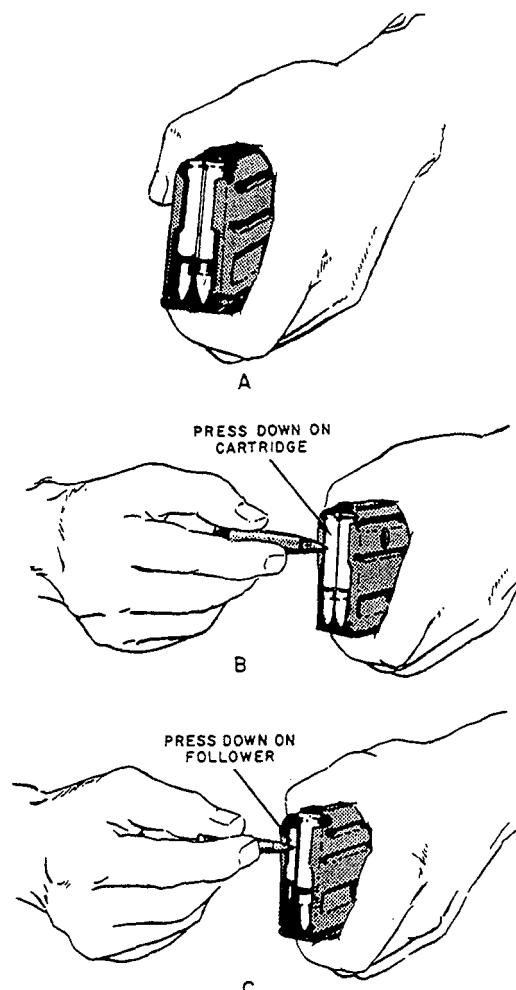

Figure 3-22.—Unloading the magazine with the nose of a cartridge.

LOADING THE RIFLE

With the hammer cocked, place the selector lever on SAFE. (See fig. 3-6.) Notice that you cannot place the selector lever on SAFE unless the rifle is cocked. You may insert the magazine with the bolt and bolt carrier open or closed; however, you should learn to load with the bolt open. This reduces the possibility of first-round stoppage and saves the time needed to pull the charging handle to the rear.

Hold the stock of the rifle under your right arm with your right hand. Grasp the pistol grip; then point the muzzle in a safe direction. With your left hand, insert the loaded magazine into the magazine housing. Push upward until the magazine catch engages and holds the magazine. Rap the base of the magazine sharply with the heel of your hand to ensure positive retention. If the action is open, release the bolt by depressing the upper portion of the bolt catch with the thumb of your left hand, allowing the action to close, chambering the round. If the action is closed when the magazine is inserted, pull

the charging handle fully to the rear with your right hand and release it. (See fig. 3-7.)

NOTE: Do not “ride” the charging handle forward with the right hand. If the charging handle is eased forward from the open position, the bolt may fail to lock. If the bolt fails to go fully forward, use the bolt closure forward assist assembly (fig. 3-1) with the heel of your right hand. The rifle is now loaded and is ready to fire when you place the selector lever in the automatic or semiautomatic position. If it is not ready to fire, make sure the selector lever is on SAFE.

After the last round has been fired, the bolt catch holds the bolt carrier to the rear. To change the magazine for reloading, press the magazine catch button; remove the empty magazine from the weapon.

FIRING THE RIFLE

The rifle fires semiautomatically or automatically when you move the selector lever to the desired position. (See fig. 3-5.) With the selector lever in the semiautomatic position, the rifle fires one round each time you pull the trigger. With the selector lever in the automatic position, the M16A1 rifle continues to fire until the magazine is empty or you release the trigger. The M16A2, mentioned earlier, cannot fire fully automatically, but fires in short bursts of three rounds. When the rifle is fired in either SEMI or AUTO, the bolt locks in the open position when the last round from the magazine has been fired.

MALFUNCTION, STOPPAGE, AND IMMEDIATE ACTION

A malfunction is the failure of a weapon to function satisfactorily, usually because of excessive friction caused by dirt, improper lubrication, or carbon buildup. To correct this problem, you must clean the weapon.

A stoppage is any interruption in the cycle of functioning caused by faulty action of the weapon or faulty ammunition. To correct this problem, you should replace either the worn or broken part or the ammunition.

Immediate action is the action you take to correct the stoppage without analyzing the cause. Immediate action to clear a stoppage in the rifle is as follows:

1. Strike the forward assist assembly to ensure the extractor has engaged the round. Tap upward on the bottom of the magazine to ensure that it is fully seated. Pull the charging handle fully to the rear. Watch for the ejection of a complete cartridge or cartridge case.

2. If a cartridge or case is ejected, release the charging handle to feed a new round (do not ride the charging handle forward). Then strike the forward assist assembly to assure complete bolt closure. Attempt to fire the weapon. If the weapon fails to fire, inspect it to determine the cause of the malfunction and take the correct action.

3. If the cartridge or case is not ejected, check for around in the chamber. If the chamber is clear, release the charging handle to feed a round, strike the forward assist assembly, and attempt to fire. If the weapon still fails to fire, clear and inspect it to determine the cause of the malfunction and take the correct action.

4. If a cartridge or case is visible in the chamber, you must remove it before attempting to reload or recycle the rifle. Remove the stuck cartridge or case by inserting the cleaning rod into the bore from the muzzle end of the rifle and tapping the cartridge or case.

MISFIRE AND COOK OFF

These malfunctions rarely happen when you fire only authorized and properly maintained ammunition in properly maintained and operated weapons. However, you must understand the nature of each kind of malfunction as well as the proper preventive and corrective procedures in order to avoid personal injury or damage to your rifle. The following procedures for removing chambered cartridges associated with these malfunctions are given below:

1. **MISFIRE.** A misfire is a complete failure to fire, NOT a delay in firing that may be caused by a faulty firing mechanism or a faulty element in the propelling charge explosive train.

2. **COOK OFF.** A cook off is a functioning of any or all of the explosive components of a cartridge chambered in a hot weapon because of the heat from the continued firing of the weapon. When this happens, attempt to remove the cartridge before 10 seconds elapse. If a cartridge is chambered in a hot rifle and can neither be fired nor removed, keep your rifle trained in a safe direction. Then allow for a minimum of 15 minutes to elapse before taking any further corrective action.

UNLOADING AND CLEARING THE RIFLE

To unload the rifle and make it safe, place the selector lever on the SAFE position (fig. 3-5); and remove the magazine by pressing the magazine catch

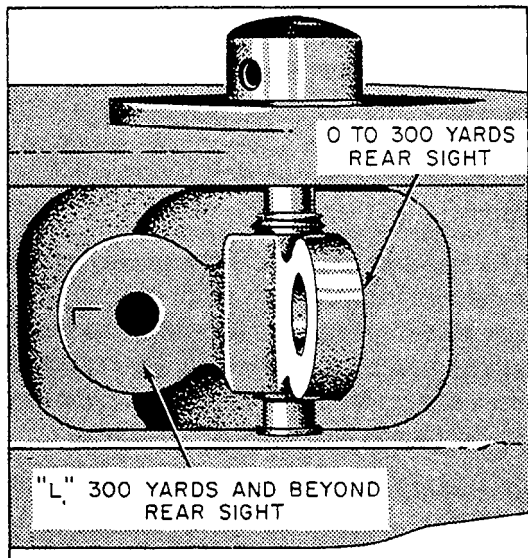

Figure 3-23.—Rear sight aperture.

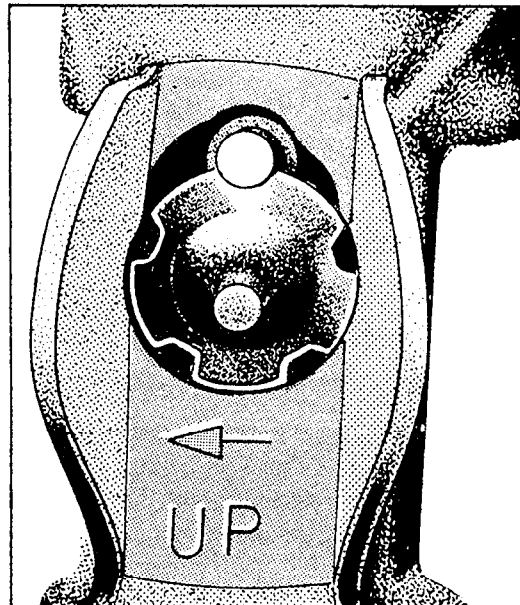

Figure 3-25.—Front sight, M16A1.

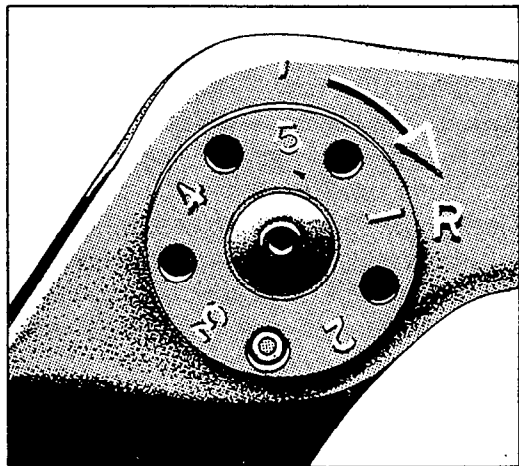

Figure 3-24.—Windage drum.

The rear sight consists of two apertures, as shown in figure 3-23, and a windage drum with a spring-loaded detent, as shown in figure 3-24. The aperture marked "L" is for use for ranges beyond 300 yards; and the unmarked aperture is for use for ranges from 0 to 300 yards. Adjustments for windage are made by pressing in on the spring-loaded stud with either a pointed instrument or the tip of a cartridge and rotating the windage drum in the desired direction.

The front sight of the M16A1 rifle consists of a rotating sight post with a spring-loaded stud (fig. 3-25). Adjustments are made by using a pointed instrument or a tip of a cartridge. To raise or lower the front sight post, depress the spring-loaded stud and rotate the post in the desired direction of change. A spring-loaded detent keeps the post from being moved accidentally. To raise the strike of the bullet, depress the detent and rotate the sight post clockwise.

Each click of elevation or windage adjustment will move the strike of the bullet a specific distance at a specific range. At a range of 100 yards, one click of either elevation or windage on the sights of the rifle will move the strike of the bullet approximately 1 inch, or 2.54 centimeters, up or down.

AMMUNITION FOR THE RIFLE

The 5.56-mm ammunition, as shown in figure 3-26, for the M16 rifle is classified as small arms ammunition and is issued in the form of a complete round. A complete round (cartridge) consists of all the components necessary to fire the weapon once; that is,

button (fig. 3-6). Pull the charging handle to the rear (fig. 3-7), ejecting any round from the chamber. Inspect the chamber and receiver to ensure that it is clear. Releasing the charging handle will allow the bolt to close. To keep the bolt open, depress the lower portion of the bolt catch before returning the charging handle forward (fig. 3-8). The rifle is clear only when no case or round is in the chamber, the magazine is out, the bolt carrier is to the rear, and the selector lever is on the SAFE position.

SIGHTS OF THE RIFLE

The sights of the rifle are adjustable for both windage and elevation. Windage adjustments are made on the rear sight; elevation adjustments are made on the front sight.

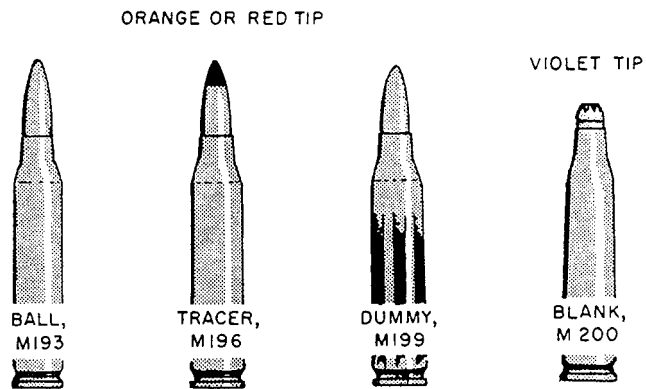

Figure 3-26.—5.56-mm ammunition for the M16A1 and M16A2 rifles.

projectile (bullet), propellant, and primer. Based upon the type of projectile, the ammunition for use in the rifle is classified as follows:

1. The ball cartridge, M193, is for field use and has no distinguishing marks. When shot from the rifle, its muzzle velocity is approximately 3,250 feet per second. It has a maximum range of 3,000 yards, but the maximum effective range is 500 yards.

2. The tracer cartridge, M196, is used to observe fire and for incendiary effect. You can identify it by an orange- or a red-painted tip, depending on the ammunition lot number. The use of only tracer cartridges may cause deposits of the bullet-jacket material (metal fouling) to form in the bore and rifling

grooves of the barrel. These tracer deposits are extremely difficult to remove and are a potential safety hazard. Therefore, when tracer ammunition is fired in the M16 rifle, you should intermix it with ball ammunition in a ratio of no less than four ball rounds to each tracer round.

3. The dummy cartridge, M199, cannot be fired. You can identify it by six lengthwise ridges in the case. The dummy cartridge is for use in training only.

4. The blank cartridge, M200, is for use in training and ceremonial salutes. Its case mouth is closed with a rosette crimp that has a violet tip. You can identify it by the knurled band around the lower portion of the case. The grooves help identify the types of cartridges by feel when you cannot see the colored tip in the dark

CARING AND CLEANING OF THE RIFLE AND AMMUNITION

A clean, properly lubricated and maintained rifle loaded with clean ammunition will fire when needed. In order to keep the rifle in good condition, it must have care and cleaning. Under bad weather conditions, some key parts may need care and cleaning several times a day. The cleaning material, as shown in figure 3-27, used for the care of the rifle, is carried in the rifle stock. Special attention must be given to the following areas:

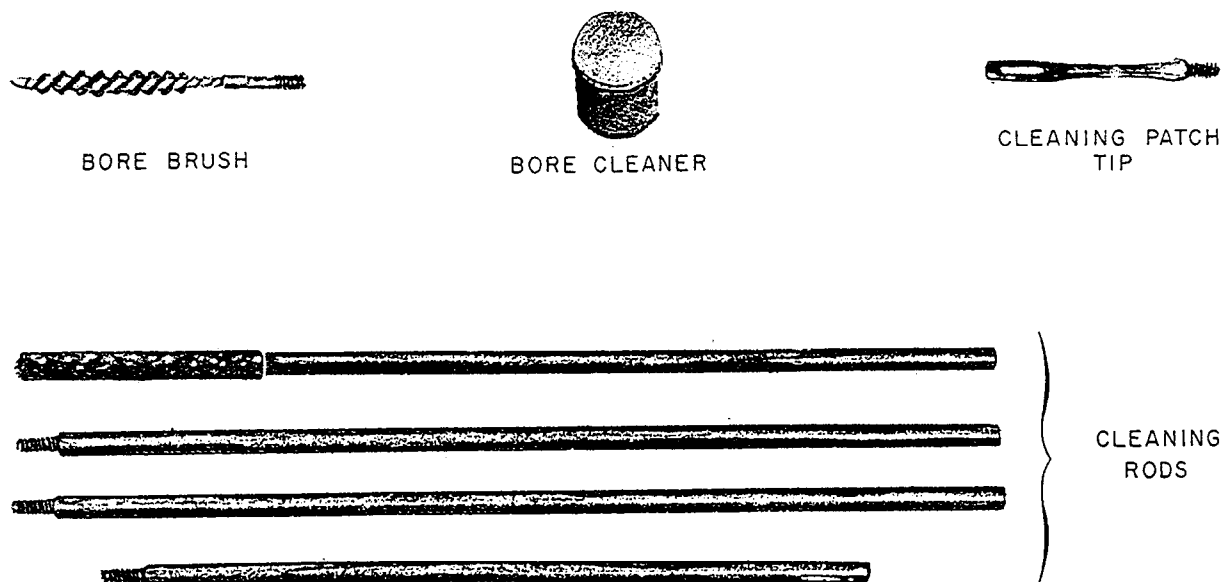

Figure 3-27.—M16A1 and M16A2 rifle cleaning material.

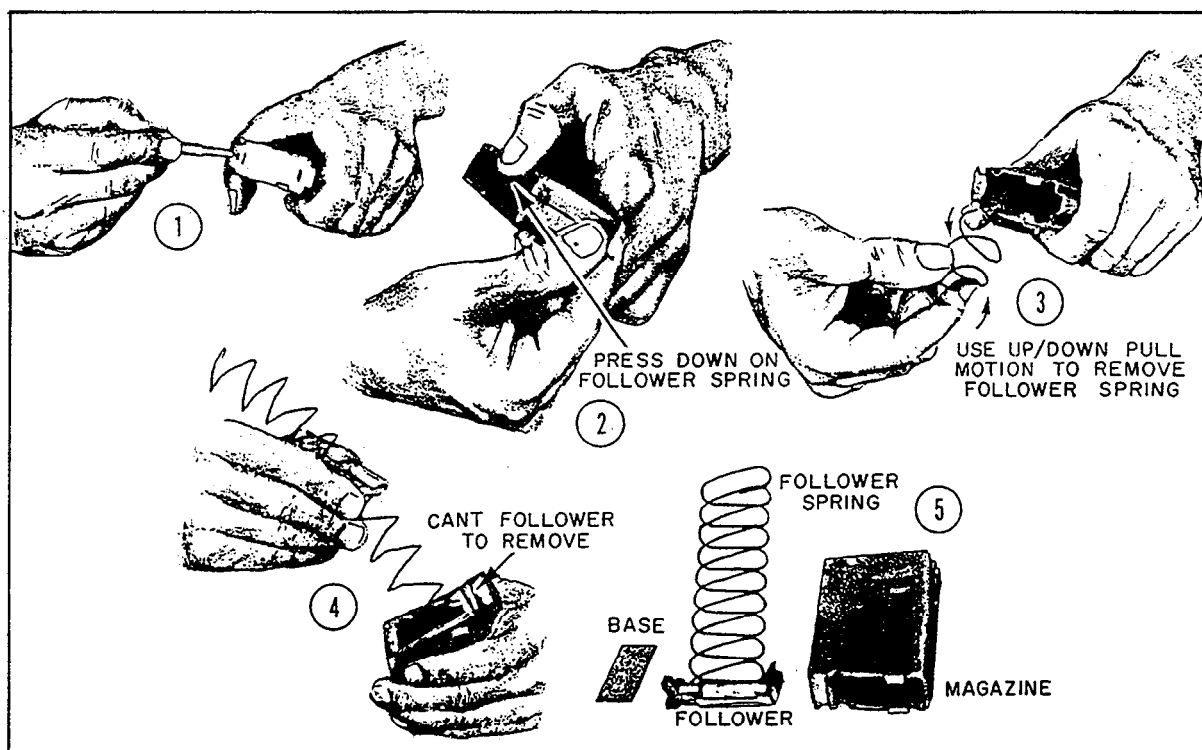

Figure 3-28.—Disassembly of the 20-round magazine.

1. **BARREL BORE and CHAMBER.** After dipping a bore brush in the bore cleaner, brush from the chamber to the muzzle, using straight-through strokes. Do NOT reverse the brush while it is in the bore or it may jam. A jammed brush is hard to remove, and it can possibly damage the bore when you do this. After dipping the brush in bore cleaner, clean the chamber with the chamber brush. Replace the bore brush with a slotted cleaning patch tip, and push the dry patches through the bore and chamber until they come out clean. After cleaning the bore, lightly lubricate the bore and chamber to prevent corrosion and pitting, using the recommended lubricant on a patch. Lightly lubricate the lugs in the barrel extension.

2. **BOLT CARRIER GROUP.** Dip the bore brush in the bore cleaner, and clean the inside of the carrier key. Dry with a pipe cleaner. Clean the locking lugs, bolt, extractor ejector, and bolt rings with the bore brush. Remove any accumulation of dirt, carbon, or oil from the firing pin and the external and internal surfaces of the bolt and bolt carrier. Be sure to wipe all parts dry; then lubricate them with the recommended lubricant.

3. **UPPER RECEIVER GROUP.** With the bore brush or a swab coated with bore cleaner, remove the powder fouling collected on the group. Clean the protruding gas tube inside and outside. After cleaning

these components, wipe them dry, and apply a light coat of the recommended lubricant.

4. **LOWER RECEIVER GROUP.** With the bore brush or a swab coated with bore cleaner, remove dirt, carbon, and sand from the lower receiver group. Dry and apply a light coat of the recommended lubricant.

5. **AMMUNITION MAGAZINES.** After removing all cartridges from the magazine, depress the spring steel lock band on the bottom of the magazine, using the nose of a cartridge (fig. 3-28, view 1). Slide the base until it is free of the tabs, and remove it from the magazine body (fig. 3-28, view 2). Remove the magazine spring and follower (fig. 3-28, view 3), but do not remove the follower from the spring (fig. 3-28, views 4 and 5). Clean the exterior and interior of the magazine with a dry rag or swab. Apply a light coat of the recommended lubricant to the magazine spring only; otherwise, keep the magazine dry. You assemble the magazine in reverse order and test it to ensure that the follower is free to move without binding. If the magazine and the ammunition in it gets wet, be sure to wipe them dry as soon as possible. When left wet, both the magazine and the ammunition can become corroded and are dangerous to use. Remember not to use oil or grease on any cartridge. If you do this, injurious abrasives can collect in the weapon or produce excessive and hazardous

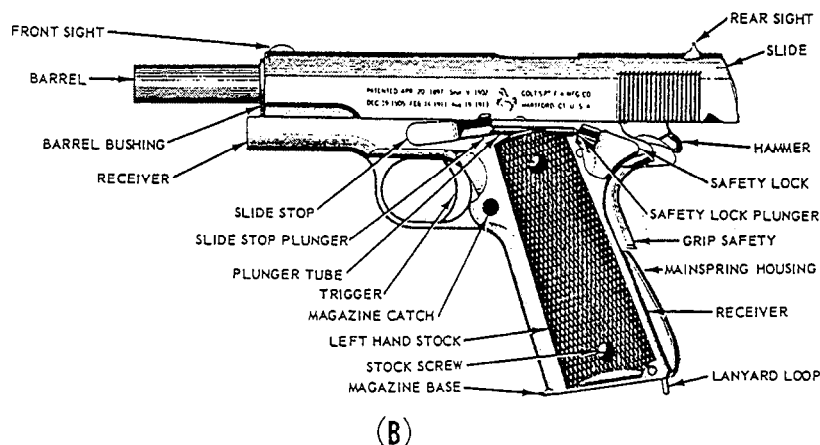
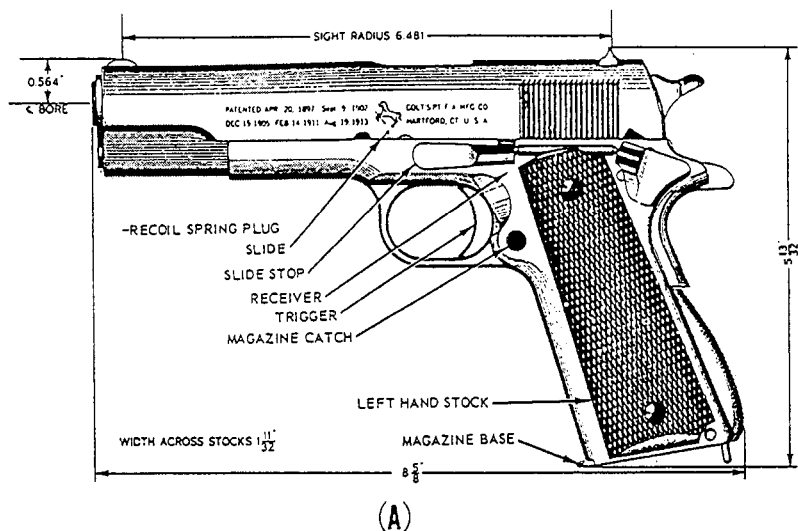

Figure 3-29.—.45-caliber semiautomatic service pistol—(A) assembled and (B) sectional view in recoil position.

chamber pressures when the weapon is fired. Whenever practical, ammunition should be stored under cover. This applies particularly to tracer ammunition.

THE .45-CALIBER SERVICE PISTOL

The .45-caliber service pistol shown in figure 3-29 is an individual weapon intended for use in close combat. The .45-caliber pistol is a semiautomatic, recoil-operated, magazine-fed hand weapon. The pistol fires one round each time the trigger is squeezed. The pistol can be carried in either a hip or shoulder holster.

The magazine holds seven cartridges. The forward movement of the slide strips the upper cartridge from the magazine into the chamber. After the last cartridge from the magazine has been fired, the slide remains in the rear.

Only your ability to change magazines, aim, and squeeze the trigger rapidly limits the rate of fire of the .45-caliber service pistol.

The pistol is 8 5/8 inches in length and weighs 3 pounds frilly loaded, with a maximum range of 1,500 yards, and a maximum effective range of 50 yards. It uses different kinds of .45-caliber ammunition. (These will be discussed later under ammunition.)

As a Seabee, you are expected to keep this weapon in good working condition. To ensure that it will function correctly, you must disassemble it to inspect and clean the parts. Procedures for general disassembly (field-stripping), assembly, functioning, loading, firing, unloading, malfunctions, stoppages, immediate action, and the care and cleaning of the service pistol will be covered in the following sections.

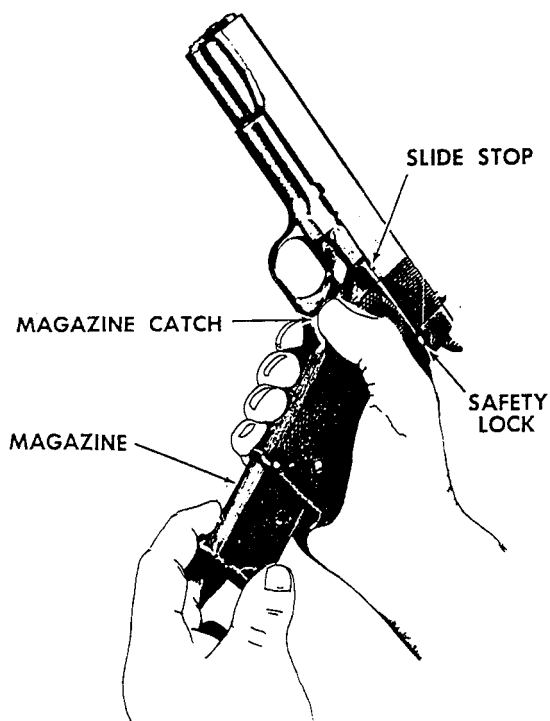

Figure 3-30.—Magazine removal and chamber inspection for a right-handed firer.

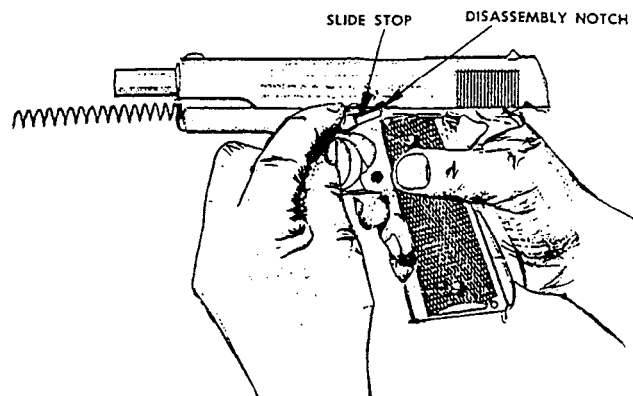

Figure 3-32.—Slide stop removal.

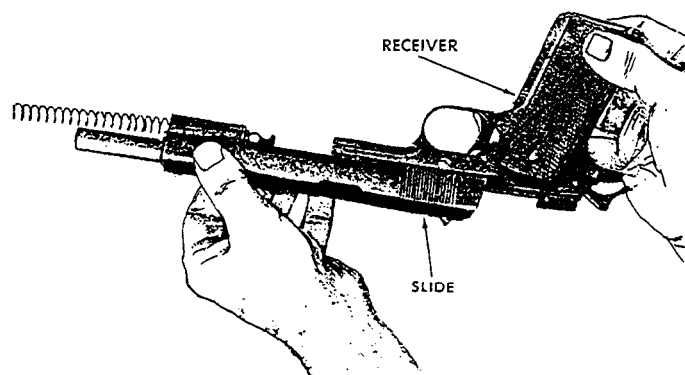

Figure 3-33.—Separating the receiver from the slide by pulling the receiver rearward.

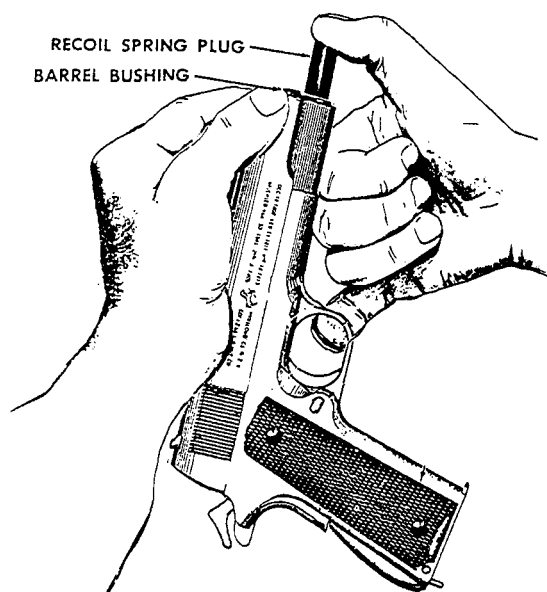

Figure 3-31.—Recoil spring plug removal from the recoil spring.

GENERAL DISASSEMBLY (FIELD-STRIPPING)

General disassembly is the disassembly necessary for normal care and cleaning. To field-strip the service pistol, perform the steps in the following order:

1. Hold the pistol in the raised pistol position, press the magazine catch, and remove the magazine, as shown

in figure 3-30, for a right-handed firer. The left-handed firer should reverse hands for this procedure. Pull the slide to the rear and inspect the chamber to see that the weapon is clear. Press down on the slide stop and allow the slide to move forward. Press the thumb safety lock upward to the SAFE position.

2. Press down on the recoil spring plug and turn the barrel bushing one-fourth turn clockwise, as shown in figure 3-31. Allow the recoil spring to expand slowly, under control, to prevent injury or loss of the part and remove the plug. Turn the recoil spring plug counterclockwise and remove it. Leave the recoil spring in place.

3. Press the thumb safety lock downward to the FIRE position. Push the slide to the rear until the disassembly notch, as shown in figure 3-32, is aligned with the rear projection on the slide stop. Press the protruding end of tie slide stop, and then pull out the slide stop.

4. Pull the receiver rearward to separate it from the slide, as shown in figure 3-33.

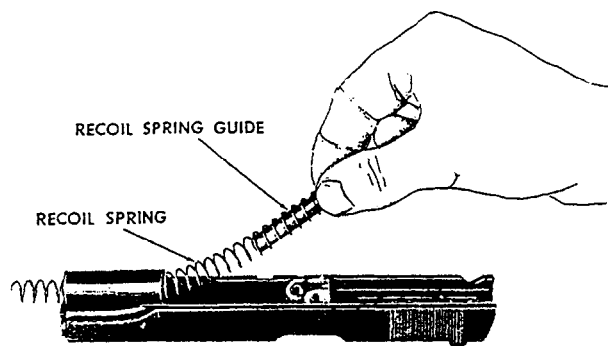

Figure 3-34.—Recoil spring guide and recoil spring removal.

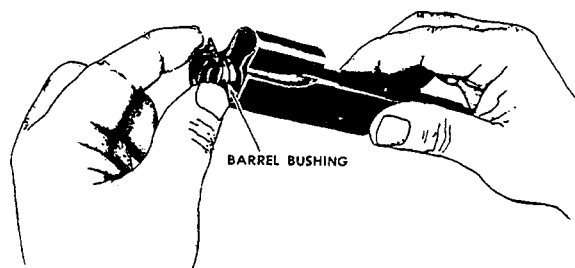

Figure 3-35.—Barrel bushing removal from the slide.

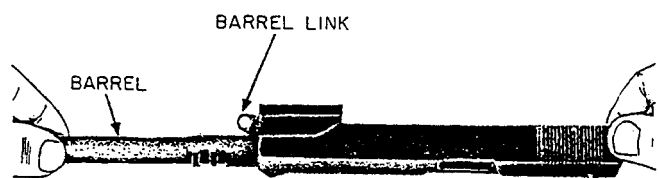

Figure 3-36.—Barrel removal from the slide.

5. Remove the recoil spring guide and recoil spring, as shown in figure 3-34. Separate the two parts with a twisting action.

6. Remove the barrel bushing by turning it counterclockwise, as shown in figure 3-35, and pulling it from the slide.

7. Push the barrel link forward and remove the barrel from the front end of the slide, as shown in figure 3-36. This completes the field-stripping. Observe figure 3-37. It shows the parts of the pistol in the order of the field-stripping just completed.

ASSEMBLY

To assemble the pistol after the field-stripping procedure, replace the parts in the reverse order of the disassembly.

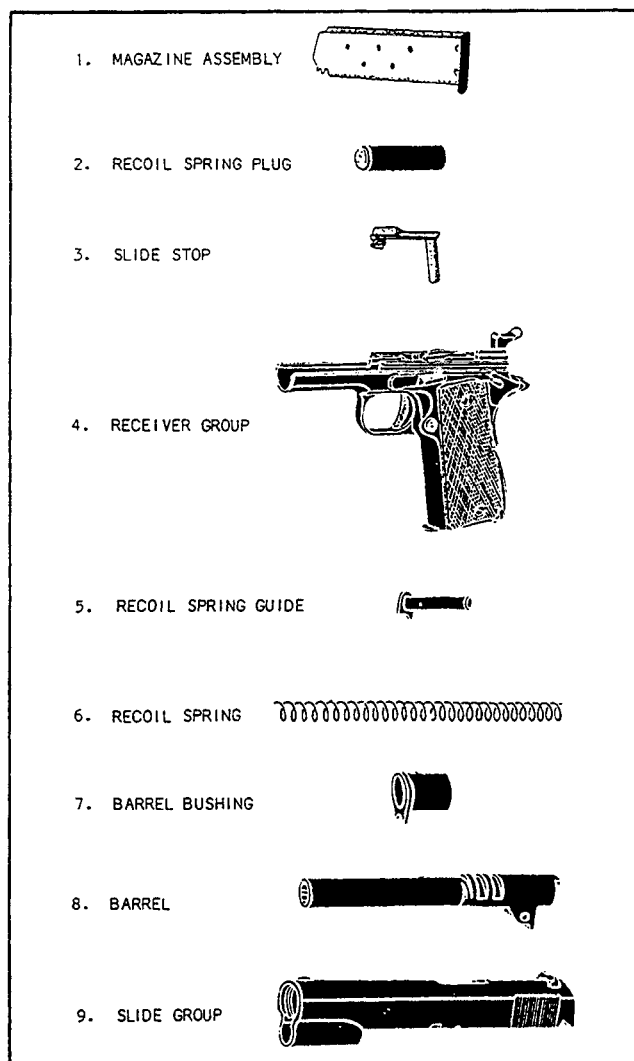

Figure 3-37.—Parts of the pistol in order of field-stripping.

1. BARREL. Push the barrel link forward on the barrel and replace the barrel, chamber end first, in the slide. (See fig. 3-36.)

2. BARREL BUSHING. Place the barrel bushing on the muzzle end of the barrel, push it into the slide, and turn it clockwise. (See fig. 3-35.)

3. RECOIL SPRING AND RECOIL SPRING GUIDE. Insert the recoil spring guide into the tightest end of the recoil spring. Replace these parts in the slide. (See fig. 3-34.) Be sure the concave cut on the recoil spring guide collar is properly seated in the barrel. Push the barrel, recoil spring, and recoil spring guide frilly forward in the slide, ensuring that the barrel link is positioned forward and rests against the hole in the recoil spring guide. (See fig. 3-33.)

4. **ASSEMBLING THE RECEIVER GROUP TO THE SLIDE GROUP.** Hold the slide with the sights down in the palm of one hand. Invert the receiver (the safety lock must be in the FIRE position) and engage the guide rails of the receiver in the grooves of the slide. (See fig. 3-33.) Push the receiver all the way forward on the slide with a quick motion.

5. **SLIDE STOP.** Hold the pistol as shown in figure 3-33. Look through the slide stop pinhole in the receiver for alignment of this hole with the hole in the barrel link. If the holes are not aligned, move the muzzle end of the barrel forward or rearward to align them. Insert the slide stop pin into the holes. Move the slide forward until the disassembly notch is over the square hole in the left side of the receiver. (See fig. 3-32.) Press the slide stop up and in to seat it fully. In some cases, a punch may be required to depress the slide stop plunger in order to seat the slide stop fully.

6. **RECOIL SPRING PLUG.** Push the slide frilly forward on the receiver and press the thumb safety lock upward to the SAFE position. Place the recoil spring plug on the recoil spring. Turn the recoil spring plug clockwise to lock the plug to the recoil spring. Holding the pistol, as shown in figure 3-31, insert the recoil spring and push downward on the recoil spring plug, compressing the spring until the plug is inside of the slide. Turn the barrel bushing counterclockwise to lock the recoil spring plug in place. Press the safety lock downward to the FIRE position and squeeze the trigger.

7. **MAGAZINE.** Insert the magazine into the magazine recess of the pistol until it is fully seated and held by the magazine catch. (See fig. 3-30.) This completes the pistol assembly.

FUNCTIONING

By disassembling and assembling the pistol, you become familiar with the parts. Understanding how the pistol functions will help you keep the weapon in operating condition and reduce stoppages that may occur during firing.

Each time a cartridge is fired, the parts inside the pistol (fig. 3-29) function in a given order. This is known as the cycle of operation (functioning).

The cycle of operation of the pistol is divided into eight basic steps; however, more than one step may be occurring at the same time. The following steps occur in the order listed below:

1. **FEEDING**—placing a cartridge in the receiver, approximately in back of the barrel ready for cambering

2. **CHAMBERING**—moving the cartridge from the magazine into the chamber

3. **LOCKING**—sealing the cartridge in the chamber and blocking the breech end of the barrel

4. **FIRING**—igniting the primer and firing the cartridge

5. **UNLOCKING**—unsealing the breech end of the barrel

6. **EXTRACTING**—removing the cartridge case from the chamber

7. **EJECTING**—removing the cartridge case from the weapon

8. **COCKING**—returning the firing mechanism to the cocked position ready to fire another cartridge

SAFETY DEVICES

The pistol has three safety devices: the safety lock the grip safety, and the half-cock notch on the hammer. The safeties must be tested often, and always before the pistol is fired. The disconnecter is not considered a positive safety like the three safeties listed above. The disconnecter is not a positive safety because it is designed for use to fire the pistol on semiautomatic fire and cannot be controlled by the firer.

OPERATIONAL SAFETY CHECKS

WARNING

Before making the following test, inspect the pistol to ensure that the magazine is removed and the chamber is empty.

SAFETY LOCK. Cock the hammer and press the safety lock up into the SAFE position. Grasp the stock so that the grip safety is depressed and squeeze the trigger three or four times. If the hammer falls, the safety lock is not safe; and it must be replaced.

GRIP SAFETY. Cock the hammer, being careful not to depress the grip safety, and squeeze the trigger three or four times. If the hammer falls, the grip safety or sear spring must be replaced.

HALF-COCK NOTCH. Pull the hammer rearward until the sear engages the half-cock notch and squeeze

the trigger. If the hammer falls, the hammer or sear must be replaced.

LOADING

Draw the pistol from the holster and hold it at the raised pistol position. Insert a magazine loaded with from one to seven rounds of ammunition. Grasp the slide with the left hand, thumb on the right side of the slide. Pull the slide fully to the rear, release, and press the safety lock up to the SAFE position with the left forefinger. Left-handed personnel should reverse the hand positions for this procedure.

FIRING

To fire the pistol right handed, press the safety lock down to the FIRE position with the left thumb to prevent disturbing the firing grip of the right hand. Left-handed Seabees should reverse the above thumb and hand directions to complete this procedure. Obtain the correct sight alignment and sight picture and squeeze the trigger. To fire successive shots, you must release the trigger and squeeze again. When the last cartridge from the magazine has been fired, the slide returns to the rear.

UNLOADING

To unload the pistol, hold it at the raised pistol position. Press the magazine catch and remove the magazine. If the slide is in the forward position, pull the slide to the rear, and push the slide stop up. Inspect the chamber to ensure that the pistol is clear. Press the slide stop down, allowing the slide to go forward. Keep the pistol at the raised pistol position, squeeze the trigger, and then holster the weapon.

MALFUNCTIONS

A malfunction is a failure of the weapon to function satisfactorily. Malfunctions are classified as defects in the weapon that normally do not cause a break in the cycle of operation. You may discover a malfunction, for example, when the grip safety does not block the trigger or when the slide does not remain to the rear after the last round is fired.

STOPPAGES

A stoppage is any unintentional interruption in the cycle of operation. If the pistol stops firing through no fault of yours or the weapon does not fire when you attempt to fire it, then a stoppage has occurred.

Stoppages are classified as a malfunction of one of the eight steps in the cycle of operation given in the previous section. Stoppages are usually the result of worn parts or improper care of the weapon.

IMMEDIATE ACTION

Immediate action is the prompt action you take to reduce a stoppage. The procedure for immediate action should be instinct when you are armed with the pistol. If a stoppage occurs, apply immediate action automatically in an effort to reduce the stoppage without attempting to discover the cause at that time.

If the slide is fully forward, the hammer falls but the pistol fails to fire, apply immediate action as follows:

1. Manually cock the hammer without opening the chamber and make one additional attempt to fire. If the pistol still fails to fire, wait 10 seconds; then come to the raised pistol position. Grasp the slide with the thumb and first finger of the left hand, keeping the thumb on the right side of the slide. Left-handed shooters should reverse hand and thumb directions for this procedure. Rapidly pull the slide rearward to its full extent. Rotate the pistol to the right allowing the unfired round to drop out, release the slide, and allow it to return to the forward position, cambering anew cartridge.

CAUTION

Keep the pistol pointed down range during this operation.

2. Aim and attempt to fire.

If the slide is not fully forward, apply immediate action as follows: remove the trigger finger from the trigger guard; and with the nonfiring hand, attempt to push the slide fully forward.

If the slide will not move forward, proceed as follows:

1. Bring the weapon to the raised pistol position.
2. Remove the magazine.
3. Grasp the slide with the nonfiring hand, pull the slide to the rear, and lock it with the slide stop.
4. Inspect the chamber. Remove any obstructions.
5. Insert another loaded magazine into the pistol.
6. Release the slide.

7. Aim and attempt to fire.

CARING AND CLEANING THE PISTOL

Care and cleaning the pistol includes daily preventive maintenance, which is the ordinary care of the pistol required to preserve its condition and appearance when no firing is done. Cleaning before firing ensures that the pistol is safe to fire and is properly lubricated for efficient operation. Cleaning after firing ensures that all corrosion-inducing agents deposited in the bore and chamber of the pistol are completely removed.

Daily Preventive Maintenance

Damp air and sweaty hands are great promoters of rust. You should clean your pistol and protect it with the recommended oil after every firing or handling. You should inspect the pistol each day and clean it if necessary.

To clean the pistol, rub it with a rag lightly saturated with oil; then rub it with a dry cloth. Clean the bore with a swab saturated with oil, and then, with a dry swab. Dust out all crevices with a small, clean brush.

To protect the pistol after cleaning it, cover all the surfaces, including the bore and chamber, with a light coat of lubricating, preservative oil.

After cleaning and oiling the pistol, place it back in your holster or the pistol rack. Do not place a cover, such as canvas, over the pistol because it collects moisture that rusts the metal.

Care and Cleaning before Firing

Before the pistol is fired, you should clean and dry the bore and chamber and exterior parts of the receiver of the pistol. You should lubricate the guide rails on the receiver and the grooves on the slide with oil. Place a light coat of oil on all other interior metal parts EXCEPT those that come in contact with the ammunition. Excess oil should be removed from the grips and the grip area of the receiver to aid you in gripping the weapon.

Care and Cleaning after Firing

You must clean the pistol as soon as possible on the day of firing and daily for the next 3 days, or longer if necessary. Do this in the following manner:

1. Disassemble the pistol.

2. Clean all parts with a rag lightly saturated with oil. Dry all parts and apply a light coat of oil.

3. Clean the bore and chamber as follows:

a. Wet a swab with rifle bore cleaner and run it back and forth through the bore several times.

b. Attach the pistol bore brush to the cleaning rod and run it through the bore and chamber several times.

c. Run dry swabs through the bore and chamber until they are clean.

d. Inspect the bore for cleanliness. If it is not free of all residue, repeat the cleaning process.

e. When the bore and chamber are clean, coat them with rifle bore cleaner and leave it on overnight.

f. Assemble the pistol.

g. Apply a light coat of oil to the exterior surfaces of the pistol.

h. After the third daily cleaning, if the bore and chamber are clean, remove the rifle bore cleaner. Replace the bore cleaner with a light coat of lubricating, preservative oil.

AMMUNITION

As a Seabee armed with the .45-caliber pistol, you must be familiar with the types of ammunition for your pistol and be able to identify each type of ammunition.

A pistol cartridge is a complete assembly consisting of all the components necessary to fire the weapon once; that is, the cartridge case, bullet, propellant powder, and primer.

The types, uses, and means of identification of the ammunition used in the .45-caliber pistol are the following:

1. Ball cartridge, M1911, is for use against personnel and light material targets. The ball round consists of a metal jacket surrounding a lead alloy core. The bullet tip is unpainted.

2. Blank cartridge, M9, is used to simulate fire and for salutes. This cartridge can be fired single shot only in the pistol. You can identify it by the absence of a bullet and by its tapered mouth.

3. Dummy cartridge, M1921, is used for training personnel in the operation of loading and unloading the pistol and for testing weapons. It is used also in marksmanship training by mixing it with live

ammunition during instruction practice firing. You can identify this cartridge by the empty primer pocket and the two holes in the cartridge case.

4. Tracer cartridge, M26, is used for observation of fire. Secondary uses are for incendiary effect and for signaling. The cartridge consists of three parts: (1) a copper-plated, or guiding metal-clad, steel jacket; (2) a slug of lead, hardened with antimony (a chemical hardening element); and (3) a tracer mixture in the rear portion of the jacket. For identification, the bullet is painted red for a distance of approximately three-sixteenths of an inch from the tip.

Small arms ammunition is generally safe to handle. However, you must protect the ammunition you are using from mud, sand, dirt, and water. Keep it clean, dry, and ready for use.

Do NOT oil or polish pistol cartridges.

Do NOT expose the ammunition to direct sunlight for any length of time. If the powder is heated, excessive pressure develops when the weapon is fired. This condition affects the accuracy and the operation of the weapon.

Do NOT attempt to fire cartridges that have dents, scratches, loose bullets, or corroded cases. If any cartridges are defective, turn them in to your supply point. Do not throwaway or attempt to destroy defective ammunition.

Do NOT strike the primer of a cartridge; it may ignite and cause injury.

MARKSMANSHIP

The purpose of marksmanship training is to provide proper information and instruction so you can become a safe and effective shooter.

Good shooting, whether on the firing range or in combat, depends upon the application of basic marksmanship principles. These principles are interrelated and must be practiced each time you fire a shot so you achieve effective results.

There are two parts to this section. The first part describes the techniques of firing a rifle and a pistol. The second part deals with the principles and practices of directing and controlling the combined fire power of rifles and machine guns.

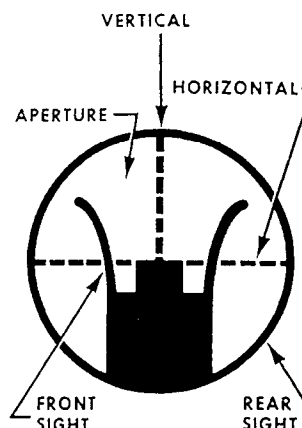

Figure 3-38.—Proper sight alignment.

FIRING TECHNIQUES—RIFLE

The most important factors involved in correct sighting and aiming are proper sight alignment and a correct aiming point. Together they make up the sight picture.

Sight Alignment

Sight alignment is the art of looking through the rear sight aperture, focusing the eye on the front sight post (or blade), and centering the front sight post exactly in the rear sight aperture both vertically and horizontally. The body of the front sight post, or blade, is centered vertically. The tip of the front sight post, or blade, is centered horizontally within the rear sight aperture (fig. 3-38).

REAR SIGHT.— In each firing position (prone, standing, kneeling, and sitting), the aiming eye is at a slightly different distance from the rear sight. This distance, referred to as eye relief, causes the opening (peep) of the rear sight to appear larger or smaller, depending on the firing position. Regardless of the apparent size of the rear sight opening, the front sight must be aligned in the center of the opening. It is important to keep your eye the same distance from the peep sight in any particular firing position. To ensure this distance is always the same, you must hold the rifle in the same exact location for each shot. This location is commonly called the SPOT WELD, or anchor. There are several tricks shooters use to help them maintain this distance. One is to place a small piece of tape on the stock of the rifle where it touches the cheek. In this manner, the shooters can feel whether their cheek has the proper eye relief.

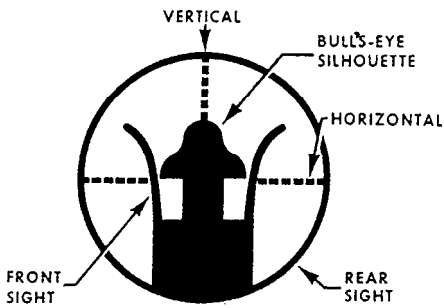

Figure 3-39.—6 o'clock sight picture held on "A" target at a range of 200 yards.

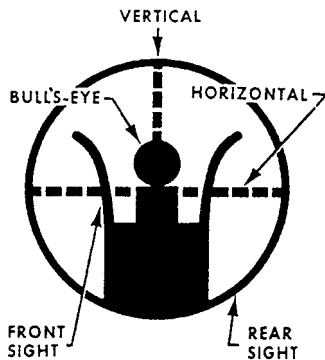

Figure 3-40.—6 o'clock sight picture held on "D" target at a range of 200 yards.

FRONT SIGHT.— The front sight always appears to be the same size. However, depending on the distance your eye is from the rear sight, more or less of the front sight may be visible in the sight picture. The front sight, not the target, is the point of focus for the eye; and as such, it will be sharp and distinct in outline. For this reason, keep the front sight square, leveled, and blackened.

AIMING POINT.— The aiming point is that point on the target upon which the sights of the weapon are brought to bear. The correct aiming point is at 6 o'clock; that is, the bottom of the bull's-eye of a type "A" target (fig. 3-39) or the silhouette of a type "D" target (fig. 3-40). Any location on the target face is always given relative to a similar position on a clockface regardless of the target shape. Therefore, a vertical line in the exact center of the target would be described as running from 12 o'clock (top) to 6 o'clock (bottom).

SIGHT PICTURE.— You obtain the correct sight picture by aligning the rear sight, the front sight, and the bull's-eye (figs. 3-39 and 3-40). Each of these three elements affects the sight picture. As you can see from figure 3-41, any error in sight alignment will increase as the range increases. An error in the aiming point remains constant as the range increases. Therefore, of the two, sight alignment is the most important.

At close ranges, the bull's-eye or silhouette will appear larger in relation to the front sight, than it will at longer ranges. This means that the sight picture will vary

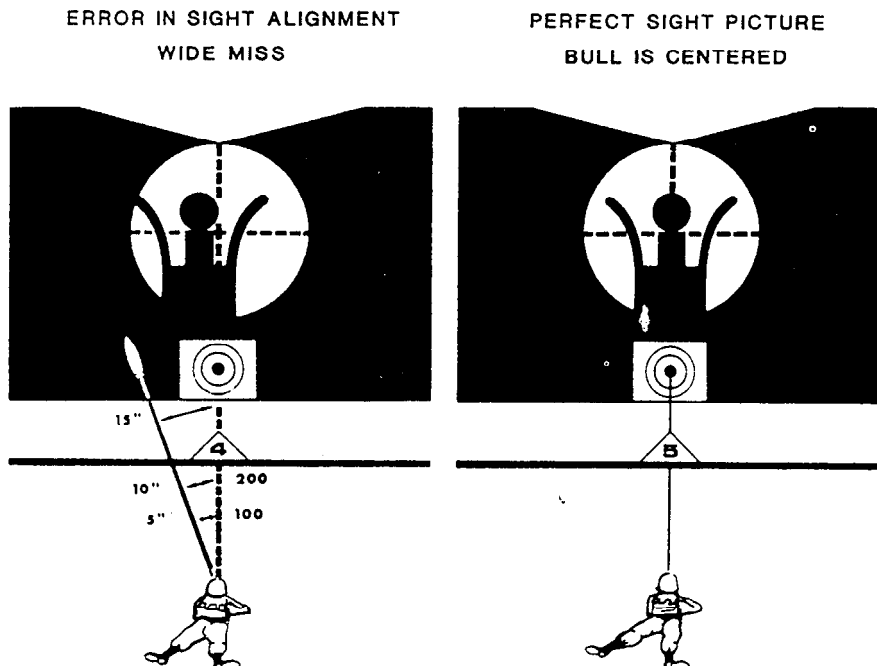

Figure 3-41.—Error in sight alignment increases as range increases.

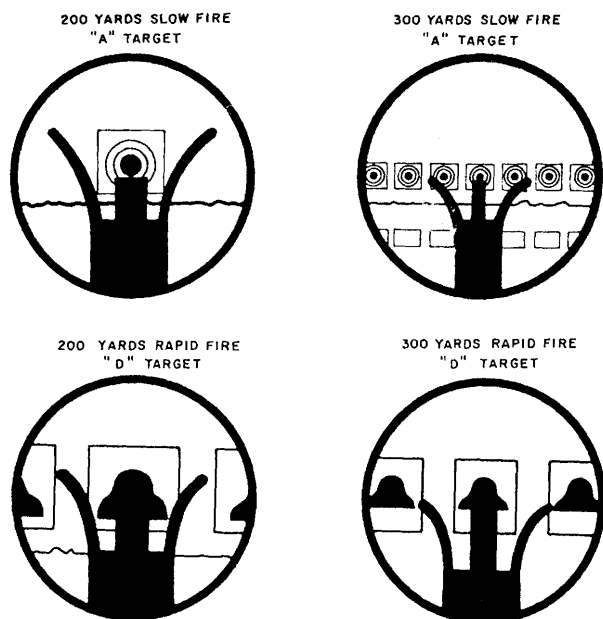

Figure 3-42.—Variation in sight picture for each range of fire.

not only from one firing position to another but also from one firing line to another (fig. 3-42).

TRAINING.— You will receive training in aiming along with the position and trigger squeeze before actually firing on the rifle range. You do this by aiming at a series of small bull's-eyes at least 20 feet away on a “dry-firing” range; this training is known as “snapping in.”

BLACKENING SIGHTS.— You should blacken the sights during sighting and aiming exercises to help eliminate light reflection or glare. Blacken all sights, both front and rear, on the base of the receiver and the top of the barrel. The usual way of blackening a sight is by means of a smudge pot, carbide lamp, oily patch, candle, cigarette lighter, or

ordinary match. Be sure to remove all oil from the sight before blackening it.

Shooting Positions

A correct shooting position is essential to obtain the best results in rifle shooting. The better the position, the easier it is to hold the rifle and squeeze the trigger while the sights are properly aligned on the target. However, no degree of excellence in the position will compensate for lack of practice. You may have difficulty in assuming a correct position until sufficient practice has limbered up your muscles. Once your muscles are limber, you will find the positions both comfortable and steady.

The Seabee qualification course requires you to learn and use four standard positions: prone, standing, kneeling, and sitting. These positions have been selected as a result of experience and have been found to produce excellent results with men and women of all physical types.

Once you master the correct positions, you must combine sighting and aiming with your practice. Learn to get into the correct position and align the sights without moving the rifle. If the target is not properly aligned with the sights, you must move your body instead of the rifle until you obtain the proper sight picture.

PRONE POSITION.— The prone position (fig. 3-43) is a steady position that is easy to assume and excellent for initial training. In the field, the position presents a low silhouette and is readily adaptable to the use of cover and support. However, observation from this position is difficult.



Figure 3-43.—Prone position.



Figure 3-44.—Standing position.



Figure 3-46.—Sitting position.

this position when engaging targets less than 100 yards in range and when you are constantly firing and moving.

KNEELING POSITION.— The kneeling position (fig. 3-45) is a natural position that can be assumed quickly. It is suitable for use on level ground or on ground that slopes upward

SITTING POSITION.— There are three variations of the sitting position: open leg, cross leg, and cross ankle. The position used depends entirely on the shooter. For steadiness, the open-leg position (fig. 3-46) is second only to the prone position. This position is especially suited for use on ground that slopes downward. The other two alternate sitting positions are the cross-legged position (fig. 3-47) and the cross-ankled position (fig. 3-48).

Trigger Control

The most important single factor in marksmanship is trigger control. Everything about your position and aim may be perfect; but if you do not squeeze the trigger properly, your shot will not go where you aimed it.

The prime consideration in trigger control is that the trigger must be squeezed smoothly, gradually, and evenly straight to the rear. Any sideward pressure, however slight, applied to the trigger during its rearward movement will likely result in a wide shot. Similarly, upward or downward pressure on the trigger will result in high or low shots.

The trigger hand must grasp the stock or pistol grip firmly, but without strain, so the trigger finger will have proper support in overcoming the trigger weight. An



Figure 3-45.—Kneeling position.

STANDING (OFF-HAND) POSITION.— The standing position (fig. 3-44) is used to engage surprise targets that appear at close ranges. Normally, you use



Figure 3-47.—Cross-legged position.



Figure 3-48.—Cross-ankled position.

unnatural, straining grasp will cause excessive muscular tension in the hand, resulting in a tremor, that will also be transmitted to the weapon.

The index finger should make contact with the trigger at the place that will best produce a movement straight to the rear. This is usually between the first joint and the tip. The trigger (index) finger must not touch the receiver or rifle.

Once the sights are lined up, apply pressure on the trigger and gradually increase it until the hammer releases and the shot fires. If at any time during this process the sights drift off the target, interrupt the trigger squeeze, but maintain the pressure. When the sight picture is again correct, continue the squeeze until you fire the shot.

When you fire from the standing position, coordination of trigger squeeze and proper aim is critical. The shooter must start and continue his or her

squeeze only when the front sight is momentarily at rest or is slowly moving in the smallest area of the bull's-eye. An inexperienced shooter usually tends to "snap shoot" in this position; that is, he or she attempts to complete the trigger action instantly as the front sight moves across the aiming point. This invariably results in jerking the rifle and producing a wild shot.

Squeezing the trigger correctly is not as easy as it may appear; the technique must be fully mastered. To assist you in remembering the correct technique, the acronym, BRASS, was developed.

B—BREATH. Proper breathing is essential. It will help you relax, steady your aim, and clear your vision. First, take a normal breath; then release part of it (enough to be comfortable); and hold the remainder. Do not hold your breath for more than 10 seconds before shooting. This may tense your muscles and blur your vision. If you do not shoot during this breathing period, take another normal breath and repeat the procedure.

R—RELAX. You must relax. The more relaxed you are the better your shot will be.

A—AIM. Concentrate on the proper sight alignment of the correct sight picture. Focus your eye on the front sight post (blade).

S—SLACK. Some rifles have a certain amount of slack in the trigger. Take up this slack before starting your squeeze to the rear to fire. The M16 trigger slack is insignificant, and this step is generally omitted when firing that weapon. Knowing your weapon is important here.

S—SQUEEZE. Squeeze the trigger as previously described. If you squeeze it properly, you will not know when the round will fire. This will prevent flinching, caused by anticipation of the shock, or recoil, from the exploding cartridge.

Calling Your Shot

One of the best ways of developing good shooting habits is to learn to call your shot. To do this, you must notice exactly where you aim the sights at the instant you fire the shot and call out immediately where you think the bullet will hit. This takes a lot of concentration. Any shooter who cannot call his or her shot correctly is either blinking or flinching. Shots are called by the "clock method." An example would be "bull's-eye at 4 o'clock"; that is, the shot hit the lower right portion of the bull's-eye.

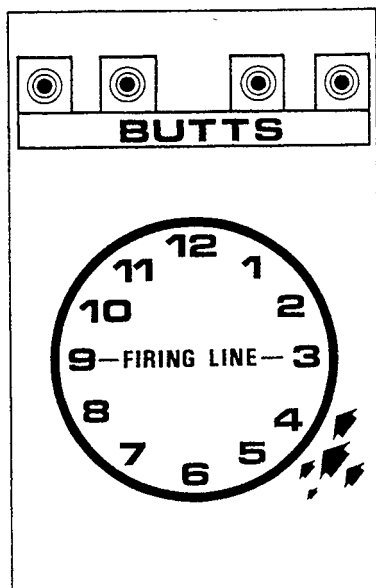

Figure 3-49.—4 o'clock wind.

FLAG STRAIGHT OUT WIND FORCE MEDIUM TO HEAVY 15 TO 25 MPH		WINDAGE EFFECT 200 YARDS 2 TO 3 CLICKS 300 YARDS 3 TO 5 CLICKS
FLAG 30° TO 45° OUT WIND FORCE LIGHT TO MEDIUM 7 TO 11 MPH		WINDAGE EFFECT 200 YARDS 0 TO 2 CLICKS 300 YARDS 2 TO 3 CLICKS
FLAG 8° TO 10° OUT WIND FORCE NONE TO LIGHT 2 TO 5 MPH		WINDAGE EFFECT 200 YARDS 0 CLICKS 300 YARDS 0 TO 1 CLICK

Figure 3-50.—Range flag wind reading.

Wind and Wind Effect

One of the most important influences on rifle shooting is wind. Wind affects shooting in two principal ways: it literally blows the bullet off course; and it buffets the shooter, making proper aiming difficult.

The effect of the bullet in flight progressively increases as range increases. A wind that will have little or no effect on a bullet at 200 yards will have some effect on one at 300 yards. The effect of the wind on the bullet in flight is compensated for by applying proper windage to the sights.

The effect of the wind on the body of the shooter depends on the relative stability of the various shooting

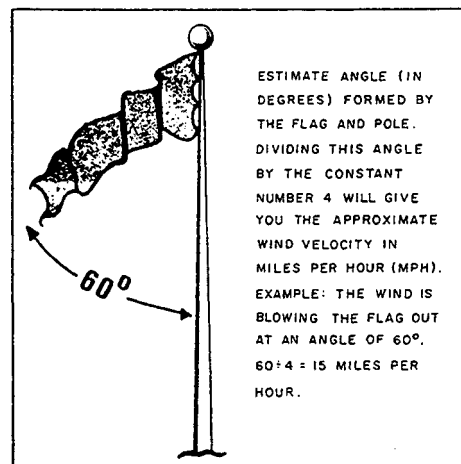

Figure 3-51.—Estimating wind velocity.

positions. Wind that has no effect on the prone shooter might have some effect on the sitting shooter, a greater effect on the kneeling shooter, and a definite adverse effect on the standing shooter. The effect of the wind on your body can be decreased through the development of the best possible shooting positions.

Wind Direction and Force

The direction of wind is explained by reference to the face of a clock. The firing line is thought of as the center of a big clockface with 12 o'clock toward the target butts and 6 o'clock to the rear. Wind blowing from the right rear is a 4 o'clock wind (fig. 3-49).

Wind Reading Aids

Wind direction and force can be quickly determined by observing the range flags. Figures 3-50 and 3-51 give examples using the range flag. If no flag is visible, use the following observations as a guide in determining wind velocities:

1. Smoke drifts slightly—less than 2 mph wind
2. Wind can be felt lightly—3 to 5 mph wind
3. Tree leaves move constantly—5 to 8 mph wind
4. Wind raises dust and loose paper—8 to 12 mph wind
5. Small trees sway—12 to 15 mph wind

FIRING TECHNIQUES—PISTOL

Good pistol shooting, like rifle shooting, depends upon your ability to master and apply certain basic marksmanship principles. You must practice these principles—aiming, position, and trigger squeeze—often.

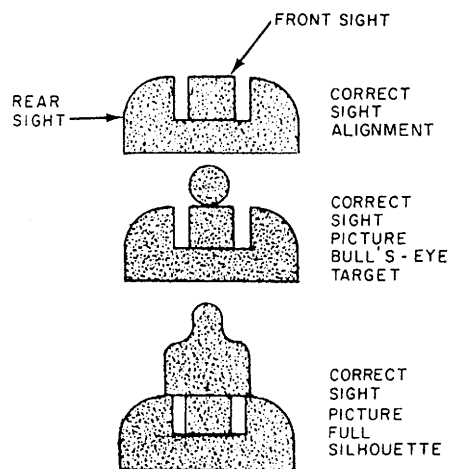

Figure 3-52.—Correct sight alignment and sight picture.

Apply these fundamentals of marksmanship! If your life ever depends on how well and accurately you shoot the pistol, you can be the one who walks away alive.

Aiming the Pistol

Aiming the pistol consists of combining proper sight alignment with the correct aiming point to obtain a correct sight picture.

SIGHT ALIGNMENT.— Sight alignment is best defined as placing the front and rear sights into correct alignment with the eye. For a correct sight alignment, you must center the front sight in the rear sight, bringing the top of the front sight exactly level with the top of the rear sight (fig. 3-52). Correct sight alignment is essential for accuracy. It is particularly important with the pistol because of the short sight radius (about 6 1/2 inches). For example, if a 1/10-inch error is made in aligning the front sight in the rear sight, the bullet will miss the point of aim by almost 15 inches at 25 yards of range.

AIMING POINT.— The correct aiming point, when you fire at a bull's-eye target at 25 yards, is a 6 o'clock sight picture. At 15 yards, bring the aiming point well up into the black. When you fire at an "E" type of silhouette target, the aiming point is in the center of the target.

CORRECT SIGHT PICTURE.— A sight picture is the pattern of the pistol sights in relation to the target as you aim the pistol. A correct sight picture combines correct sight alignment and correct aiming point (fig. 3-52). When you are aiming, your eye cannot focus simultaneously on three objects (rear sight, front sight, and bull's-eye) at different ranges. Therefore, the last focus of the eye should always be on the front sight. You will see the front and rear sights sharp and clear, but the bull's-eye will appear to be a bit hazy. If sight alignment



Figure 3-53.—Standing position (pistol).

is correct, the bullet will strike the bull's-eye, even if the sight picture is partially off center but still touches the bull's-eye. Since it is physically impossible to hold the weapon perfectly still, you must learn to apply trigger squeeze and to maintain correct sight alignment while the weapon is moving around the bull's-eye. This movement of the pistol is referred to as the "wobble area." You must accept this wobble area, or movement, and endeavor to keep it to a minimum.

Position

To position yourself properly for firing the pistol, you need to know how to grip the pistol correctly and how to position your body in relation to the target. Only the standing position will be covered in this section, because it is the one used in qualification. However, the pistol can also be fired accurately from the kneeling, crouch, and prone positions. The pistol may be gripped with either a one-hand grip or a two-hand grip.

STANDING POSITION ONE-HAND GRIP.— To assume the standing position using the one-hand grip (fig. 3-53), face the target squarely and then execute an



Figure 3-54.—Gripping the pistol (one hand).

exaggerated half left face (about 50 degrees). Spread your feet about shoulder width apart until you stand comfortably. Your legs should be straight, but not stiff, and your hips should be level. Extend the index finger of your shooting hand and point it at the target. Adjust your stance until your finger points naturally, without muscle tension, at the center of the target. Pick the pistol up with your other hand and place it in your shooting hand. The mainspring housing should rest firmly in your palm with the grip safety pressed into the Y, formed between the thumb and forefinger. Hold your hand as high as possible on the receiver without squeezing the flesh between the hammer and grip safety.

Grip the receiver firmly with the hand and fingers. Wrap the three lower fingers around the receiver, and place the trigger finger inside the trigger guard. Hold your thumb up and along the side of the pistol with enough pressure to steady the pistol and to equalize any pressure from the other side by the palm and forefinger (fig. 3-54). Once a firm grip is obtained, maintaining the same degree of firmness throughout firing is important. A change in your grip will change the location of the shot group on the target. A tight grip tends to cause the bullet to strike low and a loose grip to strike high. Keep your trigger finger away from the receiver.

With a proper grip on the pistol, the muscles of your arm should be firm, but not rigid. Your arm should be straight with your wrist and elbow locked. This will prevent excessive up-and-down movement of the weapon. When the weapon is fired, the recoil will be absorbed through the arm to the shoulder. If you are in the correct position, the pistol will return to approximately the same sight picture after each shot.



Figure 3-55.—Standing position (pistol), two-handed grip.

STANDING POSITION TWO-HANDED GRIP.— In this position (fig. 3-55), you face the target squarely with your feet placed comfortably about shoulder width apart. Keep your legs straight without stiffness and your hips level and slightly forward. Relax the muscles of your diaphragm, and make no effort to hold in your abdomen.

Grasp the pistol in the same manner as if you were firing one-handed. Next, with your free hand extended forward, palm up, place the butt of the weapon into your extended palm. Place the little finger of your shooting hand between the index and middle finger of your other hand. The thumb of your free hand is straight up alongside the pistol grip with the thumb of your shooting hand locked over the top of the other thumb. Bring the last three fingers of your other hand up and over the back of your shooting hand, locking the weapon firmly in both hands (fig. 3-56). Bring the weapon onto the center of the target by shifting your feet.

MISCELLANEOUS.— In both the one-handed and two-handed positions, you position your head so that



Figure 3-56.—Two-handed grip.

you are looking straight out through your shooting eye. Keep your shooting arm fully extended.

In the one-handed position, the shoulder of your shooting hand should be slightly raised. Turn your head in order to see the target through the sights. The ease with which your head can be turned is another determining factor in how far you must turn to the right or left. There should be no strain on the neck muscles with your head held upright. The whole position, with the exception of your shooting arm, is one which can be maintained with the least muscular effort. Your body is balanced rather than held in position. The muscles of your shooting arm and shoulder should be tightened somewhat to sustain the weight of the pistol and to maintain a correct grip. Excessive tightening of the muscles of your shooting arm and hand should be avoided. The tension in the muscles of your shooting arm and hand should be maintained after the hammer falls. This will assist in getting off your second shot quicker.

Because of the differences in the body structure of individuals, the standing position will vary slightly. But regardless, your position should be relaxed and comfortable. The pistol should point at the center of the target or you will be tense while firing. If you are tense, there will be excessive muzzle movement.

Trigger Squeeze

Poor shooting is most often caused by disturbing your aim as the bullet is leaving the barrel. This is usually the result of jerking the trigger, or flinching. The trigger does not have to be jerked violently to spoil your aim; even a slight off-center pressure of

your finger while squeezing the trigger is enough to move the strike of the bullet several inches. **FLINCHING** is a subconscious reflex caused by anticipating the recoil from firing. **JERKING** results from attempting to fire the pistol at the precise time that you align the sights with the target. Both flinching and jerking will cause the bullet to strike the lower left section of the target. An attempt to correct flinching and jerking by tightening the large muscle in the heel of the hand may cause heeling. **HEELING** causes the bullet to strike the target high and to the right. You can correct all these shooting errors by understanding and using the correct trigger squeeze. Improper trigger squeeze will cause more misses on the target than any other single step of preparatory marksmanship training.

You obtain correct trigger squeeze by applying a uniformly increasing pressure on the trigger straight to the rear without disturbing the sight alignment until the pistol fires. The trigger slack, or free play, is taken up first, and the correct squeeze continues steadily until the hammer falls. If the trigger is squeezed properly, you will not know when the hammer will fall. This is the best way to prevent jerking, flinching, and heeling.

To assist you in squeezing the trigger properly, use the acronym **BRASS** as you did with the rifle. You must also learn to call your shots. If you cannot call your shots correctly, you are not concentrating properly on sight alignment and trigger squeeze.

TECHNIQUE OF FIRE

The technique of fire is the application and control of the combined fire of a fire unit. The rest of this chapter concerns the technique of fire for rifle and machine gun units.

FIRE CHARACTERISTICS

The fire of rifles and machine guns has the following characteristics: trajectory, danger space, burst of fire, dispersion, shot patterns, and beaten zone.

The **TRAJECTORY** is the curved path of the bullet in its flight through the air. Trajectory is influenced by three forces: velocity of the projectile, gravity, and air resistance. The farther the bullet travels, the greater the curvature of its path becomes. The highest point on the trajectory (called the maximum ordinate) is a point at

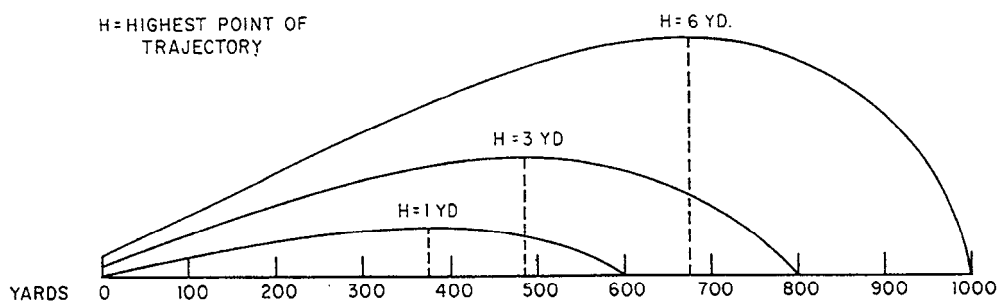

Figure 3-57.—Projector of 7.62-mm ammunition showing maximum ordinate (H) of trajectory.

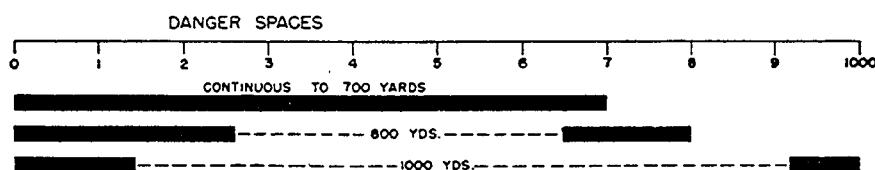

Figure 3-58.—Danger space at 1,000-yard range.

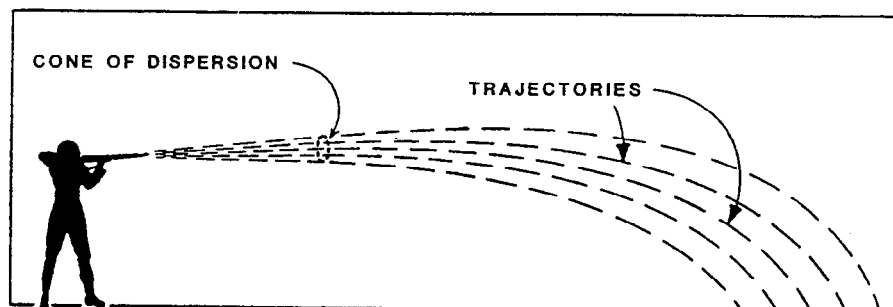

Figure 3-59.—Cone of dispersion, or cone of fire.

approximately two-thirds of the range from the weapon to the target (fig. 3-57).

DANGER SPACE is the area between the weapon and the point of impact in which the bullet does not rise above the average height of a man (presumed to be 68 inches). At ranges up to 750 yards, a rifle bullet fired over level or uniformly sloping ground does not rise above this height; therefore, for such ranges, the danger space is continuous. At ranges greater than 750 yards, a portion of the trajectory is above this height; therefore, the danger space is not continuous but exists for a variable distance in front of the muzzle and in front of the point of impact. In the latter case, the danger space begins again when the bullet comes within 68 inches of the ground. The length of the two danger space zones is dependent upon the range, as shown in figure 3-58.

A number of shots fired automatically with a single pressure on the trigger is called a BURST OF FIRE. For normal ground targets, the number of rounds in a burst is usually from four to ten.

When several bullets are fired from a rifle or machine gun held in a fixed position, there is a slight variation in the trajectories. The causes of these differences are in the powder charge, the weight of the bullet, atmospheric and wind conditions, and vibration of the weapon. These variations are known as DISPERSION. The several dispersions, plotted in profile, form a cone with its apex to the muzzle of the weapon; this is known as the cone of dispersion, or the cone of fire (fig. 3-59).

The impact pattern of the cone of dispersion on a vertical target (which would be oval in shape) is called the VERTICAL SHOT PATTERN. (See fig. 3-60.) The

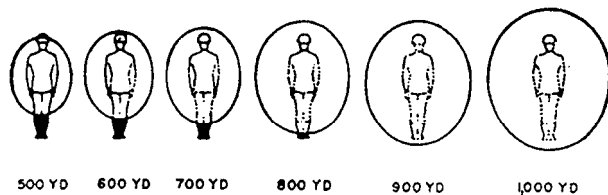

Figure 3-60.—Vertical shot pattern at various ranges.

RANGE IN YARDS	TABLE OF APPROXIMATE EFFECTIVE BEATEN ZONES ON LEVEL GROUND
500	150 YDS. LONG - 1 YD. WIDE
1000	90 YDS. LONG - 2 YDS. WIDE
1500	65 YDS. LONG - 3 YDS. WIDE
2000	55 YDS. LONG - 4 YDS. WIDE

Figure 3-61.—Horizontal shot patterns at various ranges.

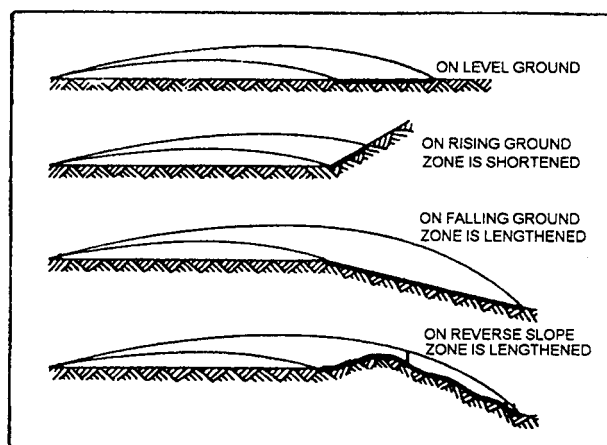

Figure 3-62.—Effect of ground slopes on beaten zone.

impact pattern on a horizontal target, which would be a long, narrow ellipse, is known as the **HORIZONTAL SHOT PATTERN** or **BEATEN ZONE**. (See fig. 3-61.)

The **BEATEN ZONE** is the area of the ground the bullets strike. The size and shape of the beaten zone depend upon the range and slope of the ground, as shown in figure 3-62.

CLASSES OF FIRE

Fire is classified with respect to the target, the ground, and the gun. (See figs. 3-63 through 3-65.)

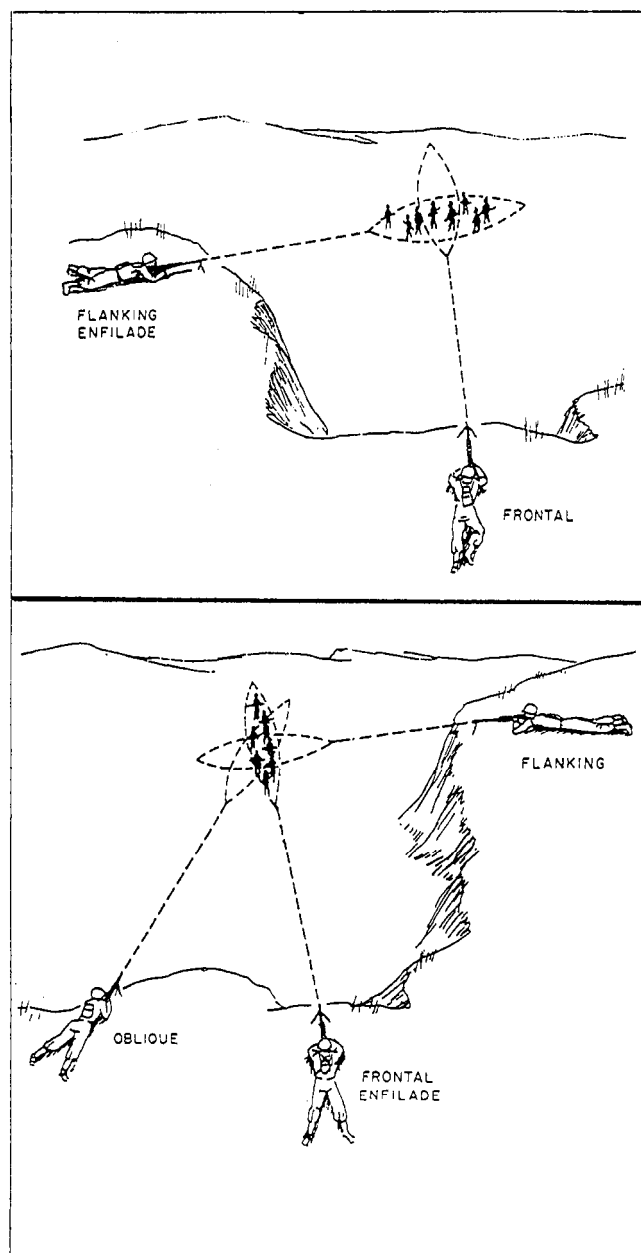

Figure 3-63.—Fire in respect to the target.

Fire with respect to the target may be **FRONTAL** (delivered perpendicular to the enemy front), **FLANKING** (delivered perpendicular to the enemy flank), or **ENFILADE** (delivered so the long axis of the beaten zone corresponds with the long axis of the target). **ENFILADE** fire may be either frontal or flanking, depending on the direction of the long axis of the target. Since it makes maximum use of the beaten zone in relation to the shape of the target, enfilade fire is the most effective. Fire delivered from a direction that is neither frontal nor flanking is called **OBLIQUE** fire.

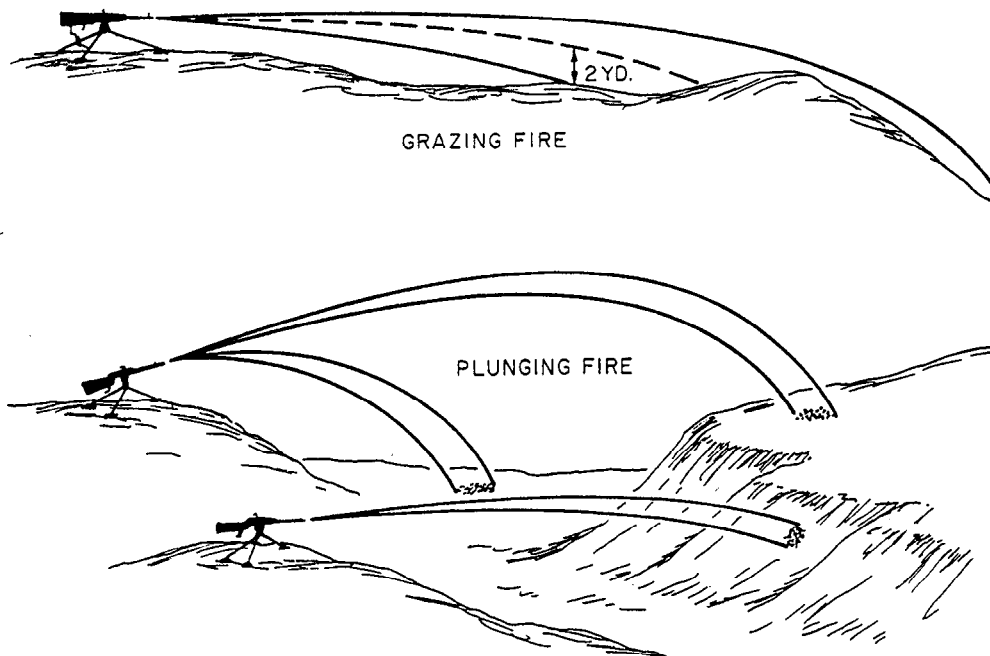

Figure 3-64.—Fire in respect to the ground.

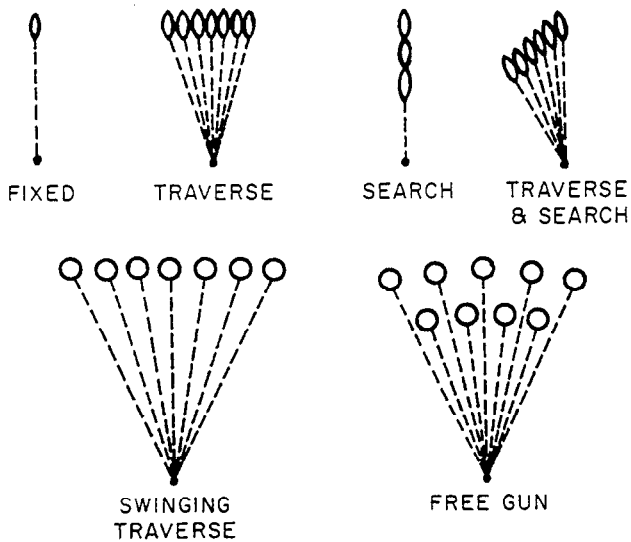

Figure 3-65.—Fire in respect to the gun.

Fire with respect to the ground can be classified as grazing, plunging, or overhead.

- **GRAZING** fire has a trajectory not higher than 68 inches above the ground. Grazing fire can exist for 750 yards over level or uniformly sloping ground.

- **PLUNGING** fire strikes the ground from above at a considerable angle. The danger space of plunging fire is practically limited to the beaten zone.

- **OVERHEAD** fire is delivered over the heads of friendly troops. It must usually be high trajectory, plunging fire.

Fire with respect to the machine gun maybe fixed fire, searching fire, traversing fire, or combined traversing and searching fire, swinging traverse fire, and free gunfire.

- **FIXED FIRE** is delivered against targets that only require a single aiming point. The depth of the beaten zone must be large enough to include the target. Fixed fire is continuous as long as any portion of the target remains in the zone of fire.

- **SEARCHING FIRE** is distributed in depth by successive changes in the elevation of the gun. Searching fire is used against targets too deep to be included in the beaten zone of fixed fire. A burst of free is delivered after each change in elevation.

- **TRAVERSING FIRE** is distributed in width by successive changes in the horizontal direction of the gun. A burst of fire is delivered after each change or during the swing.

- **COMBINED TRAVERSING AND SEARCHING FIRE** is distributed both in width and depth and by changes in both elevation and horizontal direction.

- **SWINGING TRAVERSE FIRE** is delivered against targets too wide to cover with the traversing

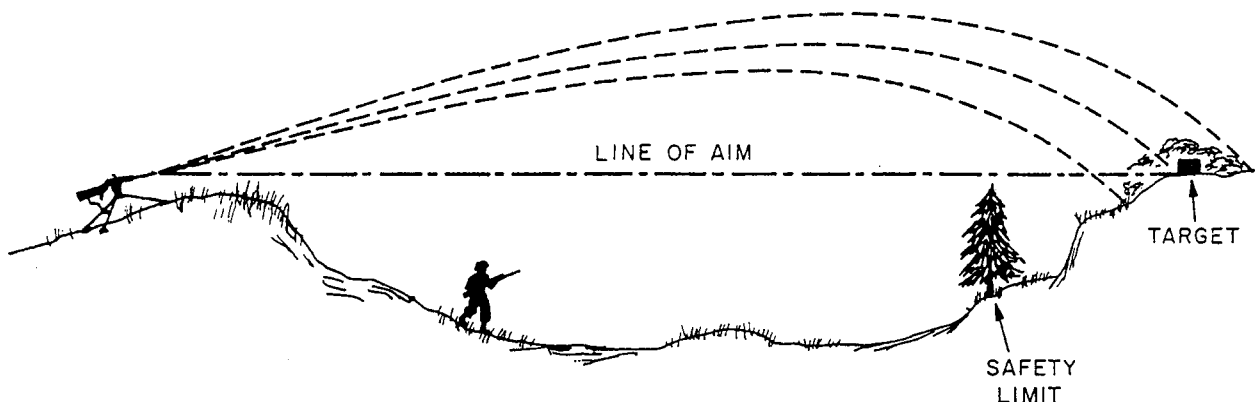

Figure 3-66.—Delivering of overhead fire.

handwheel. Also, it is used against targets that are moving so rapidly across the front of the gunner that he or she cannot maintain effective fire while using the traversing handwheel.

- **FREE GUNFIRE** is delivered from the tripod mount against a target requiring rapid, major changes in direction and elevation that cannot be made with the traversing and elevating mechanism. Free gunfire can also be used from a vehicular mount against a target that cannot be adequately covered by selecting a series of aiming points.

All types of fire can be delivered with biped-, tripod-, or vehicular-mounted guns except as follows: swinging traverse fire cannot be delivered with bipod- or vehicular-mounted guns; free gunfire cannot be delivered with bipod-mounted guns.

OVERHEAD FIRE

Overhead fire with the rifle is safe when the ground affords protection to friendly troops or when the troops are far enough below the line of fire (fig. 3-66). Whether or not overhead fire should be used in any particular case is a matter of judgment.

A machine gun on a tripod is capable of delivering accurate overhead fire because of the small, uniform dispersion of the cone of fire. In the attack, the use of overhead fire permits the machine gun to support the advance of the rifle units. To permit overhead fire on any target, pass the cone of fire over the heads of friendly troops by a certain distance, called the **MINIMUM CLEARANCE**. Two rules are prescribed by which the minimum clearance may be determined: the **GUNNER'S RULE** for ranges up to 900 yards and the **LEADER'S RULE** for ranges greater than 900 yards.

Overhead fire will not be delivered by use of these rules at ranges less than 400 yards or greater than 1,800 yards.

The steps in using the **GUNNER'S RULE** are as follows:

1. Lay the gun on the target with the correct sight setting to hit the target.
2. Without disturbing the lay of the gun, set the rear sight at 1,500 yards.
3. Look through the sights and note the point where this new line of aim strikes the ground. If this point is beyond the feet of friendly troops, you may deliver overhead fire safely until the troops reach this point. It is not safe to fire when they pass this point.

The steps in the application of the **LEADER'S RULE** are as follows:

1. Select a point on the ground to which you believe friendly troops can advance with safety.
2. Determine the range to this point by the most accurate means available.
3. Lay the gun on the target with the correct sight setting to hit the target.
4. Set the rear sight at 1,500 yards or at the estimated range to the point plus 600 yards, whichever is greater, without disturbing the lay of the gun. Under no condition should the sight setting be less than 1,500 yards.
5. Note the point where the new line of aim strikes the ground. If it strikes at the selected point, that point marks the limit of safety.
6. If the new line of aim strikes the ground short of the selected point, troops can advance safely to the point where the line of aim strikes the ground and to an

unknown point beyond. If you desire to fire after friendly troops advance farther than the point where the line of aim strikes the ground, you must determine this farther point by testing new points until the line of aim and the selected point coincide.

RANGE ESTIMATION

In combat, you seldom know ranges in advance. To bring effective fire to bear on the enemy, train the riflemen and machine gunners to estimate ranges quickly and accurately. Ranges are estimated either by eye or by observation of fire.

ESTIMATION BY EYE is the usual method of estimating range in combat. You accomplish this by mentally applying a unit of measure to the distance to the target. This unit is normally 100 yards. You need to be familiar with the appearance of this unit of measure at various distances and over varying types of terrain to be able to use this method effectively when estimating ranges by eye.

Eye estimation is difficult to apply for ranges of more than 500 yards. When the range exceeds 500 yards, estimate a point halfway to the target; then, double the estimate.

When much of the ground between the observer and the target is hidden, eye estimation is difficult. In some cases, you may overcome this difficulty by the use of a MENTAL ARC. Move your gaze in a mental arc to the right or left of the target. Find a prominent object at about the same range as the target, and use it to estimate this range.

When none of the previously described methods are feasible, you may possibly estimate the range by the appearance of objects. Conditions of light, atmosphere, color, and terrain affect the apparent distance of objects.

Accurate estimation of ranges by eye requires considerable practice over all types of terrain and under all conditions of visibility. The use of known distance ranges, marked off in 100-yard intervals, is recommended for initial training.

Range estimation of OBSERVATION OF FIRE is determined by observing the flight of tracer bullets or by observing the points where projectiles strike.

Tracer bullets leave a red trail for about 950 yards of their flight. The shooter first estimates the range by eye to determine the initial sight setting. Thereafter, by watching the strike of the tracer bullets, he or she corrects the sight setting to hit the target.

When you are in suitable terrain, watch a projectile strike the ground. If it kicks up dust or other visible material, follow the same procedure as you would with tracers.

FIRE DISCIPLINE

Fire discipline is the state of order, coolness, efficiency, and the obedience existing among troops in a fire fight. It implies the careful observance of instructions in the use of weapons in combat and the execution of the exact orders of the leader. To have effective fire discipline, control it by having leaders. The responsibility for fire discipline in the platoon rests with the platoon commander, assisted by his or her subordinates. The squad leader maintains discipline in the squad. There is a tendency for untrained machine gunners and riflemen to open fire at night when hearing noises and on seeing imaginary targets. This is dangerous and wastes ammunition; but more important, it gives the position away. Also, the enemy could stand off and send a couple of scouts into fire several shots or to throw some grenades at the defensive positions to draw responsive fire. If the fire discipline is poor, the defenders return the fire. The enemy can then plot the locations of the defense positions, plan an attack to avoid strong points, or direct supporting fire accurately on the defenders. The squad leader is responsible for controlling these tendencies in his or her squad.

FIRE CONTROL

Fire control includes all operations connected with the preparation and actual application of fire to a target. Fire control implies the following abilities of the leader:

- To have his or her unit open fire the instant he or she desires
- To adjust the fire of his or her weapons on the target
- To shift fire from one target to another
- To regulate the rate of fire
- To cease firing at will

Lack of proper fire control causes the loss of the surprise effect, premature disclosure of the position, misapplication of fire on unimportant targets, and waste of ammunition. DISCIPLINE and CORRECT TECHNICAL TRAINING are fundamental in ensuring fire control.

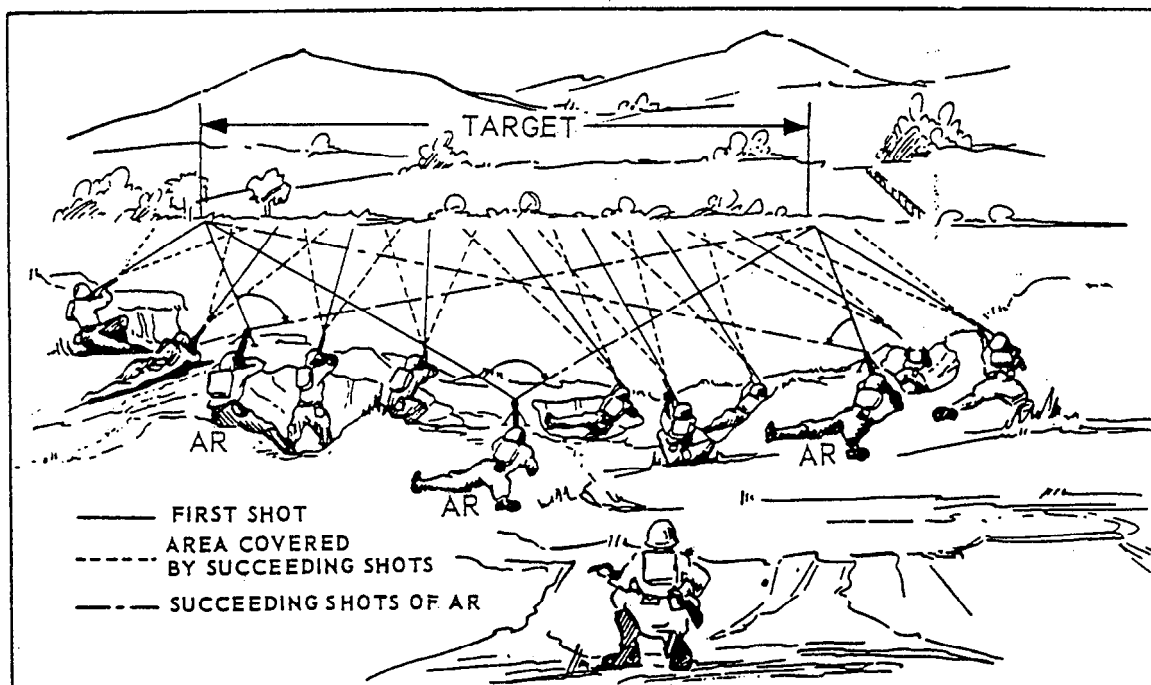

Figure 3-67—Fire distribution by individuals of the rifle squad.

The platoon commander's order to his or her section or squad leaders assigns a mission to each section or squad; gives the firing position area each squad will occupy and the targets it will engage; or the sector of fire it will cover. In addition, he or she frequently prescribes the technique to use in engaging targets.

The section or squad leader's order prescribes the location for each weapon, the targets, and the technique to be used. In the absence of orders from the next higher commander, the platoon, section, or squad leaders regulate opening fire and lifting, shifting, and rate of fire.

FIRE DISTRIBUTION

The distribution of fire, to be effective, must be over the entire target. Improper distribution results in gaps between zones and allows part of the enemy to escape, to advance, or to use their weapons without effective opposition.

Rifle Fire

The fire of a rifle unit is either concentrated or distributed. The nature of the target, as given in the fire order, will determine in each mind of the rifleman the type of fire to use.

- **CONCENTRATED FIRE** is directed at a single point. Enemy machine guns, bunkers, and heavy weapons are examples of suitable targets for concentrated fire.

- **DISTRIBUTED FIRE** is fire distributed in width for the purpose of keeping all parts of a larger-than-point target under effective fire. Each rifleman fires his or her first shot at that portion of the target corresponding generally to his or her position in the squad. He or she then distributes his or her succeeding shots over that part of the target extending a few yards right and left of the point of aim for his or her first shot. The width of target he or she will cover will be the maximum on which he or she can deliver accurate fire without changing his or her position, as shown in figure 3-67.

In **PLATOON FIRING**, unless otherwise ordered, each squad completely covers the target designated for the platoon. This enables the leader to shift part of his or her fire to a new target or to remove a squad from the line without leaving a portion of the target not under fire. If the platoon leader does not desire each squad to cover the entire platoon target, he or she assigns definite sectors of fire to each squad.

In **DETERMINING EXTENT OF TARGET**, it is difficult or impossible to pick out visually each individual enemy in either a dug-in or camouflaged position. A muzzle blast may show the location of a few

individual positions, but many positions will be too well camouflaged to see. However, engaging the whole target is imperative in order to inflict decisive casualties and neutralize the fire of the enemy. Pinning down only the obvious positions and allowing the remaining enemy to fire unmolested does little good.

Under these circumstances, to apply the proper fire distribution effectively, the unit leader must first determine the locations of the flanks of the enemy. The flanks may be obvious and easy to see. They may be limited by natural features, such as woods, a cliff, or a gully; or they may be approximately located from the direction and sound of the firing of the enemy.

After determining the flanks of the enemy, the squad leader must designate the portion of the target, whether in part or in its entirety, that he or she wishes his or her squad to engage. This can best be done by using tracers fired on either flank. The squad then opens fire using the normal fire distribution.

Machine Gun Fire

In fire control terminology, target width is designated in mils. A MIL is a unit of angular measurement; there are 1,600 mils in 90 degrees. Gun angles of train and elevation are measured in roils. A target width of 50 mils has no relationship to the actual width of the target. This expression simply means that moving the gun through a train (horizontal angle) of 50 mils will cover the entire target front. Thus, a wide target could have a target width of 50 mils at long range, while a narrow target would have the same width at much shorter range.

No fixed rule about the maximum width of a target that a single gun may profitably engage can be given. But preferably targets for light machine guns should be less than 50 mils in width. The section (two guns) is the machine gun fire unit. Whenever practical, both guns cover the same target area, although an occasion may arise to use single guns profitably. Assigning both guns to a single target area ensures continuous fire should either gun be put out of action, provides a greater volume of fire on the target, and reduces the time required to cover the target.

Targets having a width or depth no greater than the beaten zone of the weapon engaging them are considered POINT targets. You should engage point

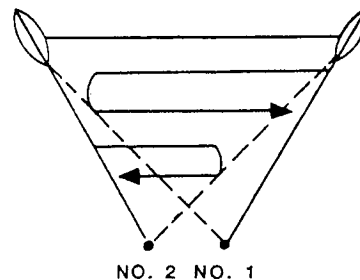

Figure 3-68.—Traversing method by section. Both flanks are visible to the gunners. Target is less than 50 mils in width.

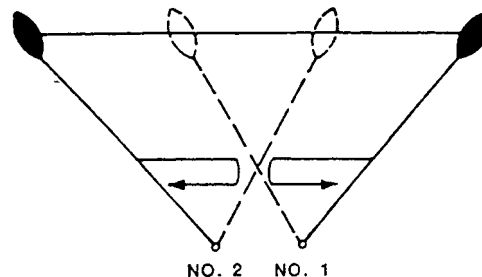

Figure 3-69.—Traversing method by section. Targets 50 Mil or more in width. (Each gun assigned a portion of the target.)

targets with fixed fire. The command for such fire is **FIXED**. Gun crews are trained to follow any movement or change in formation made by the enemy after the initial burst of fire.

When sections engage frontal targets that are less than 50 mils wide and less than the length of the beaten zone in depth, the leader uses the normal traversing method. Each gun lays just outside its corresponding target flank and traverses across the target front to a point just outside the opposite target flank (fig. 3-68). The command for this type of fire is **TRAVERSE**.

When the target measures 50 mils or more in width and is less than the length of the beaten zone in depth, the leader assigns a portion of the target to one gun and the remainder to the other. Each gun lays on the outside flank of its assigned portion and traverses back and forth across the portion assigned. (See fig. 3-69.) The command would be, for example: No. 1 gun, **RIGHT HALF**; No. 2 gun, **LEFT HALF**; **TRAVERSE**.

If the flanks of the target cannot be seen, the leader should order each gun to traverse so many roils from a point between the flanks. The designated number of roils should be large enough

for each gun to traverse to a point beyond the suspected position of the flank.

Searching fire covers targets deeper than the length of the beaten zone. If the target is stationary, has limited mobility, or is moving slowly toward you, and if the ends are visible, No. 1 gun lays on the near end and searches down. If the estimated depth of the target is 200 yards or less, the leader announces the range for both guns to the middle of the target. If the estimated depth of the target is more than 200 yards, he or she announces the range to the near end for No. 1 gun and the range to the far end for No. 2. The command for this type of fire is SEARCH.

If the target is moving rapidly toward the guns, both guns lay on the near end with the range to that point and search up. If the target is moving rapidly away from the guns, both guns lay on the far end and search down. The distribution element of the command for covering a rapidly approaching or receding target is ALL GUNS, NEAR (FAR) END, SEARCH.

FIRE COMMANDS

The leader of a fire unit, after making the decision to fire on a target, must give instructions about how to engage the target. He or she gives these instructions in the form of a fire command. A fire command for machine guns contains four basic elements: the ALERT, the TARGET, the DESIGNATION, the METHOD OF FIRE, and the command to OPEN FIRE. Examples of the four elements are given below.

1. The alert designates the gun crew that is to fire and alerts them to receive the command. The alert includes the following:

Gun crew to fire—FIRST SECTION

Target alert—FIRE MISSION, with STATIONARY TARGET,

MOVING TARGET, or other additional necessary information

2. The leader gives the target designation as follows:

Direction—FRONT

Target description—COLUMN OF TROOPS

Range—FIVE FIVE ZERO (yd)

3. He or she designates the method of engaging by naming the method, such as TRAVERSE. The rate of fire is a part of the method of fire. The leader states the amount of fire to place on the target, such as 75 ROUNDS PER MINUTE or MEDIUM RATE.

4. The command to open fire is COMMENCE FIRING or FIRE. When a large volume of sudden surprise fire is desired, the leader may preface the command with the preparatory command, On My Command. The unit leader then waits until all gunners have located the target and aimed before giving the command of execution.

Fire control will also include any necessary adjustment corrections for machine guns, as RIGHT TWO ZERO MILS, ADD THREE MILS.

A fire command for riflemen and automatic riflemen contains six basic elements: the alert, the direction, the target description, the range, the target assignment, and the fire control.

The ALERT brings the unit to a state of readiness to receive further information. If all men or women in the unit are not to fire, the command also designates those who are to fire. If all men or women are to fire, the command for the alert is SQUAD. If only certain men or women are to fire, the names of the men or women are stated after the word SQUAD.

The DIRECTION element tells the riflemen the target direction. It may be given orally, such as RIGHT FRONT or by pointing or firing in the direction of the target. If the target is not readily visible, a reference point may be used. A reference point is some prominent terrain feature, either natural or artificial, to use to make the target easier to locate. The reference point should be well defined and easily recognized. If possible, the point should be on a line with, and beyond, the target because, in this position, it is a more accurate reference for a number of men or women firing from separate positions.

For the sake of brevity, the leader designates the reference point by the single word REFERENCE, followed by a description of the point, such as FARM HOUSE ON HORIZON. He or she should give the distance right or left. He or she may give this distance in FINGER MEASUREMENTS in which the method to use is as follows:

1. Extend your arm full length with the palm up. Point the appropriate number of fingers, beginning

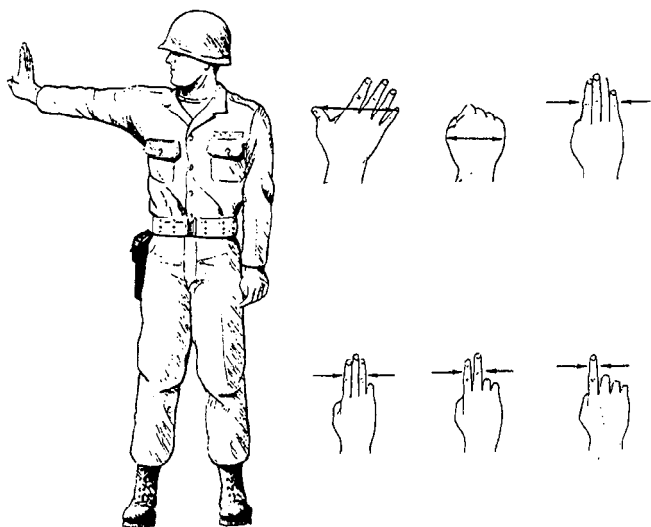

Figure 3-70.—Measurement of angles by hand and fingers.

with the index finger, vertically to the reference point. (See fig. 3-70.)

2. Close one eye, sight along the outside of the index finger so one edge is on the reference point. Use the other edge of the appropriate number of fingers (one, two, three, or four) to locate the hidden target. When this method is used, the command will sound like-

FROM REFERENCE POINT

MOVE LEFT THREE FINGERS

FIRE WHEN READY

TARGET DESCRIPTION should be brief and accurate. A target maybe POINT, such as a machine gun, LINEAR, such as a line of skirmishers, or AREA, such as men or women dispersed through a clump of woods.

RANGE may be announced orally or indicated by arm-and-hand signals.

TARGET ASSIGNMENT designates who is to fire at the target. If the whole unit has been alerted and if the leader desires that they all fire, then target assignments may be eliminated.

The FIRE CONTROL element normally consists of the command, COMMENCE FIRING or FIRE, plus any designation the leader desires about rate of fire, such as QUICK FIRE, FIRE FASTER, FIRE SLOWER.

The following is an example of a simple fire command:

SQUAD

RIGHT FRONT

SNIPER ON ROOF OF FARMHOUSE

TWO HUNDRED

JONES AND SMITH

COMMENCE FIRING

An example of a fire command using a reference point and finger measurements is the following:

LEFT FRONT

Reference: WHITE CHURCH SPIRE

ON HORIZON, RIGHT THREE FINGERS

Target: MACHINE GUN IN BUSHES

THREE HUNDRED

TEAMS ONE AND TWO

COMMENCE FIRING

APPLICATION OF FIRE

Application of fire consists of placing the fire of a unit on the desired target at the proper time and the control of the fire after that. Accurately controlled fire on the enemy has both a physical (casualty producing) and a morale effect.

FINAL PROTECTIVE LINES

A final protective line is a predetermined line where interlocking bands of grazing fire are placed in order to stop enemy assaults. The elevation and direction of the fire are fixed and capable of being delivered under any condition of visibility.

Because of irregularities in the terrain, fixed machine gun fire cannot always produce the maximum effective grazing fire. Then the leader uses rifle fire to ensure that all the final protective lines are covered.

Fire on the final protective line during periods of good visibility is aimed and adjusted fire. Under such conditions, the section leader will generally determine the rate of fire and may also give the order to cease firing.

Under conditions of poor visibility, the battalion order may prescribe the rates of fire. In the absence of instructions, the usual rate of fire for a section on a final protective line is the rapid rate for the first 2 minutes, then the medium rate until ordered to cease firing.

CHAPTER 4

COMBAT MANEUVERS, FORMATIONS, PATROLS, AND AMBUSHES

In this chapter, moving through enemy controlled terrain either on your own or in small groups is discussed. Usually in such instances, your movement must not be seen or heard. When this cannot be avoided, you must at least be able to move quickly with a minimum of exposure. Actions, such as moving, rushing, hitting the deck crawling, moving silently, and taking action under flares, are also discussed in this chapter.

MOVEMENT

When you move about, it is best to travel a short distance quickly; then stop, listen, observe, and move on again. Before moving from the concealment or cover of one position, always pick out your next position. In addition, look for an alternate new position in case you are unable to reach your first choice. Observe the area carefully for enemy activity; then select the best available routes to the new location. Take advantage of darkness, fog, smoke, or haze to assist in concealing your movement.

Change direction from time to time when moving through tall grass. When you move in a straight line, the grass waves with an unnatural motion that could attract attention. The best time to move is when the wind is blowing the grass.

When stopping between movements, you should observe briefly whether birds or animals are alarmed. Their flight or movement may attract the attention of the enemy, or they may provide a clue as to the location of the enemy.

Take advantage of distractions caused by noises, such as bombing, shelling, rifle fire, or vehicle movement.

Travel across roads, trails, and rivers where the most cover and concealment exist. Search for a large culvert, a low spot, or a curve; keep in mind that these are the most likely spots for enemy mines and booby traps.

Avoid steep slopes and areas with loose stones or gravel. Also, avoid ridges or clearings where you would make a good silhouette.

RUSHING

Rushing is the fastest means of moving from one position to another. It should always be used when you are moving but not concealed. Generally, you should start rushing from the prone position (fig. 4-1, view 1). Slowly move your head to select the new position to which you will move (fig. 4-1, view 2). Avoid raising your head too high, and always look around the side of an object rather than over the top, so you do not make a sharp silhouette. Slowly lower your head; then draw your arms in close to your body; keep your elbows down, and pull your right leg forward (fig. 4-1, view 3). With one movement, raise your body by straightening your arms (fig. 4-1, view 4). Spring to your feet quickly, step off with your left foot (fig. 4-1, view 5), and run to the new location by the quickest and shortest route. Keep low and use all available cover (fig. 4-1, view 6).

HITTING THE DECK

After reaching your new position at the end of the rush, you must quickly get into the prone position again. Getting into the prone position from rushing is known as hitting the deck or dirt. To do this, plant your feet firmly, about 18 inches apart, and while sliding your hand to the heel of the rifle butt (fig. 4-1, view 7), drop to your knees (fig. 4-1, view 8). Fall forward, breaking your fall with the butt of your rifle (fig. 4-1, view 9) unless you are armed with the M16; then, after shifting your weight to your left side, bring your rifle forward (fig. 4-1, view 10). Place the butt of the rifle in the hollow of your shoulder; then roll into a firing position (fig. 4-1, view 11). If your weapon has a stock made of plastic or fiber glass, such as the M16, you should not use it to break your fall. Instead, grasp your rifle in one hand and break your fall with the other.

Lie as flat as possible. If you think you were observed, move to the right or left, preferably where there is cover and concealment.

CRAWLING

There are times when you must move with your body close to the ground to avoid enemy fire or

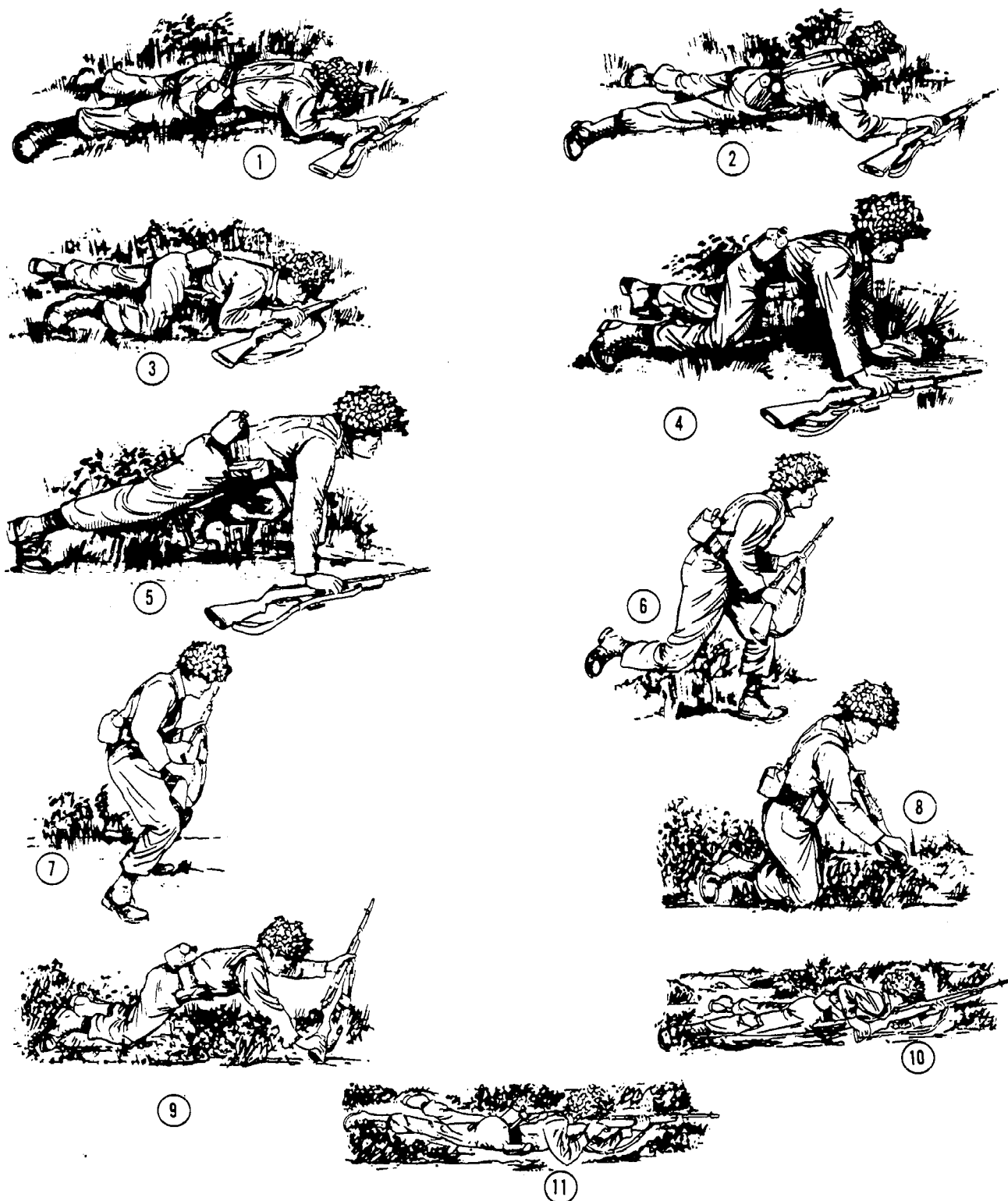

Figure 4-1.—Rushing and hitting the deck or dirt.

observation. There are two ways of doing this, the **LOW CRAWL** and the **HIGH CRAWL**. It is up to you to decide which method is best suited to the conditions of visibility, cover and concealment, and the speed required.

Use the **LOW CRAWL** method when cover and concealment are scarce, when visibility permits good enemy observation, and when speed is not essential. Keep your body as flat as possible against the ground. Grasp your rifle sling near the upper sling swivel. Allow

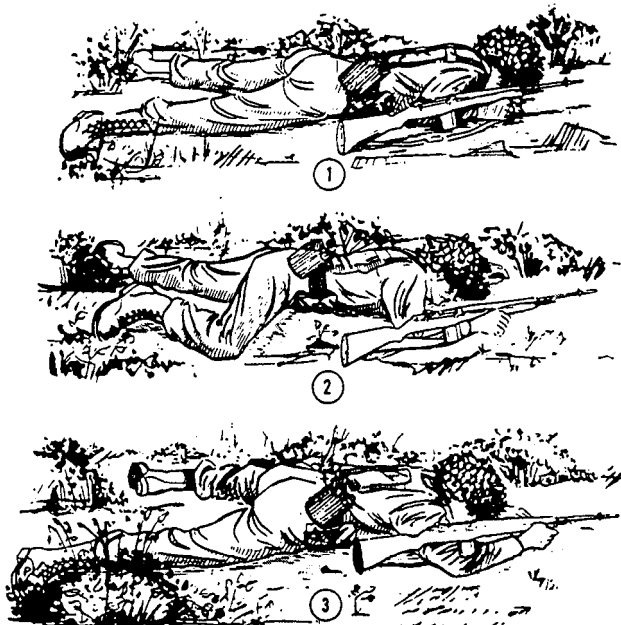

Figure 4-2.—The low crawl.



Figure 4-3.—The high crawl.

the balance to rest on your forearm, and let the butt drag along the ground. Keep the muzzle and operating rod clear of the ground (fig. 4-2, view 1).

To start forward, push your arms ahead and pull your fight leg forward (fig. 4-2, view 2). Move by pulling with your free arm and pushing with your right leg. Every so often, change your pushing leg to avoid getting tired (fig. 4-2, view 3).

Use the **HIGH CRAWL** method when cover and concealment are available, when poor visibility reduces enemy observation, and when more speed is needed.

Keep your body free of the ground and rest your weight on your forearms and lower legs. Cradle the rifle in your arms, keeping the muzzle off the ground. Keep your knees well behind your buttocks so your rump remains low. Move forward by alternately advancing your right elbow and left knee and then your left elbow and right knee (fig. 4-3).



Figure 4-4.—Crawling silently.

The low crawl and high crawl are not suitable for moving silently. To crawl silently, you must move on your hands and knees (fig. 4-4): Start by laying your weapon carefully on the ground to your side. With your right hand, feel or make a clear spot for your knee. While keeping your hand on the spot, bring your right knee forward until it meets your hand. Next, clear a spot with your left hand and move your left knee up in the same reamer. Be sure your weapon is always within reach! To move your weapon, feel for a place, clear it, and lift the weapon into position. Crawl very slowly and keep your movements absolutely silent.

MOVING SILENTLY

The movements just explained, rushing and crawling, are not particularly useful when you are close to the enemy because they often create a shuffling noise. When extremely quiet movement is necessary, especially when you are on patrol or stalking an enemy, you must use the movements described below. These



Figure 4-5.—Walking gently with your toe down first.

movements are particularly useful when you are moving at night. The movements must be made slowly; they are tiring and require extreme patience and self-control to be performed properly.

WALKING SILENTLY

While walking, hold your weapon at port arms. Make your footing sure and solid by keeping your weight on one foot as you step with the other. When stepping, raise your foot high. This enables you to clear the brush and grass. With your weight on the rear leg, gently let your foot down, toe first (fig. 4-5). Feel softly with your toe to pick a good, solid spot; then lower your foot. Shift your weight and balance to your foot that is forward and then continue. Take short steps to avoid losing your balance. At night and when moving through dense vegetation, you should avoid making unnecessary noise by holding your weapon with one hand and extending your other hand forward to feel for obstructions as you move.

ASSUMING THE PRONE POSITION SILENTLY

To assume the prone position silently (fig. 4-6), hold your weapon under one arm and crouch slowly. Feel for the ground with one hand, making sure it is clear by removing small twigs and other objects that make noise. Lower your knees one at a time until your weight is on both knees and your free hand. Shift your weight to your

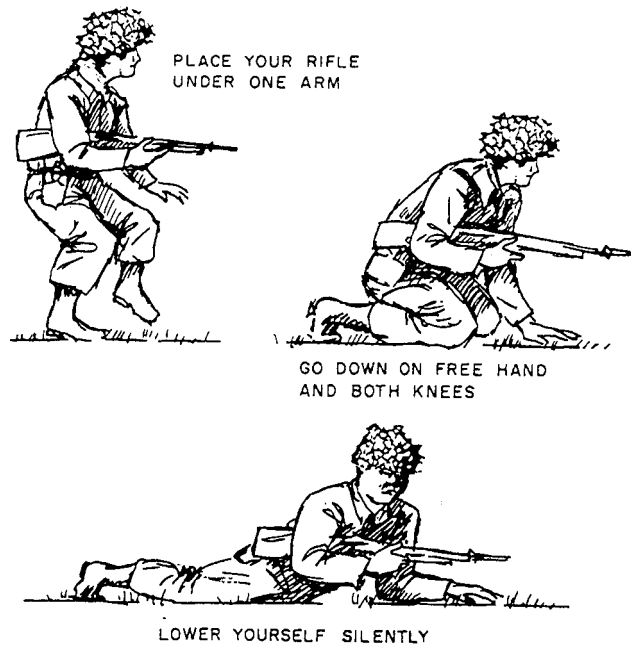

Figure 4-6.—Assuming the prone position silently.

free hand and opposite knee. Raise your free leg up and back slowly; then lower it to the ground gently, feeling with your toe for a clear spot. Roll gently to that side and move your other leg into position in the same way. Roll quietly into the prone position.

ACTION UNDER FLARES

When you are caught in the open by an overhead flare, you should immediately hit the deck. Since the burst of light is temporarily blinding to the enemy also, there is a chance that you may not have been seen. If you hear the flare being fired, try to get down before it bursts. Resume movement as soon as the flare burns out.

When you are caught in the light of a ground flare, move out of the area of light as quickly and quietly as possible. Keep moving until you are well away from the area; then reorient yourself and continue on.

If you are caught by a flare when crossing an obstacle, such as barbed wire, crouch low and remain motionless until the flare burns out.

When you are assaulting a position and a flare bursts, continuing your assault is imperative.

COMBAT FORMATIONS

Combat formations are designed to group individuals into effective fighting teams that can move to and assault an enemy position with minimum confusion. The use of combat formations, with related arm-and-hand signals (as shown in chapter 8), enables a squad leader to control the fire and to maneuver his unit just as the quarterback of a football team uses plays and signals. A person who cannot remember the plays or signals on the ball field endangers the ability of the team to win the game. On the battlefield, the stakes are much higher. The success of your mission, as well as your survival, depends on teamwork.

When the situation, terrain, or enemy activity does not permit close formations, the unit leader should deploy his men in an extended formation. Deployment is executed on signals or commands. The leader may deploy his units in a variety of formations at any one time, depending on the situation. Relative positions within these formations are flexible, and the leader should take advantage of the cover and concealment offered by the terrain; however, he must take care not to mask the fire of another unit. Maintaining exact distances between individuals and units is unnecessary as long as control is not lost; however, under ideal conditions, the recommended space between individuals is 5 yards. All leaders and units must maintain sight and voice contact with each other. Any changes information should be by the shortest practical route. Leaders must take full advantage of cover and concealment and avoid backward or lateral movement.

FIRE TEAM MOVEMENT

The FIRE TEAM LEADER controls the use of the formations. He places himself in a position where he can best observe and control the fire team and, in addition, receive orders from the squad leader. The fire team leader must also be in a position to quickly and effectively control the employment of the automatic rifle.

The AUTOMATIC RIFLEMAN is an interior man. He should position himself between the fire team leader and rifleman No. 1. Here, he can quickly deliver fire to either flank, as directed by the fire team leader, and receive help and protection from the adjacent rifleman.

RIFLEMAN NO. 1 assists the automatic rifleman by supplying him with loaded magazines and by keeping the automatic rifle in action. He coordinates both his position and movement with those of the automatic rifleman.

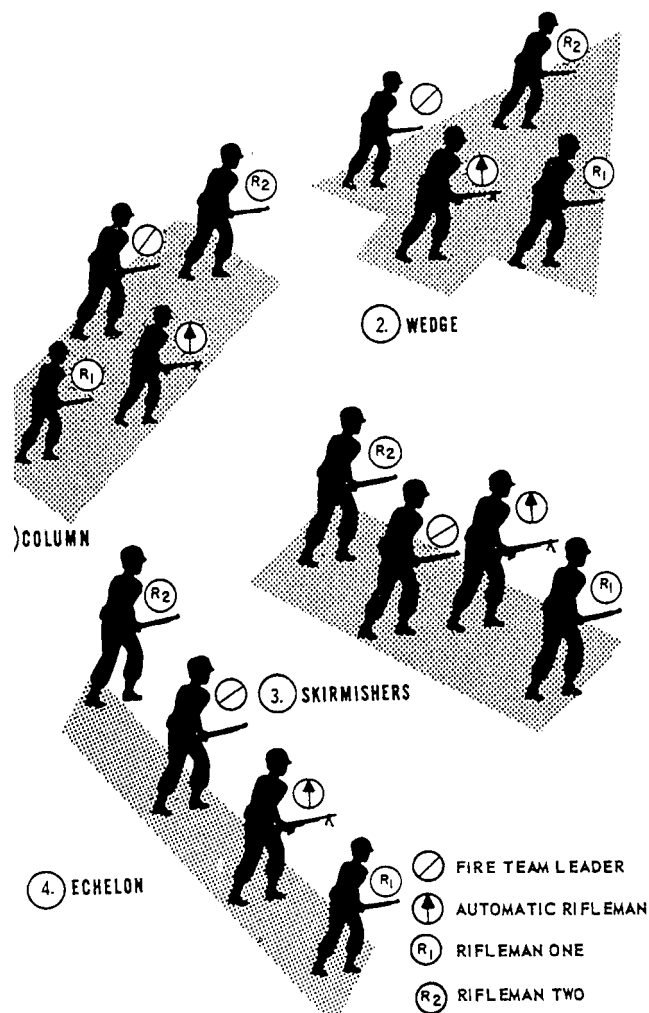

Figure 4-7.—Basic formations, fire team.

RIFLEMAN NO. 2 is at the place in the fire team formation that enemy action or probable enemy action threatens. He acts as a security element; for example, when the team is moving toward the enemy, he is in the foremost position.

The basic fire team formations are COLUMN, WEDGE, SKIRMISHERS RIGHT or LEFT, and ECHELON RIGHT or LEFT.

FIRE TEAM COLUMN

The fire team column formation (fig. 4-7, view 1) is used when speed and control are governing factors, such as moving through woods, fog, smoke, and along roads and trails. This formation is favorable for fire and maneuvers to either flank but is vulnerable to fire from the front because its own fire in that direction is limited.

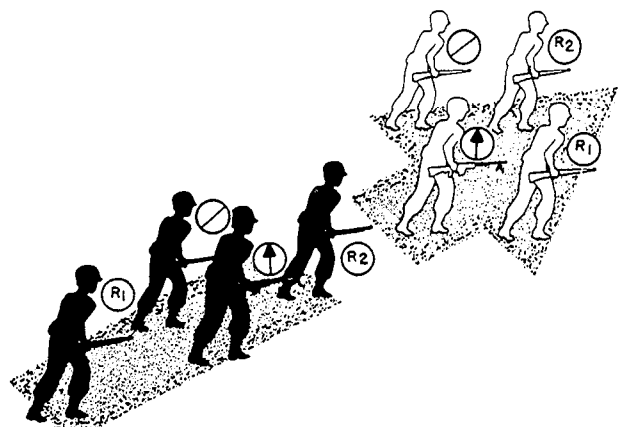

Figure 4-8.—Column to wedge.

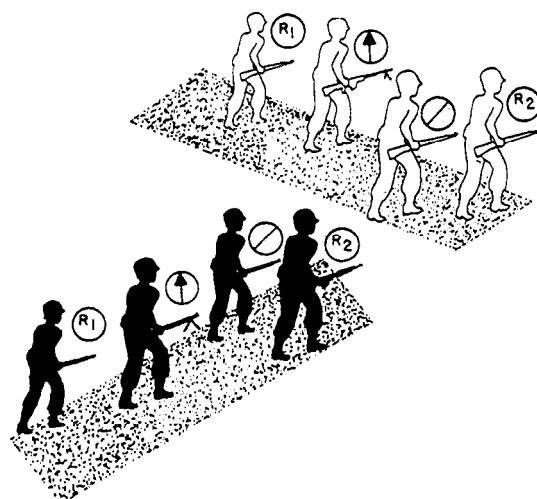

Figure 4-11.—Column to echelon left.

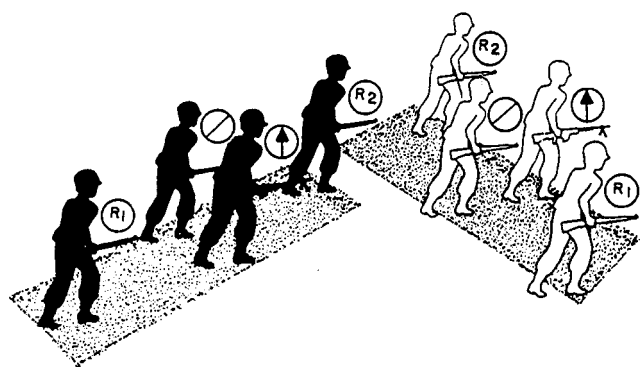

Figure 4-9.—Column to skirmishers right.

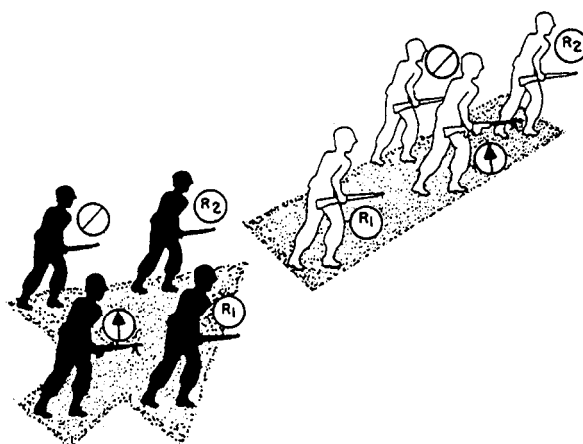

Figure 4-12.—Wedge to column.

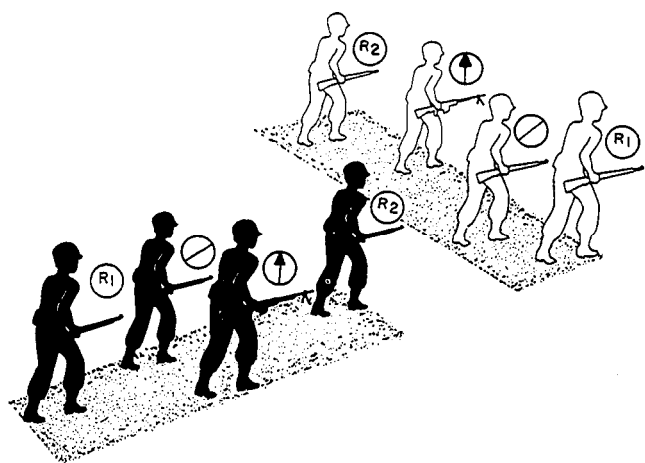

Figure 4-10.—Column to skirmishers left.

FIRE TEAM WEDGE

The fire team wedge formation (fig. 4-7, view 2) is used when the enemy situation is unknown but contact is possible. When the terrain and the visibility require dispersion of the men, the wedge formation provides

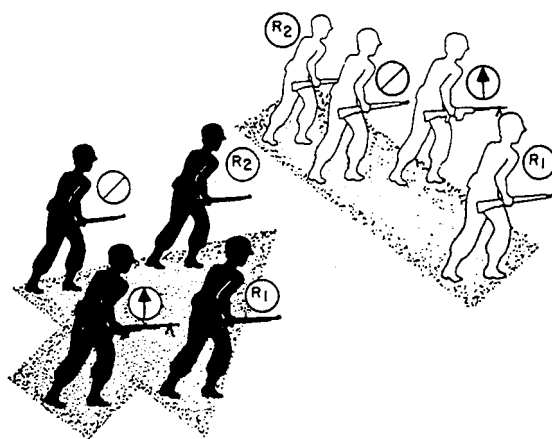

Figure 4-13.—Wedge to skirmishers right.

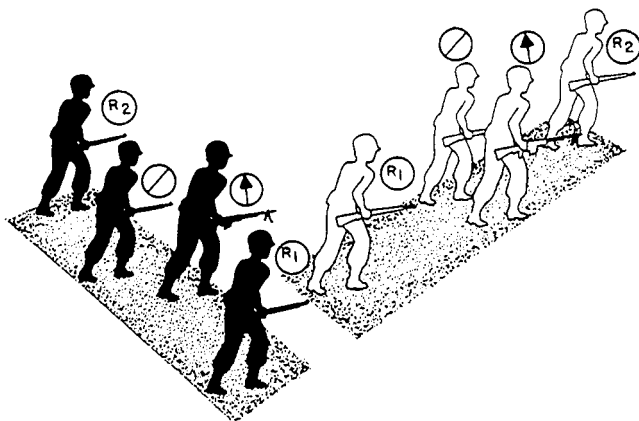

Figure 4-14.—Skirmishers right to column.

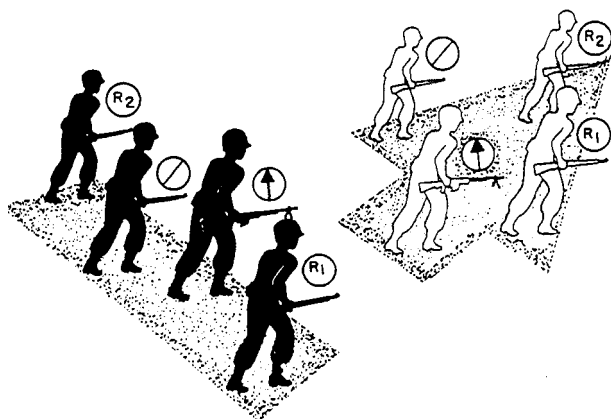

Figure 4-15.—Skirmishers right to wedge.

all-around protection and flexibility and is easy to control.

FIRE TEAM SKIRMISHERS RIGHT OR LEFT

Fire team skirmishers right or left (fig. 4-7, view 3) can be used most effectively when you are assaulting a known enemy position. It is also useful for “mopping up” operations (searching for enemy stragglers) and crossing short, open areas. Because the fire team is in a line, skirmishers right or left provides maximum firepower to the front. However, the formation is difficult to control.

FIRE TEAM ECHELON RIGHT OR LEFT

Fire team echelon right or left (fig. 4-7, view 4) is used primarily to protect an exposed flank. This formation permits heavy firepower to both the front and the direction of echelon. As with skirmishers, the formation is difficult to control; therefore, movement is

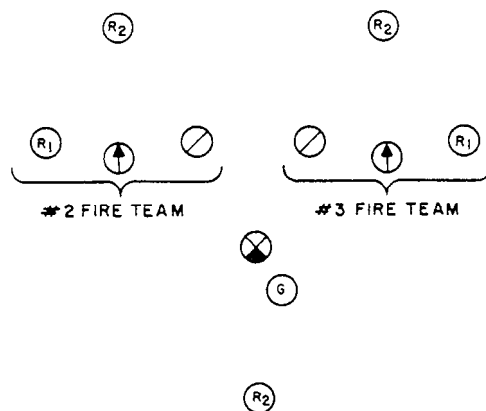

Figure 4-16.—Squad vee, fire teams in wedge.

generally slow, especially during conditions of reduced visibility.

CHANGING FIRE TEAM FORMATIONS

Depending upon the changing terrain features or the tactical situation, the fire team leader should change formations to meet these new conditions. Figures 4-8 through 4-15 show the manner in which each individual moves when changing from one formation to another.

RIFLE SQUAD FORMATIONS

The squad formations are similar to those of the fire team. However, an additional formation known as the SQUAD VEE is used by the squad, and skirmishers right or left is called SQUAD LINE.

The SQUAD LEADER designates the type of formation to be used, and he places himself in a location where he can readily observe his fire teams and the enemy. Normally, the fire team formation within the squad formation is left to the discretion of the fire team leader. For example, the squad may be in SQUAD VEE, but the fire team(s) may be in the fire team wedge (fig. 4-16). The exact formation is flexible at any level and is influenced by the terrain and the circumstances.

The grenadier always remains close to the squad leader regardless of the formation. His exact location in any formation depends upon the orders of his squad leader.

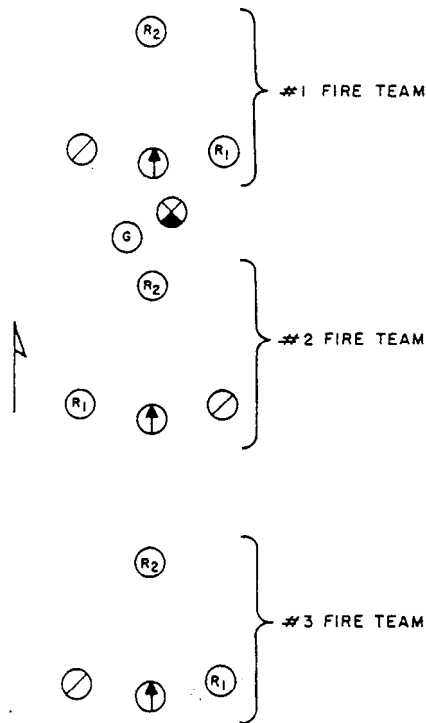

Figure 4-17.—Squad column, fire teams in wedge.

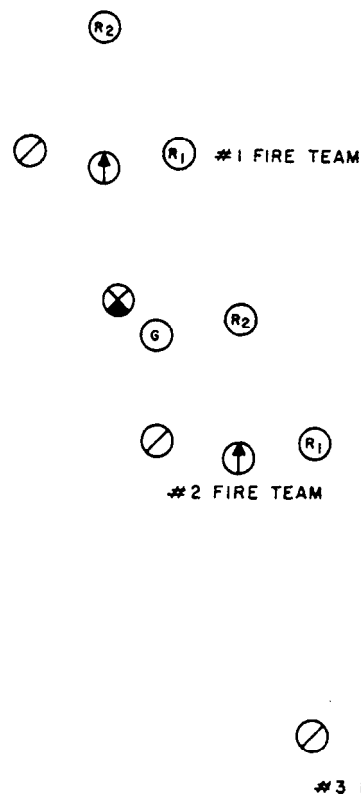

Figure 4-19.—Squad echelon right or left, fire teams in wedge.

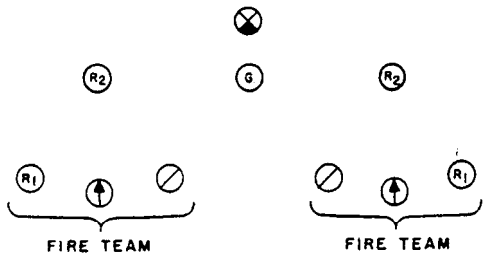
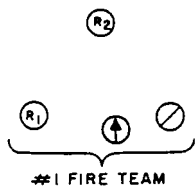

Figure 4-18.—Squad wedge, fire teams in wedge.

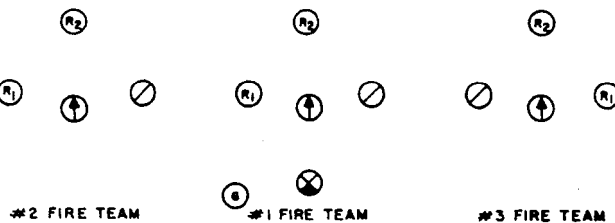

Figure 4-20.—Squad line, fire teams in wedge.

Squad Wedge and Squad Vee

The squad wedge (fig. 4-18) and squad vee (fig. 4-16) formations provide good security to both the front and the flanks. These formations are relatively easy to maneuver and control and can be quickly adapted to meet new tactical situations. The nature of the terrain generally determines which of the two formations should be used, the amount of frontage to cover, and the proximity and actions of the enemy.

Squad Echelon Right or Left

In squad echelon right or left, the fire teams are placed diagonally, one behind the other (fig. 4-19). This formation is used to protect an exposed flank, particularly when the enemy is known to be on that flank. From this formation, maximum firepower can be

Squad Column

In SQUAD COLUMN (fig. 4-17), the fire teams are arranged in succession, one behind the other. This formation is vulnerable to fire from the front, but controlling and maneuvering are easy. It is especially suitable for wading, covered routes of advance; for maneuvering through gaps between areas receiving hostile artillery fire; for maneuvering through woods; and for moving in fog, smoke, or darkness.

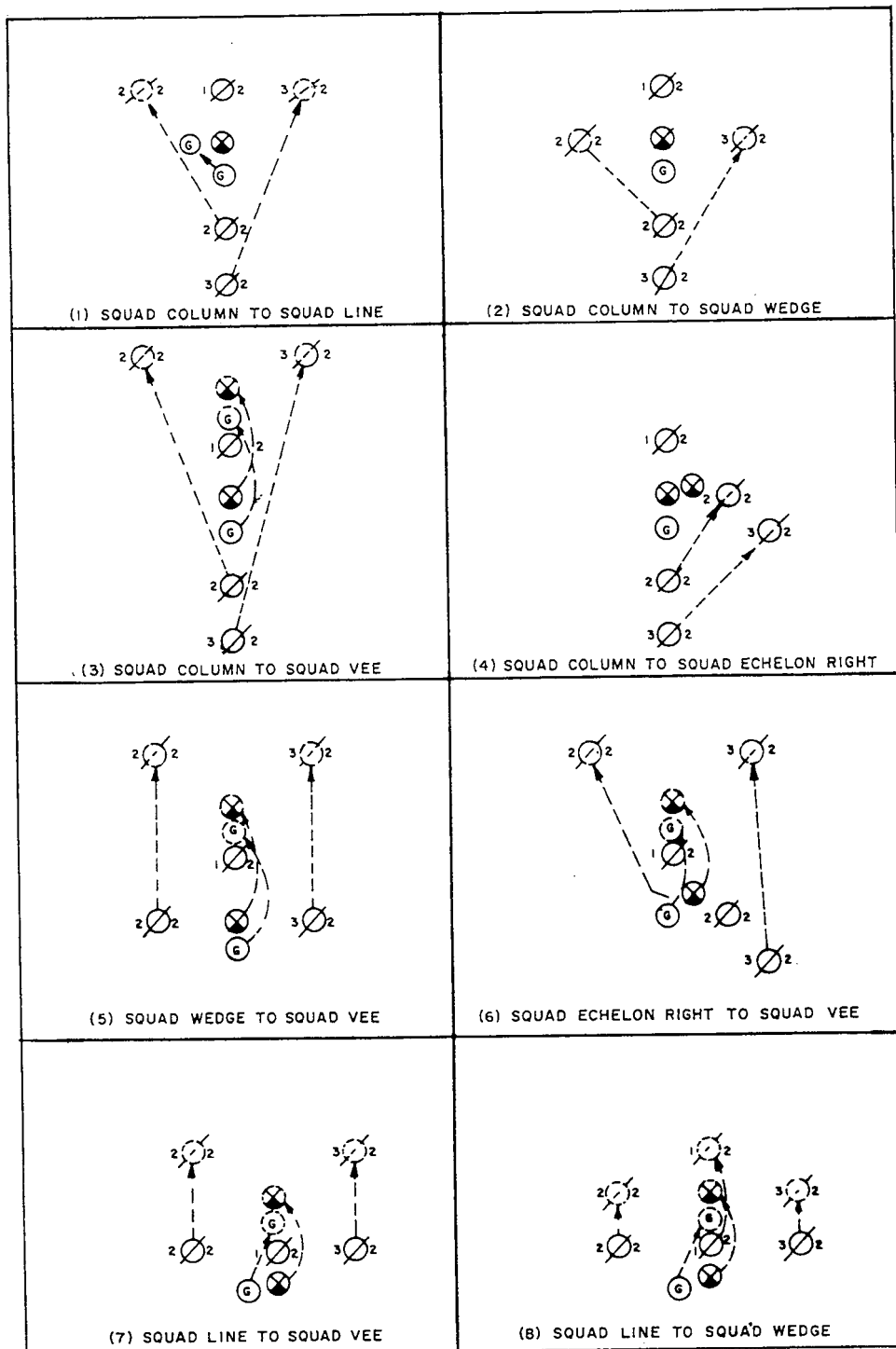

Figure 4-21.—Change squad formations.

promptly delivered to the right or left flank or toward the right or left front.

Squad Line

The squad line, as the name implies, places all three fire teams abreast of one another on a line (fig. 4-20). This permits maximum firepower to the front in the shortest time, so the squad line is used extensively

during an assault on a known enemy position. The squad line is suitable for rapidly crossing an unavoidable open area covered by enemy machine guns or artillery.

Changing Squad Formations

Squad leaders change squad formations in the same way and for the same reasons as the fire team leaders change the fire team formations. Figure 4-21 shows the

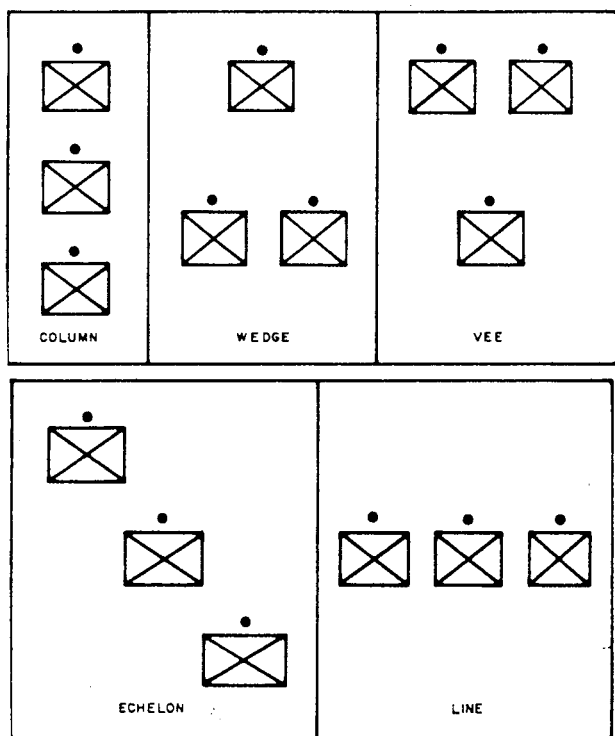

Figure 4-22.—Rifle platoon formations.

majority of these changes. Notice that the first fire team is used as a pivot for all formations and that the other fire teams take the most direct route to their new location. Although any formation shown can also be used to show the opposite movement, remember that all movement is to the front. For example, figure 4-21, view 1, shows a squad column moving to the squad line. To move from the squad line back into the squad column, fire teams two and three would not move to the rear and fall in behind team one. Instead, fire team one would move forward rapidly. Then teams two and three would move at a forward angle in behind it.

RIFLE PLATOON FORMATIONS

The platoon commander selects the initial attack formation for his platoon. However, he may change this formation as the attack progresses to meet a changing tactical situation. The available avenues of approach toward the enemy affect the platoon commander's choice to a great degree. Also, the need for security, control, flexibility, and speed influences his choice. On occasion, the platoon commander may prescribe the initial formation of the fire teams within the squads.

Platoon formations (fig. 4-22) are similar to squad formations and are described below.

Platoon Column

The platoon column makes control easier and action to the flanks favorable. It uses minimum firepower in a forward direction and is useful when speed and control are governing factors and when visibility is limited. The platoon column is suitable for advancing through narrow, covered avenues of approach with maximum speed and control.

Platoon Wedge

The platoon wedge makes control easier, provides good all-around security, and is extremely flexible. It permits reasonable firepower to both the front and the flanks. When the enemy is known to be in the area but his exact strength and location are unknown or not clear, the platoon wedge should be used. Also, it is useful when the terrain and visibility require a greater dispersion of the platoon. The wedge tends to keep the bulk of the platoon from becoming engaged with the enemy too soon. It also permits flexibility in the employment of squads when contact is established.

Platoon Vee

The platoon vee uses movement into the platoon line formation (fig. 4-22). The platoon vee provides excellent firepower to both the front and the flanks, and it is useful primarily when the strength of the enemy and their location to the front are known. The platoon vee is easy to control and provides good security but is less maneuverable than the wedge.

Platoon Echelon Right or Left

The platoon echelon formations are hard to control; therefore, movements are slow and maneuvering difficult. However, it does provide heavy firepower to the front and in the direction of echelon. The platoon echelon is used primarily in protecting an exposed flank either right or left.

Platoon Line

The platoon line formation allows the platoon to deliver maximum firepower to the front. It is difficult to control and is most often used in the coordinated assault of all three squads.

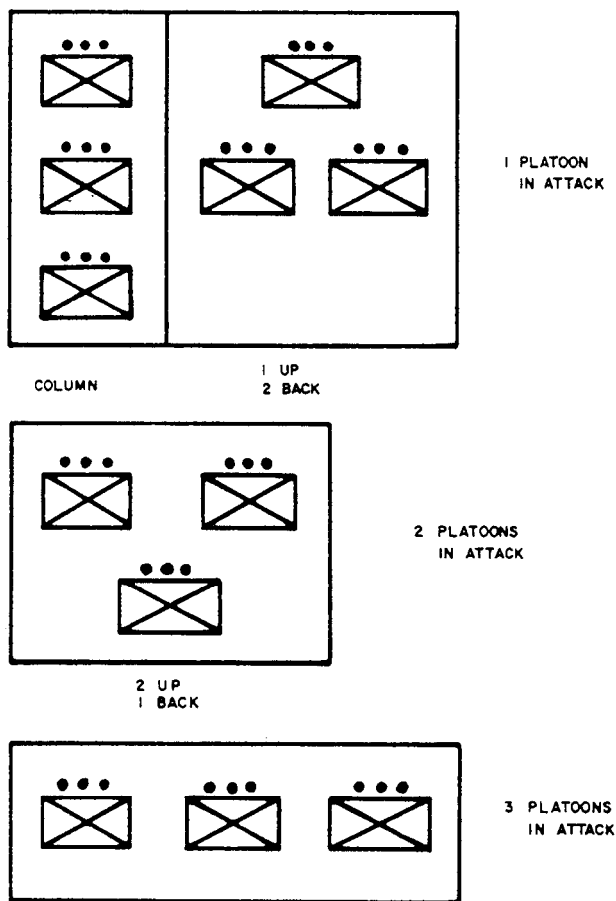

Figure 4-23.—Rifle company attack formations.

Changing the Platoon Formation

Generally, the relative positions of the squads within the platoon remain fairly constant. However, since combat is unpredictable, changes are often necessary. As usual, these changes must be made as rapidly and smoothly as possible.

Platoon formation changes are identical to those of the squads, as shown in figure 4-21. The platoon commander, along with his staff, tries to stay in a central location to best observe the situation and to control the attack

RIFLE COMPANY ATTACK FORMATIONS

The rifle company commander distributes his company into three elements: a main attacking force, a supporting attack force, and a reserve force. Attacking forces, fire support forces, and the reserves are all specifically designated in an ATTACK ORDER issued by the senior commander. Usually, the supporting attack is an attack by fire, whereas one or more rifle platoons maneuvering to seize the assigned objective(s) compose

the main attack force. The supporting attack force may contain units from the weapons platoon. In fact, the two major construction or rifle companies (Charlie and Delta) of a construction battalion each have their own weapons platoon. The reserve force is kept to the rear of the attacking forces where it can readily move to the attack should the need arise. There are no fixed conditions to determine the most appropriate formation for a given situation. The company commander must weigh all circumstances of terrain, the strength and location of the enemy, and the friendly fire support available to decide on one of the following attack formations (fig. 4-23).

One Platoon in Attack

A formation of one platoon in attack and two platoons in reserve provides limited firepower to the front and a strong reserve. This formation should be used when information about the enemy is vague or when the company attacking has one or both flanks exposed. This formation may be used when only a single, narrow avenue of approach is available or when you are attacking to seize an objective deep in enemy territory. The reserve platoons may follow the attacking platoon in company column, or they may be positioned to protect one or both flanks. This formation provides a lot of variety in positioning and moving reserve platoons and allows the company commander maximum flexibility in maneuvering and controlling these platoons.

Two Platoons in Attack

Two platoons in attack and one platoon in reserve provide moderate firepower to the front while retaining a reserve large enough to influence the action. This formation may be appropriate when relatively detailed information concerning the enemy is available.

Three Platoons in Attack

When formation has three platoons in attack and none in reserve, the company lacks a reserve force to influence the action. This formation provides maximum firepower to the front and is useful when a wide area must be cleared rapidly or when the enemy situation is known.

WEAPONS UNITS FORMATIONS

Weapons platoons provide maneuvering rifle units with machine gun, rocket, and mortar fire during the attack. This is normally done by deploying the weapons

units in strategic locations, so they can deliver a large volume of fire against the enemy position. This fire, known as the BASE OF FIRE, is intended to keep the enemy pinned down while the rifle units maneuver against them.

After a decision is made for a weapons unit to accompany a rifle unit in the assault, that unit (team, squad, or platoon) is directly under the command of the senior rifle unit leader. For example, one machine gun squad consisting of two machine gun teams could be attached to a single rifle platoon. Then the machine gun squad leader is directly under the control of the rifle platoon commander. During any advance or movement, the machine gun section leader positions himself within easy signaling distance of the rifle platoon commander. The positions of the two machine gun teams are well within the advancing unit in sight of their squad leader. Preferably, they are in a position to move quickly to either flank. The rifle unit leader must provide the weapons units with security in all directions. When possible, there should always be at least one fire team between a weapons unit and the enemy.

There are no combat formations specifically designed for the weapons units. However, the units should assume a formation similar to that being used by the unit to which they are attached. So, if the rifle unit leader forms his men into a line to cross an open area, the weapons unit leader should do the same with his men.

Once a position is reached where the weapons can effectively provide a base of fire, the rifle unit leader should order the weapons unit leader to set up his weapons. Targets should be designated by the rifle unit leader. Once the enemy is engaged, the rifle units can maneuver to overrun and destroy them. The weapons units should continue to deliver fire until the enemy is destroyed or until they are endangering their own troops.

PATROL AND AMBUSH

A patrol is a detachment of troops sent out from a larger body on a mission of combat, reconnaissance, security, or contact with friendly units. There are two general classes of patrols—reconnaissance and combat—either of which could have a mission of security. The classification is derived from the mission assigned to a patrol. In the Seabees you are primarily concerned with defensive combat; therefore, when training your men in patrolling, your emphasis should be on security patrolling, rather than aggressive patrolling.

In security patrolling, both reconnaissance (recon) and combat patrols are used. The typical Seabee defense is a static defense; therefore, the recon patrol is mainly used to detect enemy movement toward your position. The combat patrol is used to destroy enemy recon patrols and to delay and confuse an enemy attack.

RECONNAISSANCE PATROL

Reconnaissance patrols are sent out to gain information about the enemy or the terrain. These patrols engage in combat only when it becomes necessary to accomplish their mission or to protect themselves. In general, they should avoid combat and accomplish their mission by stealth.

Reconnaissance patrols have a variety of missions, but their primary mission is to obtain and report information in a timely manner to the commander who desires it.

A reconnaissance patrol might be dispatched to do the following:

1. Locate and observe the characteristics of a hostile position or installation
2. Reconnoiter a possible route of march for an enemy force.
3. Reconnoiter a certain terrain feature or the general nature of the terrain in a given locality.
4. Patrol the perimeter of the defense area in a static defense. Of primary importance is enemy troop buildup or movement and the type of weaponry in their possessions.

The missions mentioned above are by no means all-inclusive and are provided merely as examples.

PRIMARY AND SECONDARY MISSIONS

A patrol should never be given more than a single primary mission. However, an ALTERNATE mission can be assigned that may be carried out if the primary mission cannot be achieved. In addition, SECONDARY missions may be assigned when they are consistent with carrying out the primary or alternate mission.

SIZE OF PATROLS

A patrol may consist of two men, a fire team, or a larger tactical unit. The size of a combat patrol or reconnaissance patrol depends on several influencing factors that must be considered before the patrol is dispatched. Sometimes, a small patrol may be able to

execute the mission. At other times, a strong combat patrol may be needed. In general, a patrol is comprised of the least number of men needed to carry out a given mission, with careful thought given to safety, time available, and messenger requirements.

The size of a patrol is influenced by the following factors:

1. Mission
2. Terrain and visibility
3. Distance from friendly troops
4. Time the patrol will be out
5. Number of messages the patrol may have to send back
6. Whether prisoners are to be captured and sent back

Patrols with missions requiring combat or a strong likelihood of combat are usually stronger than patrols on reconnaissance missions. Also, when a patrol intends to be gone for some time and is going to operate at a considerable distance from friendly troops, the patrol must be stronger because there is greater danger from enemy attack.

A reconnaissance patrol rarely exceeds a squad in size. Units larger than a squad are too noisy, more difficult to control, move more slowly, and have greater difficulty approaching the enemy without detection. The fire team is ideal for short-range reconnaissance patrols.

The patrol leader receives a **PATROL ORDER** containing all the instructions, information, and guidance needed to plan, prepare for, and accomplish a particular type of mission. Patrol orders are discussed further in chapter 11.

A patrol order varies according to circumstances, such as checkpoints, general route, and communications plan.

The **TIME OF DEPARTURE** may be in general terms: "Leave after dark" or "Leave before daylight." However, a patrol order may give a specific time of departure to avoid congestion in a particular area, to reduce the possibility of collision between patrols, to maintain strict control by the command, or for other reasons.

The **TIME OF RETURN** maybe either general or specific. Information obtained by a reconnaissance patrol can have a significant impact on future combat operations. Every effort must be made to provide reports at the time(s) specified.

CHECKPOINTS are points along the patrol route from which the patrol is expected to report in-usually by radio.

The **GENERAL ROUTE** is usually designated by checkpoints. An exact route is seldom feasible except in reconnaissance. When command desires to maintain strict control of the patrol, the order may specify an exact route.

The **COMMUNICATIONS PLAN** lists the reports the patrol must make and the medium (usually radio) by which they are to be sent.

PATROL FORMATIONS

A particular patrol formation. should provide for all-around security and good control. The formation chosen should be such that only a minimum number of men within the patrol are likely to be pinned down at any one time by surprise fire.

Patrol formations must be fluid and flexible. They must be changed to meet varying terrain and visibility conditions. The patrol leader designates the original formation. Individual members then maintain assigned positions as long as they can see each other and, at the same time, make full use of available cover and concealment.

Patrols use basic combat formations. For small patrols in open terrain, the wedge is a suitable formation. For larger patrols or when visibility becomes restricted, the column formation, with its necessary security elements, should be used.

When enemy contact is near or has already been made, patrol leaders should adopt more deployed formations.

Normally, the following factors influence and change a patrol formation:

- Mission
- Terrain
- Visibility
- Enemy situation
- Size of patrol
- Required speed of movement

The formations taken by a patrol are **ALWAYS** influenced by the need for maintaining

1. security,

2. the mission, and
3. the route of the patrol.

CONTROL

The patrol leader places himself where he can best maintain control. Normally, this is at, or near, the head of the patrol but depends somewhat upon the patrol route. When the route is clearly defined, the leader should take a position within the patrol wherever his signals can best be seen by patrol members. If the route is ill-defined as in dense woods, jungle, or at night, the leader must be in, or with, the leading group.

The second in command, the assistant patrol leader, assists the patrol leader in controlling the patrol. He helps the patrol leader by controlling the rear of the patrol and by preventing men from falling behind or getting out of position. He is continually alert for signals or orders and watches to see the other members receive those orders or signals. He observes the rear to prevent the patrol from attack from that direction. He is ready to assume command of the patrol if the leader becomes a casualty.

Patrols are controlled in the daytime by arm-and-hand signals and oral orders. Each member of a patrol must be thoroughly familiar with the standard arm-and-hand signals. These signals are discussed in chapter 11. Before contact with the enemy has been made, the patrol leader must issue his orders. Oral orders are a sure means of control. Commands should be just loud enough to be heard by patrol members. When near the enemy, you should halt the patrol before issuing orders. The leader moves from man to man and quietly provides instructions. Sound signals may be used if they will not be confused with other noises. When a sound signal is to be used, the patrol leader should rehearse it before beginning the patrol. Control by voice is usually better than by other sound signals.

Though darkness helps a patrol move close the enemy without being detected, it increases the problem of control. To overcome this, each man is required to keep in sight of the man to his front and flank. This procedure ensures everyone is in position to receive signals and orders.

SECURITY

All-around security must be maintained at all times. This is done within a patrol by using formations that provide protection to the front, flanks, and rear. These elements are the eyes, ears, and fingers of the patrol

leader. The patrol moves by following his signals. They must maintain contact with him at all times, except when a bush or small terrain feature briefly gets in the way. To maintain contact with the patrol leader, security elements must glance in his direction every few steps.

Point and Scouts

Small patrols may use only one man or as many as a fire team as the point. The size depends on the enemy situation, terrain, and patrol route. Normally, a squad-size patrol uses two riflemen as scouts; however, should the patrol come into a dangerous area or close to the enemy, the leader might increase the number in the point. The leader may use an entire fire team to cover the advance of the patrol.

The automatic rifleman moves slightly behind the rest of the fire team. From this position, he can cover the movements of the scouting element. The size of the point increases in relation to the size of the patrol.

The point is responsible for investigating the route of advance immediately to the front of the patrol. When visibility is good, it may precede the main body by as much as 100 yards. The point must always maintain visual contact with the patrol leader.

Flanks

One man on each side may provide flank security for a patrol the size of a squad, or less. The flanks move as directed by the patrol leader. In special instances, two-man groups may be necessary. Such a group keeps one man where he can see the patrol leader at all times. He remains within 100 yards of the leader. The man farther out remains in sight of the inside man, normally within 20 to 25 yards.

In open terrain, the flankers should investigate cover within 100 yards of the general route of march of the patrol. Flankers may become impractical because of reduced visibility in dense woods or jungle. Then the men normally assigned to flank protection move with the patrol itself. They maintain close observation to their assigned flank.

Rear Point

A small patrol normally has only one rifleman assigned as rear point. He remains in sight and within about 50 yards of the last man of the patrol. This rifleman maintains rear security for the patrol by constantly observing to the rear. If the patrol is ambushed, he stays out of the fire fight. If the patrol is annihilated or

obviously will be, he is the getaway man and returns to friendly lines to report the situation.

The rear point varies in size, depending on the enemy situation and the size of the patrol. Usually, keeping a sharp lookout to the rear to prevent a surprise enemy attack from that direction is necessary.

MOVEMENTS

Before leaving friendly lines, the patrol leader must select a route to his final destination. This may be done on a map, on an aerial photograph, or on the actual ground to be covered. He should select intermediate objectives along that route. These successive objectives regulate the progress of the patrol.

A patrol should always designate one or more rally points where it can reassemble if it is dispersed, ambushed, or surprised by enemy attack. Normally, an intermediate objective becomes the rallying point as the patrol moves beyond it. In this way, the patrol leader can be sure each individual of the patrol is thoroughly familiar with the rallying point locations.

Members of a dispersed patrol should try to reach the designated rallying point quickly so the mission may be readily resumed. If the patrol leader does not arrive within a reasonable period of time, the second in command must reorganize the patrol and carry out the mission.

SPECIAL ORGANIZATION

A special organization is simply a general organization varied to suit a particular mission or a particular set of circumstances; for example, in area reconnaissance, a patrol might be organized into several reconnaissance teams with each team providing its own security and NO separately organized security element; however, the patrol leader uses the same security techniques he uses for a day patrol, modifying them only as necessary.

PATROL PLANNING AND PREPARATION

The first requirement for a patrol leader is a thorough understanding of the patrol order. Be sure you understand all of the instruction clearly and take notes. After you have heard the order, if there are points on which you are not entirely clear, ASK QUESTIONS.

To make the best use of time, facilities, and personnel, the squad leader and the fire team leader

follow a standard procedure (listed below) while preparing for and executing assigned missions. Depending upon the circumstances and the type of operation, the leader may take some steps before he takes others. At times, some steps may not be required or may not be possible because of time limitations. Time is the governing factor in applying patrol planning steps. All steps should be considered, although the degree of consideration for each step may vary. The normal sequence is as follows:

1. Study the mission.
2. Plan use of time.
3. Study terrain and situation.
4. Organize the patrol.
5. Select men, weapons, and equipment.
6. Issue the warning order.
7. Coordinate (continuous throughout the patrol).
8. Make reconnaissance.
9. Complete detailed plans.
10. Issue patrol order.
11. Supervise (at all times), inspect, rehearse, and reinspect.
12. Execute the mission.

STUDY THE MISSION

The patrol leader carefully studies the mission. Through study of the mission, the terrain, and the situation, he identifies the essential tasks to be accomplished to execute the mission. These essential tasks become missions of the patrol's elements and teams for which the organization, personnel, and equipment must be considered.

PLAN USE OF TIME

The first step in planning is to allot (approximately) the available time remaining before departure. When you fully understand the order, mentally outline everything that must be done before you leave, and allot time for each item. Start with the time of departure and work backward. This procedure, titled BACKWARD PLANNING, helps to ensure that you have allowed sufficient time for each necessary action.

STUDY TERRAIN AND SITUATION

Study the friendly and enemy situation closely for the effect that troop dispositions, strengths, and capabilities may have on your mission. These factors will influence the route you take, the size and organization of your patrol, and the weapons and equipment the patrol will carry.

Study the map of the terrain over which the patrol intends to operate. The nature of the terrain in the vicinity of the objective will determine the number of security teams needed and the manner in which you will conduct your leader's reconnaissance of the objective.

ORGANIZE THE PATROL

Organizing consists of determining the elements and teams required to accomplish the mission of the patrol. Organization of the patrol, either special or general, is given in the patrol warning order.

SELECT MEN, WEAPONS, AND EQUIPMENT

The patrol leader selects patrol members from the platoon or squad he commands. He should maintain the regular fire team or squad organization when possible. No man who may interfere with the mission should be included in the patrol. An example is a man with a cold. His coughing or sneezing could give the patrol away to the enemy.

The patrol takes along only those weapons absolutely necessary for mission accomplishment. The same criterion applies to the equipment. Five categories of equipment are usually required. They are as follows:

- **OBJECTIVE AREA** equipment. This IS the equipment you need to accomplish the mission. It includes such items as weapons and ammunition, demolition charges, and fiber line (small stuff) for binding prisoners.

- **EN ROUTE** equipment. This is equipment that assists or enables you to reach the objective. It includes such items as maps, compasses, binoculars, flashlights, wire cutters, and stream-crossing lines.

- **CONTROL** equipment. This is equipment for maintaining communications and control. It includes telephones, whistles, pyrotechnics, flashlights, and luminous tape.

- **WATER AND FOOD.** Every man carries a canteen of water. On a long patrol, each man may carry

two canteens plus rations to cover mealtimes during absence. For a very long patrol, arrangements must be made to resupply food and water.

- **ROUTINE** equipment. This is the equipment patrol members carry. It includes the uniform and web equipment. Usually, each man carries a poncho and one extra pair of socks. Gloves should be worn, even in warm weather, to protect your hands from thorns, sharp rocks, and barbed wire.

ISSUE THE WARNING ORDER

To give individual patrol members maximum time to prepare, the patrol leader should issue a **WARNING ORDER** to **ALL** members as soon as possible after the patrol order is received. The warning order should include the following:

- A brief statement of the situation so patrol members will know what friendly and enemy units are doing.
- The mission of the patrol, given exactly as it was received.
- General instructions.

General instructions should include the following:

- The patrol's general or special organization; that is, assigning specific tasks to specific elements.
- The specified uniforms, including any camouflage and identification measures.
- The specific weapons, ammunition, and equipment.
- The individuals to accompany the patrol leader on reconnaissance and those individuals that are to supervise subcategories of preparation.
- Instructions for obtaining water, rations, weapons, ammunition, and equipment.

The chain of command. (In a patrol composed of personnel from different units, the patrol leader establishes a chain of command.)

The time schedule. (The time schedule includes mealtimes and the time, place, and uniform for receiving the patrol leader's order.)

COORDINATION

In general, coordination means the arrangements made by other units to cooperate in the mission of the patrol. Examples are as follows:

Friendly units in whose areas the patrol will operate must be informed so the patrol will not be endangered by fire from other friendly units.

To depart from or reenter a friendly area, the unit occupying that area may be required to provide guides to lead the patrol around obstacles, such as mines or wire.

Friendly units may be called on to give the patrol fire support. Fire support is fire delivered for the purpose of aiding another unit by doing the following:

- Inflicting casualties on the enemy
- Diverting the attention of the enemy from the patrol
- Concealing the movements of the patrol by smoke
- Providing illumination
- Giving the patrol directional guidance

You may be required to establish coordination with other units yourself, or some or all of your coordination may be established by the command. In the latter case, you must check to ensure that nothing required has been overlooked.

MAKE RECONNAISSANCE

While the patrol is preparing for the mission, the leader should make a visual reconnaissance, when possible, to get information not available on the map. This should be an aerial reconnaissance, if possible. Check the route to be followed, noting prominent features of the terrain and any signs of enemy activity. When aerial reconnaissance is impossible, try to find a good location from which to observe the area.

COMPLETE DETAILED PLAN

After the patrol leader has received the patrol order, issued the warning order, and made a reconnaissance, he prepares a detailed plan for accomplishing the mission. This plan includes the following:

The specific duties of each element.

The route of return and an **ALTERNATE** route in case of detection by the enemy.

Patrol conduct, such as

- the formation to maintain and the order of movement to follow,
- the points of departure from and reentry into friendly areas,
- the rallying points and the action(s) to take there,
- the action to take upon enemy contact,
- the action to take in danger areas, and
- the action to take at the objective.

Check to ensure that all the weapons, ammunition, and equipment specified in the warning order have been obtained.

Determine the disposition to be made of friendly forces that are wounded and enemy prisoners.

Signal system to use.

Report system to follow.

Challenge and password to use not only within the patrol but also in areas covered by other friendly units.

Check to ensure that everybody has a place in the chain of command.

Location of leaders—that is, where the leader plans to be in the formation and where the leader plans to station the assistant patrol leader.

ISSUE OF PATROL ORDERS

A patrol leader should issue orders in a clear, concise, and forceful manner. Follow the standard operation order format, as shown in figure 11-36 of chapter 11. All patrol members should be present. The patrol leader precedes the order with a complete oral description of the plan and answers all questions after completing the order.

SUPERVISE, INSPECT, REHEARSE, AND REINSPECT

The patrol leader should hold a **REHEARSAL** of the mission, even if the patrol is thoroughly experienced. Before the rehearsal, the leader should hold an **INSPECTION** to determine the state of readiness, both physical and mental, of the men. The patrol leader must satisfy himself as to the completeness and correctness of uniform, weapons, and equipment. Then he will

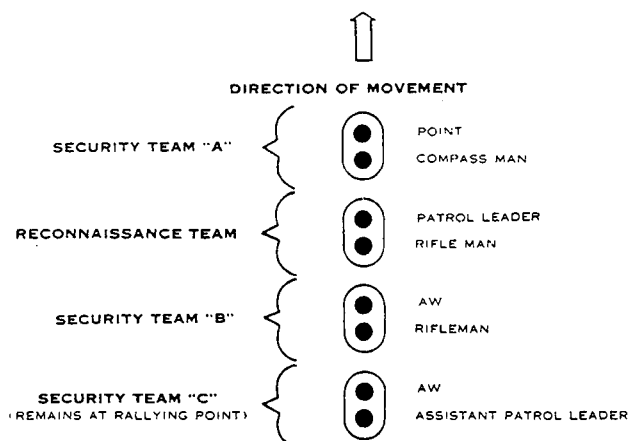

Figure 4-24.—Sample of reconnaissance patrol organization for movement.

question the men to ensure that each man knows the following:

- The planned operations of the patrol
- The part he will play
- What others will do, insofar as their actions relate to him
- All challenges, passwords, reporting times, and other significant details

A rehearsal improves the operational proficiency of the patrol and allows you to check the plans and to make needed changes. If the patrol is to operate at night, conduct both day and night rehearsals. When possible, use terrain similar to that over which you will operate. If time permits, rehearse all actions. Where time is limited, rehearse critical actions. Action at the objective is the most critical phase of the patrol and should always be rehearsed.

Supervision is continuous by all patrol leaders throughout the planning, preparing, and completing of the patrol mission.

EXECUTE THE MISSION

The successful completion of a patrol is the end result of the continuing efforts of every patrol member, including yourself, who has earnestly applied knowledge, skills, and ingenuity to accomplish the mission.

Some of the principles to follow in the conduct of your patrol and some of the techniques you may use are provided below. Remember, details vary with different circumstances.

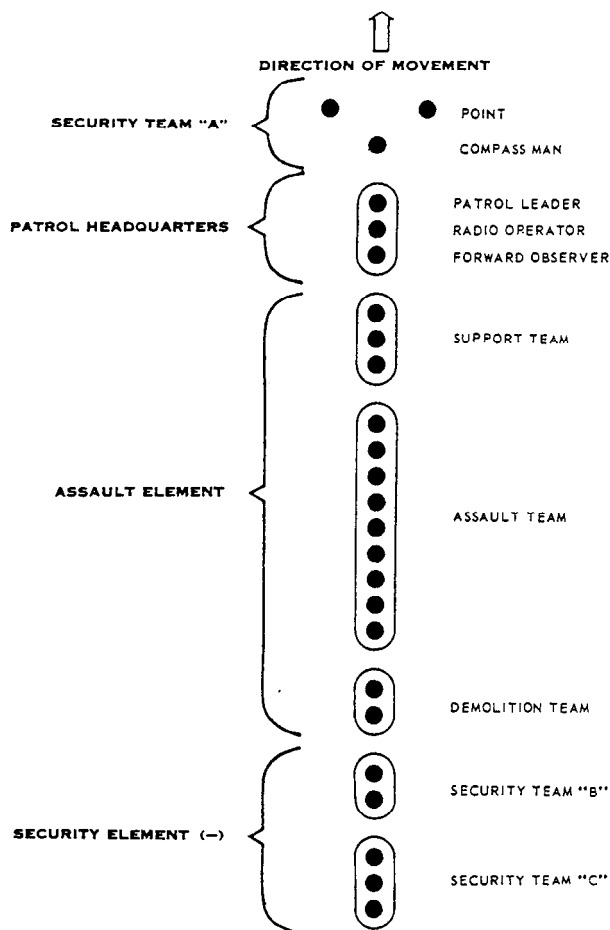

Figure 4-25.—Example of combat patrol organization for movement.

Formation and Order of Movement

The elements of the patrol are established by its general organization. The formation in which the patrol moves forward and the location of elements in the formation are called **ORGANIZATION FOR MOVEMENT**. An example of a reconnaissance patrol organization for movement is shown in figure 4-24. An example of a combat patrol organization for movement is shown in figure 4-25.

Departure and Reentry of Friendly Areas

Move cautiously when you approach positions in friendly areas; you will be regarded as an enemy until identified otherwise. The patrol leader should halt the patrol near the position; then go forward and contact the position and, if possible, the local **LEADER**. He takes at least one man with him. He may take more if the situation permits, but remember that unusual activity at a forward position may attract enemy attention. The

patrol leader tells personnel at the position the information they may need to assist him, such as the size of his patrol, his general route, and his expected time of return.

Request the latest information on the enemy, the terrain to the front, and any known obstacles or dangers. Check for communication facilities, fire support, and other assistance they can provide. Check the challenge and password, and determine whether the same personnel will be manning the position when you return. If not, ask them to relay information about your patrol to their relief. If you intend to be out longer than 1 day, obtain the challenge and passwords for each day you are out.

Rallying Points

A rallying point is a designated place where a patrol that has been dispersed can assemble and reorganize. It should provide cover, concealment, and be defensible for at least a short time. It must be easily recognizable and be known to all members of the patrol. Until a rallying point has been actually reached and found to be suitable, you should designate it as a **TENTATIVE RALLYING POINT**. To designate a definite rallying point, the patrol leader halts the patrol when he arrives there. He then announces, "This is a rallying point," and points out the identifying features.

There are three **TYPES** of rallying points:

1. **INITIAL** rallying point. This is a point within the friendly area where the patrol can rally if it becomes scattered before leaving the friendly area or before reaching the first tentative rallying point outside the friendly area.

2. **EN ROUTE** rallying point. This is a rallying point lying between the foremost friendly area and the objective.

3. **OBJECTIVE** rallying point. This is a rallying point near the objective where the patrol assembles after accomplishing the mission.

The patrol leader must select and designate a tentative initial and objective rallying point before the patrol starts off. If these points prove suitable when he reaches them, then he confirms them by declaring them rallying points. He will select other points en route as he reaches suitable locations.

The following are general rules for the use of rallying points:

1. Select the initial and the en route rallying points to prevent complete disintegration of the patrol if it is unavoidably dispersed before reaching the objective.

2. The objective rallying point makes it possible for the patrol to reassemble after it has dispersed to carry out the objective.

3. If the patrol is dispersed in friendly areas, it reassembles at the initial rallying point.

4. If the patrol is dispersed between the initial rallying point and the first en route rallying point, it will assemble at one or the other of these points. The patrol leader must designate in his patrol order whether he desires reassembly at the initial rallying point or the first en route rallying point.

5. If the patrol is dispersed between en route rallying points, it will assemble either at the last rallying point or at the next (tentative) rallying point. Again, the patrol leader must designate which of these alternatives he desires. In this and the former case, circumstances will control his decision.

Action on Enemy Contact

A patrol is subject to two types of enemy contact: (1) **CHANCE** contact and (2) **AMBUSH**. In chance contact, you come on the enemy unexpectedly, and the enemy is not prepared to deal with you. In ambush, you are subjected to an intentional surprise attack by an enemy that is concealed and lying in wait.

In a chance contact, you must break contact as quickly as possible and continue the mission. If you engage the enemy any longer than necessary, you could jeopardize the mission. The "clock" system is one way of breaking contact. The line of direction along which the patrol is moving is considered to be 12 o'clock. If the patrol leader called out "10 o'clock-200," that would order the patrol to move off 200 yards in the 10 o'clock direction. The patrol must, as far as possible, keep the original formation.

FIRE AND MOVEMENT is another way of breaking a chance contact. One portion of the patrol returns enemy fire while another portion moves off. The two groups alternate covering fire and movement until both have broken contact.

In an ambush, you may have the alternative of an assault in force to break through the ambush or a withdrawal like that used in a chance contact; however, a well-placed ambush usually prevents withdrawal by the flank. When you must break through by assault,

quickly determine the point of weakest enemy fire and assault this point with maximum firepower.

Action at Patrol Objectives

On a reconnaissance patrol, the patrol leader halts and conceals the patrol near the objectives; the place where he does this is usually the objective rallying point. He conducts a leader's reconnaissance to pinpoint the objective, then returns to the patrol and positions security teams according to the plan. He places these teams where they can best provide early warning of enemy approach and best cover the reconnaissance element. Then he reconnoiters the objective.

The patrol leader may be able to get the required information quickly and simply. Usually, the patrol leader must move to several positions, perhaps making a circle around the objective. In the event he must do this, the patrol leader instructs his assistant patrol leader to continue the mission if he does not return within a reasonable time. When reconnaissance is complete, the patrol leader assembles the patrol at the objective rallying point and tells everyone what he saw and heard. He has each man contribute anything significant that may have been seen or heard. He makes a preliminary report by radio whenever possible; then he returns to the unit as quickly as possible to make a full report.

AMBUSH

An ambush is a surprise attack from a concealed position upon a moving or temporarily halted target. The ambush is one of the oldest and most effective military operations. Ambush may include assault to close with, and decisively engage, the target or the attack maybe by fire only. Ambush is highly effective in conventional operations but is even more suitable and effective in guerrilla and counter guerrilla operations.

Ambush is a favorite tactic of guerrilla forces because it does not require that ground be seized and held. Also, it enables small forces with limited weapons and equipment to harass or destroy larger, better armed forces. An ambush is an effective counter guerrilla measure because it forces the guerrillas to engage in decisive combat at unfavorable times and places. An ambush denies the guerrillas the freedom of movement on which their success so greatly depends. It also deprives the guerrillas of weapons, ammunition, and equipment that is difficult to replace; and the death or capture of "hard core" personnel greatly weakens the guerrilla force.

Ambushes are executed for the general purpose of reducing the overall combat effectiveness of the enemy and for the specific purposes of destruction and harassment. Destruction is the primary purpose because the loss of men killed or captured and the loss of equipment and supplies destroyed or captured critically affects the enemy. The capture of equipment and supplies may assist our forces.

Harassment is a secondary purpose. Though less apparent than physical damage, it is very important. Frequent ambushes force the enemy to divert men from other missions to guard convoys, troop movements, and carrying parties. When patrols fail to accomplish their missions because they have been ambushed, the enemy is deprived of the valuable contributions these patrols would make to the combat effort. A series of successful ambushes causes the enemy to be less aggressive and more defensive. They become apprehensive, overly cautious, reluctant to go on patrols, to move in convoys, or to move in small groups. After being ambushed, the enemy seeks to avoid night operations, are more subject to confusion and panic, and generally decline in effectiveness.

The two main types of ambush are point ambush and area ambush. A **POINT AMBUSH** is one where forces are deployed to support the attack of a single killing zone. An **AREA AMBUSH** is one where forces are deployed for multiple, related point ambushes.

In a deliberate ambush (an ambush planned as a specific action against a specific target), detailed information about the target is required: the size, nature, organization, armament, equipment, route of movement, and the times the target will reach or pass certain points on its route. There are two situations where deliberate ambushes should be planned. The first situation is when you receive reliable information on intended movement of a specific force; the second is when patrols, convoys, carrying parties, or similar forces establish patterns of size, time, and movement sufficient to permit detailed planning for this ambush.

The ambush of a target of opportunity is often the action of a search and attack patrol. When available information does not permit the detailed planning required for deliberate ambush, an ambush of opportunity is planned. Then the ambush force plans and appeals. A search and attack patrol, before departing, plans and rehearses the ambush of the types of targets that may be encountered. This force establishes and executes ambushes as targets of opportunity arise.

FUNDAMENTALS OF SUCCESSFUL AMBUSH

Surprise, coordinated fire, and control are the basic elements essential to a successful ambush.

Surprise must be achieved or the attack is not an ambush; surprise distinguishes ambush from other forms of attack. Also, surprise allows the ambush force to seize and retain control of the situation. When complete surprise cannot be achieved, it must be so nearly complete that the target is not aware of the ambush until too late for effective reaction. Surprise is achieved by careful planning, thorough preparation, and exact execution. Only through detailed planning and thorough preparation can you make a sound decision on when, where, and what type of targets you should or should **NOT** attack and how you will attack so the enemy is **LEAST** prepared.

All weapons, including mines and demolitions, must be positioned. All firepower, including that of available artillery and mortars, must be coordinated to achieve the isolation of the killing zone to prevent escape or reinforcement. An ambush must also achieve the surprise delivery of a large volume of highly concentrated fire into the killing zone. The fire must inflict maximum damage so, when desired you can speedily assault and completely destroy the target.

Close control must be maintained during movement to, occupation of, and withdrawal from the ambush site. The ambush commander must effectively control all elements of the ambush force. Control is most critical at the time of approach of the target. Control measures must provide for the following:

1. Early warning of target approach
2. Withholding of fire until the target has moved into the killing zone
3. Opening fire at the proper time
4. Initiation of the right actions if the ambush is prematurely detected
5. Lifting or shifting of supporting fires when the attack includes assault of the target
6. Timely and orderly withdrawal of the ambush force to an easily recognizable rally point

The men of the ambush force must maintain maximum control themselves so they do not compromise the ambush. They must use patience and self-discipline by remaining still and quiet while waiting for the target to appear. They may have to endure insect

bites, to thirst in silence, to resist the desire to sleep, to ease cramped muscles, and to perform normal body functions. When the target approaches, the men must resist the temptation to open fire before the signal is given.

POINT AMBUSH

A point ambush can be used independently or as part of an area ambush. In a point ambush, the attack force is positioned along the target's expected route of approach. The formation is an important consideration because it determines whether a point ambush is able to deliver the heavy volume of highly concentrated fire necessary to isolate, trap, and destroy the target.

The formation is determined by careful consideration of possible formations and the advantages and disadvantages of each in relation to the following:

1. The terrain, conditions of visibility, forces, weapons, and equipment
2. The ease of difficulty of control, and the target to be attacked
3. The overall combat situation

In this training manual, a few formations that have been developed for the deployment of point ambushes are discussed. Those discussed are identified by giving them names that correspond to the general pattern formed on the ground by the deployment of the attack force.

Line

The attack force is deployed generally parallel to the target's route of movement (road, trail, stream, etc.) This positions the attack force parallel to the long axis of the killing zone and subjects the target to heavy flanking fire. The area that the attack force can effectively cover with a heavy volume of highly concentrated fire limits the size of the killing zone that can trap the target. The target is trapped in the killing zone by natural obstacles, mines (Claymore, antivehicular, and antipersonnel), demolitions, and direct and indirect fire. A disadvantage of the line formation is the chance that lateral dispersion of the target may be too great for effective coverage. The line formation is appropriate in close terrain that restricts target maneuvers and in open terrain where one flank is restricted by natural obstacles or can be restricted by mines, demolitions, man-traps, or stakes. Similar obstacles can be placed between the attack force and the killing zone to provide protection from the target's

counterambush measures. When a destruction ambush is deployed in this reamer, access lines are left so the target can be assaulted. An advantage of the line formation is its relative ease of control under all conditions of visibility.

The L

The L-shaped formation is a variation of the line formation. The long side of the attack force is parallel to the killing zone and delivers flanking fire. The short side of the attack force is at the end of, and at right angles to, the killing zone and delivers enfilading fire that interlocks with fire from the other leg. This formation is very flexible. You can establish it on a straight stretch of a trail, stream, or at a sharp bend in a trail or stream. When appropriate, fire from the short leg can be shifted to parallel the long leg if the target attempts to assault or escape in the opposite direction. In addition, the short leg prevents escape in its direction and reinforcement from its direction

The Z

The Z-shaped formation is another variation of the line formation. The attack force is deployed as in the L formation, but with an additional side so the formation resembles the letter Z. The additional side may serve any of the following purposes:

1. To engage a force attempting to relieve or reinforce the target
2. To seal the end of the killing zone
3. To restrict a flank
4. To prevent envelopment

The T

In the T-shaped formation, the attack force is deployed across and at right angles to the target's route of movement so the attack force and the target form the letter *T*. This formation can be used day or night to establish a purely harassing ambush and, at night, to establish an ambush to stop or hamper enemy movement through open, hard-to-seal areas, such as rice paddies.

A small force can use the T formation to harass, slow, and disorganize a larger force. When the lead elements of the target are engaged, they normally attempt to maneuver right or left to close the ambush. Mines, man-traps, and other obstacles placed to the flanks of the killing zone slow the movements of the enemy. They also permit the ambush force to deliver

heavy fire and withdraw without becoming decisively engaged. An ambush established and executed in this manner is called a "bloody nose" ambush.

The T formation can be used to stop or hamper small groups attempting night movement across open areas; for example, you can deploy the attack force along a rice-paddy dike with every second man facing in the opposite direction. The attack of a target approaching from either direction requires only that every second man shift to the opposite side of the dike. Each man fires only to his front and only when the target is at very close range. Attack is by fire only and each man keeps the target under fire as long as it remains on his front. When the target attempts to escape in either direction along the dike, each man takes it under fire as it comes to his vicinity. The T formation is very effective at halting infiltration. But it has one chief disadvantage—there is a possibility that the ambush will engage a superior force at night while spread out; therefore, use of this formation must fit the local enemy situation.

The V

Deploy the V-shaped attack force along both sides of the target's route of movement so it forms the letter *V*. Care is taken to ensure that neither group nor leg fires into the other. This formation subjects the target to both enfilading and interlocking fire. The V formation is best suited for fairly open terrain but can also be used in the jungle. When established in the jungle, the legs of the V close in as the head elements of the target approach the apex of the V and open fire from close range. Here, even more than in open terrain, all movement and fire must be carefully coordinated and controlled to ensure that the fire of one leg does not endanger the other. The wider separation of forces makes this formation difficult to control, and there are fewer sites that favor its use. The main advantage of the V formation is the target has difficulty detecting the ambush until the ambush force is well into the killing zone.

COUNTERAMBUSH DRILLS

When a patrol is ambushed, the immediate action drill to use is determined by whether the ambush is near or far.

In a NEAR ambush, the killing zone is under heavy, highly concentrated, close-range fire. There is little time or space for men to maneuver or seek cover. The longer they remain in the killing zone, the more certain their destruction; therefore, if attacked by a NEAR ambush, the patrol should react as follows:

1. Men in the killing zone, **WITHOUT ORDER OR SIGNAL**, immediately assault directly into the ambush position, occupy it, and continue the attack or break contact as directed. This action moves them out of the killing zone, prevents other elements of the ambush from firing on them without firing on their own men, and provides positions from which other actions may be taken.

2. Men not in the killing zone must maneuver against the attack force and other elements of the ambush as directed.

3. To eliminate the ambush or to break contact, the men continue the attack as directed.

In a **FAR** ambush, the killing zone is also under heavy, highly concentrated fire but from a greater range. This greater range provides men in the killing zone some

space to maneuver and an opportunity to seek cover at lesser risk; therefore, if attacked by a Far ambush, the patrol should react as follows:

1. Men in the killing zone, **WITHOUT ORDER OR SIGNAL**, immediately return fire. They should take the best position available and continue firing until directed otherwise.

2. Men not in the killing zone must maneuver against the ambush force as directed.

3. To eliminate the ambush or to break contact, the men continued the attack as directed.

In each situation, the success of the counterambush drill used is dependent on the men being well trained in recognizing the nature of an ambush and well rehearsed in the proper reaction.

CHAPTER 5

LAND NAVIGATION

Terrain is another name for a piece of ground. For our purposes, it is a region or territory viewed for its suitability as a battleground. How you make use of the terrain—its texture, even its color at different times of the day—affects everything you or the enemy do or can do. Both you and the enemy have the terrain of the battlefield in common. More often than not, victory goes to whoever understands and uses the terrain best.

Usually, the terrain dictates troop movements and formations, positions to be defended, and locations of weapons. You cannot memorize definite rules to cover every situation. However, there are certain principles discussed in this chapter that, when applied intelligently, will result in sound solutions or decisions. Knowledge of these principles is not enough to give you the advantage. You must know the terrain intimately to use it properly. Other than making a personal reconnaissance of the terrain, you must be thoroughly familiar with the use of commercially prepared maps as well as maps drawn hastily in the field. You must also interpret signs and symbols used on maps, prepare field sketches and overlays, and use the lensatic compass properly.

TERRAIN APPRECIATION

Terrain appreciation is the analysis of an area to determine the effect that the terrain features have on probable military operations by either of the opposing forces. Terrain can be viewed with either offensive or defensive intentions in mind. However, regardless of the type of mission, each Seabee leader must evaluate the terrain for both offense and defense. Then the Seabee leader can anticipate the enemy's analysis of the situation as well as his own. Information on the terrain may be acquired through various sources, but a physical reconnaissance of the area is the most important and reliable method of obtaining accurate information. When a physical reconnaissance is not possible or additional information is desired, it may be provided by one or more of the following sources:

1. Aerial reconnaissance and photographs
2. Maps of the area
3. Terrain models provided by higher authority

4. Intelligence reports
5. Patrolling
6. Friendly natives, undercover agents, or captured enemy prisoners

COMPONENTS OF TERRAIN

In military terminology, terrain is simply the ground over which we intend or propose to fight. To a military man, the word *terrain* is an all-inclusive term, referring not only to the ground itself, but to all other conditions that influence the ability of the combatant to carry out an assigned mission. For the sake of simplicity, terrain has two major aspects. The first is weather, climate, and season; the second is topography.

WEATHER CLIMATE, AND SEASON

WEATHER is the day-to-day changes in atmospheric conditions. CLIMATE is the average weather over an extended period of time. SEASONS are characterized by particular conditions of weather, such as summer and winter in the United States or the rainy and dry seasons in Southeast Asia. Of these three elements, weather is the most important consideration from a tactical viewpoint. For long-range planning or in the absence of weather information, climatological and seasonal data may be used to estimate weather conditions.

The Elements of Weather

Weather consists of several atmospheric elements, each affecting tactics in its own way. These elements are as follows:

1. TEMPERATURE. The degree of hotness or coldness in a geographic area.
2. HUMIDITY. The percentage of water vapor in the air.
3. VISIBILITY. The ability to see both horizontally and vertically. It is influenced by fog, haze, heat refraction, clouds, or precipitation.

4. **PRECIPITATION.** The depositing of moisture (rain, mist, snow, sleet, hail) from the atmosphere upon the surface of the earth, expressed in kind and amount.

5. **WIND.** The movement of air within the atmosphere. It is expressed as strength (velocity) and direction.

6. **PHASES OF THE MOON.** Usually, phases of the moon are expressed in quarters. The first quarter is between the new moon and the full moon; the second, or last quarter, between the full moon and the new moon. The two phases have a direct bearing on night visibility and the amount of rise and frill of the tides.

The Effect of Weather on Tactics

Weather has a direct effect on the visibility, the movement, and the use and effect of weapons. Horizontal visibility may be materially reduced (resulting in reducing the observation of the enemy or the effect of your fire on them) by fog, haze, heat refraction, or precipitation. Vertical visibility may be restricted by fog, precipitation, or a large mass of low-lying clouds, thus reducing the effectiveness of air support or aerial reconnaissance. Ease of movement, both logistical and tactical, on roads or cross-country may vary drastically from day to day because of precipitation and temperature changes. A heavy rain may change a passable area into an impassable quagmire; but a severe temperature drop may cause the same quagmire to freeze, thus aiding movement.

Weather affects weapons, both in employment and in the effectiveness of the weapon itself. The trajectory of artillery and mortar rounds is greatly influenced by temperature and humidity. Extreme cold and hot weather require special treatment and handling of gasoline engines, thus affecting the use of equipment and vehicles. The effects of weather are particularly noticeable in air and naval weapon systems support. Air support may be restricted or prevented entirely by clouds, fog, or heavy precipitation. Fog, snow, or heavy rainfall reduce visibility; therefore, naval gunfire support cannot be delivered as effectively, and new targets cannot be rapidly located and engaged.

TOPOGRAPHY

Topography consists of the physical aspects of the surface of the earth and includes such features as relief and drainage, vegetation, surface materials, and cultural features.

Relief and Drainage

RELIEF is the term given to the differing areas of elevation and depression on the surface of the earth. **DRAINAGE** refers to those areas of surface depression that serve as water runoffs or collection points, such as marshes, swamps, streams, rivers, ponds, and lakes. Knowledge of the general shape of the land is gained through a detailed study of the relief and drainage features. The steepness of slopes; the height and size of hill masses; the depth, the width, and the length of drainage features; and the sizes of valleys and draws are major features to consider when studying the terrain of a given area. These irregularities in the surface of the earth influence tactics by the degree of observation they provide the opposing forces, the ease or difficulty of movement, and the degree of protection provided against enemy fire. Flat ground provides equal observation for the opposing forces; normally, high ground in rolling or mountainous terrain provides for better observation.

Any advances made parallel to a series of ridges or to a river or stream are mechanically easier than movement perpendicular to them. The steepness of a slope may limit movement; tanks, for instance, cannot climb slopes greater than 30 degrees.

Flat ground offers little protection against enemy fire, but rolling ground will, particularly against flat-trajectory weapons.

Vegetation

Vegetation is classified for practical purposes as either **NATURAL** or **CULTIVATED**. Natural plant life includes all types of grasses, bushes, and trees growing without the assistance of man; cultivated vegetation includes all crops and orchards tended by man. Density, height, and types of growth, as well as the diameter of tree trunks, are significant features when you are studying vegetation.

Although vegetation may restrict vision, it offers concealment and limited cover. Of course, the thicker the growth, the harder it is for the forces to move about.

Surface Materials

Surface materials are studied to determine the trafficability of an area. "Trafficability" is defined as the ability of a soil in its normal state to support vehicular traffic moving cross-country or on unimproved roads and trails. In general, all types of soil, except very loose sand, afford good trafficability when dry. However, soils

are seldom completely dry. Water may change soil from a hard, baked clay to slippery, impassable mud within a matter of minutes, especially in tropical areas. Another aspect to consider, along with the types and condition of the soils, is the slope of the ground, the type of vegetation, and the roughness of the surface.

Cultural Features

CULTURAL FEATURES include all the works of man, such as towns, airfields, roads, railroads, and bridges. For military purposes, man-made features are considered an integral part of terrain. Cities and towns are frequently the objectives of an attacking force. For tactical purposes, cultural features may be centers of resistance as well as physical obstacles in your path. Roads, railroads, and bridges are vulnerable links in logistics and communication networks.

MILITARY ASPECTS OF TERRAIN

Various combinations of weather and topography give certain qualities to an area. These qualities, known as the MILITARY ASPECTS OF TERRAIN, must be closely evaluated by each unit leader. These qualities determine to a large degree how he employs his forces and weapons. You can remember these military aspects of terrain by using the acronym KOCOA.

- K – Key terrain features
- O – Observation and fields of fire
- C – Cover and concealment
- O – Obstacles
- A – Avenues of approach

KEY TERRAIN FEATURES

Key terrain is any locality or area that provides the possessor a marked advantage over the enemy. Usually, the factors that make a feature or an area key terrain are superior observation and fields of fire. Obstacles may be considered key terrain when their possession by one force prevents the movement of the opposing force. In some areas, such as mountains and jungles, where movement depends on established roads and paths, routes of communications could be key terrain. A bridge over an unfoldable river could be key terrain, particularly when its seizure eliminates the need for an assault crossing. An airfield could be key terrain when its seizure facilitates the success of local operations or serves as a base to support future operations.

In selecting key terrain, the unit leader is beginning to tie his mission to the ground. Inasmuch as key terrain features offer an advantage to one or both combatants, it is apparent that the defender will strive to retain them while the attacker tries to seize them. For this reason, key terrain is often assigned as the objectives of attacking units; conversely, key terrain aids the defender in disposing his forces to best maintain his battle position.

Selection of key terrain features varies according to the mission. In the attack, the unit leader selects key terrain features forward of the line of departure. In the defense, the terrain that must be held to maintain the integrity of the battle position is designated as key terrain.

Selection of key terrain also varies at the different levels of command. For example, at force level, a large city may offer a marked advantage as a communications center or as a base for supply and maintenance facilities. At division or regiment level, high ground dominating the city may be important for observation and fields of fire. At battalion, company, and lower echelons, key terrain might be hills and valleys within the general high ground around the city.

OBSERVATION AND FIELDS OF FIRE

OBSERVATION of the battlefield is essential to bring effective fire on the enemy, to control maneuvering of your troops, and to prevent being surprised by the enemy. Observation is classified as either long or short range. Long-range observation is that which provides observation in excess of the effective range of small-arms fire (usually over 400 meters). Short-range observation covers the immediate foreground and extends to the effective range of small-arms fire. Observation is limited or denied by such factors as fog, heavy precipitation, heat refraction, darkness, vegetation, cultural features, and relief.

FIELDS OF FIRE are areas into which your weapons can be fired effectively. An ideal field of fire for the defense would be gentle sloping ground, fitted to the trajectory of your weapons, and on which the enemy can be seen with no protection from your fire. This situation is rarely encountered. However, you can improve the natural fields of fire by cutting or burning weeds, grass, and crops; by clearing brush and trees; by demolishing buildings; and by cutting lanes through woods. The commander must exercise caution in ordering such work, since obviously constructed fire

lanes can disclose the location of your positions to an observant enemy.

Observation and fields of fire are so closely related that they are considered together. They are not synonymous, but fields of fire are based on observation, since the enemy must be seen to bring effective fire on him. These aspects are particularly important to the defender. The primary considerations for choosing a defensive position are maximum observation and long fields of fire.

COVER AND CONCEALMENT

COVER is shelter protection from enemy fire, either natural or artificial. Geographical relief features, drainage areas, cultural features, and other artificial shelters provide cover. Cover from flat trajectory fire is best exemplified by the concept of reverse slope; that is, when there is a projection of relief, such as a hill, between you and the enemy. Cover must be considered in relation to the types of fire encountered. For example, a trench offers excellent protection against rifle fire, but only limited protection against mortar or artillery fire.

CONCEALMENT is protection from observation. Vegetation, cultural features, geographical relief features, drainage areas, weather conditions, and darkness can provide protection from observation. Frequently, you can obtain concealment by properly evaluating and using just the terrain. At other times, you may need artificial means (camouflage) in addition to natural, available concealment.

Concealment is the reverse concept of observation. Since the defender usually has the opportunity to choose the ground he wishes to defend, he selects positions that take maximum advantage of natural cover and concealment, adding field fortifications and natural concealment with camouflage to improve the position. It is important that you judge your own cover and concealment by looking at it from the point of view of a potential attacker.

OBSTACLES

Obstacles are obstructions that stop or divert troop movement. Common natural obstacles of military value include mountains, rivers, streams, lakes, marshes, gullies, steep inclines, and heavily wooded areas. Common artificial obstacles include minefield, cut and falls, trenches, antitank ditches, roadblocks, barbed wire, blown bridges, and road craters. The proper evaluation of natural obstacles permits the most effective use of artificial obstacles. Obstacles perpendicular to the

advance route of the enemy generally favor the defending force. Obstacles parallel to the advance of the enemy may favor the enemy by protecting his flanks, although the obstacles may also limit his lateral movement. The effectiveness of an obstacle must be carefully examined. An obstacle by itself is rarely an absolute block to military movement by a determined enemy. A defender who puts full faith in an obstacle by itself stands the risk of being surprised by enemy movement over or through that obstacle. Maximum effectiveness is gained from an obstacle kept under observation and fire.

AVENUES OF APPROACH

An avenue of approach is a terrain feature or combination of features that offer a maneuvering unit a suitable route of movement to their objective. The desirable characteristics of an avenue of approach are listed below.

- **EASE OF MOVEMENT** toward the objective
- **COVER** and **CONCEALMENT** from the fire and observation of the defender
- **FAVORABLE OBSERVATION** and fields of fire for the attacker
- Adequate **ROOM FOR MANEUVER** and dispersal by the attacking unit

You, as a defender, must pay particular attention to all avenues of approach. These approaches into your Seabee position represent potential weak spots in the defense, and Seabees must be positioned to block and cover them effectively. As a defender, you must also consider the use of these avenues of approach by your own forces should you wish to launch a counterattack.

MAPS AND THE COMPASS

In a combat situation, your life may depend upon your ability to read and use a map and compass. When you are on a night patrol and become separated from the rest of the patrol, you must find your way back to friendly lines by yourself. This could be next to impossible without using a map that shows the approximate location of friendly forces. With a map and compass, you should be able to locate your position and then follow a route to your destination.

In this phase of our discussion, we discuss military maps first. Then, special attention is given to topics that should help you to read maps accurately and intelligently. Later, we discuss the use of a lensatic

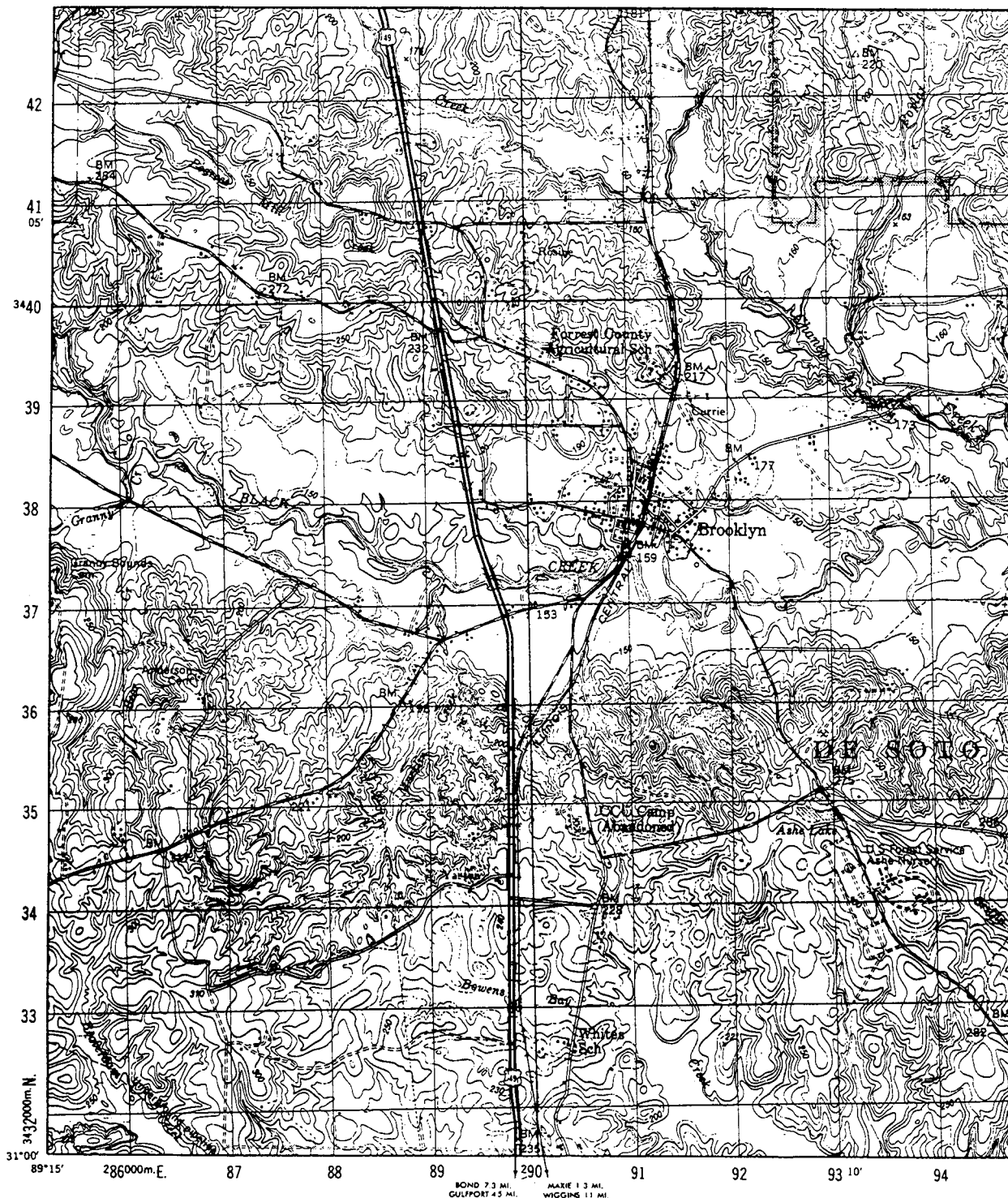

Figure 5-1.—Portion of military map.

compass. Finally, we include instruction on ways to orient a map with a lensatic compass.

MAPS

A map is a small-scale, flat-surfaced representation of a part of the surface of the earth. Man-made and

natural features are shown by the use of symbols, lines, colors, and forms. (See fig. 5-1.) Maps show the location and distances between ground features, such as towns, populated areas, roads, airfields, streams, and other lines of communication. They also indicate variations in the landform and the height of natural features.

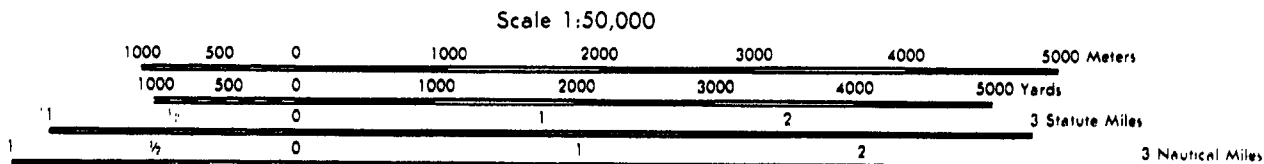

CONTOUR INTERVAL 10 FEET

SPHEROID
GRID
PROJECTION
VERTICAL DATUM
HORIZONTAL DATUM
CONTROL BY
PREPARED BY
PRINTED BY

CLARKE 1866
1,000 METER UTM, ZONE 16 (BLACK NUMBERED LINES)
TRANSVERSE MERCATOR
SEA LEVEL DATUM OF 1929
1927 NORTH AMERICAN DATUM
USC&GS, USGS AND USED
U.S. ARMY TOPOGRAPHIC COMMAND
U.S. ARMY TOPOGRAPHIC COMMAND 4-71

GRID CONVERGENCE
1°06' (20 MILS)
FOR CENTER OF SHEET

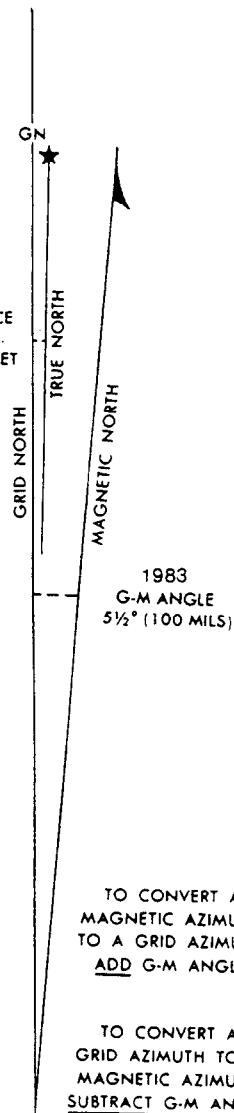

<p style="text-align: center;">SAMPLE 1,000 METER GRID SQUARE</p> <div style="text-align: center;"> </div> <hr/> <p style="text-align: center;">100,000 M. SQUARE IDENTIFICATION</p> <p style="text-align: center; font-size: 1.2em;">BK CK</p> <p style="text-align: center;">300</p> <hr/> <p style="text-align: center;">GRID ZONE DESIGNATION</p> <p style="text-align: center; font-size: 1.2em;">16R</p>	<p style="text-align: center;"><u>100 METER REFERENCE</u></p> <ol style="list-style-type: none"> 1. Read large numbers labeling the VERTICAL grid line left of point and estimate tenths (100 meters) from grid line to point. 2. Read large numbers labeling the HORIZONTAL grid line below point and estimate tenths (100 meters) from grid line to point. <p style="text-align: center;">Example: 123456</p> <hr/> <p style="text-align: center;">WHEN REPORTING ACROSS A 100,000 METER LINE, PREFIX THE 100,000 METER SQUARE IDENTIFICATION, IN WHICH THE POINT LIES.</p> <p style="text-align: center;">Example: BK123456</p> <hr/> <p style="text-align: center;">WHEN REPORTING OUTSIDE THE GRID ZONE DESIGNATION AREA, PREFIX THE GRID ZONE DESIGNATION.</p> <p style="text-align: center;">Example: 16RBK123456</p>
--	--

Figure 5-1.—Portion of military map—Continued.

Some of the types of maps you will use areas follows:

- **TOPOGRAPHIC MAP.** This map portrays terrain and landforms in a measurable form as well as the horizontal positions of the features represented. The vertical positions, or relief, are normally represented by contours. On relief maps, the elevations and contours

are measured from a specified vertical datum plane, usually mean sea level.

- **PLANIMETRIC MAP.** This map presents only the horizontal positions for the features represented. The omission of relief in a measurable form distinguishes it from a topographic map.



Prepared under the direction of the Department of Defense and published by the U.S. Army Topographic Command, Washington, D.C.



LEGEND

MAP INFORMATION AS OF 1983

IN DEVELOPED AREAS, ONLY THROUGH ROADS ARE CLASSIFIED

Hard surface, heavy duty road, four or more lanes wide		4 LANES 16 LANES	Improved light duty road, street	
Hard surface, heavy duty road: Two lanes wide; Three lanes wide		13 LANES	Unimproved dirt road	
Hard surface, medium duty road, four or more lanes wide		4 LANES 16 LANES	Trail	
Hard surface, medium duty road: Two lanes wide; Three lanes wide		13 LANES	Route markers: Interstate; Federal; State	
Buildings			Mines: Open pit; Horizontal shaft; Vertical shaft; Prospect	
Barns, sheds, greenhouses, stadiums etc.			Bench mark, monumented	
RAILROADS			Bench mark, non-monumented	
Standard gauge	Single track	Multiple track	Spot elevations in feet: Checked; Unchecked	
Narrow gauge			Light, lighthouse; Windmill, wind pump	
In street			Woodland; Scrub	
Car line			Vineyard; Orchard	
BOUNDARIES			Intermittent lake	
National			Intermittent stream; Dam	
State (with monument)			Marsh or swamp	
County			Rapids; Falls	
County subdivision			Large rapids; Large falls	
Corporate limits				
Military reservation		MIL RES		
Other reservation				

SHEET **3146 II** SERIES **V743** EDITION **6-TPC** **NEW AUGUSTA**

Figure 5-1.—Portion of military map—Continued.

- **PHOTOMAP.** This map is a reproduction of an aerial photograph or a photomosaic made from a series of aerial photographs. Photomaps show grid lines, marginal data, place names, route numbers, important elevations, boundaries, approximate scale, and approximate direction.

- **PICTOMAP.** A map on which the photographic imagery of a standard photomap has been converted into interpretable colors and symbols.

Reference Systems

One of the oldest reference systems is based upon the geographic coordinates—meridians and parallels. **MERIDIANS** are great circles of north-south rings crossing the equator at right angles and converging at the North and South Poles. (See fig. 5-2.) One meridian that runs through Greenwich, England, is known as the prime meridian. Meridians are used to measure **LONGITUDE**—the distance of a point east or west of the prime meridian. **PARALLELS** are great circles of

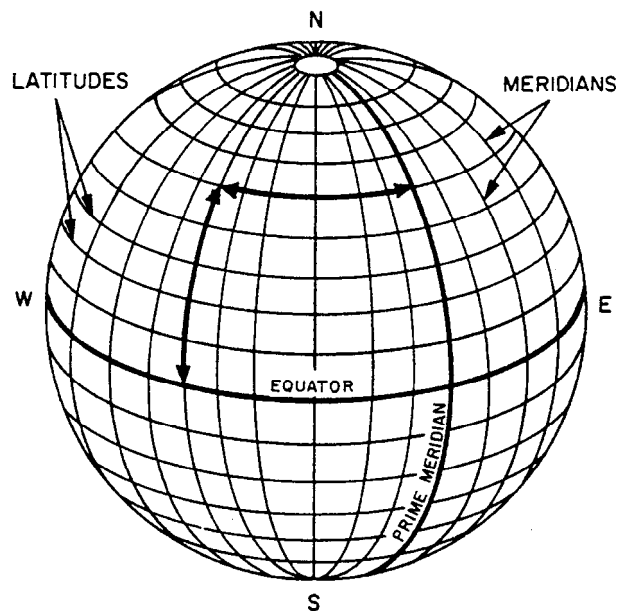

Figure 5-2.—Reference lines.

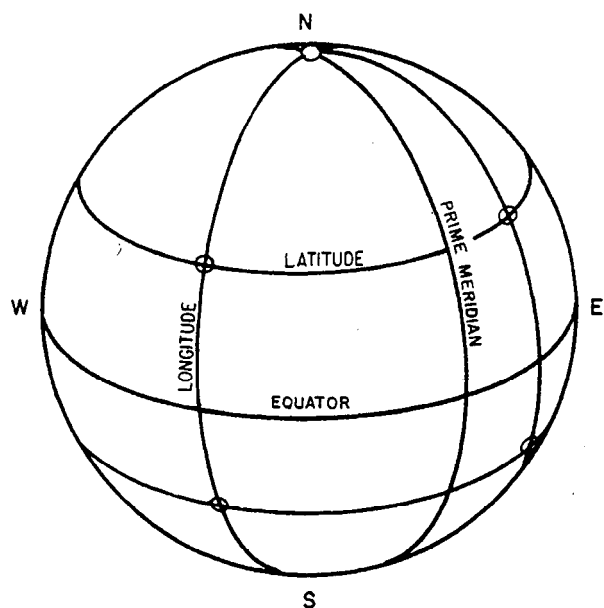

Figure 5-3.—Position location.

east-west rings running parallel to the equator. (See figs. 5-2 and 5-3.) Parallels are used to measure LATITUDE—the distance of a point north or south of the equator. Using meridians and parallels, you can locate any point on the surface of the earth.

Geographic coordinates are expressed in angular measurement. The earth is divided into 360 degrees; each degree into 60 minutes; and each minute into 60 seconds. The degree is symbolized by °; the minute by ′; and the second by ″.

Starting with 0° at the equator, the parallels of latitude are numbered to 90° both north and south. The extremities are the North Pole at 90° north latitude and the South Pole at 90° south latitude. Latitude can have the same numerical value north or south of the equator, so the direction N or S must always be given.

Starting with 0° at the prime meridian, longitude is measured both east and west around the world. Lines east of the prime meridian are numbered from 0° to 180° and are identified as east longitude. Lines west of the prime meridian are numbered 0° to 180° and are identified as west longitude. The direction E or W must always be given to longitude. The line directly opposite the prime meridian, 180°, may be referred to as either east or west longitude.

Grids

Military maps are divided into grids to provide a uniform system for referencing and making

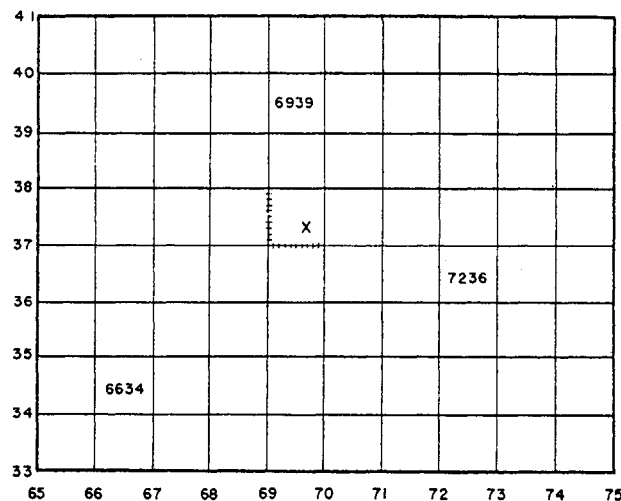

Figure 5-4.—Grid system.

measurements. Military grids consist of two sets of equally spaced parallel, straight lines intersecting at right angles and forming a series of squares. Each grid line is an even interval of the selected measurement unit, such as yards or meters. A portion of a military grid, or map, is shown in figure 5-1. The dimensions and orientation of different types of grids vary, but all military grids have three things in common:

1. They are all true rectangular grids.
2. They are superimposed; that is, drawn on top of the geographic projection.
3. They permit linear and angular measurements.

The regularly spaced lines that make up the grids on any large-scale map are divisions of the 100 000-meters square; the lines are spaced at 10 000- or 1000-meter intervals. Each of these lines is labeled at both ends with a number showing its relation to the origin of the zone. For the 1000-meter grid, except for the numbers labeling the first grid line in each direction from the southwest corner of the sheet, the last three digits (000) of the number are omitted. (See fig. 5-1.) Two digits of the numbers are printed in large type, and the same two digits appear at intervals along the grid line on the face of the map. They are called the PRINCIPAL DIGITS and represent the 10,000 and 1,000 digits of the grid number; they are of major importance to the map reader because they are numbers he uses most often for referencing points. The smaller digits complete the COORDINATES of the grid lines, but they are rarely used for point designation. On sheets with grid line spacing at 10000 meters, only one principal digit is shown, representing the 10,000 digit of the grid number.

38

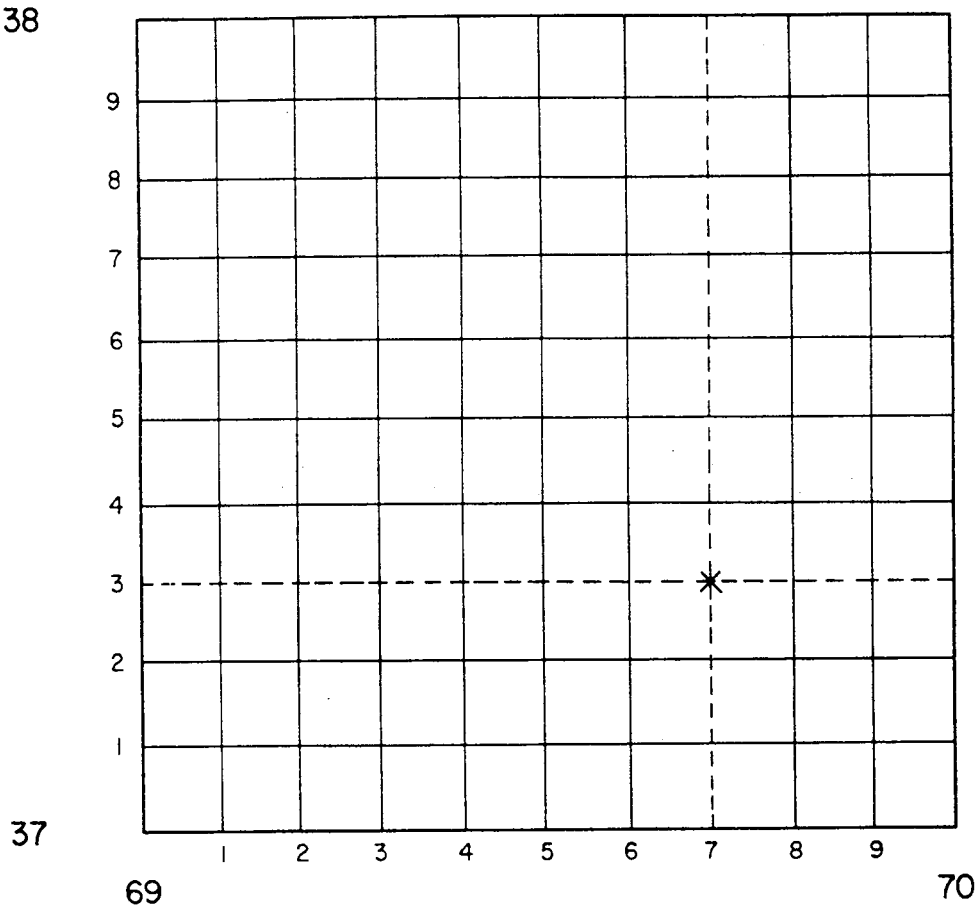

Figure 5-5.—Grid square, close-up.

The designation of a point is based on the military principle of “Read RIGHT then UP.” The precision desired determines the number of digits to be read beyond the principal digits. Remember that the term *grid coordinate* often indicates both the 100 000-meters-square identification and the desired number of digits. In many instances, it is a tactical requirement that the 100 000-meters-square identification be included in any point designation. Figure 5-4 shows a section of a simple grid system. Each line is numbered, starting at the lower left-hand corner, reading to the right and up. Remember, when you read a military map, you should always read from left to right and from bottom to top. Three squares in figure 5-4 have numbers in them to identify that particular grid square. The letter X has been placed in grid square 6937. To locate this point more precisely, see figure 5-5. You can see that the sides of the grid square have been divided into ten parts. This can be done by eye or with a scale. As shown in this figure, the X is located at coordinate 697373. The grid coordinates are written as one number but always

contain an even number of digits. Examples are 6937 and 697373.

Elevation and Relief

A knowledge of map symbols, grids, scale, and distance provides enough information to identify two points. You locate them, measure between them, and determine the length of time required to travel between them. But what happens if there is a 300-foot cliff between the two points? The map user must also become proficient in recognizing the various landforms and irregularities of the surface of the earth. Then he is able to determine the elevation and differences in the height of all terrain features.

1. **DATUM PLANE.** This is a reference from which vertical measurements are taken. The datum plane for most maps is mean, or average, sea level.

2. **ELEVATION.** This is defined as the height (vertical distance) of an object above or below a datum plane.

3. **RELIEF.** Relief is the representation of the shape and height of landforms and the characterization of the surface of the earth.

The elevation of points and the relief of an area affect the movement and deployment of units by limiting the route of travel, their speed of movement, and the ease or difficulty of attacking or defending an area. Also relief affects observation, fields of fire, cover, concealment, and the selection of key terrain features.

Contour Lines

There are several ways of indicating elevation and relief on maps. The most common way is by contour lines. A **CONTOUR LINE** is a line representing an imaginary line on the ground along which all points are at the same elevation.

Contour lines indicate a vertical distance above or below a datum plane. Starting at sea level, normally the zero contour, each contour line represents an elevation above sea level. The vertical distance between adjacent contour lines is known as the **CONTOUR INTERVAL**. The amount of the contour interval is given in the marginal information. On most maps, the contour lines are printed in brown. Starting at zero elevation, every fifth contour line is drawn with a heavier line. These are known as **INDEX CONTOURS**. Someplace along each index contour, the line is broken and its elevation is given. The contour lines falling between index contours are called **INTERMEDIATE CONTOURS**. They are drawn with a finer line than the index contours and, usually, do not have their elevations given.

Using the contour lines on a map, you may determine the elevation of any point as follows:

1. Find the contour interval of the map from the marginal information, and note both the amount and the unit of measure.
2. Find the numbered contour line (or other given elevation) nearest the point for which the elevation is being sought.
3. Determine the direction of slope from the numbered contour line to the desired point.
4. Count the number of contour lines that must be crossed to go from the numbered line to the desired point and note the direction-up or down. The number of lines

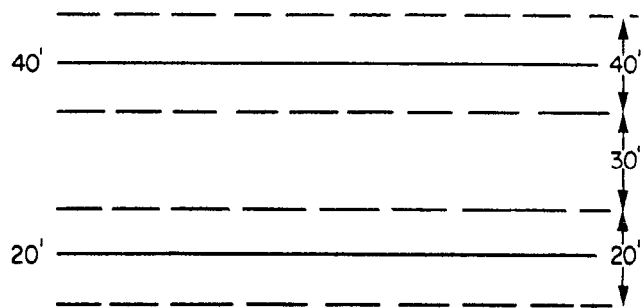

Figure 5-6.—Estimating elevations between contour lines.

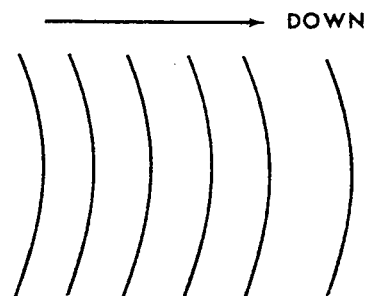
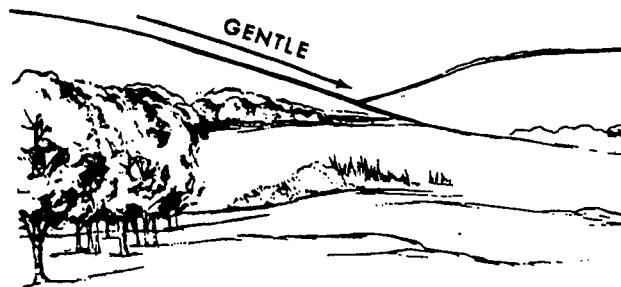

Figure 5-7.—Uniform, gentle slope.

crossed multiplied by the contour interval is the distance above or below the starting value.

When the desired point is on a contour line, its elevation is that of the contour.

For a point between contours, most military needs are satisfied by estimating the elevation to an accuracy of one half of the contour interval. All points less than one fourth of the distance between the lines are considered to be at an elevation of one half of the contour interval above the lower line (fig. 5-6).

To estimate the elevation of the top of an unmarked hill, add half of the contour interval to the elevation of the highest contour line around the hill.

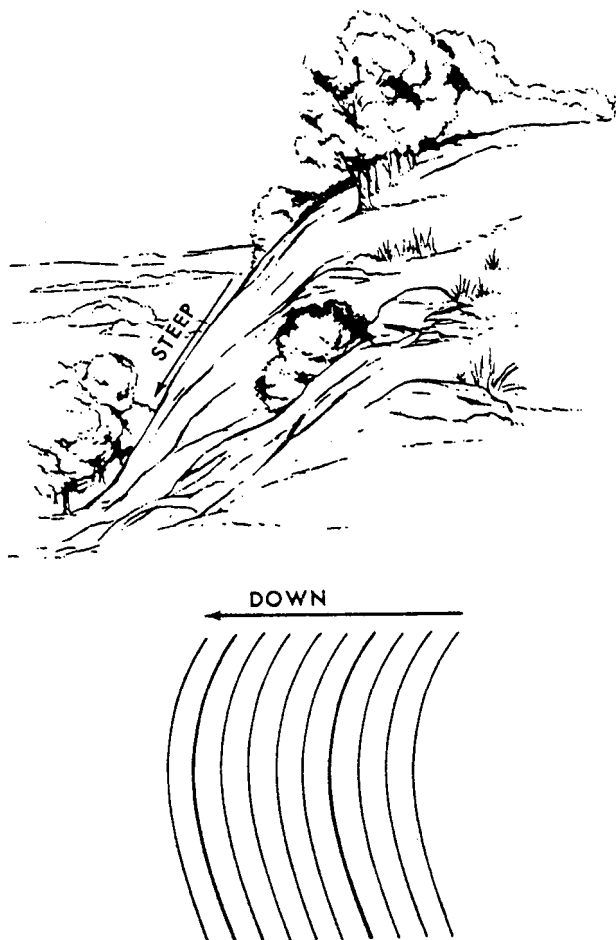

Figure 5-8.—Uniform, steep slope.

To estimate the elevation of the bottom of a depression, subtract half of the contour interval from the value of the lowest contour around the depression.

On some maps, the index and intermediate contour lines do not show the elevation and relief in as much detail as may be needed; then **SUPPLEMENTARY CONTOURS** may be used. These contour lines are dashed brown lines, usually at one half of the contour interval for the map. A note in the marginal information indicates the interval used. They are used exactly like solid contour lines.

On some maps, the contour lines may not meet the standards of accuracy but are sufficiently accurate in both value and interval to be shown as contours rather than as form lines. On maps of this type, the contours are considered as approximate and are shown with a dashed symbol; elevation values are given at intervals along the heavier (index contour) dashed lines. The

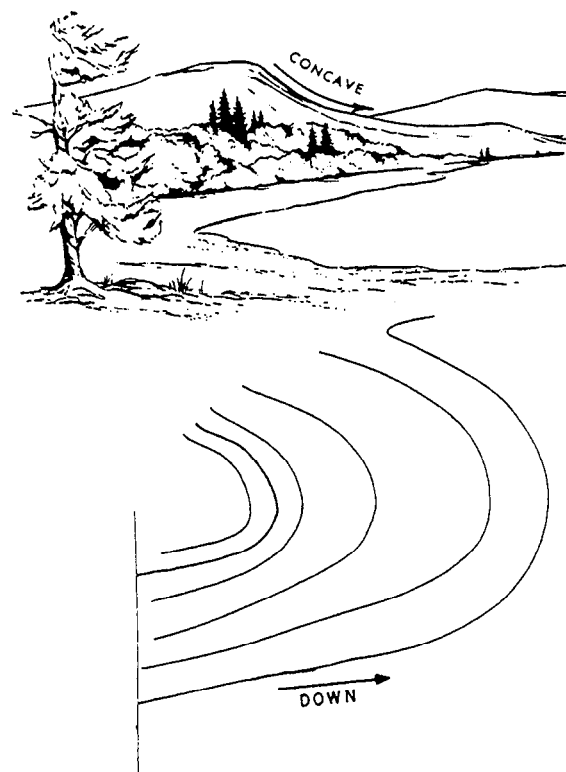

Figure 5-9.—Concave slope.

contour note in the map margin identifies them as approximate contours.

In addition to the contour lines, bench marks and spot elevations are used to indicate points of known elevation on the map. **BENCH MARKS**, the more accurate of the two, are symbolized by a black X, for example, XBM 124. The elevation value shown in black refers to the center of the X. **SPOT ELEVATIONS**, shown in brown, generally are located at road junctions, on hilltops, and other prominent landforms. The symbol $\wedge P \wedge P$ designates an accurate horizontal control point. When a bench mark and a horizontal control point are located at the same point, the symbol $BM \wedge P \wedge P$ is used.

The spacing of the contour lines indicates the nature of the slope. Contour lines evenly spaced and wide apart indicate a uniform, gentle slope (fig. 5-7). Contour lines evenly spaced and close together indicate a uniform, steep slope. The closer the contour lines are to each other, the steeper the slope (fig. 5-8).

Contour lines closely spaced at the top and widely spaced at the bottom indicate a concave slope (fig. 5-9). Considering relief only, an observer at the top of a concave slope can observe the entire slope and the

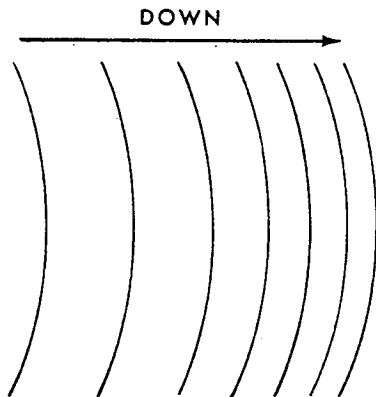
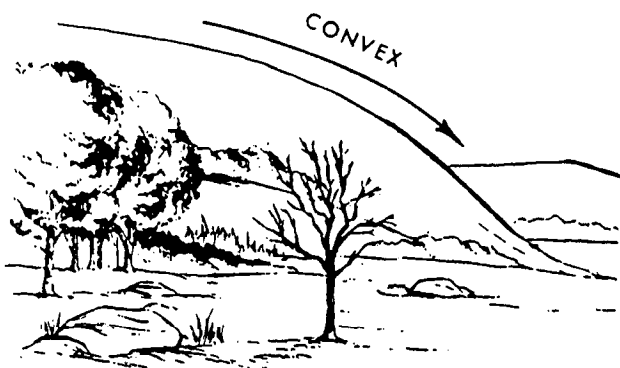

Figure 5-10.—Convex slope.

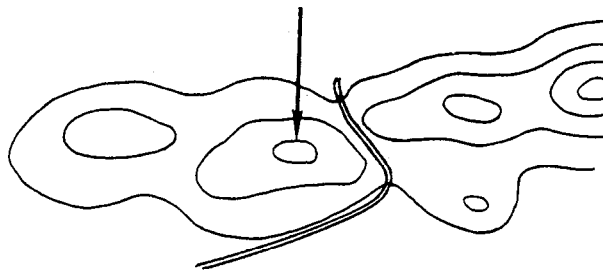
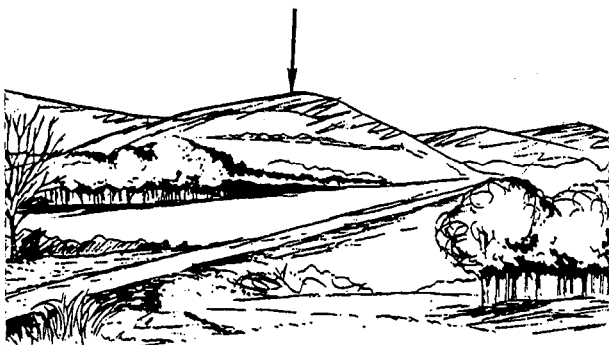

Figure 5-11.—Hill.

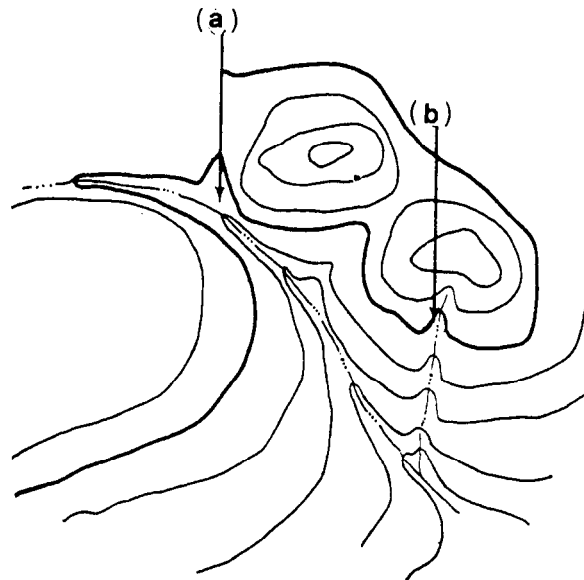
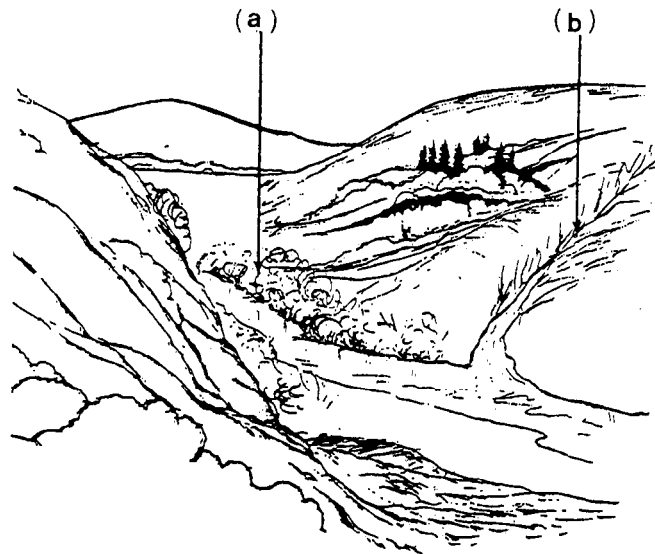

Figure 5-12.—(a) Valley; (b) Draw.

terrain at the bottom. However, a unit attacking up a concave slope would have no cover or concealment from observers or weapons at or near the top; also, farther up the slope, the climb would be more difficult.

Contour lines widely spaced at the top and closely spaced at the bottom indicate a convex slope (fig. 5-10). An observer at the top of a convex slope would have no observation of most of the slope or of the terrain at the bottom. But a unit attacking up a concave slope would have a much greater degree of cover and concealment than on a convex slope; also, the climb farther up the slope would be easier.

In order to show the relationship of land formations to each other and how they would be symbolized on a

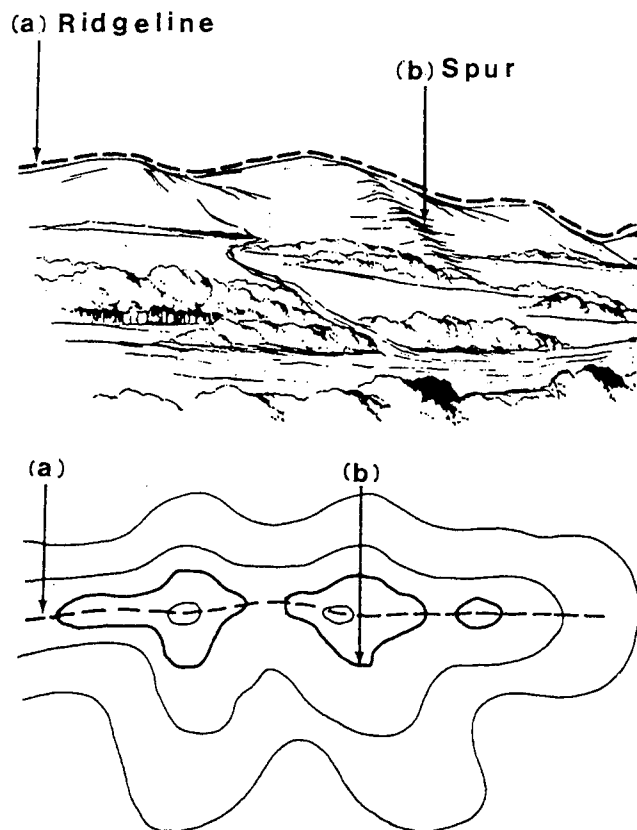

Figure 5-13.—(a) Ridge; (b) Spur.

contour map, stylized panoramic sketches of the major relief formations are drawn. Then a contour map of each sketch is developed. Each of the figures that follow shows a sketch and a map with a different relief feature and its characteristic contour pattern.

1. **HILL.** This is a point or small area of high ground (fig. 5-11). When you are located on a hilltop, the ground slopes down in all directions.

2. **VALLEY.** A valley is a course of a stream that has at least a limited extent of reasonably level ground bordered on the sides by higher ground. (See fig. 5-12, views A and B, top and bottom.) The valley generally has maneuvering room within its confines. Contours indicating a valley are U-shaped and tend to parallel a major stream before crossing it. The more gradual the fall of a stream, the farther each contour parallels it. The curve of the contour crossing always points upstream.

3. **DRAW.** A draw is a less developed course of a stream in which there is essentially no level ground and, therefore, little or no maneuvering room within its confines. (See fig. 5-12, views A and B, top and

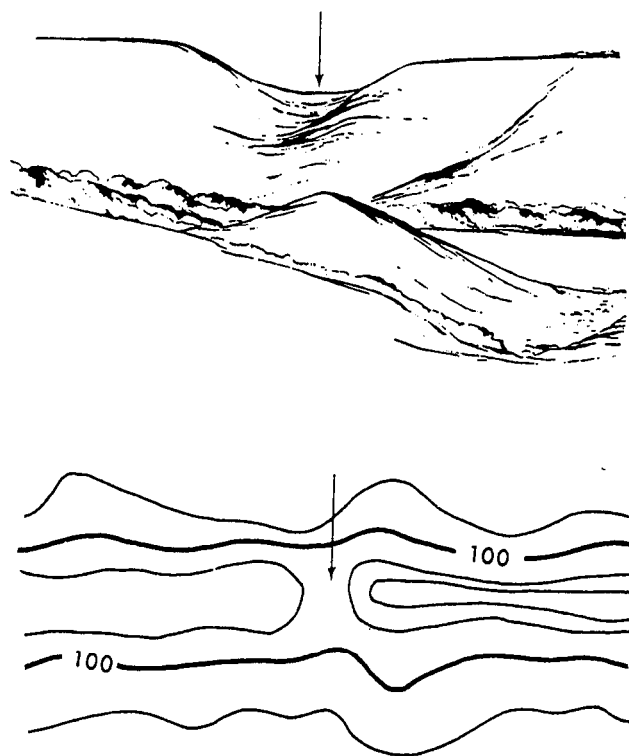

Figure 5-14.—Saddle.

bottom.) The ground slopes upward on each side and toward the head of the draw. Draws occur frequently along the sides of ridges at right angles to the valleys between them. Contours indicating a draw are V-shaped, with the point of the V toward the head of the draw.

4. **RIDGE.** Normally, a ridge is a line of high ground with minor variations along its crest. (See fig. 5-13, views A and B, top and bottom.) The ridge is not simply a line of hills; all points of the ridge crest are appreciably higher than the ground on both sides of the ridge.

5. **SPUR.** A spur is a short, continuously sloping line of higher ground normally jutting out from the side of a ridge. (See fig. 5-13, views A and B, top and bottom.) A spur is often formed by two roughly parallel streams cutting draws down the side of a ridge.

6. **SADDLE.** A saddle is a dip or low point along the crest of a ridge. A saddle is not necessarily the lower ground between two hilltops; it may be simply a dip or break along an otherwise level ridge crest (fig. 5-14).

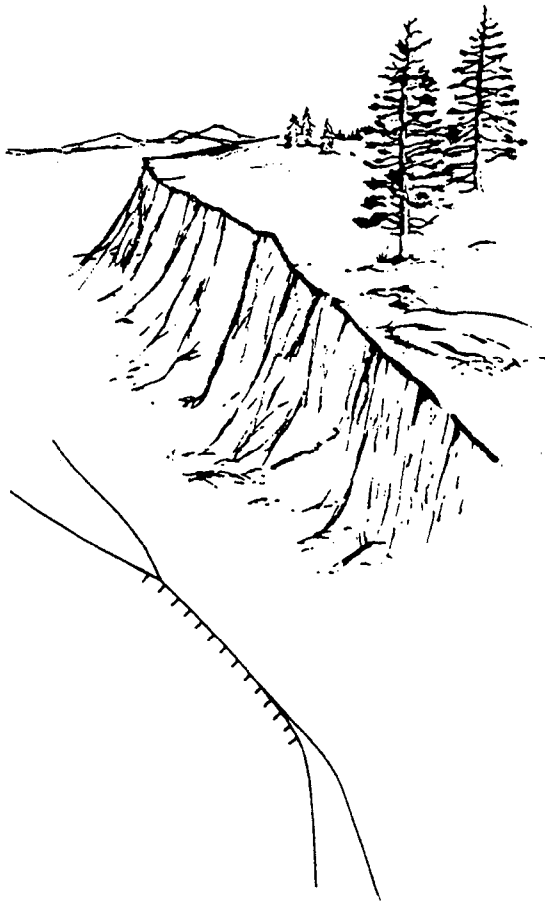

Figure 5-15.—Cliff.

7. CLIFF. A cliff is a vertical or near vertical slope (fig. 5-15). When a slope is so steep that it cannot be shown at the contour interval without the contours coming together, it is shown by a ticked “carrying” contour or contours. The ticks always point toward lower ground.

8. CUTS and FILLS. Cuts and fills are man-made features caused when the bed of a road or railroad is graded or leveled by cutting through high areas and filling in low areas along the right-of-way. (See fig. 5-16, views A and B, top and bottom.)

9. DEPRESSION. A depression is a low point or a sinkhole, surrounded on all sides by higher ground (fig. 5-17).

Slope

The rate of rise or fall of a landform is known as its slope and may be described as being gentle or steep. The question arises as to how gentle or how steep? The speed at which equipment or personnel can move is

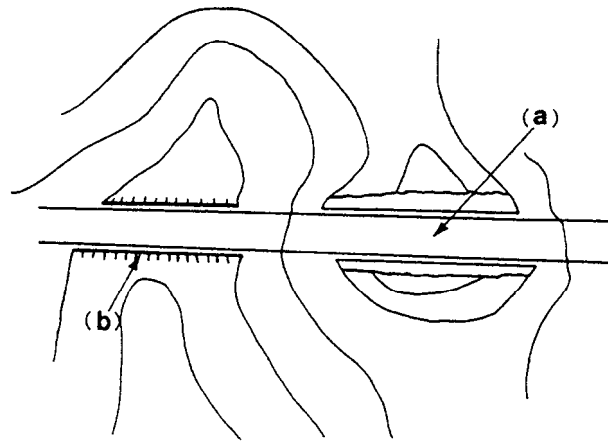
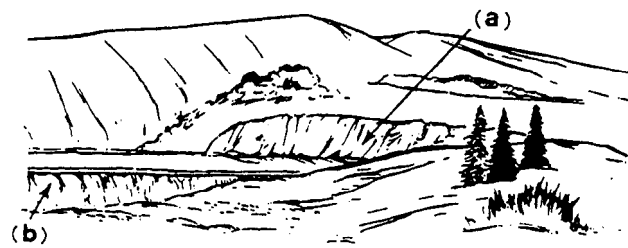

Figure 5-16.—(a) Cut; (b) Fill.

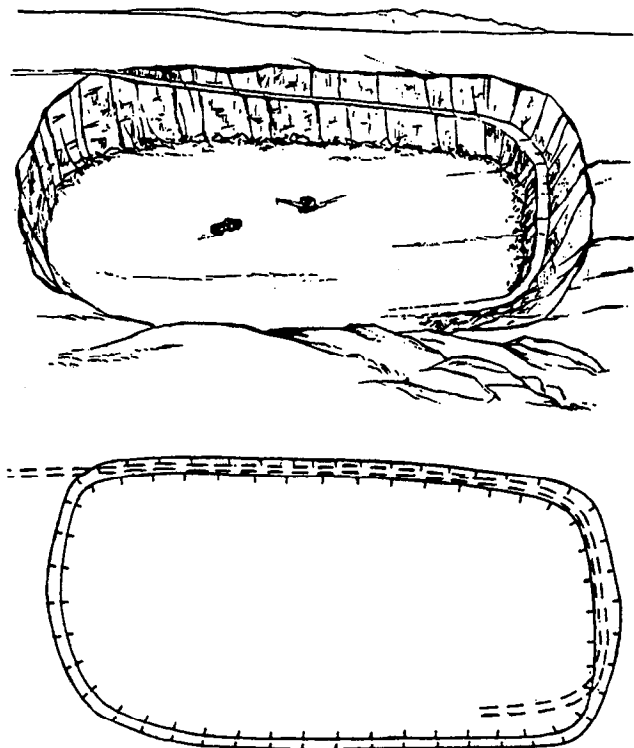

Figure 5-17.—Depression.

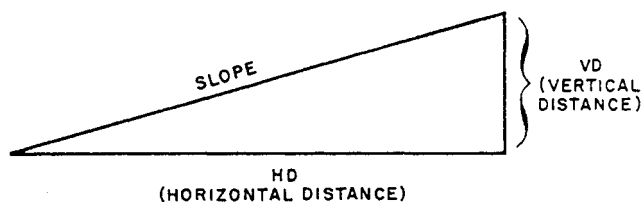

Figure 5-18.—Slope diagram.

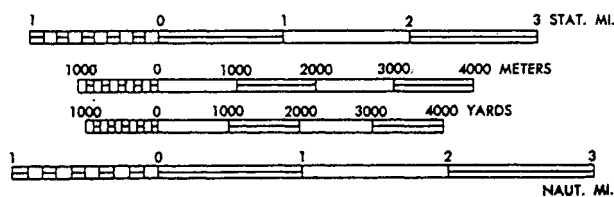
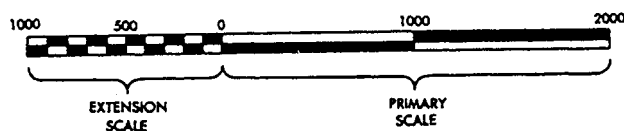

Figure 5-19.—Graphic scale.

affected by the slope of the ground. Most equipment has a limit on the steepness of slope it can negotiate. So a more exact way of describing a slope is demanded. Slope may be expressed in several ways, but all of them depend upon a comparison of vertical distance (VD) to horizontal distance (HD) (fig. 5-18). VD is the difference between the highest and lowest elevations of the slope and is determined from the contour lines. HD is the horizontal ground distance between the highest and the lowest elevations of the slope.

The VD and HD must be expressed in the same units. Both measurements must be made with extreme accuracy in order to have a valid determination of steepness. The computations normally are made for only the steepest part of a slope.

Scale and Distance

A map is a graphic representation of an area and, therefore, is not made to full scale (actual size). Since it is not full size, some means of measuring the distance from one point on the map to another is necessary. This is done with the aid of a scale.

There are two types of scales in general use on military maps. The first is called a graphic scale and is

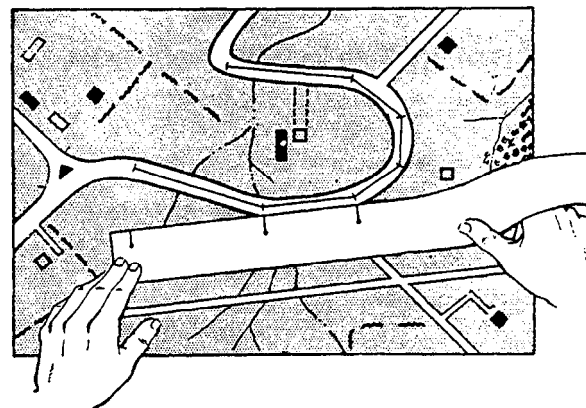

Figure 5-20.—Measuring curved line distance on a map.

indicated by a special scale legend that is printed on the map. The second type of scale is the ratio between the horizontal distance on the map and the corresponding distance on the ground.

The GRAPHIC SCALE that is printed on your map is especially made for that map and should not be used on any other map. Figure 5-19 shows a typical graphic scale. To the right of the zero (0), the scale is marked in full units of measure and is called the PRIMARY SCALE. The part to the left is zero (0) and is divided into tenths of a unit and is called the EXTENSION SCALE. Most maps have three or more graphic scales, each of which indicates distance in a different unit of measure. To determine the straight-line distance between two points on a map, use the following steps:

1. Lay the straightedge of a piece of paper on the map so the edge of the paper touches both points.
2. Make a mark on the edge of the paper at each point.
3. Move the paper down to the graphic scale, and from the scale, read the ground distance between the points. Be sure to use the scale that indicates the unit of measure desired.

To measure distance along a winding road, stream, or other curved line, the straightedge of a piece of paper should be used again.

1. Make a mark at or near one end of the paper and place it at the point from which the line is to be measured, as shown in figure 5-20.
2. Align the edge of the paper along a straight portion, and make a tick mark on both the map and the paper at the end of the aligned portion

3. Keeping both tick marks together, place the point of the pencil on the tick mark of the paper to hold it in place. Pivot the paper until another straight portion is aligned and make another mark on both map and paper.

4. Continue in this manner until the measurement is complete. Then place the paper on the graphic scale and read the ground distance.

The **RATIO-TYPE SCALE** is simply a comparison between a given distance measured on the map and on the ground. It is independent of any unit of measure. A scale of 1/25,000 means that one unit of measure on the map is equal to 25,000 of the same units of measure on the ground. The ground distance between two points may be determined by measuring between the points on the map and multiplying the map measurement by the scale. For example, the distance between two bridges on a certain map is 15 inches. The scale of the map is 1:50,000. Therefore, the actual distance on the ground is found by multiplying 15 inches by 50,000 (15 times 50,000 equals 750,000 inches). If this is to mean anything to you, change it to units that can be easily pictured in your mind. These units might be feet, yards, meters, kilometers, or miles. To change the 750,000 inches to feet, you need to divide by 12 (the number of inches in a foot); hence 750,000 divided by 12 equals 62,500 feet. To change the 62,500 feet to miles, divide again by 5,280 (the number of feet per mile); thus 62,500 divided by 5,280 equals 11.8 miles.

By using either of the methods described above, you can determine the distance between any two points.

Direction

Directions are expressed in everyday life as right, left, straight ahead, and so forth. But the question arises, To the right of what? Military personnel require a method of expressing a direction that is accurate, adaptable for use in any area of the world, and has a common unit of measure.

Directions are expressed as units of angular measure, and there are several systems used.

1. The most commonly used unit of angular measure is the degree with its subdivisions of minutes and seconds.

2. Another unit, less frequently used, is the mil (abbreviated m). For the U.S. military Purposes, a complete circle is divided into 6,400 mils. The mil is

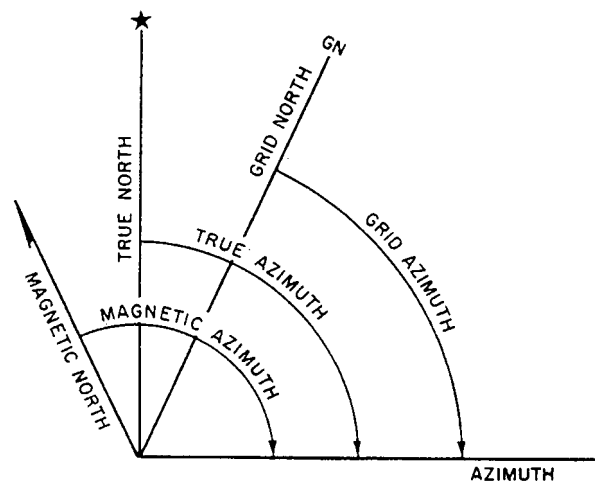

Figure 5-21.—True, magnetic, and grid azimuths.

commonly used in artillery, tank, and mortar gunnery. It is convenient for many practical uses because it is approximately one unit of length at a distance (range) of one thousand units.

Base Line

In order to measure anything, there must always be a starting point, or zero measurement. To express a direction as a unit of angular measure, there must be a starting point, or zero measure, and a point of reference. These two points designate the base, or reference, line. There are three base lines—true north, magnetic north, and grid north. Those most commonly used are magnetic and grid; the magnetic when working with a compass, and the grid when working with a military map.

TRUE NORTH. This is a line from any position on the surface of the earth to the North Pole. All lines of longitude are true north lines. True north is usually symbolized by a star (fig. 5-21).

MAGNETIC NORTH. The direction to the magnetic North Pole is indicated by the north-seeking needle of a magnetic instrument. Magnetic north is usually symbolized by a half arrowhead (fig. 5-21).

GRID NORTH. This is the north established by the vertical grid lines on the map. Grid north may be symbolized by the letters *GN* (fig. 5-21).

Topographic Map Symbols

The purpose of a topographic map is to permit you to visualize an area of the surface of the earth with

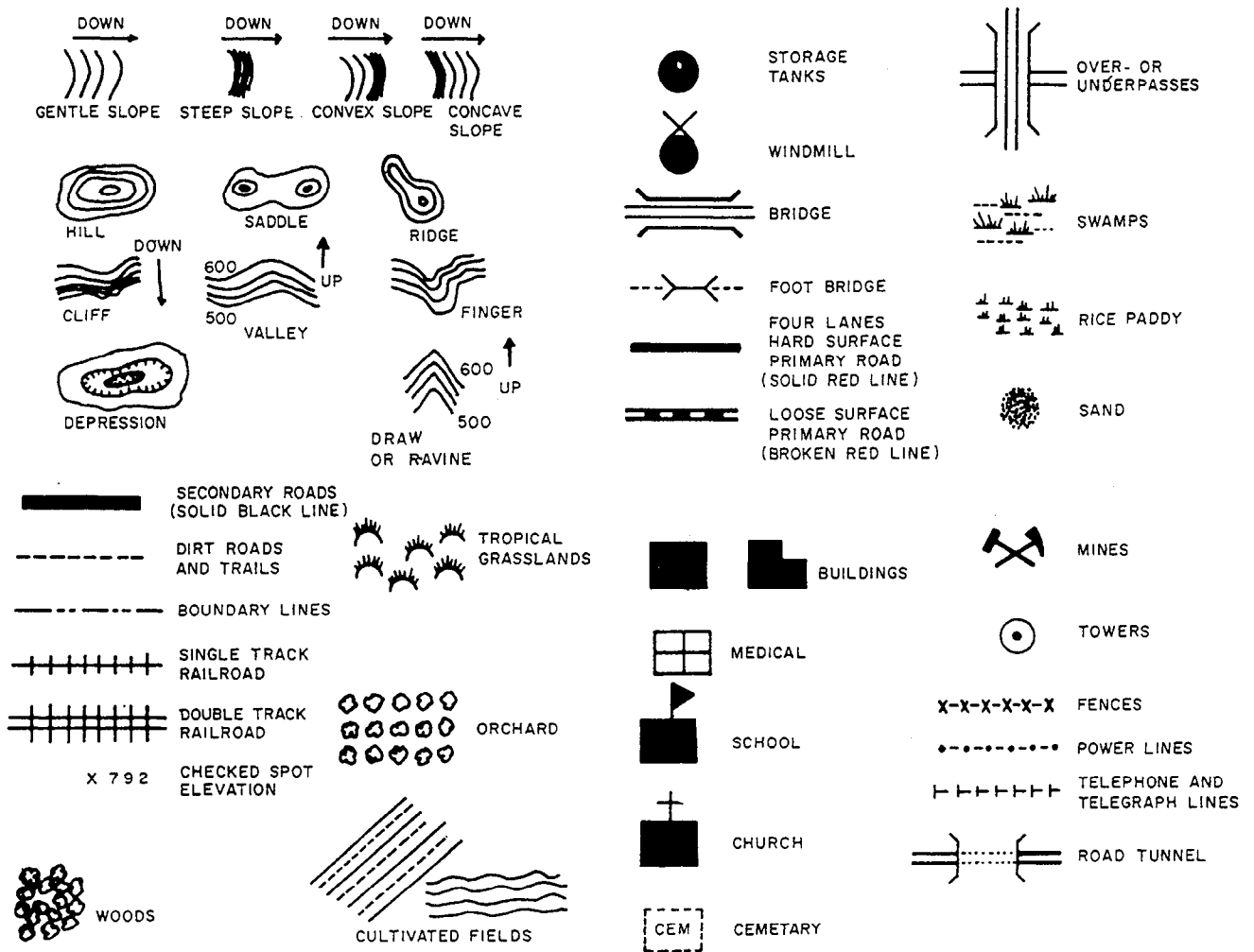

Figure 5-22.—Topographic symbols.

pertinent features properly positioned. Ideally, all features within an area would appear on the map in their true proportion, position, and shape. However, this is not practical. Many of the features would be unimportant and others could not be recognized because of their reduction in size. Therefore, the map maker has been forced to use symbols to represent these features. These symbols resemble, as closely as possible, the actual features themselves. (See fig. 5-22.)

Topographic symbols are usually printed in a number of standardized colors. This is done so the features on the map are easier to identify and to give them a more natural appearance and contrast.

Black—the majority of cultural or man-made features

Blue—water features, such as lakes, rivers, and swamps

Green—vegetation, such as woods, orchards, or vineyards

Brown—all relief features, such as contours

Red—main roads, built up areas, and special features

Others—occasionally used to show special information; generally, explained in the marginal notes

Military Symbols

In addition to topographic symbols used to represent natural and man-made features of the earth, the military establishment requires some method for showing the identity, strength, locations, and movements of its troops, activities, and installations. The symbols used to represent these features are known as military symbols. As these features are constantly changing and moving, they are not normally printed on the maps. They appear on special maps and overlays and are handled by

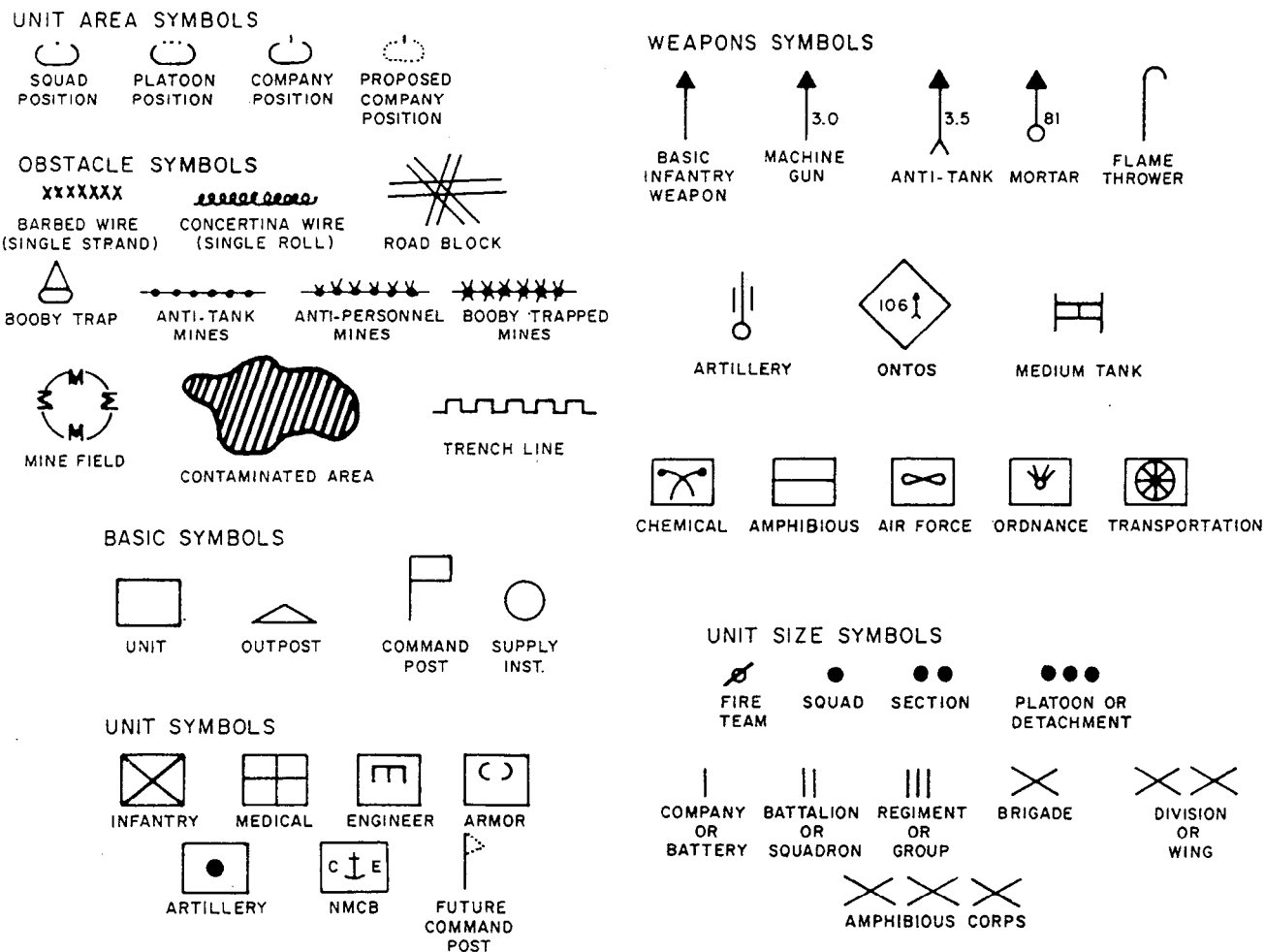

Figure 5-23.—Typical military symbols.

following proper security precautions. Figure 5-23 shows many of these symbols.

Care of Maps

One of the first precautions in caring for maps is folding the map properly. Figures 5-24 and 5-25 show ways of folding maps to make them small enough to be carried easily and still be available for use without having to unfold them entirely.

Your maps may have to last a long time, so protect them as best you can. Whenever possible, carry a map in a waterproof packet, in a pocket, under an outer garment, or other place where it is handy but still protected.

In marking a map, use light lines that maybe erased easily without smearing, smudging, or leaving marks that may later tend to confuse someone. If you must trim the margins of a map for any reason, be careful to copy any marginal information that may be needed later, such

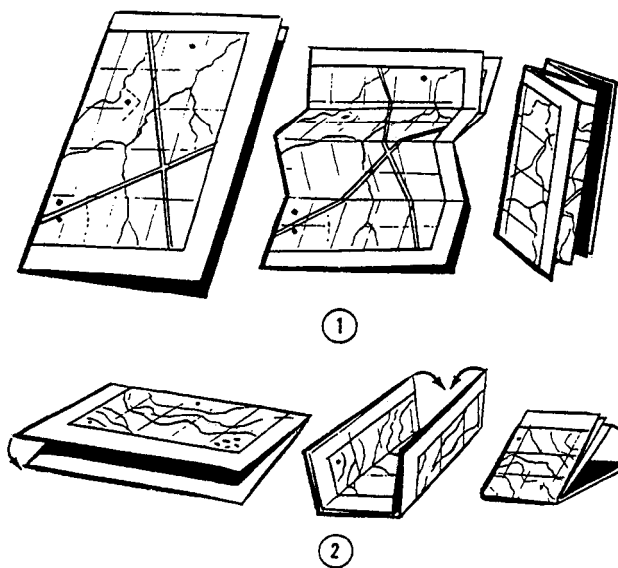

Figure 5-24.—Two methods of folding a map.

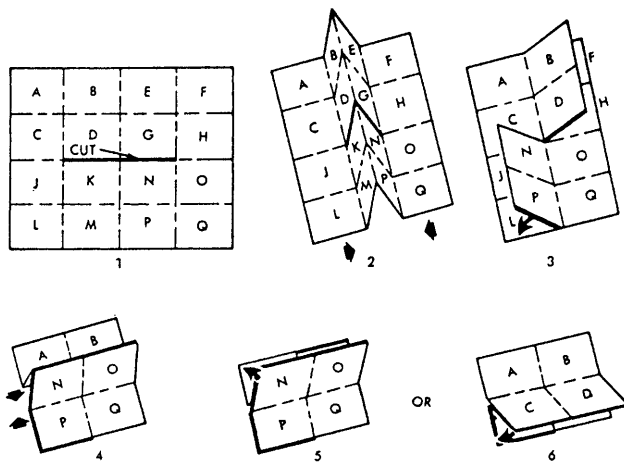

Figure 5-25.—How to slit and fold.

as grid and magnetic declination data or overlapping grid values and ticks.

LENSATIC COMPASS

The lensatic compass is the most commonly used and simplest instrument for measuring directions and angles in the field. Two varieties of magnetic compasses are standard for military use today: the lensatic compass (fig. 5-26) and the artillery (M2) compass. Since the M2 is a special-purpose compass, it is not discussed in this chapter.

In order to use a map effectively in the field for purposes of identification, location, or reporting, you must orient, or align, the map with the ground. A map is oriented when, in a horizontal position, its north points to the north and all map lines are parallel to their corresponding lines on the ground. A map user is oriented when he knows his position on the oriented map.

A fast and accurate way to orient a map is with a lensatic compass. When a compass rose (picture of a compass card) appears on the map, place the map on a flat surface and draw the magnetic north line. Open the compass and place it over the magnetic north line so the sight points toward the top of the map and is directly over the magnetic north line that you have drawn. Turn the map, taking care not to move the compass from its position over the north line until the north arrow of the compass is aligned under the index line of the compass. The map is now oriented. For maps that do not have a compass rose, align the compass sights over a north-south grid line. Then rotate the map and compass together until the north arrow of the compass points in the same direction and amount from the grid line, shown in the declination diagram.

To orient a map when a compass is not available requires a careful examination of the map and the ground features of the area to find linear features that are common to both the map and the ground. Linear

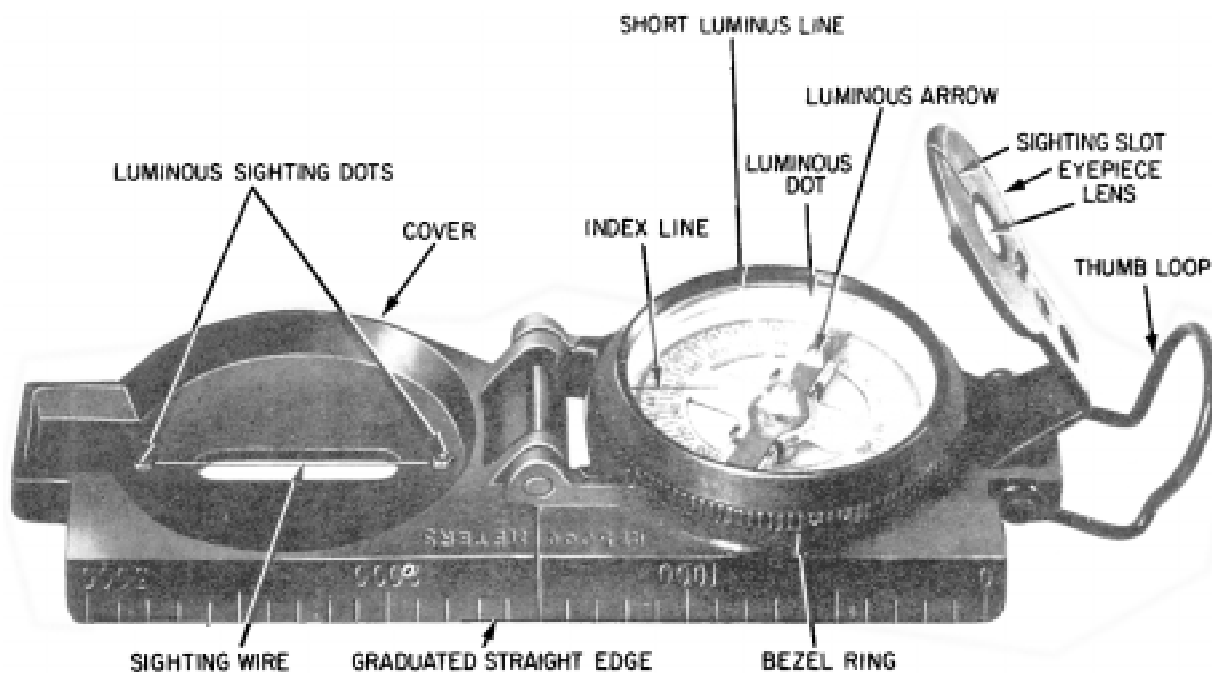

Figure 5-26.—Lensatic compass.

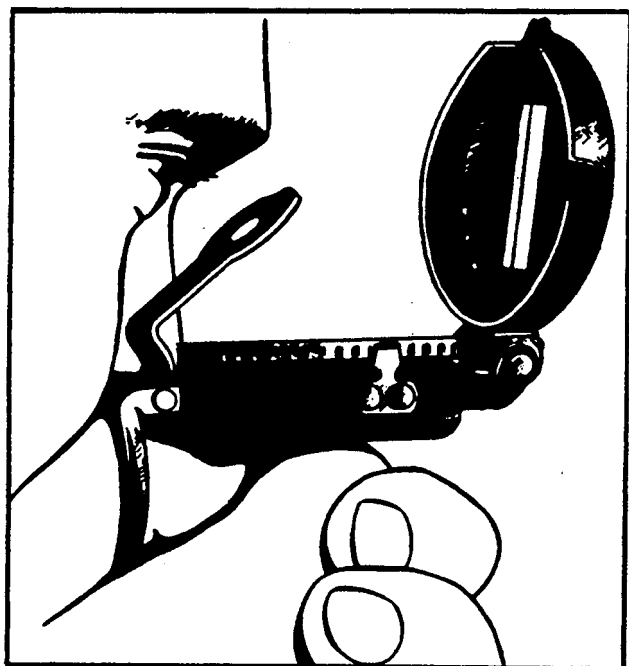

Figure 5-27.—A method of holding the compass.

features are those that have length. Good examples are roads, railroads, fence lines, power lines, and so forth. By aligning the features on the map with the features on the ground, you can orient the map.

The lensatic compass must always be held level and firm when you are sighting on an objective and reading an azimuth (a horizontal angle measured in a clockwise reamer from a north base line). There are several techniques for holding the compass and sighting, but we will discuss only two methods.

To sight an objective and read an azimuth with the first method, use the following steps:

1. Open the cover of the compass so it forms a right angle with the compass. Move the eyepiece so the compass dial is visible through the lens, as shown in figure 5-27.

2. Align the slot in the eyepiece with the hairline sighting wire in the cover and with the target.

3. Read the azimuth by glancing down at the dial through the lens.

This technique provides a reading precise enough to use for "Intersection" and "Resection" (discussed later in this chapter).

The second method has an advantage because it keeps the compass lower and farther away from the steel

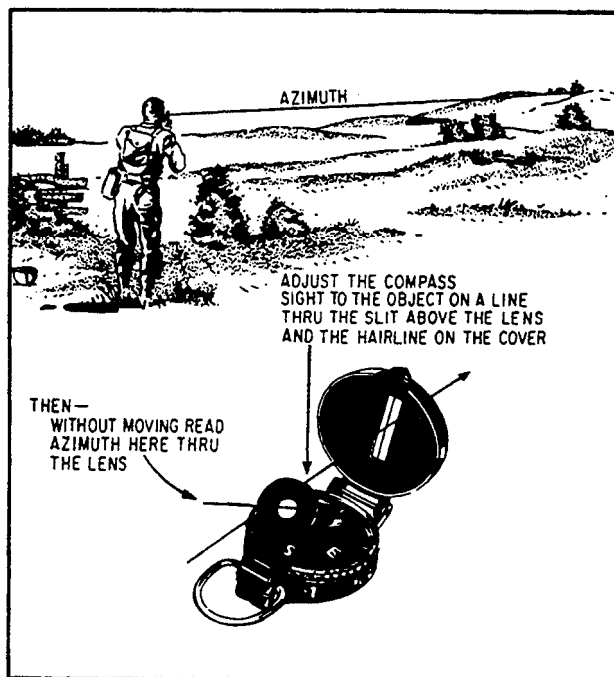

Figure 5-28.—A method of determining the azimuth of a visible object.

helmet of the user; but it is less precise than the method just described.

To learn the second method, study the following steps:

1. Open the cover until it forms a straightedge with the compass base, as shown in figure 5-26.

2. Pull the eyepiece as far to the rear as possible, perpendicular to the compass base.

3. Place your thumb through the thumb loop, forming a steady base with your third and fourth fingers, and extend your index finger along the side of the compass.

4. Extend the other index finger along the remaining side of the compass and place the remaining fingers around the fingers of the other hand.

5. Pull your elbows firmly into your sides. This places the compass between your chin and your belt.

6. To take an azimuth reading, simply turn your entire body toward the object, pointing the compass cover directly at the object. (See fig. 5-28.)

7. Then just look down and read the azimuth from beneath the fixed, black index line.

For night use, special features of the compass are the luminous markings and the 3° bezel serration and

clicking device. Turning the bezel ring to the left causes an increase in azimuth, while turning it to the right causes a decrease. The bezel has a stop and spring that allows clockwise and counterclockwise turns at 3° intervals per click and holds the bezel ring in any desired position. One method for determining compass directions at night is as follows:

1. Rotate the bezel until the luminous line is over the black index line.

2. Hold the compass with the left hand and continue to rotate the bezel ring with the right hand in a counterclockwise direction for the number of clicks required. The number of clicks is determined by dividing the value of the required azimuth by 3. For example, for an azimuth of 51° , the bezel ring is rotated 17 clicks counterclockwise.

3. Turn the compass until the north arrow is directly under the luminous line on the bezel.

4. Hold the compass open and level in the palm of the left hand with the thumb along the flat side of the compass. In this manner, the compass can be held consistently in the same position. Position the compass approximately halfway between the chin and the belt, pointing directly ahead of yourself. A little practice in daylight should make you proficient in pointing the compass the same way every time. Looking directly down into the compass, turn your body until the north arrow is under the luminous line. Then move forward in the direction of the front cover luminous sighting dots (fig. 5-26).

Certain precautions about the care and use of a lensatic compass are important because they assure, within reason, that a compass works when and where you need it.

1. Handle the compass with care. The dial is set at such a delicate balance that a shock could damage the compass.

2. Close and return the compass to its special container when it is not in use. In this way, it is not only protected from possible damage but is readily available for use when needed.

3. When the compass is to be used in darkness, an initial azimuth should be set, whenever possible, while light is still available. With this initial azimuth as a base, you can read any other azimuth that is a multiple of 3° by using the clicking feature of the bezel.

4. Compass readings should NEVER be taken near visible masses of iron or electrical circuits. The

following are suggested as approximate safe distances to ensure proper functioning of the compass:

High tension power lines 55 yards

Field gun, truck, or tank 18 yards

Telegraph and telephone wires and
barbed wire 10 yards

Machine gun 2 yards

Helmet or rifle 0.5 yards

Nonmagnetic metals and alloys do not affect compass readings.

5. Practice by using the compass at regular intervals. This is to help you become competent in its use during an emergency.

Azimuth and Back Azimuth

The most common military method of expressing a direction is by using azimuths. As stated before, an "azimuth" is defined as a horizontal angle, measured in a clockwise reamer from a north base line. When the azimuth between two points on a map is desired, the points are joined by a straight line. Then a protractor is used to measure the angle between grid north and the drawn line. This measured angle is the grid azimuth of the drawn line (fig. 5-29). When using an azimuth, you imagine the point from which the azimuth originates as

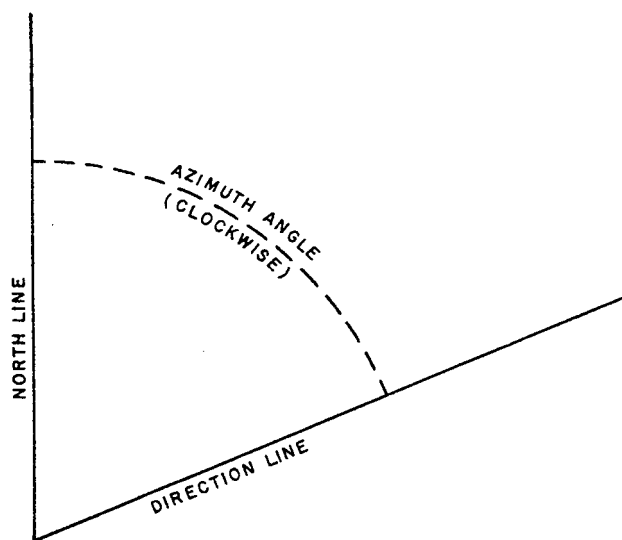

Figure 5-29.—Azimuth angle.

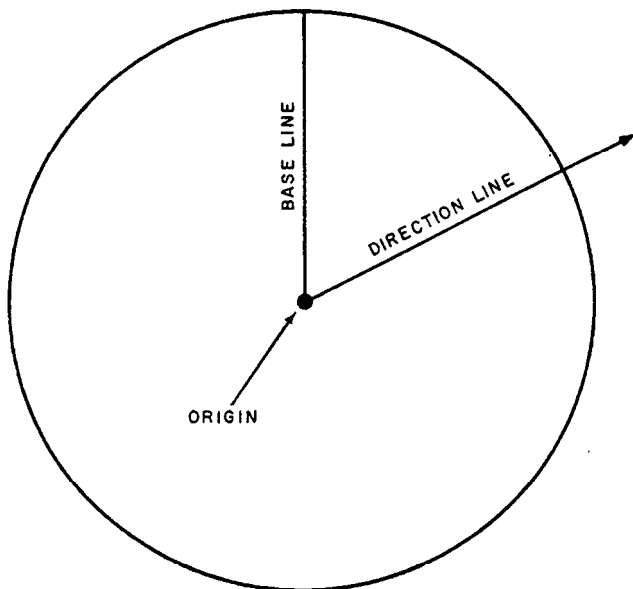
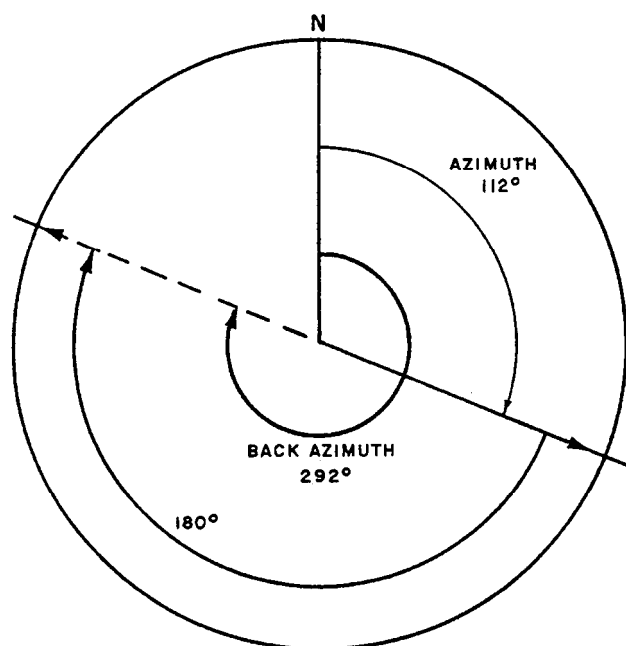

Figure 5-30.—Origin of azimuth circle.



AZIMUTH = CLOCKWISE ANGLE FROM BASE DIRECTION
 BACK AZIMUTH = AZIMUTH + 180° OR 3200 MILS.

Figure 5-31.—Azimuth and back azimuth.

the center of the azimuth circle (fig. 5-30). Azimuths take their name from the base line from which they have been measured; true azimuths from true north, magnetic azimuths from magnetic north, and grid azimuths from grid north (fig. 5-21). Therefore, any one given direction can be expressed in three different ways: a grid azimuth, when measured on a military map; a magnetic azimuth, when measured by a compass; or a true azimuth, when measured from a meridian of longitude.

The **BACK AZIMUTH** of a line is its forward azimuth plus 180°; or if this sum is greater than 360°,

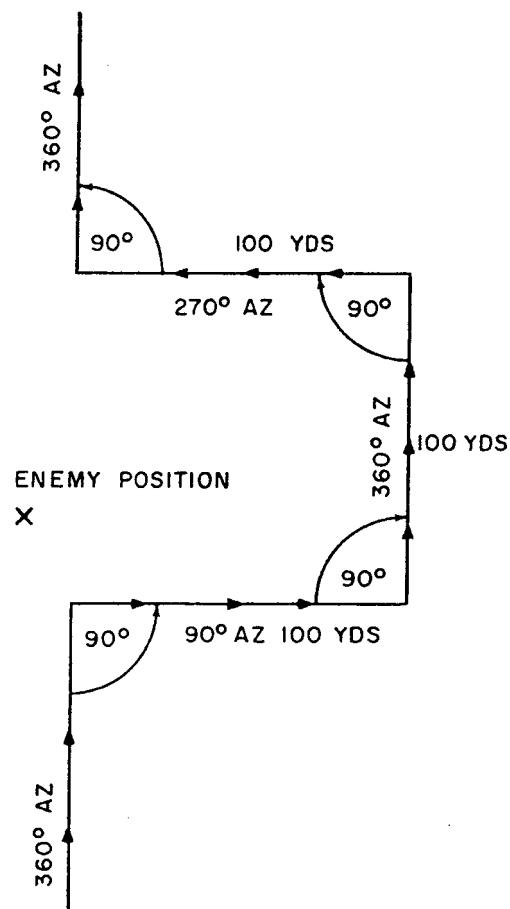

Figure 5-32.—Detour around enemy positions or obstacles.

the back azimuth is the forward azimuth minus 180°. For example, if the forward azimuth of a line is 112° (fig. 5-31), the back azimuth is as follows:

$$112^{\circ} + 180^{\circ} = 292^{\circ}$$

When the forward azimuth of a line is 310°, the back azimuth is as follows:

$$310^{\circ} - 180^{\circ} = 130^{\circ}$$

Figure 5-32 shows an example of how to bypass enemy positions or obstacles by detouring around them. This allows you to stay oriented by moving at right angles for specified distances. For example, if you are moving on an azimuth of 360° and wish to bypass an obstacle or position, you change direction to 90° and travel for 100 yards; change direction back to 360° and travel for 100 yards; change direction to 270° and travel for 100 yards; then change direction to 360°; and you are back on your original azimuth.

Bypassing an unexpected obstacle at night is a fairly simple matter. To make a 90° turn to the right, hold the compass as described earlier in the method for night use; turn until the center of the luminous letter *E* is under the luminous line (do NOT change the setting of the

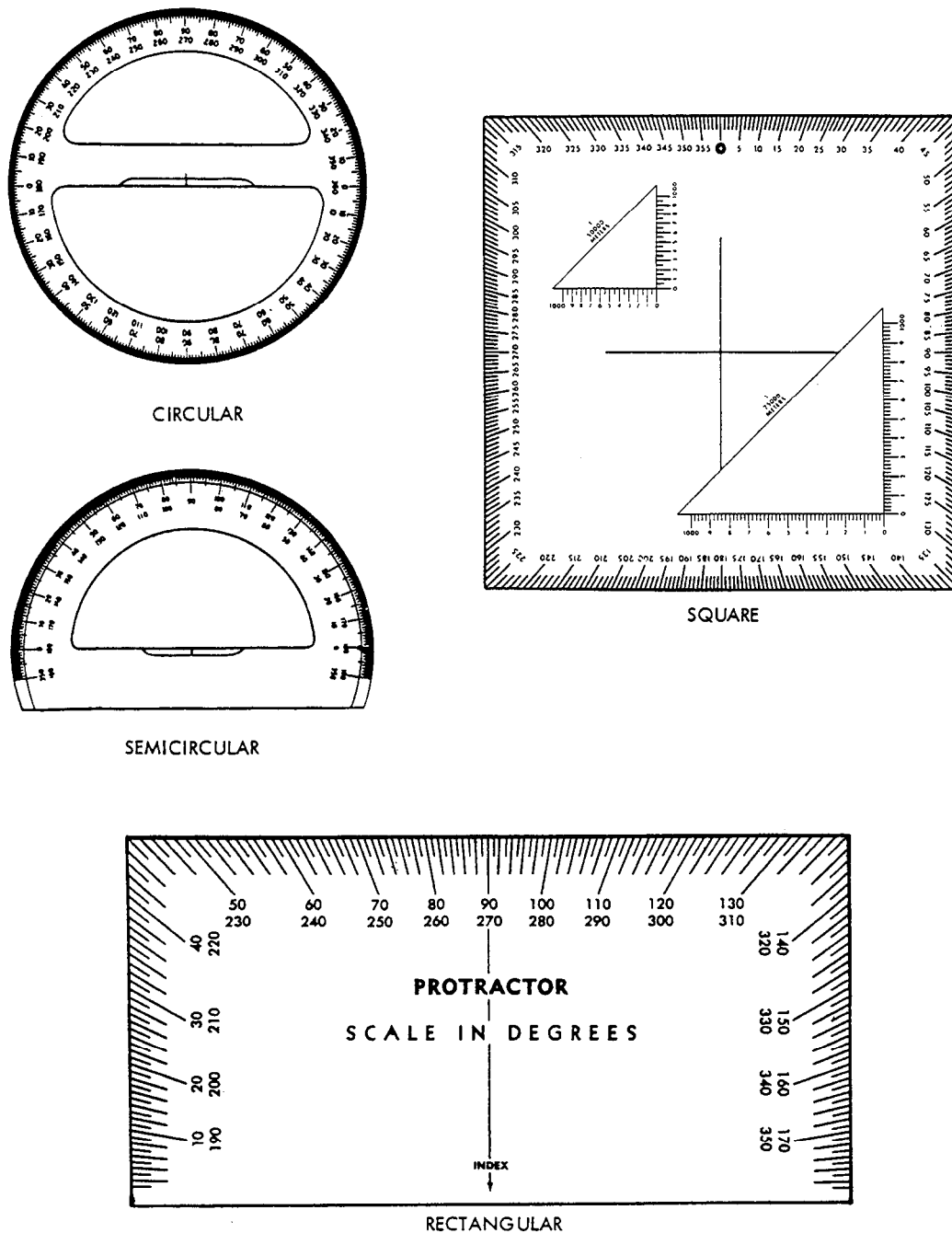

Figure 5-33.—Types of protractors.

luminous line). To make a 90° turn to the left, turn until the center of the luminous letter *W* is under the luminous line. The compass setting (bezel ring) does not require changing, and you can be sure of accurate 90° turns. For example, you decide to detour to the right. You turn until *E* is under the luminous line and move ahead in that direction until you have outflanked the obstacle. You then turn until the north arrow is under the luminous line and move parallel to your original course until you have bypassed the obstacle. You then turn again until the *W*

is under the luminous line and move back the same distance you originally moved out. Finally, you turn until the north arrow is under the luminous line and go ahead on your original course. This method works regardless of what your initial azimuth may be.

Protractor

Protractors come in several forms—full circle, half circle, square, and rectangle (fig. 5-33). All of them

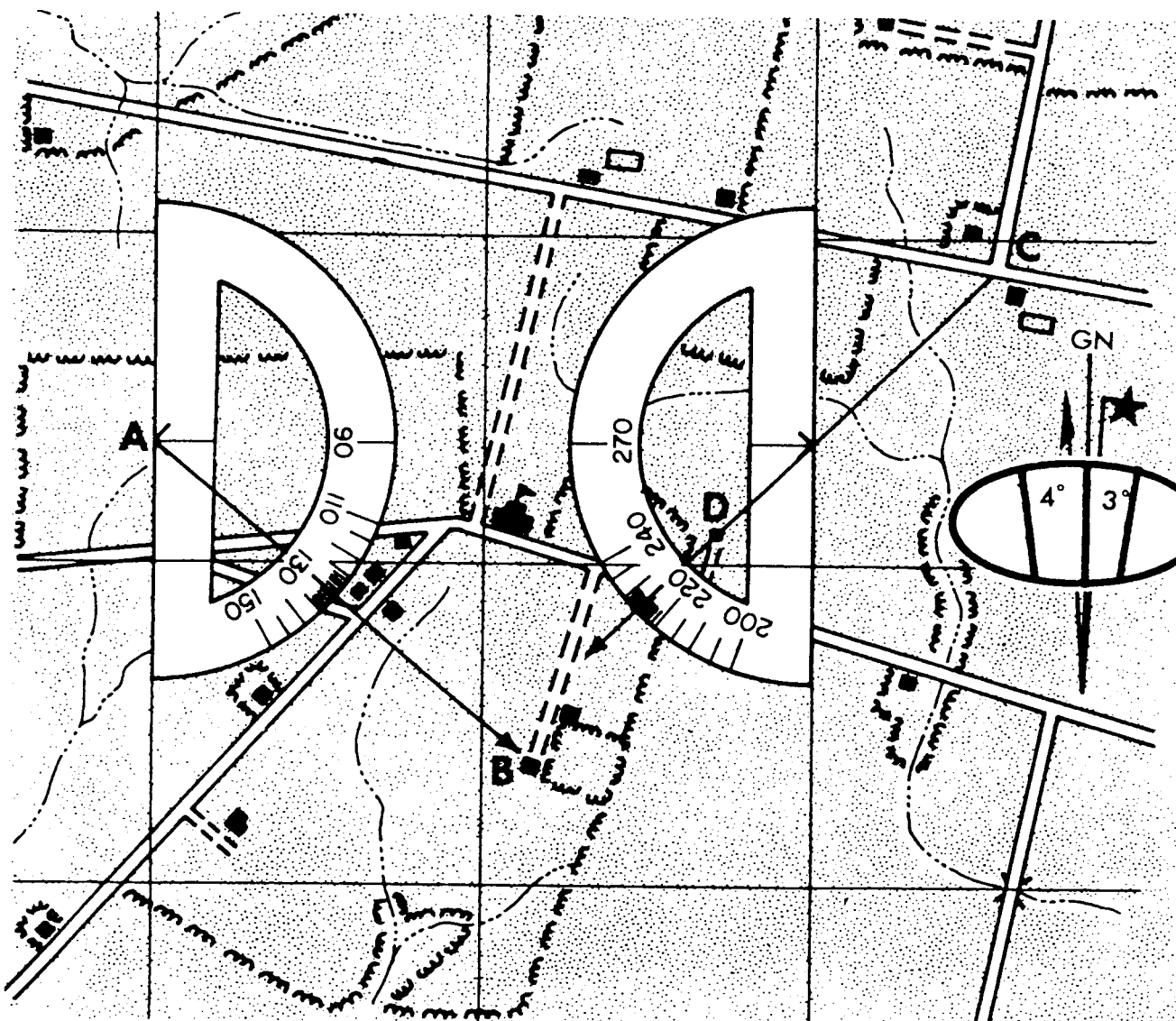

Figure 5-34.—Measuring an azimuth on a map.

divide a circle into units of angular measure; and regardless of their shape, they consist of a scale around the outer edge and an index mark. The INDEX MARK is the center of the protractor circle from which all the direction lines radiate.

To determine the grid azimuth of a line from one point to another on the map (from A to B or C to D), refer to figure 5-34 as you study the following:

1. Draw a line connecting the two points.
2. Place the index of the protractor at the point where the line crosses a vertical (north-south) grid line.
3. Keeping the index at this point, align the 0°-180° line of the protractor on the vertical grid line.

4. Read the value of the angle from the scale; this is the grid azimuth of the point.

To plot a direction line from a known point on a map, refer to figure 5-35 as you study the following:

1. Convert, if necessary, the direction to azimuth.
2. Construct a north-south grid line through the known point. Then proceed in the following steps:
 - First, approximately align the 0°- 180° line of the protractor in a north-south direction through the known point.

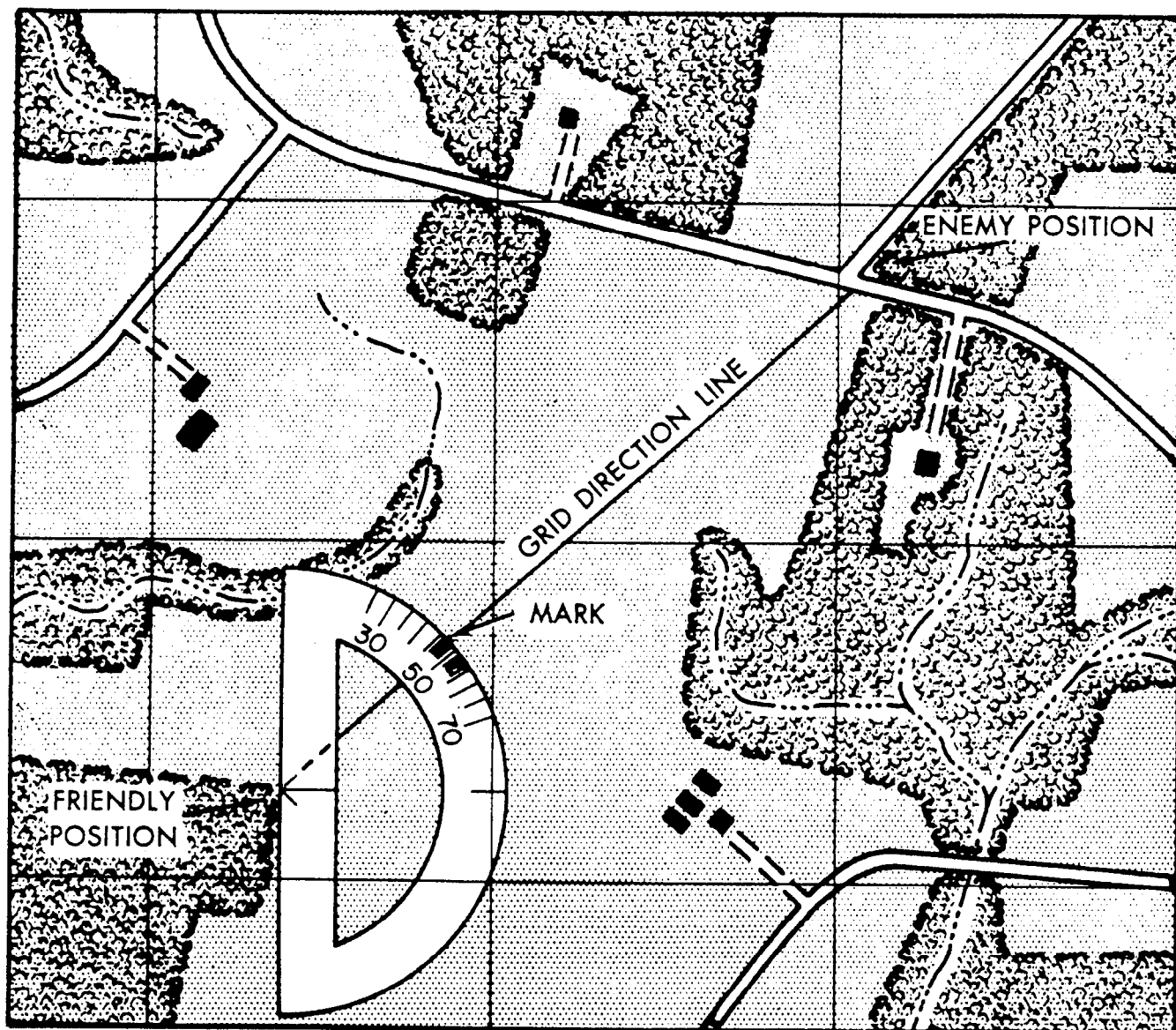

Figure 5-35.—Plotting an azimuth on a map.

- Second, holding the 0° - 180° line of the protractor on the known point, slide the protractor in the north-south direction. Slide it until the horizontal line of the protractor (connecting the protractor index and the 90° tick mark) is aligned on an east-west grid line.

- Draw a line connecting 0° , the known point, and 180° .

- Holding the 0° - 180° line coincident with this line, slide the protractor index to the known point.

- Make a mark on the map at the required angle.

- Draw a line from the known point through the mark made on the map. This is the GRID DIRECTION line.

Intersection

Locating an unknown point by successively occupying at least two, but preferably three, known positions and sighting on the unknown point is called intersection. It is used to locate features that are not defined on the map or which are not readily identifiable. The two methods of intersection are the map and compass method and the straightedge method.

MAP AND COMPASS METHOD.— Study the following steps to locate an unknown point using the

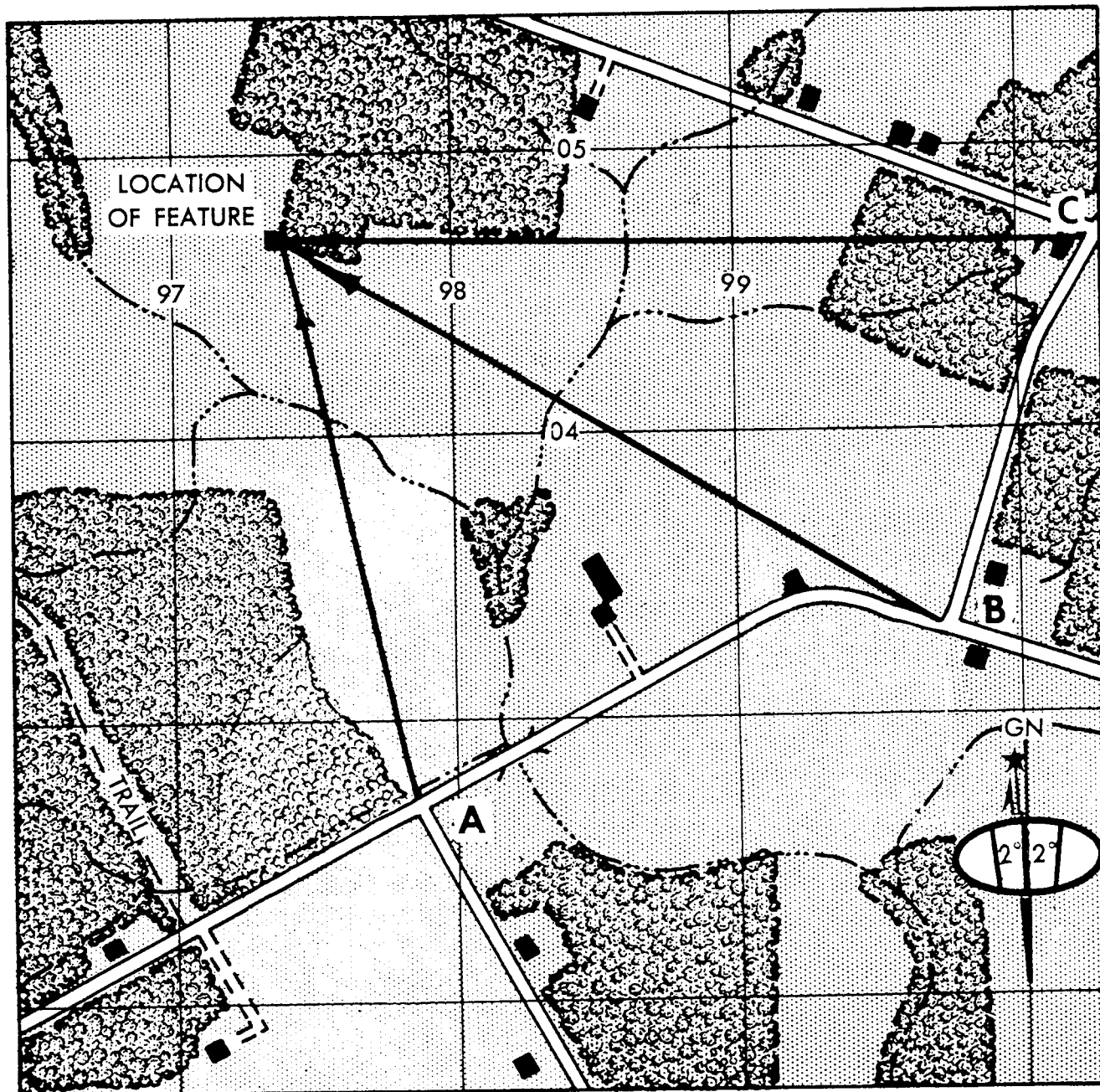

Figure 5-36.—Intersection using map and compass.

map and compass method of intersection. (See fig. 5-36.)

1. Orient the map using the compass.
2. Locate and mark your position (Point A) on the map.
3. Measure the magnetic azimuth to the unknown position; convert it to grid azimuth.
4. Draw a line on the map from your position on this grid azimuth.

5. Move to a second known position (Point B) from which the unknown point is visible. Locate this position on the map and again orient the map using the compass.

6. Repeat Steps 3 and 4 above.

7. As a check on accuracy, move to a third position (Point C) and repeat Steps 1 through 4 above.

8. The point where the lines cross is the location of the unknown position. Using three lines, you sometimes form a triangle instead of an intersection. This is called the **TRIANGLE OF ERROR**. If the triangle is large,

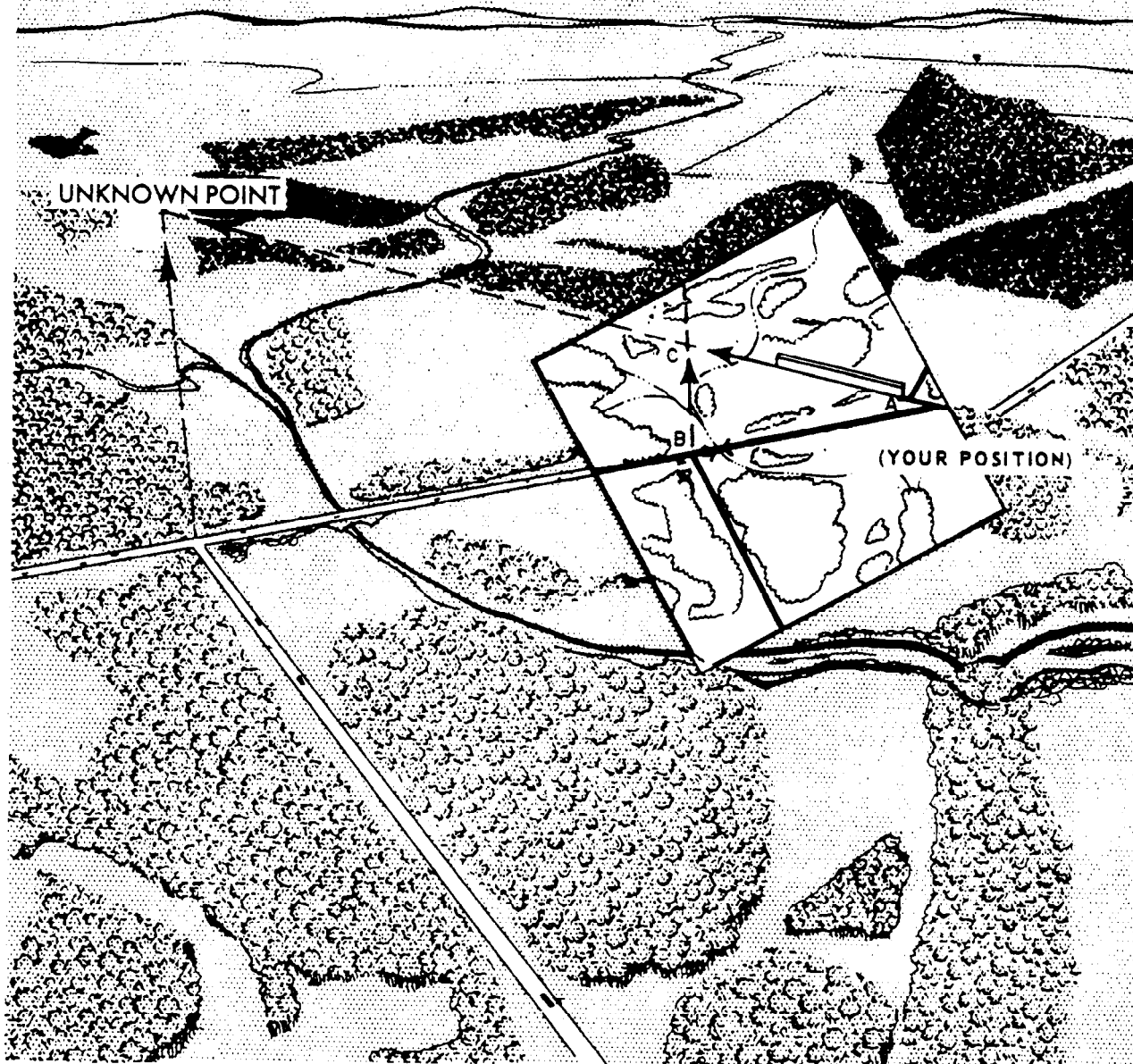

Figure 5-37.—Intersection without compass.

recheck your work to find the error. Do not assume that the position is at the center of the triangle.

STRAIGHTEDGE METHOD (WHEN NO COMPASS IS AVAILABLE).— Study the following steps to locate an unknown point using the straightedge method of intersection. (See fig. 5-37.)

1. Orient the map on a flat surface by the inspection method.
2. Locate and mark your position on the map.
3. Lay a straightedge on the map and place one end at the position of the user (Point A) as a pivot point. Then

rotate the straightedge until the unknown point is sighted along the edge.

4. Draw a line along the straightedge.
5. Repeat the above procedures at Point B, and for a check on accuracy, at a third position.
6. The intersection of the lines is the location of unknown Point C.

Resection

Locating the unknown position of the user by sighting on two or three known features is called

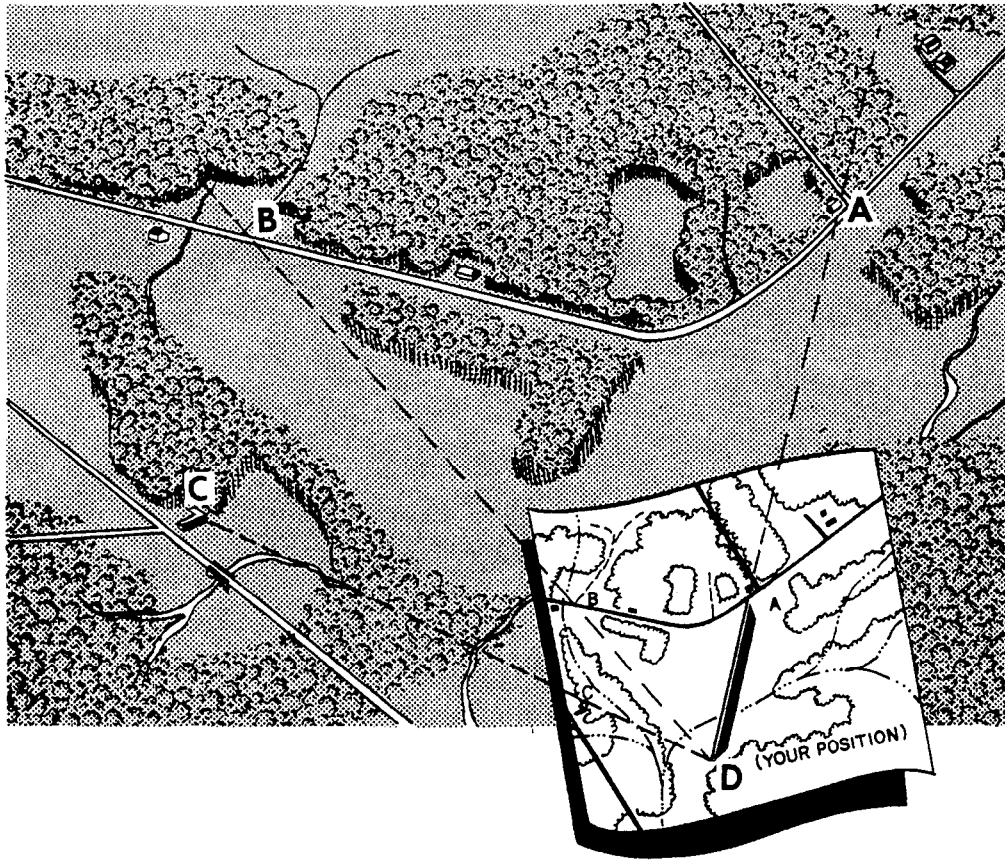

Figure 5-38.—Resection.

resection (fig. 5-38). Resection can be done with or without a compass.

MAP AND COMPASS METHOD.— Study the following steps to locate the unknown position of the user by the map and compass method:

1. Orient the map using the compass.
2. Locate two or three known positions on the ground and mark them on the map.
3. Measure the magnetic azimuth to a known position; convert it to grid azimuth.
4. Change the grid azimuth to a back azimuth and draw a line on the map from the known position back toward your unknown position.
5. Repeat Steps 3 and 4 above for a second known position.
6. For a check on your accuracy, repeat Steps 3 and 4 above for a third known position.
7. The intersection of the lines is your location. Using three lines, a triangle of error maybe formed. If the triangle is large, recheck your work.

STRAIGHTEDGE METHOD.— Study the following steps to locate the unknown position of the user by the straightedge method:

1. Orient the map on a flat surface by the inspection method.
2. Locate two or three known positions on the ground and mark them on the map.
3. Lay a straightedge on the map with the center of the straightedge at a known position as a pivot point. Rotate the straightedge until the known position on the map is aligned with the known position on the ground.
4. Draw a line along the straightedge away from the known position on the ground toward your position.
5. Repeat Step 3 above using a second known position; and as a check on your accuracy, repeat Step 3 above, using a third known position.
6. The intersection of the lines is your location.

SKETCHES AND OVERLAYS

You are not expected to be a draftsman. But you should be able, if necessary, to make rough drawings of maps, field sketches, and overlays. The instruction presented in this chapter about maps is designed to assist you in making rough drawings of them. The information below will be useful in preparing a rough drawing of a field sketch or map overlay.

The two types of sketches are panoramic and topographic.

PANORAMIC SKETCHES

A panoramic sketch is a picture of the ground or terrain. It shows the height and view from your point of observation. A panoramic sketch prepared by one scout may assist another scout in finding himself for a brief time in the same location.

To make a panoramic sketch, use the following guidance:

1. First, determine the information you desire to convey.
2. Next, draw in the landscape lines that are more or less horizontal.
3. Show the main points of the area on the sketch. Do not put in any unimportant details that might only be confusing, and do not show the foreground. Be sure you show the location of the information you are conveying.
4. Place any explanatory notes above the sketch with arrows pointing to the features explained.
5. The most prominent point in the sketch should be used as a reference point. After selecting this point, indicate the azimuth reading used to locate it.
6. Place a title on the sketch, show where it was prepared, indicate the date and the time it was made; then sign it.

TOPOGRAPHIC SKETCHES

A topographic sketch is prepared so the person receiving it can plot on a map your scouting position or the information you wish to convey. To prepare a topographic sketch, you need a map similar to one your commander has in his possession.

1. Read the azimuth from your position to the position of an object you can easily see and describe.
2. Estimate the distance, using the most accurate means available.
3. Draw the azimuth line from you to the object. Then mark the azimuth above this line and the distance below this line.
4. At the proper end of the line, indicate the object. At the other end of the line, indicate your own position.
5. Find the azimuth and the distance to some other point on the map or to the position of the command post.
6. Draw this line on the sketch. Then indicate the azimuth, the distance, and the object to which it is drawn.
7. Finally, sign the sketch.

MAP OVERLAYS

A map overlay is generally used to send back reconnaissance information. The overlay is made by placing a piece of transparent paper on a map, marking the location, and numbering the corners of the grid squares. At least two corners should be marked or crossed. These crosses are called REGISTER MARKS and are used to orient the overlay on a map later on. After the register marks have been made, you only need to write the information that is to be sent back to the command post. When the overlay is received it will be placed on a similar map and oriented by its register marks and the information you recorded.

CHAPTER 6

EVASION, SURVIVAL, AND ESCAPE

The tactical need for greater individual and unit dispersion in warfare increases the possibility that your unit may be temporarily isolated from friendly forces. Experience shows this temporary isolation is fairly common and normal in both conventional warfare and counterinsurgency operations. For example, enemy action may cause relocation of adjacent units so you lose immediate contact with friendly forces; a sudden massing of guerrilla forces may isolate your unit in a guerrilla-controlled area; or as a member of a patrol operating in an enemy area, you may become separated from your patrol and find yourself alone or with a small group. If you do become isolated, you and your group or unit must still try to accomplish your assigned mission. After you complete your mission, your primary task is to rejoin friendly forces.

When you are isolated in an enemy area, your major problems are (1) avoiding the enemy (EVASION), (2) the possibility of living in the field with limited equipment (SURVIVAL) until you can return to friendly forces, and (3) the problem of escaping from the enemy if captured (ESCAPE).

This chapter contains information on the principles and techniques of evasion, survival, and escape that have been used successfully worldwide. The information given here is by no means all-inclusive, but it should serve as an aid if the need arises.

EVASION

Obviously, the most important consideration in evasion is knowing the location of the enemy. If you do not know where the enemy is located when you become separated from your unit, some of the more obvious signs to help you determine this are the following:

- Signs of the passage of groups, such as crushed grass, broken branches, footprints, cigarette butts, or other discarded trash. These may reveal the identity, size, direction of travel, and time of passage of the people.
- Workers in fields may indicate the absence of the enemy.
- Apparently, normal activities in villages may indicate the absence of the enemy.

Less obvious signs are conditions that are a type of negative information, for example:

- The absence of workers in fields is an indication that the enemy is near.
- The absence of children in a village is an indication that they have been hidden to protect them from action that may be about to take place.
- The absence of young men in a village is an indication that the village is controlled by the enemy.

No identifiable specific techniques are involved in evasion, but you need to use all other phases of your combat training. You will use cover, concealment, camouflage materials, day-and-night movement techniques, maintaining direction, security, passing of obstacles, silent weapons, health measures, physical conditioning, and patrolling. These are basic to evasion as well as to survival and to escape.

You must know the following:

1. Ways of concealing yourself when the enemy is near and how to move without silhouetting yourself against the skyline; ways to keep from being spotted from enemy aircraft.
2. The distance that noises carry in fog, falling snow, heavy foliage, or over rocky surfaces.
3. How smells from food being cooked, tobacco and wood smoke, body odors, and body wastes can reveal your location.
4. The dangers of sudden, rapid movement.
5. Ways to observe the enemy without being observed.
6. Methods to use for camouflaging yourself, your camp, and your equipment without using too much camouflage.
7. How to select routes for movement that avoid exposed areas; ways to move quietly without leaving obvious tracks; and how to determine travel time for yourself or for a group.
8. How to signal using your voice, hands and arms, pebbles, and pieces of wood.

EVASION TRAVEL

The route that you select to travel while trying to evade the enemy depends upon the situation in which you find yourself, the weather conditions, and the nature of the terrain. Whether you select a ridge, stream, valley, coastline, dense forest, or mountain range to follow, be sure it is the safest rather than the easiest way. Experience has proven that the most difficult route is frequently the safest.

A route along a ridgeline is usually easier to follow than one through a valley. Game trails are frequently on top of ridges, and you can use them to guide your travel. Also, you find less vegetation, frequent high points for observing landmarks, and few streams and swamps to ford.

The use of a stream as a route is of particular advantage in strange country because it provides a fairly definite course and might lead to populated areas; also, the stream may provide you with fish and water and serve as a vehicle for travel by boat or raft. However, be prepared to ford, detour, or cut your way through the thick vegetation lining the stream. When you are following a stream in mountainous country, watch for falls, cliffs, and tributaries as checkpoints. In flat country, streams usually meander, are bordered by swamps, and are thick with undergrowth. Travel on these streams provides little opportunity to observe landmarks.

When you decide to follow a coastline, you can figure on a long, roundabout route. But it is a good starting point, an excellent base line from which to get your bearings, and a probable source of food.

In strange country, study outstanding terrain features as you travel, and concentrate on maintaining your course. Climb to a high point and look at the general pattern of the land, character of the vegetation, the drainage patterns, and the trend of mountains and ridges. Choose a prominent landmark that you can see while you travel. As you near this landmark, line up another one ahead of you.

If you are traveling in a dense forest, you probably will not be able to spot distant landmarks. You can hold a course by lining up on two trees forward of your position in your direction of travel. As soon as you pass the first one, line up another beyond the second. You might find it helpful to look back occasionally to check the relative positions of landmarks or ground slope and contour.

You can usually use streams, ridges, and trees as guides in open country and as a means of retracing your route. On overcast days, in areas where the vegetation is dense, or whenever the country appears the same, mark your route. Use bent bushes, rocks, or notches placed on the back sides of trees at approximately eye level. Mark bushes by cutting vegetation or bending it so the under and lighter side of the leaves are facing upward. These signs are especially conspicuous in dense vegetation. But use them with discretion because you risk discovery by the enemy when you mark your route too plainly.

Even with a map, do not guide too confidently on man-made features or landmarks that are likely to change. The only safe landmarks are natural features, such as rivers and hills. In the jungle, for example, when a village site marked on a map is investigated, it often is an overgrown clearing. Similarly, one rainy season can change the course of a small stream or close an unused trail with dense shrub.

Use trails as guides that lead in the general direction of friendly forces; and when you come to a fork, use the path that appears most traveled as a guide. If you guide on the wrong trail and find yourself lost, stop and try to remember the last time you were sure of your location. Mark your location where you were lost and start backtracking. Sooner or later you will discover a recognizable feature with which you can pinpoint your position.

Traveling at night is safe in the desert or open country but is not advisable in strange, wooded country. However, if you do travel at night, use a shielded light only when necessary to find your way over rough, dangerous spots or to read a map or compass. Since your eyes adjust to the darkness, a light blinds you to all but a small area that is illuminated. You can keep a fairly accurate course for short distances in open country by picking a bright star near the horizon as a guide star in your line of travel. Then line up the trees and other skyline landmarks ahead with the star. Be sure to check your direction frequently with the North Star or the Southern Cross and change guide stars whenever you need to change direction.

You may have to detour frequently in rough country. To do this, you should try to follow methods, such as the one shown in figure 6-1. This method is used for estimating distance and average angle of departure for short detours. On your return from the detour, you estimate the angle and distance to regain your original line of travel. For greater accuracy, count paces and use a compass. Another method (fig. 6-2) allows you to

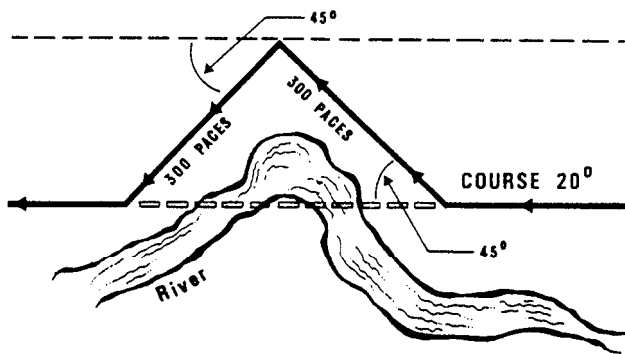

Figure 6-1.—Estimating distance and average angle of departure.

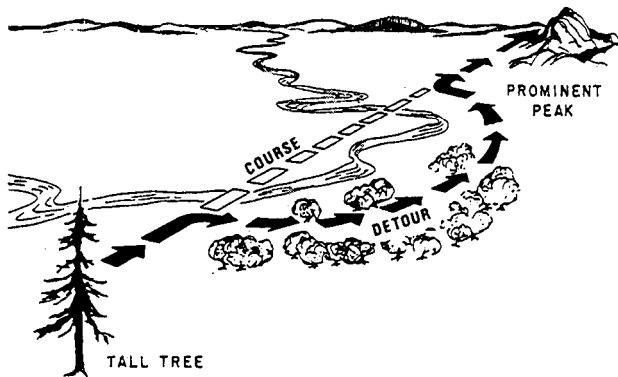

Figure 6-2.—Using a prominent landmark.

select a prominent landmark ahead and behind your line of travel. On returning from your detour, walk until you are again “lined up” on the two landmarks; then follow your original course. Another example for detouring is by compensating by paces and right angles, as shown in figure 6-3.

TRAVEL TIPS FOR EVASION

Be patient, cautious, and avoid overconfidence. An enemy approach is no cause for panic. Normally, the chances of remaining unobserved are good.

Conserve your strength by avoiding exhaustion. When you are compelled to remain in one place for an extended period, exercise moderately in order to keep fit.

Generally, avoid eating uncooked food or drinking unboiled water. Select a hiding place, cook the food, and boil the water to be used en route to the next evasion objective.

Retain items of personal clothing and equipment that can serve a useful purpose during evasion. Keep some item that identifies you as a serviceman, such as

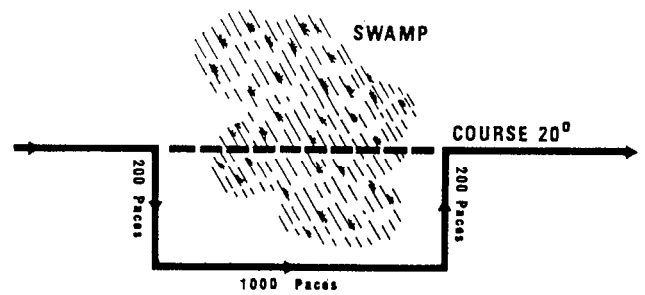

Figure 6-3.—Compensating by paces and right angles.

your dog tags. If you are not able to identify yourself as a serviceman, you maybe treated as a spy, if captured. You may also be refused assistance by escape organizations or friendly locals.

Do not leave or throw away articles that, if found would reveal your presence. Bury or otherwise dispose of the effects of your campsite; otherwise, these effects could give the enemy a clear picture of your direction of travel.

Practice supply economy. The same jacket or pair of shoes may have to be used throughout the entire evasion trip. This may cover hundreds of cross-country miles during both winter and summer seasons. Build up your food and water supplies and ration them carefully so they last until you can reach an evasion objective or replenish them or both.

Use firearms only in an emergency, and keep them concealed at all times during your evasion unless a situation arises that requires a show of arms.

Avoid people as long as possible. However, if you find that you can no longer hope to go ahead on your own because of sickness, lack of food, or other compelling reasons, then, and only then, should you seek help from the local populace. Assistance may come from individual locals who are sympathetic to the Allied cause or from members of the underground who operate escape lines for the purpose of returning evaders to friendly forces. You must be wary when contacting locals regardless of what they claim to be. When you are fortunate enough to travel through an area where an organized escape line exists, the chances are good that a spotter will seek you out. Spotters for resistance or underground organizations are particularly alert when they have reason to believe that friendly forces are in their area. But this also applies to the enemy police and counterintelligence agents. Persons wearing civilian clothing in enemy-held territory are not necessarily civilians; many enemy soldiers have been found disguised as civilians.

CRUCIAL PHASE OF EVASION

Establishing contact with friendly lines or crossing the border to a neutral country is the most crucial point of evasion. All of your patience, planning, and hardships have been in vain if you are not wary when contacting friendly frontline forces. Many personnel operating behind enemy lines have been killed by friendly outposts while attempting to pass through friendly lines. Evaders have been shot by friendly patrols because they did not identify themselves properly. Many refugees have been accidentally killed by friendly forces. While trying to escape to freedom, most of these refugees would not have been shot if they had used caution and followed a few simple rules. The normal tendency is to throw caution to the wind when you are in sight of friendly forces. Realize that the situation is very sensitive, and this tendency should be overcome.

Regular patrols or special-mission personnel operating behind enemy lines are given the challenge and password of the day as a security measure. This provides for the identification of the patrol as it approaches a friendly position. In addition, frontline troops are told the time and place where patrols are to leave and enter the lines. The password of the day will not help you unless you are able to rejoin your unit within 24 hours after separation. You must follow certain established procedures and hope the frontline troops also follow them. Frontline troops (especially those employed several miles forward of the battle area) usually shoot first and ask questions later. It is obvious that contact with these troops is, at the least, sensitive and a calculated risk. However, in the absence of an opportunity to contact a friendly patrol, this may be the only alternative. Generally, frontline troops are told that the display of a white flag or another white object should be honored and that the unknown person be allowed to advance and be recognized.

Once back in friendly hands, it is natural to talk about your exploits. And you will undoubtedly be asked countless questions by frontline troops. This is the time for you to remain silent because if you talk at this point, you may endanger the lives of those who helped you. In addition, your answers may compromise the methods used to evade the enemy that could be used by some other unfortunate serviceman in evading safely. You are authorized to give only information of immediate tactical importance to frontline units, unless you are a member of regular patrol actions. Advise the first officer or petty officer you contact that you are returning to duty from missing in action, prisoner of war, or internment

status; then request someone authorized to receive evasion and escape information.

SURVIVAL

The experience of hundreds of servicemen isolated during World War II, the Korean conflict, and the Vietnam conflict proved that survival is largely a matter of mental outlook. The will to survive is the deciding factor. Whether with a group or alone, you experience emotional problems resulting from fear, despair, loneliness, and boredom. Also, your will to live is sure to be taxed by injury and pain, fatigue, hunger, and thirst. When you are not prepared mentally to overcome all obstacles and accept the worst, your chances of coming out alive are greatly reduced.

INDIVIDUAL SURVIVAL

The shock of finding yourself isolated behind the enemy lines, in a desolate area, or in enemy hands can be reduced or even avoided if you remember the meaning of the letters in the keyword *S-U-R-V-I-V-A-L* (fig. 64).

- **S**—Size up the situation by considering yourself, the country, and the enemy.

When you think about yourself, hope for the best, but be prepared for the worst. Recall your survival training and expect it to work. After all, you have been

Size up the situation
Undue haste makes waste
Remember where you are
Vanquish fear and panic
Improvise
Value living
Act like the natives
Learn basic skills

Figure 6-4.—Factors for survival.

through this before—the only difference is that this is the real thing. If you think this way, you can increase your chances for success by being confident that you can survive. Get to a safe, comfortable place as quickly as possible. Once you find a safe place, look things over, think, and form a plan. Your fear will lessen; your confidence will increase. Becalm. Take it easy until you know where you are and where you are going.

Part of your fear may come from being in a strange country; therefore, try to determine your location by landmarks, by compass directions, or by recalling intelligence information passed on to you by your leaders.

When you think about the enemy, put yourself in the shoes of the enemy. What would you do? Watch the habits and routines of the enemy. Base your plan on your observations. Remember, you know where the enemy is, but he does not know where you are.

- U—Undue haste makes waste.

Do not be too eager to move. It makes you careless and impatient. You begin to take unnecessary risks, and you might end up like the man who rushed ahead without a plan. He tried to travel at night but only injured himself by bumping into trees and fences. Instead of laying low and trying to evade the enemy, he fired at them with his rifle and was caught. Do not lose your temper. Loss of self-control may cause you to stop thinking. When something irritating happens, stop. Take a deep breath and relax; start over.

Face the facts—danger does exist. Trying to convince yourself otherwise only adds to the danger.

- R—Remember where you are.

You may give yourself away because you are used to acting in a certain way. Doing “what comes naturally” could be the tip-off that you do not belong there.

- V—Vanquish fear and panic.

To feel fear is normal and necessary. It is nature’s way of giving you that extra shot of energy just when you need it. Learn to recognize fear for what it is and control it. Look carefully at a situation and determine whether your fear is justified. After you investigate, you will usually find many of your fears are unfounded.

When you are injured and in pain, controlling fear is difficult. Pain sometimes turns fear into panic and causes a person to act without thinking. Panic can also be caused by loneliness. It can lead to hopelessness, thoughts of suicide, and carelessness—even capture or

surrender. Recognition of the effect of fear and its results helps you overcome panic.

- I—Improvise.

You can always do something to improve the situation. Figure out what you need; take stock of what you have; then improvise. Learn to put up with new and unpleasant conditions. Keeping your mind on SURVIVAL helps. Do not be afraid to try strange foods.

- V—Value living.

Conserve your health and strength. Illness or injury greatly reduces your chance of survival and escape. Hunger, cold, and fatigue lower your efficiency and stamina, make you careless, and increase the possibility of capture. Knowing this makes you especially careful because you realize that your spirits are low due to your physical condition—not from the danger involved. Remember your goal—getting out alive. Concentrating on the time after you get out alive will help you value living now.

- A—Act like the local populace.

“At the railroad station, there were German guards,” one escapee related. “I had an urgent need to urinate. The only rest room was an exposed one in front of the station. I felt too embarrassed to relieve myself in front of all the passersby. I walked throughout the entire town stopping occasionally and inquiring if a rest room was available.” This man was detected and captured because he failed to accept the customs of the locals. When you are in a strange situation, accept and adopt local behavior. In this way, you avoid attracting attention to yourself.

- L—Learn basic skills.

The best life insurance is to make sure that you learn the techniques and methods of survival so thoroughly that they become automatic. Then the chances are that you will do the right thing, even in panic. Work on the training you are given because it may mean saving your life. Be inquisitive and search on your own for additional survival knowledge.

GROUP SURVIVAL

You and your entire squad, platoon, or group must make your reactions to survival situations automatic. The best chance for survival belongs to the group that works TOGETHER and has a leader who fulfills his responsibilities to the group. If the group remembers the following factors while evading capture, their return to friendly forces should be successful.

Group survival activities should be organized. Group survival depends largely upon the organization of its manpower. Organized action by group members that know what to do and when to do it, during ordinary circumstances and during a crisis, prevents panic. One technique for achieving organized action is to keep the group well informed. Another is to devise a plan and then stick to it.

Assigning each man a task that fits his personal qualifications most closely is another way of organizing a group. If one man feels he can fish better than he can cook, let him provide the fish. Always determine and use special skills of members within the group.

Panic, confusion, and disorganization are lessened by good leadership. It is the responsibility of the senior member of a group to assume command and establish a chain of command that includes all members of the group. Make certain that each man knows his position in the chain of command and is familiar with the duties of every other man, especially your duties if you are senior. Under no circumstances should leadership of the group be left up to chance acceptance by some member after a situation arises.

If senior, lead your men. Group survival is a test of effective leadership. Maintain respect for your leadership by using it wisely; be the leader, set the example. Watch out constantly to prevent serious arguments. To keep troublemakers from attracting undue attention, to keep those who may "crackup" from disrupting the group, and to prevent carelessness caused by fatigue, hunger, and cold are important parts of your job. Know yourself and your men and be responsible for the welfare of each individual.

Develop a feeling of mutual dependence within the group by stressing that each man depend on the other men for survival. Emphasize that wounded or injured men will not be left behind—that responsibility of each member is to see that the group returns intact. This attitude fosters high morale and unity. Each member receives support and strength from the others.

No matter what the situation, the leader must make the decisions. Because he needs intelligence upon which to base his decisions, he should ask for information and advice from other members of the group—much as a general uses his staff. Above all else, the leader must, at all times, appear to be decisive.

Situations arise that must be acted upon immediately. The ability to think on your feet usually determines successful survival. Consider the facts and make decisions rapidly.

SURVIVAL TECHNIQUES

According to the Code of Conduct for members of the armed forces, it is your duty to evade capture by the enemy. Also, if captured, you must make every effort to escape. As a Seabee, you face the chance of being exposed to conditions that can force you into a life-or-death struggle. Survival, in this case, depends on your ability to apply the techniques of evading and escaping. There can be no more important reason for making survival techniques part of your basic combat skills.

You can remain alive anywhere in the world when you keep your wits. This is a major lesson in survival. Remember that nature and the elements are neither your friend nor your enemy. Instead, your determination to live and your ability to make nature work for you are the deciding factors.

Your job is to get back. The more you know about conditions peculiar to the region you are in, including the plant and animal life, the better your chances are for survival.

Survival in remote and desolate areas, in the Arctic, desert, or jungle, depends on you. You must be physically fit, have a fundamental knowledge of how to locate water, know what foods are available, and ways to find and prepare them. You must also be able to recognize plants and animals that can harm you.

Water

Without water your chances of living are nil, and all the food in the area means nothing. This is especially true in hot climates where you perspire a lot. Even in cold weather your body needs at least 2 quarts of water each day; a lesser amount reduces your efficiency.

When you cannot find surface water, tap through the earth to the water table for groundwater—rain or melted snow that has sunk into the ground. Access to this table and its supply of water depends upon the contour of the land and the character of the soil.

In rocky soil look for springs and seepage. Limestones have more and larger springs than any other type of rock. Because limestone is easily dissolved, caverns are easily etched by groundwater. Look in these caverns for natural springs. Because lava rock is porous, it is also a good source for seeping groundwater. Look for springs along the walls of valleys that cross the lava flow. Be on the lookout for seepage where a dry canyon cuts through a layer of porous sandstone. In areas with a lot of granite rock look over the hillsides for green

grass. Dig a ditch at the base of the greenest area and wait for the water to seep into it.

Water is usually more plentiful and easier to find in loose soil than in rocks. Look for groundwater along valley floors or on the slopes bordering the valley because the water table is more likely to surface in these areas. Land above a river valley also yields springs or seepage along the base, even when the stream is dry. If you decide to dig for water, first look for signs that it is present. Dig in the floor of a valley under a steep slope, or dig out a green spot where a spring was during the wet season. In the low forests, along the seashore, and in river plains, the water table is close to the surface. Very little digging can yield a good supply of water. Runoff water is found above the water table and includes streams, stagnant pools, and water in bogs. Consider this water contaminated and dangerous, even if it is away from human habitation. Boil or treat this water with water purification tablets before you drink it.

You can find water in the dunes above the beach or even in the beach itself. Look in hollows between sand dunes for visible water, and dig if the sand seems moist. On the beach, scoop holes in the sand at low tide about 100 yards inland of the high-tide mark. This water may be brackish, but it is reasonably safe. Run it through a sand filter to reduce the brackish taste. **DO NOT** drink seawater. The salt concentration of seawater is so high that body fluids must be drawn to eliminate it. Eventually, your kidneys will cease functioning.

Watch for water indicators when you are isolated in the desert or arid regions. Some of the signals include the direction in which certain birds fly, the presence of plants, and converging game trails. The sand grouse of Asia, crested larks, and zebra birds visit water holes at least once a day; parrots and pigeons must live within reach of water. Note the direction in which these birds fly and chances are you will find something to drink. Cattails, greasewood, willows, elderberry, rushes, and salt grass grow only where groundwater is near the surface. Look for these signs and dig. If you do not have a bayonet or entrenching tool, dig with a flat rock sharp stick, your knife, or a spoon. Places that are visibly damp, where animals have scratched, or where flies hover indicate recent surface water. Dig there for water.

Collect dew on clear nights by sponging it up with your handkerchief. During a heavy dew, you should be able to collect about a pint an hour.

When you are unsuccessful in your search for ground or runoff water or if you do not have time to purify the questionable water, a water-yielding plant

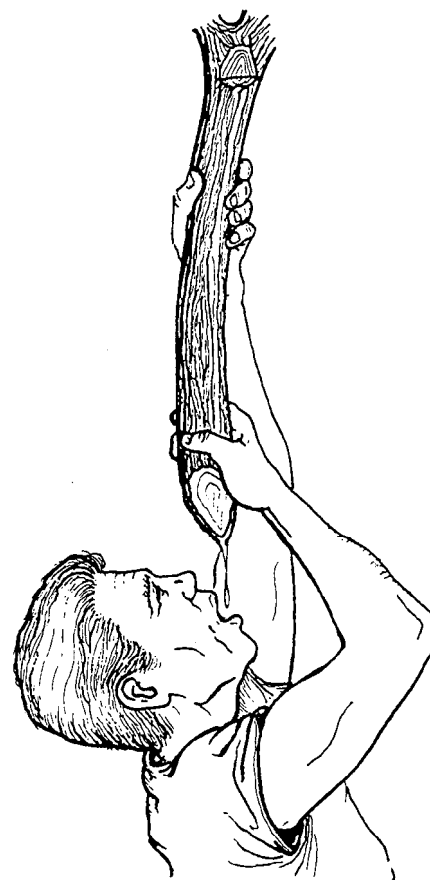

Figure 6-5.—Extracting water from vines.

may be your best bet. Clear, sweet sap from many plants is easily obtained. This sap is pure and chiefly water. Many plants with fleshy leaves or stems store drinkable water. Try them wherever you find them. Desert plants often have their roots near the surface. The Australian water tree, desert oak, and bloodwood are some examples. Pry these roots out of the ground and cut them into 24- to 36-inch lengths. Remove the bark and suck out the water.

Not all vines yield palatable water, but try any vine you find. Use the following method for tapping a vine. It works on any species.

1. Cut a deep notch in the vine as high up as you can reach.
2. Cut the vine off close to the ground and let the water drip into your mouth or a container.
3. When the water ceases to drip, cut another section off the top.
4. Repeat this until the supply of fluid is exhausted. (See fig. 6-5.)



Figure 6-6.—Wild potatoes.

If the liquid in sap is dark in color, it is not drinkable. If the liquid is clear, test it for odor. When slightly pink or red in color, it probably contains tannic acid. If it has no taste or does not taste bad, then it is a good source of water.

Buri, coconut, sugar, and nips palms contain a drinkable sugary fluid. To start the fluid of coconut palm flowing, cut off the tip of the flower stalk after bending it downward. If you cut off a thin slice every 12 hours, you can renew the flow of liquid and collect up to a quart a day.

Food

In a short time, you will realize your second requirement is food. This is especially true during a survival episode when you need every ounce of energy and endurance that you can muster.

Men have been known to live for more than a month without food. But unless you are in extremely difficult circumstances, there is little need to be deprived of something to eat. Nature can be your provider if you

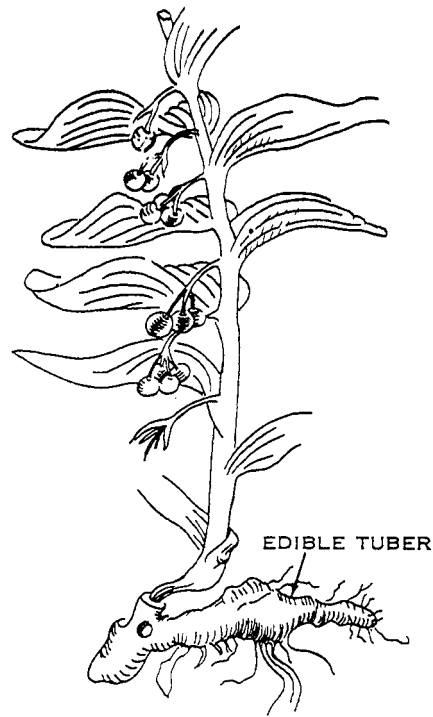

Figure 6-7.—Solomon's seal.

know how to use her bounty. Apply the following rules as soon as you realize that you are isolated:

1. Inventory your rations and water. Estimate the length of time you will be on your own.
2. Divide your food—two thirds for the first half of your isolation and one third for the second half.
3. Avoid dry, highly flavored foods and meats when you have less than 1 quart of water each day. Remember—eating makes you thirsty. Eat food high in carbohydrates—hard candy and fruit bars.
4. Keep strenuous work to a minimum. The less you work, the less food and water you require.
5. Eat regularly when possible; do not nibble. Plan one good meal each day and cook it if you can. Cooking makes food safer, more digestible, and palatable. Also, the time you spend cooking gives you a rest period or time to relax.
6. Always be on the lookout for wild food. With few exceptions, everything you see that walks, crawls, swims, or grows from the soil is edible. Learn to live off the land.

Plants

Experts estimate that about 300,000 classified plants grow on the surface of the earth, including many

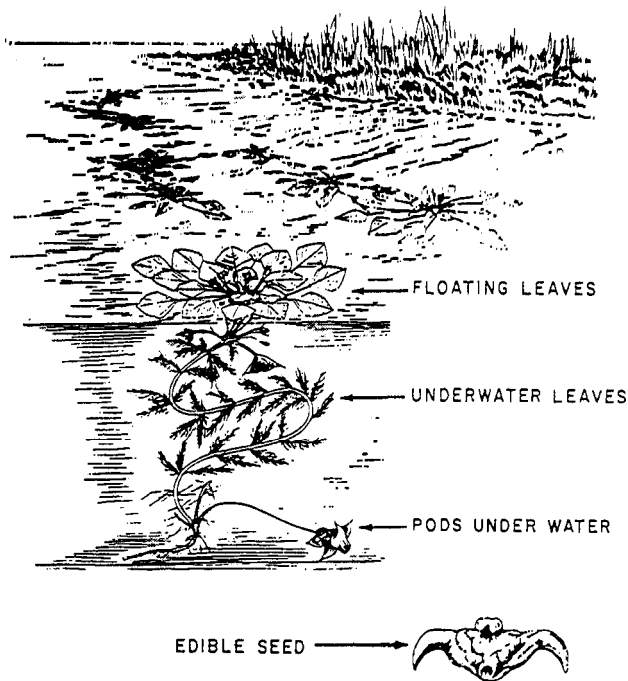

Figure 6-8.—Water chestnut.

that grow on mountaintops and ocean floors. Of these, 120,000 varieties are edible. Obviously, you will not be able to learn about all of these plants from reading this manual. But if you know what to look for in the area in which you find yourself stranded, can identify it, and know how to prepare it properly, you should find enough to eat to keep you alive. You may even surprise yourself with a delicious meal.

Although plants may not provide a balanced diet, especially in the Arctic where the heat-producing qualities of meat are essential, they will sustain you. Many plants, such as nuts and seeds, will give you enough protein for normal efficiency. All edible plants provide energy and calorie-giving carbohydrates.

Plants are available everywhere to provide the necessary energy while you forage for wild meat. You can depend on them to keep you alive if you are injured and unarmed in enemy territory or in an area where wild life is not abundant.

It is generally safe to try wild plant foods if you see them being eaten by birds and animals; however, you find few plants of which every part is edible. In addition to the obvious sources of plant foods (fruits, nuts, berries, etc.), many plants have one or more identifiable parts that have considerable food value. For example, certain roots and other underground parts of plants are rich in starch and are excellent source of food. Some examples are the following:

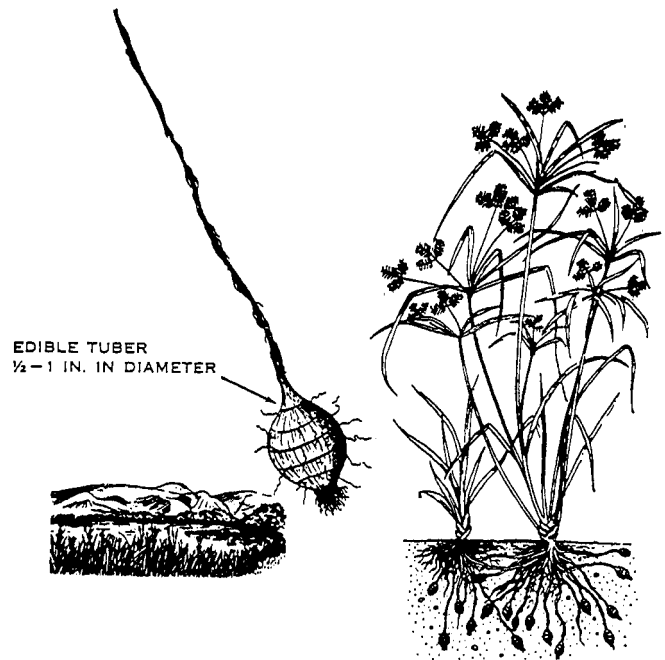

Figure 6-9.—Nut grass.

1. **WILD POTATO.** This is an example of an edible tuber. The plant is small and found throughout the world, especially in the Tropics. (See fig. 6-6.)

2. **SOLOMON'S SEAL.** Tubers of Solomon's seal grow on small plants and are found in North America, Europe, northern Asia, and Jamaica. Boiled or roasted, they taste much like parsnips (fig. 6-7).

3. **WATER CHESTNUT.** The water chestnut is a native of Asia, but it has spread to both Tropical and Temperate areas of the world, including North America, Africa, and Australia. It is found as a free-floating plant on rivers, lakes, and ponds in quiet water. The plant covers large areas wherever it occurs and has two kinds of leaves—the submerged leaves that are long and rootlike and the feathery and the floating leaves that form a rosette on the surface of the water. The nuts borne beneath the water are an inch or two wide with strong spines that give them the appearance of a homed steer. The seed within the horny structure may be roasted or boiled. (See fig. 6-8.)

4. **NUT GRASS.** Nut grass is widespread in many parts of the world. Look for it in moist, sandy places along the margins of streams, ponds, and ditches. It occurs in both Tropical and Temperate climates. The grass differs from true grass because it has a three-angle stem and thick underground tubers that grow 1/2 to 1 inch in diameter. These tubers are sweet and nutty. Boil, peel, and grind them into flour. This flour can be used as a coffee substitute. (See fig. 6-9.)

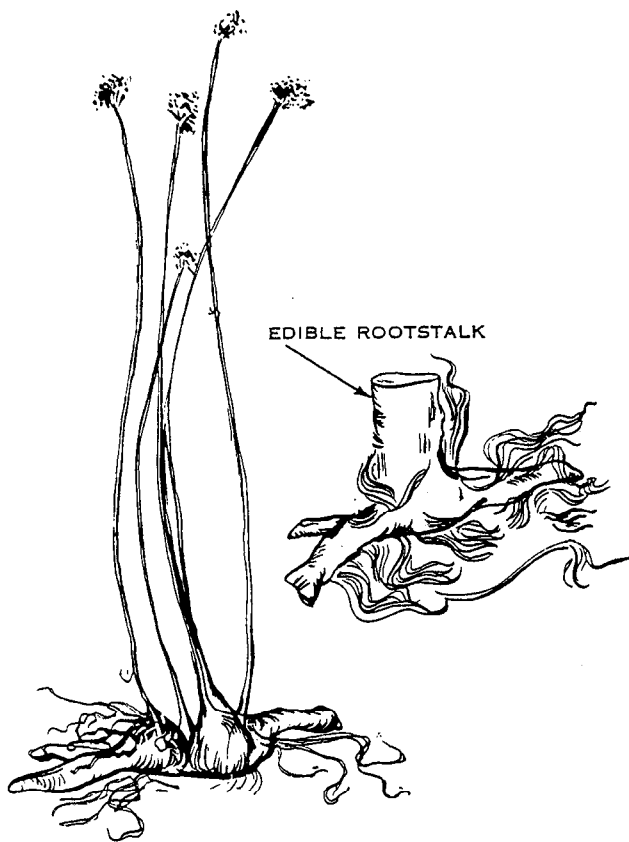

Figure 6-10.—Bulrush.

5. TARO. The taro grows in moist, forested regions of nearly all Tropical countries. Taro looks much like a calla lily with leaves up to 2 feet long and stems about 5 feet high. The bloom on this plant is a pale yellow flower about 15 inches long. It has an edible tuber growing slightly belowground level. This tuber must be boiled to destroy irritating crystals. After boiling the tuber, eat it like a potato.

6. BULRUSH. This familiar tall plant is found in North America, Africa, Australia, East Indies, and Malaya. It is usually present in wet, swampy areas. The roots and white stem base may be eaten cooked or raw. (See fig. 6-10.)

7. TI PLANT. This plant is found in Tropical climates, especially in the islands of the South Pacific. It is cultivated over wide areas of Tropical Asia. Both the wild and cultivated plants have coarse, shiny, leathery leaves arranged in crowded fashion at the tips of thick stems. The leaves are green and sometimes reddish. This plant grows a large plumelike cluster of flowers that usually droop. It bears berries that are red

when ripe. The fleshy rootstalk is edible and full of starch, and it should be baked for best results.

Animals

Foods derived from animals have more food value per pound than those derived from plants. You can increase your chances of survival by learning the edible or otherwise useful parts of animals. Also, learn how to prepare the edible parts for cooking.

Most birds should be plucked and cooked with the skin on to retain their food value. After a bird is plucked, cut off the neck close to the body and clean out the inside through the cavity. Wash it out with fresh, clean water. Save the neck, liver, and heart for stew. Most birds are easier to pluck after being scalded. Waterfowl are an exception; they are easier to pluck dry. Scavenger birds, like buzzards and vultures, should be boiled at least 20 minutes before you cook them. This kills the parasites. Save all the feathers plucked from birds. You may want to use them for insulating your shoes or clothing or for bedding. Bird eggs are among the safest of foods. You can hard-boil eggs and carry them for days as reserve food.

Clean and dress the carcass of a fur-bearing animal as soon as possible after killing it because to delay will make your job harder. Cut the throat of the animal and allow the blood to drain into a container. The boiled blood is a valuable source of food and salt. Save the kidneys, liver, and heart. Use the fat surrounding the intestines. All parts of the animal are edible, including the meaty parts of the skull, such as the brain, eyes, tongue, and fleshy portions. Save the skin. It is light when dried and is good insulation as a bed cover or article of clothing.

The meat of rats and mice is palatable, particularly if cooked in a stew. Rats and mice should be skinned and gutted, then boiled about 10 minutes before cooking. Either may be cooked with dandelion leaves. Always include the livers. Snakes (excluding sea snakes) and lizards are also edible. Remove the head and skin before boiling or frying snakes.

Dogs, cats, hedgehogs, porcupines, and badgers should be skinned and gutted before cooking. Prepare them as stew with a quantity of edible leaves. Dog and cat livers are especially valuable.

Crabs, crayfish, shrimps, prawns, and other crustaceans require cooking in order to kill disease-producing organisms. They spoil rapidly, however, and should be boiled alive immediately after capture. Shellfish can be steamed, boiled, or baked in the shell. Shellfish make excellent stew with greens or tubers.

Grasshoppers, locusts, large grubs, termites, ants, and other insects are easy to catch and will provide nourishment in an emergency.

Methods of Cooking and Preserving Foods

Other than making most foods more tasty and digestible, cooking makes them safer to eat by destroying bacteria, toxins, and harmful plant and animal products in the food. Your survival chances increase as your knowledge of field survival skills increase, as you improve your ability to improvise, and as you learn to apply the principles of cooking and preserving the foods you obtain in the field.

ROASTING OR BROILING.— This is a quick way to prepare wild plant foods and tender meats. Roast meat by putting it on a stick and holding it near embers. Roasting hardens the outside of the meat and retains the juices.

BAKING.— Baking is cooking in an oven over steady, moderate heat. The oven may be a pit under your fire, a closed vessel, leaf, or clay wrapping. To bake in a pit, first fill it with hot coals. Drop the covered vessel containing water and food in the pit. Place a layer of coals over it; then cover the vessel and pit with a thin layer of dirt. Whenever possible, line your pit with stones so it holds more heat. Pit cooking protects food from flies and other pests and reveals no flame at night.

STEAMING.— Steaming can be done without a container and is suitable for foods that require little cooking, like shellfish. Place your food in a pit filled with heated stones over which leaves are placed. Put more leaves over your food. Then force a stick through the leaves down to the food pocket. Pack a layer of dirt on top of the leaves and around the stick. Remove the stick and pour water to the food through the hole that remains. This is a slow but effective way to cook.

PARCHING.— Parching maybe a desirable method of preparing some foods, especially grains and nuts. To parch food, place it in a metal container and heat slowly until thoroughly scorched. In the absence of a suitable

container, a heated, flat stone may be used. Anything that holds food or water may be used as a container—turtle shells, seashells, leaves, bamboo, or a section of bark.

DRYING.— Plant food can be dried by wind, sun, air, fire, or combination of these four. The object of drying food is to get rid of the water. Cutting meat across the grain in 1/4-inch strips and either drying it in the wind or smoke produces “jerky.” Put the strips of meat on a wooden grate and dry them until the meat is brittle. Use willow, alders, cottonwood, birch, and dwarf birch for firewood because woods that contain pitch, such as pine and fir, make the meat unpalatable. Hang the meat high and build a slow smoldering fire under it. Perhaps a quicker method of smoking meat is the following:

1. Dig a hole in the ground about a yard deep and one-half yard wide.
2. Make a small fire at the bottom of the hole. (After starting the fire, use green wood because it will smoke.)
3. Place an improvised wooden grate about three fourths of a yard up from the bottom.
4. Use poles, boughs, leaves, or other available material to cover the pit.

The methods of preserving fish and birds are much the same as for other meats. To prepare fish for smoking, cut off the heads, and remove the backbones. Then spread the fish flat and skewer in that position. Thin willow branches with bark removed make good skewers. Fish also may be dried in the sun. Hang them from branches or spread them on hot rocks. When the meat dries, splash it with seawater to salt the outside. Do not keep seafood unless it is well dried and salted. Plantains, bananas, breadfruit, leaves, berries, and other wild fruits can be dried by air, sun, wind, or fire, either with or without smoke. Cut fruit into thin slices and place in the sun or before a fire. Mushrooms dry easily and may be kept indefinitely. If the mushrooms are dried, soak them in water before you use them.

Harmful Plant and Animal Foods

There are relatively few poisonous plants and animals. Learn to recognize and avoid them.

In some places, such as the arctic and subarctic regions, there are less than a dozen plants that are

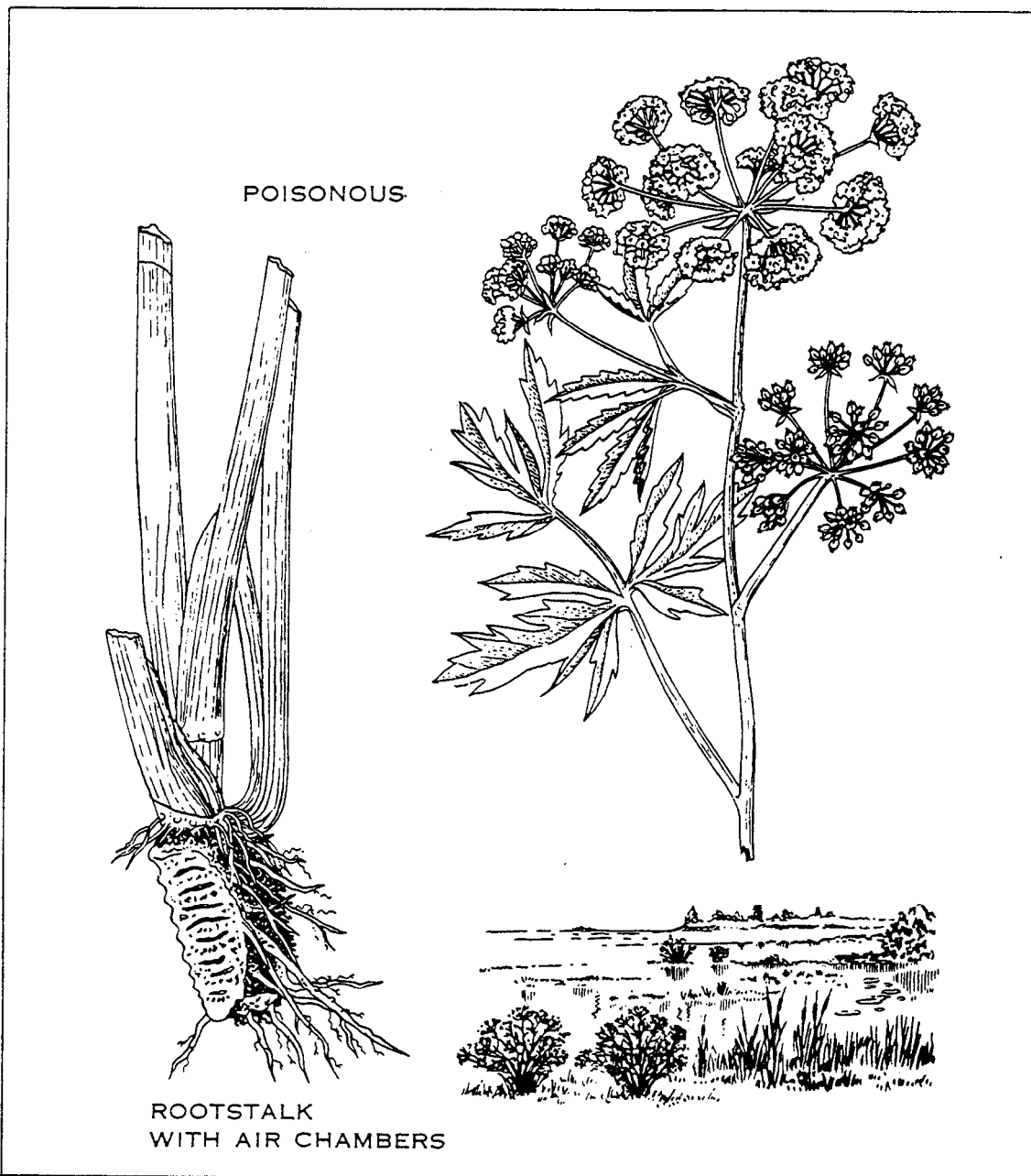

Figure 6-11.—Water hemlock.

poisonous. Included are the water hemlock (fig. 6-11) and poisonous mushrooms shown in figures 6-12 and 6-13.

Poisonous plants are found in the Tropics in no greater proportion than in the United States. When in doubt about whether plants are poisonous or nonpoisonous, use the following rules:

- Observe the habits of vegetable-eating animals, such as birds, rodents, monkeys, baboons, and bears. Usually, the foods these animals eat are safe for humans.

Cook all plant foods because cooking removes plant poisons, except those in mushrooms.

- Avoid eating plants that taste bitter. Also avoid eating untested plants that have milky juices. Do not let the milky juice contact your skin. This does not apply to the numerous figs, breadfruits, papaya, and barrel cactus.

- Guard against fungus poisoning from infected heads of cereals or grasses by discarding grain heads having black spurs in place of normal seed grains.



Figure 6-12.—Fly agaric.

Most animal foods that you encounter are edible; but some, like mollusks, may introduce parasites into your body, especially when eaten uncooked or when they are not fresh. Crustaceans are almost always edible; but they spoil rapidly and harbor harmful parasites. Be sure to cook the freshwater variety; eat the saltwater variety raw if you desire.

There are no simple way of telling whether or not a fish is edible. Often fish that are edible in one area are not in another. This depends on the place, their source of food, or even the season of the year. At first, eat only small portions of any fish. If you feel no ill effects, it is probably safe to continue eating the fish.

In the Arctic there is a fish called the sculpin that lays poisonous eggs; the black mussel maybe poisonous at any season, and its poison is as dangerous as strychnine. If you kill a seal or polar bear, do not eat its liver. This liver is too high in vitamin A, which can make you sick Do not eat polar bear meat before it is cooked. It is always diseased.

ESCAPE

What happens if you become a prisoner of war? After all, it is possible. Isolation, fear, injury—all work

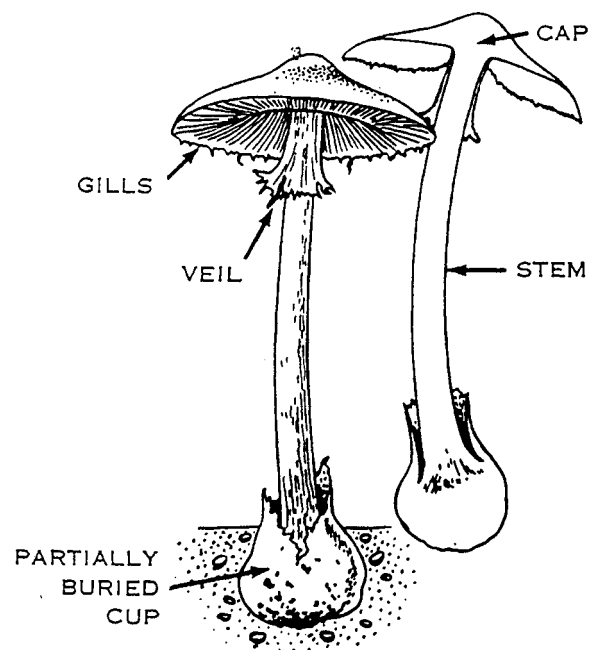

Figure 6-13.—Death angel with gills, veil, stem, and cap.

in favor of the enemy to increase your chances of capture in spite of a determined effort on your part to evade. The surrender of your weapon, however, does not mean that you forfeit your responsibilities as a member of the fighting forces of the United States. The Code of Conduct of the armed forces directs you to begin planning your escape the minute you are taken prisoner.

Escape is tough; making it work is even tougher. It demands courage, cunning, and much planning-of seeking ways out, a route to follow, and the location of friends. Above all, escape demands physical stamina—stamina that you must acquire under the worst conditions imaginable. Experience has proved that “model” camps, where rations are regular and treatment considerate, are the exception. But no matter what extremes you encounter as a POW, your aim should be—to keep yourself as physically able and sufficiently equipped—breaking out as soon as possible.

If you are captured, try to make your escape early. You may never be in better physical condition to escape than at the moment you are captured. Prison rations are barely enough to sustain life, certainly not enough to build up a reserve of energy. The physical treatment, lack of proper medical care, and insufficient rations of prison life soon show their effects in morale and physical weakness, night blindness, and loss of coordination and reasoning power. There are other reasons for making your escape early.

Friendly artillery fire or air strikes may give you a chance to escape. The first guards you will have are not as well trained in handling prisoners as the guards that are farther back from the front lines. Some of the first-line guards may even be walking wounded and distracted by their own physical condition. You know something about the terrain where you are captured, and you know the approximate location of friendly units. Several days later and many miles away, you may be in strange territory.

The exact way to make your escape depends on what you can think of to fit the particular situation. The only general rules are to make an early escape and to do it when the enemy is distracted.

To escape from a prison camp is much more difficult and requires more detailed planning. It must be organized and supported in the same way as other military operations.

Once you escape, it may not be easy to contact friendly units, even when you know where they are. Approach the solution of the problem in the same way as you would if you were a member of a lost patrol. Time your movements so you can pass through the enemy forward areas at night and arrive between the enemy and friendly units at dawn. A good plan is to find a ditch or shell hole where you have cover from both friendly and enemy fire. Attract the attention of the friendly forces by waving a white cloth, shouting, exposing or laying out a panel, or some other method. Doing this alerts friendly forces, who are prepared to accept any small group that appears willing to surrender or regain contact. Alerted, they are not as likely to shoot you on sight.

S-A-T

Since the conditions in various POW camps differ, it is impossible to provide a specific survival plan for each situation. What you need is a guide so you can make the best of what you have. Here is one such plan that you can remember by the word *S-A-T*—Save, Add to, Take care of.

Save

What can you save in a POW camp? Everything—clothing, pieces of metal, cloth, paper, string—anything. A piece of twine may mean success or failure when it comes time to breakout. Hide these items under the floor or in a hole in the ground. If these items are discovered, they may appear harmless and little or nothing will be done to punish you.

Wear as few clothes as possible. Save your shoes, underwear, shirts, jacket, and any other items of clothing that protect you from the elements when you begin your trip back.

Save any nonperishable foods you receive from the Red Cross or your captors. Candy, for example, comes in handy as a quick source of energy when you are traveling. If you do not receive candy, save each issue of sugar given you by the enemy. When you get enough, boil it down into hard candy. **SAVE** it until you buildup your supply. Canned foods that you might receive are ideal for storing. However, if the enemy punctures the cans to prevent your saving them, you may still preserve the food by resealing the cans with wax or some other field expedient. It maybe feasible for you to save this food by re cooking it and changing its form. Other foods to hoard for the day of your escape include suet and cooked meat, nuts, and bread.

Save pieces of metal no matter how insignificant they may seem. Nails and pins can serve as buttons or fasteners. Old cans are excellent for improvised knives, cups, or food containers. If you are fortunate enough to have a razor blade, guard it. Use it for shaving only. Devise ways of sharpening it—rub it on glass or stone or some other hard surface. A clean shave is a good morale booster.

Save your strength but keep active. A walk around the compound or a few mild calisthenics keep your muscles toned. Sleep as much as you can. You will not get much rest on your way back after you escape.

Add To

Use your ingenuity. Select those items that you cannot get along without and supplement them; for example, your rations. There is more to eat in and around your compound than you think. When you are allowed to roam around the campgrounds, look for natural foods native to the area, such as roots, grasses, leaves, barks, and insects. If possible, add these foods to your escape cache. They will keep you alive when the going gets tough.

Supplement your clothing so the more durable garments are in good repair when you escape. A block of wood and a piece of cloth make good moccasins; they will save your boots. Rags can substitute for gloves; straw can be woven into hats. Do not forget to salvage clothing from the dead.

Take Care Of

Probably the most important part of any plan for survival is the “take-care-of” phase. Maintain what you have. There will not be reissue when your shoes wear out or your jacket is lost. Also, it is easier to maintain good health than to regain it once you lose it.

Put some of your clothing into your escape cache. Watch the rest for early signs of wear and repair it with improvised material, if necessary. A needle made from a thorn, nail, or splinter and threaded with unraveled cloth can mend a torn pair of trousers. Wood, canvas, or cardboard bound to the soles of your shoes can save them from wear. Even paper can suffice as a reinforcing insole when your shoes do wear through.

Good physical health is essential to survival under any circumstances. It is especially important in a POW camp where living conditions are crowded and food and shelter inadequate. This means you must use every device possible to keep yourself well.

Soap and water is a basic preventive medicine; so keep clean. If water is scarce, collect rainwater, use dew, or simply rub yourself daily with a cloth or your bare hands. Pay attention to areas on your body that are susceptible to rash and fungus infection—between your toes, your crotch, and your scalp.

Keeping clean also applies to your clothing. Use soap and water when you can spare it. Hang your clothes in the sun to air if soap and water are not available. Examine the seams of your clothing and hairy portions of your body frequently for lice and their eggs. Lice infected with disease can kill you. A possible way to get laundry service or even a bath is to tell your guard that you are infested with lice, whether or not your complaint is true. The prison authorities, fearing that lice on prisoners may cause an outbreak of disease among the civilian and guard population, might provide this service.

In the event you become ill, report your condition to the camp authorities. The chance that you could receive aid is well worth the try.

CHAPTER 7

INDIVIDUAL PROTECTIVE MEASURES

This chapter presents the principles of constructing, camouflaging, and using individual protective measures. Camouflaging is nothing more than hiding or concealing your position or equipment by blending it in with the natural or local surroundings to avoid detection by the enemy. Intelligent use of the terrain sometimes reduces the labor and time required for the construction of emplacements or positions to provide you protection while firing at the enemy. In many cases the natural configuration of the ground provides emplacements that require little, if any, improvements. The following information gives you guidance on the correct application of these protective measures.

COVER AND CONCEALMENT

COVER is protection from the fire of hostile weapons. It may be natural or artificial. Natural cover (ravines, hollows, and reverse slopes) and artificial cover (fighting holes, trenches, and walls) protect you from flat trajectory fire (projectiles traveling at nearly horizontal angles), and partially protect you from high-angle fire and the effects of nuclear explosions.

CONCEALMENT is protection from hostile ground or air observation, but not from hostile fire. It, too, is natural or artificial. Natural concealment is provided by objects in their natural locations, such as bushes, grass, and shadows. Artificial concealment is made from materials, such as burlap, nets, or tents, or from natural material.

The best combat position provides, at one and the same time, maximum cover and maximum concealment.

FIGHTING EMPLACEMENTS

A **FIGHTING EMPLACEMENT** is the position you occupy for the purpose of firing your weapon at the enemy. It provides a good firing position with maximum cover and concealment. A temporary position is converted to a fighting emplacement, or its character, as such, may be improved by digging in, construction, concealment of fresh soil, and improvement.

Digging In

Start digging in when the combat situation requires or allows it, and take advantage of all available natural cover. You should have an entrenching tool; however, you can dig with your bayonet or helmet, or both. When necessary, clear the brush to improve your **FIELD OF FIRE** (the direction you will be firing at the enemy).

Since the Seabees work with ditchdiggers, back-hoes, and other types of heavy construction equipment, you probably have access to this equipment to help in digging and building your fighting emplacement. Of course this depends upon where it is, what the defensive situation is, and how long you are expected to stay in the position.

Construction

Construction includes the improvement of earthworks by placing logs or other objects in defensive positions, such as along parapets (a wall or bank) and overhead. A position should be continually improved as long as it is occupied.

Another area in which a Seabee might show a difference in the construction of his defensive position would be if a battalion used a prefabricated fighting hole made from corrugated metal, or a bunker made of block or concrete with a metal plate for a roof. Since Seabees have access to construction materials, their positions can be made more permanent. Seabee positions are used as abase camp, or a central position, where they can go to project sites and return when the project has been completed.

Concealment of Fresh Soil

The appearance of fresh soil betrays the location of your emplacement to enemy observers. Therefore, the plan for your dug-in emplacement must include some way to dispose of the soil. Use part of it to make a parapet or ridge around the emplacement. When you start digging in, first slice off the top turf and set it aside. Then as you dig out fresh soil, use it to build a parapet around the position about 6 inches high and 3 feet wide. Then lay the turf back on this parapet. If more fresh soil must come out, place it in a sandbag or on a canvas and move

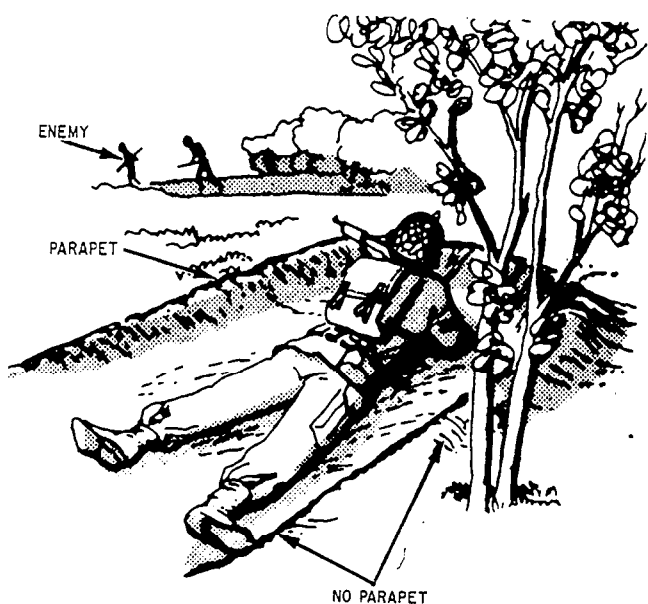

Figure 7-1.—Skirmisher's trench.

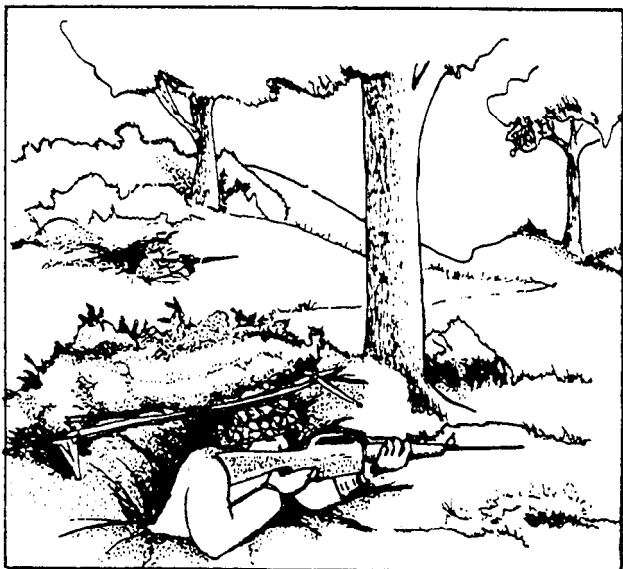
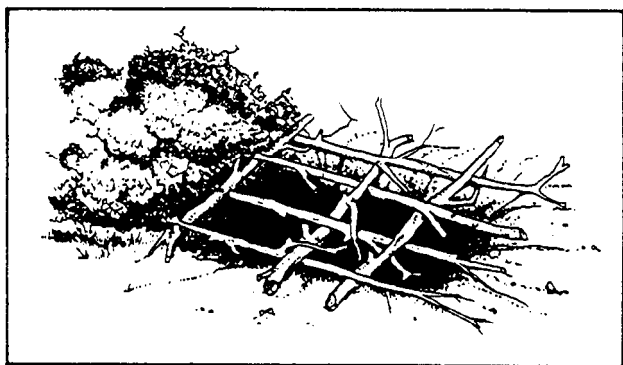

Figure 7-2.—Camouflaged fighting holes.

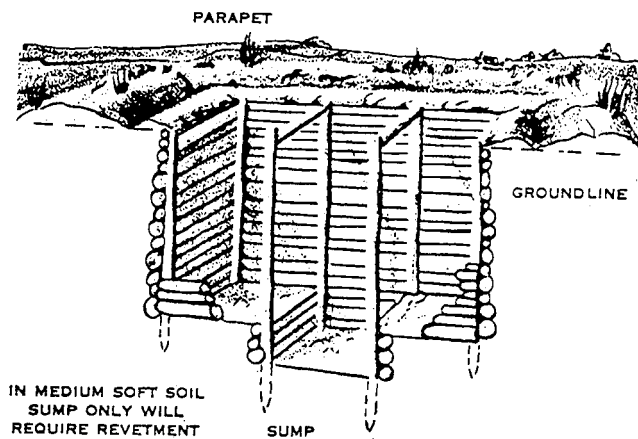

Figure 7-3.—Cut-timber revetment.

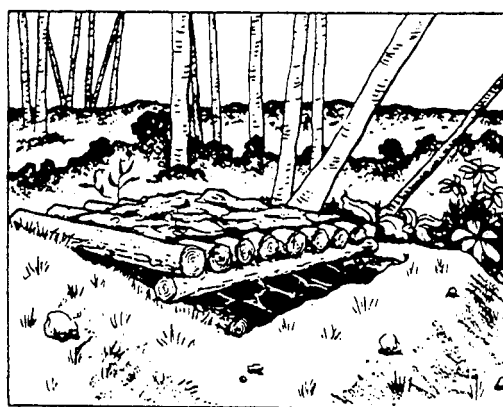

Figure 7-4.—Fighting hole with overhead cover.

it well away from the position. Dispose of fresh soil under low bushes, in a stream, pond, or ravine, or camouflage it in another manner, to the rear of the forward edge of battle area.

Types of Dug-in Emplacements

The simplest type of dug-in emplacement is the SKIRMISHER'S TRENCH, as shown in figure 7-1. This shallow pit type of emplacement provides a temporary, open, prone firing position for the individual rifleman. When the situation demands immediate shelter from heavy enemy fire and when existing defiladed firing positions (positions which provide protection from fire or observation, such as ridges, embankments, and ravines) are not available, each man lies prone or on his side. With his entrenching tool, he scrapes and piles the soil in a low parapet between him and the enemy. Thus a shallow, body-length pit can be formed quickly in all but the hardest ground. The trench

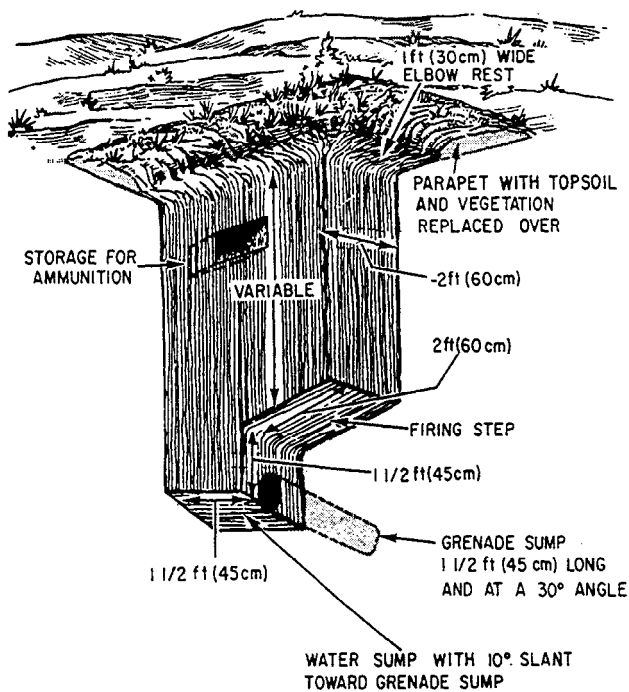

Figure 7-5.—One-man fighting hole.

should be oriented with respect to the line of fire of the enemy so it is least vulnerable to enfilade fire (fire from the flanking or side position). In a skirmisher's trench, a man presents a low silhouette to the enemy and is afforded some protection from small-arms fire.

Figure 7-2 shows CAMOUFLAGED FIGHTING HOLES that may be built either while in contact with the enemy or before contact with the enemy is made. They are a more permanent type of construction than the skirmisher's trench. They may or may not be covered. The two shown are covered, which helps prevent detection, but they are not provided much protection from enemy fire. They are constructed to enable a man to fire from a standing position with most of his body protected from enemy fire. These emplacements help provide protection from small-arms fire, shell fragments, bombings, and the crushing action of tanks.

Figure 7-3 shows a CUT-TIMBER REVETMENT, constructed when the soil is soft enough to require the timber support shown. Again, this is a more permanent type of emplacement and is normally built only when a unit expects to stay in an area for quite some time. You would fire from a standing position with most of your body protected from enemy fire. Figure 7-4 shows a fighting hole with an overhead cover providing cover from enemy fire as well as concealment from the enemy.

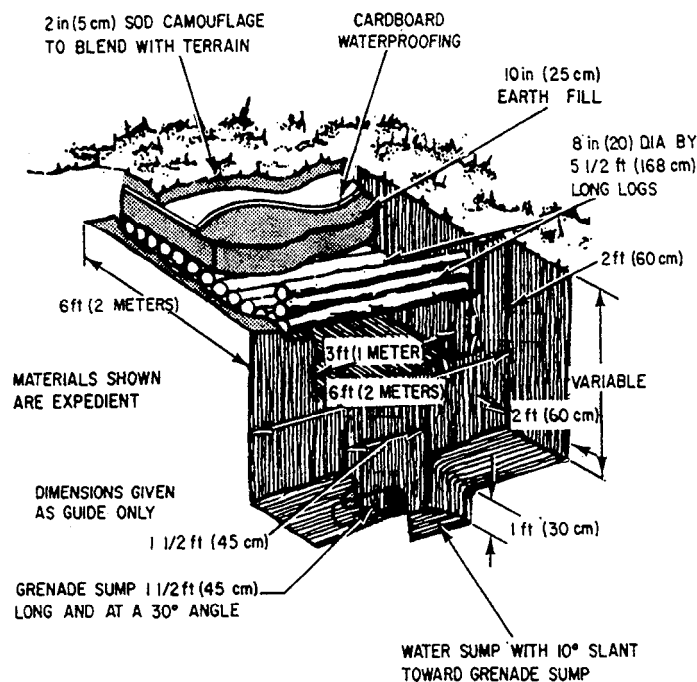

Figure 7-6.—Two-man fighting hole.

The internal construction of a ONE-MAN FIGHTING HOLE is shown in figure 7-5. It is made as small as possible to present the smallest target to the enemy, but wide enough to accommodate a man's shoulders, and deep enough to use entrenching tools at the bottom. A sump should be built below the firing step, at one end, to catch rainwater. The firing step should be deep enough to protect most of a man's body while firing. A circular grenade sump, large enough to accept the largest known enemy grenade, is sloped downward at an angle of 30 degrees and is excavated under the fire step. Hand grenades thrown into the fighting hole are exploded in this sump, and their fragmentation is restricted to the unoccupied end of the fighting hole. The soil from the hole is used to build a parapet. The edge of the hole is used for an elbow rest while firing. Be sure to camouflage the soil used for your parapet to help avoid detection.

Figure 7-6 shows a TWO-MAN FIGHTING HOLE that is essentially two one-man holes. The two-man fighting hole provides some advantages over the one-man fighting hole. By being in such close proximity, each man gains a feeling of more security, and it allows one man to rest while the other man is observing the area. One disadvantage is since it is longer than a one-man hole, it provides less protection from tanks, bombing, strafing, and shelling.

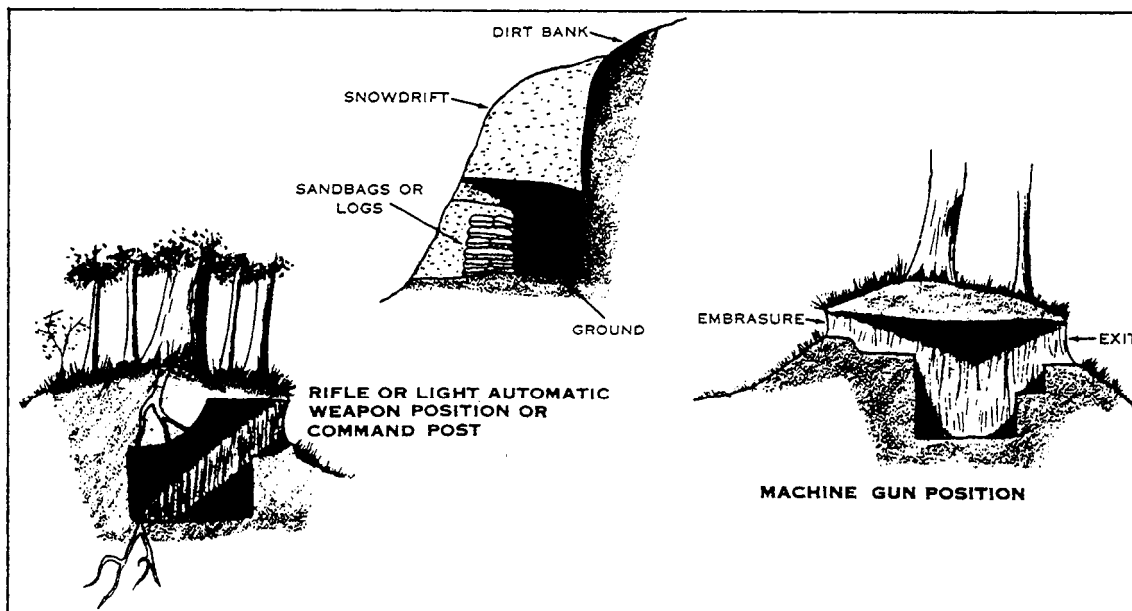

Figure 7-7.—Dug-in cave holes.

The types of dug-in CAVE HOLES shown in figure 7-7 are dug in the side of hills or mountains and are used as a command post for the unit, a machine gun position, or a rifle or light automatic-weapon position. When possible, the entrance to these emplacements should be concealed and camouflaged. They provide excellent protection from enemy observation and fire.

A PRONE EMPLACEMENT (fig. 7-8) provides protection from small-arms fire, shelling, bombing, and strafing by enemy planes. It is a one-man hole and is normally the type of emplacement dug by and for command post personnel.

Temporary Battlefield Positions

Figure 7-9 shows the application of cover and concealment principles in the selection of a temporary battlefield position. The illustrations indicate you should observe and fire around the side of an object, and keep as low as possible to cover and conceal most of your head and body. The illustrations show a rifleman who is right-handed firing or observing; a rifleman who fires left-handed would observe and fire from the left side of the object he is using for cover and concealment.

CONCEALMENT

The FIRST principle of concealment is to AVOID ALL UNNECESSARY MOVEMENT. You may frequently be in a position where you can escape

observation if you remain still, but instantly attract attention if you move. Any movement against a stationary background causes you to stand out very clearly; therefore, if you change position, move carefully (over a concealed route if possible) to the new position.

The SECOND principle is to USE ALL AVAILABLE CONCEALMENT. Background is important; blend in with it to prevent detection. Trees, bushes, grass, earth, and artificial structures form backgrounds of various colors, and color is a factor in whether or not you will be concealed by blending. Select a background that blends with your uniform and absorbs the outline of your figure. Stay in the shadows whenever possible.

The THIRD principle of concealment is KEEP LOW; that is, maintain a crouch or squat, or better still, a prone position. The lower silhouette you present, the more difficult it is for the enemy to see you. Keep off the skyline, even at night.

Finally, EXPOSE NOTHING THAT SHINES. Sunlight reflecting off a shiny surface can be seen for a great distance and attracts attention instantly.

CAMOUFLAGE

Camouflage is a general term applied to measures (either natural or artificial) taken to conceal yourself, your position, and your equipment from enemy

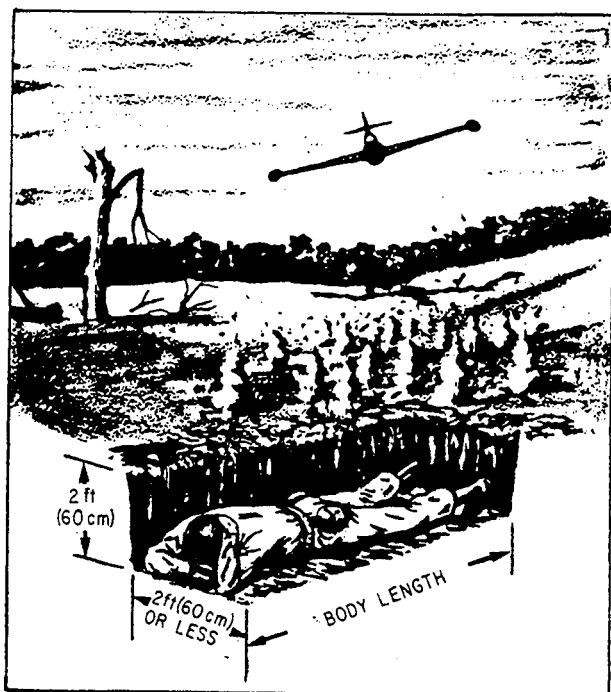

Figure 7-8.—Prone emplacement.

observation. Three general rules for camouflage are as follows:

1. Take advantage of all available natural concealment.
2. Camouflage by altering the form, shadow, texture, and color of objects.
3. Camouflage against both ground and air observation.

Camouflaging a Position

To avoid detection by the enemy, use the following methods of camouflaging a position:

1. Before constructing your position, study the terrain and vegetation in the area so after your position is completed, by the use of camouflage, you are able to restore the area as near as possible to its original appearance.
2. Do not use more material than you need. Too much camouflage can reveal a position as quickly as too little camouflage.
3. Obtain natural material from a wide area. When you strip a small adjacent area of foliage, the stripped area gives the position away.

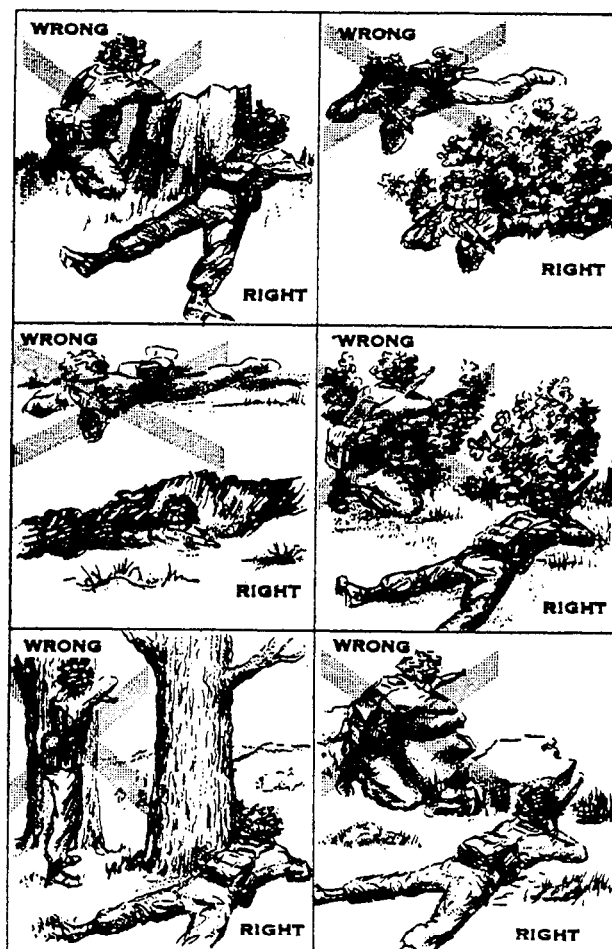

Figure 7-9.—Correct and incorrect battlefield positions.

4. Always conceal excavated soil by covering it with leaves or grass or by dumping it under bushes, into streams, or into ravines.

5. After camouflaging, inspect the position carefully from the viewpoint of the enemy. Check it repeatedly to ensure that it remains natural in appearance and continues to conceal the position.

6. Practice CAMOUFLAGE DISCIPLINE. Avoid doing anything, such as scattering cans or boxes around the camouflaged position, that may give the position away. When possible, use old, established paths to and from your position. Do not create new paths that can be seen from the air. If necessary, vary the route to and from the position so there is no beaten path into the position.

Camouflaging Personal Equipment

The color of field uniforms and web equipment—pack, belt, and canteen cover—blends well with most terrain unless the equipment is badly faded. If it is faded,

color it to blend with the surrounding terrain. When no paint is available, use mud, charcoal, or crushed grass. Color in bold, irregular patterns.

Alter the distinctive outline of your helmet with a cover of cloth or burlap colored to blend with the terrain. Let foliage stick over the edges, but do not use too much of it. Use a camouflage band, string, burlap strips, or rubber bands to hold the foliage in place.

Use mud or dirt to dull shiny surfaces of weapons, being careful not to foul working parts.

Camouflaging the Person

Exposed skin—even dark skin—reflects light. To prevent this, you should use camouflage face paint sticks. They are issued and used in a two-color combination. Although these sticks are called face paint sticks, they are used on any exposed skin and are issued and used in the following combinations:

1. Loam and light green for light-skinned personnel in other than snow regions
2. Sand and light green for dark-skinned personnel in other than snow regions
3. Loam and white for all personnel in snow regions

Apply face paint sticks or other materials as follows:

1. Paint the shiny areas (forehead, cheeks, nose, chin, exposed skin on the back of your neck and your hands and wrists) with the darker color. Paint the shadow areas (around the eyes and under the nose and chin) with the lighter color.
2. When applying face paint, use the buddy system with one man working on and checking another.
3. When face paint is not available, burnt cork, charcoal, or lampblack may be used. Mud should be used only when nothing else is available. Mud changes color as it dries, and when dry, it may flake off and leave exposed skin. Also, mud may contain harmful bacteria and should be used only on approval of a medical officer.

Camouflaging of Vehicles

A badly concealed vehicle can lead to much more than just a lost vehicle; it may mean discovery of your unit or complete destruction of an installation. As is always the case in camouflage, the aim should be to occupy a position without altering its appearance. To do this, you should park the vehicle under natural cover whenever available. When cover is inadequate, the

vehicles should be parked so their shape will disappear into the surroundings. Better concealment can be obtained by using natural rather than artificial material to breakup the shape and shadow of the vehicles. This type of material is always available near a parking site or motor pool and can be erected and removed quickly. When cut foliage is used, be sure it is put up as it was growing because the underside of the leaves is much lighter than the topside, and the difference in color could give your position away. In addition, cut foliage should be replaced as soon as it starts to wither.

The principal artificial materials used to conceal vehicles are drape nets. They are easy to use, quickly erected, and quickly removed. Drape nets give complete concealment against direct observation, but, as with most artificial camouflage materials, they can frequently be detected by photographic observation because they often fail to blend with the background properly. In any case, drapes do conceal the identity of a vehicle, even though the drape net itself may be detected.

Camouflaging of Buildings

The basic methods of concealment—blending, hiding, and deceiving—can be applied either to existing buildings or new construction. However, concealment is much easier when the camouflage scheme is incorporated into the designs for new construction and site selection.

Buildings can be concealed by screens of garnished nettings. Another method is to have disruptive patterns painted over the netting, roof, and gable-end walls. Where concealment from close observation is required, the netting should be sloped gradually to the ground. For structures with roofs steeper than 30 degrees, the netting must cover the whole building.

When the terrain permits, a new structure can be partially dug-in to reduce the height and, in turn, its shadows. The nature and size of buildings can be disguised in many ways, such as the following:

1. Placing trees between the buildings
2. Painting the roofs to match the surrounding terrain
3. Varying roof lines with wooden framework, then covering them with burlap or fine-mesh wire netting to simulate sloping hip roofs
4. Erecting superstructures over existing buildings and covering them with burlap, plastic, or other material

to alter their appearance so they resemble the surrounding native buildings

Camouflaging of Supply Points

From a camouflage viewpoint, the large concentration of materials is the main problem. Huge amounts of equipment and supplies of all kinds are usually brought up at the same time. They must be unloaded and concealed quickly and yet be easily accessible for redistribution. Therefore, natural cover and concealment must be used at supply points whenever possible. Dispersal of these supplies is a must to minimize damage from a single attack. Existing overhead cover should be used when new access roads are planned. When the supply point is to be permanent, the tracks running in and out of the installation can be concealed by overhead nets slung between trees. Traffic control should include measures to conceal activity and movement at, to, and from the installation. When natural cover is sparse or nonexistent, be sure the natural terrain features are used to advantage.

Maintain camouflage discipline at supply points including a minimum of changes in the appearance of

the terrain. Control the debris so it does not accumulate and attract enemy attention.

Camouflaging of Water Points

Water points must have adequate concealment, either artificial or natural, for operating personnel, storage tanks, pumping, and purification equipment. When the surrounding terrain foliage is not thick enough for perfect concealment, it can be supplemented by natural or artificial camouflage materials.

To keep the enemy from observing the shine of water in the tanks, place canvas covers or natural foliage over them. By using foliage or artificial materials, you can distort their features.

Small, open areas that must be crossed by vehicles or personnel operating in the area can be concealed with natural or artificial materials.

A water supply schedule must be instituted and maintained. Without camouflage discipline or with a violation of the schedule, a concentration of waiting vehicles that cannot be readily concealed could occur.

CHAPTER 8

ENTANGLEMENTS

This chapter provides information about the construction and use of wire entanglements.

BARBED-WIRE ENTANGLEMENTS

Barbed-wire entanglements are artificial obstacles designed to slow the movement of foot troops and, in some cases, tracked and wheeled vehicles. The materials used in constructing barbed-wire entanglements are relatively lightweight and inexpensive, considering the protection they afford. You can breach barbed-wire entanglements by fire but they are built, repaired, and reinforced rapidly.

SITE AND LAYOUT

To be effective, you should select the site and lay out barbed-wire entanglements to meet the following requirements:

1. Perform the work under friendly observation, covered by fire, and where practicable, protected by antipersonnel mines, trip flares, and warning devices.
2. Conceal the entanglements from enemy observation as far as practicable by incorporating terrain features, such as reverse slopes, hedges, woods, paths, and fence lines.

3. Erect them in irregular and nongeometrical traces.

4. Use them in bands or zones wherever practicable.

5. Coordinate the entanglements with other elements of the defense.

CLASSIFICATION

You should classify entanglements according to use and depth and whether they are fixed or portable. They are classed by use as tactical, protective, or supplementary. The use of these types of entanglements in a defensive area is shown schematically in figure 8-1.

Tactical-Wire Entanglements

Establish tactical-wire entanglements parallel to and along the friendly side of the final protective line. Use them to breakup enemy attack formations and to hold the enemy in areas covered by the most intense defensive fire. Extend tactical entanglements across the entire front of a position, but you need not make them continuous.

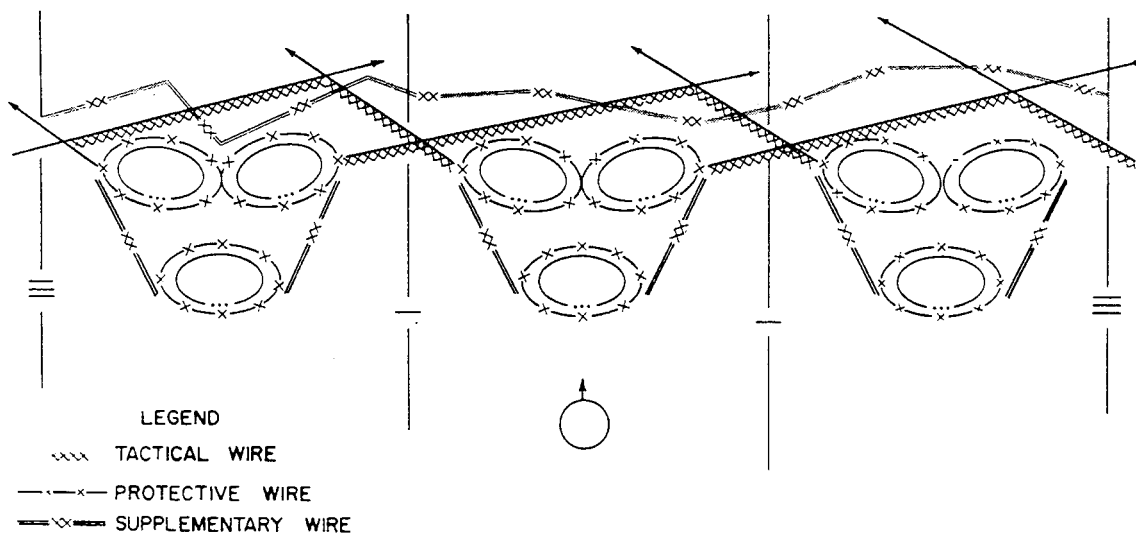

Figure 8-1.-Schematic layout of barbed-wire entanglements in a defensive area.

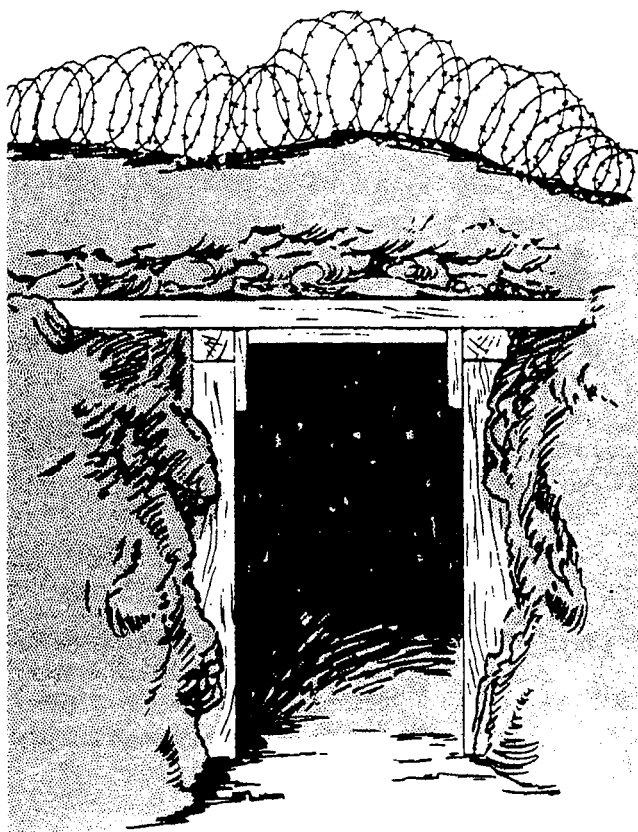

Figure 8-2.—Protective wire on top of overhead cover.

Protective-Wire Entanglements

Locate protective-wire entanglements to prevent surprise assaults from points close to the defense area. As with all antipersonnel obstacles, they are close enough to the defense area for day-and-night observation. They are also far enough away to prevent the enemy from using hand grenades effectively from points just beyond the obstacle, normally 131 to 328 feet. Surround the individual units of a command, usually the platoon (fig. 8-1), with protective wire. Connect these entanglements to entanglements around other platoons by supplementary wire to enclose the entire defensive positions. Erect protective entanglements around rear-area installations in the same manner to serve the same purpose as protective wire around defensive positions in forward areas. You should also include the entanglements of protective wire over the tops of installations provided with overhead cover (fig. 8-2).

Supplementary-Wire Entanglements

Use supplementary-wire entanglements in front of the forward edge of the battle area (FEBA) to conceal

the exact line of the tactical wire. To the rear of the FEBA, use supplementary wire to enclose the entire defensive position by connecting the protective-wire entanglements. Use supplementary-wire entanglements to break up the line of tactical wire. These supplementary-wire entanglements should be identical to the tactical-wire entanglements and constructed simultaneously with them whenever possible.

Depth of Entanglements

You should classify entanglements by depth as belts, bands, or zones.

A BELT is an entanglement one fence in depth.

A BAND consists of two or more belts in depth, with no interval between them. The belts may be fences of the same type, or the band may be composed of two or more fences of different types.

A ZONE consists of two or more bands or belts in depth with intervals between them.

Equivalent Effectiveness

You should describe or specify entanglement depths in terms of comparative effectiveness. Use tactical-wire entanglements with an equivalent in effectiveness to three belts of 4- and 2-pace double-apron fence whenever possible. Use protective wire in any type of entanglement provided its effectiveness is at least the equivalent of the 4- and 2-pace double-apron fence. Use supplementary wire with an effectiveness equivalent to that of the type of wire it supplements. It should be equivalent to tactical wire or equivalent to the type of protective wire being used if it connects the outer perimeters of protective wire at the flanks and rear.

Portability

By definition, fixed entanglements are erected in place and they cannot be moved unless completely disassembled.

Conversely, you can move portable, entanglements without complete disassembly. Portable entanglements have been developed for one of the following reasons:

- To permit assembly in rear areas with ease of transportation and rapid installation in forward positions
- For the temporary closing of gaps or lanes that can be reopened quickly for patrols or counterattacking forces

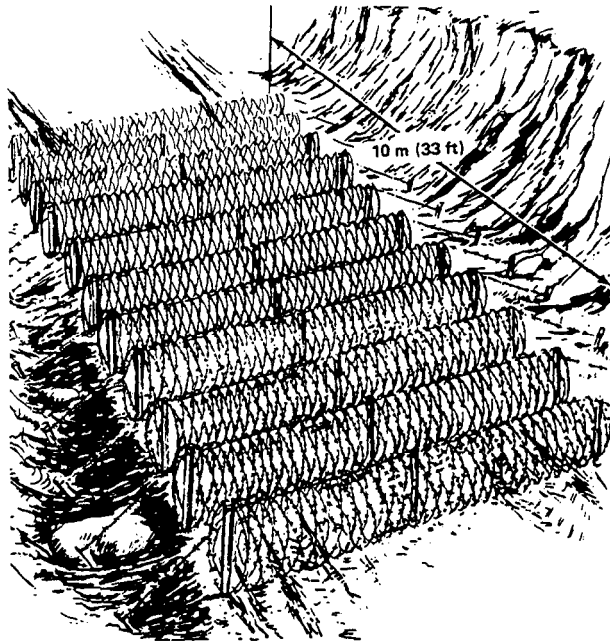

Figure 8-3.—Concertina roadblock.

Lanes and Gaps

Provide lanes and gaps for the passage of patrols, working parties, and attacking or counterattacking forces. When they are not in use, keep them closed with portable obstacles covered by fire. In barbed-wire zones, stagger lanes and gaps in a zigzag pattern.

USES OF BARBED-WIRE ENTANGLEMENTS

The uses of barbed-wire entanglements are listed below.

Outpost Area

Surround combat outposts with wire entanglements. Site these entanglements carefully to serve as both protective and tactical wire, and cover them by small-arms fire. Supplement the wire obstacles with antipersonnel mines, warning devices, and booby traps.

Battle Position

In the battle area, surround each company defense position with a wire entanglement that is connected laterally across the front of the entanglements surrounding the other units in the position.

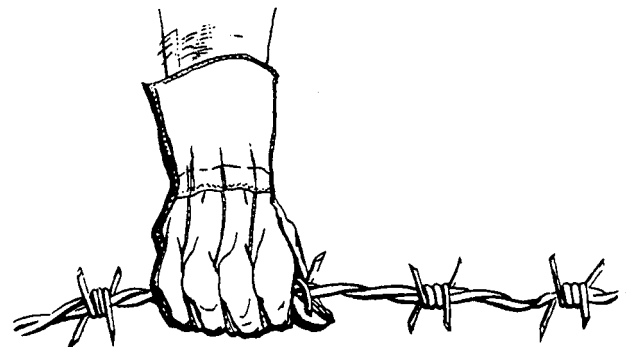

Figure 8-4.—Standard barbed wire.

Artillery and Reserve Area

Use wire entanglements in the outer protection areas of howitzer positions. Similarly, protect heavier weapons, reserve area shelters, and other installations in the reserve area if justified by the situation.

Antipersonnel Obstacles

Site barbed-wire entanglements, trip flares, noisemakers, and antipersonnel mines to detect enemy patrol action or infiltration at night; to prevent the enemy from delivering a surprise attack from positions close to the defenders; and to hold, fix, or delay the enemy in the most effective killing ground. Site such obstacles near enough to defensive positions for adequate surveillance by the defenders by night and day and far enough away to prevent the enemy from using hand grenades against the defender from points just beyond the obstacles.

Roadblocks

Figure 8-3 shows a series of barbed wire concertinas that will stop wheeled vehicles. Use a series of these blocks placed about 33 feet apart. Wire together the ends of adjacent coils and lightly anchor the obstacle at the sides of the road. Site the block to achieve surprise.

Strengthening Natural Obstacles

Deep rivers, canals, swamps, and cliffs are effective delaying obstacles to infantry. Thick hedgerows, fences, and woods can slow troops to a lesser degree. You can improve both of them by lacing the obstacles with barbed wire, by the addition of parts of standard fences on one or both sides, or by entangling with loose wire.

STANDARD BARBED WIRE

Standard barbed wire is a two-strand twisted No. 12 steel wire with four-point barbs at 4-inch intervals (fig. 8-4).

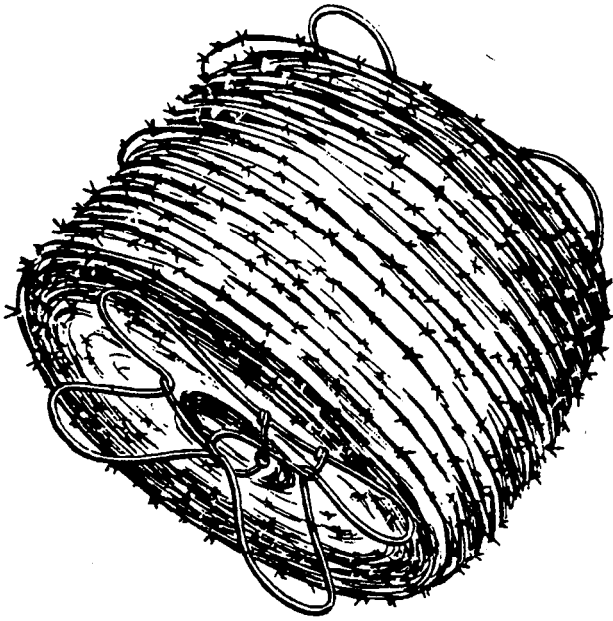

Figure 8-5.—Barbed-wire reel.

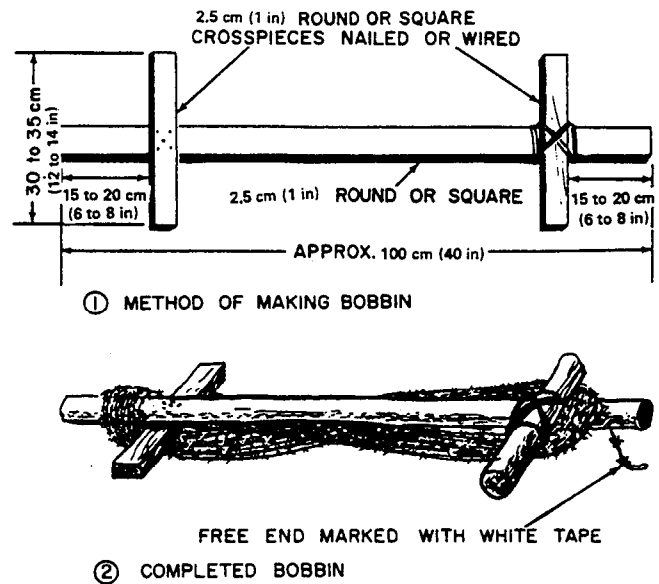

Figure 8-6.—Barbed-wire bobbin.

Handling

When handling barbed wire, wear the standard barbed-wire gauntlets shown in figure 8-4 or heavy leather gloves. They permit faster work and protect against cuts and scratches. As an added safety precaution, grasp the wire with your palms down.

Issue

Barbed wire is issued in reels (fig. 8-5), containing about 1,312 feet of wire. The wire weighs 90 pounds and the reel about 1.3 pounds. When a fence is being built, two men carry one reel.

Bobbins

Bobbins (fig. 8-6) holding about 98 feet of wire are prepared, normally in rear areas, for use in building short lengths of fence and in repairing entanglements. When bobbins are used, two men handle one bobbin. One unwinds the bobbin and the other installs the wire. Two or more men can make the bobbins by following these steps:

1. Prepare the bobbin sticks.
2. Rig the reel on an improvised trestle or other Support.
3. Have one man unroll and cut 98-foot lengths of wire, fastening one end of each to the trestle.

4. Wind the wire in a figure-eight shape on the bobbin sticks.

5. Tie a piece of white tracing tape to the loose end of the wire to facilitate finding it.

BARBED-STEEL TAPE

The physical characteristics of barbed-steel tape (fig. 8-7) are as follows:

Width: 3/4 inch

Thickness: 0.022 inch "

Weight: 4,438 pounds/164 feet

Width of barb: 7/16 inch

Interval between barbs: 1/2 inch

Breaking load: 500 pounds

Two significant characteristics listed above that are important to field users are the weight and the breaking load. A comparison of pertinent characteristics of barbed tape and barbed wire is shown below.

<u>CHARACTERISTIC</u>	<u>BARBED TAPE</u>	<u>BARBED WIRE</u>
Weight (1,312 feet)	35.5 pounds	104.5 pounds
Breaking load	270.0 pounds	1,075.0 pounds
Barbed interval	1/2 inch	4 inches
Size (9,900 feet)	18 5/8 x 19 1/2 x 17112 inches	23 inches
cube	3.6 feet ²	9.7 feet ²

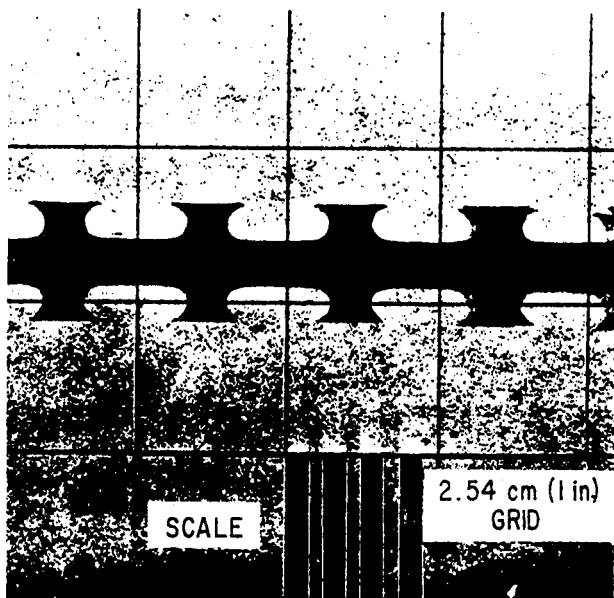

BARBED STEEL TAPE

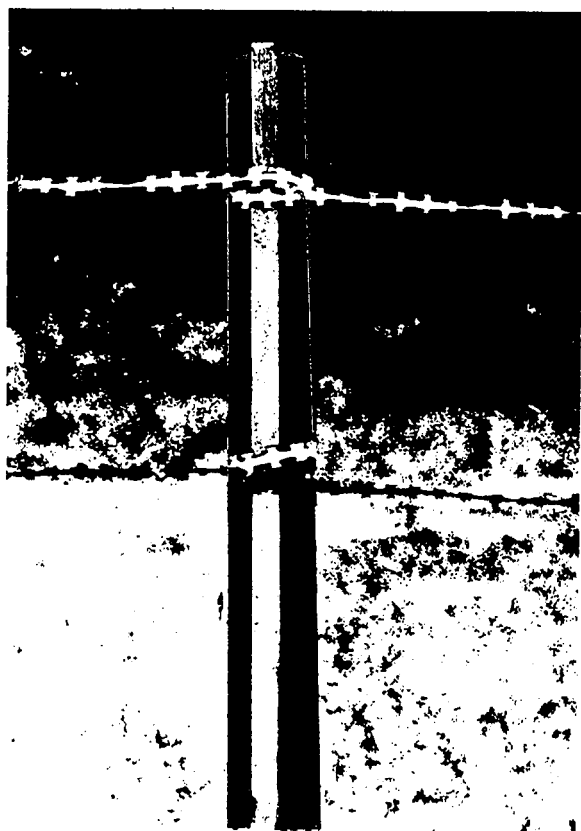

WRAP-AROUND TIE

Figure 8-7.—Barbed-steel tape.

Handling

In handling barbed tape, use heavy barbed-tape gauntlets instead of the standard gauntlets (fig. 8-8). Small metal clips on the palm and fingers prevent the

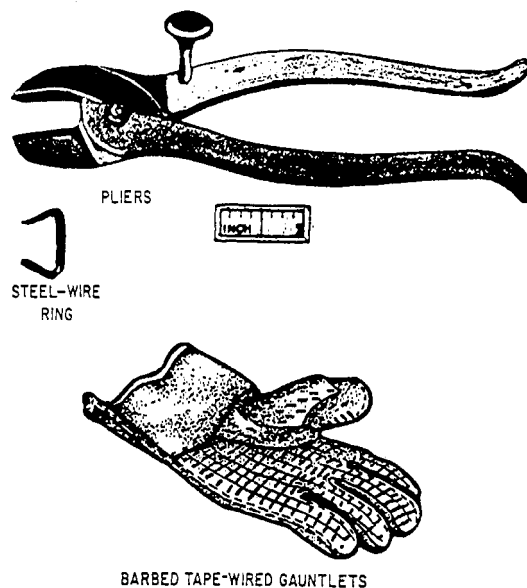

BARBED TAPE-WIRED GAUNTLETS

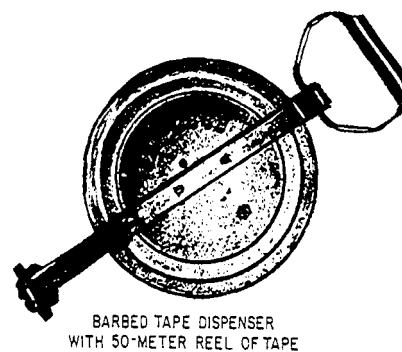

BARBED TAPE DISPENSER WITH 50-METER REEL OF TAPE

Figure 8-8.—Barbed-tape equipment.

barbs of the tape from cutting the leather. Barbed tape is lightweight and compact, and it is much easier to handle, store, and transport than barbed wire.

Issue

The barbed tape is issued in a 164-foot reel that weighs about a pound. There are six reels to a cardboard carrying case.

Barbed Tape Dispenser

A dispenser (fig. 8-8) is required to install barbed tape. It consists of a frame to hold the 164-foot reel of barbed tape and two sets of rollers. Insert the reel on the spindle and thread the tape through the two sets of parallel rollers. Then turn the outside set of rollers 90 degrees in a clockwise direction. Now close the hinged arm of the frame and lock it in place by the frame of the rotating rollers. As the tape unwinds from the reel, the two sets of rollers oriented 90 degrees to each other

impart a twist to the tape. For it to be effective, you must twist the barbed tape as it is installed.

Uses

You can use barbed tape in place of standard barbed wire in most all cases except when it is to be repeatedly recovered and reused. The most effective fence you can construct using barbed tape is the "Double-Apron Fence" (discussed below).

ADVANTAGES OF BARBED TAPE.— The principal advantages of barbed tape are its size and weight. For equal lengths, barbed tape occupies a third of the space and weighs a third as much as standard barbed wire. A double-apron fence constructed with barbed tape is more difficult to breach by crawling through than one constructed with standard barbed wire because the barbs of the barbed tape are closer together. Because of the flat configuration, it is more difficult to cut barbed tape with wire cutters.

DISADVANTAGES OF BARBED TAPE.— At the present time, the major disadvantage of barbed tape is its breaking strength. Standard barbed wire is twice as strong. Installation of barbed tape requires a dispenser. A major problem could arise if the dispenser is not available. The tape is not recoverable to its original condition. However, it may be recovered on bobbins in a twisted condition. Barbed tape is more easily cut by shell fragments than standard barbed wire. Barbed tape can also be cut with a bayonet.

Double-Apron Fence

The standard double-apron fence is one of the best obstacles that can be made with barbed tape. The effectiveness of this obstacle is increased by (1) raising the top wire to preclude crossing the obstacle by stepping over it and (2) placing low wires 4 inches above the ground to prevent personnel from crawling under the obstacle.

Tying Procedures

In tying barbed tape, use the wraparound tie (fig. 8-7), since the sharp bends of other ties weaken the tape. Steel-wire rings, crimped on, provide effective ties and may be used where available (fig. 8-8).

Splices

Connecting slots at each end of a 164-foot reel provide a quick method of splicing reels of barbed tape

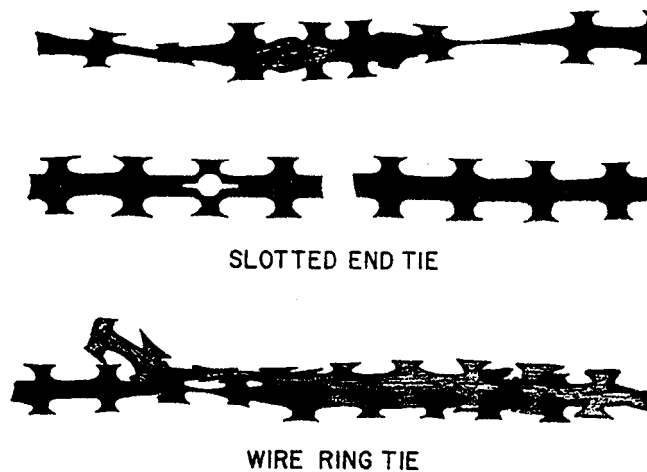

Figure 8-9.—Splicing barbed-steel tape.

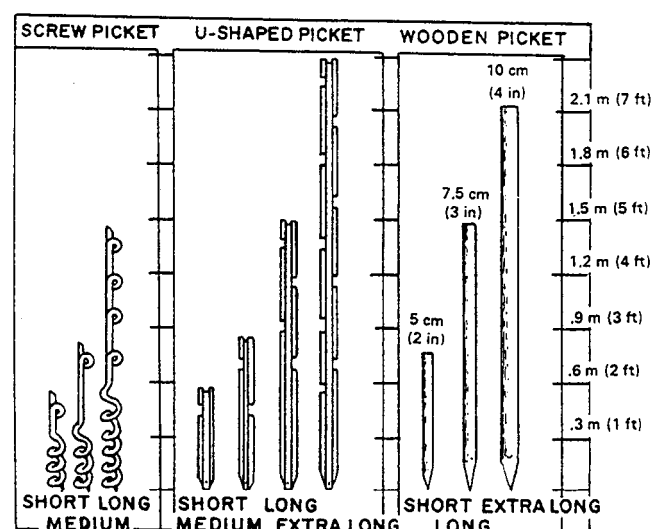

Figure 8-10.—Pickets for use with barbed wire.

(fig. 8-9). You can also splice barbed tape by interlocking the twisted barbs of two separate lengths, then completing the splice by affixing one steel-wire ring to each end of the area where spliced (fig. 8-9).

METAL PICKETS

Metal pickets are issued in two types: screw and U-shaped. The standard lengths are short (or anchor), medium, and long (fig. 8-10). The U-shaped picket also comes in an extra-long length. Pickets that are serviceable can be recovered and used again.

Screw Pickets

Drive the screw picket into the ground by turning it in a clockwise direction using a driftpin, stick or another

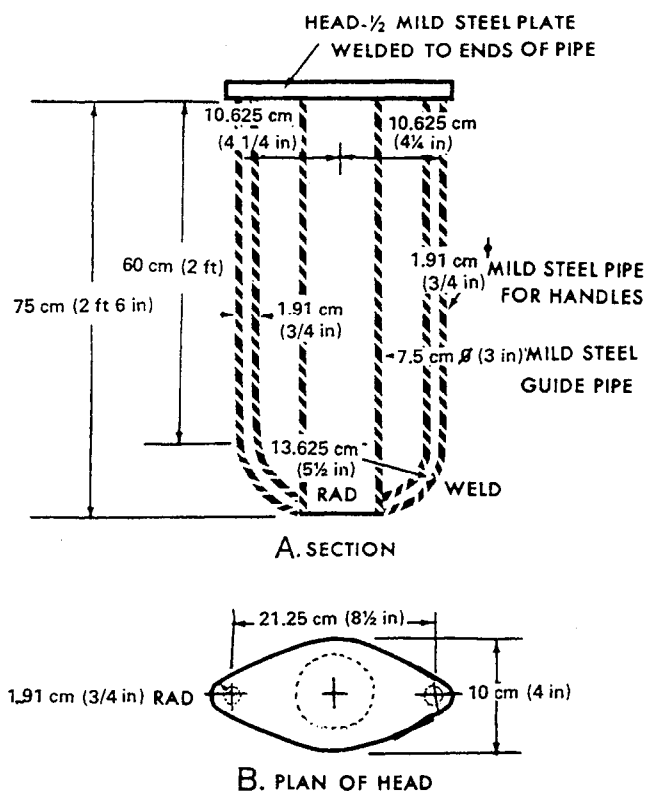

Figure 8-11.-Expedient picket driver.

picket inserted in the bottom eye of the picket for leverage. Use the bottom eye in order to avoid twisting the picket. Install screw pickets so the eye is to the right of the picket, as seen from the friendly side, and standard ties can be made easily. Screw pickets tend to be less rigid than other types but are desirable because you can install them rapidly and silently. When silence is necessary, wrap the driftpin used in installing the pickets with cloth.

U-shaped Pickets

The U-shaped picket is a cold-formed steel picket with a U-shaped cross section, pointed at one end for driving. It is notched for wire ties and the pointed end has a punched hole for wires used in bundling the pickets. Drive the U-shaped pickets with a sledgehammer. Use a stake driving cap on the tip of the picket to prevent the sledge from deforming it. Driving the pickets is noisier than installing screw pickets. However, you can reduce the noise by placing a piece of rubber tire over the driving face of the sledge. The pickets are rigid and sturdy when installed properly. They are preferable to screw pickets in situations where noise is not a disadvantage and time is available. Drive the pickets

with the hollow surface (concave side) facing the enemy, so friendly small-arms fire will not ricochet back toward your position. An expedient picket driver, which can be fabricated locally, is shown in figure 8-11. Constructed as shown, it weighs approximately 5 1/2 pounds and is operated by two men. One man holds the picket in a vertical position, and the other slides the driver over the picket and drives it into the ground. Then both men work the picket driver up and down until the required depth is reached. Drive short pickets by turning the picket driver upside down and using the head as a hammer. Use the bucket of a front-end loader to push U-shaped pickets into the ground when the tactical situation permits the use of equipment.

In locations where frozen ground prevents driving of the U-shaped pickets, use an Arctic adapter. The adapter is made of steel and consists of a baseplate equipped with an adjustable channel receptacle and two anchor pins. Anchor it by driving the anchor pins through holes in the baseplate into the ground. One anchor-pin drive sleeve with a driving pin is provided with each 20 adapters to aid anchor pin emplacement. When adapters are not available, start a hole with a picket. The picket can be frozen in place by pouring water and snow into the hole.

WOODEN PICKETS

You can use expedient wooden pickets of several types.

Cut round poles 4 inches in diameter to standard picket lengths, sharpen them on one end, and drive them with a maul. Use the pickets without peeling the bark to prevent the wire from sliding on the picket and to simplify camouflage. You need longer pickets in loose or sandy soil and when driving through a snow cover. Driving wooden pickets is not as noisy as driving steel pickets, and you can reduce the noise further by fastening a section of tire tread over the face of the hammer or maul. For driving in hard earth, wrap the picket tops with wire to avoid splitting. Hardwood pickets, properly installed, are sturdy and rigid.

You can use dimensional lumber that is ripped to a square cross section instead of round poles. This is equally satisfactory except that it is more difficult to camouflage. These pickets may be dipped in camouflage paint before driving.

Standing trees and stumps may be used as pickets when their location permits.

Table 8-1.—Wire and Tape Entanglement Materials

Material	Approximate weight		Approximate length		No. carried by one man	Approximate weight of man-load	
	kg	lb	meters	feet		kg	lb
Barbed wire reel.....	41.5	91.8	400	1312	1/2	21	46
Bobbin.....	3.5- 4.0	7.7- 8.8	30	98	4-6	14.5-24.5	32-54
Barbed tape dispenser.....	0.77	1.7	0.45	1.5	20	15.5	34
Barbed tape carrying case.....	14.5	31.9	300	984	1	14.5	32
Standard barbed tape concertina.....	14	31.8	15.2	50	1	14	31
Standard barbed wire concertina.....	25.4	55.8	15.2	50	1	25	55
Expedient barbed wire concertina.....	13.5	29.7	6.1	200	1	13.5	30
Screw pickets:							
Long.....	4	8.8	1.6	5.25	4	16.3	36
Medium.....	2.7	5.9	0.81	2.66	6	16.3	36
Short.....	1.8	3.9	0.63	1.75	8	14.5	32
U-shaped pickets:							
Extra long.....	7.25	16	2.4	7.9	3-4	21.8-29.0	26-64
Long.....	4.5	9.9	1.5	4.9	4	18.1	40
Medium.....	2.7	5.9	0.81	2.66	6	16.3	36
Short.....	1.8	3.9	0.61	2.0	8	14.5	32
Wooden pickets:							
Extra long.....	7.7-10.5	16.9-23.1	2.13	7.0	2	15.4-20.8	34-46
Long.....	5.4- 7.25	11.8-15.9	1.5	4.9	3	16.3-21.7	36-48
Short.....	1.4- 2.7	3- 5.9	0.75	2.5	8	11.0-21.7	24-48

Table 8-1 lists information pertaining to materials used in the construction of barbed-wire entanglements.

CONCERTINA FENCING ENTANGLEMENTS

The standard barbed wire concertina (fig. 8-12) is a commercially manufactured barbed-wire obstacle made

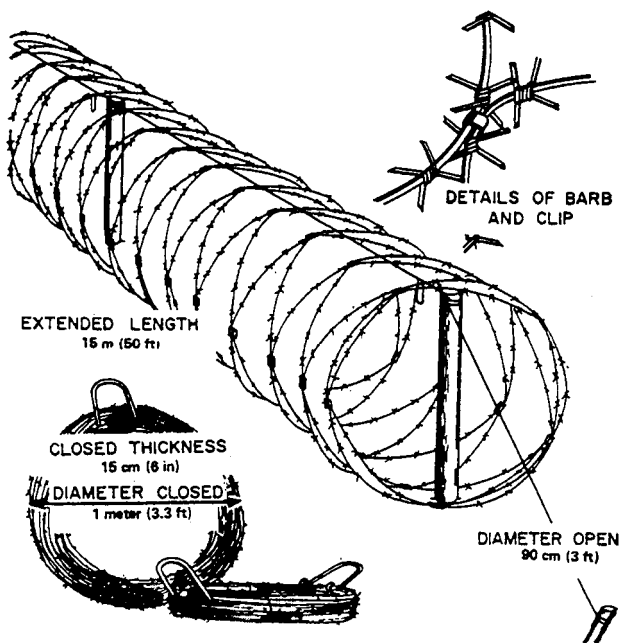

Figure 8-12.—Standard barbed-wire concertina.

of a roll of single-strand, high-strength, spring-steel wire with four-point barbs attached at 2-inch intervals. Wires forming the coils are clipped together at intervals so the concertina opens to a cylindrical shape 16.4 to 49.2 feet long (depending on structure and build of opening) and 3 feet in diameter. The 16.4-foot length prevents smaller enemy personnel from crawling through the wire because the coils are closer together. Use tanglefoot (discussed later in this chapter) in conjunction with the wire to further increase the effectiveness of the barrier. The concertina is opened and collapsed easily, and it can be used repeatedly. The wire is much harder to cut than standard barbed wire. The concertina weighs about 11 1/2 pounds.

HANDLING

The collapsed concertina is tied with plain-wire bindings attached to the quarter points of a coil at one end of the concertina. When opening the concertina, remove these bindings and twist them around the carrying handle for use in retying the concertina when it is again collapsed. You need four men to open a concertina and to extend it to the 16.4- to 49.2-foot length. Place one man to work at each end and the other two spaced along its length to ensure that it opens and extends evenly. When necessary, two men can easily open a concertina by bouncing it on the ground to prevent snagging as they open it.

Table 8-2.-Material and Labor Requirements for 984-Foot Sections of Various Barbed.Wire Entanglements

Type of entanglement	Pickets				Barbed wire No. of 400 m, 41.5 kg reels ¹	No. of concertina ⁴	Staples	Kg of materials per lin m of entanglement ⁵	Lb of materials per lin m of entanglement ⁵	Man-hours to erect 300 m of entanglement ³
	Extra long	Long	Medium	Short						
Double-apron, 4- and 2- pace		100		200	14-15 (19) ⁶			4.6 (3.5) ⁶	10 (7.7) ⁶	59
Double-apron, 6- and 3- pace		66		132	13-14 (18) ⁶			3.6 (2.6) ⁶	8 (5.7) ⁶	49
High wire (less guy wires)		198			17-19 (24) ⁶			5.3 (4.0) ⁶	11.6 (8.8) ⁶	79
Low wire, 4- and 2-pace 4-strand fence		100	100	200	11 (15) ⁵			3.6 (2.8) ⁶	7.9 (6.1) ⁶	49
Double expedient concertina		100		2	5- 6 (7) ⁵			2.2 (1.8) ⁶	4.8 (3.9) ⁶	20
Triple expedient concertina		101		4	3	100	295	6.9	15.1	40
Triple standard concertina	51	101		7	4	148	295	10.4	22.8	99
Triple standard concertina		160		4	3 (4) ⁶	59	317	7.9 (5.4) ⁶	17.3 (11.8) ⁶	30

¹ Lower number of reels applies when screw pickets are used; high number when U-shaped pickets are used. Add difference between the two to the higher number when wood pickets are used.

² Average weight when any issue metal pickets are used.

³ Man-hours are based on the use of screw pickets. With the exception of the triple-standard concertinas, add 20 percent to the man-hours when driven pickets are used. With experienced troops, reduce man-hours by one-third. Increase man-hours by 50 percent for nightwork.

⁴ Based on concertinas being made up in rear areas and ready for issue. Once expedient concertina opens to 19.7 ft length, as compared with 15 meters for a standard concertina; it requires 302 feet of standard barbed wire, also small quantities of No. 16 smooth wire for ties.

⁵ Number of 984 ft, 14.5 kg barbed tape carrying cases required if barbed tape is used in place of barbed wire.

⁶ Kgs of materials required per linear meter of entanglement if barbed tape is used in place of barbed wire and barbed tape concertina is used in place of standard barbed wire concertina.

Two men can collapse a concertina in the following manner:

1. First, remove all the kinks in the coils.
2. Tighten or replace the loose clips with plain wire.
3. Station one man at each end of the concertina and have them place one foot at the bottom of the coil and one arm under the top of the coil to close it.
4. Now, have two men walk toward each other closing the concertina as they go by feeding the wire over their arms and against their feet.
5. After closing, lay the concertina flat and compress it with your feet.
6. The the concertina with plain-wire bindings.

One man can carry the collapsed concertina by stepping into it and picking it up by the wire handles attached to the midpoints of an end coil.

Use improvised staples, approximately 18 inches long and made of 1/2-inch driftpins or similar material, to fasten the bottoms of concertina fences securely to the ground.

Barbed-tape concertina comes in a diameter of 33 inches and an expanded length of 50 feet. It is formed of barbed tape wrapped around a high-strength,

spring-steel, core wire. Its configuration, method of handling, and method of employment are similar to standard barbed-wire concertina. One roll weighs 31 pounds.

ORGANIZATION OF WORK

Table 8-2 lists the materials and man-hours required to assemble various entanglements. The normal sizes of work crews are listed in the descriptions of the entanglements. For each construction project, the senior petty officer divides his crew into groups of approximately equal size, based on his knowledge of the skill and the speed of each man. He organizes them in such a way that construction proceeds in proper order and at a uniform rate. Each individual must know exactly what his group is to do and his job in the group. Each man should have barbed wire gauntlets. The sequence of operations for each fence is given in the paragraph describing the erection of the fence. Follow the sequence outlined, and as you gain experience, you may vary the size and composition of the work groups. For each section of entanglement, all fence-building operations normally proceed from right to left, as one faces the enemy. It may, however, be necessary to work from left to right. Men should, as time permits, be taught to work in either direction. In case of heavy casualties, the senior officer or petty officer decides what wires, if any, are to be omitted.

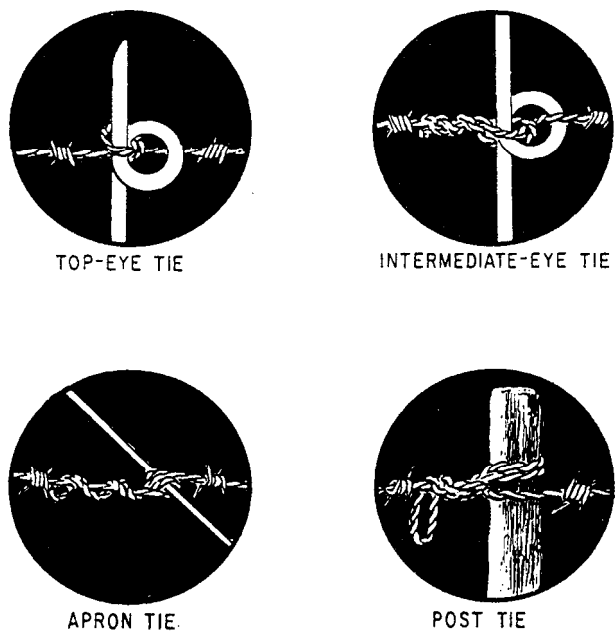

Figure 8-13.—Ties for erecting entanglements as seen from the friendly side.

For night construction, make the following additional preparations:

1. Lay tracing tape from the materials dump to the site of work and then along the line of fence where possible.

2. Tie materials together in man loads and pickets, bundled tightly to prevent rattling.

3. Remove and replace wire fastenings of wire coils and pickets with string that can be broken easily.

4. Tie a piece of tape to the ends of the wire on each reel or bobbin.

Proper supervision of entanglement construction includes the following:

1. Organizing the work into tasks
2. Ensuring the tasks are carried out in proper sequence
3. Preventing bunching and overcrowding of personnel
4. Ensuring the wires are tightened properly and spaced correctly
5. Checking ties to see they are being made correctly and at the right points

When the enemy is in close proximity, the necessary precautions include the following:

1. Providing security around the work party.
2. Maintaining silence.

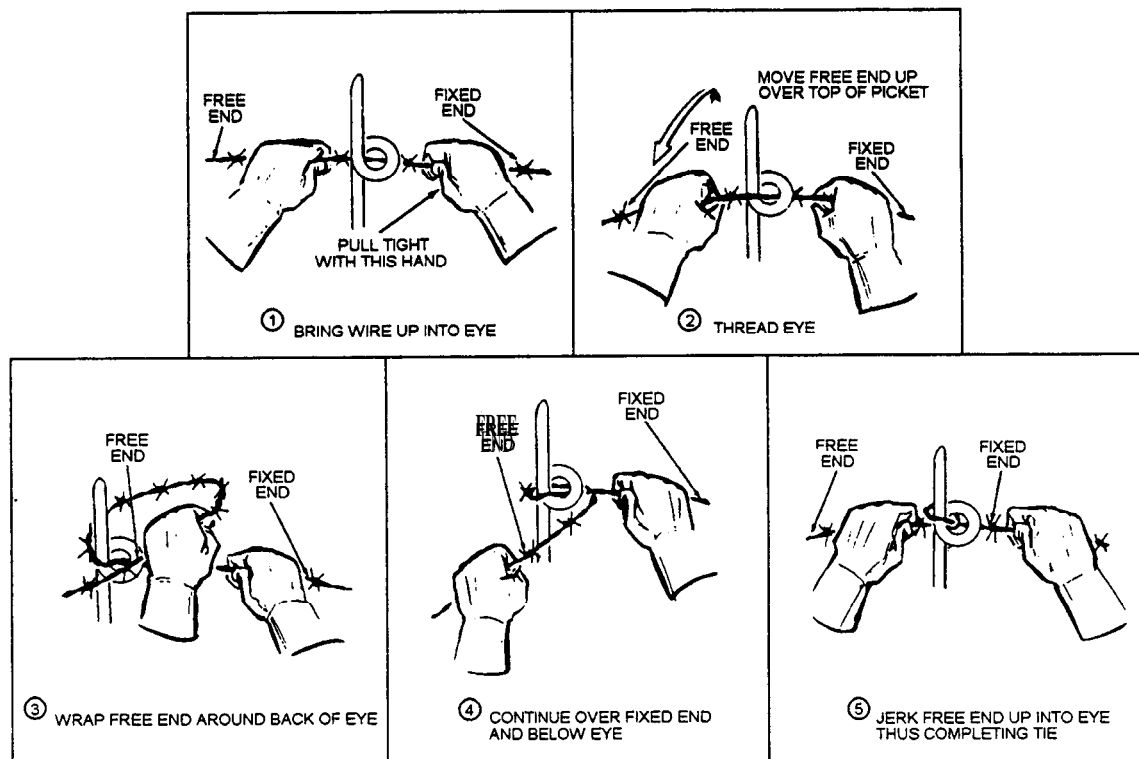

Figure 8-14.—Top-eye tie.

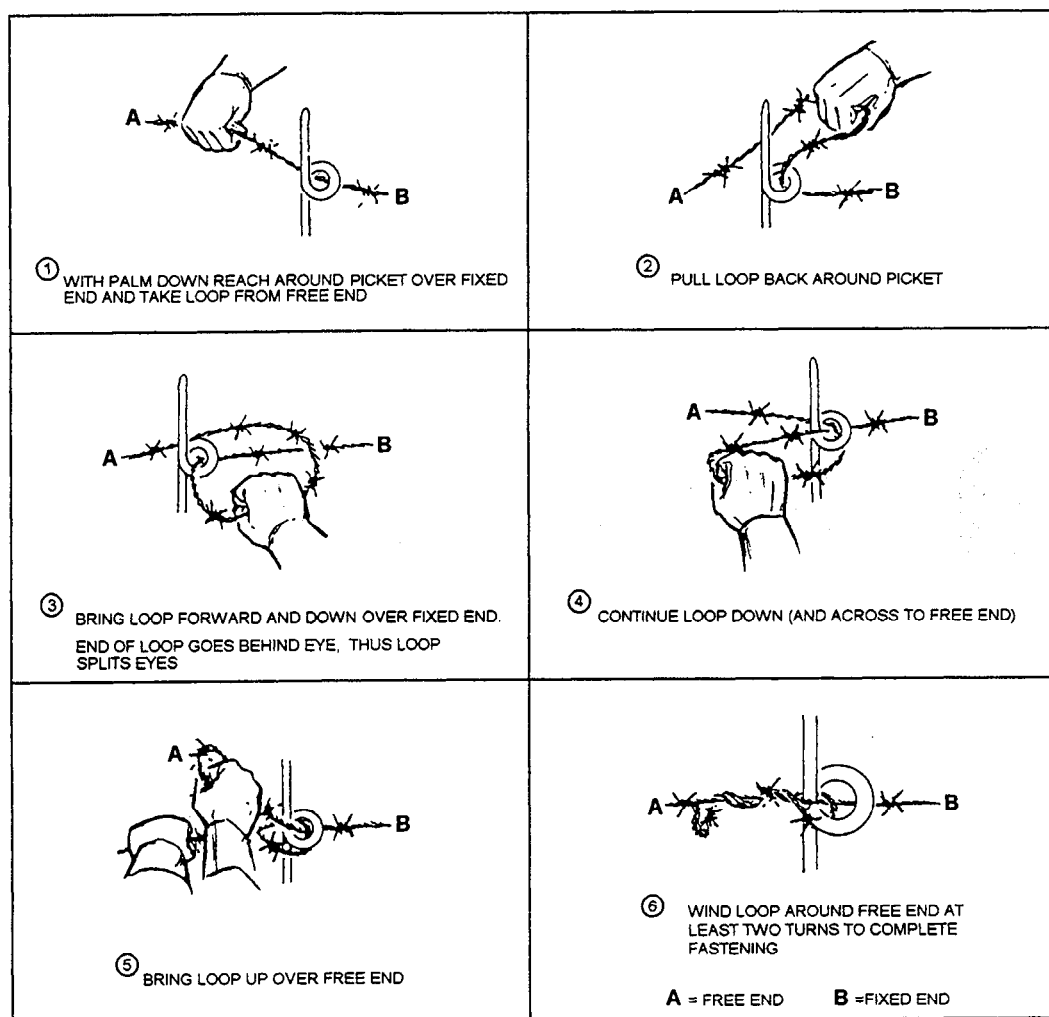

Figure 8-15.—Intermediate-eye tie.

3. No working on the enemy side of the fence unless absolutely necessary.

4. Using screw pickets, when available.

5. Men that are not working should lie down near the start of work until they can continue their work

6. Keeping individual weapons nearby at all times.

TIES FOR ASSEMBLING ENTANGLEMENTS

Wires are tied to pickets by men working from the friendly side of the wire and picket, stretching the wire with the right hand as the tie is started. The four ties used in erecting wire entanglements are shown in figure 8-13.

Top-Eye Tie

Use the top-eye tie to fasten standard barbed wire to the top eye of the screw pickets. Make the top-eye tie

with one continuous movement of the left hand (fig. 8-14), while the right hand exerts a pull on the fixed end of the wire. This is a secure tie, it is quickly made, and it uses only a short piece of wire.

Intermediate-Eye Tie

Use the intermediate tie to fasten standard barbed wire to eyes other than the top eye in screw pickets. Make it as shown in figure 8-15. This tie and the other ties described below require more time to make than the top-eye tie, and each uses several inches of wire. In making the intermediate-eye tie shown in figure 8-15, the following points are especially important:

1. The right hand reaches over the fixed wire and around the picket with the palm down. The left hand holds the fixed end for tension.

2. The loops are removed from the free end and wrapped around the picket.

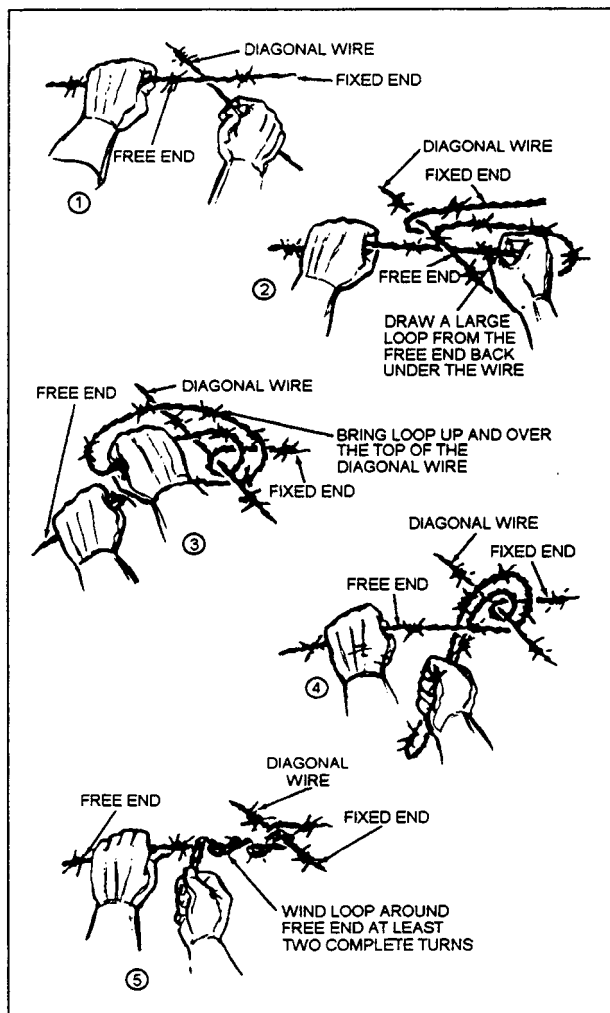

Figure 8-16.—Standard barbed-wire apron tie.

3. One side of the loop should pass above the eye and the other side below the eye.

Apron Tie

Use the apron tie whenever two wires that cross must be tied together. Tie it in the same reamer as the post tie except that a wire is substituted for the post (fig. 8-16).

Post Tie

Fasten standard barbed wire to wooden pickets or to the steel U-shaped picket with the post tie shown in figure 8-17. Wrap the wire tightly around the post to keep the barbs from sliding down. With the U-shaped picket, engage the wire wrapping in a notch in the picket.

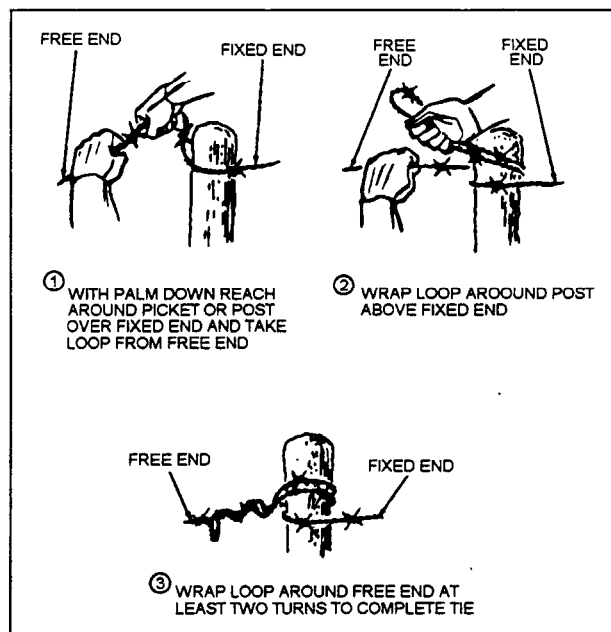

Figure 8-17.—Post tie.

This method is essentially the same as that of the intermediate-eye tie.

Barbed-Tape Splices

Connecting slots at each end of a 164-foot reel provide a quick method of splicing reels of barbed tape. You can also splice barbed tape by interlocking the twisted barbs of two separate lengths, then completing the splice by twisting a short piece of wire to each end of the area where spliced.

INSTALLING WIRES

To install the wires, follow these steps:

1. Attach the end of the wire to the first anchor picket. This is the picket at the right end of a section of entanglement from the friendly side. Build fences from the right to the left as this makes it easier for a right-handed man to make the ties while facing toward the enemy.

2. Insert a bar in the reel and carry the reel 75 to 88 feet, allowing the wire to unreel from the bottom. Do this on the friendly side of the row of pickets to which the wire is to be tied.

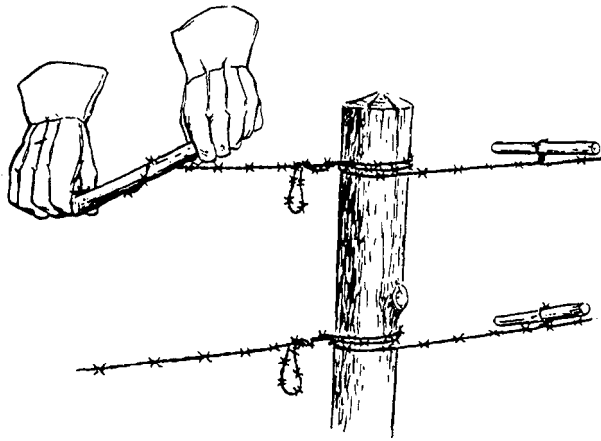

Figure 8-18.—Tightening wire by racking.

3. Put slack in the wire by moving back toward the starting point; then add the ties by two men leapfrogging each other. When available, assign two men to make the ties as the reel is unwound.

After a wire is installed, tighten it, if necessary, by racking with a driftpin or short stick (fig. 8-18). Do not rack the wires at ties or where they intersect other wires because this makes salvage of the wire very difficult. Fences are similarly racked to tighten them when they sag after having been installed for some time. Wires should be just taut enough to prevent them from being depressed easily by boards, mats, or similar objects thrown across them. When you stretch the wires too tightly, they are more easily cut by fragments. NEVER tighten barbed-steel tape by racking.

FOUR-STRAND CATTLE FENCE

The four-strand center section of a double-apron fence can be installed rapidly to obtain some obstacle effect. The aprons can be added later to develop it into a double-apron fence. In country where wire fences are used by farmers, obstacles in the form of four-strand cattle fences (fig. 8-19) will blend with the landscape. Their design should follow the local custom as closely as possible, usually wooden pickets at about 2- to 4-pace intervals with four horizontal strands of barbed wire fixed to them. Site them along footpaths and edges of fields or crops where they do not look out of place. When conditions permit, you may improve this fence by installing guy wires in the same manner as the diagonal wires of the

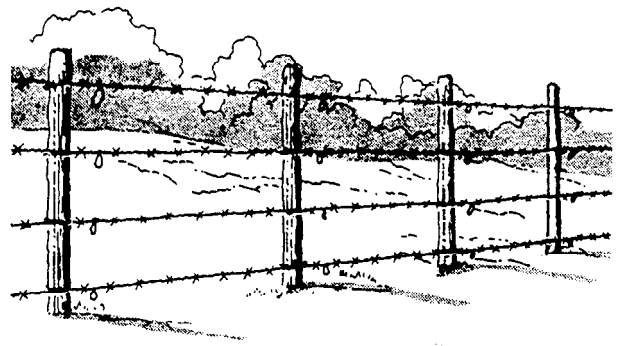

Figure 8-19.—Four-strand cattle fence as viewed from the enemy side.

double-apron fence. All longitudinal wires of this fence must start and end at an anchor picket.

Phase One

Use 8 men on short sections of this fence and up to 16 men on 984-foot sections. The two operations are (1) laying out and installing pickets and (2) installing wire.

Divide the working party into two groups of approximately equal size. The first group carries and lays out long pickets at 9.8-foot intervals along the center line of the fence. They begin and end the section with an anchor picket and include anchor pickets for guys, if needed. The second group installs the pickets.

Phase Two

As the first task is completed, move men individually to the head of the fence and organize them into teams of two or four men to install the wires. For four-man teams, two men carry the reel and two men make ties and pull the wire tight. For two-man teams, the wire must first be unrolled for 164 to 328 feet; then the men come back to the head of the work and make the ties, or the wire may first be made up into bobbins to be carried and unwound by one man, while the other man makes the ties. The first team installs the bottom fence wire and draws it tight and close to the ground. Succeeding teams install the next wires in order.

DOUBLE-APRON FENCE

There are two types of double-apron fence: the 4- and 2-pace fence and the 6- and 3-pace fence. The

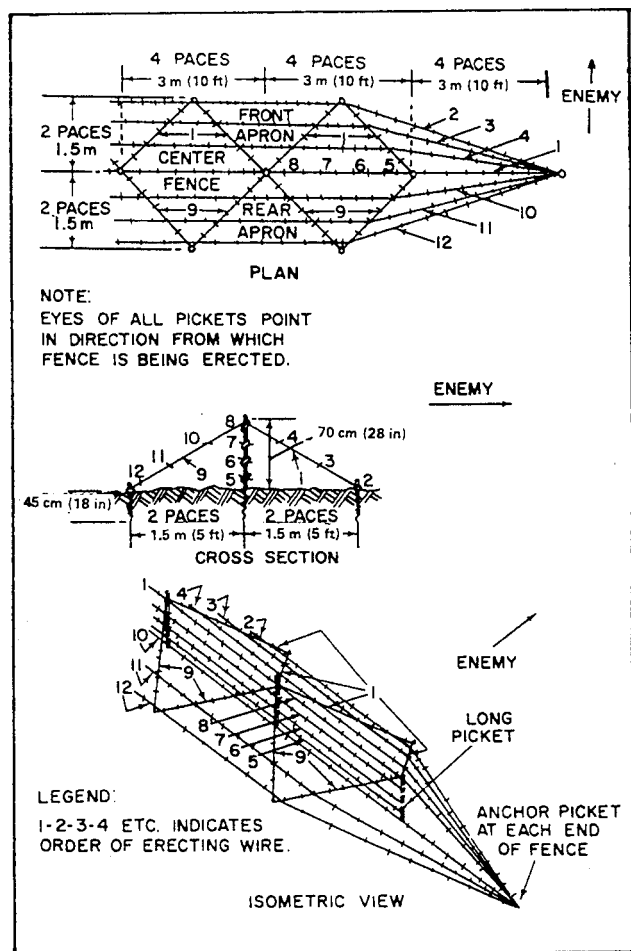

Figure 8-20.—Double-apron fence.

4- and 2-pace fence (fig. 8-20) is the better obstacle of the two and is the type more commonly used. In this fence, the center pickets are 4 paces apart and the anchor pickets are 2 paces from the line of the center pickets and opposite the midpoint of the space between center pickets. The 6- and 3-pace fence follows the same pattern with pickets at 6- and 3-pace intervals. For this fence, less material and construction time are required, but the obstacle effect is substantially reduced, because with the longer wire spans, it is easier to raise the lower wires and crawl over or under them. Except for picket spacing, the 4- and 2-pace and the 6- and 3-pace fences are identical. Only the 4- and 2-pace fence is discussed in detail.

A 984-foot section of either type of double-apron fence is a platoon task normally requiring 1 1/2 hours, assuming 36 productive men per platoon. There are two operations in building a double-apron fence: (1) laying out and installing pickets and (2) installing wire. The first operation is nearly completed before starting the second. The second operation is started as men become

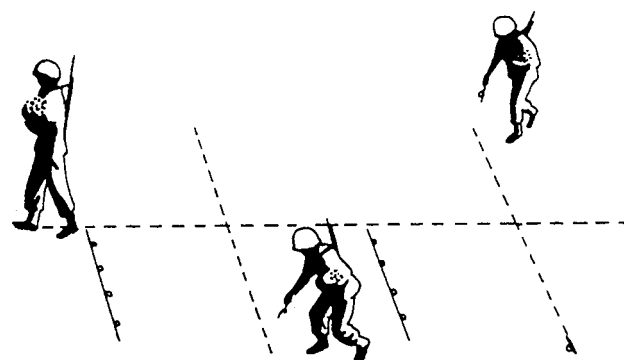

Figure 8-21.—Laying out anchor pickets,

available and the first operation has moved far enough ahead to avoid congestion. A platoon is normally assigned to build a 984-foot section.

Phase One

Divide the working party, if not organized in three squads, into three groups of approximately equal size. One squad lays out the long pickets along the center line of the fence at 4-pace intervals at the spots where they are to be installed and with their points toward the enemy. Another squad lays out the anchor pickets with points toward the enemy and positioned 2 paces each way from the center line and midway between the long pickets (fig. 8-21). The spacing is readily checked with along picket. The third squad installs all the pickets with the help of the two other squads, as the latter finishes the work of laying out the pickets. When installed, the lower notch or bottom eye of the long pickets should be approximately 4 inches off the ground to make passage difficult either over or under the bottom wires.

Phase Two

As the groups complete the first operation, they return to the head of the fence and begin installing wire. The order in which the wires are installed is shown in figure 8-20 and is further illustrated in figure 8-22. Take care to avoid having any of the men cutoff between the fence and the enemy. Divide the men into two- or four-man groups and have them proceed to install the wires in numerical order; that is, as soon as the men installing one wire have moved away from the beginning of the fence and are out of the way, the next wire should be started. Installation is as follows:

1. The No. 1 wire is the diagonal wire on the enemy side and is secured with a top-eye tie to all pickets. It is important to keep this wire tight.

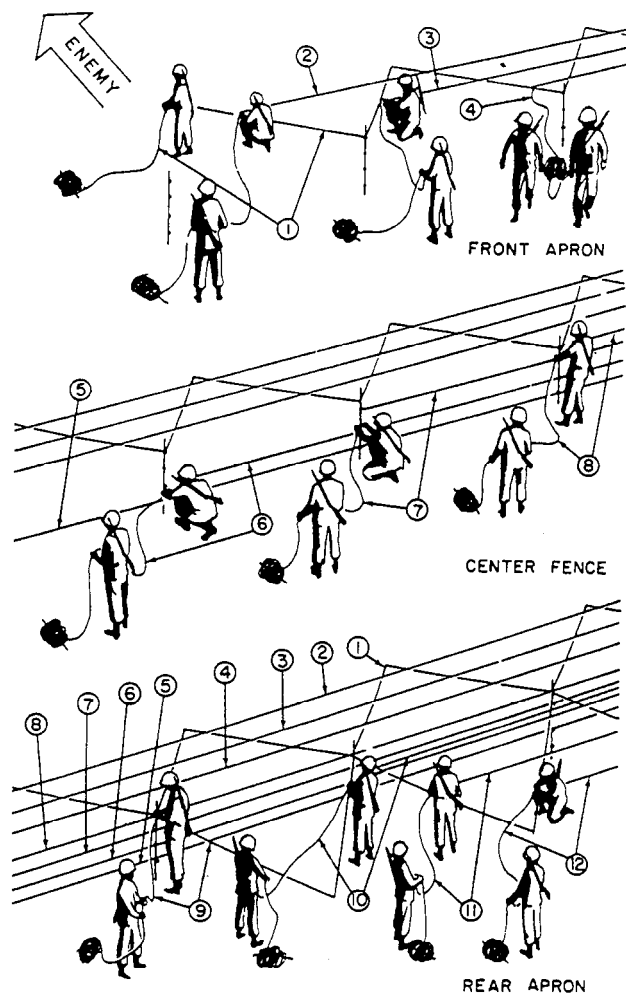

Figure 8-22.—Sequence of installing wire in a double-apron fence.

2. The No. 2 wire is the trip wire on the enemy side of the fence and is secured to both diagonals just above the anchor picket with the apron tie. This wire must be tight enough and close enough to the ground to make passage over or under the wire difficult.

3. The No. 3 wire is an apron wire on the enemy side of the fence. It is secured to the first diagonal wire, and thereafter to each alternate diagonal, and then to the last diagonal wire. The No. 4 wire is also an apron wire on the enemy side of the fence. It is secured to the first diagonal wire (No. 1), thereafter to the diagonal wires which are not tied to the No. 3 wire, and then to the last diagonal wire. Apron wire Nos. 3 and 4 are equally spaced along the diagonal wire.

4. The No. 5 wire is the first one that is not started from the end anchor picket. It is started at the first, long picket and ended at the last, long picket. It is secured

with the intermediate-eye tie and is stretched tightly to prevent passage over or under it.

5. Wire Nos. 6, 7, and 8 complete the center portion of the fence and are secured to the long pickets Nos. 6 and 7 with the intermediate-eye tie. They also start at the first and end at the last, long picket. No. 8 is secured with the top-eye tie. These wires (Nos. 6, 7, and 8) form the backbone of the fence and are drawn up tightly to hold the pickets in position.

6. Wire No. 9 is the diagonal apron wire on the friendly side of the fence and is secured with the top-eye tie to all pickets. Wire Nos. 10 and 11 are apron wires, and wire No. 12 is the trip wire on the friendly side of the fence. Wire No. 12 is installed in the same manner as wire No. 2.

7. If the fence is not satisfactorily tight when installed, wires are tightened by racking as described above.

STANDARD CONCERTINA FENCE

As an obstacle, in most situations, the triple standard concertina fence is better than the double-apron fence. The material for it weighs about 50 percent more, but it is erected with about one half of the man-hours. Every concertina fence is secured firmly to the ground by driving staples at intervals of not more than 6.6 feet. The staples are used on the single concertina fence and on the front concertina of the double and triple types. The two types of fence areas follows:

1. **SINGLE CONCERTINA.** This is one line of concertinas. It is erected quickly and easily but is not an effective obstacle in itself. It is used as an emergency entanglement or for the temporary closing of gaps between other obstacles. It is for such purposes that one roll of concertina maybe habitually carried on the front of each vehicle in combat units.

2. **DOUBLE CONCERTINA.** This consists of a double line of concertinas with no intend between lines. The two lines are installed with staggered joints. As an obstacle, the double concertina is less effective than a well-emplaced, double-apron fence. It is used in some situations to supplement other obstacles in a band or zone.

TRIPLE STANDARD CONCERTINA FENCE

This fence consists of two lines of concertinas serving as a base, with a third line resting on top, as

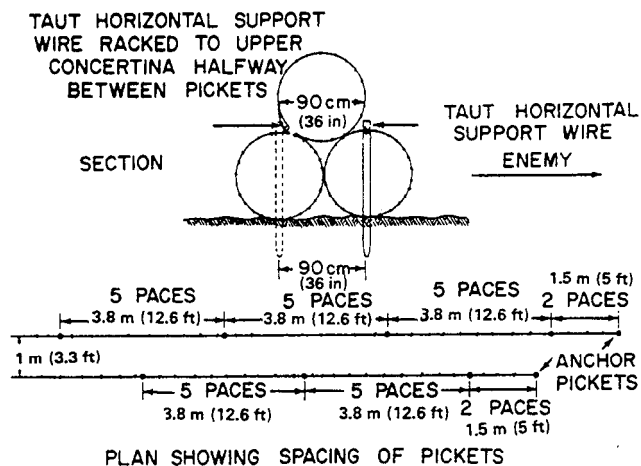

Figure 8-23.—Triple standard concertina fence.

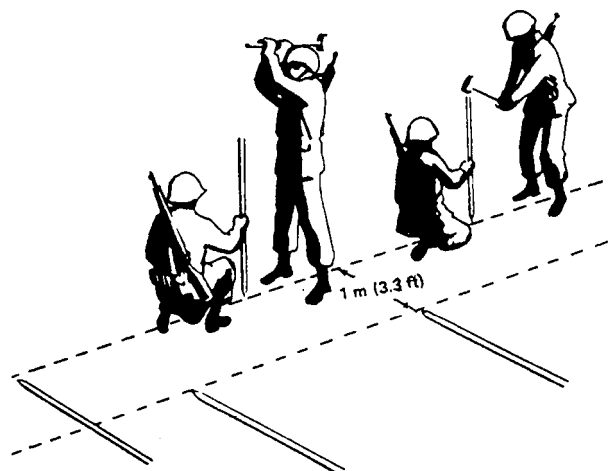

Figure 8-25.—Installing front-row pickets for triple concertina fence.

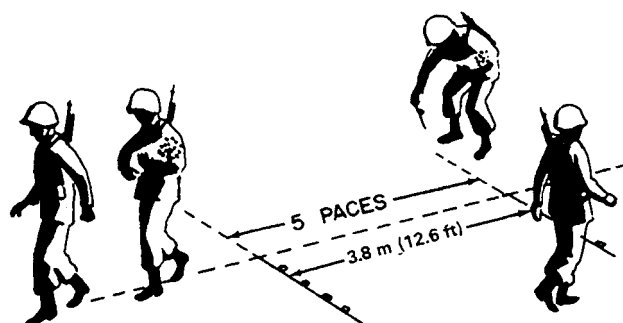

Figure 8-24.—Laying out long pickets for triple concertina fence.

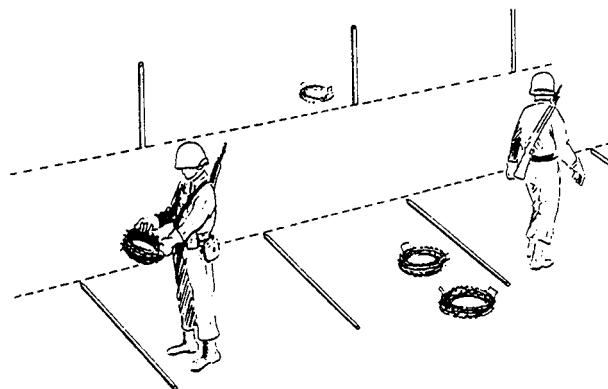

Figure 8-26.—Laying out concertina.

shown in figure 8-23. All lines are installed with staggered joints. Each line is completed before the next is started, so a partially completed concertina entanglement presents some obstruction. It is erected quickly and is difficult to cross, cut, or crawl through.

A 984-f60t section of this fence is a platoon task normally requiring less than 1 hour. There are two operations in building this fence: (1) carrying and laying out pickets and concertina rolls and installing concertina fence and (2) opening and installing concertinas.

Phase One

For the first operation, divide the working party into three groups of approximately equal size: one to lay out all concertina fence, one to install all concertina fence, and one to lay out all concertina rolls.

The first group lays out front-row long pickets of concertina fence at 5-pace intervals on the line of the fence (fig. 8-24) with points of pickets on line and pointing toward the enemy. The rear-row long pickets are then laid out on a line 3 feet to the rear and opposite the center of interval between the front-row long pickets. An anchor picket is laid out at each end of each line, 5 feet from the end long picket.

The second group installs pickets beginning with the front row (fig. 8-25). As in other fences, eyes of screw pickets are to the right. Concave faces of U-shaped pickets are toward the enemy.

The third group lays out concertinas along the rows of pickets (fig. 8-26). In the front row, one roll is placed at the third picket and one at every fourth picket thereafter. Sixteen staples accompany each front-row

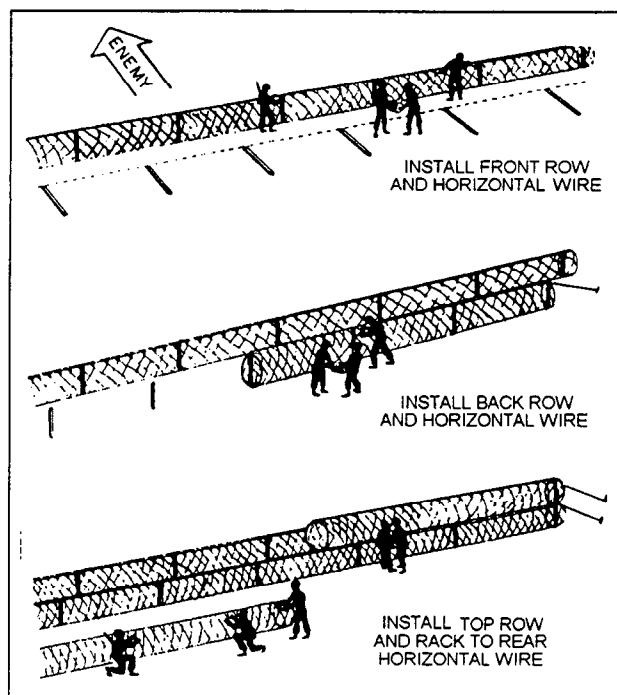

Figure 8-27.—Installing concertina.

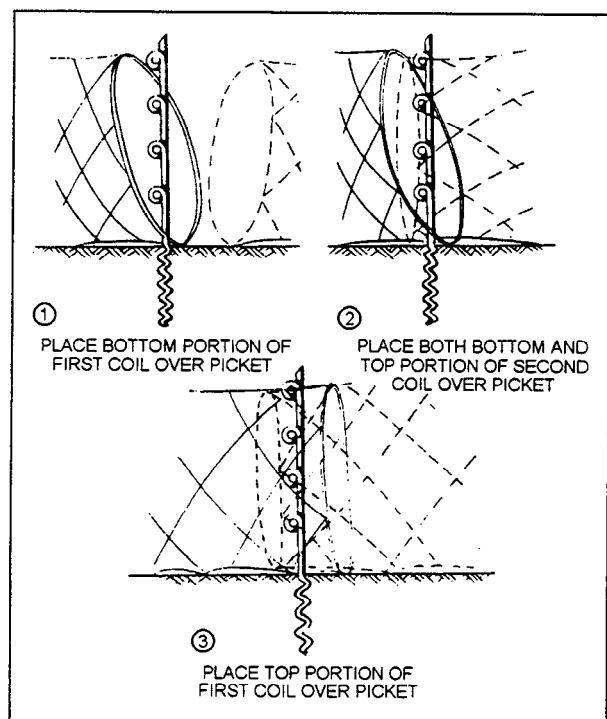

Figure 8-28.—Joining concertina.

concertina. In the second row, two rolls are placed at the third picket and two at every fourth picket thereafter. As each roll is placed in position, its binding wires are unfastened but are left attached to the hoop at one end of the roll.

Phase Two

As they complete the first operation, organize all men in four-man parties (fig. 8-27) to open and install concertinas, beginning at the head of the fence. The sequence shown in general in figure 8-27 is as follows:

1. Open the front-row concertinas in front of the double line of pickets and the other two in the rear.

2. Lift each front-row concertina, in turn, and drop it over the long pickets; then join concertina ends, as shown in figure 8-28.

3. Fasten the bottom of the concertina to the ground by driving a staple over each pair of end hoops: one over the bottom of the coil at each long picket and one at the one-half and one-fourth points of the 12.5-foot picket spacing. Securing the front concertina to the ground is essential and must be done before installing another concertina in the rear unless the enemy side of the entanglement is sure to be accessible later.

4. Stretch a barbed-wire strand along the top of each front row and fasten it to the tops of the long pickets, using the top-eye tie for screw pickets. Stretch these wires as tightly as possible to improve the resistance of the fence against crushing.

5. Install the rear-row concertina as described above for the front-row concertina.

6. Install the concertina in the top row (fig. 8-27), fastening the end hoops of 50-foot sections with plain, steel-wire ties. Begin this row at sections with plain, steel-wire ties. Begin this row at a point between the ends of the front and rear of the lower rows, thus breaking all end joints.

7. Rack the top concertina to the rear horizontal wire at points halfway between the long pickets. If there is safe access to the enemy side of the fence, similarly rack the top concertina to the forward horizontal wire.

LOW-WIRE ENTANGLEMENT

This is a 4- and 2-pace double-apron fence in which medium pickets replace long pickets in the fence center

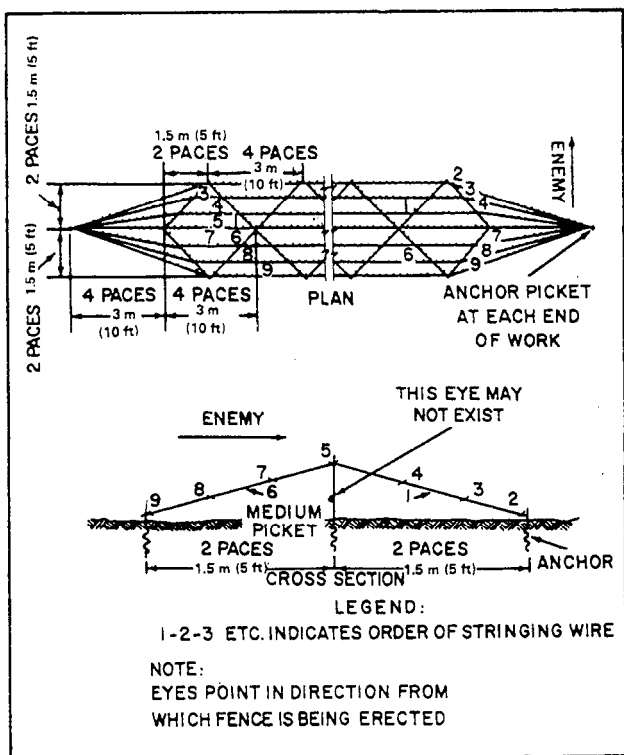

Figure 8-29.—Low-wire fence.

line (fig. 8-29). This results in omission of wire Nos. 6, 7, and 8, and in bringing all the apron and diagonal wires much closer to the ground, so passage underneath this fence is difficult. This fence may be used advantageously on one or both sides of the double-apron fence. The low-wire entanglement is used where concealment is essential. In tall grass or shallow water, this entanglement is almost invisible and is particularly effective as a surprise obstacle. However, a man can pick his way through this low-wire fence without much difficulty; therefore, for best results, it must be used in depth.

Except for the omission of three wires and the substitution of medium pickets, this fence is constructed in the same reamer as the double-apron fence.

HIGH-WIRE ENTANGLEMENT

This obstacle consists of two parallel 4-strand fences with a third 4-strand fence zigzagged between them to form triangular cells. With two rows of pickets, as shown in figure 8-30, the entanglement is classed as a belt; with one or more additional rows of fences and triangular cells, it is a band. To add to the obstacle effect, install front and rear aprons and place spirals of loose wire in the triangular cells.

A 984-foot section of high-wire entanglement with two rows of pickets, as shown in figure 8-30, is a platoon

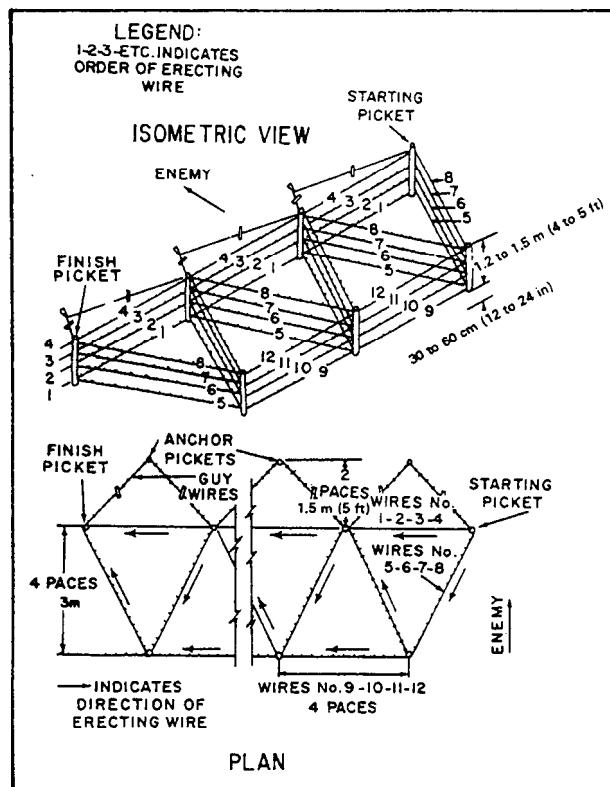

Figure 8-20.—High-wire entanglement.

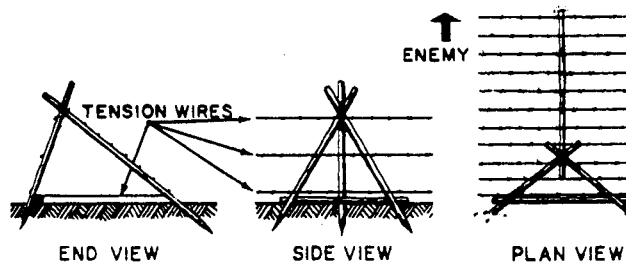

Figure 8-31.—Trestle apron fence.

task normally requiring about 2 hours, assuming 38 men per platoon. The two operations are laying out and installing pickets and installing wire.

Phase One

For this operation, divide the working party into two groups: two thirds of the men going to the first group and one third to the second. The first group carries and lays out pickets, front row first and at 10-foot intervals. Second-row pickets are laid out in a line 10 feet to the rear of the front row and spaced midway between them. The first group also lays out an anchor picket in line with each end of each 4-strand fence, 10 feet from the nearest long picket. If guys are needed, anchor pickets are also

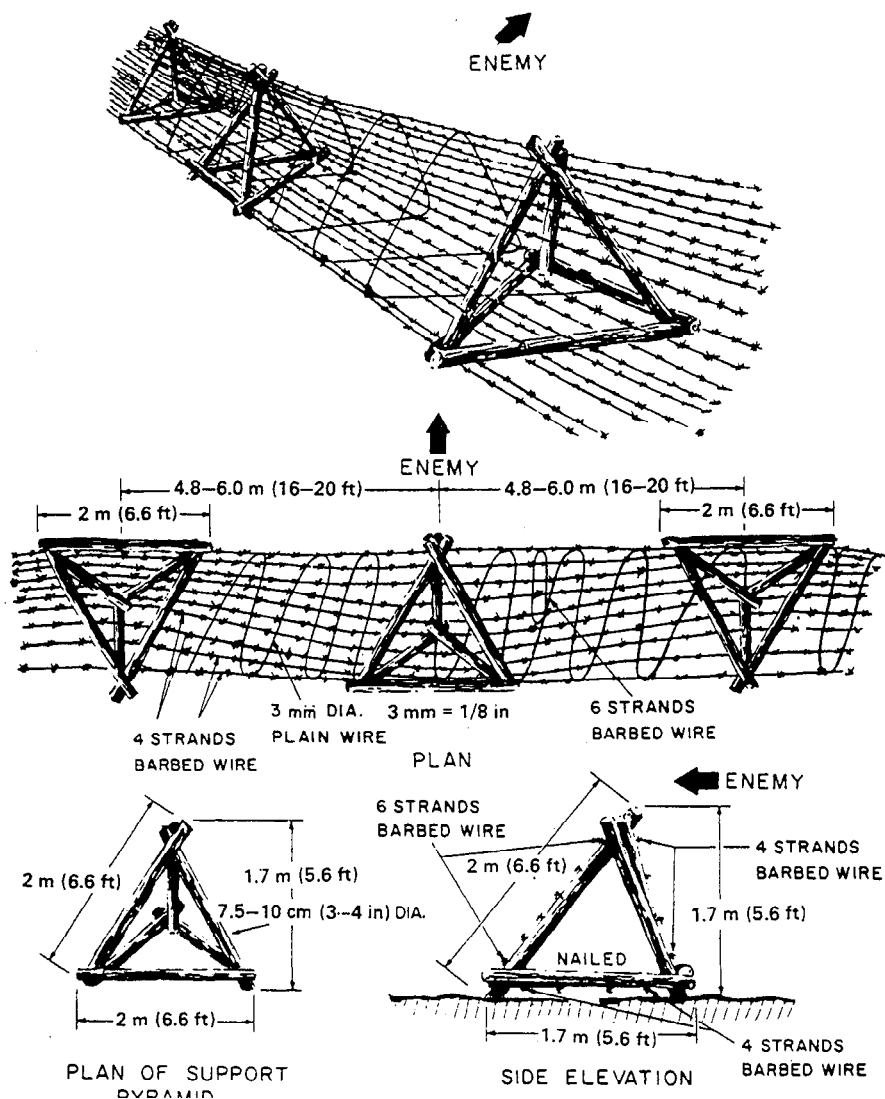

Figure 8-32.—Lapland fence.

laid out in lines 2 paces from the lines of the front and rear fences, opposite and midpoint of spaces between the long pickets. The second group installs front-row pickets, returns to the head of the fence, installs the rear row, and then installs the anchor pickets. When the first group finishes laying out pickets, they begin installing wire and help finish installing the pickets.

Phase Two

As the first task is completed, men move individually to the head of the fence and are organized into teams of two or four men to install wires in the same manner as for the 4-strand fence. The order of installation is as shown in figure 8-30, except if front guys are used, they are installed before the No. 1 wire; rear guys after the No. 12 wire. The lengthwise wires of each 4-strand fence begin and end at an anchor picket.

TRESTLE APRON FENCE

The trestle apron fence (fig. 8-3 1) has inclined crosspieces spaced at 15.7- to 19.7-foot intervals to carry longitudinal wires on the enemy side. The rear ends of the crosspieces are carried on triangular timber frames that are kept from spreading by tension wires on the friendly side. The crosspiece maybe laid flat on the ground for tying the longitudinal wires in place and then raised into position on the triangular frames. The frames are tied securely in place and held by the tension wires. The fence should be sited in such a way that it can be guyed longitudinally to natural anchorages and racked tight.

LAPLAND FENCE

Figure 8-32 shows the Lapland fence that can be used equally well on frozen or rocky ground and on bogs

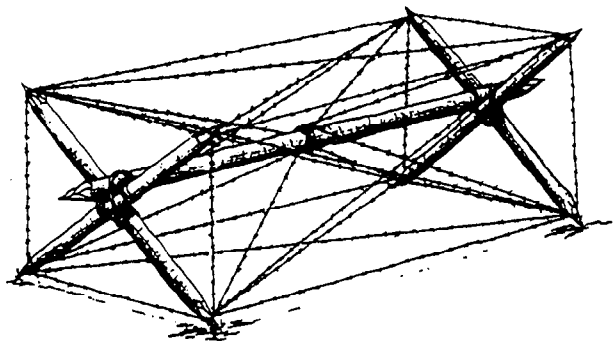

Figure 8-33.—Knife rest.

or marshland. This fence is wired with six strands of barbed wire on the enemy side, four strands on the friendly side, and four strands on the base. In snow, the tripods can be lifted out of the snow with poles or other means to reset the obstacle on top of newly fallen snow. On soft ground, the base setting of tripods and the base wires give enough bearing surface to prevent the obstacle from sinking.

PORTABLE, BARBED-WIRE OBSTACLES

Standard concertinas are readily moved and are well adapted for the temporary closing of gaps or lanes, or for adding rapidly to the obstacle effect of fixed barriers, such as the double-apron fence. Other portable, barbed-wire obstacles are described below.

Spirals of Loose Wire

By filling open spaces in and between wire entanglements with spirals of loose wire, the obstacle effect is substantially increased. Men are tripped, entangled, and temporarily immobilized. Spirals for such use are prepared as follows:

1. Drive four 3.3-foot posts in the ground to form a diamond 3.3 by 1.6 feet.
2. Wind 246 feet of barbed wire tightly around the frame. Start winding at the bottom and wind helically toward the top.
3. Remove the wire from the frame and tie it at quarter points for carrying or hauling to the site where it is to be opened and used. One spiral weighs less than 20 pounds and a man can carry three or more of them by stepping inside the coils and using wire handles of the type furnished with the standard concertina.
4. If spirals are needed in large quantities, mount the diamond-shaped frame on the winch of a truck and use the winch to coil the wire.

Knife Rest

The knife rest (fig. 8-33) is a portable, wooden or metal frame strung with barbed wire. Use it wherever a readily removable barrier is needed; for example, at lanes in wire obstacles or at roadblocks. With a metal

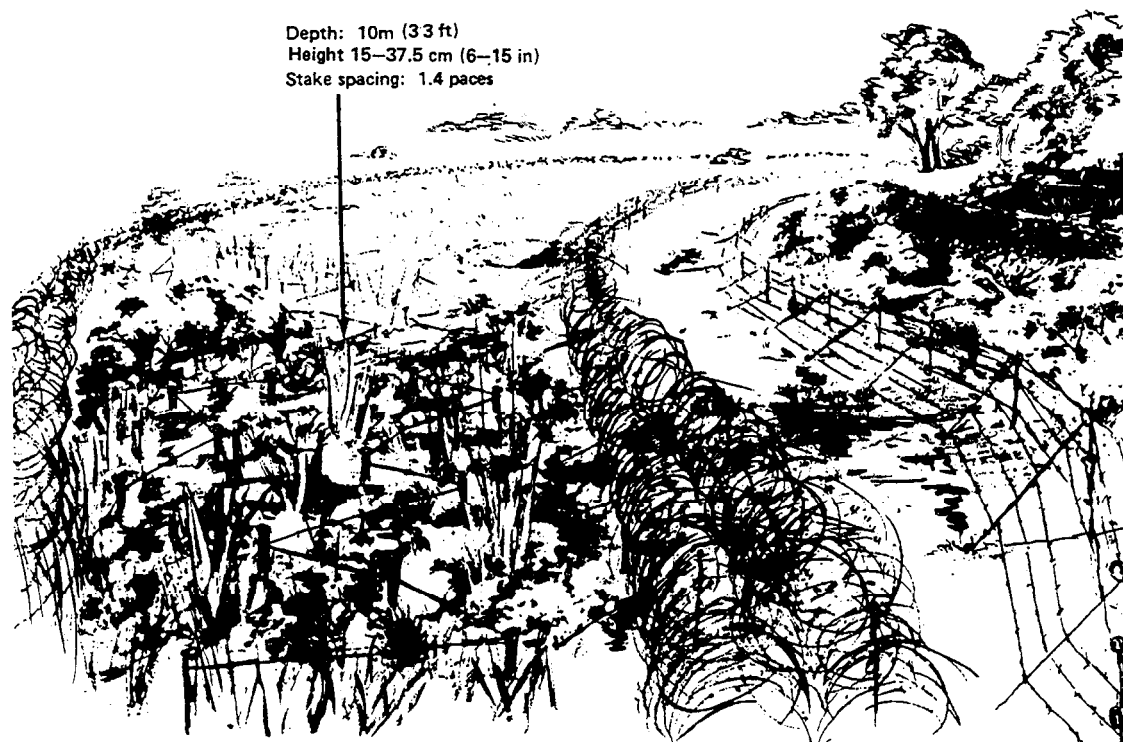

Figure 8-34.—Tanglefoot in barrier system.

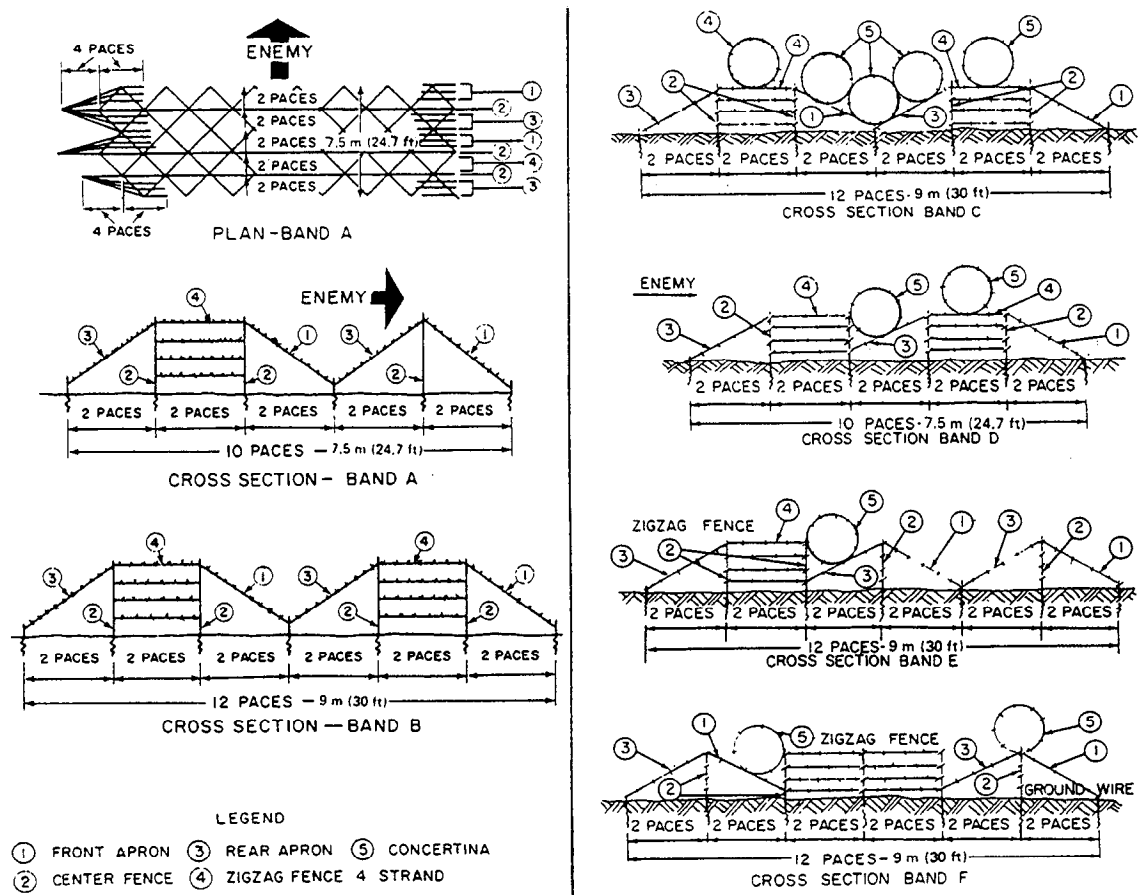

Figure 8-35.—Combination bands of wire obstacles.

frame, you can use it as an effective underwater obstacle in beach defense. Knife rests are normally constructed with 9.8 to 16.4 feet between cross members. They should be approximately 3.3 feet high. The cross members must be firmly lashed to the horizontal member with plain wire. When placed in position, knife rests must be fixed securely.

Trip Wires

Immediately after a defensive position is occupied and before an attempt is made to erect protective wire, place trip wires just outside of grenade range, usually 98 to 131 feet. These wires should stretch about 9 inches above the ground and be fastened to pickets at not more than 16.4-foot intervals. Conceal them in long grass or crops on a natural line, such as the side of a path or the edge of a field. Place the trip wires in depth in an irregular pattern.

Tanglefoot

Use tanglefoot (fig. 8-34) where concealment is essential and to prevent the enemy from crawling between fences and in front of emplacements. Use the obstacle in a minimum depth of 32.8 feet. Space the

pickets at irregular intervals of 2.5 to 10 feet. The height of the barbed wire should vary between 9 and 30 inches. Site tanglefoot in scrub, if possible, using bushes as supports for part of the wire. In open ground, use short pickets. Control the growth of grass to help prevent the enemy from secretly cutting lanes in, or tunneling under, the entanglement.

COMBINATION BANDS

The high-wire entanglement may be built with additional rows of fences and triangular cells to form bands of any desired depth, or it may be made more effective by adding front and rear aprons. Other types of fences may be combined in bands to form obstacles that are more difficult to breach than a single belt. Portable, barbed-wire obstacles may be added as described previously. The construction of bands of various types is desirable because this makes it difficult for the enemy to develop standard methods of passage. It also allows for fitting the obstacles to the situation with the time and materials available. Six different types of effective combination bands are shown in figure 8-35. Other variations can be developed readily.

BASIC CONSIDERATIONS

Barbed-wire obstacles are constructed primarily from issue materials; thus both logistical and construction estimates are involved. Table 8-1 gives weights, lengths, and other data required for estimating truck transportation and carrying party requirements. Table 8-2 gives the material and labor requirements for construction of various wire entanglements. Table 8-2 is based on daylight work; for nightwork the man-hours must be increased 50 percent.

REQUIREMENTS FOR A DEFENSIVE POSITION

Table 8-2 gives quantities and weights of material per linear foot of entanglement. When a layout to scale can be developed, the lengths of the various types of entanglements are scaled and the quantities and weights are computed. When a scaled layout cannot be prepared, the rule-of-thumb method may be used for estimating the required lengths of tactical- and protective-wire entanglements. If the length of front is taken as the

straight-line distance between limiting points, the rules are as follows:

1. The length of tactical-wire entanglement is 1.25 times the length of the front, times the number of belts, regardless of the size of the unit involved.

2. The length of protective-wire entanglement for a defensive position is five times the length of the front being defended, times the number of belts. Since protective wire encircles each platoon area of a command, the protective-wire entanglement for units is 2.5 times the average platoon frontage, times the number of platoons involved.

3. Supplementary wire in front of the FEBA is used to breakup the line of tactical entanglements. Its length is 1.25 times the unit's frontage, times the number of belts. The length of the supplementary-wire entanglement behind the FEBA is approximately equal to 2.5 times the distance from the FEBA to the rearmost reserve unit, times the number of belts. This rule of thumb is adequate for all units.

CHAPTER 9

CHEMICAL, BIOLOGICAL, AND RADIOLOGICAL (CBR) DEFENSE

Although chemical and biological warfare has been outlawed by international agreements, the potential for such warfare is real. Likewise, radiological or nuclear warfare is an ever-present concern to the Seabees as well as all other U.S. military personnel. The first part of this chapter discusses the effects of chemical, biological, and radiological (CBR) weapons on personnel and equipment. This information includes the symptoms of CBR poisoning and its first-aid treatment. The next section discusses Seabee CBR defense responsibilities in detail. Individual protective measures and CBR defense equipment are discussed in this section. Completing the Seabee's mission while under CBR conditions is also covered in this chapter. The last two topics are CBR defense training and marking contaminated areas.

CBR Defense Readiness Policy states that mission accomplishment in a CBR environment is dependent on two basic requirements:

1. The individual Seabee must have been trained to take whatever action is necessary for survival during a CBR attack
2. Seabee units must have been trained to perform their assigned missions in a CBR-contaminated environment.

So these basic requirements can be fulfilled, CBR training needs to be integrated into all facets of individual and unit training. Sufficient training time must be allocated to ensure that actions required for initial survival and subsequent mission accomplishment are conditioned responses.

EFFECTS OF CHEMICAL WEAPONS

Chemical agents are used to produce death, injury, temporary incapacitation, or irritating effects. (Screening smokes are not toxic unless they are inhaled in large amounts. Incendiaries are used primarily to start fires. These two agents are not discussed further.)

Broadly speaking, there are three types of antipersonnel agents: casualty, incapacitating, and harassing.

CASUALTY AGENTS are highly poisonous and are intended to kill or seriously injure. Included in this group are nerve, blister, choking, and blood agents. Nerve agents, as a group, are probably the most effective because only small doses are needed to produce death. Some agents are so persistent (when dispersed as a liquid) that they can remain effective for several days. They enter the body by the victim's breathing or swallowing or through the skin of the victim. Blister agents cause severe burns, blisters, and general destruction of body tissue. When they are inhaled, the lungs are injured. Choking agents inflame the nose, throat, and particularly the lungs. Blood agents interfere with the distribution of oxygen by the blood.

Some casualty agents have a cumulative effect, which means that successive doses add to the effect of each preceding dose. You might receive a nonlethal dose of a nerve agent, for example, followed within a few hours by another nonlethal dose. The cumulative effects of the two exposures, however, could be sufficient to cause death.

A new development is the NONLETHAL INCAPACITATING AGENT. It renders personnel incapable of performing their duties by interfering with the mental processes that control bodily functions. Reactions vary among individuals. One person might go into shock, and still another might have a feeling of extreme fatigue. These agents are difficult to detect because most of them are colorless, odorless, and tasteless.

HARASSING AGENTS include tear and vomiting gases that cause temporary disability. Tear gases are used mainly for controlling riots, but they have been used in warfare with varying degrees of success. Without a gas mask, the individual is rapidly incapacitated, but the effects disappear in 5 to 10 minutes after the person dons a protective mask or gets to fresh air.

Vomiting gases are useful when the enemy intends to launch an attack with casualty agents. They cause extreme nausea and vomiting, requiring those who have been exposed to remove their masks, thus exposing personnel to the casualty agents.

EFFECTS OF BIOLOGICAL WEAPONS

Biological operations use living organisms to cause disease or death. They act on living matter only. Most organisms that produce disease enter the body of the victim and grow in the human tissues. Some organisms produce toxins (poisons) in food or water, and the poison causes disease after the victim eats or drinks it.

Large-scale biological attacks by an enemy are as yet an untried weapon. As far as it is known, there has been no open attempt by any country to use this form of attack. Biological agents, however, have certain characteristics that favor them over other types of warfare, and the possibility of their use in the future must be anticipated. Only small amounts of the agents are needed, because the organisms are alive and multiply in the victims. Moreover, they are difficult to detect and slow to identify. A whole ship's company might be infected before the medical department realized a disease existed on board.

The most efficient means of delivering biological agents on a large scale is through aerosols, which generally are invisible and odorless. Aerosols can be released from aircraft in bombs or direct sprays, from surface vessels on onshore winds, or from any number of explosive munitions, such as projectiles, guided missiles, and rockets.

Animals and insects can be used as carriers to spread biological agents.

Another method of quickly infecting large numbers of people is for saboteurs to contaminate a water supply. Diseases, such as typhoid fever, cholera, and influenza, can be spread by infecting water, milk, and food supplies with the proper microorganisms.

EFFECTS OF NUCLEAR WEAPONS

Nuclear weapons produce explosions of great force and heat and release nuclear radiation. Their primary purpose is the mass destruction of property and personnel. Their effects are divided into three categories: blast, heat, and nuclear radiation.

BLAST

Injuries caused by blast can be divided into primary (direct) injuries and secondary (indirect) injuries. Primary blast injuries result from the direct action of the air shock wave (overpressure) on the human body. The greater the size of the weapon, the greater the effective range of the blast wave will be with a subsequent increase in casualties.

Secondary blast injuries are caused mainly by collapsing buildings and by timber and other debris flung about by the blast. Personnel may also be hurled against stationary objects or thrown to the ground by high winds accompanying the explosion. Injuries sustained are similar to those resulting from a mechanical accident, such as bruises, concussions, cuts, fractures, and internal injuries.

At sea, the shockwave or base surge accompanying an underwater burst will produce various secondary injuries. Casualties resemble those caused by more conventional underwater weapons, such as mines and depth charges; but instead of being localized, they extend over the entire ship. Injuries also will result from personnel being thrown against fixed objects or structures. Equipment, furniture, boxes, and similar gear, when not secured properly, can act as missiles and cause many injuries.

Frequently, hemorrhage and shock are serious complications of blast injuries. The importance of shock cannot be overemphasized, because it is often the main consideration in determining the fate of the patient.

HEAT

Heat from nuclear weapons causes burns. These burns can be grouped into two categories: primary and secondary. Primary burns are a direct result of the thermal radiation from the bomb. Secondary burns are the result of fires caused by the explosion.

As with blast injuries, shock is commonly associated with extensive burns. Burns are also subject to infection, which may produce serious consequences.

Flash burns are likely to occur on a large scale as a result of an air or surface burst of a nuclear weapon. Because thermal radiation travels in straight lines, it burns primarily on the side facing the explosion; but under hazy atmospheric conditions, a large proportion of the thermal radiation may be scattered, resulting in burns received from all directions. Depending on the size of the weapon, second-degree burns may be received at distances of 25 miles or more.

The intense flash of light that accompanies a nuclear burst may produce flash blindness, even at a range of several miles. Flash blindness is normally of a temporary nature since the eyes can recover in about 15 minutes in the daytime and in about 45 minutes at night. A greater danger lies in receiving permanent damage to your eyes caused by burns from thermal radiation,

which may occur 40 miles or more from a large-yield nuclear weapon.

NUCLEAR RADIATION

Nuclear radiation consists of four types: alpha and beta particles, neutrons, and gamma rays.

ALPHA and BETA particles can be ignored as initial radiation because they are very short-range; however, they can be a hazard as residual radiation. Alpha particles have little penetrating power; but if they are ingested into the body, they can cause serious harm. Beta particles also are of little concern unless they are on the body (in dust, dirt, etc.) or get into the body.

NEUTRONS are a direct hazard only during the initial radiation phase and then only in the general area of ground zero. In the residual phase, however, they cause whatever material absorbs them to become radioactive and emit gamma rays and beta particles.

GAMMA RAYS (similar to, but more powerful than, X rays) are the most hazardous form of radiation. They can travel long distances in air and have great penetrating power, making it difficult to provide sufficient shielding to protect personnel.

Radiation hazards are of three types: PENETRATION DOSE, SKIN DOSE, and INTERNAL CONTAMINATION. Penetration doses and internal contamination have the most serious effects. You can be protected against penetration doses by proper shelter. You can avoid internal contamination by wearing the protective mask and not eating or drinking food and water until they are declared safe. Skin doses, which cause injuries similar to burns, can be reduced by your wearing of proper battle dress.

CBR CONTAMINATION DETECTION AND IDENTIFICATION

For Seabees to carry out their mission, they must be able to detect and identify CBR agents immediately. The very nature of CBR agents, however, makes it difficult to detect and identify them.

In a nuclear attack for instance, you know an attack is taking place because you can see it, hear it, and feel it. But you cannot see the nuclear radiation that can be just as deadly over a period of time as the blast itself. In the same invisible way, biological agents can be present with the possibility of no one knowing until it is too late. Recent developments in chemical operations make some of the chemical agents colorless and odorless. You

must be able, therefore, to recognize them whenever you or your shipmates are victims.

You must learn the symptoms of each type of attack so you can take the proper action when exposed and so you can apply the correct self-aid and first-aid measures.

SYMPTOMS OF CHEMICAL AGENT CONTAMINATION

Chemical agents make you a casualty when your body comes in contact with a bigger dose than it can withstand. The limits of tolerance of the human body extend from short periods of exposure and low concentrations of certain agents to extended periods of exposure and high concentrations of certain other agents. Furthermore, the limits of tolerance to specific agents vary with individuals. In any event, your principal concern is recognizing the symptoms and relieving the effects of exposure before the limit of exposure is exceeded.

Nerve Agent Symptoms

Symptoms of nerve agent contamination are runny nose; tightness of chest with difficulty in breathing; contraction of eye pupils; and nausea, cramps, headache, coma, and convulsions. All of these symptoms can take place in 30 seconds when the dose is sufficiently heavy.

Vapors of the G- or V-series nerve agents, even in low concentrations, cause contraction of the eye pupils. This action affects the sight, especially in dim light, and induces a headache. After a brief exposure to the vapors, a feeling of tightness in the chest maybe noticed, which increases deep breathing. The liquid substance does not injure the skin but penetrates it and poisons the body. Contraction of the pupils, in such an instance, may not appear as a warning sign.

A 1- to 5-minute exposure of personnel not wearing protective masks for low concentrations of G- or V-agent vapors causes difficulty in vision. Slightly greater exposure causes headache, nausea, pain in the chest, and more serious visual difficulties. Exposure of unbroken skin to vapor alone, however, entails little danger of serious injury.

Liquid contamination from a nerve agent to the skin is a real hazard. One of the first signs of exposure when liquid contaminates the skin may be excessive sweating and twitching of the muscles at the site of contamination. Small amounts of liquid left undisturbed on the skin can cause death in a matter of a few minutes. The entrance

to the body is even more rapid through the surface of the eye and through the linings of the mouth and nose. A lethal dose can be absorbed as rapidly by getting liquid in the eyes as by inhaling concentrated vapor. When poisonous vapors are swallowed, the first symptoms are excess flow of saliva, intestinal cramps, nausea, vomiting, and diarrhea. When the nerve agent is absorbed into the system after the victim is exposed to liquid or vapor, the symptoms may be generalized sweating, difficulty in breathing, muscular weakness, and eventually convulsions, paralysis, and unconsciousness.

Blister Agent Symptoms

Immediate contact with LIQUID MUSTARD or MUSTARD VAPOR causes no eye or skin pain or any other immediate symptoms. Exposure to mustard gas for more than half an hour, however, produces these symptoms: Half an hour to 12 hours after exposure, the contaminated eyes water, feel gritty, and become progressively sore and bloodshot. The eyelids become red and swollen. Infection frequently results.

Mustard vapor will burn any area of the skin, but the burn will be most severe in moist areas (neck, private parts, groin, armpits, bends of knees, and elbows). Redness of the skin follows in one half to 36 hours after exposure. This condition may be accompanied by intense itching, and blisters may then appear. Stiffness, throbbing pain, and swelling may also be observed.

A few hours after breathing mustard vapor, a victim experiences irritation of the throat, hoarseness, and coughing. After severe exposure, the lining of the respiratory system swells and interferes with breathing. Frequently, pneumonia develops.

When the whole body is exposed to mustard vapor, the body goes into a state of shock. This reaction is accompanied by nausea and vomiting.

NITROGEN MUSTARDS irritate the eyes before they affect the skin or respiratory system. The action of nitrogen mustards on the eyes occurs in a shorter time than does mustard. Even low concentrations of these agents may seriously decrease vision during or shortly after exposure. Later effects are similar to those of mustard. Contact of these agents with the skin produces damage like that produced by mustard, and their effects on the respiratory system are also similar.

Blood Agent Symptoms

Symptoms produced by blood agents, such as HYDROGEN CYANIDE, depend upon the concentration of the agent and the duration of the exposure. Typically, either death occurs rapidly or recovery takes place within a few minutes after removal of a victim from the contaminated area. When the victim inhales a high concentration of a blood agent, the victim begins to breathe more deeply within a few seconds, has violent convulsions after 20 to 30 seconds, stops breathing regularly within 1 minute, then gives occasional shallow gasps, and finally the heart stops only a few minutes after the onset of exposure. After moderate exposure, giddiness, nausea, and headache appear very early, followed by convulsions and coma. Long exposure to low concentrations may result in damage to the central nervous system. Mild exposure may produce headache, giddiness, and nausea, but usually recovery is complete.

The effects of CYANOGEN CHLORIDE combine the properties of two agents: chlorine and cyanogen. The chlorine properties induce coughing, dryness of the nose and throat, tightness across the chest, and smarting and watering of the eyes, resulting finally in the accumulation of fluid in the lungs. Cyanogen is similar to hydrogen cyanide and, like that agent, causes giddiness, headaches, unconsciousness, convulsions, and death.

Choking Agent Symptoms

In low concentrations, choking agents produce an action on the respiratory system that results in the accumulation of fluid in the lungs. This effect may lead to death. High concentrations produce death for the same reason, but the upper respiratory tract may be involved as well. Exposure to choking agents may produce immediate dryness of the throat, coughing, choking, tightness across the chest, headache, nausea, and at times, smarting and watering of the eyes. Symptoms usually are delayed, however, and it is possible that no immediate symptoms will appear when you are exposed to a fatal dose.

Even mild exposure to a choking agent that is accompanied by immediate symptoms may cause fluid to accumulate in the lungs within 2 to 24 hours after exposure. The presence of this fluid is indicated by shallow and rapid breathing, hacking and painful cough, frothy saliva, and an ashen-gray color of the skin.

Vomiting Agent Symptoms

Exposure to vomiting agents is followed soon by a pepperlike burning of the eyes, nose, throat, and air passages. The burning sensation is accompanied by a flow of tears and by repeated coughing and sneezing. These symptoms increase in severity for several minutes, even after the victim dons a mask. The victim becomes sick to the point of vomiting. When the mask is removed, the victim is then exposed to even more hazardous agents.

Tear Agent Symptoms

Tear agents (also called riot control agents) are local irritants which, in low concentration, act primarily on the eyes, causing intense pain and a considerable flow of tears, stinging of moist, warm skin, and irritation of the nose. High concentrations affect the upper respiratory tract and lungs and cause nausea and vomiting. The agents may be either solids or liquids and may be dispersed as vapors or smokes. The newest agent, CS, is the most effective, causing incapacitation 20 to 60 seconds after exposure. Recovery can be expected 5 to 10 minutes after the victim is breathing fresh air.

Incapacitating Agent Symptoms

Incapacitating agents can cause mental symptoms and may also produce physical symptoms, such as staggering gait, dizziness, and blurred vision. Some of these agents cause fainting spells, and others cause severe muscle weakness. The mental symptoms often resemble alcoholic drunkenness; for example, individuals may act silly, giggle, or become angry and belligerent similar to a "fighting drunk." Sometimes incapacitating agents can cause hallucinations. (Like alcoholic "DTs," victims may imagine that they see snakes or enemy soldiers, or they may imagine that colors have changed.) Many of these incapacitating gases prevent sleep. Some people may stay wide awake for 4 days and be mentally confused for the whole period. These agents do not kill, but they can make a man unfit for duty. Many of them do not produce effects until several hours after inhalation. These effects can last from 8 hours to 4 days.

SYMPTOMS OF BIOLOGICAL CONTAMINATION

In the early stages of any biological disease, the general symptoms are fever, malaise, and inflammation.

The degree of fever varies with the individual, depending on his or her resistance, but it does serve as a rough guide to the severity of infection. Often the fever is preceded by a violent chill. Whether the chill occurs or not, the fever is usually one of the earliest symptoms.

Malaise is a feeling of bodily discomfort and weakness. There may be nausea, dizziness, loss of appetite, and general aches and pains.

Inflammation is caused by the reaction of body tissues combating and sealing off an infection. In almost every case, there is pain, redness, and swelling. Some types of infection result in a characteristic rash, making it possible for the doctor to make an early diagnosis.

SYMPTOMS OF NUCLEAR RADIATION

The first symptoms of exposure to nuclear radiation are nausea and vomiting. Later (2 weeks or more) symptoms are diarrhea, loss of hair, loss of weight, sore throat, and skin hemorrhage. Death rates depend on the amount of the dose and the general physical condition of the victim. Unless a very heavy dose is received, ultimate recovery can be expected in most instances.

SEABEE CBR DEFENSE RESPONSIBILITIES

The battalion commander is responsible for planning the overall CBR defensive measures for a Seabee's encampment. The battalion commander then presents to the battalion those requirements for defense measures that should be provided by other forces.

Protective measures used against other weapons give only partial protection against CBR attacks. Provisions must be made for CBR defense, such as the following:

- Greater emphasis must be placed on unit separation, dispersion, and mobility.
- Increased air and ground reconnaissance.
- Training and indoctrination of personnel.
- Warning, reporting, detection, and identification of CBR agents and hazards.
- Individual and collective protection.
- Decontamination of personnel, equipment, supplies, and terrain, when directed.
- Plans for handling mass casualties, to include medical operations and first aid.

CHEMICAL DEFENSE

The best defense against a chemical attack is constant monitoring with equipment to detect chemical agents as soon as possible. To provide adequate time to take protective measures, commanders should use all available chemical detection equipment.

The protective measures taken by individuals and units when operating under the threat of chemical attack or in a chemical environment are governed by the nature of the threat, mission, situation, and weather. Movement of troops and supplies should be planned so contaminated terrain is avoided to the maximum extent possible. Contaminated terrain is crossed only when absolutely necessary and then as quickly as possible. Preferably, you should move in vehicles at speeds and intervals that minimize contamination. When the situation and mission permit, heavy work-rate activities of personnel dressed in chemical protective clothing and equipment should be minimized. Essential work should be planned for the coolest part of the day, when possible.

Protective Measures before Chemical Attack

In any combat situation, the commander should designate a level of Mission-Oriented Protective Posture (MOPP) for the unit. MOPP is discussed in detail later in this chapter. The following protective measures must be taken before a chemical attack.

EXTENDED WEAR OF PROTECTIVE CLOTHING.—Based on the MOPP level designated by the commander, the individual may have to adapt to requirements for wearing his or her protective clothing and equipment for extended periods. The amount of time required to put all of these items on during a chemical attack exceeds the amount of time required to receive a casualty-producing dose of chemical agent.

M9 CHEMICAL AGENT DETECTOR PAPER.—The M9 chemical agent detector paper (fig. 9-1) detects the presence of liquid chemical agents encountered by the individual. It does NOT detect chemical agent vapors. The paper indicates the presence of a nerve agent (G and V) or a blister agent (H and L) by turning a red or reddish color.

The M9 paper is self-adhesive; you can attach it to most surfaces. When you attach it to clothing, place it on the upper portion of the right arm, left wrist, and either the left or right ankle to allow adequate representation of contamination encountered by the Seabee. When you place it on a piece of equipment, it must be in a location free of dirt, oil, and grease and

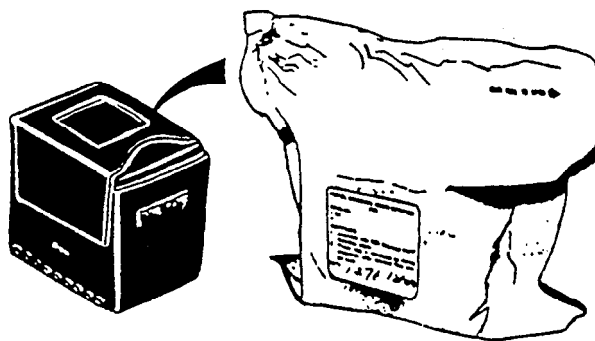

Figure 9-1.—M9 chemical agent detector paper.

where it cannot be stepped on. The M9 paper may be used in any weather, in temperatures above 32°F or 0°C. However, take care not to expose it to extremely high temperatures, scuffs, or certain types of organic liquids and DS2, as they all cause false readings. If spots or streaks on the paper appear pink, red-brown, red-purple, or any shade of red, assume it has been exposed to a chemical agent.

ALERTNESS AND PROFICIENCY.—Individuals must remain alert and constantly aware of the chemical threat, especially when duty requirements preclude the wearing of full protective equipment. Individuals must understand the chemical alarms and signals and be proficient in attaining the maximum level of protection when alerted to a chemical attack.

PROTECTION OF INDIVIDUAL EQUIPMENT.—To the extent possible, individuals must protect equipment and supplies against liquid chemical agent contamination by keeping them organized and covered. Hastily constructed fighting hole covers, ponchos, shelter halves, or other suitable materials can be used for protection. Individuals should wear full protective clothing and equipment when sleeping and, to the extent possible, cover themselves and their equipment before they go to sleep.

Protective Measures during Chemical Attack

A chemical attack may come directly in the area in which individuals are located or upwind from that area. In either case, when alerted to a chemical attack they must take the following immediate defensive actions:

- Stop breathing.
- Don protective mask
- Give the alarm.
- Continue the mission and wait for further orders.

- When the situation permits, assist others who need help.

Protective Measures after Chemical Attack

Whether an attack comes in the form of a vapor, aerosol spray, or a liquid agent, remain in protective gear and continue your mission. When the time and the mission permit, give first aid to casualties in the immediate vicinity, and report the local casualty status to the appropriate authority. All personnel must await the commander's order for unmasking. After a chemical attack **DO NOT UNMASK UNTIL AUTHORIZED BY YOUR IMMEDIATE COMMANDER**. In the absence of command guidance, the procedures described below should be followed.

PROCEDURE WHEN A DETECTOR KIT IS AVAILABLE.— Use a chemical agent detector kit to test for the presence or absence of chemical agents.

After determining the absence of agents, two or three individuals should unmask for 5 minutes, then remask. Check for chemical agent symptoms. If no chemical agent symptoms appear in 10 minutes, the remainder of the troops may safely unmask. Bright light causes contraction of the pupils that could be erroneously interpreted as a nerve agent symptom.

PROCEDURE WHEN A DETECTOR KIT IS NOT AVAILABLE.— Observe animal life within your surrounding area for symptoms of chemical agent poisoning. If the local animals appear affected by a chemical agent and if it does not impede your mission, move to an area where the animals appear normal before you attempt the procedures listed below. These procedures should also be used in an extreme emergency. Two or three individuals should be selected to take a deep breath, hold it, break the seal of their masks, and keep their eyes wide open for 15 seconds. They then should clear their masks, reestablish the seal, and wait for 10 minutes. If no symptoms appear after 10 minutes, these same individuals should again break the seal, take two or three breaths, and clear and reseal the mask. After another 10-minute wait, if no symptoms have developed, these same individuals should unmask for 5 minutes and then remask. After this procedure, if no symptoms have appeared, the remainder of the group can safely unmask. However, remain alert for the appearance of any chemical symptoms. If symptoms occur, resume the wearing of masks.

Protection of Unit Equipment and Supplies

Because contaminated equipment and supplies pose a threat to personnel, covers should be used to protect equipment and supplies stored outdoors, if possible. The following guidance is appropriate for combat, combat support, and combat service support units.

EQUIPMENT.— Important items of equipment must be covered. Plastic sheets serve as excellent covers because they are nonporous. If plastic material is not available, tarpaulins or other suitable material may be used. If nothing else is available, dense foliage will provide some protection.

PACKAGED FOOD ITEMS.— Vapor, aerosol spray, or liquid chemical agents can contaminate food. The type of food, type and amount of agent, and effectiveness of protective measures influence the edibility of food. Food not in protective packages generally presents the major problem. Chemical agents may penetrate packaged food when it is left exposed over an extended period of time.

UNPACKAGED FOOD ITEMS.— Oily and fatty unpackaged foods are particularly vulnerable to chemical contamination. These foods are protected from contamination when stored in containers, such as field iceboxes and refrigerators, if the sealing gaskets are serviceable. As a rule of thumb, **CONTAMINATED UNPACKAGED FOOD MUST NOT BE EATEN!**

WATER.— Medical personnel are responsible for recommendations on the potability of water. Water that is not in sealed containers may become contaminated. Water suspected of contamination should not be consumed until tested and declared safe.

First Aid and Self-Aid

First aid includes the immediate actions required to prevent further injury or complications from the effects of chemical agents. First aid necessarily includes the prompt removal of agents from the eyes and decontamination of the skin to avoid casualties from lethal liquid agents. Therefore, first aid must include performing self-aid, or personal decontamination, automatically and without orders when it is required. First aid also includes the use of appropriate medications or actions to reduce the effects of the agent, such as the use of the nerve agent antidote injector for nerve agent poisoning. Each individual must be thoroughly trained in both first aid and personal decontamination so he or she can perform these actions quickly.

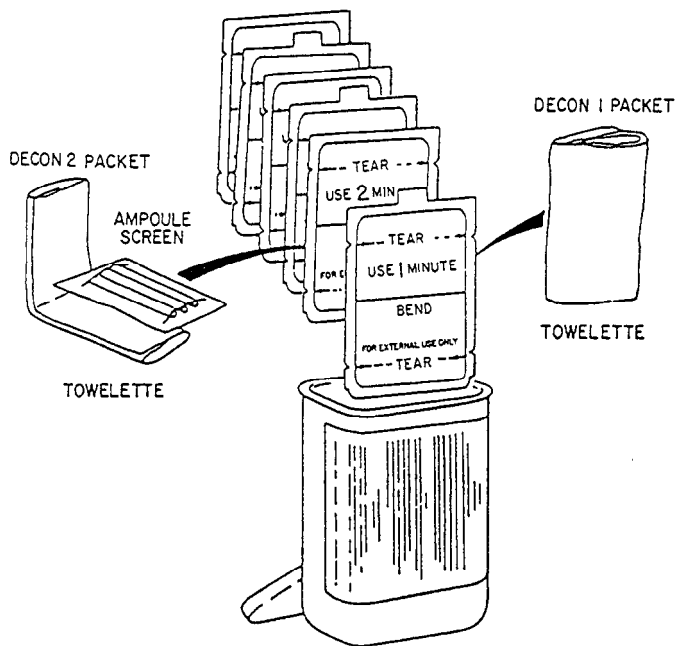

Figure 9-2.—M258A1 skin decontamination kit.

UNIDENTIFIED CHEMICAL AGENTS.— In most cases, the individuals are not able to identify the chemical agent used in the attack. When exposed to an enemy chemical attack while dressed in chemical protective clothing and equipment, he or she is not normally concerned with immediate decontamination.

When the skin of an individual becomes contaminated, it must be decontaminated immediately. Skin decon is the neutralization or removal of contamination from exposed portions of the skin. The individual performs the decon by using M258A1 skin decon kit (fig. 9-2). This kit is designed for chemical decon, but it can be used to remove radiological contamination. If the contaminated person is incapacitated, another person must perform the decontamination so that he can survive.

For decontaminating skin, each Seabee receives the M258A1 kit in a hard plastic case. Avoid getting decontaminants into eyes, open wounds, or mouth. If contaminants enter these areas, flush them with water. If symptoms appear, seek medical attention as soon as possible. The kit is normally attached to the protective mask carrier or the load-bearing equipment (LBE). It contains three sets of foil-packaged towelettes saturated with different decontaminating solutions. These solutions neutralize most nerve and blister agents.

Protect the kit from temperatures above 110°F (43°C) and below 32°F (0°C). The solutions are flammable and unstable in storage at temperatures above 110°F (43°C) or for prolonged periods of time in sunlight.

Shelter is necessary to prevent further contamination during the decontamination process. If no overhead cover is available, throw a poncho or shelter half over your head before beginning decontamination.

CAUTION

Do not let the solution from the M258A1 kit get in your eyes!

NERVE AGENTS.— If you are told that your pupils are getting very small or if you are having trouble breathing and your chest feels tight, use the atropine nerve agent antidote kit (NAAK), Mark I.

The injectors contain medications to treat the initial symptoms of nerve agent poisoning. But, most importantly, it will check the more serious effects of nerve agent sickness. The injectors are antidotes, not a preventive device; therefore, only use the injectors when you actually experience symptoms of nerve agent poisoning. (See fig. 9-3.) The directions for use are as follows:

1. Put on the protective mask.

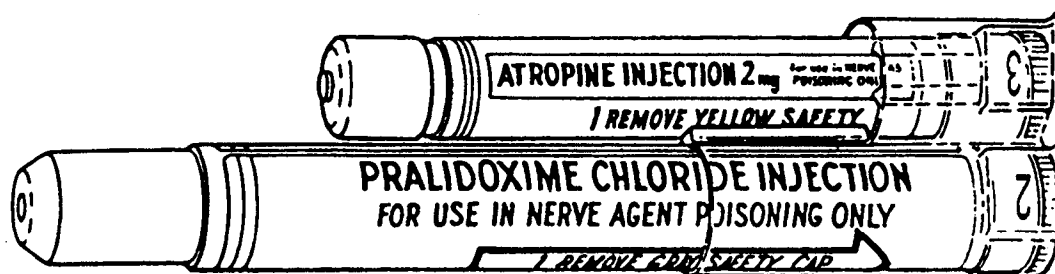

Figure 9-3.—Nerve agent antidote kit (NAAK), Mark I.

2. Remove a (NAAK), Mark I, from the protective mask carrier.

3. Inject the thigh with the first injector from the kit (atropine, small autoinjector). (See fig. 9-4.) Hold the injector against the thigh for at least 10 seconds. Remove the injector.

4. Follow immediately with the second injector (2-PAM chloride, large injector) and inject the thigh. Hold the injector against the thigh for at least 10 seconds.

5. Remove the injector and place each injector needle through the pocket flap of the overgarment. Bend each needle to form a hook.

6. Massage the injection site, if time permits.

7. The interval between injecting each set of autoinjectors is 10 to 15 minutes when symptoms persist or recur. A Seabee must not administer more than three NAAK sets. The administration of more than three sets must be authorized by medical support personnel.

WARNING

If within 5 minutes after the administration of any set of injections your heart beats very rapidly AND your mouth becomes very dry, **DO NOT** give yourself another set of injections.

When an individual experiences severe symptoms from nerve agent poisoning and is unable to administer self-aid, a buddy must perform the following aid measures:

1. Mask the casualty.
2. Using the NAAK belonging to the victim, administer three sets of injections immediately and in rapid succession in the thigh muscle of the leg.
3. Hook the expended autoinjectors to the overgarment pocket flap of the victim.
4. Administer the back pressure arm-lift method of artificial ventilation if breathing is difficult or has ceased.
5. Seek medical attention as soon as possible.

Continue to perform your duties if you feel relief from the atropine and can breathe freely again. Dryness of the mouth is a good sign. It means that you have had enough atropine to overcome the dangerous effects of the nerve agent.

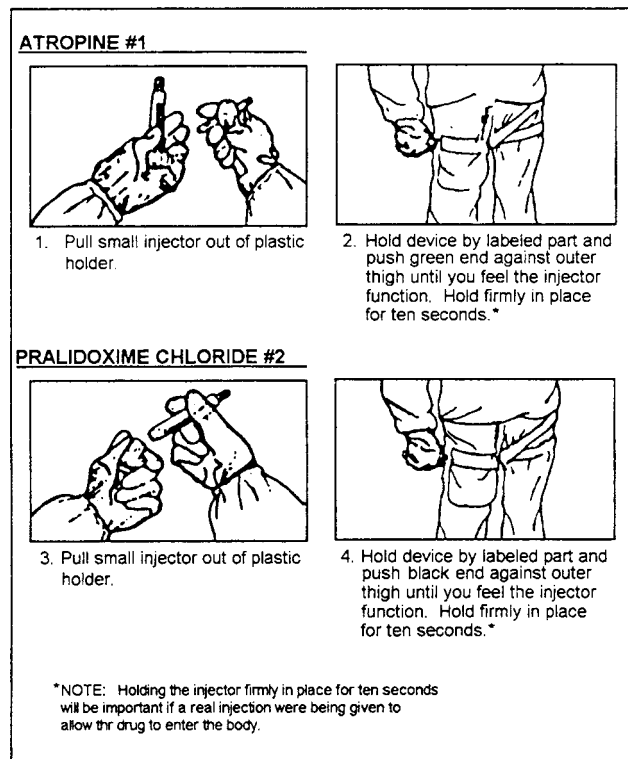

Figure 9-4.—Instructions for use of NAAK, Mark I.

If you should get a splash of liquid nerve agent in your eyes, instant action is necessary to avoid serious injury. Obtain water as fast as possible, tilt your head back so your eyes look straight upward, slowly pour water into the your eyes, and flush them out. Hold your eyes open with your fingers, if necessary. Pour the water slowly so the irrigation lasts not less than 30 seconds. This irrigation must be done in spite of the danger of breathing nerve gas vapor. Don your mask quickly after irrigation is complete. Then, if the symptoms of nerve gas poisoning develop, give yourself an injection from the NAAK, Mark I.

If liquid nerve gas gets on your skin or clothing, fast action is needed to get rid of it. Immediately use the M258A1 decontamination kit. Then carry on with your combat duties. Meanwhile, watch for muscles twitching in the contaminated area. If twitching does not develop in the next half hour and there is no tightness in your chest, you have been decontaminated successfully.

If twitching of the muscles in the area of contamination does develop, do not wait for other symptoms to appear. Give yourself the injections from the NAAK, Mark I, at once. If no other symptoms develop, one series of injections is enough. The atropine

does not relieve the local twitching of muscles, but this twitching is not dangerous.

Avoid water and food that may be contaminated with nerve agents. Let the medical personnel check the food and water for safety before you consume them. If you have swallowed contaminated food or water and all of the following symptoms occur—increased flow of saliva, nausea, pains in the stomach, and tightness in the chest—give yourself the injections from the NAAK, Mark I.

BLISTER AGENTS.— Casualties of blister agents, such as HD (distilled mustard), exhibit redness and inflammation of the eyes. Usually several hours after exposure, reddening of the skin appears, followed by the appearance of blisters. There is NO first aid for blister agents other than decontamination. Blister agent effects are delayed for several hours today. To decontaminate your eyes, flush with plain water repeatedly. Any blister agents on the skin and clothing should be removed using the M258A1 decontamination kits. Seek medical care as soon as possible. If evacuation to a medical facility is required, blister agent casualties receive the same treatment given other burn victims.

BLOOD AGENTS.— Agents, such as AC and CK, enter the body by inhalation and produce symptoms ranging from convulsions to coma. They act on the body by interfering with the ability of oxygen-carrying cells to transfer oxygen to other body tissue. They may have an imitating effect on nasal passages.

There is currently no self-aid or buddy aid treatment for blood agent symptoms. Affected personnel should seek medical attention.

CHOKING AGENTS.— This agent produces coughing, choking, nausea, and headaches in casualties. Delayed effects include rapid and shallow breathing, painful cough, discomfort, fatigue, and shock. First aid includes immediate masking. Masking may prevent further damage. No specific first aid other than efforts to prevent shock is available.

VOMITING AGENTS.— For protection against vomiting agents, put on your mask and wear it in spite of coughing, sneezing, salivating, or nausea. If necessary, briefly lift the mask from your face to permit vomiting or to drain saliva from the facepiece. Clear your mask each time you adjust it to your face and before you resume breathing. Carry on with your duties as vigorously as possible; this helps to lessen and to shorten the symptoms. Combat duties can usually be performed in spite of the effects of vomiting agents.

TEAR AGENTS.— When liquid or solid agents have entered your eyes, force your eyes open and flush them with water. Put on your protective mask, cover the outlet valve and voice meter, and blow hard to clear the mask. Keep your eyes open as much as possible. When your vision clears, continue to perform your duties. When it is safe to remove your mask, blot away tears, but do not rub your eyes. Now face into the wind.

INCAPACITATING AGENTS.— By the time a victim who is exposed to an incapacitating agent realizes something is wrong, he or she may be too confused mentally to handle his or her own decontamination. These cases should be taken to medical personnel immediately. If many people are affected, it may be necessary to confine them temporarily under guard to prevent accidents. These personnel must not be allowed to enter critical or dangerous spaces until complete recovery is achieved, because these victims may not be responsible for their actions. In addition, some of these agents prevent sweating, which increases the danger of heat stroke on hot days.

Personnel Decontamination

Decontamination can be accomplished by the removal, neutralization, absorption, or weathering of the chemical agent. The primary purposes of decontamination are to prevent casualties and to remove obstacles that may prevent mission accomplishment.

Individual decontamination or self-aid is performed by an individual with materials on hand. It is performed on himself or herself and the equipment he or she uses. It is performed as soon as practical and is usually sufficient to allow the individual to carry on his or her assigned mission. The M258A1 is used for limited decontamination of all items of individual clothing and equipment.

Unit decontamination is an organized effort performed by personnel of the unit, with equipment available to the unit, when directed by the commander, and under the supervision of trained CBR specialists. All officers and qualified CBR specialists should be prepared to act as supervisors of decontamination teams when required.

Support-Level Equipment Decontamination

Equipment decontamination stations are located as far forward upwind as possible and are normally run by a specialized decontamination team or unit.

BIOLOGICAL DEFENSE

Protective measures against a biological threat include training, immunization of personnel, and strict personal hygiene.

Biological Defense Training

Training for defense against biological agents must stress the necessity for an alert and questioning attitude toward any indication that biological agents may have been used. Although knowledge of these agents is important, there must be no unreasonable fear of disease from a suspected biological attack. Personnel should be instructed not to repeat or exaggerate rumors. Seabees should also know the following facts about a biological attack.

- It is normally impossible to recognize or detect.
- It may be used to supplement other types of attack
- It may be used to cause either delayed death or incapacitation for strategic purposes.

Prevention of Disease

Casualties from a biological attack can be reduced by using the following preventive measures:

- Strict personal hygiene
- Immunization
- Quarantine of contaminated structures and areas
- Instruction in the proper care of cuts or wounds
- Use of approved sources of food and drink

High standards of personal hygiene and, when practical, avoidance of practices that produce a run-down condition. This assists personnel in fighting an infection. The importance of good protective mask discipline and proper field sanitation measures must be emphasized.

Indications of a Biological Attack

These are indications of a biological attack.

- Low-flying aircraft that appear to be producing a mist or spray
- The function of any type of spray device

- The function of a submunition, such as a bomblet, that appears to have no immediate effect
- Unusual types of bomblets found in the area
- Swarms of insects, such as mosquitoes, suddenly appearing after an aircraft has dropped containers that did not appear to have immediate effect

Defensive Measures after a Biological Attack

Units are not equipped with devices to indicate a biological hazard. After a suspected biological attack, individuals must continue wearing their protective masks until authorized to remove them by competent authority.

DECONTAMINATION OF PERSONNEL.— After a suspected biological warfare attack individuals can decontaminate themselves by showering with soap and hot water. The fingernails and toenails should be thoroughly cleaned and the hairy parts of the body should be thoroughly scrubbed. Contaminated clothing must be washed in hot soapy water when it cannot be sent to a field laundry for decontamination. Cotton items may be boiled.

DECONTAMINATION OF OUTDOOR AREAS.— Sunlight kills most microorganisms and usually decontaminates unshaded outdoor areas. However, shaded areas may remain hazardous from several hours to several days. Decontamination of a large area is not feasible.

DECONTAMINATION OF INDOOR AREAS.— Personnel in a shelter or building that is suspected of being contaminated with biological agents should wear their protective masks until they leave the building.

GUARDING AGAINST CONTAMINATION.— All exposed surfaces are assumed to be contaminated. Sealed containers, such as bottles and cans containing food and water, should be washed down and boiled before opening.

REPORT SICKNESS PROMPTLY.— Prompt reporting of sickness serves two major purposes:

1. It gives medical personnel the opportunity to identify the biological agent to which the individuals were exposed. Once the disease has been identified, effective medical measures can be taken.
2. It helps to prevent the spread of disease from person to person.

TREATMENT OF CASUALTIES.— There are no self-aid measures for the diseases that are caused by agents. In comparison to measles, the symptoms of biological warfare diseases appear in a like manner. Although it maybe a matter of days before the types of biological warfare agents are identified, medical personnel will direct the decontamination of these casualties.

Even though the Navy provides preventive shots for some diseases, additional shots have been developed that will be given to all hands if biological warfare ever occurs. If you contract a disease from biological warfare in spite of the shots, the sickness should be mild, and medical personnel will ensure that you receive the best treatment available.

NUCLEAR DEFENSE

On a nuclear battlefield, units must be dispersed to the greatest extent possible consistent with the situation and the mission. Dispersed units present smaller targets and, hence, are less vulnerable. In contingency planning, the positioning, movement, and missions of units may require adjustment by the commanders to minimize the effects of nuclear bursts while maintaining the ability to continue construction operations and hold defensive positions. Defensive measures for individuals and units should include protection from blast, heat, and initial and residual radioactive fallout.

Defensive Measures before a Nuclear Attack

When a nuclear attack is imminent, the best defense is to dig in. Earth is one of the best shielding materials available in the field. Seabee defensive positions, which vary from individual fighting holes to improved defensive positions, should be prepared whenever the tactical situation permits. Read chapter 7 for detailed information on constructing fighting holes and shelters.

FIGHTING HOLE.— A properly constructed fighting hole provides excellent protection against initial radiation. The deeper the fighting hole, the more protection it provides. An overhead covering of earth or other material will help reduce the amount of thermal and initial nuclear radiation and fallout material from reaching the individual. However, this cover must be sturdily constructed to withstand the blast wave.

FIELD SHELTERS.— Tunnels, caves, and storm drains provide effective shelter. Culverts and ditches can be used in an emergency, although they offer only partial protection. Vehicles made of steel, such as tank and armored personnel carriers, provide some protection.

Buildings usually are not strong enough to provide effective shelter, but the middle floors or basement of a reinforced concrete or steel-frame building offers protection from all effects except the blast. Personnel should avoid the areas around windows and other openings.

SUPPLIES AND EQUIPMENT.— Individual equipment and supplies not being worn should be placed in the fighting hole. None of this equipment can be left unsecured because the blast wave converts them into lethal missiles. Unit supplies, particularly explosives and flammables, should be dispersed within the unit area and protected or shielded. Debris must be kept to a minimum and not be allowed to collect because it could become a fire hazard. Objects, such as radios, generator tools, and gas cans, must always be secured to minimize the danger of flying debris caused by the blast wave.

Defensive Measures during a Nuclear Attack

A nuclear attack may come without warning. The first indication will be intense light. Heat and initial nuclear radiation come with the light and the blast follows. There is little time to take protective measures since the blast wave travels at the speed of sound (about 1,000 feet per second). Individual defensive actions must be automatic and instinctive. Unit activities will be suspended for a short period while all personnel take cover. When a surprise attack is a possibility, all personnel not engaged in essential activities should remain undercover as much of the time as possible. Individuals who are exposed when a nuclear detonation occurs should do the following:

- Immediately drop flat on the ground (facedown) or to the bottom of a fighting hole.
- Close your eyes.
- Protect exposed skin from heat by putting hands and arms near or under your body. Keep your helmets on.
- Remain down until after the blast has passed and debris has stopped falling.
- Stay calm, check for injury, check weapons and equipment for damage, and prepare to continue the mission.

Defensive Measures after a Nuclear Attack

Following a nuclear attack, designated individuals should begin fallout monitoring, so fallout arriving in

the unit area can be detected quickly. When warned of the arrival of fallout and the tactical situation permits, individuals should take cover and remain protected until instructed otherwise.

A handkerchief or similar cloth maybe worn over the nose and mouth. If dust particles make breathing difficult or cause discomfort, the protective masks should not be used as a dust respirator. If it is necessary to remain in an area having fallout, individuals should dig in quickly, sweep fallout particles away from the area around fighting holes, and remain covered until fallout stops.

The skin and clothing of individuals exposed to fallout or who have traveled through a radiologically contaminated area may cause a skin rash. If the situation prohibits complete decontamination, then field-expedient methods should be used to reduce the radiation hazard. Some of these methods that remove alpha- and beta-emitting particles include the following:

- Removal and vigorous shaking of clothing or brushing the clothing with brushes (avoid breathing dust)
- Removing dust from the hair and from under the fingernails
- Wiping exposed skin with a damp cloth

All personnel should bathe and change clothing as soon as the tactical situation permits. Remember that runoff water is contaminated, and appropriate defensive measures should be taken.

The requirement for decontamination of individual equipment, vehicles, weapons, and ammunition can be reduced, if, before fallout arrives, they are covered with materials such as tarpaulins, shelter halves, or ponchos. An effective way to remove radiological contamination is to wash it with water.

Contamination Avoidance

Contamination avoidance can help minimize exposure by doing the following:

- Limiting the duration of exposure by reducing the amount of time in the hazardous area
- Delaying entry time until radiation decays enough to permit safe passage or occupancy or both
- Avoiding and bypassing contaminated areas

First-Aid Treatment

The casualty-producing effects of a nuclear explosion are blast, heat, and nuclear radiation. First-aid measures are limited to those for burns caused by thermal radiation and injuries caused by the blast. There are no immediate lifesaving measures for the treatment of radiation sickness or blindness caused by the intense light.

When the tactical situation prohibits you from going to a decontamination station, you must remove most of the radioactive material with whatever you have on hand. If you become heavily contaminated, the following measures are recommended:

1. You must remove your outer garments. Shake them vigorously or brush them off. Be sure the clothing is held downwind. This will remove most of the radioactive material unless it is wet and muddy.
2. When it is too cold or wet to remove your outer clothing, brush or scrape them carefully.
3. The same procedure should be used to decontaminate your equipment.

Personnel Decontamination Station

Complete personnel decontamination is conducted at a personnel decontamination station (PDS). The PDS is setup in a secure, uncontaminated area, located as far forward as the tactical situation permits. Personnel from both the decontamination and the supported unit operate the PDS under the supervision of the Chemical, Biological, and Radiological Defense Officer (CBRDO), NOBC 2765 or the Disaster Preparedness Operations and Training Specialist, NEC 9598.

SEABEE CBR DEFENSE EQUIPMENT

NOTE

The following information was current when it was written. Because of the frequency of change in CBR defense equipment, consult the Disaster Preparedness School (NCTC, Gulfport, Mississippi, or Port Hueneme, California) nearest you for the latest information.

Individual CBR defense equipment consists of permeable protective clothing, protective footwear covers, protective masks, skin decontamination kits, and atropine.

CBR Permeable Protective Clothing

This two-piece overgarment consists of one coat and one pair of trousers. It is packaged in a sealed vapor barrier bag to provide protection while not in use against rain, moisture, and sunlight. Refer to the bag for detailed instructions for using the protective clothing. The coat and trousers are made of material having an outer layer of nylon and cotton and an inner layer of charcoal-impregnated polyurethane foam that gives protection against vapors, aerosols, and small droplets of nerve and blister agents. The overgarment is intended to be worn over the duty uniform; however, in high temperatures, it may be worn directly over the underwear. The overgarment is not designed to be decontaminated and reimpregnated for reuse. It is discarded within 6 hours after being contaminated with liquid chemical agents or after 14 days of wear.



Figure 9-5.—Chemical protective footwear covers (overboots).

Chemical Protective Footwear Covers (Overboots)

Overboots (fig. 9-5) are worn over standard combat boots. They protect the feet from contamination by all known chemical agents, vectors, and radiological dust particles.

The overboots are impermeable and have unsupported butyl-rubber soles and butyl sheet-rubber uppers. When insulated boots (cold weather “Mickey Mouse” boots) are worn with the overgarment, the overboots are not necessary. The insulated boots provide adequate protection in a chemical environment.

Chemical Field Protective Masks

These masks, when properly fitted and worn with the hood, give protection against field concentrations of all known enemy chemical agents in vapor or aerosol form. They do so by filtering contaminated air to remove the agents, not by producing oxygen. When the air has a low-oxygen content or when individuals are in tunnels or caves with a heavy concentration of aerosolized particles, such as burning smoke mixtures, the protective mask does not provide breathable air. These masks also do not protect against ammonia vapors or carbon monoxide.

The MCU-2/P, MCU-2A/P mask is the standard field protective mask. Masks are shipped from the manufacturer with the following components:

1. MCU-2/P mask

2. M1 waterproof bag
3. Mask carrier
4. Clear facepiece outsert
5. C₂ canister

The following are accessories for the mask:

1. Protective hood
2. Optical inserts
3. M4 winterization kit

The MCU-2/P has one C₂ canister that is designed for protection against normal field concentrations of all known toxic chemical agents and is considered adequate for all foreseeable field use. Canisters must be replaced carefully under the following circumstances: when directed by higher headquarters; after prolonged usage; once every 15 days after initiation of chemical warfare; when they impose severe impedance to breathing; after immersion in water; upon visual examination, when they are found to be damaged or unserviceable; or when the lot numbers do not match.

Skin Decontaminating Kit M258A1

An M258A1 is issued to each individual during operations in a toxic chemical environment. It decontaminates both nerve and blister agents. The use of this kit was discussed earlier in this chapter. The kit contains three towelettes of each type (a total of six). Each pad is sealed in tearaway impermeable foil packets. A single M258A1 kit contains materials to allow the individual three complete decontamination.

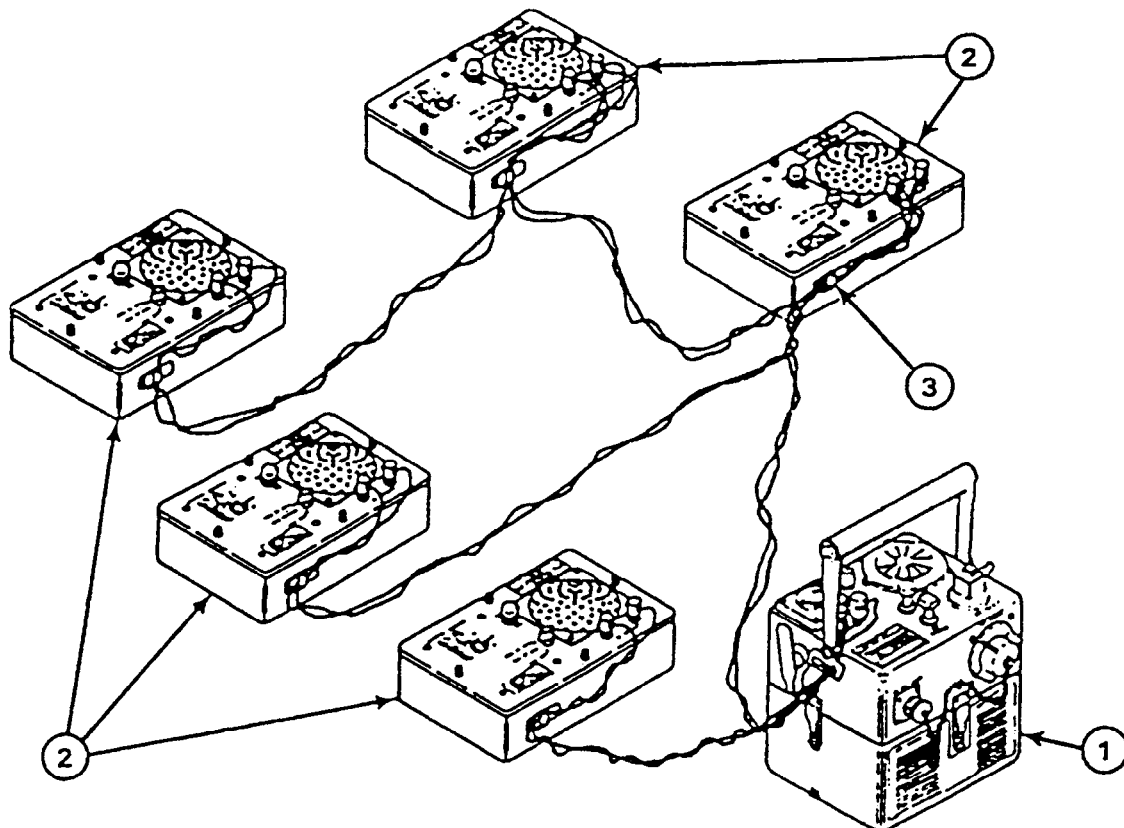

- (a) Use the figure as a guide for connecting more than one M42 Alarm to an M43 Detector.
- (b) Allowing about 1 foot of slack at the end of each cable, string WD-1/TT telephone cable between M43 Detector (1) and M42 Alarm (2) as shown in figure.
- (c) About 9 inches from end of telephone cable, tie each telephone cable to D-ring (3) on its M42 Alarm (2).
- (d) Strip about 1 inch of insulation from the end of each wire to be connected.

NOTE

Maximum cable length must not exceed 400 meters from the detector to farthest alarm.

Figure 9-6.—M42 remote alarm connected to M43 detector.

NAAK, Mark I

Three NAAK, Mark I, injectors are carried by the individual in the top outside pocket of the mask carrier. These injectors are used for nerve agent first aid. This solution has a relatively high-freezing point and should be removed from the carrier and placed inside the field uniform in cold weather (below 45°F).

CBR UNIT EQUIPMENT

Each Seabee unit should have the equipment discussed below.

Automatic Chemical Agent Alarm M8A1

The M8A1 automatic chemical agent alarm consists of the M43A1 detector unit and the M42 alarm unit.

This unit is the primary means of detecting chemical agents arriving in a unit area from an upwind chemical attack. It can detect chemical agents in vapor and aerosol form and can alert personnel by audible and visual signals. It is issued to platoons, companies, and similar units.

The M43 detector unit of the automatic chemical agent alarm continuously samples the air at its location and indicates the presence of nerve agents. The M43 gives an audible alarm. The M42 remote alarm unit provides both an audible and visual alarm when connected by wire to the M43 detection. The M42 audible alarm can be turned off manually. Up to five M42s can be connected to the M43 (fig. 9-6). Maximum cable length must not exceed 400 meters from the detector to the farthest alarm.

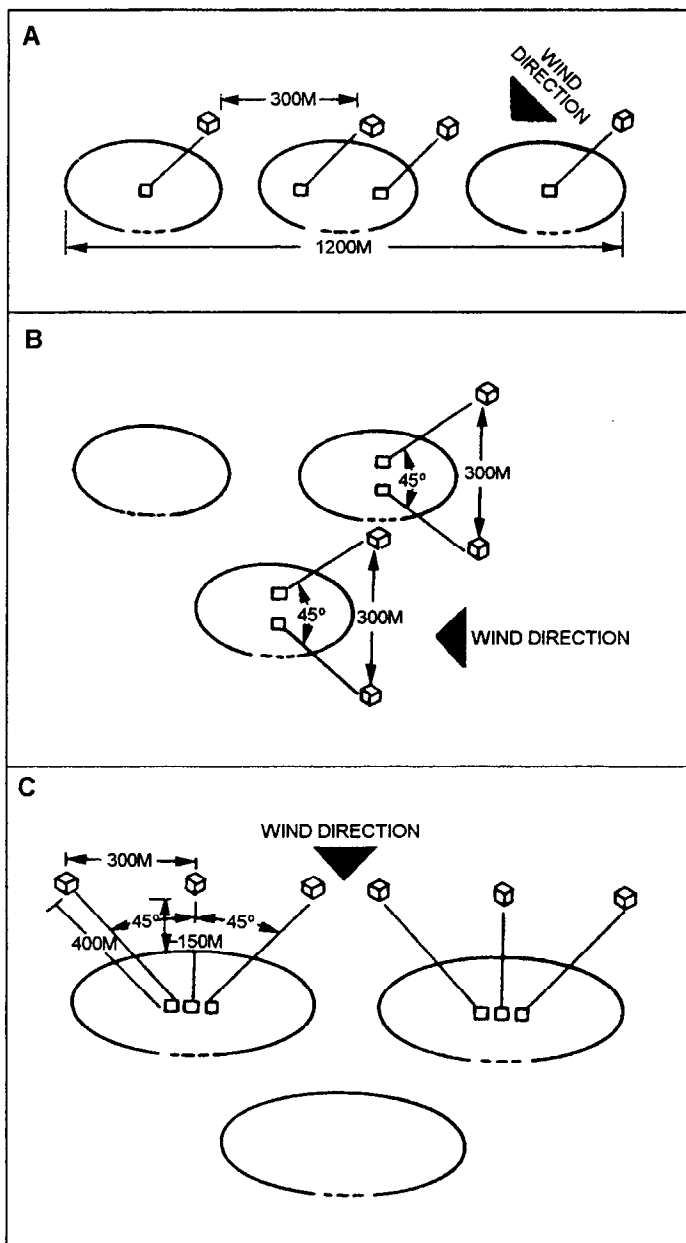

Figure 9-7.—Deployment of automatic chemical agent alarms.

Figure 9-7, view A, shows a situation where four detectors are emplaced with three platoons online. Note the orientation on the wind direction. The detector is oriented on wind direction, not on the direction of the enemy. When the automatic chemical agent alarms are mounted on vehicles, consideration must be given to wind direction for the protection of the main body.

Figure 9-7, view B, shows an array using four detectors with the wind direction coming from the right flank of the unit. A significant difference between a four-detector array and a six-detector array is that with



WARNING

DS2 IS FLAMMABLE. DS2 ALSO CAN SEVERELY BURN THE SKIN, CAUSE BLINDNESS, AND / OR DETERIORATE THE BATTLED DRESS OVERGARMENT. DO NOT USE IT NEAR AN OPEN FLAME OR ALLOW IT TO TOUCH SKIN OR CLOTHING. PERSONNEL HANDLING DS2 MUST WEAR PROTECTIVE CLOTHING AND EYE PROTECTION.

Figure 9-8.—ABC-M11 portable decontaminating apparatus.

only four detectors they may must be shifted when the wind direction shifts greater than 20 degrees.

Figure 9-7, view C, shows a company in a defensive position with six detectors deployed. The actual number of alarm systems per unit varies depending upon the table of allowance (TOA). The 300-meter distance between the M43 detectors reduces the possibility that agent clouds might drift through holes in the array. This array provides a high probability of detecting an off-target attack within a reasonable warning time.

NOTE

Remember that the detector is oriented on wind direction, **NOT** on the direction of the enemy.

IM-143/PD or IM-143A/PD Dosimeter

This is the standard tactical dosimeter in use today. It is a direct reading instrument capable of detecting and recording a total dose of up to 600 rads. It is termed a *pocket* dosimeter and is about the size and shape of a fountain pen.

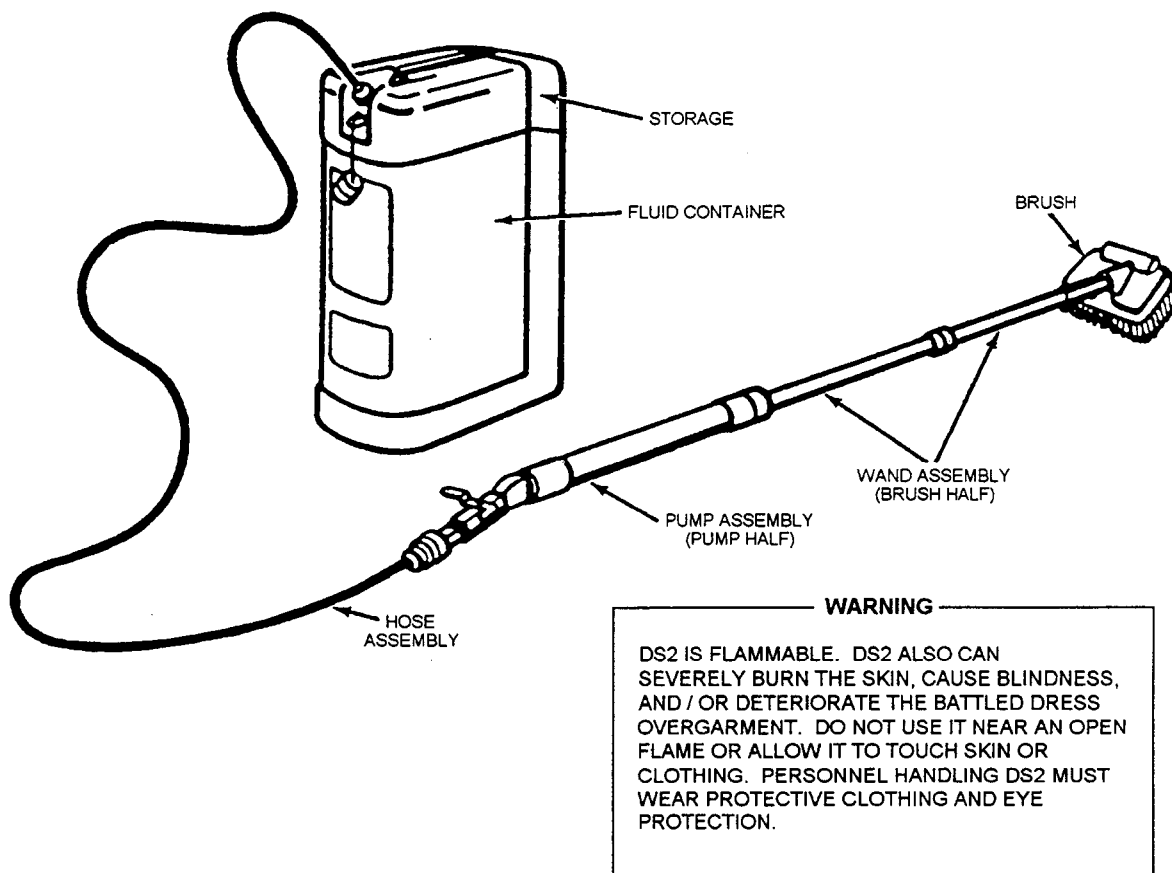

Figure 9-9.—M13 portable decontaminating apparatus.

AN/PDR-27 Radiac Set

It contains a low-range dose rate of a Geiger-Mueller type of instrument, used for monitoring contamination of personnel, food, and equipment. It measures gamma and detects beta radiation.

ABC-M11 Portable Decontaminating Apparatus, DS2

The ABC-M11 apparatus (fig. 9-8) decontaminates small areas, such as the steering wheel or other equipment, that Seabees must touch. It is a steel container with an aluminum spray-head assembly and a nitrogen-gas cylinder that provides the pressure. It is filled with 11/3 quarts of DS2, which is sufficient for covering 135 square feet. The effective spray range is 6 to 8 feet. After each use, refill the M11 with DS2 and fit it with a new nitrogen cylinder. It is now ready to use again.

M13 Portable Decontaminating Apparatus

Use the M13 apparatus to decontaminate vehicles and crew-served weapons larger than .50 caliber. The M13 (fig. 9-9) is about the size of a 5-gallon gasoline can. It comes prefilled with 14 liters of DS2 decon agent. Decon capability is 1,200 square feet. A hose assembly, pump assembly, wand assembly, and brush are attached to the fluid container for disseminating DS2. The brush is for removal of thickened agents, mud, grease, or other material.

MISSION-ORIENTED PROTECTIVE POSTURE

Mission-oriented protective posture (MOPP) is a flexible system of protection against chemical agents, used to facilitate mission accomplishment in chemical warfare. MOPP requires the individual to wear protective equipment consistent with the chemical threat, the work rate imposed by the

Table 9-1.—MOPP Levels before Chemical Attack

MOPP LEVEL	OVERGARMENT	OVERBOOTS	MASK WITH HOOD	GLOVES
1	WORN, OPEN OR CLOSED BASED ON TEMPERATURE	CARRIED	CARRIED	CARRIED
2	SAME AS MOPP-1	WORN	CARRIED	CARRIED
3	SAME AS MOPP-1	WORN	WORN, HOOD OPEN OR CLOSED BASED ON TEMP	CARRIED
4	WORN, CLOSED	WORN	WORN, HOOD CLOSED	WORN

mission, and the temperature. (See table 9-1 for MOPP levels.)

All combat operations are conducted under the mission-oriented protective posture system. Of course, when there is no threat, then there is no protection requirement, but this is still a MOPP. At the other extreme, when there is a continuing, immediate threat of chemical attack and the enemy has the capability to produce an unacceptable casualty level among unprotected troops, the troops may be required to wear protective clothing and equipment for extended periods. In this case, some form of safe area must be provided, so troops can perform the necessary functions that require removal of some or all of the protective gear.

MOPP FLEXIBILITY-LIMITING FACTORS

The flexibility of MOPP in providing individual protection is limited by the temperature of the surrounding area, fatigue level of the troops, the degree to which the troops need to use their senses, and personal needs.

Heat Exhaustion

Individuals operating a moderate-to-heavy work rate while in chemical protective gear may experience heat exhaustion (dizziness and fainting) at any time, especially during periods of high temperature.

Fatigue

Individuals in full chemical protective clothing and equipment tend to experience fatigue resulting from such factors as mask breathing resistance, increase in body temperature from work energy and solar heat, and psychological and physiological stress. This condition of fatigue increases the need for rest and sleep to maintain individual alertness and efficiency.

Senses

Individuals required to perform duties involving their senses or related functions, such as manual dexterity, visual activity, and voice communication, operate at varying levels of efficiency, depending on training and proficiency while in full protective gear.

Personal Needs

Individuals cannot be in full chemical protection for indefinite periods and still attend to certain personal needs, such as eating, caring for wounds, shaving, and eliminating of bodily wastes.

MARKING OF CONTAMINATED AREAS (STANAG 2002)

The markers, or signs, are used in areas containing radiological, biological, and chemical contamination. The colorings and markings of the signs are according

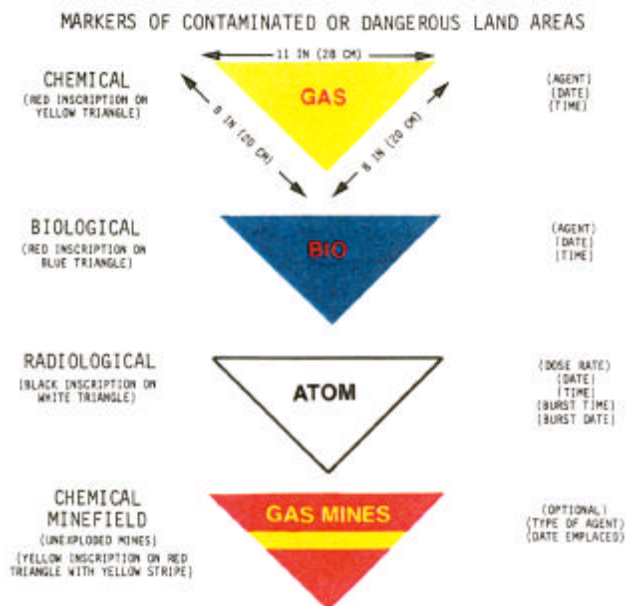

C3.178

Figure 9-10.—CBR contamination markers.

to STANAG 2002 and are shown in figure 9-10. The base of the triangle should be about 11 inches (28 cm) and the opposite sides about 8 inches (20 cm). The signs are in the shape of a right isosceles triangle (90 degrees by 45 degrees by 45 degrees) and are made of plastic, wood, metal, or other rigid material, with holes or “ears” that are used for hanging them about the ground. They are placed on wire boundary fences, poles, trees, or rocks.

CHEMICAL CONTAMINATION MARKERS

The triangle is yellow on both sides. The word *GAS* in red 2-inch (5 cm) block letters is placed on the side of the markers facing away from the contamination

(front). Fluorescent paint is used, when available. The name of the agent, if known, and the date and time of detection are also placed on the front of the marker at the time of emplacement with paint, marking pencil, or grease pencil.

BIOLOGICAL CONTAMINATION MARKERS

The triangle is blue on both sides. The letters *BIO* in red (fluorescent paint, if available) 2-inch (5 cm) block letters are placed on the side of the marker facing away from the contamination (front). The name of the agent, if known, and the date and time of detection are also placed on the front of the marker at the time of emplacement.

RADIOLOGICAL CONTAMINATION MARKERS

The triangle is white on both sides. The word *ATOM* in black 2-inch (5 cm) block letters is placed on the side of the markers facing away from the contamination (front). The dose rate, date, and time of reading, and the date and time of burst, if known, are also placed on the front of the marker at the time of emplacement.

CHEMICAL MINEFIELD MARKERS

The triangle is red on both sides. On the side facing away from the contamination (front) appear the words *GAS MINES* in yellow 1-inch (2.5 cm) block letters (fluorescent paint, if available) with a horizontal yellow 1-inch (2.5 cm) stripe underneath the lettering. The chemical agent in the mines and the date of emplacement may also be inscribed on the front of the marker if desired by the commander.

CHAPTER 10

FIRST AID AND FIELD SANITATION

This chapter will help you understand the importance of first aid to an injured person and will provide you with an explanation of the first-aid measures that you can apply to yourself and to other persons before trained medical personnel arrive. How-to instructions in lifesaving measures are provided for clearing the upper airway, giving artificial ventilation, stopping bleeding, controlling shock, and protecting the wound. In addition, the fundamentals of field sanitation are presented.

First aid is the emergency care given to sick or injured persons. Emergency care must not take the place of proper medical or surgical treatment but should consist only of furnishing temporary assistance until competent medical aid is available.

The purposes of first aid are (1) to save life, (2) to prevent further injury, and (3) to preserve vitality and resistance to infection.

Everyone in the Navy must know when and how to apply first-aid measures. They also must be prepared to provide competent assistance to persons injured in battle, collision, fire, and other accidents that may occur on land, on sea, or in the air. A real knowledge of first aid and its purposes, when applied properly, can mean the difference between life and death, between rapid recovery and long hospitalization, and between temporary disability and permanent injury.

When administering first aid, you have three primary tasks. They are (1) to maintain breathing, (2) to stop bleeding, and (3) to prevent or reduce shock

You must work quickly, but do not rush around frantically. Do not waste time looking for ready-made materials, but do the best you can with whatever is at hand. Also, send for medical help as soon as possible.

GENERAL FIRST-AID RULES

Although each case of injury or sickness presents its own special problems, there are some general rules that apply to practically all situations. Before proceeding to learn the specific first-aid treatment for various types of injuries, you should have a thorough understanding of the following rules:

1. Keep the victim lying down, with his head level with his body, until you have determined what type of injury the person has and how serious it is; however, if the victim has one of the following problems, you need to place him in a different position:

- a. Vomiting or bleeding about the mouth and semiconscious. When the victim is in danger of sucking in blood, vomited matter, or water, place him on his side or back, with his head turned to one side, lower than his feet.

- b. Shortness of breath. When the victim has a chest injury or breathing difficulties, place him in a sitting or semisitting position.

- c. Shock When the victim is in shock place him on his back with his head slightly lower than his feet. When injuries permit, the victim's feet should be raised and supported 6 to 12 inches off the deck.

2. In examining the victim, move him no more than is absolutely necessary. You may need to remove some clothing to determine the extent of his injuries. Remove enough clothing to get a clear idea of the extent of the injury. If done incorrectly, removing clothing may do great harm, especially in fracture injuries. When necessary, rip or cut the clothing along the seams. When clothing is removed, ensure the victim does not become chilled. Shoes may have to be cut off to avoid causing pain or increasing an injury.

3. Keep the victim reassured and as comfortable as possible. Often a restoration of confidence is very helpful. Assure the victim that his injuries are understood and that he will receive medical attention as soon as possible.

4. Do not touch open wounds or burns with your fingers or other objects, except when sterile compresses or bandages are not available and it is absolutely necessary to stop severe bleeding.

5. Do not try to give an unconscious person solid food or liquid by mouth. The victim may vomit and get some of the material into his lungs when he breathes, causing choking. Death could result.

6. When a bone is broken or when you suspect that one is broken, do not move the victim until you have

immobilized the injured part. This may prove to be lifesaving in cases of severe bone fractures or spinal cord injuries, because a jagged bone may sever nerves and blood vessels, damage tissues, and increase shock. Of course, the threat of fire and other similar situations may require that the victim be moved. But the principle should always be kept firmly in mind and considered against other factors.

7. When transporting an injured person, always make sure the litter is carried feet forward no matter what injuries the victim has. This enables the rear bearer to observe the victim for any respiratory obstruction or breathing problem.

8. Keep the injured person comfortably warm-warm enough to maintain normal body temperature.

Very serious and mutilating injuries may require heroic first-aid measures on your part. Most injuries require minimum physical effort but a maximum effort in judgment and self-control to prevent everyone from trying to do too much.

Basic life support is a term you have probably heard before. It consists of emergency techniques for recognizing and treating failures of the respiratory system and heart function. The primary emphasis is placed on maintaining an open AIRWAY to counter upper-airway obstruction, restoring BREATHING to counter respiratory arrest, and restoring CIRCULATION to counter cardiac arrest. These are the ABCs of basic life support. This chapter attempts to cover some of the essentials of basic life support. Remember: this chapter does not substitute for a formal course in basic life support. Formal courses, such as those given by the American Red Cross or the American Heart Association, provide hands-on training, using manikins. This training is essential for proper execution of the emergency techniques necessary in basic life support.

UPPER AIRWAY OBSTRUCTION

Most people who are choking automatically clutch at their throat. This is recognized as the universal distress signal for upper airway obstruction (fig. 10-1). The most common cause of upper airway obstruction in a conscious person is improperly chewed food.

PARTIAL OBSTRUCTION. When the victim coughs or when there is adequate air exchange, encourage the victim to continue with his own efforts to expel the foreign body. Do not interfere with the victim's

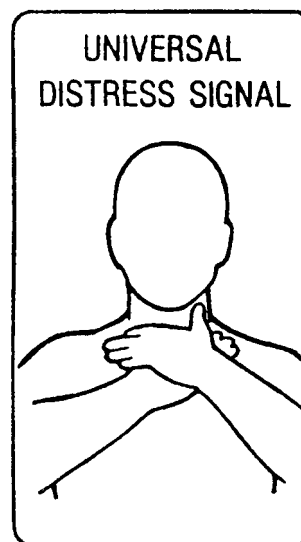

Figure 10-10.—Universal distress signal.

efforts to remove the obstruction. Observe the victim closely for increased distress, and be prepared to treat him for a completely blocked airway.

When there is inadequate air exchange, which is indicated by a weak or ineffective cough, high-pitched noises while the victim attempts to inhale, and bluish discoloration of the skin (especially around the nails and lips), handle the problem as though it were a complete airway obstruction.

COMPLETE AIRWAY OBSTRUCTION. Complete airway obstruction is indicated by no air exchange and an inability to speak, cough, or breathe. If the victim is conscious, he may exhibit the universal distress signal, as identified above.

When the victim is unconscious, check for breathing. When the victim is not breathing, his tongue or some other object may be blocking the air passage. The airway may be opened by tilting his head back and lifting his chin. Or when his head should not be moved, in the case of neck injuries, his jaw may be thrust forward. These techniques are described below.

OPEN THE AIRWAY

The most important action for successful resuscitation is to open the airway immediately. In the absence of sufficient muscle tone, the tongue or epiglottis will obstruct the pharynx or the larynx, respectively (fig. 10-2, Top). The tongue is the most common cause of obstruction in an unconscious victim.

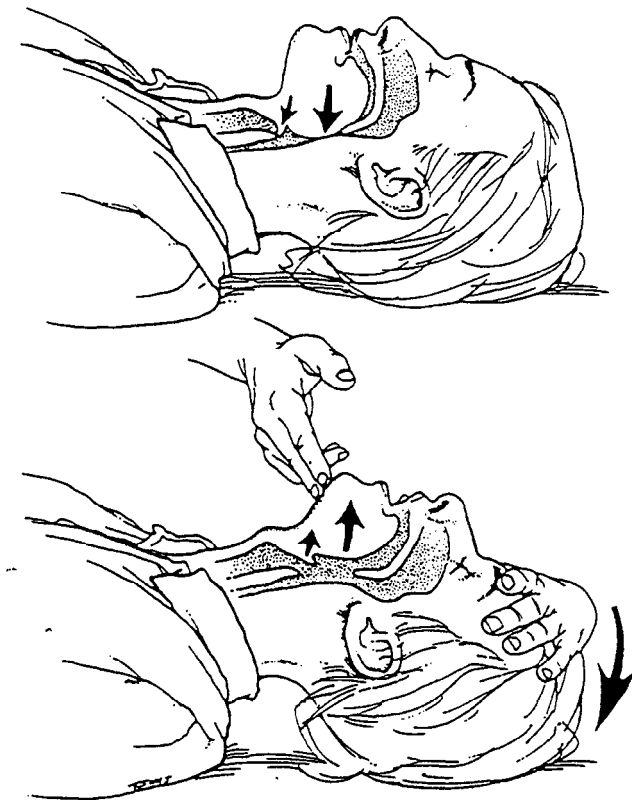

Figure 10-2.—Opening the airway. Top: Airway obstruction produced by the tongue and epiglottis. Bottom: Relief by head tilt or chin lift.

Since the tongue is attached to the lower jaw, moving the jaw forward lifts the tongue and the epiglottis away from the back of the throat and opens the airway (fig. 10-2, Bottom). Also, either the tongue or the epiglottis, or both, may produce obstruction when negative pressure is created in the airway by inspiratory effort, causing a valve type of mechanism to include the entrance to the trachea. Opening the airway maybe all that is needed to relieve the obstruction and allow the victim to breathe.

HEAD TILT OR CHIN LIFT

The rescuer should use the head-tilt or chin-lift maneuver, described below (fig. 10-3), to open the airway. When foreign material or vomitus is visible in the mouth, it should be removed. Excessive time must not be taken. Liquids or semiliquids should be wiped out with the index and middle fingers covered by a piece of cloth; solid material should be extracted with a hooked index finger.

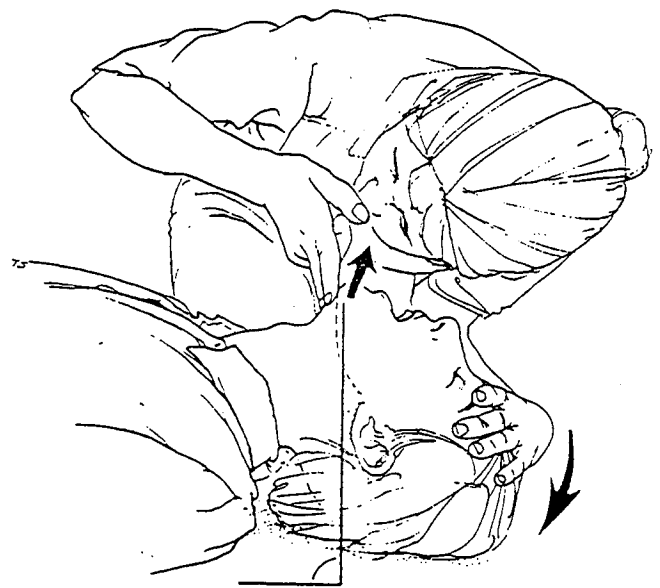

Figure 10-3.—Head-tilt or chin-lift maneuver. Perpendicular line reflects proper neck extension; that is, a line along the edge of the jawbone should be perpendicular to the surface on which the victim is lying.

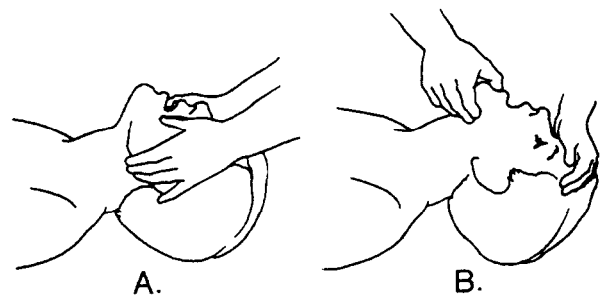

Figure 10-4.—Jaw thrust.

JAW THRUST TECHNIQUE

Another technique for opening the airway is the jaw thrust. This technique is accomplished by kneeling by the top of the victim's head and placing your fingers behind the angles of the lower jaw, or hooking your fingers under the jaw, then bringing the jaw forward. Separate the lips with your thumbs to allow breathing through the mouth as well as the nose, as shown in figure 10-4. This technique should be used when a neck injury is suspected. Note that the head is not tilted.

Each of these techniques offer some relief for most forms of airway obstruction. They also prepare the way for artificial ventilation.

After having opened the airway, check the mouth for mucus, food particles, foreign objects, or loose dentures. When present, open the victim's mouth and

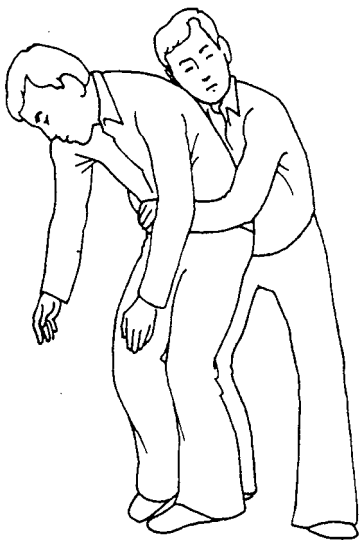

Figure 10-5.—Position for standing abdominal thrust.

clear away the matter by inserting a finger into the mouth and gently sweeping from the inside of one cheek to the other. Be careful not to force the material into the victim's throat. Next, reposition the victim's head, ensuring an open airway, and place your ear next to the victim's nose and mouth. While in this position, listen and feel for air exchange, and look at the victim's chest and abdomen for movement.

If the airway is still obstructed, it may be necessary to try to remove the obstruction by using the abdominal thrust or chest thrust methods.

ABDOMINAL THRUST TECHNIQUE

When the back blows are unsuccessful, use the abdominal thrust. This procedure pushes air from the lungs and forces the object from the air passage.

ABDOMINAL THRUST STANDING TECHNIQUE

1. Stand behind the victim and wrap your arms around the victim's waist, as shown in figure 10-5.
2. Make a fist with one hand and place it thumb side against the abdomen, slightly above the navel.
3. Grasp the fist with the other hand (fig. 10-6).
4. Give four quick upward thrusts to the victim. The obstruction should pop out like a champagne cork.

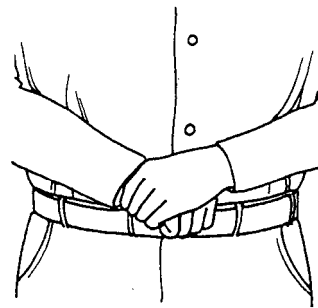

Figure 10-6.—Correct hand positioning.

ABDOMINAL THRUST RECLINING TECHNIQUE

This technique is performed with the victim lying flat, faceup.

1. Position yourself for the thrust by straddling the victim at the hips.
2. Place the heel of one hand on top of the other, slightly above the navel, with the fingers pointing toward the head.
3. Give four quick upward thrusts to the abdomen.

Following the cycle of 6 to 10 abdominal thrusts, turn the victim's head to one side, and check for loose foreign matter with a sweeping movement of the index finger inside the mouth, then ventilate. Repeat cycles of 6 to 10 abdominal thrusts, finger sweeps, and ventilation until the obstruction is dislodged or until a rescue team arrives.

CHEST THRUSTS TECHNIQUE

For obese or pregnant victims, the chest thrust method is recommended for removing airway obstructions, since manual pressure to the abdominal area of these people would either be ineffective or cause internal damage.

CHEST THRUSTS STANDING TECHNIQUE

1. Bring your arms under the arms of the victim and encircle the lower chest, as shown in figure 10-7.
2. Position your hands as described for the abdominal thrust standing technique.
3. Keep your fist on the middle of the sternum (breastbone), not the lower part.
4. Apply pressure to the chest with quick, backward thrusts.



Figure 10-7.—Position for standing chest thrust.

CHEST THRUSTS RECLINING TECHNIQUE

This technique is performed with the victim lying flat, faceup.

1. kneel at the victim's side.
2. Place the heel of one hand on the middle of the sternum and cover with the other hand, keeping your fingers off the chest.
3. Give four downward thrusts.
4. Repeat cycles of chest thrusts and finger sweeps, following the same technique you would use with abdominal thrusts.

SELF-HELP FOR AIRWAY OBSTRUCTION

If you are alone and you are the victim of an airway obstruction, do not be afraid for you can help yourself. Using your own fist, you can perform the abdominal thrust standing technique. You may also use the back of a chair to exert abdominal pressure. (See fig. 10-8.)

BREATHING

The second aspect of basic life support is to restore breathing in cases of respiratory arrest (the victim has stopped breathing). Failure of the breathing mechanism may be caused by various factors. They include complete airway obstruction, acute trauma, suffocation, electric shock drowning, and drug overdose. Unless something is done when the victim is not breathing, the

PROCEDURE FOR:



Figure 10-8.—Procedure for self-help.

heart will soon stop beating. In such instances, be prepared to start cardiopulmonary resuscitation (CPR).

The signs of respiratory arrest are an absence of respiratory effort, a lack of detectable air movement through the nose or mouth, unconsciousness, and a bluish discoloration of the lips and nail beds.

ARTIFICIAL VENTILATION

The purpose of artificial ventilation is to provide a method of air exchange until natural breathing is reestablished. Artificial ventilation should be given only when natural breathing has stopped; it must not be given to any person who is breathing naturally. Do not assume that a person's breathing has stopped merely because the person is unconscious or has been rescued from the water, from poisonous gas, or from contact with an electric wire. Remember: **DO NOT GIVE ARTIFICIAL VENTILATION TO A PERSON WHO IS BREATHING NATURALLY.**

In the last section, we discussed the methods to open the blocked airway. When the victim is not breathing, it is essential for the airway to be open so the rescuer can begin respiratory life support. When the victim does not begin spontaneous breathing after opening the airway, begin artificial ventilation immediately. When ventilation is inadequate, readjust the head, using one of the methods described earlier and attempt to ventilate again. If the airway is obstructed, use the thrust techniques discussed previously, followed by another attempt at artificial ventilation.



Figure 10-9.—Feeling for the carotid pulse.

appears bloated. This condition is called gastric distention. If gastric distention develops, open the airway even more and cut down on the amount of air you are providing, BUT DO NOT attempt to expel the stomach contents by pushing on the abdomen. If the patient vomits while you are giving mouth-to-mouth ventilation, turn his head to one side and clear the airway.

CIRCULATION

Cardiac arrest occurs when the heart stops functioning. If the victim is to live, take action immediately to restore the victim's heart function. The signs of cardiac arrest include the absence of a pulse, because the heart is not beating, and the absence of breathing.

A rescuer who knows how to administer CPR increases the chances of a victim's survival. CPR consists of artificial ventilation and external heart compressions. The lungs are ventilated by using the mouth-to-mouth or mouth-to-nose technique; the compressions are performed by pressing the chest with the heels of your hands. The victim should be laying faceup on a firm surface.

CPR should not be attempted by a rescuer who has not been properly trained, as mentioned earlier in this chapter. To learn this technique, contact your medical education department.

The rescuer must not assume that cardiac arrest has occurred solely because the victim is lying on the deck and appears to be unconscious (fig. 10-10). First, try to arouse the victim by gently shaking his shoulders and by trying to obtain a response; loudly ask, "Are you OK?" Be careful if the victim shows signs of head and spinal injuries. If there is no response, place the victim faceup on a firm surface. Kneel at a right angle to the victim, and open the airway, using the head tilt-neck lift, the head tilt-chin lift, or the jaw thrust methods previously discussed. Look for chest movement. Listen and feel for air coming from his nose or mouth for at least 5 seconds. If the pulse is absent, call for help and begin CPR.

Locate the lower margin of the victim's rib cage on the side closest to you by using your middle and index fingers. Then move your fingers up along the edge of his rib cage to the notch (xiphoid process) where the ribs meet the sternum in the center of his lower chest. Your middle finger should be placed on the notch with your index finger next to it. The heel of your other hand should be placed along the midline of his sternum, next to your index finger. You must keep the heel of your hand

Mouth-to-Mouth Ventilation

To perform mouth-to-mouth ventilation, place one hand under the victim's neck; place the heel of the other hand on his forehead; use the thumb and index finger to pinch his nostrils shut. Tilt his head back to open the airway. Take a deep breath, cover the victim's mouth with your own, and blow into the victim's mouth. Briefly remove your mouth from the victim's mouth to allow exhalation. Initially, give four quick breaths in succession, allowing the lungs to deflate, only partially. Observe the victim's chest for movement. Check the victim's neck pulse (carotid artery), as shown in figure 10-9. When a pulse is present, continue rescue breathing at the rate of 12 ventilations per minute (one breath every 5 seconds).

Mouth-to-Nose Ventilation

Mouth-to-nose ventilation is effective when the victim has extensive facial or dental injuries; this permits an effective air seal.

To administer this method, seal the victim's mouth with your hand, take a deep breath, and place your lips over the victim's nose and blow. To assist the victim to exhale, you may open the lips. Start artificial ventilation with four quick breaths in succession, allowing the lungs to deflate, only partially. Check the victim's neck pulse. If a pulse is present, continue rescue breathing at the rate of 12 ventilations per minute (one breath every 5 seconds).

Gastric Distention

Sometimes during artificial ventilation, air enters the stomach instead of the lungs, and the abdomen

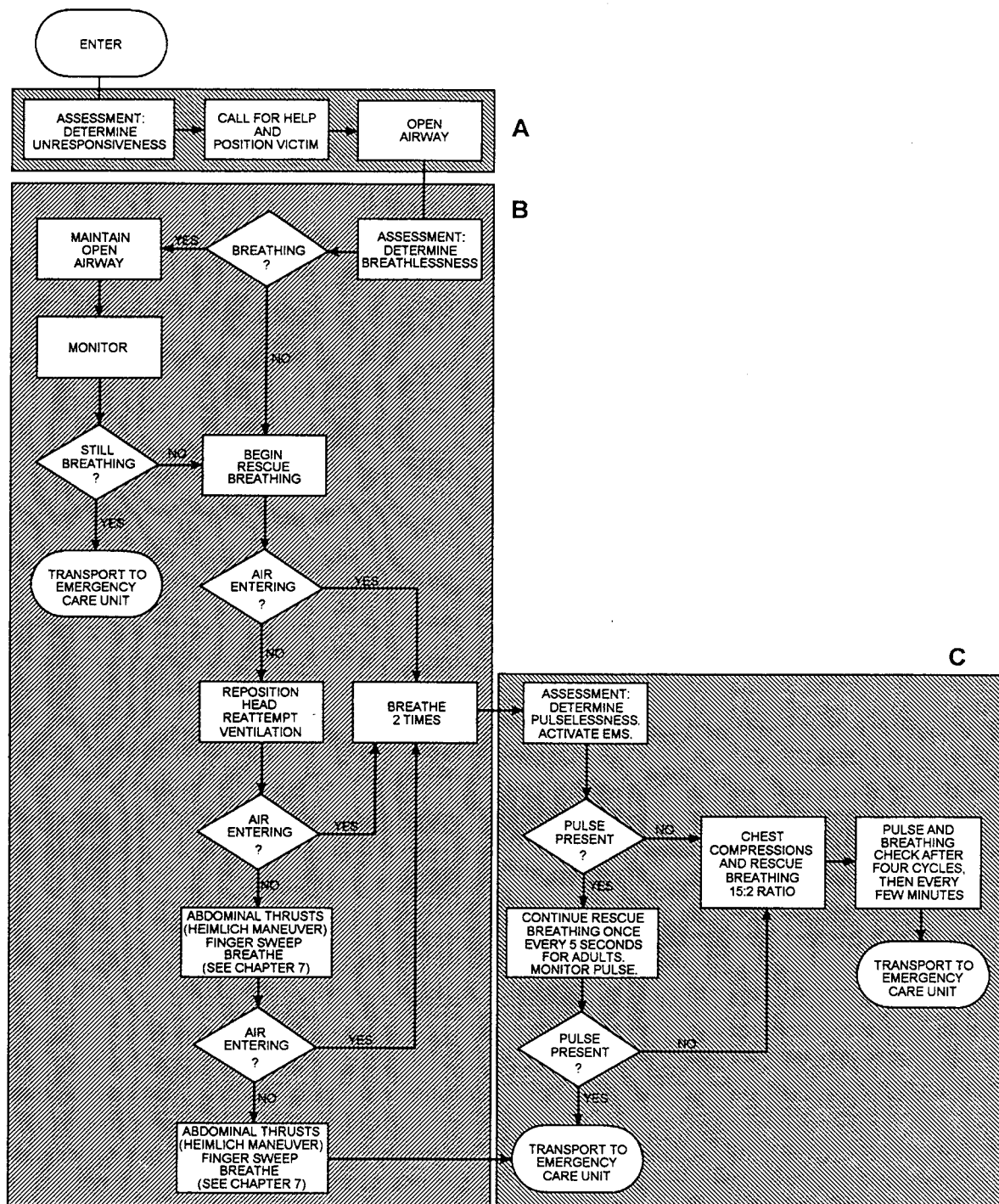
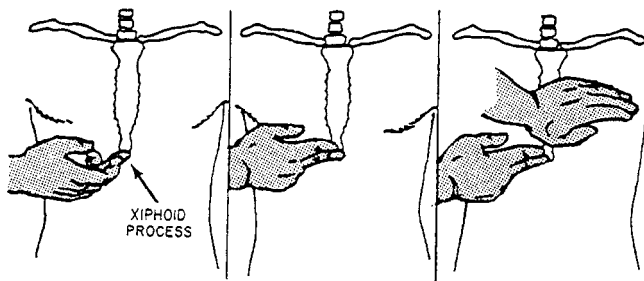

Figure 10-10.—One-rescuer CPR decision tree.



POSITION OF HANDS

Figure 10-11.—Xiphoid process.

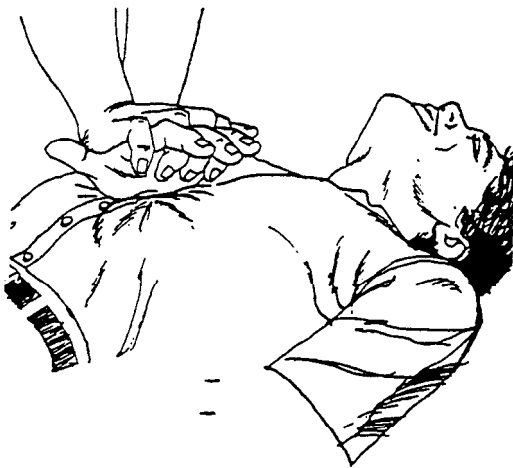

Figure 10-12.—Interlocking fingers to help keep fingers off the chest wall.

off the xiphoid process (fig. 10-11). A fracture in this area could lacerate the liver.

Place the heel of one hand directly on the lower half of the sternum two fingers up from the notch and the heel of the other on top of the first hand. Interlock your fingers or extend them straight out, and **KEEP THEM OFF THE VICTIM'S CHEST!** (See fig. 10-12.)

With your elbows locked, apply vertical pressure straight down to depress the sternum (adult) from 1 1/2 to 2 inches. Then release the pressure, keeping the heels of your hands in place on his chest. This process compresses the heart between the sternum and the victim's back thus pumping blood to the vital parts of the body.

When you use the proper technique, a more effective compression will result, and you will feel less fatigue. Ineffective compression occurs when the elbows of the rescuer are not locked, he is not directly over the sternum, or his hands are improperly placed on the sternum.

When one rescuer performs CPR, the ratio of compressions to ventilations is 15 to 2, and it is performed at a rate of 80 compressions per minute. Vocalize "1, and 2, and 3," and so forth, until you reach

15. After 15 compressions, you must give the victim 2 ventilations. Continue for four full cycles of 15 compressions and 2 ventilations. Then take 5 seconds to check for the carotid pulse and spontaneous breathing. When there are still no signs of recovery, continue CPR. If a periodic check reveals a return of pulse and respiration, discontinue CPR; but closely monitor the victim's pulse and respirations, and be prepared to start CPR again, if required. When a pulse is present but no respiration, continue to give the victim one ventilation every 5 seconds and check his pulse frequently.

Before moving on to the next technique, let us review the following steps for one-rescuer CPR:

1. Determine whether the victim is conscious.
2. Open the airway (it maybe necessary to remove the airway obstruction).
3. Look, listen, and feel.
4. Ventilate for four cycles.
5. Check his pulse-if none, call for help.
6. Begin the compression-ventilation ratio of 15 to 2 for four complete cycles.
7. Check again for a pulse and breathing. If no change, continue the compression-ventilation ratio of 15 to 2 until the victim is responsive, until you are properly relieved, until you can no longer continue because of exhaustion, or until the victim is pronounced dead by a medical officer.

The diagrams in figures 10-13 and 10-14 show the step-by-step methods discussed in this chapter, and it serves as a good review.

TRANSPORTATION OF SICK AND INJURED

Knowing how to transport a seriously injured casualty is one of the most important parts of first aid. Careless or rough handling not only increases the seriousness of his injury but may also cause his death. Unless there is a good reason for transporting a casualty, do not attempt this until some means of medical evacuation is provided. Sometimes when the situation is urgent and you know that no medical evacuation facilities are available, you may have to transport the casualty yourself. This is the reason why you should know the different ways of transporting a casualty. Give the appropriate first aid before leaving with him. If he has a broken bone, do not transport him until you have splinted or immobilized it.

DEFINITIONS

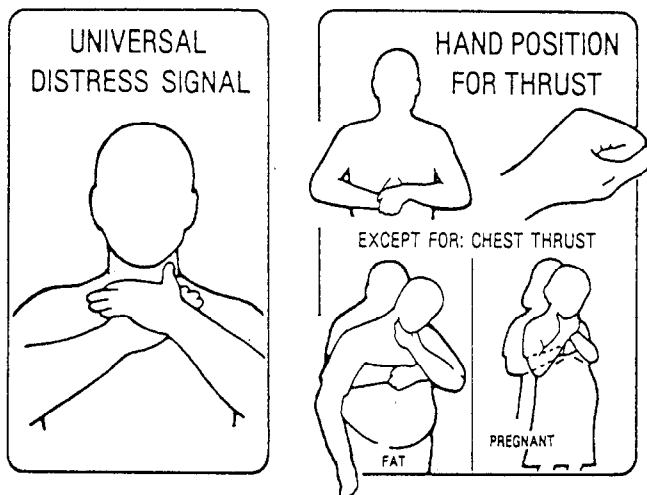

PROCEDURE

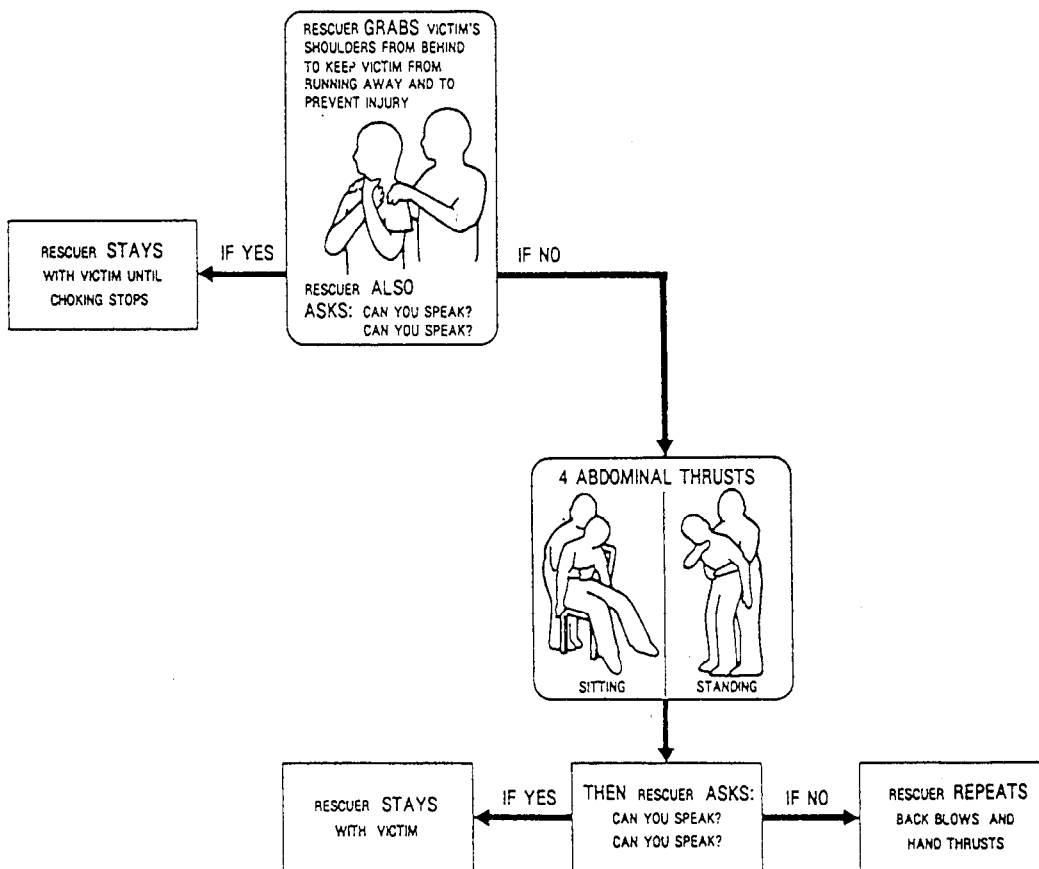
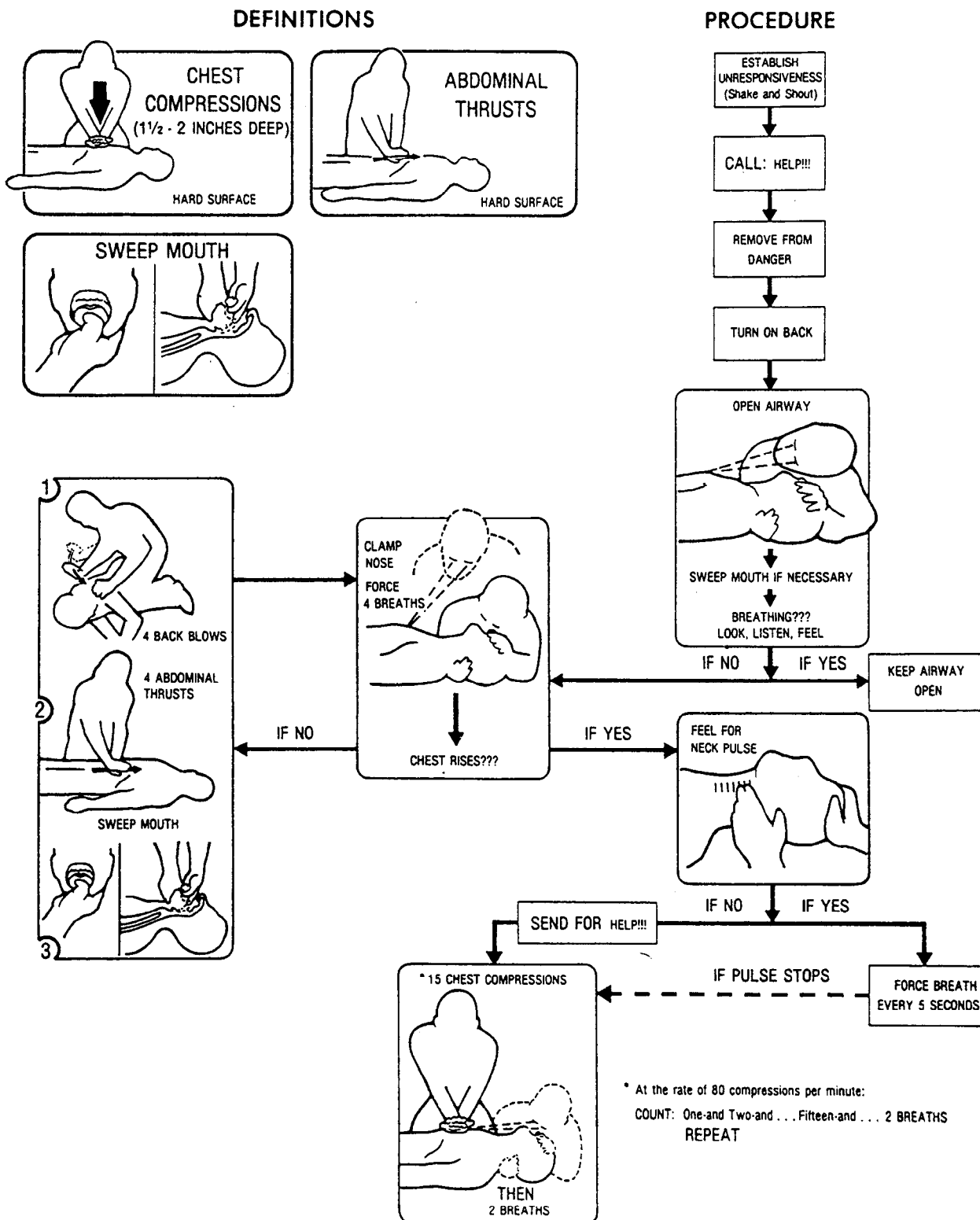

Figure 10-13.—Choking procedures.



* At the rate of 80 compressions per minute:
COUNT: One-and Two-and . . . Fifteen-and . . . 2 BREATHS
REPEAT

Figure 10-14.—One-rescuer CPR.

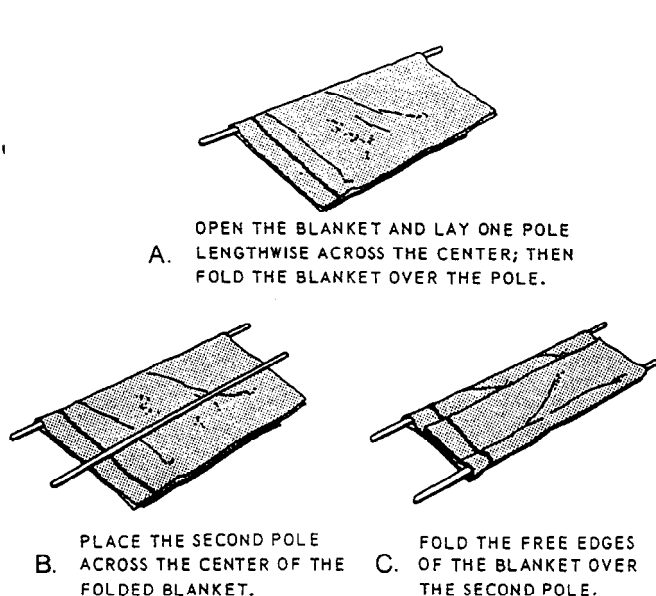

Figure 10-15.—Litter made with poles and blanket.

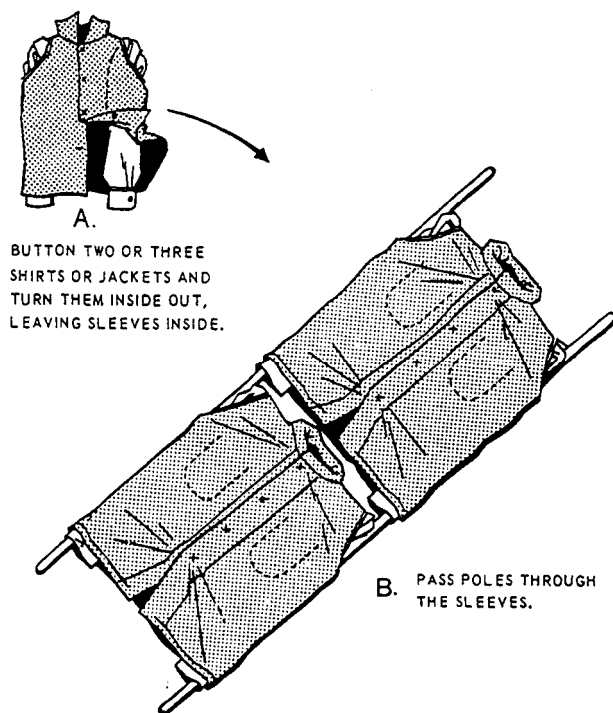

Figure 10-16.—Litter made with poles and jackets.

Do not transport a casualty with a fractured back or neck without a litter. When the casualty has a fracture of any other bodily part, transport him in such a way that it does not aggravate the fracture. An unconscious casualty should be transported on a litter or carried in such away that he will not fall. Transportation by litter is safer and more comfortable for all casualties as well as easier for you. When carrying the casualty is the only

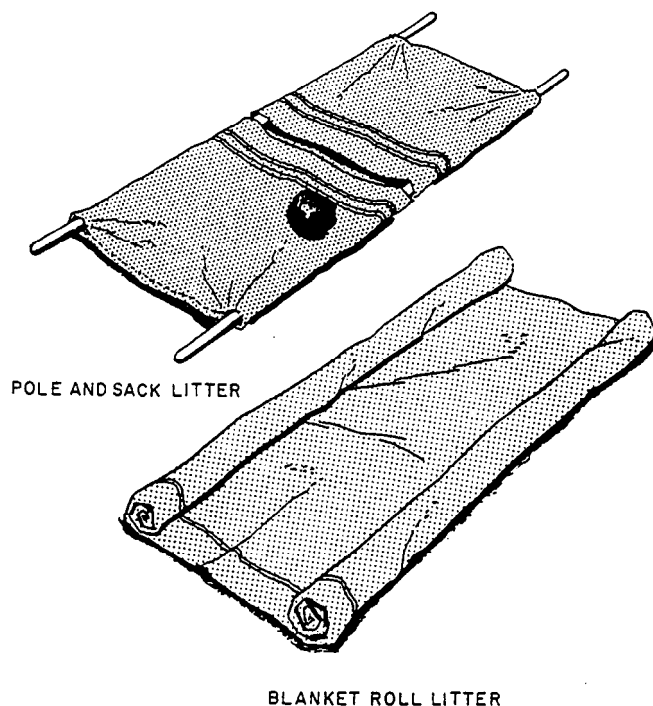

Figure 10-17.—Litters made by inserting poles through sacks and by rolling blanket.

feasible method because of the terrain or the combat situation or is necessary to save the casualty's life, it should be used; but the casualty should be transferred to a litter as soon as one can be made available or improvised.

IMPROVISED LITTERS

A litter can be improvised from many different things. Most flat-surfaced objects of suitable size can be used as litters. Such objects include boards, doors, window shutters, benches, ladders, cots, and poles tied together. If possible, such objects should be padded

Satisfactory litters can also be made by securing poles inside such items as blankets, shelter halves, tarpaulins, jackets, shirts, sacks, bags, and mattress covers. Poles can be improvised from strong branches, rifles, tent supports, skis, and other items.

CAUTION

When weapons are used as splints, be absolutely sure they are unloaded.

When poles cannot be obtained, a large item, such as a blanket, can be rolled from both sides toward the center; then the rolls can be used to obtain a firm grip for carrying the casualty. Several methods of improvising litters are shown and explained in figures 10-15 through 10-17.

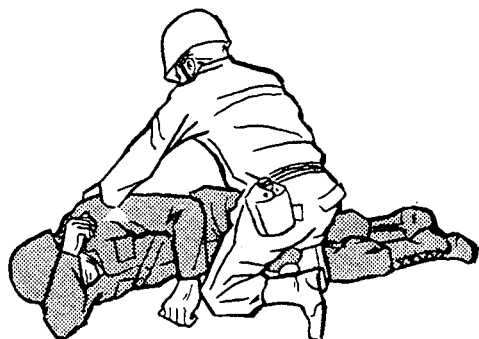

STEP ONE: IF THE CASUALTY IS LYING ON HIS BACK, KNEEL AT HIS UNINJURED SIDE, PLACE ONE OF HIS ARMS ACROSS HIS FACE, AND GENTLY ROLL HIM TOWARD YOU ONTO HIS ABDOMEN. HIS ARM PROTECTS HIS FACE FROM THE GROUND.

Figure 10-18.—Fireman's carry (step one).

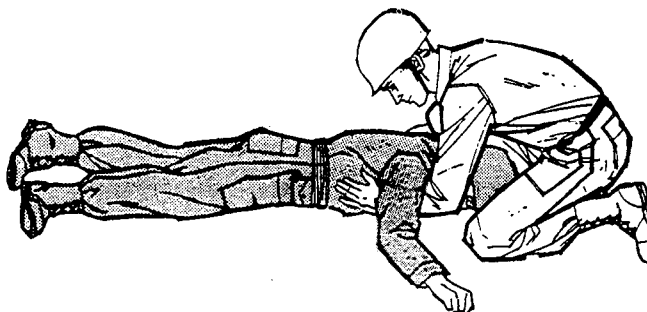

STEP TWO: KNEEL ON ONE KNEE AT THE CASUALTY'S HEAD, FACING HIS FEET; THEN GRASP HIM BY EXTENDING YOUR HANDS UNDER HIS ARMPITS, DOWN HIS SIDES, AND ACROSS HIS BACK.

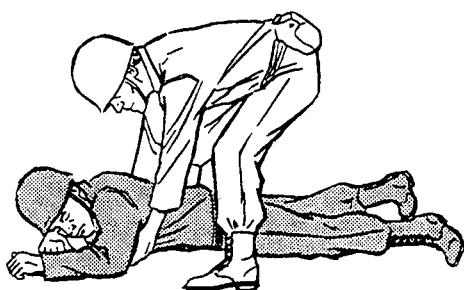

STEP TWO: STRADDLE THE CASUALTY AND GRASP HIM BY EXTENDING YOUR HANDS UNDER HIS ARMPITS AND AGAINST HIS CHEST.



STEP THREE: AS YOU RISE, LIFT THE CASUALTY TO HIS KNEES; THEN SECURE YOUR HOLD AND RAISE HIM TO A STANDING POSITION UNTIL HIS KNEES LOCK.

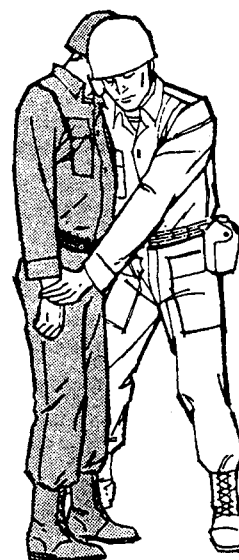

STEP FOUR: SUPPORTING THE CASUALTY WITH YOUR RIGHT ARM AROUND HIS WAIST, TAKE HOLD OF HIS RIGHT WRIST WITH YOUR LEFT HAND.

Figure 10-20.—Fireman's carry (steps two, three, and four alternate method).

METHODS OF CARRYING A CASUALTY

A casualty may be transported by using one-man and two-man carries. The two-man carries should be used whenever possible, as they provide more comfort to the casualty, are less likely to aggravate his injury, and are less tiring to the carriers. The particular one-man or two-man carries selected for use should be the one that is least likely to aggravate the casualty's injury.

Fireman's Carry

This method is one of the easiest ways for one man to get a casualty off the ground and to carry him. Figures 10-18 through 10-22 show the steps in the fireman's

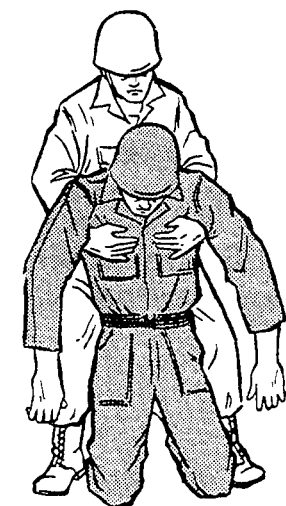

STEP THREE: LIFT THE CASUALTY TO HIS KNEES; THEN SECURE YOUR HOLD AND RAISE HIM TO A STANDING POSITION UNTIL HIS KNEES LOCK.

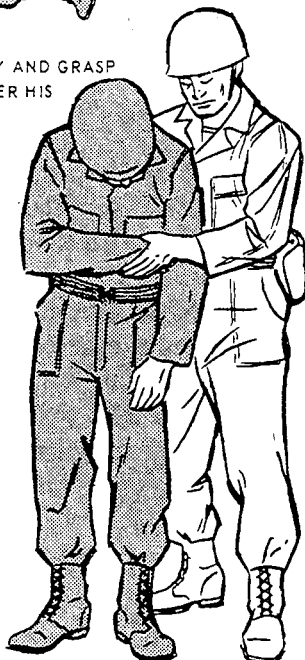

STEP FOUR: SUPPORTING THE CASUALTY WITH YOUR RIGHT ARM AROUND HIS WAIST, TAKE HOLD OF HIS RIGHT WRIST WITH YOUR LEFT HAND AND MOVE IN FRONT OF HIM.

Figure 10-19.—Fireman's carry (steps two, three, and four).

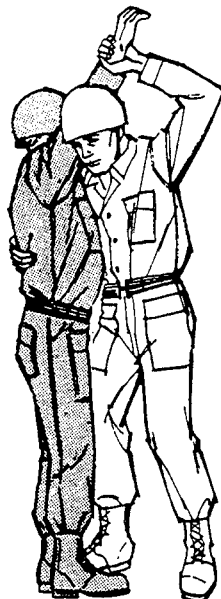

STEP FIVE: RAISE THE CASUALTY'S RIGHT ARM OVER YOUR HEAD.



STEP SIX: BEND AT THE WAIST AND KNEES; THEN PULL THE CASUALTY'S ARM OVER AND DOWN YOUR LEFT SHOULDER, THUS BRINGING HIS BODY ACROSS YOUR SHOULDERS. AT THE SAME TIME PASS YOUR RIGHT ARM BETWEEN HIS LEGS AND GRASP HIS RIGHT KNEE WITH YOUR HAND.

Figure 10-21.—Fireman's carry (steps five and six).



STEP SEVEN: STAND WITH CASUALTY ON YOUR SHOULDERS.

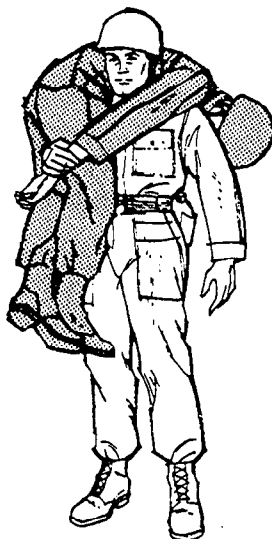

STEP EIGHT: GRASP THE CASUALTY'S RIGHT WRIST WITH YOUR RIGHT HAND, LEAVING YOUR LEFT HAND FREE. A MAN CAN CARRY ANOTHER PERSON SOME DISTANCE IN THIS MANNER.

Figure 10-22.—Fireman's carry (steps seven and eight).

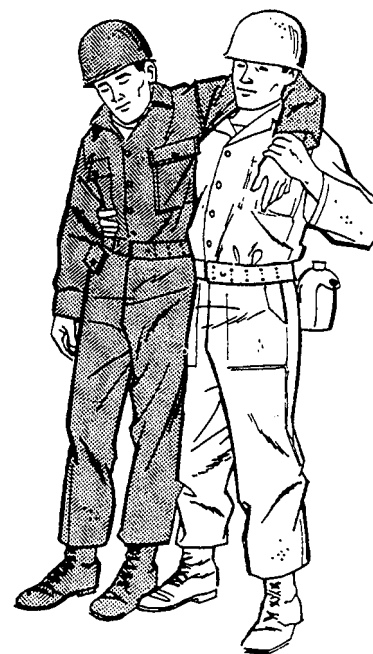

Figure 10-23.—Supporting carry.

The steps (two, three, and four) for getting the casualty off the ground may be accomplished in one of two ways, depending upon the location of the casualty's injury. The carrier should decide which method would be better for the casualty. Furthermore, the carrier should bring the casualty onto his back from the side that will avoid pressure on the injured part.

Supporting Carry

This carry is useful when the casualty is only slightly injured.

1. Lift the casualty off the ground as shown in the first three steps of the fireman's carry (figs. 10-18 through 10-20).
2. Grasp the wrist of the casualty's uninjured arm and draw his arm around your neck (fig. 10-23).
3. Let the casualty walk using you as a crutch.

Arms Carry

This carry is useful for a short distance.

1. Lift the casualty off the ground as shown in the first three steps of the fireman's carry (figs. 10-18 and 10-19).

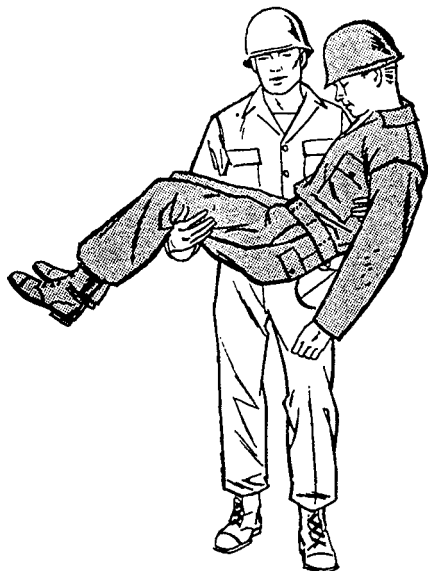

Figure 10-24.—Arms carry.



Figure 10-25.—Saddleback carry.

2. Position your arms on the casualty, as shown in figure 10-24, and lift him into your arms.

3. Carry the casualty high to lessen fatigue.

Saddleback Carry

1. Lift the casualty off the ground as shown in the first three steps of the fireman's carry (figs. 10-18 through 10-20).

2. Supporting the casualty with one of your arms around him, turn so the casualty can encircle your neck with his arms; then stoop, clasp your hands beneath his thighs, and raise him upon your back (fig. 10-25).



Figure 10-26.—Pack-strap carry.

Pack-Strap Carry

1. Lift the casualty off the ground as shown in the first three steps of the fireman's carry (figs. 10-18 through 10-20).

2. Supporting the casualty with your arm around him, grasp his wrist closest to you and place his arm over your head and across your shoulders; then move in front of him while supporting his weight against your back grasp his other wrist, and place this arm over your shoulder (fig. 10-26, view A).

3. Bend forward and hoist him as high on your back as possible so all his weight is resting on your back (fig. 10-26, view B).

Back Lift and Carry

For use of this carry, the casualty must be conscious and able to stand on at least one leg.

1. Raise the casualty to a standing position and place your back to his back; then have him stretch out his arms sideways.

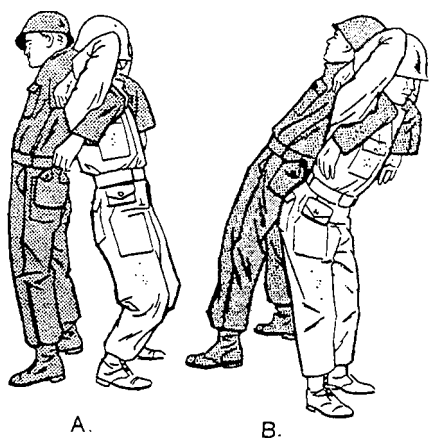
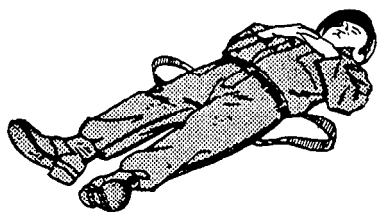

Figure 10-27.—Back lift and carry.



STEP ONE: LINK TOGETHER TWO PISTOL BELTS TO FORM A SLING. PLACE THE SLING UNDER THE CASUALTY'S THIGHS AND LOWER BACK SO THAT A LOOP EXTENDS FROM EACH SIDE.



STEP TWO: LIE BETWEEN THE CASUALTY'S OUTSTRETCHED LEGS. THRUST YOUR ARMS THROUGH THE LOOPS. GRASP CASUALTY'S HAND AND TROUSER LEG ON HIS INJURED SIDE.

Figure 10-28.—Pistol-belt carry (steps one and two).

2. Bending backward, put your hands under his arms and grasp his upper arms near the armpits (fig. 10-27, view A).

3. Bend forward, pulling him onto your back (fig. 10-27, view B).

Pistol-Belt Carry

This method can be used for a long distance without undue fatigue on the carrier. When pistol belts are not available, other items can be used, such as one rifle sling, two cravat bandages, two litter straps, or any suitable material that will not cut or bind the casualty. The steps in this method are provided in figures 10-28 through 10-30.

STEP THREE: ROLL TOWARD THE CASUALTY'S UNINJURED SIDE ONTO YOUR ABDOMEN, BRINGING THE CASUALTY ONTO YOUR BACK. ADJUST SLING AS NECESSARY.

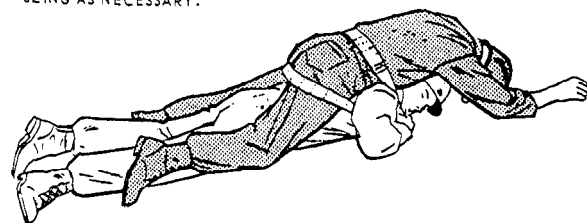

STEP FOUR: RISE TO A KNEELING POSITION. THE BELT WILL HOLD THE CASUALTY IN PLACE.

Figure 10-29.—Pistol-belt carry (steps three and four).

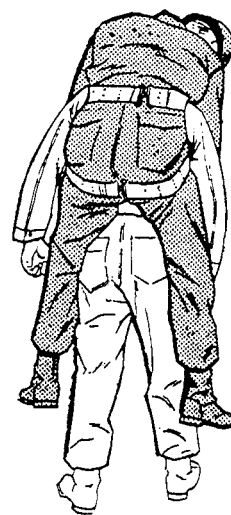

STEP FIVE: PLACE ONE HAND ON YOUR KNEE FOR SUPPORT AND RISE TO AN UPRIGHT POSITION. THE CASUALTY IS NOW SUPPORTED ON YOUR SHOULDERS.

STEP SIX: CARRY THE CASUALTY WITH YOUR HANDS FREE FOR USE IN FIRING RIFLE, CLIMBING BANKS, OR SURMOUNTING OBSTACLES.



Figure 10-30.—Pistol-belt carry (steps five and six).

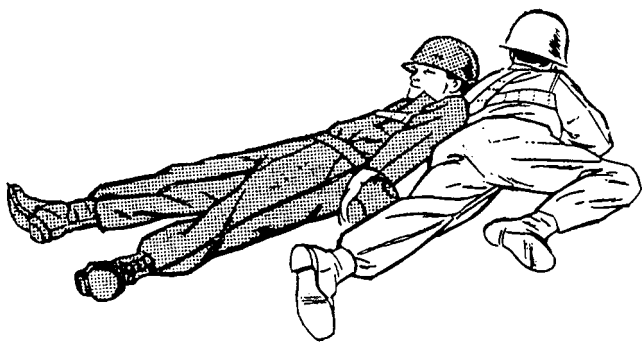
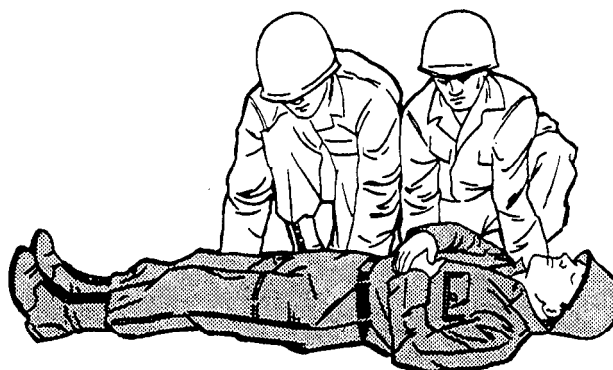

Figure 10-31.—Pistol-belt drag.



STEP ONE: TWO MEN KNEEL AT ONE SIDE OF THE CASUALTY AND PLACE THEIR ARMS BENEATH THE CASUALTY'S SHOULDERS, BACK, HIPS, AND KNEES.

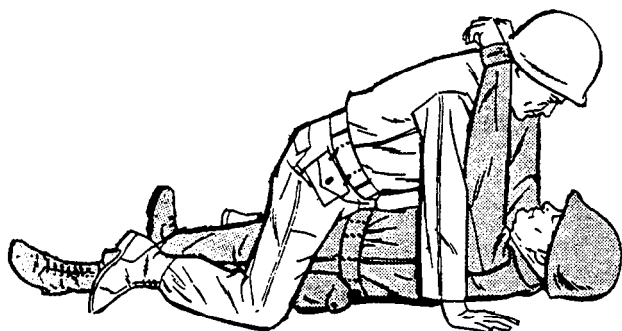
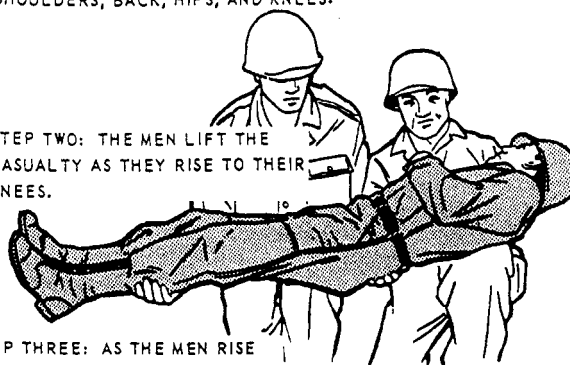

Figure 10-32.—Neck drag.

STEP TWO: THE MEN LIFT THE CASUALTY AS THEY RISE TO THEIR KNEES.



STEP THREE: AS THE MEN RISE TO THEIR FEET, THEY TURN THE CASUALTY TOWARD THEIR CHESTS. THEY CARRY HIM HIGH TO LESSEN FATIGUE.

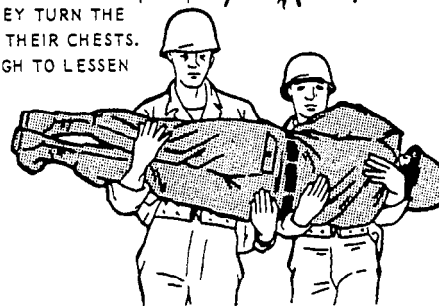

Figure 10-33.—Two-man supporting carry.

Figure 10-34.—Two-man arms carry (steps one, two, and three).

1. Form a sling by extending two pistol belts or other suitable items to their full length and connecting the ends.

2. With the casualty on his back, pass the sling over his head and position it across his chest and under his armpits.

3. Cross the sling straps at a point near the casualty's shoulder, forming a loop for your shoulder.

4. Lie on your back alongside the casualty and slip the loop over your arm that is closer to the casualty; then turn away from the casualty onto your abdomen, thus causing the loop to fit tightly around your shoulder.

5. Place your arm, the one nearer the casualty, underneath his head to protect it during movement.

6. Crawl along, dragging the casualty with you.

Pistol-Belt Drag

This method (fig. 10-3 1) enables you and the casualty to remain low on the ground, more protected from enemy fire; however, it is satisfactory for only a short distance.

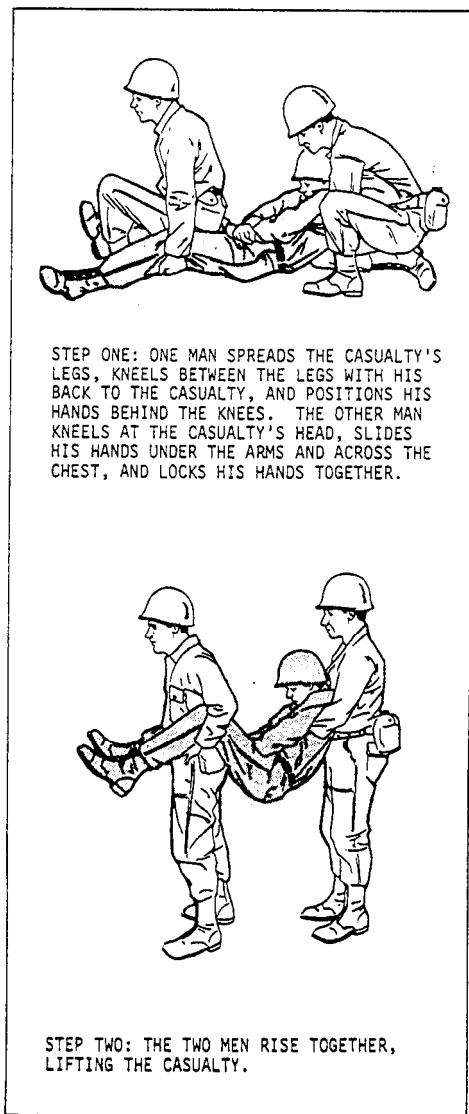

Figure 10-35.—Two-man saddleback carry(steps one and two).

Neck Drag

This method (fig. 10-32) enables you and the casualty to remain close to the ground.

1. Tie the casualty's hands together and loop them around your neck.
2. Crawl along, dragging the casualty with you.

Two-Man Supporting Carry

1. Two men help the casualty to his feet and support him with their arms around his waist(fig. 10-33).
2. They grasp the casualty's wrists and draw his arms around their necks.
3. The casualty walks, using the two men as crutches.

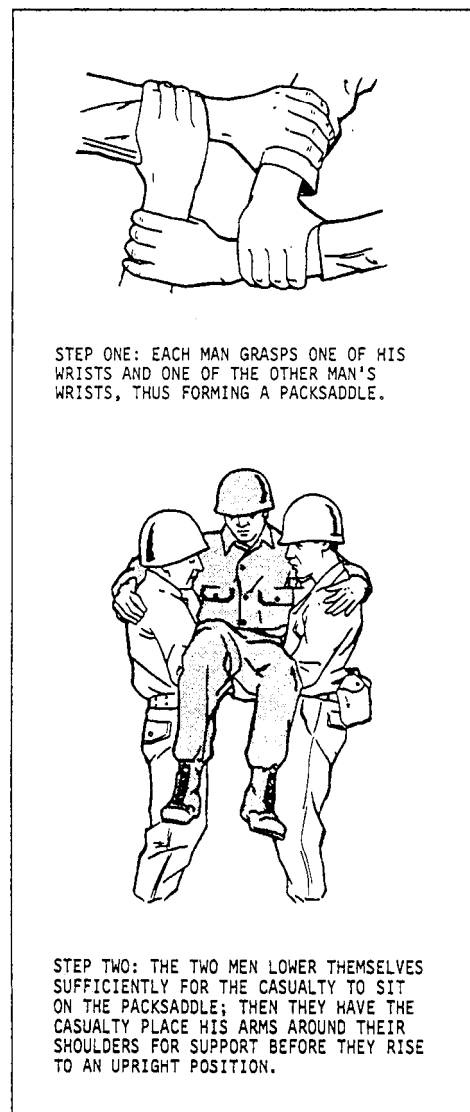

Figure 10-36.—Four-hand (packsaddle) carry (steps one and two).

Two-Man Arms Carry

Two men lift and carry the casualty, as shown and explained in figure 10-34.

Two-Man Saddleback Carry

This carry is useful for a short distance. Two men lift and carry the casualty, as shown and explained in figure 10-35.

Four-Hand (Packsaddle) Carry

Two men make a packsaddle and carry the casualty on it, as shown and explained in figure 10-36.

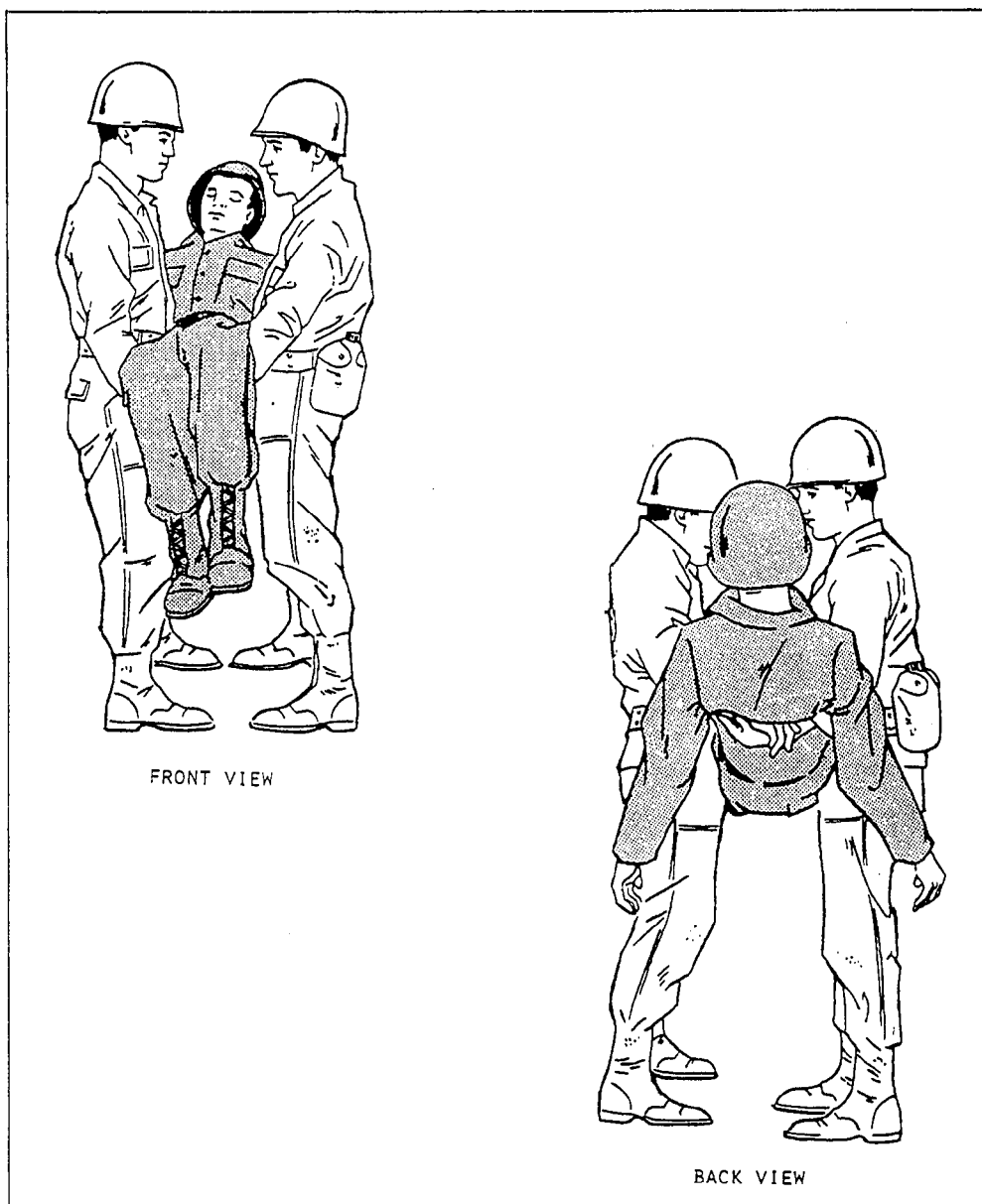

Figure 10-37.—Four-hand arms carry (front and back views).

Four-Hand Arms Carry

1. Two men kneel on opposite sides of the casualty at his hips (fig. 10-37).
2. Each man passes his arms under the casualty's thigh and back and grasps the other man's wrist.
3. The two men rise, lifting the casualty.

HEMORRHAGE

Blood is circulated throughout the body by means of three different types of blood vessels: arteries, veins, and capillaries. ARTERIES are large vessels that carry

blood away from the heart, VEINS are large vessels that carry blood back to the heart, and CAPILLARIES form a connecting network of smaller vessels between the arteries and the veins.

Hemorrhage (bleeding) occurs whenever there is a break in the wall of one or more blood vessels. In most small cuts, only the capillaries are injured. Deeper wounds result in injury to veins or arteries. Injury to the capillaries is not serious and can generally be controlled by a small bandage strip or pad. Injury to veins or arteries is serious and may endanger life.

One twelfth to one fifteenth of the body weight is blood. A person weighing 150 pounds has

approximately 10 to 12 pints of blood. One pint of blood can usually be lost without harmful effect; in fact, this is the amount usually given by blood donors. However, the loss of 2 pints usually causes shock, and shock becomes greater and greater as the amount of blood loss increases. If one half of the blood in the body is lost, death usually results.

Capillary blood is usually brick red in color. When capillaries are cut, the blood oozes out slowly. Blood from the veins is dark red. When a vein is cut, the blood escapes in a steady flow. When an artery near the surface is cut, the blood gushes out in spurts that are synchronized with heart beats; but if the cut artery is deeply buried, the bleeding appears in a steady stream. Arterial blood is usually bright red in color.

In actual practice, you may find it difficult to decide whether the bleeding is venous or arterial, but the distinction is usually not important. A person can bleed to death quickly from a cut artery; prolonged bleeding from any large cut can, of course, have the same effect. The important thing to know is that all bleeding must be controlled as quickly as possible.

CONTROL OF HEMORRHAGE

When administering first aid to a bleeding victim, you must remain calm. Loss of blood is a dramatic event and always appears severe. In fact, most bleeding is less severe than it may appear to be at first glance. Most of the major arteries are deep and well protected by tissue and bony prominence. Although bleeding can be fatal, you usually have enough time to think and act calmly before the victim expires. Remember that most errors in first aid are made because of acting without thinking.

The four methods for controlling hemorrhage are direct pressure, elevation, indirect pressure, and the use of a tourniquet.

Direct Pressure

Direct pressure is the first method to use when you are trying to control hemorrhage. In almost every case, bleeding can be stopped by the application of pressure directly on the wound, as shown in figure 10-38. Use a sterile first-aid dressing, when available, and tie the knot directly over the wound, only tight enough to stop the bleeding. Any clean material can be used in the absence of regular first-aid dressings. If the bleeding does not stop, firmly apply another dressing over the first dressing, or apply direct pressure with your hand or fingers over the dressing. This pressure may be applied by the victim himself or by a buddy. Under no

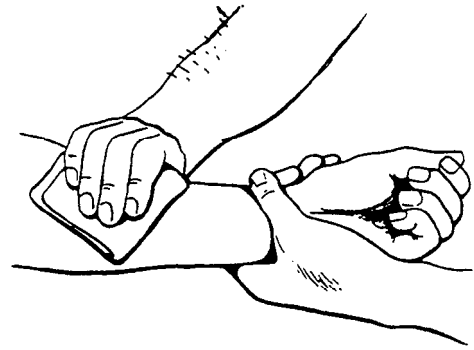

Figure 10-38.—Direct pressure.

circumstances should a dressing be removed once it is applied.

In cases of severe hemorrhage, do not worry too much about the dangers of infection. Although the prevention of infection is important, the basic problem is to stop the flow of blood. When no material is available, simply thrust your hand onto the wound.

Elevation

Elevating or raising an injured limb above the level of the heart helps to control the bleeding. Elevation should be used together with direct pressure; however, do not elevate a limb when you suspect a fracture until the fracture has been splinted and you can be reasonably certain that elevation will not cause further injury. Use a stable object to maintain elevation, for propping the limb on an unstable object can do more harm than good.

Indirect Pressure

In instances of severe bleeding where direct pressure and elevation are not controlling the bleeding, indirect pressure may be used. Bleeding from a cut artery or vein can often be controlled by applying pressure to the appropriate pressure point. This pressure point is a place where the main artery to the injured part lies near the skin surface and over a bone. Pressure at such a point is applied with the fingers, thumb, or with the heel of the hand; no first-aid materials are required. The object of the pressure is to compress the artery against the bone, thus shutting off the flow of blood from the heart to the wound.

CAUTION

Use of pressure points may cause damage to the limb as a result of an inadequate flow of

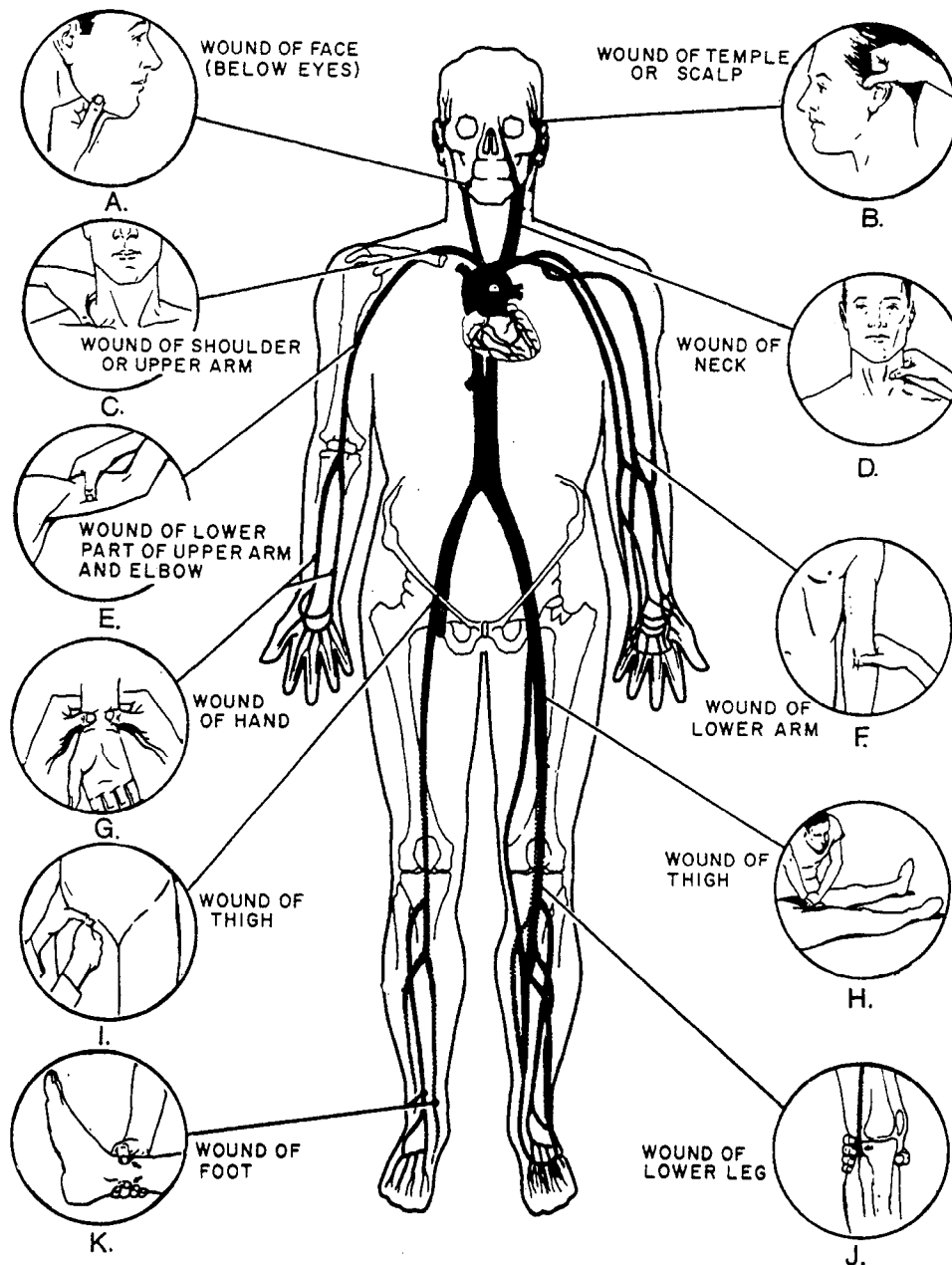

Figure 10-39.—Pressure points for control of bleeding.

blood. When the use of indirect pressure at a pressure point is necessary, do not substitute indirect pressure for direct pressure; use both. Figure 10-39 shows the locations of pressure points and the area of bleeding they control. Pressure points on the arms (brachial pressure points) and in the groin (femoral pressure points) are the ones that are most often used in first-aid treatment. These pressure points should be thoroughly understood.

Pressure on the brachial artery is used to control severe bleeding from an open wound on the upper extremity (arm). This pressure point is located in a

groove on the inside of the arm and the elbow. Using either the fingers or the thumb, apply pressure to the inner aspect of the arm. Figure 10-39, view E, shows the proper location for the digital pressure.

The femoral artery is used to control severe bleeding from a wound on the lower extremity (leg). The pressure point is located in the front, center part of the crease in the groin area. This is where the artery crosses the pelvic basin on the way into the lower extremity. To apply pressure, position the victim flat on his back, if possible. Kneeling on the opposite side from the wounded limb, place the heel of one hand directly on the pressure point, and lean forward to apply the small amount of pressure

needed to close the artery (fig. 10-39, view H). If bleeding is not controlled, it may be necessary to press directly over the artery with the flat surface of the fingertips and to apply additional pressure on the fingertips with the heel of the other hand.

Tourniquet

A tourniquet should be used only as a last resort for severe, life-threatening hemorrhage that cannot be controlled by any other method. First-aiders should thoroughly understand the dangers and limitations of its use.

CAUTION

A tourniquet may be dangerous. Its application may cause tissue injury or even loss of the injured limb. It is only rarely required and should be used only in cases of partial or complete severance of a limb or when bleeding is uncontrollable.

The standard tourniquet is usually a piece of web belting about 36 inches long, with a buckle or snap device to hold it tightly in place when applied. A tourniquet can be improvised from a strap, belt, neckerchief, or other similar material. A tourniquet should be at least 2 inches wide to distribute pressure over tissues. Never use wire, cord, or anything that will cut into the flesh.

To apply an emergency tourniquet made from material resembling a cravat or neckerchief, wrap the material once around the limb, and tie an overhand knot. Place a short stick on the overhand knot, and tie a square knot over it. Then twist the stick to tighten the tourniquet. The stick may be tied in place with another strip of material. Figure 10-40 demonstrates the proper method for applying a tourniquet.

The following are major points that you must know about the use of a tourniquet:

- Do not use a tourniquet unless you cannot control the bleeding by any other means.
- Only use a tourniquet on an arm or a leg.
- Always apply a tourniquet between the wound and the heart, making it as close to the wound as possible. When the wound is just below the elbow or knee, the tourniquet may have to be placed above the joint to get good compression on the limb.

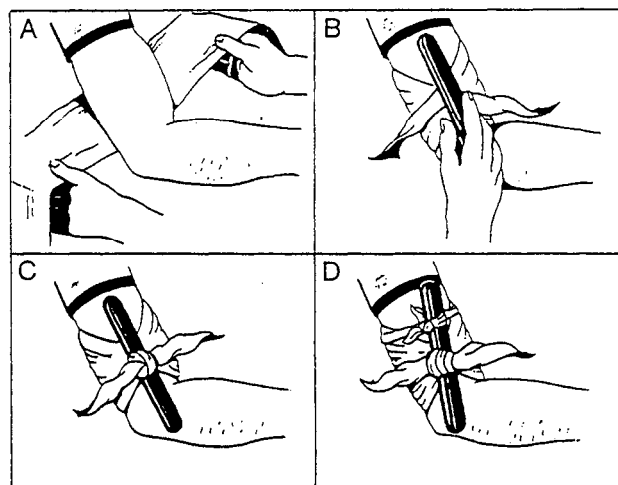

Figure 10-40.—Applying a tourniquet.

- Make sure you draw the tourniquet tight enough to stop the bleeding but do not make it tighter than necessary.
- Never loosen a tourniquet once it has been applied. The loosening of a tourniquet may dislodge clots and result in enough blood loss to cause severe shock and death.
- Do not cover a tourniquet with a dressing. If it is necessary to cover the injured person, make sure all the other people concerned with the case know about the tourniquet. Using crayon, skin pencil, or blood, mark a large “T” on the victim’s forehead and on a medical tag attached to the victim’s wrist. The time the tourniquet was applied must also be indicated.

Armpit Tourniquet

A deep wound high up on the arm or an amputation at the upper part of the arm may require a tourniquet at the armpit to control bleeding. If needed, apply as follows:

1. Place the center of a narrow cravat bandage in the armpit over a firm pad or padded object.
2. Cross the ends on the shoulder over a pad.
3. Carry the ends around the back and chest to the opposite side and tie them over the pad.
4. To tighten, insert a small stick or smaller object under the cross of the bandage on the shoulder and twist. Twist only until the bleeding is controlled. Then secure or anchor the stick to prevent untwisting (fig. 10-40, view D).

5. Again, do not loosen the tourniquet except if directed to do so by a physician.

EMERGENCY SITUATIONS

Bleeding from most external wounds is fairly easy to control; however, when some of the larger arteries are cut, hemorrhage may be so rapid that death will result within a few minutes. Methods of controlling the flow of blood in some of these emergency situations are briefly described below.

Wounds of the neck are often caused by sharp objects, such as knives, razors, and glass fragments. Sometimes a large artery is cut, sometimes a large vein, and sometimes both. In any event, the blood loss is extremely rapid. In treating wounds to the neck, an occlusive dressing should be applied over a sterile absorbent dressing to prevent air from entering the circulation system. It may also be possible to control the bleeding from these wounds by applying hand pressure above and below the cut; such pressure must be maintained until a medical officer gives further instructions. It is a good idea to use cloth under your hands, if any is available, because the blood makes his neck very slippery and difficult to hold.

When the large artery in the leg is cut, the bleeding is very rapid. At least partial (and perhaps complete) control of the hemorrhage can be attained by applying extreme pressure directly over the wound. Cover your clenched fist with clothing or type of other cloth that is available, and thrust your fist directly onto the wound. (If no cloth is available, use your fist alone; but you will find it more difficult to control the bleeding by this method because your fist and the wound will both become very slippery.) If a tourniquet becomes necessary, continue to apply direct pressure with your hand while the tourniquet is being applied.

Internal bleeding may be caused by deep wounds or by heavy blows that rupture internal blood vessels. When you suspect internal bleeding, anticipate that the victim may vomit blood. Give the victim nothing by mouth and keep him lying down, preferably on his side with a loosened collar and belt. Make him as comfortable as possible and reassure him. The victim should always be treated for shock (discussed below).

GENERAL FIRST-AID MEASURES

In addition to knowing ways to control serious bleeding by the application of pressure, you must be familiar with the following measures that are important in the first-aid treatment of a person who has suffered

severe bleeding. Any person who has lost a large amount of blood must be treated by medical personnel as soon as possible. In the meantime, you can greatly improve his chances for recovery by treating him for shock as soon as possible and by keeping the person quiet.

Shock is always present in persons who have lost a great amount of blood. If you do not notice symptoms of shock treat the victim for it anyway. Since the measures used to prevent shock are the same as those used to treat it, you may prevent its occurrence or, at least, lessen its severity.

Equally important, you must keep the casualty quiet. Try to keep him from getting excited. Do not move the victim unnecessarily, and do not handle him roughly. Keeping him quiet allows a clot to form in the wound and also helps to prevent the occurrence of shock. Try in every way to be careful and gentle in handling the victim, and do everything you can to make him as comfortable as possible under the circumstances.

SHOCK

You recall that in our discussion of hemorrhage, we said that the loss of 2 or more pints of blood usually causes shock. You should also know that shock can occur with any injury. And, in fact, some degree of shock usually accompanies serious injuries. You should, therefore, consider shock whenever handling a person who has been injured.

To understand how shock develops, let us look at what happens when you hit the end of your finger with a hammer. Your whole body responds. Since your finger hurts, you might think it is the only part of you that is responding to the injury; but, in fact, a great many changes are taking place in your body while you are concerned with the immediate pain. Your body AS A WHOLE is injured and your body AS A WHOLE attempts to recover from the injury. A series of changes takes place, designed to restore the body to its normal, healthy condition.

Sometimes, however, the changes that occur may in themselves cause further damage to the body. To some extent, this is what happens in shock. When a person is injured, the blood flow in his entire body is disturbed. To overcome this difficulty, the heartbeats faster and the blood vessels near the skin and in the arms and legs constrict, thus sending most of the available blood supply to the vital organs of the body and to the nerve centers in the brain that control all vital functions.

While this is occurring, the other cells do not receive enough blood and, therefore, do not receive enough oxygen or food. The blood vessels, like the rest of the body, suffer from this lack and eventually lose their ability to constrict. When this happens, the vital organs and the brain do not receive enough blood, and the condition of shock becomes worse and worse. If this continues, the present damage becomes so extensive that recovery is impossible. In less severe cases, prompt first-aid treatment for shock may mean the difference between life and death. In mild cases of shock, recovery usually occurs naturally and rather quickly.

Basically, then, SHOCK is a condition in which the circulation of the blood is seriously disturbed. As we will see later, the measures used to combat shock are aimed at helping the body recover from this disturbance of the blood flow.

CAUSES OF SHOCK

Serious shock occurs as a result of severe injury to any part of the body.

- Crush injuries, fractures, burns, poisoning, and prolonged bleeding are very likely to cause serious shock.
- An interruption of breathing, from whatever cause, is usually followed by severe shock.
- Blast and concussion injuries, caused by pressure waves resulting from the detonation of high explosives in the air or underwater, may severely damage the internal organs of the body and cause extensive shock (as a matter of fact, signs of shock are sometimes the only outward indication of a blast or concussion injury).

As noted above, any damage to the body is accompanied by or followed by some degree of shock.

There are a number of factors that affect the seriousness of shock. Age, for example, is often a determining factor. Very young children and very old people do not usually have as much resistance to shock as young or middle-aged adults. Pain can produce shock or increase its severity. People who have been starved, deprived of water, or exposed to the extremes of cold or heat can go into shock very easily. Excessive fatigue can increase the severity of shock. In general, people who have any chronic illness are more likely to go into shock than healthy individuals. In addition to these factors, there are some unexplained differences between individuals in regard to their resistance to shock—an injury that might cause mild shock in one person could cause serious, perhaps fatal, shock in another.

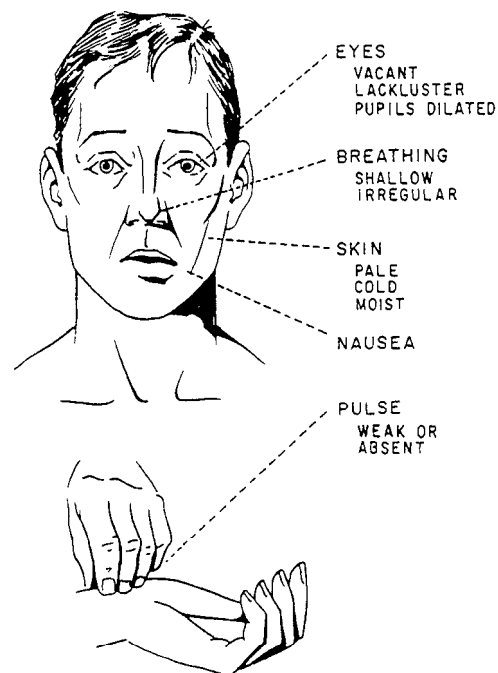

Figure 10-41.—Symptoms of shock.

There are many different causes and types of shock. It is not within the scope of this text to identify all of them here. You should remember, however, that shock is certain to accompany or follow a serious injury and is often the most serious consequence of the injury.

HOW TO RECOGNIZE SHOCK

A person who is going into shock may show quite a few signs or symptoms. Some of these are indicated in figure 10-41 and are discussed below. Remember, however, that the signs of shock do not always appear at the onset of the injury; in fact, in many very serious cases, the signs may not appear until hours later.

The symptoms shown by a person suffering from shock are, directly or indirectly, due to the fact that the circulation of the blood is disturbed.

- The pulse is weak and rapid.
- Breathing is likely to be shallow, rapid, and irregular, because poor circulation of the blood affects the breathing center in the brain.
- The face, arms, and legs feel cold to the touch. The temperature near the surface of the body is lowered because of the poor blood flow.
- Sweating is likely to be very noticeable.

- A person in shock is usually very pale; but in some cases, there may be a bluish or reddish color to the skin.

- The pupils of the eyes are usually dilated (enlarged).

When the victim is conscious, the additional symptoms of shock may be displayed. He may do the following:

- complain of thirst;
- have a feeling of weakness, faintness, or dizziness;
- feel nauseous; or
- be very restless and feel frightened and anxious.

As shock deepens, these signs gradually disappear and the victim becomes less and less responsive to what is going on around him. Even pain may not arouse him. Finally, the victim may become unconscious.

It is unlikely that you will see all of these symptoms of shock in any one case. Some of them appear only in the later stages of shock when the disturbance of the blood flow has become so great that the victim's life is in serious danger. Sometimes the signs of shock maybe disguised by other signs of injury. It is important to know what symptoms indicate the presence of shock, but do not ever wait for symptoms to develop before beginning treatment for shock Remember, **EVERY SERIOUSLY INJURED PERSON IS LIKELY TO DEVELOP SERIOUS SHOCK.**

PREVENTION AND TREATMENT OF SHOCK

In many emergency situations, the most helpful thing you can do for an injured person is to begin treatment for shock. When shock has not yet developed, the treatment may actually prevent its occurrence; if it has developed, you may be able to keep it from reaching a critical point. As we have seen, shock creates a vicious cycle; that is, the worse it is, the worse it becomes. It is extremely important that you begin treatment at the earliest opportunity.

It is important to keep the victim as calm as possible because excitement and fright affects his condition and may even bring on shock. Try to prevent the victim from seeing his injuries, and reassure him that he will receive proper care. Keep unnecessary persons away, as their conversation regarding the victim's injuries may increase his agitation.

Fluids

A person in shock is often thirsty. No particular harm will be done if you allow the victim to moisten his mouth and lips with cool water. But, in general, there is no need to give him anything to drink unless you are in a position whereby medical assistance will not be available for along period of time.

When medical care is not available, you should give the victim **SMALL AMOUNTS** of warm water, preferably mixed with 1 teaspoon of salt and 1/2 teaspoon of baking soda per quart or liter. This should only be done when he is conscious, able to swallow, and has not suffered internal injuries.

In the case of burns, an exception must be made to the rule of not giving a person liquids. A seriously burned person has an overwhelming need for fluids. It is, therefore, a permissible and even desirable part of first-aid treatment. Sweet tea, fruit juices, or sugar water may be given when the casualty is conscious and able to swallow, has no internal injuries, and vomiting is not a problem.

One final precaution must be given concerning the use of liquids: **NEVER GIVE ALCOHOL TO A PERSON IN SHOCK OR A PERSON WHO MAY GO INTO SHOCK.** Alcohol increases the blood supply to surface vessels, and it diminishes the blood supply to the brain and other vital organs.

Heat

Heat is important in the treatment of shock to the extent that the injured person's body heat must be conserved. Exposure to cold, with resulting loss of body heat, can cause shock to develop or to become worse. You must judge the amount of covering to use by considering the weather and the general circumstances of the accident. Often a light covering is enough to keep the casualty comfortable. Wet clothing should be removed and dry covering provided, even on a hot day. Use blankets or other dry material to conserve body heat. Under normal circumstances, artificial means of warming (for example, hot-water bottles, heated bricks, or heated sand) should not be used. Artificial heat can cause the loss of body fluids (by sweating), and it brings the blood close to the surface, thus defeating the body's own efforts to supply blood to the vital organs and to the brain. Also, the warming agent may burn the victim. **KEEP AN INJURED PERSON WARM ENOUGH FOR COMFORT, BUT DO NOT OVERHEAT HIM.**

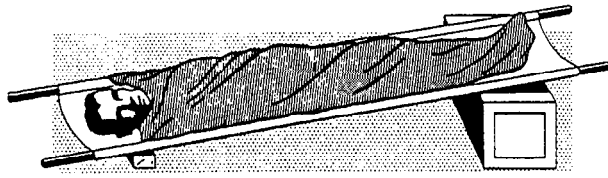

Figure 10-42.—Position for treatment of shock.

Position

The best position to use for the prevention or treatment of shock is one that encourages the flow of blood to the brain. When it is possible to place the injured person on his back on a bed, cot, or stretcher, you should raise the lower end of the support about 12 inches so his feet are higher than his head, as shown in figure 10-42. When the circumstances of the accident make it impossible to do this, you should still endeavor to raise his feet and legs enough to help the blood flow to his brain. Sometimes it is possible to take advantage of a natural slope of ground and place the casualty so his head is lower than his feet.

In every case, of course, you have to consider what type of injury is present before you can decide on the best position; for example, a person with a chest wound may have so much trouble breathing that you must raise his head slightly. When his face is flushed rather than pale or if you have any reason to suspect head injury, do not raise his feet. Rather, you should keep his head level with or slightly higher than his feet. When the person has broken bones, you will have to judge what position is best both for the fractures and for shock. A fractured spine must be immobilized before the victim is moved to avoid further injuries. When you are in doubt about the correct position to use, have the victim lie flat on his back. **THE BASIC POSITION FOR TREATING SHOCK IS ONE IN WHICH THE HEAD IS LOWER THAN THE FEET.** Do the best you can, under the particular circumstances, to get the injured person into this position. In any case, never let a seriously injured person sit, stand, or walk around.

MYTHS AND FACTS ABOUT PAIN

The following is a list of common myths and facts concerning pain:

MYTH: All extensive injuries are associated with severe pain and the more extensive the injury, the worse the pain.

FACT: Severe and even fatal injuries may be considerably less painful than a mashed fingertip, which can cause agony.

MYTH: With similar injuries, everyone experiences the same amount of pain.

FACT: Some feel pain far more severely than others. Also, those who would not be in much pain from a wound when they are rested, relaxed, and confident might experience severe pain from the same wound when exhausted, tense, and fearful.

MYTH: Only people in severe pain go into shock.

FACT: Persons in shock tend to feel less pain; however, pain, unless relieved, can cause or increase shock.

RELIEF OF PAIN

Relief of pain can often be accomplished without the use of drugs. Reassure the injured person and make him realize that his injuries are understood and that he will get the best possible care. He should also be informed of plans to get medical help or plans to move him to a place where medical assistance is available.

Pain can often be relieved by furnishing adequate support for an injury. Fractures of bones in which the surrounding tissue swells rapidly are extremely painful when left unsupported. Adequate immobilization of fractures not only relieves pain but prevents further tissue damage and shock. Needless suffering can often be eliminated by unlacing or slitting a shoe or loosening tight clothing in the region of the injury. Often a simple adjustment of a bandage or splint is of much benefit to the casualty, especially when accompanied by a few encouraging words.

HEAT EXPOSURE INJURIES

Excessive heat affects the body in a variety of ways. When a person exercises in a hot environment, heat builds up inside the body. The body automatically reacts to get rid of this heat through the sweating mechanism. When the body loses large amounts of water and salt from sweating, heat cramps and heat exhaustion are likely to follow. When the body becomes overheated and cannot eliminate the excessive heat, heatstroke will result.

HEAT CRAMPS

Heat cramps usually affect people who work in hot environments or who engage in strenuous exercise

without acclimatization and proper training. Excessive sweating may result in painful heat cramps in the muscles of the abdomen, legs, and arms. Heat cramps may also result from drinking ice water or other cold drinks either too quickly or in too large a quantity after exercise. Muscle cramps are often an early sign of approaching heat exhaustion. Muscle spasms or heat cramps usually last only a few minutes and disappear spontaneously.

TREATMENT. To provide first-aid treatment for heat cramps, move the person to a cool place. Since heat cramps are caused by loss of salt and water, give the victim plenty of water to drink adding about 1 teaspoon of salt to a quart of water. Apply manual pressure to the cramped muscle, or gently massage the muscle to relieve the spasm. In the event that the heat cramps do not pass or become more severe, other symptoms may follow and the victim should be treated as a heat exhaustion casualty and then transferred to a medical facility for treatment.

HEAT EXHAUSTION

Heat exhaustion is the most common condition resulting from exposure to hot environments. Heat exhaustion can be a combination of several entities and is, therefore, not an easy condition to diagnose. Because of different causes, for example, water depletion or salt depletion or a combination of both, the signs and symptoms vary.

As a general rule, heat exhaustion involves a serious disturbance of blood flow to the brain, heart, and lungs that may cause the victim to experience weakness, fatigue, headache, loss of appetite, and nausea. He may faint but will probably regain consciousness when his head is lowered to improve the blood supply to his brain. The victim appears ashen gray; his skin is cold, moist, and clammy; and the pupils of his eyes are dilated (enlarged). The vital signs are usually normal; however, the victim may have a weak pulse, together with rapid and shallow breathing. The body temperature may be below normal. Heat exhaustion is a complex malady and is often misdiagnosed, even by medical personnel. You, as a first-aider, should treat prolonged heat cramps and any heat injury that is obviously not heatstroke as heat exhaustion.

TREATMENT. Care for the victim as if he were in shock. Move the victim to a cool or air-conditioned area. Loosen clothing, applying cool wet cloths to the head, axilla, groin, and ankles, and fan the victim. Do not allow the victim to become chilled (if this does occur,

then cover the victim with a light blanket and move him into a warmer area). When the victim is conscious, give him a solution of 1 teaspoon of salt dissolved in a quart of cool water. If the victim vomits, do not give him any more fluids. Transport the victim to a medical facility as soon as possible.

HEATSTROKE

Sunstroke is more accurately called heatstroke since it is not necessary to be exposed to the sun for this condition to develop. It is a less common but far more serious condition than heat exhaustion since it carries a 20-percent mortality rate. The most important feature of heatstroke is the extremely high body temperature (105°F [41°C] or higher) that accompanies it. In heatstroke, the victim has a breakdown of his sweating mechanism and is unable to eliminate excessive body heat. When the body temperature rises too high, the brain, kidneys, and liver may be permanently damaged.

Sometimes the victim may have preliminary symptoms, such as headache, nausea, dizziness, or weakness. Breathing is deep and rapid at first; later, it is shallow and almost absent. Usually the victim is flushed, very dry, and very hot. His pupils are constricted (pinpointed) and the pulse is fast and strong. See figure 10-43 for a comparison of these symptoms with those of heat exhaustion.

TREATMENT. When providing first aid for heatstroke, keep in mind that this is a true life and death emergency. The longer the victim remains overheated, the more likely he is to suffer irreversible body damage.

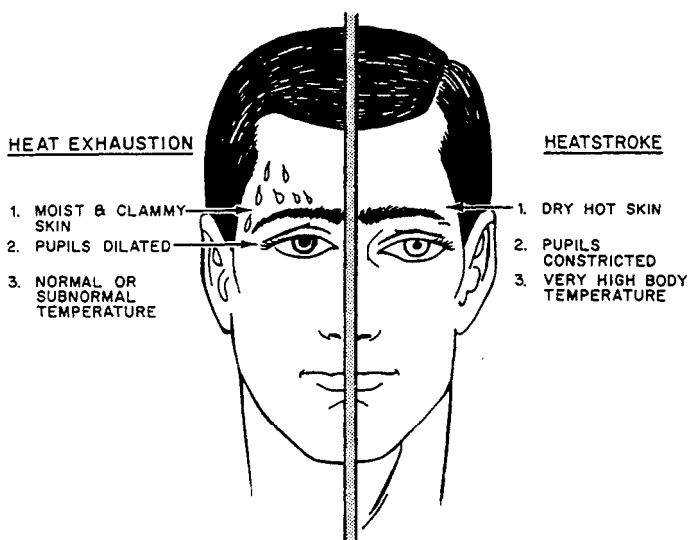

Figure 10-43.—Symptoms of heatstroke and heat exhaustion.

or death. The main objective of first aid is to get the body temperature down as quickly as possible.

Move the victim to the coolest possible place, and remove as much clothing as possible. Body heat can be reduced quickly by immersing the victim in a cold-water bath. When a cold-water bath is not possible, give the victim a sponge bath by applying wet, cold towels to the whole body. Exposing the victim to a fan or air conditioner also promotes body cooling. When cold packs are available, place them under his arms, around his neck at his ankles, and in his groin. When the victim is conscious, give him cool water to drink Do NOT give him hot drinks or stimulants.

Because of the seriousness of heatstroke, it is important to get the victim to a medical facility as soon as possible. Cooling measures must be continued during transportation.

COLD WEATHER INJURIES

When the body is subjected to severely cold temperatures, blood vessels constrict and body heat is gradually lost. As the body temperature drops, tissues are easily damaged or destroyed.

All cold injuries are similar, varying only in degree of tissue injury. The extent of injury depends on such factors as wind speed, temperature, type and duration of exposure, and humidity. Tissue freezing is accelerated by wind, humidity, or a combination of the two. Injury caused by cold, dry air is less than that caused by cold, moist air, or exposure to cold air while you are wearing wet clothing. Fatigue, smoking, drugs, alcoholic beverages, emotional stress, dehydration, and the presence of other injuries intensify the harmful effects of cold.

You should also know that in cold weather, wounds bleed easily because the low temperatures keep the blood from clotting and increased bleeding, of course, increases the likelihood of shock. Also, wounds that are open to the cold weather freeze quickly. The body loses heat in the areas around the injury, as blood soaks the skin around the wound, and clothing is usually torn. Therefore, early first-aid treatment becomes even more important during periods of low temperatures.

GENERAL COOLING (HYPOTHERMIA)

General cooling of the entire body is caused by continued exposure to low or rapidly dropping temperatures, cold moisture, snow, or ice. Those persons exposed to low temperatures for extended periods may

suffer ill effects, even if they are well protected by clothing, because cold affects the body system slowly, almost without notice. As the body temperature drops, there are several stages of progressive discomfort and disability. The first symptom is shivering, which is an attempt by the body to generate heat. This is followed by a feeling of listlessness, drowsiness, and confusion. Unconsciousness may follow quickly. You will have already noted signs of shock. As the temperature drops even lower, the extremities (arms and legs) freeze. Finally, death results.

TREATMENT. Hypothermia is a **MEDICAL EMERGENCY. THE VICTIM NEEDS HEAT.** Rewarm the victim as soon as possible. It may be necessary, however, to treat other injuries before the victim can be moved to a warmer place. Severe bleeding must be controlled and fractures splinted over clothing before the victim is moved.

When the victim is inside a warm place and is conscious, the most effective method of warming him is immersion in a tub of warm water (100°F to 105°F [38°C to 41°C]) or warm to the elbow-never hot). When a tub is not available, apply external heat to both sides of the victim, using covered hot-water bottles or, if necessary, any sort of improvised heating pads. Do not place artificial heat next to bare skin. When immersion is used, only the body, not the limbs, should be immersed. Immersion of the arms and legs causes cold blood to flow from them to the body core, causing further detrimental cooling of the core. Dry the victim thoroughly when water is used to rewarm him. The most frequently recommended field treatment is "buddy warming." Since the victim is unable to generate body heat, merely placing him under a blanket or in a sleeping bag is not sufficient. For best results, the nude victim should be placed in a sleeping bag with two volunteers stripped to their shorts to provide body-to-body heat transfer. This technique can be used by untrained personnel in a tent in the field and **WILL SAVE LIVES!!!**

When the victim is conscious, give him warm liquids to drink, Hot tea with lots of sugar is particularly good. No alcoholic beverages, please.

As soon as possible, transfer the victim to a medical facility, keeping him warm in route. Be alert for signs of respiratory failure and cardiac arrest during transfer.

IMMERSION FOOT (TRENCH FOOT)

Immersion foot, which may also occur in the hands, is a cold injury resulting from prolonged exposure to

wet, cold temperatures just above freezing. It is often associated with limited motion of the extremities and water-soaked clothing. Remember that the temperature does not need to be below 32°F (0°C) to cause this injury.

In the early stages, the feet and toes are pale and feel cold, numb, and stiff. Walking becomes difficult. When preventive action is not taken, the feet swell and become painful. In extreme cases, the flesh dies and amputation of a foot or of a leg maybe necessary.

TREATMENT. In treating immersion feet (or hands), handle the injured parts very gently. They should not be rubbed or massaged.

Get the victim off his feet as soon as possible. Remove wet shoes, socks, and gloves to improve circulation. Do not rupture blisters or apply salves or ointments. The feet may be cleansed carefully with soap and water, dried, elevated, and exposed to dry air. Keep the victim warm and transport him to a medical facility as soon as possible. Always evacuate immersion foot victims by litter.

FROSTBITE

Frostbite occurs when ice crystals form in the skin or deeper tissues after exposure to temperatures of 32°F (0°C) or lower. Depending upon temperature, altitude, and wind speed, the exposure time necessary to produce frostbite varies from a few minutes to several hours. The areas most commonly affected are the face and extremities.

The symptoms of frostbite are progressive. Victims generally incur this injury without being acutely aware of it. Initially, the affected skin reddens, and there is an uncomfortable coldness. With continued heat loss, there is a numbness of the affected area because of reduced circulation. As ice crystals form, the frozen extremity appears white, yellow-white, or mottled blue-white, and it is cold, hard, and insensitive to touch or pressure.

Frostbite is classified as superficial or deep, depending on the extent of tissue involvement.

Superficial Frostbite

In superficial frostbite, the surface of the skin feels hard, but the underlying tissue is soft, allowing it to move over bony ridges. This is evidence that only the skin and the region just below it are involved.

TREATMENT. A minor case of superficial frostbite is fairly common and serves as a warning. Superficial

frostbite can usually be thawed with body heat. Hands can be rewarmed by placing them under the armpit, against the abdomen, or between the thighs. Feet can be rewarmed by using armpit or abdomen of a buddy. Other areas of superficial frostbite can be rewarmed by warmwater immersion, skin to skin contact, or covered hot-water bottles. NEVER RUB a frostbitten area.

Deep Frostbite

In deep frostbite, the freezing reaches into the deep tissue layers. There are ice crystals in the entire thickness of the extremity. The skin does not move over the bony ridges and feels hard and solid.

TREATMENT. The objectives of treatment are to protect the frozen area from further injury, to thaw the affected area rapidly, and to be prepared to respond to circulatory or respiratory difficulties.

Carefully assess and treat other injuries first. Constantly monitor the pulse and breathing of the victim since respiratory and heart problems can develop rapidly. Be ready to administer CPR.

Make no attempt to thaw the frostbitten area when there is a possibility of refreezing. Freeze-thaw-freeze will result in extension of the injury and may result in amputation.

Treat all victims with injuries to feet or legs as litter cases. When this is not possible, it has been proven that walking does not lessen the chances of successful treatment as long as the limb has not been thawed out.

When adequate protection from further cold exposure is available, prepare the victim for rewarming by removing all constricting items of clothing, such as gloves, boots, and socks. Boots and clothing frozen on the body should be thawed by immersing them in warm water before removal.

Rapidly rewarm frozen areas by immersion in water at 100°F to 105°F (38°C to 41°C). Keep the water warm by adding fresh hot water, but do not pour it directly on the injured area. Ensure that the frozen area is completely surrounded by water; do not let it rest on the side or bottom of the tub. After rewarming has been completed, pat the area dry with a soft towel. Avoid pressure, rubbing, or constriction of the injured area. Keep the skin dry with sterile dressings, and place cotton between the toes and fingers to avoid their sticking together.

The general morale and comfort of the victim may improve by giving him hot, stimulating fluids, such as tea or coffee. Do not allow the victim to smoke or use

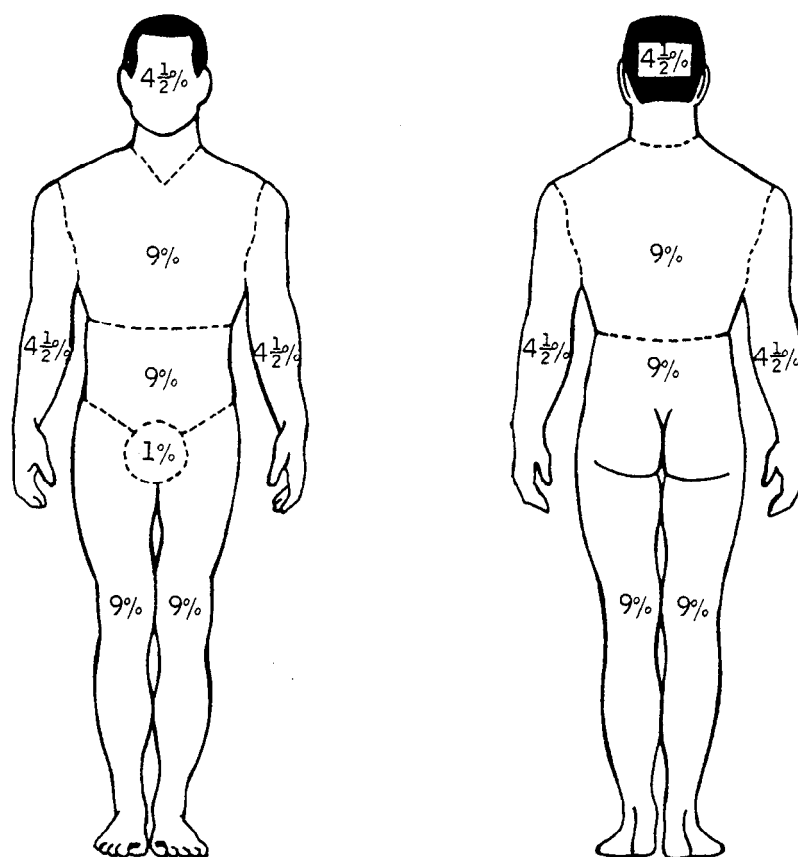

Figure 10-44.—Rule of nines.

alcoholic beverages while he is being treated at the first-aid level.

NEVER attempt to thaw frozen limbs by rubbing, exercising, or heating them in front of an open fire.

Transport the victim to a medical facility as soon as possible. During transportation, slightly elevate the frostbitten area and keep the victim and the injured area warm. DO NOT ALLOW THE INJURED AREA TO BE EXPOSED TO THE COLD.

BURNS AND SCALDS

Burns and scalds are caused by exposure to intense heat, such as that generated by fire, bomb flash, sunlight, hot liquids, hot solids, and hot gases. Contact with electric current also causes burns, especially when the skin is dry. Dry skin offers about 20 times more resistance than moist skin to the passage of electric current. Therefore, when the skin is dry, the local heating effects (burns) are greater, even though the total damage to the body is less than when the skin is wet.

Note that burns and scalds are essentially the same type of heat injury. When the injury is caused by dry heat, it is called a burn; when caused by moist heat, it is called a scald. Treatment is the same in both cases.

CLASSIFICATION OF BURNS. Burns are classified in several ways: by the extent of the burned surface, by the depth of the burn, and by the cause of the burn. Of these, the extent of body surface burned is the most important factor in determining the seriousness of the burn, and it plays the greatest role in the casualty's chances for survival.

In calculating the extent of burned surface, the **RULE OF NINES** is used, which is shown in figure 10-44. These figures aid in determining the correct treatment for a burned person. Shock can be expected in adults with burns over 15 percent or in small children with burns over 10 percent of the body surface area. In adults, burns involving more than 20 percent of the body surface endanger life, and 30-percent burns are usually fatal if adequate medical treatment is not received.

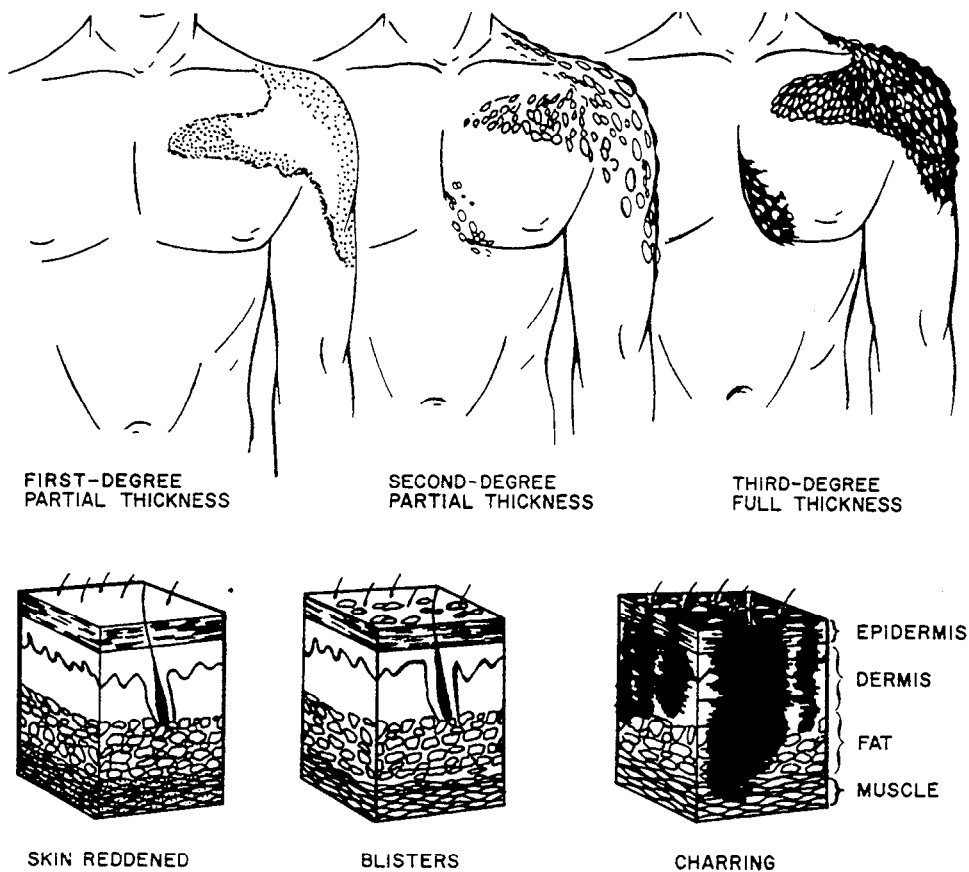

Figure 10-45.—First-, second-, and third-degree burns.

The depth of injury to the tissues is spoken of in degrees.

1. **FIRST-DEGREE** burns are the mildest. These produce redness, increased warmth, tenderness, and mild pain.

2. **SECOND-DEGREE** burns redden and blister the skin. They are characterized by severe pain.

3. **THIRD-DEGREE** burns destroy the skin. They can destroy muscle tissue and bone in severe cases.

Severe pain may be absent because nerve endings have been destroyed. The color may vary from white and lifeless (scalds) to black (charred from gasoline explosions). Figure 10-45 shows the appearance of first-, second-, and third-degree burns.

It is important to remember that the size of the burned area may be far more important than the depth of the burn. A first-degree or second-degree burn that covers a large area of the body is usually more serious than a small, third-degree burn. A first-degree sunburn, for example, can cause death when a large area of the body is burned.

The causes of burns are generally classified as thermal (heat), chemical, electrical, and radiation (as discussed in chap. 9). Another type of burn (white phosphorous) is also discussed in this chapter. Whatever the cause, shock always results when the burns are extensive.

THERMAL BURNS

Thermal burns are caused by exposure to intensely hot solids, liquids, or gases. Their care depends upon the severity of the burn and the percentage of the body area involved.

TREATMENT. Minor burns, such as first-degree burns over less than 20 percent of the body area and small second-degree burns, do not usually require immediate medical treatment. Burns of the face are the exception to this rule. The following are general rules for treating burn victims:

1. Examine for and relieve respiratory distress. Always anticipate respiratory difficulty when there are burns around the face or when the victim has been exposed to hot gases or smoke, since these may cause

the airway to swell shut. Keep the airway open by tilting the chin up and forward, or if necessary, by holding the tongue down with a flat object. Place the victim with facial burns in a sitting position, as this will further ease his breathing. Transport victims with facial burns to a medical facility as soon as possible for further evaluation.

2. Remove all rings, bracelets, and similar articles, even from unburned areas, since swelling may develop rapidly and be severe.

3. To relieve pain initially, apply cold compresses to the affected area or submerge it in cold water. Cold water not only minimizes pain but also reduces the burning effects in the deep layers of the skin. Gently pat dry the area with a lint-free cloth or gauze. Aspirin is also effective for the relief of pain.

4. Cover the burned area with a sterile dressing, clean sheet, or unused plastic bag. When the hands and feet are involved, dressings must be applied between the fingers and toes to prevent the skin surfaces from sticking to one another. Coverings, such as blankets or other materials with a rough texture, should not be used because lint may contaminate and further irritate the injured tissue.

5. Do not attempt to break blisters, and do not remove shreds of tissue or adhered particles of charred clothing. Never apply greasy substances (butter, lard, or petroleum jelly), antiseptic preparations, or ointments. These may cause further complications and interfere with later treatment by a physician.

6. When the victim is conscious and not vomiting, prepare a weak solution of salt (1 teaspoon) and baking soda (1/2 teaspoon) in a quart of warm water. Allow the victim to sip the drink slowly.

7. Treat for shock. Maintain the victim's body heat, but do not allow him to become overheated.

8. When the victim's hands, feet, or legs are affected, they should be elevated higher than the heart.

9. When a burn victim must be transported to a medical facility, try to contact the facility before he arrives to allow the facility time to prepare for immediate treatment. Inform them of the degree of the burn, the location, and the percentage of the body area involved.

CHEMICAL BURNS

When acids, alkalies, or other chemicals come in contact with the skin or other body membranes, they can

cause injuries that are generally referred to as chemical burns. For the most part, these injuries are not caused by heat, but by direct chemical destruction of body tissues. The areas most often affected are the extremities, mouth, and eyes. Alkali burns are usually more serious than acid burns for alkalies penetrate deeper and burn longer.

TREATMENT. When such burns occur on board a ship or in the shop, emergency measures must be carried out immediately, without waiting for the arrival of medical personnel. The following procedures should be followed when you are treating chemical burns:

1. Begin flushing the area immediately with large amounts of water, using a shower or hose, when available. Do not apply water too forcefully. Continue to flood the area while his clothing, including shoes and socks, is being removed, as well as afterwards.

NOTE: There are two exceptions to the above treatment: they are alkali burns and acid burns. For alkali burns caused by dry lime, the mixing of water and lime creates a very corrosive substance. Dry lime should be brushed from the skin and clothing, unless large amounts of water are available for rapid and complete flushing. For acid burns caused by phenol (carbolic acid), wash the affected area with alcohol because phenol is not water soluble. Then wash with water. When alcohol is not available, flushing with water is better than no treatment at all.

2. After thorough washing, neutralize the chemicals that remain on the affected area.

WARNING

Do not attempt to neutralize a chemical unless you are exactly sure what it is and what substance can effectively neutralize it. Further damage may be done by a neutralizing agent that is too strong or incorrect. For acid burns, mix a solution of 1 teaspoon of baking soda in a pint of water and flush it over the affected area.

3. Flush the area again with water and gently pat it dry with sterile gauze. Do not rub the area.

4. Transport the victim to a medical facility.

CHEMICAL BURNS OF THE EYE. Flush the eye immediately with large amounts of fresh, clean water. Acid burns should be flushed at least 5 minutes, and alkali burns flushed for as long as 20 minutes. Because of the intense pain, the victim maybe unable to open his eyes. When this occurs, hold the eyelids apart so water can flow across the eyes.

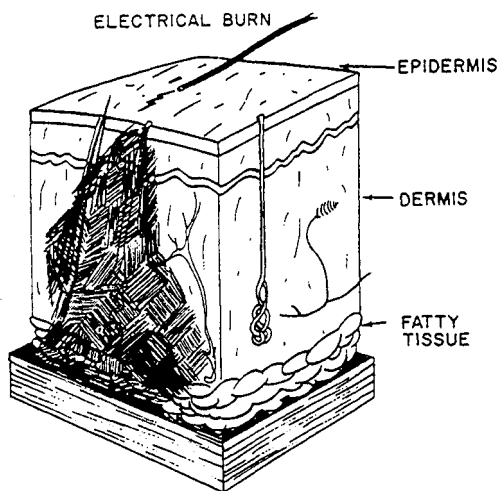

Figure 10-46.—Electrical penetration of the skin.

A drinking fountain maybe used to supply a steady stream of water. Hold the victim's head in a position that allows water to flow from the inside corner of the eye toward the outside. Do not allow the water to fall directly on the eye, nor use greater force than is necessary to keep the water flowing across the eye.

CAUTION

Never use chemical antidotes, such as vinegar, baking soda, or alcohol, in treating burns of the eye.

After thorough irrigation, loosely cover both eyes with a clean dressing.

The aftercare for all chemical burns is similar to that for thermal burns; cover the affected area and get the victim to a medical facility at once.

ELECTRICAL BURNS

Electrical burns are more serious than they first appear. The entrance wound may be small, but as electricity penetrates the skin, it burns a large area below the surface, as shown in figure 10-46. Usually there are two external burn areas: one where the current enters the body and another where it leaves.

Before administering first aid, remove the victim from the electrical source. When power equipment is involved, shut it off or disconnect it immediately. If the victim is in an automobile accident and a live wire is lying on the car, pull the wire from the car, using a nonconducting dry rope or similar object. Stay away from the severed end of the power line, because it can jump.

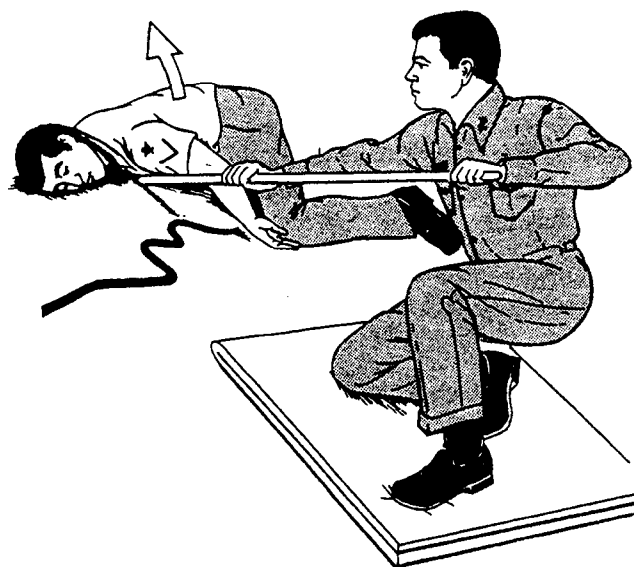

Figure 10-47.—Pushing a victim away from a power line.

When rescuing a victim who has come into direct contact with a power line, stand on a well-insulated object, and use a dry rope or a wooden pole to either push or pull the wire away from the victim or the victim away from the wire. (See fig. 10-47.) Do not touch the victim until this is done or you, too, may become a casualty.

Electrical burns are often accompanied by respiratory failure and cardiac arrest, which are of more immediate danger to the victim than the burn itself. Start CPR immediately and continue until the victim regains a normal heartbeat and breathing pattern. Finally, lightly cover the site of the burn with a dry, preferably sterile dressing, treat for shock and transport the victim to a medical facility.

WHITE PHOSPHOROUS BURNS

A special category of burns, which may affect military personnel in either a wartime or training situation, is that caused by exposure to white phosphorous (WP or 'Willie Peter'). First aid for this type of burn is complicated by the fact that white phosphorous particles ignite upon contact with air.

TREATMENT. Superficial burns caused by simple skin contact or burning clothes can be flushed with water and treated like thermal burns. Partially embedded white phosphorous particles must be continuously flushed with water while the first-aider removes them with whatever tools are available, such as tweezers and needle-nose pliers. Do this quickly but gently. Firmly or deeply embedded particles that cannot be removed by

the first-aider must be covered with a saline-soaked dressing, which must be kept wet until the victim reaches medical personnel. When rescuing victims from a closed space where white phosphorous is burning, protect your lungs with a wet cloth over your nose and mouth.

FRACTURES

Many kinds of accidents cause injuries to the bones, joints, and muscles. In providing first aid to an injured person, you must always look for signs of fractures (broken bones), dislocations, sprains, strains, and contusions (bruises).

An essential part of the first-aid treatment for fractures consists of immobilizing the injured part with splints so the sharp ends of broken bones do not move around and cause further damage to the nerves, blood vessels, or vital organs. Splints are also used to immobilize severely injured joints or muscles and to prevent the enlargement of extensive wounds. You must have a general understanding of the use of splints before going onto learn detailed first-aid treatment for injuries to the bones, joints, and muscles.

USE OF SPLINTS

In an emergency almost any firm object or material will serve as a splint. Thus umbrellas, canes, swords, rifles, tent pegs, laths, sticks, oars, paddles, spars, wire, leather, boards, pillows, heavy clothing, corrugated cardboard, and folded newspaper may be used as splints. A fractured leg may sometimes be splinted by fastening it securely to the uninjured leg.

Splints, whether ready-made or improvised, must fulfill certain requirements. They should be lightweight, strong, fairly rigid, and long enough to reach the joints above and below the fracture. Splints should be wide enough so the bandages used to hold them in place do not pinch the injured part. Splints must be well padded on the sides touching the body. If they are not properly padded, they do not fit well and will not adequately immobilize the injured part. When you have to improvise the padding for a splint, you may use articles of clothing, bandages, cotton, blankets, or other soft material. When the victim is wearing heavy clothes, you may be able to apply the splint on the outside, thus allowing clothing to serve as part of the required padding.

To apply splints to an injured limb, fasten them in place with bandages, strips of adhesive tape, articles of clothing, or other available material. Whenever

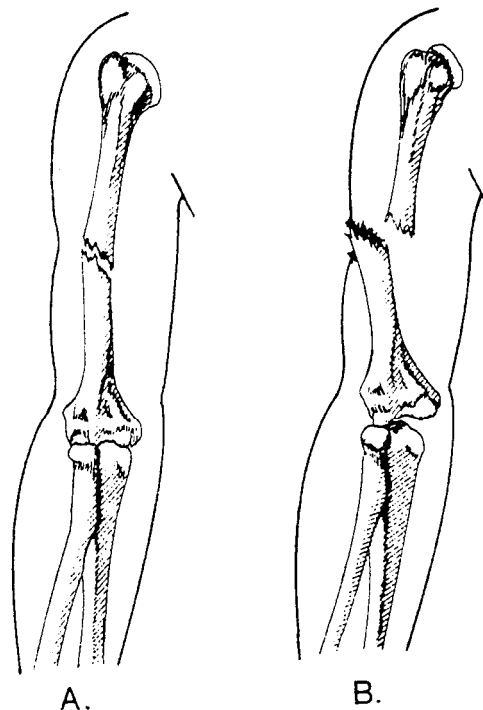

Figure 10-48.—Types of fractures.

possible, one person should hold the splints in position while another person fastens them.

Although splints should be applied snugly, they should NEVER be so tight as to interfere with the circulation of blood. When you are applying splints to an arm or leg, try to leave the fingers or toes exposed. If the tips of the fingers or toes become blue or cold, you will know that the splints or bandages are too tight. You should examine a splinted limb approximately every half hour, and loosen the fastening when the circulation appears to be impaired. Remember that an injured limb is likely to swell, and splints or bandages that are applied correctly may later become too tight.

INJURIES TO BONES

A break in a bone is called a FRACTURE. There are two main types of fractures. A CLOSED FRACTURE is one in which the injury is entirely internal; that is, the bone is broken but there is no break in the skin. An OPEN FRACTURE is one in which there is an open wound in the tissues and skin. This type of break and wound is also referred to as a compound fracture. Sometimes the open wound is made when a sharp end of the broken bone pushes out through the flesh; sometimes it is made by an object, such as a bullet, that penetrates from the outside. Figure 10-48 shows closed and open fractures.

Open fractures are far more serious than closed fractures. They usually involve extensive tissue damage and are likely to become infected. Closed fractures are sometimes converted into open fractures by rough or careless handling of the victim. Therefore, **ALWAYS USE EXTREME CARE AND CAUTION WHEN TREATING A SUSPECTED FRACTURE.**

It is not always easy to recognize a fracture. All fractures, whether closed or open, are likely to cause severe pain or shock but other symptoms may vary considerably. A broken bone sometimes causes the injured part to become deformed or to assume an unnatural position; however, this is not always the case. Pain and swelling may be localized at the fracture site, and there may be a wobbly movement if the bone is broken clear through. It maybe difficult or impossible for the victim to move the injured part. When movement is possible, the victim may feel a grating sensation as the ends of the broken bone rub against each other. However, when a bone is cracked rather than broken through, the victim may be able to move the injured part without much difficulty. An open fracture is easy to recognize if an end of the broken bone protrudes through the flesh. When the bone does not protrude, you might see the external wound but fail to recognize the broken bone.

When you are required to give first aid to a person who has suffered a fracture, follow these general rules:

1. When there is any possibility that a fracture has been sustained, treat the injury as a fracture.
2. Get the victim to a medical facility at the first opportunity. All fractures require medical treatment.
3. Do not move the victim until the injured part has been splinted, unless you must move out of a life-threatening environment to prevent further injury.
4. Treat for shock.
5. Do not attempt to locate a fracture by grating the ends of the bone together.
6. Do not attempt to set a broken bone.
7. When a long bone in the armor leg is fractured, the limb should be carefully straightened so splints can be applied. Never attempt to straighten the limb by applying force or traction. Pulling gently with your hands in the direction of the long axis of the limb is permissible and may be all that is necessary to get the limb back into position.
8. Apply splints. When the victim must be transported for some distance or when a considerable

period of time will elapse before treatment by a medical officer, it maybe better to remove enough of the victim's clothing so you can apply well-padded splints directly to the injured part. However, when the victim is to be transported only a short distance or when treatment by a medical officer will not be delayed, it is probably best to leave the clothing on and apply emergency splinting over it. If you decide to remove the clothing over the injured part, extreme care must be taken. Cut away the clothing or rip it along the seams. Remember, rough handling of the victim may convert a closed fracture into an open fracture, increase the severity of shock and cause extensive damage to the blood vessels, nerves, muscles, and other tissues around the broken bone.

9. When the fracture is open, you must take care of the wound before you can treat the fracture. Bleeding from the wound may be quite serious; however, most bleeding can be stopped by applying direct pressure on the wound or by applying digital pressure at the appropriate pressure point. When these methods are not successful, use a tourniquet. Then treat the fracture.

We have now completed the general rules for treating fractures. The symptoms and emergency treatment for fractures for the forearm, upper arm, thigh, lower leg, kneecap, collarbone, rib, nose, jaw, skull, spine, and pelvis are also discussed in this chapter.

FRACTURE OF THE FOREARM

There are two large bones in the forearm. When both are broken, the arm usually appears to be deformed. When only one bone is broken, the other acts as a splint and the arm, therefore, retains a more or less natural appearance. Any fracture of the forearm is likely to result in pain, tenderness, an inability to use the forearm, and a wobbly motion at the point of injury. When the fracture is open, there is an open wound through which the bone may show.

TREATMENT. When the fracture is open, stop the bleeding and treat the wound. Apply a sterile dressing over the wound.

Carefully straighten the forearm. (Remember that rough handling of a closed fracture may convert it into an open fracture.)

Apply two well-padded splints to the forearm, one on the top (backhand side) and one on the bottom (palm side). Make sure the splints are long enough to extend from the elbow to the wrist. Use bandages to hold the splints in place.



Figure 10-49.—Sling used to support a fractured forearm.

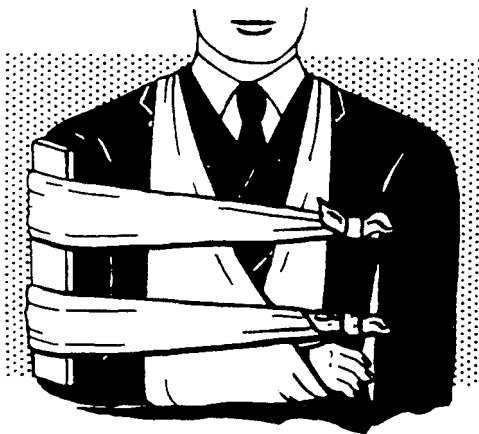

Figure 10-50.—Splint and sling for a fractured upper arm.

Put the forearm across the chest. The palm of the hand should be turned in, with the thumb pointing upward. Support the forearm in this position by means of a wide sling, as shown in figure 10-49. The hand should be raised about 4 inches above the heel of the elbow.

As in all cases of fracture, treat the victim for shock, and obtain medical care as soon as possible.

FRACTURE OF THE UPPER ARM

The signs of fracture in the upper arm include pain, tenderness, swelling, and a wobbly motion at the point of fracture. When the fracture is near the elbow, the arm is likely to be straight, with no bend at the elbow.

TREATMENT. When the fracture is open, stop the bleeding and treat the wound before attempting to treat the fracture. Treatment of the fracture depends partly upon the location of the break; that is, whether the

fracture is in the upper part of the arm, in the middle of the upper arm, or near the elbow.

When the fracture is in the upper part of the arm, near the shoulder, place a pad or folded towel in the armpit, bandage the arm securely to the body, and support the forearm in a narrow sling.

When the fracture is in the middle of the upper arm, you may use one well-padded splint on the outside of the arm. The splint should extend from the shoulder to the elbow. Fasten the splinted arm firmly to the body, and support the forearm in a narrow sling, as shown in figure 10-50.

Another method of treating a fracture in the middle of the upper arm is to fasten two wide splints, or four narrow ones, around the arm, and support the forearm in a narrow sling. If you use a splint between the arm and the body, ensure it does not extend too far up into the armpit. A splint in this position can cause a dangerous compression of the blood vessels and nerves and may be extremely painful to the victim.

When the fracture is at or near the elbow, the arm may be either bent or straight. No matter what position you find the arm in, **DO NOT ATTEMPT TO STRAIGHTEN IT OR MOVE IT IN ANY WAY.** As carefully as possible, splint the arm in the position in which you find it.

Treat the victim for shock and obtain medical care as soon as possible.

FRACTURE OF THE THIGH

The thighbone is the long bone in the upper part of the leg, between the kneecap and the pelvis. When the thighbone is fractured, any attempt to move the limb results in a spasm of the muscles and causes excruciating pain. The leg has a wobbly motion, and there is complete loss of control below the fracture. The limb usually assumes an unnatural position, with the toes pointing outward. The fractured leg is shorter than the uninjured one, by actual measurement, because of the pull of the powerful thigh muscles. Serious damage to the blood vessels and nerves often results from a fracture of the thighbone. Shock is likely to be severe.

TREATMENT. When the fracture is open, stop the bleeding and treat the wound before attempting to treat the fracture itself. Serious bleeding is a special danger in this type of injury, since the broken bone may tear or cut the large artery in the thigh.

Carefully straighten the leg. Apply two splints: one on the outside of the injured leg and one on the inside.

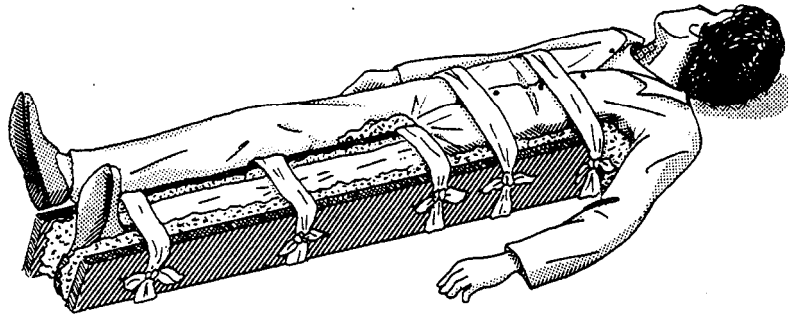

Figure 10-51.—Boards used as emergency splints for fractured thigh.

The outside splint should reach from the armpit to the foot. Make sure the inside splint reaches from the crotch to the foot. The splints should be fastened in five places: (1) around the ankle, (2) over the knee, (3) just below the hip, (4) around the pelvis, and (5) just below the armpit. Both legs should be tied together to support the injured leg as firmly as possible.

It is essential that a fractured thigh be splinted before the victim is moved. Ready-made splints are best, but improvised splints may be used. Figure 10-51 shows how boards may be used as an emergency splint for a fractured thigh. Remember, **DO NOT MOVE THE VICTIM UNTIL THE INJURED LEG HAS BEEN IMMOBILIZED.**

Treat the victim for shock and obtain medical care as soon as possible.

FRACTURE OF THE LOWER LEG

When both bones of the lower leg are broken, the usual signs of fracture are likely to be present. When only one bone is broken, the other one acts as a splint and, thus to some extent, prevents deformity of the leg; however, tenderness, swelling, and pain at the point of fracture are usually present. A fracture just above the ankle is often mistaken for a sprain. When both bones of the lower leg are broken, an open fracture is likely to result.

TREATMENT. When the fracture is open, stop the bleeding and treat the wound.

Carefully straighten the injured leg. Apply three splints: one on each side of the leg and one underneath. Ensure the splints are well padded, especially under the knee and at the bones on each side of the ankle.

A pillow and two side splints work well for treatment of a fractured lower leg. Place the pillow beside the injured leg; then carefully lift the leg and place it in the middle of the pillow. Bring the edges of

the pillow around to the front of the leg and pin them together. Then place one splint on each side of the leg, over the pillow, and fasten them in place with strips of bandage or adhesive tape.

Treat the victim for shock and obtain medical care as soon as possible.

FRACTURE OF THE KNEECAP

TREATMENT. The first-aid treatment for a fractured kneecap is as follows:

Carefully straighten the injured limb. Immobilize the fracture by placing a padded board under the injured limb. The board should be at least 4 inches wide and should reach from the buttock to the heel. Place extra padding under the knee and just above the heel, as shown in figure 10-52. Use strips of bandage to fasten the leg to the board in four places: (1) just below the knee, (2) just above the knee, (3) at the ankle, and (4) at the thigh. **DO NOT COVER THE KNEE ITSELF.** Swelling is likely to occur rapidly, and any bandage or tie fastened over the knee would quickly become too tight.

Treat the victim for shock, and obtain medical care as soon as possible.

FRACTURE OF THE COLLARBONE

A person with a fractured collarbone usually shows definitive symptoms. When the victim stands, the

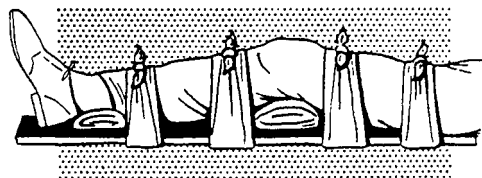

Figure 10-52.—Immobilization of fractured kneecap.

injured shoulder is lower than the uninjured one. Usually the victim is unable to raise his arm above the level of his shoulder. The injured person may attempt to support the injured shoulder by holding the elbow of that side in his other hand; that is, in fact, a characteristic position assumed by a person with a broken collarbone. Since the collarbone lies near the surface of the skin, you may be able to detect the point of fracture by the deformity and localized pain and tenderness.

TREATMENT. When the fracture is open, stop the flow of blood and treat the wound before attempting to treat the fracture. You must bend the victim's arm on his injured side and place his forearm across the chest. The palm of his hand should be turned in, with the thumb pointing up. His hand should be raised about 4 inches above the level of his elbow. Support his forearm in this position by means of a wide sling.

Next, use a wide roller bandage (or any wide strip of cloth) to fasten the victim's arm to his body. Wrap the bandage several times around his body, and ensure it goes down over the hand so the arm is held close against his body.

Treat the victim for shock and obtain medical care as soon as possible.

FRACTURE OF THE RIB

When the ribs are broken, the victim should be kept comfortable and quiet so the greatest danger—the possibility of further damage to the lungs, heart, or chest wall by the broken ends—is minimized.

The common finding in all victims with fractured ribs is pain localized at the fracture site. By asking the patient to point out the exact area of pain, you can often determine the location of the injury. There may not be a rib deformity or chest wall contusion or laceration of the area. Deep breathing, coughing, or movement is usually painful. The patient generally wishes to remain still and may often lean toward the injured side, with one hand over the fractured area to immobilize the chest and to ease his pain.

TREATMENT. In general, rib fractures are not bound, strapped, or taped when the victim is reasonably comfortable; however, they may be splinted by the use of external support. If the patient is considerably more comfortable with his chest immobilized, the best method is to use a swathe bandage (fig. 10-53) in which the arm on his injured side is strapped to his chest with the palm flat, the thumb up, and with the forearm raised to a 45-degree angle. Immobilize his chest, using wide

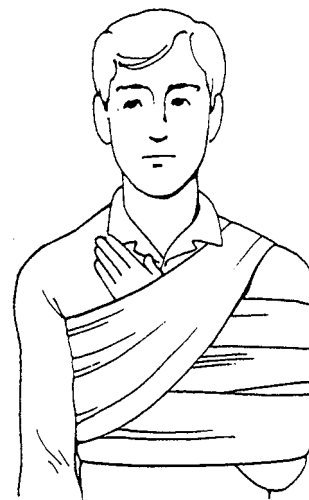

Figure 10-53.—Swathe bandaging of fractured rib victim.

strips of bandage to secure the arm to his chest. Wide strips of adhesive plaster applied directly to the skin of his chest for immobilization should not be used, since the adhesive tends to limit the ability of his chest to expand and thus interferes with proper breathing.

Treat the victim for shock, and obtain medical care as soon as possible.

FRACTURE OF THE NOSE

A fracture of the nose usually causes localized pain and swelling, a noticeable deformity of the nose, and extensive nosebleed.

TREATMENT. First, stop the nosebleed. Have the victim sit quietly, with his head tipped slightly backward. Instruct the patient to breathe through his mouth, not his nose. If the bleeding does not stop within a few minutes, apply a cold compressor ice bag over his nose.

Treat the victim for shock and obtain medical care as soon as possible. A permanent deformity of the nose may result if the fracture is not treated promptly.

FRACTURE OF THE JAW

A person with a fractured jaw may suffer serious interference with breathing. The victim is likely to have great difficulty in talking, chewing, or swallowing. Any movement of the jaw causes pain. The teeth may be out of line, and there may be bleeding from the gums. Considerable swelling may develop.

TREATMENT. One of the most important phases of emergency care is to clear the upper respiratory

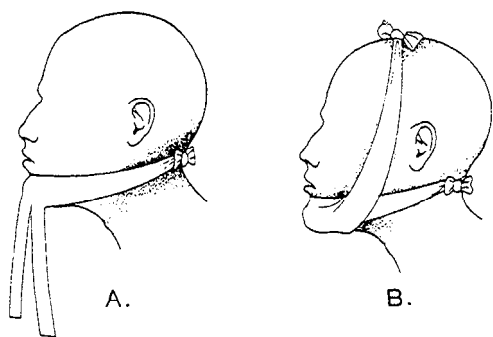

Figure 10-54.—Four-tailed bandage for a fractured jaw.

passage of any obstruction. When the fractured jaw interferes with breathing, pull his lower jaw and tongue FORWARD and keep them in that position.

Apply a four-tailed bandage, as shown in figure 10-54. Be sure the bandage pulls the lower jaw FORWARD. Never apply a bandage that forces the jaw backward, since this could seriously interfere with breathing. The bandage must be firm to support the jaw properly, but it must not press against the victim's throat. Ensure the victim has scissors or a knife to cut the bandage in case of vomiting.

Treat the victim for shock and obtain medical care as soon as possible.

FRACTURE OF THE SKULL

When a person suffers a head injury, the greatest danger is that his brain may be severely damaged. Whether or not the skull is fractured is a matter of secondary importance. In some cases, injuries that fracture the skull do not cause serious brain damage. But brain damage can, and frequently does, result from apparently slight injuries that do not cause damage to the skull itself.

It is often difficult to determine whether an injury has affected the brain because symptoms of brain damage vary greatly. Any person who has suffered a head injury of any kind must be handled carefully and given immediate medical attention.

Some of the symptoms that may indicate brain damage are listed below; however, you must remember that these symptoms are not always present in any one case and the symptoms that do occur may be greatly delayed.

1. Bruises or wounds of the scalp may indicate that the victim has sustained a blow to the head. Sometimes the skull is actually depressed at the point of

impact. When the fracture is open, you may find bullets, glass, shrapnel, or other objects that have penetrated the skull.

2. The victim maybe conscious or unconscious. When conscious, the victim may feel dizzy and weak, as though he were going to faint.

3. Severe headache sometimes (but not always) accompanies head injuries.

4. The pupils of the eyes maybe unequal in size and may not react normally to light.

5. There maybe bleeding from the ears, nose, or mouth.

6. The victim may vomit.

7. The victim may be restless and perhaps confused and disoriented.

8. The arms, legs, face, or other parts of the body may be partially paralyzed.

9. The victim's face maybe very pale, or it may be unusually flushed.

10. The victim is likely to be suffering from shock, but the symptoms of shock maybe disguised by other symptoms.

It is not necessary to determine whether or not the skull is actually fractured when you are giving first aid to a person who has suffered ahead injury. The treatment is the same in either case, and the primary intent is to prevent further damage to the brain.

TREATMENT. Keep the injured person lying down. When facial flushing is apparent, raise the victim's head and shoulders slightly. When facial pallor is present, position the victim so the head is level with or slightly lower than the body. Watch carefully for vomiting. If the victim begins to vomit, position the head so choking on the vomitus does not occur.

When there is serious bleeding from wounds, try to control it by applying direct pressure, using caution to avoid further injury to the skull or brain.

You must exercise care when moving or handling the victim. Transport the person only when necessary. If you must transport the victim, keep him lying down.

Be sure the victim is kept comfortably warm but do not overheat him. Do NOT provide the victim with anything to eat or drink. DO NOT GIVE ANY MEDICATION.

Finally, obtain medical care for the victim as soon as possible.

FRACTURE OF THE SPINE

The spinal cord, which contains nerve fibers in direct connection with the brain, is enclosed and protected by a bony structure known as the SPINAL COLUMN, or BACKBONE. The spinal column is made up of a number of small bones called the VERTEBRAE.

If the spine is fractured at any point, the spinal cord may be crushed, cut, or otherwise damaged so severely that death or paralysis can result. However, when the fracture occurs in such a way that the spinal cord is not seriously damaged, there is a good chance of complete recovery—PROVIDED THE VICTIM IS PROPERLY CARED FOR. Any twisting or bending of the neck or back whether due to the original injury or caused by careless handling later, is likely to cause irreparable damage to the spinal cord.

The primary symptoms of a fractured spine are pain, shock and paralysis. PAIN is likely to be acute at the point of fracture. It may radiate to other parts of the body. SHOCK is usually severe, but (as in all injuries) the symptoms may be delayed for sometime. PARALYSIS occurs when the spinal cord is seriously damaged. When the victim is unable to move his legs, feet, or toes, the fracture is most probably in his back. When he cannot move his fingers, his neck is probably broken. Remember, however, that a spinal fracture does not always injure the spinal cord, so the victim is not always paralyzed. Any person who has acute pain in the back or neck following an injury, should be treated as though a fracture of the spine has occurred. This remains true even though no other symptoms are present.

TREATMENT. First aid for all spinal fractures, whether of the neck or bath has two primary purposes: (1) to minimize shock and (2) to prevent further injury to the spinal cord.

You must keep the victim comfortably warm. Do NOT attempt to place the victim in the position normally used to treat shock. Any unnecessary movement may cause further injury to the spinal cord. Keep the victim lying flat. Do NOT attempt to lower the victim's head.

To avoid further damage to the spinal cord, DO NOT MOVE THE VICTIM UNLESS IT IS ABSOLUTELY ESSENTIAL. But if you must transport the victim, DO NOT BEND OR TWIST HIS BODY; DO NOT MOVE HIS HEAD FORWARD, BACKWARD, OR SIDEWAYS; AND DO NOT, UNDER ANY CIRCUMSTANCES, ALLOW HIM TO SIT UP.

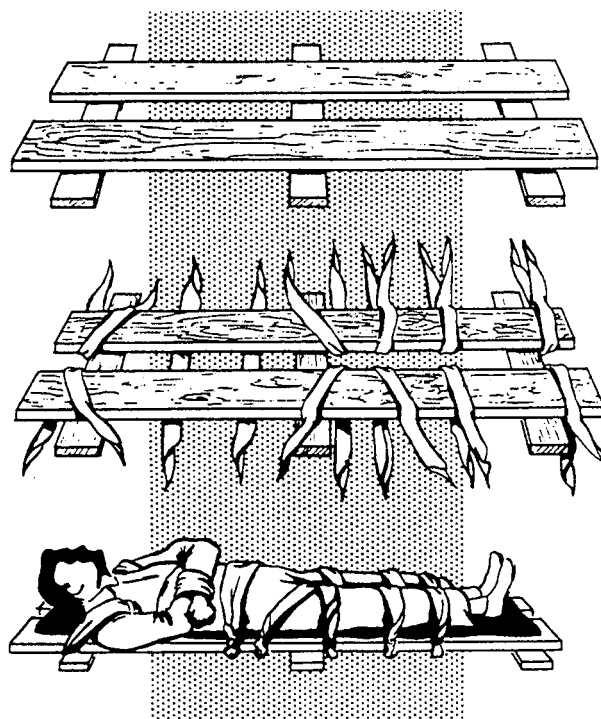

Figure 10-55.—Improvised frame for transporting victim with fractured spine.

When it is necessary to transport a person who has suffered a fracture of the spine, follow these general rules:

1. If the spine is broken at the NECK, the victim must be transported lying flat on his back with his face up. Place pillows or sandbags beside his head so it cannot be turned to either side. DO NOT PUT PILLOWS OR PADDING UNDER HIS NECK OR HEAD.
2. When you suspect the spine is fractured but do not know the location of the break treat the injury as though the victim has a broken neck. In other words, the victim should be lying on his back with his face up. When both the neck and back are broken, treat the victim in the same manner; that is, keep the victim on his back with his face up.
3. No matter where the spine is broken, USE A FIRM SUPPORT IN TRANSPORTING THE VICTIM. Use a rigid stretcher, or use a door, shutter, wide board, or a frame similar to that shown in figure 10-55. Pad the support carefully, and put blankets both under and over the victim. Use cravat bandages or strips of cloth to fasten the victim firmly to the support.
4. Hold the injured person by his clothing; then slide or pull the victim onto the support. DO NOT ATTEMPT TO LIFT THE VICTIM UNLESS YOU

HAVE ADEQUATE ASSISTANCE. Remember, any bending or twisting of the body is almost certain to cause serious damage to the spinal cord. When there are at least four (preferably six) people present to help lift the victim, they can probably accomplish the job without much movement of the victim's body. But a smaller number of people should NEVER attempt to lift the victim.

5. GET MEDICAL HELP AT ONCE.

FRACTURE OF THE PELVIS

The large pelvic bones (sometimes called hipbones) and the lower bone of the spinal column together make up the bony structure known as the PELVIS. The joint between the thighbone (the long bone of the upper part of the leg) and the pelvic bone is called the HIP JOINT.

Fractures in the pelvic region often result from falls, heavy blows, and accidents that involve crushing. The greatest danger in any pelvic fracture is that the organs enclosed and protected by the pelvis may be seriously damaged when the bony structure is fractured. In particular, there is danger that the bladder is ruptured. There is also danger of severe internal bleeding, because the large blood vessels in the pelvic region may be torn or cut by fragments of the broken bone.

The primary symptoms of a fractured pelvis are severe pain, shock, and loss of ability to use the lower part of the body. The victim is unable to sit or stand. If conscious, the victim may feel as though his body is "coming apart." When the bladder is injured, the victim's urine may be bloody.

TREATMENT. Do not move the victim unless ABSOLUTELY necessary.

Treat the victim for shock. Keep him comfortably warm. Do not attempt to place the victim in the shock position, as this may produce further damage internally.

When you must transport the victim to another place, handle him with the utmost care. Use a rigid stretcher, a padded door, or a wide board. Keep the victim lying on his back with his face up. In some cases, the victim will be more comfortable when his legs are straight. In other cases, the victim will be more comfortable with his knees bent and his legs drawn up. After you have placed the victim in the most comfortable position, immobilize him by placing bandages around his legs at the knees and ankles. Then place a pillow beside each hip and fasten each pillow securely with bandages or pieces of cloth. Finally, fasten

the victim securely to the stretcher or improvised support, and obtain medical help immediately.

FIELD SANITATION

In the field, devices necessary for maintaining personal hygiene and field sanitation must be improvised. Some of the devices for field sanitation that have been tried and used in the field successfully are described next.

LATRINES

When you are on bivouac or at a new location, it is unlikely that you will find a waterborne sewage system available for your use. The usual alternative is digging a hole (cat hole) about 1 foot deep and covering the feces completely with dirt or using a latrine.

NOTE: Latrines must be 100 yards from water supplies and messing facilities.

Straddle trench latrines are commonly used. Dig straddle trenches as soon as you arrive at a position. Use the 1:2:3 ratio (trenches 1 foot wide, 2 feet deep, and 3 feet long). No seats are provided, and the men stand along the sides. Add another foot of depth for each day you anticipate using the trench. Keep a pile of dirt and a shovel adjacent to the trench so each man may use some of the dirt to cover his waste materials. Boards may be placed around the sides to help keep steady footing.

When the latrine is filled to within 1 foot of the ground level or is to be abandoned, the following steps should be initiated:

1. Using an approved residual insecticide or diesel fuel, spray the pit contents, the sidewalls, and the ground surface extending 2 feet from the sidewalls.

2. Fill the pit to ground level with successive 3-inch layers of earth, packing each layer down before adding the next one; then mound the pit over with at least 1 foot of dirt and spray again with insecticide or diesel fuel. This prevents flies that hatch in the closed latrine from getting out.

When there is a possibility that others may come into the area, it is better to mark the closed latrine so the site will not be used again. A sign "closed latrine" with the date of closing should be placed firmly in the earth over the spot.

As soon as possible, regular pit latrines should be dug. These latrines may be 20 to 30 feet deep if the ground permits. The sides must be straight and have no ledges that could catch feces. Latrine boxes, usually of

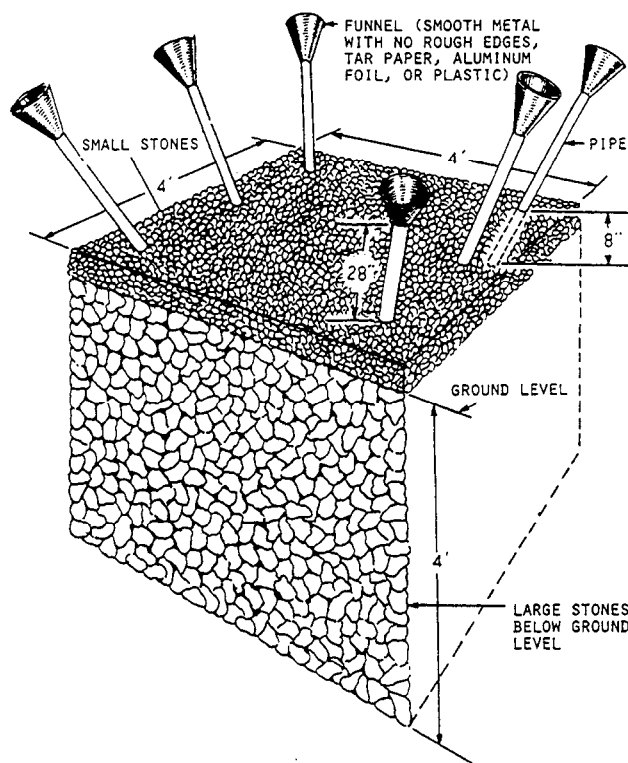

Figure 10-56.—Urinal pipes and soakage pit.

four or eight holes, and accessories, such as tent, urinals, tar paper, and screen wire, are finished ready for installation.

When the box is installed, it is lined with tar paper from the top to the bottom. The boxes also need a metal or tar paper urine deflector. This deflector is converted into a trough under the front of the seat so it drains toward one end. From this end, a pipe carries the urine to an outside soakage pit. This helps prevent a disagreeable odor from the urine. In some cases where the soil is rather porous, the urine drains into the latrine pit itself.

It is necessary to cover all cracks in the box to help make it flyproof. You do this by nailing strips of wood or tin over them. When the box is placed over the pit, it must be done carefully. If any cracks are showing, seal them by packing some dirt tightly around the edges.

A separate urine soakage pit is built when the latrine pit is in soil that absorbs liquids poorly (fig. 10-56). This pit is about 4 feet square and 4 feet deep. It is filled with pieces of broken rock brick large stone or lava rock to within 1 foot from the top. Then oiled burlap is placed over the rocks and covered with sand or earth. Vents, inserted to reduce odor, are covered at the top with fine mesh screen.

Urinals may be made of 1-inch or large-sized pipe and placed at each corner of the pit and along the sides.

The pipes should reach at least 8 inches below the ground surface. In the upper end of each pipe, place a funnel of sheet metal, tar paper, or similar material. These funnels are covered at the opening with wire mesh. This is to keep out flies, cigarette butts, or other items that would clog up the pipes.

In other cases, pail latrines maybe used in buildings where no adequate plumbing facilities are available or where it is not practical to build deep pit latrines. Usually a standard latrine box is adapted for use as a pail latrine. The pails are removed at least once daily and replaced by clean pails. Each pail should have about 1 inch of a 2-percent cresol solution or some slaked lime in it.

Pails of excreta are removed from the latines by hand, cart, wagon, or truck. The contents maybe burned, buried, or placed in flyproof concrete tanks where it decomposes.

A trough urinal is usually built as part of a latrine. The trough may be made of tin, galvanized iron, or wood. When it is made of wood, it should usually be lined with tar paper.

The trough slopes toward one end and empties into a drain pipe. The drain pipe, fitted with a fine mesh fly screen, extends into the latrine or urine soakage pit. Sometimes the pipe is omitted and the trough extends into the pit.

GARBAGE DISPOSAL

Garbage is the waste from the kitchen and mess hall. It is usually divided into two categories: WET and DRY. Both have to be removed from the mess area before they cause offensive odors or attract flies and rats.

Cans should be used for storing garbage until the garbage can be removed for disposal. The cans should be kept outside of the kitchen. Covers must be kept on the cans at all times. Cans should not be filled higher than 4 inches from the top. Regular washing of the cans is necessary to help ensure proper sanitation. When steam is available, it can be used to remove accumulated grease.

The common method of disposal is burial. Trenches or pits are dug and the garbage is deposited. Sometimes a continuous trench is used. The garbage for each day is then covered by the excavation made for the following day. The length, width, and depth of the holes vary according to the need; however, you should not pile the garbage higher than 2 feet from the top before covering it with earth.

NOTE: Garbage pits are usually not more than 30 yards from mess areas and not less than 100 yards from water supplies.

Some installations may have facilities to load the garbage on barges. The barges are taken out to sea and the garbage dumped. Where available, movable platforms accomplish this without the need of handling the garbage again.

A few installations burn dry garbage. This method of disposal should be used whenever possible because it is quick and inexpensive.

LOW-TEMPERATURE CLIMATES

In low-temperature areas, such as the Arctic, the problem of sewage and garbage disposal is more difficult than in temperate areas. The difficulty is due to the effect of the low temperature on the physical state of fluids, soils, and other materials involved in garbage and sewage disposal.

The biological and chemical reduction of organic material is a slow process in areas with low-temperature conditions. The soil will not assimilate wastes as readily as under temperate conditions, and permafrost (permanently frozen ground) often does not permit proper drainage of the soil. In addition, most solids, as well as liquids, show a decline in solubility with a decline in temperature. These and other factors have an important bearing on the type of sewage and garbage disposal methods used in the Arctic or other low-temperature areas. Let us consider briefly a few temporary methods suitable for use in such areas.

In severely cold weather, feces deposited by troops freezes quickly, and, when pulverized by wind and snow, can soon contaminate a whole area. Sometimes, on a march, a SNOW HOLE may be used, but it should be placed near a rock or terrain feature that will ensure against other troops bivouacking on the same spot at a later date.

DISPOSAL BAGS offer a good means of preventing the spread of contaminated material and should be used whenever possible. These bags are collected and stacked under rock piles, then disposed of later by dumping them on the ice of adjacent bodies of water. The bags present no problem while frozen, and they cannot be scattered until the thaw begins.

In forward bivouacs, you can expect to find a very simple facility, such as a SLIT TRENCH in the snow, protected by a windbreak. The slit trench should be located in close proximity to the group. Marking

prevents other troops from bivouacking on the same spot at a later date.

In a more permanent type of camp, a heated shelter will probably be provided. This may be a tent or prefabricated unit in which there is a portable folding box latrine. All forms of latrines should be marked with the dates they are closed.

WATER TREATMENT

Safe water in sufficient amounts is essential to field troops. Water not properly treated can give you diseases, such as typhoid fever, dysentery, cholera, and common diarrhea. In certain areas of the world, water may also transmit infectious hepatitis and amebic dysentery. The latter diseases are caused by organisms that are highly resistant to the water disinfection methods normally used.

The quantity of water required for troops varies with the season of the year, the geographical area, and the tactical situation. Dehydration may be the problem in both extremely hot and cold climates. In extremely hot climates, large quantities of drinking water are required to replace body fluid losses. In extremely cold climates, body fluid losses are not as great as in hot climates; however, water is needed in the reconstitution of dehydrated foods. Additional water is also required for maintenance of personal hygiene in both hot and cold climates. A guide for planning to meet the water requirements in a temperate zone is 5 gallons per man per day for drinking and cooking and at least 15 gallons per man per day when showering facilities are to be made available.

You may not be able to obtain water from water points set up by the Utilitiesman. If this should occur, you must obtain and treat your own water. The possible sources of water are surface water (lakes, rivers, streams, and ponds), groundwater (wells and springs), rain collected from roofs or other catchment surfaces, melted blue ice or snow, and distilled water. The cleanest source of water available should be selected. Water taken from any of these sources must be properly treated before being used, because all sources are presumed to be contaminated.

To treat water for drinking, you can use either a plastic or aluminum canteen with the water purification compounds available in tablet form (iodine) or in ampule form (calcium hypochlorite).

Before using iodine tablets, check them for physical change, as they lose their disinfecting ability with age.

If the tablets are stuck together, crumbled, or have a color other than steel gray, do not use them. When treating water in your canteen with iodine tablets, fill the canteen with the cleanest, clearest water available. Add one iodine tablet to a 1-quart canteen of clear water; add two tablets when the water is cloudy. Double these amounts for a 2-quart canteen. Place the cap on the canteen loosely; wait 5 minutes; then shake the canteen well, allowing leakage to rinse the threads around the neck of the canteen. Tighten the cap and wait an additional 20 minutes before using the water for any purpose.

To purify water in a 1-quart canteen with calcium hypochlorite ampules, fill the canteen with the cleanest, clearest water available, leaving an air space of an inch or more below the neck of the canteen. Take your canteen cup and fill it half full of water. Add the calcium hypochlorite from one ampule, and stir the water with a clean stick until the powder has dissolved. Fill the cap of a plastic canteen half full of the solution from the canteen cup and add it to the water in the canteen, then place the cap on the canteen and shake it thoroughly.

NOTE: If you have a 1-quart aluminum canteen, add at least 3 capfuls of the solution to the canteen, as its cap is much smaller than the one on the plastic canteen.

Loosen the cap slightly and invert the canteen, letting the treated water leak onto the threads around the neck of the canteen. Tighten the cap on the canteen and wait at least 30 minutes before using the water for any purpose.

You could save the remaining solution to use later if additional treated water may be needed, or you can discard it.

When you do not have disinfecting compounds, boiling the water is another method for killing disease-producing organisms; however, it has several disadvantages: (1) fuel is needed, (2) it takes along time to bring the water to a boil, and then allowing it to cool, and (3) there is no guaranteed protection against recontamination. Water must be held at a rolling boil for at least 15 to 20 seconds to make it safe for drinking.

Hand-washing devices that are easy to operate are usually provided at appropriate places in the bivouac area: outside the latrine enclosures, near the mess area, and at other locations as needed. A soakage pit is provided under each device to prevent water from collecting. The water containers for these devices are usually checked by a Utilitiesman to ensure the containers and the surrounding area are kept clean.

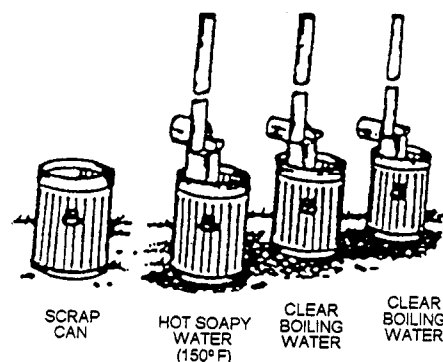

Figure 10-57.—Immersion heaters for mess kit washing setup.

In the field you must care for your own mess kit. Proper washing is important; otherwise, food particles remain and become breeding places for disease germs.

The galley maintenance personnel usually set up four corrugated cans or other similar containers, placed in a row, for washing your mess kit. The first can is used to scrape the food particles from your mess kit into. The second contains hot water with soap or detergent, and the third and fourth cans contain clear water which is kept boiling throughout the washing period (fig. 10-57). Along-handled brush is furnished so you can wash your mess kit.

To clean your mess kit properly, follow the steps given below:

1. Scrape the food particles from your mess kit into the scrap can.
2. Wash your mess kit in the first container of hot soapy water, using the long-handled brush.
3. Rinse your mess kit in the second can of boiling water by dipping it up and down several times.
4. Disinfect your mess kit by immersing it in the third container of boiling water for several seconds.
5. Shake your mess kit to remove excess water and allow it to dry in the air; then close it to keep out dust and vermin.

If your mess kit becomes soiled or contaminated between meals, it should be washed again before use.

When desirable to preheat utensils before a meal, a corrugated can with clear boiling water is placed near the start of the serving line. It is important that such water be maintained at a rolling boil throughout the meal service period.

CHAPTER 11

ORGANIC COMMUNICATIONS EQUIPMENT

Communication is the voice of command. Without the equipment to provide rapid, reliable, secure, and efficient tactical communications, a commander in the field cannot effectively exercise command and control of his forces, call in available fire support, or maintain adequate channels of logistics. In battle, poor communications cost lives. On a construction project, inefficient communications cost time, money, and material; however, even the most advanced and sophisticated communication system is of little consequence in the hands of untrained personnel. Either by design or through necessity, any one of us, as Seabees, could be called upon to use the battalion's tactical communications equipment in an emergency; therefore, familiarize yourself with the communications systems in this chapter. Know what each system does, how it works, and when and where to use it. The intent of this chapter is to do just that. Do not be a liability to your shipmates. A well-rounded understanding of communications by all hands greatly upgrades the overall operational efficiency of the battalion.

MEANS OF COMMUNICATION

The most common means of communication is simply speaking to one another—voice communication. When you need to communicate over longer distances, your voice is transmitted and received by electrical means, such as radio or telephone. Other means of communicating by sound are by whistles, sirens, horns, gunfire, and so forth. Messages may also be communicated through visual means (hand signals, smoke, and flags) and in writing (orders, messages, and reports). Each of these means of communication are discussed in this chapter.

Effective communication is essential for control of the company and its elements. The company uses a combination of radio, wire, messenger, visual, and sound communications to provide as many ways to transmit messages as conditions permit. Radio is the primary means of communication in all tactical, on-the-move operations. Communications (COMM) wire is the primary system used during a static defense.

Each commander is responsible for the installation, operation, and maintenance of his unit's communication

system and for its efficient operation as a part of the next higher unit's system. Each commander exercises tactical and technical supervision over the communication system of all the units of the command.

RESPONSIBILITIES

Every Seabee is responsible for good communications. The importance of passing the word cannot be overemphasized. Knowing what is happening and what is expected aids us in achieving a successful mission. You must develop good, two-way communications both up and down the chain of command if you are to stay alive in combat. The responsibility for communication among units is subject to the following general rules:

- The higher unit is responsible for establishing communication with the next lower unit and attached units.
- A unit supporting another unit establishes two-way communication with that unit.
- Lateral communication between adjacent units is established and maintained by the unit on the left to the unit on the right, unless directed otherwise by higher authority.
- Although one unit is specifically charged with establishing and maintaining communications with another unit, only through the mutual efforts of all the members of each unit can continual communications be maintained.
- The company commander is responsible for the installation, operation, and maintenance of the company communications system and for its efficient operation as part of the battalion system. Instructions about all communications are found in the operation orders.

COMMUNICATIONS

Radio and messengers are the primary means of communication for offensive combat and for other operations involving rapid or extensive movement. These methods may be supplemented by visual and

sound signals. As a Seabee, you normally use the radio as the main source of communication while on a convoy because most of your vehicles have radios mounted in them.

Normally, wire and messengers are the primary means of communication in defense. Radio is used when wire service is interrupted after the enemy has made contact or when ordered by a higher command. Two or more wire lines should be installed over different routes to connect two units. This allows communication to be quickly reestablished if one line goes out. Visual and sound signals may be used to supplement wire in the defense, but only when they do not compromise security.

Visual signals include panel sets, pyrotechnics, smoke of various types and colors, arm and hand signals, flashlight, tracer ammunition, improvised lights, and flags. Higher headquarters normally prescribes the use of pyrotechnics or smoke signals to call for shift, lift, fire, or illumination.

Sound signals are normally used for alarms to warn of air, chemical, biological and radiological (CBR), or ground attack Whistles, horns, bells, small arms, or other noisemakers may be used for sound signals.

No matter what type of communication is used, assume that you are being monitored by the enemy. This is particularly true of radio, which is the **LEAST secure** means of communication.

UNDERSTANDING RADIO AND TELEPHONE NOMENCLATURE

The radios, telephone, and the switchboard discussed in this section are those presently on the NMCB Table of Allowance (TOA). To help you understand the component nomenclature and their family names, the following examples are provided:

- AN/PRC-77 and AN/PRC-104 radios
 1. The AN indicates the users (Army/Navy).
 2. The P indicates the type of installation (pack, portable).
 3. The R indicates the type of equipment (radio).
 4. The C indicates the purpose (communications).
 5. The numbers 77 and 104 indicate the model numbers.

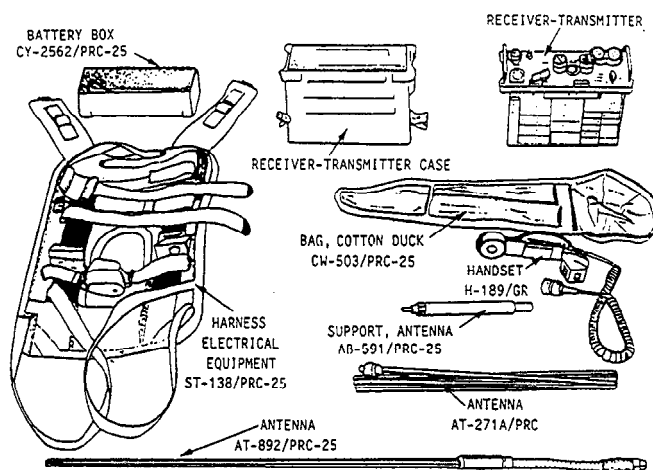
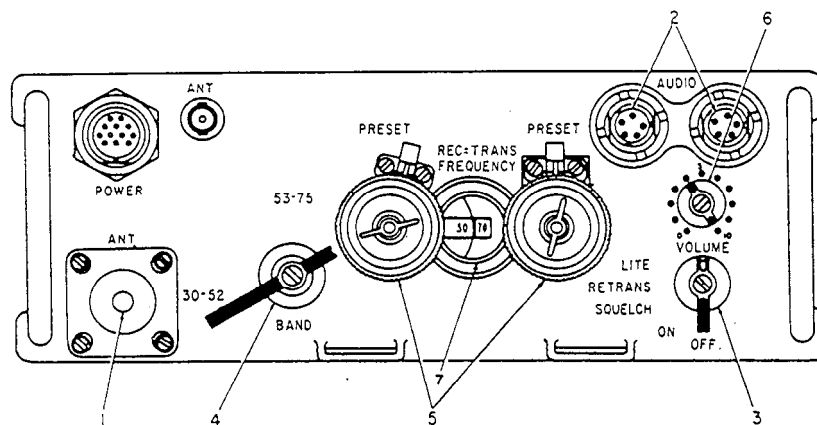

Figure 11-1.—Radio Set AN/PRC-77 components.

- TA-312/PT and TA-1/PT telephones
 1. The TA indicates the type of equipment (telephone apparatus).
 2. The numbers 312 and 1 indicate the model numbers.
 3. The P indicates the installation (pack, portable).
 4. The T indicates the type and purpose of the equipment (telephone [wire] transmitting).
- SB-22/PT switchboard
 1. The SB indicates the type of equipment (switchboard).
 2. The number 22 indicates the model number.
 3. The P indicates the installation (pack, portable).
 4. The T indicates the purpose of the equipment (telephone [wire] transmitting).

AN/PRC-77 Radio

The AN/PRC-77 radio set shown in figure 11-1 is a short-range, man-packed, portable, frequency-modulated (FM) receiver-transmitter used to provide two-way voice communication. The AN/PRC-77 operates on low power and at very high frequencies (vhf). The location of the equipment greatly affects its operating range. Normally, a line-of-sight range can be expected; that is, when the other station can be seen,



TO OPERATE SET

A. THE NUMBERS OF STEPS 1 THROUGH 6 BELOW RELATE TO THE NUMBERS ON THE DIAGRAM.

- (1) INSTALL THE ANTENNA REQUIRED FOR THE TYPE OF OPERATION IN THE ANT MOUNT.
- (2) ATTACH HANDSET H-189/GR TO EITHER AUDIO CONNECTOR.
- (3) TURN THE FUNCTION SWITCH TO ON.
- (4) TURN THE BAND SWITCH TO THE DESIRED OPERATING FREQUENCY BAND.
- (5) TURN THE MHZ TUNING AND KHZ TUNING CONTROL KNOBS UNTIL THE DESIRED FREQUENCY APPEARS IN THE CHANNEL DIAL (7).
- (6) TURN THE VOLUME CONTROL TO 4.
- (7) PRESS THE HANDSET H-189/GR PUSH-TO-TALK SWITCH AND SPEAK INTO HANDSET. RELEASE THE PUSH-TO-TALK SWITCH TO LISTEN.
- (8) ADJUST THE VOLUME CONTROL (6) FOR A DESIRABLE SOUND LEVEL.
- (9) TO REDUCE THE RUSHING NOISE WHEN NO SIGNAL IS BEING RECEIVED, TURN SWITCH (3) TO SQUELCH.

TO TURN SET OFF

B. TURN THE FUNCTION SWITCH (3) TO OFF.

Figure 11-2.—Operating instructions for Radio Set AN/PRC-77.

satisfactory operation improbable. An intervening hill or a tall building may hamper or prevent contact with other stations.

Valleys, densely wooded areas, and low places are poor sites for setting up communications. A hilltop or a tower location increases the operating distance. When possible, avoid locations near a source of electrical interference, such as power or telephone lines, radar sets, and field hospitals.

The AN/PRC-77 consists of a receiver-transmitter (Radio RT-841/PRC-77) and minor components. The receiver-transmitter is held in the receiver-transmitter case by four screws. The battery box is attached to the receiver-transmitter case by two clamps. The complete unit, when assembled, is watertight. All controls are located on the front panel. A battery plug projects from the receiver-transmitter and mates with the connector of the battery. The power for this set is provided by a BA-4386 magnesium-alloy battery that enables the radio to operate for about 30 hours before a replacement battery is needed.

Minor components include a cotton duck harness (ST-138/PRC-25) so the radio can be strapped to the operator's back; a short antenna (AT-892/RC-25) for general, short-range service; a six-section, long antenna (AT-271A/RC) for maximum range; and antenna support (AB-591/PRC-25) for use with the long antenna; a handset (H-189/GR) that consists of a microphone and receiver for transmitting and receiving signals; and a cotton duck bag (CW-503/PRC-25) that is divided into several pockets used to store the two antennas, the antenna support, and the handset. Operating instructions for the AN/PRC-77 are shown in figure 11-2.

AN/GRC-160 Radio

The Radio Set AN/GRC-160 is designed for use in vehicles, and it uses the same radio (RT-841) as the AN/PRC-77. An AM-2060 amplifier provides operating voltage to the RT-841/PRC-77 and, also, has a self-contained loud speaker that amplifies the signal received. The installation kits are provided for specific vehicles and are permanently installed in the vehicles.

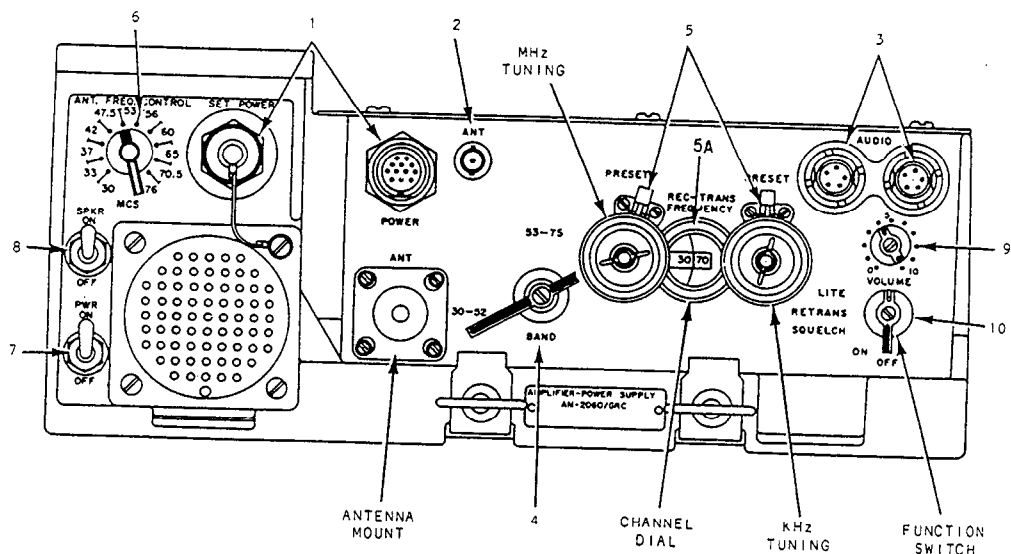

Figure 11-3.—Amplifier-Power Supply AM-2060/GRC and Receiver-Transmitter, Radio RT-505/PRC-27, 77.

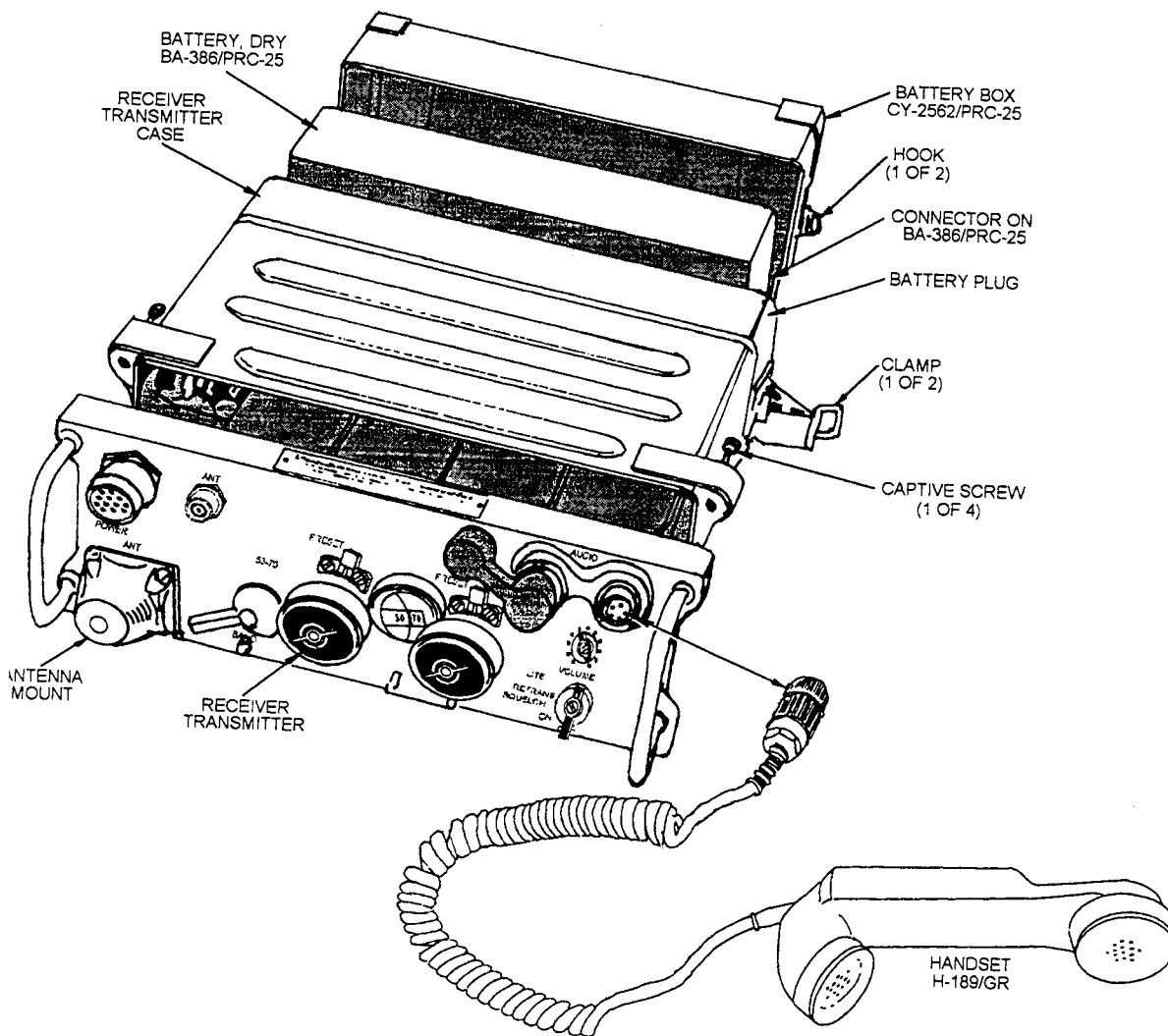

Figure 11-4A.—Receiver-Transmitter 841 for Radio Set AN/GRC-160.

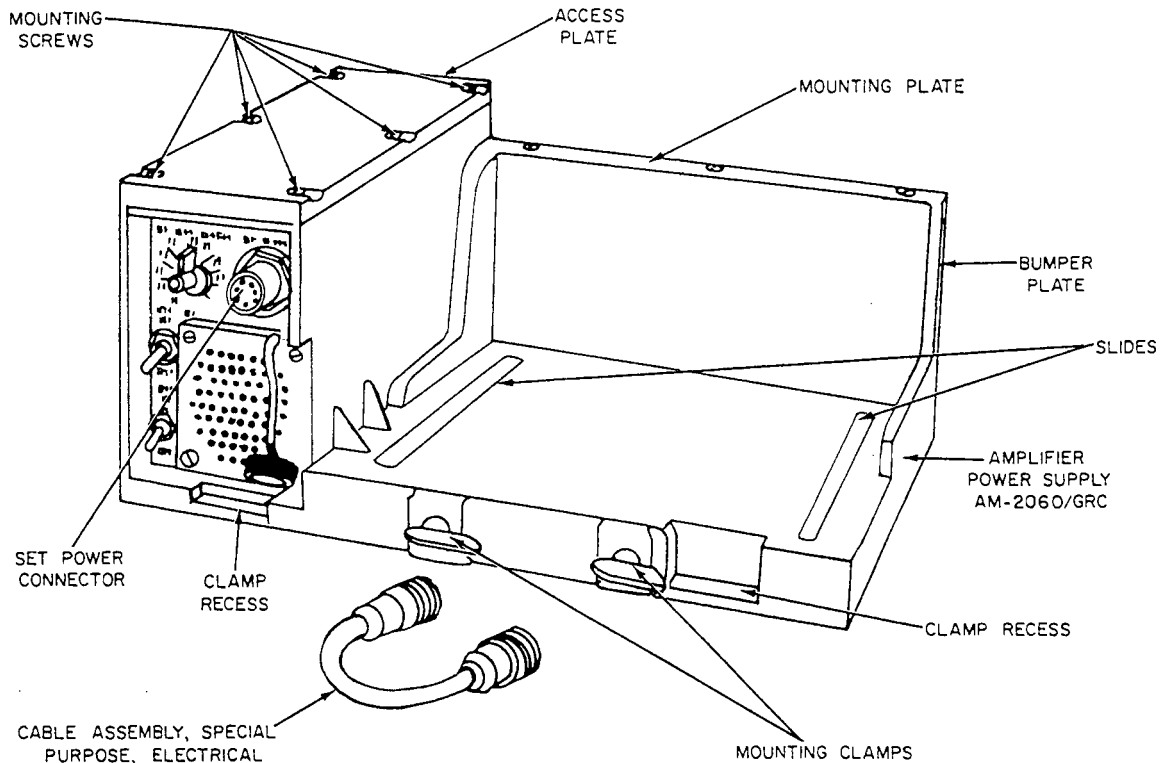

Figure 11-4B.—Amplifier AM-7060 for Radio Set AN/GRC-160.

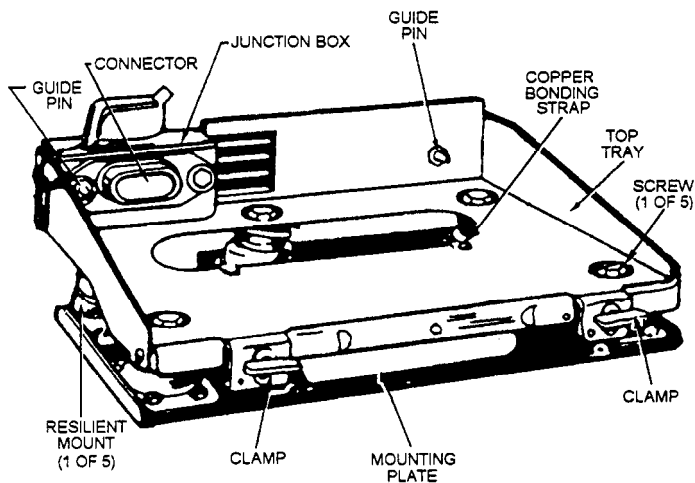

Figure 11-4C.—Mounting MT-1029/URC for Radio Set AN/GRC-160.

To operate the radio, follow these steps. (The numbers of Steps 1 through 10 below are keyed to the numbers on the diagram shown in figure 11-3.)

- 1 Attach Cable CX-4665/GRC between the power connectors (SET POWER).
- 2 Attach the antenna cable to the antenna connector (ANT).
- 3 Attach Handset H-189/GR (fig. 11-1) to either audio connector (AUDIO).

4. Turn the band switch to the desired operating frequency band.
5. Turn the MHz tuning and the kHz tuning control knobs until the desired frequency appears in the channel dial. (5A: REC-TRANS FREQUENCY).
6. Set the antenna frequency control to match the frequency appearing in the channel dial (5A).
7. Turn the power switch to PWR ON.
8. Turn the speaker switch to SPKR ON.
9. Turn the volume control to 4.
10. Turn the function switch to ON.
11. Press Handset H-189/GR (fig. 11-1) PUSH-TO-TALK switch (on the right side of the handset) and speak into the handset. Release the PUSH-TO-TALK switch to LISTEN.
12. Adjust the VOLUME control (1 O) for a desirable sound level.
13. To reduce the rushing noise when no signal is being received, turn switch (10) to SQUELCH.

Figures 11-4A, 11-4B, 11-4C, and 11-4D present the components of the AN/GRC-160.

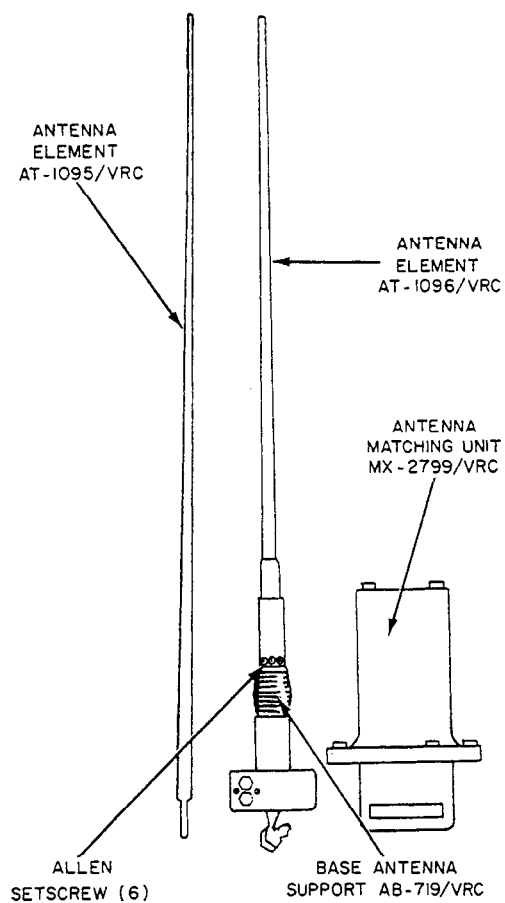

Figure 11-4D.—Antenna AT-912/URC for Radio Set AN/GRC-160.

AN/PRC-104 Radio Transceiver

The AN/PRC-104 (fig. 11-5A, 11-5B, and 11-5C) is a state-of-the-art lightweight radio transceiver (transmitter and receiver combined) that operates in the high frequency (hf) and upper part of the low frequency (lf) portions of the radio spectrum. The receiver/transmitter circuits can be tuned to any frequency between 2.0000 and 29.9999 MHz in 100 Hz increments, making it possible to tune up to 280,000 separate frequencies. The radio set operates in the upper sideband (USB) or lower sideband (LSB) modes for voice communications, CW for morse code, or frequency shift keying (FSK) for transmission of teletype signals or other data. In the man-pack configuration the radio set is designed to be carried and operated by one manor, with the proper accessories, the radio set can be configured for vehicular or fixed-station use.

The control panel (fig. 11-6) was engineered for ease of operation by making it possible for the operator to adjust the front panel controls—even while wearing

heavy gloves. Unlike older, similar radio sets, there are no front-panel meters or indicator lights on the AN/PRC-104. The functions that formerly required these types of indicators (antenna tuning, battery condition, etc.) are monitored by the radio itself and communicated to the operator as special tones in the handset. This feature is particularly useful during tactical black-out operations. The superior design and innovative features of the AN/PRC-104 radio set now make it possible to maintain a reliable long-range communications link using lightweight, portable equipment that can be operated by personnel with a minimum amount of training.

RADIO SET.— The AN/PRC-104 radio set consists of three units: (fig. 11-7) low-power receiver-transmitter RT-1209/URC (receiver/exciter), 20-watt radio frequency amplifier AM-6874/PRC-104 (amplifier/coupler), and battery case CY-7541/PRC-104 (battery pack). Quick-disconnect latches secure the receiver/exciter to the amplifier/coupler, and each is latched to one end of the battery pack. When latched together, the receiver/exciter is electrically interconnected with the amplifier/coupler through a built-in connector; the battery pack power is connected to the amplifier/coupler. All of the operator controls and connections are located on the receiver/exciter front panel, except for the antenna select switch and antenna connections located on the amplifier/coupler unit. They are constructed on a die-cast aluminum housing; the battery pack housing is tough plastic. Watertight seals for the covers and panels make the three units watertight, submersible, and capable of rough handling and abuse in any field environment. The unit circuits are modular for ease of repair. The total weight of the assembled AN/PRC-104 (three units with battery) is 14 pounds, making it a lightweight and easily carried package.

MAN-PACK OPERATION.— The basic man-pack configuration (fig. 11-8) consists of the radio set (three units), a whip antenna, and an audio input/output device. Antenna AT-217A/PRC is a 10-foot standard whip antenna that screws into the Spring Section Antenna AB-129/PR (shock mount) which, in turn, screws into the antenna mount on the amplifier/coupler. The whip antenna is adequate for most short-range requirements (less than 10 miles). Two standard input/output devices come with the radio set: Handset H-189/GR and Telegraph Key KY-872/PRC-104. These are attached to either of the two AUDIO connectors on the receiver/exciter. The radio transmitter (exciter) is enabled (keyed) by the handset push-to-talk (PTT) button or by depressing the telegraph key to contact. The receiver is operative only when the transmitter is disabled;

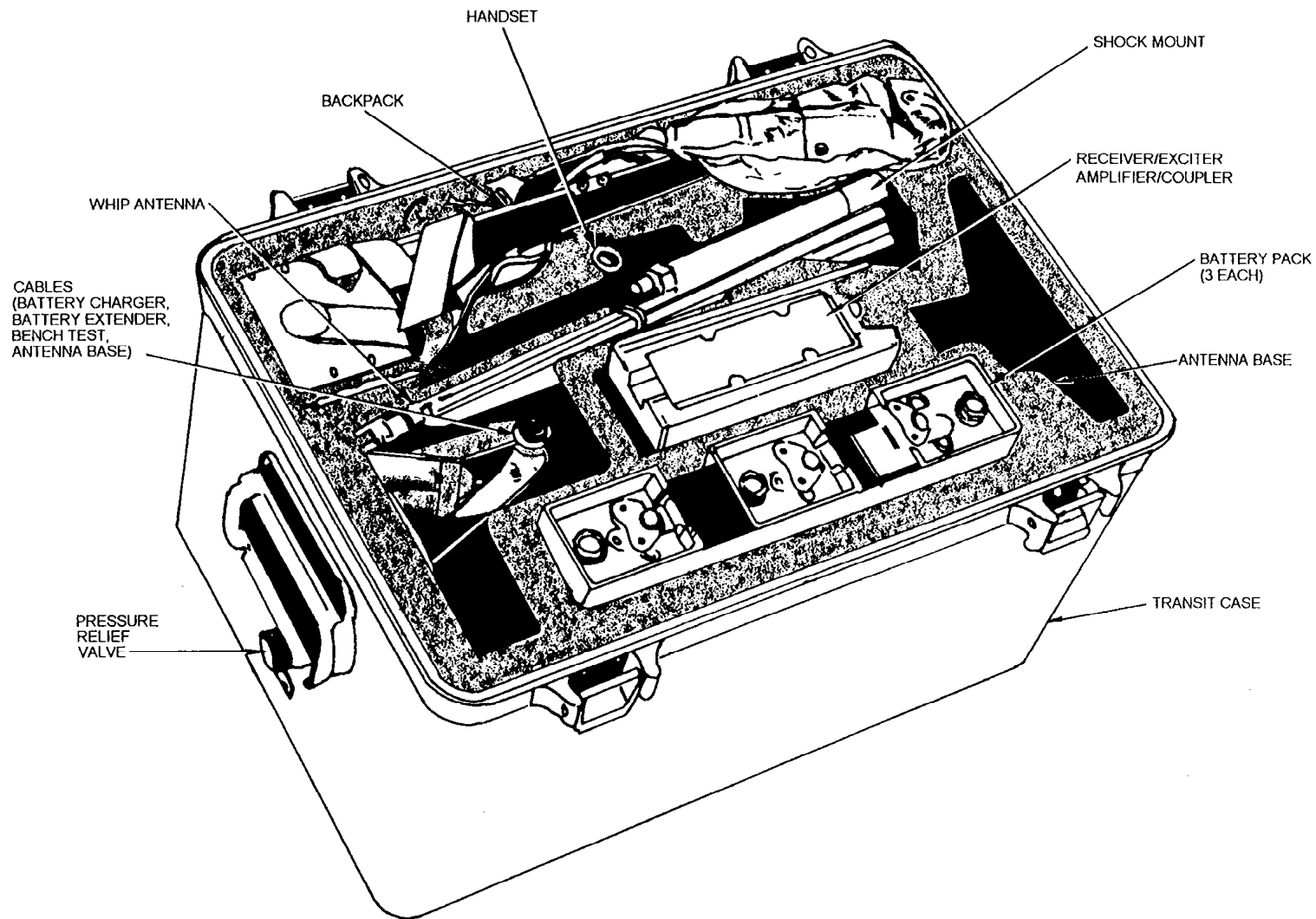

Figure 11-5A.—Radio Set AN/PRC-104 equipment supplied.

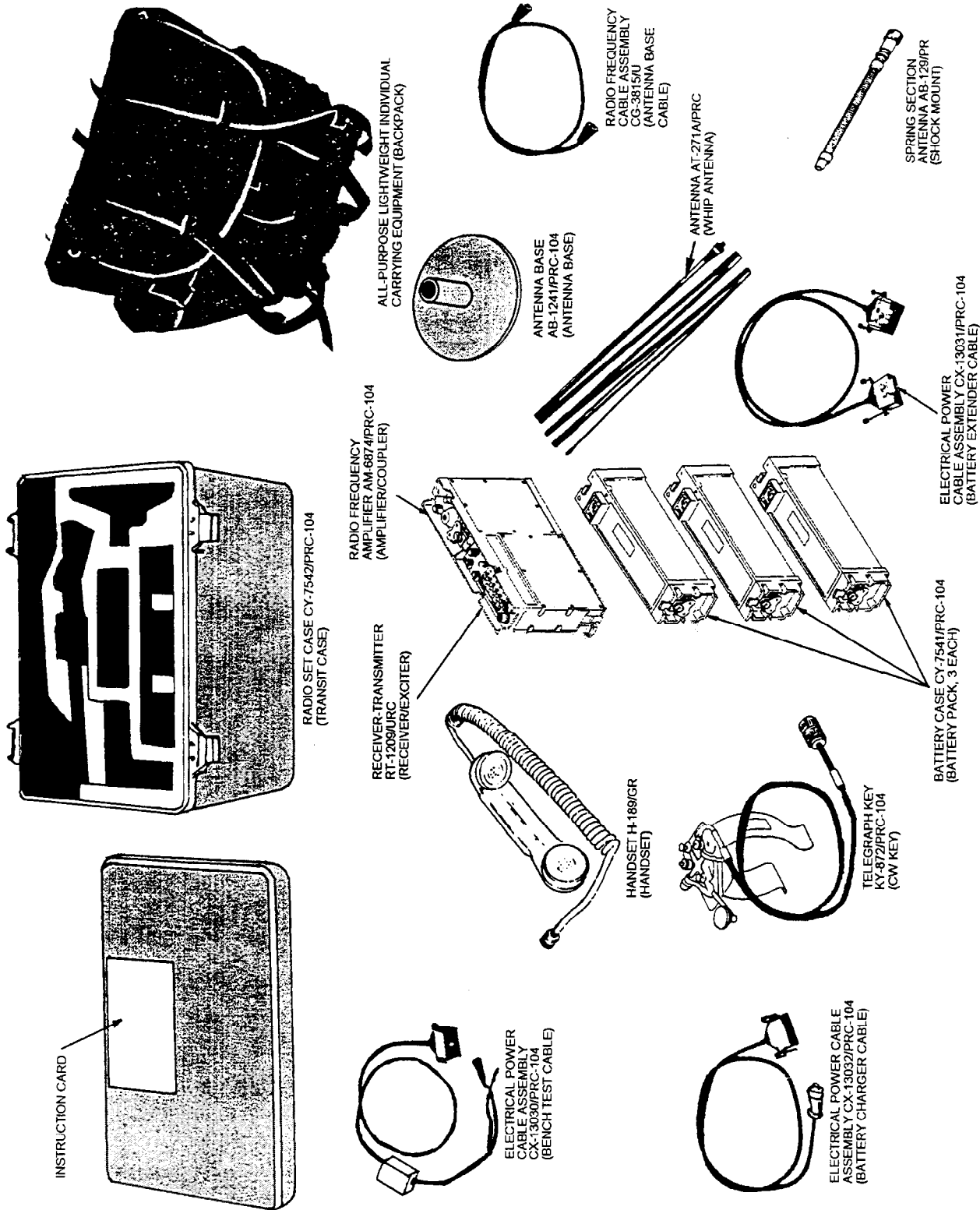

Figure 11-5B.--Radio Set AN/PRC-104 equipment supplied.

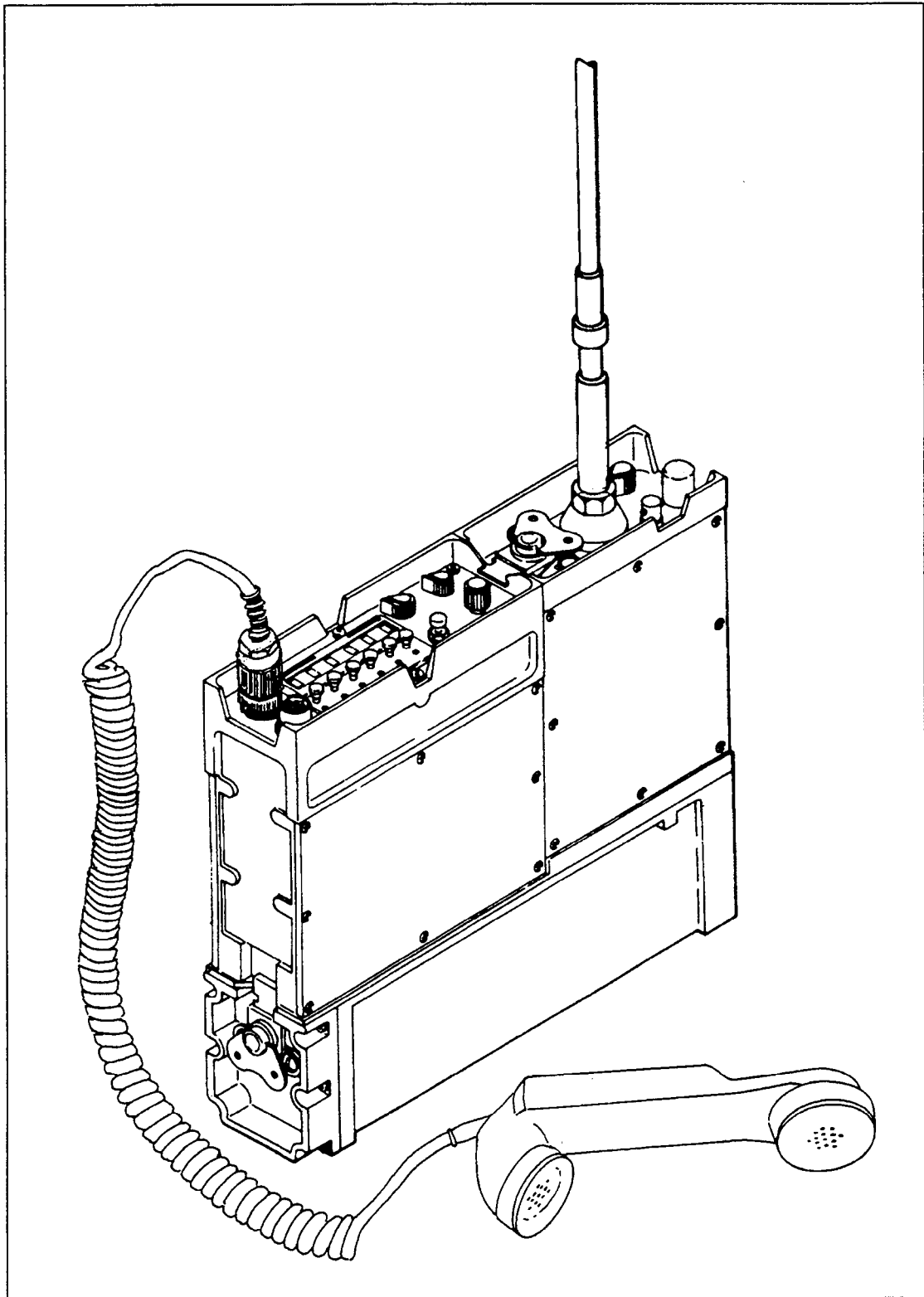

Figure 11-5C.—Radio Set AN/PRC-104 equipment supplied.

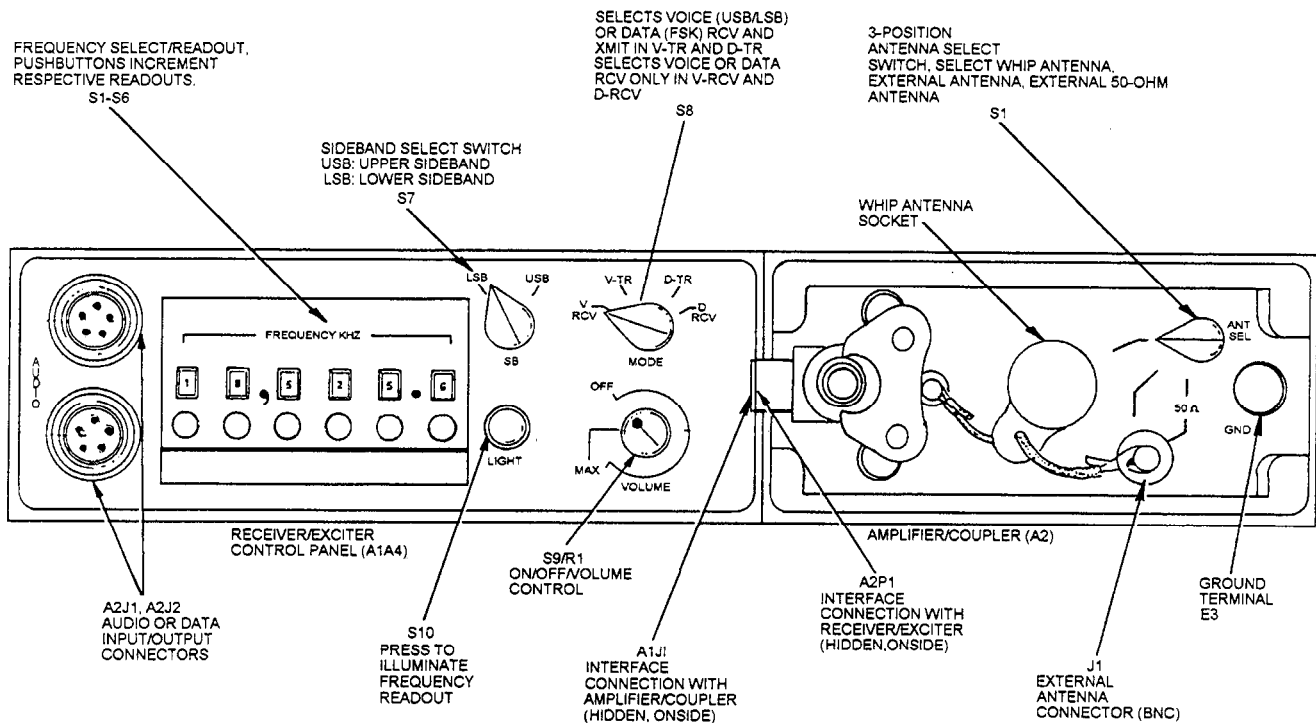

Figure 11-6.-AN/PRC-104 controls and indicators.

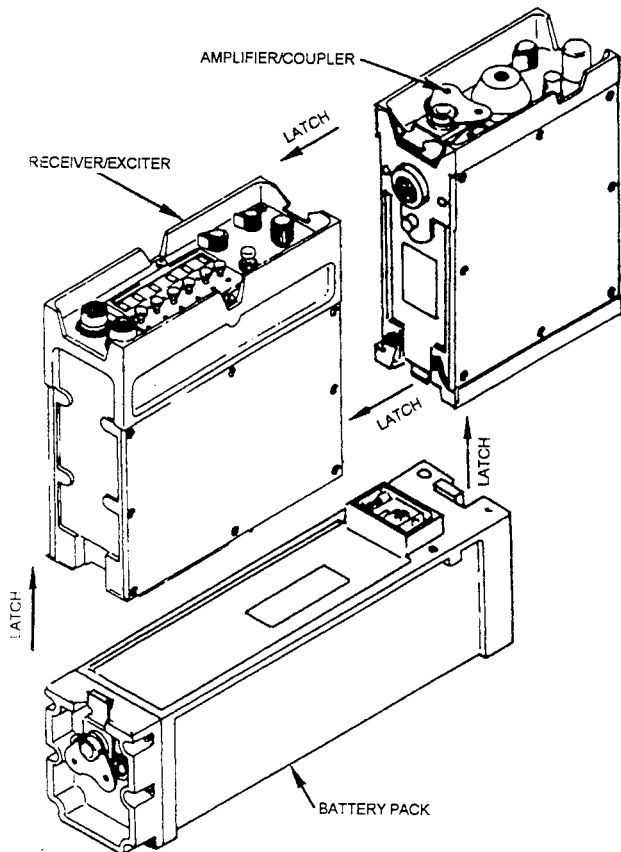

Figure 11-7.—Radio set installation and setup.

therefore, communication is on a one-way reversible (half-duplex) basis. The radio set with whip and handset weighs 15.7 pounds.

BATTERY PACK.— The radio set operates from a nominal 28-volt dc battery pack with an acceptable voltage input between 20 and 32 vdc. The battery pack consists of 16 silver-zinc storage battery cells inside the battery case and is usually latched to the other two units; however, it may be connected to the amplifier/coupler through the 3-foot Electrical Power Cable Assembly CX-13031/PRC-104 (battery extender cable). This connection permits extended battery life by allowing the battery pack to be carried by the operator under the protection of cold weather clothing. Normal life of the battery pack is approximately 16 hours of operation, assuming 10 percent transmit time. The silver-zinc battery is charged using Battery Charger PP-6241/U via the battery charger cable, Electrical Power Cable Assembly CX-13032/PRC-104. For operation without the battery pack, a dc power source can be connected to the amplifier/coupler through the bench test cable, Electrical Power Cable Assembly CX-13030/PRC-104.

FIXED-SITE OPERATION.— When the tactical situation permits, the effective range of the

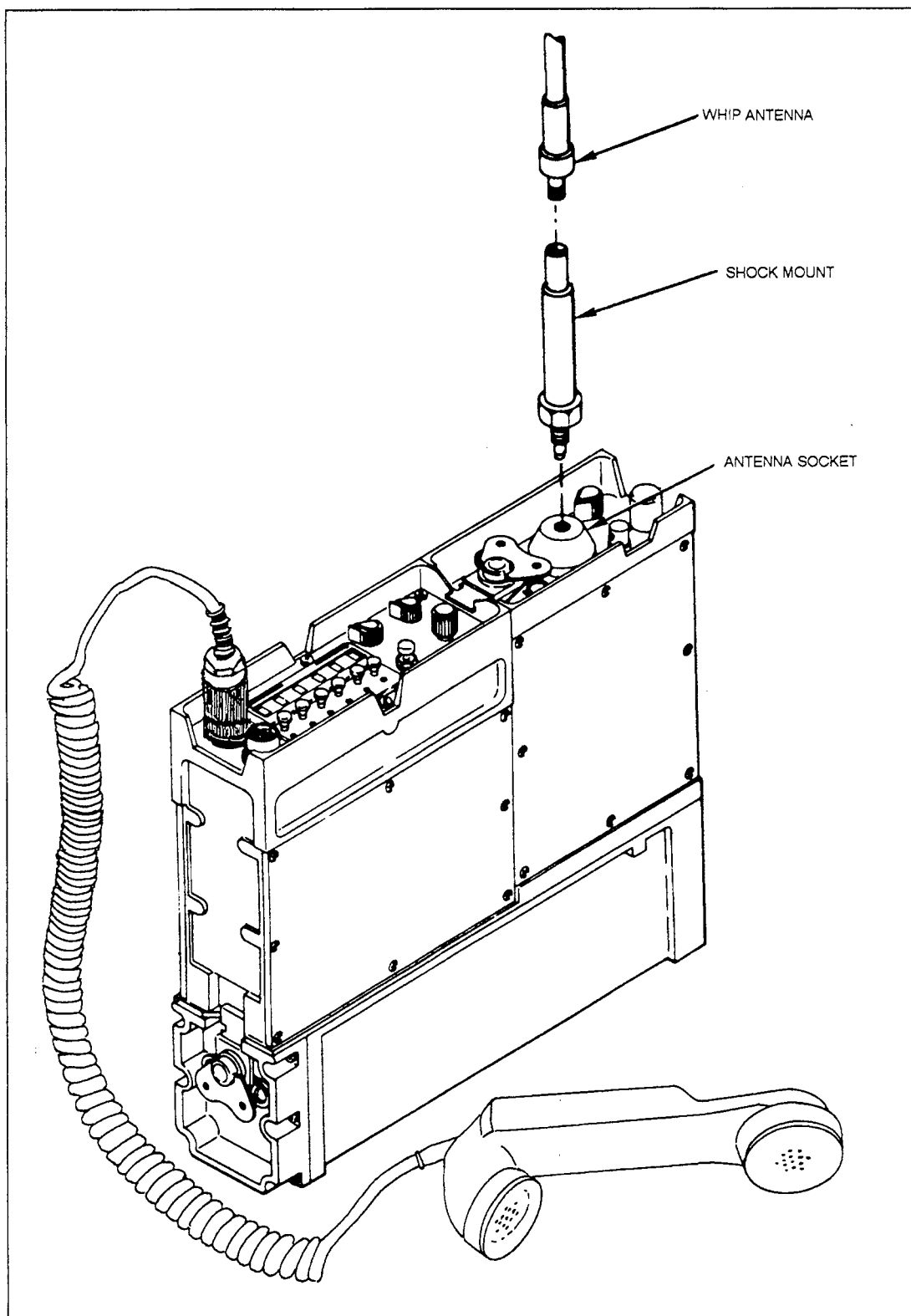
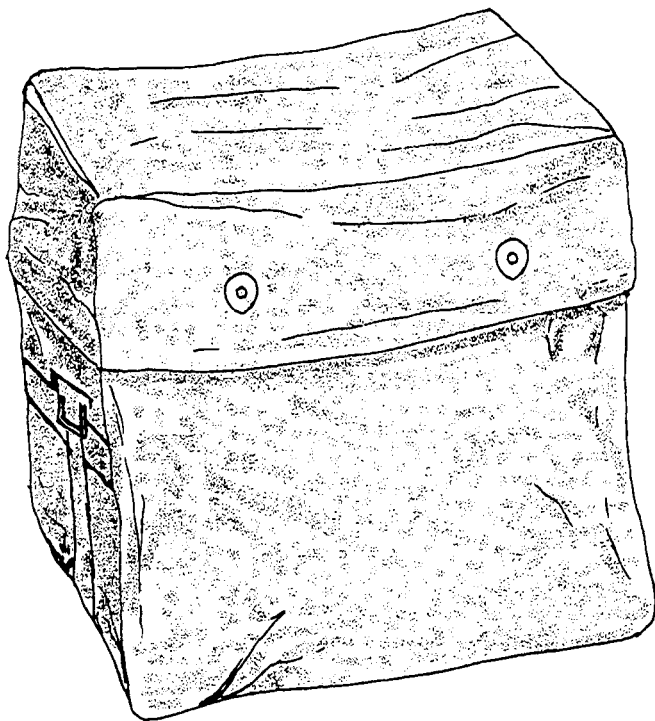
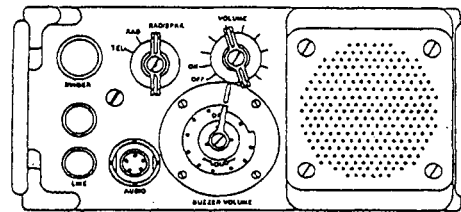
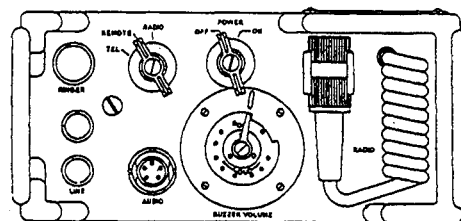
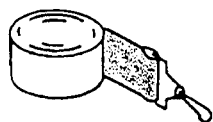

Figure 11-8.—Radio set man-pack setup.



BAG, COTTON DUCK CW-598/GRA-39

(NOTE 1)
CONTROL, RADIO SET C-2328/GRA-39(NOTE 1)
CONTROL, RADIO SET C-2329/GRA-39

SLING, CARRYING BAG AND CASE

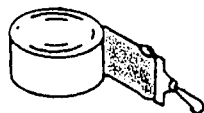

AUXILIARY SLING

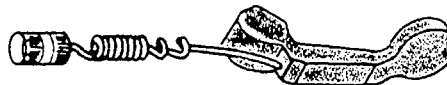
(NOTE)
HANDSET M-189/GR

NOTES:

1. -A AND -B MODELS OF CONTROLS ARE PROVIDED WITH **CALL** LAMP.
2. HANDSET H-138/U MAY BE ISSUED IN LIEU OF H-189/GR

Figure 11-9.—Radio Set Control Group AN/GRA-39, components and their functions.

AN/PRC-104 may be extended by using an AS-2259/GR antenna, the 15-foot near-vertical incidence sky-wave (NVIS) antenna. The Radio Frequency Cable Assembly CG-3815/V (antenna base cable) is used to connect the NVIS Antenna Base AB-124/PRC-104 to the BNC jack of the amplifier/coupler.

Radio Set Control Group AN/GRA-39

Radio Set Control Group AN/GRA-39 (fig. 11-9) provides the capability of remotely controlling a radio set up to a distance of 2 miles, using standard field wire. Remote control allows us to operate the radio set at the desired installation, yet locate the radio set in the best position for more efficient communication between the remote and the local control unit operators. It also

provides a buzzer system so the operators may alert one another. The major components of the AN/GRA-39 are the local control unit and the remote control unit.

1. BAG CW-598: Used for storage and transportation of the AN/GRA-39.
2. Sling, carrying bag, and case: Used for transportation of the bag.
3. Auxiliary sling: Used for carrying either the remote or the local receiver/exciter unit separately.
4. Control Group C-2328: Used to transmit or receive over the remote radio set.
5. Control Group C-2329: Connects to the radio being remotely. Connects on the radio audio connector.

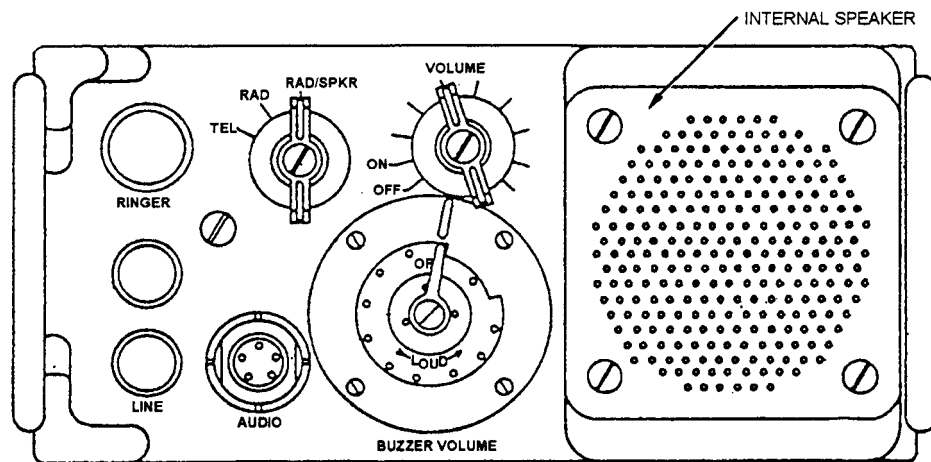

Figure 11-10.—Remote control unit C-2328/GRA-39.

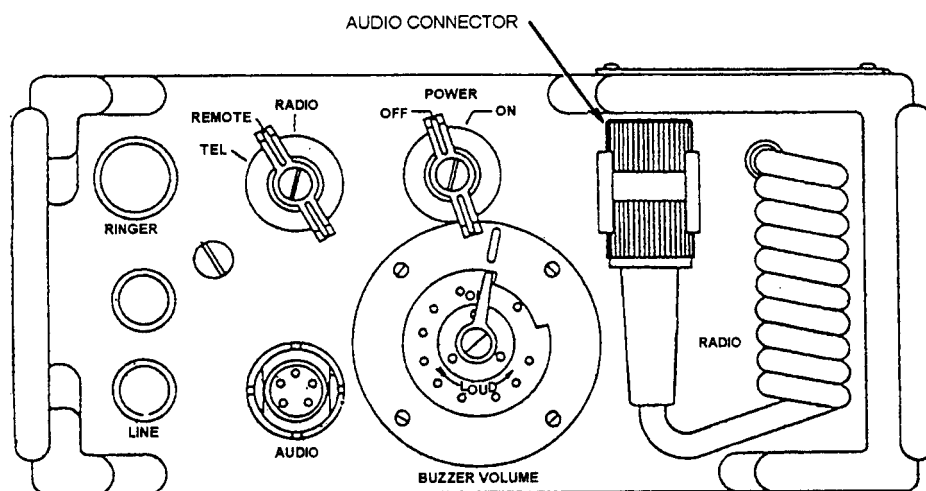

Figure 11-11.—Led control unit C-2329/GRA-39.

6. Handset H-189/PT: Allows an operator to receive and transmit voice communications through a radio.

REMOTE CONTROL UNIT.— The remote control unit (fig. 11-10) allows the operator at the remote site to transmit or receive through a radio set from a distance of up to 2 miles. The power supply (six BA-30s) for the remote control unit has a life expectancy of 24 hours.

LOCAL CONTROL UNIT.— The local control unit (fig. 11-11) is of the same general construction as the remote control unit. The local control unit is connected to the remote control unit by field wire. The local control unit is connected to the radio set being remote with the audio connector. The power supply, composed of six

BA-30s, for the local control unit has a life expectancy of 72 hours.

SETUP PROCEDURES USING RADIO SET AN/PRC-77.— The setup procedures for the AN/PRC-77 radio set used in conjunction with the AN/GRA-39 radio control group includes the following steps:

1. Setup the radio set and establish communication with a distant station before removing.
2. Ensure the Radio Control Group AN/GRA-39 is complete and that 12 BA-30s and field wire are available.
3. Installation of the batteries requires the following procedures:

- For the local control unit (C-2329):
 - a. Unsnap the two rear clamps and remove the rear cover.
 - b. Install the size BA-30 batteries according to instructions on the rear of the case.
 - c. Replace the rear cover and clamp it.
 - d. Locate the local control unit near enough to the radio so the audio connector cord can reach it.
- For the remote control unit (C-2328):
 - a. Perform the procedure in (a) through (c) above.
 - b. Position the remote control unit as required (up to 2 miles from the local control unit).

4. To make appropriate connections, you must ensure the procedures indicated below are followed carefully:

- For the local control unit (C-2329):
 - a. Remove the radio connector from the retaining clip on the front panel.
 - b. Connect the radio connector to the audio connector of the radio set; ensure proper connection is made.
 - c. Strip the insulation from the field wire (1/2 inch) and connect the wire to the binding posts by pressing the post down, inserting the wire into the slots provided, and releasing the posts.
 - d. Connect the handset from the radio set to the local control unit.
- For the remote control unit (C-2328):
 - a. Strip the insulation from the ends (1/2 inch) and connect the wire to the binding post by pressing the posts down, inserting the field wire into the slots provided, and release.

WARNING

DO NOT PRESS THE RINGER BUTTON WHILE CONNECTING THE FIELD WIRE TO THE LINE BINDING POSTS.

- b. Connect the handset provided with the AN/GRA-39, to the audio connector ensuring a secure connection.

OPERATING PROCEDURES.— Perform the following actions:

- For the local control unit (C-2329):
 - a. Turn the POWER switch ON.
 - b. Set the BUZZER VOLUME/LAMP (the one desired) near mid-range.
- For the remote control unit (C-2328):
 - a. Turn the volume control to mid-range.
 - b. Set the BUZZER VOLUME/LAMP (the one desired) to near mid-range.

The Radio Set Control Group AN/GRA-39 provides three types of operation:

1. Telephone communications between remote and local control unit operation.
 - a. Press the ringer button on the front panel several times to gain the attention of the other operator.
 - b. Set the remote control unit TEL/RAD/RAD-SPKR switch to TEL.
 - c. Turn and hold the local unit TEL/REMOTE/RADIO switch to TEL.
 - d. Press the handset press-to-talk switch to talk to the other operator, release to receive.
2. Radio set transmission and reception from the local unit.
 - a. Set and hold the TEL/REMOTE/RADIO switch to RADIO.
 - b. Press the handset press-to-talk switch to transmit, release to receive.
3. Radio set transmission and reception from the remote control unit.
 - a. Set TEL/REMOTE/RADIO switch on the local control unit in the remote position.
 - b. Local operator adjust volume on radio set for a comfortable listening level.
 - c. Set the TEL/RAD/RAD-SPKR switch on the remote unit to RAD or RAD-SPKR.
 - d. Adjust the volume control to the desired listening level.

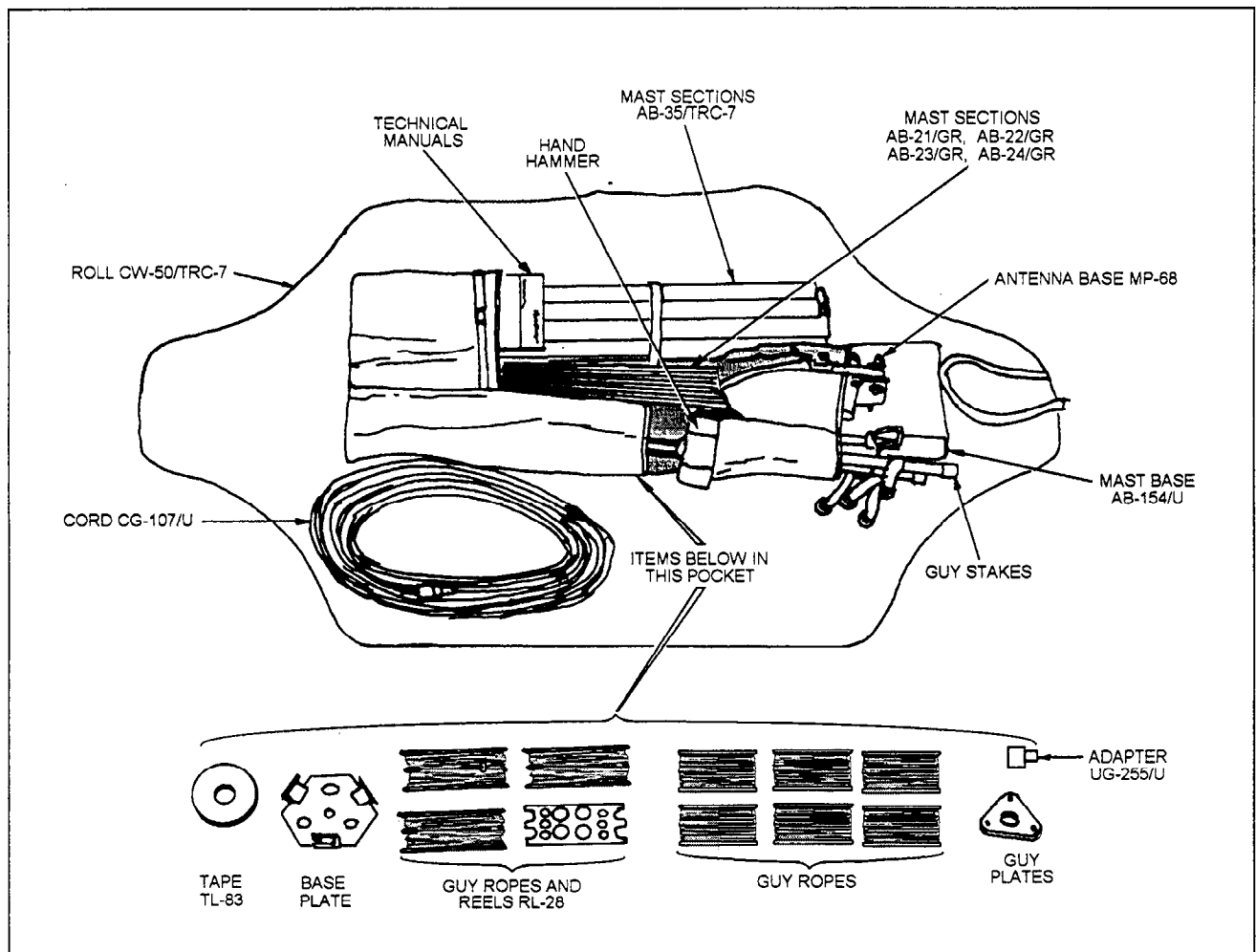

Figure 11-12.—Antenna equipment RC-292, components and spare parts.

- e. Press the handset push-to-talk switch to transmit; release to receive.
- f. If chatter (a motor boat sound) is heard in the speaker or handset, turn the volume down on the radio set and re-adjust the volume from the remote control unit.

The three operating procedures described above should be applied each time the AN/GRA-39 is put into operation, because it allows the operator to hold a complete operational check of the Radio Set Control AN/GRA-39.

SECURING PROCEDURE.— To secure the AN/GRA-39, perform the following actions:

1. Turn the power switches to OFF on both units.
2. Remove the batteries.

3. Disconnect the wires, handsets, and radio connector.

4. Store all components in the carrying bag and return it to storage after preventative maintenance has been performed by the operator.

ANTENNA EQUIPMENT RC-292

The RC-292 antenna (fig. 11-12) is an elevated, wide-band, modified ground-plane antenna designed to increase the range of radio sets in the 30 to 76 MHz range. The reception range for the RC-292 is 8 to 36 miles, depending on the type of radio set being used and the terrain.

The RC-292 can be used with the AN/PRC-77, AN/PRC-104, AN/GRC-160, and AN/GRA-39.

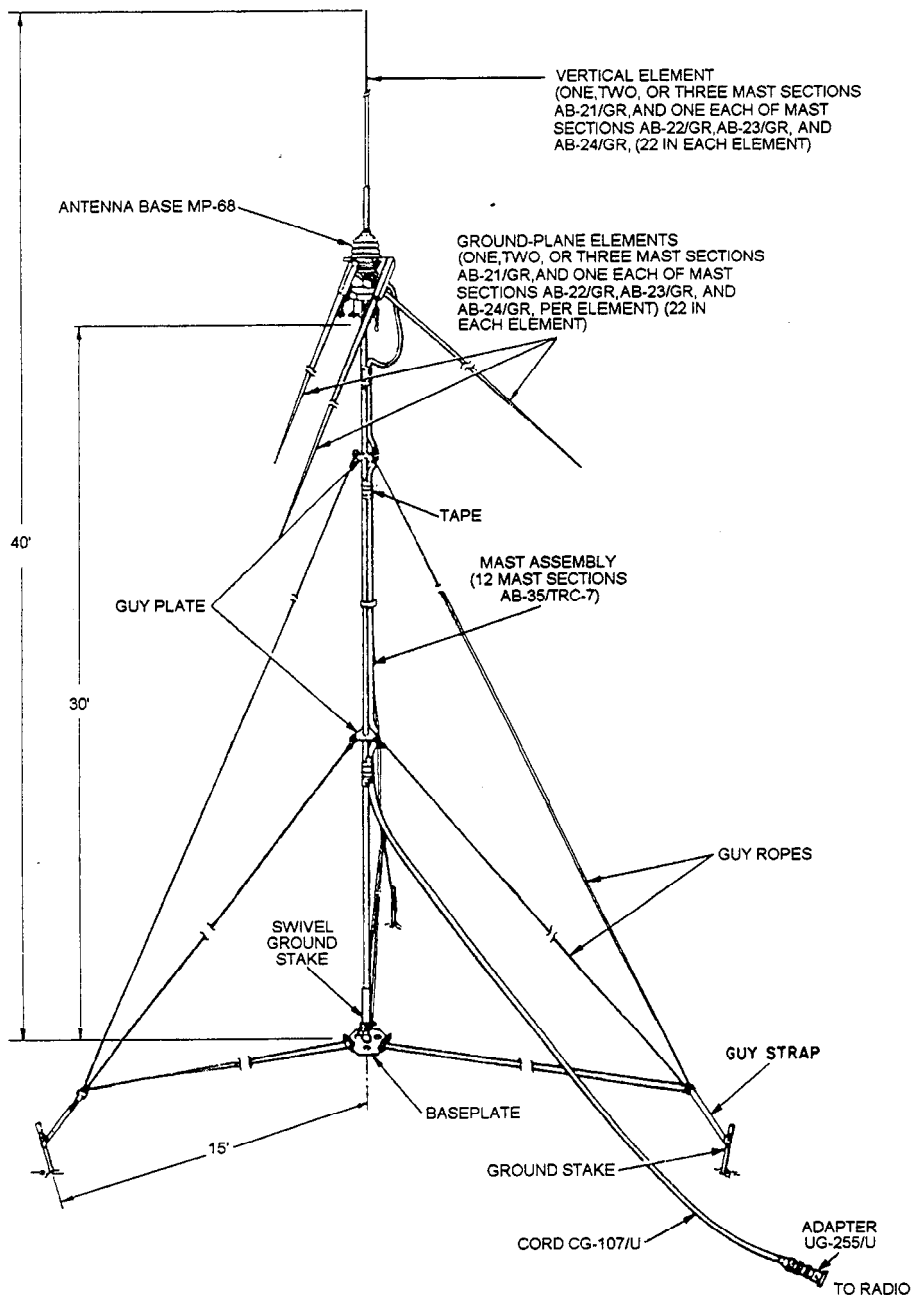

Figure 11-13.—Antenna RC-292 setup.

The antenna (fig. 11-13) consists of one vertical radiating element that makes an angle of 140 degrees with the vertical element. Antenna Base MP-68 mounts the four antenna elements and provides for connecting the antenna to the radio set by the CG-107/U. Twelve Mast Sections AB-35/TRC-7, joined together, form the 30-foot mast assembly for elevating above ground. The mast assembly is supported on Mast Base Assembly AB-154/U installed in the baseplate and is held in a vertical position by six guy ropes. The lengths of the antenna elements are adjusted for different frequency ranges by changing the number of mast sections that

make up the antenna elements. The swivel stake on which the mast is supported facilitates lowering of the antenna to make such changes. The equipment maybe transported by hand (manually) or by vehicle. When disassembled, the RC-292 should be packed in a canvas roll.

The components of the antenna RC-292 are as follows:

1. Antenna Elements. The vertical radiating element and three ground-plane elements consist of one, two, or three Mast Sections AB-21/GR, and one each of

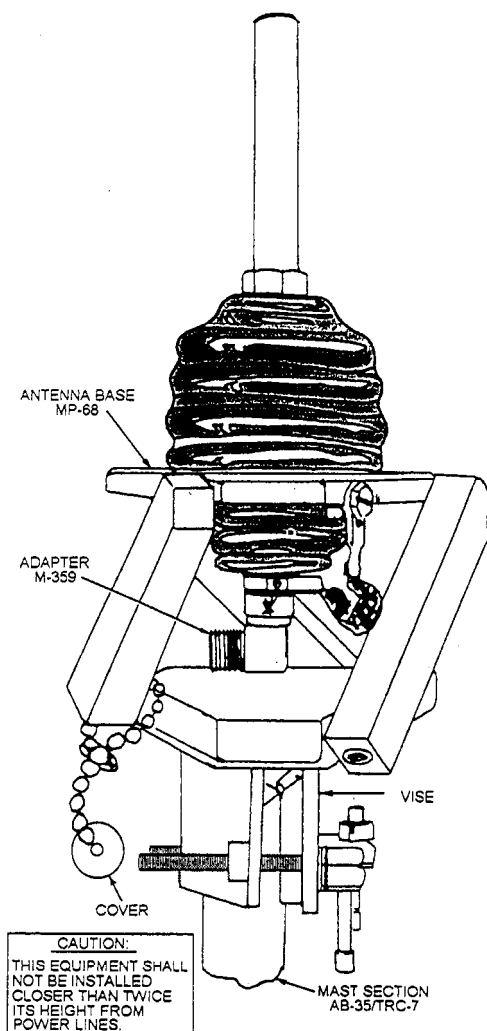

Figure 11-14.—Antenna base MP-68 mounted on mast.

Mast Sections AB-22/GR, AB-23/GR, and AB-24/GR. The mast sections are copper plated, painted tubes of high-strength steel that can be screwed together.

2. Antenna Base MP-68. The MP-68 (fig. 11-14) is comprised of a ceramic feed-through insulator, sockets for mounting the antenna elements, an M-359 adapter, and a vise. The feed-through insulator permits the vertical radiating antenna element socket to be connected through the M-359 adapter to the center conductor of the CG-107/U. The three ground-plane sockets and the outer conductor of the CG-107/U connect to the metal framework of the antenna base. The vise enables the antenna base to be clamped to the top of the supporting mast assembly.

3. Mast Section AB-35/TRC-7. Twelve sections are provided for assembling the 30-foot supporting mast assembly. Each section is tubular and has a male and female end that permit the sections to be fitted together.

4. Mast Base Assembly AB-154/U. This assembly consists of Guy Stake GP101/U attached to a yoke and clevis pin assembly. The lowermost Mast Section Assembly AB-35/TRC7 is placed in the yoke and clevis pin assembly. The yoke and clevis pin arrangement allows the mast assembly to be lowered to the ground by pivoting around the stake.

5. Guy Ropes, Guy Plates, and Guy Stakes. These items hold the mast assembly in a vertical position (fig. 11-13).

6. Reel R1-28. Three of these reels are provided; two are wound on each of the three reels.

7. Cable Assembly, Radio Frequency Cord CG-107/U. The CG-107/U is a 68-foot length of 50-ohm, solid-dielectric, coaxial radio-frequency (rf) cable, terminated in male Plugs PL-259-A.

8. Adapter M-442. The M-442 consists of an angle bracket provided with Socket SO-259, an insulated lead, and a ground lead that permits the CG-107/U to be easily connected to Radio Sets SCR-508, SCR-528, SCR-608, and SCR-628.

9. Adapter Connector UG-255/U. The UG-255/U is required to adapt the CG-107/U to Receiver-Transmitters RT-66/GRC, RT-67/GRC, T-68/GRC, RT-246/VRC, RT-524/VRC, and Radio Sets AN/PRC-8, AN/PRC-9, and AN/PRC-10.

10. Roll CW-50/TRC-7. The CW-50/TRC-7 is a canvas roll with pockets and straps to hold the antenna components for transportation in the field. A shoulder strap is provided for easy carrying.

11. Guy Plate. One guy plate is inserted between the sixth and seventh sections of the mast assembly and another between the eleventh and twelfth sections. The upper and lower guy ropes attach to these plates.

WARNING

DO NOT CONNECT THE POWER CABLE BEFORE CONNECTING THE ANTENNA. HIGH RADIO-FREQUENCY (RF) VOLTAGES ARE PRESENT IN THE ANTENNA CONNECTOR WHEN THE TRANSMITTER POWER IS ON. ALSO, DO NOT TOUCH THE ANTENNA ABOVE THE INSULATING BOOT DURING TRANSMISSION BECAUSE YOU CAN BE SEVERELY BURNED.

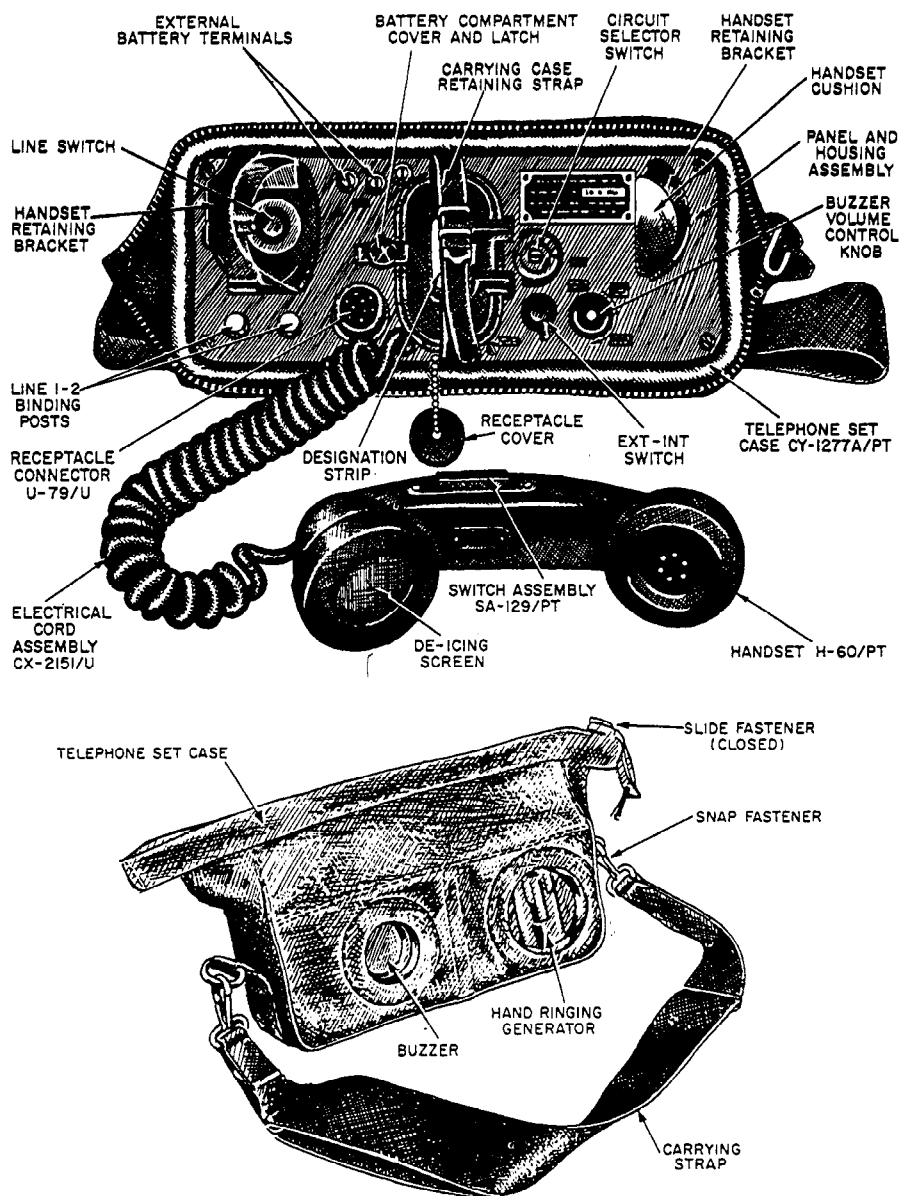

Figure 11-15.—TA-312/PT telephone set.

VINSON COMSEC KY-57

The KY-57 is the primary piece of VINSON COMSEC equipment used today for voice/data encryption on VHF radios and for a large number of wireline devices. When hooked to a radio, a teletype piece of gear, or a telephone device, the KY-57 can scramble (encrypt) the information being passed through it so only stations on our net having the same key as we do receive the information. The KY-57 uses electronic keys to encrypt the information, can be rekeyed remotely, and can accept signal fades up to 12 seconds without losing synchronization with the transmitting station. The KY-57 can be set up in the man-pack, vehicular, or fixed-site configuration.

TA-312/PT TELEPHONE

The TA-312/PT telephone set shown in figure 11-15 is a lightweight, waterproof, battery-powered, field telephone designed for local-battery or common-battery circuits. It has facilities for operating push-to-talk radio circuits and a range of 14 to 22 miles. The set weighs about 9 1/2 pounds.

The TA-312/PT consists of three primary components.

1. The telephone set case, made of reinforced canvas.
2. The panel and housing assembly that encloses all electrical components.

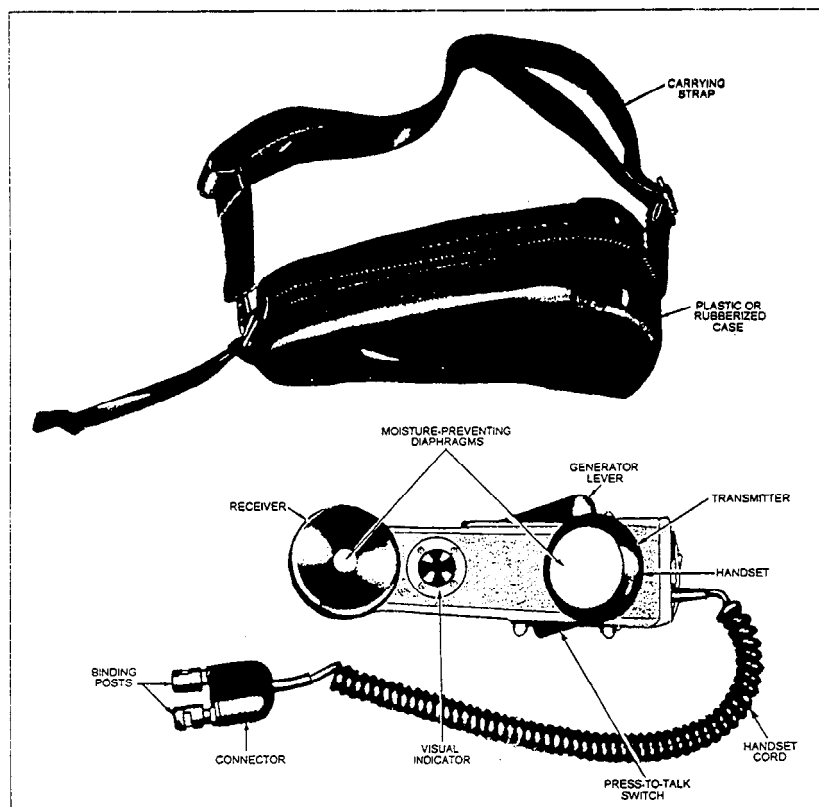

Figure 11-16.—TA-1/PT telephone set.

3. A transmitter, a receiver with a push-to-talk switch, and a retractable cord.

The power supply for the transmitter consists of two dry-cell (BA-30) batteries in series furnishing 3 volts for local battery (LB) operation. The batteries are used on both local-battery and common-battery signaling (CBS) circuits. One battery is installed in the battery compartment with the positive end up; the other with the positive end down. After you install the batteries, close the battery compartment cover and fasten the cover latch. An external, 3-volt battery source maybe used in place of the two BA-30s. Connect the back from the external batteries to the BAT binding posts on the panel. No batteries are required for common-battery operation.

In order to operate the TA-312 with the handset, follow the instructions listed below.

1. Put the EXT-INT SWITCH in the INT position.
2. To place a call in LB operation, leave the handset in the retaining brackets and turn the generator hand crank. Remove the handset from the brackets and listen for the party you are calling to answer.
3. To place a call in CB operation, remove the handset from the retaining brackets and listen for the operator to answer.

4. To talk and listen in CBS operation, push in on the press-to-talk switch when you talk release it when you listen.

5. To talk and listen in CB operation, you do not operate the press-to-talk switch.

6. To adjust the buzzer volume, request a distant party to signal; then place the handset in the brackets. When a signal is received, rotate the buzzer control for desired volume.

7. To complete the call, place the handset in the retaining brackets. When the set is connected through an LB switchboard, ring off by turning the hand crank.

TA-1/PT TELEPHONE

The TA-1/PT telephone set is a lightweight, waterproof, sound-powered, field telephone for use on field-wire lines to communicate with other field telephones or local, battery-operated switchboards. The TA-1/PT is equipped with a visual, incoming-signal indicator and a generator ringer. It has a talking range of 3 to 6 miles, which is ideal for use on a listening post. The set weighs about 2.7 pounds. The basic parts of the set are shown in figure 11-16.

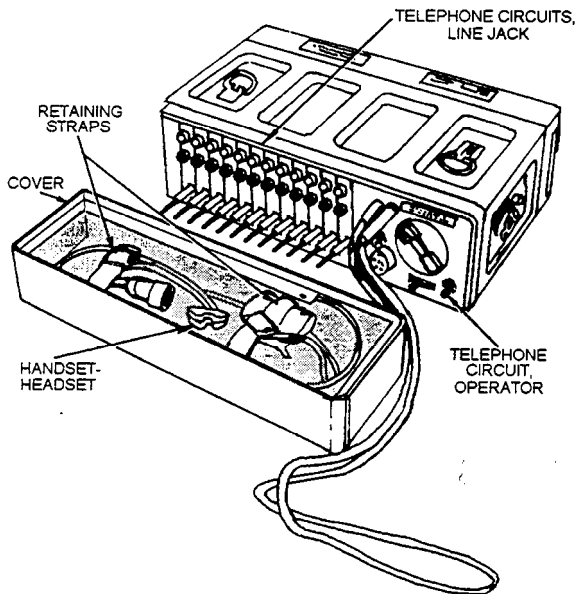

Figure 11-17.—Manual SB-22/PT telephone switchboard.

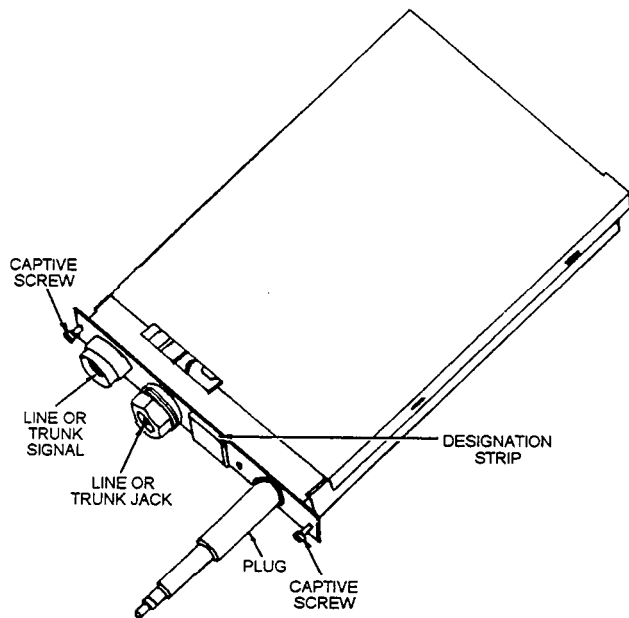

Figure 11-19.—TA-222/PT line and trunk pack.

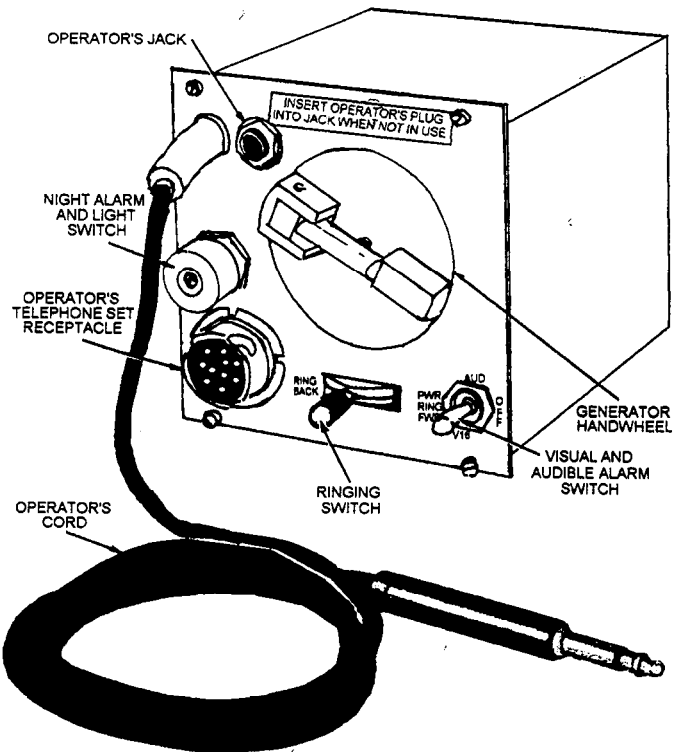

Figure 11-18.—TA-221/PT operator's pack.

The TA-1/PT can be used with the SB-22/PT telephone switchboard. To place an outgoing call with the TA-1/PT, first press the generator lever. Then, listen for the distant party to answer. When you are ready to talk press the talk switch. When listening, release the Dress-to-talk switch. The buzzer sounds for an incoming

call except when the buzzer volume control is set in the OFF position. The visual indicator shows four white, luminous markings that remain visible until you press the talk switch. Rotate the buzzer volume knob to adjust the buzzer volume. For maximum volume, rotate the knob counterclockwise as far as possible. For volume less than maximum, first request the distant party or switchboard for a ringing signal. When the buzzer sounds, rotate the buzzer volume knob clockwise until you obtain the desired volume.

SB-22/PT TELEPHONE SWITCHBOARD

The SB-22/PT telephone switchboard shown in figure 11-17 is a lightweight, battery-operated, field switchboard that has 12 interconnecting voice-frequency circuits. The SB-22/PT is normally used to interconnect local-battery telephone circuits, remote-controlled radio circuits, and voice-frequency teletypewriter circuits. Four BA-30 flashlight batteries provide 3 volts of direct current for its operation. The SB-22/PT has a range of 14 to 22 miles. The switchboard unit weighs about 30 pounds.

The SB-22/PT consists of four basic parts: the operator's pack (fig. 11-18); the line and trunk pack (fig. 11-19); the accessory kits (fig. 11-20); and the handset-headset (fig. 11-21).

Before operating the SB-22/PT switchboard, you should first become familiar with the different controls

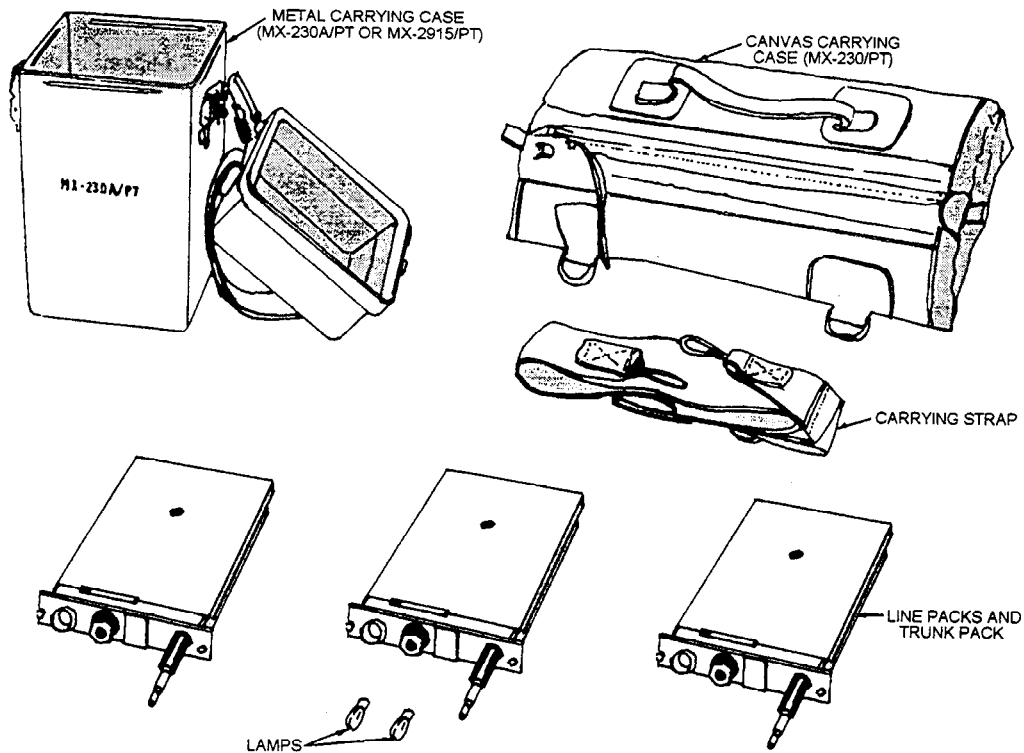

Figure 11-20.—Accessory kits, MX-230/PT, MX-230A/PT, and MX-2915/PT.

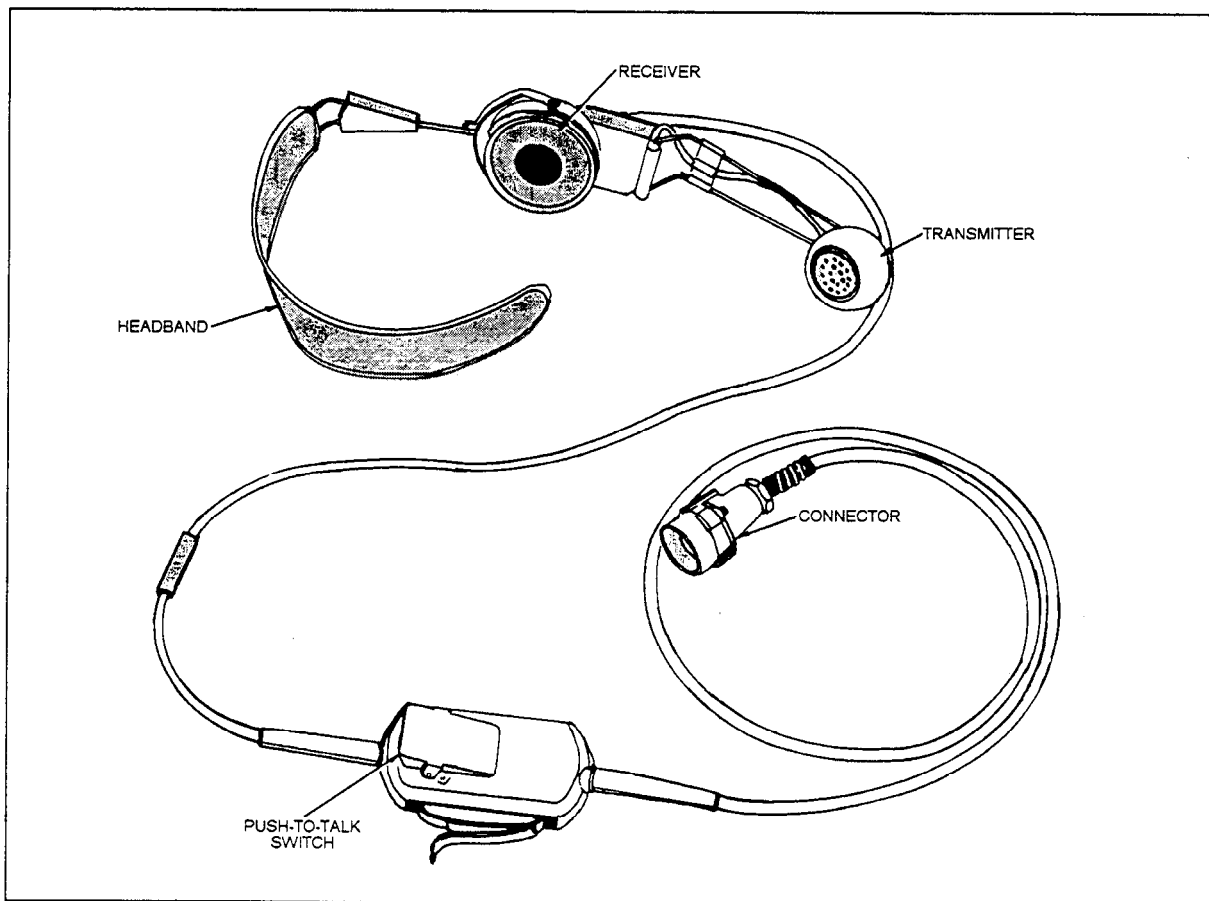

Figure 11-21.—Handset-headset, H81A/U.

Control	Function
	Switch position
Ringling switch.	RING BACK . . . Connects ringing current to the calling party's line.
	PWR RING . . . Connects ringing current to the called party's line when an external source of ringing current is used.
	FWD
Night alarm and light switch.	NA-IN. Permits the lamp to be used as a silent alarm.
	LITE-OUT . . . Lights the lamp to illuminate the switchboard.
Visual and audible alarm switch.	OFF. Disconnects the alarm circuit.
	VIS Connects the lamp to the alarm circuit.
	AUD Connects a buzzer to the alarm circuit.
Operator's cord and plug.	Connects the operator's circuit to the line or trunk pack.
Operator's jack.	Disconnects the operator's telephone set battery when the operator's cord plug is inserted.
Generator hand-wheel.	Provides ringing current when turned.
Operator's telephone set receptacle.	Permits connection of the operator's telephone set to the operator's pack.

Figure 11-22.—Operator's pack control and function.

and their functions. Figure 11-22 lists the controls and their functions in operating the OPERATOR'S PACK; figure 11-23 lists the controls and their functions in operating the LINE and TRUCK PACKS.

To put the SB-22/PT switchboard into operation, you first put on your HANDSET-HEADSET and

Control	Function
Jack (one for each line and trunk pack).	Provides access to the line or trunk.
Cord plug (one for each line or trunk pack).	Permits interconnection of lines or trunks through the jacks.
Signal (one for each line or trunk pack).	Indicates the circuit requires attention when operated to the <i>white</i> position.

Figure 11-23.—Line and trunk packs control and function.

connect it to the switchboard in the following manner:

1. Place the headset (fig. 11-21) over your head so the receiver covers one ear.
2. Position the transmitter directly in front of your mouth.
3. Align the connector (fig. 11-21) on your headset cord with the receptacle on the operator's pack (fig. 11-18). Push it into the connector and turn it to the right so it locks in place.

NOTE: The spacing of the lugs around the inside of the connector determines the position of the connector.

4. Clip the PUSH-TO-TALK SWITCH on the handset-headset to the front of your shirt.

After inserting the plug of your operating cord into the operator's pack (fig. 11-18), place the push-to-talk switch into any of the positions shown in figure 11-24.

When answering the calling party, watch the signals on the front of the line packs (fig. 11-19); the line signals turn from black to white. Follow the procedures below to answer the incoming call (fig. 11-25, view A).

1. Remove the plug of the operator's cord from the operator's jack and insert it into the jack that shows the white line signal (calling party's line signal).
2. Obtain the called party's name or number from the calling party and then proceed to interconnect the parties.

When connecting the calling party to the called party (fig. 11-25, view B), pull out the cord in the calling party's line and insert the plug into the called party's line

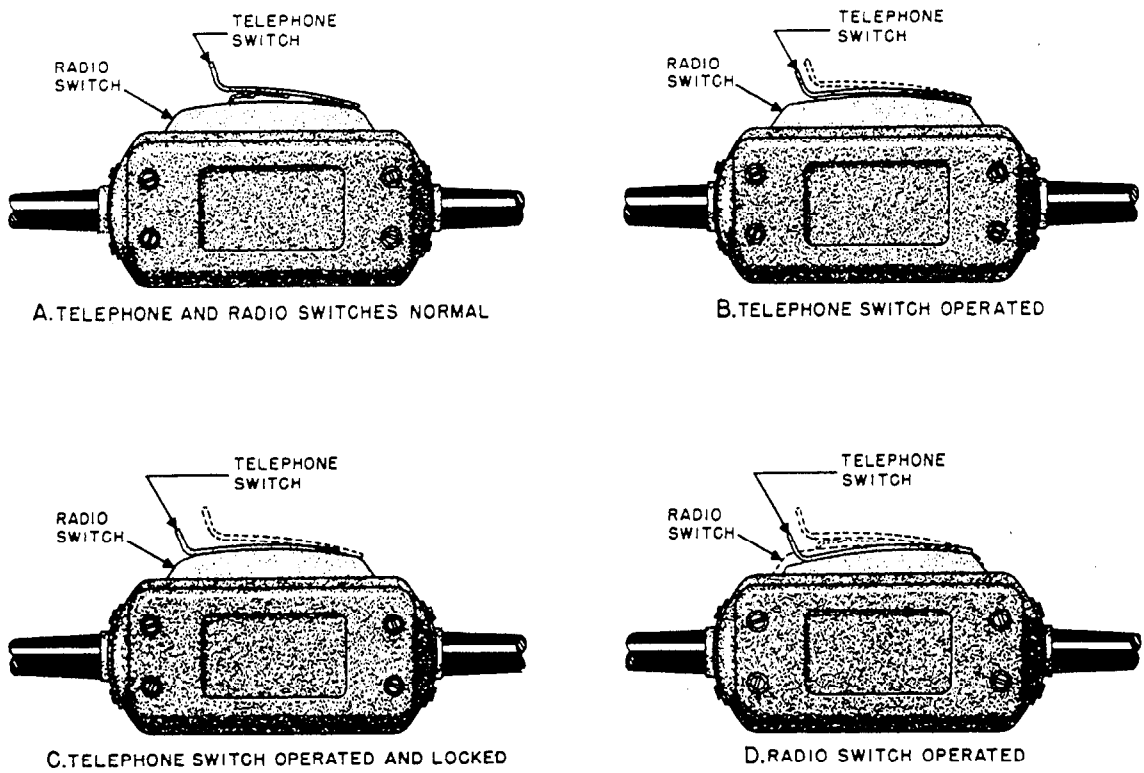

Figure 11-24.—Operating positions of the push-to-talk switch.

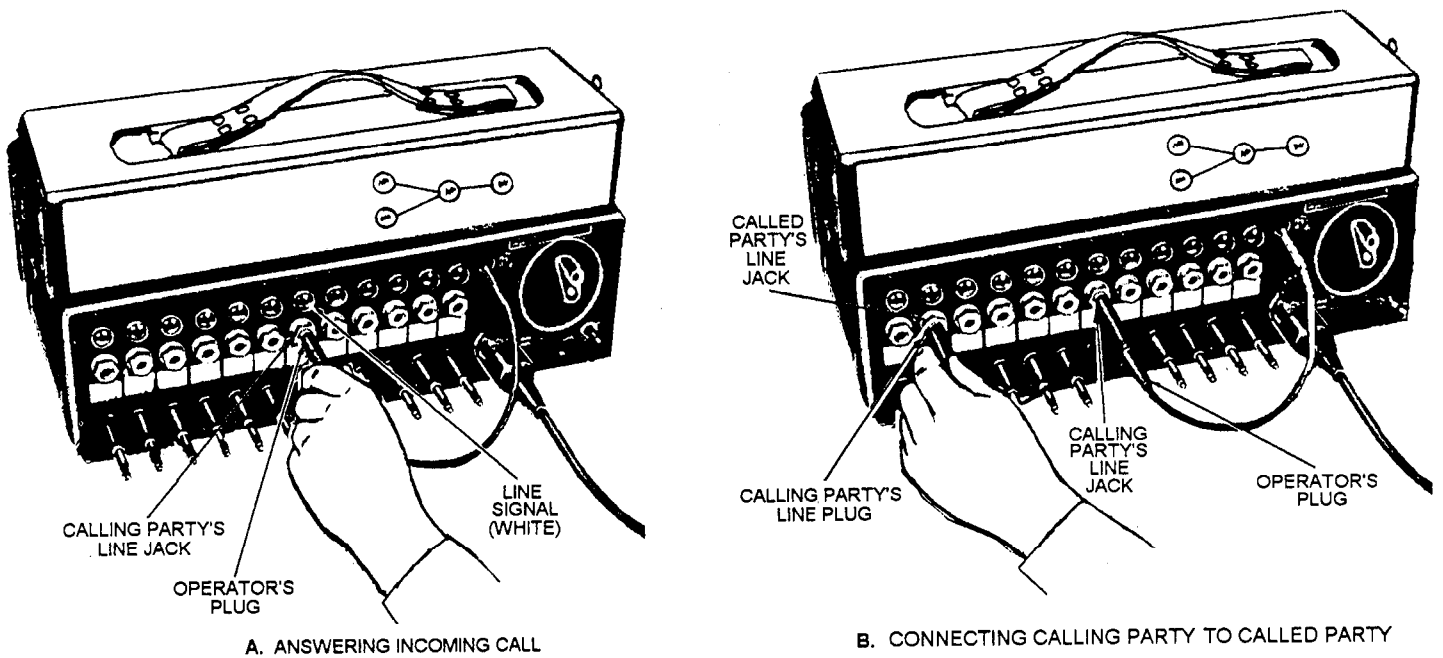

Figure 11-25A and B.—Steps required to connect local calls through the SB-22/PT switchboard.

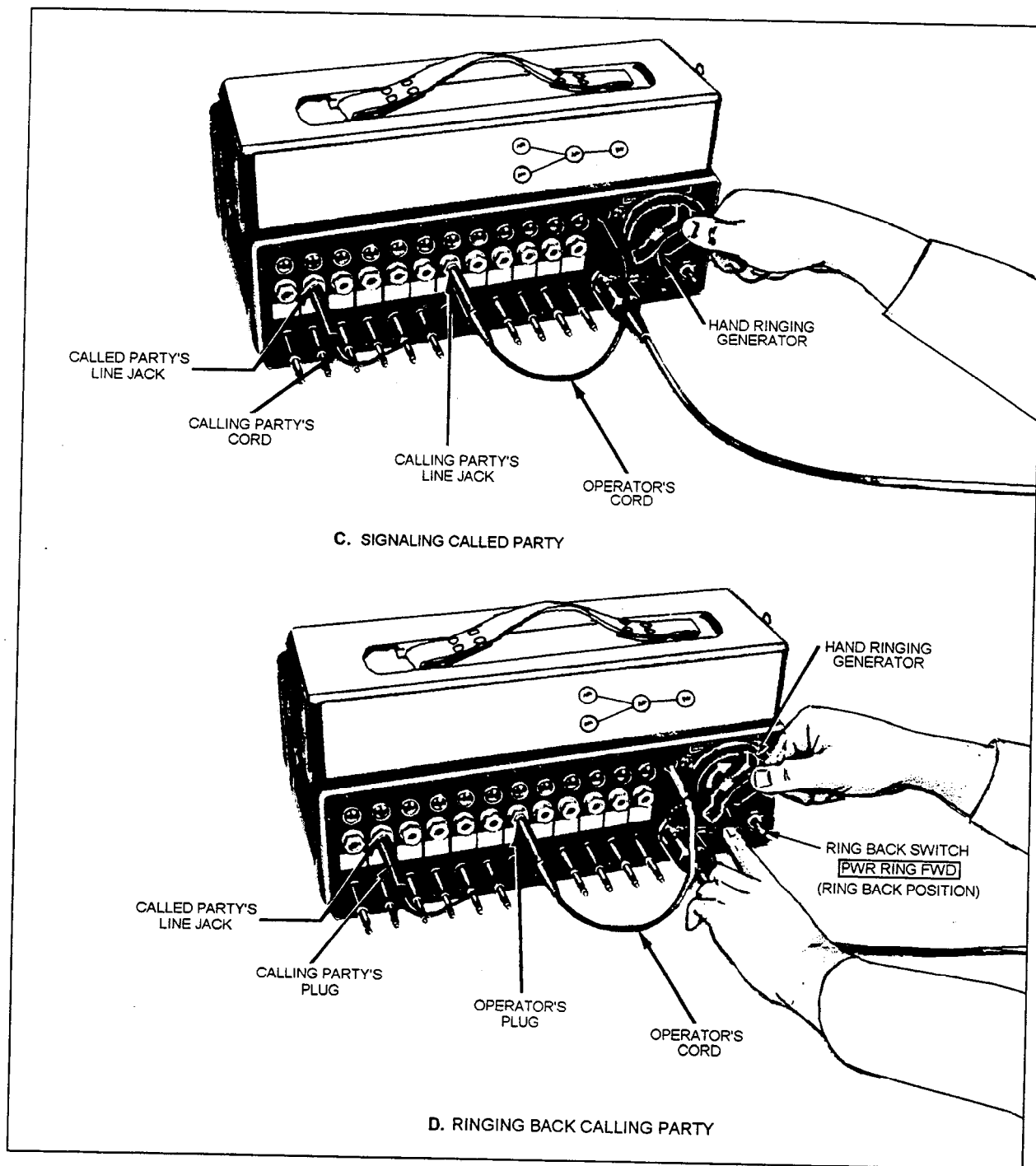

Figure 11-25 C and D.—Steps required to connect local calls through the SB-22/PT switchboard.

jack (fig. 11-25, view C). Then, signal the called party by turning the hand-ringing generator (fig. 11-18) rapidly for approximately 10 turns. Do NOT operate the RING BACK-PWR RING FWD switch to either position. Wait for the called party to answer. After the called party answers, remove the operator's plug from the called party's jack and insert it into the operator's jack.

After the calling and called parties finish talking, both parties should ring off. The ring-off signal causes

the calling party's line to turn white. If you should have to challenge the ring-off signal, remove the operator's plug from the operator's jack and insert it into the calling party's jack. Ask the parties if they have finished. If no one answers, disconnect the circuit. Remove the operator's plug from the calling party's jack and insert it into the operator's jack.

If the calling party disconnects before the called party answers or before the conversation is completed,

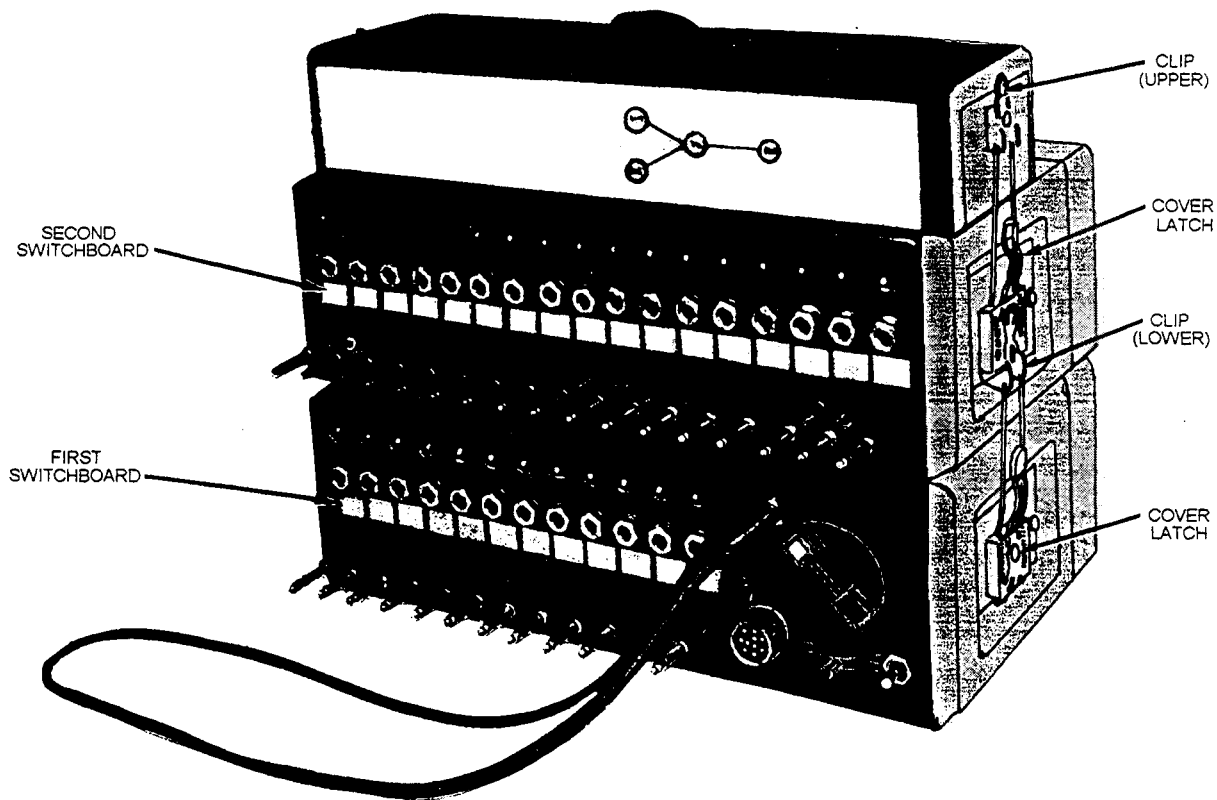

Figure 11-26.—Installation arrangement for two switchboards.

you can ring back the calling party (fig. 11-25, view D). You do this by removing the plug of the operator's cord from the operator's jack on the operator's pack and inserting it into the calling party's jack. Operate the RING BACK-PWR RING FWD switch to the RING BACK, turn the hand-ringing generator rapidly approximately 10 turns. Remove the operator's plug from the calling party's jack and insert it into the operator's jack when both parties answer.

If the called party disconnects before the conversation is completed, remove the plug of the operator's cord from the operator's pack and insert it into the jack of the calling party's line jack. Operate the hand-ringing generator rapidly about 10 turns. Remove the plug of the operator's cord from the jack of the calling party's line jack and insert it into the operator's jack on the operator's pack after both parties have answered.

If you must leave the switchboard, move the visual and audible alarm switch (fig. 11-1 8) from VIS to AUD. The alarm is silent on VIS, but audible on AUD. When the alarm is not required, place the VIS/AUD switch in the OFF position.

To operate your switchboard in the dark, pull out on the lamp cap and turn the lamp on. Remember, though, when the lamp is lighting the switchboard, the night alarm cannot be used at the same time.

STACKING OF TWO SWITCHBOARDS

To serve more than 12 but fewer than 30 lines, stack the 12-line switchboards. Remove the operator's pack from the switchboard and install five line packs in the empty space. Place this modified switchboard on top of a normally equipped switchboard. Use two jumpers to connect the two switchboards. One jumper must be connected to the NA binding posts of both switchboards, and the other jumper must be connected to the GND binding posts of both switchboards. Be sure that the jumpers pass through the slot at the side of each switchboard. Only one set of batteries is required to serve both switchboard; remove the battery case from the one containing the 17 line packs (from which the operator's pack has been removed). The field telephones can then be connected. A maximum of 29 lines can be served with this arrangement as shown in figure 11-26.

RADIO AND TELEPHONE PROCEDURES

Even though your primary duties are those of a rifleman, machine gunner, or mortarman, you may be called upon to pick up a radio to pass some valuable information to one of the platoons or to the battalion headquarters.

The intent of this section is to provide enough knowledge of correct radio and telephone procedures so you can operate the voice radio equipment in a Seabee battalion.

The following terms are defined to give you a better understanding of the explanations in the following section:

1. **TRANSMISSION:** A communication sent by one station and intended for reception by another station or stations.

2. **ANSWER:** A transmission made by a station called in response to the call received.

3. **CALL SIGN:** A call sign is a word, or a combination of words, intended for transmission by voice means, and it identifies the command, unit, or authority of the radio station.

4. **NET CALL SIGN:** The collective call sign that represents all the radio stations operating together on a particular radio net.

5. **NET CONTROL STATION:** A radio station appointed by higher authority to direct and control the operation and flow of all traffic handled on the radio net.

6. **PROWORD:** A pronounceable word or phrase that has been assigned a meaning to speed up message handling on radio nets that use radio and telephone. A list of prowords and their meanings is presented later in this section.

7. **ABBREVIATED PLAINDRESS MESSAGE:** A message that has certain elements of the message heading omitted for speed of handling. Anyone or all of the following may be omitted: precedence, date, date-time group, and group count.

8. **RECEIPT:** A communication sent by the receiving operator indicating that the message or other transmission has been satisfactorily received.

9. **ACKNOWLEDGMENT:** A separate message originated by the addressee to inform the originator that his message has been received and is understood.

PHONETIC ALPHABET AND NUMERALS

When necessary to identify a letter of the alphabet, the standard phonetic alphabet should be used. This helps to prevent the receiving operator from copying your words or groups of words incorrectly. Bs, Ps, Ts, and other letters that sound alike can be confusing when heard on radio telephone nets. Learn the phonetic alphabet listed below and the proper pronunciation as spoken over radio nets.

<u>Letter</u>	<u>Phonetic Equivalent</u>	<u>Pronounced</u>
A	ALFA	AL fah
B	BRAVO	BRAH voh
C	CHARLIE	CHAR lee or SHAR lee
D	DELTA	DELL tah
E	ECHO	ECK oh
F	FOXTROT	FOKS trot
G	GOLF	GOLF
H	HOTEL	hoh TELL
I	INDIA	IN dee ah
J	JULIETT	JEW lee ett
K	KILO	KEY loh
L	LIMA	LEE mah
M	MIKE	MIKE
N	NOVEMBER	no VEM ber
O	OSCAR	OSS cah
P	PMA	pah PAH
Q	QUEBEC	keh BECK
R	ROMEO	ROW me oh
S	SIERRA	see AIR rah
T	TANGO	TANG go
U	UNIFORM	YOU nee form
V	VICTOR	VIK tah
W	WHISKEY	WISS key
X	XRAY	ECKS ray
Y	YANKEE	YANG key
Z	ZULU	ZOO loo

USE OF THE PROWORD "I SPELL." Difficult words or groups within the text of the message maybe spelled out using the phonetic alphabet and should be started with the proword "I SPELL."

EXAMPLE: CATENARY "I SPELL" CHARLIE, AMA, TANGO, ECHO, NOVEMBER, ALFA, ROMEO, YANKEE. . . CATENARY Where the text is composed of easily pronounced words, they can be spoken.

USE OF PROWORD "FIGURES." In order to distinguish numerals from words similarly pronounced, you may use the proword "FIGURES" before numbers.

TRANSMITTING NUMERALS. When numerals are transmitted by radiotelephone, the rules for their proper pronunciation are as follows:

<u>Numeral</u>	<u>Spoken as</u>
0	ZE RO
1	Wun
2	Too
3	Thuh-ree
4	Fo-wer
5	Fi-yiv
6	Six
7	SEV en
8	Ate
9	NIN er

TRANSMITTING NUMBERS. Numbers are transmitted digit by digit except that exact multiples of hundreds and thousands may be spoken as such; however, there are special cases when the normal pronunciation of numerals is as follows:

<u>Number</u>	<u>Spoken as</u>
44	Fo-wer fo-wer
90	Niner zero
136	Wun thuh-ree siz
500	Fi-yiv hun-dred
1478	Wun fo-wer seven ate
7000	Seven thow-zand
16000	Wun six thow-zand
16400	Wun six fo-wer hun-dred
812681	Ate wun two six ate wun

PROWORDS

The following prowords and their meanings, authorized for general use, are those that are commonly used on the Seabee battalion radio nets.

ALL AFTER: The portion of the message to which I have reference is all of the message which follows .

ALL BEFORE: The portion of the message to which I have reference is all of the message which precedes .

BREAK: I hereby indicate the separation of the text from other portions of the message.

CORRECTION: An error has been made in this transmission. I will continue with the last word I transmitted correctly.

DISREGARD THIS TRANSMISSION: The transmission is an error. Disregard it. This proword shall not be used to cancel a message that has been completely transmitted and for which receipt or acknowledgement has been received.

DO NOT ANSWER: Stations called are not to answer this radio call, receipt for this message, or otherwise transmit in connection with this transmission. When this proword is used, the transmission shall be ended with the proword OUT.

EXEMPT: The addressee call signs immediately following are exempted from the collective call or net call.

FIGURES: Numerals or numbers to follow.

FROM: The originator of this message is indicated by the call sign immediately following.

INFO: The addressee(s) immediately following is/are addressed for information.

I SAY AGAIN: I am repeating transmission or portion indicated.

I SPELL: I shall spell the next word phonetically.

MESSAGE FOLLOWS: A message that requires recording is about to follow. Transmitted immediately after the radio call. (This proword is intended for use when messages are passed on tactical or reporting nets. It is not used on nets intended primarily for conveying messages.)

NUMBER: Station serial number of messages sent. Normally run in sequence for one 24-hour period.

OUT: This is the end of my transmission to you and no answer is required or expected.

OVER: This is the end of my transmission to you and a response is necessary. Go ahead; transmit.

PRECEDENCE PROWORDS: Four precedence designations are used in handling radio messages. These precedence prowords indicate the order in which one message is handled relative to other messages. The originator of the message assigns the precedence of the message. The precedence prowords in order of their importance are as follows:

1. FLASH
2. OPERATIONAL IMMEDIATE
3. PRIORITY
4. ROUTINE

READ BACK: Repeat this entire transmission back to me exactly as you received it.

RELAY Transmit this message to each of the addressees immediately following.

ROGER: I have received your last transmission satisfactorily.

SAY AGAIN: Repeat all of your last transmission. When followed by identification data means "Repeat portion indicated."

THIS IS: This transmission is from the station whose call sign immediately follows.

TO: The addressee(s) immediately following is/are to take action on this message.

WAIT: I must pause for a few seconds.

WAIT OUT: I must pause longer than a few seconds.

WILCO: I have received your message, understand it, and will comply. To be used only by the addressee. Since the meaning of ROGER is included in that of WILCO, the two prowords are never used together.

WORD AFTER: The word of the message to which I have reference is that which follows .

WORD BEFORE: The word of the message to which I have reference is that which precedes .

WORDS TWICE: Communication is difficult. Transmit each phrase (or each code group) twice. This proword may be used as an order, request, or as information.

WRONG: Your last transmission was incorrect. The correct version is .

FIELD MESSAGE FORMAT AND PREPARATION

The field message book, NAVMC 694, is primarily and extensively used in a tactical environment. Each book contains a hundred message forms that are self-carboning for easy duplication. A sample message and instructions for preparing field messages are depicted in figure 11-27. Spaces are provided at the bottom of the form to record the time of receipt (TOR) and time of delivery (TOD). The form is also a convenient reference when records are necessary.

TACTICAL MESSAGE FORMATS

The different types of reports and their content are published in the battalion's operations order (OPORD). On a patrol or in an emergency, you cannot always readily refer to the OPORD. Providing inadequate information, or even worse no information, about tactical situations can be harmful and can prevent a proper response. Always depict who, what, when, where, and how, if known; then, follow it up later as more information becomes available. The rule of thumb for reporting tactical information is to remember the following acronym SALUTE.

Size of enemy unit

Activity of enemy unit

Location of enemy unit(s)

Uniform worn by the enemy

Time of each activity noted

Equipment used or carried by the enemy

SECURITY

An important rule of communication is to remember that the enemy is always listening; therefore, we must always use correct security procedures when communicating classified information. Even seemingly unimportant unclassified information can be a valuable source of intelligence to the enemy. So certain information is prohibited from being transmitted in the clear. This type of information is known as Essential Elements of Friendly Information (EEFI).

The EEFI system is actually a code that allows us to notify one another of a security breach that has occurred over a circuit. The term used to identify a violation of this type is *BEADWINDOW* (example: *BEADWINDOW THREE*). This indicates to the

PROTECTOR INSERT
Place this under the last copy of each message written.

SAMPLE MESSAGE

Z	O	P	R	DTG (COMM. USE) 080855 W Aug 80	FM: 3D MAR	
TO: 3/3						
BT	TOPSEC	SECRET	CONF	UNCLAS		
CONTINUE ATTACK AT 0930. REPORT WHEN OBJECTIVE IS CONSOLIDATED.						
RELEASING OFFICER'S SIGNATURE <i>G.D. Barrett</i>					TOR/TOD 3/3/4125 MHz 80/0901 W	PAGE 1 of 1

INSTRUCTIONS FOR PREPARING FIELD MESSAGES

1. DRAFTER:

- a. Place the protector insert under the message blanks to limit the number of copies produced. Retain one copy in the book as a file copy. Classify cover in accordance with contents.
- b. Use BLOCK CAPITAL letters for all entries.
- c. To assign precedence, circle the appropriate letter using the table on front cover as a guide.
- d. Print organization originating message in "FM" space. (DO NOT USE CALL SIGN.)
- e. Print organization(s) for whom the message is intended in the "TO" space. (DO NOT USE CALL SIGNS.)
- f. To assign classification, circle the appropriate classification printed on the message blank.
- g. DO NOT USE ABBREVIATIONS IN TEXT. (Abbreviations lengthen transmit time.) Be brief. Use simple words. Use "ø" for all zeros. Number pages in appropriate space.
- h. Drafter is responsible for all message drafting functions to include the use of brevity codes and numeral/letter encryption.

2. RELEASING OFFICER:

- a. Ensure drafter functions are completed.
- b. Sign appropriate space if message is approved. (First page only.)

3. OPERATOR:

- a. Assign local-time date-time-group, "DTG", if required by unit SOP.
- b. Convert "FM" and "TO" entries to call signs. (FOR UNSECURE VOICE TRANSMISSIONS ONLY.)
- c. Fill in TOR/TOD information, as appropriate:

TOR: TIME/OPERATOR INITIAL/FREQUENCY	TOD: STATION CALLED	FREQUENCY
	OPERATOR INITIAL	TIME

Figure 11-27.—Sample message and instructions.

transmitting station that he has violated security. The only response to a BEADWINDOW is ROGER OUT. All violations must be reported. BEADWINDOW procedures are incorporated into the OPORD. They are given below. Others can be added at the discretion of the commander.

BEADWINDOW CODES:

Position - 01	Friendly or enemy position, movement or intended movement: position, course, speed, altitude, or destination of 'any air, sea, or ground element unit or force.
Capabilities - 02	Friendly or enemy capabilities or limitations: force composition or identity, capabilities, limitations or significant casualties to special equipment, weapon systems, sensors, units, or personnel. Percentages of fuel or ammunition remaining.
Operations - 03	Friendly or enemy operations, intentions, progress or results: operational or logistic intentions, assault objectives, mission participants, flying programs, mission situation reports, results of friendly or enemy operations.
Electronic Warfare - 04	Friendly or enemy electronic warfare emission control (EW/EMCON) intentions, progress, or results: intention to employ electronic countermeasures (ECM), results of friendly or enemy electronic counter-countermeasures (ECCM), results of electronic warfare support measures (ESM), present or intended EMCON policy, and equipment affected by EMCON policy.

Personnel - 05

Friendly or enemy key personnel: movement or identity of friendly or enemy flag officers, distinguished visitors, unit commanders, and movements of key maintenance personnel indicating equipment limitations.

COMSEC - 06

Friendly or enemy communications security (COMSEC) locations: linkage of codes or code words with plain language, compromise of changing frequencies or linkage with line numbers, circuit designator linkage of changing call signs with previous call signs or units, compromise of encrypted or classified call signs, and incorrect authentication procedure.

Wrong Circuit - 07

Inappropriate transmission: information requested, transmitted or about to be transmitted that should not be passed on the circuit because it either requires greater security protection or is not appropriate to the purpose for which the circuit is provided.

MESSENGERS

Messenger service is the backbone of the rifle company communication system and is a backup for both the wire and radio systems. Wire lines maybe cut by enemy fire or by enemy infiltration. Radio communication is insecure and should not be relied upon as the only means of communication; therefore, the foot runner is most dependable. The manner in which messengers are used depends on the tactical situation. Normally, a messenger from each rifle platoon is sent to the company command post. Then, with each displacement, he is replaced with a new messenger. This provides the company commander with a runner who knows the exact location of his parent rifle platoon. One company messenger is located in the battalion command

post and is replaced by another upon each company displacement.

Communication by Messenger

When time permits, a message should be written; however, oral messages are often necessary. A complete message must answer the questions of what, when, and where; but a message should be made as brief as possible, omitting words that do not add to the meaning.

A written message should be printed in plain block letters; individual letters contained in the message should be spelled out using the phonetic alphabet (as, Zulu for letter Z). The name of the command authorizing the message and the name of the command to which it is being sent must be written in the message. The actual writer of the message must sign his name and rank or rate.

Messenger Training

A combat messenger must be trained carefully in the following skills:

1. How to deliver messages, either oral or written.
2. How to travel over various kinds of terrain at prescribed speeds.
3. How to use a compass for orientation and direction.
4. How to read maps.
5. How to select routes that provide the best cover and concealment.
6. How to recognize units and command posts with which communication is maintained.

Messenger Briefing

Each messenger must receive a briefing with the following information:

1. The name and location of the post, unit, or person to whom the message is to be delivered.
2. The route to be followed.
3. The danger points to be avoided.
4. The speed required.
5. Whether or not an answer is required.
6. Where to report in case the message cannot be delivered.

7. The contents of the message if the situation warrants.

8. Special instructions, if any.

For an oral message, the messenger must be required to repeat the message to the sender, to memorize it, and to deliver it word-for-word.

COMBAT SIGNALS

Oral (that is, voice) communication is often difficult or impossible under combat conditions. At times, complete silence must be maintained. Under such conditions, signals are used to transmit commands or information. Three types of combat signals are used:

1. Whistle signals
2. Special signals
3. Arm and hand signals

Understanding combat signals is important for a fire team. Make sure you become thoroughly familiar with each signal described in this section. Bear in mind, too, that practice in the use of combat signals is essential if the signals are to be used effectively.

Whistle Signals

As a rule, only three whistle signals are used, since a large variety could cause confusion. The following three are commonly used whistle signals:

1. ATTENTION TO ORDERS is indicated by one short blast on the whistle. It is used to fix the attention of unit members on the unit leader who gives the signal and means that other signals, orders, or commands are to follow.

2. CEASE FIRING is indicated by one long blast on the whistle. This signal is verified immediately by an arm and hand signal or by some other means.

3. HOSTILE AIRCRAFT or MECHANIZED VEHICLE is indicated by three long blasts repeated several times.

Special Signals

Special signals cover all the special methods and devices used to transmit commands or information. Rifle shots or automatic rifle bursts maybe used when the entire command knows their meanings and the sound

1. **DECREASE SPEED**
EXTEND THE ARM HORIZONTALLY SIDWARD, PALM TO THE FRONT, AND WAVE ARM DOWNWARD SEVERAL TIMES, KEEPING THE ARM STRAIGHT. ARM DOES NOT MOVE ABOVE THE HORIZONTAL.
2. **CHANGE DIRECTION; OR COLUMN (RIGHT OR LEFT)**
EXTEND ARM HORIZONTALLY TO THE SIDE, PALM TO THE FRONT.
3. **ENEMY IN SIGHT**
HOLD THE RIFLE HORIZONTALLY, WITH THE STOCK IN THE SHOULDER, THE MUZZLE POINTING IN THE DIRECTION OF THE ENEMY.
4. **RANGE**
EXTEND THE ARM FULLY TOWARD THE LEADER OR MEN FOR WHOM THE SIGNAL IS INTENDED WITH FIST CLOSED. OPEN THE FIST EXPOSING ONE FINGER FOR EACH 100 YARDS OF RANGE.
5. **COMMENCE FIRING**
EXTEND THE ARM IN FRONT OF THE BODY, HIP HIGH, PALM DOWN, AND MOVE IT THROUGH A WIDE HORIZONTAL ARC SEVERAL TIMES.
6. **FIRE FASTER**
EXECUTE RAPIDLY THE SIGNAL "COMMENCE FIRING." FOR MACHINEGUNS, A CHANGE TO THE NEXT HIGHER RATE OF FIRE IS PRESCRIBED.

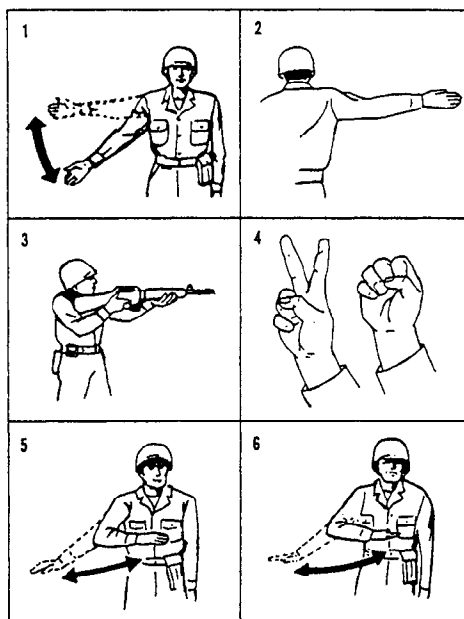

7. **FIRE SLOWER**
EXECUTE SLOWLY THE SIGNAL "COMMENCE FIRING." FOR MACHINEGUNS, A CHANGE TO THE NEXT LOWER RATE OF FIRE IS REQUIRED.
8. **CEASE FIRING**
RAISE THE HAND IN FRONT OF THE FOREHEAD, PALM TO THE FRONT, AND SWING THE HAND AND FOREARM UP AND DOWN SEVERAL TIMES IN FRONT OF THE FACE.
9. **ASSEMBLE**
RAISE THE HAND VERTICALLY TO THE FULL EXTENT OF THE ARM, FINGERS EXTENDED AND JOINED, PALM TO THE FRONT, AND WAVE IN LARGE HORIZONTAL CIRCLES WITH THE ARM AND HAND.
10. **FORM COLUMN**
RAISE EITHER ARM TO THE VERTICAL POSITION. DROP THE ARM TO THE REAR, DESCRIBING COMPLETE CIRCLES IN A VERTICAL PLANE PARALLEL TO THE BODY. THE SIGNAL MAY BE USED TO INDICATE EITHER A TROOP OR VEHICULAR COLUMN.

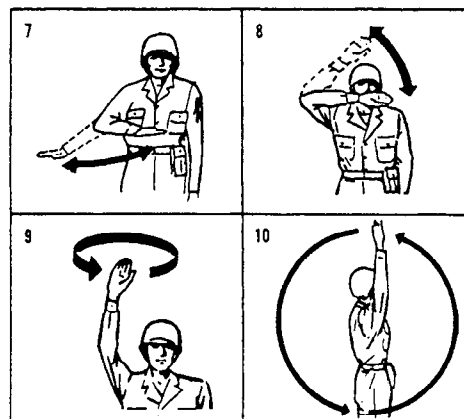

Figure 11-28.—Combat arm and hand signals.

is distinct enough to be heard easily. A squad leader operating at night may find the use of raps on his helmet or rifle effective. Signals must be determined and practiced before they are used. Various pyrotechnic and smoke signals may be chosen as signals to attack, withdraw, mark front lines, or indicate targets.

Certain special signals are standard for all branches of the armed forces to indicate the approach or presence of hostile aircraft or mechanized vehicles. They are as follows:

1. Three long blasts of a whistle, vehicular horn, siren, or Klaxon repeated several times.
2. Three equally spaced shots with rifle or pistol.
3. Three short bursts of fire from automatic small arms.

In daylight, an individual giving the signal should point toward the danger; at night, the alarm should be supplemented by voice warning to indicate the direction—for example, **ENEMY TANKS APPROACHING BY THE NORTH ROAD** or **HOSTILE AIRCRAFT APPROACHING FROM THE WEST**.

Unit leaders should devise special signals whenever they appear to be useful in a particular situation. Before devising a special signal for the unit, the leaders should make certain that higher authority has not assigned some other meaning to the same signal.

Combat Arm and Hand Signals

Signals are used to transmit commands or information when voice communication is difficult or impossible or when silence must be maintained. Leaders

11. **ARE YOU READY?**
EXTEND THE ARM TOWARD THE LEADER FOR WHOM THE SIGNAL IS INTENDED, HAND RAISED, FINGERS EXTENDED AND JOINED, THEN RAISE ARM SLIGHTLY ABOVE HORIZONTAL, PALM FACING OUTWARD.
12. **I AM READY**
EXECUTE THE SIGNAL ARE YOU READY.
13. **SHIFT**
RAISE THE HAND THAT IS ON THE SIDE TOWARD THE NEW DIRECTION ACROSS THE BODY, PALM TO THE FRONT; THEN SWING THE ARM IN A HORIZONTAL ARC, EXTENDING ARM AND HAND TO POINT IN THE NEW DIRECTION.
14. **ECHELON RIGHT (LEFT)**
FACE THE UNIT(S) BEING SIGNALLED AND EXTEND ONE ARM 45° ABOVE AND THE OTHER ARM 45° BELOW THE HORIZONTAL, PALMS TO THE FRONT. THE LOWER ARM INDICATES THE DIRECTION OF ECHELON. SUPPLEMENTARY COMMANDS MAY BE GIVEN TO ENSURE PROMPT AND PROPER EXECUTION.
15. **AS SKIRMISHERS (FIRE TEAM);
LINE FORMATION (SQUAD)**
RAISE BOTH ARMS LATERALLY UNTIL HORIZONTAL, ARMS AND HANDS EXTENDED, PALMS DOWN. IF IT IS NECESSARY TO INDICATE A DIRECTION, MOVE IN THE DESIRED DIRECTION AT THE SAME TIME.
16. **WEDGE**
EXTEND BOTH ARMS DOWNWARD AND TO THE SIDE AT AN ANGLE OF 45° BELOW THE HORIZONTAL, PALMS TO THE FRONT.
17. **VEE**
EXTEND ARMS AT AN ANGLE OF 45° ABOVE THE HORIZONTAL FORMING THE LETTER "V" WITH ARMS AND TORSO.
18. **FIRE TEAM**
THE RIGHT ARM SHOULD BE PLACED DIAGONALLY ACROSS THE CHEST.
19. **SQUAD**
EXTEND THE HAND AND ARM TOWARD THE SQUAD LEADER, PALM OF THE HAND DOWN; DISTINCTLY MOVE THE HAND UP AND DOWN SEVERAL TIMES FROM THE WRIST, HOLDING THE ARM STEADY.
20. **PLATOON**
EXTEND BOTH ARMS FORWARD, PALMS OF THE HANDS DOWN, TOWARD THE LEADER(S) OR UNIT(S) FOR WHOM THE SIGNAL IS INTENDED AND DESCRIBE LARGE VERTICAL CIRCLES WITH HANDS.
21. **CLOSE UP**
START SIGNAL WITH BOTH ARMS EXTENDED SIDEWARD, PALMS FORWARD, AND BRING PALMS TOGETHER IN FRONT OF THE BODY MOMENTARILY. WHEN REPETITION OF THIS SIGNAL IS NECESSARY, THE ARMS ARE RETURNED TO THE STARTING POSITION BY MOVEMENT ALONG THE FRONT OF THE BODY.
22. **OPEN UP; EXTEND**
START SIGNAL WITH ARMS EXTENDED IN FRONT OF THE BODY, PALMS TOGETHER, AND BRING ARMS TO THE HORIZONTAL POSITION AT THE SIDES, PALMS FORWARD. WHEN REPETITION OF THIS SIGNAL IS NECESSARY, THE ARMS ARE RETURNED ALONG THE FRONT OF THE BODY TO THE STARTING POSITION AND THE SIGNAL IS REPEATED UNTIL UNDERSTOOD.

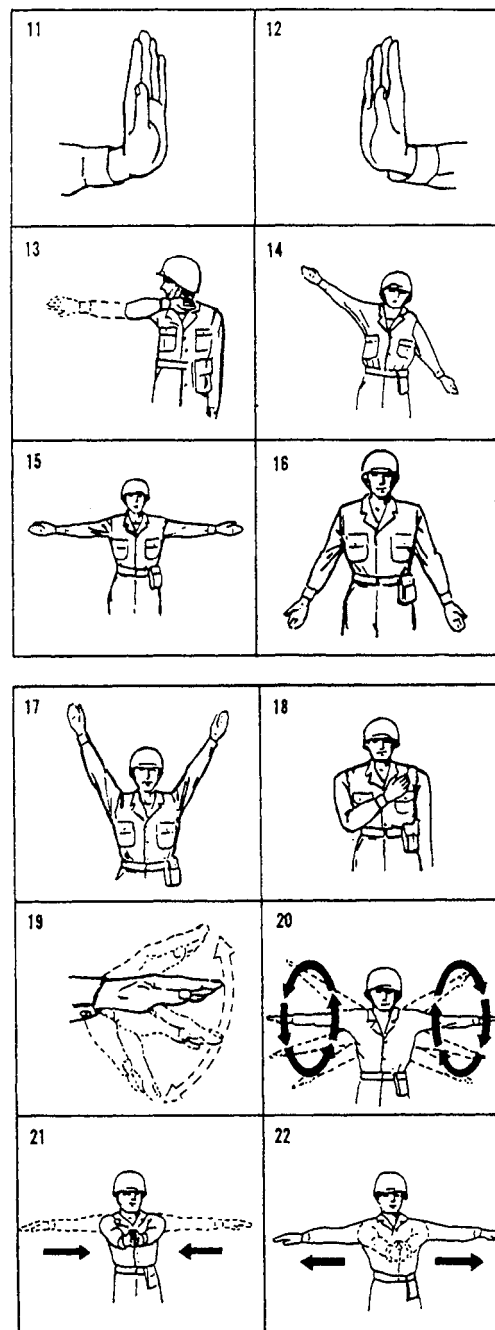

Figure 11-28.—Combat arm and hand signals—Continued.

should repeat signals to their units whenever necessary to ensure prompt and correct execution of orders. Leaders giving arm and hand signals should remember that these are an order of command. The signal is given smartly. Leaders must be aware of their location to ensure the signal can be seen by the intended unit. When a movement is to be executed by particular unit(s), a signal appointing the unit(s) precedes the signal for the actual movement. If a movement is to be executed in

unison, the signal for the movement should be followed by the signal READY. After the READY signal is acknowledged, the movement is executed at the same time that the arm is lowered. Signals requiring a change of direction have no connection with the direction in which the person giving the signal is facing. The direction of movement is shown by the direction in which the arm of the signaler points. Standard arm and hand signals are explained in figure 11-28.

23. **DISPERSE**
EXTEND EITHER ARM VERTICALLY OVERHEAD; WAVE THE HAND AND ARM TO THE FRONT, LEFT, RIGHT, AND REAR, THE PALM TOWARD THE DIRECTION OF EACH MOVEMENT.
24. **I DO NOT UNDERSTAND**
FACE TOWARD SOURCE OF SIGNAL; RAISE BOTH ARMS SIDEWARDS TO THE HORIZONTAL AT HIP LEVEL, BEND BOTH ARMS AT ELBOWS, PALMS UP, AND SHRUG SHOULDERS IN THE MANNER OF THE UNIVERSAL "I DUNNO."
25. **FORWARD; ADVANCE; TO THE RIGHT (LEFT); TO THE REAR (USED WHEN STARTING FROM A HALT)**
FACE AND MOVE IN THE DESIRED DIRECTION OF MARCH; AT THE SAME TIME EXTEND THE ARM HORIZONTALLY TO THE REAR; THEN SWING IT OVERHEAD AND FORWARD IN THE DIRECTION OF MOVEMENT UNTIL IT IS HORIZONTAL, PALM DOWN.
26. **HALT**
CARRY THE HAND TO THE SHOULDER, PALM TO THE FRONT; THEN THRUST THE HAND UPWARD VERTICALLY TO THE FULL EXTENT OF THE ARM AND HOLD IT IN THAT POSITION UNTIL THE SIGNAL IS UNDERSTOOD.
27. **FREEZE**
MAKE THE SIGNAL FOR "HALT" AND MAKE A FIST WITH THE HAND.
28. **DOWN; TAKE COVER**
EXTEND ARM SIDEWARD AT AN ANGLE OF 45° ABOVE HORIZONTAL, PALM DOWN, AND LOWER IT TO SIDE. BOTH ARMS MAY BE USED IN GIVING THIS SIGNAL. REPEAT UNTIL UNDERSTOOD.
29. **INCREASE SPEED; DOUBLE TIME**
CARRY THE HAND TO THE SHOULDER, FIST CLOSED; RAPIDLY THRUST THE FIST UPWARD VERTICALLY TO THE FULL EXTENT OF THE ARM AND BACK TO THE SHOULDER SEVERAL TIMES. THIS SIGNAL IS ALSO USED TO INCREASE GAIT OR SPEED.
30. **HASTY AMBUSH RIGHT (LEFT)**
RAISE FIST TO SHOULDER LEVEL AND THRUST IT SEVERAL TIMES IN THE DESIRED DIRECTION.
31. **RALLY POINT**
TOUCH THE BELT BUCKLE WITH ONE HAND AND THEN POINT TO THE GROUND.
32. **OBJECTIVE RALLY POINT**
TOUCH THE BELT BUCKLE WITH ONE HAND, POINT TO THE GROUND, AND MAKE A CIRCULAR MOTION WITH THE HAND.

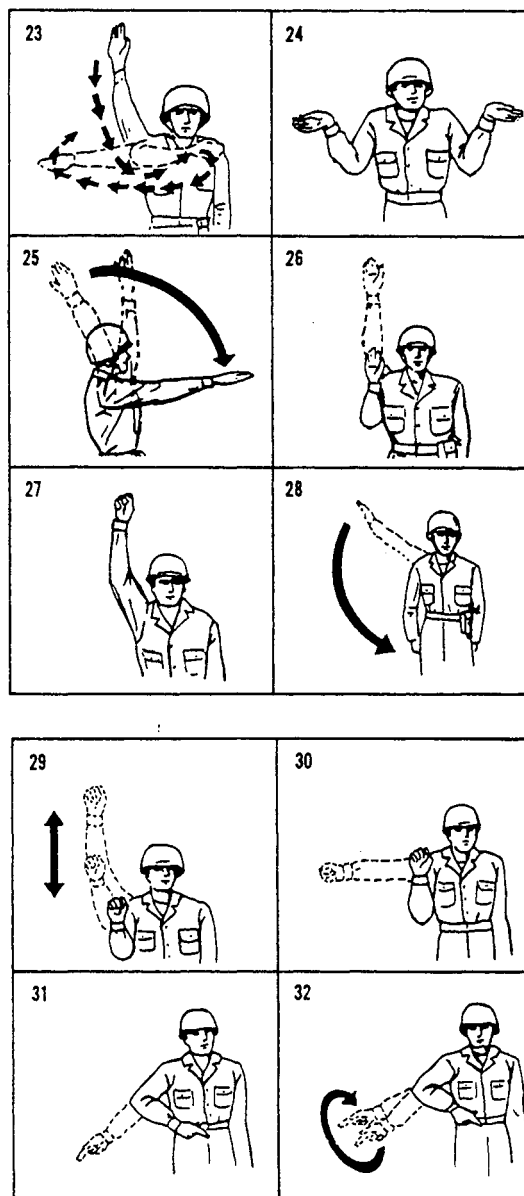

Figure 11-28.—Combat arm and hand signal—Continued.

In modern warfare, a helicopter is a common sight during combat. All personnel should be familiar with hand signals that assist helicopter pilots in landing. Hand signals for guiding a pilot are as follows:

1. To Direct Helicopter Forward. Extend your arms and hands above your head with your palms facing away from the helicopter. Move your hands in a manner that simulates a pulling motion. (See fig. 11-29.)

2. To Direct Helicopter Backward. Extend your arms and hands above your head with your palms facing toward the helicopter. Move your hands in a manner that simulates a pushing motion. (See fig. 11-30.)

3. To Direct Helicopter Sideways. Extend your arms and palms out to your side with your palms facing

the direction that the helicopter should move. Move your hands in a manner that simulates pushing the helicopter in the desired direction. (See fig. 11-31.)

4. To Direct Helicopter to Land. Bend your arms at the elbows with your lower arms held parallel to the ground at waist level. Keep palms facing downward parallel to the ground, and forearms moving to simulate a downward pushing motion. (See fig. 11-32.)

5. To Direct Helicopter to Take Off. Extend both hands above your head with fists clenched and thumbs raised. (See fig. 11-33.)

6. To Direct Helicopter to Hold Its Present Position. Cross your forearms above your head with both fists clenched. (See fig. 11-34.)

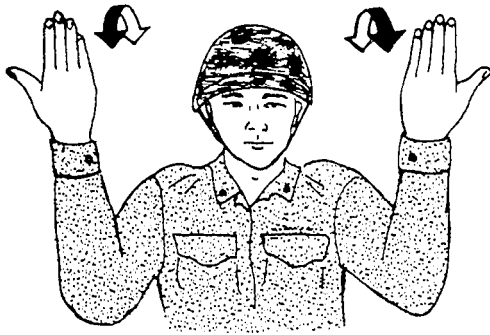

Figure 11-29.—To direct helicopter forward.

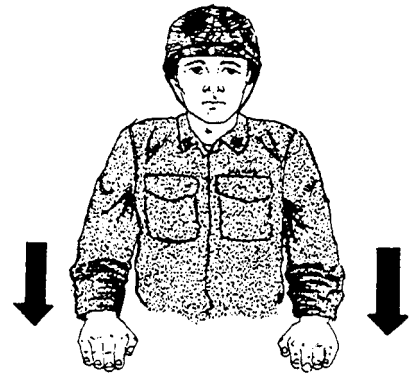

Figure 11-32.—To direct helicopter to land.

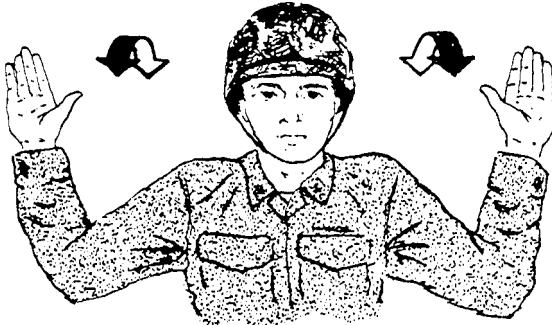

Figure 11-30.—To direct helicopter backward.



Figure 11-33.—To direct helicopter to take off.

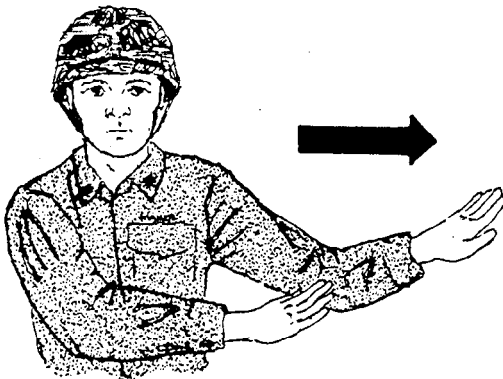

Figure 11-31.—To direct helicopter sideways.

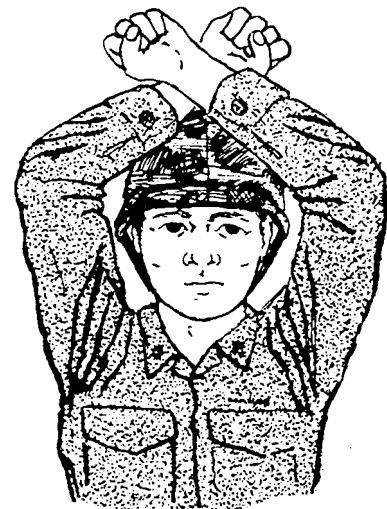

Figure 11-34.—To direct helicopter to hold its present position.

WRITTEN ORDERS

An NMCB's standard operating procedures (SOPs) are a set of written orders issued by the battalion commander. They cover the battalion administrative and tactical operations that lend themselves to a definite or a standardized procedure without loss of effectiveness. The uses of SOPs are as follows:

- To simplify the preparation and transmission of orders;
- To simplify and perfect training of the troops;
- To facilitate operations;
- To minimize confusion and errors; and

- To promote understanding and teamwork between the battalion commander and his subordinates.

Written orders are prepared to cover battalion operations and are available to all personnel for guidance in the absence of other instructions or orders. The details contained in SOPs depend on the desires of the commander and the direction of the higher

	Copy Number Issuing Unit Place of Issue Date Time Group of Issue
CLASSIFICATION	
OPERATION ORDER NMCB ZERO 0-70	
TIME ZONE _____	
TASK ORGANIZATION: NMCB ZERO (Detail Zero, etc.)	
REFERENCES: (a) CONSECORD/THIRDRCB OPORD _____ (b) CONSECORD/THIRDRCB INSTRUCTION 3121.1 series (c) etc.	
1. SITUATION: A brief statement as to why the detail is required to deploy to a given area. a. Enemy Forces b. Friendly Forces c. Attachments and detachments	
2. MISSION: A brief statement of the construction or the disaster recovery mission to be accomplished by the unit executing the operation, or the combat defense role.	
3. EXECUTION: a. What, When, Who, and Where b. Concept of Operations (cite Annex) c. Coordinating instructions (1) Advance Party	
4. ADMINISTRATION AND LOGISTICS: a. Cite Annexes	
5. COMMAND AND COMMUNICATIONS: a. Operations of communications b. Location of command posts c. Axis of communication	
BY COMMAND OF _____ SIGNED _____ RANK AND SERVICE	
ANNEXES: (as applicable) B Concept of Operations C Intelligence D Training E Construction Tasks F Communications I Civic Action O Logistics P Admin and Personnel R Reports S Safety T Medical and Dental U Disaster Control V Public Affairs X Contingency Planning Y Distribution Z Record of Changes	

Figure 11-35.—Standard format for an operation order.

command; however, SOPs must contain all the information needed to serve as a guide for new personnel assigned to the battalion.

Operation Orders (OPORD)

An OPERATION PLAN (OPLAN) is a detailed statement of a course of action to be followed to accomplish a future mission. An OPERATION ORDER (OPORD) (See fig. 11-35.) puts an OPLAN into effect. The OPORD is a formal statement issued by the senior commander to subordinate commanders that outlines the coordinated execution of a future operation in the field.

In five paragraphs, OPLANs and OPORDs detail the complete information and orders necessary to carry out the decision of the commander. They are written so

subordinate units and agencies can have a thorough understanding of the part each is to play in the operations.

OPORDs may be oral, dictated, or in written form. The most important determining factor of the form and method of issuing an OPORD is the time available for its preparation and distribution. An order should reach its destination in enough time to avoid halting troops while they wait for further instructions. Even the lowest subordinate commander needs time to reconnoiter, place his troops in position, make other necessary arrangements, and issue his own orders before the hour set for beginning the action.

Oral and dictated orders are similar because both are spoken orders. When oral orders are issued, notes are made by the persons receiving them. Dictated orders are recorded verbatim by the receiver. A complete copy of

PATROL LEADER'S ORDER	
1. SITUATION	
a. Enemy Forces: Weather, terrain, identification, location, activity, strength.	
b. Friendly Forces: Mission of next higher unit, location and planned actions of units on right and left, fire support available for patrol, mission and route of other patrols.	
c. Attachments and Detachments.	
2. MISSION - What the patrol is going to accomplish.	
3. EXECUTION - (Subparagraph for each subordinate unit.)	
a. Concept of operation.	
b. Specific duties of elements, teams, and individuals.	
c. Coordinating instructions.	
(1) Time of departure and return	(6) Actions on enemy contact
(2) Formation and order of movement	(7) Actions at danger areas
(3) Route and alternate route of return	(8) Actions at objective
(4) Departure and reentry of friendly area(s)	(9) Rehearsals and inspections
(5) Rallying points and actions at rallying points	(10) Debriefing
4. ADMINISTRATION AND LOGISTICS	
a. Rations.	
b. Arms and ammunition.	
c. Uniform and Equipment (state which members will carry and use).	
d. Method of handling wounded and prisoners.	
5. COMMAND AND SIGNAL	
a. Signal.	
(1) Signals to be used within the patrol.	
(2) Communication with higher headquarters - radio call signs, primary and alternate frequencies, times to report and special code to be used.	
(3) Challenge and password.	
b. Command.	
(1) Chain of command.	
(2) Location of patrol leader and assistant patrol leader in formation.	

Figure 11-36—Format for patrol leader's order.

the order or notes is kept by the staff of the issuing commander.

Written orders may be in a message or other convenient form. The use of accompanying maps, photomaps, overlays, and tables saves time and words and minimizes errors. In many cases, an entire OPORD can be placed on a map or overlay.

Format for OPORD

The HEADING contains the security classification, a statement about changes from oral orders, copy number (handwritten), issuing headquarters, the place of issue, date and time of issue, file notation, title and serial number of the order, references (maps, charts, and photomaps), and the time zone to be used throughout the

order. When a code name for the operation is used, it is written on the same line as the OPORD title and number.

The BODY contains the task organization (when too complicated or lengthy to be contained in paragraph 3) and the five main numbered paragraphs. The five paragraphs cover the following topics in the order listed: (1) SITUATION, (2) MISSION, (3) EXECUTION, (4) ADMINISTRATION AND LOGISTICS, and (5) COMMAND AND COMMUNICATIONS. The acronym SMEAC (using the first letter of each topic) helps you remember these topics. Remember that the five main topics of an operation order must be covered whether the order is from a battalion commander, platoon commander, squad leader, or fire team leader. Naturally, battalion operation orders are quite lengthy, and a patrol leader's order is usually brief. The format of a patrol leader's order is shown in figure 11-36. The

orders of a patrol leader are usually given orally. Each patrol member should take accurate notes.

The task organization of an operation order includes the task subdivisions or tactical components that make up the command together with the names and grades of the commanders. (See fig. 11-35 again.) Support units are shown under the headquarters of the major unit that commands them—not under the headquarters of the unit they support. Attached units are shown under the headquarters of the unit to which they are attached. Units should be listed under paragraph letters that correspond to those in paragraph 3. Only the task subdivisions in the echelon of command just below the issuing unit are normally shown.

Paragraph 1. **SITUATION** always has three subparagraphs: Enemy Forces, Friendly Forces, and Attachments and Detachments. This paragraph contains information only. It does not include plans or instructions.

Paragraph 1.a. Enemy Forces contains information about the enemy that affects the operation, such as their locations, dispositions, strength, activities, and capabilities.

Paragraph 1.b. Friendly Forces contains a statement of the mission of the next higher unit; the location and planned actions of the unit on the right and left; the fire support available for the patrol; and the mission and route of other patrols.

Paragraph 1.c. Attachments and Detachments contains a list of nonorganic units attached to, and organic units detached from, the command for the specific operation. It includes the date/time the attachment or detachment is to take place.

Paragraph 2. **MISSION** contains a concise statement of the mission, its purpose, and of the command as a whole. It includes “what,” “how,” “where,” and as much of “why” as maybe proper. There are no subparagraphs.

Paragraph 3. **EXECUTION** assigns definite tasks to each element of the command, organic and attached, that contributes to carrying out the overall mission. No restrictions are set on the number of subparagraphs.

Paragraphs 3.a. Concept of Operations is a clear, concise summary of how the commander visualizes the operation should be conducted. This is an enlargement of the decision contained in the commander’s estimate. This paragraph should be as brief as possible; but it may be published as an annex or shown on an operation overlay when it is lengthy or detailed. When an overlay

is used, it need not be written. When an overlay or annex is used, this paragraph makes reference to it.

Paragraphs 3.b., 3.c., and so forth (tasks for subordinate units) are assigned separate subparagraphs lettered in alphabetical sequence to each major subordinate element. These subparagraphs correspond to the alphabetical listings in the task organization. Except as outlined below, all instructions to any unit having a tactical mission should appear in the subparagraph of paragraph 3 about that unit. Subparagraphs that assign tasks to other combat and combat support elements (if applicable) should follow.

The final subparagraph of paragraph 3, always entitled Coordinating Instructions, contains the details of coordination and the control measures that apply to the command as a whole; for example, objectives, comments, qualifying time of attack line of departure, boundaries, beaches, bomblines, and reference to march table annex. Many of these and other instructions that apply to two or more elements of the command maybe indicated in an attached overlay. In this case, they need not be repeated here. In this paragraph essential elements of information might be included (unless an intelligence annex is issued). Examples are operational reports to be submitted, if not set forth elsewhere by written order, preparatory fire information, and the effective time of the order.

Paragraph 4. **ADMINISTRATION AND LOGISTICS** contains administrative and logistic instructions, when an administrative order is not issued. When an order is issued, this paragraph refers to that order. In a small command, such as a Naval Mobile Construction Battalion, this paragraph contains all the necessary information and instructions about supply, evacuation, hospitalization, transportation, service, personnel, and similar matters.

Paragraph 5. **COMMAND AND SIGNAL** contains instructions about the command, command relationships, and the operations of communications and electronics.

Paragraph 5.a. Signal may refer to a standard plan or to a communications annex if one has been issued. When a communications annex has not been issued, paragraph 5a should contain references to the index of communications instructions (COI) currently in effect, instructions on the use of radio and pyrotechnics, and restrictions on the use of any means of communication.

Paragraph 5.b. Command gives the location of the command post of the issuing unit and those of subordinate units, when they are known. When the

location of the command post or subordinate units is unknown, instructions about the reporting of command posts when opened maybe included.

Paragraph 5.c. This subparagraph shows the axis of communications (indicated by successive tentative command post locations) and the location and time of opening of the message centers.

Also, subparagraphs may be included about recognition and identification instructions, electronic policy, code words, liaison, and command relationships. Most items in paragraph 5 can usually be shown graphically on the operation map or overlay. When this is done, they need not be repeated in writing.

The ENDING of an operation order contains the signature, a list of annexes (if any), the distribution, the authentication (except on the original), and the classification.

Annexes to Operation Orders

Annexes to OPORDs include those used for purposes of brevity, clarity, and simplicity (for example, maps and overlays). Annexes may also be used to amplify an order when the volume is too great to be included in the order itself.

Annexes are issued to all units whose actions or movements are affected by the information and instructions they contain.

Written annexes usually follow the form required for the complete OPORD except that information and instructions already given in the order need not be repeated in the annex. Annexes are lettered alphabetically in the order they are used in the OPORD.

Maps of the following types are frequently used as annexes: situation maps, operation maps, administrative maps, and circulation maps.

Annexes dealing with embarkation, debarkation, entraining, entrucking, march tables, and other technical data are shown in tabular form.

Prepare and submit the annexes to the commander for approval and signature before issue. Another staff officer verifies the annexes.

Preparing OPORDs

Orders must be clear, concise, and direct. Those giving missions to a subordinate unit should prescribe only the details or methods of execution needed to ensure that the actions of that specific subordinate unit

conforms to the plan of operations for the force as a whole.

Paragraphs 1 and 2 of an OPORD are usually written in present tense. For simplicity and clarity, the affirmative form of expression is used throughout the order.

When the date and hour are undetermined, D-day and H-hour may be substituted; when the final date and hour are selected, they are communicated later to those concerned.

When the hour is given, it is expressed in the 24-hour-clock system with no punctuation between the hours and minutes. When orders apply to units in different time zones, Greenwich mean time or the time zone specified by higher headquarters should be used. The zone suffix letter immediately follows the last digit of the group; for example, time expressed as 060225Z March 94, indicates 6 March 1994 at 2:25 a.m. Greenwich mean time.

An OPORD that specifies a night should include both dates; for example, "night 4-5 Aug 94."

Boundaries are assigned that limit zones of action or movement and areas of responsibility. These are designated by easily distinguishable terrain features in the sequence in which they occur on the ground. This sequence is normally given in the direction of the enemy, but in the case of retrograde movement, in the reverse direction.

Geographical names are written or printed in capital letters. This minimizes the chance of error and makes the places mentioned stand out prominently in the order. The spelling in the order must be the same as that on the map referred to in the heading of the order.

Compass points are preferable to the terms *right* and *left*. Should right or left be necessary, the user is assumed to be facing the enemy or downstream when used with reference to a river.

When places or features are difficult to find on the map or when confusion may arise with names of similar spelling, they should be identified by coordinates or by stating locations in relation to some easily recognizable feature or place on the map.

Roads are identified by name or by a sequence of points on the road; they are named in the direction of movement. When there is no movement from right to left or rear to front, it is assumed that the person naming the road is facing the enemy. All other lines are designated in the same manner.

Areas are indicated by names, counterclockwise with a suitable number of limiting points. The first point named, regardless of whether the area pertains to friendly troops or to the enemy, is one on the right front facing friendly troops.

Expressions like “attack vigorously” are avoided. They are not only meaningless and wordy, but also weaken the force of later orders in which the expression does not appear. “Holding attack” “secondary attack/” and “main attack,” which qualify the vigor of the operation, and “try and hold” and “far as possible,” which lessen responsibility, are further examples of undesirable phrases for use in OPORDs.

In operation orders, it is essential that there be no opportunity for misunderstanding by any subordinate of the exact intended meaning of each term used. When you are leading partially trained troops and staffs, remember that the use of technical military language may cause misunderstandings; therefore, the use of technical expressions in combat orders should be avoided when there is any danger of misunderstanding by personnel in the unit. You should substitute words that are easy to understand even at the expense of brevity. Clarity is the first essential; technique is secondary.

COUNTERSIGNS

The commanding officer directs the use of the countersign. Sentries of an interior guard may use the countersign, but countersigns are primarily for use by sentries or persons defending tactical areas.

By Whom Authorized

When a countersign is prescribed, the highest headquarters within a zone or area devises it. The authority to designate a countersign may be delegated to subordinate units for their immediate use when necessary; however, these units must notify higher headquarters of such action without delay. Only one countersign can be used within a command during a specified period.

Selecting the Countersign

The choice of words or sounds for the countersign is made with care. When possible, words are selected that are difficult for the enemy to pronounce. The word selected for the secret challenge, or countersign must not suggest the word selected for the password. Doing this minimizes the possibility of an unauthorized person

guessing the password. (For example, the secret challenge, ATOMIC, suggests the password BOMB.)

Using the Countersign

The initiative for use of the countersign rests with the challenging sentry. Positive recognition of each person claiming authority to pass is the main consideration of the sentry. When he does not visually recognize the challenged person or party, he uses the countersign to make a positive recognition. When there is any doubt as to the authority of the challenged person to pass, even if he gives the correct password, he is detained for further action by the corporal of the guard. When the sentry recognizes the challenged person or party before using the countersign and there is no doubt the person or party has authority to pass, the sentry does not use the countersign.

Mutual identification is essential. If the person challenged does not recognize the secret countersign, he should not give the password.

When a secret challenge and password are prescribed, the secret challenge is given by the sentry after the person is advanced to be recognized. The person challenged should then give the password. Both the secret challenge and the password are given in a low tone to prevent them from being heard by others.

For example, a sentry observes a person approaching his post during the time for challenging. When the person is still far enough away from the sentry’s post for the sentry to take effective measures should the person rush him after being challenged, he commands, “HALT! WHO IS THERE?” After receiving an answer (such as, “Lieutenant Jones, Company B”) indicating the person is friendly and may be authorized to pass, the sentry says, “Advance, Lieutenant Jones to be recognized.” When Lieutenant Jones reaches a point where the secret challenge, spoken in a low tone, can be heard only by him, the sentry again commands, “HALT!” then he gives the secret challenge or countersign, in a low tone (for example, “SNOWFLAKE”). After receiving the correct password from Lieutenant Jones (for example, “ROOSTER”) and otherwise satisfying himself that the Lieutenant is authorized to pass, the sentry says, “Advance, Lieutenant Jones” and salutes, if appropriate. If Lieutenant Jones is one of a party challenged and is the person advanced according to the procedures discussed here, the sentry then tells Lieutenant Jones to bring up his men and identify each individual before he passes.

CHAPTER 12

HAND GRENADES, LAND MINES, TRIP FLARES, AND BOOBY TRAPS

The reasons Seabees fight and the types of fighting they do are different from those of other sailors. The primary job of the Seabee is to build, but you cannot build unless you control the jobsite. Since, in many instances, the jobsite maybe in a forward or unfriendly area, the need for being able to conduct a proper defense becomes obvious. For this reason there are certain military requirements imposed on Seabees.

When required, your job is to use the defensive techniques and tactics you have learned in military training. The objective of this chapter is to make you familiar with the various types of grenades, land mines, flares, and booby traps you might use or encounter in tactical situations. You will learn how to use them, their components, their safety features, and how to take counter-measures against their effective use by the enemy.

HAND GRENADES

Hand grenades are nothing more than small bombs, containing explosives or chemicals, that can be thrown by hand or rigged as booby traps. Their origin has been traced back many centuries, and it is generally agreed that the Chinese, whom we credit with the invention of gunpowder, were first to use them. However, it was not until World War I that they were sufficiently developed to be effective and safe. By World War II, the grenade inventory expanded to include smoke grenades for signaling and screening, phosphorus and fragmentation grenades to produce casualties, and gas grenades for both casualty and riot control effects. The grenades being used today are in many respects representative of the entire history of the development of grenades.

TYPES AND PURPOSES OF GRENADES

There are several varieties of hand grenades designed for many purposes. All of these grenades can be broadly classified into six general types: fragmentation, illumination, chemical, incendiary, smoke, and practice and training grenades.

Fragmentation Grenades

Fragmentation grenades are used to produce casualties by the high-velocity projection of fragments

from the grenade case. The M67 fragmentation grenade (fig. 12-1) is the standard grenade used by Seabees. It has a smooth, sheet-metal body and is shaped like a ball. Its outer case is lined on the inside with a serrated wire coil. It is filled with 6.5 ounces of an explosive, known as Composition B, and uses a detonating type of fuze. When the detonator causes Composition B to explode, fragments of the body and fuze assembly are hurled in all directions. The M67 weighs 14 ounces and the average man can throw it 40 meters. The effective casualty-producing radius is 15 meters.

Illuminating Grenades

The MK1 (fig. 12-2) is the only illuminating grenade currently available. Its main use is to illuminate

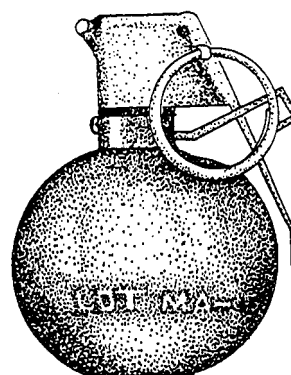

Figure 12-1.—Fragmentation hand grenade, M67.



Figure 12-2.—Illuminating hand grenade, MK1.

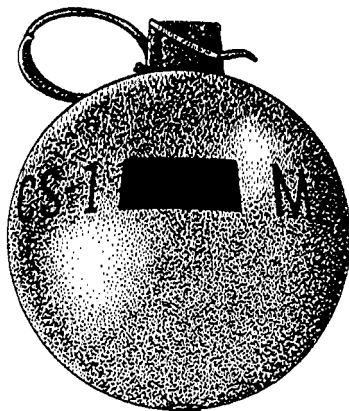

Figure 12-3.—ABC-M25A2, CS riot control hand grenade.

terrain in night operations. It provides about 55,000 candlepower for a period of 25 seconds. The MK1 grenade may also be used as an incendiary grenade to start fires in dry grass, leaves, or brush. When the two halves of the body are separated by the burning of an illuminating charge, they project with considerable velocity. Friendly forces should take cover until the illumination can be seen. Once the safety pin of this grenade has been removed, **the grenade is armed and MUST be thrown.** Do **NOT** attempt to replace the safety pin.

Chemical Grenades

Chemical grenades are chemical-filled munitions designed to be thrown by the individual or projected from the service rifle by means of an adapter. Chemical grenades are used for incendiary, screening, signaling, training, and riot control purposes as well as booby traps.

Perhaps the most commonly used chemical grenade is the ABC-M25A2, CS riot control hand grenade (fig. 12-3). This is a special-purpose bursting type of munition used for control of riots and for training purposes. The grenades are filled with chloracetophenone, a type of tear gas that causes irritation and watering of the eyes, resulting in temporary, partial, or total blindness. The body of the grenade is spherical and is made of plastic. It contains about 3.5 ounces of a mixture of CS and weighs about 7.5 ounces.

This grenade does not have a safety lever as other grenades do. To prevent the grenade from activating after the safety pin is removed, you must keep pressure on the top of the arming sleeve with the thumb of your throwing hand.

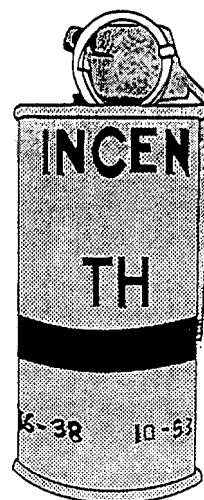

Figure 12-4.—Incendiary hand grenade.

The radius of the burst is approximately 6 meters, but fragments of the plastic body occasionally fly as far as 27 meters. Effective portions of the agent may be carried as far as 75 to 100 meters downwind. Personnel using these grenades should wear protective gas masks.

Incendiary Grenades

The AN-M14 incendiary (thermite) hand grenade is cylindrical in shape and has a sheet metal body with emission holes in the top (fig. 12-4). It weighs 32 ounces and contains a filler of 26.5 ounces of TH3 thermite mixture. It uses an igniting fuze that sets fire to the thermite filler after the normal delay. The thermite filler burns for approximately 40 seconds at a temperature of about 4300°F. A portion of the thermite filler changes into molten iron that flows out of the grenade and produces intense heat over a small area. This molten iron ignites or fuzes whatever it touches. It is used to ignite combustible materials and to destroy all types of equipment. It burns through about one-fourth inch of steel and welds together steel or iron machinery parts when molten iron flows between them.

Smoke Grenades

The M34 white-phosphorous smoke hand grenade is designed to replace the M15 white-phosphorous hand grenade. The body of the grenade is cylindrical with a tapered bottom. It contains a filler of about 12 ounces of white phosphorous and is serrated to break up easily when detonated. The grenade weighs 27.2 ounces and the average Seabee can throw it 35 meters. The effective casualty radius is 25 meters; however, particles of phosphorous may be thrown as far as 30 meters.

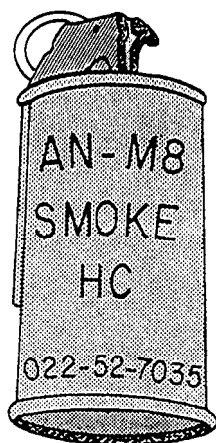

Figure 12-5.—Typical smoke grenade.

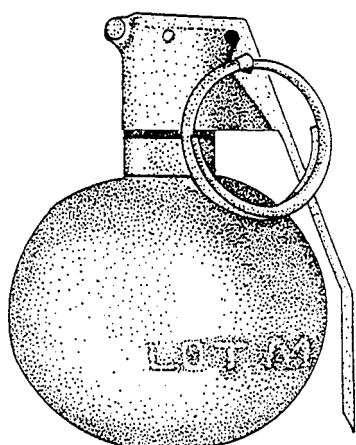

Figure 12-6.—Practice hand grenade.

M8 colored-smoke hand grenades are the same size and shape as the HC smoke grenades. The M8 will produce red, green, or yellow smoke for 1 to 1 1/2 minutes when ignited. The color of the filler is indicated in writing on the body of the grenade, and both ends are colored the same as the smoke the grenade will produce. The M8 is used for ground-to-air or ground-to-ground signaling (fig. 12-5).

NOTE

Under the new standard marking system, these grenades have a light green body with black lettering.

Practice and Training Grenades

Practice and training grenades (fig. 12-6) are used for training personnel in the care, handling, and use of hand grenades before using service grenades. Practice grenades simulate functioning of service grenades to provide realism in training. Training grenades are completely inert and do not function in any way.

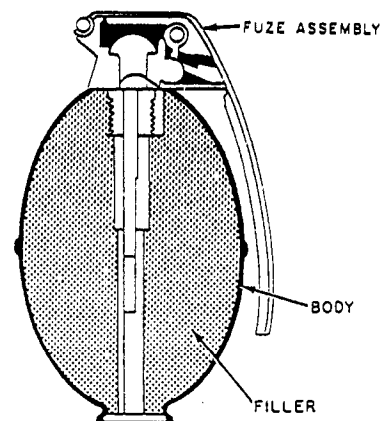

Figure 12-7.—Three main parts of the grenade.

GENERAL CHARACTERISTICS OF HAND GRENADES

The RANGE of hand grenades, in relation to other weapons, is very short. This range depends entirely on the throwing ability of each individual. As a well-trained Seabee, you should be able to throw a grenade, such as the M67 fragmentation grenade, about 35 to 40 meters.

The EFFECTIVE CASUALTY RADIUS of a hand grenade is defined as the radius of a circular area around the point of detonation within which at least 50 percent of the exposed personnel become casualties. The radius is about 16.5 yards (15 meters). This radius is small compared to the effective casualty radius of the other Seabee weapons, such as the 60-mm mortar. You must remember, however, that casualties can and do occur at distances much greater than the so-called effective casualty radius.

Except for the M36A2 fragmentation grenade with the M217 impact fuze, the grenades do NOT detonate on impact. All casualty-producing grenades (fragmentation and white phosphorus) have a 4- to 5-second delay fuze. Chemical grenades, except white phosphorus and the M25AZ tear gas grenade, have a 2-second delay fuze element.

You can compare a hand grenade to an ordinary firecracker. It consists of a paper body filled with gunpowder that is set off by a fuze. For example, when you light the fuze, it burns until it reaches the powder, which then explodes and shatters the paper body. A hand grenade functions in the same manner and consists of the same principal parts: filler, body, and fuze assembly (fig. 12-7).

The body is the container that holds the filler. It may be made of metal, glass, cardboard, or other suitable material. It may be circular, cylindrical, or

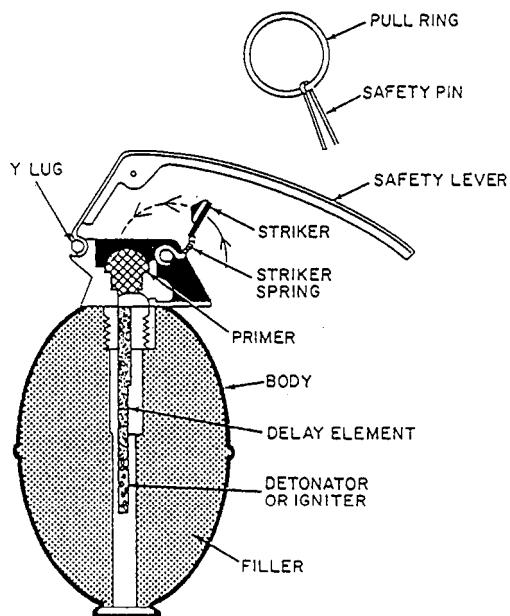

Figure 12-8.—Functioning of the fuze.

lemon-shaped. Regardless of their makeup and shape, all grenade bodies have two things in common: (1) they are hollow to contain a filler and (2) they have an opening or threaded hole to receive the fuze.

Filler is placed in the grenade body. The filler may be an explosive, such as TNT, Composition B (a composite explosive more sensitive than TNT), or black powder. It may also be a chemical, such as tear gas, thermite (incendiary), or white phosphorus.

The fuze assembly is a mechanical and chemical device that causes the filler to detonate or burn. Fuzes that burn are used primarily with chemical grenades; fuzes that detonate are used to explode fillers, such as TNT and Composition B.

When you pull the safety pin from the grenade, the safety lever should be held down firmly by your grip. When you loosen or relieve this grip, the safety lever is forced free from the grenade by a spring, allowing the striker to hit the primer (fig. 12-8). The primer sets off the delay element that burns into the detonator and igniter; this chain reaction is ended by bursting or burning of the filler in the grenade body. This entire action requires only a few seconds, so stay alert when you are handling and throwing hand grenades.

GRENAD-THROWING PROCEDURES

The two primary objectives of a hand grenade training program are to develop your proficiency in

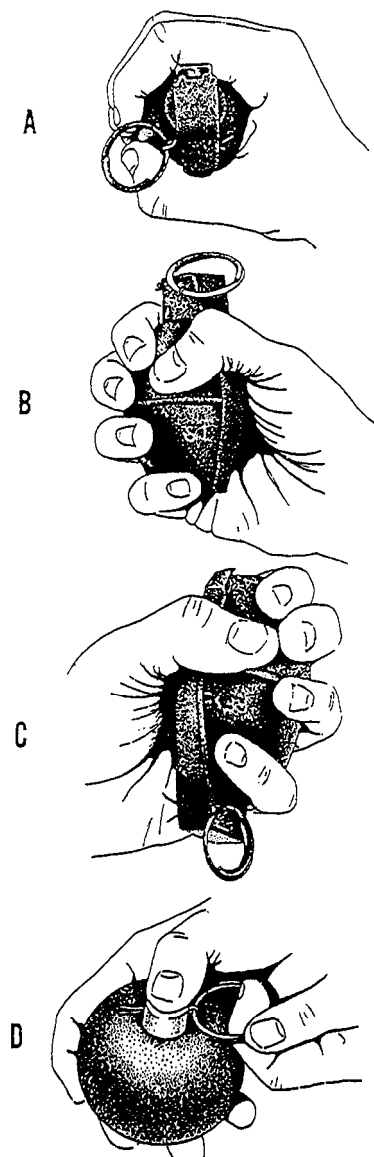

Figure 12-9.—Methods of holding the grenade.

grenade throwing and to overcome any fear that you may have of handling explosives.

Consider safety first when you are determining the proper method of holding the grenade. For maximum safety and throwing comfort, cradle the grenade in your throwing hand with the safety lever held in place by that part of your thumb between the first and second joints (fig. 12-9, view A).

For right-handed personnel, hold the grenade upright (fig. 12-9, view B). This positions the pull ring so you can remove it easily with the index finger of your free hand. For left-handed personnel, invert the grenade (fig. 12-9, view C) in your hand with the fingers and thumb of the throwing hand in the same position as right-handed personnel.

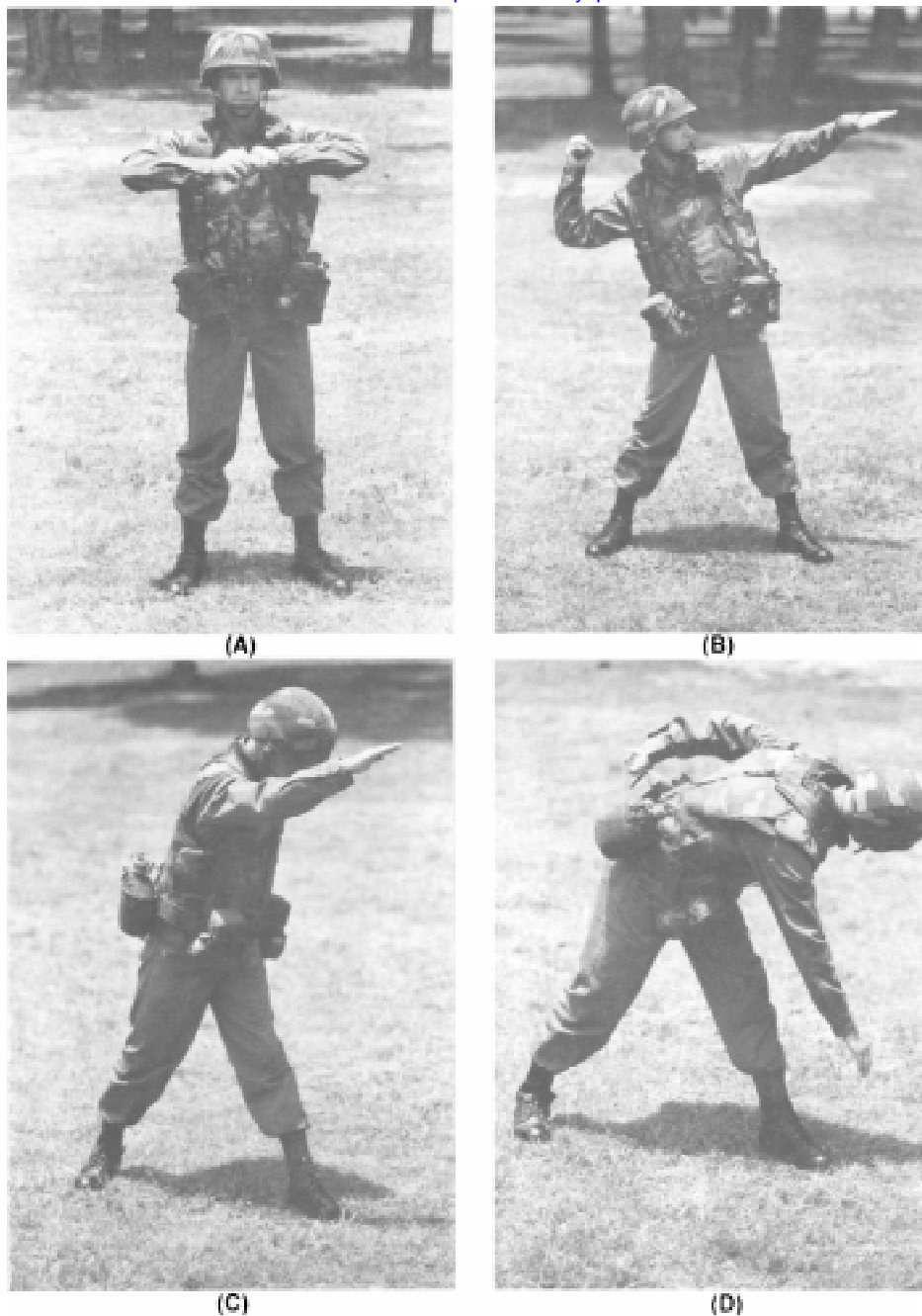

Figure 12-10.—Throwing the hand grenade.

The ABC-M25A2 riot control hand grenade has an arming sleeve that serves the same purpose as the safety lever on other types of grenades. Before throwing the riot control grenade, hold the arming sleeve in place (fig. 12-9, view D) by applying constant pressure with the thumb of your throwing hand.

Since few men throw in the same manner, it is difficult to establish firm throwing rules or techniques. However, there is a recommended method of throwing

a grenade that can be mastered easily. By practicing the steps given below, you can develop your throwing proficiency to a point where your reaction to a target becomes immediate.

1. First, observe the target and establish the distance between your throwing position and the target area.

2. Hold the grenade at shoulder level with the grenade in your throwing hand and the index finger of your opposite hand grasping the pull ring (fig. 12-10,

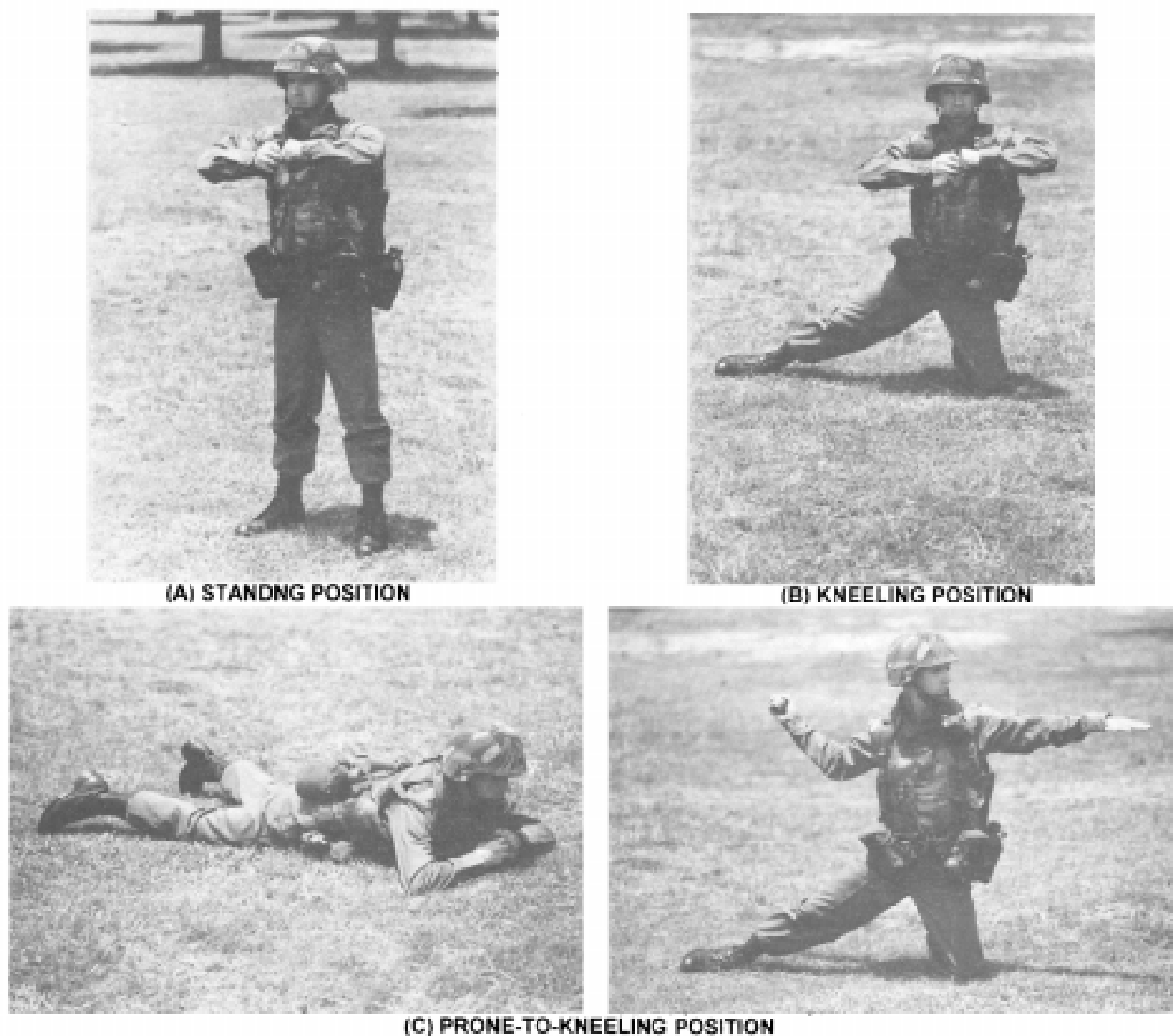

Figure 12-11.—Throwing positions.

view A). Remove the safety pin with a pulling, twisting motion. If the situation permits, you should observe removal of the safety pin.

NOTE

When the safety pin cannot be pulled out, shorten the distance between the legs of the safety pin to aid in its removal. However, if the grenade is not used, spread the legs of the safety pin for safety in carrying.

3. As you remove the safety pin, immediately look toward your target.

4. Throw the grenade with an overhead throwing motion, keeping your eyes trained at all times on the

target. Release the grenade somewhere forward of your body and in your general field of vision (fig. 12-10, views B and C). In this way you take advantage of the hand-and-eye coordination inherent in most people.

5. Follow through on your throwing motion beyond the point where you released the grenade (fig. 12-10, view D). This follow-through improves distance and accuracy and relieves the strain on your throwing arm.

6. When available, duck behind cover to avoid being hit by fragments of the grenade. When no cover is available, drop to the prone position with your helmet facing in the direction of detonation.

Although proper positioning techniques of throwing hand grenades are usually stressed during

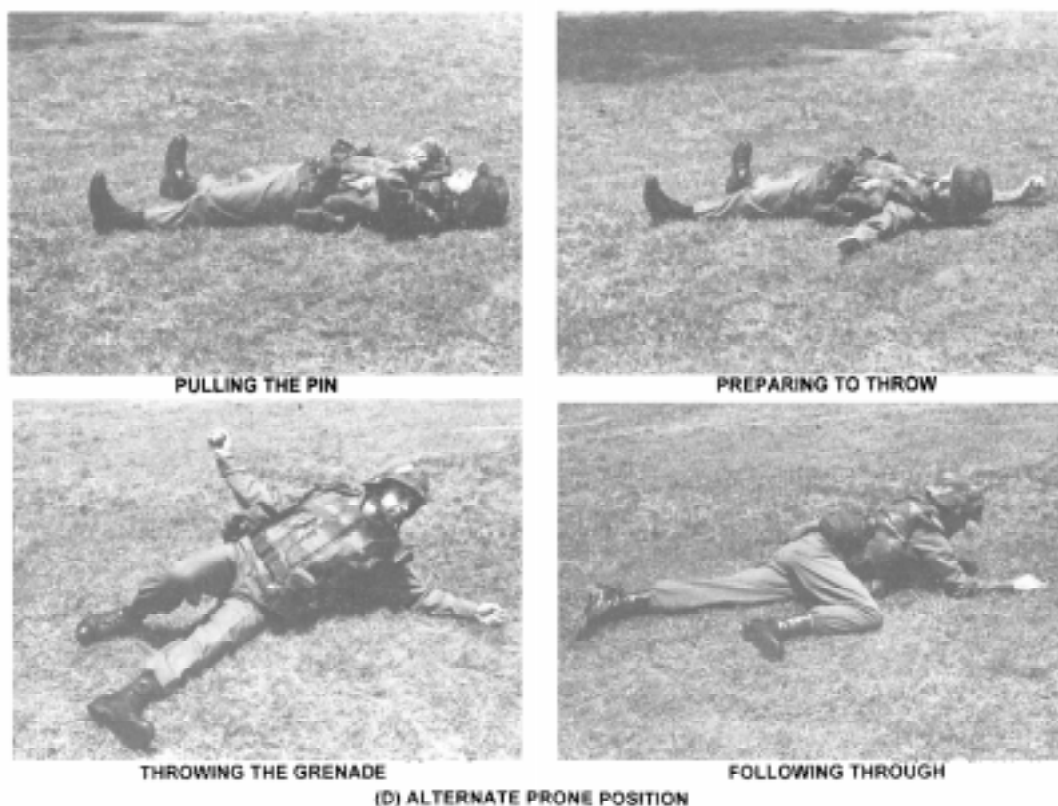

Figure 12-11.—Throwing positions—Continued.

military training exercises, your position during a combat situation is dictated by the amount of available cover and the location of the target. The positions given below point out the use and limitations of each position.

The **STANDING POSITION** (fig. 12-11, view A) is the most natural one from which to throw grenades. This position allows you to obtain the greatest possible throwing distance. To throw from this position, use the instructions listed above and shown in figure 12-10.

The **KNEELING POSITION** (fig. 12-11, view B) reduces the distance that you can throw a grenade. Use this position when you have only a low wall, a shallow ditch, or a similar type of cover to protect you. To throw from this position, use the following instructions:

1. Using the proper grip and holding the grenade shoulder high, kneel in the most comfortable manner.
2. Throw the grenade with a natural throwing motion. Push off with your trailing foot to put more force in the throw.
3. As you release the grenade, drop to the prone position or behind available cover to reduce your exposure to fragmentation.

Use the **PRONE-TO-KNEELING POSITION** (fig. 12-11, view C) when no cover is available and the grenade must be thrown a greater distance than is possible from the prone position. To throw from this position, use the following instructions:

1. Face the target and assume the prone position. Hold the grenade forward of your head where you can observe the grenade as you remove the safety pin.
2. After the safety pin is removed, quickly assume the kneeling position.
3. After throwing the grenade, quickly return to the prone position with your helmet facing in the direction of the target.

The **ALTERNATE PRONE POSITION** (fig. 12-11, view D) reduces both throwing distance and accuracy. This position should be used when you are pinned down by hostile fire and are unable to rise and engage your target. To throw from this position, use the following instructions:

1. Lie on your back with your body perpendicular to the intended line of flight of the grenade. Hold the grenade at shoulder level as in the standing position

2. Your right leg (left leg for left-handed throwers) should be cocked with your foot braced firmly against the ground. After removal of the safety pin, hold the grenade away from your body with your arm cocked for throwing.

3. With your free hand, grasp any object that is capable of giving you added leverage. This leverage will increase your throwing distance. In throwing the grenade, push off with your rearward foot to give added power to your throw. After throwing the grenade, roll over onto your stomach and press yourself flat against the ground.

HAND GRENADE SAFETY

This section deals with safety precautions that must be observed by the handlers and throwers of all hand grenades and by other persons who may be located within the danger area of the grenade.

Any handler or thrower of a casualty-producing hand grenade or person who is within the danger area (approximately 50 meters) of the grenade must wear a steel helmet.

No hand grenades, other than fuzed practice grenades, should be defuzed by any person EXCEPT qualified and authorized ordnance maintenance personnel.

When handling grenades armed with an impact detonating fuze, you should NOT release the safety lever before throwing NOR observe the impact of the grenade. Wait at least 5 minutes before approaching a dud. If a grenade armed with an impact detonating fuze is accidentally dropped after the safety pin has been removed, the grenade MUST be picked up and thrown to a safe area. Under NO circumstances should the grenade be kicked or tossed into a sump or ditch, since any sudden jarring of the grenade after the arming delay is expended causes detonation.

Do NOT remove the safety pin on a grenade until you are ready to throw it. In training, once you remove the safety pin, it must not be placed back into the grenade; the grenade must be thrown.

You, or anyone else not experienced in ordnance disposal, must not recover, handle, or otherwise tamper with dud grenades.

If you should accidentally drop a casualty-producing hand grenade after pulling the safety pin, shout GRENADE to alert other personnel in the area and ensure that the grenade is picked up and thrown in a low arc into a safe area.

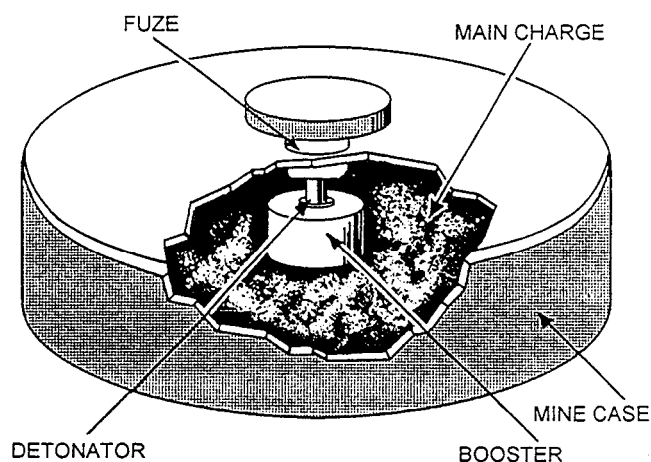

Figure 12-12.—Typical pressure type of land mine mechanism.

Under no circumstances should you attach grenades to clothing or equipment by the PULL RING. Attaching grenades to clothing or equipment by the pull ring can easily result in the safety pin being accidentally removed from the grenade.

When handling a noncasually-producing hand grenade, such as the chemical type, you should not be closer than 10 meters to the grenade while it burns. You should not look directly into the thermite mixture since it may cause temporary blindness or even permanent eye damage.

The safety lever of a chemical hand grenade, other than the ABC-M25A2, should not be released before the grenade is thrown because of its extremely short time-delay period.

Riot control hand grenades should not be thrown into a closed area nor should they be detonated within 5 meters of personnel.

Smoke hand grenades should not be used in a closed area.

At least a 30-minute waiting period should elapse before you approach a chemical grenade dud, and then only authorized ordnance-disposal personnel should approach it.

LAND MINES

A land mine is a concealed explosive charge, placed in an area where it can be detonated by contact with enemy personnel or vehicles. Detonation can be initiated by pressure, pull, or electrical action. The mechanism of a pressure mine is shown in figure 12-12. The mine is buried with the fuze pressure plate just above the ground surface and detonates when the plate is pressed down.

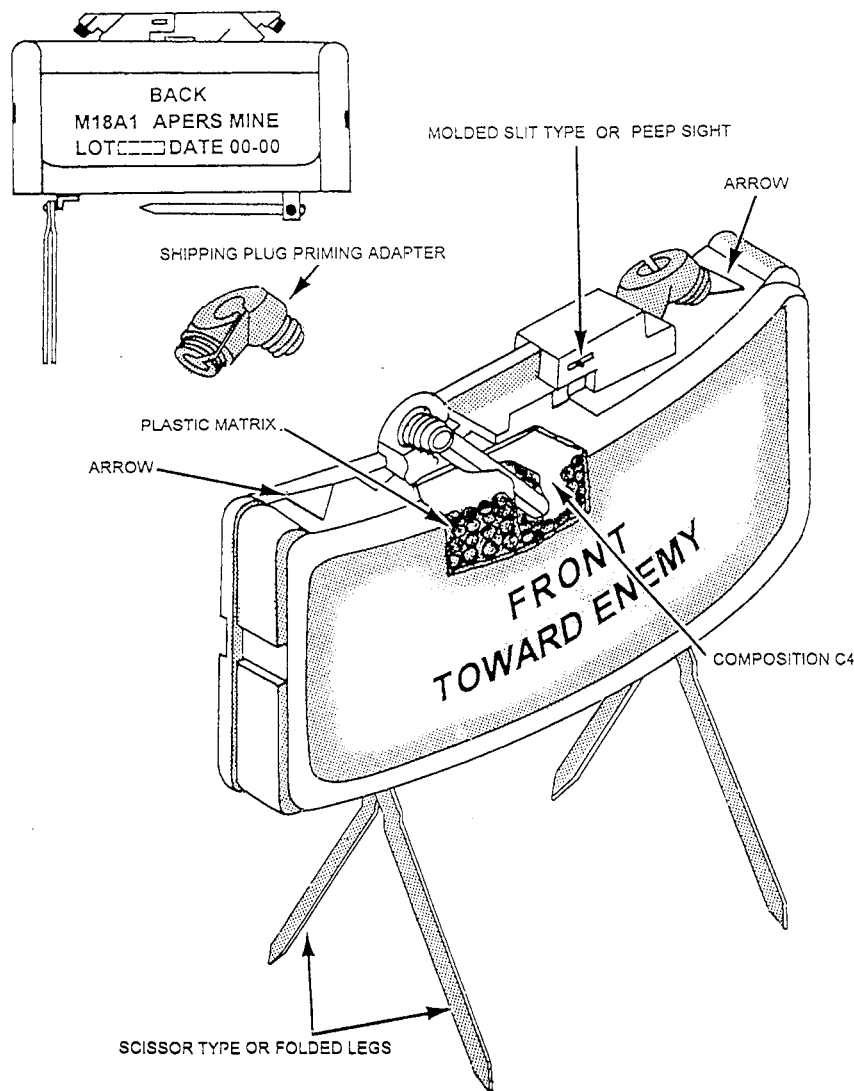

Figure 12-13.—The M18A1 antipersonnel mine (Claymore).

A pull-action mine is one that is detonated by the pull on a trip wire, stretched where enemy personnel or vehicles may contact it. A pull-action mine is usually a pressure mine. Whether it is used as a pull-action or pressure mine depends on whether or not the ground surface makes the concealment of a trip wire possible.

For pressure installation, bury the mine with the top of the fuze flush with the ground surface and only the prongs protruding above it. Install the trip wire with the top cap of the fuze and the prongs protruding above the surface. Run trip wires from the fuze cap to stakes or other anchorages, in feasible directions.

An electrical-action mine can be exploded by a remote-control firing device of the type used for blasting in construction.

Except for the M18A1 antipersonnel mine described below, mines are NOT authorized for use by

the Naval Construction Force (NCF). Personnel who encounter other types of mines should not attempt to disarm or use them or handle them in any manner. When located in the field, you should mark the mines clearly and furnish their locations to the battalion security officer or authorized ordnance disposal personnel.

M18A1 CLAYMORE MINE

The M18A1 Claymore mine, currently the only mine authorized for use by the Seabees, is used only as an electrically controlled, one-shot weapon. It is used for support of other weapons used in the final protective fire of the unit.

The M18A1 antipersonnel mine (fig. 12-13) was standardized in 1960. It is a directional, fixed-fragmentation mine and is designed primarily for use against massed infantry attacks. The Claymore mine is

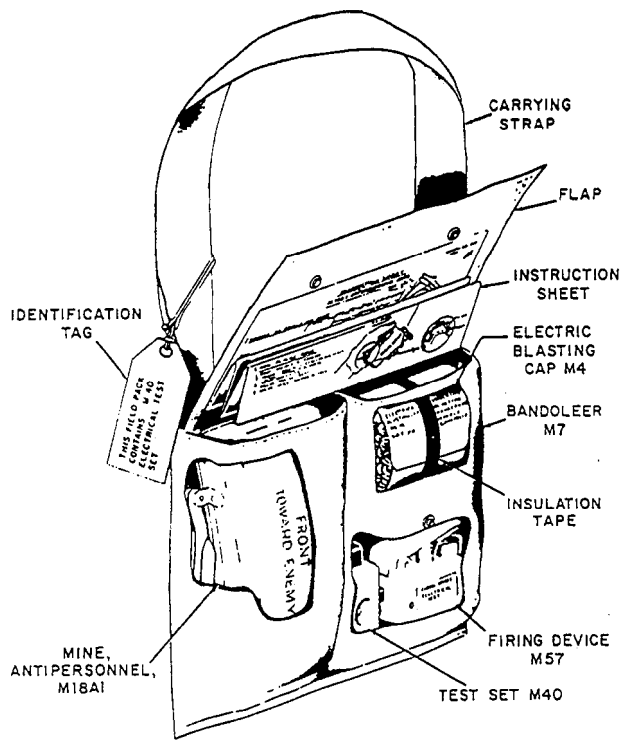

Figure 12-14.—The M18A1 antipersonnel mine and accessories packed in the M7 bandoleer.

equipped with a fixed plastic, slit type of sight, adjustable legs, and two detonator wells. The mine and all its accessories are carried in the M7 bandoleer (fig. 12-14).

The mine weighs about 3 1/2 pounds and is 8 1/2 inches long, 1 3/8 inches wide, and 3 1/4 inches high.

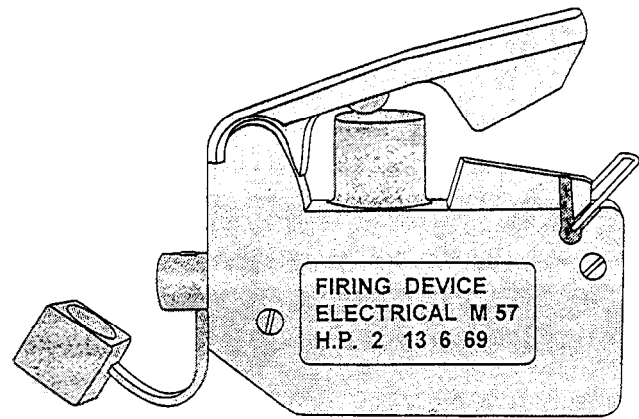

Figure 12-16.—The M57 firing device.

The outer surface is a curved rectangular, olive drab, molded plastic case. The front portion of the case has a fragmentation face containing steel spheres embedded in a plastic matrix (enclosure). The back portion of the case contains 1 1/2 pounds of Composition C4 (composite explosive).

When detonated, the M18A1 mine projects steel fragments over a 60-degree fan-shaped pattern approximately 6 feet high and 50 meters wide at a range of 50 meters (fig. 12-15). These fragments are moderately effective up to a range of approximately 100 meters and can travel up to 250 meters. The optimum effective range—the range at which the most desirable balance is achieved between lethality and area coverage—is 50 meters.

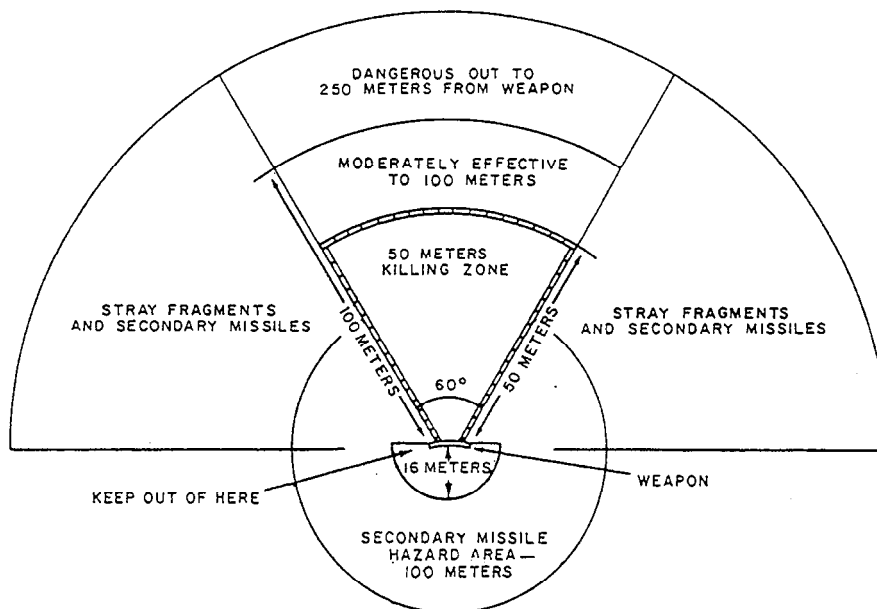
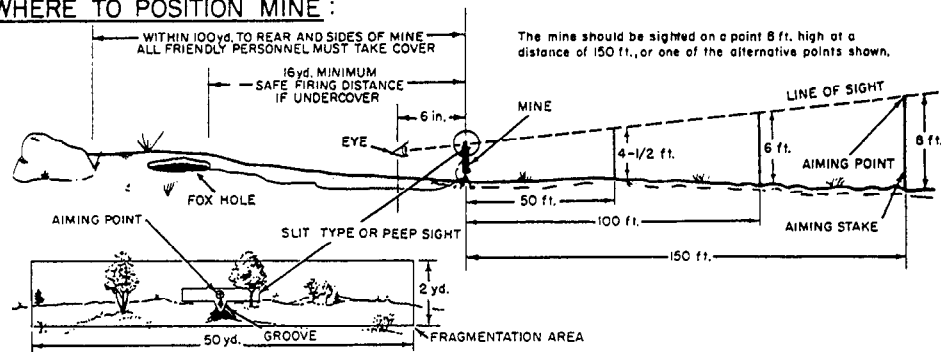

Figure 12-15.—Range and effects of the M18A1.

1. WHERE TO POSITION MINE :



2. HOW TO AIM MINE :

1. TURN LEGS OF MINE DOWNWARD AND SPREAD APART. TWIST THE SPREAD LEGS TO LIE TO THE FRONT AND BACK AS SHOWN. ARROWS POINT TO ENEMY.



2. AIM MINE BY SIGHTING THROUGH SLIT SIGHT. SHIFT MINE TO PUT GROOVE IN LINE WITH AIMING POINT. PRESS LEGS FIRMLY INTO GROUND RECHECKING AIM.

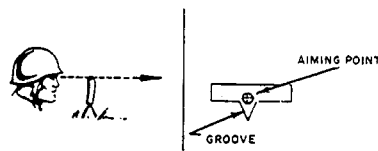

3. HOW TO ARM MINE :

1. UNROLL PAPER FROM BLASTING CAP ASSEMBLY BY PULLING INSULATING TAPE TAB (SAVE TAPE FOR POSSIBLE REPAIR OF WIRE.)
2. LAY WIRE BETWEEN MINE AND FIRING POSITION (CAN UNROLL WIRE FROM MINE OR FIRING POSITION) WRAP WIRE AROUND LEG OF MINE AS SHOWN AND BURY WIRE IF POSSIBLE.
3. INSERT BLASTING CAP IN EITHER DETONATOR WELL AND LOCK WITH SHIPPING PLUG-PRIMING ADAPTER.
4. RECHECK AIM OF MINE AFTER ABOVE ARMING.

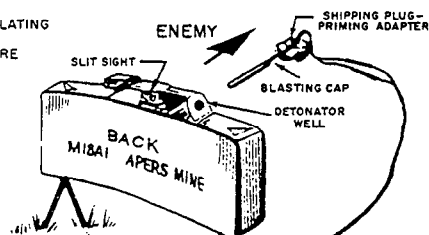

4. HOW TO TEST CIRCUIT :

- (TAKE COVER AT FIRING POSITION)
1. REMOVE SHORTING PLUG FROM BLASTING CAP WIRE.
 2. INSERT PLUG OF BLASTING CAP WIRE INTO TEST SET.
 3. INSERT PLUG OF TEST SET INTO FIRING DEVICE.
 4. SWING SAFETY BAIL TO FIRING POSITION AND FROM COVERED POSITION DEPRESS FIRING HANDLE. LIGHT IN WINDOW OF TEST SET INDICATES GOOD CIRCUIT. IF NO LIGHT, WIRE OR CAP MAY BE DEFECTIVE. CHECK AND REPAIR WIRE WITH TAPE SAVED FROM WRAPPER OR REPLACE CAP.

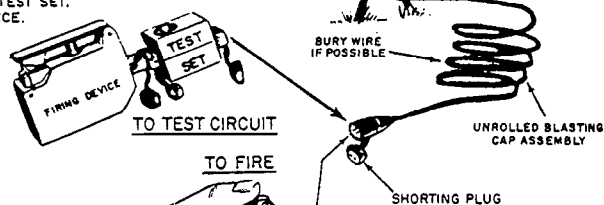

5. HOW TO FIRE MINE :

- (TAKE COVER AT FIRING POSITION)
1. INSERT PLUG OF BLASTING CAP WIRE DIRECTLY INTO FIRING DEVICE (SAFETY ON)
 2. WHEN READY TO FIRE, SWING SAFETY BAIL TO ARMED POSITION.
 3. FIRE BY DEPRESSING HANDLE SMARTLY.

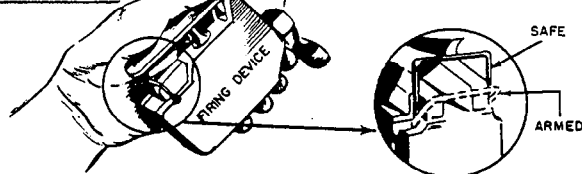

Figure 12-17.—The instruction sheet attached to the M7 bandoleer.

M57 FIRING DEVICE

One M57 firing device (fig. 12-16) is issued with each M18A1 mine. The device is a hand-held pulse generator. A squeeze of the handle produces a double 3-volt electrical pulse of sufficient energy to fire the electric blasting cap through the 100 feet of firing wire issued with the mine. On one end of the firing device is a rubber connecting plug with a dust cover.

The safety bail on the firing device has two positions. In the upper SAFE position, it acts as a block

between the firing handle and the generator. In the lower FIRE position, the generator can be activated.

INSTALLATION AND FIRING

Complete instructions for installing, arming, testing, and firing the M18A1 antipersonnel mine are attached to the flap of the M7 bandoleer. The instruction sheet is shown in figure 12-17, and the directions should be carefully followed by users of these mines.

COVERAGE AND METHODS OF FIRE

Since the M18A1 can only be fired once, FIRE DISCIPLINE is of major importance. The mine should not be used against single personnel targets; rather, it should be used for its intended purpose—massed personnel. When lead elements of an enemy formation approach within approximately 20 to 30 meters of the mine, it should be detonated.

EFFECTIVE COVERAGE of the entire front of a position by the mines can be accomplished by placing them in a line no closer together than 5 meters and no farther apart than 45 meters. A preferred lateral and rearward separation distance is approximately 25 meters.

METHODS OF FIRING the M18A1 mine can be in either the controlled or uncontrolled role. An uncontrolled mine is essentially a booby trap, and its use by Seabees is not authorized. In a controlled role, the operator detonates the mine as the enemy approaches within the killing zone. The operator can, by use of either an electrical or a nonelectrical firing system, control detonation. In almost all cases, mines used by the Seabees are fired electrically with the M57 firing device.

TRIP FLARES

A trip flare is used primarily to illuminate and to give warning of attacking or infiltrating enemy troops. Normally, it is placed in the path of, and activated by, an advancing enemy. Trip flares are usually available to an individual or small unit and can provide temporary close-in illumination. Trip flares are not suitable for producing continuous illumination and have little, if any, application in other than defensive operations.

The M49 trip flare resembles a hand grenade in size and shape, except that it is provided with a bracket for attachment to a tree or post and a trigger mechanism for firing. The flare burns with a yellowish light and illuminates an area radius of approximately 300 meters. The trip fuze M12 resembles the hand grenade fuzes for cylindrical hand grenades, but it has no body tube or delay charge.

The flare has a laminated paper body, containing an 1 1-ounce flare charge and is closed at both ends by metal caps. The upper cap has taped holes and a threaded central hole for the trip fuze M12. The mounting bracket and trigger mechanism are attached to the base cap. The bracket consists of a triangular anchor clip with one hole at its lowest end, for insertion of a nail, and two square holes to permit engagement with tabs of the mounting

plate, which also has two holes for insertion of nails. The trigger mechanism consists of a spring-loaded trigger. One end of the trigger has the spring assembly anchored thereto and has a hole for insertion of the trip wire. The other end of the trigger has a narrow tongue used to hold the safety lever in place when the trigger is turned in the vertical position. The spring is wound around the trigger pivot.

The location chosen for the flare should be to the right (looking toward the enemy) of the field to be illuminated, so the trip wire, when attached, runs to the right of the flare when facing the trigger. Using two of the nails supplied, nail the holder plate with ends of the two tabs upward to a stake, post, or suitable support at the height desired for the trip wire (usually 15 to 18 inches above the ground). Mount the flare by sliding the two square holes of the anchor clip over the mating tabs on the holder and press the flare down until it is locked in position. If desired, a third nail maybe driven through the hole in the lower end of the anchor clip.

Fasten one end of the trip wire to the post, stake, or other rigid object at the desired distance from the flare (usually about 40 feet) and at the right of the flare when facing the flare trigger.

Press the fuze safety lever down with one hand and rotate the trigger one-quarter turn counterclockwise against the spring pressure with the other hand to the vertical position, so the lower end of the safety lever is behind the upper end of the trigger.

Pull the loose end of the trip wire taut and fasten it to the hole in the lower end of the trigger.

At this point, check to see that the trip wire is taut and fastened at both ends, and the trigger is vertical with the fuze safety lever behind the upper end of the trigger so when the pull ring and safety pin are withdrawn, the safety lever is still held by the trigger.

Hold the lever with one hand while carefully withdrawing the pull ring and safety pin from the flare fire.

Carefully release the hold on the safety lever, while making sure the lever is held in place by the upper end of the trigger.

To remove a trip flare, carefully depress the safety lever to align the holes in the lever and the fuze and insert the safety pin. Detach the trip wire from the trigger while holding the safety lever against the flare and rotate the trigger to its original position. Remove the nails from the holding plate and the anchor clip. Return the flare to its original position and packing.

BOOBY TRAPS

A booby trap can be an explosive charge, a nonexplosive device, or other material. Its intended use is to incapacitate, wound, or kill an unsuspecting person when he disturbs an apparently harmless object or performs a presumably safe act. Two types are in use: improvised and manufactured. Improvised booby traps are constructed from standard firing devices, explosives, weapons, missiles, or other materials generally used for other purposes. They are placed wherever enemy troops are likely to assemble or pass, such as in buildings, shelters, minefields, fords, around obstacles, and along paths, roads, and bridges. Improvised booby traps are often attached to some object that can be used or that has souvenir appeal. Manufactured booby traps are standard devices made at a factory. They are useful objects, such as pipes, books, or bottled drinks, that explode when picked up or used. When left scattered about by a retreating force, they inflict casualties and cause confusion among advancing enemy troops.

EXPLOSIVE DEVICES

Booby traps laid in and along paths and trails are both delaying and frustrating obstacles to foot troops and patrols. Improvised shrapnel charges use either pressure-release or pull or pull-release firing devices. Pressure-release devices are placed under stones, wood, or other objects, and pull or pull-release firing devices are tied to a trip wire stretched across the path. Fragmentation hand grenades are often used for this purpose. One use is to place the grenade (with safety pin removed) under an object, so the safety lever is released when the object is moved.

Other uses include the following:

GRENAD TRAP. A fragmentation grenade is attached to low underbrush, an anchor stake, or a tree trunk alongside the path. One end of a trip wire is tied to an anchor stake across the path, then stretched to the fragmentation grenade where the other end is tied to the grenade safety ring. A pull on the trip wire removes the safety ring, firing the grenade.

HAND GRENAD IN CAN. A C-ration can is attached to an anchor stake or tree trunk alongside the path. A hand grenade is placed base first into the can so the can retains the safety lever in the safe position. One end of a trip wire is tied to an anchor stake across the path, and the wire is stretched across the path and tied to the hand grenade. The grenade safety pin is then removed. A pull on the trip wire pulls the grenade from

the can, thus releasing the safety lever and firing the grenade.

MUD BALL MINE. The safety pin is removed from a fragmentation hand grenade and replaced with a 10- to 12-inch wire. A base of mud is molded around the grenade, leaving the ends of the wire exposed. When the mud has hardened enough to hold the grenade safety lever in place, the wire is removed, thus arming the grenade; however, the grenade cannot detonate until its mud case is broken. The mud ball is placed on a trail or anywhere troops may walk. Stepping on the ball breaks the dried mud and releases the safety lever, detonating the grenade.

NONEXPLOSIVE DEVICES

Guerrilla forces, particularly in jungle areas, often use booby traps that do not use explosives but are equally effective as casualty producers. All the devices are improvised from locally available materials—nails, bamboo, ropes, vines, stones, logs, and rubber—to serve the conditions that prevail at that particular time and place. The devices discussed in this section have been encountered on many occasions, but variations of these devices should be expected.

PUNJI STAKES. Punji stakes are needle-sharp bamboo spikes, sometimes barbed or fire-hardened, used to injure unsuspecting persons who step or fall on them. The pointed ends are often treated with excrement or poison so the wounds become infected or even cause death. Punji stakes are placed in the ground so they protrude just enough to inflict injury. They are often used on prospective landing zones to wound personnel as they jump from a helicopter to the ground. Punji sticks are sometimes used along paths to hamper movement. Quite often they are placed on the banks of gullies and streams where troops are likely to jump from one side to the other. They are also used along roads at the entrances to villages or at ambush sites.

FOOT TRAPS. These are small pits combined with spike board plates or punji stakes that are placed along roads, paths, and trails or wherever foot traffic is likely.

Spike board foot traps are small pits—the bottoms of which are lined with boards through which spikes have been driven. The top of the pit is camouflaged. A person stepping on the camouflage material falls through and impales his foot on the spikes. The pits are usually about 18 inches square and 12 inches deep. The spikes used in these devices vary greatly, depending on what is available. Long nails, unimproved or sharpened or barbed, are the type most commonly used. Heavy gauge

wire and metal rods, such as welding rods, have also been used. The spikes are driven through small lengths of board and placed on the ground in dense grass and undergrowth. Stepping on one of the devices causes a serious foot wound requiring evacuation of the victim.

DEADFALLS. Various devices are suspended in the dense foliage above jungle paths and trails, designed to fall or swing in an arc so as to strike intended victims as they pass below. They are released when unwary victims step on or strike with their foot a trip wire stretched across the path. Some of the devices used include the mace (a spike-studded log), the spike ball (a concrete or mortar ball into which spikes have been cast), and other deadfalls equipped with spears or spikes.

COUNTERMEASURES

Individual mines and booby traps are most often detected by visual means, by probing, or by electrical detection. Knowledge of the mining practices of a particular enemy often aids in locating mines. The following are likely locations for mines or booby traps:

1. Potholes, road patches, or soft spots in surfaced roadways.
2. Under the edges of road surfacing at the junction of the surfacing and the road shoulder.
3. On road shoulders where mines are easily laid and camouflaged.
4. At locations that block logical bypass routes around a blown bridge or cratered road.
5. Around the edges of craters and ends of damaged bridges or culverts. Antipersonnel mines are sometimes placed in craters if the craters are likely to be used as shelter from enemy artillery fire or air bombing.
6. In barbed-wire entanglements, wire fences, and similar obstacles. In any other type of obstacle, such as abandoned vehicles or among felled tree trunks or limbs across roads or trails.
7. Near an unusual object that may have been placed by the enemy for his own use, such as a minefield marker.
8. In places where it is natural to drive a vehicle, such as turnouts, parking lots, in front of the entrances to buildings, narrow alleys, and airfield runways.

9. Near bodies or souvenir materials, such as pistols, field glasses, and bottles of liquor.

10. In likely bivouac or assembly areas and in buildings suitable for use as command or observation posts.

In spite of a high incidence of mine and boobytrap activity and ingenious methods and techniques, effective defensive measures can be developed and applied in the field. The enemy is not infallible; he does make mistakes, and the material used in mine and booby-trap activities is rarely 100 percent reliable. But do NOT help the enemy by making careless mistakes of your own, such as throwing caution aside when going to the aid of shipmates who have become mine casualties. Learn ways to defend yourself against enemy mines and booby traps.

SAFEGUARD MATERIAL. From ports of entry to the most remote battle areas, the enemy makes every effort to obtain needed material and equipment. Enemy efforts can be thwarted by proper safeguards and policing of the battle area. You can do little to prevent the enemy from picking up artillery and mortar dud shells, but you need not litter the battle area with discarded hand grenades, ammunition, mines, and other items that the enemy can convert to his own use in mine and booby-trap activities.

SAFE INTERVALS. Enemy success in mine warfare is drastically reduced when safe intervals are maintained in the movement of troops and vehicles. The effect of many antipersonnel mines and most hand grenades is such that more than one individual can become a casualty within the effective casualty radius. Well-placed antitank or antivehicular mines can be equally effective against vehicles in convoy that follow too closely.

TRACK VEHICLES. Wheeled and tracked vehicle operators should follow in the tracks of the vehicle ahead when the vehicle is in sight. This reduces the possibility of detonating a pressure-activated mine that the vehicle ahead may have missed. On the other hand, old tracks should be avoided if possible because mines may well be placed in old tracks.

CONTROL VEHICLE SPEEDS. Though battles have been won through rapid and violent attacking maneuvers, speed of itself does not ensure success. It can just as well cause you to become careless or reckless, which is what the enemy relies on in his employment of mines and booby traps. The speed and spacing of vehicles should be varied to make the timing of controlled detonated mines difficult.

SANDBAG VEHICLES. Sandbag the flooring of vehicles to provide protection for mounted personnel. In addition, place a heavy rubber mat over the sandbags to reduce the possibility of injury from fragments, such as stones, sand, shrapnel, and pieces of the bags. To further reduce these chances, sandbags should not be filled with rocks or sand with room in it. When riding in sandbagged vehicles, help protect yourself by keeping your arms and legs inside.

DISPERSE KEY PERSONNEL. Key personnel who are prime targets for controlled installed mines must NOT congregate in one vehicle but should be dispersed throughout the column in the convoy.

DO NOT TRAVEL ALONE. Whenever possible, a vehicle should avoid traveling as a single unit. Doing so makes it a good target for guerrillas seeking weapons and other equipment.

CHAPTER 13

ORGANIC SUPPORT WEAPONS: M203 AND MACHINE GUNS

This chapter is a continuation of the discussion about weapons. Here you will learn about support weapons available to the Seabees. Information on the 40-mm grenade launcher, M203, the M60 machine gun, the .50-caliber Browning machine gun, and the MK 19, MOD 3, 40-mm, machine gun is provided.

THE 40-MM GRENADE LAUNCHER, M203

When equipped with a grenade launcher, the M16A1 rifle becomes the 40-mm grenade launcher, M203, and loses its identity as the M16A1 rifle.

The launcher attachment is assembled by a qualified armorer only. As a member of a weapons platoon, you only have the responsibility for the employment, trajectory, method of firing, firing effects, malfunctions, and care and cleaning of the launcher attachment.

The 40-mm grenade launcher, M203, mounted on the M16A1 is shown in figure 13-1. It is a lightweight, compact, breech-loading, pump-action (sliding-barrel), single-shot, manually operated weapon.

The launcher is approximately 16 inches in overall length; it weighs approximately 3.6 pounds loaded and 3 pounds unloaded. Its maximum range is 415 meters, its area target range is 350 meters, and its point target range is 150 meters. The grenade launcher controls and their identifications, as shown in figure 13-2, are discussed in the sections that follow.

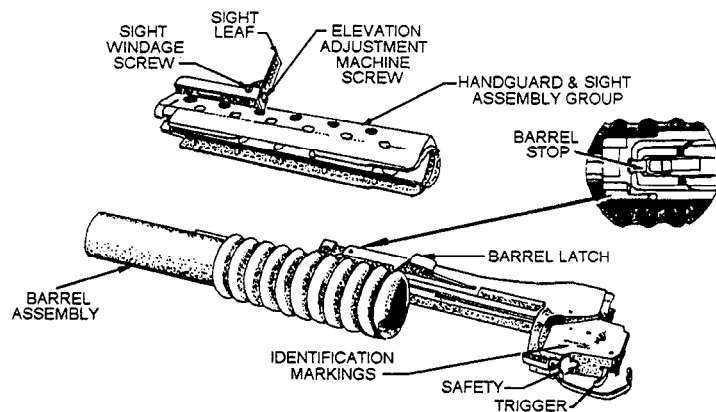

Figure 13-2.—The 40-mm grenade launcher M203, controls, and their identifications.

HANDGUARD AND SIGHT ASSEMBLY GROUP

The handguard portion of the assembly group is a molded plastic protective cover that fits over the barrel of the M16A1 rifle. The cover prevents the operator from coming into contact with the barrel when it becomes heated from rapid firing. The heat produced by the rifle barrel dissipates through the cooling holes and slots in the cover. The protruding plastic tab on the left side of the cover prevents the barrel latch of the grenade launcher from being accidentally pressed when the weapon is laid on its side.

The sight leaf portion of the assembly group is a metallic folding blade sight. It provides range selection

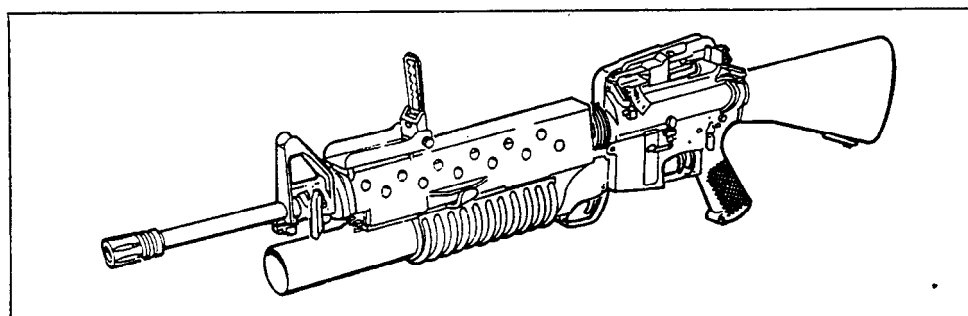

Figure 13-1.—The 40-mm grenade launcher, M203, mounted on the M16A1 rifle.

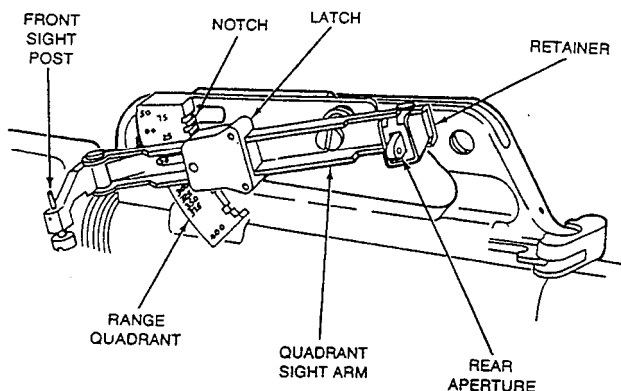

Figure 3-3.—Quadrant sight assembly.

from 50 to 250 meters in 50-meter increments. The windage adjustment screw moves the blade element horizontally to provide windage adjustment capabilities. The elevation adjustment machine screw, when loosened, allows the blade element to be moved vertically, providing elevation adjustment capabilities.

The M203 also has a quadrant sight assembly (fig. 13-3) that connects to the carrying handle of the M16 rifle. It consists of a sight arm, a range selection quadrant, an aperture, and post for sighting operation of the launcher. The range selection quadrant has embossed range graduations from 50 to 400 in 25-meter increments. The 25-meter increments also allow for better accuracy at a greater number of range variations than the quadrant sight (fig. 13-4). For elevation adjustment, turn the front sight post to the right to decrease elevation and to the left to increase elevation.

NOTE

On elevation, one notch equals 5 meters at 200 meters. For windage adjustment, press the rear sight retainer and move the aperture away from the barrel to move the trajectory of the projectile to the left. Move the aperture toward the barrel to move the trajectory to the right.

NOTE

On windage adjustment, one notch equals 1.5 meters at 200 meters.

BARREL ASSEMBLY

The barrel of the barrel assembly is constructed of specially treated and machined aluminum. The barrel extension is a rectangular, chrome-plated steel bar. It attaches to the barrel and provides a means of attaching the barrel to the receiver assembly. The handgrip is a molded plastic corrugated sleeve. When the grenade launcher is being fired, the plastic handgrip allows the operator to hold the launcher without discomfort from the heat.

RECEIVER ASSEMBLY

The receiver assembly consists of an aluminum receiver that houses the barrel latch, the barrel stop, and the firing mechanism. The receiver assembly attaches to the barrel of the rifle, thereby mounting the grenade launcher to the rifle. The receiver assembly also contains

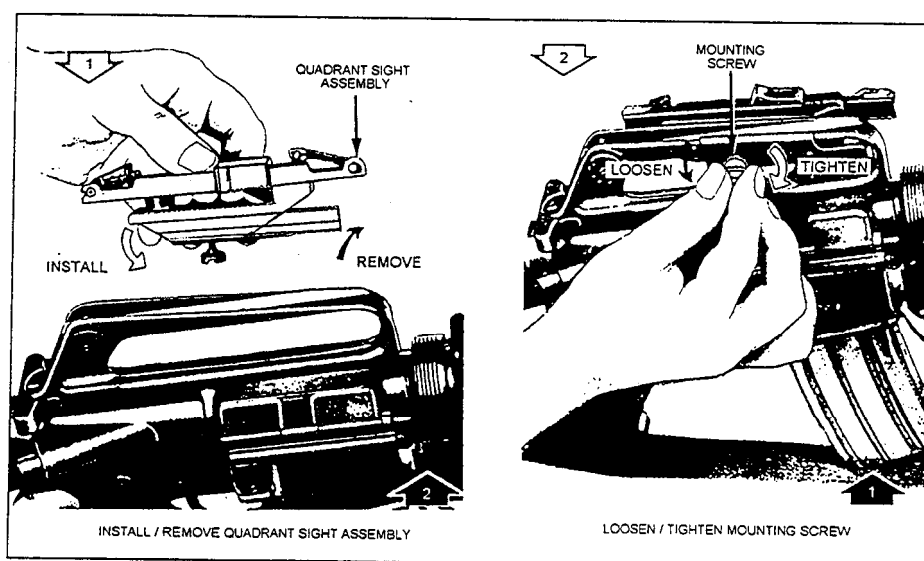

Figure 3-4.—Installation/removal of quadrant sight assembly.

the follower assembly, the trigger, and the safety components that serve to fire or prevent accidental firing of the grenade launcher.

BARREL AND BARREL LATCH

The barrel latch, when depressed, unlocks the barrel so it can be moved forward along the receiver assembly. As the barrel and barrel extension, which is interlocked with the cocking lever, move forward, the cocking lever is forced downward. The cocking lever, in turn, forces the spring-loaded firing pin rearward. At the same time, the spring-loaded follower follows the barrel extension forward. As the barrel continues its forward movement, the barrel extension disengages from the cocking lever; the movement of the follower is restricted by the receiver and the follower holds the cocking lever in the down position. When the barrel is moved rearward, the follower is driven rearward; the cocking lever again engages the barrel extension, and the firing pin moves slightly forward and engages the sear.

BARREL STOP

The barrel stop limits the forward motion of the barrel assembly. This prevents the barrel assembly from sliding off the receiver-assembly barrel track during loading and cocking operations. When depressed, the barrel stop allows the barrel assembly to be removed from the receiver assembly for maintenance purposes.

CLEARING THE GRENADE LAUNCHER

Before clearing the launcher, be sure to point the muzzle clear of all other personnel within the area. Press the barrel latch and slide the barrel forward until the barrel stop is engaged. Inspect the chamber for the possible presence of a round, expended casing, or other obstruction, and remove it if they are present. Be sure the barrel, bore, and chamber are wiped dry with a clean cloth after checking and before firing.

LOADING PROCEDURES

Press the barrel latch and slide the barrel assembly forward until the barrel stop is engaged. Insert a cartridge into the chamber; slide the barrel-assembly sharply rearward until the barrel locks; and then move the safety rearward.

FIRING PROCEDURES

The grenade launcher may be fired from any of the following positions: prone, sitting, kneeling, or standing. For all positions, the firing procedures are as follows:

1. With the grenade launcher loaded, position the weapon and sight.
2. Move the safety to the fire position.
3. Place the butt of the stock firmly against your shoulder. In firing long range from the prone position, place the butt of the stock firmly on the ground. Take aim and squeeze the trigger to fire the weapon.

WARNING

When firing high-explosive (HE) rounds at targets within leaf sight ranges of 50 to 80 meters, you should be in a protected position. Also, targets within an 80-meter radius of unprotected friendly troops should not be engaged. The danger radius of practice rounds is 20 meters. In addition, observe precautions and warnings pertaining to the type of ammunition being used.

LEAF SIGHT ZEROING PROCEDURES

To zero in the grenade launcher leaf sight, you should set up a target at 200 meters. Remember not to perform these procedures at ranges less than 100 meters. The 50-meter mark on the leaf sight blade is marked in red to emphasize that this range is not to be used in the zeroing-in procedures.

Be sure to perform the before-firing preventive maintenance services and the loading procedures as specified. Place the leaf sight blade of the weapon in the upright position. Choose your firing position, preferably a supported prone position. Align the target with the appropriate range increment of the leaf sight blade and the front post sight of the rifle. Fire the weapon, using the firing procedures given. Make any applicable windage or elevation adjustments.

NOTE

Turning the sight windage screw clockwise moves the leaf sight to the left. Raising the leaf sight increases the range, and lowering the leaf sight decreases the range.

When you must adjust for wind, each increment turn of the windage screw equals a 1 1/2-meter adjustment when you are firing on the 200-meter range.

When you must adjust for elevation, each increment turn of the elevation adjustment machine screw equals a 10-meter adjustment when you are firing on the 200-meter range.

Fire three rounds and make the necessary adjustments after each round. When three consecutive rounds land within 5 to 10 meters of the target, the zeroing-in procedures are complete.

MISFIRE, HANGFIRE, AND STOPPAGE

A MISFIRE is a complete failure to fire because of a mechanical failure, not a delay in firing like a hangfire. It is not dangerous, but it must be treated as a hangfire (which is dangerous) until such possibility has been eliminated.

A HANGFIRE is a delay in the functioning of the propelling charge. Wait 30 seconds from the time the charge fails to fire before opening the breech for unloading procedures. Caution is required, as this can be very dangerous. Clear the area of all personnel not needed to correct the hangfire.

A STOPPAGE is any interruption in the cycle of operation caused by faulty action of the weapon or ammunition.

When a weapon fails to fire, the possibility of a misfire or hangfire exists. Therefore, the following precautions must be observed until the round has been removed from the weapon and the cause of the failure determined:

1. Keep the weapon trained on the target and be sure all personnel are clear of the muzzle.
2. Wait 30 seconds from the time the weapon fails to fire before opening the breech for unloading.
3. Exercise extreme caution during unloading procedures; where circumstances permit, either catch the ejected round or reduce the distance of free fall to the ground.
4. After the round has been removed from the receiver, store it separately until you determine whether the round or the firing mechanism is defective. If the round is defective, it must be kept separated from other rounds until it can be disposed of properly. If examination reveals that the firing mechanism is defective, the round may be reloaded and fired after the firing mechanism has been repaired by the armorer.

UNLOADING THE LAUNCHER

To unload the launcher, press the barrel latch and move the barrel forward. The expended casing is automatically extracted and ejected.

CLEANING AND LUBRICATING AFTER FIRING

Clean dust, dirt, and mud from all surfaces of the handguard assembly, the sight assembly, and the receiver assembly with a clean, dry cloth. Remove powder fouling from the heat shield of the handguard using rifle bore cleaner (RBC). Wipe the inside of the barrel with a cloth soaked in rifle bore cleaner. Remove any deposits or residue inside the barrel by using a bore brush.

Press the barrel latch and move the barrel forward until the barrel stop is engaged. Lubricate the barrel assembly track by applying a light coat of semifluid lubricating oil recommended by the armorer. Wipe all exposed metal surfaces with a cloth saturated with the recommended lubricant. Touch up any scratched or worn surfaces with a solid film of lubricant. Before applying the lubricant, wipe the surfaces with a dry-cleaning solvent to ensure they are thoroughly cleaned of all foreign matter. Separate the upper and lower receiver groups on the rifle. With the launcher cocked, remove the backplate and follower, flush inside the trigger housing with rifle bore cleaner, wipe dry, and lubricate with the recommended lubricant. This action should be done only under the supervision of an armorer.

GRENADE LAUNCHER AMMUNITION

The cartridges used with the launcher, as shown in figure 13-5, are fixed types of ammunition that consist of two major assemblies: the cartridge case and the projectile.

Five standard A types of 40-mm ammunition are used with the launcher: high explosive (HE), high explosive airburst (HE airburst), high explosive smokeless and flashless, high explosive dual purpose (HEDP), and training practice (TP).

These cartridges are ready for use as issued. No prior preparation of the rounds is required other than removal from the packing and insertion into the weapon.

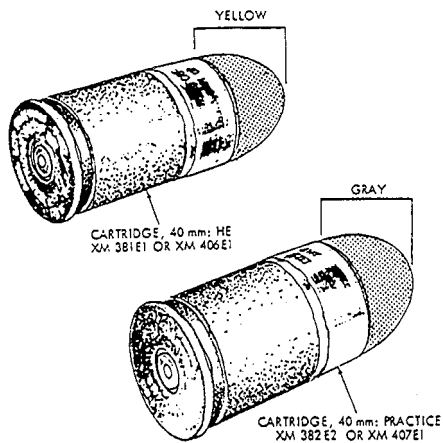

Figure 13-5.—Cartridges used with grenade launcher, M203.

SAFETY PRECAUTIONS

The safety precautions that should be observed to prevent injury to personnel using the launcher and/or damage to the ammunition are given below.

1. The cartridges should be free of sand, mud, moisture, frost, snow, ice, grease, or other foreign matter before insertion into the weapon.
2. Do not fire ammunition that is corroded.
3. Take care at all times to protect the primer and the aluminum give (diagonal rib on the round). They are easily dented and should be protected from hard knocks or blows. The plastic inserts used in the packing of these rounds serve this purpose.
4. Do not use cartridges that have been damaged or those having an indication of separation.
5. Do not fire ammunition unless it has been identified by its lot number and grade.
6. Misfires and hangfires must be handled as previously stated in the above sections.
7. Do not fire at targets within an 80-meter radius of friendly troops or yourself, unless there is adequate protection from fragment hazards.
8. Do not fire canopy smoke cartridges in such a way that the falling ignited projectile could descend upon friendly troops, causing injury to friendly personnel or damage to their material or both.

M60 MACHINE GUN

The M60 machine gun is one of two fully automatic weapons in the Seabee battalion. The other being the 50-caliber M2 machine gun, which is discussed later in this chapter.

The M60 is used to support the rifle fire teams in a unit. The M60 is capable of delivering a heavy volume of controlled and accurate fire, both in offensive and defensive situations. Its capability is more than that of other individual small arms. The M60 machine gun can effectively engage predetermined targets under all conditions of visibility. Naval Construction Battalion fire plans are made around the final protective fires of the M60 machine gun.

CHARACTERISTICS OF THE M60 MACHINE GUN

The M60 machine gun is an air-cooled, belt-fed, gas-operated automatic weapon. The weapon features fixed headspace that permits rapid changing of the barrel. Two barrels are issued with each weapon, and an experienced gun crew can change the barrel in a few seconds.) The M60 fires from the open-bolt position. Ammunition is fed into the gun by a disintegrating metallic split-link belt. The gas from the previously fired round provides energy to cock, load, and fire the next round. The bolt must be to the rear before the round can be picked up and fed into the chamber. It fires the standard 7.62-(North Atlantic Treaty Organization) cartridge at a sustained rate of 100 rounds per minute with six to eight rounds per burst, for 10 minutes; then you must change the barrel. On rapid fire, it can deliver up to 200 rounds per minute for 2 minutes before the barrel must be changed. The cyclic rate of fire is 550 to 600 rounds per minute, with a barrel change required every minute. Muzzle velocity is 2,700 feet per second, with a maximum range of 3725 meters. The maximum effective range is 1100 meters.

GENERAL DATA

Ammunition	7.62-mm ball, tracer, blank, and dummy
Length	43.5 inches
Weight	23.2 pounds
Weight of M122 tripod with traversing and elevating mechanism, pintle, and platform	19.5 pounds
Weight of spare barrel case, complete	13.5 pounds (rubberized case) 16.5 pounds (canvas case)
Height of gun on tripod	16.5 inches

Rates of fire:

Sustained	100 rounds per minute
Rapid	200 rounds per minute
Cyclic	550 to 600 rounds per minute
Maximum range	3725 meters (approximate)
Maximum effective range	1100 meters
Elevation, tripod, controlled	265 mils
Depression, tripod, controlled	200 mils
Elevation, tripod, free	445 mils
Depression, tripod, free	445 mils
Traverse, tripod, traversing bar	875 mils (425 left and 450 right)
Traverse, tripod, traversing handwheel	100 mils
Traverse, free	6400 mils

The external nomenclature of the M60 machine gun is shown in figure 13-6.

The M60 has a front sight permanently affixed to the barrel. The rear sight leaf, as shown in figure 13-7, is mounted on a spring type of dovetail. It can be folded forward horizontally when the gun is to be moved. The range plate on the sight leaf is marked for each 100 meters, from 300 meters to the maximum effective range of 1100 meters. Range changes may be made by using either the slide release or the elevating knob. The slide release is used for making major changes in elevation. The elevating knob is used for fine adjustments, such as those made during zeroing. Four clicks on the elevating knob equal a 1-mil change in elevation. The sight is adjustable for windage 5 mils right and left of zero. The windage knob is located on the left side of the sight. One click on the windage knob equals a 1-mil change of deflection.

A safety lever is located on the left side of the trigger housing. It has an S (safe) and an F (fire) position. On the S position, the bolt cannot be pulled to the rear or released to go forward. The cocking handle on the right

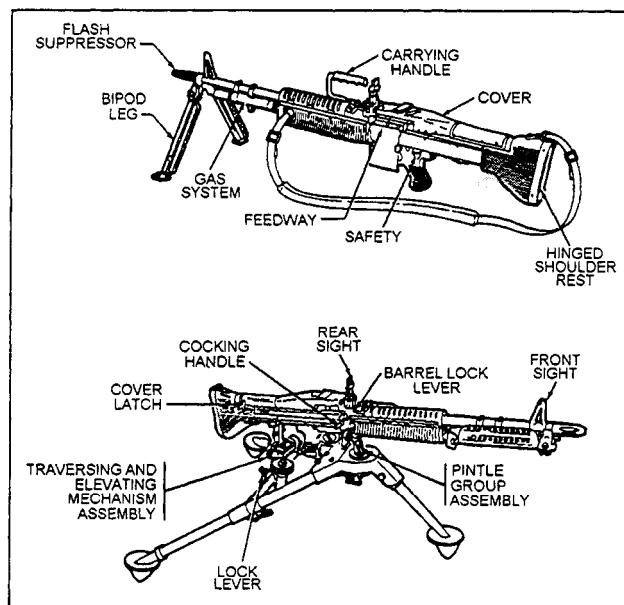

Figure 13-6.—External nomenclature of the M60 machine gun.

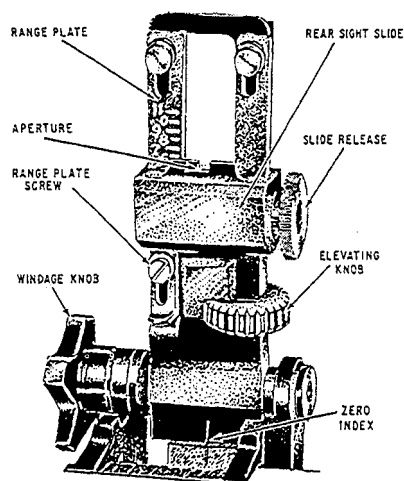

Figure 13-7.—The rear sight.

side of the gun is used to pull the bolt to the rear. Always remember that the cocking handle must be returned manually to its forward position each time the bolt is manually pulled to the rear.

The flash suppressor is affixed to the muzzle of the barrel. The ribs of this suppressor vibrate during firing and dissipate flash and smoke.

The M60 can be effectively fired from the integral bipod mount (fig. 13-6). The hinged shoulder rest provides support for the rear of the gun. The movable carrying handle provides a method for carrying the gun

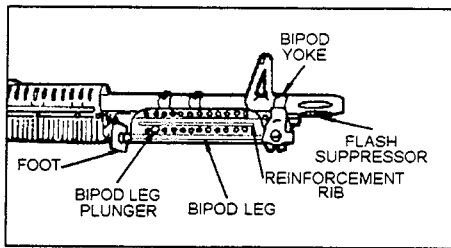

Figure 13-8.—Bipod mount.

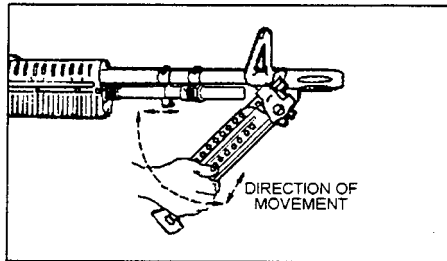

Figure 13-9.—Lowering the bipod leg.

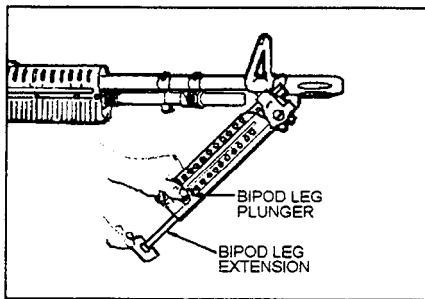

Figure 13-10.—Adjusting the bipod leg extension to lengthen the leg.

short distances and can be positioned out of the gunner's line of sight.

The bipod mount is an integral part of the barrel group. The bipod yoke fits around the barrel and is held in position by the flash suppressor, as shown in figure 13-8. To lower a bipod leg, pull it to the rear (compressing the lock spring) and push it downward, as shown in figure 13-9. The leg automatically y locks when in the down position.

To lengthen a bipod leg, pull down on the foot, as shown in figure 13-10. The bipod leg plunger engages a notch in the bipod leg extension and holds it in the desired position. To shorten the bipod leg, depress the bipod leg plunger and push upon the bipod foot.

The M122 tripod mount provides a stable and durable mount for the M60 machine gun. Firing the gun from the tripod permits a high degree of accuracy and control.

The M122 tripod mount consists of the tripod assembly, the traversing and elevating mechanism, and the pintle and platform group.

The tripod mount consists of a tripod head with a pintle bushing and pintle lock, one front and two rear legs, and a traversing bar, as shown in figure 13-11. The traversing bar connects the two rear legs and supports the traversing and elevating mechanism. Engraved on the bar is a scale that is divided into 100-mil major divisions and 13-mil subdivisions, 450 mils to the left and 425 to 430 mils to the right of center. A sliding sleeve

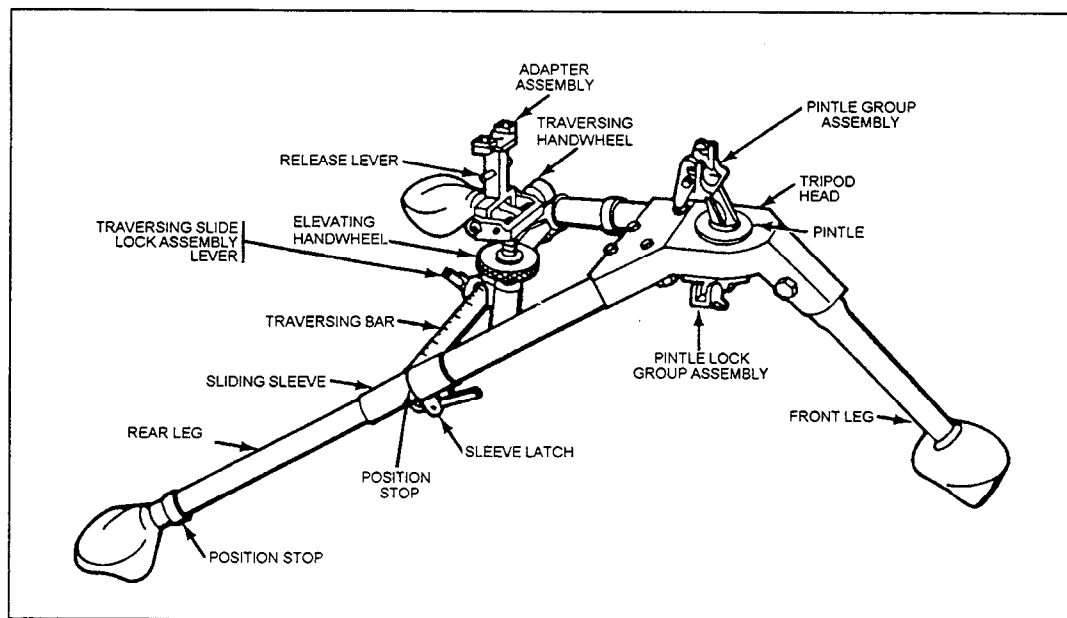

Figure 13-11.—Machine gun tripod mount, M122.

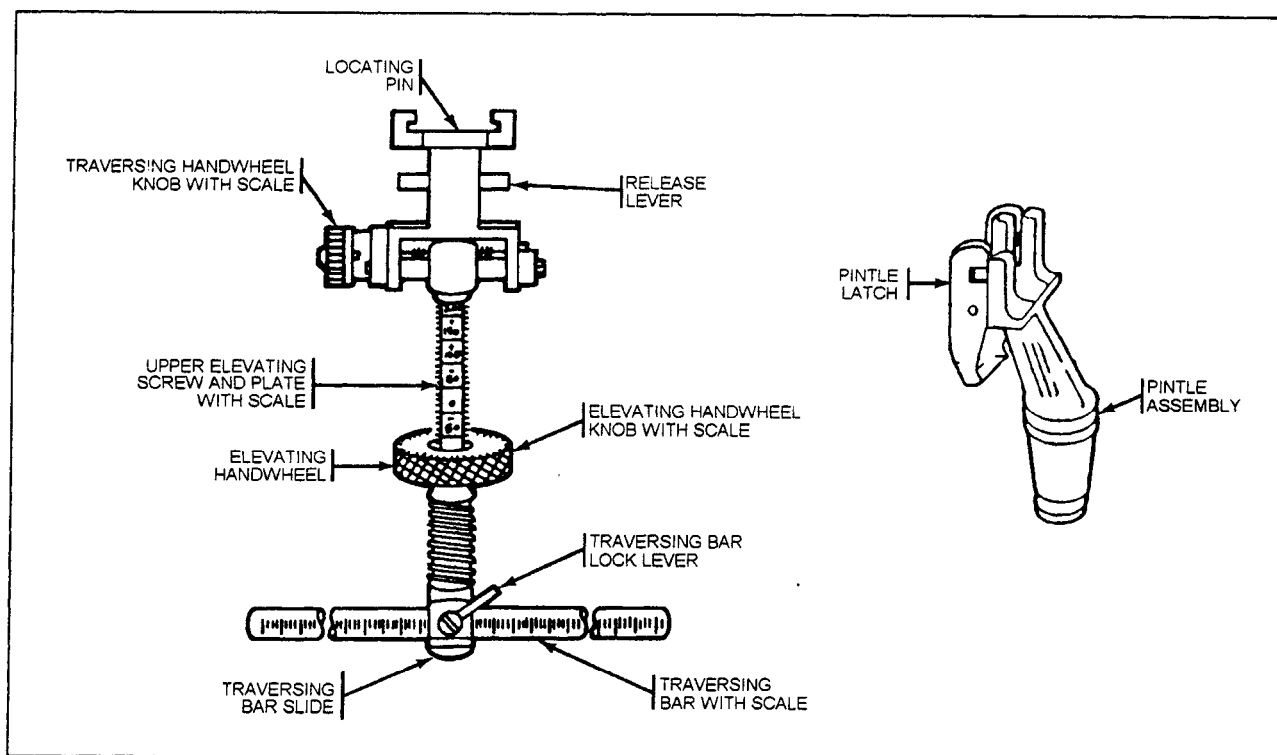

Figure 13-12.—Traversing and elevating mechanism, pintle, and platform group.

connects the traversing bar and a rear leg to permit the legs to fold. Position stops are provided to stop the traversing bar in the open or closed positions. The sleeve latch on the right rear leg secures the traversing bar when in the open position. (See fig. 13-11.)

The traversing and elevating mechanism shown in figure 13-12 consists of (1) the elevation adapter that connects to the mounting plate on the bottom of the receiver and (2) the traversing handwheel that has a rill-click device built into it. One click equals a 1-mil change. Engraved on the traversing handwheel is a scale that is divided into 1-mil increments for a total of 25 mils. Use of the traversing mechanism allows the gun to be traversed approximately 100 mils (50 mils right and left of center).

The elevating handwheel has a mil-click device built into it. One click equals a 1-mil change. Engraved on the handwheel is a scale divided into 5-mil major divisions and 1-mil subdivisions. The scale is read directly from the indicator. The upper elevating screw has the elevating screw plate, which is graduated into 50-mil increments. There are 200 mils above and 200 mils below the zero mark for a total of 400 mils in elevation change.

The traversing slide lock lever allows rapid lateral adjustments along the traversing bar. Readings are taken from the left side of the slide.

The pintle and platform group shown in figure 13-12 consist of the gun platform and the pintle, which is secured to the tripod assembly.

To mount the gun, (1) lock the pintle and platform group into the pintle bushing, as shown in figure 13-13;

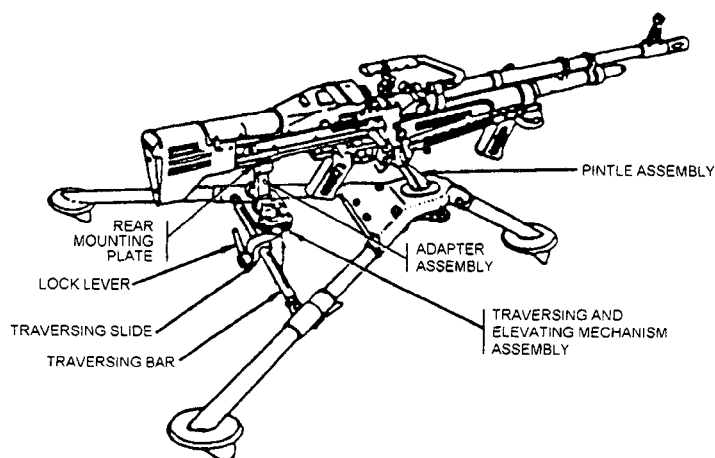

Figure 13-13.—Gun in relation to the tripod.

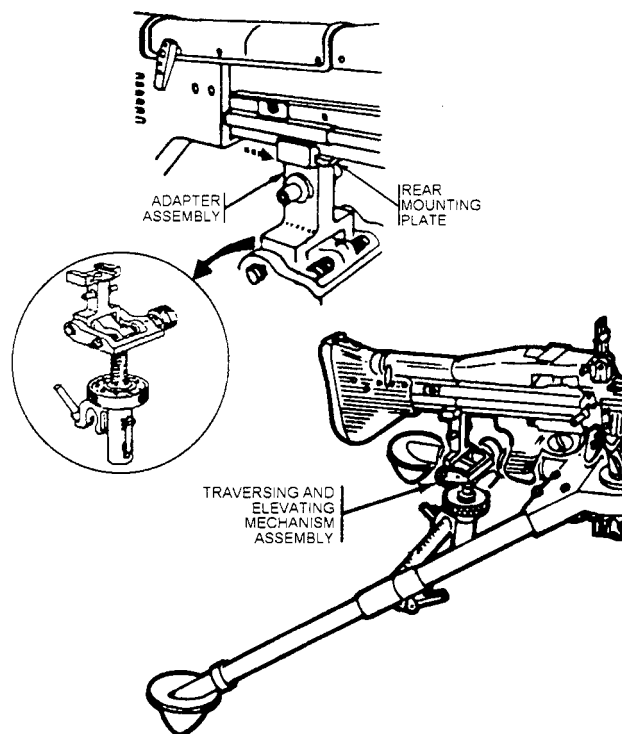

Figure 13-14.—Attaching the traversing and elevating mechanism.

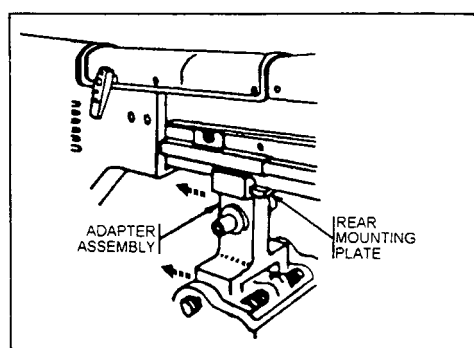

Figure 13-15.—Removing the traversing and elevating mechanism.

(2) position the front locating pin (in the forearm assembly) in the front mounting lug; and (3) lower the receiver so the rear locking pin snaps under the platform latch.

To attach the traversing and elevating mechanism, take the following steps: (1) mount the gun on the tripod, release the platform lock, and raise the rear of the gun; (2) place the mounting plate recess on the rear of the mounting plate and push it forward, as shown in figure 13-14 (the adapter pin automatically locks into position in the bottom of the mounting plate); and (3) lower the rear of the gun, place the traversing slide (with the traversing slide-lock lever to the rear) on the traversing bar, and lock into position.

To remove the traversing and elevating mechanism, release the traversing slide-lock lever and raise the rear of the gun. Pull down on the adapter pin release and pull the mechanism straight back off the mounting plate, as shown in figure 13-15.

Return the platform lock to the down position. Stand to the left of the gun and grasp the carrying handle with your left hand. With your right hand, depress the platform latch and raise the rear of the gun slightly, thus removing the rear locking pin from under the platform latch. Place your right hand on the top of the stock, pull the gun slightly to the rear, pushdown on the stock, and lift the gun from the mount.

OPERATION

The M60 machine gun is loaded, fired, unloaded, and cleared in the OPEN-BOLT position. The safety must be placed in the F (Fire) position before the bolt can be pulled to the rear.

To load the machine gun, check to make sure the safety is in the F position. Using the cocking handle, pull the bolt to the rear. When the bolt is held to the rear by the sear, return the cocking handle to the forward position and place the safety in the S (Safe) position. Raise the cover to ensure that the feed tray, receiver, and the chamber are clear. Place the first round of the belt in the feed tray groove and close the cover, ensuring that the round remains in the feed tray groove.

To unload the machine gun, pull the bolt to the rear, place the safety in the S position, and return the cocking handle to the forward position. Raise the cover and remove any ammunition or links from the feed tray.

To clear the machine gun, pull the cocking handle to the rear, place the safety in the S position, and push the cocking handle forward. Then raise the cover and inspect the chamber; if it is clear, close the cover and place the safety in the F position; then pull the trigger. After the bolt has gone forward, place the safety in the S position.

FUNCTIONING

By having a basic knowledge of how the machine gun functions, you should be able to recognize and correct stoppages that occur during firing.

The machine gun is designed to function automatically as long as ammunition is fed into the chamber and the trigger is held to the rear. Each time a round is fired, the parts of the machine gun function in

a certain sequence. The sequence of operation is known as the cycle of functioning.

The cycle of functioning is divided into eight basic steps that are listed below in the order they occur; however, more than one step may occur at the same time.

FEEDING—A round is positioned into the feed tray groove.

CHAMBERING—A round is stripped from the belt and placed in the chamber.

LOCKING—The bolt is locked inside the barrel socket.

FIRING—The firing pin strikes and detonates the primer of the cartridge.

UNLOCKING—The bolt is unlocked from the barrel socket.

EXTRACTING—The empty case is pulled from the chamber.

EJECTING—The empty cartridge case is thrown from the receiver.

COCKING—The sear engages the sear notch.

MALFUNCTIONS

A malfunction is a failure of the gun to function satisfactorily. Defective ammunition or improper operation of the gun by either you or one of your crew members is not considered a malfunction of the gun. Two of the more common malfunctions of the M60 machine gun are sluggish operation and a runaway gun. Sluggish operation of the gun is usually caused by excessive dirt or carbon, lack of proper lubrication, burred parts, or excessive loss of gas. Clean and lubricate the gun; inspect for burred parts and have them replaced as necessary by the armorer. Excessive loss of gas is usually caused by a loose or missing gas-port plug.

The best method of stopping a runaway gun depends on many factors. Some of these factors are the amount of ammunition remaining in the belt, how the gun is mounted, and whether an assistant gunner is present. For example, in assault firing with the bandoleer attached to the gun, you will continue to move forward, keeping the gun on target until the ammunition is expended. In other types of firing, the primary consideration is keeping the gun on target; however, either you or the assistant gunner may be able to stop the gun by twisting or breaking the belt to stop the feeding.

When you have ceased firing the gun, field-strip it and check the sear and sear notch for excessive wear.

Check the gas system to ensure that the gas-port plug, gas-cylinder extension, and gas-cylinder nut are tight. Clean the operating rod tube. Replace parts as necessary.

STOPPAGES

A stoppage is any interruption in the cycle of functioning caused by a faulty action of the gun or ammunition. Stoppages are classified by the relationship to the cycle of functioning. Table 13-1 shows the types of stoppages, their causes, and the corrective action to be taken.

IMMEDIATE ACTION

Immediate action is the action taken to reduce the stoppage without investigating the cause. This action must be accomplished within 10 seconds, including waiting time, when the barrel is hot enough to cause a cook off. A cook off is the ignition of a round caused by the heat of the chamber without the firing pin striking the primer of the cartridge. One hundred and fifty rounds fired in a 2-minute period may heat the barrel sufficiently to cause a cook off.

If a stoppage occurs, wait 5 seconds. (The bolt must remain forward for the first 5 seconds because of the possibility of a hangfire.)

After the 5-second wait, raise the cover and remove the ammunition belt and the links from the feed tray.

Pull the cocking handle to the rear, making sure the sear engages the sear notch in the operating rod; close the cover immediately; then return the cocking handle to its forward position.

During the retraction of the bolt, observe the round being extracted and ejected. If the round is NOT extracted, pull the trigger, attempting to fire the round. If the round does not fire and the barrel is hot, wait at least 5 minutes with the bolt in the forward position to prevent damage or injury to personnel in the event of a cook off. After the 5-minute wait, remove the round by using a cleaning rod inserted from the muzzle end of the gun.

When the round is extracted or when a round is removed from the chamber, inspect the gun and ammunition to determine the cause of the stoppage.

After cleaning the machine gun, reload, rezero in on the target, and attempt to fire.

Table 13-1.—Malfunctions or Stoppages, Their Causes, and Corrective Action

Malfunction or stoppage	Probable cause	Corrective action	Malfunction or stoppage	Probable cause	Corrective action	
Failure to feed.	Gas pressure insufficient	Clean gas port.	Failure to extract.	Ammunition faulty	Replace ammunition.	
	Feed pawl or feed pawl spring defective	Return to Armorer.		Chamber dirty	Clean or change barrel.	
	Front and rear cartridge guides defective	Return to Armorer.		Operating rod drive spring weakened or damaged	Armorer replaces spring.	
	Cover latch defective	Return to Armorer.		Extractor or spring broken	Armorer replaces spring.	
	Feed lever cam spring defective	Return to Armorer.		Short recoil	Clean gas port, operating rod tube, and lubricate.	
	Cam roller defective	Return to Armorer.		Gas piston installed backwards	Install properly.	
	Lubrication inadequate	Apply lubricant.		Failure to eject.	Short recoil	Clean gas port.
	Ammunition or link defective	Insert new ammunition or link.			Ejector or ejector spring frozen or damaged	Clean or armorer replaces port.
	Ammunition belt installed wrong.	Reverse belt with open portion of link down.		Failure to cock.	Sear broken	Return to armorer.
	Operating rod spring damaged or weakened	Armorer replaces spring.			Operating rod sear notch worn	Return to armorer.
Obstruction in receiver	Remove obstruction.	Runaway gun.	Sear plunger or spring broken or defective.	Return to armorer.		
Failure to chamber.	Ruptured cartridge case		Remove cartridge case.	Obstruction in receiver	Clear as required.	
	Caked carbon in gas cylinder		Remove carbon.	Short recoil Sear broken or worn	Clean gas port.	
Failure to fire.	Caked carbon in receiver	Remove carbon.	Sluggish operation.	Sear notch on operating rod worn	Return to armorer.	
	Round damaged	Remove round.			Excessive friction	Clean and lubricate.
	Firing pin damaged or broken	Armorer replaces firing pin.			Excessive loss of gas	Tighten or replace gas port plug.
	Firing pin spring damaged or broken	Armorer replaces spring.				

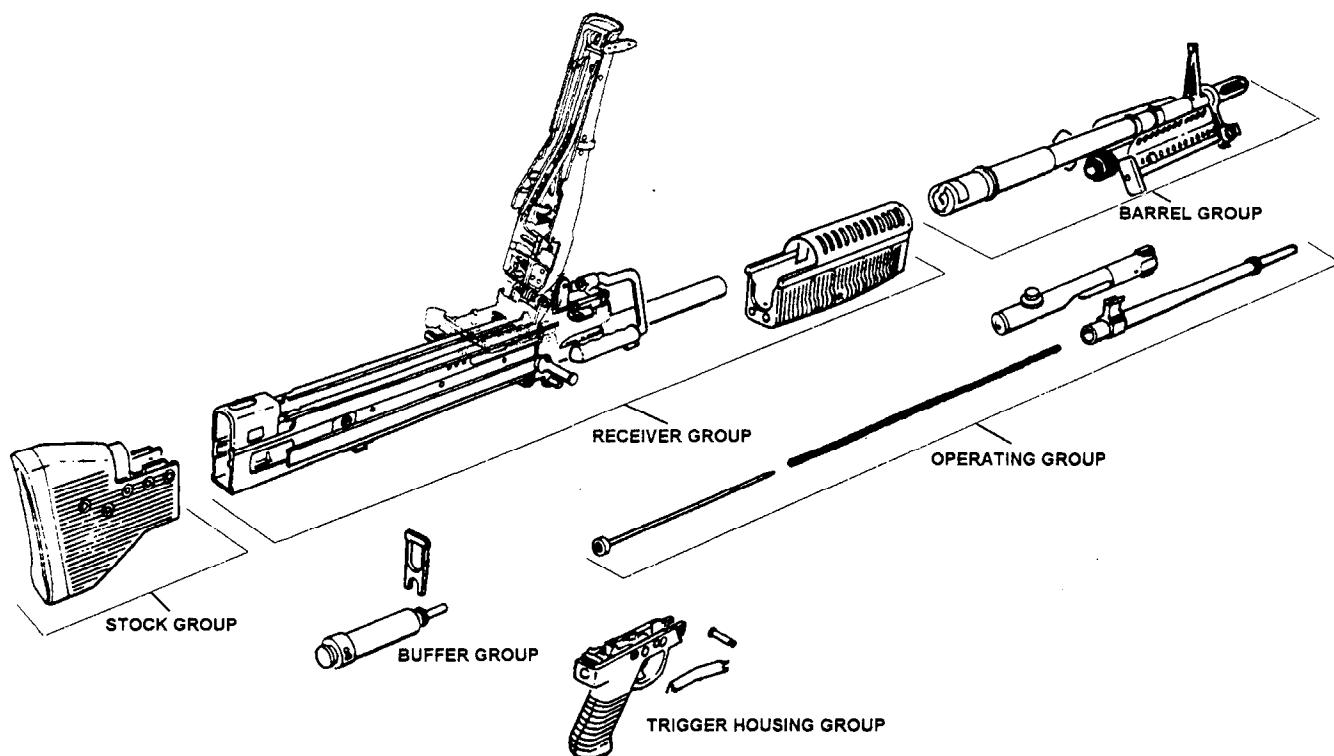

Figure 13-16.—M60 machine gun disassembled into six major groups.

CLEANING AND LUBRICATING

Immediately after firing and on 2 consecutive days thereafter, thoroughly clean the bore, the chamber, and the parts that have become powder-fouled with bore cleaner. Do not wipe it dry. On the third day after firing, clean the M60 with bore cleaner, wipe it dry, then lightly coat it with oil.

Weekly thereafter when the M60 is not being fired, clean the bore and chamber with bore cleaner, wipe it dry, and then oil it. The rest of the machine gun should be cleaned with a dry-cleaning solvent immediately after firing and weekly thereafter. Wipe it dry and oil it.

Do not clean the inside of the M60 gas system unless blank ammunition has been used or unless the gun fires sluggishly after all other reasons for sluggishness have been checked.

Lubricate the machine gun with a general-purpose lubricant when operating in an average climate. For hot, humid climates, inspect the M60 more frequently for signs of rust. Keep it free of moisture and lightly oiled with a special general-purpose lubricant. When exposed to salt air, high humidity, or water, clean and oil the M60 more frequently to remove contaminated lubricants.

ACTION BEFORE AND DURING FIRING

Before firing, wipe the bore dry, inspect the weapon, and ensure the M60 is properly lubricated.

During firing, change the barrels as prescribed for the number of rounds fired in a given period of time, periodically inspecting the M60 to ensure it is properly lubricated; then follow the procedures given when malfunctions or stoppages occur.

FIELD STRIPPING

The M60 machine gun can be disassembled and assembled without the use of force. With exception of the barrel group, all disassembly can be accomplished with a cartridge or some other pointed object.

As you disassemble the machine gun, be sure to place the parts in the order in which they were removed on a clean, flat surface, such as a table or workbench. This reduces the possibility of losing parts and aids in assembling the gun.

A general disassembly (field stripping), as shown in figure 13-16, and reassembly involve removing and replacing the six major groups. These groups consist of the STOCK GROUP, BUFFER GROUP, OPERATING GROUP, TRIGGER HOUSING GROUP, BARREL GROUP, and RECEIVER GROUP.

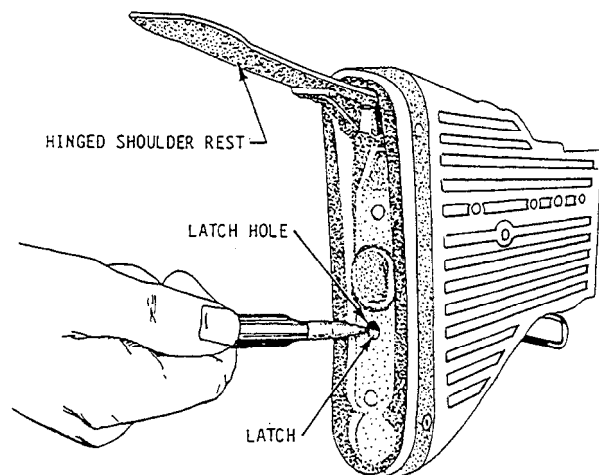

Figure 13-17.—Releasing the stock latch.

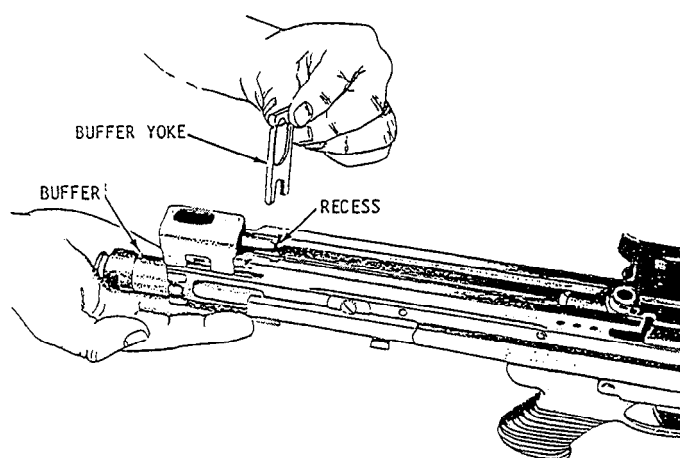

Figure 13-18.—Removing the buffer group.

General disassembly begins with the bolt forward, the cover closed, and the safety in the S position. Before the weapon is disassembled, be sure it has been cleared as outlined in previous sections of this chapter.

Removing the Stock Group

Raise the hinged shoulder rest and insert the nose of a cartridge into the latch hole, as shown in figure 13-17. With the latch depressed, remove the stock by pulling it directly to the rear.

Removing the Buffer Group

The M60 buffer group consists of the buffer yoke and the buffer, as shown in figure 13-18. Hold the palm of your hand against the exposed buffer and press lightly, as shown in the figure. Remove the buffer yoke from the top of the receiver and withdraw the buffer

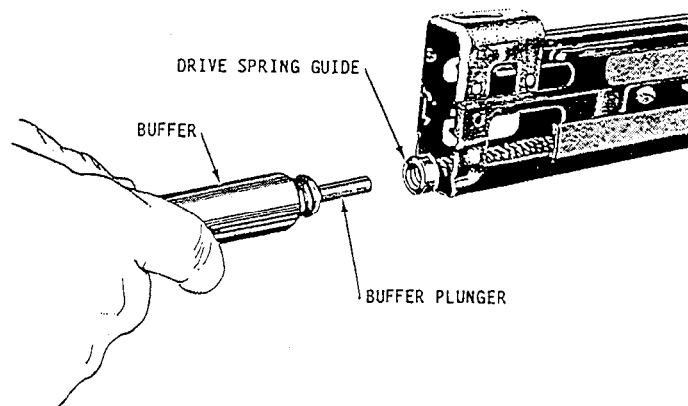

Figure 13-19.—Separating the buffer group (buffer plunger) from the operating group (drive spring guide).

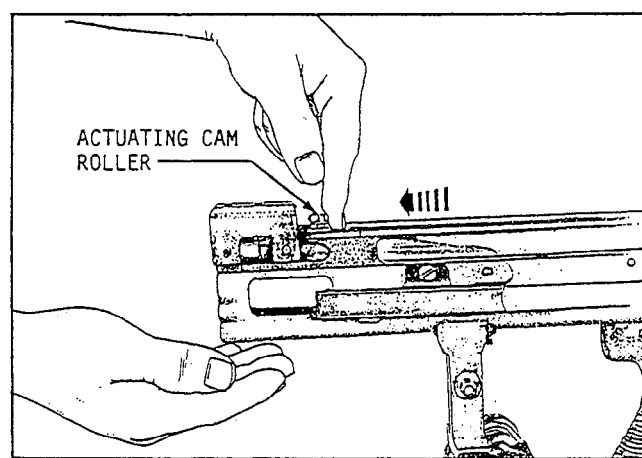

Figure 13-20.—Pull the operating rod and bolt to the rear by pulling on the cam roller.

slowly. Allow the drive spring to expand until the end of the drive spring is exposed at the rear of the receiver, as shown in figure 13-19. Pull the buffer plunger from the spring guide.

Removing the Operating Group

The operating group of an M60 consists of the operating rod, bolt, drive spring, and drive spring guide. Pull the drive spring guide and spring from the receiver and separate them. With the left hand, grasp the pistol grip and pull the cocking handle to the rear until the bolt is separated from the barrel socket. Continue to pull the operating rod and bolt to the rear by pulling on the cam roller, as shown in figure 13-20.

When the operating rod and bolt are exposed approximately 4 inches to the rear of the receiver, grasp

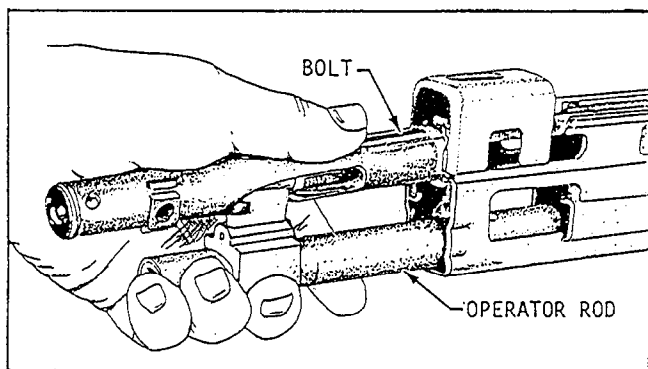

Figure 13-21.—Withdrawing the operating group from the receiver.

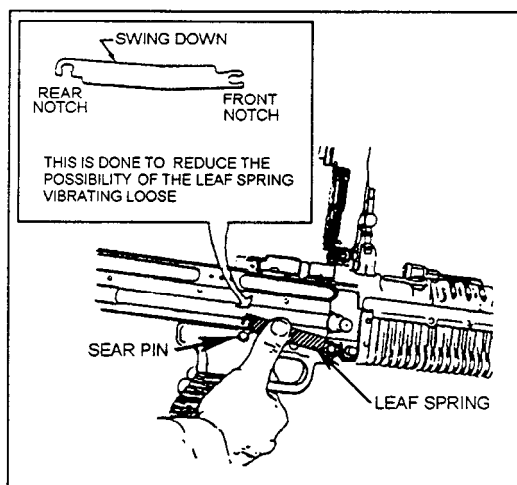

Figure 13-22.—Removing the leaf spring.

them securely to prevent the bolt from rotating and remove them from the receiver, as shown in figure 13-21. Relax the grip and allow the bolt to rotate slowly. Do not separate the bolt from the operating rod.

Removing the Trigger Housing Group

The M60 trigger housing group consists of the trigger housing assembly (trigger housing, sear, sear plunger, sear plunger spring, trigger pin, and trigger), trigger housing pin, and the leaf spring.

Press in on the front of the leaf spring and rotate the front end down to clear it from the trigger housing pin, as shown in figure 13-22. Pull forward to disengage the rear notch from the sear pin. Remove the trigger housing pin by pushing it to the left.

Slide the trigger housing group slightly forward, rotate the front of the housing down, and remove it, as shown in figure 13-23.

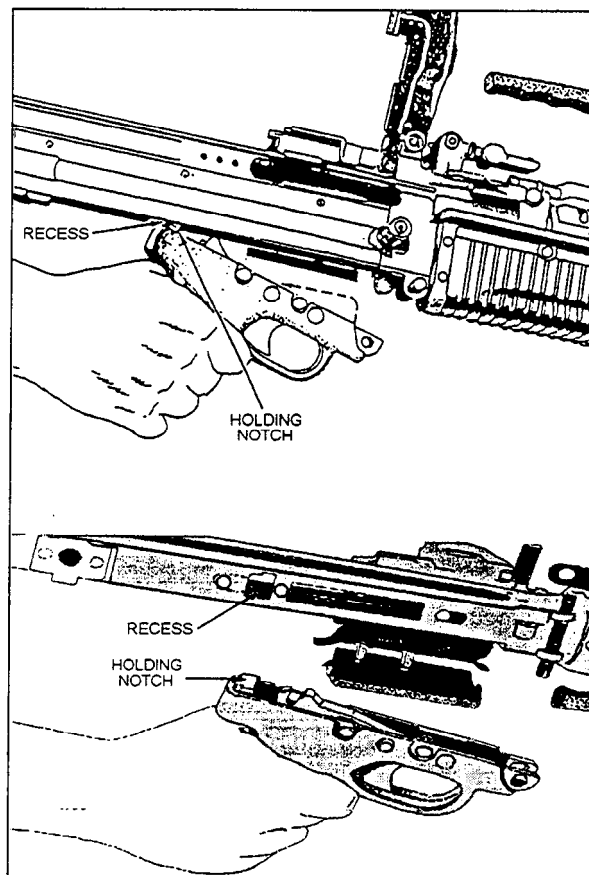

Figure 13-23.—Removing the trigger housing group.

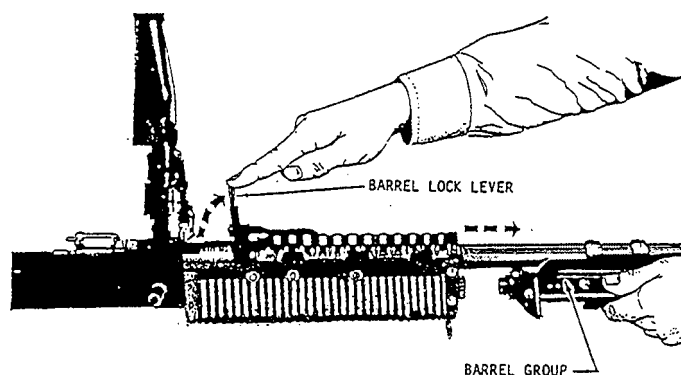

Figure 13-24.—Removing the barrel group.

Removing the Barrel Group

The M60 barrel group consists of the barrel, flash suppressor, front sight biped assembly, and gas cylinder. Raise the barrel lock lever to the vertical position and remove the barrel group by pulling it to the front, as shown in figure 13-24.

Removing the Receiver Group

The M60 receiver group consists of the receiver, forearm assembly, rear sight, cover, feed tray, and

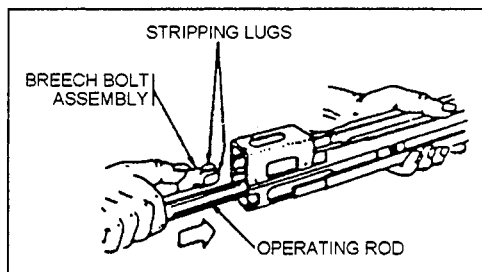

Figure 13-25.—Inserting the operating group in the receiver.

carrying handle. General disassembly is completed after removal of the other five groups from the receiver group.

Replacing the Barrel Group

Ensure the barrel-lock lever on the M60 is in the vertical position (fig. 13-24). Insert the rear of the barrel under the barrel cover and align the gas cylinder nut with its recess in the forearm assembly. Lower the barrel-lock lever.

Replacing the Trigger Housing Group

Engage the holding notch of the M60 trigger housing in its recess in the bottom of the receiver (fig. 13-23). Rotate the front of the trigger housing up and align the holes of the trigger housing with the mounting bracket on the receiver. Insert the trigger housing pin from the left.

Engage the rear leaf spring with the sear pin (fig. 13-22). Ensure the leaf spring is positioned so the bent portion is pressed against the side of the trigger housing. Rotate the front of the spring up and engage it with the trigger housing pin.

Replacing the Operating Group

Insert the end of the M60 operating rod into the receiver. Hold the rod with one hand. With your other hand, push forward on the rear of the bolt, causing the bolt to rotate until the locking lugs are in a vertical position, as shown in figure 13-25.

With the cam roller up, push the operating rod and the bolt into the receiver until the end of the operating rod is even with the rear of the receiver, as shown in figure 13-26.

Insert the drive spring guide into the drive spring; then insert the opposite end of the drive spring into the recess of the operating rod (fig. 13-26). Pull the trigger

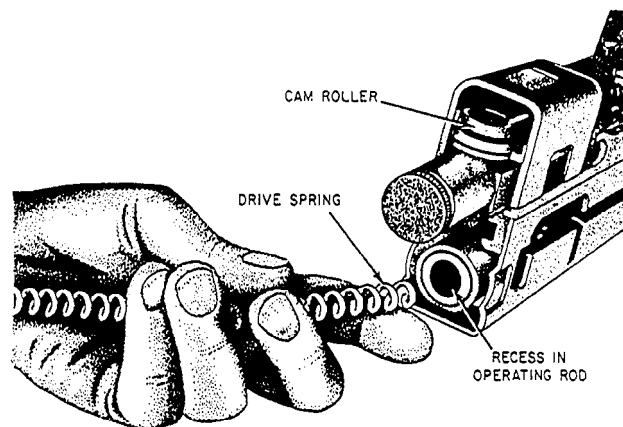

Figure 13-26.—Inserting the drive spring.

and push in the drive spring until the head of the guide is approximately an inch from the receiver (fig. 13-19).

Replacing the Buffer Group

Insert the buffer plunger into the drive spring guide (fig. 13-19). Push forward on the buffer until the operating rod and bolt go forward fully.

Push in on the buffer until the recesses on the buffer are aligned with the recesses in the receiver. Replace the buffer yoke from the top of the receiver (fig. 13-18).

Replacing the Stock Group

Align the guide rails of the M60 stock with the guide rails on the receiver. Push forward until the stock is frilly seated. A distinct click will be heard when the latch engages.

Check for Correct Assembly

To check for correct assembly, pull the cocking handle to the rear and return it to its forward position. Close the cover and pull the trigger. The bolt should go forward.

AMMUNITION

As a member of the M60 machine gun crew, you must be able to recognize the types of ammunition available and know how to care for the different types.

Based upon the type of projectile, the ammunition authorized for the M60 machine gun is classified as follows:

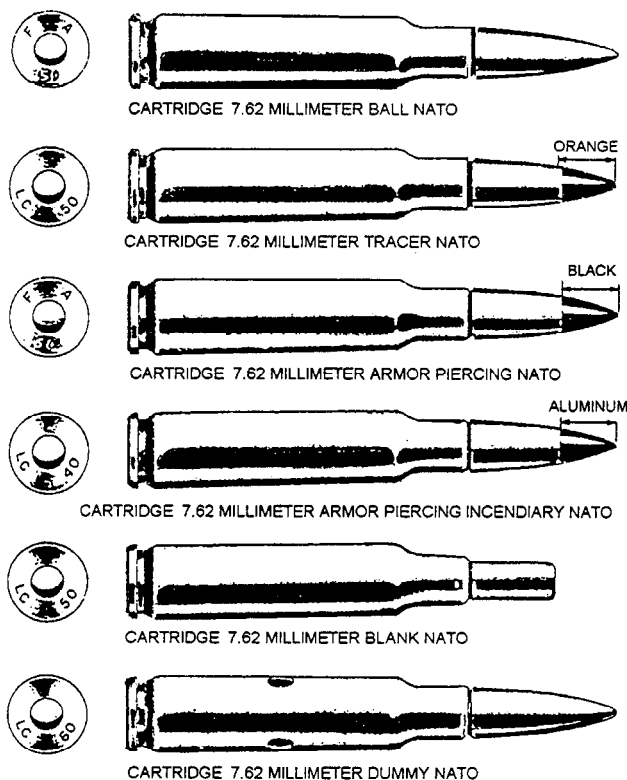

Figure 13-27.—NATO 7.62-mm cartridges for the M60 machine gun.

1. Ball cartridges are used against light material targets, such as houses and personnel, and during training.

2. Armor-piercing cartridges are used against lightly armored targets where armor-piercing effects are desired.

NOTE

This type of cartridge is NOT authorized for training purposes.

3. Armor-piercing incendiary cartridges are used for desired armor-piercing effects combined with fire-producing (incendiary) effects.

NOTE

This type of cartridge is NOT authorized for training purposes.

4. Tracer cartridges are used for observation of fire, incendiary effects, signaling, and during training.

5. Dummy cartridges are used during training.

6. Blank cartridges are used during training when simulated live fire is desired.

The different types of 7.62-mm NATO cartridges can be easily identified by the color of the projectile tips, the manufacturer's initials, and the year of manufacture stamped on the base of the cartridge case, as shown in figure 13-27.

Machine gun ammunition is generally safe to handle. However, you must protect the ammunition you are using from mud, sand, dirt, and water. Heavily corroded cartridges, or cartridges with dented cases or loose projectiles, should not be fired.

Do not expose ammunition to the direct rays of the sun. If the powder becomes hot, excessive pressure can be developed when the gun is fired.

Do not oil or grease ammunition. If it is oiled, dust and other abrasives can collect on it and damage the operating parts of the gun.

FIRING TECHNIQUES FOR THE M60 MACHINE GUN

To become an effective machine gunner, you must apply and master the following four fundamental points of good marksmanship applicable to machine guns:

1. Obtaining an accurate initial burst of fire
2. Learning to adjust your fire
3. Developing mechanical skill in manipulating the controls
4. Developing speed

ACCURATE INITIAL BURST

Obtaining an accurate initial burst of fire is essential. If you can hit the enemy first, he is not going to be able to return your fire effectively. To do this, you must be able to estimate the range to the target correctly; you must correctly set your sights, and you must be able to lay the gun properly by manipulating the traversing and elevating mechanism (T& E). After the estimated range has been set on the rear sight, the gun is adjusted until the line of sight intersects the target at its center base.

Position and Grip

Except for the assault positions, the machine gunner should fire the M60 machine gun from the prone position, using either the biped or the tripod. In

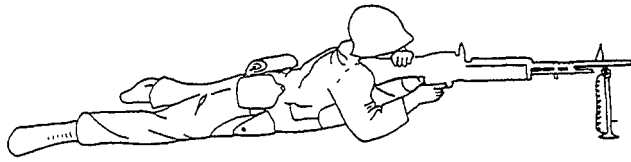

Figure 13-28.—Prone position with bipod-mounted machine gun.

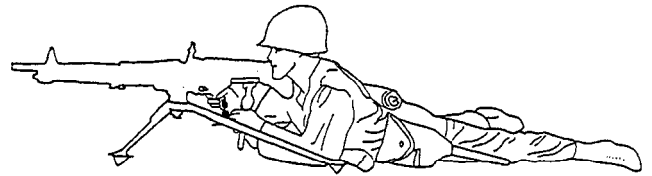

Figure 13-30.—Prone position with tripod-mounted machine gun.

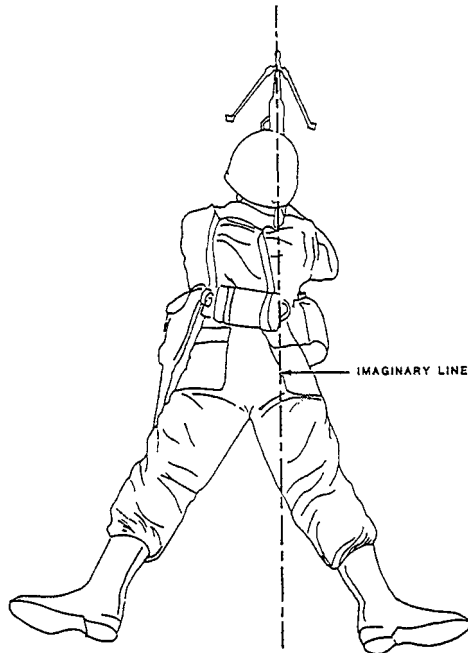

Figure 13-29.—Imaginary line.

permanent defensive positions, machine gun emplacements may be dug deep enough so the gunner may stand while firing.

BIPOD-MOUNTED GUN.— When firing the M60 from the bipod (fig. 13-28), you must assume a prone position at the rear of the gun. Your right shoulder should be placed firmly against the butt stock group and under the raised shoulder rest. An imaginary straight line, extending through the barrel and receiver, should pass through your right shoulder and hip (fig. 13-29). Your legs should be spread comfortably apart, with your heels down (when possible). Grasp the handgrip with your right hand and place your index finger on the trigger. Place your left hand palm-down over the rear of the feed cover and apply downward pressure. Rest your cheek against your hand and the feed cover. While aiming and firing, exert firm pressure to the rear with both hands.

TRIPOD-MOUNTED GUN.— The firing position when firing from the tripod mount (fig. 13-30) is similar to the position used when firing from the bipod. The difference is that the hinged shoulder rest is not used,

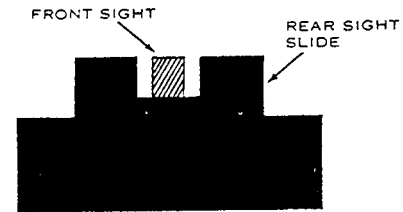

Figure 13-31.—Sight alignment.

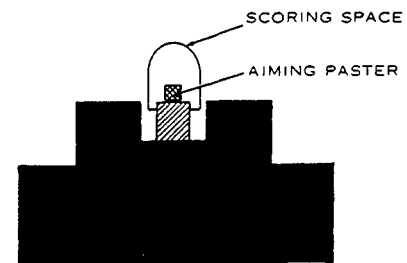

Figure 13-32.—Correct sight alignment and correct sight pictures.

and your elbows should be inside the tripod legs, but not touching the tripod. Your left hand should grasp the elevating handwheel, palm down to accomplish all manipulation. When firing and aiming, exert firm pressure to the rear with both hands as you would when firing from the bipod.

Sighting and Aiming

After the proper range (elevation) and windage (deflection) have been set on the sights, they must be properly aligned with the target. This is done by manipulating the T & E mechanism.

SIGHT ALIGNMENT.— To align the sights of the M60 machine gun correctly, center the front sight blade vertically in the aperture of the rear sight slide. The top of the front sight blade should be even with the top of the rear sight slide (fig. 13-31).

SIGHT PICTURE.— With the sight properly aligned, obtain a 6 o'clock sight picture on the target (fig. 13-32). Always aim at the center base of the target for your initial burst of fire. When shooting at enemy personnel, aim at their beltlines.

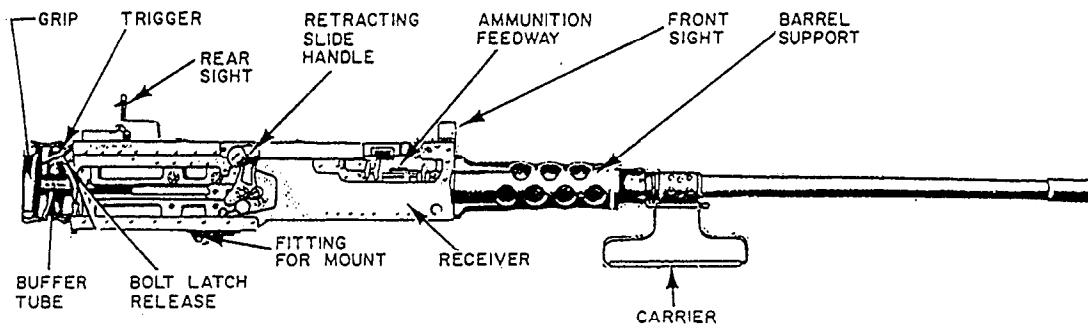

Figure 13-33.—The .50-caliber Browning machine gun (BMG), M2HB.

ADJUSTMENT OF FIRE

Adjustment of fire is the second fundamental point of good marksmanship. Both the team leader and the gunner must observe the strike of the bullets from the initial burst. They must be able to evaluate and adjust their fire rapidly if they are not on target.

When firing the biped-mounted gun, you adjust fire by changing the position of your body. When firing the tripod-mounted gun, you adjust fire by manipulating the tripod traversing and elevating handwheel.

ZEROING-IN

Zeroing-in the M60 is similar to zeroing-in the service rifle. Three rounds are fired at a target with a predetermined range, generally of 500 meters. The rear sight is set to 0 windage and to the corresponding range (500 meters). After the three rounds are fired, the center of the group is estimated. Next, adjust the windage knob on the rear sight, as required, bringing the strike of the bullet to the vertical center of the bull's-eye. One click clockwise or counterclockwise of the windage knob is a 1-mil adjustment. This means that at 500 meters one click will move the strike of the bullet 18 inches either right or left. Next, you must change the elevation, if required, by turning the elevation knob. A one-click adjustment clockwise or counterclockwise of the elevation knob equals a 1/4-mil change. At 500 meters this would be 4 1/2 inches.

With the correct adjustments made to the rear sight, the T & E mechanism is manipulated until the correct sight picture is again obtained. You then fire one round to confirm your sight setting. If the round misses your point of aim, you must repeat the above procedure, making the necessary adjustments until the bullet strikes where you are aiming.

After the final adjustments are made, putting the strike of the bullet at the aiming point, you must adjust the rear sight range plate. To do this, loosen the screw and move the plate until the 500-meter range mark coincides with the top left edge of the rear sight slide. Tighten the range plate screw and then record the amount of deflection for future reference.

THE .50-CALIBER BROWNING MACHINE GUN

Browning machine guns (BMGs) are standard weapons used throughout the Navy. The .50-caliber BMG issued to naval activities is designated the M2. The weapon is available with two types of barrels. An aluminum alloy "light" barrel is used for the aircraft version of the .50-caliber BMG, M2. A "heavy" barrel (HB) is issued for ship and surface craft use. Our discussion centers around the .50-caliber BMG, M2HB (fig. 13-33).

GENERAL DESCRIPTION

The .50-caliber BMG is a belt-fed, crew-served, recoil-operated, air-cooled weapon. It can be set for automatic and semiautomatic fire. The .50-caliber BMG does not have any positive safeties.

Ammunition is supplied to the receiver (ammunition feedway) of the gun by a disintegrating metallic link belt. The BMG is capable of alternate feed. Normally, the gun is fed from its left side; but by repositioning certain component parts, the belt may be fed from the right side.

One person can operate the .50-caliber BMG. However, two people, the gunner and assistant gunner, are normally used. The gunner actually fires the weapon.

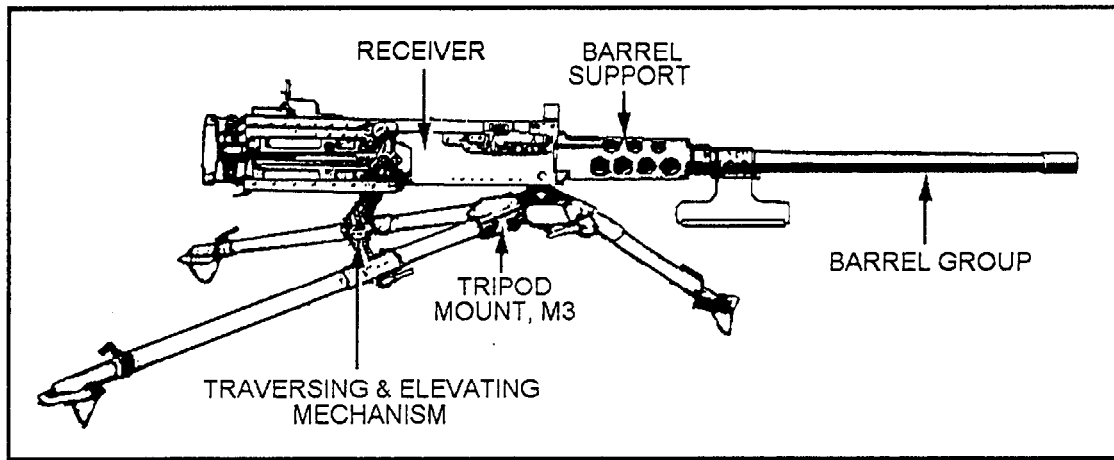

Figure 13-34.—The 30-caliber BMG on an M3 tripod mount.

The assistant gunner helps to load and reload the ammunition into the receiver. Other personnel—ammunition bearers—can be used to keep the assistant gunner supplied. Speed, skill, and teamwork are important.

The force for recoil is finished by the expanding gases of the fired cartridges. The recoil operation is controlled by various springs, cams, and levers within the gun.

Most of the barrel and receiver is exposed to the air to cool the .50 caliber BMG. Perforations (holes) in the barrel support allow air to circulate around the breech end of the barrel. A heavy barrel (HB) is used to retard, or slow down, early overheating.

The .50-caliber BMG has a leaf type of rear sight. It is graduated in both meters and mils for ranges from 100 to 2600 meters and from 0 to 62 mils. A windage knob permits deflection changes of 5 mils right or left of the center. The front sight is a semifixed blade type with a cover.

Because of its size and weight, the .50-caliber BMG usually needs some type of mounting support. Figure 13-34 shows the M3 tripod mount arrangement. Other devices or stands may also be used. The primary reason for mounting the weapon is to increase its firing accuracy.

The main characteristics of the .50-caliber BMG are listed below.

Weight of receiver group . . . 60 pounds

Weight of barrel 24 pounds
(approximately)

Weight of tripod mount
M3 (w/traversing and
elevating mechanism
and pintle w/bolt) 44 pounds

Total weight of gun,
complete, on tripod
mount, M3 128 pounds
(approximately)

Maximum range
(M2 ball) 6800 meters
(approximately)

Maximum effective
range 1830 meters

Rates of fire:

Sustained 40 rounds or less
per minute

Rapid 40 rounds or more
per minute

Cyclic rate of fire 450 to 550 rounds
per minute

Muzzle velocity
(M2 ball) 3,050 feet/second
(2,080 mph)

Length of gun, overall 65 inches
(approximately)

Length of barrel 45 inches

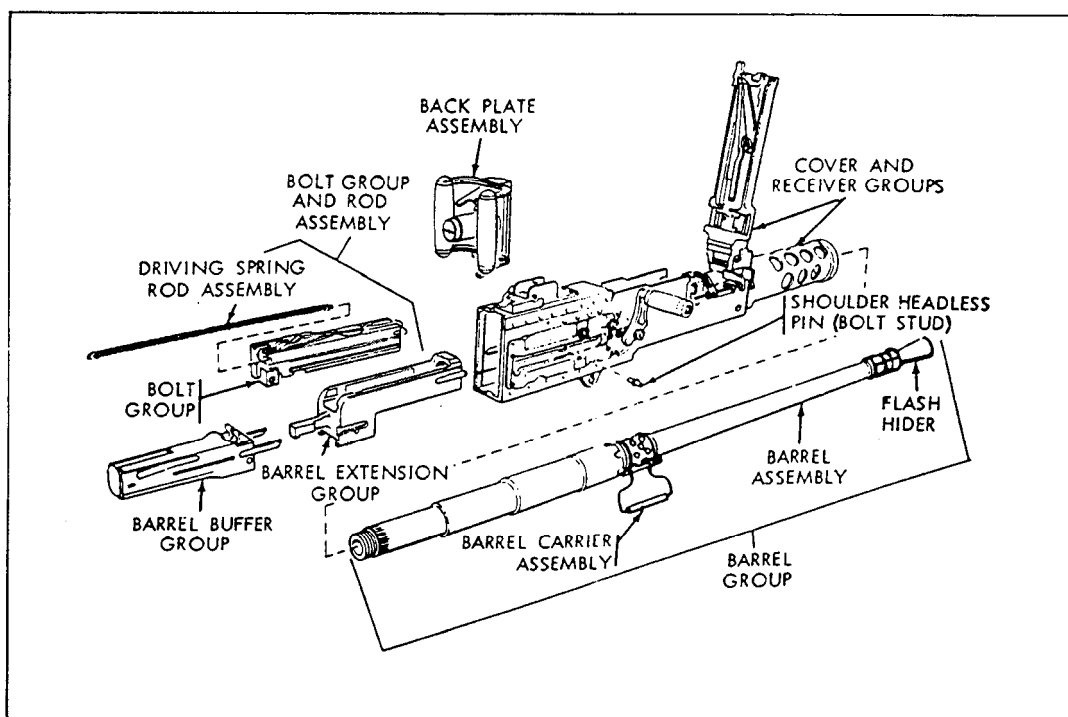

Figure 3-35.—Major component groups and assemblies.

GENERAL DISASSEMBLY

Figure 13-35 shows the major component groups and assemblies of the .50-caliber BMG. For routine cleaning and maintenance, you need to know the general disassembly procedures. Detailed disassembly procedures remove all parts from each group. These steps are explained in the FM23-65 of the U.S. Army. Be sure to consult the field manual if you must do a detailed disassembly.

Before starting general disassembly procedures, you must clear the weapon. This includes ensuring the gun is unloaded, cocked, and the bolt is forward. The primary steps involve removal of the following parts:

1. Barrel group
2. Backplate assembly
3. Driving spring rod assembly
4. Bolt stud
5. Bolt group
6. Buffer body and barrel extension groups
7. Buffer assembly

Remove Barrel Group

The actions required to remove the barrel group are shown in figure 13-36. Turn the cover latch lever forward and raise the cover group (view A). Pull the retracting slide (bolt) handle to the rear slowly (view B). That moves the recoiling parts of the gun to the rear.

Pull rearward until the lug on the barrel locking spring aligns with a 3/8-inch hole. The hole is in the right sideplate of the receiver, just below the feedway exit. The barrel can be turned only when the lug is aligned with the 3/8-inch hole. Place the smallest loop of a .50-caliber belt link (or suitable spacer) between the trunnion block and the barrel extension. This holds the barrel locking spring lug in alignment with the 3/8-inch hole in the right sideplate (view C).

Now, unscrew the barrel from the receiver (view D). Be careful not to damage the threads or barrel-locking notches when setting the barrel down. Complete this phase of disassembly by pulling back slightly on the retracting slide handle. Then remove the .50-caliber link (or spacer) from the receiver. Do not allow the bolt to slam forward with the barrel removed; this causes damage. Let the retracting slide handle (and bolt) ease forward carefully.

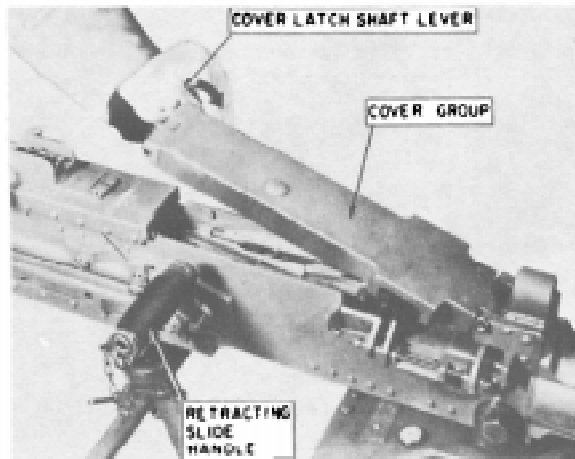

A-RAISING THE COVER GROUP.

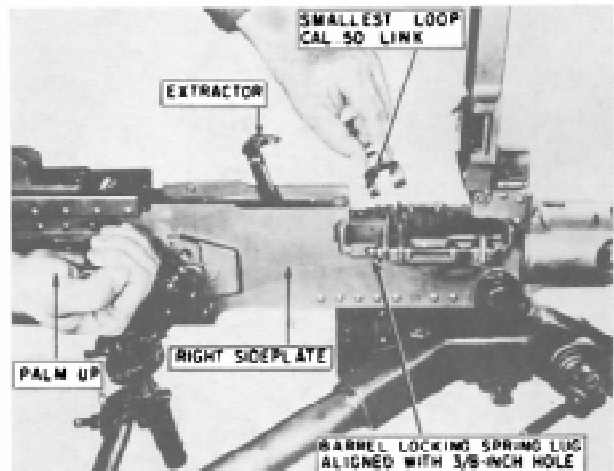

B-ALIGNING THE LUG ON THE BARREL LOCKING SPRING WITH THE 3/8-INCH HOLE IN THE RECEIVER'S RIGHT SIDEPLATE.

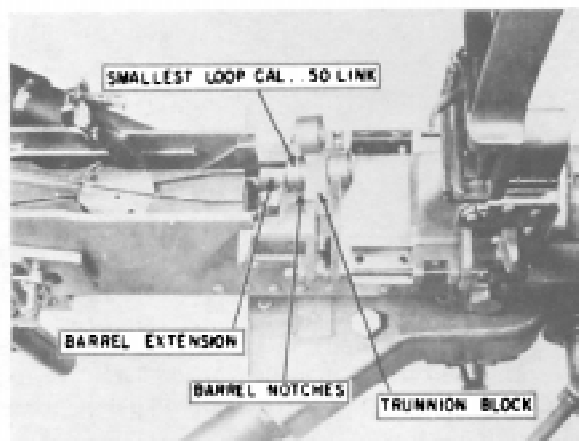

C-USING THE SMALLEST LOOP OF A .50-CAL LINK TO KEEP THE BARREL LOCKING SPRING LUG ALIGNED WITH THE 3/8-INCH HOLE.



D-UNSCREWING THE BARREL GROUP FROM THE RECEIVER

Figure 13-36.—Removing the barrel group.

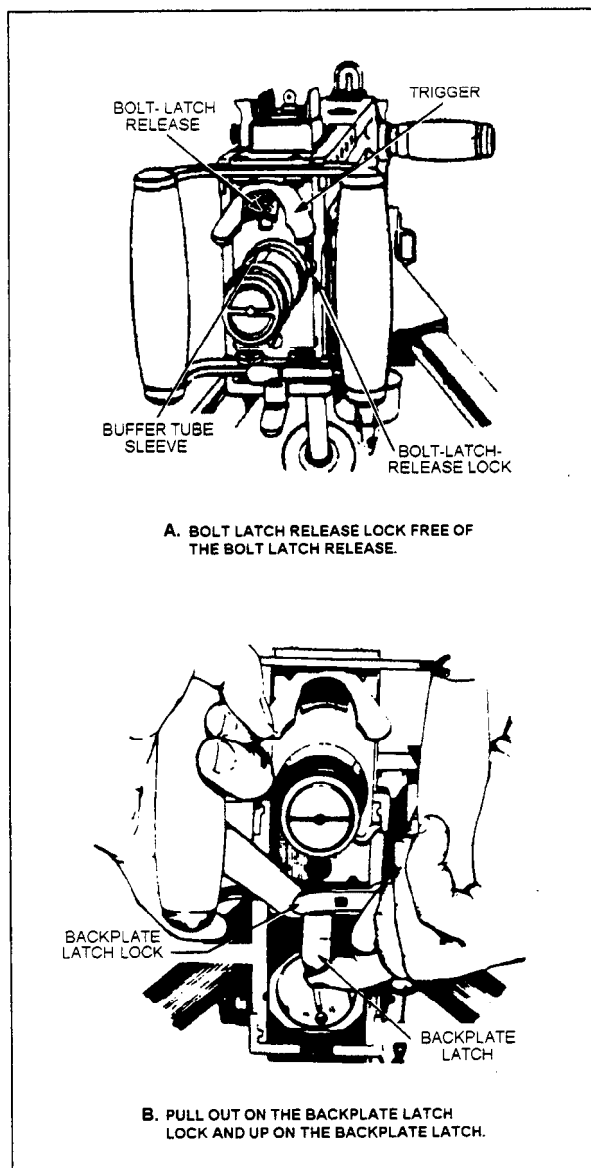

Figure 13-37.—Removing the backplate assembly.

Remove Backplate Assembly

To remove the backplate assembly, refer to figure 13-37. Two conditions must exist before the backplane assembly can be removed. First, the bolt latch release must be up and free of the bolt latch release lock. If it is not, push down on the bolt latch release (fig. 13-37, view A). Turn the buffer tube sleeve to the right. Keep turning until the bolt latch release lock is free of the bolt latch release.

The second condition is that the bolt must be forward. If it is not, depress the bolt latch release. At the same time, use the retracting slide handle to ease the bolt

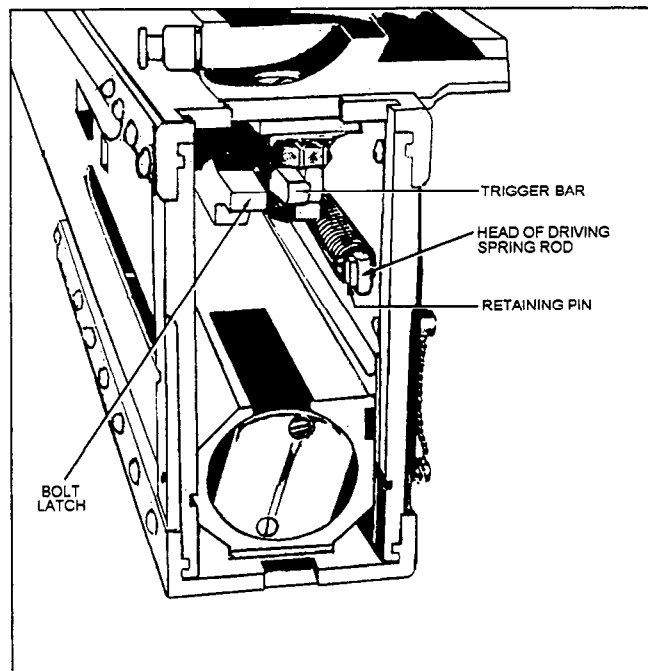

Figure 13-38.—Removing the driving spring rod assembly.

forward. When the bolt latch release is up and the bolt is forward, the backplate assembly can be removed. Located below the buffer tube sleeve are the backplate latch and latch lock. Pull out on the latch lock and up on the latch, as shown in figure 13-37, view B. Remove the backplate by lifting it straight up.

Remove Driving Spring Rod Assembly

The driving spring rod assembly consists of its inner and outer springs and a rod. The assembly is located next to the right sideplate inside the receiver (fig. 13-38).

To remove the assembly, push in on the head of the driving spring rod. Push it to the left and remove the driving spring rod retaining pin from its seat in the right sideplate. Full the complete assembly to the rear and out of the receiver.

Use caution when removing the driving spring rod assembly. You should feel a slight pressure on the springs when the bolt is forward. Never attempt to cock the gun while the backplate assembly is off and the driving spring rod assembly is installed. Cocking the gun compresses the spring group. If the retaining pin slips from its seat, the rod will come flying out! Anyone standing behind the gun could be injured.

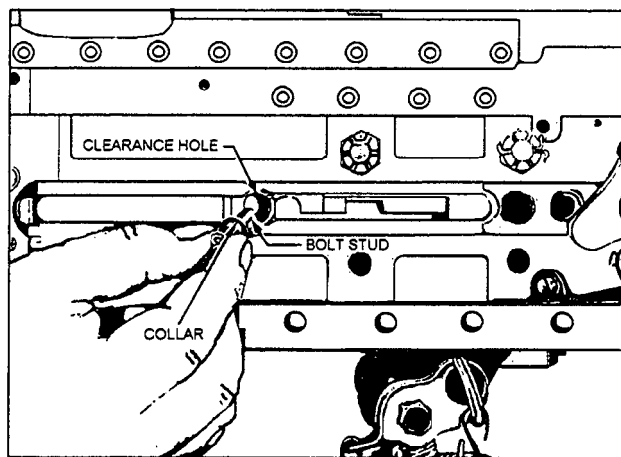

Figure 13-39.—Removing the bolt stud.

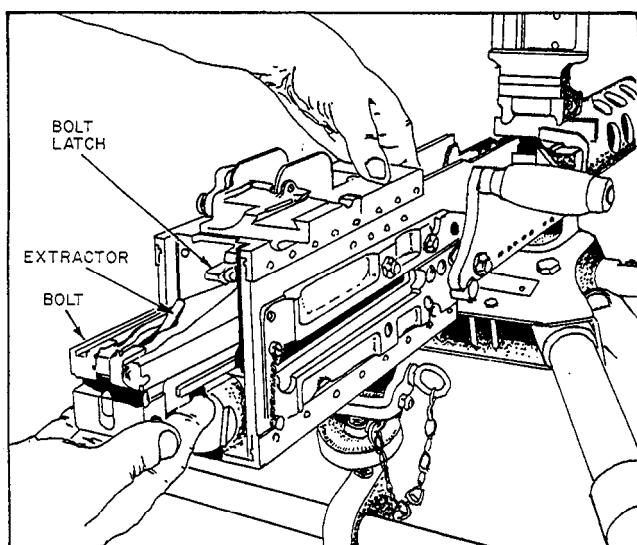

Figure 13-40.—Removing the bolt group.

Remove Bolt Stud

To remove the bolt stud (a shoulder headless pin), grasp the retracting slide handle. Give the handle a quick jerk, moving it about halfway to the rear. That action frees the bolt group from the barrel extension group. Move the bolt rearward until the shoulder on the bolt stud aligns with a clearance hole. The hole is in the bolt slot on the right sideplate (fig. 13-39). Removing the bolt stud frees the bolt group.

If the bolt is accidentally moved all the way to the rear, it will lock in place. If that occurs, raise the bolt latch. (See fig. 13-40.) Push the bolt forward to align

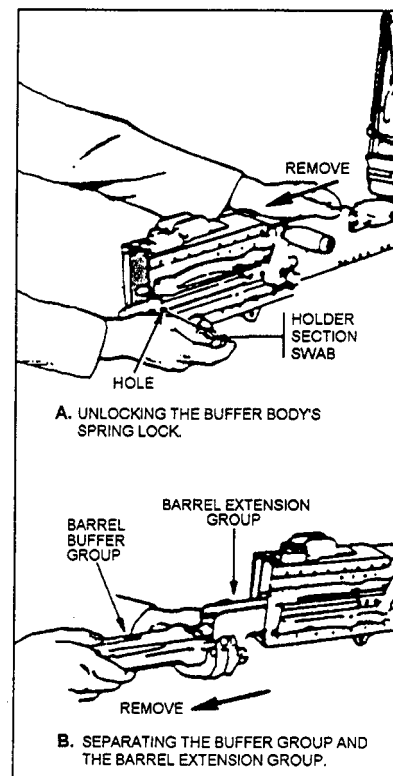

Figure 13-41.—Removing the buffer body and barrel extension groups.

the bolt stud with the clearance hole. Then proceed as before.

Remove Bolt Group

After freeing the bolt, slide it from the rear of the receiver (fig. 13-40). Place the bolt down on its right side with the extractor arm up. That prevents the extractor from falling out of the bolt.

Remove Buffer Body and Barrel Extension Groups

These two groups are removed as a unit. To remove them, insert a pointed tool through a hole in the lower rear corner of the right sideplate (fig. 13-41, view A). Pushing in on the tool releases the spring lock of the buffer body. At the same time, pull and remove the two groups from the rear of the receiver.

Now separate the buffer body group from the barrel extension group. Hold the unit as shown in view B of the figure. Push forward on the tips of the accelerator and pull the two groups apart.

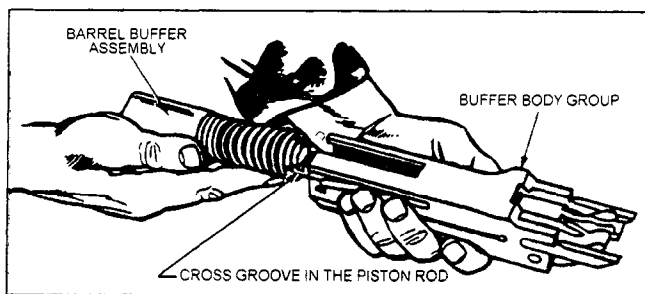

Figure 13-42.—Removing the buffer assembly.

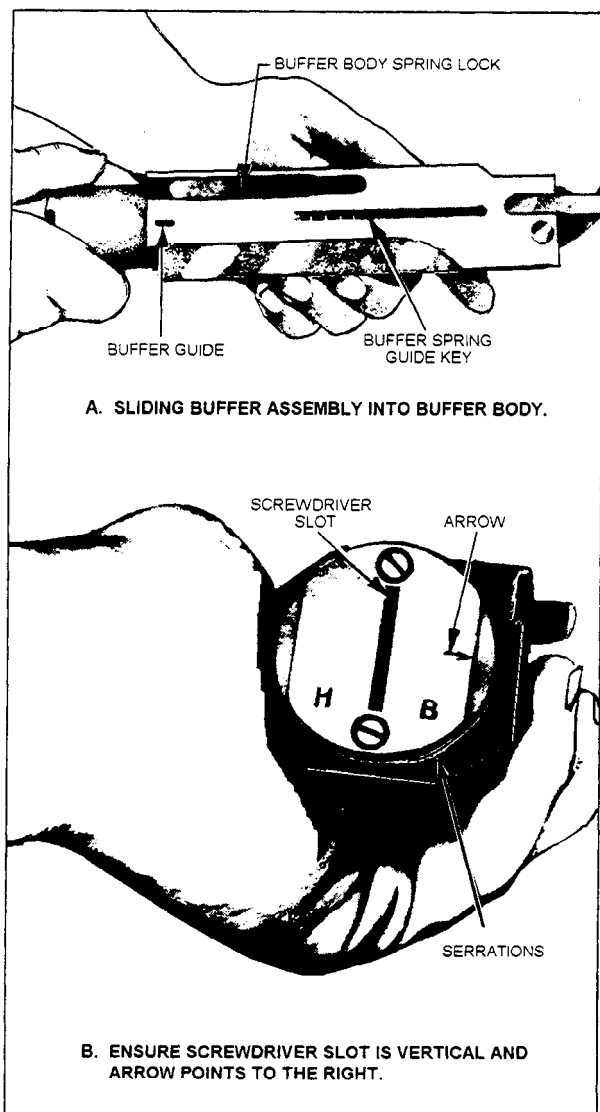

Figure 13-43.—Replacing the buffer assembly.

Remove Buffer Assembly

To remove the buffer assembly, hold the buffer body, as shown in figure 13-42. Pull the buffer assembly to the rear. That completes the general disassembly of the .50-caliber BMG. Limited cleaning, maintenance, and major part/group replacement can be done now.

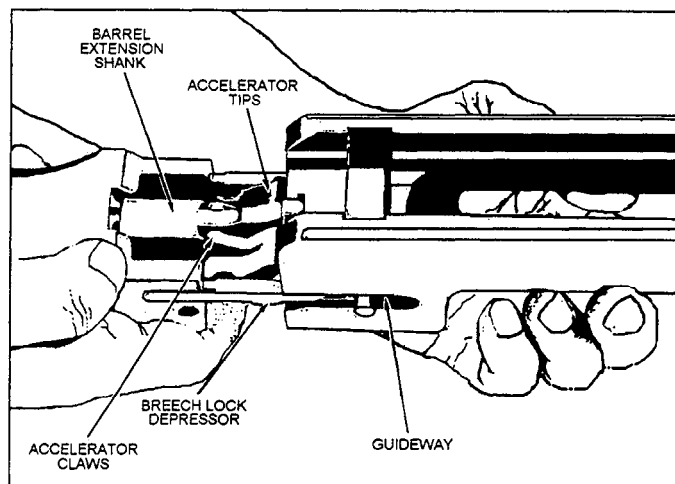

Figure 13-44.—Joining the buffer body and barrel extension groups.

GENERAL ASSEMBLY

To reassemble the .50-caliber BMG, replace the major component groups in reverse order. You should follow certain procedures to do the job correctly. These procedures are explained in the following paragraphs.

Replace Buffer Assembly

Slide the buffer assembly into the buffer body group, as shown in figure 13-43, view A. Ensure the spring guide key fits into the slot in the buffer body.

Turn the buffer tube until the screwdriver slot is vertical (view B). The arrow on the tube must point to the right. The stud on the tube lock will now engage the serration in the buffer tube. That keeps the tube from turning. Push the buffer assembly all the way forward.

Replace Buffer Body and Barrel Extension Groups

Figure 13-44 shows how these two groups are joined together. Align the breech lock depressors with their guideways in the barrel extension. Also, engage the barrel extension shank to the accelerator claws, as shown.

Push the two groups together. Press down on the accelerator tips to ensure the two groups are locked together. Place them into the rear of the receiver. Push them forward until the buffer body spring lock (fig. 13-43, view A) snaps in place. Properly locked in place, the buffer tube should protrude about 1 1/8 inches from the rear of the buffer body group.

Replace Bolt Group

Figure 13-45 shows how the bolt group is replaced into the receiver. The top of the cocking lever must be

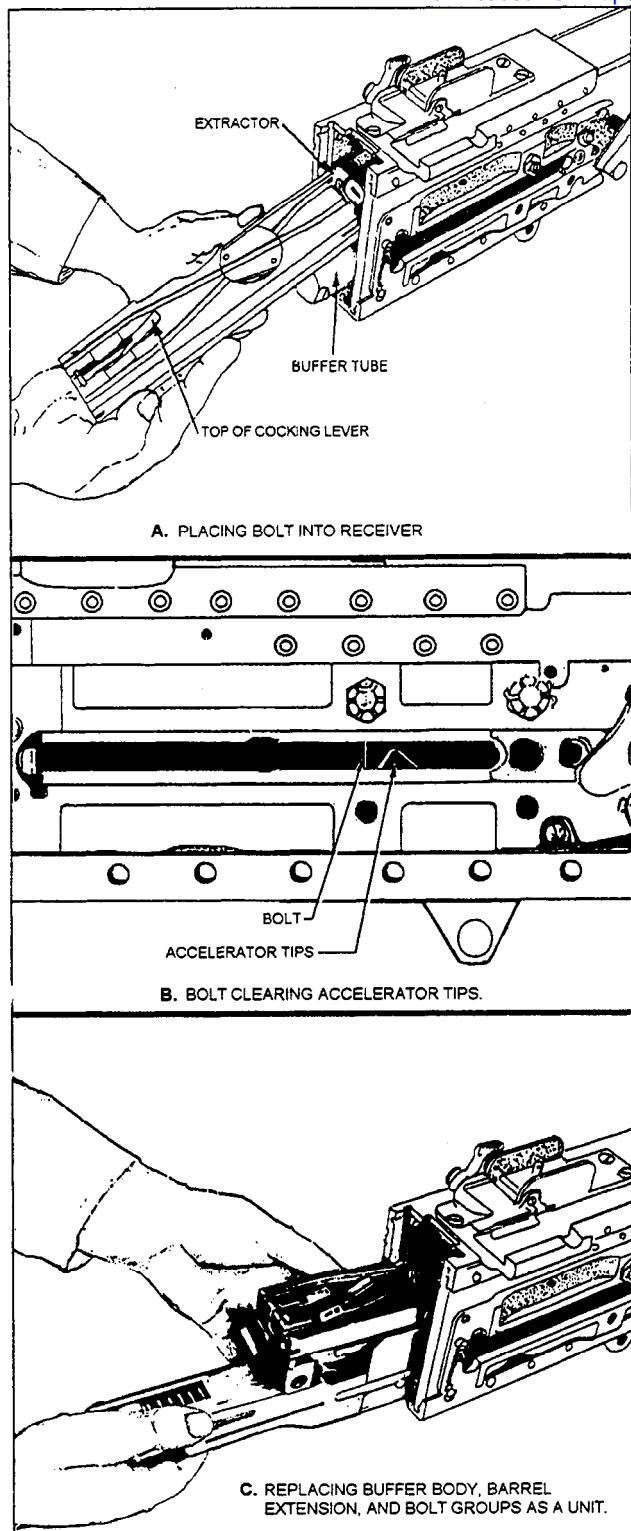

Figure 13-45.—Replacing the bolt group.

forward and the extractor must be down (flat), as shown in view A.

Push the bolt forward, maneuvering it so the front end clears the accelerator tips, as shown in view B. That condition can be seen through the sideplate of the receiver. Continue pushing the bolt forward until the bolt latch engages the notches in the top of the bolt.

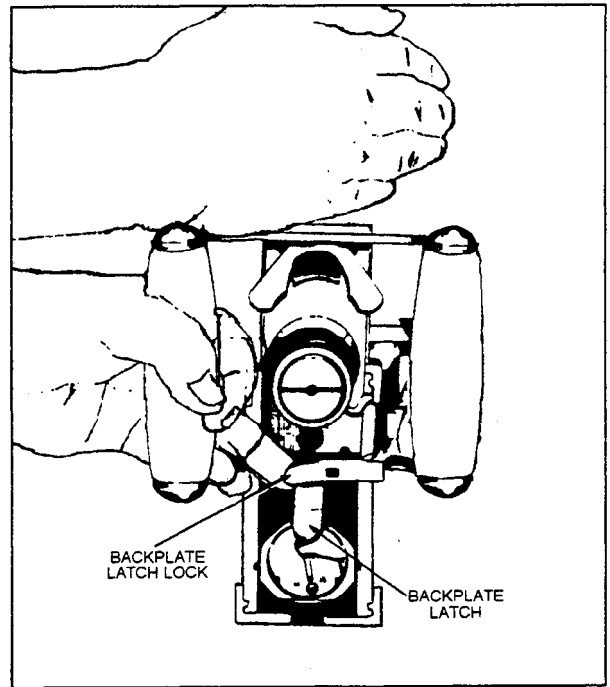

Figure 13-46.—Replacing the backplate assembly.

View C of the figure shows an optional procedure. The buffer body, barrel extension, and bolt groups can be assembled outside the receiver. Then, all three groups are inserted as a single unit.

Replace Bolt Stud

The actions required to replace the bolt stud are almost the same as those required to remove it. (See fig. 13-39.) Align the stud hole in the bolt with the clearance hole in the right sideplate. Ensure the shoulder of the stud fits inside the sideplate.

Replace Driving Spring Group

To replace the driving spring group, press up on the bolt latch. Move the bolt all the way forward by pushing on the bolt stud only. Place the end of the driving spring rod in its hole in the back of the bolt. Then push forward on the driving spring group and the buffer tube. Press in and push the head of the rod to the right. Insert the retaining pin in its seat in the right sideplate. (See fig. 13-38.)

Replace Backplate Assembly

To replace the backplate, hold its latch down and the trigger up. Position the backplate guides in their guideways. Hold the latch lock out and slide the backplate down until the latch snaps into place, as shown in figure 13-46. Release the latch lock and tug up on the backplate assembly to ensure it is firmly seated.

Replace Barrel Group

To replace the barrel group, pull the retracting slide handle to the rear. Do so until the lug on the barrel locking spring is visible through the 3/8-inch hole in the right sideplate. (See fig. 13-36.) Again, insert the smallest loop of a .50-caliber link, or suitable spacer, between the trunnion block and barrel extension.

Screw the barrel all the way into the barrel extension. Then, and this is important, unscrew the barrel two notches. Remove the link and close the cover group. That completes the general assembly of the .50-caliber BMG.

OPERATING THE .50-CALIBER BMG

The safest and best way to operate the .50-caliber BMG is to follow established procedures. In doing so, you prevent damage to the gun and injury to yourself and others. The basic operating procedures involve the following steps:

1. Loading
2. Half-loading
3. Full-loading
4. Unloading

Semiautomatic Operation

If single-shot firing is desired, the gun must be set for semiautomatic operation. To do so, you must ensure the bolt latch release is in the up position (or not locked down). (The bolt latch release can be seen in view A of fig. 13-37.)

When the bolt latch release is up, the bolt latch assembly is depressed. In this position, the latch assembly can engage notches on top of the bolt when it (the bolt) is to the rear. Thus, when the bolt recoils after around is fired, it remains locked to the rear.

Depressing the bolt latch release raises the latch assembly. The assembly disengages from the notches on top of the bolt. That allows the bolt to be driven forward into the battery.

To fire the .50-caliber BMG when set for semiautomatic, (1) depress the bolt latch release and (2) depress the trigger. These two actions must be done for each round fired.

Automatic Operation

If automatic firing is desired, the gun must be set for automatic operation. To do so, you must ensure the bolt latch release is depressed and locked down. That is done by turning the buffer tube sleeve. The bolt latch release lock is rotated to engage the bolt latch release, locking it down. (See view A of fig. 13-36 again.)

When the bolt latch release is locked down, the bolt latch assembly remains in its up position. Thus, when the bolt recoils, it is automatically free to return forward into the battery.

To fire the .50-caliber BMG in automatic, (1) lock the bolt latch release down and (2) depress the trigger. Short bursts are generally recommended, rather than sustained firings.

Loading Operation

The .50-caliber BMG is loaded manually. This involves placing an ammunition belt into the receiver of the gun. Ammunition for the .50-caliber BMG comes prebelted and is shipped in a standard .50-caliber ammunition box.

To load the gun, open and remove the lid on the ammunition box. Then open and raise the cover group on the gun (fig. 13-47). Insert the double-loop end of the ammunition belt into the feedway of the receiver. Ensure the first cartridge is held by the belt-holding pawl. Close the cover group on the gun and make sure it is latched securely.

If two personnel are operating the .50-caliber BMG, the assistant gunner loads the ammunition belt. The gunner performs the next two operations-half-loading and full-loading.

Half-Loading Operation

Half-loading is a term associated with the .50-caliber BMG. It can be compared to feeding. Feeding is the first of eight steps in a cycle of operation. It places a round in the receiver just to the rear of the receiver. Do not confuse loading the .50-caliber BMG (described earlier) with half-loading. The two operations are different.

Half-loading the gun is done after the ammunition belt is installed and the cover group closed. To half-load the gun, the gunner grasps the retracting slide handle, pulls it smartly to the rear, and releases it. At this point, two things can occur. What happens depends on whether the gun is set for automatic or semiautomatic fire.

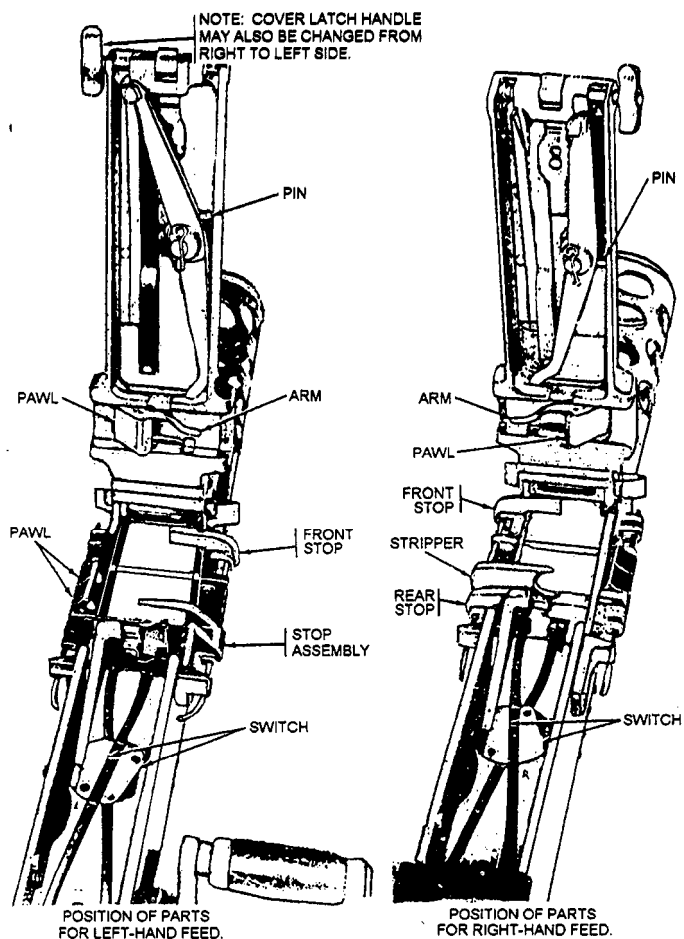

Figure 13-47.—Feeding mechanism parts of the receiver setup for left-hand and right-hand feeding.

When the gun is set for automatic fire, the bolt latch release lock holds the bolt latch release down. When the retracting slide handle is released, it and the bolt will go forward. They are driven forward under pressure from the driving spring group. The gun is now half-loaded (in automatic).

When the gun is set for semiautomatic fire, the bolt latch release is up. When the retracting slide handle is released, it and the bolt will remain to the rear. To complete the half-load operation, the gunner must do two things. First, the retracting slide handle must be pushed all the way forward. Second, the bolt latch release must be depressed. That unlocks the bolt and it drives forward. The gun is now half-loaded (in semiautomatic).

Can the .50-caliber BMG be fired now that it is half-loaded? The answer is no. Half-loading only places a round into the receiver behind the barrel. The round must be chambered before it can be fired.

Full-Loading Operation

Full-loading a .50-caliber BMG can be compared to cambering. Cambering was the second of eight steps in a cycle of operation. It places a new round in the chamber of the gun.

To load the gun fully, you must repeat the half-loading sequence. Pull the retracting slide handle to the rear and release it. The weapon is now ready to fire.

Unloading Operation

To unload a .50-caliber BMG, unlock the bolt release latch (if applicable) and open the cover group. Lift the ammunition belt out of the feedway. Pull the retracting slide handle to the rear and lock the bolt. Look and/or feel to make sure no ammunition is in the gun.

If the weapon is clear, lower the extractor. Release the bolt and ease the retracting slide handle forward. Then lower and secure the cover group. To complete unloading operations, depress the trigger to uncock the firing mechanism.

Cycle of Operation

The first two steps of the eight-step cycle of operation have already been discussed. Initial feeding and cambering are accomplished during the manual half- and full-loading operations. After the first round is fired, feeding and cambering are done by the action of the gun.

The remaining steps in the cycle of operation of a .50-caliber BMG are summarized below.

1. Locking—The bolt is locked to the barrel and barrel extension.
2. Firing—The firing pin is released and driven forward to strike the primer of the cartridge.
3. Unlocking—The bolt unlocks from the barrel and barrel extension.
4. Extracting—The empty cartridge case is pulled from the chamber.
5. Ejecting—the empty cartridge case is ejected from the receiver.
6. Cocking—The firing pin is withdrawn into its cocked position.

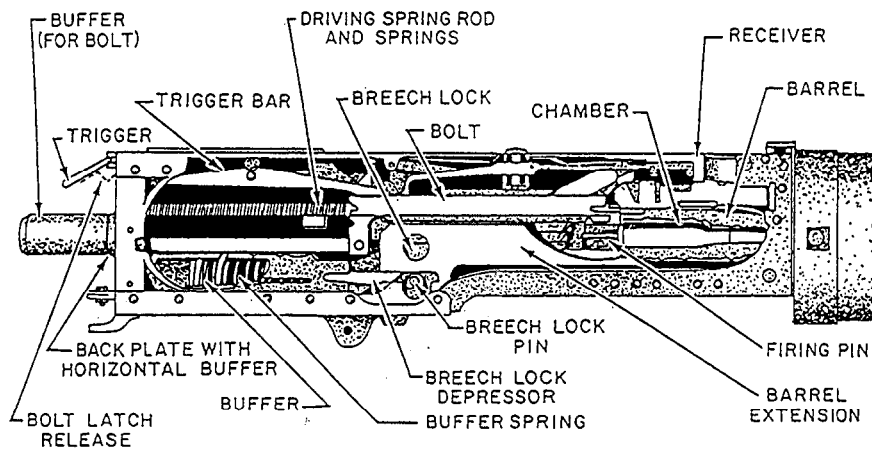

Figure 13-48.—The .50-caliber BMG receiver; cutaway view.

You can follow most of the operating cycle of the gun by referring to figure 13-48. Assume the chamber is loaded, the gun is cocked, and the bolt latch is released. When the trigger is depressed, the trigger bar pivots and releases the cocked firing mechanism. The spring-loaded firing pin strikes the primer and the cartridge fires. Pressure from the expanding gases causes the recoiling parts of the gun to start moving rearward.

During the first $3/4$ inch of rearward travel, the recoiling parts remain locked together. However, the breech lock depressors are acting on the breech lock pin. That action forces the breech lock down and out of the bolt. As a result, at the end of the first $3/4$ inch of recoil, the bolt is unlocked. It is free to continue recoiling independent of the barrel and barrel extension.

The barrel extension hits the accelerator. It, in turn, hits the bolt and accelerates it (the bolt) to the rear. The barrel and barrel extension recoil another $3/8$ inch ($1\ 1/8$ -inch-total travel). They are stopped by the buffer assembly.

Meanwhile, the bolt recoils an additional $6\ 3/8$ inches to the rear ($7\ 1/8$ -inch-total travel). During this movement, the driving spring group is compressed and the bolt is stopped by the bolt buffer mechanism. The fired cartridge is extracted and the firing mechanism is cocked.

Counter recoil forces the-bolt forward and the empty cartridge case is ejected. The bolt locks to the barrel extension and both move forward into the battery. Feeding and cambering have taken place and the gun is ready to fire. The cycle begins when the firing pin is released to set off the next cartridge.

Headspace and Timing Adjustments

By now, you should realize that the .50-caliber BMG is a complex working machine. The care and maintenance given this gun are critical for safe and continued operation. In addition to normal lubrication and cleaning practices, checking and adjusting the headspace and timing of the weapon are mandatory.

HEADSPACE ADJUSTMENT.— Headspace is the distance between the face of the bolt and the base of a seated cartridge case. The distance is correct when the following conditions are met:

1. The recoiling groups are fully forward.
2. There is no independent rearward movement between the bolt, barrel, and barrel extension.

Improper headspace adjustment can cause a lot of problems. It causes the gun to operate improperly and, frequently, causes damage to the weapon or injury to personnel.

Headspace must be checked and set before the gun is fired. Other instances when it must be checked include the following:

1. When the gun is assembled
2. When the barrel or any major group or assembly within the receiver is replaced
3. When there is doubt that correct headspace is set

A special tool is used to check and set the headspace distance. It is called the "headspace gauge" and is part of the headspace and timing gauge set (fig. 13-49). The tool should be kept with the gun at all times. For now, we are only interested in the GO-NO-GO headspace

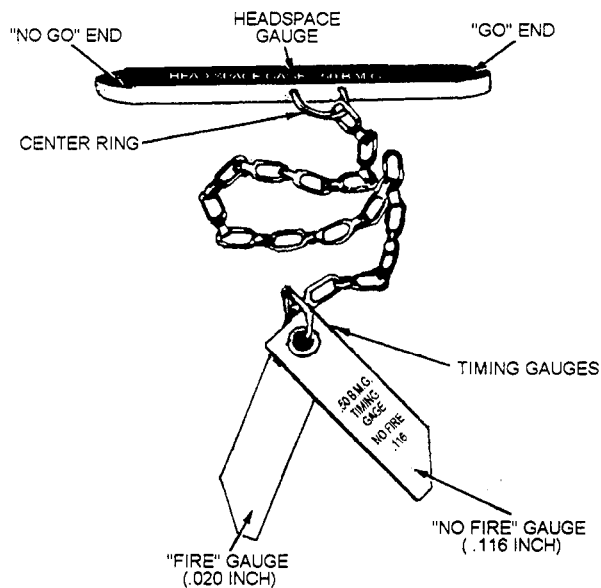

Figure 13-49.—Headspace and timing gauge set.

gauge. The following steps explain how to check and set the headspace adjustment:

1. With the cover group closed, cock the gun. Do so by pulling the retracting slide handle all the way to the rear.
2. Depress the bolt latch release and slowly ease the restricting slide handle and bolt all the way forward.
3. Raise the cover group. Pull back on the retracting slide handle slightly. Move the bolt not more than $1/16$ inch to the rear. That prevents the driving spring group and the weight of the parts from giving a false reading. Raise the extractor.
4. Insert the GO end of the headspace gauge into the T-slot. The T-slot is between the face of the bolt and the rear of the barrel, as shown in figure 13-48. The GO end of the gauge should enter the T-slot freely up to the center ring of the gauge. Remove the gauge and try to insert the NO-GO end into the T-slot. If the NO-GO end does not enter the slot, headspace distance is correct.

Headspace Too Tight.— If the headspace is too tight, the GO end of the gauge cannot enter the T-slot freely. To correct this situation, take the following steps:

1. Pull back on the retracting slide handle. Do so until the lug on the barrel locking spring is visible through the $3/8$ -inch hole in the right sideplate. (See fig. 13-36.)
2. Unscrew the barrel one notch (click).
3. Ease the retracting slide handle and bolt fully forward.

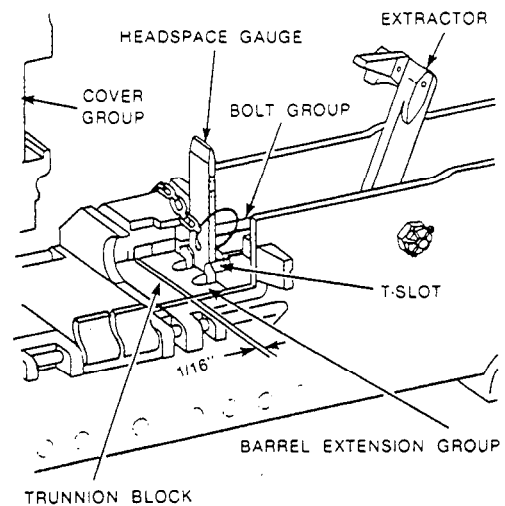

Figure 13-50.—Checking the headspace with the GO end of the headspace gauge.

4. Retract the bolt slightly, not exceeding $1/16$ inch (fig. 13-50). Recheck the headspace adjustment as before.

If necessary, repeat this procedure to obtain the proper adjustment. Be sure to unscrew the barrel only one notch (click) each time. If the adjustment cannot be made within one to five (maximum) notches (clicks), notify the maintenance supervisor.

Headspace Too Loose.— If the headspace is too loose, the NO-GO end of the gauge will enter the T-slot freely. The adjustment procedures for this situation are the same as those just described. However, screw the barrel in one notch (click) at a time for each adjustment attempt.

TIMING ADJUSTMENT.— Timing of the weapon is as critical as headspace adjustment. Timing ensures that firing takes place when the recoiling parts are between .020 and .116 inch out of the battery. That prevents contact between the front end of the barrel extension and the trunnion block. Timing is correct when the following conditions are met:

1. The recoiling parts are locked together.
2. Firing takes place just before the recoiling parts are in the battery (fully forward).
3. The gun fires on the FIRE gauge and does not fire on the NO-FIRE gauge.

The timing of the gun is checked with the FIRE (.020 inch) and NO-FIRE (.116 inch) gauges, as shown in figure 13-49. Timing must be checked and/or set (1) each time headspace is adjusted and (2) whenever the

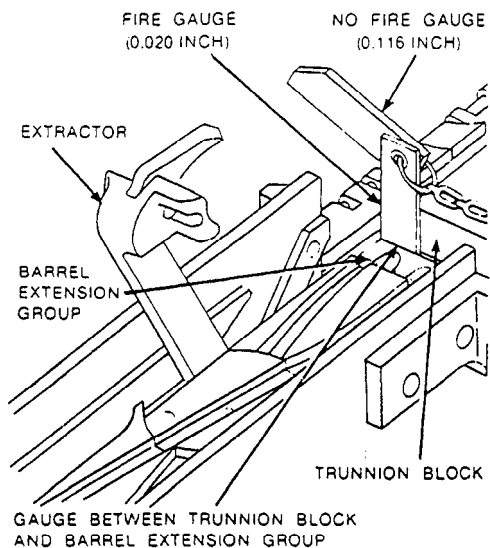

Figure 13-51.—Checking the timing with the fire gauge installed.

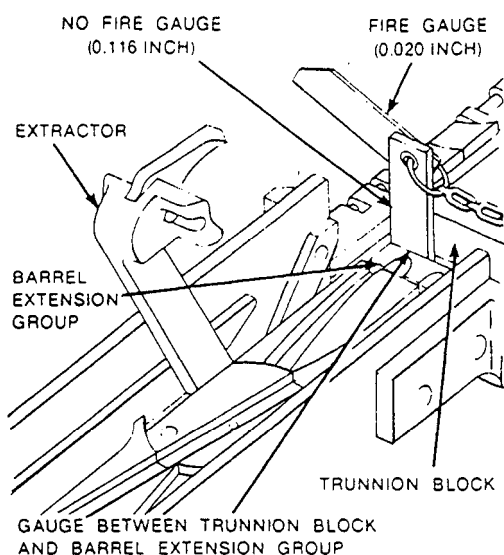

Figure 13-52.—Checking the timing with the NO-FIRE gauge installed.

timing is questionable. The following steps explain how to check and set the timing adjustment:

1. Ensure the headspace adjustment is correct. If not, correct it before checking the timing.
2. Ensure the firing pin is cocked and the recoiling parts are forward in the battery position.
3. Raise the extractor.
4. Retract the recoiling parts enough to insert the FIRE (.010 inch) gauge. Place it between the barrel extension and trunnion block (fig. 13-51).

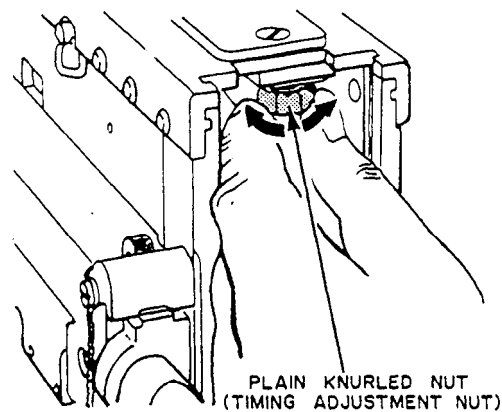

Figure 13-53.—Turning the trigger bar adjusting nut: Turn to the right to correct for late timing; turn to the left to correct for early timing.

5. Allow the barrel extension to close on the gauge slowly.

6. Depress the trigger. The firing pin should release. Releasing indicates that the timing is correct (or not late).

7. Retract the recoiling parts enough to remove the FIRE gauge. Cock the gun and allow the recoiling parts to go forward into the battery.

8. Retract the recoiling parts enough to insert the NO-FIRE (.116 inch) gauge. Place it in the same location, between the barrel extension and the trunnion block (fig. 13-52).

9. Depress the trigger. The firing pin should not release. Its failure to release indicates that the timing is correct (or not early).

Late Timing Adjustment.— If the timing of the gun is late, the firing pin will not release with the FIRE gauge installed. (Refer to Step 6 above.) To correct this situation, perform the following steps:

1. Retract the recoiling parts enough to remove the FIRE gauge. Allow them to return forward into the battery.
2. Remove the backplate assembly. (See fig. 13-34.)
3. Locate and turn the trigger bar adjusting nut one notch to the right (fig. 13-53).
4. Reinstall the backplate assembly. (See fig. 13-46.)
5. Retract the recoiling parts enough to insert the FIRE gauge again. Allow the barrel extension to close on the gauge slowly.

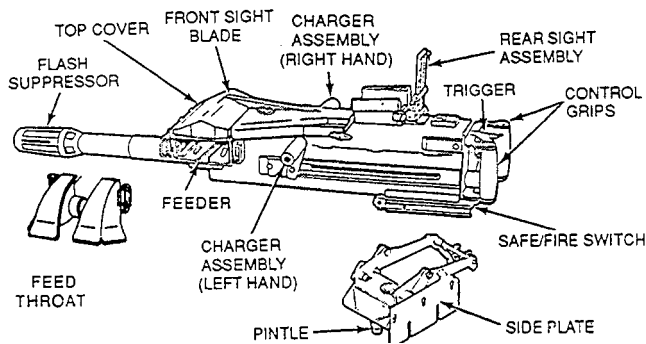

Figure 13-54.—MK 19 MOD 3 40-mm machine gun.

6. Depress the trigger. The firing pin should release.

If necessary, repeat the procedure until the firing pin releases with the FIRE gauge installed.

Early Timing Adjustment.— If the timing of the gun is early, the firing pin will release with the NO-FIRE gauge installed. The adjustment procedures for this situation are the same as those described above. However, turn the trigger bar adjusting nut one notch to the left. Reinstall the NO-FIRE gauge and depress the trigger. The firing pin should not release. Repeat the procedure as necessary.

The importance of obtaining the correct headspace and timing adjustments on the .50-caliber BMG cannot be stressed enough. The U.S. Army field Manual (FM23-65) and appropriate MRCs for the weapon describe the required procedures in detail. Consult those references to make these adjustments. Do them carefully and deliberately.

MK 19 MOD 3 40-MM MACHINE GUN

This section is intended to finish you with basic information about the MK 19 machine gun. The MK 19 will become part of the TOA in the near future. Information on safety, operation, and maintenance is available in TM 9-1010-230-10.

The MK 19 MOD 3 (fig. 13-54) is a machine gun that fires a 40-mm grenade with antipersonnel fragmentation and light anti-armor capability. It fires 40-mm grenades at the rate of 325 to 375 rounds per minute. The MK 19 MOD 3 is an air-cooled, belt-fed, blowback-operated, fully automatic weapon. Because it fires from an open bolt, the MK 19 MOD 3 does not “cook off.”

- Lower gun cradle onto mount. Insert pintle into center hole.
- Flip down pintle lock on mount.
- Disengage stow pin.
- Attach T & E to gun cradle.

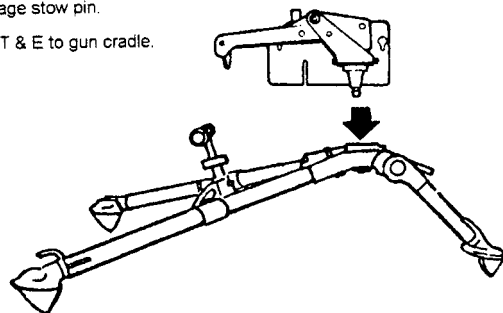

Figure 13-55.—MK 64 mount/cradle and M3 tripod.

DATA

Weight	75.6 pounds; crew transportable
Length	43.1 inches
Width	13.4 inches
Height	8.8 inches
Rate of Fire (Cyclic)	325 to 375 rounds per minute

Range:

Effective Point Target . . .	1500 meters
Effective Area Targets . . .	2212 meters

MK 64 MOUNT

Weight	21 pounds
Length	17.5 inches
Height	9.5 inches

MK 64 MOUNT and M3 TRIPOD

The MK 64 mount/cradle attaches to the M3 tripod (fig. 13-55) and a variety of vehicle mounts. The MK 64 holds the gun and allows it to traverse and elevate on the vehicle or tripod. It also features a travel lock that holds the weapon in travel position during vehicle operation.

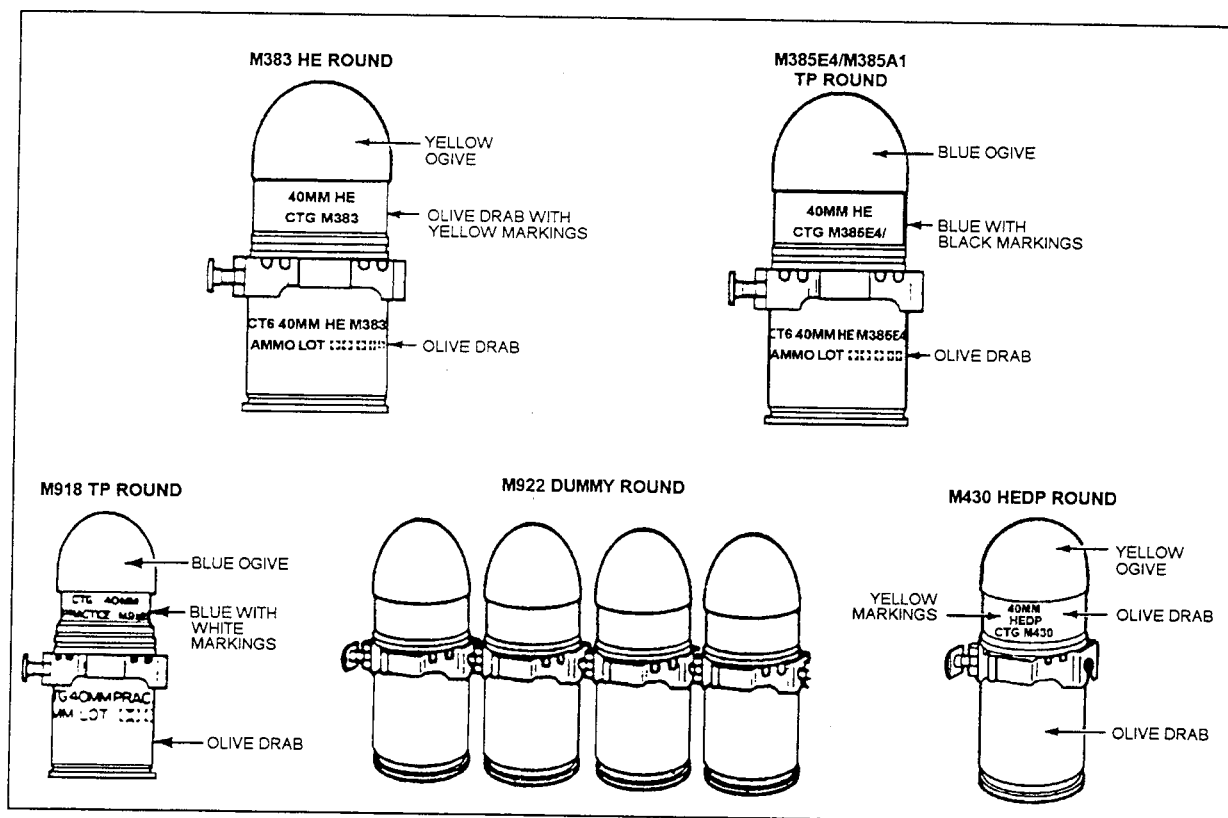

Figure 13-56.—MK 19 MOD 3 ammunition.

AMMUNITION

M383 HE ROUND (fig. 13-56)

- A high-explosive (HE) grenade
- Designed to inflict personnel casualties
- Arming Distance: 18 to 36 meters
- Wound Radius: 15 meters

M385E4/M385A1 TP ROUNDS (fig. 13-56)

- Training practice (TP), inert rounds with a propelling charge
- Muzzle Velocity: 244 mps
- Maximum range: 2200 meters

M918 TP ROUND (fig. 13-56)

- A target practice round with flash signature
- Muzzle Velocity: 244 mps

- Maximum Range: 2200 meters
- Arming Distance: 18 to 30 meters

M922 DUMMY ROUND (fig. 13-56)

- Totally inert
- Used to check gun functioning and for gun crew training

M430 HEDP ROUND (fig. 13-56)

- A high-explosive, dual-purpose grenade
- Arming Distance: 18 to 30 meters
- Kill Radius: Approximately 5 meters
- Wound Radius: Approximately 15 meters
- Muzzle Velocity: 244 mps
- Maximum Range: 2200 meters

CHAPTER 14

ORGANIC SUPPORT WEAPONS: 60-MM MORTAR
AND AT4

The mortar is perhaps the oldest type of firearm known to mankind, and its existence dates back as early as the fourteenth century. At that time, it was nothing more than a shallow steel pot filled with gunpowder and rocks that was aimed in the general direction of the target and fired by touching the powder with a red-hot iron rod. As you can guess, it was very inaccurate; however, it did possess one extremely important characteristic that is just as important today as it was then. This characteristic is the high angle of fire that enables it to be fired over obstacles, such as hills, forests, walls, or other defenses. As you can see, this is very important. The weapon can reach and destroy targets beyond the capabilities of flat trajectory weapons, such as a rifle, but the crew firing it is also protected from enemy observation and fire by these same obstacles.

The modern mortar is an extremely accurate and effective weapon that has an adjustable biped and telescopic sight (fig. 14- 1). The modern mortar has a

one- or two-piece baseplate that allows it to be fired in any direction.

A variety of shells and fuzes have been developed to make the 60-mm mortar a versatile weapon. It can be used as either an offensive or a defensive weapon.

GENERAL DESCRIPTION AND DATA

The mortar is a smoothbore, muzzle-loaded, high-angle-of-fire weapon. It consists of a mortar barrel with a baseplug and a fixed firing pin for drop firing. The mount consists of a biped with traversing and elevating mechanisms. A spring type of shock absorber absorbs the shock of recoil in firing. The baseplate is a unit that supports and aligns the mortar. For firing, the baseplug of the barrel is seated and locked into the baseplate with the barrel passing through the yoke of the biped mount and secured to the shock absorber. For transporting, disassemble the mortar into three groups: barrel, biped, and baseplate. This weapon may be transported by one crew member without disassembling it.

The mortar is fired by inserting a complete round into the muzzle, fin assembly down. The elevation of the barrel causes the round to slide toward the base of the barrel. On reaching the base, a propelling charge on the round is ignited by the firing pin. The pressure of the gas produced by the burning propelling charge drives the round up and out of the barrel. The fin assembly stabilizes the round in flight.

The mortar can deliver fire at ranges up to approximately 3490 meters. The sustained and maximum rates of fire are related to the type of round and charge being used.

The complete mortar weighs 46.5 pounds in the conventional mode and 18 pounds in the hand-held mode. This includes the cannon (14.4 pounds), the biped (15.2 pounds), and the M7 baseplate (14.4 pounds) and the M8 baseplate (3.6 pounds). The overall length is 40 inches.

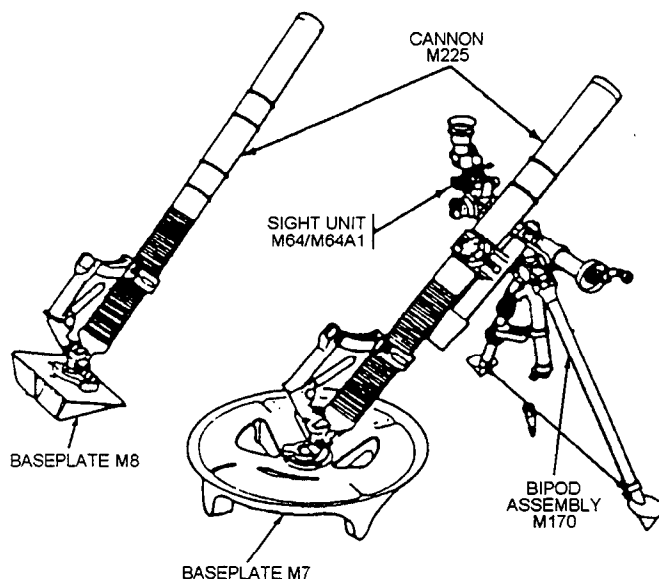

Figure 14-1.—The 60-mm lightweight mortar (M224).

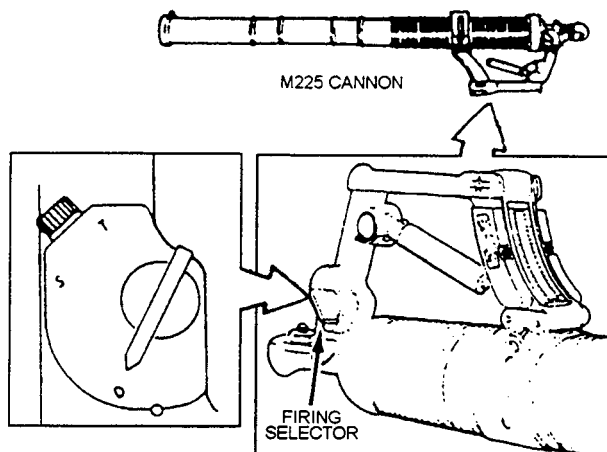

Figure 14-2.—M225 cannon.

ASSEMBLIES AND COMPONENTS

The barrel assembly used with the 60-mm mortar is the M225 cannon (fig. 14-2). It consists of a barrel, fire selector, firing pin, trigger, and range indicator. The lower portion of the barrel is externally threaded. The external threads provide extra cooling surface and also help to strengthen the barrel. The baseplug ends in a spherical projection that is flattened on two sides. The spherical projection fits into the locking cap of the M7 and M8 baseplates. The M224 has two firing modes: conventional and hand-held. Each mode requires different equipment and procedures.

CONVENTIONAL MODE

The BIPOD ASSEMBLY (fig. 14-3) consists of three major assemblies: the leg assembly, the elevating mechanism assembly, and the traversing mechanism assembly.

The BASEPLATE ASSEMBLY (fig. 14-4) is of one-piece construction and it supports and aligns the mortar for firing. The baseplate contains a rotating socket that holds the spherical projection of the barrel. The socket retaining ring holds the rotating socket in place. The open end of the socket MUST ALWAYS point in the direction of fire. The bottom of the baseplate has reinforced ribs that hold the baseplate in position after being seated in the ground.

In the conventional mode, the M7 baseplate, the sight unit (M64/M64A1), and the bipod are used. The

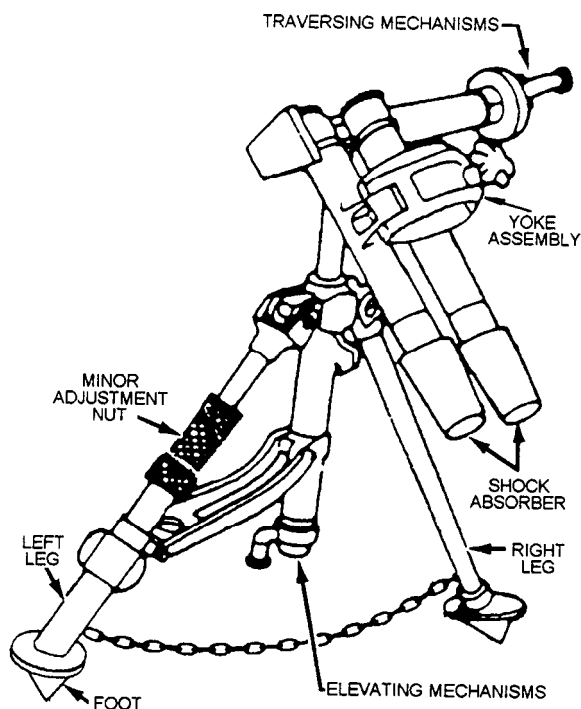

Figure 14-3.—Bipod assembly (M170).

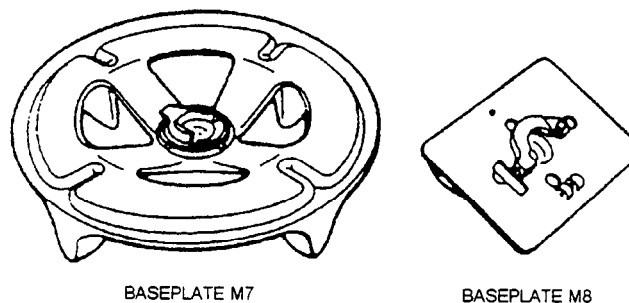

Figure 14-4.—Baseplate (M7 and M8).

principle of this weapon is similar to the 81-mm mortar or any other mortar.

HAND-HELD MODE

The M225 cannon and M8 baseplate weigh approximately 18 pounds. This is a lightweight and highly mobile weapon that can be used in this mode on patrols with minimum deployment.

The SIGHT UNIT (M64/M64A1) (fig. 14-5) is the standard sight used with the 60-mm mortar. Once a sight has been calibrated on a mortar, it should always be used with that mortar. It is used for laying-in the mortar for elevation and deflection. The sight unit consists of a

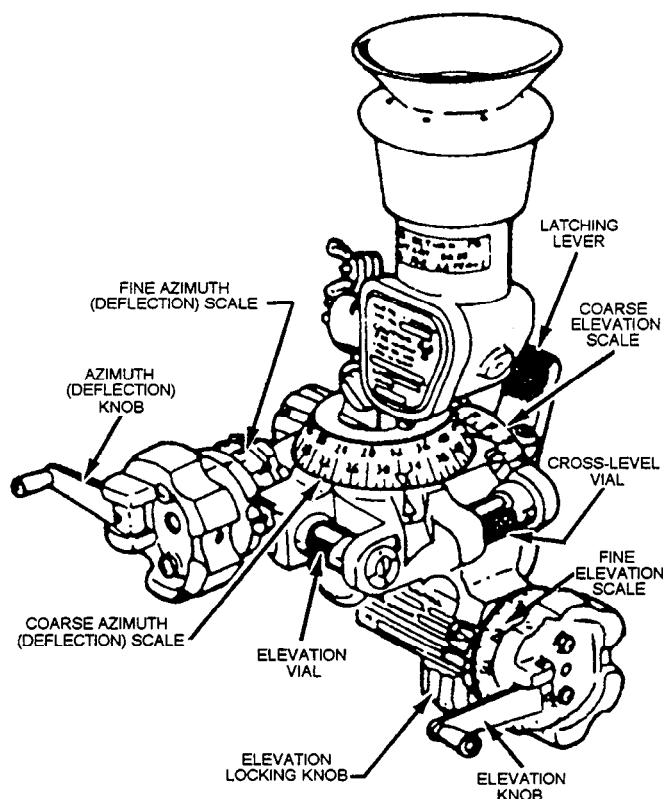

Figure 14-5.—Sight unit (M64/M64A1).

telescope mount and a nonmaintainable elbow telescope, fastened into one unit for operation. The elbow telescope provides magnification and a line of sight from which the mortar is aimed. The elbow telescope is a 1.5-power, fixed-focus telescope. The cross lines are at right angles to each other.

The TELESCOPE MOUNT consists of the lower, center, and upper parts. The lower part contains a locking lever latch, an elevation micrometer knob with scale, and an elevation locking knob. There is also a dovetail bracket located on the right side of the mount that mates with the dovetail slot located on the yoke of the biped. A semicircular, coarse elevation scale indicates from 700 to 1,600 mils in 100-mil increments.

The ELEVATION KNOB contains an elevation micrometer scale of 100 mils, numbered in 1-mil increments from 0 to 100. Turning the elevation knob tilts the mount in elevation to the desired angle, as read on the coarse and micrometer elevation scales. The elevation locking knob prevents the elevation knob from rotating during firing.

The center part of the telescope mount has a deflection knob that rotates the mount for direction. A crank is provided on the knob for rapid deflection movement. The deflection locking knob locks the

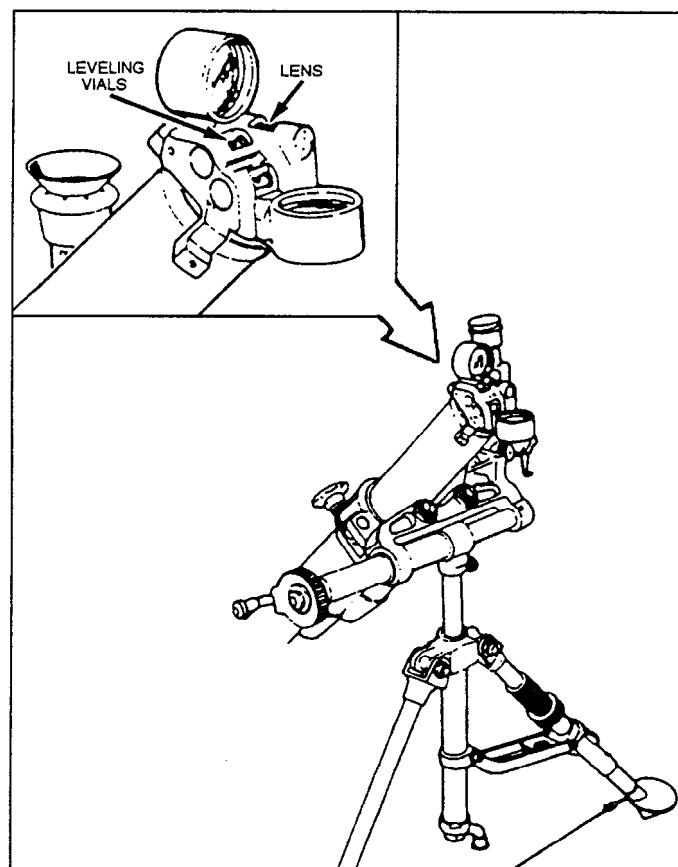

Figure 14-6.—Boresight (M115).

deflection knob during firing. The coarse deflection scale is fixed to the upper parts of the center section and has 64 graduations. This scale rotates with the upper part of the telescope mount. The coarse deflection slip scale is located adjacent to the coarse deflection scale. The micrometer deflection slip scale has 100 black graduations, numbered from 0 to 100 in increments of 1 mil. The M225 cannon, the M8 baseplate, and a heat protective mitten are all that is required to use this weapon in the hand-held mode.

The BORESIGHT (M115) (fig. 14-6) is used to calibrate the sight for the mortar. Since no two mortars are exactly alike, each sight **MUST** be calibrated on its own mortar. The body of the boresight contains three level vials. They are used to determine that the angle of elevation (preset at 800 mils) and to determine that the V-slides are in a perpendicular position.

THE AIMING POST (M1A2) is used with the mortar as an aiming point. Two aiming posts are provided for each mortar. These aiming posts can be separated in the center so as to be more compact when

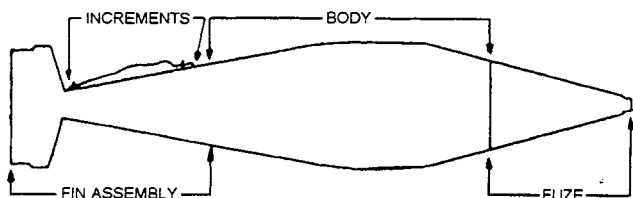

Figure 14-7.—A typical round of mortar ammunition.

being transported. There is a carrying bag made of canvas to hold each of the sections. The aiming posts are 8 feet long and 1 1/8 inches in diameter. They are painted with 5-inch red and white horizontal stripes to aid in sighting the mortar. The lower section of each aiming post has a pointed end to help place it in the ground. Most of these aiming posts become unserviceable because of improper use. These posts are hollow and can be easily bent if dropped. When positioning the posts in hard or frozen earth, you should loosen the ground with an entrenching tool before trying to seat them. Do NOT attempt to hammer the aiming posts into the ground. This may bend the sections or burr the connections, making the posts unserviceable.

The AIMING POST (M14) is used with the mortar as an aiming point. Two aiming posts are provided for each mortar. When positioning the posts in hard or frozen earth, you should loosen the ground with an entrenching tool before trying to seat them. DO NOT attempt to hammer the aiming posts into the ground. This may bend the sections or burr the connections, making the posts unserviceable.

The AIMING POST LIGHT (M58, GREEN AND M59, ORANGE) is used for night firing by clamping the light to the aiming post. You can only see the glow of the aiming post light from the direction of the mortar position. The colored lights aid the gunners in identifying their own aiming posts.

60-MM MORTAR AMMUNITION

Ammunition for the 60-mm mortar is issued in the form of "semifixed" complete cartridges (rounds). The term *semifixed* used in connection with ammunition signifies that the propelling charge is adjustable, and the round is loaded into the weapon as a unit. Except for the M69 training round, all 60-mm mortar rounds have three main assemblies: the fuze assembly, the body assembly, and the fin assembly (fig. 14-7). The M69 training round has no fuze assembly.

The body is the main component of the round and contains the material (explosive charge, illuminating charge, or smoke) that produces the desired effect of the round. The fuze assembly controls the method of exploding the shell. The fin assembly stabilizes the round in flight and causes the round to strike with the fuze end first. A propelling charge is attached to or near the fin assembly of the projectile.

When fired, the mortar round carries all of its components. Thus the mortar is ready to fire the next round. These rounds are shown in figure 14-8. The principal types of ammunition used in a mortar round are discussed in the topics that follow.

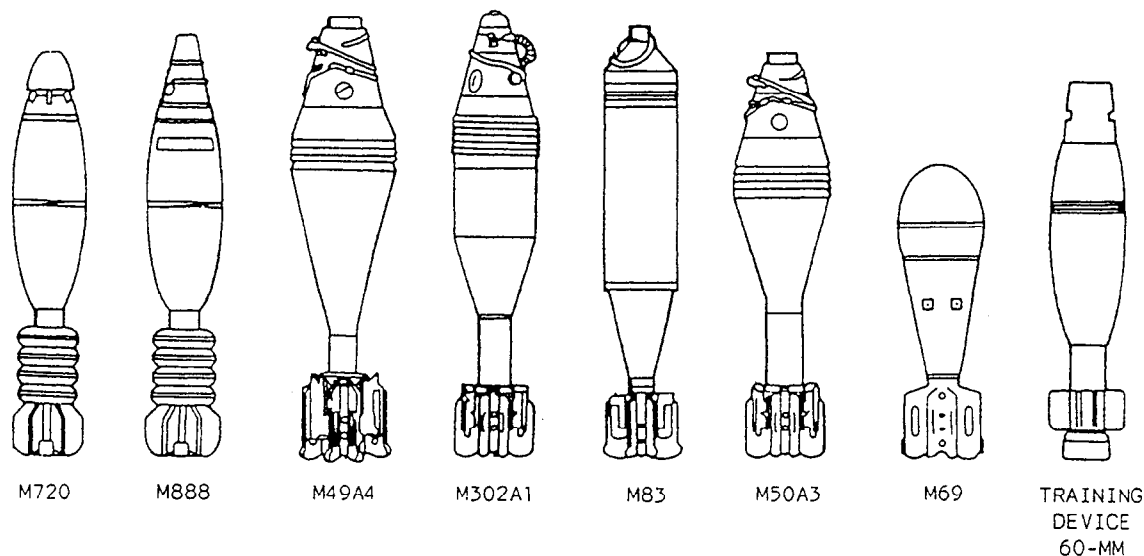

Figure 14-8.—Types of 60-mm mortar ammunition.

CARTRIDGE	OLD COLOR CODE	NATO STANDARD CODE
High Explosive (HE)	OD w/yellow labeling	OD w/yellow labeling
Smoke (WP) (FS)	Gray w/yellow labeling	Light Green w/red labeling
Illuminating (ILLUM)	Gray w/white labeling	White w/black labeling
Practice (TP)	Blue w/white labeling	Blue w/white labeling
Training	Black	Blue w/white labeling

Figure 14-9.—Ammunition color codes.

HIGH EXPLOSIVE (HE) AMMUNITION

High-explosive ammunition is used to destroy or cause casualties to enemy personnel, emplacements, and vehicles. High-explosive ammunition causes damage by blast, fire, and fragmentation of the metal body.

SMOKE, WHITE PHOSPHORUS (WP) AMMUNITION

White phosphorus ammunition is used for smoke screening, casualty-producing, incendiary (burning) action, and signaling. The WP rounds cause material damage by fire when the white phosphorus burns.

ILLUMINATING AMMUNITION

Illuminating ammunition contains a flare attached to a parachute and is used for battlefield illumination and signaling.

TRAINING PRACTICE (TP) AMMUNITION

This type of ammunition is used for target practice firing. The training practice (TP) round is used for training mortar crews in the handling and firing of live ammunition. This round is similar to the high-explosive round, but it does not have a high-explosive filler in the body. It has only a small spotting charge to mark the point where the round hits the ground.

TRAINING AMMUNITION

The training round is provided for training mortar crews in loading and firing the mortar. This round is completely inert and has no fuze. The propelling charge for the training round cannot be varied. This round is fired on training ranges at reduced distances. It is

propelled only by an ignition cartridge up to a range of 275 meters.

IDENTIFICATION OF AMMUNITION

All mortar rounds are painted to prevent rust and to provide an easy means of identification. The color of the body identifies the classification of the round according to tactical use. The information stenciled on the round provides detailed information concerning that particular round.

Color codes of ammunition have been modified by NATO agreement. Until ammunition manufactured before this agreement has been expended, the user must know both codes. The old and new codes are shown in figure 14-9. Along with color codes, each round has the following information (fig. 14-10) stenciled on its body:

1. Caliber of mortar in which the round is to be fired (60 mm).
2. Type of filler (TNT, Comp B, Smoke WP, Illum).

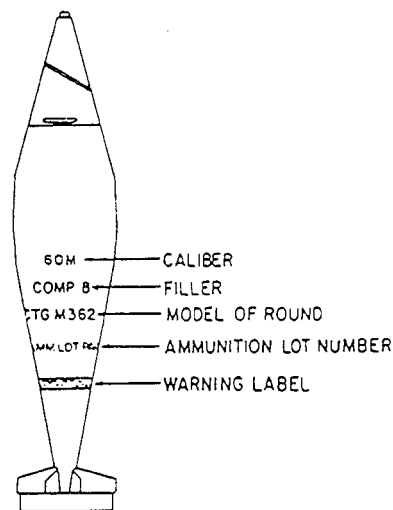

Figure 14-10.—Markings on rounds.

3. Model of round (Cartridge M888, M49A4, M302A1, M83, etc.).

4. Ammunition lot number (AMM LOT PA-36-339). This is a number assigned to identify each group of rounds manufactured.

5. Warning label, if required. Some rounds have a warning label fixed on the body of the round. This warning label specifies the maximum propellant charge to be used when firing these rounds in the 60-mm mortar.

FUZES

The fuzes used on mortar rounds are designed to activate the fired round at the desired time or place (fig. 14-11). There are three types of fuzes used with the 60-mm mortar ammunition: impact, graduated time, and variable time.

The **IMPACT FUZE** causes the round to function when it comes in contact with an object. Impact fuzes

can be either point detonating (PD) or base detonating. Point-detonating fuzes that function immediately upon impact are called superquick (SQ). Point-detonating fuzes that have some penetration into the ground before functioning are called quick (Q). Point-detonating fuzes that enter the ground before functioning are known as delay (D).

The **GRADUATED TIME FUZES** cause the round to function at a prescribed (set) time after the round is fired. Graduated time fuzes may function at the prescribed time only. These fuzes are known as time (T) fuzes. Graduated time fuzes may also have an impact element that causes the fuze to function on impact if it does not function at the set time. These fuzes are known as **TIME AND SUPERQUICK (TSQ) FUZES**.

The **VARIABLE TIME FUZES** have their own radio transmitter and receiver. They transmit a radio signal. This signal is reflected back to the fuze. As the fuze (round) approaches an object, the strength of the

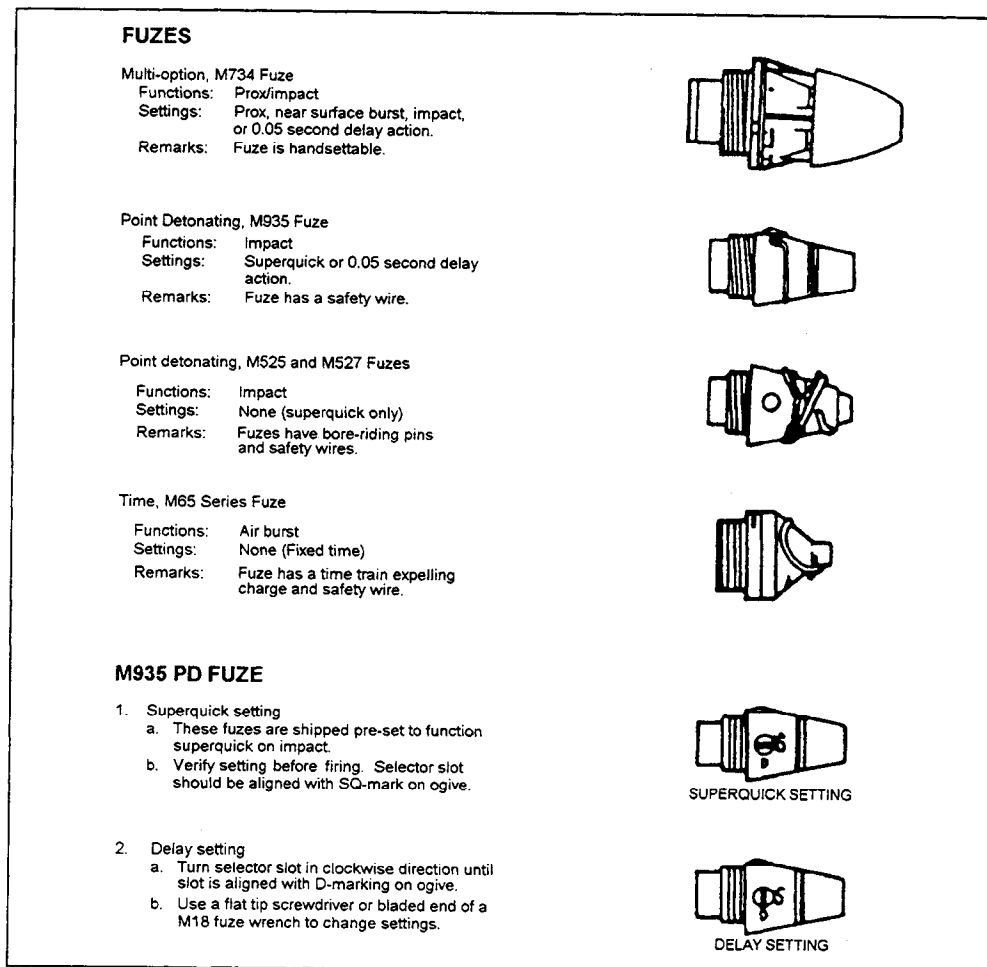

Figure 14-11.—Fuzes.

reflected signal increases. When the returning signal reaches a predetermined strength, the fuze explodes the round. These fuzes are known as proximity or VARIABLE TIME (VT) FUZES. The object that reflects the signal is not necessarily the target. It may be any object that can reflect the signal. The VT fuze explodes at a height of about 1 to 6 meters over normal terrain; however, the better reflecting surfaces cause the fuze to explode at a higher height and the poorer reflecting surfaces at a lower height. Trees increase the height of burst. Even clouds have caused the fuze to detonate.

MORTAR SQUAD EQUIPMENT

Each member of the mortar squad is responsible for certain equipment used in placing, firing, and maintaining the 60-mm mortar. Leaders must conduct frequent inspections to ensure that proper maintenance is available for this equipment.

Mortar Squad Leader. The squad leader is responsible for all equipment issued to his squad. In addition, this person carries the following items: a pair of binoculars, a flashlight, and two baseplate stakes. The baseplate stakes, similar to a surveyor's hub stake, are an optional item. When the squad does not have a communicator attached, the squad leader must also carry a radio or field telephone and wire.

Gunner (Crew Leader). The gunner is responsible for all equipment issued to his crew.

Assistant Gunner. The assistant gunner is responsible for loading the mortar. He also carries several rounds of ammunition.

Ammunition Bearer Number 1. He carries several rounds of ammunition.

Ammunition Bearer Number 2. He carries several rounds of ammunition.

POSITIONING THE MORTAR

Normally, the combat mission of the construction battalion, and especially that of the mortar platoon, is of a defensive nature. The mortars are set up within the perimeter of the camp in improved, permanent positions. The ammunition and equipment are kept nearby in readiness. However, the unit commander does have authority to deploy these weapons in offensive missions and the following procedures relate to this type of deployment. By learning these simple procedures, a

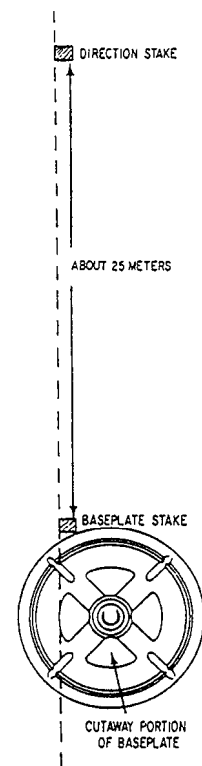

Figure 14-12.—Placing baseplate against baseplate stake.

well-trained crew should be able to prepare a mortar for firing in approximately 1 minute.

Direct the initial fire of the mortar to the center of the target sector. The initial direction of fire is determined by the section leader or given to them by the forward observer (FO) or by the fire direction center (FDC). The section leader points out the mortar position and announces the direction of fire to the squad leader. The squad leader then places a baseplate stake where the baseplate is to be positioned. The squad leader then places a lensatic compass on the baseplate stake and rotates the compass until he can sight along the determined direction. He directs the ammo bearer to place a direction stake into the ground at least 25 meters from the baseplate stake along their line of sight. After the direction stake has been placed, the number 1 ammunition bearer for the squad places the outer edge of the baseplate against the baseplate stake, so the left edge of the cutout portion of the baseplate is aligned with the left edge of the stake (fig. 14-12).

PREPARATION FOR FIRING

Emplace the baseplate by standing on it and rocking back and forth. Rotate the locking cap until the opening in the cap points in the direction of the target. Place the base of the cannon into the cap opening. Rotate the

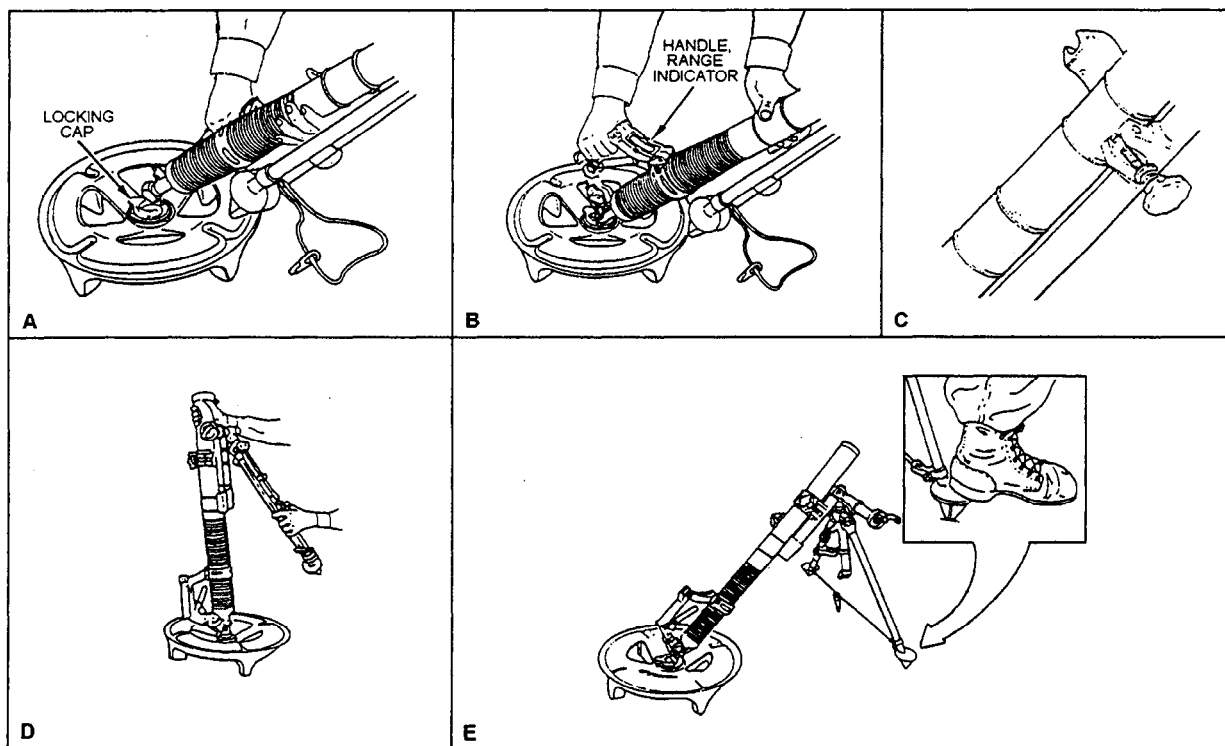

Figure 14-13.—Preparation for firing.

cannon one-fourth turn, so the handle is in an upward position (fig. 14-13, views A and B).

Loosen the knob on the biped, and swing it downward. Open the collar. There are two saddles on the M225 cannon for positioning the biped. The upper saddle is used for elevations of 1,000 roils or less and the lower saddle for elevations greater than 1,000 roils. (The upper saddle must be used for boresighting this weapon). Place the upper or lower saddle of the cannon into the collar of the biped (fig. 14-13, view C). The handle and firing mechanism assemblies are straight-up on the top of the barrel. Close the collar and swing the knob into place and tighten. Hold the barrel in a vertical position, and pull the legs of the biped up to unlatch and swing out (fig. 14-13, view D). Unfasten the hook and cable. Loosen the coarse cross-leveling nut and spread the legs. When the biped is attached to the upper saddle, set the feet about 1 1/2 feet in front of the baseplate. When the biped is attached to the lower saddle, set the feet about 1 foot in front of the baseplate. Press the biped feet firmly into the ground (fig. 14-13, view E). With the coarse cross-leveling nut still loose, adjust the cross-leveling mechanism until the elevating mechanism is nearly vertical. Cross-leveling removes cant from the weapon. Hand tighten the nut. Adjust the fine cross-leveling nut clockwise to move the elevating

mechanism to the left or counterclockwise to move the elevating mechanism to the right, until it is vertical. Now, remove the sight unit (M64/M64A1) from its case. Press the latching lever while installing the sight unit on the biped. Release the latching lever and check to see that the sight unit is firmly locked to the biped. The gunner sets the deflection scale at 0 mils and the elevation at 1,000 mils. He then centers the elevation bubble and cross-levels the mortar. The mortar is now mounted and ready to be laid.

When more than one mortar is to be used for a mission, it is important that they be mounted and laid parallel. This ensures proper target coverage and accurate destruction of targets when they are engaged.

LAYING A MORTAR USING THE COMPASS METHOD

Several methods are used to lay mortars parallel. The most rapid, but the least accurate, method is by using a compass. In this method the section leader stands approximately 6 feet behind the mortar and sights through the compass at a given direction. The section leader then directs the gunner to move the lay of the barrel left or right until the barrel and the sight wire of the compass are lined up. At this time the gunner

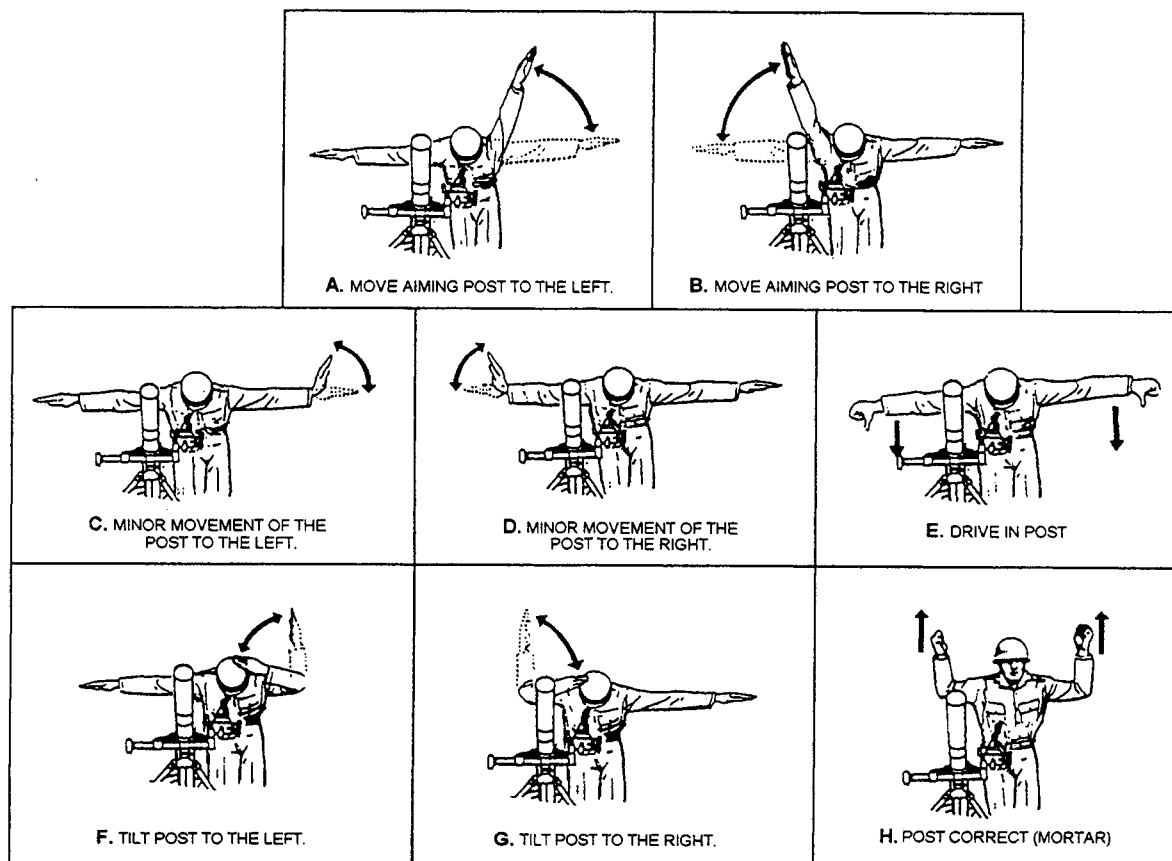

Figure 14-14.—Arm-and-hand signals used in placing out aiming post.

rechecks to see that all level vials are centered. When the center of the barrel and the sight of the compass are in line and all bubbles level, the gun is laid. The section leader then directs the gunner to refer the sight and put out their aiming posts. “Refering the sight” means making a deflection change on the sight without moving the mortar. To refer the sight, you turn the deflection knob until the given deflection is set on the sight. When using the M64/M64A1 sight, you can place the aiming posts where they can best be observed because the deflection scale can be slipped to read the desired deflection. The sight (M64/M64A1) is initially referred to a 0-nil reading, and the aiming posts are set on that deflection.

PLACING AIMING POSTS

Normally two aiming posts are placed out to establish the aiming line. The rounds are fired from the mortar in reference to this line. After the mortar has been mounted and laid on the direction stake, the sight is normally referred to 2,800 mils, and the aiming posts are placed along this line of sight. The aiming posts are

placed on the new line of sight by the first ammunition bearer, observing the arm-and-hand signals (fig. 14-14) of the gunner. The posts are called the far post and the near post. The far post is placed out 30 to 50 meters from the mortar, and the near post is placed at 15 to 30 meters (fig. 14-15). When this is not possible, because of terrain or situation, the post should be placed out as far as possible, keeping in mind that the distance between the two posts must be equal. The far post is always placed first and the near post last. When these two posts are seen through the sight, they appear as one. This is called

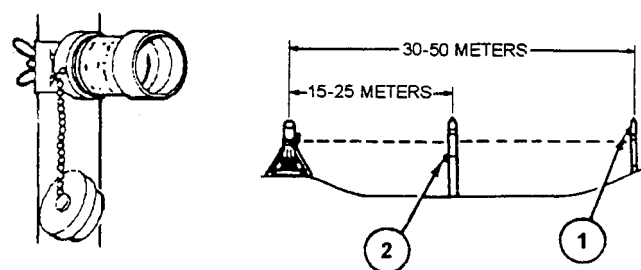

Figure 14-15.—Aiming post and lights (M58/M59).

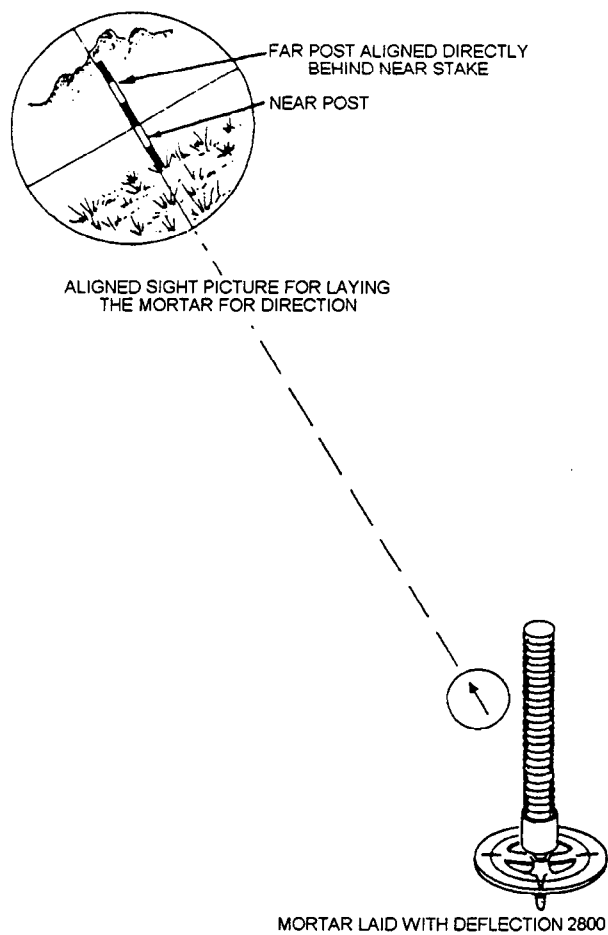

Figure 14-16.—Aligned sight picture.

the **ALIGNED** sight picture (fig. 14-16). If the two aiming posts do not appear as one, displacement of the sight or the baseplate has occurred. This separation is caused by one or two things: either (1) a large deflection shift that moves the entire sight out of the plane passing through the aiming posts; or (2) a lateral (left or right) displacement of the baseplate caused by the shock of firing, which also moves the sight out of the plane of the aiming post. When both the far post and the near post are visible, it is called a **COMPENSATED** sight picture (fig. 14-17).

MASK CLEARANCE

Mask clearance is the clearance required for firing the weapon without danger of a premature detonation of the round by obstructions, such as trees, hills, or buildings. After the mortar is mounted, the gunner must determine the minimum and the maximum mask clearance. This determination helps to ensure troop safety at the mortar position and also helps the fire

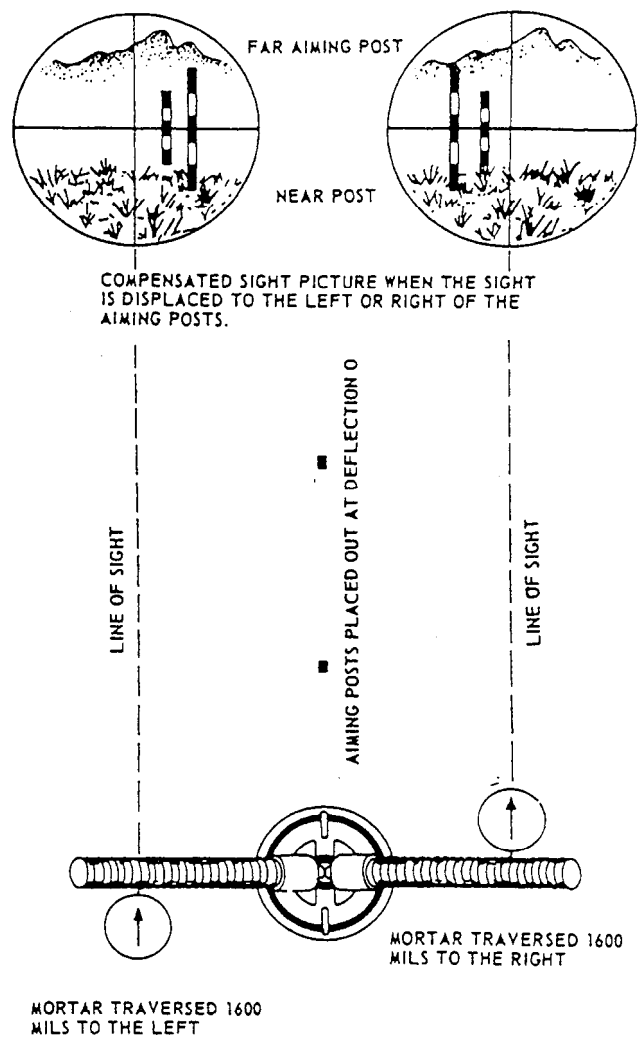

Figure 14-17.—Compensated sight picture.

direction center (FDC) to know whether or not a particular mission can be completed with that mortar.

To determine mask clearance, the gunner sets the sight at 0 deflection and 0 elevation, making the line of sight parallel with the axis of the bore. The gunner then raises or lowers the barrel until the cross hairs of the sight just touch the obstruction (tree, hill, etc.). The gunner then levels the elevation bubble by turning the elevation knob on the sight and reads the elevation from the elevation scale. This reading is the minimum (or maximum, depending on the location of the obstruction) mask clearance. For a safety factor, 30 mils is added to (or subtracted from) the elevation reading.

Mask clearance must be determined in a complete circle around the mortar to every object that could interfere with firing. The gunner reports all these figures, stating the azimuth and clearance to the squad leader and FDC. He also keeps a record for himself.

In emergency situations, where time is extremely important, the gunner can quickly determine the mask clearance for any given target by placing his head near the baseplug and sighting along the top of the barrel. When the line of sight clears the mask, it is safe to fire. Of course, it takes considerable time to sight this way before every fire mission; therefore, at the first opportunity, determine the minimum and maximum clearance by using the sight and then record it.

SIGHT PICTURE

The gunner can only have one of two sight pictures when the mortar is fired: either the **ALIGNED** sight picture or the **COMPENSATED** sight picture. To use the aligned sight picture correctly, the gunner must lay the vertical line of the sight reticle, so it just touches the left side of the visible aiming post (fig. 14-16).

To use the compensated sight picture correctly, the gunner must lay the vertical line of the sight reticle, so the left edge of the far aiming post is placed exactly midway between the left edge of the near aiming post and the vertical line of the sight reticle. This corrects for displacement of the sight (fig. 14-17).

SIGHTING

The gunner is responsible for setting the mortar to the correct deflection and elevation. Remember, when the gunner lays the mortar, the sight is first set for deflection then for elevation, while the mortar is first laid for elevation then deflection. You can readily remember this sequence by keeping in mind the key word *DEED*.

1. Place Deflection on sight
2. Place Elevation on sight
3. Level for Elevation
4. Level for Deflection

For example, we will use the fire command for an HE round at a deflection of 2,700 mils, charge two, and an elevation of 1,150 mils. Assume the mortar is facing the principal direction of fire and the sight is aligned with the aiming posts at a deflection of 2,800 mils.

Setting the Sight

The gunner first sets the new deflection of 2,700 mils on the sight unit. To do this, the gunner rotates the

deflection knob counterclockwise until the index points to 2,700 on the deflection scale and to 0 on the micrometer scale. Notice that moving the knob counterclockwise has moved the sight to the left. A clockwise movement would move the sight to the right.

The gunner should always keep in mind that the barrel moves in the opposite direction of the sight. In addition, the gunner must know in which direction the barrel is pointing after a given deflection change.

Any deflection command that causes the barrel to be moved over 90 degrees either right or left of the principal direction of fire (PDF) is always given as a **REAR** deflection. (For example: **DEFLECTION REAR TWO-SEVEN-HUNDRED**.) Notice that a rear deflection is directly opposite the equivalent **FRONT** deflection. Any deflection without the command **REAR** is understood to be **FRONT**.

After rotating the sight to the new deflection of 2,700 mils, the gunner sets the new elevation by rotating the elevation knob until the index on the elevation scale points between 1,100 and 1,200, and the index of the elevation micrometer is pointed at 50 mils.

Laying for Direction

As the deflection placed on the sight is greater than 95 mils, it cannot be made by turning the traversing crank. Therefore, the gunner assisted by the assistant gunner must lay the barrel in the new direction of fire by moving the biped. Whenever the biped is moved in this manner, the gunner should always rotate the barrel to the center of the mechanism to give maximum flexibility at the new setting. As a rule of thumb, the biped should always be moved whenever the new deflections more than 20 mils either side of center. Care should be taken in moving the biped to get roughly within two turns (20 mils) of the aiming posts to avoid excessive traversing.

With the barrel in its new position and the vertical cross hair aligned with the left edge of the aiming posts again, the gunner next levels the barrel for elevation by turning the elevating crank until the bubble of the elevation level is centered. The gunner then turns the adjusting nut of the cross-leveling assembly until the cross-level bubble is centered. After a final check with the aiming posts, the mortar is now laid in the new direction of fire and is ready for firing.

FIRE COMMANDS

Fire commands originate with the computer at the FDC or when the mortars are used without an FDC, with the leader at the observation post. These commands contain the technical instructions that enable the gunners to lay the mortars for deflection and elevation.

It is often desirable to transmit fire commands in fragmentary form as the elements of the command are determined. When transmitted in this manner, the command can be executed while it is being issued. Whenever practical, fire commands are given orally. When it is not practical to give oral commands in person, telephone or radio may be used. The gunners repeat the elements of every fire command as they receive them. There are two types of fire commands: the initial fire command and the subsequent fire command.

NOTE: All fire commands, initial and subsequent, are repeated by the gunner.

The elements of both follow a definite sequence; however, subsequent commands include only such elements as are changed, except that elevation is always announced.

Initial Fire Command

The initial fire command consists of the data necessary to fire the first round. There are eight elements of the initial fire command which are as follows:

1. MORTARS TO FOLLOW. (Alerts the firing element.)
2. SHELL AND FUZE. (Specific ammunition type and fuze to be used.)
3. MORTAR TO FIRE. (Designates the specific weapon or weapons to fire. Each weapon has a different number.)
4. METHOD OF FIRE. (Indicates the number of rounds to be fired and any special instructions.)
5. DEFLECTION. (The word *deflection* always precedes the sight setting. This element gives the exact deflection required to engage the target.)
6. CHARGE. (This element is announced by CHARGE and followed by the desired number.)
7. TIME. (This element provides the fuze setting for the illuminating rounds. Omit this element for HE rounds.)

8. ELEVATION. (Elevation is given in roils preceded by ELEVATION. Elevation is the authority to fire except when the method of fire includes the statement AT MY COMMAND.)

Subsequent Fire Command

The subsequent fire command contains changes to the initial fire command data. Subsequent commands include only those elements that have changed except that elevation is ALWAYS announced, changed or not. Changes in direction are given in total deflection; for example, to change deflection from 2,700 to the left 50 roils, the leader would give a subsequent command of DEFLECTION TWO-SIX-FIVE-ZERO. When a change is made in mortars to fire or in the method of fire, the leader gives a subsequent command that includes both elements to avoid a misunderstanding.

Action

As soon as the gunner receives and repeats the command, he begins setting the designated deflection and elevation on the sight unit. The number 1 ammo bearer, as soon as the gunner repeats the command, prepares the round for firing and hands it to the assistant gunner who does the actual loading. By the time the mortar is laid to the direction, the ammunition should be ready for loading.

PREPARING THE AMMUNITION

When the fire command is issued, the first ammunition bearer prepares the ammunition for firing.

Continuing with our example fire command, the gunner selects an M888 HE round. As this round is normally fuzed with the M734 fuze, the ammo bearer must first remove this fuze and replace it with the proximity fuze as designated in the fire command. To do this, he removes the fuze with the M18 fuze wrench. He then takes the proximity fuze from its container and inspects the threads to ensure they are in good condition. The fuze is then inserted into the fuze cavity of the projectile and manually screwed in by grasping the base of the fuze. Using the fuze wrench, he tightens the fuze until no clearance exists between it and the body of the projectile.

With the new fuze installed, the ammo bearer next adjusts the propellant charge. The fire command called for a CHARGE TWO. As the M888 HE round is issued

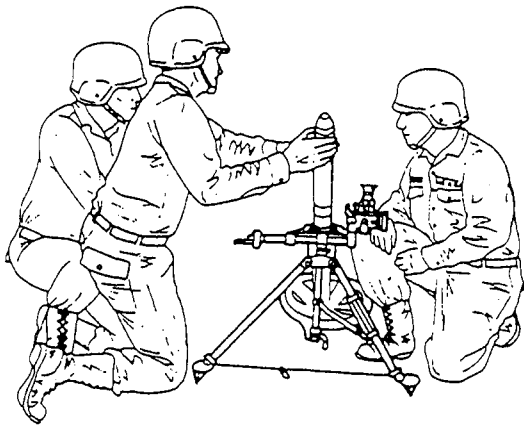

Figure 14-18.—Firing position: Conventional mode.

with a total of four propellant increments, he must remove two of these.

After the round is prepared for firing, do NOT try to change the fuze. The ammo bearer removes the safety (cotter) pin and passes it to the assistant gunner who does the loading.

LOADING AND FIRING

In the drop-fire method (conventional mode), as soon as the gunner ensures that the mortar is laid correctly, he removes the sight unit and sets the selector to the D (drop) position. This is done only for the first three rounds or until the baseplate is settled, at which time the sight may stay on the mortar while firing.

The gunner kneels on the left side of the cannon and looks into the sight unit. The assistant gunner kneels on the right side in front of the traversing mechanism, facing rearward. The ammunition handler kneels beside the assistant gunner slightly to the rear (fig. 14-18).

The ammunition handler adjusts the propellant charge for the desired range, sets the fuze for the desired

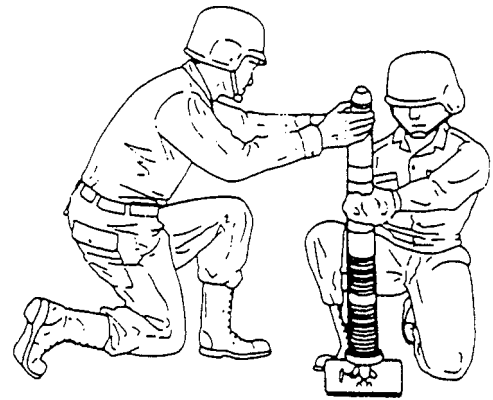

Figure 14-19.—Firing position: Hand-held mode.

burst effect, removes the safety wire/pin, and hands it to the assistant gunner. As the example fire command stated earlier, the method of fire is ONE ROUND AT MY COMMAND; the gunner cannot fire until given the command. When the gun is ready to fire, the gunner notifies the FDC or squad leader that the gun is UP. The gunner then kneels in an upright position. The next command that the gunner receives is HALF LOAD. As the gunner repeats the command, the assistant gunner grasps the body of the round with two hands near the center of the round. He inserts it, fuze end up, into the muzzle beyond the narrow part of the body.

CAUTION

If a crew member is within one meter of the muzzle during firing, hearing protection must be used.

At the command FIRE, the assistant gunner releases the round, passes his hands partly down the outside surface of the barrel while pivoting to his left and bending toward the ammunition handler.

When the firing selector is set at the T (trigger) position, the gunner squeezes the trigger after the round hits bottom on the command to FIRE.

The hand-held mode (fig. 14-19) requires no sight unit. The range indicator assembly is used to estimate target range. Use of the range indicator is for M720/M888 cartridges only. As the gunner kneels directly behind the barrel, he places a glove on his left hand to hold the barrel. Next, he puts his right hand on the trigger/handle and points the mortar toward the target. At this time, the gunner reads the range indicator.

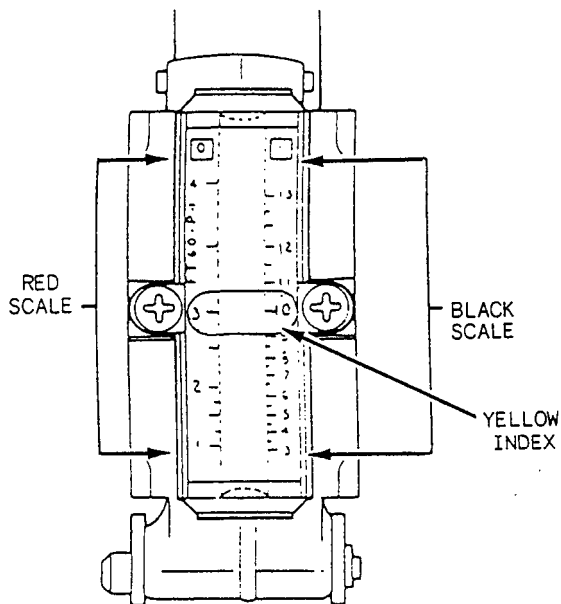

Figure 14-20.—Range indication.

The range indicator (fig. 14-20) consists of a vial that contains a ball that moves when the cannon is elevated or depressed to indicate the firing range.

The black scale is for charge one; the red scale is for charge zero. The yellow index (range 3 on the red scale and range 10 on the black scale) is a warning reminder to brace the baseplate before firing.

The ammunition handler prepares the cartridge. As the gunner sets the firing selector in the T (trigger) position, the assistant gunner inserts the round into the muzzle, releases the round, and assumes a safe position. The gunner lays-in the weapon by using the range indicator and sighting over or on the side of the muzzle for the azimuth. Holding the mortar steady, the gunner assumes a safe firing position. When the weapon is on target, the gunner squeezes the trigger to fire, then releases the trigger in preparation for the next round.

MISFIRES

A MISFIRE is a round that has been inserted in the mortar but has failed to fire. A misfire is a complete failure to fire. It may be caused by a faulty firing mechanism or a faulty element in the propelling charge explosive train. A misfire in itself is not dangerous, but since it cannot be immediately distinguished from a delay in functioning of the firing mechanism or from a hangfire, it must be handled with care. Mechanical malfunctions may be caused by a faulty firing pin,

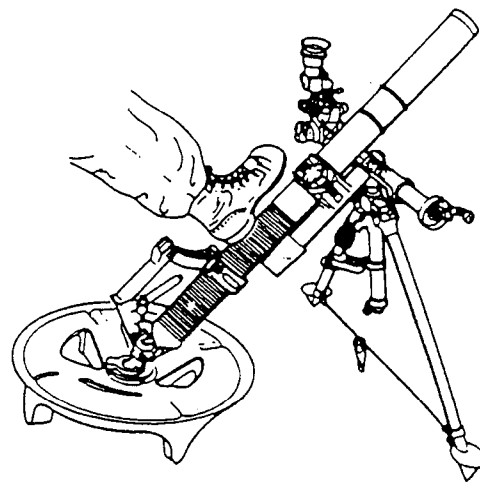

Figure 14-21.—Misfire procedure: Dislodging the round.

rounds lodging in the barrel because of burrs, excess paint, oversize rounds, or foreign matter in the tube.

A HANGFIRE is a round that gets lodged in the barrel for one reason or another, and the round does not strike the firing pin. Thus a hangfire cannot be distinguished immediately from a misfire. Any round that fails to fire should be treated as a misfire. When a firing malfunction occurs, any member of the squad noticing that a misfire has occurred immediately announces MISFIRE. When conditions permit, the mortar crew should wait approximately 1 minute before attempting to clear the misfire. This waiting period may avoid an accident, caused by a delayed action of the ignition cartridge. If the barrel is excessively hot, it should be cooled to avoid cooking off the misfire. Wet sandbags or water or both maybe used to cool the mortar barrel. All persons not actively engaged in clearing the misfire should be kept at a safe distance until the misfire has been removed.

The above procedures are similar for both the conventional mode and the hand-held mode. The major difference is the support needed for the M225 cannon, since the hand-held mode is without a biped. Sandbags, empty ammo boxes, or anything else that will furnish the required support may be used to maintain safe elevation of the muzzle.

If a misfire occurs, the gunner sets the fire selector to the T (trigger) position and squeezes the trigger twice to confirm the malfunction. If the weapon fails to fire after the second try, any crew member noticing it announces MISFIRE. The gunner changes the firing selector to the S (safe) position, and then kicks the lower portion of the cannon (fig. 14-21). This is to dislodge

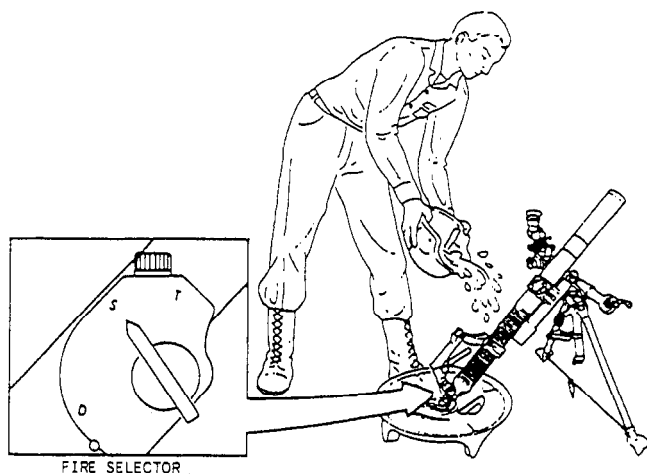

Figure 14-22.—Misfire procedure: Cooling the barrel.

the round. The gunner ensures the weapon is aimed down range, changes the fire selector to T (trigger) position, then squeezes the trigger. The round should fire. If it does not, he returns the selector to the S (safe) position and keeps the muzzle elevated and pointed down range. He then allows the outer surface to cool. This can be done by using water (fig. 14-22) or just allowing the air to cool it until the cannon can be handled with bare hands. The gunner lifts the base cap end (fig. 14-23) of the cannon, and the assistant gunner places his hands around the outer edge of the muzzle. As the base cap end is lifted, the round should slide out. The assistant gunner stops it with his thumbs, then removes the round from the bore and places it in the designated area.

CAUTION

Never put your hands in front of the muzzle.

CARE AND CLEANING

The mortar squad members are responsible for the care and cleaning of the gun. Basically, each member is responsible for the part of the gun that he carries.

A schedule should allow time for supervised cleaning on each day the mortar is fired and once weekly when it is not in use.

General Cleaning

To clean the bore, attach cotton waste or rags to the cleaning staff and insert them into the bore. Move the staff in and out several times with a turning motion. Replace the dirty rags with clean rags. This cleaning

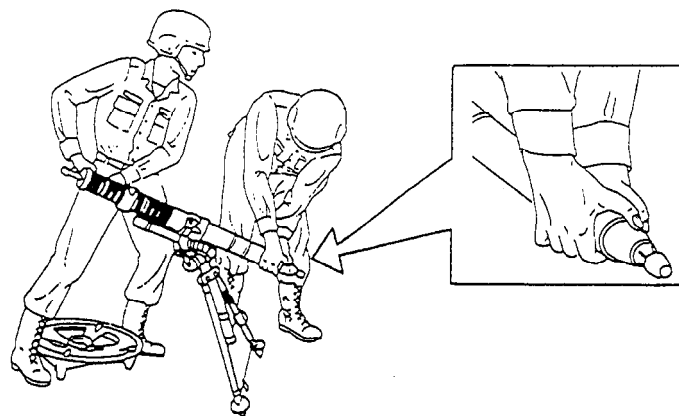

Figure 14-23.—Misfire procedure: Removing the round.

removes accumulations of dust, dirt, and thickened oil. Repeat this procedure until the cotton waste/rags comes out clean. When necessary, wash the outside of the barrel with a soap solution, rinse it with clean water, dry it, and apply a light coat of preservative lubricating oil. You must be careful to rinse and dry all parts of the mortar thoroughly after using soap and water.

CAUTION

When cleaning the bore, be careful not to leave any waste on the firing pin.

To clean the firing pin, remove it by using an Allen wrench. Insert the firing-pin vent cleaning brush into the vent. While exerting light pressure, turn the brush clockwise to remove excess foreign material from the shoulders of the vent. Clean the shoulders carefully, because the firing pin does not seat correctly when there is foreign material left on the shoulder. This results in gas leakage while firing. Next, wrap a rag around the vent cleaning brush and insert it into the firing pin vent. Clean the vent by moving the rag back and forth through it. Replace the dirty rag and repeat this procedure until the rag comes out clean; then saturate the clean rag with preservative lubricating oil, and push it in and out of the vent. Next, clean the firing pin, oil it lightly, and properly reseat it into the baseplug.

To clean the mount, keep all parts of the biped and baseplate clean and free of foreign matter. Keep all moving parts and polished surfaces lightly coated with oil. Use a small paintbrush or toothbrush to clean the screw threads and crevices. To remove moisture and dirt from the metal surfaces, rub them with a dry cloth; then wipe them with a cloth containing a small quantity of

preservative lubricating oil. Maintain this protective film at all times. Clean and lightly oil the socket, socket cap, and collar of the baseplate.

Cleaning Before Firing

Before firing, the mortar crews should complete the following actions:

1. Inspect the three units of the mortar for cleanliness.
2. Clean the bore and firing pin with a clean, dry cloth. Do not apply oil to these parts before firing.
3. Do not leave any waste on the firing pin or in the barrel. Do not use grease.
4. Clean thoroughly and oil lightly all metal moving parts with preservative lubricating oil.

Cleaning After Firing

Clean the bore and all working parts of the mortar immediately after you complete firing. When cleaning cannot be accomplished immediately, apply oil to prevent corrosion. At the first opportunity, clean, oil, and inspect the mortar. If necessary, have repairs and replacements made by the unit armorer.

Clean the bore with rifle-bore cleaner immediately after you complete firing and 3 consecutive days thereafter (a minimum of four cleanings). The barrel should be cool enough to touch with your bare hand before using bore cleaner on it. The cleaner evaporates at 150°F, and such evaporation causes dark spots on the barrel. When rifle-bore cleaner is not available, use a hot soapy solution or plain hot water. Clean the vent and firing pin, as described previously, using a liberal quantity of soapy solution instead of rifle-bore cleaner. Dry the parts by using clean rags and applying preservative lubricating oil. When cleaning the mount, take care to remove dirt from all crevices. Clean all moving parts with rifle-bore cleaner, dry them, and apply preservative lubricating oil to all surfaces. To distribute the oil over the working surfaces, operate the traversing and elevating cranks. Clean the socket on the baseplate, as discussed previously.

FORWARD OBSERVER

The forward observer (FO), as the “eyes” of the indirect-fire team, has the primary mission of locating

suitable targets and calling for and adjusting fire on these targets. He also has the mission of collecting intelligence information that can be derived from surveillance of his area of responsibility. Such information is reported through channels to higher headquarters.

To accomplish his primary mission, the FO must select an observation post (OP) from which he can obtain maximum observation of his area of responsibility and still have the necessary cover and concealment. (It is also desirable for the approach to the OP to have more than one covered and concealed route, so the FO cannot be observed by the enemy as he moves in or out of this OP.)

The forward observer, working as part of the indirect-fire team, functions as an effective part of the team if he understands and applies the procedures and techniques discussed below.

Target-Grid Method of Adjustment

Using the target-grid method of adjustment, anyone with a means of communication to an infantry or artillery fire direction center and who can read an azimuth can adjust fire on the targets he can see. From the forward observer's viewpoint, this method is much simpler than previous methods because he does not have to know the location of the guns and he does not have to compute as much data. It makes no difference how far he is off the gun-target line because the fire direction center (FDC) makes adjustments to keep the burst on the observer-target line. To place fire on the target, the forward observer follows three simple steps:

1. He establishes communication with the FDC.
2. He attempts to locate the target for the FDC.
3. If the initial round or rounds miss the target, he sends corrections to the FDC that will cause subsequent rounds to hit the target.

A trained FO or a communications expert is not necessary to observe and adjust fire for mortars; however, it helps to know communication procedures and the method of conducting fire as explained in this chapter.

The target-grid method of adjustment has the following advantages:

1. The FO enjoys freedom of movement on the battlefield since he is not concerned with the location of the mortar and the mortar-target line. This enables him

to accompany the unit he is supporting, thereby giving it close and continuous fire support.

2. One forward observer can mass the fires of all mortar and artillery units within supporting range on a given target.

3. The combat Seabee can fill any gaps in the forward observer's field of view, thus giving better indirect fire support to infantry units.

4. It simplifies the work of the forward observer and places the burden of computing on personnel at the FDC who usually work under better conditions.

5. It eliminates the necessity of training a large number of forward observers to compute correction factors and requires only relatively few trained computers at the FDC.

6. The system does not depend entirely on the accuracy of the forward observer's azimuth to the target. Errors as great as 100 mils can be made without having any appreciable effect on the adjustment. Larger errors throw the burst off the observer-target (OT) line; however, such errors are easily detected by the computer, and the correct azimuth can be quickly determined by connecting two on-line bursts on the plotting board and reading the azimuth of this line.

Forward Observer Procedures

When the FDC controls the fire of mortars emplaced in a section, anyone of the three forward observers can be used to adjust fire for the unit. Each forward observer is accompanied by a radiotelephone operator who carries and operates a radio. The forward observer also carries a telephone and a reel of wire. When necessary, the mortar squad leaders supplement or relieve the forward observers.

Each FO is assigned to observe and conduct fire for a particular rifle unit in the company sector or zone of operation. He is also charged with maintaining contact with the supporting unit and keeping himself and the FDC completely informed of the tactical situation. His primary activity is to watch the movement of the supporting unit and to adjust mortar fire on those targets interfering with the mission of that unit. His secondary mission is to provide military information to higher echelons through his means of communication. He does this through observing and correcting of prearranged fire and by adjusting fire on targets of opportunity that he observes or which are identified to him by others.

The relative position of the OT line with respect to the mortar-target line does not affect the forward observer's procedure in adjusting observed fire. The forward observer makes his spottings and gives his connections with respect to the OT line. He determines errors and sends corrections to the FDC. The FDC converts these corrections to appropriate fire commands. This is done by plotting the forward observer's corrections so the mortar section can place the next burst at the point designated by the observer. To assist in the reporting of targets, each FO may be given a freehand sketch or a suitable map showing the registration point and any other reference points whose chart locations are known at the FDC.

Terminology used by forward observers has been standardized throughout the Army, Navy, and Air Force. Therefore, the FO of a mortar section who is familiar with the basic principles of forward observation procedures is capable of adjusting the fire of any type of indirect-fire weapon. To adjust the fire of indirect weapons of units outside his own company, he establishes communication with the firing unit and maintains it throughout the adjustment.

Location of Target

The observer may report the location of a target for the FDC by one of three different methods: grid coordinates, shift from the reference point, and polar coordinates. These are listed in the order of preferred use.

GRID COORDINATES. The forward observer may send the location of a target by grid coordinates, referring to a map or photomap. In this method, the forward observer sends an eight-digit coordinate that locates the target to the nearest 10 meters.

SHIFT. The forward observer reports the location of a target through a shift or change from a reference point, which may be the registration point, a marking round (to help identify the round, the observer may request a smoke round or airburst), a numbered target, or any other point whose chart location is known at the FDC. He gives the shift as a correction in meters to the nearest 10 for deviation and 25 for range from the reference point. When either the direction or altitude of the target is the same as that of the reference point, he omits the connection. The forward observer determines the shift as follows:

1. **DEVIATION.** He measures the deviation in mils from the reference point to the target with binoculars and

estimates the distance to the reference point. Then he determines the correction in meters from the reference point to the OT line by use of the mil-relation formula or the deflection table and the observer reference-point distance. He includes this deviation correction in his call for fire.

2. **HEIGHT OF TARGET.** When the difference in altitude between the reference point and the target is 50 or greater, this connection is announced in the call for fire. The height of the target may be determined as follows: Measure the angle of site to the target and to the reference point; then, by the mil relation, compute the amount so each is above or below the observation point. From these values, compute the connection for difference in altitude of reference point and target.

3. **RANGE.** The forward observer estimates the distance along the OT line to the target from the reference point. This distance is the range correction and is included in his call for fire.

The shift method gives accurate results for shifts of 400 mils or less and acceptable results for shifts up to 600 mils. For greater shifts in direction, the deviation error and the difficulty of estimating the distance from the reference to the target increase rapidly. For this reason, the forward observer selects and adjusts on other reference points so the large shifts to any likely targets can be kept to a minimum.

POLAR COORDINATES. When the forward observer's location is known by the FDC, report the initial location of the target by polar coordinates. The FDC plots the target along the azimuth and at the range from the observer's location as reported by the observer. This method is particularly desirable in the case of large lateral shifts and short observing (OT) distances. When the observer's location is not known at the FDC, he may send it by grid coordinates or some other means.

Correction by the Forward Observer

In fire without an FDC, the forward observer makes corrections differently than when operating with a fire direction center. He makes all deviation connections with respect to the gun-target line rather than with respect to the observer-target line. All deviation corrections are sent to the mortar in mils or turns of the traversing handwheel.

Observer Within 100 Meters of the Mortar Position. The best location for the forward observer for rapid-fire adjustment is at the mortar position where his deviation

spotting and deflection correction in roils, to be placed on the mortar sight, are the same. The tactical employment of the mortar usually makes it necessary for the forward observer to be in a position other than at the mortar; however, when the forward observer is located within 100 meters of the mortar position, the deviation error that he reads in his binoculars can be applied directly to the sight without any computations. This is true because the angle that exists between the observer-burst line and observer-target line is, for all practical purposes, equal to the angle that exists between the mortar-burst and the gun-target lines. Any slight difference between these two angles is compensated for by the inherent dispersion of the weapon and the bursting area of the round. For example, when the observer, from a position within 100 meters of the mortar location, observes the burst to the left of the target and reads that it is 40 mils left on the mil scale of his binoculars, he orders a correction of **RIGHT-FOUR-ZERO**.

The gunner applies this connection directly to the previous deflection setting, using the LARS (left add, right subtract) rule.

Observer More than 100 Meters from the Mortar Position. It is not always possible for the observer to be located within 100 meters of the mortar position. When he cannot locate himself within 100 meters of the mortar position, he must locate himself within 100 meters of the gun-target line. It can be readily seen that this might present some difficulty in visualizing the gun-target line and getting within 100 meters of it. When the observer is attacking targets over a wide frontage, he is required to move frequently and his movement is limited. In this situation, the angle that exists between the mortar-burst and the gun-target line is not equal to the angle that exists between the observer-burst and the observer-target line, and certain computations must be made to correct the differences in these angles. For example, when the observer is halfway between the mortar and the target, the correction to be made on the sight is one half of his deviation spotting; when the mortar is halfway between the observer and the target, the correction is twice his deviation spotting. As other distances give other ratios, it is necessary to apply a correction factor to the number of mils spotted before ordering a deflection change. This factor is a fraction, the numerator of which is the observer-target distance, and the denominator of which is the gun-target distance; that is

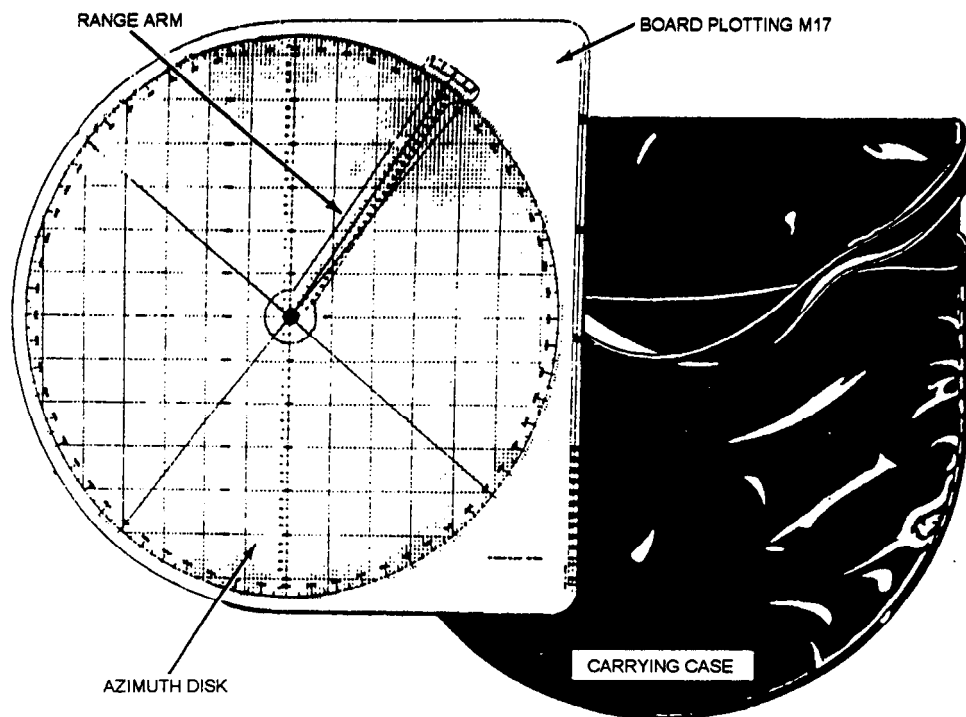

Figure 14-24.—Plotting board and carrying case.

Correction factor is

$$\frac{\text{observer-target distance}}{\text{gun-target distance}} \text{ or } \frac{OT}{GTA}$$

For example, suppose the distance from the observer to the target is 1000 meters, the gun-target distance is 1200 meters, and the deviation of the burst from the target as read by the observer is 60 mils. The correction factor is

$$\frac{1,000}{1,200} \text{ or } \frac{5}{6}$$

The change in deflection equals

$$\frac{5}{6} \times 60 \text{ mils or } 50 \text{ mils}$$

In this method, you should round off distances to the nearest 100 meters for simplicity and speed of computation.

FIRE DIRECTION CENTER PROCEDURES

The FDC is located in the headquarters section of the mortar platoon. Through the FDC, the platoon commander is able to control and quickly mass the fire

of his entire unit. The FDC is normally located at or near the firing position and maintains contact with the guns by use of wire communications. Calls for fire are reported from all sources directly to the FDC where the targets are plotted on the firing chart (plotting board). From this chart, firing data is prepared by the computer (a member of the FDC) and announced to the mortar crews as fire commands. The FDC can be operated by the computer alone; however, it is desirable to include a radiotelephone operator, so the computer can be dedicated to computing firing data and issuing fire commands.

PLOTTING BOARD

The M17 plotting board is a fire-control instrument that helps in computing firing data by providing the range and direction from the mortar position to the target. The M17 plotting board is sturdy, easy to operate, accurate, and suitable for use in the field under adverse atmospheric conditions. The plotting board consists of a pivoted disk of transparent plastic and a removable range scale arm, both attached to a flat base grid. The M17 plotting board is carried in a durable nylon case, as shown in figure 14-24.

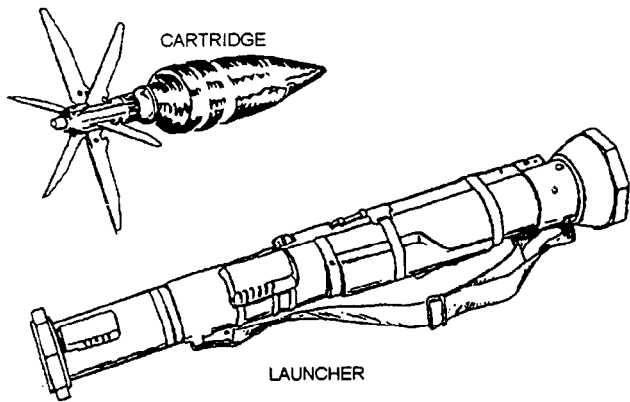

Figure 14-25.—Launcher 84-mm, M136 (AT4), Heat.

LAUNCHER AND CARTRIDGE, 84-MM, M136 (AT4), HEAT

The launcher and cartridge, 84-mm, M136 (AT4), HEAT, is a lightweight, self-contained antiarmor weapon. It consists of a free-flight, fin-stabilized cartridge packed in an expendable launcher. It is issued as a round of ammunition and requires minimum operator maintenance. The launcher (fig. 14-25) serves as a watertight packing container for transportation and

storage; however, when the launcher is placed in the firing position, it serves to ignite and guide the rocket on its initial flight toward the target. Once fired, the launcher is designed to be discarded.

The AT4 is designed to withstand arctic, tropic, and desert conditions or any combination of natural environments. It may be used under conditions of limited visibility. Target engagement, however, is limited by the ability of the firer to detect and identify the target visually and to determine the range to the target.

LAUNCHER

The launcher is a one-piece, disposable, fiberglass-wrapped tube. The launcher has the following components affixed to it (fig. 14-26).

- Transport Safety Pin. Provides safety for transporting. It is attached to the launcher by a lanyard.
- Cocking Lever. Cocks firing mechanism.
- Fire-Through Muzzle Cover. Keeps out moisture and prevents foreign objects from entering the muzzle.
- Color-Code Band. Indicates type of cartridge.

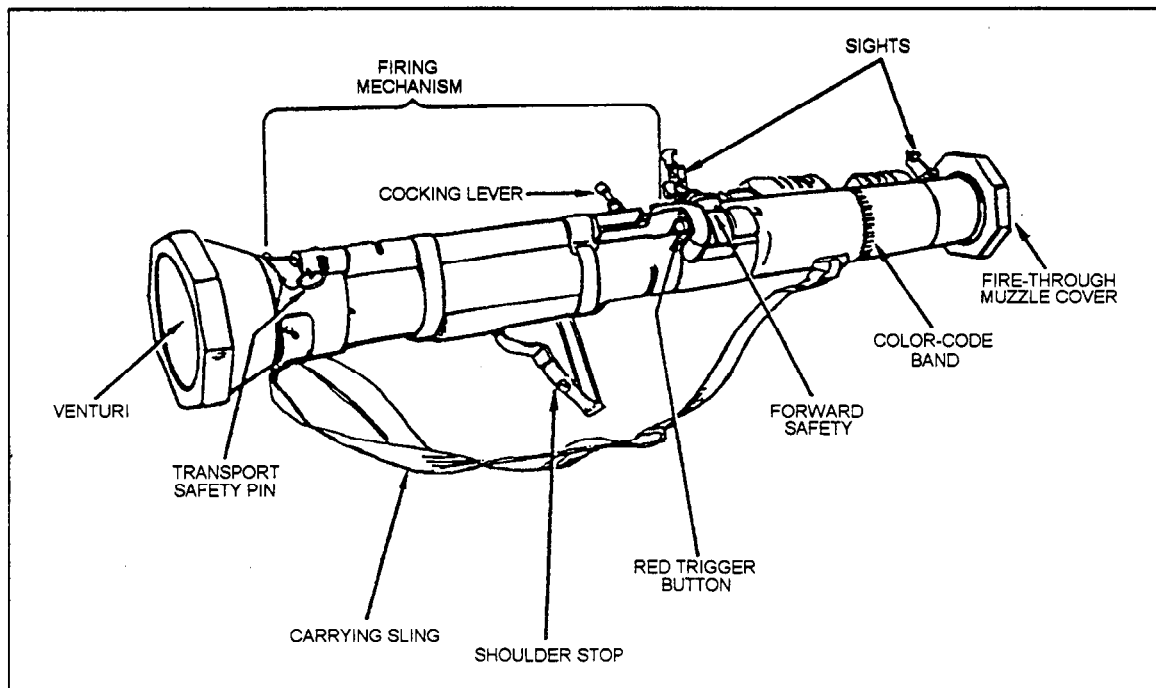

Figure 14-26.—Launcher components.

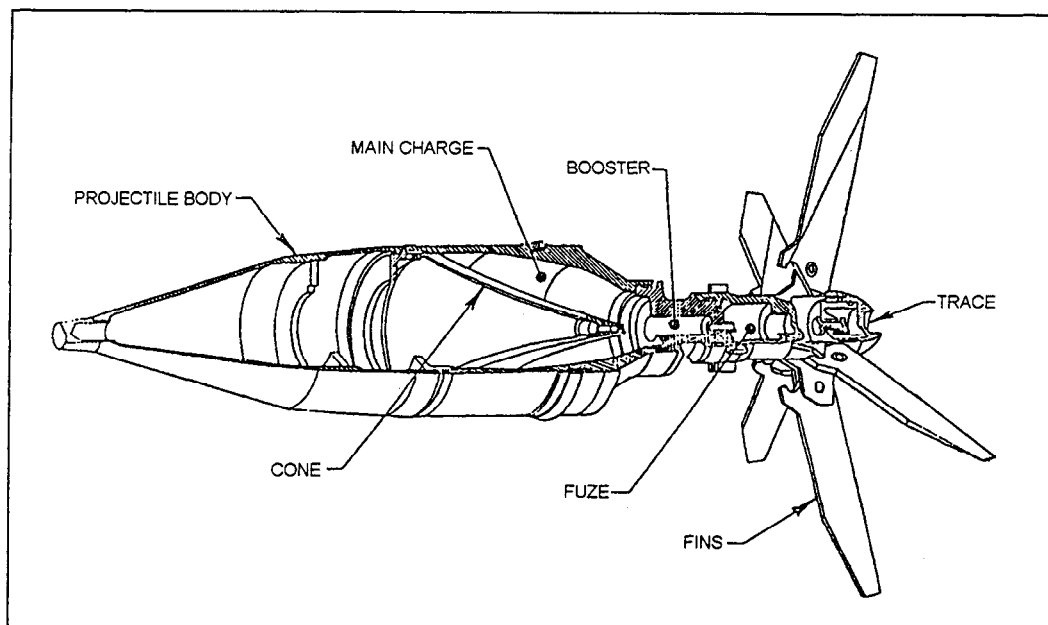

Figure 14-27.—Cartridge XM136 (AT4).

1 Sights.

1. **Front sight.** Consists of a sight blade, center post, and right and left lead posts.

2. **Rear sight.** Consists of a sight blade, range setting knob, range indicator, 2-mm peephole, and 7-mm peephole.

- Venturi. Performs two functions:
 1. Protects the weapon from damage if dropped.
 2. Directs the flow of the backblast.
- Forward Safety. Must be fully depressed and held before pressing trigger button or launcher will not fire.
- Red Trigger Button. Fires the weapon.
- Shoulder Stop. Helps stabilize the launcher on the shoulder.
- Carrying Sling. Provides a means for carrying the launcher.
- Firing Mechanism.

AMMUNITION

The AT4 is issued as a round of ammunition. The cartridge consists of a fin assembly with tracer element; point-initiating, piezoelectric fuze; warhead body with liner; and a precision-shaped explosive charge (it is the

only tactical ammunition for the AT4) (fig. 14-27). The AT4 is used mainly as an antiarmor weapon; however, it can be used against gun emplacements and bunkers.

TECHNICAL DATA

Launcher

Weight:	Overall system: 14.8 pounds. Cartridge: 4 pounds.
Caliber:	84 mm.
Length:	40 inches.
Muzzle Velocity:	950 feet per second.
Range:	Maximum range: 2100 meters or 6,890 feet. Maximum effective range: 300 meters or 985 feet. Minimum arming range: 10 meters or 33 feet.

Tactical Cartridge

Length:	460 mm (18 inches).
Caliber:	84 mm.
Warhead:	HEAT (precision-shaped charge).
Fuze:	Piezoelectric crystal.

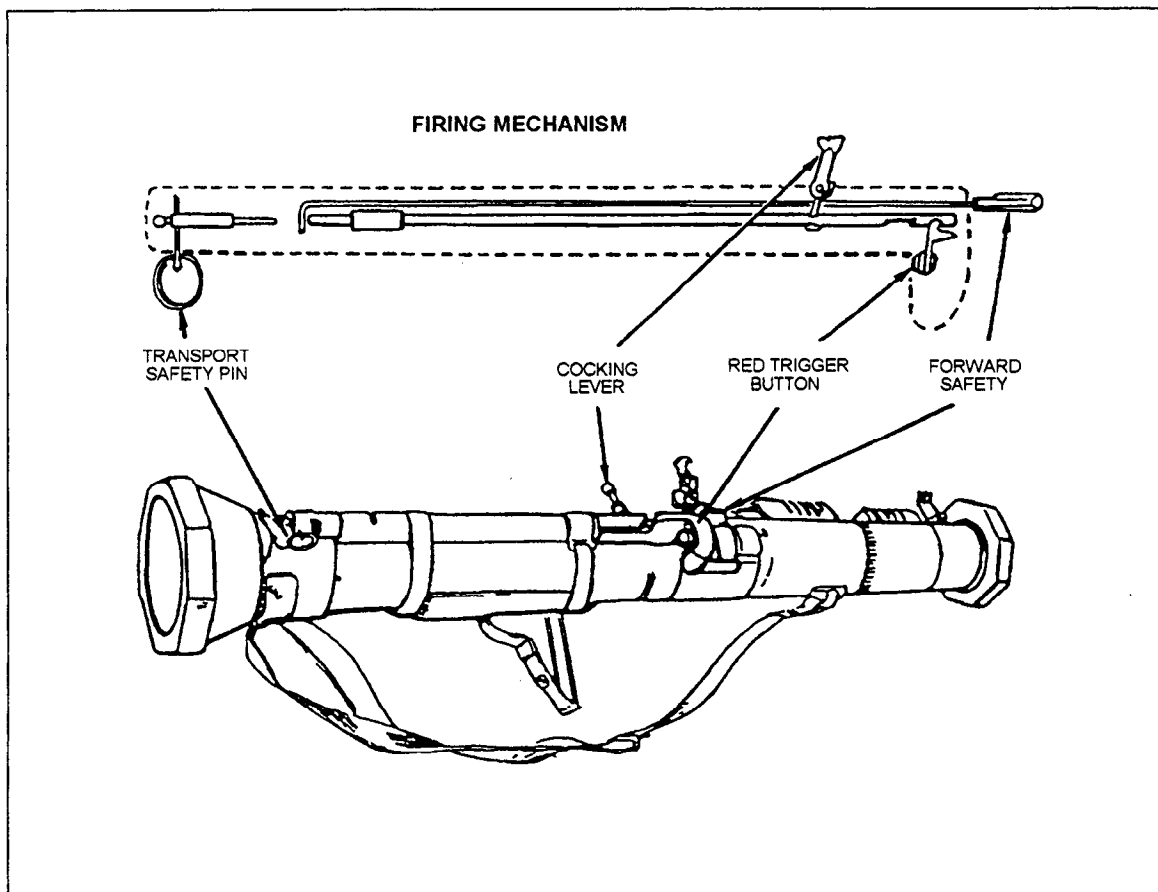

Figure 14-28.—Firing mechanism.

CONTROLS

The firing mechanism is mechanical (fig. 14-28). It includes the red trigger button, the enclosed firing rod with firing rod spring, and three safety devices. The red trigger button is located forward of the cocking lever just behind the forward safety. The weapon cannot be fired unless the three safety devices have been disengaged.

1. Transport Safety Pin (Step 1, fig. 14-29). The transport safety pin blocks the movement of the firing pin and prevents it from striking the cartridge percussion cap (not shown). To disengage the transport safety pin, pull it out and release.

2. Cocking Lever (Step 2, fig. 14-29). The cocking lever is attached to the firing rod. When the cocking lever is in the SAFE position, there is no contact between the firing rod and the trigger. To cock the AT4, push the cocking lever forward and down with the thumb of your right hand. When the weapon is cocked, the firing rod

is engaged with the trigger through the hooks on the front part of the firing rod and red trigger button.

3. Forward Safety (Step 3, fig. 14-29). The forward safety is located on the forward end of the firing mechanism. The forward safety is connected to a steel rod that prevents the firing rod from striking the firing pin. The forward safety must be fully depressed and held down before the launcher can be fired.

OPERATION

The following procedures are used to prepare the AT4 for immediate firing:

WARNING

BE SURE EARPLUGS ARE INSERTED. KEEP WEAPON POINTED TOWARD THE TARGET. KEEP BACKBLAST AREA CLEAR.

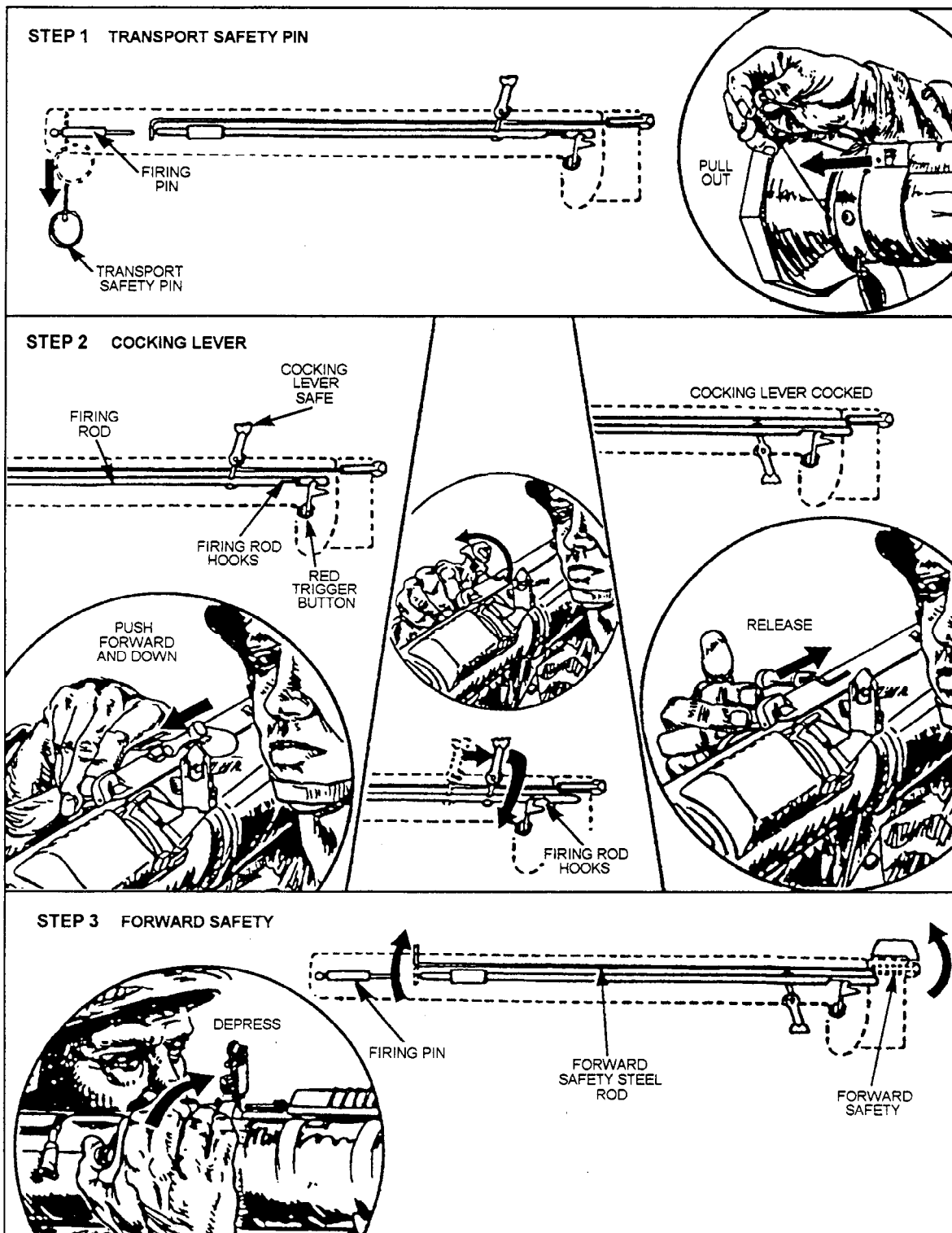

Figure 14-29.—Functioning of the firing mechanism.

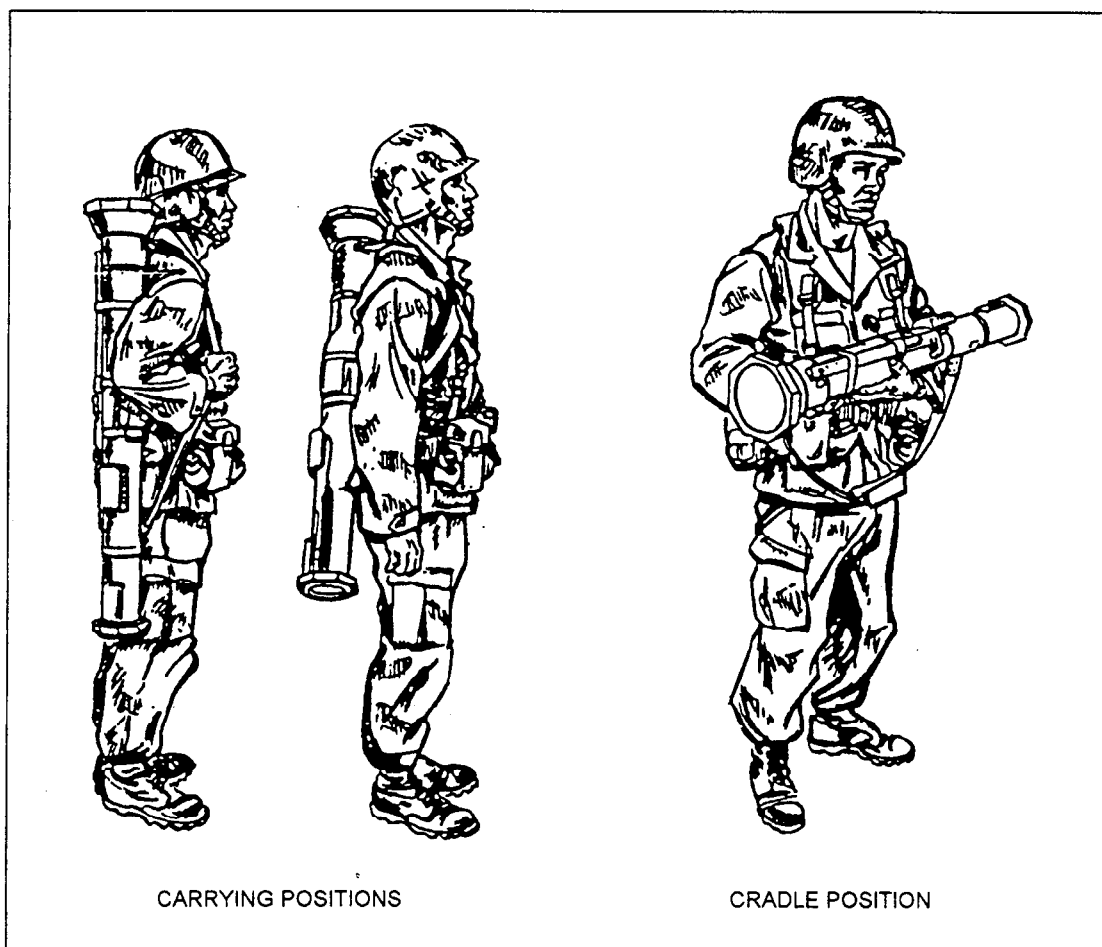

Figure 14-30.—Carrying and cradle positions.

- Remove the launcher from the carrying position and cradle it in your left arm (fig. 14-30).

- Remove the transport safety pin by pulling it out with your right hand and releasing it (Step 1, fig. 14-31).

NOTE: Be sure that the transport safety pin is attached to the lanyard and the lanyard is attached to the launcher. If it is not, retain the transport safety pin (it must be reinserted if the launcher is not fired).

- Unsnap the shoulder stop and unfold it (Step 2, fig. 14-31).

- Place the launcher on your right shoulder.

- Release the sights. Release the front sight by pressing down on the sight cover and sliding the cover to the rear. Release the rear sight by pressing down on the rear sight cover and sliding the cover to the front. Each sight pops up after release procedures (Step 3, fig. 14-31).

WARNING

KEEP WEAPON POINTED TOWARD TARGET. CHECK BACKBLAST AREA.

- Cock the launcher (Step 4, fig. 14-31) by unfolding the cocking lever with your right hand. Place your thumb under the cocking lever and, with the support of your fingers in front of the firing mechanism, push the cocking lever forward and then downward to the right. Let the cocking lever slide back

CAUTION

DO NOT REFOLD THE COCKING LEVER. THIS WILL INTERFERE WITH THE FUNCTION OF THE FIRING MECHANISM.

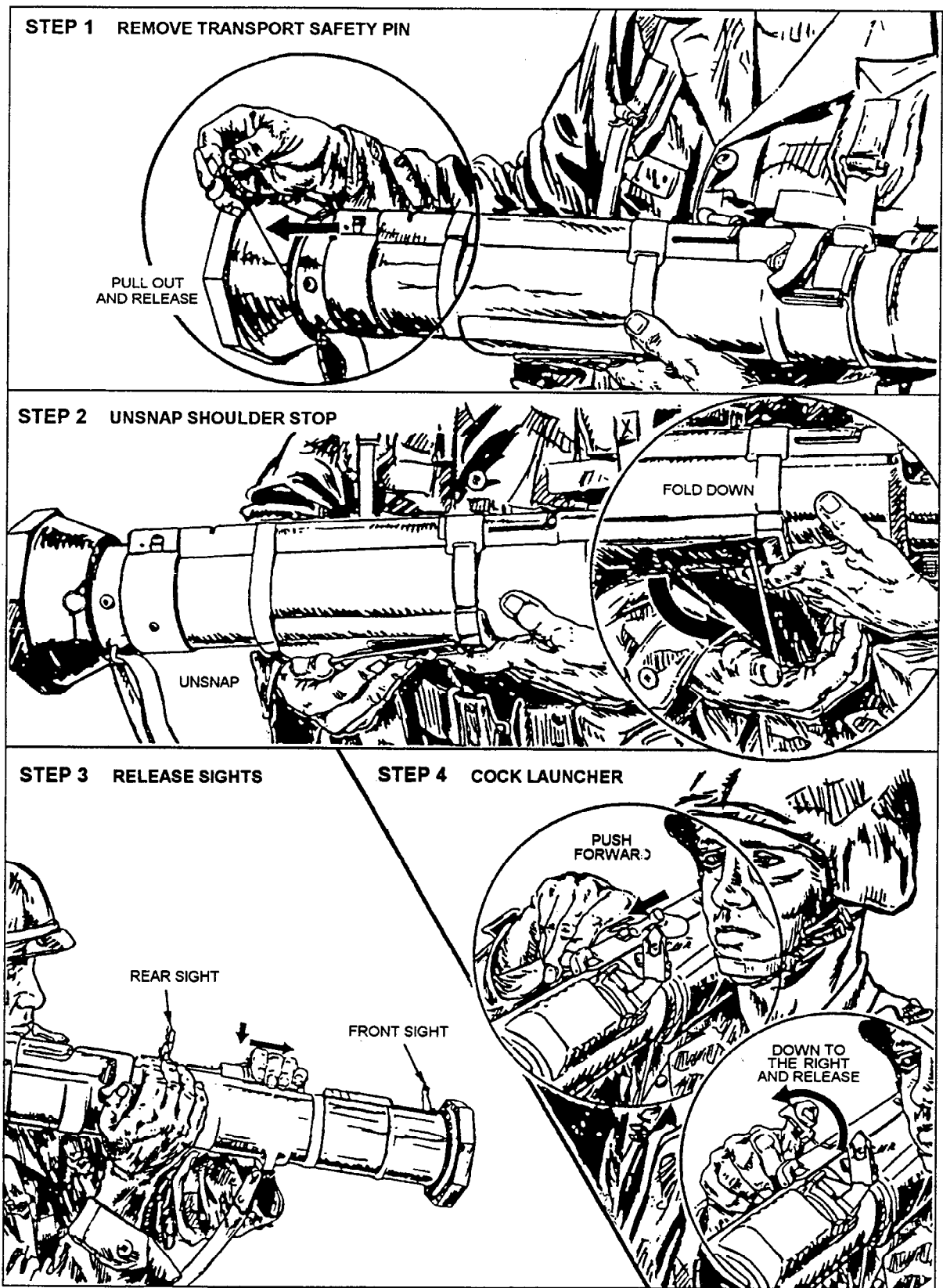

Figure 14-31.—Preparation for immediate firing.

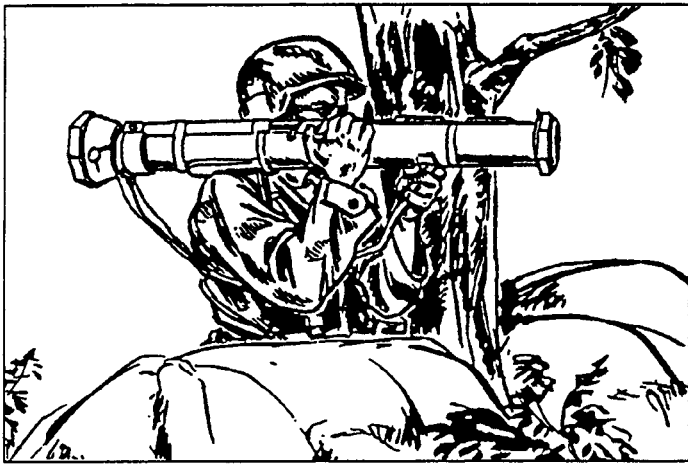

Figure 14-32.—Shoulder the weapon.

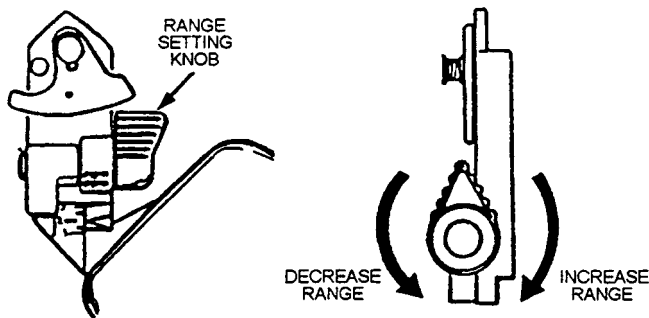

Figure 14-33.—Adjust range setting.

- Press the shoulder stop against your shoulder (fig. 14-32). For added stability, grasp the carrying sling near the muzzle with your left hand and pull back on the carrying sling until the shoulder stop is snug against your shoulder.

- Adjust the rear sight (fig. 14-33). When uncovered, the rear sight is preset on 200 meters, which is the battle-sight setting. During target engagement for targets more than 200 meters, a sight adjustment is necessary; for targets less than 200 meters, no adjustment is necessary. The sight is adjustable below 200 meters; however, because of the flight dynamics of the projectile, adjusting the range setting does not increase the hit probability for targets less than 200 meters.

- Using the index and middle fingers of your right hand, press the forward safety all the way to the left and hold it. At the same time, pull the launcher into your shoulder with your left hand, keeping your right hand against the forward edge of the firing mechanism housing for firing stability.

- To fire the launcher, press the red trigger button by gently applying pressure straightforward with the tip of your right thumb in a steady, smooth movement.

When the launcher is prepared for firing but is not fired, it is taken out of operation as follows:

- Release the forward safety.
- Return the cocking lever to the SAFE, uncocked position by reversing the procedures for cocking, and then fold the cocking lever down.
- Remove the launcher from your shoulder. Keep it pointed toward the target.
- Reinsert the transport safety pin all the way into the pinhole.
- Return the rear sight to the battle-sight setting of 200 meters; fold down the front and rear sight; close the sight covers.

CAUTION

REAR SIGHT MAY BE DAMAGED IF IT IS NOT RETURNED TO THE BATTLE-SIGHT SETTING (200 METERS) BEFORE CLOSING THE SIGHT COVER

- Refold the shoulder stop and snap it back into position; sling the launcher over either shoulder with the forward (muzzle) end down.

MISFIRE PROCEDURES

A misfire is a complete failure to fire and maybe caused by a faulty firing mechanism or by an element in the propelling charge explosive train.

CAUTION

KEEP THE WEAPON POINTED TOWARD THE TARGET.

Misfire Procedures (Training)

1. When the launcher fails to fire, immediately shout, "Misfire."
2. Maintain the original sight picture.
3. Release the forward safety.
4. Recock the cocking lever. Check the backblast area; aim, fully depress, and hold down the forward safety; and press the red trigger button.
5. If the launcher still fails to fire, repeat Steps 1 through 4.
6. If the launcher still fails to fire, release the forward safety and return the cocking lever to the SAFE, uncocked position.
7. Take the launcher off your shoulder; keep the muzzle pointed toward the target.

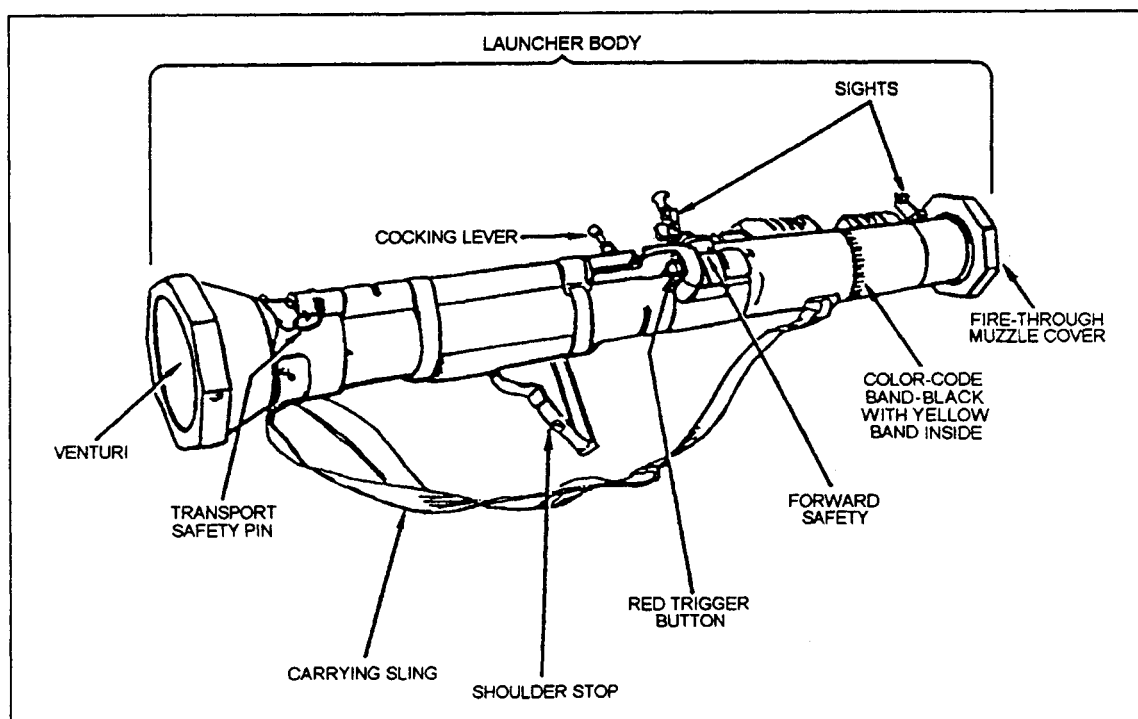

Figure 14-34.—Launcher inspection.

8. Reinsert the transport safety pin.

9. Wait 2 minutes, then carefully lay the faulty launcher on the ground, muzzle facing toward the target.

10. Dispose of the faulty launcher according to SOP (Range Safety Officer).

Misfire Procedures (Combat)

1. Release the forward safety. Immediately recock the cocking lever. Check the backblast area; aim, fully depress, and hold down the forward safety; and press the red trigger button.

2. If the launcher still does not fire, maintain your firing position, and return the cocking lever to the SAFE position. Remove the launcher from your shoulder and reinsert the transport safety pin. Lay the faulty launcher aside; keep the muzzle pointed toward the target. Immediately use another launcher to engage the target. Dispose of or destroy the faulty launcher according to standard operating procedures.

MAINTENANCE

The AT4 requires no preventive maintenance or repairs at the first or second echelon. No repair parts are supplied to the using organization.

DESTRUCTION

When capture of the AT4 is imminent or if it becomes necessary to abandon the system in a combat

zone, the unit commander may order its destruction. Priority is given to the destruction of those parts most difficult to replace, such as the sight, firing mechanism, and launching tube. The same parts of the system should be destroyed to prevent the enemy from reconstructing one complete unit from several damaged ones. In combat, after the launcher has been fired, it should be destroyed to prevent the enemy from converting the launcher into a booby trap.

Destruction can be accomplished by four methods:

- Burning
- Demolition
- Gunfire
- Crushing

INSPECTION BEFORE FIRING

Since the AT4 is issued as a round of ammunition, rather than as a weapon, the launcher is completely sealed. Inspection is limited to visual examination of the external components. The launcher is waterproof. When the fire-through muzzle cover is intact, the launcher remains waterproof until fired. The overall condition of the launcher should be inspected before being used (fig. 14-34). The firer should ensure that

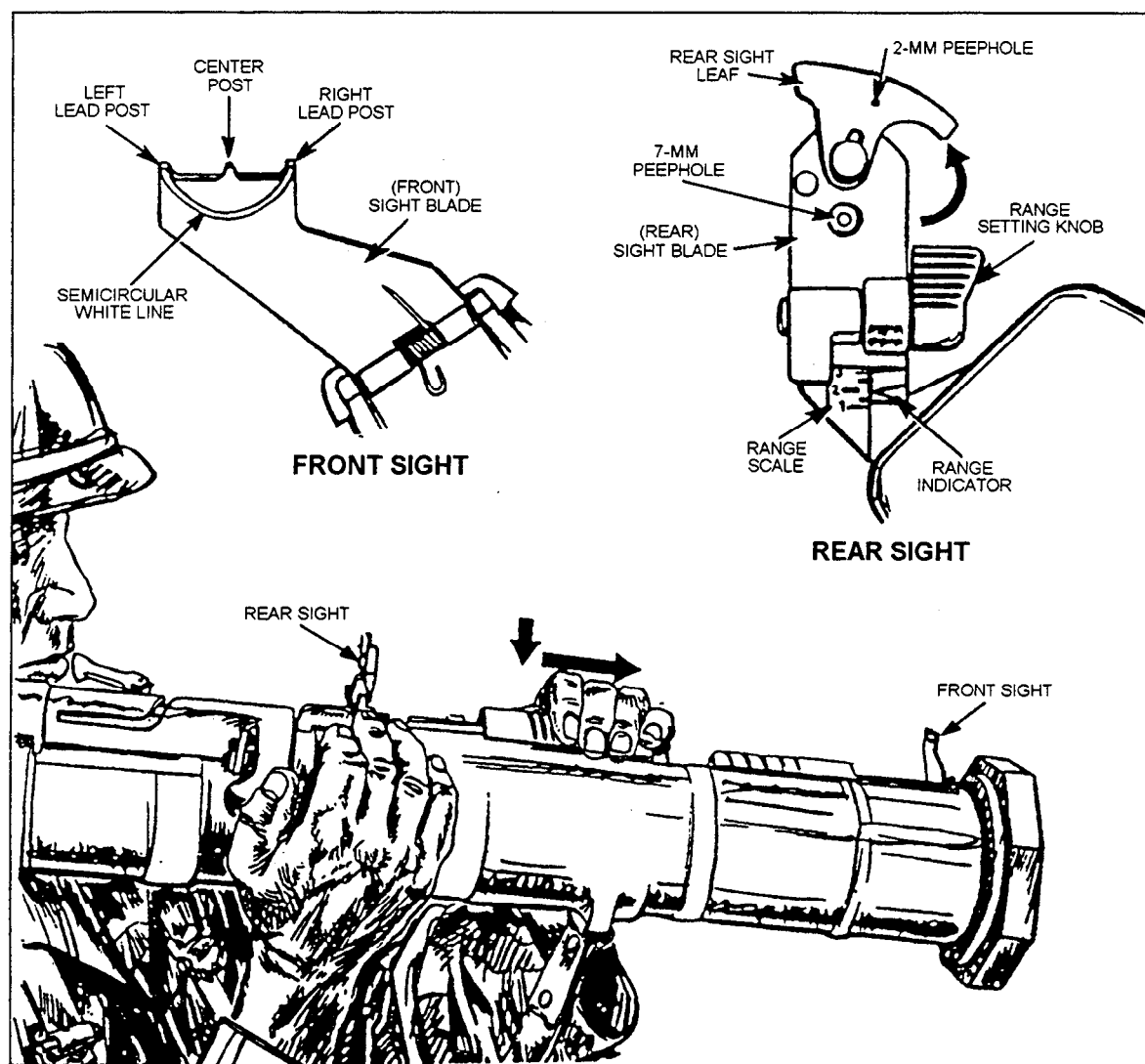

Figure 14-35.—Sight system.

- the transport safety pin is in place and fully inserted. The lanyard is attached.

- the cocking lever is in the SAFE position and folded down.

- the fire-through muzzle cover is intact. If the seal is ruptured or torn, cut the seal out to ensure there are no foreign objects inside the launcher tube. To remove foreign objects, turn the tube muzzle down and shake it gently. Before firing, ensure there are no foreign objects in the muzzle.

- the launcher being used has a black color-code band with a yellow band inside.

- the sights function properly. Open the covers to see if the sights pop up and are not damaged.

- the forward safety does not move when depressed.

- the rear seal is not cracked or damaged. The rear seal is inside the venturi and is made of brown plexiglass. Before firing, ensure there are no foreign objects obstructing the rear of the launcher.

- the shoulder stop is not broken or damaged, and it unsnaps and folds down.

- the carrying sling is not frayed and is attached firmly to the launch tube.

- the launcher body has no cracks, dents, or bulges.

- the red trigger button is not missing, broken, or damaged.

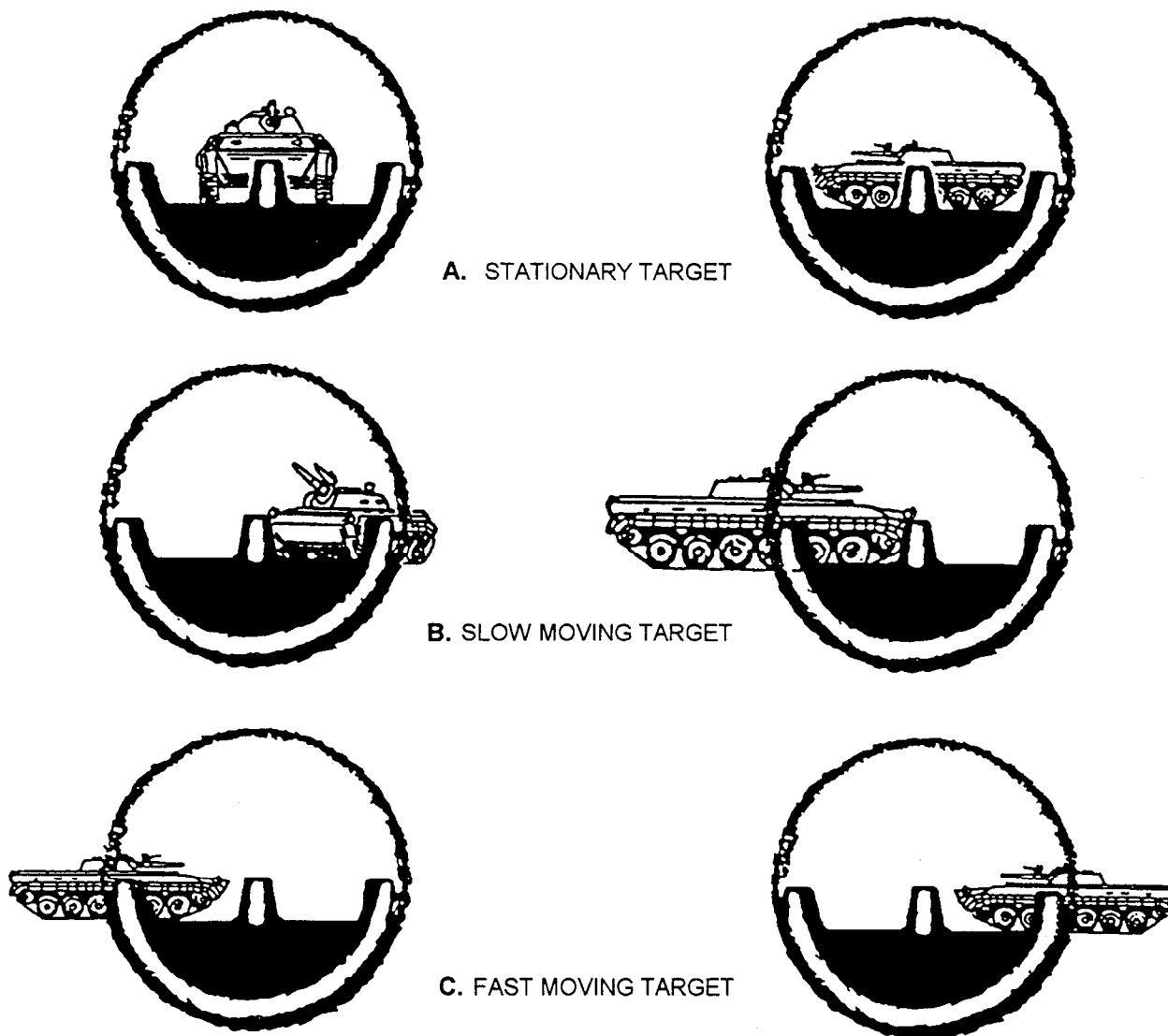

Figure 14-36.—Correct placement of the front sight lead posts.

SIGHTS

- **Front Sight.** The front sight consists of a sight blade with a center post and left and right lead posts (fig. 14-35). It has a semicircular white line to aid in obtaining the proper sight picture. To open the front sight cover, press down on the sight cover and slide it rearward.

- **Rear Sight.** The rear sight consists of a sight blade, range setting knob, range scale, 2-mm peephole (for normal light conditions), and 7-mm peephole (for limited visibility) (fig. 14-35). To open the rear sight cover, press down on the cover and slide it forward.

AIMING

In general, to aim the launcher, you must first estimate the range to the target. Once the range is

determined, the launcher is placed in position on the right shoulder so the right eye is 2 1/2 to 3 inches from the rear sight. The firer is concerned with correctly pointing the AT4 so the cartridge hits the target when he fires. To do this, he must have the rear sight, the front sight posts, and the target (or aiming point) in proper relationship—known as the sight picture. A correct sight picture is obtained when the sights are properly aligned and the aiming point (target) is in correct relationship to the front sight posts.

ENGAGING THE TARGET

1. To engage a stationary target. Place the center post at the center mass of the target. Targets moving directly toward or away from the firer are the same as stationary targets (fig. 14-36, view A).

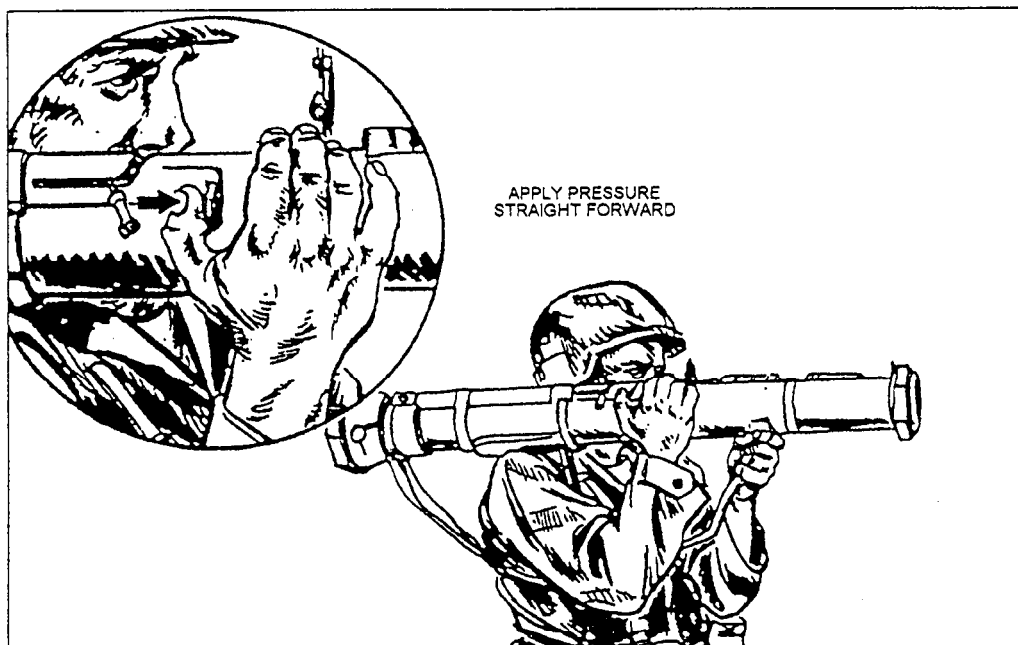

Figure 14-37.—Trigger manipulation.

2. To engage a slow moving target. Place the center post on the front leading edge of the vehicle (less than 10 miles per hour). This includes oblique moving targets (fig. 14-36, view B).

3. To engage a fast moving target (more than 10 miles per hour). When the target is moving to the left, place the right lead post at the center of the mass. When the target is moving to the right, place the left lead post at the center of the mass (fig. 14-36, view C).

TRIGGER MANIPULATION

The trigger for the AT4 is a red button on the right side of the tube. To fire the launcher, you must apply pressure straight forward with the thumb of your right hand in a steady, smooth movement. Proper trigger manipulation (fig. 14-37) can be developed by dry-fire practice with an expended AT4 or AT4 training devices.

FIRING POSITIONS

The AT4 is fired from the right shoulder only. It may be fired from the standing, kneeling, sitting, or prone position. The exact position may vary slightly to allow for the configuration of an individual's body. Any of these positions are suitable for stationary targets. In general, the most suitable positions for engaging moving targets are standing and kneeling. Situation, terrain, and gunner preference should govern the

selection of the best position. Whenever possible, support should be used to stabilize the gunner's aim.

Standing Position

The standing position (fig. 14-38) is similar to that of firing a rifle. Face the target, execute a half-right face, spread your feet a comfortable distance apart, and place the launcher on your right shoulder; your body should be well-balanced with your hips level. Your left hand



Figure 14-38.—Standing position.

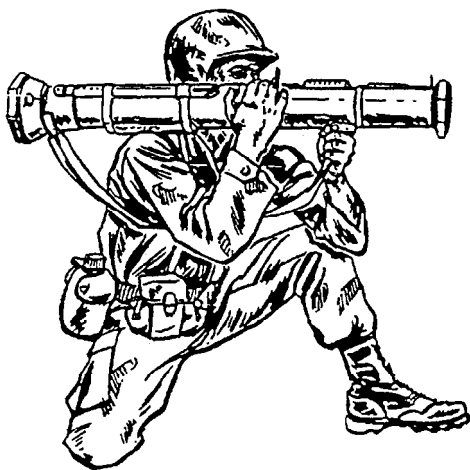

Figure 14-39.—Kneeling position.

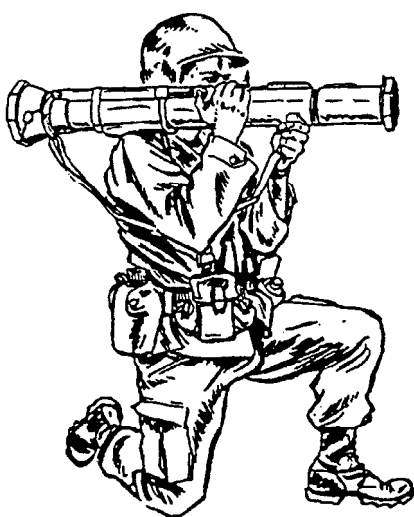

Figure 14-40.—Modified kneeling position.

should be directly under the front of the launcher, grasping the carrying sling. Your left elbow should be placed against your body for stability. Grasp the firing mechanism with your right hand and keep your right elbow placed tightly against the body.

Advantages— Freedom of movement for tracking targets.
Good visibility.

Disadvantage— You are a good target.

Kneeling Position

The kneeling position (fig. 14-39) is similar to the kneeling supported position for firing a rifle. To assume this kneeling position, first assume the standing position. Kneel on the right knee and point your left leg

toward the target. Keep your left foot at a right angle to and opposite your right knee, forming a right angle to the ground with your left leg. Sit back on your right heel, while shifting the weight forward. Rest your left elbow just forward of your left knee. Avoid bone-to-bone contact. Hold your right elbow firmly against your body.

Advantage— Stable firing position.

Disadvantage— Limited movement for tracking.

Modified Kneeling Position

The modified kneeling position (fig. 14-40) is the best for tracking moving targets. To get into this position for engaging moving targets, first assume the standing position. Kneel on your right knee, keeping the thigh of your right leg vertical. Keep your buttocks and back straight. Point your left leg toward the target, keeping your left foot at a right angle to and opposite your right knee. Keep your left thigh parallel to the ground. Keep your elbows tucked against your sides.

Advantage— Freedom of movement for tracking.

Disadvantage— Unstable firing position.

Use either position when firing at stationary or moving targets; however, the modified version allows tracking similar to the standing position. Maximum use of protective barriers and supported positions is essential with the kneeling positions to increase stability and reduce vulnerability.

Sitting Position

There are two sitting positions that are suitable for firing at stationary targets and are more stable than the kneeling positions.

1. For the sitting position (fig. 14-41), keep the launcher pointed toward the target and execute a



Figure 14-41.—Sitting position.

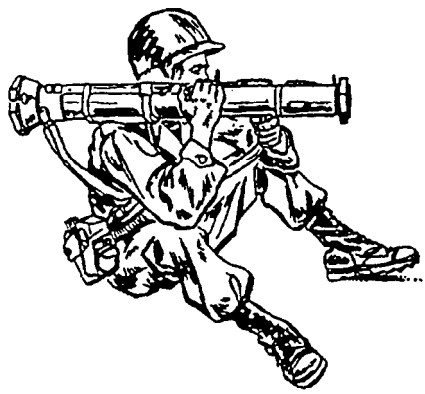

Figure 14-42.—Modified sitting position.

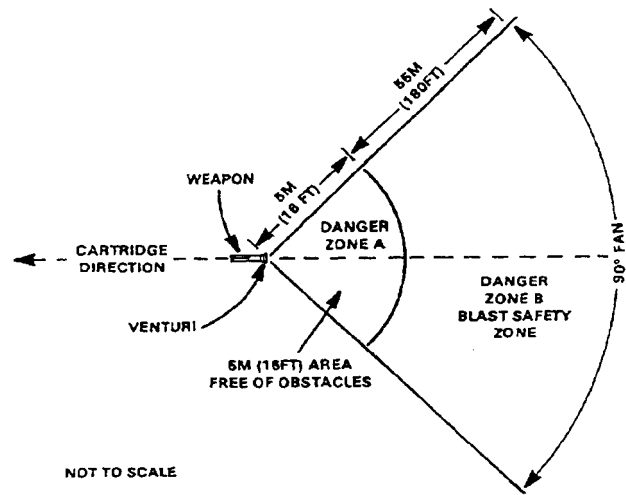

Figure 14-44.—Backblast danger zones.



Figure 14-43.—Prone position.

half-left face. Sit with your legs crossed, and place the launcher on your right shoulder. Place your right hand on the firing mechanism and grasp the carrying sling with your left hand. Lean slightly forward from the hips, and rest your elbows forward of your knees to avoid bone-to-bone contact.

2. To assume the modified sitting position (fig. 14-42), keep the launcher pointed toward the target and execute a half-left face. Sit with your legs partly extended and well apart; place the launcher on your right shoulder. Dig your heels into the ground as in the conventional rifle position. Rest your elbows forward of your knees to avoid bone-to-bone contact.

Advantages— Stable firing position.
You are a small target.

Disadvantages— Restricted movement.
Limited visibility.

Prone Position

To assume the prone position (fig. 14-43), first lay the launcher on the ground, pointed toward the target. Then lie on your stomach at an angle of not less than 90 degrees to the line of fire to keep your body clear of the backblast. Your body should be straight, and your right leg should be directly on a line running through your right hip and right shoulder. Move your left leg to the left as far as possible without discomfort. Keep both heels close to the ground. Place the launcher on your right shoulder and place both elbows under the launcher. Hold your head steady with your right eye lined up with the sights. Tracking a moving target from the prone position is not recommended. The firer's movement is limited. Your legs and feet could be injured by the backblast by changing the position of the launcher.

Advantages— Very stable firing position.
You are a small target.

Disadvantages— Limited movement for tracking.
Limited elevation of the launcher.
Poor visibility.

GENERAL SAFETY PRECAUTIONS

The following precautions are necessary to prevent injury to personnel and damage to material:

1. Take care in selecting positions for firing. Avoid areas that could cause you to fire through a screen of

brush or trees. Impact with a twig or branch may deflect the rocket or cause it to detonate. You must try to obtain concealment, but not at the risk of safety.

2. To prevent the rocket from striking the foreground and causing serious injury to personnel, maintain the launcher in the firing position until the rocket has left the launcher.

3. Avoid the blast of flame and ejected residue to the rear of the launcher. Remove flammable material,

such as dry vegetation, from the backblast area (fig. 14-44). Keep personnel and ammunition clear of the rear danger area unless adequate shelter protection is provided. Sand or loose dirt in the backblast area can also reveal your position to the enemy.

4. Do not fire rockets at temperatures below -40°F or above 140°F .

5. Never fire a damaged weapon.

APPENDIX I

GLOSSARY OF COMMON MILITARY TERMS

- ADDRESSEE**— The activity or individual to whom a message is to be delivered.
- ADJUST**— A command to the spotter or observer to initiate an adjustment on a designated target.
- ADJUSTMENT**— Process used to obtain correct line, range, and connect height of burst (if time fuzes are used) in engaging a target by observed fire.
- ADMINISTRATIVE PLAN OR ORDER**— A combat plan or order relating to the operation plan or order for a tactical operation, that is issued as its paragraph 4. It sets forth information and instructions governing the logistical and administrative support of the operation.
- ADVANCE**— The forward movement of a unit toward the enemy.
- ADVANCE BY BOUNDS**— An advance controlled by the assignment of successive objectives, usually from one terrain feature to the next.
- ADVANCE GUARDS**— A security element that precedes and protects the main body of a force, whatever its formation, and covers its deployment for action if enemy contact is made.
- ADVANCE PARTY**— A security element organic to the advance guard that precedes and protects the support.
- ALIGNMENT**— The formation in a straight line of several elements.
- ALTERNATE POSITION**— The position designated to serve as the primary position under certain conditions.
- AMPLIFIER**— A device that increases signal power.
- ANGLE OF ELEVATION**— The vertical angle between the line from the muzzle of a weapon to the target and the axis of the bore when the weapon is laid for range.
- ANNEX**— A document appended to and forming a part of a complete plan, order, or other document.
- ANTENNA**— An electrical conductor, or system of conductors, used to transmit or receive radio waves.
- ANTIGUERRILLA OPERATIONS**— Operations conducted by conventional forces against guerrilla forces in rear areas at the same time the conventional force is engaged in conventional combat operations in the forward areas.
- APERTURE SIGHT**— A lensless sight by which the target is viewed through a hole, or aperture (as contrasted with an open sight having only a V-cut notch).
- APPROACH MARCH**— The advance toward the enemy from the point where the zone of hostile artillery or other distant fire is entered.
- AREA DEFENSE**— A form of defense oriented toward the retention of specific terrain; area defense relies mainly on deployed forces that fire to stop and repulse the attacker.
- AREA OF CONCENTRATION**— A limited area on which a volume of fire is placed within a limited time.
- ASSAULT**— The final step of the attack phase; the rush to close combat with the enemy and to drive him out in hand-to-hand combat with the extensive use of bayonets and hand grenades.
- ASSAULT POSITION**— A position located between the line of departure and the object.
- ASSEMBLY**— Two or more parts fastened together and not usually disassembled except for replacement.
- ASSEMBLY AREA**— The area where a command assembles preparatory to making a move.
- ATTACHED**— A unit is attached to another when command, operational, and administrative control of the attached unit passes from its parent unit to the commander of the unit to which attachment is made.
- ATTACK**— A phase of offensive combat; offensive action directed against the enemy with the intent to kill, capture, or drive him from his position.
- ATTACK POSITION**— The most forward covered and concealed position in rear of the line of departure occupied by assault units for the minimum amount of time necessary to coordinate final details and preparations for the attack.

AUTOMATIC— The self-powered action of a weapon, using recoil, gas, or blowback operation, that produces a rapid and continuous burst of shots while the trigger is depressed.

AXIS OF THE BORE— An imaginary centerline of the bore of a gun.

AZIMUTH— A direction in a horizontal plane.

BARRAGE— Final protective fires of indirect fire weapons.

BARREL— A metal tube used to direct the bullet in its line of flight.

BASE (BASE UNIT)— The element or unit in a tactical operation around which a movement or maneuver is planned and performed.

BASE OF FIRE— One or more units that give supporting fire to an attacking unit and serve as the base around which attack operations are carried out.

BATTALION FORWARD DEFENSE AREA— Portion of a battle area defended by front-line companies; it extends to the limit of the rearward extension of lateral boundaries of the front-line companies.

BATTERY— The position of a weapon when cocked and its recoiling parts are forwarded.

BATTLE AREA— The area in which the forward forces and their reserves are located; it is described by coordinating points, flank boundaries, and sometimes a rear boundary.

BATTLE POSITION— The position on which the main effort of defense is, or is to be made.

BEACHHEAD— A designated area on a hostile shore or territory which, when seized and held, ensures the continuous landing of troops and material, and provides maneuvering space for subsequent projected operations into enemy territory; the physical objective of an amphibious or airborne operation.

BEATEN ZONE— The area on the ground or target on which the shots forming the cone of dispersion strike.

BLADE— The front sight; usually a small piece of metal used in conjunction with the rear sight for sighting the target.

BLOWBACK— The energy produced in a weapon by expanding gases and powder; it forces the cartridge case rearward out of the chamber.

BOLT— A mechanical device for blocking the breech and holding the cartridge in the chamber during firing to prevent rearward escape of gases.

BORESIGHTING— A process by which the axis of a gun bore and the line of a gunsight are made parallel or are made to converge on a point.

BOUNDARIES— The battalion and company defense areas that are limited because of terrain features and avenues of approach.

Company boundaries immediately forward of the FEBA assign responsibility for an avenue of approach to a company, preferably the company most threatened by the avenue. Boundaries between companies extend forward of the FEBA, but stop short of the combat outpost line (COPL). They extend to the rear far enough to provide sufficient area for the companies to organize their defense in depth.

Establishing rear boundaries may become necessary during fluid operations when infiltration and guerrilla activities are possible. Rear boundaries help the company coordinate and control its maneuvers and fires.

BREECH— The rear end of the barrel.

BREECHBLOCK or BREECH MECHANISM— The metal block used to seal the rear end of the bore against the force of the charge; in small arms, the breech mechanism is the bolt.

BRIDGEHEAD— An area of ground taken and held in enemy territory.

BULLET— The projectile of a small-arms cartridge that is discharged from a weapon toward a target.

BURST OF FIRE— A number of shots fired automatically with a single squeeze of the trigger.

BURSTING CHARGE— The force of an explosive that breaks the casing of a projectile to produce a demolition, fragmentation, or chemical action.

CADENCE— A rhythmic rate of march at uniform step.

CALIBER— The diameter of the bore measured from land to land; usually expressed in decimal fractions of an inch.

CAM— An inclined surface that imparts a desired motion to a sliding piece. (This is a generalized small-arms definition.)

CANNIBALIZATION— The act of taking apart or parts from an unserviceable piece of equipment to make another piece of equipment serviceable.

- CARTRIDGE**— A small-arms round ready for firing; its components are the cartridge case, primer, propellant, and bullet.
- CARTRIDGE CASE**— A metal case that houses the primer and propellant and holds the bullet.
- CHAMBER**— The enlarged part of the bore at the breech that holds the cartridge.
- CHAMBERING**— The process of placing a round into the chamber of a weapon after it has been fed into the weapon.
- CHANNEL**— An electrical path over which transmissions can be made from one station (unit) to another.
- CHARGE**— A part of the fire command that established the amount of propellant to be used with a shell.
- CHECKPOINT**— An easily identifiable point on the terrain that is used in controlling movement or reporting locations of friendly units.
- CIRCUIT**— A communications link between two or more points.
- CIVIC ACTION**— The use of military forces on projects that contribute to the economic development of the local population. The projects concern education, training, public works, agriculture, transportation, communications, health, sanitation, and others.
- CLANDESTINE (SECRET) OPERATION**— Intelligence, counterintelligence, and other similar activities sponsored or conducted by governmental departments or agencies using secret or illicit means against another nation.
- CLIP**— A device that holds cartridges so they can be loaded into a weapon.
- CLOSE AIR SUPPORT**— Air operations against the enemy executed at very close range to friendly front lines.
- CLOSE COMBAT**— Hand-to-hand fighting with weapons, such as bayonets, hand grenades, service rifles, or pistols.
- COCKING**— The phase of operation that pertains to the locking of the hammer or firing assembly, slide assembly, or bolt group in a fixed (or held) position under spring tension and with all parts in position. Depressing the trigger allows the firing pin to strike the primer.
- COLUMN**— A formation in which the elements are placed one behind the other; a section or platoon is in column when its squads are in column and abreast.
- COMBAT ORDER**— An order issued by a commander for a combat operation specifying time and date of execution.
- COMBAT OUTPOST**— A security element for a battalion defensive position located approximately 1,000 to 2,500 yards forward of the main line of resistance; its primary purpose is to engage the enemy.
- COMBAT PATROL**— A patrol whose primary mission is to engage actively in combat with the enemy and whose secondary mission is to gain information about the enemy and the terrain.
- COMBAT PLAN**— A plan issued for a combat operation that may be effective immediately for planning purposes or for specified preparatory action. It is not put into execution until directed by the commander in a separate order of execution or until certain specified conditions are determined to exist. When its execution is directed, a combat plan becomes, in effect, a combat order.
- COMMAND POST (CP)**— The location of a unit's headquarters from which the commander and the staff operate.
- COMMUNICATIONS CENTER**— An agency that is responsible for the receipt, transmission, and delivery of messages.
- COMMUNICATIONS NETWORK**— A system consisting of a number of designated stations connected with one another by any means of communications.
- COMMUNICATIONS SECURITY**— The protection by all measures to deny unauthorized persons information of value that might be derived from a study or receipt of communications.
- COMPANY FORWARD DEFENSE AREA**— Portion of a battle area defended by front-line platoons; it extends laterally to the company boundaries, forward to the FEBA, and rearward to the supplementary positions required by the front-line platoons.
- CONCEALMENT**— The protection from observation Only.
- CONNECTING ELEMENT**— A file or group of personnel whose mission is to maintain contact between elements of a command.

CONSOLIDATION— A phase of offensive combat consisting of the hasty assumption of the defense and reorganization on the seized objective.

COOK OFF— A cook off is a functioning of any or all of the explosive components of a cartridge or shell caused by a weapon that has become very hot from continuous firing.

CORRIDOR— A strip of land forming a passageway between two opposing forces; in battle, no man's land.

COUNTERATTACK— An attack by a part or all of a defending force against an enemy attacking force. The specific purpose of the attack is to regain ground lost or to cut off or destroy enemy advance units. The general objective of the attack is to deny friendly territory to the enemy.

COUNTERRECOIL— The return of a breech mechanism to battery position after it has reached recoil limit. In small-arms weapons, it is usually accomplished by the release of compressed springs.

COUNTERSLOPE— A position located on the forward slope of the next elevation to the rear of the main line of resistance.

COVER— Any object that gives protection from enemy fire.

COVERT OPERATIONS— Operations that are so planned and executed as to conceal the identity of the sponsor.

CRITICAL TERRAIN— Terrain—the possession of which is vital to the accomplishment of the mission.

CRYSTAL— A natural substance, such as quartz or tourmaline, that is used to control the frequency of radio transmitters.

CYCLIC RATE OF FIRE— The theoretical number of rounds a weapon can fire in 1 minute, disregarding the limits of overheating and the capacity of the magazine.

CYLINDER— The chamber in which the piston moves in gas-operated weapons.

DANGER SPACE— The area between the muzzle of a direct fire weapon and the point of impact of its projectile (not to exceed the height of an average standing man).

DATE-TIME GROUP (DTG)— The date and time that identifies when a message is prepared for transmission. The DTG is expressed in six digits followed by a zone suffix—the first pair of digits

denotes the date, the second pair the hours, and the third pair the minutes.

D-DAY— The day on which an operation commences or is to commence.

DEAD SPACE— The area within the maximum range of a weapon that cannot be covered by fire from a particular position because of intervening obstacles or because of the nature of the ground.

DEBARKATION— The unloading of troops, equipment, or supplies from a ship or aircraft.

DEFENSIVE POSITION— A portion of a defense area physically occupied by troops and weapons.

DEFILADE— A position protected from hostile ground observation and fire by a mask.

DEFILE— A narrow place or space, such as a mountain pass, a ford, or a bridge, that restricts the advance of a force on a wide front or its movement to the sides.

DEFLECTIONS— The setting on the scale of a gunsight to place the line of fire in the direction desired; the horizontal clockwise angle between the axis of the bore and the line of sighting.

DELAYING ACTION— A form of defensive action used to slow up the enemy's advance (without becoming decisively engaged) to gain time.

DEPLOYMENT— An extension of width or depth of a unit or both; how a unit is organized for combat.

DEPTH— The distance from front to rear of an element, formation, or position.

DIRECT FIRE— Fire delivered by a weapon sighted directly at the target.

DIRECT SUPPORT— The support given directly to a specific force in response to its request for assistance.

DISPERSION— The spreading of troops and material over a wide area to avoid offering the enemy a concentrated target; a scattered pattern of hits of bombs dropped under identical conditions or of shots fired from the same gun with the same firing data.

DISPLACEMENT— The movement of supporting weapons or elements from one position to another.

DISTANCE— Space between elements in the direction of depth. Between individuals, it is the space between your chest and the person to your front.

DOUBLE ACTION— An action of depressing the trigger, as in revolvers, that cocks the hammer and then releases it to fire the weapon. Both occur on one pull of the hammer.

DOUBLE TIME— Cadence at 180 steps (36 inches in length) per minute.

DUMP— An area used for the temporary storage and disbursing of military supplies.

ECHELON— A subdivision of a headquarters, such as forward echelon or rear echelon; a separate level of command; a fraction of a command in the direction of depth to which a principal combat mission is assigned, such as attack echelon, support echelon, or reserve echelon; a formation in which the elements are placed one behind another, extending beyond and unmasking one another wholly or in part.

EJECTION— The process of expelling the empty cartridge case from a weapon through the use of an ejector.

EJECTOR— The part that expels the empty cartridge case from the receiver of a weapon; it may be fixed, spring-loaded, or movable.

ELEMENT— An individual squad, section, platoon, company, or another unit that is part of a larger unit.

EMBARKATION— The loading of troops, equipment, or supplies into a ship or aircraft.

EMPLACEMENT— A prepared position from which a weapon executes its fire mission.

ENFILADE FIRE— Fire delivered so the long axis of the beaten zone coincides with the long axis of the target.

ENVELOPMENT— An attack made on one or both of the enemy's flanks or rear; usually accompanied by an attack on his front.

EROSION— The wearing away of the inner surface of a gun barrel as a result of mechanical wear and the chemical action of powder gases.

EVACUATION— The process of moving casualties from a battlefield and subsequently of moving them along the chain of evacuation, as necessary; the clearance of personnel or material or both from a given locality.

EVASION AND ESCAPE (E&E)— The procedures and operations whereby military personnel and other selected individuals are enabled to emerge from an

enemy-held or hostile area to areas under friendly control.

EXPLOITATION— The last phase of offensive combat that follows the reorganization of the attacking unit on the objective. In this phase of combat, the attacking unit may be directed to continue the attack, to pursue the enemy, or to mop up.

EXTRACTION— The phase of operation that deals with the removal of the empty cartridge case from the chamber of an extracting device before ejection.

EXTRACTOR— The part that withdraws the empty cartridge case from the chamber of a weapon.

FEBA (FORWARD EDGE OF THE BATTLE AREA)— An imaginary line joining the forward edges of the most advanced defensive positions of the battle area.

FEEDING— The mechanical positioning of an individual round for subsequent insertion into the chamber of a weapon during the cycle or operation.

FIELD FORTIFICATION— Entrenchments, emplacements, and obstacles constructed in the field to increase the natural defensive strength of the terrain.

FIELD OF FIRE— The area that a weapon or group of weapons covers effectively with fire.

FIELD STRIPPING— Removal of the groups from a weapon; does not include disassembly of groups.

FILE— A single column of men or vehicles, one behind the other.

FINAL PROTECTIVE FIRES— The "all-out" fires of the defending unit fired as the enemy approaches close to the front-line positions.

FINAL PROTECTIVE LINE— A line along which interlocking bands of grazing fire are placed to stop enemy assaults. The line is placed at a predetermined distance from all available weapons fixed in direction and elevation that are capable of delivery under conditions of visibility.

FIRE AND MANEUVER— The close coordination of the movement of a unit with its own fire or the fire of supporting weapons. This coordination enables a portion of the unit to move forward, while the remaining portion covers the forward movement by fire.

FIRE CONTROL— All operations connected with the preparation and application of fire to a target.

FIRE DIRECTION CENTER— The element of a command post, consisting of gunnery and communication personnel and equipment, by means of which the commander exercises fire direction and fire control.

FIRE MISSION— A target assigned to a unit or personnel manning a certain weapon or weapons with instructions as to the time and method of firing and placing fire on the target.

FIRE UNIT— A unit whose fire is under the immediate and effective control of one leader.

FIRING MECHANISM— The parts of a weapon that move together to cause the cartridge primer to be struck when the trigger is depressed.

FIRING POSITIONS— Defensive positions from which fire missions are carried out; they are designated primary, alternate, or supplemental

FIXED FIRE— Fire delivered on a point target.

FLANK— The right or left extremity of a unit; the element on the extreme right or left of the line; a direction at right angles to the direction a unit is facing.

FLANK GUARD— A security detachment that protects the flank of a body of troops on the march.

FLANKING FIRE— Fire delivered at right angles to the enemy flank.

FLAT TRAJECTORY— A trajectory having little or no curvature.

FORMATION— Arrangement of the elements of a unit in line, in column, or in any other prescribed manner.

FORWARD DEFENSE AREA— Portion of a battle area defended by front-line companies or platoons.

FORWARD SLOPE— The slope of elevated terrain in the direction of the enemy.

FREQUENCY— The band on which a unit is to operate its radio communications.

FRONT— The line of contact of two opposing forces; the length of space of an element or formation measured from one flank to the other; the direction of the enemy.

FRONTAL FIRE— Fire delivered perpendicular to the enemy (across his front).

FUZE— A device for setting off an explosive charge; a command or request to indicate the type of fuze

action desired, such as delay, quick or time for the 60-mm mortar.

GAS OPERATED— The small-arms principle by which gas pressure from a fired cartridge activates the operating parts of a weapon using a piston and cylinder arrangement.

GAS PORT— A small hole drilled in the barrel to allow the expanding gases to strike the piston in the cylinder of a gas-operated weapon; sometimes called a vent.

GENERAL SUPPORT— The support given to a force as a whole and not to any particular subdivision thereof.

GRAZING FIRE— Fire in which the trajectory does not rise higher than the height of a man standing.

GRENADE SUMP— A circular hole large enough to accept the largest known enemy grenade; it slopes downward under the fire step in the fighting hole. Hand grenades thrown into the fighting hole are exploded in this sump; their fragmentation is restricted to the unoccupied end of the fighting hole.

GROOVES— The depressed areas between the lands (raised surfaces) in the bore; the cutaway portion of the rifling into which the jacket or rotating band of a bullet fits to impart rotation to the bullet in its line of flight.

GROUND ZERO— The point on the ground or directly above at which a nuclear weapon has exploded.

GROUP— Two or more parts or assemblies that either function together in a gun or are so closely related to one another that they should be considered as a unit.

GUERRILLAS— Combatants that are members of an organized and recognized military force whose activities normally are directed to harassing, delaying, or disrupting opposing forces; they normally wear civilian clothes.

GUIDE— The individual (base) upon which a formation, or an element thereof, regulates its march.

HAMMER— A lever that is swung around by spring pressure to strike the firing pin of a weapon.

HANGFIRE— A delay in the functioning of a propelling charge explosive train at the time of firing. In most cases the delay, though unpredictable, ranges from a split second to several minutes.

HEAD— The leading element of a column.

HEADSPACE— In small-arms weapons, the distance between the face of the bolt and the base of the cartridge when it is fully chambered and the bolt is locked.

H-HOUR— The hour an attack is to be launched, an assault wave is to land, or a movement is to begin.

INDIRECT FIRE— Fire delivered at a target that cannot be seen from the gun position.

INFILTRATE— To pass troops in relatively small numbers through an opening in the enemy's position or his field of fire or through territory occupied by other troops or organizations.

INITIAL POINT— A place at which various subdivisions of a command are required to arrive at the proper time to join a marching column.

INSURGENCY— Subversive political activity, civil rebellion, revolt, or insurrection designed to weaken and overthrow a duly constituted authority by its own people.

INSURRECTION— A rising up against an established authority by its own people.

INTERFERENCE— Natural or man-made radiation of electrical energy that causes difficulty in reception of radio signals.

INTERVAL— The lateral space between elements on the same line.

JAMMING— Deliberate interference intended to prevent reception of radio signals in a specific frequency band.

KEY TERRAIN— Land, the possession of which could prove decisive in combat.

LANDS— The spiral raised surface in the bore of a weapon.

LEAF SIGHT— A type of metallic sight in which the aperture is raised to operating position by being swung upward on a hinged leaf.

LEFT (RIGHT) FLANK— The extreme left (right) element or edge of a body of troops in relation to the enemy, regardless of the direction in which the body of troops is facing.

LIMITING POINT— The point along a line of resistance where the responsibility of one unit stops and that of another begins. Limiting points are placed on the boundaries between companies to indicate specific localities on the ground where the

battalion command wishes the company commanders to coordinate their defense.

LINE— A formation in which the elements are abreast, except that a section or platoon is in line one behind the other when its squads are in line.

LINE OF DEPARTURE— A line designated to coordinate the departure of attack elements.

LISTENING POST— A one- or two-man post located forward of the battle position for the purpose of listening for enemy activity.

LOADING— The manual procedure of inserting a magazine, clip, belt, or single round into a weapon or its feeding mechanism and the subsequent action for feeding, cambering, or cocking; the physical placing of personnel, equipment, or supplies aboard their carriers.

LOCAL SECURITY— A security element, independent of any outpost, established by a commander to protect his unit against surprise and to ensure its readiness for action.

LOCKING LUGS— Metal projections on the bolt that cam into recesses cut in the sides of the receiver to lock a weapon before firing.

LOCKING RECESSES— Spaces cut in the side of the receiver into which the locking lugs of the bolt are rotated into locking position.

MACHINE GUN— An automatic, rapid-fire weapon that is fired from a mount.

MAGAZINE— A device that stores and supplies ammunition and feeds the ammunition by means of its own spring and follower.

MAIN ATTACK— The part of an attack where the commander concentrates the greater portion of offensive power.

MAIN LINE OF RESISTANCE— An imaginary line along the forward edge of the battle position designed to coordinate the fires of all units and supporting weapons.

MALFUNCTION— The failure of a weapon to function satisfactorily.

MARCH OUTPOST— A security echelon established by a unit on a march during short halts.

MARK— Call for fire on a specified location to orient the spotter or observer or to indicate targets.

MASK— A natural or artificial obstruction that gives shelter from or interferes with observation or fire.

MAXIMUM ORDINATE— The highest point of trajectory.

MEANS OF SIGNAL COMMUNICATION— The means by which a message is conveyed from one person or place to another.

MESSAGE— Any thought or idea expressed in brief form or in plain or secret language; prepared in a form suitable for transmission by any means of communication.

MILITARY CREST— The highest point near the top of a slope from which the entire valley below is visible.

MISSION— The specific task or duty assigned to an individual, weapon, or unit.

MOUNT— The stand on which a weapon is secured to hold it in position for rapid fire. A mount is either fixed (immovable) or flexible (movable). A flexible mount permits the weapon to move in azimuth and elevation.

MUZZLE— The front or forward end of the barrel; the mouth of the barrel.

MUZZLE VELOCITY— The speed at which a bullet travels when it leaves the muzzle of the barrel.

NAVAL LANDING PARTY— A force of naval personnel organized from a ship's complement for the conduct of ground-force operations ashore.

OBJECTIVE— The physical object of the action taken or the effect desired.

OBLIQUE FIRE— Fire delivered from a direction that is diagonal to the long axis of the target; or fire delivered on an enemy from a direction that is between his front and flank.

OBSERVATION POST (OP)— A vantage point from which enemy activity in front of the FEBA is observed.

OBSTACLE— Any barrier-natural or artificial-that stops or impedes the movement of a unit.

OPERATION PLAN OR ORDER— A combat plan or order dealing with tactical operations and setting forth the mission of the unit; it deals with the commander's decision, plan of action, and such details as to the method of execution as will ensure coordinated action by the whole command.

OPTICAL SIGHT— A sight having lenses as contrasted with one having an aperture or open sight.

ORGANIC— Assigned to and forming an essential part of a military organization.

ORIGINATOR— The command by whose authority a message is sent.

OUTGUARD— The principal security element of a combat outpost.

OUTPOST— A stationary body of troops placed at some distance from the main body while at a halt or in a defensive position. These troops protect the main body from surprise, observation, or annoyance by enemy ground forces.

OUTPOST LINE OF RESISTANCE— A line passing through the forward edge of the outpost positions and designed to coordinate the fires of the elements of the outpost and its supporting fires.

OVERHEAD FIRE— Fire delivered over the heads of friendly troops.

OVERLAY— A transparent or translucent medium upon which special military information has been plotted at the same scale of a map, photograph, or other graphic.

PACE— The length of a full step in quick time; 30 inches.

PARTISAN— A devoted adherent to a cause generally nationalistic in nature; the adherent may not be an armed combatant and is not normally a member of an organized military force.

PASSAGE OF LINES— A rearrangement of units in which the rear unit moves forward through the already established line, while the replaced unit remains in position or moves to the rear.

PATROL— A detachment sent out by a larger unit for the purpose of gathering information or carrying out a destructive, harassing, mop up, or security mission.

PA— A part of the feeding device on a machine gun that permits feeding of the ammunition belt into the weapon; it holds the belt securely so it does not move in reverse direction.

PENETRATION— An attack that puts the main attacking force through the enemy's principal defensive position.

PHASE LINE— A line used for control and coordination of military operations; it is usually a terrain feature extending across the zone of action.

PIECE— Any firearm.

PLUNGING FIRE— Fire that strikes the ground at a sharp angle.

- POINT**— The security element that forms the leading element of an advance guard or the rear element of an advance guard or the rear element of the rear guard.
- POINT OF DEPARTURE**— The point on the line of departure at which an attacking force in column crosses.
- POINT OF DRESS**— The point toward which all elements of a unit establish their alignment.
- POLITICAL WARFARE**— Aggressive use of political means to achieve national objectives.
- POSITION**— The location of a gun, unit, or individual from which fire can be delivered upon a given target.
- POST**— The prescribed limits of a sentry's responsibility.
- PREARRANGED FIRE**— Supporting fire for which the fire data is prepared in advance. It is delivered on a time schedule or on call from the support troops.
- PRINCIPAL DIRECTION OF FIRE (PDF)**— A specific direction within the sector of fire of a flat-trajectory weapon, which is designated as its primary fire mission. Within a rifle platoon, automatic weapons are assigned a PDF. Units are not assigned PDFs nor can a weapon be assigned more than one PDF.
- PROBABLE LINE OF DEPLOYMENT**— The location on the ground where the commander of a force plans to complete final deployment before moving out with squads as skirmishers.
- PROPAGANDA**— Any information, ideas, doctrines, or special appeals spread to influence the opinions, emotions, attitudes, or behavior of any specified group to benefit the sponsor, either directly or indirectly.
- PROPELLING CHARGE**— An explosive that throws the projectile from a gun.
- PROTECTIVE FIRE**— Fire delivered by supporting weapons and directed against the enemy for the purpose of hindering his fire or movement against friendly attacking units.
- QUICK TIME**— Cadence at 120 steps (12, 15, or 30 inches in length) per minute.
- RADIO CHANNEL**— A band of adjacent frequencies having sufficient width to permit its use for radio communications.
- RAID**— An operation, usually small scale, involving a swift penetration of hostile territory to secure information, confuse the enemy, or destroy his installations. The operation ends with a planned withdrawal upon completion of the assigned mission.
- RANK**— A line of men or vehicles placed side by side; officer's grade or position.
- REAR**— The direction away from the enemy.
- REAR AREA**— The area in the rear of the combat and forward areas.
- REAR GUARD**— The security element that follows and protects the rear of a marching force.
- REBELLION**— Organized, armed, open resistance to the authority or government in power.
- RECONNAISSANCE PATROL**— A patrol whose mission is to gain information about the enemy and the terrain.
- REGISTRATION**— The adjustment of fire to determine firing corrections.
- RELAY**— A transmission forwarded through an intermediate station.
- RELEASE POINT**— A point at which a higher command releases control of a unit to its commander.
- RELIEF OF FRONT-LINE UNITS**— A rearrangement of units in which the rear unit moves forward to the battle position and occupies the defensive positions there; at the same time the forward unit in the battle position relinquishes these positions and moves to the rear.
- REPEAT**— A command or request to fire again the same number of rounds with the same method of fire.
- RESERVE**— An element of the battalion or higher unit held initially under the control of the commander as a maneuvering element to influence future action.
- RESERVE AREA**— The area that extends from the rear of the forward defense area to the rear of the battle area. The RESERVE FORCE is located in the reserve area.
- RETIREMENT**— An operation in which a force withdraws without enemy pressure to avoid combat under the existing situation.
- RETROGRADE MOVEMENT**— Any movement of a command to the rear, or away from the enemy,

- whether forced by the enemy or voluntary, including a withdrawal, retirement, or delaying action.
- REVERSE SLOPE**— Any slope that descends away from the enemy.
- REVOLT**— A casting off of allegiance or a refusal to submit to established authority.
- REVOLUTION**— A rebellion that succeeds in overthrowing an old government and establishing a new one.
- RIGHT (LEFT) FLANK**— The extreme right (left) element or edge of a body of troops in relation to the enemy, regardless of the direction in which the body of troops is facing.
- ROADBLOCK**— A barrier or obstacle to block or limit the movement of hostile vehicles along a road.
- ROUTE MARCH**— The advance in column on roads.
- SCREEN FIRE**— A curtain of smoke that protects a force from enemy ground observation.
- SEARCHING FIRE**— Fire distributed in depth by successive changes in elevation of a weapon.
- SECTION**— A military unit that is smaller than a platoon and larger than a squad; the basic tactical unit in the weapons platoon of the rifle company.
- SECTOR**— A clearly defined area that a given unit protects or covers with fire.
- SECTOR OF FIRE**— A section of terrain designated by boundaries that is assigned to a unit or to a weapon to cover by fire.
- SECURITY**— Measures taken by a command to protect itself from espionage, observation, sabotage, annoyance, or surprise.
- SECURITY AREA**— The area forward of the FEBA assigned to a battalion or company. A battalion's security area extends to whatever distance security forces, uncontrolled by the battalion, are employed. A company's security area extends 400 to 500 yards (maximum effective range of small-arms fire) to the most forward extension of the company's lateral boundary.
- SHOCK ACTION**— Actual hand-to-hand combat between opposing troops; an offensive movement by fast-moving forces in which they tend to overrun the enemy by the force of their own momentum.
- SHORT**— A spotting or an observation used by a spotter or an observer to indicate that a burst fell SHORT of the TARGET in relation to a line perpendicular to the spotting line.
- SITREP**— A situation report.
- SKETCH**— A hasty, pictorial drawing showing only desired map features and objects in relative position; usually for a specific use.
- SKIRMISHERS**— A line of troops in extended order during a tactical exercise or attack.
- SNAP**— In commands or signals, the quality that inspires immediate response.
- STATIC**— Any electrical disturbance caused by atmospheric conditions. Interferes with radio communications.
- STEP**— The distance from heel to heel between the feet of a marching man; normally 30 inches.
- SUPPLEMENTARY POSITION**— An extra position other than the designated primary or alternate position.
- SUPPLY POINT**— A point where supplies are issued (for example, depot, railhead, truckhead, airhead, or navigation-head).
- SUPPORT**— The action of a force that aids, protects, complements, or sustains another force according to a directive requiring such actions; a unit that helps another unit in battle; the reserve of a rifle company or platoon in the attack or defense; an element of a command that assists, protects, or supplies other forces in combat.
- SUPPORTING FIRE**— Fire delivered by weapons of supporting units to assist or protect a unit in combat.
- SUPPORTING WEAPONS**— Weapons other than those with which a rifle unit is normally equipped.
- TERRAIN**— An area of ground, considered as to its extent and natural features, in relation to its use in a particular operation.
- TOPOGRAPHICAL CREST**— The highest point on elevated terrain.
- TRAJECTORY**— The path described by a projectile in flight.
- TRAVERSING FIRE**— Fire distributed in width by successive changes in direction of a weapon.
- UNDERGROUND**— A civilian organization that supports the resistance movement through covert (secret) actions. Such actions include intelligence collection, subversion, sabotage,

terror, assassination, and dissemination of propaganda in areas denied to the guerrilla force.

UNIT— Any military force having a prescribed organization.

UNIT OF FIRE— A unit of measure for ammunition supply. It represents a specific number of rounds of ammunition per weapon.

WEDGE FORMATION— A tactical formation in the form of a *V* with the point toward the enemy; a

formation with elements in echelon to the right and left rear. Also called a *V*-formation.

WITHDRAWAL— A movement whereby a force disengages from an enemy force according to the will of the commander.

ZONE OF ACTION— Geographical area within which a military unit is to act, and for which it is responsible.

ZONE OF FIRE— An area into which a particular unit delivers, or is prepared to deliver, fire.

APPENDIX II

REFERENCES USED TO DEVELOP
THE TRAMAN

<u>References</u>	<u>Chapters</u>
<i>Communications</i> , Thirty-first Naval Construction Regiment, Naval Construction Battalion Center, Port Hueneme, Calif., 1988.	11
<i>Communications Handbook</i> , Landing Force Training Command, Atlantic, U.S. Marine Corps, Naval Amphibious Base Little Creek Norfolk Va., 1990.	11
<i>Disaster Recovery Training, Chemical, Biological, Radiological (CBR)</i> , Course A-494-0004, Naval Construction Training Center, Gulfport, Miss., 1989.	9
<i>Hospital Corpsman 3 & 2</i> , NAVEDTRA 10669-C, Naval Education and Training Program Management Support Activity, Pensacola, Fla., 1989.	10
<i>Interim Organizational and Intermediate Maintenance Manual for Machine Gun, 7.62mm, M60E3 and Mount, Tripod, Machine Guns, 7.62mm, M122</i> , TM 02705E-24 & P/2, Headquarters, U.S. Marine Corps, Arlington, Va., 1985.	13
<i>Lightweight Company Mortar 60mm, M224</i> , TM 9-1010-223-10, Headquarters, Department of the Army, Washington, D.C., 1987.	14
<i>M16A1 Rifle and Rifle Marksmanship</i> , FM 23-9, Headquarters, Department of the Army, Washington, D.C., 1989.	3
<i>Machine Gun, 7.62mm, M60E3 and Mount, Tripod, Machine Gun, 7.62mm, M122</i> , TM 02705E-10/1, U.S. Marine Corps Development and Education Command, Quantico, Va., 1985.	13
<i>Marine Rifle Squad</i> , Operational Handbook 6-6, U.S. Marine Corps Development and Education Command, Quantico, Va., 1983.	4

<u>References</u>	<u>Chapters</u>
<i>Operator's and Organizational Maintenance—including repair parts and tools for Land Mines</i> , TM 9-1345-203&P, Headquarters, Department of the Army, Washington, D.C., 1977.	12
<i>Operator's and Organizational Maintenance Manual for Radio Set AN/PRC-104(A)</i> , TM-11-5820-919-12, Headquarters, Department of the Army, Washington, D.C., 1986.	11
<i>Organizational, Direct Support and General Support Maintenance Manual including repairs parts and special tools for Launcher, Grenade, 40-mm, M203, W/E</i> , TM 9-1010-221-24&P, Headquarters, Department of the Army, Washington, D.C., 1985.	13
<i>Organizational Direct support, General support, and Depot Maintenance Manual for Machine Gun, Caliber .50: Browning, M2, and Tripod Machine Gun: M3</i> , TM 9-1005-213-25, Headquarters, Department of the Army, Washington, D.C., 1968.	13
<i>Radioman 3 & 2</i> , NAVEDTRA 10228-H1, Naval Education and Training Program Management Support Activity, Pensacola, Fla., 1986.	11
<i>The United States Marine Battle Skills Training/Essential Subjects Handbook</i> , P1500.44, Director Marine Corps Institute, Arlington, Va., 1989.	1 - 14

INDEX

A

- Action under flares, 4-4
- Airway obstruction, 10-2
 - abdominal thrust technique, 10-4
 - chest thrust technique, 10-4
 - head tilt or chin lift, 10-3
 - jaw thrust technique, 10-3
 - self-help, 10-5
- AN/CRP-104 radio set, 11-6
- AN/CRP-160 radio set, 11-3
- AN/GRA-39 radio set, 11-12
- AN/PRC-77 radio set, 11-2
- Antenna equipment RC-292, 11-15
- Artificial ventilation (breathing), 10-5
- AT4 (M136) 84-MM launcher and cartridge, 14-20
 - aiming, 14-29
 - ammunition, 14-21
 - controls, 14-22
 - destruction, 14-26
 - firing positions, 14-30
 - inspection before firing, 14-27
 - misfire procedures, 14-26
 - operation, 14-22
 - safety procedures, 14-32

B

- Barbed-wire entanglements, 8-1
 - barbed-steel tape, 8-4
 - barbed-wire, standard, 8-3
 - classification, 8-1
 - pickets, 8-6
 - site and layout, 8-1

- Booby traps, 12-12
 - countermeasures, 12-14
 - deadfalls, 12-14
 - explosive, 12-12
 - nonexplosive, 12-12
- Breathing, 10-5
- Browning machine gun (BMG), .50 caliber, 13-18
 - assembly, 13-24
 - characteristics, 13-18
 - disassembly, 13-20
 - headspace and timing adjustments, 13-28
 - operation, 13-26
- Burns and scalds, 10-29
 - chemical, 10-31
 - classification, 10-30
 - electrical, 10-32
 - thermal, 10-30
 - white phosphorous, 10-32

C

- Camouflage, 7-4
- Care and maintenance of clothing/equipment, 2-23
- CBR contamination, 9-3
 - biological symptoms, 9-5
 - chemical agent symptoms, 9-3
 - marking contaminated areas, 9-18
 - nuclear symptoms, 9-5
- CBR unit equipment, 9-15
- CBR weapon effects, 9-1
 - biological, 9-2
 - chemical, 9-1
 - nuclear, 9-2
- Circulation, 10-6

Civil engineer corps, 1-1
 Code of the U.S. Fighting Force, 1-22
 Cold weather injuries, 10-27
 frostbite, 10-28
 hypothermia, 10-27
 immersion foot (trench fret), 10-28
 Combat arm-and-hand signals, 11-33
 Concealment, 7-1
 dug-in emplacements, 7-2
 fresh soil, 7-1
 Concertina fence entanglements, 8-8
 basic considerations, 8-22
 defensive position requirements, 8-22
 portable barbed-wire obstacles, 8-20
 standard, 8-15
 ties, 8-11
 triple standard, 8-15
 wire installation, 8-12
 Counterambush, 4-22
 Countersigns, 11-40
 CPR, 10-6
 Crawling, 4-1

E

84-MM AT4 (M136) launcher and cartridge,
 14-20
 aiming, 14-29
 ammunition, 14-21
 controls, 14-22
 destruction, 14-26
 firing positions, 14-30
 inspection before firing, 14-27
 misfire procedures, 14-26
 operation, 14-22
 safety procedures, 14-32
 Evasion travel, 6-2

F

Field sanitation, 10-40
 garbage disposal, 10-41
 low-temperature (arctic) climates, 10-42
 pit latrines, 10-40
 urinals, 10-41
 water treatment, 10-42
 .50-caliber browning machine gun (BMG),
 13-18
 assembly, 13-24
 characteristics, 13-18
 disassembly, 13-20
 headspace and timing adjustments, 13-28
 operation, 13-26
 Fighting emplacements, 7-1
 First-aid rules, general, 10-1, 10-22
 Flares, trip, 12-12
 Formations, 4-5
 ambush, 4-21
 combat, 4-5
 patrol, 4-13
 rifle company, 4-11
 rifle platoon, 4-10
 rifle squad, 4-7
 weapons platoon, 4-12
 40-MM grenade launcher, M203, 13-1
 ammunition, 13-4
 clearing, 13-3
 leaf sight zeroing, 13-3
 loading and firing, 13-3
 misfire, hangfire, and stoppage, 13-4
 safety procedures, 13-5
 40-MM machine gun, MK 19 MOD 3,
 13-31
 ammunition, 13-32
 MK 64 mount and M3 tripod,
 13-31

- .45-caliber service pistol, 3-13
 - ammunition, 3-18
 - assembling, 3-15
 - field-stripping, 3-13
 - functioning, 3-16
 - loading and firing, 3-17
 - malfunctions, 3-17
 - safety procedures, 3-16
- Fractures, 10-33
 - pelvis, 10-40
 - skull, 10-38
 - spine, 10-39
- G**
- Grenade launcher, M203 40 MM, 13-1
 - ammunition, 13-4
 - clearing, 13-3
 - leaf sight zeroing, 13-3
 - loading and firing, 13-3
 - misfire, hangfire, and stoppage, 13-4
 - safety procedures, 13-5
- Grenades, hand, 12-1
 - characteristics, 12-3
 - safety, 12-8
 - throwing procedures, 12-4
 - types, 12-1
- H**
- Hand grenades, 12-1
 - characteristics, 12-3
 - safety, 12-8
 - throwing procedures, 12-4
 - types, 12-1
- Headquarters company, 1-11
- Heat exposure, 10-25
 - cramps, 10-26
 - exhaustion, 10-26
 - heatstroke, 10-26
- Hemorrhage, 10-18
 - controlling, 10-19
 - emergency situations, 10-22
 - tourniquets, 10-21
- Hitting the deck, 4-1
- K**
- KY-57 VINSON COMSEC, 11-18
- L**
- Land mines, 12-8
 - claymore, M18A1, 12-9
 - countermeasures, 12-14
 - coverage and methods of fire, 12-12
 - firing device, M57, 12-11
 - installation and firing, 12-11
- Laws of war, 1-18
 - personal conduct, 1-21
- M**
- M136 (AT4) 84-MM launcher and cartridge, 14-20
 - aiming, 14-29
 - ammunition, 14-21
 - controls, 14-22
 - destruction, 14-26
 - firing positions, 14-30
 - inspection before firing, 14-27
 - misfire procedures, 14-26
 - operation, 14-22
 - safety procedures, 14-32
- M16A1 and M16A2 rifles, 3-1
 - ammunition, 3-10
 - assembling, 3-6
 - clearing, 3-3
 - field-stripping, 3-4
 - magazine loading and unloading, 3-8
 - malfunction and stoppage, 3-9

- M16A1 and M16A2 rifles—Continued
 - misfire and cook off, 3-9
 - sights, 3-10
- M18A1 claymore mine, 12-9
- M203 40-MM grenade launcher, 13-1
 - ammunition, 13-4
 - clearing, 13-3
 - leaf sight zeroing, 13-3
 - loading and firing, 13-3
 - misfire, hangfire, and stoppage, 13-4
 - safety procedures, 13-5
- M57 firing device, 12-11
- M60 machine gun, 13-5
 - adjustment of fire, 13-18
 - ammunition, 13-15
 - characteristics, 13-5
 - operation, 13-9
 - field stripping, 13-12
 - firing techniques, 13-16
 - functioning, cycle of, 13-9
 - malfunctions, 13-10
 - sight alignment, 13-17
 - stoppage, 13-10
- Machine gun, MK 19 MOD 3 40 MM, 13-31
 - ammunition, 13-32
 - MK 64 mount and M3 tripod, 13-31
- Machine gun, M60, 13-5
 - adjustment of fire, 13-18
 - ammunition, 13-15
 - characteristics, 13-5
 - operation, 13-9
 - field stripping, 13-12
 - firing techniques, 13-16
 - functioning, 13-9
 - malfunctions, 13-10
- Machine gun, M60—Continued
 - sight alignment, 13-17
 - stoppage, 13-10
- Machine guns and rifle units, 3-27
 - characteristics, 3-27
 - fire commands, 3-35
 - fire control, 3-32
 - fire discipline, 3-32
 - fire distribution, 3-33
 - firing techniques, 3-27
 - overhead, 3-30
 - range estimations, 3-32
- Maps and compass, 5-4
 - azimuth and back azimuth, 5-21
 - grids, 5-8
 - lensatic compass, 5-19
 - military symbols, 5-17
- Marking contaminated areas (STANAG 2002), 9-18
- Marksmanship, 3-19
 - pistol firing techniques, 3-24
 - rifle firing techniques, 3-19
 - shooting positions, 3-21,3-26
- Mines, land, 12-8
 - claymore, M18A1, 12-9
 - countermeasures, 12-14
 - coverage and methods of fire, 12-12
 - firing device, M57, 12-11
 - installation and firing, 12-11
- Mission-oriented protective posture (MOPP), 9-17
- MK 19 MOD 3 40-MM machine gun, 13-31
 - ammunition, 13-32
 - MK 64 mount and M3 tripod, 13-31
- Mortar, 60 MM (M224), 14-1
 - ammunition, 14-4
 - care and cleaning, 14-15

Mortar, 60 MM (M224)—Continued

- conventional mode, 14-2
- fire commands, 14-12
- fire direction center procedures, 14-19
- forward observer, 14-16
- hand-held mode, 14-2
- loading and firing, 14-13
- mask clearance, 14-10
- misfires, 14-14
- placing the aiming post, 14-9
- preparation for firing, 14-7
- preparing the ammunition, 14-12
- sighting, 14-11

Movement, 4-1

- fire team, 4-5
- silent, 4-4

N**Naval construction regiments (NCRs), 1-9****Naval mobile construction battalions, 1-9****Nuclear radiation, 9-3****O****Observation and fields of fire, 5-3****Operation orders (OPORD), 11-36**

- format, 11-37
- annexes, 11-39
- preparation, 11-39

P**Patrol planning and preparation, 4-15****Phonetic alphabet and numerals, 11-26****Pistol, .45 caliber service, 3-13**

- ammunition, 3-18
- assembling, 3-15
- field-stripping, 3-13
- functioning, 3-16

Pistol, .45 caliber service—Continued

- loading and firing, 3-17
- malfunctions, 3-17
- safety procedures, 3-16

Prowards, 11-27**R****Radio and telephone procedures, 11-26****Radio sets**

- AN/CRP-160, 11-3
- AN/CRP-104, 11-6
- AN/GRA-39, 11-12
- AN/PRC-77, 11-2

RC-292 antenna equipment, 11-15**Reconnaissance patrol, 4-12****Rifle company headquarters, 1-12****Rifle units and machine guns, 3-27**

- characteristics, 3-27
- fire commands, 3-35
- fire control, 3-32
- fire discipline, 3-32
- fire distribution, 3-33
- firing techniques, 3-27
- overhead, 3-30
- range estimations, 3-32

Rifles, M16A1 and M16A2, 3-1

- ammunition, 3-10
- assembling, 3-6
- clearing, 3-3
- field-stripping, 3-4
- magazine loading and unloading, 3-8
- malfunction and stoppage, 3-9
- misfire and cook off, 3-9
- sights, 3-10

Rushing, 4-1**S****SB-22/TP telephone switchboard, 11-20**

- Seabag and 782 gear layout, 2-25
- Seabee CBR defense responsibilities, 9-6
 - biological defense, 9-11
 - CBR equipment, 9-14
 - chemical defense, 9-6
 - decontamination, 9-10, 9-11
 - first aid and self-aid, 9-7, 9-13
 - nuclear defense, 9-12
 - protective measures, 9-6, 9-7, 9-14
- Shock, 10-22
 - causes, 10-23
 - prevention and treatment, 10-24
 - recognition, 10-23
- 60-MM mortar (M224), 14-1
 - ammunition, 14-4
 - care and cleaning, 14-15
 - conventional mode, 14-2
 - fire commands, 14-12
 - fire direction center procedures, 14-19
 - forward observer, 14-16
 - hand-held mode, 14-2
 - loading and firing, 14-13
 - mask clearance, 14-10
 - misfires, 14-14
 - placing the aiming post, 14-9
 - preparation for firing, 14-7
 - preparing the ammunition, 14-12
 - sighting, 14-11
- Sketches and overlays, 5-29
- Special clothing, standard issue, 2-1
- Special issue (782 gear), 2-20
- Standard issue (782 gear), 2-3
 - existence/bivouac equipment, 2-13
 - large pack, 2-11
 - cleaning and maintenance, 2-13
 - medium pack, 2-10
- Survival, 6-4
 - escape, 6-13
 - group, 64
 - individual, 6-4
 - techniques, 6-5
- T**
 - TA-1/FT telephone, 11-19
 - TA-312/PT telephone, 11-18
 - Tactical message format, 11-28
 - beadwindow codes, 11-30
 - combat signals, 11-31
 - security, 11-28
 - Telephone switchboard SB-22/TP, 11-20
 - Telephone TA-1/PT, 11-19
 - Telephone TA-312/PT, 11-18
 - The frost seabees, 1-1
 - Topography, 5-2
 - Transporting sick and injured, 10-8
 - litters, improvised, 10-11
 - methods of carrying, 10-12
 - Traps, booby, 12-12
 - countermeasures, 12-14
 - deadfalls, 12-14
 - explosive, 12-12
 - nonexplosive, 12-12
 - Trip flares, 12-12
- U**
 - Units of the naval construction force, 1-6
- V**
 - VINSON COMSEC KY-57, 11-18
- W**
 - Warning order, 4-16
 - Written orders, 11-35

Assignment Questions

Information: The text pages that you are to study are provided at the beginning of the assignment questions.

ASSIGNMENT 1

Textbook Assignment: "History and Organization of the Seabees and Laws of War," and "Special Clothing and Equipment." Pages 1-1 through 2-20.

Learning Objective: Describe the events that led to the establishment of the Civil Engineer Corps and the Seabees.

Learning Objective: Indicate the general organization of the Naval Construction Force (NCF), types of Seabee units within the NCF, and their objectives and organization.

1-1. Before World War II, the bulk of Navy construction work was accomplished by which of the following personnel?

1. Seabee
2. Naval
3. Army
4. Contractor

1-2. The underscored parts of what words gave rise to the name, Seabees?

1. Seagoing Battalion
2. Construction Battalion
3. Carpenter, Builder
4. Steelworker, Engineering Aid, Builder

1-3. During World War II, regular Navy ratings were used by the Seabees. The Seabees were set apart from their fleet counterparts by what distinguishing feature?

1. By uniform
2. By hat insignia
3. By shoulder patch
4. By service number

1-4. What types of training were included for new Seabees at their boot camp in the early days of World War II?

1. Combat orders and jungle warfare
2. Earthmoving and dry refrigeration
3. Pontoon assembly and hut erection
4. Building trades and counterinsurgency

1-5. Operational and administrative control over the Naval Construction Force is provided by the

1. Construction Force Commander
2. Commander Naval Beach Group
3. Fleet Commander
4. Naval Surface Force Commander

IN ANSWERING QUESTIONS 1-6 THROUGH 1-10, SELECT FROM COLUMN B THE NAVAL CONSTRUCTION FORCE UNIT THAT PERFORMS THE TASK IN COLUMN A. THE RESPONSES IN COLUMN B MAY BE USED MORE THAN ONCE.

<u>A. TASKS</u>	<u>B. NCF UNITS</u>
1-6. Maintains an advance base that has been completed	1. CBMU 2. CBU
1-7. Installs tanker-to-shore bulk fuel delivery systems	3. PHIBCB 4. UCT
1-8. Provides public works type of support for fleet hospital units	
1-9. Surveys the sea bottom for an underwater facility	
1-10. Provides a uniform flow of material and services required by a landing force	

Learning Objective: Point out the services provided by the organizations that support the Naval Construction Force.

1-11. NAVFAC supports the NCF in meeting fleet support missions by providing

1. personnel
2. equipment only
3. engineering material only
4. engineering material and equipment

1-12. When an NMCB has been commissioned by the CNO, which of the following supporting elements usually outfits it?

1. Brigade
2. Home port NCR
3. CBC
4. NCTC

1-13. The mission of the home port NCR includes which of the following objectives?

1. Achieving the highest possible state of readiness for all units
2. Supplying military construction support to the armed forces
3. Receiving and separating Seabee personnel
4. Each of the above

Learning Objective: Point out the missions, functions, and the structure of the Naval Mobile Construction Battalions.

1-14. In addition to a headquarters company, an NMCB has which of the following companies?

1. Eight rifle companies
2. Two construction companies and two rifle companies
3. Eight construction companies
4. Four construction/rifle companies

1-15. The NCF Support Unit provides logistical support for an NCR and other supported NCF units in which of the following ways?

1. It performs inventory management of construction materials
2. It maintains inventory control
3. It operates and performs maintenance, repair, and upkeep of NCF auxiliary construction equipment
4. Each of the above

1-16. An NMCB can change quickly from a military support function to a construction support function because of what factor?

1. Assignment of personnel to perform construction tasks only
2. Assignment of personnel to perform military duties only
3. Establishment of construction military billets
4. Organization as rifle/machine gun companies

Learning Objective: Describe the organization and mission of the headquarters company and the duties of its personnel.

1-17. In addition to providing defense as a company unit in a combat situation, the headquarters company of an NMCB acts as the reserve force for what companies?

1. A and B companies only
2. C and D companies only
3. Each of the construction rifle companies

1-18. A headquarters company may be organized into a total of how many rifle and weapons platoons, respectively?

1. One; two
2. Two; one
3. Three; two
4. Four; two

- 1-19. Protecting and defending the battalion command post are the responsibilities of what person?
1. The company chief petty officer
 2. The platoon commander
 3. The headquarters company commander
 4. The squad leader

- 1-20. Which of the following individuals may serve as headquarters' platoon commander in a battalion?
1. Admin and personnel officers
 2. Supply and logistic officers
 3. Both 1 and 2 above
 4. Company chief petty officers

Learning Objective: Describe the duties of rifle company personnel.

- 1-21. In a rifle company, what individual is personally responsible to the battalion commander to ensure orders issued by the battalion are followed?
1. The company commander
 2. The company chief petty officer
 3. The platoon commander
 4. The company guidon

- 1-22. What person is responsible to the company commander for administrative task performance during home-port training periods?
1. The company chief petty officer
 2. The company clerk
 3. The project crew leader
 4. The right guide

- 1-23. The company guidon has which of the following responsibilities?
1. Construction expediter
 2. Supply coordinator
 3. Ammunition distribution
 4. Each of the above

Learning Objective: Identify the members of a rifle platoon and their duties.

- 1-24. A rifle platoon commander should position himself in what location during combat?
1. In the center of the platoon, near the grenadier
 2. Where he can readily control the squad leaders only
 3. Where he can remain in contact with the company commander only
 4. Both 2 and 3 above
- 1-25. If the platoon commander in a rifle platoon becomes a casualty, what person normally assumes control of his platoon?
1. The senior squad leader in the platoon
 2. The platoon's automatic rifleman, first squad
 3. The platoon petty officer
 4. The platoon guide
- 1-26. Keeping platoon personnel supplied with construction and combat materials is a task of what member of the rifle platoon headquarters?
1. The platoon commander
 2. The platoon petty officer
 3. The platoon messenger
 4. The platoon guide

- 1-27. In a combat situation, the platoon petty officer in a rifle platoon should place himself in what position?
1. Adjacent to the grenadier in the first squad but far enough from the platoon commander to prevent both from becoming a casualty at the same time
 2. Within hearing range of the platoon commander and far enough away to prevent himself from becoming a casualty should the commander be hit
 3. At the rear of the platoon but far enough from the platoon commander to prevent him and the platoon commander from becoming casualties at the same time
 4. In the center of the platoon but far enough from the platoon commander to prevent both from becoming casualties at the same time

Learning Objective: Identify the members of a rifle squad and specify their duties.

- 1-28. In addition to the fire team member, a rifle squad consists of a
1. squad leader and grenadier
 2. squad leader and corpsman
 3. corpsman and grenadier
 4. squad leader and an automatic rifleman
- 1-29. The fire discipline of the fire teams within a squad is the responsibility of what person?
1. The fire team leader
 2. The squad leader
 3. The automatic rifleman
 4. The grenadier

- 1-30. In the event the squad leader becomes a casualty, which of the following individuals takes control of the squad?
1. The grenadier
 2. The senior fire team leader
 3. The senior automatic rifleman
 4. The platoon right guide

Learning Objective: Identify the members of a rifle fire team, and specify their duties and individual weapons.

- 1-31. In an NMCB, which of the following units is the basic combat unit of the rifle squad?
1. Rifle fire team
 2. Fire support team
 3. Fire direct team
 4. Each of the above
- 1-32. Which, if any, of the following members of the rifle fire team carry(ies) the .45 caliber service pistol?
1. Fire team leader
 2. Automatic rifleman
 3. Rifleman No. 1 and 2
 4. None of the above
- 1-33. What member of the fire team may act as a scout?
1. Rifleman No. 1
 2. Rifleman No. 2
 3. Both 1 and 2 above
 4. Team leader

Learning Objective: Identify the fire support elements of the rifle companies in a battalion, describe the organization of a weapons platoon, and denote individual responsibilities.

- 1-34. The fire support elements for the construction/rifle companies of a battalion include which of the following elements?
1. 60-mm mortar platoon
 2. Antitank weapon (AT4)
 3. Weapons platoon
 4. Each of the above
- 1-35. Of the following units, which is NOT in the weapons platoons?
1. The platoon headquarters
 2. The machine gun squad
 3. The grenadier squad
 4. The AT4 squad
- 1-36. Within the weapons platoon, what person is directly responsible for preventive maintenance on the weapons?
1. The platoon commander
 2. The platoon petty officer
 3. The ammunition technician/guide
 4. Each of the above
- 1-37. In the weapons platoon, which of the following persons must be efficient in using and maintaining the machine guns used by the platoon?
1. The communicator
 2. The ammunition technician/guide
 3. The weapons platoon petty officer
 4. The weapons platoon commander

Learning Objective: Identify the members of the machine gun and antitank squads, their equipment, and their duties.

- 1-38. Which of the following machine gun team members is/are armed with the .45-caliber service pistol?
1. Ammunition carrier No. 1
 2. Ammunition carrier No. 2
 3. Gunner and team leader
 4. Squad leader
- 1-39. Which of the following members of the machine gun team provide(s) security for the team?
1. Ammunition carrier No. 1 only
 2. Ammunition carrier No. 2 only
 3. Ammunition carriers No. 1 and 2
 4. Team leader
- 1-40. In addition to the squad leader, the antitank (AT4) squad consists of a total of how many men?
1. Six
 2. Seven
 3. Eight
 4. Nine
- 1-41. What person selects the exact positions and targets for the antitank (AT4) teams?
1. The antitank (AT4) squad leader
 2. The weapons platoon leader
 3. The gunner
 4. The assistant gunner
- 1-42. There should be what number of AT4s in an antitank squad?
1. 15
 2. 20
 3. 30
 4. 40

Learning Objective: Identify the mission and duties of the 60-mm mortar platoon and positioning of the mortar.

- 1-43. The 60-mm mortar has what defensive role?
1. To defend a position against enemy ground forces
 2. To illuminate an area during nighttime operations
 3. To provide support during an assault
 4. Each of the above
- 1-44. In a defensive position, the 60-mm mortar is generally placed in what location?
1. On the battalion perimeter
 2. In the battalion headquarters area
 3. In the battalion command post
 4. On a heavy-duty truck
- 1-45. What number of 60-mm mortars are assigned to a battalion?
1. Seven
 2. Six
 3. Five
 4. Four
- 1-46. To reduce the possibility of having two mortars eliminated by a single enemy shell, you should place the 60-mm mortars what distance apart?
1. 50 yards
 2. 40 yards
 3. 35 yards
 4. 25 yards
-
- Learning Objective: Identify the principles of the laws of war and Code of Conduct as they apply to the individual Seabee.
-
- 1-47. The laws of armed conflict are a direct concern of which of the following people?
1. The President of the United States
 2. The Secretary of the Navy
 3. The Assistant Secretary of the Navy for Manpower
 4. Every service member
- 1-48. The United States is the world leader in adopting rules for its armed forces.
1. True
 2. False
- 1-49. As a Seabee fighting in a foreign country, what type of information about the country is of least importance to you?
1. The climate and terrain
 2. The general economic posture of the country
 3. The ethnic background of the people
 4. The complete history of the country
- 1-50. Under the laws of armed conflict, which of the following people are considered combatants?
1. Uniformed chaplains
 2. Hospital corpsmen
 3. Armed guerrillas
 4. Each of the above
- 1-51. Which of the following are NOT principles in handling POWs?
1. Search and secure
 2. Silence and segregate
 3. Strip and sanitize
 4. Safeguard and speed to the rear
- 1-52. If you mistreat POWs, you are subject to which of the following punishments?
1. Verbal reprimand
 2. Letter of reprimand
 3. Captain's Mast
 4. Court-martial
- 1-53. After capturing an enemy soldier, you can take which of the following articles from him?
1. Weapon
 2. Watch
 3. Personal photograph
 4. Each of the above

- 1-54. Under the laws of armed conflict, you are NOT allowed to take which of the following actions?
1. Attack villages, towns, or cities
 2. Have POWs search for, clear, or place mines
 3. Shoot at hospitals, churches, or orphanages
 4. All of the above
- 1-55. Parachutists are considered combatants and may be fired upon while they are still in the air.
1. True
 2. False
- 1-56. Under the laws of armed conflict, Seabees can take which of the following actions without approval from higher authority?
1. Burn civilian homes and villages
 2. Pose as Red Cross volunteers
 3. Destroy the noncombatant food and water supplies
 4. Refuse orders to commit criminal acts
- 1-57. Conduct for U.S. servicemen as POWs is specified in which of the following articles of the Code of the U.S. Fighting Force?
1. I and VI
 2. II only
 3. III, IV, and V
 4. II and V
- 1-58. Conduct of Seabees on the battlefield is addressed in what article of the Code of the U.S. Fighting Force?
1. I
 2. II
 3. III
 4. IV
-
- Learning Objective: Identify the fundamentals and practices of issuing, wearing, and caring for items of special clothing and rank devices.
-
- 1-59. When is your initial allowance of olive-green uniforms issued to you?
1. When you leave boot camp
 2. As you check into your unit
 3. When you leave your unit
 4. As you enter boot camp
- 1-60. After the olive-green utility uniforms are issued, who is responsible for their upkeep?
1. The person to whom they are issued
 2. The distributing agency official
 3. The supply officer
 4. The battalion storekeeper
- 1-61. Where on your green shirt, on the tape provided, must your name be stenciled in 3/4-inch block letters?
1. In the center of the left breast pocket
 2. Above the right breast pocket
 3. On the back with a control number
 4. Above the left breast pocket
- 1-62. Enlisted personnel in what pay-grades are required to wear cap and collar devices with their olive-green utility uniforms?
1. E-7 and E-8 only
 2. E-4 through E-8 only
 3. E-4 through E-9 only
 4. E-1 through E-9
- 1-63. The cap device is worn in the center of the cap and what distance above the visor?
1. 1 inch
 2. 3/4 inch
 3. 1 1/4 inches
 4. 1 1/2 inches

1-64. The belt end that passes through the buckle to the left must extend what approximate distance past the buckle?

1. 1 to 2 inches only
2. 2 to 3 inches only
3. 2 to 4 inches
4. 4 to 6 inches

Learning Objective: As part of the standard issue 782 gear, identify items of load-carrying equipment and indicate how they are assembled and used.

1-65. What are the three categories of standard issue 782 gear?

1. Fighting load-carrying, bivouac, and protective equipment
2. Bivouac, protective, and camping equipment
3. Fighting load-carrying, bivouac, and eating equipment
4. Protective, antiriot, and field-pack equipment

1-66. To ensure individual loads can be carried more comfortably, you should comply with which of the following directions?

1. Assemble the equipment properly
2. Know the equipment
3. Keep every item in its proper place
4. Each of the above

1-67. In addition to helping support the field pack, the pistol belt is used to carry which of the following equipment?

1. Canteen and cover, entrenching tool with cover, ammo pouches, and the first aid or compass cases
2. Insect screen and bars
3. Tent pole, ropes, and pins
4. Sleeping bag with liner and cover

1-68. The suspenders and what other piece of equipment make up the basic individual fighting load-carrying equipment?

1. Field pack
2. Pistol belt
3. Camouflage cover
4. Poncho

1-69. The first-aid case may be used to carry what type of gear?

1. Field dressing only
2. Unmounted magnetic compass only
3. Unmounted magnetic compass or a field dressing

1-70. The supporting strap of the ammunition pouch is attached to what gear and in what manner?

1. The front suspender strap, with a hook and eyelet
2. The front shoulder pad, with one attaching clip
3. The top of the entrenching tool carrier, with a hook and eyelet
4. The metal loop at the bottom edge of the shoulder pad, with a snap fastener

1-71. When the poncho is being used as a sleeping bag in a combat area, the poncho fasteners should not be fastened together for what reason?

1. The normally high temperature created by a closed bag could result in heat prostration
2. Fastening the snaps is too bothersome
3. The snap fasteners cannot be opened quickly
4. Fastening the snaps results in a sleeping bag that is too small for the average-size person

1-72. What should you do with the mess gear after washing and rinsing it?

1. Air-dry it
2. Dry it with a damp cloth
3. Dry it with a paper towel

- 1-73. The helmet helps protect its wearer from which of the following hazards?
1. Fragments of artillery fire
 2. Ricocheting bullets
 3. Fragments of grenades
 4. All of the above

- 1-74. The camouflage cover is held in place on the helmet by which of the following methods?
1. By clipping it to the chin straps
 2. By fastening it around the bottom of the helmet
 3. By tying it directly to the helmet
 4. By extending the six cover retaining tabs down and around the fixed web strap of the suspension system

ASSIGNMENT 2

Textbook Assignment: "Special Clothing and Equipment" and "Service Rifle and Pistol Marksmanship." Pages 2-20 through 3-27.

Learning Objective: Recognize the proper uses of special issue equipment.

- 2-1. Special issue equipment does NOT include which of the following items?
1. A sleeping mat
 2. A camouflage band
 3. An armored vest
 4. A poncho
- 2-2. When issued an armored vest as a protective measure, you should wear it in what manner?
1. Over your green shirt but under other outer clothing
 2. Over all the clothing you are wearing
 3. Either 1 or 2 above
 4. Wherever it fits best
- 2-3. Your mountain sleeping bag keeps you warm and comfortable when you take which of the following steps after unrolling it?
1. Fluff it
 2. Leave it in the waterproof case
 3. Place it over an air mattress, clothes, or other padding
 4. Each of the above
- 2-4. You are sleeping in a sleeping bag and come under enemy attack. What is the quickest way to release the slide fastener?
1. Pull the slide fastener up to the very top
 2. Pull the slide fastener down to the bottom
 3. Either 1 or 2 above, depending on the size of the person
 4. Push in on the slide

- 2-5. By what means is camouflage material usually held in place on your helmet?

1. Glue
2. String
3. Elastic band
4. Tape

Learning Objective: Specify practices in cleaning, pressing, or stowing items of standard issue clothing, and in repairing standard issue and special issue items of equipment.

- 2-6. You are pressing cotton clothing with a nonsteaming electric iron. Which, if any, of the following steps is appropriate?
1. Place a damp cloth between the iron and the fabric
 2. Apply the iron directly to the fabric
 3. Dampen the fabric before applying the iron to it
 4. None of the above
- 2-7. Which of the following steps should you take before stowing cotton and wool clothing?
1. Ensure they are clean
 2. Brush them
 3. Sun and air-dry them
 4. Each of the above

- 2-8. When boots become wet, you can dry them in which of the following ways?
1. Leave them on while hanging your feet over an open fire
 2. Take them off and place them in a sunny spot where they can dry fast
 3. Take them off and hang them directly over an open fire where they can dry fast
 4. Stuff paper in the toes, and place them in a warm, dry spot where they can dry slowly
- 2-9. After cleaning your web equipment, you notice a few small rips and tears in it. What action should you take?
1. Repair the rips and tears as quickly as possible
 2. Turn the equipment in for replacement
 3. Draw the rips and tears together and tie them with string
- 2-10. Which, if any, of the following procedures can make a slide fastener work more smoothly?
1. Coat each track with a thin coat of wax only
 2. Put only lead-pencil graphite on each track
 3. Apply either wax or graphite on each track
 4. None of the above
-
- Learning Objective: Specify the correct procedures for clearing, field stripping, and firing an M16 rifle.
-
- 2-11. Refer, to figure 3-1. On an M16 rifle, the magazine release button is in what location?
1. Right side of the weapon, top front of the trigger guard
 2. Right side of the weapon, bottom front of the trigger guard
 3. Left side of the weapon, top front of the trigger guard
 4. Left side of the weapon, bottom front of the trigger guard
- 2-12. To remove the magazine from an M16 rifle, you must take which of the following actions?
1. Turn the selector lever to SAFE
 2. Pull out the magazine release button
 3. Push in the magazine release button
 4. Pull out the magazine
- 2-13. To lock the bolt open on an M16 rifle, you must take which of the following actions?
1. Pull out the charging handle latch with the right hand when the bolt is fully rearward and allow it to lock the bolt open
 2. Depress the charging handle with the left hand when the bolt is fully rearward, then allow it to lock the bolt
 3. Pull out the catch when the bolt is fully rearward with the thumb and forefinger of the left hand until it locks the bolt
 4. Press the bottom of the bolt catch with the thumb or forefinger of the left hand when the bolt is fully rearward until it engages the bolt catch, then return the charging handle to the forward position
- 2-14. To prevent damage to the automatic sear during assembly/disassembly, you must place the selector of an M16 rifle in what position?
1. SAFE
 2. FIRING
 3. AUTO
 4. SEMI

2-15. Without supervision, the individual Seabee is authorized to disassemble an M16 rifle to what level?

1. Detailed stripping
2. Modified detailed stripping
3. Field stripping
4. Modified field stripping

2-16. Refer to figure 3-10. On an M16 rifle, the takedown pin is in what location?

1. Behind the pistol grip, on the right side of the weapon
2. In front of the pistol grip, on the right side of the weapon
3. Behind the piston grip, on the left side of the weapon
4. In front of the pistol grip, on the left side of the weapon

2-17. Without supervision, individual Seabeeshould NOT remove which of the following pieces when field stripping an M16 rifle?

1. Takedown pin only
2. Receiver pivot pin only
3. Takedown pin and receiver pivot pin
4. Extractor spring

2-18. In assembling an M16 rifle, the individual Seabee, NOT under supervision, should first take which of the following steps?

1. Insert the assembly spring into the lower receiver extension
2. Assemble the bolt carrier group
3. Replace the handguards
4. Make a functional check of the rifle

2-19. A complete functional check of an M16 service rifle consists of operating the rifle while the selector is in which of the following position(s)?

1. SAFE
2. SEMI
3. AUTO
4. Each of the above

Learning Objective: Point out the correct and safe procedures for preparing ammunition for loading and firing the M16A1 and M16A2 rifles.

2-20. The magazine of an M16 rifle has a capacity for a maximum of how many cartridges?

1. 30
2. 25
3. 20
4. 15

2-21. What occurs when you overload the magazine used in an M16 rifle?

1. A runaway rifle
2. Various malfunctions
3. The lips of the magazine become deformed
4. Both 2 and 3 above

2-22. When you load an M16 rifle, the hammer should be in what position?

1. In its normal position, not cocked, with the selector lever on SEMI
2. Cocked, with the selector lever on SAFE
3. In its normal position, not cocked, with the selector lever on SAFE
4. Cocked, with the selector lever on AUTO

2-23. To ensure positive retention of the magazine in an M16 rifle, you should take which of the following steps?

1. Rap the magazine sharply with the heel of your hand
2. Hold in the magazine release button while inserting the magazine
3. Hit the magazine with another empty magazine
4. Hit the magazine against a tree or on the ground

Learning Objective: Specify the correct procedures for clearing an M16 rifle of stoppages and the immediate action taken.

2-24. In relationship to firing a weapon, such as an M16 rifle, what is a stoppage?

1. All rounds in the magazine have been expended
2. Half of the rounds in the magazine have been expended
3. Unintentional interruption in the cycle of functioning operation
4. Firer has temporarily suspended firing

2-25. Which, if any, of the following actions completes the first step of immediate action?

1. Strike the forward assist assembly, tap upward on the bottom of the magazine, and pull the charging handle fully to the rear
2. Push the charging handle forward, remove the magazine, and insert a new magazine
3. Remove the round in the chamber, tap the weapon on the ground slightly, and insert a new magazine
4. None of the above

Learning Objective: Point out sight adjustments and positions to an M16 rifle.

2-26. The sights of an M16 rifle are adjustable for windage and elevation in which of the following ways?

1. Front sight, windage; rear sight, elevation
2. Front and rear sight; windage and elevation
3. Front sight, elevation; rear sight, windage

2-27. When you are shooting at an enemy located approximately 200 yards from your position, what aperture of the rear sight of an M16 rifle should be used ?

1. L
2. O
3. Marked
4. Unmarked

2-28. Should the strike of the bullet be high on the target, you should adjust the front sight post of an M16 rifle in what manner?

1. Rotate it clockwise
2. Rotate it counterclockwise
3. Lower the front sight post one click
4. Raise the front sight post one click

Learning Objective: Describe the types and uses of M16 ammunition.

2-29. The 5.56-mm ammunition is issued as a complete round or cartridge that consists of which of the following parts?

1. Projectile
2. Propellant
3. Primer
4. All of the above

2-30. Tracers can be identified by what color of tip?

1. Orange only
2. Red only
3. Orange or red
4. Violet

2-31. The use of 100 percent tracers could cause an M16 rifle to have what problem(s)?

1. To overheat excessively
2. To have deposits of their bullet-jacket material form in the bore and rifling grooves
3. To become a potential safety hazard
4. Both 2 and 3 above

Learning Objective: Define a misfire and specify the procedures to be used in the care and cleaning of an M16 rifle and its ammunition.

2-32. In regard to cleaning an M16 rifle, what parts must receive special attention?

1. The bolt carrier group and the upper and lower receiver groups only
2. The barrel bore and chamber, bolt carrier group, and the ammunition magazines only
3. The upper and lower receiver groups and the bolt carrier group only
4. The barrel bore and chamber, bolt carrier group, upper and lower receiver groups and the ammunition magazines

2-33. When cleaning the ammunition magazine of an M16 rifle, you should take which of the following actions?

1. Disassemble it to include the spring from the follower
2. Oil all the parts
3. Oil the spring only

2-34. For what reason, if any, should you keep ammunition magazines dry at all times?

1. To prevent the magazines from corroding
2. To prevent the ammunition in them from corroding
3. Both 1 and 2 above
4. None, both the magazine and the ammunition are corrosion-proof

Learning Objective: Specify procedures in cleaning, field stripping, functioning, loading, firing, and unloading the .45-caliber service pistol.

2-35. The .45-caliber service pistol is a recoil-operated, magazine-fed

1. single-shot hand weapon
2. fully automatic hand weapon
3. semiautomatic hand weapon

2-36. The .45-caliber service pistol has a maximum effective range of how many yards?

1. 25
2. 50
3. 75
4. 100

2-37. Refer to figure 3-37. What parts should you remove (a) first and (b) last when you are field stripping the .45-caliber service pistol?

1. (a) Magazine assembly
(b) barrel
2. (a) Magazine assembly
(b) slide group
3. (a) Magazine assembly
(b) barrel bushing

2-38. When replacing the recoil spring guide, you must ensure which of the following actions is taken?

1. That the concave out on the recoil spring collar is properly seated in the barrel
2. That the barrel bushing has not been put on the muzzle end of the barrel
3. That the barrel is ready to be attached in the next step
4. That the receiver group has already been placed in the pistol

2-39. When assembling the receiver group to the slide group, you must have the safety lock in what position?

1. SEMI
2. FULL
3. FIRE
4. SAFE

2-40. You are assembling a .45-caliber service pistol. If the holes do NOT align when trying to insert the slide-stop pin, you should take what action?

1. Move the receiver group until they are aligned
2. Move the muzzle end of the barrel in whatever direction required to align them
3. Remove the recoil spring plug and start over
4. Remove the magazine and start over

2-41. What is the sequence of operation for a .45-caliber service pistol?

1. Loading, feeding, chambering, locking, and firing only
2. Loading, feeding, chambering, locking, firing, unlocking, extracting, ejecting, and cocking
3. Feeding, chambering, locking, and firing
4. Feeding, chambering, locking, firing, unlocking, extracting, ejecting, and cocking

2-42. To fire successive shots with a .45-caliber service pistol, you must take what action?

1. Release the trigger and squeeze it each time a shot is desired
2. Have the safety lock on SEMI
3. Have the safety lock on SAFE
4. Squeeze the trigger and hold it

Learning Objective: Describe practices in the care and cleaning of a .45-caliber service pistol.

2-43. Preventive maintenance in the care and cleaning of a .45-caliber service pistol should be accomplished at what intervals?

1. Monthly
2. Bimonthly
3. Weekly
4. Daily

2-44. After firing a .45-caliber service pistol, you should clean it as soon as possible that day, and normally how many days afterwards?

1. 1
2. 2
3. 3
4. 10

Learning Objective: Describe the types and uses of .45-caliber ammunition.

2-45. For what purpose is the cartridge, caliber .45, M1921 used?

1. Training of personnel
2. Observation of fire
3. Simulated fire
4. Causing personnel casualties

Learning Objective: Identify principles and techniques of rifle marksmanship, including sighting and aiming, shooting positions, trigger control, and estimating wind speed.

2-46. The distance between the rear sight and the shooter's aiming eye is known as the

1. aiming distance
2. peep distance
3. eye relief
4. peep relief

2-47. Which of the following pictures depicts proper sight alignment?

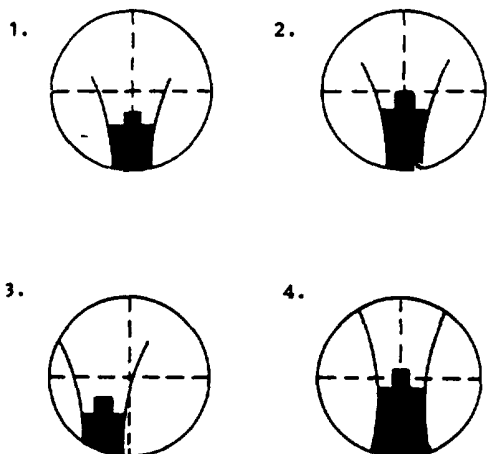

2-48. The location at which the rifle must be held to ensure that the eye relief does not vary for any given firing position is known by which of the following terms?

1. Spot weld
2. Anchor
3. Both 1 and 2 above
4. Exact position

2-49. As the eye relief changes, the apparent size of the front sight

1. changes
2. diminishes
3. increases
4. remains the same

2-50. The front sight should be kept square, blackened, and level because

1. the eye should focus on it only
2. the eye should focus on it and the target
3. it should be easy to remove and replace
4. it should not become a source of distraction

IN ANSWERING QUESTIONS 2-51 THROUGH 2-53, SELECT THE SIGHT PICTURE IN COLUMN B THAT BEST SHOWS THE BULLET IMPACT POINT DESCRIBED IN COLUMN A. NOT ALL RESPONSES ARE USED.

A. IMPACT POINTS

B. SIGHT PICTURES

2-51. Bullet will be wide at 9 o'clock

2-52. Bullet will strike the bull's eye

2-53. Bullet will be wide and high at 2 o'clock

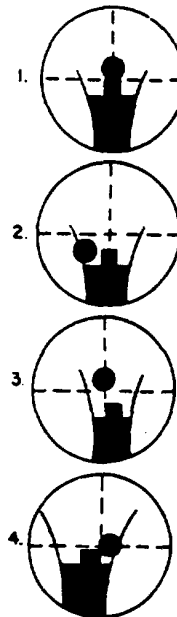

2-54. To help eliminate glare, you should blacken what part(s) of the rifle?

1. Both front and rear sights
2. Top of the barrel
3. Base of the receiver
4. All of the above

2-55. After getting into the proper position for rifle firing, you obtain proper sighting in what manner?

1. By moving the rifle so the target lines up with the sights
2. By changing to a target that aligns itself with the sights
3. By moving your body so the target lines up with the sights

- 2-56. What is the most important single factor in marksmanship?
1. Aligning the sights
 2. Controlling the trigger
 3. Assuming the firing positions correctly
 4. Selecting the right ammunition
-
- Learning Objective: Identify principles and techniques of marksmanship, including sighting and aiming, shooting, trigger control, and estimating wind speed.
-
- 2-57. Of the following actions, which one helps you in controlling the trigger of the rifle?
1. Gripping the stock of the rifle firmly and naturally with the trigger hand
 2. After the sights are lined up, pulling the trigger evenly, gradually, and straight to the rear until the weapon fires
 3. Not touching the receiver with your trigger finger
 4. Each of the above
- 2-58. In firing a rifle, when, if ever, do you continue to maintain pressure on the rifle trigger but interrupt your trigger squeeze?
1. When you lose control of your breathing
 2. When the rifle becomes too heavy because of fatigue
 3. When your rifle sights drift off the target
 4. Never
- 2-59. An inexperienced shooter tends to "snap shoot" when firing from what position?
1. Sitting
 2. Kneeling
 3. Prone
 4. Standing
- 2-60. In regard to breathing correctly, you should take which of the following actions at the moment you fire?
1. Inhaling
 2. Exhaling
 3. Holding your breath
- 2-61. To develop good shooting habits, you must notice where your sights are aimed at the instant of firing, then immediately call out where the bullet will strike. This is known as
1. sight concentration
 2. calling your shot
 3. target-sight coordination
 4. target concentration
- 2-62. In which of the following ways does the wind affect shooting?
1. It causes dust that makes seeing difficult and blows the bullet off course
 2. It makes your eyes water which causes sighting difficulties and makes the target sway
 3. It buffets the shooter and blows the bullet off course
 4. It buffets the shooter and decreases the range of the bullet
- 2-63. What should you do about the affect of wind on the bullet in flight?
1. Apply windage to the rifle sights
 2. Raise or lower the elevation of the rifle sights
 3. Assume that when the wind speed is less than 10 mph, it will not affect the bullet
- 2-64. When firing in a moderate wind, you should assume what firing position?
1. Sitting
 2. Kneeling
 3. Prone
 4. Standing

2-65. Refer to figure 3-51. To compute wind velocity by using the range flag, you should estimate the angle in degrees between the range flag and

1. the range flagpole and divide by 12
2. the range flagpole and divide by 4
3. a horizontal line and divide by 3
4. range flagpole and divide by the length of the flag in inches

Learning Objective: Identify principles and techniques of pistol marksmanship, including sighting and aiming, shooting positions, and trigger control.





2-66. What are the basic marksmanship principles of good pistol shooting?

1. Loading, aiming, and firing
2. Aiming, position, and firing
3. Aiming, position, and trigger squeeze
4. Loading, aiming, and trigger squeeze

2-67. As the pistol is fired, the last object your eye should focus on is the

1. target
2. rear sight
3. front sight
4. pistol receiver

2-68. Which of the following pictures depicts the correct pistol sight picture?

1. 
2. 
3. 
4. 

2-69. When in the standing position using the one-hand grip, you should place your feet about shoulder width apart and face how many degrees to the left of the target?

1. 90°
2. 50°
3. 45°
4. 30°

2-70. When holding the pistol using the one-hand grip, you place your right thumb along the left side of the pistol for what reason?

1. To steady the pistol
2. To equalize pressure from the right side by the palm and forefinger
3. Both 1 and 2 above
4. To move the safety lever easily

2-71. Gripping the pistol too tightly tends to cause the bullet to strike

1. high
2. low
3. to the left
4. to the right

2-72. You should lock your wrist and elbow as you fire the pistol for which of the following reasons?

1. To help absorb the pistol recoil
2. To prevent the recoil from being absorbed through the arm to the shoulder
3. To prevent excessive up-and-down movement of the pistol
4. To prevent excessive side-to-side movement of the pistol

2-73. When using the two-hand grip, your left palm supports the pistol butt and the left thumb is straight along the left side of the pistol grip with the right thumb locked over the top of the left thumb. You should bring the pistol onto the center of the target by using what body movement(s)?

1. By shifting your feet
2. By shifting your shoulders
3. By shifting your arms
4. Each of the above

2-74. In pistol marksmanship, jerking is caused by

1. gripping the pistol too tightly
2. gripping the pistol too loosely
3. attempting to fire the pistol at the precise time the sights are aligned with the target
4. anticipating the recoil from firing

2-75. In squeezing the trigger of a pistol, you should take which of the following actions?

1. Take up trigger slack before beginning the squeeze
2. Uniformly increase trigger pressure straight to the rear
3. Correctly call your shot
4. Each of the above

ASSIGNMENT 3

Textbook Assignment: "Service Rifle and Pistol Marksmanship" and "Combat Maneuvers, Formations, Patrols, and Ambushes." Pages 3-27 through 4-19.

Learning Objective: Identify the fire characteristics of rifles and machine guns, and denote the different classes of fire with respect to the target, the ground, and the gun.

IN ANSWERING QUESTIONS 3-5 THROUGH 3-7, MATCH THE TYPE OF FIRE WITH RESPECT TO THE TARGET IN COLUMN B WITH THE FIRE DESCRIPTION IN COLUMN A. NOT EVERY RESPONSE IN COLUMN B IS USED.

	A. FIRE <u>DESCRIPTIONS</u>	B. FIRE <u>TYPES</u>
3-1. After the bullet has been fired from the weapon, its curved path in flight through the air is known as its <ol style="list-style-type: none"> 1. horizontal shot pattern 2. trajectory 3. beaten zone 4. air resistance 	3-5. Fire delivered perpendicular to the enemy flank	<ol style="list-style-type: none"> 1. Enfilade 2. Flanking
3-2. Of the following characteristics of firing, which ones apply to rifles as well as machine guns? <ol style="list-style-type: none"> 1. Trajectory and danger space 2. Burst of fire and beaten zone 3. Shot pattern and dispersion 4. Each of the above 	3-6. Fire delivered so the long axis of the beaten zone corresponds with the long axis of the target	<ol style="list-style-type: none"> 3. Frontal 4. Oblique
3-3. A burst of automatic fire for normal ground targets is approximately how many rounds? <ol style="list-style-type: none"> 1. 5 to 15 2. 2 to 5 3. 10 to 20 4. 4 to 10 	3-7. Fire delivered perpendicular to the enemy front	
3-4. Because of dispersion, the impact pattern on a horizontal target is a long, narrow ellipse. This is known as the <ol style="list-style-type: none"> 1. trajectory 2. cone of dispersion 3. beaten zone or horizontal shot pattern 4. vertical shot pattern or beaten zone 		

IN ANSWERING QUESTIONS 3-8 THROUGH 3-10, MATCH THE TYPE OF FIRE CLASSIFIED WITH RESPECT TO THE GROUND IN COLUMN B WITH THE FIRE DESCRIPTION IN COLUMN A. NOT EVERY RESPONSE IN COLUMN B IS USED.

	A. FIRE <u>DESCRIPTIONS</u>	B. FIRE <u>TYPES</u>
3-8. Fire that strikes the ground from above at a considerable angle. The danger space is practically limited to the beaten zone	3-8. Fire that strikes the ground from above at a considerable angle. The danger space is practically limited to the beaten zone	<ol style="list-style-type: none"> 1. Overhead 2. Plunging 3. Grazing 4. Searching
3-9. Fire delivered over the heads of friendly troops	3-9. Fire delivered over the heads of friendly troops	
3-10. Fire in which the trajectory is not over 68 inches	3-10. Fire in which the trajectory is not over 68 inches	

- 3-11. A machine gun on a tripod is capable of delivering accurate overhead fire because of which of the following factors?
1. The small, uniform dispersion of the cone of fire
 2. The high rate of fire
 3. The gun is kept in reserve
 4. The large, uniform dispersion of the cone of fire
- 3-12. To permit overhead machine gun fire on a target, the gunner must direct the cone of fire in which of the following ways?
1. To have a minimum clearance
 2. To pass over the heads of friendly troops
 3. Both 1 and 2 above
 4. To be fixed fire
- 3-13. When applying the leader's rule, you select a safe point of advancement at an estimated range of 1,000 yards and lay the gun on target. Then without disturbing the lay of the gun, you place the rear sight at what setting?
1. 500 yards
 2. 1,000 yards
 3. 1,500 yards
 4. 1,600 yards
-
- Learning Objective: Specify the principles of fire discipline, control, and distribution as they apply to platoon firing, fire squads, rifle fire, machine gun fire, and firing commands.
-
- 3-14. Which of the following techniques is best for estimating by eye the range of a target that exceeds 500 yards?
1. Estimate the entire distance to the target in units, each 100 yards long
 2. Select a point halfway to the target and estimate the range of this point in units, then double the estimate
 3. Select a point one fourth of the way to the target and estimate the range of this point in units, each 200 yards long, then double the estimate
- 3-15. When estimating by eye the distance to a target in which the intervening ground is hidden, you should pick a prominent object to the right or left of the target and at the same range, toward which the intervening ground is visible, and then estimate the distance to this object. This is known as using a/an
1. alternate estimate
 2. mental arc
 3. substitute object
 4. alternate object
- 3-16. The method of estimating range by observing flights of tracer bullets or the points where projectiles strike is called fire by
1. observation of fire
 2. fire discipline
 3. impact observation
 4. trajectory observation
- 3-17. Fire discipline of a squad is the responsibility of what individual?
1. The squad leader
 2. The machine gunner
 3. The assistant machine gunner
 4. The assistant squad leader

- 3-18. Effective fire control ensures which of the following factors?
1. That ammunition is conserved
 2. That the surprise effect is not lost
 3. That application of fire is on the proper targets
 4. Each of the above

- 3-19. In distributed fire, the width of the target covered by a rifleman is the maximum on which he can deliver fire accurately without
1. exceeding a 10-degree arc
 2. changing positions
 3. exceeding a 30-degree arc
 4. changing the windage settings

- 3-20. Unless otherwise ordered in platoon firing, each squad covers what amount of the target?
1. Just the portion immediately in front of it
 2. One fourth of the target
 3. One half of the target
 4. The complete target

- 3-21. The preferred width of a machine gun target is how many mils?
1. Less than 50
 2. 50 to 75
 3. 75 to 100
 4. 100 to 125

IN ANSWERING QUESTIONS 3-22 THROUGH 3-24, MATCH THE FIRE COMMAND FOR MACHINE GUNS IN COLUMN B WITH THE TARGET DESCRIBED IN COLUMN A. NOT ALL RESPONSES IN COLUMN B ARE USED.

A. TARGET	B. FIRE
<u>DESCRIPTIONS</u>	<u>COMMANDS</u>
3-22. Target is less than 50 mils wide and less than the beaten zone in depth	1. Fixed 2. Traverse 3. No. 1 gun, right half; No. 2 gun, left half; traverse
3-23. The target is less than the width of the beaten zone of the machine gun	4. Search
3-24. The target is deeper than the length of the beaten zone and is moving slowly toward the two machine guns	
<hr/>	
3-25. By what means does a leader of a machine gun fire unit issue his instructions?	1. Message 2. Radio 3. Fire commands 4. Hand signals

IN ANSWERING QUESTIONS 3-26 THROUGH 3-28, MATCH THE FIRE COMMAND ELEMENT FOR MACHINE GUNS IN COLUMN B WITH THE FIRING INFORMATION IN COLUMN A. NOT ALL RESPONSES IN COLUMN B ARE USED.

	A. FIRING INFORMATION	B. FIRE COMMAND ELEMENTS
3-26.	Designation of gun crew to fire	1. Method of fire
3-27.	Direction of, type of, and range to the target	2. Fire 3. Target designation
3-28.	Command to start firing	4. Alert
3-29.	A fire command, such as <i>quickfire</i> , should be given to riflemen or automatic riflemen just after the <ol style="list-style-type: none"> 1. alert of a possible target 2. target description 3. range to the target 4. target assignment 	
3-30.	When the target is to the right or left of an easily visible reference point, the distance between the target and reference point is reported by what unit of measurement? <ol style="list-style-type: none"> 1. Arm length 2. Degree 3. Finger width 4. Pace 	
3-31.	A final protective line is what type of predetermined line? <ol style="list-style-type: none"> 1. Where visibility is poor 2. Where the fence line is located 3. Where bands of grazing fire interlock 4. Where the elevation and direction of fire is not fixed 	

Learning Objective: Specify methods of moving individuals and formations in a combat area and conditions under which individual methods should be used.

- 3-32. When moving on foot in enemy controlled terrain, you should use which of the following methods?
1. Move short distances quickly
 2. Pick your next position before moving
 3. Pick an alternate route before moving
 4. Each of the above
- 3-33. When crossing roads, trails, and rivers in a combat zone, you should cross at what location?
1. An area with the most cover and concealment
 2. Any culvert large enough to crawl through
 3. Any low spot to help avoid detection
 4. Any curve to cut down on the distance you can be seen
- 3-34. When hitting the dirt or deck while armed with an M16 rifle, you should take which of the following actions?
1. Slide your hand to the heel of the butt
 2. Hold the rifle in one hand and break your fall with the other
 3. Be sure to break your fall with the rifle butt
 4. Grip the rifle by the sling near the sling swivel
- 3-35. Of the following factors, which one does NOT determine whether the high or low crawl should be used?
1. Visibility
 2. Speed required
 3. Cover or concealment
 4. Number of troops moving

- 3-36. When using the low crawl, you should carry an M16 rifle in what manner?
1. Cradle it in your arms
 2. Grip it by the sling near the butt and pull it with the muzzle to the rear
 3. Grip it by the sling near the upper sling swivel and let the balance rest in your forearm
 4. Grip it by the muzzle and let the butt drag along the ground

- 3-37. When on a night patrol very near an enemy encampment, you should use what method of moving?
1. Rush
 2. Low crawl
 3. High crawl
 4. Walking silently

- 3-38. From a standing position, you are trying to assume the prone position silently. With one hand, you first feel the ground and clear it of a noisemaking object. What is your next step?
1. Lower both knees to the ground at the same time until they support the weight of your body
 2. Lower your knees to the ground one at a time until your weight is supported by one hand and both knees
 3. Lower both knees while falling forward on your stomach
 4. Lower both knees while falling forward on your right or left elbow

Learning Objective: Indicate actions to be taken by an individual when he is caught in the light of an overhead or ground flare.

- 3-39. If you are caught in the open when an overhead flare goes off, you should take which of the following actions?
1. Crouch low and remain motionless until the flare burns out
 2. Immediately hit the dirt or deck until the flare burns out
 3. Move out of the lighted area as quickly and quietly as possible
 4. Silently get in the prone position as fast as possible

- 3-40. In which of the following situations should you crouch as low as possible and remain motionless when caught by an overhead flare?
1. When crossing barbed wire
 2. When caught in an open field
 3. Both 1 and 2 above
 4. When assaulting an enemy position

Learning Objective: Differentiate between types of fire team formations relative to purpose, use, and their limitations under given combat conditions: specify the duties of the fire team leader assigned to basic fire team formations and movements.

- 3-41. When, if ever, must the squad leader have each individual maintain exact distances between individuals and units that are in combat formations?
1. When the formations are under heavy enemy fire
 2. When he cannot maintain control in another way
 3. When he is using hand-and-arm signals to communicate
 4. Never

3-42. In basic fire team formations, the fire team leader should place himself in what position?

1. Between rifleman No. 1 and rifleman No. 2
2. Where he can best observe the fire team
3. Where he can best be protected
4. In the foremost position

3-43. The automatic rifleman is positioned within the basic fire team formation to ensure that he can perform which of the following functions?

1. Direct rifleman No. 1
2. Receive ammunition from rifleman No. 2
3. Provide security for the fire team
4. Quickly deliver fire to each flank

3-44. In a fire-team column formation, the firepower is limited in what direction?

1. Front
2. Right flank
3. Left flank
4. Rear

3-45. In regard to firepower, an echelon-right formation provides

1. maximum firepower to the front
2. all-around security
3. minimum firepower to the front and maximum to the right
4. maximum firepower to the right and to the front

3-46. If you are assigned as fire team leader, what factors will control the type of fire-team formation you use?

1. Visibility and types of weapons
2. Ease of control and speed
3. Enemy firepower and ease of control
4. Terrain features and tactical situations

Learning Objective: Specify the kinds of rifle squad formations used in given combat situations and how squad formations are changed to meet changing tactical situations.

3-47. When a unit is moving in the fog or through the woods, the squad column should be used because it provides which of the following benefits?

1. Good control and maneuverability
2. Security to the front and both flanks
3. Maximum firepower to the front
4. Protection to exposed flanks

3-48. When the squad formation is being changed, which of the following squad members should be used as the pivot?

1. Squad leader
2. First fire team
3. Second fire team
4. Third fire team

Learning Objective: Specify the kinds of rifle platoon formations used under given combat conditions.

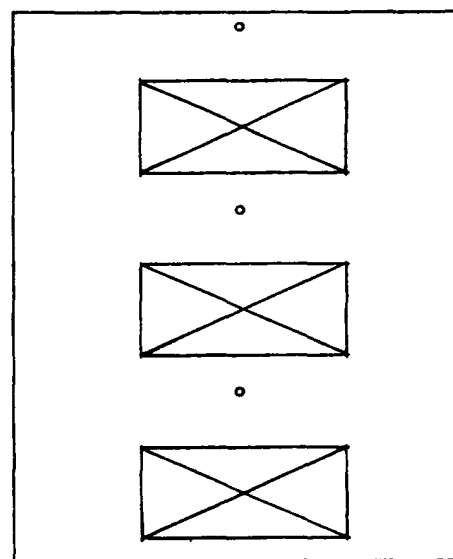

Figure 3A

IN ANSWERING QUESTION 3-49, REFER TO
FIGURE 3A.

3-49. The platoon formation shown is used by the platoon leader under which of the following situations?

1. Maximum security to both flanks is required
2. Maximum speed and control are required
3. The enemy is known to be in the area
4. Maximum firepower to the front is required

3-50. When the enemy's position is to the front and to the left of you, what type of platoon formation should you use to direct maximum firepower at the enemy?

1. Platoon line
2. Platoon skirmishers left
3. Platoon echelon left
4. Platoon wedge

3-51. There is a total of how many different elements in a rifle company's attack formations?

1. Six
2. Two
3. Three
4. Five

3-52. The task of taking an assigned objective is given to what element of a rifle company?

1. The main attacking force
2. The supporting attack force
3. The weapons platoon

3-53. The formation of one platoon in attack and two in reserve is used when the rifle company is in which of the following situations?

1. One or both flanks are exposed and the enemy's location is unknown
2. A wide area must be cleared rapidly
3. Its maximum firepower is to the front
4. Detailed information on the enemy's position is available

Learning Objective: Specify the purpose and use of the weapons unit formation during an attack.

3-54. A large volume of mortar, rocket, or machine gun fire delivered on an enemy position during an assault is designed to keep the enemy pinned down and is called a/an

1. covering fire
2. supporting fire
3. base of fire
4. attack by fire

3-55. What person is responsible for the security of a mortar team assigned to a rifle unit?

1. The platoon leader
2. The senior rifle unit leader
3. The squad leader
4. The company commander

3-56. When a weapons unit is assigned to a rifle unit, the targets for the unit are assigned by the

1. weapons unit leader
2. senior rifle unit leader
3. support attack force leader
4. reserve attack force leader

Learning Objective: Describe a patrol in terms of its objective and orders.

3-57. What is the main objective of most Seabee patrols?

1. Static defense
2. Delaying the enemy
3. Security patrolling
4. Aggressive patrolling

- 3-58. As leader of a reconnaissance patrol, you may engage your unit in combat to accomplish which of the following goals?
1. To destroy an enemy patrol
 2. To accomplish your mission
 3. To delay an enemy attack
 4. To confuse an enemy attack
- 3-59. Of the following types of information, which should be contained in a patrol order?
1. Time of departure and time of return
 2. Communications plan for the mission
 3. General route to the objective position
 4. Each of the above
-
- Learning Objective: Define the duties and positions of patrol personnel and techniques of control, security, and movement.
-
- 3-60. Where in a patrol should the patrol leader position himself?
1. At the head of the patrol
 2. Where he can best control the patrol
 3. Near the center of the patrol
 4. At the rear of the patrol
- 3-61. When you are the patrol leader and the route takes you near an enemy position, you should issue orders to control the patrol in which of the following ways?
1. By halting the patrol and giving each man his orders one at a time
 2. By giving hand-and-arm signals only while on the move
 3. By using sound signals only while on the move
 4. By assembling the patrol and passing the word orally to the assembly
- 3-62. The responsibility of the point in a patrol is to investigate which of the following positions?
1. The area to both sides of the route of march only
 2. The area directly in front of the patrol only
 3. The rallying points before the patrol arrives
 4. The front and sides of the route of march
- 3-63. The progress of the patrol toward its final objective is regulated by a series of preplanned points known as
1. intermediate objectives
 2. primary objectives
 3. rallying points
 4. alternate objectives
- 3-64. When you are on a patrol that has been ambushed and the patrol is forced to separate, you should immediately proceed to what location?
1. Primary objective
 2. Closest alternate objective
 3. Closest rallying point
 4. Intermediate objective
- 3-65. When you plan a patrol, which, if any, of the following factors governs the operation?
1. Personnel
 2. Mission
 3. Time
 4. None of the above
- 3-66. After a mission has been studied and its tasks identified, which of the following factors must be considered to execute the mission?
1. Personnel
 2. Equipment
 3. Organization
 4. Each of the above

- 3-67. The size of a patrol, its route, and the types of weapons and equipment it will carry are all affected by which of the following factors?
1. Terrain features, cover, and concealment
 2. Troop disposition, strength, and capabilities
 3. Time left before departure of the patrol
 4. Distance the patrol must cover
- 3-68. Each of your patrol members should carry a poncho, a pair of gloves, and an extra pair of socks in addition to the uniform and web equipment he is wearing. All of this gear is classified as what type of equipment?
1. Enroute
 2. Control
 3. Objective
 4. Routine
- 3-69. The patrol's mission, general instructions, and a short briefing of the situation are given to patrol members in what format?
1. The patrol order
 2. The warning order
 3. The complete detailed plan
 4. The patrol leaders' order
- 3-70. Suppose your patrol requires fire support to divert the enemy's attention while you are leaving friendly lines. Which, if any, of the following patrol planning steps covers this situation?
1. Execute the mission
 2. Organize the patrol
 3. Coordinate
 4. None of the above
- 3-71. When it is not possible to make an aerial reconnaissance while your patrol is preparing for a mission, you should try to obtain the required information in which of the following ways?
1. By enlarging area maps
 2. By studying aerial photographs
 3. By observing from a vantage point
- 3-72. Before issuing orders to members of his patrol, a patrol leader should take which of the following actions?
1. Inspect men and equipment
 2. Describe the plan orally
 3. Rehearse the mission by day and by night
 4. Announce departure and return times only
- 3-73. Even though time is limited, a patrol must always rehearse its actions at which of the following times?
1. At the point where the patrol will leave friendly lines
 2. At the point where the patrol will return to friendly lines
 3. At the objective area
 4. At the site where the patrol is likely to be ambushed
- 3-74. A patrol's formation in combat or on a reconnaissance mission en route to an objective is known as its
1. general organization
 2. conduct during the patrol
 3. organization for movement
 4. coordination for the patrol

3-75. When a patrol departs friendly lines and plans to be out 2 days, the patrol leader must be sure to obtain which of the following information?

1. Challenge for the second day only
2. Password for the second day only
3. Passwords and challenges for both days
4. Codewords and authentication keys for both days

ASSIGNMENT 4

Textbook Assignment: "Combat Maneuvers, Formations, Patrols, and Ambushes," "Land Navigation," and "Evasion, Survival, and Escape." Pages 4-19 through 6-4.

Learning Objective: Define the duties and positions of patrol personnel and techniques of control, security, and movement.

- 4-1. Rallying points that the patrol leader selects when making up the patrol plan are known as
1. tentative
 2. objective
 3. initial
 4. en route
- 4-2. Your patrol becomes engaged in a fire fight with the enemy and is dispersed between its first and second en route rallying points. At what point should the patrol reassemble?
1. At the first en route rallying point only
 2. At the second en route rallying point only
 3. At either 1 or 2 above, whichever the patrol order designates
 4. At the objective rallying point
- 4-3. During a patrol, you come upon the enemy unexpectedly and a fire fight occurs. Which of the following actions should you take?
1. Attack the enemy at their weakest point
 2. Break contact as soon as possible and continue the mission
 3. Disperse and regroup at the designated rallying point
 4. Direct maximum firepower at the enemy until they retreat

4-4. If caught in an enemy ambush set up so withdrawal appears impossible, a patrol should be ordered to

1. surrender
2. break contact by fire and movement
3. break contact by movement to the right
4. assault the weakest point of the ambush with maximum firepower

Learning Objective: Point out principles and techniques of ambush.

- 4-5. What is the primary purpose of an ambush?
1. To harass the enemy
 2. To confuse and panic the enemy
 3. To divert enemy troops from other missions
 4. To destroy enemy personnel and equipment
- 4-6. When against a small enemy force that requires you to create only one killing zone, what type of ambush should succeed?
1. Area
 2. Deliberate
 3. Opportunity
 4. Point

- 4-7. You are on a patrol sent into enemy territory to destroy small enemy units. You have no definite information about the enemy, so you must ambush the first suitable target. This is an example of what type of ambush?
1. Opportunity
 2. General purpose
 3. Deliberate
 4. Clandestine
- 4-8. Although you must always maintain close control of your men at an ambush site, this control is most important at which of the following times?
1. During the ambush
 2. When the target is approaching
 3. When withdrawing from the ambush site
 4. When arriving at the ambush site
- 4-9. The formation of a point ambush mainly determines whether or not a point ambush can
1. deliver the coordinated volume of fire required
 2. achieve the surprise necessary to trap the enemy
 3. achieve a timely and orderly withdrawal
 4. approach the target area without detection
- 4-10. In what terrain is the line formation of a point ambush effective?
1. In open terrain where one flank is or can be restricted by natural or artificial obstacles
 2. In open terrain where both flanks are accessible
 3. In terrain where lateral dispersion of the enemy is possible
 4. In close terrain where both flanks are accessible
- 4-11. The short side of an L-formation should be deployed in what area?
1. On the opposite side of the enemy's route of march
 2. Parallel to the enemy's route of march
 3. Across the enemy's route of march
 4. At the end of and at right angles to the killing zone
- 4-12. Which of the following types of ambush formations may be used strictly as a harassing ambush?
1. Line
 2. L
 3. T
 4. V
- 4-13. The main disadvantage of using a T-ambush formation is that the attack force may
1. engage a superior force at night while spread out
 2. not be able to withdraw without decisively engaging the enemy
 3. not be able to prevent assault or escape in the opposite direction
 4. not be able to concentrate its fire power in the killing zone
- 4-14. What is the main advantage of using the V-ambush formation?
1. It is easy to control
 2. It is hard for one leg of the V to fire into the other leg
 3. It is difficult to detect until the enemy is well into the killing zone
 4. It subjects the enemy to both enfilading and interlocking fire

- 4-15. When caught in the killing zone of a near ambush, a patrol should react by
1. assaulting the enemy when ordered by the patrol leader
 2. returning fire and taking cover as ordered by the patrol leader
 3. returning fire and taking cover without orders from the patrol leader
 4. assaulting the enemy position without orders from the patrol leader
- 4-16. An assault on a near enemy ambush should continue until the patrol is able to
1. reach suitable cover and eliminate return fire
 2. make a breach in the ambush so contact can be broken
 3. get room in which to maneuver
 4. eliminate the ambush or break contact as directed
- 4-17. Whether a patrol succeeds or fails in breaking out of an enemy ambush depends mainly on the
1. purpose of the ambush
 2. extent to which the patrol is trained and rehearsed
 3. type of ambush formation the enemy is using
 4. number of enemy weapons being used against you
-
- Learning Objective: Denote the principles of terrain appreciation. Explain the aspects of weather, climate, and seasons as they influence the terrain.
-
- 4-18. In a military operation, the analysis of an area by the defense or offense to determine how the terrain features can be used is known as
1. terrain components
 2. terrain appreciation
 3. intelligence reporting
 4. reconnaissance
- 4-19. From a tactical standpoint, which of the following aspects of terrain is considered to be the most important?
1. Season
 2. Climate
 3. Weather
 4. Water
- 4-20. Air support during a combat situation can be restricted by which of the following elements?
1. High or low temperature
 2. Fog, rain, or a large mass of low-flying clouds
 3. High or low humidity
 4. First or second quarter of the moon
-
- Learning Objective: Point out those qualities known as the military aspects of terrain that can be used by each unit leader in the employment of his forces and weapons.
-
- 4-21. When holding key terrain in an area, you have the advantage over the enemy in regard to
1. cultural features
 2. fields of fire only
 3. observation only
 4. fields of fire and observation
- 4-22. What are the primary considerations in choosing your defensive position?
1. Minimum observation and short fields of fire
 2. Maximum observation and short fields of fire
 3. Maximum observation and long fields of fire
 4. Minimum observation and long fields of fire

- 4-23. Of the following conditions, which one is an artificial obstacle to troop movement through an area you are defending?
1. Swamp
 2. Gully
 3. Barbed wire
 4. Each of the above

Learning Objective: Locate a point on a map when given the references, and use procedures for locating an object with the grid system.

- 4-24. The principal digits of a grid number on a military map enable the map reader to determine which of the following information?
1. Precise angles
 2. Elevations between contour lines
 3. Referencing points
 4. Precise distances
- 4-25. Which of the following grid coordinates is correctly written?
1. 35°E, 71°N
 2. 3571
 3. 14250
 4. 71°N, 35°E

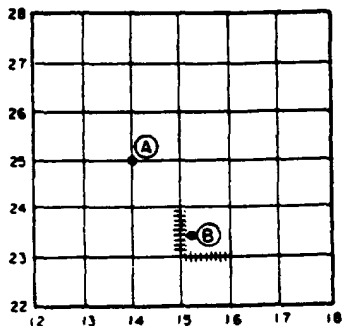

Figure 4A

IN ANSWERING QUESTIONS 4-26 AND 4-27,
REFER TO FIGURE 4A.

- 4-26. What are the grid coordinates of Point A?
1. 140250
 2. 14250
 3. 2514
 4. 2541

- 4-27. What are the grid coordinates of Point B?
1. 1523
 2. 152234
 3. 234152
 4. 230150

Learning Objective: Determine how contour lines are used for indicating elevation and relief on military maps.

- 4-28. Elevations are represented on a map by what means?
1. Contour lines
 2. Grids
 3. Planimeter lines
 4. Meridians and parallels of latitude
- 4-29. A heavy-contour line having its elevation given alongside is known as a/an
1. index contour
 2. supplementary contour
 3. precise contour
 4. intermediate contour
- 4-30. When you subtract half the contour interval from the elevation of the lowest contour line around a depression, you obtain what information?
1. The estimated elevation at the top of the depression
 2. The estimated elevation at the bottom of the depression
 3. The mean sea level at the bottom of the depression
 4. The average sea level at the top of the depression

- 4-31. You can find the value of the interval between supplementary contour lines on a map in what location?
1. In a contour note on the map relief
 2. In a note on the map margin
 3. Alongside an index contour line
 4. Alongside the dashed-brown contour lines

- 4-32. On a military map, the elevation value of a bench mark is shown in what color?

1. Red
2. Blue
3. Black
4. Brown

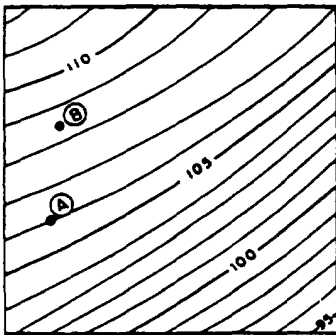

Figure 4B

IN ANSWERING QUESTIONS 4-33 AND 4-34, REFER TO FIGURE 4B.

- 4-33. What is the approximate elevation, in feet, of Points A and B?

1. A, 106; B, 105
2. A, 107; B, 105.5
3. A, 106; B, 108.5
4. A, 105; B, 110

- 4-34. Which of the following areas is flattest?

1. The area between contour lines 95 and 100
2. The area between contour lines 100 and 105
3. The area between contour lines 105 and 110

- 4-35. Contour lines are sometimes united to show an extremely steep slope on a map. What type of contour is used to indicate this slope?

1. Intermediate
2. Index
3. Supplementary
4. Ticked "carrying"

- 4-36. What two basic types of scales are used on military maps?

1. Graphic and linear
2. Graphic and ratio
3. Linear and ratio
4. Graphic and orthographic

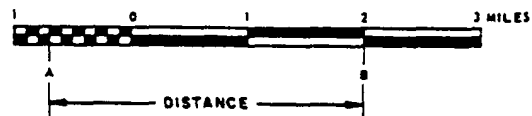

Figure 4C

IN ANSWERING QUESTION 4-37, REFER TO FIGURE 4C.

- 4-37. What is the distance between Points A and B?

1. 1.3 miles
2. 1.7 miles
3. 2.3 miles
4. 2.7 miles

- 4-38. The scale of a map is 1/5000 and the distance between two points on the map is 2.4 inches. What is the distance on the ground between these two points?

1. 240 feet
2. 420 feet
3. 1,000 feet
4. 2,000 feet



Learning Objective: Describe how direction and base lines are used in the preparation of military maps, and identify topographic and military features represented on military maps as symbols.

Learning Objective: Describe the components and the use of the lensatic compass, in relation to an azimuth, back azimuth, intersections, and resections.

4-39. Of the following land navigation terms, which are considered to be base lines for expressing directions on a map?

1. True north, grid north, and magnetic north
2. Greenwich meridian and International Date Line
3. Parallels of latitude and meridians of longitude
4. Datum plane, index contour, and bench mark

4-40. The symbol for true north on a military map is

1. 
2. TN
3. 
4. Y

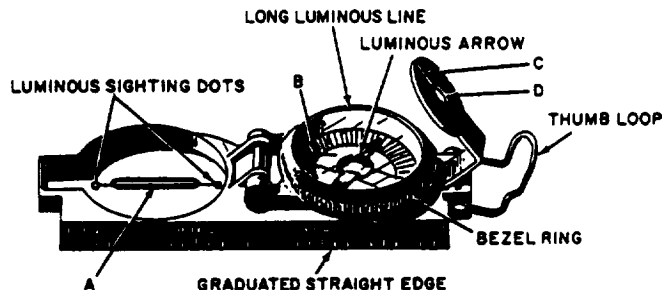
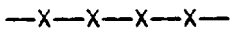
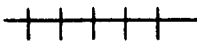



Figure 4D

IN ANSWERING QUESTIONS 4-44 THROUGH 4-46, REFER TO FIGURE 4D AND SELECT FROM COLUMN B THAT PART OF THE LENSATIC COMPASS THAT CORRESPONDS TO THE LETTER DESIGNATION IN COLUMN A. NOT ALL RESPONSES IN COLUMN B ARE USED.

	<u>A. LETTERS</u>	<u>B. LENSATIC COMPASS PARTS</u>
4-44.	A	1. Lens
4-45.	B	2. Sighting wire
4-46.	C	3. Index line
		4. Sighting slot

IN ANSWERING QUESTIONS 4-41 THROUGH 4-43, SELECT FROM COLUMN B THE TOPOGRAPHIC FEATURE REPRESENTED BY THE SYMBOL IN COLUMN A. NOT ALL RESPONSES IN COLUMN B ARE USED.

	<u>A. SYMBOLS</u>	<u>B. TOPOGRAPHIC FEATURES</u>
4-41.		1. Hill
4-42.		2. Single-track railroad
4-43.		3. Boundary line
		4. Fence

4-47. Sighting on an object and reading an azimuth, a horizontal angle is measured in what manner?

1. Counterclockwise from a south base line
2. Clockwise from a north base line
3. Counterclockwise from a north base line
4. Clockwise from a south base line

- 4-48. When you are holding a compass and sighting through the eyepiece, which of the following objects tend to distort your azimuth reading?
1. The sun
 2. The moon
 3. Your steel helmet
 4. Your hand

- 4-49. Which of the following features of a lensatic compass are designed for night use?

1. The luminous line and arrow
2. The two luminous sighting dots
3. The bezel ring and clicking device
4. All of the above

- 4-50. A total of how many counter-clockwise clicks of the bezel ring are required for an azimuth of 72 degrees?

1. 17
2. 24
3. 38
4. 42

- 4-51. The azimuth angle in figure 5-29 can be measured accurately with a

1. compass
2. protractor
3. straightedge
4. pair of scissors

- 4-52. When, if ever, can a given direction be expressed as a true azimuth?

1. Only if measured on a military map
2. Only if measured by a compass
3. Only if measured from a meridian of longitude
4. Never

- 4-53. The forward azimuth to a target is 130 degrees. What is its back azimuth?

1. 292 degrees
2. 310 degrees
3. 1850 mils
4. 6400 mils

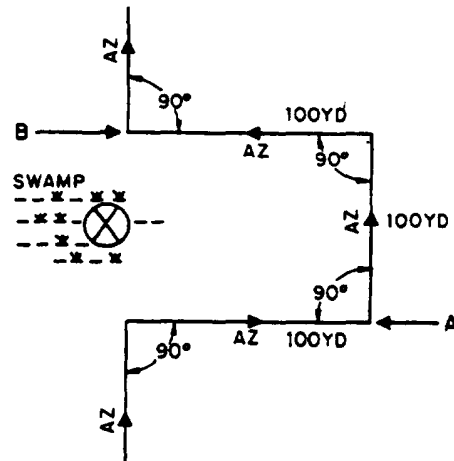

Figure 4E

IN ANSWERING QUESTIONS 4-54 AND 4-55, REFER TO FIGURE 4E. ASSUME YOU ARE TRAVELING ON AN AZIMUTH OF 90 DEGREES AND WISH TO BYPASS THE SWAMP.

- 4-54. At what azimuth are you traveling when reaching Point A?

1. 90 degrees
2. 180 degrees
3. 270 degrees
4. 360 degrees

- 4-55. At what azimuth are you traveling when reaching Point B?

1. 90 degrees
2. 180 degrees
3. 270 degrees
4. 360 degrees

- 4-56. What method should you use to locate a feature NOT defined on your map?

1. Intersection
2. Resection
3. Bypass
4. Introspection

4-57. What term is applied to locating your unknown position by sighting on two or more positions?

1. Intersection
2. Resection
3. Map overlay
4. Bypass

Learning Objective: Identify steps in drawing sketches and describe ways to register a map overlay properly.

4-58. What is the final step in making a panoramic sketch?

1. Title it and show where it was prepared
2. Sign it
3. Indicate the time and date it was prepared
4. Establish the most prominent point in the area as the reference for the sketch

4-59. You are preparing a topographic sketch. After drawing the azimuth line from your position to the sighted object, where should you show the distance?

1. On the marginal notes
2. Above the azimuth line
3. Below the azimuth line
4. At the end of the azimuth line

4-60. An overlay should be marked to orient it on a map correctly by what means?

1. By marking and numbering, with a register mark, one grid square on the overlay
2. By marking and numbering at least two crosses (register marks) on the grid square on two opposite corners of the overlay
3. By marking the distance and azimuth from a prominent point of your position on the overlay
4. By placing the grid numbers of a prominent object on the overlay

Learning Objective: Specify the travel and observation techniques for evading the enemy under given conditions.

IN ANSWERING QUESTIONS 4-61 THROUGH 4-64, SELECT FROM COLUMN B THE PIECE OF INFORMATION THAT MAY BE INDICATED BY THE CONDITION IN COLUMN A. RESPONSES IN COLUMN B MAY BE USED MORE THAN ONCE.

	<u>A. CONDITIONS</u>	<u>B. PIECES OF INFORMATION</u>
4-61.	Workers in a field	1. Enemy is not present
4-62.	Absence of children in a village	2. Village is controlled by the enemy
4-63.	Absence of young men in a village	3. Action is about to take place
4-64.	Apparently normal activity in a village	

4-65. While evading the enemy in a strange country, you should use which of the following techniques because it is the best way to remain on your intended course?

1. Choose a man-made landmark in your direction of travel; then proceed toward it
2. Choose as a landmark a prominent natural feature in your direction of travel; then proceed toward it
3. Mark your route by cutting vegetation or by bending bushes and limbs

4-66. When following a trail that comes to a fork, what should you do?

1. Take the least traveled path
2. Take the most traveled path
3. Start to backtrack
4. Request further instructions

4-67. What should you do when you can no longer proceed on your own because of illness?

1. Seek help from friendly natives
2. Surrender before it is too late
3. Seek shelter and doctor yourself
4. Hide indefinitely

4-68. As an evader approaching friendly lines, which of the following steps should help you contact friendly frontline troops?

1. Shout out to them that you are a Seabee
2. Expose yourself and raise your arms as your approach
3. Display a white flag or another white object before exposing yourself
4. Fire your weapon three times as you approach

4-69. What information, if any, should you provide friendly frontline troops after having evaded the enemy ?

1. Any and all information requested
2. Immediate tactical information only
3. A description of the methods you used successfully during evasion
4. None

ASSIGNMENT 5

Textbook Assignment: "Evasion, Survival, and Escape," "Individual Protective Measures," "Entanglements," and "Chemical, Biological, and Radiological (CBR) Defense." Pages 6-4 through 9-5.

Learning Objective: Denote principles and techniques of survival for individuals or group leaders during evasion.

- 5-1. If you find yourself isolated behind enemy lines, the letters of what keyword tell you what to do?
1. E-V-A-S-I-O-N
 2. E-S-C-A-P-E
 3. S-U-R-V-I-V-A-L
 4. K-O-C-O-A
- 5-2. When sizing up the situation after finding yourself isolated behind enemy lines, what three factors should you consider?
1. Escape routes, weather, and water
 2. Yourself, the enemy, and the weather
 3. The enemy, water, and escape routes
 4. The country, yourself, and the enemy
- 5-3. After being cut off from your troops, you get to a safe, comfortable place where you have time to think and look things over. What should be your first action?
1. Try to contact your group leader
 2. Start writing a diary
 3. Form a plan of survival
 4. Prepare to defend your position
- 5-4. Which of the following feelings is natural and provides an extra shot of energy when you need it?
1. Loneliness
 2. Fear
 3. Hunger
 4. Eagerness
- 5-5. Isolated within enemy territory, you need something that is not handy. Which of the following actions should you take?
1. Learn basic skills
 2. Seek and destroy
 3. Improvise
 4. Act like a native
- Learning Objective: Identify requirements and responsibilities of a group leader while he or his group are isolated behind enemy lines.
- 5-6. As the leader of a group evading capture while attempting to return to friendly forces, you should take which of the following actions to keep the group organized?
1. Ensure the group is kept well-informed
 2. Change the evasion plan from day to day
 3. Assign tasks to individuals based on expediency

5-7. In making decisions for an evasion group, which, if any, of the following actions should be taken by the group leader?

1. Ignore advice volunteered by other members of the group
2. Ask for information and advice from other members of the group
3. Offer two courses of action, then let the other members of the group decide which is better
4. None of the above

Learning Objective: Specify survival techniques to be used while evading the enemy.

5-8. To maintain efficiency, you need, as a minimum, what amount of water each day?

1. 1 pint
2. 2 quarts
3. 1 quart
4. 1 gallon

5-9. The water table is closest to the surface in which of the following places?

1. Lands overlooking river valleys
2. Rock-covered hilltops
3. Low-lying forests
4. Large, open fields

5-10. To obtain drinking water from the seashore, you should dig holes in the sand approximately what distance above the high-tide mark at low tide?

1. 100 yards
2. 200 yards
3. 100 feet
4. 50 feet

5-11. What is the proper method for extracting water from a growing vine?

1. Cut the vine in 24- to 36-inch lengths, remove the outer covering, then suck out the water
2. Cut a deep notch high on the vine, cut the vine off close to the ground, then let the water drip into your mouth or a container
3. Cut the vine in short sections and beat them with a rock over a pan to catch the water
4. Remove the outer covering of the vine, cut the inner pulp in short sections, then chew the sections

5-12. After estimating that you will be on your own for 30 days, you should plan to budget your food supply in which of the following ways?

1. One half for the first 15 days and one half for the last 15 days
2. Two thirds for the first 15 days and one third for the last 15 days
3. Three fourths for the first 15 days and one fourth for the last 15 days
4. One third for the first 10 days and two-thirds for the last 20 days

5-13. Nuts and seeds provide what nutrient that the human body requires to function efficiently?

1. Calcium
2. Protein
3. Phosphate
4. Minerals

5-14. What type of fowl is easier to pluck dry, rather than after being scalded?

1. An eagle
2. A duck
3. A buzzard
4. A pheasant

5-15. What type of food is considered safest for eating?

1. Shrimp
2. Crabs
3. Eggs
4. Shellfish

5-16. To increase the heat retention of a baking pit, you should line it with which of the following materials?

1. Charcoal
2. Leaves
3. Dirt
4. Stones

5-17. What are the ideal dimensions of a smoking pit?

1. 1 foot wide and 2 feet deep
2. 2 feet wide and 1 foot deep
3. 1/2 yard wide and 1 yard deep
4. 1 yard wide and 1 yard deep

5-18. You can determine whether a plant growing in the tropics is edible by

1. tasting it
2. noticing whether wild animals eat it
3. examining the leaves
4. smelling it

Learning Objective: Stipulate ways to plan for a successful escape and the actions required to aid you in maintaining your health.

5-19. If captured, you should begin planning your escape at which of the following times?

1. After arriving at the POW camp
2. 2 days after being captured
3. 5 days after being captured so you have time to observe the enemy's habits
4. Immediately after being captured

5-20. After being captured, when, if ever, is the best time for you to try and escape?

1. During the first week of capture
2. Approximately 2 weeks after capture
3. As soon as possible
4. Never

5-21. After you have escaped, what is the best time to arrive at friendly lines?

1. Dusk
2. Dawn
3. Midnight
4. Noon

5-22. To keep your cache of escape material from being noticed and taken away while in a POW camp, you should hide it in which of the following locations?

1. In your locker
2. In your pockets or clothing
3. In a hole in the ground or under the floor of your room

5-23. What is a good way to persuade your captors to provide you with laundry service and a bath?

1. Tell the guards that you are infested with lice
2. Complain to the guards that you intend to write the International Red Cross if they do not grant your request
3. Tell the guards that you will cooperate with them if they provide soap and water

Learning Objective: Specify principles of cover and concealment and their application in construction of a fighting emplacement.

- 5-24. Which of the following positions can protect you against flat trajectory fire?
1. Reverse slopes
 2. Ravines and hollows
 3. Fighting emplacements
 4. Each of the above
- 5-25. Which of the following locations can be an excellent combat position?
1. One with maximum cover only
 2. One with maximum concealment only
 3. One with maximum cover and concealment
- 5-26. As a means of covering and concealing most of your head and body while occupying a temporary battlefield position, you should take which of the following actions?
1. Maintain a high profile
 2. Choose a position close to a river
 3. Observe the enemy and keep silent
 4. Observe and fire around the sides of objects
- 5-27. What is the first principle of concealment?
1. Keep low
 2. Move only when necessary
 3. Expose nothing that shines
 4. Use all available concealment
- 5-28. A fresh soil parapet or ridge around a fighting emplacement should have what approximate dimensions?
1. 1 foot high and 3 feet wide
 2. 2 feet high and 4 feet wide
 3. 6 inches high and 3 feet wide
 4. 6 inches high and 4 feet wide
- 5-29. What is the simplest type of dug-in emplacement?
1. A camouflaged fighting hole
 2. A skirmisher's trench
 3. A cut-timber revetment
 4. A cave hole
-
- Learning Objective: Specify the principles of camouflage and some methods of camouflaging a temporary battlefield position, yourself, your equipment, buildings, and supply points.
-
- 5-30. What is the purpose of camouflaging?
1. To keep the enemy from seeing you, your position, or your equipment
 2. To keep the enemy from firing on you or your position
 3. To afford protection against small-arms fire
 4. To afford protection against the effects of aerial bombs
- 5-31. The web equipment of your 782 gear has faded and no camouflage paint is available. In which, if any, of the following ways should you camouflage your equipment using mud?
1. Make irregular patterns that blend with the terrain around you
 2. Make regular patterns that contrast with the terrain around you
 3. Spray a thin layer of mud evenly over all your equipment
 4. None of the above
- 5-32. Which of the following practices is recommended for applying loam and light green face paint?
1. Paint shiny areas with loam and shadow areas with light green paint
 2. Paint shiny areas with light green paint and shadow areas with loam
 3. Paint hands with light green paint and wrists with loam

- 5-33. Which of the following materials should NOT be substituted for face paint unless the medical officer approves its use?
1. Lampblack
 2. Burnt cork
 3. Charcoal
 4. Mud
- 5-34. When netting is used to camouflage a building, it should be placed over the whole building when the roof is steeper than how many degrees?
1. 10°
 2. 20°
 3. 30°
 4. 40°
- 5-35. Which of the following methods aids in maintaining the camouflage discipline at supply points?
1. Maximum alteration of the terrain
 2. Minimum of changes in the appearance of the terrain
 3. Control of debris
 4. Both 2 and 3 above
-
- Learning Objective: Identify design features of wire entanglements and recognize their construction and handling procedures.
-
- 5-36. Barbed wire entanglements are designed to slow the movement of (a) what type of troops with (b) what type of obstacle?
1. (a) Airborne (b) natural
 2. (a) Infantry (b) natural
 3. (a) Airborne (b) artificial
 4. (a) Infantry (b) artificial
- 5-37. What are the three classifications of barbed wire?
1. Tactical, protective, and supplementary
 2. Protective, fixed, and supplementary
 3. Portable, protective, and tactical
 4. Tactical, protective, and fixed
- 5-38. Portable barbed wire entanglements are used for which of the following reasons?
1. For temporarily closing gaps in lanes
 2. To permit assembly in rear areas
 3. For rapid installation in forward positions
 4. Each of the above
- 5-39. Antipersonnel obstacles should be positioned to allow for which of the following actions?
1. Adequate surveillance by day
 2. Adequate surveillance by night
 3. Both 1 and 2 above
 4. Throwing of hand grenades
- 5-40. You should take which of the following safety precautions while handling barbed wire?
1. Wear standard combat gear
 2. Wear standard barbed wire gauntlets
 3. Wear heavy leather gloves
 4. Either 2 or 3 above, depending on availability or preference
- 5-41. For field users, which of the following characteristics of barbed-steel tape are the most significant?
1. Width and thickness
 2. Weight and interval between barbs
 3. Width of barb and breaking load
 4. Weight and breaking load

- 5-42. What type of barbed-steel tape is the most effective?
1. Single apron
 2. Double apron
 3. Triple apron
- 5-43. What is the major disadvantage of barbed-steel tape?
1. It requires a dispenser for installation
 2. It can be seen by the enemy
 3. Its breaking strength
 4. It is not recoverable for reuse
- 5-44. You can increase the effectiveness of the standard double-apron fence by taking which of the following steps?
1. Make the top wire knee-high
 2. Raise the top wire to preclude stepping over it
 3. Place low wires 4 inches above the ground
 4. Both 2 and 3 above
- 5-45. What is the major advantage of concertina wire?
1. It can be used repeatedly
 2. It is much harder to cut
 3. It is sold commercially
 4. Each of the above
- 5-46. When expanded, barbed-tape concertina comes in what lengths?
1. 25 feet
 2. 50 feet
 3. 75 feet
 4. 100 feet
- 5-47. When installing barbed wire, you should tighten it in which of the following ways?
1. Rack it with a driftpin or short stick
 2. Use the M16 bayonet
 3. Assign two men to pull on the top strand
 4. Attach the wire to a truck and pull slowly
- 5-48. What step is accomplished in phase one of installing a four-strand cattle fence?
1. Unrolling the wire
 2. Laying out and installing the pickets and the wire
 3. Tightening the wire
 4. Installing the bottom fence wire
- 5-49. As an obstacle, the triple-standard concertina fence is better than which of the following other fences ?
1. Single concertina
 2. Double concertina
 3. Double apron
 4. Triple apron
- 5-50. You should use a knife rest with barbed wire for which of the following types of barriers?
1. Permanent
 2. Movable
 3. Semipermanent
 4. Unsecured
- 5-51. Trip wires should be placed about how many feet from the FEBA?
1. 18 to 48
 2. 31 to 89
 3. 48 to 81
 4. 98 to 131
-
- Learning Objective: Describe the effects of chemical, biological, and nuclear weapons.
-
- 5-52. Chemical agents can be used to produce temporary incapacitation.
1. True
 2. False
- 5-53. Of the following CBR weapons, which one is NOT a type of chemical antipersonnel agent?
1. Casualty
 2. Incapacitating
 3. Incendiary
 4. Harassing

- 5-54. Of the following chemical agents, which one is the most effective and lethal?
1. Blood
 2. Choking
 3. Blister
 4. Nerve
- 5-55. What type of chemical agent interferes with mental processes that control body functions?
1. Harassing
 2. Cumulative nerve
 3. Nonlethal incapacitating
 4. Nontoxic blister
- 5-56. What method of transmission is the most efficient for delivering biological agents?
1. Contamination
 2. Animals
 3. Insects
 4. Aerosols
- 5-57. The effects of a nuclear explosion are divided into what categories?
1. Direct, indirect, and heat
 2. Blast, heat, and nuclear radiation
 3. Primary and secondary
 4. Primary radiation and nuclear radiation
- 5-58. Secondary blast injuries from nuclear weapons can be caused by which of the following forces?
1. Flying debris
 2. Blinding light
 3. Air shock wave
 4. Each of the above
- 5-59. Permanent damage to your eyes can occur from thermal radiation at a distance of how many miles from a large-yield nuclear weapon?
1. 10
 2. 20
 3. 30
 4. 40
- 5-60. What type of nuclear radiation has little penetrating power?
1. Alpha
 2. Beta
 3. Neutron
 4. Gamma
- 5-61. You can avoid internal contamination from radiation by which, in any, of the following means?
1. Use a concrete bunker
 2. Wear battle dress
 3. Wear a protective mask
 4. None of the above
- 5-62. Exposure to a nerve agent is indicated by which of the following symptoms?
1. Irritation to the throat
 2. Tightness of the chest
 3. The eyes feel gritty
 4. Intense itching
-
- Learning Objective: Recognize the symptoms and effects of CBR agents.
-
- 5-63. Burns from mustard vapor are most severe in which of the following body areas?
1. Moist
 2. Ear
 3. scalp
 4. Exposed skin only
- 5-64. The severity of the symptoms produced by blood agents depends on what factor(s)?
1. Concentration of the agent only
 2. Duration of exposure only
 3. Concentration of the agent and duration of exposure

IN ANSWERING QUESTIONS 5-65 THROUGH 5-68, SELECT THE AGENT FROM COLUMN B THAT CAUSES SYMPTOMS SPECIFIED IN COLUMN A. THE RESPONSES IN COLUMN B MAY BE USED MORE THAN ONCE.

<u>A. Symptoms</u>	<u>B. Agents</u>
5-65. Pepperlike burning of the eyes, nose, and air passages, followed by flow of tears and repeated coughing and sneezing	1. Blister 2. Choking 3. Vomiting
5-66. Eyes water, feel gritty, become sore and bloodshot; eyelids become red and swollen	
5-67. Deep breathing, violent convulsions within 20 to 30 seconds; breathing stops in 1 minute	
5-68. Dryness of the throat, coughing, choking, tightness across the chest, nausea, and smarting and watering of the eyes	

5-69. The tear agent CS causes incapacitation within how many seconds?

1. 1 to 2
2. 20 to 60
3. 3 to 8
4. 10 to 20

5-70. A CBR victim that appears drunk is suffering from what type of agent?

1. Choking
2. Nerve
3. Incapacitating
4. Vomiting

ASSIGNMENT 6

Textbook Assignment: "Chemical, Biological, and Radiological (CBR) Defense" and "First Aid and Field Sanitation." Pages 9-5 through 10-28.

Learning Objective: Recognize Seabee CBR defense responsibilities.

- 6-1. The planning of the overall CBR defensive measures for an encampment is the responsibility of what individual?
1. The chief of staff
 2. The security officer
 3. The battalion commander
 4. The operations officer
- 6-2. What measure is considered the best defense against a chemical attack?
1. Protective equipment maintenance
 2. CBR training
 3. Decontamination of personnel and equipment
 4. Constant monitoring with detection equipment
- 6-3. When, if ever, should you cross contaminated terrain?
1. During the hottest part of the day
 2. Approximately 24 hours after the initial attack
 3. Only when absolutely necessary
 4. Never
- 6-4. MOPP stands for which of the following CBR defense terms?
1. Mission, orientation, planning, and preparation
 2. Mission-oriented protective posture
 3. Military operation protective plan
 4. Mobile-oriented protective posture
- 6-5. When the M9 chemical agent detector paper turns red, it is indicating the presence of what type of agent?
1. Liquid nerve
 2. Vapor nerve
 3. Liquid blood
 4. Vapor blood
- 6-6. To what part of the body should you attach the self-adhesive M9 paper?
1. Upper part of the left arm
 2. Upper part of the right arm
 3. Lower part of the left leg
 4. Lower part of the right leg
- 6-7. When you are the first to learn of a chemical attack, which, if any, of the following actions should you take first?
1. Sound the alarm
 2. Assist stricken buddies
 3. Don your protective mask
 4. None of the above
- 6-8. After a chemical agent attack, you should not unmask until authorized by your immediate commander.
1. True
 2. False
- 6-9. To neutralize or remove chemical contamination from exposed skin, you should use what kit?
1. M150AE
 2. M190AC
 3. M78A1
 4. M258A1

- 6-10. If you develop the symptoms of nerve-agent poisoning, what medication, if any, should you use?
1. Amyl-nitrite Mod 1
 2. Morphine
 3. Atropine (NAAK) Mark I
 4. None
- 6-11. A Seabee may use a maximum of how many NAAK injectors without authorization from medical personnel?
1. One
 2. Two
 3. Three
 4. Four
- 6-12. After taking atropine to overcome the effects of a nerve agent, what symptom is a good sign of recovery?
1. Dryness of the mouth
 2. Appetite returns
 3. Limber arms and legs
 4. Double vision clears up
- 6-13. When an enemy aircraft flies low over your area and produces a mist, more than likely this is an indication of what type of warfare?
1. Biological
 2. Chemical
 3. Radiological
 4. Each of the above
- 6-14. What is the best defense before a nuclear attack?
1. Get inside a building
 2. Wear full clothing
 3. Dig in
 4. Don your mask
- 6-15. What is the first indication of a nuclear attack?
1. Loud noise
 2. Intense light
 3. Intense heat
 4. Shock wave
-
- Learning Objective: Recognize and describe Seabee CBR defensive equipment.
-
- 6-16. The two-piece permeable protective clothing may be worn for a maximum of how many days?
1. 6
 2. 8
 3. 12
 4. 14
- 6-17. The CBR field protective mask does NOT protect you from which of the following agents?
1. Mustard gas
 2. G-vapors
 3. Carbon monoxide
 4. Hydrogen cyanide
- 6-18. The filter on the MCU-2/P mask must be replaced under which of the following circumstances?
1. Every 20 days of prolonged use
 2. When directed by your squad leader
 3. Only after immersion in water
 4. When the lot number series is expired
- 6-19. The automatic chemical agent alarm alerts personnel in what manner?
1. By an audio signal only
 2. By changing colors of its chromate paper
 3. By both audio and visual signals
 4. By a digital readout of the air content
- 6-20. The M43 detection unit is orientated in what way?
1. Toward the location of the enemy
 2. By wind direction
 3. Downhill

6-21. What standard tactical doismeter is used by the Seabees?

1. IM-174/PD
2. CD-316/PD
3. IM-143A/PD
4. AN126/PD

Learning Objective: Describe the mission-oriented protective posture and its limitations.

6-22. Combat operations are conducted under the MOPP system except when there is no CBR threat.

1. True
2. False

6-23. Of the following factors, which one does NOT limit the flexibility of MOPP?

1. Surrounding temperature
2. Training level
3. Personal needs
4. Fatigue level of the troops

Learning Objective: Recognize the markers used in CBR contaminated areas.

IN ANSWERING QUESTIONS 6-24 THROUGH 6-27, SELECT THE AGENT FROM COLUMN B THAT MATCHES THE DESCRIPTION OF THE TRIANGULAR CHEMICAL CONTAMINATION MARKER SPECIFIED IN COLUMN A. RESPONSES IN COLUMN B MAY BE USED MORE THAN ONCE .

A. MARKER		B. AGENT
	<u>DESCRIPTION</u>	
6-24.	A blue triangle with red letters on the side facing away from the contamination	1. Gas 2. Bio-logical 3. Radiol-logical
6-25.	A white triangle with black letters	4. Chemical Minefield
6-26.	A yellow triangle with red letters	
6-27.	A red triangle with yellow letters	

Learning Objective: Define first aid and identify the general first-aid rules.

6-28. What is the definition of first aid?

1. Emergency care given to a sick or injured person
2. Aid given by trained medical personnel
3. Emergency care that takes the place of medical care
4. Permanent assistance given to an injured person

6-29. When should you send for medical help in an emergency?

1. Before transporting the injured
2. Immediately after you have evaluated the injuries
3. Only after you have administered first aid
4. As soon as possible

6-30. A basic rule of first aid states, "keep the victim lying down, head level with the body, until you have found out what kind of injury has taken place." Which of the following conditions warrants an exception to this rule?

1. Respiratory failure
2. Cardiac arrest
3. Shortness of breath
4. Traumatic amputation

6-31. When a victim shows signs of shock and the injuries permit, you should take which of the following actions?

1. Elevate the head 6 to 12 inches
2. Elevate the feet 6 to 12 inches
3. Elevate the legs 45 degrees
4. Keep the victim lying flat

6-32. It is advisable to remove some or all of the victim's clothing for what primary reason?

1. To keep the victim from becoming overheated
2. To prevent further injury to the victim
3. To use the clothing as padding for splints
4. To determine the full extent of the injuries

6-33. Under what circumstance, if any, should you touch an open wound with your fingers?

1. To stop severe bleeding
2. To remove a protruding foreign body
3. To replace protruding abdominal organs
4. None

6-34. When, if ever, should you move a victim with a serious fracture before immobilizing the bone?

1. When life threatening situations are present
2. Only when a doctor gives you permission
3. When the ambulance is delayed
4. Never

6-35. An injured person should be carried feet first when transported by litter for what reason?

1. To enable the lead litter bearer to see better
2. The rear litter bearer can observe the victim better
3. The rear litter bearer can protect the victim from being hit by flying debris
4. To distribute the victim's body weight more equally

Learning Objective: Define basic life support.

6-36. Basic life support consists of emergency techniques for recognizing and treating failures of the respiratory system only.

1. True
2. False

6-37. The primary emphasis of basic life support focuses on which of the following categories?

1. Abrasions, bleeding, and circulation
2. Bleeding, fractions, and airway
3. Circulation, transportation, and breathing
4. Airway, breathing, and circulation

Learning Objective: Recognize the signs of airway obstruction and describe the steps necessary to clear the airway.

6-38. Which of the following actions is recognized as the universal distress signal for choking?

1. Both hands straight up in the air
2. Clutching at the throat
3. Both arms held around the chest
4. Hands clutching at the heart

6-39. What problem is the most common cause of upper airway obstruction in a conscious person?

1. Broken neck
2. Improperly chewed food
3. Muscular contraction in the neck
4. Nondigestible objects

6-40. Weak, ineffective coughing, bluish skin around the lips, and high-pitched noise when inhaling are signs of what problem?

1. Inadequate air exchange
2. Upper respiratory infection
3. Inflamed tonsils closing off the throat
4. Obstruction of the airway not needing treatment

6-41. A rescuer should use the jaw thrust maneuver on a victim with an obstructed airway for what primary reason?

1. You cannot lift the jaw in the head and neck method
2. There is a suspected neck injury
3. Slapping someone on the back does not dislodge the obstruction
4. The victim has extensive facial injuries

6-42. After you have opened the airway, what step should you take?

1. Call for help
2. Treat bleeding
3. Check the mouth
4. Elevate the feet

6-43. When you reposition the head to ensure an open airway, you should check for breathing by following what procedure?

1. Watch the chest to see if it rises
2. Check the fingernails for bluish color
3. Hold your hand over the mouth and feel for air
4. Look, listen, and feel for air exchange

6-44. When the airway is obstructed, you may need to use which of the following methods?

1. Jaw thrust
2. Abdominal thrust
3. Chest thrust
4. Both 2 and 3 above

Learning Objective: Recognize and describe the steps necessary to perform artificial ventilation.

6-45. What is the purpose of artificial ventilation?

1. To provide an exchange of air until natural breathing is established
2. To provide arterial circulation until the heart beat is restarted
3. To assist a person who is breathing naturally, but with some difficulty
4. To remove or dislodge an obstruction in a victim's airway

6-46. What is the rate of breathing in mouth-to-mouth ventilation?

1. One breath every 12 seconds
2. One breath every 5 seconds
3. Four breaths every 5 seconds
4. Five breaths per minute

Learning Objective: Recognize and describe the steps necessary to perform CPR.

6-47. You come upon a victim who appears unconscious. What immediate action should you take?

1. Begin CPR
2. Attempt artificial ventilation
3. Take a carotid pulse
4. Try to arouse the victim

- 6-48. When positioning your hands in preparation to start CPR, take care to ensure that you
1. do not place the heel of your hand on the xiphoid process
 2. bend your elbows
 3. spread your fingers out evenly on the chest
 4. kneel directly above the victim's head
- 6-49. When one rescuer is performing CPR, what is the ratio of compressions to ventilations?
1. 5 to 2
 2. 5 to 5
 3. 15 to 2
 4. 15 to 5
-
- Learning Objective: Describe the methods used to control bleeding.
-
- 6-50. When an artery is cut near the surface, blood exits the wound in what manner?
1. In a steady stream
 2. Off and on
 3. spurts synchronized with the heart beat
 4. When the artery is deep, the tissues prevent the blood from exiting the wound
- 6-51. What is the first method you should use to control bleeding?
1. Elevation
 2. Pressure points
 3. Tourniquet
 4. Direct pressure
- 6-52. When, if ever, should you remove a pressure dressing from a wound?
1. A clean dressing becomes available
 2. The dressing becomes saturated with blood
 3. The victim complains of discomfort
 4. Never
- 6-53. To control hemorrhaging from one leg, you should use direct pressure and what other first-aid procedure?
1. Elevate the limb
 2. Apply a splint
 3. Apply a tourniquet
 4. Treat for shock
- 6-54. A tourniquet should be used as a means to control bleeding only under which of the following conditions?
1. When an artery is cut
 2. As a last resort
 3. For a deep laceration
 4. After a limb is deeply cut
- 6-55. When a tourniquet has been applied but medical help is not expected to arrive for several hours, what should you do about the tourniquet?
1. Leave it in place and do not loosen it
 2. Loosen it if the bleeding appears to have stopped
 3. Loosen it every 20 minutes
 4. Loosen it every 2 hours
- 6-56. A person that has lost a large amount of blood should be treated for which of the following problems?
1. Shock
 2. Respiratory failure
 3. Cardiac arrest
 4. All of the above
-
- Learning Objective: Define shock and identify its signs, symptoms, and treatment.
-
- 6-57. Shock may be defined by which of the following conditions?
1. Too much carbon dioxide in the blood
 2. Circulatory interference resulting from internal injuries
 3. Too little oxygen in the blood
 4. Disturbance of blood circulation

- 6-58. What are the signs of shock?
1. Skin hot and dry, pupils dilated, pulse rapid and weak
 2. Skin hot and dry, pupils constricted, pulse slow and strong
 3. Skin moist and clammy, pupils dilated, pulse rapid and weak
 4. Skin moist and clammy, pupils constricted, pulse slow and strong
- 6-59. When should a seriously injured person be treated for shock?
1. As soon as symptoms develop
 2. Immediately, even when symptoms are not present
 3. When authorized by a physician
 4. Only when bleeding is present
- 6-60. Because conserving body heat is important in treating shock, which of the following body warmers are recommended to ensure adequate heat conservation?
1. Hot-water bottles
 2. Heating pads
 3. Dry blankets
 4. Warm, moist towels
- 6-61. Shock victims should be placed in what position?
1. Elevate the injured part
 2. Elevate the head above the feet
 3. Elevate the feet and legs above the head
 4. Place the victim on the uninjured side
-
- Learning Objective: Identify the cause and treatment of injuries caused by exposure to heat or cold.
-
- 6-62. Excessive exercise and gulping large quantities of cold drinks can cause what heat exposure problem?
1. Heat exhaustion
 2. Heat prostration
 3. Heatstroke
 4. Heat cramps
- 6-63. What is the most common condition resulting from exposure to hot environments?
1. Heat exhaustion
 2. Heat prostration
 3. Heat cramps
 4. Heatstroke
- 6-64. Which of the following heat injuries is a true life-or-death situation?
1. Heat cramps
 2. Heatstroke
 3. Heat prostration
 4. Heat exhaustion
- 6-65. What is the purpose of all first-aid measures concerning heatstroke?
1. To restore salt and water
 2. To relieve shock
 3. To prevent convulsions
 4. To lower body temperature
- 6-66. What type of weather causes the most severe cold injuries?
1. Cold, wet, and windy
 2. Cold, dry, and windy
 3. Cold, wet, and calm
 4. Cold, dry, and calm
- 6-67. What is the first symptom of hypothermia?
1. Cyanosis
 2. Anxiety
 3. Shivering
 4. Listlessness

6-68. What is the most readily available first-aid method for treating a victim of hypothermia during field operations?

1. Warm, moist towels
2. Electric blankets
3. Warm water baths
4. "Buddy warming"

6-69. You should NOT take which of the following actions for frost-bitten fingers?

1. Warm them with body heat
2. Immerse them in warm water
3. Use covered hot-water bottles
4. Rub them

6-70. You should allow a deeply frost-bitten area to remain frozen in which of the following circumstances?

1. The diagnosis has not been confirmed
2. To minimize the severity of pain
3. There is a possibility of refreezing after thawing
4. To increase the acclimatization process

ASSIGNMENT 7

Textbook Assignment: "First Aid and Field Sanitation," "Organic Communications Equipment," and "Hand Grenades, Land Mines, and Booby Traps." Pages 10-30 through 12-12.

Learning Objective: Identify the treatment of first aid to victims of various types of burns.

- 7-1. A burn in which the skin is reddened but not blistered is what type of burn?
1. First degree
 2. Second degree
 3. Third degree
 4. Fourth degree
- 7-2. What effect does cold water have on thermal burns?
1. It relaxes the victim
 2. It relieves pain
 3. It increases tissue swelling
 4. It speeds up blister formation
- 7-3. With of the following chemical burns should NOT be flushed with water?
1. Dry lime and carbolic acid
 2. Atropine and dry lime
 3. Carbolic acid and amyl nitrite
 4. Phenol and carbolic acid
- Learning Objective: Recognize the steps in treating and immobilizing a fracture.
-
- 7-4. What is the main reason for immobilizing a fracture?
1. To prevent further injury
 2. To eliminate pain and swelling
 3. To decrease blood circulation
 4. To increase blood circulation
- 7-5. To fit well and provide adequate immobilization to an injured part, you must have a splint with which of the following features?
1. It must be strong, rigid, and applied tightly
 2. It must be extended 3 inches above and below a fracture
 3. It must be twice the width of the limb
 4. It must be well padded at body contact areas
- 7-6. When applying splints, you should leave the fingers exposed for what reason?
1. To allow use of the fingers
 2. To tell whether the splint is too tight
 3. To check when the swelling goes down
- 7-7. To minimize danger to the lungs and heart of a victim with fractured ribs, you should take which of the following actions?
1. Strap the ribs with adhesive tape
 2. Keep the victim comfortable and quiet
 3. Lay the victim on the injured side
 4. Give the victim oxygen
- 7-8. Victims suspected of having spine fractures should be treated as though they have which of the following injuries?
1. Advanced shock
 2. Broken neck
 3. Broken pelvis
 4. Ruptured bladder

Learning Objective: Identify field sanitation methods used to dispose of human waste and garbage.

7-9. For each day you anticipate using the straddle trench latrine, it should be dug how many feet deeper?

1. 1
2. 2
3. 3
4. 4

7-10. Dirt should be placed over human waste in a trench latrine at which of the following times?

1. Once a day
2. Twice a day
3. Once every 2 days
4. After every use

7-11. What is the most common method of garbage disposal?

1. Burning
2. Burial
3. Chemical treatment
4. Extraction at sea

Learning Objective: Identify the procedures taken to purify drinking water.

7-12. When water is taken from natural sources, what should you assume about the water?

1. It is good, clear water
2. It is contaminated and should be treated
3. It may be contaminated, but treat only if deemed necessary

7-13. You have filled a 1-quart canteen and the water is cloudy. You should add how many iodine water purification tablets to purify the water?

1. One
2. Two
3. Three
4. Four

7-14. Before drinking iodine-treated water made in your canteen, you should wait what length of time?

1. 15 minutes
2. 17 minutes
3. 25 minutes
4. 30 minutes

Learning Objective: Recognize the fundamentals of tactical combat communications.

7-15. The most common means of communication is

1. visual signaling
2. transmitting electrically
3. writing
4. speaking

7-16. For a company engaged in a static defense, the primary means of communications is by

1. radio
2. telephone
3. flares
4. horns

7-17. Under normal circumstances, what unit establishes and maintains lateral communications between two adjacent units?

1. The larger unit
2. The unit on the left
3. The unit on the right
4. The smaller unit

- 7-18. In a Naval Construction Force (NCF) convoy, the primary means of communications is usually by
1. whistles
 2. flags
 3. smoke
 4. radio
- 7-19. Of the communications used by the Seabees, what method is least secure from enemy monitoring?
1. Visual
 2. Wire
 3. Radio
 4. Courier
-
- Learning Objective: Identify the radio and telephone sets in general use in the Naval Construction Force, their characteristics, components, and operating procedures.
-
- 7-20. The battery for the AN/PRC-77 radio provides a maximum of how many hours of operation?
1. 10
 2. 20
 3. 30
 4. 40
- IN ANSWERING QUESTIONS 7-21 THROUGH 7-23, REFER TO FIGURE 11-2.
- 7-21. Of the steps listed, which is the first step in setting up the AN/PRC-77 radio set for operation?
1. Plug in the antenna
 2. Plug in the headset
 3. Turn function switch 3 to ON
 4. Set the frequency band switch
- 7-22. You may reduce the rushing noise heard on the AN/PRC-77 when no signal is being received by turning function switch 3 to what position?
1. Lite
 2. Retrans
 3. Squelch
 4. Off
- 7-23. When operating the AN/PRC-77 radio, you press the handset switch for which of the following reasons?
1. To talk and release it to listen
 2. To listen and release it to talk
 3. To the right to talk and to the left to listen
 4. To the left to talk and to the right to listen
- 7-24. The TA-312/PT telephone has a receiving or transmitting range of about how many miles?
1. 8 to 12
 2. 14 to 22
 3. 28 to 33
 4. 38 to 45
- 7-25. To set the TA-1/PT telephone buzzer volume for less than maximum, what must you do?
1. Turn the buzzer volume control knob fully counterclockwise
 2. Turn the buzzer volume control knob fully clockwise
 3. Request the distant switchboard or party for a ringing signal; then adjust the volume by rotating the buzzer volume knob clockwise when the buzzer sounds
 4. Request the distant switchboard or party for a ringing signal; then adjust the volume by rotating the buzzer volume knob counterclockwise when the buzzer sounds
- 7-26. Refer to figure 11-22. What switch if any, of the SB-22/PT telephone switchboard enables you to use its lamp as a silent alarm?
1. Ringing
 2. Night alarm and light
 3. Visual and audible alarm
 4. None

- 7-27. Refer to figure 11-23. What controls provide the means for interconnecting the lines or trunks through the jacks?
1. Jacks
 2. Signals
 3. Cord plugs
 4. Each of the above
- 7-28. When operating the SB-22/PT switchboard, you have an incoming call when the line signals change color from
1. white to black
 2. black to blue
 3. blue to white
 4. black to white
-
- Learning Objective: Select the correct definitions of terms pertaining to radio and telephone communicating procedures.
-
- 7-29. A word or combination of words that identifies a specific radio station is known as its
1. proword
 2. precedence
 3. net call sign
 4. call sign
- 7-30. To expedite traffic, you use a word or phrase that has been assigned a specific meaning for telephone and radio transmission purposes. This is what type of word?
1. Proword
 2. Precedence
 3. Catenary
 4. Net control
- 7-31. Numbers that are part of the text of a message should be preceded by what proword?
1. Numbers
 2. Numerals
 3. Figures
 4. Digits
- 7-32. To identify a radio message that is lowest in order of importance, you should use which of the following precedence prowords?
1. Flash
 2. Deferred
 3. Routine
 4. Priority
-
- Learning Objective: Identify principles of communications by messenger and signals.
-
- 7-33. What is the most secure and dependable means of communications as used by a rifle company?
1. Radio
 2. Wire
 3. Arm-and-hand signals
 4. Messenger
- 7-34. When writing a message to be sent by messenger, you should use which of the following techniques?
1. Pad it with extra words to confuse the enemy
 2. Make it as brief as possible
 3. Provide all the information you have on the topic
- 7-35. A combat messenger should possess which of the following skills?
1. Use of cover and concealment
 2. Use of maps and compass
 3. Recognition of units and their CPs
 4. All of the above

- 7-36. During daylight hours, special signals warn of approaching danger. These signals should be supplemented in which of the following ways at night?
1. With lights that shine in the direction of danger
 2. With shots fired in the direction of danger
 3. With an oral description that includes the direction of danger
- 7-37. The signal to execute a movement in unison should be followed by what other signal?
1. ATTENTION
 2. READY
 3. FORWARD
 4. SHIFT
- 7-38. To indicate the direction that a column is to move, the signaler, using hand-and-arm signals, takes what action?
1. Faces that direction
 2. Points with his arm
 3. Waves his arms in that direction
-
- Learning Objective: Identify the elements and format of operation orders.
-
- 7-39. The standard operation order format includes a total of how many numbered paragraphs in the body?
1. Nine
 2. Seven
 3. Three
 4. Five
- 7-40. Spoken orders that are recorded verbatim by the receiver are known as
1. oral orders
 2. dictated orders
 3. recorded orders
- 7-41. The topics of the paragraphs in the body of an operation order may be remembered by what code word?
1. SMAEC
 2. SMCEA
 3. SMCAE
 4. SMEAC
- 7-42. When issued by the squad leader, an operation order contains a total of how many main topics?
1. One
 2. Two
 3. Three
 4. Five
- 7-43. Where in the operation order is a supporting unit usually shown?
1. In paragraph 1d
 2. In paragraph 1a
 3. Under the headquarters that commands it
 4. Under the headquarters of the major unit supported
-
- Learning Objective: Denote the purpose of annexes to an operation order and rules for the preparation of an operation order.
-
- 7-44. What is the purpose of the operation order annexes?
1. To amplify the operation order
 2. To set forth the basic mission
 3. To repeat instructions given in the operation order
 4. To provide step-by-step procedures
- 7-45. Boundaries of zones of responsibility, action, or movement are usually designated to what map features?
1. Political jurisdictional boundaries
 2. Lines of latitude and longitude
 3. Military grid lines
 4. Terrain features

- 7-46. In an operation order, geographic names are written in what format?
1. Lettered in italics
 2. Handwritten in lowercase letters except for the first letter
 3. Written or printed in capital letters
 4. Underlined
- 7-47. Areas may be designated by naming a series of limiting points in what manner?
1. Counterclockwise from the enemy's right front
 2. Clockwise from the enemy's left front
 3. Counterclockwise from the friendly troops right front
 4. Clockwise from the friendly troops left front

IN ANSWERING QUESTIONS 7-48 THROUGH 7-53, REFER TO FIGURE 11-36 AND SELECT FROM COLUMN B THE NUMBER OF THE MAIN PARAGRAPH OF THE PATROL LEADER'S ORDER THAT CONTAINS THE SUBTOPIC IN COLUMN A. RESPONSES IN COLUMN B MAY BE USED MORE THAN ONCE.

<u>A. SUBTOPICS</u>	<u>B. MAIN PARAGRAPH NUMBERS</u>
7-48. Uniforms	1. 1
7-49. Password	2. 5
7-50. Enemy forces	3. 3
7-51. Rations	4. 4
7-52. Team duties	
7-53. Ammunition	

Learning Objective: Identify types of hand grenades and specify their components, principles of operation, uses, and procedures for throwing and handling them safely.

- 7-54. Fragmentation and chemical hand grenades are used primarily against what type of targets?
1. Material
 2. Vehicles
 3. Structures
 4. Personnel
- 7-55. The MK1 illumination grenade provides 55,000 candlepower of light for a maximum of how many seconds?
1. 15
 2. 25
 3. 30
 4. 40
- 7-56. When, if ever, can the safety pin of the MK1 illuminating grenade, be replaced?
1. During the training phase of hand grenade throwing
 2. As long as the safety lever has not been released
 3. Only during combat conditions
 4. Never
- 7-57. Practice and training grenades are used for which of the following purposes?
1. To train personnel in sending smoke signals
 2. To expose personnel to the effects of tear gas
 3. To familiarize personnel in the care and handling of service grenades
- 7-58. The fuzes for casualty-producing hand grenades have a delay time of how many seconds?
1. 1 to 2
 2. 2 to 3
 3. 3 to 4
 4. 4 to 5
- 7-59. A fragmentation type of hand grenade uses which, if any, of the following fuze assemblies?
1. Ignition
 2. Impact
 3. Flammable
 4. None of the above

- 7-60. The arming sleeve is held in place before the grenade is thrown in what type of grenade?
1. Fragmentation
 2. Riot control
 3. Illuminating
 4. Practice
- 7-61. If a grenade armed with the impacting detonating fuze is accidentally dropped after the safety pin has been removed, what action must you take to ensure the safety of friendly personnel?
1. Pick it up and replace the safety pin
 2. Pick it up and throw it to a safe area
 3. Leave it where it is, shout "grenade", and seek cover
 4. Kick it or toss it into a nearby sump or ditch
- 7-62. The safety lever of a chemical hand grenade should NOT be released before it is thrown for what reason?
1. There is an extremely short time-delay fuze
 2. There is danger of the lever hitting friendly personnel
 3. The time delay fuze is too long to do otherwise safely
 4. The fuze may not become activated
-
- Learning Objective: Specify the purpose of land mines and the methods of detonating and disposing of them.
-
- 7-63. Land mines are used to inflict casualties or damage against
1. heavy equipment only
 2. enemy personnel only
 3. enemy personnel and vehicles
 4. light tanks only
- 7-64. As a Seabee, what type of mine are you authorized to use?
1. Pull action
 2. Pressure actuated
 - 3* Antivehicle
 4. Antipersonnel
-
- Learning Objective: Give the uses, construction features, and range of the Claymore mine.
-
- 7-65. The Claymore mine used by Seabees is detonated by what means?
1. Pressure release
 2. Trip wire
 3. Pull or jerk
 4. Electrical control
- 7-66. What type of explosive charge is used in the Claymore mine?
1. Dynamite
 2. TNT
 3. Composition C4
 4. Black powder
- 7-67. Which of the following types of firing devices is used with the Claymore mine?
1. Pulse generator
 2. Electric battery
 3. Trip wire
 4. Pressure fuze
- 7-68. What amount of wire is issued with the Claymore mine?
1. 100 feet
 2. 200 feet
 3. 100 yards
 4. 200 yards
- 7-69. Complete instructions for use are in what location on a Claymore mine?
1. Bandoleer flap
 2. Firing device
 3. Back
 4. Front

7-70. What is the most effective range of a Claymore mine, in meters?

1. 10 to 20
2. 20 to 30
3. 30 to 40
4. 40 to 50

ASSIGNMENT 8

Textbook Assignment: "Hand Grenades, Land Mines, and Booby Traps," and "Organic Support Weapons: M203 and Machine Guns." Pages 12-12 through 13-31.

Learning Objective: Recognize the construction features of and uses for trip flares and the methods of setting and removing them.

8-1. As a Seabee, you should use trip flares for what function?

1. Continuous illumination
2. Giving warning of attack or infiltration of the enemy
3. Illuminating large areas
4. Signaling other units

8-2. The mounting bracket and trigger mechanism of the trip flare are attached to what other part?

1. Upper cap
2. Fuze
3. Base cap
4. Safety lever

8-3. You are changing defensive positions, and you wish to use the same trip flares in the new position. Before moving them to the new position, what should you do first?

1. Detach the trip wires from the triggers
2. Rotate the trigger mechanisms to their original positions
3. Depress the safety levers and replace the safety pins
4. Remove the fuzes from the trip flares

Learning Objective: Differentiate between explosive and nonexplosive booby traps and give methods of triggering, likely places of concealment, and materials for making them.

8-4. A concealed device contrived to wound or kill when some harmless looking object is touched is known as a

1. Claymore mine
2. land mine
3. booby trap
4. trip flare

8-5. What type of military force is most likely to use manufactured booby traps?

1. Attacking
2. Retreating
3. Defensive
4. Ambush

8-6. What causes the safety lever in a mudball mine to be released?

1. Pulling the safety pin
2. Breaking of the dried mud
3. Exerting pressure on the fuze
4. Pulling the 10- to 12-inch trip wire

8-7. A pit lined with boards that have spikes driven through them is known as what type of trap?

1. Punji stake trap
2. Delaying booby trap
3. Pit booby trap
4. Spike board foot trap

8-8. A deadfall trap functions in what manner?

1. It swings down and strikes the intended victim
2. It swings up and strikes the intended victim
3. It detonates when the trip wire is touched
4. It detonates when the victim falls into it

Learning Objective: Specify the methods of detecting mines and booby traps and protecting yourself against them.

8-12. The M203 grenade launcher fires what size round?

1. 10 mm
2. 20 mm
3. 30 mm
4. 40 mm

8-9. What can the individual Seabee do to keep materials and equipment from falling into enemy hands and being used as mines or booby traps?

1. Safeguard the materials at the point of entry
2. Remove all mortar and artillery duds from the battle area
3. Remove all mines and booby traps from the battle area
4. Prevent littering of the battle area with discarded weapons and ammunition

8-13. The leaf sight on an M203 grenade launcher allows the firer to select (a) what range, and in (b) what increments, in meters?

1. (a) 100 to 350 (b) 100
2. (a) 75 to 300 (b) 75
3. (a) 50 to 250 (b) 50
4. (a) 25 to 200 (b) 25

8-10. What type of material should be placed in sandbags for use in vehicles?

1. Sand only
2. Sand and coarse gravel
3. Sand with large rocks
4. Sand with small rocks

8-14. In what portion of an M203 grenade launcher are the components located that serve to fire or prevent accidental firing?

1. Barrel and barrel latch
2. Receiver assembly
3. Barrel stop
4. Bolt and bolt housing

8-11. When traveling in a truck convoy, you should place key personnel in what vehicle(s)?

1. The vehicle at the head of the convoy
2. Two vehicles, one at the front and one at the rear of the convoy
3. The same vehicle at the center of the convoy
4. Different vehicles dispersed throughout the convoy

Learning Objective: Recognize the steps used in clearing and firing an M203 grenade launcher.

8-15. Before clearing an M203 grenade launcher, you must follow what procedure?

1. Remove all live rounds from around the weapon
2. Remove any rounds or other obstruction
3. Clear the area of all personnel not needed to clear the weapon
4. Point the muzzle clear of all personnel within the area

Learning Objective: Specify procedures for installing an M203 grenade launcher on an M16A1 rifle.

8-16. When firing an M203 grenade launcher, you may use what position?

1. Prone
2. Standing
3. Sitting or kneeling
4. Each of the above

8-17. When using an M203 grenade launcher, you should not engage targets within what radius of unprotected, friendly troops?

1. 80 meters
2. 90 meters
3. 100 meters
4. 105 meters

Learning Objective: Describe the procedure used to correct an M203 grenade launcher misfire and define a stoppage in an M203.

8-18. What is a grenade launcher stoppage?

1. Any interruption of setting the launcher in position
2. Any interruption in the cycle of operation caused by faulty action of the weapon
3. Any interruption in the cycle of operation caused by the ammunition
4. Both 2 and 3 above

8-19. After a 30 second wait and while using the correct unloading procedures after a misfire with the grenade launcher, you should take which of the following actions?

1. Catch the ejected round
2. Reduce the distance of the ejected round
3. Both 1 and 2 above

Learning Objective: Describe the types of ammunition used and the safety precautions to be observed when firing an M203 grenade launcher.

8-20. What standard "A" type(s) of ammunition is/are used with the grenade launcher?

1. HE only
2. HE airburst and HE smokeless and flashless only
3. HE, HE airburst, smokeless and flashless, and HEDP only
4. TP, HE, HE airburst, smokeless and flashless, and HEDP

8-21. For safety, the rounds used in the grenade launcher are packed to prevent damage to the primer and diagonal ribs on the round by use of

1. shredded paper
2. plastic inserts
3. plastic "peanuts"
4. excelsior

8-22. When firing canopy smoke cartridges, you must be careful for which of the following reasons?

1. To prevent giving your position away
2. To prevent causing smoke inhalation
3. To prevent ignited projectiles from falling upon friendly troops
4. To prevent extremely explosive charges from going off prematurely

Learning Objective: Recognize the characteristics and data of an M60 machine gun.

8-23. An M60 machine gun barrel can be changed quickly because of which of the following features?

1. A standard length barrel
2. A locknut barrel fastener
3. A fixed head space
4. A nonfixed barrel adapter

- 8-24. The gunner must change an M60 machine gun barrel after what number of rounds in the rapid fire position?
1. 100
 2. 200
 3. 300
 4. 400
- 8-25. When the safety lever of an M60 machine gun is in the S position, what movement, if any, can you obtain from the bolt?
1. It can be pulled to the rear only
 2. It can be released to go forward only
 3. It can be pulled to the rear but cannot be released forward
 4. None
- 8-26. For maximum stability, an M60 machine gun should be fired from what mount?
1. Bipod mount only
 2. Tripod mount only
 3. Either a bipod or tripod mount
- 8-27. When using the traversing handwheel on an M60 machine gun, you can traverse the gun from the center how many mils to the right and to the left?
1. 50
 2. 60
 3. 70
 4. 100
- 8-28. In elevating an M60 machine gun, you can elevate, in 50-mil increments, from zero in either direction up to how many mils?
1. 200
 2. 300
 3. 400
 4. 500
- 8-29. To mount an M60 machine gun, you should first take which of the following actions?
1. Position the front locating pin in the front mounting leg
 2. Lower the receiver so the rear locating pin snaps under the platform latch
 3. Lock the pintle and platform group into the pintle bushing
 4. Place the mounting plate recess on the rear of the mounting plate
-
- Learning Objective: Specify operating principles of an M60 machine gun, actions taken to correct malfunctions or stoppages, and clearing procedures.
-
- 8-30. An M60 machine gun can be loaded, fired, unloaded, and cleared when the bolt is in what position?
1. Open only
 2. Closed only
 3. Either open or closed
- 8-31. To load an M60 machine gun, you should first check to make sure the safety is in what position?
1. SAFE only
 2. FIRE only
 3. SAFE or FIRE
 4. AUTOMATIC
- 8-32. When clearing an M60 machine gun, you should place the safety on SAFE under which of the following conditions?
1. Before pulling the cocking handle to the rear
 2. After raising the cover, inspecting the chamber, finding it clear, and then closing the cover
 3. After pulling the trigger and the bolt has gone forward

- 8-33. Which, if any, of the following alternatives gives the complete sequence of the cycle of operation for an M60 machine gun?
1. Feeding, locking, firing, extracting, and locking
 2. Feeding, chambering, locking, unlocking, extracting, ejecting, and cocking
 3. Feeding, chambering, locking, firing, unlocking, extracting, ejecting, and cocking
 4. None of the above
- 8-34. Which of the following is a malfunction of an M60 machine gun?
1. Defective ammunition
 2. Improper operation by one of the gunners
 3. Sluggish operation of the gun
- 8-35. A runaway machine gun can be stopped by which of the following methods?
1. Raising the feed cover
 2. Twisting or breaking the ammunition belt
 3. Pulling the cocking handle to the rear
 4. Each of the above
- 8-36. What number of rounds fired within a 2-minute period can cause a cookoff in an M60 machine gun?
1. 150
 2. 125
 3. 100
 4. 75
- 8-37. If a stoppage occurs in an M60 machine gun, you should take which, if any, of the following actions?
1. First wait 5 seconds, then raise the cover and remove the ammunition belt and links from the feed tray
 2. Immediately raise the cover and remove the ammunition belt and links from the feed tray
 3. Call for the armorer to clear and fix the gun
 4. None of the above
- 8-38. After clearing a stoppage in an M60 machine gun, you should take what action?
1. Have it replaced or checked by the armorer
 2. Reload it, rezero it, and attempt to fire it again
 3. Have the barrel replaced
 4. Return it to supply
- 8-39. Before firing an M60 machine gun, you should first prepare it by taking which of the following actions?
1. Checking its serviceability and then loading it
 2. Wiping it dry and then inspecting it
 3. Wiping the bore dry, inspecting it, and then lubricating it
 4. Loading and firing it when ready
-
- Learning Objective: Describe the procedures used in field stripping, disassembly, and assembly of an M60 machine gun.
-
- 8-40. General disassembly of an M60 machine gun should be started with the safety on S and the bolt in what position?
1. Removed and the cover up
 2. To the rear and the cover closed
 3. Forward and the cover closed

- 8-41. The operating group of an M60 machine gun consists of what parts?
1. Operating rod, bolt, drive spring, drive spring guide, and sear only
 2. Operating rod, bolt, drive spring, and drive spring guide only
 3. Trigger housing pin, leaf spring, sear, and sear plunger spring
- 8-42. The receiver group for an M60 machine gun consists of the receiver and which, if any, of the following parts?
1. Forearm assembly, rear sight, cover, feed tray, and the carrying handle
 2. Forearm assembly, rear sight, cover, and the feed tray only
 3. Forearm assembly, and the feed tray only
 4. None of the above
- 8-43. What is the last step in replacing the trigger housing group on an M60 machine gun?
1. Rotate the rear leaf spring clockwise and engage it with the trigger housing bolt
 2. Rotate the rear leaf spring counterclockwise and engage it with the trigger housing pin
 3. Rotate the front of the rear leaf spring up and engage it with the trigger housing pin
 4. Rotate the front of the rear leaf spring up and engage it with the trigger housing bolt
- 8-44. What is the first step in replacing the operating group on an M60 machine gun?
1. Insert the end of the operating rod into the receiver
 2. With the cam roller up, push the operating rod and receiver into the end of the operating rod
 3. Pull the trigger, and push in the drive spring until the head of the guide is approximately 1 inch from the receiver
- 8-45. When replacing the stock group on an M60 machine gun, you can tell when the latch is engaged by what indication?
1. By a scraping noise
 2. By a bell-like sound
 3. By a distinct click
 4. By a metal against metal sound
-
- Learning Objective: Describe the types and uses of M60 machine gun ammunition.
-
- 8-46. What types of M60 machine gun cartridges are NOT authorized for training purposes?
1. Ball and tracer
 2. Dummy and blank
 3. Armor-piercing and armor-piercing incendiary
- 8-47. Refer to figure 13-27. The 7.62-mm NATO cartridge for an M60 machine gun is distinguishable by what characteristics, if any?
1. Appearance, paint on tip, and stamped manufacturer's initial
 2. Shape and lot number
 3. Year of manufacture on the base of the cartridge case, its painted tip, stamped initial of the manufacturer, and appearance
 4. None

8-48. The ammunition used in an M60 machine gun should not be oiled or greased for which of the following reasons?

1. Dust or other abrasives could collect on it and damage the operating parts of the gun
2. The ammunition is harder to handle when being placed in the gun
3. It may stick together

Learning Objective: Identify principles and techniques of M60 machine gun marksmanship, including obtaining an accurate initial burst of fire, adjusting the fire, manipulating the controls, and developing speed.

8-49. When firing an M60 machine gun using the bipod mount, you assume a prone position to the rear of the gun with your right shoulder in which of the following positions?

1. Firmly against the butt stock group
2. Under the raised shoulder rest
3. Both 1 and 2 above
4. Resting on the rear of the feed cover

8-50. When an M60 machine gun is fired from a tripod mount, which of the following gun parts is NOT used?

1. Hinged shoulder rest
2. Butt stock group
3. T & E mechanism
4. Feed cover

8-51. What members of a machine gun crew are responsible for observing the strike of the bullets and making necessary adjustments?

1. Team leader and ammo carrier No. 1
2. Gunner and ammo carrier No. 2
3. Team leader and gunner
4. Squad leader and gunner

8-52. After making the rear sight adjustments, you should adjust what part to obtain the correct sight picture?

1. Bipod
2. Tripod
3. Range plate
4. T & E mechanism

Learning Objective: List characteristics, components, and parts in disassembly, assembly, and maintenance of the .50-caliber machine gun.

8-53. What is the best description of a .50-caliber machine gun?

1. A recoil-operated, air-cooled, magazine-fed machine gun capable of semiautomatic and automatic fire
2. A recoil-operated, air-cooled, belt-fed machine gun capable of semiautomatic and automatic fire
3. A gas-operated, air-cooled, belt-fed machine gun capable of automatic fire only
4. A gas-operated, water-cooled, belt-fed machine gun capable of semiautomatic and automatic fire

8-54. What is the (a) respective maximum effective range (b) muzzle velocity (M2 ball), and (c) cyclic rate of fire of a .50-caliber BMG?

1. (a) 1830 m, (b) 3050 fps, (c) 450-550 rpm
2. (a) 1830 m, (b) 2500 fps, (c) 350-400 rpm
3. (a) 7400 yd, (b) 2500 fps, (c) 350-400 rpm
4. (a) 7400 yd, (b) 3050 fps, (c) 450-500 rpm

- 8-55. What procedure should you follow to remove the barrel of a .50-caliber BMG?
1. Rotate the barrel one-half turn clockwise and pull it out
 2. Rotate the barrel one-half turn counterclockwise and pull it out
 3. Raise the cover, retract and lock the recoiling parts in their rear-most position, disengage the barrel-locking spring, and rotate the barrel to remove
 4. Raise the cover, pull recoiling parts to the rear to align the barrel-locking spring with a hole in the side plate, and unscrew and remove the barrel
- 8-56. In the process of removing the bolt on a .50-caliber BMG, you accidentally moved the bolt all the way to the rear. What action should you take now to align the bolt stud with the clearance hole in the receiver?
1. Slide the bolt all the way forward and then slowly move it to the rear
 2. Press in on the oil buffer spring then lock and slide the bolt forward
 3. Raise the bolt latch and move the bolt forward
 4. Push the tips of the accelerator forward to unlock the oil buffer
- 8-57. General disassembly of a machine gun is completed by which of the following actions?
1. By removing the buffer assembly from the buffer body
 2. By removing the buffer group from the barrel extension
 3. By disassembling the barrel extension
 4. By disassembling the buffer
- 8-58. What distance should the buffer tube protrude from the rear of the buffer body group when the groups are properly locked in the receiver?
1. 1 inch
 2. 1 1/8 inches
 3. 3/4 inch
 4. 3/8 inch
- 8-59. Before installing the driving spring group, you should ensure that which of the following actions has occurred?
1. The bolt is all the way forward
 2. The bolt is all the way to the rear
 3. The buffer tube protrudes about 1 inch from the receiver
 4. The tips of the accelerator are rotated forward
- 8-60. After screwing the barrel in all the way, you should back it off how many notches?
1. One
 2. Two
 3. Three
 4. Four
- 8-61. To fire a .50-caliber BMG in semi-automatic mode, you should
1. depress the bolt latch release and engage the bolt latch release lock
 2. depress the trigger
 3. depress the bolt latch release and depress the trigger
 4. slide the bolt to the rear and engage the bolt latch release lock

- 8-62. Assume that a belt of ammunition has been inserted into a .50-caliber machine gun, the first round is engaged by the belt holding pawl, and the bolt latch release is locked. What action is necessary to load the gun fully?
1. Pull the retracting slide handle all the way to the rear and release
 2. Pull the retracting slide handle all the way to the rear, depress the trigger, and pull the slide handle to the rear a second time
 3. Pull the retracting slide handle to the rear and move it forward, release the bolt, pull the retracting slide handle to the rear a second time and move it forward, and release the bolt again
 4. Pull the retracting slide handle all the way to the rear and release it twice
- 8-63. Before pulling the bolt of a .50-caliber BMG to the rear during unloading, you should perform which of the following actions?
1. Remove the ammunition belt from the gun
 2. Raise the top cover
 3. Unlock the bolt latch release
 4. Each of the above
- 8-64. On a .50-caliber BMG, headspace is the distance measured between what two parts?
1. Rear of the firing chamber and origin of the rifling
 2. Rear of the barrel and face of the bolt
 3. Base of a chambered cartridge and face of the bolt
 4. Face of the bolt and barrel extension
- 8-65. When you cannot insert the GO end the headspace gauge, what is the problem and what corrective action should you take?
1. Excessive headspace; unscrew the barrel one notch at a time
 2. Excessive headspace; screw in the barrel one notch at a time
 3. Insufficient headspace; unscrew the barrel one notch at a time
 4. Insufficient headspace; screw in the barrel one notch at a time
- 8-66. Timing of a .50-caliber BMG is important for which of the following reasons?
1. Timing ensures the gun is operating properly
 2. When the timing is not set correctly, a round cannot be chambered
 3. Timing prevents contact between the front end of the barrel extension and the trunnion block
 4. With the gun out of timing, it does not operate as fast as it should
- 8-67. What condition is indicated if the gun does NOT fire with the fire gauge installed?
1. Early timing
 2. Timing is correct
 3. Late timing
 4. Improper headspace
- 8-68. What manual contains detailed procedures for adjusting a .50-caliber BMG?
1. FM 23-65
 2. OP 3115
 3. OP 2665
 4. FM 20-21

ASSIGNMENT 9

Textbook Assignment: Organic Support Weapons: 60-mm mortar and AT4. Pages 14-1 through 14-33.

Learning Objective: Describe the main parts, functions, characteristics, and capabilities of a 60-mm mortar.

- 9-1. What are the characteristics of the 60-mm mortar?
1. Rifle-bore, breech-loaded, and high-angle-of-fire weapon
 2. Rifle-bore, muzzle-loaded, and direct-fire weapon
 3. Smooth-bore, muzzle-loaded, and direct-fire weapon
 4. Smooth-bore, muzzle-loaded, and high-angle-of-fire weapon
- 9-2. The 60-mm mortar has what maximum effective range, in meters?
1. 2780
 2. 3490
 3. 4737
 4. 5126
- 9-3. A complete 60-mm mortar, in the conventional mode, weighs a total of how many pounds?
1. 18.0
 2. 27.5
 3. 39.0
 4. 46.5
- 9-4. What cannon is used with a 60-mm mortar?
1. M223A1
 2. M224
 3. M225
 4. M226E1
- 9-5. The bipod consists of what number of major assemblies?
1. One
 2. Two
 3. Three
 4. Four
- 9-6. Before firing a 60-mm mortar, you should ensure the open end of the socket on the baseplate is pointing in what direction?
1. Toward the gunner
 2. Away from the target
 3. Away from the assistant gunner
 4. Toward the target
- 9-7. With a 60-mm mortar in the conventional mode, you should use what baseplate?
1. M8
 2. M7
 3. M6
 4. M5
- 9-8. The 60-mm mortar uses which of the following standard sights when it is in the conventional mode?
1. M29A2
 2. M34A1
 3. M53A2
 4. M64A1
- 9-9. The sight unit is used for what primary purpose?
1. To calibrate the weapon
 2. To lay-in the elevation and deflection
 3. To observe the target
 4. To estimate target distance
- 9-10. When in the hand-held mode, a 60-mm mortar weighs a total of how many pounds?
1. 15
 2. 18
 3. 22
 4. 26

- 9-11. To calibrate the sight unit for a 60-mm mortar correctly, the mortar crew most often uses what instrument?
1. The M115 boresight
 2. The M321A calibrator
 3. The M64A1 aiming cycle
 4. The M2 compass
- 9-12. To see the aiming post at night, the gunner uses what instrument(s)?
1. The M1 rheostat light
 2. The M53 and M54 instrument lights
 3. The M58 and M59 aiming posts
 4. The M23 hand-held flashlight
-
- Learning Objective: Point out the types and uses of 60-mm mortar ammunition.
-
- 9-13. What type of 60-mm mortar ammunition is used to destroy or cause casualties to enemy personnel, emplacements, and vehicles?
1. High explosive
 2. White phosphorus
 3. Illuminating
 4. Each of the above
- 9-14. Mortar rounds are all color coded. They are also stenciled with which of the following information?
1. Model of round
 2. Caliber of round
 3. Ammunition lot number
 4. Each of the above
- 9-15. What type of fuzes can be used with 60-mm mortar ammunition?
1. Time, superquick, and variable times
 2. Impact, graduated time, and variable time
 3. Delay, quick, and impact
 4. Point detonating, time, and superquick
-
- Learning Objective: Specify the duties and responsibilities of mortar squad members.
-
- 9-16. When a communicator is not attached, the mortar squad leader must carry what additional items of equipment?
1. Baseplate stakes and compass
 2. Field radio only
 3. Field telephone and wire only
 4. Either a field radio or a field telephone and wire
- 9-17. What member of the mortar squad establishes the baseplate position?
1. Squad leader
 2. Gunner
 3. Assistant gunner
 4. Crew leader
-
- Learning Objective: Describe procedures for positioning the mortar and preparing it for firing.
-
- 9-18. Which, if any, of the following methods is the most rapid for laying a mortar?
1. Compass
 2. Aiming circle
 3. Sight to sight
 4. None of the above
- 9-19. After inserting the spherical projection of the cannon into the locking cap of the baseplate, you should rotate the cannon how much of a turn?
1. One eighth
 2. One fourth
 3. One third
 4. One half

- 9-20. The bipod should be placed on what part of the barrel to attain an elevation of 1435 mils?
1. Lower saddle
 2. Upper saddle
 3. Center saddle
 4. Half the distance between the white lines
- 9-21. To calibrate a 60-mm mortar, you should place the bipod on what part of the barrel?
1. Lower saddle
 2. Upper saddle
 3. Center saddle
 4. Half the distance between the white lines
- 9-22. When the bipod is attached to the upper saddle, the feet of the bipod should be set at what approximate distance, in feet, from the baseplate?
1. 1
 2. 2
 3. 1 1/2
 4. 2 1/2
- 9-23. When placing the aiming post, you should place the far post approximately how many meters from the mortar?
1. 15 to 25
 2. 30 to 50
 3. 45 to 65
 4. 70 to 90
- 9-24. When placing the aiming posts, you should always place the near post first?
1. True
 2. False
- 9-25. When you look through the sight and see the aiming posts, they appear as one. This is what type of sight picture?
1. Parallel
 2. Centered
 3. Aligned
 4. Compensated
- 9-26. In firing the mortar, you should take mask clearance into consideration for which of the following reasons?
1. To prevent enemy counter-mortar fire
 2. To keep the position of the mortar secret
 3. To prevent the enemy from falsifying their location
 4. To prevent premature detonation of fired rounds
- 9-27. Mask and overhead clearance must be determined and reported to which of the following locations?
1. The fire direction center
 2. The battalion command post
 3. The headquarters company
 4. The ammunition supply point
- 9-28. To sight the mortar when the aiming post appears to be separated, you should take which of the following actions?
1. Align the mortar sight on the left edge of the far post
 2. Use the compensated sight picture
 3. Use the aligned sight picture
 4. Align the mortar sight on the right edge of the near post
- 9-29. What key word is used to apply firing data to the sight and the mortar?
1. LARS
 2. DEAD
 3. RALS
 4. DEED
-
- Learning Objective: For the 60-mm mortar, name the types of firing commands, the elements of each type, and the person or position responsible for giving them.
-

- 9-30. Where do fire commands normally originate?
1. The fire direction center
 2. The squad leader
 3. The mortar platoon leader
 4. The fire support coordination center
- 9-31. What are the two types of fire commands?
1. First and second
 2. First and subsequent
 3. Initial and subsequent
 4. Primary and alternate
- 9-32. There is a total of how many elements in the initial fire command?
1. Five
 2. Six
 3. Seven
 4. Eight
- 9-33. What portion of the initial fire command should always be included in a subsequent fire command?
1. Alert
 2. Method of fire
 3. Mortar to fire
 4. Elevation
- 9-34. The number of increments left on a round of ammunition is announced in what portion of the fire command?
1. Alert
 2. Elevation
 3. Charge
 4. Method of fire
-
- Learning Objective: Describe techniques of preparing ammunition for loading and firing in a 60-mm mortar.
-
- 9-35. What member of the mortar squad removes the mortar sight during the firing of the first three rounds or until the baseplate is firmly seated?
1. Squad leader
 2. Gunner
 3. Assistant gunner
 4. Ammo bearer
- 9-36. When a 60-mm mortar, in the conventional mode, is used in the drop-fire method, the firing selector should be set to what position?
1. T
 2. S
 3. F
 4. D
- 9-37. When firing a 60-mm mortar, crew members should wear hearing protection whenever they are within what distance of the muzzle?
1. 1 meter
 2. 2 meters
 3. 1 1/2 meters
 4. 2 1/2 meters
- 9-38. When laying-in a 60-mm mortar, in the hand-held mode, you should use what device to estimate the target range before firing?
1. The M64A1 sight unit
 2. The range indicator assembly
 3. The canter indicator assembly
 4. The M54A1 sight unit
- 9-39. What type of cartridge is designed for use with a 60-mm mortar when it is in the hand-held mode?
1. HE, M49A1
 2. HE, M720
 3. WP, M321A2
 4. WP, M322
- 9-40. What color on the indicator scale is used for charge one?
1. Red
 2. Yellow
 3. Black
 4. White

- 9-41. A mortar round misfire normally occurs when a round has which of the following problems?
1. It misses the impact area of the target
 2. It hangs in the barrel without striking in the firing pin only
 3. It strikes the firing pin and fails to fire only
 4. It hangs in the barrel or strikes the firing pin and fails to fire

- 9-42. When a misfire is first detected, what person should sound the alarm?
1. The gunner
 2. The assistant gunner
 3. The ammunition bearer
 4. The crew member who first notices it

- 9-43. For safety reasons, the mortar crew must wait what length of time before attempting to remove a mortar round?
1. 1 minute
 2. 2 minutes
 3. 3 minutes
 4. 4 minutes

- 9-44. When clearing a misfire, the assistant gunner should stop the misfire round with which of the following objects?
1. His thumbs
 2. A piece of wood
 3. His helmet
 4. A pair of asbestos gloves

Learning Objective: Describe the practices used in the care, cleaning, and lubrication of a 60-mm mortar.

- 9-45. The care and cleaning of a 60-mm mortar and its accessories are essential duties of what squad members?
1. The ammunition carriers only
 2. The gunner and assistant gunner only
 3. The crew members of the mortar squad
 4. The unit armorers

- 9-46. After the mortar has been fired, the barrel should be cleaned how many times?
1. Five
 2. Two
 3. Three
 4. Four

- 9-47. You should let the mortar barrel cool before using bore cleaner on it for which of the following reasons?
1. To prevent rust from forming on the barrel
 2. To prevent dark spots from forming on the barrel
 3. To prevent a cracked barrel
 4. To prevent a bulged barrel

Learning Objective: Define the functions and duties of the forward observer and the fire direction center.

- 9-48. What person is known as the "eyes" of the indirect-fire team?
1. Gunner
 2. Squad leader
 3. Forward observer
 4. Advanced guard

- 9-49. When in communication with either an infantry or artillery fire direction center, an individual can effectively place mortar fire on any target that cannot be seen visually in which of the following ways?
1. By using the target-grid method
 2. By giving known bench marks
 3. By giving the size, in feet, of prominent terrain features
 4. By using the prominent height of nearby objects
- 9-50. The forward observer's azimuth to the target may have errors as great as how many mils without having an appreciable effect on adjustment?
1. 100
 2. 110
 3. 115
 4. 120
- 9-51. As a Seabee forward observer (FO), you may be working with the Army, Navy or Air Force. To work effectively, you need what special knowledge, if any?
1. The terminology peculiar to each of the armed services
 2. The international, interservice special FO terminology
 3. The indirect-fire weapons command terminology
 4. None
- 9-52. An FO may report the location of a target for the FDC by using which of the following methods?
1. Grid coordinates
 2. Shifts from the reference point
 3. Polar coordinates
 4. Each of the above
- 9-53. The FDC of a Seabee battalion should be in which of the following locations during a defensive operation?
1. The battalion command post
 2. The firing position, or close to it
 3. The battalion fire support center
 4. The headquarters company command post
-
- Learning Objective: Describe the launcher and cartridge, 84-mm M136 (AT4) HEAT lightweight, antiarmor weapon system relative to purpose, use, operation, range, weight and components.
-
- 9-54. What are the primary duties of the FDC?
1. To receive and compute fire requests into fire commands
 2. To keep a detailed record of all fire commands during a given operation
 3. To maintain records concerning the amount of ammunition on hand
 4. Each of the above
- 9-55. The rocket for an AT4, 84-mm M134 Heat has which of the following components?
1. Fin assembly
 2. Point-initiating, piezoelectric fuze
 3. Precision-shaped explosive charge
 4. All of the above

- 9-56. What is the (a) length, (b) overall weight, and (c) the maximum range of the AT4?
1. (a) 30 inches
(b) 13.4 pounds
(c) 2100 meters
 2. (a) 36 inches
(b) 18.2 pounds
(c) 1975 meters
 3. (a) 40 inches
(b) 14.8 pounds
(c) 2100 meters
 4. (a) 40 inches
(b) 14.3 pounds
(c) 2150 meters
- 9-57. What is the total weight of an AT4 cartridge?
1. 9 pounds
 2. 7 pounds
 3. 5 pounds
 4. 4 pounds
- 9-58. The forward safety of an AT4 is located on what part of the firing mechanism?
1. Next to the transport safety pin
 2. Below the cocking lever
 3. To the right of the front sight
 4. On the forward end of the firing mechanism
- 9-59. You are preparing to fire the AT4. Which of the following steps is out of sequence?
1. Place the launcher on your shoulder
 2. Release the sights
 3. Cock the launcher
 4. Remove the transport safety pin
- 9-60. For targets less than 200 meters, you must make an adjustment to the rear sight.
1. True
 2. False
- 9-61. When the launcher is prepared but not fired, you can take it out of operation by which of the following steps?
1. Release the forward safety
 2. Return the cocking lever to the safe, uncocked position, and remove the launcher from your shoulder
 3. Reinsert the transport safety pin all the way into the pinhole
 4. All of the above
- 9-62. When in combat, the AT4 fails to fire. You should take which of the following actions first?
1. Release the forward safety
 2. Dispose of the faulty launcher
 3. Remove the launcher from your shoulder
 4. Wait 2 minutes and try again
- 9-63. What repairs, if any, are authorized at your level of maintenance?
1. Sight replacement
 2. Minor dent repair
 3. Muzzle seal replacement
 4. None
- 9-64. In combat, after the AT4 is fired, it should be destroyed to prevent enemy use. The methods of destruction are burning, demolition, and what other actions?
1. Submergence in water and removal of sights
 2. Gunfire and crushing
 3. Removal of sights and the safety pin
 4. Gunfire and removal of sights
- 9-65. When sighting an AT4, the gunner must first take which of the following steps?
1. Place the 200-meter range on the target center of mass
 2. Apply the lead cross rule
 3. Estimate the distance to the target
 4. Estimate the speed of the target

9-66. The AT4 can be fired from either the right or left shoulder.

1. True
2. False

9-67. Which of the following positions is most suitable for engaging moving targets?

1. Standing only
2. Kneeling only
3. Both standing and kneeling
4. Prone

9-68. To limit the possibility of malfunctions with the AT4, you should NOT use the weapon outside of what temperature range?

1. -40°F to 140°F
2. -50°F to 130°F
3. -60°F to 120°F
4. -70°F to 110°F

