

T.O. 33B-1-1
NAVAIR 01-1A-16
TM 1-1500-335-23

TECHNICAL MANUAL

**NONDESTRUCTIVE INSPECTION
METHODS, BASIC THEORY**

(ATOS)

THIS MANUAL SUPERSEDES T.O. 33B-1-1, DATED 1 JANUARY 2005, AND ALL SUBSEQUENT CHANGES.

THIS MANUAL HAS BEEN EXTENSIVELY REWRITTEN; THEREFORE, REVISION BARS HAVE BEEN OMITTED.

ARMY PERSONNEL: Wherever the text of this manual refers to Air Force technical orders for supportive information, refer to the comparable Army documents.

NAVY PERSONNEL: OPNAV instruction 4790.2 and weapon system specific manuals take precedence over this manual.

DISTRIBUTION STATEMENT A: Approved for public release; distribution is unlimited. PA Case Number SPR50014. Submit recommended changes or problems with this Technical Order to 558 CBSS/GBHA.

Published under Authority of the Secretary of the Air Force

15 JUNE 2007

T.O. 33B-1-1

INSERT LATEST CHANGED PAGES. DESTROY SUPERSEDED PAGES.

LIST OF EFFECTIVE PAGES

NOTE: The portion of the text affected by the changes is indicated by a vertical line in the outer margins of the page. Changes to illustrations are indicated by shaded or screened areas, or by miniature pointing hands.

Dates of issue for original and changed pages are:

Original..... 0 15 June 2007

TOTAL NUMBER OF PAGES IN THIS MANUAL IS 774, CONSISTING OF THE FOLLOWING:

Page No.	*Change No.	Page No.	*Change No.	Page No.	*Change No.
Title		0			
A		0			
i - xxiii.....		0			
xxiv Blank.....		0			
1-1 - 1-16		0			
2-1 - 2-122		0			
3-1 - 3-127		0			
3-128 Blank		0			
4-1 - 4-95		0			
4-96 Blank		0			
5-1 - 5-109		0			
5-110 Blank		0			
6-1 - 6-195		0			
6-196 Blank		0			
Glossary 1 - Glossary 80.....		0			

*Zero in this column indicates an original page

TABLE OF CONTENTS

Chapter	Page
INTRODUCTION.....	xix
SAFETY SUMMARY.....	xxi
1 NONDESTRUCTIVE INSPECTION METHODS, GENERAL INFORMATION	1-1
SECTION I NONDESTRUCTIVE INSPECTION (NDI) METHODS	1-1
1.1 Why We Do Nondestructive Inspection (NDI).....	1-1
1.1.1 Nondestructive Inspection Data	1-1
1.1.2 Structural Management Programs	1-1
1.1.3 Mechanisms for Using NDI Data	1-1
1.1.4 Tools for Gathering NDI Data.....	1-2
SECTION II PERSONNEL TRAINING/QUALIFICATION/CERTIFICATION	1-3
1.2 Personnel Training/Qualification/Certification	1-3
1.2.1 Training Introduction.....	1-3
1.2.2 Training Requirements	1-3
1.2.3 Certification Requirements.....	1-3
1.2.4 Physical Requirements	1-3
1.2.5 Requirement for Special Task Certification and Recurring Training.....	1-3
SECTION III REPORTING NEW OR IMPROVED NDI TECHNIQUES	1-5
1.3 Reporting New/Improved Nondestructive Inspection Techniques	1-5
1.3.1 Need for Reporting New and Improved Techniques	1-5
1.3.2 Authority	1-5
1.3.3 AFTO Form 242.....	1-5
1.3.4 Scope.....	1-5
1.3.5 Responsibilities for Updating Techniques	1-5
1.3.6 AFTO Form 242 Entries	1-6
SECTION IV NDI EQUIPMENT	1-9
1.4 Procuring NDI Equipment (AIR FORCE Only).....	1-9
1.4.1 Centrally Procured NDI Equipment.....	1-9
1.4.2 Weapon System Specific/Special Purpose Equipment.....	1-9
1.4.3 Local Purchase Equipment.....	1-9
SECTION V PROCESS CONTROL.....	1-10
1.5 Process Control.....	1-10
1.5.1 Reason for Controlling the Process	1-10
1.5.2 Scope of Process Control.....	1-10
1.5.3 Process Control Documentation Requirements	1-12
1.5.4 Establishing a Documentation Method.....	1-12
1.5.5 Suggested Documentation Method	1-12
SECTION VI LABORATORY INFORMATION	1-13
1.6 General Laboratory Information	1-13

T.O. 33B-1-1

1.6.1	Constructing a Nondestructive Inspection Laboratory	1-13
1.6.2	Building Requirements	1-13
1.6.3	Electrical and Mechanical Requirements.....	1-14
1.6.4	Room Identification.....	1-15

2	LIQUID PENETRANT INSPECTION METHOD	2-1
---	--	-----

SECTION I	LIQUID PENETRANT INSPECTION METHOD	2-1
-----------	--	-----

2.1	General Capabilities of Liquid Penetrant Inspection	2-1
2.1.1	Introduction to Liquid Penetrant Inspection.....	2-1
2.1.2	Background of Liquid Penetrant Inspection.....	2-1
2.1.3	Why Use Liquid Penetrant Inspection.....	2-1
2.1.4	Limitations of Liquid Penetrant Inspection.....	2-1
2.1.5	Advantages of Liquid Penetrant Inspection.....	2-2
2.1.6	Disadvantages of Liquid Penetrant Inspection	2-2
2.1.7	Basic Penetrant Inspection Process.....	2-3
2.1.8	Personnel Requirements	2-4
2.1.9	Understanding Penetrant Classification and Processes	2-4
2.1.10	Qualification of Penetrant Material	2-9
2.1.11	Qualification of Penetrant Sensitivity	2-9
2.1.12	Penetrant Material Performance.....	2-9

SECTION II	PRINCIPLES AND THEORY OF LIQUID PENETRANT INSPECTION.....	2-11
------------	---	------

2.2	Principles and Theory of Liquid Penetrant Inspection	2-11
2.2.1	General.....	2-11
2.2.2	Characteristics of a Penetrant.....	2-11
2.2.3	Mechanisms of Penetrant Action.....	2-11
2.2.4	How Liquid Penetrant Enters Discontinuities	2-17
2.2.5	Mechanisms and Principles of Penetrant Removal.....	2-17
2.2.6	Mechanisms of Developer Action	2-21
2.2.7	Cleaning and Surface Preparation.....	2-22
2.2.8	Surface Conditions Affecting Penetrant Inspection	2-22
2.2.9	Contaminants and Soils.....	2-22
2.2.10	Coatings	2-27
2.2.11	Effects of Surface Deformation, Wear, and Surface Roughness on Penetrant Inspection.....	2-29

SECTION III	LIQUID PENETRANT INSPECTION EQUIPMENT.....	2-31
-------------	--	------

2.3	Equipment.....	2-31
2.3.1	General.....	2-31
2.3.2	Portable Equipment	2-31
2.3.3	Stationary Inspection Equipment - General Purpose	2-31
2.3.4	Small Parts Inspection Systems	2-31
2.3.5	Automated Inspection Systems	2-31
2.3.6	Inspection Lamps.....	2-31
2.3.7	Process Control Equipment.....	2-35

SECTION IV	LIQUID PENETRANT APPLICATION METHODS	2-36
------------	--	------

2.4	Application Method.....	2-36
2.4.1	General.....	2-36
2.4.2	Basic Penetrant Processes	2-36
2.4.3	Pre-Testing	2-41
2.4.4	Pre-Cleaning Performed by NDI Personnel	2-41
2.4.5	Penetrant Application	2-42
2.4.6	Temperature Limitations	2-44
2.4.7	Penetrant Dwell	2-47

2.4.8	Penetrant Removal.....	2-53
2.4.9	Water Washing/Rinsing Technique	2-64
2.4.10	Drying	2-65
2.4.11	Application of Developers	2-67
2.4.12	Post-Cleaning After Penetrant Inspection.....	2-76
2.4.13	Protection of Parts Following Penetrant Inspection.....	2-77
SECTION V INTERPRETATION OF LIQUID PENETRANT INSPECTION		2-78
2.5	Interpretation of Indications	2-78
2.5.1	General.....	2-78
2.5.2	Importance of Understanding the Interpretation Process.....	2-78
2.5.3	Personnel Requirements	2-78
2.5.4	Lighting.....	2-78
2.5.5	Inspection Conditions.....	2-83
2.5.6	Evaluating Indications	2-83
SECTION VI PROCESS CONTROL OF LIQUID PENETRANT INSPECTION.....		2-92
2.6	Liquid Penetrant Process Control	2-92
2.6.1	General.....	2-92
2.6.2	Need for Process Quality	2-92
2.6.3	Why Test New Materials	2-92
2.6.4	Why Test In-Use Materials.....	2-92
2.6.5	Causes of Material Degradation.....	2-92
2.6.6	Establishing Work Center Process Control Intervals.....	2-93
2.6.7	Process Control Equipment.....	2-93
2.6.8	Process Control Requirement.....	2-96
2.6.9	Control of New Materials	2-101
2.6.10	Testing In-Use Materials.....	2-102
SECTION VII SPECIAL PURPOSE LIQUID PENETRANTS		2-118
2.7	Special Purpose Liquid Penetrant	2-118
2.7.1	General.....	2-118
2.7.2	Liquid Oxygen (LOX) Compatible Penetrants.....	2-118
2.7.3	Low Sulfur, Low Chlorine Penetrant Systems.....	2-119
2.7.4	High Temperature Penetrant Materials.....	2-119
2.7.5	Dye Precipitation Penetrant Systems.....	2-119
2.7.6	Reversed Fluorescence Method	2-119
2.7.7	Thixotropic Penetrant	2-120
2.7.8	Dilution Expansion Developers	2-120
2.7.9	Plastic-Film Developers	2-120
SECTION VIII LIQUID PENETRANT INSPECTION SAFETY.....		2-121
2.8	Liquid Penetrant Inspection Safety.....	2-121
2.8.1	Safety Requirements.....	2-121
2.8.2	General Precautions.....	2-121
2.8.3	Personal Protection Equipment	2-121
2.8.4	Ventilation.....	2-121
2.8.5	Matting.....	2-122
2.8.6	UV-A (Black Light) Hazards.....	2-122
3	MAGNETIC PARTICLE INSPECTION METHOD	3-1
SECTION I MAGNETIC PARTICLE INSPECTION METHOD		3-1
3.1	General Capabilities of Magnetic Particle Inspection.....	3-1
3.1.1	Introduction to Magnetic Particle Inspection (MPI).....	3-1

T.O. 33B-1-1

3.1.2	Benefit of Magnetic Particle Inspection	3-1
3.1.3	Basic Concept of Magnetic Particle Inspection	3-1
SECTION II MAGNETIC PARTICLE PRINCIPLES AND THEORY		3-2
3.2	Principles and Theory of Magnetic Particle Inspection	3-2
3.2.1	Principles of Magnetization	3-2
3.2.2	Basic Terminology	3-2
3.2.3	Magnetic Field Characteristics	3-3
3.2.4	Currents Used to Generate Magnetic Fields	3-9
3.2.5	Ferromagnetic Material Characteristics	3-10
SECTION III MAGNETIC PARTICLE INSPECTION EQUIPMENT		3-14
3.3	Magnetic Particle Inspection Equipment and Materials	3-14
3.3.1	Selection of Magnetic Particle Inspection Equipment	3-14
3.3.2	Categories of Magnetic Particle Inspection Equipment	3-14
3.3.3	Inspection Equipment Accessories	3-17
3.3.4	Special Purpose Equipment	3-17
3.3.5	Field Strength Measurement Devices	3-18
3.3.6	Understanding and Selecting Magnetic Particle Inspection Materials	3-20
SECTION IV MAGNETIC PARTICLE INSPECTION APPLICATIONS		3-27
3.4	Magnetic Particle Inspection Application Methods	3-27
3.4.1	Inspection Preparation	3-27
3.4.2	Magnetic Particle Inspection Techniques	3-29
3.4.3	Selecting a Magnetizing Current	3-30
3.4.4	Magnetic Field	3-33
3.4.5	Field Strength Measurement Techniques	3-39
3.4.6	Methods of Particle Application	3-41
3.4.7	Wet Fluorescent Inspection Technique	3-50
3.4.8	Portable Magnetic Particle Inspection	3-51
3.4.9	Special Magnetization Techniques	3-53
3.4.10	Multidirectional Magnetization	3-55
3.4.11	Demagnetization	3-55
3.4.12	Post Inspection Cleaning	3-62
3.4.13	Magnetic Rubber Inspection	3-63
SECTION V MAGNETIC PARTICLE INSPECTION INTERPRETATIONS		3-73
3.5	Magnetic Particle Inspection Interpretation	3-73
3.5.1	Formation of Discontinuities and their Indications	3-73
3.5.2	Definition of Terms	3-75
3.5.3	Basic Steps of Inspection	3-75
3.5.4	Classes of Discontinuities	3-80
3.5.5	Non-Relevant Indications	3-98
3.5.6	Interpretation and Elimination of Non-Relevant Indications	3-103
3.5.7	Methods of Recording MPI Indications	3-103
SECTION VI PROCESS CONTROL OF MAGNETIC PARTICLE INSPECTION		3-106
3.6	Magnetic Particle Process Control	3-106
3.6.1	Purpose and Scope	3-106
3.6.2	General	3-106
3.6.3	Causes of System Degradation	3-106
3.6.4	Frequency of Process Control	3-107
3.6.5	Evaluating the Magnetic Particle Process	3-107
3.6.6	Evaluating Equipment Effectiveness	3-107
3.6.7	Evaluating Material Effectiveness	3-113

3.6.8	Additional Tests for Water Baths	3-118
3.6.9	Disposition for Nonconformance Materials.....	3-119
3.6.10	Magnetic Particle Process Checklist.....	3-119
SECTION VII MAGNETIC PARTICLE INSPECTION EQUATIONS		3-121
3.7	Magnetic Particle Equations.....	3-121
3.7.1	Rule-of-Thumb Formulas	3-121
3.7.2	Cross-Sectional Area	3-121
3.7.3	Calculating Coil Current	3-122
SECTION VIII MAGNETIC PARTICLE INSPECTION SAFETY.....		3-126
3.8	Magnetic Particle Safety	3-126
3.8.1	Safety Requirements.....	3-126
3.8.2	General Precautions.....	3-126
3.8.3	Floor Matting.....	3-126
3.8.4	Wet Suspension Precautions	3-126
3.8.5	Arcing Precautions	3-126
3.8.6	Head Stocks	3-126
3.8.7	UV-A (Black Light) Hazards.....	3-126
3.8.8	Hazards of Aerosol Cans	3-127
3.8.9	Magnetic Rubber Precautions	3-127
4	EDDY CURRENT INSPECTION METHOD.....	4-1
SECTION I EDDY CURRENT TESTING (ET) METHOD		4-1
4.1	General Capabilities of ET.....	4-1
4.1.1	Introduction to ET	4-1
4.1.2	Definition of Eddy Current	4-2
4.1.3	Inspection With Eddy Current	4-2
4.1.4	Limitations of Eddy Current Method	4-2
4.1.5	Variables Affecting Eddy Currents.....	4-2
4.1.6	Eddy Current Techniques.....	4-3
4.1.7	Effect of Conductivity on Eddy Currents.....	4-4
4.1.8	Crack Detection in Non-Ferromagnetic Materials	4-9
4.1.9	Phase Lag at Depth	4-11
SECTION II EDDY CURRENT PRINCIPLES AND THEORY		4-13
4.2	Principles and Theory of ET.....	4-13
4.2.1	Materials and Processes	4-13
SECTION III EDDY CURRENT EQUIPMENT TYPES		4-27
4.3	ET Equipment.....	4-27
4.3.2	Components of an ET System	4-27
4.3.3	Eddy Current Subsystems	4-28
4.3.4	Functions of the Eddy Current Instrument.....	4-31
4.3.5	General Requirements	4-31
4.3.6	Specific Instrumentation Requirements	4-31
4.3.7	Special Circuits and Processes.....	4-33
4.3.8	Amplitude Detection.....	4-33
4.3.9	Multi-Frequency Eddy Current Systems	4-33
4.3.10	Pulsed Eddy Current Techniques.....	4-33
4.3.11	Metal Thickness Measurements.....	4-33
4.3.12	Presentations and Displays.....	4-33
4.3.13	Meters	4-33
4.3.14	Cathode Ray Tube (CRT) Display	4-33

T.O. 33B-1-1

4.3.15	Digital Display.....	4-33
4.3.16	Linear Time Base Display	4-34
4.3.17	Recorders	4-34
4.3.18	Impedance Plane Eddy Current Test Equipment	4-34
4.3.19	Digital Equipment.....	4-34
4.3.20	Mechanical Scanning.....	4-34
4.3.21	Multi-Frequency Testing Techniques	4-34
4.3.22	Dual Frequency Testing	4-34
4.3.23	Pulsed Eddy Current Testing	4-34
4.3.24	Low Frequency ET.....	4-35
4.3.25	Barkhausen Noise Testing of Ferromagnetic Materials.....	4-35
4.3.26	Alpha-Case on Titanium	4-35
4.3.27	Titanium Aluminide	4-35
4.3.28	Magneto-Optic Imaging (MOI).....	4-35
4.3.29	Application of Advanced Techniques.....	4-35
SECTION IV APPLICATION OF ET.....		4-36
4.4	General	4-36
4.4.1	Operating Point.....	4-36
4.4.2	Filters	4-36
4.4.3	Modulation Analysis.....	4-37
4.4.4	Frequency Response	4-38
4.4.5	Inspection of Fastener Holes.....	4-40
4.4.6	Fastener Hole Inspection Equipment	4-40
4.4.7	Lift-Off Compensation for Bolt-Hole Inspection	4-40
4.4.8	Sensitivity Settings	4-41
4.4.9	Scanning Speed.....	4-41
4.4.10	Bolt Hole Preparation.....	4-41
4.4.11	Probe to Edge Spacing	4-41
4.4.12	Fixtures and Guides.....	4-42
4.4.13	Fastener Holes Non-Removable Fasteners	4-42
4.4.14	Probe Selection	4-42
4.4.15	Standards for Nonremovable Fastener Holes	4-42
4.4.16	Fillets and Rounded Corner	4-42
4.4.17	Impedance Diagrams	4-43
4.4.18	Corrosion.....	4-47
4.4.19	Frequency Selection	4-48
4.4.20	Probe Selection.....	4-48
4.4.21	Corrosion Reference Standards.....	4-48
4.4.22	Inspection Procedure-Corrosion Detection	4-48
4.4.23	Part Preparation	4-48
4.4.24	Field Measurement of Conductivity	4-48
4.4.25	Conductivity of Aluminum Alloys	4-48
4.4.26	Heat Treatment Effects on Aluminum Conductivity	4-49
4.4.27	Discrepancies in Aluminum Alloy Heat Treatment.....	4-49
4.4.28	Applications of Conductivity Measurement.....	4-49
4.4.29	Conductivity Measurement.....	4-50
4.4.30	Equipment for Magnetic Materials	4-50
4.4.31	Effects of Variations in Material Properties.....	4-50
4.4.32	Effects of Variations in Test Conditions	4-51
4.4.33	Flaw Detection.....	4-52
4.4.34	Inspection Material	4-52
4.4.35	Accessibility.....	4-52
4.4.36	Crack Detection	4-52
4.4.37	Probe Selection	4-52
4.4.38	Lift-Off Effects.....	4-56
4.4.39	Lift-Off Compensation Methods.....	4-56
4.4.40	Effects of Crack Location on Detectability.....	4-60
4.4.41	Effects of Scanning Techniques on Detection	4-62

4.4.42	Reference Standards for Cracks.....	4-64
4.4.43	Thickness Measurement.....	4-70
4.4.44	Measurement of Total Metal Thickness.....	4-71
SECTION V INTERPRETING EDDY CURRENT SIGNALS.....		4-76
4.5	ET Interpretation.....	4-76
4.5.1	Flaw Detection.....	4-76
4.5.2	Evaluation of Crack Indications.....	4-76
4.5.3	Effect of Scan Rate and Pattern.....	4-77
4.5.4	Openings, Large Holes, and Cutouts.....	4-78
4.5.5	Conductivity Measurement.....	4-78
4.5.6	Inspection Procedures.....	4-78
4.5.7	Calibration for Measuring Conductivity Values.....	4-79
SECTION VI EDDY CURRENT PROCESS CONTROL.....		4-80
4.6	ET Process Control.....	4-80
4.6.1	General.....	4-80
4.6.2	Probe Test.....	4-80
4.6.3	Slot Test.....	4-80
SECTION VII EDDY CURRENT EQUATIONS.....		4-81
4.7	Tables and Equations.....	4-81
4.7.1	Resistance.....	4-88
4.7.2	Inductance.....	4-89
4.7.3	Fill Factor.....	4-90
4.7.5	Permeability.....	4-91
4.7.6	Depth of Penetration (δ).....	4-92
4.7.7	Limit Frequency, f_g , and the "Similarity" Law.....	4-93
4.7.8	Characteristic Frequency.....	4-93
4.7.10	Calculating Flaw Frequency for Setting Filters.....	4-93
4.7.11	Measurement of Conductivity.....	4-94
SECTION VIII EDDY CURRENT SAFETY.....		4-95
4.8	ET Safety.....	4-95
4.8.1	Safety Requirements.....	4-95
4.8.2	General Precautions.....	4-95
4.8.3	ET.....	4-95
5	ULTRASONIC INSPECTION METHOD.....	5-1
SECTION I GENERAL CAPABILITIES OF ULTRASONIC INSPECTION.....		5-1
5.1	Introduction.....	5-1
5.1.1	Introduction to Ultrasonic Inspection.....	5-1
5.1.2	Development of Ultrasonics.....	5-1
5.1.3	Ultrasonic Testing.....	5-1
SECTION II PRINCIPLES AND THEORY OF ULTRASONIC INSPECTION.....		5-2
5.2	Introduction.....	5-2
5.2.1	Characteristics of Ultrasonic Energy.....	5-2
5.2.2	Generation and Receiving of Ultrasonic Vibrations.....	5-2
5.2.3	Modes of Ultrasonic Vibration.....	5-3
5.2.4	Refraction and Mode Conversion.....	5-5
5.2.5	Ultrasonic Inspection Variables.....	5-7
5.2.6	Sound Beam Characteristics.....	5-8

T.O. 33B-1-1

SECTION III	ULTRASONIC INSPECTION EQUIPMENT AND MATERIALS	5-12
5.3	Introduction.....	5-12
5.3.1	Ultrasonic Instruments.....	5-12
5.3.2	Transducers	5-20
5.3.3	Specialized Transducers	5-24
5.3.4	Wedges and Shoes.....	5-25
5.3.5	Couplants	5-33
5.3.6	Inspection Standards.....	5-34
5.3.7	Bonded Structure Reference Standards	5-34
5.3.8	Thickness Measurement Equipment	5-36
SECTION IV	ULTRASONIC INSPECTION APPLICATION	5-38
5.4	Introduction.....	5-38
5.4.1	Guidelines for Inspector Familiarization	5-38
5.4.2	Basic Ultrasonic Inspection.....	5-38
5.4.3	Ultrasonic Reflections	5-39
5.4.4	Data Presentation Methods.....	5-40
5.4.5	Relationship of a Scan Waveform Display to Distance.....	5-42
5.4.6	Common Inspection Techniques.....	5-42
5.4.7	Ultrasonic Technique Development.....	5-47
5.4.8	Distance Amplitude Correction (DAC) Curve	5-49
5.4.9	Attenuation Correction (Transfer).....	5-50
5.4.10	Inspection of Bonded Structures.....	5-56
5.4.11	Thickness Measurement	5-56
5.4.12	Calibration and Thickness Measurement.....	5-57
SECTION V	ULTRASONIC INSPECTION INTERPRETATION	5-59
5.5	Introduction.....	5-59
5.5.1	Evaluation of Discontinuity Indications	5-59
5.5.2	Types of Discontinuity Indications.....	5-59
5.5.3	Test Part Variables	5-65
5.5.4	Discontinuity Variables	5-68
5.5.5	Inspection Coverage of Bonded Structures	5-68
5.5.6	Inspection Methods for Bonded Structures	5-70
5.5.7	Techniques Associated With Instruments Dedicated to Bond Inspection.....	5-78
5.5.8	Thickness Measurement Test Part Preparation	5-82
5.5.9	Thickness Measurement Considerations.....	5-82
SECTION VI	ULTRASONIC INSPECTION PROCESS CONTROLS.....	5-83
5.6	Introduction.....	5-83
5.6.1	Ultrasonic Process Control Requirements	5-83
5.6.2	Reference Standard Configuration	5-83
5.6.3	System (Equipment) Checks	5-87
5.6.4	Transducer Verifications	5-96
SECTION VII	ULTRASONIC INSPECTION EQUATIONS	5-101
5.7	Introduction.....	5-101
5.7.1	General.....	5-101
5.7.2	Snell's Law	5-101
5.7.3	Determining the Angle of Incidence in Plastic to Generate 45-Degree Shear Wave in Aluminum	5-101
5.7.4	Near Field	5-101
5.7.5	Beam Spread.....	5-102
5.7.6	Calculating Acoustic Impedance.....	5-102
5.7.7	Thickness Measurement Correlation Factor	5-105

SECTION VIII	ULTRASONIC INSPECTION SAFETY.....	5-107
5.8	Introduction.....	5-107
5.8.1	Safety Requirements.....	5-107
5.8.2	General Precautions.....	5-107
5.8.3	Ultrasonic Inspection.....	5-107
6	RADIOGRAPHIC INSPECTION METHOD.....	6-1
SECTION I	RADIOGRAPHIC INSPECTION METHOD	6-1
6.1	General Capabilities of Radiographic Inspection.....	6-1
6.1.1	Introduction to Radiographic Inspection	6-1
6.1.2	History of X- and Gamma Radiation	6-2
6.1.3	Factors of Radiographic Inspection	6-3
6.1.4	The Physics of X-rays.....	6-3
6.1.5	Properties of X- and Gamma Radiation	6-5
6.1.6	Differential Absorption of Radiation in Matter.....	6-5
6.1.7	Exposure of Film to Radiation.....	6-7
6.1.8	When to use Radiography.....	6-8
6.1.9	Unique Properties of Gamma Radiation.....	6-8
SECTION II	PRINCIPLES AND THEORY OF RADIOGRAPHIC INSPECTION.....	6-10
6.2	How X-rays Are Produced.....	6-10
6.2.1	Generating X-Radiation.....	6-10
6.2.2	Type of Radiation Produced by a Tube Head.....	6-11
6.2.3	Effects of Voltage and Amperage on X-ray Production.....	6-12
6.2.4	X-ray Generators	6-13
6.2.5	Intensity and Distribution of an X-ray Beam.....	6-15
6.2.6	Interaction of Radiation With Matter	6-18
6.2.7	Radiation Energy	6-22
6.2.8	Scatter Radiation.....	6-23
6.2.9	Material Contrast.....	6-24
6.2.10	Understanding Radiographic Film	6-24
6.2.11	Fundamentals of Digital Radiography	6-29
SECTION III	RADIOGRAPHIC EQUIPMENT	6-33
6.3	Radiographic Inspection Equipment.....	6-33
6.3.1	Types of X-ray Generators.....	6-33
6.3.2	Types of X-ray Tubes	6-33
6.3.3	Considerations in Choosing Equipment.....	6-33
6.3.4	Considerations When Operating X-ray Equipment.....	6-35
6.3.5	Standard Industrial X-ray Equipment in the DoD	6-36
6.3.6	Isotope Source Equipment	6-37
6.3.7	Radiographic Film	6-39
6.3.8	Film Holders, Film Cassettes, and Radiographic Screens	6-44
6.3.9	Quality Indicators	6-47
6.3.10	Radiation Monitoring Devices and Instruments.....	6-50
6.3.11	Radiographic Processing Equipment	6-53
6.3.12	Film Evaluation Equipment	6-53
6.3.13	Digital Radiographic Viewing, Storage, Archival, and Printing Systems.....	6-54
SECTION IV	APPLICATION OF RADIOGRAPHIC INSPECTION.....	6-55
6.4	Effective Radiographic Inspections	6-55
6.4.1	Introduction.....	6-55
6.4.2	Factors Affecting Image Quality	6-55

T.O. 33B-1-1

6.4.3	Radiographic Sensitivity.....	6-67
6.4.4	Improving Radiographic Sensitivity	6-71
6.4.5	Darkroom Design	6-76
6.4.6	Radiographic Film	6-79
6.4.7	Film Handling Problems	6-80
6.4.8	Preparation for Manual Processing.....	6-83
6.4.9	Storage of Radiographs	6-83
6.4.10	Processing Chemicals	6-84
6.4.11	Processing Radiographic Film	6-86
6.4.12	Manual Film Processing Procedure	6-94
6.4.13	Automatic Film Processing	6-97
6.4.14	Silver Recovery	6-100
6.4.15	Film Reproduction Technique.....	6-100
6.4.16	Film Artifacts.....	6-101
6.4.17	Special Radiographic Techniques.....	6-102
6.4.18	Digital Radiographic Techniques.....	6-111
SECTION V INTERPRETATION OF RADIOGRAPHIC INSPECTION.....		6-112
6.5	Radiographic Interpretation.....	6-112
6.5.1	General.....	6-112
6.5.2	Radiographic Image Quality	6-112
6.5.3	Sensitivity	6-112
6.5.4	Definition or Detail	6-112
6.5.5	Density	6-114
6.5.6	Contrast.....	6-115
6.5.7	Fog	6-115
6.5.8	Distortion and Magnification	6-116
6.5.9	Kilovoltage and Processing.....	6-116
6.5.10	Viewing Radiographs	6-116
6.5.11	Reading (Interpreting) Radiographs.....	6-118
6.5.12	Typical Use of Radiography	6-118
6.5.13	Castings.....	6-118
6.5.14	Casting Defects.....	6-120
6.5.15	Welds	6-128
6.5.16	Welding Defects and Conditions	6-128
6.5.17	In-Service Inspections	6-145
6.5.18	Assemblies	6-146
6.5.19	Radiographic Standards.....	6-146
6.5.20	Digital Radiographic Image Analysis.....	6-146
SECTION VI PROCESS CONTROL OF RADIOGRAPHIC INSPECTION.....		6-149
6.6	Radiographic Process Control.....	6-149
6.6.1	Scope and Purpose	6-149
6.6.2	Radiographic Process Control Requirements	6-149
6.6.3	Process Control in the Darkroom	6-149
6.6.4	Controlling the Development Process	6-153
SECTION VII RADIOGRAPHIC INSPECTION EQUATIONS		6-155
6.7	Radiographic Equations.....	6-155
6.7.1	General.....	6-155
6.7.2	Inverse Square Law	6-155
6.7.3	Source-to-Film Distance (SFD)	6-155
6.7.4	Film Density	6-156
6.7.5	Logarithms for Density and Exposure Calculations	6-156
6.7.6	Material Contrast Factor.....	6-159
6.7.7	Image Unsharpness.....	6-159
6.7.8	Heel Effect.....	6-160

SECTION VIII RADIOGRAPHIC INSPECTION SAFETY	6-161
6.8 Scope and Purpose of Radiation Protection	6-161
6.8.1 General	6-161
6.8.2 Responsibilities	6-161
6.8.3 (ALL) Qualifications of Civilian Industrial Radiographers	6-166
6.8.4 (ALL) Industrial Radiographic Safety Training	6-167
6.8.5 (ALL) Radiation Protection	6-169
6.8.6 Industrial Radiographic Operations	6-180
6.8.7 Industrial Radiographic Installation Classifications	6-181
6.8.8 Mandatory Operating Procedures	6-187
6.8.9 NDI Facility Design and Modification	6-193
GLOSSARY	Glossary 1

LIST OF ILLUSTRATIONS

Number	Title	Page
1-1	Typical Nondestructive Inspection Facility	1-16
2-1	The Penetrant Inspection Process	2-4
2-2	The Results of Inspection With a Medium Sensitivity Level Penetrant and a High Sensitivity Level Penetrant	2-8
2-3	The Contact Angle, θ , is the Angle Between the Liquid and Solid Surface and is a Measure of the Wetting Ability	2-12
2-4	The Rise and Depression of Liquid in a Capillary Tube is Dependant Upon the Contact Angle	2-13
2-5	Indications Produced by Penetrant of Four Different Sensitivity Levels Using Dry Developer	2-16
2-6	Diffusion of Emulsifier Into Penetrant During Lipophilic Emulsifier Dwell	2-18
2-7	Action of the Hydrophilic Remover Process	2-20
2-8	The Effects of a Developer	2-21
2-9	Cross-Section of a Typical High-Pressure Mercury Vapor Arc Bulb	2-33
2-10	Transmission Curve for Kopp 41 Glass	2-35
2-11	Flow Chart for Water Washable Penetrant Process (Method A)	2-37
2-12	Flow Chart For Post-Emulsifiable Lipophilic Penetrant Process (Method B)	2-38
2-13	Flow Chart for Solvent Removable Penetrant Process (Method C)	2-39
2-14	Flow Chart for Post-Emulsifiable Hydrophilic Penetrant Process (Method D)	2-40
2-15	Graph Showing the Approximate Drying Times for Two Types of Nonaqueous Developers at Various Temperatures	2-46
2-16	Graph Showing the Viscosities of Several QPL Penetrants at Various Temperatures	2-49
2-17	Graph Showing the Comparison of Dwell Time Vs. Viscosity for Two Types of Penetrants	2-50
2-18	Comparison of Adequate Dwell Vs. Insufficient Dwell on a Thermally Cracked Aluminum Block	2-52
2-19	Cracked-Chrome Panels Showing Effects of Insufficient Wash, Optimum Wash, and Excessive Wash	2-55
2-20	Effects of Optimum, Insufficient, and Excessive Hydrophilic Removal Dwell Time	2-58
2-21	Effects of Optimum, Insufficient, and Excessive Remover Dwell Time	2-60
2-22	Effects of Proper vs. Excessive Drying	2-66
2-23	Cracked, Aluminum Panel Comparing Results of an Optimum Thickness Layer of Developer (Top) to an Excessive Thickness Layer of Developer (Bottom)	2-72
2-24	Comparison of Four Cracked Chrome Test Panels With Different Sensitivity Levels	2-75
2-25	Electromagnetic Spectrum Shows the Relatively Narrow Band of Black Light	2-79
2-26	Relative Response of a Typical Human Eye to Visible Light at Two Different Light Levels, (A) 100 Lumens, and (B) 2.0 Lumens	2-80
2-27	Typical Penetrant Indications (a, b, c, d)	2-85
2-28	Micrograph of a Cross-Section Through a Fatigue Crack Showing the Transgranular Progression of the Crack	2-87
2-29	Micrograph of a Cross-Section Through a Stress-Corrosion Crack	2-88
2-30	Location of Camera and Lights for Photographing Fluorescent Indications	2-90

T.O. 33B-1-1

2-31	Processed Starburst Panel With Indications	2-94
2-32	Magnified View of Largest Manufactured Indication	2-95
2-33	Illustration of Crack Depth in Cracked-Chrome Panel	2-104
2-34	Specific Gravity Hydrometer Readings for Two Water-Suspended Developers	2-114
2-35	Specific Gravity Hydrometer Readings Versus Concentration for One Manufacturer's Water-Soluble Developers	2-116
3-1	Horseshoe Magnet	3-3
3-2	Horseshoe Magnet With Poles Close Together	3-3
3-3	Horseshoe Magnet Fused Into a Ring	3-4
3-4	Crack in Fused Horseshoe Magnet	3-4
3-5	Horseshoe Magnet Straightened to Form a Bar Magnet	3-4
3-6	Slot (Keyway) in Bar Magnet Attracting Magnetic Particles	3-5
3-7	Crack in Bar Magnet Attracting Magnetic Particles	3-5
3-8	Magnetic Field Surrounding an Electrical Conductor	3-6
3-9	Magnetic Field in a Part Used as a Conductor	3-6
3-10	Creating a Circular Magnetic Field in a Part	3-7
3-11	Using a Central Conductor to Circularly Magnetize a Cylinder	3-7
3-12	Using a Central Conductor to Circularly Magnetize Ring-Like Parts	3-7
3-13	Magnetic Lines of Force (Magnetic Field) in a Coil	3-8
3-14	Longitudinal Magnetic Field Produced in a Part Placed in a Coil	3-8
3-15	Longitudinal Field Produced by the Coil Generates an Indication of Crack in Part	3-8
3-16	Field Produced in a Bar by a "Parallel" Current	3-9
3-17	Hysteresis Curve for a Ferromagnetic Material	3-10
3-18	Flux Waveform During Demagnetization, Projected from the Hysteresis Loop	3-12
3-19	Magnetization With a Permanent Magnet	3-16
3-20	Current and Field Distribution in a Bearing Race Being Magnetized by the Induced Current Method	3-18
3-21	Typical Field Indicators	3-19
3-22	Typical Use of Gauss Meter Probes	3-20
3-23	Comparison of Indications of Surface Cracks on a Part Magnetized With AC, DC, and Three-Phase Rectified AC	3-22
3-24	Drawing of a Tool Steel Ring Specimen (Ketos Ring) With Artificial Sub-Surface Defects	3-33
3-25	Magnetic Flux Distribution in a Central Conductor and a Cylindrical Test Part	3-36
3-26	Shim-Type Magnetic Flux Indicators	3-39
3-27	Hall-Effect Sensors	3-41
3-28	Field Inspection of Nose Wheel Strut	3-53
3-29	Hysteresis Loops Produced During Demagnetization	3-56
3-30	Part in Demagnetizing Yoke	3-59
3-31	Non-Contact Demagnetization	3-61
3-32	Preparation for Magnetic Rubber Inspection	3-66
3-33	Using Pole Pieces to Improve Magnetic Contact	3-67
3-34	Magnetic Rubber Replica With No Indication	3-71
3-35	Magnetic Rubber Replica With Good Indication	3-71
3-36	Magnetic Rubber Replica With Excessive Magnetization	3-72
3-37	Magnetic Rubber Replica With Crack Indications	3-72
3-38	Sequence of Steel Processing Stages, Indicating the Principle Operations and the Defects Most Likely to be Found in the Material After Each Process	3-74
3-39	Sharp, Well Defined Indication of Surface Discontinuity in a Weld	3-76
3-40	Broad Indication of Subsurface Discontinuity in a Weld	3-76
3-41	Typical Magnetic Particle Indications of Cracks	3-77
3-42	Magnetic Particle Indication of a Forced Fit	3-78
3-43	Particle Indication at the Weld Between a Soft and a Hard Steel Rod	3-78
3-44	Magnetic Particle Indication of the Braze Line of a Brazed Tool Bit	3-79
3-45	Magnetic Particle Indications of Segregations	3-80
3-46	Cross-Section of Ingot Showing Shrink Cavity	3-81
3-47	Magnetic Particle Indication of a Subsurface Stringer of Nonmetallic Inclusions	3-82
3-48	Scabs on the Surface of a Rolled Bloom	3-83
3-49	How Laps and Seams Are Produced from Overfills and Under-Fills	3-84
3-50	Magnetic Particle Indication of a Seam on a Bar	3-85
3-51	Magnetic Particle Indications of Laminations Shown on Flame-Cut Edge of Thick Steel Plate	3-86
3-52	Section Through Severe Cupping in a 1 3/8-Inch Bar	3-87

3-53	Magnetic Particle Indications of Cooling Cracks in an Alloy Steel Bar	3-88
3-54	Magnetic Particle Indications of Flakes in a Bore of a Large Hollow Shaft.....	3-89
3-55	Magnetic Particle Indications of Forging Cracks or Bursts in an Upset Section, Severe Case	3-90
3-56	Surface of a Steel Billet Showing a Lap	3-91
3-57	Cross Section of a Forging Lap (Magnified 100X)	3-91
3-58	Magnetic Particle Indication of Flash Line Tear in a Partially Machined Automotive Spindle Forging	3-92
3-59	Magnetic Particle Indications of Defects in Castings	3-92
3-60	Magnetic Particle Indications of Quenching Cracks Shown With Dry Powder	3-93
3-61	Fluorescent Magnetic Particle Indications of Typical Grinding Cracks.....	3-94
3-62	Magnetic Particle Indications of Grinding Cracks in a Stress-Sensitive, Hardened Surface	3-95
3-63	Magnetic Particle Indications of Plating Cracks	3-96
3-64	Magnetic Particle Indication of a Typical Fatigue Crack	3-97
3-65	Fluorescent Magnetic Particle Indications of Cracks in Crankshaft of Small Aircraft Engine Damaged in Plane Accident	3-97
3-66	Creation of Magnetic Writing	3-99
3-67	Local Poles Created by Shape of Part	3-100
3-68	Concentration of Field in a Keyway.....	3-101
3-69	External Leakage Field Created by an Internal Keyway	3-101
3-70	Non-Relevant Indications of Shaft Caused by Internal Spline	3-102
3-71	Non-Relevant Indications Under the Head Created by Slot in Bolt.....	3-102
3-72	Ketos Ring	3-110
3-73	Filling Centrifuge Tube from Hose.....	3-116
3-74	Drawing Fine Magnetic Particles from Vehicle With Horseshoe Magnet	3-118
3-75	Calculating Effective Diameter	3-124
4-1	Generation of Eddy Currents in Various Part Configurations	4-2
4-2	Relative Magnitude and Distribution of Eddy Currents in Good or Poor Conductors.....	4-4
4-3	Relative Magnitude and Distribution of Eddy Currents in Conductive Material of High or Low Permea- bility.....	4-5
4-4	Relative Intensity of Eddy Currents With Variations in Lift-Off.....	4-6
4-5	Distribution of Eddy Currents in Thin Conductors Backed by Materials of Different Conductivity	4-7
4-6	Impedance Diagram Showing the Effect of Specimen Thickness (paragraph 4.4.17.4).....	4-8
4-7	Shallow Surface Crack	4-9
4-8	Deeper Surface Crack.....	4-10
4-9	Three Standard Depths of Penetration	4-10
4-10	Subsurface Crack	4-11
4-11	Deep Subsurface Crack	4-11
4-12	Depth in Part.....	4-12
4-13	Simplified Bridge Circuit	4-15
4-14	Sinusoidal Variation of Alternating Current and Induced Voltage in a Coil.....	4-17
4-15	Combining of Out-of Phase Voltages	4-18
4-16	Vector Diagram Showing Relationship Between Resistance, Reactance, and Impedance.....	4-19
4-17	Diagram Showing Relationship of Voltage Drops Across Coil Resistance and Coil Reactance.....	4-20
4-18	Primary and Secondary Magnetic Fields in ET.....	4-22
4-19	Impedance Diagram Showing the Effect of Lift-Off	4-24
4-20	Relative Effect of Frequency on Depth of Penetration.....	4-25
4-21	Block Diagram of ET System	4-27
4-22	Basic Coil Configurations	4-29
4-23	Single and Double Test Coil Configurations-Encircling Coils	4-30
4-24	Basic Bridge Circuit	4-32
4-25	Illustration of the Effects of Different Filters on the Eddy Current Signal	4-37
4-26	Effect of Material Variables on Magnitude of Alternating Current in Test Coil With Constant Scanning Speed	4-39
4-27	Distortion of Eddy Current Flow at the Edge of a Part.....	4-43
4-28	Vector Representation of Impedance	4-44
4-29	Phase Angle Difference Between Lift-Off and Conductivity	4-45
4-30	Vector Representation of an Impedance Change Due to Lift-Off.....	4-46
4-31	Impedance Diagram Illustrating Effects of Variable Conductivity.....	4-47
4-32	Advantages of Pointed and Radiused Probes for ET	4-54
4-33	Impedance Diagram Showing the Effect of a Crack.....	4-57
4-34	Decrease in Crack Response With Increasing Lift-Off.....	4-58

T.O. 33B-1-1

4-35	Phase Relationship Between Lift-Off and Crack Response for Various Materials and Frequencies.....	4-59
4-36	Lift-Off Resulting From Probe Wobble.....	4-60
4-37	Edge Probe Guide.....	4-61
4-38	Effect of Scanning Speed on Meter Deflection from a Crack.....	4-63
4-39	Air Force General Purpose Eddy Current Standard.....	4-65
4-40	Navy Eddy Current Reference Standard.....	4-68
4-41	Effect of Discontinuities on Distribution of Eddy Currents.....	4-76
4-42	ECI Acceptable Signal Response.....	4-80
4-43	Sinusoidal In-Phase Variation of Alternating Current and Induced Magnetic Field.....	4-89
5-1	Generation of Ultrasonic Vibrations.....	5-3
5-2	Coupling Between the Transducer and the Test Part to Transmit Ultrasonic Energy.....	5-3
5-3	Longitudinal and Transverse Wave Modes.....	5-4
5-4	Surface Wave Mode.....	5-5
5-5	Distribution of Surface Wave Energy With Depth.....	5-5
5-6	Sound Beam Refraction.....	5-6
5-7	Relative Amplitude in Steel of Longitudinal, Shear, and Surface Wave Modes With Changing Plastic Wedge Angle.....	5-6
5-8	Schematic Presentation of Sound Beam.....	5-8
5-9	Amplitude Response Curve of Typical Transducer.....	5-9
5-10	Example of Beam Spread Causing Confusing Signals.....	5-10
5-11	Main Sound Beam and Side Lobe Energy.....	5-10
5-12	Focused Sound Beams.....	5-11
5-13	Time Base.....	5-13
5-14	Relationship of CRT Sweep to Time Base.....	5-14
5-15	Ultrasonic Contact Inspection.....	5-14
5-16	Display Screen Before Adjusting Sweep Delay.....	5-15
5-17	Display Screen After Adjusting Sweep Delay.....	5-16
5-18	Effect of Sweep Length on CRT Display.....	5-16
5-19	Decibel-to-Amplitude-Ratio Conversion Chart.....	5-18
5-20	Reject Control.....	5-19
5-21	Straight Beam Contact Transducer.....	5-21
5-22	Angle Beam Contact Transducers.....	5-21
5-23	Dual Transducer Operation.....	5-22
5-24	Angle Beam Dual Transducers.....	5-23
5-25	Water Delay Column Transducers.....	5-24
5-26	Wheel Transducer.....	5-25
5-27	Angle Beam Inspection of Curved Surface Using Flat Transducer.....	5-26
5-28	Angle Beam Wedge With Hole for Mounting Transducer.....	5-27
5-29	Use of a Coupling Fixture to Hold Transducer on Shoe.....	5-28
5-30	Angle Beam Wedge Requiring a Coupling Fixture.....	5-28
5-31	Typical Curved Surface.....	5-29
5-32	Generation of Unwanted Surface Waves During Inspection of Cylindrical Part in the Longitudinal Direction.....	5-30
5-33	Slots in Shoe to Eliminate Unwanted Surface Waves.....	5-30
5-34	Generation of Unwanted Longitudinal and Surface Waves on Curved Surface.....	5-31
5-35	Example of Determining the Sound Beam Path in a Test Part With a Curved Surface.....	5-32
5-36	Straight Beam Inspection of Test Part With Curved Surface.....	5-33
5-37	Example of Reference Standard for Types I and II Unbonds.....	5-36
5-38	Immersion Method.....	5-39
5-39	Ultrasonic Reflection.....	5-40
5-40	Typical A-Scan Display for Contact Inspection.....	5-41
5-41	Typical C-Scan Inspection and Presentation.....	5-42
5-42	Inspection of Test Part Opposite Sides to Provide Coverage of Dead Zone Areas.....	5-43
5-43	Through-Transmission Inspection.....	5-44
5-44	Angle Beam Inspection.....	5-45
5-45	Surface Wave Inspection.....	5-46
5-46	Surface Wave Familiarization.....	5-46
5-47	Correct and Incorrect Transducer Orientation for Finding Cracks With Surface Waves.....	5-47
5-48	Typical Straight Beam DAC Curve.....	5-50
5-49	Transducer Unit on ASTM Block for Determining Transfer Amount.....	5-51

5-50	ASTM Block and Test Part Back Surface Signals.....	5-52
5-51	Reference Standard for Inspection for Cracks in Skin.....	5-53
5-52	Positioning Transducer for Establishing Transfer	5-54
5-53	Transfer Limits.....	5-55
5-54	Example of Multiple Indications and Decrease in Multiple Back Reflections Caused by Large Grain Size or Porosity.....	5-60
5-55	Effect of Delaminations in a Plate on Multiple Back Surface Signals	5-61
5-56	Irrelevant Surface Wave Signals.....	5-62
5-57	Reference Standard for Inspection of a Bolt.....	5-63
5-58	Angle Beam Technique for Locating Discontinuities at Boundaries	5-63
5-59	Example of Ringing Signals Due to a Loose Transducer Element.....	5-64
5-60	Double Shield for Reducing External Noise Signals	5-65
5-61	Concave Sound Entry Surface.....	5-66
5-62	Convex Sound Entry Surface.....	5-66
5-63	Example of Mode Conversion.....	5-67
5-64	Bonded Structure Configurations and Suggested Inspection Coverages	5-69
5-65	Through-Transmission Technique.....	5-72
5-66	Procedure for Through-Transmission Inspection of a Stabilator View A - C	5-73
5-67	Procedure for Through-Transmission Inspection of a Stabilator View D.....	5-74
5-68	Pulse-Echo Technique	5-75
5-69	Mapping of Unbonds, Pulse-Echo Technique	5-76
5-70	Ringing Technique.....	5-77
5-71	Damping Technique.....	5-78
5-72	Resonance Method.....	5-79
5-73	Impedance Plane Display of a Pitch/Catch Impulse Technique	5-79
5-74	Pitch/Catch Probe Positions for Mapping Unbonds.....	5-80
5-75	Pitch/Catch Swept-Frequency Signal Patterns.....	5-81
5-76	Mechanical Impedance Analysis Display	5-81
5-77	ASTM Reference Blocks.....	5-84
5-78	Angle Beam Block.....	5-86
5-79	Use the Type 2 IIW Block to Check Horizontal Linearity.....	5-88
5-80	Use a Type 2 IIW Block to Check Back Surface Resolution	5-90
5-81	Use a Type 2 IIW Block to Check Entry Surface Resolution.....	5-91
5-82	Straight Beam Distance Calibration With IIW Block.....	5-93
5-83	Straight Beam Distance With Miniature Angle Beam Block	5-94
5-84	Angle Beam Distance Calibration With IIW Block.....	5-95
5-85	Angle Beam Distance Calibration With Miniature Angle Beam Block.....	5-96
5-86	Point of Incidence Determination With IIW Block.....	5-97
5-87	Point-of-Incidence Determination With Miniature Angle Beam Block	5-98
5-88	Beam Misalignment (Skew Angle).....	5-98
5-89	Skew Angle Measurement.....	5-99
5-90	Angle Determination With Type 2 IIW Block.....	5-100
5-91	Angle Determination With Miniature Angle Beam Block.....	5-100
6-1	Nuclear Structure	6-1
6-2	Wavelength.....	6-4
6-3	Diagram of Radiographic Exposure	6-6
6-4	Effect of Change in Thickness Cracks.....	6-7
6-5	Diagram of Nuclear Disintegration	6-9
6-6	Electron Cloud	6-10
6-7	X-ray Production.....	6-11
6-8	Typical X-ray Spectrum	6-12
6-9	Effect of Filament Current on Radiation Quantity (Intensity).....	6-13
6-10	Fundamentals of X-ray Tube.....	6-14
6-11	Effective Focal Spot Size	6-15
6-12	Variation of Intensity in the Primary Beam Due to the Heel Effect.....	6-16
6-13	Illustration of Various Radiation Absorption Interactions	6-19
6-14	Absorption Coefficients for Different Modes of Absorption in Iron	6-21
6-15	Absorption Curves of Monochromatic and Multi-Energy Radiation.....	6-23
6-16	Sketch of Cross Section of X-ray Film	6-25
6-17	Typical Characteristic Curve.....	6-28

T.O. 33B-1-1

6-18	Microdensitometer Tracings of Images of DIN Wire Penetrators	6-40
6-19	Relationship Between Signal-to-Noise Ratios and Speeds of Film	6-42
6-20	Penetrator Information	6-49
6-21	Effect of Kilovoltage on Transmitted Radiation Output	6-55
6-22	Radiographs of Honeycomb Showing Effect of Kilovoltage on Contrast	6-56
6-23	Possible Geometric Distortions	6-58
6-24	Nomogram to Assist in Solving Equation $U_g = Ft/d$	6-59
6-25	Preferred Geometry for Radiography of Curved Surfaces	6-60
6-26	Inverse Square Law Diagram	6-61
6-27	Density Changes Due to Varying Crack Widths and Intersection Angles	6-63
6-28	Sources of Scatter Radiation	6-65
6-29	Masking to Avoid Scatter	6-66
6-30	Effect of Development Time Upon Film Speed, Contrast, and Fogging	6-67
6-31	Radiation Transmission Versus Thickness of Aluminum at 150 kVp	6-69
6-32	Radiation Transmission Versus Thickness for Various Densities at 150 kVp	6-70
6-33	A Typical X-ray Exposure Technique Chart	6-72
6-34	Sketch of Desirable Stepped Block for Radiation Measurements	6-74
6-35	Typical Technique Constant-Density Chart	6-75
6-36	Suggested Arrangement of Manual Film Processing Tank	6-77
6-37	Typical Arrangement of Through-the-Wall Automatic Processing Darkroom	6-78
6-38	Development Time Related Photographic Properties of X-ray Film	6-87
6-39	Effects of the Developer Replenisher on the Properties of X-ray Films	6-89
6-40	Clearing Time and Fixing Capacity of Fixers	6-91
6-41	Fixer Temperature-Time Curve	6-92
6-42	Manual Film Processing	6-96
6-43	Sectional View of Fuji FIP 4000 Processor	6-98
6-44	Triangulation Technique Used to Determine Flaw Depth in an Object	6-105
6-45	Sketch Showing Procedure for Making and Viewing Stereo Radiographs	6-107
6-46	Typical Image Intensifier Tube	6-109
6-47	Pinhole Picture of Focal Spot	6-113
6-48	Geometrical Factors	6-114
6-49	Dark Adaptation Diagram	6-116
6-50	Cavity Shrinkage	6-121
6-51	Filamentary Shrinkage	6-122
6-52	Sponge Shrinkage	6-123
6-53	Gas Porosity	6-124
6-54	Inclusions	6-125
6-55	Sand Inclusions	6-126
6-56	Core Shifts	6-127
6-57	Inadequate Weld Reinforcement	6-129
6-58	Offset	6-130
6-59	Excessive Reinforcement	6-131
6-60	Internal Undercutting	6-132
6-61	External Undercutting	6-133
6-62	Suck Back	6-134
6-63	Slag Inclusions	6-135
6-64	Porosity	6-136
6-65	Cluster Porosity	6-137
6-66	Cracks	6-138
6-67	Cracks	6-139
6-68	Lack of Fusion	6-140
6-69	Cold Lap	6-141
6-70	Tungsten Inclusions	6-142
6-71	Oxide Inclusions	6-143
6-72	Burn-Through	6-144
6-73	Radiation Symbol	6-189

LIST OF TABLES

Number	Title	Page
1-1	NDI Method Codes.....	1-7
1-2	Major Command Codes.....	1-7
1-3	Frequency for Process Control.....	1-10
2-1	Classification of Penetrant Materials Contained in SAE AMS 2644.....	2-5
2-2	Minimum Penetrant Dwell Times.....	2-52
2-3	Comparison of Hydrophilic Vs. Lipophilic Methods.....	2-57
2-4	Developer Dwell Times.....	2-73
2-5	Developer Forms and Application Methods in a Decreasing Sensitivity Order.....	2-74
2-6	Empirical Black Light Intensity Requirements at Various Ambient Light Levels for Portable Inspections.....	2-81
2-7	Process Checks PT.....	2-96
3-1	Requirements for Magnetic Particle Wet Relative Permeability for Some Ferromagnetic Materials Method Oil Vehicle (A-A-59230).....	3-25
3-2	Procurement Data for Magnetic Particles per ASTM E 1444.....	3-26
3-3	Relative Permeabilities for Some Ferromagnetic Materials.....	3-37
3-4	Magnetic Rubber Equipment.....	3-64
3-5	Magnetic Rubber Inspection Materials.....	3-64
3-6	Magnetic Field Strength and Duration Recommendations.....	3-68
3-7	Cure Times for Different Amounts of Catalyst.....	3-69
3-8	Ring Specimen Indications.....	3-110
3-9	MT Process Checks.....	3-120
3-10	Coil Size Vs. Maximum Diameter for Parts Magnetized in Bottom of Coil.....	3-121
3-11	Typical Coil-Shot Current for a Five-Turn Coil With Part in Bottom of Coil.....	3-122
3-12	Comparison of Coil Amperages for Solid vs. Hollow Parts.....	3-124
4-1	Common Applications of ET.....	4-81
4-2	Conductivities of Some Commonly Used Engineering Materials.....	4-81
4-3	Conductivity and Effective Depth of Penetration in Various Metals.....	4-82
4-4	Conductivity and Effective Depth of Penetration in Nonclad Aluminum Alloys.....	4-83
4-5	Standard Depths of Penetration for Metal Alloys at Various Frequencies.....	4-85
4-6	Standard Depths of Penetration for Clad Aluminum Alloys at Various Frequencies.....	4-87
4-7	Conductivity and Effective Depth of Penetration for Clad Aluminum Alloys.....	4-88
4-8	Effects of Material and Inspection Variables on the Sensitivity and Range of Thickness Measurements.....	4-88
5-1	Ultrasonic Inspection Techniques for Bonded Structures.....	5-70
5-2	Ultrasonic Inspection Techniques for Bonded Structures.....	5-71
5-3	Reference Standard Metal Travel Tolerances.....	5-84
5-4	Relative Signal Response from FBHs in ASTM Blocks.....	5-85
5-5	Minimum Sensitivity Requirements.....	5-89
5-6	Limits of Boundary Surface Resolution.....	5-90
5-7	Incident Angles in Plastic for Refracted Shear Wave Angles in Test Materials.....	5-104
5-8	Measurement Error Introduced by Surface Roughness of Reference Standard or Test Part.....	5-106
5-9	Ultrasonic Properties of Materials.....	5-108
6-1	History of X- and Gamma Radiation.....	6-2
6-2	Exposure-Time Correction Factors for Different Source to Film Distances.....	6-17
6-3	Relationship of Light-Transmission to Film Density.....	6-26
6-4	Appropriate Radiation Energies for Radiography of Steel.....	6-33
6-5	Relative Speeds of X-ray Films Exposed at 100 kVp.....	6-41
6-6	Film Classes.....	6-42
6-7	Speed and Signal-to-Noise Ratio.....	6-43
6-8	Sample Result.....	6-46
6-9	Recommended Survey Instruments and Relative Energy Response.....	6-53
6-10	Approximate Radiation Energies Compatible With Various Absorbers.....	6-57
6-11	Correlation Between Beam Divergence and Crack Detectability.....	6-64
6-12	Radiation Cone Radii at Various Intersect Angles and FFDs.....	6-64

T.O. 33B-1-1

6-13	Relative Absorption of Materials Material Kilovoltage Exposure	6-67
6-14	Developing Time Versus Temperature	6-88
6-15	Film Size Versus Relative Area.....	6-88
6-16	Examples of Temperature Adjustments for Processing Solutions.....	6-93
6-17	Manual Washing of Radiographic Film.....	6-94
6-18	Conditions for Manual and Automatic Processing.....	6-99
6-19	Description of Film Artifacts	6-101
6-20	Visual Size Versus Physical Size.....	6-117
6-21	Characteristics of Logarithms.....	6-156
6-22	Four-Place Logarithms to the Base 10	6-157
6-23	Antilogarithms	6-158
6-24	Effect of Relative Exposure on Film Sensitivity.....	6-159
6-25	Investigation Levels (Extract of Table 2-1, DA PAM 40-18*).....	6-174
6-26	Dosimeter Results Require Notification of OTSG (Extract of Table 4-1, DA PAM 40-18).....	6-175
6-27	Radiation Area Definitions (ALL).....	6-185
6-28	Maximum Permissible Dose Rate Versus Hourly Duty Cycle.....	6-190
6-29	Use Factors (U)*.....	6-193
6-30	Occupancy Factors (T).....	6-193
6-31	Peak Voltage (kVp).....	6-194

INTRODUCTION

1. PURPOSE.

Nondestructive Inspection (NDI) is the inspection of a structure or component in any manner that will not impair its future usefulness. The purpose of the inspection may be to detect flaws, measure geometric characteristics, determine material structure or composition, or it may characterize physical, electrical, or thermal properties without causing any changes in the part. The five standard NDI disciplines include:

Liquid Penetrant

Magnetic Particle

Eddy Current

Ultrasonic

Radiography

NOTE

T.O. 33B-1-1 SHALL NOT be used as a stand alone inspection manual. Any reference to perform an inspection “In Accordance With T.O. 33B-1-1” or any ASTM standard without sufficient supplemental information, which comprises a complete inspection procedure (paragraph 2) SHALL be challenged by submitting an AFTO Form 22 to the responsible System Program Office to be placed in the proper technical manual. New T.O. 33B-1-2 “General NDI Procedures and Process Controls” can be used as a stand alone inspection document when T.O. 33B-1-1 or an ASTM standard is referenced as the inspection document or no other inspection guidance exist. It remains a priority to develop and publish specific inspection procedures for test parts that require routine or recurring inspections. All AFTO Form 22 submissions for NDI techniques should include an AFTO Form 242 demonstrating the suggested technique procedure.

2. SCOPE.

This publication contains the concepts, process controls, and theory of NDI methods and SHALL be used as a guide in development of NDI procedures and manuals. Guidance for development of NDI procedures is contained in MIL-DTL-87929C, Appendix F. NDI procedures SHALL be detailed step-by-step instructions with illustrations so a qualified NDI technician can perform the required inspection. In addition this manual provides guidance in safety guidelines of these NDI methods.

3. FORMAT OF PROCEDURES.

Though MIL-DTL-87929C is a directive for NDI Work Packages, it provides the proper format for detailed/repetitive NDI procedures. To ensure continuity of inspections, all on and off equipment maintenance NDI manuals (e.g. -9, -36, etc.) SHALL be written to adopt the special requirements of MIL-DTL-87929C into MIL-PRF-83495 when writing NDI procedures for these maintenance manuals. An individual qualified and certified to Level 3 in accordance with NAS 410 in the inspection method being used, SHALL approve all written procedures. References to ASTM standards alone SHALL NOT be used since they do not provide any inspection/part/material details. MIL-DTL-87929C also directs that procedures for commodity items and support equipment contained in or on the weapon system SHALL be included in the system peculiar manual. To clarify this, if the part is an aircraft commodity it will be contained in the aircraft T.O., if the part is a ground support commodity it will be in the ground support T.O., etc. For specific information on the operation, maintenance, or inspection of a particular piece of NDI equipment or a weapons system, consult the appropriate technical manual.

4. KNOWLEDGE OF NDI.

NDI methods in the hands of a trained and experienced technician are capable of detecting flaws or defects with a high degree of accuracy and reliability. It is important maintenance-engineering personnel are fully knowledgeable of the capabilities of each method but it is equally important they recognize the limitations of the methods. Rarely should an NDI method ever be considered conclusive. Often but not always, a defect indication detected by one method must be confirmed by another method to be considered reliable. The equipment is highly sensitive so the limits for acceptance and rejection are

T.O. 33B-1-1

as much a part of an inspection as the method itself. As an example, ultrasonic inspection criteria must be designed to overlook these ‘normal’ indications and to discriminate in favor of the discontinuities that will affect the service of the component.

5. TRI-SERVICE MANUAL.

The 33B-1-1 is a Tri-service manual and some information may be directed at one branch of service and not the others. You will see references to Technical Order (T.O.), Technical Manual (TM), and Naval Air Regulation (NAVAIR) throughout this publication. All references have the same meaning. All inquiries regarding the technical content should be addressed to the Air Force NDI Office which is the Office of Primary Responsibility (OPR) for this publication at AFRL/MLS-OL, 4750 Staff Dr., Tinker AFB, OK 73145-3317; DSN 339-4931. To suggest changes to this publication, AF users SHALL use an AFTO Form 22 and send suggestion to the previous address; Army users SHALL send comments and suggested improvements on DA Form 2028 (Recommended Changes to Publications and Blank Forms) directly to: PEO Aviation, SFAE-AV-AS-AG, Bldg 5308, Redstone Arsenal, AL 35898-5000, Phone: commercial (256) 313-0199 or DSN 897-0199; and Navy and Marine Corps Personnel SHALL submit changes/corrections at <http://www.natec.navy.mil> the Technical Publication Discrepancy Reporting (TPDR) process on-line. Instructions for submission of TPDRs are in COMNAVAIRFORINST 4790.2 (NAMP), Volume V, Chapter 10.

SAFETY SUMMARY

1. GENERAL SAFETY INSTRUCTIONS.

The following are general safety precautions and instructions individuals must understand and apply during many phases of operation and maintenance to ensure personal safety, health, and the protection of Air Force property. Portions of this may be repeated elsewhere in this publication for emphasis. Additional safety precautions are contained in AFOSH STD 91-110, 91-501, and, Army: AR 385-10 paragraph 1.

2. SHALL, SHOULD, MAY, AND WILL.

Use the word “SHALL” whenever a manual expresses a provision that is binding. Use “SHOULD” and “MAY” whenever it is necessary to express non-mandatory provisions. “WILL” may be used to express a declaration purpose. It may be necessary to use “WILL” in cases where simple futurity is required (e.g. “Power for the meter WILL be supplied by the ship”).

3. WARNINGS, CAUTIONS, AND NOTES.



This highlights an essential operating or maintenance procedure, practice, condition statement, etc., which if not strictly observed, could result in injury to, or death of, personnel or long term health hazards.



This highlights an essential operating or maintenance procedure, practice, condition, statement, etc., which if not strictly observed, could result in damage to, or destruction of, equipment or loss of mission effectiveness.

- WARNINGS and CAUTIONS are used in this manual to highlight operating or maintenance procedures, practices, conditions, or statements considered essential to protection of personnel (WARNING) or equipment (CAUTION). WARNINGS and CAUTIONS immediately precede the step or procedure to which they apply. WARNINGS and CAUTIONS consist of four parts: a heading (WARNING, CAUTION, or Icon); a statement of the hazard, minimum precautions, and possible result if disregarded. NOTES may precede or follow the step or procedure, depending upon the information to be highlighted. The heading used and the definitions are as follows.

NOTE

This highlights an essential operating or maintenance procedure, condition, or statement.

4. HAZARDOUS MATERIALS WARNINGS.

Consult the Material Safety Data Sheets (MSDS) (Occupational Safety and Health Administration (OSHA) Form 20 or equivalent) for specific information on hazards, effects, and protective equipment requirements. If you do not have a MSDS for the material involved, contact your supervisor, or the base Safety or Bioenvironmental Engineering Offices.

5. SAFETY PRECAUTIONS.

The following safety precautions SHALL be observed while performing procedures in this manual.

- CAUTION AROUND LIVE CIRCUITS. Operating personnel must observe safety regulations at all times. Do not replace components or make adjustments inside equipment with the electrical supply turned on. Under certain conditions, such as residual charges on capacitors, danger may exist even when the power control is in the off position. To avoid injuries, always disconnect power, discharge and ground circuit before touching it. Adhere to all lockout/tag-out requirements.

T.O. 33B-1-1

- **DO NOT SERVICE ALONE.** Under no circumstances should any persons perform maintenance on the equipment except in the presence of someone who is capable of rendering aid.
- **RESUSCITATION.** Personnel working with or near high voltage SHALL be familiar with modern methods of resuscitation. Such information may be obtained from the Director of Base Medical Services.
- **FINGER RINGS AND OTHER JEWELRY.** Remove rings, watches, and other metallic objects during all maintenance activity that may cause shock, burn, or other hazards. Snagged finger rings have caused many serious injuries.
- **PERSONAL PROTECTIVE EQUIPMENT (PPE).** The work center supervisor SHALL contact the Base Bioenvironmental Office and/or the Base Safety Office for a list of approved protective clothing/equipment (gloves, apron, eye protection, etc.) for the chemicals, materials, and tools being used. Use nitrile, neoprene, or other protective gloves, aprons, and goggles. The Base Bioenvironmental Office SHALL approve these items in writing. PPE SHALL be worn when and where directed to do so by the Base Bioenvironmental Office.
- **COMPRESSED AIR.** Use of compressed air can create an environment of propelled foreign particles. Excessive air pressures MAY cause injury. NDI Labs typically use compressed air reduced to less than 30-psig and used with effective chip guarding and personal protective equipment (PPE). Lab supervisors SHALL contact the local Wing Safety Office for guidance.
- **PRECAUTIONS WITH EYEWARE.** Personnel who wear contact lens shall identify this to their supervisor and refer to the appropriate material safety data sheets (MSDS) for possible hazards involved in wearing contact lens around chemicals and abide by the guidance for that chemical. Photochromatic lenses (lenses that darken when exposed to sunlight or ultraviolet light), sunglasses, and colored contacts reduce the visibility of fluorescent indications. This leads to the possibility of faint indications not being seen by the inspector. Therefore, glasses with photochromatic lenses, sunglasses or colored contact lenses SHALL NOT be worn when performing fluorescent penetrant or fluorescent magnetic particle inspections.
- **SAFETY WITH BLACK LIGHTS.** Black light bulbs SHALL NOT be operated without proper filters. Cracked, chipped, or ill-fitting filters SHALL be replaced before using the lamp. Unfiltered ultraviolet radiation can be harmful to the eyes and skin. Prolonged direct exposure of hands to the filtered black light main beam may be harmful. Suitable gloves SHALL be worn when exposing hands to the main beam; UV-A filtering safety glasses, goggles, or face shields SHALL also be worn. A black light bulb heats the external surfaces of the lamp housing. The temperature of some operating black light bulbs reaches 750°F (399°C) or more during operation. The temperature is not high enough to be visually apparent, but it is high enough to cause severe burns with even momentary contact of exposed body surfaces. Extreme care SHALL be exercised to prevent contacting the housing with any part of the body. These temperatures are also above the ignition or flash point of fuel vapors. These vapors WILL burst into flames if they contact the bulb. These black lights SHALL NOT be operated when flammable vapors are present.
- **SOLVENTS, CHEMICALS, AND OTHER TOXIC MATERIALS.** Solvents used may contain aromatic, aliphatic, or halogenated compounds. Many are high flammable while others may decompose at elevated temperatures. Solvents SHALL be kept away from heat and open flames. Vapors also may be harmful to personnel, thus adequate ventilation SHALL be used. Contact with skin and eyes SHALL be avoided. Solvents SHALL NOT be ingested. Waste material disposal SHALL be according to applicable directives or as specified by the local Bioenvironmental Engineer/Environmental Management Offices. Keep cleaners/chemicals in approved safety containers and maintain minimum quantities. Some cleaners/chemicals may have an adverse effect on skin, eyes, and respiratory tract. Observe manufacturer's WARNING labels; Material Safety Data Sheet (MSDS) instructions for proper handling, storage, and disposal; and current safety directives. Use cleaners/chemicals only in authorized areas. Discard soiled cloths into approved safety cans. Consult the local Bioenvironmental Engineer for specific protective equipment and ventilation requirements.
- **USE OF RESPIRATORS.** Dry developer particles are not toxic materials. However, like any solid foreign matter, they SHALL NOT be inhaled. Air cleaners, facemasks, or respirators may be required. The Base Bioenvironmental Engineer SHALL be consulted if the process generates airborne particles.
- **EXPOSURE TO SF₆ GAS.** Exposure to excessive amounts of Sulphur Hexafluoride (SF₆) gas can cause asphyxiation by displacing oxygen in the air. Care SHALL be taken not to release large quantities of SF₆ gas into unvented work areas. The amount leaked into the air while performing normal X-ray tube repair does not create an asphyxiation hazard. When SF₆ is heated, it liberates hazardous fluorine gas into the air. This possibility of producing fluorine gas exists in most X-ray tube heads. Precautions SHALL be taken to guard against the inhalation of the gas released from X-ray tubes that have been energized.

- **IMPROPER CLEANING PROCEDURES.** Improper cleaning procedures/materials can cause severe damage to the material under inspection. Preparation of parts to include but not limited to paint removal and chemical etching SHALL be accomplished by maintenance personnel who are properly trained, highly skilled, and experienced in those particular specialties and are aware of the effects on the part/material due to the use of these chemicals and methods. T.O. 1-1-691 applies to the Air Force, T.M. 1-1500-344-23 applies for the Army; and N.A. 01-1A-509 applies for the Navy and Marine Corps.
- **PRECAUTIONS DURING RADIOGRAPHIC INSPECTIONS.** Exposure to excessive X or gamma radiation is harmful to personnel and especially an unborn fetus. All applicable safety precautions SHALL be complied with. While most X-ray equipment is designed to minimize the danger of exposure to direct or stray radiation, certain precautions SHALL be observed. Failure to comply with safety procedures may result in serious injury to personnel in the area. Coordinate all operational changes with the Base Radiation Safety Officer. Radiation protection requirements are discussed further in (paragraph 6.8) of this manual for additional safety information. (NAVY ONLY: Radiation safety guidance is provided by NAVSEA S040-AA-RAD-010.)
- **PRECAUTIONS DURING PENETRANT INSPECTIONS.** Penetrant inspection includes the use of black light and exposure to flammable chemicals that may affect skin, eyes, and respiratory tract. Care SHALL be exercised when using hot black lights so as not to burn hands, arms, face, or other exposed body areas. Wear nitrile, neoprene, or other approved gloves and keep the insides of gloves clean when handling penetrate materials. When processing parts through chemicals in the stationary lines, appropriate eyewear, rubber apron, and protective gloves SHALL be worn. During times of portable inspection, a minimum of protective gloves and eye protection SHALL be worn. Consult your local Bioenvironmental and Safety offices for further guidance. Ensure the Base Bioenvironmental Office performs an adequate surface area exhaust ventilation evaluation annually. When recommended by the Base Bioenvironmental Engineer, an approved respirator SHALL be worn when working in areas where adequate ventilation cannot be practically provided. The use of visible dye penetrant is PROHIBITED on engine, aircraft, and missile parts except for those with specific engineering approval for each inspection.
- **PRECAUTIONS DURING MAGNETIC PARTICLE INSPECTIONS.** Magnetic particle inspection includes exposure to chemicals, ultraviolet light, and electrical current. Rubber insulating floor matting, rated for the voltage of the equipment being worked on, SHALL be used in front of magnetic particle units. Care SHALL be exercised when using hot black lights so as not to burn hands, arms, face, or other exposed body areas. Wear nitrile, neoprene, or other approved gloves and keep the insides of gloves clean when handling penetrate materials. When processing parts through chemicals in the stationary lines, appropriate eyewear, rubber apron, and protective gloves SHALL be worn. During times of portable inspection, a minimum of protective gloves and eye protection SHALL be worn. Consult your local Bioenvironmental and Safety offices for further guidance. Ensure the Base Bioenvironmental Office performs an adequate surface area exhaust ventilation evaluation annually.

6. ACCESS TO SURFACES AND PART PREPARATION.

Access to aircraft surfaces (e.g. panel removal) requiring Nondestructive Inspection, SHALL be accomplished by maintenance personnel who have properly documented training and are highly experienced in those particular specialties. Improper cleaning procedures/materials can cause severe damage to the material under inspection. Preparation of parts to include, but not limited to, paint removal and chemical etching SHALL be accomplished by maintenance personnel who are properly trained, highly skilled, and experienced in those particular specialties and are aware of the effects on the part/material due to the use of these chemicals and methods. T.O. 1-1-691 applies for the Air Force, T.M. 1-1500-344-23 applies for the Army, and N.A. 01-1A-509 applies for the Navy and Marine Corps.

CHAPTER 1

NONDESTRUCTIVE INSPECTION METHODS, GENERAL INFORMATION

SECTION I NONDESTRUCTIVE INSPECTION (NDI) METHODS

1.1 WHY WE DO NONDESTRUCTIVE INSPECTION (NDI).

NOTE

(NAVY Only) Policy guidance in OPNAV Instruction 4790.2 SHALL take precedence over the policy contained within this manual.

1.1.1 Nondestructive Inspection Data. Nondestructive Inspection (NDI) data for aircraft, missiles, engines, and accessory items provides material condition information to the engineers and managers in the System Program Offices (SPO). The SPO uses this data to manage assets.

1.1.2 Structural Management Programs. Several major programs use NDI data. The Aging Aircraft Program (AAP) looks at maintaining our aircraft fleet from “cradle to grave,” and applies technology to maintain aircraft and/or extend their useful life. Two specific programs using the AAP are the Aircraft Structural Integrity Program (ASIP) and the Engine Structural Integrity Program (ENSIP).

1.1.2.1 Aircraft Structural Integrity Program (ASIP). ASIP is a program that determines the structural life of specific aircraft. MIL-HDBK-1530 addresses the requirements of the ASIP program. An aircraft manufacturer (Boeing Military Aerospace Company, Lockheed-Martin Aerospace Company, Northrop-Grumman, etc.) develops an aircraft specific ASIP master plan in accordance with MIL-HDBK-1530. This plan describes the mission, design requirements and operational assumptions, inspection areas, proposed inspection methods, and the critical crack criteria to assess the condition of aircraft. The Air Logistics Centers (ALC) at Oklahoma City, OK, Ogden, UT, and Warner-Robins, GA, maintain a cadre of material and structural engineers that use NDI data to determine the safe operating conditions for aircraft. The original aircraft manufacturer also maintains a similar cadre of engineers. The combined efforts of the aircraft manufacturer and the ALC determine the conditions for safe operation of the aircraft, recommended inspection intervals, and the inspection requirements.

1.1.2.2 Engine Structural Integrity Program (ENSIP). ENSIP determines the structural lifetime of engine components. An engine manufacturer (Pratt-Whitney, General Electric, Rolls Royce, Allison, etc.) develops an ENSIP program for their specific engine. The manufacturers and the Oklahoma City Air Logistics Center maintain a cadre of material and structural engineers to evaluate the engine structure. This program describes the design requirements and operational assumptions, inspection areas, proposed inspection methods, and the critical crack criteria to assess the condition of the engine. The engine components have both high-cycle and low-cycle fatigue damage. Some damage is a combination of high temperature, erosion, corrosion, and fatigue damage. Critical engine inspections are performed both in the field and depots, with the more thorough or in-depth inspections being performed at depot level. All inspections are just as important to the safe operation of the engine, and to provide information back to the engine managers and engineers.

1.1.3 Mechanisms for Using NDI Data. Here are some specific mechanisms used by the previous programs for assessing NDI data.

1.1.3.1 Durability and Damage Tolerance Assessment (DADTA). Durability Assessment is the ability of the aircraft to withstand normal operating conditions and still be operational. Damage Tolerance Assessment is the ability of the aircraft to remain operational after damage occurs. The combination of Durability and Damage Tolerance Assessment is used to predict the safe operating characteristics for the aircraft. DADTA analysis is taken from fatigue test articles, field reports, and flaw damage assumptions. DADTA engineers assume a certain flaw size in areas of the aircraft structure. They use computer models to predict the growth of these flaws to critical size. The time interval, under normal operating characteristics required to grow a crack from an assumed size to a critical size is approximately equal to two depot maintenance or inspection cycles. DADTA analysis often use crack sizes derived from Probability of Detection (POD) studies and field reports to determine what should be assumed as the initial flaw size. This means no matter what inspection is being used, the inspector should be

T.O. 33B-1-1

ever vigilant to finding and characterizing any flaws they find because the data is used to manage the aircraft for safe operation.

1.1.3.2 Fracture Mechanics. Aircraft designers use a process to design aircraft structures called “Fracture Mechanics.” Fracture mechanics use the principle of “leak before break.” The design of critical structure relies on this principle. Each material has a degree of fracture toughness or resistance to crack initiation. Each material has a degree of damage tolerance (durability) or the resistance to crack growth. The combined effect of fracture toughness and durability determines the use of the material in aircraft design. The designer uses the information on the material’s characteristics to design a part that will indicate the presence of a crack or flaw long before the flaw causes a complete failure of the structure. In the case of pressure vessels, the vessel will “leak” before it fails. NDI plays an important role in fracture mechanics. Because not every part on an aircraft has the ability to “leak,” NDI is the detection function on which engineers rely. Proper and accurate application of NDI finds the flaws before the part fails.

1.1.4 Tools for Gathering NDI Data.

1.1.4.1 Probability of Detection (POD) Studies. The 90% POD value is an estimate of the defect size an inspector can find 9 out of 10 times. The 95% confidence bound (also known as the 90/95 POD) provides information about the variability of the POD experiment (like the number of flawed and unflawed specimens used, and the distribution of cracks in the specimens). The 90% POD to assess their individual capabilities, or to compare the abilities of inspection systems or procedures. Risk Assessment Engineers can use the 95% Confidence Bounds (90/95 POD) to set initial and recurring inspections for a particular application. More information on performing POD assessments can be found in MIL-HDBK-1823, Nondestructive Evaluation System Reliability Assessment, available at <http://assist.daps.dla.mil/quicksearch>.

1.1.4.2 Analytical Condition Inspection (ACI). ACI inspections are required occasionally on certain areas of the aircraft. ACI inspections are added to normal routine inspections to determine if there are sites of damage not addressed under the ASIP, ENSIP, or other maintenance programs. When engineers have reason to believe there may be damage occurring to areas of the aircraft not normally inspected, they require special inspections. These inspections go beyond what is normally required in ASIP or Programmed Depot Maintenance (PDM) work. The results of an ACI may influence future ASIP and PDM inspections.

1.1.4.3 Human Factors. As technology advances, one factor we need to make sure we consider as we insert new technology is human factors. Human Factors is the application of how we see, hear, think and physically function to the design of inspection methods and processes. Both human capabilities and human limitations need to be taken into account for the design and selection of any inspection equipment. Human factors also need to be taken into consideration for facilities, procedures and training requirements. We know that certain environmental characteristics affect our ability to perceive certain events. Physical stress (e.g. reaching overhead), psychological tension (e.g. upcoming WAPS exams), attention demands (e.g. completing report forms), visual/audio distractions (e.g. ramp traffic/rivet guns), heavy workload (e.g. 12-hours shifts) and complex decision making processes (e.g. shear wave UT with multiple peaks rising and falling), are just some of the factors affect human capabilities.

SECTION II PERSONNEL TRAINING/QUALIFICATION/CERTIFICATION

1.2 PERSONNEL TRAINING/QUALIFICATION/CERTIFICATION.

1.2.1 Training Introduction. Personnel require formal training, on-the-job training (OJT), and certification prior to performing NDI inspections. Formal training SHALL be from an accredited institution approved by the military. Offices providing this approval are listed in (paragraph 1.2.2.1). OJT SHALL be provided by the work center. Certification SHALL be by attainment of certain specialty codes, job positions, rank, and/or formal certification.

1.2.2 Training Requirements.

1.2.2.1 Formal Training. Accredited facilities and instructors SHALL provide training in the basic theory and application of NDI disciplines. Accreditation of all training programs SHALL be made by the responsible military agency for each branch of service. The Air Force NDI Office, AFRL/MLSST 4750 Staff Drive, Tinker AFB, OK 73145-3317 is the responsible agency for accrediting NDI training facilities and instructors for the Air Force, other than the USAF NDI school at Pensacola NAS, Florida which is governed by the Air Education and Training Command (AETC). Army personnel SHALL be trained in accordance with Department of the Army Pamphlet 611-21, to include alternate training sources as approved by TRADOC or the Program Manager, National Guard Bureau (NGB) NDT Program, Aviation Systems Branch. Navy personnel assigned to NAVAIR SHALL be trained in accordance with OPNAVINST 4790.2. Air Force, Army, and NAVAIR uniformed service members all receive formal training at the Naval Air Station in Pensacola, FL.

1.2.2.2 On-The-Job Training (OJT). Hands-on training for the practical application of NDI disciplines SHALL be received from personnel qualified and certified as OJT trainers for the inspection. All OJT SHALL be documented and the documents SHALL indicate the name of the trainee, the name and signature of the OJT trainer, the date of the training, the NDI procedure used, and signature of the certifier.

1.2.3 Certification Requirements. All personnel performing nondestructive inspections SHALL be certified in both method and procedure. All military personnel SHALL be certified, in writing, in accordance with their military service directives.

NOTE

(Air Force Only)The Air Force currently recognizes National Aerospace Standard NAS 410, NAS Certification & Qualification of Nondestructive Test Personnel as the approved standard for qualification and certification. This standard establishes minimum requirements for personnel involved in nondestructive inspection. These requirements include training, experience, and examination for personnel performing NDI in the aerospace manufacturing, service, maintenance, and overhaul industry. Military personnel (Active Duty, Air National Guard, Reserves) SHALL be certified in accordance with procedures outlined in their Career Field Education and Training Plan (CFETP) for Air Force Specialty Code (AFSC) 2A7X2. All Air Force civil service personnel (MEO, HPO, DEPOT, AMARC or civil service managed contracted labs) SHALL be certified and qualified IAW National Aerospace Standard (NAS) 410 as required AFI 21-101. Exception: Civil service personnel working under the direction of a military NDI section chief SHALL be qualified and certified, in writing, by the section chief with documentation similar to the CFETP. Contracted lab personnel (managed by private contractor or Civil Service) SHALL be certified in accordance with NAS 410 as required by AFI 21-101. The contractor SHALL certify contractor personnel working under the direction of a military NDI section chief in accordance with NAS 410.

1.2.4 Physical Requirements.

1.2.4.1 Near Vision Requirements. NDI personnel SHALL receive a near vision acuity test (Jaeger #1 at 12 inches) annually while certified. The near vision test is required for only one eye either natural or corrected.

1.2.4.2 Color Perception Requirements. NDI personnel SHALL receive a color perception test prior to initial certification. Any limits on color perception SHALL be placed in the individual's training records.

1.2.5 Requirement for Special Task Certification and Recurring Training. AIR FORCE Only: The weapon system SPO, ALC NDI Manager, or lab supervisor determines special task certification and recurring training for NDI tasks.

T.O. 33B-1-1

Document special task certification IAW AFI's 21-101, 36-2232, and/or local directives. Inspections performed on Safety of Flight structures shall require special task certification when listed as a Safety of Flight Inspection (SOFI) in the weapon system NDI manual. Task certification is only required if the SOFI is performed by the maintenance activity. For Depot laboratories task certifications may be grouped when techniques are similar in nature and/or complexity. Laboratory supervisors have the discretion to add additional tasks as a requirement for their specific laboratory. The initiating office generally determines the training interval and provides specific guidance and criteria for certification.

SECTION III REPORTING NEW OR IMPROVED NDI TECHNIQUES

1.3 REPORTING NEW/IMPROVED NONDESTRUCTIVE INSPECTION TECHNIQUES.

1.3.1 Need for Reporting New and Improved Techniques. Developing new NDI techniques is expensive and time consuming. In addition, techniques and procedures can be applied to all aircraft where similar problems exist. Interchanging information on newly developed NDI techniques between operating commands will reduce maintenance costs and enhance safety. It is always beneficial to check with your MAJCOM Functional, ALC NDI Manager, and the AF NDI Office to see if other bases have been experiencing the same problems. This section prescribes the procedures for reporting the development of new or improved nondestructive inspection techniques. It also provides for the reporting of a NDI method application to a part or item not previously inspected by NDI methods.

1.3.2 Authority. The authority for reporting new or improved NDI techniques or new applications of NDI methods is contained in AFI 21-105, Air and Space Equipment Structural Maintenance.

1.3.3 AFTO Form 242. The AFTO Form 242 permits detailed feedback and interchange of new or improved NDI techniques, procedures, and applications from base level NDI laboratories to the System Program Offices (SPO), Air Logistics Centers (ALC), and other NDI operational facilities. The Army equivalent of AFTO Form 242 is DA Form 2028 (paragraph 1.3.5.5). Navy and Marine Corps personnel MAY use the AFTO Form 242 and forward via the Aircraft Controlling Custodian/Type Commander (ACC/TYCOM) to the cognizant Fleet Support Team (FST).

1.3.4 Scope. The procedures prescribed herein apply to all Major Commands (MAJCOM) operating NDI Laboratories per AFI 21-105.

1.3.4.1 An AFTO Form 242 SHALL be submitted whenever an NDI technique is developed, improved, or is considered desirable and is not sufficiently described or contained in existing manuals. An AFTO Form 242 SHALL NOT be used in the following cases:

- Reporting minor technical inaccuracies in NDI involving the use of the same technique.
- Reporting techniques requiring the use of nonstandard equipment not listed in AS 455. However, this does not include locally manufactured shoes, holders, or wedges for use with AS 455 equipment. Reporting requirements for equipment evaluation will be provided by the AF NDI Program Manager and directed by the MAJCOM NDI Functional Manager.
- Reporting changes or deficiencies in inspection requirements, such as contained in Technical Orders/Maintenance Manuals.

1.3.5 Responsibilities for Updating Techniques.

1.3.5.1 Initiator. The initiator SHALL initiate and complete the applicable sections of the AFTO Form 242 in accordance with the instructions prescribed in subsequent paragraphs (see paragraph 1.3.6). An initiator is any NDI technician who:

- Develops an NDI technique or procedure not presently contained in the existing NDI applications manuals or other applicable T.O. manuals, or
- Improves an existing NDI procedure, or
- Determines an area or condition where an NDI procedure would be advantageous.

1.3.5.1.1 The initiator SHALL also prepare an AFTO Form 22 in accordance with TO 00-5-1 to serve as a processing document for the AFTO Form 242. The AFTO Form 22 SHALL cite the NDI applications manual (-9, -36, etc.) for the applicable weapon system or other manual in which the proposed procedure should be incorporated. On commodity items that do not have an NDI applications manual, the technical order manual containing service, operating, and maintenance instructions SHALL be cited. One copy of the AFTO Form 242 SHALL be attached to each copy of AFTO Form 22.

1.3.5.2 Initiators Supervisor. The supervisor of the person submitting a recommended change will ensure the recommendation is valid and warrants submittal (see TO 00-5-3, paragraph 7.4 and 7.4.5). A fully certified NDI technician (e.g., AFSC 2A772, NAS 410 Level II, etc.) other than the originator SHALL witness the demonstration of the complete procedure to ensure its technical adequacy and accuracy.

1.3.5.2.1 In cases when there are no inspection procedures available, the laboratory supervisor SHALL request immediate engineering disposition from the owning SPO responsible for that weapon system or commodity. The ALC NDI Manager should be able to help you identify a good Point of Contact (POC) within that office. The laboratory supervisor SHALL send

T.O. 33B-1-1

via: phone, fax, or e-mail, a request for inspection instructions/approval IAW TO 00-25-107. Send a courtesy copy of this information to the ALC NDI Manager.

NOTE

An AFTO Form 242 associated with non-weapon system support equipment items (hooks, AGE, etc.) may be approved by the local lab supervisor.

1.3.5.2.2 After verifying the technique, the supervisor SHALL forward the AFTO Forms 22 and 242 to the responsible SPO and the appropriate ALC NDI Manager. AFTO FORM 242 inspections SHALL NOT be used to perform inspections on aircraft until approved by the appropriate SPO.

1.3.5.3 System Program Office (SPO). The SPO SHALL coordinate efforts with the responsible ALC NDI Manager or their designee to ensure all AFTO Forms 22 and 242 submitted for NDI suggestions are reviewed for technical accuracy. Upon approval of the recommended change, the SPO SHALL provide immediate guidance to all users of the affected manual by issuing a message to be incorporated into the manual until a Block Cycle Update (BCU) or Rapid Action Change (RAC) is submitted for incorporation into the affected manual.

1.3.5.4 Air Logistics Center (ALC) NDI Manager. The ALC NDI Manager or their designee is responsible for ensuring the technical accuracy of the technique. As the lead NDI Level III engineer for the ALC, this person SHALL use all available assets to add, revise, or supplement the submitted technique as required to produce a workable procedure. The ALC NDI Manager or designee SHALL validate the technique and return this information to the SPO to take action on field notification and include it in the appropriate technical order.

1.3.5.5 Army Personnel Technique Development. The Army uses DA Form 2028 when developing an NDI technique or procedure not presently contained in existing manuals. AFTO Forms may be reproduced and used to supplement DA Form 2028. Send to: “PEO Aviation, SFAE-AV-AS-AG, Bldg. 7770, Redstone Arsenal, AL 35898-5000.”

1.3.6 AFTO Form 242 Entries.

NOTE

If it is not possible to provide a complete detailed description of the NDI technique on a single AFTO Form 242, the form SHALL be supplemented with additional sheets of plain white paper.

Entries for inspection methods are similar and are described in the appropriate paragraphs. The first twelve blocks on AFTO Form 242 are used to identify the submitting initiators contact information and the information for the actual part or component to be inspected. It also provides space for a description of the condition or reason for the inspection. The instructions for completing these twelve blocks are provided in the following paragraphs.

1.3.6.1 Block 1 (Control Number). This is a standardized number that reflects the command and organization developing the technique and method used. The control number SHALL be made up of three series of numbers and letters as follows:

- Two digits of the calendar year with an alphabetic character designating the applicable NDI method code ([Table 1-1](#)). If more than one inspection method is used to determine the integrity of a part, and both techniques are listed on the same AFTO Form 242, use a letter for each inspection method, (e.g., 86CA) with the letter for the primary inspection method being listed first.
- The code for the major command ([Table 1-2](#)) and the organization or unit number of the technique originator.
- A sequential number assigned by the originating organization without regard for method of inspection or calendar year. Example, Report/Control No. 04A-T366-12 will be shown as:

04	-	represents the calendar year 2004
A	-	represents the method code for penetrant inspection
T	-	represents the Major Command Code for ACC
366	-	represents the Unit Number, i.e., 366th Maintenance Squadron
12	-	represents the twelfth technique submitted by the 366th MXS

Table 1-1. NDI Method Codes

NDI Method	Method Code
Penetrant	A
Magnetic Particle	B
Electromagnetic	C
Ultrasonic	D
Radiographic	E

Table 1-2. Major Command Codes

Major Command	Command Code
US Air Forces Europe (USAFE)	D
Air Force Materiel Command (AFMC)	E
Air Force Education and Training Command (AETC)	J
Air Force Reserve (AFRES)	M
Air Combat Command (ACC)	T
Air Mobility Command (AMC)	Q
Air Force Space Operations Command (AFSOC)	S
US Air Force Pacific (PACAF)	R
Air National Guard (ANG)	Z

1.3.6.2 **Block 2 (Organization and Base).** Example: 366 MXS, Mountain Home AFB, ID.

1.3.6.3 **Block 3 (End Item (M/D/S)).** Enter the major end item on which the part/area to be inspected is installed. Include the Mission/Designator/Series (M/D/S) or Federal Stock Class (FSC) number, as applicable.

1.3.6.4 **Block 4 (Nomenclature).** Specify the name of item/component or assembly to be inspected.

1.3.6.5 **Block 5 (Part/Assembly Number).** Enter part or assembly number of the item to be inspected.

1.3.6.6 **Block 6 (T.O. Number).** Enter technical order number of illustrated parts manual or service and maintenance manual that shows the item/assembly to be inspected. Enter page, figure, index number, and date of issue of the manual where applicable.

1.3.6.7 **Block 7 (Next Higher Assembly).** Enter name and part number of next higher assembly. If there is insufficient space, complete the entry on a continuation sheet of plain bond paper.

1.3.6.8 **Block 8 (Manufacture/Serial Number).** Enter manufacturer's name and serial number as applicable.

1.3.6.9 **Block 9 (Initiator and Phone Number).** Enter the name, rank, and phone number of initiator or person who developed the technique.

1.3.6.10 **Block 10 (Description of Defect/Condition or Reason for Inspection).** Provide a narrative description of defect/condition or reason for inspection. Narration SHALL include location and orientation of the expected discrepancy if known.

1.3.6.11 **Block 11.** Place a check mark or an "X" in appropriate block indicating whether inspection is performed with part installed or removed.

T.O. 33B-1-1

1.3.6.12 Block 12 (Part Preparation). Describe any disassembly or system preparation necessary. Examples: “Remove retaining bolt P/N 1, lower inboard flaps” or “Remove access cover number 001.” Also, describe any part preparation requirements.

SECTION IV NDI EQUIPMENT

1.4 PROCURING NDI EQUIPMENT (AIR FORCE ONLY).

1.4.1 Centrally Procured NDI Equipment. Centrally procured NDI equipment is purchased by the Support Equipment and Vehicle Management Directorate at Warner-Robins Air Logistics Center (WR-ALC) using special support equipment funding (called 3010/BP12 funds). They calculate requirements using a computation process within the Air Force Equipment Management System.

1.4.1.1 Allowance Standard (AS) 455. This document identifies the types and quantities of centrally procured, weapon system specific, and special purpose NDI support equipment authorized for both field and depot NDI organizations. WR-ALC manages all allowance standards for HQ USAF.

1.4.1.2 Purpose of Centrally Procured NDI Equipment. HQ USAF directs the use of standardized NDI equipment and processes whenever possible, and has assigned engineering authority for this direction to the: AF NDI Office, AFRL/MLSST, 4750 Staff Dr. Tinker AFB, OK 73145. The use of centrally procured equipment reduces the initial cost of the equipment and any associated repairs. It also reduces technical manual updates/changes and reduces training costs. The AF NDI Office coordinates efforts with the MAJCOMs, ALCs, and the other branches of service before new procurements to determine specific technical requirements. During the acquisition process, new equipment is both laboratory and field tested to ensure safety, deployability, sensitivity, repeatability, and maintainability. After structural engineers within the SPO have identified an inspection requirement, the (ALC/SPO/Contractor) NDI Level III will develop an inspection procedure using centrally procured NDI equipment whenever possible. The use of non-standard NDI equipment must be coordinated through the SPO, AS 455 Manager, and the AF NDI Office.

1.4.2 Weapon System Specific/Special Purpose Equipment.

CAUTION

- Equipment purchased for specific weapons systems or other purposes SHALL NOT be used to substitute for equipment or to conduct inspections designed for equipment listed in AS 455. Equipment purchased in this manner SHALL ONLY be used when written permission and procedures have been authorized by the specific SPO. The laboratory NCOIC SHALL maintain a copy of this written authorization with the equipment. Navy field activities SHALL obtain authorization to substitute NDI equipment from the cognizant engineering authority.
- On occasion, equipment may be required for specific tasks associated with specific weapon systems. This equipment is called out within NDI technical manuals (-9, -36, etc.) or in some cases by an official letter or message. Equipment called for in this method is purchased and maintained by the SPO requiring the inspection.

1.4.3 Local Purchase Equipment. Equipment items for nondestructive inspections SHALL NOT be purchased locally without the knowledge and approval of the responsible ALC manager or the NDI Program Office. Black lights, consumable support items, and replacement parts may be purchased at any time without approval.

T.O. 33B-1-1

SECTION V PROCESS CONTROL

1.5 PROCESS CONTROL.

NOTE

Specific process controls are discussed in section six of chapters 2 through 6 of this manual. Specific process control procedures will be phased out of this Technical Order as new T.O. 33B-1-2 "Nondestructive Inspection General Procedures and Process Controls" is implemented in the field. There will be a relatively short period of time where the two manuals will overlap and may have slightly different instructions due to the change schedule of the manuals. For Air Force units the specific process control procedures in T.O. 33B-1-2 SHALL be used.

1.5.1 Reason for Controlling the Process. Process control is an essential ingredient in achieving consistent and reliable results with NDI inspections. A well regimented NDI process control program will not allow conditions to develop that render inspection methods as a source of misinformation. This misinformation may take two forms: 1) When NDI determines a part is defective, when in truth it is not, resulting in a false call. This is a waste of resources and an unnecessary reduction in mission capability. 2) Even more dangerous is determining a part to be serviceable when in fact it is defective resulting in a missed call. Both forms of misinformation can be minimized through the implementation of effective process control.

1.5.2 Scope of Process Control. All aspects of these categories are interrelated. They have to be tuned to each other to achieve valid inspection results. If any one of these requirements is altered, the final outcome of the inspection will change, regardless of the inspector's proficiency.

1.5.2.1 Process control is a general term used to encompass the actions and documentation required by established directives and logic. These controls are necessary for an NDI method to be effective in detecting conditions of interest (e.g., cracks, foreign objects, corrosion, alignment of parts, and thickness of parts).

1.5.2.2 Areas that fall within the scope of process control are as follows:

- Training and the demonstrated practical skills of inspectors.
- Inspection environment. (e.g., temperature, specific type and levels of light, safety, and human engineering.)
- Material control. (e.g., serviceability of ultrasonic transducers, eddy current probes, penetrant materials, X-ray film and chemicals, and magnetic particle suspensions.)
- Equipment control. (e.g., operational and performance capability or Test Measurement Diagnostic Equipment (TMDE)/user calibration.)
- Written inspection instructions. (e.g., adequate, -9, -26, and -36 technical orders and Time Compliance Technical Orders (TCTOs).)
- Adherence to written inspection instructions. (e.g., distinguishing requirements dictated by specific NDI procedures versus commonly accepted basic NDI practices.)

Table 1-3. Frequency for Process Control

Liquid Penetrant	Interval	Para
System Performance Test (Cracked Chrome Panels)	Weekly	2.6.10.2
System Performance Test (Starburst - PSM) (Depot Only)	Daily	2.6.10.1.1

Table 1-3. Frequency for Process Control - Continued

Water Wash Pressure	Daily or Prior to use	2.4.9.1.2
Water Wash Temperature	Daily or Prior to use	2.4.9.1.3
Black Light Intensity	Daily or Prior to use	2.5.4.1.3
Inspection Booth Cleanliness	Daily	Table 2-7
Penetrant Contamination of Remover	Daily or Prior to use	2.6.10.4.6.1.4
Penetrant Contamination of Developer (Aqueous: Soluble and Suspendable)	Daily or Prior to use	2.6.10.4.7.4, 2.6.10.4.8.2
Developer Coverage (Aqueous: Soluble and Suspendable)	Monthly	2.6.10.4.7.3
Penetrant Contamination of Dry Developer	Daily or Prior to use	2.6.10.4.9.2
Penetrant (Method A) Water Concentration	Monthly	2.6.10.4.4
Lipophilic Emulsifier Performance Test	Monthly	2.6.10.4.5.1
Hydrophilic Remover Concentration	Monthly	2.6.10.4.6.1.1
Hydrophilic Remover Performance Test	Monthly	2.6.10.4.6.1.5
Developer Concentration (Aqueous: Soluble and Suspendable)	Monthly	2.6.10.4.8.1, 2.6.10.4.7.2
Ambient White Light	60 Days	2.5.4.2, 2.5.4.1.3
Drying Oven Calibration	IAW T.O. 33K-1-100-CD-1	Table 2-7
Magnetic Particle Testing	Interval	Para
Concentration/Suspension Settling Test	Prior to use and after 8- hours of continuous use	3.6.4, 3.6.7.5.3.1
Vehicle Fluorescence Test	In Conjunction with Concentration/Suspension Settling Test	3.6.7.5.4
System Effectiveness Test	Weekly	3.6.6.4.1
Ambient Light Check	60 Days	3.6.6.8.2
Black Light Intensity	Daily or Prior to Use	3.6.6.8.1
Amperage Indicator Check	90 Days	3.6.6.5
Quick Break	90 Days	3.6.6.6
Water Break Test (Water Baths Only)	Daily or Prior to use	3.6.8.3
Dead Weight	90 Days	3.6.6.7
Eddy Current	Interval	Para
Probe Test	At Acceptance and Prior to Use	4.6.2
Ultrasonic Inspection	Interval	Para
Vertical Linearity	Quarterly	5.6.3.1.1
Horizontal Linearity	Quarterly	5.6.3.1.2
Sensitivity Check	Quarterly	5.6.3.2
Resolution Check	Quarterly	5.6.3.3
Dead Zone Check	Quarterly	5.6.3.3.2.2
Angle Beam Point of Incident	Quarterly	5.6.4.1.1
Angle Beam Angle Determination	Quarterly	5.6.4.1.4.1

T.O. 33B-1-1

Table 1-3. Frequency for Process Control - Continued

Angle Beam Skew Angle	Quarterly	5.6.4.1.2
Radiography Inspection	Interval	Para
Safelight Fog Evaluation	Initial install and requirements described in indicated paragraphs	6.6.3.3.1 through 6.6.3.3.4.3
Interlock Functional Check	Prior to X-ray operation	6.8.5.7.2.3.4
Interlock System Inspection	180 Days	6.8.7.5.e
Safe Light Filter Check	Monthly	6.6.3.4
Fixer Control	Monthly	6.6.4.3.3
Development Process	Weekly	6.6.4.1 through 6.6.4.2.1

1.5.3 Process Control Documentation Requirements. Documentation of process controls are completed to verify conformance to established requirements in the areas described in (paragraph 1.5.2). The requirements prescribed within this technical order apply to all Major Air Force Commands, including the Air National Guard and Air Force Reserve that use Nondestructive Inspection Laboratories. These requirements also apply to Army, Army National Guard, and Army Reserve units.

1.5.3.1 Separate documentation SHALL be maintained for each NDI method, equipment, and material with established process control requirements. Process control requirements SHALL NOT be documented on the same form used for equipment maintenance, but may be documented on the same type of form. As a minimum, this documentation SHALL reflect each element of process control with respect to required time intervals between checks, date of accomplishment for each check, condition of element checked, corrective action taken (if required), initials of the person performing test, serial number or identification number of the element tested, manufacturer, lot or number if applicable, and date put into service. Unless otherwise directed, only the most recent required documentation that provides a satisfactory history concerning equipment/materials, needs to be maintained.

1.5.4 Establishing a Documentation Method. Each MAJCOM Functional Manager SHALL determine the method their assigned NDI laboratories will utilize for documenting process control verification. Army units will maintain records of process control requirements at the unit level.

1.5.5 Suggested Documentation Method. The use of a general-purpose form or computer database is relatively inexpensive and could be easily formatted to fit specific NDI method and equipment process control requirements. An alternative to the general-purpose form is to interface process control with a computer, utilizing the Process Control Automated Management System (PCAMS), which was developed for use in the Air Force Nondestructive Inspection career field. The Air Force NDI Office has authorized and highly recommends the use of this program to document process controls. See TO 00-20-5 for documentation guidance of the AFTO Form 244.

1.5.5.1 Process Control Automated Management System (PCAMS). The Process Control Automated Management System (PCAMS) is a database developed for the NDI career field in an effort to reduce paper and improve the management of process controls and equipment maintenance (AFTO Form 244). PCAMS is currently based on the latest version of Microsoft Access™. When using PCAMS as your documentation tool there are a few minimal steps to follow:

- a. Print a daily inspection report at the beginning of each duty day. Each shift supervisor SHALL review PCAMS at the beginning of each shift to verify any equipment problems.
- b. Provide the employee number and initials of the person performing each inspection on the printed report as each inspection is completed. Transfer this information to the computer and file the printed report.
- c. Back-up PCAMS to a separate disk once each week. The printed reports MAY be disposed of once all data is safely backed up.
- d. In case of deployments, inspections due prior to use, or identified discrepancies, print out the AFTO Form 244 and maintain the form with the item requiring the inspection.

SECTION VI LABORATORY INFORMATION

1.6 GENERAL LABORATORY INFORMATION.

1.6.1 Constructing a Nondestructive Inspection Laboratory. This section describes a typical Nondestructive Inspection (NDI) Laboratory. Publications, which may provide the Civil Engineers more guidance for constructing these facilities, are AFH 32-1084, AFI 32-1023, and any applicable Engineering Technical Letters (ETL). AFH 32-1084 lists the NDI Lab as Category Code 211-153. It is important to consider current AND future mission requirements when planning to size your laboratory. A larger or modified facility may be warranted depending on which weapon system(s) may be serviced and it may be cost prohibitive to expand at a later date. (Figure 1-1) shows a typical floor plan reflecting the MINIMUM requirements (4000 Sq Ft) for a full laboratory. IAW AFH 32-1084, undergraduate pilot training (UPT) bases and bases with F-15 aircraft are authorized space for an X-ray exposure room that can accommodate an entire aircraft. Due to local building codes and state environmental regulations each laboratory may vary slightly. The floor plan in (Figure 1-1) and the associated notes SHOULD be used in conjunction with both the applicable manufacturer's installation instructions for current equipment required and the information provided in the radiation protection section of (paragraph 6.8) in Chapter 6 of this technical order.

NOTE

- Other offices/organizations to contact for information include but aren't limited to: the base Bioenvironmental Office, the base Safety Office, and the local Environmental Protection Agency (EPA).
- (AF PERSONNEL) Prior to planning, constructing, or modifying a new or current facility, the Laboratory Supervisor SHALL contact the Air Force NDI Office: AFRL/MLS, 4750 Staff Dr., Tinker AFB, OK 73145-3317, DSN 339-4931 for guidance. It may be necessary to submit a copy of the proposed floor plans for review.
- (NAVY PERSONNEL) Navy and Marine Corps radiographic facilities SHALL comply with NAVSEA S0420-AA-RAD-010.
- (ARMY PERSONNEL) Prior to planning, constructing, or modifying a new or current facility, the supervisor SHALL contact PEO Aviation NDTCOE, Bldg. 7770, Rm. 18, Redstone Arsenal, AL 35898. DSN 897-0211.

1.6.2 Building Requirements.

- A ceiling height of 10-feet is required throughout the facility with the exception of (Rooms 1, 7, 8, and 12).
- Clear ceiling height in the X-ray exposure room (Room 1) SHOULD be 12-feet where practical, to avoid difference in roof level. The height MAY be 14-feet where the using command can justify it on the basis of sizes of components to be inspected in the foreseeable future.

NOTE

Door and monorail between (Rooms 1 and 8) are optional. Where a monorail is provided, adjust the ceiling heights in both rooms to suit the monorail operation.

- Size of the lead-faced doors into the exposure room depend on the size of items to be inspected. These doors SHOULD be as small as practical for efficient operation. The door between (Rooms 1 and 8) can be above the floor, at any height to suit operations as long as all safety concerns are met and approved by the Bioenvironmental Office
- Materials and construction SHALL be in accordance with AFI 32-1023.
- The category construction of this building is to be "permanent non-combustible."

T.O. 33B-1-1**1.6.2.1 X-Ray and Environmental Protection.****CAUTION**

- For additional guidance (paragraph 6.8) in [Chapter 6](#), of this technical manual.
- Radiation shielding, barricades, and warning devices are dependent on each specific X-ray operation and equipment being used. Contact the local Bioenvironmental Office to calculate formulas that will meet or exceed current radiation protection design and equipment technology.

1.6.2.2 Radiation exposure (Room 1) SHALL conform to the requirements specified in the National Institute of Standards Technology (formerly National Bureau of Standards) Handbook 93, "Safety Standards for Non-Medical X-ray and Sealed Gamma-ray Sources." (Bioenvironmental Engineers or health physicists SHALL be consulted for help in interpreting Handbook 93 and performing shielding calculations.) Review the following paragraphs: (paragraph 6.8.9), (paragraph 6.8.2.1.1) and (paragraph 6.8.2.2.1).

1.6.2.3 If use of radioisotopes is anticipated, this SHALL receive additional consideration when calculating shielding requirements.

WARNING

Buildings NOT equipped with ceiling shielding SHALL consider that maintenance personnel may place a ladder at any location along the roof of the building or have blind access from another location within the building. "Warning sign(s), rope barriers, and when possible, access locking mechanism(s)" SHALL be used at all access points to warn personnel and notify them to check in with the NDI Laboratory Supervisor to ensure X-ray operations are not taking place while personnel are in the area.

1.6.2.4 Radiation protection shielding SHALL be used on the ceiling of the exposure room when required by shielding calculations. When ceiling shielding IS NOT provided, a barrier limiting access to the portion of roof above the exposure facility SHALL be used with a warning sign and light at each point of access.

1.6.2.5 The design and specifications for the NDI exposure facility SHALL be reviewed by a Bioenvironmental Engineer or health physicist and approved by the Director of Base Medical Service prior to contract solicitation.

1.6.2.6 Before a new radiation exposure facility is placed in routine operation, the medical service SHALL be notified and a request submitted for a radiation protection survey by a qualified Bioenvironmental Engineer or health physicist.

1.6.2.7 Radiation exposure facility design SHALL show the cable passage between the exposure room and the controls outside this room. Cable passage SHALL be "S-shaped" and provide the same level of shielding as the X-ray barrier.

1.6.2.8 Provide appropriate ventilation in (Rooms 2 and 8) for radiographic film processing and the penetrant and magnetic particle inspection processes.

1.6.2.9 Heating/ventilation/and air conditioning return air ducts in with building system SHALL NOT be tied together. All supply air SHALL be exhausted to exterior with explosion proof exhaust fans.

1.6.2.10 Include all necessary provisions for handling waste materials (penetrants, silver recovery, etc.) containing pollutants in drainage system. One example, an oil/water separator, may be required to meet local EPA guidelines.

1.6.3 Electrical and Mechanical Requirements.

1.6.3.1 Due to the storage of X-ray film, chemical baths, and oil analysis, environmental control is recommended 24-hours per day; 7-days per week for the entire facility with optimum relative humidity and temperature of 50% and 78°F.

1.6.3.2 Recessed lighting fixtures MAY be used where operationally required; use surface mounted fixture when practical. Fixtures in (Room 1) SHOULD be surface mounted if shielding is applied on ceiling.

1.6.3.3 Provide two-hour, fire-rated walls and doors in (Room 10). All electrical wiring SHALL meet or exceed Class I, Division II requirements.

1.6.4 Room Identification. The following is a list of typical rooms in the NDI laboratory:

- Room 1. X-ray vault
- Room 2. X-ray film processing room
- Room 3. X-ray control room
- Room 4. X-ray film processing room entrance
- Room 5. Film viewing room
- Room 6. Consolidated equipment room
- Room 7. Office
- Room 8. Main inspection bay
- Room 9. Training room
- Room 9a. Shop stock and storage
- Room 10. Oil Analysis lab
- Room 11. Corridor
- Room 12. Latrine
- Room 13. Mechanical equipment room

CHAPTER 2

LIQUID PENETRANT INSPECTION METHOD

SECTION I LIQUID PENETRANT INSPECTION METHOD

2.1 GENERAL CAPABILITIES OF LIQUID PENETRANT INSPECTION.

2.1.1 Introduction to Liquid Penetrant Inspection. Penetrant inspection is a method used to detect surface-breaking discontinuities (e.g., cracks, pits, etc.) in nonporous materials. This method utilizes a dye containing fluid which penetrates surface discontinuities through capillary action. The trapped penetrant increases the visibility of the discontinuity by providing a visual contrast between the discontinuity and the surrounding surface.

2.1.2 Background of Liquid Penetrant Inspection. Liquid penetrant inspection is one of the oldest nondestructive inspection methods. It was first used in the railroad maintenance shops in the late 1800s. Parts to be inspected were immersed in used machine oil. After a suitable immersion time, the parts were withdrawn from the oil and the excess surface oil wiped off with rags or wadding. The part surfaces would then be coated with powdered chalk or a mixture of chalk suspended in alcohol (whiting). Oil trapped in cracks or flaws would bleed-out causing a noticeable stain in the white chalk coating. This became known as the oil-and-whiting method.

2.1.2.1 The oil-and-whiting method was replaced by magnetic particle inspection on steel and ferrous parts in 1930. However, industries using non-ferromagnetic metals, especially aircraft manufacturers, needed a more reliable and sophisticated tool than discolored machine oil and chalk. In 1941, fluorescent dye materials were added to highly penetrating oil to make a penetrant material. Colored dyes, primarily red, were introduced a little later. Since then, a large number of penetrant systems or families have evolved. These include developments in various types and concentrations of dye materials, types of penetrating oils and additives, materials and methods for removing the excess surface penetrant, and various materials and forms of developing agents.

2.1.3 Why Use Liquid Penetrant Inspection. Penetrant inspection is an inexpensive and reliable nondestructive inspection method for detecting discontinuities open to the surface of the item to be inspected. It can be used on metals and other nonporous materials not harmed by penetrant materials. With the proper technique, it will detect a wide variety of discontinuities ranging in size from large, readily visible flaws down to the microscopic discontinuities, as long as the discontinuities are open to the surface and are sufficiently free of foreign material.

2.1.3.1 Penetrant is also used to detect leaks in containers. The same basic fundamentals apply, however, the penetrant removal step is typically omitted. The container is either filled with penetrant or the penetrant is applied to one side of the container wall. The developer is applied to the opposite side. After an appropriate dwell time, the developer coated side is inspected for evidence of penetrant leaking through the container wall. This method is most applicable on thin parts where access is available to both internal and external surfaces and the discontinuity is expected to extend through the material.

2.1.3.2 Due to its ability to inspect ferrous and nonferrous parts of all sizes and shapes, and its portability, the liquid penetrant NDI method can be used at both depot and field repair stations. For a specific aircraft type, a technical manual on nondestructive inspection is used to define the method, technique, equipment, component preparation, and precautions required to perform NDI on each component of the aircraft. A separate manual is used for engines.

2.1.3.3 With wider use of the eddy current NDI method, liquid penetrant is now becoming the secondary method for many applications. This is a result of the improved sensitivity of new eddy current inspection techniques and the fact that eddy current does not require use and disposal of potentially hazardous chemicals. For batch inspection of large areas, the penetrant method is still preferred due to the shorter total process time when compared to eddy current. In addition, penetrant is often used as a backup method for verification of defects found by eddy current inspection.

2.1.4 Limitations of Liquid Penetrant Inspection.

2.1.4.1 Restricted Flaw Openings. Penetrant inspection depends upon the ability of the penetrant to enter and exit the flaw opening. Any surface condition, such as coatings (e.g., paint, plating), dirt, oil, grease, or resin that interferes with the entry or exit, reduces the effectiveness of the inspection. Even when the coating does not cover the opening, the material at the edge of the opening may affect the entry or exit of the penetrant and greatly reduce the reliability of the inspection.

T.O. 33B-1-1

Coatings at the edge of a discontinuity will also retain penetrant, causing background interference. An inspection method other than penetrant SHALL be used if the organic coating cannot be stripped or removed from the surface to be inspected.

2.1.4.2 Smear Metal.**CAUTION**

Mechanical operations such as shot peening, plastic media blasting (PMB), machine honing, abrasive blasting, buffing, brushing, grinding, and sanding may smear or peen the surface of metals and may close or reduce the surface opening of any existing discontinuities. Any operation which results in surface material smearing or peening SHOULD NOT precede liquid penetrant inspection unless effective chemical etching is performed or unless specifically authorized by the cognizant engineering authority. Once the part has been put back in service and has experienced normal service loads, it MAY be assumed any cracks closed by any of the above mechanical operations except shot peening will be re-opened by the service loads and penetrant inspection MAY again be performed without etching. This mechanical working closes or reduces the surface opening of any existing discontinuities. Mechanical working (smearing or peening) also occurs during service when parts contact or rub together. Penetrant inspection may not reliably detect discontinuities when performed after a mechanical operation or service use that smears or peens the surface. Further discussion of mechanical working processes and surface preparation methods are provided further in this chapter.

2.1.4.3 Porous Surfaces. Penetrant inspection is impractical on porous materials, such as some types of anodized aluminum surfaces, and other protective coatings on other metals. The penetrant rapidly enters the pores of the material and becomes trapped. This can result in background that would reduce contrast or mask any potential discontinuity indications. In addition, removal of the penetrant may not be possible after the inspection.

2.1.5 Advantages of Liquid Penetrant Inspection.

- Liquid penetrant inspection is capable of examining all of the exterior surfaces of objects. Complex shapes can be immersed or sprayed with penetrant to provide complete surface coverage. Other nondestructive methods cover a specific area or location and must then be repeated to cover other areas or locations.
- Liquid penetrant inspection is capable of detecting very small surface discontinuities. It is one of the more sensitive nondestructive inspection methods for detecting surface flaws.
- Liquid penetrant inspection can be used on a wide variety of materials: ferrous and nonferrous metals and alloys, fired ceramics, powdered-metal products, glass, and some types of organic materials.
- Liquid penetrant inspection can be accomplished with relatively inexpensive, unsophisticated equipment. If the area to be inspected is small, the inspection can be accomplished with portable equipment.
- Through penetrant bleed-out, liquid penetrant inspection magnifies the apparent size of discontinuities resulting in a more visible indication. In addition, the discontinuity location, orientation, and approximate length are indicated on the part, making interpretation and evaluation possible.
- Liquid penetrant inspection is readily adapted to volume processing, permitting 100-percent inspection of all accessible surfaces. Small parts may be placed in baskets for batch processing. Specialized systems may be semi- or fully automated to process as many parts per hour as required.
- The sensitivity of a penetrant inspection process may be adjusted through selection of materials and techniques. This allows suppression of indications from small, inconsequential discontinuities while indicating larger discontinuities of concern.

2.1.6 Disadvantages of Liquid Penetrant Inspection.**NOTE**

Although advantages and disadvantages may appear to be straightforward, the decision to select the penetrant test method or any other NDI method is often not obvious and depends upon a large number of factors. A thorough knowledge of the capabilities and limitations of all NDI methods is required. Whenever possible, the decision on which method to use should be referred to the responsible NDI engineering activity.

- Penetrant inspection depends upon the ability of the penetrating media to enter and fill discontinuities. Penetrant inspection will only reveal discontinuities open to the surface.

- The surfaces of objects to be inspected must be clean and free of organic or inorganic contaminants that will prevent the action of the penetrating media. It is also essential for the inside surface of the discontinuities be free of materials such as corrosion, combustion products, or other contaminants that would restrict the entry of penetrant.
- Penetrants are usually oily materials with strong solvent powers and highly concentrated dyes. They will attack some non-metallic materials such as rubber and plastics. There is also the possibility of permanent staining of porous or coated materials.

WARNING

- Due to the oily nature of most penetrants, they SHALL NOT be used on parts such as assemblies where they cannot be completely removed and will subsequently come in contact with gaseous or liquid oxygen. Oils, even residual quantities, may explode or burn very rapidly in the presence of oxygen. Only materials specifically approved for this application SHALL be used if penetrant inspection is required and complete removal of the residue is not possible. Each application of these special oxygen-compatible materials SHALL be directed by the applicable technical order and/or upon direction by the responsible NDI engineering agency.
- Some penetrant materials may contain sulfur and/or halogen compounds (chlorides, fluorides, bromides, and iodides). These compounds may cause embrittlement or cracking of austenitic stainless steels if not completely removed prior to heat-treating or other high temperature exposure. Entrapped halogen compounds may also cause corrosion of titanium alloys if not completely removed after the inspection is completed and the part is subjected to elevated temperatures. Use of these materials SHALL be directed by the applicable technical order and/or upon direction by the responsible NDI engineering agency.

2.1.7 **Basic Penetrant Inspection Process.** The basic fundamentals of the penetrant process have not changed from the oil-and-whiting days. A simplified description of the fundamental penetrant process steps is located in (paragraph [2.4.2.1](#)).

T.O. 33B-1-1

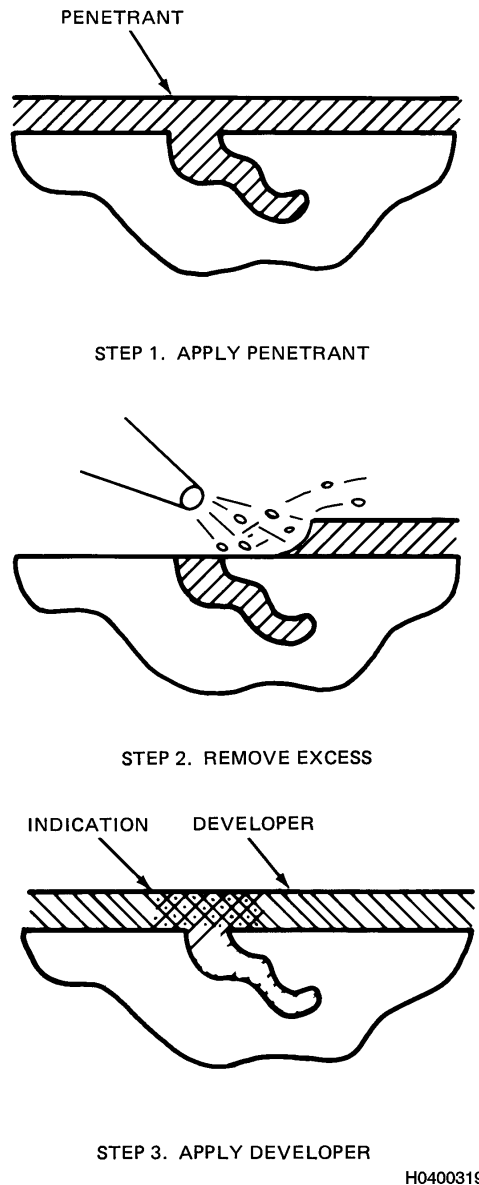


Figure 2-1. The Penetrant Inspection Process

2.1.8 Personnel Requirements.

NOTE

All individuals who apply penetrant materials or examine components for penetrant indications SHALL be qualified as specified in accordance with (paragraph 1.2).

The apparent simplicity of the penetrant inspection is deceptive. Very slight variations in the inspection process performance can result in reduced inspection sensitivity and failure to indicate serious flaws. It is essential for personnel performing penetrant inspection be trained and experienced in the penetrant process.

2.1.9 Understanding Penetrant Classification and Processes. This section defines the various classifications of penetrant testing materials and the general process steps of penetrant inspection. The information in this section is intended as

introductory material for management, supervisors, and other personnel who are required to know the general applications and classifications of penetrants, but do not require detailed NDI information. It can also be used in the training of beginning NDI personnel. We will review the various specifications, which define the penetrant material performance requirements and control the application of the penetrant process. Finally, we will also discuss the quality control and process testing requirements for penetrant materials. Detailed, technical information on penetrant materials and application processes is provided in subsequent sections.

2.1.9.1 Classification of Penetrant Materials and Processes.

2.1.9.1.1 **SAE AMS 2644 Categories.** The aerospace materials specification SAE AMS 2644 defines the categories universally used for classifying penetrant inspection materials. The categories are defined as follows and are further defined in (Table 2-1).

- Type - Specifies the type of contrast dye used in the material.
- Method - Specifies the method used to remove the penetrant material.
- Level - Specifies the sensitivity level of a particular penetrant system.
- Form - Specifies the form (type) of developer being used.
- Class - Specifies the class of solvent remover to be used.

Table 2-1. Classification of Penetrant Materials Contained in SAE AMS 2644

Type	
Type I	Fluorescent Dye
Type II	Visible Dye
Type III	Dual Mode (Visible and Fluorescent Dye)
Method	
Method A	Water-Washable
Method B	Postemulsifiable, Lipophilic
Method C	Solvent Removable
Method D	Postemulsifiable, Hydrophilic
Sensitivity Level	
Level 1/2	Very Low
Level 1	Low
Level 2	Medium
Level 3	High
Level 4	Ultra High
Developer	
Form a	Dry-Powder
Form b	Water-Soluble
Form c	Water-Suspendible
Form d	Nonaqueous (Wet; for Type I)
Form e	Nonaqueous (Wet; for Type II)
Form f	Specific Application

T.O. 33B-1-1**Table 2-1. Classification of Penetrant Materials Contained in SAE AMS 2644 - Continued**

Solvent Remover	
Class 1	Halogenated
Class 2	Nonhalogenated
Class 3	Specific Application

2.1.9.1.2 Penetrant Types.

2.1.9.1.2.1 Type I - Fluorescent Penetrant. Some chemical compounds have the capability of emitting visible light when exposed to near-ultraviolet radiation (UV-A, energy with a wavelength of 320 to 400 nanometers), commonly called black light. This property is termed fluorescence (paragraph 2.2.3.2.2.6). Type I penetrants are formulated with a dye that exhibits the property of fluorescence when exposed to UV-A radiation. Type I penetrants provide excellent detection sensitivity to small surface discontinuities as very small quantities of fluorescent penetrant will emit highly visible indications when exposed to black light.

2.1.9.1.2.2 Type II - Visible Penetrant.**CAUTION**

DoD prohibits the use of visible penetrant on aircraft, engines, and missiles, except for those parts with specific engineering approval.

Visible-dye or color-contrast penetrants contain a red dye dissolved in the penetrating oil. The visibility is further enhanced during the penetrant process by the application of a layer of white developer. The white developer provides a high contrast background for the bright red penetrant when viewed under natural or white light.

2.1.9.1.2.3 Type III - Dual-Mode Penetrant.**CAUTION**

DoD prohibits the use of dual-mode penetrant on aircraft, engines, and missiles, except for those parts with specific engineering approval.

Dual-mode penetrants contain specifically formulated dyes to provide high contrast indications under natural white light conditions as well as provide fluorescing indications when exposed to UV-A radiation.

2.1.9.1.3 Methods of Penetrant Removal. Penetrants are formulated and categorized by the specific removal method, not the material used to formulate it. The following are definitions of these methods:

2.1.9.1.3.1 Method "A" - Water Washable Penetrant.**CAUTION**

Water washable (Method "A") penetrants are prohibited for use on all flight critical aircraft components and on all engine components. Water washable penetrants SHALL NOT be used without specific written approval from the responsible engineering authority.

The usual liquid base or vehicle for a penetrant is petroleum oil, which is insoluble or immiscible in water. This means the penetrant cannot be removed with water, however, there are chemical compounds called emulsifiers that when mixed with the oil vehicle form a mixture that can be removed with water. The chemical compound forming the emulsifiable mixture is

called an emulsifying agent or an emulsifier. Water-washable penetrants are formulated with an emulsifier as an integral component of the penetrant vehicle. This permits direct removal by water immediately after the penetrant dwell.

2.1.9.1.3.2 Method “B” - Postemulsifiable Lipophilic Penetrant.

CAUTION

Postemulsifiable Lipophilic (Method “B”) penetrants are prohibited for use on critical rotating engine components.

Lipophilic is a word derived from the Greek words “lipo” for oil or fat, and “philos” meaning loving. Lipophilic emulsifiers are oil-based products, which are applied with the sole purpose to convert the excess surface penetrant into an emulsifiable mixture that can be removed with water. Method B penetrants are formulated to optimize their penetrating and visibility characteristics. They do not contain emulsifying agents and cannot be completely removed with water alone. Removal is made possible by applying an emulsifier in a separate process step.

2.1.9.1.3.3 Method “C” - Solvent Removable Penetrant.

WARNING

Solvents used may contain aromatic, aliphatic, or halogenated compounds. Aromatic compounds are characterized by a strange aroma and are formed from hydrocarbons and benzene. Aliphatic compounds are derived from fat; paraffin is an example. Halogenated compounds are materials in combination with the halogens, fluorine and/or chlorine. Many solvents are highly flammable while others may decompose at elevated temperatures. Keep all solvents away from heat and open flame. Vapors may be harmful, so use adequate ventilation. Avoid contact with skin and eyes. Do not take internally.

Method “C” is most often used with spray cans. The solvent removable method utilizes a solvent wipe to remove excess surface penetrant. Usually the penetrants used in the solvent removable process are the postemulsifiable penetrants; however, water washable penetrants can also be used. This method may be deceiving since all penetrants can be removed with solvents.

2.1.9.1.3.4 Method “D” - Postemulsifiable, Hydrophilic Penetrant. The word hydrophilic is derived from the Greek words “hydro” meaning water and “philos” meaning loving. The penetrants are often the same as those used in the lipophilic method; however, the hydrophilic emulsifier method requires the use of a separate water-based remover solution. Hydrophilic emulsifiers, also more accurately known as hydrophilic removers, are water-soluble and actually remove excess surface penetrant by means of a detergent action rather than an emulsification action. In this chapter, “remover” will be used when discussing hydrophilic material. This is the method generally used by the aerospace industry.

2.1.9.1.4 Levels of Penetrant Sensitivity. The following are the different levels of penetrant sensitivity you will see.

- Sensitivity Level 1/2 – Ultra-Low sensitivity
- Sensitivity Level 1 – Low sensitivity
- Sensitivity Level 2 – Medium sensitivity
- Sensitivity Level 3 – High sensitivity
- Sensitivity Level 4 – Ultra-high sensitivity

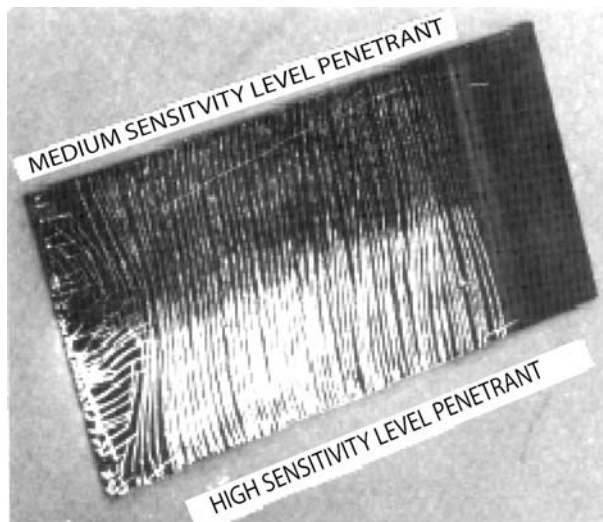
T.O. 33B-1-1

Figure 2-2. The Results of Inspection With a Medium Sensitivity Level Penetrant and a High Sensitivity Level Penetrant

2.1.9.1.5 Forms of Developer Application. The following are the developer forms you may see during penetrant inspection.

- Form a - Dry-powder
- Form b - Water-soluble
- Form c - Water Suspensible
- Form d - Nonaqueous, Type I, Fluorescent Systems (solvent based)
- Form e - Nonaqueous, Type II, Visible Dye Systems (solvent based)
- Form f - Special/Specific Applications

2.1.9.1.5.1 Other Classification Documents for Developers. The Aerospace Materials Specification SAE AMS 2644 classifications are also referenced in latest version of the process standard ASTM E 1417, the American Society for Testing and Materials (ASTM) Practice for Liquid Penetrant Examination. The Type and Method classifications and the descriptions of the first four kinds of developers are referenced in ASTM E 165, Standard Test Method for Liquid Penetrant Examination.

2.1.9.1.6 Classifications of Solvent Removers. The following are the classifications of solvent removers you may see during penetrant inspection.

- Class 1 – Halogenated
- Class 2 – Nonhalogenated
- Class 3 – Special/Specific Application

2.1.9.1.7 Developers, Solvents, and the Penetrant Family System Concept.

CAUTION

The penetrant family system concept does not permit penetrant inspection materials (penetrant, solvents, removers, emulsifiers, or developers) of different types or from different manufacturers to be mixed together. For example, a qualified nonhalogenated solvent remover from “manufacturer A” SHALL NOT be mixed with a qualified nonhalogenated solvent remover from “manufacturer B,” and a qualified water-soluble developer from “manufacturer C” SHALL NOT be mixed with a qualified water-soluble developer from “manufacturer D.”

A penetrant family system is defined as a penetrant and emulsifier together, from the same manufacturer. SAE AMS 2644 requires a penetrant/emulsifier combination be qualified and used together for both the lipophilic emulsifier and hydrophilic remover methods. For the water washable and solvent removable methods, the penetrant system consists of the penetrant alone. Solvent removers and developers are qualified independently and may be used with any qualified penetrant system. Therefore, a qualified post-emulsifiable penetrant system from one manufacturer may be used with any qualified developer; a qualified solvent removable system may be used with any qualified solvent and developer, and a qualified water washable penetrant system may be used with any qualified developer (approved for water washable systems). There may be a rare occasion where an incompatibility may exist between specific penetrant formulations and developer forms. The manufacturer’s restrictions as well as any restrictions defined in SAE AMS 2644 SHALL be followed.

2.1.10 Qualification of Penetrant Material. The SAE AMS 2644 defines the penetrant material performance requirements and is used to procure penetrant materials. This document requires extensive testing on new penetrant material formulations. The test results and a sample of the material are then submitted to the qualifying agency. The qualifying agency reviews the reports and conducts additional tests to verify the acceptability of the material. If the candidate material(s) meets or exceeds the requirements of the specification, a letter of notification approving the material(s) for listing is issued and at the next revision, the material(s) and manufacturer are listed on the Qualified Products List (QPL) SAE AMS 2644. All materials listed in a given classification category are considered equivalent in meeting the generic specification requirements. Consequently, any manufacturer’s penetrant system listed in the QPL, for a given type, sensitivity, and removal mode may be substituted for any other penetrant system listed to the same classification. Copies of QPL SAE AMS 2644 can be obtained from the Defense Automated Printing Service, 700 Robins Avenue, Bldg. 4, Section D, Philadelphia, PA, 19111.

2.1.11 Qualification of Penetrant Sensitivity. The qualification test for penetrant sensitivity involves a comparison of the brightness of indications produced by a candidate penetrant system (penetrant and emulsifier) versus the indications produced by a penetrant system designated as a reference standard. The test panels for visible-dye penetrants are thermally cracked aluminum blocks. The test panels for fluorescent-dye penetrants are a series of titanium or nickel alloy panels containing various sizes of laboratory generated fatigue cracks. There is only one set of the latter qualification test panels, and it is not presently possible to produce duplicate fatigue cracks with identical penetrant performance characteristics. Therefore, non-qualification sensitivity comparison tests, which are not used for qualification purposes, may be accomplished with fatigue cracks or cracked-chrome plated panels.

2.1.12 Penetrant Material Performance.

2.1.12.1 Quality Conformance Testing of Penetrant Materials. Listing of materials on the QPL does not guarantee subsequent products of the same formulation will be acceptable. Listing on the QPL merely indicates the original raw materials, formulation, and compounding practice can result in an acceptable product. There are many factors and conditions involved in compounding and manufacturing penetrants that can affect their performance. QPL SAE AMS 2644 includes an option for a procuring activity to contractually require a manufacturer to provide quality conformance test results and a sample of the material from the lot or batch to be supplied. The procuring activity itself has the option of performing tests to verify the conformance of a material, whether a sample and test report is or is not contractually required.

2.1.12.2 Reporting of Nonconforming Materials.

NOTE

Knowledge of penetrant problems, even relatively minor ones, is essential for improvement of the NDI program, the materials specification, and the qualification tests.

T.O. 33B-1-1

Information copies of written correspondence concerning unsatisfactory penetrant materials SHALL be submitted to the Air Force NDI Office, AFRL/MLSST 4750 Staff Dr., Tinker AFB, OK 73145-3317; DSN 339- 4931; and AFRL/MLSA, Bldg. 652, 2179 Twelfth Street, Room 122, Wright-Patterson Air Force Base, OH 45433-7718. Unsatisfactory materials SHALL be reported in accordance with TO 00-35D-54 (Air Force) or AR 735-11-2 (Army). A copy of the quality conformance test results SHALL be included as substantiating data.

SECTION II PRINCIPLES AND THEORY OF LIQUID PENETRANT INSPECTION

2.2 PRINCIPLES AND THEORY OF LIQUID PENETRANT INSPECTION.

2.2.1 General. This section provides basic, operating, and advanced level information on the theory and mechanisms of penetrant action, and on the physical and chemical properties of penetrant materials. Also included is a discussion on their effects on the inspection process. In addition, a discussion of the mechanisms of penetrant removal and the development process are provided.

2.2.2 Characteristics of a Penetrant. There are a number of characteristics desired in a material for it to function as a penetrant. The four primary requirements are as follows:

- It SHALL be capable of entering and filling surface openings even though they may be very small.
- Penetrant in a discontinuity SHALL resist washing out during removal of the excess penetrant material on the surface of the part.
- It SHALL exit from the discontinuity after the surface penetrant has been removed.
- It SHALL present a readily visible or noticeable indication of the discontinuity.

2.2.2.1 The primary requirements listed do not include the factors of being economical, safe, and practical to use. The primary requirements, combined with the additional factors, complicate the formulation of a penetrant material. The behavior of a penetrant is controlled by a number of physical and chemical properties, many of which are conflicting. As a result, commercial penetrants are a complex mixture of chemicals formulated for specific performance characteristics. Unfortunately, there is no simple rule for formulating a penetrant material, nor is there a set of characteristics which, if provided, will ensure a final material is completely satisfactory for all applications.

2.2.3 Mechanisms of Penetrant Action. To understand how penetrant works one must first understand the principles and properties associated with it. These are discussed in the following paragraphs.

2.2.3.1 Physical Principles. The penetrant inspection process requires a liquid that can flow over and wet a surface. The ability of a liquid to cover the surface of a part and enter any surface opening depends on 1) surface tension, 2) wetting ability, and 3) capillary action.

2.2.3.1.1 Surface Tension. Surface tension can be defined as the force required to expand (or pull apart) the surface of a liquid. The surface of a liquid exhibits certain features resembling the properties of a stretched elastic membrane. These features are due to the cohesive forces holding the surface molecules together, hence the term "surface tension". As an example, one may lay a needle or safety razor blade upon the surface of water and it will lie at rest in a shallow depression caused by its weight. The forces drawing surface molecules together can be very strong. These forces, or surface tension, cause a droplet of liquid to have a spherical shape. A sphere has the smallest surface for a given volume of liquid. This has a direct effect upon the ability of a penetrant to wet a surface.

2.2.3.1.2 Wetting Ability. When a liquid comes into contact with a solid surface, the cohesive force responsible for surface tension competes with or is countered by the adhesive force between the liquid molecules and the solid surface. These forces determine the contact angle the liquid forms with the surface. The contact angle is the measured angle a drop of liquid makes with a solid surface. If the contact angle is zero the liquid will "wet" and spread. If the contact angle is 90-degrees or more the liquid will not "wet" the surface and will remain as a rounded drop. Intermediate contact angles indicate intermediate degrees of wetting. Three examples of contact angle are illustrated ([Figure 2-3](#)). The Greek letter "theta" designates contact angle.

T.O. 33B-1-1

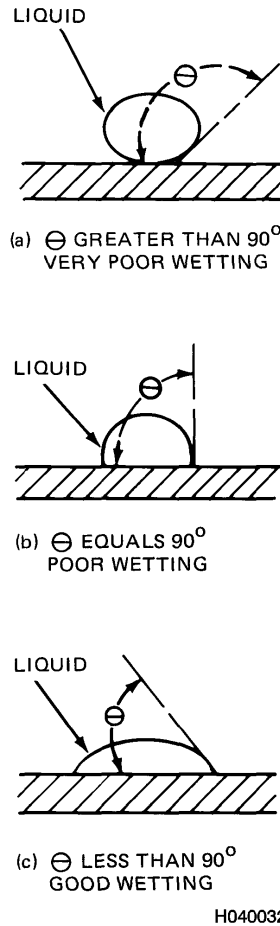
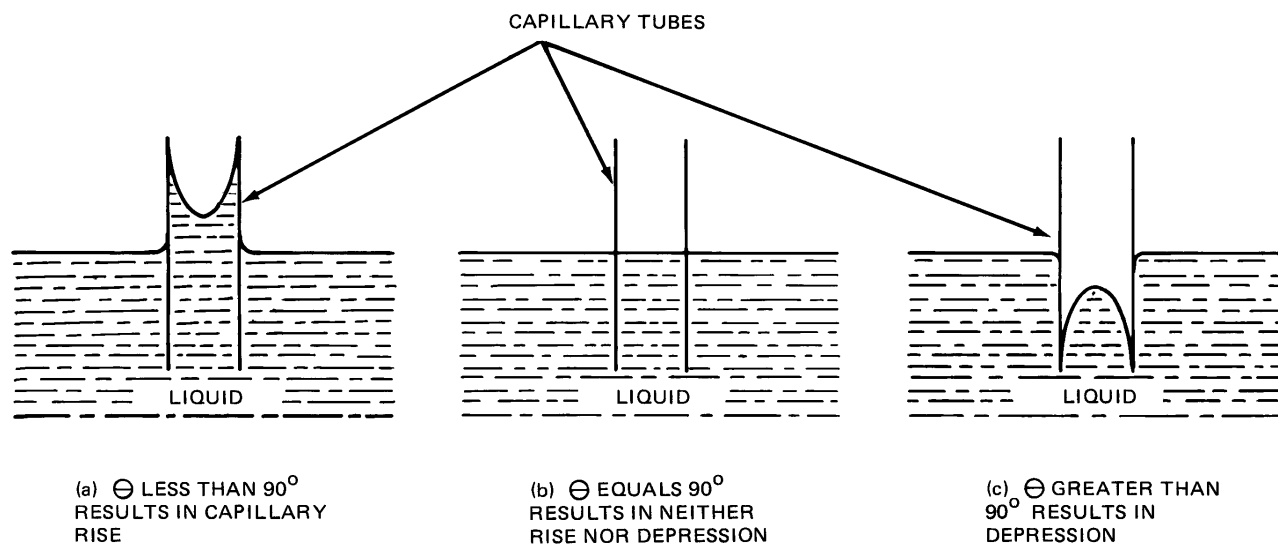


Figure 2-3. The Contact Angle, θ , is the Angle Between the Liquid and Solid Surface and is a Measure of the Wetting Ability

2.2.3.1.3 Capillary Action. Capillary action is defined as the tendency for a liquid to penetrate or migrate into small openings, such as cracks, pits, or fissures. Capillary action is associated with wetting ability. For example, when a tube with a small inside diameter is inserted into a liquid, the liquid level inside the tubing may rise above, remain even, or be lower than the outside liquid level. If the contact angle between the liquid and the tubing wall is less than 90-degrees (the liquid wets the tube wall), the liquid will be higher in the tube than on the outside. When the contact angle is 90-degrees or greater (poor wetting and high surface tension), the liquid will not rise above the outside level and may even be depressed. Capillary rise occurs when a liquid wets the inside of a tube and the surface tension draws additional liquid into the wetted area. The effects of contact angles and capillary action are illustrated (Figure 2-4).

2.2.3.2 Penetrant Properties. Surface tension and wetting action are only two requirements of a penetrant. In addition to penetrating ability, a satisfactory penetrant must resist removal from discontinuities when excess surface penetrant is removed from the surface, produce a noticeable indication, and be practical and economical to use. Formulation, selection, and application of penetrant materials requires consideration of many physical and chemical properties. Some of these properties, other than surface tension and wetting ability, are discussed in the following paragraphs.



H0400322

Figure 2-4. The Rise and Depression of Liquid in a Capillary Tube is Dependant Upon the Contact Angle

2.2.3.2.1 Physical Properties.

2.2.3.2.1.1 Viscosity. Viscosity is a measure of a liquid's resistance to a change in physical shape and is related to internal friction. The viscosity of a liquid decreases as the temperature is raised and viscosity increases as the temperature is lowered. Viscosity has no effect on penetrating ability. Some highly viscous fluids, such as molasses, have very good penetrating ability, while some low viscosity liquids, such as pure water, have very poor penetrating ability. However, from an application viewpoint, viscosity affects the speed with which a penetrant enters a discontinuity. Viscosity also determines how much penetrant will remain on a part surface during the dwell period. High viscosity penetrants cling to the surface, requiring increased effort for removal. Very thin penetrants (low viscosity) may drain from the part surface so quickly insufficient penetrant remains to enter into discontinuities.

2.2.3.2.1.2 Specific Gravity. Specific gravity is the ratio of the density of a substance to the density of distilled water usually measured at 60°F (15.6°C). This is also the ratio of the weight of the substance to an equal volume of water. Specific gravity has no direct effect on the performance of a penetrant. Most commercial penetrants have a specific gravity of less than one, primarily because they are made up of organic materials having low specific gravities. For this reason, water contamination sinks to the bottom of the penetrant tank.

2.2.3.2.1.3 Flash Point. Flash point is the lowest temperature at which vapors of a substance ignite in air when exposed to a flame. The flash point does not affect the performance of a penetrant. High flash points are desirable to reduce the hazard of fire. Penetrants and lipophilic emulsifiers meeting the requirements of SAE AMS 2644 have a minimum flash point of 200°F (93°C) if they are to be used in open tanks.

2.2.3.2.1.4 Volatility. The vapor pressure or boiling point of a liquid characterizes its volatility. It is associated with the evaporation rate of liquids and is desirable for penetrant materials to have a low volatility, i.e., a high boiling point. However, in the case of petroleum products, viscosity increases as the boiling point goes up. In this group of materials, the lower viscosity is preferred because they require less penetrating time. Still, for practical purposes, high volatility should be avoided before viscosity becomes a problem. High volatility results in a loss of penetrant in open tanks and can result in penetrant drying on a part during the penetrant dwell, leaving a film difficult to remove. Entrapped, highly volatile penetrant would also have a tendency to dry or lose its liquid properties, resulting in failure to bleed back out of a discontinuity and to produce an indication. In general, low volatility provides four advantages:

- Low economic loss due to low evaporation loss.
- Low fire hazard because few flammable vapors form above the liquid.
- Low toxicity because of low hazardous vapor concentrations in the test area.
- Uniform removal and fluorescent properties because of minimal evaporation.

T.O. 33B-1-1

2.2.3.2.1.5 Fluorescent Dye Thermal Stability. The dyes used in fluorescent-dye penetrants lose their brightness or color when subjected to elevated temperature. Loss of brightness or color also occurs at moderate temperatures, but at a slower rate. This loss is termed “heat fade.” SAE AMS 2644 specifies the maximum allowable brightness loss (heat fade) as a function of penetrant sensitivity. This test is performed after a penetrant has been subjected to an elevated temperature. Thermal stability is an important consideration during hot air drying before or after developer application.

2.2.3.2.1.6 Water Washable Penetrant Thermal Stability. Thermal stability is the ability of water washable penetrants to resist physical changes under normal operating (temperature) conditions. SAE AMS 2644 requires water washable penetrants submitted for qualification to be thermally cycled between 0°F and 150°F for 8-hours without separation or major degradation in performance.

2.2.3.2.1.7 Storage Temperature Stability.

NOTE

Penetrant materials, excluding dry developer, SHALL NOT be stored in direct sunlight or at temperatures above 130°F (55°C) or below 32°F (0°C).

Storage temperature stability is the ability of a penetrant to resist physical and chemical changes when stored in sealed containers at appropriate temperatures. SAE AMS 2644 requires penetrants to resist physical changes including settling, or gelling after a one-year storage period. Most liquid penetrant materials are not greatly affected over time as long as they are kept in closed storage containers.

2.2.3.2.2 Chemical Properties.

2.2.3.2.2.1 Chemical Inertness.

CAUTION

Penetrant materials MAY cause deterioration and damage to materials that react to hydrocarbons. Penetrant materials SHALL NOT react with the materials to be inspected.

It is necessary for the penetrant, emulsifier, and developer material be chemically inert relative to the parts being inspected. Most oil based materials meet this requirement; however, water contamination of many oils may cause the mixture to become alkaline. This is one of the reasons why water contamination must be avoided. While oily penetrant materials are generally inert to most metals, there is no one material that can be formulated for all parts. Chemical reactivity of penetrant materials must be considered whenever a new application is encountered. Some rubber (natural and synthetic) and plastic (transparent and opaque) parts are susceptible to attack by the solvents and oils in the penetrant materials. Some metals can be degraded at elevated temperatures by the trace amounts of sulfur or chlorine in conventional penetrants. Special low sulfur and low chlorine materials are available and are discussed in (paragraph 2.7.3).

2.2.3.2.2.2 Toxicity. Toxicity is the measure of adverse effects on humans resulting from contact with the material. It applies to any abnormal effects ranging from nausea and dermatitis through dysfunction of major organs, such as the liver or kidneys. It is essential for penetrant materials to be nontoxic. In qualifying penetrant materials for the QPL, the manufacturer must submit a certified statement identifying each ingredient in the product by a recognizable chemical or trade name. The USAF Occupational and Environmental Health Laboratory SHALL evaluate this information for toxicity before the material is listed as a qualified product.

2.2.3.2.2.3 Solvent Ability. The visibility of indications depends upon the fluorescent or visible dye dissolved in the penetrant oils. The oils used in penetrants must have good solvent properties to dissolve and hold the dye in solution. It must maintain the dye in solution under the wide range of temperatures encountered during transit and storage of the penetrant. If even a small amount of separation occurs, recombination may be very difficult or impossible, resulting in decreased penetrant performance.

2.2.3.2.2.4 Removability. This term describes two conflicting requirements for a penetrant: a) the ability to be removed from a surface leaving little or no residual background and b) resistance to being removed from discontinuities. In order to meet the first requirement, the penetrant must maintain the dyes in solution even when in the form of a thin film on the

surface of a part and without its more volatile components lost during the dwell time. This requirement is more difficult for water washable penetrants than postemulsifiable penetrants because the water washable penetrant does not receive the additional solvent or surfactant of the emulsifier/remover during the removal process. The second requirement is met by the penetrant resisting the removal process. For water washable penetrants and postemulsifiable penetrants used with a lipophilic emulsifier, this is accomplished by the formation of a gel with the penetrant/water mixture during washing that protects the penetrant in discontinuities from removal. For postemulsifiable penetrants used with a hydrophilic remover (Method D), the resistance to removal is due to the lack of diffusion of the surfactants into the surface penetrant layer, thus making only the thin surface layer emulsifiable and not the penetrant in discontinuities beneath the layer. When using solvent removable penetrants the same effect can be achieved by minimizing the amount of solvent used during the removal process.

2.2.3.2.2.5 Water Tolerance. When penetrants are used in open tanks some water contamination is inevitable. Postemulsifiable penetrants are inherently tolerant to water intrusion. Since they are oil based materials, any extraneous water will settle to the bottom of the tank. Although their performance is not degraded, corrosion of the tank can occur. However, water washable penetrants contain emulsifiers and will combine with water. They can tolerate the addition of small amounts of water without losing their properties. The penetrant material procurement specification, SAE AMS 2644, requires Method A penetrants to tolerate the addition of 5-percent of water, based on volume, without gelling, separating, clouding, coagulating, or floating of water on the surface.

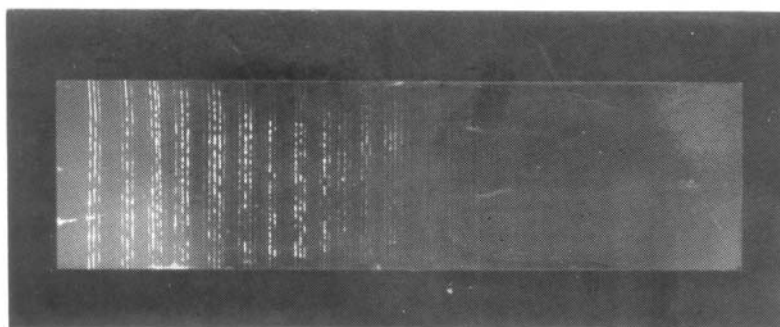
2.2.3.2.2.6 Mechanism of Fluorescence. The mechanism of fluorescence involves two factors: the atomic structure of the fluorescent material and the energy level or wavelength of the radiation source. The basic component of all matter is the atom that consists of protons, neutrons, and electrons. The protons and neutrons form a positively charged nucleus or core, while the negatively charged electrons circulate in orbits around the nucleus. The orbits are actually shells or rings of discrete energy levels with a definite number of electrons in each shell. A material will fluoresce only if it has a certain atomic structure: 1) the energy holding the electrons in orbit in the outer shells must be low, and 2) there must be vacant electron space in the outermost shell. When a photon of electromagnetic radiation from an X-ray or ultraviolet light impacts an electron in an atom of fluorescent material, the electron absorbs some of the photon energy and jumps from its natural shell to a higher energy shell. The electron is unstable in this condition and immediately returns to its natural shell or orbit. In returning to equilibrium, the electron releases its excess energy as electromagnetic radiation. The released electromagnetic energy always has a longer wavelength than the exciting radiation. Thus, ultraviolet radiation with a wavelength of 365 nm (nanometer, a unit of length) causes some fluorescing materials to release energy that has a longer wavelength of 400 to 700 nm. This is the wavelength range of visible light. The human eye is most sensitive to yellow-green light at approximately 510-560 nm in darkness. Most dyes are formulated to emit this range.

2.2.3.2.2.7 Brightness. One of the more important factors responsible for the effectiveness of the penetrant process is the visibility of the indication. Penetrants containing fluorescent dyes are not especially visible under white light. However, when subjected to near ultraviolet (365 nm) radiation (UV-A or black light), the dyes emit visible light. Some dyes emit more visible light per unit of ultraviolet energy than others. In addition, the amount of light given off is proportional to the amount of dye in the penetrant. Brightness is a measure of the amount of visible light given off when fluorescent dye is exposed to ultraviolet radiation. It is controlled by the particular dye's efficiency in converting ultraviolet radiation (black light) into visible light and by the quantity of dye dissolved in the penetrant. High efficiency dyes are brighter than low efficiency dyes when exposed to the same wavelength and intensity of ultraviolet radiation.

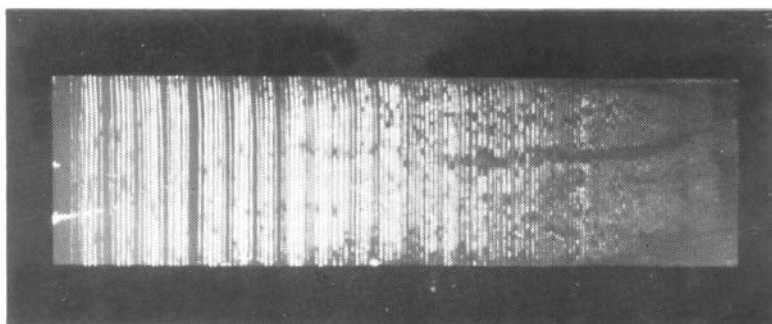
2.2.3.2.2.8 Ultraviolet Stability. Fluorescent dyes lose their ability to fluoresce after prolonged exposure to ultraviolet radiation. Resistance to this loss is termed ultraviolet stability. SAE AMS 2644 requires a diluted sample of fluorescent penetrant to retain a minimum brightness, after a one-hour exposure to 800 $\mu\text{W}/\text{cm}^2$ (micro-watts per square centimeter) of ultraviolet (black light) exposure.

2.2.3.2.2.9 Penetrant Sensitivity. The term "sensitivity," when used to describe a penetrant performance characteristic, is the ability to produce indications from very small, tight cracks. This characteristic involves the combined properties of penetrating ability and brightness. The flaw opening in discontinuities is usually restricted, and the void volume is such that only a very small amount of penetrant can be entrapped. The penetrant must enter and exit the flaw with enough dye to produce a noticeable indication.

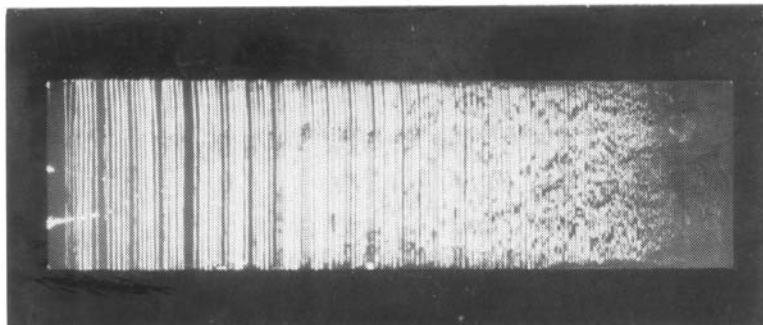
T.O. 33B-1-1



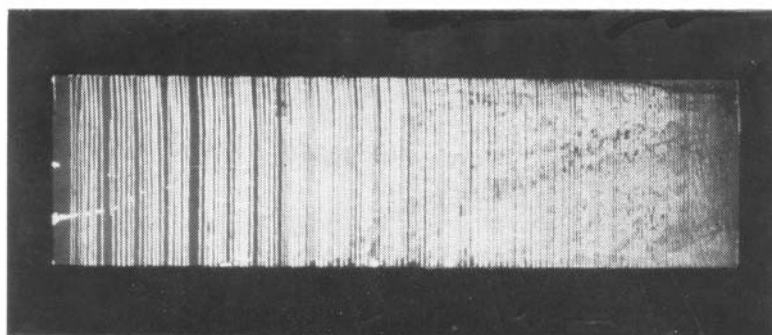
LEVEL 1



LEVEL 2



LEVEL 3



LEVEL 4

Figure 2-5. Indications Produced by Penetrant of Four Different Sensitivity Levels Using Dry Developer

2.2.4 How Liquid Penetrant Enters Discontinuities. If one end of a capillary tube is closed, such as occurs in the case of a flaw, the capillary rise is affected by compression of the air trapped in the closed end. The phenomenon of capillary action enables penetrant to enter a flaw, even in an inverted position, such as on a lower wing surface. However, flaws are not capillary tubes as the sides are not parallel and are not circular. The ability of penetrant to successfully enter and exit discontinuities is dependant on a number of factors. The points to remember about penetrant entry into discontinuities are as follows:

- A high surface tension and small contact angle are desirable in a penetrant, however these are conflicting properties. High surface tension tends to increase contact angle and decrease wetting ability, but enhances drawing penetrant into wetted areas.
- Capillary force increases with smaller flaws.
- Viscosity does not affect the penetrating ability but it can affect the time required for penetration.
- Shape of a discontinuity can affect penetrant entry.
- Temperature affects the surface tension.
- Roughness of the flaw walls affects penetrant entry.
- Contamination in the flaw can affect penetrant entry.
- Residual cleaning solution in the flaw can affect penetrant entry.

2.2.5 Mechanisms and Principles of Penetrant Removal.

2.2.5.1 Mechanisms of Method “A” Water Washable Penetrant Removal. Water washable penetrants contain an emulsifying agent. Following the penetrant dwell time excess Method A penetrants are removed with a water spray. The water washable penetrant is converted into small, suspended oil droplets by the mechanical force of the water spray. A separate process step of applying emulsifier is not required. Water washable penetrants are often called “self-emulsifying” and are one of the most widely used NDI methods. Water washable penetrants exist in all penetrant system sensitivity levels.

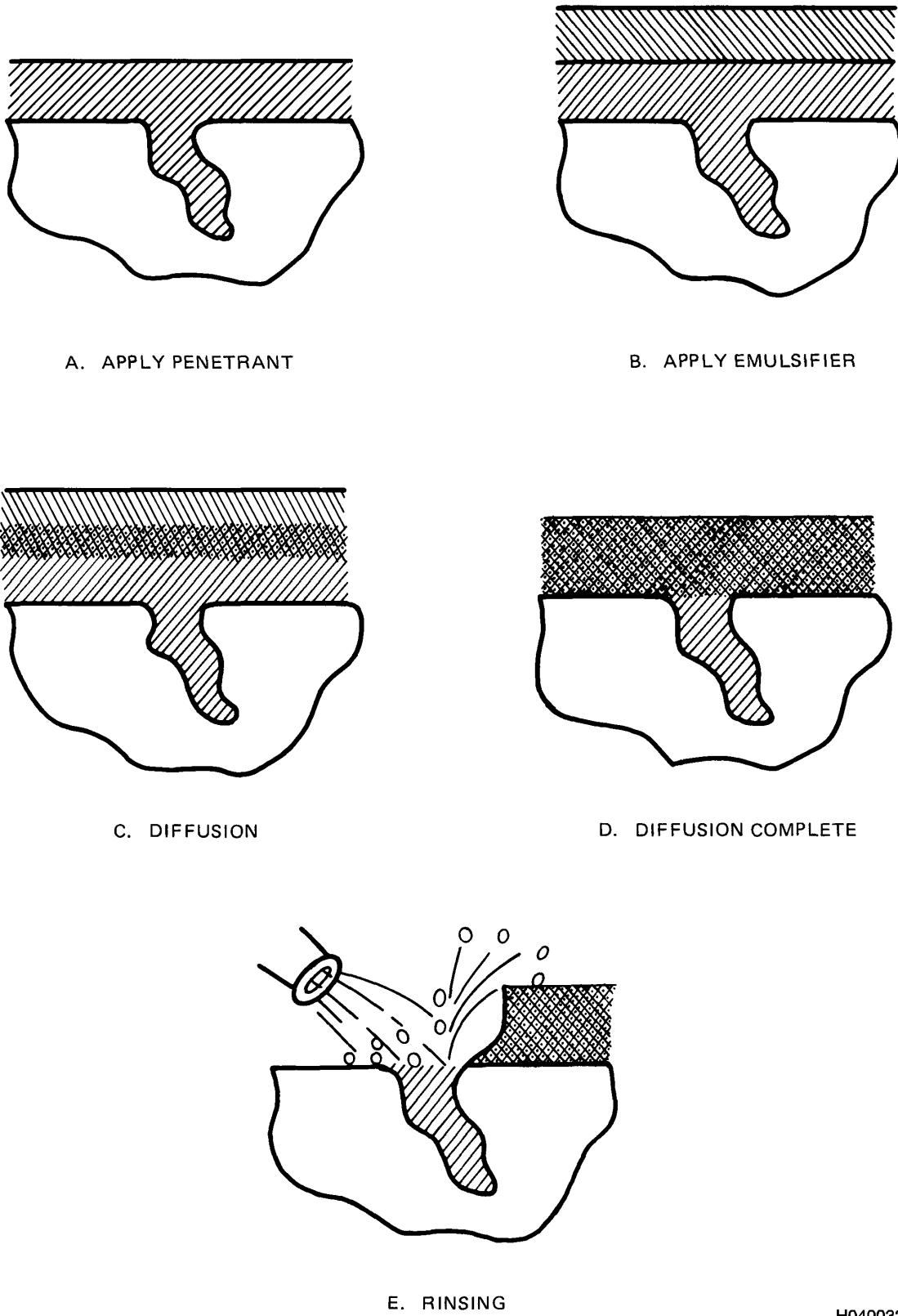
2.2.5.1.1 Method “A” Emulsification. Generally, oil and water do not mix; however, this is not always the case. If equal amounts of oil and water are placed in a bottle, they will immediately separate into two distinct layers. If the bottle is shaken, the oil will form into globules, which are dispersed throughout the mixture. When the bottle is allowed to rest, the globules will rise to the surface and reform into a separate oil layer. The process of the globules combining to form this layer is called coalescence. If the amount of oil is small compared to the quantity of water, and the bottle is violently shaken, the oil will be separated into very small droplets. On standing, most of the droplets will coalesce at a slower rate than previously described. However, some of the very small droplets will remain suspended in the water giving it a cloudy or milky appearance. Depending on the droplet size, it may require an extremely long time for separation to take place. This cloudy water mixture is called a colloidal suspension and the process by which it is formed is termed emulsification. Certain chemicals have the ability to combine with oily materials to form an easily emulsifiable mixture. This is the case when an emulsifier is applied to a penetrant on a part. The penetrant is oil that repels water and resists removal. However, when combined with an emulsifier, the resulting colloidal mixture can be removed with a water spray.

2.2.5.2 Mechanisms of Method “B” and Method “D” Penetrant Removal.

2.2.5.2.1 Lipophilic Emulsifier (Method “B”) Mechanism and Modes of Action. The lipophilic emulsifier has two primary modes of penetrant removal, chemical diffusion, and draining. These processes are described as follows:

2.2.5.2.1.1 Mode 1 - Chemical Diffusion. For lipophilic emulsifiers, diffusion into the oil-base penetrant is the primary mode of action. Diffusion is the intermingling of molecules or other particles as a result of their random thermal motion. If two miscible (capable of being mixed) liquids or gases are placed in a container, they will eventually mix into a uniform solution. For example, if a sugar solution (a heavy solution) is placed in the bottom of a glass, and plain water (lighter medium) is placed on top, the sugar will migrate across the boundary. After a period of time, the entire quantity of liquid will reach a nearly uniform concentration. This is what happens when emulsifier (Method B) is applied to a layer of penetrant on a part (Figure 2-6).

T.O. 33B-1-1



H0400324

Figure 2-6. Diffusion of Emulsifier Into Penetrant During Lipophilic Emulsifier Dwell

2.2.5.2.1.2 Mode 2 - Drain and Dwell.

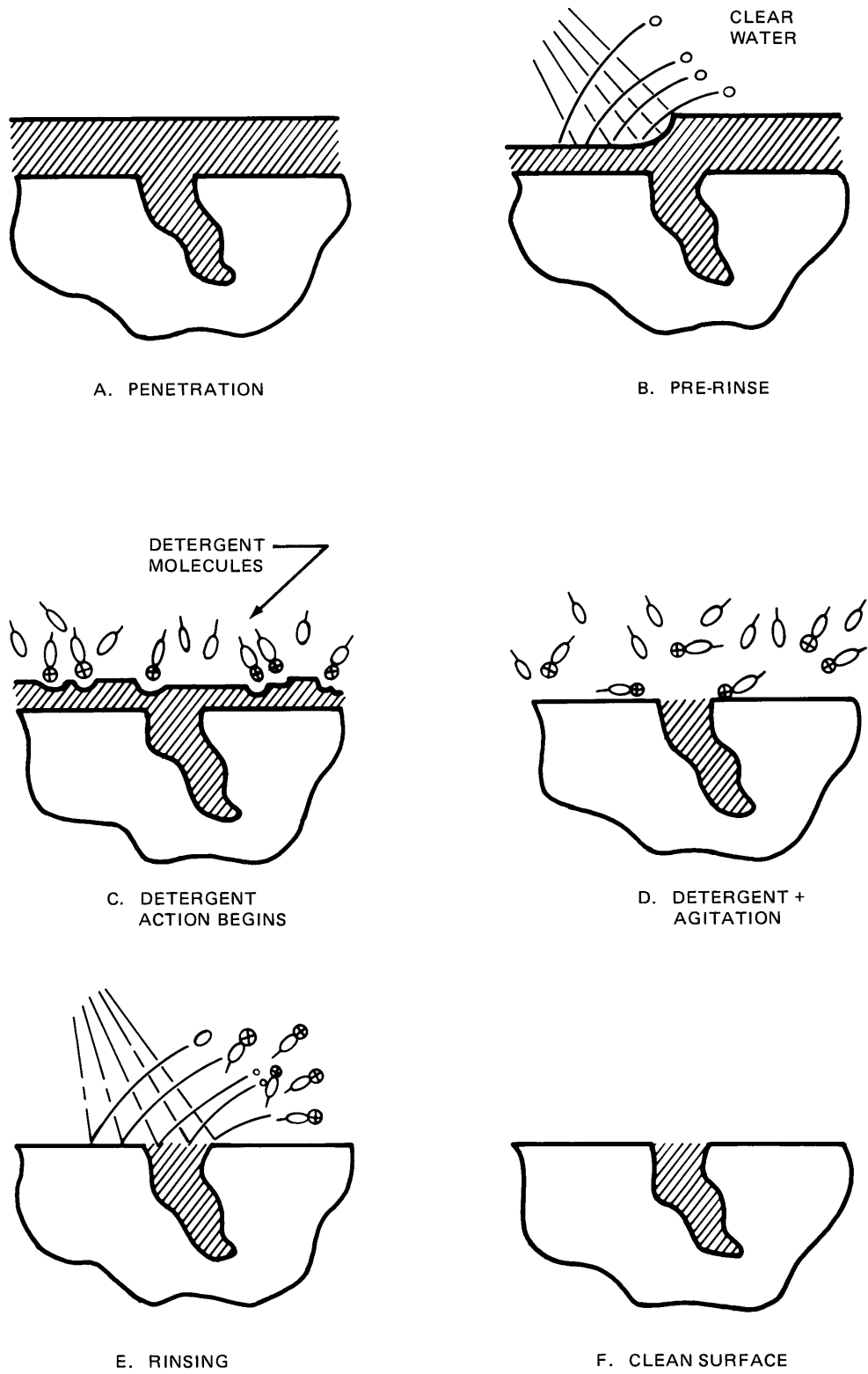
NOTE

Parts SHALL NOT remain in the emulsifier and care SHALL be exercised to prevent pooling in cavities during the dwell.

It was once thought emulsification occurred only through the chemical action of diffusion. It should be recognized a second mode of emulsification is also involved. This mode occurs as the emulsifier drains from the part surface during the dwell period. As the emulsifier drains, the movement carries with it considerable surface penetrant. This scrubbing or mechanical action reduces the amount of penetrant to be emulsified and also initiates the chemical or diffusion action. Without this mixing action, emulsifier dwell time might be as long as ten or twenty minutes. It is for this reason parts SHALL NOT be left in the emulsifier and care SHALL be exercised to prevent pooling in cavities during the dwell.

2.2.5.2.2 Hydrophilic Remover (Method "D") Mechanism and Mode of Action. Hydrophilic removers are basically detergent/dispersing concentrates consisting of water-soluble chemicals, usually non-ionic surface-active agents called surfactants. They are supplied as concentrated liquids and are mixed with water either before or during the removal process. The surface-active agent in the remover displaces a small quantity of penetrant from the surface and disperses or dissolves it, preventing it from recombining with the remaining penetrant layer. Unlike lipophilic emulsifier, hydrophilic remover is immiscible with penetrant and diffusion does not occur. All of the removal action takes place at the exposed surface, and penetrant just below the surface is not involved until it becomes exposed. Gentle agitation of the liquid helps remove the displaced penetrant and allows fresh remover to contact the remaining penetrant layer. The action stops when the part is withdrawn from the remover. This process is significantly different from lipophilic emulsifiers that become active after withdrawal and during drainage. Hydrophilic remover action is illustrated ([Figure 2-7](#)).

T.O. 33B-1-1



H0400325

Figure 2-7. Action of the Hydrophilic Remover Process

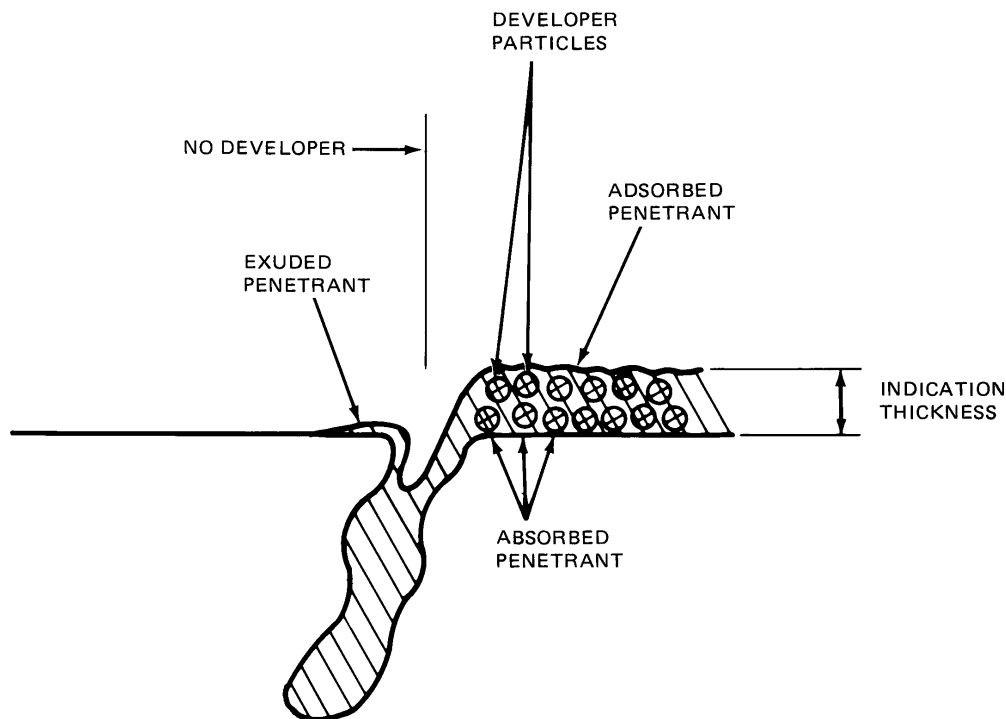
2.2.5.2.3 Solvent Removable (Method “C”) Mechanism and Mode of Action. The solvent-wipe method for removal of excess surface penetrant relies on a combination of dilution and mechanical action. Solvent removers are formulated to dissolve and dilute surface penetrant to enable effective absorption and removal by wiping the surface with a solvent dampened rag or towel. Desirable properties are low toxicity, solvency for liquid penetrant, and a compromise between maximum drying speed and minimum fire hazard.

2.2.6 Mechanisms of Developer Action.

2.2.6.1 Functions of a Developer. The basic function of all developers is to improve the visibility of the entrapped penetrant indication. The improvement in visibility is achieved through a number of mechanisms including the following:

- Assist in extracting the entrapped penetrant from discontinuities.
- Spread or disperse the extracted penetrant laterally on the surface, thus increasing the apparent size of the indication.
- Improve the contrast between the indication and the background.

2.2.6.1.1 Adsorption and Absorption. The mechanism of development is a combination of both adsorption and absorption (Figure 2-8). Adsorption refers to the collection of a liquid on the outer surface of a particle due to adhesive forces. This action contributes to the developer particle build-up at a crack as the particles adhere to the exuded penetrant. Absorption refers to the blotting action that occurs when a liquid merges into an absorbent particle.



H0400326

Figure 2-8. The Effects of a Developer

2.2.6.1.2 Contrast Enhancement. Developers improve the visibility of indications by providing a contrasting background. They reduce reflections from a part surface and appear blue-black under black light (UV-A) illumination. The blue-black color provides a high contrast with the fluorescent yellow-green penetrant indication. Water-suspended and some nonaqueous developers produce a solid white coating, which provides a contrasting background for red visible-dye penetrant.

2.2.6.1.3 Solvent Action. Nonaqueous developers contain solvents that hold the developer particles in suspension. When sprayed on the part, the solvent combines with any entrapped penetrant, diluting it. This increases the volume and reduces the viscosity of penetrant that exudes from the discontinuity, thus improving the visibility of the indication. Nonaqueous developers are capable of providing the highest sensitivity of any of the developer forms.

T.O. 33B-1-1

2.2.6.1.4 Scattering of Light. The developer particles scatter both the incoming ultraviolet light and the exiting visible light. This property enhances the brightness of a fluorescent indication by causing more of the ultraviolet light to be absorbed by the penetrant and more of the visible (fluorescent) light to escape the penetrant layer and reach the inspector's eye.

2.2.7 Cleaning and Surface Preparation**2.2.7.1 Responsibility for Cleaning and Surface Preparation****CAUTION**

Due to the various and potentially catastrophic effects various surface preparation processes may have on different materials, only properly trained personnel SHALL accomplish surface preparation processes. This training SHALL be documented in personnel training records. Nondestructive inspection personnel are neither trained nor experienced in performing paint stripping or cleaning.

Properly performing surface treatment operations, such as paint stripping and cleaning of military system metals and alloys, require skill and knowledge. Improper methods, materials, or procedures can result in severe damage to surfaces and parts.

2.2.7.2 Need for Clean Surfaces. The proper preparation of parts prior to inspection is critical. Successful detection of discontinuities by penetrant inspection depends upon the ability of the penetrant to enter and exit from the discontinuity. The resulting indication must be readily distinguishable from the background. Surface conditions, such as coatings or soil contamination, can reduce the effectiveness of the inspection by interfering with the entry and exit process or producing a high residual background. Penetrant inspection is reliable only when the parts to be inspected are free of contaminants. Foreign material, either on the surface or within the discontinuity, can produce erroneous results. Proper cleaning or surface treatment prior to penetrant application must remove any interfering conditions.

2.2.8 Surface Conditions Affecting Penetrant Inspection. There are three general categories of surface condition that have detrimental effects on penetrant inspection. These conditions are classified as contaminants/soils, coatings, and surface deformation. Each of these conditions can negatively affect penetrant inspection and must be corrected before penetrant inspection can be properly performed. The following sections provide a discussion of each category and highlight the methods used to correct these conditions.

2.2.9 Contaminants and Soils. In this section, the terms "contaminants" and "soils" are used interchangeably and refer to matter on a part or component that may affect the penetrant testing process. Contaminants may be intentionally applied, such as greases or corrosion prevention compounds, which may result from prior processes, such as heat-treating, or cleaning, or may be the consequence of service, e.g., corrosion, carbon deposits, lubricating fluids, or dirt particles. The effects of contaminants on the penetrant inspection process depend on the type of soil and whether it is on the part surface or entrapped in a discontinuity.

2.2.9.1 Contamination/Soil Removal - Factors in Selecting a Cleaning Process**CAUTION**

Improper cleaning methods can cause severe damage or degradation of parts. Only properly trained/qualified personnel SHALL select or apply cleaning processes. This training SHALL be documented in personnel training records.

The success of any penetrant inspection procedure depends upon the cleanliness of the part surface and discontinuities being free of any contaminants or soils. There are a variety of cleaning methods which may be utilized. The methods are generic and are used principally for corrosion prevention and preparation of items for surface treatments. The most common cleaning methods are discussed in the following paragraphs.

2.2.9.1.1 Cleaning is a broad term covering methods and materials used to remove contaminants or soils from a surface. Cleaning is routinely used for corrosion control and to prepare surfaces for other treatments. There are no special methods or materials specifically dedicated to penetrant inspection. Different materials and parts require separate or individual cleaning

processes. No one cleaning method is equally effective on all contaminants. The selection of a suitable cleaning process is complex and depends on a number of factors, such as:

- Type of soil(s) or contaminant(s) to be removed.
- Part material - Strong alkaline or acid cleaners can attack some nonferrous metals, e.g., aluminum and magnesium. Steels, especially in the heat-treated condition, are likely to become embrittled by acid cleaners. Cleaning compounds containing halogen and sulfur compounds can attack other metals, e.g., titanium and high nickel alloys, if residual cleaning compounds are present and are exposed to high temperatures.
- Part surface condition - Rough surfaces tend to hold soil, making it harder to remove.
- Part surface accessibility and geometry - Complex shapes make it difficult to clean all of the surfaces, and soils lodged in restricted areas may escape the effects of cleaning.
- Required degree of cleanliness - The degree of cleanliness may be dictated by the postpenetrant inspection surface treatment or the service conditions the component will encounter.
- Availability and adequacy of cleaning facilities - For example, a large part cannot be placed in a small alkaline or ultrasonic cleaning tank.

2.2.9.2 Types of Contaminations and Soils.

2.2.9.2.1 Light Oils and Soft Films. Examples of light oils and soil films are: hydraulic oils, lubricating oils, machining and cutting fluids, thin greases, e.g., petroleum jelly, and film corrosion preventive compounds.

2.2.9.2.1.1 Effect: Light oils and soft films have several adverse effects on the penetrant inspection process. They readily enter surface openings, thus reducing or preventing penetrant entrapment. Oily materials on the part surface interfere with mechanisms which enable penetrants to enter and exit from discontinuities. Also, many oils and greases fluoresce under black light. When on a part surface, this fluorescence could obscure a discontinuity indication or produce a false indication.

2.2.9.2.1.2 Removal: Oils and soft films may be removed by solvent washing, aqueous degreasing, or by ultrasonic cleaning with detergent or solvent. Vapor degreasing was the most effective method but has been discontinued due to environmental damage caused by the release of 1-1-1-Trichloroethane into the atmosphere. When present as thin films, these contaminants are easily removed by solvents. However, when they contain solid particles, e.g., metal chips, sand, or dirt, removal is more difficult. The oily phase is readily removed, leaving the solid particles adhering to the surface. Removal of the solid particles may require a mild mechanical action, e.g., hand wiping, pressure spray, solution agitation, or ultrasonic vibration.

2.2.9.2.2 Heavy Oils and Solid Films. Examples of heavy oils and solid films are viscous oils, thick greases, hard film corrosion preventative compounds, and particulate lubricants such as graphite and molybdenum disulfide. These contaminants or soils are more difficult to remove than light oils.

2.2.9.2.2.1 Effect: Heavy oils and solid films have the same adverse effects on penetrant inspection as light oils and soft films. Heavy oils and films on the surface of a part, even in trace amounts, interfere with the entry and exit of penetrant discontinuities. The heavy oils and greases are viscous and flow very slowly; many of them have excellent penetrating ability and readily enter surface discontinuities. Many heavy oils and semi-solid films fluoresce under black light. This fluorescence can obscure valid indications and produce false indications.

2.2.9.2.2.2 Removal: Complete removal may require solvent or chemical action plus considerable mechanical action. Mechanical action can be solution agitation, manual scrubbing or pressure spraying. Cleaning for penetrant inspection presents special problems. Removal of heavy oils requires considerable mechanical action where the forces are concentrated at the surface. Use of excessive mechanical forces to remove heavy oils and films may further aggravate problems by smearing metal over narrow discontinuities.

2.2.9.2.3 Carbon, Varnish, and Other Tightly Held Soils. Examples of origins of carbon, varnish, and other tightly held soils are; partially burned petroleum and other combustion products, residues from evaporated fuel and oils, and dry film lubricants. The soils may have been baked at elevated temperatures to form a vitreous or glass-like coating.

2.2.9.2.3.1 Effect: Tightly held soils, e.g., carbon, engine varnish, and other dry soils, can seriously interfere with the penetrant inspection process soils. The soils can bridgeover or partially fill the discontinuity, blocking or reducing the amount of penetrant in the void. When on the part surface, soils interfere with the forces or mechanism causing penetrant entry and exit from discontinuities. When dry, they tend to absorb moisture that also interferes with penetrant entry and exit. As surface contaminants, soils retain the penetrant, leading to a residual background and false indications during inspection.

T.O. 33B-1-1

2.2.9.2.3.2 **Removal:** Carbon, varnish, and tightly held soils are generally adherent and are difficult to remove. The soils require special cleaning compounds and processes to dissolve and loosen the soil. There are special solvent and alkaline cleaners for baked soil removal. Many of the paint removal materials and processes are used in removing carbon, varnish, and other tightly held soils that are not baked. Strong mechanical action, such as scrubbing, pressure spray, or solution agitation may also be required. Care must be used, since many of the cleaning compounds will attack metals and alloys.

2.2.9.2.4 **Scales, Oxides, and Corrosion Products.** Scale and oxides generally occur as a result of exposure to high temperatures.

2.2.9.2.4.1 **Effect:** Scale, oxides, and corrosion products can bridge or partially fill discontinuities restricting penetrant entry. When on the part surface, they interfere with the mechanism of penetration, impeding both penetrant entry and exit from discontinuities. They also retain penetrant on the surface, leading to a high residual background and false indications. Stress corrosion products occur within the flaws and may be impossible to completely remove. Penetrant inspection for stress corrosion cracking flaws generally requires extended dwell times to permit penetrant entry.

2.2.9.2.4.2 **Removal:** Scale and oxides are usually very difficult to remove and may require aggressive cleaning methods, such as acid pickling, abrasive blasting, or other metal removal operations. Some of these processes will have an adverse effect on the penetrant inspection process and should be avoided. Corrosion products, particularly from stress corrosion, often occur or are lodged within discontinuities resulting in removal problems.

2.2.9.2.5 **Water or Moisture.** Water or moisture on a part can occur from many sources. The most common source is inadequate drying after aqueous (water solution) cleaning.

2.2.9.2.5.1 **Effect:** Water or moisture on the part surface or in the discontinuity seriously interferes with the penetration process. It is essential that water be removed not only from the part surface but also from the inside of any discontinuities that may be present. Moisture in the form of condensation from high humidity or low temperatures may occur and must be removed.

2.2.9.2.5.2 **Removal Method:** Thorough drying of the component in an oven is the most effective method of removing water from part surfaces and within discontinuities.

2.2.9.2.6 **Residues From a Cleaning Process.** **Effect:** The chemicals used for cleaning solutions may contain strong alkalis and acids. If not completely removed from the part surface before penetrant inspection, they can interfere with the penetrant process in several ways. Residues can impede surface wetting and prevent the penetrant from evenly coating the inspection area. They also interfere with the mechanism causing the penetrant to enter and exit discontinuities. Strong alkalis and acids can decompose or degrade dyes and other chemicals in the penetrant, causing weak or faint indications. Chromate residues absorb black light, leaving less energy to excite the fluorescent dyes in the penetrant. Therefore, removal or neutralization of residual solution is always important and often imperative.

2.2.9.2.6.1 **Removal:** Complete removal of all cleaning process residues is very important. The usual process to accomplish removal is through the use of warm water and agitation followed by repeated immersions in fresh water. In some cases, residues of strong alkalis and acids are subjected to a rinse with a weak-neutralizing solution followed by fresh water rinses.

2.2.9.2.7 **Residues From Previous Inspections.** Residues from previous penetrant inspections can affect subsequent inspection results and the serviceability of the part. The effects of residues from previous penetrant inspections are discussed in the following paragraphs.

2.2.9.2.7.1 **Inadequate Post-Inspection Cleaning Effects on Subsequent Inspections.** If the post-inspection cleaning is inadequate, the residues must be considered as contaminants during a subsequent penetrant inspection. Developer residues on the part surface will retain penetrant causing a high residual background that can obscure valid indications. When retained in crevices, joints or faying surfaces, developer residues will cause false indications. Developer residues also absorb and retain moisture and, if not dried, may cause corrosion of the part. Penetrant residues, if not removed from discontinuities, will dry forming a varnish-like material in the flaw. This entrapped residue may not fluoresce and will reduce or prohibit entry of penetrant during future tests of the part.

2.2.9.2.7.2 **Visible-Dye Penetrant Contamination.**

CAUTION

DOD prohibits the use of Type II, visible-dye penetrant on aircraft, engine, and missile parts. Visible-dye penetrants SHALL NOT be used without specific engineering approval.

The red dye in visible-dye penetrant acts as a filter to UV-A radiation. When red dye residues mix with fluorescent penetrant in a discontinuity, the fluorescent brightness can be reduced or destroyed. Visible-dye penetrant SHALL NOT be used if the part may be inspected with fluorescent penetrant at some future time. If a part has been previously inspected with visible penetrant and requires re-inspection, the re-inspection should be performed using visible-dye penetrant. If fluorescent penetrant inspection is required to achieve the required sensitivity, special cleaning processes SHALL be used to ensure removal of all visible penetrant residues from previous inspections.

2.2.9.3 Cleaning Methods for Contamination/Soil Removal.

2.2.9.3.1 Alkaline Cleaning.

CAUTION

- Some alkaline cleaning compounds will attack aluminum parts and components. Care SHALL be used in selecting the proper cleaning process for the materials to be cleaned. Traces of cleaner alkali remaining on test components after rinsing are objectionable because they might cause dermatitis or other health hazards or interfere with the action of liquid penetrants during the penetrant inspection operation.
- Aqueous cleaners containing silicates SHALL NOT be used before penetrant inspection. Cleaners with high silicate content can leave silicate residues in discontinuities blocking the penetrant from entering.

Alkaline cleaners are water solutions of chemicals, which remove soils by a chemical action such as saponifying (converting chemicals into soap) or displacement rather than dissolving the soils. Cleaners of this type usually have components to aid in lifting the soils from the part surface. After displacement, the soil may be carried as a suspension in the cleaner, it may separate, or in the case of fatty soils, react with the cleaner to form water-soluble soaps. Alkaline cleaning is usually accomplished in immersion tanks with the solution at or near its boiling point. The cleaning action is expedited by agitation. The four variables that affect the performance of an alkaline cleaning process are immersion time, agitation aggressiveness, solution concentration, and solution temperature. The cleaning process is more effective when each of these factors are increased. Following alkaline cleaning, parts and components must be thoroughly rinsed to remove any traces of the cleaning compound prior to penetrant inspection.

2.2.9.3.2 Steam Cleaning.

CAUTION

- Due to the risk of changes to material properties due to elevated temperature exposure, the Aircraft Corrosion Control Manual (NAVAIR 01-1A-509/T.O. 1-1-691/TM 1-1500-344-23) restricts the use of steam cleaning.
- Steam cleaning is a form of alkaline or detergent cleaning. Diluted solutions of alkaline cleaners, detergent cleaners, or mixtures of both are injected into a live steam spray. The steam/cleaner mixture is under pressure and the jet is directed at the part surface by a spray wand. Steam cleaning provides both chemical and strong mechanical action at elevated temperatures. Mobile steam generators permit application on parts and structures that cannot be brought into the cleaning shop.
- Steam cleaning SHALL NOT be used on aircraft and missile components unless specifically authorized. Elevated temperature exposure can result in changes to material properties, in addition steam cleaning can cause damage to composite structures, sealant, acrylic windows, and electrical wiring. Steam cleaning erodes paint, crazes plastic, debonds adhesives, damages electrical insulation, and drives lubricants out of bearings.

T.O. 33B-1-1**2.2.9.3.3 Detergent Cleaning.****CAUTION**

Detergent cleaners may be alkaline, acidic, or neutral but SHALL be non-corrosive to the material being inspected.

Detergent cleaners are water-based chemicals called surfactants, which surround and attach themselves to particles of surface soil. Solution agitation, pressure spray, or hand wiping then washes the particles of soil and detergent away. The action is identical to hydrophilic removers in the penetrant process. The cleaning properties of detergent solutions facilitate complete removal of light soils from the part surface, preparing it for penetrant inspection.

2.2.9.3.4 Emulsion Cleaning. Emulsion cleaners consist of an organic solvent and a detergent in a water-based solution. The organic solvent may be a petroleum-based liquid. The soils are removed through a combination of solvent and detergent action. The cleaner is lightly alkaline and is usually sprayed on the part. Emulsion cleaning may leave a light oil film (solvent residue) on the part surface; therefore, emulsion cleaned parts SHALL be hot water rinsed or wiped with a solvent to remove the oily residue prior to penetrant inspection.

2.2.9.3.5 Solvent Cleaning. Solvent cleaning removes soils by dissolving them. Solvents can be used on oils, greases, waxes, sealants, paints, and general organic matter. The resulting solution may leave a thin film or residue of an oily nature. This oily film must be removed with another solvent, vapor degreasing, alkaline, or detergent cleaning prior to penetrant inspection. Solvent cleaning may be accomplished by tank immersion, but more often applied by spraying or hand wiping when alkaline, detergent, or vapor degreasing is impractical.

2.2.9.3.6 Vapor Degreasing.**CAUTION**

- Methyl chloroform (1.1.1-trichloroethane), formerly the most commonly used solvent in vapor degreasers, is no longer available or permitted for use by government facilities because of its detrimental effect on the ozone layer.
- Titanium alloys must not be placed in a vapor degreaser or exposed to halogenated solvents. Halogenated solvents are those containing chlorine, fluorine, or other halogens.

In vapor degreasing the hot vapors of a volatile solvent are used to remove oils, greases, and waxes from metallic test objects in preparation for liquid penetrant testing. A steel tank fitted with a heater, solvent reservoir, condensing coil, and removable cover is used to heat the solvent to boiling, generating a vapor zone above the solvent. The vapor condenses on the relatively cool metal surface of parts placed in the vapor zone. The condensed solvent dissolves the organic contaminants on the part. Contaminated solvent condensation then drips back into the tank reservoir, carrying the contaminants into the bath. During evaporation only clean solvents are produced so the test parts are exposed to only clean soil-free solvent. Vapor degreasing is particularly suitable for removal of soluble organic contaminants, such as mineral oils, and greases. Vapor degreasing is not effective for removal of solid contaminants (carbon, varnish, paints, scale, corrosion products, or oxides). In some cases, restrictions are placed on vapor degreasing of chloride sensitive metals and alloys with halogenated degreasing solvents.

2.2.9.3.7 Ultrasonic Cleaning. This method utilizes ultrasonic agitation within a solvent detergent solution to accelerate the cleaning process. The agitation is the result of cavitations of the liquid when subjected to the high and low pressure (partial vacuum) of the ultrasonic waves. The formation and collapse of the cavities in the liquid provides a scrubbing action to the surface of the part. The agitation increases action of the cleaning solution and decreases cleaning time. Ultrasonic cleaning is particularly effective in removing contaminants trapped in discontinuities; however, its effectiveness is dependent upon the cleaning medium. It should be used with water and detergent on inorganic soils, e.g., rust, dirt, salts, and corrosion products. It should be used with an aromatic or halogenated solvent if the soil to be removed is organic, such as oil or grease. Ultrasonic cleaning has limitations, which affects its efficiency, part size, configuration, and the effectiveness of the cleaning solution for the type of soil to be removed.

2.2.9.3.8 Salt Bath Descaling and Deoxidizing. Molten salt baths are used for removing heavy, tightly held scale, and oxide from low alloy steels, nickel, and cobalt base alloys, and some types of stainless steel. Salt baths cannot be used on aluminum, magnesium, or titanium alloys. The process involves immersing the parts in molten caustic soda at about 700°F (370°C). The difference in thermal expansion between scale and base metal separates some scale and causes the remainder to crack. The molten caustic soda also chemically reacts with the scale, reducing it to lesser oxides and metals. When the part is removed from the molten salt, it is plunged into water creating a thermal shock. Various amounts of scale can be blasted off as steam at the part surface, scours remaining scale from the part. Following quenching, the parts are rinsed in clean water.

2.2.9.3.9 Acid Cleaning.

CAUTION

Acid cleaning requires very careful control of procedures and solutions to prevent damage to the parts. Acid cleaning SHALL BE conducted ONLY by properly trained/qualified personnel.

Solutions of acids or their salts are often used to remove rust, scale, corrosion products, and dry shop soils. The type of acid and its concentration depends on the part material and contaminant to be removed. Acid cleaners are not generally effective on oily soils. Oils and greases must first be removed by some other cleaning method so the acid can react with the scale, oxides, or other tightly held soil.

2.2.10 Coatings.

NOTE

- Penetrant inspection SHALL NOT be performed on painted components or on parts contaminated with fuel sealant unless these coatings and their residues are completely removed.
- Penetrant inspection SHALL NOT be performed on ion vapor deposition (IVD) coated components, or on chrome, cadmium plated, or high velocity oxi-fuel coated components unless specifically authorized by technical directive. Penetrant inspection SHALL NOT be performed on IVD coated components that have been abrasively blasted.
- Removal of conversion coatings such as alodine and anodize is not required prior to penetrant inspection provided the coatings do not result in excessive penetrant background that would interfere with the inspection. If the presence of conversion coatings results in excessive penetrant background they SHALL be removed prior to penetrant inspection.

Surface coatings (e.g., paint, anodize, ion vapor deposition (IVD) coatings, chrome plating, high velocity oxi-fuel (HVOF) coatings, etc.), are not foreign soils since they are intentionally applied to the part surface to provide corrosion or wear protection. However, they can have several adverse effects on the penetrant inspection process. Many of the coatings such as paint, fuel sealant, and IVD coatings are elastic or are more ductile than the substrate and may not form openings when the base metal cracks from service stress. When this occurs, the surface opening is bridged or covered, preventing penetrant entry. On aluminum components with IVD aluminum coating, inspection with eddy current is recommended to supplement penetrant inspection in critical locations. IVD aluminum coatings are pure aluminum, are more ductile (deforms more easily) than the aluminum alloy substrate, and may conceal tight fatigue cracks from detection by penetrant. In addition, abrasive blasting (even relatively gentle PMB) of an IVD coated surface peens the soft aluminum surface to the extent that commonly used pre-penetrant chemical etching processes are insufficient to open cracks. Hard coatings such as chrome plating, HVOF coatings may often crack before the substrate due to contact wear or coating damage. Damage or cracking of these hard surface coatings can result in excessive non-relevant indications or may interfere with proper interpretation of relevant indications. Some hard anodize coatings and paint (especially when oxidized or weather checked) can retain penetrant during removal causing high residual background or false indications. Chrome, HVOF, IVD, anodize, and alodine coatings require specialized electro-chemical or mechanical removal methods and will not be discussed further in this document. Consult the responsible engineering authority for removal of these surface treatments. Typical methods for removal of paint, primer, and fuel sealant are discussed in the following paragraphs.

T.O. 33B-1-1

2.2.10.1 Coating Removal Methods. There are a large variety of paint coatings, primers, fuel sealant, and finish systems in use on aircraft parts and surfaces. Some conventional coatings are readily removed using standard methods, however, advances in technology have resulted in finishes that can only be removed with unique materials and techniques. There are three general types of coating removal methods: (1) chemical, (2) mechanical, and (3) burning or ignition. Critical structures cannot tolerate the use of products that may be damaging to their metals or alloys. This requires careful attention when using abrasive techniques or chemical methods which may remove, etch, or embrittle the substrate.

2.2.10.1.1 Chemical Paint Stripping.**WARNING**

When solvent removal techniques are used, it is essential to remove traces or residues of the solvents and other contamination using cleaning techniques discussed previously.

CAUTION

Paint strippers often contain toxic materials. Furthermore, only properly trained personnel SHALL accomplish surface preparation processes due to the various and potentially catastrophic effects various chemical paint strippers may have on different materials. This training SHALL be documented in personnel training records. NDI personnel are neither trained, nor experienced in performing paint stripping or cleaning.

NOTE

Many paint removal operations leave a thin film of dissolved or softened paint and remover chemicals on the part surface or in discontinuities. This often occurs when local or spot paint removal is performed. Care must be taken to ensure the area to be inspected is free of paint and remover residues since they interfere with the penetrant inspection process.

Chemical stripping is the preferred method for paint removal prior to penetrant inspection as it will not result in mechanical deformation of the substrate surface and if controlled properly, will result in a very clean surface. Various chemical paint strippers are available for both dip tank and in-place applications. There are two basic chemical paint stripping methods, solvent strippers and alkaline/acid strippers. The primary factors that influence the ease of paint removal include: (1) surface preparation before painting, (2) type of paint primer, (3) type of paint used, (4) number of paint coats, (5) age or cure of the paint finish, (6) type of paint removers used, and (7) nature of the substrate.

2.2.10.1.2 Mechanical Removal. Mechanical working removes soils and contaminates by physical action. This physical action may also remove or deform the part surface. Mechanical removal methods can be divided into two general categories: (1) abrasive blast, and (2) grinding/sanding/brushing.

2.2.10.1.2.1 Abrasive Blast. Abrasive blast media used to remove paint coatings include, but are not limited to, materials such as plastic media, glass bead, dry ice, and alumina grit. Plastic Media Blast (PMB) is currently the preferred process for paint removal on aluminum and magnesium components due, largely, to its relatively minimal peening effect on the part surface. However, even though PMB has less effect on the surface than most other materials, it has been shown to cause enough surface deformation of aluminum and magnesium to cause crack closure and prevent fluorescent penetrant entry. In addition to closing cracks by the peening effect of the particles hitting the surface, abrasive blast may also clog cracks with residues of the abrasive media preventing effective penetrant inspection. Blasting must be used only with careful process controls, and must be limited to the minimum time necessary to strip the primer, paint, and sealants. Glass bead and alumina grit blast are considerably more aggressive processes and should only be used when specific engineering directive authorizes their use. If alumina grit blast is used, the grit material SHALL NOT be courser than 100-grit, unless specifically authorized by engineering authority.

2.2.10.1.2.2 Grinding, Sanding, Brushing.

CAUTION

Power tools SHALL NOT be used for cleaning except when specific technical directives authorizes such use and should not be used if another cleaning method will work. The use of power tools such as rotary discs or wheels SHALL be followed with chemical etch prior to penetrant inspection. Steel wire brushes SHALL NOT be used on nonferrous alloys.

NOTE

If any form of abrasive blasting, including PMB, has been applied to the surface of the part, since the part was last in service, etching SHOULD be performed to reopen cracks prior to penetrant inspection.

Grinding, sanding, and brushing are typical mechanical methods used for localized removal of coatings such as paint and fuel sealant. These methods include the use of high-speed abrasive wheels, wire brushes, sand paper, emery cloth, and abrasive polishing pads. Aggressive mechanical removal methods such as grinding and wire brushing and power sanding can cause crack closure due to surface metal disturbance or obstruction of the crack opening due to entrapped grit and SHALL NOT be performed prior to penetrant inspection unless specifically authorized by engineering authority. Small areas may be cleaned by fine-grit hand sanding without generating a requirement for etching. Abrasives for the final sanding SHALL NOT be coarser than 320-grit to prevent scratches that could initiate cracks.

2.2.10.1.2.3 Etching After Abrasive Blast, Grinding, or Course Sanding. When accomplishing penetrant inspections, the preferred finish removal method is chemical. If the finish must be removed by mechanical means, an acid etch is recommended prior to penetrant inspection. Etching following mechanical removal is not standard practice in the Air Force. Failure to acid etch following mechanical removal of surface coating prior to penetrant inspection may degrade inspection sensitivity. Where a chemical cleaning process is specified and a mechanical process is used in its place, contact the appropriate engineering authority for guidance to determine if etching is required. For repair specific and inspection technical data that call out mechanical removal and do not specify etching, it is assumed engineering has determined etching is not required. Navy personnel SHALL perform acid etching prior to penetrant inspection on aluminum and magnesium test parts when mechanical paint removal methods (including abrasive blasting), have been employed prior to penetrant inspection. Contact Navy engineering offices for guidance.

2.2.10.1.3 Burning/Ignition.

WARNING

Ignition or burning off of paint and primer SHALL NOT be used on aircraft components.

Many paint and elastomer coatings are easily removed or burned off by the application of high heat or flame. However, burning and ignition techniques are difficult to control and may result in damage to the substrate materials as a result of high temperature exposure. Removal of coatings by burning techniques is prohibited on aircraft components.

2.2.11 Effects of Surface Deformation, Wear, and Surface Roughness on Penetrant Inspection.

2.2.11.1 Surface Deformation and Wear.

T.O. 33B-1-1**CAUTION**

- Surface deformation as a result of machining, grinding, wear, or shot-peening may reduce the surface opening of small discontinuities thus, reduce the effectiveness of the penetrant inspection process. Chemical etching may be necessary prior to penetrant inspection. Etching **SHALL NOT** be performed on shot-peened components unless specifically authorized by engineering authority.
- Severe mechanical working processes such as abusive machining, grinding, and shot peening can completely close the surface openings of large discontinuities and prevent the formation of penetrant indications. Penetrant inspection **SHALL** be accomplished prior to shot peening or other mechanical work processes that severely displace surface metal. If it is not feasible to perform penetrant inspection prior to these processes and pre-penetrant etch is not permitted, then another inspection method **SHALL** be considered. An exception to this requirement is when penetrant inspection is performed to detect discontinuities formed by mechanical working, such as machining tears or grinding cracks.

NOTE

If a conflict arises pertaining to the proper inspection method to use following mechanical working, the appropriate engineering activity **SHALL** be contacted for final determination.

Surface material deformation usually takes the form of metal flow or metal displacement. The amount of deformation depends on the type and severity of the working plus the ductility of the part. Deformation is typically a thin layer, surface metal flow that seals or reduces the opening of discontinuities. The smeared metal over the surface opening prevents or severely restricts the penetrant entry into any discontinuities. There are a number of mechanical processes that may deform the surface of a part. These processes include but are not limited to, machining, grinding, shot-peening, and surface wear. Forms of surface wear include fretting and galling. Mechanical polishing and/or etching is often required prior to penetrant inspection to remove disturbed material and re-expose defect opening to the surface. Polishing and etching **SHALL NOT** be performed on shot-peened surfaces unless specifically authorized by the appropriate engineering authority.

2.2.11.2 Surface Roughness. Parts with excessive surface roughness present a unique challenge to penetrant inspection. Rough surface hinders the removal of excess surface penetrant resulting in high residual background and poor defect detectability. Surface polishing and subsequent etching may be required to reduce surface roughness prior to penetrant inspection.

2.2.11.3 Chemical Etching for Removal of Disturbed Surface Metal.

CAUTION

Chemical etching **SHALL** be performed by highly trained personnel and only with specific engineering approval and written detailed process and application instructions. NDI personnel are not properly trained to perform chemical etching.

Chemical removal or etching of deformed or disturbed surface metal is necessary if flaws are to be detected by penetrant inspection. Etching is performed using a mixture of appropriate acids or alkalis plus inhibitors. The type of etching solution depends on the part material and condition. Chemical etching requires very close control of the etching solution composition, process procedures, and time of contact. Minor deviations in processing parameters will result in a number of adverse effects, such as:

- Excessive metal removal.
- Selective etching of critical surfaces.
- An increase in susceptibility to stress corrosion.
- Reduction of residual surface stress (shot peened surfaces) and a corresponding reduction in fatigue life.

SECTION III LIQUID PENETRANT INSPECTION EQUIPMENT

2.3 EQUIPMENT.

2.3.1 General. The equipment used in the penetrant inspection process varies from aerosol spray cans to complex automated systems. Some of the more generally used types of equipment are briefly described in the following paragraphs.

2.3.2 Portable Equipment. Portable penetrant inspection kits are for penetrant inspection of parts too large to be brought into the inspection lab, or for laboratories which process only a minimum number of parts requiring penetrant inspection. Penetrant materials are in small lightweight kits that can be easily transported to any location. Such kits are available for both visible and fluorescent penetrant processes and usually contain aerosol spray cans of penetrant, solvent remover, and developer. Penetrants may also be provided in small containers with a brush for penetrant application. Generally, portable penetrant applications are limited to localized area or spot inspections rather than entire part surfaces.

2.3.3 Stationary Inspection Equipment - General Purpose. The type of equipment most frequently used in fixed installations consists of a series of modular workstations. At each station an inspector performs a specific task. The number of stations in a processing line varies with the type of penetrant method used. A penetrant line will typically have the following stations:

- Penetrant dip tank.
- Emulsifier/remover (Methods “B” and “D”) dip tank. (This station is not applicable for Method “A”. Method “D” systems SHOULD include a rinse station prior to the remover tank.)
- Rinse station with black light.
- Developer tank (if liquid is used).
- Drying oven.
- Developer tank (if dry-powder is used).
- Inspection booth with black light.

2.3.3.1 Drain and dwell stations may be placed between each primary station depending on the method and equipment configuration use.

2.3.4 Small Parts Inspection Systems. There are inspection systems designed specifically for processing small parts. These units are smaller than the general systems described in (paragraph 2.3.3) above, and some of the stations serve multiple purposes. In use, the parts are loaded into wire baskets, then batch processed through each of the stations. The wash station may contain a water-driven, rotary table with spray jets to supplement the hand-held spray wand.

2.3.5 Automated Inspection Systems. The penetrant inspection process can be adapted for use with fully and semi-automated processing equipment. Semi-automated systems consist of a conveyor belt or table for moving the parts through one or more of the processing steps. Applications of penetrant, emulsifier or remover, rinse, or developer are manually performed. In fully automated systems, all of the processing steps are mechanically performed without an operator. Automated equipment allows large numbers of parts to be rapidly processed with a minimum of personnel and time. Automated equipment also provides a more uniform, though not necessarily more sensitive, testing process.

2.3.6 Inspection Lamps.

2.3.6.1 Inspection Lamp Sources. Fluorescent materials used in nondestructive testing generally respond most actively to radiant energy with a wavelength of about 365 nm. This wavelength represents near ultraviolet or UV-A radiation, light just outside the visible range on the blue or violet side, but not sufficiently far removed to be in the ultraviolet range. Because it is invisible, radiation at this frequency is commonly referred to as black light. Common sources of near UV-A radiation include:

- Incandescent lamps.
- Metallic or carbon arcs.
- Integrally filtered tubular fluorescent lamps.
- Tubular fluorescent lamps.
- Enclosed mercury vapor arc lamps.
- Metal halide or halogen lamps.

T.O. 33B-1-1

2.3.6.1.1 Incandescent and Carbon Arc Systems. Electric current heating a tungsten element to incandescence is the most familiar visible light bulb familiar to everyone. The wavelength of the associated electromagnetic radiation is generally in the visible and infrared range. It is characterized by large amounts of heat (infrared) and visible light. Electric current arcing between two carbon electrodes generates a high quantity of electromagnetic radiation in the carbon arc lamp. The radiation spans a range of wavelengths from about 10 nanometers to over 10 micrometers. This covers the entire ultraviolet and visible light ranges and a portion of the infrared range; however, little if any useful ultraviolet radiation is produced. In addition, the lamps require a high electrical power supply and are very bulky or large due to the need for electrode drive mechanisms. Incandescent and carbon arc systems are not used for fluorescent penetrant inspection.

NOTE

Incandescent carbon arc lamps SHALL NOT be used for penetrant inspection.

2.3.6.1.2 Low Pressure Fluorescent “BL” Bulbs.**NOTE**

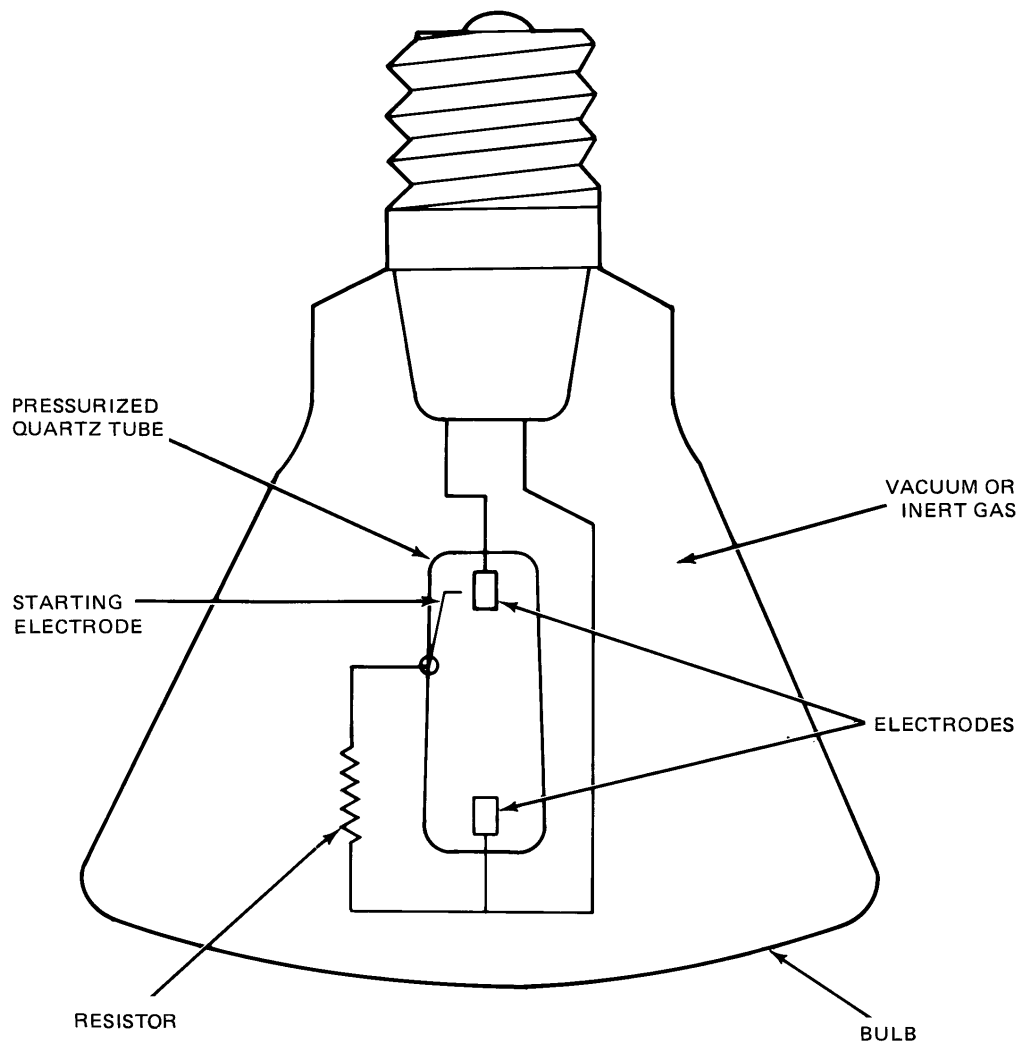
Fluorescent “BL” black lights SHALL NOT be used for detecting fluorescent indications.

Low pressure, fluorescent bulbs are similar to standard fluorescent tubes, however, instead of an inert gas, the tube contains metallic mercury. When an electric current is applied, the mercury vaporizes and emits hard (deeply penetrating) ultraviolet radiation with a wavelength of approximately 254 nm. This wavelength is not useful for fluorescent penetrant inspection. Therefore, the inside of the tube is coated with a phosphor activated by the hard ultraviolet and emits black and visible light in the wavelength range of 320 to 440 nm. The amount of useful black light at 365 nm is relatively small; however, there is a large amount of both harmful short wavelength black light, (below 320 nm) and visible light, (above 400 nm) emitted through the phosphor. Some of these undesirable wavelengths are removed by the use of filters. While this reduces the unwanted radiation, it also reduces the already low amount of useful black light in the range of 365 nm. In addition, fluorescent black light bulbs, because of their configuration, cannot be easily focused and their intensity per unit area is below other types of bulbs. Most fluorescent bulbs will not produce an output sufficient to meet the minimum black light intensity requirements (paragraph 2.5.4.1.3), also required by ASTM E 1417.

2.3.6.1.3 Mercury Vapor Bulbs.**NOTE**

Bulbs, less than 100-watts, SHALL NOT be used for penetrant inspection unless specifically authorized.

High pressure, mercury vapor bulbs are the most common sources for black light. They are also recommended for fluorescent penetrant inspection because they have an acceptable output at a reasonable distance from the bulb. They can be focused to increase their intensity over a localized area. They are available in a wide range of sizes from a 2-watt pencil type to a 400-watt floodlight. The most frequently used size is the 100-watt bulb mounted in a variety of fixtures or housings and fairly portable. A cross-section of a typical mercury vapor, arc discharge bulb is shown in (Figure 2-9).



H0400327

Figure 2-9. Cross-Section of a Typical High-Pressure Mercury Vapor Arc Bulb

2.3.6.1.3.1 Warm-Up Requirements for Mercury Vapor Bulbs.

NOTE

Black lights **SHALL NOT** be used for inspection before the required intensity at the inspection surface (paragraph 2.5.4.1.3) is achieved.

The high-pressure component is a quartz tube containing some mercury plus a small amount of neon gas. When the lamp is first turned on, the mercury is condensed as a liquid and an arc between the electrodes cannot be generated, this is the reason for the neon gas. A small amount of current, limited by the resistor, causes a discharge from the starting electrode through the neon gas. This glow is sufficient to vaporize the mercury, which then allows the arc to pass between the main electrodes. This starting procedure requires from 5 to 15-minutes to fully vaporize the mercury and produce full output of black light. Some UV-A lamps may be warmed-up in 2-3 minutes, refer to the owner's manual of the light you are using.

T.O. 33B-1-1**2.3.6.1.4 Gas Discharge Lamps.****WARNING**

Due to the potential for exposure to high intensity ultraviolet light, use of UV filtering safety glasses, goggles, or faceshields is required. Since highly focused black light provided by some spot light configurations might result in eye injury if exposed for more than a few seconds, only flood reflector equipped gas discharge lamps SHALL be used. Skin exposure SHALL also be avoided. Precautions SHALL be taken to cover exposed skin that is routinely exposed to the direct beam of any black light.

Gas discharge lamps are a relative newcomer to nondestructive inspection as high intensity sources for black-light (ultraviolet) illumination. Gas discharge lamps have many advantages over Mercury Vapor Arc lamps. These include very short warm-up times (10-15 seconds), lightweight, very little heat generation, and produce as much as 45 times greater ultraviolet output than most common lamps available. Because of the potential hazards associated with the high ultraviolet output of gas discharge lamps, the following restrictions SHALL be enforced:

- Spot focused reflectors or lens SHALL NOT be used.
- Ultraviolet filtering safety eyewear SHALL be worn.
- Precautions SHALL be taken to cover exposed skin that is routinely exposed to the direct beam of any black light.

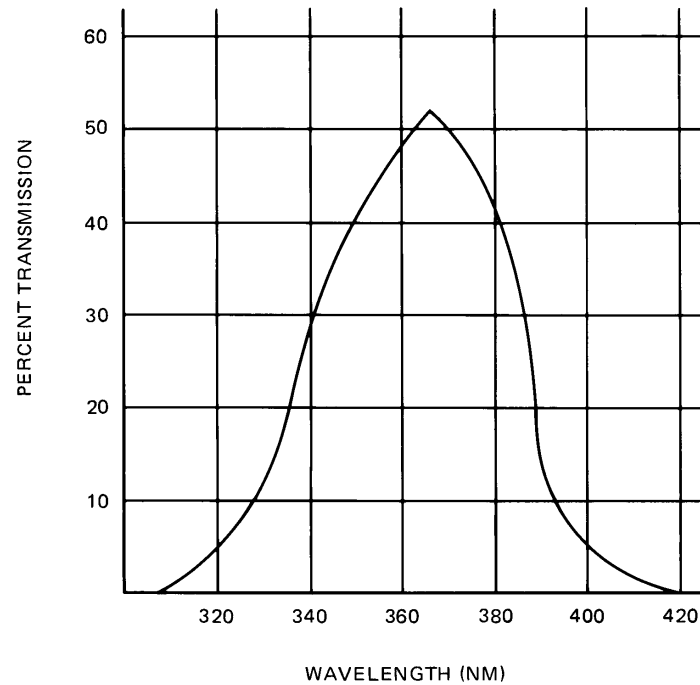
2.3.6.2 Inspection Lamp (UV-A Black Light) Fixtures.**CAUTION**

Black light bulbs SHALL NOT be operated without filters. Cracked, chipped, or ill-fitting filters SHALL be replaced before using the lamp. High intensity “super” black lights that use bulbs with integral filters SHALL have a splashguard attached to the front of the lamp housing to prevent accidental implosion of the bulb.

A high pressure, mercury vapor, black light bulb requires a housing, filter, regulating ballast or transformer, and connecting cables or wires. The housing, which may be metal or plastic, serves several functions:

- Hold and protect the bulb.
- Hold and support the filter.
- Prevent leakage of unwanted visible light.
- Permit directing the beam on the surface to be inspected.
- Provide a means for handling the bulb.

2.3.6.3 Inspection Lamp (UV-A Black Light) Filters. The filter is a special material that prevents the passage of short wavelength ultraviolet and long wavelength visible light. The filter transmits ultraviolet between 320 nm and 400 nm. This wavelength causes maximum fluorescence of the penetrant dyes. Black lights used for penetrant inspection SHALL have a peak wavelength between 340 and 380 nm. The transmission characteristics of Kopp 41 filter glass is shown ([Figure 2-10](#)). Filters for penetrant inspection can be either a smooth or fluted surface. The fluted surface provides a slightly larger focused spot than a smooth surface filter.



H0400328

Figure 2-10. Transmission Curve for Kopp 41 Glass

2.3.7 Process Control Equipment. The performance of liquid penetrant inspection systems depends on the processing material quality of pre-cleaning chemicals, liquid penetrant, emulsifier, developer, and the continued proper functioning of the several processing stages. A sudden undetected deterioration of one of these processing stages may result in missing an indication. To learn more about the equipment used to monitor the penetrant process, (paragraph 2.6.7).

2.3.7.1 Black Light Performance Requirements.

2.3.7.1.1 New Black Light and Bulb Performance Requirements. New black light and replacement bulbs SHALL produce a minimum of 1000 micro-watt/cm² of UV-A radiation over a 3-inch diameter circle as measured by a UV-A light meter placed at a distance of 15 inches from the lamp filter. Battery powered black light performance shall exhibit this minimum performance during the entire battery life. White light output SHALL NOT exceed 2 ft-candles as measured with a white-light meter at a distance of 15-inches from the lamp filter. Black lights and/or bulbs not meeting the above requirements SHALL NOT be procured for general use. The requiring activity may waive the minimum beam diameter requirements for special purpose lights.

2.3.7.1.2 In-Service Black Light Performance Requirements. To be acceptable for continued inspection use, a used black light must produce a minimum of 1000 micro-watts/cm² UV-A radiation at the point of highest intensity and a minimum of 500 micro-watts/cm² over a 3-inch diameter circle as measured by a UV-A light meter placed at a distance of 15 inches from the lamp filter. White light output SHALL NOT exceed 2 ft-candles as measured with a white-light meter at a distance of 15-inches from the lamp filter. Lights which do not meet this requirement even with new bulbs shall be disposed of.

T.O. 33B-1-1

SECTION IV LIQUID PENETRANT APPLICATION METHODS

2.4 APPLICATION METHOD.

2.4.1 General. This section provides basic, intermediate, and detailed information on the specific processes relative to the performance of penetrant inspection. Functions not specifically performed by NDI personnel, such as general cleaning, are not covered under this section.

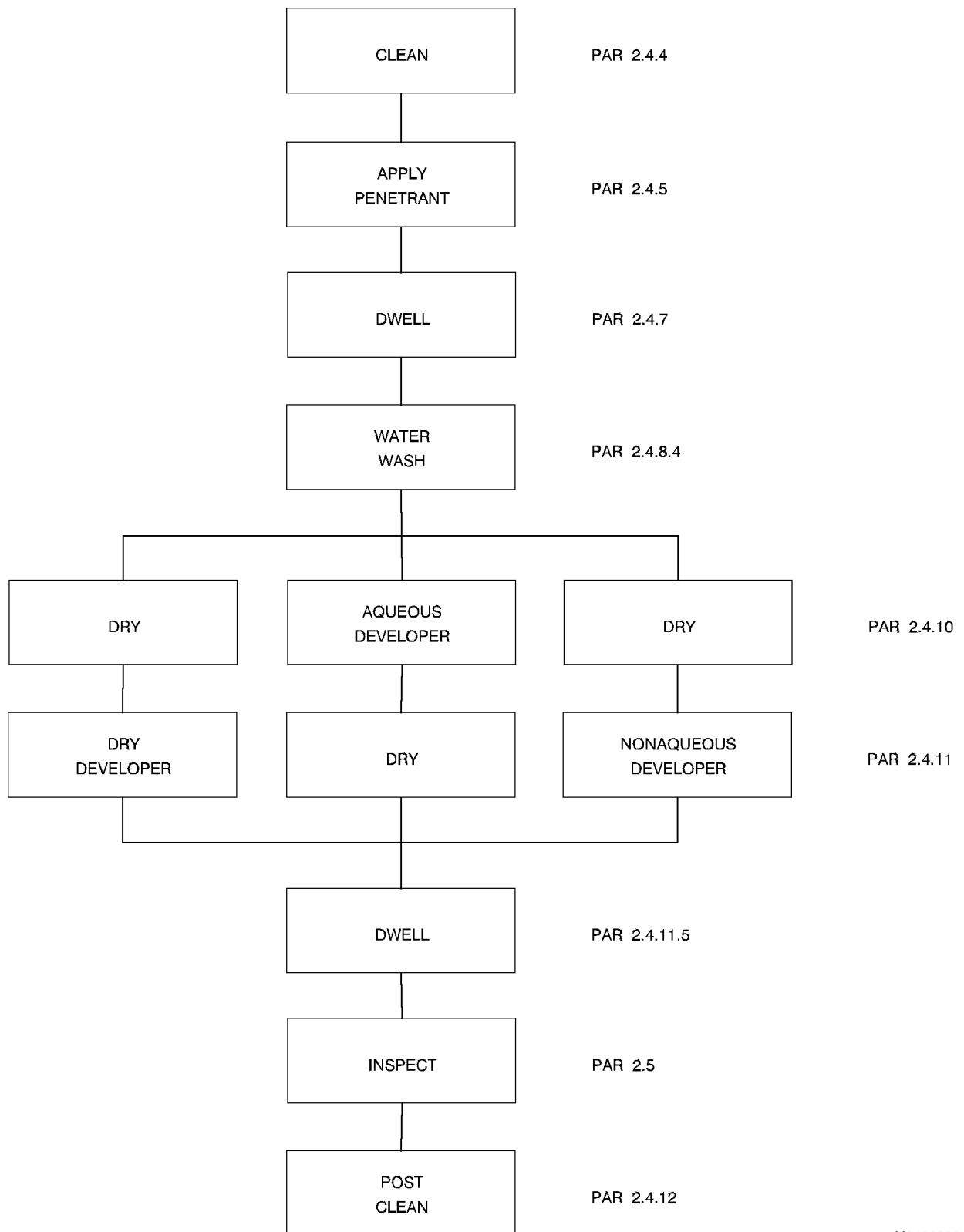
2.4.2 Basic Penetrant Processes. Abridged penetrant process flow charts illustrating the general process steps for the four penetrant methods are provided in (Figure 2-11 through Figure 2-14). Detailed descriptions of application procedures are contained in later sections and paragraphs. The process flow charts contain reference locations for the detailed information. Since the application procedures for fluorescent (Type I) and visible-dye (Type II) penetrants are similar, the process flow charts are applicable to both types of penetrants.

NOTE

Specific inspection procedures SHALL be developed and SHOULD be approved by an NDI Level III.

2.4.2.1 Basic Inspection Steps. The basic fundamentals of the penetrant process have not changed from the oil-and-whiting days. The following provides a simplified description of the fundamental penetrant process steps. More explicit process details are discussed in subsequent sections (Figure 2-1) for an illustration of the basic principles of the penetrant inspection process.

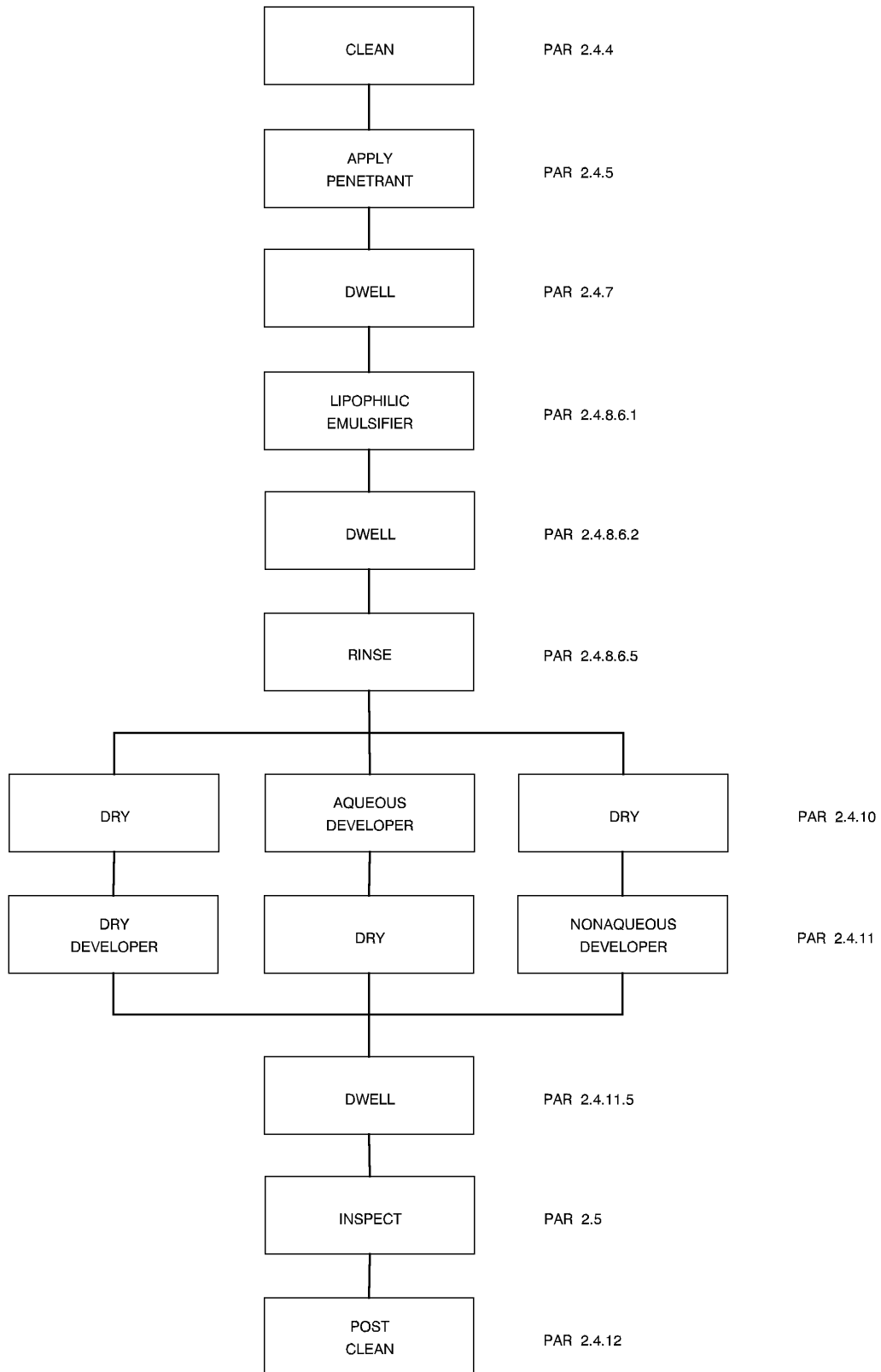
- a. Cleaning is performed to remove residues and soils from the part surface. Cleaning is a critical part of the penetrant process and is emphasized because of its effect on the inspection results. Contaminants, soils, or moisture, either inside the flaw or on the part surface at the flaw opening, can reduce the effectiveness of the inspection. For a complete discussion on the precleaning process (paragraph 2.4.4).
- b. After cleaning is complete and the part is thoroughly dry, a penetrating liquid containing dye is applied to the surface of a clean part to be inspected. The penetrant is allowed to remain on the part surface for a period of time to allow it to enter and fill any surface breaking openings or discontinuities. For a complete discussion of the penetrant application and dwell process (paragraph 2.4.5 and paragraph 2.4.7).
- c. After a suitable dwell period, the penetrant is removed from the part surface. Care SHALL be exercised to prevent removal of penetrant contained in discontinuities. For a complete discussion on the penetrant removal process (paragraph 2.4.8).
- d. A material called a developer is then applied. The developer aids in drawing any trapped penetrant from discontinuities and improves the visibility of indications. For a complete discussion on the development process (paragraph 2.4.11).
- e. Following developer application the next step is a visual examination under appropriate lighting conditions to identify relevant indications. For a complete discussion on the examination/interpretation process (paragraph 2.5).
- f. The final step is a post-cleaning of the part. This step is very important as penetrant residues can have several adverse effects on subsequent processing and service. For a complete discussion on the post-cleaning process (paragraph 2.4.12).



H0400329

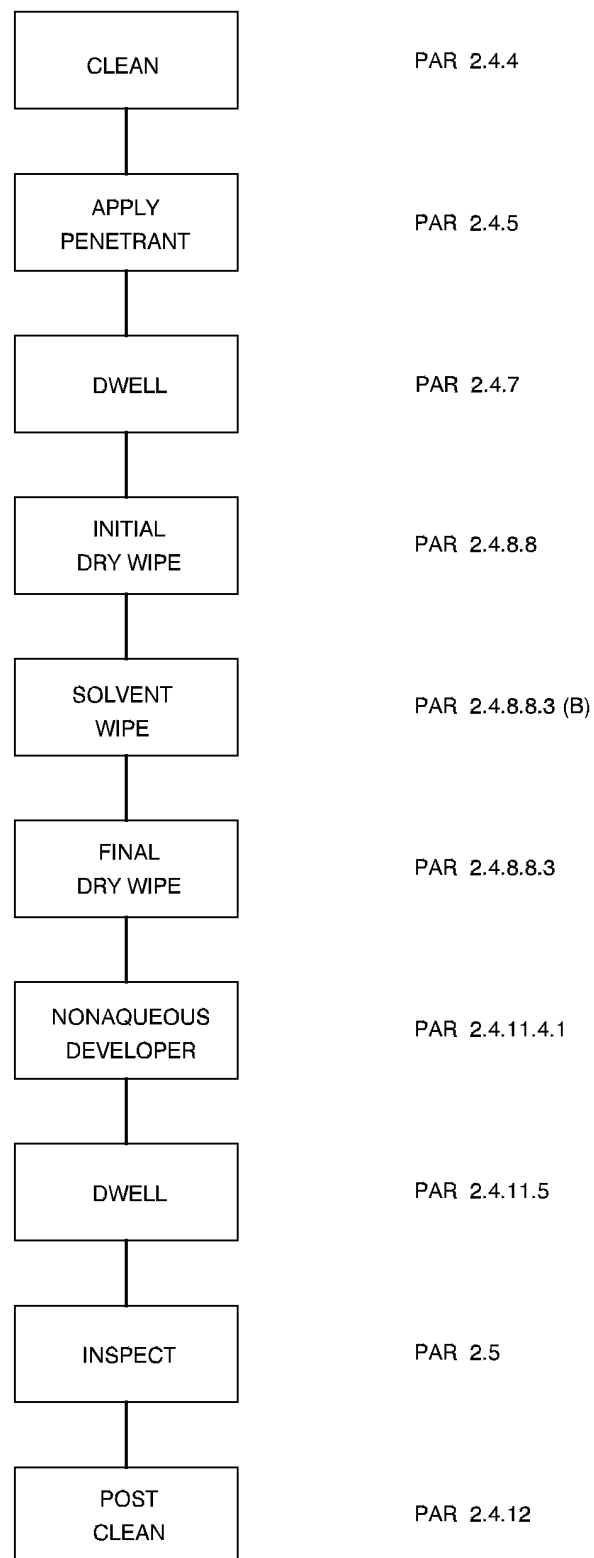
Figure 2-11. Flow Chart for Water Washable Penetrant Process (Method A)

T.O. 33B-1-1



H0400330

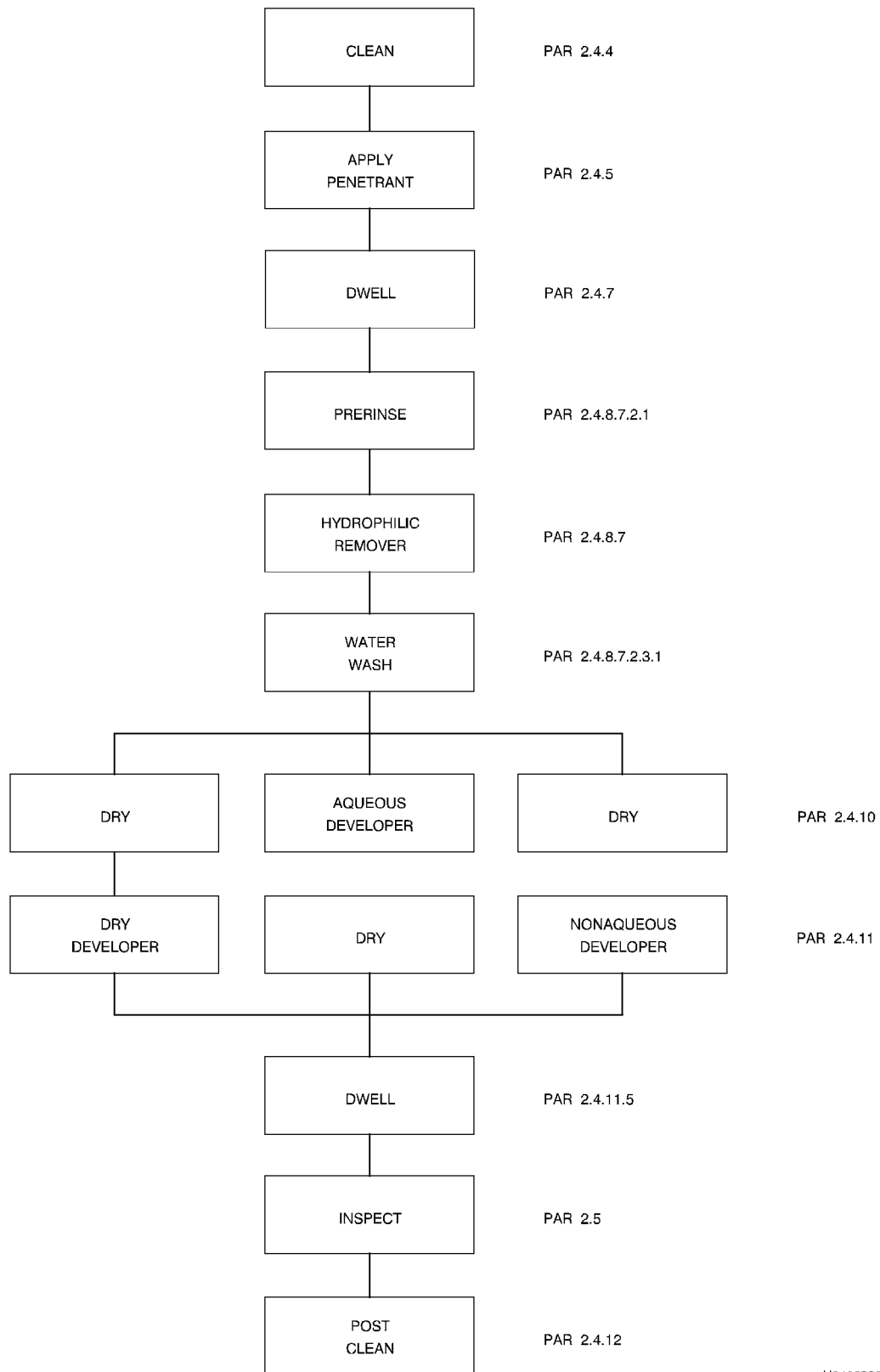
Figure 2-12. Flow Chart For Post-Emulsifiable Lipophilic Penetrant Process (Method B)



H0400331

Figure 2-13. Flow Chart for Solvent Removable Penetrant Process (Method C)

T.O. 33B-1-1



H0400332

Figure 2-14. Flow Chart for Post-Emulsifiable Hydrophilic Penetrant Process (Method D)

2.4.3 Pre-Testing.

NOTE

All nonmetallic parts not previously inspected, and which do not have approved technical or nondestructive inspection procedures SHALL be pre-tested.

Some nonmetallic parts, such as plastics, rubbers, and Plexiglas may react with the oils and solvents contained in penetrant inspection materials. These oils and solvents can cause swelling, softening, distortion, crazing, or other surface effects resulting in damage to the part. The purpose of pre-testing is to ensure parts to be inspected will not be damaged by penetrant materials.

2.4.3.1 Pre-Testing Procedure.

NOTE

Specific inspection guidance SHALL be provided by the agency requiring the inspection. If necessary, the responsible Air Logistic Center (ALC) NDI Manager or responsible engineering authority SHALL be contacted for assistance. Some materials may not show effects until they are subjected to service conditions (aging, cold, heat, moisture).

Pre-testing SHALL be performed as follows:

- a. If spare or extra parts are available, the entire surface to be inspected may be pre-tested. If the part to be inspected must be reused, the pretest SHALL be performed on a small area where possible damage can be tolerated.
- b. The part to be pre-tested SHALL be cleaned and visually examined for evidence of pre-existing damage.
- c. Apply the penetrant to be used to the area selected and allow it to remain on the surface for at least twice the proposed dwell time. Wipe excess penetrant from the area and closely examine for any surface changes.
- d. Repeat step c with the remover and developer to be used, examining the part surface for any evidence of change between each process step.
- e. If any evidence of adverse effects is noted, the penetrant inspection method SHALL not be used.

2.4.4 Pre-Cleaning Performed by NDI Personnel. Pre-cleaning is the surface preparation performed by NDI personnel prior to an inspection. The purpose of pre-cleaning is to remove light soils and contaminants that have accumulated since major cleaning, touch-up critical areas such as bolt threads, and remove residue from other cleaning processes. Parts requiring more extensive cleaning will be sent to the appropriate cleaning shop or corrosion control facility.

2.4.4.1 Pre-Cleaning With Aerosol Spray Solvents.

WARNING

Isopropyl Alcohol and most Class 2 solvent removers are flammable.

CAUTION

With the elimination of the use of 1.1.1 trichloroethane (methyl chloroform), the solvent remover in portable penetrant kits is most likely to be Class 2 (non-halogenated). Only solvent removers listed in QPL-SAE-AMS-2644 SHALL be used for pre-cleaning just prior to penetrant inspection. Technical grade Isopropyl Alcohol (TT-I-735, Grade A) is also acceptable. Significant care must be taken to ensure solvent has completely evaporated before penetrant application.

Most Class 2 solvent removers are hydrocarbon solvents such as aliphatic naphtha. While they are excellent solvents, because of their high boiling point (in excess of 300°F) such Class 2 solvent removers will not rapidly evaporate at room temperature.

T.O. 33B-1-1

Consequently, when used as a pre-cleaner, care SHALL be taken to assure there is no residual solvent remover on the part surface prior to the application of penetrant. This can be accomplished by thoroughly drying the surface with a lint free cloth or rag, dry the part in an oven, or alternatively, use a more volatile solvent such as Isopropyl Alcohol to remove the less volatile solvent remover. Portable penetrant kits contain aerosol spray cans of penetrant, developer, and solvent remover. The solvent remover is used in three ways 1) it serves as a pre-cleaner before penetrant application, 2) it removes the last of the excess penetrant after completion of the penetrant dwell, and 3) it serves as a post-cleaner to remove residual penetrant materials when the inspection has been completed.

2.4.4.2 Method of Applying Spray Solvent as a Pre-Cleaner.**CAUTION**

When used as a pre-cleaner, the solvent remover may be sprayed directly on the test surface. Solvent SHALL NOT be sprayed directly on the surface of parts when removing excess surface penetrant during a penetrant inspection process.

The method of applying spray solvent remover as a pre-cleaner is different than when it is used to remove penetrant following penetrant dwell. As a pre-cleaner, a liberal amount of solvent should be applied and the excess solvent and contaminants wiped from the test surface with a dry, lint free cloth or paper towels. The spray and wiping operation SHALL be repeated until a clean surface is obtained. Following the application of spray solvent, sufficient dwell period SHALL be allowed to permit evaporation of any residual solvent before applying penetrant. A drying oven will accelerate the evaporation process, significantly reducing the dwell time and SHOULD be used whenever possible.

2.4.5 Penetrant Application.

2.4.5.1 General. This section provides basic, intermediate, and advanced information on the methods and procedures used in applying penetrant to components to be inspected. The first portion of the section contains information related to penetrant application methods. The second portion provides information related to the temperature limitations for application. The third portion covers dwell time requirements and considerations.

2.4.5.2 Penetrant Application Methods.**CAUTION**

Care SHALL be taken to avoid trapping air bubbles or pockets during penetrant application to complex shaped parts by immersion. Oil and air passages and blind holes SHALL be plugged prior to penetrant application by immersion. Remove the plugs immediately after the inspection process.

Penetrant can be applied by any of several methods, immersion or dipping, spraying, brushing, swabbing, or flowing. The method to be used depends on several factors, including size, shape, and configuration of the part or area to be inspected, accessibility of the area to be inspected, and availability of inspection equipment. All methods of application are acceptable provided the surface or area to be inspected is completely coated with penetrant, however, there are certain requirements that must be met for each method.

2.4.5.2.1 Immersion/Dipping.**NOTE**

When parts are batch processed in a basket, they SHALL be separated from each other during the immersion and dwell period. Contact between parts interferes with the formation of a smooth, even penetrant coating.

Immersing or dipping is the preferred method of applying penetrant when the entire surface of a part must be inspected. The method is limited by the size of the tank or penetrant container. Parts can be immersed one at a time or, if small, can be batch processed by placing them in a basket or rack.

2.4.5.2.1.1 Immersion Considerations.

NOTE

It is difficult or impossible to completely remove penetrant from passages and blind holes following inspection. Therefore, oil or air-cooling passages and blind holes SHALL be plugged or stopped off with corks, rubber stoppers, or wax plugs prior to immersion in penetrant. These devices SHALL be removed immediately after the inspection process.

Certain part configurations require special attention during application of penetrant by immersion. Parts containing concave or recessed surfaces can trap an air bubble or pocket when immersed. Air bubbles or pockets will prevent the penetrant from contacting the part surface. Complex shaped parts SHALL be inverted or turned over while immersed to dislodge any entrapped air. Precautions must also be taken when immersing parts with air-cooling or oil passages and blind holes. During immersion, the passages and holes will fill with penetrant that will bleed out during development and obscure any discontinuity indications in the area. Air cooling passages and blind holes SHALL be plugged prior to immersion.

2.4.5.2.2 Spraying. Penetrant, emulsifiers or removers, and wet developers may be applied by any of several manual or automated spray methods. Spray application is especially suitable for parts too large to be immersed or processed via conveyor lines automated systems. The spray method is also applicable for on-aircraft inspections (portable), and when only a portion or local area of a large part or component requires inspection. In applying penetrant by the spray method, the requirement is to apply a thin layer that completely covers the area to be inspected. Spray application of penetrant provides several advantages over the immersion method. It is usually more economical since large tanks of penetrant are not needed, and pooling of penetrant in part cavities is reduced. In immersion application, pooling removes substantial amounts of penetrant by drag out.

2.4.5.2.2.1 Air or Pressure Spray.

WARNING

Paint type respirators SHALL be required when spraying penetrant as determined by the local Base Bioenvironmental Engineering. Additionally, atomized penetrant is very flammable.

Penetrants can be applied from most types of spray equipment using liquid pressure only, air aspiration only, or a combination. The equipment used is similar to that used in spraying paint. It consists of a supply tank, hoses, and a spray gun or nozzle. The supply tank is pressurized to force the penetrant through the fluid hose to the gun. The gun, which may be hand held or mounted in a fixture for automated spraying, is connected to an airline. The air applied to the gun converts the stream of penetrant into a spray. The air pressure, usually between 10 and 90 psig, controls the size of the spray droplets. Too low a pressure may produce a solid stream of penetrant. This would cover only a narrow area requiring many passes to coat the surface, and it also splatters the penetrant on adjacent surfaces. Too high a pressure can atomize the penetrant into a fine fog with poor covering ability and which drifts away from the part. Spray gun application, other than isolated cases, requires a spray booth and exhaust system for confining and reducing overspray.

2.4.5.2.2.2 Electrostatic Spray. The equipment required for electrostatic spraying is similar to that used in air spraying. In addition, a high voltage power supply is connected to the gun. This puts a positive electrical charge on the penetrant particles as they leave the gun. The part is electrically grounded and attracts the charged penetrant particles. The attraction is strong enough to pull the particles to surfaces not in front of or perpendicular to the spray. This ability makes electrostatic spray a preferred method for automated lines where complex shaped parts are to be coated; however, coverage inside cavities is limited. An advantage of the electrostatic spray method is the large savings resulting from reduced material requirements. Electrostatic spraying deposits a thinner layer of penetrant on the part than air spraying and greatly reduces penetrant loss due to overspray. Savings of over 80-percent compared to immersion application have been claimed.

2.4.5.2.2.3 Aerosol Spray. Penetrant packaged in aerosol containers provides a convenient method of application. The advantages and disadvantages to aerosol spray are:

2.4.5.2.2.3.1 Advantages:

T.O. 33B-1-1

- Portability.
- Packaging in sealed containers also eliminates contamination and evaporation of penetrant.
- There is little to no need for special exhaust equipment, as the amount of penetrant involved is small.

2.4.5.2.2.3.2 Disadvantages:

- Aerosol packaging increases material cost.
- Should not be used on large areas due to small spray pattern and high material cost.
- Overspray coats adjacent surfaces and complicates penetrant removal.
- Aerosol cans are known to lose propellant resulting in having to discard unused penetrant.

2.4.5.2.2.3.3 Mixing Aerosol Penetrants.**NOTE**

The propellant pressure is directly proportional to the ambient temperature. At temperatures below 60°F (15.6°C), the pressure may be too low for proper spraying. Conversely, the pressure may become excessive and the container may burst if the temperature reaches 120°F (49°C).

Penetrants, unlike nonaqueous developers, do not settle out of solution. Therefore, a mixing ball in the container is not essential; however, some manufacturers buy only a single type aerosol can, which is then used to package penetrant, solvent remover, or nonaqueous developer. Whether the can does or does not contain a mixing ball, it is good practice to shake the can thoroughly before spraying to ensure an even distribution of penetrant and propellant.

2.4.5.2.2.3.4 Applying Aerosol Penetrants. When applying penetrant from an aerosol container, the nozzle should be held 3 to 6-inches from the part surface and the can moved in a line to completely cover the area to be inspected. A thin, even coating with no breaks or non-wetted area is necessary. Excessive penetrant is not desirable as it tends to run or drain off the area and complicates removal. Holding the can motionless or moving it too slowly while spraying will result in an excessive layer of penetrant. Short distances between the can nozzle and the part reduce the size of the spray pattern, and produce a thick layer of penetrant in a small area. Long distances between the nozzle and part increase the size of the spray pattern, and reduce the penetrant layer thickness. There is also an increase in overspray and the possibility of uncovered areas.

2.4.5.2.3 Brush or Swab Application.**CAUTION**

Care must be taken to avoid spilling the penetrant while on or in an aircraft or other sensitive locations.

NOTE

Synthetic sponges may dissolve in penetrant.

Penetrant may be applied to large parts by brushing, wiping, or even pouring from a container. The brush or swab method is most frequently used to coat a small area of a large structure. Brushing or swabbing provides control over the placement of penetrant on the desired area, improves the ability to regulate the quantity or thickness of the penetrant layer, and eliminates overspray. Any brush, swab, rag, or even sponge may be used provided the applicator material will not react with the penetrant. The size of the brush may vary from large paint brushes down to small acid or artist brushes, depending on the size of the area to be covered. Any type of clean container may be used to hold the penetrant.

2.4.6 Temperature Limitations.**NOTE**

Penetrants may be applied over a range of ambient temperatures; however, certain limits must not be exceeded as the inspection process may be degraded. The operating range for conventional penetrants is 40°F (4°C) to 125°F (52°C). There are special penetrants formulated for hot applications exceeding these limits. Special purpose penetrants are discussed in (paragraph 2.7).

2.4.6.1 Low Temperature Limitations.

NOTE

Penetrant inspection SHALL NOT be performed when the test part temperature is less than 40°F (4°C). Reasons for this restriction are:

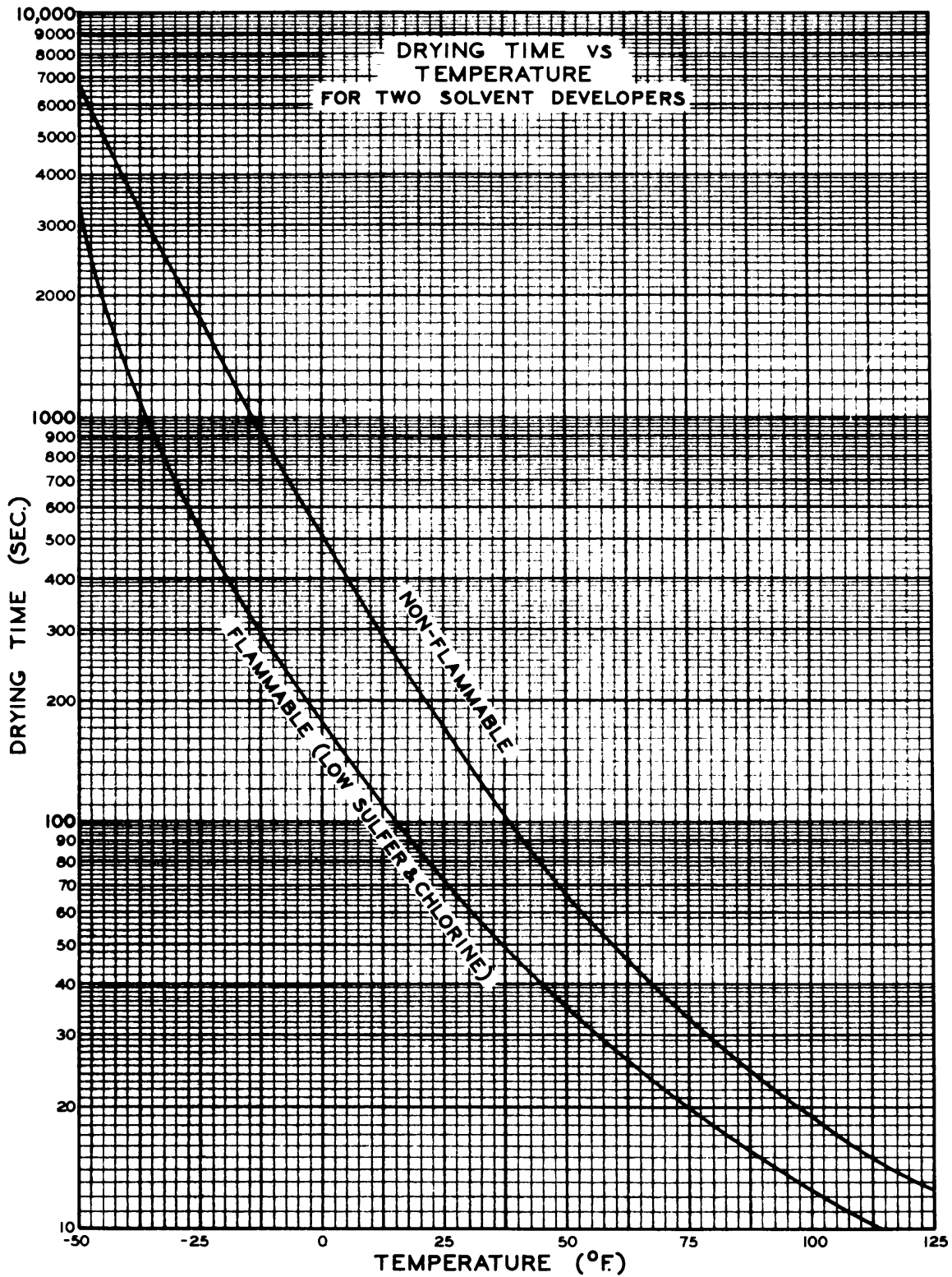
2.4.6.1.1 At 32°F (0°C) or less, any moisture, even from the inspector's breath, will form ice crystals on the part, which will interfere with the penetration process.

2.4.6.1.2 The propellant pressure in aerosol containers is affected by temperature. The gas pressure decreases with lower temperatures. When the temperature drops below 60°F (15.6°C), the reduced pressure can result in an erratic spray pattern.

2.4.6.1.3 The evaporation rate of solvent cleaners and nonaqueous developers is reduced at lower temperatures. The evaporation or drying time for two types of nonaqueous developers at various temperatures is shown in [Figure 2-15](#). The graph shows a ten-fold increase in drying time between the temperatures of 60°F (15.6°C) and 0°F (-18°C).

2.4.6.1.4 Viscosities of penetrants increase as the temperature decreases. When temperatures are between 40°F (4°C) and 60°F (15.6°C), the penetration dwell time SHALL be increased in accordance with (paragraph [2.4.7.4.2](#), [Table 2-2](#)) due to the increased viscosity. The increase in solvent cleaner evaporation time, penetrant dwell time, and developer drying time required at temperatures lower than 40°F (4°C), makes the total inspection time far too long to be practical.

T.O. 33B-1-1



H0400333

Figure 2-15. Graph Showing the Approximate Drying Times for Two Types of Nonaqueous Developers at Various Temperatures

2.4.6.2 High Temperature Limitations.

WARNING

The disadvantages of elevated temperatures outweigh the advantages. Penetrant application and dwell SHALL NOT be initiated on parts where temperatures exceed 125°F (52°C), unless special high temperature penetrants are used.

Sensitivity is improved slightly when test part temperatures are 125°F (52°C) to 150°F (65.5°C). The higher temperature evaporates some of the liquid, which increases the dye concentration and improves the visibility of indications. The elevated temperature also reduces viscosity, which speeds penetration. At temperatures of 125°F (52°C), the volatile components of penetrants are rapidly evaporated. During penetrant dwell, the layer of penetrant is very thin and with a part temperature of more than 125°F (52°C), the loss of volatile components will drastically change the penetrants composition. Elevated temperatures also reduce visible dye color and fluorescence (heat fade), making indications less visible. In general if a part is too hot to handle, it is too hot for penetrant testing.

2.4.7 Penetrant Dwell.

2.4.7.1 Definition of Penetrant Dwell. Penetrant dwell is the total length of time the penetrant is allowed to remain on the part before removal of the penetrant. This includes immersion, soak, and drain times. The purpose of dwell is to allow the penetrant to seep into and fill any surface openings.

2.4.7.2 Factors Influencing Penetrant Dwell Time. There are a number of interacting factors that influence the length of time required for penetrant to enter and fill a surface void. Some of the factors are listed below with a description of each following: void size (geometry and volume), penetrant sensitivity, part material and form, discontinuity type, discontinuity contamination, insoluble soil contamination, and soluble soil contamination.

2.4.7.2.1 Void Size. The dwell time required for a penetrant to enter and fill a surface void depends mainly on the width of the surface opening and depth of the void. Penetrant enters and fills voids with wide openings more rapidly than those with narrow openings. Very narrow or tight flaws, such as those associated with fatigue cracking, may require 2 to 5 times the length of dwell time compared to a wider flaw such as a crack caused by over-stressing. The larger void depth requires more time to fill because there is more volume of void.

2.4.7.2.2 Penetrant Sensitivity. The sensitivity of penetrants is affected by the length of penetrant dwell time. The differences in dwell times are due to the differences in surface tension, contact angle, and viscosity of the various penetrant types and sensitivities. While material viscosity between manufacturers of the same type and sensitivity level vary, the combination of factors tends to stabilize dwell time for each type and sensitivity. This allows penetrants within each of the sensitivity levels to have equivalent dwell times.

2.4.7.2.2.1 Sensitivity Selection. Selection of the sensitivity level to be used depends on a number of factors: potential flaw size, width of opening, volume of the discontinuity, part size, part shape, surface finish, residual stress, allowable flaw size, and intended service of the part. The rule-of-thumb is to use the highest sensitivity possible to reveal critical discontinuities while at the same time ensuring complete removal of all surface penetrant to reduce or eliminate background. Difficulties can be experienced if the sensitivity level is either too low or too high. Low sensitivity levels may not reveal critical flaws, while excessive sensitivity can result in an excessive residual background that would obscure any discontinuity indications or produce nonrelevant indications.

2.4.7.2.3 Part Material and Form. The effect of part material (steel, magnesium, aluminum, etc.) and form (castings, forgings, welds, etc.) on penetrant dwell relates to the type of flaw typically found. For example, cold shuts in steel casting tend to have tighter openings than cold shuts in magnesium castings. Therefore, the dwell times for cold shuts in steel castings are typically longer than the dwell times in magnesium and aluminum castings. Discontinuities occurring in forgings are typically tighter than in castings and require more dwell time.

2.4.7.2.4 Discontinuity Type. The various types of discontinuities differ in the width of the opening. Laps are tighter than porosity, and fatigue cracks are tighter than either laps or porosity. The required length of penetrant dwell increases as the discontinuity width decreases (surface opening becomes tighter or narrower).

T.O. 33B-1-1

2.4.7.2.5 Discontinuity Contamination. Penetrant dwell times are based on clean parts without entrapped contaminants. Inspection of parts that have been in service can be complicated by the difficulty of removing all of the entrapped soil from the discontinuities. The effect of the entrapped soil on the penetrant dwell time depends upon the type and amount of soil involved.

2.4.7.2.6 Insoluble Soil Contamination. If the discontinuity is full of soil, is not soluble in penetrant, penetration cannot occur. A change in penetrant sensitivity or dwell time will not help since penetrant cannot enter such flaws. A discontinuity only partially filled with insoluble soil will produce a smaller and less visible indication. Increasing the dwell time will not improve the indication; however, a more sensitive penetrant with its higher dye content will produce a more visible indication.

2.4.7.2.7 Soluble Soil Contamination. When discontinuities contain soils soluble in penetrants, such as un-pigmented grease, oils, cleaning solutions and other soluble organic materials, penetration of the inspection fluid into the discontinuity can occur. The penetrant will fill any vacant space in the discontinuity and then stop. Diffusion then begins between the penetrant and soluble soil. In a short time, the penetrant and soil become mixed; however, this mixture will fluoresce much less and may not give a useful indication. An increase in dwell time will improve the visibility of the indication. With increased dwell time some of the soil diffuses out of the discontinuity and is replaced with pure penetrant. Using a more sensitive penetrant will improve the visibility of the indication since the higher dye content can withstand more dilution.

2.4.7.3 Affects of Temperature and Viscosity on Dwell Time.

2.4.7.3.1 Penetrant Viscosity Vs. Temperature Change. Viscosity of oils, which includes penetrants, changes drastically with temperature. Oils become thin (less viscous) at high temperatures and thick (more viscous) at low temperatures. How the viscosities of a number of penetrants change with temperature is illustrated in (Figure 2-16). The horizontal and vertical scales are spaced to show the viscosity changes as a straight-line function. This chart also shows that the viscosity of a high sensitivity, postemulsifiable (PE) penetrant is about 3 centistokes (cs) at 120°F (49°C) and about 75 cs at -10°F (-23.4°C), or becomes about 25 times thicker. The same chart shows the viscosity of visible dye is about 2 cs at 120°F (49°C) and 22 cs at -10°F (-23.5°C), which is an eleven times increase in viscosity. The required part temperature range for applying penetrants is 40°F (4°C) to 120°F (49°C). Most penetrants are applied at or near a part temperature of 70°F (21.1°C). Therefore, nearly all operating instructions or procedures specifying dwell times are based on applying penetrant to a part at or near a temperature of 70°F (21.1°C). The viscosity of a typical high sensitivity postemulsified penetrant (7 cs) at 70°F (21.1°C) is twice the viscosity (14 cs) at 40°F (4°C) and about half the viscosity (3 cs) at 120°F (40°C). Other penetrants show a similar range of viscosity change with temperature. These viscosity changes are significant enough to require the adjustment of dwell times for temperature extremes.

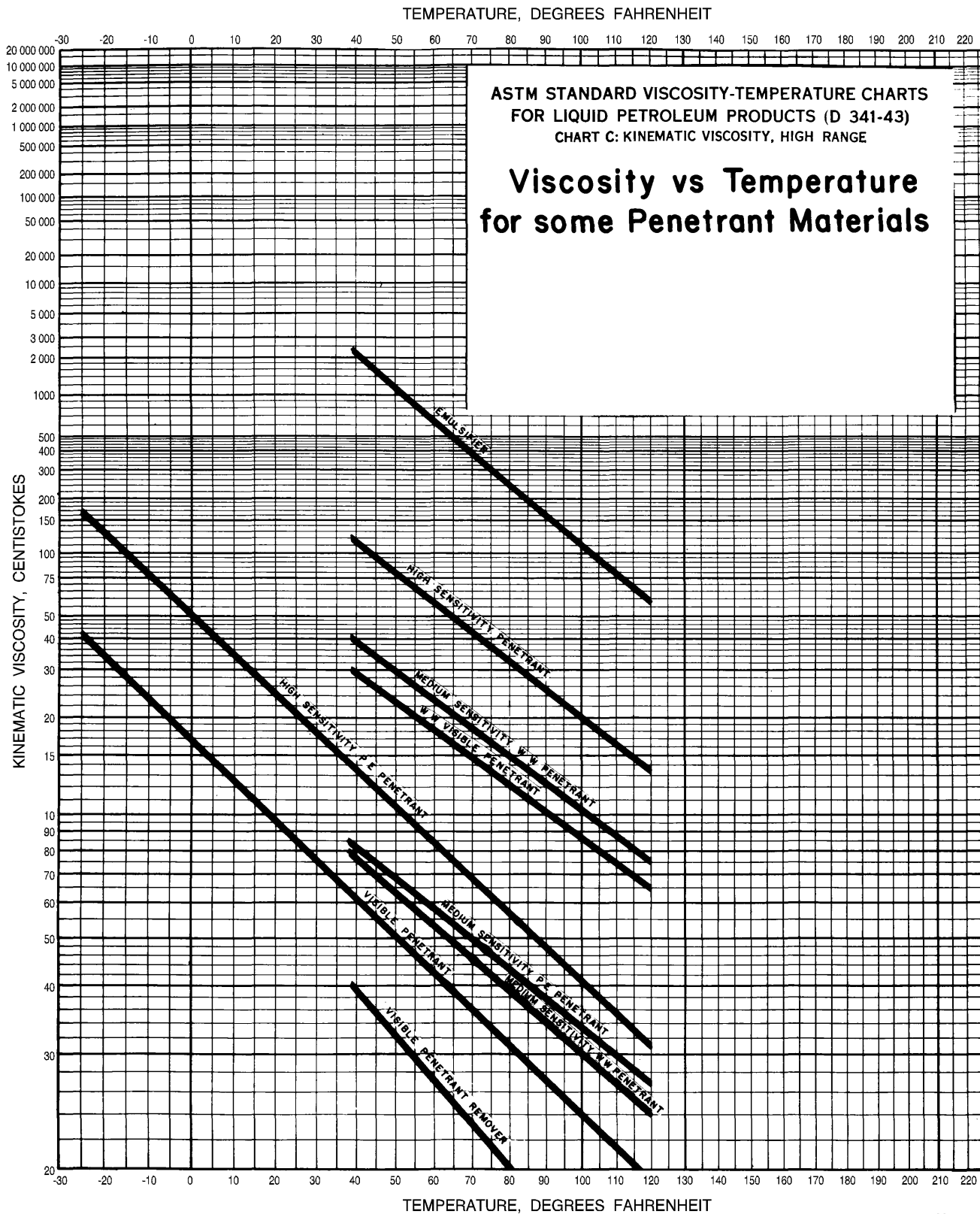
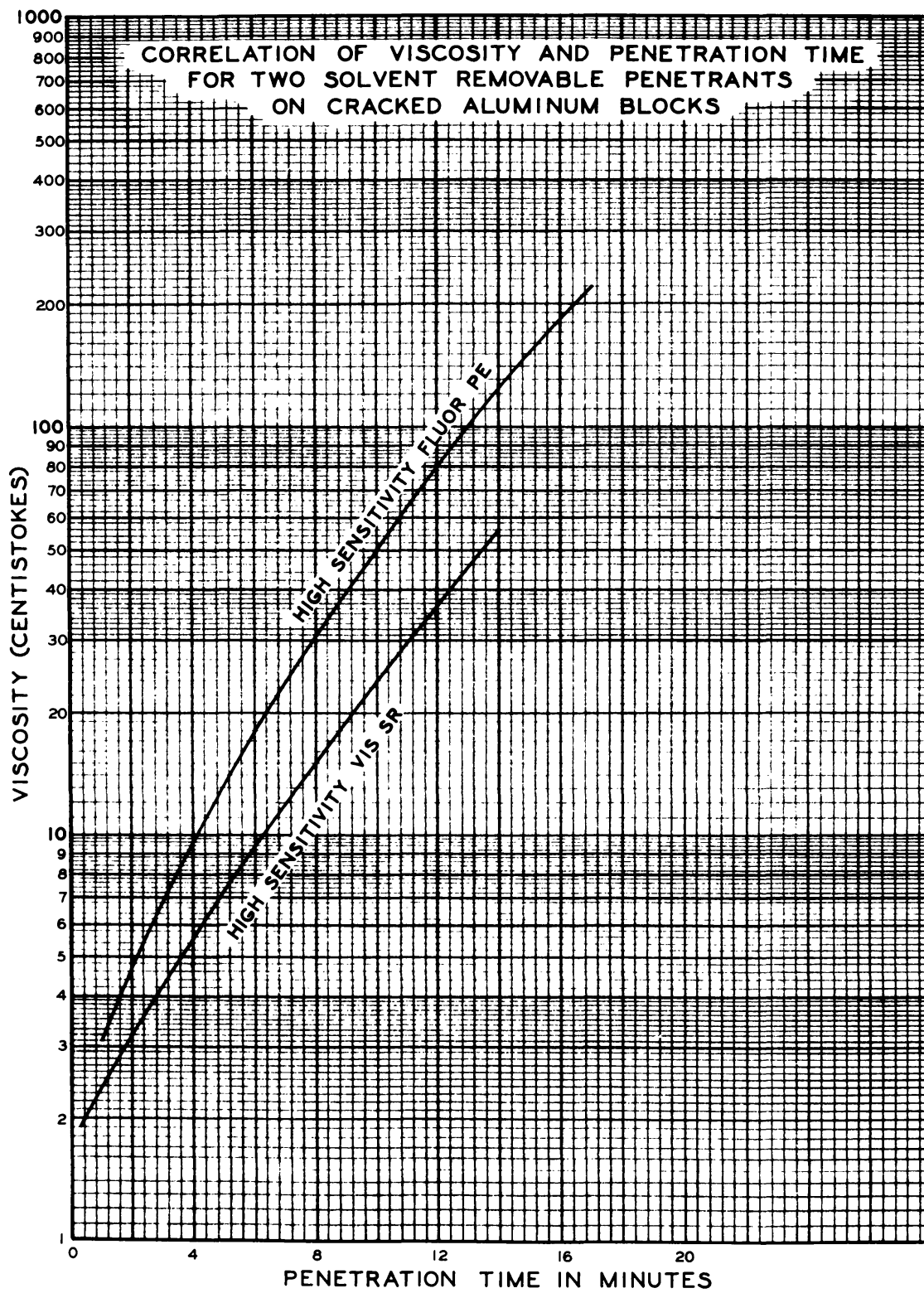


Figure 2-16. Graph Showing the Viscosities of Several QPL Penetrants at Various Temperatures

T.O. 33B-1-1



H0400334

Figure 2-17. Graph Showing the Comparison of Dwell Time Vs. Viscosity for Two Types of Penetrants

2.4.7.3.2 Dwell Time Vs. Temperature and Viscosity.

NOTE

The evaporation rate of penetrant is increased at temperatures above 100°F (37.2°C). Care SHALL be taken to prevent the penetrant from drying.

Laboratory experiments have demonstrated penetrant dwell time does not have to be changed in the same ratio as the viscosity changes. The minimum dwell times for the penetrants previously discussed is compared in (Figure 2-17). The high sensitivity PE penetrant, with a viscosity of 7 cs at 70°F (21.1°C), required a penetrating time of 3 minutes. At 40°F (4°C), the viscosity doubled to 14 cs, while the dwell time increased by 1.75 to 5.5 minutes. At 120°F (49°C), viscosity of penetrant drops to less than one-half (3 cs) and the dwell time decreases by two-thirds (1 minute). The thinner visible-dye penetrant, with a viscosity of 3.6 cs at 70°F (21.1°C), required a penetrant dwell time of 2.4 minutes. At 120°F (49°C), the viscosity was reduced by almost one-half (2.0 cs), while the required dwell was reduced to one-fifth of the time (0.5 minutes).

2.4.7.4 Penetrant Dwell Characteristics.

2.4.7.4.1 Dwell Modes. There are two basic penetrant dwell modes, “immersion” and “drain.”

2.4.7.4.1.1 Immersion Dwell Mode. In this mode the part remains submerged in a tank of liquid penetrant for the entire dwell period. Immersion dwell can also be performed by continuously brushing with fresh penetrant throughout the dwell period.

2.4.7.4.1.2 Drain Dwell Mode.

NOTE

Drain dwell is the preferred mode and SHALL be used unless the inspection instruction specifies immersion dwell.

With drain dwell, the part is first covered with penetrant by spraying, brushing, or immersion. Once coated, the part is placed on a rack or rest and allowed to drain during the dwell period. Comparison tests with aluminum crack blocks and nickel-chrome penetrant panels have demonstrated the improved performance of drain dwell mode compared immersion dwell mode. This improved performance is due to the changes in penetrant composition that occurs during the dwell period. The penetrant vehicle is a mixture of heavy oils that dissolve and hold the dye materials in solution; and thin or lightweight solvents or oils that reduce the viscosity of a penetrant. During the drain dwell period, the lighter weight liquids evaporate, which increases the concentration of the dye material entrapped in discontinuities. The increased dye concentration enhances the visibility of the indication. The drain dwell mode is also more economical than immersion dwell mode since the excess penetrant drains from the part and is recovered. The savings with drain dwell are two-fold, since the drained penetrant is recovered and the remaining penetrant layer is much thinner than an immersion dwell layer. The thinner penetrant layer requires less emulsifier during the removal process. Generally, the immersion is momentary, but at most, it should be no longer than half the total dwell period.

2.4.7.4.2 Minimum Penetrant Dwell Times.

CAUTION

The minimum dwell time for service-induced defects SHALL NOT be less than 30-minutes, unless otherwise specified by a specific part procedure.

T.O. 33B-1-1

NOTE

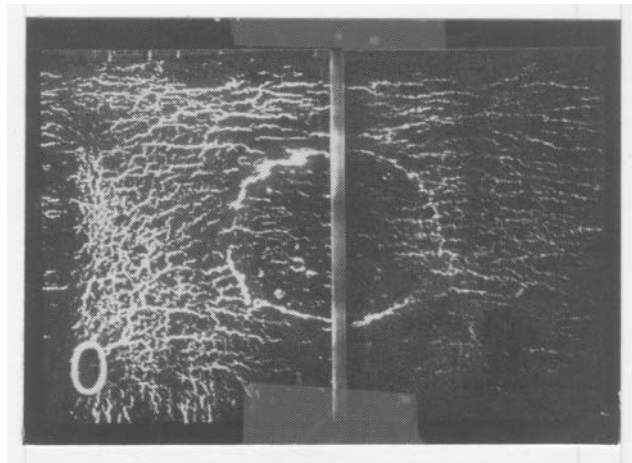
Selection of a penetrant dwell time is complex and depends upon a large number of factors. A thorough knowledge of the penetrant capabilities and limitations of the penetrant system used for the type of discontinuity to be detected is required. Whenever possible, the decision of dwell time should be based upon experience of the responsible engineering support. Documents governing dwell time SHALL specify the mode and time of dwell. The number of factors influencing the entry of penetrant into a discontinuity complicates setting uniform minimum penetrant dwell times.

Most dwell times are based on past experience with similar parts, materials and potential flaws. The minimum penetrant dwell time that SHALL be used is provided in (Table 2-2). These dwell times are based on the expected flaw condition and ambient temperature conditions. Minimum penetrant dwell times for manufacturing induced defects SHALL be as specified by ASTM E 1417 or as specified by specific technical directive or procedures. Minimum penetrant dwell times SHOULD be specified in the technical directives or part specific procedures mandating the inspection.

Table 2-2. Minimum Penetrant Dwell Times

Temperature 40° - 60° F	Minimum
Service Damage/Fatigue Cracks	60 minutes
Stress Corrosion Cracks	240 minutes
Temperature 60° - 125° F	Minimum
Service Damage/Fatigue Cracks	30 minutes
Stress Corrosion Cracks	240 minutes

2.4.7.4.3 Effects of Insufficient Dwell. When the dwell time is too short to allow the penetrant to completely fill the discontinuity, the visibility of the resulting indication will be reduced. A thermally cracked, aluminum block with one half receiving an adequate dwell, and the other half an insufficient dwell is shown in (Figure 2-18). The differences in dwell times have different effects depending on the flaw size. The very small flaws are not indicated, the visibility of indications from medium size flaws is greatly reduced, and there is a slight reduction in the visibility of larger size flaw indications. If it is suspected a part has not had an adequate dwell, the part SHALL be completely cleaned and then reprocessed through the entire inspection process.

**Figure 2-18. Comparison of Adequate Dwell Vs. Insufficient Dwell on a Thermally Cracked Aluminum Block**

2.4.7.4.4 Effects of Excessive Dwell.

NOTE

Fresh penetrant SHALL be applied at 60-minute intervals when long dwell times are required. When intermediate dwell times of 45-minutes or more are involved, fresh penetrant SHALL be applied 15-minutes before removal or at any time the penetrant appears to be drying on the part. The penetrant SHALL NOT be allowed to evaporate to the tacky or dry state while on the part. If, for some reason, the penetrant is allowed to become tacky, the part SHALL be subjected to a complete reprocessing through the pre-cleaning and penetrant inspection cycle.

Once the penetrant has completely filled a void, extending the dwell time will not improve the indication; except for the case of the contaminated flaw. Application of fresh penetrant improves the rate of penetration and makes it easier to remove the excess surface penetrant at the end of the dwell period. Evaporation is accelerated by temperatures above 100°F (37.2°C) or by rapid air movement. When inspections require excessively long penetrant dwell times, another inspection method, such as eddy current, may be considered to reduce inspection time.

2.4.8 Penetrant Removal. This section provides basic, intermediate, and advanced information on the methods and procedures used in removing excess surface penetrant. The first portion of the section contains general information applicable to all removal methods. The second portion is devoted to the water washable penetrant processes and water washing or spray rinsing. The remaining portion covers the methods and procedures used in the postemulsifiable lipophilic, postemulsifiable hydrophilic, and solvent removable penetrant processes.

2.4.8.1 After the penetrant has been applied and has filled any open discontinuities, the excess penetrant on the surface SHALL be removed. Removal of the excess surface penetrant is a critical step in the inspection process. Improper removal can lead to misinterpretation and erroneous results. Excessive or over-removal will reduce the quantity of penetrant entrapped in a flaw, resulting in either a failure to produce an indication or an indication with greatly reduced visibility. Incomplete or insufficient removal will leave a residual background that may interfere with the detection of flaw indications. The term “removability” applies to the ease of removing the excess surface penetrant. “Washability” is sometimes used interchangeably in commercial application; however, the materials specification and this manual will use “washability” only in the case of water-washable penetrants.

2.4.8.2 Factors Influencing Penetrant Removal.

2.4.8.2.1 Part Surface Condition. The surface condition of the part has a direct effect on removability. Smooth, polished surfaces such as chromium-plated panels can be easily processed by any of the removal methods with no residual background. As the surfaces become rougher, such as chemically etched or sand blasted parts, the removal of surface penetrant becomes more difficult. Rough surfaces reduce removability in two ways 1) The roughness restricts the mechanical force of the spray rinse in the indentations or low points and 2) the roughness prevents the emulsifier from evenly combining with the surface penetrant. It is not always possible to produce a background-free surface on rough parts. The wash or emulsification time required for a completely clean surface may result in removal of some of the penetrant entrapped in flaws. In this case, the wash or emulsification time may be shortened, leaving some residual background. The amount of residual background SHALL be limited to allow any flaw indications to be visible through the background.

2.4.8.2.2 Part Shape or Geometry. The part shape and geometry may indirectly affect removability by causing a thicker layer of penetrant to accumulate during the dwell period and restrict accessibility to the test surface by the spray rinse. One of the factors involved in removing excess surface penetrant is the mechanical action or force of the spray rinse. When parts contain surfaces where the spray cannot directly strike the surface, such as concave or recessed areas, holes, and screw threads, the removal time is increased in these local areas. Also, the thickness of the penetrant layer in these inaccessible areas is usually greater than on the adjacent surfaces. This is due to the tendency of the penetrant to drain and collect in these areas. For example, during the dwell period the penetrant will drain from the top or crown of a thread and will flow into the thread root area. The increased layer thickness in the thread root requires a longer removal time than the thin layer at the thread crown. The inaccessible surfaces usually have thicker layers of penetrant and require additional removal time. Care SHALL be exercised to prevent over-removal on the accessible surfaces with thinner penetrant layers, while trying to adequately clean the thicker penetrant layer from an adjacent inaccessible surface.

T.O. 33B-1-1

2.4.8.2.3 Narrow Deep Flaws. Flaw size and shape may complicate the removal process. Narrow, deep flaws, while requiring long penetrant dwell times, provide a relatively large reservoir to hold entrapped penetrant. The narrow surface opening reduces both the diffusion rate of emulsifier into the flaw and the effect of mechanical force of the spray rinse on the entrapped penetrant. The result, narrow, deep flaws produce highly visible indications with a minimum of removal problems.

2.4.8.2.3.1 Narrow, Shallow Flaws. The removal process becomes slightly more critical when narrow, shallow flaws are present. Narrow, shallow flaws do not have a large reservoir to hold entrapped penetrant. The visibility of an indication depends on the amount of penetrant that exits from the flaw. If the flaw is shallow, only a small amount of penetrant is available, and the indication may be faint. Over-removal of any entrapped penetrant will reduce the visibility of an already faint indication. In addition, a small amount of residual background (insufficient removal) will obscure faint indications.

2.4.8.2.3.2 Broad, Shallow Flaws. Broad, shallow flaws are defined as those with the surface opening equal to or greater than the depth. They present the most critical case for penetrant removal. The opening does not reduce the force of the spray rinse, nor does it restrict the emulsification rate, and entrapped penetrant is easily removed. Extreme care must be used during penetrant removal if broad, shallow flaws are likely to be present.

2.4.8.3 Removability Properties of Penetrant. Penetrant materials vary widely in their ease of removal. There are differences in removability between the various penetrant types, classes, and sensitivity levels. Also, similar penetrants provided by different manufacturers vary in removability. One penetrant characteristic affecting removability is the viscosity. High viscosity (thick) penetrants are more difficult or more slowly removed than low viscosity (thin) penetrants. The penetrant system sensitivity level also affects removability. Higher system sensitivity level penetrants contain more dye per unit volume, and trace quantities of residual penetrant will produce a higher background than the same quantity of a penetrant system with a lower sensitivity level. It is necessary to remove more of the residual high sensitivity penetrant to produce an equivalent background.

2.4.8.4 Removal of Water Washable (Method "A") Penetrants.

CAUTION

Water washable (Method A) penetrants are prohibited for use on all flight critical aircraft components, and on all engine components. Water washable penetrants SHALL NOT be used without specific written authority from the responsible engineering authority.

NOTE

Water washing of fluorescent penetrant SHALL be accomplished under UV-A black light illumination. The wash station should be in subdued light, if possible (less than 20 lumens).

Water washable penetrant is removed after penetrant dwell by subjecting the part to a water spray wash. The spray wash may be a hand-held nozzle, a semi-automatic system, or a fully automated system. Care SHALL be exercised to prevent over-removal since the penetrant entrapped in discontinuities contains an emulsifying agent and is easily removed. Removal is controlled by length of wash time and the wash SHALL be stopped when an acceptable background is reached. Cracked-chrome panels, following different wash times is shown (Figure 2-19). Insufficient wash, optimum wash, and excessive wash are shown. The smooth surface of the chrome-plated panel is deceptive. If the surface were rougher, some residual background may have been retained on the optimum-wash sample.

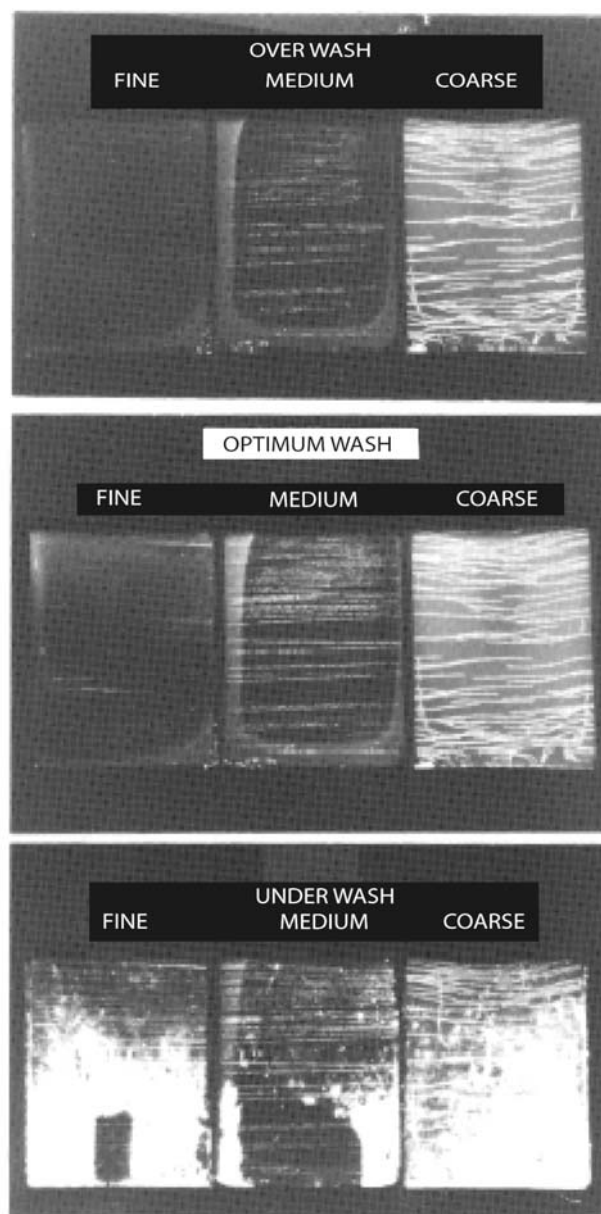


Figure 2-19. Cracked-Chrome Panels Showing Effects of Insufficient Wash, Optimum Wash, and Excessive Wash

2.4.8.4.1 Advantages of Water Washable, (Method “A”) Penetrant. Water Washable, Method “A”, penetrants have several advantages over other methods:

- Elimination of the separate emulsification process step results in cost savings:
 - The cost of the combined penetrant emulsifying agent is less than the total cost of separate penetrant and separate emulsifier.
 - A separate tank or station for emulsifier is not required.
 - Cost of automating is reduced.
 - Process flow time, especially on volume is reduced.

T.O. 33B-1-1

- The emulsifiable mixture is easily removed from complex shaped parts, making it advantageous for use on threads and keyways.
- The variables associated with controlling emulsifier dwell time are eliminated.

2.4.8.4.2 Disadvantages of Water Washable, (Method “A”) Penetrant. Water Washable, Method “A”, penetrants also have disadvantages:

- There is no control over the diffusion or emulsified layer. Penetrant entrapped in flaws contains emulsifying agent, making it susceptible to removal by over-washing. It is also easily removed from broad, shallow flaws.
- Water rinse time is critical and SHALL be carefully controlled.
- Residual background is higher than from the same sensitivity level postemulsifiable penetrant system.
- The penetrant emulsifying agent mixture is susceptible to water contamination.
- Treatment or disposal of large quantities of rinse water contaminated with water washable penetrant is required.

2.4.8.5 Comparison of Lipophilic, Method “B” and Hydrophilic, Method “D” Penetrants.

CAUTION

Post-emulsifiable lipophilic (Method “B”) penetrants are prohibited for use on all rotating engine components without specific authorization from the responsible engineering authority.

The main difference between methods “B” and “D” is not in the penetrant material, but in the process used to remove the penetrant. Unlike Method “A” penetrant materials, which have a built-in remover action, the removability action is aided by emulsifier or remover. Close attention SHALL be given to knowing which method you are using and the advantages and disadvantages to using both.

Both Method “B” (Lipophilic) and Method “D” (Hydrophilic) penetrants are oil-based vehicles containing highly visible colored or fluorescent dyes. They are formulated to optimize their penetration and visibility capabilities. They differ from water washable penetrant in they resist removal by water washing since they do not contain an emulsifier. A separate process step of emulsification is required for removal.

2.4.8.5.1 Lipophilic Emulsifier Versus Hydrophilic Remover Processes. Differences between the lipophilic and hydrophilic processes are summarized as follows:

- Lipophilic emulsifier is supplied as a ready to use liquid, whereas hydrophilic remover is supplied as a liquid concentrate, which must be diluted with water before use.
- The hydrophilic process requires an additional pre-rinse step immediately following the penetrant dwell period.
- The methods of applying the emulsifier and remover differ. Parts are dipped into lipophilic emulsifier and then immediately removed to drain. Parts either are immersed into hydrophilic remover for the entire removal time or are subjected to a spray of remover for the specified time.
- The modes of action by which the lipophilic emulsifier and hydrophilic remover remove the excess penetrant differ.

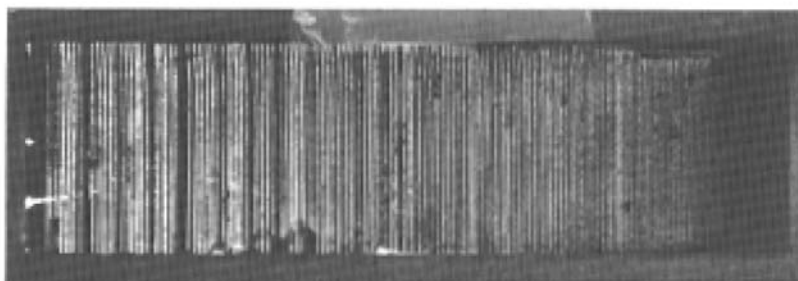
2.4.8.5.2 Advantages of Using Hydrophilic Removers Over Lipophilic Emulsifiers. A comparison of the physical, chemical, and application differences between the hydrophilic and lipophilic techniques is provided in (Table 2-3). There are several benefits to using the hydrophilic method over the lipophilic method. The hydrophilic process has the ability to remove surface penetrant with reduced effect on penetrant entrapped in a crack. Another major advantage of hydrophilic removers is the increased process tolerance (e.g., hydrophilic removal time is not as critical as lipophilic emulsification dwell). Hydrophilic removal times of 1 or 2-minutes have little effect on penetrant entrapped in a discontinuity, while exceeding the maximum lipophilic emulsification times by as little as 10 or 15-seconds can seriously degrade a flaw indication. A cracked-chrome plated panel processed to show the effects of optimum, insufficient, and excessive hydrophilic removal (Figure 2-20). The cracks in the panel are progressively smaller from left to right in the figure. Another advantage to using hydrophilic remover is the relative insensitivity to removal of penetrant entrapped in a discontinuity. This permits complete removal of fluorescent background in most cases. In contrast, when using lipophilic emulsifier on slightly rough surfaces, it is desirable to leave a faint residual background when maximum sensitivity is required. The reduction of background fluorescence with the hydrophilic remover improves the contrast, making faint indications easier to see. The hydrophilic method also allows spot touch-up removal on local areas during the final clear water rinse. Spot touch-ups cannot be done with the lipophilic method, since the oil base emulsifier will not tolerate water. Hydrophilic removers also provide

better control, handling, and recycling of the process materials. This can significantly decrease wastewater treatment costs and minimize water pollution.

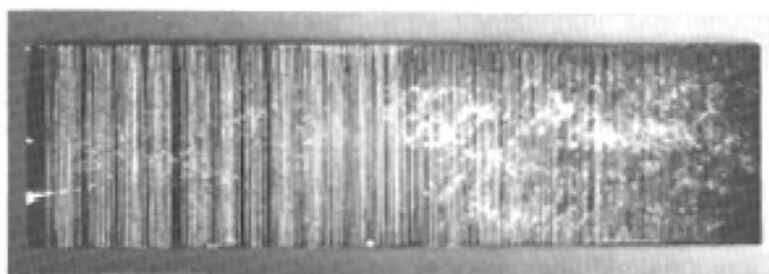
Table 2-3. Comparison of Hydrophilic Vs. Lipophilic Methods

<ol style="list-style-type: none"> 1. Supplied as a concentrate 2. Water base when mixed 3. Low viscosity 9 to 12 cs 4. Limited penetrant tolerance 5. Miscible with water in all concentrations 6. Applied as dip or spray 7. Action: Dip-detergent with scrubbing wash 8. Reduced drag-out 	<ol style="list-style-type: none"> 1. Supplied as a ready to use fluid 2. Oil base 3. High viscosity 35 to 120 cs 4. Miscible with penetrant in all concentrations 5. Limited water tolerance 6. Applied as a dip 7. Action: Diffusion activated by scrubbing 8. Critical emulsion time
--	---

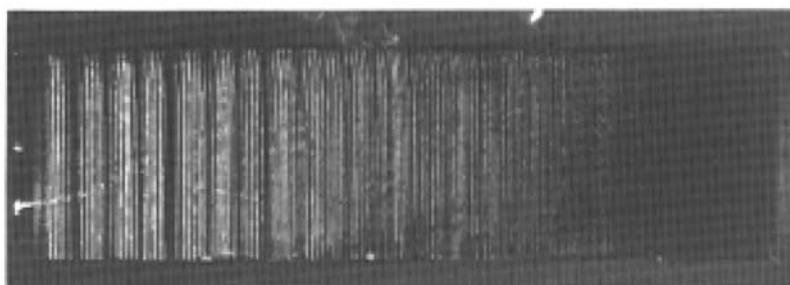
T.O. 33B-1-1



OPTIMUM REMOVAL



UNDER REMOVAL



OVER REMOVAL

Figure 2-20. Effects of Optimum, Insufficient, and Excessive Hydrophilic Removal Dwell Time

2.4.8.6 Removal of (Method "B") Penetrants with Lipophilic Emulsifier.

2.4.8.6.1 Using Lipophilic Emulsifier (Method "B") ([Figure 2-12](#)).

NOTE

When the part surface has been coated with emulsifier, the part SHALL be removed from the liquid and allowed to drain. The part SHALL NOT remain in the emulsifier during the dwell period.

Lipophilic emulsifier is applied, after a sufficient penetrant dwell time, by dipping or immersing the part in a tank of emulsifier. Lipophilic emulsifier is used as supplied by the manufacturer. Application of the material SHALL NOT be accomplished by spraying, flowing, brushing, or wiping onto the part. The two major problems with spraying and flowing are the difficulty in applying a uniform thickness and the difficulty of applying enough emulsifier without the mechanical force of the spray scrubbing the penetrant layer. Brushing or wiping on material produces an uncontrolled and uneven mixing action. There are a few automated systems where the emulsifier is applied as a fog.

2.4.8.6.2 Lipophilic Emulsifier Dwell.

CAUTION

Dwell time is critical in this process and SHALL be monitored closely to avoid over-emulsification.

After the emulsifier has been applied and the part is draining, a period of time is allowed for diffusion of the materials. During diffusion, a water removable colloidal mixture is being formed. This is the emulsifier dwell time and is one of the most critical factors in the lipophilic process. A timing device is required to control this process. The objective is to stop the diffusion when the emulsifier has just reached the part surface and before it diffuses into any penetrant entrapped in a discontinuity. Penetrant without emulsifier resists removal. If the dwell time is too long, the emulsifier will diffuse into entrapped penetrant easily removed causing loss of sensitivity and missed flaws. If the time is too short, the thin layer of surface penetrant not emulsified will cause an excessive background that can obscure a discontinuity indication. A number of factors which influence the dwell times are discussed in the following paragraphs.

2.4.8.6.3 Factors Influencing Lipophilic Emulsifier Dwell Time.

2.4.8.6.3.1 Part Surface. Very smooth polished surfaces retain only a thin layer of penetrant and require a relatively short emulsifier dwell period. On the other hand, longer emulsifier dwell times are required for rough surfaces, which retain a thicker layer of penetrant. Inspections of components with rough surfaces, such as sand castings, dictate a longer time for the emulsifier to diffuse to the bottom of the surface indentations.

2.4.8.6.3.2 Flaw Type. Tight flaws, with significant depth relative to flaw width, are more tolerant to longer emulsification dwell time than are wide, shallow flaws. The diffusion rate of even the more active emulsifiers is slowed down when diffusing into constricted or narrow openings. The diffusion rate on wide, shallow flaws can be rapid and it is easy to over-emulsify. Some overemulsification can be tolerated with deep flaws, which provide large reservoirs for entrapped penetrant. A degree of under-emulsification (or residual background) may be required when detection of shallow flaws in parts with rough surfaces is required.

2.4.8.6.3.3 Penetrant Dwell Time. Long penetrant dwell times permit more penetrant to drain from the part, resulting in a thinner surface layer. Since diffusion rate for a given emulsifier is constant, the emulsifier dwell time required is proportional to the thickness of the penetrant layer (e.g., thicker layers require more emulsification dwell time, and thinner layers require less time).

2.4.8.6.3.4 Emulsifier Contamination. As parts are processed, the emulsifier becomes contaminated with penetrant from both the initial immersion and the drain cycle. While penetrant and emulsifier are soluble in all combinations, the gradual increase of penetrant in the emulsifier slows the emulsification action. With combined build-up, the mixture will eventually stop functioning as an emulsifier. The slowing action due to penetrant contamination is very gradual, and at concentrations of less than 25-percent (penetrant in emulsifier) the performance of the emulsifier is generally not affected.

2.4.8.6.4 Determining Lipophilic Emulsification Dwell Time.

CAUTION

- The lipophilic emulsion step does not tolerate deviation from the optimum dwell time. A relatively short over-emulsification time of 10-seconds on a 1-minute dwell period can result in failure to indicate small flaws.
- Emulsifier dwell time SHALL NOT exceed 5-minutes.

T.O. 33B-1-1

Although emulsifier dwell time is critical for most defects, the large number of influencing factors make it impossible to develop a general dwell timetable. Optimum emulsifier dwell time must be determined on each part by experiment, even here, dwell times may require adjustment to compensate for local conditions. At the extreme, dwell times may range from 10-seconds to 5- minutes; however, typical dwell times of less than 1-minute are adequate. Cracked-chrome plate panels and the affects of insufficient, optimum, and excessive emulsifier dwell are shown in (Figure 2-21).

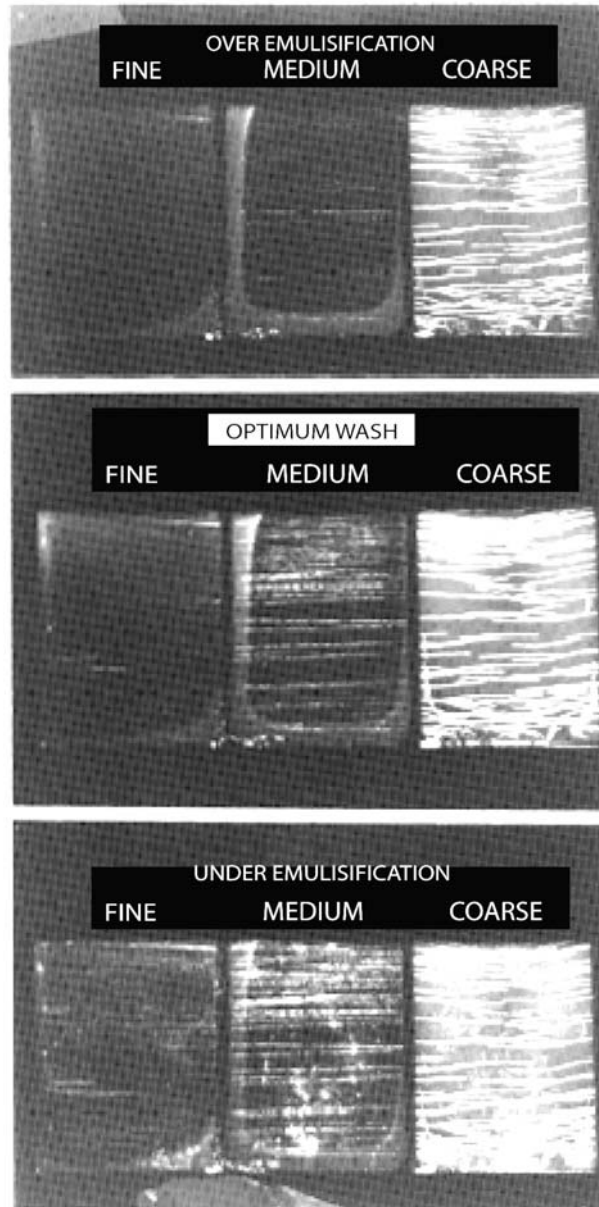


Figure 2-21. Effects of Optimum, Insufficient, and Excessive Remover Dwell Time

2.4.8.6.5 Rinse - Stopping the Emulsification Action.

CAUTION

- Postemulsifiable penetrant entrapped in flaws and not diffused with emulsifier is relatively resistant to water spray and rinse time is not critical, however, excessive spray pressure or hot water can remove entrapped penetrant and SHALL be avoided.
- For an agitated immersion rinse, the dwell time SHALL be the minimum required to remove the emulsified penetrant. Examine the components under appropriate illumination after rinsing. Clean and reprocess those parts exhibiting excessive background.
- The air nozzle SHALL be held at a sufficient distance from the part to ensure the developing indication is not smeared by the air blast.

After the appropriate dwell time, emulsification SHALL be stopped by agitated immersion or water rinse. If rinsing is used an initial light water spray over the entire surface of the part SHALL be performed. This initial rinse stops the diffusion process and eliminates excessive emulsifier dwell on any surface. Further water spraying to remove the excess emulsified surface layer is performed only after the entire surface has been wetted and the diffusion process has been stopped. After rinsing, allow the water to drain from the component. Utilize repositioning, suction, blotting with clean absorbent materials or filtered shop air at less than 30 psi to prevent pooling of water.

2.4.8.6.6 Batch Processing Using Lipophilic Emulsifier.

CAUTION

When a number of parts are being inspected, they SHALL be processed one at a time through the emulsifier, emulsifier dwell, and wash steps unless they are small enough to be batch processed.

Because emulsification time is critical for the Method B process, the dwell time for each part SHALL be closely monitored. Excessive dwell will occur when emulsifier is applied to a number of individual parts and they are then individually washed. Batch processing of parts is the preferred method for the inspection of multiple components provided the parts are small enough they can be processed simultaneously without touching one another.

2.4.8.6.7 Insufficient and Excessive Emulsification.

CAUTION

The part SHALL be completely reprocessed if, during or after the rinse step, it is suspected to be too short (insufficient emulsification) or too long (excessive emulsification) a dwell time has occurred.

Correction of dwell time cannot be achieved by immersing in penetrant or emulsifier. The part must be cleaned to remove all residual penetrant and reprocessed through the entire process. A good indicator of over-wash or over-removal of the surface penetrant is evidenced by a total lack of residue that may occur on all or specific areas of the part.

T.O. 33B-1-1**2.4.8.7 Removal of (Method “D”) Penetrants with Hydrophilic Remover.****2.4.8.7.1 Hydrophilic Remover Concentration.****CAUTION**

Penetrant and remover are qualified as a system to be used together and SHALL NOT be interchanged.

Each penetrant manufacturer has its own formulation that varies in aggressiveness. The concentrations of hydrophilic remover (in water) can range from 5 to 35-percent. The concentrations used for qualification are identified in the Qualified Products List (QPL SAE AMS 2644) and should not be exceeded without approval from the responsible engineering authority. Caution SHALL be exercised when changes in suppliers are involved because the required concentration may change.

2.4.8.7.2 Using Hydrophilic Remover, (Method “D”) (Figure 2-14).

2.4.8.7.2.1 Hydrophilic Remover Pre-Rinse. The hydrophilic remover method differs from the lipophilic emulsifier in two ways: hydrophilic remover baths require mild agitation and pre-rinse is performed before parts are placed in the remover bath. The hydrophilic method requires spraying the part with clean water immediately following the penetrant dwell. The mechanical action of the water spray removes over 80-percent of the excess surface penetrant, leaving only a very thin uniform layer of surface penetrant on the part. The post penetrant dwell spray helps optimize the removal process by reducing the amount of remover consumed, and in immersion setups, minimizes contamination of remover due to penetrant carry-over. It also reduces remover contact time by approximately 50-percent compared to when no pre-rinse step is used. A pre-rinse step cannot be used in the lipophilic process, as the oil base emulsifier does not tolerate water. Slight agitation of the remover bath or movement of the part in the bath is regularly required to maintain fresh remover on the part surface while the part is submerged.

2.4.8.7.2.1.1 Pre-Rinse Procedure. The pre-rinse step SHALL be used since it improves the efficiency of the process and minimizes hazardous waste. The pre-rinse cycle SHALL be a coarse spray of plain water at a maximum pressure of 40 psi (275 kPa) for 30 to 120 seconds. The water temperature SHALL be between 50°F (10°C) and 100°F (38°C). The water pre-rinse SHALL be applied for the minimum amount of time required to achieve removal of the bulk surface penetrant. The objective is to reduce the amount of surface penetrant, while leaving only a thin layer remaining on the part.

2.4.8.7.2.2 Different Hydrophilic Remover Application Techniques. The removal of excess surface penetrant using hydrophilic removers is accomplished through the use of “immersion”, “spray technique”, or a combination of both. Each technique offers certain advantages as well as disadvantages discussed in the following paragraphs.

2.4.8.7.2.2.1 Hydrophilic Remover Immersion.**NOTE**

Excessive agitation as evidenced by foaming SHALL be avoided.

The primary advantage of the hydrophilic immersion technique compared to the spray technique is its effectiveness on hollow or complex geometry parts where the configuration interferes with the spray impinging on the part surface. In use, the part or parts are immersed in the remover tank while still wet from the pre-rinse. A slight agitation is necessary to bring fresh solution in contact with the surface. Agitation can be movement of the part through the solution, but is most usually produced by an air manifold in the bottom of the tank. Time of immersion depends on a large number of factors and will vary between 30-seconds up to 2-minutes and SHOULD be no more than necessary. The maximum time of 2-minutes is seldom required, except on very rough surfaces or when remover is depleted. Remover immersion time SHALL NOT exceed 2-minutes.

2.4.8.7.2.2.1.1 Remover Appearance. A freshly mixed remover bath is a transparent or clear, pink solution. During use, as penetrant is removed from the parts and retained, the bath becomes turbid or cloudy with distinct color change. As additional parts are processed and the penetrant tolerance point is approached, globules of penetrant will rise to the surface, and then slowly disperse back into the mixture. This effect is not usually noticed in an agitated bath, but is visible when the agitation is shut off. When the penetrant tolerance point is reached, the penetrant will remain floating on the surface. A characteristic of the bath is that the excess penetrant does not spread across the surface, but collects at the sides. The remover

will continue to function in this condition, but at a reduced rate. In addition to the longer removal time, another problem with using remover after the penetrant reaches its tolerance point, is the tendency of the floating penetrant to deposit on the part as it is withdrawn from the solution, resulting in an objectionable background. If the bath is to be used after the tolerance point is reached, the majority of the floating penetrant SHALL be removed. Do this by wiping the tank edges with absorbent newspaper, paper towel, or rags. To learn more about Process Control for penetrants, (paragraph 2.6).

2.4.8.7.2.2.1.2 Penetrant Tolerance. One of the disadvantages of the hydrophilic immersion technique is the remover's limited tolerance to penetrant contamination. As parts are processed, the amount of penetrant in the remover gradually increases. If the removal process is closely monitored, penetrant contamination will reach a point where a distinct performance change occurs. The amount of penetrant causing this performance change is called the "remover's penetrant tolerance point". The amount of penetrant tolerated is directly related to the concentration of the remover and sensitivity level of the penetrant. Typical tolerance levels for a remover concentration of 33-percent is 5 to 6-percent for a Sensitivity Level 3 penetrant, and 3 to 4-percent for a Sensitivity Level 2 penetrant.

2.4.8.7.2.2.2 Hydrophilic Remover Spray Technique.

2.4.8.7.2.2.2.1 Hydrophilic Remover Spray Mechanism. The modes of action are the same in both hydrophilic immersion and spray remover techniques; however, the relation between the chemical and mechanical action complicates the mechanism during the spray removal technique. As the spray water pressure is increased, the rate of removal also increases. A common misconception is the increased rate of removal is due solely to the greater mechanical action. The higher water pressure actually increases both mechanical and chemical action. As the water pressure increases, more solution contacts the surface per unit of time, thereby increasing the chemical action.

2.4.8.7.2.2.2.2 Hydrophilic Remover Spray Equipment. A practical and efficient way of handling the low remover concentrations is by continuously metering the remover directly into the stream of water. This can be done with an aspirator device that employs the water flow to create a vacuum (Bernoulli Effect), drawing up the concentrate directly from the container. The method is inexpensive and only requires a minimum of equipment and provides intermittent, on/off operation. A disadvantage of this system is the variation in concentration with water pressure. This requires the careful control of water pressure as well as the mixing ratio. The most commonly used system is the installation of a three-way valve on the water rinse or wash line. The aspirator is connected to one side, fresh or plain water to the second, while the third position is off. This allows the existing wash tank to be used for both spray removal and fresh water rinsing. For portable applications, a simple garden sprayer may also be used, provided the maximum 5-percent concentration is not exceeded.

2.4.8.7.2.2.2.3 Hydrophilic Remover Spray Technique. Hydrophilic remover can be applied by spraying the part with a mixture of water and remover. This method of application has several advantages: it does not require a separate tank; it works well on simple contoured parts; and it can be easily automated. The procedures, and equipment, and parameters are identical with those used in spray rinsing. The usual concentration range is 1 to 5-percent remover to water by volume. The concentration of remover SHALL NOT exceed 5-percent.

2.4.8.7.2.3 Hydrophilic Remover Final Water Post-Rinse. A clean water rinse SHALL be performed after the immersion or spray hydrophilic removal steps. The purpose is to remove any remover residues that could contaminate the developer or interfere with the development process. The rinse step is a water spray in the station or tank used for the pre-rinse. The process step is not critical and requires very few controls. The cycle SHALL be a plain water spray of up to a maximum of 120-seconds duration using a pressure of not greater than 40 psi (172 kPa) and the water temperature SHALL be between 50°F (10°C) to 100°F (38°C). Rinsing of fluorescent penetrants SHALL be accomplished under a black light.

2.4.8.7.2.3.1 Hydrophilic Remover Touch-Up. One of the advantages of the hydrophilic technique is the ability to do touch-up removal on local areas after the initial application of the water rinse. Hydrophilic remover touch-up can be performed provided the combined remover dwell time of the first and second remover applications does not exceed 120-seconds (2-minutes). The hydrophilic remover touch-up, SHALL be applied using remover at or below the concentration of the initial remover step using either immersion or spray. If spray application is used, the remover concentration SHALL NOT exceed 5-percent. After touch-up, the part SHALL be fresh water rinsed. A check of the hydrophilic remover touch-up spray concentration SHALL be accomplished by one of the methods explained in (paragraph 2.6.10.4.6.1.6).

2.4.8.8 Removal of (Method "C") Penetrant With Solvent (Figure 2-13).

2.4.8.8.1 General. All oil-based penetrants are soluble in a large number of organic liquids; however, postemulsifiable penetrants are most frequently used in Method C processes. The majority of solvent removers are Class 2 (non-halogenated), and they can be further subdivided on the basis of their flash points or boiling points. For almost all solvent removers,

T.O. 33B-1-1

removal of the excess surface penetrant is accomplished through dissolving and dilution. The exception to this is when an aqueous based detergent mixture is used as a solvent remover. Furthermore, when higher boiling point solvents are used care must be taken to control the amount of solvent applied to the surface. Excess solvent can strip penetrant from defects or dilute the penetrant in a defect with the result of producing dim, fuzzy indications.

2.4.8.8.2 Factors Influencing Solvent Remover Selection. The selection of a suitable solvent remover depends on a number of factors. The most significant factors are the evaporation rate (boiling point), flammability, and cost. Solvency is a factor but becomes significant only when the removal process allows excess solvent to remain on the surface of the part, thus diluting penetrant trapped in defects. For smooth surfaces, high boiling point solvents can be used with minimal concern since residual solvent can be easily wiped from the surface with a dry cloth. The higher boiling point solvents are also less flammable than lower boiling point solvents. For rougher surfaces, caution is required with the use of the higher boiling point materials; the lower boiling point solvents may be more appropriate since any residual solvent would evaporate before it could dilute the penetrant in a flaw. With the lower boiling point solvents, however, safety (flammability) may be a concern.

2.4.8.8.3 Solvent, (Method "C") Removal Procedure.

CAUTION

- The solvent cleaner SHALL NOT be applied directly onto the inspection area to remove excess penetrant.
- Only solvents appearing on QPL SAE AMS 2644 or technical grade Isopropyl Alcohol (TT-I-735, Grade A) SHALL be used for Method C removal of excess penetrant.

The use of high sensitivity, postemulsifiable penetrant with the solvent removal method will produce indications from small, tight flaws, however, improper application procedures will seriously degrade the indications. The use of excess solvent will remove or dilute entrapped penetrant resulting in a failure to produce a visible indication. The following outlines the recommended practice for the Method C process:

- a. Following the penetrant dwell period, the surface SHALL be wiped with a clean, dry lint-free rag or paper towel to remove the major portion of surface penetrant. The proper procedure, which SHALL be followed, is to make only a single pass and then fold the rag or towel over to provide a fresh surface for each succeeding wipe.
- b. When the surface penetrant has been reduced to a minimum, any remaining residual penetrant is removed with a fresh lint-free rag or towel moistened with solvent. The amount of solvent applied to the rag or towel is critical. The cloth or towel SHALL only be lightly moistened with the application of a fine spray of solvent to the cloth. The cloth SHALL NOT be saturated either by pouring, immersion or excessive spraying.
- c. A black light SHALL be used to examine the part surface during the intermediate and final wiping stages. The surface of the rag SHALL also be examined with the black light after the final solvent wipe. If the rag shows more than a trace of penetrant, it SHALL be folded to expose a clean surface, remoisten with solvent, and again wiped across the part.
- d. This procedure SHALL be repeated until the rag shows little or no trace of penetrant.
- e. Finally the part SHALL be wiped with a clean, dry rag to remove any residual solvent on the surface.

2.4.9 Water Washing/Rinsing Technique. Water washing or spray rinsing is usually accomplished in a stationary rinse tank, which is provided with a hose, nozzle, drain, and in the case of fluorescent penetrant, a black (UV-A) light. Rinsing procedures used for removal of water-washable penetrant, Method "A", and postemulsifiable penetrant, Method "B" (after emulsification), and Method "D" (after remover application) are nearly identical. The difference is in controlling the rinse time. Rinse times for Method "A" penetrants are very critical as the entrapped water-washable penetrant can be removed from discontinuities if the time is not controlled. Entrapped postemulsifiable penetrants not diffused with emulsifier resist removal, and rinse times are not as critical. The conditions and procedures described in the following paragraphs are applicable to both water-washable and postemulsifiable penetrants.

2.4.9.1 Factors Influencing Effectiveness of Wash/Rinse.

2.4.9.1.1 Size of Water Droplets. Removal of excess surface penetrant depends upon the mechanical force of the water impacting the part surface. The impact force consists of the droplet mass and velocity at impact. The two factors are related, and increasing either will produce a higher mechanical force. There are limits on both size and velocity; the latter is derived from the water pressure. If the droplet is small or if the pressure is too high, the result will be a fog or mist with little removal ability. On the other hand, a solid stream of water is not desirable either because it covers only a small area at one time or is actually one large continuous drop.

2.4.9.1.2 Water Pressure. Increased water pressure increases the speed of removal; however, excessive pressure can atomize the water into a fog that is useless for removal. Normal line pressure, approximately 10 to 40 psig, is acceptable and is generally used. Water pressures in excess of 40 psig or injection of compressed gas or air into the water system SHALL NOT be used.

2.4.9.1.3 Water Temperature. The temperature of the rinse water will affect the washability. Some penetrant-emulsifier combinations may form a gel with water temperatures of 50°F (10°C) or less. This gel can be removed but requires longer wash times. Other penetrant emulsifier combinations have reduced removability at elevated temperatures, above 110°F (43°C). The effect of temperature on washability depends upon the penetrant formulation, which varies between suppliers. Penetrant-emulsifier combinations meeting specification requirements are washable in the temperature range of 50°F (10°C) to 100°F (38°C). Therefore, the rinse water temperature SHALL be maintained between 50°F (10°C) to 100°F (38°C).

2.4.9.1.4 Spray Angle.

CAUTION

Water nozzles capable of producing spray patterns such as solid streams or a fine mist SHALL NOT be used. Rinsing dye penetrant from the surfaces of parts SHALL be accomplished with a fan-shaped, coarse spray.

The angle of spray may be varied over a wide range with only slight effects on the removal time. When the angle is close to perpendicular (80 to 90 degrees), the droplets will rebound into the oncoming water, diverting the fresh droplets, which reduces the scrubbing action. The scrubbing action is also reduced when the spray is close to parallel with the part surface (10 to 20 degrees), since there is little energy transfer at the point of impact. Generally, an angle of 45 to 70 degrees is most effective.

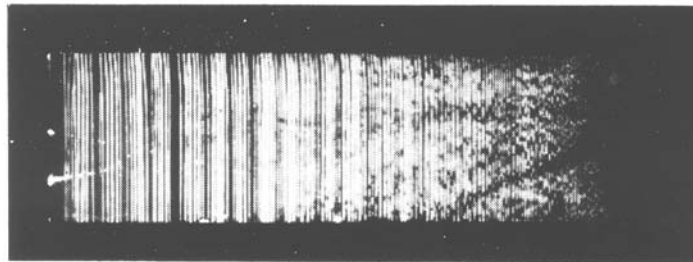
2.4.9.1.4.1 Recommended Spray Rinse Procedure. Washing is best accomplished with a fan shaped, coarse spray. The water temperature SHALL be in the range of 50°F (10°C) to 100°F (38°C), and line water pressure SHALL NOT exceed 40 psig. The wash time will depend upon the surface roughness of the part. Water-washable penetrant can easily be over-washed and wash time SHALL be closely controlled. Washing of fluorescent penetrant SHALL be performed under UV-A black light illumination in a semi-darkened area. The washing SHALL be stopped when a low background level is reached. If small defects must be detected in parts with rough surfaces, some residual background may be necessary. The total rinse time SHALL NOT exceed 120-seconds.

2.4.10 Drying. After removal of excess surface penetrant, the part SHALL be dried prior to applying nonaqueous or dry developer. When aqueous developers are used, part drying before developer application is not required. Drying can be accomplished in a number of ways:

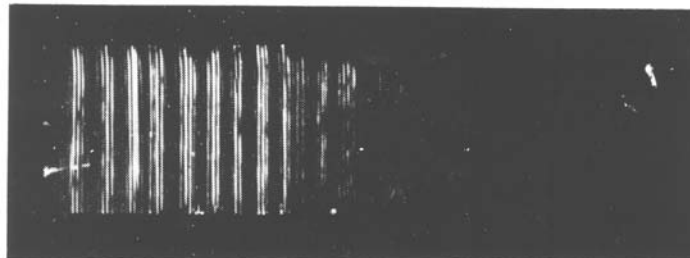
- Allow the parts to set at room temperature in still air. The length of time required for this method depends upon temperature and humidity of the air and is usually too long to be used for drying wet developer.
- Warm air blowers are often used on large parts that cannot be oven dried. This method may not uniformly dry wet developers.
- The most frequently used method of drying parts is with a recirculating hot air oven. It provides a rapid means of properly drying parts and wet developer, is adaptable to production, and permits control of the temperature.

T.O. 33B-1-1**2.4.10.1 Time and Temperature Effects on Drying.****NOTE**

- Depots with automated and semi-automated penetrant inspection systems may exceed the 140°F (60°C) drying oven temperature while performing inspections with these systems. The part temperature **SHALL NOT** exceed 140°F (60°C). All parts remaining at 140°F (60°C) for longer than ten minutes or exceeding 140°F (60°C) **SHALL** be reprocessed (cleaned and reinspected).
- When drying test parts in a recirculating oven, both time of exposure and dryer temperature **SHALL** be carefully monitored. The smallest quantity of penetrant entrapped in discontinuities can be subject to dye degradation and/or large evaporation losses. Fluorescent dyes experience heat fade or permanent loss of fluorescence at elevated temperatures. Heat fading of the penetrant starts at about 140°F (78°C) and increases rapidly with increased temperatures and time. Evaporation loss can decrease the small amount of penetrant entrapped in a discontinuity to such a low level it will not contact the developer on the surface and an indication will not form. The effects of drying temperature and time are more severe when a dry developer is used. Aqueous or wet developers are applied before application of heat in a drying oven and may retain contact with the penetrant during the drying cycle. The base vehicle (water) of the developer tends to mix with the penetrant in the defect. The evaporating action of the base vehicle helps to draw the penetrant from the defect to form the indication. For comparisons of proper versus excessive drying for Sensitivity Level 3 penetrant prior to applying dry developer ([Figure 2-22](#)). Proper drying was performed at 120°F (49°C) for five minutes. Excessive drying was at 150°F (66°C) for ten minutes. The fine indications are the first to disappear.



PROPER DRYING



OVER DRYING

Figure 2-22. Effects of Proper vs. Excessive Drying

2.4.10.2 Procedure for Determining Pre-Developer Drying Parameters.

CAUTION

Parts SHALL be separated with an air space between them. If the part temperature reaches and remains at 140°F (60°C) for over ten minutes, the inspection sensitivity can be reduced. As a guideline remove the parts before they become too hot to handle with bare hands. This is a temperature of about 120-125°F (49-52°C).

It is easy to monitor and control oven temperature, but almost impossible to monitor test part temperatures. Another complicating factor is the rate at which the part undergoing the test, heats. Thin sections will reach oven temperature and dry before thick sections become warm. The recommended procedure is to set the oven temperature between 120 and 140°F, and check the part every 5-10 minutes. Remove the part as soon as it is dry.

2.4.11 Application of Developers.

2.4.11.1 (Form a) - Dry Developer.

2.4.11.1.1 Description.

CAUTION

Dry developers SHALL NOT be used with visible-dye penetrants since they do not provide adequate contrast.

Dry developer is characterized by their fluffy nature and low bulk density, i.e., one pound of dry developer occupies 2 or 3 times the volume required for wet developer powders in the dry form. Dry developer is loosely held on the part surface by adhesion and the coating layer is very thin and uniform. In fact, dry developers leave very little visible trace, but their presence becomes readily obvious when a finger or rag is wiped across the surface. Dry developers can be used with any method of fluorescent penetrant, but not with visible-dye penetrant.

2.4.11.1.2 Advantages of (Form a) - Dry Developer.

- Does not require a liquid bath.
- Easier to transport than liquid bath.

2.4.11.1.3 Disadvantages of (Form a) - Dry Developer.

- Air cleaners, facemasks, or respirators may be required.
- Part must be completely dry prior to application.

2.4.11.1.4 Using (Form a) - Dry Developer.

2.4.11.1.4.1 Preparation of (Form a) - Dry Developer. There is no preparation short of having a container that will help to keep moisture out of the developer.

2.4.11.1.4.2 Application of (Form a) - Dry Developer.

WARNING

Dry developer particles are not toxic materials; however, like any solid foreign matter; they SHALL NOT be inhaled. Air cleaners, facemasks, or respirators may be required. The Base Bioenvironmental Engineer SHALL be consulted if the process generates airborne particles.

T.O. 33B-1-1**NOTE**

Dry developers SHALL NOT be applied to a part until the surface and any discontinuities are thoroughly free of moisture. The presence of even a little moisture will interfere with the developer action and small flaws may be missed.

Dry developers can be applied in a number of ways:

- Blowing the powder with a bulb type blower.
- Immersing the part in a container of dry particle powder.
- Pouring the powder over the parts.
- Using a dust or fog chamber where the particles are blown into an air suspension.
- Spraying with an electrostatic system or a low-pressure flock gun.

2.4.11.1.4.2.1 After application, the excess developer SHALL be shaken off or removed with a hand air bulb or squeeze blower. The developer particles are not loosely held, but care SHALL be taken to not remove them during handling. Wiping, brushing, or compressed air in excess of 5 psig SHALL NOT be used. Care SHALL be taken to prevent contamination of the dry developer. The two most frequent contaminants are water (or moisture) and penetrant. Water in dry developer comes from parts that have not been completely dried or from careless splashing during the wash step. Water or moisture contamination will cause the dry developer to form lumps or to cake, thus reducing its effectiveness. Penetrant contamination occurs when particles of penetrant soaked developer fall from poorly washed parts or heavy indications. Penetrant contamination will cause false indications either on the part being processed or on subsequent parts.

2.4.11.2 (Form b) – Water-Soluble (Wet Aqueous) Developer.

2.4.11.2.1 Description. Water-soluble developers are developer particles dissolved in a water solution. Water-soluble developers contain wetting agents, corrosion inhibitors, and biocides. They differ from wet suspended developer since the particles dissolve in water to form a clear, lightly tinted solution. During the drying process, the developer particles crystallize out of solution as the water evaporates. The resulting coating is thick, bright white and readily visible. The dry layer is thicker than wet suspended developer coating, and much thicker than a dry developer coating.

2.4.11.2.2 Advantages of (Form b) - Water-Soluble Developers.

- The primary advantage of water-soluble compared to water-suspended developer is the elimination of the need for agitation to keep the particles in suspension.
- The coating does not produce streaks or runs that often occur with wet suspended developers.
- The developer particles, being soluble in water, are very easy to remove during post-cleaning.

2.4.11.2.3 Disadvantages of (Form b) - Water-Soluble Developers.

CAUTION

Water-soluble developers SHALL NOT be used on parts processed with water-washable penetrant or visible-dye penetrants.

NOTE

Water-soluble developers are subject to bacterial growth. The susceptibility is dependent on the geographical area and the type of local water. The first indication can be a foul odor or visible growth.

- Water-soluble developers contain wetting agents that can act as penetrant removers and SHALL be used very carefully. This removal action is accelerated with water washable penetrants and is the reason water-soluble developers SHALL NOT be used with water washable penetrants.
- Even though a thick, white coating is produced, water-soluble developers do not function well with visible-dye penetrants.
- Like the wet suspendible developers, the biocides in water-soluble developers only delay growth. The water-soluble

developers SHALL be discarded when bacterial growth is noticed and the tank or container SHALL be completely disinfected prior to mixing a new solution.

2.4.11.2.4 Using (Form b) - Water-Soluble Developer.

2.4.11.2.4.1 Preparation of (Form b) - Water-Soluble Developer. Water-soluble developers are supplied as dry-powders and SHALL be completely dissolved in water before use. The proportions of dry-powder to water depend upon the type of developer and the manufacturer. The manufacturer's recommendations on concentration SHALL be followed. In making up the bath, the dry-powder SHALL be stirred into the water until it has completely dissolved. Since the developer particles are dissolved in the solution, agitation is not required after the developer has been initially mixed with water.

2.4.11.2.4.2 Application of (Form b) - Water-Soluble Developer.

CAUTION

Water-soluble developers SHALL NOT be used on parts processed with water-washable, Method A, fluorescent penetrants or any visible-dye penetrants.

NOTE

Water-soluble developer in open immersion tanks is subject to evaporation. As the water evaporates, the developer concentration increases. A solution concentration level SHALL be established and maintained by the addition of water or dry-powder. For process checks and methods for measuring solution concentration (paragraph 2.6).

The inspector may apply developer with spraying, flowing, or immersion techniques. If the immersion process is used, the part SHALL not remain in the solution any longer than required to provide complete coverage. The developer may be applied to parts while they are still wet from the water wash after penetrant removal. Care SHALL be exercised to prevent entrapment of soluble developer in the part cavities or concave surfaces (pooling). The developer should wet the part surface with no water break areas after application. After the developer is applied, the parts SHALL be oven dried, since room temperature evaporation is too slow. The developing action does not start until the developer is dry.

2.4.11.3 (Form c) - Water-Suspended (Wet Aqueous) Developer.

2.4.11.3.1 Description.

NOTE

Developing action in wet suspended developers will not start until all the absorbed and adsorbed water has been driven off. Developer dwell time SHALL NOT begin until the part is completely free of moisture.

Water-suspended developers consist of inert particles in a water suspension. The developers are supplied as either concentrated liquid or as a bulk, dry-powder that must be mixed with water prior to use. In addition they contain chemical dispersing agents to reduce the tendency of the developer particles to stick together or form clumps. Wetting agents are added to provide complete and thorough coverage of the parts. Corrosion inhibitors are added to protect the part from corrosive attack. Finally, biocides are added to provide a reasonable tank life by delaying bacterial growth. When applied, water-suspended developers evaporate very slowly at room temperature and require a hot air oven for proper drying.

2.4.11.3.2 Advantages of (Form c) - Water-Suspended Developer.

- The particles are insoluble in water and when dry, are highly adsorptive and absorptive.
- It can be used with Method A - Water-Washable Penetrants.

2.4.11.3.3 Disadvantages of (Form c) - Water-Suspended Developer.

- Agitation is required to keep the particles in suspension.
- Water-suspended developers may produce streaks or runs.

T.O. 33B-1-1**2.4.11.3.4 Using (Form c) - Water-Suspended Developer.**

2.4.11.3.4.1 Preparation of (Form c) - Water-Suspended Developer. Use of wet suspended (Form c) developer requires the use of a drying oven therefore it is always used in stationary penetrant systems. Wet developer concentrates SHALL be mixed with water in the proportions recommended by the manufacturer. The concentrations vary between types and manufacturers. The measured quantity of powder or liquid concentrate is added to the water, while stirring constantly until a smoothly mixed suspension is obtained. A newly mixed batch of suspended developer SHALL stand for 4 or 5-hours before use to allow the developer particles to wet.

2.4.11.3.4.2 Application of (Form c) - Water-Suspended Developer.**CAUTION**

The drain time for water-suspended developers SHALL NOT exceed 30-seconds.

Water-suspended developers may be applied by spraying, flowing or immersion. Wet developer, since it has a water base, can be applied to parts still wet from penetrant removal. When the part has been thoroughly covered with the developer solution, it SHALL be immediately removed from the solution and allowed to drain for a short time. Care must be exercised to prevent entrapment of soluble developer in the part cavities or concave surfaces (pooling). The developer SHALL wet the part surface with no water break areas after application. After the developer is applied, the parts SHALL be oven dried, since room temperature evaporation is too slow.

NOTE

The developing action DOES NOT start until the developer is dry.

2.4.11.4 (Form d and Form e) – Nonaqueous Solvent-Suspended Developer.

2.4.11.4.1 Description. Nonaqueous solvent-suspended developers are composed of particles of developer suspended in a mixture of volatile solvents. These developers are typically packaged in ready-to-use aerosol cans. The penetrant materials specification QPL SAE AMS 2644 classifies nonaqueous solvent-suspended developers into two categories; (Form d), formulated for Type I fluorescent penetrant systems and (Form e), formulated for Type II visible penetrant systems. Many nonaqueous developers are formulated to perform as both (Form d and Form e) developers. The suspending solvents of these developers are carefully selected for their compatibility with penetrants. Solvent developers also contain surfactants and dispersants whose functions are to coat the particles and reduce their tendency to clump or collect together. Solvent developers are the most sensitive forms of developers due to the solvent action contributing to the adsorption and absorption mechanisms. In many cases where tight, small flaws occur, the dry and aqueous developers do not contact the entrapped penetrant. This results in the failure of the developer to create the necessary capillary and surface tension forces that serve to pull the penetrant from the flaw. The nonaqueous developer solvents enter the flaw and dissolve into the penetrant. This action increases the volume and reduces the viscosity of the penetrant. Developer manufacturers must carefully select and compound the solvent mixture. Either excessive or inadequate volatility or solubility will adversely affect the performance of the developing action. High volatility reduces the time for the developer to function before it evaporates, while low volatility increases the drying time. Low solubility reduces the penetrant dissolving action, so the extraction of the penetrant from the flaw will not be enhanced.

2.4.11.4.2 Advantages of (Form d and Form e) - Nonaqueous Developers.

- Nonaqueous-wet developers are packaged in portable aerosol containers.
- Nonaqueous-wet developers are volatile and fast drying in air, thus eliminating the need for a drying oven.
- Nonaqueous-wet developers are sealed in their containers and are not recovered after their initial use, which eliminates any degradation by contamination.
- When proper techniques are used, nonaqueous-wet developers provide a smooth, even layer of developer whose thickness can be controlled by the operator.
- Nonaqueous-wet developers can be used with both fluorescent and visible-dye penetrants.
- Nonaqueous-wet developers are capable of producing the highest level of sensitivity of any of the developer forms due to their solvent action.

2.4.11.4.3 Disadvantages of (Form d and Form e) – Nonaqueous Developers.

WARNING

Nonaqueous-wet developers contain solvents that can be flammable, and when used in confined locations, present a health hazard. Caution SHALL be exercised to prevent ignition and to avoid inhalation of the vapors.

- The developer particles are suspended in the solvent and tend to rapidly settle out. Agitation of the container prior to and during application is required.
- The portable aerosol containers have a small spray coverage that makes coating of a large surface very time consuming. The aerosols are best limited to small, local areas.
- Aerosol cans exhibit a gradual loss of pressure over a period of time and occasionally there are leaks due to improper sealing. When the pressure is lost, the can and its remaining contents must be properly discarded.
- If the nozzle is not free of dried developer particles, spray patterns can be very erratic. It is necessary to clean the nozzle after every use by inverting the can and pressing the spray nozzle until only propellant escapes.

2.4.11.4.4 Using (Form d and Form e) – Nonaqueous Developer.

2.4.11.4.4.1 Preparation of (Form d and Form e) – Nonaqueous Developer.

CAUTION

The presence of any moisture will interfere with the developer action and small flaws may be missed. Like dry-powder developers, solvent developers SHALL NOT be applied to a part until the surface and any discontinuities are thoroughly free of moisture.

Since these developers are self-contained in a pressurized spray can, the only preparation required is shaking the can in order to thoroughly mix the developer, carrier solvent, and propellant.

2.4.11.4.5 Application of (Form d and Form e) – Nonaqueous Developers.

NOTE

Excessive thickness of developer SHALL NOT occur. Parts that have received excessive developer SHALL be completely reprocessed. Liquid flow on the part surface SHALL be avoided.

Nonaqueous-wet developers are always applied by spraying. Proper spraying produces a thin, uniform layer very sensitive in producing indications. Dipping, pouring, or brushing is not suitable for applying solvent-suspended developer. Dipping and pouring increases the time the solvent is dissolving and diluting the entrapped penetrant so much of it ends up in the unevaporated liquid developer layer. During the drain, the penetrant will flow from the flaw site, and any indications that do form will be weak and badly distorted. Application of solvent developer by brushing will leave streaks and distort and smear flaw indications into unrecognizable forms. Nonaqueous-wet developer SHALL be applied only as a fine spray or mist. Spraying of nonaqueous developer is most often done with pressurized, aerosol containers. There are a few production lines that use pressure pots and spray guns. Electrostatic spraying is possible, but is seldom used due to the poor throwing power of the spray. Prior to spray application, the container SHALL be agitated. Nonaqueous-wet developer is usually a suspension and the particles settle out in a matter of minutes. The spray can or gun SHALL be held far enough from the surface to produce a light, moist film. The recommended technique is to apply a very thin, dry layer and build up the thickness with several passes rather than applying a single, wet pass. The optimum coating thickness depends on the penetrant system type (i.e., visible or fluorescent dye) and must be judged from its appearance, based upon prior experience. When using Type I penetrant systems, the luster or surface texture of the part surface SHALL NOT be completely hidden. If the metallic luster cannot be seen, the developer layer is too thick, and small indications may be masked or too widely spread or blurred. Developer coatings that are too thin may not extract a sufficient amount of entrapped penetrant to form an indication. Also, too thin of a coat does not allow the penetrant to spread and magnify the indication. For Type II penetrant systems, a thicker coating is required to provide a solid white background to contrast with the visible indication. Observe the comparison of a cracked aluminum panel with optimum developer thickness for a Type II (visible) penetrant system, to one where an excessive developer layer has been applied is reflected in (Figure 2-23).

T.O. 33B-1-1

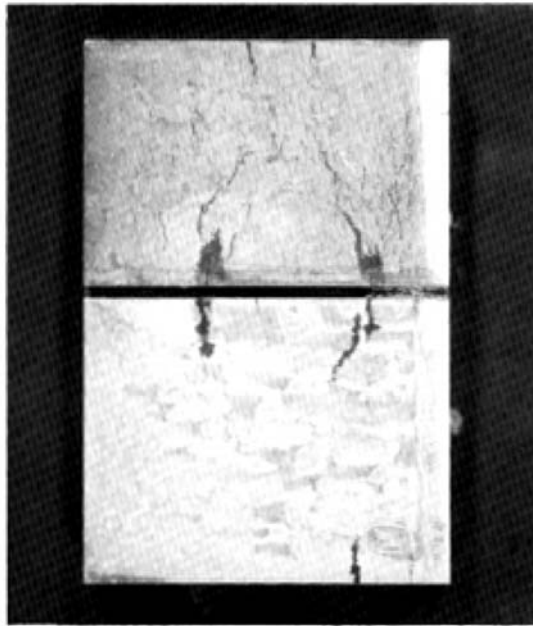


Figure 2-23. Cracked, Aluminum Panel Comparing Results of an Optimum Thickness Layer of Developer (Top) to an Excessive Thickness Layer of Developer (Bottom)

2.4.11.5 Developer Dwell (Development Time).

NOTE

- The developer dwell time SHALL NOT start until part is completely free of moisture.
- The maximum dwell times specified are based on small discontinuities. Medium or large discontinuities, which develop faster, will be blurred at these maximum dwell times; however, medium or large discontinuities contain enough penetrant to form an observable indication even though it is blurred. Indications from small discontinuities may be missed if the maximum dwell times are exceeded. The maximum developer dwell time SHALL NOT exceed the following: (Table 2-4).
- Extraction of the penetrant entrapped in a flaw is a function of time and volume of available penetrant. Sufficient time SHALL be allowed for the developer to draw the entrapped penetrant from the flaw and spread it on the part surface to form the indication. The length of developing time varies widely with a number of influencing factors.
- To increase penetrant system capability, parts should be viewed periodically during developing; however, the minimum dwell time SHALL be met. Over-development (e.g., too long a development time), is possible and SHALL be avoided. Developer action starts when the developer is completely dry and continues until all of the available penetrant is extracted. An indication will gradually form, reach a maximum resolution point (bright and sharp), and then begin to degrade. The lateral diffusion of penetrant over a period of time can be so great that the indication becomes indistinct. Medium or large discontinuities will appear as a smear or blob of penetrant. Small indications are especially critical, since the small amount of penetrant may not be observed when it diffuses.

2.4.11.5.1 Minimum and Maximum Developer Dwell Times. The minimum and maximum developer dwell times SHOULD be specified in the technical directives or part specific procedures mandating the inspection. Both the minimum and maximum developer dwell times that SHALL be used in the absence of specific technical directives or procedures are

listed in (Table 2-4). These dwell times are based on the developer form, the ambient temperature, and the expected flaw condition.

Table 2-4. Developer Dwell Times

Temperature 40° - 60°F		
<u>Nonaqueous Developer</u>	<u>Minimum</u>	<u>Maximum</u>
Service Damage/Fatigue Cracks	20 minutes	60 minutes
Stress-Corrosion Crack	60 minutes	120 minutes
<u>Aqueous Developer</u>		
Service Damage/Fatigue Cracks	30 minutes	120 minutes
Stress-Corrosion Crack	60 minutes	120 minutes
<u>Dry Developer</u>		
Service Damage/Fatigue Cracks	30 minutes	240 minutes
Stress-Corrosion Crack	60 minutes	240 minutes
Temperature 60° - 125°F		
<u>Nonaqueous Developer</u>	<u>Minimum</u>	<u>Maximum</u>
Service Damage/Fatigue Cracks	10 minutes	30 minutes
Stress-Corrosion Crack	30 minutes	60 minutes
<u>Aqueous Developer</u>		
Service Damage/Fatigue Cracks	15 minutes	60 minutes
Stress-Corrosion Crack	30 minutes	120 minutes
<u>Dry Developer</u>		
Service Damage/Fatigue Cracks	15 minutes	120 minutes
Stress-Corrosion Crack	30 minutes	240 minutes

To increase penetrant system capability, parts should be viewed periodically during developing. Over-development (i.e., too long a development time), is possible and SHALL be avoided. Developer action starts when the developer is completely dry and continues until all of the available penetrant is extracted. An indication will gradually form, reach a maximum resolution point (bright and sharp), and then begin to degrade. The lateral diffusion of penetrant over a period of time can be so great the indication becomes indistinct. Medium size or large discontinuities will appear as a smear or blob of penetrant. Small indications are especially critical, since the small amount of penetrant may not be observed when it diffuses.

2.4.11.6 Comparison of Developers. The relative sensitivities of penetrant inspection with various forms of developer are influenced by a number of factors. The method of applying the developer produces a range of sensitivities for each of the developer forms. Some of the common forms of developer, plus the application method, arranged in order of decreasing sensitivity are listed (Table 2-5). This is the sensitivity order most generally accepted. It is recognized that solvent- suspended developers applied by spraying produce a highly sensitive penetrant system. Industry agreement on the developer sensitivity order ends at this point. The type of test sample, type of flaw, flaw size and shape, type of penetrant, method of removal, and drying procedures will affect the sensitivity of the penetrant system. The number of variables involved has resulted in conflicting reports on the relative performance of dry versus water-based (suspended and soluble) developers. When properly applied, it is agreed the water-based developers form a coating with a finer matrix of developer particles that are in more intimate contact with the part surface when compared to dry developers. The opposing argument is that an uneven coating of water-based developers can mask indications. There is agreement that water-soluble developers SHALL NOT be used on

T.O. 33B-1-1

water washable penetrant. Photographs of a single cracked-chrome plated panel, that has been processed with four forms of developer using application methods available to base level NDI laboratories are contained in (Figure 2-24).

Table 2-5. Developer Forms and Application Methods in a Decreasing Sensitivity Order

Developer Form	Application Method	Sensitivity
Nonaqueous-Wet (Solvent Suspended)	Spray	Highly Sensitive
Water-Soluble	Spray	Highly Sensitive
Water- Suspended	Spray	Highly Sensitive
Water-Suspended	Immersion	Highly Sensitive
Water-Soluble	Immersion	Highly Sensitive
Dry-Powder	Electrostatic Spray	Decreasing Sensitivity
Dry-Powder	Fluidized Bed	Decreasing Sensitivity
Dry-Powder	Air Agitated Dust Cloud	Decreasing Sensitivity
Dry-Powder	Dip and Pour	Least Sensitive

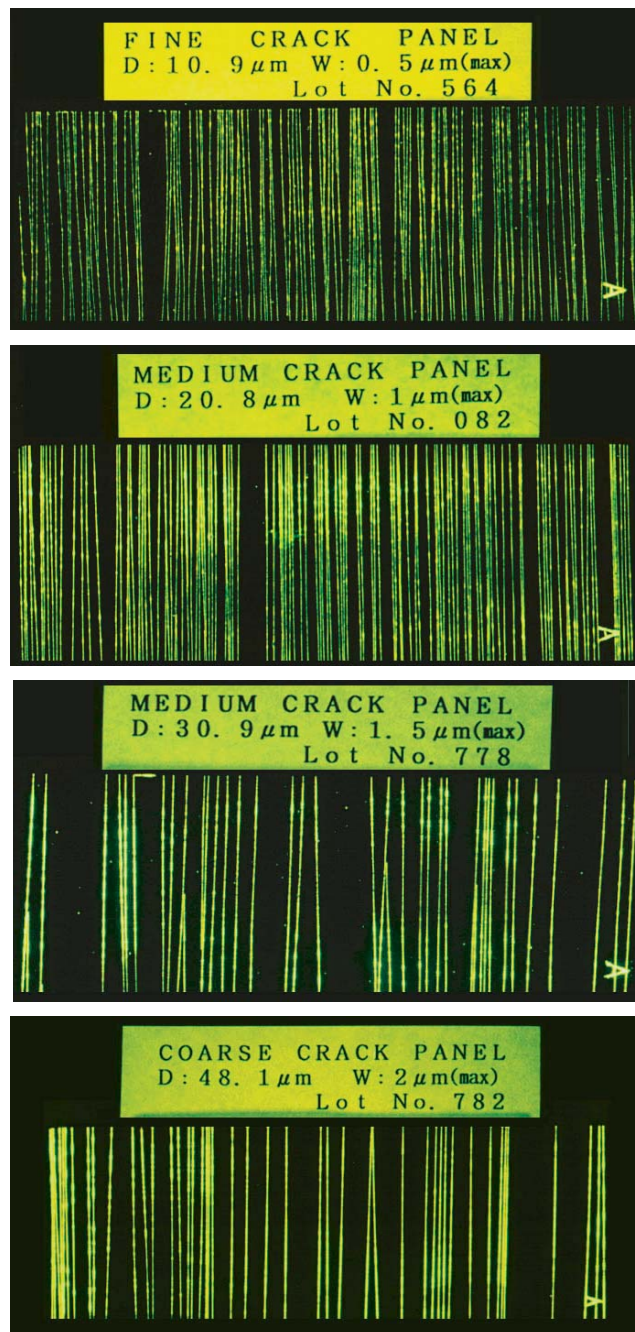


Figure 2-24. Comparison of Four Cracked Chrome Test Panels With Different Sensitivity Levels

T.O. 33B-1-12.4.11.7 Self-Development.**CAUTION**

Self-development SHALL NOT be used in aircraft and engine maintenance inspection where service-induced flaws must be detected. Self-development SHALL NOT be used for aircraft and engine component inspection unless specifically approved by the responsible NDI engineering authority.

Self-development is the formation of an indication without the application of a developer material. All penetrants are capable of some degree of self-development since they will exude from a discontinuity and spread over the surface. The critical factors are the size and volume of the discontinuities that must be detected. A relatively large volume of entrapped penetrant is required, and self-development is not reliable in detecting small, tight flaws.

2.4.12 Post-Cleaning After Penetrant Inspection.2.4.12.1 Effects of Inspection Residues on Subsequent Service.**WARNING**

Parts that will contact liquid oxygen SHALL be given special attention. Traces of oil can cause an explosion when contacted by liquid oxygen.

Penetrant inspection residues can have several adverse effects on subsequent processing and service. Developer and penetrant residues left on the test part, have detrimental effects on the application of surface finishes such as painting, plating, and anodizing. Penetrant residues left in the discontinuities can seriously affect the weld quality if not removed prior to repair welding. Developer residues can interfere with the functioning of the part if they involve a moving or wear surface. In addition, developer materials can absorb and retain moisture resulting in corrosion of the part.

2.4.12.2 Removal of Inspection Residues. Chemicals used in the penetrant inspection process could present problems to the inspection and/or the part after the inspection. Care SHALL be taken to ensure the part is free of all residues, which could present problems to the inspection process or the parts usability.

2.4.12.2.1 Developer Residue Removal. Developers are the last material applied in the penetrant process and may be one of several forms. The form of developer applied (dry-powder, nonaqueous, water suspendible, or water-soluble) greatly influences the method and difficulties of removal. One point common to most developers is the increase in adherence with time on the part. The longer a developer remains on a part, the more difficult it is to remove. Removal of the developer coating SHALL be accomplished as soon as possible after completing the penetrant inspection.

2.4.12.2.1.1 Removal of Dry-Powder Developer. Dry-powder developer adheres to all areas where applied. Some dry-powder may lodge in recessed areas, faying surface joints, or crevices. Dry-powder particles can be removed with a water-soluble detergent wash followed by a water rinse. Dry-developer particles adhering to penetrant bleed-out SHALL be removed during the "Removal of Penetrant Residues" described below in (paragraph 2.4.12.2.2).

2.4.12.2.1.2 Removal of Nonaqueous Developer.**NOTE**

To avoid spreading developer particles over a larger area, aerosol solvent SHALL NOT be directly sprayed on the developer without first hand-wiping.

Aerosol solvent spraying may be used as a final step to remove residual or trace amounts of developer when it is not practical to use water. Nonaqueous developer is usually applied by spraying from an aerosol can. The majority of applications involve a relatively small area. This makes it advantageous to initially remove the developer by hand-wiping the surface with a dry cloth or paper towel. The remaining traces of developer can then be removed with water or alcohol moistened rag or paper towel. The inspected area may contain threads, crevices, and surface recesses where wiping will not remove all of the developer particles. These areas should be pressure sprayed with a water and detergent solution after the initial wipe. Solvent

spraying is not particularly effective, as the developer is usually insoluble. A vapor degreaser SHALL NOT be used because the elevated temperature bakes or hardens the developer coating.

2.4.12.2.1.3 Removal of Water-Soluble Developer. Water-soluble developer is the easiest form to remove since the developer coating readily re-dissolves in water. Immersion or pressure spraying with water SHALL be performed to remove water-soluble developer.

2.4.12.2.1.4 Removal of Water Suspending Developer. The removal characteristics of water suspending developer are very similar to non-aqueous developer. The best method of removal is immersion and pressure spraying with a hot detergent solution. It can also be removed with a plain water spray and hand scrubbing with a fiber bristle brush.

2.4.12.2.2 Removal of Penetrant Residues. Removal of residual penetrant is almost always required. This step usually follows the developer removal. The amount of residual penetrant is small, consisting of penetrant retained in discontinuities, crevices, and part surface irregularities. Penetrant residues generally can be removed with liquid solvents and detergent or alkaline cleaning.

2.4.13 Protection of Parts Following Penetrant Inspection. The penetrant inspection process and subsequent removal of inspection residues leave the parts with a chemically clean surface. These surfaces, especially ferrous materials, are highly reactive and may corrode from the moisture in air. Such parts should receive a corrosion protection treatment as soon after the inspection and subsequent cleaning as required.

T.O. 33B-1-1

SECTION V INTERPRETATION OF LIQUID PENETRANT INSPECTION

2.5 INTERPRETATION OF INDICATIONS.

2.5.1 General. Successful detection of flaws by the penetrant inspection method depends upon many factors, chiefly, among which are the selection of the appropriate materials and process, the proper application of the chosen process, the quality of lighting during the examination and the ability of a technician to detect flaw indications. Interpretation is the process of determining whether an indication is relevant, non-relevant, or false. Evaluation involves assessing a relevant indication to determine its cause and type and reporting its category, location, and approximate size.

2.5.2 Importance of Understanding the Interpretation Process. The purpose of the penetrant inspection process is to detect flaws that will affect the integrity of a part. Many of these flaws may be very small. All of the penetrant materials, procedures, and process controls are oriented to producing valid indications from surface discontinuities. The inspection or examination step is one of the most important and frequently the least controlled of all the process steps. Marginally controlled inspection or examination conditions will degrade the entire penetrant process. Maximum benefits can only be obtained when all aspects of the process (e.g., personnel training and qualification, lighting, and inspection environment) receive equal management emphasis.

2.5.2.1 The apparent simplicity of the penetrant process is misleading. While the penetrant process is relatively straightforward, a successful inspection depends upon following very carefully prepared step-by-step procedures, from initial part cleaning to part examination and indication interpretation. An improper or marginal process step may not be recognizable in the inspection booth. As a result, a serious flaw may not be indicated. Many times, the first indicator of process degradation occurs during an individual process step. For example, an excessive emulsification time or an improper water-spray pattern can be identified at the time of the respective process steps, but the consequent removal of penetrant from a defect would go unnoticed.

2.5.3 Personnel Requirements.

CAUTION

All personnel performing any of the penetrant process steps SHALL be qualified in accordance with (paragraph 1.2).

Personnel, responsible for processing of part through one or more of the penetrant process steps, but do not inspect or interpret indications, SHALL have a basic knowledge of the process theory, practical aspects, and equipment operation. They SHALL be aware of the process control requirements and of the effects of improper procedures or degraded materials on the formation of indications.

2.5.3.1 Personnel, responsible for processing of part through one or more of the penetrant process steps, and for interpreting and evaluating penetrant indications SHALL have a detailed knowledge of the theory, practical aspects, and application procedures for the major penetrant processes. They SHALL be capable of performing all of the process steps, performing materials, and process control tests, and providing technical guidance to operators and trainees. In addition, they SHALL have knowledge of the potential types of discontinuities peculiar to the part being inspected, be familiar with the appearance of penetrant indications of those discontinuities, and have experience in interpretation and evaluation of indications. It is essential for an inspector to gain experience by working with other individuals who possess the required skill before being assigned interpretation responsibilities.

2.5.4 Lighting.

2.5.4.1 Ultraviolet (UV-) Light Illumination.

2.5.4.1.1 Characteristics. Ultraviolet (UV-) light is electromagnetic radiation with a wavelength ranging between X-rays and visible light, but is not visible to the human eye. The ultraviolet range is usually divided into three bands:

2.5.4.1.1.1 UV-A - Soft ultraviolet or long wavelength (320 to 400 nm), commonly called "black light." UV-A has the smallest bandwidth of the ultraviolet range and is just below visible wavelength range of 400 to 700 nm. The electromagnetic

spectrum showing the relatively small band of black light used in fluorescent penetrant inspection (Figure 2-25). Black light is near the violet end of the visible light range (near 400 nm).

2.5.4.1.1.2 UV-B - Medium wavelength (270 to 320 nm), used for examining minerals and in suntan lamps.

2.5.4.1.1.3 UV-C - Hard ultraviolet or short wavelength (4 to 270 nm), used in germicidal or sterilizing lamps.

WAVELENGTH MEASUREMENT UNITS

PM	=	PICOMETER	=	$1 \times 10^{-12}M$
μM	=	MICROMETER	=	$1 \times 10^{-6}M$
NM	=	NANOMETER	=	$1 \times 10^{-9}M$
MM	=	MILLIMETER	=	1 M
M	=	METER	=	1×10^3M
KM	=	KILOMETER		

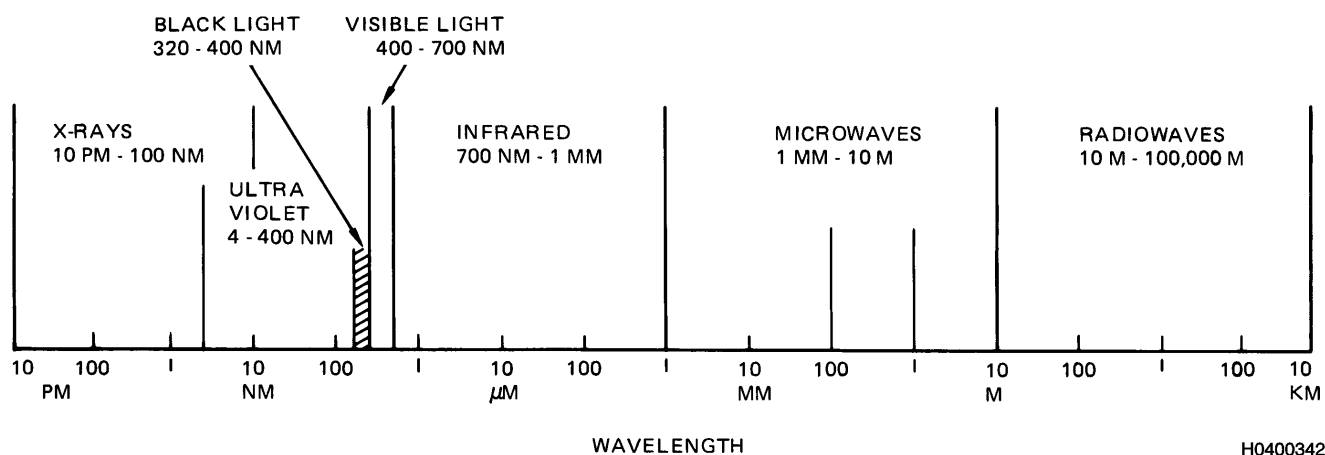


Figure 2-25. Electromagnetic Spectrum Shows the Relatively Narrow Band of Black Light

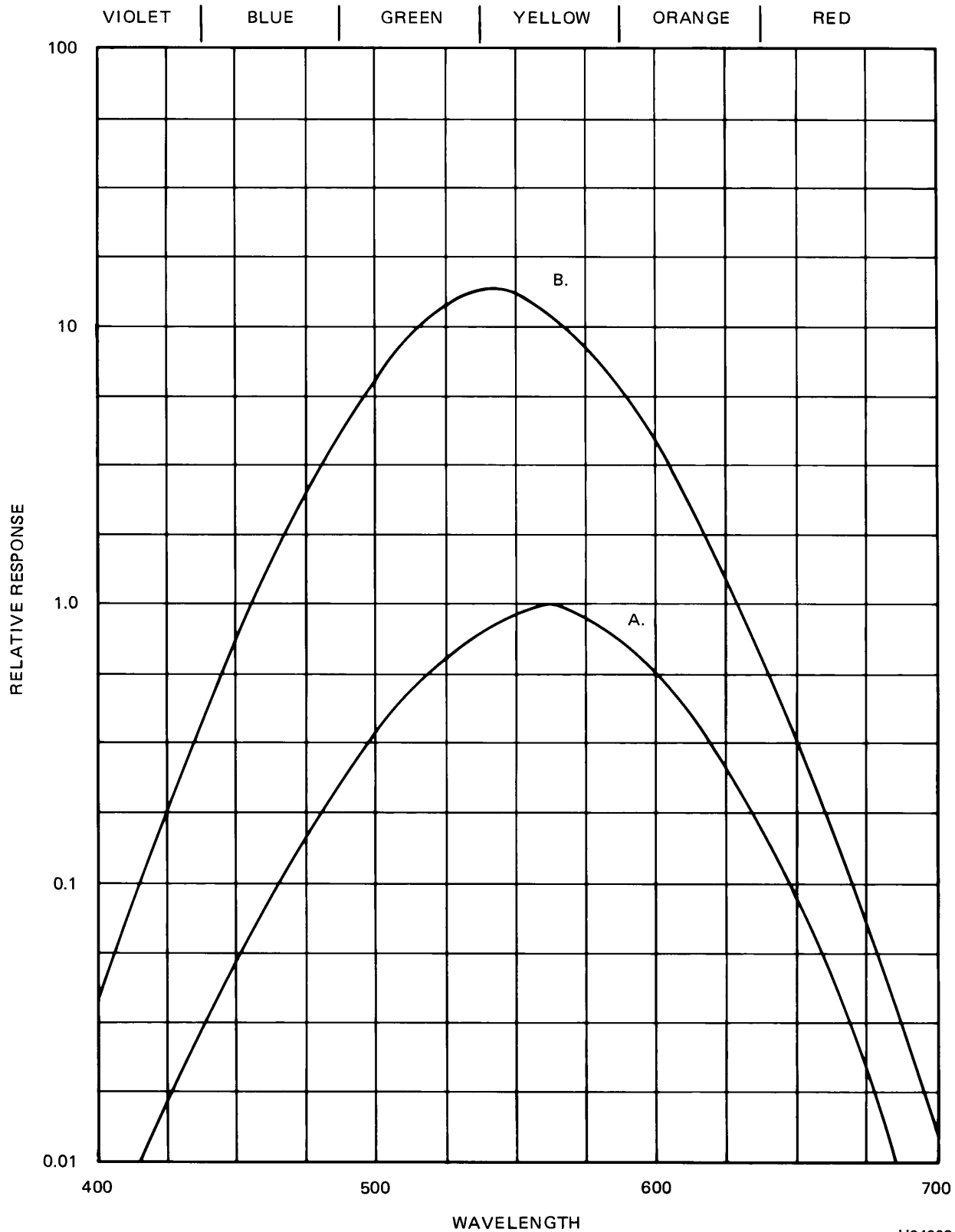
2.5.4.1.2 The Interaction of UV-A Radiation and Fluorescent Materials.

CAUTION

Some optical plastics used in eyeglass lenses can fluoresce, causing a loss of eye sensitivity when exposed to ultraviolet light. UV filtering safety glasses, goggles, or face shields SHALL be worn over such glasses to block the black light.

Fluorescence is the ability of some chemical compounds to emit visible light when exposed to near ultraviolet radiation. When fluorescent materials are energized by ultraviolet radiation, visible light is emitted. The color of the emitted light depends upon the material. Each type emits a specific wavelength ranging from violet (400 nm) to red (700 nm). Factors in selecting a fluorescent dye are a) the color emitted, and b) the intensity of emitted fluorescent light. The most frequently used dyes emit a yellow-green light in the wavelength band of 510 to 560 nm. This color is chosen since the human eye has its highest response to wavelengths in the 550 nm range. The relative response of a typical human eye compared to various wavelengths of visible light using two different lighting conditions are shown (Figure 2-26). Curve A at 100 lumens (100-foot-candles) is typical of a well-lighted inspection bench. Curve B at 2 lumens (2-footcandles) is the maximum white light level allowed in a fluorescent penetrant inspection booth. Under the darkened condition, the sensitivity of the eye increases about 30 times and shifts slightly to the blue region. At a light level of 2 lumens, it is possible for the eye to see some light wavelengths below 400 nm and above 700 nm.

T.O. 33B-1-1



H0400343

Figure 2-26. Relative Response of a Typical Human Eye to Visible Light at Two Different Light Levels, (A) 100 Lumens, and (B) 2.0 Lumens

2.5.4.1.3 UV-A Black Light Intensity and Ambient Light Requirements.

CAUTION

When performing portable fluorescent penetrant inspection, a dark colored canvas or photographers black cloth SHALL be used to darken the area during the examination. Portable fluorescent penetrant inspection SHALL NOT be performed in ambient conditions lighting conditions above 20-foot-candles.

The adequacy of a black light source for fluorescent penetrant inspection is determined by measuring the intensity of the black light with a UV-A meter placed at a distance of 15-inches from the front or outside surface of the black light source filter. The intensity SHALL be at least 1000-micro-watts per square centimeter ($\mu\text{W}/\text{cm}^2$), and sources providing less than this intensity SHALL NOT be utilized. For stationary inspections (laboratory inspection booths) the ambient white light SHALL NOT exceed 2-foot-candles. Ambient white light SHALL be measured with a white light meter with the black lights on. For portable inspections, where ambient light conditions cannot be controlled below 2-foot-candles, higher UV-A intensities at the inspection surfaces are required. The minimum UV-A intensity under varying ambient light levels (Table 2-6). Values of 3,000 $\mu\text{W}/\text{cm}^2$ can be achieved with acceptable black light sources by moving the source closer than 15-inches to the part, yet leaving sufficient space to observe the specific area of interest.

2.5.4.1.3.1 Excessive White Light. Some black lights may have excessive white light output based on construction, damage, and/or reflector used. All black lights (portable and stationary) SHALL be tested individually for white light output using a photometer at a distance of 15 inches in a fully darkened booth (0.01 to 2 foot-candles). Cumulative ambient light from the fully darkened booth and black light/white light output shall not exceed 2 foot-candles. All black lights (portable and stationary) and inspection booths will be checked per Table 1-3 for white/ambient light output.

Table 2-6. Empirical Black Light Intensity Requirements at Various Ambient Light Levels for Portable Inspections

Ambient Light (Foot-Candle)	Inspection Conditions	Minimum UV-A Intensity at Inspection Surface $\mu\text{W}/\text{cm}^2$
0.01 to 2	Fully darkened inspection booth	1000
2 to 10	Dark-to-dim interiors such as warehouses or storage areas	3000
10 to 20	Dim interiors	5000

2.5.4.1.4 Measurement of Black Light Intensity.

2.5.4.1.4.1 Measurement Devices. Ultraviolet light is electromagnetic radiation and is measured in units of energy per time, namely the unit of watt (W). Digital radiometers are currently the most commonly used instrument for conducting this measurement. Radiometers typically measure the energy of ultraviolet light in units of energy per time per area, i.e. watts per square meter or microwatts per square centimeter where one watt per square meter (W/m^2) equals 100 micro-watts per square centimeter ($\mu\text{W}/\text{cm}^2$). Care SHALL be exercised to assure the instrument used for this measurement is designed for the black light (UV-A) or 365-nm band.

2.5.4.1.4.2 Guidelines for Black Light Intensity Measurement. There are a few precautions to be observed when using black light intensity measuring instruments.

2.5.4.1.4.2.1 Some instruments have selectable ranges, and the proper range for the intensity being measured SHALL be used. The range selector may be changed while under the black light.

2.5.4.1.4.2.2 The sensing element should be at the location and orientation of the part surface to be inspected. Some instruments have detachable sensors that may be placed directly on the part surface.

2.5.4.1.4.2.3 White light does not affect the reading of the instrument.

2.5.4.1.4.2.4 The minimum UV-A output for a black light SHALL be 1000 $\mu\text{W}/\text{cm}^2$ measured at a distance of 15-inches from the outside face of the filter.

T.O. 33B-1-1**2.5.4.1.5 Variables in Black Light Sources.****NOTE**

- Intensity of new bulbs SHALL be at least 1000 $\mu\text{W}/\text{cm}^2$ at a distance of 15-inches from the outside face of the filter.
- Black lights that will be used periodically during the day SHOULD be allowed to remain on until their last use of the day. This practice will extend the useful bulb life.

2.5.4.1.5.1 Manufacturing Variations - Black light bulbs are manufactured for other industrial applications. Non-destructive inspection (NDI) uses only a small portion of this production. The primary users do not require a specific output or consistency between bulbs. Consequently, new bulbs may vary by as much as 50-percent in their initial output. This means that of two new bulbs, one may have an intensity that is double that of the other without either being defective.

2.5.4.1.5.2 Line Voltage Variations - Black light intensity varies almost linearly with line voltage. A common misconception is the black light ballast or transformer will regulate line variations. Below approximately 90-volts, the lamps will not sustain the mercury arc and the lamp will extinguish, and will not restart until it has cooled. Black light lamps should be connected to stable power sources. If none are available and line voltage fluctuates, a constant potential transformer should be used.

2.5.4.1.5.3 Service and Aging Variations - During use, dust and dirt will collect on both the bulb face and filter. Even small amounts will reduce the intensity and, if allowed to build up, can result in as much as a 50-percent decrease in ultraviolet radiation output. The bulb face and filter SHALL be kept clean. The output of black light bulbs will also vary due to changes in operating characteristics, as the operating hours add up and the bulb ages, the intensity will gradually decrease and will decrease the bulbs output. Of greater significance is the number of bulb starts. A single start can equate to 2 or 3-hours of continuous use on operating life.

2.5.4.1.6 Black Light Safety. Ultraviolet radiation below 320 nm can be hazardous and may cause permanent effects. The output of a black light bulb is principally at 365 nm and the amount of radiation at shorter wavelengths rapidly falls off. The amount of radiation emitted at or below 320 nm is typically less than 1-percent; however, this quantity is enough to require a filter. Germicidal, sun tanning, and mineral light bulbs that emit short and medium wavelength ultraviolet light SHALL NOT be used for penetrant inspection. Ultraviolet light filtering safety eyewear and gloves shall be used to minimize potential detrimental health effects.

2.5.4.1.6.1 Eyeball Fluorescence under Ultraviolet Radiation. The fluid in the eye will fluoresce when exposed to ultraviolet radiation. An operator may experience this phenomenon as a clouding of the vision when the ultraviolet radiation is reflected into the operator's eyeball or if ultraviolet radiation is reflected from highly reflective surfaces. This can usually be corrected by positioning the lamp so the radiation is not directed or reflected into the inspector's eye. The use of eyewear designed to protect the eyes from UV-A and UV-B will reduce this effect.

2.5.4.1.6.2 Restrictions on Eyeglasses.**CAUTION**

Contact lenses, sunglasses, and glasses with photochromic lens that darken when exposed to sunlight SHALL NOT be worn when performing fluorescent penetrant inspection.

Sunglasses reduce the amount of visible light radiating from a fluorescing indication and faint indications may not be seen. Photochromic lens will darken when exposed to black light and reduce the ability to see small indications. Furthermore, eyeglass frames that fluoresce under black light can cause glare or unnecessary fluorescent background illumination and should not be used in the inspection booth.

2.5.4.2 Ambient Visible Light.

2.5.4.2.1 Requirements. Inspection of a part for fluorescent penetrant indications with a black light SHALL always be done under the lowest possible level of ambient light. This increases the contrast between the light emitted from the

indication and the background. A low level of visible ambient light is critical for maintaining the sensitivity of the inspection. Ambient light in stationary inspection system booths SHALL NOT exceed 2 foot-candles. If a stationary black light booth is not adequate or appropriate, other provisions SHALL be made.

2.5.4.2.2 Measurement of Ambient Visible Light. Visible light is measured easily by using photometers or light meters. The light meter responds to electromagnetic energy with wavelengths of approximately 380 to 750 nm. This range extends into the longer wavelength black light and shorter wavelength infrared ranges. Precise measurement is possible with filters excluding black light and infrared radiation. The unit of measurement is the foot-candle. Another term often used to measure light intensity is the lux, which equals 1-lumen per square meter of surface area. One foot-candle equals approximately 10 lux. Measurement of ambient white light SHALL be performed in stationary inspection booths at the required intervals defined in (paragraph 2.5.4.1.3). Ambient light measurements SHALL be performed in accordance with (paragraph 2.6.6) and SHALL be performed with the black lights on.

2.5.4.2.3 White Light Requirements for Type II Penetrant Inspection. For inspecting parts that have been processed with visible-dye penetrant (Type II), the lighting system in the viewing area SHALL provide at least 100-foot-candles (1000 lux) of visible white light at the examination surface.

2.5.5 Inspection Conditions.

2.5.5.1 Dark Adaptation.

CAUTION

An inspector entering a darkened area SHALL allow at least 5-minutes for dark adaptation before examining parts. Furthermore, wearing clothing which fluoresces under ultraviolet light SHALL NOT be permitted during the performance of fluorescent penetrant inspection as it may raise the ambient white light in the inspection area to an unacceptable level.

The human eye becomes approximately 30-times more sensitive to light under dark conditions. This increased sensitivity gradually occurs when the light conditions change from light to dark. When first entering a dark area from a lighted area, little or nothing can be seen. During dark adaptation the human eye begins to adjust to the lower light levels in two ways. First, the pupil of the eye must widen to admit additional light. Second, the retina of the eye becomes more sensitive during dark adaptation as the retina switches from the cone to the rod receptors. Full sensitivity or dark adaptation requires about 20-minutes. A dark adaptation time of 5-minutes is usually sufficient for fluorescent penetrant inspection with black light. The human eye contains a protective mechanism that further complicates dark adaptation. The pupil of the eye responds very rapidly to bright light. A very short, bright light exposure cancels the slowly acquired dark adaptation. Time for dark adaptation SHALL be allowed whenever an inspector enters the darkened station or is exposed to bright ambient light. A timer capable of measuring this time period SHALL be visibly or audibly available within the darkened area.

2.5.5.2 Cleanliness. The inspection area and the hands/gloves and clothing of the inspector SHALL be clean and free of extraneous penetrant material. Non-relevant indications may be formed when parts contact extraneous penetrants. In addition, the fluorescence from the penetrant will raise the ambient light level, thus reducing sensitivity.

2.5.6 Evaluating Indications.

2.5.6.1 Evaluating and Interpreting Relevant and Non-relevant Indications. A distinction must be made between relevant indications, non-relevant indications, discontinuities, and flaws or defects. A relevant indication is one resulting from a discontinuity. A non-relevant indication can result from an intentional change in part shape such as threads or small radii, or may be caused by improper or careless processing procedures. Non-relevant indications are of concern because they may mask or cover a true discontinuity indication. A discontinuity is an unintentional change in part surface or physical condition such as tooling marks, scratches or gouges, cracks, seams, laps, and porosity. A discontinuity may or may not affect the serviceability of the part. If the discontinuity reduces or interferes with the serviceability, it is classified as a flaw or defect. It is possible for a part to contain multiple indications that may be any combination of non-relevant discontinuities not affecting serviceability and defects requiring corrective action.

2.5.6.2 Inspectors Interpretation Responsibility. NDI personnel SHALL be capable of interpreting indications and evaluating discontinuities in accordance with the specifications and procedures for the inspection process in use. They are not

T.O. 33B-1-1

normally responsible for disposition decisions on flawed parts, but they must report the type, location, and approximate size of any flaws present. Acceptance, rework or repair, and rejection limits are contained in the repair manuals and are the responsibility of the applicable work center.

2.5.6.3 Appearance of Indications. The size and shape of the discontinuity, the type of penetrant system, processing technique, type of developer, and the length of developer dwell influence the appearance of penetrant indications. These factors hold true for all types and forms of material and apply to both large and small parts.

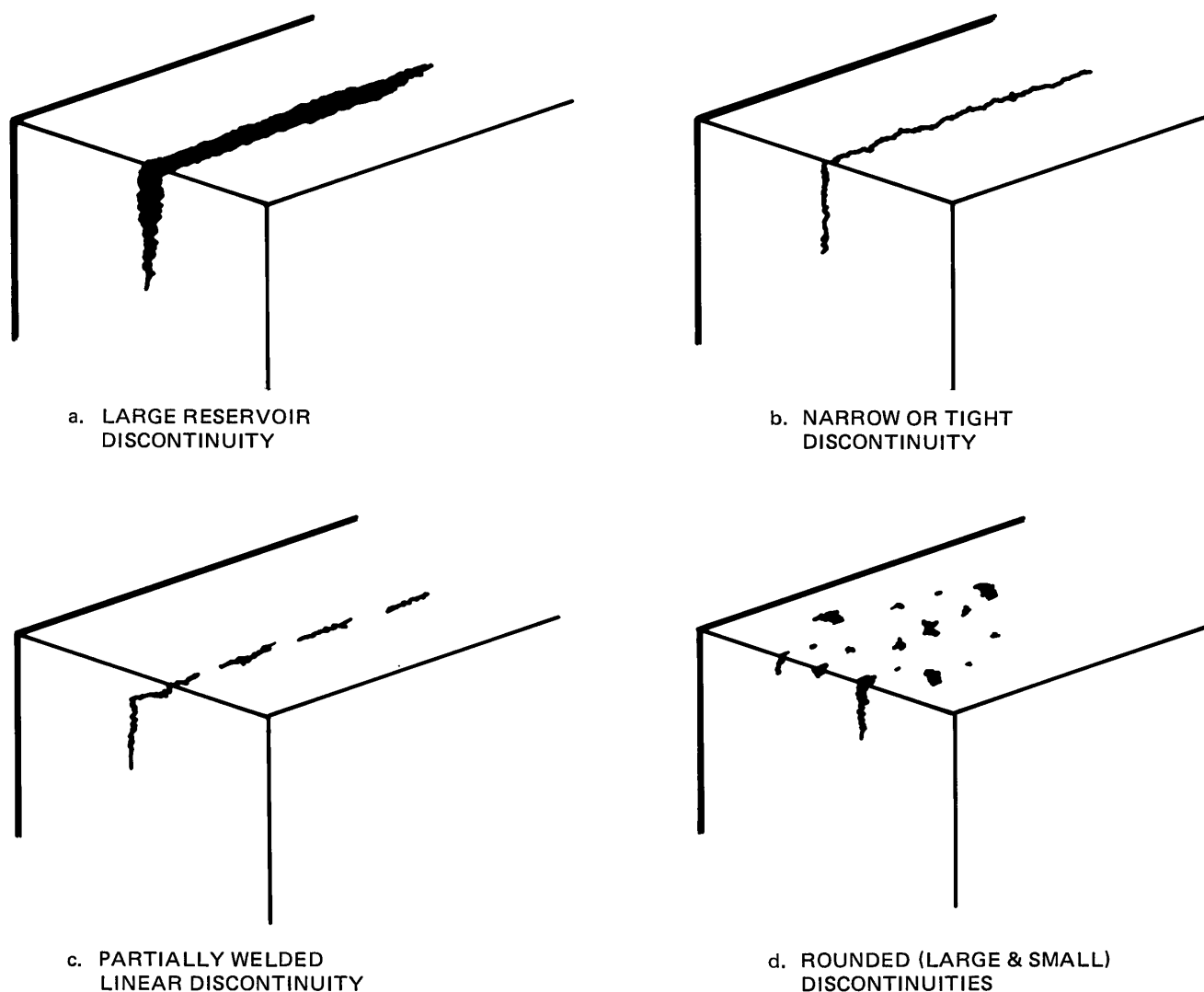
2.5.6.4 Classification of Discontinuity Indications.

NOTE

Remember, although an indication may signify a discontinuity in the test part, an indication is not always a sign of a defect. The responsible engineering authority SHALL make a determination if a discontinuity will be classified as a defect.

There are a number of ways of classifying discontinuities, such as appearance of the indication, its cause, material, and service conditions. The method of classification used depends upon the test method, the use of the parts, and the original designer. Many of the NDI application manuals, which are usually prepared by the original manufacturer, contain several discontinuity classifications in the same manual. Some of the indication types are discussed in the following paragraphs.

2.5.6.4.1 Continuous Linear Indications. Linear penetrant indications are caused by discontinuities such as cracks, seams, or laps. The width and brightness of the indication depend upon the volume of entrapped penetrant. The indication may be fairly straight or may have some curvature depending on how the discontinuity was formed. Also, the edges may be jagged or smooth, where the discontinuity meets the part surface. The surface appearance and a cross-section through a linear discontinuity with a large reservoir is shown ([Figure 2-27, \(a\)](#)). A narrow or tight linear discontinuity is also shown ([Figure 2-27, \(b\)](#)).



H0400344

Figure 2-27. Typical Penetrant Indications (a, b, c, d)

2.5.6.4.2 Intermittent Linear Indications. Intermittent linear indications are caused by the same discontinuities that form continuous linear indications; however, either a subsequent process or service use has partially sealed the surface edges. This occurs in forging laps or where the part has been subjected to a mechanical smearing action. A sub-surface discontinuity that intermittently breaks the surface for its entire length or a partially filled seam will also produce an intermittent linear indication as shown in (Figure 2-27, (c)).

2.5.6.4.3 Round or Dot Indications. Round indications are characterized as having a length and width of approximately equal dimensions. Porosity or relatively small areas of unsoundness in metal components usually form rounded indications; however, the actual surface opening may be irregular in shape. Deep discontinuities, such as weld crater cracks, may appear rounded due to the large volume of entrapped penetrant. The appearance of large and small rounded indications is reflected in (Figure 2-27, (d)).

T.O. 33B-1-1

2.5.6.4.4 Manufacturing Discontinuities. Many discontinuities result from manufacturing and repair processes. These will probably be detected each time the part is reinspected. The NDI inspector must, therefore, be familiar with their appearance and cause, in order to make valid interpretations of inspection results. Some of the common types of manufacturing discontinuities are described in the following paragraphs.

2.5.6.4.4.1 Porosity. Porosity is common to all cast parts, particularly aluminum and magnesium. Porosity occurs when gases are entrapped in the molten metal during pouring and solidification and may also occur during welding. It does not always break the surface, and internal porosity is not detected by penetrant inspection. Porosity can be very small and distributed throughout the material, in which case, it is called microporosity or you may see larger pores, which are called macroporosity. Microporosity may or may not cause a penetrant indication. In castings, porosity is usually not considered a defect, unless it is extensive enough to cause a structural weakness or allow the leakage of a fluid intended to be contained by the casting.

2.5.6.4.4.2 Inclusions. Inclusions are particles of foreign material, usually slag, oxides, sulfides, or silicates trapped in the metal during solidification. If the material is mechanically worked into plate, sheet, or bar, the inclusions will be elongated by the forming operations. They are not usually at the part surface but may become exposed by subsequent machining. Since inclusions are solid foreign matter, they will not form penetrant indications unless the foreign material is porous. Inclusions are usually considered defects only when they are open to the surface, have a measurable length, and are located in a critical area.

2.5.6.4.4.3 Seams. Seams occur in rolled bar stock or parts machined from bar stock. They are inclusions, porosity, or more commonly, metal folds that have been elongated by the rolling process during fabrication. They are long, straight discontinuities running parallel to the direction of mechanical working. If the seams contain foreign material, they may produce no indications, or very faint indications. They may be classified as defects depending on size and location.

2.5.6.4.4.4 Forging Laps. Forging laps are formed when a portion of the metal is creased and folded over during the forging operation. They produce a wavy, irregular, linear indication, which may be faint or intermittent, since the lap breaks the surface at an angle and the edges may be partially welded. They may or may not be considered a defect, depending on size and location.

2.5.6.4.4.5 Flash-Line Cracking. Forging flash is the line of excess metal extruded into the space at the junction between the top and bottom dies. Cracking can occur when this excess metal is removed causing the linear type of indications. The cracking always occurs along and within the trimming marks.

2.5.6.4.4.6 Extrusion Tears. Extrusion involves forcing a metal through a die to produce a desired shape. This process is similar to squeezing toothpaste out of a tube. If the die lip has a nick, burr or lump of oxide, the die can produce tears in the extruded part. Extrusion tears are usually short linear defects perpendicular to the extrusion direction.

2.5.6.4.4.7 Thermal Cracks. When metals are subjected to a high temperature, localized stresses can occur due to unequal heating or cooling, restricted movement within the part, or unequal cross-section. Cracking will occur when the stresses exceed the tensile strength of the material. There are several types of thermal cracking depending upon the heating process.

2.5.6.4.4.7.1 Grinding Cracks. Grinding of hardened surfaces frequently introduces surface cracks. Localized overheating due to insufficient or poor coolant, improper grinding wheel, too rapid feed or too heavy a cut causes these thermal cracks. The cracks are shallow and sharp at the root, generally occur at right angles to the direction of grinding, and usually but not always, occur in multiples. Grinding cracks are considered defects since they reduce the fatigue strength.

2.5.6.4.4.7.2 Heat Treat Cracks. Heat-treat or quench cracks form as a result of unequal heating or cooling within a part. The cracks are deep, usually forked, and seldom form a pattern. These cracks are considered defects.

2.5.6.4.4.7.3 Weld Cracks. Welds can contain a number of discontinuities detectable by penetrant. They may be due to lack of penetration, lack of fusion, heating or quenching cracks in the weld bead and heat affected zone, and grinding cracks occurring during removal of the weld crown. Crack-like discontinuities are considered defects. Two typical examples are, weld grinding cracks; and, shrinkage or quench crack.

2.5.6.4.5 Service Induced Discontinuities. The most frequently encountered service discontinuities detected by penetrant inspection are fatigue cracks. Stress corrosion and overload cracking are also common. Overload fractures occur when the stress exceeds the tensile strength of the part. This is greater than the yield point, and the fracture is accompanied by some

distortion. Cracks caused by overloading are relatively large and are further magnified by distortion, making them easy to detect visually without penetrant inspection.

2.5.6.4.5.1 Fatigue Cracking. Repeated or cyclic loading below the yield strength of the metal causes fatigue cracks. They initiate after a large number of load cycles usually at a surface imperfection such as a pit, scratch, tool mark, or at sharp change in cross-section. The initial crack is very small and forms a quarter or half-arc around the initiation point and then stops. After an additional number of load cycles, the crack grows slightly. This growth-arrest cycle produces a characteristic pattern on the fracture face, termed clamshell or beach mark pattern. Fatigue cracks have many common features. They occur in regions of high stress, are perpendicular to the direction of principal stress at their origin, and are transgranular. A good example of a fatigue crack is seen in (Figure 2-28). Transgranular means the cracking progresses through or across the grains of metal rather than around them. Fatigue cracking occurs on a wide variety of parts and is considered a defect. It will continue to grow in-service, and the rate of growth increases as it becomes larger.

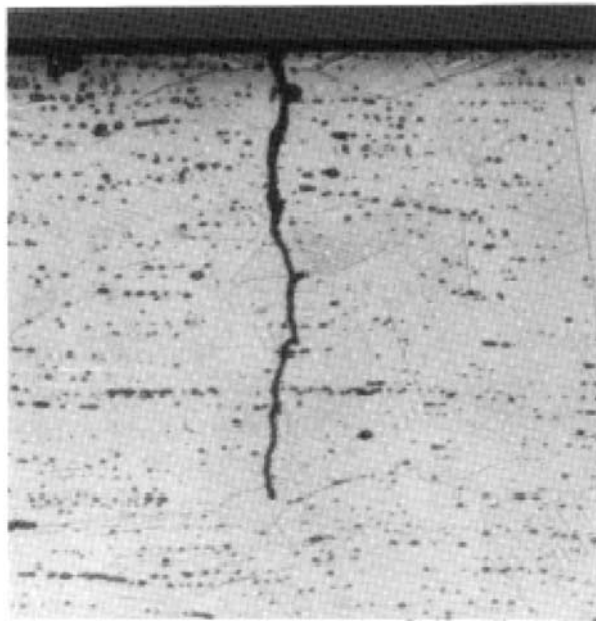


Figure 2-28. Micrograph of a Cross-Section Through a Fatigue Crack Showing the Transgranular Progression of the Crack

2.5.6.4.5.2 Stress-Corrosion Cracking. Stress-corrosion cracking is caused by a combination of stress and corrosion action. The stress may be either from service loads or a residual stress in the part. The residual stress can cause cracking of a part never in service. Stress-corrosion cracks have many of the characteristics of fatigue cracks. They occur in high stress areas at right angles to the stress and will grow in-service. Stress corrosion cracking may form a network of fine spider web-like cracks on the part surface. Penetrant indications of stress-corrosion cracks can also appear identical to indications of fatigue cracks. It is not always possible to distinguish between fatigue cracks and stress corrosion cracks from their surface appearance. Metallurgical examination is required to identify stress corrosion from fatigue cracks, since cross-sectioning will show stress-corrosion cracks are intergranular (meaning they propagate between the metal grains) whereas fatigue cracks are transgranular (they propagate through the metal grains). A micrograph of a stress-corrosion crack is shown (Figure 2-29). As with fatigue cracks, it is important to know the history or circumstances associated with the occurrence of the stress-corrosion cracking. Depending upon the service of the part, fatigue cracks may be free of contamination and may be easily detected with penetrant testing or they may be filled with contamination or under such high residual compressive stress they are impossible to detect with penetrant. Stress-corrosion cracks may have very little or a lot of corrosion products trapped in the cracks. The amount of corrosion product present significantly affects the detectability of this type of cracking. As with fatigue cracks, certain types of stress-corrosion cracking may not be detectable with penetrant methods. Extended dwell times may also be required to detect stress-corrosion cracking.

T.O. 33B-1-1

Figure 2-29. Micrograph of a Cross-Section Through a Stress-Corrosion Crack

2.5.6.4.5.3 Corrosion. The penetrant inspection method is occasionally used to detect corrosion. Corrosion usually attacks the material at the grain boundaries faster than at the interior of the grains and forms a network of very fine cracks. Corrosion may also be found as pitting on part surfaces. In the early stages, the crack or pitting are visible only under 10X or greater magnification. Penetrant indications of intergranular corrosion or surface pitting appear as a residual background that can only be resolved under magnification. Developer is not used when evaluating a penetrant indication using a magnifying glass. Penetrant inspection is often used to monitor the surface for adequacy of corrosion removal by grinding. Caution SHALL be exercised, since the mechanical removal causes smearing, which may obscure indications of remaining corrosion. In monitoring corrosion grind-out areas, a developer SHALL not be used. Following removal of excess surface penetrant, the area is examined using a low-power magnifying glass (3X to 5X). The examination SHALL be repeated after a minimum 5-minute dwell in lieu of developer. When the corrosion is no longer detected, the inspection process SHALL be repeated using nonaqueous developer.

2.5.6.5 Evaluation of Indications (Bleed-Back Method). Indications can be indistinct and blurred while still being highly visible. The following method may be used to verify and evaluate the type of indication. Lightly dampen a clean rag or cotton swab with an approved fast drying solvent, such as Isopropyl Alcohol. Carefully wipe the indication area only once with the solvent dampened rag or swab. After the solvent has evaporated, examine the bare surface with a 3X to 5X magnifying glass and watch the indication as it begins and continues to develop without developer applied. Evaluation of penetrant indications with a magnifying glass SHALL be accomplished with the developer removed. The developer will blur and enlarge the indication. The initial evaluation SHALL be done at low magnification (3X to 5X), with higher magnification (10X) used only after the indication has been located. If the indication cannot be located, spray a very light layer of nonaqueous developer over the area and watch the indication as it begins and continues to develop. If no penetrant bleed-out or surface imperfection can be seen, the original indication could have been non-relevant, possibly due to improper processing.

2.5.6.6 Photography of Indications.

2.5.6.6.1 General. Photography can be a good method of producing a permanent record of penetrant indications. Photography, both film and digital, can provide a very descriptive record since they show both the indication size and location on the part. They are permanent, reproducible, and the required equipment is available. Film photography of penetrant indications is slightly different than normal photography and requires care, practice, and a series of trial and error

exposures to produce an optimum photograph. Digital photography provides the greatest flexibility and ease of use compared to the film photography method and is considered the method of choice. Digital photography allows for rapid reproducibility and transportability of the imagery data, provides for very rapid optimization of exposure parameters and is much faster in terms of processing time. The resolution of digital cameras are approaching that of film and the quality (spatial and contrast resolution) is often more than sufficient for this application. With both the film and digital methods, it is often difficult to produce identical photographs when there is a time lapse between exposures. Photographs made at different times will vary due to a number of factors, such as changes in part position, camera position, black light intensity, filters used, or with film changes in film processing or development.

2.5.6.6.2 Camera Equipment. When photographing penetrant indications, which are generally very small, the camera must be held close to the object. This requires, at a minimum, a set of close-up (macro) lenses. Tripod or other means of holding the camera steady, and a cable release shutter are recommended for both the digital and film methods to reduce blurring caused by camera motion.

2.5.6.6.2.1 Filters. When compared to the human eye, photographic films and digital camera sensors have a higher response to ultraviolet light. When photographing fluorescent indications, the ultraviolet light must be removed or filtered to obtain a usable photograph. The basic filter used is a No. 2B. (The name Wratten is often associated with the filter numbers, after the man who devised the numbering system.) The 2B filter will absorb the invisible ultraviolet while passing the visible blue light. This approach, when used with color film or digital cameras, provides a photograph representative of what the eye sees. Color balance will be normal and the part will appear as a blue outline with the fluorescent indication appearing as bright yellow-green as normally seen. With black and white film or digital images, the part will be outlined and the indication will appear as a white line or dots. Some developers that form a bright background decrease the contrast between the part and indication, which may be compensated for by using a 2E filter. The 2E filter reduces the background brightness without reducing the indication brightness. When using a 2E filter and color film, the color balance will shift and the photograph may be more yellow than desired. For black and white photography, Nos. 3, 4, 8, or 15 filters may be used to improve the contrast of the indication, but these filters will transmit only the light from the indication, and the part outline will not be visible. When using film photography, white light can be flashed during the black light exposure to provide an outline of the part. Alternatively, to show the part, double expose the film using white or visible light for the second exposure. When using the double exposure procedure for black light photography, the white light exposure should be 1/3 or less of the normal exposure. This will make the part appear as dark as it would in the normal inspection station. If a normal exposure were used, the contrast between the part and the indication would be largely lost. When using digital photography the same effect can be produced by illuminating the part with a very subdued white light while illuminating the indication with a black light.

2.5.6.6.2.2 Film Types. All types of color and black and white film can be used. Slow film speed will increase contrast and decrease grain effects.

2.5.6.6.3 Camera Positioning. Penetrant indications are usually small. On large parts, it may not be possible to include the entire part in the photograph and still get acceptable detail on the indication. The camera must be moved in close to the indication, showing just enough of the part to adequately identify the location of the indication. When photographing penetrant indications, a through-the-lens viewing system is preferred. Cameras with a separate viewing lens will not include the exact area when making close-up photographs. Compensate for this by shifting the viewer aiming spot, the distance between the lens and viewer opening.

T.O. 33B-1-1

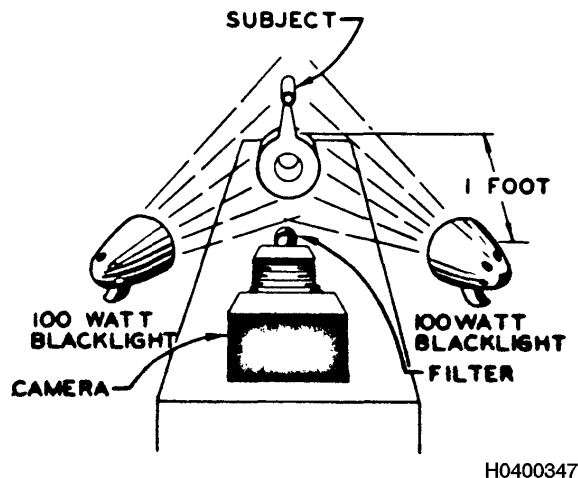


Figure 2-30. Location of Camera and Lights for Photographing Fluorescent Indications

2.5.6.6.4 Photographic Lighting. The maximum possible amount of black light energy SHALL be used to reduce exposure time. The usual procedure is to use two black light lamps placed at equal distances on each side of the indication and position the camera in the middle. This procedure provides equal light intensity across the length of the indication. The black light lamps SHALL be positioned so the direct beams, nor reflections from them, enter the camera. Tubular (fluorescent) black light bulbs, and many ultraviolet-light guide sources emit more visible blue light than high pressure, mercury bulbs. Therefore, a No. 2E filter will produce a more natural photograph when fluorescent black lights are used.

2.5.6.6.4.1 Light Meters. Photographic light meters may be used to estimate exposure criteria for film photography of fluorescent indications but they are not precise. Normal photographic exposure meters respond to black light to a greater degree than does the human eye. The exposure meter SHALL be equipped with the same ultraviolet absorbing filter used on the camera. The level of light emitted by fluorescing indications is low and a sensitive meter SHALL be used. A meter with a narrow angle aperture is better than a wide-angle type because most black light lamps are spot type sources, and there are wide variations in intensity over the part surface. Meter readings will be influenced by the size of the fluorescing indication. The meter readings will be correct or slightly over-exposed when the indications are large and emit considerable light. On average size indications, the meter reading will be correct or slightly under exposed. In general, it is wise to assume the meter reading is only a starting point. Light meters provide a more consistent and accurate reading when photographing visible-dye indications. White developer backgrounds may result in a meter reading calling for a slight under exposure. This can be compensated for by slightly increasing the exposure.

2.5.6.6.4.2 Lens Opening, Exposure, and Bracketing.

CAUTION

Always use the smallest lens opening (largest F-stop number) possible to get an acceptable depth of field to keep the entire part in focus.

Close-up photography requires care in selecting the lens opening to obtain an acceptable depth of field. Depth of field is the distance range that is in focus. Lens openings are called F-stops with larger numbers indicating a smaller lens opening, as the lens opening increases, (smaller F-stop numbers), the depth of field decreases. The lens opening number should be higher than F5.6 for most close photography of this type as stated. Stop numbers of F6 or smaller will result in portions of the picture being out of focus. Close-up photography of fluorescent indications may require a number of exposures to obtain optimum results. Therefore, with black and white film, three exposures should be made: the first at the meter indicated F-stop number; the second at two F-stop numbers under the meter reading; and the third at two F-stop numbers over the meter indicated number. A fourth exposure may be required at an intermediate setting. With color film, the same three-exposure procedure should be used to obtain a usable quality picture; however, it is recommended that the lens openings be adjusted at

one stop intervals with allowance for indication size as discussed above. With very large or very small indications, the optimum lens opening may be three or four F-stop numbers off the indicated value.

T.O. 33B-1-1

SECTION VI PROCESS CONTROL OF LIQUID PENETRANT INSPECTION

2.6 LIQUID PENETRANT PROCESS CONTROL.

2.6.1 General. This section provides basic, operating and advanced level information on the procedures necessary to assure a high quality performance from the penetrant inspection system. The first part of the section discusses the reasons for process and materials control. The second part describes procedures to verify materials quality.

2.6.2 Need for Process Quality.

CAUTION

The process materials and equipment SHALL be periodically tested and inspected to be sure they are all functioning properly.

Materials and process deficiencies are not always obvious. It is not easily determined if a penetrant has lost its ability to penetrate into a given flaw. Penetrant inspection, as well as, all other nondestructive inspection processes, is not a perfect process. Flaws can be present and not be indicated for a number of reasons. The two main reasons for discrepancies in inspection results are:

- Substandard inspection materials due to either receipt of bad material from the manufacturer or degradation in storage or service.
- Process deviations in equipment, procedures, or operating conditions

2.6.3 Why Test New Materials. Penetrant materials are subjected to extensive testing during their formulation to assure their proper composition, however, materials not performing satisfactorily can still be received. In a number of instances the discrepancies in performance have not been detected until a number of parts have been processed. Considerable effort must then be expended to locate and reinspect the suspect parts. Unsatisfactory materials can result from a number of causes. The penetrant supplier may inadvertently omit an ingredient or a process. An ingredient with similar characteristics may be substituted if the original material is unavailable. The substitution of ingredients may occur at the penetrant formulator's supplier.

2.6.4 Why Test In-Use Materials. Some inspection processes use the penetrant materials one time with no attempt to recover the excess. The materials are usually applied by spraying, and only enough material is applied to perform the test. The materials are stored in closed containers until they are used. These processes minimize the possibility of material contamination or degradation during use. More often, however, the materials are used in open tanks or open containers. When the immersion method is used, the surplus materials are allowed to drain from the part back into the tank. When penetrants are applied by brushing, the brush is alternately stroking the part surface and being immersed in the container. Both methods provide numerous opportunities for contamination and deterioration. Materials handled in this manner SHALL be checked periodically to be sure they are functioning acceptably.

2.6.5 Causes of Material Degradation.

2.6.5.1 Materials Contamination. Materials contamination is a primary source of penetrant system performance degradation. There are a number of contaminating materials and their effect on performance depends upon the contaminant type. Some of the common contaminants frequently encountered are:

- Water- Probably the most common type of contaminant. This can occur by careless or improper rinsing or carry over from other parts.
- Organic materials - Paint, lubricants, oils, greases, and sealant are other sources of contamination. These materials, if not removed from parts during precleaning, can dissolve in the penetrant and react with or dilute it, so it loses some or all of its ability to function.
- Organic solvents - Degreaser fluid, cleaning solvent, gasoline, and antifreeze solution are common types of solvent contaminants. These materials dissolve in the penetrant and reduce its effectiveness in proportion to the amount present. A small change in performance is usually not noticeable (5-percent or less of the total volume). The method of entry into penetrant is usually carry-over on the interior cavities of the part.

- Dirt, soil, other insoluble solids - Soil/solid contamination can be carried into the penetrant, emulsifier, and developer as a result of improper pre-cleaning and carry-over from other parts. Another common source of soil contamination occurs when the dwell stations are used to store parts. Most dwell stations have drain pans, which return the effluent back to the immersion tanks. Any soil falling from unclean parts into the drain pan will be washed into the tank with the drain effluent.
- Acid and alkaline materials - Acid and alkaline contamination is extremely serious. They react with the penetrant to destroy fluorescence brightness even when present in fairly small quantities. They are usually residues from etching; plating or the cleaning processes.
- Penetrant - Penetrant is a normal contaminant of emulsifier in the postemulsifiable process. It can be carried in on penetrant covered parts during the penetrant dwell step. As the penetrant builds up in volume, it will gradually slow the emulsifying action, and if the level becomes high enough, the emulsification process will stop.

2.6.5.2 Evaporation Losses. Penetrant materials used in open tanks are continuously undergoing evaporation. The rate of evaporation is increased with warmer temperatures and large tank surfaces. Evaporation losses of penetrant result in an increase in viscosity, thus slowing penetration and emulsification. Evaporation of water washable penetrant may slow or speed washability, depending on the penetrant formula. Evaporation losses in developer solutions increase the concentration, which produces a heavier coating that may mask smaller indications. Since evaporation losses take place very gradually, performance change may become significant before it is noticed.

2.6.5.3 Heat Degradation. Penetrants, especially fluorescent penetrants, are sensitive to elevated temperatures. Exposing penetrants to temperatures over 140°F (60°C) can reduce the fluorescence; and temperatures over 250°F (121°C) may destroy the penetrant completely. High temperatures also speed evaporation of the volatile components of penetrants, causing undesired performance changes. High temperatures exposure of penetrants can occur from the following:

- Immersion of heated or hot parts.
- Inspection of hot surfaces resulting from exposure to the sun, such as flight-line aircraft.
- Improper storage of penetrant materials (such as in direct sunlight) before being placed in use.
- Excessive exposure to heat in drying ovens.

2.6.5.4 Process Degradation. Not only do materials degrade, but equipment and procedures (other elements of the process) can deteriorate as well. Black-light bulbs age, degrade, and also become dirty, reducing their output. Drying oven thermostats can be improperly set or may malfunction, resulting in excessive temperatures causing critical procedures to be performed incorrectly. Materials, equipment, and procedures SHALL be periodically audited during their service life to assure satisfactory process performance.

2.6.6 Establishing Work Center Process Control Intervals.

CAUTION

The MAXIMUM process control intervals allowed is established in (Table 1-3). Each activity SHALL set inspection intervals based on their workloads. Laboratories SHALL use the guidelines listed below to establish their process control requirements and intervals. The inspection intervals SHALL be documented as discussed in (paragraph 1.5.5).

One of the factors influencing the degradation of a penetrant process (materials, equipment, and procedures) is the volume of parts being processed. The opportunities for materials contamination, drag-out, equipment malfunction, and procedure deviation are directly proportional to the number of parts being inspected. Equipment and process control inspection intervals vary depending upon the specific item to be checked. Many items will degrade on a time rather than a use basis. Since there is no uniformity in workload between activities, a single calendar schedule cannot be established. The process and equipment SHALL be inspected at weekly, monthly, quarterly, or semiannual intervals.

2.6.7 Process Control Equipment. The performance of liquid penetrant systems depends on processing material quality, including the pre-cleaning chemicals, liquid penetrant, emulsifier and developer, plus the continued proper functioning of the several processing stages. A sudden undetected deterioration of one of the processing chemicals or malfunction in one of the stages may result in a defect escape and the acceptance of a defect containing part. The penetrant operator must be alerted to the sudden change or deterioration in materials and in equipment (paragraph 2.3.7) as soon as possible and certainly before processing a substantial quantity of parts. The following paragraphs describe the various configurations of process monitoring devices available that are often used in determining the performance of the penetrant system.

T.O. 33B-1-1**2.6.7.1 Penetrant System Monitor (PSM) Panel.****CAUTION**

The PSM panel SHALL NOT be used as a substitute for the cracked-chrome plate panels except on automatic or semi-automatic spray systems used in some depot laboratories.

One example of a process-monitoring device is the Penetrant System Monitor (PSM), also known as the “star burst” panel. The PSM is alternatively specified as Pratt and Whitney TAM Panel 146040, Sherwin Company P/N PSM-5 and Magnaflux Company P/N 198055. The PSM is especially suitable for high volume, semi-automated, and fully automated depot systems. It is intended for use as a daily or weekly monitor of the entire penetrant process. When properly used, the PSM will signal changes affecting the integrity of a penetrant inspection process, changes that may have occurred in the materials, equipment, or procedures.

2.6.7.1.1 PSM Configuration. The PSM is a stainless steel panel measuring 4-inches wide by 6- inches long. A chrome-plated strip runs the length while the other side is a medium roughness, grit blasted surface. The chrome-plated strip contains five, evenly spaced, crack centers. The crack centers are in circular patterns varying in size from about 1/4-inch diameter down to about 1/32-inch diameter, and are arranged in order of magnitude. The cracks radiate from the center in a star or sunburst pattern. No two panels are completely identical and crack patterns and sizes vary from panel to panel.

CAUTION

Careful and thorough ultrasonic cleaning of the PSM panels between uses is mandatory. Use extreme care in handling and storing the panels. Do not drop, hit, or place undue mechanical stress on the test panels. Do not attempt to bend or straighten the test panels. Do not expose the test panels to temperatures above 212°F (100°C). Careful and thorough ultrasonic cleaning of all panels after each use is mandatory. Handle the panels with care. The panels are easily damaged by rough handling or when dropped. Panels indicating or showing evidence of damage SHALL be immediately replaced.

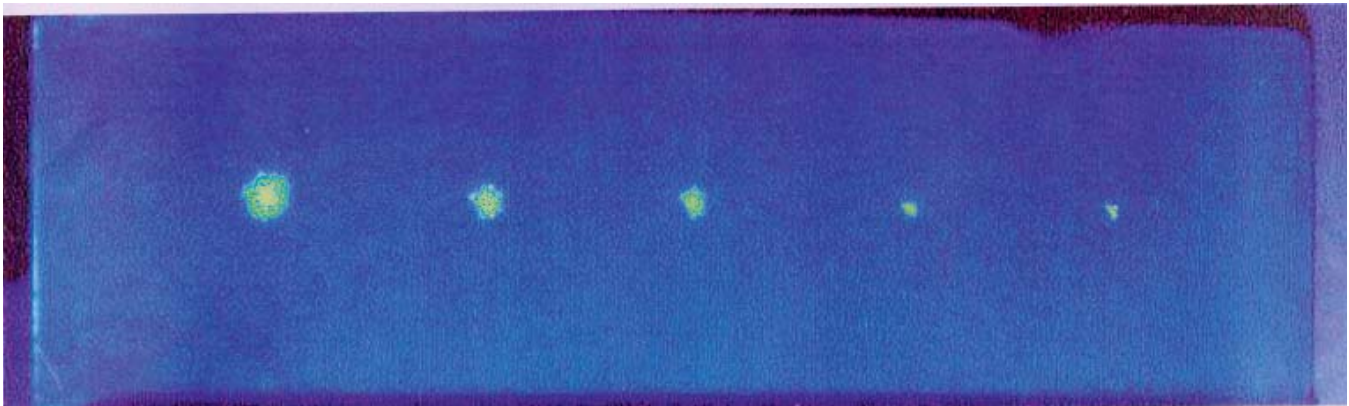


Figure 2-31. Processed Starburst Panel With Indications

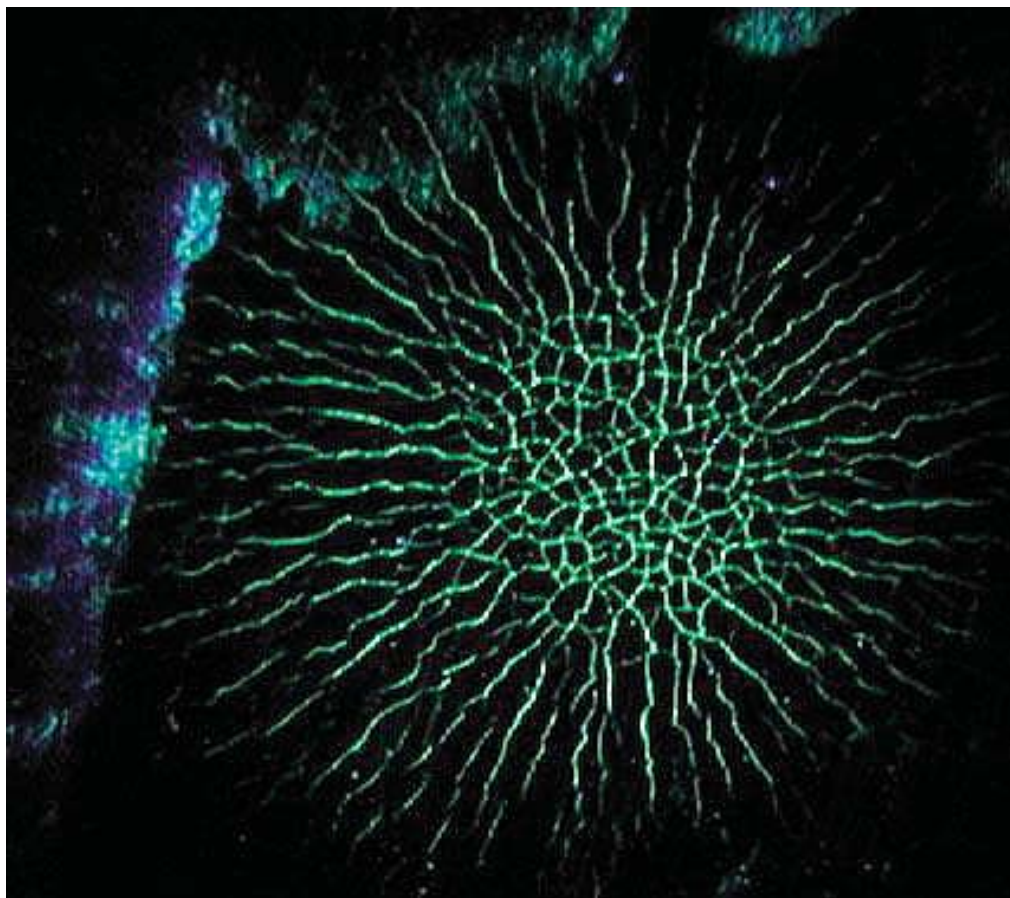


Figure 2-32. Magnified View of Largest Manufactured Indication

2.6.7.1.2 Monitoring of Sensitivity and Removability Using the PSM (Starburst) Panel. The PSM can monitor the entire process because it can be processed directly in the working tanks along with production parts. In addition, the grit blasted strip will separately indicate the effectiveness of just the removal process steps. One disadvantage is that small or gradual changes are not readily noticed. Furthermore, as with cracked chrome plate panels, the PSM indications deteriorate with handling and repeated use. Also, the PSM panel can retain large amounts of residual penetrant, so careful and thorough cleaning is mandatory.

2.6.7.2 Monitoring of Sensitivity with the Cracked-Chrome Panel.

CAUTION

Careful and thorough ultrasonic cleaning of cracked-chrome panels is mandatory.

The cracked-chrome panel is used for the evaluation of a liquid penetrant system's discontinuity detection performance. They are typically used to provide a qualitative side-by-side comparison of liquid penetrant performance. Their primary advantage is that small or gradual changes are readily noticed. Generally, tests made with cracked-chrome panels do not provide useful information on the background color or fluorescence caused by surface roughness of test parts or on the ability of a liquid penetrant to reveal micro-cracks in the presence of severe background porosity indications. Cracked-chrome plate panel indications will deteriorate with handling and repeated use. The panels are supplied in sets of two, with the supplier matching the panels as closely as possible. One panel is reserved for use as a "reference" or "transfer" standard while the other is the "working" panel.

T.O. 33B-1-1

2.6.7.2.1 Cracked-Chrome Panel. The cracked-chrome panel is made by burnishing a 2.80-inch wide brass or copper plate to a mirror finish, then electroplating a thin layer of chrome on this surface. The chrome layer is brittle and cracks can be generated in it by bending the panel over a curved form. Crack depth is controlled by the thickness of the chrome plating. Crack width is determined by the degree of deformation of the panel during bending and straightening and is not controlled. After the plate is chrome plated and cracked, it is cut in half, lengthwise to produce two panels containing symmetrical crack patterns in each panel. Since the cracks extend across the original panel, the two panels are provided as a set with each panel measuring 3.94-inches (100 mm) long and 1.38-inches (35 mm) wide. Panels are typically available with cracks of 10, 20, 30, and 50 microns. The 30 and 50-micron panels are most often used with low and medium sensitivity penetrants. The 10 and 20-micron panels are usually used with high and ultra-high sensitivity penetrants. The standard panel is the 20-micron panel.

2.6.8 Process Control Requirement. The capability and reliability of penetrant inspections depend upon the 1) materials, 2) equipment, and 3) procedures. Degradation in any of the three areas will reduce the effectiveness of the process. The following Table contains process checks for the penetrant system. The NDI supervisor SHALL perform an assessment of the penetrant process periodically. The interval of the assessment is at the NDI supervisor's discretion and does not require documentation. It is recommended that the process checklist be performed and documented whenever a unit self-assessment is accomplished. The process checks are presented in checklist format including a criticality identification system used in most Air Force checklists. The criticality is relevant to the penetrant process alone and should not be used by outside inspection agencies during assessments of the NDI Laboratory to determine the severity of an inspection finding. The criticality identifiers are as follows:

2.6.8.1 Critical Compliance Objectives (CCO). Items identified as key result areas for a successful mission accomplishment including, but not limited to, items where non-compliance could result in injury, excessive cost, or litigation. CCOs are shown in "**BOLD AND ALL CAPS FORMAT.**"

2.6.8.2 Core Compliance Items (CCI). Areas that require special vigilance and are important to the over-all performance of the unit, but are not deemed "Critical." Non-compliance would result in some negative impact on mission performance or could result in injury, unnecessary cost, or possible litigation. CCIs are shown in "ALL CAPS FORMAT."

2.6.8.3 General Compliance Items (GCI). Areas deemed fundamental to successful overall performance of the unit, but non-compliance would result in minimal impact on mission accomplishment or would be unlikely to result in injury, increased cost, or possible litigation. GCIs are shown in "sentence case format."

2.6.8.4 General Data Information (GDI). Information required to validate equipment care and requisition priorities. GDIs are shown in "*italic sentence case format.*"

Table 2-7. Process Checks PT

CCO.1	PART PREPARATION CHECKS – CLEANING/PRE-CLEANING. PRIOR TO APPLICATION OF PENETRANT, EXAMINE THE PRE-CLEANED PARTS FOR THE FOLLOWING:	YES or NO
CCI.1.a	ARE COATINGS, SOIL, AND CONTAMINANTS COMPLETELY REMOVED?	
GCI.1.b	Has all cleaning process residues been removed?	
GCI.1.c	Are test parts dried, especially in recessed areas?	
CCI.2	ARE NEW AND IN-USE MATERIALS CHECKED TO DETERMINE THEY MEET OR EXCEED THE MANUFACTURES SPECIFICATIONS?	
GCI.3	Are tests on new materials are being properly performed and documented?	
CCO.4	ARE TESTS ON IN-USE MATERIALS PROPERLY PERFORMED AND DOCUMENTED USING THE MAXIMUM PROCESS CONTROL INTERVALS ESTABLISHED (Table 1-3)?	
GCI.5	Process Control of Penetrant. Observe the application of penetrant paying attention to the following:	

Table 2-7. Process Checks PT - Continued		
CCI.5.a.	DO PART TEMPERATURES EXCEED 125°F PRIOR TO PENETRANT APPLICATION?	
GCI.5.b.	Is the penetrant applied properly for the method being used?	
GCI.5.c.	Is the entire part surface or area to be inspected completely and evenly covered?	
GCI.5.d.	When using the immersion method are parts with concave or complex surfaces rotated in the penetrant to assure no air pockets remain?	
GCI.5.e.	Is drain and dwell accomplished in a satisfactory manner including the removal of any pooled penetrant?	
CCI.5.f.	DO PENETRANT DWELL TIMES COMPLIES WITH THE SPECIFIC PROCEDURE REQUIREMENTS?	
GCI.6	Emulsifier and Remover Process Checks. Are the application, dwell and removal steps for lipophilic emulsifiers and hydrophilic removers closely monitored?	
GCI.7	Lipophilic Emulsifier Process Checks. Is the lipophilic emulsifier process observed and checked periodically to verify the following:	
GCI.7.a.	Is in-process Method B removability tests being properly performed and documented at intervals established in (Table 1-3)?	YES or NO
GCI.7.b.	Is the test part is rapidly and completely covered with emulsifier? Is their minimum mechanical action and no air pockets or uncoated surfaces?	
GCI.7.c.	Are test parts rotated to avoid pooling during the drain and dwell?	
CCI.7.d.	IS EMULSIFIER DWELL CLOSELY TIMED AND COMPLIES WITH SPECIFIC PROCEDURE REQUIREMENTS?	
CCI.7.e.	IS TEST PART PRODUCTION TIMED AND SPACED SO THAT NO DELAY OCCURS WHEN MOVING PARTS FROM EMULSIFIER DWELL STATION INTO THE RINSE STATION?	
GCI.8	Hydrophilic Remover Process Checks. When the hydrophilic remover method is used, are the following applicable steps periodically observed and checked?	
GCI.9	Hydrophilic Remover Process Checks – Pre-Rinse Step. Is the pre-rinse step periodically observed and checked to verify the following:	
CCI.9.a.	DOES THE WATER PRESSURE, WATERS TEMPERATURE, DROPLET SIZE, SPRAY PATTERN MEET SPECIFICATIONS OF THE SPECIFIC PROCEDURE, TO 33B-1-1 OR 33B-1-2?	
GCI.9.b.	Are all surfaces adequately rinsed?	
GCI.10	Hydrophilic Remover Process Checks – Immersion Application. When hydrophilic remover is applied by the immersion method is the process observed and checked to verify the following:	
CCO.10.a.	ARE IN-USE PERFORMANCE TESTS PROPERLY PERFORMED AT INTERVALS ESTABLISHED IN (Table 1-3)?	
GCI.10.b.	Is the surface of the remover examined with a black light for any signs of fluorescence?	
GCI.10.c.	Is there no odor or evidence of algae, fungi, or other growth?	
GCI.10.d.	Is agitation sufficient to move fresh remover in and around test parts but not excessive?	
GCI.10.e.	Are test parts completely immersed and when necessary rotated to eliminate air pockets?	
GCI.10.f	Are complex shaped parts rotated after removal to reduce pooling?	YES or NO

T.O. 33B-1-1

Table 2-7. Process Checks PT - Continued		
CCI.10.g.	IS DRAIN TIME AFTER REMOVAL FROM BATH LESS THAN 30-SECONDS BEFORE RINSING IS STARTED?	
GCI.11	Hydrophilic Remover Process Checks-Spray Application. When hydrophilic remover is applied by the spray application method, is the process observed and checked to verify the following:	
CCO.11.a.	ARE SPRAY REMOVER CONCENTRATION TESTS BEING PROPERLY PERFORMED USING THE PROCESS CONTROL INTERVALS ESTABLISHED IN (Table 1-3)?	
GCI.11.b.	Is spraying done under black light and in a shaded area?	
GCI.11.c.	Does the water pressure, temperature, droplet size, and spray pattern meet criteria established in the specific procedure, TO 33B-1-1, or TO 33B-1-2?	
GCI.11.d.	Is the test part rinsed with fresh water following the spray removal?	
GCI.12	Post-Rinse Process Checks. Is the rinse step periodically observed and checked to verify the following:	
GCI.12.a.	Is the rinse station is adequately shaded?	
CCI.12.b.	IS RINSING ACCOMPLISHED UNDER BLACK LIGHT?	
CCI.12.c.	DOES THE WATER PRESSURE, TEMPERATURE, DROPLET SIZE, AND SPRAY PATTERN MEET CRITERIA ESTABLISHED IN THE SPECIFIC PROCEDURE, TO 33B-1-1, OR TO 33B-1-2?	
GCI.12.d.	On parts processed with lipophilic emulsifier, is the entire surface rapidly wetted to stop the emulsification process before attempting removal?	
GCI.12.e.	On parts processed with hydrophilic remover, is the entire part rinsed to remove all traces of remover?	
GCI.12.f.	Is the test part free of pockets or splashes of penetrant after rinse?	
GCI.12.g.	Are test parts showing evidence of excessive residual penetrant (lipophilic process) completely cleaned and reprocessed through penetrant and emulsifier?	
GCI.13	Drying Process Checks. Is the drying process observed and checked periodically using the process control intervals established in (Table 1-3)?	
CCI.13.a.	IS THE OVEN THERMOSTAT CALIBRATED FOR ACCURACY AT INTERVALS DETERMINED BY T.O. 33K-1-100-CD-1? IS THE CALIBRATION ACCOMPLISHED PER MANUFACTURER'S INSTRUCTIONS?	YES or NO
GCI.13.b.	Is the oven area inspected with a black light to ensure it is clean and without fluorescent penetrant contamination?	
GCI.13.c.	Are fans working properly and airflow not restricted?	
GCI.13.d.	Is all pooled rinse water removed?	
CCI.13.e.	IS THE DRYER OVEN TEMPERATURE SETTINGS AT 140°F OR LESS? (FOR AUTOMATED OR SEMIAUTOMATIC SYSTEMS USED IN SOME DEPOTS REFER TO EQUIPMENT OR PART SPECIFIC PROCESS ORDER)	
CCI.13.f.	DO TEST PARTS REMAIN IN OVEN ONLY UNTIL DRY?	
GCI.14	Developer Process Checks.	

Table 2-7. Process Checks PT - Continued		
GCI.14.a.	Is the developer area inspected with a black light to ensure it is clean and without fluorescent penetrant contamination? Is it also free of any other contaminant, which may adversely affect penetrant inspection results (i.e., liquids, grease, excess developer, overspray, and extraneous parts and materials)? Is the area expose to black light and visually examined for any signs of fluorescence?	
GCI.14.b.	Are test parts in suitable condition (e.g., dry or wet) for the developer involved?	
CCI.14.c.	DO TEST PARTS DWELL THE REQUIRED TIME AFTER THE PART IS DRY (WATER OR SOLVENT DEVELOPERS)?	
GCI.15	Dry-Powder Developer Process Checks.	
GCI.15.a.	Is the developer dry with no clumping or fluorescent contamination?	
GCI.15.b.	Is the dry developer loose, fluffy, and pours easily?	
GCI.16	Dry-Powder Process Checks - Dip and Pour Method.	
GCI.16.a.	Is the developer dwell area clean and has adequate room for the parts being processed?	
GCI.16.b.	Is the entire part surface is covered	
GCI.16.c.	Is excess developer powder removed without brushing or rubbing?	
GCI.17	Dry-Powder Process Checks - Fog Chamber Method.	YES or NO
GCI.17.a.	Are work and dwell areas adequate with controls accessible for adjustment?	
GCI.17.b.	Does the system have an adequate reservoir with positive feed and no caking or uncovered pressure tubes?	
GCI.17.c.	Is good fog cloud produced with controlled air pressure?	
GCI.17.d.	Does the chamber or tank does create excessive air pollution?	
GCI.18	Water-Suspended Developer Process Checks.	
CCI.18.a.	ARE PERFORMANCE COMPARISON TESTS PERFORMED ON SCHEDULE AND RECORDED?	
CCO.18.b.	ARE CONCENTRATION CHECKS CORRECTLY PERFORMED ON SCHEDULE IN ACCORDANCE WITH THE PROCESS CONTROL INTERVALS ESTABLISHED IN (Table 1-3)?	
GCI.18.c.	Is the solution clean with no penetrant on the surface?	
GCI.18.d.	Does agitation produce a uniform suspension with no caking on the bottom or in the corners of the tank?	
GCI.18.e.	Is the entire part covered with no water breaks or air pockets?	
GCI.18.f.	Is the test part drained over the tank or recovery tray to reduce drag-out losses?	
GCI.18.g.	Are complex test parts rotated during drain to reduce pooling?	
GCI.18.h.	Is the developer coating is light and even after drying, with no retracted areas of beading or poor wetting?	
GCI.18.i.	Does the developer dwell time start when the part is free of moisture?	
GCI.19	Water-Soluble Developer Process Checks.	
CCI.19.a.	ARE PERFORMANCE COMPARISON TESTS PERFORMED ON SCHEDULE AND RECORDED?	
GCO.19.b.	ARE THE CONCENTRATION CHECKS PROPERLY PERFORMED ON SCHEDULE AND DOCUMENTED?	
GCI.19.c.	Are surfaces free of floating penetrant? (paragraph 2.6.10.4.8.2).	

T.O. 33B-1-1

Table 2-7. Process Checks PT - Continued		
GCI.19.e.	Is there no odor or evidence of algae, fungi, or other growth?	YES or NO
GCI.19.f.	Does the developer wet the part surface; with no water break areas after spray or immersion?	
GCI.19.g.	Are test parts drained over the tank or recovery tray to reduce drag-out losses?	
GCI.19.h.	Are complex shaped parts turned over or rotated during draining to remove any pools?	
GCI.19.i.	Is the correct developer dwell time used; with dwell time beginning after the coating has dried?	
GCI.19.j.	Is the coating transparent and relatively even after drying?	
GCI.20	Inspection Booth Checks.	
GCI.20.a.	Is the inspection booth area clean?	
GCI.20.b.	Is the booth used to store parts or other items that could cause penetrant contamination to test surfaces?	
GCI.20.c.	Is the area free of spilled penetrant and does not fluoresce excessively when exposed to black light?	
CCI.20.d.	IS THE AREA DARKENED TO 2-FOOT-CANDLES OR LESS AND IS PERIODICALLY CHECKED WITH AN ACCURATE VISIBLE LIGHT METER? IS THE CHECK DOCUMENTED AT INTERVALS STATED IN Table 1-3 OR WHEN A BLACK LIGHT BULB IS CHANGED?	
GCI.20.e.	Are black light bulbs and filters kept clean?	
CCI.20.f.	IS THE INTENSITY OF BLACK LIGHT CHECKED AND DOCUMENTED AT LEAST ONCE EACH DAY OR PRIOR TO USE?	
GCI.20.g.	Are filters inspected for fit and are crack free?	
GCI.20.h.	Are black lights positioned so they do not shine into the technician's eyes?	
GCI.20.i.	Do technicians observe the 5-minute dark adaptation period?	
GCI.21	Portable Inspection Part Preparation - Cleaning/Pre-cleaning.	
GCI.21.b.	Has the surface been damaged by mechanical paint removal methods?	
GCI.21.c.	Has paint stripping residues or other inorganic contaminants been removed?	YES or NO
GCI.21.d.	Is aerosol spray cleaner-remover suitable for pre-cleaning?	
GCI.21.e.	Has sufficient time been allowed for the pre-cleaning solvent to evaporate?	
GCI.22	Portable Inspection Penetrant Application Checks.	
GCI.22.a.	Are spray nozzles clean and free of dried or tacky penetrant?	
GCI.22.b.	Are aerosol cans shaken to thoroughly mix solvents prior to spraying?	
GCI.22.c.	Is a good spray technique used, with the can moving smoothly at the proper distance from the part?	
GCI.22.d.	Are brushes, swabs, and small containers used to apply penetrant clean and free of contaminates?	
GCI.22.e.	Is penetrant applied in an even layer, not excessively thick, and is free of runs?	
GCI.23	Portable Inspection Penetrant Removal Checks.	
GCI.23.a.	Is initial penetrant removal done with clean, dry cloth, folded between wipes to provide a fresh surface during each wipe?	

Table 2-7. Process Checks PT - Continued		
GCI.23.b.	Is final removal accomplished with a clean cloth, moistened (not saturated) with solvent? The cloth must be folded over with each wipe.	
CCI.23.c.	IS SOLVENT SPRAYED OR Poured DIRECTLY ON THE INSPECTION AREA?	
GCI.23.d.	Is a black light used to check for traces of residual penetrant during penetrant removal?	
GCI.24	Portable Inspection Developer Application Checks.	
GCI.24.a.	Are can nozzles clean and free of caked developer?	
GCI.24.b.	Is the can agitated (mixing ball is loose) until all developer is in suspension?	
GCI.24.c.	Is the developer coating not excessively thick and applied in multiple thin layer passes, rather than a single layer?	
CCI.24.d.	IS THE REQUIRED DWELL TIME ALLOWED AFTER THE SOLVENT HAS EVAPORATED?	YES or NO
GCI.24.e.	Is the developer spray pattern uniform?	
GCI.25	Portable Inspection Area Checks.	
CCI.25.a.	IS THE INSPECTION AREA SHADED OR SHIELDED TO REDUCE AMBIENT LIGHT TO ACCEPTABLE LEVELS? THE USE OF A PORTABLE CLOTH MAY BE REQUIRED TO ACCOMPLISH THIS.	
CCI.25.b.	ARE BLACK AND AMBIENT LIGHT INTENSITIES WITHIN ACCEPTABLE LIMITS? (paragraph 2.5.4.1.3)	
GCI.26	Post Cleaning Checks.	
GCI.26.a.	Are developer residues removed in a satisfactory manner?	
GCI.26.b.	Are penetrant residues removed in a satisfactory manner?	

2.6.9 Control of New Materials.

2.6.9.1 Approved Materials. With the exception of solvent removers only penetrant materials listed on the latest version of QPL SAE AMS 2644 may be procured and used.

2.6.9.2 Provisions for Procurement of New Materials. Penetrant system material procurement SHALL meet the following requirements:

- Materials SHALL comply with the current version of SAE AMS 2644.
- Except for solvent removers, bidders SHALL have material listed (or approved for listing) on the most current revision of QPL SAE AMS 2644.
- Contract and special purchase orders for procurement of materials SHALL require a certified test report and a quality conformance sample submitted in accordance with the latest revision of QPL SAE AMS 2644.
- Materials listed on QPL SAE AMS 2644 and centrally procured using generic national stock numbers (NSNs) need not comply with the certified test report and quality conformance sampling requirement.

2.6.9.3 Sampling of Newly Received Materials.

2.6.9.3.1 General. Two samples are required from each batch or lot of penetrant, emulsifier or remover, and/or wet and dry developer when received. Only one additional sample will be required if the supplier has submitted a quality conformance sample. Either one or two samples SHALL be taken from each batch or lot of penetrant, emulsifier and remover, and wet and dry developer, when received and prior to use. One sample, either from the supplier or locally taken, will be used to verify the Quality Conformance. The second sample, which may be larger than the first, will be retained by the using activities as a reference standard for periodic process performance tests.

T.O. 33B-1-1**2.6.9.3.2 Sample Size.**

2.6.9.3.2.1 Quality Conformance Sample. For all items except developer solids, one sample of not less than 1-quart or no more than 1-gallon SHALL be taken from each batch or lot of each material. For each batch or lot of wet developers in the dry condition, a 2-pound sample SHALL be selected, and from each batch or lot of dry developer solids a 1-pound sample SHALL be selected.

2.6.9.3.2.2 Process Control Reference Sample. These samples SHALL also be retained for use as reference or master standards in comparing the performance of the in-use material. The sample size will depend upon the workload, which determines the frequency of process control testing. A suggested sample size for high volume workload systems is 1 to 2-gallons (for all items except developer solids) from each batch or lot of materials. The suggested quantity of wet developers in the dry condition is 2-pounds. A 2-pound sample is recommended for dry developer solid. Each depot and base SHALL be responsible for determining the sample size required for its workload. The reference sample SHALL be large enough to permit the required process control checks during the life of the material and still have a quantity of reference sample to run a comparison check against the new materials when the old solution is finally discarded.

2.6.9.4 Handling and Storage of New Samples. Care SHALL be exercised in obtaining, handling, and storage of the reference samples to prevent contamination or degradation. The containers SHALL be metal or glass since the penetrant oils and solvents attack many plastics. The same restriction applies to the seals or washers in the container lids. The sample containers SHALL be clean, dry, and have tight fitting lids or covers. The devices used for obtaining the sample SHALL NOT contain traces of other batch or lot materials. The samples SHALL be stored in a cool area and not exposed to sunlight, black lights, or high intensity white lights.

2.6.9.5 Quality Conformance Testing of New Materials. Depots with the appropriate analytical equipment and competent technicians to perform the required tests may test the following properties for compliance with QPL SAE AMS 2644 in accordance with applicable procedures referenced in the specification:

- Flash point (penetrants and lipophilic emulsifiers).
- Viscosity (penetrants and emulsifiers).
- Fluorescent brightness (penetrants).
- Thermal stability (penetrants).
- Water tolerance (water washable penetrants and lipophilic emulsifiers).
- Redispersibility (nonaqueous-wet and aqueous suspended developers).
- Fluorescence (developer).
- Removability (penetrant).
- Water content (hydrophilic remover concentrate).

2.6.9.6 Reporting Unsatisfactory Materials.**NOTE**

Reporting problems, even relatively minor items, is essential for improvement in the NDI program, the materials specifications, and qualification testing. Information copies of written correspondence concerning unsatisfactory penetrant materials SHALL be furnished to AFRL/MLS, 2179 Twelfth Street, Bldg 652, Rm 122, Wright-Patterson Air Force Base, OH 45433-7718.

Unsatisfactory materials SHALL be reported in accordance with TO 00-35D-54 (Air Force) or AR 735-11-2 (Army). A copy of the quality conformance test report SHALL be included as substantiating data. The Air Force NDI Program Office, AFRL/MLS-OL, 4750 Staff Dr. Tinker AFB, OK 73145-3317 is the focal point collecting material deficiency reports relative to NDI materials. They may be contacted for assistance when preparing a material deficiency report. (For the Navy: Commanding Officer Naval Aviation Maintenance Office, Attn.: NDI PM, Patuxent River, MD 20670; for the Army: PEO Aviation, SFAE-AV-AS-AG, Bldg 7770, Redstone Arsenal, AL 35898 (NDT-COE@peoavn.redstone.army.mil).

2.6.10 Testing In-Use Materials.

2.6.10.1 Monitoring the System Performance of the Stationary Penetrant Line. In-use materials SHALL be periodically tested to assure they are capable of acceptable performance. Frequency of in-process testing SHALL be as determined based on the guidelines provided in (Table 1-3) and documented in accordance with (paragraph 1.5). Some in-process checks can be performed in the process tanks, while others are more conveniently performed on small samples taken from the tanks.

2.6.10.1.1 Monitoring of Sensitivity and Removability Using the PSM (Starburst) Panel.

NOTE

PSM (Starburst) panels are required at depot facilities with automatic or semi-automatic spray systems and optional at field labs.

The PSM is used to monitor the entire process because it can be processed directly in the working tanks along with production parts. In addition, the grit blasted strip will separately indicate the effectiveness of just the removal process steps. One disadvantage is small or gradual changes are not readily noticed. Furthermore, as with cracked chrome plate panels, the PSM indications deteriorate with handling and repeated use. Also, the PSM panel can retain large amounts of residual penetrant, so careful and thorough cleaning is mandatory.

2.6.10.1.2 Response of PSM Panels. PSM Panels are usually provided by the manufacturer to provide a minimum number of indications as specific penetrant sensitivity levels. However, significant response variability may occur from panel to panel. All PSM panels SHALL be initially evaluated upon receipt. The panels SHALL be processed through the penetrant line and the number of indications recorded along with the panel serial number. The panels SHALL show, as a minimum, the number of indications permitted during calibration and listed as follows:

Minimum Number of Indications:

Level 1 and Level 2	3 Indications
Level 3	4 Indications
Level 4	5 Indications

2.6.10.1.3 Use of PSM Panels. When used in depot inspection facilities the PSM panel SHALL be used to verify the penetrant system performance at the beginning of each shift. Because the PSM panel is a qualitative indication of the penetrant system performance the inspector must be able to “discern” a difference in the panels appearance from one test to another; such as increased background fluorescence or decreased flaw indications or brightness of indications.

2.6.10.1.3.1 Reading PSM Starburst Indications. The inspector SHALL examine the starburst crack centers for the number of starburst indications as well as the brightness of the indications. For example if the developer component is malfunctioning, crack centers may be still be indicated, but they may not be as bright as normal. The minimum number of indications defined in paragraph 2.6.10.1.2 SHALL be observed. Furthermore, when using aqueous developers, the developer SHALL provide a uniform coating over the chrome surface. Failure of the aqueous developer to wet the chrome may mean the solution strength is low, or the wetting agent has biodegraded. If a performance problem is noted additional testing is required to determine the cause.

2.6.10.1.3.2 Reading PSM Fluorescent Background. Washability and background fluorescence must also be interpreted. The grit blasted side of the PSM panel is used for this purpose. Some penetrant systems, especially high and ultra-high sensitivity systems, leave a fluorescent background on the panel’s grit blasted area. Other systems may leave no background. Neither condition, in itself, is alarming, unless it represents a change from the normal system performance. For example, with a hydrophilic remover system, higher than normal background fluorescence might indicate over dilution of the remover, shortened remover dwell times, absence of an effective pre-wash, etc. Lower background fluorescence might indicate failure to dilute the remover, over-extended remover dwell, inadequate developer application, etc. If a problem is noted additional testing is required to determine the cause.

2.6.10.1.3.3 Cleaning PSM Panels. PSM Panels SHALL be thoroughly cleaned prior to use and immediately after use in accordance with (paragraph 2.6.10.3.2).

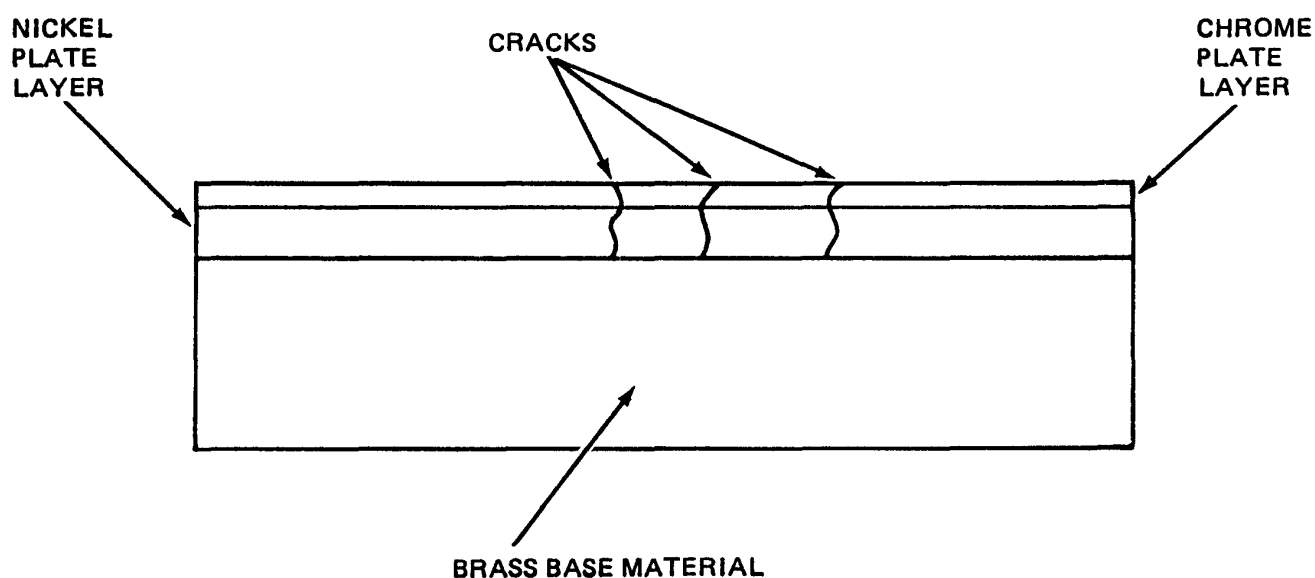
2.6.10.2 System Performance Test Procedure - Cracked-Chrome Panels.

T.O. 33B-1-1

CAUTION

Use extreme care in handling and storing the panels. Do not drop, hit, or place undue mechanical stress on the test panels. Do not attempt to bend or straighten the test panels. Do not expose the test panels to temperatures above 212°F (100°C). Careful and thorough ultrasonic cleaning of cracked-chrome panels after each use is mandatory. Handle the panels with care. The panels are easily damaged by rough handling or when dropped. Panels indicating or show evidence of damage SHALL be immediately replaced.

The cracked-chrome panel is used for the evaluation of a liquid penetrant system's discontinuity detection performance. They are typically used to provide a qualitative side-by-side comparison of liquid penetrant performance. Their primary advantage is that small or gradual changes are more readily noticed. Generally, tests made with cracked-chrome panels do not provide useful information on the background color or fluorescence caused by surface roughness of test parts or on the ability of a liquid penetrant to reveal micro-cracks in the presence of severe background porosity indications. Furthermore, the chrome-plated panel's mirror surface finish and flaw shape are not representative of normal aircraft parts. This requires special procedures when using the test panels. The main difference is the extreme care that SHALL be taken during the surface penetrant removal step. It is very easy to remove entrapped penetrant from the test panel cracks. Panels are cracked on one face only. When the penetrant materials are applied to the cracked face, surplus penetrant materials often get on the back of the panel. Penetrant materials on the back SHALL be removed to keep from contaminating the cracked panel face. Perform the test as follows:



H0400348

Figure 2-33. Illustration of Crack Depth in Cracked-Chrome Panel

- a. Clean the panels in accordance with (paragraph 2.6.10.3.2).
- b. Prepare a small quantity of working bath material and a small quantity of reference material. Place each in separate containers to be used specifically for this test. A small glass or paper container will suffice for this. Prepare the reference developer sample by mixing a small batch of previously reserved developer solids in the same ratio as the solution in your tank. For example, if the solution in your tank was prepared at 1/2 pound per gallon of water then mix the reference sample at 1/2 pound per gallon of water. This one-gallon reference sample can be used until depleted, but SHALL be discarded when the solution in the tanks is changed, along with the remainder of your dry reference solids.

CAUTION

Use the working materials on one panel and the reference materials on the other. To avoid contaminating the entire reference sample, the reference material SHALL NOT be applied to the cracked-chrome panel directly from its storage container. The working bath and reference material SHALL NOT be applied to the cracked-chrome panel with the same brush or swab. Any mixing of the two samples will invalidate the test results.

- c. Apply penetrant by brushing, swabbing, or flowing. Brushing or swabbing is preferred since it permits better control over the quantity of penetrant applied. Allow the penetrant to dwell for 5-minutes. This short time is usually adequate since the shallow cracks are rapidly penetrated.

NOTE

If a lipophilic emulsifier is used proceed to step e. If solvent removable method is used, proceed to step f. If a hydrophilic remover is used, conduct a pre-rinse not to exceed 20 seconds.

- d. The emulsifier/remover time SHALL be the shortest possible time required to remove the surface penetrant. Emulsification or removal time is very short, typically around 10 to 20 seconds. This will vary with different penetrant emulsifier or remover combinations. Initially, several trials SHALL be made to determine the proper emulsification or removal time. Water washable penetrants SHALL be washed as gently as possible under a black light. Wash time SHALL be limited to removal of surface penetrant only. The following methods SHALL be used to apply emulsifiers/removers:
 - (1) The lipophilic emulsifier SHALL be applied by carefully flowing or pouring the working bath and reference samples from their containers onto their correlating panels.
 - (2) The hydrophilic remover SHALL be applied by immersing the panels in their correlating working bath and reference containers.
- e. Solvent removal SHALL be accomplished by hand wiping with a separate clean dry cloth or towel on each panel. Final removal of any residual penetrant SHALL be accomplished with a clean cloth or towel just lightly moistened with solvent. Caution SHALL be exercised not to saturate the cloth or towel with the solvent. Caution SHALL be exercised to prevent mixing of test and reference materials during removal.
- f. Apply developer as follows:

CAUTION

Water-suspended developers SHALL be thoroughly agitated just before applying them to the panels. If water-soluble developers are used, agitation is not required. If dry-powder or nonaqueous is used, the panels SHALL be dry prior to applying developer.

- (1) Ensure developers have been properly mixed. (CAUTION above)
 - (2) Apply developer by immersion, flowing, or spraying depending on the developer form. Minimum drying time SHALL be used to ensure the panels do not become too hot to handle with bare hands.
 - (3) Developer dwell time of 5-minutes SHALL be used. The dwell begins after the panels are completely free of moisture.
 - (4) Care SHALL be exercised when drying the panels since the volatile components of the penetrant may quickly evaporate from the shallow cracks.
- g. Examine the panel's side-by-side, under a black light, first noting the overall brightness and color of the indications. Second, examine each in detail by following individual indications across both panels. Note the presence, absence, or diminishing of crack indications on the working bath panel as compared to the reference sample panel and observe the difference in continuity, size and color. Any distinct difference SHALL be cause for additional testing to determine if the penetrant, emulsifier/remover, or the developer caused the difference in the indications. Perform

T.O. 33B-1-1

additional tests as described in (paragraph 2.6.10.4). If no distinct difference is noted, the system performance test is complete.

- h. The cracked-chrome panels SHALL be cleaned immediately after completing the system performance test. The cleaning procedure described in (paragraph 2.6.10.3.2) SHALL be used.

2.6.10.2.1 Validating a Failed System Performance Test.

2.6.10.2.1.1 Testing for Failed Penetrant. If the system performance test indicates a loss of sensitivity or brightness, use a set of clean, dry cracked-chrome panels to repeat the material test procedure (paragraph 2.6.10.2) with the following changes: use the reference samples of emulsifier/remover and developer on both panels. If crack indications on the two panels show clearly visible differences in sensitivity, brightness or color, the penetrant SHALL be discarded in accordance with local directives.

2.6.10.2.1.2 Testing for Failed Emulsifier/Remover/Developer. If there is little or no difference in the crack indications during the penetrant performance test, clean the panels and repeat the performance test procedure to test the emulsifier/remover or the developer. Use reference samples of penetrant on both panels, with the exception of applying the appropriate working sample of emulsifier/remover/developer to one specimen at the appropriate point in the process.

2.6.10.3 Storage and Cleaning of Process Control Panels. The panels SHALL be stored in a clean environment to retard degradation. It is recommended the panels be stored in a clean solvent such as Isopropyl Alcohol or acetone. If the panels are to be stored in mineral spirits, a thorough cleaning in accordance with (paragraph 2.6.10.2) is still required. The cracked-chrome panels do not have an indefinite life. Penetrant and developer residues plus oxides retained in the cracks will gradually clog or fill the cracks, thus reducing the apparent size of the indications.

2.6.10.3.1 Storage of Process Control Panels. All process control panels (cracked-chrome panels, PSM panels, grit-blast panels) SHALL be stored in a clean environment to retard degradation. It is recommended the panels be stored in a clean solvent such as Isopropyl Alcohol or acetone. If the panels are to be stored in mineral spirits, a thorough cleaning in accordance with (paragraph 2.6.10.3.2) is still required. The cracked-chrome panels and PSM panels do not have an indefinite life. Penetrant and developer residues plus oxides retained in the cracks will gradually clog or fill the cracks, thus reducing the apparent size of the indications.

2.6.10.3.2 Cleaning of Process Control Panels. All process control panels (cracked-chrome panels, PSM panels, grit-blast panels) SHALL be cleaned prior to and after use in accordance with the following steps:

NOTE

Examples of cleaning materials are given in the procedure below, other penetrant material manufacturers make equivalent cleaners and these may also be used.

- a. Water spray will generally wash developer residue from the surface of the panel.
- b. Focus solvent spray such as Magnaflux SKC-S, SKC-HF (or equivalent), or Isopropyl Alcohol on the panels' defects to wash penetrant from the tight defects.
- c. Ultrasonically clean the panel in aqueous cleaner such as Magnaflux MagnaVu, Duraclean 212, (or equivalent) for 15-20 minutes. Follow mixing, safety, and concentration guidelines provided by the manufacturer.
- d. Rinse panel with clean water and then spray indications with solvent.
- e. Ultrasonically clean again for 10 minutes. Rinse with clean water and spray panel again with solvent.
- f. Panels may be stored in solvent such Isopropyl Alcohol, in a closed safety container away from open flames and sparks or dried and stored in the original or equivalent container.

CAUTION

Solvents are flammable and should be used in a flame free environment. Follow label precautions.

- g. When the panel is to be used, spray the panel with Magnaflux SKC-S, SKC-HF (or equivalent), or Isopropyl Alcohol and allow to dry.

2.6.10.4 Additional Testing of Penetrant Material. Additional tests to determine the total working condition of the penetrant include:

2.6.10.4.1 Surface Wetting Test. Apply a small amount of penetrant to the clean, shiny surface of commercially available aluminum foil with a cotton swab. After 10-minutes observe to ensure the penetrant readily wets the surface and the penetrant film does not retract or form beads.

2.6.10.4.2 Penetrant Brightness Test - (DEPOT ONLY). Perform this test on all Type I fluorescent penetrants as follows:

- a. Pour 10 milliliters of IN-USE SAMPLE penetrant into a graduated cylinder. Allow the penetrant to drain down the inside cylinder walls. Add or remove penetrant as required to achieve exactly 10-milliliters. Clean off the outside of the cylinder.
- b. Fill the graduated cylinder to the 100-ml level with an acetone (Specification 0-A-51F).
- c. Stopper the cylinder and slowly invert the graduated cylinder several times to mix the contents. Care SHALL be used to not shake or agitate the cylinder vigorously.
- d. Using tweezers, insert a quartered piece of filter paper into the cylinder mixture, withdraw the paper and set it aside to air dry for a minimum time of 5-minutes.
- e. Discard the contents of the graduated cylinder and clean the cylinder with an approved solvent (Specification O-C-265 or equal). Dry with clean filtered compressed air.
- f. Pour 10 milliliters of REFERENCE SAMPLE penetrant into the graduated cylinder. Allow the penetrant to drain down the inside cylinder walls. Add or remove penetrant as required to achieve exactly 10 milliliters. Clean off the outside of the cylinder.
- g. Fill the graduated cylinder to the 100-ml level with acetone.
- h. Stopper and slowly invert the graduated cylinder several times to mix the contents. Care SHALL be used to not shake or agitate the cylinder vigorously.
- i. Using tweezers, insert a quartered piece of filter paper into the cylinder mixture, withdraw the paper and set it aside to air dry for a minimum time of 5-minutes.
- j. When both filter papers (in-use and reference) are dry, compare the fluorescent brightness of the filter papers to each other under a black light. If a significant difference of fluorescent brightness is noted, the fluorescent properties of the in-use production line penetrant have deteriorated, and the fluorescent sensitivity will probably not be acceptable. Follow accepted activity standards to process and perform additional testing or to discard the contaminated/degraded material.
- k. At the conclusion of the fluorescent brightness testing, clean the cylinder with acetone rinse with water, and again clean with acetone. Dry with clean filtered compressed air.

2.6.10.4.3 Penetrant Rapid Brightness Test (FIELD LABS). A rough check of penetrant baths can be accomplished by comparing their appearance on an absorbent material, preferably filter paper. Perform this test on all Type I fluorescent penetrants as follows:

- a. Place a drop of the working bath penetrant on the absorbent material, preferably the filter paper.

T.O. 33B-1-1

- b. Place a second drop of penetrant from the reference standard on the same absorbent material near the drop from the working bath.
- c. When the two drops merge, examine under a black light for difference in color and brightness.

2.6.10.4.4 Testing Concentration of Water Based (Method "A") Penetrants. There is a small number of approved Method "A" penetrants currently containing water as a major consistent. These penetrants have been formulated to provide similar sensitivity performance to penetrant within the same sensitivity level while at the same time providing more environmentally friendly characteristics. Because water is a main constituent and evaporation losses may affect the penetrant performance, a periodic water concentration check is required. The refractometer method described in (paragraph [2.6.10.4.6.1.1](#)) SHALL be used to check concentration of water-based penetrants in the absence of specific manufacturer procedures. If the manufacturer provides specific water concentration test procedures the manufacturer's procedures SHALL take precedent.

2.6.10.4.5 Testing Lipophilic Emulsifier (Method "B"). Penetrant is an unavoidable contaminant of lipophilic emulsifier. It is carried into the emulsifier on the surface of parts where it dissolves and is washed off during immersion and drain process. Since emulsifier and penetrant are capable of being mixed in all concentrations, even small quantities of fluorescent dye will cause the emulsifier to fluoresce. The fluorescent brightness increases with increasing dye content, but it is impossible to visually estimate penetrant contamination by observation of the tank surface. Emulsifier will continue to function when contaminated with penetrant; however, when the penetrant concentration reaches a certain level, the emulsification action slows and eventually stops. The penetrant material specification (SAE-AMS-2644) requires a 4-to-1 mixture of emulsifier to penetrant to leave no more residual background than the uncontaminated emulsifier.

2.6.10.4.5.1 Lipophilic Emulsifier Removability Test.

NOTE

- The annealed type 301 or 302 stainless steel panel may be locally manufactured. It is a two-inch by four-inch, 16-gauge (0.060) panel and is required to perform this test. The panel SHALL be ultrasonically cleaned or vapor degreased and grit blasted on both sides using 100 mesh, aluminum oxide grit (not beads), using 60 psig air pressure, with the gun held normal to and approximately 18-inches from the panel surface. After blasting, the panel SHALL be ultrasonically cleaned in acetone or other suitable solvent. Ensure the panel is dry and free of residues after cleaning. The panel SHALL be handled by the edges only and protected from contamination by wrapping in tissue paper.
- Locally manufacture a simple stand large enough to hold the panel and maintain a 60° (±15°) angle. This stand SHALL permit the material to be applied without pooling of the material.

The removability test requires using the annealed type 301 or 302 stainless steel panel. In-use lipophilic emulsifiers SHALL be periodically tested for contamination in accordance with (Table 1-3). The process for performing the removability test is as follows:

- Immerse the panels in the working penetrant bath and allow it to drain for 10-minutes at approximately a 60° (±15°) angle.
- At the end of the drain period apply working bath emulsifier to one-half of the panel and reference standard emulsifier to the other half. Application may be either by pouring or immersion. If pouring is used, place a small quantity of both working bath emulsifier and reference standard emulsifier into separate containers that are suitable for pouring. Apply the emulsifier to the upper edge of the panel so it flows down across half of the panel face. This SHALL be done with the panel in an upright 60° (±15°) angle position. It is desirable to have both emulsifier flows close together at the center of the panel without allowing them to contact each other, however, this is not always possible so care SHALL be taken to refrain mixing of the two samples to a minimum. An overlapping of the two emulsifiers of less than 1/4 inch is acceptable; however, any overlap greater than 1/4 inch will reduce the accuracy of the test, requiring the panels to be reprocessed.
- Allow an emulsifier dwell time of 2-minutes and a wash time of 60-seconds. The water spray SHALL be applied equally to both panel halves with the nozzle at a constant distance from the surface. The bare metal SHALL be examined for signs of fluorescent background after the process has been applied.
- The panels SHALL be oven dried for approximately 5-minutes or until panels are completely dry, whichever time is shorter.
- Apply developer and allow the panel to dwell for 5-minutes.
- Evaluate the panels under black light. A distinct difference in residual background indicates excess penetrant contamination of the working bath lipophilic emulsifier.

CAUTION

The procedure to extract and replace a portion of used emulsifier SHALL be done only once before changing the entire tank. It is acceptable to extract a quantity of used emulsifier and replace it with fresh unused emulsifier. At least 25-percent to 50-percent of the tank volume SHALL be extracted and replaced. Following this procedure the emulsifier mixture SHALL be retested as described in (paragraph 2.6.10.4.5) to ensure proper functioning of the emulsifier bath.

2.6.10.4.6 Hydrophilic Remover Bath Concentration Test.

2.6.10.4.6.1 Hydrophilic Remover Immersion Bath Test. Freshly mixed (new) hydrophilic remover is characterized by a pinkish-red color that varies in intensity with the water content. There are three methods which follow are used to verify initial remover concentration.

T.O. 33B-1-1**2.6.10.4.6.1.1 Hydrophilic Remover Refractometry Test.****NOTE**

The refractometry test is the preferred method for measuring the concentration of hydrophilic remover baths. Since the refractive index and light transmission properties of removers vary from batch to batch, even with the same type and manufacturer, each NDI lab SHALL develop a graph of concentration versus refractive index number reading for each batch or lot of remover when it is mixed to verify the manufacturer's graph.

Refractometry is a test method by which the refractive index (Snell's Law) of a material is measured using a simple device called a refractometer. A refractometer measures the refractive index using the refractive index scale, which ranges from 0 to 320, with water having a refractive index of 0. A refractometer is supplied in the penetrant process control kit and is the recommended method to use in determining the initial water content concentration. Refractometry is also an acceptable method for testing in-use hydrophilic remover concentration provided that penetrant contamination is not excessive. A hydrophilic remover performance check (paragraph 2.6.10.4.6.1.5) will usually indicate excessive penetrant contamination before the refractive index is affected by penetrant contamination. The test is performed as follows:

- a. Dip the plastic rod supplied with the refractometer in the solution of new hydrophilic remover and water being tested. A metal or glass rod SHALL NOT be used as it may scratch the refractometer prism face. The test solution SHALL be well mixed to achieve accurate results.
- b. Raise the cover plate on the refractometer and place two or three drops of the test solution on the prism face. Close the cover plate; making certain the test solution film completely covers the prism face.
- c. With the cover plate contacting the prism, look through the eyepiece, hold the refractometer close to a bright light source so light illuminates and enters the prism. Overhead fluorescent lamps may not furnish sufficient illumination. Read the Brix value (refractive index units) where the bright and dark areas meet. Adjust the position between the light source and the prism face to create a clearer meeting line.
- d. Record the refractive index units as indicated. Using the manufacturer's literature, determine the concentration of the test sample from the refractive index value. Compare this value with the graph you created when mixing the bath. The working bath solution SHALL be within 5-percent of the required concentration.
- e. When the test has been completed, clean the refractometer cover plate and prism face with a soft lint-free cloth. Place the refractometer in its own protective pouch, and return it to the penetrant test kit carrying case.

2.6.10.4.6.1.2 Hydrophilic Remover Visual Colorimetry Test.**NOTE**

There is no requirement at this time to perform this test.

Visual Colorimetry is an alternate method for measuring the concentration of hydrophilic remover solutions. It is a method which utilizes the measurement of the light absorption by colored solutions. The fundamental principles of visual colorimetry state: the amount of light absorbed by a given substance in a solution is proportional to the intensity of incident light and to the concentration of absorbing material. Colorimetry is a simple method and is fairly precise. It matches the color of a standard solution with an unknown; when they become identical they must contain the same amount of colored substance. The instrument used to perform this task is known as a colorimeter. This method may be performed by depots with the appropriate equipment.

2.6.10.4.6.1.3 Hydrophilic Remover Hydrometry Test.**NOTE**

The refractometry method is the preferred method for measuring the concentration of hydrophilic emulsifiers. Hydrometry may be used if recommended by the manufacturer of the hydrophilic remover.

The hydrometry test involves the use of a hydrometer to determine the concentration of a solution by specific gravity. This method is very similar to the method used to check water-soluble and water suspendible developers. When using the hydrometer, perform a water concentration test in accordance with the following procedure:

- a. Mix a reference sample of new hydrophilic remover as recommended by the manufacturer in a 500-ml graduated cylinder or similar container.
- b. Using the hydrometer, check the concentration of the reference sample by noting its specific gravity and recording this reading.
- c. Place the hydrometer in the working bath. The working bath solution shall be adjusted to achieve a concentration within 5-percent of the same concentration level as the reference sample.

2.6.10.4.6.1.4 Hydrophilic Remover Quick Test for Penetrant Contamination. The quick test will determine if penetrant is present in the remover in large enough quantities to become a possible contaminant. Perform this test by passing a UV-A black light over the surface of the remover in the tank and visually examining it for signs of fluorescence. Gobbles of penetrant SHALL be removed by skimming or absorbing the penetrant with a paper towel.

2.6.10.4.6.1.5 Hydrophilic Remover Performance Check.

CAUTION

The immersion removal time cited in the following procedure is typical. Time will depend upon type of penetrant, type of remover, agitation, and remover concentration. The time SHALL be determined at each depot or field laboratory for each system involved. Trials SHALL be accomplished using fresh or uncontaminated remover. The objective is to use the minimum time necessary to produce a background-free surface on the immersion panel when the remover is uncontaminated.

NOTE

- The annealed type 301 or 302 stainless steel panel may be locally manufactured. It is a two-inch by four-inch, 16-gauge (0.060) panel and is required to perform this test. The panel SHALL be ultrasonically cleaned or vapor degreased and grit blasted on both sides using 100 mesh, aluminum oxide grit (not beads), using 60 psig air pressure, with the gun held normal to and approximately 18-inches from the panel surface. After blasting, the panel SHALL be ultrasonically cleaned in acetone or other suitable solvent. Ensure the panel is dry and free of residues after cleaning. The panel SHALL be handled by the edges only and protected from contamination by wrapping in tissue paper.
- Locally manufacture a simple stand large enough to hold the panel and maintain a 60° (±15°) angle. This stand SHALL permit the material to be applied without pooling of the material.

Penetrant materials, especially hydrophilic removers used in open tanks, continuously experience evaporation. This evaporation may increase viscosity and also affect removability of the material. Therefore, before changing the remover bath, the concentration test SHALL be performed. A performance check will verify the concentration or contamination of used immersion hydrophilic remover baths. Residual penetrant from parts disperse in the remover, causing turbidity making color comparison invalid. Residual penetrant also changes the refractive index of the solution potentially resulting in skewed refractometer measurements. Performance testing is the easiest and most practical way of determining the adequacy of a remover bath. This testing will usually indicate a problem with the remover bath (e.g., penetrant contamination, unacceptable concentration) well before a refractometer measurement will indicate a problem. The performance test involves processing the two panels with different removal contact times and comparing the results using the following procedure:

- a. Immerse the panels in the working penetrant bath and allow it to drain for 10-minutes at approximately a 60° (±15°) angle.
- b. Process the first panel through a 10-second pre-rinse, 10-second drain, 20-second immersion in remover, 5-second drain, and 10-second rinse.
- c. Process the second panel through the same cycle except double the immersion time to 40-seconds in the remover.

T.O. 33B-1-1

- d. Examine both panels under black light. When the remover is fresh and uncontaminated, neither panel should exhibit any background fluorescence. As the penetrant level in the remover starts to build up, the short immersion time panel will begin to show some residual fluorescence while the longer immersion panel remains free of background. As the amount of penetrant in the remover continues to increase, the level of fluorescence on the short immersion panel stabilizes and the longer immersion panel begins to show some residual background. When the remover reaches its penetrant tolerance limit, there will be negligible difference in fluorescence background on the two panels. The remover SHALL be changed at this point.
- e. Clean the panels by ultrasonically cleaning in acetone or other suitable solvent. Refer to paragraph 2.6.10.3.2 for more information. Ensure the panel is dry and free of residues after cleaning. The panel SHALL be handled by the edges only and protected from contamination by wrapping in tissue paper.

2.6.10.4.6.1.5.1 Hydrophilic Remover Background Fluorescence Check. If the performance check does not indicate remover degradation, using the same panels, determine if penetrant is causing the background fluorescence by proceeding as follows:

- a. Immerse the panels in the working penetrant bath and allow it to drain for 10-minutes at approximately a 60° (±15°) angle.
- b. Process the first panel using a 10-second pre-rinse, 10-second drain, 30-second immersion in the working bath remover, 5-second drain, and a 10-second rinse.
- c. Process the second panel using the same procedures above, except this time use the reference remover.
- d. Examine both panels under a black light.
- e. If background fluorescence is present on both panels, the working bath penetrant is contaminated and SHALL be replaced. If the panel processed with the reference remover is free of background fluorescence, and the other panel exhibits any background fluorescence, then the determination can be made that the working bath remover has reached its penetrant tolerance limit and SHALL be replaced.
- f. Ultrasonically clean the grit blasted panels using the cleaning process described in (paragraph 2.6.10.3.2). Ensure the panels are dry and free of residues after cleaning. The panel SHALL be handled by the edges only and protected from contamination by wrapping in tissue paper.

2.6.10.4.6.1.6 Hydrophilic Remover Spray Solution Test. Remover spray solutions are normally used only once with the effluent being disposed of after contact with the part. Contamination of the working solution is not a problem; however, the aspirator injection system requires frequent checks to ensure that the proper concentration is produced. Concentration of remover in the spray SHALL be measured whenever the aspirator or water pressure valve is adjusted and at the intervals prescribed in (Table 1-3). Measurement SHALL also be made whenever there is an unexplained change in background fluorescence. Test hydrophilic spray remover as follows:

2.6.10.4.6.1.6.1 A check of the hydrophilic remover touch-up spray concentration SHALL be accomplished by one of the methods explained in (paragraph 2.4.8.7.2.3.1). The concentration of the spray remover is much lower than immersion baths, and the results of the check SHALL reflect this change. Important items to remember are:

- If the hydrophilic remover touch-up spray is not of the same batch as the remover in the immersion tank, a new graph SHALL be plotted for the touch-up material.
- Make sure the temperature of the touch-up remover is within the parameters of the instrument/graph being used or compensated for.

2.6.10.4.6.1.6.2 The system concept for penetrant-material SHALL apply to the hydrophilic remover used in the touch-up step of the penetrant inspection. The material being used in the immersion remover tank and the touch-up spray SHALL be of the same manufacturer and SHALL be qualified as a penetrant system listed in the qualified products list in accordance with QPL SAE AMS 2644.

2.6.10.4.7 Testing Water-Suspended Developer.

CAUTION

Prior to using a new solution, a working level SHALL be established by measuring the distance from the top of the tank to the solution itself. This working level SHALL be maintained by the addition of water to replace evaporation losses.

2.6.10.4.7.1 Why Test Water-Suspended Developer. There are a number of service factors affecting the performance of water-suspended developers. Most significant of these are changes in concentration and contamination problems.

2.6.10.4.7.1.1 Water-Suspended Developer Concentration Level. Reduced concentration results in thin coatings, which decrease the sensitivity of the system. Developer concentration may vary for a number of reasons:

- Evaporation – As water evaporates, the concentration levels increase, causing excessive coating thickness on the part.
- Drag-out - As parts are processed, developer is removed due to the film adhering to the part surface, or entrapped in recesses of the part. This loss of developer is termed drag-out and, unless concentrate is added, will result in reduced developer concentration.
- Inadequate agitation - Allows some of the developer particles to settle out, which also reduces concentration.
- Caking - It is also possible for the developer particles to cake on the bottom or in the corners of the tank preventing them from being suspended.

2.6.10.4.7.1.2 Contamination of Water-Suspended Developer. Developer contamination takes a close second to concentration problems. Fluorescent dye contamination can be caused by the wetting agents inherent in the developer, which can remove penetrant entrapped in the part.

2.6.10.4.7.2 Water-Suspended Developer Concentration Test.

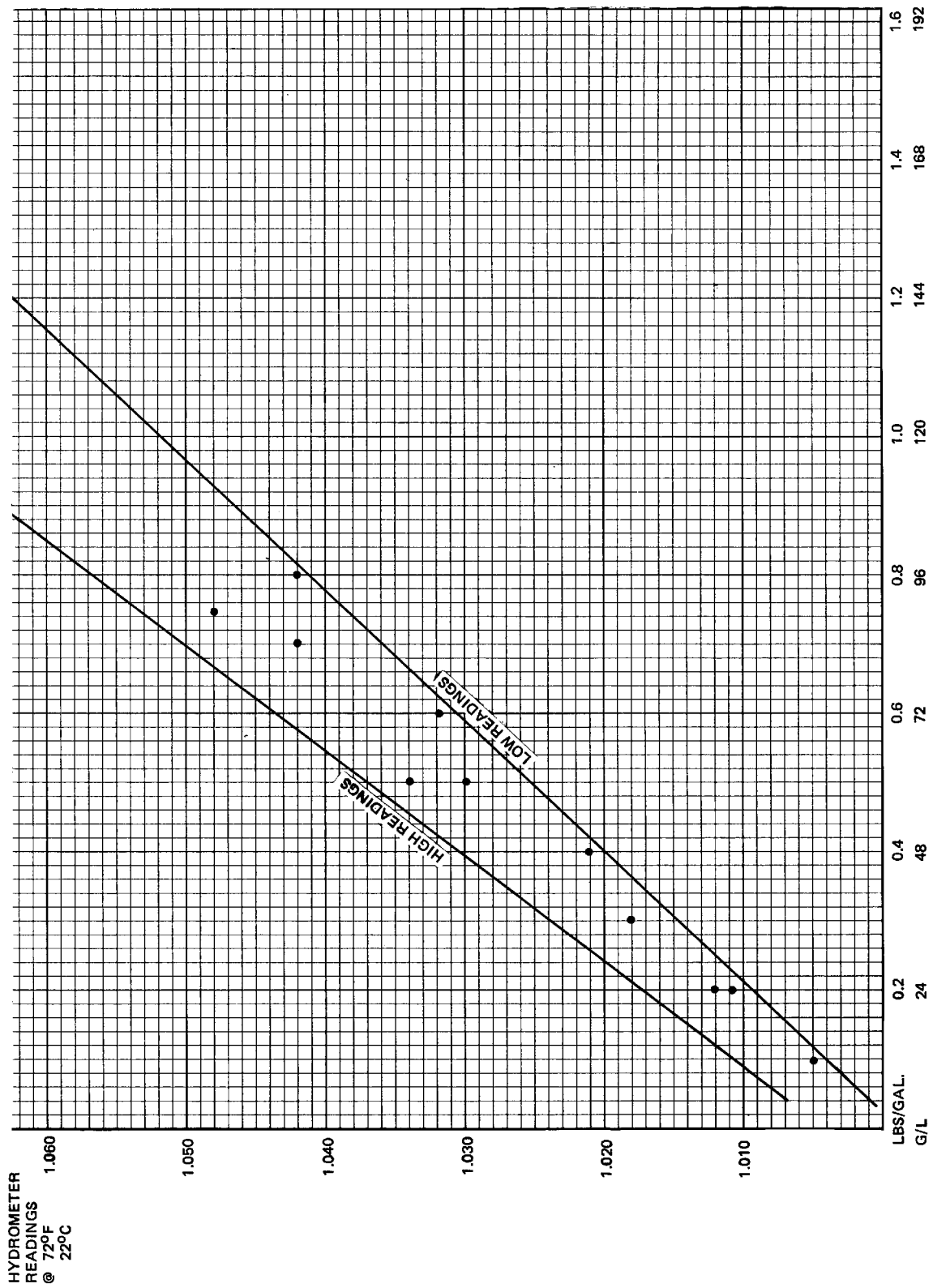
CAUTION

Prior to obtaining the hydrometer reading, the working solution SHALL be filled to the proper working level (as previously measured and marked), thoroughly agitated, and the tank checked for caked particles on the bottom or in the corners. Newly prepared solutions SHALL NOT be used or checked for concentration until 4-hours after mixing. This aging period allows the developer particles to become wetted or saturated. The solution SHALL be stirred after the 4- hour aging period.

This graph SHALL be used when checking the developer concentration. An example of such a specific gravity vs. concentration graph for two water-suspended developers is illustrated in (Figure 2-34). This graph illustrates the variation that can occur in the specific gravity's of different water-suspended developers, even from the same manufacturer. Frequency of the inspection is located in (Table 1-3). The reading from the hydrometer is then compared to an accurate graph/conversion chart, which may be obtained from the supplier for the specific developer. This graph/chart SHALL be used when checking the developer concentration is shown in (Figure 2-35). A graph of specific gravity versus concentration for two water-suspended developers illustrating the variation that can occur in the specific gravity's of different water-suspended developers, even from the same manufacturer. The process for performing a concentration test is as follows:

- a. Place the hydrometer directly in the tank, ensuring it floats free, not touching the tank sides. The specific gravity is read from the scale on the hydrometer. Alternatively, it may be more convenient to take a sample from the tank using a long, narrow glass container such as a graduated cylinder, which is deep enough to float the hydrometer.
- b. Compare the reading from the hydrometer to the graph of specific gravity and make adjustments to the developer concentration as required. The developer concentration shall be maintained within 5 percent of the required concentration.

T.O. 33B-1-1



H0400349

Figure 2-34. Specific Gravity Hydrometer Readings for Two Water-Suspended Developers

2.6.10.4.7.3 Water-Suspended Developer Coating Uniformity Test. Water-suspended developers do not perform properly unless they wet the part surface and form a smooth, even coating once it dries. Lumpy or thick areas will hide small indications, while uncoated areas will not provide developer action. Poor wetting is usually due to the addition of too much water, which is used to replace water losses caused by drag-out or by developer wetting agents degrading over time.

Contamination by oily materials may also destroy the wetting agents. Use clean cracked-chrome panels and perform the coating test as follows:

- a. Apply the working bath developer to one half of the panel and the reference standard developer to the other half of the panel.
- b. Inspect for signs of non-wetting, such as formation of beads and pulling away from edges or crack locations.
- c. The panel SHALL then be dried and examined for even and complete developer coverage.

2.6.10.4.7.4 Water-Suspended Developer Penetrant Contamination Test. Water-suspended developer may also become contaminated with penetrant. Check for fluorescent penetrant dye contamination by visual examination of the bath surface by passing a black light over it. Uncontaminated developer appears dull white while fluorescent dye contamination will show up as specks of yellow-green, floating on the top of the bath. Low-levels of contamination can be skimmed off of the developer liquid surface. Baths that exhibit significant amounts of surface penetrant that cannot be completely separated must be replaced.

2.6.10.4.8 Testing Water-Soluble Developer.

NOTE

Water-soluble developer SHALL NOT be stirred or agitated after its initial mixing or for this test.

Water-soluble developers reduce the number of in-service problems encountered with suspended developers since agitation is not required and the particles do not settle out, however, there is still concentration and contamination problems to be aware of. As stated with water-suspended developers, evaporation and drag-out still factor in concentration changes, and the wetting agents can still remove entrapped penetrant resulting in contamination. Due to these factors, water-soluble developers SHALL be periodically tested to ensure acceptable performance is maintained.

2.6.10.4.8.1 Water-Soluble Developer Concentration Test.

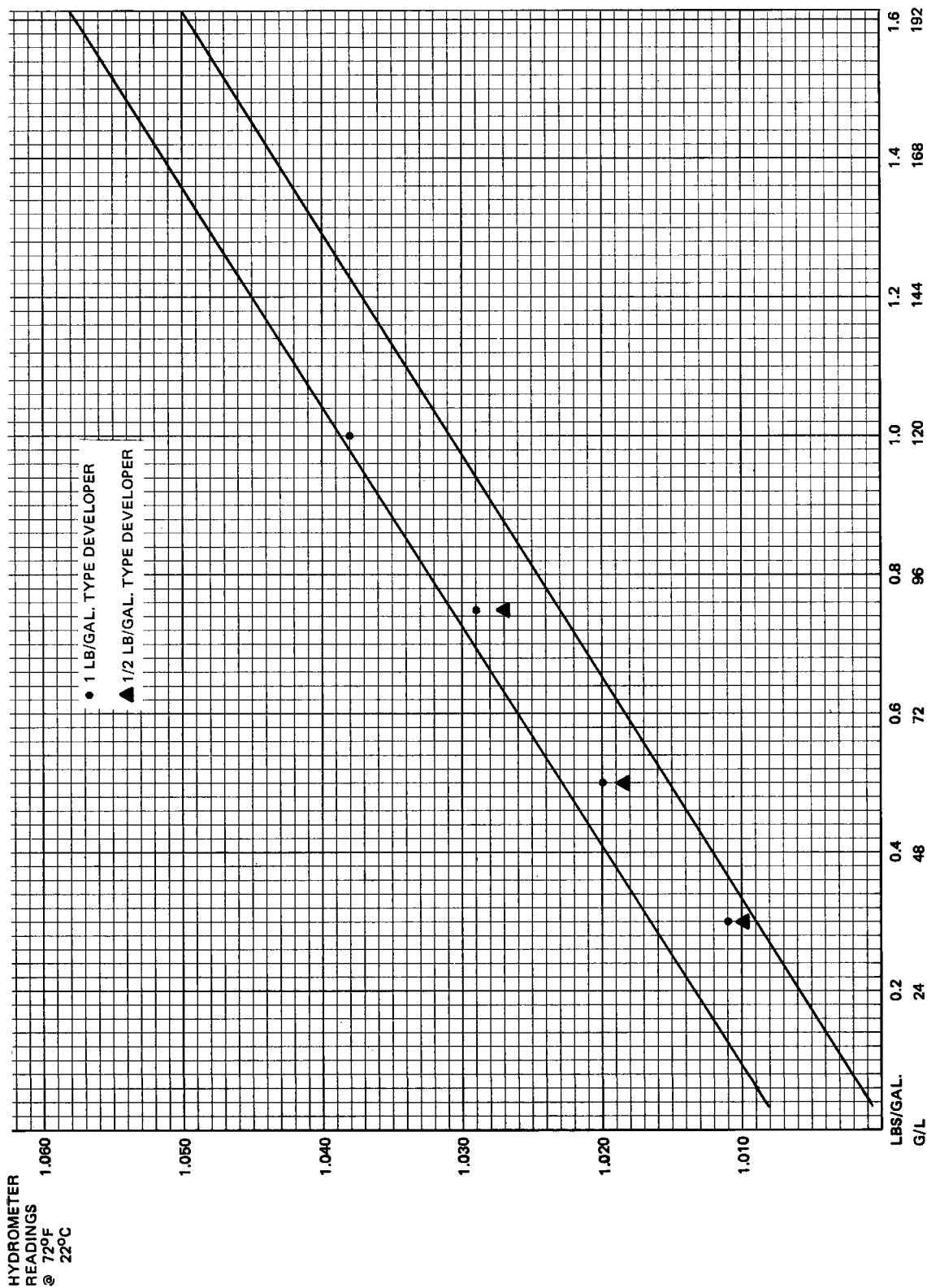
NOTE

There are a wide variety of materials available to formulate water-soluble developers; therefore, the specific gravity hydrometer readings versus concentration will vary more than they will for the water-suspended developers. Generally, the manufacturer's recommended concentration level is used in standard penetrant systems. Poor water quality can cause situations where water-soluble developer does not completely dissolve in the concentration recommend by the manufacturer. Using warm distilled or filtered water may increase the amount of developer dissolved in the solution. Generally, concentrations lower than 0.5 lbs per gallon are not recommended because the solution may not contain enough chemical additives to prevent algae growth or poor wetting qualities.

The concentration of water-soluble developers SHALL be measured by taking specific gravity readings with a hydrometer. The concentration range (between the lines) for several water-soluble developers of one manufacturer is shown in (Figure 2-35). The supplier can provide an accurate conversion chart for its particular developer, which SHALL be used when checking the developer concentration. The process for performing a concentration test is as follows:

- a. Place the hydrometer directly in the tank, ensuring it floats free, not touching the tank sides. The specific gravity is read from the scale on the hydrometer. Alternatively, it may be more convenient to take a sample from the tank using a long, narrow glass container such as a graduated cylinder, which is deep enough to float the hydrometer.
- b. Compare the reading from the hydrometer to the graph of specific gravity and make adjustments to the developer concentration as required.

T.O. 33B-1-1



H0400350

Figure 2-35. Specific Gravity Hydrometer Readings Versus Concentration for One Manufacturer's Water-Soluble Developers

2.6.10.4.8.2 Water-Soluble Developer Penetrant Contamination Test. Water-soluble developer may also become contaminated with penetrant. Check for fluorescent penetrant dye contamination by examining the bath surface using black light illumination. Uncontaminated developer appears dull white while fluorescent dye contamination will show up as specks of yellow-green, floating on the top of the bath. Low-levels of contamination can be skimmed off of the developer liquid surface. Baths that exhibit significant amounts of surface penetrant that cannot be completely separated must be replaced.

2.6.10.4.9 Testing Dry Developer.

2.6.10.4.9.1 Why Test Dry Developer. Dry developers, unlike water-based developers, do not have problems with concentration changes, however they do become contaminated. This contamination comes from moisture condensation; water from inadequately dried parts or splashed into nearby containers by careless rinsing. Dry developers may also become contaminated by penetrant transported by improperly rinsed parts. This forms lumps of penetrant-soaked developer usually from heavy indications and may fall off during developer application.

2.6.10.4.9.2 Dry Developer Contamination Test. Dry developers SHALL be periodically checked for evidence of contamination by doing the following:

- a. Penetrant Contamination - Test for penetrant contamination by examination of the developer under black light, while stirring or mixing the dry-powder.

NOTE

For dry developer that is recycled, ten or more fluorescent specks observed under black light in a 4-inch (10-cm) diameter circle when a sample is spread into a thin layer on a clean flat surface, is unsatisfactory. Penetrant contaminated dry developer SHALL be discarded.

- b. Moisture - Visually examine for moisture while stirring or mixing the dry-powder and checking for evidence of clumps. It may be possible to dry the powder if the water content is low by removing the lumps of developer and crushing it into loose flakes. If it is not possible to restore the original consistency, the developer SHALL be discarded.

T.O. 33B-1-1

SECTION VII SPECIAL PURPOSE LIQUID PENETRANTS

2.7 SPECIAL PURPOSE LIQUID PENETRANT.

2.7.1 General.

NOTE

The materials described in this section are not covered in QPL SAE AMS 2644. There are a number of penetrant materials that differ from the materials described in the previous sections. These materials are formulated for special applications and purposes. These materials SHALL NOT be used without specific guidance from the responsible engineering authority.

This section describes these special purpose materials and discusses the reasons for their use. The application procedures vary widely between materials and manufacturers; therefore procedures are intentionally not covered. Each of the manufacturers provides detailed application procedures for the particular material when it is procured.

2.7.2 Liquid Oxygen (LOX) Compatible Penetrants. Liquid oxygen (LOX) has a high degree of chemical reactivity. It will explosively react or combine with a large number of materials. This includes traces or residues from normal penetrant inspection materials. There are special cleaning procedures to be used on parts and components that will be contacting gaseous or liquid oxygen. Disassembled parts may be penetrant inspected in the lab, but SHALL be sent to the cleaning shop for complete removal of residual inspection materials. Difficulties are encountered with assembled parts (on or off of aircraft) and complex shaped parts containing crevices, recessed areas, or faying surfaces where inspection materials become trapped and are not easily removed by cleaning. Such items SHALL be inspected by another nondestructive test method or special penetrant materials SHALL be used which do not react with oxygen. There are LOX compatible materials available by special order. These materials are mainly intended for use on space vehicles and can be used on aircraft when required.

2.7.2.1 Requirements for LOX Compatible Materials. Testing for LOX compatible materials involves dropping a weight on the material in a LOX environment. If the material is not compatible (e.g., will readily burn in an oxygen rich atmosphere), it will cause an audible explosion, a visible flash in a darkened room, discolor the impact surface, or leave evidence of charring. There are two ways of avoiding a LOX reaction from penetrant materials:

- a. Completely remove all conventional inspection material residues. NDI inspectors are not properly trained in these cleaning processes.
- b. Use only materials inert in an oxygen environment. This is not simple, since the penetrant system is specifically formulated to detect very small flaws. These penetrants are designed to resist removal from cracks and crevices and the organic dyes are oxygen reactive.

2.7.2.1.1 Choosing LOX Compatible Penetrants. There are three approaches used in choosing LOX compatible penetrant systems:

- a. Use materials soluble in water and lending themselves to complete removal during post cleaning. These penetrants have dyes and developer materials soluble in water. Water-soluble penetrants, if their water content is high, are LOX insensitive, however, when the water evaporates, the residues can become LOX sensitive. Water-soluble penetrant systems have been approved for some LOX related applications since their residues are water-soluble surface agents similar to detergents. Approval for LOX applications is based on their ease of removal from surfaces and flaw entrapment using plain water.
- b. Use materials that are completely volatile and evaporate from the parts without leaving a residue. These penetrants have a class of dyes that sublimates at room or up to temperatures in the range of 130° to 200°F (50° to 90°C). These and other materials will fluoresce from a discontinuity and will dissipate entirely from the flaw on setting or when the part is slightly heated. The materials have been used in formulating volatile penetrant systems. The problems to be considered are:
 - Even though the materials evaporate from the surface or a flaw, there is still the possibility of it re-depositing at another location.
 - Determination of 100-percent dissipation as judged by the disappearance of an indication does not mean a residual-free surface or crack.

- c. Use non-reactive liquids that maintain the dyes in solution and are completely wetted by the liquid at all times. Another method of formulating penetrants not LOX-reactive is to dissolve the dye in a non-reactive, non-volatile liquid or vehicle. The liquid serves to quench the reactivity of the dye and, since it is non-volatile, does not produce a reactive residue. Water based penetrants do not meet this criteria, since they evaporate, leaving a reactive residue. There are some useful fluorinated hydrocarbon liquids, commonly called fluorocarbon or fluorolube oils that may be employed as penetrants. Fluorolube oils are quite non-volatile and are non-reactive with LOX. They also act to quench any LOX reactivity of dye that is dissolved in or wetted by the fluorolube oil. Unfortunately, they are not good solvents for fluorescent dye.

2.7.3 Low Sulfur, Low Chlorine Penetrant Systems.

NOTE

Low sulfur and low halogen penetrant material requirements are not covered in QPL SAE AMS 2644.

There is considerable concern over the effects of small quantities of sulfur and halogens present in penetrant materials. This concern is due to the increased use of high temperature alloys such as nickel and cobalt-base alloys, austenitic stainless steel, and titanium in aircraft and engines. These alloys are susceptible to hydrogen embrittlement, intergranular corrosion, and stress corrosion. Small amounts of sulfur and halogens, principally chloride, remaining on the alloys during service will increase their susceptibility to attack. Sulfur and halogens are not essential compounds in penetrant materials, nor are they deliberately added. They are usually introduced as contaminants in the raw materials. There is considerable difference of opinion as to the allowable limits of these contaminants. Nuclear and boiler codes specify from 0.5% to 1% by weight as the maximums. Many of the QPL materials will meet at least the upper limit. The position is similar to that for LOX compatible materials, namely, there is no requirement for special penetrants if the part to be inspected is disassembled and can be sent to the cleaning shop for the removal of all inspection residues. The aircraft or engine manufacturer's recommendations SHALL be followed for on-aircraft and assemblies.

2.7.4 High Temperature Penetrant Materials. Standard penetrant materials are limited to temperatures of 120°F (49°C). There are special penetrant systems formulated for use above 120°F (49°C). These special high-temperature penetrants contain visible and fluorescent dyes that resist heat degradation. The vehicles and solvents are carefully chosen to remain liquid and resist evaporation at the operating temperature. The nonaqueous-wet developer must be modified since standard developer will peel or curl on hot surfaces. The upper temperature limits are in the range of 350°F (177°C) to 400°F (204°C). Typical applications for high temperature penetrant systems are the inspection of live steam valves and lines and intermediate weld beads prior to laying down a covering bead.

2.7.5 Dye Precipitation Penetrant Systems.

NOTE

Dye precipitation penetrant systems are not covered by penetrant material specification SAE AMS 2644.

Dye precipitation penetrant systems are commonly referred to as high-resolution penetrants. The penetrant contains a high concentration of either visible or fluorescent dye dissolved in a highly penetrating, volatile solvent. The penetrant is usually applied by brushing on the surface to be inspected. The penetrant will enter any discontinuities, and during the dwell period, the solvent evaporates, precipitating the dye as a solid, which fills the discontinuity. A very thin layer of solvent developer is sprayed onto the surface after removal of the excess surface penetrant and while using a two-step development process. The developer re-dissolves the solid penetrant dye entrapped in the flaw, expands its volume, and extracts it from the flaw. It is possible to build the indication to any desired size and resolution by applying additional thin coats of solvent developer. When the indication reaches the desired size, it is fixed by applying a layer of plastic developer. The plastic developer allows the developer coating with the embedded indication to be removed or stripped from the part. There is also a one-step developer that provides the same result. Dye precipitation penetrant systems are extremely sensitive.

2.7.6 Reversed Fluorescence Method. The reversed fluorescence method is similar to a photographic negative of the standard fluorescent penetrant inspection. A standard visible-dye penetrant is applied to the surface to be inspected and after the dwell; the excess is removed in the normal manner. A special developer, containing a low intensity fluorescing dye and a relatively small amount of developer powder, is applied by spraying under a black light. The entire surface will fluoresce, except for the flaw, which appears as a dark line where the penetrant has quenched the fluorescent dye.

T.O. 33B-1-1

2.7.7 Thixotropic Penetrant. A thixotropic material is one that changes form or structure as a function of time or shear stress. Thixotropic penetrants are applied as a solid or gel and then change to a liquid after application. They are used when it is difficult to apply the penetrant as a liquid. One example is a high temperature penetrant in the form of a crayon or stick used to inspect welds before they have cooled.

2.7.8 Dilution Expansion Developers. Dilution expansion developers differ from the conventional powder type developers in they do not utilize the absorption-adsorption action of powder particles. In fact, powder particles are not required and may even interfere with the action of dilution-expansion developers. The action of dilution-expansion developer is to dissolve the exuded and exposed layer of entrapped penetrant and disperse it in the thicker layer of developer. Dilution-expansion developers have a layer thickness equivalent to that of conventional powder developers.

2.7.9 Plastic-Film Developers. Plastic-film developers form a dry, flexible layer that can be peeled or stripped to provide a record of indications on test surfaces. The most frequently used plastic-film developers are two-part systems. The first part provides developer action while forming a white, reflecting background. The second part forms a clear layer that freezes the indication and provides film strength and some flexibility. The layers combine and can be removed from the part as a thin film and maintained as a record of the indication.

SECTION VIII LIQUID PENETRANT INSPECTION SAFETY

2.8 LIQUID PENETRANT INSPECTION SAFETY.

2.8.1 Safety Requirements. Safety requirements SHALL be reviewed by the laboratory supervisor on a continuing basis to ensure compliance with provisions contained in AFOSH Standard 91-110 as well as provisions of this technical order and applicable weapons systems technical orders. The material safety data sheet (MSDS) for each penetrant material SHALL be reviewed by the shop supervisor before the material is first put into use. Recommendations of the Base Bioenvironmental Engineer and the manufacturer regarding necessary personnel protective equipment SHALL be followed.

NOTE

Air Force Occupational Safety and Health (AFOSH) Standard 91-110 SHALL be consulted for additional safety requirements.

2.8.2 General Precautions. Precautions to be exercised when performing penetrant inspection include consideration of ventilation, skin irritation, fire, electrical, and use of black light. The following minimum safety requirements SHALL be observed when performing penetrant inspections.

2.8.3 Personal Protection Equipment. Penetrants, emulsifiers, and some types of developers have very good wetting and detergent properties, and can act as solvents for fats and oils. If they are allowed to remain in contact with body surfaces for extended periods, they MAY cause skin irritation. Personal protective equipment SHALL be supplied and worn when handling penetrant materials. Wear eye protection, an apron, and gloves while processing parts and changing chemicals.

2.8.3.1 Protective Gloves. Neoprene gloves are an excellent choice when handling penetrant materials, and SHOULD be worn unless another suitable substitute is identified and approved by the Base Bioenvironmental Office. The insides of gloves SHALL always be kept clean. Wash exposed areas of body with soap and water, continual contact with penetrant materials MAY cause skin irritation and a removal of natural body oils.

2.8.3.2 Eye Protection. Wear eye protection (e.g., goggles, face shield, safety glasses) while using penetrant inspection material. Protect the eyes from all possible hazards associated with the penetrant process. At different stages of the process different eye protection may be required. For ultraviolet light, UV filtering safety glass are sufficient. UV filtering safety goggles or face shields are more appropriate for combination chemical splash and UV protection.

2.8.4 Ventilation.

WARNING

Penetrant inspection materials MAY be harmful when vapors are inhaled when exposed to skin for an extended period of time. Proper safeguards and personnel protective equipment (PPE) SHALL be used as recommended by the local Base Bioenvironmental Office and product manufacturer.

CAUTION

Many penetrant materials are combustible, but most have relatively high flash points. They are not considered a serious fire hazard in open tanks, however, when sprayed as a fine mist, they are easy to ignite and open ignition sources SHALL be avoided when spraying is used.

Some penetrant materials contain volatile solvents that can be nauseating. This is especially true of the vehicles in aerosol or pressure spray containers. Provide adequate ventilation when penetrant inspection is being performed. When recommended by the base bioenvironmental engineer, wear an approved respirator working in areas where adequate ventilation cannot practically be provided. Dry developer materials are a fine dust. A protective device SHALL be worn over the nose and mouth during this process.

T.O. 33B-1-1

2.8.5 Matting. Use rubber insulating floor matting in front of penetrant lines. This matting is required to reduce electrical and slipping hazards. This matting SHALL be replaced when it is worn to one-half the original thickness (approximately 1/8-inch). Use only one continuous length of matting and ensure it continues beyond the ends of the equipment for at least 24-inches.

2.8.6 UV-A (Black Light) Hazards. Prolonged direct exposure of hands to the filtered UV-A lamp main beam MAY be harmful. Suitable gloves SHALL be worn, during inspections, when exposing hands to the main beam for extended periods.

- The temperature of some operating black light bulbs reaches 750°F (399°C) or more during operation. This is above the ignition or flash point of fuel vapors. These vapors will burst into flame if they contact the bulb. Black lights SHALL NOT be operated when flammable vapors are present.
- Exercise care when using hot black lights so as to not burn hands, arms, face, or other exposed body areas. Do not lay hot black lights on combustible surfaces. The bulb temperature also heats the external surfaces of the lamp housing. The temperature is not high enough to be visually apparent, but is high enough to cause severe burns with even momentary contact of exposed body surfaces. Extreme care SHALL be exercised to prevent contacting the housing with any part of the body. Consult your local bioenvironmental office for specific guidance.
- Ensure workers do not handle black lights at the penetrant rinse station when washing parts, because of electrical hazard present.
- UV-A filtering safety glasses are specifically designed for penetrant and magnetic particle inspections and are recommended as they will filter out glare and reduce eyestrain. Install ultraviolet filters on all mercury vapor lamps used for penetrant inspection. Replace cracked, chipped, or broken filters before using the light. Injury to eyes and skin will occur if the light from the mercury vapor bulbs is not filtered. UV-A filtering safety glasses, goggles, or face shields SHALL be worn and precautions SHALL be taken to cover exposed skin that is routinely exposed to the direct beam of any black light.

2.8.6.1 Black Light Physiological Effects.**WARNING**

Unfiltered ultraviolet radiation can be harmful to the eyes and skin. Black light bulbs SHALL NOT be operated without filters. Cracked, chipped, or ill-fitting filters SHALL be replaced before using the lamp.

2.8.7 Aerosol cans are a convenient method of packaging a wide variety of materials. Their wide use, both in industry and the home, has lead to complacency and mishandling.

2.8.7.1 Aerosol cans are gas pressured vessels, when heated to temperatures above 120°F (49°C) the resulting gas pressure may potentially burst the container. Any combustible material, regardless of flash point, can ignite with explosive force when it is finely divided and dispersed in air. Penetrant materials SHALL be stored in a cool dry area, protected from direct sunlight.

2.8.7.2 Penetrant materials (penetrant, cleaner/remover and developer) MAY contain petroleum distillates and aliphatic (kerosene, mineral spirits, etc.) or aromatic (benzene type hydrocarbon) solvents. These chemicals SHALL be carefully used in the aerosol form to avoid health hazards.

CHAPTER 3

MAGNETIC PARTICLE INSPECTION METHOD

SECTION I MAGNETIC PARTICLE INSPECTION METHOD

3.1 GENERAL CAPABILITIES OF MAGNETIC PARTICLE INSPECTION.

NOTE

The terms MPI, MPT, and MT are used interchangeably in this chapter.

3.1.1 Introduction to Magnetic Particle Inspection (MPI). Magnetic particle inspection is an NDT method used to reveal surface and near subsurface discontinuities in magnetic materials. This inspection method can only be used on materials that can be magnetized (known as ferrous). The MPI process, when properly performed, establishes a field leakage site on the surface of the part below which the flaw lies.

3.1.2 Benefit of Magnetic Particle Inspection. MPI is the method of choice on ferrous materials instead of liquid penetrant because it is faster, requires less surface preparation, and in some instances is able to locate subsurface flaws.

3.1.3 Basic Concept of Magnetic Particle Inspection. MPI relies on the principle of magnetism (paragraph 3.2.1). Very small ferrous particles, which are suspended in a bath of oil or water, are attracted to magnetic field leakage sites, just as iron filings are attracted to the poles of a magnet. Cracks and similar types of discontinuities cause disruptions in the magnetic field of magnetized parts, in turn attracting these ferrous particles to the leakage site. This allows the inspector to visualize where the discontinuities are located in the part. The keys to MPI is adequate (but not too much) magnetization of the part, in a direction at right angles to flaw direction, and adequate contrast between the part's surface and the particles used to identify the flaw. The particles used in magnetic particle testing are precipitated soft iron. These particles are stained or dyed in various colors, usually with a fluorescent dye or a red dye. Fluorescent dyes on particles in a liquid suspension are used to find very tight surface flaws. Visible dyes on dry particles are less sensitive to tiny surface defects, but are better for finding sub-surface flaws. The type of flaw and/or the inspection environment determines selection of the color or type of particles.

3.1.3.1 The following paragraphs describe in detail the standard terminology used, the theory of magnetism, MPI magnetization and demagnetization techniques, process controls, and safety concerns.

T.O. 33B-1-1

SECTION II MAGNETIC PARTICLE PRINCIPLES AND THEORY

3.2 PRINCIPLES AND THEORY OF MAGNETIC PARTICLE INSPECTION.

3.2.1 Principles of Magnetization. When parts made of ferrous materials, such as iron, are placed in a strong magnetic field or have electric current flowing through them, they will become “magnetized.” The degree of magnetization is affected by the strength of the magnetizing field or the amount of current flow. How strongly the ferrous part will be magnetized after the magnetizing force is removed is called “retentivity.” Permanent magnets have high retentivity and conductors normally have low retentivity. When a surface or near-surface discontinuity interrupts the magnetic field in a magnetized part, some of the field is forced into the air above the discontinuity resulting in a leakage field. The size and strength of the leakage field depends on the size and proximity of the discontinuity to the magnetic field. The discontinuity is detected by the use of finely divided iron particles applied to a part’s surface and attracted to the leakage field. This collection of particles indicates the presence and location of the discontinuity.

3.2.2 Basic Terminology. The following terms and definitions are basic to an understanding of the MPI method.

NOTE

Letters in parentheses refer to the hysteresis curve ([Figure 3-17](#)).

3.2.2.1 Coercive Force. The negative or reverse applied magnetizing force (H) necessary to reduce the residual magnetizing force (B) to zero in a ferromagnetic material, after magnetic saturation has been achieved. The line (O/G) represents the magnitude and direction of this force.

3.2.2.2 Direct Contact Magnetization. Use of current passed through the part via contact heads or prods to produce a magnetic field.

3.2.2.3 Ferromagnetic. A term that describes a material which exhibits both magnetic hysteresis and saturation, also whose magnetic permeability is dependent on the magnetizing force present. In magnetic particle testing, we are concerned only with ferromagnetic materials.

3.2.2.4 Circular Magnetic Field. A circular magnetic field is a magnetic field surrounding the flow of the electric current. For magnetic particle testing, this refers to current flow in a central conductor or the part itself.

3.2.2.5 Longitudinal Magnetic Field. A longitudinal magnetic field is a magnetic field wherein the flux lines transverse the component in a direction essentially parallel with its longitudinal axis.

3.2.2.6 Magnetic Field. The term used to describe the volume within and surrounding either a magnetized part or a current-carrying conductor wherein a magnetic force is exerted.

3.2.2.7 Magnetic Leakage Field. The magnetic field outside of a part resulting from the presence of a discontinuity, a change in magnetic permeability, or a change in the part’s cross-section.

3.2.2.8 Magnetic Flux Density (B). The strength of a magnetic field is expressed in flux lines per unit cross-sectional area.

3.2.2.9 Flux Lines or Lines of Force. A conceptual representation of magnetic flux illustrated by the line pattern produced when iron filings are sprinkled on paper laid over a permanent magnet.

3.2.2.10 Magnetic Hysteresis. The phenomenon exhibited by a magnetic system wherein its state is influenced by its previous history.

3.2.2.11 Induced Current Magnetization. Use of current induced in a part to produce a magnetic field.

3.2.2.12 Magnetizing Current (I). The electric current passed through or adjacent to an object that produces a designated magnetic field.

3.2.2.13 Magnetizing Force (H). The magnetizing field applied to a ferromagnetic material to induce magnetization.

3.2.2.14 Magnetic Permeability (μ). Magnetic permeability is the ease with which a ferromagnetic part can be magnetized. It is equal to the ratio of the flux density (B) produced to the magnetizing force (H) inducing the magnetic field. It changes in

value with changes in the strength of the magnetizing force. A metal easy to magnetize, such as soft iron or low carbon steel, has a high permeability or is said to be highly permeable.

3.2.2.15 Residual Magnetism. This is the magnetic field that remains in the part when the external magnetizing force has been reduced to zero.

3.2.2.16 Retentivity. The property of a metal that remains magnetized after the magnetizing force has been removed. A metal, such as hard steel has a high percentage of carbon, and will retain a strong magnetic field after removal of the magnetizing current. Hard steel has high retentivity, or is said to be highly retentive.

3.2.2.17 Magnetic Saturation. This is the level of magnetism in a ferromagnetic material where the magnetic permeability is equal to one. This is characterized as that level where an increasing in magnetizing force (H) results in no greater increase in magnetic field (B) than would occur in a vacuum or air.

3.2.3 Magnetic Field Characteristics.

3.2.3.1 Horseshoe Magnet. A familiar type of magnet is the horseshoe magnet (Figure 3-1). Like a bar magnet, this is a permanent magnet and possesses residual magnetism. It will attract iron filings to its ends where a leakage field occurs. By convention, these ends are commonly called “north” and “south” poles, indicated by N and S on the diagram. Continuous magnetic flux lines, or lines of force in leakage fields, flow from the north to the south pole. In an ideal horseshoe magnet, the flux lines leave only at the poles and consequently an external magnetic force capable of attracting magnetic materials exists only at the poles. This action provides an example of a longitudinal magnetic field. In a real horseshoe magnet very small discontinuities are distributed throughout creating small, weak, localized leakage fields distributed over the surface of the magnet.



Figure 3-1. Horseshoe Magnet

3.2.3.1.1 If the shape of an ideal horseshoe magnet is changed (Figure 3-2), the ends will still attract iron filings. However, if the ends of the magnet are fused or welded into a continuous ring as shown (Figure 3-3), the magnet will no longer attract or hold exterior magnetic materials. This is because the north and south poles no longer exist; thus a leakage field does not exist. The magnetic field will remain as shown by the arrows, but no iron filings are attracted.

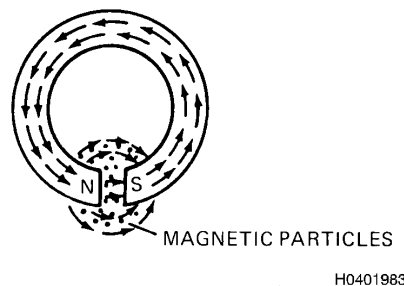
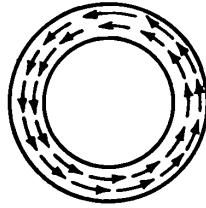


Figure 3-2. Horseshoe Magnet With Poles Close Together

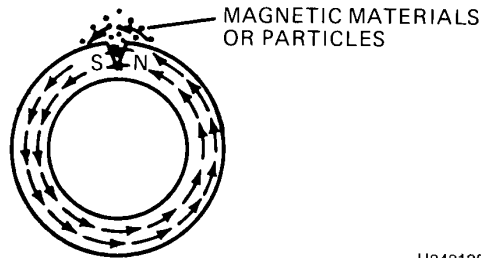
T.O. 33B-1-1



H0401984

Figure 3-3. Horseshoe Magnet Fused Into a Ring

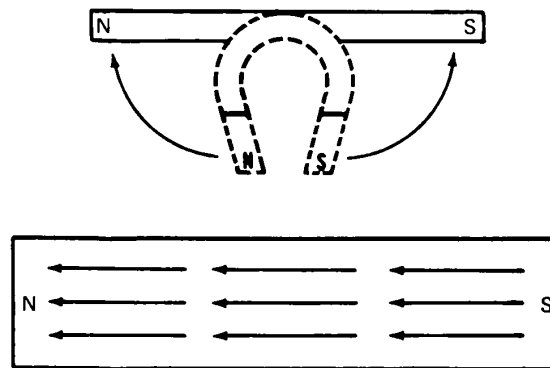
3.2.3.1.2 A transverse crack in the fused magnet or circularly magnetized part (Figure 3-4) will create a leakage field with north and south poles on either side of the crack. Some of the magnetic flux (lines of force) will exit the metal and form a leakage field. The leakage field created by the crack, forming an indication of the discontinuity in the metal part, will attract ferrous particles. This is the principle whereby magnetic particle indications are formed.



H0401985

Figure 3-4. Crack in Fused Horseshoe Magnet

3.2.3.2 **Bar Magnet.** If a horseshoe magnet is straightened, a bar magnet is created (Figure 3-5). The bar magnet has poles at either end and the magnetic lines of force flow through the length, returning around the outside. Magnetic particles SHOULD be attracted only to the poles (in the ideal case). Such a part is said to have a longitudinal field, or is longitudinally magnetized.



H0401986

Figure 3-5. Horseshoe Magnet Straightened to Form a Bar Magnet

3.2.3.2.1 A transverse slot or discontinuity in the bar magnet that crosses the magnetic flux lines will create north and south poles on either side of the discontinuity (Figure 3-6). The resulting leakage field will attract magnetic particles. In a similar manner, a crack, even though it is very fine, will create magnetic poles as indicated in (Figure 3-7). These poles will also

produce a leakage field that can attract magnetic particles. The strength of the leakage field will be a function of the number of flux lines (e.g., the strength of the internal field), the depth of the crack, and the width of the air gap at the surface. The strength of this leakage field, in part, determines the number of magnetic particles gathered to form indications. Clear indications are found at strong leakage fields, while weak indications are formed at weak leakage fields.

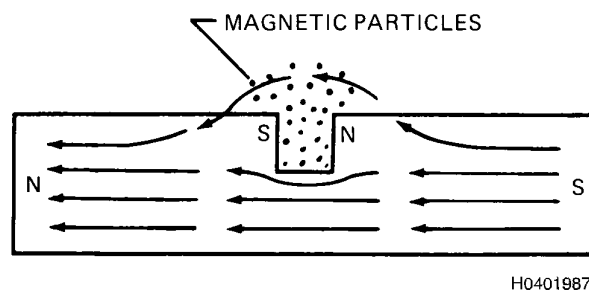


Figure 3-6. Slot (Keyway) in Bar Magnet Attracting Magnetic Particles

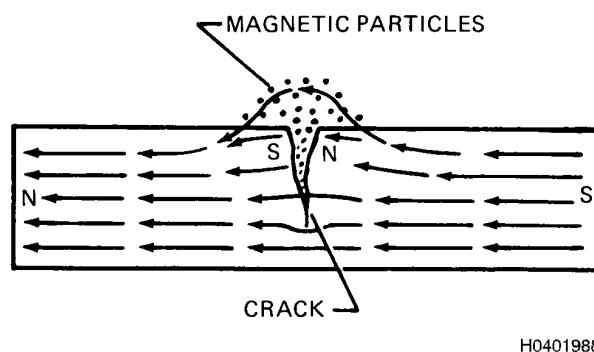


Figure 3-7. Crack in Bar Magnet Attracting Magnetic Particles

3.2.3.3 Electricity and Magnetism. Electric current can be used to create or induce magnetic fields in parts made of ferromagnetic materials. Magnetic lines of force are always aligned at right angles (90°) to the direction of electric current flow. It is possible to control the direction of the magnetic field by controlling the direction of the magnetizing current. This makes it possible to induce magnetic lines of force so they intercept defects at right angles.

3.2.3.4 Magnetic Attraction. Magnetic attraction can be explained by using the concept of flux lines or lines of force. Each flux line forms a closed continuous loop, which is never broken. For a circularly magnetized object, the flux lines are wholly contained in the object (ideal case). No external magnetic poles are present and therefore there is no attraction for other ferromagnetic objects. For a longitudinally magnetized object, the flux lines leave and enter at magnetic poles. They always seek the path of least resistance (e.g., maximum permeability and minimum distance). When a piece of soft iron is placed in a magnetic field it will develop magnetic poles. These poles will be attracted to the poles of the magnetic object that created the initial field. As it approaches closer to the source of the original field, more flux lines will flow through the piece of iron, thus creating stronger magnetic poles and further increasing the attraction. This concentrates the lines of flux into the easily traversed high permeability (iron path) rather than the alternative low permeability (air paths). This is magnetic attraction and is the reason magnetic particles concentrate at leakage fields. The leakage field is established across an air gap of relatively low permeability at the discontinuity. Since they offer a higher permeability path for the flux lines, the magnetic particles are drawn to the discontinuity and bridge the air gap to the extent possible.

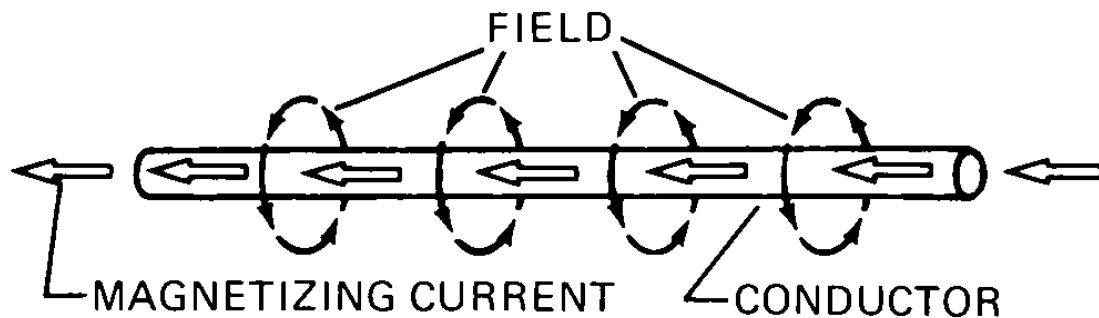
3.2.3.5 Effects of Flux Direction. The magnetic field must be in a favorable direction, with respect to a discontinuity, to produce an indication. When the flux lines are parallel to a linear discontinuity, the indications formed will be weak. The best results are obtained when the flux lines are perpendicular (at right angles) to the discontinuity.

T.O. 33B-1-1

NOTE

When an electrical current is used for magnetizing, the best indications are produced when the path of the magnetizing current is parallel to and in-line with the discontinuity.

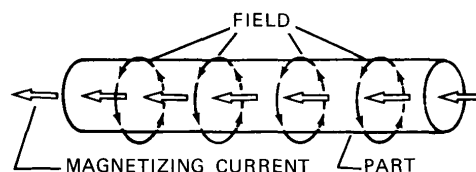
3.2.3.6 **Circular Magnetization.** A circular magnetic field always surrounds a current carrying conductor, such as a wire or a bar (Figure 3-8). The direction of the magnetic lines of force (magnetic field) is always at right angles to the direction of the magnetizing current. Field orientation and magnitude are based on the direction and amount of current flow.



H0401989

Figure 3-8. Magnetic Field Surrounding an Electrical Conductor

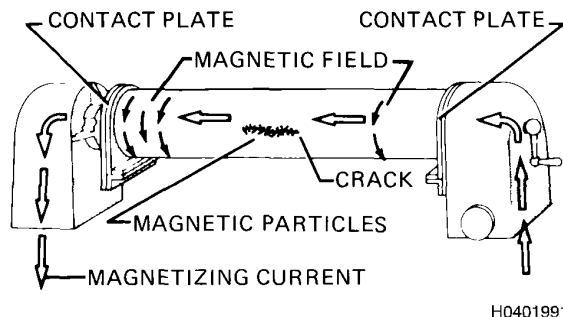
3.2.3.6.1 Since metals are conductors of electricity, an electric current passing through a metallic part creates a magnetic field (Figure 3-9). The magnetic lines of force are at right angles to the direction of the current. This type of magnetization is called circular magnetization because the lines of force, which represent the direction of the magnetic field, are circular within the part.



H0401990

Figure 3-9. Magnetic Field in a Part Used as a Conductor

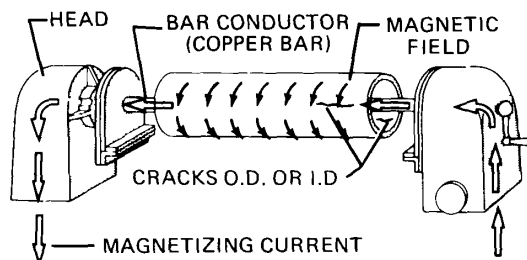
3.2.3.6.2 **Circular Magnetization with Inspection Equipment.** One method of creating or inducing a circular field within a part with stationary MPI equipment is to clamp the part between two contact plates and pass current through the part as indicated in (Figure 3-10). If a longitudinally aligned crack or discontinuity exists within the part, a leakage field will be established at the site of each crack or discontinuity. The leakage field will attract magnetic particles to form an indication of the discontinuity.



H0401991

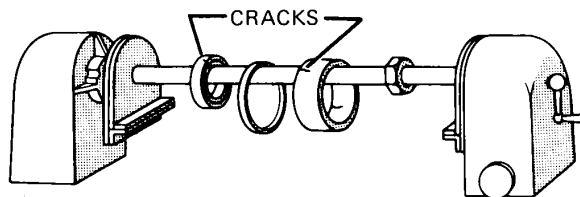
Figure 3-10. Creating a Circular Magnetic Field in a Part

3.2.3.6.2.1 For hollow or tube-like parts, it is often important to inspect both the inside and outside surfaces. When such parts are circularly magnetized by passing the magnetizing current through the part ends (Figure 3-11) (Figure 3-12), the magnetic field on the inside surface is smaller and opposite than what is produced on the outside surface. To produce a stronger magnetic field on both the inner, and outer surface of the part, a separate conductor, such as a copper rod, is positioned inside the hollow part. Since a circular magnetic field surrounds such conductors when an electric current is passed through them, it is possible to induce a satisfactory magnetic field on the inside surface and depending on the thickness of the part, the outside surface as well.



H0401992

Figure 3-11. Using a Central Conductor to Circularly Magnetize a Cylinder

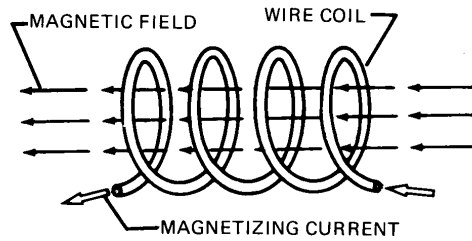


H0401993

Figure 3-12. Using a Central Conductor to Circularly Magnetize Ring-Like Parts

3.2.3.7 Longitudinal Magnetization. Electric current can also be used to create a longitudinal magnetic field in a test part with a current carrying encircling coil. Based on the perpendicular direction of magnetism to current direction, any segment of a coiled conductor will show the field within the coil consists of contributions from each turn of the coil and is aligned lengthwise as indicated (Figure 3-13).

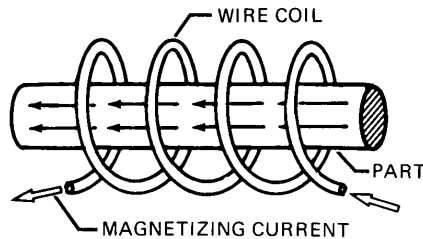
T.O. 33B-1-1



H0401994

Figure 3-13. Magnetic Lines of Force (Magnetic Field) in a Coil

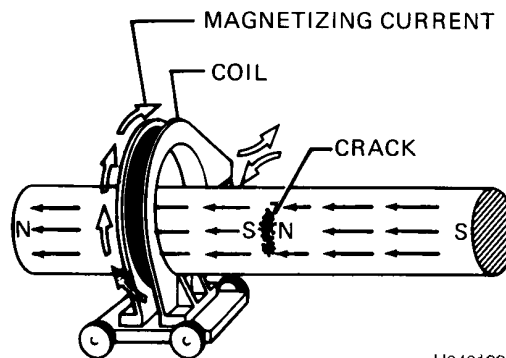
3.2.3.7.1 If a part is placed inside a coil (Figure 3-14), the magnetic lines of force created by the coil are aligned along the longitudinal axis of the coil. If the part is ferromagnetic, the high permeability concentrates the lines of flux within the part and induces a strong longitudinal magnetic field.



H0401995

Figure 3-14. Longitudinal Magnetic Field Produced in a Part Placed in a Coil

3.2.3.7.2 Longitudinal Magnetization with Inspection Equipment. Inspection of a cylindrical part using longitudinal magnetization is shown (Figure 3-15). When a transverse discontinuity exists in the part, as in the illustration, a magnetic leakage field is formed at the crack location. This attracts magnetic particles, forming an MPI indication of the transverse discontinuity. Compare (Figure 3-15) with (Figure 3-10), and note in both cases, a magnetic field has been induced in the part at right angles to the defect. This is the most desirable condition for reliable inspection.



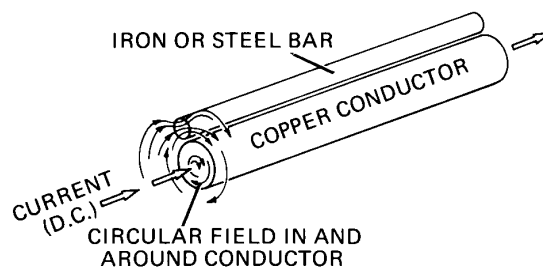
H0401996

Figure 3-15. Longitudinal Field Produced by the Coil Generates an Indication of Crack in Part

3.2.3.8 Multi-Directional Magnetic Field. Two separate fields, having different directions, cannot exist in a part at the same time. However, two or more fields in different directions can be imposed upon a part sequentially in rapid succession.

When this is done, magnetic particle indications can be formed when discontinuities are located favorably with respect to the directions of any of the applied fields, and will persist as long as the rapid alternations of field direction continue. Indications can only be formed if the part is pre-wetted with magnetic particles. This enables the detection of defects oriented in any direction in one operation. The indications must be viewed when the fields are being applied because they are weakly held after the current is discontinued and can be easily dislodged.

3.2.3.9 Parallel Current Induced Magnetic Field. If a ferromagnetic bar is placed alongside, and parallel to, a conductor carrying current, a magnetic field will be set up in the bar more transverse than circular (Figure 3-16). Such a field is of very little use for magnetic particle testing. Operators have tried to use this method as a substitute for a headshot for the purpose of producing circular magnetization, but the field produced is not circular and is extremely limited in the transverse direction when inspecting for defects such as seams. Furthermore, the external field around the conductor and the bar can attract magnetic particles and produce confusing backgrounds.



H0401997

Figure 3-16. Field Produced in a Bar by a “Parallel” Current

3.2.4 Currents Used to Generate Magnetic Fields. There are several types of current used in MPI. These are Straight Direct Current (DC), Single-Phase Alternating Current (AC), Three-Phase AC Current, Half-Wave Rectified Alternating Current (HWRAC or HWDC), Full-Wave Rectified AC Current, and Three-Phase Full-Wave Rectified AC Current (commonly known as DC). Of these, three types of magnetizing current are most often used in magnetic particle inspection. Only one type of current is best suited for each type of inspection to be performed. Alternating current (AC) is preferred for the detection of surface discontinuities. Direct current (DC), full-wave direct current (FWDC), or half-wave direct current (HWDC) can be used for both surface and subsurface discontinuities. Detail on each current follows:

3.2.4.1 Alternating Current (AC). Alternating current, which is single phase when used directly for magnetizing purposes, is taken from commercial power lines, or portable power sources, and can be 50 or 60-hertz. Magnetizing currents up to several thousand amperes are used, derived from step-down transformers connected to common line voltages (e.g., 115, 230, or 460-volts).

3.2.4.2 Direct Current (DC). Rectified alternating current is by far the most satisfactory source of direct current. By the use of rectifiers, commercially available single and three-phase AC can be converted to a unidirectional current. Rectified three-phase AC is equivalent to straight DC, but exhibits a slight ripple.

3.2.4.3 Half-Wave Rectified Single-Phase Alternating Current. Half-wave rectified single-phase Alternating Current, also called Half-Wave Direct Current (HWDC), results in a pattern of unidirectional current flow made up of positive half cycles of the original AC waveform. The negative (reverse) half of each cycle is completely blocked out resulting in a pulsating unidirectional current. That is, the current rises from zero to a maximum and drops back to zero (replicating the AC’s half cycle). This is blocked during the reverse cycle (no current flows), and then repeats the first half cycle.

3.2.4.4 Full Wave Rectified Single-Phase Alternating Current. This pulsating unidirectional current is sometimes used in MPI for certain special purpose applications. In general, however, it possesses no advantage over single-phase half-wave rectified waveforms. Because of its extreme “ripple,” it is not as satisfactory as rectified three-phase current when DC is required. It is also more costly since it draws a higher average current from the AC line than does rectified half-wave AC for a given magnetizing strength.

3.2.4.5 Induced Current Magnetization. When direct current in a circuit is instantly cut off, the field surrounding the conductor collapses, or falls rapidly to zero. If an electrically conductive ferromagnetic material is present in such a field, the

T.O. 33B-1-1

collapse of that field will induce a current in the material the same direction as present in the neighboring conductor before cut-off. This phenomenon can be used to solve specific magnetizing problems that have no other practical solution. A useful application of the collapsing field technique has been found in the inspection of ring-shaped parts, such as bearing races, without the need to make direct contact with the surface of the part. Regardless of the type of magnetizing current employed, whether AC, DC, or half-wave, the induced current technique is usually faster and more satisfactory than the contact method. Only one operation is required, and the possibility of damaging the part due to arcing is completely eliminated since no external contacts are made on the part.

3.2.5 Ferromagnetic Material Characteristics.**NOTE**

Refer to the hysteresis curve for the letters in parentheses (Figure 3-17).

All ferromagnetic materials, after having been magnetized, will retain some residual magnetic field. The strength and direction of the residual field depends upon all the magnetizing forces applied since the material was last demagnetized, and the retentivity of the material. The manner in which ferromagnetic materials respond to magnetizing forces is most often portrayed in a plot of the flux density (B) as a function of the magnetizing force (H). The flux density (B) is the number of magnetic lines of flux formed per cross-sectional area as a result of the magnetizing force (H). For an encircling coil, the magnetizing force is the accumulative effect of each turn of the coil and the current passing through it. Therefore, (H) is proportional to the current passing through the coil, multiplied by the number of turns in the coil. A typical (B/H) curve for a ferromagnetic material starting in a demagnetized condition and then cycled to saturation in two opposite directions is shown (Figure 3-17).

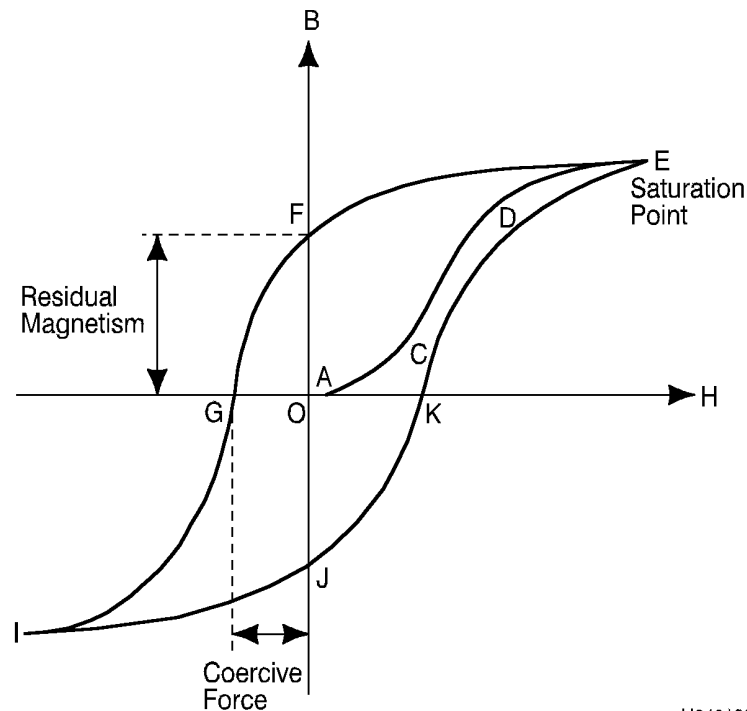


Figure 3-17. Hysteresis Curve for a Ferromagnetic Material

3.2.5.1 Hysteresis Curve.

NOTE

Refer to the hysteresis curve for the letters in parentheses ([Figure 3-17](#)).

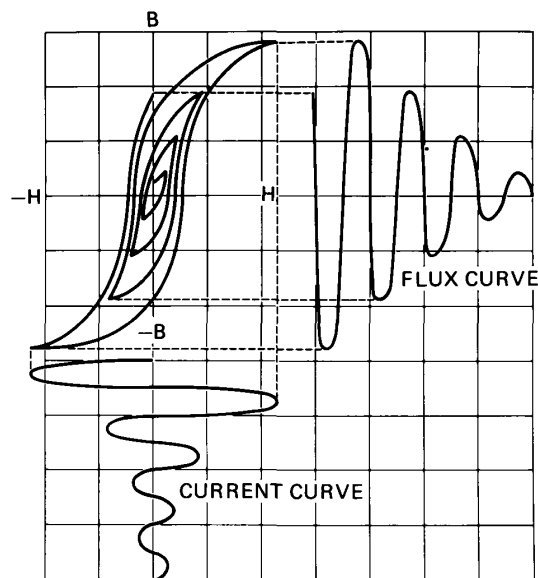
The magnetic field within an unmagnetized piece of steel is zero. As the magnetizing force (H) is increased from zero, the flux density (B) within the part will also increase from zero. The curve from points (A/E) illustrates this behavior. In the region of point (E), the flux density increases up to a point and then tends to level off; this condition is called magnetic saturation and for a magnetically saturated ferromagnetic material the relative permeability (μ) is approximately equal to one. When the magnetizing force is reduced to zero, the flux density does not return to zero. Instead, the flux density returns to a value shown at point (F). This is the amount of residual magnetism resulting from the applied magnetizing force (H) that reached point (E) in the hysteresis curve. As the magnetizing force (H) is increased from zero in the opposite direction, the flux density (B) will decrease to zero, as shown at point (G), and then start to increase to point (I). The magnetizing force (H) represented by the distance (O/G) on the (H) axis is called the coercive force. It represents the strength of the magnetizing force (H) required to reduce the flux density (B) to zero in a saturated ferromagnetic material. A further increase in the magnetizing force (H) to the point (I) results in saturation of the material in a direction opposite to that represented by point (E). Reduction of the magnetizing force (H) to zero from point (I) will reduce the flux density (B) to the value represented by point (J). Application of a magnetizing force (H) in the original direction will change the flux density (B) as shown in the portion (J/K) of the hysteresis curve. Increasing the magnetizing force (H) sufficiently will return the material to saturation as illustrated at point (E).

3.2.5.2 Magnetic Domains in Ferromagnetic Material. The behavior of ferromagnetic materials resulting in properties evidenced by hysteresis curves can be explained in terms of magnetic domains. Domains are small regions within a ferromagnetic material that have a permanent magnetic flux density (B) not equal to zero. In a completely demagnetized ferromagnetic material, the domains are randomly oriented resulting in an overall flux density of zero. When saturated, the domains are all aligned in the direction of the applied field. When the applied field is removed, after saturation, some domains return to their previous orientation, but most remain aligned in the direction of the previously applied field. This results in the residual magnetism observed in ferromagnetic fields. The magnetic behavior then is a result of behavior of the domains within the ferromagnetic material. Magnetization is the alignment of domains in a single direction; demagnetization is a random arrangement of the domains resulting in a zero net residual magnetism.

3.2.5.3 Demagnetization of Ferromagnetic Material. All parts SHOULD be demagnetized after MPI. Demagnetization may be easy or difficult depending on the type of material, part geometry, and magnetic field orientations used. Demagnetization involves subjecting a magnetized part to a continuously reversing magnetic field that gradually decreases in strength. This action reduces the strength of the residual magnetic field in the part. Although some residual magnetization will remain, this method can reduce the residual magnetic field to acceptable levels.

3.2.5.3.1 There are a number of methods of demagnetization available with varying degrees of effectiveness and they can be explained with the hysteresis curve shown in ([Figure 3-17](#)). Nearly all are based on the principle of subjecting a part to a continually reversing magnetic field that gradually reduces in strength down to zero. This principle is illustrated in ([Figure 3-18](#)). The waveform is shown at the bottom of the graph of the reversing current used to generate the hysteresis loops. As the current diminishes in value with each reversal, the loop shrinks and traces a smaller and smaller path.

T.O. 33B-1-1



H0401999

Figure 3-18. Flux Waveform During Demagnetization, Projected from the Hysteresis Loop

3.2.5.3.1.1 The waveform at the upper right (Figure 3-18) represents the flux in the part as indicated on the diminishing hysteresis loops. Both current and flux waveforms are plotted against time, and when the current reaches zero the residual field in the part will also have approached zero. Precautions to be observed in the use of this principle are:

- Be certain the magnetizing force is high enough at the start to overcome the coercive force, and to reverse the residual field initially in the part.
- The decrease between successive reductions of current is small enough so the reverse magnetizing force will be able, on each cycle, to reverse the field remaining in the part from the previous reversal.

3.2.5.3.1.2 Frequency of reversals is an important factor affecting the success of this method. With high frequency of current reversals, the field generated in the part does not penetrate deeply into the part section since penetration decreases as frequency increases. At a frequency of perhaps one reversal per second, penetration of even a large section is probably near 100-percent. For moderately sized parts, the 50 or 60-hertz commercial frequencies of alternating current give quite satisfactory results.

NOTE

Materials heated above their Curie temperature become nonmagnetic, thus offering another method of demagnetization.

3.2.5.3.2 Limitations of Demagnetization. “Complete” demagnetization is usually not possible, even though it is often specified. All practical demagnetization methods leave some residual field in the part. Therefore, demagnetization is either the best effort that existing means permit or reduction in magnetism to a residual level considered permissible in the particular part involved. It is extremely difficult to bring the steel back to the original zero point by any magnetic manipulation. In fact, it is so difficult that for all practical purposes, it may be said the only way to completely demagnetize a piece of steel is to heat it to its Curie temperature or above, and cool it with its length directed east and west in order to avoid magnetization by the earth’s natural magnetic field, north/south. This method of demagnetization is never used because it is not only impractical, but such heating will alter the properties of the part.

3.2.5.3.2.1 Remember, the earth’s magnetic field can determine the lower limit of practical demagnetization. Long parts, or assemblies of long parts, such as welded tubular structures, are especially likely to remain magnetized at a level determined by the earth’s natural magnetic field, in spite of the most careful demagnetization technique.

3.2.5.3.2.2 Many articles and parts become quite strongly magnetized from the earth's natural magnetic field alone. Handling of parts, such as transporting from one location to another, may produce this effect. Long bars, demagnetized at the point of testing, have been found magnetized at the point of use. It is not unusual to find steel aircraft parts are magnetized after having been in service for some time, even though they may never have been near any intentionally produced magnetic field. Parts may also become magnetized by being near electric lines carrying heavy currents, or near some form of magnetic equipment.

3.2.5.3.2.3 The limits of demagnetization may be considered to be either the maximum extent to which the part can be demagnetized by available procedures, or the level to which the terrestrial (earth's) field will permit it to become demagnetized. These limits may be further modified by the practical degree or limit of demagnetization actually desired or necessary.

T.O. 33B-1-1

SECTION III MAGNETIC PARTICLE INSPECTION EQUIPMENT

3.3 MAGNETIC PARTICLE INSPECTION EQUIPMENT AND MATERIALS.

3.3.1 Selection of Magnetic Particle Inspection Equipment. When selecting magnetic particle inspection equipment, the inspector must consider the type of current to be used and the location and nature of inspection.

3.3.1.1 A variety of equipment is available which can be used for either circular or longitudinal magnetization. The equipment ranges in size from small, general-purpose portable units capable of being carried by hand to large, custom-built stationary units with separate power supplies.

3.3.2 Categories of Magnetic Particle Inspection Equipment.

3.3.2.1 Stationary Equipment. A variety of stationary, bench-type MPI units are available, with many characteristics that fit different testing requirements. The smaller size units are used for small parts easily transported and handled on the unit by hand. The larger ones are used for heavy parts such as long engine crankshafts, where handling must be by crane. Such units are made to deliver AC or DC with various types of current control.

3.3.2.1.1 A typical stationary horizontal wet magnetic particle inspection unit has two contact heads (headstock and tailstock) for either direct contact or central conductor, circular magnetization using a copper rod between the heads, or a cable connected to a contact block between the heads. Many of the units contain a coil used for longitudinal magnetization. The coil and one contact head are movable on rails. The other contact head is fixed; the contact plate on it being air cylinder operated, provides a means for clamping the part. The unit has a self-contained power supply with all the necessary electrical controls. Magnetizing currents are usually three-phase full-wave DC or AC depending upon usage requirements. The units are made in several different sizes to accommodate different length parts and with various maximum output currents. A full-length tank with pump, agitation and circulation system for wet inspection media is located beneath the head and coil mounting rails. A hand hose with nozzle is provided for applying the bath. On special units, automatic bath application facilities are provided.

3.3.2.2 Mobile Equipment. The distinguishing feature of mobile equipment is the wheels the unit is mounted on. Mobile units can be easily moved to any inspection site where suitable line input voltages and current capacity are available. Mobile units may be similar to the Magnaflux Model M-530 weighing in at 670 – 900-pounds. Mobile inspection units are available in several sizes ranging from 3000 to 6000-amperes of AC and half-wave DC outputs. The units may have remote current output, ON/OFF and MAG/DEMAG controls that permit one-man operation at the site of inspection. The units can be used with either rigid or cable-wrapped coils for longitudinal magnetization and demagnetization. Cables connected to a part or passing through it are used for circular magnetization or demagnetization. This type of equipment is sturdy and well suited for both fabrication and overhaul inspections.

CAUTION

Contact prods SHALL NOT be used on aerospace components or parts.

3.3.2.2.1 Both half-wave DC and AC outputs are included in most mobile and portable units to increase their versatility. Half-wave DC current and dry magnetic powder make the best combination for detecting subsurface flaws in welds, particularly when used with the prod method of inspection. Half-wave DC is also useful for detecting subsurface discontinuities when the wet method is used. The use of alternating current is limited to the detection of discontinuities that are open to the surface, such as cracks, and for demagnetizing parts.

3.3.2.3 Portable Equipment. Portable MPI equipment is manufactured in a variety of sizes, shapes, voltages, and current outputs. Portable equipment operates on the same principle as stationary and mobile equipment; however, the compactness allows areas to be inspected where larger equipment may prohibit access. Portable equipment is usually operated on 110 or 220 volt AC and is rated between 200 and 1000-amperes. Portable equipment can be either AC, or a combination of AC and half wave DC. They can be used wherever an adequate 115-volt AC power source exists.

3.3.2.3.1 Portable equipment is suitable for examining small areas in large components where suspected cracks may be found. For example, critical engine mount fittings and landing gear assemblies, which are difficult to inspect in stationary units, can be examined quickly with minimum disturbance and with attention concentrated on points most subject to

cracking. Portable equipment can be moved to large items in need of magnetic particle testing and inspections can often be performed without disassembly.

3.3.2.3.2 Categories of Portable Equipment.

3.3.2.3.2.1 Portable Power Pack. Portable power packs are high Amp output devices. Examples of this equipment are the Magnaflux P-1500 or DA-1500, which are capable of putting out 1500-Amps AC or HWDC fields. These power packs weigh in at 93-pounds and have a duty cycle of 2-minutes on and 2-minutes off. Field selection is determined by using the appropriate field cable connector. Current output is indefinitely variable from zero to maximum by use of the current control located on the front panel meter. The actual current output is determined by cable size and length. These units can also be found mounted to carts (e.g., KH-07).

3.3.2.3.2.1.1 Portable power packs are usually used with cables for cable-wrap generation of longitudinal magnetization and for demagnetization; or with prods, clamps, or magnetic leeches for generating circular magnetization. The portable power pack can also be used to provide current via the cables to a small stationary unit for head and coil shots.

3.3.2.3.2.2 Probes and Yokes. The term probe and yoke are virtually interchangeable in this discussion. Probes and yokes (e.g., Magnaflux DA-200 or Y-7) are versatile, lightweight (approximately 8-pounds) hand-held devices used for inspection of small parts and localized inspections of large parts. Probes and yokes are easily used and often provide adequate inspections. They are essentially U-shaped laminated cores of soft iron with a coil wound around the base of the U. Probes and yokes are capable of putting a strong magnetic field into that portion of the part that lay between the poles of the probe or yoke. When electrical current is passing through the coil, the two ends of the core are magnetized with opposite polarity and the combination is an electromagnet similar to a permanent horseshoe magnet. They are capable of putting out constant AC or pulsed DC fields with the flip of a switch. A probe or yoke may be used to induce only a longitudinal field in a part. No electrical current passes through the part. They also have a duty cycle of 2-minutes on and 2-minutes off.

3.3.2.3.2.2.1 Probe and Yoke Current Induction.

3.3.2.3.2.2.1.1 Alternating Current (AC) Probes and Yokes. Alternating current, which is single phase when used directly for magnetizing purposes, usually has a frequency of 50 or 60-hertz. The AC longitudinal magnetizing field induced in the part is restricted to the surface due to its skin effect. AC provides a very desirable field for maintenance and overhaul inspection work due to its high sensitivity to surface defects. The peak AC current produces a surge peak in the magnetic field well above the average DC current required to develop a field of equivalent strength.

3.3.2.3.2.2.1.1.1 AC magnetic fields form eddy currents that tend to guide or restrict the magnetic lines of flux into a narrow pattern between the poles. Alternating magnetic fields cause surface vibration that adds mobility to the inspection particles to form larger and more distinct build-up of particles at the defect.

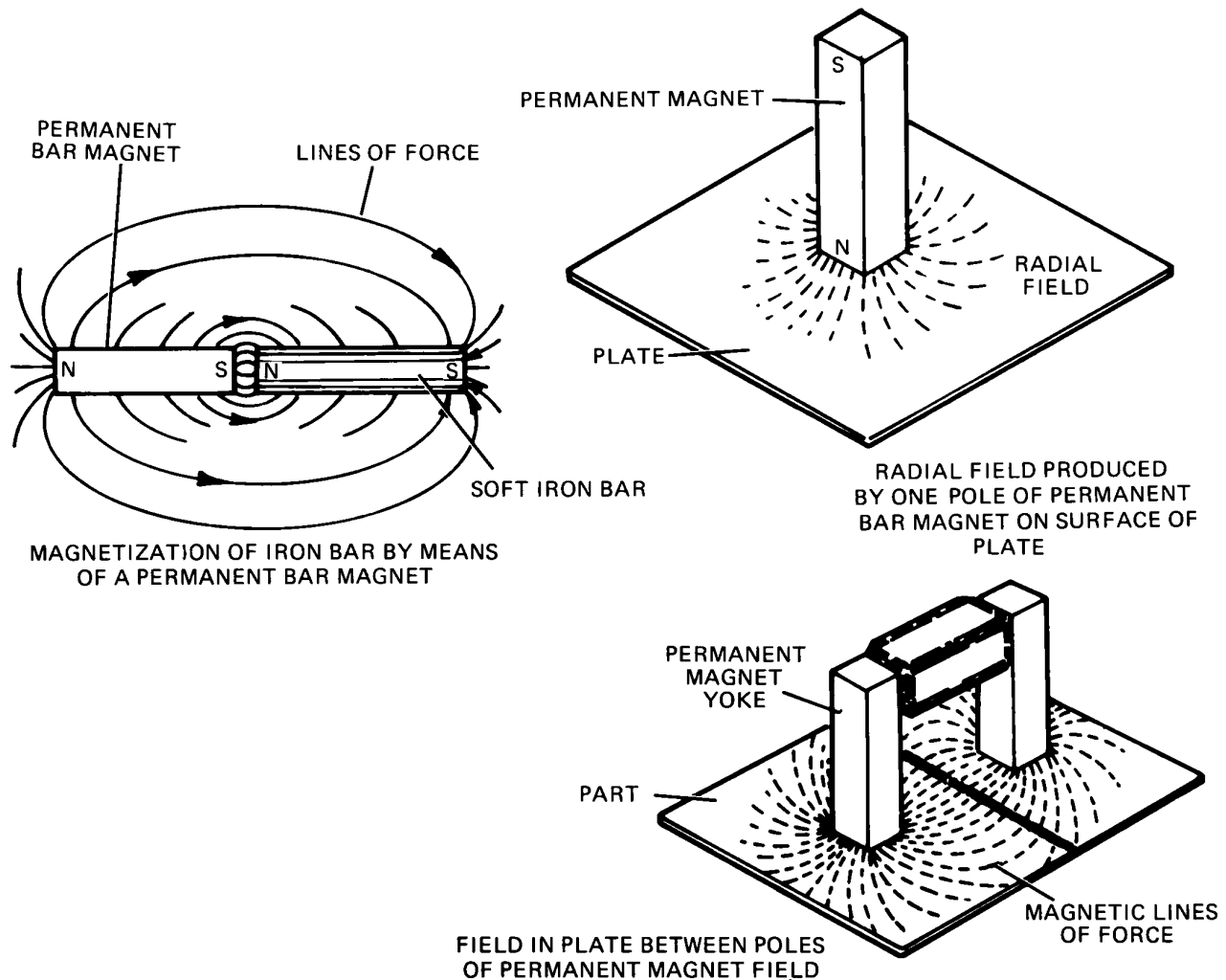
3.3.2.3.2.2.1.1.2 An AC magnetic field can be used when it is necessary to discriminate between surface indications and subsurface defects that might be revealed with a DC magnetizing field. Yokes utilizing AC magnetization also have the additional advantage of being readily used for demagnetization.

3.3.2.3.2.2.1.2 Direct Current (DC) Probes and Yokes. An electro-magnet powered by DC provides a very strong magnetic field. However, being a constant field and lacking any vibratory action, it is sometimes difficult to gather enough particles at the defect to form a visible indication. To overcome this difficulty, full-wave or half-wave rectified single-phase alternating current is used. This adds mobility to the magnetic inspection particles comparable to that produced by AC.

3.3.2.3.2.2.1.3 Permanent Magnet Yokes. Permanent magnets can also be used to magnetize parts in MPI. This method of magnetization has severe limitations and is properly used only when these limitations do not prevent the formation of satisfactory leakage fields at discontinuities. Permanent magnet yokes create longitudinal fields. The poles created on the parts may result in confusing particle indications. Control of field direction is possible only over a limited area. If you stand a permanent bar magnet on end on a steel plate, it will create a radial field in the plate around the pole in contact with the plate as shown (Figure 3-19). The flux produced by this radial field travels a distance from this point of contact until it leaves the surface of the plate, only to return to the pole at the opposite end of the magnet. Cracks crossing such a field pattern may be seen provided the field produced in the plate is sufficiently strong and properly oriented. The flux generally follows along a straight line drawn between the poles, and is strongest near the poles of the yoke and weakest at the point midway between the poles. The magnetic field strength within the part depends on the strength of the yoke magnetization and the distance between the poles. Outside this limited area, the field spreads out, and cracks favorably located with respect to field direction

T.O. 33B-1-1

may or may not be shown. This method of magnetization SHALL NOT be used unless the inspector is aware of, and understands the limitations of this technique.



H0402000

Figure 3-19. Magnetization With a Permanent Magnet

3.3.2.3.2.2.1.3.1 Some of the other drawbacks when using permanent magnets are:

- The strength of the field is not continuously variable.
- Large areas or masses cannot be magnetized with enough field strength to produce a satisfactory crack indication.
- It may be difficult to remove a strong magnet once it is in contact with the part.

3.3.2.3.2.2.2 Probe and Yoke Leg Configuration.

3.3.2.3.2.2.2.1 Fixed Leg Probe/Yoke. The legs of a fixed leg yoke are spaced approximately 5-inches apart providing a usable magnetic field area of approximately 25 in². Fixed leg probes can be used on flat, contoured, or irregular surfaces. However, the fixed leg position might preclude their use on some parts of a complex configuration, unless special pole pieces are available to adapt the legs to the part's surface.

3.3.2.3.2.2.2.2 Articulated Leg Probe/Yoke. An articulated or movable-leg yoke contains all the features of a fixed-leg yoke. They are, however, more versatile in their use and application because of the movable legs. The legs may be moved

inward to the decreased position or extended outward to the maximum position to obtain optimum contact, assuring a better induced magnetic field. When in the decreased position, the area of the usable magnetic field is decreased and the magnetic field is increased, permitting the detection of finer discontinuities. When in the extended position, the area of the usable magnetic field is increased though the field strength is weaker. Thus the discontinuities being sought must be larger. Movable-leg yokes are more suitable for demagnetization than fixed-leg yokes. The space between the poles or legs can be adjusted so the parts to be demagnetized pass snugly between them to obtain maximum demagnetization.

3.3.3 Inspection Equipment Accessories.

3.3.3.1 Contact Prods.

CAUTION

Contact prods SHALL NOT be used on aerospace components or parts.

When a non-aircraft part is too large to fit into a stationary unit, or if only mobile or portable equipment is available, then the part, or areas of the part, can be magnetized using cables and two hand-held prods. The current passing between the two contact prods creates a circular field. Great care SHALL be used to prevent local overheating, arcing, or burning the surface being inspected, particularly on high-carbon or alloy materials where hard spots or cracks could be produced.

3.3.3.2 Contact Clamps.

CAUTION

When parts are being magnetized by the use of spring loaded contact clamps to generate circular magnetization, the contact clamps SHALL NOT conduct more than 800-amperes.

Contact clamps can be used with cables instead of contact prods, particularly when the parts are relatively small in diameter. Care SHALL be used to avoid burning of the part under the contact clamps. Dirty contacts, insufficient contact clamp pressure, or excessive currents may cause burning and heating. Cracks may be produced as a result of the transient heating. Position the clamps so it directs the current to pass through the inspection area. Make sure the circular field created is perpendicular to the direction you think cracks may be developing.

3.3.4 Special Purpose Equipment. Special purpose equipment is equipment which has been specifically designed to take care of unusual situations where standard units are inappropriate. These may be special as to the method of magnetization or particle application, or be designed to handle unusual size, shape, or number of parts. Also, these may be operated manually or automatically. Special purpose equipment can be further broken down into two groups:

- Specific Purpose Units. Equipment built to do a specific job or part, and may have no other possibility of a processing technique. This specific job may be a variation in a magnetization technique, in the way the magnetic particles are applied, or in the way parts are handled.
- Automatic Units. Automatic units are those in which part or all of the handling and processing steps are performed automatically. Either single-purpose or general-purpose units may be partly or entirely automatic. Even standard units, by addition of standard accessories, may be made automatic in some of their functions. The principal purpose of automatic units is to speed up the inspection cycle. This is accomplished through automation of one or more of the important steps involved in a given testing operation.

3.3.4.1 Multidirectional Magnetization Equipment. Complex-shaped parts can be inspected rapidly with equipment capable of producing magnetic fields in two mutually perpendicular directions in rapid succession. For large parts such as shipyard castings, the equipment produces three-phase full-wave rectified AC and rapidly switches it between several different magnetizing modes. An alternate approach, used for smaller parts, is to use each of the three phases, either rectified or unrectified, for a separate magnetizing mode. Such equipment can then apply up to three magnetizing modes in rapid succession to a part. The multidirectional units produce a multidirectional magnetization effect by rapidly changing the magnetizing directions. For equipment utilizing the switched mode of operation, the switching can be on the order of 0.1 seconds. For the other type of equipment, the magnetizing modes are out of phase by 120-degrees. For 60-hertz current this is equivalent to switching magnetization directions in less than 0.006-seconds. These units are capable of producing indications

T.O. 33B-1-1

of discontinuities with widely differing orientations in a single operation, thus saving the time to conduct two or more separate inspections with different magnetic field excitation setups. It is not possible to estimate the required magnetizing currents before hand to produce the required magnetic field strengths and directions. Consequently, sensors **SHALL** be used to determine the resulting strength and orientation of the magnetic fields in order to develop valid inspection techniques with multidirectional magnetization methods.

3.3.4.2 Induced Current Magnetization Equipment. When inspecting ring-like parts for defects in a circumferential direction, the induced current technique can sometimes be used. As an example, a ring-shaped part is placed inside and concentric to a magnetizing coil being excited with AC (**Figure 3-20**). A laminated ferromagnetic core is placed inside the part and parallel to the axis of the coil in order to concentrate the magnetic field. The time-varying AC induces eddy currents in the test piece, which in turn induce a circular magnetic field within the test part. Such a field is used to detect circumferential defects within the test part. The core piece used **SHOULD** be laminated and made of low retentivity iron. If the part is ring-shaped, the core length should be approximately equal to the ring diameter or longer, but **SHALL NOT** be less than six inches, and **SHALL** be centered in the part. For a disc-shaped part with no bore, shorter core pieces **SHOULD** be placed on either side of the disc so they are parallel to the axis of the part. In some cases it is advantageous to shape the ends of the core pieces adjacent to the part to facilitate bath application. Since the induced current method does not require contacting the part, there is no danger of local part overheating.

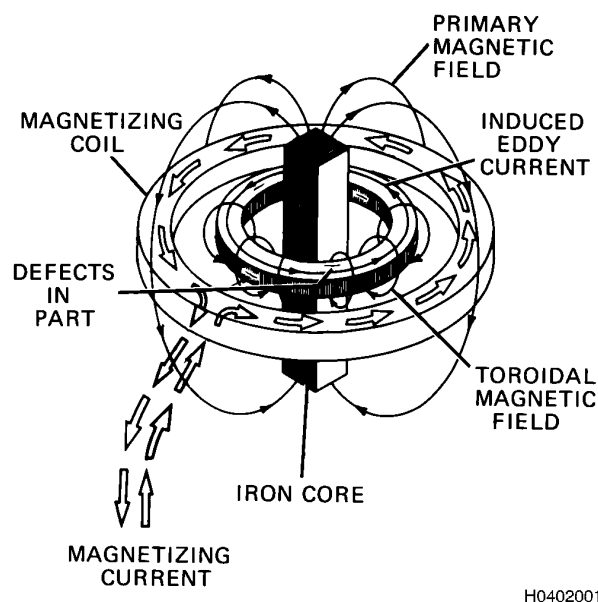


Figure 3-20. Current and Field Distribution in a Bearing Race Being Magnetized by the Induced Current Method

3.3.4.3 Hand-Held Coil. For longitudinal magnetization of shafts, spindles, rear axles, and similar small parts, the hand-held AC coil offers a simple and convenient method of inspecting for transverse cracks. Parts are magnetized and demagnetized with the same coil.

3.3.4.4 Special Demagnetizing Equipment. The most common type of demagnetizing equipment consists of an open, tunnel-like coil through which AC is passed at the line frequency, usually 60-Hertz. The larger type equipment is frequently placed on its own stand, incorporating a track or carriage to facilitate moving large and heavy parts through the demagnetizing equipment. The demagnetizing equipment can also include tabletop units, yokes, or plug-in coils more suited for the demagnetization of small parts. However, the large stationary type equipment is preferable when geometrically complex parts are involved.

3.3.5 Field Strength Measurement Devices. Equipment used for testing/measuring field strength is a: dial probe, field indicator, compass indicator, steel wire indicator, Hall-effect Gauss/Tesla Meter, and Quantitative Quality Indicators (QQI).

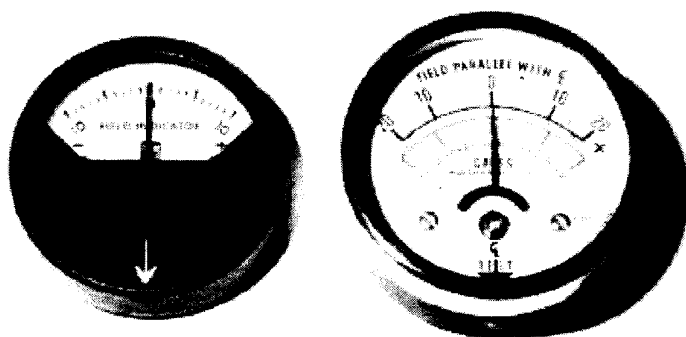
3.3.5.1 Dial-Probe. The dial-probe is used by placing the probe into the test hole or on the test surface and slowly rotating the probe counterclockwise. The maximum dial reading is the magnetic field strength.

3.3.5.2 Field Indicator.

CAUTION

Field indicators SHALL be kept away from fields strong enough to damage the needle because of rapid or violent deflection beyond full-scale reading. Field indicators, SHALL NOT be stored within the influence of magnetizing or demagnetizing magnetic flux.

The field indicator, a pocket instrument, is used to determine the comparative intensity of leakage fields emanating from a part. A typical field indicator is shown (Figure 3-21). The theory of operation is quite simple. When a field indicator is placed in a magnetic field, it responds to that portion of the magnetic field that passes through the sensing element of the indicator. The indicator responds to the magnetizing force of the leakage field passing through its sensing element, rather than the flux density in the part from which the leakage field emanates. When measuring the strength of the leakage field emanating from a part, the indicator senses only the field at some distance from the part. This distance is from the center of the sensing element to the bottom of the indicator when it is placed on the part's surface. The flux density of the field in the part will be greater than indicated by the field indicator. How much greater will depend upon the permeability of the part, shape of the part, and the effect of distance from the part to the sensing element in the indicator. Since these variables have an effect on determining flux density, it is recommended the field indicator be used only as a comparative indicator of the flux leakage from a part. The sensing element in newer indicators is of a ceramic-like material, which is very resistant to demagnetization.



H0402002

Figure 3-21. Typical Field Indicators

3.3.5.3 Compass Indicator. A compass is sometimes used for indicating the presence of external leakage fields. A compass can be placed upon a nonmagnetic surface and a magnetized part (aligned due east and west) moved slowly toward the east or west side of the compass case. The presence of an external leakage field from the part can cause the compass needle to deviate from its normal north-south alignment. However, demagnetized parts will cause the needle to deviate from its normal position if the compass case is not approached from an easterly or westerly direction. The theory of operation is very similar to the field indicator since the compass needle is a permanent bar magnet.

3.3.5.4 Steel Wire Indicator. A piece of iron or steel wire can be fashioned into a fair detector when nothing else is available. By forming a loop at one end of a piece of tag wire approximately 6-inches long, it can be suspended from a second wire supported in the horizontal plane. The part in question is then brought into contact near the free end of the vertically suspended wire. The presence of leakage fields will cause the wire to deviate from its normal vertical position as the part is slowly withdrawn in a horizontal direction. Care SHALL be taken to demagnetize the vertically suspended wire between each test. Small pieces of tag wire about 1-inch long can also be used to indicate the presence of leakage fields. The piece of demagnetized wire is placed upon a horizontal nonmagnetic surface, and the part in question is placed on top of it. If the piece of tag wire can be lifted off the surface as the part is slowly raised, the leakage fields are excessive.

T.O. 33B-1-1

3.3.5.5 **Gauss Meter.** The Hall-effect Gauss (Tesla) Meter has interchangeable probes to permit measurement of the magnetic field either parallel or perpendicular to the axis of the probe. Place the probe in the hole or on the surface as shown (Figure 3-22).

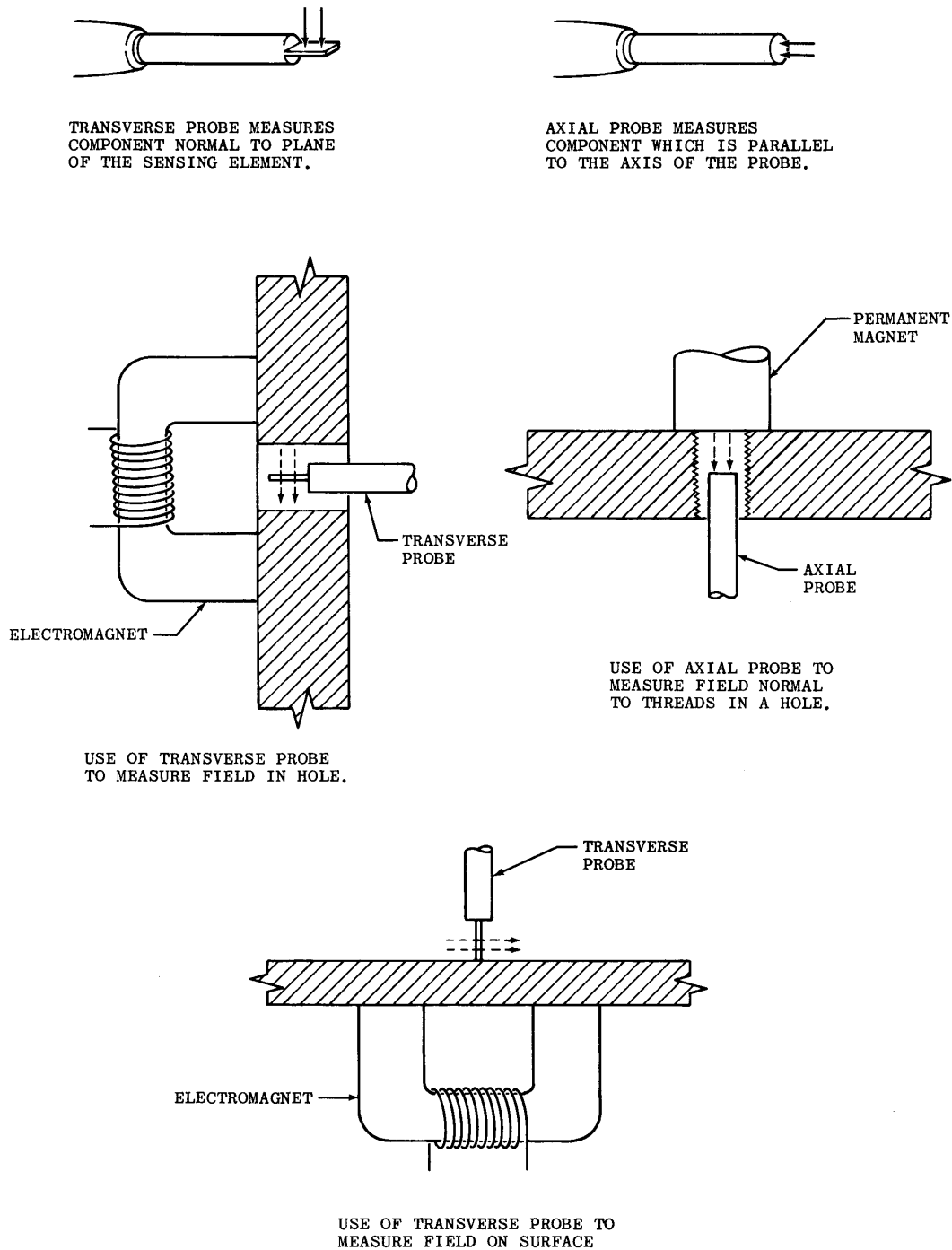


Figure 3-22. Typical Use of Gauss Meter Probes

3.3.6 Understanding and Selecting Magnetic Particle Inspection Materials.

3.3.6.1 General. An important consideration in the magnetic particle testing process is the use of the proper type of materials to secure the best possible indications of the particular type of defect being sought under a given condition. The choice of which materials to use is important, since the appearance of the particle patterns at discontinuities will be affected by this choice, even to the point of whether or not a pattern is even formed. Since the results of magnetic particle tests depend on the interpretation of the particle pattern, the appearance of this pattern is of fundamental importance. The reproducibility of results by inspectors at different locations is dependent on the same type of particles being used by each inspector, and the same magnetizing procedure.

3.3.6.1.1 There are two basic classes of magnetic particles available for use, wet and dry. The wet method particles use a liquid vehicle for suspension; the dry method particles are borne by air. Either water or oil may be used as a vehicle for the wet method. The particles are colored to provide good color contrast with the surface being inspected. The wet particles are best suited for the detection of fine surface cracks such as fatigue cracks. They are usually used with stationary equipment where the bath can be reused until it becomes contaminated. For field applications, aerosol cans of magnetic wet bath are available. Dry particles are more sensitive for detecting defects beneath the surface and are usually used with portable equipment.

3.3.6.2 Particle Properties and Their Effects.

3.3.6.2.1 Particle Description. The particles used in the magnetic particle inspection process are finely divided ferromagnetic material, usually combinations of iron and iron oxides. Properties of these particles include the size, shape, density, magnetic properties, mobility, and color. These properties may vary depending on the application.

3.3.6.2.2 Particle Size. It is self-evident that size plays an important part in the behavior of magnetic particles in a magnetic field, which can be quite weak at a discontinuity. A large heavy particle is not likely to be arrested and held by a weak field when such particles are moving over a part surface. On the other hand, very weak fields will hold very fine powders, since their mass is very small. Consequently, extremely fine particles may adhere to the very weak leakage fields caused by acceptable surface and/or material variations. Particle size has a profound effect upon its mobility.

3.3.6.2.2.1 Dry Powder Particle Size. In general, for the dry powders, sensitivity to very fine defects increases as particle size decreases, but with definite limitations. If the particles are extremely small, on the order of a few microns, they behave like a dust. They accumulate and adhere even on very smooth surfaces. The particles will adhere at any damp or slightly oily area, whether or not leakage fields exist. Extremely fine powders, though undoubtedly sensitive to very weak fields, are not desirable for general use because they leave a heavy, dusty background. In some special applications, particles of a specific size range are used (e.g., where it is desired to detect rather large, coarse discontinuities, only large-sized particles are used). However, most dry ferromagnetic powders used for detecting discontinuities are mixtures of particles in a range of sizes. The smaller particles add sensitivity and mobility, while the large particles not only aid in locating large defects, but also by a sort of sweeping action, counteract the tendency of the fine ones to leave a dusty background. Thus, by including a wide size range, a balanced powder with sensitivity over most of the range of sizes of discontinuities is produced.

3.3.6.2.2.2 Wet Method Particle Size. When the ferromagnetic particles are applied as a suspension in some liquid medium, much finer particles can be used. The upper limit of particle size in most wet method, visible materials used for magnetic particle testing purposes is in the range of 20 to 25-microns (about 0.0008 to 0.0010-inch). Particles larger than this are difficult to hold in suspension, and even the 20 to 25-micron sizes settle out of suspension rather rapidly and are left behind as the suspension drains off. Such particles often line up in what are called drainage lines to form a watermark that could be confused with indications of discontinuities.

3.3.6.2.2.2.1 In the case of the finer particles, the stranding due to the draining away of the liquid occurs much later, giving the particles mobility long enough to reach the influence of leakage fields and accumulate to form the indications. The minimum size limit for particles to be used in liquid suspensions is indeterminate. Ferromagnetic materials commonly used include some exceedingly fine particles. In actual use, however, particles of this size never act as individuals. Because they are magnetized in use, they become actual tiny magnets. Under conditions of quiet settling in a suspension, these particles are drawn together as a result of their retained magnetism to form clumps or aggregates of particles. These aggregations then tend to act as a unit when they are applied to the surface of parts for magnetic particle testing. The speed and extent to which this process takes place increases with the retentivity of the particle material. Agitating the suspension breaks up the aggregates, but they begin to form again as soon as agitation ceases. This happens when the suspension has been applied over the surface of the part, since the particles act as agglomerated units of varying size, and not as individual particles.

3.3.6.2.2.2.2 Advantages of an Agglomeration of Fine Wet Particles. This agglomeration of fine particles into larger clumps is advantageous as long as the size of the aggregate does not become larger than the limit mentioned in (paragraph

T.O. 33B-1-1

3.3.6.2.2.2). Individual particles of exceedingly small-size move very slowly through the liquid of the suspension under the influence of leakage fields at discontinuities. Unless special techniques are used, exceedingly small-size particles are not particularly useful for the location of very fine cracks until the process of agglomeration into somewhat larger units has taken place. In practical applications this process takes place while drainage of the suspension from the surface of the part is occurring. As the agglomeration proceeds the clumps formed will vary in size, and since these clumps act as individual units the effect is that of a particle size range from very fine to relatively coarse.

3.3.6.2.2.3 Fluorescent Particles. The information in (paragraph 3.3.6.2.2.2) applies primarily to magnetic particles not treated with fluorescent pigments. Fluorescent particles (or even colored visible particles) must be compounded and structured to produce a pigmented or colored coating that will not readily separate from the ferromagnetic core.

3.3.6.3 Particle Shape. The shape of the magnetic particles used for magnetic particle testing has a strong bearing on their behavior in locating defects. When in a magnetic field the particles tend to align themselves along the lines of force. This tendency is much stronger with elongated or rod-like particles than with more compact or globular shapes because the long shapes develop stronger polarity. Due to the attraction exhibited by opposite poles, the north and south poles of these tiny magnets arrange themselves into strings of particles, north to south, much more readily than do globular shapes. The result is the formation of stronger patterns in weak leakage fields, as these magnetically formed strings of particles bridge the discontinuity. The superior effectiveness of the elongated shapes over the globular shapes is particularly noticeable in the detection of wide, shallow discontinuities, or of those discontinuities, which lie wholly below the surface. The leakage fields at such defects are more diffuse, and the formation of strings due to the stronger polarity of the elongated-shaped magnetic particles makes for more visible indications in such cases.

3.3.6.3.1 Dry Powders and Particle Shape. In the case of the dry powders, there is another effect from the shape of the particles which must be taken into account. Dry particles are applied to the surfaces of parts by means of plastic powder bottles, rubber squeeze bulbs, or by the use of compressed air guns. The ability to flow freely and to form uniformly dispersed clouds of powder that will spread evenly over a surface is a necessary characteristic for rapid and effective dry powder testing. A powder composed only of elongated shapes tends to gather together in the container, and to be ejected in uneven clumps. When a powder behaves in this manner, the inspection becomes extremely slow and difficult. On the other hand, globular-shaped particles flow freely and smoothly under similar conditions. A dry powder must have free-flowing properties for easy application, yet have optimum shape for the greatest sensitivity for the formation of strong indications. These two opposing needs are met by blending particles of different shapes. A fair proportion of rod-like particles must be present for a sensitive blend. A sufficient proportion of more compact shapes must be present in order to have a powder that will flow well for easy and uniform application.

3.3.6.3.2 Wet Method Particle Shape. In the case of particles for the wet method of inspection, the individual particles are kept dispersed by mechanical agitation until they are applied to the surface of the magnetized part. Therefore, no need exists to incorporate unfavorable shapes merely for the purpose of improving the flow of the particles. Long, slender particles, with otherwise desirable characteristics, could be used exclusively.

3.3.6.3.2.1 Because wet method particles are suspended in a liquid medium, which is much denser and more viscous than air, they move in the leakage fields much more slowly than the dry powders. Therefore, they accumulate much more slowly at discontinuities. In the vicinity of leakage fields, they can be seen to line up to form minute elongated aggregates. Even the unfavorable aggregate shapes, formed by simple agglomeration in suspension, will line up into magnetically held elongated aggregates under the influence of local, low-level leakage fields. This effect contributes to the high sensitivity of the fine particles comprising wet method materials.

3.3.6.4 Particle Density. Most ferromagnetic materials have fairly high densities. The densities of the materials in common use vary from around 5 to nearly 8 times the density of water. Large, heavy particles will settle out of a suspension faster than smaller, lighter particles. This constitutes one more reason for requiring magnetic particles to be small. The density of many ferromagnetic particles is lowered somewhat by compounding or coating them with pigments with densities lower than the particles; with the obvious advantage of the particles remaining suspended longer than uncoated particles. This is true of both the dry, pigmented powders and the fluorescent particles in liquid suspension.

3.3.6.5 Particle Permeability. Magnetic particles used for magnetic particle testing should have the highest permeability and the lowest retentivity possible. This is so the low-level leakage fields that occur in the vicinity of a discontinuity can easily magnetize the particles. These fields will draw the particles to the discontinuity itself and form a visible indication. However, there is little connection between permeability and sensitivity for magnetic powders. For instance, the iron-based dry-method powders have permeabilities higher than the oxides used in the wet method. Yet a typical dry powder has less ability in detecting the extremely fine surface cracks than the wet-method particles. This is because the higher permeability is

insufficient to overcome the handicaps of the other less desirable characteristics of the dry powders. Unless all other factors are in the proper range for the application at hand, high permeability alone is of little value.

3.3.6.6 Coercive Force and Retentivity Properties of Particles. As a general principle, low coercive force and low retentivity are desirable properties for magnetic particles. If these values were high in a dry powder, the particles would become magnetized during manufacture or in first use, and thus become small, strong, permanent magnets. Once magnetized, their tendency to be controlled by the weak fields at discontinuities would be overshadowed by their tendency to stick magnetically to each other and to the test surface. This acts to reduce mobility of the powder, and also to form a high level of background that obscures defect indications.

3.3.6.6.1 Wet method particles that could become strongly magnetized because of high coercive force would also form this same objectionable background. In addition, such particles would stick to any iron or steel in the tank or plumbing of an inspection unit, and cause heavy settling-out losses that would have to be made up by frequent additions of new particles to the bath. Another undesirable feature displayed by highly retentive wet method particles is their tendency to clump together quickly in large aggregates on the test surface. Excessively large clumps of material have low mobility and indications are distorted or obscured by the heavy, coarse-grained backgrounds. Therefore, particles having high coercive force and retentivity are not desirable for wet method use either.

3.3.6.6.2 Both theory and experience have shown low coercive force and retentivity are advantageous. But low does not necessarily mean minimum or none. Dry powders with some residual magnetism appear more sensitive, especially in the diffuse leakage fields formed by defects lying wholly below the surface. The reason may be the small amount of polarity established in weakly magnetized, elongated particles aid in lining them into strings when the leakage fields of discontinuities act upon them. The action is similar to the compass needle swinging in the very weak field of the earth. Similarly, wet-method particles benefit from the higher than minimum values of retentivity and coercive force. These ultra-fine particles begin to collect at discontinuities as soon as they are applied to the test surface once the agitation from the bath ceases. With insufficient retained magnetism, the particles remain fine and migrate very slowly through the liquid, due to the weak leakage fields, and the viscosity of the liquid suspending medium. The indications of discontinuities will build up, but very slowly, taking as long as five to ten-seconds. On the other hand, if excessively magnetized particles are used, the test surface is covered with large immobile clumps as soon as the bath is applied. Particles having intermediate magnetic properties collect into clumps more slowly while the indications are forming. The leakage field, strongest at the actual discontinuity, draws particles toward it, while the particles themselves are constantly enlarging due to agglomeration. At the same time, they sweep up the ultra fine particles as they move toward the defect. In this way, all the magnetic fields present work together.

3.3.6.7 Particle Mobility. When magnetic particles are applied over the surface of a magnetized part, they must move and gather at a discontinuity under the influence of the leakage field to form a visible indication. Any factor that interferes with this required movement of the particles will have a direct effect on the sensitivity of the powder and the test. Conditions promoting or interfering with mobility are different for dry and wet method materials.

3.3.6.7.1 Dry Powder Mobility. Dry powder SHOULD be applied in such a way the particles reach the magnetized surface in a uniform cloud with a minimum of motion. When this can be done, the particles come under the influence of the leakage fields while suspended in air, and have three-dimensional mobility. This condition can be approximated when the magnetized surfaces are vertical or overhead. When the particles are applied on a horizontal or sloping surface they settle directly to the surface and do not have the same degree of mobility. Tapping or vibrating the part, which jars the powder loose from the surface and permits it to move toward the leakage fields, can achieve mobility in this case. When AC or half-wave rectified AC (pulsating DC) is used for magnetization, the rapid variation in field strength while the current is on, imparts a vibratory motion to the magnetic particles on the surface of the part. This gives the particles excellent mobility for the formation of indications. The coatings applied to some of the dry-method powders to give color to the indications, also reduce friction between particles and the surface of the part, thus aiding mobility.

3.3.6.7.2 Wet Method Mobility. The suspension of particles in a liquid, which may be water or a petroleum distillate, allows mobility for the particles in two dimensions when the suspension is flowed over the surface of the part, and in three dimensions when the magnetized part is immersed in the suspension. Wet method particles readily settle out of suspension. To be effective, the magnetic particles must move with the liquid and reach every surface the liquid covers without settling out somewhere along the way. Particles settle out of suspension at a rate directly proportional to their size and density, and inversely proportional to the liquid's viscosity. While it must be balanced against many other properties, mobility is one of the factors which is important to wet method results. The viscosity of the suspension medium is also important to mobility. In thicker liquids, the magnetic particles migrate to the leakage field more slowly. If the suspension liquid is too viscous and the magnetizing cycle too short, the indication may not form adequately. As a practical rule for sensitive inspection, the viscosity of the suspension medium SHOULD NOT exceed 3-centistokes.

T.O. 33B-1-1

3.3.6.8 Visibility and Contrast.

3.3.6.8.1 Dry Powder Visibility and Contrast. These are important properties that have a great deal to do with making a magnetic powder suitable for its intended purpose. Size, shape, and magnetic properties of a particle may be adequate, but if the indication is not visible to the inspector the inspection fails.

3.3.6.8.1.1 Visibility and contrast are promoted by choosing colors of particles easy to see against the color of the surface of the test part. The natural color of the metallic powders is silver-gray. The colors in the iron oxides commonly used as the base for the wet method materials is limited to black and red. Coloring the powder particles in some way can increase visibility against certain colors. By use of pigments the silvery iron particles are colored white, black, red, or yellow, all with comparable magnetic properties. One or another of these colors gives good contrast against the surfaces of most of the parts tested. Among the dry powders, the gray-white powder gives good contrast against the surfaces of many test parts. It fails to give good visibility, however, against the silver-gray of a sand- or grit-blasted surface, or against bright machined or ground surfaces. Choice of colors SHALL be made by the inspector to provide the best possible visibility against the surfaces of the test part under the conditions of shop lighting that prevail. Similarly, the choice of either the black or the red wet method material is made to suit particular lighting conditions.

3.3.6.8.1.2 In some cases it has been found advantageous to coat the part being tested with a color to improve contrast. Chalk or whiting in alcohol has been used in the past for the inspection of large castings and weldments when lighting conditions were poor in the areas where the inspection was being conducted. Aluminum paint has been similarly used. Color contrasting is rarely used today, because the fluorescent materials now available solve the problem in a much better way.

3.3.6.8.2 Wet Method Visibility and Contrast. The ultimate in visibility and contrast is achieved by coating the magnetic particles with a fluorescent pigment (usually available in wet method materials only). The search for indications is conducted in total or semi-darkness, using ultraviolet light to activate the fluorescent dyes used. When indications glow in the dark, it is almost impossible for an inspector not to see them. Magnetically, these fluorescent materials are less sensitive than uncoated particles, but this reduction in magnetic sensitivity is more than offset by the fact patterns of particles can be readily seen even when only a few such particles make up the indication. A fluorescent indication easily visible under black light is often quite impossible to see when viewed in white light. The advantage in visibility and contrast of the fluorescent materials is so great, they are being used in a very high percentage of all applications.

3.3.6.9 Media Selection.

3.3.6.9.1 Dry Method Versus Wet Method. Principally, the following influences the choice between the dry and wet methods:

- Type of Defect (surface or subsurface). Dry powder is usually more sensitive for detection of subsurface defects.
- Size of Surface Defect. The wet method is usually best for locating very fine and shallow defects.
- Convenience. Dry powder, with a portable half-wave unit, is easy to use on large parts in the shop or for field inspection work.

3.3.6.9.1.1 The dry powder method is superior for locating defects lying wholly below the surface because of the high permeability and the favorably elongated shape of the particles. These form strings in a leakage field and bridge the area over a defect. AC with dry powder is excellent for surface cracks, which are not exceedingly fine, but it is of little value for defects lying even slightly below the surface. When the requirement is to detect very fine surface cracks, the wet method is considered superior regardless of the form of magnetizing current used. In some cases, direct current is considered advantageous for use with the wet method to get better indications of discontinuities that lie just below the surface. The wet method offers the advantage of easy complete coverage of the surface of parts of all sizes and shapes. Dry powder is often used for spot inspections.

3.3.6.9.2 Visible Particles Versus Fluorescent Particles. Selection of the color of particles to use is essentially a matter of obtaining the best possible contrast with the background of the surface of the part being inspected. The differences in visibility among the black, gray, and red particles are considerable on backgrounds which may be dark or bright and which may be viewed in various kinds of light. Black stands out against most light colored surfaces, gray against dark colored ones. Red is more visible against silvery and polished surfaces especially when the lighting is from incandescent lamps. If the indication is hard to see, the inspector should try some other color of powder. In the case of the wet method, the ultimate in visibility and contrast is obtained by the use of fluorescent particles. The fluorescent wet method has been used in increasing numbers of inspection applications for many years, principally because of the ease of seeing the faintest indication.

3.3.6.9.3 Fluorescent Particle Characteristics. When exposed to near ultraviolet light (black light), fluorescent magnetic particles emit a highly visible yellow-green color. Indications produced are easily seen, and the fluorescent particles provide much stronger indications of very small discontinuities than do the non-fluorescent magnetic particles. The differences between the wet visible method and the wet fluorescent method are comparatively minor regarding suspension characteristics, maintenance and application, as well as the inspection variables and demagnetization techniques. The following applies only to the wet fluorescent method.

3.3.6.9.3.1 Advantages and Limitations. Fluorescent particles have one major advantage over the untreated or visible particles, their ability to give off a brilliant glow under black light. This brilliant glow serves three principal purposes:

- In semi- or complete darkness even smallest amounts of the fluorescent particles are easily seen, having the effect of increasing the apparent sensitivity of the process, even though magnetically the fluorescent particles are not superior to the uncolored particles.
- Even on discontinuities large enough to give good visible indications, fluorescent indications are easier to see and the chance of the inspector missing an indication is reduced, even when the speed of inspecting parts is increased.
- Concurrent with the greater visibility of indications formed by fluorescent particles, the background caused by excessive magnetization is also more severe. Consequently, greater care SHALL be exercised in selection of the particle concentrations and magnetization levels for the inspection with fluorescent particles.

3.3.6.9.3.2 The fluorescent particle technique is faster, more reliable, and more sensitive to very fine defects than the visible colored particle method in most applications. Indications are easier to detect, especially in high volume testing. In addition, the fluorescent method has all the other advantages possessed by the wet visible suspension technique.

3.3.6.9.3.3 The wet fluorescent technique also shares the disadvantages found with the wet visible technique. In addition, there is a requirement for both a source of black light, and an inspection area from which the white light can be excluded. Experience has shown that these added requirements are more than justified by the gains in reliability and sensitivity.

3.3.6.9.4 Media Selection. NDI laboratories SHALL include the following supplemental information on the purchase order or contract when requesting new media.

- Suspension vehicle for magnetic particle inspection SHALL comply with A-A-59230 (Table 3-1).

Table 3-1. Requirements for Magnetic Particle Wet Relative Permeability for Some Ferromagnetic Materials Method Oil Vehicle (A-A-59230)

Test	Requirement		Specification/Standard
	Minimum	Maximum	
Flash Point, °C (°F)	94 (200)	—	ASTM D 93
Odor	—	None	DOD-F-87395
ASTM Color	—	1.0	ASTM D 1500
Background Fluorescence	Less than the standard		DOD-F-87395
Viscosity Centistokes	—	3.0	ASTM D 445
Particulate Matter, mg/L	—	0.5	ASTM D 2276
Total Acid Number, mg KOH/L	—	0.015	ASTM D 3242

- Magnetic particles SHALL comply with ASTM E 1444 and the specific Aerospace Material Specification (AMS) (Table 3-2).

T.O. 33B-1-1**Table 3-2. Procurement Data for Magnetic Particles per ASTM E 1444**

Type of Particles (Specification Title)	Specification
Magnetic Particle Inspection Material, Dry Method	AMS 3040
Magnetic Particles, Wet Method, Oil Vehicle	AMS 3041
Magnetic Particles, Wet Method, Dry Powder	AMS 3042
Magnetic Particles, Wet Method, Oil Vehicle Aerosol Canned	AMS 3043
Magnetic Particles, Fluorescent, Wet Method, Dry Powder	AMS 3044
Magnetic Particles, Fluorescent, Wet Method, Oil Vehicle	AMS 3045
Magnetic Particles, Fluorescent, Wet Method, Oil Vehicle, Aerosol Canned	AMS 3046

SECTION IV MAGNETIC PARTICLE INSPECTION APPLICATIONS

3.4 MAGNETIC PARTICLE INSPECTION APPLICATION METHODS.

3.4.1 Inspection Preparation.

3.4.1.1 Disassembly Requirements. There are situations when disassembly of the item is required prior to inspection:

3.4.1.1.1 Disassembly eases accessibility to most if not all surfaces, thus permitting a more thorough inspection.

3.4.1.1.2 Boundaries between two ferrous pieces, or between a ferrous and a nonferrous piece, will create a leakage field that may confuse inspection.

3.4.1.1.3 It is usually easier to handle disassembled parts for pre-cleaning, inspection, and post-cleaning.

NOTE

If the critical area of an assembly is completely accessible for inspection without any disassembly, and if the inspection medium (magnetic powder or paste) can be removed after inspection, then it is acceptable to inspect those areas or parts in place without disassembly. For example, steel propeller blades may be inspected in the blade area while they are in place on the aircraft, but to inspect the shank area, which is concealed by the hub, it is necessary to disassemble.

3.4.1.2 Plugging and Masking. When it is possible for the inspection media to become entrapped or to damage components, plugging and/or masking SHALL be used. Plug small openings and holes with hard grease or similar nonabrasive readily soluble material. This prevents the accumulation of the magnetic particles and carrier liquid where it cannot be completely and readily removed by conventional cleaning and air blasting.

3.4.1.3 Pre-Cleaning. Pre-cleaning is the removal of all foreign material (paint, grease, oil, corrosion, layout dye, wax crayon markings, etc.) which may interfere with magnetic particle testing that has accumulated since the general cleaning operation but prior to inspection.

3.4.1.3.1 Parts or surfaces SHALL be clean and dry before they are subjected to any magnetic particle inspection process. The cleaning process used SHALL NOT reduce the effectiveness of the inspection process. The cleaning process is required to remove all contaminants, foreign matter, and debris that might interfere with the application of current or the movement of the magnetic particles on the test surface.

NOTE

Thin coatings such as cadmium, chromium, or a single coat of paint, if in good condition, will not interfere with the inspection process, and do not necessarily have to be removed. Parts that have been repainted or touched up may have thicker than normal paint which may require stripping.

3.4.1.4 Selecting a Cleaning Process. The cleaning process SHALL be chosen with knowledge of the contaminant, the reaction of the cleaning process to the metal, the accessibility of the part to be inspected, whether it's on or off the aircraft, along with other specific safety precautions. No single cleaning method can assure removal of all types of contaminants and most methods are limited to the removal of only a few types of contaminants. Further, some cleaning methods require equipment that may not be adaptable to the specific job conditions (e.g., such as cleaning large parts or cleaning in place on an aircraft). Finally, some processes may cause corrosion of the part to be inspected.

T.O. 33B-1-1**3.4.1.5 Typical Cleaning Methods.****CAUTION**

Only trained and qualified personnel SHALL prepare a part (e.g., chemical/mechanical striping), which requires anything more than a simple wipe down. Improper cleaning procedures and/or materials may cause severe damage to the material. Residues from cleaning processes can remain on the part surface and contaminate the inspection. Paint removers may leave residues that either trap particles or contaminate recirculating baths. Air Force personnel SHALL refer to T.O. 1-1-691. Navy personnel SHALL refer to NA 01-IA-509. Army personnel SHALL refer to TM1-1500-344-23.

3.4.1.5.1 Alkaline Cleaning. Alkaline cleaners are nonflammable water solutions containing alkaline detergents that can remove certain types of oils by saponifying (converting the oil to soap) or displacement. They can be used hot or cold, as a dip or as a spray.

3.4.1.5.2 Solvent Cleaning. Solvent cleaners are an efficient and practical means of removing light preservatives and soil from parts taken out of storage or accumulate during transit and handling from the cleaning shop prior to the inspection process. Solvent cleaners dissolve oil, wax, grease, and some other contaminants and can be applied by spraying, wiping, or dipping.

3.4.1.5.3 Paint Strippers. Paint removers can be a solvent, bond release agent, softening agent, or combination.

3.4.1.5.4 Steam Cleaning. Steam cleaning is a form of alkaline or detergent cleaning and can remove loosely bound inorganic contamination and many organic contaminants from the test surfaces.

3.4.1.5.5 Ultrasonic Cleaning. Ultrasonic cleaning combines solvent or detergent cleaning with very vigorous mechanical action to loosen contaminants.

3.4.1.5.6 Mechanical Cleaning. Mechanical methods, such as wire brushing or abrasive blasting, can be used to remove rust or other corrosion deposits. These methods, if used improperly, can damage parts and conceal discontinuities (especially on soft metals) and SHOULD only be used as directed.

3.4.1.6 Preparation of Part Surface. In general, the same requirements apply for the wet method as for the dry method. Dirt, corrosion, loose scale, oil, or grease SHALL be removed. The oil bath will dissolve oil or grease, but this builds up the viscosity of the bath and shortens its useful life. With a water bath, oil on the surface of the part makes wetting more difficult, although the conditioners in the bath are usually sufficient to take care of a slight amount of oil. Excessive oil on part surfaces contaminates the water bath. Paint and plated coatings, if over 0.003-inch thick, may have to be stripped. Tests have shown nonmagnetic coatings of any kind, in excess of 0.003-inch in thickness, can seriously interfere with the formation of magnetic particle indications of small discontinuities.

NOTE

When preparing for contact testing, nonconductive coatings SHALL be removed from the contact areas.

3.4.1.6.1 Surface Preparation for the Dry Powder Method. In general, the smoother the surface of the part and the more uniform its color, the more favorable are the conditions for the formation and the observation of indications. This statement applies particularly to inspections being made on horizontal surfaces. Dry powder may not be held in place on very smooth, sloping/vertical surfaces by a weak leakage field. The surface SHALL be clean, dry, and free of oil and/or grease. The dry particles will stick to wet or oily surfaces and not be free to move over the surface to form indications. This may completely prevent the detection of significant discontinuities by obscuring the flaw indications with a heavy background. On surfaces cleaned of grease by wiping with a rag soaked in a petroleum distillate, a thin film of unevaporated solvent can remain, sufficient to interfere with the free movement of the powder. This film can be removed by wiping the surface with a clean, dry cloth, flushing with alcohol, or dusting the surface with chalk or talc from a shaker can, and then wiping the surface with a clean dry cloth. An initial application of the dry magnetic powder itself, followed by wiping, can also provide a surface over which a second application of powder will move readily. Vapor degreasing (if available), will provide a dry, oil-free surface.

3.4.1.6.1.1 Any loose dirt, paint, rust, corrosion, or scale can be removed with a wire brush, by shot or grit blasting, or other allowable means. Cleaning with shot or grit blasting may cause a peening effect (especially on softer steels), which may

close up fine surface discontinuities. The effect is more pronounced with shot than with grit, but if these cleaning methods are used the operator SHALL be aware of the danger of missing very fine cracks. A thin, hard, uniform coating of corrosion or scale will not usually interfere with the detection of any but the smallest defects. The inspector SHALL be aware of the smallest size defect he/she must consider, in order to judge whether or not such a coating of rust or scale should be removed.

3.4.1.6.1.2 Paint or plating on the surface of a part has the effect of making a surface defect behave like a subsurface defect. The relative thickness of the plating or paint film and the size of the defects sought, determine whether or not the coatings should be stripped. The dry method is more effective than the wet method in producing indications through such non-magnetic coatings. If fine cracks are suspected, the surface SHALL be stripped of the coating if its thickness exceeds 0.003-inch. Most coatings of cadmium, nickel, or chromium are usually thinner than this and the plating makes an excellent background for viewing indications. Hot galvanized coatings are thicker than 0.003-inch, and in general SHOULD be removed before inspections unless only gross discontinuities are important. Broken or patchy layers of heavy scale or paint also tend to interfere by holding powder around the edges of the breaks or patches and SHOULD be removed if they are extensive enough to interfere with the detection of discontinuities.

3.4.1.6.2 Surface Preparation for the Wet Suspension Method. In general, the same requirements apply for the wet method as for the dry technique (paragraph 3.4.1.3.1). Dirt, corrosion, loose scale, paint, oil, and grease SHALL all be removed prior to inspection. When preparing for contact testing, nonconductive coatings SHALL be removed from the contact areas. The test surface SHALL be free of contaminants that can dissolve into the inspection bath.

3.4.1.6.2.1 Insoluble particulate contaminants, such as corrosion, sand, and grit left on the part surface may accumulate in a recirculating wet bath. This accumulation may interfere with the formation and visibility of indications and force the bath to be discarded sooner than normal.

3.4.1.6.2.2 The removal of surface oil and grease is very important when preparing the part prior to wet fluorescent magnetic particle inspection. Oil or grease can harm aqueous inspection baths in several ways. Their presence on the test surface can either prevent the bath from wetting and covering the entire surface, or it can cause the bath to peel off the surface, stripping any indications off with it. The oil can also be emulsified in an aqueous bath, and again coagulate the magnetic particles. Such dissolved contaminants may also become concentrated in a recirculating test bath, increasing its viscosity. Most petroleum distillates, lubricating oils, and grease fluoresce.

3.4.1.6.2.3 Moisture on the test surface can be emulsified into an oil bath causing the magnetic particles to coagulate and settle out of the bath, where they are no longer available to form indications. This contamination will gradually retard the forming of indications and make them increasingly difficult to see.

3.4.2 Magnetic Particle Inspection Techniques. There are several techniques associated with the magnetic particle inspection process. Each technique has its benefits and detriments.

3.4.2.1 Determining the Choice of Technique. The choice of technique for a particular magnetic particle inspection depends upon:

- The type of discontinuity or defect being sought.
- The part's material, shape, and size.
- The magnetic particle inspection equipment available.

3.4.2.2 Technique Variations. The following variations SHALL be considered and the appropriate alternatives selected to achieve a particular inspection result:

- Type and amount of magnetizing force required producing adequate magnetization.
- The estimated flaw size and flaw orientation.
- Type of defect; surface or subsurface.
- The magnetic particles best suited for the inspection (e.g., fluorescent, red, black, etc).
- The method of particle application best suited for the inspection (e.g., wet, dry, or magnetic rubber).

3.4.2.3 Sensitivity Level. Any factor that affects the formation of magnetic indications at a discontinuity affects the sensitivity of that magnetic particle inspection. Three of the most important factors are: "field direction," "current level," and "control of the magnetic particle inspection media."

3.4.2.3.1 Effect of Field Direction on Sensitivity Level (paragraph 3.4.4.1).

T.O. 33B-1-1

3.4.2.3.2 Effect of Current Level on Sensitivity Level. The formation of magnetic particle indications at discontinuities depends upon the strength of the corresponding leakage fields. Since the strength of the leakage field results from the field generated by the magnetizing current, the greater the magnetizing current, the greater will be the strength of the leakage field. Thus, the sensitivity of a magnetic particle inspection is directly related to the applied current. A current level too low produces leakage fields too weak to form readily discernible indications; and a current level that is too high creates a heavy background accumulation of particles that masks an indication. In circular magnetization, a high current level may also burn the contact points of a part.

3.4.2.3.3 Effect of Inspection Media on Sensitivity Level. Sensitivity level is affected not only by the current amperage, but also by the type of magnetic particle inspection media, its applications, and its control.

3.4.2.3.3.1 The smaller particle sizes within liquid suspensions are the most sensitive for the detection of surface discontinuities while dry powders are better for detecting subsurface defects. Fluorescent materials have a higher apparent sensitivity than do those used with visible light, such as the black and red particles.

3.4.2.3.3.2 Inspection of parts which are only moderately retentive requires careful control of the way the inspection media is applied. Usually, maximum sensitivity is obtained by applying the media while a part is being magnetized and ending it before the magnetizing field is removed, commonly known as the continuous method (paragraph 3.4.6.4.7.3.2). This is also true in the case of automatic wet-method inspection in which the main bath stream is shut off shortly before the magnetizing current is ended to avoid washing off indications already formed.

3.4.2.3.3.3 Particle concentration in the baths SHALL be closely controlled if maximum sensitivity is to be obtained. Sensitivity is lowered if concentration of particles is too low. If concentrations are too high, fine indications may be masked by heavy background accumulations.

3.4.2.3.3.4 Contaminants, particularly in wet baths, can result in lowered sensitivity. Lubricating oils and greases for example, cause a blue background fluorescence that reduces contrast, causing fluorescent particle indications to be less visible.

3.4.2.3.3.5 Sensitivity of dry powders depends upon: "type of powder selected," "how carefully it is applied," and its "color." Most powders are made for general use and have a wide mix of particle sizes to aid in the detection of both fine surface and deep subsurface discontinuities. A powder color is usually selected which will provide the best contrast against the color of the surface upon which it is being used. Care SHALL be exercised when applying powder media. Light tossing and/or air-blowing actions are needed to allow the particles to migrate to and be held by the leakage fields at discontinuities. Excessive application of powder can cause indications to be lost in background accumulation.

3.4.2.3.3.6 The dry powder method is superior for locating defects lying entirely below the surface. This is due to the high permeability and the favorably elongated shape of the particles. These form strings in a leakage field and bridge the area over a defect. However, when the problem is to find very fine surface cracks, there is no question as to the superiority of the wet method, regardless of the form of magnetizing current used. In some cases, direct current is selected for use with the wet method to obtain the advantage of improved indications of discontinuities that lie just below the parts surface, especially on bearing surfaces and aircraft parts. The wet method offers the advantage of easy, complete coverage of the entire surface of parts. Dry powder is often used for localized inspection areas.

3.4.3 Selecting a Magnetizing Current.

3.4.3.1 Alternating Current (AC). AC in magnetic particle inspection is effective only for the detection of surface discontinuities. These types of discontinuities comprise the majority of service-induced defects. Fatigue, overload, and stress-corrosion cracks are examples of cracks usually open to the surface.

3.4.3.1.1 The shallow penetration of AC fields into the part at the usual power line frequencies of 50 and 60 hertz hinders the use of AC for the detection of subsurface discontinuities. This shallow penetration is due to a skin effect. Skin effect is the crowding of magnetic flux or electric current outward and away from the part center. Self-induced flux or currents that reduce the interior density of the flux or current causes this crowding phenomenon. Skin effect is the reason AC is recommended when inspecting for service-induced surface defects. However, the skin effect of AC is less at lower frequencies, resulting in deeper penetration of the lines of force. At 25 hertz, the penetration is considerably deeper, and at frequencies of 10 Hz and less, the skin effect is almost nonexistent.

3.4.3.1.2 The alternating currents used in magnetic particle inspection have low excitation voltages. Currents from stationary equipment range from about 100 amperes to 10,000 amperes depending upon the test part and the magnetization

technique. The high currents are obtained by using step-down transformers that reduce line voltages to about 20 volts. Lower amperages are available from hand-held devices that operate from standard 115-volt outlets. Alternating current (AC) and half-wave direct current (HWDC) are obtained from single-phase systems or from one phase of three-phase systems. Full-wave direct currents (DC) are usually obtained from three-phase systems using full-wave, three-phase bridge rectifiers.

3.4.3.1.3 If the defects sought are at the surface, AC has several advantages. The rapid reversal of the field imparts mobility to the particles, especially to the dry powders. Dry powder particles in the presence of AC or HWDC fields have mobility on a surface due to the pulsating character of the fields. Particle mobility aids considerably in the formation of particle accumulations (indications) at discontinuities. The “dancing” of the powder helps it to move to the area of leakage fields and to form stronger indications. This effect is less pronounced in the wet technique.

3.4.3.1.4 Alternating current has another advantage in the magnetizing force is determined by the value of the peak current (at the top of the sine wave of the cycle). The peak current is 1.41 times greater than the current value read on the meter. Alternating current meters read more nearly the average current for the cycle rather than the peak value.

3.4.3.2 Direct Current (DC). Magnetic fields produced by direct current penetrate deeper into a part than fields produced by alternating current, making the detection of subsurface discontinuities possible. For longitudinal magnetization DC magnetizes the entire part's cross-section more or less uniformly. For direct contact (circular) magnetization a straight-line gradient of field strength (from a maximum at the surface to zero at the center) is experienced. Direct current generally is used with wet magnetic particle techniques. In the presence of DC fields, dry powder particles are relatively immobile and tend to remain wherever they happen to land on the surface of a part.

3.4.3.2.1 Pure direct current can be obtained from automotive type storage batteries. Today this technique is seldom used except in emergencies when a battery may be used to power a hand-held magnetizing device. The disadvantages of using batteries are their weight (since a number of them must be used to obtain high currents), the frequent maintenance required, their limited life cycle, and replacement cost. An advantage is the line power requirements are far less to keep the batteries charged than to power a system operating directly from line power.

3.4.3.2.2 The prevailing approach for obtaining direct current for magnetic particle inspection is through rectification of alternating current using solid-state rectifiers. A rectifier (diode) is a device that allows electric current to flow through it in only one direction. By proper connection of rectifiers, the back and forth flow of alternating current is converted to a current flow in only one direction, which is a form of direct current. A rectifier circuit which converts both alternations (back and forth flow) of the alternating current to one direction of current flow is called a full-wave rectifier.

3.4.3.2.3 Single-phase alternating current can be rectified using a full-wave rectifier circuit to obtain direct current for magnetic particle inspection. Single-phase rectification, however, is seldom used to obtain direct current, except in the case of small hand-held magnetizing devices. Since three-phase power is so readily available in industry, direct current for magnetic particle inspection units is usually obtained using three-phase full-wave rectifiers.

3.4.3.3 Comparison of Results Using Different Currents. A comparison of indications showing the same set of fine surface cracks on a ground and polished piston pin (Figure 3-23), is obtained by using 60 cycle AC, DC from storage batteries (straight DC), and DC from rectified three-phase 60 cycle AC respectively. Four values of current were used in each case with a central conductor to magnetize the hollow pin. The indications produced with AC are heavier than the DC indications at each current level, although the difference is most pronounced at the lower current values. Straight DC and rectified AC are comparable in all cases. The AC currents are meter (R.M.S. or Root Mean Square) values, so peak of cycle currents, and therefore magnetizing forces, are 1.41 times the meter reading shown.

T.O. 33B-1-1

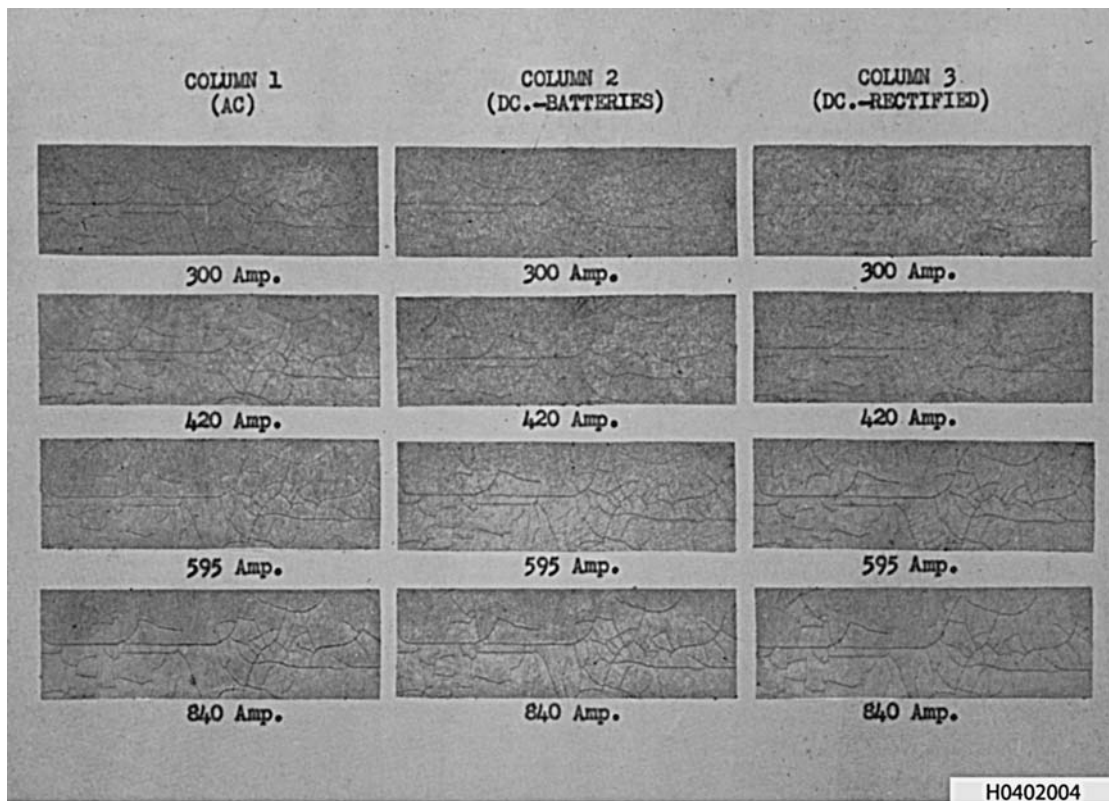
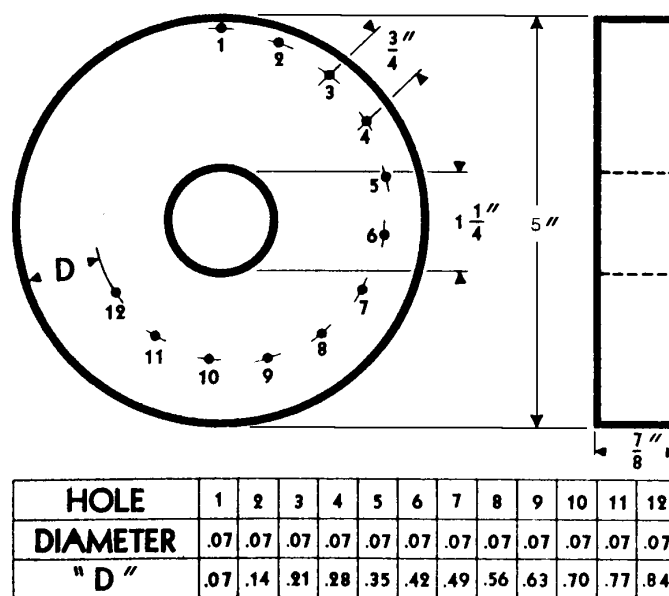


Figure 3-23. Comparison of Indications of Surface Cracks on a Part Magnetized With AC, DC, and Three-Phase Rectified AC

3.4.3.3.1 A similar comparison can be made using the Ketos ring specimen, the drawing for this is shown (Figure 3-24). The specimen, made of unhardened (annealed) tool steel (0.40 percent carbon), is 7/8 inch thick. Holes, 0.07 inch in diameter and parallel to the cylindrical surface, are located at increasing depths below the surface.



H0402005

Figure 3-24. Drawing of a Tool Steel Ring Specimen (Ketos Ring) With Artificial Sub-Surface Defects

3.4.3.3.2 For the inspection of finished parts, such as the machined and ground shafts and gears, direct current is frequently used. Although AC is excellent for the location of fine cracks that actually break the surface, DC is better for locating the very fine non-metallic stringers that can lie just under the surface.

3.4.3.3.3 Half-Wave Current provides the greatest sensitivity for detecting discontinuities that lie below the surface, particularly when using dry powder and the continuous technique. The pulsation of the half-wave current vibrates the magnetic particles, thereby aiding their migration across a surface to form indications at discontinuities. This particle mobility, which is very pronounced when dry magnetic powder is used, contrasts with the relative immobility of the powder when pure direct current is used. Due to the pulsating magnetic fields produced by half-wave current, there will be some skin effect present; however, the effect on field penetration is small at the usual frequencies of 50 and 60 Hertz.

3.4.4 Magnetic Field.

3.4.4.1 Field Direction. The proper orientation of the magnetic field in the part in relation to the direction of the defect, is a more important factor than the strength of the magnetizing current. For greatest sensitivity, the magnetic lines of force should be close to right angles to the defect to be detected. If the magnetic lines of force are parallel to the defect there will be little magnetic leakage at the defect, and therefore, if any indication is formed it is likely to be extremely small.

3.4.4.2 Right-Hand Rule. To best understand field direction and current flow, use the "right-hand-rule." The easiest way to demonstrate this rule is to grasp a straight bar in your right hand so your right thumb points in the direction the electrons would flow from negative to positive. Notice the direction your fingers curl around the bar while doing this. The direction your fingers point indicate the direction of the magnetic field in the straight bar.

3.4.4.3 Field Strength. ASTM E 1444 suggests when using a Hall-Effect probe gauss meter, tangential-field strengths measured on the part surface in the range of 30 to 60 gauss (G) peak values are normally adequate magnetization levels for magnetic particle examination. A study using DC magnetizing current confirmed this field strength could produce good indications from small defects. Other studies have suggested while good to excellent indications of defects may be produced with a tangential field in the range of 30 to 60 Gauss, the background produced from acceptable surface roughness may reduce the visibility of such indications. In such cases, lower field intensity may be optimal. If the residual method is used, field strength in the range 20 to 50 gauss are normally acceptable.

T.O. 33B-1-1

3.4.4.4 Rule-of-Thumb Formulas. These are common formulas which may be identified within this manual, in ASTM E 1444, or any other reliable technical publication. The inspector SHOULD be cautioned, when following “rule-of-thumb” formulas, the part length used in the L/D ratio is the part dimension measured in the direction of the coil axis, and the diameter is the dimension measured in the plane of the coil. For example, a 2-inch diameter steel bar, 10-inches long, will have an L/D ratio of 5 when the bar is placed in the coil with its axis parallel with that of the coil. If the bar is placed in the coil so the bar and coil axis are at right angles to each other, the L/D ratio will be only 0.2, a figure which, if used, would indicate the need for impracticably high amperages.

NOTE

All studies agree “rule-of-thumb” formulas for estimating magnetizing currents, contained in ASTM E 1444, will usually produce field strengths well in excess of what is needed for adequate magnetization with the concurrent risk of producing a background that can hide defect indications. Always use a magnetizing force sufficient to minimize background and maximize the signal to noise ratio of the method.

3.4.4.5 Circular Magnetization. Circular magnetization is used for the detection of radial discontinuities around edges of holes or openings in parts. It is also used for the detection of longitudinal discontinuities, which lie in the same direction as the current flow, either in a part or in a part that requires the use of a central bar conductor.

3.4.4.5.1 A circular magnetic field is generated in a part whenever an electric current is passed through it or through a central bar conductor. In the case of a concentric cylinder, a circular field traveling around the inside of the part will be entirely contained within the part and thus no magnetic poles will be produced from the part. Magnetic poles will be produced if the part is not a concentric cylinder, is irregularly shaped, or the path of the current flow is not located on the part’s geometric axis. In these cases, the magnetic poles are caused by a relatively small portion of the magnetic flux that passes out of the part and into the air that surrounds the part. The no pole condition in a concentric cylinder occurs both while the magnetizing current is flowing and after current flow ceases. The part is thus residually magnetized, but since no magnetic poles exist, the part appears to be in an unmagnetized state. However, if the part is cut (Figure 3-6), such as when a keyway is made, some of the field will pass out and over the cut, producing opposite magnetic poles on each side of the cut. Such poles can hold chips or metal that can interfere with subsequent machining operations or damage bearing surfaces. Care SHALL be used in the case of circular magnetization, which may not be detectable, and appropriate means to ensure demagnetization SHALL be taken. This is usually accomplished by magnetizing the part with a longitudinal field AFTER inspection with a circular field.

3.4.4.5.2 Circular Magnetization Techniques.

CAUTION

Wet the contact pads with the suspension vehicle prior to current application to help prevent overheating of the part. Ensure the contact surfaces of the part are clean and free of paint or similar coatings and have adequate pressure applied to achieve good mechanical and electrical contact over a sufficient area of the part’s surface.

There are two techniques used to induce circular magnetization: the “direct contact” technique and the “central conductor” technique.

3.4.4.5.2.1 Direct Contact Technique. This technique produces circular magnetization by passing electric current through the part itself (Figure 3-10). Direct contact is applied to parts by placing them directly between the headstocks. Lead faceplates and/or copper braid pads SHALL be used to prevent arcing, overheating, and splatter. On large parts, clamping lug-terminated cables to the part using ordinary C-clamps sometimes makes current contact. Regardless of how it is made, the electrical contact SHALL be as good as practicable to minimize any over heating or arcing at the juncture. Any excessive heating at the contact points may do a number of things (e.g., burn the part, affect its temper, finish, etc.).

3.4.4.5.2.2 Central Conductor Technique. Central conductors are any conductive material, such as a copper bar or cable, placed in the center of the part to be magnetized. This technique produces circular magnetization by passing electric current through a conductor that has been placed coaxially in an opening, frequently in the center of a part (Figure 3-11) and (Figure 3-12). A magnetizing field exists outside a central conductor carrying current, so the walls surrounding a central conductor become magnetized. Since the circular field produced around a central conductor is at a right angle to the axis of the conductor, the central conductor technique is very useful for the detection of discontinuities that lie in a direction generally parallel with the conductor.

3.4.4.5.2.2.1 Both the central conductor and the direct contact technique can be used to detect discontinuities on the outside surfaces of tubular or cylindrically shaped parts. The central conductor technique SHALL be used if longitudinal discontinuities must be detected on the inside of tubular or cylindrically shaped parts. The direct contact technique may not produce reliable results in this case, particularly if the part is a concentric tube or cylinder with good current contact at each end.

3.4.4.5.2.2.2 The central conductor technique is also very useful for detecting discontinuities, usually cracks, which emanate in a radial pattern from holes. A part, with a hole or opening to be inspected for inside and outside discontinuities, is usually positioned with the central conductor centered coaxially in the hole or opening.

3.4.4.5.2.2.3 On very large parts with large openings, the central conductor may be located close to the inside surface and several inspections made around the inside periphery of the opening. Placing the conductor close to the inside surface reduces the current requirement since the strength of the circular field increases with decreased distance from the conductor.

3.4.4.5.3 Selection of Current Amperage for Circular Magnetization. A number of factors SHALL be considered when determining what current amperage to use for circular magnetization. Some of these factors are:

- The type of discontinuity being sought and the expected ease or difficulty of finding it.
- The part's size, shape, and cross-sectional area through which the current will flow.
- The amount of heating that can be tolerated in the part and at the current contact areas.
- The relationship between the current and the leakage fields at the surface of the part.

The magnetizing force at any point on the outside surface of a part through which electric current is flowing will vary with the current. The greater the current, the greater this magnetizing force. Inside the part, just under the point on the surface, the magnetic flux density will be the product of this magnetizing force and the magnetic permeability of the part at that point. It is this magnetic flux density that determines the leakage field strength at discontinuities. Thus, current is directly related to the strength of leakage fields at discontinuities, and it is these leakage fields that capture and hold magnetic particles. The more difficult the discontinuities are to detect, the weaker the leakage fields will be for a given current level. A higher current will be required to form discernible magnetic particle indications. At the same time, leakage fields from minor surface variations can attract and hold the magnetic particles, forming a background that makes indications of true discontinuities less distinct. Increasing the magnetizing force or current will also increase the intensity of this background. The correct magnetizing force or current is one strong enough to produce indications of the discontinuities which must be detected, but not too strong so the background masks the indications sought.

3.4.4.5.3.1 Current Amperage for the Direct Contact Technique. A problem arises when deciding what current to use for a given part, particularly when the part has a complicated shape. A "rule-of-thumb" from ASTM E 1444 suggests currents from 300 to 800 amperes per inch of part diameter when the part is reasonably uniform and cylindrical in shape may be used. Except for some special alloys the use of current values in the upper half of this range will result in excessively high field strength, thus impeding the detection of discontinuities. Generally, the diameter of the part SHALL be taken as the largest distance between any two points on the outside circumference of the part. However, as a starting point, the lower limit of such "rules-of-thumb" SHALL be used as the initial magnetization current level. From this point, either use a gauss meter or shim indicators to find the correct current level.

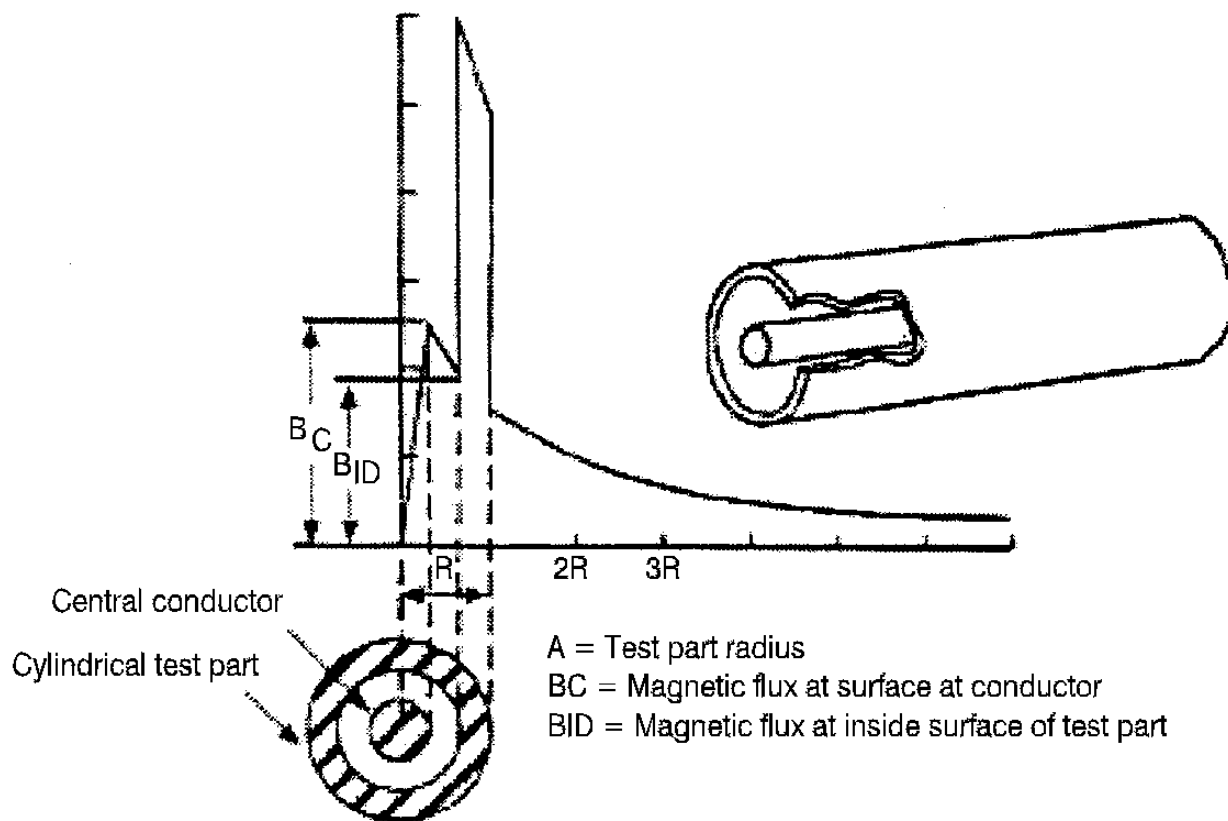
NOTE

The use of the "rule-of-thumb" for excitation currents is fairly straightforward in the case of uniform cylindrically shaped parts. On parts having complicated shapes, such as irregular forgings, machinery parts, weldments, or castings, the use of any "rule-of-thumb" is often not practical. In these cases the inspector must rely on judgment and past experience and aids such as the shims or gauss meter previously discussed, to help in the selection of the optimum current level. Experience with similar parts, which do have discontinuities, is especially helpful in this respect.

3.4.4.5.3.2 Current Amperage for the Central Conductor Technique. Induction current requirements using a central conductor will depend upon the part's size and the diameter of the opening through which the conductor is to be located. In the case of a centrally-located conductor, suggested currents from an old "rule of thumb" may range from 100 amperes per inch of the hole diameter, to as much as 1000 amperes per inch of the hole diameter, depending upon part material and the nature of the suspected discontinuities. Keep in mind the magnetizing field strength around a central conductor decreases with distance away from the conductor. The strongest flux field is present at the inner surface of the hole through which the central conductor passes as shown (Figure 3-25). Not only discontinuities parallel with the central conductor are detectable

T.O. 33B-1-1

using the central conductor technique, but radial discontinuities at the ends of holes and openings can be detected, since some portion of the magnetic lines of force will intercept these discontinuities.



H0402006

Figure 3-25. Magnetic Flux Distribution in a Central Conductor and a Cylindrical Test Part

3.4.4.5.3.2.1 When using a central conductor, alternating current SHALL only be used when inspecting for surface discontinuities on the inside circumference of the part, unless effectiveness on the outside surface has been demonstrated using QQI's. Because the skin effect with AC current decreases the field reaching the outside surface, much higher current will be required than for the inside, and on some parts, the inspection may not be possible. If only the inside surface is to be inspected, the diameter SHALL be the largest distance between two points, 180-degrees apart, on the inside circumference. Otherwise the diameter SHALL be determined as indicated (paragraph 3.4.4.5.3.1). The central conductor SHOULD have an outside diameter as close as practical to the inside diameter of the hole of the part being inspected and still permit access to apply solution.

3.4.4.6 Longitudinal Magnetization. A part is longitudinally magnetized when the field is approximately parallel with a major axis. A part magnetized in a coil, for example, will be longitudinally magnetized in a direction approximately parallel with the coil axis. A characteristic of a part magnetized longitudinally will be the appearance of opposite magnetic poles, north and south, at the extreme ends of the part. The existence of the poles is a disadvantage when magnetizing and inspecting, because much of the leakage flux from the pole-ends is not parallel with the part surface. This reduces the magnitude of flux that is parallel, thereby weakening the leakage fields at discontinuities in the end regions. The use of pole pieces as described (paragraph 3.4.4.6.4.1), overcomes this weakening effect in many cases. The poles are an advantage in demagnetizing since they make it easy to detect magnetized parts and to confirm removal of the residual fields after demagnetizing procedures.

3.4.4.6.1 Longitudinal magnetization is used for the detection of circumferential discontinuities that lie at approximately right angles to a part's axis. Circumferential discontinuities around a cylinder for example, are detected by magnetizing the cylinder longitudinally in a direction parallel with its axis. A portion of the longitudinal field will cross the discontinuities creating leakage fields that can capture and hold magnetic particles to form indications at the discontinuities.

3.4.4.6.2 **Applications.** Like all other forms of magnetization, longitudinal magnetization is used to inspect ferromagnetic components having material permeability's of about 500 or greater. This includes most steel alloys (Table 3-3). A simple test to determine whether or not a part is sufficiently magnetic is to place a permanent magnet against a part to be tested. If the attraction of the magnet can be felt, the part is sufficiently magnetic for magnetic particle inspection.

Table 3-3. Relative Permeabilities for Some Ferromagnetic Materials

Ferromagnetic Materials	Relative Permeability ¹
Iron (99% annealed in H)	200,000
Iron (99.8% annealed)	6,000
Iron (98.5% cold rolled)	2,000
Nickel (99% annealed)	600
Cobalt (99% annealed)	250
Steel (0.9% Carbon)	100
Excerpt from <u>Nondestructive Testing Handbook</u> , Vol. 6, American Society for Nondestructive Testing, 2 nd Ed., 1988	
¹ Relative to air, which has a permeability of 1.0	

3.4.4.6.2.1 Discontinuities detected by the longitudinal method are those, which lie generally in a direction transverse or crosswise to the direction of the applied field. The depth at which a discontinuity can be detected depends upon the size and shape of the discontinuity relative to:

- The size of the cross section in which it is located.
- The length to diameter ratio (L/D) of the part.
- The strength of the applied magnetizing field.

3.4.4.6.2.2 The smaller the L/D ratio, for any given coil and coil current amperage, the lower will be the magnetic flux density in the part, and the weaker will be the leakage fields over discontinuities. In other words, the smaller the L/D ratio, the greater the coil current amperage must be to produce the same flux density or field strength in the part. Coil amperages become impracticably large for L/D ratios of 3 or less. Small L/D ratios of 3 or less can be effectively increased by using pole pieces of magnetic material, one on each side of a part. All three pieces must be lined up in the direction of the applied field or coils axis. Long parts, with L/D ratios greater than 15, SHOULD receive multiple inspections along the length of a part. The most effective field in a part extends about 6 to 9-inches on each side of a coil. For multiple inspections, a coil SHALL be repositioned at intervals of from 15 to 18-inches along the part.

3.4.4.6.2.3 Longitudinal magnetization of coated parts may be accomplished depending upon the type and thickness of the coating. Metallic plating generally SHOULD NOT exceed 0.005-inch in thickness, unless it is known that the discontinuities being sought can be detected through greater thickness. Nonmetallic coatings, such as paint or other protective coatings, require removal only if they are excessively thick or damaged to the extent particles can be trapped mechanically. Any oil or grease SHALL be removed since such materials contaminate the liquid media. Any loose scale or rust SHALL also be removed from parts before inspection since they also can interfere with formation of indications and are a contaminant in a liquid bath.

3.4.4.6.2.4 Inherent with longitudinal magnetization when using a coil is the difficulty in producing good indications near the ends of the part. The leakage field that emanates from the magnetic poles generated at the part ends causes this difficulty. Longitudinal magnetization of a cylindrical part in a coil will produce free magnetic poles at the end of the part. The direction of the magnetic field in the part will be in the same direction as the magnetization force generated by the coil. However, since the flux lines are continuous, the flux lines that traverse from one pole to the other within the part will return outside the part, and in doing so travel in a direction opposite to the applied magnetizing force. This results in a reduction in field strength at the surface of the part and is called "free-pole demagnetization." The inspection of areas near the ends of such parts is improved when the quick break in the magnetizing current is used. The resulting rapid decay of the field generates a pulse of induced current in the same direction as the original magnetizing current, which in turn produces a strong surface residual

T.O. 33B-1-1

field over most of the length of a part. Parts must be moderately retentive for this type of residual inspection, and their shape must be generally cylindrical and have no long slots or cuts that would interrupt an induced current path around in the part near its outer surface. It must be mentioned the use of yokes or field flow magnetization will also assure an adequate inspection of the ends of generally cylindrical objects.

3.4.4.6.3 Longitudinal Magnetization Techniques.

3.4.4.6.3.1 Coil Technique. The most common way to longitudinally magnetize a part is by placing the part in a rigid coil on a stationary magnetic particle inspection unit. The part may be laid on the bottom inside of the coil where the field is strongest, or the part may be supported in the coil by the contact heads of the unit. Special supports are provided on some inspection units for long heavy parts, permitting rotation of parts for inspection. Coils are usually mounted on rails permitting movement along a long part for multiple inspections (multiple coil shots). Because the effective field extends only 6 to 9-inches on either side of a coil, multiple inspections are required along the part. The magnetizing field strength in the center of the magnetizing coil increases with the current passing through the coil and is proportional to the number of turns. The field strength decreases if the coil radius is made larger.

3.4.4.6.3.2 Cable Wrap Technique. Cable wrapping a coil around large or heavy parts is another method of producing longitudinal magnetization. Flexible, insulated copper cable is used. A cable-wrapped coil is connected to a magnetic particle mobile or portable power pack or it can be connected to the contact heads of a stationary inspection unit. The type of power source to be used will depend upon the type and level of current needed to accomplish the particular desired inspection, both magnetizing and demagnetizing.

3.4.4.6.3.2.1 Cable lengths used to connect cable-wrapped coils SHALL be kept as short as practical to minimize resistance losses in the cable and obtain higher magnetizing currents. In the case of AC, and to some extent half-wave DC, in addition to cable resistance, there is the inductance of the coil circuit which further reduces current flow. Twisting or taping the coil cable leads together aids in reducing the inductance of the coil circuit. Coil inductance increases directly with the coil opening area and increases as the square of the turns in the coil. Keeping each of these factors as small as practical, particularly when using AC, assures the maximum current will be obtainable from the power supply. To help keep coil current losses low, cable coils should be wrapped directly on a part or on some insulating material only a little larger than the part. Multiple inspections along a part, using a coil of only a few turns (3 to 5) is preferable to using a coil of many turns over the length of the part. The latter is occasionally done in some cases where performing multiple inspections is not possible or when a power pack having the required output voltage and current capacity is available. Finally, any cables and cable leads used with and for cable-wrapped coils SHALL have good quality electrical connections. Poor connections result in overheating and reduced coil amperage.

3.4.4.6.3.3 Cable Wrap Coil. Cables used are commonly 2/0 or 4/0 AWG (American Wire Gage), flexible stranded, insulated copper cable. The number of turns used is kept low, from 3 to 5 turns to minimize cable resistance in the case of DC and coil impedance when AC is used.

3.4.4.6.3.3.1 Multiple inspections, spaced approximately 15 to 18-inches along the length of a long part, are preferable to one inspection using one long coil of many turns. Cable lead lengths between the power source and coil wraps SHALL be kept as short as practical so maximum amperages are produced in the coil. When AC or HWDC is being used, twisting or taping together the cable lengths between the coil and the power supply can increase amperage. This reduces the coil-circuit impedance the same way that reducing turns on the coil does and makes it possible for more AC current to flow in the coil circuit. The total length of the cable, together with the resistance of its connections, determines the DC amperage obtainable in the coil. The longer the cable and the poorer the electrical connections, the less will be the DC and the half-wave DC amperages that can be obtained. Increased cable resistance also lowers available AC current, but in the case of AC, the impedance of the coil and coil length circuit has a much greater effect than does resistance in lowering and limiting available AC current.

3.4.4.6.3.4 Electromagnet Technique. Parts can be magnetized longitudinally by placing them between the pole pieces of a pair of electromagnets with the fields of the two electromagnets being directed in the same direction through the part.

3.3.12.5 Yoke Technique. Still another method is the magnetizing of parts between the feet of yoke or probe.

3.4.4.6.4 Selection of Current Amperage for Longitudinal Magnetization. A number of factors must be considered when determining current levels for longitudinal magnetization of parts. Some of the more important factors are:

- The coil diameter and the number of turns.
- Cross-sectional area of the part and the coil.
- The length to diameter (L/D) ratio of the part.

- The size, shape, and composition of the part.
- The orientation of the part within the coil.
- The kind of discontinuities being sought and their ease of detection.

3.4.4.6.4.1 If the need arises to inspect parts having L/D ratios of 3 or less, the effective L/D ratio SHALL be increased by placing the part between two pole pieces while it is being magnetized. The length dimension for the L/D ratio then becomes the length of the two pole pieces plus the part length. These pole pieces SHALL make good contact on each side of the part and SHALL be made of ferromagnetic material. Solid steel pole pieces may be used when direct current is used in the coil and the continuous method of inspection is used. If the continuous method is used with either AC or half-wave DC current in the coil, the pole pieces SHALL be made from laminated magnetic material similar to the silicon steel legs of a hand probe with articulated legs. This is also true for residual inspection. Pole pieces SHALL be made from the proper material if residual inspection, or the wet continuous method of inspection with AC or half-wave DC, is to be used.

3.4.5 Field Strength Measurement Techniques. The measurement of magnetic flux or field strength, either within a part or at the part's surface, is extremely difficult. There are several practical methods or devices for measurement all having limitations. The most direct way of determining the magnetic field strength required is to use a specimen representative of the part to be inspected, with a defect or defects representative of those to be found. This specimen would be magnetized at sequentially higher field strengths until a good indication of the defect is formed, without an excess of background from surface conditions. This magnetic field strength could then be measured and used for parts similar to the specimen utilized (e.g. creating a rule-of-thumb" formula). Since suitable specimens are seldom available, an alternative is to use the techniques discussed in the following paragraphs to simulate a defect and measure the necessary magnetic field strengths.

3.4.5.1 Measuring Residual Leakage Field Intensities. Leakage field intensities can be measured by quantitative or comparative methods. Quantitative measurements usually involve the use of instruments in conjunction with search coils, probes, or Hall Effect probes. Such instruments are classified as laboratory equipment and are not generally found in field locations. For purposes of determining the effectiveness of demagnetization efforts, residual field intensities are measured by comparative methods. A list of other leakage field intensity equipment (e.g. field indicator and field compass) is located in (paragraph 3.3.5).

3.4.5.1.1 Another method of testing for demagnetization is to use a piece of steel feeler stock in a few thousandths of an inch thick and test if the feeler stock is attracted by the part. A small piece of iron or steel, such as a ferromagnetic paper clip, can be suspended on a string near the test part to determine if it is attracted to the part.

3.4.5.2 Field Strength Indicators.

3.4.5.2.1 Quantitative Quality Indicator (QQI). The QQI is a small, thin, metal shim, made of low carbon steel that contains artificial defects for establishing or verifying MPI techniques. Examples of QQIs are illustrated (Figure 3-26). By using an etching process that can produce very narrow (0.005 inch) flaws with tightly controlled depths, typically 15-percent, 30-percent and 60-percent of a QQIs thickness, artificial defects may be formed. The thickness of the shim is either 0.002 or 0.004-inch. The basic QQI shim satisfies most needs because its circular and crossed-bar flaw configuration is suitable for longitudinal and circular fields. The bars in the cross are 0.25 inch long, while the circular slot is 0.5 inch in diameter. The circular flaw is especially useful in balancing multi-directional fields. The miniature shim is designed for small areas on a test part; each circle is 0.25-inch in diameter. The QQI with three concentric circular flaws with different depths (typically 20-percent, 30-percent and 40-percent of shim thickness) may be used for more quantitative assessment of a magnetic field; the diameters of the circles are 0.25, 0.375 and 0.5-inch in diameter. The linear shim is 2-inches long by 0.4-inch wide; it may useful in covering a curved area of a part, such as a radius.

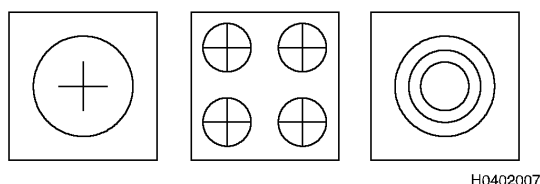


Figure 3-26. Shim-Type Magnetic Flux Indicators

3.4.5.2.1.1 QQIs are intended for use with the continuous method only. If a Gauss/Tesla meter is available, readings for both circular and longitudinal fields can be made at the point of QQI attachment. Once the readings are recorded for a part, it

T.O. 33B-1-1

may be quicker to use the meter instead of a QQI to ensure sufficient field strength when the same type of part is inspected later.

3.4.5.2.2 Advantages of the QQI.

- It is the only device able to demonstrate adequacy and balance of multidirectional magnetization.
- It is quantitative to some extent.
- It has ultra-high permeability and virtually no retentivity.
- It can bend in one direction to conform to tightly curved surfaces. The 0.002-inch thick QQIs can conform to radii down to about 1/8-inch.
- Can be re-used with careful application and removal practice.

3.4.5.2.3 Disadvantages of the QQI.

- Its usefulness is readily destroyed with careless handling.
- It is not well adapted to dry powder applications.
- Physical size limits application to some areas.

3.4.5.2.4 Application of the QQI. To be effective, the QQI SHALL be placed flat side down and in intimate contact with the part surface. Also, it SHALL be emphasized since the QQI responds to the field in its immediate vicinity, indications can be produced in the QQI when no other ferromagnetic material is present. Obviously, the primary rule of assuring the part is ferromagnetic before attempting an inspection applies with the use of QQIs. Additional information on QQIs is located in (paragraph [3.6.6.3.1](#)).

3.4.5.3 Field Strength Measurement Devices.

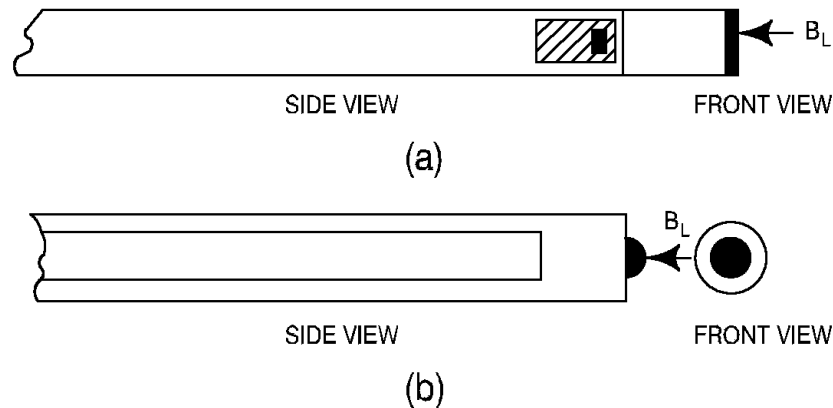
3.4.5.3.1 Hall-Effect Gauss/Tesla Meter. This is a portable, hand-held digital instrument that can be used to measure magnetic-field strength. It applies a current to a Hall-effect probe or sensor and amplifies the output voltage proportional to the magnetic flux density present at the sensor and is at right angles to the applied current. It can be used in establishing MPI procedures to indicate magnetic-field direction and to measure both applied and residual fields. One limitation is it measures only the flux passing through the probe or sensor (See [Figure 3-27](#)) and does not measure the field at or below the part surface.

- a. Tangential.
- b. Normal.

(The arrow represents an external magnetic leakage field “ B_L ” at the point of measurement.)

a) Tangential
b) Normal

(The arrow represents an external magnetic leakage field B_L at the point of measurement.)



H0402008

Figure 3-27. Hall-Effect Sensors

3.4.6 Methods of Particle Application.

3.4.6.1 Dry Versus Wet Application. Either the dry or the wet method for particle application can be used in the residual method. With the wet method, the magnetized parts may be immersed in an agitated bath of suspended magnetic particles, or they may be flooded with bath by a spray. In these circumstances a favorable factor occurs that affects the strength of indications. This factor is the time of immersion of the part in the bath. By leaving the magnetized part in the bath or under the spray for a considerable time, the leakage fields have time to attract and hold a maximum number of particles even at fine discontinuities. This produces an increase in sensitivity over the mere flowing of the bath over the surface of the part as it is being magnetized by the continuous method. It should be noted the location of the discontinuity on the part as it is immersed affects particle buildup. Build-up will be greatest on horizontal upper surfaces, and less on vertical surfaces or lower horizontal surfaces. Also, rapid withdrawal from the bath or spray may wash off indications held by extremely weak leakage fields. Care SHALL be exercised during this part of the process. The residual method, either wet or dry, has many attractive features and finds many applications, even though the continuous method has the inherent advantage of greater sensitivity.

3.4.6.2 Particle Description. The particles used in magnetic particle testing are made of ferromagnetic materials, usually combinations of iron and iron oxides, having a high permeability and low retentivity. Particles having high permeability are easily attracted to and magnetized by the low-level leakage fields at discontinuities. Low retentivity is required to prevent the particles from being permanently magnetized. Strongly retentive particles will cling together and to any magnetic surface, resulting in reduced particle mobility and increased background accumulation.

3.4.6.2.1 Magnetic particles may be applied as a dry powder or wet suspension. Dry powders are available in various colors so the user can select the color that contrasts best against the surface color of the part. Colors for use with ordinary visible light are red, gray, black, or yellow. Red and black colored particles are also available for use in visible light as wet suspensions. Wet suspensions use fluorescent yellow-green particles.

3.4.6.3 Dry Powder Magnetic Particles.

CAUTION

Dry powder method SHALL NOT be used on aerospace vehicles or aerospace parts without specific approval of the appropriate engineering authority for the individual inspection requirements.

T.O. 33B-1-1

3.4.6.3.1 The usual ways to apply magnetic particles in dry form are with: rubber squeeze bulbs, plastic squeeze bottles equipped with perforated caps having smaller holes than the normal saltshaker, or simply by hand. The objective is to lay down a light cloud of powder on the part being inspected. This is usually accomplished by using a combination of squeezing the bulb and/or tossing the powder toward the area being inspected.

3.4.6.3.1.1 The dry powder method is used for the inspection of welds and castings where the detection of defects lying wholly below the surface is considered important. The particles used in the dry method are provided in the form of a powder. They are available in red, black, yellow, and gray colors. The magnetic properties, particle size and shape, and coating method are similar in all colors making the particles equally efficient. The choice of powder is then determined primarily by which powder will give the best contrast and visibility on the parts being inspected and the degree of sensitivity desired.

3.4.6.3.2 Advantages and Limitations of Dry Powder. The dry powder method has good and bad features. The advantages and disadvantages, which may influence its use for a specific application, are summarized in the following list.

3.4.6.3.2.1 Good Features.

- Excellent for locating defects entirely below the surface and deeper than a few thousandths of an inch.
- Easy to use for large objects with portable equipment.
- Easy to use for field inspection with portable equipment.
- Good mobility when used with AC or half-wave (HW).
- Not as messy as the wet method.
- Equipment may be less expensive.

3.4.6.3.2.2 Bad Features.

- Not as sensitive as the wet method for very fine and shallow cracks.
- Not easy to cover all surfaces properly, especially of irregularly shaped or large parts.
- Slower than the wet method for large numbers of small parts.
- Not readily usable for the short, timed shot technique of the continuous method.
- Difficult to adapt to a mechanized test system.

3.4.6.3.3 Dry Powder Selection for Visibility and Contrast. Selection of the particle color to use is essentially a matter of obtaining the best possible contrast against the background of the surface of the part being inspected. The differences in visibility among the black, gray, yellow, and red particles are considerable on backgrounds which may be dark or bright, and which may be viewed under various light conditions. If difficulty is experienced in seeing indications, the inspector SHOULD try a different colored powder. Available colors for the dry powder method are:

3.4.6.3.3.1 Gray Powder. This is a general-purpose high contrast powder and by far the most widely used of the dry powders. It is effective on dark surfaces, whether black, gray, or rust colored.

3.4.6.3.3.2 Black Powder. This is especially designed for use on light colored surfaces. It is dust-free as well as the most sensitive of the dry powders. Its higher sensitivity is because it contains the highest proportion of magnetic material of all the dry powders.

3.4.6.3.3.3 Red Powder. This is a dark reddish powder used on light colored surfaces, as is the black powder. However, since the black powder on a silvery or polished surface is sometimes hard to see, the red color may offer a better contrast, particularly under incandescent lighting where the red color stands out.

3.4.6.3.3.4 Yellow Powder. This pale yellow powder features fair sensitivity and good contrast on dark colored surfaces.

3.4.6.3.4 Oil-/Water-Suspension Powder Concentrate. The requirement to meet a variety of conditions for successful magnetic particle testing has resulted in the development of different materials to obtain this result. The most commonly used materials, black and red oil/water suspensions, are listed below with the special characteristics of each:

3.4.6.3.4.1 Black Powder Concentrate. This is available as an oil- or water-suspension powder. It is especially suited for finding fine cracks on polished surfaces, such as bearings or crankshafts. It is the most sensitive of the non-fluorescent wet method powders for such applications.

3.4.6.3.4.2 Red Powder Concentrate. This is available as a reddish brown oil- or water-suspension powder. The red color provides improved contrast and visibility in situations where the contrast of the black powder is poor. This color tends to be more visible than the black under incandescent light.

3.4.6.3.5 Applying the Dry Powder. A few rules for the application of dry powder will make the process of testing easier and more effective. Dry particles are heavier and individually have a much greater mass than the very fine particles used in the wet method. If they are applied to the surface of a part with any appreciable velocity, the fields at the discontinuities may not be able to stop and retain them; this is especially true when vertical or overhead surfaces are being examined. The powder SHOULD reach the surface of part as a thin cloud, with practically zero velocity, drifting to the surface, so the leakage field has only to hold it in place. The fields of vertical and overhead surfaces must overcome the pull of gravity, which tends to cause the particles to fall from the part. Since dry particles have a wide range of sizes, the finer particles will be held under these conditions, unless the leakage fields are extremely weak. This problem is minimized on horizontal surfaces. The usual mistake is to apply too much powder. If too much powder is applied to a horizontal surface, the powder will have no mobility (unless AC or HWDC is being used) and this too heavy of an application will tend to obscure indications. If the part can be lifted and tapped, the excess powder will fall away and indications will be more readily visible. The excess powder can also be gently blown away with an air stream, which is not strong enough to blow off magnetically held particles forming an indication.

3.4.6.3.5.1 Dry Powder Applicators. Various devices have been used to make proper powder application easy. The squeeze bottle is light and easy to use. With some practice, by a combination of shaking, as with a saltshaker, and a squeeze of the bottle, powder can be ejected with minimum velocity. Practicing with the bottle on a sheet of white paper will assist in training the inspector to produce an even, gentle overall coverage. A powder gun or blower improves application, especially on vertical and overhead surfaces. The powder gun throws a cloud of powder at low velocity, much like a very thin paint spray. When held about one-foot from the surface being inspected, a very light dusting of powder permits easy observation of the formation of indications. On horizontal surfaces the excess of powder is blown away with a gentle air stream from the blower. Two push-button valves on the blower gun control the flow of powder or clean air. Less powder is used with the gun, which helps to assure a better inspection. A more elaborate gun-type powder blower has a motor-driven compressor integral with a powder container and air-powder mixer. The gun is connected to a multi-channel rubber hose and a work light is contained in the gun tip to illuminate the inspection area. A trigger on the gun controls the discharge of the powder-air mixture and blow-off air. More elaborate production systems have been built using this same principle of operation. In these cases, the discharge nozzles are mechanically controlled, as is the movement of parts through the machine. Spent powder is automatically retrieved and reused.

3.4.6.3.6 Effects of Part Surface Condition/Orientation. When the surface is horizontal, clean, smooth surfaces are best for successful dry powder inspection. If the surface is rough, powder tends to gather and be held mechanically in depressions on the rough surface. A stronger stream of air than normal may be required to blow off this loose powder. Care SHALL be taken during the inspection of rough areas (for example, a rough weld bead), so weakly held indications are not also blown away. By watching the area very carefully during powder application and while blowing off the excess, you can often see the weak indications as the powder shifts. For very critical inspections, the weld bead is sometimes machined away. Indications of discontinuities, which are below the surface, are more readily formed on the smooth machined surface of the weld. If the surface being tested is vertical or even at an angle to the horizontal, an extremely smooth surface becomes a disadvantage, since the dry powder tends to slide off easily, and weak leakage fields may not be able to hold it in place. Under these circumstances, a slightly roughened surface gives better results.

3.4.6.3.7 Inspection Technique Variables. The two basic inspection variables to be considered are the type of current to use, and the current/particle application technique. The type of current is dictated by the location of the defects, whether they are on the surface of the part, or located entirely below the surface. The choice of current is between AC and some form of DC. If the defect is on the surface, either AC or DC may be used, and the choice is determined by other considerations. AC SHALL NOT be used if the defect lies below the surface.

3.4.6.3.8 Current Selection for the Dry Powder Method. AC versus DC is the first basic choice to be made, since the skin effect of AC at 50 or 60 hertz limits its use to the detection of defects on the surface, or only a few thousandths of an inch below it. However, the skin effect of AC is less at lower frequencies, resulting in deeper penetration of the lines of force. At 25 hertz the penetration is deeper, and at frequencies of 10 hertz and less, the skin effect is almost nonexistent.

3.4.6.3.8.1 If the defects sought are on the surface, AC has several advantages. The rapid reversal of the field imparts mobility to the particles. The dancing of the powder helps it to move to the area of leakage fields and to form stronger indications. Alternating current has another advantage. The magnetizing effect is 1.41 times that of the current read on the meter. To get equivalent magnetizing effect from DC more power and heavier equipment is required.

3.4.6.3.8.2 DC on the other hand, magnetizes the entire cross section uniformly in the case of longitudinal magnetization. Direct contact (circular) magnetization produces a field that varies linearly from a maximum at the surface to zero at the center of the bar. The types of DC are; straight DC from batteries, full wave rectified three phase AC, and full wave and half-wave rectified single phase AC.

T.O. 33B-1-1

3.4.6.3.8.3 For the inspection of finished parts, such as the machined and ground shafts and gears of precision machinery, DC is frequently used. Although AC is excellent for the location of fine cracks that actually break the surface, DC is better for locating very fine nonmetallic stringers lying just below the surface. It is usually important to locate such stringers in parts of this type, since they can initiate fatigue failures. These comparisons point out the importance of choosing the right current type to give the best indications possible, and show how the choice will vary, depending upon the nature and location of the defects sought.

3.4.6.3.9 Current/Particle Application Technique. The use of dry powder with the residual inspection has several disadvantages:

- It is more difficult to apply to interior regions of a part than is wet media.
- It is more difficult to completely cover a part in a short time.
- Removal of powder from a part can be a problem.

3.4.6.3.10 Dry Powder Inspection Guidelines. Proper illumination and good eyesight are the principal requirements for observing the presence of indications on the surface of parts. Selection of the best color powder for contrast against the surface is an aid to visibility. Last, but certainly not least, magnetization SHALL be sufficient to generate a useable leakage field at the location of discontinuities, but not excessive to where the background degrades the contrast of any indications formed. On large discontinuities, dry powder build-up is often very heavy, making indications stand out clearly from the surface. Finer cracks produce less build-up, since the leakage field holds fewer particles. Extremely fine cracks require some form of the wet method, which is more sensitive to very fine discontinuities, SHOULD be used.

3.4.6.3.10.1 The same requirements for proper inspection of surfaces apply for the detection of subsurface discontinuities. The depth below the surface and the size and shape of the discontinuity determine the strength and spread of the leakage field. A proficient inspector will observe the surface as the powder is allowed to drift onto it, and will see faint but significant tendencies of the powder to gather. Often indications are seen under these conditions, but are no longer visible when more powder has been applied, the excess blown off, and the surface then examined for indications. Standardized techniques for careful and proper application of the powder can help assure the required sensitivity is achieved where similar assemblies are repetitively tested.

3.4.6.3.10.2 Indications are held at the defect by the residual field for highly retentive steels. In low carbon steels, the retentivity is very low. On these steels it is important to perform the inspection while the magnetizing current is on and the powder is being applied, since indications may not remain in place after the current is turned off. This is particularly true on vertical and overhead surfaces, where gravity plays a part in causing particles to fall away if lightly held. However, inspection requirements for the higher retentive steels often require the detection of very small defects. Even though the residual field may be high in such steel, the leakage fields for small defects will also be small, and therefore the indications are not held at the surface very well.

3.4.6.4 Wet Suspension. Either water or a high flash point petroleum distillate is used as a wet suspension vehicle.

3.4.6.4.1 Water Suspensions.

CAUTION

The use of water suspensions SHALL be carefully controlled to prevent corrosion and provide wetting of ferromagnetic aerospace components. Wetting agents and corrosion inhibitors SHALL be used with water suspensions. Weekly monitoring of corrosion inhibitor and wetting agent concentrations SHALL be conducted per the process control section (paragraph 3.6.4) and (Table 1-3).

Usually, the magnetic particle concentrates provide the correct amount of wetting agent and corrosion inhibitor for initial use. However, these materials are also available separately so the concentrations can be maintained or adjusted to suit the particular conditions. If no corrosion can be tolerated, a higher concentration of corrosion inhibitor will be used. Acidity SHALL be checked weekly and the pH of the water bath SHALL be between 6 to 10 (paragraph 3.6.8.2). If the part being inspected has a residual solvent film, more wetting agent is required so the part surface will be completely wetted. Breaking of the bath into rivulets as it is applied over a part is an indication additional wetting agent is required or the part requires further cleaning. A water break test SHALL be conducted daily using a clean specimen or part having the smoothest surface finish to be inspected (paragraph 3.6.8.3). The specimen SHALL be flooded with bath and examined once flooding is

stopped. If a smooth continuous film of bath forms over the entire surface, sufficient wetting agent is present. Reference SHALL be made to the manufacturer's recommendations for the correct quantity of wetting agent to be added.

3.4.6.4.2 Petroleum Distillate Suspensions. No additives other than the magnetic particles themselves are used with petroleum distillate suspensions. Petroleum distillate recommendations are included in manufacturer publications or specifications.

3.4.6.4.3 Advantages and Disadvantages of Wet Suspension. As is true of every process, the wet method has both good points as well as less favorable characteristics. The more important good points of the wet method, which constitute the reason for its extensive use, as well as the less attractive characteristics, are tabulated as follows:

3.4.6.4.3.1 Advantages.

- It is the more sensitive method for very shallow fine surface cracks.
- It quickly and thoroughly covers all surfaces of irregularly shaped parts, large or small, with magnetic particles.
- It is the faster and more thorough method for testing large numbers of small parts. The magnetic particles have excellent mobility in liquid suspension.
- It is easy to measure and control the concentration of particles in the bath, which makes for uniformity and accurate reproducibility of results.
- It is easy to recover and reuse the bath.
- It is well adapted to the short, timed shot technique of magnetization for the continuous method. It is readily adaptable to automatic unit operation.

3.4.6.4.3.2 Disadvantages.

- It is not usually capable of finding smaller defects lying entirely below the surface, if more than a few thousandths of an inch deep.
- It is messy to work with, especially when used for the expendable technique, and in field-testing. A recirculation system is required to keep the particles in suspension.
- It sometimes presents a post-inspection cleaning problem to remove magnetic particles clinging to the surface.

3.4.6.4.4 Wet Suspension Characteristics. Wet method particles may be suspended either in water or in a petroleum distillate. Water is initially cheaper, but it requires additives to make it a suitable medium for suspending the wet magnetic particles. Wetting agents, anti-foaming materials, corrosion inhibitors, suspending and dispersing agents are necessary and SHALL be carefully controlled. In order to assure proper control of the various conditioners, water SHALL NOT be used as a suspending liquid unless adequate process control capabilities are present.

3.4.6.4.4.1 Particle Characteristics. Dry material concentrates to be used in water suspension SHALL contain all of the extra ingredients necessary to make the finished suspension. Cost of the concentrate is comparable for water or oil suspension.

3.4.6.4.4.1.1 The need to incorporate all of the special ingredients for water or oil suspension into the concentrate necessitates two separate and distinct products. Water-suspendible concentrates cannot be used in oil. The various additives for water-suspendible concentrates are insoluble in oil and will not disperse the particles in an oil bath. Alternatively, the additions made to the concentrates intended for oil suspension are not soluble in water. However, with suitable water conditioners, some of the oil-suspendible concentrates can be used in water.

3.4.6.4.4.1.2 One outstanding characteristic of the wet visible method particles is their extremely small size. These very fine particles do not act as individuals but agglomerate into groups. Dry concentrates are almost always formulated to include all required constituents.

3.4.6.4.4.2 Vehicle Characteristics. The bath liquid or vehicle may be either a petroleum distillate or water. Both require conditioners to maintain proper dispersion of the particles and to permit the particles mobility to form indications on the surfaces of parts. These conditioners are usually incorporated with the powders.

3.4.6.4.4.2.1 Petroleum Distillates Characteristics.

T.O. 33B-1-1**WARNING**

Lighter distillates have even lower viscosities than those used, but they have other properties undesirable in a magnetic particle bath. For example, lower initial boiling points accompany the lower viscosities, and results in faster evaporation losses. In addition, a lower flash point also accompanies the lower viscosity with the resulting increase in fire hazard. Inhalation of fumes from a light distillate can impair an inspector's health. The odor of distillate can be a distraction for the inspector and is associated with color and sulfur content.

Petroleum distillates were the first choice as a suspension liquid. Significant characteristics for a suspension vehicle are low viscosity, odorless, low sulfur content, and a high flash point. The specifications for a suitable vehicle are given in (Table 3-1). Of these properties, viscosity is probably the most important from a functional standpoint. High viscosity will retard the movement of particles under the influence of leakage fields, thus slowing the build-up of particles to form indications.

3.4.6.4.4.2.2 Water Suspension Characteristics.**WARNING**

Equipment **SHALL** be thoroughly and positively grounded.

Since water is a conductor of electricity, equipment using water is designed to isolate all high voltage circuits to avoid all possibility of an inspector receiving a shock. Corrosion of equipment can occur if proper provision is not made to avoid this. However, equipment designed for use with water suspension liquid is safe for the inspector, and minimizes the corrosion problem. There is no restriction on the water to be used for the bath, as there is with oil. Ordinary tap water is suitable, and hardness is not a problem, since the mineral content of the water does not interfere with the conditioning chemicals necessary to prepare the bath.

3.4.6.4.4.2.2.1 The advantages of water versus oil for magnetic particle wet method baths are lower initial costs, lower viscosity (about 1-centistoke), not flammable, and readily availability. The disadvantages of water include potential corrosion, electrical conductivity, freezing, and the requirement for more conditioners to assure adequate particle function.

3.4.6.4.4.2.2.2 Water baths, without auxiliary heating, can be used only in shop areas where the temperature stays above freezing. Anti-freeze liquids **SHALL NOT** be used because the viscosity of the bath will then exceed the maximum allowable standards. Because detergents that assure wetting of surfaces can cause foaming of the bath, circulation systems **SHALL** be designed to avoid air entrapment or other conditions that produce foam. Anti-foaming agents help minimize this tendency, but are not 100-percent effective.

NOTE

The use of water bath suspension is not recommended for field NDI laboratories unless adequate base laboratory facilities exist to test the serviceability of the wetting agents, dispersing agents, corrosion inhibitors, anti-foam agents, and other additives required in the water suspension. Where water is used, baths **SHALL** be carefully controlled to prevent corrosion and ensure adequate wetting of parts to be inspected. This requires weekly monitoring of corrosion inhibitor and wetting agent concentration (paragraph 3.6.8.1).

3.4.6.4.4.2.3 Wetting agents and rust inhibitors **SHALL** be used with water-type wet baths. Usually, the magnetic particle concentrates provided include the correct amounts of wetting agent and corrosion inhibitor for initial use. However, these materials are available separately so concentrations can be maintained or adjusted to suit the particular conditions. Reference **SHALL** be made to the manufacturer's recommendations for the correct quantity of wetting agent to be added.

3.4.6.4.5 Wet Suspension Particles. Many techniques are used to apply liquid suspension magnetic particles. These range from simple hand pouring of the suspension onto a part, to large industrial systems in which the suspension is applied automatically by dumping or spraying. The most common technique for application is through the use of a hand-held nozzle and recirculating pump on the stationary units. Other forms of application are hand-held, lever-operated sprayers or aerosol-type cans similar to those used for spray paint.

3.4.6.4.5.1 Wet Particle Visibility.

CAUTION

The wet visible method SHALL NOT be used on aerospace vehicles or aerospace vehicle parts without specific approval of the appropriate engineering authority for the individual inspection requirements.

Once wet method magnetic particles are dispersed in the suspending liquid, they are fundamentally similar to each other. In past years, the most common form of the material concentrate was a paste. Today, however, the pastes have been almost exclusively reformulated and produced as dry powder concentrates. These powders incorporate the needed materials for dispersion, wetting, corrosion inhibition, etc. The powders are much easier to use, as they need merely to be measured out and added directly to the agitated bath. The agitation system of the modern magnetic particle units will pick up the powder and quickly disperse it in the bath.

3.4.6.4.6 Suspension Agitation. The magnetic particles are considerably heavier than the vehicle in which they are suspended. When the agitation system is turned off, the particles will rapidly settle out. All particles SHALL be agitated into suspension before conducting any inspections or concentration tests. This agitation time varies with downtime due to compacting of the particles from their own weight. The following schedule SHALL be followed to ensure particles are agitated into the suspension. When the agitation system has been off for:

- One or more weeks a 60-minute agitation SHALL be performed.
- Four or more hours a 30-minute agitation SHALL be performed.
- Thirty minutes to 4-hours a 10-minute agitation SHALL be performed.
- Less than 30-minutes does not require a pre-agitation

3.4.6.4.7 Wet Suspension Particle/Field Application Techniques. There are two techniques used to apply the particles: the residual technique or the continuous technique. The method to use in a given case depends upon the magnetic retentivity of the part being inspected, and the desired sensitivity of the inspection to be made. Highly retentive parts may be inspected using what is called the residual technique. The part may be magnetized first, and particles applied after the magnetizing force has been turned off (the residual technique). The other technique, continuous, SHALL be used on parts having low retentivity. The part may be covered with particles while the magnetizing force is still present (the continuous technique). For a given magnetizing current or applied magnetizing field, the continuous approach offers the greatest sensitivity for revealing discontinuities. With parts having high retentivity, a combination of these techniques is sometimes used.

3.4.6.4.7.1 Application of Suspension. There are many techniques to apply magnetic particles. The techniques range from a simple pouring of a bath onto a part, to large industrial systems in which the bath is applied automatically, either by immersion or flooding, and then recirculated for reuse. Occasionally small hand-held, lever-operated sprayers are used. Various sizes of ordinary pressurized paint spray tanks equipped with special guns are used, particularly with water-type baths.

3.4.6.4.7.1.1 Aerosol Cans. Prepared bath is widely available in aerosol cans. Such cans, usually containing oil-based baths, are very convenient to use for spot-checking, or small area tests in the field. They are often furnished in kits, including a permanent magnet or electromagnetic yoke, which makes a portable package for small field-testing jobs or for maintenance testing around the shop.

NOTE

- Aerosol containers SHALL be demagnetized to less than two increments on the magnetic field indicator, or three increments on the gauss meter prior to performing an inspection. If inspection fluid does not spray freely, replace spray nozzle or can.
- Shelf life dates on aerosol containers of magnetic particle materials are the final date the manufacturer will warranty its product. These products SHALL only be used after this date provided there is sufficient propellant remaining in the container and they pass the system effectiveness check (paragraph 3.6.6.4). Only aerosol containers being used to perform inspections require testing.

T.O. 33B-1-1

3.4.6.4.7.2 Wet Suspension Application Precautions. There are many techniques used to apply magnetic particles in vehicle. The techniques range from simply pouring bath onto a part, to large industrial systems where the bath is applied automatically, either by immersion/flooding where it is then recirculated. Occasionally, small hand-held, lever-operated sprayers are used to apply bath. Prepared bath is also widely available in prepackaged aerosol cans.

3.4.6.4.7.2.1 A technique practiced, mostly on small parts, is where the parts are magnetized one at a time, and then placed in a tray and immersed into a tank containing an agitated bath of magnetic particles. Sometimes, a similar situation occurs when closely laying parts in the coil prior to flooding and magnetizing them. Precaution SHALL be taken to place these parts in the tray so they do not touch each other; or else non-relevant indications from magnetic writing may be produced at the points of contact. Haphazard loading into a basket for immersion application SHALL NOT be permitted.

3.4.6.4.7.2.2 Additional Precautions. Bath concentration and immersion time also affect the production of indications. In addition, if the leakage field at the discontinuity is weak, prolonged immersion may permit more particles to come into the influence of the field and makes the indication more visible.

3.4.6.4.7.3 Method of Current Application. The residual method requires two steps: magnetization and application of particles, plus the added time for indications to build-up if the immersion method is used. It is frequently used with AC on highly retentive materials because the alternating current field produces excellent mobility of the particles. The continuous method is preferred unless special circumstances make the residual method more desirable.

3.4.6.4.7.3.1 Residual Application Technique. The residual inspection technique for applying magnetic particles, either dry powder or a liquid suspension, is applied after magnetization. This technique is used only when parts are magnetized with DC and when parts have sufficient retentivity to form and retain adequate magnetic particle indications at discontinuities. This technique can be used with both longitudinal and circular magnetization with either direct contact or central conductor application. Usually, it is limited to the search for discontinuities open to the surface such as fatigue cracks. Residual inspection permits the magnetizing of parts followed by the application of the magnetic particle media after the current is removed. When a central bar conductor is used, inspection of holes or bores is facilitated since inspection takes place after removal of the central bar conductor.

3.4.6.4.7.3.1.1 Currents used with the residual technique only need be great enough to magnetize the part sufficiently to show the type of discontinuity being sought. Some gross discontinuities may require only weak magnetization, and others, may require the maximum residual field obtainable. The residual magnetic field retained in a part is always less than the applied magnetic field strength that produced it. A maximum residual field strength results when the magnetization level within the part reaches magnetic saturation. Magnetizing currents greater than those needed to produce the maximum saturation field strength are of no value with the residual technique.

3.4.6.4.7.3.1.2 The residual method, in general, is reliable only for the detection of surface discontinuities. Since hard materials that have high retentivity are usually low in permeability, higher than usual magnetizing currents may be necessary to obtain a sufficiently high level of residual magnetism. The difference in the behavior between hard steels and soft steels is usually not very serious if only surface discontinuities are sought.

3.4.6.4.7.3.1.3 Inspector experience with typical discontinuities is very helpful to determine what current levels should be used to inspect a part using residual magnetism. In the absence of such experience, an inspector should first determine whether or not a part could be inspected using the residual approach. The part must be retentive enough so magnetic particle indications will be formed at any discontinuities in the part. Magnetizing the part in a coil with the maximum DC current available can make a rough determination of a part's retentivity. If after magnetization, the part will lift and hold an ordinary steel paper clip chances are good the part is retentive enough for residual inspection. If the part will not hold a paper clip, residual techniques may still be possible depending upon the nature of the discontinuities you expect to find. In this case, the inspector must test the part using the continuous technique, inspect for indications at possible weak areas, and then remove these indications and reapply the magnetic particle media to see if residual indications are produced. The current used to form the indications found with the continuous technique will give an inspector some indication of the current level needed for residual inspection.

3.4.6.4.7.3.1.4 The application of magnetic particle media for residual inspection is simply a matter of covering the area to be inspected. Care SHALL be taken with a liquid suspension to ensure the parts are adequately covered using low velocity streams or sprays, and the parts are positioned to take advantage of any particle flow resulting from drainage on the part surface. Some parts may need a longer drain time than others, since on smooth surfaces indications may be slower in forming. In some cases a formation of fine indications may be enhanced by immersing the magnetized part in liquid media for a considerable time. This permits time for the leakage fields to attract and hold the maximum number of particles resulting in an increase in sensitivity.

3.4.6.4.7.3.1.5 Care SHALL be taken when applying dry magnetic powders to magnetized parts to avoid getting too much powder on a part's surface and masking a discontinuity. A combination of a light blowing and tossing action is needed, either from a hand-held container or a pressurized powder blower. Additional care is also required when removing any excess powder from a surface so you will not hinder formation of indications or remove indications already formed. The use of dry powder with the residual technique has several disadvantages. It is more difficult to apply to interior surfaces of a part than is a liquid suspension and is more difficult to completely cover a part in a short time.

3.4.6.4.7.3.1.6 Spraying, flowing, or immersing the part into a tank may be used to apply liquid suspensions. Care is required on parts with smooth surfaces to avoid removing any indications by the rapid removal of a part from the bath when using the immersion technique. To ensure uniform concentration, the suspension SHALL be continuously agitated. The bath concentration SHALL be maintained within the manufacturer's specified limits, too weak a particle concentration will produce weak indications, and in borderline cases may cause fine discontinuities to go undetected. Also, too heavy a concentration produces heavy background accumulations that reduce contrast.

3.4.6.4.7.3.1.7 Most magnetic particle indications produced using the residual technique appear quickly on a part. Longer times are required when discontinuities are extremely fine. Holding the part in a position that will allow residual suspension drainage to flow across the suspected areas can sometimes speed up formation of the indications. In the case of a cylindrical part, hold it in a near vertical position allowing the drainage flow across circumferential (transverse) cracks.

3.4.6.4.7.3.1.8 One application method practiced, mostly on small parts, the parts are magnetized one at a time, and then placed in a tray and immersed in a tank containing an agitated bath of magnetic particles. These parts SHALL be placed in the tray so they do not touch each other or else non-relevant indications, known as magnetic writing (paragraph 3.5.5.2.1), may be produced at the points of contact. Parts SHALL NOT be carelessly loaded into the basket for the immersion application. Both the concentration of the bath and the immersion time affect the production of indications. If the leakage field at the discontinuity is weak, prolonged immersion permits more particles to come into the influence of the field and makes the indication more visible.

3.4.6.4.7.3.1.9 Although the residual technique is not as widely used today as the continuous technique, it does have some advantages that make it attractive in some circumstances. The residual approach is capable of close control and provides uniform results to a greater degree than the continuous technique.

3.4.6.4.7.3.2 Continuous Application Technique. The continuous technique is used primarily with liquid suspensions, although occasionally dry powder is more appropriate. This technique requires the magnetizing force be present while the liquid suspension is being applied to the part in sufficient quantity for the particles to be highly mobile. When the current is on, the maximum flux density will be created in the part and the maximum flux leakage will be present at a discontinuity to attract the magnetic particles to form an indication. Leaving the current on for long periods of time is not practical or necessary in most instances. However, when using dry particles and either AC or HWDC as the magnetizing current, the current is sometimes kept on for minutes at a time. If allowed to flow for any appreciable time, the heavy current required for proper magnetization can cause overheating of parts and contact burning or damage to the equipment. In practice, the magnetizing current is normally on for only a fraction of a second at a time since the real requirement is a sufficient number of magnetic particles have been applied to the area of interest. These particles SHALL be free to move while the magnetizing current flows. The bath ingredients are selected and formulated to enable particles to move through the film of liquid on the surface of the part and form strong, readable indications. This is a reason why the viscosity and concentration of the bath are so important.

3.4.6.4.7.3.2.1 The reason for the greater sensitivity of the continuous method is simple. When the magnetizing force is applied to a ferromagnetic part, the flux density rises. Its intensity is derived from the strength of the magnetizing force and the material permeability. When the magnetizing force is removed, the residual magnetism in the part is always less than the field present while the magnetizing force was active. The key difference depends on the retentivity of the material being magnetized. Consequently, the continuous technique, for a given value of magnetizing current, will always be more sensitive than the residual technique. Procedures have been developed for the continuous technique which make it faster than the residual technique because the indication is being formed at the time the current is being applied, plus the added time for indications to build-up allowing indications to build-up while being immersed. The indication is produced during current application and the sixty-second migration of the magnetic particles as the excess vehicle drains from the part. Parts made of low retentivity materials, such as low carbon steel, SHALL be inspected using the continuous technique; since residual leakage fields at discontinuities in these materials are too weak to produce good magnetic particle indications.

3.4.6.4.7.3.2.2 The continuous technique is the only effective technique to use on low carbon steels or on iron having little retentivity. It is frequently used with AC on such materials because the alternating current field produces excellent mobility of the particles. With the wet technique, the usual practice is to flood the surface of the part with the bath, then simultaneously terminate bath application and momentarily apply the magnetizing current. Thus the magnetizing force acts

T.O. 33B-1-1

on the particles in the film of the bath as they are draining over the surface. Strength of the particle bath has been standardized to supply a sufficient number of particles in the film to produce good indications with this technique.

NOTE

The continuous technique requires more attention and alertness on the part of the inspector than does the residual method. Careless handling of the bath/current application sequence can seriously interfere with reliable results.

3.4.6.4.7.3.2.3 Probably the highest possible sensitivity obtainable for very fine defects is achieved by immersing the part in the wet bath, magnetizing the part for a short time while immersed, and continuing to magnetize while the part is removed from the bath and while the bath drains from the surface.

3.4.6.4.7.3.2.4 Wet suspensions are primarily used with the continuous technique, with the exception being when small, subsurface defects must be found. Under some conditions, a dry particle continuous technique can produce slightly greater sensitivity. Timing of the liquid suspension application and the magnetizing current is critical to form good indications. The area of the part to be inspected SHALL be completely flooded with suspension and then the current SHALL be applied at least twice in rapid succession. Turning off or diverting the suspension flow before the final application of current ensures the force of the flow will not interfere with the formation of indications. Extra care SHALL be taken with parts having low retentivity to minimize the risk of washing away an indication. On larger parts where the entire area of interest cannot all be flooded simultaneously, additional "shots" of current SHALL be applied immediately after the suspension application hose is moved away from each point of application. If the equipment duty cycle permits, one or two additional current applications may be applied just before stopping the bath to help form small indications.

3.4.6.4.7.3.2.5 It should be noted, the continuous technique requires more attention and alertness on the part of the inspector than does the residual. Careless handling of the suspension or applying the current application sequence may seriously interfere with the results. Normally, the duration of the magnetizing shots will vary from one-half-second to 2-seconds, depending on the difficulty involved in showing the condition of interest. In some instances, when large forgings or steel castings are to be inspected with manual suspension application, the magnetizing current may be left on from 5 to 10-seconds, during which time the part may be repeatedly swept with the suspension spray. The magnetizing field is maintained for a second or two after the final spray has ceased or been diverted.

3.4.7 Wet Fluorescent Inspection Technique.

3.4.7.1 General. When exposed to near ultraviolet light (black light), fluorescent magnetic particles emit a highly visible yellow-green color. Indications produced are easily seen, and the fluorescent particles give much stronger indications of very small discontinuities than do the non-fluorescent magnetic particles. The differences between the wet visible technique and the wet fluorescent technique are comparatively minor regarding suspension characteristics, maintenance, and application, as well as the inspection variables and demagnetization techniques. The following applies only to the wet fluorescent technique.

3.4.7.2 Advantages and Limitations. Fluorescent particles have one major advantage over the untreated or visible particles. That is their ability to give off a brilliant glow under black light. This brilliant glow serves three principal purposes:

- In semi- or complete darkness, even very minute amounts of the fluorescent particles are easily seen, having the effect of increasing the apparent sensitivity of the process, even though magnetically, the fluorescent particles are not superior to the uncolored particles.
- Even on discontinuities large enough to give good visible indications, fluorescent indications are easier to see and the chance of the inspector missing an indication is reduced; even when the speed of inspecting parts is increased.
- Concurrent with the greater visibility of indications formed by fluorescent particles, the background caused by excessive magnetization is also more severe. Consequently, greater care SHALL be exercised in selection of the particle concentrations and magnetization levels for the inspection with fluorescent particles.

3.4.7.2.1 In most applications, the fluorescent particle technique is faster, more reliable, and more sensitive to very fine defects than the visible colored particle technique. Indications are easier to detect, especially in high volume testing. In addition, the fluorescent technique has all the other advantages possessed by the wet visible suspension technique.

3.4.7.2.2 The wet fluorescent technique also shares the disadvantages found with the wet visible technique. In addition, there is a requirement for both a source of black light and an inspection area from which the white light can be excluded. Experience has shown these added requirements are more than justified by the gains in reliability and sensitivity.

3.4.7.3 Inspection Materials. There is no difference in vehicle requirements between the fluorescent and non-fluorescent materials. Petroleum distillates SHALL meet the same specifications as listed in (Table 3-1), with one additional requirement, the vehicle itself SHALL NOT strongly fluoresce.

3.4.7.3.1 The particles used in the wet fluorescent technique are magnetically the same as the visible type, but they carry a fluorescent dye and the binding material that holds the dye and particle together as a unit. This coating could make the particles less effective in producing indications. However, fluorescent particle indications require only a small fraction of the particles to be easily visible as compared to the non-fluorescent type. Thus, the overall effect is a significant increase in sensitivity.

3.4.7.3.2 Fluorescent particles are supplied primarily as a dry concentrate, incorporating all the ingredients necessary for use in oil or water, as appropriate.

3.4.7.3.3 It is important the bond between the fluorescent dye or pigment and the magnetic particle is able to resist the vigorous agitation received in the circulation pump and the solvent attack from the suspension fluid. If the dye separates from the magnetic particle, the dye tends to cling to the surfaces of the part, independent of any magnetic attraction, thus increasing the background against which indications must be viewed. At the same time, the magnetic particles held magnetically at indications have lost some or all of their fluorescing ability, reducing their visibility.

3.4.7.3.4 The need to provide successful magnetic particle testing under varying conditions has resulted in the development of different materials. These fluorescent materials are readily available in a dry concentrate powder form suitable for use in water and/or oil suspensions. Prepared oil-based baths are also available in aerosol-type cans and bulk quantities.

3.4.8 Portable Magnetic Particle Inspection.

3.4.8.1 Capabilities and Limitations of Portable Inspection. Sometimes, it may not be feasible to bring a part to the laboratory for inspection, thus the inspector must travel to the part. In these cases, mobile (paragraph 3.3.2.2) and portable equipment (paragraph 3.3.2.3) SHALL be used to conduct the inspection.

3.4.8.1.1 Portable induced field inspection equipment generally refers to a power pack or a probe (yoke). Magnetic power packs, probes, and yokes are small and easily portable. The terms probe and yoke are synonymous, and differ only due to manufacturer's nomenclature. This category of inspection equipment is described here in conjunction with the techniques for their use and application.

3.4.8.1.2 This equipment is easy to use and adequate when testing small castings or machine parts for surface cracks and weld inspection. They induce a strong magnetic field into that portion of a part that lies between the poles or legs of the yoke. The induced field flows from one leg of the yoke to the other regardless of the style or leg configuration. Yokes or probes are available with either fixed or articulated legs.

3.4.8.1.3 Either dry powder or wet magnetic particles may be used in conjunction with a yoke for the detection of discontinuities. Yokes are available for operation from a 115-volt, 60-hertz AC outlet, or from a 12-volt DC battery. A permanent magnet yoke is also available, permitting inspections to be performed without the use of electric current.

3.4.8.1.4 The units are designed for simplicity, ease of handling, and one-person operation. They may be used on machine-finished surfaces, as well as castings and weldments fabricated in a variety of configurations. The units induce a strong magnetic field at the surface of the part being inspected. Since no current is flowing through the part being subjected to inspection it is impossible to overheat or burn the part. The flexibility of a yoke with articulating legs is greatly increased permitting inspections to be performed on parts of varied configurations.

3.4.8.1.5 Yokes or probes are limited to the detection of surface and near surface discontinuities only. They SHOULD NOT be used for deep-seated, subsurface discontinuities due to the limited penetration of the induced magnetic field. Because of their size, they cannot be used with a 100-percent duty cycle. Rather, they are limited essentially to spot-checking and occasional sample testing rather than continuous production testing. Under optimum operating conditions, the fixed leg yoke has a limited inspection area governed by the distance between and immediately surrounding the legs. The moveable or articulated leg yoke can inspect either a larger area (legs apart) or detect finer discontinuities by concentrating the magnetic field in a smaller area (legs closer together).

3.4.8.2 Portable Equipment Current Capabilities. Both AC and DC current can be used for electromagnetic yokes. Under certain circumstances, it is even possible to use a strong magnet to produce a field. The design of a yoke will help determine the type current it is capable of producing.

T.O. 33B-1-1

3.4.8.2.1 Alternating Current (AC). An alternating current magnetizing field induced in a part concentrates at the surface layers of the material and produces a surface longitudinal field. AC provides a very desirable and useful field. Polarity reversal at the 60-hertz rate produces a noticeable surge peak reflected in the magnetic field. Eddy currents are a by-product of AC, which tend to guide the field basically between the poles. The vibratory action of AC adds significantly to the magnetic particle mobility enhancing the formation and build-up of larger and sharper indications at discontinuities. Yokes magnetizing with AC can be readily used for demagnetizing. Because of the reversing nature of AC, the residual method of inspection cannot be used when AC is used for magnetism.

3.4.8.2.2 Direct Current (DC). Direct current provides a constant, strong magnetic field. Magnetic particle mobility is minimal and the gathering of magnetic particles at a discontinuity is quite difficult because the vibratory action of an AC field is missing. Direct current induced fields can be successfully applied to small parts. Surface and near subsurface defects can be revealed. The residual method of inspection may be used with direct current, but alternating current SHALL be used for demagnetizing.

3.4.8.2.3 Pulsed Direct Current. Pulsed direct current combines the strong magnetic field of direct current; with the particle mobility of alternating current. Pulsed direct current is produced by rectifying single-phase alternating current. This pulsating direct current pulses at a rate and level to produce a noticeable surge peak in addition to providing the necessary vibratory action for magnetic particle mobility. Though pulsed, the direct current aspect permits the residual method of inspection to be used.

3.4.8.2.4 Permanent Magnet. When permanent magnets are placed on a ferromagnetic surface, the magnetic field travels through the surface from one pole to the other. The flux field will be relatively straight along a line between the poles and strongest near the poles. Field strength will vary and be weakest at a point midway between the poles. The actual field strength at any point will depend upon the strength of the magnet and the distance between the poles.

3.4.8.3 Field Direction. Regardless of the current selected (AC or DC), or the position of the legs, the magnetic flux field induced in a test surface always traverses a path in the same direction from one pole or leg to the other. The yoke is therefore oriented in a transverse direction to the discontinuities being sought to obtain optimum results.

3.4.8.4 Selection of Application Method and Particles. The type of magnetic particles to be used boils down to two choices: application with the dry or wet method, and choose from the various colors available, including fluorescent colors.

3.4.8.4.1 Dry Powder or Wet Suspension Selection. As in all other cases of magnetic inspection, it is possible to use both dry and wet application methods during portable inspection. Portable inspection is commonly accomplished with aerosol cans containing wet/fluorescent particles, but small shakers are available to apply the dry powder. The decision for selecting an application technique is influenced principally by the following considerations:

3.4.8.4.1.1 Size/Location of the discontinuity. Dry powder is excellent for surface defects of moderate size. The wet method is usually best for very fine and shallow defects.

3.4.8.4.1.2 Convenience. The wet technique offers the advantage of easy, complete coverage of the part surface of all sizes and shapes. Dry powder is more often used for localized inspections.

3.4.8.4.2 Color Selection. Selection of the color of particles to use is essentially a matter of securing the best possible contrast with the background of the part surface being inspected. The differences in visibility among the black, gray, red, and yellow particles are considerable on backgrounds that may be dark or bright, and when viewed in various kinds of light may be difficult to see. If some difficulty is experienced in seeing indications, the inspector should try a different color of powder. For the wet technique, the best visibility and contrast is obtained by the use of fluorescent particles. The wet/fluorescent technique supplied with an aerosol can has been used in constantly increasing numbers of inspection applications for many years, principally because of the ease of seeing even the faintest indications.

3.4.8.5 Application of Current and Particles during Portable Inspection. Magnetic particles may be applied either dry or in a liquid suspension. The part may be magnetized first and the particles applied after the magnetizing force is removed (residual method, applicable to DC or specially designed AC units only), or the particles may be applied while the magnetizing force is being applied (continuous method of inspection). In order to select the proper variations to obtain optimum results, the inspector must understand the variations and how each affects the desired end result.

3.4.8.6 Portable Inspection Applications. Hand-held yokes are versatile, general-purpose magnetic particle test equipment because of their compact size, low voltage requirements, and minimal weight. They may be used at an inspection facility where parts are brought for inspection, or they may be taken to the inspection site. They are used to test large castings

and weldments, assembled and welded structures, or component parts of assemblies without the necessity of disassembly. Yokes are used on parts subject to arc burns, to detect surface cracks in welds and castings, and to locate fatigue cracks of large assemblies that may not be conveniently inspected with either mobile or stationary equipment. Where no source of electric current is available, or because of fire or explosive hazard, the use of electric current is not permitted; a permanent magnet yoke can be used for inspection. One typical application of a probe/yoke is shown (Figure 3-28). The yokes SHALL be able to pass the dead weight checks (paragraph 3.6.6.7).

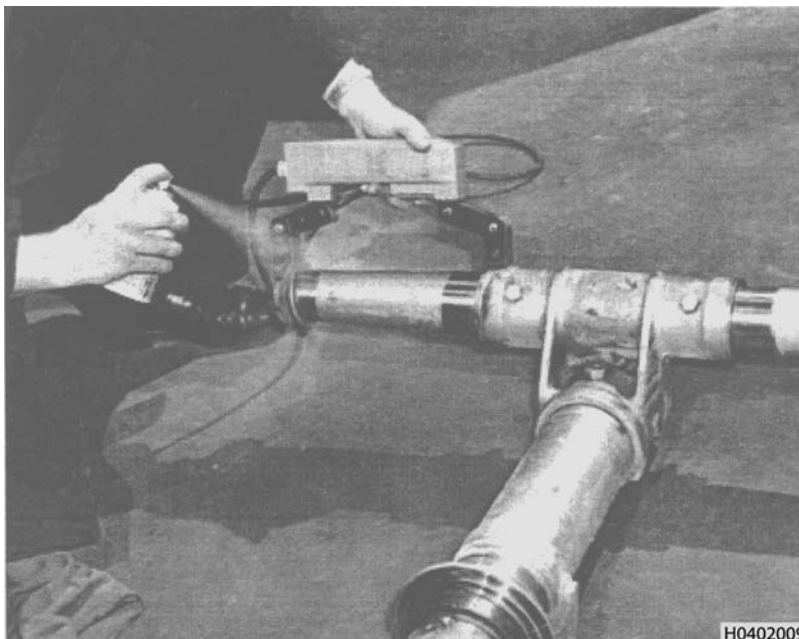


Figure 3-28. Field Inspection of Nose Wheel Strut

3.4.9 Special Magnetization Techniques. Many parts require specialized techniques to obtain a good magnetic particle inspection, because of their small L/D ratio, shape, complicated geometry, or the location and kind of discontinuities. Some of these techniques are: Induced “Current,” “Slurry,” “Mag Rubber,” and Multi-directional techniques.

3.4.9.1 Induced Current Magnetization. This technique uses the fields generated by induced currents in a part, which are produced by rapidly varying longitudinal fields. Induced current magnetization is used for the detection of circumferential defects in rings, discs, and cylinders. A varying magnetic field in any conducting metal generates electrical current in that metal. Increasing the length of the current path can reduce the amplitude of the current. Therefore, a cut, an insulated joint, or a deep surface indentation causes the current path to increase around the discontinuity. The amplitude will also depend on:

- The size and shape of the cross section through which the magnetic field varies.
- The rate of variation in flux lines per second.
- The electrical conductivity of the metal.

3.4.9.1.1 When the magnetic field strength is changing, the induced current will flow through in the part, at right angles to the magnetic field. When the magnetic field varies continuously, as it does in the case of alternating or half-wave DC fields, a succession of induced current pulses are produced. These induced current pulses are often referred to as eddy currents. The process of inducing high amplitude eddy currents in a part to be inspected can also introduce stray eddy currents in adjacent metallic components. The effect of stray eddy currents in a metal is twofold. First, heat is generated whenever an electric current flows in a conductor because of resistance. The generation of such heat is of little consequence in magnetic particle inspection because of the relatively short duration of the current flows. The second effect of stray eddy currents is important in magnetic inspection. The magnetic fields resulting from the stray eddy currents is in opposition to the magnetic fields which produce them, resulting in either a reduction of the amplitude of inducing alternating magnetic fields or a decrease in decay rate for an inducing field generated by a collapsing DC current. Either condition results in a reduction in amplitude of the induced current in the part to be inspected. Precautions SHALL be taken to minimize the generation of any induced stray eddy currents within metals in contact with, or in the immediate vicinity of the part to be inspected. Any pole pieces should be made of laminated silicon transformer steel or low carbon steel with a low magnetic retentivity. Any part, supports, or

T.O. 33B-1-1

contact plates should be split or cut partially through in such a manner as to produce as long a current path as practical. In addition to being split, some part supports are made of nonmagnetic metals such as brass or stainless steel, which are also poor electrical conductors. This also reduces the stray eddy currents generated in them.

3.4.9.2 Advantages of Induced Current Magnetization. The advantages of using the induced current method are:

- No current contact need be made on a part.
- Strong fields are generated in a part by the induced currents.
- Parts with L/D ratios of less than one can be inspected without the need for extremely high coil currents.

3.4.9.3 Induced Current Magnetization Technique. Induced current techniques require the part be circular in shape and have no deep radial cuts or slits which would prevent the generation of an induced current through the part. It is the circular field produced by such an induced current that generates the leakage fields at circumferential discontinuities. Circumferential discontinuities, in order to be detected using the induced current method, must be at or very near the surface of a part. The circular magnetic fields generated by induced currents tend to be crowded toward an outer surface. Circular, disc, or cylindrically-shaped parts, which are retentive, may be inspected residually using a single pulse of induced current; such as obtained when DC current in a coil is suddenly interrupted allowing the coil field to rapidly collapse to zero. Parts having a low retentivity SHALL be inspected using the continuous method and AC or half-wave DC current in the coil. The repetitively induced current pulses generated by each cycle of these currents is responsible for the formation of the indications at discontinuities. For parts with smooth surfaces, care is required when handling the parts after inspection to prevent mechanical loss of the indications. Washing action is much less of a problem with parts having rougher surfaces, as both mechanical and magnetic bonds hold indications.

3.4.9.3.1 Parts to be inspected using the induced current method must be positioned with their axis parallel to the coil, or coils. Two coils, one on each side of a part, may be used when the part's diameter is larger than the coils. The coils in this case must be connected electrically; assuring that the coil fields will be in the same direction through the central region of the part. If the part is retentive and is to be inspected residually, DC current is used in the coil. The power pack supplying the DC to the coil must have quick-break electrical circuitry to obtain a rapid collapse of the coil field. Alternating or half-wave DC current must be used in the coil with the continuous technique when a steel part is has a low retentivity.

3.4.9.3.2 The longitudinal flux density in a part and the rate of decay or collapse of this flux determines the magnitude of the induced current generated in the part. The higher the coil amperage, the higher the coil field strength and the flux density in a part, up to a coil amperage that produces magnetic saturation in the part. The flux density, and thus the induced currents in short cylinders having an L/D ratio of less than 3 or 4, can be increased by placing the part between two laminated pole pieces while being magnetized. Placing a laminated core or pole piece in the ring while it is being magnetized can increase induced currents in ring-shaped parts, such as bearing races. The laminated core in this case increases the total flux threading the ring. Remember when using the induced current technique, any means used to increase the flux in the direction of the coil field through the part will increase the magnitude of the induced currents, up to the point of magnetic saturation.

3.4.9.3.3 Placing a laminated core centered against each side of a disc can increase magnetic flux through the center region of disc-shaped parts. Another variation for the use of a laminated core is in the inspection of holes in large parts suspected of having circumferential discontinuities. In this case, the magnetizing coil is placed around one end of the core and the other end is used as a probe for placement in the hole. Alternating current is used to energize the coil. In operation the core is placed in a hole, liquid magnetic particle media is sprayed around the inside surfaces of the hole, and while the coil is energized. Before withdrawing the core from the hole, the coil is de-energized so as not to demagnetize the area around the hole. When demagnetization of the area is required, the core is simply removed from the hole while the AC current is flowing.

3.4.9.4 Selection of Induced Current Level. No "rule-of-thumb" formulas have been developed for the induced current method of magnetization. Lacking any other information upon which to select a current level, the "rule-of-thumb" formulas given in (paragraph 3.7.1) may be used to obtain trial amperages for parts having L/D ratios up to 15. Part diameters, which approach or are greater than the coil and are very short in length (e.g., disc-shaped parts), will usually require laminated cores to be used, so the rule-of-thumb coil formulas are not applicable. The formulas were developed for the determination of coil amperages, which will produce a longitudinal flux density in a part of 70,000 lines per square inch. The rate of change or rate of collapse of this longitudinal flux produces an induced current in the part, which in turn results in leakage fields at the discontinuities.

3.4.9.4.1 Magnetic Slurry. This specialized technique uses magnetic flakes in viscous slurry, taking advantage of the difference in light reflection from flakes reoriented by leakage fields at discontinuities. The slurry, being a viscous liquid applied by brush, has the advantage over dry powder of eliminating any hazard to adjacent equipment by airborne magnetic

particles. Another advantage is the slurry can be applied and used successfully on vertical or overhead surfaces, on wet (even underwater) or dry surfaces, and over scaly, plated, or painted surfaces if the coatings are not too thick.

3.4.9.4.1.1 A magnetic particle testing material is available that supplements both wet and dry magnetic particle testing materials. This material formulation uses selected magnetic particles dispersed in a viscous, oily vehicle which results in slurry having the consistency of paint. The material is brushed on a surface to be inspected until the magnetic particles are evenly and thoroughly distributed. A magnetic field is generated in the test part through conventional AC or half-wave DC magnetizing techniques. Any discontinuities show up as contrasting black indications on a gray background. Alternating current fields using a yoke or probe are capable of revealing very fine surface discontinuities using this slurry technique.

3.4.9.4.1.2 The slurry concentration can be varied to suit particular inspection requirements. The material is brushed evenly on a part, much as paint would be, prior to magnetization of the part. If required, the material can be brushed repeatedly permitting magnetization in various directions. The oily vehicle used in the slurry mixture is nondrying, and the slurry can be removed using dry rags, paper towels, or prepared cleaning solvents.

3.4.9.5 Magnetic Rubber. This technique uses a diluted silicone rubber containing black magnetic particles for the inspection of the interior or otherwise difficult to view surfaces. The liquid rubber is catalyzed, placed against the surface to be inspected, and held in place with the appropriate dams and fixtures. Applied magnetic fields cause the particles to migrate to defect locations while the rubber cures. After curing, the rubber material which has formed a replica of the surface against which it was placed, is viewed under low power magnification for the indications formed during the inspection.

3.4.9.5.1 Magnetic rubber formulations using finely divided magnetic particles in a silicone rubber base are used for the inspection of holes and other surfaces not easily accessible. The liquid silicone rubber mixture is poured into holes or against the surface of the magnetic parts to be inspected. Curing time for silicone rubbers varies from about 10 to 30-minutes, depending upon the particular silicone rubber, the catalyst, and the amount of catalyst used to produce the curing reaction.

3.4.9.5.2 While the rubber cures, the surface inspected must stay in the required magnetized state. This can be accomplished using a permanent magnet, a direct current yoke, an electromagnet, or some other suitable means. Whatever method of magnetization is used, the leakage fields at any discontinuities on the surfaces inspected must be maintained long enough to attract and hold in position the magnetic particles until a partial cure takes place. A two-step magnetizing procedure has been developed: 1) The first magnetization is accomplished for a short time in one direction, 2) followed by a second at 90-degrees to the first for the same length of time. This procedure SHALL be repeated for whatever period of time is needed until the cure prevents particle mobility. Magnetization in two directions 90-degrees apart assures formation of indications at discontinuities in all directions.

3.4.9.5.3 After curing, the rubber plugs which are exact replicas of the surfaces, are removed and visually examined for indications, which will appear as black lines against the gray or yellow background of the silicone rubber. Location of any discontinuities or other surface imperfections can be determined from the location of the indications on the plugs.

3.4.10 Multidirectional Magnetization. Multidirectional magnetization can be very effective in detecting randomly oriented discontinuities quickly. The technique energizes two or more magnetizing circuits in different directions very rapidly (almost simultaneously) resulting in a reduction of testing time and part handling.

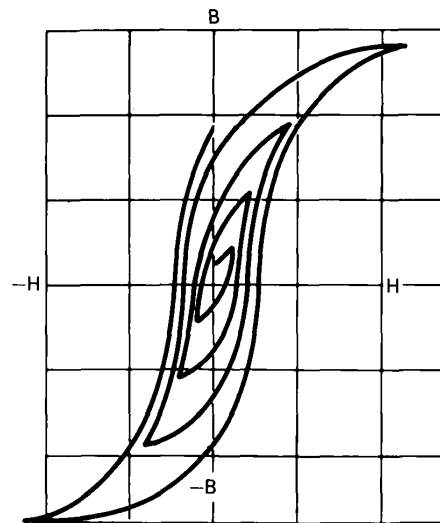
3.4.11 Demagnetization. Any ferromagnetic material subjected to magnetic particle inspection requires demagnetization. When performing magnetic particle inspection of aircraft parts, it is essential to demagnetize them. The inspector SHALL understand the reasons for this step, as well as the problems involved and the available means for solving them.

3.4.11.1 Purpose of Demagnetization. Ferromagnetic materials retain a certain amount of residual magnetism (or remnant field) after application of a magnetizing force. This does not affect the mechanical properties of the part. However, a residual field can impede the operation of some parts, as well as, affect the operation of adjacent equipment sensitive to low level stray magnetic fields.

3.4.11.2 Principles of Demagnetization. Demagnetization may be accomplished in a number of different ways. The technique used depends upon the electrical power and equipment available, the degree of demagnetization required, and the skill of the inspector.

3.4.11.2.1 One of the simpler techniques subjects the magnetized part to a magnetizing force that continually reverses its direction. At the same time, this force is gradually decreased in strength. As the decreasing magnetizing force is applied, first in one direction and then the opposite direction, the magnetization of the part is decreased. This decreasing magnetization is accomplished by smaller and smaller hysteresis loops created by the application of decreasing current as shown (Figure 3-29). The smaller the hysteresis loop produced the more demagnetization accomplished.

T.O. 33B-1-1



H0402010

Figure 3-29. Hysteresis Loops Produced During Demagnetization

3.4.11.2.2 For all practical purposes, the only way to completely demagnetize a part is by heating it to its Curie point (paragraph 3.4.11.6.1) or above.

3.4.11.2.3 Under normal conditions, a part is considered satisfactorily demagnetized if the magnetic field is at or below 3 units on a gauss meter or 2 units on a field indicator.

3.4.11.3 Requirements for Demagnetization. Ferromagnetic aircraft parts require demagnetization principally to prevent magnetic flux from affecting instrumentation. There are several additional reasons supporting the requirement for demagnetization.

3.4.11.4 Situations Requiring Demagnetization. Demagnetization is required when the residual field in a part:

- May interfere with subsequent machining operations by causing chips to adhere to the part surface, or the tip of a tool to become magnetized from contact with the magnetized part. Such chips can interfere with smooth cutting by the tool, adversely affecting both part surface finish and tool life.
- May interfere with electric arc or electron beam welding operations. Residual magnetic fields may deflect the arc or electron beam away from the point at which it should be applied.
- May interfere with the functioning of the part itself after it is placed into service. Magnetized tools (e.g., milling cutters, hobs, etc.) will hold chips and cause rough surfaces, and may even be broken by chips adhering to the cutting edge.
- Might cause trouble on moving parts, especially those running in oil, by holding particles of metal or magnetic testing particles - for instance, on balls or races of ball bearings, or on gear teeth.
- May prevent proper cleaning of the part after inspection by magnetically holding particles to the part surface.
- May interfere with subsequent magnetization requirements.
- May hold particles that interfere with later applications of coatings such as plating or paint.

3.4.11.5 Situations Not Requiring Demagnetization. Demagnetization is not usually required when:

- The parts are not aircraft parts and have low retentivity. In this case, the residual field is low or disappears after the magnetizing force is no longer acting. An example is low-carbon plate such as used for low strength weldments, tanks, etc.
- The material in question consists of non-aircraft structural parts such as weldments, large castings, boilers, etc., where the presence of a residual field would have no effect on other components or the proper service performance of the part.
- If the part is to be subsequently processed or heat-treated, and in the process will become heated above the Curie point, or about 770°C (about 1418°F). Above this temperature, steels become nonmagnetic, and completely demagnetized on

cooling when they pass through the reverse transformation.

- The part will become magnetized anyway during a subsequent process, for example, when held in a magnetic chuck.
- A part is to be subsequently magnetized in another direction to the same or higher level at which it was originally magnetized, for example, between circular and longitudinal magnetization for magnetic particle inspection.
- The magnetic field contained in a non-aircraft finished part is such there are no external leakage fields measurable by ordinary means (e.g., the field produced during magnetic particle inspection with circular magnetization).

3.4.11.5.1 The requirement cited in (paragraph 3.4.11.5) is sometimes a cause of confusion. A residual magnetic field in a ferromagnetic material exists because there is a preferred orientation of the magnetic domains caused by a previously applied magnetic field. A residual magnetic field perpendicular to a previously established residual field can only be produced by application of a magnetic field in the perpendicular direction strong enough to rotate the domain 90-degrees. Because the preferred orientation of the domains has been rotated 90-degrees, the previous residual field no longer exists. For this reason, longitudinal magnetization, strong enough to produce indications of discontinuities in a part that previously had a residual circular magnetic field, reduces the circular residual field to zero. If the magnetizing force is not of sufficient strength to establish the longitudinal field, the strength SHALL be increased or other steps taken to ensure a residual longitudinal field actually has been established. For example, a large part having a large L/D ratio may require multiple longitudinal shots along its length to eliminate the circular field. Rotation of the preferred orientation of the magnetic domains also occurs when a circular residual field is produced in a part with an existing residual longitudinal field.

3.4.11.5.2 If the two fields, longitudinal and circular, are applied simultaneously, an applied field results that is a vector combination of the two in both strength and direction. If the magnitude of the resultant applied field is large enough, then a residual field will be produced in this same direction. If, however, the fields are induced sequentially the last field applied, if strong enough to produce a residual field, will eliminate the residual field from the previous magnetization. A convenient method of assuring reduction of a residual magnetic field in one direction and establishing a field in a perpendicular direction is to slightly increase the magnetizing force of the second shot.

3.4.11.6 Demagnetization Limitations.

NOTE

Complete demagnetization is not possible even though it is often specified.

3.4.11.6.1 Curie Point. When steel is heated, it passes through its Curie point, approximately 770°C (or about 1418°F) for soft steels. Above the Curie point it is no longer ferromagnetic. When the steel cools to room temperature in the absence of a magnetic field, it will contain no residual magnetism. Other means of demagnetization always leave some residual field.

3.4.11.6.2 Earth's Magnetic Field. The earth's magnetic field can contribute to the difficulty of demagnetizing parts. A long part to be demagnetized SHOULD be placed so its principal axis is in an east-west direction. A long part lying in a north-south direction can never be demagnetized below the level of the earth's field. Rotating the part or structure on its east-west axis while demagnetizing often helps reduce the field in transverse members not lying east-west. Vibration of the structure during the demagnetization process is also helpful under these circumstances. Complete removal of all magnetic fields is virtually impossible.

3.4.11.6.2.1 The earth's field will always affect the residual magnetism in a ferromagnetic part and will often determine the lower limit of practical demagnetization. Long parts or assemblies of long parts, such as welded tubular structures, are especially likely to remain magnetized at a level determined by the earth's field, in spite of the most careful demagnetizing technique.

3.4.11.6.2.2 Many articles and parts become quite strongly magnetized from the earth's field alone. Transporting parts from one location to another may produce this effect. Long bars, demagnetized at the point of testing, have been found magnetized when delivered to the point of use. It is not unusual to find parts of aircraft, automotive engines, railroad locomotives, or any parts made from steel of fair retentivity are quite strongly magnetized after having been in service for some time, even though they may never have been near any artificially produced magnetic field. Parts also become magnetized by being near electric lines carrying heavy currents, or some form of magnetic equipment.

3.4.11.7 Demagnetization Methods.

3.4.11.7.1 General. Alternating and direct currents are used in demagnetizing aircraft parts after magnetic particle inspection. Although direct current can be used for demagnetization, alternating current demagnetization has been found to

T.O. 33B-1-1

be more convenient. Since alternating current does not penetrate very deeply below the surface of magnetic materials, some parts may be difficult to demagnetize completely using alternating current. This is particularly true with large heavy parts, and may also be the case with parts of unusual shape. Direct current can be used to demagnetize if there is provision for current decay or reduction and a means for reversing the direction of the current. Demagnetization accomplished in this manner with direct current is the most complete and effective possible.

3.4.11.7.1.1 To demagnetize with direct current, the part is placed in a coil connected to a source of direct current. The current is adjusted to a value at least as great as that used to magnetize the part and a shot of current is given at this initial value. The direction of the current is then reversed, the value reduced, and a shot of current given at the new value. This process of reversing and reducing the current is continued until a very low value is reached. The part is now effectively demagnetized.

3.4.11.7.1.2 Parts with a circular field do not have magnetic poles. This lack of measurable poles, providing there are no discontinuities present, makes it impossible to check the magnitude of residual circular magnetization with the conventional residual field indicator. A common and recommended practice on aircraft parts is to magnetize the part longitudinally after it has been circularly magnetized. The difficult to measure circular field is then replaced by an easy to measure longitudinal field.

3.4.11.7.2 AC Demagnetization.

3.4.11.7.2.1 AC Tunnel Coil. The most common and convenient method of demagnetizing small to moderate sized parts is by passing them through an open tunnel-type coil through which alternating current at line frequency (usually 50 to 60-hertz) is passing. Another practice is to pass the 50 or 60-hertz AC through a coil with the part inside the coil, and gradually reduce the current to zero. In the first case, the reduction of the strength of the reversing field is obtained by withdrawal of the part axially from the coil (or the coil from the part) and for some distance beyond the end of the coil (or part) along that axial line. In the second case, the gradual decay of the current in the coil accomplishes the same results. This method of demagnetization is particularly suitable for large numbers of relatively small parts.

3.4.11.7.2.2 Stationary MPI Bench. Stationary magnetic particle testing equipment often has demagnetization capabilities. If so equipped, AC current may be passed directly through the part or through the coil on the magnetizing unit. For demagnetization of parts, the alternating current is reduced to zero automatically by built-in means of step-down switches or variable transformers for older equipment, or solid-state devices for newer equipment. The step-down feature permits the demagnetization of parts without removal from the magnetizing equipment. This procedure is more effective on long, circularly magnetized parts than the separate coil method, but does not overcome the lack of penetration due to skin effect unless frequencies much lower than 60-hertz are used.

3.4.11.7.3 DC Demagnetization.

3.4.11.7.3.1 Stationary MPI Bench. Demagnetizing by the direct current reversing step-down feature is essentially identical in principle to the AC method, but is more effective on parts with heavy cross sections. Modern stationary DC magnetizing equipment usually incorporates this capability. The use of DC current permits a more even and complete penetration of even large cross sections. The DC current flows in one direction for a short time, it then is slightly reduced in magnitude and completely reversed in direction. The process of automatically reversing and reducing the current is continued until the current reaches zero and the part is effectively demagnetized. This method of demagnetizing is especially effective in removing circular fields when the current can be passed through the part and works well with a central conductor, when applicable. Small parts can be placed in a standard coil and larger parts can be cable-wrapped for their full-length, as induction loss is not present with DC.

3.4.11.8 Demagnetization Procedures.

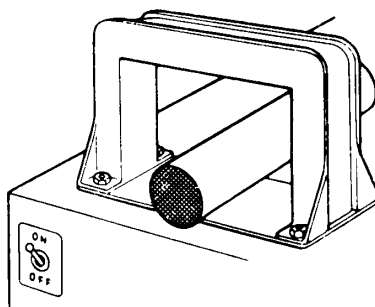
NOTE

It is important to remember the part **SHALL** be completely withdrawn from the magnetic field of the coil before the current is shut off.

3.4.11.8.1 Demagnetizing Yoke. The most common type of stationary demagnetizing equipment consists of an open yoke through which alternating current at line frequency, usually 50 to 60-hertz is used. The demagnetizing coil may be

equipped with a stand or may be constructed and placed on a bench. Larger coil sizes have a track or carriage on which parts can be placed to facilitate handling.

3.4.11.8.1.1 To use a demagnetizing yoke such as illustrated (Figure 3-30), the part is placed in the yoke and the current turned on. While the current remains on, the part SHALL be slowly withdrawn from the yoke a distance of 4 to 5-feet before the current is shut off. The axis of the part SHOULD be parallel to the axis of the yoke for regularly shaped parts. On complex parts, more complete demagnetization is sometimes possible if the part is rotated and turned end for end. For best results, the diameter of the demagnetizer yoke SHOULD be just large enough to accommodate the part. However, for practical purposes one or two yoke sizes will satisfactorily serve an inspection facility. To demagnetize small parts in a large yoke, place the parts close to the inside wall or corner of the yoke since the demagnetizing forces are strongest in that area.



H0402011

Figure 3-30. Part in Demagnetizing Yoke

3.4.11.8.2 Demagnetizing with Stationary Equipment. Magnetic particle inspection equipment that magnetizes with AC or DC is used to demagnetize parts after inspection, depending upon the demagnetization features included in the equipment and the size and shape of the part.

3.4.11.8.2.1 Step-Down Demagnetization.

CAUTION

Care SHALL be used when demagnetizing small parts using machines equipped with “step-down” demagnetizers, which do not have adjustable current tap switches. A small part such as a bolt being circularly demagnetized with this equipment may be overheated by the initial high current steps.

3.4.11.8.2.1.1 Some stationary AC equipment has a coil on rails and a toggle switch, which enables the inspector to turn the current on in the coil, and leave it on. This coil then becomes a demagnetization coil when a part is drawn through it while the current is flowing.

3.4.11.8.2.1.2 This same equipment may also have a rheostat or current control switch enabling the inspector to select different magnetizing current levels as well as initial demagnetizing current levels. These switches may be motor driven. When equipment with a motor driven switch is used for demagnetization, the inspector places the part in the equipment and presses the demagnetization switch, this causes the motor to drive the switch contactor from maximum to minimum current positions, giving a shot at each successively lower current value. This effectively demagnetizes the part and can be used either by passing the current through the coil on the equipment (longitudinal demagnetization), or by passing the current through the part itself (circular demagnetization). This process is referred to as “step-down” demagnetization.

3.4.11.8.2.1.3 A step-down reversing DC demagnetization is usually completed in about 30-seconds; one-second per step. The one-second at each step allows time for the field in the part to reach a steady state, at which time induced currents become zero, permitting maximum penetration of the field into the part. This can easily be done using a continuously variable autotransformer or electronic decay circuitry to reduce the AC current to zero.

3.4.11.8.2.2 Circular Demagnetization.

T.O. 33B-1-1**NOTE**

Circular demagnetization is particularly effective on parts of complicated shape, such as multiple throw cranks or coil springs.

Two techniques are used to circularly demagnetize parts: 1) the direct contact and 2) central conductor methods. The technique used depends upon the part's size, shape, and the technique used to magnetize it. Generally, the same technique used to magnetize is used to demagnetize a part. Though the techniques used may be the same, the type of current required to demagnetize a part may differ from that used to magnetize it. For example, parts having large cross sections which have been magnetized using AC may require step-down reversing DC to demagnetize them. The use of reversing DC overcomes the lack of field penetration, which occurs with AC.

3.4.11.8.2.3 Direct Contact Demagnetization. Alternately reversing and reducing the current in a part accomplishes demagnetization using the direct contact method. The part may be clamped between contact heads on a stationary unit having provision for demagnetization; or the part may be connected to cables and to a suitable demagnetizing current power supply. Starting with a current amperage greater than or equal to that used for magnetizing, the current is reduced to either zero or a very low amperage. Either AC or reversing DC may be used depending on the size, shape, and retentivity of the part. The AC demagnetization is usually less time consuming and is satisfactory for many small to medium-sized parts. However, for large parts or parts having thick cross sections, step-down reversing DC is required.

3.4.11.8.2.3.1 Parts having a complicated geometry or that have been magnetized using more than one current path through the part may not be completely demagnetized in one demagnetizing cycle. The same number of demagnetizing cycles may be needed, and through the same current paths, as were used for magnetization. Quite often with small, low retentivity parts, instead of repeat demagnetization on the part, a satisfactory and quicker demagnetization can be obtained using coil demagnetization with AC or reversing DC.

3.4.11.8.2.3.2 To circularly demagnetize a part by direct contact, clamp the part between the contact heads. Demagnetization is accomplished by automatically passing shots of decreasing current through the part. Care SHALL be taken not to demagnetize very small parts between the heads because the high initial current can overheat the parts. If longitudinal demagnetization is desired, the coil is then placed in position with the part still clamped in the heads. The same general procedure is followed, except the demagnetizing current passes through the coil instead of the part.

3.4.11.8.2.4 Central Conductor Demagnetization. The method used for direct contact demagnetization also applies to central conductor demagnetization. Demagnetizing currents SHOULD start from the same or slightly higher amperages than were used for magnetizing. Placement of the central conductor or threaded-cable configuration should be the same used for magnetization. Sometimes different central conductor locations or configurations must be used and be determined by experiment.

3.4.11.8.3 Demagnetizing With Mobile Equipment. Mobile equipment used for magnetization can also be used for demagnetization. Selecting a current output equal to or greater than the one used when magnetizing the part performs demagnetization. Cables are either formed into a coil of three or four turns, or wrapped around the part three or four times. The cables are then connected to the output terminals. On units without a demagnetization cycle, initiate the magnetizing cycle and pass the part through the coil or pass the coil over the part, leaving the current on until the coil and part are well separated (approximately 4 to 5-feet). On units incorporating a demagnetization capability, place the part in the coil, and initiate the demagnetization cycle that starts the automatic step-down of the applied current.

3.4.11.8.4 Demagnetizing With Portable Equipment. Portable equipment, other than hand probes or yokes will usually supply both alternating current and half-wave direct current. Demagnetization with this equipment and cables is done using alternating current through one of two methods, as follows:

- a. Make a coil with three or four loops of cable.
- b. Adjust the alternating current output to a higher level than used in magnetizing the part.
- c. Place the coil around the part and turn on the current.
- d. Then withdraw the coil four or five feet from the part and turn off the current; OR withdraw the part from the coil for four or five feet along the centerline of the coil and turn off the current.

3.4.11.8.4.1 Demagnetizing With Hand Probe or Yoke. Hand probes or yokes (AC or DC) provide a portable means for demagnetizing when other methods are impractical. In some cases, they are more effective than coil-type demagnetizers because the field of the probe or yoke can be concentrated into a relatively small area. For probes with adjustable legs, the space between the poles should be such that parts to be demagnetized will pass between them as close as possible. With AC flowing in the coil of the probe, parts are passed between the poles and withdrawn (Figure 3-31). On large parts, the probe is placed on the part and is moved around as it is slowly withdrawn. This method of demagnetizing is very effective. When the probe incorporates a DC magnetization capability, it can be used for DC demagnetization as well.

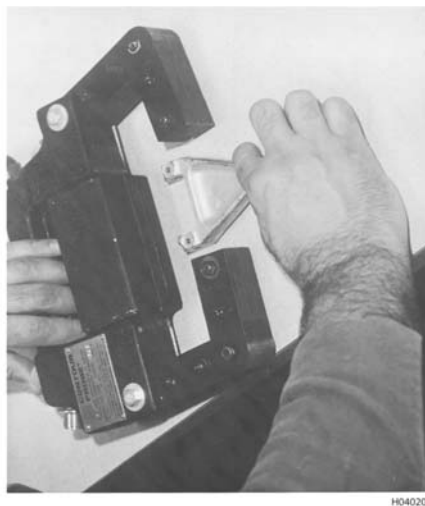


Figure 3-31. Non-Contact Demagnetization

3.4.11.9 Special Demagnetization Techniques. Where the size, shape, or techniques of part magnetization make demagnetization difficult, there are several techniques which may be used effectively. Most difficult parts can be demagnetized to the extent required for service by using the following techniques:

3.4.11.9.1 Rubber Mallet. Sometimes, striking the part with a rubber mallet during the demagnetizing operation can effectively demagnetize parts difficult to demagnetize. To use this technique, the part is placed in the demagnetizing coil and the current is turned on. The part is then hammered with a rubber mallet and withdrawn from the coil field while the hammering is continued. Care SHALL be taken so the hammering does not damage the part.

3.4.11.9.2 Positioning. Demagnetizing coils sometimes work better if they are positioned so the path of the part, as it is drawn through the coil, is in an east-west direction rather than north-south. This is particularly true for long parts that may be influenced by the earth's magnetic field.

3.4.11.9.3 Transient Demagnetization. Sometimes the residual field from heavy parts can best be removed by a technique known as the transient method of demagnetization. To perform this technique, the part is placed in the demagnetizing coil and the current turned on and off five to ten times. The current is then turned on and left on while the part is withdrawn from the magnetic field of the coil.

3.4.11.9.4 Demagnetization of Short Hollow and Cylindrical Parts. When a short, hollow, or cylindrical part is being demagnetized in an AC coil, by the method of withdrawing the part along the line of the axis of the coil, it is helpful to rotate the part both around the axis parallel to and transverse to the coil's axis. This should be accomplished while the part is in the coil as well as during the entire time of withdrawal. A part with an L/D ratio of one or less can sometimes be better demagnetized by placing it between two soft iron pole pieces of similar diameter, but longer than the part. This combination is then passed through the coil as a unit. It has the effect of increasing the L/D ratio and facilitates the removal of the field in the part.

3.4.11.9.5 Demagnetization of Ring-Shaped Parts. For the demagnetization of ring-shaped parts an effective method is to pass a central conductor through the ring. The central conductor is energized with AC and the current reduced to zero by means of either a step-down switch or a step less current control. The latter method can be quicker (down to a few seconds) than the step-down switch. This method can also be used with reversing, decaying, or step-down DC as well.

T.O. 33B-1-1

3.4.11.9.6 Demagnetization of Long Parts. Long parts, such as rods, bars, and tubes may retain an objectionable amount of residual magnetism from the earth's magnetic field. As the earth's field extends from the north to the south pole, it is desirable to demagnetize these types of parts by withdrawing from an AC coil in an east-west direction. This will minimize the effect of the earth's field on the residual magnetism in the parts.

3.4.11.9.7 Demagnetization of Large Structures. Frequently, large structures such as engine mounts may require demagnetization, and demagnetizing coils of suitable size may not be available. In such case, each individual extension from the structure, such as the legs of a mount, should be placed within the coil as close to the wall as possible and withdrawn. The structure should then be reversed. The other end is then brought close to the face of the coil and rotated, so all parts of the structure are passed across the open face of the coil. The entire structure is finally withdrawn four to five feet from the coil before it is shut off. In handling such tubular structures, it is important they be moved to and from the coil in an east-west direction.

3.4.11.9.8 Removal of Longitudinal and Circular Fields. In considering the problem of demagnetization, it is important to remember a part may retain a strong residual field after having been circularly magnetized, and yet exhibit little or no external evidence of such a condition. Such a field is difficult to remove and there is no easy way to check the success of demagnetization. There may be local poles on a circularly magnetized piece at projecting irregularities, changes or sections, that can be checked with a field indicator. However, to demagnetize a circularly magnetized part, it is often better to first convert the circular field to a longitudinal field. The longitudinal field does possess external poles, is more easily removed, and the extent of removal can be easily checked with a field indicator.

3.4.12 Post Inspection Cleaning.**CAUTION**

All plugs and masks SHALL be removed after post-inspection cleaning and the part SHALL be demagnetized to the maximum extent possible.

3.4.12.1 Particle Removal. The magnetic particle inspection process leaves behind at least a scattering of magnetic particles that are abrasive. This may or may not be harmful to the part when it is subjected to further use. Where this slight residue cannot be tolerated, it SHALL be removed. When its presence makes no difference, post-inspection cleaning can be eliminated. Dry magnetic particle inspection leaves only the particles behind. These particles are fairly coarse, quite abrasive, and probably magnetically bonded to the test surface. The wet method magnetic particles are much finer than the dry method magnetic particles (0.0002-inch instead of 0.002-inch to 0.006-inch in diameter) and are softer, though still somewhat abrasive. On highly polished surfaces, residual powder from the bath can contribute to rapid corrosion.

3.4.12.2 Inspection Vehicle Removal. The wet method inspection process will normally leave the carrier liquid or vehicle on the test surface. If the vehicle is oil, it can be removed by vapor degreasing or solvent cleaning. If the vehicle is water, the residue will consist of wetting agents and water-soluble corrosion inhibitors, which may be removed with a plain water rinse or spray. Regardless of the type of vehicle used, the part SHOULD be cleaned as soon as possible after inspection and demagnetization.

3.4.12.3 Post-Cleaning Methods.**CAUTION**

Post-cleaning methods that use water can cause corrosion of the test surfaces if the water is not promptly removed. The surfaces SHALL be thoroughly dried off by wiping, heating, or blowing with properly regulated compressed air.

Regardless of whether the wet or dry, visible or fluorescent, magnetic particle inspection process is used, once the carrier liquid or vehicle is removed, the requirement for removal of the magnetic particles is the same. Thoroughly demagnetize the part, and then remove the magnetic particles by wiping or scrubbing. Cleaners or detergents cannot break the magnetic attraction of a magnetized part. The particles cannot be dissolved from the part surface, as they are a ferrous oxide, so mechanical scrubbing or detergent washing may be necessary. Solvents may be used to remove the residue, and in some cases, the use of ultrasonic cleaning has been successful.

3.4.12.4 Requirements Following Post Inspection Cleaning. After inspection by the wet method using a petroleum distillate as the bath liquid, the surfaces of parts are left vulnerable to corrosion. The bath vehicle is, by specification, free of any residual non-volatile material and when it dries it leaves no protective film. Every effort SHALL be taken to clean a part and apply a protective finish as soon as possible after the inspection. When water is the bath vehicle, the dried film on the surface of a part consists of the various conditioners used in the bath formulation in addition to the residual magnetic particles. One of the conditioners is a corrosion inhibitor, so this inhibitor affords some corrosion protection after testing. However, this is by no means permanent and a protective finish should be applied as soon as possible.

NOTE

In the event a functional material, such as oil, grease, or anti-seize compound is removed from the part to facilitate inspection, the same material SHALL be reapplied after the part has been inspected.

3.4.13 Magnetic Rubber Inspection.

3.4.13.1 Introduction. Magnetic rubber inspection (MRI) is a nondestructive inspection technique used for detecting cracks or other flaws on or near the surface of ferromagnetic materials. Its principal applications are in certain problem areas, such as (1) areas having limited visual accessibility (e.g., inside holes, tubes, etc.), (2) coated surfaces, (3) complex shapes or poor surface conditions, and (4) inspections for defects that require magnification for detection and interpretation. Magnetic rubber inspection involves the use of a material consisting of magnetic particles dispersed in a room temperature curing silicon rubber. The material is catalyzed, applied to the test surface, and the area to be inspected is magnetized, causing the particles to migrate through the rubber and accumulate at discontinuities on the surface. Following cure, the solid replica casting is removed from the part and examined for indications. The magnetic principles discussed in Section 2 (paragraph 3.2) of this chapter apply equally to Magnetic Rubber Inspection.

3.4.13.1.1 Currently, there is only one manufacturer known to produce magnetic rubber materials. The example data presented in this section applies to that manufacturer's three material formulations; MR-502, MR-502K, & MR-502Y. However, the principles and instructions presented will apply to any material complying with SAE Specification AMS 2309.

3.4.13.1.2 MR-502 is the more viscous and slow curing of the three formulations, and provides medium sensitivity. It is usually not the best choice when highest crack detection sensitivity is required. MR-502K has the lowest viscosity and is the most sensitive. MR-502Y is MR-502K with a yellow coloring agent added. It is slightly more viscous and very slightly less sensitive than MR-502K. The yellow color makes the indications more noticeable to the inspector reading the replica, thereby improving the probability of detection for very small cracks. MR-502Y has a greater tendency to stick to the part surface after it is cured, so the use of a release agent will be required for more applications.

3.4.13.1.3 Some specifications refer only to MR-502 because this was the first material available. It is recommended cognizant engineering activities specify or authorize substitution of MR-502K or MR-502Y unless long gel time and lower sensitivity are desirable for the specific application.

NOTE

Technical directives, requiring a magnetic rubber inspection SHALL specify the formulation to be used, including any alternatives, in the procedure.

3.4.13.2 Safety Precautions. General safety precautions are applicable to magnetic rubber inspection (paragraph 3.8). The silicon rubber, dibutyltin dilaurate, stannous octoate, cure stabilizers, cleaners, and release agents are, or can be, skin and eye irritants, skin sensitizers (e.g., causing allergic reactions), inhalant, and ingestion hazards. For specific information concerning any of the materials used as magnetic rubber, magnetic rubber catalysts, release agents, or cleaners, consult the Material Safety Data Sheets, or contact the appropriate Safety Officer. Silicon oil is an ingredient in the material and can result in very slippery surfaces, especially floors, if not well controlled.

3.4.13.2.1 When performing magnetic rubber inspection on aircraft using electromagnets to magnetize, the aircraft SHALL be grounded.

3.4.13.3 Gel Time (Cure Time). Gel time (also called cure time or pot life) refers to the time from the addition of the catalyst to when the viscosity starts to noticeably increase and magnetization must be completed. Cure time is the time to completely cure to a tack-free state.

T.O. 33B-1-1**3.4.13.4 Magnetic Rubber Inspection Procedure (Typical).****CAUTION**

Areas to be magnetic rubber inspected must be free of grease, oil, dirt, and other foreign matter that could cause false or confusing indications or prevent the base material from curing.

NOTE

This procedure is provided as an example and is not authorized for use unless specified and/or approved for a specific application by a cognizant MT Level III. Directive originators SHALL obtain Level III concurrence prior to issuing a directive requiring a magnetic rubber procedure.

A general list of the required materials and equipment to obtain is contained in (Table 3-4) and (Table 3-5). Materials and equipment required for a specific inspection SHOULD be identified in the task specific directive.

Table 3-4. Magnetic Rubber Equipment

<p>Electromagnetic yoke, fixed or articulated legs (same as used for magnetic particle inspection) Permanent bar magnets Soft iron pole pieces Stereo zoom microscope (7-10X or higher) with high intensity light (mandatory) Electronic gauss meter Mechanical shaker (e.g., paint shaker) Vacuum chamber</p>
--

Table 3-5. Magnetic Rubber Inspection Materials

<p>Base material (SHALL comply with SAE specification AMS 2309) Dibutyltin Dilaurate and Stannous Octoate catalysts Sealing compound (putty for forming dams) Aluminum or plastic sheet material for forming dams Release agent to aid in the removal of replicas from holes (not silicone based) Paper or plastic cups in which to mix magnetic rubber material Tongue depressors for mixing the material Isopropyl alcohol for cleaning replicas Disposable syringe for applying the rubber mixture to the inspection area</p>
--

3.4.13.4.1 Part Preparation. Prepare the part for magnetic rubber inspection as follows:**CAUTION**

If a delay is expected that would leave any area of steel in a bare metal state for over 1-hour, protect the area from corrosion per NAVAIR 01-1A-509 (T.O. 1-1-691/TM 1-1500-344-23), Chapter 3. Volatile corrosion inhibitor (VCI) film MIL-PRF-22019 held on and sealed at the edges with AMS-T-22085 Type II preservation tape is effective and convenient where the part geometry allows its use. Upon removal of VCI film the area is not required to be cleaned again.

- a. Using cheesecloth or equivalent moistened with cleaning solvent; remove grease, oil, dirt, lint, and similar contaminants from the area to be inspected. Refer to NAVAIR 01-1A-509 (T.O. 1-1-691/TM 1-1500-344-23), [Chapter 3](#) for specific instructions and approved materials.
- b. Remove loose corrosion products, sealants, paint, plating, and other coatings, as required by the task specific directive. If removal requirements are not specified, remove all corrosion products and coatings except primer and plating which, may be left on the surface if they do not exceed 0.005 inch in total thickness. Normal primer and corrosion preventive plating MAY be assumed to not exceed 0.005 inch thick.

NOTE

- Using the procedures and materials as discussed above, virtually any area or configuration can be prepared for magnetic rubber inspection. Upside-down surfaces may be inspected by building a reservoir beneath the test area and pressure filling with magnetic rubber. A vent hole must be provided with this type of reservoir to prevent air entrapment.
 - When building dams, make certain they are small enough to allow magnets or the legs of an electromagnet to span the reservoir. Magnets or the legs of an electromagnet SHOULD NOT be placed into the uncured magnetic rubber.
- c. Prepare a dam around the surface or hole to be inspected. Examples are shown in ([Figure 3-32](#)). Use tape, aluminum foil, special sealing putty, and specially made dams (singly or in combination) to form a reservoir to hold the magnetic rubber.

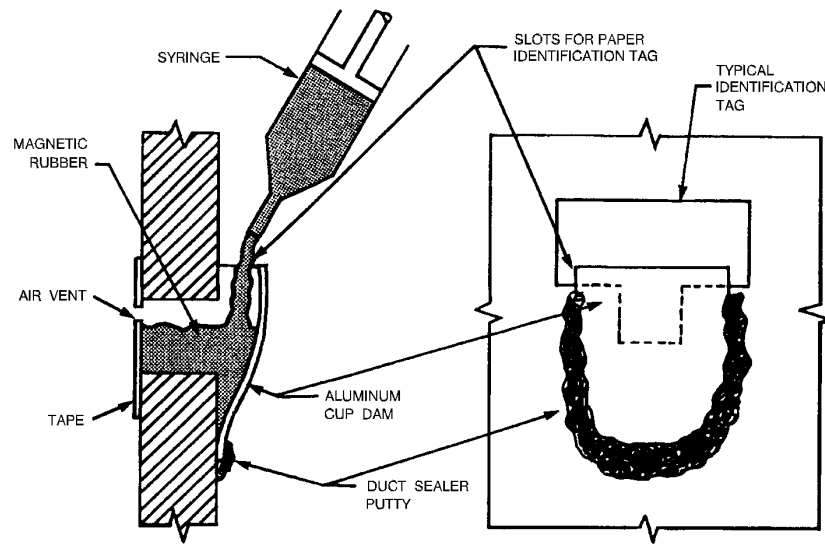
NOTE

The steps in (paragraph [3.4.13.4.2](#)) through (paragraph [3.4.13.4.7](#)) are for pre-magnetization setup and adjustment. Magnetization will be conducted after addition of the magnetic rubber.

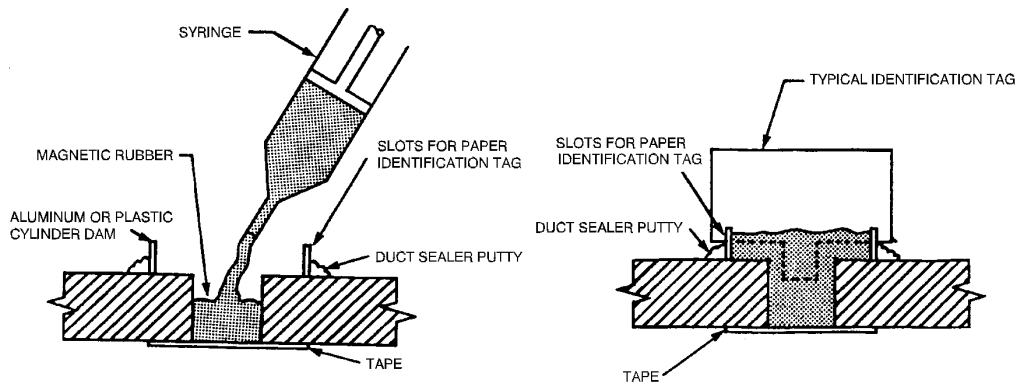
3.4.13.4.2 Select Method of Magnetization. Magnetism may be applied with portable electromagnets (yokes), permanent magnets, or conventional magnetic particle inspection equipment. DC or rectified AC current must be used to electrically generate the magnetic field. An AC generated field will not be effective with slow-moving particles. In areas of limited accessibility, soft iron, low alloy steel extensions, or pole pieces are used to transfer magnetism into the inspection area. Permanent magnets are useful in certain specialized applications, such as threaded bolts, gears, or other small parts whose shape makes magnetization difficult with an electromagnet. The magnetic fields produced in large parts by permanent magnets are often quite low and unpredictable; therefore, they SHOULD NOT be used on such parts unless a specific procedure has been developed and verified. Central conductors are effective for fastener and attachment holes; particularly when there are multiple layers of materials and the layer being inspected is not accessible to an electromagnetic yoke.

3.4.13.4.3 Select the Method of Magnetic Contact. Field strength is greatly reduced when there is poor contact between the magnet and the test piece. To improve contact, auxiliary pole pieces are useful as illustrated in ([Figure 3-33](#)). These may be machined from soft iron and attached to the poles of magnets. Pole pieces SHOULD be designed to have the least reduction in cross-section consistent with space requirements.

T.O. 33B-1-1



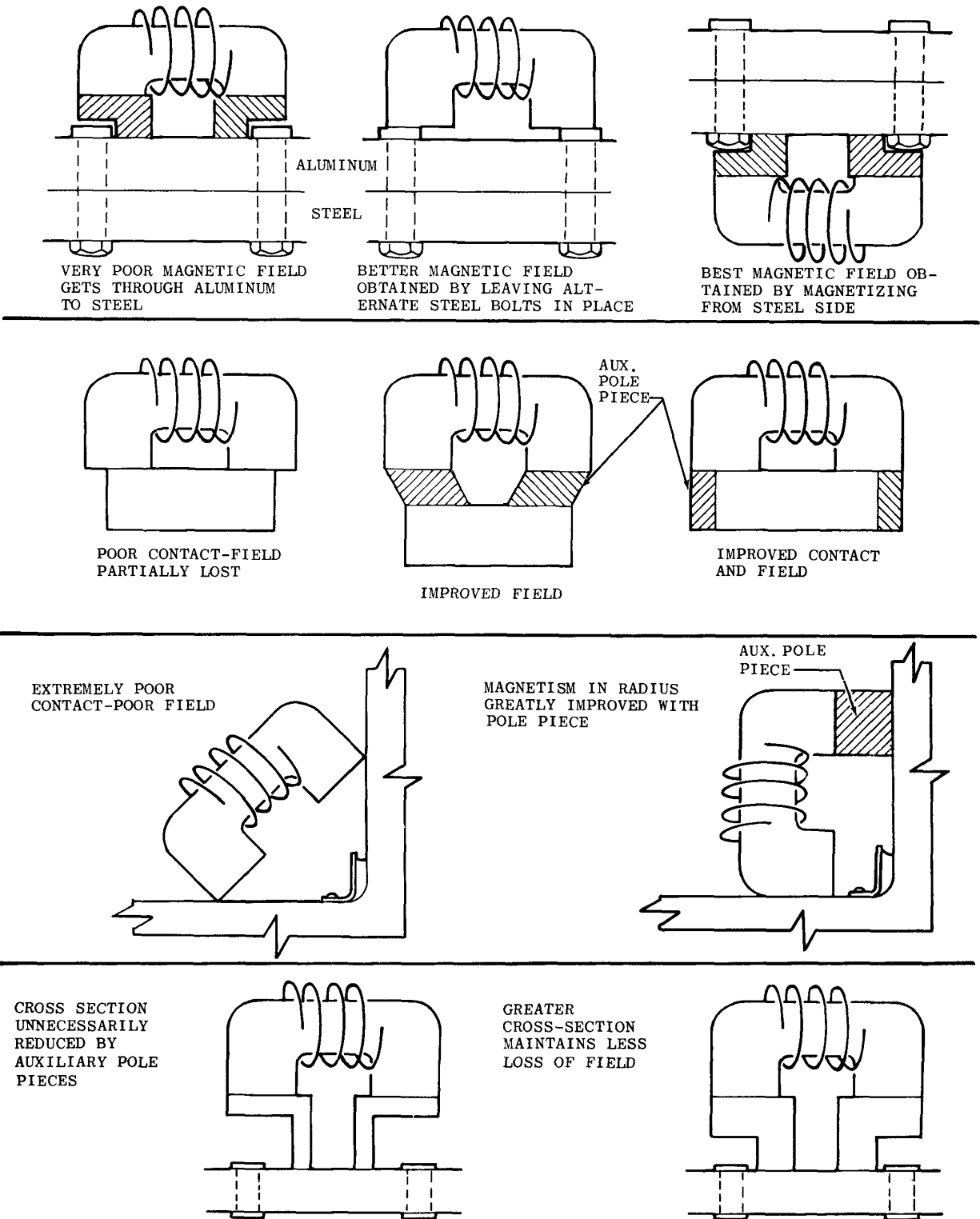
HORIZONTAL HOLE PREPARATION



VERTICAL HOLE PREPARATION

H0402013

Figure 3-32. Preparation for Magnetic Rubber Inspection



H0402014

Figure 3-33. Using Pole Pieces to Improve Magnetic Contact

T.O. 33B-1-1

3.4.13.4.4 Determine the Magnetic Field Requirements. Magnetic field recommendations (strength and duration) for inspection of holes and surfaces are shown in (Table 3-6). These are recommended starting points; actual requirements are those that produce inspection replicas with the needed defect detection sensitivity.

Table 3-6. Magnetic Field Strength and Duration Recommendations

(Variations may be required for specific applications.)			
Inspection Area	Magnetic Rubber Base Material	Field Strength (Gauss)	Magnetization Duration, Each Direction
Hole (bare)	MR-502 (NSN 6850-01-037-9015)	50 to 100	30 seconds
	MR-502K (NSN 6850-01-163-0276) MR-502Y (NSN 6850-01-163-0277)	30 to 50	30 seconds
Surface (bare)	MR-502 (NSN 6850-01-037-9015)	150	1 minute
		100	3 minutes
		50	10 minutes
	MR-502K (NSN 6850-01-163-0276) MR-502Y (NSN 6850-01-163-0277)	100	30 seconds
		50	1 minute
		30	2 minutes
Coated Holes and Surfaces	Extend magnetization duration from the times listed above depending on coating thickness.		

3.4.13.4.5 Determine Field Direction. Since cracks and other flaws are displayed more strongly when they lie perpendicular to the magnetic lines of force, the magnetism SHOULD be applied from two directions to increase reliability when the flaw direction is unknown or uncertain. Usually this is accomplished by magnetizing in one direction and then rotating the magnetization source 90-degrees and magnetizing again. When the direction of a suspected defect is known, only one magnetizing direction is required.

3.4.13.4.6 Measure the Magnetic Field Strength. Measure the magnetic field strength using a gauss meter by placing the probe in the hole or on the surface to be inspected. Most electronic gauss meters have interchangeable probes to permit measurement of the magnetic field either parallel or perpendicular (transverse) to the axis of the probe. The transverse probe, which can measure the field parallel to the part surface, will be used most often. Refer to the operating manual for the gauss meter for specific operating instructions.

3.4.13.4.7 Adjust the Magnetic Field Strength.

3.4.13.4.7.1 Electromagnets. The magnetic field strength is adjusted to the recommended value from (Table 3-6) by adjusting the control knob of the magnetization power supply. The control knob reading and the position of magnet and pole pieces are noted so these settings can be repeated when final magnetization is performed after addition of the rubber formulation.

3.4.13.4.7.2 Permanent Magnets. Appropriate bar magnets are placed to obtain the needed field strength and direction.

3.4.13.4.8 Mix, Measure, and Deaerate. Mix, measure, and deaerate (only if bubbles in replica are a problem) magnetic rubber base material as follows:

3.4.13.4.8.1 Mixing. The magnetic rubber base material must be thoroughly mixed prior to use. Prior to measuring or weighing a quantity of magnetic rubber it SHOULD be thoroughly mixed with a wooden tongue depressor or a spatula. Mixing SHOULD continue until the material contains no streaks or color variations. Materials that have settled SHOULD be agitated on a mechanical shaker (paint shaker or equivalent). Steel balls may be placed in the container containing the magnetic rubber to facilitate thorough mixing.

3.4.13.4.8.2 Measuring. The magnetic rubber base material may be weighed or measured, volumetrically, into paper cups or other suitable containers. One gram of magnetic rubber base material is equal to one cubic centimeter (cc) of base material. The number and size of the batches measured must be based on the area to be inspected. Do not measure more material per

batch than can be poured and magnetized within the gel time of the formula selected. To determine the gel time at the time of inspection, measure a small trial batch and time the gel time in the mixing cup before the inspection batch is mixed and poured.

3.4.13.4.8.3 Deaerating. Deaerate the base material for inspections of horizontal holes, upside-down surfaces and any time bubbles interfere with interpretation of the replica. The magnetic rubber base material is placed in a vacuum chamber and pumped down to 25 to 30-inches of mercury for one to two minutes. This will remove excess air and help prevent the formation of bubbles on the upper surfaces of the cured replicas.

Table 3-7. Cure Times for Different Amounts of Catalyst

Material	Gel Time	Cure Time
MR-502	8 min.	1 hr.
	15 min.	2 hrs.
	30 min.	4 hrs.
MR-502K and MR-502Y	2 min.	5 - 10 min.
	3 min.	10 - 15 min.
	5 min.	15 - 20 min.
	10 min.	1 hr. 15 min.

3.4.13.4.9 Add Magnetic Rubber.

NOTE

- The magnetic rubber will begin to thicken when curing agents are added. Therefore, magnetization must begin immediately and the entire batch must be magnetized before the gel time of the formula has expired.
- Magnetic rubber material, catalyst addition, and cure time are based on a room temperature of 76°F. The cure times are very unpredictable when the temperature is below 60°F or over 90°F.
- When inspecting deep holes with small diameters, with scored surfaces, or of unusual configuration, the inspection area may be coated with a thin film of release agent to aid in removal of the replica.

Add to the magnetic rubber base material the correct number of drops of catalysts, and cure stabilizer according to the instructions provided with the material by the manufacturer. Typical combinations of gel time and cure times attainable by varying the amount of catalyst added is shown in (Table 3-7). Higher humidity or higher temperature will increase the cure rate. When temperature or humidity change, or when material from a different batch is first used, mixing a small test batch to determine optimum ratios of catalyst to base material is recommended. If the cure is too fast and the rubber starts to gel before the magnetization is complete, the process will have to be repeated. If the cure is too slow, time is lost waiting for the replica to solidify enough for removal.

3.4.13.4.10 Mix. Using a tongue depressor or equivalent, thoroughly stir the mixture. Avoid whipping air into the mixture.

3.4.13.4.11 Fill. Using the mixing container or a syringe, fill only the number of holes or other test areas that can be magnetized within the gel time. Following fill, vent holes SHOULD be sealed with putty to prevent the continual flow of rubber.

T.O. 33B-1-1**NOTE**

Holes in steel having high retentivity may be magnetized by a “residual” method. Using this method, the hole is filled with magnetic rubber and is magnetized with an electromagnet at the maximum field obtainable for a period of about one second. This SHOULD establish a residual field of 25-100 gauss to be effective. This field must stay undisturbed for 30 to 60-seconds (depending on the level of residual magnetism). Do not magnetize the hole in a second direction or magnetize any other hole on the same test part until the 30 to 60-seconds have elapsed.

3.4.13.4.12 Magnetize. Magnetize each test area according to the pre-magnetization setup established in (paragraph 3.4.13.4.2) through (paragraph 3.4.13.4.7).

3.4.13.4.13 Identify. Replicas can be identified by inserting an identification tag into the rubber before it gels, or by individually bagging the completed replica along with the identification.

NOTE

Care SHALL be exercised to avoid disturbing the magnetic rubber in the area of interest when inserting a tag.

3.4.13.4.14 Allow magnetic rubber to cure for the time specified. Avoid movement of the part and contamination of the magnetic rubber by foreign matter.

3.4.13.4.15 Determine if the magnetic rubber is cured (tack-free) by lightly touching the replica or the material remaining in the mixing container.

3.4.13.4.16 Remove each replica as follows:

- a. Remove the magnets if applicable.
- b. Remove tape, aluminum dam, duct sealer putty, and/or central conductor and dam assembly.
- c. Gently remove replica from test area.

NOTE

The replicas tear easily.

3.4.13.4.17 Visually examine replicas for overall condition and proper identification. A stereomicroscope providing magnification of at least 10X magnification, and a high intensity illuminator SHALL be used for microscopic examination as follows:

- a. Adjust the illuminator so the light does not produce a glare on the surface of the replica. A good stereomicroscope with excellent light gathering characteristics and a strong light projected at a shallow angle is generally best for this work. Experience has proven that using a mediocre microscope or inadequate lighting may result in small cracks going undetected. The inspector may check the adjustment of the illuminator periodically on a replica known to display a faint crack indication.
- b. Hold the replica with finger tips and focus by lowering or raising the replica beneath the microscope lens (rather than raising or lowering the lens itself). This allows the inspector to view the replica at various angles and to scan the entire area of interest.
- c. Evaluate the level of magnetism. Although magnetic rubber responds satisfactorily to a wide range of magnetism, the reliability is increased if the optimum level is used. Too little magnetism will result in faint indications easily missed. Too much magnetism darkens the background so indications might be hidden. The experienced inspector can determine if the magnetism level is satisfactory by the appearance of the replica. For a hole magnetized with a yoke or permanent magnet, adequate magnetism is indicated on the replica by a dark “halo” around the edge (Figure 3-35). Adequate magnetism on flat surfaces and areas of gentle contour is indicated by darkness in the rough areas of the replica. On very smooth surfaces, external “penetrameter type” indicators such as staples, nickel foil, or other magnetic material may be taped to the part to indicate magnetism.

- d. Evaluate the replica quality. Replicas that contain excessive air bubbles, debris, or poorly mixed rubber are difficult to interpret and **SHOULD** be recast. Correct any technique or procedural errors. Clean the inspection area down to bare metal if necessary. Vary the inspection technique as appropriate.
- e. Evaluate indications of discontinuities and report relevant ones as required by the directive specifying the inspection.
- f. A replica may show obvious surface defects (tool marks, corrosion pitting, etc.) not attracting magnetic particles. The inspector is not responsible for identifying this type of defect unless the procedure specifically requires such identification.

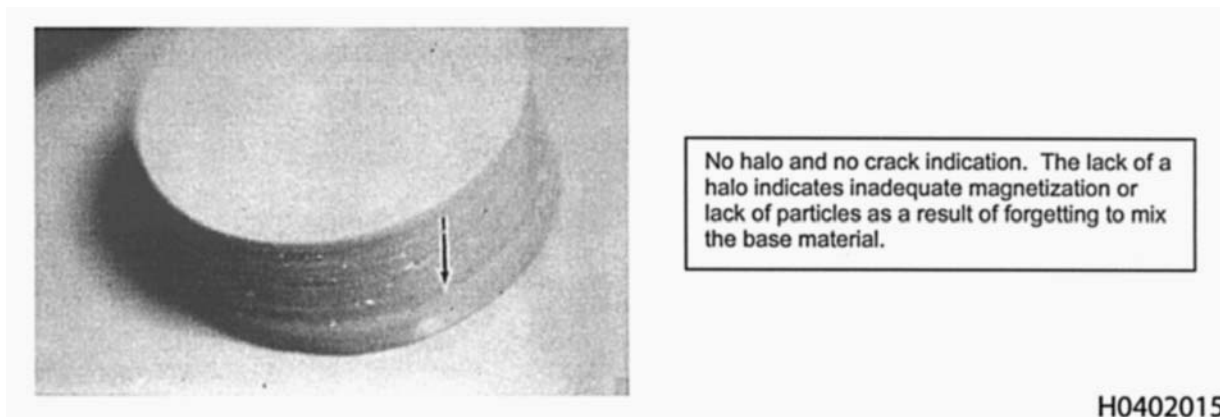


Figure 3-34. Magnetic Rubber Replica With No Indication

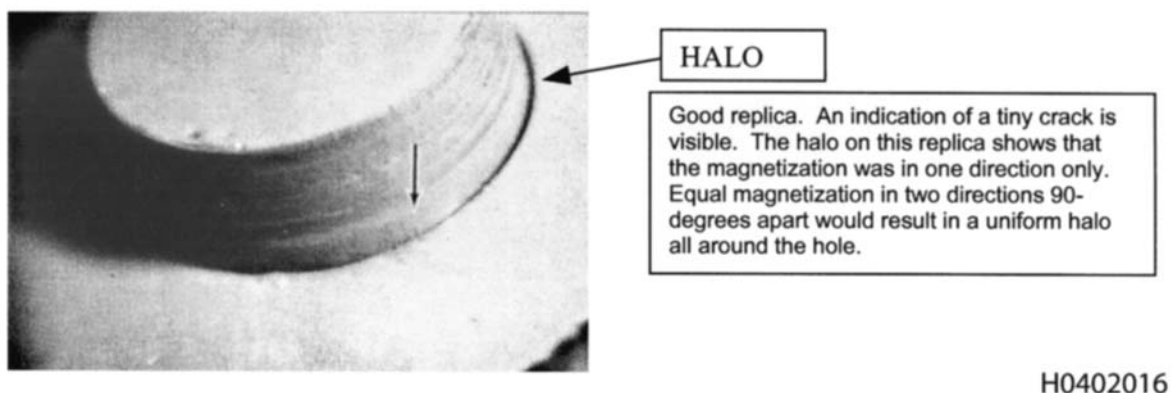
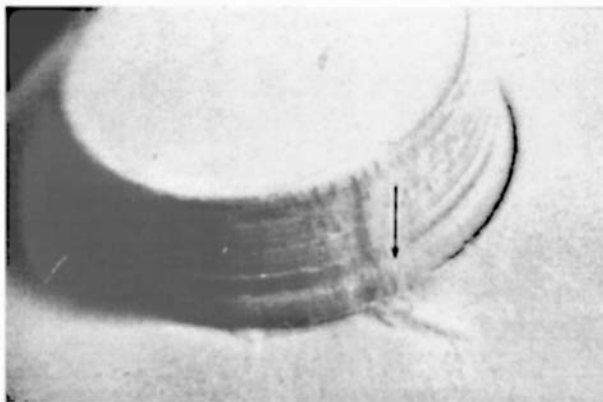


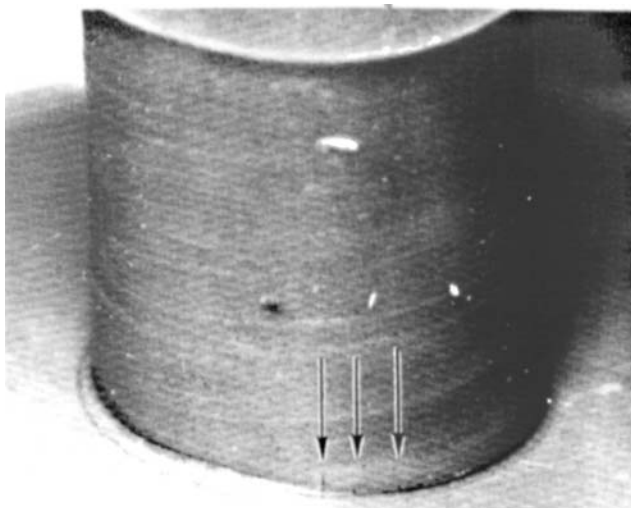
Figure 3-35. Magnetic Rubber Replica With Good Indication

T.O. 33B-1-1



Excessive magnetization. If this effect is seen, or if the halo is strong enough to mask tiny crack indications, the strength or duration of the magnetic field needs to be decreased.

Figure 3-36. Magnetic Rubber Replica With Excessive Magnetization



Corner cracks ranging in size from 0.002" to 0.015".

H0402018

Figure 3-37. Magnetic Rubber Replica With Crack Indications

3.4.13.5 Post-Inspection Procedures.

- a. Demagnetize parts until the residual magnetism is less than two gauss measured with the electronic gauss meter, or two divisions on the magnetic field indicator.
- b. Clean parts with cleaning solvent. Refer to NAVAIR 01-1A-509 (T.O. 1-1-691/TM 1-1500-344-23), [Chapter 3](#) for specific cleaning instructions and approved materials.
- c. Restore finish or apply preservative promptly if corrosion preventive plating is not present or has been breached. High strength steels like 300M and Aermet 100 in current use on high performance military aircraft are extremely sensitive to stress-corrosion cracking. Harmful corrosion can start on these materials in a matter of hours. Refer to NAVAIR 01-1A-509 (T.O. 1-1-691/TM 1-1500-344-23), [Chapter 3](#) for specific preservation instructions and approved materials.

SECTION V MAGNETIC PARTICLE INSPECTION INTERPRETATIONS

3.5 MAGNETIC PARTICLE INSPECTION INTERPRETATION.

3.5.1 Formation of Discontinuities and their Indications.

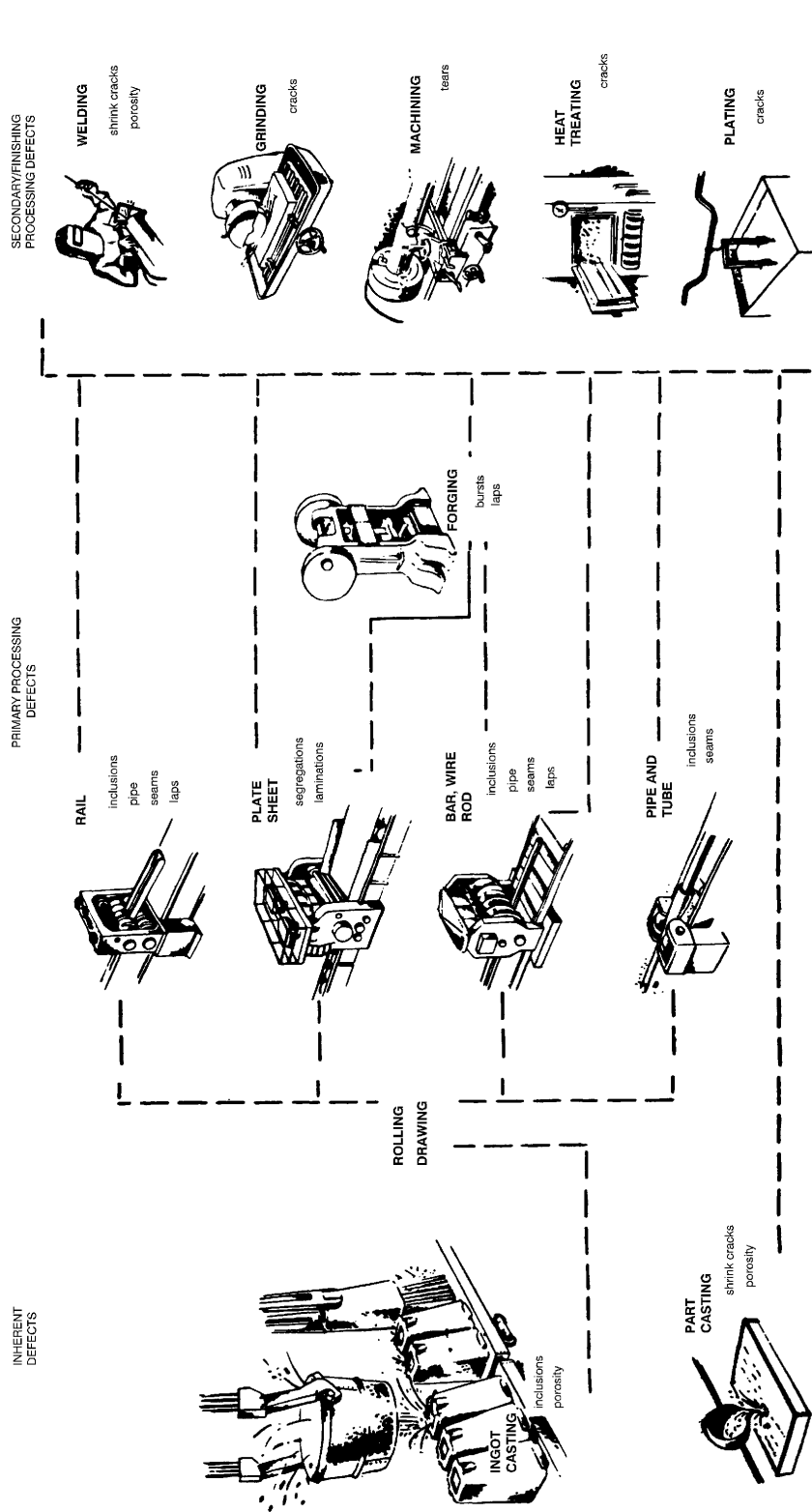
3.5.1.1 The Iron and Steel Manufacturing Processes. Knowledge of iron and steel manufacturing processes is necessary to enable an inspector to interpret and evaluate magnetic particle indications. It is not possible in this manual to explain all of the processes used in the manufacture of iron and steel parts, but a brief review will explain how some discontinuities are formed.

3.5.1.1.1 Purpose of Processing. Iron ore is converted into metal by heating it in a furnace. When it becomes liquid or molten, iron can be poured into molds and allowed to cool and solidify. In the molten state, it is possible to remove impurities and also to add other elements to form alloys. These additions, along with other appropriate metal processing steps, impart desirable properties to the finished metal that can make it:

- * Harder
- * Softer
- * Tougher
- * Stronger
- * Easier to machine
- * Resistant to heat
- * Resistant to corrosion

3.5.1.2 Ingot Production. After melting, purifying, and alloying the iron or steel, the molten metal is poured into an ingot mold where it is allowed to solidify. Most impurities rise to the top of the ingot before the metal is completely solid. However, some of the foreign materials can become trapped within the ingot during solidification. Because such entrapment is usually concentrated near the top, the ingot is cropped to remove most of the impurities.

3.5.1.3 Primary and Secondary Processing. Ingots undergo primary processing to form the metal into basic shapes according to end-product requirements. Secondary processing is subsequently used to manufacture the final products. A pictorial story of steel processing ([Figure 3-38](#)) shows in sequence the principal stages or operations where defects may be created, and indicates the defects most likely to be found in the material as it leaves each stage. This illustration SHOULD be studied in conjunction with the text in this section.



11042216

Figure 3-38. Sequence of Steel Processing Stages, Indicating the Principle Operations and the Defects Most Likely to be Found in the Material After Each Process

3.5.2 Definition of Terms. The magnetic particle inspector SHALL understand the distinctions between a discontinuity, an indication, and a defect.

3.5.2.1 Discontinuity. A discontinuity is an interruption in the normal physical structure or properties of a part. Discontinuities may be cracks, laps in the metal, folds, seams, inclusions, porosity, and similar conditions. A discontinuity may be very fine or it may be quite large. A discontinuity may or may not be a defect; that is, it may or may not affect the intended use of the product or part. A discontinuity, which would be a defect in one part, may be entirely harmless in another part designed for a different service.

3.5.2.2 Indication. An indication is an accumulation of magnetic particles being held by a magnetic leakage field to the surface of a part. The indication may be caused a discontinuity, by some other condition that produces a leakage field, or by mechanically held particle accumulation.

3.5.2.3 Defect. A defect is a discontinuity that interferes with the intended use of a part.

3.5.3 Basic Steps of Inspection. Magnetic particle inspection can be divided into three basic steps:

- Producing an indication on a part.
- Interpreting the indication.
- Evaluating the indication.

3.5.3.1 Producing an Indication. In order to produce a proper indication on a part, it is necessary to have some knowledge of the principles of magnetism, the materials used in inspection, and the technique employed. Since these subjects have been covered in previous sections of this manual, observance of the procedural steps therein should ensure a proper indication is produced.

3.5.3.2 Interpreting the Indication. After the indication is created, it is necessary to interpret that indication. Interpretation is the determination of what caused that indication. Knowledge of metal processing is often invaluable in identifying the cause of an indication.

3.5.3.2.1 Indications caused by a discontinuity at the part surface are characterized by particles tightly held to the surface by a relatively strong magnetic leakage field. The particle accumulation has well defined edges and there is a noticeable “build-up” of the particles. This build-up consists of a slight mound or pile of particles, on which deep surface cracks are sometimes high enough above the part surface to cast a shadow. If such an indication is wiped off, the discontinuity can usually be seen.

3.5.3.2.2 Indications caused by a discontinuity below the surface are characterized by a broad and fuzzy looking accumulation of particles. The particles in such an indication are less tightly held to the surface because the leakage field is weaker.

3.5.3.2.3 The difference in appearance between indications of surface and subsurface discontinuities is clearly shown (Figure 3-39) and (Figure 3-40). Notice the sharpness and definition of the accumulation of magnetic particles in (Figure 3-39). The pattern in (Figure 3-39) is much broader than in (Figure 3-40) and is quite typical of the indications formed over subsurface discontinuities.

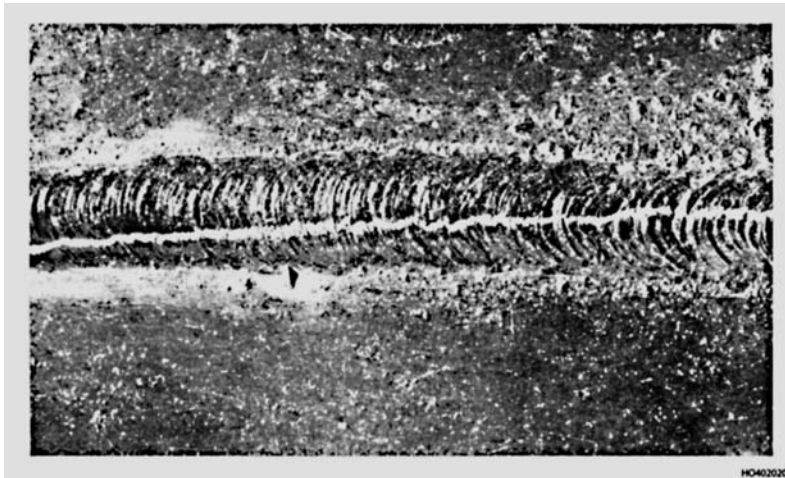
T.O. 33B-1-1

Figure 3-39. Sharp, Well Defined Indication of Surface Discontinuity in a Weld

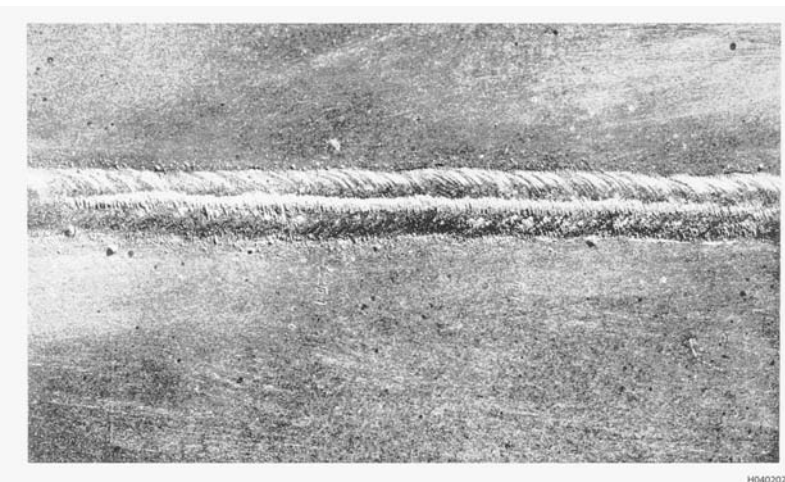


Figure 3-40. Broad Indication of Subsurface Discontinuity in a Weld

3.5.3.3 Evaluating the Indication. Finally, after the indication has been formed and interpreted, it must be evaluated. Evaluation helps determine the consequences of the discontinuity. This includes determining if the discontinuity is a defect and if so, can the part be reworked or repaired, or must the part be scrapped.

3.5.3.3.1 Generally, an inspector has fairly detailed guidance concerning the interpretation and evaluation of indications included with the procedure by which the inspection was done. In the event such guidance is not available, the following basic considerations may be used in conjunction with the inspector's knowledge and experience to help with indication evaluation.

3.5.3.3.1.1 A discontinuity of any kind lying at the surface is more likely to be harmful than a discontinuity of the same size and shape which lies below the surface.

3.5.3.3.1.2 Any discontinuity, whether surface or sub-surface, having a principal dimension, a principal plane which lies at right angles, or at a considerable angle to the direction of principal stress, is more likely to be harmful than a discontinuity of the same size, location, and shape lying parallel to the stress.

3.5.3.3.1.3 Any discontinuity that occurs in an area of high stress SHALL be more carefully considered than a discontinuity of the same size and shape in an area where the stress is low.

3.5.3.3.1.4 Discontinuities that are sharp, such as grinding cracks or fatigue cracks, are severe stress risers and are more harmful in any location than rounded discontinuities, such as scratches.

3.5.3.3.1.5 Any discontinuity that occurs in a location close to a keyway or fillet SHALL be considered more harmful than a discontinuity of the same size and shape occurring away from such a location.

3.5.3.3.2 Magnetic Particle Indications. Discontinuities in the part under examination will produce indications. These indications may not always be associated with physical discontinuities. Indications may be caused by:

3.5.3.3.2.1 An actual physical discontinuity at or near the surface of a part, which may have been present in the original metal or may have been produced by subsequent forming, heating, finishing processes, or service use (Figure 3-41).



Figure 3-41. Typical Magnetic Particle Indications of Cracks

3.5.3.3.2.2 Actual physical discontinuities which are present by design (e.g., an interference or close fit between two members of an assembly) (Figure 3-42).

T.O. 33B-1-1

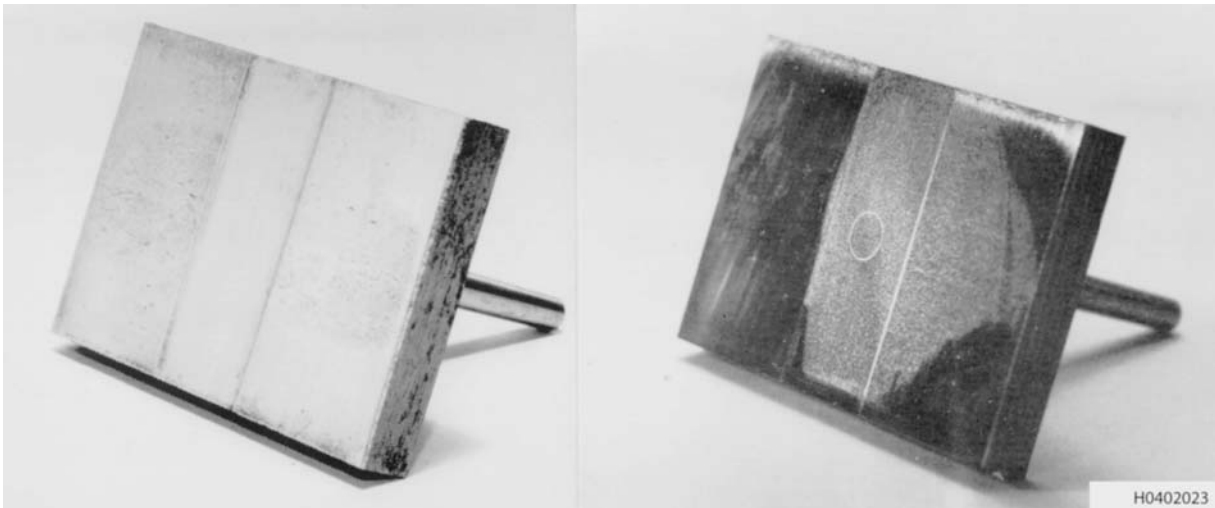


Figure 3-42. Magnetic Particle Indication of a Forced Fit

3.5.3.3.2.3 A weld between two dissimilar ferromagnetic metals having different permeabilities; or between a ferromagnetic metal and a nonmagnetic material. Indications may be produced at such a point even though the joint is perfectly sound. Such an indication may be produced in a friction or flash weld of two dissimilar metals ([Figure 3-43](#)).

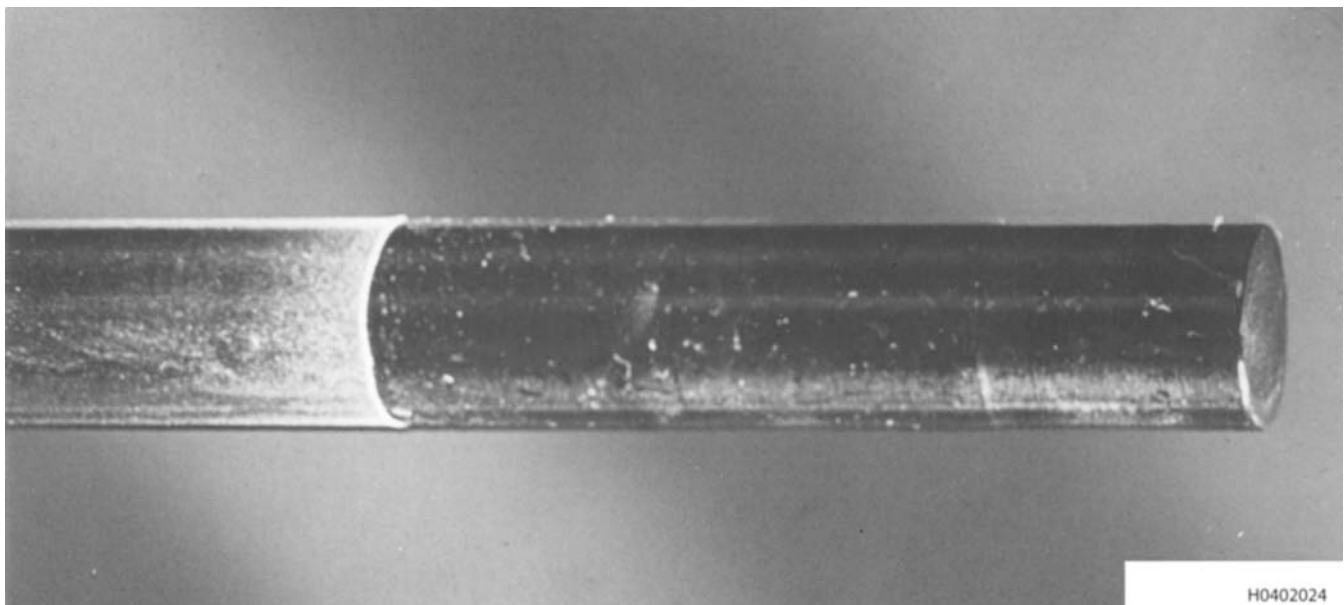


Figure 3-43. Particle Indication at the Weld Between a Soft and a Hard Steel Rod

3.5.3.3.2.4 The junction between two ferromagnetic metals by means of nonmagnetic bonding materials, as in a brazed joint. An indication will be produced though the joint itself may be perfectly sound (Figure 3-44).



Figure 3-44. Magnetic Particle Indication of the Braze Line of a Brazed Tool Bit

3.5.3.3.2.5 Segregation of the constituents of the metal, where these have different permeabilities (e.g., low carbon areas in a high carbon steel, or areas of ferrite, which is magnetic, in a matrix of stainless steel which is austenitic and therefore nonmagnetic). Another example would be in the weld zone and/or the heat-affected zone in welds between details of the same alloy (Figure 3-45).

T.O. 33B-1-1

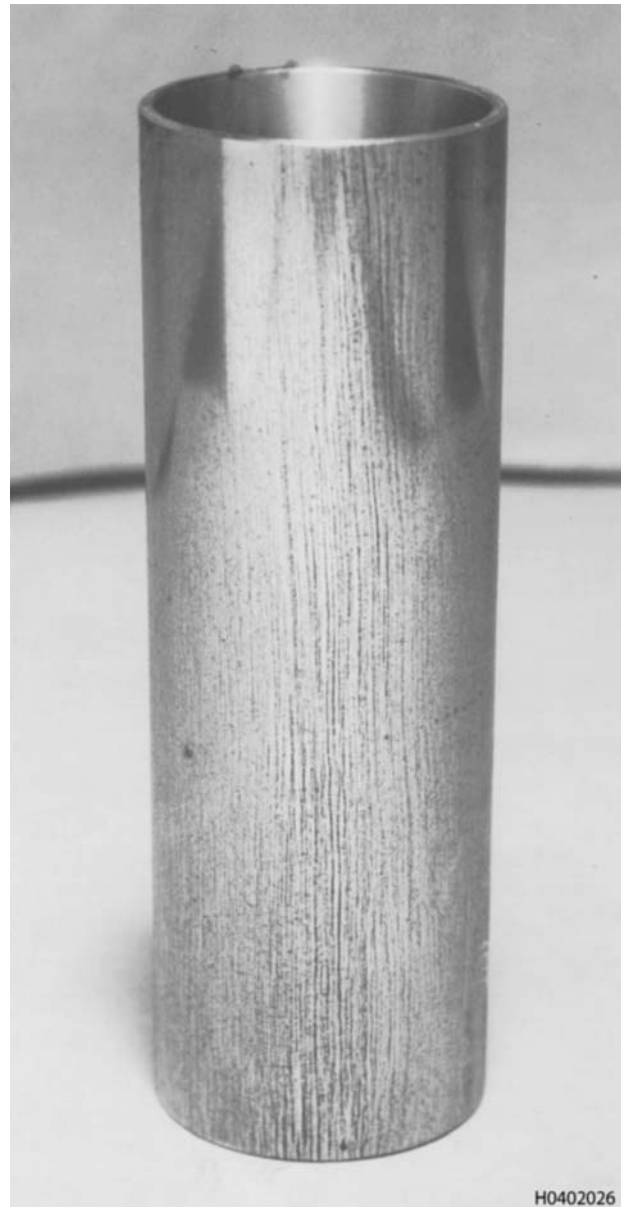


Figure 3-45. Magnetic Particle Indications of Segregations

3.5.4 Classes of Discontinuities. There are a number of ways to classify discontinuities that occur in ferromagnetic materials and parts.

- **Class by Location.** One broad grouping is based on location (surface discontinuity or subsurface discontinuity). The ability of magnetic particle inspection methods to locate members of these two groups varies sharply, but beyond this, the classification is too broad to be very useful.
- **Class by Process.** Another possible system is to classify discontinuities by the process that produced them. Although such a system is too specific to be suitable for all purposes, it is used extensively. When speaking of forming defects, welding defects, heat-treating cracks, grinding cracks, etc. Practically every process, from the original ore refinement to the last finishing operation, can and will introduce discontinuities which magnetic particle testing can find. Therefore, it is important that the nondestructive testing engineer or inspector to be aware of all of these potential defect sources.

3.5.4.1 Conventional Classification System. For many years, it has been customary to classify discontinuities according to their source or origin in the various stages of metal production, fabrication, and use:

- Inherent: Produced during solidification from the liquid state.
- Processing: Primary.
- Processing: Secondary, or finishing.
- Service.

A discussion of each class with detailed examples is given below.

3.5.4.1.1 Inherent Discontinuities. This group of discontinuities is present as the result of its initial metal solidification from the molten state, before any of the operations to forge or roll it into useful sizes and shapes have begun. The names of these inherent discontinuities are given and their sources described below.

3.5.4.1.1.1 Pipe. As the molten steel which has been poured into the ingot mold cools, solidifies first at the bottom and walls of the mold. Solidification progresses gradually upward and inward. The solidified metal occupies a somewhat smaller volume than the liquid, so there is a progressive shrinkage of volume as solidification continues. The last metal to solidify is at the top of the mold, but due to shrinkage there is not enough metal to fill the mold completely, and a depression or cavity is formed. This may extend quite deeply into the ingot (Figure 3-46). After early breakdown of the ingot into a bloom, this shrink cavity is cut away or cropped. If this is not done completely before final rolling or forging into shape, the unsound metal will show up as voids called “pipe” in the finished product. Such internal discontinuities, or pipe, are obviously undesirable for most uses and constitute a true defect. Special devices (“hot tops”) and special handling of the ingot during pouring and solidification can control the formation of these shrink cavities.

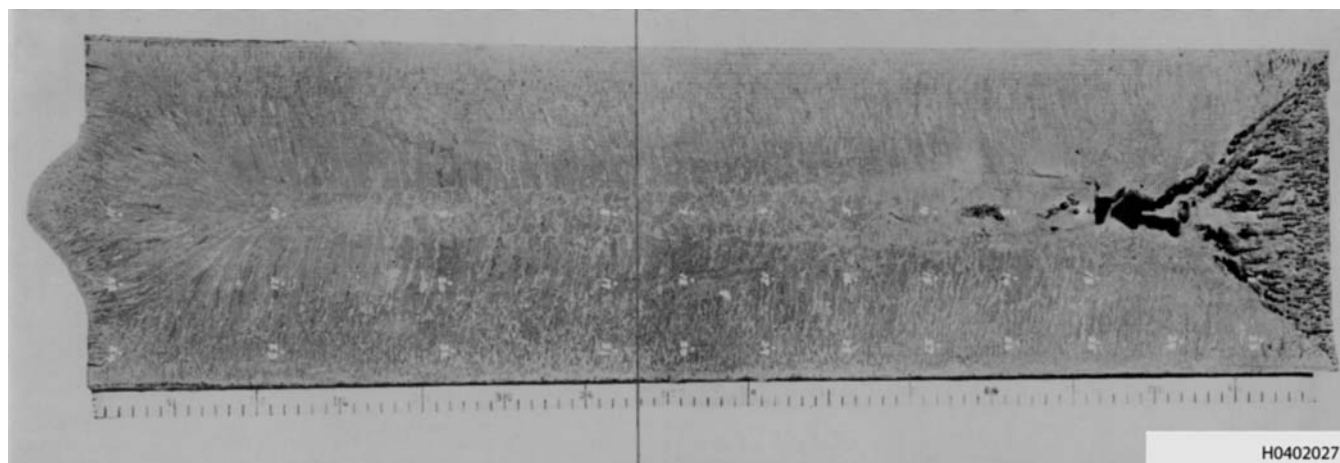


Figure 3-46. Cross-Section of Ingot Showing Shrink Cavity

3.5.4.1.1.2 Blowholes. As the molten metal in the ingot mold solidifies there is an evolution of various gases. These gas bubbles rise through the liquid and a small percentage escape. The remainder is trapped as the metal freezes. Most of these, usually small, will appear near the surface of the ingot; some often large, will be deeper in the metal, especially near the top of the ingot. Many of these blowholes are clean on the interior and are fused shut into sound metal during the first rolling or forging of the ingot, but some near the surface may have become oxidized and do not fuse. These may appear as seams in the rolled product. Those deeper in the interior, if not fused in the rolling, may appear as laminations.

3.5.4.1.1.3 Segregation. Another action that takes place during the solidification is the tendency for certain elements in the metal to concentrate in the last-to-solidify liquid, resulting in an uneven distribution of some of the chemical constituents in the ingot. Various means have been developed to minimize this tendency, but, if for any reason, severe segregation does occur, the difference in permeability of the segregated areas may produce magnetic particle indications. Segregation can adversely affect physical properties as well as contribute to the formation of defects later in the processing cycle.

T.O. 33B-1-1

3.5.4.1.1.4 Nonmetallic Inclusions. Nonmetallic inclusions are usually oxides, sulfides, or silicates. They can be introduced by the use of dirty raw materials, crucibles, or rods. Other contributing factors can be faulty linings and poor pouring practices. The inclusions can form stringers during subsequent rolling operations. These stringers can affect the physical properties of the materials and are usually considered defects. An example of an indication of nonmetallic inclusions is shown (Figure 3-47).

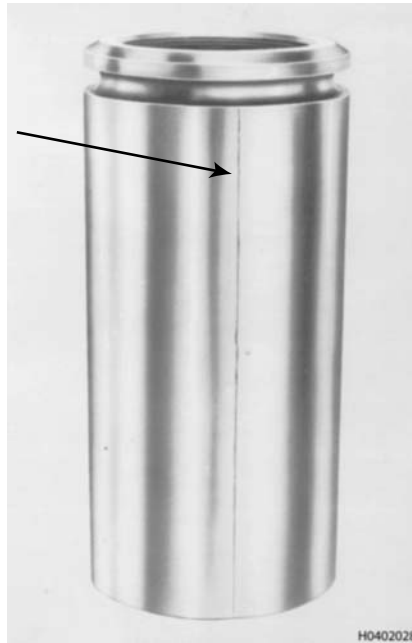


Figure 3-47. Magnetic Particle Indication of a Subsurface Stringer of Nonmetallic Inclusions

3.5.4.1.1.5 Internal Fissures. Because of the stresses setup in the ingot as the result of shrinkage during cooling, internal ruptures may occur, this may be quite large. Since air does not reach the surfaces of these internal bursts, they may be fused during rolling or other forming operations and leave no discontinuity. If there is an opening from the fissure to the surface, however, air will enter and oxidize the surfaces. In this case, fusion does not occur and they will remain in the finished product as discontinuities.

3.5.4.1.1.6 Scabs. When liquid steel is first poured into the ingot mold, there is considerable splashing or spattering up and against the cool walls of the mold. These splashes solidify at once and become oxidized. As the molten steel rises and the mold become filled, these splashes will be reabsorbed to a large extent into the metal. But in some cases they will remain as scabs of oxidized metal adhering to the surface of the ingot. These may remain and appear on the surface of the rolled product. If they do not go deeply into the surface, they may not constitute a defect, since they may be removed by machining. This condition is illustrated (Figure 3-48) on a rolled bloom.

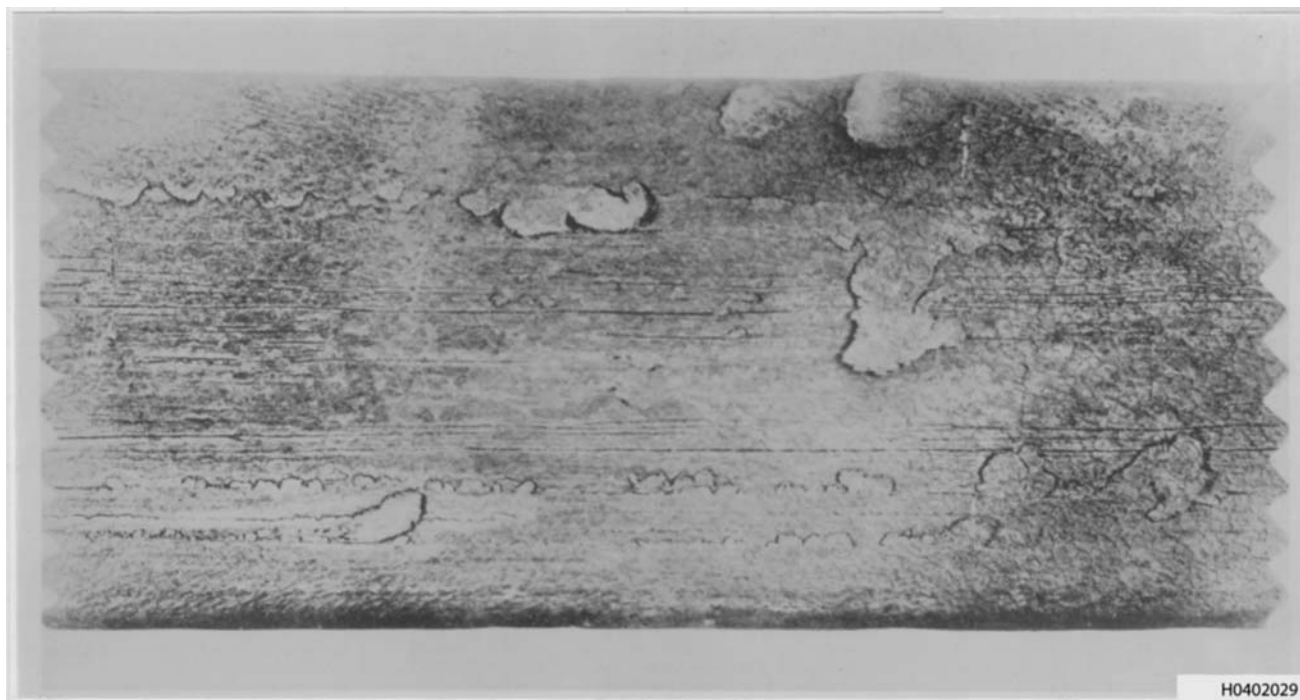


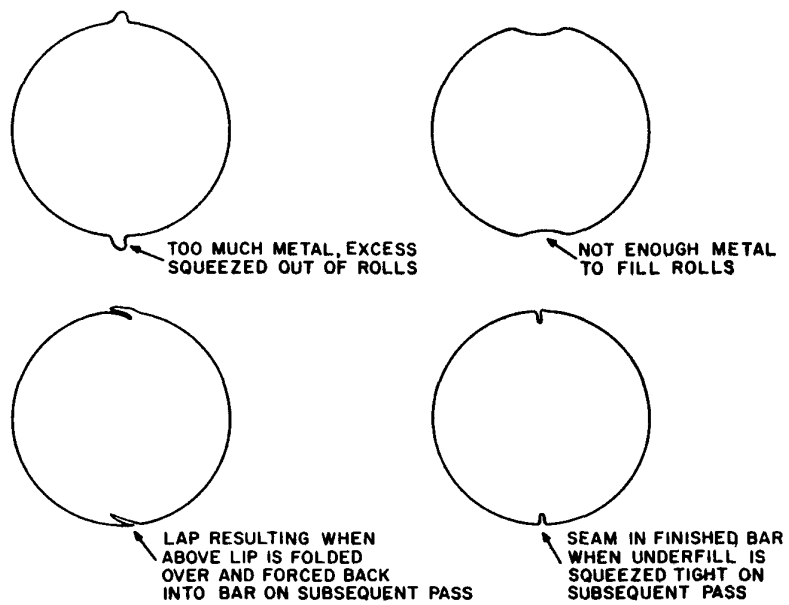
Figure 3-48. Scabs on the Surface of a Rolled Bloom

3.5.4.1.1.7 Ingot Cracks. Surface cracking of ingots occurs due to surface stresses generated during cooling of the ingot. They may be either longitudinal, transverse, or both. As the ingot is formed into billets by rolling, these cracks form long seams. Inspection of billets for seams of this type with magnetic particles is now common practice in modern mills. Detection at this point permits removal of the seams by flame scarfing, chipping, or grinding without waste of good metal. If not removed before further rolling, these seams appear greatly elongated on finished bars and shapes, often making them unsuitable for many purposes.

3.5.4.1.2 Primary Processing Discontinuities. When steel ingots are worked down into usable sizes and shapes such as billets and forging blanks, some of the above described inherent defects may appear, but the rolling and forging processes may also introduce discontinuities that may constitute defects. Primary processes are those which work the metal down by either hot or cold deformation into useful forms such as bars, rod and wire, and forged shapes. Casting is another process usually included in this group. Even though it starts with molten metal it results in a semi-finished product. Welding is included for similar reasons. A description of the discontinuities that can be introduced by these primary processes follows:

3.5.4.1.2.1 Seams. Seams in rolled bars or drawn wire are usually highly objectionable. As previously described, seams may originate from ingot cracks. Conditioning of the billet surfaces by scarfing, grinding, or chipping can eliminate the cracks before final rolling is performed, but seams can be introduced by the rolling or drawing processes themselves. Laps can occur in the rolling of the ingot into billets as the result of overfilling the rolls. This produces projecting fins, which on subsequent passes are rolled into the surface of the billet or bar. In similar fashion, under-fills in the rolling process may on subsequent passes be squeezed to form a seam, which often runs the full length of the bar. Seams derived from laps will usually emerge to the surface of the bar at an acute angle. Seams derived from the folds produced by an under-filled pass are likely to be more nearly normal to the surface of the bar. Seams or die marks may also be introduced in the drawing process due to defective dies. Such seams may or may not make the product defective. For some purposes, such as springs or bars for heavy upsetting, the most minute surface imperfections (or discontinuities) are cause for rejection. For others, where machining operations are expected to remove the outer layers of metal, shallow seams will be machined off (Figure 3-49) and (Figure 3-50).

T.O. 33B-1-1



H0402030

Figure 3-49. How Laps and Seams Are Produced from Overfills and Under-Fills

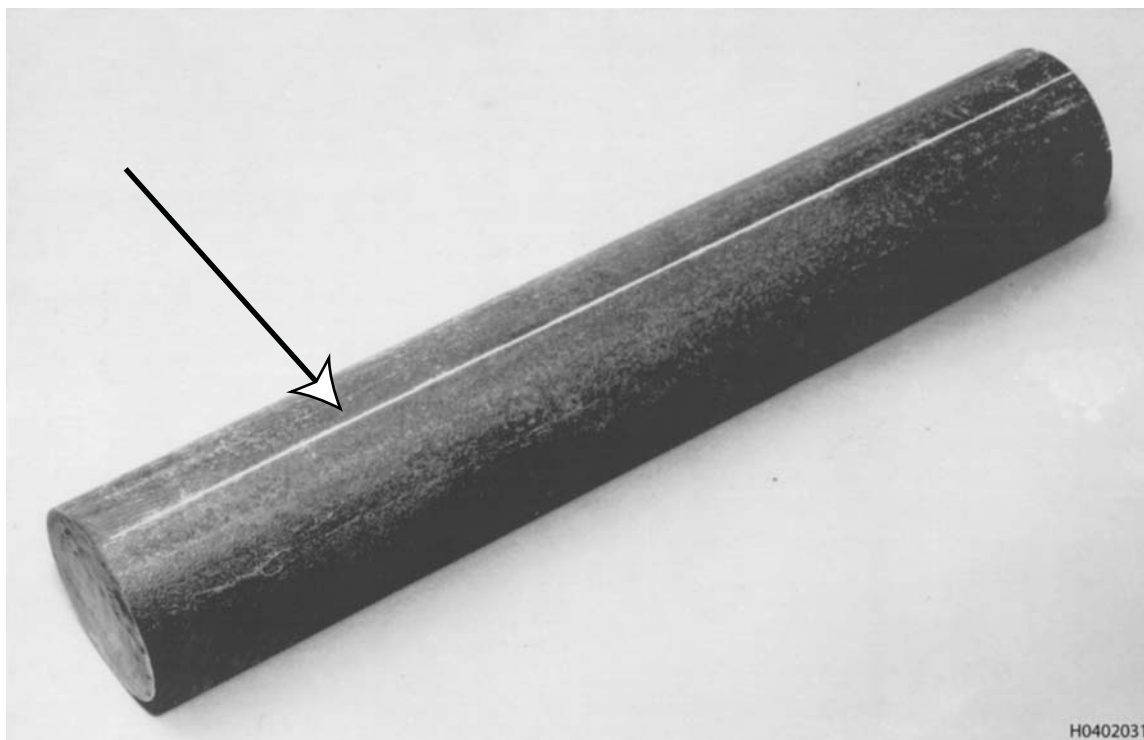


Figure 3-50. Magnetic Particle Indication of a Seam on a Bar

3.5.4.1.2.2 Laminations. Laminations in rolled plate or strip are formed when blowholes or internal fissures are not fused during rolling, but are enlarged and flattened into sometimes quite large areas of horizontal discontinuities (Figure 3-51). Laminations may be detected by magnetic particle testing on the cut edges of plate. The laminations do not give indications on plate or strip surfaces since they are internal and parallel to the surface. Ultrasonic mapping techniques are used to define them.

T.O. 33B-1-1

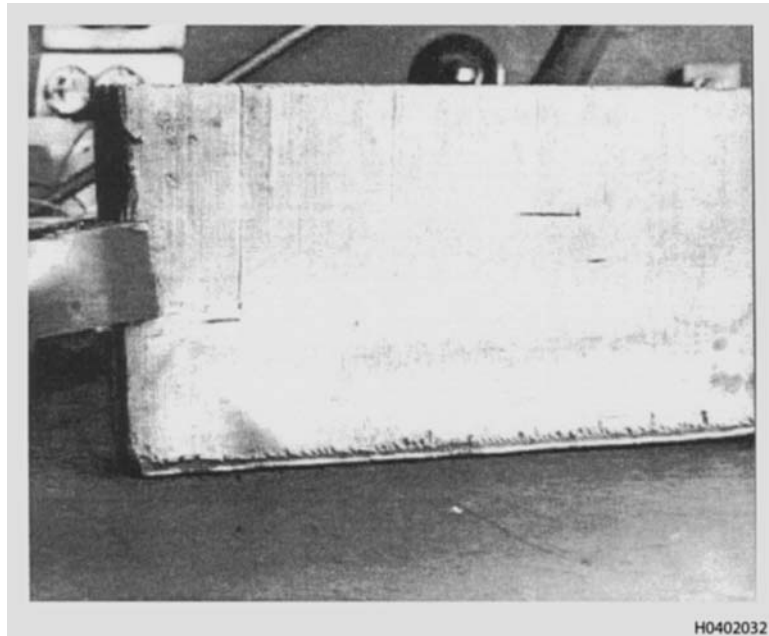


Figure 3-51. Magnetic Particle Indications of Laminations Shown on Flame-Cut Edge of Thick Steel Plate

3.5.4.1.2.3 Cupping. This is a condition created in drawing or extruding when the interior of the metal does not flow as rapidly as the surface. Segregation in the center of the metal usually contributes to this occurrence. The result is a series of internal ruptures that are severe defects whenever they occur. They may be indicated with magnetic particles if the ruptures are large and are near the surface of the part. The cupping problem can be minimized by changing die angles ([Figure 3-52](#)).

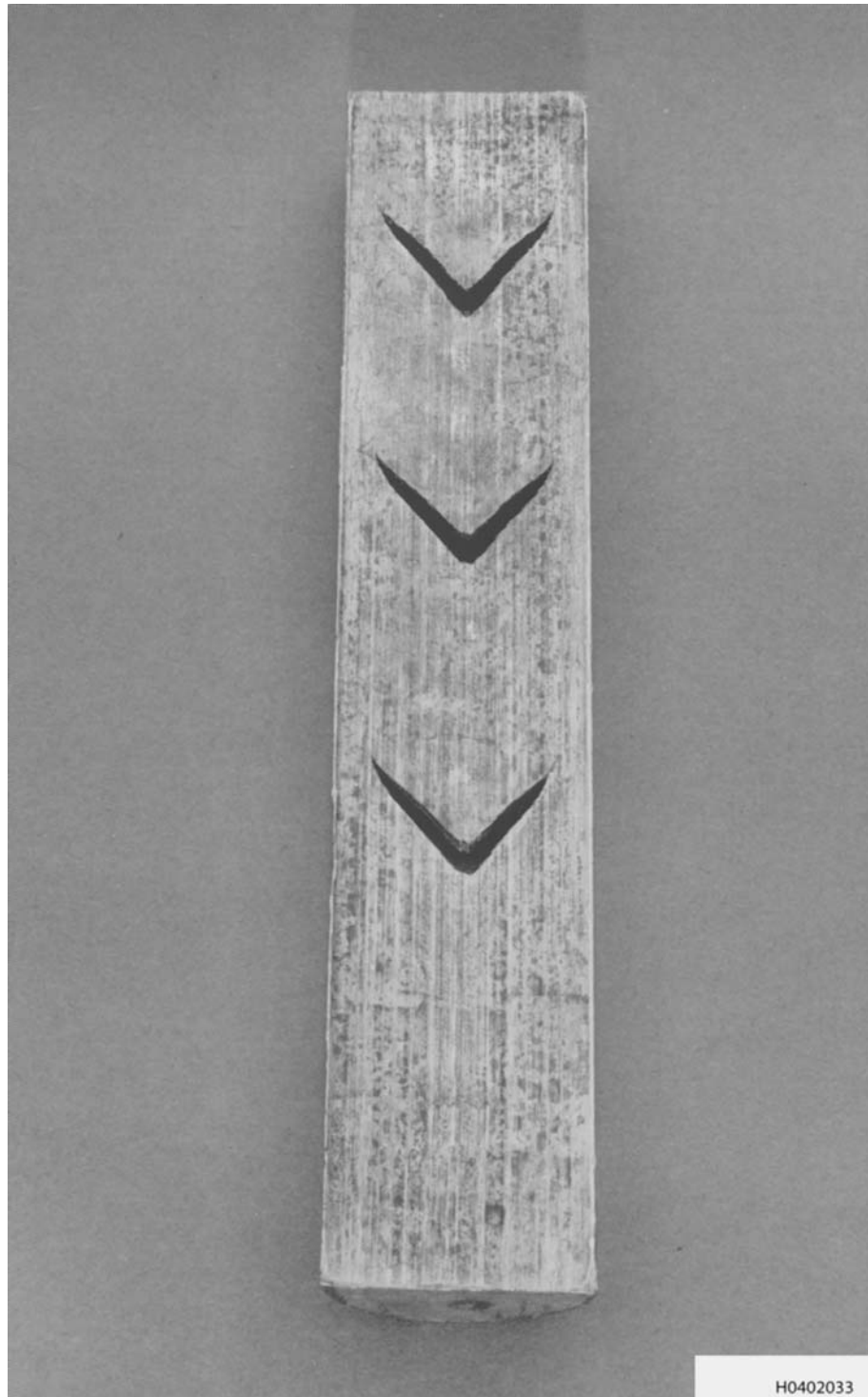


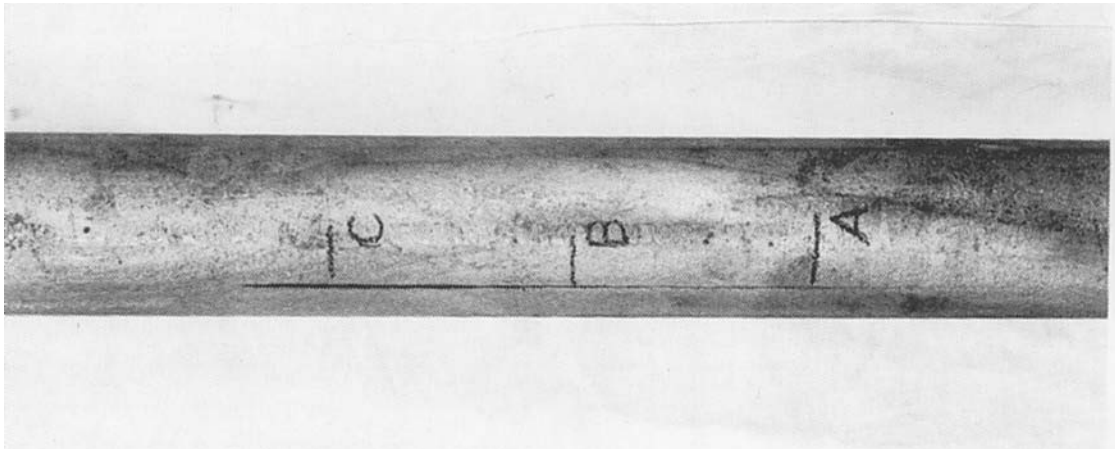
Figure 3-52. Section Through Severe Cupping in a 1 3/8-Inch Bar

3.5.4.1.2.4 Cooling Cracks. When alloy and tool steel bars are rolled and subsequently run out onto a bed or table for cooling, stresses may be set up due to uneven cooling, which can be severe enough to crack the bars. Such cracks are generally longitudinal, but not necessarily straight. They may be quite long and usually vary in depth along their length. The magnetic particle indications of such a crack are shown (Figure 3-53), along with sections through the crack at three points to

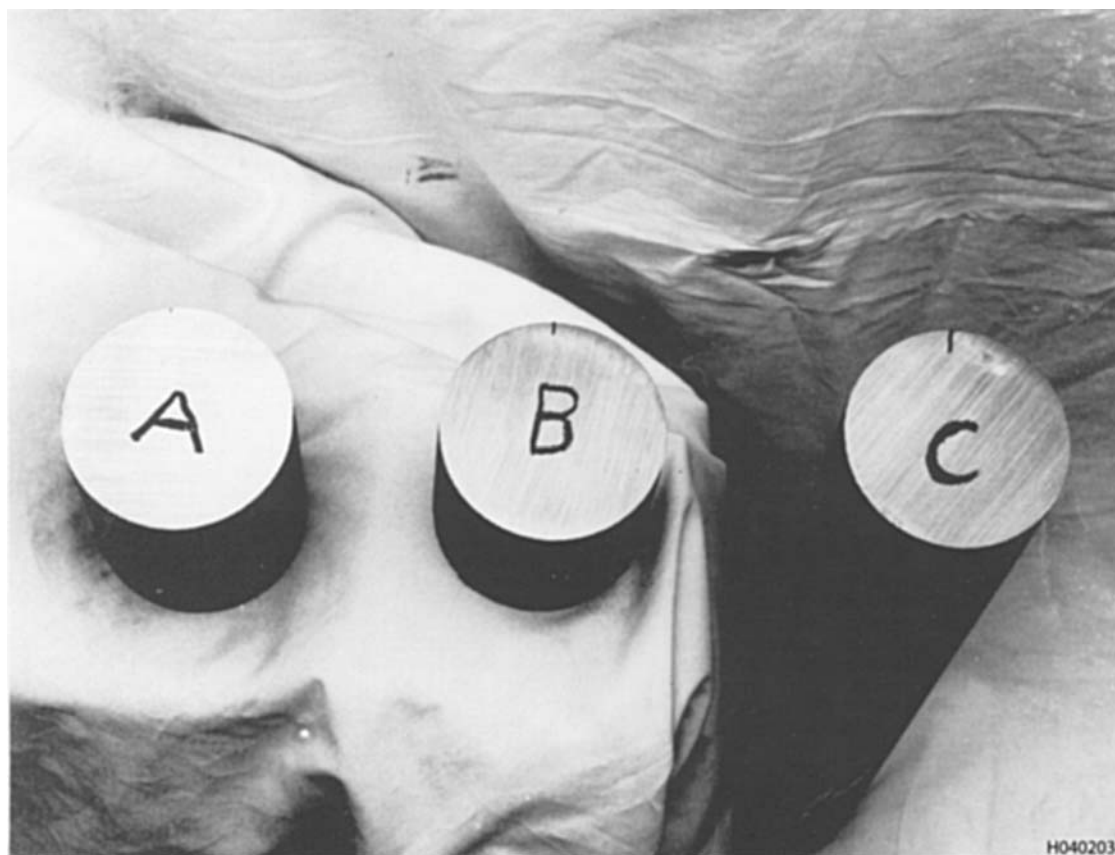
T.O. 33B-1-1

illustrate the variation in crack depth. The magnetic particle indication varies in intensity, being heavier at points where the crack is deepest.

- Surface Indications.
- Cross-Section Showing Depth.



(a) Surface Indications



(b) Cross Section Showing Depth

Figure 3-53. Magnetic Particle Indications of Cooling Cracks in an Alloy Steel Bar

3.5.4.1.2.5 Hydrogen Flakes. Flakes are internal ruptures that may occur in steel as the result of internal stresses from metallurgical changes and decreased solubility of hydrogen from excessively rapid cooling. Flakes usually occurring in fairly

heavy sections and on certain alloys are more susceptible than others. Magnetic particle indications of flakes exposed on a machined surface are shown (Figure 3-54). Since these ruptures are deep in the metal, usually half way or more from the surface to the center of the section, they will not be shown by magnetic particle testing on the original surface of the part.

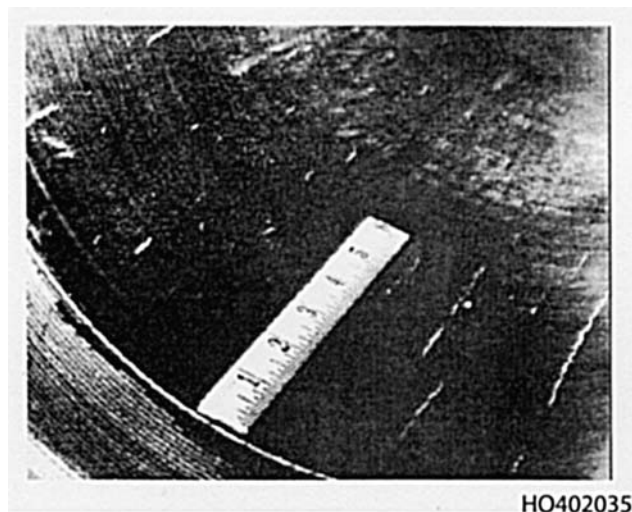


Figure 3-54. Magnetic Particle Indications of Flakes in a Bore of a Large Hollow Shaft

3.5.4.1.2.6 Forging Bursts. When steel is worked at too high a temperature, it is subject to cracking or rupturing. Too rapid or too severe a reduction of section can also cause bursts or cracks. Such ruptures may be internal bursts, or they may be cracks at the surface. Cracks at the surface are readily found by magnetic particle testing. If interior, they are usually not shown except when they have been exposed by machining (Figure 3-55).

T.O. 33B-1-1

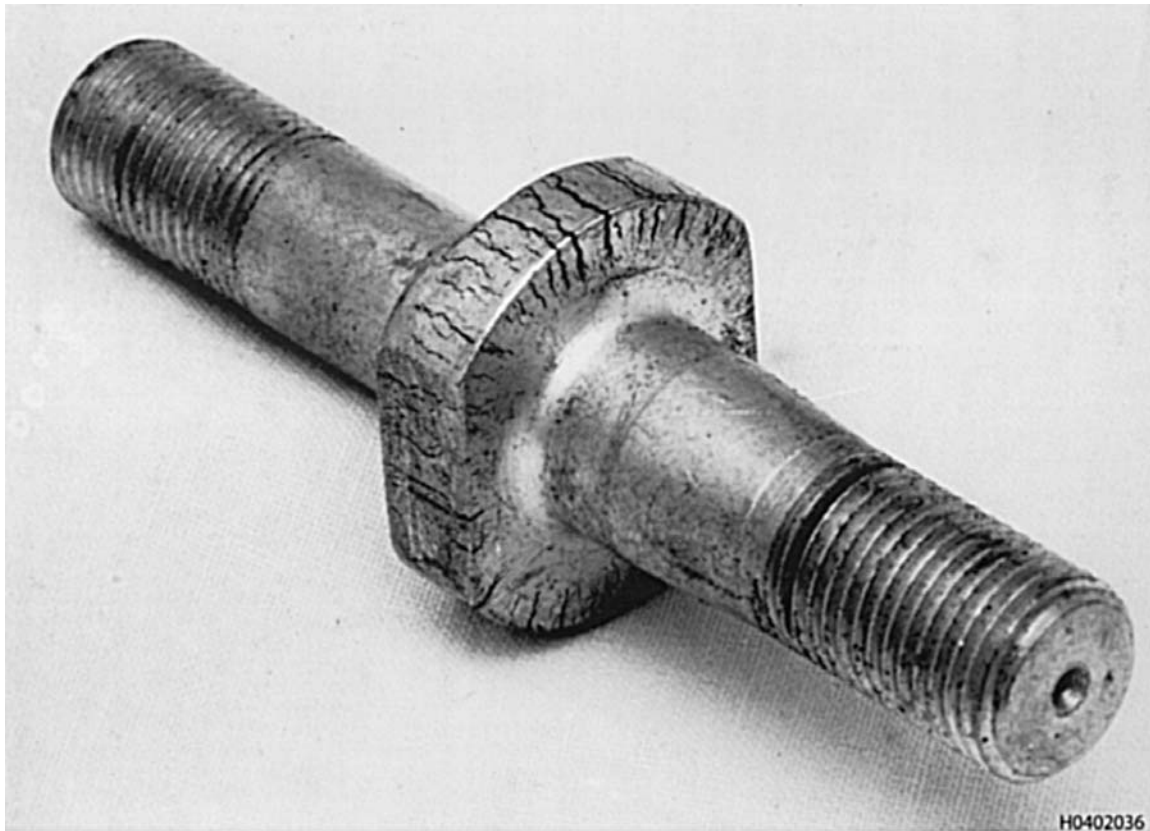


Figure 3-55. Magnetic Particle Indications of Forging Cracks or Bursts in an Upset Section, Severe Case

3.5.4.1.2.7 Forging Laps. As the name implies, forging laps or folds are formed when, in the forging operation, improper handling of the blank in the die causes the metal to flow so as to form a lap, which is later squeezed tight. Since it is on the surface and is oxidized, this lap does not weld shut. This type of discontinuity is sometimes difficult to locate because it may be open at the surface and fairly shallow, and often may lie at only a very slight angle to the surface. In some unusual cases, it also may be solidly filled with magnetic oxides ([Figure 3-56](#)) and ([Figure 3-57](#)).

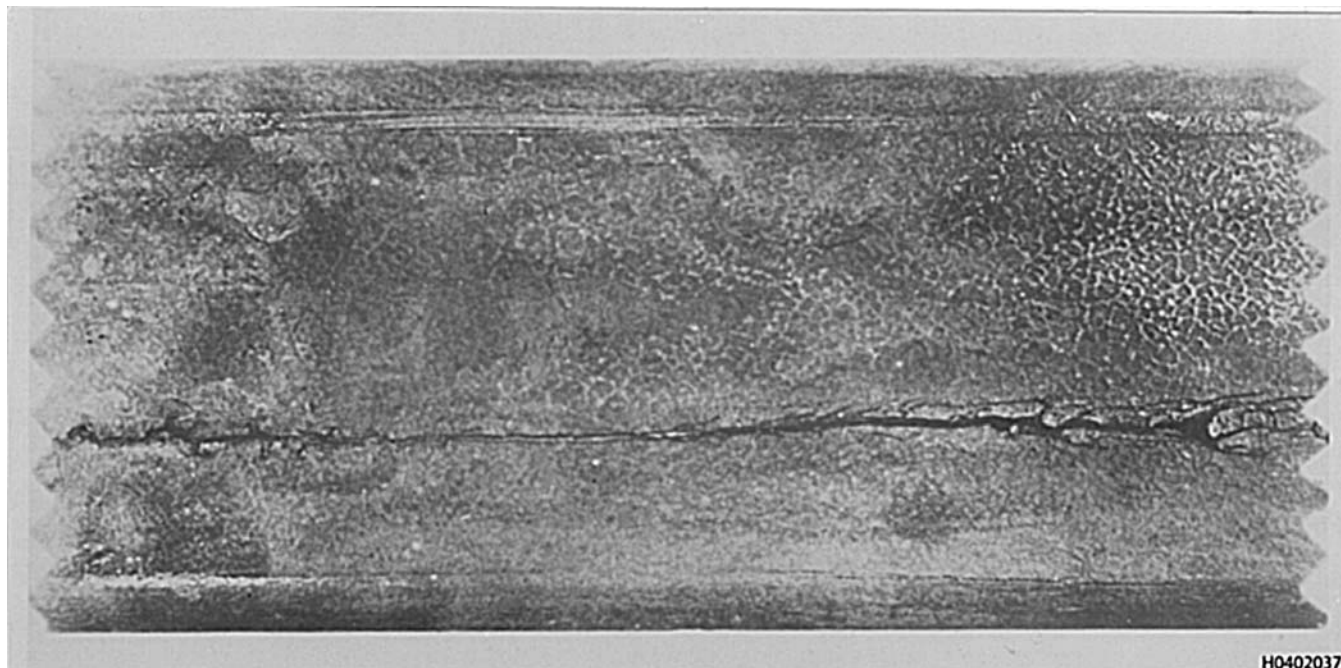


Figure 3-56. Surface of a Steel Billet Showing a Lap

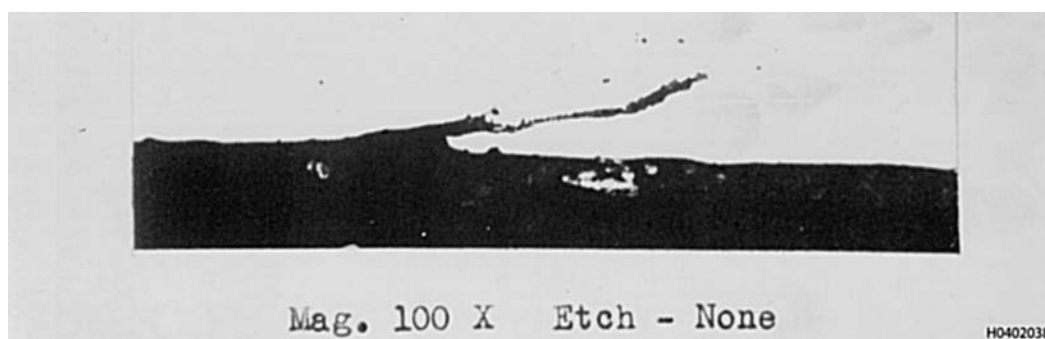


Figure 3-57. Cross Section of a Forging Lap (Magnified 100X)

3.5.4.1.2.8 Burning. Overheating of forgings to the point of incipient melting, which results in a condition that renders the forging unusable, in most cases is referred to as burning. However, the real source of the damage is not oxidation, but the material becoming partially liquefied due to the heat at the grain boundaries. Burning is a serious defect, but is not generally shown by magnetic particle testing.

3.5.4.1.2.9 Flash-Line Tears. Cracks or tears along the flash line of forgings are usually caused by improper trimming of the flash. If shallow, they may “clean up” during machining, otherwise they are considered defects. Such cracks or tears can easily be found by magnetic particles ([Figure 3-58](#)).

T.O. 33B-1-1



Figure 3-58. Magnetic Particle Indication of Flash Line Tear in a Partially Machined Automotive Spindle Forging

3.5.4.1.2.10 Casting Defects. Steel and iron castings are subject to a number of defects which magnetic particle testing can easily detect. Surface discontinuities are formed in castings due to stresses resulting from cooling and are often associated with changes in the cross section of the part. These may be hot tears or they may be shrinkage cracks that occur as the metal cools down. Sand from the mold can be trapped by the hot metal and form sand inclusions on or near the surface of castings. Gray iron castings may be quite brittle, and can be cracked by rough handling ([Figure 3-59](#)).



Figure 3-59. Magnetic Particle Indications of Defects in Castings

3.5.4.1.2.11 Weld Defects. A variety of discontinuities may be formed during welding. Some are at the surface and some are in the interior of the weldment. Some of the defects peculiar to weldments are lack of penetration, lack of fusion, undercutting, cracks in the weld metal, crater cracks, cracks in the heat affected zone, etc.

3.5.4.1.3 Secondary Processing or Finishing Discontinuities. In this group are those discontinuities associated with the various finishing operations after the part has been rough-formed by rolling, forging, casting, or welding. Discontinuities may be introduced by machining, heat treating, grinding, and similar processes. These are described below:

3.5.4.1.3.1 Machining Tears. These are caused by dragging of the metal under the tool when it is not cutting cleanly. Soft and ductile low carbon steels are more susceptible to this kind of damage than are the harder, higher carbon or alloy types. Machining tears are surface discontinuities and are readily found with magnetic particles.

3.5.4.1.3.2 Heat Treat Cracks. When steels are heated and quenched to produce desired properties for strength or wear, cracking may occur if the operation is not correctly suited to the material and shape of the part (**Figure 3-60**). Most common are quench cracks, caused when parts are heated to high temperatures and then suddenly cooled by immersing them in some cool medium, which may be water, oil, or even air. Such cracks often occur at locations where the part changes cross section or at fillets or notches in the part. The edges of keyways and the roots of splines or threads are likely spots for quench cracks to occur. Cracks may also result from too rapidly heating the part, which may cause uneven expansion at changes of cross section or at corners where heat is absorbed more rapidly than in the body of the piece. Corner cracking may also occur during quenching, because of more rapid heat loss at such locations. Heat treat cycles can be designed to minimize or eliminate such cracking; but for critical parts, testing with magnetic particle is a safety measure usually applied, since such cracks are serious and easily detectable.



Figure 3-60. Magnetic Particle Indications of Quenching Cracks Shown With Dry Powder

3.5.4.1.3.3 Straightening Cracks. The process of heat treating often causes some warping of the part due to non-uniform cooling during quenching. A hardened shaft, for example, may come from the heat treat operation not quite straight. In many cases, these can be straightened in a press, but if the amount of bend required is too great or if the shaft is too brittle, cracks may be formed. Again, these are very readily found with magnetic particles.

3.5.4.1.3.4 Grinding Cracks. Surface cracking of hardened parts as the result of improper grinding is frequently a source of trouble. Grinding cracks are essentially thermal cracks. They are caused by stresses set up by local heating under the grinding wheel. They are avoidable by using proper wheels, cuts, and coolants. They are sharp surface cracks and they are easily

T.O. 33B-1-1

detected with magnetic particle inspection. Such surfaces usually crack severely and extensively, as illustrated in (Figure 3-61) and (Figure 3-62).

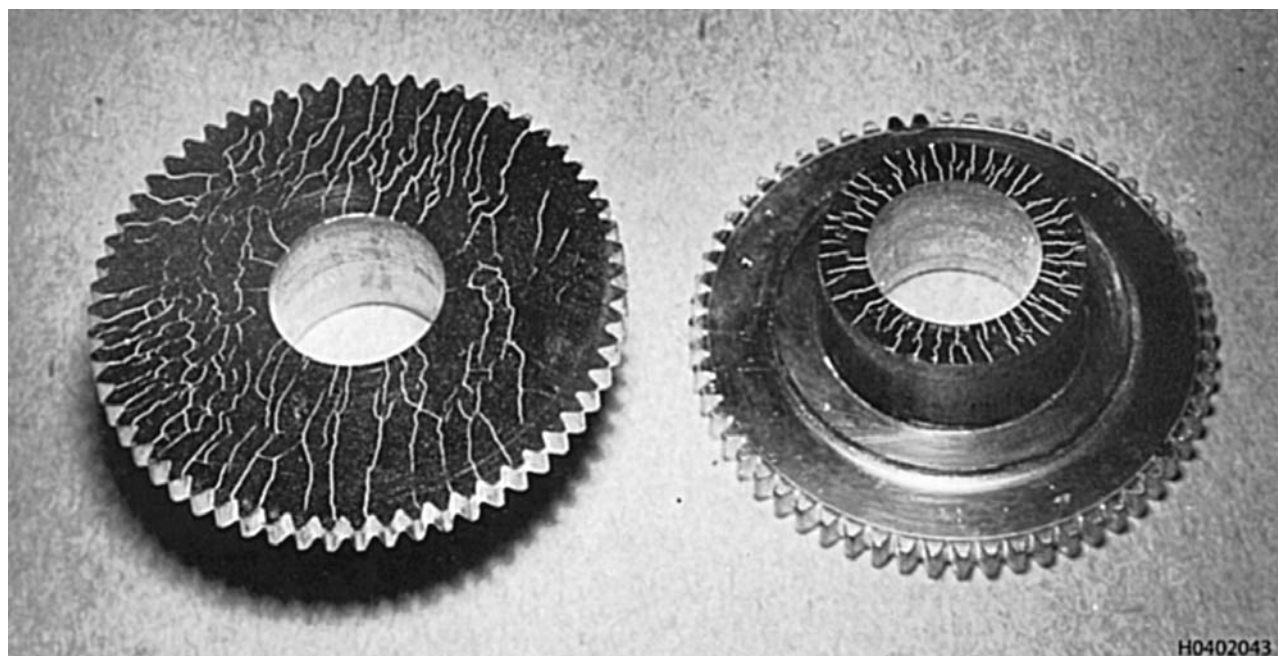


Figure 3-61. Fluorescent Magnetic Particle Indications of Typical Grinding Cracks

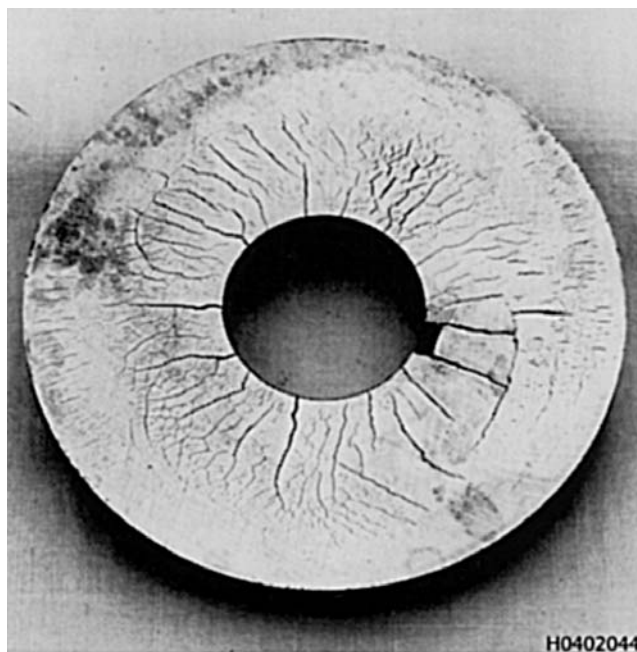


Figure 3-62. Magnetic Particle Indications of Grinding Cracks in a Stress-Sensitive, Hardened Surface

3.5.4.1.3.5 Etching and Pickling Cracks. Hardened or cold worked parts, that contain high internal and external residual stresses, may crack if they are pickled or etched in acid. Acid attack of the surface layers of the metal gives the internal stress a chance to be relieved by the formation of a crack. Before this action was fully understood, the heat treatment of the part was often blamed for the cracking. The heat treat operation did, however, deserve some of the blame by leaving the part with high residual stresses.

3.5.4.1.3.6 Plating Cracks. Plating can introduce high residual stresses at the plated surface and thus create the potential for cracking. The hot galvanizing process itself may also produce cracks in surfaces containing residual stresses by the penetration of hot zinc into the grain boundaries. Copper penetration during brazing may result in similar cracking if the parts contain residual stress (Figure 3-63).

T.O. 33B-1-1

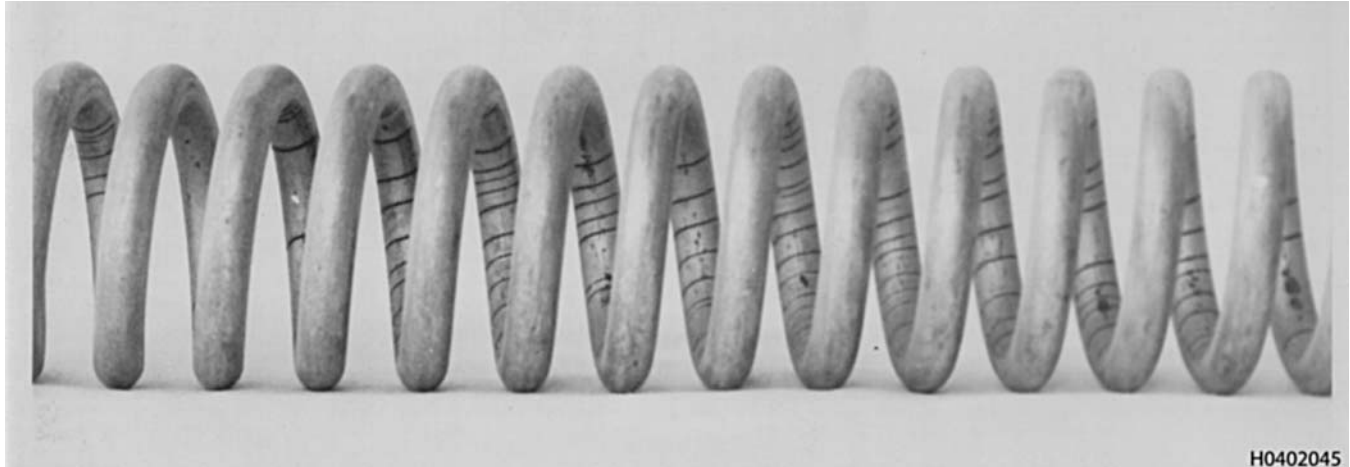


Figure 3-63. Magnetic Particle Indications of Plating Cracks

3.5.4.2 Service Cracks.

CAUTION

When performing magnetic particle inspection on landing gear parts, the paint **SHALL** be removed. Some landing gear components are vulnerable to stress-corrosion cracking and are cadmium plated for their protection. Thus, the primer layer **MAY** remain on the part. Damage to the cadmium plating **SHALL** be avoided.

The fourth major classification of discontinuities comprises those formed or produced after all fabrication has been completed and the part has gone into service. The objective of magnetic particle testing to locate and eliminate discontinuities during fabrication is to put the part into service free from defects. However, even when this is accomplished, failures in service still occur as a result of cracking caused by service conditions.

3.5.4.2.1 Fatigue Cracks. Fatigue stress will eventually cause cracks, and finally fracture. Fatigue cracks, even very shallow ones, can readily be found with magnetic particles ([Figure 3-64](#)) and ([Figure 3-65](#)).



Figure 3-64. Magnetic Particle Indication of a Typical Fatigue Crack

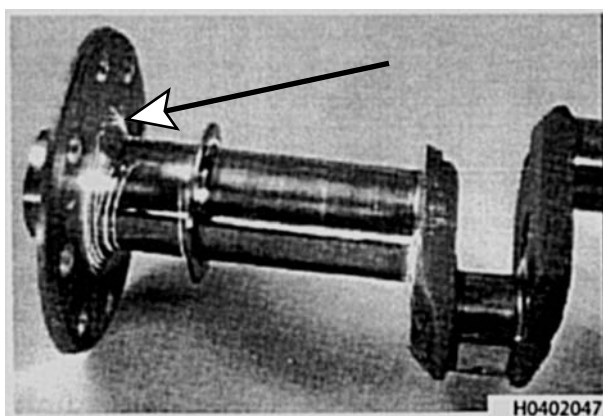


Figure 3-65. Fluorescent Magnetic Particle Indications of Cracks in Crankshaft of Small Aircraft Engine Damaged in Plane Accident

3.5.4.2.2 Stress-Corrosion Cracks. Parts under either residual or applied tensile stress and exposed to a corrosive environment may develop stress-corrosion cracking. The primary role of corrosion in this cracking mode is to produce hydrogen. The hydrogen migrates to the tip of a stress-corrosion crack where its presence increases the stresses at the tip, thus driving the crack even deeper. When corrosion is added to a fatigue-producing service condition, this type of service failure is called corrosion fatigue.

3.5.4.2.3 Overstressing. Parts stressed beyond the level for which they were designed can crack or break. Such overstressing may occur as the result of an accident, a part may become overloaded due to some unusual or emergency condition not anticipated by the designer, or a part may be loaded beyond its strength because of the failure of some related member of the structure. After complete failure has occurred, magnetic particle testing obviously has no application with regard to the fractured part. However, other parts of the assembly, that may appear undamaged, could have been overstressed during the accident or overloaded from other causes. Examination by magnetic particle testing is usually carried out in such cases to determine whether any cracks have actually formed.

T.O. 33B-1-1

3.5.4.3 Other Sources of Discontinuities. In this section, an attempt has been made to familiarize the reader with most of the common sources of discontinuities that can occur in iron and steel. Actually, the list given here is incomplete, but the inspector working with magnetic particle testing will encounter these discontinuities more frequently than those from less common conditions. The inspector will often have the metallurgical laboratory of a support organization available for consultation, and the metallurgist will usually be able to assign a cause to an indicated discontinuity and assess its importance.

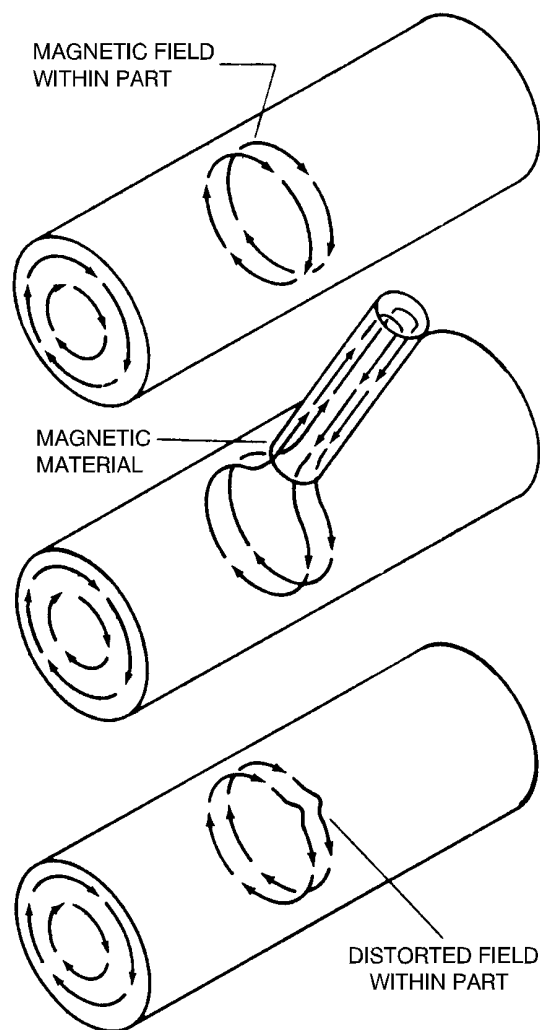
3.5.5 Non-Relevant Indications.**3.5.5.1 Nature and Type.****NOTE**

It is easier to distinguish between relevant and non-relevant indications when using fluorescent rather than visible magnetic particles.

It is possible to magnetize parts of certain shapes in such a way that magnetic leakage fields are created even though there is no discontinuity in the metal at that point. Such indications are sometimes called erroneous indications or false indications. They should be called “non-relevant indications” since they are actually caused by distortion of the magnetic field. They are true indications, but since there is no unintentional interruption of the material, they do not affect the usefulness of the part. It is important for the inspector to know how and why these non-relevant indications are formed and where they can occur.

3.5.5.2 Classes of Non-Relevant Indications.

3.5.5.2.1 Magnetic Writing. This is a condition caused by a piece of steel rubbing against another piece of steel that has been magnetized. Since either or both pieces contain some residual magnetism, the rubbing or touching creates magnetic poles at the points of contact. These local magnetic poles are usually in the form of a line or scrawl, and for this reason the effect is referred to as magnetic writing. In (Figure 3-66) the part in the top view is magnetized with a circular field. If another part made of magnetic material is rubbed against or comes into contact with the magnetized part, as in the second view, a weak field will be induced into the smaller part. After the smaller part has been removed, the circular field in the original part will be altered or distorted to some extent, as shown in the bottom view. Since there is no force to change the direction of the altered field, there will be some leakage at the point of distortion that will attract magnetic particles.



H0402048

Figure 3-66. Creation of Magnetic Writing

3.5.5.2.2 Longitudinal Magnetization. When a part is longitudinally magnetized in a coil, there are always magnetic poles at the ends of the piece. Magnetic material such as chips, magnetic powder, or paste will be attracted to these poles. The same situation occurs when a yoke is used to create a magnetic field; poles are induced on the part in the areas where the yoke touches the part.

3.5.5.2.3 Cold Working. Cold working consists of changing the size or shape of a metal part without raising its temperature before working. When a bent nail is straightened by a carpenter with a hammer, the nail is being cold worked. Cold working usually causes a change in the permeability of the metal where the change in size or shape occurs. The boundary of the area of changed permeability may attract magnetic particles when the part is magnetized.

3.5.5.2.4 Hard or Soft Spots. If there are areas of a part which have a different degree of hardness than the remainder of the part, these areas will usually have a different permeability. When a part with such areas of different permeability is inspected with magnetic particle inspection, the boundaries of the areas may create local leakage fields and attract magnetic particles to form indications.

T.O. 33B-1-1**3.5.5.2.5 High Temperature Exposure.**

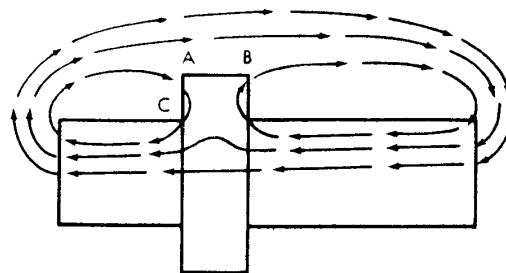
3.5.5.2.5.1 Boundaries of Heat Treated Sections. Heat treating a part consists of heating it to a high temperature and then cooling it under controlled conditions. The cooling may be relatively rapid or it may be done to decrease the hardness or the grain size of the metal by varying the temperature and the rate of cooling. On a cold chisel, the point is hardened to cut better and to hold an edge. The head of the chisel, which is the end struck by the hammer, is kept softer than the cutting edge so it won't shatter and break. The edge of the hardened zone frequently creates a leakage field when the chisel is inspected with magnetic particle inspection.

3.5.5.2.5.2 Delta Ferrite.**NOTE**

Delta Ferrite is brittle and has historically been considered a defect in applications such as aircraft exposed to tensile and cyclic loading. While the presence of delta ferrite does not indicate an actual defect, such a region would be a preferential crack initiation area.

Delta Ferrite is a ferromagnetic phase of steel that occurs at elevated temperatures. This phase primarily occurs at normal temperatures because of rapid cooling after prolonged exposure to high temperatures. A concentrated region of delta ferrite may cause non-relevant indications along the region's boundary due to the magnetic disturbance caused by its presence.

3.5.5.2.6 Abrupt Changes of Section. Where there are abrupt changes in section (e.g., thickness of a magnetized part), the magnetic field may be said to expand from the smaller section to the larger. Frequently, this creates local poles due to magnetic field leakage or distortion. If a part, as shown in (Figure 3-67), is magnetized in a coil, poles are setup at each end and some leakage occurs at A and B. Also, the change of section at C is quite abrupt and there may be a leakage across this corner as shown. These leakage fields will attract magnetic particles, thereby creating an indication. The indications formed at A and B are usually very easily interpreted; that at C may be more difficult to recognize as being non-relevant. If the indication is continuous around the shaft, it should be suspected as being caused by the shape of the part rather than by a discontinuity. The non-relevant indication at C will usually be "fuzzy" like an indication, which is produced by a defect beneath the surface. If there is a crack or discontinuity in that area, it will usually produce a sharper indication and it probably will not run completely around the part.



H0402049

Figure 3-67. Local Poles Created by Shape of Part

3.5.5.2.6.1 On parts with keyways, a circular magnetic field can also setup non-relevant indications as in (Figure 3-68). Particle accumulations may occur at A where there are leakage fields. A keyway on the inside of a hollow shaft may also create indications on the outside, as indicated at area B in (Figure 3-69).

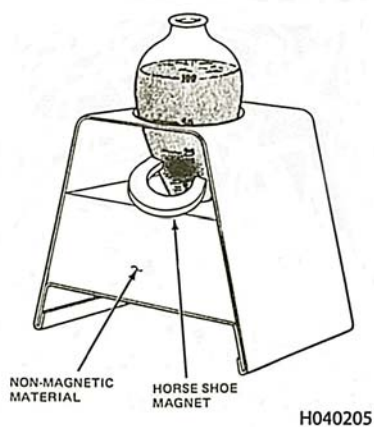


Figure 3-68. Concentration of Field in a Keyway

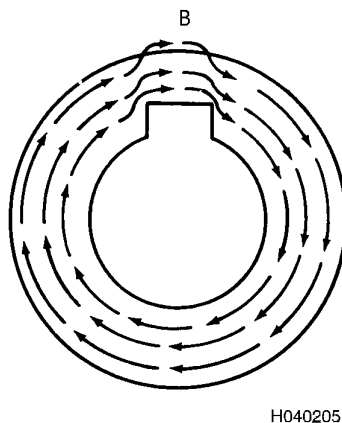


Figure 3-69. External Leakage Field Created by an Internal Keyway

3.5.5.2.6.2 The gear and spline shown in (Figure 3-70) were magnetized circularly by passing current through a central conductor. The reduced cross section created by the spline ways constricts the magnetic lines of force and some of them break the surface on the outside diameter. Particles gather where the magnetic lines of force break through the surface, thereby creating indications. A non-relevant indication is shown (Figure 3-71) on the underside of a bolt head. The slot in the head causes the indication here.

T.O. 33B-1-1

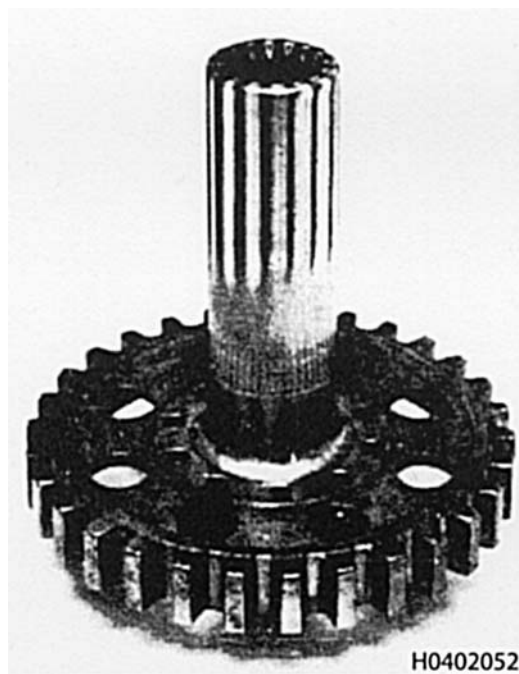


Figure 3-70. Non-Relevant Indications of Shaft Caused by Internal Spline

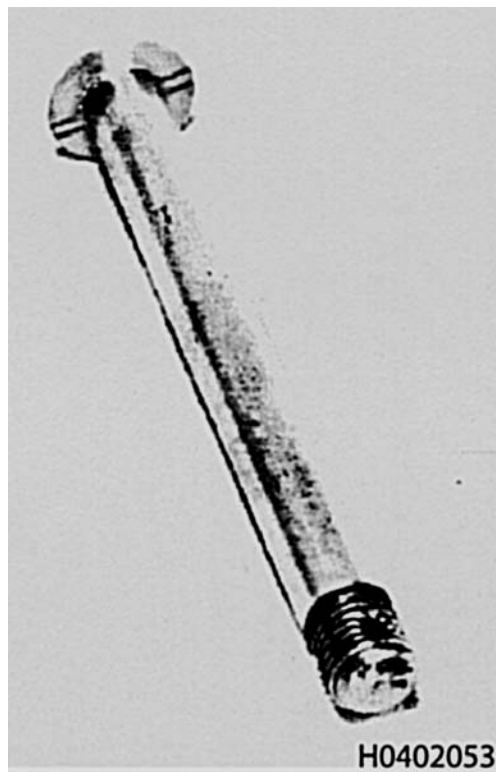


Figure 3-71. Non-Relevant Indications Under the Head Created by Slot in Bolt

3.5.6 Interpretation and Elimination of Non-Relevant Indications.

3.5.6.1 Interpretation. It may first appear to the inspector that some types of non-relevant indications discussed and illustrated in the preceding material would be difficult to recognize and interpret. For example, the non-relevant indications shown in (Figure 3-70) and (Figure 3-71) may look like indications of subsurface discontinuities. However, there are several characteristics of non-relevant indications that will enable the inspector to recognize them in the example cited and under most other conditions. These characteristics of non-relevant indications are:

- On all similar parts, given the same magnetizing technique, the indications will occur in the same location and will have identical patterns. This condition is not usually encountered when dealing with real subsurface defects.
- The indications are usually uniform in direction and size.
- The indications are usually ‘fuzzy’ rather than sharp and well defined.
- Non-relevant indications can always be related to some feature of construction or cross section, which accounts for the leakage field creating the indication.

3.5.6.2 Elimination of Non-Relevant Indications. Although non-relevant indications can be recognized in most cases, they do tend to increase the inspection time, and under certain conditions may mask or cover up indications of actual defects. Therefore, it is desirable to eliminate them whenever possible.

3.5.6.2.1 In most cases, non-relevant indications occur when the magnetizing current is higher than necessary for a given part. Consequently, these indications will disappear if the part is demagnetized and reinspected using a sufficiently low magnetizing current. Under most conditions, the value of magnetizing current that is low enough to eliminate non-relevant indications will still be sufficient to produce indications at actual discontinuities. This will be true where the non-relevant indication is magnetic writing, and for several other types, but may not hold where there are abrupt changes of section. It is therefore desirable to determine whether the non-relevant indication was caused by an abrupt change of section before re-inspecting.

3.5.6.2.2 The proper procedure is to demagnetize and reinspect the part using a lower value of magnetizing current, repeating the operation with still lower current if necessary until the non-relevant indications disappear. Care SHALL be taken not to reduce the current below the value required to produce indications of all actual discontinuities. Where there are abrupt changes of section, two inspections may be required:

- a. Conduct the first inspection at fairly low amperage, in order to inspect only the areas at the change in section.
- b. Conduct the second inspection at a higher current value, in order to inspect the remainder of the part.

Another solution is to use AC magnetization for inspection. AC magnetization responds less to changes in cross section than DC magnetization and is acceptable when it is not necessary to inspect for subsurface defects.

3.5.7 Methods of Recording MPI Indications.

3.5.7.1 General. The full value of magnetic particle inspection can be realized only if records are kept of parts inspected and the indications found. As with any inspection, the size and shape of the indication and its location on the part should be recorded along with other pertinent information such as rework performed or disposition. The inclusion of some visible record of the indications on a report makes the report much more complete.

3.5.7.2 Type of Records. The simplest record is a sketch of the part showing location and extent of the indications. On large parts, it may be sufficient to sketch only the critical area. Other types of records include preserving the actual indication on the part (where the part is to be kept for reference), transferring the indication from the part to a record sheet or report, and photographing the indication. These last three methods will be discussed in this section.

3.5.7.3 Preserving Indications on a Part.

3.5.7.3.1 Fixing Indications with Lacquer. One of the advantages of magnetic particle inspection is the indication is formed directly on the part at the exact spot of the magnetic leakage field. This makes it possible to retain the part itself for record purposes, but it is necessary to fix or preserve the indication on the part; so the part can be handled and examined without smudging or smearing the indication. One method of fixing the indication semi-permanently on the part is by using clear lacquer. The part SHALL be dry to do this; if the wet method has been used to develop the indication, the vehicle SHOULD be allowed to evaporate. Normal evaporation can be accelerated by heating the part and is usually sufficient for water; it is also possible to flow on isopropyl alcohol or other solvent that will evaporate rapidly and leave the indication dry

T.O. 33B-1-1

on the part. For an oil vehicle, use of a solvent is almost necessary to provide a dry indication in a reasonable time. It is usually desirable to thin out the clear lacquer by adding lacquer thinner. The lacquer should either be sprayed on the part or flowed on since brushing would smear the indication.

3.5.7.3.2 Applying Transparent Tape. It is also possible to preserve an indication on a part by covering it with transparent pressure sensitive tape (such as Scotch brand). This method is not as neat looking as the lacquer method, but it is easier to apply. Before applying the tape, the vehicle used in the wet method SHOULD be removed in the same manner as when using lacquer.

3.5.7.4 Tape Transfers. An accurate record of an indication can be obtained by lifting the particles forming the indication from the part with transparent pressure sensitive tape (such as Scotch brand), and then placing the tape on stiff white paper. The procedure for taking tape transfers is simple and can be accomplished quickly and accurately with a little practice. If a report is being made and it is necessary to duplicate the indication, mount the tape transfer on a sheet of clear plastic and use a standard duplicating process or prepare a photographic negative and contact print. When tape transfers are taken of indications, it is customary to sketch the part and locate the position of the preserved indication on the sketch.

3.5.7.4.1 Dry Particle Tape Transfers. If the indication is formed of dry powder particles, excess powder can be removed from the surface by gently blowing. Use a piece of tape larger than the indication and gently cover the indication with the tape. Gentle pressure should be applied so the adhesive will pick up the particles; do not press too hard or the indication will be flattened too much and the tape may be difficult to remove. Carefully lift the tape from the part and press it onto the record sheet or report. It is easier to remove the tape if a corner of it is not pressed to the part. Leaving a tab for easy removal.

NOTE

Tape preserved indications are usually a little broader than indications on the part because of the flattening effect of the tape.

3.5.7.4.2 Wet Particle Tape Transfers. If the indication is formed of particles used with the wet method, it is necessary to dry the surface of the part prior to applying the tape as described in (paragraph 3.5.7.4.1).

3.5.7.4.3 Fluorescent Tape Transfers. Tape transfers can be taken of fluorescent particle indications, but there are some disadvantages to the process. Such preserved indications usually must be viewed under black light to properly interpret them since the number of particles in the suspension is much less than when using visible particles. Some transparent tape is fluorescent and the fluorescence of the tape may mask the fluorescence of the indication.

3.5.7.5 Alginate Impression Compound Method. The alginate impression compound method of "lifting" magnetic particle indications is a method of securing indications in areas inaccessible and that cannot be viewed with a black light.

3.5.7.5.1 Alginates are hydrocolloid polysaccharides derived from seaweed kelp. Compounds such as those used for making dental impressions are based on mixtures of potassium alginate, calcium sulfate, sequestering agents such as sodium phosphate, and fillers such as silica, diatomaceous earth, or calcium carbonate. When the compound is mixed with the correct amount of water it forms a soft paste that sets up to a rubbery solid in three to four minutes. This rubbery material or gel has the property of accurately conforming to and taking an impression of the surface to which it is applied, and also absorbing or lifting traces of particulate material from the surface. This latter property is the basis for its use as an indication lifting material.

3.5.7.5.2 Transferring Indications with Alginate Impression Compound.

- a. Perform the magnetic particle inspection of the area of interest in the usual manner.
- b. The part does not have to be dried before taking an impression.
- c. Using the plastic scoop and water measuring container, follow the directions given on the can of powder and mix the powder with water to obtain a smooth creamy paste.
- d. Transfer the paste immediately to a piece of thin polyethylene film, and then apply the paste to the inspecting area. Gently press against the film to obtain a uniform contact of the paste against the inspection area. Avoid excessive working of the paste to avoid smearing of the indication. The plastic film prevents the paste from sticking to the hand. For cavities such as holes, the paste can be applied without the polyethylene film to form a plug when set.

- e. After the paste has set to a rubbery gel, in about 3 - 4 minutes, gently remove the replica from the metal part and examine under ultraviolet light. The replica may be photographed with ultraviolet light if desired.

3.5.7.6 Photographing Indications. Photographs may also be taken of indications to produce records. Enough of the part should be shown to make it possible to recognize the part and the position of the indication. It is helpful to include in the picture some common object to show the size of the part. Sometimes this can be done with a finger pointing at the indication or by placing a ruler along the part to show relative size. In photographing indications on highly polished parts, care SHALL be taken to avoid highlights or reflections that may hide indications. Taking photographs of fluorescent indications calls for special photographic techniques referenced in the penetrant chapter, (paragraph [2.5.6.6](#)), for additional information.

T.O. 33B-1-1

SECTION VI PROCESS CONTROL OF MAGNETIC PARTICLE INSPECTION

3.6 MAGNETIC PARTICLE PROCESS CONTROL.

3.6.1 Purpose and Scope. This section provides information on the procedures necessary to ensure a high quality performance for the magnetic particle inspection system. This section discusses the reasons for process control, the use of the Quantitative Quality Indicators to measure the magnetic field, and the various equipment and material control requirements.

3.6.2 General.

3.6.2.1 Need for Process Control. The presence of magnetic particle indications confirms the existence of discontinuities in the part. However, the absence of indications does not guarantee the absence of discontinuities. Flaws can be present and not be indicated for a number of reasons. Process checks are in place to verify the continuity of inspections by comparing the performance from one piece of equipment to the next, thus verifying the performance of materials and the application of the process by the inspector. Of these, the latter is far more common. These deficiencies are insidious since they may not be readily evident during the inspection of a part. It is necessary to periodically examine the materials, equipment, and process parameters to be sure they are as required for adequate inspection results.

3.6.2.2 New Materials. Magnetic particle materials are subjected to testing during their formulation to ensure their proper composition. However, it is possible to receive materials which do not perform satisfactorily. If unsatisfactory material performance is not discovered until a number of parts have been processed, then extra time and expense is required to track down and reinspect each of the suspect parts, if it is not too late. Unsatisfactory materials can result from a number of causes. The cost of verifying adequate material performance is extremely low and the required tests can be performed at any field laboratory.

3.6.2.3 In-Use Materials. Some inspection processes use the magnetic particle materials only once. In these processes, spraying or dusting is usually the means used to apply the materials. The materials are stored in closed containers until they are used. These processes minimize the possibility of material contamination or degradation during use. More often, however, the materials are used in open tanks where the excess materials are allowed to drain from the part back into the tank. This method provides numerous opportunities for contamination, deterioration, and changes in concentration. Such materials SHALL be checked periodically to be sure they are functioning satisfactorily.

3.6.3 Causes of System Degradation.

3.6.3.1 Contamination. Contamination is a primary source of magnetic particle bath performance degradation. There are a number of contaminants, and their effect on performance can vary. Some of the common contaminants frequently encountered are:

3.6.3.1.1 Water is a common contaminant in petroleum-based baths. It may occur due to condensation, leaks, dripping overhead pipes, or moisture carryover on parts.

3.6.3.1.2 Organics such as paint, lubricants, oils, greases, and sealants are other sources of contamination. These materials are usually introduced into the magnetic particle bath on the parts being inspected, and can react with, or dilute a bath so it loses some or all of its ability to function.

3.6.3.1.3 Organic solvents such as degreaser fluid, cleaning solvent, gasoline, and antifreeze solution, are also potential contaminants. These materials can mix with the inspection bath or float on top of it reducing the bath's effectiveness.

3.6.3.1.4 Dirt, soil, and other insoluble solids can be carried into the magnetic particle bath as a result of inadequate pre-cleaning.

3.6.3.1.5 Acidic and alkaline solutions can contaminate the magnetic particle baths. Acidic and alkaline solutions can be residues of previous plating, paint stripping, and cleaning processes.

3.6.3.2 Evaporation Losses. Magnetic particle bath suspension/vehicle materials used in open tanks are continuously undergoing evaporation, resulting in an increase in particle concentration. The rate of evaporation increases with warmer temperatures and larger tank surfaces. Evaporation losses take place very gradually, so performance change may become significant before it is noticed.

3.6.3.3 Drag-Out. Particle concentration is reduced when particles that adhere to parts being inspected are not returned to the suspension. Like evaporation, the resultant change occurs slowly and would probably go unnoticed until significant performance loss is experienced.

3.6.3.4 Heat Degradation. Fluorescent dyestuffs are sensitive to elevated temperatures. Temperatures of over 140° F (60° C) may reduce the fluorescence, and temperatures over 250° F (117° C), may destroy it completely. High temperatures in magnetic particle inspection materials usually occur when materials are improperly stored. A dark colored container stored in direct sunlight can reach temperatures above 140° F.

NOTE

Care SHALL be exercised when storing materials containing fluorescent dyestuffs. They SHALL be stored out of direct sunlight, in a cool dry location.

3.6.3.5 Equipment Degradation. In addition to materials degradation during use, performance of the equipment can deteriorate. The magnetizing equipment can loose power, black light bulbs age and become dirty.

3.6.3.6 Process Degradation. Critical procedural steps may be performed incorrectly or omitted completely. Periodic checks SHALL be accomplished to ensure satisfactory performance.

3.6.4 Frequency of Process Control. One of the factors influencing the degradation of a magnetic particle system (i.e., materials, equipment, and procedures) is the volume of parts being processed. Bath and equipment deficiencies can be expected to occur more often with increased workload volume. Since there is no uniformity in workload between activities, a single calendar schedule cannot be established. Each inspection activity SHALL set inspection intervals based on their workloads. Inspection intervals are listed in (Table 1-3) and SHALL be documented as shown in (paragraph 1.5.5). (Navy activities MAY use a locally produced form.) Additional guidance on concentration test inspection intervals are as follows:

- If your magnetic particle workload requires operation for eight or more hours each day, perform the concentration test (paragraph 3.6.7.4.3) every eight hours or on each shift.
- If your magnetic particle workload requires occasional or less than eight hours of operation, perform the concentration test (paragraph 3.6.7.4.3) prior to use or daily.

3.6.5 Evaluating the Magnetic Particle Process. It may be easier to complete these process checks if we break them down into categories of equipment evaluations (meaning all equipment and area checks) and materials evaluation (meaning the suspension vehicle and all associated parts). Though some of these tests intertwine, we will first look at the equipment and then move on to the materials.

3.6.6 Evaluating Equipment Effectiveness.

3.6.6.1 General. Magnetic particle equipment SHALL be maintained according to applicable technical orders, commercial manuals, or Navy Maintenance Requirements Cards (MRCs).

3.6.6.2 Equipment Tests. Intervals for process control checks are established in (Table 1-3). The minimum equipment tests which SHALL be accomplished to ensure the magnetic particle inspection process meets acceptable operating standards are as follows:

- System Effectiveness Check.
- Amperage Indicator Check.
- Quick Break Test.
- Dead Weight Check.
- Field Indicator Check.
- Lighting Checks.
- Inspection Area Cleanliness.

3.6.6.3 Evaluating Applied Magnetic Field Effectiveness.

3.6.6.3.1 Quantitative Quality Indicators (QQI). QQIs (paragraph 3.4.5.2.1) are also called shims and are used in magnetic particle inspections to evaluate the applied magnetic field and to perform system effectiveness checks (paragraph 3.6.6.4). They are also a very useful tool for technique development.

T.O. 33B-1-1**NOTE**

The QQI was designed to be used with the continuous method and the indications may disappear when the applied field is removed. Also, the QQI will not indicate background. The actual part **SHALL** be examined to determine the amount of background present.

3.6.6.3.1.1 In the absence of a cracked part to use as a reference standard, QQIs offer a valid method for assessing the adequacy of an inspection procedure. QQIs indicate the direction and strength of the applied magnetic fields. They are also useful in assessing the performance of equipment and materials associated with either magnetic particle or magnetic rubber methods.

3.6.6.3.2 Using the QQI.**WARNING**

Cleaning solvent, MIL-C-38736, is flammable and is also harmful to the skin, eyes, and respiratory tract. To prevent injury, rubber gloves and goggles **SHALL** be used. Good, general ventilation is normally adequate.

CAUTION

Exercise care when using QQIs on curved surfaces. Excessive bending will damage a QQI beyond use. Usually the thinner QQI will be used on curved surfaces; however they are fragile. The thicker QQI is less fragile, but can still be damaged by excessive bending.

NOTE

Use of a QQI **WILL** require a second magnetic particle or magnetic rubber inspection (without the QQI) if the QQI is placed in an area where an actual crack may be present.

The area where the QQI is to be placed **SHALL** be thoroughly cleaned and dried. Use cleaning solvent, MIL-C-38736. Place the appropriate QQI in place with the slot side against the surface of the part. In general, the 30-percent deep slot is adequate for most defects. Critical inspections may require the 15-percent deep slot and rough castings or weldments may require the 60-percent deep slot.

3.6.6.3.2.1 Use transparent adhesive tape (e.g., Scotch brand 191, 471, or 600 series) to hold the QQI in place. Tape **SHOULD** be applied to all four edges to ensure good contact (with no air gap) to prevent particles from getting under the QQI. The tape **SHALL NOT** cover the area of the QQI where the indications will form.

NOTE

Super glue may be used to provide a fixed bond. Super glue can be removed by soaking in acetone.

3.6.6.3.2.2 Conduct the inspection and observe the results under the appropriate lighting.

3.6.6.4 **System Effectiveness Check.** The importance of this process control step is second only to having an adequate inspection procedure. This test is unique, as it is capable of providing a relatively quick evaluation of both the equipment and the materials. The intent is to use a test specimen or set of specimens to assure the system is capable of producing an adequate magnetic particle inspection. There is no Department of Defense standard specimen for this requirement; consequently, there are a variety of ways to fulfill the requirement (Ketos ring, QQIs, and cracked parts), each with its own applicability. It is the responsibility of each laboratory supervisor to establish the system effectiveness check which best suits the requirements for their laboratory. Since each check method has strengths and limitations, it will usually be advisable to use two or more methods to validate effectiveness. If a failure is indicated during the system effectiveness check, the amperage indicator (paragraph 3.6.6.5) and material tests (paragraph 3.6.7.2) **SHALL** be accomplished to identify the problem. The following three options are presented to assist these individuals in this task.

NOTE

The prior to use or daily requirement for black light UV intensity check and particle concentration/suspension settling tests SHALL be performed and within limits prior to performing the system effectiveness check.

3.6.6.4.1 Ketos/AS5282 Ring. The Ketos/AS5282 ring has been the standard tool used by the Air Force to evaluate system effectiveness for some years now. While it is a useful tool, it has definite limitations and should not be the only system effectiveness method used. (e.g., Shortcomings include its limitation to central conductor DC magnetization.) There are two types of rings: Ketos and AS5282 certified rings. The AS5282 rings are certified by the manufacturer as conforming to SAE specification AS5282 and respond with more indications at a given amperage than the traditional Ketos ring. Using Ketos ring amperages and requirements on an AS5282 ring may mislead the technician into believing the system performance is acceptable when it is not. The requirements for minimum indications at each amperage are different for the two rings as shown in [Table 3-8](#). Technicians must know what type of ring they have and work accordingly. AS5282 rings come from the manufacturer with a certificate and the manufacturer's name, serial number and "AS5282" are marked directly on the ring. There are cases where Ketos and AS5282 rings do not respond even under optimum system conditions with the specified numbers of indications. In this case, the ring shall be baseline tested. The indications observed during baseline testing SHALL be documented and appear each time the system effectiveness test is conducted. There are two steps which SHALL be performed when using the Ketos/AS5282 ring ([Figure 3-72](#)) to conduct the system effectiveness check:

- a. Check for residual magnetism. Apply the magnetic particle bath and wait at least 60-seconds for any indications to form, and then examine the ring. If any indications are present on the outer edge, the ring SHALL be demagnetized and the check repeated until no indications are formed.
- b. Inspect the Ring. Inspect the Ketos/AS5282 ring using the wet continuous method with circular magnetization applied, then wait 60 seconds for any indications to appear. Use the amperage listed in ([Table 3-8](#)) through a one-inch diameter central conductor. Check the AC amperage first, then follow the AC amperages with all DC amperages listed in [Table 3-8](#). To prevent over magnetization of the Ketos/AS5282 ring from the required amperage listed in [Table 3-8](#), always remove the Ketos/AS5282 Ring from the central bar conductor between each magnetization shot to dial in and determine the appropriate amperage ($\pm 10\%$) on the amperage indicator. Inspect the ring to ensure the minimum number of holes listed for the amperage used is visible. Lack of this visibility may indicate a malfunctioning magnetic particle unit, a low particle concentration, or a Ketos/AS5282 ring not in the annealed condition. The cause of the malfunction SHALL be determined with additional process checks (e.g., amp indicator, concentration, etc.) and corrected prior to performing additional magnetic particle inspections with the deficient system.

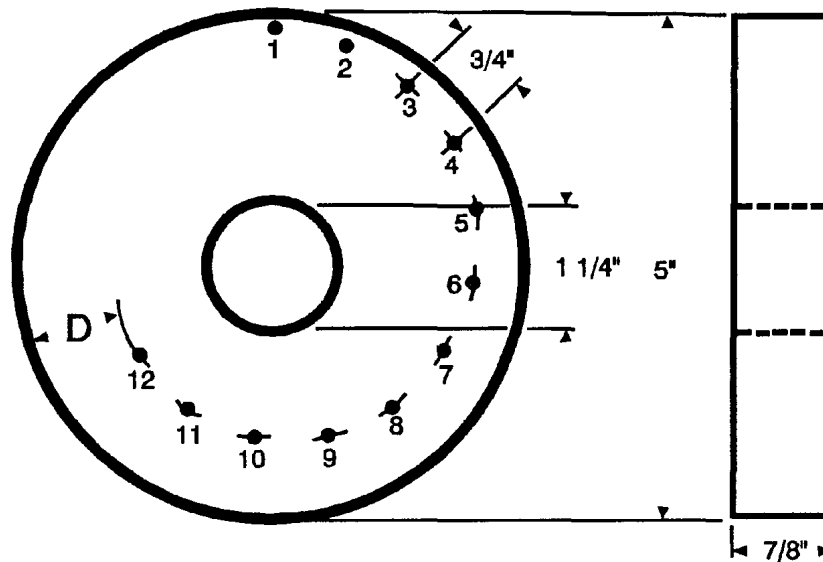
NOTE

Ketos/AS5282 rings that are plated or corroded SHALL NOT be used. Corrosion and plating can cause false readings.

3.6.6.4.1.1 Ring Baseline. Many rings may not meet the requirements for the Ketos ring or the AS 5282 ring shown in [Table 3-8](#) due to improper manufacture or exposure to heat. These rings MAY be used provided a baseline test is conducted on the ring with all other process controls in an optimum condition as listed below. The conditions SHALL be recorded on a general-purpose form or in the PCAMS system. The form SHALL be traceable to the specific ring and maintained on file. The ring is tested at each amperage value specified in [Table 3-8](#) and the number of indications visible at each amperage SHALL be recorded. Rings may show one less indication at each amperage value than shown in [Table 3-8](#). Any less and the ring SHALL be replaced. Each time the ring is used for the system effectiveness check the minimum number of indications that appeared during the baseline test SHALL again be visible; otherwise, the test is considered a failure and the cause investigated. The following conditions SHALL be met when performing the baseline procedure:

- Suspension SHALL be freshly prepared, free of fluorescence, and at optimum concentration (0.15 to 0.2 ml).
- Ambient light level at 2 foot-candles or less (measured with blacklights on).
- New black light bulbs and filters installed within one week prior to the test that meet or exceed the minimum acceptable standard for black light intensity.
- Amperage and Quick Break tests performed within one week prior to the baseline test.
- Water break test done immediately prior to baseline test (applies to water based suspensions only).

T.O. 33B-1-1



HOLE	1	2	3	4	5	6	7	8	9	10	11	12
DIAMETER	.07	.07	.07	.07	.07	.07	.07	.07	.07	.07	.07	.07
" D "	.07	.14	.21	.28	.35	.42	.49	.56	.63	.70	.77	.84

H9902418

Figure 3-72. Ketos Ring

Table 3-8. Ring Specimen Indications

Type of Suspension	DC Amperage	Ketos Ring	AS5282 Ring
Wet Visible	500	N/A	3
	1000	N/A	4
	1400	3	N/A
	1500	N/A	5
	2500	5	6
	3400	6	N/A
	3500	N/A	8
Dry Powder	500	N/A	4
	1000	N/A	6
	1400	4	N/A
	1500	N/A	7
	2500	6	8
	3400	7	N/A
	3500	N/A	9

Table 3-8. Ring Specimen Indications - Continued

Type of Suspension	DC Amperage	Ketos Ring	AS5282 Ring
Wet Fluorescent	500	N/A	3
	1000	N/A	5
	1400	3	N/A
	1500	N/A	6
	2500	5	7
	3400	6	N/A
	3500	N/A	9
	AC Amperage		
Wet Visible	1000	1	1
Dry Powder	1000	1	1
Wet Fluorescent	1000	1	1

3.6.6.4.2 Quantitative Quality Indicators (QQI). Test specimen(s) used with QQIs offer a more versatile means of checking system performance than afforded by the Ketos ring. The specimens can be real parts or designed to be representative of the most challenging inspection to be currently performed. This combination is capable of providing an adequate check on any magnetic particle inspection system. Poor indications may require further process control evaluations to be performed (e.g., amp indicator check, concentration check, etc.). Even though QQIs respond to the applied, not residual field, demagnetization is necessary of the specimen(s) in order to remove the previously applied inspection media.

3.6.6.4.3 Cracked Parts. If available, the ultimate specimens for the performance tests are cracked parts. Poor indications may require further process control evaluations to be performed (e.g., amp indicator check, concentration check, etc.). These require careful handling to remain corrosion-free and retain their flaw size.

3.6.6.5 Amperage Indicator Check. Amperage indicator accuracy check SHALL be performed using the calibrated ammeter/shunt authorized in AS-455. Authorization for any other ammeter/shunt shall be documented and approved in writing by the AF NDI Program Office. Operation for the ammeter/shunt SHALL be according to the commercial manufacturer's operating instruction. DC amperage reading variations exceeding +/- 10% of the reading, or +60 amperes, whichever is greater, and AC amperage reading variations exceeding +/-10 -percent at maximum rated unit output SHALL necessitate locating the source of the difficulty and corrective action taken. The ammeter/shunt SHALL be calibrated as prescribed in T.O. 33K-1-100-CD- 1.

3.6.6.6 Quick Break Test. A test SHALL be accomplished to ensure the presence of an accurate decay rate, which is sufficient for quick break magnetization. A quick break tester is authorized in AS-455. Operation for the quick break tester SHALL be accomplished according to the commercial manufacturer's operating instructions. Test failure SHALL necessitate locating the source of the failure and taking corrective action.

3.6.6.6.1 Generic Quick Break Test Instructions. In the absence of a commercial manufacturer's instruction, the following procedure will be sufficient for the Magnaflux Quick Break Tester, Part Number 148335 or equivalent. Clear the horizontal wet bench unit of all ferrous parts, rags, or other obstructions. Retract the tailstock and lock it down so the operator has an unobstructed access to the coil. Move the coil 12 to 18 inches from the head stock and lock it down. Remove the copper bus bar and bracket from the quick break tester. Center the tester on the bottom surface of the inside diameter of the coil. The tester should be placed perpendicular to the coils with the studs facing up. If the studs are facing up and the indicating lamp is facing the tail stocks, the tester is in the correct position. The magnetic particle unit should be set for DC operations at 2000 amperes. Initiate the coil shot and observe the indicating lamp as the shot terminates. A flash of the lamp indicates a good "quick-break." Sometimes a flash may occur at the beginning and end of the shot, this is acceptable. The absence of a flash indicates a malfunction in the circuitry of the magnetic particle unit.

3.6.6.7 Dead Weight Check. This test SHALL be conducted on portable induced field equipment (e.g., Parker Probes) and performed as follows.

3.6.6.7.1 AC electromagnet yokes SHALL have a lifting power of at least:

T.O. 33B-1-1

- 10-pounds, with a spacing of 3 to 6-inches between the legs.

3.6.6.7.2 DC electromagnetic or permanent magnet yokes SHALL have a lifting power of at least:

- 30-pounds with a 2 to 4-inch spread of the legs OR
- 50-pounds with a 4 to 6-inch spread of the legs.

3.6.6.7.3 Test weights should be locally manufactured from 1-1/4 x 4-inch SAE 4130 or SAE 4340 bar stock. A 7-inch long piece of this material will weigh approximately 10-pounds.

3.6.6.8 Lighting Checks. For additional information on black light and ambient light checks (paragraph 2.5.4.1.3).

3.6.6.8.1 Black Lights.

- a. Check the intensity of new black light bulbs once they have been changed and prior to placing them into service.
- b. Check the intensity of in-use black light bulbs daily or prior to the first use of the day if the magnetic particle process is performed less frequently.
- c. Check the physical condition of the black light housing and filter daily or prior to first use of the day if the magnetic particle process is performed less frequently. Black light housings and filters SHALL be kept clean, free of cracks or chips, and fit properly.

3.6.6.8.2 Ambient Light Requirements. Inspection booths of a stationary fluorescent magnetic particle system SHALL NOT exceed 2-foot candles of ambient light. It is not always possible to achieve ambient light levels as low as this during portable inspections. As the ambient light level is increased, the intensity of black light SHALL also be increased (paragraph 2.5.4.1.3).

NOTE

When performing portable fluorescent magnetic particle inspections, a dark colored canvas or photographers black cloth SHALL be used to darken the area of interest to the lowest possible ambient light levels during the inspection.

3.6.6.8.2.1 Measurement of Visible Light Intensity. Visible light intensity is easily measured with solid-state photometers. Measurements of visible light are keyed to the response of the visual system of a standard human observer. The unit of energy for visible light is the lumen, and represents the amount of energy in the visible light spectrum distributed in a specific way related to the response of the standard human eye. The energy flux, that is the energy per unit of time, then is the lumen. The units of measurement for visible light intensity are foot-candles, where one foot-candle equals one lumen per-square-foot. Another term often used is lux, which equals one lumen per-square-meter. The conversion between the two terms is 1-foot candle equals 10.76 lux.

3.6.6.8.2.2 Excessive White Light. Some black lights may have excessive white light output based on construction, damage, and/or reflector used. All black lights (portable and stationary) SHALL be tested individually for white light output using a photometer at a distance of 15 inches in a fully darkened booth (0.01 to 2 foot candles). Cumulative ambient light from the fully darkened booth and black light white light output SHALL not exceed 2 foot candles. All black lights (portable and stationary) and inspection booths will be checked per [Table 1-3](#) for white light output and ambient light.

3.6.6.8.3 Dark Adaptation. The human eye becomes much more sensitive to light under dark conditions. This increased sensitivity gradually occurs when the light conditions change from light to dark. When entering a darkened area from a lighted area, little if anything can be seen at first, the pupil of the eye must widen to admit additional light. The time required for the eye to adjust to the darkened condition depends upon the overall health and age of the individual. Full sensitivity or dark adaptation requires about 20-minutes. A minimum dark adaptation time of 5-minutes is usually sufficient to perform magnetic particle inspection under black light. Thus, an inspector entering a darkened area SHALL allow at least 5-minutes for dark adaptation before examining parts under black light. Once the eyes have adapted to the dark, the pupils will respond very rapidly to bright light. A very short bright light exposure cancels the slowly acquired dark adaptation. Time for dark adaptation SHALL be allowed whenever an inspector enters the darkened booth, or is exposed to a bright light (e.g., someone opening or raising the shade). A timer capable of measuring the dark adaptation time SHALL be available within the darkened area.

3.6.6.9 Inspection Area Cleanliness. The inspection area, as well as, the hands and clothing of the inspector, SHOULD be clean and free of extraneous fluorescent materials. Non-relevant indications may be formed when parts contact extraneous fluorescent materials. In addition, the fluorescence from this material will raise the ambient light level, thus increasing the amount of black light necessary to produce a visible indication of a small defect.

3.6.7 Evaluating Material Effectiveness.

3.6.7.1 General. Magnetic particle materials SHALL be maintained according to applicable technical orders, commercial manuals, or Navy Maintenance Requirements Cards (MRCs).

3.6.7.2 Applicability.

NOTE

Prior to bath replacement in a magnetic particle inspection unit, the equipment SHALL be thoroughly cleaned according to the equipment maintenance manual. This does not apply to the addition of materials (either vehicle or particles) to maintain concentration.

Material tests apply to both newly received and in-use materials. They are designed to ensure unsatisfactory materials do not enter the magnetic particle inspection process, and in-use materials continue to perform satisfactorily.

3.6.7.3 Material Tests. Frequencies of all process checks are established in [Table 1-3](#). The following lists the minimum material tests which SHALL be accomplished to ensure the magnetic particle inspection process meets acceptable operating standards:

- Concentration Check.
- Settling Check.
 - Concentration Check.
 - Background Fluorescence.
 - Contamination.
- Acidity Test.
- Water Break Test.

3.6.7.3.1 New Material Tests. New materials SHALL be subjected to the following tests, as appropriate, prior to being put into use:

- a. Perform a contamination (paragraph [3.6.7.4.2](#)) and a background fluorescence check (paragraph [3.6.7.4.2.1.1](#)) on petroleum based bulk vehicle.
- b. Use the settling test (paragraph [3.6.7.5.3](#)) to check the concentration level, background fluorescence, and for any contamination of the in-use bath.
- c. Perform a system effectiveness test (paragraph [3.6.6.4](#)) on both conventional magnetic particle inspection materials and magnetic rubber inspection materials (if used).

3.6.7.3.2 In-Use Material Tests. In-use materials SHALL be tested in accordance with the frequency established in Chapter 1 (Table 1-3).

3.6.7.4 Preparation of New Wet Suspension.

3.6.7.4.1 Tank Inspection and Cleaning. When new equipment is being installed, or after emptying dirty suspension from the in-use tank, the agitation/circulation system SHALL be inspected and cleaned as necessary to ensure it is not contaminated with particles or dirt.

T.O. 33B-1-1

3.6.7.4.2 Preparation of New Bulk Suspension Materials. This paragraph focuses on visible and non-fluorescent materials. Fluorescent materials also require an additional fluorescent background check which is discussed later (paragraph 3.6.7.4.2.1.1).

Fill the tank with oil or water, depending on which is chosen as the vehicle, and operate the agitation system to ensure it is functioning properly. If petroleum based, bulk vehicle is used, the following check SHALL be performed prior to formulating the inspection bath to prevent unsatisfactory bulk magnetic particle vehicle from being introduced into the magnetic particle inspection system.

- a. Loosen the cap on the bulk vehicle container, and leave the container undisturbed for at least 1-hour.
- b. After the time has elapsed, without disturbing the container, remove the cap, cover, seal, or plug from the bulk vehicle container.
- c. Obtain a clean glass tube of sufficient length so it reaches from the bottom of the bulk vehicle container to at least 6-inches above the container opening when the tube is held in the vertical position. Fluorescent materials require a fluorescent background check at this point (paragraph 3.6.7.4.2.1.1).
- d. Place your thumb over one end of the glass tube, and insert the other end of the glass tube slowly, in a vertical position, into the bulk vehicle.

NOTE

Ensure the tube goes all the way to the bottom of the container.

- e. Release your thumb from the upper end of the glass tube for 5 to 10-seconds, and then replace your thumb over the end of the glass tube. Remove the glass tube slowly from the bulk vehicle maintaining its vertical position.
- f. Prior to removing your thumb from the end of the glass tube, observe the level of the contamination in the glass tube. If present, water and other contaminants should be evident in the lower portion of the glass tube. (Depots: if the vehicle is suspected, the contents of the glass tube may be sent to the depot chemical laboratory for analysis).
- g. If contaminants are evident in the bottom of the container, siphon off the good vehicle to within 2-inches of contamination level.
- h. Disposition instructions for contaminated bulk vehicle are located in (paragraph 3.6.9).

3.6.7.4.2.1 New Bulk Wet Fluorescent Suspension Preparation. In addition to the previous preparation details (paragraph 3.6.7.3.2), the following subparagraphs list steps to check the fluorescent background and are required for fluorescent suspension preparation.

3.6.7.4.2.1.1 Fluorescent Background Check for New Bulk Suspension. A fluorescent background check SHALL be accomplished on vehicle material used in the fluorescent magnetic particle inspection method if conformance to DOD-F-87935 is in question. One procedure for checking the background is as follows:

- a. Obtain a clean glass tube of sufficient length to reach from the middle of the bulk vehicle container to at least 6-inches above the container opening when it is in the vertical position.
- b. Insert the tube slowly into the bulk vehicle.
- c. Place thumb over protruding end of the glass tube and remove the tube from the container.
- d. Illuminate vehicle in the glass tube with a black light in a darkened area.
- e. If vehicle does not fluoresce, proceed with its use. If the vehicle fluoresces, determine the fluorescence in accordance with the appropriate section of DOD-F-87935. Dispose of vehicle not conforming to DOD-F-87935.

3.6.7.4.3 Particle Concentration Test.

NOTE

Prior to adding the magnetic particles to the vehicle, they SHALL be demagnetized to eliminate any agglomeration that may have developed during storage due to magnetization.

The concentrates to be added to the bath, and the volume of solid materials which settle out when the bath is made up, should conform to the manufacturer's data supplied with the concentrate. Concentrate SHALL be added when the particle concentration is low. Evaporation or liquid drag-out SHALL be monitored and volume maintained when the level drops appreciably. Loss of liquid may be either by drag-out or by evaporation, and corrective measures are different for both types of loss. Adding additional oil or water is all that is required to make up for evaporation loss. To make up for the drag-out loss, the addition of bath liquid and particles may be required.

3.6.7.4.3.1 The strength of the bath is a major factor in determining the quality of the indications to be obtained. Too heavy of a concentration will give a confusing background with excessive adherence of particles at external poles, thus, reducing the visibility of indications from very fine discontinuities.

3.6.7.4.3.2 It is difficult to know what the cause of volume loss actually is in any given case. For a unit in constant use, it can be assumed that more than 50-percent of the loss is due to drag-out. For a unit used only occasionally, loss by evaporation is likely to be the major cause. Actually, the problem is not serious, because with constant use the accumulation of dirt, scraps, lint, etc. requires the dumping of the tank and a new bath before loss of liquid becomes serious. Magnetic particle content is of most critical importance and SHALL be carefully watched at all times.

3.6.7.4.3.3 Dirt accumulation in the magnetic particles bath can usually be observed in the settling test (paragraph 3.6.7.5.3). Dirt, lint, etc. are usually lighter and settle later. Dirt, lint, etc. are often seen as a second layer on top of the particles or as a non-fluorescent band or strip in the particle layer. For particle determination, this layer of dirt SHALL be carefully excluded from the total volume read. When the contamination exceeds 30-percent of the volume of the particle layer, formation of proper indications will be impeded, and the bath SHALL be dumped and a new one made up. This may occur as often as once a week when a unit is in constant use. The layer of dirt and the vehicle immediately above it SHALL NOT fluoresce. If oil is used as a suspension, it SHALL be considered a petroleum product and disposition of the bath SHALL conform to all applicable regulations.

3.6.7.4.3.4 The following ranges are rather broad for uniform results and are provided for maintaining magnetic particles suspension concentration. These ranges should be reduced by each laboratory depending on their specific requirements.

- Visible magnetic particle bath concentrations SHALL be: 1.2 to 2.4-milliliters (ml) of particles per 100 ml of vehicle. The optimum range is 1.5 to 2.0 ml/100 ml.
- Fluorescent magnetic particle bath concentrations SHALL be: 0.1 to 0.4-ml of particles per 100 ml of vehicle. The optimum range is 0.15 to 0.20 ml/100 ml.

3.6.7.4.4 Adding Dry Powder Concentrate. Measure out the required amount of powdered concentrate, and pour it directly into the bath within the tank. The agitation system should be running and the concentrate poured in at the pump intake so it will be quickly drawn into the pump and dispersed into the bath. The new pre-wet concentrates will disperse very quickly even through the large volume of bath in large units. After 10-minutes of operation, the bath strength SHOULD be checked with a settling test (paragraph 3.6.7.5.3). The amount of settled material SHOULD check approximately with the volume requirements in (paragraph 3.6.7.4.3.4).

3.6.7.4.5 Adding Paste Concentrate. The procedure is similar to the dry powder concentrates, except the paste SHALL be weighed instead of measured. It is transferred to a mixing cup or bowl, bath liquid is added a little at a time, and mixed until smooth, thin, slurry has been produced. This slurry is then poured into the tank at the point where the agitation system will pick it up and disperse it into the bath. After agitating 10-minutes, the strength SHOULD be checked by the settling test (paragraph 3.6.7.5.3) as in the case of the dry powder concentrate.

3.6.7.5 Evaluating In-Use Wet Suspensions.

3.6.7.5.1 Suspension Maintenance. As the suspension bath is used for testing, it will undergo changes due to use. Some of these changes are:

- Drag-out of magnetic particles, by mechanical and magnetic adherence to parts.
- Drag-out of liquid due to the film that adheres to the surface of parts.

T.O. 33B-1-1

- Loss of liquid by evaporation.
- A gradual accumulation of contaminants: shop dust, dirt from parts not properly cleaned, lint from wiping rags, and oil from parts that carry a residual film of oil.
- Miscellaneous objects and materials which are dropped into the tanks.
- Dilution/contamination of the bath from wet test pieces, dripping overhead pipes, and moisture condensation.

3.6.7.5.2 Suspension Agitation. The magnetic particles are considerably heavier than the vehicle in which they are suspended. When the agitation system is shut off, the particles rapidly settle out. All particles SHALL be agitated into suspension before conducting any inspections or process control tests (paragraph 3.4.6.4.6). This agitation time varies with the downtime due to compacting of the particles from their own weight.

3.6.7.5.3 Settling Test. This paragraph focuses on new and in-use visible and non-fluorescent materials. Fluorescent materials also require additional tests which is discussed later (paragraph 3.6.7.5.3.2).

3.6.7.5.3.1 The following procedure SHALL be used to determine the concentration (paragraph 3.6.7.4.3.3) of magnetic particles and to check for the accumulation of dirt or other contaminants in a suspension. The equipment required is a 100-cubic centimeters (cc) or 100-milliliters (ml) pear-shaped, graduated centrifuge tube and stand (Figure 3-73). The difference between milliliters (ml) and cubic centimeters (cc) in this case is negligible, and the two terms are used interchangeably for this paragraph.

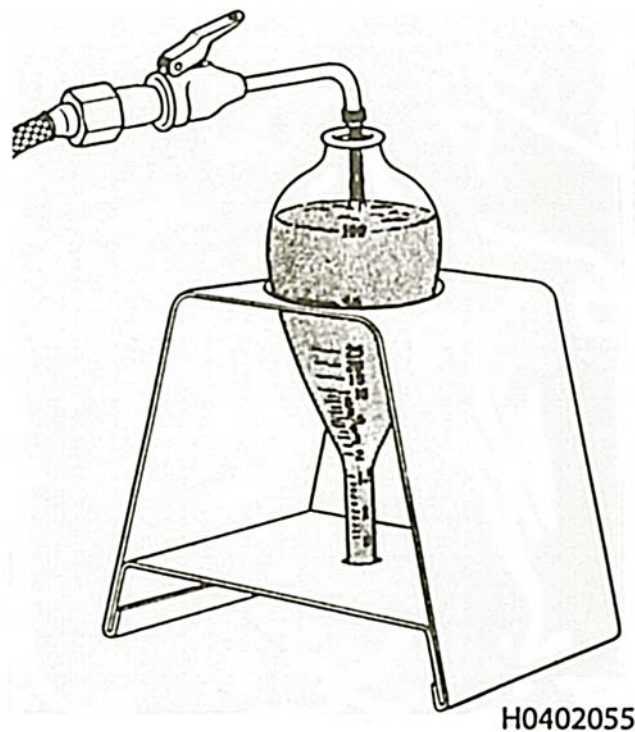


Figure 3-73. Filling Centrifuge Tube from Hose

- Thoroughly agitate the suspension.
- Run suspension through the hose and nozzle for at least 1-minute. This is to ensure the suspension in the hose is fresh and agitated.
- Fill the 100 cc (100 ml) centrifuge tube with agitated suspension using the hose.
- Demagnetize the suspension in the tube to reduce clumping.
- Place the centrifuge tube in its non-ferromagnetic stand, and allow the suspension to set on a vibration free surface for:

- (1) 1-hour for oil baths, OR.
- (2) 30-minutes for water baths.

NOTE

Part processing and/or process control inspections SHALL NOT be accomplished prior to the full 1-hour (or 30-minute) time limit has passed and the bath has been approved for daily use. The suspension concentration SHALL be within T.O. limits prior to use.

- f. Observe the total level (concentration) of settled particles at the end of the settling period. The graduated cylinder reads directly in milliliters. The level of contaminants SHALL be subtracted from the total concentration to obtain the current concentration of particles (paragraph 3.6.7.4.3.4).

NOTE

Besides the magnetic particles, dirt in the bath will also settle out and usually show as a separate layer on top of the particles. The layer of dirt and lint is usually easily distinguishable, since it is of a different color and texture from the particles. The layer of dirt and lint is usually easily distinguishable, since it is of a different color and texture from the particles. Also easily distinguishable are iron peening shot and blasting grit; both will settle faster and lie beneath the magnetic particles.

- g. If the concentration of magnetic particles is above or below the range required (paragraph 3.6.7.4.3.4), correct by adding vehicle or magnetic particle powder respectively. Repeat step “a” through “f” of the settling test after making corrections.
- h. Return contents of centrifuge tube to the in-use tank suspension (bath), and clean the tube prior to next test.

3.6.7.5.3.2 Additional Settling Test Requirements for Wet Fluorescent Suspension. The rules are identical with those described in (paragraph 3.6.7.4.3). However, there are three additional sources of deterioration that can occur in a bath of fluorescent particles, and require discarding of the bath when the condition becomes excessive.

3.6.7.5.3.2.1 Additional Sources of Deterioration in Wet Fluorescent Suspension. The first source of deterioration is the separation of the fluorescent pigment from the magnetic particles. Such separation causes a reduction of fluorescent brightness of indications and an increase in the overall fluorescence of the background. When this occurs to a noticeable degree, the bath SHALL be changed. This condition is difficult to detect in the settling test, but can be observed by directing a black light at the settling tube after the normal settling period. Additional steps to aid interpretation of observations are located in (paragraph 3.6.7.4.4). Noticeable fluorescence of the solution, with a reduced fluorescence of the particles, signifies separation. Observation by the inspector in the way the bath performs is another method of detecting separation.

3.6.7.5.3.2.2 A second source of deterioration of the bath of fluorescent particles is the accumulation of non-fluorescent magnetic dust or dirt in the bath. When there is a considerable amount of finely divided magnetic material in the dust carried by the air, this material will accumulate in the bath along with other dust and dirt. In a bath of wet visible non- fluorescent particles this does no specific harm until the accumulation of total dirt is excessive. In the case of fluorescent particles, it tends to decrease the brightness of the indication. The fine magnetic material is attracted to indications along with the fluorescent particles, and it takes very little of such non-fluorescent material to significantly reduce the brightness or visibility of the indication.

3.6.7.5.3.2.3 A third source of deterioration of the fluorescent particle bath is the accumulation of fluorescent oils and greases from the surfaces of tested parts. This accumulation, over time, builds up the fluorescence of the liquid vehicle to the point it interferes with the visibility of fluorescent particle indications.

3.6.7.5.4 Vehicle Fluorescence Check. The settling test (paragraph 3.6.7.5.3) for particle concentration can be used to also judge vehicle fluorescence and is readily performed at a stationary unit. It is not as accurate as the laboratory test but is reasonably quantitative and reproducible. It can be easily standardized with the material in use, and is quite satisfactory as a daily guide for the inspector. The following procedure SHALL be used in performing the vehicle fluorescence check after the steps in the settling test have been completed (paragraph 3.6.7.5.3).

- a. Illuminate the suspension in the centrifuge tube with black light in a darkened area. Only the particle layer SHOULD fluoresce. Dirt, lint, etc. will usually settle more slowly than the particles and may be seen as a non-fluorescent band

T.O. 33B-1-1

or strip toward the top of the particle layer. For particle concentration (paragraph 3.6.7.4.3.4) determination, this layer of dirt SHALL be carefully excluded from the total volume read. Dirt accumulation that exceeds 30-percent of the total volume of the particle layer can impede the formation of indications, requiring replacement of the bath.

- b. Fluorescence in the liquid may indicate bath breakdown (fluorescent pigmentation being stripped from the magnetic particles or fine magnetic particles remaining suspended in the vehicle). If the vehicle fluoresces excessively, place the centrifuge tube in its stand (which SHALL not be ferromagnetic) with a horseshoe magnet in contact with the centrifuge tube (Figure 3-74), and let sit on a vibration free surface for 1-hour for oil baths and 30-minutes for water baths. Illuminate the vehicle in the centrifuge tube with black light in a darkened area. If the vehicle's fluorescence is reduced or eliminated, the cause of the fluorescence is fine magnetic particles remaining suspended. If the level of fluorescence remains at the same level, the fluorescent pigmentation has been stripped from the magnetic particles.
- c. If it is determined the cause of the vehicle's fluorescence is stripping of the pigmentation, the suspension SHALL be replaced if it is serious enough to interfere with the results of the system effectiveness check (paragraph 3.6.6.4) using the Ketos ring.
- d. If it is determined the cause of the excessive suspension fluorescence is fine magnetic particles remaining in the vehicle, and they are of a volume to interfere with the results of the system effectiveness check (paragraph 3.6.6.4) using the Ketos ring; an effort SHOULD be made to remove them from the holding tank's magnetic particle bath. This can be done with magnets. The magnetic particle bath in the magnetic particle machine's holding tank SHOULD be allowed to rest (not agitated) for 40-minutes. Place the magnets in the magnetic particle bath, taking care not to place them so deep they will attract the particles that have settled out of suspension. The length of time or number of times that the magnets will have to be cleaned of particles and submerged is dependent upon the seriousness of the problem. The bath SHALL be able to pass the system effectiveness check (paragraph 3.6.6.4), after the removal of as many suspended particles as possible or be replaced.
- e. If a magnet was used to remove fine magnetic particles from suspension in the centrifuge tube, the suspension SHALL be demagnetized prior to being poured back into the magnetic particle machine.
- f. The inside of the centrifuge tube SHALL be cleaned to eliminate any residual fluorescence remaining after each use.

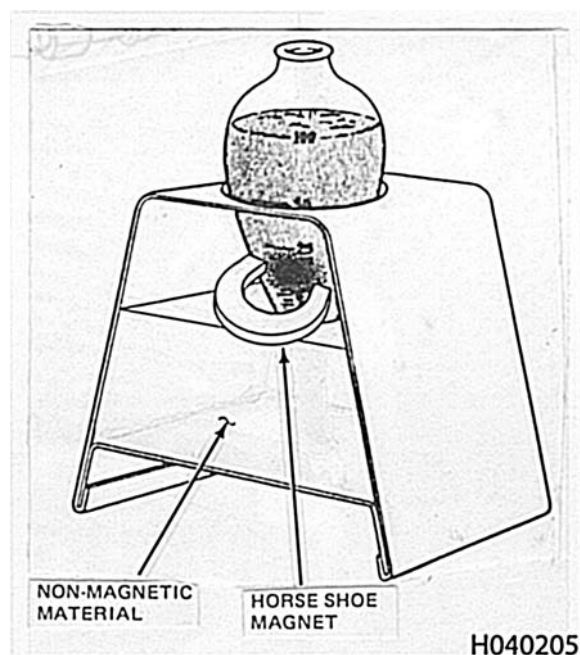


Figure 3-74. Drawing Fine Magnetic Particles from Vehicle With Horseshoe Magnet

3.6.8 Additional Tests for Water Baths.

3.6.8.1 Wetting Agents and Corrosion Inhibitors. Usually magnetic particle concentrates provide the correct amount of wetting agent and corrosion inhibitor for initial use. However, these materials are also available separately so the concentrations can be maintained or adjusted to suit the particular conditions. If no corrosion can be tolerated, a higher concentration of corrosion inhibitor will be used.

3.6.8.2 Acidity Test. The acidity of a water bath SHALL be checked weekly. The pH of the water bath SHALL be between 6 to 10 (paragraph 3.4.6.4.1). If the parts being inspected have a residual solvent film, more wetting agent is required so the parts' surface will be completely wetted. Breaking of the bath into rivulets as it is applied over a part is an indication an additional wetting agent is required or the part requires further cleaning.

3.6.8.3 Water Break Test. A water break test SHALL be conducted daily using a clean specimen or part having the smoothest surface finish to be inspected (paragraph 3.4.6.4.1). The specimen SHALL be flooded with bath and examined once flooding has stopped. If a smooth continuous film of bath forms over the entire surface, sufficient wetting agent is present. Reference SHALL be made to the manufacturer's recommendations for the correct quantity of wetting agent to be added.

3.6.9 Disposition for Nonconformance Materials.

NOTE

Knowledge of problems, even relatively minor ones, is essential for improvement in the NDI program. Information copies of written correspondence concerning unsatisfactory magnetic particle inspection materials SHALL be furnished to: (Air Force NDI Office, AFRL/MLS-OL, 4750 Staff Dr., Tinker AFB, OK 73145-3317; DSN 339-4931 and AFRL/MLSA, 2179 Twelfth Street, Ste. 1, Wright-Patterson Air Force Base, OH 45433-7718); (Army: Commander, US Army Aviation and Missile Command, ATTN: AMSAM-DSA-AS-AS, Redstone Arsenal, AL 35898-5000).

All materials which DO NOT meet the minimum requirements SHALL be rejected. Rejected materials SHALL be reported in accordance with TO 00-35D-54. (Navy: SHALL refer to OPNAV 4790.2 Quality Deficiency Reporting QDR requirements.)

3.6.9.1 Open tank baths SHALL be changed (replaced or replenished) when they do not meet the minimum inspection requirements.

3.6.10 Magnetic Particle Process Checklist. The following table contains process checks for the magnetic particle system. The NDI supervisor SHALL perform an assessment of the magnetic particle process periodically. The interval of the assessment is at the NDI supervisor's discretion and does not require documentation. It is recommended that the process checklist be performed and documented whenever a unit self-assessment is accomplished. The process checks are presented in checklist format including a criticality identification system used in most Air Force checklists. The criticality is relevant to the magnetic particle process alone and should not be used by outside inspection agencies during assessments of the NDI Laboratory to determine the severity of an inspection finding. The criticality identifiers are as follows:

3.6.10.1 Critical Compliance Objectives (CCO). Items identified as key result areas for a successful mission accomplishment including, but not limited to, items where non-compliance could result in injury, excessive cost, or litigation. CCOs are shown in "**BOLD AND ALL CAPS FORMAT.**"

3.6.10.2 Core Compliance Items (CCI). Areas that require special vigilance and are important to the over-all performance of the unit, but are not deemed "Critical". Non-compliance would result in some negative impact on mission performance or could result in injury, unnecessary cost, or possible litigation. CCIs are shown in "**ALL CAPS FORMAT.**"

3.6.10.3 General Compliance Items (GCI). Areas deemed fundamental to successful overall performance of the unit, but non-compliance would result in minimal impact on mission accomplishment or would be unlikely to result in injury, increased cost, or possible litigation. GCIs are shown in "sentence case format."

3.6.10.4 General Data Information (GDI). Information required to validate equipment care and requisition priorities. GDIs are shown in "*italic sentence case format.*"

T.O. 33B-1-1

Table 3-9. MT Process Checks

	Magnetic Particle Process Checklist	YES or NO
GCI.27	Pre-Cleaning.	
CCI.27.a.	ARE OILS, GREASE, MOISTURE, DIRT, RUST, SCALE, AND LOOSE PAINT REMOVED IN A SATISFACTORY MANNER?	
GCI.27.b.	Are cleaning residues removed?	
GCI.27.c.	Are parts are adequately dried, especially in recessed areas?	
GCI.27.d.	Are all areas requiring masking and/or plugs covered satisfactorily?	
GCI.28	Inspection Operations.	
CCI.28.a.	IS THE CURRENT APPLICABLE TECHNICAL DATA AVAILABLE?	
GCI.28.b.	Is the appropriate magnetizing current used (AC, DC, rectified AC)?	
GCI.28.c.	Is the appropriate magnetic particles used (wet, dry, visible, fluorescent)?	
GCI.28.d.	Is the application of inspection media correct (continuous, residual)?	
CCI.28.e.	ARE THE REQUIRED FIELD DIRECTIONS INDUCED?	
GCI.28.f.	Are the sequences of induced fields (circular versus longitudinal) acceptable? Whenever practical, the circular field SHOULD be indicated first to facilitate the demagnetization process.	
CCI.28.g.	IS THE REQUIRED MAGNETIZING AMPERAGE USED AND THE PART CHECKED FOR PROPER MAGNETIZATION?	
GCI.28.h.	Is the black light allowed to warm up for a minimum of 10-minutes, or until the required intensity (1000 mwatts/cm ²) is achieved?	
GCI.28.i.	Is the required demagnetization procedure is used (30-point step-down, AC coil, etc.)?	
GCI.28.j.	Are the field-indicators working properly and capable of determining the adequacy of demagnetization?	
GCI.28.k.	Was the demagnetization process effective?	
GCI.29	Post Cleaning	
GCI.29.a.	Are all inspection materials removed?	
GCI.29.b.	Are all masking and plugging materials removed?	

SECTION VII MAGNETIC PARTICLE INSPECTION EQUATIONS

3.7 MAGNETIC PARTICLE EQUATIONS.

3.7.1 Rule-of-Thumb Formulas. Rule-of-thumb formulas have been developed to help determine the amount of amperage required to induce an adequate longitudinal magnetic field in a part. These formulas apply particularly well to cylindrically shaped parts and are explained with examples shown in the following paragraphs. However, as discussed previously, blind adherence to these “rules of thumb” can result in over magnetization with a subsequent loss of inspection sensitivity.

3.7.2 Cross-Sectional Area. It is critical to determine the relationship between the cross-sectional area of the part and the cross-sectional area of the coil(s). This relationship/ratio will determine whether the part can be inspected within a coil of a given diameter by laying the part in the bottom or next to the side of the coil wall, or by centering the part in the coil, and which formula will be used for estimating the amperage required. The cross-sectional area for the part and coil are determined as follows:

$$A = \Pi r^2$$

Where: A = Cross-sectional Area

$$\Pi = 3.1416$$

r = radius (1/2 of the diameter). The diameter of the part SHALL be taken as the largest distance between any two points on the outside circumference of the part.

Example: A 12-inch diameter coil is to be used to inspect a part having a 2-inch diameter.

Area of Coil (12" diameter)

$$A = \Pi r^2$$

$$A = \Pi(6)^2$$

$$A = 113 \text{ sq. inches}$$

Area of Part (2" diameter)

$$A = \Pi r^2$$

$$A = \Pi(1)^2$$

$$A = 3.14 \text{ sq. inches}$$

3.7.2.1 When the cross-sectional area of the part is less than one-tenth of the cross-sectional area of the coil, the part SHOULD be magnetized lying in the bottom of the coil.

3.7.2.2 When the cross-sectional area of the part is greater than one-tenth of the cross-sectional area of the coil, the part must be magnetized in the center of the coil.

3.7.2.3 When using a cable wrap or when the cross-sectional area of the part exceeds one-half of the cross-sectional area of the coil, the part SHOULD be centered in the coil and the formula for high fill factor coils SHALL be used for estimating the required amperage.

3.7.2.4 The diameter of the largest part that can be magnetized lying in the bottom of a coil or placed next to the coil wall for some typical coil sizes is listed in (Table 3-10). For any given coil diameter, parts with diameters larger than those listed SHALL be magnetized by some other method, such as centering them in the coil, using a cable wrap, or using a larger coil.

Table 3-10. Coil Size Vs. Maximum Diameter for Parts Magnetized in Bottom of Coil

Coil Diameter (inches)	Maximum Part Diameter (inches)
8	2.5
12	3.8
15	4.8
18	5.7
20	6.3
24	7.6

T.O. 33B-1-1

3.7.3 Calculating Coil Current. Two rule-of-thumb formulas have been developed for use in estimating the coil current levels to be used for longitudinal magnetization. One formula is for a part centered in the coil and the other for a part lying in the bottom of the coil. These formulas apply to cylindrical and irregularly shaped parts and at one time were thought to estimate the required current to within 10-percent. Recent studies show in almost all instances they overestimate the required current by at least 50-percent. They use the part length-to-diameter (L/D) ratio. The useful magnetizing field produced by an encircling coil extends approximately 6 to 9-inches to either side of the coil. For parts longer than the effective field distance, one or more inspections are required along the length of the part. When repositioning these longer parts in the coil, allow a 3-inch effective field overlap. The formulas are intended for part with a L/D ratio between 3, and 15. To inspect parts with an L/D ratio of 3 or less, (paragraph 3.7.3.6). For parts with an L/D ratio greater than 15, use 15 as the value for the ratio.

3.7.3.1 Formula for Part Lying in Bottom of Coil. The following formula can be used when the cross-sectional area of the part is less than one-tenth the cross-sectional area of the coil(s) and SHALL be used whenever the part is lying in the bottom of the coil, or is placed next to the coil wall during magnetization. If the part has hollow portions, replace D with D_{eff} (paragraph 3.7.3.4).

$$I = \frac{KD}{NL}$$

Where:

I = Current through coil (amperes)

K = 45,000 (a constant, ampere-turns)

L = Length of the part (inches)

D = Diameter of the part (inches)

N = Number of turns in coil

Example: Determine the current required to longitudinally magnetize a steel part, 10-inches long with a diameter of 2-inches using a 12-inch diameter coil having 5 turns. To determine cross-sectional area ratio between part and coil, refer to (paragraph 3.7.2). Substituting the known values and doing the calculations gives:

$$I = \frac{45000 \times 2}{5 \times 10}$$

$$I = 1800 \text{ amperes}$$

Typical currents for a five turn coil with the parts lying in the bottom of the coil or held next to the coil wall are provided in (Table 3-11).

Table 3-11. Typical Coil-Shot Current for a Five-Turn Coil With Part in Bottom of Coil

Part Length in Inches (L)	Part Diameter in Inches (D)	L/D Ratio	Ampere-Turns Required	Amperes Required
12	3	4	11,250	2,250
12	2	6	7,500	1,500
16	2	8	5,625	1,125
10	1	10	4,500	900
18	1 1/2	12	3,750	750
14	1	14	3,214	643

3.7.3.2 Formula for Part in Center of Coil. This formula SHALL be used when the cross-sectional area of part is greater than one-tenth and less than one-half of the cross-sectional area of the coil(s).

$$I = \frac{KR}{N(6(L/D) - 5)}$$

Where:

I = Current through coil (amperes)	(paragraph 3.7.3.1)
K = 43,000 (a constant, ampere-turns)	(paragraph 3.7.3.1)
R = Radius of coil (inches)	
N = Number of turns in coil	(paragraph 3.7.3.1)
L = Length of part (inches)	
D = Diameter of the part (inches)	(paragraph 3.7.3.1)

The term $6(L/D)-5$ is called the effective permeability.

Example: Determine the current needed to longitudinally magnetize a 12-inch long part with a diameter of 4-inches and using a 5 turn, 12-inch diameter coil. To determine the cross-sectional area ratio between the part and the coil, refer to (paragraph 3.7.2). If the part contains hollow portions, D should be replaced with D_{eff} (paragraph 3.7.3.4).

Substituting known values gives:

$$I = \frac{43000 \times 6}{5(6(12/4) - 5)}$$

$$I = 3969 \text{ amperes}$$

3.7.3.3 Formula for Cable Wrap or High Fill-Factor Coils. When using a cable wrap or when the cross-sectional area of the part is greater than one-half of the cross-sectional area of the coil, the following formula SHALL be used for estimating the current required to longitudinally magnetize a part centered in the coil. If the part has hollow portions, replace D with D_{eff} in the formula (paragraph 3.7.3.4).

$$I = \frac{K}{N((L/D) + 2)}$$

Where:

I = Current through coil (amperes)	(paragraph 3.7.3.1)
K = 35,000 (a constant, ampere-turns)	(paragraph 3.7.3.1)
N = Number of turns in coil	(paragraph 3.7.3.1)
L = Length of part (inches)	
D = Diameter of the part (inches)	(paragraph 3.7.3.1)

Example: Determine the required current to longitudinally magnetize a part, 12-inches long with a 4 inch diameter using the cable wrap technique with a 3 turn wrap.

Substituting known values gives:

$$I = \frac{35000}{3((12/4) + 2)} \qquad I = 35000/3(12/4 + 2)$$

$$I = 2333 \text{ amperes}$$

3.7.3.4 Formula for Hollow Parts or Parts Having Hollow Portions. If a part has hollow portions, replace the diameter (D) with the effective diameter (D_{eff}), which is calculated using:

3.7.3.4.1 Determining the Effective Diameter. For hollow and cylindrical test parts, the diameter of the test part is substituted with the calculated effective diameter. Calculate the effective diameter as follows:

$$D_{\text{eff}} = \sqrt{(OD)^2 - (ID)^2}$$

T.O. 33B-1-1

3.7.3.4.1.1 Example: Determine the effective diameter of a tube-shaped part with an outside diameter equal to 5-inches and an inside diameter of 4.5-inches.

$$= \sqrt{(25 - 20.25)}$$

$$= \sqrt{4.75}$$

$$D_{\text{eff}} = 2.179$$

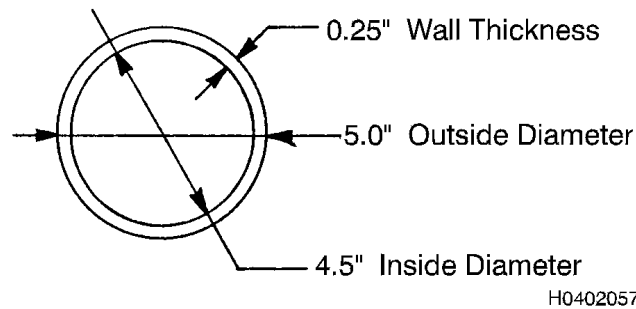


Figure 3-75. Calculating Effective Diameter

3.7.3.4.1.2 To calculate the current required to longitudinally magnetize the part in the above example, use the formula from (paragraph 3.7.3.1) for the part in the bottom of a 12-inch diameter coil with 5 turns, except replace D with D_{eff} (2.179):

$$I = \frac{KD}{NL}$$

$$I = \frac{45000 \times 2.179}{5 \times 10}$$

$$I = 1961 \text{ amperes}$$

3.7.3.5 In the examples of (paragraph 3.7.3.1) and (paragraph 3.7.3.4) above, the differences in the current required to longitudinally magnetize the solid and hollow parts are compared in (Table 3-12). The only difference in the two parts is one was hollow and the other was solid. If the effective diameter D_{eff} had not been considered, the current for the hollow part would have been over estimated by 927 amperes. This additional amperage would certainly result in excessive background and possibly false indications from over-magnetizing the part.

Table 3-12. Comparison of Coil Amperages for Solid vs. Hollow Parts

	Solid Part	Hollow Part
Part Length	10 inches	10 inches
Part Diameter	2 inches	2 inches
Coil Description	5-turn, 12-inch diameter	5-turn, 12-inch diameter
Amps Required	1800	873

3.7.3.6 If the need arises to inspect parts having L/D ratios of 3 or less, the effective L/D ratio SHALL be increased by placing the part between two pole pieces while it is being magnetized. The length dimension for the L/D ratio then becomes the length of the two pole pieces plus the part length. Such pole pieces must make good contact on each side of the part and must be made of ferromagnetic material. Solid steel pole pieces may be used when direct current is used in the coil and the continuous method of inspection is used. If the continuous method is used with either AC or half-wave DC current in the coil, the pole pieces SHALL be made from laminated magnetic material similar to the silicon steel legs of a hand probe with articulated legs. This is also true for residual inspection. Pole pieces SHALL be made from the proper material if residual inspection, or the wet continuous method of inspection with AC or half-wave DC, is to be used.

T.O. 33B-1-1

SECTION VIII MAGNETIC PARTICLE INSPECTION SAFETY

3.8 MAGNETIC PARTICLE SAFETY.

3.8.1 Safety Requirements. Safety requirements SHALL be reviewed by the laboratory supervisor on a continuing basis to ensure compliance with provisions contained in AFOSH Standard 91-110 as well as provisions of this technical order and applicable weapons system technical orders. Recommendations of the Base Bioenvironmental Engineer and the manufacturer regarding necessary personnel protective equipment SHALL be followed.

NOTE

Air Force Occupational Safety and Health (AFOSH) Standard 91-110 and 91-501 SHALL be consulted for additional safety requirements.

3.8.2 General Precautions. Precautions to be exercised when performing magnetic particle inspection include consideration of exposure to oils, pastes, and electrical current. The following minimum safety requirements SHALL be observed when performing magnetic particle inspections.

3.8.3 Floor Matting. Use rubber insulating floor matting in front of magnetic particle units. This matting SHALL be rated for the voltage of the equipment being utilized. This matting SHALL be replaced when it is worn to one-half the original thickness (approximately 1/8-inch). Use only one continuous length of matting and ensure it continues beyond the ends of the equipment for at least 24-inches.

3.8.4 Wet Suspension Precautions. Wet magnetic particle materials are normally nontoxic, but continuous exposure to oils and pastes used in the wet bath method may cause dermatitis or cracking of the skin. Protective gloves SHALL be worn during this process.

3.8.4.1 If a magnetic particle suspension oil, with a flash point of less than a 200° F is maintained in a Type II stationary magnetic particle unit, the following minimum safety requirements apply:

- Provide an adequate surface area exhaust ventilation system as determined by the local base bioenvironmental engineer.
- Maintain less than 25 gallons of liquid suspension in the tank.
- Cover the liquid suspension by a screened drain board.
- Provide a portable fire extinguisher, sufficient in size and/or volume to suppress any fire which could occur from the magnetic particle suspension oil. The fire extinguisher size and/or volume SHALL be determined by the local fire chief.

3.8.5 Arcing Precautions. Arcing may be caused by poor contact between the head stocks of the stationary magnetic particle unit. This arcing or excessive magnetizing current may injure the eyes. Arcing may also ignite combustible magnetic particle baths (e.g., oil). Ensure good electrical contact between the heads and the inspected part to prevent this possibility. The head stocks SHALL be wetted with the magnetic particle bath prior to energizing to reduce the possibility of arcing.

NOTE

The use of prods is prohibited on aircraft parts. Ensure they are not used in any hazardous area.

3.8.6 Head Stocks. Many units can be hand cranked to hold the part in place between the head stocks, and then air controlled pressure is applied with a foot pedal to ensure a solid fit between the stocks. In order to avoid injuring the inspector's hands, extreme care SHALL be maintained when placing articles between the head stocks of a magnetizing unit.

3.8.7 UV-A (Black Light) Hazards. Prolonged direct exposure of hands to the filtered UV-A lamp main beam may be harmful. Suitable gloves SHALL be worn during inspections when exposing hands to the main beam for extended periods.

3.8.7.1 The temperature of some operating black light bulbs reaches 750°F (399°C) or more during operation. This is above the ignition or flash point of fuel vapors. These vapors will burst into flame if they contact the bulb. Black lights SHALL NOT be operated when flammable vapors are present.

3.8.7.1.1 Exercise care when using hot black lights so as not to burn hands, arms, face, or other exposed body areas. Do not lay hot black lights on combustible surfaces. The bulb temperature also heats the external surfaces of the lamp housing. The temperature is not high enough to be visually apparent, but is high enough to cause severe burns with even momentary

contact of exposed body surfaces. Extreme care SHALL be exercised to prevent contacting the housing with any part of the body. Consult your local bioenvironmental office for specific guidance.

3.8.7.1.2 When practical, provide brackets or hangers in the area of black light use to permanently mount black lights at the wash station and within the inspection booth.

3.8.7.1.3 UV-A filtering safety glasses are specifically designed for penetrant and magnetic particle inspections and are recommended as they will filter out glare and reduce eyestrain. Install ultraviolet filters on all mercury vapor lamps used for penetrant inspection. Replace cracked, chipped, or broken filters before using the light. Injury to eyes and skin will occur if the light from the mercury vapor bulbs is not filtered. UV-A filtering safety glasses, goggles, or face shields SHALL be worn and precautions SHALL be taken to cover exposed skin that is routinely exposed to the direct beam of any black light.

3.8.7.2 Black Light Physiological Effects.



Unfiltered ultraviolet radiation can be harmful to the eyes and skin. Black light bulbs SHALL NOT be operated without filters. Cracked, chipped, or ill-fitting filters SHALL be replaced before using the lamp.

3.8.8 Hazards of Aerosol Cans. Aerosol cans are a convenient method of packaging a wide variety of materials. Their wide use, both in industry and the home, has led to complacency and mishandling. Some of the hazards in the use of aerosol cans are discussed below.

3.8.8.1 The containers are gas pressure vessels which when heated to temperatures above 120°F (49°C) increases the gas pressure resulting in possibly bursting the container. Any combustible material, regardless of flash point, can ignite with explosive force when it is finely divided and dispersed in air. Magnetic particle materials SHALL be stored in a cool dry area, protected from direct sunlight.

3.8.9 Magnetic Rubber Precautions. General safety precautions are applicable to magnetic rubber inspection. The silicon rubber, dibutyltin dilaurate, stannous octoate, cure stabilizers, cleaners, and release agents are or can be skin and eye irritants, skin sensitizers (causing allergic reactions), inhalant and ingestion hazards. For specific information concerning any of the materials used as magnetic rubber, magnetic rubber catalysts, release agents, or cleaners consult the Material Safety Data Sheets, or contact the appropriate Safety Officer. Silicon oil is an ingredient in the material and can result in very slippery surfaces, especially floors, if not well controlled. When performing magnetic rubber inspection on aircraft using electromagnets to magnetize, the aircraft SHALL be grounded.

CHAPTER 4

EDDY CURRENT INSPECTION METHOD

SECTION I EDDY CURRENT TESTING (ET) METHOD

4.1 GENERAL CAPABILITIES OF ET.

4.1.1 Introduction to ET. This method is used to detect discontinuities in parts that are conductors of electricity. An eddy current is a circulating electrical current induced in a conductor by an alternating magnetic field. A coil of copper wire is placed in a holder called a “probe.” The probe produces the alternating magnetic field used in ET. The eddy currents induced in an electrical conductor vary in magnitude and distribution in response to specimen properties such as electrical conductivity, magnetic permeability, geometry, and discontinuities. When eddy currents encounter an obstacle, such as a crack, the normal path and strength of the currents is changed. This change is detected on a display or a meter. ET is a “reference” type inspection. The term “reference” means a standard is used to setup the equipment. Results are only as good as the reference standard(s) used. For flaw detection, a minimum of three flaws of varying sizes is recommended for setup. The three flaws represent a closer standardization method for inspection reliability and probability of detection (POD) data. Calibration standards are also used for thickness measurements and conductivity testing. The term “calibration” refers to the use of standards directly traceable to a National Institute of Standards and Technology (NIST) standard that is government controlled.

T.O. 33B-1-1

4.1.2 Definition of Eddy Current. Eddy currents are electrical currents induced in a conductor by a time-varying magnetic field. Eddy currents flow in a circular pattern, but their paths are oriented perpendicular to the direction of the magnetic field.

NOTE

When the ferromagnetic properties of the specimen are of interest, magneto inductive testing is the more appropriate term. For the purposes of this chapter ET will be the term of choice. Eddy currents flowing in various configurations are illustrated in (Figure 4-1).

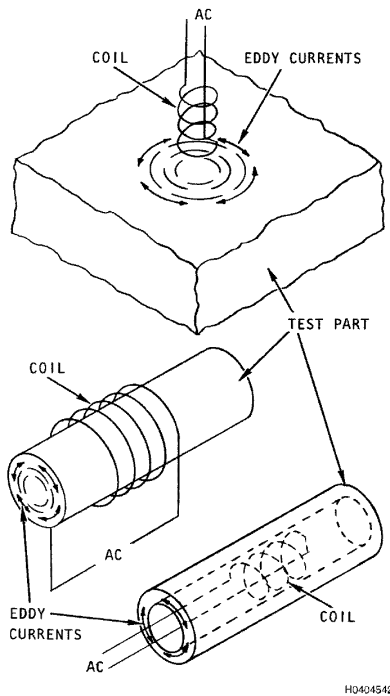


Figure 4-1. Generation of Eddy Currents in Various Part Configurations

4.1.3 Inspection With Eddy Current. ET can do the following:

- Detect surface and some subsurface cracks.
- Detect discontinuities in materials.
- Determine material properties.
- Measure thickness of thin metals, conductive coatings, and non-conductive coatings on conductive substrate.

4.1.4 Limitations of Eddy Current Method. The following are some limitations to the ET method:

- Inspection is limited to electrically conductive materials.
- Flaws that run parallel to the surface are difficult to detect.
- Ferromagnetic materials have permeability effects that conflict with conductivity.

4.1.5 Variables Affecting Eddy Currents. The generation and detection of eddy currents in a part are dependent on the following:

- The inspection system.
- Material properties of the part.
- The test conditions.

4.1.5.1 Inspection parameters such as the coil-to-specimen separation (also called lift-off or fill-factor, depending on the type of coil used) and coil assembly design may cause the eddy currents to vary. A consequence of this is often that ET for

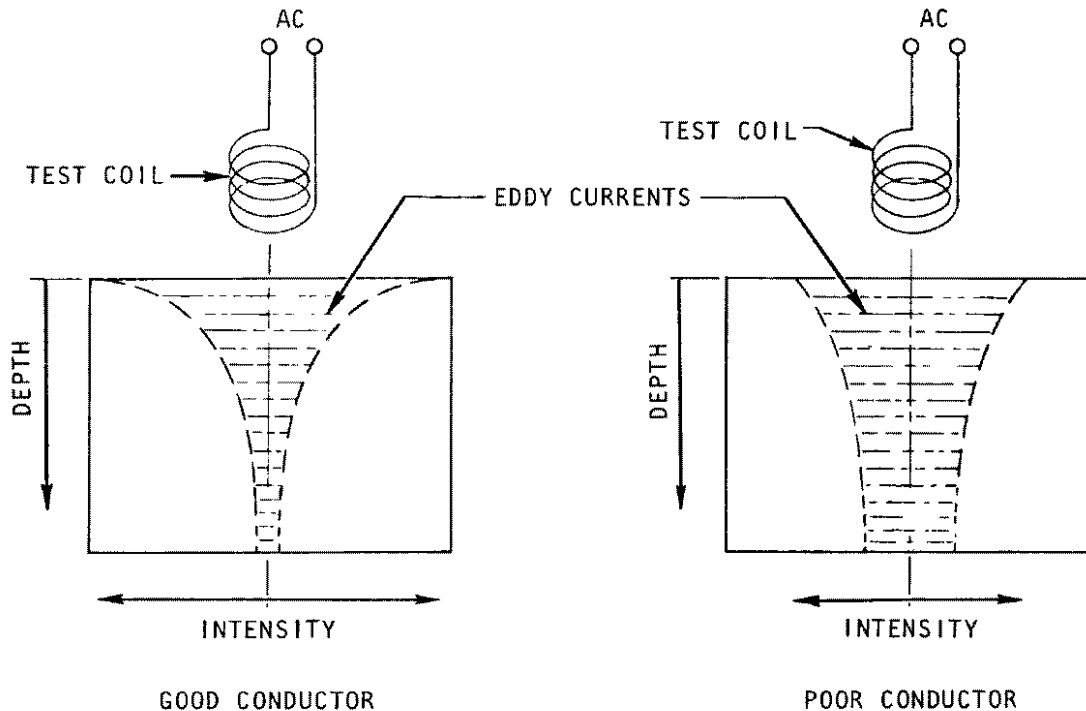
one condition (e.g., presence of discontinuities), can be hampered by variations in properties not of concern (e.g., specimen geometry). In most cases, the effects of variations in properties not of interest can be minimized or suppressed.

4.1.6 Eddy Current Techniques. There are a wide variety of Eddy Current techniques. A technique can be defined by the test frequencies, coil arrangements, data analyses, and data displays that are used. The techniques in (Table 4-1, Section 4.7) are common applications used to measure or detect a variety of conditions. The table is categorized according to the actual material property or inspection parameter to be measured.

4.1.6.1 Field Application. The Eddy Current method is suited for detection of service-induced cracks in aircraft parts and related equipment. In addition, eddy current equipment is portable, with most systems using battery power. Eddy current applications are best suited for inspecting small localized areas. Scanning large areas for randomly oriented cracks is discouraged unless the system is automated. Eddy current can be more economical than other methods, because stripping and refinishing of surface coatings is not normally required.

T.O. 33B-1-1

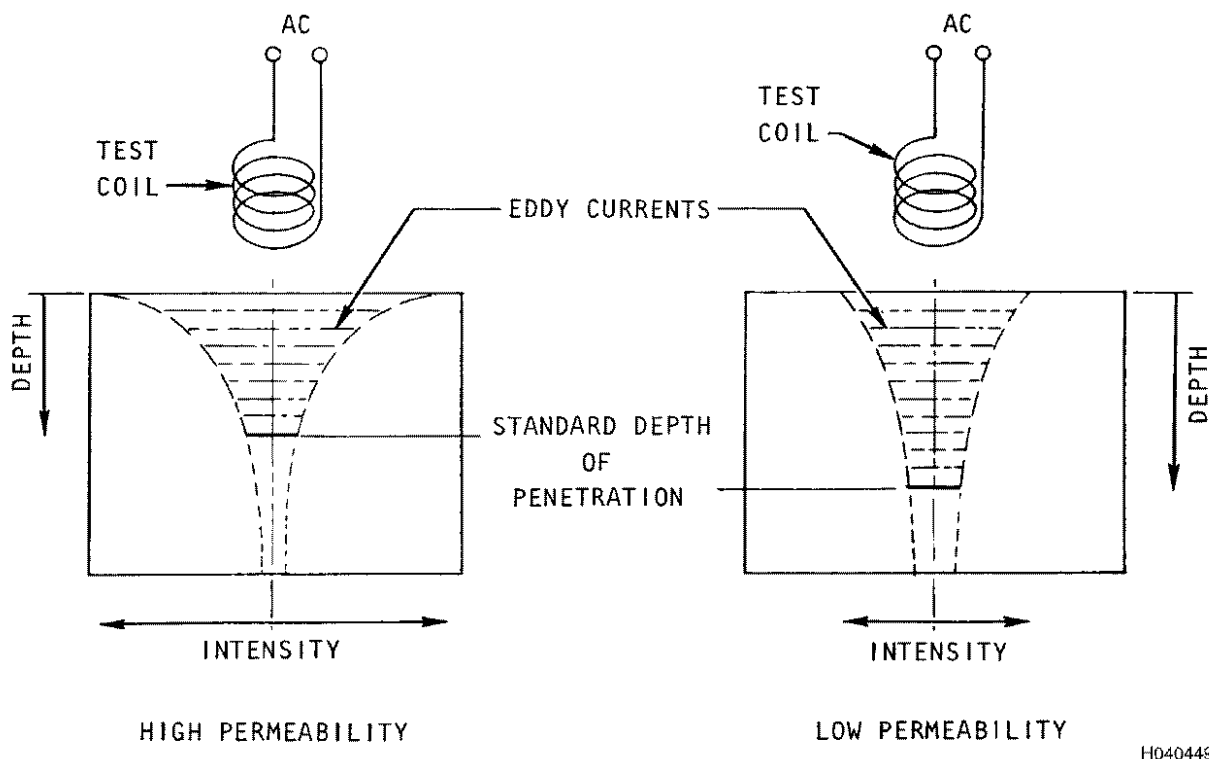
4.1.7 Effect of Conductivity on Eddy Currents. The distribution and intensity of eddy currents in non-ferromagnetic materials is strongly affected by electrical conductivity (paragraph 4.7.1.4). In a material of relatively high conductivity, strong eddy currents are generated at the surface. In turn, the strong eddy currents form a strong secondary electromagnetic field opposing the applied primary field. As a result, the strength of the primary field decreases rapidly with increasing depth below the surface. In poorly conductive materials, the primary field generates small amounts of eddy currents, which produce a small opposing secondary field. Therefore, in highly conductive materials, strong eddy currents are formed near the surface, but their strength reduces rapidly with depth. In poorly conductive materials, weaker eddy currents are generated near the surface, but they penetrate to greater depths. The relative magnitude and distribution of eddy currents in good and poor conductors are shown in (Figure 4-2).



H0404496

Figure 4-2. Relative Magnitude and Distribution of Eddy Currents in Good or Poor Conductors

4.1.7.1 Permeability. Eddy current testing of ferromagnetic parts is usually limited to testing for flaws or other conditions that exist at or very near the surface of the part. In a ferromagnetic material, as compared to a non-ferromagnetic material, the primary field results in a much greater internal field because of the large relative magnetic permeability. The increased field strength at the surface results in increased eddy current density. The increased eddy current density generates a larger secondary field that rapidly reduces the overall field strength a short distance from the surface. Consequently, the effective depth of penetration during ET is much less in ferromagnetic materials than in other conductive materials. The high relative permeability acts as a shield against the generation of eddy currents much below the surface in a ferromagnetic part. The relative effects of permeability variations on the depth of penetration and the intensity of the eddy currents are shown in (Figure 4-3).



H0404497

Figure 4-3. Relative Magnitude and Distribution of Eddy Currents in Conductive Material of High or Low Permeability

4.1.7.2 Magnetic Permeability. Relative magnetic permeability is the principal property that affects eddy current responses. The relative permeability depends on a wide variety of parameters; alloy composition, degree of magnetization, heat treat, and residual stress, to name a few. Variations in permeability due to non-flaw conditions mask effects from discontinuities or other conditions of interest. There are some situations where the permeability in the area of interest is not an interfering parameter and ET can be successfully applied. An increase in conductivity or a decrease in permeability causes a decrease in measured impedance. Conversely, a decrease in conductivity or an increase in magnetic permeability causes an increase in measured impedance.

4.1.7.3 Geometry. Eddy currents occupy a volume in a conductive material that is relatively small. As indicated in (Figure 4-2) and (Figure 4-3), the volume is approximately conical and not very deep. The maximum diameter will be on the order of twice the diameter of the driving coil and the depth is estimated by the equation discussed in the equations, (Section 4.7). Part geometry only becomes significant when this volume exceeds the volume available within the part. This happens when the thickness of the region of the part inspected is less than the effective depth of this conical volume or when an area near edges of the part is inspected.

4.1.7.4 Lift-Off. As an eddy current probe is brought near a conductive part, you will note a change in the detected signal. With the probe near a part, a pronounced signal change will be observed in response to a small change in distance between probe coil and part. This effect is termed "lift-off." The signal change occurs because the intensity of the eddy currents in the part decreases considerably with a slight increase in coil-to-part spacing. This condition is demonstrated in (Figure 4-4). Calibrated measurements of lift-off can be used to determine the thickness of non-conductive coatings on conductive parts.

T.O. 33B-1-1

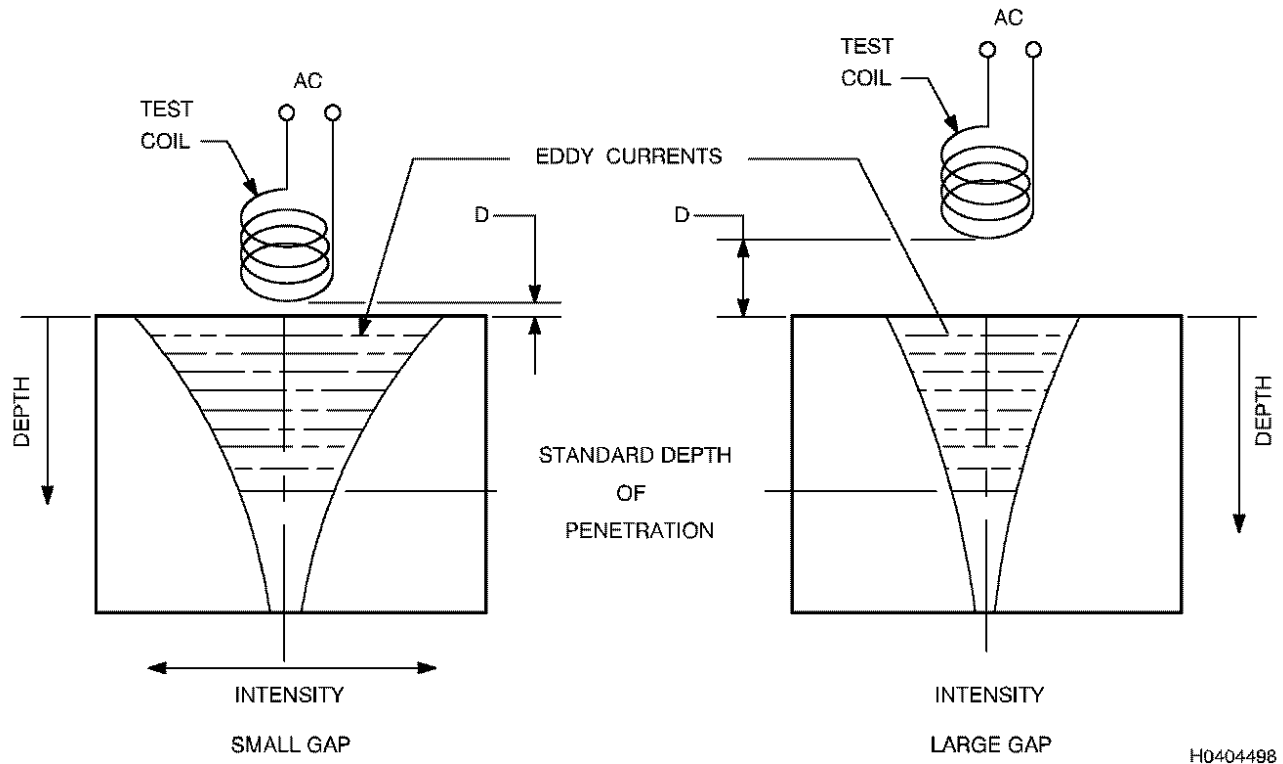
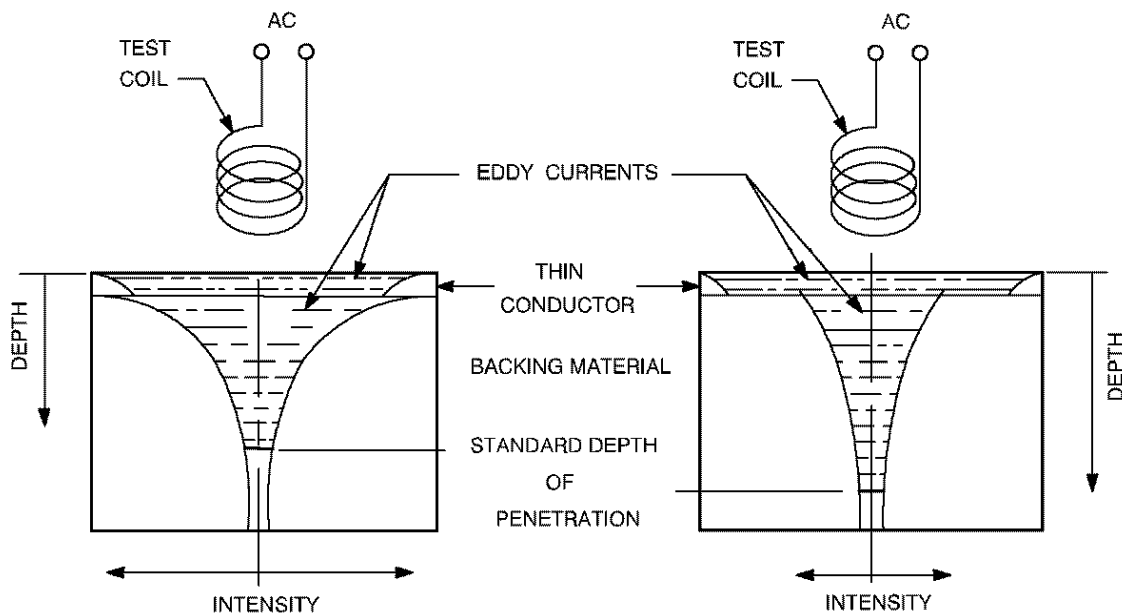


Figure 4-4. Relative Intensity of Eddy Currents With Variations in Lift-Off

4.1.7.5 Material Thickness. In sheet material with a thickness less than the effective depth of penetration, the electromagnetic field is not zero at the back surface. As the thickness decreases, the field at the back surface increases. And, as the thickness increases, the back surface field decreases. This provides a mechanism for thickness gauging of thin materials. Furthermore, a material of either lower or higher conductivity at the far side will change the magnitude and distribution of the eddy currents as shown in (Figure 4-5). This provides a means for thickness gauging of thin, conductive coatings on underlying materials that are either more or less conductive than the coating.

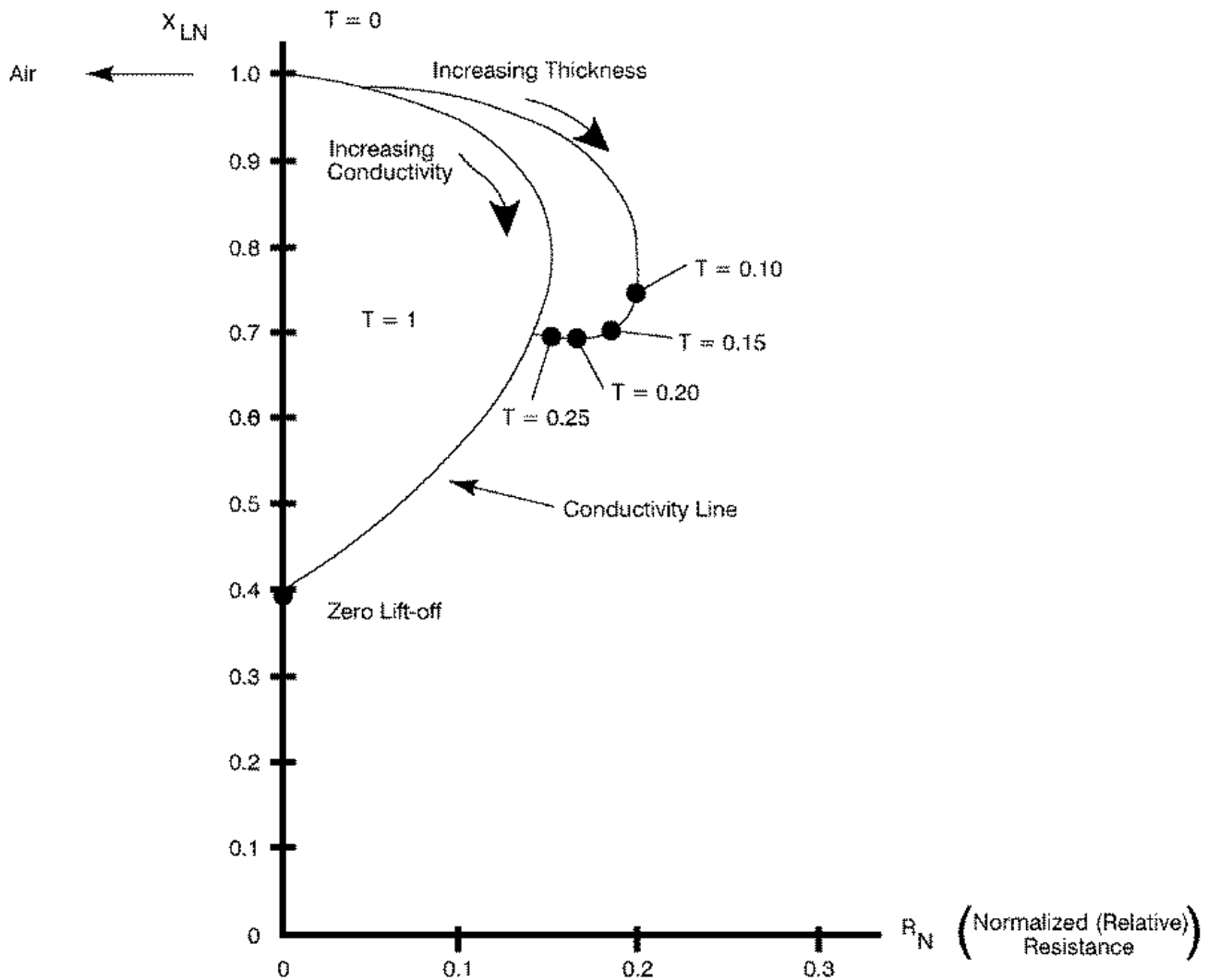


H0404499

Figure 4-5. Distribution of Eddy Currents in Thin Conductors Backed by Materials of Different Conductivity

4.1.7.6 Thickness Variations. When the part thickness is less than the effective depth of penetration of the test coil at the inspection frequency employed, the impedance curve departs from the conductivity curve as shown in (Figure 4-6). Typically, there is an increase in the resistive component of the impedance with thinner parts, as compared to parts that have thickness equal to or greater than the effective depth of penetration. As the thickness of the parts increase and approach more closely the effective limit of penetration, the curve tends to spiral as it approaches the end point ($T=1$) on the conductivity curve, where T equals the ratio of the specimen thickness to the effective depth of penetration in that specimen.

T.O. 33B-1-1



HD404800

Figure 4-6. Impedance Diagram Showing the Effect of Specimen Thickness (paragraph 4.4.17.4)

4.1.7.7 Conductive Layers. The impedance curve for thin conductive layers on a substrate of different conductivity is also represented as a change in the impedance curve for conductivity. The impedance for the layered material departs from the conductivity curve at the value corresponding to the substrate conductivity and forms a loop that rejoins the conductivity curve at the conductivity of the metal in the outer layer. Increasing thickness of the outer layer corresponds to a clockwise direction along the loop. The point at which the loop rejoins the curve represents the effective depth of penetration in the coating.

4.1.7.8 Cracks, Lift-Off, and Conductivity. The impedance changes due to surface cracks of different depths. The change for cracks will lie between the lift-off and conductivity. As the crack depth increases, the response moves farther from lift-off and closer to decreasing conductivity.

4.1.7.9 Heat Treat Condition or Hardness. Heat treating (or age hardening) a metal changes its hardness and its electrical conductivity. Just as above, the aluminum alloys have been the most investigated for the hardness/conductivity

effect. Again, the impedance change is along the conductivity curve in the range of 25% to 65% International Annealed Copper Standard (IACS).

4.1.7.10 Temperature. Changing the temperature of a part changes its electrical conductivity. All metals become less conductive as temperature rises. This would be seen on the impedance plane as a movement along the conductivity curve toward the zero (air) end of the curve. For aluminum alloys, conductivity decreases about 1% IACS for a 20° F increases in temperature. If a conductivity meter is being used to check for proper alloy or heat treat condition, the temperature of all parts and calibration standards must be the same and kept constant. A change in temperature could be interpreted as a change in alloy or hardness, since all three factors may change the conductivity of a metal.

4.1.8 Crack Detection in Non-Ferromagnetic Materials. The amplitude of the response from a surface crack increases as the crack gets deeper. When the crack reaches three standard depths (paragraph 4.2.1.27.8) it is interrupting essentially all of the eddy current flow and no increase in amplitude is seen as it gets still deeper. Besides an amplitude increase for deeper cracks, the phase angle of the crack indication changes. A shallow crack interrupts little of the eddy current flow, so the amplitude of its signal is small. Also, it is essentially a surface condition, so the direction (phase) of the signal response is very close to that of lift-off (Figure 4-7). A deeper crack interrupts more of the eddy current flow, so its signal has greater amplitude. It extends well below the surface, the direction (phase) of its signal is farther away from lift-off (Figure 4-8). The three standard depths crack has the largest amplitude response. It interrupts the eddy currents as far down in the metal as the test can sense, it looks like a change in the bulk property of lower conductivity, and the crack signal direction (phase) is along the conductivity curve (Figure 4-9).

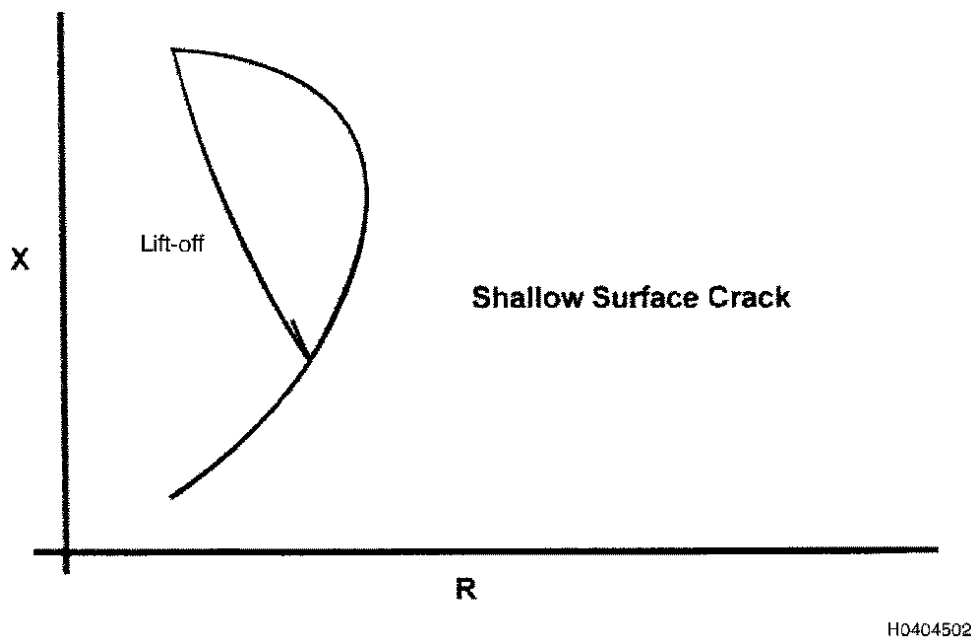


Figure 4-7. Shallow Surface Crack

T.O. 33B-1-1

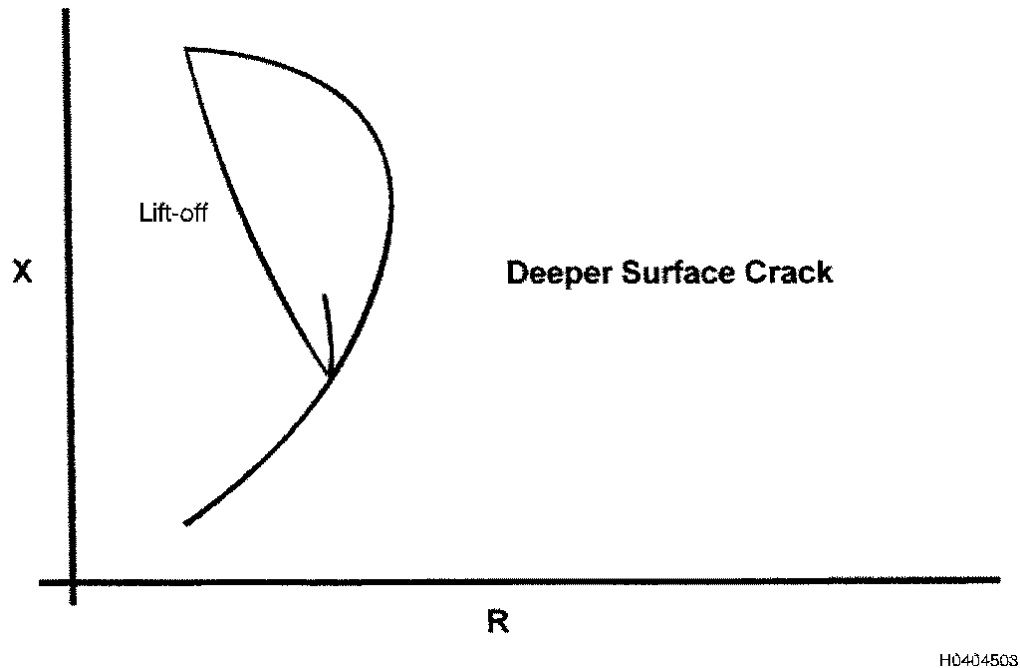


Figure 4-8. Deeper Surface Crack

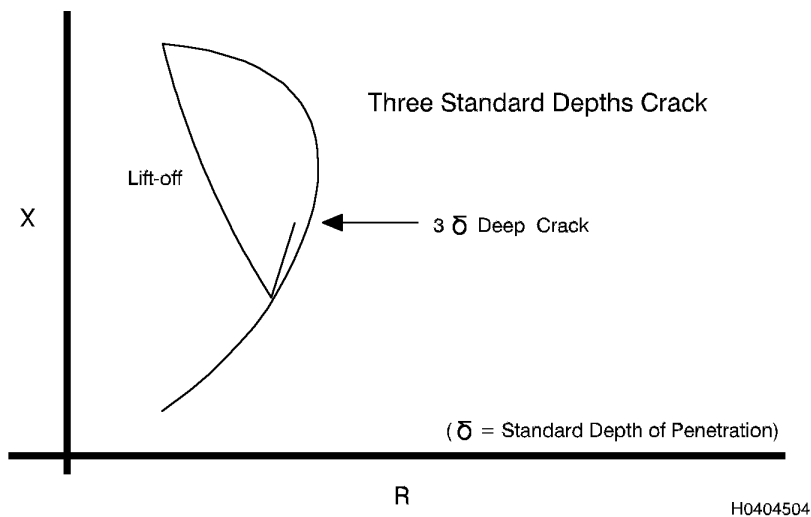


Figure 4-9. Three Standard Depths of Penetration

4.1.8.1 Making the three standard depths crack deeper will not change the signal response because there will be no eddy current flow for it to interrupt. However, there will be a change in the signal response for a subsurface crack. First, eddy currents will flow over the top of the crack (at the surface), the subsurface crack will not block as much of the EC flow and the amplitude of the signal must decrease. Second, the crack is now farther away from the surface so its phase angle must still be further away from lift-off (Figure 4-10).

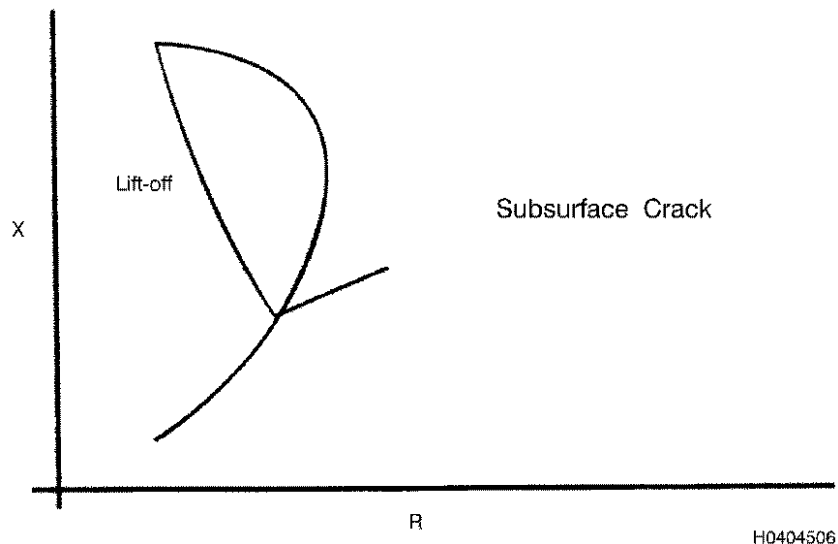


Figure 4-10. Subsurface Crack

4.1.8.2 Signal response decreases as the depth of the crack below the surface increases. As the subsurface defect gets further away from the surface the signal amplitude gets smaller and the phase angle rotates clockwise, away from lift-off (Figure 4-11).

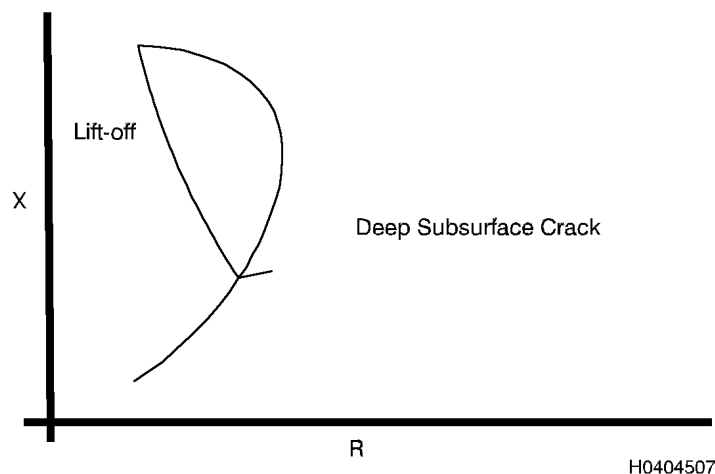


Figure 4-11. Deep Subsurface Crack

4.1.9 Phase Lag at Depth. A phase angle shift can occur and change the eddy current field time and travel distance. Changes at the surface of the part are seen immediately by the coil, while disturbances to the field at some depth in the part require some travel time to return to the surface where they are seen by the coil. Electrically, this is described as phase lag at depth, and the amount of phase lag is 1 radian (57°) per standard depth of penetration (Figure 4-12). This phase lag from the lift-off (surface) signal may be used to measure the depth of defects. The phase angle of a defect signal correlates to defect depth.

T.O. 33B-1-1

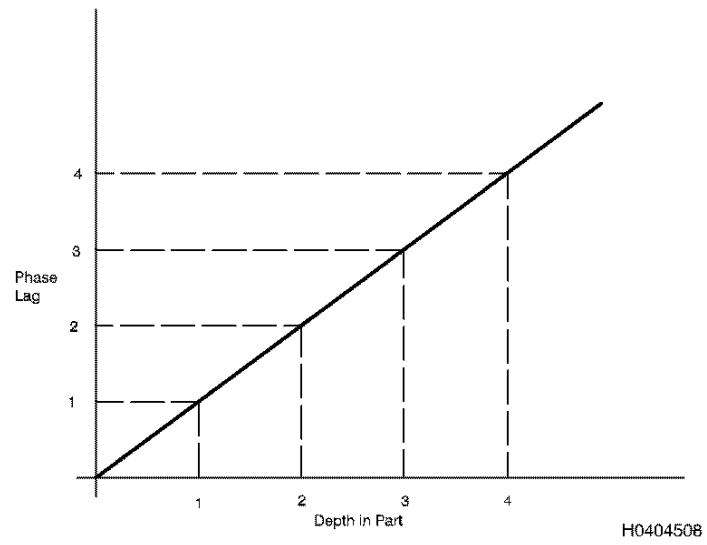


Figure 4-12. Depth in Part

SECTION II EDDY CURRENT PRINCIPLES AND THEORY

4.2 PRINCIPLES AND THEORY OF ET.

4.2.1 Materials and Processes.

4.2.1.1 Structure of Metals. The atoms of a chemical element have a nucleus or center with a positive charge. Around each nucleus are orbiting electrons. Each element has a different size nucleus surrounded by a characteristic number and arrangement of orbiting electrons. The distribution and number of the outermost electrons determine the properties of the element, including its metallic or nonmetallic nature. In a crystalline solid the atoms are stacked in an orderly arrangement called a lattice.

4.2.1.2 Mechanical Properties. Yield strength, tensile strength, and fatigue strength are determined by resistance to plastic deformation. Plastic deformation is permanent distortion of the metal and results from shearing along layers of atoms. Plastic deformation is made easier by the presence of localized imperfections in the lattice. These lattice imperfections are called dislocations and are present in great numbers in all commercial metals and alloys. If the resistance to movement of the dislocations can be increased, the strength of the metal can be increased.

4.2.1.3 Electrical Conductivity. Electrical conductivity is a measure of the ease with which electrons can move within a material. Good conductors of electricity have loosely bound electrons in the atomic lattice or crystalline structure and are relatively free of obstacles to the movement of those electrons. Metals have greater conductivity than nonmetals, but even within metals there is a wide range of conductivity. A perfect lattice is one in which there is no interruption in the orderly arrangement of the atoms making up the material. This situation offers the fewest obstacles to electron flow, and therefore, the highest conductivity. Any irregularity or distortion of the atomic lattice impedes the flow of electrons. Sources of such obstructions include atoms of alloying elements and grain boundaries (where lattice mismatches occur because of differing crystalline orientations). Additional obstructions are created when heat treat processes precipitate alloying elements at grain boundaries to increase strength. Cold working also creates obstructions to the flow of electrons, because of its disruption of the lattice structure. During NDI inspections it is important to note cracks and other discontinuities will also impede electron flow.

4.2.1.4 Mechanical Properties of Pure Metals. A pure metal is one composed entirely of a single element. These metals are rarely used in structural applications and are usually difficult to prepare because of problems in removing all traces of other elements. They have relatively low resistance to deformation because there are few mechanisms to prevent the movement of dislocations through the metal. Two conditions can add to the strength of pure metals. Yield strength, which is a measure of the first detectable plastic deformation, can be increased very slightly by decreasing grain size. A grain is a small volume of the metal with the same three dimensional repetitive patterns of atoms. Most engineering metals are made up of a large number of grains fitted together along grain boundaries usually not visible to the unaided eye. Difference in lattice orientation in adjoining grains provides increased resistance to dislocation movement. A second strengthening mechanism for pure metals is cold working. Cold working multiplies the number of dislocations, and interaction between dislocations on different lattice planes increases the resistance to further deformation.

4.2.1.5 Alloys. Most engineering metals are alloys. An alloy is formed by adding one or more metals or non-metals to a base metal to form a metal of desired properties. Alloying elements are usually added during melting of a base metal and the quantities added are specified as a percentage range. The alloying elements can be in one or more forms in the solidified state depending on the amount added and the rate of cooling from the melting temperature. Some elements may occupy lattice positions normally occupied by atoms of the principle element in the material. The alloy thus formed is called a substitutional solid solution. Very small atoms such as those of carbon, nitrogen, and hydrogen take up positions between the base metal atoms to form interstitial solid solutions. This action can actually change the lattice structure, an example being the addition of carbon to iron to form steel. Alloying elements can also form new lattice structures which are continuous throughout the metal or distributed as small particles of various sizes throughout the metal. The distribution of the alloying elements is dependent on the amount of alloying elements that are added in relation to the amount that can be tolerated in the lattice of the base metal and their change in solubility with temperature.

4.2.1.6 Alloy Effects on Mechanical Properties. All of the alloying element distributions increase the resistance of a metal to deformation. Increased strength results from the interference of the alloying atoms of particles formed by the alloying atoms with the movement of dislocations or by the generation of new dislocations. This distribution can often be modified by heat treatment.

T.O. 33B-1-1

4.2.1.7 Heat Treatment. The properties of metals can be altered by changing the number and distribution of dislocations, alloying atoms, and particles of different composition. These changes can be accomplished through various types of heat treatment. The three principal types of heat treatment are: (1) annealing, (2) solution heat treatment, and (3) precipitation heat treatment or artificial aging.

4.2.1.8 Annealing. In annealing, the metal is heated to a sufficiently high temperature to remove the effects of cold working by redistribution of dislocations and, in some instances, by the formation of new stress-free grains (recrystallization). During the annealing of alloys, the temperature is selected sufficiently high to permit the alloying atoms to readily migrate. However, this selected temperature is sufficiently below maximum solubility to favor the formation of separate particles and compounds by the alloying atoms. Slow cooling from the annealing temperature encourages even more alloying atoms to move from their random position in the base metal lattice to aid in the growth of larger secondary compounds.

4.2.1.8.1 Annealing Effects on Mechanical Properties. Annealing removes many of the obstacles to plastic flow, such as interacting dislocations, the numerous individual alloying atoms, and fine particles that normally resist plastic deformation. These processes generally result in metals of lower strength and greater ductility after annealing.

4.2.1.9 Solution Heat Treating. The minimum number of alloying atoms will occupy lattice sites of the base metal when a temperature slightly below melting point is reached. In interstitial solid solutions, the maximum number of atoms will occupy interstitial positions. As temperatures are lowered, the atoms of many alloying elements will tend to diffuse together and form separate compounds or regions with a different lattice. If the metal is cooled rapidly, the atoms do not have time to diffuse and are held in their original lattice positions (retained in solution). The process is called solution heat treating. Any delay in rapid cooling (delayed quench) or a slow rate of cooling will permit an increased amount of diffusion and reduce the number of alloying atoms held in solution.

4.2.1.9.1 Solution Heat Treating Effects on Mechanical Properties. The alloying atoms retained in base metal lattice positions by solution heat treating present obstacles to dislocation movement. The resistance to plastic deformation increases the strength of the metal. In many instances, more than one alloying element contributes to the higher strength of alloys. Slow rates of cooling from solution heat treating temperatures or too low a solution heat treating temperature can reduce the strength of the heat treated alloy.

4.2.1.10 Precipitation Heat Treatment. If an alloy has been solution heat treated to retain atoms in the same lattice occupied at high temperature, properties can be further modified by a precipitation or aging treatment. During a precipitation treatment, an alloy is heated to a temperature which will allow alloying atom diffusion and coalescence to form microscopic particles of different composition and lattice structure within the metal. The number, size, and distribution of the particles are controlled by the time and temperature of the aging process. Temperatures are much lower than those required for solution heat treating or annealing. Lower temperatures and shorter times result in smaller particle sizes. Higher temperatures favor the formation of fewer but larger particles.

4.2.1.10.1 Precipitation Treatment Effects on Mechanical Properties. Precipitation or aging treatments are generally designed to increase the strength of alloys, particularly the yield strength. The strengthening is accomplished by the formation of small particles of different composition and lattice structure from the original lattice. The small particles provide obstacles to the movement of dislocations in which planes of atoms slip one over the other causing plastic deformation. Greatest strengthening usually occurs at a specific range of particle size for a particular alloy system. In many cases, aging is performed under conditions designed to provide a specific combination of strength and ductility, or corrosion resistance. As aging increases beyond the optimum time or temperature, particle size increases and gradual softening occurs. When material has been aged for an excessive time or at too high a temperature, it is said to be over-aged.

4.2.1.11 Measurement of Mechanical Properties. The most common method of determining the strength of metals is by means of a tensile strength test. In the tensile strength test, a specimen is cut from the metal to be tested, machined to a specified configuration, and tested until it fails. This is accomplished by applying a known tensile force. Tensile force is the stress at which a known amount of plastic deformation occurs, and the breaking stress can then be determined. Many other destructive type tests can be performed to establish such properties as impact resistance, notch sensitivity and fatigue strength. All of these methods require destroying a section of the part to be tested and involve considerable time and expense.

4.2.1.12 Hardness Testing. An approximate measure of strength of metals may be established by hardness testing. Hardness is usually determined by the resistance of a metal to penetration by a rounded or pointed indenter pressed into the surface with a known static force. Measurement of hardness is based on the depth of penetration of the indenter, or the plane area of the indentation. For many metals, correlation has been established between hardness and tensile strength. Hardness

supplies no information regarding ductility although portable hardness testers are available; access and geometry often limit their use.

4.2.1.13 Overview of Signal Detection, Processing, and Display.

4.2.1.13.1 Signal Sources. When performing an eddy current technique, material changes can be detected by monitoring the alternating current in the coil (single coil arrangement) or using a separate sensing coil to monitor the resultant electromagnetic field. These signals can be analyzed for information relevant to the inspection being conducted. The important thing to note is the coil that is acting as the receiver is producing an electrical current that either leads or lags the instruments oscillator current. The difference in this “leading” or “lagging” is the phase angle.

4.2.1.13.2 Signal Detection. A simple but effective signal detection technique is to use a bridge circuit as illustrated in (Figure 4-13). With current flowing through the test coil and the coil positioned on a flaw-free or reference area, the variable impedance Z_1 can be adjusted so zero current flows through the amplifier. This adjustment is termed either “balancing” or “nulling” the bridge. When the coil is placed on a flawed or damaged area, the resultant change in current through the coil “unbalances” the bridge and current flows through the amplifier. This current is the inspection signal. The signal has the same frequency as the current through the coil. The phase and amplitude of this signal contains information on the condition that caused the bridge unbalance.

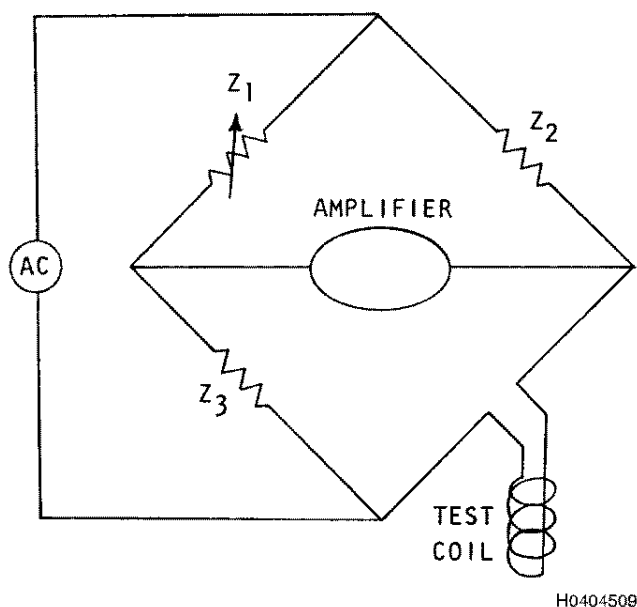


Figure 4-13. Simplified Bridge Circuit

4.2.1.13.3 Signal Analysis. In the simplest type of instrumentation, analysis of the signal consists of measuring the change in magnitude of the current flowing through the bridge. Changes in the magnitude of the alternating current are amplified and converted to a direct current for display or readout. In more sophisticated instrumentation, both amplitude and phase are measured.

4.2.1.14 Displays. The method by which eddy current signals are presented is dictated by the type of information required and the complexity of the instrumentation. When only signal amplitude is measured, meters, alarm signals, or recorders are commonly used. When both amplitude and phase information are to be displayed, a two-dimensional display device is normally used.

4.2.1.14.1 Amplitude Display. Meters may be analog (needle moving over a fixed numerical scale) or digital. Audible or visual alarms may be set to trigger when the signal amplitude exceeds a predetermined threshold. A recorder presents a continuous record of the signal amplitude during an inspection for subsequent analysis.

T.O. 33B-1-1

4.2.1.14.2 Impedance Plane Display. Defects or other variations in material characteristics will alter the strength and distribution of an induced eddy current flow. Changes in the eddy current flow will result in changes in the inducing coil or sensor coil currents. These changes can be expressed as an apparent change in the coil's electrical impedance. This makes it possible to associate changes in material properties with specific changes in the apparent impedance of either the excitation or sensor coils. The two-dimensional display that permits this is the most commonly used and is called an impedance plane display.

4.2.1.15 Inductance of a coil. The inductance of a coil depends upon the number of turns in the coil, the size of the coil, the permeability of the material within the coil (e.g., the core of the coil), and total magnetic flux through the coil.

An alternate method of expressing self-inductance (L) is:

$$L = n \Phi / I$$

Where:

- L = Inductance (Henrys)
- n = Number of turns in coil
- Φ = Magnetic flux (Webers)
- I = Current through coil (Amperes)

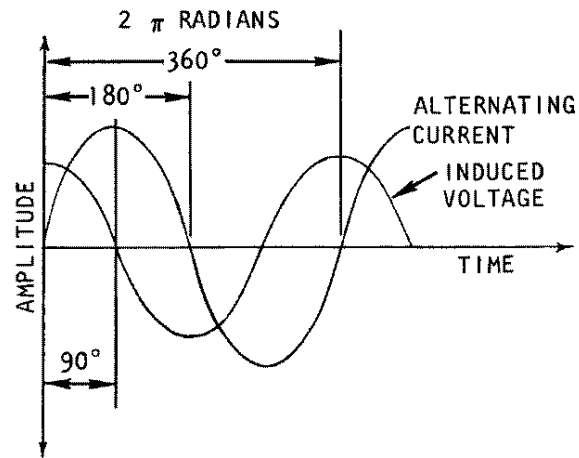
4.2.1.15.1 Inductive Reactance. The measure of the amount of opposition or resistance (Ohms) to alternating current flow due to inductance in a coil is called inductive reactance. Inductive reactance is dependent upon the value of the inductance of the coil and the frequency of the alternating current. The inductive reactance increases as the inductance or frequency increases. This can be stated by the following equation:

$$X_L = 2 \pi fL$$

Where:

- X_L = Inductive reactance (Ohms)
- $\pi = 3.141596$
- f = frequency (Hertz)
- L = Inductance (Henrys).

4.2.1.15.2 The inductive reactance results from the electromotive force generated across a coil by the alternating current. The instantaneous value of this induced voltage, increases and decreases as the rate of change of the applied alternating current increases and decreases as shown in (Figure 4-14). The voltage is at its maximum value when the rate of current change is at its maximum; this occurs when the current value is at zero. Conversely, the voltage is zero when the rate of current change is zero; this occurs when the current is at its maximum value. Considering 360-degrees to be one complete cycle, the induced voltage leads the current (e.g., is out of phase with the current) by 90-degrees as illustrated in (Figure 4-14). The induced voltage is in opposition to the electromotive force applied to the coil, reducing the amplitude of the resultant current.

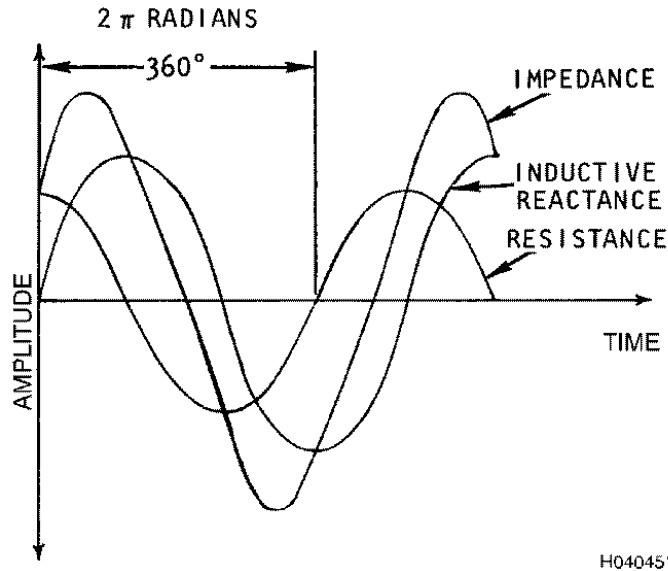


H0404510

Figure 4-14. Sinusoidal Variation of Alternating Current and Induced Voltage in a Coil

T.O. 33B-1-1

4.2.1.16 Combining Out of Phase Quantities. A real coil has a resistive component of the impedance in addition to the inductive reactance. They can be combined to describe the net impedance. A coil can be considered to be a resistor in series with an inductor. Applying an alternating current to this series circuit will result in two voltages, one across the resistor and another across the inductor. The net voltage across the combination of the resistor and inductor (e.g., across a real coil), will be the combination of the two voltages. The voltage across the resistor will be in phase with the current while the voltage across the inductor will lead the voltage across the resistor by 90-degrees. The combination of the two voltages, as illustrated in (Figure 4-15), results in a voltage that will be out of phase with the current but not by a full 90-degrees.



H0404511

Figure 4-15. Combining of Out-of Phase Voltages

4.2.1.16.1 X-Y Plot Representation. Another way to illustrate the combination of out-of-phase quantities in a coil is illustrated in (Figure 4-17). Here the two voltages drop; one across the resistor (V_R) and the other across the inductor (V_L) are plotted at right angles to each other. This represents the two quantities being 90-degrees out of phase. The combination of the two quantities is represented by the diagonal line OA that is at the angle " θ " with respect to the voltage drop across the resistor.

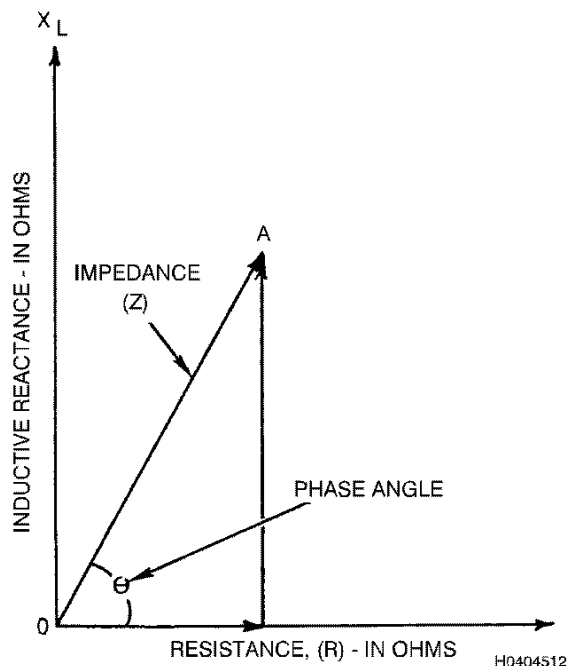


Figure 4-16. Vector Diagram Showing Relationship Between Resistance, Reactance, and Impedance

4.2.1.16.2 Impedance Plane Representation. Just as the two voltages can be combined to produce the net voltage across a coil as illustrated in (Figure 4-17); the resistive and inductive impedance components can be combined to produce the net impedance of a coil. In (Figure 4-16), inductive reactance (X_L) is plotted on the y-axis and resistance (R) is plotted along the x-axis. These two values define the impedance that is represented by the vector OA . The value of the angle “ θ ” for the net impedance is the same as the angle “ θ ” illustrated in (Figure 4-17) for the net voltage. This is important because it shows that the impedance of a coil can be displayed as the combination of two out-of-phase voltage drops. The amplitude of the impedance may be determined from the known values of resistance and inductive reactance according to the following formula:

$$Z = (X_L^2 + R^2)^{1/2}$$

Where:

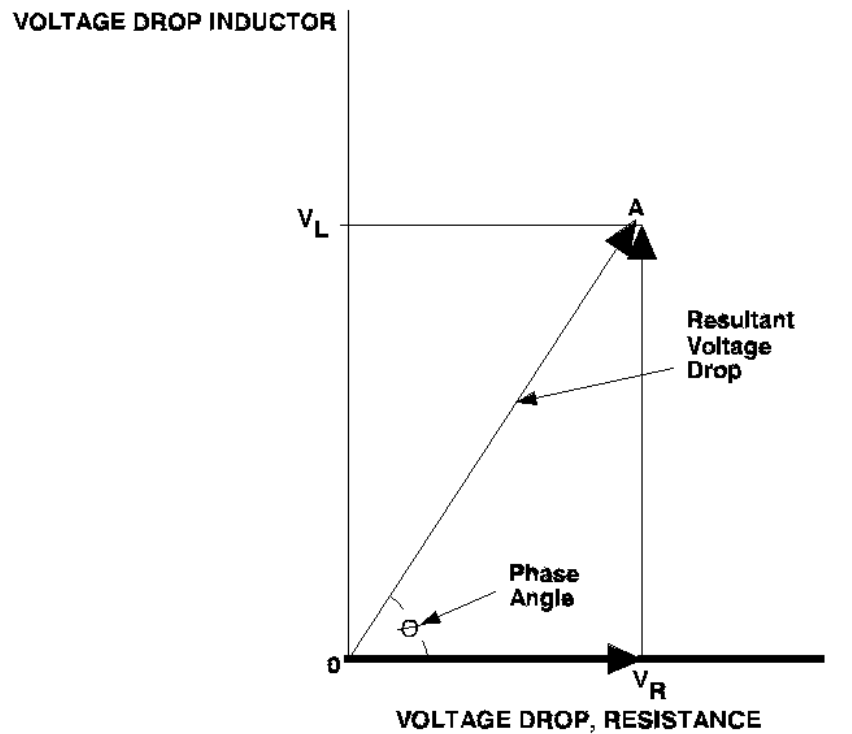
Z = Impedance magnitude (ohms)

X_L = Inductive reactance (ohms)

R = Resistance (ohms)

X_C = 0 Capacitive reactance is negligible.

T.O. 33B-1-1



H0404513

Figure 4-17. Diagram Showing Relationship of Voltage Drops Across Coil Resistance and Coil Reactance

4.2.1.16.3 The phase angle (θ) of the impedance can be calculated from the values of resistance and inductive reactance as follows:

$$\tan \theta = X_L / R$$

Where:

θ = Phase angle (degrees)

X_L = Inductive reactance (ohms)

4.2.1.17 Impedance Changes. The impedance of a coil appears to change when it is placed adjacent to an electrically conductive or ferromagnetic part. The eddy currents induced in the part produce a secondary magnetic field that opposes the primary field. This opposing field also induces a current flow in the coil in opposition to the primary current. If the part is not ferromagnetic, the net magnetic field resulting from the combination of the primary and secondary fields is decreased in magnitude, as is the current flow in the coil. This is equivalent to decreasing the inductance and increasing the resistance of the coil. If the part is ferromagnetic, the net magnetic field is increased because of the magnifying effect of the relative magnetic permeability, but the current flow in the coil is decreased because of the opposing effect of the secondary magnetic field from the induced eddy currents. This is equivalent to increasing both the inductance and resistance of the coil. In this manner changes in a part that affect either the strength of the magnetic field at the surface of the part or the strength and distribution of the eddy currents in the part, change the apparent impedance of the test coil(s). These variations in current flow, both phase and amplitude, can be detected, amplified, displayed, and analyzed as eddy current test results. The amplitude and phase changes in the signals can be related to changes in the parts inspected.

4.2.1.17.1 Impedance Plane Analysis. Most ET applications have two major problems to overcome. The first is to ignore changes in parameters not of interest during the test; an example is lift-off variation while inspecting for cracks. The second is to recognize valid indications while other changes are occurring. Another way of stating this is variations in a parameter such as lift-off SHOULD NOT be mistaken for valid defect indications, and valid defect indications SHOULD NOT be hidden by changes in parameters such as lift-off. Impedance plane analysis, also called phase analysis, is a tool that is effective in solving these problems.

4.2.1.18 Phase Detection. Phase angle measurements are a good way to detect a variety of flaw conditions. The information in the vector diagram (Figure 4-16) illustrates this fact. Decrease of conductivity (e.g., cracks) and permeability changes could produce the same signal amplitude, and it would be difficult to differentiate between cracks and normal permeability changes in a part. However, the phase angle of a conductivity change is very different from a permeability change if the correct test frequency is chosen. Using phase detection techniques, it becomes a simple matter to detect the difference between permeability variations and cracks. This also applies to determining the depth of a flaw, which is phase sensitive, or separating lift-off effects from flaw conditions. Phase sensitive detectors use a variety of techniques such as phase splitters, phase shifters, averaging, half-wave and full-wave detection, sampling, and subtractive and additive techniques. The presentation of the impedance plane on waveform display eddy current instrument; uses two-phase sensitive detectors to provide horizontal and vertical phase detection. This information is combined to produce a dot or point on the screen which represents the relative phase and amplitude of an eddy current signal. Some types of meter instruments utilize an adjustable phase control or phase gate to allow only signal detection at a particular phase angle of interest.

4.2.1.19 Primary Electromagnetic Field. Eddy currents are generated when a time-varying magnetic field penetrates an electrically conductive material. The source of the varying magnetic field is the electromagnetic field produced by a coil carrying an alternating electric current. This field is called electromagnetic because the magnetic field is produced from electricity rather than from a permanent magnet. The rate at which the electromagnetic field varies is called the frequency. The strength of the electromagnetic field at the surface of the conductor depends on the coil size and configuration, the amount of current through the coil, and the distance from the coil to the surface.

4.2.1.20 Induction of Eddy Currents. As the electromagnetic field from a coil penetrates a conductor, it generates eddy currents parallel to the surface of the part and at right angles to the direction of the applied field (Figure 4-18). The frequency of eddy current flow is the same as the electromagnetic field.

4.2.1.20.1 Secondary Electromagnetic Field. Eddy currents also generate an electromagnetic field in the part. This field, called the secondary electromagnetic field, opposes the primary electromagnetic field (Figure 4-18) and is a consequence of Lenz's Law. Lenz's Law, as applied to this case, states induced currents (eddy currents) act to reduce the magnitude of the inducing current. The opposition of the secondary field to the primary field decreases the overall electromagnetic field strength and reduces both the current flowing through the coil and the resultant eddy currents. Changes to the properties of the inspection article produce changes to the eddy currents and thus their secondary magnetic fields. In this manner, changes in the inspection article produce effects that can be detected by monitoring either the source of the primary electromagnetic field or the overall electromagnetic field.

T.O. 33B-1-1

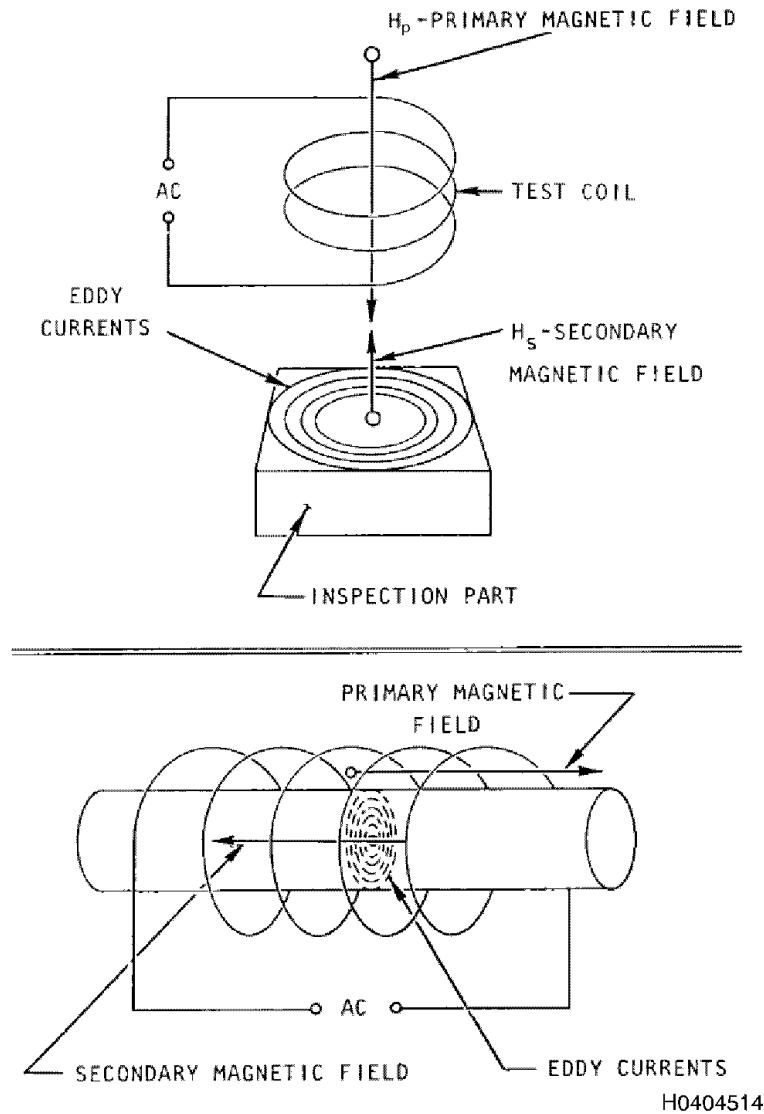


Figure 4-18. Primary and Secondary Magnetic Fields in ET

4.2.1.21 Alloy Effects on Conductivity. The conductivity of a metal is decreased as increasing amounts of alloying elements are added. Even small amounts of foreign atoms can greatly reduce conductivity. Some alloying elements have a much greater effect on conductivity than others. Generally, atoms that most severely differ in size and electron distribution from the base metal cause the greatest decrease in conductivity. The lattice distortion caused by the alloying atoms and particles of different chemical composition inhibits the flow of electrons through the lattice. Because of variations in chemical composition resulting from the tolerances in alloy additions, a conductivity range rather than a specific conductivity value is obtained for each alloy.

4.2.1.21.1 Annealing Effects on Conductivity. The annealing process reduces obstacles to electron flow. Therefore, annealing improves the conductivity of a metal.

4.2.1.21.2 Solution Heat Treating Effects on Conductivity. The distortion and stresses established by the substitution of alloying atoms for those of the base metal reduce the conductivity of the metal. The greater the number of solute atoms of a specific material, the greater the reduction there will be in conductivity. The presence of lattice vacancies, caused by solution heat treating, also disrupts the electronic structure of an alloy and contributes to lower conductivity.

4.2.1.21.3 Precipitation Hardening Effects on Conductivity. The removal of foreign atoms from the parent lattice during precipitation hardening removes much of the distortion of the electron distribution in the lattice. This action favors the movement of electrons through the metal and results in higher conductivity. As increased amounts of foreign atoms are removed from solution and particle growth occurs during over-aging, conductivity continues to increase.

4.2.1.22 Conductivity and Mechanical Properties. The same variables of chemical composition, heat treatment, and metal working that determine the mechanical properties of a metal, also establish its electrical conductivity and magnetic permeability. As a result, correlation has been obtained between electrical conductivity and mechanical properties. This correlation does not mean the conductivity value of a metal will reliably measure its mechanical properties. However, for some metals, change of the measured conductivity from a specified conductivity range or excessive variation in conductivity within a given part or specimen indicates a probable change in properties. This change may be detrimental to the performance of the metal. It requires additional engineering investigation using hardness testing and other forms of testing to determine the magnitude of the change and disposition of the parts. The correlation of conductivity measurement with mechanical properties requires a clearly defined change in conductivity between the various alloys, tempers, or heat treatments involved. Differences in conductivity and/or permeability exist between alloys of many metals including aluminum, copper, magnesium, steel, and titanium. Not all alloys in each system are separable because of overlapping conductivity ranges. If one material has a relatively high conductivity and the other is relatively low within the given range, material separation is possible. Some metals have clearly defined differences in conductivity or permeability between the standard heat treat tempers. This situation exists for most structural aluminum alloys, many magnesium alloys, some copper alloys, and various steels. Little or no difference in conductivity is noted between the various heat treat conditions of titanium alloys.

4.2.1.23 Geometry. Geometric features such as edges, curved surfaces, changes in thickness, and non-conductive coatings (such as paint) on surfaces affect the distribution and strength of eddy currents. As a probe approaches an edge the eddy current response is known as edge effect and appears similar to a response from a crack. Similarly, curved surfaces and non-conductive coatings can vary the distance between the probe coil and the part. These changes are known as lift-off, and the consequent effects on the eddy current signal are called lift-off effects. Lift-off usually cannot be completely prevented; therefore compensating for some lift-off is part of the setup procedure. Part thickness variations can also produce an interfering response in some eddy current units when the thickness is in the range of the depth of penetration of the eddy current field.

4.2.1.24 Lift-Off. The effects of lift-off can be used to measure coating thickness. Changes in lift-off can be calibrated to allow measurements of nonconductive coating thickness. Fill-factor applies to parts passed through an encircling coil and, in a manner similar to lift-off, can be used to gauge some dimensions. As a test coil is moved away from a part (increasing lift-off) the coupling between test coil and inspection part is decreased. The magnitude of the impedance change for a specific change in an inspection variable is also decreased. For probe coils, the dotted lines connecting points representing the same material properties but with various amounts of lift-off have some curvature as shown in (Figure 4-19). The line A-B-C represents the increase lift-off for material one. Line D-E-F represents the increased lift-off for material two. The line from point A to point D represents the increase in conductivity of material two compared to material one at one lift-off value. Lift-off lines B-E and C-F are increasingly shorter, indicating a smaller change in the conductivity.

T.O. 33B-1-1

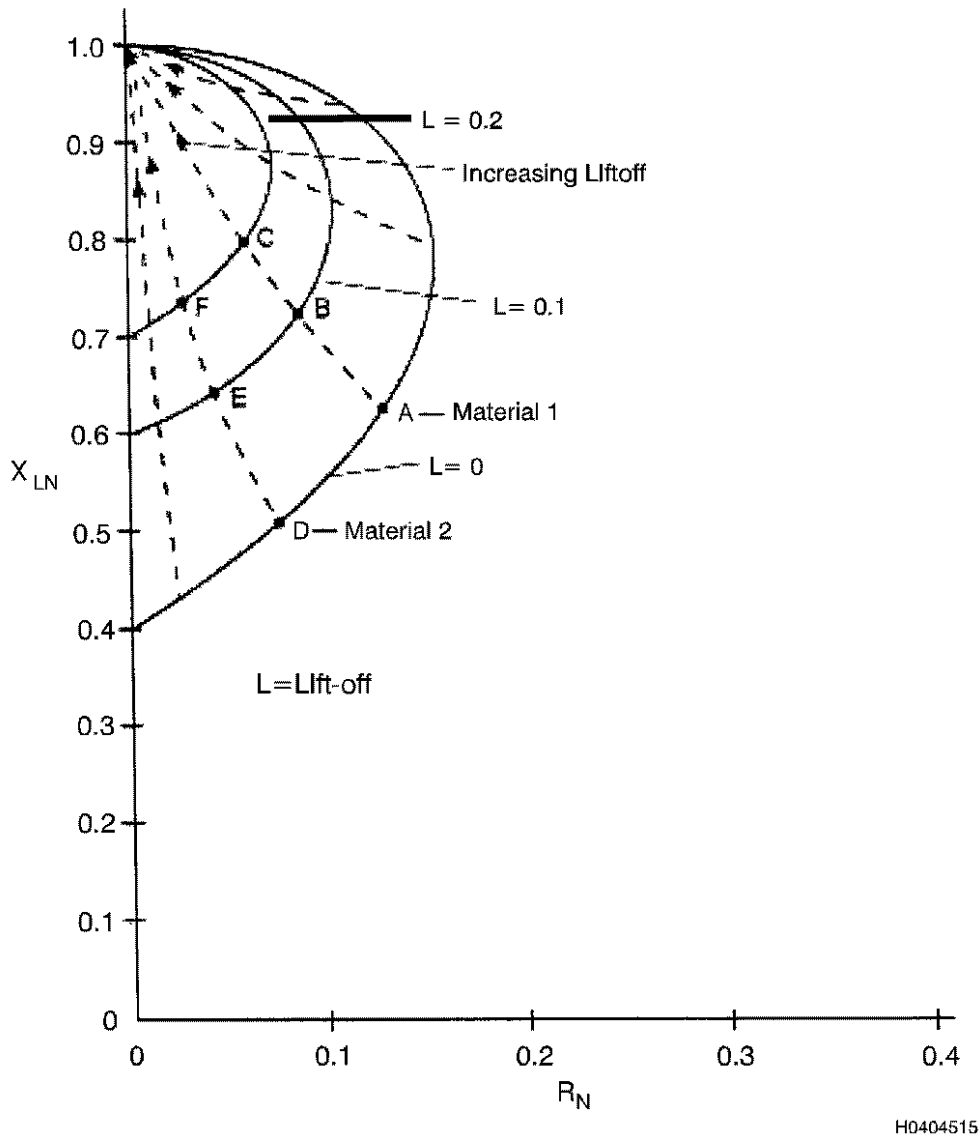


Figure 4-19. Impedance Diagram Showing the Effect of Lift-Off

4.2.1.25 Measurement of Resistivity. Electrical resistance is a measure of the resistance to the flow of electric current in a conductor. Resistance depends on the length and area of the current path, and the conductivity of the conductor. Resistance is commonly measured in ohms. If a material allows one volt (electric potential) of driving force to push one ampere of current through a conductor, the electrical resistance of the conductor is defined as one ohm of resistance. Resistivity is a material parameter independent of the size of a material sample and is related to resistance. Resistivity is defined as ohms times cross-sectional area divided by unit of length (paragraph 4.7.1.3).

4.2.1.26 Measurement of Conductivity. Electrical conductivity is the reciprocal of electrical resistivity. The reciprocal of the "ohm" is commonly called the "mho." Conductivity is commonly expressed in units of mho's per unit length; such as mho/inch or mho/meter. The relationships between conductivity, resistivity, and resistance are expressed by the equations in (paragraph 4.7.11).

4.2.1.26.1 Conductivity Based on the Percentage of International Annealed Copper Standard (%IACS). An alternative way of expressing conductivity is a percent of the conductivity of a known material. The International Electrotechnical Commission has designated the conductivity of a specific grade of high purity copper to be the standard for

this alternative method with a conductivity of 100-percent. It is called the International Annealed Copper Standard (IACS). The conductivity of all other metals is then expressed as a percentage of this standard. Values of conductivity of some commonly used engineering materials are listed in (Table 4-2) and (Table 4-7) in Section 4.7.

4.2.1.27 Effects of Inspection Conditions on Eddy Currents.

4.2.1.27.1 Frequency. The magnitude of the induced eddy currents in the part increases as the frequency of the inducing current increases. In turn, the higher intensity eddy currents generate a stronger opposing magnetic field, reducing the penetration of the primary field. Therefore, all other factors remaining constant, higher frequencies result in shallower depths of penetration as shown in (Figure 4-20).

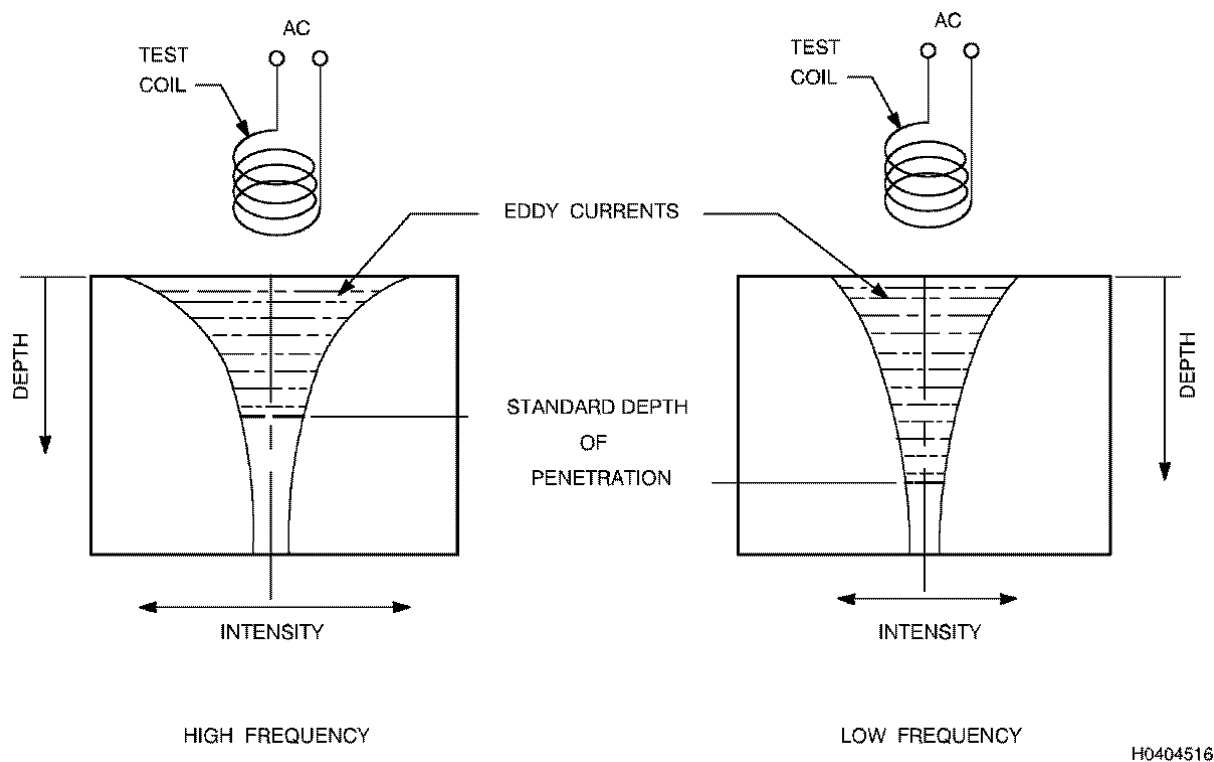


Figure 4-20. Relative Effect of Frequency on Depth of Penetration

H0404516

4.2.1.27.2 Conductivity and Frequency Diagrams. There is a relationship between conductivity and frequency. As an example, an ET for cracks in aluminum alloy 7075-T6, with a conductivity of about 30% IACS uses a frequency of 200 kHz. To perform a comparable inspection on a titanium alloy, TI 6Al-4V with a conductivity of about 1% IACS, a frequency of about 6 MHz would be required. An identical diagram could be developed to show the effect of changing frequency. One point on the curve would be established by nulling the probe in air and placing the probe on a specimen. Then, other points would be obtained by changing the test frequency, nulling the probe in air again, and placing the probe on the same specimen. After the data is normalized, a plot would be created. With increasing frequency, the impedance of the probe on the specimen would move in the same direction as an increase in conductivity of the specimen. A decrease in frequency would cause the probe impedance to move in the same direction as a decrease in conductivity.

4.2.1.27.3 Electromagnetic Coupling. The interaction between the primary electromagnetic field generated by the coil and the inspection article, is referred to as electromagnetic coupling. Because the field decreases in strength with increasing distance from the coil, resultant eddy currents at the surface of the part will also decrease in intensity. An electrical engineering term that could also be used is inductive coupling.

4.2.1.27.4 Fill-Factor. When an encircling coil is used to inspect a cylindrically shaped part, the degree of magnetic coupling is dependent upon the difference between the internal diameter of the coil and the external diameter of the part. This effect is termed fill-factor. For internal coils, electromagnetic (inductive) coupling is determined by the air gap between the

T.O. 33B-1-1

external diameter of the coil and the internal diameter being inspected. Fill-factor is calculated using the basic formula, but in this case “ d_i ” is the inside diameter of the part and “ D_0 ” is the outside diameter of the coil placed in the part (paragraph 4.7.3).

4.2.1.27.5 Coil Current. With all other factors constant, an increase in current flowing through the coil results in a higher magnetic field strength.

4.2.1.27.6 Temperature. The temperature at which an inspection is performed affects both the electrical conductivity and the ferromagnetic properties of the inspection article. Electrical conductivity generally decreases with increasing temperature, and conversely increases with decreasing temperatures. The reduction at higher temperatures occurs because of the scattering of conduction electrons by atoms moving with increased thermal oscillations. Temperature effects on the ferromagnetic properties of a material are generally negligible with one exception. Above a specific temperature called the Curie temperature (about 1400° F), ferromagnetic properties disappear. Because of the thermal effects on conductivity, increasing temperature of the inspection article slightly decreases the intensity of eddy currents at the surface of a part and slightly increases the depth of penetration. Temperature variations also affect the inductance of the coil. Remember, changes in temperature affect ET results. Therefore, during inspections, time SHOULD be allowed for the test system and the test part to stabilize to the ambient temperature.

4.2.1.27.7 Depth of Penetration. The intensity of eddy currents decreases exponentially with depth in a material. The intensity at any given depth is affected by the same variables that influence the surface intensity of eddy currents, although not always in the same manner or by the same amount. To put it another way, the depth of penetration of a specific intensity of eddy currents is affected by the variables, as indicated in (Table 4-3 in Section 4.7). Generally, any parameter that increases the depth of penetration would provide an equivalent eddy current response at a greater depth in a test part.

4.2.1.27.8 Standard Depth of Penetration. Three of these variables (conductivity, relative magnetic permeability, and frequency) are used to define the standard depth of penetration. Standard depth of penetration is the depth below the surface of the inspection article at which the magnetic field strength, or the intensity of the induced eddy currents, is reduced to 36.8-percent of the value at the surface. The standard depth of penetration is expressed by the following formula in (paragraph 4.7.6). Since the depth of penetration is related only to a percentage of surface field strength (eddy current intensity) some test variables are not included in the formula. Coil configuration, size, current, and magnetic coupling are not considered in this formula. These variables affect the absolute magnitude of the eddy currents at a specified depth but not the standard depth of penetration. The standard depth of penetration values for select frequencies for various alloys, bare aluminum alloys, and clad aluminum alloys are shown in (Table 4-5) through (Table 4-6) in Section 4.7.

4.2.1.27.9 Effective Depth of Penetration. Effective depth of penetration is the depth in the inspection article at which the magnetic field strength or the intensity of the induced eddy currents is reduced to 5-percent of the value at the surface. This depth is approximately 3 times the standard depth of penetration (3δ According to ASTM E 1005, the effective depth of penetration used for the purposes of conductivity testing is 2.66δ). The effective depth of penetration is used to determine test frequency when working with thin materials, so the overall electromagnetic field does not extend beyond the back surface of the test part so thickness variation effects can be suppressed. The minimum material thickness required for conductivity testing various alloys at 60 kHz and 480 kHz using the ASTM values of 2.66δ is shown in (Table 4-3 in Section 4.7).

4.2.1.27.10 Temperature and Depth of Penetration. For most applications, temperature is not a major factor in determining depth of penetration. However, if necessary the effects of temperature would be included as adjustments to the values for conductivity and relative magnetic permeability used in the formula to calculate the standard depth of penetration.

SECTION III EDDY CURRENT EQUIPMENT TYPES

4.3 ET EQUIPMENT.

4.3.1 Most eddy current nondestructive test instruments for field use are portable AC or battery powered units. They are generally lightweight, less than 6 lbs., with batteries that provide up to 12 hours of operation. They can have a liquid crystal display (LCD), or electroluminescent (EL) displays. Some units have dual frequency operations with interchangeable display features. Newer units have state-of-the-art circuitry with advanced microprocessors. Frequency ranges of approximately 100 Hz to 6 MHz for detection of large and minute discontinuities. These units can be used to inspect first and second layer cracks, coating, plating thicknesses, and conductivity testing.

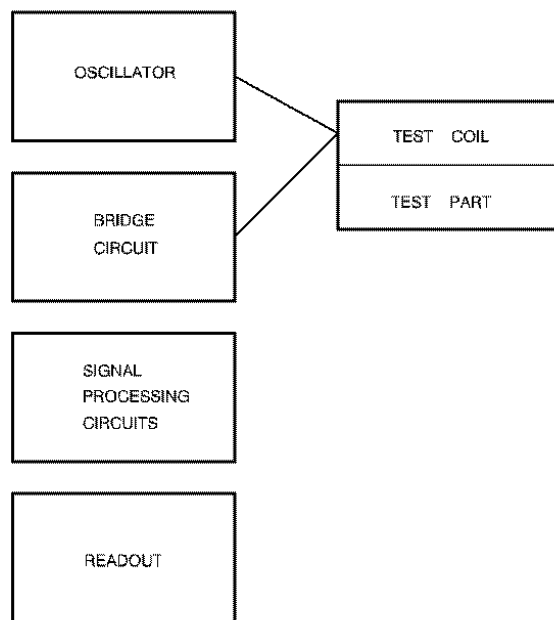
4.3.2 Components of an ET System. In its simplest form, an ET system consists of the following components:

- An oscillator.
- A coil assembly.
- A bridge circuit.
- Signal processing circuits.
- A readout/screen.

4.3.2.1 A block diagram of an inspection system is shown in (Figure 4-21) with the coil applied to a test part. Systems may be constructed for multiple purposes or for very specialized functions. In general, instruments designed for specific tasks, such as measuring coating thickness or electrical conductivity, are easier to calibrate and operate than general-purpose instruments but also are limited to their designed application.

4.3.2.2 Oscillator. The oscillator provides an alternating current of one or more frequencies to the test coil. The frequency used is determined by the intent of the inspection and the material being inspected. Frequencies used for ET range from less than 100 Hz to greater than 6 MHz.

4.3.2.3 Coil Assembly (Probe). The coil assembly induces eddy currents into the part being inspected and detects changes in eddy current flow. For some applications, a single coil is used for both functions. More commonly, multiple coils are employed in an assembly. A common configuration has one coil inducing the eddy current flow and separate coils used as detectors. Another configuration uses one coil as both an inducer and a detector on the test part.



H0404517

Figure 4-21. Block Diagram of ET System

T.O. 33B-1-1

4.3.2.4 Bridge Circuit. The bridge circuit converts changes in eddy current magnitude and distribution into signals that are ultimately processed and displayed. A common mode of operation is to have the output of the bridge equal zero for a “good” or “non-flaw” condition. Presence of a flaw or an “other-than-good” condition results in an unbalance of the bridge, thus producing a relatively small signal. This signal becomes the input to subsequent circuits.

4.3.2.5 Signal Processing Circuits. The processing of the signal from the bridge circuit depends on the type of information to be displayed. Simple eddy current devices can be built that detect and amplify the signal or convert the signal into digital format (e.g., a conductivity value). More sophisticated systems can process the complex electromagnetic signal into amplitude and phase, and provide filtering to suppress unwanted signals. Details of the processes are discussed further in later sections.

4.3.2.6 Output Display. Eddy current test data can be presented in analog or digital format. Some common output devices are meter readout, a strip chart, an X-Y recorder plot, an oscilloscope display or a video screen presentation. Meters are suitable for performing specific types of tests requiring a measurement of signal amplitude only. Strip charts, X-Y recorders, and digital storage allow the signal amplitude to be displayed and correlated with some other parameter such as time or position. Eddy current instruments with a two-dimensional graphical display are used where both the eddy current signal amplitude and phase must be measured. These are becoming the most common instruments available, and provide the inspector with the greatest capability to interpret the results of an ET for cracks.

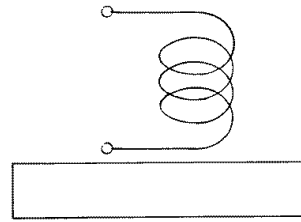
4.3.3 Eddy Current Subsystems. Eddy current systems generally consist of three subsystems. One is the probe or probe subsystem. Second is the eddy current instrument. The third is the accessory subsystem. Scanners and recorders are included with some subsystems and are considered to be accessories.

4.3.3.1 Probes (Coil Assemblies). Eddy current probes consist of one or more coils designed to induce eddy currents into a part being inspected and detect changes within the eddy current field. A fundamental consideration in selecting an eddy current probe is its intended use. A small diameter probe or narrow encircling coil will provide increased resolution of small defects. A larger probe or wider encircling coil will provide better averaging of bulk properties with a loss in sensitivity to small defects. Also the probe or coil must match the impedance range of the eddy current instrument with which it is to be used.

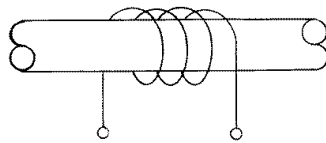
4.3.3.2 Classification of Probes. Eddy current probes and coils can be classified by mode of operation, application, or design.

4.3.3.2.1 Mode of Operation. There are three general modes of operation for eddy current coil assemblies; absolute, differential, or driver/receiver (also called reflection). Absolute probes consist of a single coil and interrogate the area immediately adjacent to the coil. They may have other discrete electrical elements such as capacitors included in the probe housing for matching to specific equipment requirements. Differential probes, on the other hand, consist of two or more coils and operate by comparing the response of one coil to the response of another coil. Normally, one coil is used for interrogating the area of interest on the part while another coil is responding to an adjacent area on the same part or an area on a known good part being used as a reference standard. The usual equipment connections to the differential probe allow subtraction of the response of the reference coil from the response of the interrogating coil. Driver/receiver probes can have a wide variety of configurations, but all have a driver coil physically separate from one or more receiver coils. The driver coil is used to induce the eddy current flow in the part. A common configuration for the receiver coils is for one receiver coil to be adjacent to the part inspected and the other to be removed from the part (but still within the probe housing and near the driver coil). The eddy current instrument is adjusted for zero output for this condition. Then as the area interrogated by the first coil changes, the eddy current instrument output changes in a manner that can be related to the change in the area inspected.

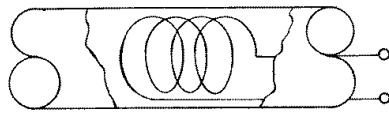
4.3.3.2.2 Method of Probe Application. Eddy current probes can also be classified by the method of application. The most common application is the contact or surface probe used for flat or relatively flat surfaces of a part. Eddy current probes used to encircle a part are called encircling coils. Eddy current probes completely encircled by the part are called ID coils or bobbin coils. Through-transmission probes, which utilize a coil on each side of a part (a sheet of aluminum for instance) is another method of application. All of these probe applications can be operated in absolute or differential modes (Figure 4-22) and (Figure 4-23). Eddy current probes can also be classed according to the shape or some other prominent feature of the probe. Very thin probes are called pencil probes. Probes with special electromagnetic shielding are called shielded or focused probes. Probes used in rivet or bolt holes are called bolt hole probes. Certain types of probes with shaped ferrite cores may be referred to as E-core, U-core, and pot or cup core probes.



Surface Coil



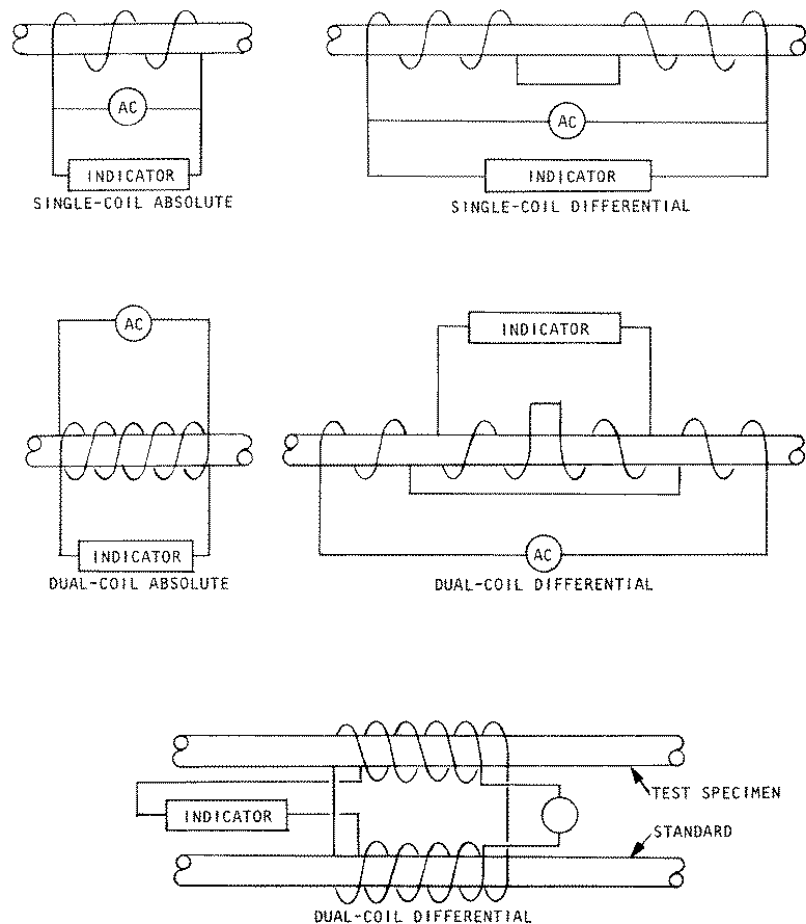
Encircling Coil



Inside Coil H0404518

Figure 4-22. Basic Coil Configurations

T.O. 33B-1-1



HQ404519

Figure 4-23. Single and Double Test Coil Configurations-Encircling Coils

4.3.3.3 Probe Design Considerations and Limitations. Eddy current probes have several conflicting requirements. First, they must be a reasonable match to the electrical impedance requirements of the instrument to which they are connected. The closer the impedance match, the higher the signal-to-noise ratio. Also, the coils need to be designed for the flaw size to be detected. Smaller flaws require smaller coils. Most eddy current testing in the field is accomplished with surface probes. The surface probe is used on plates, sheets, irregularly shaped parts, and in holes. The extent of the area to be tested by the probe is controlled by the coil diameter and by the presence of coil shielding. When the area to be scanned is large, pancake-type surface coils or overlapping multi-coil probes can be used to reduce the time required to inspect the part. When small flaws must be detected, coils, as small as 1/32 inch in diameter, can be used to examine limited areas.

4.3.3.4 Use and Limitations of ID and Encircling Coils. An inside diameter (ID) coil may be used on tubes, pipes, or other cylindrical parts where the geometry is regular and the interior is accessible. The ID coil should nearly fill the part opening in order to provide a high fill-factor for maximum test sensitivity. The use of ID coils can be restricted by bends or non-uniform diameters. Encircling coils are used primarily for inspecting rods, tubes, cylinders, or wire in manufacturing applications. With both encircling and inside coils, the entire circumference of the specimen is evaluated at one time. Consequently, while the axial location of defects (along the part length) can be determined, circumferential location (around the part) cannot be defined.

4.3.4 Functions of the Eddy Current Instrument. The eddy current test instrument performs three basic functions. First, it generates the alternating current that induces the eddy current flow in the part to be inspected. Second, it processes the responses to the induced eddy current flow. Third, it displays the responses in a manner to aid interpretation.

4.3.4.1 Current Generators. The current generator is usually a variable frequency oscillator operated at a single frequency for any given inspection. Most instruments have the capability of operating at frequencies from 100Hz to 6 MHz. Newer instruments have the ability to provide multiple frequencies to the test coil(s), either sequentially or simultaneously.

4.3.4.2 Processing. The processing function of the eddy current instrument includes a number of sub-functions. Most instruments include some form of a balancing or compensating circuit which is adjusted to provide essentially a zero output for non-flaw conditions. The signal from the bridge circuit is amplified before proceeding to the detector and/or analysis circuitry. Signals can be analyzed for their amplitude and phase. The output from the analysis circuits may be further filtered to assist interpretation before display.

4.3.4.3 Display Methods. The primary display method of most eddy current devices is either one dimensional, such as a meter, or two-dimensional, such as a CRT or an LCD screen. The outputs can also be transferred to X-Y recorders, strip chart recorders, magnetic storage media or even computers to both generate inspection records as well as aid in the analysis of the eddy current signals.

4.3.5 General Requirements. Eddy current instrumentation is the core of an eddy current system, whether the system is a simple instrument/coil combination or a fully automated scanning inspection station. To assure reliable operation, the instrumentation must have the capabilities described below.

4.3.5.1 Sensitivity. A term that refers to the instruments capability to find the most difficult to locate flaws; with reference to the size and type that need to be detected.

4.3.5.2 Low Noise. The noise should be low enough so the signal from the smallest flaw to be found (or smallest calibration flaw) is at least three times the noise level of the instrumentation.

4.3.5.3 Response Time. The response time of the circuitry must be fast enough to process and display signals at the required scanning rate.

4.3.5.4 Selectivity. The instrumentation should be immune to external sources of electromagnetic interference.

4.3.5.5 Stability. The instrumentation display should remain frequency drift-free, during the required testing period.

4.3.5.6 Ruggedness. The instrumentation must be capable of operating in the test environment. This may include a variety of environmental extremes of temperature, humidity, dust, and vibration.

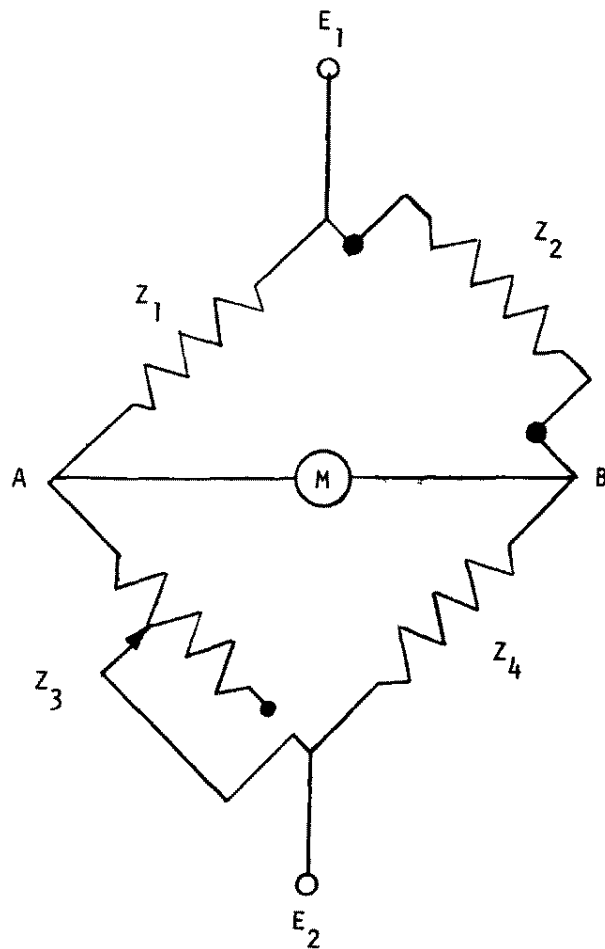
4.3.6 Specific Instrumentation Requirements. Choice of an eddy current test instrument must take into account the type of flaw to be detected, the permeability of the material (nonferromagnetic or ferromagnetic), type of probe to be used, display method (meter, CRT, digital display, recorders, etc.), test frequency, and signal processing requirements, portability, if needed, and any accessories to be used.

4.3.6.1 Instrumentation Components. In general, most eddy current instruments consist of an oscillator, a bridge circuit or similar null balancing system, and a variety of other circuits for processing and display of the eddy current signal. Units will vary depending upon the complexity of the instrumentation and the requirements of the test.

4.3.6.2 Variable Frequency Oscillator. A basic eddy current instrument, while operating at a single frequency during a particular test, usually has an operating frequency range that is adjustable to meet a large variation of inspection situations. Low frequencies increase depth of penetration and consequently would be used for subsurface flaw detection in high conductivity materials. Higher frequencies limit depth of penetration and thus are used for low conductivity materials as well as for detecting smaller flaws. Some instruments also incorporate a fine adjustment of frequency as a mechanism for suppressing lift-off. These instruments incorporate the probe coil in parallel with a capacitor as one leg of a bridge. The coil/capacitor combination is resonant near the intended operating frequency. The frequency selected for operation is off-resonant enough to where lift-off causes less of an impedance change than caused by a defect and the impedance change for increasing lift-off is opposite to that for a defect.

T.O. 33B-1-1

4.3.6.3 Bridge Circuit. A basic bridge circuit is shown in (Figure 4-24). In this example, a voltage is applied at points E1 and E2 to the bridge containing impedances Z1, Z2, Z3, and Z4. Z1 and Z4 are fixed impedances of the same value; Z3 is an adjustable impedance; and Z2 the unknown or test probe impedance. Initially, Z3 is adjusted so that no current flows through the amplifier. This means the voltage at points A and B is the same and the bridge is said to be balanced or nulled. Any change in impedance of Z2, the test probe impedance, will result in a current change through the leg of the bridge and consequently a change in the voltage at point B. A current will then flow through the amplifier, since a voltage or potential difference exists between points A and B. The bridge is now said to be unbalanced. The bridge can again be balanced by adjustment of Z3 and the change in the test probe impedance, Z2, may be determined by measuring the change in Z3 required to rebalance the bridge. The bridge circuit in an eddy current test instrument is termed an impedance bridge since the circuit contains both resistive and reactive elements. Impedance Z2 in (Figure 4-24) would consist of the eddy current test coil. Other reactive elements, inductors, and capacitors may be included in the impedance bridge depending upon the specific design and function. However, the basic principle is that a change in impedance of the test coil results in an imbalance of the bridge circuit. The output (imbalance) from the bridge circuit can be amplified, processed and displayed.



H0404520

Figure 4-24. Basic Bridge Circuit

4.3.6.4 Amplification Circuits. The imbalance in the bridge circuit is due to an impedance change at the test probe. It results in a change in signal amplitude, signal phase or both. These signal changes must be amplified, detected or demodulated, and processed for presentation on the output device (meter, scope, or recorder, etc.). The flaw signal may be only several micro volts in amplitude and may require amplification of one thousand to one million times for further processing and display. The frequency content of the flaw signal can range from very low (essentially DC) to the maximum operating frequency of the eddy current instrument. This defines the distortion-free frequency response of the amplifier. The

amplifier must also be very stable with very little drift in order to maintain the required sensitivity and calibration throughout the duration of the test.

4.3.7 Special Circuits and Processes. A wide variety of electronic techniques have been developed for particular inspection problems in eddy current testing. The circuits used depend upon the type of output, the type of flaw to be detected, or when a particular test variable (such as lift-off) must be suppressed in order to detect other conditions. The following circuits are commonly used by many eddy current test instruments.

4.3.8 Amplitude Detection. The most common type of detection meter on eddy current instruments is one which needs to detect signal amplitude changes without the use of phase information. In this case, amplitude detection with a simple diode type detector can be used. The diode rectifies the bridge output to produce a variable amplitude direct current signal.

4.3.9 Multi-Frequency Eddy Current Systems. Multi-frequency eddy current systems can be used to detect cracks in the presence of geometric changes in a complex part. Each condition to be suppressed must produce significant impedance changes for one frequency and less significant changes for the other frequencies used in the inspection. An example would be using a dual frequency inspection for subsurface corrosion while compensating for lift-off. A low frequency would be selected that would allow sufficient penetration to detect the corrosion. Lift-off responses would also be present from this frequency. Using a higher frequency would respond to lift-off but, not have sufficient penetration to respond to the corrosion. The analysis of these signals can become extremely complex. Presently, most multi-frequency testing is limited to dual-frequency testing. This technique is also used in tube testing to discriminate between ID and OD defects in tubing.

4.3.10 Pulsed Eddy Current Techniques. The pulsed eddy current technique is a noncontinuous wave test technique, and also has multi-frequency characteristics. The width of the pulse establishes the lower frequency limit while the sharpness of the pulse corners establishes the upper frequency limit.

4.3.11 Metal Thickness Measurements. A wide range of thicknesses can be measured with low frequency eddy current test equipment.

4.3.12 Presentations and Displays. The output from an eddy current instrument may be read on a meter, impedance plane display, or recorder depending on the type of information required from the test. An analog (pointer) type meter is the simplest type of output indicator. An output consisting of amplitude and phase is called an impedance plane display, and can be displayed on either a Cathode Ray Tube (CRT), Liquid Crystal Display (LCD), or an Electroluminescent (EL) Digital Display. LCD/EL display's show the eddy current signal, menu sidebar, status bar, other indicators, and full screen text.

4.3.13 Meters. Portable metal flaw and conductivity detectors use a meter that essentially indicates the degree of bridge imbalance in terms of amplitude. Depending upon the instrument circuitry, phase differences may also be displayed on a meter. Most eddy current instruments contain built-in output meters specifically designed or selected for use with the particular circuitry involved. The meter should have a speed of response sufficient to detect the discontinuities of interest at the highest expected scan speed. However, the meter should be sufficiently damped so "noise" indications do not confuse the inspector, but not damped to the point information of interest may be suppressed. Optimum meter response is a balance between speed of response and damping.

4.3.14 Cathode Ray Tube (CRT) Display. The CRT is a device for display and measurement of electrical phenomena. The CRT consists of four basic parts:

- A glass envelope.
- An electron gun.
- A means of deflecting, or controlling the electrons produced by the gun.
- A screen, which transforms the electrical energy of the electrons from the electron gun into light.

4.3.14.1 The screen consists of a phosphor coating on the inside face of the glass envelope (tube). When electrons strike the screen, light is generated. The relative length of time that the screen continues to glow or give off light after the electrons have impacted the tube is termed "persistence or persistency." Generally, CRT persistence is on the order of 0.1 to 1-second. Storage oscilloscopes have CRTs with long persistency on the order of many minutes. Storage oscilloscopes are used in most CRT type eddy current equipment. A CRT output is used on eddy current instruments where impedance plane analysis techniques are required in order to separate test variable.

4.3.15 Digital Display. Many eddy current units provide waveform output on a two-dimensional display of small, square spots called pixels. Light is generated on such a screen by applying a small voltage to the individual pixels. A wave form is created by energizing the pixels needed to shape the appropriate waveform. Since the persistency of a digital display is

T.O. 33B-1-1

controlled by an applied voltage rather than by electron impact with a phosphor coating, the persistence can be controlled by the operator. In general, the lighted pixel will remain lighted until the operator 'erases' them by turning off the voltage to the pixels.

4.3.16 Linear Time Base Display. Some types of eddy current test equipment use a linear time base display. The display's vertical signal (e.g., the phase shift), is received from the test coil. The display's horizontal signal (e.g., time), is received from a timing voltage. The timing voltage is adjusted to the frequency or period of the generator and provides a linear horizontal sweep of the vertical input voltage. A change in reactance of the test coil result, in a phase change of the voltage across one of the bridge circuit arms (vertical signal). This phase change is evidenced by a shifting (along the horizontal base-line) of the waveform. During operation, the timing or sweep voltage is used to adjust the display to show the desired number of waveform cycles (usually one). Generally, control is also included to control the horizontal position of the waveform on the screen.

4.3.17 Recorders. Recorders are used primarily in testing where the test coil or the test parts are moving relative to one another. Many newer applications using a test fixture and a mechanical scanner to move an eddy current probe across a specific area of a part can use a recorder to map the flaw indications. A recorder for eddy current applications may be any of several types. However, the strip chart recorder is probably the most common. Newer eddy current instruments provide means of storing information on digital media. This is particularly useful where down time is important, since testing can be accomplished as rapidly as possible, and the information stored on tape for later analysis. When selecting a recorder for use with a particular eddy current instrument, several factors must be considered:

- Impedance match between recorder and instrument.
- Frequency response of recorder.
- Recorder sensitivity (voltage range).
- Response time.

4.3.18 Impedance Plane Eddy Current Test Equipment. A significant increase in testing capability has been realized by the upgrading of existing test techniques with newer instrumentation. The use of modern impedance plane equipment has greatly increased the flaw analysis capability of the inspection process.

4.3.19 Digital Equipment. The use of digital test equipment, along with digital computers to process and analyze data, has provided significant reduction in the noise levels. This has effectively increased the sensitivity of the flaw detection process.

4.3.20 Mechanical Scanning. Increased use of mechanical scanners to control probe movement has increased the detection capability of many test methods. Repeatability of testing is also enhanced by mechanical scanning. A mechanical scanner can provide testing of difficult to reach areas of parts. Remote video cameras can also be incorporated with a mechanical scanner to provide visual coverage during the testing of inaccessible areas.

4.3.21 Multi-Frequency Testing Techniques. Have a variety of applications in which several material properties are changing at the same time. A single frequency test signal is composed of phase and amplitude. Only two variables such as the phase and amplitude of a signal response from a crack can be measured. If the wall thickness of a part is also changing, the variation could affect the phase and amplitude of the crack signal. By the use of multiple frequency techniques, multiple variables can be selectively detected and analyzed during the same test. For example, this allows dimensional and/or permeability variations to be filtered out during the testing process.

4.3.22 Dual Frequency Testing. If only two frequencies are used, one frequency channel can operate in the differential probe mode and the other frequency channel can operate in the absolute mode. With this setup, the differential mode can be used to detect discrete indications such as small cracks and holes. The absolute mode can be used simultaneously to record wall thickness or other dimensional changes in the test part.

4.3.23 Pulsed Eddy Current Testing. Conventional multi-frequency systems usually use two or three frequencies. Additional frequencies require very complex multiplex mixing systems to analyze the information from the test. A variety of experimental techniques have used the multi-frequency characteristics of a short electrical pulse to achieve the same type of results as the multi-frequency test technique. In principle, this technique is advantageous in it requires simpler electronics to process the data. It can potentially generate higher frequencies than fixed frequency systems. This would allow testing of thinner materials and materials with very low electrical conductivity (high resistivity). The eddy current pulse can also be a very short, high voltage pulse that can be used to momentarily produce magnetic saturation in a ferromagnetic part. This will allow detection of subsurface flaws in ferromagnetic materials.

4.3.24 Low Frequency ET. Low frequency eddy current means the inspection requires frequencies below 50 kHz. Improved equipment and data processing techniques now allow the use of test frequencies as low as 55 Hz. Along with impedance plane equipment to measure signal phase, this has provided a means for testing multilayer thick materials. Detection of deep subsurface cracks, cracking in intermediate layers of material, and corrosion on the backside of a material is possible.

4.3.25 Barkhausen Noise Testing of Ferromagnetic Materials. Abnormal stresses induced by shot peening, other cold working processes, and grinding burns affect the structural properties of a material, and can lead to flaw growth and part failure. In ferromagnetic materials, these processes affect the ease with which the magnetic domains in the surface of the material can be moved. In unmagnetized ferromagnetic material, the magnetic domains are randomly oriented. If the material is subjected to a magnetic field, the magnetic domains tend to align themselves in the direction of the magnetic field. When the domains move to align themselves, electrical pulses are generated during the domain movement, this is called Barkhausen noise. This electrical noise can be detected and measured by Hall Effect sensors. If the material is free of abnormal stresses, the domains are relatively free to move and little Barkhausen noise is generated. Areas of tensile stress parallel to the applied magnetic field cause an increase in Barkhausen noise. Examples of applications of this test method are ferromagnetic engine components and landing gear. Barkhausen noise measurements are also used to detect the quality of drilling and reaming of holes in ferromagnetic material.

4.3.26 Alpha-Case on Titanium. Oxygen diffusion from the surface of titanium alloys, known as alpha-case, can lead to surface embrittlement and cracking. This condition can be detected using high frequency (frequencies above 500 kHz) eddy current testing.

4.3.27 Titanium Aluminide. Brazed honeycomb panels formed from titanium alloys and 3003 aluminum create a brittle intermetallic titanium aluminide at the braze interface. The thickness of this interface is critical to the integrity of the structure. While eddy current methods show promise of measuring the interface thickness, further testing is required to produce reliable measurements.

4.3.28 Magneto-Optic Imaging (MOI). Magneto-optic imaging depends on the ability of certain materials to rotate the plane of polarization of light in the presence of a magnetic field. This Faraday Effect is used to detect disturbances in the magnetic field produced by passing an alternating current in a thin planar foil of doped yttrium iron garnet. When the foil is placed near the surface of a metallic test object, eddy currents are produced which modify the magnetic field in the foil. When defects or other material discontinuities, such as rivets or holes, divert the otherwise uniform flow of electric current near the surface of the test piece, magnetic fields perpendicular to the surface of the test piece are produced which can be imaged in real time by an appropriately designed optical system. Since the system provides optical information, the results can be videotaped for analysis and permanent documentation.

4.3.29 Application of Advanced Techniques. Several of the advanced techniques and processes discussed above do not have fully developed and recognized test procedures, process controls, and qualification procedures. Specific application of these processes and techniques SHALL be in accordance with approved procedures and engineering approval.

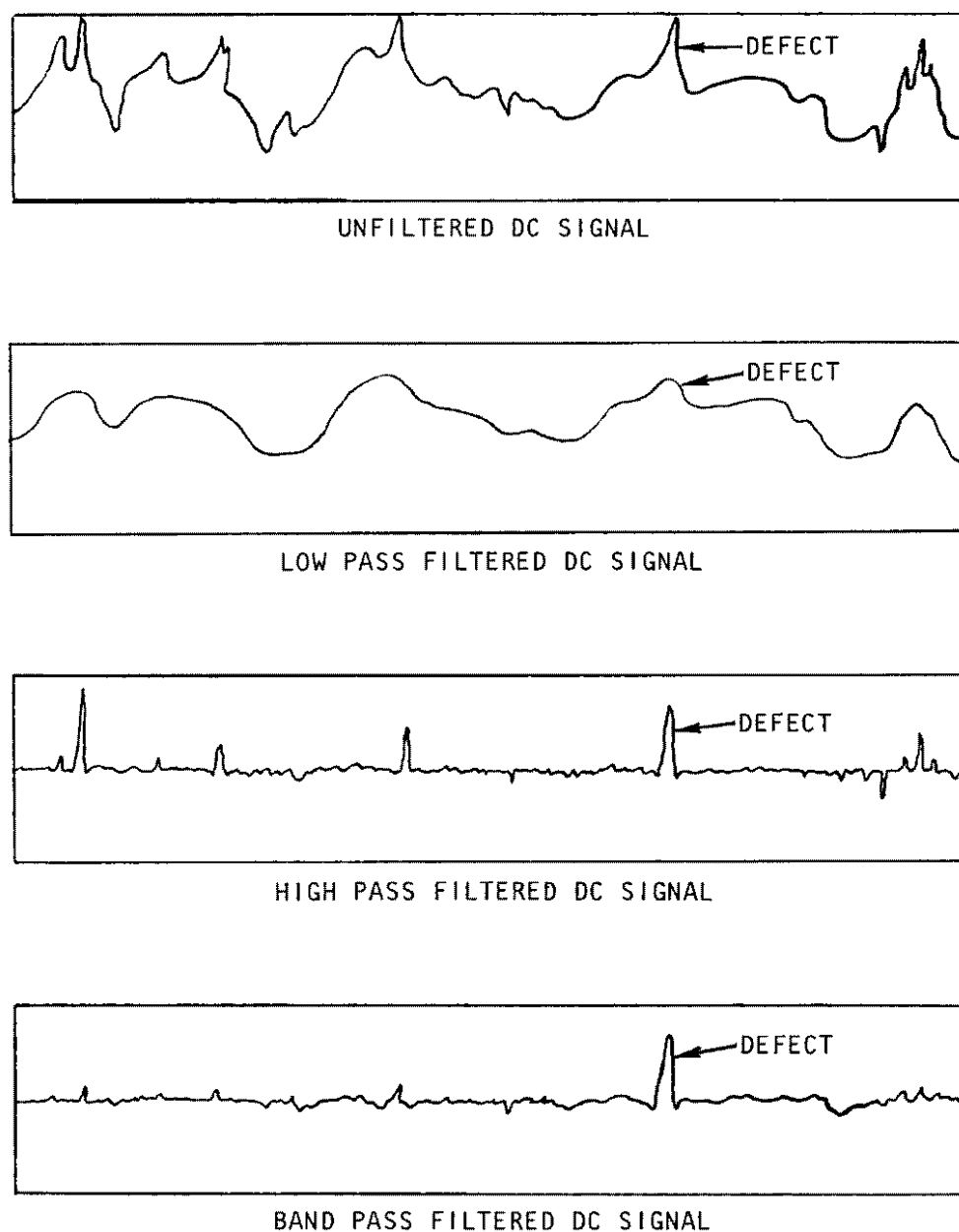
SECTION IV APPLICATION OF ET

4.4 GENERAL.

All inspections for cracks or other in-service flaws **SHOULD** be considered critical. Each inspection on every aircraft or weapon system should be approached with utmost care and concentration. Always setup your eddy current instrument in accordance with the established procedures. Be sure to check your setup several times during the inspection to insure your equipment is responding properly. Take time to ensure you have carefully scanned the entire area of inspection, double checking your scans if necessary. The inspection you perform may be the last line of defense against a possible failure due to crack growth. Not finding a defect in an area during a previous inspection, does not discount the odds of it presenting itself in the future. Approach each inspection as if there were a known flaw in the area you are inspecting.

4.4.1 Operating Point. The operating point, or null point, is the location an impedance plane at which the eddy current instrument is nulled. For instrumentation with two-dimensional displays, the null point is usually the “good” or reference condition. For instrumentation with one-dimensional or meter displays, the null point would be unsatisfactory because any change in the specimen would cause an unbalance of the bridge circuit with a subsequent indication displayed on the meter. It would be impossible to discriminate against any variable affecting the impedance of the test coil. Consequently, the operating point is displaced from the point representing null for a “good” condition.

4.4.2 Filters. Filtering is often used to improve the signal-to-noise ratio in the eddy current signal display as illustrated in (Figure 4-25). As stated in previous paragraphs, three types of filters can be used: the high-pass, the low-pass, and the band-pass. High pass filtering removes the low frequency components of the eddy current signal from the bridge. This type of filtering can eliminate the effect of gradual variations in conductivity or dimensions on the ET response. Low pass filtering removes rapid (high frequency) response from electronic noise and from harmonic frequencies related to variations in magnetic permeability. Band pass filters combine low and high pass filters to allow a response over a specific range of frequencies and suppress frequencies above and below this range.



H0404532

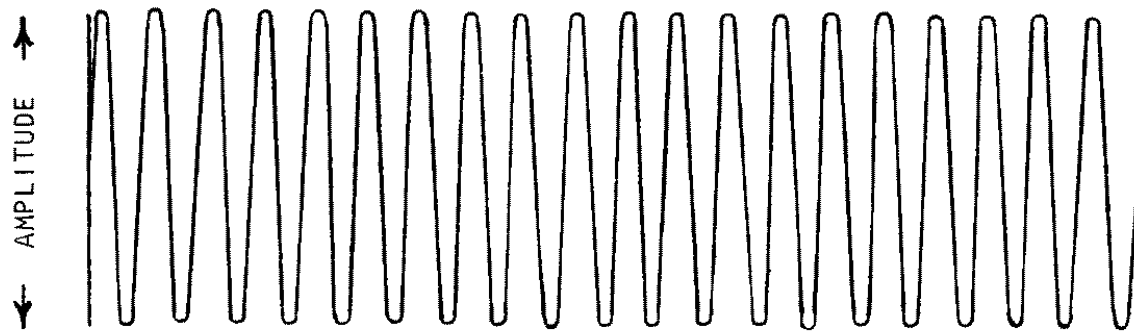
Figure 4-25. Illustration of the Effects of Different Filters on the Eddy Current Signal

4.4.3 Modulation Analysis. A technique useful in separating signals of interest from other signals relies on an analysis of signals as a function of time. A good example of this is using a sweep display or a strip chart where the amplitude of the signal appears on the vertical scale and the times at which the signal appears and disappears is monitored on the horizontal. When a CRT is used in the sweep mode during a rotating bolt-hole inspection, the equipment is often set so each trace across the sweep represents one rotation in the hole. The clock position of an indication in the hole can be determined by its location across the sweep. Of more importance is the width of the indication or how long it deviates from the baseline. In this technique how long the indication is detected (width) is used to identify whether or not it is due to a variable of interest. For example, out of roundness in a bolt hole will produce an indication that lasts a long period, while a crack is very narrow and

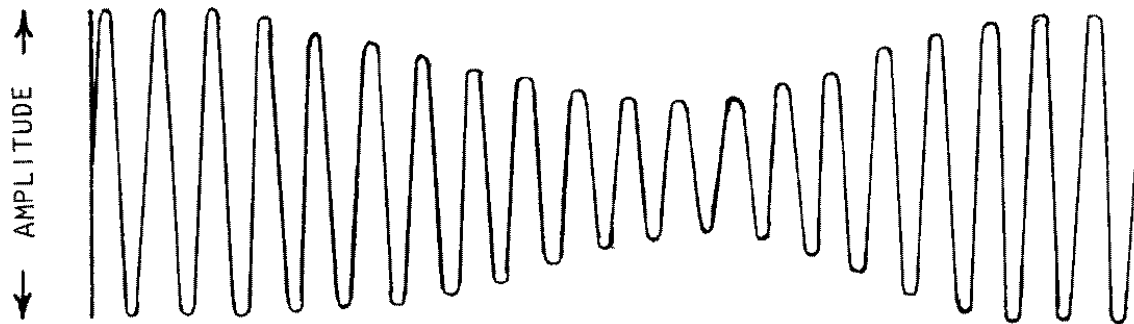
T.O. 33B-1-1

produces an indication that lasts a short period. Both indications may have the same amplitude, but perhaps only the crack is of interest. An electronic filter can be used to suppress long lasting signals (low frequency) leaving only the crack indication (high frequency) on the display for the inspector to view. It is important to understand the terms high and low frequency refer to how long the indication lasts, not the frequency of the alternating current in the coil. The frequency of an indication is the reciprocal of the period that it lasts, or put another way how many such events (cycles) could occur in 1-second. For example, suppose the indication of the out of round hole discussed above lasts for 0.1-seconds across the sweep, and the indication of the crack lasts for 0.01-seconds across the sweep. The frequency “f,” of the out-of-round signal would be $1/0.1$ or 10 cycles/sec (Hz), and that of the crack would be $1/0.01$ or 100 cycles/sec (Hz). A high pass filter could be set at 50 Hz to suppress signals under 50 Hz and allow signals over 50Hz to be displayed. Because there can also be signals that have a higher frequency than the variable of interest, a low-pass filter may also be used to suppress high frequency noise. This filter might be set at 200 Hz for the above example. Used together the high and low-pass filters form what is called a band pass filter, meaning only signals having a frequency over a specific range are displayed. In the above example, signals above 200 Hz are suppressed by the low-pass filter, and signals below 50 Hz are suppressed by the high-pass filter. In order to pass through both filters, the signal must be between 50 and 200 Hz, or last from 0.005 to 0.02 seconds.

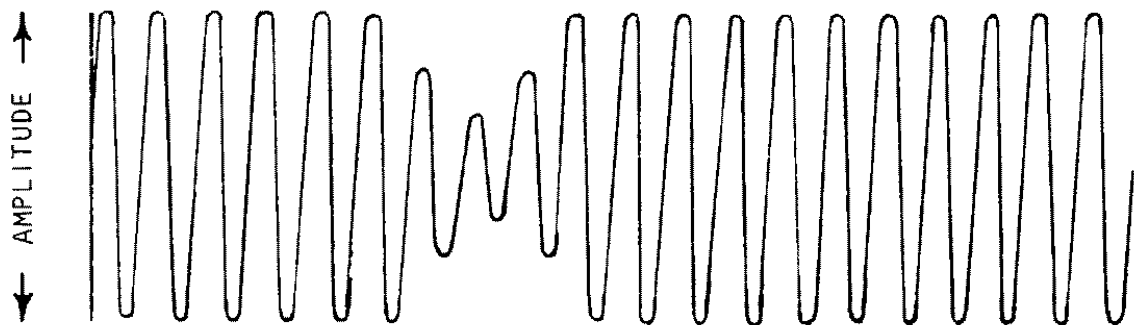
4.4.4 Frequency Response. Frequency response analysis is the most common form of modulation analysis. During ET, the impedance of the test coil remains constant provided there is no change in inspection conditions or material properties. When variations in impedance do occur, the rates of change in the impedance and resultant eddy current signal are proportional to the rates at which material properties are changing and the scanning speed. Consequently, a small crack would provide a rapid change in impedance during scanning and a corresponding high frequency eddy current signal. These signals can be viewed on a video display or a strip chart recorder as a function of time. The effect on amplitude, while encountering different kinds of material variations, and scanning at a constant speed is shown in (Figure 4-26). A fast signal change is often a good indicator of a small flaw or an abrupt change in material characteristics. A slow signal change usually indicates a gradual change in dimensions, lift-off, or some other property.



TIME →
NO CHANGE IN INSPECTION MATERIAL



TIME →
SLOW CHANGE IN INSPECTION MATERIAL



TIME →
RAPID CHANGE IN INSPECTION MATERIAL

H0404535

Figure 4-26. Effect of Material Variables on Magnitude of Alternating Current in Test Coil With Constant Scanning Speed

T.O. 33B-1-1

4.4.5 Inspection of Fastener Holes.

4.4.5.1 Cracks in Fastener Hole Walls. A common application of ET in aircraft structures is the detection of cracks in fastener holes, or walls. These cracks are usually generated by fatigue, stress corrosion, or a combination of fatigue and corrosion. The progress of these cracks is often slow in the initial stage, early detection can prevent possible catastrophic failure.

4.4.5.2 Fatigue Cracks. Fatigue cracks are usually caused by repeated cyclic loading of a structure at lower stress levels than required for visible deformation. Because stress is concentrated at areas of localized weakness, such as holes, fatigue cracks often initiate at such points. The cracks usually propagate normal to the direction of the maximum applied tensile stress. The following describe two types of fatigue:

4.4.5.2.1 High Cycle Fatigue (HCF). HCF usually means the stress applied is low compared to the ultimate tensile strength of the material but subjected to a very high number of cycles.

4.4.5.2.2 Low Cycle Fatigue (LCF). LCF usually means the stress applied is high compared to the ultimate tensile strength of the material but subjected to a very low number of cycles.

4.4.5.3 Stress Corrosion Cracks. Stress corrosion cracks occur under the combined influence of a tensile stress and a corrosive environment on a material susceptible to stress corrosion cracking. The tensile stress may result from either an applied stress or a residual stress. Moisture in the air combined with a sufficiently corrosive environment may create stress corrosion cracking in some instances. In addition, a combination of cyclic fatigue in the presence of corrosion cracks can cause rapid growth of cracks.

4.4.5.4 Hole Wall Finish and Dimensions. The hole wall finish and dimensions influence both the occurrence and the detectability of cracks in fastener holes. Hole wall damage such as scratches, chatter, and grooves created during manufacturing can create additional stress concentrations at the hole wall and provide preferred sites for crack initiation. Loose fitting bolts caused by oversize or out-of-round holes allow movement in the area of the hole and allow fatigue action. These same conditions can influence the reliability of inspection. During inspection, severe damage to the hole wall results in eddy current indications that may not be separable from crack indications. Excessive lift-off from out-of-round conditions can also mask indications from cracks. All of these conditions can be created during manufacturing processes on the hole or as a result of fatigue action during service and from bolt removal.

4.4.5.5 Edge Effects. Many cracks in fastener holes occur at or near the edge of the hole. Adjoining structures, non-uniform countersink and deburring radii, and damage at the hole edges increase the background noise and decrease the signal-to-noise ratio. This leads to a general loss of detection of cracks at the edge of holes. Further effects on crack detectability result from the presence of other metals adjacent to the hole edge. Countersunk surfaces also limit ET by manual techniques adjacent to hole edges.

4.4.6 Fastener Hole Inspection Equipment. For some bolt hole inspections, recorders are used in conjunction with the instrument. Increased use is being made of automatic scanning equipment. This equipment provides a hand held scanning unit which drives a probe in a helical pattern through the length of the hole or rotates a probe at high revolutions per minute. This equipment maintains a constant speed of revolution. Results can be retained on a strip chart recorder or displayed on a storage oscilloscope. For most applications, no additional equipment is required. Occasionally, a special shim is necessary to provide a flat surface on which to position the probe stop or scanning unit to maintain good alignment between the probe and the hole. Equipment that rotates the probe in a helical pattern is referred to as a translational rotation scanner. High speed scanners have no automated translational movement. They depend on the rate at which the operator pushes and pulls the probe into and out of the hole.

4.4.7 Lift-Off Compensation for Bolt-Hole Inspection. The lift-off adjustment for bolt hole inspection is dependent upon the surface quality and dimensions of the hole. Optimum lift-off adjustment is that which just suppresses lift-off variations within the hole, but does not provide excessive compensation. Excessive lift-off compensation can reduce sensitivity and increase noise. When using unshielded probes, specific amounts of lift-off adjustment can be obtained by using a shim between the coil of the bolt hole probe and the hole wall. The thickness of the shim must equal the amount of lift-off adjustment desired and must be relatively tough to prevent tearing during insertion and removal of the probe. Teflon tape SHALL be used for this purpose. Lift-off adjustment is usually performed in the hole at a point from the edge or at the center if the part thickness is less than 1/2-inch thick. More tolerance in lift-off adjustment settings is permissible when using automatic scanning equipment or shielded probes.

NOTE

The practice of performing a lift-off adjustment by pushing the coil away from the hole wall can lead to indefinite amounts of lift-off adjustment and should be used with caution.

4.4.8 Sensitivity Settings. The sensitivity settings are based on response to a specified reference standard. A wide variety of test standards are used for bolt-hole inspection. They include cracked parts, electrical discharge machined notches, notches cut with a jeweler's saw, differences in conductivity standards, and a multitude of other standards with larger notches and/or cracks. Each individual procedure usually specifies the standard to be used and the required response in terms of meter deflection or indication size on a recorder, strip chart, or scope. When it is necessary to find small flaws and the possibility exists that different types of probes (coil size and frequency) may be used, it is preferable to use a reference with the same approximate dimensions as the flaws to be detected such as electrical discharge machined notches.

4.4.9 Scanning Speed. Scanning speed and pattern must be considered in the setup procedure. Since the probe response with manual scanning will not be the same as that during mechanized scanning, setup SHALL be performed at the same scanning rate used during inspection.

NOTE

Inspection must not be performed on holes which are offset at interfaces.

4.4.10 Bolt Hole Preparation. Holes in mating surfaces must be realigned prior to ET or drilled to a larger diameter, which is concentric through the mating parts. Prior to performing bolt-hole inspection, all foreign material must be removed from the hole. Foreign material can include sealant, lubricants, metal slivers, and paint chips. Usually this material can be removed using cotton swabs and a suitable solvent. Holes which are severely damaged during service or during fastener insertion/removal may require reaming prior to ET.

4.4.10.1 Manual Bolt-Hole Scanning Procedures. Manual scanning of bolt holes is performed at specified levels throughout the depth of the hole. Inspection is usually initiated with the probe core positioned immediately within the upper or lower edge of the hole so that the outside edge of the core is even with the surface of the part. The probe core position is adjusted to the specified level below the collar of the probe, and the probe is inserted into the hole until the probe collar rests against the surface of the part. If inspection is performed for fatigue cracks parallel to the length of the hole, the inspector observes the display for any rapid deflection. Occasionally, intergranular stress corrosion (IGC) can occur along a plane roughly parallel to the part surface. The indication from this type of corrosion appears similar to an elliptical shape hole, or slow change in conductivity. Wrong application of bandpass filtering may hide the presence of IGC.

4.4.10.2 Scan Pattern. The distance between scans or the scanning increment is determined by the minimum crack size required to be detected. The scanning procedure is repeated after setting the probe coil at each scanning position until the entire length of the hole has been inspected. When inspecting multiple layers, inspection should be performed in the materials of both layers adjacent to each interface. When the specific interface position between layers of similar material is not known, its position may be established by running the probe down past the interface and marking the position of maximum deflection.

4.4.10.3 Automatic Bolt-Hole Scanning. Automatic bolt hole scanning should be accomplished in accordance with the scanner manufacturer's recommendations for operation and the applicable T.O. covering the particular test to be performed. The specific weapon system T.O. always takes precedence over the manufacturer's recommendations.

NOTE

(NAVY Only) Technicians normally perform rotating eddy current techniques only when authorized by technical directives containing detailed procedures and qualification requirements.

4.4.11 Probe to Edge Spacing. When inspecting for small cracks initiating from edges, probe-to-edge spacing can become a concern. There are two basic approaches for inspecting at part edges. In addition to these two approaches, selecting other parameters that minimize the volume of material sensed by the probe will improve the inspection results. Increasing the frequency of the eddy current generating source; reducing the physical size of the eddy current generating source; and reducing the physical size of the coil allow inspection closer to the edge because of the reduced volume of material sensed and result in greater sensitivity to small flaws. Probe-to-edge spacing becomes even more of a concern when the edge of the

T.O. 33B-1-1

part is in contact with a ferromagnetic part such as a bearing or bushing. Again, minimizing the volume of material sensed by the probe will optimize the ET of such geometry.

4.4.12 Fixtures and Guides. Probe guides increase ET detectability and should be used whenever possible. The simplest ET scanning guide is a section of thin flexible plastic cut to conform to the inspection area with allowance for probe positioning. Such a guide can be easily prepared from used x-ray film. The flexibility permits fitting of the guide to compound curvatures. It is necessary that the edge used to guide the probe be smooth to allow steady movement at a constant distance from the edge of the opening. The guide can either be held in place or taped in the required position. Another type of probe guide which can be used for small openings, including holes with bushings, consists of a circular insert which fits into the hole and has a larger diameter at one end to provide the required offset distance from the edge of the hole. Probe guides SHOULD be constructed to provide the required offset from the edge for a specified type of probe and SHOULD NOT interfere with movement of the probe.

4.4.13 Fastener Holes Non-Removable Fasteners.

4.4.13.1 Inspection Application of Fastener Holes. If a fastener cannot be removed from a hole because of fastener type or location, inspection can be performed around the fastener to detect cracks growing from beneath the fastener head or nut. The size of detectable cracks is dependent upon the distance which must be maintained between the probe and the edge of the fastener. In many respects, this application is similar to inspection for cracks at the edge of openings and cutouts. Large low frequency probes and sliding reflectance probes can also be scanned over countersunk fasteners and identify cracks at the 1st, 2nd, and 3rd layers.

4.4.13.2 Probe to Fastener Spacing. If only required to detect relatively large cracks, such as those extending between two fasteners, ET can usually be performed at a sufficient distance from the fastener heads to eliminate their effect on eddy current response. When small cracks must be detected, the probe must be positioned closer to the edge of the fastener, and the probe to fastener distance must be held constant during scanning. When fasteners fabricated of magnetic materials such as steel are used in nonmagnetic parts, a relatively large spacing must be used. Also, shielded probes can be used to minimize the distance between the probe and the fastener, allowing inspection near the fastener.

4.4.13.3 Scanning Guides Around Nonremovable Fasteners. For nonferrous (nonmagnetic) fasteners, the head of the fastener may be used as a probe guide. Only those fasteners which protrude from the surface of the part and are concentric with the hole can be used as guides. For fasteners with heads not concentric with the holes, such as hexagonal and serrated heads, a collar fitted to the fastener head can be used as a scanning guide. Most shielded probes can be scanned around steel fasteners without requiring a collar. Templates must be positioned concentric to the fastener head to assure relatively consistent meter response from defect-free material as the probe is guided around the fastener.

4.4.14 Probe Selection. As with many other flaw detection applications, the use of small diameter, radiused probes is recommended. These probes permit better visibility of probe coil location and permit more flexibility in establishing spacing between the probe and the fastener. Radiused probes are also less susceptible than flat surface probes to lift-off variations with changes in probe to surface angle.

4.4.15 Standards for Nonremovable Fastener Holes. Whenever possible, the standards for inspecting around the heads of nonremovable fasteners should duplicate as closely as possible the conditions of the inspection area. If cracked specimens representing the minimum crack size to be detected are not available, EDM slots cut at the edges of holes in the reference standard can be used. Material, geometry, hole size, fastener type, and installation should be the same for the reference part as for the inspection area, unless prior correlation with other available references has been established. Duplication of part geometry in the reference minimizes differences in response between references and cracks in the part.

4.4.16 Fillets and Rounded Corner.

4.4.16.1 Edges (Including Corners and Radii). For most eddy current techniques, the flow is circular and parallel to the surface of the part. If the flow of eddy currents intercepts an edge, corner, or radius of the part, the circular pattern is disrupted and the eddy currents are confined to a smaller volume. This action changes the magnitude and distribution of the eddy currents and is known as edge effect (Figure 4-27). As illustrated, the current density will be slightly greater at the edge of the part than at the interior. This will result in a slight increase in sensitivity to discontinuities located at the edge.

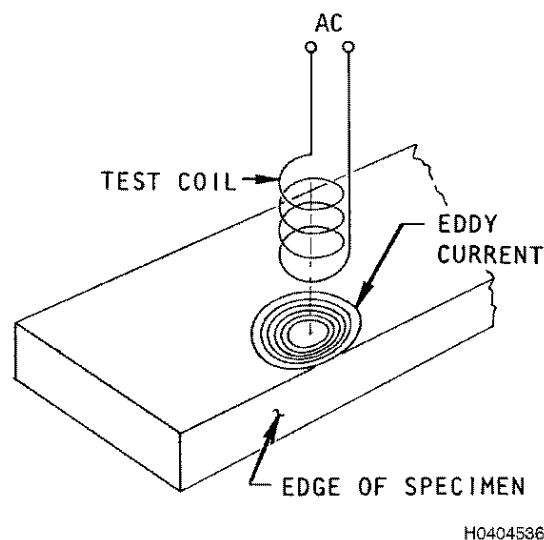


Figure 4-27. Distortion of Eddy Current Flow at the Edge of a Part

4.4.16.2 Crack Occurrence. Repeated bending loads applied to fillets and radii (rounded corners) of a part can lead to fatigue cracks. Fatigue cracks usually lie parallel to the radius. In formed radii, cracking usually occurs near the center of the radius where there is maximum thinning. In machined fillets or radii of extruded shapes where part thickness is greater at the center of the radius, fatigue cracks are more likely to occur at the tangent point of the radius. Stress corrosion cracking can sometimes occur in the radii and fillets of machined parts where tensile stresses are applied or areas of residual tensile stresses are exposed. Stress corrosion cracking is often promoted by the collection of moisture in these fillets and radii.

4.4.16.3 Equipment Requirements for Fillets and Radii. In general, no special equipment is required for the inspection of fillets and radii. Adequate inspection can be performed using eddy current instruments with a radiused tip probe or an equivalent test system. The radius of the probe tip must be less than the radius of the fillet to be inspected to ensure relatively constant contact between probe and part and thereby avoid excessive changes in lift-off. For inspection of the edges of radii or fillets, a thin plastic straight edge is desirable to maintain probe-to-edge spacing in the fillet. Occasionally, a fixture similar to those used for the bead seat radii in wheels can be used for fillets and radii. Fixtures decrease inspection time, improve inspection detectability, and assure complete coverage.

4.4.16.4 Reference Standards for Fillets. The best reference standard is an actual part with an actual flaw. If that can't be obtained then a specimen that represents the configuration of the part to be tested should be used for setup. Therefore, it is preferable to have a standard of the same material, finish, and radius as the fillet to be tested. A flaw or multiple flaws can be placed in the inspection area on the reference standard. The standard should contain at least one flaw equal to or smaller than the required flaw size of the inspection. Flat standards can be used if a standard of the required configuration is not available. Response from flat standards differs very little from response from cracks or slots in fillets or curved surfaces if a radiused probe is used. Slots at edges are not interchangeable with slots located away from the edge.

4.4.17 Impedance Diagrams.

4.4.17.1 Purpose. The impedance diagram shows how changes in eddy current test variables change the apparent impedance of a coil. Typical variables displayed are electrical conductivity, relative magnetic permeability, fill-factor or lift-off, part thickness, and test frequency. Impedance diagrams are very useful in determining optimum inspection parameters and understanding eddy current results when more than one variable is changing. The vector representation of inductive reactance on the y-axis and resistance on the x-axis of (Figure 4-28) is the basis of the impedance diagram. Let the point A represent the impedance of a test coil while on a part. If the probe is moved to a place on the part with a flaw, the impedance will change. This new impedance can be represented by the point B, as shown in (Figure 4-28). Each change in the impedance will create a new point on the diagram.

T.O. 33B-1-1

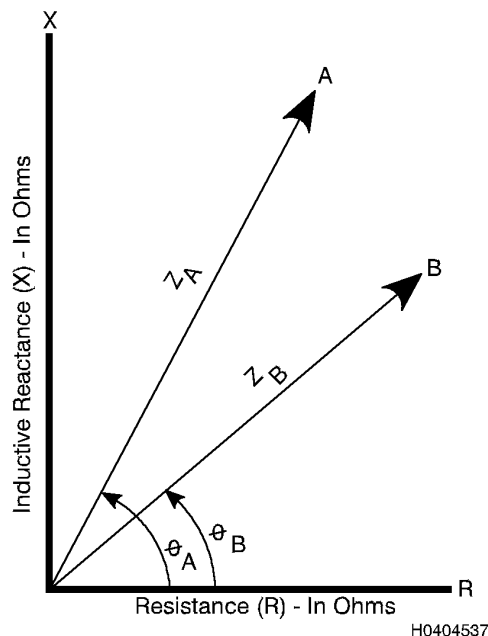
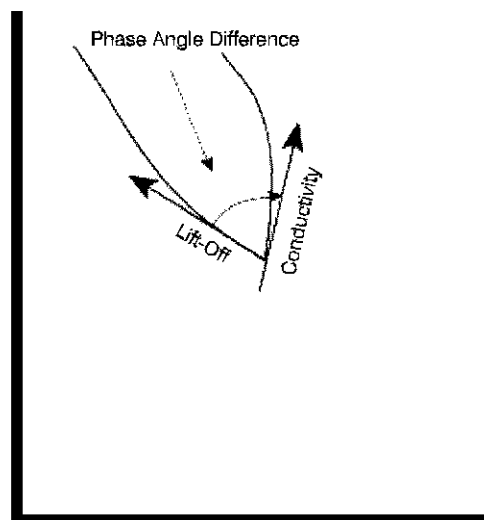


Figure 4-28. Vector Representation of Impedance

4.4.17.2 Development of an Impedance Diagram. To make the impedance diagram into a useful tool for understanding eddy current testing, it is necessary to systematically change a single test parameter such as conductivity, and observe the changes in the impedance. Using an eddy current instrument with a two-dimensional graphical display, a surface probe, a piece of ferrite (a nonconductive, ferromagnetic ceramic) and several nonmagnetic metal specimens representing a range of conductivity's from low (titanium, Inconel) to high (copper, silver), approximate impedance diagrams can be developed and demonstrated. The specimens must have clean, flat, and bare surfaces. When the eddy current probe is held away from the part (in the air) and the instrument is nulled, an indication (dot) will appear on the display. The null point can be repositioned near the upper left hand corner of the display, as indicated by point A in (Figure 4-30) and (Figure 4-31). The null point in air will be used as a point of reference for the rest of the diagrams. Next, the ferrite specimen is used to establish the direction of inductive change. Place the probe on the ferrite and adjust the phase control so that the change from air to ferrite is vertical (parallel to the y-axis). When the probe is placed on the copper specimen, the point will move to a new location on the screen, represented by point I in (Figure 4-31). As the probe is lifted from the specimen, the point will move back to the air null point (A), as shown in (Figure 4-30) and (Figure 4-31). The path that the indication follows as the probe is moved onto and off the specimen is called the lift-off trace/line.

4.4.17.3 Typical Uses of an Impedance Diagram. The impedance diagram shown in (Figure 4-31) illustrates the conductivity curve can be used to measure the relative conductivity of an unknown material by comparing the position of its indication on the conductivity curve to the positions of indications from known materials. Notice also the lift-off lines are in a different direction than the conductivity line. Changes in conductivity and lift-off are said to have different phase angles. This phase angle difference is further illustrated in (Figure 4-29). The lift-off curve can be used to measure the thickness of non-conductive coatings on a conductive surface. This is done by comparing the length of lift-off line for an unknown coating thickness to the lengths of lift-off lines for known thickness.



H0404538

Figure 4-29. Phase Angle Difference Between Lift-Off and Conductivity

4.4.17.4 Normalization of Impedance. To illustrate general principles of ET or to present data in a universal form independent of specific coil impedance values, impedance diagrams are usually normalized. In normalization, the inductive reactance and the resistance of the coil on the part are divided by the value of the inductive reactance of the coil in air. Therefore, the vertical axis of the impedance diagram equals the relative inductive reactance (X_{LN}) of the test coil; and the horizontal axis of the impedance diagram equals the relative resistance (R_N) of the test coil. Normalization is a convenient method to allow comparisons of eddy current data from a large number of tests using different probes and materials. The shapes of the impedance diagrams remain the same. However, the air null point A in (Figure 4-19) becomes 1 on the y-axis of the impedance diagram after normalization. The impedance diagrams in this manual will all be represented by the normalized reactance (X_{LN}), on the y-axis and normalized resistance (R_N) (Figure 4-20) on the x-axis.

T.O. 33B-1-1

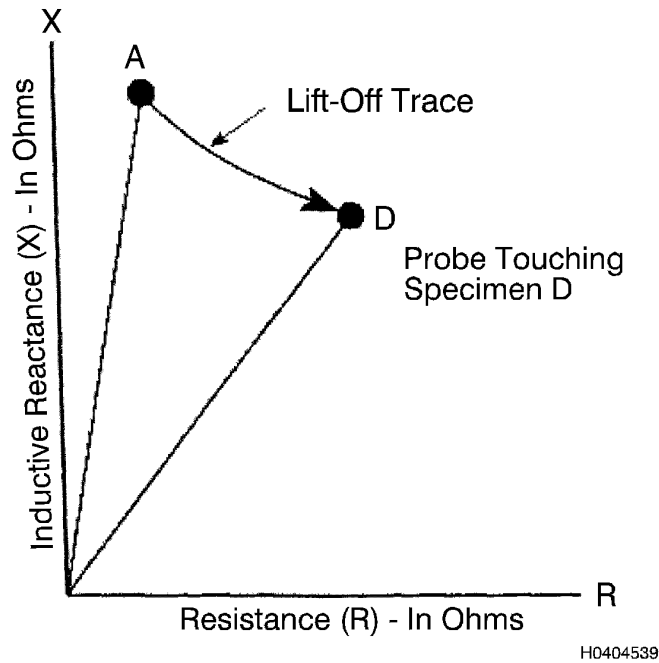
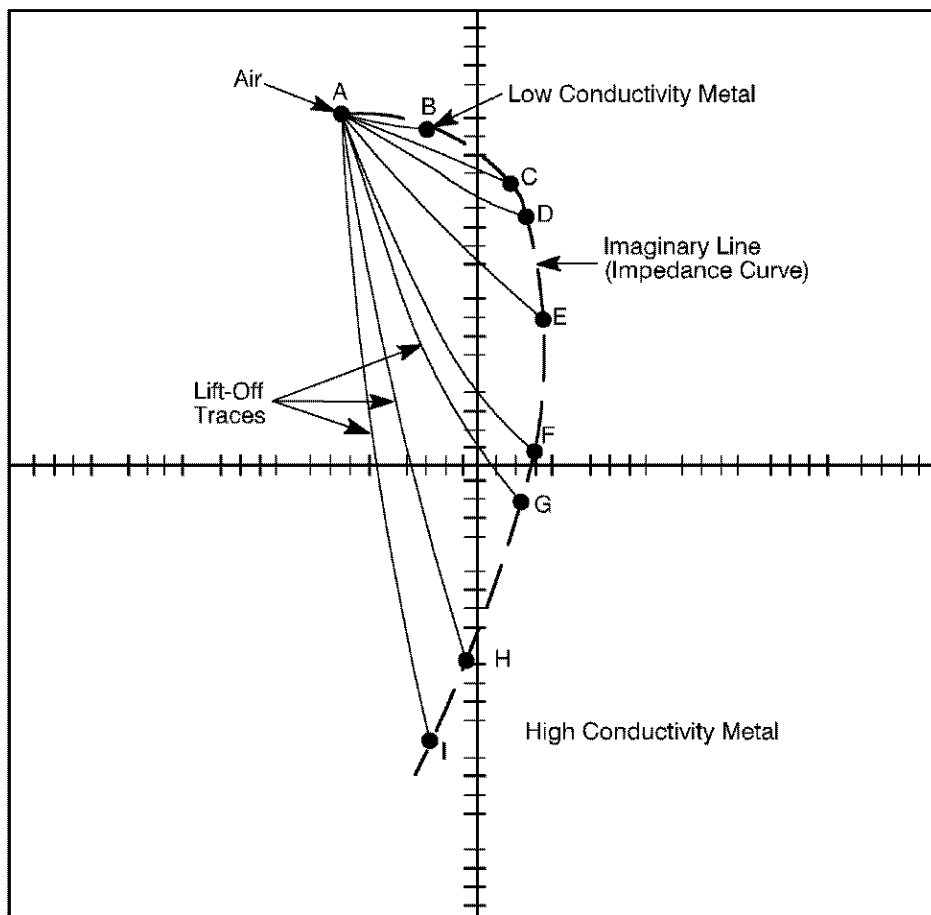


Figure 4-30. Vector Representation of an Impedance Change Due to Lift-Off

4.4.17.5 The gain and phase controls can be adjusted to place point I anywhere on the display. Because copper has high conductivity, it will be convenient to adjust the gain to put point I in the lower part of the screen, (Figure 4-31). When the probe is placed on the other metal samples, the respective impedance points “B through H” (Figure 4-31) are recorded. Note for each of the different materials, the point will be located at a different location on the screen (e.g., each different specimen has a different impedance). Each line from the null point A, to the impedance point for a particular specimen represents a lift-off trace. If a smooth curve is drawn from the null point A through each of the impedance points B through I, a conductivity curve will be formed. The point on the curve closest to the air null point represents the material with the lowest conductivity (e.g., titanium). The point on the curve farthest from the air null point represents the material with the highest conductivity (high purity copper). This diagram also shows the relative conductivity of the other specimens.



H0404540

Figure 4-31. Impedance Diagram Illustrating Effects of Variable Conductivity

4.4.18 Corrosion.

4.4.18.1 Test System Requirements for Corrosion Detection. The test system requirements for corrosion detection depends on the type and depth of corrosion for which inspection is performed. For uniform etch corrosion and for large pits, thickness measuring systems provide optimum detectability. For small pits and small areas of exfoliation or intergranular attack, the inspection requirements become similar to those for subsurface flaws. Instrumentation and probes with a broad selection of operating frequencies may be needed to cover the wide range of material types and thickness. Battery operated impedance plane analysis equipment can be used for corrosion detection and has many advantages for these applications in most field situations.

4.4.18.2 Types of Corrosion. Corrosion is the deterioration of metals by chemical action. Corrosion occurs where two different metals are in contact via a conducting material. For corrosion to occur, electrons must be moved from one metal to another. This movement can occur through any conductive material, including air, water, or conductive adhesives. As a solution's conductivity increases, its potential to cause corrosion increases. Thus, corrosion is more prominent in humid or saline environments. Although corrosion may be classified in many ways, for purposes of detection, five principal forms are considered: (1) uniform etch, (2) pitting, (3) intergranular attack, (4) exfoliation, and (5) stress corrosion cracking.

4.4.18.2.1 Uniform Etch. Uniform etch corrosion is characterized by a general overall reduction in thickness of the metal in which some areas may be corroded more rapidly than others. This form of corrosion is readily detectable by visual means

T.O. 33B-1-1

on exposed surfaces. Corrosion of inaccessible surfaces of thin metal structures is detectable with eddy currents if access is available to the uncorroded side. Detection of this type of corrosion then becomes a matter of thickness measurement with some variations expected because of small areas with increased corrosion or the presence of metallic materials at the far surface.

4.4.18.2.2 Pitting. Small localized areas of corrosion are termed pitting. Pitting can vary from pinpoint size to relatively large areas. The detection and measurement of corrosion pits must take these possible variations into account.

4.4.18.2.3 Intergranular Attack. In some materials, including many structural aluminum alloys, corrosion occurs preferentially along grain boundaries. Although slight amounts of corrosion pitting may be observed at the surface, the extent of damage is not readily observable by visual means because of the small crack-like penetrations. This type of attack is particularly applicable to aluminum alloys.

4.4.18.2.4 Exfoliation. Exfoliation corrosion initiates along grain boundaries parallel to the surface and propagates from these initiation sites. The corrosion products force the metal upward resulting in blistering and flaking of the metal. This corrosion form is most prevalent in structural aluminum alloys such as 7075-T6.

4.4.18.2.5 Stress Corrosion Cracking. The combination of a constantly applied residual or service stress and a corrosive environment can lead to stress corrosion cracking in many high strength metals. Residual stress can result from heat treating, machining, forming, shrink fits, welding, and assembly mismatch. Depending on the type of metal and the corrosive environment, stress corrosion cracking may or may not be associated with other forms of corrosion. This form of corrosion is primarily a crack and its detection has been covered under applications related to crack detection.

4.4.19 Frequency Selection. The choice of frequency depends on the type of corrosion to be detected and the thickness of the material through which inspection is being performed. Higher frequencies favor resolution of small pits or small areas of intergranular corrosion or exfoliation. Lower frequencies increase the depth of penetration.

4.4.20 Probe Selection. The probe must match the frequency at which the inspection for corrosion is performed. When more than one model of probe is operable at the inspection frequency, part and probe geometry are the determining factors in probe selection. For narrow contact areas, a smaller diameter probe may be advantageous. Larger diameter probes provide for greater averaging of thickness and provide somewhat better sensitivity in thicker areas.

4.4.21 Corrosion Reference Standards. Because of the unique action of each type of corrosion and its effect upon conductivity, reference standards must be fabricated from the same alloy, temper, and thickness as the material being inspected. When faying surfaces are involved in corrosion detection, the standard should be built up to simulate the joint including nonconductive shims for gap, paint, and primer thickness. Standards for pitting may also be used for exfoliation and intergranular attack. Standards should also have approximately the same geometry as the part.

4.4.22 Inspection Procedure-Corrosion Detection. Detection of corrosion with eddy current techniques is applied to aircraft skins when corrosion may occur on inaccessible interior surfaces. Corrosion usually results in areas where moisture is entrapped. If relatively uniform thinning is expected, corrosion detection may be simply a matter of thickness measurement. In most instances, corrosion is confined to smaller localized areas of relatively small diameter. As skin thickness increases, sensitivity to small areas and shallow depths of corrosion is reduced.

4.4.23 Part Preparation. Prior to inspection, all foreign material should be removed from the area to be inspected. Any roughness, sharp edges, or protrusions that could damage the probe or cause errors in readings should be removed by light sanding within the limits of the applicable T.O.'s. The locations of all fasteners, edges, and changes in structure on the far side of the inspection surface should be established and marked with an approved removable marker to aid in the interpretation of inspection results. Paint removal is not required if it is relatively uniform and not loose or flaking. Because of the wide variety of corrosion attack, inspection SHALL be performed in accordance with the applicable T.O.

4.4.24 Field Measurement of Conductivity. Eddy current instrumentation is used for determination of electrical conductivity under production and field conditions. The eddy current instruments are calibrated against standards of known conductivity. When available, instruments designed specifically for measurement of conductivity are used. These instruments measure conductivity directly in %IACS.

4.4.25 Conductivity of Aluminum Alloys. Conductivity measurement is applied most often to aluminum alloys. This application results from the extensive use of aluminum alloys in the aerospace industry and the wide variation in the electrical conductivity and mechanical properties between different alloys and heat treatment. For most aluminum alloys in common usage, specific conductivity ranges have been established for each alloy and temper. The conductivity ranges for

most of the aluminum alloys commonly used in aircraft structural applications are listed in (Table 4-7 in Section 4.7). These values represent a collection of values obtained from various airframe manufacturers and Government agencies. The ranges include all values obtained for standard heat treatments except for extreme values obtained from one or two sources which were clearly outside the ranges of all other lists. If a measured conductivity value for an aluminum alloy and temper is outside of the applicable range, its mechanical properties SHOULD be considered suspect. Measured conductivity values SHOULD be in accordance with MIL-H-6088, ASTM E 1004 or another suitable standard.

4.4.26 Heat Treatment Effects on Aluminum Conductivity. An aluminum alloy has the highest conductivity and lowest strength when it is in the fully annealed temper. After quenching from the solution heat treating temperature, the strength is increased and the conductivity decreased. Many aluminum alloys are unstable for a considerable period of time after solution heat treatment, even if held at room temperature during this time. A certain amount of atom migration takes place to initiate the formation of submicroscopic particles. This process, sometimes called natural aging, increases the strength of the alloy but has either no effect on conductivity or a slight decrease in the conductivity value. Some aluminum alloys remain unstable for such long periods after quenching they are never used in the solution heat treated condition (e.g., 7075). If a solution heat treated alloy is precipitation hardened by heating at relatively low temperature (generally 200-450°F), alloying atoms form small particles. At a critical size and distribution of particles, the strength of the aluminum alloy reaches a maximum. Conductivity increases during the precipitation hardening or artificial aging process. If aging is carried on beyond the point where optimum strength is obtained, strength will decrease, but conductivity will continue to increase.

4.4.27 Discrepancies in Aluminum Alloy Heat Treatment. Variations from specified heat treating practice can result in aluminum alloys with strengths below required levels. Heat treat discrepancies include changes or misapplication of the following processes:

- Solution heat treating temperature.
- Solution heat treating time.
- Quenching practice.
- Aging temperature.
- Aging time.
- Annealing temperature and time.
- Uncontrolled temperature application.

4.4.28 Applications of Conductivity Measurement.

4.4.28.1 Separation of Alloys and Tempers. Conductivity measurement can be used to separate mixtures of two or more alloys and/or tempers. Separation is possible when the electrical conductivity of each grouping is clearly different. The process of separation may be accomplished with an instrument calibrated in %IACS.

4.4.28.2 Magnetic Materials. Use of general purpose instruments may be extended to the separation of magnetic materials where the product of permeability and conductivity of each of the alloys is clearly different. Conductivity meters will not measure the conductivity of magnetic materials.

4.4.28.3 Typical Application. Eddy current techniques are used to separate metal parts or raw materials of similar geometry which have lost alloy and/or temper identification and have become mixed in manufacture or storage. Such procedures can be applied at any stage in the processing, storage, or service of the material.

4.4.28.4 Control of Heat Treatment. The relationship between electrical conductivity and heat treat condition has permitted the use of eddy current techniques for checking the adequacy of heat treatment in aluminum alloys. In this application, conductivity measurements by eddy current techniques are used to supplement a minimum amount of tensile testing and/or hardness testing. Eddy current conductivity measurements are particularly valuable for determining the uniformity of heat treatment of large and complex aluminum alloy structures when tensile specimens are not obtainable and part geometry limits accessibility for hardness testing. Adequacy of heat treatment of aluminum alloys is determined by conformance of the material to the pre-established conductivity ranges. This method of heat treat control has been applied extensively to aluminum alloys. Eddy current techniques are used for evaluation of heat treatment of steels. Generally, more sophisticated instrumentation is used for steels, but general purpose instruments can be used for many applications. Acceptance standards are usually used for ET of steel. Conductivity measurement is applied to a lesser degree for heat treat control of copper and magnesium alloys. Eddy current techniques can be used for heat treat control in any alloy system where consistent but different conductivity ranges or permeability values occur with the various heat treating conditions. Conductivity measurement has not been established as a method of determining heat treat response in titanium alloys.

T.O. 33B-1-1

Differences in conductivity between various heat treat conditions for most titanium alloys are insufficient to permit determination of temper.

4.4.28.5 Determination of Heat and Fire Damage. A common application of conductivity measurement in field applications is the determination of heat and/or fire damage to aircraft structures. Because of the extensive use of aluminum alloys for aircraft structures and their sensitivity to mechanical property losses at relatively low temperatures, greatest experience and data have been generated for these materials. Heat and fire damage to other metals can be detected if temperatures become high enough to affect conductivity, permeability, and mechanical properties. Damage is detected in aluminum alloys as changes in conductivity from the specified range for the alloy and temper being inspected. Heat and fire damage usually vary over a part because of nonuniform application of heat. Nonuniform heat application, in turn, results in variations in electrical conductivity. Unless the temperature and time of heat application is known, or testing is performed on a number of parts with the same history of heat application, quantitative values of mechanical properties cannot be established from the electrical conductivity values. Hardness testing and conductivity measurement give a good indication of heat and fire damage. Both testing must be performed to get an idea of the amount of damage.

4.4.29 Conductivity Measurement. To determine conductivity directly, eddy current instruments are available which provide a value of conductivity in % IACS. These instruments do not cover the entire conductivity range. The most common range of instrument coverage is approximately 8 to 110 % IACS. Although instruments with other conductivity ranges are available, they have more limited application and are not generally available at field bases. Percent IACS measuring instruments usually require only two standards of known conductivity for calibration. If direct conductivity measuring equipment is not available, general purpose eddy current equipment may be adapted for measuring conductivity. Use of general purpose equipment requires a larger number of standards to establish a calibration curve. The number of standards necessary for a conductivity measuring application is determined by the range of conductivity to be covered and the accuracy required. General purpose equipment can also be used in a go no-go function to separate metals above and below a specified conductivity value. A standard representing the minimum acceptable or disallowable conductivity must be available.

NOTE

(Navy Only) Unit of measurement is 5-105% IACS with variable frequency.

4.4.30 Equipment for Magnetic Materials. Impedance plane analysis instruments can be used to measure the conductivity of ferromagnetic materials because the permeability and conductivity can be separated in phase. However, the combination of conductivity and permeability, in many cases, can be related to variations in alloy, temper, and strength. General purpose meter type instruments can then be used to separate or grade various levels of properties. The number of standards required depends on the number of categories of materials to be established.

4.4.31 Effects of Variations in Material Properties.

4.4.31.1 Conductivity. Conductivity variations can occur in metals as a result of improper heat treatment or as a result of exposure to excessive temperatures during service and cold working. These are the conditions for which ET is usually performed. Conductivity variations can stem from other sources. Separation of elements during solidification of metals can lead to either localized or uniform differences in conductivity. For instance, a variation in conductivity can exist with increasing depths beneath the part surface particularly in heavier sections which have not been worked extensively. Slight differences in heat treating time, temperature, or quenching rates imposed by limitations in heat treating facilities or changes in part configuration also lead to variations in conductivity of a part. Localized cold working of metals, when not followed by heat treatment to relieve residual stress, can reduce electrical conductivity. Many of the variations are considered normal to the processing of the parts and the conductivity lies within the acceptable range for the alloy specification and temper. Conductivity outside the specified range for a given alloy and temper should be considered unacceptable and further investigation should be performed using hardness testing techniques.

4.4.31.2 Edge Effects. If the electromagnetic field of the probe is affected by the geometry of the edge of the part, an error will occur in the measurement of the conductivity. The probe should be located several probe diameters away from the nearest edge or transition boundary.

4.4.31.3 Curvature. Lift-off effects caused by the probe-to-curve surface fit-up will cause an error in the conductivity measurement. On curved surfaces, the smallest practical probe should be used to minimize lift-off effects.

4.4.31.4 Clad Materials. Cladding will affect the measured conductivity of the base metal. The degree to which the cladding will affect the value obtained depends on the conductivity of the cladding, the thickness of the cladding, and the

operating frequency. Present applications are usually limited to “Alclad” aluminum alloys in the range of 0.050 to 0.080-inch thick using conductivity meters with operating frequencies of 60 kHz. Special conductivity ranges are required for clad aluminum alloys. The thicknesses of cladding, which are usually based on a percentage range of the overall thicknesses, can vary slightly because of normal tolerances. At 60 kHz, conductivity readings from aluminum alloys less than 0.050-inch in thickness are affected by both cladding and part thickness. Eddy current testing of complex cladding systems is still in an experimental stage for the most part.

4.4.31.5 Magnetic Permeability. Direct meter measurement of electrical conductivity is applicable to nonmagnetic materials with a relative magnetic permeability of one or nearly one. If magnetic permeability exceeds one, it will produce a bridge unbalance in the meter system which can not be separated from the conductivity measurement and erroneous readings will be obtained. For this reason, conductivity of steels, nickel, and other magnetic materials can not be determined with conventional eddy current conductivity meters. Some stainless steels (e.g., 300 series) are essentially nonmagnetic in the annealed condition, but slight amounts of cold working or exposure to extremely low temperature can cause transformation to a magnetic structure. Impedance plane analysis equipment can readily separate magnetic permeability and conductivity, allowing an accurate measurement of conductivity of ferromagnetic materials.

4.4.31.6 Geometry. Any change in part configuration that affects distribution or penetration of eddy currents will result in erroneous electrical conductivity readings. The following sources of error are included in these categories:

- Proximity to part edges or adjoining structure.
- Metal thickness less than the effective depth of penetration in the metal.
- Excessive curvature of part surface.

4.4.31.7 Metal Thickness. If metal thickness is less than the effective penetration of the eddy currents, the measured conductivity will differ from the true value. Notice the effective penetration depth is approximately three times the standard depth of penetration. With meter equipment it is important to determine the operating frequency of the instrument. The operating frequency must not exceed the effective penetration depth of the material being tested. Impedance plane analysis equipment has a very wide range of operating frequencies, and the frequency can be adjusted to limit penetration to less than the effective depth. The standard depth can be determined by using the equation in (paragraph 4.7.6). Special slide rules are available for calculating depth of penetration. Effective depth is approximately three times greater than the standard depth calculated by this equation. The material thickness must be greater than the effective depth or errors in conductivity measurement will occur.

4.4.32 Effects of Variations in Test Conditions.

4.4.32.1 Frequency. Because frequency affects distribution of eddy currents within the test part, it affects the minimum thickness which can be measured without special adjustments. Higher frequencies permit measurement of thinner metals without compensation for thickness. Frequencies that provide less than 3 standard depths of penetration in the metal being tested are necessary for reasonably accurate conductivity measurement. However, the higher frequencies are more strongly affected by localized variations in conductivity or by conductive coatings and cladding on metals. Excessive high frequencies SHOULD NOT be used for conductivity measurements.

4.4.32.2 Probes for Conductivity Measurements. With instruments designed for conductivity measurement, probes are carefully matched to the instruments and are usually obtained from the instrument manufacturer. Probes for conductivity measuring instruments are larger than those normally used for defect detection. This design provides for averaging of conductivity over a relatively large area. Probes are designed with plastic or ceramic shoes to prevent damage to the coil. With continued use, wear on the face of the probe reduces the coil-to-surface distance, and calibration cannot be obtained. As wear occurs, the probe shoe must be changed and the instrument recalibrated.

4.4.32.3 Lift-Off Effects on Conductivity. Meter type conductivity measuring eddy current instruments often have a pre-set lift-off adjustment. The lift-off adjustment is usually set during calibration of the instruments. Applicable maintenance manuals describe the procedures that can be performed by trained NDI personnel. With probe wear and changes in instrument electrical components over a period of time, lift-off adjustment can change. Therefore, when conductivity measurements are to be performed on rough surfaces or through thin nonconductive coatings, lift-off adjustment SHOULD be checked prior to performing the measurements. After calibrating an instrument against the conductivity standards, lift-off adjustment SHOULD be checked against a specimen with conductivity representative of the test part. Lift-off, greater than the amount of preset lift-off adjustment (if any), results in errors in conductivity readings.

T.O. 33B-1-1

4.4.32.4 Temperature Effects on Conductivity Measurements. Higher temperature increases the thermal activity, of the atoms in a metal lattice. The thermal activity causes the atoms to vibrate at high amplitude about their position in the lattice. This thermal vibration of the atoms increases the chances of a collision with electrons in the material. This increases the resistance to electron flow, thereby lowering the conductivity of the metal. Lower temperatures reduce thermal oscillation of the atoms resulting in an increased electrical conductivity. The conductivity of standards is usually determined at a specific temperature; 68°F (20C) is most commonly used. Typical conductivity values and allowable conductivity ranges are also established at approximately this temperature. If all instrument calibration and conductivity measurements could be performed at this temperature, errors in conductivity measurement related to temperature variation would not occur and/or temperature compensation would not be required. In field applications, testing temperatures can conceivably be anywhere in the range of 0°F to 120°F. Unless precautions are taken in selection of standards, calibration of the instrument, and testing, errors will occur in the measured conductivity values. Two ways in which erroneous readings may be obtained are:

- Difference in temperature between standards and test part.
- Difference in temperature at which conductivity of the standard was originally established and the temperature at which instrument calibration and conductivity measurements are performed.

4.4.32.5 To prevent errors from differences in temperature between the standard and test part, the instrument and standards SHOULD be allowed to stabilize at the test part temperature before calibration and conductivity measurements are performed. Measurements SHALL NOT be taken if part and standards temperature differ by more than 10°F. Even though the standard and test part are at the same temperature, errors in determining conductivity values occur when the measuring temperature differs from the temperature at which the conductivity of the standards was originally established. The magnitude of the error becomes larger as this difference in temperature increases.

4.4.33 Flaw Detection. Service-induced cracks in aircraft structures are generally caused by fatigue or stress corrosion. Both types of cracks initiate at the surface of a part. If this surface is accessible, either by direct surface contact or by penetration of the eddy current field through the material, ET can be performed with a minimum of part preparation and a high degree of sensitivity. When establishing an eddy current technique for crack detection, the following factors must be considered:

- Location and size of cracks to be detected.
- Type of material to be inspected.
- Accessibility of inspection area.
- Test system capabilities.

4.4.34 Inspection Material. The material from which the inspection part is fabricated is of primary importance when determining if ET should be used and the limitations involved with this method. Conductivity and magnetic permeability influence frequency requirements, instrument choice, signal-to-noise ratio, filtering needs, resulting sensitivity, and reliability of inspection. If surface cracking is to be detected in ferromagnetic material, a high frequency can be used to limit penetration or a high pass filter can be used to minimize permeability problems.

4.4.35 Accessibility. Most of the eddy current equipment presently available for use in the field is small, portable, and battery powered. This permits its operation in relatively tight quarters. However, ET is only feasible for surface or near surface conditions because of its limited depth of penetration. For this reason, direct access to the surface to be inspected is usually preferred. Sufficient freedom of movement must be available in the area to be inspected to allow positioning and movement of the probe to detect or measure the specified variable. The inspection area must be visible to enable the inspector to determine the position of the probe. Alternatively, a special probe, a fixture, or a guide can be used to position and hold probes in the required location. The extent of disassembly required for inspection should be defined in applicable written procedures.

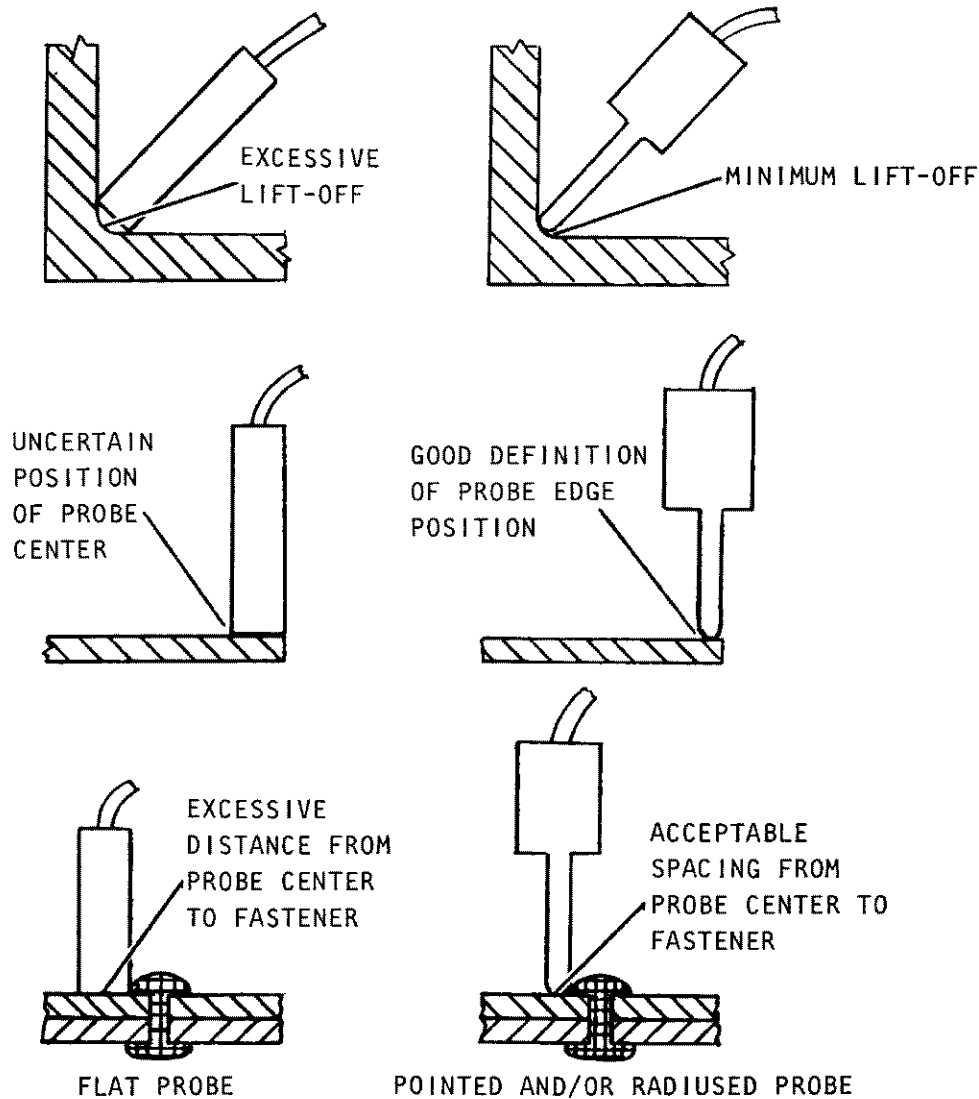
4.4.36 Crack Detection. The test system for crack detection includes the probe(s), the eddy current instrument, any additional recording or measuring instruments, and reference standards. A wide variety of eddy current units are fabricated for general purpose ET. General purpose ET instruments are used for flaw detection. In the aerospace industry, very few general purpose eddy current instruments use meter displays. For the most part, two-dimensional displays of the impedance plane that display the detailed phase and amplitude analysis are used. Also, the storage scope, type of instrument, and magnetic tape recording systems are very useful for automated high speed testing.

4.4.37 Probe Selection. The primary consideration in selecting an eddy current probe is the type of inspection being performed. To detect small cracks, a shielded probe coil of small diameter with a ferrite core is desirable to concentrate the induced field into a small volume. A small crack has a proportionately greater effect on a small probe field than on a large probe field. In the event encircling coils or inside coils are used, short or narrow coils are preferred for inspection of small

localized conditions. Spacing of the coils must be considered when determining the resolution required. The coil or probe must match the frequency range and output impedance of the instrument being used. In general, cracks whose lengths are less than half the diameter of the coil are difficult to detect.

4.4.37.1 Probe Housings. The housing for most general purpose surface probes is cylindrical in configuration and from 1/8 to 3/8-inch in diameter. Probes can be shielded with either non-permeable (μ) metal or ferrite to concentrate the field. When defect detection around fasteners, in radii, or adjacent to edges is required, it is often advantageous to have a pointed or small rounded tip at the end of the probe. The pointed end allows the probe to be inserted closer to the inspection surface, or edge, and permits better visibility of probe coil position. The advantages of a pointed probe for these applications are illustrated in (Figure 4-32). For inspection of bolt holes, special probes are manufactured that permit contact with the side of the hole at any desired level in the hole. For inspection areas where accessibility is a problem, or where probe positioning is critical, it is often desirable to fabricate special probe housings as an aid in performing the inspection. The use of special housings can greatly decrease the loss of sensitivity associated with probe wobble and lift-off during scanning. When large quantities of parts are to be inspected, special probes present a distinct advantage if they enable per unit inspection time to be reduced. Test procedures and technical orders for the ET of specific aircraft components SHOULD specify the probe and special fixtures and may specify the design also. Probability-of-Detection studies have indicated that probe guides and special fixtures increase inspection reliability and SHOULD be used instead of freehand scanning.

T.O. 33B-1-1



H0404541

Figure 4-32. Advantages of Pointed and Radiused Probes for ET

4.4.37.2 Probe Types. Here we will discuss four different probe types, absolute, differential, reflectance, and remote field probes.

4.4.37.3 Absolute Probe. The most common type of eddy current probe used in field applications is the absolute probe. The absolute probe contains a single coil that is placed in contact with, or adjacent to, the part being inspected. Since any changes in the area interrogated by the coil produce a response, absolute probes can be used to measure specific materials properties such as electrical conductivity and magnetic permeability.

4.4.37.4 Differential Probes. Differential probes contain two or more coils and are intentionally designed to produce a response when changes are sensed by the active coil only. Consequently, if the differential probe has two coils mounted side by side, gradual changes in electrical conductivity or magnetic permeability would be sensed by two coils simultaneously and no response would occur. On the other hand, if an abrupt change in conductivity should occur, localized to where it can be sensed by only one coil at a time, then there would be a response. Cracks cause a localized conductivity change and consequently can be readily detected by differential probes in the presence of slowly varying changes in electromagnetic properties or conditions that would cause interfering responses in absolute probes.

4.4.37.5 Reflectance Probes. Reflectance probes have two or more coils. One coil is the driver coil and produces the magnetic field that produces the eddy currents. One or more pickup coils are used as receivers to pick up the resultant conductivity changes.

4.4.37.6 Remote Field Probes. Remote field probes have two or more coils. The driver is a distance from the receiver coil(s). Remote field eddy current probes are used for deep penetration into thicker structures.

4.4.37.7 Sensitivity. The ability of an eddy current instrument to detect small variations in test coil impedance is a measure of its sensitivity. This quality is interrelated with the properties of the test coil and the operating frequency. Therefore, instrument sensitivity to a particular flaw condition or material property SHOULD be established from reference standards representing this condition.

4.4.37.8 Frequency Requirements. As the eddy current test frequency is increased for a specific eddy current application, the eddy currents are confined to a smaller volume adjacent to the inspection probe coil. This concentration increases the proportion of generated eddy currents intercepted by a small crack or other defect. Higher frequencies should then provide better response to the smallest defects. This statement holds in general, but other conditions may limit the sensitivity when using higher frequencies. In some instruments, high induction losses limit instrument output at these higher frequencies. Lower frequencies may be required for increased penetration to detect subsurface or far surface flaws. Optimum sensitivity to cracks or other flaws generally occurs in specific frequency ranges for each combination of metal, flaw size and flaw depth. Operating frequency ranges can be established for each application by using the calculated depth of penetration using the conductivity and permeability of the material. These calculations SHOULD be confirmed with the use of reference standards which simulate the anticipated flaws to be detected.

4.4.37.9 Resolving Power. The ability of a test system to separate the signals from two indications that are close together is defined as “resolving power.” This property plus sensitivity must be considered in every flaw evaluation situation. Probe design, test frequency, and instrumentation design are all factors in determining the resolution of an eddy current system.

4.4.37.10 Signal-to-Noise Ratio. As the gain of a test system is increased, a background of electrical noise will be observed. This may be represented by erratic meter movement, excessive background signals on a waveform display, or excessive, random patterns on a recorder. This “noise” can be the result of random variations in the electrical system of the test instrument, normal variations in material properties, or stray electrical signals from other electrical devices. Signal-to-noise ratio is not a function of the instrument alone, but is also dependent upon lift-off, surface finish, conductivity, and permeability variations within the inspection part. For an eddy current test instrument or any other electrical test instrument to be useful, it must provide flaw signal information greater than the background noise of the test system. Otherwise the inspector could not see the difference between the flaw signal and the background noise. For maximum reliability in ET, a high signal-to-noise ratio is desired. No specific signal-to-noise ratio is mandatory, but a minimum of 3-to-1 is desirable for flaw detection.

4.4.37.11 Signal-to-Noise Ratio and Sensitivity. As the required crack size to be detected is decreased, the gain or sensitivity of the eddy current instrumentation must be increased to provide readable indications from small cracks. The higher gain results in greater indications from small cracks. The higher gain also results in greater response from variables other than cracks and the noise level increases. This decreases the signal-to-noise ratio, making it more difficult to observe the small flaw indication. The decrease in signal-to-noise ratio lowers the reliability of the inspection. Therefore, an increase in gain will increase the amplitude of the flaw signal as well as increase the level of noise. Thus, useful sensitivity must be measured in relation to the noise of the test system.

4.4.37.12 Influence of Frequency on Noise. Increasing the operating frequency for ET improves the sensitivity to near-surface defects, but also tends to increase noise from surface related factors such as lift-off scratches, rough surface, and probe wobble.

4.4.37.13 Suppression Techniques. Suppression techniques are used to eliminate or reduce instrument response to one or more inspection variables to permit better identification of changes in the parameters of interest during ET. When the display is rotated as previously indicated, lift-off variations produce little or no signals in the vertical direction. Even though the crack signal is predominately horizontal, it has a significant vertical component. This vertical component can be amplified independently and monitored visually or electronically. A box gate (alarm) can be used to electronically monitor the vertical component of indications and set off visible and audible alarms on the equipment to draw inspector attention. The typical box alarm is a rectangle whose position, height and width can be adjusted to selectively monitor a portion of the impedance plane. Box alarms can be set to trigger when the crack indication signal enters the box (Positive) or when the signal leaves a box (Negative). Where liftoff is horizontal and crack indications are vertical, a “positive” triggered box alarm

T.O. 33B-1-1

can be set slightly above the path of the lift-off lines and low enough to be crossed by crack indications. In the example described, defect indications will enter the box alarm over a fairly large area of lift-off conditions while the slight vertical component of these lift-off responses remains outside.

4.4.38 Lift-Off Effects.

4.4.38.1 Sources of Lift-Off Variations. During ET, changes in spacing between the probe coil and the inspection surface will cause variations in test coil impedance. These changes in lift-off result from surface roughness, slight contour changes, probe wobble, probe bounce, and inconsistent thickness of nonmetallic coatings, such as paint, primer, and anodic coatings. The magnitude of impedance changes resulting from small amounts of lift-off variations can exceed the response from a crack. Consequently, some means of eliminating or separating this effect must be provided.

4.4.38.2 Lift-Off Suppression. One option for minimizing lift-off effects from the variable to be measured is the use of impedance plane analysis, where the phase direction of the response from the desired variable is separated from the phase direction of signals caused by lift-off variations. This type of analysis can be performed using any of the waveform display instruments that provide amplitude and phase of the signal. The small, meter readout type battery-powered instruments provide only a total amplitude measurement and require some means of lift-off suppression. For these instruments, lift-off compensation is obtained by selection of an off null operating point. The off null operating point is selected to provide equal current flow (meter reading) with the probe on bare metal and at a designated amount of lift-off. ET using small amounts of lift-off compensation or adjustment is also termed intermediate layer technique. The amount of lift-off adjustment is selected to minimize any surface roughness or variation in coating thickness on the part.

4.4.39 Lift-Off Compensation Methods.

4.4.39.1 Impedance Plane Analysis Instruments. Instruments that present the phase and amplitude of the signal on a CRT have phase rotation controls which allow the eddy current signal to be rotated until the phase is in a particular orientation. For instance, the phase can be rotated until the lift-off signals move in a horizontal motion, with increasing lift-off represented by movement to the left or right on the screen. Flaw signals or loss of conductivity will generally be in a vertical direction. The phase angle and amplitude of an indication will depend upon the depth of the flaw and the frequency of the test.

4.4.39.2 Phase Adjustment. In eddy current instruments with two-dimensional displays, the signals displayed can be rotated to align the direction of changes caused by the variable of no interest with the horizontal (or vertical, if so desired) axis as shown in (Figure 4-33). This is also called phase adjustment and its purpose is to position the response associated with lift-off variations in a direction that does not interfere with the interpretation of responses from variables of interest. The effectiveness of this technique increases as the phase difference between lift-off and the variable of interest increases from 0° to 90°.

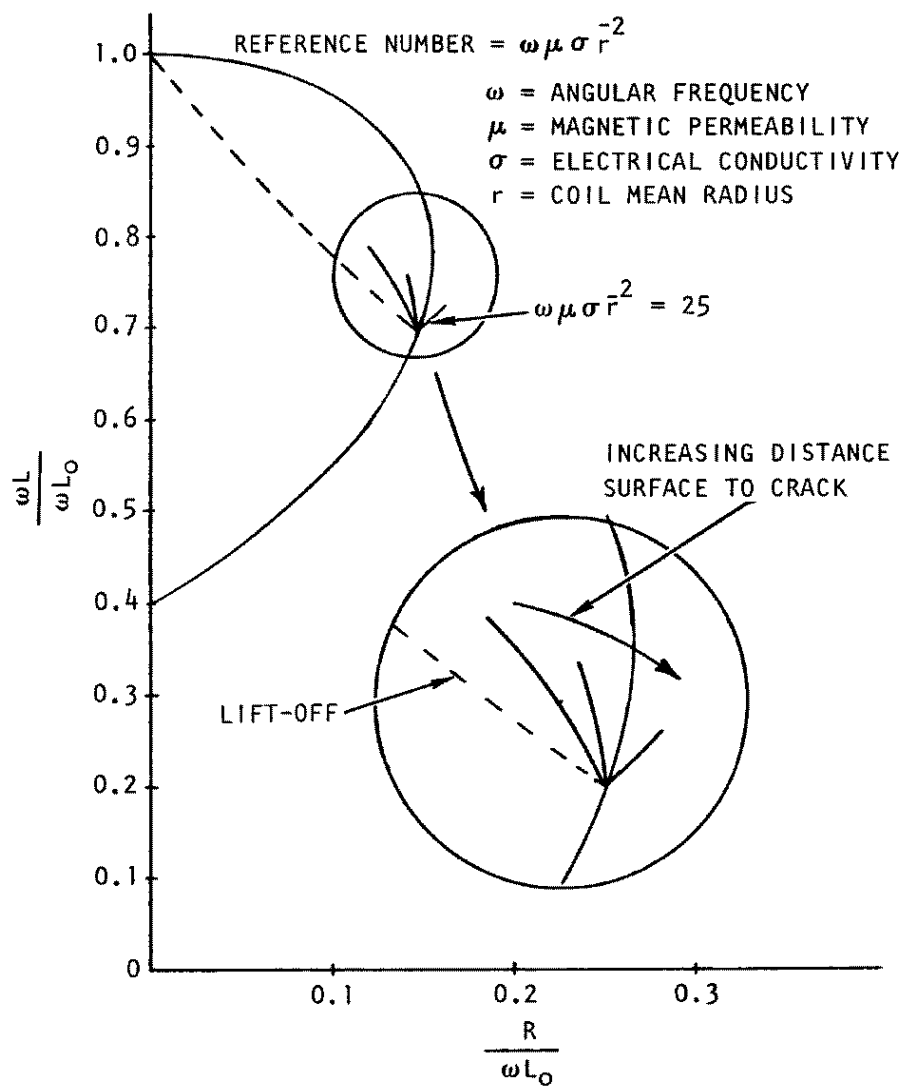
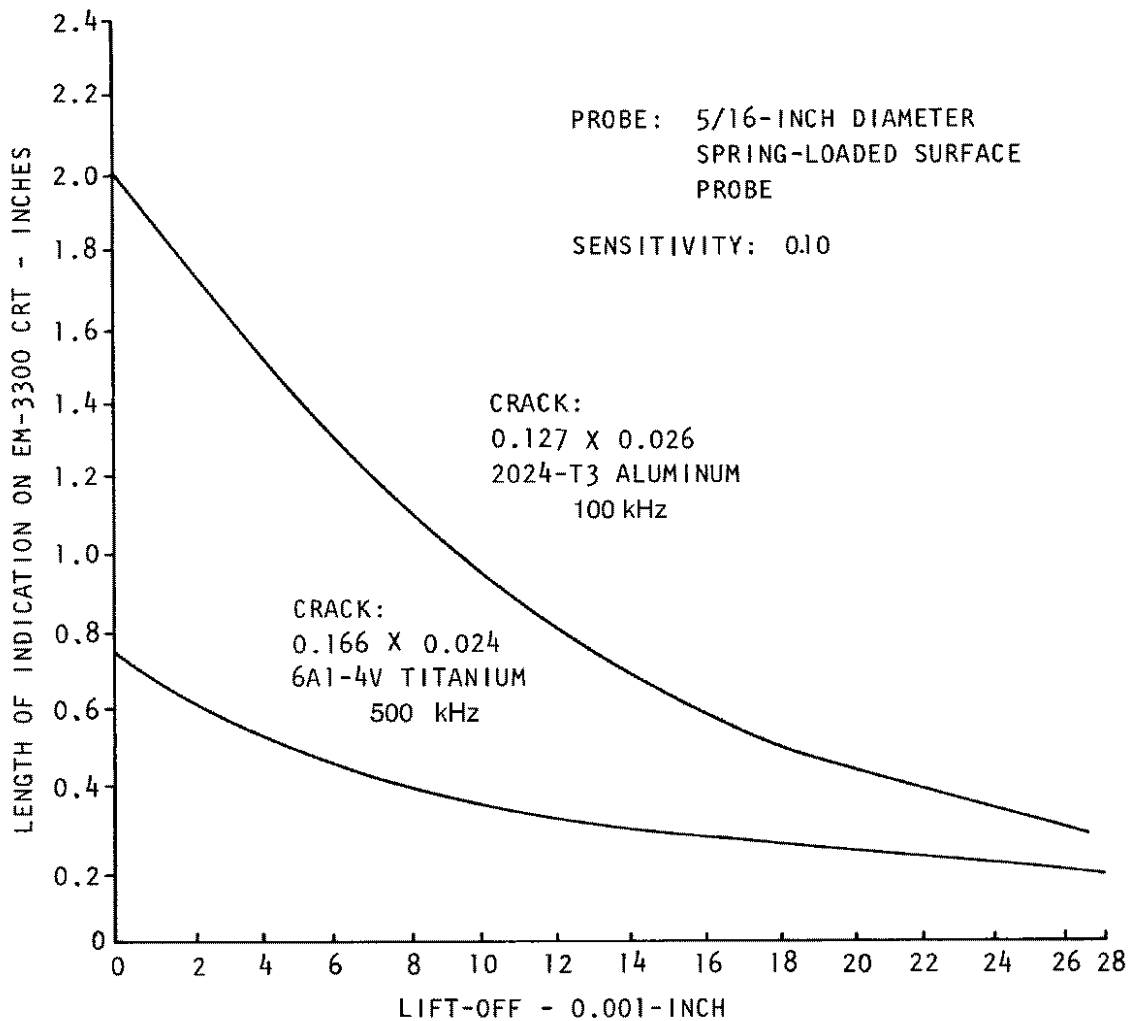


Figure 4-33. Impedance Diagram Showing the Effect of a Crack

4.4.39.3 Lift-Off Effects on Sensitivity. As lift-off increases, sensitivity of the eddy current system decreases. The magnitude of the response from a crack or other defect decreases continuously as the distance between the cracked metal and the probe increases. The typical effect of increasing lift-off on crack response is shown in (Figure 4-34). The magnitude of the total response obtained from two cracks is plotted against the controlled thickness of an intermediate layer between the probe and the part.

T.O. 33B-1-1



H0404522

Figure 4-34. Decrease in Crack Response With Increasing Lift-Off

4.4.39.4 Lift-Off Compensation Effects on Sensitivity. Lift-off must be minimized or compensated for to maintain a known level of sensitivity during an ET. A meter type of eddy current instrument requires some form of lift-off adjustment. Otherwise, slight variations in lift-off would provide strong signals which would completely mask the response from cracks. The magnitude of crack response is considerably reduced by lift-off compensation. The reduction in sensitivity depends upon the particular eddy current system in use. Each system must be set up for the particular application.

4.4.39.5 Phase Response from Cracks. Difference in phase between lift-off response and crack response is essential for the detection of cracks in most applications of ET. Depending on the crack indication on the impedance diagram, the phase angle between lift-off and crack response can be very small. This makes it very difficult to detect the difference between lift-off and probe motion from crack indications. Referring to (Figure 4-34), as lift-off increases and/or the frequency decreases, the impedance of the system approaches the air null point, the phase angle between lift-off and the conductivity line decreases. By maintaining a high fill-factor or low lift-off and operating at a high enough frequency, a crack indication (loss of conductivity) can be easily distinguished from lift-off signals because of the larger phase angle. These relationships, as seen on an impedance plane analysis eddy current instrument, are shown in (Figure 4-35) for aluminum, titanium and steel alloys. As crack depth increases, the phase angle approaches more closely the phase angle for conductivity changes.

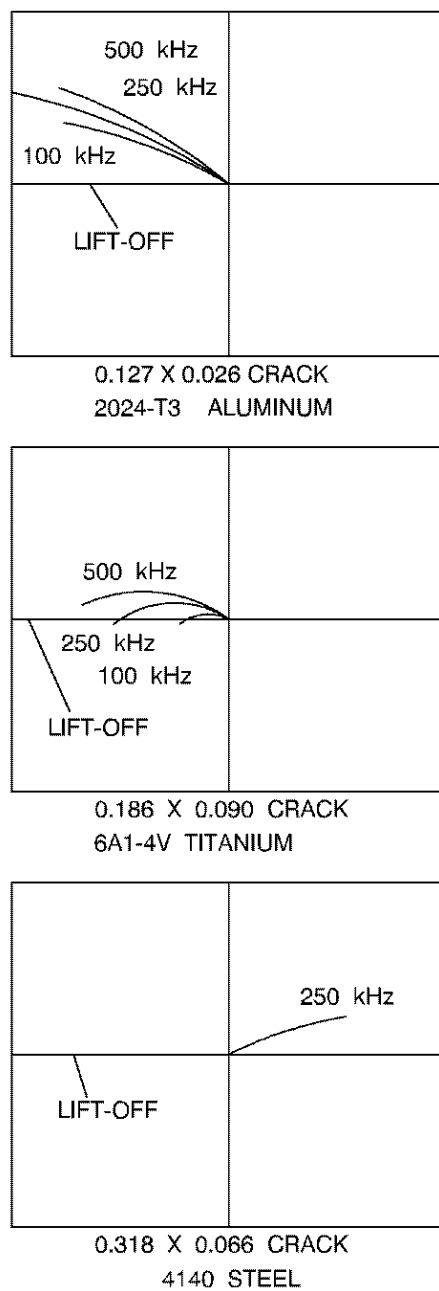


Figure 4-35. Phase Relationship Between Lift-Off and Crack Response for Various Materials and Frequencies

4.4.39.6 Ferromagnetic Materials. Variability in permeability can make the ET of ferromagnetic materials difficult. Permeability and lift-off have approximately the same direction of impedance change in unmagnetized ferromagnetic materials, but there can be very large variations in permeability that are very difficult to compensate. Magnetic saturation can be used to overcome the difficulties presented by permeability effects. In this technique, the material is magnetically

T.O. 33B-1-1

saturated by a high DC magnetic field. This reduces the permeability to about 1 and makes it a constant. This results in a relatively low conductivity material, essentially non-ferromagnetic, for ET applications.

4.4.39.7 Phase Discrimination. Each of the ET variables (lift-off, conductivity, thickness, permeability, and flaws) has a characteristic effect on the net impedance of a coil. The display of the impedance curves caused by changes in the inspection variables can be of great assistance in determining the cause of a change.

4.4.39.8 Probe Wobble. In performing manual ET with a surface probe or pencil probe, it is usually impossible to maintain the probe at the same angle, with respect to the inspection surface, as position is changed. In some instances, holders may be fabricated to guide the probe and hold the angular relationship with the inspection surface. The angular change between the probe and the inspection surface is termed probe wobble. Probe wobble results in changes in lift-off shown in (Figure 4-36). The amount of lift-off obtained because of changes in probe angle depends on the diameter and shape of the probe tip. Rounded tips of small diameter probes result in less lift-off than flat tipped probes with larger diameters. On impedance display instruments, lift-off effect can be lessened by changing the vertical to horizontal sensitivity ratio.

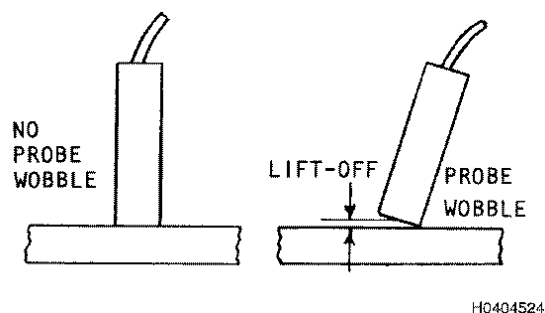


Figure 4-36. Lift-Off Resulting From Probe Wobble

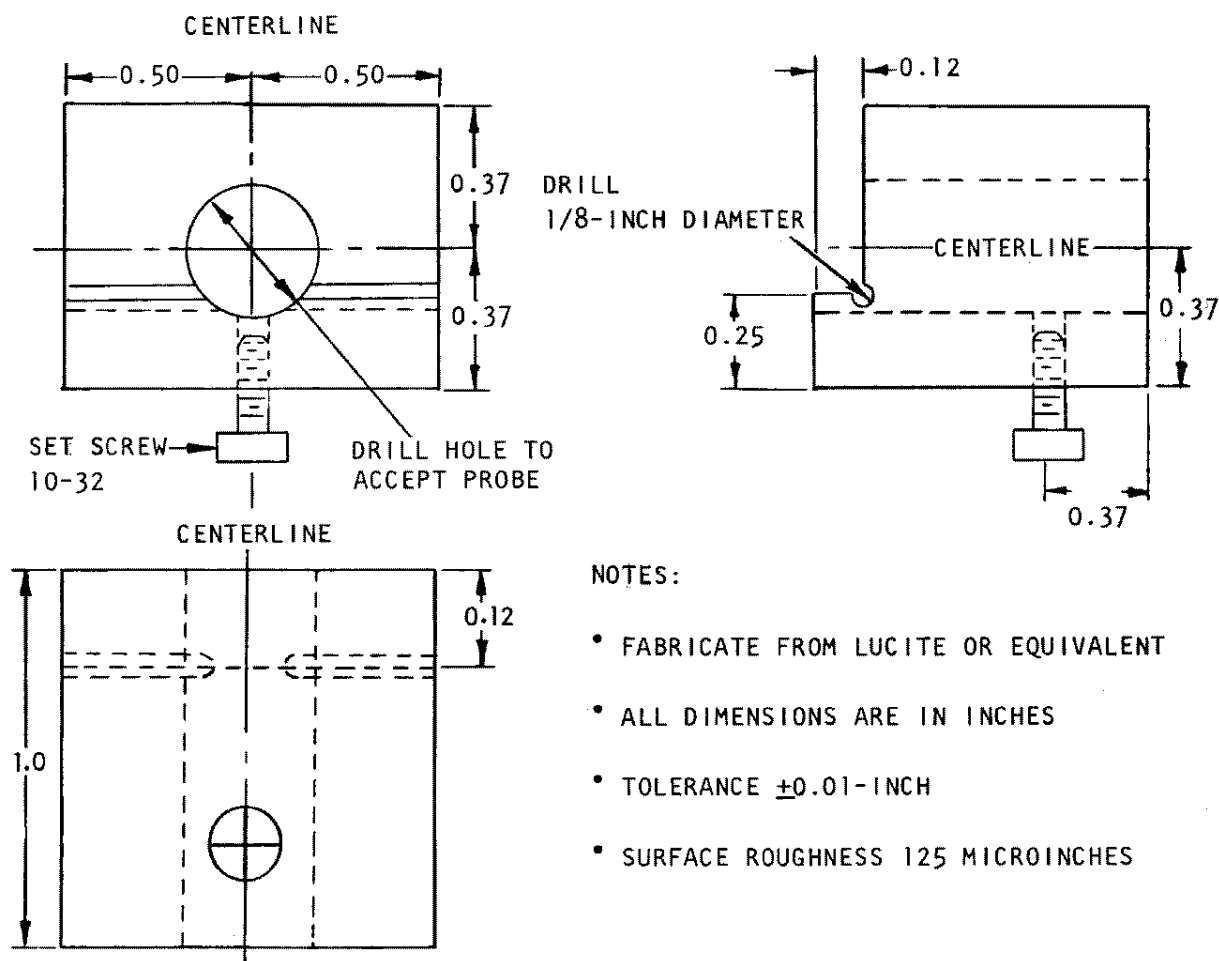
4.4.40 Effects of Crack Location on Detectability.

4.4.40.1 Crack Location and Orientation. Information on the history of cracks in specific inspection sites is very important. Time Compliance Technical Orders (TCTO) are often issued based on problems that have occurred on one or more aircraft systems. This means there is a known problem and inspections are necessary. Precise location of suspect cracks and their orientation produces more reliable inspections. Often, this information is provided from previous history of cracks in the designated locations. In other cases, such information may be determined from knowledge of stress distribution during service. Increasing definition of crack location and orientation permits the inspector to reduce his inspection time. For manual ET, reduction in scanning time provides less operator fatigue and consequent improvement in inspection reliability.

4.4.40.2 Cracks at Part Edges. The edge of a part can be represented as an infinitely large crack and, consequently, produces a strong signal during ET. The problem in inspecting part edges for cracks is separation of crack response from the strong edge response (edge effect). By fixing the distance of the probe from an edge, edge effect is minimized. Probe guides improve crack detection capabilities on edges.

4.4.40.3 Inspection at Part Edges. Two approaches can be used to inspect for cracks at part edges. The first method is to null the instrument with the probe at the edge of the part. Then, usually with a non-conductive fixture or some other method, the probe is maintained at the edge as it is scanned along the edge. If this position can be maintained, the inspection can be done with greater sensitivity than is possible with the same instrument and probe away from the edge. The second approach is to use a shielded probe, thus minimizing response from edges.

4.4.40.4 Fixtures and Holders for Edge Inspection. One of the simplest methods for ET adjacent to a linear edge of a part is to tape or hold a straight edge at a predetermined distance from the edge. Nonmetallic straight edges SHOULD be used for this purpose. A simple fixture which can assist in positioning the probe adjacent to an edge is shown in (Figure 4-37). This fixture maintains the probe center 1/8-inch from the edge, but closer edge inspection can be obtained by varying the position of the drilled hole.



H0404525

Figure 4-37. Edge Probe Guide

4.4.40.5 Curvature. When small diameter pencil probes are employed, curvature has minimal effect on crack response. This is due to the minimal lift-off effect of the small size of the probe tip. For most applications involving inspection of curved surfaces with small diameter pencil probes, flat standards can be satisfactorily used for curved surfaces in establishing sensitivity requirements.

4.4.40.6 Subsurface Flaw Detection. Increasingly, applications arise where it is desired to inspect for cracks initiating beneath an accessible surface. This could be a crack initiating on the opposite side of the accessible surface, in the structure contacting the opposite surface of an accessible surface, or beneath a conductive coating or plating. ET can be a powerful tool for the detection of subsurface flaws.

4.4.40.7 Impedance Plane Analysis of Subsurface Flaws. If the required frequency is used with impedance plane analysis instrumentation, eddy current penetration to the flaw area can be obtained. The phase and amplitude information received from the flaw can be directly related to the flaw depth.

4.4.40.8 Detection of Cracks under Metallic Coatings. The detection of cracks under metallic plating and coating is similar to detection of subsurface flaws. The magnitude of the total response consistently decreases with increasing coating thickness. With meter type instrumentation with a constant frequency test system, the thickness of plating or coating through which cracks can be detected decreases with increasing plating conductivity and magnetic permeability. In general, decreasing frequency permits detection of larger cracks under thicker coatings because of the increased depth of penetration.

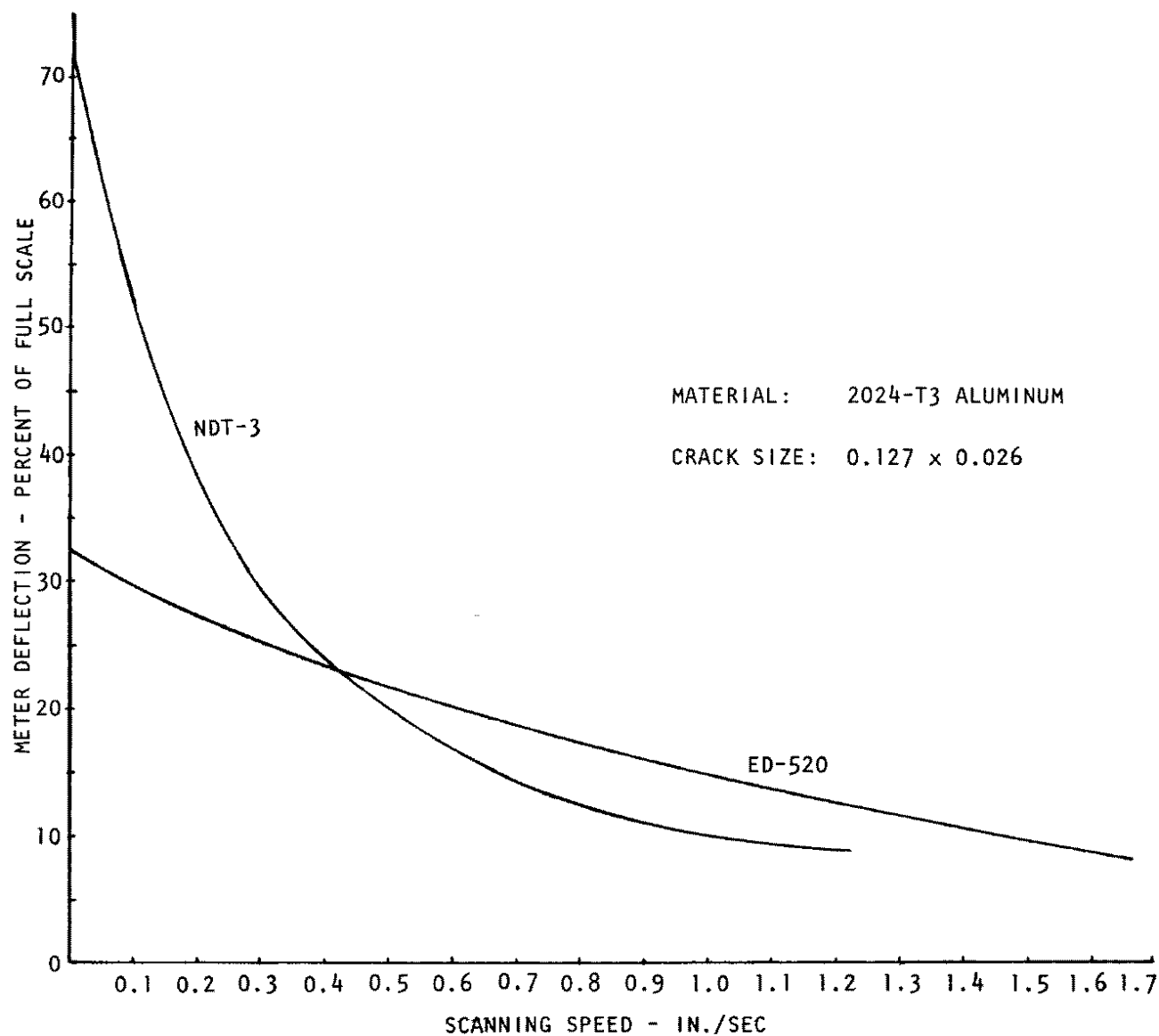
T.O. 33B-1-1

Detection of cracks under metallic coatings with phase analysis instrumentation using the impedance plane diagram can be performed with more accuracy and sensitivity than with meter instruments because phase information can be measured. Recent research has shown that multi-frequency eddy current systems may find application for detecting and measuring cracks under metallic coatings.

4.4.41 Effects of Scanning Techniques on Detection.

4.4.41.1 Inspection Technique. Consistent positioning of the probe in relation to edges and interfaces during setup and scanning should be established to ensure maximum response from flaws with minimum interference from other sources of indications. If conditions are known to exist which may result in false indications or which could mask true indications from flaws, these conditions SHOULD be noted in the procedure and a means of interpreting or evaluating the false indications provided. In performing ET of an area, the distance between scans or between measurements must be selected to ensure complete coverage for the minimum size flaw or variation in properties to be detected. In determining maximum distance between scans, consideration must be given to the change in magnitude of flaw response as the probe coil center position increases in distance from the center of the crack.

4.4.41.2 Scanning Speed. The scanning speed used in ET for cracks is related to the type of equipment and the inspection technique used. Slower scanning speeds are necessary when the inspector is required to interpret the readout while manually directing the probe in the specified scanning pattern ([Figure 4-38](#)).



H0404526

Figure 4-38. Effect of Scanning Speed on Meter Deflection from a Crack

4.4.41.3 Scanning Pattern. The scanning pattern required for ET is based on the possible initiation site of the crack, the orientation of the cracks, and the size of the cracks which must be detected. If cracks initiate from an edge in thin material (0.050-inch or so), ET is usually limited to a single scan of the edge. For thicker materials, scans might be required on both surfaces adjacent to the edge and one or more scans of the material between the edges. When cracks initiate beneath the heads of non-removable fasteners, the pattern usually consists of a single scan around the protruding head of the fastener to detect cracks growing outward from the hole. If cracks can occur at a variety of positions and orientations, as is possible on flat surfaces, in radii, and on cylindrical surfaces, scanning must be performed in a manner which will assure detection of the smallest cracks required to be found. For these types of inspection areas, the direction of scanning, the number of scans, and the distance between scans SHOULD be specified.

T.O. 33B-1-1

4.4.41.4 Automatic or Semi Automatic Equipment. Automatic eddy current equipment in conjunction with high speed recorders is capable of operation at extremely high speeds. The upper limits of scanning speed are based on the operating frequency and the sampling rates of the recorder or readout. The principal use for automated eddy current equipment by the military is for the inspection of bolt holes. In this application, rotational speeds of 40-3000 rpm can be obtained by the inspection system.

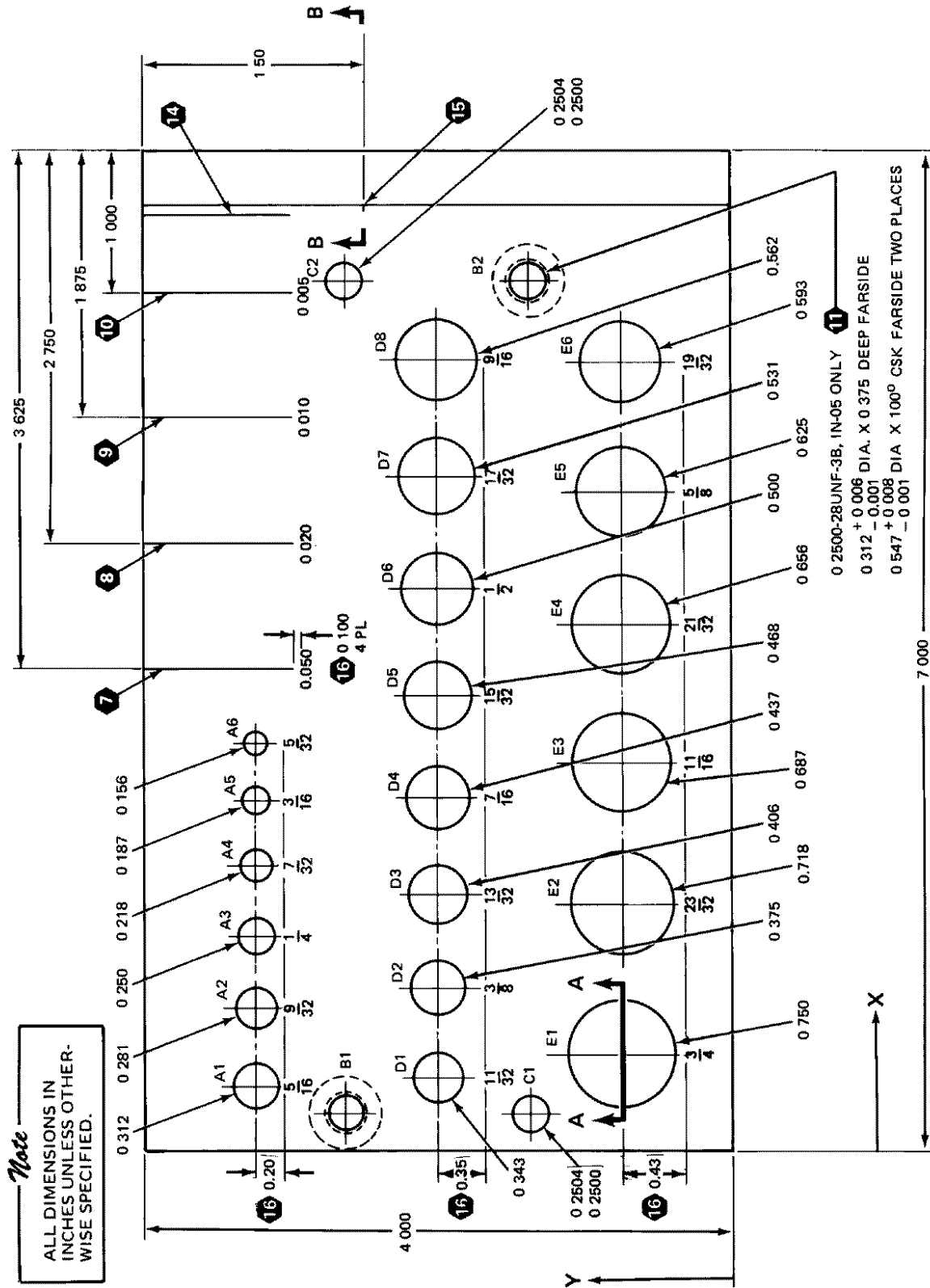
4.4.41.5 Use of Recorders or Oscilloscopes. The use of recorders or oscilloscopes (CRT type eddy current instruments) permits increasing the speed of manual scanning to the limits imposed by the reaction time of these instruments. Generally, other restrictions related to guiding the probe in the prescribed scanning pattern become the controlling factor when recorders or oscilloscopes are used.

4.4.42 Reference Standards for Cracks. There are several different materials undergoing inspection within the Department of Defense. An inspector will find two primary general purpose eddy current standards in the field: the Air Force standard, NSN 6635-01-092-5129, P/N 7947479-10 (aluminum) and the Navy standard, PN NRK-3A (aluminum). The aluminum Navy standard has a higher conductivity bottom plate. The Navy also has a kit consisting of three standards of the same geometric configuration, each of a different material (kit PN NRK-3AST). This kit consists of:

- One aluminum standard, P/N: NRK-3A, is made of 7075-T651 top & middle layers and a 7075-T73 bottom layer.
- One steel standard, P/N: NRK-3S, is made of 4340 alloy on all three layers.
- One titanium standard, P/N: 6AL4V, is alloy on all three layers.

NOTE

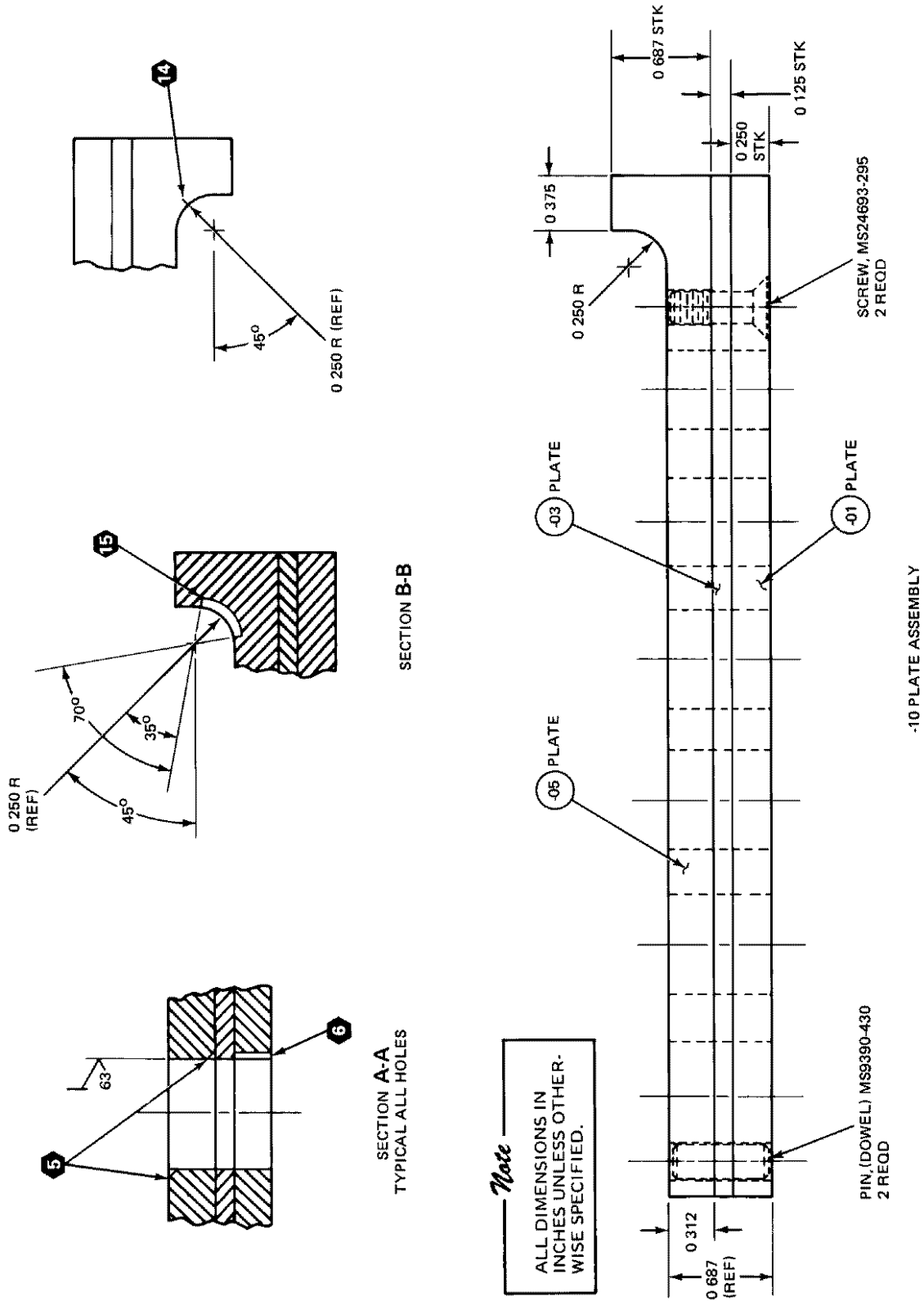
Unless otherwise specified by the weapon system engineering authority, the Air Force general purpose eddy current standard (Figure 4-39, Sheet 1) through (Figure 4-39, Sheet 3) SHALL be the common standard used to perform ET's on aluminum components within the Air Force. The standard made to the Navy configuration (Figure 4-40) may be used as a substitute for the Air Force general purpose eddy current standard. When using the Navy standard, calibrate on the long EDM notches for surface inspections and the corner notches in the upper layers for bolt hole inspections unless otherwise directed by a part specific procedure.



H0404527

Figure 4-39. Air Force General Purpose Eddy Current Standard (Sheet 1 of 3)

T.O. 33B-1-1



H0404528

Figure 4-39. Air Force General Purpose Eddy Current Standard (Sheet 2)

DRILLING LEGEND

QUANTITY REQUIRED		6	2	2	2	8	6		
HOLE DIAMETER		~	~	~	~	~	~		
POSITION		HOLE SYMBOL							
X →	Y ↑	A	B	C	D	E	F	G	H
0.437	3.250	A1							
0.983	3.250	A2							
1.498	3.250	A3							
1.982	3.250	A4							
2.435	3.250	A5							
2.856	3.250	A6							
0.250	2.625	B1							
6.094	1.375	B2							
0.250	1.375		C1						
6.094	2.625		C2						
0.500	2.000			D1					
1.125	2.000			D2					
1.781	2.000			D3					
2.468	2.000			D4					
3.186	2.000			D5					
3.936	2.000			D6					
4.717	2.000			D7					
5.529	2.000			D8					
0.687	0.750				E1				
1.718	0.750				E2				
2.718	0.750				E3				
3.686	0.750				E4				
4.623	0.750				E5				
5.529	0.750				E6				

PARTS LIST

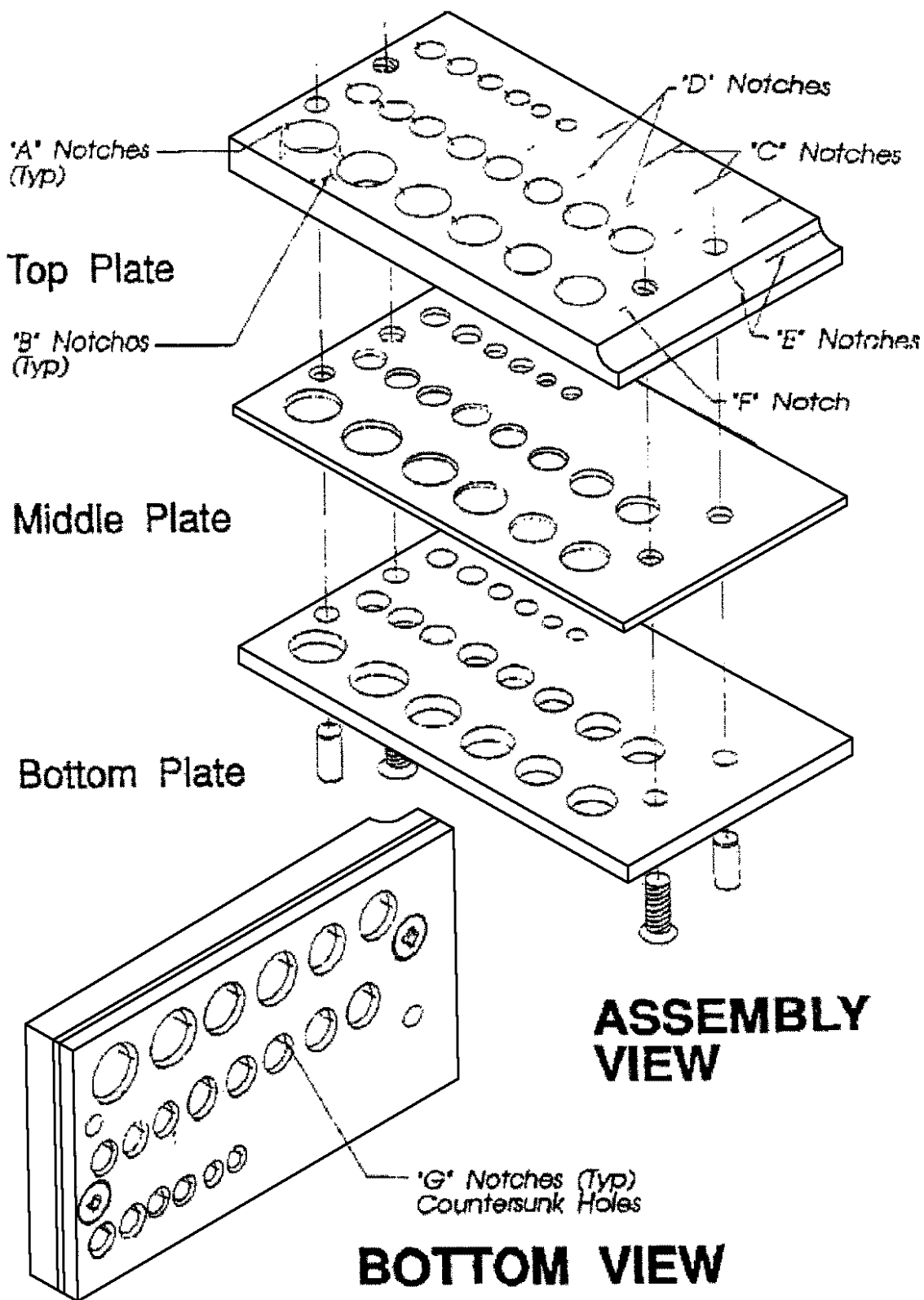
QTY	NOMENCLATURE	PART NO.	MATERIAL/SPECIFICATION
2	SCREW	MS24693-295	
2	PIN	MS9390-430	
1	PLATE	-05	AL ALY PL 0.687 THK QQ-A-250/12. CMPSN 7075, CONDTN T6
1	PLATE	-03	AL ALY SH 0.125 THK QQ-A-250/12 CMPSN 7075, CONDTN T6
1	PLATE	-01	AL ALY PL 0.250 THK QQ-A-250/12 CMPSN 7075, CONDTN T6
	PLATE ASSY	-10	

- Note*
- 1 INTERPRET THIS DRAWING PER MIL-STD-100
 2. IDENTIFY PART PER MIL-STD-130
 3. BREAK SHARP EDGES EXCEPT AT HOLES AND REMOVE BURRS
 - 4 FINISH ANODIZE AL ALY PARTS PER MIL-A-8625, TYPE II, CLASS I
 - 5 ELOX SLOT, 0.030 X 0.030 X 0.004 ± 0.001.
 - 6 ELOX SLOT, 0.020 X 0.250 X 0.004 ± 0.001
 - 7 ELOX SLOT, 0.050 X 1.000 X 0.004 ± 0.001
 - 8 ELOX SLOT, 0.020 X 1.000 X 0.004 ± 0.001
 - 9 ELOX SLOT, 0.010 X 1.000 X 0.004 ± 0.001
 - 10 ELOX SLOT, 0.005 X 1.000 X 0.004 ± 0.001
 - 11 THREADS PER MIL-S-7742
 12. SURFACE ROUGHNESS $63\sqrt{\text{ }}$ MAX ALL OVER PER ANSI B46 1-1978
 - 13 THE EDDY CURRENT METHOD IS USED TO DETECT CRITICAL CRACKS ORIGINATING IN HOLES OF LOWER WING SKIN OF ALL AIRCRAFT
 - 14 ELOX SLOT, TAPERED 0.200 AT EDGE CORNER TO 0.000 X 1.000 X 0.004 ± 0.001
 - 15 ELOX SLOT, 0.050 DEEP X 0.004 ± 0.001 AND PERPENDICULAR TO THE RADIUS
 - 16 MECHANICAL ETCH NUMBERS 0.093 HIGH AS SHOWN.
 - 17 ALL DIMENSIONS IN INCHES UNLESS OTHERWISE SPECIFIED

H0404530

Figure 4-39. Air Force General Purpose Eddy Current Standard (Sheet 3)

T.O. 33B-1-1



H0404531

Figure 4-40. Navy Eddy Current Reference Standard

4.4.42.1 Cracks as Reference Standards. When an eddy current instrument is setup for detection of cracks, some means must be provided to assure that the sensitivity of the test system is sufficient to detect the smallest required crack size. Ideally, the best standard would be a section of the same material containing a crack of this minimum size. Cracks of specified sizes are difficult to obtain. With few specimens to choose from, such situations are rare. Fatigue cracks of specified size can be grown under laboratory conditions, but this method is extremely expensive. The length of the crack along the surface and its width at the surface is easily measurable. The depth of the crack is generally unknown and must be approximated from other data. Because of difficulty in obtaining actual cracks for reference standards, a number of other standards may be used. These standards are discussed below.

4.4.42.2 Requirements for Reference Standards. The primary requirement for eddy current reference standards is they provide uniformity of response which can be correlated to the condition or material property to be detected or measured. Two fundamental ideas are assumed by uniformity of response. First, this means all tests can be done with the same sensitivity or that different levels of sensitivity can be compared on a quantitative basis. Second, standards fabricated to a specific design should be stable devices able to provide a repeatable response within certain specified limits. To be useful for flaw size and type evaluation, the reference standard must relate to the flaw to be detected. By means of correlation data, prior history or investigation, the response from the reference standard must relate to the response from the condition or material property of the part. To permit fabrication of standards at a number of locations, material, alloy, temper and dimensional tolerances which will provide the required response should be defined in the applicable technical order for the test being performed. Methods of fabrication which use simple tools SHOULD be specified when adequate uniformity and sensitivity can be obtained. Ideally, when an instrument has been adjusted for a specified response from the standard, a signal of approximately the same amplitude and phase (where applicable) should be obtained from the condition or material property with an eddy current instrument and probe of the same general type.

4.4.42.3 Standards for Specific Tests. Standards must be designed for the specific material property or condition being tested. Specific standards are required for each type of test being performed. Calibration standards used to sort alloys must meet very specific conductivity requirements. Calibration standards for measuring coating thickness of conductive coatings would not be suitable for measuring coating thickness of paint or other nonconductive coatings or for detecting cracks around rivet holes. Drilled holes or EDM (electro-discharge-machining) notches in an aluminum block SHOULD NOT be used to test for material thickness or alloy composition of titanium or stainless steel parts.

4.4.42.4 Artificial Defects for Standards. Due to the difficulty of obtaining the types and sizes of real flaws in parts for use as reference standards; a variety of artificial flaws have been developed to simulate the real flaws. Fatigue cracks have been grown under laboratory conditions, but reproducible sizes in sufficient quantity for standards are impractical. Artificial flaws, such as drilled holes, EDM notches, saw cuts, two surfaces clamped together to simulate a crack, or chemically produced conditions to simulate pits or corrosion, can be produced in a variety of ways. Ideally an artificial flaw will produce an eddy current response identical to the response from a real flaw of the same size, orientation, and location. This ideal is seldom achieved with artificial flaws. Estimation of flaw size from the response to artificial flaws must be based upon correlating previous known flaw sizes with the response from the artificial flaws. To maintain the quality of this correlation, it is necessary to carefully specify the material properties and fabrication process of the artificial defect standard.

4.4.42.5 Simulated Conditions for Standards. When using eddy current techniques to measure conductivity, coating thickness, permeability, alloy sorting, and hardness, standards can usually be obtained which represent the materials and conditions being tested. These calibration standards are used for direct comparison to the response seen on the part being tested. Great care must be exercised in handling these types of calibration standards. Scratches, dents, distortion, oxidation, or other conditions can alter the calibration standards making them useless for comparison and calibration purposes. The primary standards are usually maintained under laboratory storage conditions, and may be traceable to the National Bureau of Standards, American Society for Testing Materials (ASTM) or similar agency. The secondary standard, is compared to the primary standard for response; the secondary standards are said to be traceable to the primary standard. The actual testing in the field environment use the secondary (or tertiary) standards and the standards are periodically compared to the primary standard to assure integrity.

4.4.42.6 EDM Notches. Electrically discharge machined (EDM) notches, in a variety of sizes, shapes and locations, can be placed in almost all metals. The width of the notch can be held to as small as 0.003-inch, and although far greater in width than most cracks, this method provides a narrower slot, or notch, than all other fabricating techniques such as saw cuts. Similar responses are obtained on real cracks.

4.4.42.7 EDM Notches in Ferromagnetic Steel. The eddy current signal does not penetrate well in ferromagnetic materials because of the shielding effect of the high magnetic permeability. EDM notches are useful as examples of flaws open to the surface of a part. Surface breaking cracks are best detected by using a very high frequency (500 kHz and greater)

T.O. 33B-1-1

which is not meant to penetrate deeply into the part. Under these conditions the test provides very high sensitivity to surface flaws in ferromagnetic materials. Likewise the test provides little if any information on flaw depth.

4.4.42.8 Saw Notches. Probably the simplest method of preparing eddy current standards is by means of a jeweler's saw. With a 7/0 blade, notches as narrow as 0.007 to 0.008-inch can be made in the edge of a standard. Circular jeweler's slotting saws are also available for other notch locations. Phase response is similar to that obtained from cracks. However, as notch width increases, the similarity to a crack decreases.

4.4.42.9 Machined Notches. Standards with machined notches can be used under some test conditions. However, the response of a particular probe size and frequency to the notch must be evaluated for its applicability to a test situation.

4.4.42.10 Choosing Reference Standards for Cracks. As previously discussed, the primary requirement for eddy current reference standards is they provide uniformity of response that can be related to the minimum size crack to be detected. To various degrees, several types of reference standards may meet this criterion. Consequently, such factors as cost, ease of fabrication, availability, and field application become prime considerations.

4.4.43 Thickness Measurement.

4.4.43.1 Criteria for Application.

4.4.43.2 Types of Measurements. In general, three types of thickness measurements may be performed by eddy current techniques. The total thickness of thin metallic products, such as foil, strips and sheets, may be determined when the thickness dimension is less than the effective depth of penetration of eddy currents in the material. A second category of thickness measurement includes the measurement of metallic plating or coating on a conductive or magnetic base. Subcategories of plating and coating measurements can be established on the basis of the relative conductivity or permeability of the plating and the base metal on which it is plated. Typical subcategories of plating measurements include the following:

- Low conductivity plating on high conductivity base.
- High conductivity plating on low conductivity base.
- Low permeability plating on a high permeability base.
- High permeability plating on a low permeability base.

4.4.43.3 The terms high and low are relative and are not meant to indicate specific values. The third category of measurement is the determination of nonconductive coating thickness on a metallic base. This application can also be extended to measure the total thickness of thin nonconductive materials that are accessible from both sides.

4.4.43.4 General Limitations of Plating Thickness Measurement. The use of eddy current techniques for thickness measurement is confined to thin materials. This limitation results from the inability of the eddy current field to penetrate deeply into conductive materials. The effective depth of penetration, and therefore the thickness that can be measured, decreases as the conductivity and/or permeability of the metal increases. To determine the thickness of plating or coatings on metallic substrates, a difference must exist in conductivity or permeability between the surface material and base material. Increased sensitivity is obtained, as the differences between plating and substrate conductivity or permeability become larger. For nonconductive coatings, the sensitivity improves with increasing frequency. Larger probe diameters provide greater sensitivity for measurement of thicker plating. A summary of the effects of an increase in material properties and inspection variables on the sensitivity and range of thickness measurements is presented in (Table 4-8 in Section 4.7).

4.4.43.5 Test Systems. A wide variety of specialized equipment is manufactured for thickness measurement. Many such instruments are optimized for one or two types of applications. Examples include instruments designed to measure nonconductive coatings on nonmagnetic metals or instruments for measuring nonmagnetic plating on a magnetic substrate. Because of limited requirements, such specialized equipment is usually not available for use in the field. In most cases, general purpose instruments may be adapted for thickness measurement. Many of the meter type instruments can be used for a wide variety of thickness measurement operations. Impedance plane analysis equipment is very useful for thickness measurement. Phase change is nearly linear with increasing depth of penetration, thereby providing more consistent sensitivity and accuracy over the entire range of measurement.

4.4.43.6 Thickness Measuring Procedures. Before thickness measurement can be performed, the eddy current measurement procedures SHOULD be carefully established and proven to ensure accuracy and reliability. Curves SHOULD be prepared to relate instrument readings to known thickness standards. A sufficient number of samples within the thickness

range to be measured must be used in preparing the curves to ensure that a smoothly increasing or decreasing curve will be obtained. The type and number of standards necessary for instrument standardization SHALL be defined. The limitations of the procedures in terms of material and dimension applicability SHALL be established and noted in the procedures. Because instrument settings for a specific inspection may vary slightly with test conditions, different probes, and variations between instruments, specific instrument settings are not usually provided for these applications.

4.4.44 Measurement of Total Metal Thickness.

4.4.44.1 Applications of Total Thickness Measurement. The primary use of eddy current techniques for measuring the total thickness of metal parts is to detect corrosion on the far sides, or between layers of structure. However, this technique can also be used to establish the thickness of a thin sheet, to determine wear or thinning of sheet materials, and to measure thickness, erosion, or corrosion of tubing walls. Thickness measurement with ET is generally used when –

- calipers or other mechanical measurement is impractical.
- ultrasonic equipment is not available.
- if very thin materials are to be measured.

4.4.44.2 Total Thickness Limitations. The accuracy and range of metal thickness measured with ET are dependent upon the electromagnetic properties of the material and the test system. Increasing conductivity and magnetic permeability increase accuracy in measuring very thin specimens, but decrease the effective range of measurement and the accuracy at greater depths. Therefore, at a specified frequency, you can measure thicker metals that have low conductivity and/or low magnetic permeability compared to metals that have high conductivity and/or high permeability.

4.4.44.3 Frequency Effects in Total Thickness Measurement. Just as decreasing frequency increases the depth of penetration of eddy currents in a conductor, decreasing frequency also increases the thickness of a metal that can be measured by ET techniques. Higher sensitivity is obtained for the thinnest specimens with a higher frequency. For thicknesses (over 0.050-inch), the lower frequency provides greater sensitivity and greater overall penetration. Sensitivity in any thickness range can be determined by slope of the plotted thickness line: the greater the slope (ordinate over the abscissa) the better the sensitivity. Optimum frequency can be estimated by using the formula for one standard depth of penetration.

4.4.44.4 Effects of Probe Construction. Probes designed specifically for thickness measurement have air cores, and are generally larger in diameter than the ferrite core probes used for flaw detection. Larger diameter probes average thickness measurements over a larger area. Smaller diameter probes, and probes with ferrite cores, reduce the area of measurement, and therefore can be used in smaller areas and closer to edges. The larger air core probes can provide greater sensitivity for thickness measurements than the ferrite core pencil probes.

4.4.44.5 Operating Procedures for Total Thickness Measurement. All thickness measuring SHOULD be performed in accordance with pre-established procedures. In general, these procedures will include the following steps:

- a. Prepare part for thickness measurement.
- b. Establish the presence of geometrical factors, which will limit or restrict thickness measurement.
- c. Select appropriate test system, probe, and operating frequency.
- d. Develop or verify a calibration curve by using either NIST traceable calibration standards or using known thickness reference standards to setup your test system.
- e. Perform thickness measurements at designated points.
- f. Record thickness and report all rejectable values as required by the written procedure.

NOTE

When measuring thickness using ET, make sure there are no interfering conductive materials that will affect the eddy currents. Metal standards on metallic table tops should be avoided because of conductive interference.

T.O. 33B-1-1

4.4.44.6 Prepare Part for Thickness Measurement. Many thickness measurements must be performed through nonconductive coatings such as paint or anodic coatings. Lift-off compensation must be used during the calibration. Any loose foreign material SHOULD be removed from the surface where thickness is being determined. Any sharp edges, protrusions, or chemicals that are potentially damaging to the probe SHOULD be removed.

4.4.44.7 Presence of Geometrical Limitations. Prior to measuring thickness by eddy current techniques, the presence and position of any structural features that could restrict accessibility or reduce accuracy of measurement must be established. Thickness measurement must be performed sufficiently far away from fastener and other conductive objects to prevent its influencing the meter reading. Limited access may restrict the type of probe to be used. In most cases, written inspection procedures will define geometrical limitations.

4.4.44.8 Selection of Test System. The test system selected for thickness measuring must be based on thickness measuring requirements, frequency of the eddy current instrument, and the types of probes available.

4.4.44.9 Selection of Test Frequency for Thickness Measurement. For each thickness measurement task to be performed by eddy current techniques there is an optimum frequency or range of frequencies that will provide optimum sensitivity at the depth to be measured. The product of the material conductivity in percent IACS and the relative magnetic permeability is plotted along the vertical axis, and frequency in kilohertz is plotted along the horizontal axis. Lines representing optimum thicknesses are plotted on the graph. To determine the recommended frequency, the product of material conductivity and relative permeability of the material to be measured is found on the vertical axis. Follow this point horizontally to the diagonal line representing the thickness to be measured. The recommended frequency is found on the horizontal axis by extending a line vertically downward from the established point. Considerable variation from this frequency value will still provide sufficient sensitivity for most applications. When in doubt, the adequacy of a frequency may be determined by establishing a trial calibration curve.

4.4.44.10 Instrument Setup. Because the general-purpose instruments are not specifically designed for thickness measuring, correlation must be established between instrument readings and thickness dimensions. Therefore, the thickness ranges over which measurements are to be performed SHOULD be defined as closely as possible to minimize the number of data points to be established. Where applicable, lift-off compensation should be used to minimize the effects of variations in surface finish on thickness readings.

4.4.44.11 Record Thickness and Report Rejectable Values. Most written procedures provide acceptance limits for the thickness dimension. When a rejectable value is obtained, it is advisable to recheck the instrument using the reference or calibration standards. The written procedure usually provides methods for reporting rejectable values.

4.4.44.12 Standards for Total Thickness Measurement. The standards used for setup for thickness measurement must have the same electrical conductivity, magnetic permeability, and geometry as the material being measured. The same electrical conductivity is usually obtained by requiring the standards to be fabricated from the same alloy and temper as the inspection material. In magnetic materials, permeability can vary to such a degree within a single alloy and temper that selection of representative standards can be difficult. The high permeability of iron and ferromagnetic steel restricts the use of eddy current thickness measurement to very thin metals. The curvature of the standards SHOULD be the same as the part being inspected. All standards SHOULD be uniform in thickness and the accuracy of the standard thickness SHOULD be at least 10 times that required for the accuracy of the thickness measurement. For example if thickness measurement is required to the nearest 0.001-inch, the standards SHOULD be accurate to the nearest 0.0001-inch. All standards SHOULD be clearly identified with alloy, temper and thickness.

4.4.44.13 Accuracy of Thickness Measurement. The accuracy obtained in metal thickness measurement varies widely depending on material properties, thickness, frequencies used, and system noise level. With higher frequencies (500 kHz and up) on thin materials (0-010-inch and less), thicknesses may be measured to the nearest 0.0001-inch. As frequencies are lowered and thicknesses increase, accuracy decreases. For maximum accuracy, variations in lift-off, conductivity, geometry and magnetic permeability must be reduced to the lowest possible level.

4.4.44.14 Application of Conductive Coating Measurement. ET techniques are commonly used to measure the thickness of conductive plating on metallic materials. These measurements may be used as a process control to determine the proper thickness of plating or conductive coatings has been applied to a substrate. The thinning of such plating and coatings, because of erosion or corrosion, can also be established. ET is sometimes used to determine the presence and thickness of surface layers which have been altered in composition from the metal deeper within the part. This application includes the measurement of carburized cases in steel and the depth of oxygen or hydrogen contamination of the surface layers of titanium alloys. The absorption of carbon into the surface layers of steel effectively lowers the magnetic permeability. The solution of

hydrogen and oxygen in the surface of the titanium alloy lowers the conductivity of the surface. The amount of surface contamination can be measured by measuring the changes in permeability and conductivity.

4.4.44.15 Effect of Material Properties on Plating Thickness Measurements. Although the depth of penetration of eddy currents in metals decreases with increasing electrical conductivity, lack of penetration for measuring plating thickness is seldom a problem. Plating and coating thicknesses rarely exceed 0.005-0.010-inch and in many instances are less than 0.003-inch thick. The sensitivity of inspection is controlled to a large measure by the difference in conductivity and/or magnetic permeability between the base metal and the plating. Coating or plating thickness measurement is considered feasible if the product of conductivity and permeability for the base metal and the coating have a ratio of 1.5 or greater or 0.67 or less. Sensitivity increases as the difference in the conductivity or permeability value between coating and substrate increases. Therefore, a rough determination of sensitivity can be obtained from an impedance curve, which shows the positions of substrates and coating at the frequency and probe size used for inspection.

4.4.44.16 Effect of Test Conditions on Plating Thickness Measurement. Normally, the frequencies used for plating thickness measurement are relatively high, 100 kHz and greater in specialized equipment; frequencies as high as 6 MHz are available. These frequencies provide high sensitivities for very thin coatings. As the conductivity differences between plating and base metal decrease, the frequency may be either increased or decreased as necessary to obtain equivalent sensitivity for the thickness to be measured. Considerable latitude from these approximate values may be exercised in choosing the actual operating frequency. If doubt exists, a trial calibration curve should be prepared. To reduce the effects of surface roughness and variations in nonconductive coatings, lift-off compensation (intermediate layer technique) SHOULD be used. Generally, 0.002 to 0.003-inch lift-off compensation is sufficient unless very rough surfaces are present in the test area. An increase in probe diameter and the use of air cores rather than ferrite cores has the effect of increasing measuring sensitivity and extending the depth to which accurate plating thickness measurement can be performed.

4.4.44.17 Procedures for Plating Thickness Measurement. An approved written procedure is required for each application of ET techniques for plating thickness measurement. Each procedure SHOULD include the following steps:

- a. Define the objective of the plating or coating thickness measurement. The type of base metal and plating SHOULD be included in the procedure.
- b. Clean any foreign material from the inspection area. Even though lift-off compensation is used, excessive build-up of foreign material in excess of lift-off adjustment could lead to significant errors.
- c. Select the test system, instrumentation, and probe that will perform the thickness measurement to the required accuracy.
- d. Develop or verify calibration curve, and standardize the test system using the specified standards. A calibration curve must be available for each combination of instrument and probe.
- e. Perform plating thickness measurements at the designated points. At least three readings SHOULD be taken at each measurement position to ensure accurate and repeatable values. The probe should be held against the part with constant pressure (when available, spring loaded probes can be used to aid in maintaining constant pressure). For curved surfaces, a fixture may be used to maintain the probe normal to the surface. Plating thickness measurements SHOULD be made in areas where the readings are not affected by adjoining structures, edges, or variations in total plating plus substrate thickness that are within the effective limit of penetration.
- f. The calibration of the instrument SHOULD be periodically checked against the standards to guard against instrument drift.
- g. Check all measured values against the tolerances specified by the written procedure. All abnormal values SHOULD be reported as required by the procedure.

4.4.44.18 Plating Thickness Reference Standards. Reference standards for plating thickness measurements must have the same electrical conductivity, magnetic permeability, and geometry as the part. These requirements apply to both the base material and the plating. Electrical conductivity and magnetic permeability for the base material are usually obtained by using the same alloy and temper for the standards as used in the part. Particular care SHOULD be taken in processing the materials to ensure that similar properties are obtained. The surface finishes of the part and standard SHOULD also be alike. To obtain the same electrical conductivity, magnetic properties, and surface finish for plating on the parts and reference standards, the plating must be performed in baths of similar composition and subject to similar controls. If the plating on the part is stress-relieved prior to thickness measurement, the references SHOULD receive the same treatment. Several methods of determining plating thickness on reference standards can be used. One of these is to carefully measure the thickness prior to

T.O. 33B-1-1

plating and again after plating. The difference represents the thickness of the plating which is applied to one side only. A second method is to measure the plating on an adjacent area by sectioning a metallographic specimen. The total thickness of the plating plus substrate must exceed the effective depth of penetration in the part. A total thickness of 2.5 to 3 combined standard depth of penetration is usually considered sufficiently thick. This thickness may be determined by adding the standard depth of penetration in the plating and the substrate at the frequency used. For example, if approximately 0.003-inch thick silver plating on aluminum is to be measured at 200 kHz, the minimum total thickness can be determined as follows:

4.4.44.18.1 The standard depth of penetration of silver at a frequency of 200 kHz is 0.007-inch. Therefore, the 0.003-inch of silver in the plating represents 0.4 standard depth of penetration.

4.4.44.18.2 The 2024-T3 aluminum base material must be at least $2.5 - 0.4 = 2.1$ standard depth of penetration.

4.4.44.18.3 If the conductivity and magnetic permeability of a metal are known, the standard depth of penetration can be determined.

4.4.44.19 Measurement of Nonconductive Coatings.

4.4.44.19.1 Nonconductive Coatings. A wide variety of nonconductive coatings are applied to military hardware. Primers, paints, and plastics and sealants are widely used to protect metals from corrosion. Anodic coatings are used on metals, particularly aluminum, to prevent surface deterioration. Other oxide coatings provide protection against heat or wear. Boron epoxy laminates increase stiffness and strength. To control the thickness of such nonconductive coatings or to measure their loss during service, ET techniques have been used with a high degree of accuracy.

4.4.44.19.2 Basis for Measurement of Nonconductive Coatings. The determination of thickness of nonconductive layers or materials is a relative measure of the magnetic coupling between the probe and the underlying conductive material. In other terms, the thickness of a nonconductor is a direct measurement of lift-off or the spacing between the probe and the conductor. Because the properties (electrical conductivity, magnetic permeability, and geometry) of the underlying materials affect the signal detected by the probe, they must be constant or their variation minimized by instrument adjustment. Three requirements for measurement of nonconductive coatings by eddy current techniques are:

- The nonconductive coating must be in intimate contact with a conductive material.
- The thickness of the coating must be less than the effective range of the varying magnetic field generated by the probe.
- The thickness of the substrate must be at least 2.5 times the standard depth of penetration at the test frequency.

4.4.44.19.3 Impedance Effects of Nonconductive Coatings.

NOTE

(NAVY Only) Follow PD-214 instructions for nonconductive coating thickness measurement. When an eddy current probe is placed on bare metal, the impedance of the coil is changed by an amount that is dependent on the frequency of the oscillating current, the conductivity, magnetic permeability, and geometry of the test part, and the geometry and construction of the test coil. When impedance measuring eddy current instruments are used, the measurement of nonconductive coating thickness is determined from variation in current or voltage across the coil as the coil impedance changes due to increase or decrease in lift-off.

4.4.44.19.4 Influence of Material Properties and Frequency. An increase in the conductivity or magnetic permeability of the base metal or in the operating frequency improves the sensitivity of the thickness measurement of nonconductive coatings.

4.4.44.19.5 Test Systems for Nonconductive Coating Measurement. Nonconductive coating thickness can be measured with almost any ET system. Sensitivity is limited by the frequency attainable with available test instruments. Accuracy and range of measurement are increased with increasing frequency. The size and construction of available probes, and instrument circuit design affect the accuracy of measurement. Accuracy decreases with increases in coating thickness. Sometimes probes are spring-loaded to prevent variations in readings caused by inconsistent pressures.

4.4.44.19.6 Procedures for Measuring Nonconductive Coatings. The following steps SHOULD be followed to perform thickness measurements on nonconductive coatings:

- a. Establish the range of thickness to be measured and the accuracy required.

- b. Select test system capable of performing required thickness measurement to specified tolerances.
- c. Prepare the part or area for thickness measurement.
- d. Prepare calibration curve or verify calibration curve with existing calibration standards. A calibration curve is required for each combination of instrument and probe and for each base metal.
- e. Perform thickness measurement checking the calibration occasionally with the known calibration standards.

4.4.44.20 Standards for Measurement of Nonconductive Coatings. If calibration standards are unavailable, standards for measurement of nonconductive coatings **MAY** be obtained from a number of sources. Layers of paper, plastic, and tape are three of the most available standards. Standards **SHOULD** be uniform in thickness and conform to the surface of the bare metal representing the part to be measured. When standards are stacked layers of material, no gaps or pockets should exist between the layers. Standards can also be actual sections of parts with known thicknesses of the nonconductive coating applied. These standards usually require more effort and expense to prepare. When possible, standards **SHOULD** be measured to an accuracy of 10 times greater than the accuracy required for the measurement of the nonconductive coating. This may not always be possible under field conditions.

T.O. 33B-1-1

SECTION V INTERPRETING EDDY CURRENT SIGNALS

4.5 ET INTERPRETATION.

4.5.1 Flaw Detection. When eddy currents are induced in a metal in the region of a crack or other flaw, the eddy current flow is distorted. The distortion results in a localized decrease in electrical conductivity. In this manner an ET is able to detect flaws.

4.5.2 Evaluation of Crack Indications.

4.5.2.1 Acceptance Rejection Criteria. In most cases, the depth of flaws detected by ET cannot be directly measured. In almost all cases, the eddy current signal of the flaw must be compared to the eddy current signal produced by the reference standard. The relationship between response to the standard and the corresponding response to the defect size must be established prior to the test and should be considered an essential part of the setup process. Prior to the start of any test, the instrument setup process SHOULD confirm that the test can be conducted with the required sensitivity.

4.5.2.2 Conditions Affecting Flaw Evaluation. Inspection for cracks, measurement of conductivity, or hardness can often be complicated by the surface damage, and manufacturing processes. Included in this category are scratches, gouges, pitting, and metal smearing. Severe damage may require refinishing of the area prior to inspection, inspection at a lower sensitivity, or selection of another test method.

4.5.2.3 Discontinuities. Discontinuities in an electrically conductive material can also change the circular eddy current flow pattern as shown in (Figure 4-41). Discontinuities include cracks, inclusions, voids, seams, pits, laps, and numerous other material variables related to the production, fabrication and use of metallic parts. The change in the magnitude and distribution of the eddy currents is roughly proportional to the size of the discontinuity intercepted by the eddy currents. Because of the weaker eddy currents at increasing depths beneath the surface, the eddy current response to flaws at or near the surface is greater than the reaction from same size flaws at greater depths.

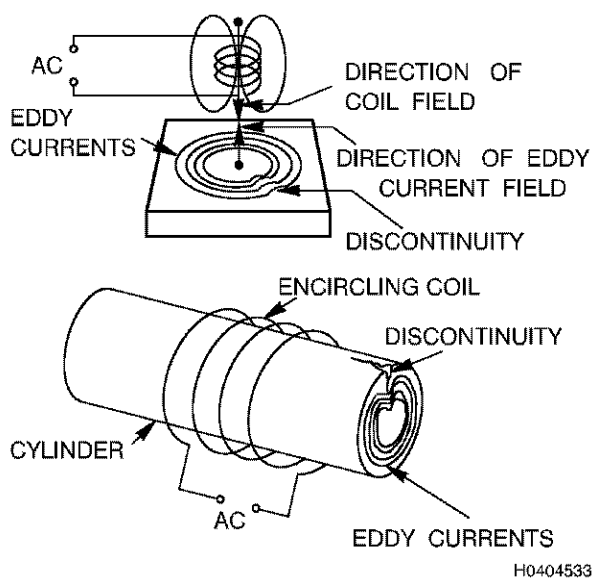


Figure 4-41. Effect of Discontinuities on Distribution of Eddy Currents

4.5.2.4 Metal Smearing. Flowing of surface metal may result from machining operations, abrasion during service, or by deformation during assembly or disassembly of an aircraft or component. The depth of smearing in nonmagnetic materials and its metallurgical effects will rarely exceed 0.002 to 0.003-inch. At normal crack detection frequencies, the metallurgical changes created by smeared metal may not affect eddy current response. However, metal build-up and depressions associated with the smearing create changes in lift-off. Because the phase angle is displayed, impedance plane analysis instruments will

detect flaws even with changes in lift-off. In ferromagnetic steel, eddy current penetration is very shallow and any blemish of the surface increases the difficulty of inspection.

4.5.2.5 Metal Spacing. The spacing of metal sheets separated by a nonconductive adhesive layer can be successfully measured by using an eddy current frequency for which the thickness of both metal sheets is less than, or equal to three times the corresponding standard depth of penetration.

4.5.2.6 Scratches, Gouges, and Pitting. Scratches, gouges, and pits may result in eddy current signals similar in magnitude to those from cracks. As test frequencies increase, the sensitivity to scratches tends to increase, because the eddy current field is more concentrated at the surface.

4.5.2.7 Rate of Deflection. Rapidity of response with an impedance plane display instrument is also a means of evaluating indications. When traversing a crack, a quick rapid deflection is obtained. Variations in conductivity, gradual thickness changes, out-of-round holes, and variations in edge-to-probe spacing provide a slow, gradual change in measured response. The inspector SHOULD be aware of the rate of change in response from cracks, as contrasted to the rate of signal change from slow changing material properties or test conditions.

4.5.2.8 Estimation of Crack Size. Cracks have the three dimensions of length, width, and depth. All three of these dimensions have an effect on the eddy current response from the flaw. In general, the length of the flaw can be related to the distance over which a signal above a specified level is obtained. When the crack is perpendicular to the surface, the approximate depth of the crack can be determined from the eddy current indication. With meter type instruments this will usually be related to the signal amplitude. With impedance plane analysis instruments the depth can be determined by the phase angle and amplitude of the indication. The width of the crack also influences the magnitude of the indication. With impedance plane analysis instruments, the signal shape, phase, and amplitude can be used to estimate the depth and area of the crack. Generally, the crack dimension of greatest interest is the depth. With impedance plane analysis instruments, crack depth measurements in non-ferromagnetic materials can be performed when based upon the phase response.

4.5.3 Effect of Scan Rate and Pattern.

4.5.3.1 Signal Response of Impedance Plane Analysis Instruments. The speed of manual scanning with impedance plane analysis instrumentation does not affect signal response because the system response time is not limited by the response of a meter movement.

4.5.3.2 Indications on Storage Oscilloscope or Strip Chart Recorder. The use of a strip chart recorder or storage oscilloscope for recording indications during manual scanning of fastener holes makes evaluation less subjective. Comparison of rate of deflection from indications in the hole and the reference can be observed at the same time.

NOTE

(NAVY Only) Technicians normally perform rotating ET's only when authorized by technical directives containing detailed procedures and qualification requirements.

4.5.3.3 Indications with Automatic Bolt-Hole Scanning. Beneath the rough surface of many bolt holes, numerous indications are obtained from causes other than cracks. Indications should therefore be examined carefully to establish if indications could be from cracks or if they are attributable to other causes. Evaluation can be made on the basis of direction of deflection and rate of deflection.

4.5.3.4 Indications from Indexing Automatic Scanners. The controlled rate of scanning obtained with the indexing automatic scanning (rotational/translational scanners) unit provides additional improvement in ease of evaluation. Because of the small scanning increment (pitch of scanner screw), usually 0.025-inch [40 threads to the inch], any crack of significant size will be detected during at least three consecutive revolutions of the scanner. This should result in three or more evenly spaced indications on the strip chart recorder or storage oscilloscope. If crack-like indications are observed, inspect the hole visually to determine if the indications are due to obvious deformations such as metal tears or gouges. Gouge indications, while cyclic in nature, are generally recognized due to the fact such indications usually appear 180-degrees opposite in phase (or polarity) to crack or slot indications. Additionally, a gouge indication will usually not be as sharply peaked as an indication from a crack or slot. Careful study must be made of such indications to ensure that they do not mask an indication of a crack at the bottom of the gouge.

T.O. 33B-1-1

4.5.4 Openings, Large Holes, and Cutouts.

4.5.4.1 Location and Orientation of Cracks. An opening or cutout in a stressed aircraft part serves as a stress riser and a potential source of fatigue cracks and/or stress corrosion cracks. Fatigue cracks initiate at the edges of an opening, hole, or cutout and grow away from the edge at right angles to the direction of stress. Stress corrosion cracking usually occurs in sections subject to either an applied or residual tensile stress. The direction of tensile stresses can often be defined by engineering stress analysis or from the history of previous cracking in the part. This application covers openings for doors and accesses in aircraft skins, cutouts at part edges, and attachment holes too large for bolt-hole probes.

4.5.4.2 Inspection Requirements. If inspection is required only for large cracks (greater than approximately 1/4-inch in length) adequate inspection can usually be performed without special equipment or fixtures. For such cracks, inspection can be performed sufficiently far enough from the edge to avoid interference from edge effects. To detect small cracks, a relatively constant probe-to-edge distance must be maintained. For maximum reliability, a fixture or probe guide is used to establish probe positioning.

4.5.5 Conductivity Measurement.

4.5.5.1 Size and Accuracy of Conductivity Standards. For convenience of transportation and storage, conductivity standards are usually kept relatively small. Standards must have sufficient size to prevent edge effects or thickness from having a bearing on conductivity readings. These requirements can be satisfied by requiring length and width to be 1-inch greater than the probe diameter and the thickness greater than 3.5 times the standard depth of penetration at the test instrument frequency. Standards should be flat, have a surface finish of 63 RMS or better, and be free of any coatings. Standards used for calibrating instruments immediately prior to measuring conductivity SHOULD be accurate within $\pm 0.5\%$ IACS of the nominal value. A second set of standards accurate within 0.35% IACS SHOULD be periodically made available for checking the performance of instruments and field calibration standards. Calibration standards shall be traceable to NIST. Standards are available from manufacturers of eddy current conductivity instruments.

4.5.5.2 Conductivity Range. The conductivity range of the standards must be within the range of the instrument and cover the range of conductivity values to be measured. The calibration blocks shall have the same change in resistivity with temperature as the test parts.

4.5.5.3 Stability of Standards. Excessively high temperatures and sudden changes in temperature can have damaging metallurgical effects on standards. Aluminum alloys are particularly susceptible to thermal shock. Surfaces of standards can also corrode if exposed to moisture or other hostile environments. Damage due to rough handling can cause erroneous conductivity readings. For these reasons, standards shall be transported and stored in dry, clean, protected areas not subject to excessive temperatures.

4.5.5.4 Number of Standards Required. A minimum of two calibration blocks with accurately determined conductivity values must be available for calibration of eddy current conductivity meters. When using general purpose instruments, the number of standards may vary from two to several depending on the inspection purpose and the accuracy required.

4.5.6 Inspection Procedures.

4.5.6.1 Conductivity Procedure Requirements. Procedures for conductivity measurement should take into account the varieties of environments and test part conditions which might be encountered. In preparing for conductivity measurement, the following steps should be considered:

- Background and objectives of the inspection.
- Equipment requirements.
- Part preparation.
- Instrument calibration including calibration standards.
- Conductivity measurement procedures.
- Acceptance/rejection criteria.

4.5.6.2 Background and Objectives. An understanding of the problem that initiates a conductivity measurement requirement enables the inspector to better interpret inspection results and handle unexpected test conditions. The purpose of the test can be separation of mixed or improper alloy, determination of improper heat treatment, and detection of heat or fire damaged material. The types of material involved and the location of the inspection SHOULD be specifically established.

Heat and/or fire damage may be confined to a portion of a part and may vary in the degree of damage. These variables must be considered during conductivity measurement.

4.5.6.3 Part Preparation. As with all types of ET, areas on which conductivity measurement is to be performed must be free of any sharp slivers or foreign material that could damage a probe or cause lift-off changes. Such conditions can be removed with fine emery paper or other approved means. Conductivity measurements can be performed through nonconductive coatings that have thicknesses equal to or less than the amount of lift-off adjustment on meter type equipment. Both the thickness and uniformity of the coating thickness and the amount of lift-off adjustment provided should be checked prior to measuring conductivity through nonconductive coatings. If lift-off adjustment cannot be obtained, correction factors can be determined for uniform coatings by establishing the change in conductivity readings caused by the coating and adding this change to each of the measured values. Non-uniform coatings in excess of lift-off adjustment must be removed prior to measuring conductivity. Excessively rough surfaces SHOULD be smoothed with emery paper to provide a surface finish 250 RMS or better before performing conductivity measurements.

4.5.7 Calibration for Measuring Conductivity Values.

NOTE

(NAVY Only) PD-214. Follow instructions in the instruments' conductivity program. To calibrate a general purpose instrument for measuring conductivity directly, the following procedures should be followed:

- a. Select a sufficient number of standards to obtain a smooth continuous curve over the range of conductivity to be measured. The actual number of samples will depend on the expected range to be measured and the accuracy required.
- b. Adjust the instrument for lift-off, if applicable, and a standard representing approximately mid-range of the conductivities to be measured.
- c. Determine the meter or scope readings corresponding to each of the intermediate standards and record the conductivity value.
- d. Note each of the values on a graph with meter or scope readings on the vertical axis and conductivity values on the horizontal axis.
- e. Construct a smooth curve through all the points. The curve should increase or decrease smoothly throughout the range with no minimum or maximum values. This curve is used to measure conductivity with the specific instrument and probe.

4.5.7.1 Calibration for Separation of Mixed Alloys. To calibrate the general purpose instruments for separating two groups of materials with different conductivity, the instrument is set to obtain readings at one end of the scale for one group of material, and the other end of the scale for the second group of material. Lift-off is usually set on a specimen representing the group with the lower value of conductivity or permeability.

4.5.7.2 Calibration Check. Calibration SHOULD be checked approximately every 10-minutes during continual use and whenever abnormal values are obtained. Whenever an instrument is found to be out of calibration, all measurements performed since the previous calibration verification SHOULD be rechecked.

4.5.7.3 Acceptance/Rejection Criteria. Acceptance/rejection criteria can be found in the applicable T.O. or material specifications. Acceptable conductivity ranges for many aluminum alloys are shown in ([Table 4-7](#) in Section 4.7).

T.O. 33B-1-1

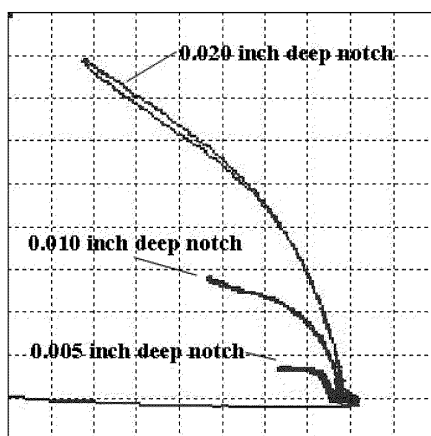
SECTION VI EDDY CURRENT PROCESS CONTROL

4.6 ET PROCESS CONTROL.

4.6.1 **General.** For maximum reliability in ET, a high signal-to-noise ratio is desired. No specific signal-to-noise ratio is mandatory, but a minimum of 3-to-1 is desirable for flaw detection.

4.6.2 **Probe Test.** The eddy current probe check is a 3-point calibration to determine a probe meets a specific sensitivity requirement. The test **SHALL** be performed before a probe is placed in service and prior to any inspection procedure. The check is for general purpose eddy current probes only, special purpose probes **SHOULD** be checked IAW a specific procedure or manufacturer's recommendation. The following procedure **SHALL** be used to check eddy current probes:

- a. Set-up eddy current instrument for aluminium surface inspection IAW TO 33B-1-2 Chapter 4, Section I (Air Force) or the manufacturer's operating instructions.
- b. Scan the 0.020 EDM notch on the Air Force/Navy general purpose aluminium standard. Adjust the gain to achieve an eight division signal from the null point.
- c. Scan the 0.010 EDM notch. A minimum of two division signal from the null point **SHALL** be received (three division is optimum).
- d. Scan the 0.005 EDM notch. A minimum of one-half of one division **SHALL** be received (one division is optimum).
- e. If the probe fails to meet minimum standards change the cable and repeat. Replace the probe if it fails again.
- f. A visual examination of the probe is also required. Replace probes that are cracked or broken, have loose connectors, or worn tips (exposed coils). See [Figure 4-42](#) for an example of an acceptable 3-point calibration presentation.



H0604224

Figure 4-42. ECI Acceptable Signal Response

4.6.3 **Slot Test.** There is no longer a field test for eddy current standards. At the NDI supervisor's discretion an extremely worn standard may be sent to the Air Force NDI Program Office for testing and evaluation.

SECTION VII EDDY CURRENT EQUATIONS

4.7 TABLES AND EQUATIONS.

NOTE

The following formulas are used by NDI engineers and inspection developers. Technicians should have a working knowledge of the most basic electrical component equations as presented in the classroom.

Table 4-1. Common Applications of ET

Electrical Conductivity	Magnetic Permeability *	Geometry	Material Discontinuities	Lift-Off or Fill- Factor
Alloy Sorting	Alloy Sorting	Metal Thickness	Cracks	Insulation Thickness
Heat-Treat Condition	Heat-Treat Condition		Segregation	Nonmetallic Coatings Thickness
Heat Damage	Case Depth		Seams	Proximity Gage
Plating Thickness	Plating Thickness		Inclusions	Diameter (e.g., of bar stock with encircling coil)
Cladding			Corrosion	
Thickness				
			Porosity	
			Carbon Fiber	
* Ferromagnetic Materials Only				

Table 4-2. Conductivities of Some Commonly Used Engineering Materials

Metal	Conductivity	60 kHz Probe	480 kHz Probe	Resistivity
	% IACS	Minimum Thickness (Inch)	Minimum Thickness (Inch)	$\mu \Omega \text{ cm}^*$
Silver	105	0.028	0.010	1.64
Copper, annealed	100	0.028	0.010	1.72
Aluminum Bronze- 5%, annealed	17	0.068	0.024	10.14
70-30 Brass	28	0.053	0.019	6.16
Cartridge Brass	28	0.053	0.019	6.16
Phosphor Bronzes	11	0.085	0.030	15.68
Phosphor Bronze- 5%, annealed	15	0.073	0.026	11.50
Gold	73.4	0.033	0.012	2.35
Magnesium	37	0.046	0.016	4.66
Magnesium, K60A-0	30	0.052	0.018	5.75
Magnesium, AZ31B- T5	18.5	0.066	0.023	9.32
Nickel, 99.4%	18	0.067	0.024	9.58
Nickel, 99.95%	25.2	0.056	0.020	6.84

T.O. 33B-1-1

Table 4-2. Conductivities of Some Commonly Used Engineering Materials - Continued

Metal	Conductivity	60 kHz Probe	480 kHz Probe	Resistivity
	% IACS	Minimum Thickness (Inch)	Minimum Thickness (Inch)	$\mu \Omega \text{ cm}^*$
Inconel 600	1.7	0.217	0.077	101.43
Monel 400	3.6	0.149	0.053	47.90
Monel	3.6	0.149	0.053	47.90
Zirconium	3.4	0.153	0.054	50.72
Zircaloy-2	2.4	0.182	0.064	71.85
Titanium	3.1	0.160	0.057	55.62
Ti-55A	3.1	0.160	0.057	55.62
Ti-8Al-1Mo-1V	0.87	0.303	0.107	198.20
Ti-6Al-4V	1	0.282	0.100	172.43
430 Stainless Steel	2.9	0.166	0.059	59.46
304 Stainless Steel	2.5	0.179	0.063	68.97
Inconel 600	1.7	0.217	0.077	101.43
Hastelloy X	1.5	0.231	0.082	114.95
Waspaloy	1.4	0.239	0.084	123.17
Platinum, 99.85%	16.3	0.070	0.025	10.60
Cobalt	27.6	0.054	0.019	6.24
Lead, 99.73%	8.4	0.098	0.035	20.65

* micro ohm per centimeter

Table 4-3. Conductivity and Effective Depth of Penetration in Various Metals

Metal	Conductivity	60 kHz Probe	480 kHz Probe	Resistivity
	% IACS	Minimum Thickness (Inch)	Minimum Thickness (Inch)	$\mu \Omega \text{ cm}^*$
Silver	105	0.028	0.010	1.64
Copper, annealed	100	0.028	0.010	1.72
Aluminum Bronze- 5%, annealed	17	0.068	0.024	10.14
70-30 Brass	28	0.053	0.019	6.16
Cartridge Brass	28	0.053	0.019	6.16
Phosphor Bronzes	11	0.085	0.030	15.68
Phosphor Bronze- 5%, annealed	15	0.073	0.026	11.50
Gold	73.4	0.033	0.012	2.35
Magnesium	37	0.046	0.016	4.66
Magnesium, K60A- 0	30	0.052	0.018	5.75
Magnesium, AZ31B-T5	18.5	0.066	0.023	9.32
Nickel, 99.4%	18	0.067	0.024	9.58
Nickel, 99.95%	25.2	0.056	0.020	6.84
Inconel 600	1.7	0.217	0.077	101.43

Table 4-3. Conductivity and Effective Depth of Penetration in Various Metals - Continued

Metal	Conductivity	60 kHz Probe	480 kHz Probe	Resistivity
	% IACS	Minimum Thickness (Inch)	Minimum Thickness (Inch)	$\mu \Omega \text{ cm}^*$
Monel 400	3.6	0.149	0.053	47.90
Monel	3.6	0.149	0.053	47.90
Zirconium	3.4	0.153	0.054	50.72
Zircaloy-2	2.4	0.182	0.064	71.85
Titanium	3.1	0.160	0.057	55.62
Ti-55A	3.1	0.160	0.057	55.62
Ti-8Al-1Mo-1V	0.87	0.303	0.107	198.20
Ti-6Al-4V	1	0.282	0.100	172.43
430 Stainless Steel	2.9	0.166	0.059	59.46
304 Stainless Steel	2.5	0.179	0.063	68.97
Inconel 600	1.7	0.217	0.077	101.43
Hastelloy X	1.5	0.231	0.082	114.95
Waspaloy	1.4	0.239	0.084	123.17
Platinum, 99.85%	16.3	0.070	0.025	10.60
Cobalt	27.6	0.054	0.019	6.24
Lead, 99.73%	8.4	0.098	0.035	20.65

* micro ohm per centimeter

Table 4-4. Conductivity and Effective Depth of Penetration in Nonclad Aluminum Alloys

Nonclad Aluminum Alloy	Temper	Conductivity (% IACS)	60 kHz Probe Minimum Thickness	480 kHz Probe Minimum Thickness
1100	T0	57-62	0.037	0.013
3003	T0	44.5-50.5	0.042	0.015
5052	T0	34-37	0.048	0.017
2014	T0	43.5-51.5	0.043	0.015
2014	T3	31.5-35	0.050	0.018
2014	T4	31.5-34.5	0.050	0.018
2014	T6	35.5-41.5	0.047	0.017
2024	T0	46-51	0.042	0.015
2024	T3	28.5-32.5	0.053	0.019
2024	T4	28.5-34	0.053	0.019
2024	T6	36.-40.5	0.047	0.017
2024	T8	35-42.5	0.048	0.017
2048	T8	35-42.5	0.048	0.017
2124	T3	28.5-32.5	0.053	0.019
2124	T8	35-42.5	0.048	0.017
2219	T0	44-49	0.043	0.015

T.O. 33B-1-1

Table 4-4. Conductivity and Effective Depth of Penetration in Nonclad Aluminum Alloys - Continued

Nonclad Aluminum Alloy	Temper	Conductivity (% IACS)	60 kHz Probe Minimum Thickness	480 kHz Probe Minimum Thickness
2219	T3	26-31	0.055	0.020
2219	T37	27-31	0.054	0.019
2219	T4	28-32	0.053	0.019
2219	T6	32-35	0.050	0.018
2219	T8	31-35	0.051	0.018
2219	T87	31-35	0.051	0.018
6061	T0	42-49	0.044	0.015
6061	T4	35.5-43	0.047	0.017
6061	T6	40-47	0.045	0.016
6063	T0	57-65	0.037	0.013
6063	T1	48-58	0.041	0.014
6063	T4	48-58	0.041	0.014
6063	T5	50-60	0.040	0.014
6063	T6	50-60	0.040	0.014
6066	T0	42-47	0.044	0.015
6066	T4	34-41	0.048	0.017
6066	T6	38-50	0.046	0.016
7049	O	44-50	0.043	0.015
7049	T73	40-44	0.045	0.016
7049	T76	38-44	0.046	0.016
7050	T0	44-50	0.043	0.015
7050	T73	40-44	0.045	0.016
7050	T736	40-44	0.045	0.016
7050	T76	39-44	0.045	0.016
7075	T0	44-48	0.043	0.015
7075	T6	30.5-36	0.051	0.018
7075	T73	40-43	0.045	0.016
7075	T76	38-42	0.046	0.016
7178	T0	43-47	0.043	0.015
7178	T6	29-34	0.052	0.019
7178	T76	38-42	0.046	0.016

Table 4-5. Standard Depths of Penetration for Metal Alloys at Various Frequencies

Metal	Conductivity		Standard Depth of Penetration (Inches)												
	% IACS		100 Hz	500 Hz	1 kHz	5 kHz	10 kHz	50 kHz	100 kHz	200 kHz	500 kHz	1 MHz	2 MHz	6 MHz	
Silver	105		0.254	0.113	0.080	0.036	0.025	0.011	0.008	0.006	0.004	0.003	0.002	0.001	
Copper, annealed	100		0.260	0.116	0.082	0.037	0.026	0.012	0.008	0.006	0.004	0.003	0.002	0.001	
Aluminum Bronze 5% annealed	17			0.282	0.199	0.089	0.063	0.028	0.020	0.014	0.009	0.006	0.004	0.003	
70-30 Brass	28		0.491	0.220	0.155	0.069	0.049	0.022	0.016	0.011	0.007	0.005	0.003	0.002	
Cartridge Brass	28		0.491	0.220	0.155	0.069	0.049	0.022	0.016	0.011	0.007	0.005	0.003	0.002	
Phosphor Bronzes	11			0.351	0.248	0.111	0.078	0.035	0.025	0.018	0.011	0.008	0.006	0.003	
Phosphor Bronze 5% annealed	15			0.300	0.212	0.095	0.067	0.030	0.021	0.015	0.009	0.007	0.005	0.003	
Gold	73.4		0.303	0.136	0.096	0.043	0.030	0.014	0.010	0.007	0.004	0.003	0.002	0.001	
Magnesium	37		0.427	0.191	0.135	0.060	0.043	0.019	0.014	0.010	0.006	0.004	0.003	0.002	
Magnesium K60A-0	30		0.475	0.212	0.150	0.067	0.047	0.021	0.015	0.011	0.007	0.005	0.003	0.002	
Magnesium AZ31B-T5	18.5			0.270	0.191	0.085	0.060	0.027	0.019	0.014	0.009	0.006	0.004	0.002	
Nickel 99.4%	18			0.274	0.194	0.087	0.061	0.027	0.019	0.014	0.009	0.006	0.004	0.003	
Nickel 99.95%	25.2			0.232	0.164	0.073	0.052	0.023	0.016	0.012	0.007	0.005	0.004	0.002	
Inconel 600	1.7					0.282	0.199	0.089	0.063	0.045	0.028	0.020	0.014	0.008	
Monel 400	3.6				0.433	0.194	0.137	0.061	0.043	0.031	0.019	0.014	0.010	0.006	
Monel	3.6				0.433	0.194	0.137	0.061	0.043	0.031	0.019	0.014	0.010	0.006	
Zirconium	3.4				0.446	0.199	0.141	0.063	0.045	0.032	0.020	0.014	0.010	0.006	
Zircaloy-2	2.4					0.237	0.168	0.075	0.053	0.038	0.024	0.017	0.012	0.007	
Titanium	3.1				0.467	0.209	0.148	0.066	0.047	0.033	0.021	0.015	0.010	0.006	
Ti-55A	3.1				0.467	0.209	0.148	0.066	0.047	0.033	0.021	0.015	0.010	0.006	

T.O. 33B-1-1

Table 4-5. Standard Depths of Penetration for Metal Alloys at Various Frequencies - Continued

Metal	Conductivity % IACS	Standard Depth of Penetration (Inches)												
		100 Hz	500 Hz	1 kHz	5 kHz	10 kHz	50 kHz	100 kHz	200 kHz	500 kHz	1 MHz	2 MHz	6 MHz	
Ti-8Al-1 Mo-1V	0.87				0.394	0.279	0.125	0.088	0.062	0.039	0.028	0.020	0.011	
Ti-6Al-4V	1				0.368	0.260	0.116	0.082	0.058	0.037	0.026	0.018	0.011	
430 Stain- less Steel	2.9			0.483	0.216	0.153	0.068	0.048	0.034	0.022	0.015	0.011	0.006	
304	2.5				0.233	0.164	0.074	0.052	0.037	0.023	0.016	0.012	0.007	
Stainless Steel														
Inconel 600	1.7				0.282	0.199	0.089	0.063	0.045	0.028	0.020	0.014	0.008	
Hastelloy X	1.5				0.300	0.212	0.095	0.067	0.047	0.030	0.021	0.015	0.009	
Waspaloy	1.4				0.311	0.220	0.098	0.069	0.049	0.031	0.022	0.016	0.009	
Platinum 99.85%	16.3		0.288	0.204	0.091	0.064	0.029	0.020	0.014	0.009	0.006	0.005	0.003	
Cobalt	27.6	0.495	0.221	0.157	0.070	0.049	0.022	0.016	0.011	0.007	0.005	0.003	0.002	
Lead 99.73%	8.4		0.402	0.285	0.127	0.090	0.040	0.028	0.020	0.013	0.009	0.006	0.004	

Table 4-6. Standard Depths of Penetration for Clad Aluminum Alloys at Various Frequencies

Clad Aluminum Alloy	Temper	Standard Depth of Penetration (Inches)											
		100 Hz	500 Hz	1 kHz	5 kHz	10 kHz	50 kHz	100 kHz	200 kHz	500 kHz	1 MHz	2 MHz	6 MHz
2014	T6	0.436	0.195	0.138	0.062	0.044	0.020	0.014	0.010	0.006	0.004	0.003	0.002
2024	T3	0.487	0.218	0.154	0.069	0.049	0.022	0.015	0.011	0.007	0.005	0.003	0.002
2024	T4	0.487	0.218	0.154	0.069	0.049	0.022	0.015	0.011	0.007	0.005	0.003	0.002
2024	T6	0.439	0.197	0.139	0.062	0.044	0.020	0.014	0.010	0.006	0.004	0.003	0.002
2024	T8	0.439	0.197	0.139	0.062	0.044	0.020	0.014	0.010	0.006	0.004	0.003	0.002
2219	T6	0.460	0.206	0.145	0.065	0.046	0.021	0.015	0.010	0.007	0.005	0.003	0.002
2219	T8	0.467	0.209	0.148	0.066	0.047	0.021	0.015	0.010	0.007	0.005	0.003	0.002
6061	T6	0.411	0.184	0.130	0.058	0.041	0.018	0.013	0.009	0.006	0.004	0.003	0.002
7075	T6	0.471	0.211	0.149	0.067	0.047	0.021	0.015	0.011	0.007	0.005	0.003	0.002
7075	T76	0.422	0.189	0.133	0.060	0.042	0.019	0.013	0.009	0.006	0.004	0.003	0.002
7178	T6	0.483	0.216	0.153	0.068	0.048	0.022	0.015	0.011	0.007	0.005	0.003	0.002

T.O. 33B-1-1

Table 4-7. Conductivity and Effective Depth of Penetration for Clad Aluminum Alloys

Clad Aluminum Alloy	Temper	Conductivity Range (% IACS)	60 kHz Probe Minimum Thickness (Inch)	480 kHz Probe Minimum Thickness (Inch)
2014	T6	35.5-44	0.047	0.017
2024	T3	28.5-35	0.053	0.019
2024	T4	28.5-35	0.053	0.019
2024	T6	35-45	0.048	0.017
2024	T8	35-45	0.048	0.017
2219	T6	32-37	0.050	0.018
2219	T8	31-37	0.051	0.018
6061	T6	40-53	0.045	0.016
7075	T6	30.5-36	0.051	0.018
7075	T76	38-42	0.046	0.016
7178	T6	29-34	0.052	0.019

Table 4-8. Effects of Material and Inspection Variables on the Sensitivity and Range of Thickness Measurements

Variable Increased	Sensitivity of Measurement	Range of Measurement
Conductivity	Increases for thin metallic parts and plating. Increases throughout affect range for nonconductive coatings.	Decreases for metallic materials. Increases for nonconductive coatings.
Permeability	Increases for thin metallic parts and plating. Decreases for thick metallic parts and plating. Increases throughout for nonconductive coatings	Decreases for metallic materials. Increases for nonconductive coatings.
Frequency	Increases for thin metallic parts and plating. Decreases for thicker metallic parts and plating. Increases throughout the effective range for nonconductive coatings.	Decreases for metallic materials. Increases for nonconductive coatings.
Probe Diameter	Increases for thicker metallic parts and plating and throughout effective range for nonconductive coatings.	Increases for metallic parts, plating, and nonconductive coatings.

4.7.1 **Resistance.** When AC or DC flows through a purely resistive element (e.g., a straight section of wire or a carbon resistor) of an electrical circuit, the impedance is resistance only and is expressed as:

$$R = E / I$$

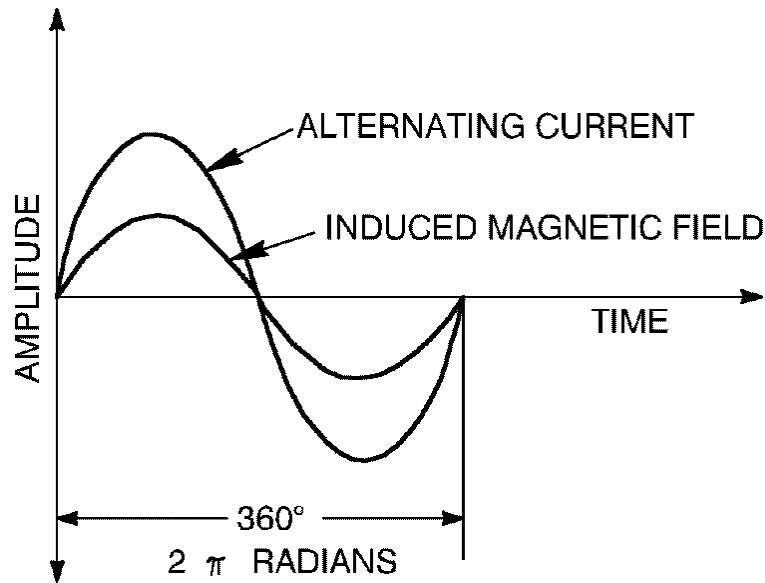
Where:

R = Resistance (ohms)

E = Voltage drop across the resistor (volts)

I = Current flowing through circuit (amperes)

4.7.1.1 In an AC circuit containing resistance only, the voltage and the current are in phase. The term “in phase”, when used to describe the relationship between the voltage and current, indicates that changes in current occur at the same time and in the same manner (direction) as changes in voltage. Examples of two quantities that are in phase are shown in (Figure 4-43).



H0404534

Figure 4-43. Sinusoidal In-Phase Variation of Alternating Current and Induced Magnetic Field

4.7.1.2 Resistance:

$$R = \frac{\ell \rho}{A} \text{ ohm}$$

Where:

ℓ

= Length of conductor

ρ
 A

= Resistivity

= Area (cross sectional) of conductor

4.7.1.3 Resistivity:

$$\rho = \frac{RA}{\ell} \text{ ohm mm}$$

4.7.1.4 Conductivity (inverse of resistivity)

$$\sigma = \frac{\ell}{RA} \text{ mho/mm or siemen/mm}$$

$$1 \text{ mho} = \frac{1}{\text{ohm}}$$

4.7.2 **Inductance.** The inductance of an eddy current probe is the result of magnetic field effects of the alternating electric current in the probe. Inductance is a measure of the capability of a circuit to induce current flow in another circuit. It is proportional to the ratio of the magnetic flux linking (encircling) a circuit to the current (I) that produced the flux. When the

T.O. 33B-1-1

flux from one inductor is linked to (passes through) another inductor, the inductance is called mutual inductance (M). An electrical transformer is an example of a device where “M” is a significant parameter. For eddy current testing, we consider only the inductance of a single circuit element, specifically, the coil used to sense changes in eddy current flows in test specimens. This inductance is called self-inductance (L).

$$L = \frac{0.8 \times (rN)^2}{6 \times r + 9 \times l + 10 \times b}$$

L	=	in micro-henrys
r	=	mean coil radius
l	=	coil height
b	=	coil wrap thickness
N	=	number of turns

4.7.2.1 Self Inductance. Self-inductance (L) is expressed in “henrys.” A “henry” is the inductance by which one volt is produced across a coil when the inducing current is changed at the rate of one ampere per second. A formula for self-inductance expressed in these terms is as follows:

$$L = \frac{E}{(\delta I / T)}$$

Where:

L	=	Inductance (henrys)
E	=	Induced Electromotive Force (volts)
δI	=	Change in Current (amperes)
T	=	Time (seconds)

Because the “henry” is such a large unit, inductance is more commonly expressed in terms of “millihenrys” (1/1000 “henry”) or “micro-henrys” (1/1,000,000 “henry”). Typical coils used in ET have self-inductances in the range of 10 to several hundred “micro-henry.”

4.7.3 Fill Factor. Is the ratio of the effective cross-sectional area of the primary internal probe coil to the cross-sectional area of the tube interior.

$$\eta = \left(\frac{D_o}{D_i} \right)^2$$

Where:

η	=	Fill factor
D_o	=	Outside diameter of test part
D_i	=	Inside diameter of coil

4.7.3.1 Example: if an encircling coil with an internal diameter of 2.25-inches were used to inspect 2.00-inch diameter rod, the fill factor would be:

$$\eta = \left(\frac{D_o}{D_i} \right)^2 = \left(\frac{2.00}{2.25} \right)^2 = (0.889) = 0.79$$

4.7.3.2 For internal coils, electromagnetic (inductive) coupling is determined by the air gap between the external diameter of the coil and the internal diameter being inspected. Fill-factor is calculated using the basic formula, but in this case “ D_i ” is

the inside diameter of the part and “ D_o ” is the outside diameter of the coil placed in the part. For example, if a coil with an external diameter of 1.5-inches is used to inspect tubing with an internal diameter of 1.6-inches, the fill factor is given by:

$$\eta = \left(\frac{D_o}{D_i}\right)^2 = \left(\frac{1.5}{1.6}\right)^2 = (0.9375)^2 = 0.88$$

4.7.3.3 Inductive Reactance (Lenz Law) and Capacitive Reactance:

$$X_L = 2\pi fL, L \text{ in Henrys and } X_L \text{ in ohms}$$

$$X_c = \frac{1}{2\pi fC}, C \text{ in Farads and } X_c \text{ in ohms}$$

4.7.4 Impedance: Impedance is the opposition to current flow and is a two-dimensional parameter consisting of resistance and reactance. Resistance is the opposition to the flow of both direct and alternating current. Reactance is the opposition to flow of alternating current only. Reactance can be either capacitive or inductive. Both resistance and reactance are measured in ohms. Of primary interest in ET are resistance and inductive reactance, the latter due to inductance of a coil. Capacitive reactance becomes significant in only a few cases and will be discussed later. The impedance of a test coil is related to the current flow in and voltage drop across the coil as follows:

$$Z = \frac{E}{I}$$

Where:

Z	=	Impedance of coil (ohms)
E	=	Voltage drop across the coil (volts)
I	=	Current through coil (amperes)

4.7.4.1 Impedance formula:

$$Z = \sqrt{R^2 + (X_L - X_c)^2}$$

4.7.5 Permeability.

$$\mu = \frac{B}{H}$$

Where:

T.O. 33B-1-1

μ	=	permeability
H	=	magnetizing force oersteds or amp – turns
B	=	flux density in Gauss or Tesla (10000 G = 1 T)

4.7.5.1 Relative Permeability:

$$\mu_{rel} = \frac{B}{H\mu_0}$$

Where:

μ_0 of free space = $4\pi \times 10^{-7}$
 Ferromagnetic $\mu_{rel} \gg 1$
 Paramagnetic $\mu_{rel} \geq 1$ Nonferrous
 Diamagnetic $\mu_{rel} < 1$ Au, I

4.7.6 Depth of Penetration (δ).

$$\rho = \frac{172}{IACS}, \text{ resistivity in micro-ohm cm}$$

$$\delta = 660 \sqrt{\frac{1}{IACS \times \mu \times f}}, \text{ depth of penetration in mm}$$

$$\delta = 26 \sqrt{\frac{1}{IACS \times \mu \times f}}, \text{ depth of penetration in inches}$$

$$\delta = 1.98 \sqrt{\frac{\rho}{\mu \times f}}, \text{ depth of penetration in inches, using resistivity in micro-ohm cm.}$$

4.7.6.1 Frequency necessary for one standard depth:

$$f = \frac{676}{\mu \times IACS \times \delta^2}$$

Where:

f	=	frequency in Hertz, Hz
μ	=	relative permeability

$IACS$ = conductivity as a percentage of the conductivity of copper
 δ = the standard depth of penetration in inches

4.7.6.2 Phase Lag at one Standard Depth:

$$\theta = \frac{\text{Depth}}{\delta} \times 57^\circ$$

Phase lag on impedance diagram is

2 times θ , signal down and back
 at 1δ phase lag is 114°

4.7.7 Limit Frequency, f_g , and the "Similarity" Law.

$$f_g = \frac{5066}{d^2 \mu \sigma}$$

$$\sigma \dots = \text{conductivity} = \frac{m}{\text{ohm} \cdot \text{mm}^2}$$

d = diameter of test object in cm
 f = frequency I Hz
 μ_{rel} = relative permeability

4.7.8 Characteristic Frequency. f_g is lowest frequency where eddy currents are induced in a material. Where frequency and conductivity for one material is known, the frequency for "similar" phase separation can be calculated for another material of known conductivity.

$$f_1 \times \sigma_1 = f_2 \times \sigma_2$$

4.7.9 Coverage of coil or effective coil diameter:

Unshielded = coil diameter + 4δ
 Shielded = coil diameter
 δ = Standard depth of penetration

4.7.10 Calculating Flaw Frequency for Setting Filters. Assume flaw is infinitely narrow compared to coil:

4.7.10.1 For scanning across a surface, surface speed is how fast the probe is moved across that surface.

4.7.10.2 For a rotating bolt-hole inspection, surface speed depends on the rotational speed of the scanner and the diameter of the probe. Surface speed may be calculated as follows:

T.O. 33B-1-1

$$\textit{Flaw Frequency} = \frac{\textit{Surface Speed}}{\textit{Effective Coil Diameter}}, \textit{ Hz}$$

$$\textit{Surface Speed} = \textit{Scanner RPM} \times \pi \times \textit{Probe Diameter}$$

4.7.11 Measurement of Conductivity. Formula: $\sigma = L/RA = 1/\rho$; therefore, $R = \rho L/A$

Where:

σ	=	electrical conductivity (mhos/unit-length)
L	=	length
R	=	resistance (ohms)
A	=	cross-sectional area
ρ	=	resistivity (ohms-unit-length)

SECTION VIII EDDY CURRENT SAFETY

4.8 ET SAFETY.

4.8.1 Safety Requirements. Safety requirements SHALL be reviewed by the laboratory supervisor on a continuing basis to ensure compliance with provisions contained in AFOSH Standard 91-110 as well as provisions of this technical order and applicable weapons systems technical orders. Recommendations of the Base Bioenvironmental Engineer and the manufacturer regarding necessary personnel protective equipment SHALL be followed.

NOTE

Air Force Occupational Safety and Health (AFOSH) Standard 91-110 SHALL be consulted for additional safety requirements.

4.8.2 General Precautions. Precautions to be exercised when performing ultrasonic inspection include consideration of exposure to electrical current. The following minimum safety requirements SHALL be observed when performing eddy current inspections.

4.8.3 ET. Eddy Current equipment can safely be used in and around aircraft provided the following electrical safety guidelines are followed.

4.8.3.1 Care SHALL be exercised when performing maintenance on or around the cathode-ray tube (CRT) of this equipment.

4.8.3.1.1 Ensure the CRT is electrically discharged according to applicable manufacturer's technical manuals prior to performing any maintenance on the equipment.

WARNING

Use care not to break the CRT, since a violent implosion can result. An extreme hazard exists if equipment is not used properly in hazardous areas. Consult TO 1-1-688, "Use of Electronic Equipment in Hazardous Areas" for guidance on electrical safety requirements in hazardous areas.

CHAPTER 5

ULTRASONIC INSPECTION METHOD

SECTION I GENERAL CAPABILITIES OF ULTRASONIC INSPECTION

5.1 INTRODUCTION.

5.1.1 Introduction to Ultrasonic Inspection. The term ultrasonic pertains to sound waves having a frequency greater than 20,000 Hz. For most ultrasonic nondestructive inspection, the ultrasound will be generated by a device called a transducer, which will be discussed at length later in this chapter. The more general term “search unit” is also used to refer to the device introducing ultrasound into a part. For purposes of this manual, the two terms are considered synonymous.

5.1.2 Development of Ultrasonics. Developments in submarine warfare in the mid-twenties created a need for underwater communication. Early research for a suitable communicating method led to the invention of sonar, underwater ranging, and depth indicating devices.

5.1.2.1 In the late thirties, considerable work was done in applying ultrasonic waves to nondestructive inspection of materials. The first instruments were considered to be laboratory items, and were mostly for metallurgical research. Since then, ultrasonics has come a long way. The need for ultrasonics has grown with the advancement of aircraft, materials, and technologies.

5.1.3 Ultrasonic Testing. Ultrasonics uses (ultra) sound to detect internal discontinuities ranging from cracks to disbonds. Ultrasound can be used on almost any material to locate discontinuities from large disbonds, down to the smallest defects. It can also be used to measure the overall thickness of a material, and the specific depth of a defect. The part requires little or no preparation; however, knowledge of the internal geometry of a part is critical to interpretation of any defect signal.

T.O. 33B-1-1

SECTION II PRINCIPLES AND THEORY OF ULTRASONIC INSPECTION

5.2 INTRODUCTION.

5.2.1 Characteristics of Ultrasonic Energy.

5.2.1.1 Characteristics of Sound. The transmission of both audible sound and ultrasound is characterized by periodic vibrations of molecules or other small volume elements of matter. The vibration propagates through a material at a velocity characteristic to that material. As a particle is displaced from its rest position by any applied stress, it moves to a maximum distance away from its rest position (this is called a maximum displacement). The particle then reverses direction and moves past its rest position to a maximum position in the negative direction (a second maximum displacement). The particle then moves back to its rest position that completes one cycle. This process continues until the source of vibration is removed and the energy is passed on to an adjacent particle. The amplitudes of vibration in parts being ultrasonically inspected impose stresses low enough, so that, there is no permanent effect to the part.

5.2.1.2 To better understand the characteristics of sound, you must understand the terms associated with ultrasonics.

5.2.1.2.1 The term “period” means the amount of time it takes to complete one cycle.

5.2.1.2.2 The term “velocity” means the distance traveled per unit time (second).

5.2.1.2.3 The term “frequency” means the number of complete cycles that occur in one second.

5.2.1.2.4 The term “hertz” means the cycles per second. For example: 1 hertz (Hz) = one cycle; 1 kilohertz (kHz) = 1,000 cycles; 1 Megahertz (MHz) = 1,000,000 cycles.

5.2.1.2.5 The term “wavelength” is the distance a wave travels while going through one cycle.

5.2.1.2.5.1 Wavelength is defined by the formula:

$$\lambda \text{ (lambda)} = v/f$$

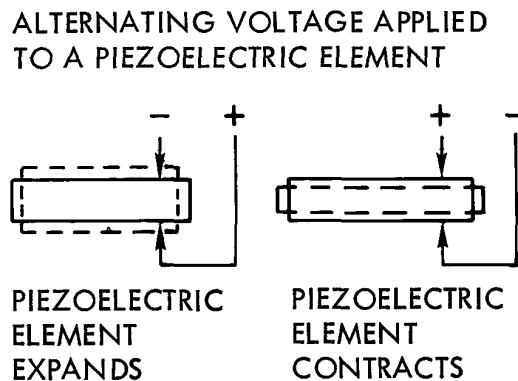
Where:

λ = wavelength (normally inches or centimeters)

v = velocity (inches or centimeters per second)

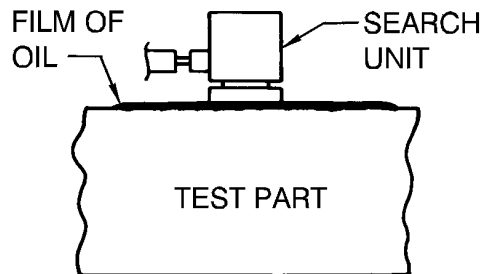
f = frequency (hertz)

5.2.2 Generation and Receiving of Ultrasonic Vibrations. Ultrasonic vibrations are generated by applying electrical energy to piezoelectric element contained within a transducer. This applied energy will be either a sudden high voltage spike from a discharging capacitor (a spike pulse), or a short pulse of constant voltage called a square wave. Also used where maximum power is needed from the transducer is a tone burst, which is a rapid series of square waves at a frequency matched to the transducer. The spike pulse is most commonly used. The transducer element transforms the electrical energy into mechanical energy (vibration) at a frequency determined by the material and thickness of the element. For aircraft NDI, this frequency will be ultrasonic. This element is also capable of receiving ultrasonic (mechanical) energy and transforming it into electrical energy (e.g., reverse piezoelectric effect) (Figure 5-1). Ultrasonic energy is transmitted between the transducer and the test part through a coupling medium (e.g., oil, grease, or water) (Figure 5-2). The purpose of a coupling material is to eliminate air at the interface between the transducer and the part under inspection. Air has high acoustic impedance, and thus, is a poor transmitter of ultrasound. Like audible sound waves, ultrasonic waves are capable of propagating through any elastic medium (solid, liquid, gas), but not in a vacuum. Propagation in any gas is very poor.



H0402813

Figure 5-1. Generation of Ultrasonic Vibrations



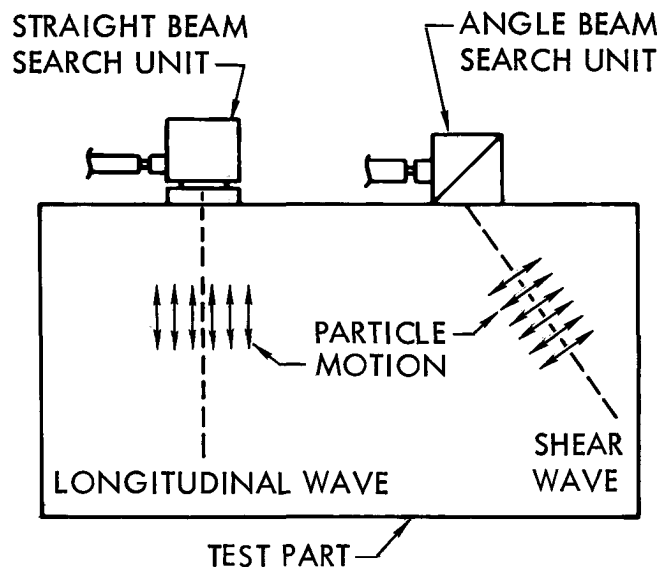
H0402814

Figure 5-2. Coupling Between the Transducer and the Test Part to Transmit Ultrasonic Energy

5.2.3 Modes of Ultrasonic Vibration. Ultrasonic energy is propagated in a material by the vibration of particles in the material. The mode of vibration is dependent upon the direction in which the particles vibrate in relation to the propagation direction of the bulk ultrasonic beam. Ultrasonic waves are classified by the following modes of vibration: longitudinal, transverse, surface, and Lamb modes.

5.2.3.1 Longitudinal Waves. Waves in which the particle motion of the material moves in essentially the same direction as the sound wave propagation, are called longitudinal waves (also referred to as “compressional waves” or “L-waves”) (Figure 5-3). Longitudinal waves can be generated within solids, liquids, and gases. Longitudinal waves are generated in a part under inspection when an incident longitudinal wave is near normal to the surface of the part under inspection. The longitudinal wave velocity is determined by the material’s elastic modulus and density, and is a constant for each material. Longitudinal wave inspections are used extensively for thickness inspections, corrosion thinning, and for the detection of other defects parallel to the inspection surface.

T.O. 33B-1-1

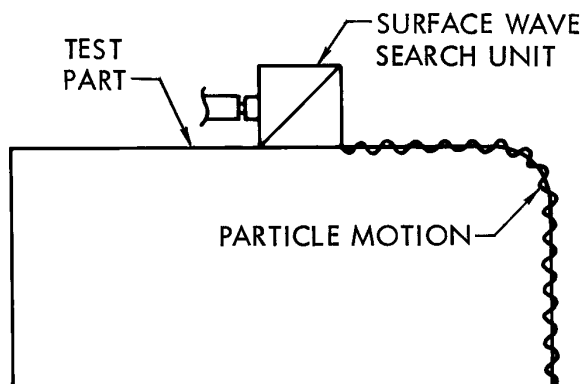


H0402815

Figure 5-3. Longitudinal and Transverse Wave Modes

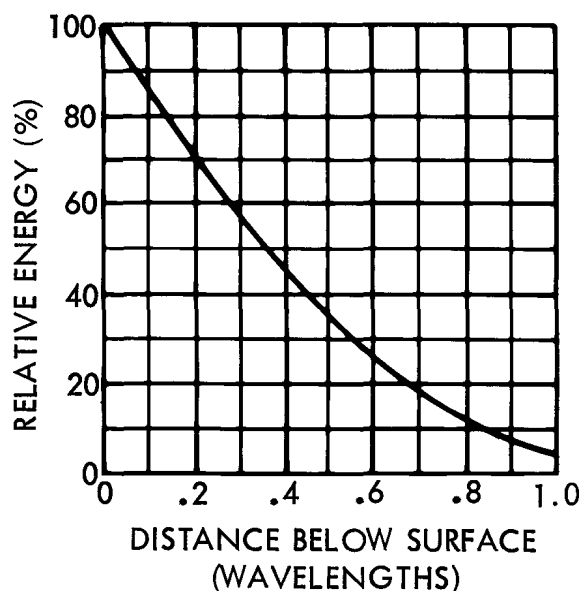
5.2.3.2 Transverse (Shear) Waves. Transverse (also known as “shear” or “s-waves”) waves denote the motion of waves in which the particle motion is perpendicular to the direction of propagation (Figure 5-3). These inspections are also called angle beam inspections. Shear waves travel at approximately 50-percent (half) of the velocity of longitudinal waves for the same material. Transverse waves can exist in any elastic solid, but are not supported by liquids or gases. Shear waves are generated in a test piece when a longitudinal wave impinges on the surface at an angle within a range of angles other than normal (90°) to the surface. This range is from the first to the second critical angles. These will be discussed at length later in this chapter. (The angle between the incident longitudinal wave and a line normal to the surface is referred to as the incident angle.) Part of the sound is reflected, but over a wide range of incident angles, part of the sound enters the test piece where mode conversion and refraction occur, resulting in a shear wave at an angle in the part. The portion converted to a shear wave will vary with the incident angle. Shear wave inspections are used extensively for crack and other defect inspections where the defect is suspected to be located at other than parallel to the inspection surface.

5.2.3.3 Surface (Rayleigh) Waves. Surface (Rayleigh) waves have a particle motion elliptical in a plane, parallel to the propagation direction, and perpendicular to the surface. Surface waves are generated when an incident longitudinal wave (paragraph 5.2.4.2) impinges on the test piece at an incident angle just beyond the second critical angle for that material. Once generated, surface waves can travel along curves and complex contours. Surface waves travel at approximately 90-percent of the velocity of shear waves for the same material. Surface waves are confined to a thin layer of the material under inspection, up to one wavelength deep, and can only be sustained when the medium on one side of the interface is a gas. An angle beam transducer containing a steeply angled wedge is shown in (Figure 5-4). The energy of surface waves decays rapidly below the surface of a test part as shown in (Figure 5-5). Surface waves are most suitable for detecting surface flaws, but may also be used to detect discontinuities lying up to one-half wavelength below the surface.



H0402816

Figure 5-4. Surface Wave Mode



H0402817

Figure 5-5. Distribution of Surface Wave Energy With Depth

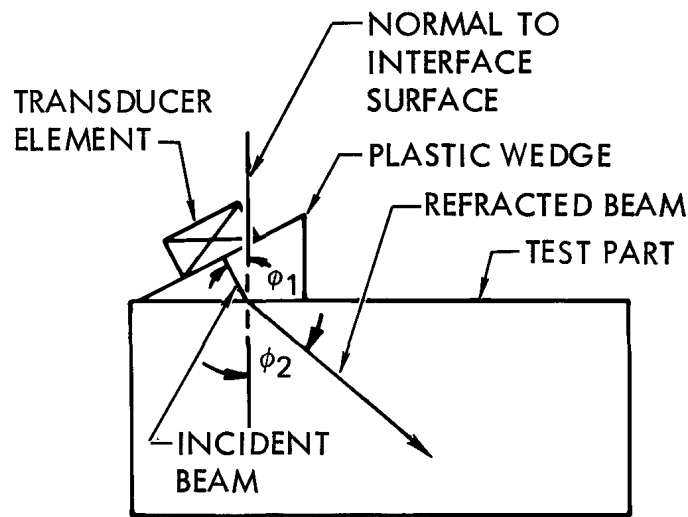
5.2.3.4 Lamb (Plate) Waves. Lamb (plate) waves propagate within thin plates, a few wavelengths thick. Wave propagation is between the two parallel surfaces of the test piece, and can continue for long distances. Lamb waves are generated in a complex variety of modes. The propagation characteristics of Lamb waves are dependent on the properties and thickness of test material, as well as the test frequency. Two basic forms of Lamb waves exist symmetrical and asymmetrical. Although not widely used in production, Lamb wave are beneficial in large area inspection applications, such as corrosion and disbonds, because they can propagate for long distances.

5.2.4 Refraction and Mode Conversion.

5.2.4.1 Snell's Law. When an incident longitudinal beam is normal to the test part surface ($\theta_1 = 0^\circ$), the longitudinal sound beam is transmitted straight into the test part and no refraction occurs. When the incident angle is other than normal;

T.O. 33B-1-1

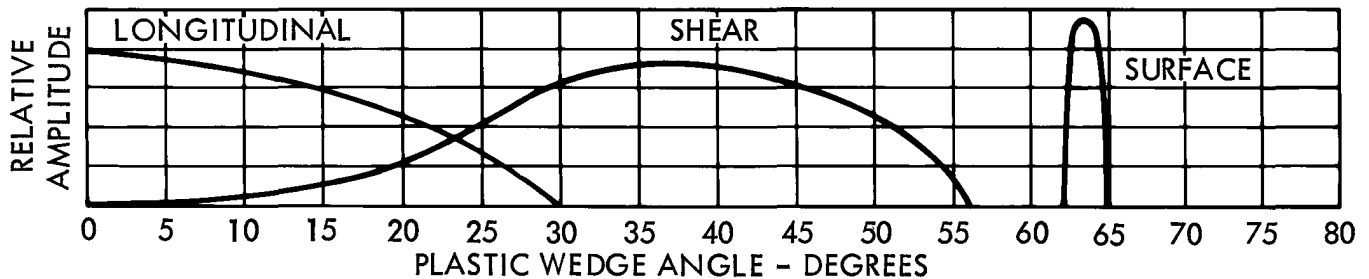
refraction, reflection, and mode conversion occur. Refraction is a change in propagation direction. Mode conversion is a change in the nature of the wave motion. A portion of the longitudinal incident beam is refracted into one or more wave modes traveling at various angles in the test piece (Figure 5-6). Wave refraction at an interface is defined by Snell's Law. The Snell's Law formula is located in (paragraph 5.7.2).



H0402821

Figure 5-6. Sound Beam Refraction

5.2.4.2 Refracted Beam Energy. The relative energy for longitudinal, shear, and surface wave beams in steel, for different incident angles of longitudinal waves (paragraph 5.2.3.1) in plastic, is shown (Figure 5-7). The curves shown were obtained using plastic wedges on steel. Similarly shaped curves MAY be obtained for other test materials (i.e., aluminum and titanium). Similarly curves MAY also be generated for the immersion inspection (paragraph 5.4.2.1.1.2) in water. Refraction angles are greater in water than plastic.



H0402822

Figure 5-7. Relative Amplitude in Steel of Longitudinal, Shear, and Surface Wave Modes With Changing Plastic Wedge Angle

5.2.4.3 Multiple Refracted Beams. When an incident longitudinal beam is normal to the test part surface ($\theta_1 = 0^\circ$), the longitudinal sound beam is transmitted straight into the test part and no refraction occurs. When the incident angle is other than normal, refraction and mode conversion occur. A portion of the longitudinal incident beam is refracted into one or more wave modes traveling at various angles and intensities depending on the incident angle of the longitudinal beam. The angles of the refracted beams are determined by Snell's law (paragraph 5.7.2). The relative energy for longitudinal, shear, and surface wave beams in steel, for different incident angles of longitudinal waves (paragraph 5.2.3.1) in plastic, is shown in

(Figure 5-7). The curves shown were obtained using plastic wedges on steel. Similarly shaped curves can be obtained for other test materials, such as aluminum and titanium. Similarly curves can also be generated for the immersion inspection (paragraph 5.4.2.1.1.2) with the plastic replaced by water. Refraction angles are greater with water than plastic.

5.2.4.3.1 Critical Angles. In angle beam inspection, it is important to know what types of waves and at what angles the waves exist in the test material. Because shear waves (paragraph 5.2.3.2) and longitudinal waves (paragraph 5.2.3.1) travel at different velocities in a given material, confusing signals can be generated and lead to false calls or missed indications.

5.2.4.3.1.1 The incident angle that yields a 90° longitudinal wave is defined as the first critical angle. At incident angles equal to or greater than the first critical angle, longitudinal waves no longer exist in the material. Beyond this angle, only shear waves remain in the test material.

5.2.4.3.1.2 The incident angle at which the refracted angle for shear waves reaches 90° is defined as the second critical angle. At incident angles equal to or greater than this, shear waves no longer exist in the material. Instead, surface waves (paragraph 5.2.3.3) are propagated along the surface of the material.

5.2.4.3.1.3 Most angle beam inspections are performed with only a shear wave present in the test material, therefore most incident angles useful for shear-wave inspection NDI fall between the two critical angles. The first critical angle in plastic for steel (Figure 5-7) is approximately 30°; the second critical angle is approximately 56°. For surface wave inspection the incident angle is purposely increased past the second critical angle to generate the desired surface wave.

5.2.4.3.1.4 Incident angles useful for shear-wave NDI fall between the two critical angles.

5.2.4.4 Determining the Angle of Incidence in Plastic to Generate 45-Degree Shear Waves in Aluminum. Field NDI personnel are responsible for using the correct refracted beam angle for a particular application. The specific procedure details the correct refracted beam angle; however, it is important for the field NDI inspector to know how the correct angle was obtained. Snell's law is the tool for determining wedge angles for contact testing (paragraph 5.4.2.1.1.1), or the angle of incidence in water for immersion testing (paragraph 5.4.2.1.1.2). An example showing how Snell's law is used to determine the angle of incidence in plastic needed to generate 45° shear waves is shown in (paragraph 5.2.3.2).

5.2.5 Ultrasonic Inspection Variables. Ultrasonic inspection is affected by several variables. The ultrasonic inspection system consists of the instrument, transducer, wedges or shoes, coupling medium, etc. A discussion of variables related to the test part follows the paragraphs describing system variables. It is important the operator be familiar with and recognize the effects of all these variables.

5.2.5.1 Frequency. For flaw detection using the contact method (paragraph 5.4.2.1.1.1), frequencies between 2.25 MHz and 10 MHz are commonly used. The higher frequencies in this range provide greater sensitivity for detection of small discontinuities, but do not have the penetrating power of the lower frequencies. The higher frequencies can also be more affected by small metallurgical discontinuities in the structure. Signals from these discontinuities can often interfere with the detection of relevant discontinuities, such as small cracks. The size of the defect detected SHOULD be the prime consideration when selecting the inspection frequency. Typically, defects must have at least one dimension equal to or greater than 1/2 the wavelength in order to be detected. For example, straight beam (paragraph 5.3.2.3.1) inspection of aluminum at 2.25 MHz with a wavelength of 0.111-inch, requires a defect be 0.066-inch or larger in order to be detected (e.g., at 5 MHz, the minimum defect size is 0.025-inch and at 10 MHz, it is 0.012-inch).

5.2.5.2 Frequency Bandwidth. The above discussion on frequency pertains to the peak frequency used in an inspection. In all cases, the ultrasonic instrument and transducer produces a band of ultrasonic energy covering a range of frequencies. The range is expressed as bandwidth. Ultrasonic inspection procedures can be sensitive to frequency; therefore, the inspection results can be affected by variation in the bandwidth of the inspection system. For example, certain inspections use loss of back reflection as criteria for rejection. Frequencies too high can lead to diminished or complete loss of back reflection due to the sound being scattered by a rough inspection surface, large grain structure in the test material, or small irrelevant discontinuities. In other words, improper choice of peak frequency and bandwidth of the inspection system (instrument and transducer) can produce irrelevant indications that affect inspection results. Both the instrument and the transducer affect the bandwidth of the inspection. Therefore, it is best to have a reference standard of the same material manufactured with the same manufacturing process and the same surface conditions as the test part, so the inspection results will be the same for different inspection systems. Instruments are constructed to pulse the transducer, and measure the response in different ways with respect to bandwidth.

5.2.5.2.1 Some instruments use a spike pulser and a broadband amplifier. With these instruments, the bandwidth is controlled by the transducer. A given transducer has a maximum response at the natural resonant frequency of the transducer

T.O. 33B-1-1

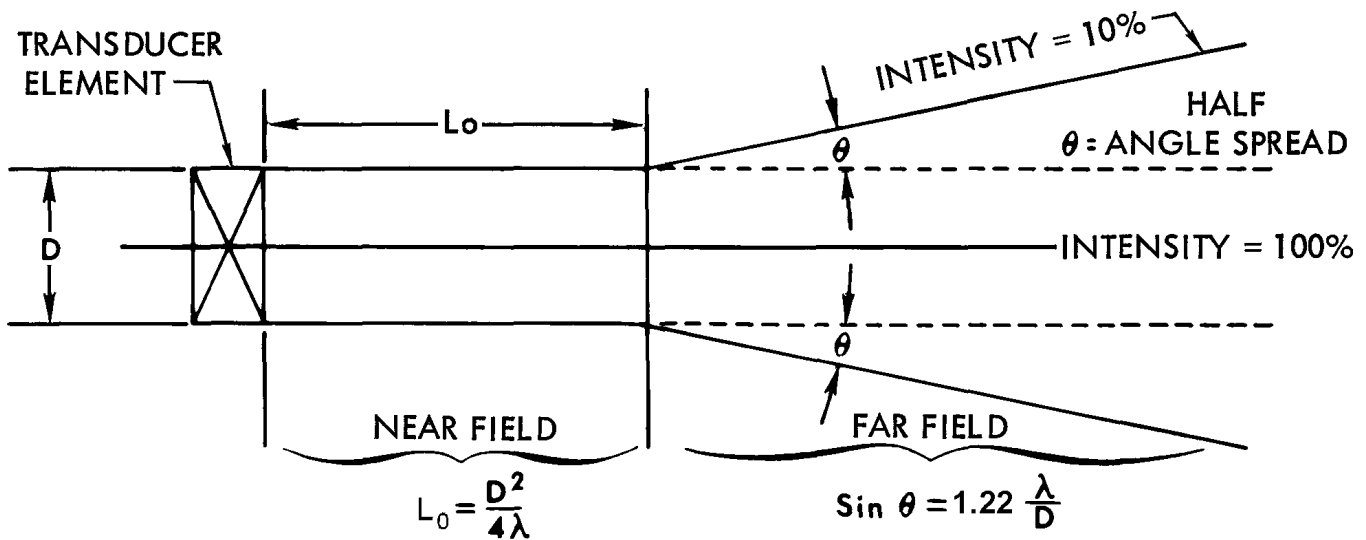
element; however, the element will also respond at other frequencies. The transducer response to these other frequencies is controlled by its internal construction. Modern instruments are designed to be operated in either narrow band or broadband modes to accommodate a variety of transducers. A broad bandwidth means better resolution; and a narrow bandwidth means greater sensitivity. Ultrasonic systems are generally designed with respect to bandwidth to provide a reasonable compromise between resolution and sensitivity.

5.2.6 Sound Beam Characteristics. The sound beam does not propagate uniformly through the volume defined by the straight-sided projection of the transducer face. Side lobes exist along the outer edges of the beam near the transducer face, and sound intensity is not uniform throughout the beam.

5.2.6.1 Dead Zone. During contact testing (paragraph 5.4.2.1.1.1), there is test specimen thickness beneath the transducer in which no useful ultrasonic inspection can take place. This region is defined as the dead zone. When a transducer is excited, it vibrates for a finite amount of time during which it cannot act as a receiver for a reflected echo. Reflected signals from defects located in the dead zone arrive back at the transducer while it is still transmitting. A dead zone is inherent in all ultrasonic equipment. In some ultrasonic inspection equipment, the transmitted pulse length can be electronically shortened, effectively making the dead zone shallower, but it cannot be eliminated. The dead zone length can be estimated experimentally.

5.2.6.2 Near Field. Extending from the face of the transducer is an area characterized by wide variations in sound beam intensity. These intensity variations are due to the interference effects of spherical wave fronts emanating from the periphery of the transducer crystal. The region where this interference occurs is called the near field (Fresnel Zone) (Figure 5-8). Due to inherent amplitude variations, inspection within the near field is not typically recommended. The equation for calculating the length of the near field is located in (paragraph 5.7.4).

The smaller the transducer element diameter or the lower the frequency, the shorter the near field will be. Due to inherent amplitude variations, inspection within the near field is not recommended without careful calibration on reference flaws within the near field.



H0402820

Figure 5-8. Schematic Presentation of Sound Beam

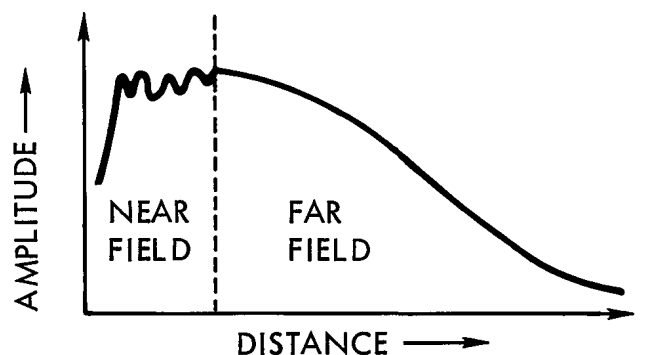
5.2.6.3 Far Field. At distances beyond the near field there are no interference effects. This region is called the far field (Fraunhofer Zone) (Figure 5-8). Most ultrasonic inspection procedures are designed to occur in the far field. The intensity of the sound beam in the far field falls off exponentially as the distance from the face of the transducer increases.

5.2.6.4 Distance Versus Amplitude.

NOTE

The important thing to remember is, wide variations in amplitude from discontinuities can occur when inspecting in the near field.

It is always best to compare discontinuity signals with signals from reference standards, such as flat-bottom holes having the same metal travel distance as the discontinuity. A typical curve showing the amplitude response versus distance from the transducer face is shown (Figure 5-9).



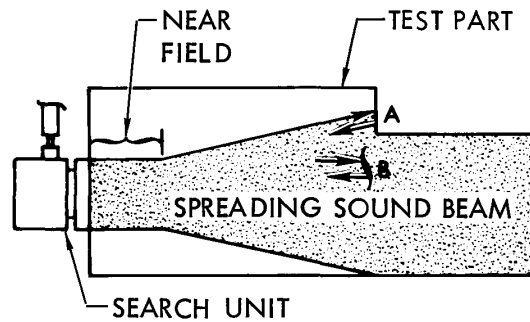
H0402823

Figure 5-9. Amplitude Response Curve of Typical Transducer

5.2.6.5 Beam Spread. In the near field, the sound beam essentially propagates straight out from the face of the transducer. In the far field, the sound beam spreads outward and decreases in intensity with increasing distance from the transducer face as shown in (Figure 5-9). Beam spread is an important consideration because in certain inspection applications the spreading sound beam may result in erroneous or confusing A-scan presentations. The formula for calculating the half-angle of the beam spread is located in (paragraph 5.7.5).

5.2.6.5.1 Beam spread is important to consider because in certain inspection applications the spreading sound beam may reflect off of walls or edges and cause confusing signals on the A-scan presentation (Figure 5-10).

T.O. 33B-1-1

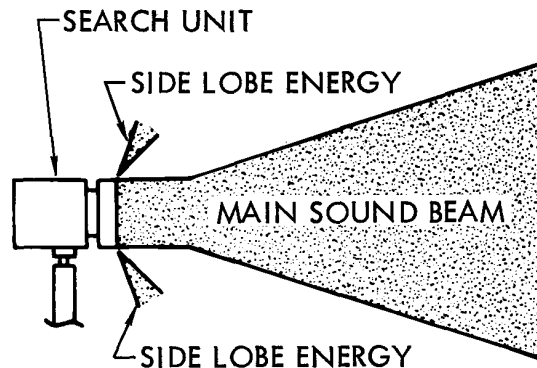


NOTE:
THE BEAM SPREAD CAUSING THE RE-
FLECTION FROM THE WALL AT A
COULD MASK THE REFLECTED SIGNAL
FROM THE DISCONTINUITY AT B.

H0402824

Figure 5-10. Example of Beam Spread Causing Confusing Signals

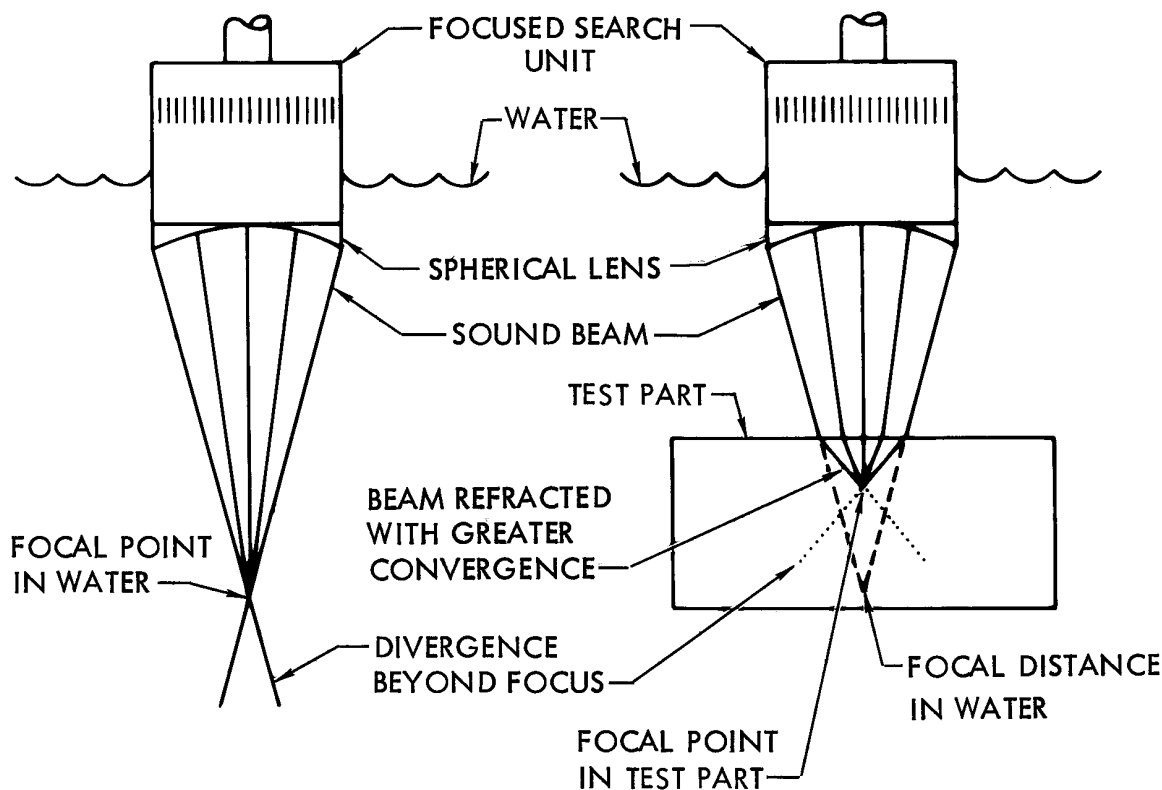
5.2.6.5.2 In addition to the main sound beam pattern discussed above, there is also a small amount of side lobe energy (Figure 5-11). Some of the effects of this side lobe energy are discussed in (paragraph 5.5.3.1). Another adverse affect of side lobes, is a reduction in the efficiency of the transducer. Due to the interference created by the side lobes, the actual useable width of a sound beam near the face of the transducer is less than the actual width of the piezoelectric element (Figure 5-11).



H0402825

Figure 5-11. Main Sound Beam and Side Lobe Energy

5.2.6.6 Focused Sound Beams. On some immersion inspections (paragraph 5.4.2.1.1.2) or special contact tests with a water delay column, a focused sound beam is used (Figure 5-25). As shown in (Figure 5-12), the focusing is produced by using a transducer containing a plastic acoustic lens on the face of the transducer element. The acoustic lens causes the sound beam to converge as the sound travels away from the transducer. Due to refraction at the plastic-water interface, a peak in amplitude is obtained at the focal point. The amplitude decreases rapidly on each side of this point. This type of transducer has a high sensitivity for discontinuities located at the focal point distance due to the concentration of energy at this focal point, but the depth of material inspected in any one scan is limited. Beam shaping, which “tucks in” the side lobes can also be accomplished by using an acoustic lens without creating a focused transducer.



NOTE:
 DUE TO THE REFRACTION AT THE WATER TO TEST PART INTERFACE,
 THE FOCAL DISTANCE IS SHORTENED IN THE TEST PART .

H0402826

Figure 5-12. Focused Sound Beams

5.2.6.7 Beam Intensity. Beam intensity is the sound wave energy transmitted through a unit cross-sectional area of the beam. The intensity is proportional to the square of the acoustic pressure exerted in the material by the sound wave. The acoustic pressure is directly related to the amplitude of the material particle vibrations caused by the sound wave. Transducer elements sense the acoustic pressure of the reflected sound wave and convert it to an electrical voltage. Ultrasonic instrument receiver-amplifier circuits receive the input voltage from the transducer and produce an output voltage value proportional to the intensity of the reflected sound. This output voltage is typically displayed on the instrument display as an A-scan signal.

5.2.6.8 Attenuation. Attenuation is the loss in acoustic energy that occurs between any two points of travel. The amount of loss is measured in decibels, but direct measurement of material attenuation can be very difficult. Beam attenuation occurs due to many factors that include absorption, scattering, diffraction, beam spread, geometry of the part, or other material characteristics.

T.O. 33B-1-1

SECTION III ULTRASONIC INSPECTION EQUIPMENT AND MATERIALS

5.3 INTRODUCTION.

5.3.1 Ultrasonic Instruments.

5.3.1.1 General Description. Ultrasonic equipment performs the functions of generating, receiving, and displaying pulses of electrical energy, which have been converted to and from pulses of ultrasonic energy by a transducer attached to an instrument. All portable ultrasonic equipment consists of a power supply, a clock circuit, a pulser, a sweep circuit, a transducer, a receiver-amplifier circuit, and an instrument display. By properly adjusting an instrument an operator can measure the amplitude of displayed pulse signals and determine the time/distance relationships of the received signals. Detailed instructions for operation of individual models SHALL be obtained by consulting the operating and maintenance manual for the specific instrument being used.

5.3.1.2 Scanning Equipment. Many applications lend themselves to either automated, or semi-automated scanning techniques. Most scanning applications are computer controlled and can result in A-scan, B-scan, or C-scan outputs. Scanning equipment ensures full coverage of the inspection zone and can be accomplished at resolutions unobtainable by manual scanning. Scanning mechanisms come in many levels of sophistication. Two-axis scanners can be manually manipulated or computer-automated to any extent. Large gantry-based immersion or “squirter” systems have up to 16 or more axes and offer full-contour scanning of complex shapes.

5.3.1.3 Physical Characteristics of Instrument Controls. The physical nature of the instrument controls varies with the type and age of the instrument. Older instruments have rotary knobs for fine adjustments, slide switches for coarse adjustments, and screwdriver rotary controls for infrequent adjustments, of waveform position and visibility. Newer instruments have push buttons or a sealed membrane keypad, both to select the desired control from a displayed menu and to make the respective adjustments. Alternatively, some menu driven instruments have a single rotary (“smart”) knob for making adjustments after a control has been selected from the menu.

5.3.1.4 Waveform Display Controls. An ultrasonic instrument may have one of several types of waveform displays; traditional cathode ray tube (CRT), liquid crystal display (LCD), or electroluminescent display (EL). Controls affecting the waveform display are discussed below.

5.3.1.4.1 Scale Illumination.

CAUTION

If the intensity of a CRT is allowed to remain at a high level for long periods, it is possible to permanently burn the display.

The horizontal and vertical scales are illuminated in various ways. On some instruments, the scales are scribed on the faceplate and cannot be illuminated. On a CRT, the brightness control for the scales may be integrated with a rotary power switch or a separate control. Other types of display may simply have an on/off switch for illumination control.

5.3.1.4.2 Waveform Positioning Controls. The events in an ultrasonic inspection are related to time referenced to the pulses produced by the instrument. Pulses or signals will be represented along a horizontal line (typically called the sweep or baseline) at the bottom of the screen. Time starts at the left end of the sweep and progresses to the right. The sweep, included within the “frame” (Figure 5-13), is a visual presentation of a portion of the time base. The following typical controls are used to properly align the baseline on the display screen. These two adjustments are generally not required on digital display flaw detectors.

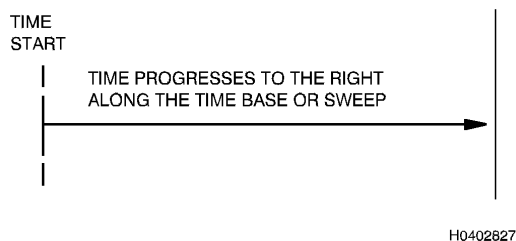


Figure 5-13. Time Base

5.3.1.4.2.1 Horizontal Position. The horizontal position control should be adjusted so that the horizontal baseline (sweep) begins at the left edge of the display.

5.3.1.4.2.2 Vertical Position. The vertical position control should be adjusted so the horizontal time base is at zero position of the vertical scale.

5.3.1.4.3 Type of Waveforms.

5.3.1.4.3.1 Radio-Frequency (RF) Display, (Non-rectified). This type of waveform has the baseline at 50-percent of full screen height and shows the full waveform with both the positive and negative peaks. This type of waveform contains all of the signal information and is often used during procedure development to decide which waveform display is best suited for a particular inspection.

5.3.1.4.3.2 Full-Wave (FW) (Rectified Video Display). This type of waveform shows the positive peaks and the negative peaks, but the negative peaks are reversed and made positive.

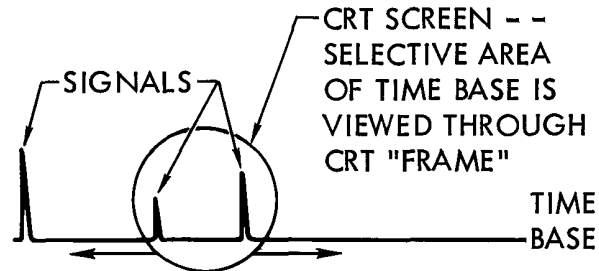
5.3.1.4.3.3 Positive Half-Wave (HW+ or HWP) (Rectified Video Display). This type shows only the positive peaks.

5.3.1.4.3.4 Negative Half-Wave (HW- or HWN) (Rectified Video Display). This type shows only the negative peaks.

5.3.1.4.4 Video Filtering. Some instruments provide varying degrees of filtering of the rectified waveforms. Filtering smoothes out the waveform, but some loss of information occurs. With minimum filtering, the presentation has greater resolution and signal definition. Video filtering MAY affect the vertical linearity of the instrument.

5.3.1.4.5 Sweep Delay. The sweep delay control determines what part of the time base is viewed on the display. An area circled to frame the portion of the time base that an inspector wants to view is shown (Figure 5-14) on the instrument display. Adjustments to the sweep delay move the frame to the desired portion of the time base, that is, sweep delay delays the start of the sweep with respect to the start of the time base.

T.O. 33B-1-1



SWEEP DELAY CONTROLS THE POSITION OF THE CRT "FRAME" ALONG THE LENGTH OF THE TIME BASELINE.

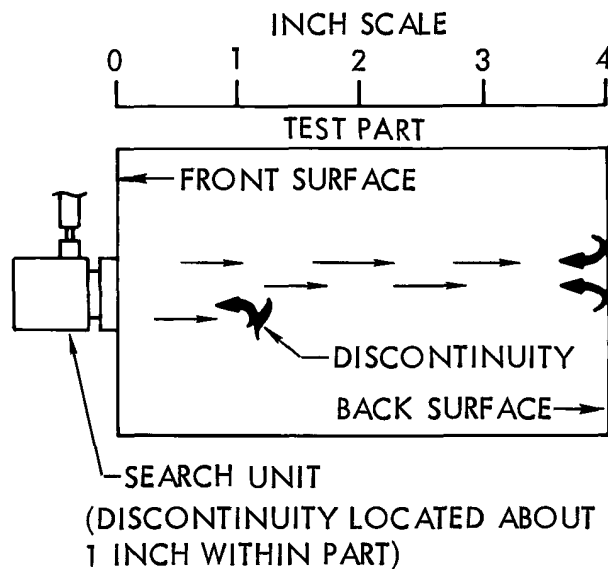
H0402828

Figure 5-14. Relationship of CRT Sweep to Time Base

5.3.1.4.5.1 To see how the sweep delay works, consider the inspection shown in (Figure 5-15). Under certain control settings (e.g., immersion testing) (paragraph 5.4.2.1.1.2), an instrument with a CRT might have a sweep appear as in (Figure 5-16) showing only the front surface and discontinuity signals. By adjusting the sweep delay to move the "frame" to the right along the time base, the display shown in (Figure 5-17) is obtained.

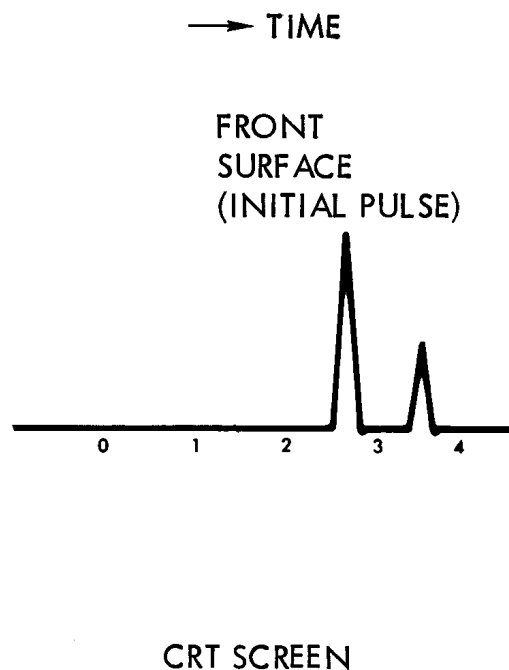
NOTE

The front surface signal now appears on the far left, and the back surface signal can now be viewed also. The distance between the front surface and the discontinuity signals has not changed from (Figure 5-16).



H0402829

Figure 5-15. Ultrasonic Contact Inspection



H0402831

Figure 5-16. Display Screen Before Adjusting Sweep Delay

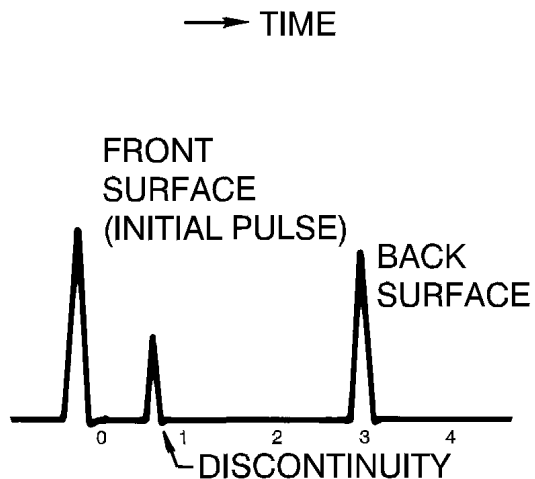
5.3.1.4.6 Sweep Length/Range. The sweep length (range) control determines how much time/distance is represented by the sweep on the display. If the range is adjusted to decrease the time/distance represented, the spacing between the signals will increase. The range control is used to calibrate the time base to specific distances for measurement purposes. In (Figure 5-17), if the sweep length/range is adjusted to decrease the time/distance represented (the sweep length/range), the spacing between the signals will increase, as seen in (Figure 5-18).

NOTE

The front surface signal did not move; only the distances between the front surface signal and the other signals increased.

5.3.1.4.6.1 Referring back to (Figure 5-15), the 4-inch length of the test part and the 1-inch depth of the discontinuity are represented by the signals in (Figure 5-18) at “4” and “1” respectively. In other words, the sweep length/range control is used to calibrate the time base to the test part using the horizontal scale on the display.

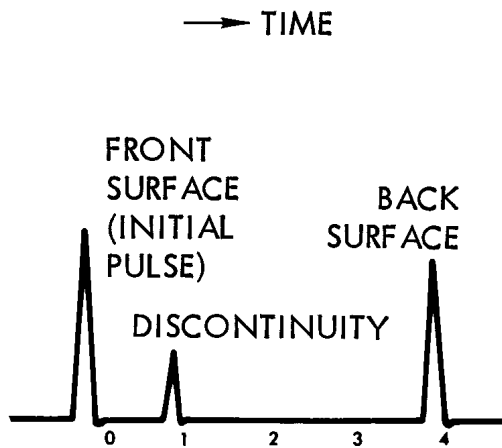
T.O. 33B-1-1



CRT SCREEN

H0402832

Figure 5-17. Display Screen After Adjusting Sweep Delay



CRT SCREEN

H0402833

Figure 5-18. Effect of Sweep Length on CRT Display

5.3.1.4.7 Zero Offset (Zero). A zero offset (zero) control is a fine-delay control used to compensate for transducer face-plate wear. In angle beam inspections with a wedge, or straight beam inspections with a delay line, this control can be used to compensate for the distance the sound beam travels in a plastic wedge or delay line. Essentially, it allows the inspector to set “time zero” for electronic distance calculations to the exact instant the sound pulse enters the part.

5.3.1.4.8 Velocity. The velocity control allows the inspector to enter the material velocity of the material under inspection. By entering the velocity in conjunction with proper range and delay settings, the horizontal scale of the display will be automatically calibrated to provide the depth of any discontinuity detected in that particular test part.

5.3.1.5 Pulser Controls. When electronically triggered by the clock circuit, the pulser sends a high voltage spike to the transducer producing the initial pulse. Adjustments of the following pulser controls (if permitted by procedure) can be made to more clearly define the discontinuity indications.

5.3.1.5.1 Pulse Repetition Rate (Rep Rate or PRR). The pulse repetition rate is the actual number of trigger pulses produced per second and is controlled by the clock circuit. Typical rates are 300 to 2000 pulses per second. Typically, the higher the rate, the faster the scanning speed can be while still maintaining the required sensitivity. The maximum rep rate is the rate beyond which unattenuated echo signals occur on the display from an earlier pulse; this is called “wrap around” or “ghost” signals. These signals can be recognized by the occurrence of unexplained signals on the display which disappear if the rep rate is decreased while the transducer is held motionless on the test part. Some instruments include an automatic override to set the rep rate at a reduced value if the inspector tries to set it manually above a value compatible with the sweep settings.

5.3.1.5.2 Pulse Controls. On some instruments, the following controls are automatically set to default values when a new setup is initiated or when other interactive controls are adjusted. Adjustments of the following controls (if permitted) MAY be made to more clearly define the discontinuity indications.

NOTE

Minimum pulse length, (maximum damping) is obtained with the load resistance as small as possible for the circuitry. Load resistance selections may range from 16 ohms for maximum damping to 500 ohms for maximum pulse length (minimum damping).

5.3.1.5.2.1 Pulse Length (Damping). The pulse length (damping) control is used to adjust the time duration of the high-voltage spike pulse applied to the transducer. A higher damping value (shorter pulse length) provides the best near-surface resolution. A lower damping value (longer pulse duration) may provide more penetrating power for highly attenuative materials, such as rubber and concrete. The length of the initial pulse SHOULD be kept to a minimum, and increased only to gain signal strength when required; excessive pulse length can obscure signals from discontinuities close to the inspection surface (poor near-surface resolution).

5.3.1.5.2.2 Pulse Voltage. This control determines the amplitude of the generated initial pulse. Some instruments have incremental voltage adjustments; for example, from 40 to 400-volts in 5-volt increments. Other instruments have adjustments for only low, medium, or high voltages.

5.3.1.5.2.3 Pulse Width. Some instruments generate a square pulse as opposed to a spike pulse. The pulse width control sets the width of the square pulse, usually in nanoseconds. The effect of the pulse width is similar to the damping control, although the electronic nature of each is different.

5.3.1.6 Receiver Controls.

5.3.1.6.1 Receiver Gain. The gain control is used to adjust the amplitude (height) of signals on the waveform display. A positive increase in the gain control will increase the amplitude of the signals; however, on a few instruments the control is actually an attenuation control, with which a positive adjustment will decrease the amplitude of the signals. Some instruments will have both gain and attenuation controls. On most instruments, the gain control is calibrated in terms of the decibel (dB). The decibel is used to express the relationship between two signal amplitudes:

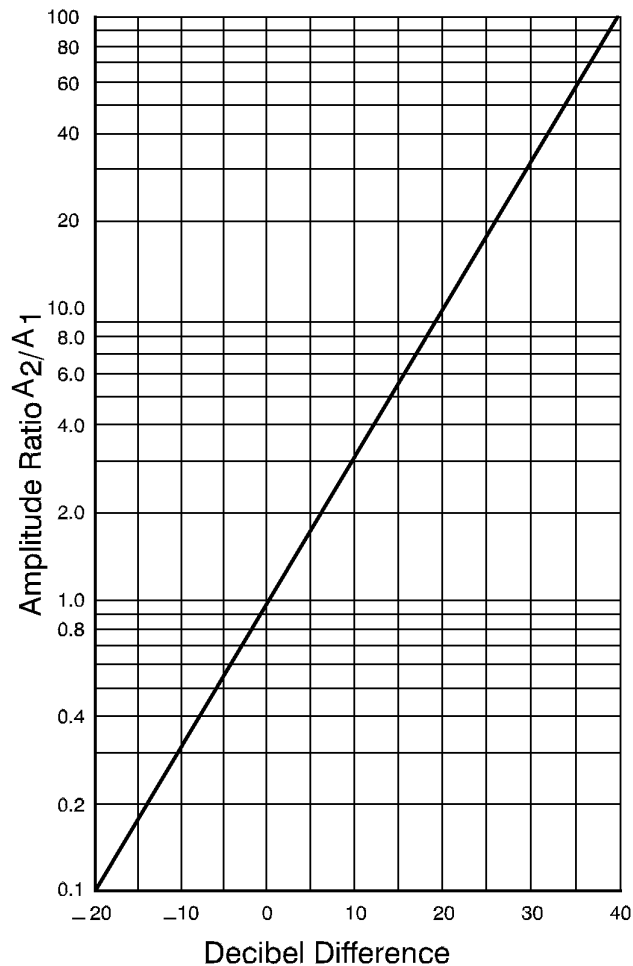
$$\text{dB} = 20 \log_{10}(A_2/A_1)$$

where:

A_2 and A_1 are the two amplitudes that are being compared.

T.O. 33B-1-1

5.3.1.6.1.1 For every 6 dB increase, the amplitude of a signal doubles. Thus, with an 18 dB increase, a signal would have eight times the original amplitude. Conversely, the signal amplitude is cut in half with a decrease of 6 dB. The relationship of dB to the amplitude ratio is shown in (Figure 5-19).



H0402834

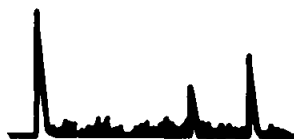
Figure 5-19. Decibel-to-Amplitude-Ratio Conversion Chart

5.3.1.6.2 Reject.

CAUTION

The REJECT control SHALL NOT be set at or above the rejectable signal threshold because this will cause defects to be missed.

The reject control is used to attenuate irrelevant low-level signals and noise on the waveform display. This often permits easier interpretation of echo signals, but can also obscure wanted signals if applied inappropriately. Most new instruments have linear reject controls which eliminate the low-level signals without affecting the amplitude of the relevant echo signals. The effect of the linear reject control is illustrated in (Figure 5-20).



WITHOUT REJECT



NOTE
WITH REJECT - SMALL BASE
LINE SIGNALS HAVE BEEN
CLIPPED OFF PRESENTING
A CLEANER BASELINE

H0402835

Figure 5-20. Reject Control

5.3.1.6.3 Frequency. The Frequency control allows the inspector to select the frequency corresponding to a transducer or to select the broadband mode to cover all frequencies. The selection that gives the best echo signal is normally used.

5.3.1.6.4 Single/Dual Transducer. This control configures the transducer-cable receptacles for single-element transducer, dual-element transducer, or two separate transducers (through-transmission) inspection. The Dual position of the control is used for both dual-element-transducer and two-transducer inspections; in these cases, some instruments specify one receptacle as transmitter and the other as receiver. For single-element-transducer inspections, only one receptacle is used. Consult the instrument manual or procedure for the appropriate use of the connectors.

5.3.1.6.5 Electronic Distance Amplitude Correction (DAC). Distance Amplitude Correction (DAC) MAY also be called STC (Sensitivity Time Control), TCG (Time Corrected Gain), TVG (Time Varied Gain). DAC electronically compensates for material attenuation. Attenuation typically results in decreasing amplitude echoes from equal-size reflectors located at increasing travel distances from the transducer. After DAC is applied over a particular thickness, all the echoes from reflectors of equal size and in the same orientation within that thickness, will be displayed at the same amplitude.

5.3.1.7 Flaw Gates. A gate is an electronic feature that allows an inspector to monitor for discontinuities within specific zones of the test part. A gate appears on the display as a short horizontal sweep segment above the baseline. The gate can be adjusted so any signal that appears within the limits of the gate will energize an audible or visual alarm alerting the inspector to a possible flaw that needs to be investigated further. Controls for the gate on the display are as follows.

T.O. 33B-1-1

5.3.1.7.1 Gate Start. This control is used to adjust the location of the leading edge of the gate on the display.

5.3.1.7.2 Gate Width/Length. This control is used to adjust the width of the gate or the location of the trailing edge of the gate.

5.3.1.7.3 Threshold/Alarm Level. This control adjusts the vertical position of the gate trigger level (accept/reject level). A positive gate is defined when a signal triggers the gate as it exceeds the threshold level. A negative gate is defined when a signal triggers the gate as it falls below the threshold level. Negative gates are typically used in back wall procedures, following inspection techniques. Only signals that exceed the level of the gate cause an alarm or a record to be made.

5.3.2 Transducers.

CAUTION

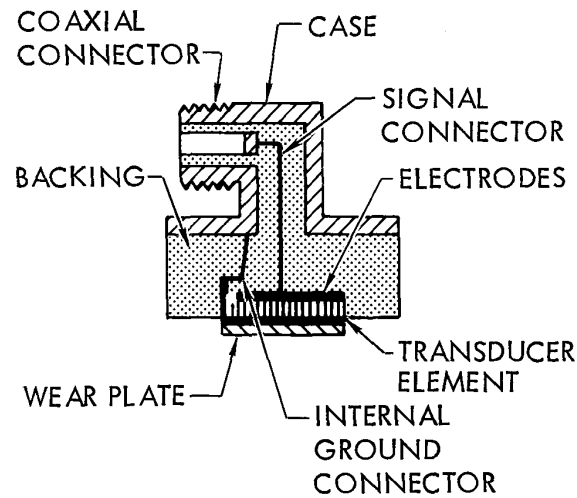
Transducers are fragile and SHALL be handled with care. Sharp blows, caused by dropping or banging a transducer against a surface, could cause extensive damage.

5.3.2.1 General Description. Transducers serve to convert electrical energy received from the ultrasonic instrument pulser into acoustic energy through the use of piezoelectric elements. The acoustic energy enters the test piece and returns to the transducer where it is converted back to electrical energy and returned to the ultrasonic instrument for display. Transducers are available in a great variety of shapes and sizes.

5.3.2.2 Transducer Construction. The schematic in (Figure 5-21) shows the basic parts of a typical straight beam transducer used for contact inspection, while (Figure 5-22) schematically shows an angle beam transducer. The backing material, shown in (Figure 5-21), serves to damp the ringing of the transducer element after it is excited. This affects the resolution of an inspection as explained in (paragraph 5.2.1.2). The plastic wedge, serves to transmit longitudinal waves to the test part surface where mode conversion occurs. Refracted longitudinal, shear, or surface waves (depending on the angle of the plastic wedge) are generated in the test part.

5.3.2.3 Types of Contact Transducers. Contact transducers are typically hand-held and manually scanned in direct contact with the inspection piece. A couplant material is required to ensure sound transmission between the transducer and the test piece.

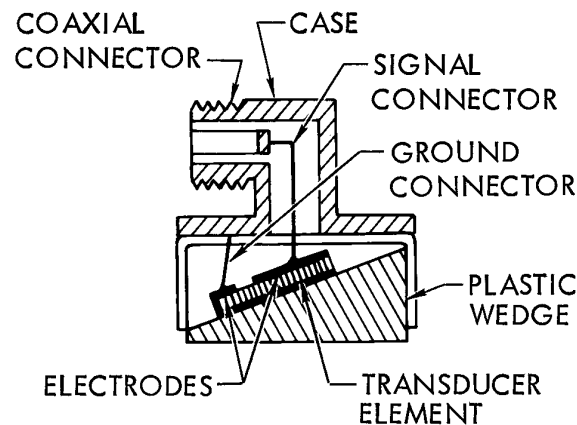
5.3.2.3.1 Straight Beam. Straight beam transducers are used to launch longitudinal sound beams into a test piece and can be used singularly in a pulse-echo scenario or in tandem for through-transmission or pitch-catch techniques. Typically straight beam transducers are used in a pulse-echo mode detecting laminar discontinuities with surfaces lying parallel with the inspection surface. The basic parts of a typical straight beam transducer used for contact inspection are schematically shown in (Figure 5-21).



H0402836

Figure 5-21. Straight Beam Contact Transducer

5.3.2.3.2 Angle Beam. Angle beam transducers are used to launch shear wave sound beams into a test piece and are typically used in a pulse-echo scenario. Typical uses for angle beam transducers include tube, plate, or pipe welds or anywhere there is a need to launch a sound wave at other than parallel to the test piece surface. An angle beam transducer is schematically shown in (Figure 5-22). The plastic wedge serves to transmit longitudinal waves to the test part surface where mode conversion occurs. Refracted longitudinal, shear, or surface waves (depending on the angle of the plastic wedge) are generated in the test part.



H0402837

Figure 5-22. Angle Beam Contact Transducers

5.3.2.4 Transducer Sensitivity and Resolution.

5.3.2.4.1 Sensitivity. Sensitivity is the ability of an inspection system to detect small discontinuities. It is generally rated by the ability to detect a specified size and depth of a flat-bottom hole in a standard test block. Sensitivity is unique to each

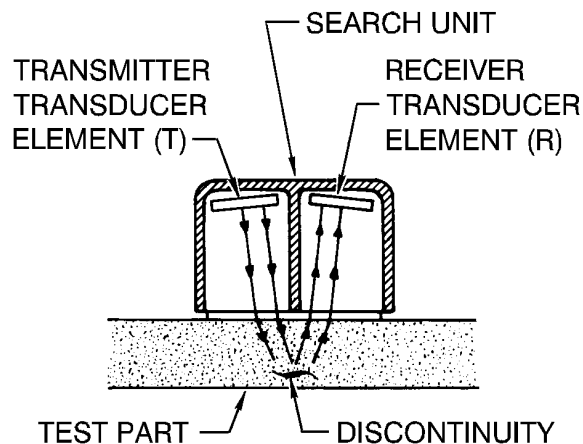
T.O. 33B-1-1

combination of transducer and test instrument. The ability to detect small discontinuities is typically increased by using a higher frequency (shorter wavelength) although penetrating power is sacrificed.

5.3.2.4.2 Resolution. Resolution refers to the ability of an inspection system to separate (distinguish) signals from two interfaces close together in depth. An example of two such signals is the front surface signal and the signal from a small discontinuity just beneath the surface. The damping or backing material affects the time required for the transducer to stop “ringing” after being excited by a pulse from the test instrument. Low damping causes high “ringing” resulting in a wide, high-amplitude front surface signal. This would cause a long dead zone and a subsequent loss of resolution. Generally, resolution improves with a higher frequency.

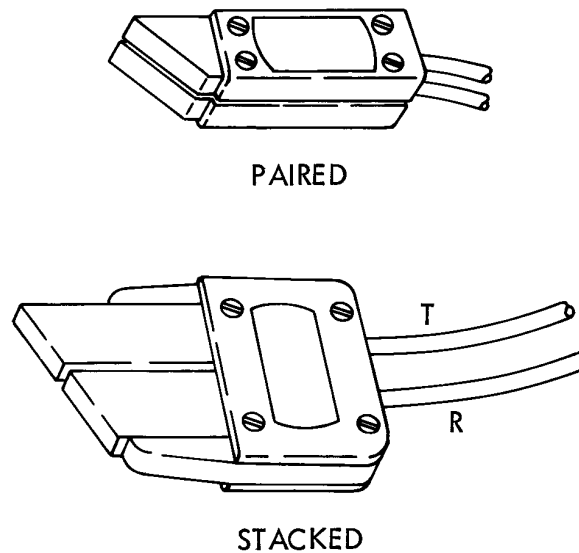
5.3.2.5 Transducer Shape and Size. The variety of sizes and configurations of transducers that can be used is almost endless. Transducer faces can be round or rectangular. Transducers 1/8-inch diameter and smaller have been used.

5.3.2.6 Dual Transducers. Dual transducers are used primarily in applications where good near-surface resolution is required. Ultrasonic thickness measurement instruments commonly use dual transducers. The operation of a typical dual transducer is shown in (Figure 5-23). The spaces under the transducer elements are usually filled with plastic material that serves as a delay line. Thus, the initial pulse does not interfere with any echoes from the near surface of the test piece. Dual transducers are also used in angle beam inspection. Two types of angle beam dual transducers are shown in (Figure 5-24).



H0402838

Figure 5-23. Dual Transducer Operation



H0402839

Figure 5-24. Angle Beam Dual Transducers

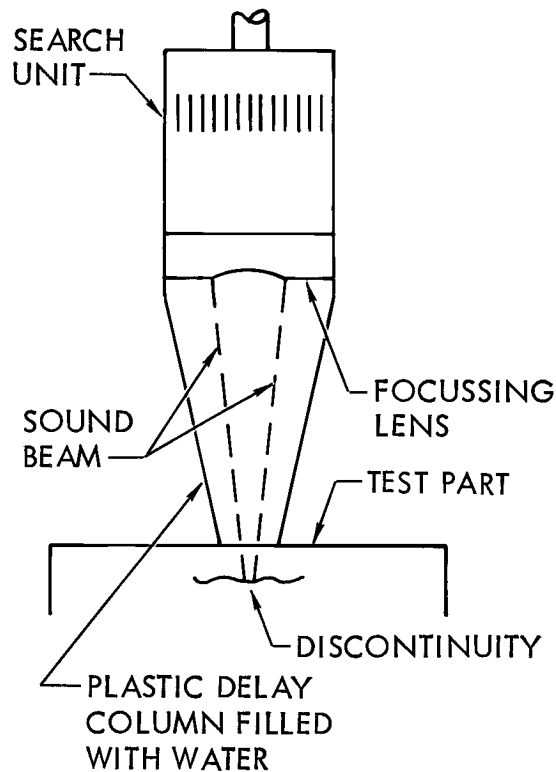
5.3.2.7 Wear Faces. Transducers are often fabricated with removable plastic or rubber wear faces. These faces improve coupling on rough surfaces and prevent wear of the transducer face; however, the flexible wear faces reduce the amount of power available from the transducer.

5.3.2.8 Delay Lines. A transducer may have a solid, or a fluid delay line. Delay lines move the part surface out of the dead zone, thereby improving near-surface resolution. Because of the increased resolution, delay lines are used extensively for thickness measurements and other applications that require a high degree of resolution.

5.3.2.8.1 Solid Delay Line. A solid delay line may be an integral part of the transducer or may be removable. An integral delay line is bonded to the transducer element. A removable delay line requires a couplant between it and the transducer face. Various lengths of removable delay lines can be interchanged and can be replaced when worn.

5.3.2.8.2 Fluid Delay Line. Some transducers are equipped with water delay columns. The water column also permits the use of focused transducers. The delay line can either have an open bottom requiring a rapid flow of water to maintain coupling, or it can be equipped with a thin membrane at the bottom. This form is common in large automated scanning systems. The membrane is usually punctured in the middle to provide a slow flow of water for coupling. Water delay lines with flowing water are also called “bubblers” or “squirters.” A variety of sizes are used. Fluid delay lines provide the same advantages in resolution as solid delay lines.

T.O. 33B-1-1



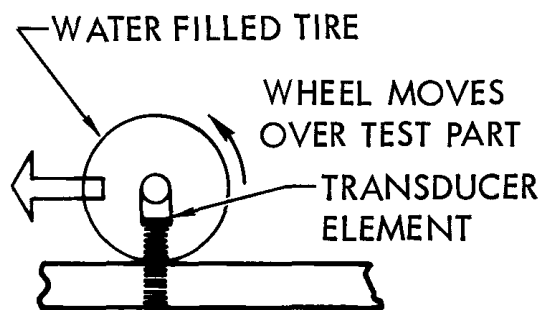
H0402840

Figure 5-25. Water Delay Column Transducers

5.3.3 Specialized Transducers.

5.3.3.1 Focused Beam. Some immersion probes or special contact probes have focused beams. As shown in (Figure 5-12), the focusing is produced by using a plastic acoustic lens on the face of the transducer element. The acoustic lens causes the sound beam to converge as the sound travels away from the transducer. Due to refraction at the plastic-water interface, a peak in amplitude is obtained at the focal point. The amplitude decreases rapidly on each side of this point. This type of transducer has a high sensitivity for discontinuities located at the focal point distance due to the concentration of energy at this focal point, but the depth of material that can be inspected in any one scan is limited.

5.3.3.2 Wheel Transducers. A wheel search unit operates much like an immersion probe and consists of a flexible tire filled with liquid and containing one or more transducer elements. As shown in (Figure 5-26), sound is transmitted through the liquid, the tire, and to the part through a thin couplant film between the tire and the part. Wheel search units can be used for straight beam and angle beam applications and are most advantageous for large area scanning of plate or other flat stock material.



H0402841

Figure 5-26. Wheel Transducer

5.3.3.3 Paint Brush or Array Probes. Large-area inspections can sometimes be made easier by use of a paint-brush probe. These probes are made up of an array of transducers or crystals in an extended length that allows a wide inspection area to be covered with one scan. The crystals that make up the array must be matched such that the beam intensity does not vary greatly over the length of the probe.

5.3.3.4 Collimators. Transducers can be equipped with collimators to reduce the size of the sound beam entering the test part. The collimator may be a solid cone (usually acrylic plastic) bonded to the face of the transducer. This type of collimator reduces the diameter of the sound beam entering the test part to the diameter of the tip of the cone. The cone also acts as a delay line and can result in better near surface resolution. However, this type of collimator reduces the energy entering the test part. Hollow cylindrical collimators **MAY** also be used in immersion inspections in which the collimator is attached to an immersion transducer to control the beam shape.

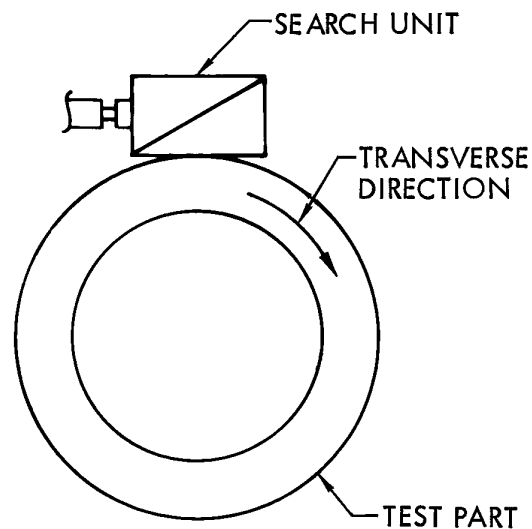
5.3.4 Wedges and Shoes. Wedges and shoes are used to adapt transducers for angle beam and surface wave inspections and for inspecting parts with curved surfaces. If flat probes are used on convex surfaces, the ultrasonic energy transmitted into the part is drastically reduced, because only the center of the transducer makes good contact with the part. Flat transducers of small size (1/4-inch or less diameter or width) can be used in some cases on convex surfaces down to 1.5-inch radius. However, loss of power results due to the smaller contact area. Inspections performed with flat-faced transducers on curved surfaces will be hindered by the tendency of the transducer to rock. This varies the angle of the incident and refracted sound beam and causes problems in interpretation.

5.3.4.1 Guidelines for Use of Curved Wedges and Shoes.

5.3.4.1.1 Wedges and shoes **SHALL** be used on all convex surfaces with a radius or curvature of 1.5-inches or less. They **SHOULD** be used on all convex surfaces with a radius or curvature between 1.5 and 4.0-inches.

5.3.4.1.2 Wedges and shoes **SHALL** be used on all concave surfaces with a radius of curvature of less than 4-inches.

T.O. 33B-1-1



NOTE

FLAT SURFACE OF SEARCH UNIT MAKES SEARCH UNIT UNSTEADY, COULD CAUSE ROCKING BACK AND FORTH. THIS CHANGES INCIDENT AND REFRACTED ANGLES.

H0402842

Figure 5-27. Angle Beam Inspection of Curved Surface Using Flat Transducer

5.3.4.2 Design and Fabrication of Wedges and Shoes.

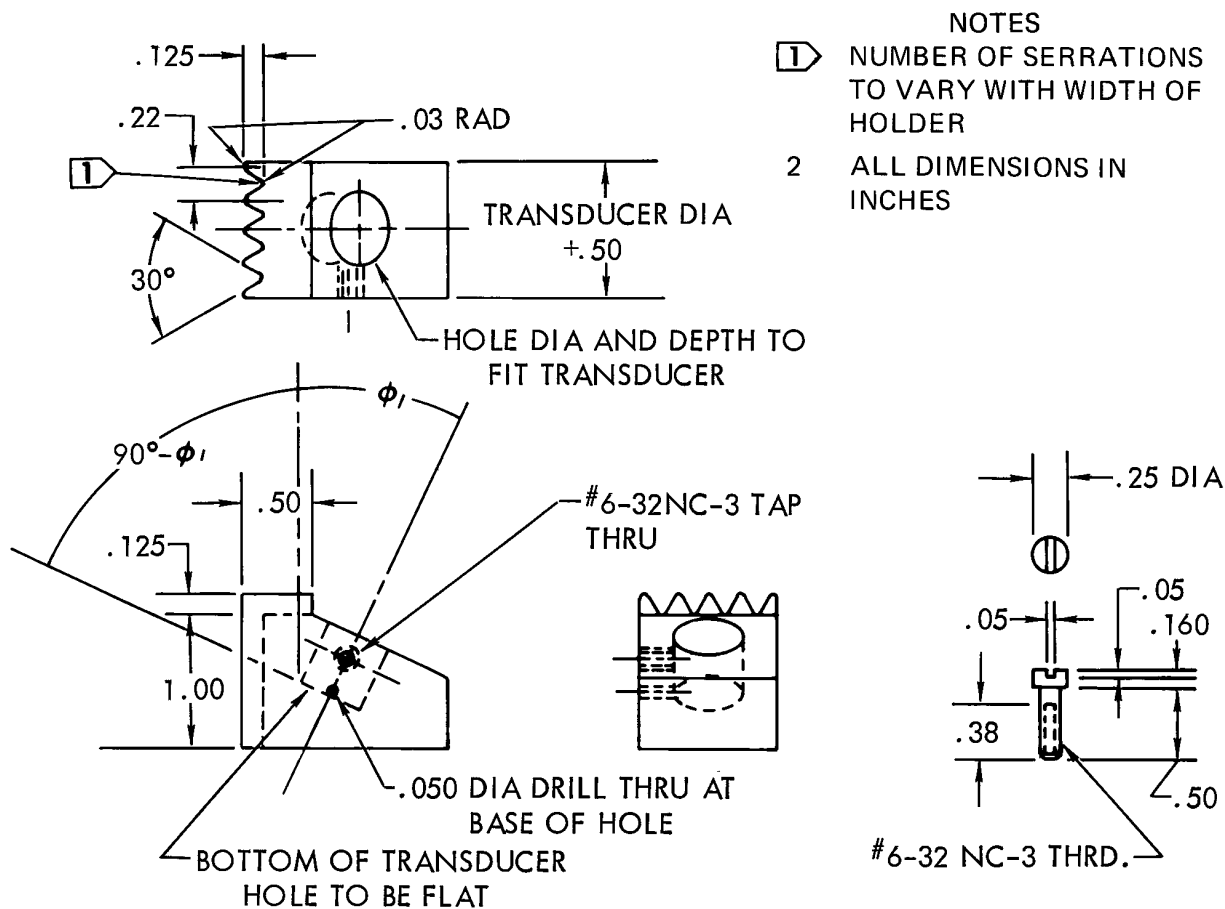
CAUTION

- Field units SHALL NOT manufacture shoes and/or wedges unless specifically directed by T.O. or other approved written procedure. If authorized, the procedure SHALL provide material requirements and detailed dimensional requirements.
- Excessive heat, generated during fabrication (machining or sanding), of acrylic plastic wedges and delay elements, MAY significantly increase the attenuation of ultrasound in this material.

5.3.4.2.1 Plastic wedges and shoes can be fabricated from Lucite, polystyrene, or other acrylic (Item Grade C plastic of Federal Specification L-P-391) plastics. Some plastics will scatter ultrasonic energy; so before using a plastic, a sample SHALL be checked to ensure sound can be adequately transmitted through the material. The sample SHALL be at least as thick as the wedge or shoe to be fabricated. Check the sample using a straight beam (paragraph 5.3.2.3.1) inspection and the highest frequency that will be used with the completed wedge or shoe, and note the back reflection signal. If a strong back reflection (at least 100-percent saturation) cannot be obtained with a reasonable gain setting, new material SHALL be procured and checked.

5.3.4.2.2 Angle beam wedges MAY be fabricated according to (Figure 5-28) or (Figure 5-30). The wedge in (Figure 5-28) has provisions built in for mounting the straight-beam transducer, while the wedge in (Figure 5-30) requires a coupling

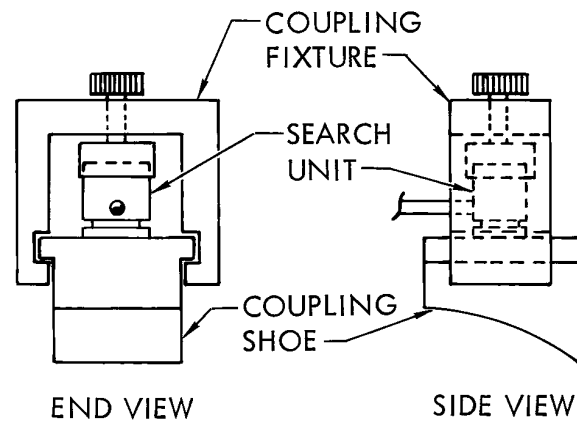
fixture (Figure 5-29) for mounting the straight-beam transducer. Similar fixtures MAY be procured or locally manufactured. The incident angle, " Φ_1 ", for each wedge SHALL be determined by using Snell's law and the respective velocities of the wedge, test material and the refracted angle, " Φ_2 ", required by the inspection procedure. Values for " Φ_1 ", calculated for listed refracted angles in materials are contained in (Table 5-7).



H0402843

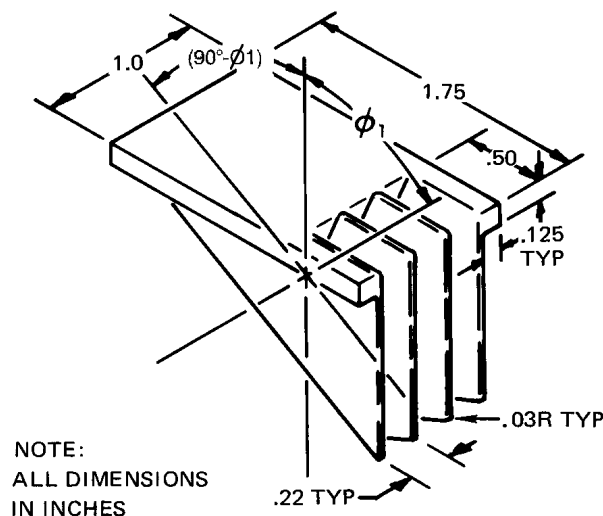
Figure 5-28. Angle Beam Wedge With Hole for Mounting Transducer

T.O. 33B-1-1



H0402862

Figure 5-29. Use of a Coupling Fixture to Hold Transducer on Shoe



H0402865

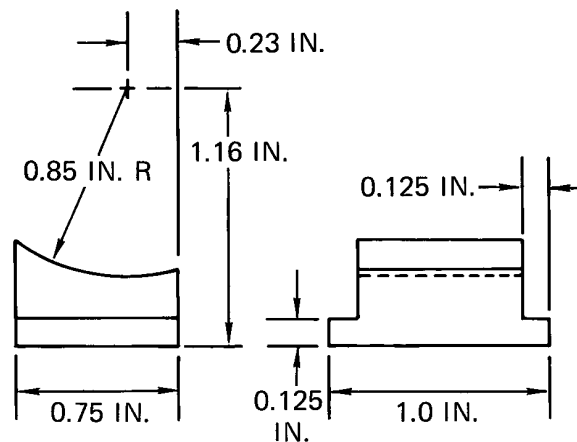
Figure 5-30. Angle Beam Wedge Requiring a Coupling Fixture

5.3.4.2.3 Notice the serrations on the wedges in (Figure 5-28) and (Figure 5-30). These serve to dampen and scatter reflected sound that does not initially enter the test part. The serrations, therefore, reduce false signals.

5.3.4.2.4 The configurations of the wedges in (Figure 5-28) and (Figure 5-30) MAY be modified as required to take care of special geometry situations. In all cases, wedges SHALL be fabricated to provide the proper refracted angle for the desired mode of vibration. In addition, they SHALL provide for transmission of sound into the test part at the locations required to cover the areas of suspected flaws.

5.3.4.2.5 Look at (Figure 5-29) to see how the coupling fixture is used with the wedge in (Figure 5-30). A few drops of couplant material is needed between the transducer and any wedge to ensure good sound transmission.

5.3.4.2.6 A typical shoe used for curved surfaces is shown in (Figure 5-31). This example MAY be used as a guideline for fabrication of shoes for curved surfaces. Dimensions MAY be changed to accommodate the specific part to be inspected.



NOTE
DIMENSIONS MAY BE CHANGED
TO ACCOMMODATE THE CONFIG-
URATION TO BE INSPECTED
AND PROVIDE THE PROPER
SOUND ENTRY ANGLES.

H0402864

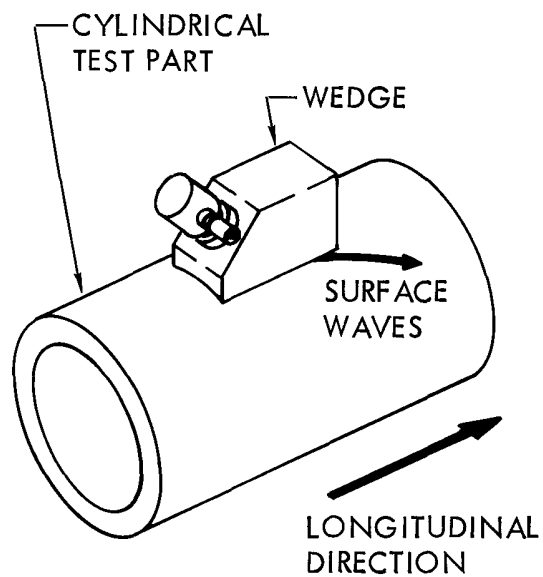
Figure 5-31. Typical Curved Surface

5.3.4.2.7 Although shoes for curved surfaces are usually fabricated from acrylic plastic, sometimes shoes are fabricated from the same material as the test part. When using shoes of the same test part material, the sound beam travels straight into the test part from the shoe; refraction does not occur.

5.3.4.2.8 The radius of curvature of each shoe **SHOULD** match the radius of curvature of the test part. Small changes in the curvature of the shoe can be accomplished on the test part by inserting number 400 or finer grit sandpaper between the shoe and the test part, and then sliding the shoe across the sandpaper. Major shaping of a shoe **SHOULD** be done in a machine shop, because the shoe cannot be held steady enough by hand.

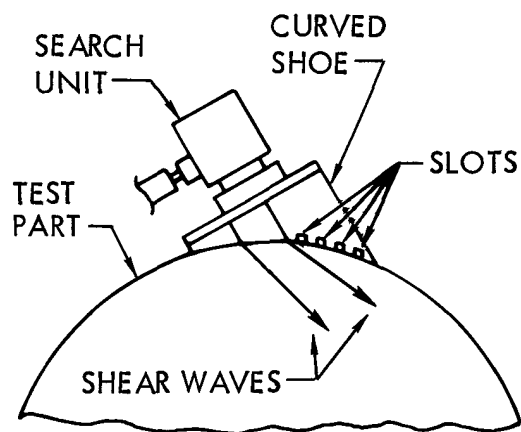
5.3.4.2.9 In some cases, when using plastic shoes for angle beam inspection on curved surfaces, the portion of the sound beam (away from the beam center) could produce unwanted longitudinal and/or surface waves as shown in (Figure 5-33). This effect increases with decreasing radii of curvature. Also, when using large angles (70° or larger) for inspecting cylindrical shapes in the longitudinal direction, interfering surface waves could be generated. These waves leave the shoe on both sides at an angle to the longitudinal direction (Figure 5-32). In these cases, it is not desirable to adapt the shoe to a close fit with the part. The shoe **SHOULD** be made so only the central portion of the beam centers the test part. As an option, slots **MAY** be cut in the bottom surface of the shoe. The slots **SHOULD** be oriented perpendicular to the direction of propagation of the unwanted surface waves and located away from the exiting beam center (Figure 5-34). The dimensions of the slots **SHOULD** be about 1/8-inch wide by 1/8-inch deep.

T.O. 33B-1-1



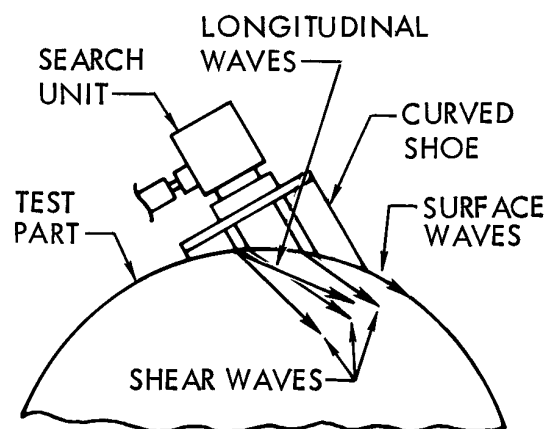
H0402866

Figure 5-32. Generation of Unwanted Surface Waves During Inspection of Cylindrical Part in the Longitudinal Direction



H0402867

Figure 5-33. Slots in Shoe to Eliminate Unwanted Surface Waves



H0402868

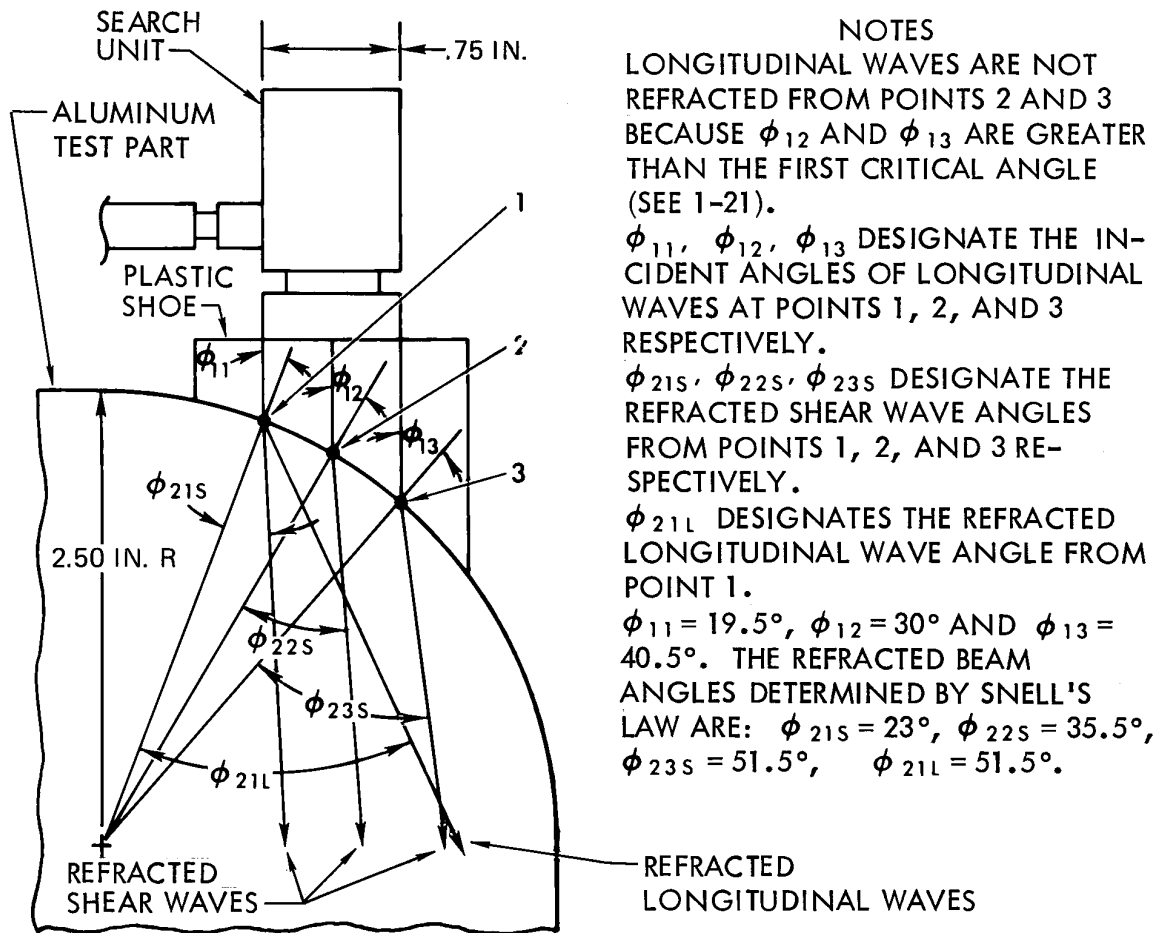
Figure 5-34. Generation of Unwanted Longitudinal and Surface Waves on Curved Surface

NOTE

Unwanted surface waves can be detected by noting additional unexpected signals on the waveform display. If these signals can be damped and traced to their source using an oil-wetted finger, as explained in (paragraph 5.4.6.4.3) c, unwanted surface waves are being generated.

5.3.4.2.10 When designing shoes for curved surfaces, the sound beam path in the shoe and the test part SHALL be considered in order to ensure coverage of the area of interest within the test part. Generally, the sound beam path in the shoe can be considered to be a straight projection of the transducer face; in almost all cases the sound travel in the shoes will be in the near field (paragraph 5.2.4.2) and (Figure 5-6) characterized by no beam spread. The beam path in the part can be obtained by using Snell's Law (paragraph 5.2.4.1) and (Figure 5-35) to determine the refracted angle at various points across the sound beam where it enters the test part surface.

T.O. 33B-1-1



NOTES

LONGITUDINAL WAVES ARE NOT REFRACTED FROM POINTS 2 AND 3 BECAUSE ϕ_{12} AND ϕ_{13} ARE GREATER THAN THE FIRST CRITICAL ANGLE (SEE 1-21).

ϕ_{11} , ϕ_{12} , ϕ_{13} DESIGNATE THE INCIDENT ANGLES OF LONGITUDINAL WAVES AT POINTS 1, 2, AND 3 RESPECTIVELY.

ϕ_{21S} , ϕ_{22S} , ϕ_{23S} DESIGNATE THE REFRACTED SHEAR WAVE ANGLES FROM POINTS 1, 2, AND 3 RESPECTIVELY.

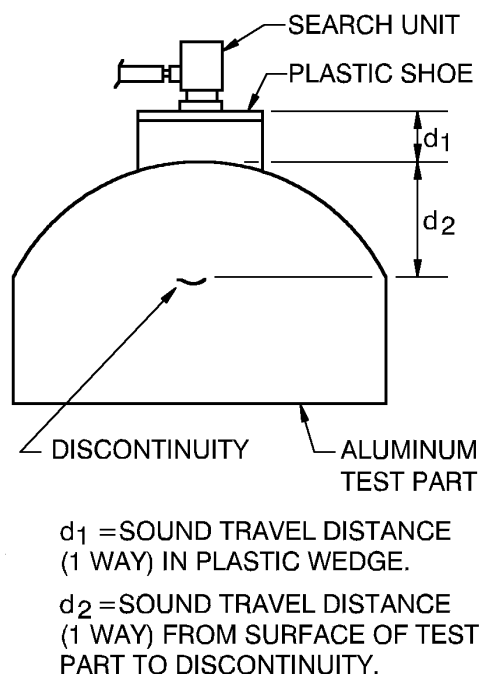
ϕ_{21L} DESIGNATES THE REFRACTED LONGITUDINAL WAVE ANGLE FROM POINT 1.

$\phi_{11} = 19.5^\circ$, $\phi_{12} = 30^\circ$ AND $\phi_{13} = 40.5^\circ$. THE REFRACTED BEAM ANGLES DETERMINED BY SNELL'S LAW ARE: $\phi_{21S} = 23^\circ$, $\phi_{22S} = 35.5^\circ$, $\phi_{23S} = 51.5^\circ$, $\phi_{21L} = 51.5^\circ$.

H0402869

Figure 5-35. Example of Determining the Sound Beam Path in a Test Part With a Curved Surface

5.3.4.2.11 With certain inspection setups, particularly when using shoes to generate straight beams (paragraph 5.3.2.3.1) in parts with curved surfaces, multiple reflections from the shoe-to-test part interface can interfere with the inspection. To avoid this, the shoe SHALL be made thick enough to avoid interference with the intended inspection application. Consider the inspection setup shown in (Figure 5-36). It is important only that the inspector be able to recognize and identify indications on the waveform display. Reflections caused by the shoe are easily recognized simply by raising the shoe off the surface of the material. If the indications remain on the screen, the plastic shoe is the cause. Slotting the shoe as shown in (Figure 5-33) may reduce or eliminate such interference signals. It is not necessary for the operator to calculate the sound paths to and from various reflectors; however, it is important the operator know how to recognize non-relevant indications from the reflectors and minimize their cause.



H0402870

Figure 5-36. Straight Beam Inspection of Test Part With Curved Surface

5.3.5 Couplants. Air is a poor transmitter of sound at the frequencies typically used for ultrasonic inspection. Therefore, to perform ultrasonic contact inspection (paragraph 5.4.2.1.1.1) the use of a couplant material is necessary to eliminate the air between the transducer and test piece interface.

CAUTION

“Ultragel” cannot be left on transducer/delay line interfaces for long periods of time because it will corrode the metallic finish of the transducer, seize the connecting ring and transducer housing causing the transducer to become unstable.

NOTE

Glycerin, silicones, and graphite greases SHALL NOT be used as couplants unless authorized by specific engineering approval.

5.3.5.1 Properties of Couplants. Couplant materials SHALL meet the following requirements:

- Couplant SHALL be able to wet both the face of the transducer and the test part.
- Couplant SHALL NOT be corrosive or toxic.
- Couplant can be applied and removed easily.
- Couplant SHALL be homogeneous and free of bubbles.
- Couplant SHALL be viscous (adhere well) enough to prevent rapid flow off the test part.

5.3.5.2 Types of Couplant. Typical couplant materials include water, oil, grease, commercial gels. For overhead or vertical surfaces, higher viscosity materials may be required. Wetting agents MAY be added to water to lower the surface tension aid in its adherence to the test piece. Water SHOULD be avoided on carbon steel components to prevent corrosion.

T.O. 33B-1-1

5.3.6 Inspection Standards. To ensure consistency of inspections from inspector to inspector many ultrasonic inspection techniques require the use of a reference standard for setup and/or calibration. The use of an inspection standard allows the operator to adjust the ultrasonic instrument controls properly, ensuring that the combination of ultrasonic instrument and transducer meets the specified sensitivity requirements. Standards can be locally manufactured to specific engineering instructions, an actual failed in-service component or any one of numerous standard reference blocks.

5.3.6.1 Standard Reference Blocks. These are blocks, whose dimensions have been sanctioned and/or required by professional organizations or commercial codes (e.g., ASME, IIW, AWS, ASTM). Only the most likely used standard reference blocks are described here.

5.3.6.1.1 Area-Amplitude Blocks. The area-amplitude blocks are intended to establish the correlation between the signal amplitude with the area of a flat bottom hole reflector. These sets of blocks contain flat-bottom holes of differing diameters all at the same distance from the sound entry surface.

5.3.6.1.2 Distance-Amplitude Blocks. The distance-amplitude blocks are intended to establish the correlation between the signal amplitude with the corresponding distance to a flat bottom hole reflector. These sets of blocks contain flat-bottom holes all at varying distances from the sound entry surface.

5.3.6.1.3 American Society of Testing and Materials (ASTM) Standard Reference Block Set. Each Air Force NDI laboratory SHOULD possess an aluminum alloy ASTM standard reference block set (or equivalent). Army AVIM units are encouraged to procure the ASTM reference block set. The dimensions for all ASTM blocks are specified in ASTM E 127, which also includes recommended practices for fabrication and control of the aluminum alloy reference blocks. ASTM E 428 contains the recommended practice for fabrication and control of the steel standard reference blocks.

5.3.6.1.3.1 The basic ASTM block set includes ten, 2.0-inch diameter blocks of the same material stock. Each block has a 0.75-inch deep flat-bottom hole (FBH) drilled in the center of the bottom surface. One block has a 3/64-inch diameter hole at a 3-inch metal travel distance. Seven blocks have 5/64-inch diameter holes at metal travel distances of 1/8, 1/4, 1/2, 3/4, 1.5, 3.0 and 6.0-inches. The remaining two blocks have 8/64-inch diameter holes at 3.0 and 6.0-inch metal travel distances. Each block is identified by a five-digit code (X-ABCD). The first digit is the diameter of the hole in 1/64-inch, the four other digits are the metal travel distance from the top surface to the hole bottom in 1/100-inch. For example, the block marked 8-0300 has a 8/64-inch diameter hole with a 3.0-inch metal travel distance.

5.3.6.1.3.2 The three blocks with 3.0-inch metal travel and 3/64, 5/64 and 8/64-inch are utilized as an area-amplitude set. The seven blocks with #5 (5/64-inch) flat-bottom holes are utilized as a distance-amplitude set.

5.3.6.1.4 International Institute of Welding (IIW) Blocks. Each Air Force NDI laboratory SHOULD possess an aluminum alloy and steel, Type 2 IIW standard reference block. The material and dimensional requirements of the IIW blocks are specified by the International Institute of Welding. The Type 2 IIW Blocks are primarily used for measuring the beam exit point and refracted angle of angle beam transducers and for calibrating angle beam metal path distances. Straight beam distance resolution and distance calibration can also be accomplished with use of certain known notches and block distances.

5.3.6.1.5 Miniature Angle Beam Block. The miniature angle beam block is a smaller and lighter version of the Type 2 IIW block and can be used for the same purpose.

5.3.6.2 Locally Manufactured Standards. Where locally manufactured standards are specified in a procedure, specific engineering instructions SHALL be provided that detail the manufacturing requirements. Typical ultrasonic standard manufacturing requirements include flat-bottom holes, side-drilled holes, and EDM notches. Flat-bottom holes are used for area-amplitude type calibrations. Side-drilled holes are used for developing distance-amplitude correction (DAC) curves. EDM or other type notches are used to determine the sensitivity to surface breaking flaws such as cracks. Thickness measurement requirements may require the manufacture of step-wedges or other specific thickness components.

5.3.7 Bonded Structure Reference Standards.

5.3.7.1 Configuration. The reference standard MAY be a duplicate of the test part except for the controlled areas of unbond. As an option, simple test specimens which represent the respective different areas of the test part and contain controlled areas of unbond MAY be used. Reference standards SHOULD:

- Be similar to the test part with respect to material, geometry, and thickness. (This includes closure members, core splices, stepped skins, and internal ribs similar to the test part if bonded areas over or surrounding base details are to be inspected.)
- Contain bond(s) of good quality except for controlled areas of unbond fabricated as explained below.
- Be bonded using the adhesive and cure cycle prescribed for the test part.

5.3.7.2 Defect Types. Defects are separated into five general types to represent the various areas of bonded sandwich and laminate structures. The five general types are:

- Type I: Unbonds or voids in an outer skin-to-adhesive interface.
- Type II: Unbonds or voids at the adhesive-to-core interface.
- Type III: Delaminations or voids between layers of a laminate.
- Type IV: Voids in foam adhesive or unbonds between the adhesive and a closure member at core-closure member joints.
- Type V: Water in the core.

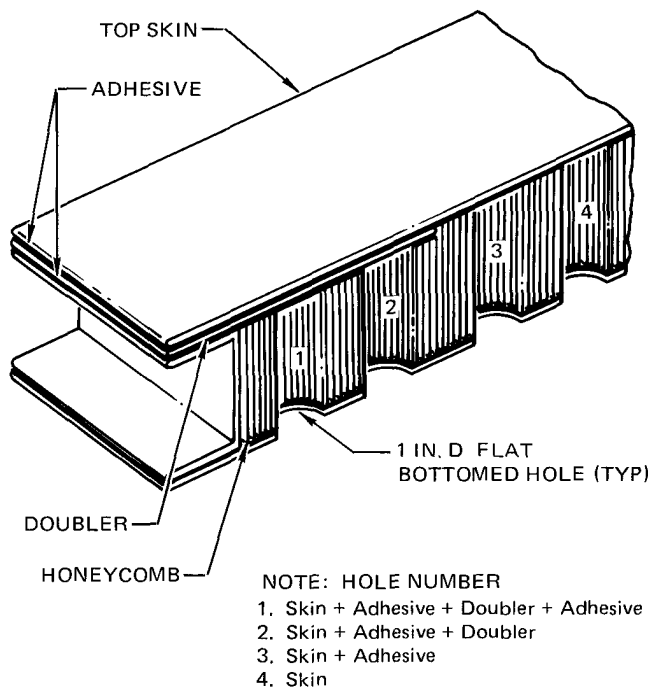
5.3.7.3 Fabrication of Bonded Reference Standards. The reference standards SHALL contain unbonds equal to the sizes of the minimum rejectable unbonds for the test parts. Information on minimum rejectable unbond sizes for test parts SHALL be obtained from the prime depot level engineering activity.

5.3.7.3.1 Producing unbonds by use of grease, vinyls, and other foreign material not covered below is prohibited. One or more of the following techniques SHALL be used in fabricating reference defects. Since bonding materials vary, some of the methods may not work with certain materials.

5.3.7.3.1.1 Standards for Types I, II, III, and IV unbonds MAY be prepared by placing discs of 0.006-inch thick (maximum) Teflon sheets over the adhesive in the areas selected for unbonds. For a Type-II unbond, place the Teflon between the core and adhesive. Assemble the components of the standard and cure the assembly.

5.3.7.3.1.2 Types I, II, and III standards MAY also be produced by cutting flat-bottomed holes of diameter equal to the diameter of the unbonds to be produced. The holes are cut from the backsides of bonded specimens, and the depths are controlled to produce air gaps at the applicable interfaces (Figure 5-37). When using this method, patch plates MAY be bonded to the rear of the reference standard to cover each hole and seal the reference standard.

T.O. 33B-1-1



H0402871

Figure 5-37. Example of Reference Standard for Types I and II Unbonds

5.3.7.3.1.3 Type II standards MAY be produced by locally undercutting (before assembly) the surface of the core to the desired size unbond. The depth of undercut SHALL be sufficient to prevent adhesive flow, causing bonds between the undercut core and the skin.

5.3.7.3.1.4 Type IV standards MAY be produced by removing adhesive in selected areas prior to assembly.

5.3.7.3.1.5 Type V standards MAY be produced by drilling small holes in the back of the standard and injecting varying amounts of water into the cells with a hypodermic needle. The small holes can then be sealed using a small amount of water-resistant glue or adhesive.

5.3.8 Thickness Measurement Equipment. A written procedure SHALL specify equipment, transducer, reference standard, and calibration requirements.

5.3.8.1 Thickness Measurement Instruments. Some ultrasonic instruments are designed specifically for thickness measurements and typically have a digital read-out. Some basic ultrasonic inspection units also have built-in thickness measurement options. Detailed instructions for performing thickness measurement with these units MAY be obtained by consulting the specific instrument manual.

5.3.8.2 Thickness Measurement Transducers. Transducers for thickness gauging are highly damped for a very short duration pulse for best resolution. With general purpose flaw detectors, best results will usually be obtained by using transducers specifically designed for thickness gauging. Typically, transducers with a narrow dead zone and superior near-surface resolution are required for measurement of thin materials. Therefore, dual-element transducers/search units with delay lines are routinely used. For measurements of thicker materials, a conventional straight beam contact transducer MAY be sufficient. Instruments dedicated to thickness measurements are often supplied with compatible transducers. These often have unique connectors to ensure only dedicated probes are used. Transducers recommended by the instrument manufacture SHALL be used with dedicated thickness measurement instruments. With a dual-element transducer, the ringing of the transducer element is not detected by the instrument; therefore, received signals close to the initial pulse can be clearly resolved. Dual-element transducers are limited in how thin they can measure by virtue of the elements being side-by-side. A

plastic delay line coupled to the face of a single-element transducer separates the initial pulse from the front surface signal; this improves near-surface resolution (e.g., shortens the dead zone).

5.3.8.3 Thickness Measurement Reference Standards. Reference standards are required to calibrate the instruments prior to thickness inspection (paragraph 5.7.7). The material and heat treat condition of the reference standards **SHOULD** be the same as the test part. The sound velocity in the reference standard **SHALL** be the same, within acceptable tolerances, as in the part being measured or a correction factor **SHALL** be used. Thickness measurements of curved and radiused parts may require reference standards with the same curvature. In addition, curved-shoe test units **MAY** be required on these type parts.

T.O. 33B-1-1

SECTION IV ULTRASONIC INSPECTION APPLICATION

5.4 INTRODUCTION.

5.4.1 Guidelines for Inspector Familiarization. Familiarization with the methods and equipment can be obtained by:

- Performing the familiarization tests included in the instrument manuals.
- Performing the calibration procedures.
- Making distance amplitude correction (DAC) curves (paragraph 5.4.8) and establishing transfer (paragraph 5.4.9) on some specimens.
- For surface wave familiarization, (paragraph 5.4.8.3).

5.4.1.1 All familiarization tests and procedures SHOULD be followed in detail by new inspectors. It is recommended the procedures be run through several times. The inspector SHOULD experiment with various combinations of specimens and transducers to become familiar with different ultrasonic inspection procedures and equipment.

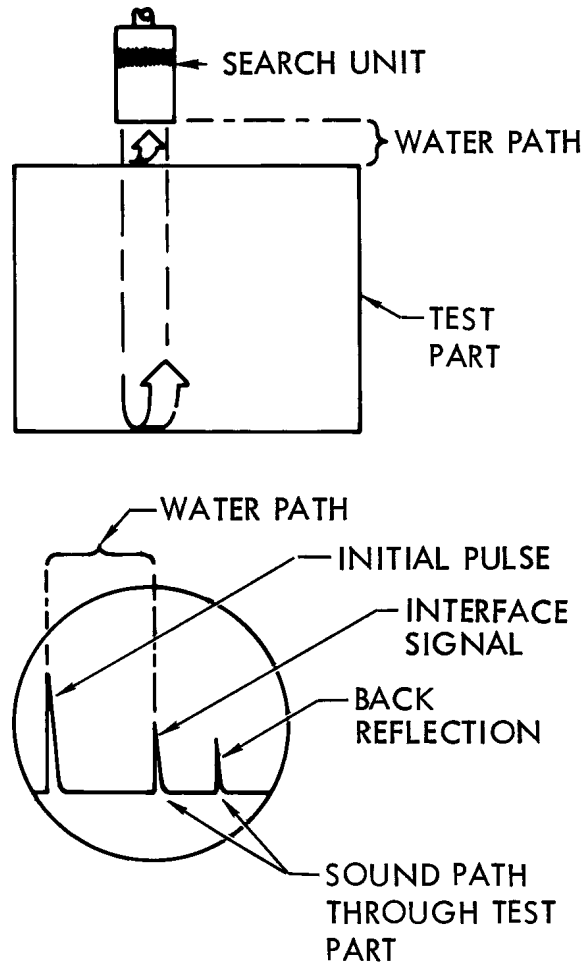
5.4.2 Basic Ultrasonic Inspection.

5.4.2.1 Coupling Methods.

5.4.2.1.1 Contact and Immersion Testing. The transducer must be adequately coupled to the test piece to ensure adequate sound transmission. Coupling is accomplished either through direct contact with the test piece or through a fluid interface between the transducer and the test piece. Thus, coupling methods can be separated into two basic categories: contact inspection and immersion inspection.

5.4.2.1.1.1 Contact Inspection. Contact Inspection is the method in which the transducer makes direct contact with the material. The contact method requires the use of a couplant to ensure sufficient ultrasonic energy transmission into the part. The couplant is an approved substance (usually a liquid) applied as a thin film between the transducer face and the test piece.

5.4.2.1.1.2 Immersion Inspection. Immersion inspection is an examination method where the transducer and the material are submerged in a tank of water (Figure 5-38). In some instances, a water column is maintained between the transducer and test material. In either case, the water must be free of air bubbles and other foreign material that could interfere with ultrasonic tests. If necessary, corrosion inhibiting agents and wetting agents MAY be added to the water to inhibit corrosion and to reduce the formation of air bubbles on the material and transducer surfaces. Immersion inspections are no longer confined to a tank of water in a laboratory or factory. Bubblers, squirters, and water columns enable the use of immersion techniques with portable ultrasonic scanning equipment in field inspections.

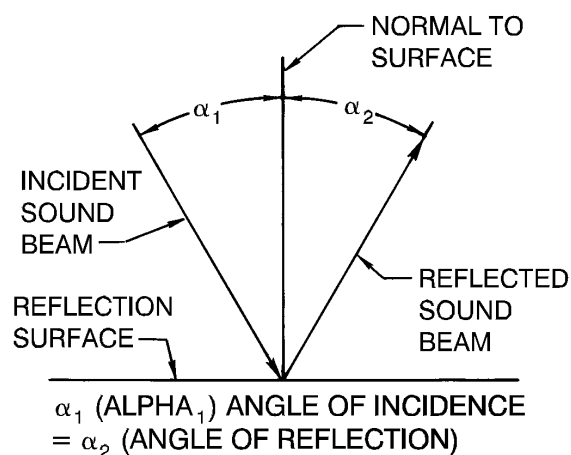


H0402873

Figure 5-38. Immersion Method

5.4.3 Ultrasonic Reflections. Ultrasonic sound beams have properties similar to light beams. For example, when an ultrasonic beam strikes an interrupting object, sound beam energy is reflected from the surface of the interrupting object. The angle of incidence is equal to the angle of reflection (Figure 5-39).

T.O. 33B-1-1

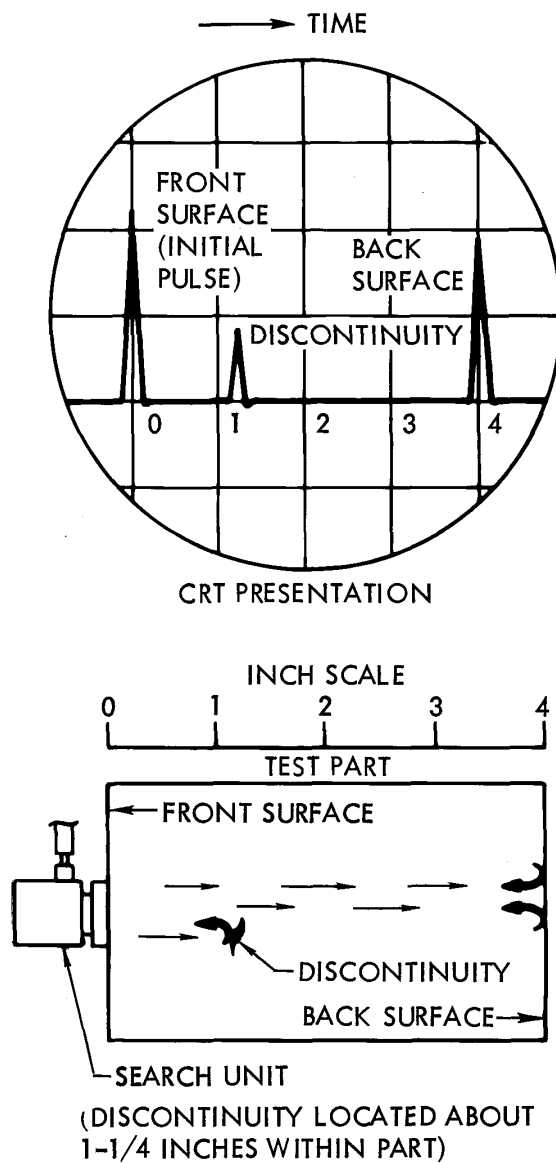


H0402672

Figure 5-39. Ultrasonic Reflection

5.4.4 Data Presentation Methods. There are three methods of data presentation used for ultrasonic inspection: A-scan, B-scan, and C-scan.

5.4.4.1 A-Scan. An A-scan presentation is a plot of time versus amplitude and is displayed on an ultrasonic unit in the form of a horizontal baseline that indicates time or distance. A-scan signals deflect vertically from the baseline to indicate the amplitude of electrical pulses (echoes) received from the transducer. On a calibrated ultrasonic unit, flaw depth can be determined from the horizontal position of the echo on the baseline. The upper half of (Figure 5-40) represents an A-scan display corresponding to the contact inspection shown in the lower half of the figure. A-scan presentations are the most utilized ultrasonic data presentation method and are also referred to as distance-amplitude presentations.



H0402874

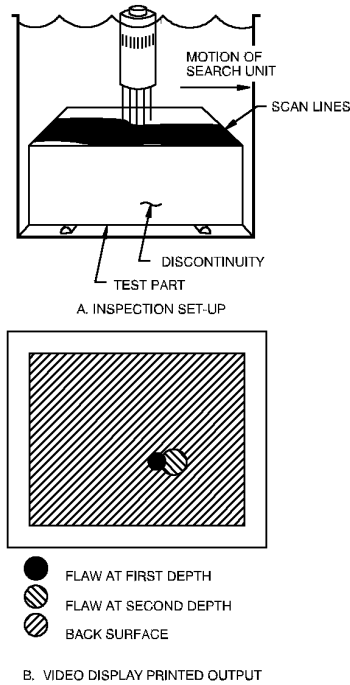
Figure 5-40. Typical A-Scan Display for Contact Inspection

5.4.4.2 B-Scan. A B-scan presentation provides a cross-sectional view of the test piece. This requires a device that plots the time of arrival of the pulse, as a function of the physical location of the transducer. B-scans are typically generated by scanning the transducer at a uniform rate, in a straight line across the surface of the test piece. B-scans may be displayed in real-time on the ultrasonic unit, an external monitor or an x-y plotter.

5.4.4.3 C-Scan. A C-scan presentation provides a plain view of the material and discontinuities therein. This is accomplished by collecting an electronically gated output of an A-scan presentation. The C-scan is generated as the part is scanned in a raster pattern with a manual or automated two-axis scanner. Discontinuities are indicated at positions

T.O. 33B-1-1

corresponding to the actual x-y locations of the discontinuities in the part (Figure 5-41). Devices to track and relay transducer position to the recorder or display are required. Typically, video displays are produced after the analog signal is converted to digital data. The display can be adjusted so different colors or shades of gray represent different depths or thickness. Signal amplitudes can also be displayed in various colors schemes. Numerous image processing tools may be available to the operator depending on system capabilities.



H0402875

Figure 5-41. Typical C-Scan Inspection and Presentation

5.4.5 Relationship of a Scan Waveform Display to Distance. In a test part containing a discontinuity, ultrasonic energy is reflected as echoes from the discontinuity and the back surface of the test part. Referring back to Data Presentation Method, there are three methods of data presentation used for ultrasonic inspection: A-scan, B-scan, and C-scan. Notice the positions of the displayed signals on the display screen in relation to the actual positions of the test-part front surface, discontinuity, and back surface. The distance along the display screen baseline is proportional to the distance to the discontinuity and back surface in the test part. In Data Presentation Methods, there are three methods of data presentation used for ultrasonic inspection: A-scan, B-scan, and C-scan. The signals on the display screen were adjusted to position the initial pulse on the grid marked "0" and the back surface signal on the grid marked "4." The discontinuity then appeared just to the right of the grid marked "1." The adjustments of the signals on the display screen were accomplished by varying two controls on the instrument, the Sweep Delay and the Sweep Length or Range. The adjustment made each space between the vertical grid lines on the display screen equivalent to 1 inch in the test part.

5.4.6 Common Inspection Techniques.

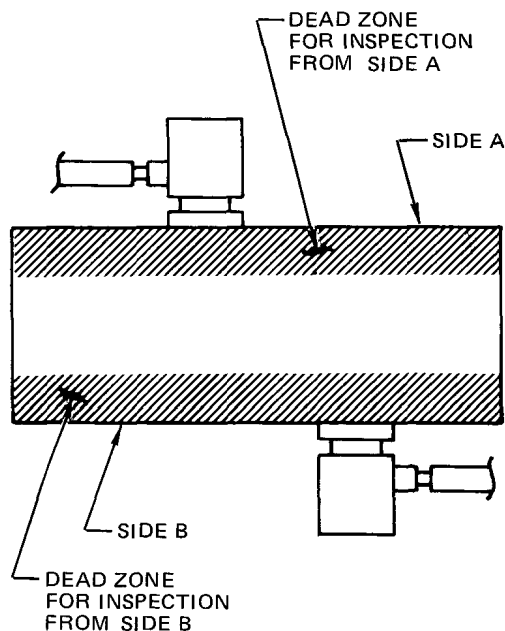
5.4.6.1 Straight Beam (Longitudinal) Pulse-Echo Technique.

5.4.6.1.1 **General.** This technique uses longitudinal waves (paragraph 5.2.3.1).

5.4.6.1.2 Limitations.

5.4.6.1.2.1 **Dead Zone.** The dead zone (paragraph 5.2.6.1) interferes with contact inspection (paragraph 5.4.2.1.1.1) of near-surface regions of parts. When required, the coverage of a straight beam inspection in near-surface regions can be extended by several different techniques, such as the following:

- Inspect the part from opposite sides. The dead zone, which is not inspected from the first side, is covered when inspecting from the second side (Figure 5-42).
- Use a dual-element transducer (paragraph 5.3.1.6.4).
- Use a delay line contact transducer (paragraph 5.3.2.8).
- Use an immersion inspection method.



THE DEAD ZONE OF THE SIDE A INSPECTION IS COVERED BY THE SIDE B INSPECTION; THE DEAD ZONE OF THE SIDE B INSPECTION IS COVERED BY THE SIDE A INSPECTION.

H0402876

Figure 5-42. Inspection of Test Part Opposite Sides to Provide Coverage of Dead Zone Areas

5.4.6.1.2.2 High Attenuation. In some cases, when inspecting thick sections, the sound energy in the part drops below usable levels. If this happens, inspecting from opposite sides can help, since only half the section thickness needs to be covered in a single inspection. If inspecting from two sides, the zones must overlap by a minimum of 1/2-inch. The through-transmission technique may also help alleviate high attenuation limitations

5.4.6.2 Straight Beam Multi-Transducer Technique.

5.4.6.2.1 Through-Transmission Technique. Through-transmission also uses the straight beam (paragraph 5.3.2.3.1) method, but this method requires two transducers, one to transmit the signal and one to receive the signal. In through-transmission inspection, a transmitting transducer is placed on one surface and the receiving transducer is placed on the opposite surface of the test piece. In this technique, discontinuities (voids) block the passage of sound resulting in a reduction of the received signal (Figure 5-43). Since the echoes from the discontinuities are not received the depth of information cannot be determined.

T.O. 33B-1-1

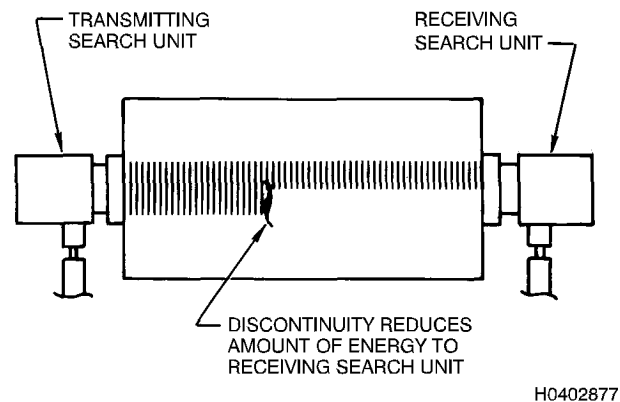


Figure 5-43. Through-Transmission Inspection

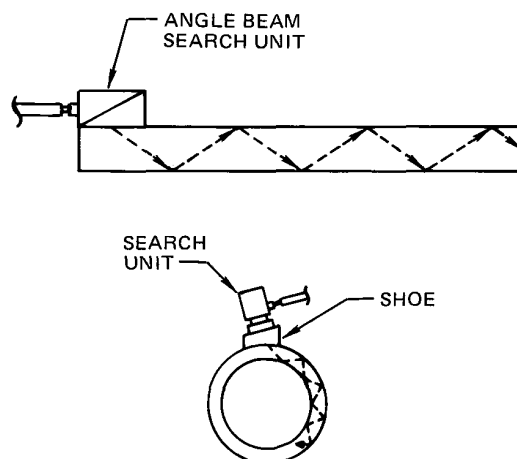
5.4.6.2.1.1 Beam Alignment. A major problem encountered with through-transmission testing is maintaining alignment of the transducers. Misalignment can reduce the amplitude of the received signal. Anything causing the received energy to suddenly drop can be misinterpreted as a defect. The through-transmission technique is useful when insufficient energy is obtained with the pulse-echo method and can be applied to inspect thick materials (distances up to 80-feet have been inspected). The through-transmission technique can also be used to advantage on thin test parts when the dead zone prevents an inspection with the pulse-echo method.

5.4.6.2.2 Application of Through-Transmission. The straight beam (paragraph 5.3.2.3.1) technique is used to detect discontinuities with at least one surface oriented parallel to the test surface. Typical discontinuity examples are laminations, corrosion, high- and low-density inclusions, porosity, forging bursts, and cracks. Applications of the straight beam technique depend upon the test part geometry.

5.4.6.3 Angle Beam (Shear Wave) Technique.

5.4.6.3.1 General. This method generally uses shear waves (paragraph 5.2.3.2) refracted in the test part at angles of 30° to 70°.

5.4.6.3.2 Angle Beam Applications. The angle beam technique is used extensively in field nondestructive inspections and can provide for inspection of areas with complex geometries or limited access. This is because angle beams can travel through a material by bouncing from surface to surface. Useful inspection information can be obtained at great distances from the transducer. Angle beam inspections are particularly applicable to inspections around fastener holes, inspection of cylindrical components, examination of skins for cracks, and inspection of welds; (Figure 5-44) shows typical angle beam inspections.



H0402878

Figure 5-44. Angle Beam Inspection

5.4.6.3.3 Multiple Search Units (Angle Beam). Most angle beam methods use a single transducer with one transducer element for transmitting and receiving ultrasonic energy. Special applications MAY utilize dual angle-beam transducers (Figure 5-24) or two or more angle beam units, one for transmitting, the rest for receiving, but due to beam alignment issues, this technique generally requires special fixtures to ensure correct transducer spacing and alignment.

5.4.6.4 Surface Wave (Rayleigh) Technique.

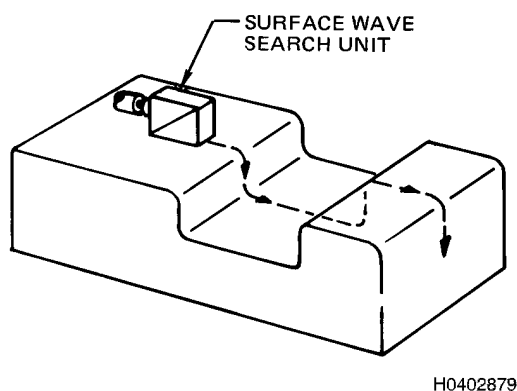
NOTE

When surface waves are used to inspect painted surfaces, the technician SHOULD be aware during setup and interpretation, the possibility of surface reflection from scratches and breaks in the painted surface. Rough surfaces or liquid on the surface can also attenuate surface waves. When sliding a transducer toward and then away from the suspect area, a ridge of couplant is often created that can reflect part of the surface wave energy and be mistaken for a crack. The area in front of the transducer SHALL be kept free of all, but the minimum amount of couplant needed for the inspection.

5.4.6.4.1 General. This technique uses surface (Rayleigh) waves (paragraph 5.2.3.3) refracted in the test part at an angle of 90°. Only during contact inspection, surface waves propagate along the part's surface and must be bound by air. The surface wave technique only works during contact inspection because the part surface, along which the surface wave propagates (paragraph 5.4.2.1.1.1).

5.4.6.4.2 Surface Wave Applications. Surface wave inspections can be utilized in many field NDI applications involving surface cracks or slightly subsurface discontinuities. On smooth surfaces, sound energy can travel long distances with little energy loss. Surface waves travel around curved surfaces. They reflect at sharp edges (radius less than one wavelength). Complete reflection does not occur even at sharp edges.

T.O. 33B-1-1

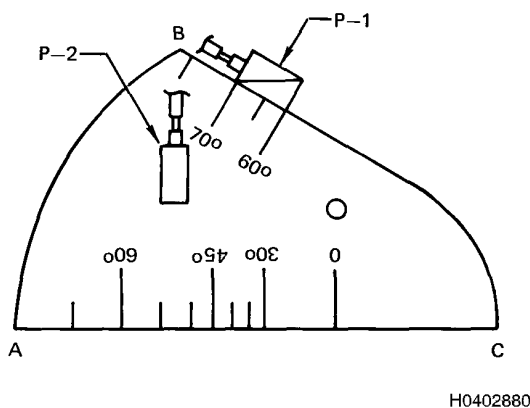


H0402879

Figure 5-45. Surface Wave Inspection

5.4.6.4.3 Surface Wave Familiarization.

- a. Use a miniature angle-beam block. Attach a 2.25 MHz surface wave transducer to the ultrasonic instrument.
- b. Position the transducer at P-1 as shown in (Figure 5-46). Adjust the sweep and gain to obtain a signal from corner C.



H0402880

Figure 5-46. Surface Wave Familiarization

- c. Moisten a finger with couplant and move it across the surface from the transducer toward corner C.

NOTE

The corner signal is damped until the finger moves beyond the corner.

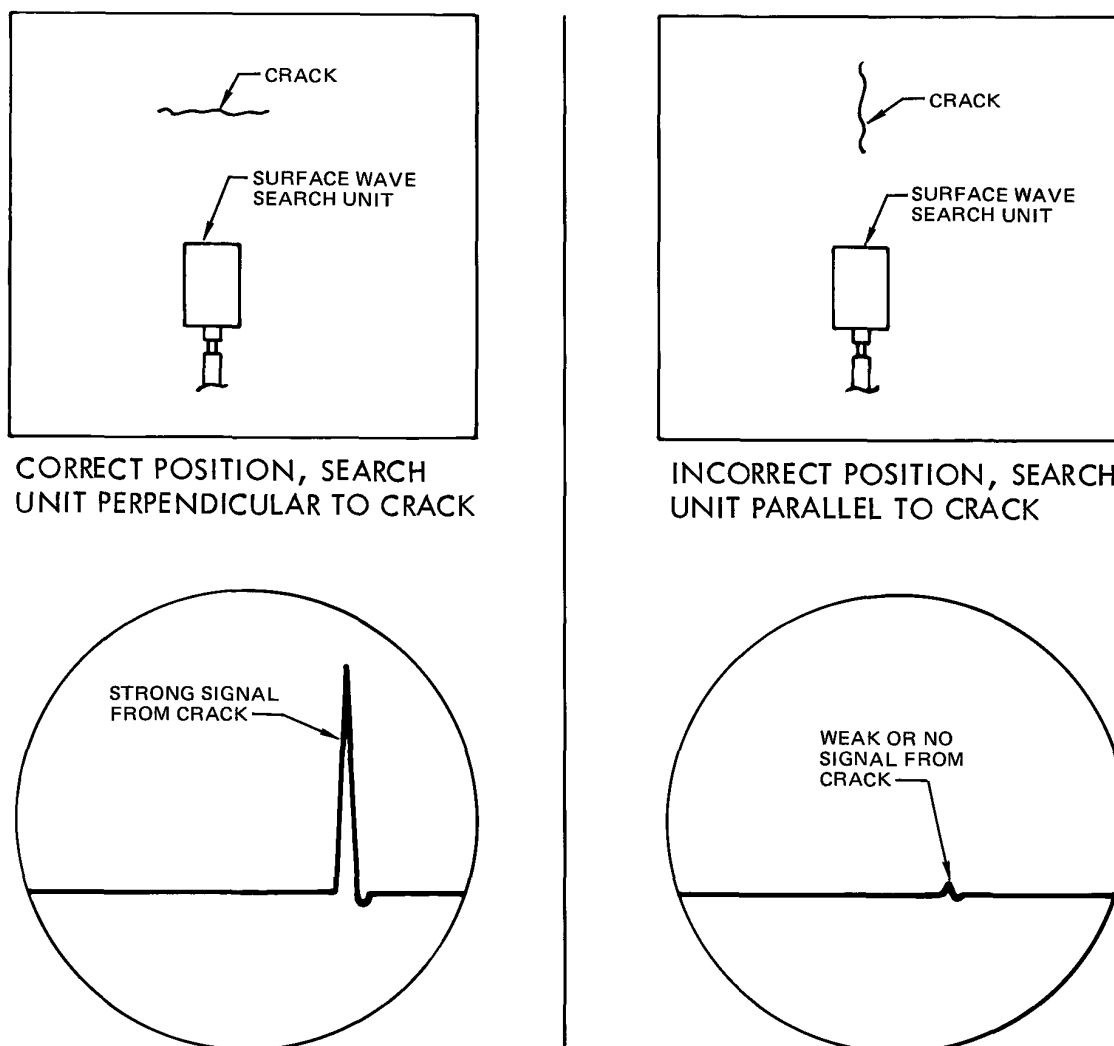
- d. Move the transducer away from corner C toward corner B as shown in (Figure 5-46).

NOTE

The corner C signal moves to the right along the time base.

- e. Position the search unit at P-2 as shown in (Figure 5-46). Orient the transducer perpendicular to edge AC. Adjust the sweep and gain to obtain a signal from edge AC.

- f. Rotate the transducer and note the signal from the edge decreases as the transducer is rotated away from the normal to the edge. This illustrates surface waves SHOULD always be directed perpendicular to the expected plane of cracks (Figure 5-47).



H0402881

Figure 5-47. Correct and Incorrect Transducer Orientation for Finding Cracks With Surface Waves

5.4.6.5 Lamb (Plate) Wave Technique. If the thickness of a test part is less than one wavelength of the sound introduced at the appropriate incident angle, lamb waves (paragraph 5.2.3.4) travel between the two parallel surfaces of the part. This is a special technique not widely used.

5.4.7 Ultrasonic Technique Development. As with the other NDI disciplines, most ultrasonic techniques used in the field are established at the depot. In certain situations, it MAY be necessary to develop a technique in the field. If such a need arises, the following information will aid in developing the required techniques. The information may also lead to a better understanding of established techniques.

5.4.7.1 Information Required. When establishing an ultrasonic inspection technique, it is first necessary to obtain as much information as possible about the test part. Information required is as follows:

T.O. 33B-1-1

- Type of material to be inspected, and heat treatment.
- Surface condition.
- Accessibility.
- Shape/geometry of test part
- Type of discontinuity to look for.
- Expected location and orientation of discontinuity.
- Expected orientation of discontinuity with respect to sound path.
- Size defect that must be reliably detected (acceptance/rejection criteria).
- Inspection technique required.
- Inspection zones, if applicable.

5.4.7.1.1 Information on many of the above items can be obtained by visual examination of the test part and study of applicable manuals and drawings. Examination of failed parts is helpful for obtaining information on the location of and type of discontinuity causing failure.

5.4.7.2 Defining the Technique. The information required by (paragraph 5.4.7.1), along with the information in this chapter, is used to establish the technique variables. In addition, if welds are to be inspected (TO 00-25-224). Items that need to be defined are listed below and described in more detail in the subsequent paragraphs.

- Inspection surfaces.
- Mode(s) of inspection: longitudinal, shear and/or surface wave, contact, or immersion.
- Scanning plan.
- Reference standard(s).
- Transfer method.
- Frequency.
- Transducer.
- Requirements for special wedges or shoes.
- Surface preparation required and method to be used.
- Type of couplant used.

5.4.7.2.1 Inspection Surfaces, Scan Plan, and Mode(s). The expected location and orientation of discontinuities, along with accessibility of the inspection area, are used to help define which surfaces will be used for sound entry, the mode(s) of sound energy used, and the scanning procedure. The sound SHOULD be directed normal to the expected plane of the largest surface of the discontinuity. Therefore, straight beam (paragraph 5.3.2.3.1) inspection would be used to locate laminar discontinuities, and angle beam inspection would be used to locate internal discontinuities not parallel to the inspection surface. For many angle beam inspections, the sound is directed so it bounces back from a corner formed by a crack and the far surface or a fastener hole. When discontinuities are expected on the inspection surface, a surface wave inspection may be a better choice.

5.4.7.2.2 Reference Standard. The reference standard SHOULD be fabricated from material with the same acoustic properties as the test part. When possible, the reference standard SHOULD be of the same alloy, heat treat condition, same hot/cold work condition, and the same surface condition as the test part. When the material condition of the standard cannot exactly match the part, a transfer technique (paragraph 5.4.9) may be needed to compensate for the differences. The geometry of the reference standard SHOULD match the geometry of the test part so the sound path will be the same. The simulated discontinuities SHOULD be in accordance with the applicable specification for the test part. Refer to MIL-STD-2154 for general information.

5.4.7.2.3 Frequency Selection. The frequency is selected based upon the acceptance criteria, and the acoustic properties of the test part. A good rule to remember is, "Use the highest frequency that will provide the necessary depth of penetration." When geometry permits, the test part SHALL be checked at the intended frequency to verify a strong back reflection is obtained. The frequency SHOULD also be appropriate for detecting the minimum size discontinuity anywhere in the test part. Frequencies in the range of 2.25 MHz, 5 MHz and 10 MHz are popular for inspections. When using both the angle beam method (either refracted shear or longitudinal wave) (paragraph 5.3.2.3.2) and the straight beam method (longitudinal wave) (paragraph 5.3.2.3.1), the frequency used for the angle beam shear wave inspection SHOULD be about one-half the frequency used for the straight beam inspection. This provides approximately the same wavelength for both the longitudinal and shear waves (paragraph 5.2.3.2). Refracted longitudinal wave inspection SHOULD be at the same frequency used for straight longitudinal wave (paragraph 5.2.3.1) inspection.

5.4.7.2.4 Transducer Selection. The transducer is selected based on the requirements for mode, frequency, beam direction, and beam size. The part geometry and the limitations on accessibility to the inspection surface determine if special wedges or shoes are required. Refer to (paragraph 5.3.4) for information on wedges and shoes.

5.4.7.2.5 Surface Preparation. The sound entry surface is visually examined to determine if any special preparation is required to provide a suitable condition for ultrasonic inspection. The surface finish SHOULD be 250-microinches or smoother. Painted surfaces can normally be inspected without removing the paint, if the paint is uniform and is tightly adhered to the part surface. Loose or uneven, patchy paint SHALL be stripped prior to ultrasonic inspection.

5.4.7.2.6 Couplant Selection. The couplant is selected based upon the surface condition, the surface orientation, and the information in (paragraph 5.3.5).

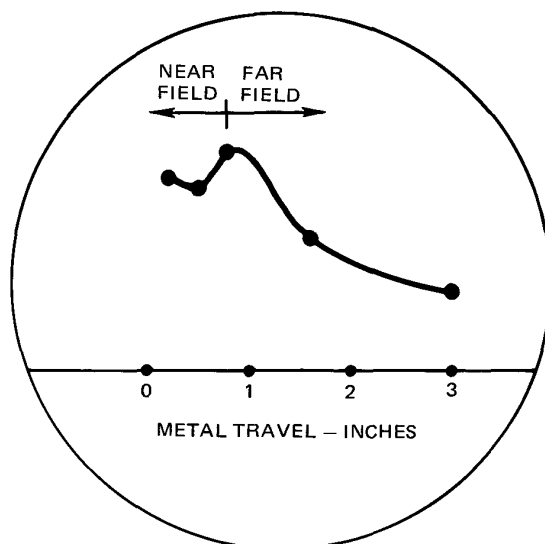
5.4.8 Distance Amplitude Correction (DAC) Curve.

5.4.8.1 General. Distance Amplitude Correction (DAC) is not a process control, but is used when it is necessary to compensate for sound attenuation with increasing metal travel distance. Many instruments have built-in DAC features, in these cases; follow the instructions in the operator's manual for establishing a DAC curve.

5.4.8.2 Straight Beam DAC (ASTM Blocks). A GENERAL PROCEDURE for establishing a straight beam (paragraph 5.3.2.3.1) DAC curve is given as follows:

- a. Connect the transducer and instrument to be used in the inspection, turn the instrument on, and turn the reject control to its minimum position. Adjust the time-base until the peak of the initial pulse is positioned on the zero or far left-hand side of the screen.
- b. Use all of the ASTM blocks with #5 (5/64) flat bottom hole (FBH) that cover the entire range of metal travel distance to be used in the inspection. For example:
 - (1) When inspecting a 1 1/2-inch specimen, use the blocks with 1/8, 1/4, 1/2, 3/4 and 1 1/2-inch metal travel.
 - (2) When inspecting a 2-inch specimen, use the inspection blocks with 1/8, 1/4, 1/2, 3/4, 1 1/2, and 3-inch metal travel.
 - (3) When inspecting a 5-inch specimen, use the 1/8, 1/4, 1/2, 3/4, 1 1/2, 3, and 6-inch metal travel blocks.
- c. From this group of blocks, select the block with the longest metal travel distance. Place the transducer on top of the block and adjust the time base using the delay and/or sweep controls until the peak of the initial pulse is positioned on the 0 or first scale marker. Move the transducer until the maximum reflected signal from the FBH is obtained.
- d. Position the reflected signal (FBH peak) on-screen at 100-percent full screen width (ensure the initial pulse remains in the original position). As an option, the FBH peak can be placed at another value to make distance determinations easier. If, for example, the largest block selected had a 3-inch metal travel distance, the signal from the FBH could be positioned at "9," whereby each scale marker would represent 1/3-inch of metal travel distance.
- e. Place the transducer on each block and adjust the position of the transducer to obtain a maximum signal from the respective FBH. Make a note of which block produced the largest FBH signal.
- f. With the transducer on the block that gives the maximum signal from the FBH, adjust the gain to bring the signal amplitude to 80-percent of full screen height.
- g. Without changing any unit settings, measure the maximum signal amplitudes from the FBH's on the other test blocks. Mark the position of each signal on the display face of the ultrasonic unit with a grease pencil. Drawing a smooth curve through these points produces the DAC curve on the face of the display. A typical DAC curve is shown in (Figure 5-48).

T.O. 33B-1-1



H0402882

Figure 5-48. Typical Straight Beam DAC Curve

5.4.8.3 Surface Wave Distance Amplitude Correction (DAC). A DAC curve is usually not necessary for surface wave inspections, because the transducer can generally be moved back and forth from a discontinuity to maximize the signal. If a DAC curve is needed for a surface wave inspection, it can be easily established. The transducer is placed at a few points at different distances from the reference standard reflector. At each point, the peak amplitude is measured and marked on the display. A smooth curve is then drawn through the points as in the straight beam (paragraph 5.3.2.3.1) and angle beam (paragraph 5.3.2.3.2) procedures.

5.4.9 Attenuation Correction (Transfer).

5.4.9.1 Description. Transfer (attenuation correction) refers to methods used to compensate for differences in ultrasonic transmission characteristics between the test part and the reference standard. For example, the surface condition of the reference standard, test part, and the internal structures (e.g., grain size, heat treat condition, etc.) could differ. Such differences may cause the signal from a discontinuity in the test part to differ from the signal from the same size discontinuity in the reference standard. In order to obtain consistent results from ultrasonic inspections, it is necessary to use transfer to correct for these differences.

5.4.9.2 General Procedure.

- a. Transfer SHALL be accomplished by making note of the dB or gain difference in the responses received from reflectors in the reference standard and the part or piece of material to be inspected.
- b. Use the echo signals from the same type of reflector in both the reference standard and the test part to establish transfer. For example, use back surfaces, flat-bottom holes, side-drilled holes or “V”-notches (for angle beam inspections). If possible, a minimum of four reflections from different locations in the part or piece of material to be tested SHALL be noted, and the lowest response SHALL be used for comparison with the response from the reference standard. In practically all cases, any alteration of the test part is prohibited. Therefore, transfer SHALL be accomplished using reflectors already included in the test part. Typical reflectors are the back surface or a fastener hole.

5.4.9.3 Examples of Transfer.

5.4.9.3.1 Straight Beam Inspection of a Two Inch Plate.**NOTE**

Newer UT machines with Time Controlled Gain (TCG) eliminate the need for manual transfer.

- a. Suppose a specification requires any material with a discontinuity signal greater than the signal from a 5/64-inch diameter FBH is unacceptable. The inspection is set up by establishing a DAC curve in accordance with (paragraph 5.4.8.2). Use ASTM blocks with 5/64-inch diameter FBH's and metal travel distances of 1/8, 1/4, 1/2, 3/4, 1-1/2, and 3-inches. Assume the curve shown in (Figure 5-48) is obtained.

NOTE

Since the dead zone extends beyond 1/8-inch, the 1/8-inch point is not shown. Also notice, the near field appears to end around 3/4-inch.

- b. After constructing the DAC curve, the amount of transfer is established through use of back surface reflections. The transducer is placed on the 1 1/2-inch metal travel ASTM standard as shown in (Figure 5-49). This gives 2 1/4-inch metal travel to the back surface. The gain control is set to bring the back surface signal to the DAC curve as shown in (Figure 5-50). This gain setting is maintained, and the transducer is placed on the test part. Assume the first signal shown in (Figure 5-52) is obtained. This is 50-percent lower or 6 dB lower than the DAC curve at the 2-inch metal travel distance. This is the amount of transfer; the amount by which the gain must be increased after calibration.

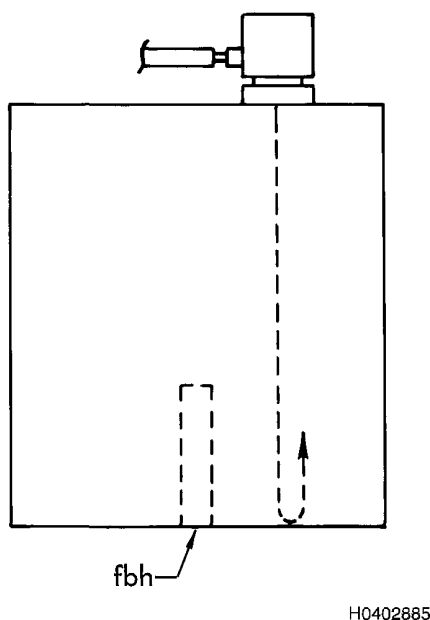
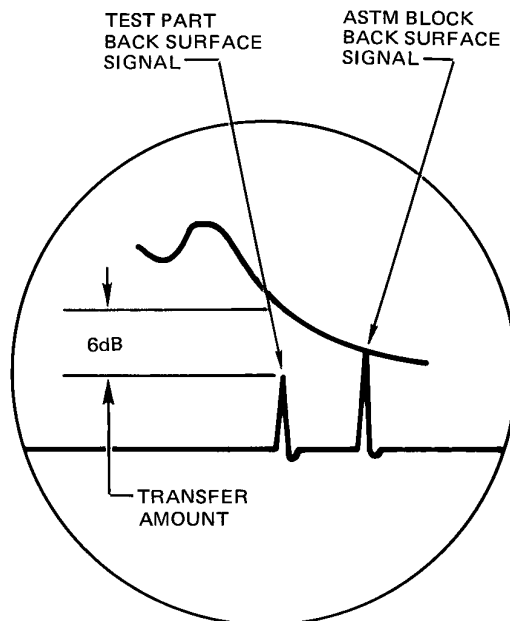


Figure 5-49. Transducer Unit on ASTM Block for Determining Transfer Amount

T.O. 33B-1-1



H0402886

Figure 5-50. ASTM Block and Test Part Back Surface Signals

- c. The transducer is now placed on the ASTM block with 1 1/2-inch metal travel distance to the FBH. The signal from the FBH is maximized, and the gain is adjusted to bring the signal to the DAC curve level. Transfer is now applied by increasing the gain setting to double the amplitude. On an instrument with dB gain controls, this is easily accomplished by adding 6 dB to the gain or subtracting 6 dB of attenuation. On an instrument without dB controls, the gain must be increased to double the amplitude of a signal on the display. A correct way of doing this is as follows:
- (1) Place the transducer on the 3-inch travel distance block and adjust the position for maximum signal from the FBH. Note the amplitude of the signal. (It SHOULD be close to 30-percent of full screen height.)
 - (2) Increase the gain until the amplitude of the signal is doubled (e.g., 30-percent to 60-percent). The gain is now set for evaluation of discontinuities in the test part. Any discontinuity signal that exceeds the DAC curve is cause for rejection.

NOTE

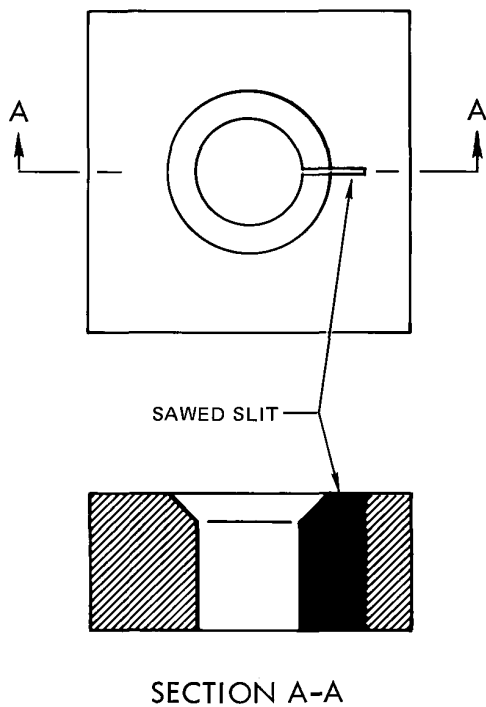
Doubling the gain by doubling the signal (e.g., 50-percent saturation to 100-percent saturation) from the flat bottom hole in the 1 1/2-inch metal travel distance ASTM block would be improper; the 100-percent of saturation signal is in a possible nonlinear area of the display. Signals at levels above 90-percent of saturation SHALL NOT be used for applying transfer.

- d. The gain setting obtained after applying transfer is used for evaluation of discontinuities in the test part. It is advisable to perform the initial inspection using an even higher gain setting. This provides for more reliable detection of discontinuities. When discontinuities are found, the gain is reduced to the level established by the transfer technique. At this gain setting, any discontinuity signal that exceeds the DAC curve is cause for rejection.

NOTE

In the above example, the metal travel distances to the back surface of the reference standard and the test part were not equal. By using the DAC curve in establishing the transfer, this difference was corrected.

5.4.9.3.2 Transfer of Angle Beam Inspection for a Skin Crack. Use a reference standard configuration as shown in (Figure 5-51). The reference standard SHOULD be same thickness and material as skin to be examined. Specify the size of the saw cut; the inspection is set up using the saw cut to establish the sensitivity. Any discontinuity having a signal exceeding 25-percent of the saw cut signal is cause for rejection. Transfer is established as follows:

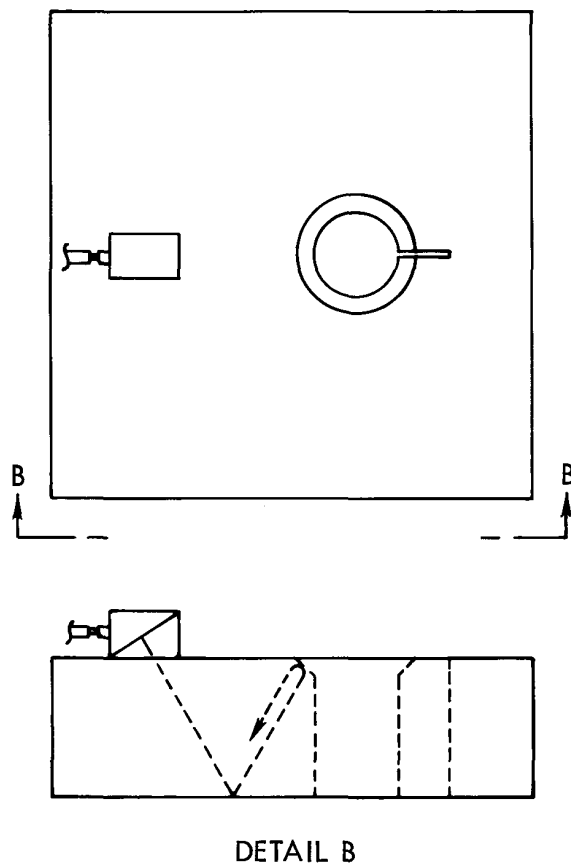


H0402887

Figure 5-51. Reference Standard for Inspection for Cracks in Skin

- a. Place the search unit on the reference standard, as shown in (Figure 5-52), and position it to obtain a maximum signal from the top corner of the wall of the fastener hole. Adjust the gain to bring the signal to 50-percent of saturation.

T.O. 33B-1-1



H0402888

Figure 5-52. Positioning Transducer for Establishing Transfer

- b. Place the transducer on the skin, and maximize the signal from the same size fastener hole as in the standard by adjusting the position of the transducer. The gain setting used for the fastener hole in the standard SHALL NOT be changed.
- c. Suppose the signal obtained from the fastener hole in the skin is 80-percent of saturation. This is an increase of 60-percent (4 dB) of the signal from the reference standard fastener hole ($30 = 60\text{-percent of } 50$). This is the amount of transfer, the amount by which the rejection (alarm) level has to be raised.
- d. Place the transducer back on the reference standard to obtain the signal from the saw cut. Increase the gain until the signal is at some convenient level, for example, 80-percent of saturation. At this gain 20-percent of full scale would be the rejection level, since any signal exceeding 25-percent of the saw cut signal is cause for rejection; however, this rejection level must be increased to 32-percent of full scale by the amount of transfer (60-percent or 4 dB). Therefore, any discontinuity that exceeds 32-percent of saturation is cause for rejection. As in the previous example, the initial scanning is performed at a higher gain setting.

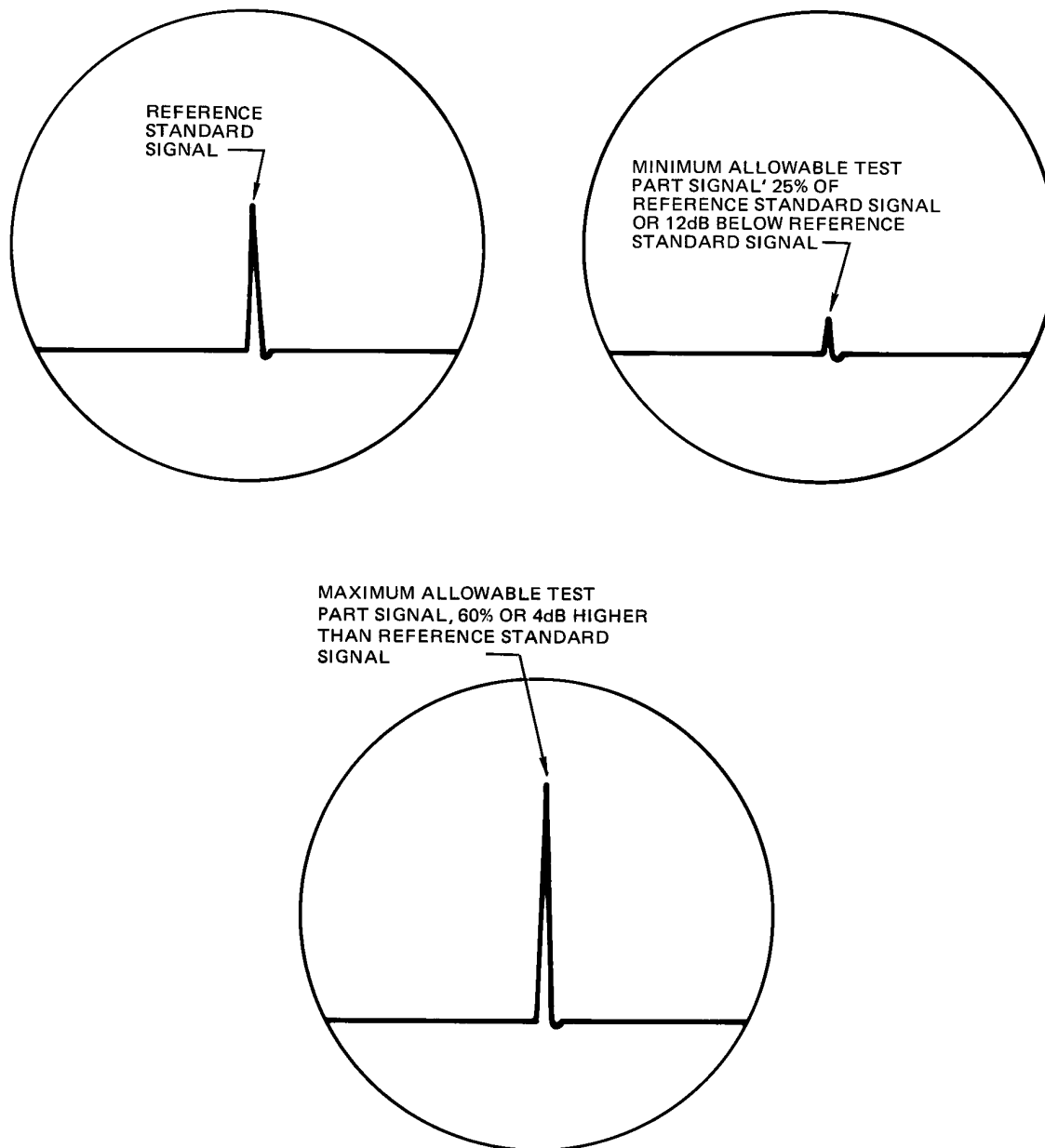
5.4.9.3.3 Straight Beam Technique of Transfer Applied to Angle Beam Inspection. The straight beam inspection (paragraph 5.3.2.3.1) technique of transfer (paragraph 5.4.9.3.1) may also be applied to angle beam inspections. A straight beam transducer is used to determine the amount of transfer. This amount of transfer is then applied to the angle beam inspection. When using this technique, the following conditions SHALL be met.

5.4.9.3.3.1 The frequency of the straight beam transducer SHALL be approximately double the frequency of the angle beam transducer. For a 2.25 MHz angle beam transducer, use a 5 MHz straight beam transducer. For a 5 MHz angle beam unit, use a 10 MHz straight beam transducer.

5.4.9.3.3.2 The back surface of the standard and the test part must be located in the far field of the straight beam transducer.

5.4.9.3.3.3 The back surfaces of the reference standard and the test part must be parallel with the front surfaces.

5.4.9.4 Transfer Limits. When using the transfer technique, if the signal from the test part is less than 25-percent (-12 dB) or more than 60-percent (+4 dB) of the signal from the reference standard (Figure 5-53), the reference standard may be of the wrong material, heat treat condition and/or surface condition. If the signal from the test part is not within the above limits, another reference standard SHOULD be tried, or the prime depot SHOULD be contacted.



H0402889

Figure 5-53. Transfer Limits

T.O. 33B-1-1**5.4.10 Inspection of Bonded Structures.**

5.4.10.1 Definition. A bonded structure is one consisting of two or more components adhesively bonded together. The structure can be all metallic or nonmetallic, or it can consist of both types of material. A bonded structure can contain honeycomb or other type of light-weight core. Sheets of metal or nonmetal can be bonded together to provide the appropriate thickness. Carbon/epoxy composites are bonded structures although the individual layers are only a few thousands of an inch thick, and essentially lose their individual identity in the curing process; however, separations (delaminations) do occur between layers as a result of external impacts with foreign objects.

5.4.10.2 Variables Applicable to Bonded Structures. There are many configurations and types of bonded structures, thus, there are many variables to consider when performing NDI.

- Probe-side skin material and thickness.
- Adhesive type and thickness.
- Underlying structure - core material, thickness of core, cell size, and thickness of cell wall, far-side skin material and thickness, quantity, thickness and material of doublers, attachments of closure members, foam adhesive, steps in skins, internal ribs, and makeup of nonmetallic composite laminates (material, number of layers and layer thickness).
- Accessibility - one skin or both skins.

5.4.10.2.1 All of these variations complicate the application of ultrasonic inspection methods. A method, which works well on one part or in one area of the part, MAY NOT be applicable for different parts or different areas of the same part.

5.4.10.3 Special Requirements. Because of the many inspection configurations, each application must be examined in detail. The advantages and limitations of each inspection method must be considered, and reference standards (representative of the structure to be inspected) SHALL be ultrasonically inspected to verify proposed techniques. Scanning speeds must be identical on both the standard and the test part. Scan line indexing must be no larger than one-half the width of the smallest rejectable discontinuity.

5.4.10.3.1 The internal configuration of the bonded test part must be understood by the operator. Drawings SHOULD be reviewed and, when necessary, radiographs taken to provide a better understanding of the area under investigation. Knowledge of details such as the location and boundaries of doublers, ribs, etc. is required for valid interpretation of ultrasonic inspection results. The boundaries of internal details SHOULD be marked on the test part using an approved marking method.

NOTE

Grease pencils, chalk, or other marking device may harm the material under evaluation (e.g., lead pencil could lead to burn through). The weapons system technical manual SHALL be consulted for guidance on marking methods.

5.4.10.3.2 This section does not include all the information required to establish techniques. Detailed techniques for specific structures SHOULD be obtained from the applicable NDI manual, or from written authority provided by the prime depot level engineering activity. In addition, further information on the operation of specific instruments SHOULD be obtained from the applicable equipment manuals.

5.4.11 Thickness Measurement.**NOTE**

State-of-the-art instruments provide highly accurate thickness measurements from 0.005-inch up to several inches. These instruments not only measure thicknesses in inches and millimeters, but can also determine the velocity of the material under test.

5.4.11.1 Thickness Measurement Applications. Examples of applications for ultrasonic thickness measurement are as follows:

- Checking part thickness when access to the backside is not available.
- Checking large panels in interior areas where a conventional micrometer cannot reach.
- Maintenance inspections for checking thickness loss due to wear and/or corrosion.

5.4.11.2 General Principles. Two basic methods of measuring thickness ultrasonically are the pulse-echo method and the resonance method.

5.4.11.2.1 Thickness Measurement With the Pulse-Echo Method. The pulse-echo method is now the most commonly used ultrasonic thickness measurement method. This method uses the basic principle defined by the following equation:

$$d = vt$$

Where:

d = distance (inches)

v = velocity (inches per second)

t = time (seconds)

5.4.11.2.1.1 The ultrasonic instrument is capable of measuring time between the initial front and back surface signals or between successive multiple back reflection signals. Since the velocity for a given material is a constant, the time between these signals is directly proportional to the thickness. Calibration procedures are used to obtain a direct readout of test part thickness. Depending on the instrument and material under test, ranges from 0.005-inch to several feet can be measured with pulse-echo thickness measurement instruments. The accuracy depends on the surface condition, the transducer and the instrument. On smooth surfaces (63-microinches or less), accuracy of ± 0.001 -inch, or better, can be obtained on the lower ranges of some digital-readout instruments. Readout resolution is usually 0.001 inches. On other ranges, ± 0.5 -percent of full scale is a typical accuracy.

5.4.11.2.2 Resonance Technique. Resonance equipment has been largely replaced by pulse-echo equipment for thickness measurement. This technique uses an instrument which applies continuous (as opposed to pulsed) electrical energy to the transducer. The frequency of this energy is continuously changing; therefore, the wavelength of the sound transmitted by the transducer is continuously changing too, but it is changing inversely in proportion to the velocity of the material being tested ($\lambda = v/f$). When the transducer is coupled to a test part, and when one of the transmitted wavelengths is a multiple of the thickness of the part, the piezoelectric element in the search unit vibrates with higher amplitude. When this occurs, the transducer is said to be in resonance with the part. If the instrument is calibrated on a reference standard so that the peaks in the transducer element vibration amplitude correspond to known reference thicknesses, the instrument will indicate unknown thickness of a test part.

5.4.11.3 Thickness Measurement Correlation Factor. As discussed earlier, reference standards are required to calibrate the instruments prior to thickness inspection. If reference standards of a different material or heat treat condition are used, the resultant thickness readings SHALL be corrected by a correlation factor. The correlation factor is located in (paragraph 5.7.7).

5.4.11.3.1 Flat surfaced reference standards MAY be used for measurements on convex radii of curvature as small as 1-inch and concave radii of curvature as small as 3-inches. Test parts with radii smaller than 1-inch convex or 3-inches concave, require reference standards with curved surfaces and radii equal to the test part radii, ± 10 -percent. In addition, shoes are required (paragraph 5.3.4.1) and (paragraph 5.3.4.2).

5.4.11.3.2 The surface finish of reference standards SHOULD be 63-microinches or better if maximum accuracy is to be obtained. Surface roughness introduces errors as shown (Table 5-8).

5.4.11.3.3 The thickness of reference standards SHALL be measured by mechanical or optical means. Unless otherwise specified, the maximum tolerance for these measurements SHALL be ± 0.001 inch or $\pm 0.1\%$ of the thickness, whichever is greater.

5.4.11.3.4 If there are two or more areas of different thickness on the test part within the limits of (paragraph 5.4.11.3.3), which can be measured both ultrasonically and mechanically, or optically, these areas MAY be used as the standards.

5.4.12 Calibration and Thickness Measurement. Accurate thickness measurements require the reference standards and the test part, to have equal temperatures, within 10° F. Calibration SHALL be performed in the same physical location as the measurements on the test part. Adequate time SHOULD be allowed for the reference standard to reach the test part temperature. The horizontal linearity of the test equipment is crucial, and must be checked prior to calibration and any thickness measurement. Follow detailed instructions for performing thickness measurement with the specified ultrasonic unit by consulting the specific instrument manual. A basic ultrasonic instrument with only A-scan capabilities can also be used for thickness measurements using the general setup and calibration procedure specified below.

T.O. 33B-1-1

5.4.12.1 If only a basic A-scan ultrasonic instrument is available, and no specific instructions are given, the following procedure MAY be used; however, automatic calibration “Autocal” procedures are available on newer UT units.

- a. Obtain two reference standards. For best results, one reference standard SHOULD be approximately one-half the expected thickness of the test part, and one reference standard SHOULD be approximately twice the expected thickness of the test part.
- b. Select a transducer that will resolve the back surface of the reference standards.
- c. Decide which divisions on the horizontal scale of the display graticule would be convenient locations for the echo signals from the back surfaces of the references. For example, if the reference standards are 0.25 and 0.5-inch thick, scale divisions at 2.5 and 5.0 could be used, or for better resolution 5.0 and 10.0 could be used. In the first case, each major division on the scale equals 0.1-inch. In the second case, each major division equals 0.05-inch. In general, each major division equals 0.1 of the thickness for which the echo signal is placed at division 10.
- d. Obtain an echo signal from the thinner reference standard, and adjust the instrument “delay control” to position the signal at the chosen scale division.
- e. Obtain an echo signal from the thicker reference standard and adjust the instrument “range control” to position the signal at the chosen scale division.
- f. Repeat paragraphs “d” and “e” until no further adjustment is necessary of either the thin or thick peak.

NOTE

To ensure the greatest accuracy, always use the same vertical portion of the echo signals when adjusting the peak locations (e.g., use the point where the signal breaks the baseline, crosses the 10-percent vertical-scale line, or any other chosen vertical-scale line).

- g. Place the transducer on the test part and obtain an echo signal. Read the thickness from the horizontal scale of the display, using the same vertical portion of the echo signal that was used when calibrating. On parts with rough or pitted surfaces, take several readings and record the average. If the surface is curved, additional instructions are contained in (paragraph 5.5.9.2). As required, multiply the readings by a correction factor (paragraph 5.4.11.3).
- h. The calibration SHOULD be rechecked every 30-minutes during continuous use. If it is determined that the instrument is out of calibration, all measurements made since the last satisfactory calibration SHOULD be repeated.

SECTION V ULTRASONIC INSPECTION INTERPRETATION

5.5 INTRODUCTION.

5.5.1 Evaluation of Discontinuity Indications. When a discontinuity indication is found, it is desirable to learn as much as possible about the discontinuity (or discontinuities). Information on the location, size, orientation, and spacing helps in determining the seriousness of a discontinuity.

5.5.1.1 Discontinuity Location. The location is determined by noticing the position of the indication on the waveform display and comparing this position to the positions of indications from known reflectors, such as the front and back surface. This is simple for straight beam inspections and is explained in (paragraph 5.4.5). For angle beam inspections, the position is determined by first determining the angle of the refracted beam and then performing a distance calibration. With this information, the beam path and distance to the discontinuity in the test part can be determined. It is often helpful to use a cross-sectional sketch of the test part and draw the beam path on the sketch. For surface wave inspections, the location of a discontinuity is easily determined by wetting a finger with couplant, and then moving the finger along the test part surface away from the transducer. The surface waves will be damped by the wet finger, and the discontinuity signal will be reduced in amplitude until the finger moves just past the discontinuity. By noting when the discontinuity signal first starts to increase in amplitude, the location of the discontinuity is determined. A distance calibration can also be easily set up for surface waves. The transducer is placed on the test part at a known distance away from a reflector, such as an edge of the test part, or the transducer can be placed at a known distance from a reflector on the IIW block.

5.5.1.2 Discontinuity Size. The size of a small discontinuity (less than the diameter of the sound beam) is estimated by measuring the maximum signal amplitude produced by the discontinuity. Information on sound beam diameter (beam spread) is contained in (paragraph 5.2.6.5). In general, the amplitude from a small discontinuity is proportional to the cross-sectional area of the discontinuity, if the discontinuity is oriented normal to the sound beam. Since natural discontinuities usually have irregular shapes and rough surfaces, determination of the actual size of small discontinuities in general MAY NOT be possible with ultrasonics. Therefore, estimating the size of small discontinuities by comparing their signal amplitude with the signal amplitude of reference standard discontinuities is subject to errors. When making such comparisons (only to be used for rough estimates), the transfer technique SHOULD be used (paragraph 5.4.9). If, after applying transfer, the test part discontinuity signal is as large or larger than the signal from the reference standard discontinuity, it can be concluded the test part discontinuity is at least as large as the reference standard discontinuity. The transfer technique adjusts for differences in material attenuation, not for differences in discontinuity surface irregularities. Estimating the size of discontinuities larger than the sound beam is done by moving the transducer over the discontinuity, and mapping the extremities of the discontinuity. The outer edges of a discontinuity can be estimated by noting the positions of the center of the transducer when the signal amplitude from the discontinuity is reduced to 1/2 its peak value. This procedure estimates the projected area of discontinuities in a plane perpendicular to the incident sound beam.

5.5.1.3 Discontinuity Orientation. In evaluating discontinuities, it is helpful, if possible, to evaluate the discontinuities from several different directions. This can be accomplished by using a combination of angle, and straight beam methods, and/or sound entry from different surfaces. Inspecting in these various directions reveals more about the discontinuity. The direction where the highest amplitude signal is obtained is most nearly perpendicular to the plane of the discontinuity for equivalent distances. If the discontinuity signal changes very little with changing direction, the discontinuity is probably rounded. The sound scattered from a rounded discontinuity is independent of the incident direction. A flat discontinuity gives a maximum reflection when the incident sound beam is perpendicular to the discontinuity.

5.5.1.4 Discontinuity Spacing. Closely spaced small discontinuities can produce multiple indications often accompanied by the loss of back reflection. An example of how large grain size porosity can produce multiple indications and reduce the amplitudes of back-reflection multiples is shown in (Figure 5-54). It is necessary to change the A-scan settings to check for both the effects, because the back surface signal probably saturates the display at the gain setting that shows the multiple indications. By lowering the gain and lengthening the sweep range, the decreasing amplitude of multiple back reflections is observed. The rate of decrease in the amplitudes of the back reflection signals will be greater than for an area with no discontinuities.

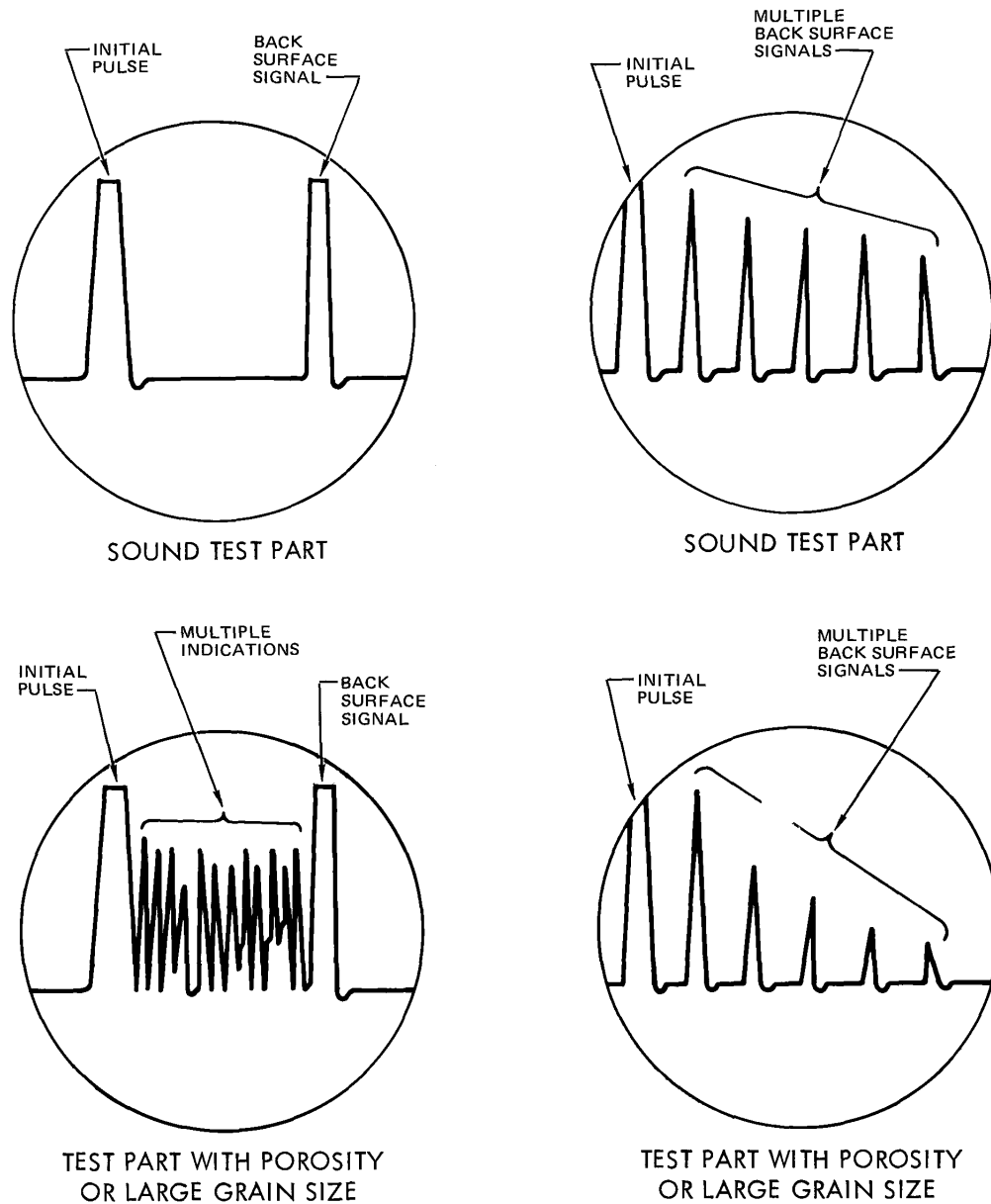
5.5.2 Types of Discontinuity Indications. Several different types of indications will be encountered in ultrasonic inspections. Some of these indications can cause confusion, resulting in false conclusions. It is important for the operator be familiar with the ultrasonic system variables (paragraphs 5.2.5) through (paragraphs 5.2.6.8) and the additional information below. This will help the operator in evaluating inspection results and avoiding erroneous conclusions.

T.O. 33B-1-1

5.5.2.1 Loss of Back Reflection and/or Multiple Indications. Loss of back reflection with no other indication can be caused by a number of factors such as the following:

- Large grain size.
- Porosity.
- Dispersion of precipitated particles in the material.
- Overheated structure.

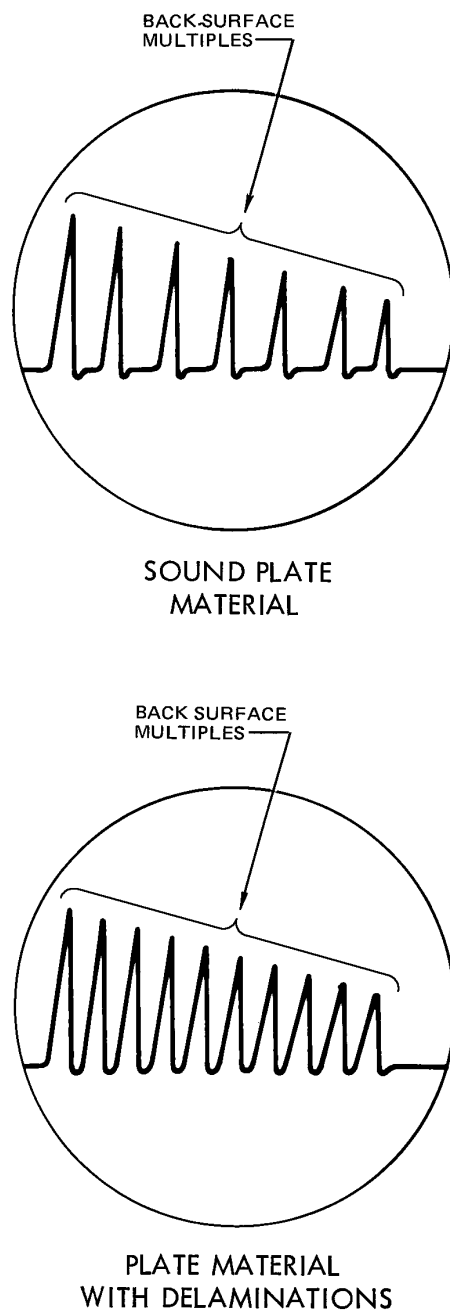
5.5.2.1.1 However, these features could produce multiple indications (Figure 5-55). Lowering the frequency will generally reduce the multiple indications. When either multiple indications and/or loss of back reflection is noted, the test part SHOULD be compared with the reference standard using transfer in accordance with (paragraph 5.4.9). The results SHOULD be evaluated in accordance with the limits in (paragraph 5.4.9.4).



H0402890

Figure 5-54. Example of Multiple Indications and Decrease in Multiple Back Reflections Caused by Large Grain Size or Porosity

5.5.2.2 Delaminations. When inspecting either metal parts fabricated from sheet or plate, or nonmetallic composite parts, delaminations can be detected by noting what appears to be a reduction in the distance between back reflection multiples as shown in (Figure 5-55). Actually, the signals indicate multiple echoes from the delamination instead of the back surface.

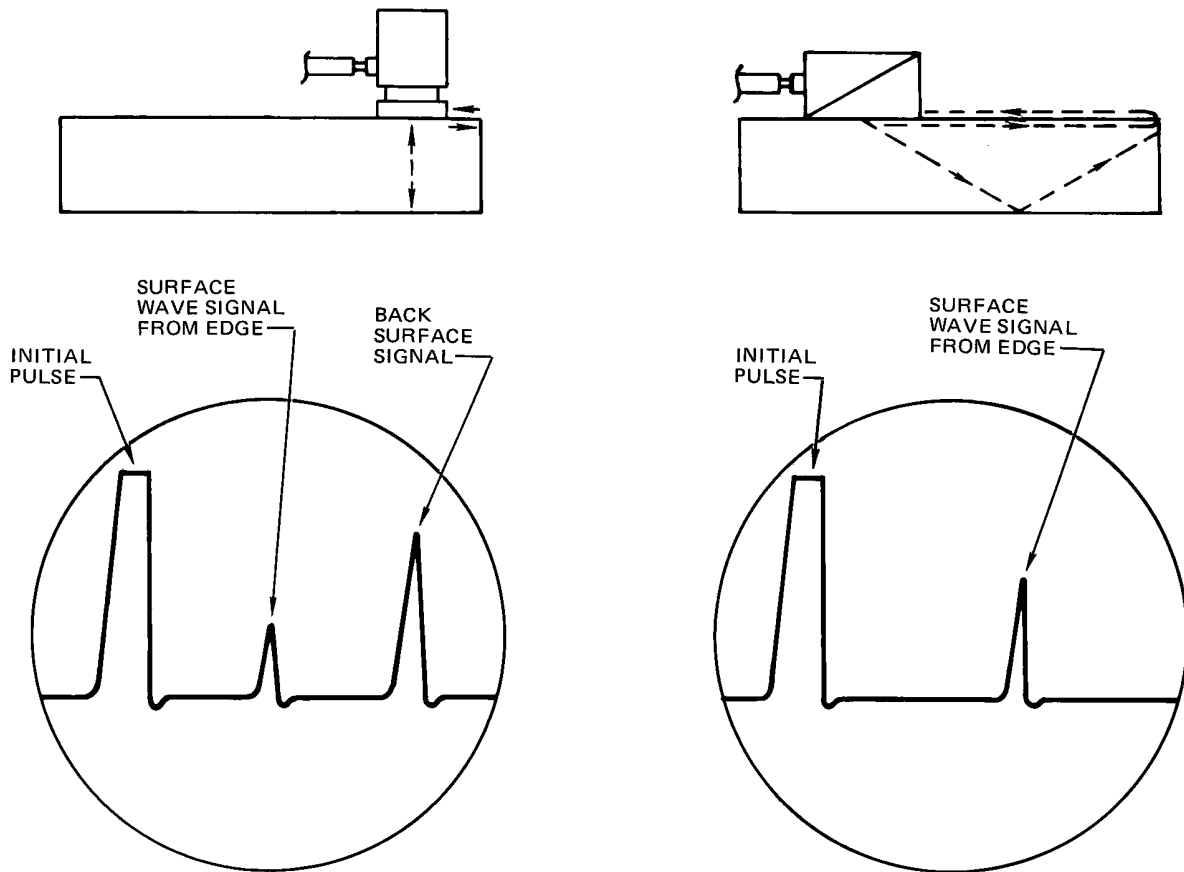


H0402891

Figure 5-55. Effect of Delaminations in a Plate on Multiple Back Surface Signals

T.O. 33B-1-1

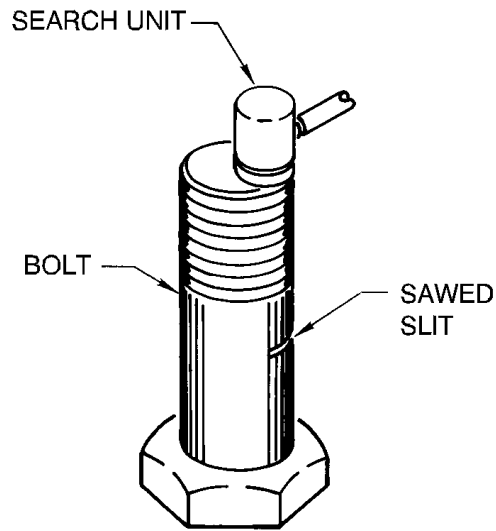
5.5.2.3 Surface Wave Indications in Straight Beam and Angle Beam Inspections. Due to the side lobe energy, surface waves can be generated when using straight beam transducers (Figure 5-11). Surface waves have also been observed in some inspections using angle beam transducer. These surface waves can cause signals from edges of the test part which can be mistaken for a discontinuity. These signals (Figure 5-56) are easily identified by varying the distance between the transducer and the part edge, and watching the signal move. The surface wave signal will move toward the initial pulse as the transducer is moved toward the edge.



H0402892

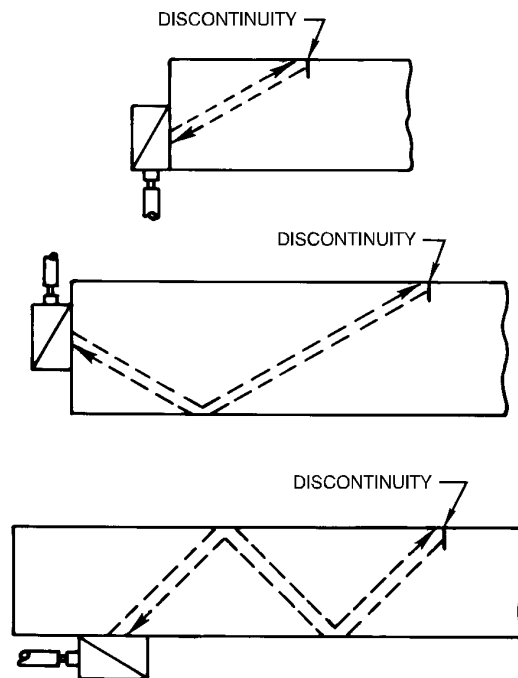
Figure 5-56. Irrelevant Surface Wave Signals

5.5.2.4 Parallel Boundaries. When using straight beam inspection near a boundary parallel to the sound beam axis, the spreading sound beam results in reflections and mode conversion at the boundary (Figure 5-10). These reflections from the boundary interfere with the main sound beam and can greatly reduce the sensitivity for detecting discontinuities close to or coming from the boundary. Such a case could occur when inspecting a bolt. As the transducer is moved closer to the boundary, the sensitivity is further reduced. When inspecting close to a boundary, it is therefore necessary to use a reference standard with the reference discontinuity located at the boundary. An example of such a discontinuity is a lateral saw cut (Figure 5-57). Flaws close to boundaries are better located by using, when possible, angle beam techniques (Figure 5-58).



H0402893

Figure 5-57. Reference Standard for Inspection of a Bolt



H0402894

Figure 5-58. Angle Beam Technique for Locating Discontinuities at Boundaries

T.O. 33B-1-1

5.5.2.5 Loose Transducer Element. A transducer element can separate from the damping material in a transducer. This will cause the initial pulse to become a long ringing signal (Figure 5-59). Such a situation will cause the search unit to fail the dead zone test. When this happens, the transducer SHALL be replaced.

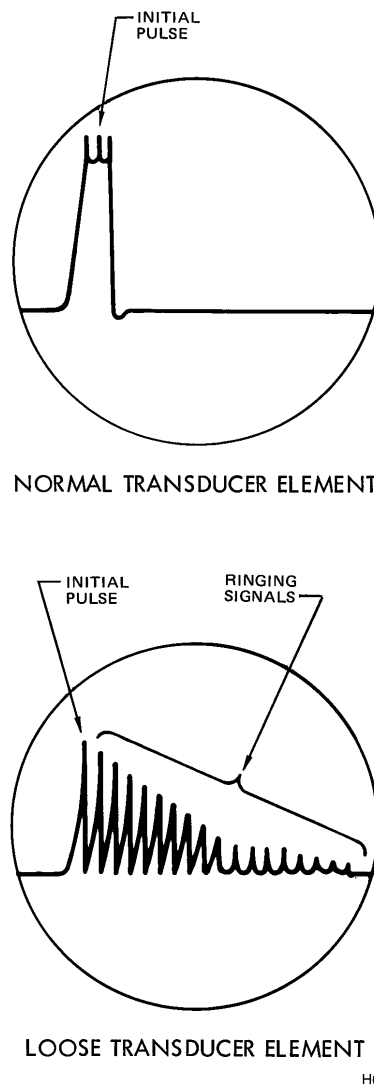


Figure 5-59. Example of Ringing Signals Due to a Loose Transducer Element

5.5.2.6 External Noise. Noise can be indicated on the waveform display when disturbances are created by such sources as follows:

- Nearby operation of electrical machinery or radio or radar transmitters.
- Machining on the test part (grinding, cutting, filing, etc.) during the inspection.
- Ground loop.

5.5.2.6.1 Noise from the causes listed above are more likely to be encountered when using equipment with a broadband receiver amplifier and/or long cables between the transducer and the instrument. Sometimes a double shield on the cable, as shown in (Figure 5-60), will help reduce this noise. In this case, the ground electrode of the transducer element is not connected to the metal case of the transducer, and the external shield of the connecting cable. The ground electrode is connected to the instrument ground via a second internal shield of the cable. Ground loops are created when instruments, cables, alarm boxes, etc. is not grounded to a common ground point. Also, a good earth ground is essential, not only for

preventing stray electrical interference, but also for safety reasons. If a ground loop is suspected, tie all grounds together, and connect them to a good earth ground. Portable a/c units can be operated, with constant voltage transformers, and if electrical interference on the a/c circuit is suspected, special transformers are available to block such interference.

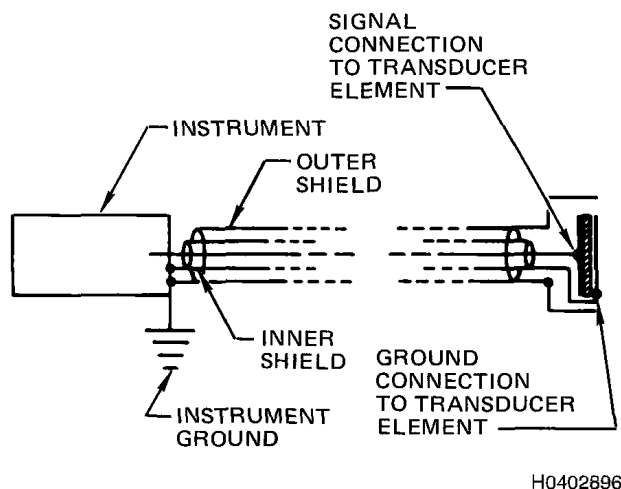


Figure 5-60. Double Shield for Reducing External Noise Signals

5.5.3 Test Part Variables.

5.5.3.1 Surface Condition. Rough surfaces, and surfaces with loose or pitted paint, scale, or corrosion, distort ultrasonic inspection results, and can prevent a meaningful inspection due to scattering of the sound beam and/or poor coupling. This can cause:

- Insufficient ultrasonic energy reaching discontinuities within the part.
- Loss of resolving power due to an increase in the length of the dead zone caused by a lengthening of the front surface echo. This is caused by reflections of side lobe energy. On smooth surfaces, the side lobe energy is not normally reflected back to the transducer; and therefore, does not interfere with inspection.
- Beam divergence, or widening of the sound beam within the test part.

5.5.3.1.1 To minimize these effects, the sound entry surface and the back surface of a test part **SHALL** be free from loose, heavy or uneven scale, machining or grinding particles, or other loose foreign matter.

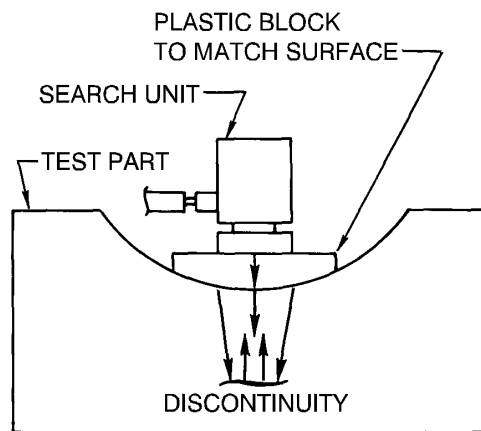
5.5.3.2 Geometry of the Part. The position and shape of the sides and back wall of the part can affect the test. A back surface not parallel to the front surface can result in internal mode conversion and cause confusing indications or complete loss of back reflection. It is important the inspector be familiar with the part geometry prior to inspection.

5.5.3.3 Flat Sound-Entry Surfaces. In the case of test parts with parallel front and back surfaces, it is often required to monitor the back reflection signal in order to evaluate the material and/or assure ultrasonic energy is passing through the part. Any loss of back reflection **MAY** be cause for rejection, unless it can be shown that the loss of back reflection is due to a non-parallel back surface or back surface roughness. If back surface roughness is found to be the cause of the back reflection loss and cannot be eliminated, the entire test item **SHALL** be inspected with another technique to assure conformance to the applicable specification or test procedure.

5.5.3.4 Curved Sound-Entry Surfaces. If the test specimen surface is curved beyond certain limits, a plastic shoe is required to match the transducer face to the curved surface (paragraph 5.3.4).

5.5.3.4.1 Concave and Convex Surfaces. For a concave surface, the sound beam tends to be focused as it passes into the test part (Figure 5-61). Depending on the depth in the part, discontinuity signals can be increased in amplitude over signals received from an equivalent discontinuity in a part with a flat sound entry surface.

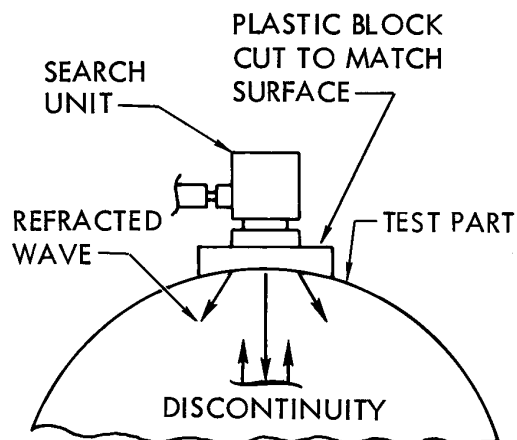
T.O. 33B-1-1



H0402897

Figure 5-61. Concave Sound Entry Surface

5.5.3.4.1.1 For a convex surface, the acoustic power that reaches an internal discontinuity is reduced by refraction at the test surface (Figure 5-62). Signals received from a discontinuity have less amplitude than signals received from the same size discontinuity in a test specimen with a flat sound entry surface.



H0402898

Figure 5-62. Convex Sound Entry Surface

5.5.3.4.2 Because of the variation in a signal due to curved surfaces, it is best to have a curved surface reference standard for setup of the test. The curved surface of the reference standard SHOULD be similar to the curved surface of the test part. Specifically, when performing straight beam inspection on curved surfaces of cylindrical or irregularly shaped products, special ultrasonic test blocks, containing specified radii of curvature and flat-bottom holes of standard diameter, may be required. For inspecting parts with convex surfaces or radii up to 4-inches (8-inch diameter), blocks conforming to the applicable specification or procedure SHALL be used. For parts with convex radii over 4-inches, use standard flat face blocks. For more information see ASTM standard E-1315 for steel blocks (ultrasonic examination of steel with convex cylindrically curved entry surfaces.)

NOTE

When shoes are made of plastic, (Figure 5-61) and (Figure 5-62) applies to the previous paragraph; however, shoes MAY be fabricated from the same material as the test part. If this is done, the sound will propagate straight into the test part. Refraction does not occur because the velocity in the shoe equals the velocity in the test part. For immersion techniques, no shoe is required, but refraction will be greater than illustrated in (Figure 5-62) and (Figure 5-63).

5.5.3.5 Internal Mode Conversion. A frequently misinterpreted form of mode conversion found in the field is shear wave converted to longitudinal. For example, on an H-3 sleeve and spindle inspection using a 45 ° transducer to inspect a large radius or bore, a non-relevant indication occurs in the area of interest as a result of this conversion (Figure 5-63). At a certain transducer position, part of the shear wave will convert to longitudinal as it reflects from the bore. This longitudinal wave (paragraph 5.2.3.1) will travel at double the velocity of the shear wave and will be reflected to the surface, then back to the bore. It then returns to the transducer to cause a non-relevant indication similar to a crack indication. In this case, finger damping the part surface where the longitudinal wave reflects off of the part surface in front of the transducer will identify the indication as non-relevant.

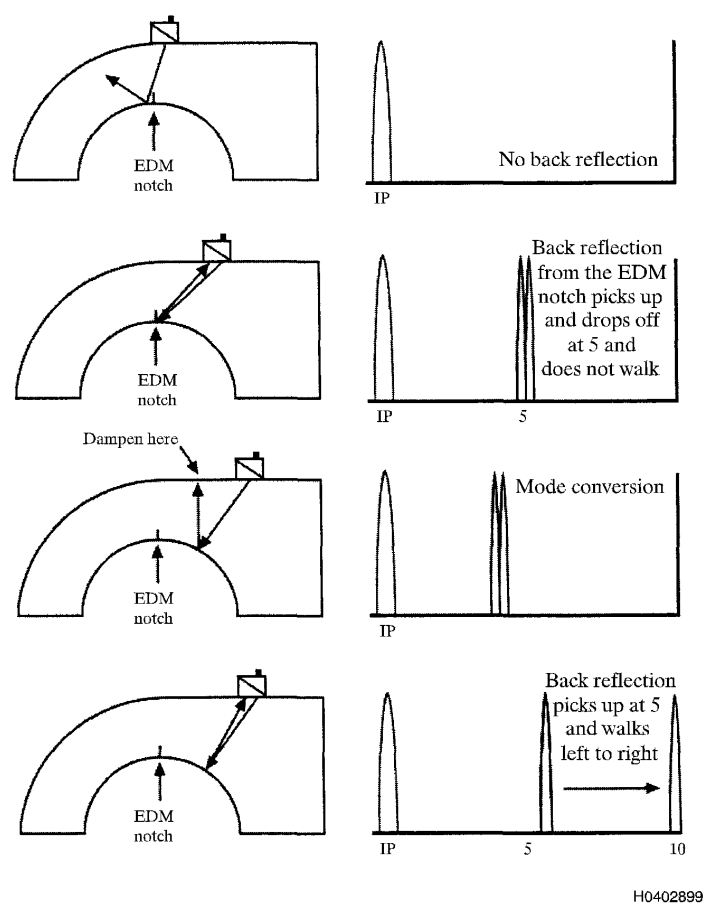


Figure 5-63. Example of Mode Conversion

5.5.3.6 Internal Structure. Discontinuities inherent in the test article, such as grain boundaries, affect the ultrasonic test by scattering the ultrasonic energy. This reduces the energy available for finding detrimental discontinuities and causes “noise” in the waveform presentation. Effects on an inspection increase as the frequency is increased and are most noticeable in materials with relatively large grain size. In certain applications, the loss in ultrasonic energy caused by internal scattering can be measured to evaluate metallurgical structures.

T.O. 33B-1-1

5.5.4 Discontinuity Variables. Ultrasonic beams can be reflected at various angles at the discontinuity interface; and can also spread or focus depending on the shape of the discontinuity.

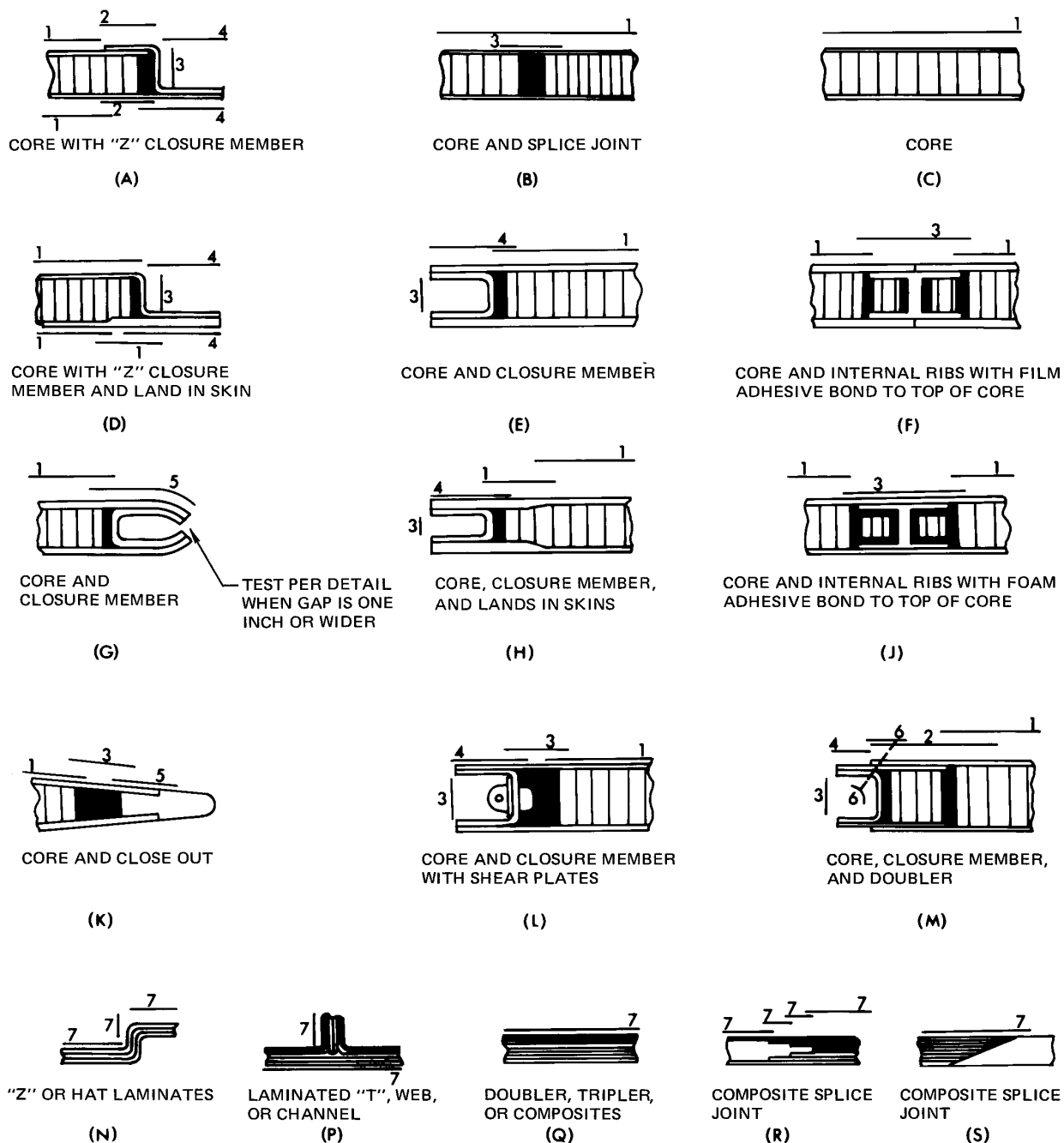
5.5.4.1 Size and Shape. When discontinuities smaller than the sound beam are oriented with one surface perpendicular to the incident sound beam, the amplitude of a reflected ultrasonic beam from a discontinuity increases as the area of the surface normal to the incident sound beam increases. An irregularly shaped, or round discontinuity reflects sound energy at many angles thus resulting in a loss of sound energy back to the transducer. A flat discontinuity, perpendicular to the sound beam, reflects the greatest amount of sound energy back to the transducer.

5.5.4.2 Orientation. Discontinuities, with surfaces oriented at angles other than perpendicular to the sound beam, reflect only a portion (if any) of the sound beam back to the transducer. If discontinuities are suspected to be located at angles other than parallel to the entry surface, consider angle beam inspection, or straight beam inspection from another surface (e.g., if the discontinuity is expected to be parallel to that surface). To help in detecting discontinuities oriented at angles to an incident straight beam, it may be helpful to monitor the back surface reflection. A sudden decrease in back reflection when scanning could indicate a discontinuity or possibly a number of small discontinuities. If a discontinuity signal is observed which is proportional to the loss in back reflection, the discontinuity is probably flat and oriented normal to the incident sound beam. If the discontinuity signal is small in relation to the loss of back reflection signal, the discontinuity is probably turned at an angle to the incident sound beam or is rounded. A decrease in back reflection accompanied by multiple discontinuity signals or a general increase in the noise level MAY indicate the presence of multiple discontinuities.

5.5.4.3 Acoustic Impedance. The acoustic impedance of the discontinuity material in relation to the acoustic impedance of the test part is important. The reflections from an air interface such as a crack or void are large due to the acoustic impedance ratio. If a discontinuity had acoustic impedance close to the acoustic impedance of the test material, the acoustic impedance ratio would be small and very little reflection would occur. When an ultrasonic beam strikes a boundary between two different materials, part of the energy is transmitted to the second medium and a portion is reflected. The percentage of sound energy transmitted and reflected is related to the ratio of the acoustic impedances of the two materials. The acoustic impedance calculation is shown in (paragraph 5.7.6).

5.5.4.3.1 Determining Reflected Energy at an Interface. Acoustic impedance can be used to calculate the theoretical reflected and transmitted energy for an interface. The greater the difference in acoustic impedance across the interface, the greater amount of sound reflected. The theoretical reflection at a water-steel interface is 88-percent; at a water-aluminum interface it is 72-percent; however, the actual reflection often differs significantly from the calculated theoretical reflection. Surface roughness is one of the variables besides acoustic impedance that affects the percentage of reflection. The acoustic impedance of the discontinuity material in relation to the acoustic impedance of the test part is important. The reflections from an air interface, such as a crack or void, are large due to the acoustic impedance ratio. If a discontinuity had acoustic impedance close to the acoustic impedance of the test material, the acoustic impedance ratio would be small and very little reflection would occur. The formula used to determine the amount of reflected energy that occurs at an interface is located in (paragraph 5.7.6.1).

5.5.5 Inspection Coverage of Bonded Structures. Examples of bonded structures, along with suggested inspection coverage, is shown in (Figure 5-64). The ultrasonic inspection methods applicable to the numbered coverage shown in the figure are listed in (Table 5-1). Due to access limitations, it will not be possible, in many cases to apply the inspections in all the areas shown. These coverage's and associated methods are guidelines only. Details of inspection coverage and inspection methods for a particular assembly SHALL be obtained from the applicable NDI manual or the depot engineering activity.



NOTES:

1. THE NUMBERED LINES SURROUNDING EACH VIEW INDICATE THE SCAN PLANES. THE NUMBER ON EACH LINE IS USED TO DETERMINE THE ACCEPTABLE INSPECTION METHODS BY REFERRING TO TABLE 4-7.
2. WHERE SURFACES ARE SYMMETRICAL, THE COVERAGE ILLUSTRATED SHALL BE CONSIDERED TYPICAL FOR BOTH SIDES.
3. SHADED AREAS (■) REPRESENT FOAM ADHESIVE.
4. WHEN THE SAME METHOD(S) ARE SPECIFIED IN MORE THAN ONE SCAN PLANE, CALIBRATION SHALL BE VERIFIED FOR EACH PLANE.

H0402900

Figure 5-64. Bonded Structure Configurations and Suggested Inspection Coverages

T.O. 33B-1-1

Table 5-1. Ultrasonic Inspection Techniques for Bonded Structures

Scan Line Number	Applicable Methods	
1	<u>Near-Side Skin-to-Core</u> a. Pitch/Catch b. Mechanical Impedance Analysis c. Resonance d. Eddy-sonic e. Through-transmission f. Pulse-echo g. Ringing	<u>Core Damage</u> a. Mechanical Impedance Analysis b. Through-transmission c. Pulse-echo <u>Far Side Skin-to-Core</u> a. Mechanical Impedance Analysis b. Through-transmission
2	<u>Near-Side Skin-to-Core</u> a. Resonance b. Mechanical Impedance Analysis c. Through-transmission d. Ringing <u>Core Damage</u> a. Mechanical Impedance Analysis b. Through-transmission	<u>Far-Side Skin-to-Core</u> a. Mechanical Impedance Analysis b. Through-transmission
3	a. Resonance b. Mechanical Impedance Analysis	c. Ringing
4	a. Resonance b. Ringing	c. Through-transmission d. Ringing
5	a. Resonance	b. Ringing
6	a. Through-transmission (with fluid delay lines)	
7	a. Resonance b. Mechanical Impedance Analysis	c. Through-transmission d. Ringing

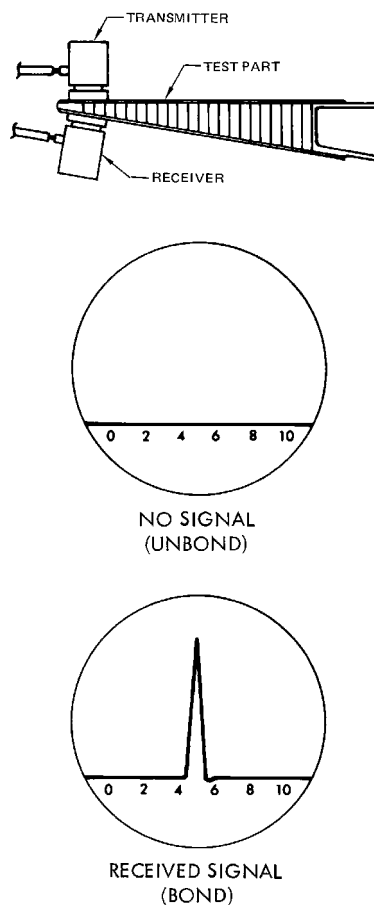
5.5.6 Inspection Methods for Bonded Structures. Ultrasonic bond inspection techniques, along with advantages and limitations of each technique, are provided in (Table 5-2). Additional information on each technique is provided in the following paragraphs.

Table 5-2. Ultrasonic Inspection Techniques for Bonded Structures

Inspection Method				
	Resonance	Pitch-Catch	MIA	Eddy - Sonic
Advantages	Applicable to structures with multiple layers, with or without honeycomb. Detects unbonds between any layer or in honeycomb. Detects small defects (larger than the diameter of receiving search unit).	Applicable to honeycomb structures with thick or thin skins. Detects small unbonds (search unit diameter and smaller).	Applicable to complex shapes. Detects small near-surface unbonds (larger than diameter of search unit).	Applicable to multi-layered structures with thick or thin sheets. Detects unbonds between any layers. Detects small unbonds (larger than diameter of search unit).
Limitations	Access to both sides of part required. Does not determine layer position of unbonds. Alignment of search units is critical. Couplant is required. Inspection rate is slow.	Inspection from both sides required. Does not detect far-side unbonds. Applicable only to honeycomb sandwich structures, usually those with single-layer skins. Couplant is required.	Applicable only to near-surface unbonds. Works best on unbonds between top sheet and adhesive layer, may miss unbonds on other side of adhesive. Works best on metals. Couplant required.	Applicable only to laminated (non-honeycomb) structures. Access to both sides is required. Does not determine layer position of unbond. Couplant is required.
Advantages	Locates layer position of unbonds. Applicable to laminate or honeycomb structures. Applicable to complex shapes.	No couplant required, potential for faster scanning. Special displays make interpretation easier.	No couplant required. Can be used on irregular or curved surfaces. Most effective on honeycomb structures: skin-to-core dis bonds and core defects.	No couplant required, potential for faster scanning.
Limitations	Inspection required from both sides of honeycomb structures. Couplant required.	Reduced effectiveness for unbonds greater than 0.80 inch below inspection surface. Access to both sides of honeycomb required. Probe is directional with respect to locating boundaries of unbonds.	Reduced effectiveness on purely laminated structures.	Works only on metals. Reduced effectiveness for unbonds farther from inspection surface and for low conductivity metals (titanium).

5.5.6.1 Through-Transmission Technique. Through-Transmission Technique. The principle of this technique is shown in (Figure 5-65). Delaminations in either skin, unbonds between skin and core, and core damage prevent the transmission of sound to the receiving transducer. The minimum size flaw detected is proportional to the size of the receiving transducers. The received signal does not have to disappear completely to indicate a flaw. Any flaw large enough to lower the received signal noticeably can be detected. Care SHALL be taken to move both transducers in tandem; otherwise, misaligned transducers will generate false indications.

T.O. 33B-1-1

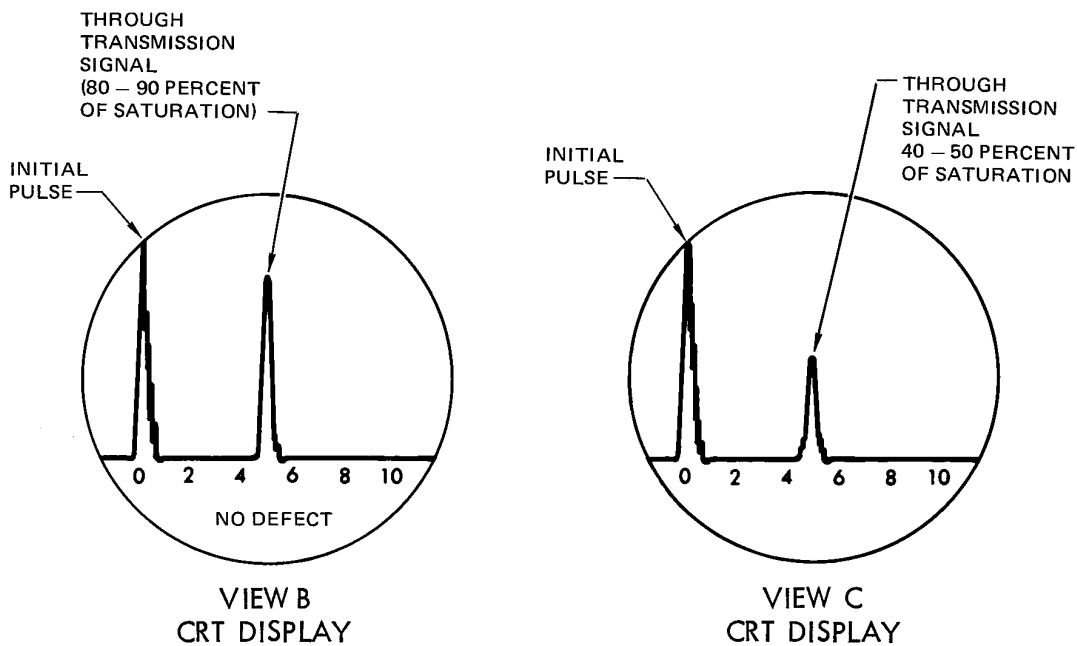
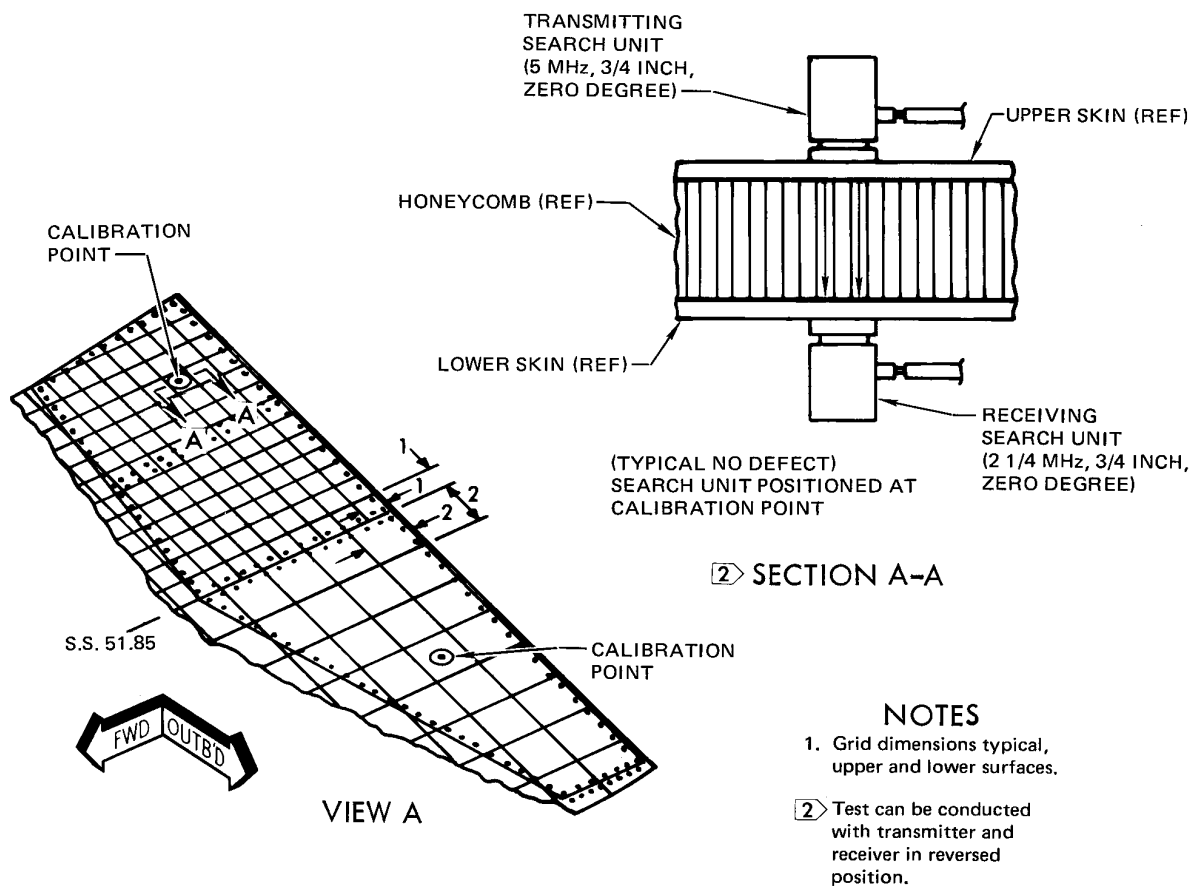


H0402801

Figure 5-65. Through-Transmission Technique

5.5.6.1.1 The structure is an aluminum honeycomb sandwich structure. Grids are marked on the surfaces to aid in maintaining transmitter/receiver alignment mapping boundaries of suspected flaws, assuring complete inspection coverage. The grid sizes are proportional to the critical flaw size of the respective zones. During the inspection one transducer is placed in the center of a grid square and the other is manipulated to maximize the received signal, as indicated in view B (Figure 5-66). Each square is inspected in turn. If the through-transmission signal falls below 50-percent of saturation, as indicated in view C (Figure 5-66), couplant and transducer alignment **SHOULD** be checked. If there is a definable area where the signal is less than 50-percent, mark the boundary (at the centerline of the receiving transducer) where the signal equals 50-percent according to the procedure in view D (Figure 5-67).

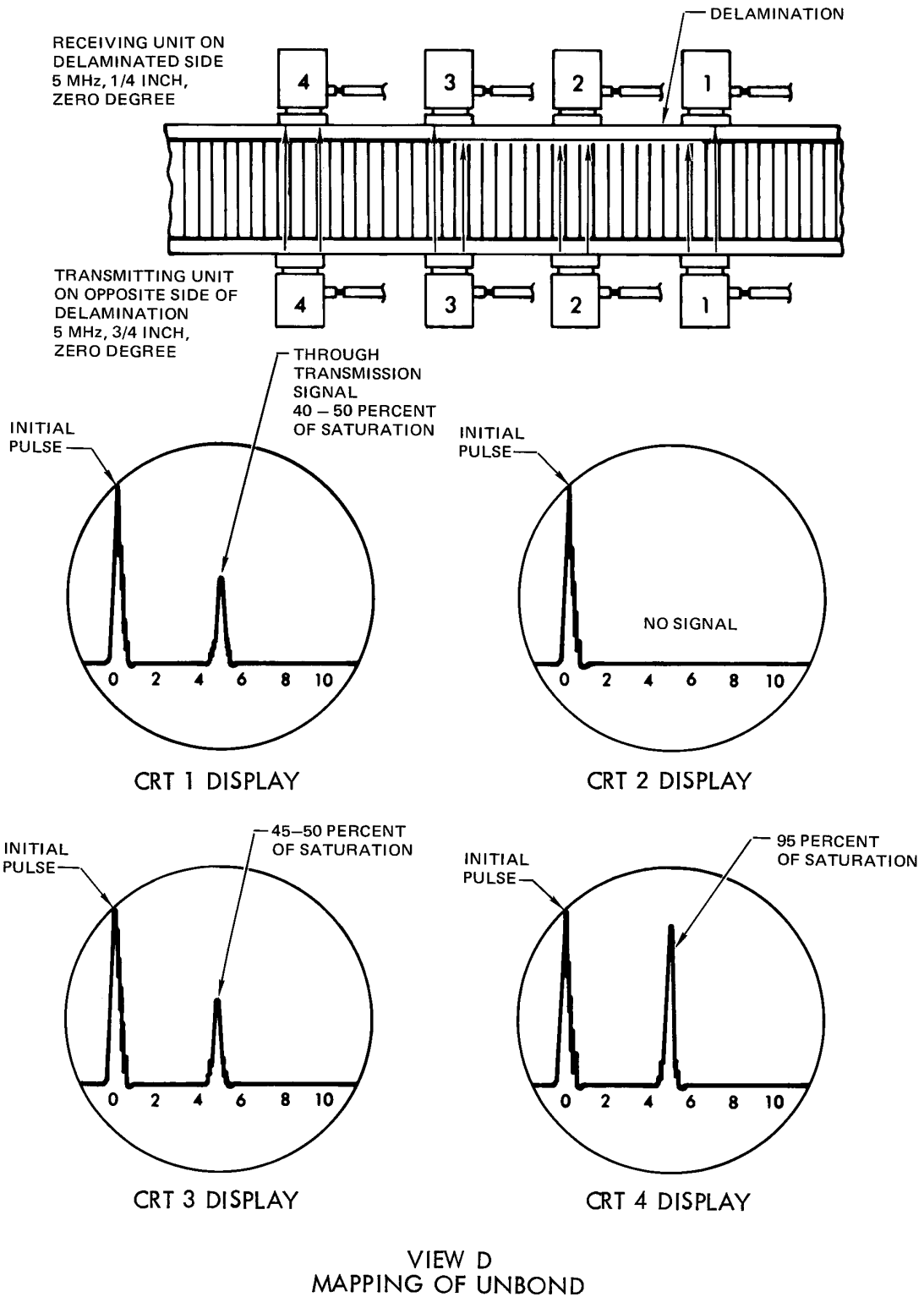
5.5.6.2 **Pulse-Echo Technique.** The basic principle of this technique is shown in (Figure 5-68). It employs an angle beam transducer because straight beam transducers can produce multiple echo signals from the layers that would interfere with echo signals from the core. This method is applicable only to honeycomb structures and is best applied to structures with single-layer skins as indicated in view C (Figure 5-68) when the through-transmission technique cannot be used. Straight beam transducers could provide better results on structures with multi-layer skins. This technique **SHOULD** be used as a backup to techniques associated with dedicated bond inspection instruments discussed below. Angle beam transducers producing refracted angles of 30° to 90° **MAY** be used. The angle selected **SHOULD** be the one that produces the maximum signal response from the back of the core.



H0402902

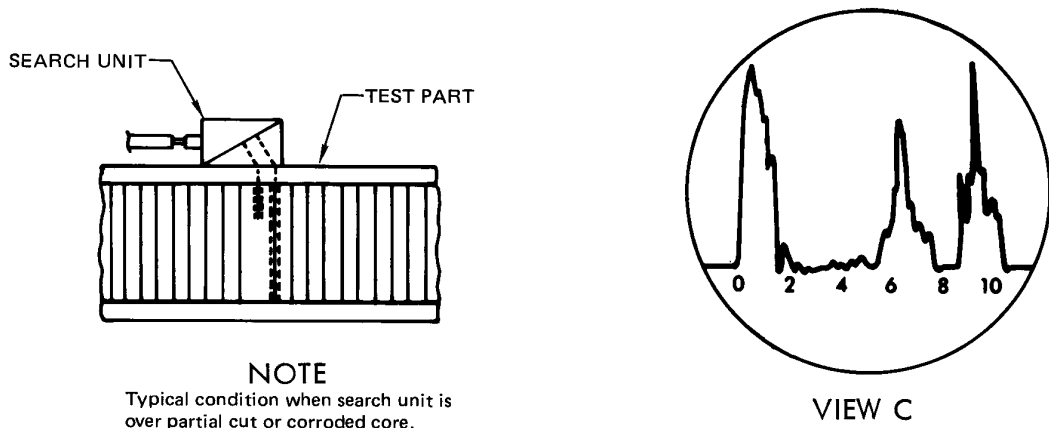
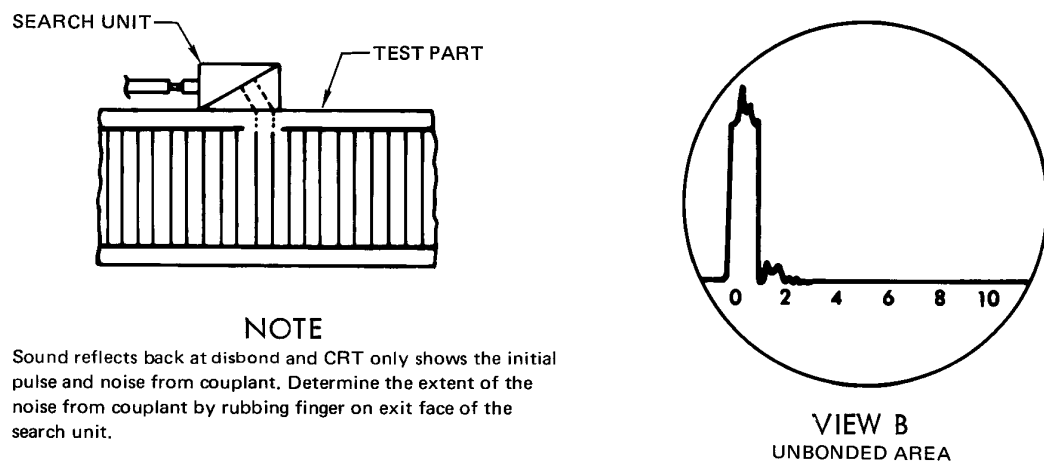
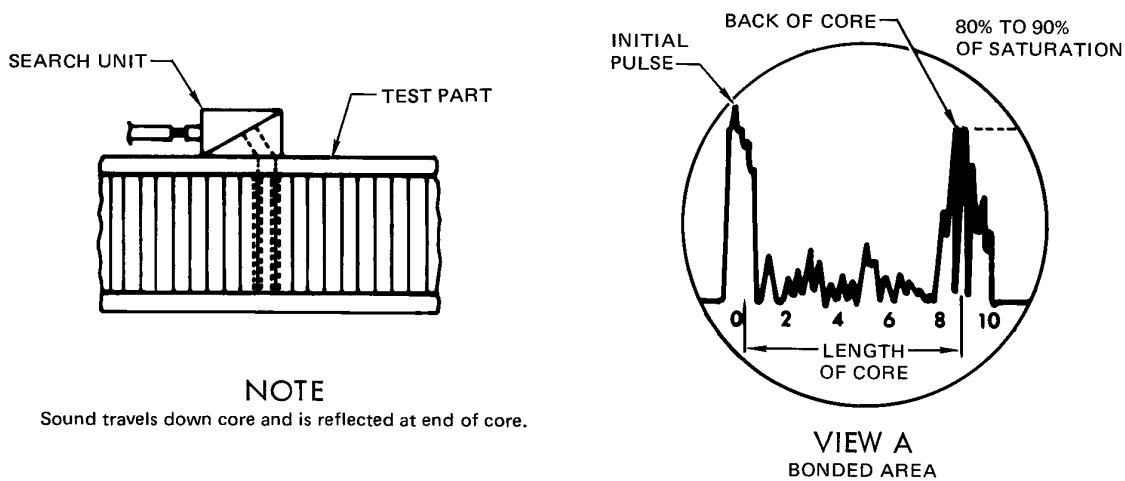
Figure 5-66. Procedure for Through-Transmission Inspection of a Stabilator View A - C

T.O. 33B-1-1



H0402903

Figure 5-67. Procedure for Through-Transmission Inspection of a Stabulator View D



H0402904

Figure 5-68. Pulse-Echo Technique

T.O. 33B-1-1

5.5.6.2.1 This technique can detect near-skin-to-core unbonds and broken or corroded core. Unbonds will cause a complete loss of the signal from the back of the core as indicated in view B (Figure 5-68). Broken or corroded core will reduce or completely eliminate the signal from the back of the core and can produce an echo signal as indicated in view C (Figure 5-68).

5.5.6.2.2 Indications MAY be mapped by marking the boundaries, where the back echo signal drops below 50-percent of the amplitude obtained in a good area (Figure 5-69).

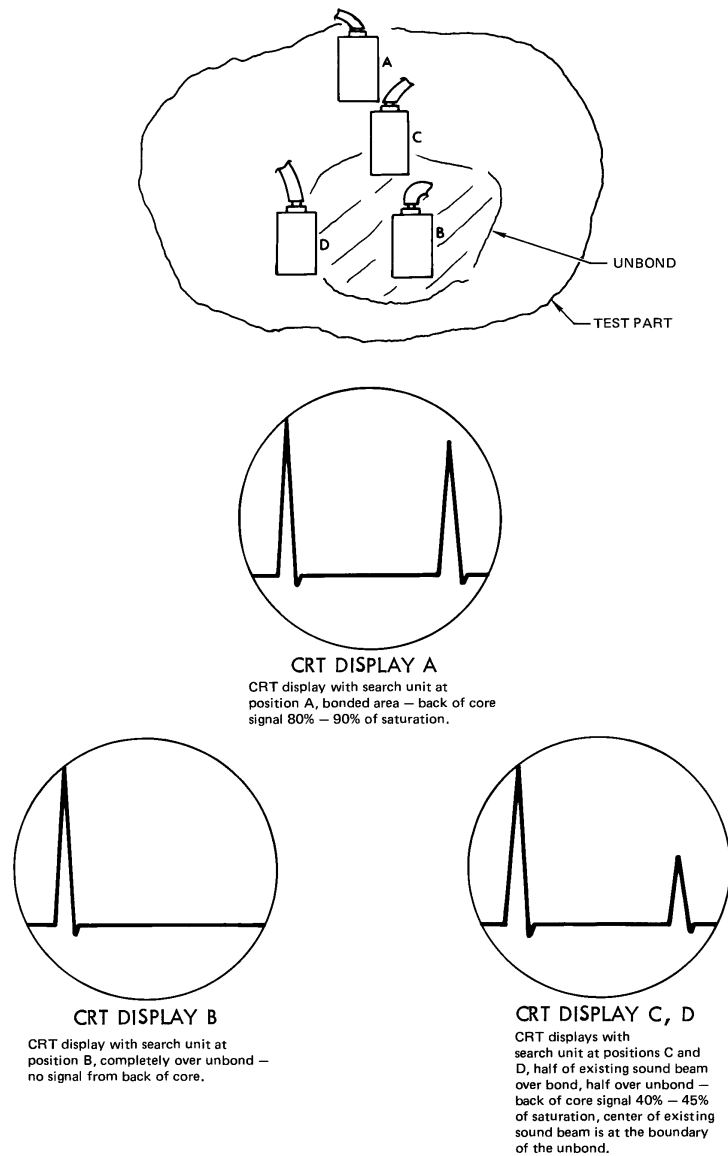
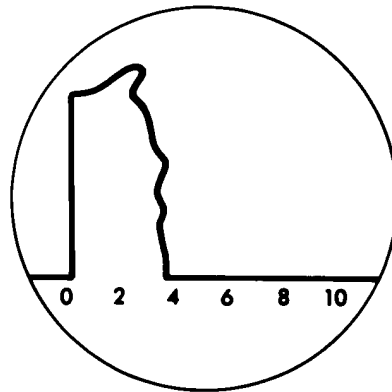
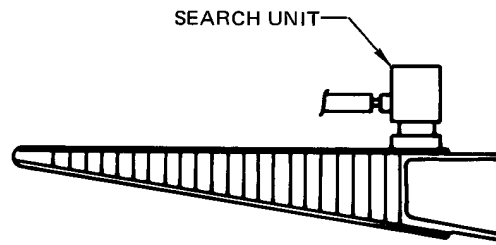
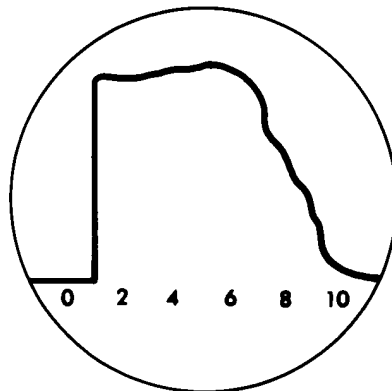


Figure 5-69. Mapping of Unbonds, Pulse-Echo Technique

5.5.6.3 Ringing Technique. The principle of this technique is shown in (Figure 5-70). The A-scans in the figure represent the outline of multiple echo signals from the skin that cannot be individually resolved. This technique is most sensitive to unbonds between a single layer of skin and the adhesive layer. An unbond between the adhesive and the core, or another layer of skin or a doubler, will often not produce a ringing signal, because the adhesive bonded to the top sheet dampens the signal. Because of this limitation, it is recommended that this technique be applied only when one of the other techniques is not applicable. A good application for this technique is the inspection of core-to-closure-member bonds.



DAMPED SIGNAL
FROM BONDED AREA



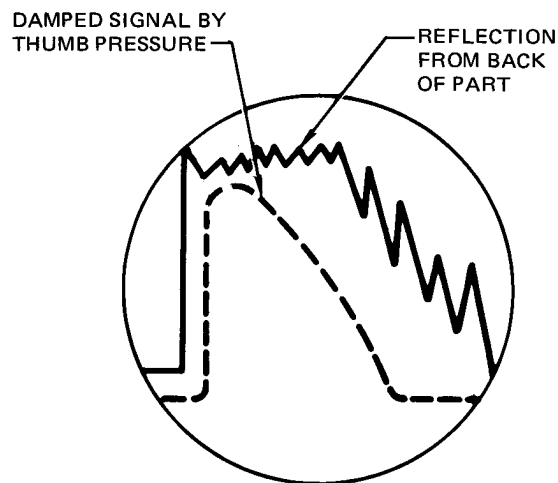
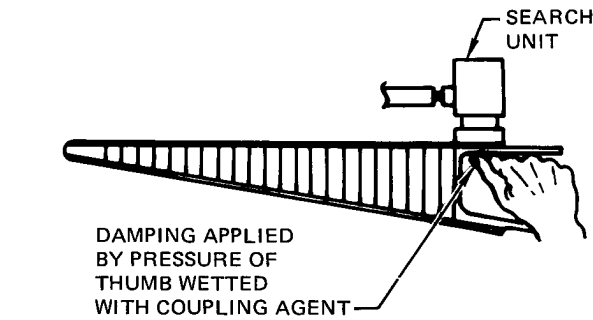
RINGING SIGNAL
FROM UNBONDED AREA

H0402907

Figure 5-70. Ringing Technique

5.5.6.4 Damping Technique. This technique, illustrated in (Figure 5-71), is effective for laminate, doubler, and skin-to-closure-member bonds when access to the backside is available. If the inspector can dampen the multiple echoes from the far side of the bonded structure with a wet finger, then the bond is good. Otherwise, the sound is being reflected by an unbond and is not reaching the far surface, so it cannot be damped. Unbonds equal to or larger than the size of the transducer are easily detected.

T.O. 33B-1-1



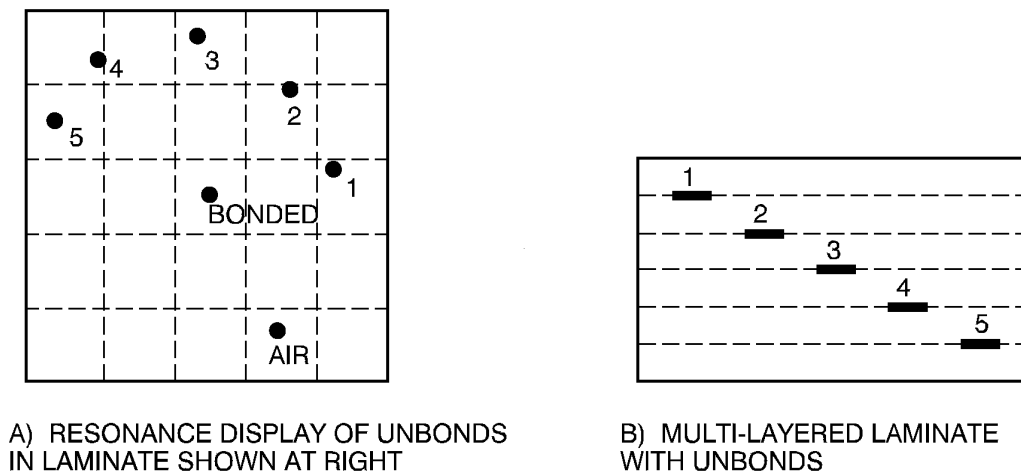
H0402908

Figure 5-71. Damping Technique

5.5.7 Techniques Associated With Instruments Dedicated to Bond Inspection. Refer back to the bottom half of (Table 5-1) for a summary of these methods, which are described in detail below.

5.5.7.1 Resonance Technique. When an ultrasonic transducer is placed on a test sample, with couplant, it is driven at its resonance frequency by an oscillator in the instrument. The detector in the instrument measures the phase and amplitude components of the electrical impedance of the probe, which are affected by changes in the acoustic impedance of the test part. The acoustic impedance of a part is altered by a lack of bond, commonly referred to as delamination. Bonded laminates act like a thin plate, which vibrates and generates a standing wave. Changes in the effective thickness caused by the delaminations will significantly affect the phase and amplitude of the acoustic wave in the part. With the resonance technique, the instrument indicates the probe's impedance with a 'flying spot' on an ultrasonic impedance plane display. Amplitude changes in impedance are indicated by the radial distance of the spot from the center of the display (null reference point), and changes in the phase are indicated by the rotation of the spot around the center null point. An example of an ultrasonic impedance plane display (Figure 5-72) "A" shows the spot positions corresponding to different depths of unbonds (delaminations) in the bonded laminate in (Figure 5-72) "B". The laminate is an example of a typical reference standard used for calibration. The positions can be gated, so a disbond produces an alarm, or the display can be monitored to determine between which layers a disbond occurs. The resonance mode works very well for detecting disbonds at metal-to-metal,

metal-to-composite and composite-to-composite interfaces, for finding delaminations within composite materials, and for detecting skin-to-core disbonds in honeycomb sandwich structures.



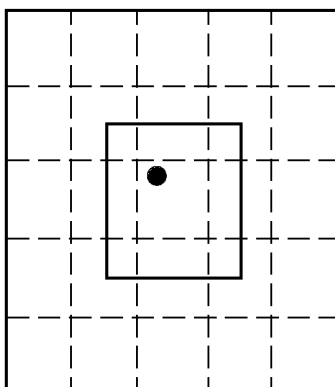
H0402909

Figure 5-72. Resonance Method

5.5.7.2 Pitch/Catch Impulse Method. The dual transducer, pitch and catch method uses a pair of transducers displaced from each other by a fixed distance. The transducers are placed on the same or opposite sides of the part. A single ultrasonic frequency is transmitted into the part by one transducer; a second transducer in the same probe assembly receives the returned signal. Contact with the part is made through nylon wear tips on spring-loaded metal rods attached to the respective transducers. The ultrasound travels through the material between the two probe tips. Depending on the instrument, the received signals are displayed in various ways:

- Amplitude and phase components are displayed on separate meters.
- The resultant signal activates a light-emitting-diode (LED) display.
- The phase and amplitude components are combined to position a “flying spot” on an impedance plane display.

The display in (Figure 5-73) shows a box in the middle of the display, which is the gate that sets off an alarm if the spot lands inside, indicating a disbond.

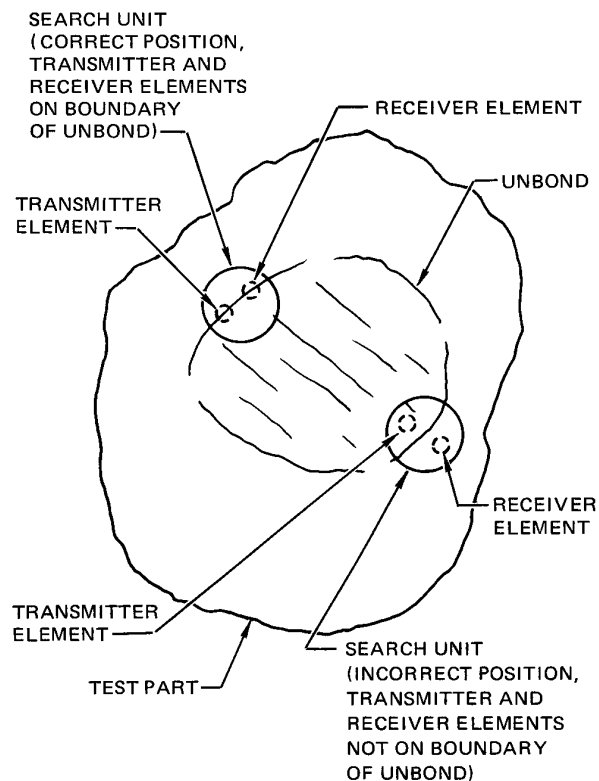


H0402910

Figure 5-73. Impedance Plane Display of a Pitch/Catch Impulse Technique

T.O. 33B-1-1

5.5.7.2.1 The pitch/catch impulse probe is directionally sensitive, such that both active tips must be over the same condition of bond for unambiguous signal interpretation. For example, (Figure 5-74) shows the proper way to align the active tips for precise mapping of unbonds.

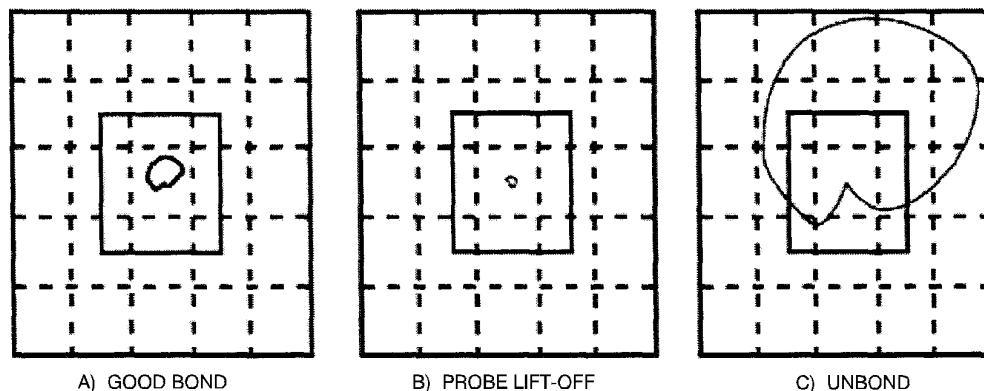


H0402911

Figure 5-74. Pitch/Catch Probe Positions for Mapping Unbonds

5.5.7.2.2 Some pitch/catch instruments permit the operator to select the frequency, while in the frequency are fixed. Typically, selectable frequencies range from 2.5 to 70 kHz; the frequency providing the largest received signal, due to maximum flexure in the layer being tested, is chosen for the inspection. A typical fixed frequency is 25 kHz. The low frequencies eliminate the need for liquid couplant between the transducer and the test part. On some instruments, a variable time gate is used to select the part of the received pulse that has the greatest change in amplitude when the probe is moved from a bonded area to an unbonded area. The amplitude will be larger over the unbond area than a bonded area because the motion of the layer is restricted over a bonded area and energy is lost into the second layer. The pitch catch mode works on composite delaminations, skin-to-core unbonds, metal-to-metal unbonds and skin-to-core disbonds. The technique tends to lose its effectiveness if the material thickness between the probe and the delamination exceeds 0.08-inch of aluminum or 0.30-inch of nonmetallic composite. In addition, the minimum dimension of a detectable flaw is greater than or equal to the probe tip spacing.

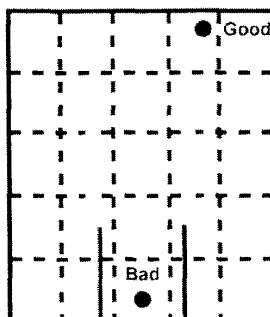
5.5.7.3 Pitch/Catch Swept Frequency Technique. Instead of a single frequency, each pulse contains a range of frequencies (e.g., 20 - 40 kHz or 30 - 50 kHz), generating ultrasonic Lamb (plate) waves within the part. These waves are attenuated by coupling into the second layer in well bonded joints. In an unbond region, the waves travel with very little attenuation or leakage into the second layer and produce larger indications. Both the swept and impulse techniques will find similar types of defects; however, with the swept technique, calibration interpretation of the signals are easier because both the amplitude and phase signals are simultaneously displayed in the form of circular patterns on one X-Y active screen. Instrument displays corresponding to three situations detected with the Pitch/Catch Swept-Frequency Technique are shown in (Figure 5-75).



H0402912

Figure 5-75. Pitch/Catch Swept-Frequency Signal Patterns

5.5.7.4 Mechanical Impedance Analysis (MIA) Technique. The driver portion of a single-tip dual-element probe generates low-frequency sound waves that transfer to mechanical movements in the test material. The stiffness and mass of the material are measured by the receiving sensor, and displayed in terms of both phase and amplitude values. The receiver element at the bottom of the probe has its loading affected by the part stiffness, which changes from very high over bonded regions to low over unbonded regions. Since the measurements are a comparison of stiffness, results are better on stiff structures. Flexible composites would not have much change in stiffness from bonded to unbonded areas. The MIA mode does not require couplant, and has a small contact area so it can be used on irregular or curved surfaces. The MIA technique seems most suitable for detecting damage associated with honeycomb core such as: skin-to-core disbonds, severely corroded aluminum core, and buckled or crushed core; additionally, disbonds and delaminations also can be detected with this technique. Typical positions of indications produced with the MIA technique are shown in (Figure 5-76). During an inspection, only the “flying spot” would be present on the display. The gate box can be positioned anywhere on the display; the appropriate position is determined during calibration. The alignment problem is normally solved by placing the inspection area into grids to keep the inspection area down to a manageable size. If the area is very large, special fixtures are normally manufactured to hold both transducers and keep them aligned.



H0402913

Figure 5-76. Mechanical Impedance Analysis Display

T.O. 33B-1-1**5.5.7.5 Eddy-Sonic Method.****CAUTION**

Gradual changes in indications on an instrument display **SHOULD** be evaluated to see if the part thickness is changing. If the part thickness has changed, recalibration is required. When possible, scanning **SHOULD** be performed in directions of constant thickness.

Since this method is based on the generation of eddy currents in the test part, it will work only on metal structures. The instrument sends electrical pulses, with frequencies in the low kilohertz range, to a coil in the probe. The resultant pulsating magnetic field produces eddy currents in the part; the eddy currents cause the part to vibrate, and a microphone on the axis of the coil detects the sonic vibrations. Unbonds cause changes in the vibrations of the part. The detected changes produce an indication on a meter or an LED array. The probe usually has a mechanical lift-off adjustment that sets the air gap between the coil and the test surface to minimize the noise produced by probe scanning. This method works best on metallic honeycomb structures with thin skins (0.062 inch or less). Other methods do as well on such configurations, because the eddy-sonic is rather limited in its application, it is not commonly used.

NOTE

For a reliable bond inspection, the inspection surfaces of the test part **SHALL** be free of loose paint and foreign matter.

5.5.8 Thickness Measurement Test Part Preparation.

5.5.8.1 Surface Contamination. All foreign matter that might interfere with the thickness measurements **SHALL** be removed. Examples of such matter are loose scale, paint, dirt, and rust. For maximum accuracy, paint **SHOULD** be removed in the area to be measured. Paint can introduce errors in the measurements up to three times the maximum thickness of the paint. Metallic plating on the surface of the test part (Cr, Cd, Ni, etc.) will not significantly affect the accuracy of the readings; usually, this plating is relatively thin (0.0005-inch).

5.5.8.2 Surface Roughness. The surface finish of the test part affects the accuracy of the reading as shown in (Table 5-8). If the surface of the test part is pitted or irregular, consistent readings will not be obtained. If permitted by the applicable weapons system manual or the prime depot engineering authority, local areas **MAY** be sanded to provide a smooth surface for increased accuracy in the thickness measurements.

5.5.9 Thickness Measurement Considerations.

5.5.9.1 Corrosion Pitting. The effect, corrosion pits on the back surface of the test part has on thickness measurements, depends on the size of the pits and the size of the search unit. The depth of large pits (the size of the search unit diameter or greater) can be measured by subtracting minimum readings from maximum readings obtained on adjacent areas of the test part. Smaller pits will generally cause a broadening of the back surface reflection signals, and sometimes a reduction in amplitude, due to scattering of the sound beam. These effects can be observed on instruments equipped with waveform displays. Smaller pits also lower the average thickness readings of the test part.

5.5.9.2 Curved Surfaces. Measurements of curved surfaces require reference standards in accordance with (paragraph 5.7.7). In addition, for convex radii less than 1-inch or concave radii less than 3-inches, shoes are required to adapt the search unit to the curved surface. Detailed procedures for taking the measurements **SHALL** be obtained from the applicable NDI manual or the depot level engineering activity. On all curved surfaces, it is recommended an instrument with a waveform display be used. Small-diameter transducers (1/4-inch or less) are also recommended. When making a measurement on a curved surface, the back surface signals **SHOULD** be maximized by rocking the transducer on the surface until the back surface signals peak and the thickness reading is at a minimum. The minimum thickness reading **SHOULD** be recorded as the test part thickness.

SECTION VI ULTRASONIC INSPECTION PROCESS CONTROLS

5.6 INTRODUCTION.

5.6.1 Ultrasonic Process Control Requirements. In the ultrasonic inspection process like all other processes, you must know your equipment is functioning properly. The following information on process control in ultrasonic testing is designed to help ensure repeatability and accuracy. You **SHOULD NOT** have only one transducer for a specific application. A transducer element can separate from the damping material, causing the initial pulse to become a long ringing signal. Such a situation will cause the transducer to fail the dead zone test. A transducer, in this case, **SHALL** be replaced. This type of process control will help ensure quality inspections. Frequency of process control checks on equipment **SHOULD** come from the operations manual on the equipment. Frequency of transducer checks **SHOULD** be determined by the amount of use. The operator is the critical link in this process. Even if all the equipment is working properly, the inspector must follow the written procedure and use the correct standard. No deviations **SHALL** be made without proper engineering authority. In this chapter, the terms “reference standard,” “reference block,” “test block,” and “calibration standard” all have the same meaning as defined in the glossary. Reference standards are used by the instrument operator. Calibration of reference standards by laboratories is not required; however, to ensure uniform inspection sensitivity, reference standards **SHALL** be traceable to a “master standard” in terms of discontinuity response. Minimum interval frequency for process control checks on equipment and transducers are stated in [Table 1-3](#).

5.6.1.1 Required Use. All inspections **SHALL** include the use of one or more reference standards for setting up an inspection. In addition, all discontinuity indications **SHALL** be compared to a reference standard by comparing the signal amplitude of the discontinuity with the signal amplitude of the reference standard. This is done either in percent signal amplitude, or by noting the difference in amplitude in decibels (dB) when the instrument is equipped with dB attenuation controls.

5.6.2 Reference Standard Configuration. The reference standard **MAY** be a block containing a flat-bottom or side-drilled hole with a known size, a machined slot or notch, or an actual test part or similar manufactured part, with an actual discontinuity of known size. Inspection procedures must be carefully reviewed for the following specific requirements:

- Flat surface reference standards used for test setup and for evaluation of discontinuity size and metal travel **SHALL** be fabricated and checked in accordance with ASTM standard practices. For more information see ASTM E-127, E-128, and E-1158.
- Curved surface reference standards **MAY** be required when performing straight beam inspection of curved entry surfaces on cylindrical or irregularly shaped products. Special ultrasonic test blocks containing specified radii of curvature and flat-bottom holes of standard diameter **SHALL** be used. For parts with convex radii over 4-inches, use standard flat face blocks. Flat blocks **MAY** be used to inspect other curved surfaces when supported by test data showing correction factors and must be acceptable to the responsible engineering activity.
- Hollow cylindrical standards, for inspection of hollow cylindrical parts or sections, **SHALL** be fabricated in accordance with a particular specification.
- International Institute of Welding (Type 2 IIW) blocks **SHALL** be used as specified for determining certain characteristics of angle beam and straight beam transducer and **MAY** be used for distance calibrations.
- Holes, notches, and other reflectors **SHALL** be protected against corrosion and mechanical defacing that would alter the ultrasonic echo signal. For example, it is recommended all holes be sealed to prevent corrosion of the hole face.
- For most inspections performed to locate cracks, an effective reference standard can be made by electrical discharge machining (EDM) notches. Notches must be replicated for verification. The notch of appropriate size **SHOULD** be placed in the expected location of cracks (or per drawing) with the plane of the notch in the expected plane of cracks. Information on the expected location and orientation of cracks **SHALL** be obtained from the depot-level engineering activity. Other reflecting surfaces meeting the requirements of MIL-STD-2154 are permitted. All standards **SHOULD** be clearly identified so that the material, hole or notch size, angles, and dimensions are clear.

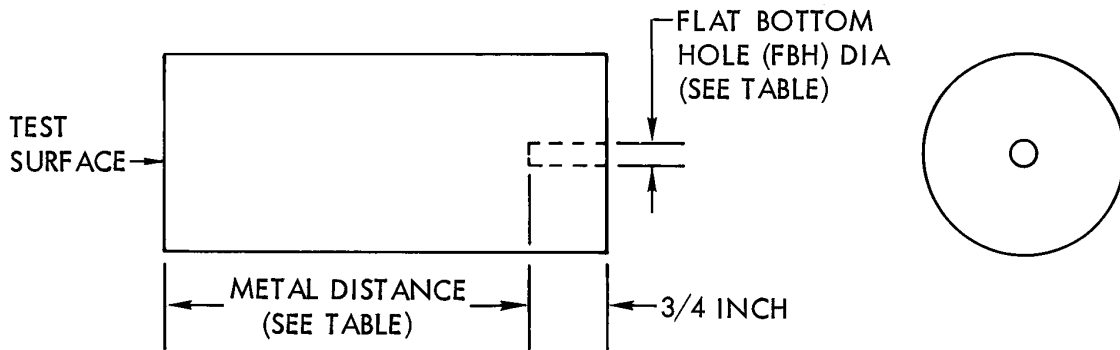
5.6.2.1 Metal Travel Distance. The metal travel distance (distance from sound-entry surface to a discontinuity) for the test part and the reference standard must be the same within the tolerances shown in ([Table 5-3](#)); as an option, distance amplitude correction could be used.

T.O. 33B-1-1

Table 5-3. Reference Standard Metal Travel Tolerances

Metal Travel Distance to Discontinuity in Test Part (inches)	Tolerances on Metal Travel Distance to Discontinuity in Reference Standard (inches)
Up to 1/4	± 1/16
1/4 to 1	± 1/8
1 to 3	± 1/4
3 to 6	± 1/2
Over 6	± 10% of metal travel

5.6.2.2 Straight Beam Reference Standards. The ASTM test block configuration is shown in (Figure 5-77). Two sets of ASTM test blocks, one for aluminum and one for steel, are included in AS 455. Two ASTM specifications cover manufacturing and verification of these reference standards. They are ASTM E-127 (aluminum test blocks) and ASTM E-428 (steel test blocks). ASTM E-428 also allows the use of reference standards of other materials such as titanium. For more information see ASTM E-1158, "Standard Guide for Material Selection and Fabrication of Reference Blocks for the Pulsed Longitudinal Wave Ultrasonic Examination of Metal and Metal Alloy Production Material."



METAL DISTANCE, INCHES	1/8	1/4	1/2	3/4	1-1/2	3	3	3	6	6
FBH DIA IN 64THS INCH	5	5	5	5	5	3	5	8	5	8

H0402914

Figure 5-77. ASTM Reference Blocks

- a. When applicable, (Table 5-4) MAY be used as an aid if the required flat-bottom hole, (FBH), reference standard is not available. The second column lists relative amplitudes of echoes from successive sizes of FBH's. For example: the signal from a #5 FBH is 4 dB larger than the signal from a #4 FBH, so the instrument gain would have to be decreased by 4 dB if a #4 FBH were available, but a #5 FBH was the required standard. If a #5 FBH were available, but a #2 FBH were required, the instrument gain would have to be increased 16 dB (7+5+4) for the inspection.

Table 5-4. Relative Signal Response from FBHs in ASTM Blocks

FBH Number (Size in 64ths of an inch)	Difference (dBs) From Previous FBH Size
2	
3	7
4	5
5	4
6	3
7	3
8	2

- b. Hole bottoms are checked for flatness, and hole orientation is checked for perpendicularity to the block surface.
- c. When FBH size is plotted versus respective ultrasonic echo amplitude for a given equipment setup, a straight line ± 2 dB SHOULD pass through the plotted points.

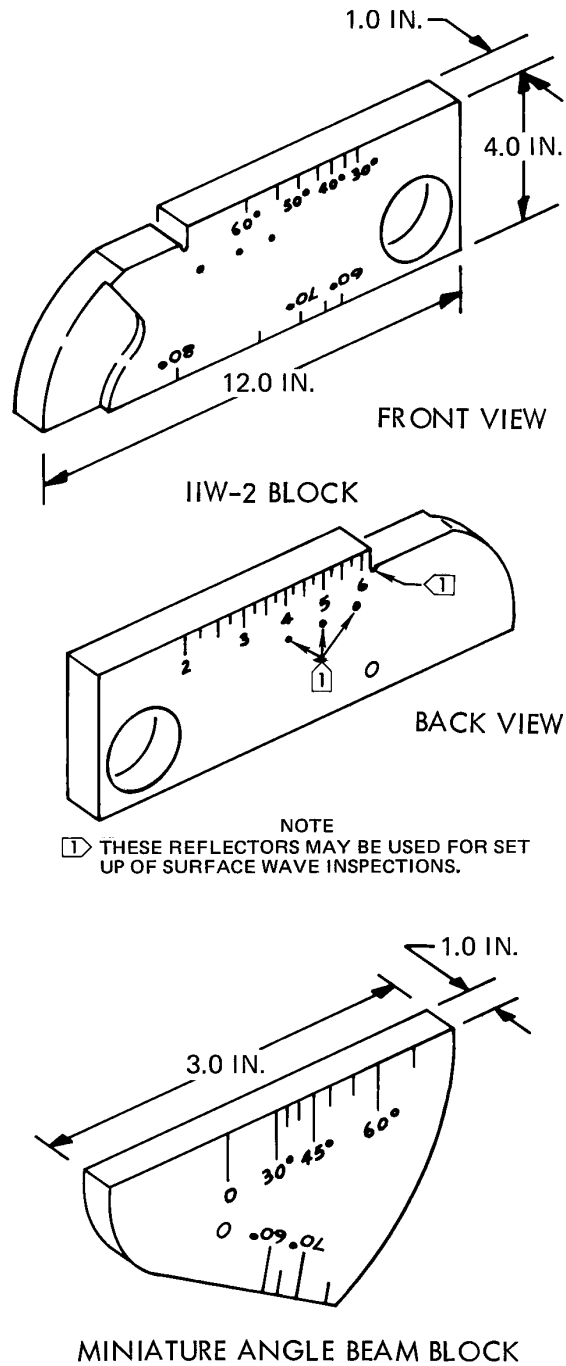
5.6.2.3 Angle Beam Reference Standards. There are two types of angle beam calibration blocks included in AS 455: the miniature angle beam block and the International Institute of Welding Type 2 IIW block (Figure 5-78). Either of these blocks MAY be used to perform the following tests for angle beam transducers:

- a. Check the refracted angle of the sound beam.
- b. Check the point-of-incidence of the refracted sound beam.
- c. Calibrate the sweep of the ultrasonic instrument.

NOTE

Angle beam blocks made of aluminum and steel are standard; other materials MAY be specifically ordered. Shear wave velocities for titanium and aluminum are close, so aluminum blocks MAY be used for shear wave inspection of titanium; however, adjustments in distance calibration MAY have to be made. These blocks are also used for straight beam tests, which are covered in (paragraph 5.3.6).

T.O. 33B-1-1



H0402915

Figure 5-78. Angle Beam Block

5.6.2.4 Surface Wave Reference Standards. A variety of reflectors can be used to set up surface wave inspections. Electrical discharge machined notches, saw cuts, chiseled notches, and drilled holes can be used. Suggested surface wave standards are the side-drilled holes and the notch in the IIW block, when the transducer is placed on the large front, or back surface of the block. The reflected signal from one of the holes, or the notch, can be compared with the reflected signals from

discontinuities in test parts. Signals SHOULD be compared at equivalent travel distances (distance from transducer to reference standard reflector, equal to distance from transducer to test part discontinuity).

5.6.3 System (Equipment) Checks. The most important calibration is the verification of each inspection setup through use of the applicable reference standards. An ultrasonic system consists of the inspection unit, search unit (transducer) and the coaxial cable. It is essential this verification be accomplished before each and every inspection; however, there are general calibration procedures that can be used to ensure the system is within the parameters required to perform ultrasonic inspections. The procedures, which follow in the remaining paragraphs of this section, SHOULD be performed, and documented, at the time intervals prescribed in applicable specifications or procedures, whenever an operator suspects there is a problem with the equipment.

5.6.3.1 System Linearity.

5.6.3.1.1 Vertical Linearity.

5.6.3.1.1.1 Limits.

5.6.3.1.1.1.1 The upper linearity limit is the level of vertical deflection defining the upper limit of an observed constant relationship between the amplitude of the indications on an A-scan screen, and the corresponding magnitude of the reflected ultrasonic wave from reflectors of known size. The minimum acceptable limit of full screen height is 95-percent.

5.6.3.1.1.1.2 The lower linearity limit is the level of vertical deflection defining the lower limit of an observed constant relationship between the amplitude of the indications on an A-scan screen and the corresponding magnitude of the reflected ultrasonic wave from reflectors of known size. The maximum acceptable limit of full screen height is 10-percent.

5.6.3.1.1.2 Procedure for Determining Vertical Linearity Limits (ASTM Blocks).

- a. Use three ASTM blocks, all with 3-inch metal travel distances, and one each with a 3/64, 5/64, and 8/64-inch diameter flat-bottom hole (FBH).
- b. Move the search unit over the surface of the 5/64-inch FBH block until a maximum response is obtained from the FBH. Make sure that the reject control and filters are in the "off" or minimum positions. Adjust the instrument gain control until the FBH signal is 35-percent of saturation on the CRT.
- c. Leave the gain fixed as adjusted above in "b." Maximize the FBH signal on the 3/64 and 8/64 FBH blocks. Record the FBH signal amplitudes.
- d. If the instrument is linear, the signals from the 3/64 and 8/64 FBH's will be 13% \pm 3% and 90% \pm 5% of saturation respectively. Thus, a 3/64 FBH signal between 10% and 16% of saturation is considered linear; an 8/64 FBH signal between 85% and 95% of saturation is considered linear.
- e. Instruments not linear (within the above limits) SHALL be repaired or replaced.

5.6.3.1.2 Horizontal Linearity.

5.6.3.1.2.1 Definitions.

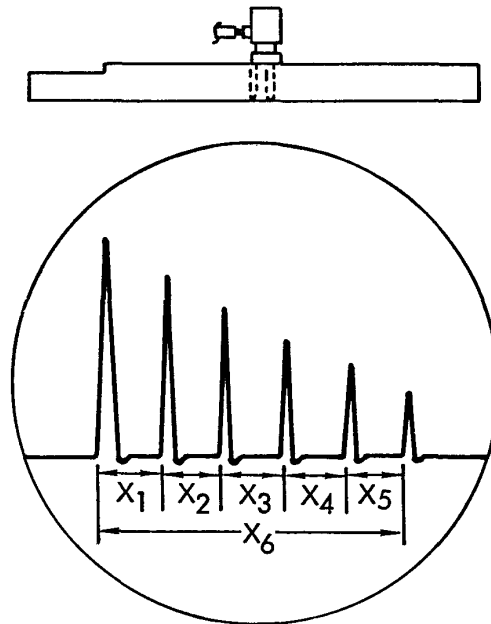
5.6.3.1.2.1.1 The horizontal limit is the maximum readable length of horizontal deflection determined either by an electrical or physical limit in the A-scan presentation of an ultrasonic testing instrument. Horizontal limit is expressed as the maximum observed deflection in inches from the left side, or the start, of the horizontal line representing the time base. The horizontal limit is full scale.

5.6.3.1.2.1.2 The horizontal linearity range is the range of horizontal deflection in which a constant relationship exists between the incremental horizontal displacement of vertical indications on the A-scan presentation and the incremental time required for reflected waves to pass through a known length in a uniform transmission medium. The acceptable horizontal linearity range is 85-percent of the horizontal linearity range.

T.O. 33B-1-1

5.6.3.1.2.2 Procedure for Determining Horizontal Linearity Limits (Type 2 IIW Block). In lieu of any specific linearity requirement, the horizontal linearity MAY be checked as follows:

- a. Use the IIW block and a straight beam transducer (Figure 5-79).



ACCEPTABLE HORIZONTAL LINEARITY
INDICATED BY $X_1 = X_2 = X_3 = X_4 = X_5$
WITHIN $\pm 3\%$ of X_6 .

H0402916

Figure 5-79. Use the Type 2 IIW Block to Check Horizontal Linearity

- b. Place the transducer on the IIW block and adjust the gain, sweep, and sweep delay to obtain six back reflections on the display screen. The first back reflection SHOULD be located at the left side of the base line (the initial pulse SHOULD be off the screen), and the 6th back reflection SHOULD be located at the right side of the base line.
- c. Measure the distance between the leading edge of adjacent back reflections. Ideal horizontal linearity will be indicated by an equal distance between the leading edges of adjacent back reflections. If all the values are equal within $\pm 3\%$ of the full scale width, the instrument is considered linear in the horizontal direction.
- d. Instruments not linear within the above limits SHALL be repaired or replaced.

5.6.3.2 System Sensitivity.

5.6.3.2.1 Definition. Sensitivity is a measure of the ability of the inspection system (e.g., instrument and transducer) to detect discontinuities producing relatively low-amplitude signals because of the size, geometry, or location of the discontinuities. Noise can limit the ability to detect discontinuities by masking their indications. Generally, sensitivity, resolution and signal-to-noise ratio are interdependent and SHOULD be evaluated under similar test conditions.

5.6.3.2.2 Procedure for Determining the Inspection Sensitivity (ASTM Blocks).**NOTE**

The 1 MHz and 15 MHz requirements are applicable only when these frequencies are to be used; they are not specific requirements for all instruments.

Unless otherwise specified in a detailed procedure, use the ASTM reference blocks with flat-bottom holes (FBH). The FBH, which SHOULD be detectable with the respective frequencies, are shown in (Table 5-5).

- a. Select the ASTM block with the appropriate FBH at a depth of 3-inches. Table 5-5 was used to calculate the dB compensation values included in Table 5-7. When the 3/64 FBH and the 5/64 FBH are used in place of the 2/64 and 4/64 respectively. For example: When using the 3/64 FBH instead of the 2/64, the equipment gain must be increased 7dB.
- b. Obtain a peak signal from the appropriate FBH.

Table 5-5. Minimum Sensitivity Requirements

Frequency (MHz)	1	2.25	2.25	5	5
FBH Size (inch/64)	8	5	4	3	2
dB Compensation	N/A	+4	N/A	+7	N/A

- c. Adjust the Gain control of the instrument until the discontinuity indication is 60-percent of full screen height.
- d. Notice the baseline noise in the test region (adjacent to the FBH indication). The noise SHOULD be no higher than 20-percent of full screen height.
- e. When a reference standard, specified by a detailed inspection procedure, is used the minimum signal-to-noise ratio is also 3 to 1.
- f. If the inspection system does not meet these sensitivity requirements, the transducer and/or cable SHALL be replaced and the sensitivity checked again. If the inspection system still does not meet the above requirements, the instrument SHALL be repaired or replaced.

5.6.3.3 System Resolution.**NOTE**

Before evaluating entry surface resolution, perform the distance calibration to avoid misinterpreting an indication of a multiple echo from a discontinuity as the indication of the first echo.

5.6.3.3.1 Definition. Resolution is the minimum spacing between discontinuities for which separate and distinct ultrasonic echo signals can be obtained. Spatial resolution refers to the lateral separation of discontinuities. Depth resolution, as the name implies, refers to depth separation between internal discontinuities or a discontinuity and a boundary surface. The following procedures are concerned only with entry and back surface resolutions, which are defined as the inspectable distances nearest to the respective surfaces of the test material. Resolution SHALL be checked when specified and SHALL meet the minimum requirements as given in (Table 5-6). This evaluation requires a reference standard with reference discontinuities at the respective distances from the appropriate surfaces of the standard.

NOTE

The 1 MHz and 15 MHz requirements are applicable only when these frequencies are used; they are not general requirements for all instruments.

T.O. 33B-1-1

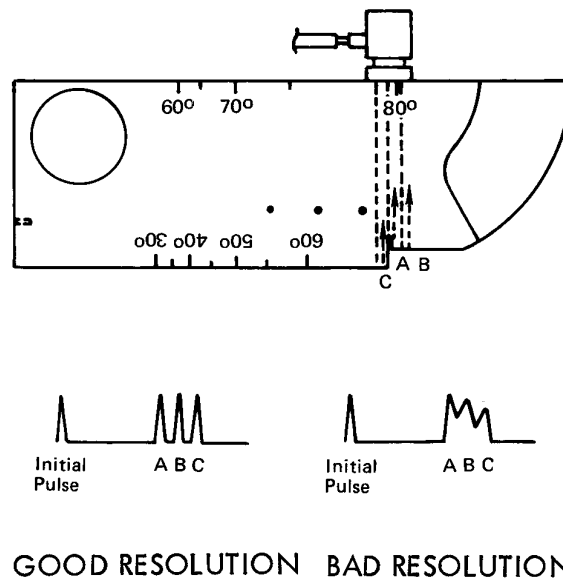
Table 5-6. Limits of Boundary Surface Resolution

Frequency (MHz)	1	2.25	5	10	15
Entry Surface Resolution in Aluminum (inch)	0.5	0.375	0.25	0.125	0.125
Back Surface Resolution in Aluminum (inch)	0.5	0.3	0.2	0.1	0.1

5.6.3.3.2 Checking Resolution (Type 2 IIW Block). When no resolution is specified, the following procedures MAY be used to check resolution:

5.6.3.3.2.1 Back Surface Resolution. (See Figure 5-80).

- Position the transducer on an Type 2 IIW block, and peak the signal from reflector A.
- Maximize the separation of the signals from the reflectors A, B, and C.
- Evaluate the resolution by matching the signal patterns. Good resolution is indicated by the respective signals returning to the baseline.
- If a test system with a 2.25 MHz search unit does not meet these resolution requirements, the transducer and/or cable SHALL be replaced and the resolution checked again. If the inspection system still does not meet the above requirements, the instrument SHALL be repaired or replaced.

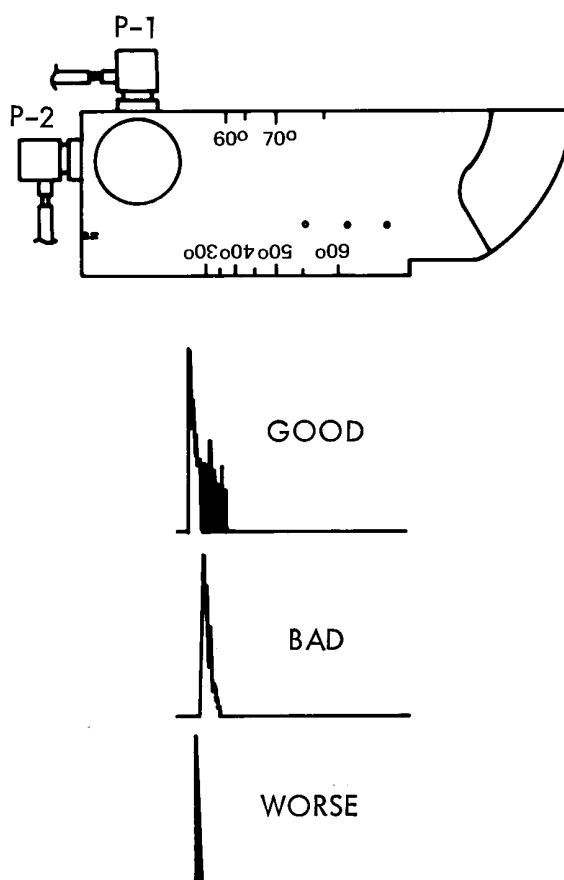


H0402920

Figure 5-80. Use a Type 2 IIW Block to Check Back Surface Resolution

5.6.3.3.2.2 Entry Surface Resolution (Dead Zone) (Type 2 IIW Block).

- a. Position the transducer on an IIW block at P-1 or P-2 as shown in (Figure 5-81). P-1 gives 0.2-inch metal travel distance to the edge of the large hole. P-2 gives 0.4-inch metal travel distance.
- b. Maximize the separation between the initial pulse and the hole signal. Evaluate the signal pattern according to the criteria given in (Figure 5-81).
- c. Check that the signal of the hole is actually the indication of the first echo from the hole by noting the position of the hole signal on the calibrated distance scale of the waveform display. The distance SHOULD be the actual depth of the hole.
- d. The first echo from the edge of the hole SHALL be completely separate from the initial pulse. The initial pulse SHALL return to the baseline, as shown in the “good” example of (Figure 5-81), for the following conditions:
 - 10 MHz: Good at P-1 and P-2.
 - 5 MHz: Good at P-2.
 - 2.25 MHz: Good at P-2.
- e. If the first echo from the edge of the hole is not completely separate from the initial pulse as required above, the transducer and/or cable SHALL be replaced and the dead zone checked again. If the inspection system still does not meet the above requirements, the instrument SHALL be repaired or replaced.



H0402921

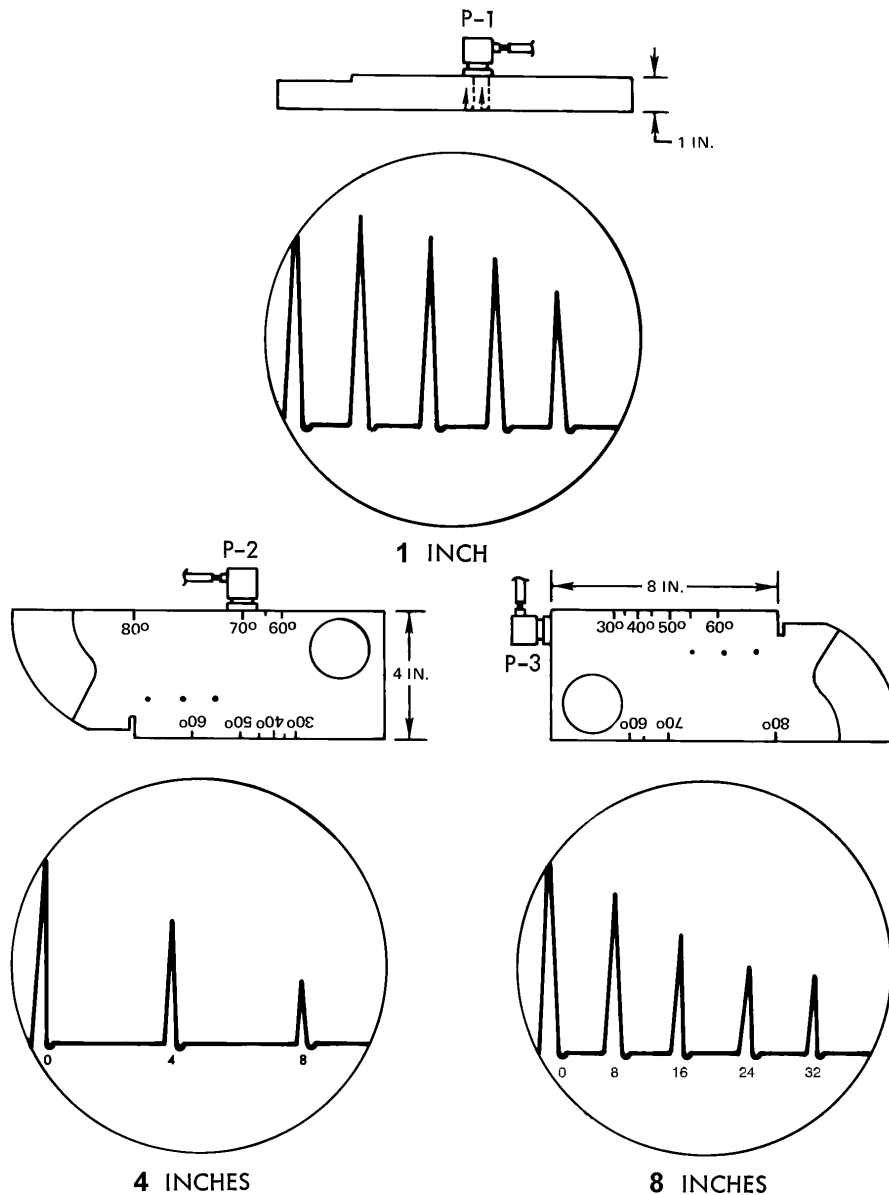
Figure 5-81. Use a Type 2 IIW Block to Check Entry Surface Resolution

T.O. 33B-1-1**5.6.3.3.3 Entry Surface Resolution (ASTM Blocks).**

- a. Use an ASTM block with a #5 FBH or other size if specified. Choose a block with a metal travel distance according to the frequency being used ([Table 5-6](#)).
- b. Maximize the separation between the initial pulse and the signal from the hole.
- c. Check that the signal from the hole is actually the indication of the first echo from the hole by noting the position of the signal from the hole on the calibrated distance scale of the waveform display. The distance **SHOULD** be the actual depth of the hole.
- d. Evaluate the waveform patterns.

5.6.3.4 Distance Calibration.**5.6.3.4.1 A-Scan Straight Beam Distance Calibration.****5.6.3.4.1.1 Straight Beam Calibration for Weld Inspection (Type 2 IIW Block).**

- a. Position the search unit on an IIW block at P-1, P-2 or P-3 as shown in ([Figure 5-82](#)). The distance between multiple back reflections is as follows:
 - 1.00 inch at P-1.
 - 4.00 inch at P-2.
 - 8.00 inch at P-3.
- b. Set the time base for the applicable distance calibration. Example: see display screens for various distance calibrations are shown in ([Figure 5-82](#)).



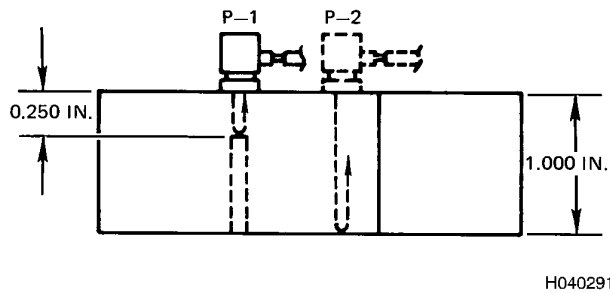
H0402922

Figure 5-82. Straight Beam Distance Calibration With IIW Block

5.6.3.4.1.2 Straight Beam Distance Calibration (Miniature Angle Beam Block).

- Position the transducer on the miniature block at P-1 or P-2 as shown in (Figure 5-83). The distance between multiple back reflections is as follows:
 - 0.250 inch at P-1.
 - 1.000 inch at P-2.
- Set the time base for the applicable distance calibration.

T.O. 33B-1-1



H0402919

Figure 5-83. Straight Beam Distance With Miniature Angle Beam Block

5.6.3.4.1.3 Straight Beam Distance Calibration (ASTM Blocks). Distance calibration MAY be performed using multiple reflections from the FBH or the back surfaces of ASTM blocks. The procedures are identical to the procedures outlined above using the Type 2 IIW block and the miniature angle beam block.

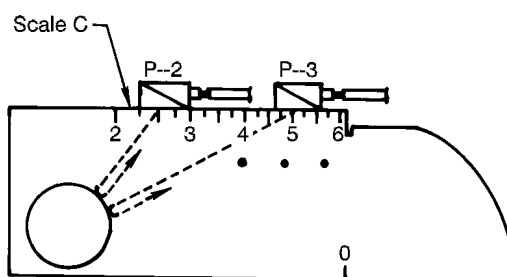
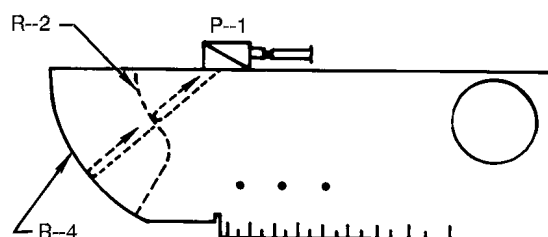
5.6.3.4.2 Angle Beam Distance Calibration.

5.6.3.4.2.1 Angle Beam Distance Calibration (Type 2 IIW Block).

NOTE

This procedure works with all commonly used angles.

- a. Position the transducer at P-1 (Figure 5-84) and adjust the location of the transducer to be directed at radius R-2. Peak the signal from radius R-2 by sliding the transducer toward and away from R-2 until the signal reaches maximum amplitude. Use the DELAY control to position the peaked signal to the appropriate location on the horizontal baseline using the RANGE control. Repeat these steps until the peaked signals from R-2 and R-4 are located at the required positions on the baseline.
- b. This method works for 45 degree transducers only: position the transducer along scale "C" and obtain a peak signal from the hole as shown in (Figure 5-84). Distance is read directly off the scale. P-2 shows 2.5-inches; P-3 shows 5-inches.



H0402923

Figure 5-84. Angle Beam Distance Calibration With IIW Block

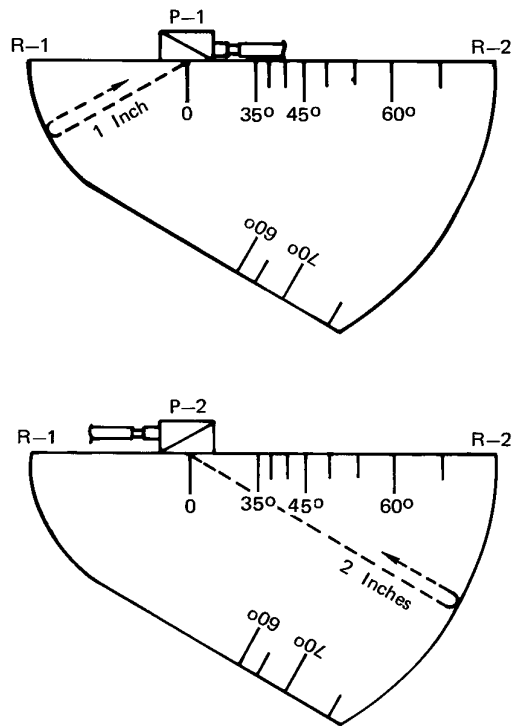
5.6.3.4.2.2 Angle Beam Distance Calibration (Miniature Angle Beam Block). This procedure works with angles over 45 degrees.

- a. Position the transducer at P-1 and then P-2 as shown in (Figure 5-85). Obtain peak signals from R-1 and then from R-2.
- b. The angle beam metal travel at P-1 is 1-inch; at P-2, it is 2-inches.

CAUTION

Ensure you are using the proper transducer and standard matched for the material you wish to inspect.

T.O. 33B-1-1



H0402924

Figure 5-85. Angle Beam Distance Calibration With Miniature Angle Beam Block

5.6.4 Transducer Verifications.

NOTE

Verification checks as written in this Technical Order may not be reproducible on some special purpose transducers mainly due to construction features of the transducer. Manufacturer's guidelines and inspection intervals SHALL be used for special purpose transducers that cannot be inspected with the general verification checks in this Technical Order.

5.6.4.1 Angle Beam Checks. Calibration prior to angle beam inspection is typically accomplished with use of Type 2 IIW standard calibration block. Prior to accomplishing any angle beam calibrations, the beam point-of-incidence and refracted angle SHALL be known.

5.6.4.1.1 Point-of-Incidence.

NOTE

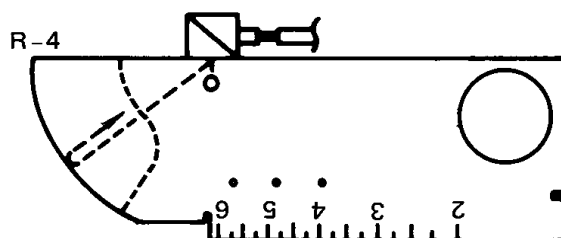
Due to a problem with the Type 2 IIW aluminum reference blocks, it SHALL NOT be used for determining the point-of-incidence on all shear wave transducers having a refracted angle greater than 45° (e.g., 60°, 70°, etc.). A steel Type 2 IIW block or the steel miniature block SHALL be used for testing Point-of-Incidence (POI) on all shear wave transducers over 45° intended for aluminum inspections. All other process control tests will be performed using the correct material reference block for the transducer used.

5.6.4.1.1.1 Angle Beam Point-of-Incidence (Type 2 IIW Block). The point-of-incidence is defined as the center point of the sound beam exiting the transducer wedge. It is usually indicated by a mark on the side of the wedge at the point where an imaginary line through the exit point of the beam intersects the side of the wedge.

- a. Move the transducer back and forth from the curved surface at R-4 (Figure 5-86) until the peak signal from R-4 is obtained.
- b. The transducer point-of-incidence now coincides with the line marked "0" on the block. Mark the point-of-incidence on the side of the search unit.

NOTE

Marking (etching) by mechanical means MAY damage the sensitive transducer.



H0402925

Figure 5-86. Point of Incidence Determination With IIW Block

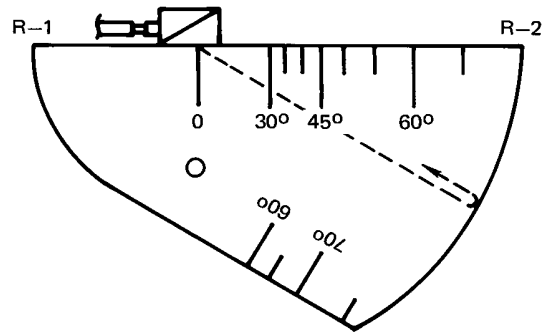
5.6.4.1.1.2 Angle Beam Point of Incidence (Miniature Angle Beam Block).

NOTE

The point-of-incidence as determined in accordance with these procedures MAY NOT correspond with the point-of-incidence placed on the transducer by the transducer manufacturer. Once the point-of-incidence is located and marked on the transducer, distance determinations shall be done using reference blocks made of the same material as that to be inspected, or a material of approximately the same shear wave velocity if the same material is not available. For example, if inspecting titanium, an aluminum block may be used if a titanium reference block is not available.

- a. Move the transducer back and forth from the curved surface at R-2 (Figure 5-87) until the peak signal from R-2 is obtained. Once the point-of-incidence is located and marked on the transducer, distance determinations shall be done using reference blocks made of the same material as that to be inspected, or a material of approximately the same shear wave velocity, if the same material is not available. For example, if inspecting titanium, an aluminum block may be used if a titanium reference block is not available.
- b. The transducer point-of-incidence now coincides with the line marked "0" on the block. Mark the point-of-incidence on the side of the transducer.

T.O. 33B-1-1

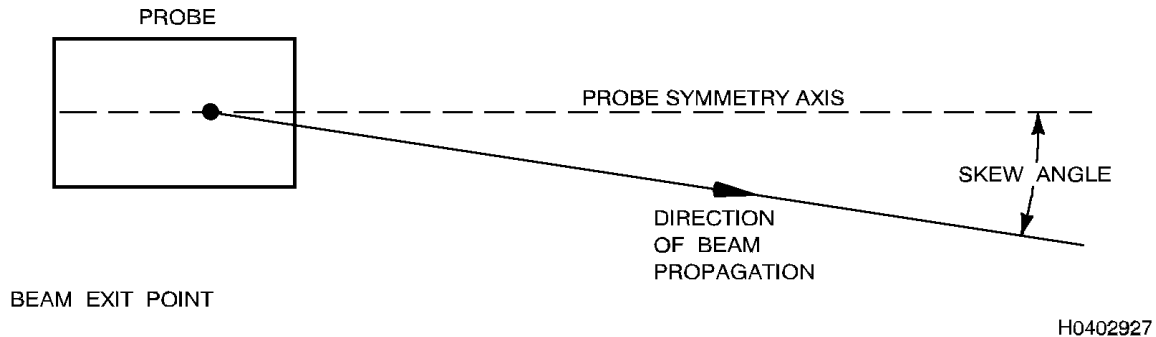


H0402926

Figure 5-87. Point-of-Incidence Determination With Miniature Angle Beam Block

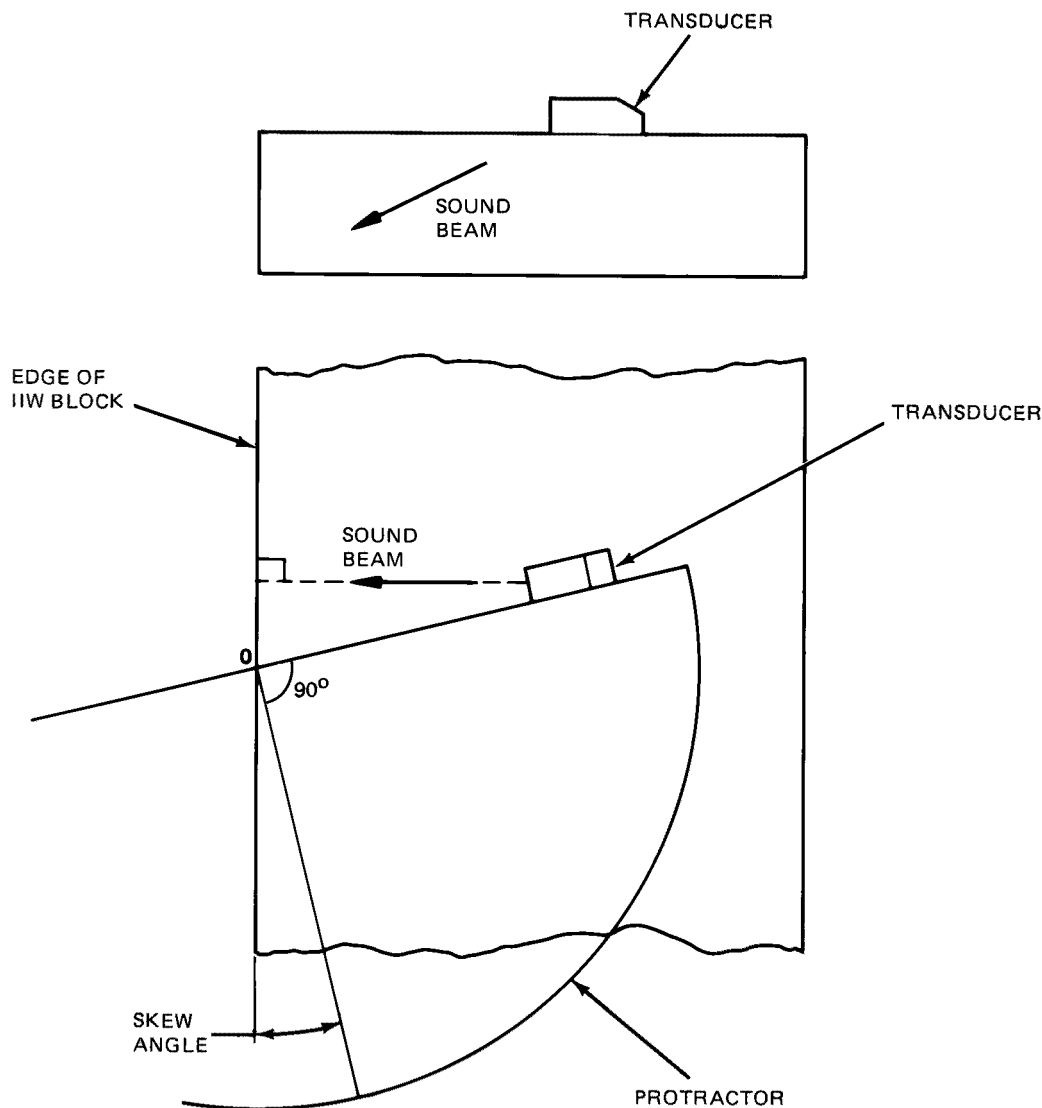
5.6.4.1.2 Determining Angle Beam Misalignment (Skew Angle). Skew angle is a measure of the misalignment angle between the ultrasonic beam and the search units' axis of symmetry (Figure 5-88).

- Place the Type 2 IIW block flat on the side and adjust the search unit to maximize the echo from the other corner of the block (Figure 5-89). The corner of the block where there are no scale engravings SHALL be used.
- Place a protractor on the block, as shown in (Figure 5-89) and measure the skew angle.



H0402927

Figure 5-88. Beam Misalignment (Skew Angle)



H0402928

Figure 5-89. Skew Angle Measurement

5.6.4.1.3 Angle Beam Transducer Parameters. The skew angle of new and used ultrasonic transducers SHALL be maintained within 2-degrees of what is required to perform an ultrasonic inspection. Transducers that do not fall within this parameter SHALL NOT be used to perform ultrasonic inspections. If possible, transducers out of tolerance SHALL be reworked within parameters to extend their usefulness. The rework procedure consists of wet sanding the wear plate/wedge very slowly using 600-grit or finer sandpaper, or equivalent emery cloth. Extreme care SHALL be taken during sanding not to raise the temperature of the wear plate/wedge. Temperature increases will affect the acoustic impedance of the wear plate/wedge and therefore, the overall transducer sensitivity of the transducer.

5.6.4.1.4 Transducer Angle Determination.

5.6.4.1.4.1 Angle Beam Angle Determination (Type 2 IIW Block).

- a. Position the transducer on scale "A" or "B" as shown in (Figure 5-90). Move the transducer back and forth until the peak signal from the hole is obtained.

T.O. 33B-1-1

- b. Read the refracted angle from the position on scale "A" or "B" coinciding with the point-of-incidence. In (Figure 5-90), P-1 shows 60°; and P-2 shows 45°

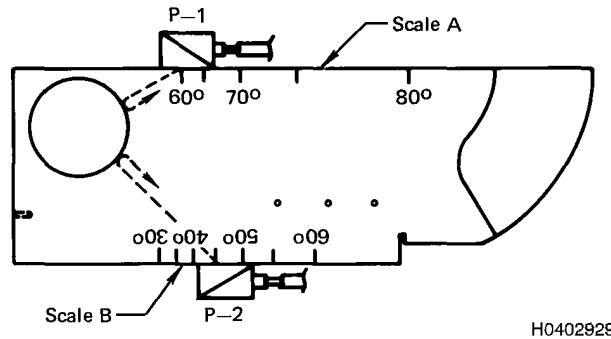


Figure 5-90. Angle Determination With Type 2 IIW Block

5.6.4.1.4.2 Angle Beam Angle Determination (Miniature Angle Beam Block).

- Position the transducer on scale "A" or "B" as shown in (Figure 5-91). Move the transducer back and forth until the peak signal from the hole is obtained.
- Read the refracted angle from the position on scale "A" or "B" coinciding with the point-of-incidence. In (Figure 5-91), P-1 shows 45°; and P-2 shows 70°
- Angle beam determination can also be done with the miniature angle beam block (Figure 5-91).

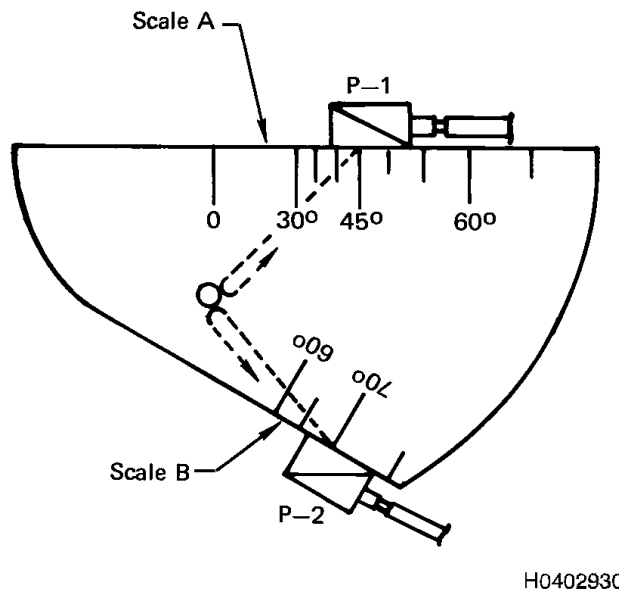


Figure 5-91. Angle Determination With Miniature Angle Beam Block

SECTION VII ULTRASONIC INSPECTION EQUATIONS

5.7 INTRODUCTION.

5.7.1 General. Understanding where your sound beam is located is very important in order to distinguish relevant discontinuities from non-relevant discontinuities.

5.7.2 Snell's Law. As we covered in (paragraph 5.2.4.1), when an incident longitudinal beam is normal to the test part surface ($\theta_1 = 0^\circ$), the longitudinal sound beam is transmitted straight into the test part and no refraction occurs. When the incident angle is other than normal, refraction, reflection, and mode conversion occur. Refraction is a change in propagation direction. Mode conversion is a change in the nature of the wave motion. A portion of the longitudinal incident beam is refracted into one or more wave modes traveling at various angles in the test piece (Figure 5-6). Wave behavior at an interface is defined by Snell's Law. The Snell's Law formula follows:

$$\frac{\sin \theta_1}{\sin \theta_2} = \frac{v_1}{v_2}$$

H0402931

Where:

θ_1 = angle of incidence

θ_2 = angle of refracted beam

v_1 = velocity of incident sound beam

v_2 = velocity of refracted sound beam

5.7.3 Determining the Angle of Incidence in Plastic to Generate 45-Degree Shear Wave in Aluminum. As covered in (paragraph 5.2.4.4), Snell's law is the tool for determining wedge angles for contact testing (paragraph 5.4.2.1.1.1), or the angle-of-incidence in water for immersion testing (paragraph 5.4.2.1.1.2). The following example shows how Snell's law is used to obtaining the required refracted beam and determine the angle-of-incidence in plastic to generate 45-degree shear waves in aluminum:

$$\theta_2 = 45^\circ; \sin 45^\circ = 0.707$$

$$v_1 = \text{velocity of longitudinal wave in plastic wedge} = 1.05 \times 10^5 \text{ in/sec (see Table 5-9)}$$

$$v_2 = \text{velocity of shear waves in aluminum} = 1.22 \times 10^5 \text{ in/sec (see Table 5-9)}$$

$$\sin \theta_1 = v_1; \sin \theta_1 = \frac{1.05 \times 10^5}{1.22 \times 10^5} \text{ or } \sin \theta_1 = (0.707) (1.05 \times 10^5) = 0.608$$

$$\sin \theta_2 \quad v_2 \quad 0.707 \quad 1.05 \times 10^5 \quad 1.22 \times 10^5$$

H0402932

Therefore, $\theta_1 = 37.5^\circ$

NOTE

When determining an angle, use the angle having the sine value closest to the calculated sine value.

5.7.4 Near Field. The near field (paragraph 5.2.6.2) extends from the face of the transducer and is an area characterized by wide variations in sound beam intensity. These intensity variations are due to the interference effects of spherical wave fronts (side lobes) emanating from the periphery of the transducer crystal. The region where this side lobe interference occurs is called the near field (Fresnel Zone) (Figure 5-8). Due to inherent amplitude variations, inspection within the near field is not typically recommended. The length of the near field is calculated with the following equation:

T.O. 33B-1-1

$$N = \frac{D^2}{4\lambda} = \frac{D^2 f}{4v}$$

H0402934

Where:

 L_o = near field length (inches)

D = diameter of transducer element in a round transducer or maximum diagonal of transducer element in a rectangular or square transducer (inches)

 λ = wavelength of sound in the test material (inches)

f = frequency (hertz)

v = velocity (inches per second)

5.7.4.1 The smaller the transducer element diameter or the lower the frequency, the shorter the near field will be. Due to inherent amplitude variations inspection within the near field is not recommended without careful calibration on reference flaws within the near field.

5.7.5 **Beam Spread.** As we covered in (paragraph 5.2.6.5), the sound beam in the near field, essentially propagates straight out from the face of the transducer. In the far field, the sound beam spreads outward and decreases in intensity with increasing distance from the transducer face as shown in (Figure 5-9). Beam spread is an important consideration, because in certain inspection applications the spreading sound beam could result in erroneous or confusing A-scan presentations. The half-angle of the beam spread is calculated as follows:

$$\sin \theta = \frac{1.22 \lambda}{D}$$

Where:

 θ = half-angle of spread

D = transducer diameter (inches)

 λ = wavelength (inches)

Example: Given 2014-T4 aluminum being tested with a 1/4-inch diameter unit at 5 MHz, what is the half angle of the beam spread?

D = 1/4 inch (0.25 inch)

 λ = 0.049 inch

$$\sin \theta = (1.22) \frac{0.049}{0.25} = 0.2391$$

 $\theta = 14^\circ$

As denoted by the beam spread formula at a given frequency, the smaller the transducer element, the greater the beam spread. Also, for a given diameter, a lower frequency results in more beam spread.

5.7.6 **Calculating Acoustic Impedance.** As we covered in (paragraph 5.5.4.3), the reflections from an air interface, such as a crack or void are large due to the acoustic impedance ratio. If a discontinuity had acoustic impedance close to the acoustic impedance of the test material, the acoustic impedance ratio would be small and very little reflection would occur. When an ultrasonic beam strikes a boundary between two different materials, part of the energy is transmitted to the second

medium and a portion is reflected. The percentage of sound energy transmitted and reflected is related to the ratio of the acoustic impedances of the two materials. Acoustic impedance can be calculated as follows:

$$Z = \rho v$$

Where:

Z = acoustic impedance of a material

ρ (rho) = material density

v = velocity of sound in the material

5.7.6.1 Determining Reflected Energy at the Interface. Acoustic impedance can be used to calculate the theoretical reflected and transmitted energy for an interface. The following formula is used to determine the amount of reflected energy that occurs at an interface.

$$R = \left(\frac{Z_2 - Z_1}{Z_2 + Z_1} \right)^2 \times 100$$

H0402935

Where:

R = percentage of energy reflected at the interface.

Z_2 = acoustic impedance of the discontinuity

Z_1 = acoustic impedance of the test material

Example: A tungsten inclusion is found in a piece of titanium. How much energy will be reflected at the interface if 100-percent of the sound energy strikes the tungsten?

Known from:

Acoustic impedance of tungsten (Z_2) = 14.20 (10^4 (lb/in² -sec))

Acoustic impedance of titanium (Z_1) = 3.94 (10^4 (lb/in² -sec))

Solution:

$$R = \left(\frac{14.20 - 3.94}{14.20 + 3.94} \right)^2 \times 100 = \left(\frac{10.26}{18.14} \right)^2 \times 100 = (0.5656)^2 \times 100 = 0.32 \times 100 = 32\%$$

H0402936

Therefore, 32-percent of the energy will be reflected at the interface by the tungsten inclusion. A crack would reflect virtually 100-percent of the energy because it is filled with air.

T.O. 33B-1-1

Table 5-7. Incident Angles in Plastic for Refracted Shear Wave Angles in Test Materials

Incident Longitudinal Wave Angle in Plastic (degrees)								
Refracted Shear Wave Angle in Test Materials (Degrees)	Steel	Stainless Steel 302	Stainless Steel 410	Ti 150A	A1 1100-0	Al 2014-T4	Inconel Wrought	Magnesium AM35
20	16.4	17.0	17.8	17.0	17.1	17.1	17.6	17.1
21	17.2	17.9	18.7	17.9	18.0	18.0	18.5	18.0
22	18.0	18.7	19.5	18.7	18.8	18.8	19.3	18.8
23	18.8	19.5	20.4	19.5	19.7	19.7	20.2	19.7
24	19.6	20.4	21.3	20.4	20.5	20.5	21.1	20.5
25	20.4	21.2	22.2	21.2	21.3	21.3	21.9	21.3
26	21.2	22.0	23.0	22.0	22.2	22.2	22.8	22.2
27	22.0	22.9	23.9	22.9	23.0	23.0	23.7	23.0
28	22.8	23.7	24.8	23.7	23.9	23.9	24.5	23.9
29	23.6	24.5	25.7	24.5	24.7	24.7	25.4	24.7
30	24.4	25.3	26.5	25.3	25.5	25.5	26.2	25.5
31	25.2	26.2	27.4	26.2	26.3	26.3	27.1	26.3
32	26.0	27.0	28.2	27.0	27.2	27.2	27.9	27.2
33	26.8	27.8	29.1	27.8	28.0	28.0	28.8	28.0
34	27.5	28.6	30.0	28.5	28.8	28.8	29.6	28.8
35	28.3	29.4	30.8	29.4	29.6	29.6	30.5	29.6
36	29.1	30.2	31.7	30.2	30.4	30.4	31.3	30.4
37	29.8	31.0	32.5	31.0	31.2	31.2	32.1	31.2
38	30.6	31.8	33.4	31.8	32.0	32.0	33.0	32.0
39	31.3	32.5	34.2	32.6	32.8	32.8	33.8	32.8
40	32.1	33.4	35.0	33.4	33.6	33.6	34.6	33.6
41	32.8	34.2	35.9	34.2	34.4	34.4	35.5	34.4
42	33.6	34.9	36.7	34.9	35.2	35.2	36.3	35.2
43	34.3	35.7	37.5	35.7	36.0	36.0	37.1	36.0
44	35.0	36.5	38.3	36.5	36.7	36.7	37.9	36.7
45	35.8	37.2	39.2	37.2	37.5	37.5	38.7	37.5
46	36.5	38.0	40.0	38.0	38.3	38.3	39.5	38.3
47	37.2	38.7	40.8	38.7	39.0	39.0	40.3	39.0
48	37.9	39.5	47.5	39.5	39.8	39.8	41.1	39.8
49	38.5	40.2	42.4	40.2	40.5	40.5	41.9	40.5
50	39.3	41.0	43.2	41.0	41.3	41.3	42.6	41.3
51	40.0	41.7	43.9	41.7	42.0	42.0	43.4	42.0
52	40.6	42.4	44.7	42.4	42.7	42.7	44.2	42.7
53	41.3	43.1	45.5	43.1	43.5	43.5	44.9	43.5
54	42.0	43.8	46.3	43.8	44.2	44.2	45.7	44.2
55	42.6	44.5	47.0	44.5	44.9	44.9	46.4	44.9
56	43.3	45.2	47.8	45.2	45.6	45.6	47.1	45.6
57	43.9	45.9	48.5	45.9	46.2	46.2	47.9	46.2
58	44.5	46.5	49.2	46.5	26.9	26.9	48.5	26.9
59	45.1	47.2	49.9	47.2	47.6	47.6	49.3	47.5

Table 5-7. Incident Angles in Plastic for Refracted Shear Wave Angles in Test Materials - Continued

Incident Longitudinal Wave Angle in Plastic (degrees)								
Refracted Shear Wave Angle in Test Materials (Degrees)	Steel	Stainless Steel 302	Stainless Steel 410	Ti 150A	A1 1100-0	Al 2014-T4	Inconel Wrought	Magnesium AM35
60	45.7	47.8	50.7	47.8	48.2	48.2	50.0	48.2
61	46.3	48.5	51.4	48.5	48.9	48.9	50.6	48.9

5.7.7 Thickness Measurement Correlation Factor. As we covered in (paragraph 5.4.11.3), prior to performing thickness measurement, consult the instruments operator's manual to see if one or two reference standards are required. If two are required, it is best to have one 50-90-percent of the nominal thickness to be measured, and one 110-150-percent of the nominal thickness to be measured. Only one reference standard is required when using a basic pulsed instrument for thickness measurement. Direct, accurate readings of thickness can be obtained only when the acoustic velocity in the reference standard is equal to the acoustic velocity in the test part. For this reason, the material and heat treat condition of the reference standard SHOULD be identical to the test part. If reference standards, of a different material, or heat treat condition is used; the resultant thickness readings SHALL be corrected by a correlation factor. The correlation factor MAY be established in two ways:

- a. Use the ratio

$$\frac{V_2}{V_1}$$

when the velocities of the test part and reference standard are known.

Where:

v_2 = acoustic velocity in the test part material

v_1 = acoustic velocity in the reference standard material

Example: Assume the calibration blocks are made of 2014-T4 aluminum and the test part material is 410 stainless steel.

v_2 = longitudinal wave velocity in 410 stainless steel

$$= 2.91 \times 10^5 \text{ inches/sec.}$$

v_1 = longitudinal wave velocity in 2014-T4 aluminum

$$= 2.46 \times 10^5 \text{ inches/sec.}$$

$$\frac{V_2}{V_1} = \frac{2.91 \times 10^5}{2.46 \times 10^5} = 1.18 = \text{the correction factor}$$

All readings on the test part are now multiplied by 1.18 to obtain the actual thickness. If a test part reading is 0.110-inch, correct this by multiplying by the correction factor:

$$0.110\text{-inch} \times 1.18 = 0.130\text{-inch} = \text{the actual test part thickness}$$

T.O. 33B-1-1

b.

Use the ratio $\frac{d_2}{d_1}$ when one area of the test part is accessible for direct measurement.

H0402939

Where:

d_2 = the thickness of an area of the test part as measured by mechanical or optical means

d_1 = the thickness of the same area as indicated by the ultrasonic instrument calibrated on material similar to the test part

Example: Assume an area of a test part is measured with a micrometer and is 0.167-inch thick ($d_2 = 0.167$ -inch). This same area is measured with ultrasonic instrument and gives a reading of 0.133-inch ($d_1 = 0.133$ -inch).

c. $\frac{d_2}{d_1} = \frac{0.167}{0.133} = 1.25$ = the correction factor

d. All ultrasonic readings on the test part are now multiplied by 1.25 to obtain the actual thickness. If another area of the test part gives an ultrasonic reading of 0.200-inch, correct this by multiplying by the correction factor:

0.200-inch x 1.25 = 0.250-inch = the actual test part thickness.

Table 5-8. Measurement Error Introduced by Surface Roughness of Reference Standard or Test Part

Surface Finish (microinches)	Measurement Error (inch)
0-63	0.0005
63-125	0.002
125-250	0.005
250-500	0.010
500-20000	0.020

SECTION VIII ULTRASONIC INSPECTION SAFETY

5.8 INTRODUCTION.

5.8.1 Safety Requirements. Safety requirements SHALL be reviewed by the laboratory supervisor on a continuing basis to ensure compliance with provisions contained in AFOSH Standard 91-110, as well as, provisions of this technical order and applicable weapons systems technical orders. Recommendations of the Base Bioenvironmental Engineer and the manufacturer regarding necessary personnel protective equipment SHALL be followed.

NOTE

Air Force Occupational Safety and Health (AFOSH) Standard 91-110 SHALL be consulted for additional safety requirements.

5.8.2 General Precautions. Precautions to be exercised when performing ultrasonic inspection include consideration of exposure to electrical current. The following minimum safety requirements SHALL be observed when performing ultrasonic inspections.

5.8.3 Ultrasonic Inspection. Ultrasonic equipment can safely be used in and around aircraft provided the following electrical safety guidelines are followed.

5.8.3.1 Care SHALL be exercised when performing maintenance on or around the cathode-ray tube (CRT) of this equipment.

5.8.3.1.1 Ensure the CRT is electrically discharged according to applicable manufacturer's technical manuals prior to performing any maintenance on the equipment.

5.8.3.1.2 Use care not to break the CRT, since a violent implosion can result.

5.8.3.2 Hazards exist when ultrasonic equipment is not properly used in some hazardous environments. Consult the local safety authority for guidance prior to performing ultrasonic inspections in a hazardous area.

Table 5-9. Ultrasonic Properties of Materials

Material	Velocity (10 ⁵ inches/sec)		Wave Length (inches)						Acous- tic im- pedance (10 ⁴ lb/in ² - sec)							
	Longi- tudinal Waves	Sur- face Waves	Longitudinal Waves (mhz)			Shear Waves (mhz)				Surface Waves (mhz)						
			1	2.25	5	10	1	2.25		5	10	1	2.25	5	10	
METALS:																
Aluminum 1100 - 0	2.50	1.22	1.14	0.250	0.111	0.050	0.025	0.122	0.054	0.024	0.012	0.114	0.051	0.023	0.011	2.45
Aluminum 2014 - T4	2.46	1.22	1.10	0.246	0.109	0.049	0.025	0.122	0.054	0.024	0.012	0.110	0.049	0.022	0.011	2.49
Beryllium	5.02	3.43	3.10	0.502	0.224	0.101	0.050	0.343	0.152	0.069	0.034	0.610	0.138	0.062	0.031	3.32
Brass, Naval	1.75	0.83	0.77	0.175	0.078	0.035	0.017	0.083	0.037	0.017	0.008	0.077	0.034	0.015	0.008	5.13
Bronze, Phosphor, 5%	1.39	0.88	0.79	0.139	0.062	0.028	0.014	0.088	0.039	0.018	0.009	0.079	0.035	0.016	0.008	4.44
Copper	1.84	0.89	0.76	0.184	0.081	0.037	0.018	0.089	0.040	0.018	0.009	0.076	0.036	0.015	0.008	5.96
Lead, Pure	0.85	0.28	0.25	0.085	0.038	0.017	0.009	0.028	0.012	0.006	0.003	0.025	0.011	0.005	0.003	3.50
Lead, Antimo- ny, 6%	0.85	0.32	0.29	0.085	0.038	0.017	0.009	0.032	0.014	0.006	0.003	0.029	0.013	0.006	0.003	3.36
Molybdenum	2.48	1.32	1.22	0.248	0.110	0.050	0.025	0.132	0.059	0.028	0.013	0.122	0.054	0.024	0.012	9.04
Nickel	2.22	1.17	1.04	0.222	0.099	0.045	0.022	0.177	0.052	0.023	0.012	0.104	0.046	0.021	0.010	7.05
Inconel, Wrought	3.08	1.19	1.10	0.308	0.136	0.061	0.031	0.119	0.053	0.024	0.012	0.110	0.049	0.022	0.011	9.18
Montel, Wrought	2.38	0.97	0.77	0.236	0.105	0.047	0.024	0.107	0.048	0.021	0.011	0.077	0.034	0.015	0.008	7.56
Silver - 18Ni	1.82	1.27	0.66	0.182	0.080	0.036	0.018	0.091	0.040	0.018	0.009	0.066	0.029	0.013	0.007	5.74
Iron	2.32	0.95	1.10	0.232	0.103	0.046	0.023	0.127	0.056	0.025	0.013	0.110	0.049	0.022	0.011	6.45
Iron, Cast	1.89	1.23		0.189	0.084	0.039	0.019	0.095	0.042	0.019	0.010					5.30
Steel, 302	2.24	1.22	1.23	0.223	0.099	0.045	0.022	0.123	0.055	0.025	0.012	0.123	0.055	0.025	0.012	6.35
Steel, 347	2.26	1.18	0.85	0.226	0.100	0.045	0.023	0.122	0.054	0.024	0.012					6.35
Steel, 410	2.91	1.28		0.291	0.129	0.058	0.029	0.118	0.052	0.024	0.012	0.085	0.038	0.017	0.008	8.05
Steel 1020	2.32	1.26		0.232	0.103	0.046	0.023	0.128	0.057	0.026	0.013					6.45
Steel 1095	2.32	1.10		0.232	0.103	0.046	0.023	0.126	0.056	0.022	0.013					6.53
Steel, 4150, Rc 14	2.31	1.25		0.231	0.103	0.046	0.023	0.110	0.049	0.025	0.011					6.52

Table 5-9. Ultrasonic Properties of Materials - Continued

Material	Velocity (10 ⁵ inches/sec)			Wave Length (inches)												Acous- tic im- pedance (10 ⁴ lb/in ² - sec)	
	Longi- tudinal Waves	Shear Waves	Sur- face Waves	Longitudinal Waves (mhz)			Shear Waves (mhz)			Surface Waves (mhz)							
				1	2.25	5	10	1	2.25	5	10	1	2.25	5	10		
Steel, 4150, Rc 18	2.31	1.26		0.231	0.103	0.046	0.023	0.125	0.056	0.025	0.012						6.53
Steel, 4150, Rc 43	2.31	1.09		0.231	0.103	0.046	0.023	0.126	0.056	0.025	0.013						6.51
Steel, 4150, Rc 44	2.30	1.26		0.230	0.102	0.046	0.023	0.109	0.048	0.022	0.011						6.46
Steel, 4340	2.30	1.23		0.230	0.102	0.046	0.023	0.126	0.056	0.025	0.013						7.24
Titanium, 150 A	2.40	1.13	1.10	0.240	0.107	0.048	0.024	0.123	0.055	0.025	0.012	0.110	0.049	0.022	0.011		3.94
Tungsten	2.04		1.04	0.204	0.091	0.041	0.021	0.113	0.050	0.023	0.011	0.104	0.046	0.021	0.010		14.20
NON-METALS:																	
Air	0.13			0.013	0.006	0.003	0.001										0.00047
Walter	0.59			0.059	0.026	0.012	0.006										0.212
Motor Oil, SAE20	0.68			0.068	0.030	0.014	0.007										0.214
Transformer Oil	0.54			0.054	0.024	0.011	0.005										0.181
Bakelite	1.02			0.102	0.045	0.020	0.010										0.515
Lucite	1.06	0.50		0.106	0.047	0.021	0.011	0.050	0.022	0.010	0.005				0.005		0.448
Plastic, Acrylic Resin	1.05	0.44		0.105	0.046	0.021	0.010	0.044	0.020	0.009	0.004						0.455
Plexiglass	1.09			0.109	0.048	0.022	0.011										0.494
Teflon	0.57			0.057	0.026	0.011	0.006										0.426
Quartz, Natural	2.26			0.226	0.100	0.045	0.023										2.16
Fused Quartz	2.33	1.48	1.33	0.233	0.104	0.047	0.023	0.148	0.066	0.030	0.015	0.133	0.059	0.027	0.013		1.85
Pyrex	2.20	1.35	1.23	0.222	0.097	0.044	0.033	0.135	0.060	0.027	0.014	0.123	0.055	0.025	0.012		1.77
Plate Glass	2.28	1.35	1.24	0.220	0.100	0.045	0.023	0.135	0.060	0.027	0.014	0.124	0.055	0.025	0.012		2.06

CHAPTER 6 RADIOGRAPHIC INSPECTION METHOD

SECTION I RADIOGRAPHIC INSPECTION METHOD

6.1 GENERAL CAPABILITIES OF RADIOGRAPHIC INSPECTION.

6.1.1 Introduction to Radiographic Inspection. This chapter will provide guidance for radiographic inspection. Additional helpful material is cited in the form of references, primarily books and standards. References are listed at the end of this chapter.

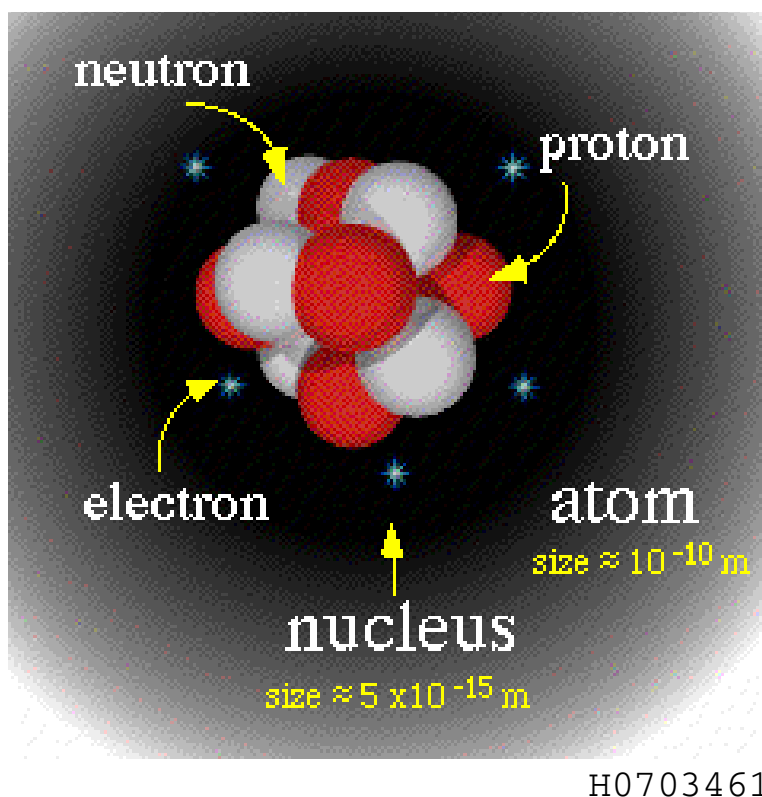


Figure 6-1. Nuclear Structure

6.1.1.1 Nuclear Structure. An atom consists of an extremely small, positively charged nucleus surrounded by a cloud of negatively charged electrons. Although typically the nucleus is less than one ten-thousandth the size of the atom, the nucleus contains more than 99.9% of the mass of the atom. Nuclei consist of positively charged protons and electrically neutral neutrons held together by the so-called strong or nuclear force. This force is much stronger than the familiar electrostatic force that binds the electrons to the nucleus, but its range is limited to distances approximately a few $\times 10^{-15}$ meters.

6.1.1.1.1 The number of protons in the nucleus, "Z," is called the atomic number. This determines what chemical element the atom is. "N" denotes the number of neutrons in the nucleus. The atomic mass of the nucleus, "A," is equal to $Z + N$. A given element can have many different isotopes, which differ from one another by the number of neutrons contained in the nuclei. In a neutral atom, the number of electrons orbiting the nucleus equals the number of protons in the nucleus. Since the electric charges of the proton and the electron are +1 and -1 respectively (in units of the proton charge), the net charge of the atom is zero. At present, there are 112 known elements which range from the lightest, hydrogen, to the recently discovered

T.O. 33B-1-1

and yet to-be-named element 112. All of the elements heavier than uranium are man made. Among the elements are approximately 270 stable isotopes, and more than 2000 unstable isotopes.

6.1.2 History of X- and Gamma Radiation. X-rays were discovered by chance in 1895 by W.C. Roentgen. He noticed a screen painted in barium platinocyanide fluoresced when placed in close proximity to a cathode-ray tube. He called these X-rays, because their nature was unknown. In 1912, M. von Laue and other investigators identified X-rays as electromagnetic waves similar in nature to visible light; however, X-rays are invisible and they have far greater penetrating power than light.

6.1.2.1 Radium emits alpha and beta particles and gamma rays, which are penetrating in the same manner as X-rays. In 1898, Marie Curie termed the emanations of this element radioactivity. Besides radium, many radioactive elements have since been discovered. At present, not only the rays emitted by such radioactive sources, but beams emitted in nuclear reactions are also derived from radioactivity. Of these radioactive sources, X- and gamma radiation are widely used in industrial radiography. X-radiation has a continuously heterogeneous energy spectrum, while gamma radiation has a discrete spectrum characteristic to the particular radioactive element involved. Other important discoveries in the history of radiation are explored in (Table 6-1).

Table 6-1. History of X- and Gamma Radiation

Year	Scientist(s)	Discovery
1704	<u>Isaac Newton</u>	Proposed a mechanical universe with small solid masses in motion.
1803	<u>John Dalton</u>	Proposed an “atomic theory” with spherical solid atoms based upon measurable properties of mass.
1832	<u>Michael Faraday</u>	Studied the effect of electricity on solutions, coined term “electrolysis” as a splitting of molecules with electricity, developed laws of electrolysis. Faraday himself was not a proponent of atomism.
1859	J. Plucker	Built one of the first gas discharge tubes (“cathode ray tube”).
1869	<u>Dmitri Mendeleev</u>	Arranged elements into 7 groups with similar properties. He discovered that the properties of elements were periodic functions of their atomic weights. This became known as the Periodic Law.
1873	<u>James Clerk Maxwell</u>	Proposed electric and magnetic fields filled the void.
1874	<u>G.J. Stoney</u>	Proposed that electricity was made of discrete negative particles he called electrons.
1879	<u>Sir William Crookes</u>	Discovered cathode rays had the following properties: travel in straight lines from the cathode; cause glass to fluoresce; impart a negative charge to objects they strike; are deflected by electric fields and magnets to suggest a negative charge; cause pinwheels in their path to spin indicating they have mass.
1886	E. Goldstein	Used a CRT to study “canal rays” which had electrical and magnetic properties opposite of an electron.
1895	<u>Wilhelm Roentgen</u>	Using a CRT, he observed that nearby chemicals glowed. Further experiments found very penetrating rays coming from the CRT that were not deflected by a magnetic field. He named them “X-rays.”
1896	<u>Henri Becquerel</u>	While studying the effect of x-rays on photographic film, he discovered some chemicals spontaneously decompose and give off very penetrating rays.
1897	<u>J.J. Thomson</u>	Used a CRT to experimentally determine the charge to mass ratio (e/m) of an electron = 1.759×10^8 coulombs/gram.
1897	<u>J.J. Thomson</u>	Studied “canal rays” and found they were associated with the proton H^+ .
1898	<u>Rutherford</u>	Studied radiations emitted from uranium and thorium and named them <i>alpha</i> and <i>beta</i> .
1898	<u>Marie Sklodowska Curie</u>	Studied uranium and thorium and called their spontaneous decay process “radioactivity.” She and her husband Pierre also discovered the radioactive elements polonium and radium.
1900	<u>Soddy</u>	Observed spontaneous disintegration of radioactive elements into variants he called “isotopes” or totally new elements, discovered “half-life,” made initial calculations on energy released during decay.

Table 6-1. History of X- and Gamma Radiation - Continued

Year	Scientist(s)	Discovery
1900	<u>Max Planck</u>	Used the idea of quanta (discrete units of energy) to explain hot glowing matter.
1903	<u>Nagaoka</u>	Postulated a “Saturnian” model of the atom with flat rings of electrons revolving around a positively charged particle.
1904	Abegg	Discovered that inert gases had a stable electron configuration which lead to their chemical inactivity.
1906	<u>Hans Geiger</u>	Developed an electrical device to “click” when hit with alpha particles.
1909	<u>R.A. Millikan</u>	Oil drop experiment determined the charge ($e=1.602 \times 10^{-19}$ coulomb) and the mass ($m = 9.11 \times 10^{-28}$ gram) of an electron.
1911	<u>Ernest Rutherford</u>	Using alpha particles as atomic bullets, probed the atoms in a piece of thin (0.00006 cm) gold foil. He established that the nucleus was very dense, very small and positively charged. He also assumed that the electrons were located outside the nucleus.
1914	<u>H.G.J. Moseley</u>	Using x-ray tubes, determined the charges on the nuclei of most atoms. He wrote, “The atomic number of an element is equal to the number of protons in the nucleus.” This work was used to reorganize the periodic table based upon atomic number instead of atomic mass.
1919	Aston	Discovered the existence of isotopes using a mass spectrograph.
1922	<u>Niels Bohr</u>	Developed an explanation of atomic structure that underlies regularities of the periodic table of elements. His atomic model had atoms built up of successive orbital shells of electrons.
1923	<u>de Broglie</u>	Discovered that electrons had a dual nature-similar to both particles and waves. Particle/wave duality. Supported Einstein.
1927	<u>Heisenberg</u>	Described atoms by means of formula connected to the frequencies of spectral lines. Proposed Principle of Indeterminacy - you cannot know both the position and velocity of a particle.
1929	<u>Cockcroft/Walton</u>	Built an early linear accelerator and bombarded lithium with protons to produce <i>alpha particles</i> .
1930	<u>Schrodinger</u>	Viewed electrons as continuous clouds and introduced “wave mechanics” as a mathematical model of the atom.
1930	<u>Paul Dirac</u>	Proposed <i>anti-particles</i> . Anderson discovered the anti-electron (positron) in 1932 and Segre/Chamberlain detected the anti-proton in 1955.
1932	<u>James Chadwick</u>	Using alpha particles discovered a neutral atomic particle with a mass close to a proton. Thus was discovered the neutron.
1938	<u>Lise Meitner, Hahn, Strassman</u>	Conducted experiments verifying that heavy elements capture neutrons and form unstable products which undergo fission. This process ejects more neutrons continuing the fission chain reaction.
1941 - 1951	<u>Glenn Seaborg</u>	Synthesized 6 transuranium elements and suggested a change in the layout of the periodic table.
1942	<u>Enrico Fermi</u>	Conducted the first controlled chain reaction releasing energy from the atom’s nucleus.

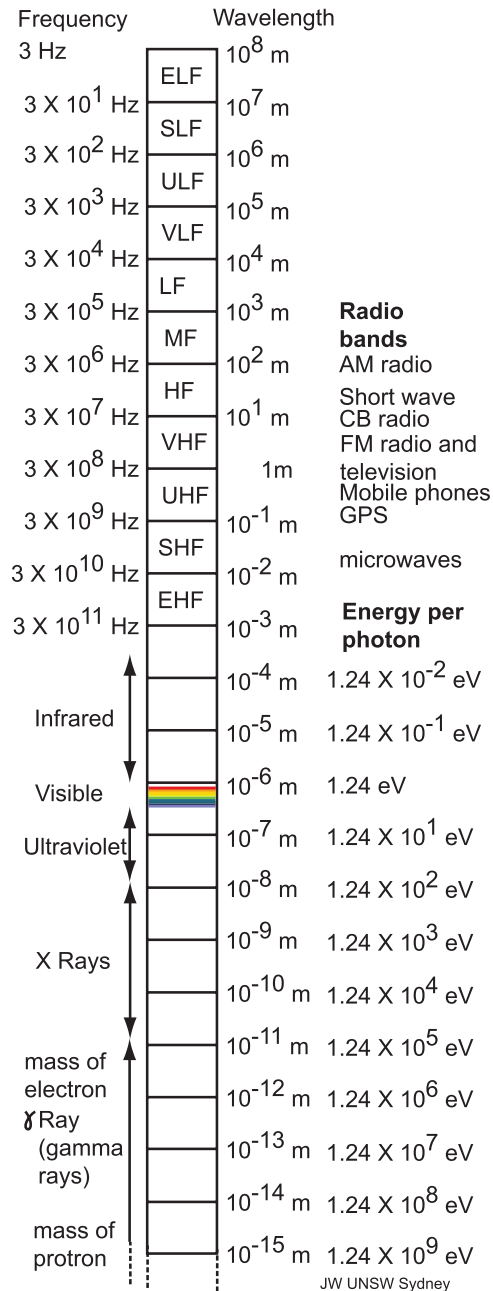
6.1.3 Factors of Radiographic Inspection. X- and gamma radiographic inspection uses the penetrating abilities of electromagnetic radiation to examine the interior of objects. Three prime factors determine the amount of information radiography can provide about an object: 1) The composition of the object, 2) The density of the material making up the object, 3) The energy of the X- or gamma rays incident upon the object. Discontinuities within the object can cause localized changes in the first two characteristics above and thus, become detectable.

6.1.4 The Physics of X-rays. X-rays are high-energy photons that are produced when electrons make transitions from one atomic orbit to another. These transitions can be generated via the photoelectric effect as illustrated in (Figure 6-X). If you send a photon into an atom with an energy greater than the binding energy of an electron in that atom, the photon can

T.O. 33B-1-1

knock that electron out of its orbit, leaving a hole (or vacancy). This hole can then be filled by another electron in the atom, giving off an x-ray in the transition to conserve energy. This process is known as fluorescence. Many different atomic electrons of different binding energies can fill this hole, so you would expect to see many energy peaks in an x-ray spectrum.

6.1.4.1 The Nature of Radiation. All together, X-rays and gamma rays, visible light, ultraviolet light, infrared radiation, microwaves, and radio waves make up the electromagnetic spectrum (Figure 6-2). Electromagnetic radiation is dualistic; meaning it exhibits some characteristics of a wave and some characteristics of a particle. In this case, the particle is called a photon, which is a quantum of light. Depending upon the application, X-rays might exhibit a more wave-like behavior or more quantum-like behavior.



H0401867

Figure 6-2. Wavelength

WARNING

Exposure to excessive X- or gamma radiation is harmful to human beings. While most X-ray equipment is designed to minimize the danger of exposure to direct or stray radiation, certain precautions SHALL be observed. Radiation protection requirements are discussed in (paragraph 6.8) of this chapter.

6.1.4.2 The most distinguishing characteristic of X-rays is their short wavelength. The penetrating ability of X-rays is directly proportional to their energy, which in turn, is inversely proportional to their wavelength; that is, the shorter the wavelength, the higher the energy; the longer the wavelength, the lower the energy. Short wavelength X-rays are commonly described as “hard” while long wavelength X-rays are referred to as “soft.”

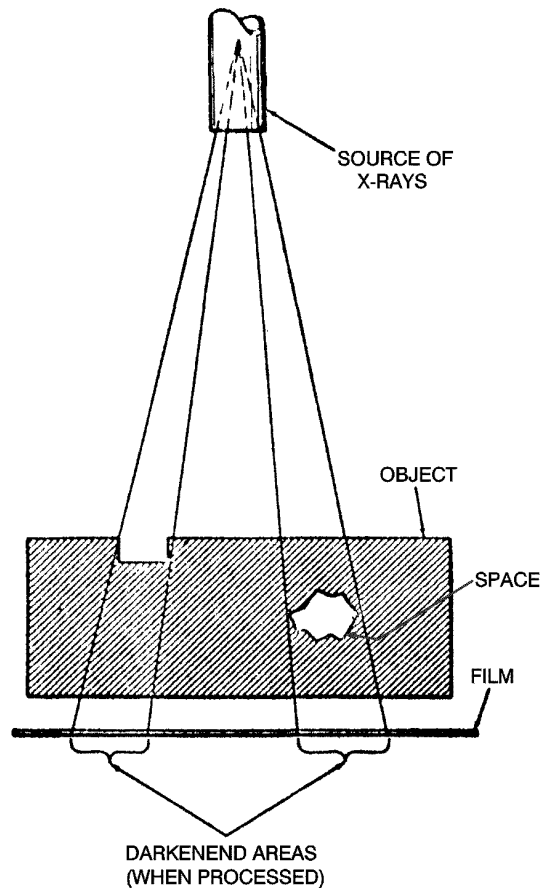
6.1.5 Properties of X- and Gamma Radiation. There are several properties which X-rays and gamma rays possess making them useful for radiographic inspection. X-rays and gamma rays are the same form of energy as visible light; both are part of the electromagnetic spectrum. Like light, both are refracted when they pass through glass, such as a lens, or any other medium; however, the amount of refraction of X- or gamma rays using visible-light optics is so slight as to be unnoticeable. Although the properties of X- and gamma rays and visible light are theoretically similar, the differences in application make it most convenient to consider X- and gamma rays as being different, since their observable effects are quite different from those of light. This is noted particularly in the ability to penetrate matter. Some general properties of X- and gamma rays may be summarized as follows:

- They are invisible to humans.
- They propagate in straight lines in free space.
- In special cases they are reflected, diffracted, refracted, and polarized as light, but to a much smaller degree.
- They propagate at a velocity of 3×10^8 meters per second as does light.
- They consist of transverse electromagnetic vibrations as does light.
- X-rays have energies between roughly 1 kilo electron volt (keV) and 50 MeV.
- X-rays for NDI are produced by the interaction of high-energy electrons or ions with matter.
- Gamma rays are produced in nuclear transformations, such as radioactive decay.
- X-rays and gamma rays expose (darken) photographic film.
- They stimulate fluorescence and phosphorescence in some materials.
- They are capable of ionizing gases and changing the electrical properties of some liquids and solids.
- They are able to damage and kill living cells and to produce genetic mutations.
- They are differentially absorbed or scattered by different media.
- X-rays may be diffracted by the crystalline structure of materials, which acts like a grating.
- They do not affect fuel cells or munitions.

6.1.5.1 All of these properties contribute in some degree to the understanding of the radiographic process. Most important of these in terms of usefulness to NDI are the differential absorption of radiation in matter and the ability of radiation to expose film. In the remainder of this chapter the term “X-rays” will be more prevalent since that form of radiation is most used. Except where noted the discussion will also apply to gamma rays.

6.1.6 Differential Absorption of Radiation in Matter. A material discontinuity, such as a void or change in configuration (Figure 6-3), changes the effective thickness of a material, and thus changes the degree of radiation absorption. Since all radiation not absorbed or scattered within a material is transmitted, the amount of transmitted radiation varies with localized changes in effective material thickness.

T.O. 33B-1-1



H0401868

Figure 6-3. Diagram of Radiographic Exposure

6.1.6.1 It is the transmitted radiation intensity generally used to find a material defect. If the material discontinuity represented in (Figure 6-4) were a foreign material inclusion, it also would cause a change in the apparent composition of the material and again result in a change in the transmitted radiation intensity. The degree of this change would be dependent on the relative effects of the test object and the included material on the incident radiation.

6.1.6.1.1 Some voids are difficult to detect, because they present a very slight change in material thickness to a beam of radiation. An important example of this type of defect is a crack, which represents a tear or rupture within a homogeneous material. If a crack is open, meaning the opening is wide (Figure 6-4 a), it appears to the radiation beam as a significant change in effective material thickness and is thus readily detected. However, if a crack is under compression and is very tight or closed, as illustrated in (Figure 6-4 b), then its detection may become very difficult, if not impossible, because the apparent change in material thickness is negligible. It is important to note, crack orientation to the primary beam has a very significant effect on the detectability of the crack using a radiographic technique. If the crack in (Figure 6-4 b) were oriented parallel with the radiation beam, the effective change in material thickness would be enough to make the crack easily detectable. However, in most situations the probability of aligning a beam with a tight crack is low, so other NDI techniques SHOULD be relied upon as backup inspections. The problems associated with crack detection will be dealt with at length in later paragraphs.

NOTE

Although radiography will reveal the interior of opaque objects, it cannot detect all types of irregularities or discontinuities. Small defects such as fine cracks or indentations in thick objects are difficult to detect. In applying radiography as an inspection method, the sensitivity of the method must be kept in mind. The limitations of radiography will become more apparent in subsequent discussions.

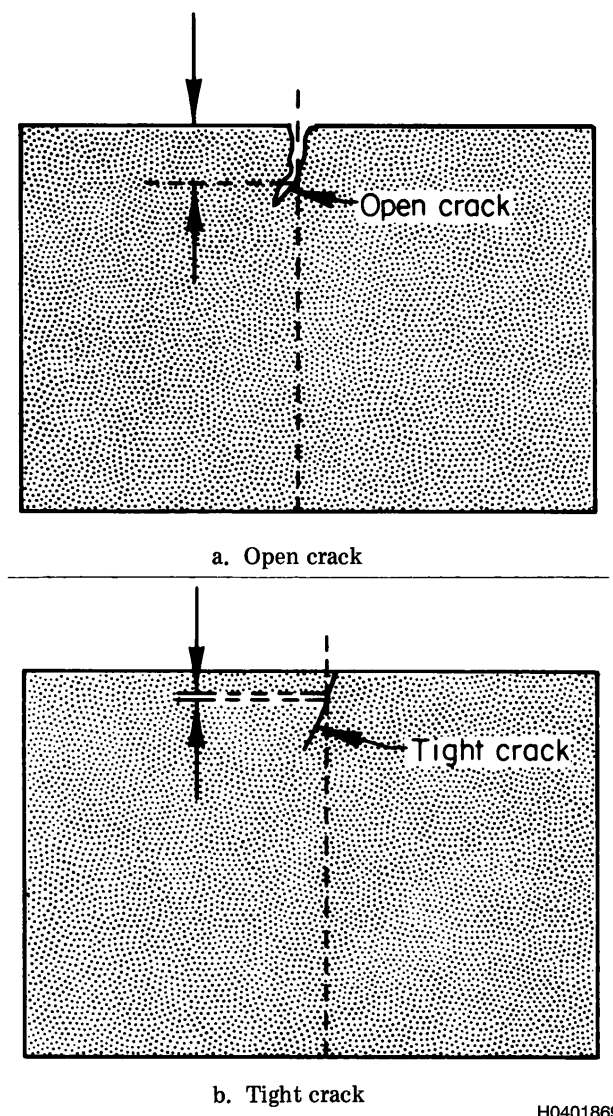


Figure 6-4. Effect of Change in Thickness Cracks

6.1.7 Exposure of Film to Radiation. X- or gamma radiation differs from ordinary light in their action on photographic film. Examination of microscopic sections through the sensitive layer of exposed films has shown radiation, unlike light, produces an equal distribution of grains of reduced silver throughout the entire thickness of the layer, whereas light produces an effect mainly on the surface of the emulsion. Consequently, a greater blackening of the emulsion can be produced by increasing the thickness of the emulsion and by coating both sides of the base of radiographic film. This darkening effect MAY then be used to obtain a photographic record, or radiograph, which is produced by the passage of X-rays or gamma rays through an object and onto a film. Thus a radiograph is a shadow picture of an object and its interior; dark regions on the film represent the more penetrable regions of the part and lighter areas on the film represent the more dense areas of the part. Film MAY be coupled with various screens to improve the image and reduce problems associated with scattered radiation.

6.1.7.1 The term exposure, as used in this manual, refers to the amount of radiation energy reaching a particular area of the film. It could be expressed as “ergs-per-square-centimeter,” but it is more convenient for practical use when expressed in terms of “dimensionless-relative-units,” one particular exposure value being used as a reference for other exposures. Characteristic curves are used to relate the action of exposure to radiation on a film, which becomes apparent in varying degrees of blackening in the processed film.

T.O. 33B-1-1

6.1.8 When to use Radiography. Radiography satisfies the three primary requirements of any nondestructive inspection:

- There is an energy form that can be usefully produced in a controlled manner.
- This energy form is capable of interacting with material in a manner that causes a change in the energy form, but not in the material.
- After such interaction, the energy form MAY be detected and MAY be interpreted to define what material condition produced the observed result.

6.1.8.1 Guidelines for Using Radiography. Here are some basic guidelines that MAY be followed to determine situations in which radiography is applicable:

- The area/defect of interest must cause a detectable change in apparent thickness, density, or composition of the test material.
- The material SHOULD be reasonably homogeneous, so an indication of a defect can be recognized.
- The part SHALL be configured so the inspector will have access to both sides of the area that must be inspected. This is a requirement to ensure the area to be inspected is between the primary beam and the film.
- The defect to be detected SHOULD be properly oriented in the path of the radiation beam.

6.1.8.2 Limitations to Radiographic Inspection. Radiography is not a cure-all and SHOULD only be used when the above conditions are satisfied. Multiple film techniques and other special methods, which will be covered in (paragraph [6.4.17.2.2](#)), make radiography a versatile tool for material evaluation.

6.1.8.3 Typical Uses for Radiographic Inspection.

6.1.8.3.1 Radiography is a useful nondestructive inspection method for detecting internal discontinuities in many materials.

6.1.8.3.2 Radiography MAY be applied to the inspection of castings, welds, and assembled components. Various metals, both ferrous and nonferrous, as well as non-metallic substances, such as ceramics and plastics, can successfully be inspected.

6.1.9 Unique Properties of Gamma Radiation.

6.1.9.1 Introduction to Gamma Radiography. Gamma radiography is basically the same as X-radiography. The differences in material properties and effects between them are largely a matter of degree. The major advantage of using gamma rays over X-rays is the fact gamma ray sources are small and provide access to small spaces, thereby simplifying exposure technique. A downside to using gamma rays is the fact that the exposure period is generally longer with gamma ray sources, and the gamma ray source cannot be turned off like an X-ray unit can.

6.1.9.2 Phenomenon of Gamma Radiation. Many atoms exhibit a property called radioactivity, which is a phenomenon of spontaneous disintegration or decay. This characteristic is believed to be caused by the instability of the complex structure of the atom under the action of the electric, magnetic, and gravitational forces existing within. This energy release is uncontrolled and is a result of forces in the atom. Radium is one of the elements with a natural unbalance that releases energy in the form of gamma rays to achieve a more stable condition. Radium-226 has no gamma energies over 0.27 MeV. In addition to the gamma rays, some alpha particles (helium nuclei) and beta particles (electrons) are allowed to escape. The atomic structure of many materials can be artificially made to release energy by subjecting them to strong fields of neutrons generated in nuclear reactors. These neutron fields add energy to the atom, which upsets the balance within the nucleus and causes the atom to emit one or more types of energy. Cobalt is one element commonly made artificially radioactive and used in NDI since the energy it releases is a very penetrating form of gamma rays. Co-60 has energies above 1 MeV. An example of nuclear disintegration and the release of energy is shown ([Figure 6-5](#)).

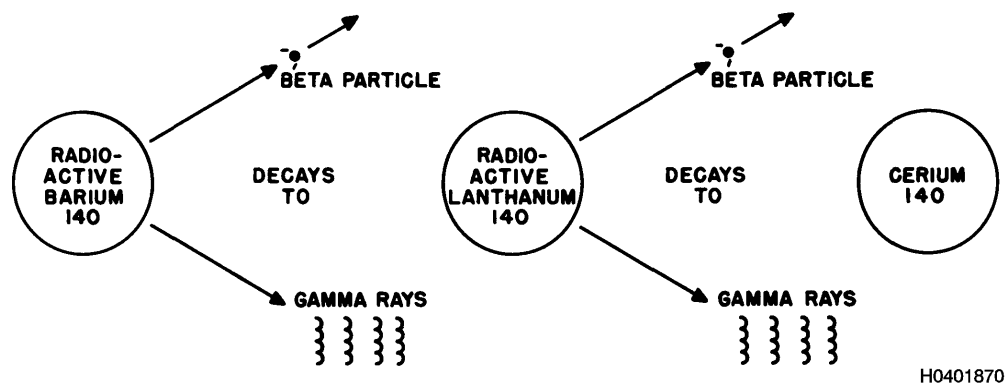


Figure 6-5. Diagram of Nuclear Disintegration

6.1.9.3 Typical Gamma Ray Source. The typical gamma ray source is composed of a metal container, called a camera, which contains a radioactive element, and has provisions to allow the element to be moved to a desired exposure position. Cameras are made of very dense material in order to shield the radioactive material. Typical gamma ray sources contain such artificially radioactive elements as cobalt-60, iridium-192, cesium-137, thulium-170, and ytterbium-169.

T.O. 33B-1-1

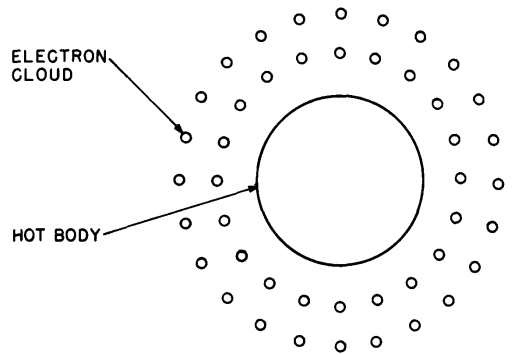
SECTION II PRINCIPLES AND THEORY OF RADIOGRAPHIC INSPECTION

6.2 HOW X-RAYS ARE PRODUCED.

6.2.1 Generating X-Radiation.

6.2.1.1 Basic Requirements. There are three basic requirements, which must be met to produce X-rays; 1) supply electrons, 2) move electrons, and 3) impinge electrons onto the target.

6.2.1.1.1 Supply Electrons. Since all matter is generally considered to be composed of electrons and other minute particles, electron sources are readily obtainable. Electrons can be supplied by simply raising the temperature of a suitable material. To excite the electron, it is necessary to sufficiently heat the material. As the temperature rises, the electrons become more and more agitated until they finally “escape” or “boil-off” the material. The excited electrons will surround the material in the form of an electron cloud (Figure 6-6), commonly known as thermionic emission. In an X-ray tube, the heated material is called the filament, which is similar to the filament in a light bulb. Just as in a light bulb the filament is heated by passing electrical current through it. This cloud of electrons simply hovers around and returns to the emitting substance unless some external action or force pulls it away. Therefore, electron emission is facilitated by heating a filament which is incorporated into the cathode.



H0401871

Figure 6-6. Electron Cloud

6.2.1.1.2 Move Electrons. As high voltage, direct current is applied between the cathode and the anode, the cathode emits electrons which flow toward the anode. This movement is brought about due to the repelling and attracting forces inherent in an electric circuit. The fundamental law of electrostatics states: “like charges repel and unlike charges attract.” Electrons are negative charges, thus repel each other, however, a stronger attracting force is needed to accelerate the electrons to a higher velocity. Therefore, a strong opposite (positive) charge is used to move the electrons from one point to another. This voltage force, which drives electrons from the cathode to the anode, is known as kilovoltage with a unit symbol “kVp.” It is important this movement is conducted in a good vacuum; otherwise the electrons collide with air molecules and lose energy through ionization and scattering. In an X-ray tube, the anode (target) is given a positive charge with respect to the filament, which is part of the cathode. A focusing cup in the cathode is used to direct the stream of electrons to the target.

6.2.1.1.3 Impinge Electrons Onto the Target. The voltage applied between the cathode and anode is called the X-ray tube voltage, and the surface of the anode which is struck by electrons is called the target. When the rapidly moving electrons collide with the target stopping their rapid motion, a small portion of their energy is transformed into X-rays. The remainder of the energy is turned into heat, raising the temperature of the target (anode). Because the target is heated to extremely high temperatures, it is made of a high melting point material like tungsten.

6.2.1.1.3.1 The number of electrons emitted from the cathode and the dose of X-rays generated off the target of the anode can be adjusted by changing the filament current of the X-ray tube. When the X-ray tube voltage is changed, the speed at which electrons strike the target is changed, causing a change in the energy level of the X-rays and their wavelength. X-rays

which have relatively short wavelengths are called hard X-rays, and those with relatively long wavelengths are called soft X-rays.

6.2.2 Type of Radiation Produced by a Tube Head.

6.2.2.1 The Continuous Radiation. When the electrons bombard the target, they are brought to an abrupt halt. Unfortunately most of the electrons' kinetic energy is converted into heat, which must be dissipated by the target material. Only a small percentage of the energy available in the electron beam is converted into X-ray photons, which can have energies ranging from zero to a maximum determined by the original kinetic energy of the electrons and by how rapidly the electrons are decelerated. This process produces the continuous portion of the X-ray spectrum and is known either by the German term "Bremsstrahlung," meaning braking radiation, or by the term "white radiation" (paragraph 6.2.7.1). X-rays are produced regardless of the material bombarded, whether it is a solid, liquid, or gas. In the X-ray tube, a solid material is used for the target. For efficient X-ray production, the target material must have a high atomic number.

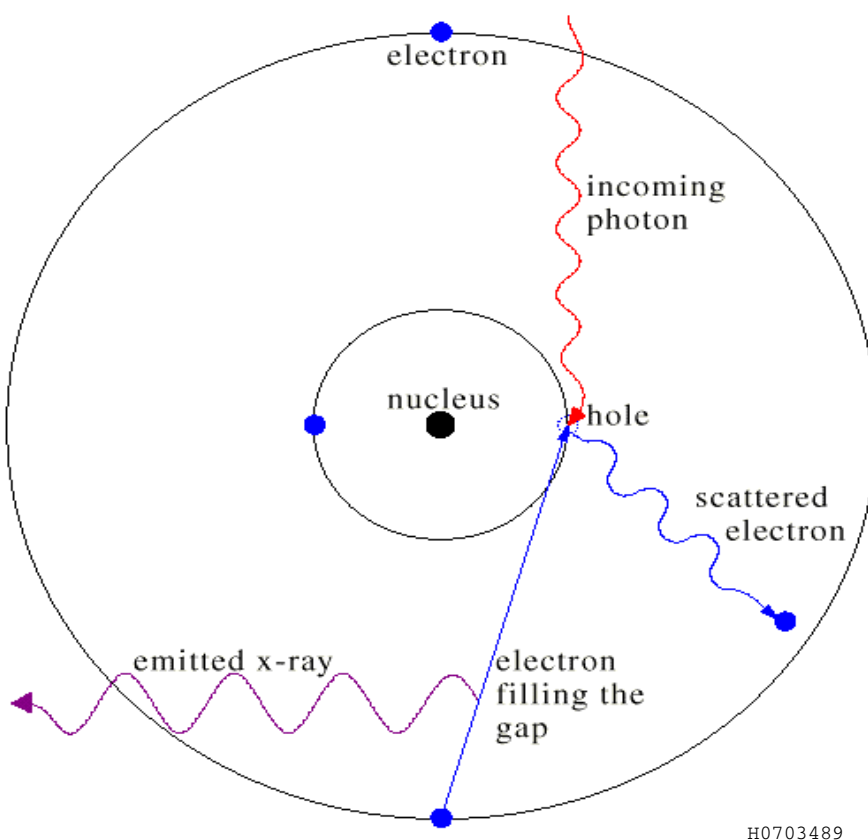
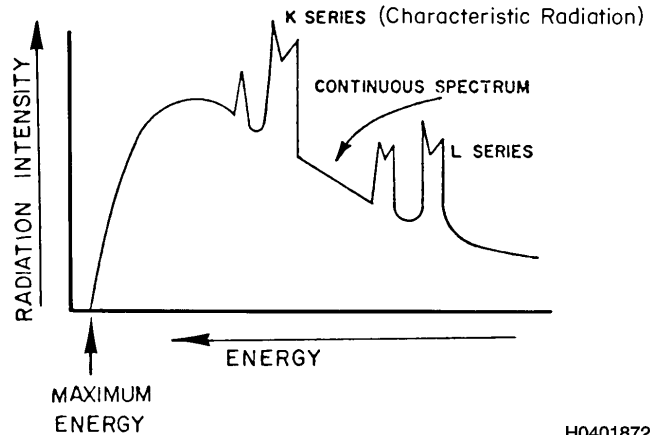


Figure 6-7. X-ray Production

6.2.2.2 Characteristic Radiation. In addition to "white radiation" (paragraph 6.2.7.1), there are several other characteristic spikes in a typical X-ray spectrum. These intensity spikes are caused by interaction between the impinging stream of high-speed electrons and the electrons bound tightly to the atomic nuclei of the target material. If an atom is considered as a planetary system with the nucleus of protons and neutrons at the center and the electrons moving in orbits around the nucleus, modern physics predicts the orbital electrons near the nucleus will have very well defined energies, and electrons in different orbits having different energy levels. If an electron from an external beam collides with an orbital electron with sufficient energy, and knocks it from its orbit, an electron from a higher energy level would, after a time, drop down to fill the void and restore atomic stability. When that electron drops to the lower energy level, it gives off a photon with energy equal to the

T.O. 33B-1-1

difference in energy levels. Since these energy levels depend strictly upon a particular atom, the radiation emitted is called “characteristic radiation.” The “characteristic radiation.” emitted by the target material is superimposed upon the “continuous spectrum.” A typical X-ray spectrum of radiation generated by an X-ray tube would appear as (Figure 6-8). The K- and L-series of characteristic radiation designate the radiation emitted from different electron orbits around the nucleus of the atom. As energy levels increase, electrons are dislodged from the various orbits with the K-series being the closest to the nucleus.



H0401872

Figure 6-8. Typical X-ray Spectrum

6.2.3 Effects of Voltage and Amperage on X-ray Production.

6.2.3.1 Effect of Voltage. In different equipment, different methods are used to accelerate the electrons. In the smaller X-ray generators, up to and including two-million volt units, acceleration is accomplished with transformers to step-up the incoming power line voltage and applies it between the anode and the cathode of the X-ray tube. Since X-ray generators operate at very high voltages, the unit kilovolt (kV) is used to designate one thousand volts. As the kilovoltage (the potential causing the electrons to accelerate) is changed, the kinetic energy of the moving electrons is changed, altering the energy of the resulting X-radiation. Also, as the kilovoltage is increased, the efficiency of converting the electrical energy into X-rays is increased. Therefore, when kilovoltage is changed, the penetrating capability (the quality) of the generated radiation is changed, and the “quantity” of radiation is altered due to the efficiency of electrical energy converted into X-rays. Selecting the proper kilovoltage is very important in industrial radiographic applications.

6.2.3.2 Effect of Amperage. Amperage is a measure of the amount of electrical current applied to the filament. It is also a direct measurement of the number of free electrons available in the X-ray tube and is independent of variations in kilovoltage. Thus the “quantity” of X-radiation is in direct relation to the filament current. Typically, the amount of current is small, so the unit milliamper (mA) is used to designate one one-thousandth of an ampere. The effect of mA changes on the radiation output is shown (Figure 6-9).

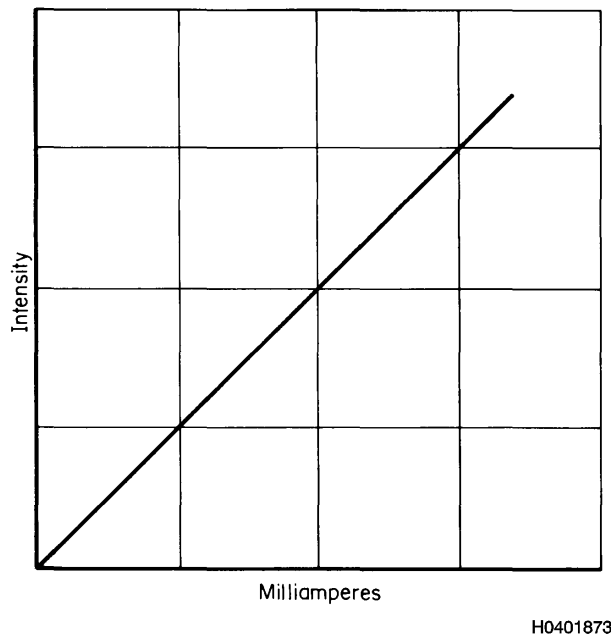


Figure 6-9. Effect of Filament Current on Radiation Quantity (Intensity)

6.2.4 X-ray Generators.

6.2.4.1 What are X-ray Generators. X-ray generators are man-made electronic devices designed to produce X-radiation. X-ray generators are obtained commercially and the equipment is either portable or stationary. Portable X-ray generators are used for inspection of test objects either impossible or very difficult to transport or safely inspect. Stationary X-ray generators are used in shielded facilities where the objects to be tested can be readily transported to the X-ray equipment (paragraph 6.3).

6.2.4.2 Components and Properties of an X-ray Tube. The X-ray tube houses the cathode “negative terminal” and the anode “positive terminal” under a high vacuum. Traditionally, this tube has been a glass envelope with a reduced thickness at the window (the point where the X-rays exit), to reduce X-ray absorption. The high vacuum reduces the problem of the electrons colliding with, and being absorbed by, molecules of air and provides electrical insulation between the cathode and anode. In some designs, a “beryllium window” is incorporated to further reduce absorption of the X-ray beam, particularly the lower energies. In many applications metal-ceramic envelopes are replacing glass envelopes. These tubes usually involve a metal cylinder with a ceramic disk at each end to hold and insulate the cathode and anode assemblies. The metal-ceramic tube is more durable than the glass tube and is less susceptible to thermal and mechanical shock.

6.2.4.2.1 Glass Envelope. It is important this movement of electrons is conducted in a good vacuum; otherwise the electrons collide with air molecules and lose energy through ionization and scattering. A glass envelope with a strong vacuum is needed to ensure this happens.

6.2.4.2.2 Cathode. A structure known as the cathode serves as the electron source (Figure 6-10). Actually, it is a “filament” or “coil” of thoriated tungsten wire that emits electrons when heated to a high temperature. Since the filament gives off electrons in all directions, some means must be used to focus them on a target. The filament is centered within a “reflector” or “focusing cup” within the cathode structure and serves to focus the electron beam like a light is focused by a flashlight reflector.

T.O. 33B-1-1

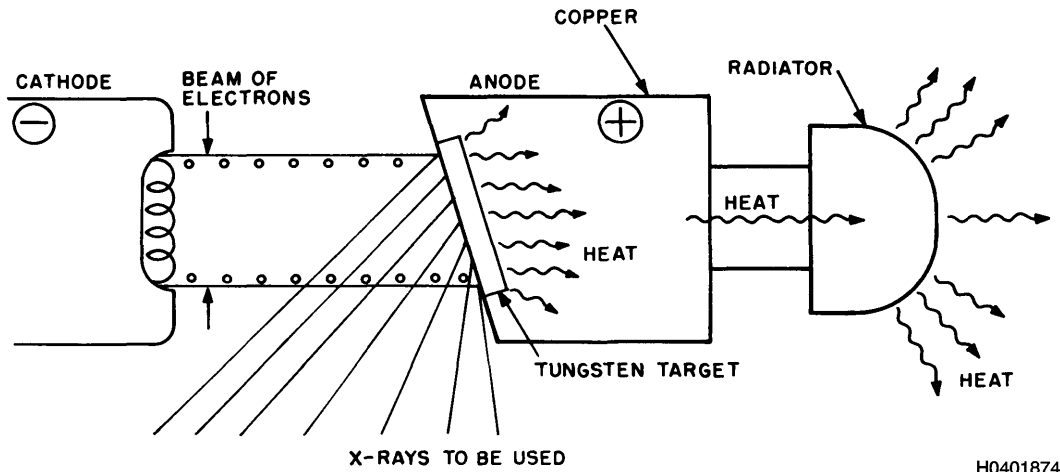


Figure 6-10. Fundamentals of X-ray Tube

6.2.4.2.3 Focusing Cup. A negatively charged focusing cup is used to direct the stream of electrons toward the anode (target).

6.2.4.2.4 Anode. There must be a target for the electron beam to strike before X-rays are actually produced. In radiographic tubes the target material is generally made of tungsten. The choice of tungsten as a target for industrial radiography is based on four material characteristics:

- High Atomic Number (74). The higher the atomic number of a material the more efficient is the conversion from electrical energy into X-ray energy.
- High Melting Point (6170°F). Most of the energy in the electrons bombarding the target is dissipated in the form of heat. The extremely high melting point of tungsten (W) permits operation of the target at very high temperatures.
- High Thermal Conductivity. This permits rapid removal of heat from the target, allowing maximum energy input for a given area size.
- Low Vapor Pressure. This reduces the amount of target material vaporized during operation.

6.2.4.2.4.1 The tungsten (W) target material is usually imbedded into a massive copper rod. Copper is an excellent thermal conductor and is used to remove the heat from the target, which then, depending on tube design and operation, is dissipated by air, oil, or water-cooling. This target acts as the anode, and to produce X-rays, it SHALL be at a positive potential (voltage) with respect to the cathode in order to attract the electrons available at the cathode.

6.2.4.2.5 Focal Spot. The focal spot is the area of the target bombarded by the electrons from the cathode. The focal spot is determined by the shape and size of the focusing cup of the cathode along with the length and diameter of the filament. The size of the focal spot has a very important effect upon the quality of the X-ray image. The smaller the focal spot, the better the detail of the image. The electron stream from the filament is focused as a narrow rectangle on the anode target. The typical target face is made at an angle of about 20-degrees to the cathode. When the rectangular focal spot is viewed from below, in the position of the film, it appears to be more like a small square. Thus, effective area of the focal spot is only a fraction of its actual area (Figure 6-11). By using the X-rays that emerge at this angle, a small focal spot is created, improving radiographic definition. Because the electron stream is spread over a greater area of the target, heat dissipation by the anode is improved.

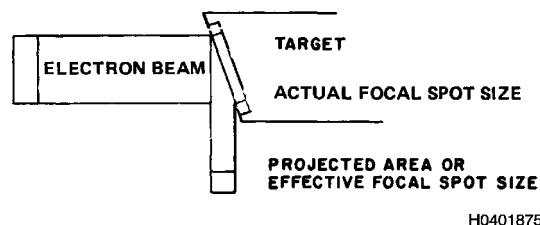


Figure 6-11. Effective Focal Spot Size

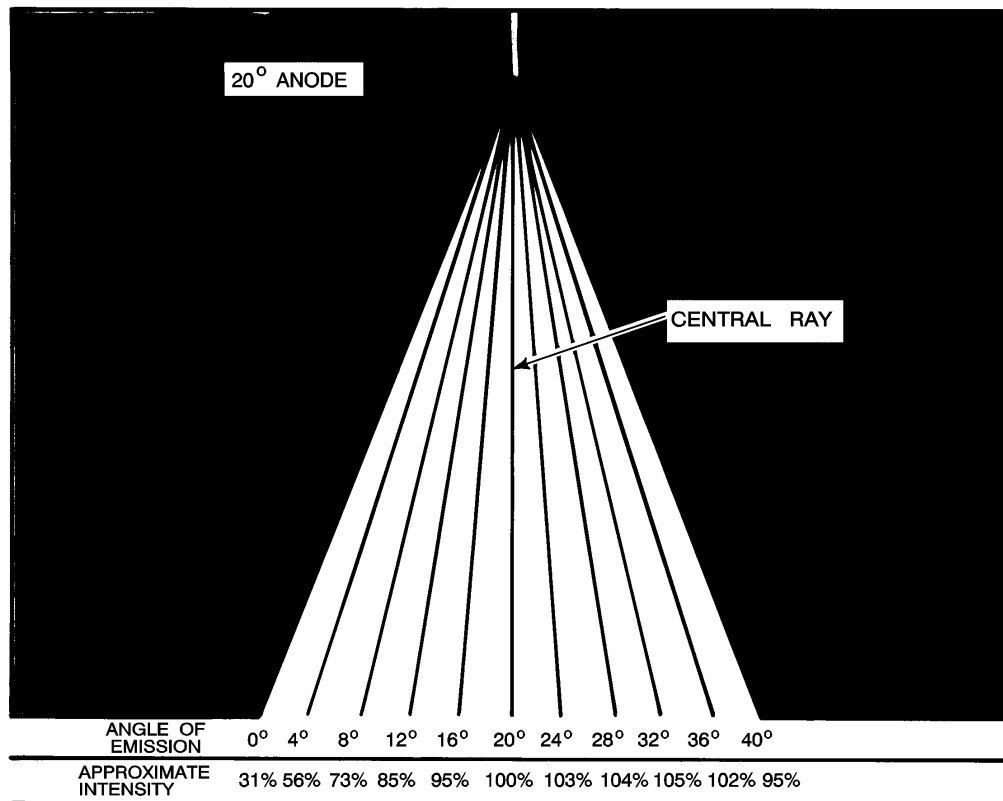
6.2.4.3 Inherent Filtration. Inherent filtration is the filtration or reduction in radiation energy due to absorption by the material necessary to provide the vacuum, the electrical insulation, and mechanical rigidity of the X-ray tube. In construction of some glass X-ray tubes, the port is reduced in thickness to provide less inherent filtration. In some other tubes, the port is made of beryllium, which is a light metal of low atomic number and low X-ray absorption. Because of tremendous pressures exerted by the atmosphere on large evacuated containers, X-ray ports must be designed with sufficient thickness to withstand these pressures without implosion. In center-grounded X-ray equipment, it is also necessary to provide gas (e.g., sulfur hexafluoride SF_6) and solid insulation for electrical isolation of the X-ray tube. Excessive inherent filtration reduces the X-ray output as well as the radiographic contrast on equipment of a given rating. In normal practice, it is acceptable to tolerate inherent filtration equivalent to 1-mm of aluminum up to 100 kVp (kilovolts peak); 3-mm of aluminum up to 175 kVp; 5-mm of aluminum equivalent up to 250 kVp; and higher filtration in 1,000 to 2,000 kVp units. Inherent filtration above these tolerances reduces contrast, and hence, the sensitivity of radiographic inspection, especially on thin sections and light alloys. For this reason, during radiographic inspections using kilovoltage of 150 kVp or less, the tube head SHALL be configured so generated radiation will travel from the target through a beryllium window without passing through any media other than air or insulating gas.

6.2.4.4 Cooling Requirements. The product of mA and kV equals watts of electrical power in the electron beam striking the X-ray target. One watt of electrical power is equal to one volt-ampere. Therefore, in an X-ray tube operating at 10 mA (or 0.01 amperes) and 140 kV (140,000 volts), 1400 watts of electrical power are in the electron beam. Only a very small amount of the energy in the electron beam, about 0.05-percent at 30 kV to approximately 10-percent in the MeV energy range is converted into X-radiation. Most of the other electron beam energy is converted into heat. This heat in the X-ray tube target material is one of the limiting factors in the capabilities of the X-ray tube. Thus, it is necessary to remove this heat from the target as rapidly as possible. Various techniques are used for removal of this heat. In some instances, the target is comparatively thin, and requires a suitable oil to be circulated on the back surface to remove the heat. In other cases, (where the anode is being operated at ground potential) use a water-antifreeze mixture to conduct heat away from the target. Most X-ray targets are mounted in copper, which is used as a heat sink. Some units have no external method of heat removal, but depend upon heat dissipation into the atmosphere by the fins of a thermal radiator. Some totally enclosed tubes depend upon the heat storage capacity of the anode structure to absorb the heat generated during X-ray exposure. This heat is then dissipated after the unit is turned off. These units usually have a duty cycle limiting the operation. This duty cycle is dependent upon the heat storage capacity of the anode structure and the rate of heat dissipation by thermal radiation. The rate of heat removal from the X-ray target is the primary limiting factor in X-ray tube operation.

6.2.5 Intensity and Distribution of an X-ray Beam.

6.2.5.1 Heel Effect. For simplicity's sake, most literature states the intensity of radiation of the primary beam is constant, this is not quite correct. There is a variation in intensity due to the angle at which X-rays are emitted from the focal spot. This variation in intensity is called the heel effect (Figure 6-12).

T.O. 33B-1-1



H0401876

Figure 6-12. Variation of Intensity in the Primary Beam Due to the Heel Effect

6.2.5.1.1 The intensity of the beam diminishes rapidly from the central ray toward the anode side and increases slightly toward the cathode side. In general practice, the heel effect is not evident, provided the maximum lateral dimension of the object to be radiographed is less than half the source-to-film distance (SFD). In other words, coverage of a 14-inch by 17-inch film requires an SFD of approximately 36-inches to provide a field intensity of plus or minus 12-percent over the entire film. This is based upon using part of the radiation field within a cone having a 30-degree included angle. Remember, the source for an X-ray tube is the focal spot. For a single exposure of larger areas requiring multiple films, the SFD must be increased. A detailed example for figuring the heel effect is in (paragraph 6.7.8).

6.2.5.2 **Beam Coverage.** The greater the field size available from an X-ray unit, the greater its radiographic inspection capacity. Except at extremely high voltages, the X-ray beam has an angle of coverage that is a function of the X-ray target angle, the geometry of the focal spot, and the X-ray port size. As indicated in the discussion on “heel effect” in the previous paragraph, the physical size of the field of uniform intensity increases directly in proportion with the distance from the target to the film. However, the beam intensity decreases proportionally with the square of the distance. As a result, the exposure (product of amperage and time) must be increased to produce equivalent density on the radiograph. If a technique has been established but the situation requires a different SFD (Table 6-2), use these multiplication factors for calculating new exposure times to be used with the original kV and mA values.

NOTE

To change the SFD from any given distance to any desired distance, locate the given distance on top of the chart. Next, read down the left side of the table to the desired distance. Multiply the original exposure by the number common to both the distance in the given column and the distance in the desired row to get the new exposure. This chart MAY be used for distance changes providing the kV and mA levels are not changed.

Table 6-2. Exposure-Time Correction Factors for Different Source to Film Distances

	Desired Distance (Feet)										Given Distance (Feet)									
	1	2	3	4	5	6	7	8	9	10	11	12	13	14	15	16	17	18	19	20
↓	1	0.25	0.11	0.06	0.04	0.03	0.02	0.01	0.01	0.01	0.01	0.01	0.01	0.01	0.01	0.01	0.01	0.01	0.01	0.01
1	1	1	0.44	0.25	0.16	0.11	0.08	0.06	0.05	0.04	0.03	0.03	0.02	0.02	0.02	0.02	0.01	0.01	0.01	0.0
2	4	2.3	1	0.56	0.36	0.25	0.18	0.14	0.11	0.09	0.07	0.06	0.05	0.05	0.04	0.04	0.03	0.03	0.02	0.02
3	16	4	1.8	1	0.64	0.44	0.33	0.25	0.20	0.16	0.13	0.11	0.09	0.08	0.07	0.06	0.06	0.05	0.04	0.04
4	25	6.3	2.8	1.6	1	0.69	0.57	0.4	0.31	0.25	0.21	0.17	0.15	0.13	0.11	0.10	0.09	0.08	0.07	0.06
5	36	9	4	2.3	1.4	1	0.73	0.56	0.44	0.36	0.30	0.25	0.21	0.18	0.16	0.14	0.12	0.11	0.10	0.09
6	49	12.3	5.4	3.1	2	1.4	1	0.77	0.60	0.49	0.40	0.34	0.29	0.25	0.22	0.19	0.17	0.15	0.14	0.12
7	64	16	7.1	4	2.6	1.8	1.3	1	0.80	0.64	0.53	0.44	0.38	0.33	0.28	0.25	0.22	0.20	0.18	0.16
8	81	20.3	9	5.1	3.2	2.2	1.7	1.3	1	0.81	0.67	0.56	0.48	0.41	0.36	0.32	0.28	0.25	0.22	0.20
9	100	25	11.1	6.3	4	2.8	2	1.6	1.2	1	0.83	0.69	0.59	0.57	0.44	0.39	0.35	0.31	0.28	0.25
10	121	30.2	13.4	7.6	4.8	3.4	2.5	1.9	1.5	1.2	1	0.84	0.72	0.62	0.54	0.47	0.42	0.37	0.34	0.30
11	144	36	16	9	5.8	4	2.9	2.3	1.8	1.4	1.2	1	0.85	0.73	0.64	0.56	0.50	0.44	0.40	0.36
12	169	42.2	18.8	10.6	6.8	4.7	3.4	2.6	2.1	1.7	1.4	1.2	1	0.86	0.75	0.66	0.58	0.52	0.47	0.42
13	196	49	21.7	12.3	7.8	5.4	4	3.1	2.5	2	1.6	1.4	1.2	1	0.87	0.77	0.68	0.61	0.54	0.50
14	225	56.2	25	14	9	6.3	4.6	3.5	2.8	2.2	1.9	1.6	1.3	1.1	1	0.88	0.78	0.69	0.62	0.56
15	256	64	28.4	16	10.2	7.1	5.2	4	3.2	2.6	2.1	1.8	1.5	1.3	1.1	1	0.89	0.79	0.71	0.64
16	289	72.2	32.1	18.1	11.6	8	5.9	4.5	3.6	2.9	2.4	2	1.7	1.5	1.3	1.1	1	0.89	0.80	0.72
17	324	81	36	20.2	13	9	6.6	5.1	4	3.2	2.7	2.3	1.9	1.6	1.4	1.3	1.1	1	0.89	0.81
18	361	90.2	40.1	22.6	14.4	10	7.4	5.6	4.5	3.6	3	2.1	1.8	1.6	1.4	1.2	1.1	1.1	1	0.90
19	400	100	44.4	25	16	11.1	8.2	6.3	4.9	4	3.3	2.8	2.4	2	1.8	1.6	1.4	1.2	1.1	1
20																				

T.O. 33B-1-1**6.2.6 Interaction of Radiation With Matter.**

6.2.6.1 Absorption Mechanisms. Absorption of gamma or X-radiation by materials requires detailed consideration. These radiation photons are electromagnetic waves of energy, have no mass or electrical charge, and can penetrate the densest of materials. These waves are dimensionally so short they have wavelengths less than the electron spacing in the atoms and therefore have the capability of traveling through the atomic structure. The absorption of the photons is a result of the photon either striking an electron or entering the nuclear field of the atom. The energy lost by a radiation beam as it travels through matter is due to interactions of the photons with matter. In these interactions, the energy of the photon is transferred principally through three processes. These are “photoelectric absorption,” “Compton effect,” and “pair production” (Figure 6-13). At extremely high photon energies a small amount of absorption is due to the photodisintegration process, but this is of little consequence in radiographic applications. Most of the radiation absorption is due to interaction of the photons with electrons in the atoms of the absorbing material. Therefore, an absorber may be judged somewhat in relationship to the electron density of the absorber, or approximately the number of electrons in the radiation beam path. The parameters that contribute to this electron density are the atomic number, the density, and the thickness of the absorber. The atomic number is the number of protons in the nucleus of the particular atom, and material density (usually expressed as grams per cubic centimeter) is related to the number of atoms compacted in a given material volume. The thickness of the absorber can be mechanically measured. Atomic number, material density, and absorber thickness combine to present an absorber value to the radiation. The radiation photons interact with the atoms in the absorber in different manners, depending upon the energy or wavelength of the photon.

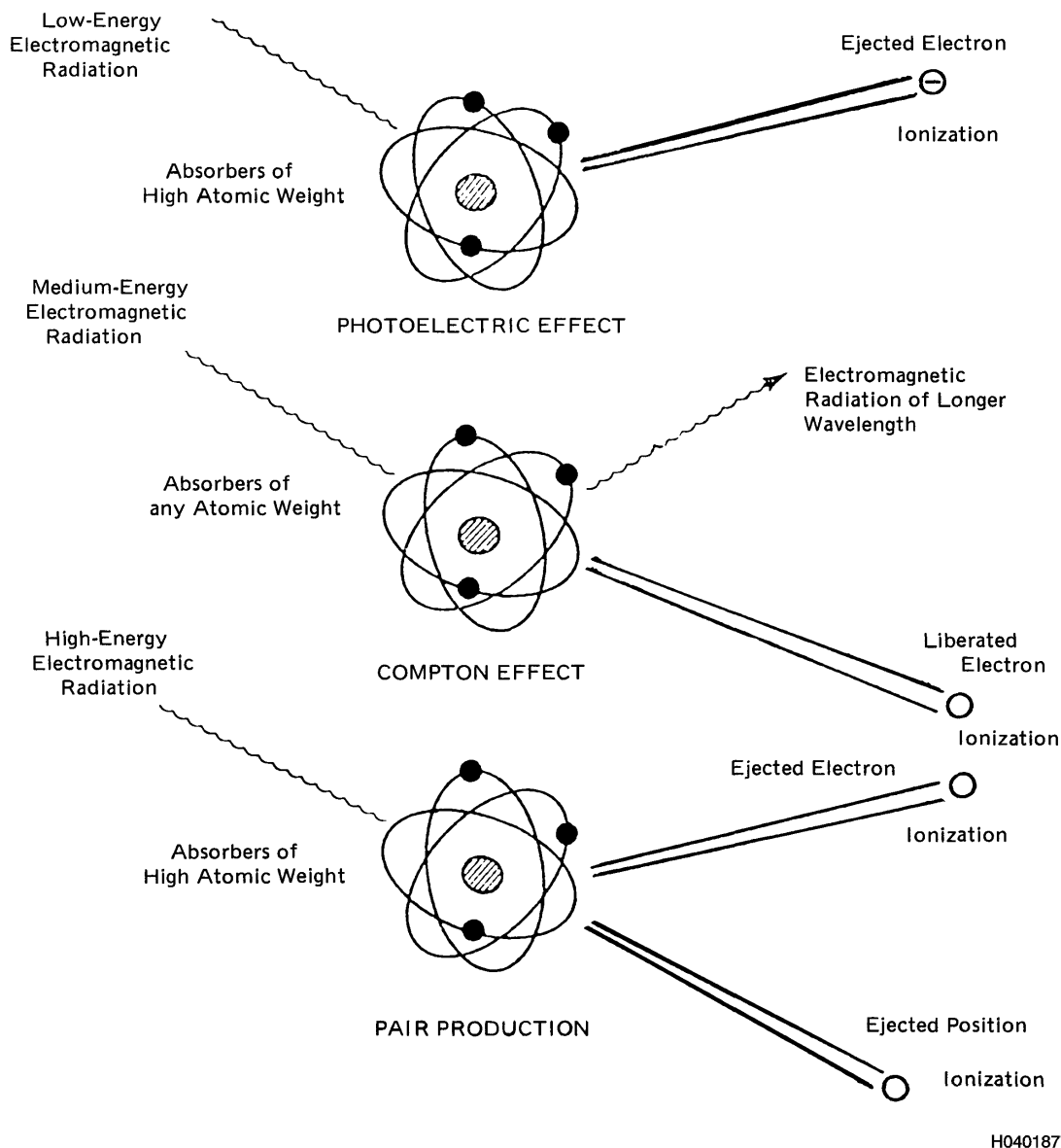


Figure 6-13. Illustration of Various Radiation Absorption Interactions

6.2.6.1.1 Photoelectric Absorption. When the photons have energies of 100 keV or less, they are readily absorbed by the electrons in the orbital shells of the atoms of the absorber. The energy of the photon is transferred to the electron; often dislodging it from its orbit and the remainder of the photons energy is used to give the electron kinetic energy or velocity. These ejected electrons are called “photoelectrons” and the process is known as “photoelectric absorption.” The moving electrons lose their energy through Coulombic interactions and can produce ion pairs.

NOTE

During this process, the radiation photon has given up all of its energy and no longer exists. This mechanism of absorption has a very high probability for very low energy radiation and accounts for the major absorption of radiation when photon energies are 100 keV and less.

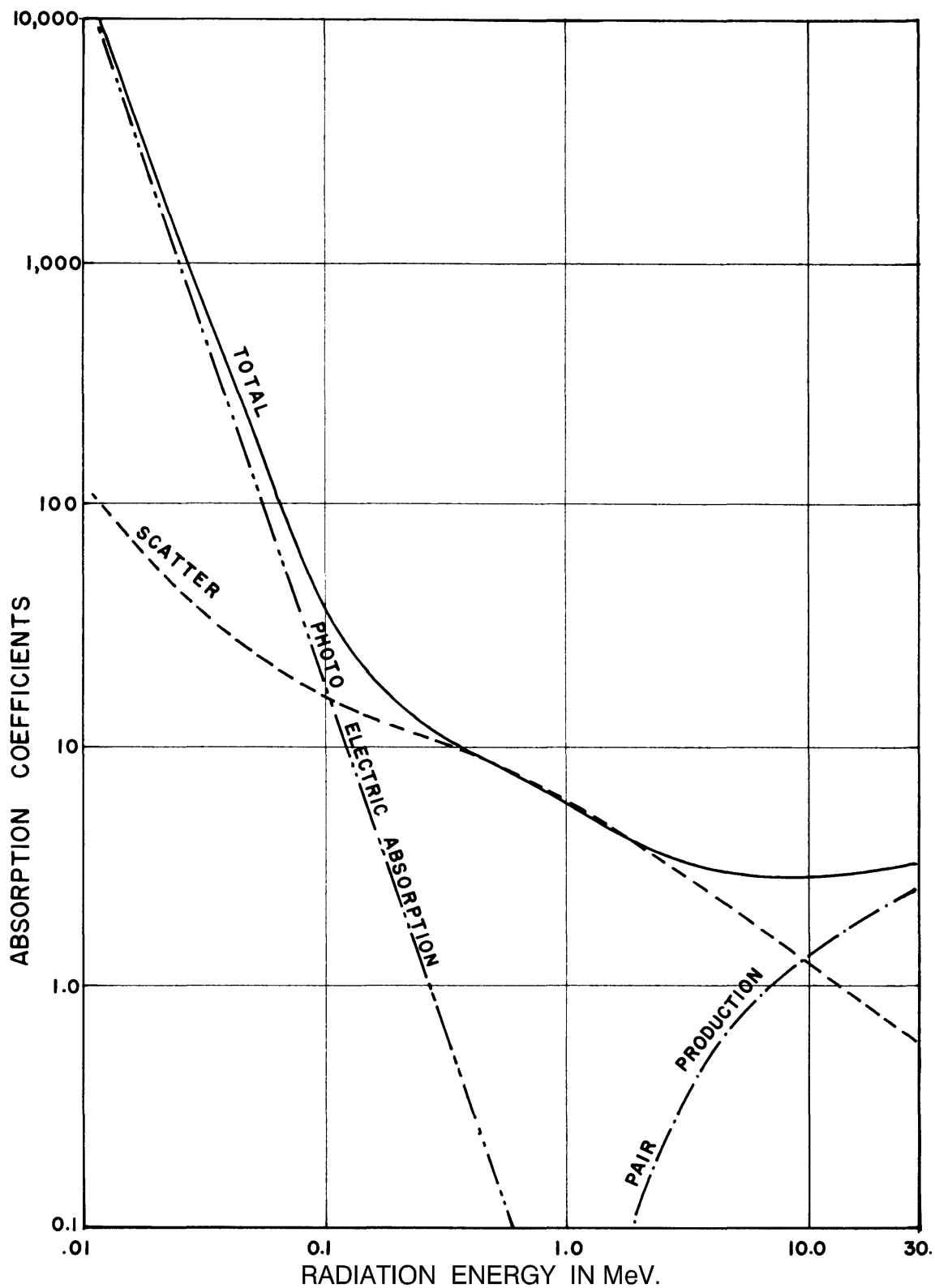
6.2.6.1.2 Compton Effect (Scattering). When the photon energies are in the 100 keV to 10 MeV range, all of the energy is not required to dislodge an orbital electron and accelerate it by induction of kinetic energy. In this case, photoabsorption

T.O. 33B-1-1

can occur, but the photon continues at some different path and at a reduced energy level, due to the loss of energy to the electron. By this mechanism of absorption, the path of the photon is altered and its energy decreased. This mechanism of absorption is referred to as Compton Effect or Compton Scattering. Compton Effect accounts for the major absorption of radiation in the energy range between 100 keV and 10 MeV.

6.2.6.1.3 Pair Production. When photon energies exceed 1.02 MeV, their energy can cause pair production. In this event, the nuclear field surrounding the nucleus of the atom disintegrates the high-energy photon. The energy of the photon converts into an electron-positron pair. The positron has the same mass as an electron and is of equal, but opposite charge. It may be noted in this absorption mode, the energy of the massless photon is converted to mass. Einstein's equation states energy equals mass times the square of the velocity of light ($E = mc^2$). If this equation is used, it can be found the mass of an electron is equivalent in energy to a 0.51 MeV photon. This explains the requirements for a photon to have energy of at least 1.02 MeV before pair production can occur. Additional energy above the 1.02 MeV causes the pair of particles to have kinetic energy or velocity. The positron may cause ionization or it may combine with an electron, causing annihilation and emission of two gamma photons of 0.51 MeV per photon. These lower energy photons may subsequently interact by either the photoelectric or Compton Effect absorption modes.

6.2.6.2 Significance of Absorption Mechanisms. With three different absorption mechanisms, it is evident an absorber, when bombarded by photons of electromagnetic radiation, has absorption characteristics highly affected by photon energy. A graph illustrating the three major modes of absorption (Figure 6-14) is how they contribute to the total absorption in the element iron with its atomic number of 26. It should be noted from (Figure 6-14) nearly all of the absorption of radiation below 100 keV is due to the photoelectric effect. This absorption is highly dependent upon the atomic structure and the binding energies between the electrons and the nucleus. Therefore, the atomic number of the material will greatly affect radiation absorption by the photoelectric effect. When radiation energy is between 100 keV and about 10 MeV, absorption is almost entirely due to Compton Effect and atomic number is no longer the major criteria of absorption; instead, material density is the major controlling factor. In the energy range between 10 and 100 keV, radiation absorption is very sensitive to keV changes; a unit change in keV will cause three units of change in the atomic absorption coefficient. For energies between 200 keV and about 3 MeV a unit change in keV will only cause half a unit change in the atomic absorption coefficient, so the absorber is much less sensitive to changes in radiation energy. When the radiation energy is between 3 and 30 MeV, the atomic absorption coefficient is for practical purposes unchanged.



H0401878

Figure 6-14. Absorption Coefficients for Different Modes of Absorption in Iron

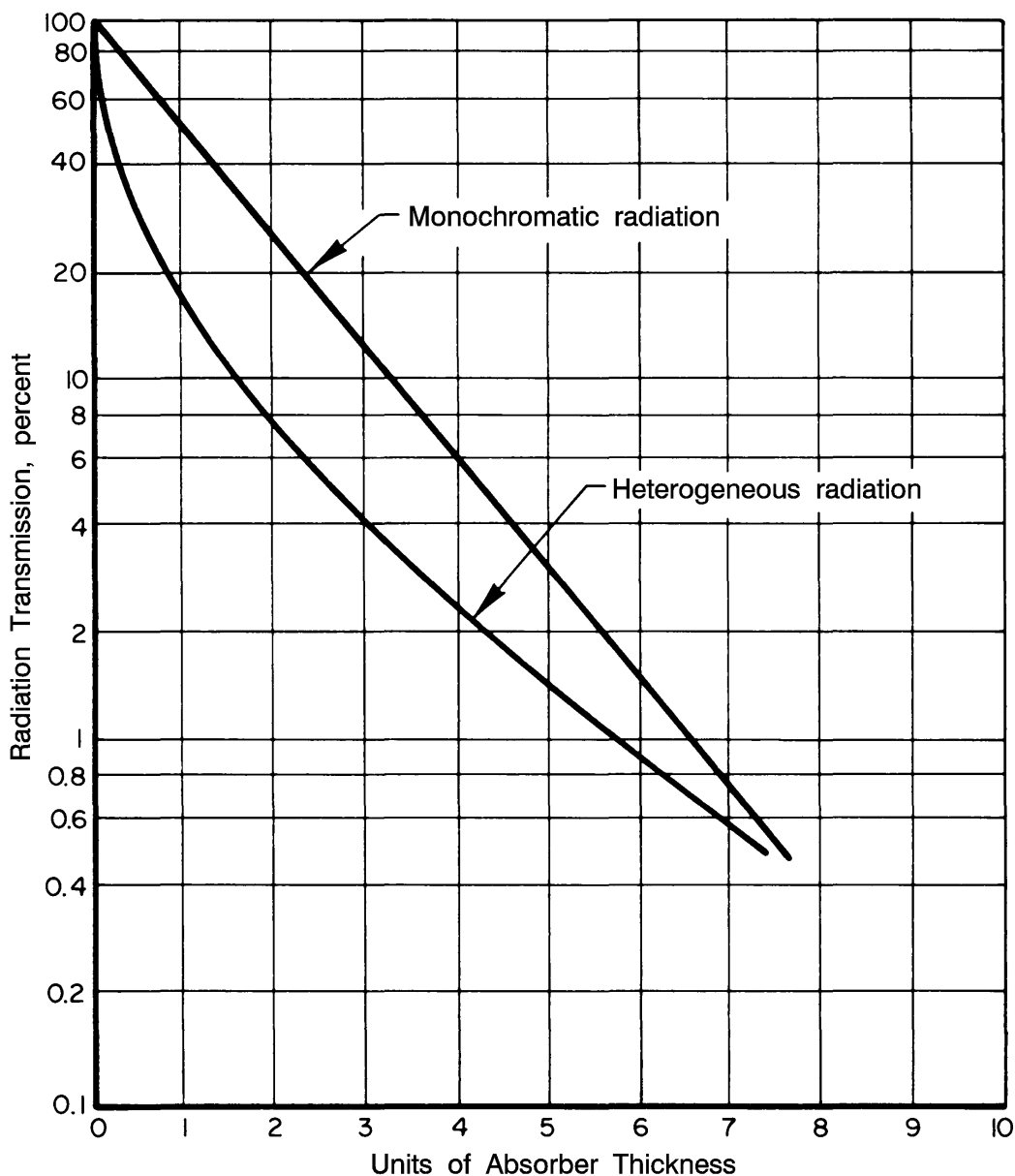
T.O. 33B-1-1

6.2.6.3 Real Life Absorbers. In industrial applications, test specimens are being bombarded by the radiation photons, which are absorbed and scattered. In this process, electrons are ejected from the atoms of the test material. These absorbers are not ideal; they do not act as an ideal absorber in they do not attenuate radiation in accordance with theoretical physics. Electrons, degenerated scattered photons, characteristic radiation from the test material, and some of the primary beam are all present on the film side of the test object simultaneously. The classical attenuation equation does not consider all these various components, so it is not strictly applicable in actual radiographic practices.

6.2.6.4 Diffraction Patterns. In the radiography of very coarse grain structure materials, such as inconel and cast irons, diffraction patterns are often revealed in the radiographic image. These patterns are due to the selective diffraction and absorption by the atoms of a definite pattern in the crystal structure. The definitive pattern of the atoms of a crystal can be aligned with the X-ray beam at a particular angle, so the radiation is altered in its direction of travel and concentrated upon the film as a linear indication. These crystalline diffraction patterns are superimposed upon the radiographic image and make interpretation very difficult. Often these dense, sharp lines caused by the crystal diffraction are interpreted as internal cracks. If uncertainty exists as to interpretation of a particular indication, a second radiograph can be made at a slightly different angle (less than 10 degrees difference). It is unlikely the crystal causing the diffraction pattern would be located in precisely the same relative position as to cause the diffracted line to strike the film in the same relative position. Changes in radiation energy will also affect diffraction patterns. Often by changing the operating kilovoltage, the problem of diffraction patterns can be reduced.

6.2.7 Radiation Energy.

6.2.7.1 White Radiation. Radiation generated by an X-ray tube contains various energies and therefore is referred to as white radiation (Figure 6-15). The X-rays are a continuous spectrum and the beam is selectively attenuated as it passes through an absorber. The low energy radiation is highly absorbed by the first few layers of the absorber medium and the spectral distribution is altered by this selective absorption. Thus, as an absorber is absorbing the white radiation, the attenuation rate more nearly approaches monochromatic radiation. Figure 6-15 shows a semi-logarithmic graph of the absorption of a monochromatic beam and a multienergy beam of white radiation. For approximate estimations of effective X-ray attenuation coefficients, it may be assumed the average energy of an X-ray beam is about 50-percent of the peak operating kilovoltage for glass window tubes and 30-percent for beryllium window X-ray tubes.



H0401879

Figure 6-15. Absorption Curves of Monochromatic and Multi-Energy Radiation

6.2.8 Scatter Radiation.

6.2.8.1 Description of Scatter Radiation. When high-energy electromagnetic radiation bombards matter, some of the radiation photons are scattered by electrons. This process is called the Compton Effect. If the photon has a greater quantity of energy than necessary to eject an electron from its orbital path, it continues to travel with a loss of energy at some angle to its original path. The photon energy must be reduced to a very low value before complete annihilation is possible by photoelectric absorption. In low atomic number materials the photon direction is changed with little loss of energy and its energy must be reduced to a very low energy to be absorbed completely. Thus, a single photon might scatter many times, losing all semblance of its original path. If this scattered photon strikes the film, it reduces the image definition since it exposes the film at a spot other than directly under the point where it first entered the test material. High atomic number materials rob the photon of greater amounts of its original energy and also have much higher photoelectric absorption values. These more quickly reduce the photon energy to the point where the photon is completely absorbed. For these reasons, low

T.O. 33B-1-1

atomic number materials transmit larger quantities of scattered radiation than high atomic number materials. More information on scatter radiation can be found in (paragraph 6.4.2.11).

NOTE

Low atomic number materials SHOULD be removed from the beam to the extent possible, to prevent scattering of the primary beam. Wood, concrete, or other low atomic number materials in the radiation beam SHOULD be covered with lead or a high atomic number material to reduce the scatter. In actual practice this means tables, floors, or walls behind/beside and close to the test part SHOULD be covered with lead.

6.2.8.2 Scatter Radiation Build Up. Scattering is due to photon collision with electrons in their path. As material thicknesses increase up to a critical thickness, the amount of scattered radiation emanating from the material increases. If additional thicknesses of material are added, the scattered radiation generated in these added layers has insufficient energy to penetrate the material between them and the film. The amount of scattered radiation emanating from the back of a part under inspection increases with part thickness up to a total, which varies with radiation energy. Since absorption due to the Compton Effect decreases with increasing radiation energy, less scattering occurs at higher radiation energy levels. Build-up scatter radiation can introduce contrast problems in the radiography of low atomic number materials such as graphite, plastics, and magnesium.

6.2.9 Material Contrast.

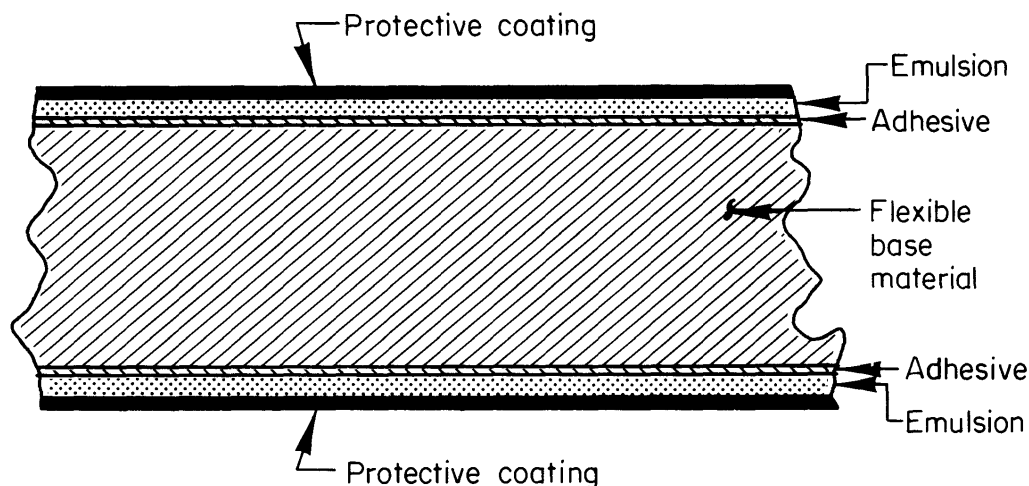
6.2.9.1 Material Contrast Factor. In consideration of the previous discussion on radiation absorption, the most important variable that can be controlled by the radiographer in industrial X-ray inspection is the kilovoltage. The amount of radiation absorbed by the part being inspected depends on the atomic number, density, and thickness of the material. The radiographer cannot change these factors, but can change the energy of radiation. In the attenuation equation, $\ln(-\mu x) = IT/I_0$, it can be visualized the linear attenuation coefficient (μ) can be changed by changing radiation energy. This in turn will change the ratio I^T/I^0 , or the percent radiation transmitted through a part of thickness, x . In industrial radiographic applications, the difference in thickness (often due to discontinuities) is the actual parameter from which interpretation is made. Therefore, the greater the change in the radiation transmitted due to a particular change in material thickness, the more obvious is the thickness change revealed in the final image. This radiation difference due to material thickness change is called the material contrast. The material contrast is a function of the absorption characteristics of the part being inspected and the radiation energy level. When measurements have been made and a numerical value has been established, it is called the material contrast factor.

6.2.9.2 Percent Radiation Transmission. When monochromatic radiation is used, the percentage of radiation transmission can be calculated from the formal laws of attenuation. Since this condition seldom exists in actual practice, the percent of radiation transmitted must be empirically measured. When the proper recorder is used, the actual measurements will include the scattered radiation as well as the transmitted primary beam, both of which can be expected to expose a film or interact with any other recorder in a typical industrial radiographic set-up.

6.2.10 Understanding Radiographic Film.

6.2.10.1 Function of Radiographic Film. Films can be used as a recording medium because their emulsions are sensitive to the quantity and the energy of electromagnetic radiation over a wide spectral range. In the photographic process, the electromagnetic radiation of the visible spectrum is focused with a lens on the film surface to record the variations of light intensities and form an image. In radiographic applications, the radiation is of such high energies they cannot be focused by a lens. In radiography, recording the variations in radiation quantities caused by absorption and scattering by the test specimen forms a shadowgraph of the test object. After final processing, film exposed with X- or gamma rays is called a radiograph; film exposed by using a radioisotope might be called a gammagraph. Films are an excellent recording medium with a very high signal-to-noise ratio and high amplification. This section describes how films work, reviews how films respond to radiation, and discusses radiographic paper.

6.2.10.2 Structure of Industrial Radiographic Film. Industrial X-ray film consists of an emulsion and a blue tinted base of polyester. The schematic structure of radiographic films is below (Figure 6-16).



H0401880

Figure 6-16. Sketch of Cross Section of X-ray Film

6.2.10.2.1 Adoption of a Polyester Base. It has been many years since flammable cellulose nitrate film base was replaced first with inflammable cellulose acetate then with polyester base materials. Polyester base materials have advantages because they provide flatness and great strength. Little expansion and contraction takes place and the material is not hygroscopic. These advances in a polyester film base are indispensable to rapid film transport in automatic processors.

6.2.10.2.1.1 Polyester Base. Most modern films have a polyester base which is either transparent or has a slightly blue tint. The polyester is very durable, does not absorb water or processing chemicals, is dimensionally stable, dries easily, and will not support combustion. The polyester base is approximately 175 μ thick.

6.2.10.2.2 Emulsion. The emulsion consists of silver halide crystals as photosensitive material, plus additives and gelatin. The silver halides form an image when exposed by X-rays, gamma rays, secondary electrons, or fluorescent light. The emulsion in films used for general photography is coated only on one side of the base, whereas it is coated on both sides of most industrial X-ray films. Since the thin support material offers very little absorption to the X-rays normally used for industrial applications, the double emulsions essentially reduce exposure requirements to one-half that required for a single emulsion, however, some films intended for radiography in which visibility of the smallest detail is required, have emulsion only on one side. The absorption of high energy X-rays or gamma rays is increased by using two emulsion layers so the photosensitive silver compound is utilized more effectively for the absorption of radiation and electrons. Furthermore, the two emulsion layers help to increase contrast and image density of the radiographs. Each layer of emulsion is approximately 10 to 15 μ thick.

6.2.10.2.3 Outer Protective Layer. The emulsion may be coated on one or both sides of the base in layers and protected on both sides with very thin outer protective layers. Each outer protective layer is approximately 1 μ thick.

6.2.10.3 Latent Image. The latent image is formed by interactions of the electromagnetic radiation with the silver bromide crystals. When solid silver bromide is formed in the manufacture of film, the silver atoms give up an orbital electron to a bromine atom. Since the silver atoms have given up an electron, they have a positive electrical charge and are silver ions (Ag^+). The bromine atoms have acquired this negative electron and have become bromide ions (Br^-). The silver bromide crystal is a cubical array of the silver and bromine ions. The cubical crystalline structure of the silver bromide crystal is not perfect; if it were, the photographic process could not exist. Within the crystal lattice structure are extra silver ions called interstitial ions; these do not occupy a lattice position in the crystal. There are also foreign molecules or dislocations (distortions) of the crystal array within the crystal, all of which form latent image sites.

6.2.10.3.1 The accepted theory of the formation of the latent image (an image which may be revealed by development) in a photosensitive emulsion is based upon the Gurney-Mott concept of exposure. It is theorized the formation is a two-step process. The electromagnetic radiation ejects an electron from the negatively charged bromine ion in the crystalline structure, thus converting the ion into a bromine atom. The free electron can travel within the crystal to a dislocation or other latent image site where it is trapped, establishing a negative electrical charge at that point. This negative electrical charge attracts

T.O. 33B-1-1

one of the positively charged interstitial silver ions to the latent image site. When the silver ion reaches the image site, the negative electron counteracts its positive charge and it becomes neutralized and exists as a silver atom. The latent image site is now electrically neutral. This process MAY be repeated several times, adding silver atoms to the latent image site in the crystal. These few silver atoms act as a catalyst for reducing action of the developer, thus making the entire emulsion grain susceptible to conversion to metallic silver in development.

6.2.10.4 Films Reaction to Development. The developing agent selectively reduces those crystals containing latent images into black metallic silver, but has a much smaller effect on those crystals not exposed. The metallic silver is opaque and forms the radiographic image.

6.2.10.4.1 Theory of Film Developer. The purpose of the developing solution, or developer, is threefold. First, it blackens those parts of the emulsion exposed (e.g., when a crystal of the film's silver bromide emulsion has been exposed to X-ray radiation, and is put into a developing solution, the developer takes the bromide away from the silver and leaves black metallic silver in the gelatin). Where full exposure has occurred, a maximum number of crystals are affected and almost all of them are reduced by the developing solution to metallic silver. Second, it produces various shades of gray where the film has been only partially exposed. These grays are the result of partial removal of bromide. The concentration of black metallic silver per unit area of the film is dependent upon the amount of exposure received, and determines the factor known as "film density". The image of the object radiographed consists of varying densities spread over the film, corresponding to the varying amounts of exposure received by the film. Third, is its effect on those parts of the film which have received no exposure. Since no crystals were affected, the developer SHOULD leave these parts unchanged. Thus, a developing solution SHOULD remove bromide from the film emulsion where exposure has occurred, but SHOULD NOT produce effect on unexposed areas of the film.

6.2.10.4.1.1 A very limited number of chemicals possess the ability to distinguish between exposed and unexposed crystals and therefore only a few are suitable for use in developers. No chemical known will leave an unexposed area indefinitely unchanged. All will begin to develop unexposed parts after a period of time, producing a condition called "chemical fog." All developing agents have a definite fogging time beyond which bromide will be freed in unexposed areas.

6.2.10.5 Image Quality. Microscopic variations in the response of film to the incident radiation produce effects of considerable practical significance. The number of sites, where the silver atoms can respond to the radiation vary in location throughout the emulsion and are inversely proportional to the size of the silver bromide grains. Thus, after exposure to radiation, the density of the image will vary. The larger the number of sites activated by radiation, the larger the number of silver atoms per unit area, and, statistically, the smaller the density variations. The practical factors are:

6.2.10.5.1 Graininess. The graininess of the film is the visual impression of non-uniformity of density in a radiographic image. Graininess increases with increasing film speed and with increasing energy of the radiation. Apart from the visual appearance of graininess, the effect may be subjected to physical measurements. This measured property is referred to as "granularity." This term has been adopted as an expression for physical measurements of the statistical fluctuations of density over the area of a photographic emulsion. Obtain granularity measurements by scanning a sample of emulsion with a small spot of light (diameter of the order of 0.08 mm) and record the resulting irregular fluctuations of the transmitted light.

6.2.10.5.2 Signal-to-Noise Ratio. The accidental variation in image density makes it more difficult to identify the deliberate variation in image density resulting from use of the film. The relationship between the two density variations is known as the signal-to-noise ratio. The ration for threshold visibility of detail SHALL be at least five.

6.2.10.6 Film Image Density. In photographic usage, density is a measure of the degree of blackening of the processed film caused by exposure to radiation. Film image density is the logarithm of the reciprocal of the fraction of light transmitted through the film with respect to the light incident on the film and is discussed further in (paragraph 6.7.4).

6.2.10.6.1 The relationship of light transmission and density are in (Table 6-3). A typical density used in practical radiography is 2.0 and represents 1-percent transmittance.

Table 6-3. Relationship of Light-Transmission to Film Density

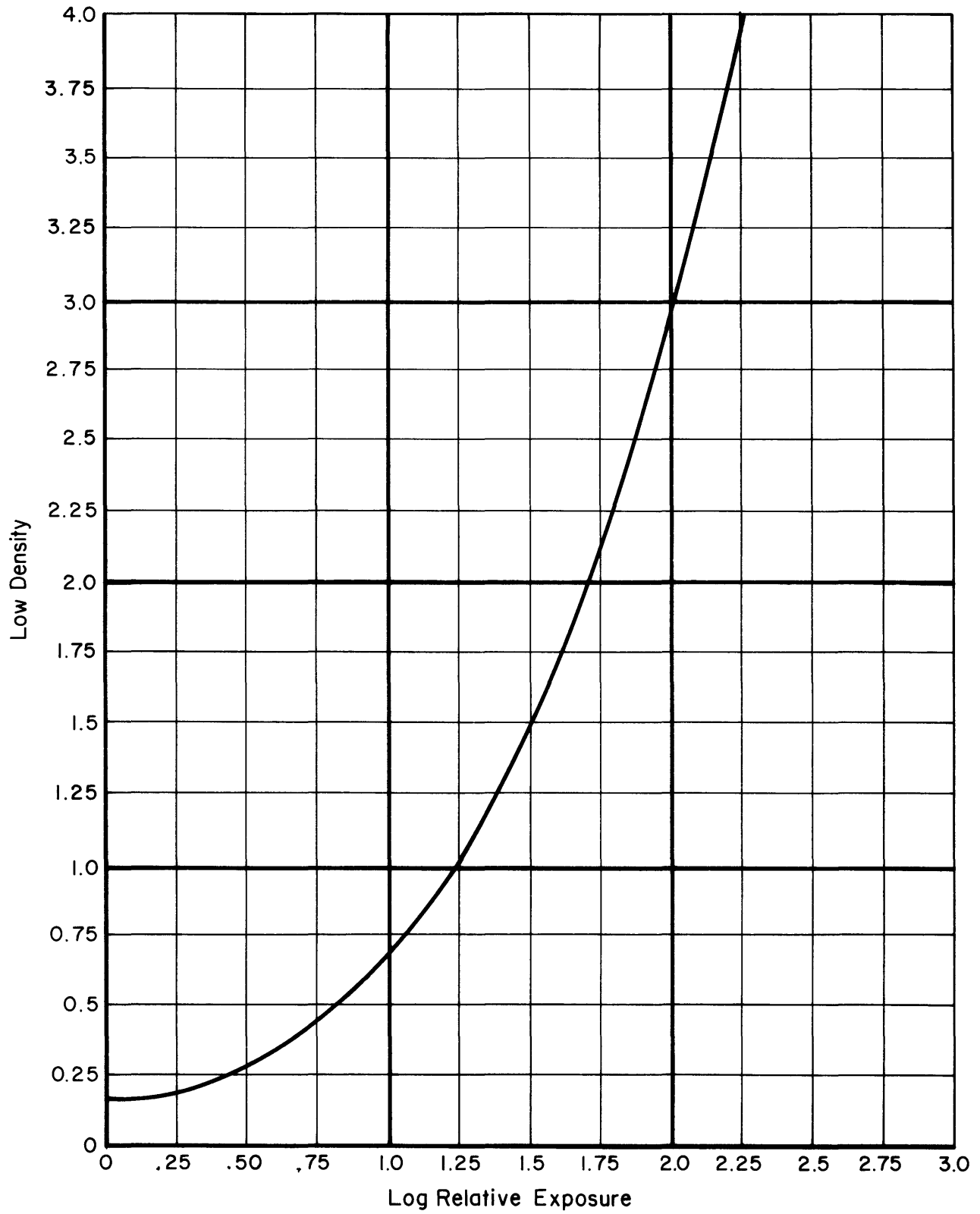
Transmittance (I_T/I_0)	Percent Transmittance (I_T/I_0) x 100	Opacity (I_0/I_T)	Film Density $\text{Log}_{10} (I_0 / I_T)$
1.00	100	1	1
0.50	50	2	0.3

Table 6-3. Relationship of Light-Transmission to Film Density - Continued

Transmittance (I_T/I_0)	Percent Transmittance (I_T/I_0) x 100	Opacity (I_0/I_T)	Film Density $\text{Log}_{10}(I_0/I_T)$
0.25	25	4	0.6
0.10	10	10	1.0
0.01	1	100	2.0
0.001	0.1	1,000	3.0
0.0001	0.01	10,000	4.0

6.2.10.7 Characteristic Curve. The characteristic curve is the response of a type of film to radiation of a particular energy. It is obtained by plotting the correlation between the film-image density against the logarithm of relative exposure. Since density is a logarithm (paragraph 6.7.5), log-log scales are used for the plot. Log-log scales not only make interpretation of the graph easier, but also the important values of relative exposure can be derived easily by subtracting one logarithm value from another. At low exposures, a large change in exposure is needed to produce a significant change in density (Figure 6-17). As relative exposure increases, the film emulsion becomes more sensitive and the same exposure change produces a greater density difference. The gradient (slope) of the curve increases with increasing exposure (Figure 6-17). At very high values, the gradient may start to decrease; that is, the film again becomes less sensitive, however this effect, is not often encountered in industrial radiography, though common with medical film. The term used to refer to the gradient of the characteristic curve is "film contrast."

T.O. 33B-1-1



H0401881

Figure 6-17. Typical Characteristic Curve

6.2.10.7.1 A characteristic curve provides information about speed, contrast (average gradient), and fog of X-ray film. The characteristic curve is significant because it demonstrates, within limits, that a dense film is more sensitive to small variations in exposure than a light film. Therefore, the dense film is better to show small changes in subject contrast due to discontinuities and geometric changes in the part. Characteristic curves can also be used to calculate exposure changes needed to optimize a technique when altering film type or desired density.

6.2.10.8 Film Speed. Film speed is a factor in determining the amount of radiation a film must receive to obtain a given density. Generally, film speed varies with film grain size. The larger grain film is faster and the smaller grain film is slower. While film speed is sometimes an important consideration for economy, normally the prime consideration is resolution of the details. High-speed films (e.g., films with low signal-to-noise ratios), SHOULD only be used when they are capable of meeting the resolution requirements of the inspection. Where high-detail resolution is required, the slower, higher signal-to-noise ratio films SHOULD be used without exception.

6.2.10.9 Film Contrast. Film contrast is a measure of the difference in film density due to exposure to different amounts of radiation. When exposed beneath a step wedge, a film with low contrast would show only minor changes in image density between one step and another. A high-contrast film, exposed under identical conditions would show sharp graduated changes in image density between steps. The efficiency with which the emulsion responds to an increment in exposure varies with the absolute value of the exposure. If a radiograph has high contrast, small differences in light transmission are high and readily discerned by the eye. Thus, the image will reveal small discontinuities in the subject. As a result, a dense image on the film makes small discontinuities on the specimen more visible. Image densities of 2.0 or more are usually recommended or required for high sensitivity to discontinuities in critical areas of parts. This will be discussed further in a later section. Film contrast SHOULD be distinguished carefully from subject contrast (a flat sheet specimen will give negligible contrast with any film). Subject contrast is affected by X-ray kilovoltage or gamma-ray characteristics. In summary, the overall image contrast with any given specimen will depend upon:

- Kilovoltage of the X-ray beam or characteristics of gamma radiation.
- Type of screens used.
- Image density.
- Processing conditions.
- Film contrast.

6.2.10.10 Film Latitude. The film latitude is the reverse of film contrast, the higher the contrast, the smaller the latitude, the lower the contrast, the greater the latitude. Latitude is, therefore, the range of radiation intensities a film is capable of recording. Latitude is also the term used to indicate the range of material thicknesses that can be visualized in the final image. Often in the radiography of castings or circular rods, where it is necessary to visualize a large range of thicknesses, wide latitude is desirable.

6.2.11 Fundamentals of Digital Radiography.

6.2.11.1 Basic Image Types. Image types could be classified as continuous and discrete. Discrete (distinct from each other) values are digital images and the continuous (variables flow into the next) are considered to be similar to regular film images. These definitions are the basic definitions in any mathematics or scientific discipline. Continuous can be converted to discrete variables. Digitization of continuous variable is a common practice. Digital imaging techniques allow us to retrieve information electronically for easy and accurate manipulation, or analysis by computer. Digital images vary from traditional images in the way the image information is represented.

6.2.11.2 Analog versus Digital Images. Traditional images, like the image that appears on an industrial radiographic film, are made up of continuous tones. We can get an electronic representation of the continuous tones with an analog waveform generated by some measuring device. Sampling discrete sections of the waveform and storing the sampled value as strings of ones and zeros (the only digits used in modem computing equipment), produce digital images.

6.2.11.2.1 There are two ways in which computers handle graphic information. The two methods are known as “Vector” and “Raster” graphics.

6.2.11.2.1.1 In vector graphics, any image created remains separate from others. Images are described mathematically and are not tracked in pixels. Vector graphics are the graphics created in drawing and illustration programs, like clipart in word processing packages. These graphics are stored as a collection of objects described mathematically using shape, line segments, and arcs. Vector graphics are also known as object-oriented graphics because of its use of an object model to describe the mathematical shapes that construct an image.

T.O. 33B-1-1

6.2.11.2.1.2 Raster graphics, also known as bit-mapped graphics, are created by scanners and digitizers. Raster images are comprised of a two dimensional array of discrete pixels (like a computer monitor screen). A bitmap is a file that indicates a color for each pixel along the horizontal and vertical axis. Raster and bitmap images are used interchangeably. They both refer to a color format where the image is composed of either black or white pixels. Working with raster images, means working with pixels, not objects or shape. Each pixel in an image is stored in its own location within computer or storage memory as a number representing color and brightness (and sometimes transparency) or other levels. Because storing formulas for drawing shapes takes less memory in general than actually mapping out the individual pixels of the image, vector graphics tend to be much smaller in size than raster or bitmapped images.

6.2.11.3 Digital Image Quality. The quality of bit-mapped graphics is determined at capture or resampling time by two factors of resolution: “brightness resolution” and “spatial resolution.”

6.2.11.3.1 Brightness Resolution. The brightness resolution is also referred to as the grayscale or color range of an individual pixel. Brightness resolution is defined in a digital image by the pixel it represents. The value can be made of one or more “bits.” The more bits actually used to define the brightness levels in a digital image, the higher the brightness resolution (and hence the quality) of the image (paragraph 6.2.11.4). Brightness resolution is also known as pixel depth.

6.2.11.3.2 Spatial Resolution. Spatial resolution is the number of pixels horizontally and vertically in a digital image. Spatial resolution of a digital image determines the actual size of the pixel in real units, and thus is determined by the sampling interval of the original digitization operation. A longer interval produces lower spatial resolution images while a shorter interval produces higher spatial resolution. The term “resolution” when not preceded by spatial or brightness generally refers to spatial resolution.

6.2.11.4 Pixel Depth. Pixel depth, as already stated, is the measure of brightness resolution in a digital image. Here is the way in which it works for common pixel depths:

6.2.11.4.1 1-Bit Pixel – A 1-bit pixel depth image can be made up of, at the most, only two colors, generally black and white. Each pixel is represented in memory as either a one or a zero. Gray values are simulated by grouping black and white pixels over an area to make it appear brighter or darker. Fax machine printouts and even black and white newspaper photographs are examples of 1-bit images.

6.2.11.4.2 8-Bit Pixel – An 8-bit pixel image can display 256 colors or grayscale levels at the most. They are comprised of individual pixels made up of eight bit each, yielding 2 to the 8th power brightness (or color) levels. Color images are represented by using the brightness information of the pixel as a value to use in a table of color values. Web based images with a “GIF” extension, and many grayscale computer displays are examples of 8-bit graphics.

6.2.11.4.3 12-Bit Pixels – 12-Bit images are almost always grayscale images. The value of the pixel is made up of 12 bits which equates to 4096 individual gray scale values.

6.2.11.4.4 24-Bit and higher – 24-Bit and higher color images (also known as “true-color” images) group three or more 8-bit bytes of brightness information together. Each byte represents a color channel (or an alpha transparency channel) of brightness. The effect is one of millions of colors, but with the same overall brightness resolution of an 8-bit, grayscale image. There is no difference in a 24-bit grayscale image and an 8-bit grayscale image as far as quality is concerned.

6.2.11.5 Capture. Digital radiographic images are “captured” in many different ways in industrial radiography. Some methods involve the use of standard radiographic film, “film based capture” or film designed with digitization in mind. Other methods bypass using film altogether and use direct or indirect capture methods, “filmless capture.” All rely on taking an analog signal and converting it to a sampled digital form using solid state “charge-coupled device (CCD)” sensors, photovoltaic cells, or photo-multiplier tubes for the analog signal.

6.2.11.5.1 Film Based Capture. Three methods generally used for the digitization of radiographic film. “Laser scanners” (considered the most accurate for brightness of resolution), “CCD scanners” (which although they do not perform as well for brightness of resolution, are available for higher spatial resolution than laser scanners), and the “CCD camera” aimed at a lightbox. Film scanners can convert the analog image of film into a digital image that can be shared, manipulated, and annotated electronically.

6.2.11.5.1.1 Laser Scanners. Laser scanners utilize a laser beam that passes through the film and the resulting light is converted to a voltage signal by a photomultiplier tube. The voltage values are sampled over time to produce a digital image with brightness values calibrated to optical density values.

6.2.11.5.1.2 CCD Scanners. CCD scanners use a charge-coupled device as a detector. For digital radiography purposes, the CCD is generally in array of thousands of tiny photocells that create pixels for a line of the scanned radiograph as the image is passed over it, illuminated by a fluorescent lamp. Home and desktop photographic scanners are much like the CCD scanners, except home scanners are generally not set up to handle transparency data as in a radiographic film.

6.2.11.5.1.3 CCD Camera. The least expensive of systems are generally composed of a digital camera focused on an area of a lightbox with a radiographic film placed upon it. The camera takes a digital picture using a two dimensional, CCD array of the area of the radiograph focused upon. These systems can be difficult to calibrate and depending upon the limitations of the camera CCD size, often can be used to take quality digital images of only small portions of the radiograph at a time.

6.2.11.5.2 Filmless Capture. Radiographic film is not always needed or desired for digital radiography. Several alternatives to film are available today. Let us briefly discuss the two methods (“indirect” and “direct”) of capture, and the devices used for filmless capture.

6.2.11.5.2.1 Indirect Capture. Indirect capture may be the most popular form of filmless digital radiography; this may be due to it being the easiest form to implement, and also due to a wide availability of indirect capture hardware. Indirect capture utilizes a means of converting X-ray light into visible or near visible light that can be detected and measured by photomultiplier tubes, CCD or other photo cells. Computed radiography, a photo luminescence method, is a two step radiographic imaging process. A storage phosphor imaging plate is exposed to penetrating radiation and the luminescence from the plate’s photostimulated luminescent phosphor is detected, digitized and presented via monitor or hard copy. The following are some devices used for indirect capture of images:

6.2.11.5.2.1.1 Phosphor Screens. – Phosphor screen based systems are the most like traditional film based radiography. A special capture system X-ray sensitive plate or screen captures radiographic information and is then placed in a digitizer or reader to convert the information into a digital image. The plates can be either rigid or flexible, depending upon the hardware used, and are reusable. Phosphor filmless imaging is a very popular method of digital radiography because of the ease of use, and film like nature of the process.

6.2.11.5.2.1.2 Amorphous Silicon Plates. – These devices are sometimes called “direct capture” devices because they seem to work by directly capturing X-ray data and at first glance are indistinguishable from true direct capture devices, but in truth, they are indirect capture devices because they use a scintillating crystal to convert X-ray light into visible light, which is sampled by the photovoltaic array they contain. Amorphous silicon plates generally require the use of a lab environment, as they are directly connected to the computer for digitization. They are available in real time and near real time models. An advantage of amorphous silicon systems is an overall reduction of time to acquire an image contrasted against traditional radiography. These systems are very delicate and are not recommended for field environments.

6.2.11.5.2.1.3 Digital Cameras. – Like the amorphous plates, they can produce real time images and incorporate the use of a scintillating crystal to convert X-ray light into visible light for capture. They tend to have much smaller CCD arrays compared to amorphous silicon systems, but can focus on smaller areas of a part in real time. Digital camera based, CCD, or image intensifier, all use the light that is generated off another medium, that is, light emitting phosphor screen. This image is then digitized and displayed. This process can either be either real-time or still images.

6.2.11.5.2.2 Direct Capture. Direct capture systems use selenium or some other material that produces a voltage when exposed to high energy radiation. Aside from this, they work in basically the same manner as an amorphous silicon plate. Selenium based systems can sometimes be overly responsive to external factors. These factors, such as ambient heat and high radiation can sometimes damage the device. These systems require indoor lab use with controlled conditions.

6.2.11.6 Digital Image Quality Factors. Image quality of a scanned or digitized image is dependent upon pixel size, spatial resolution, and the pixel depth (brightness resolution). The sampling time for a given area is generally proportional to the spatial resolution (number of pixels per square inch or square millimeter) and to the brightness resolution (bits per pixel). Generally, digital capture systems and scanners allow you to set these values up to the limit of the hardware. It is not always necessary to do so for all shots. Entrapped water detection, for example, would benefit from the highest brightness resolution, but would not require the highest spatial resolution. Also, the size of the stored image in bytes is directly proportional to the image spatial resolution – so it does not make sense to perform every capture at the highest possible quality. The procedure and part SHOULD dictate the resolution settings to use for digital capture. In addition to the brightness and spatial resolution of digital images, there are other factors that affect the quality of a captured digital image introduced as part of the capture process itself. Other factors are “noise,” “dynamic range,” and “artifacts.”

T.O. 33B-1-1

6.2.11.6.1 Noise. Noise is defined by ASTM as the data present in a radiological measurement which is not directly correlated with the degree of radiation attenuation by the object being examined. Scatter within the image, variations in the phosphor plate and electronic induced noise all contribute to the degradation of the image. Noise creeps into a digital radiograph in a couple of ways. There is the noise inherent in radiography, and can generally be kept to a minimum by using the proper and prescribed techniques. There is also the noise in the digital capture hardware. The modular transfer function (MTF) is used to measure the signal-to-noise ratio. This SHOULD be considered a factor when deciding upon a digital capture system for your particular application.

6.2.11.6.2 Dynamic Range. Dynamic range is the effectiveness of the scanner or capture hardware in differentiating between differing shades of gray or brightness. It is a measurement of the number of bits used to represent each pixel in a digital image. Phosphor plate capturing systems tend to excel in the dynamic range department while film digitizers tend to have a breakdown level toward the higher densities. The greater the dynamic range, the higher the contrast and color/grayscale bit depth.

6.2.11.6.3 Artifacts. Artifacts are unwanted images caused by input or output process, that is, hardware or software. Images like films are subject to artifacts created during image capture. Artifacts, such as dust and fingerprints, can also harm the quality of a digital image. Many times, artifacts are hard to distinguish from actual indications on an image because of the nature of digital imaging. It is important to keep the capturing hardware clean and to cover digitizers and scanners when they are not in use to minimize artifacts.

SECTION III RADIOGRAPHIC EQUIPMENT

6.3 RADIOGRAPHIC INSPECTION EQUIPMENT.

6.3.1 Types of X-ray Generators.

6.3.1.1 Tank Type Generators. Tank-type units are usually small and light in weight for ease of portability. The entire high voltage circuit is housed in a single housing, which is commonly known as the tube head in portable X-ray units. This arrangement avoids having to transmit high voltage from the high voltage transformer to the X-ray tube by means of insulated conductors. The housing contains the X-ray tube, the high voltage transformer, and the filament transformer. Electrical insulation is usually by transformer oil or compressed insulating gas. The control box is a separate unit that can be positioned at some remote distance to protect the operator from radiation. Different circuit designs are used in various tank-type generators.

6.3.1.2 Separate Component Generators. Separate component units are those units where the transformers are separated from the X-ray tube. The high voltage and filament connections are made between the transformers and the X-ray tube through insulated cables. These units offer the advantage of ease of positioning the X-ray tube. The tube is contained in a protective housing with adequate insulation for the high voltages to be applied to the tube. These separate component units are usually fixed installations and parts to be inspected are transported to the X-ray equipment. Size or weight of this equipment is not of importance because they are usually intended for radiography in a shielded facility.

6.3.2 Types of X-ray Tubes.

6.3.2.1 Directional Tubes. In directional X-ray tubes, the anode is set at an angle to the electron beam. When the high-speed electrons strike the target, X-radiation is generated in a solid spherical pattern. The massive anode functions as an absorber for the radiation traveling into the anode. In most X-ray tubes, lead-absorbing materials are used to restrict the exiting radiation to a cone-shaped field passing through a window. The shielding reduces the leakage radiation hazard to personnel, and prevents additional scattered radiation from surrounding materials and areas. In some portable equipment, shielding of the X-ray tube has been omitted for the advantage of saving on weight. In some very high-energy units, such as betatrons and linear accelerators, the target is comparatively thin and offers little absorption to the very high-energy radiation being generated. The radiation beam from the front of the target is shielded to provide a directional pattern, conical in shape.

6.3.2.2 Rod Anode X-ray Tubes. These tubes are designed to produce a radiation beam in a circular pattern. These tubes are used for circumferential radiography, particularly pipe welds. By use of an absorbing sleeve (usually lead), the circular radiation pattern can be reduced to a directional beam.

6.3.3 Considerations in Choosing Equipment.

6.3.3.1 Choice of Radiation Energy. The relation of X-ray voltage to the penetration for steel or other common materials depends upon the density of the material and the absorption characteristics of the material in the X-ray beam. For more information, (Table 6-4) can be used as a guide for applying X-rays to inspection problems, assuming average radiographic results are expected. It is necessary to establish lower limits as well as upper limits on material thickness because using voltages higher than required to penetrate a given thickness will reduce the radiographic contrast.

Table 6-4. Appropriate Radiation Energies for Radiography of Steel

Kilovoltage Range	Material Thickness
5-50 kV ¹	Extremely thin, such as foil up to 1/8 in.
50-150 kV	1/8 to 3/4 in. steel
100-200 kV	1/4 to 2 in. steel
200-400 kV	3/4 to 3 in. steel
1000 kV	1 to 5 in. steel
2000-6000 kV	2 to 8 in. steel

T.O. 33B-1-1

Table 6-4. Appropriate Radiation Energies for Radiography of Steel - Continued

Kilovoltage Range	Material Thickness
15-24 MeV	3 to 18 in. steel
¹ This energy range is also useful for composite structures. Note that for X-ray energies of 15 kV or less, scatter in the air path may be a problem.	

6.3.3.2 Choice of Equipment. Equipment choice SHOULD depend upon the circumstance under which radiographic inspection is to be conducted and the technique requirements. Some factors are “tube head type,” “window,” and “focal spot size.”

6.3.3.2.1 Tube Type. The choice of a directional or a rod anode tube type SHOULD depend upon the type of radiographic inspection conducted. Circumferential specimens, such as pipe welds, are compatible with the rod anode radiation. The directional X-ray tubes restrict the radiation to a smaller area and have a comparatively smaller focal spot resulting in better quality radiographic images.

NOTE

The scattered radiation is greater with the rod anode and additional personnel protection is often necessary.

6.3.3.2.2 Window. When the X-ray absorption of a test object is low, lower energy radiation is required. To take advantage of the higher contrast provided at lower energies, an X-ray tube with a beryllium window SHOULD be used since beryllium transmits the low energy radiation. The beryllium window offers advantages up to 150 kVp and, therefore, radiographic inspections requiring 150 kVp or less SHALL use a beryllium window X-ray tube. A typical glass window SHOULD prove satisfactory for energies above 150 kVp. The beryllium window and the resultant soft (low energy) spectrum SHALL also be used for the inspection of composite laminates. For example, a graphite-epoxy composite laminate 0.100-inch thick might require the use of X-ray energy in the order of 10-20 kV for optimum sensitivity. Reasonable exposures with standard portable X-ray equipment are often difficult below 25-30 kV. X-ray energies of 15 kV or less, the air between the source and object would scatter the X-rays. If the X-ray equipment will operate that low, one way to displace the air is to stuff a helium-filled plastic bag between source and object.

6.3.3.2.3 Focal Spot Size. X-ray tubes are available with different focal spot sizes. The focal spot in an X-ray tube is the area of the target that produces the primary X-ray energy (Figure 6-11). The actual size of the focal spot is determined by the electron bombardment pattern on the target. The minimum size of this area is limited by the melting point of the target material and the concentration of the bombarding electrons per unit area. Tungsten (W) is most often used as target material because of its high melting point of 6170° F, and high efficiency of X-ray production. An effort is made in X-ray tube design to achieve the smallest possible focal spot consistent with voltage, current required, melting temperature of the target material, and the field coverage needed. The smaller the focal spot size, the sharper the radiographic image. It is normal to expect a focal spot size of 2 to 10 mm (millimeters), in the voltage range of 100 to 2,000 kVp. For special applications, equipment with focal spots less than 1 mm in diameter is available. X-ray tubes with dual focal spots are often used so the operator can choose the focal spot size and operational conditions compatible with the demands of inspection quality. New X-ray machines are also available with focal spots called mini-focus (spot size in the range of 0.2 to 1 mm) and micro-focus (spot size in the range of 0.002 to 0.025 mm). These new small focal spot X-ray units provide excellent image sharpness and can also be used to enlarge the X-ray image geometrically.

6.3.3.3 Equipment Protective Devices. X-ray generators SHALL be not only safe to use, but also SHALL be protected against damage from inadvertent misuse. To accomplish this objective, X-ray equipment SHALL have protective devices as discussed in the following paragraphs.

6.3.3.3.1 Overload Thermal Circuit Breaker. The overload thermal circuit breaker (usually incorporated in the main line switch), provides protection to the equipment SHOULD a component failure be encountered. This protection assures the thermal circuit breaker will disconnect the unit from the power supply before extensive damage is done to the control or tube X-ray tube head.

6.3.3.3.2 Over-Voltage Protection Circuit. The over-voltage protection circuit works by either setting spark gaps to arc at the over-voltage point, or by a voltage sensitive relay in the control circuit of the high voltage section. Sometimes both methods are used since it is possible under extreme conditions of surges, the over-voltage relay circuit MAY NOT react. This eliminates the possibilities of voltage damage due to operator carelessness or component failure.

6.3.3.3.3 Inverse Voltage Suppressor. There is also the possibility of inverse voltage damage in a high voltage X-ray circuit. This becomes a problem when the line voltage conditions vary widely (e.g., when using X-ray equipment in the lab on constant power or in the field on a portable generator). A circuit called the inverse voltage suppressor, consisting of a resistor and rectifier network in the primary winding of the transformer is used to protect X-ray equipment under these conditions.

6.3.3.3.4 Over-Current Fuse. An over-current fuse is used in the control circuit of the filament supply to prevent damage to the tube head due to incorrect usage of the equipment or component failure. The alternative is to design components in which the combination of variables will not result in damage to the unit. This is not desirable when attempting to achieve maximum utility in a design.

6.3.3.3.5 Over-Temperature Thermostat. To achieve the maximum safe working temperature of materials such as oil and solid insulation used in high voltage X-ray circuits, it is necessary to prevent over-temperature of the materials. To accomplish this, an over-temperature thermostat is installed in the X-ray tube head to prevent damage to those materials.

6.3.3.3.6 Flow Switches and Pressurestats. When using gas as insulation material, it is necessary to provide pressurestats in the X-ray tube head. Pressurestats prevent operation and consequent damage to the equipment SHOULD the gas pressure fall below the safe operating level for insulation of the high voltage parts. Flow switches and pressurestats in the oil and water circulators are also used to prevent operation of the X-ray unit when the unit is not being properly cooled. The type of protection provided in the unit will determine the degree of dependability of the equipment.

6.3.4 Considerations When Operating X-ray Equipment.

6.3.4.1 Effect of Focal Spot Size. The size of the focal spot bombarded by the electrons affects the heat dissipation capabilities of the anode. This limits the tube rating, or the milliamperes at which the tube MAY be safely operated. Additional effects are:

6.3.4.1.1 Heat Dissipation. The method of removing heat from the X-ray tube anode affects the tube ratings. An X-ray tube dependent upon convection cooling has a lower limit of operation than the same tube where water or some other coolant is used to conduct heat away from the focal spot.

6.3.4.1.2 Operational Considerations.

CAUTION

Follow manufacturers guidance for warming up X-ray equipment.

When a new X-ray tube is put into operation, it requires a warm-up period. A tube head, new or used may have been stored for a period of time, and a very small amount of gas may have been released into the vacuum by the metallic parts within the tube. These gases can be driven back into the metal components by operating the tube at a low kilovoltage and slowly heating the anode to high temperatures. Therefore, an X-ray tube head, which has not been operated for a specified period of time, SHALL be energized at a low kilovoltage, and the kilovoltage slowly increased until maximum rating has been obtained. The same procedure SHALL be used when a unit has not been operated for 30-days or more.

6.3.4.2 Component Substitution Rules. The Department of Defense has spent many thousands of dollars on repair, replacement, and shipping costs for X-ray equipment. The following information is a guide that will assist NDI personnel when troubleshooting X-ray equipment.

- a. The most likely cause of a system malfunction could be a defective tube head cable. The cable alone may be defective or the defective cable could damage other system components.
 - (1) The first step in troubleshooting X-ray equipment is to substitute a known-good tube head control cable with the malfunctioning equipment.

T.O. 33B-1-1**CAUTION**

Never substitute a good control box or tube head without first doing this step because a bad cable may damage the known good system too.

- (2) If the system still does not work after substituting the good cable, do not then assume the original cable is good; set it aside.
- b. After ensuring a good cable is installed, the next component to substitute is a known-good tube head for the questionable one.
 - (1) When testing the system after substituting the known-good tube head, always start in the "Operate Mode" with a 0 kV and 0 mA on the set line. After pressing the "X-ray ON," advance the mA to 5.0 mA, and then the kV one kV at a time, the mA SHOULD be flowing at 5.0 mA by the time 25 kV is reached. Continue to advance the kV up to 100 kV. If no problems are encountered up to 100 kV, slowly warm the tube head up as if the tube head was not used for the previous 30-days. If problems occur at low kV, do not advance the kV.
 - (2) If no problems are noted, do not assume the original tube head is good or bad.
 - c. If malfunctions still occur, substitute a good control box. Start in the "Operate Mode" and advance mA and kV as in Step b.1.
 - d. The system SHOULD be operating properly now if all of the components used for substitution were good.
 - (1) Now check out the original tube head by putting it back on the system. Again start testing in the "Operate Mode" with 0 kV and 0 mA set on the control unit. After pressing the "X-ray ON," advance the mA to 5 mA and the kV one kV at a time. The mA SHOULD be flowing at 5.0 mA when 25 kV is reached. Continue to advance the kV up to 100 kV. If problems occur at low kV, do not advance the kV. If no problems are encountered up to 100 kV, auto-warm the tube head as if the tube head had not been used for the previous 30-days.
 - e. Continuity test the cables pin on one end, to corresponding pin on other end, and from each pin to all the other pins, and the shell on the same end of the cable. Always make sure cable connectors are fully inserted.

NOTE

A cable may be good lying in one position, but defective in another position. It is also possible to identify a bad cable by simply X-raying it with a good instrument. Broken wires are commonly found within one-foot from the end connectors.

6.3.4.3 Tube Head Rating. Several variables affect the maximum rating of an X-ray tube head. These SHALL be carefully observed to ensure the X-ray tube head rating is not exceeded. Some of the more important variables to be considered are listed below.

6.3.4.3.1 Focal Spot Size. The size of the focal spot dictates the milliamperes that can safely be conducted across the X-ray tube.

6.3.4.3.2 Method of Cooling. The method used to remove heat from the anode affects the length of time the tube head MAY be operated under a standard operating condition. The operation is extended by the use of external coolant.

6.3.4.3.3 Type of Circuit. The type of circuit design used in the X-ray generator affects the tube head rating. When self-rectified circuitry is used, the inverse voltage applied to the X-ray anode limits the operation of the tube head. Usually, the maximum operating conditions are much greater where full wave circuitry is used, in comparison to self-rectified generators.

6.3.5 Standard Industrial X-ray Equipment in the DoD.

6.3.5.1 Lorad LPX-160A Portable Industrial X-ray Unit. The LPX-160A is an air or water-cooled X-ray unit with an operating potential of up to 160 kV and a tube current of up to 5 milliamperes (mA). The tube head is insulated with sulfur hexafluoride gas, pressurized to 50 psig @ 70°F, is end grounded and has a 0.063-inch thick beryllium window (for beam filtration) located approximately 2-inches from the end of the tube. At 0.5-meter from the window, the dose rate in the

primary beam is about 240 R/min (2.4 Sv/min) and 14 R/min (0.14 Sv/min), unfiltered and filtered respectively through 0.5-inches of aluminum. The unit has a cone shaped radiation field (full angle = 40°). Leakage radiation as measured one meter from the tube head, with the main beam being absorbed by 25 half-value layers of lead, ranged from 12.7 mR/hr (0.127 mSv/hr) to 385 mR/hr (3.85 mSv/hr). The measured half-value layer (HVL) of 0.41 inches corresponds to an average X-ray energy of about 83 keV.

6.3.5.2 Magnaflux GXR7.6B/GXR7.6C 150-KVP X-ray Unit. Unit output is approximately 49 R/min (0.49 Sv/min) at one-meter from the tube target with the tube operating at 150 kVp and 7 mA. The tube head assembly contains an end-anode ceramic-enveloped X-ray tube with a 0.03-inch (0.75-mm) beryllium window for beam filtration. The unit has a cone shaped radiation field (full angle = 40°). Maximum leakage radiation is approximately 1.3 R/hr (0.013 Sv/hr) at 1-meter with the tube head placed in a horizontal position and with the beam port down and blocked by a 1/4-inch lead sheet.

6.3.5.3 Sperry SPX 160-KVP X-ray Unit. The output of this unit is approximately 60 R/min (0.6 Sv/min) at one meter from the tube target with the tube operating at 160 kVp and 5 mA. The only filtration in the primary X-ray beam is provided by the 0.092 inch (2.3 mm) beryllium window. The unit has a cone shaped radiation field (full angle = 40°). The duty cycle is continuous with external cooling. The end-anode type of X-ray tube is shielded with a 1/8-inch lead collar with a circular aperture for the primary beam. Typical tube housing leakage radiation exposure rates range from 300 to 600 mR/hr (3 to 6 mSv/hr) at one-meter from the tube target. However, a cone of leakage radiation, ranging from 1 to 4 R/hr (0.01 to 0.04 Sv/hr) at one-meter and emanating from the high-voltage-input end of the tube housing at an angle of approximately 10° - 18° with the major axis, MAY be detected with some units.

6.3.5.4 Sperry 275-KVP X-ray Unit. The maximum output of a typical 275-kVp X-ray unit is 150 R/min (1.5 Sv/min) at one-meter from the tube target with the tube operating at 275 kVp and 10 mA. The beryllium window provides an inherent filtration approximately equivalent to 0.1 mm aluminum. The unit has a cone shaped radiation field (full angle = 35°). The duty cycle is continuous with external cooling. The end-anode part of X-ray tube is shielded with a 1-inch lead collar with a circular aperture for the primary beam. Typical tube housing leakage radiation exposure rates range from 500 to 1000 mR/hr (5 to 10 mSv/hr) at one-meter from the X-ray tube head. The 1000 mR/hr (10 mSv/hr) exposure rates generally occur at 90° to the major tube axis at the high-voltage-input end of the tube housing.

6.3.5.5 Sperry 300-KVP X-ray Unit. The maximum output of the 300 kVp unit is about 117 R/min (1.17 Sv/min) in the beam at 1-meter from the tube target with the tube operating at 300 kVp and 10 mA. Filtration of the primary X-ray beam is 2.36 mm beryllium for the 35° tube heads and 0.5 mm nickel for the 360° tube heads.

6.3.5.6 Golden Engineering XR-200 Digital X-ray Unit. The Digital Radiograph System (DRS)TM model XR-200, is a pulsed X-ray unit, manufactured by Science Application International Corporation. The DRS (or Golden Source as commonly referred to) contains an X-ray tube head that is air cooled and is manufactured by Golden Engineering. The tube operating potential is 150 kV and with a 0.5-milliamperes (mA) fixed current. The maximum output of the digital X-ray unit is 3 to 3.2 mrem/pulse (0.03 to 0.032 mSv/pulse) in the primary beam at 1-foot from the tube-head target. The unit can be set at 1 to 99 pulses. The pulse rate is 25 pulses-per-second with a pulse width of 50-nanoseconds.

NOTE

The pulse rate can vary slightly according to the battery charge. The unit has a cone shaped radiation field (full angle = 40°).

6.3.6 Isotope Source Equipment.

6.3.6.1 Energy Spectra. Radioactive nuclei emit gamma rays with discrete energy levels and a spectrum consists of a series of very sharply defined energies. As the atomic nucleus of a particular radioactive isotope disintegrates, well-defined decay schemes are followed. Further, it is important to be able to express the source strength and rate of decay.

6.3.6.2 Isotope Source Strength. A new international unit for source strength is the becquerel (Bq). The becquerel is defined as "one-disintegration per second." Therefore, 1 curie (Ci) = 3.7×10^{10} Bq. The unit becquerel has no relationship to the source volume or the quantity or type of energy of the radiation emitted. This term only has meaning when the particular radioactive isotope is known. For example, five becquerels of cobalt-60 are not equivalent to five becquerels of iridium-192 because of different energy levels and decay schemes.

6.3.6.3 Isotope Source Focal Spot Size. For isotopes, the physical size of the radioactive source can be thought of as the "focal spot." Since the becquerel only relates the number of disintegrations per second, this unit has no relationship to

T.O. 33B-1-1

the volume of mass or size of the radioactive source. The term ‘‘specific activity’’ is used to define the quantity of radioactivity of one gram of the substance and is expressed as becquerels per gram. Specific activity is expressed as the number of curies or becquerels per unit mass or volume. The shorter the half-life, the less amount of material required to produce a given activity or becquerels. The higher specific activity of Iridium results in physically smaller sources. For radiographic applications, a small source size is desirable to produce images with good resolution or sharpness, just as a small focal spot in an X-ray tube is required for high-resolution radiographs. Large sources produce geometric distortion resulting in radiographs with poor definition. Effort is constantly being devoted to producing radioactive isotope sources with high becquerel strengths in small volumes of material. Some special sources are stated as high specific activity, indicating a high radiation output relative to the source size. Nevertheless, in most isotopes, the source size exceeds the focal spot size in X-ray tubes.

6.3.6.4 Isotope Source Decay Characteristics. As radioactive material decays, there are a fewer number of unstable atoms left to decay. As time passes, the radioactive material is becoming less and less radioactive. Different isotopes have different decay rates. If a single atom of an isotope existed, it would be impossible to predict at what moment in time it might disintegrate. But if large numbers of atoms exist, it is possible to measure the lapse of time required for one atom out of every two to disintegrate, this is called the half-life of an isotope. The half-life is defined, as the time required for an isotope to decay to one-half of its original radioactivity.

6.3.6.5 Isotope Source Sensitivity.

WARNING

The radiation levels at the surface of the shielded container are hazardous to personnel over prolonged periods of contact.

CAUTION

Undeveloped film SHALL NOT be stored in the immediate area of the shielded container. Radiographic definition obtained with isotope sources is usually of lower quality than obtained with X-rays because of:

6.3.6.5.1 Focal Spot Size. Usually isotope sources have a larger focal spot size than X-ray tubes in order to have a sufficient quantity of radiation to prevent very long exposure times.

6.3.6.5.2 Fixed Radiation Energy. Isotopes emit radiation with an energy characteristic of that particular radioactive material. Therefore, the operator has no choice of radiation energy, and it is not always possible to select the radiation energy compatible with the absorption characteristics of the part being inspected.

6.3.6.5.3 Exposure Techniques. Exposure times are important, and often isotopes are weak in radiation output. Consequently, source-to-film distances must be decreased to reduce exposure times. This leads to poor definition of the radiograph.

6.3.6.6 Isotope Source Cameras. Isotopes emit radiation continuously; they cannot be turned off like an X-ray generator. Isotopes are stored in radiation-shielded containers, which reduce the radiation to a safe level for personnel not making radiographic exposures. The shielded container is designed so the radioactive isotope can be remotely positioned for a radiographic exposure. Many schemes have been devised for remote handling of isotopes. Source holders, commonly called isotope cameras, generally are of two typical designs.

6.3.6.6.1 The simplest cameras are designed for direct beam radiography. The source is only allowed to produce a restricted conical direct beam. The container itself is used to absorb radiation not emanating from the window or port. Some units are designed so the window can be opened and closed from a remote distance.

6.3.6.6.2 The other type of isotope camera is normally used for circumferential radiography. These are devised to move the source from its shielded container to a point some distance away, and then upon completion of exposure, return the source to its container. In this type of camera the radiation is being emitted in all directions.

6.3.6.7 Acquisition and Maintenance of Isotope Source.

NOTE

In the event of any malfunction, the appropriate equipment service manual SHALL be consulted.

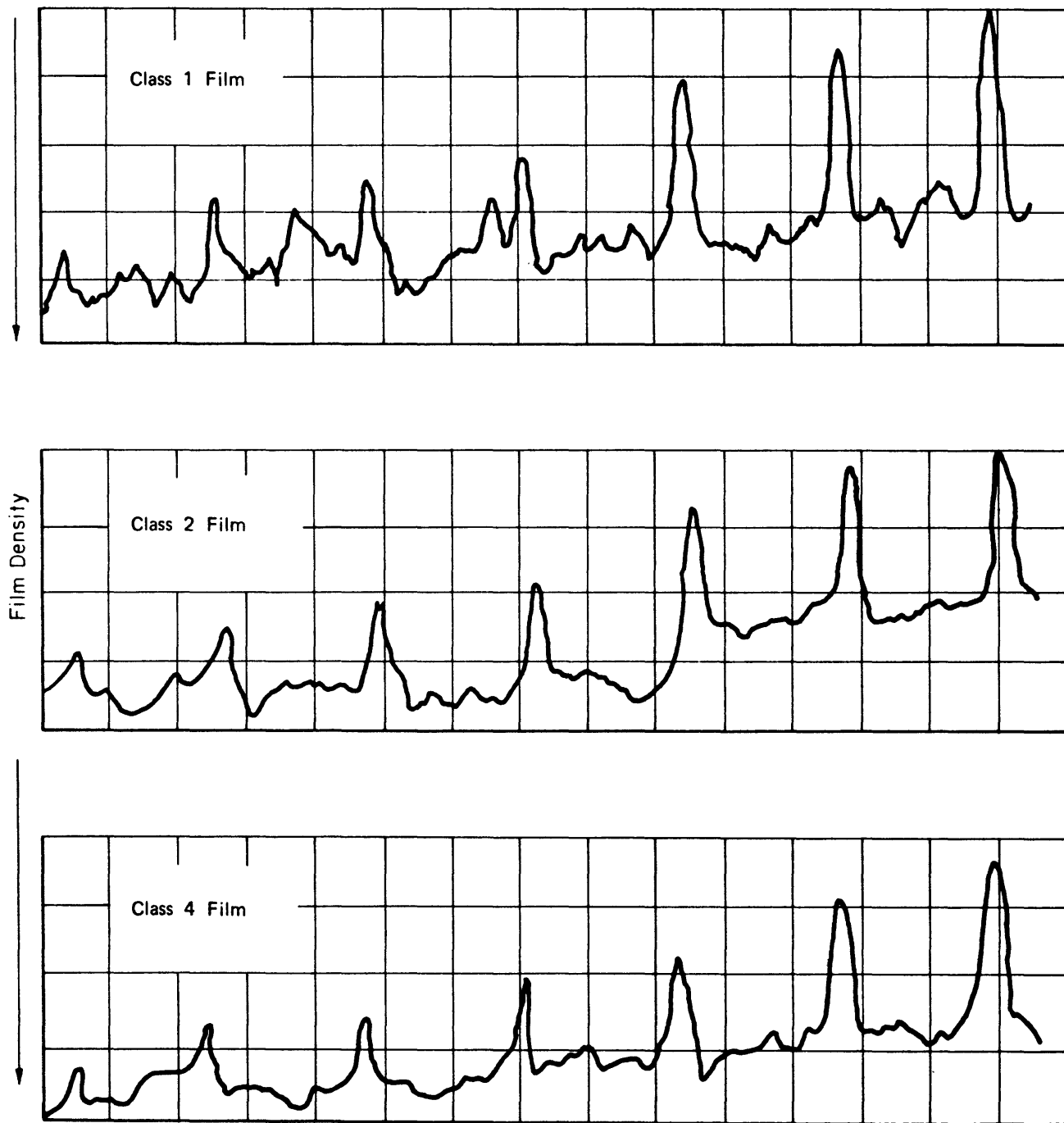
All man-made radioactive isotopes are under the jurisdiction of the Nuclear Regulatory Commission (NRC). A license is required to purchase and use these isotopes. The Air Force possesses a Master Materials License from the NRC. In order to obtain sources at base level, contact the base Radiation Safety Officer (RSO), normally the base RSO is the Bioenvironmental Engineer (BEE). The base RSO will help obtain a permit from the USAF Isotope Committee, which is the regulatory body within the Air Force. Each permit will give specific requirements for any radioactive isotope used for radiography.

6.3.7 Radiographic Film.

6.3.7.1 Classification of Radiographic Film.

6.3.7.1.1 Classification by Signal-to-Noise Ratio. The effect of signal-to-noise ratio caused by film grain size is shown with a microdensitometer trace across the radiographic images of a series of small wires made through one inch of aluminum ([Figure 6-18](#)). All exposure parameters were a constant except exposure time, which was varied to compensate for the three different film speeds. The ratios between the trace amplitudes for the wires and the respective backgrounds indicate the signal-to-noise ratios for Class 1, Class 2, and Class 4 radiographic films. Notice the higher frequency content of the Class 1 film, indicating its greater detail resolution capability.

T.O. 33B-1-1



H0401882

Figure 6-18. Microdensitometer Tracings of Images of DIN Wire Penetrators

6.3.7.1.2 Classification by Film Speed. Another way to classify film is according to film speed. The approximate relative speeds of radiographic film exposed to radiation energy between 100 and 150 keV are as follows ([Table 6-5](#)).

Table 6-5. Relative Speeds of X-ray Films Exposed at 100 kVp

Film Designation	Relative Film Speed ¹
Agfa	
D8	3.7
D7	2.7
D6R	1.5
D5	1.7
D4	1.0
D3	0.75
D3 (single coat)	0.28
D2	0.28
Kodak	
AA	3.1
T	2.07
B	2.0
M	1.0
R	0.4
R (single coat)	0.2
Fuji	
1X150	3.6
1X100	2.0
1X80	1.0
1X59	.8
1X50	0.5
1X29	0.4
1X25	0.36
¹ Film speed numbers should be compared only within a single manufacturer.	

6.3.7.2 Classes of Radiographic Film. Film is available that varies in signal-to-noise ratio, speed of response to radiation, and graininess. It is most appropriate to classify X-ray film in relation to the signal-to-noise ratios. Very fine-grain films with a very high signal-to-noise ratio, require comparatively large quantities of radiation for exposure and produce images with excellent resolution of detail. In the choice of a particular film, a trade-off must be made between resolution and speed of exposure. The criticality of an inspection will determine this tradeoff. Some commonly used X-ray films are classified as follows:

- **Class 1:** This class has the highest signal-to-noise ratio and includes such films as: Agfa D2, Kodak Type R, and Fuji IX 25. These are considered high detail resolution films and SHOULD be employed when the most sensitive radiograph is desired.
- **Class 2:** This class is considered as high in signal-to-noise ratio and includes such films as: Agfa D4, Kodak Type M, and Fuji IX 50.
- **Class 3:** These films have a moderate signal-to-noise ratio and include: Agfa D5, Kodak Type T, and Fuji IX 59 with screen.
- **Class 4:** These high-speed films, by comparison, are considered to have a low signal-to-noise ratio and include: Agfa D7, Kodak Type AA, and Fuji IX 100.

6.3.7.2.1 The previous classifications differ from others because they are based upon signal-to-noise ratio rather than film speed. We show a bar chart (Figure 6-19) reflecting the relationships of signal-to-noise ratios, film speed, and detail resolution capabilities of different film classes. We also have a more detailed guide to film classification (Table 6-6) and (Table 6-7). These tables are not inclusive of all film types or manufacturers which MAY be authorized for use, since manufacturers introduce new films or take existing films off the market from time to time. Specific inspection instructions

T.O. 33B-1-1

MAY specify film other than what is listed. Each manufacturer has a particular designation for films. Small variations may be noted in film speed and contrast of the films made by the different manufacturers within a particular class.

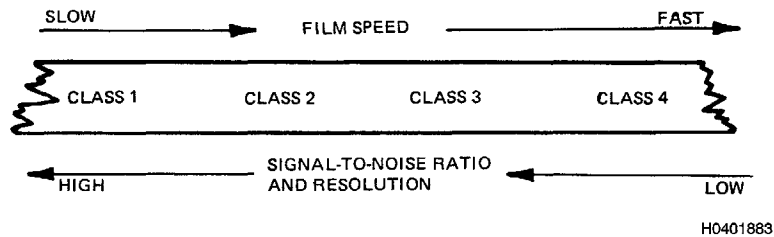


Figure 6-19. Relationship Between Signal-to-Noise Ratios and Speeds of Film

NOTE

The following classifications are based on film system rather than signal-to-noise ratio. The film plus the associated film-processing requirements are based according to the criteria established by the manufacturers of the film and processing chemicals. The classifications previously listed in this manual approximately corresponds to the new film system classifications, as follows:

- Class 1 ASTM Class Special
- Class 2 ASTM Class I
- Class 3 ASTM Class II
- Class 4 ASTM Class III
- Exceptions include films followed by an arrow; they are the equivalent of one class higher in the new system classification compared to the previous classification.

Table 6-6. Film Classes

Manufacturer	System Class			
	Special	I	II	III
Agfa	D2	D3 D4 D5	D7 (á)	D8
Fuji	IX25	IX 20 IX 50 IX 80	IX 100	IX 150
Kodak	DR	M MX 125 T	AA400 (á)	CX

The following table includes the ISO speed and signal-to-noise ratio for each film type.

Table 6-7. Speed and Signal-to-Noise Ratio

Mfr	Class											
	Special			I			II			III		
	Type	Speed	S/N	Type	Speed	S/N	Type	Speed	S/N	Type	Speed	S/N
Agfa	D2	40	371	D3	64	294	D7(á)	320	142	D8	400	114
				D4	100	232						
				D5(á)	200	169						
Fuji	IX25	50		IX 20	25		IX 100	320		IX 150	500	
				IX 50	100							
				IX 80	200							
Ko-dak	DR	32	378	M	80	320	AA400(á)	320	140	CX	400	124
				MX 125	125	220						
				T(á)	200	209						

6.3.7.3 Storage of Unexposed Film.

CAUTION

Any films in containers sealed by the manufacturer and not opened SHALL be stored with the film on edge to avoid container damage and possible film damage. Storage temperature should be between 40 and 75°F at a relative humidity range of 30 to 60%. When storage temperatures exceed 90°F for 30 days or more a fog test SHALL be performed with a limit of 0.30 density units total for base density. Regardless of storage temperatures, films SHALL be allowed to stabilize at room temperature before opening containers.

X-ray film is sensitive to the cosmic radiation that exists everywhere. This radiation will cause fogging. Fog is the darkening of the radiograph by scattered radiation, exposure to light, or pre-exposure to radiation. It can also be caused by over-development or aging. It SHOULD be noted fog brings no information to the film and merely creates a high background that reduces contrast and image visibility. The very high-speed films, being more sensitive to exposure, are more susceptible to fogging than the slower emulsions.

6.3.7.4 Film Expiration Date. The expiration date is marked on the film box at the time of manufacture. To prevent exceeding the expiration date, film SHOULD be ordered in quantities, so long-term storage is not necessary. The inventory of film SHOULD be rotated to use the older film first. Film that exceeds its “shelf life” date SHOULD NOT be put in salvage, the usability will be verified by: 1) processing an unexposed sheet to determine clearing and fog level, the density should not exceed 0.30, 2) if the clearing and fog level are satisfactory, make a radiograph of a step-wedge and penetrameters to determine the sensitivity and contrast of the film in question, a 1.4% sensitivity (2-1T) is recommended, 3) if these limits are acceptable, extend the shelf life by six months and continue using the film. Document the verification results on an AF Form 2032. At the end of the extended period reverify the film using the aforementioned procedure. If the film does not meet acceptable quality levels use the film for training, for clearing the automatic film processor, for detection of foreign objects, or if the quantity is so great to warrant, ship the film to the NDI Technical Training School, Air Education and Training Command (AETC) at NAS Pensacola. The Navy and Marine Corps can send film to NAVAL AIR Technical Training Center (NATTC) ATTN: NDI School, 230 Chevalier Field AVE, Pensacola, FL 32508. If the film is one-year past its original shelf life, the film SHALL NOT be used for crack detection and SHALL be utilized for one of the alternate purposes mentioned earlier. X-ray films present no greater fire hazard in storage in the X-ray laboratory and filing room than an equal quantity of paper records. There is no necessity for expensive vaults equipped with elaborate fire protection devices. Film storage area SHALL be kept clean.

6.3.7.5 Film Identification Methods. To properly apply information obtained through radiography, the material inspected must also be accurately identified with respect to the object radiographed. In the absence of engineering direction in a

T.O. 33B-1-1

specific weapons system technical order, the required method of film identification is lead numbers and letters, lead tape, or lead labels. The Laboratory Supervisor can approve use of perforation methods for their specific laboratory. The required identification information SHALL be: Aircraft tail numbers or part name/serial number if not an aircraft item, julian date, inspection procedure, shot number, employee number of radiographer-in-charge, and organization. The inspection procedure may be abbreviated or shortened but must be clearly understood. The organization should include the wing designation number and the laboratory office symbol (e.g., 36 MXMFN). When film size does not allow identification on the film, it will be placed in an acceptable film file pouch and the information typed or written legibly on the film file. When the x-ray film interpreter is not the radiographer-in-charge the interpreter's employee number will be written on the x-ray film with an appropriate marker (e.g., grease pencil) or on the film pouch when film size is an issue.

6.3.8 Film Holders, Film Cassettes, and Radiographic Screens.**NOTE**

Due to interaction between film and lead screens, film SHALL NOT be left in cassettes or film holders more than 24-hours.

Film holders and film cassettes are used to protect the film from light exposure while the film is being transported and while it is being exposed. These film holders are of various designs made to hold the various film sizes. Screens increase the imaging radiation being impinged upon the film and/or decrease the scatter radiation reaching the film.

6.3.8.1 Film Holders.

6.3.8.1.1 Flexible Film Holders. Flexible film holders are used where it is necessary to contour the film to achieve good film-to-test-object contact, however, sharp bends SHOULD be avoided. These holders are made of a lightproof flexible material. Lead screens with a rubber or vinyl backing are available to permit contouring and flexible positioning of the film for exposure.

6.3.8.1.2 Cardboard Film Holders. Cardboard film holders are used extensively in industrial radiography. They are simply a heavy, kraft paper envelope between hinged cardboard covers. The back has a lead foil lining to absorb back-scattered radiation. Always place the holder with the "tube side" mark toward the tube head or radiation source. If the holder position is reversed, the radiation is filtered by the lead foil backing and will result in images of lower density. The cardboard holders are economical and durable. Lead screens can be inserted into the envelope with the film for making lead screen radiographs. Intimate film-screen contact is normally accomplished by placing the object to be inspected on the cardboard holder.

6.3.8.1.3 Rigid Film Holders/Film Cassettes. The term cassette is usually applied to rigid film holders. Cassettes have a "bakelite" or "magnesium" front to allow transmission of X-rays. The back contains a lead foil lining to absorb the back-scattered radiation. Cassettes are normally used with calcium tungstate or lead screens. Cassettes provide uniform compression on the film and screens to assure good physical contact between the film and screen for ultimate image sharpness. Cassettes are comparatively heavy and somewhat difficult to handle.

6.3.8.2 Vacuum Cassettes. Vacuum cassettes are especially useful when utilized in conjunction with lead or fluorescent screens. The air is pumped out of the cassette, ensuring intimate film-screen contact. They are very flexible, allowing the film to be positioned in a confined space.

6.3.8.3 Using Film Holders and Film Cassettes. Film cassettes give better film-to-screen contact and are often used without a screen. Lead screens can be used with film holders, but care SHALL be taken to maintain even film-to-screen contact. In any critical exposure, the use of cassettes are recommended. Film holders are generally used to radiograph thin sections of materials at low kilovoltage, 150 kVp or lower. The sensitivity is reduced when using film holders on thick sections due to backscatter. Using film holders with a lead sheet backing will reduce the backscatter. At lower than 30 kVp, standard film holders cannot be used because the cardboard will show on the radiograph. For lower kilovoltage, holders can be made from vinyl or Mylar materials. A lead sheet can be taped to the back to reduce backscatter. Film holders can be taped in place or secured in any way that will not affect the radiograph adversely.

6.3.8.4 Labeling Film Holders and Film Cassettes. Ballpoint pen or other sharply pointed writing instrument SHALL NOT be used to write information on the surface of any cassette or film holder. Film artifacts may be produced which will affect radiographic interpretation. If identification is required use marking techniques, that the necessary information can be recorded on before applying to the cassette.

6.3.8.5 Bending or Kinking Film Holders/Cassettes. Care SHALL be taken not to bend or kink film holders unless absolutely necessary for placement of film for exposures. Artifacts may be produced, which could impair interpretation of the radiograph. An alternative includes the use of smaller or custom shaped film for better fit to part, if required.

6.3.8.6 Preparation of Film Holders/Cassettes.

CAUTION

Loading of film cassettes and film holders SHALL be accomplished under safe light.

- a. Remove all unnecessary materials from the workspace.
- b. Before loading the film cassette/holder, open it and examine for cleanliness and light leaks. Discard any film holders physically damaged beyond repair. Some light leaks MAY be repaired with black photographic tape. Remove any lint or dust with a clean cloth. Dust SHALL NOT be blown out since moisture may lodge on the holder and be transferred to the film.
- c. Place the film, film cassette/holder, and if used, screens in a convenient location in the darkroom to simplify loading of the film cassette/holder.
- d. If a screen is used, place it in the film holder face upwards so it will contact the film.

6.3.8.7 Loading the Film Holder/Cassette.

NOTE

Film SHALL NOT be allowed to slide into the cassette/holder pocket. Scratches from the cassette/holder or screen may result.

The procedure that follows covers only one type of film holder. Film holders vary in methods of locking and opening but the same procedure will apply except for these details.

- a. Open the inner folded cover all the way.
- b. Withdraw the film from the film box with paper cover in place. Handle the film only at the edges with light finger pressure.
- c. Grasp one side of the paper cover to open it. Place the film so the free end is against the rear edge of the holder. Lower the film slowly and allow the film to fall gently into the holder and remove the paper.
- d. Refold the inner paper cover.
- e. Close the holder cover taking care the lead screen on the cover enters the holder pocket without binding. Some holders MAY NOT have a lead screen on the cover. In this case, when the use of the screen is desired, place it in the holder pocket face down.
- f. Lower the holders cover and fasten the locking device. If the holder has a spring back, turn the latch to lock the holder.

6.3.8.8 Prepackaged Film. X-ray film suppliers offer X-ray film in prepackaged, flexible envelopes or in rolls. The prepackaged film eliminates the film loading operation in the darkroom. Packaged film is available, double-loaded with films of differing speeds, or placed between two intensifying screens incorporated in the package. This film is convenient to use and is preferred for many industrial applications. Prepackaged film is the most widely used film due to its convenience for field inspection.

T.O. 33B-1-1**6.3.8.9 Radiographic Intensifying Screens.**

6.3.8.9.1 Purpose of Radiographic Screens. X- and gamma radiation has such a great penetrating power that less than 1-percent of the energy is absorbed when striking film. Materials that emit less penetrating radiation in the form of secondary electrons or fluorescent light utilize the emitted radiation more fully. A radiographic intensifying screen is a layer of material that intensifies the imaging radiation being impinged on the film, decreasing the scatter radiation reaching the film. In industrial radiography, these are often used in direct contact with the X-ray film. There are three types of screens used to intensify an image: lead, fluorescent, and fluorometallic.

6.3.8.9.2 Types of Radiographic Screens.

6.3.8.9.2.1 Lead Screens. Certain materials emit electrons when struck by high energy X-rays or gamma rays; these electrons are called secondary electrons. X-ray film is not only sensitive to light, but to these secondary electrons. The material of choice is lead foil usually 0.001-inch to 0.040-inch thick, bonded to a flexible support. Lead screens in direct contact with film have two effects:

- **Intensify Incident Radiation.** Incident radiation with energies above 88 keV eject photoelectrons from the atoms of the lead. These photoelectrons act on the emulsion in the same way as the primary radiation beam.
- **Improve Clarity.** They improve clarity by absorbing scattered radiation of longer wavelengths.

6.3.8.9.2.1.1 When to Use Lead Screens. Lead screens SHOULD be used whenever they improve radiographic quality. Because of the resulting improvement, they are generally preferred to calcium tungstate screens. Whenever there is a need to perform a radiographic inspection using a combination of screens and film, they SHALL be of the same plane dimensions and in close contact with each other during exposure.

6.3.8.9.2.1.2 Selection of Lead Screens. Lead screens are available in various thicknesses and SHOULD be chosen relative to the radiation energy being used. The energy level threshold for lead screens is approximately 100 kVp. Any secondary electrons generated below this level have little effect towards intensification. Above 100 kVp, the general rule for lead screen selection is: For 100 – 400 kVp, use a front screen of 0.001 to 0.005-inch and a back screen between 0.005 to 0.010-inches. For isotopes (Iridium 192 and Cobalt 60), use a front screen of 0.005 to 0.010-inch and a 0.010-inch back screen. Supervoltages above 1.0 MeV require a front screen of 0.010 to 0.060-inch and a back screen between 0.010 to 0.040-inches. When used properly, they intensify the image by improving the image contrast and final radiographic sensitivity. Sample results are shown in (Table 6-8) however, the quality of the image is improved at all kVp settings.

Table 6-8. Sample Result

Source Power	Relative Exposure Times for Equivalent Density Under Standard Conditions	
	Without Screens	With Lead Screens
120 kVp	1.0	1.0
150 kVp	1.0	0.7
200 kVp	1.0	0.5
Iridium 192	1.0	0.25
Cobalt 60	1.0	0.50
NOTE		
The results were obtained with a 0.004-inch front screen and a 0.006-inch back screen.		

6.3.8.9.2.1.3 Care of Lead Screens.

CAUTION

Hydrogen peroxide or other common cleaning agents SHALL NOT be used for this purpose because their chemical composition will cause fogging of the sensitive film emulsions.

X-ray screens are given a special waterproof protection coating to both sides. Due to the high electron absorption in light materials and the intensifying action on lead foil screens caused by the electrons emitted under radiographic excitation, the surface SHALL be kept free from dust, dirt, and lint. These conditions will produce light densities on the radiograph. Sensitive surfaces of the screens SHALL NOT be touched because fingerprints may show up and interfere with accurate interpretation on the radiograph. If cleaning of the surface is required, wash with mild soap and water and dry thoroughly with a soft cloth. Remove grease and lint from the surface of lead foil screens with a solvent such as Isopropyl Alcohol. If more thorough cleaning is necessary, rub screens gently with the finest grade of steel wool. Film may be fogged if left between lead screens longer than is reasonably necessary, particularly under conditions of high temperature and humidity. When screens have been freshly cleaned with an abrasive, this effect will be increased. It is best to delay the use of freshly cleaned screens at least 24-hours.

6.3.8.9.2.1.4 Precautions When Using Lead Screens. Lead screens SHALL be used with great care. Common problems are:

- A fuzzy image resulting from lack of intimate contact between the screens and film.
- Dark lines on the image resulting from scratches on the screens.

6.3.8.9.2.2 Fluorescent Screens. Some materials fluorescence (emit light) when struck by X- or gamma radiation. Each fluorescent material normally referred to as phosphor, has its own fluorescent light spectral region. Intensification factors of 5 to 200 can be obtained by appropriate choice of phosphors relative to the spectral sensitivity of X-ray film. Due to the visible light dispersion from phosphor crystals to radiographic film, fluorescent screens render images less sharp than those obtained with direct exposure. Fluorescent screens produce radiographic images of inferior quality; therefore they are used selectively in industrial radiography for applications where they are allowed by code, and where the desired image quality requirements are met. For this reason, their use is normally limited to those situations where exposure speed is more important than image quality, or where the radiation quantity available is inadequate to perform the task. Fluorescent screens consist of a phosphor like calcium tungstate coated on a flexible support. Whenever there is a need to perform a radiographic inspection using a combination of screens and film, they SHALL be of the same plane dimensions and in close contact with each other during exposure.

6.3.8.9.2.2.1 Care of Fluorescent Screens. Fluorescent light from intensifying screens obeys all of the laws of visible light, and cannot pass through opaque bodies as X-rays do. Make every effort to keep the screens clean. To avoid extraneous shadows caused by absorption of the fluorescent light by foreign matter during exposure, dust and dirt particles SHALL NOT be allowed to collect between the film and screen surfaces. Stains upon the screens SHALL also be avoided. Calcium tungstate screens MAY be stored in the processing room but away from chemicals and other sources of contamination.

6.3.8.9.2.3 Fluorometallic Screens. Fluorometallic screens consist of calcium tungstate phosphor coated on lead foil, which in turn is coated on a suitable, flexible support. When used in appropriate applications, the combination of fluorescent phosphor and lead foil, results in substantial intensification with radiographic images having improved contrast. Intensification factors ranging from 5 to 30 can be obtained when these screens are exposed with appropriate industrial X-ray films, while factors of 30 to 150 can be realized when the screens are used with medical type films.

6.3.9 Quality Indicators.

6.3.9.1 Penetrameters/Image Quality Indicators (IQI).

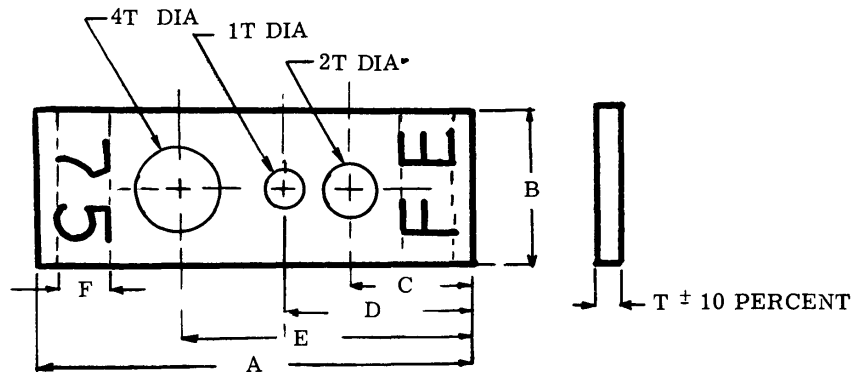
NOTE

Use of IQI's are specified within a given technique. If the IQI identified in the technique is not available, consult with the appropriate Air Logistics Center's NDI Level III for instructions. Penetrameters SHOULD be used during crack detection inspections.

T.O. 33B-1-1

Penetrameters or image quality indicators (IQI) are devices whose image is used on a radiograph to determine radiographic quality level (sensitivity). They are not intended for use in judging the size of, or in establishing acceptance limits of discontinuities. Instead, they are used to determine the acceptance level for the particular radiographic technique used to make the radiograph. The penetrometer is a test piece whose composition is similar to the material of the subject being tested. It generally is located in an appropriate location on, or adjacent to, the subject being radiographed. When it is specified by code, or when it is not practical to place the penetrometer on the subject, the penetrometer is located adjacent to the subject on a rectangular block of material similar to the penetrometer and having a thickness close to the subject.

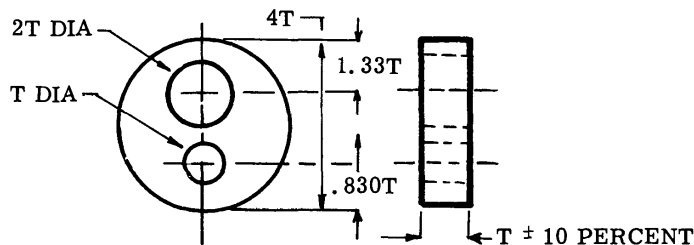
6.3.9.2 Description of Penetrameters/Image Quality Indicators (IQI). A wide range of penetrameters is specified for use by various industries. Wire penetrameters are particularly useful for weld inspection. A common form of penetrameters is a small plaque, fabricated of the same material being radiographed. The thickness of the penetrometer is a known percent of the test object thickness. Holes in the penetrometer are of diameters 1T, 2T, and 4T, where the T equals penetrometer thickness. Thickness visualization of these holes can be related to the sensitivity of the radiographic image. A typical penetrometer is shown in [\(Figure 6-20\)](#).



T	INCREMENTS	A	B	C	D	E	F
.005-.020 INCL.	.0025	2.000	.500	.520	.800	1.150	.250
.025-.050 INCL.	.005	2.000	.500	.520	.800	1.150	.250
.060-.160 INCL.	.010	2.850	1.000	.800	1.250	1.900	.375

MIN PENETRATOR THICKNESS $.005 \pm 10 \text{ PERCENT}$
 MIN DIAMETER FOR 1T HOLE $.010 \pm 10 \text{ PERCENT}$
 MIN DIAMETER FOR 2T HOLE $.020 \pm 10 \text{ PERCENT}$
 MIN DIAMETER FOR 4T HOLE $.040 \pm 10 \text{ PERCENT}$

DESIGN FOR PENETRATOR THICKNESSES UP TO AND INCLUDING 0.160



DESIGN FOR PENETRATOR THICKNESSES OF 0.180 AND OVER MADE IN .020 INCREMENTS

SYMBOL	MATERIALS (SEE 4.2.2.2.3)
SS	STAINLESS STEEL
AL	ALUMINUM
FE	STEEL
MG	MAGNESIUM
CU	COPPER
TI	TITANIUM

ALL DIMENSIONS IN INCHES.
 HOLES SHALL BE TRUE AND NORMAL TO THE SURFACE OF THE PENETRATOR. DO NOT CHAMFER.
 TOLERANCES ON PENETRATOR THICKNESSES AND HOLE DIAMETERS SHALL BE $\pm 10 \text{ PERCENT}$
 OR $1/2$ OF THE THICKNESS INCREMENT BETWEEN PENETRATOR SIZES, WHICHEVER IS SMALLER.

H0401884

Figure 6-20. Penetrator Information

T.O. 33B-1-1

6.3.9.2.1 The penetrameter has lead numbers permanently attached to the plaque that indicates the material thickness on which the penetrameter is to be used. In (Figure 6-20), the ID number indicates the penetrameter is for use on a 0.750- inch test object. The thickness (T) of the penetrameter is normally made to be 2-percent of the test object thickness. Therefore the penetrameter with an ID of 6.0-inches would be 0.120-inch thick. Except in special instances, plaque penetrameters less than 0.005-inch in thickness are not available, therefore, in normal operation, the 0.005-inch penetrameter is used on test objects when the thickness MAY be 0.25-inch or less. The use of IQIs is discussed further (paragraph 6.4.4).

6.3.10 Radiation Monitoring Devices and Instruments.**NOTE**

Calibration of both DIRECT READING dosimeters and alarming rate meters SHOULD be scheduled so sufficient quantities remain on hand to support continuing radiography operations. Additionally, except in cases of emergency, TLD badges SHOULD NOT be submitted until replacement badges have been received.

6.3.10.2 Personnel Monitoring Devices. TLDs are the primary dosimetry device and have generally replaced film badges as the legal record of radiation exposure in the Army and Air Force. For more information (paragraph 6.8.5.3.1). Each personal alarming dosimeter/alarm rate-meter SHALL:

- Be checked to ensure that alarm functions (sounds) at the start of each shift.
- Be set to give alarm signals a preset dose rate of not more than 500 mR/hr (5 mSv/hr).
- Require special means to change the preset alarm function.

6.3.10.2.1 Electronic Personnel Dosimeter (EPD). Although approved in ANSI-N13.11 as a dosimeter of record in lieu of a TLD, the EPD is currently used within DoD for instant readout of dose and dose rate. It measures gamma and X-ray radiation over the range of 20 keV to 6 MeV and beta radiation from 250 keV to 1.5 MeV, and it provides readout of both skin (7 mg/cm^2) and deep dose equivalent (1000 mg/cm^2). The readout provides a dose equivalent range of 0.1 to 1000 rem. The radiation is detected by three silicon diode detectors, which save data to secure memory every few minutes and provide visible and audible alarms if either the accumulated dose or dose rates exceed specified levels. Doses SHOULD be checked periodically throughout the day when performing radiography and SHALL be recorded in the dosimetry log at the beginning and end of each operation for future comparison with TLD results. When EPDs are submitted for calibration long-term dose memory is reset to zero. They are used in the same manner as TLDs.

6.3.10.2.1.1 Digital/Personal Alarm Dosimeter (DAD/PAD).**CAUTION**

- Geiger Mueller tubes will saturate at high dose rates (R/hr). They are never to be used in areas where dose rates can reach these levels. The DAD/PAD is a solid-state dosimeter that uses a halogen-quenched, filtered Geiger-Mueller (GM) tube for detecting and measuring radioactivity. The GM tube converts the radiation detected into pulses, which are fed to an amplifier and then to a pulse-division circuit which produces an output to the digital display counter whenever pulses equivalent to one dose increment have been accrued. At the same time, the division circuit output actuates the audible system and emits a “chirp” for each dose increment. The radiation is recorded normally in dose increments of 0.25 mR to 1 mR units.
- The DAD/PAD is a direct reading dosimeter that is approximately the size and shape of a typical telephone-paging unit. It provides both a visual and audible indication in direct proportion to radiation-intensity/dose-rate. The term “chirper” is also used as a common name for this type of dosimeter because of the audible sound emitted when operated in the presence of radiation. The DAD/PAD SHALL be worn between the neck and waist on an outer garment. It MAY also be worn on a belt provided the DAD/PAD’s securing clip is designed for attachment to a belt.

6.3.10.2.1.2 Some units of this type are equipped with a chirp rate switch allowing the user to select a low or high chirp rate. In the low position, each dose increment produces one chirp; in the high position, each increment produces about 40-chirps, giving a more immediate audible warning at relatively low exposure rates. For example, at an exposure rate of 10 mR/hr, the unit will chirp about every 6-minutes in low position and about every 10-seconds in the high position.

6.3.10.2.1.3 The alarm dosimeter has a case usually constructed from aluminum or high impact plastic. The DAD/PAD is lightweight (8-ounces or less), has a corrosion-resistant surface coating and operates on a 9-volt alkaline battery for up to 6-months of normal use.

6.3.10.2.1.4 Operation is very simple: turn the unit on. Some units reset the display each time the unit is turned on; others require resetting the display with a reset switch or button. A memory is available on some models, which allows the unit to be turned off without losing the stored dose. This feature permits a single daily recording of the wearer's exposure dose because the dosimeter will continue to monitor exposure to the radiation without having to record each exposure dose if operations are stopped and resumed several times in a day's operation.

NOTE

Dosimeter reading for each individual SHALL be entered on the utilization log at the beginning and end of the workday.

6.3.10.2.1.5 Any time a DAD/PAD is used by a different radiographer, it SHALL be reset to zero prior to use. Each radiographer SHALL wear a single DAD/PAD, which has been reset to zero prior to the start of each day's operation and calibrated in accordance with specific equipment technical data. A reading MAY be obtained at any time while working in a radiation area by simply pushing a read button to view the accumulated dose on the readout display.

6.3.10.2.2 Victoreen Model 885 PAD. This is another example of the alarm dosimeter. It detects gamma and X-rays over a range of 0-999 mR (0-10 mSv) by integrating radiation exposures. It provides both a visual and audible indication and "chirps" in direct proportion to radiation intensity/dose rate with "chirps" at the rate of one chirp per 0.025 mR. Using one 9V alkaline battery, the PAD will operate for 30-days continuously or for 120-days at 8-hours per day. (Low battery indicator denotes when battery life drops below 100-hours.)

NOTE

The Model 885 PAD SHALL be worn under outer garments when conducting operations during cold weather as it is designed to function properly only when the lower operating temperature is above 32°F (0°C).

6.3.10.3 Survey Instruments. Radiation exposure, at the energies used for industrial radiography, is most accurately measured with ionization chamber type survey instruments. These detectors use an air filled chamber across which an electric field is applied. When X-ray or gamma radiation interacts with the air in the chamber, it creates positive and negative ions that drift apart under the influence of the electric field. As the ions are collected on the electrodes within the chamber, a small current is generated which is measured by the instrument and directly related to the radiation exposure rate in air. For more information (paragraph 6.8.5.8).

6.3.10.3.1 Survey Instrument Specifications.

6.3.10.3.1.1 Descriptions and Operating Characteristics of Specific Instruments.

NOTE

The Nuclear Research Corporation SM-400 end cap contains a lever-operated alpha/beta check source to verify instrument operation each time it is used.

6.3.10.3.1.1.1 The 440, 450B, 450P, SM-400, and the VR-10 are similar in size, appearance, and specifications. All are authorized for use during NDI radiographic operations.

6.3.10.3.1.1.2 These instruments are, for practical purposes, energy independent from 15 keV to 1.2 MeV with their front caps removed.

6.3.10.3.1.1.3 The batteries for the 440 and VR-10 consist of four "D" flashlight cells. Each instrument weighs approximately 5- 1/2-pounds and its overall dimensions are 10-inches long, 4-inches wide, and 7-inches high. The SM 400 uses two "D" flashlight cells and weighs approximately 5-pounds. Its overall dimensions are 10-inches long, 4.5-inches wide, and 7-inches high.

T.O. 33B-1-1

6.3.10.3.2 Recommended Instruments. The Victoreen Model 440, Nuclear Research Corporation SM400, and the Heat Pipe Model VR-10 survey meters have been standard instruments authorized for use in the Air Force as noted in AS-455 for industrial radiography. These instruments are no longer available from the manufacturer. Suitable replacement instruments include Victoreen models 440RF/D, 450, 450B, and 450-CHP; ThermoEberline models SHP-400 and RPO-20; Inovision Radiation Measurements models 451B and 451P survey meters. Other survey instruments (Ion chambers) MAY also be considered providing they have been approved by the local Base RSO and AFIOH/SDR(Air Force). For more information (paragraph 6.8.5.8).

6.3.10.3.2.1 Victoreen Model 450P Survey Meter. The Model 450P is a lightweight portable survey meter designed to measure X-ray above 25 keV. It has a five-decade operating range from 0-5 mR/hr (0-0.05 Sv/hr) on the lowest scale to 0-5 R/hr (0-50 mSv/hr) on the highest scale and has a programmable “flash alarm” which causes the display to pulsate at a rate of once per second when the measured dose rate exceeds a preset limit. The detector is a 300-cc ionization chamber pressurized to 6 atmospheres. The Model 450P measures exposure, exposure rate, and can be used to “freeze” the maximum exposure rate encountered and displays results on an illuminated analog/digital display. For maximum sensitivity, the Model 450P survey meter SHOULD be perpendicular to the ground plane when making measurements rather than being parallel to the ground. The Model 450P is considered Hazardous Material for shipping purposes because of the pressurized ion chamber and must be shipped to TMDE accordingly.

6.3.10.3.2.2 Victoreen Model 450B and 450-CHP Survey Meters. The Model 450B and 450-CHP survey meters are similar instruments that detect gamma and X-ray radiation above 7 keV. Both have a five-decade operating range measuring from 0-5 mR/hr (0-0.05 mSv/hr) to 0-50 R/hr (0-5 Sv/hr). The detector for both instruments is a 349-cc air ionization chamber that has a 200 mg/cm² bakelight wall and a 1.7 mg/cm² mylar window. They operate continuously for about 200 hours on a set of two new 9-volt batteries. The Models 450B and 450-CHP SHOULD always be used with the cap off when measuring X-ray and gamma radiation with energies below 200 keV due to energy response variation.

6.3.10.3.2.3 Victoreen Model RPO-50 Survey Meter. The Model RPO-50 has similar controls compared to the SM-400, and Victoreen 440, but has significantly improved performance characteristics. It detects gamma and X-ray radiation above 7 keV. The Model RPO-50 has four operating ranges, measuring from 0-5 mR/hr (0-0.50 mSv/hr) to 0-5 R/hr (0-0.05 Sv/hr). The detector is a 349-cc air ionization chamber that has a 493-mg/cm² bakelight wall and a 3.5 mg/cm² window. It operates continuously for about 3000-hours on a set of four new 9-volt batteries. It is environmentally sealed and has limited RF shielding, permitting its use in demanding environments.

NOTE

The Model RPO-50 SHOULD always be used with the cap off when measuring X-ray and gamma radiation with energies below 200 keV due to energy response variations.

6.3.10.3.3 Recommended Survey Instruments for Use in RF Fields.

6.3.10.3.3.1 Victoreen Model 440 RF/D Survey Meter. The Model 440 RF/D survey meter is specially designed to be used in strong radiofrequency radiation fields up to 20 mW/cm². It detects gamma and X-ray radiation above 12 keV. The Model 440 RF/D has 5 operating ranges, measuring from 0-1 mR/hr (0-0.01 mSv/hr) to 0-100 mR/hr (0-1 mSv/hr). The detector is a cylindrical 3.56 cm diameter, 10-cm² cross-section air ionization chamber that has a 1.5 mg/cm² mylar window and a 13 mg/cm² magnesium window. It operates continuously for about 200-hours on a set of five new 9-volt batteries. The model 440 RF/D includes an internal check source to verify correct system operation. The instrument does have a significant variation in energy response, requiring the instrument reading to be corrected dependent on the kVp of the X-ray system being surveyed.

Table 6-9. Recommended Survey Instruments and Relative Energy Response

Instrument	Percent Relative Response					
	22	32	70	120	170	663(a)
Effective Energy (keV)	22	32	70	120	170	663(a)
Nuclear Research Corp. Model SM400 Cap off	100	105	108	108	107	96
Nuclear Research Corp. Model SM400 Cap off	100	105	108	108	107	96
Victoreen Model 450B (Bottom cap off)	93	98	106	108	105	–
(Bottom cap on)	58	80	112	112	106	93
Victoreen Model 450P	55	88	106	104	103	103
Victoreen Model 440	94	104	116	118	116	100

(a) Note that 663 keV represents Cs-137, which is commonly used for calibration.

NOTE

When monitoring radiation fields using instruments with caps, the caps SHOULD be removed. The caps SHOULD be replaced after use. The thin mylar cover at the end of the ionization chamber is easily punctured. If it is punctured, the instrument is inoperative and SHALL be repaired or replaced.

6.3.11 Radiographic Processing Equipment. Radiographic processing involves two basic modes, “manual” and “automatic” processing. A third mode, “digital” will be discussed later.

6.3.11.1 Manual Processing. In the case of manual processing, chemistry is placed in tanks of a suitable material. Films are affixed to corrosion resistant metal hangers, which are submerged in the chemistry during processing. Chemistry temperature needs to be controlled, and in some instances, is accomplished with an incoming water mixing valve. A separate electrical dryer unit is generally employed to dry the processed film.

6.3.11.2 Automatic Processor. Automatic dry-to-dry machine processing is in wide use today because it affords increased processing stability and results in significantly shorter total processing time. Most automatic processors incorporate mutually or simultaneously driven transport rollers. All of the rollers in the four processing stages of development, fix, wash, and dry are driven at the same speed and therefore turn together as the film is being transported between them.

6.3.11.2.1 Various sub-assemblies incorporated in automatic processors include developer, and in some instances fixer temperature control units, a dryer heater fan, and automatic chemistry replenishment pumps.

6.3.11.2.2 Maintenance of Automatic Processors. Periodic inspection, maintenance, and lubrication of radiographic film processing equipment is required by the technical manual governing its operation. It is imperative the prescribed daily, bi-weekly, and monthly requirements be strictly followed to ensure proper operation of equipment, and to support quality radiographic inspection results. With appropriate maintenance, automatic processors SHOULD give reliable and repeatable service for long periods of time.

6.3.12 Film Evaluation Equipment.

6.3.12.1 Densitometer. Measurement of radiographic density SHALL be done with electronic direct-reading type densitometers. The electronic direct-reading type densitometer is more accurate than the visual type. This densitometer SHALL be capable of measuring the light transmitted through a radiograph with a film density up to 4.0 with a density unit resolution of 0.02. When film densities greater than 4.0 are required to perform a radiographic inspection a densitometer applicable to film densities up to maximum density is necessary.

6.3.12.1.1 Film Density Reference Strip. A photographic or radiographic-calibrated reference density strip, traceable to the National Institute of Standards and Technology (NIST), SHALL be used to calibrate the densitometer prior to determining the density of a radiograph. These calibrated density strips SHALL be replaced whenever they are physically damaged (e.g., scratched, crimped, or become wet by any fluid) to such an extent it may influence their effectiveness.

T.O. 33B-1-1

6.3.12.2 Illuminators/Viewers. For information (paragraph 6.5.10.6).

6.3.13 Digital Radiographic Viewing, Storage, Archival, and Printing Systems.

6.3.13.1 Viewing Systems. Digital radiographs are viewed on systems primarily designed for digital radiography. The systems differ from ordinary image processing systems for home and photographic use in that they are tailored specifically for radiography. Systems SHOULD provide at the least all the functionality discussed in this section to allow you to be an effective digital radiographer. Hardware for digital radiography is similarly designed with radiography in mind, the computer for running the software and the interfaces to the acquisition hardware are all specialized pieces of equipment designed to handle large radiographic images with little chance of data corruption or image alteration.

6.3.13.1.1 Generally, grayscale monitors are used for digital radiography with a portrait oriented large screen and a high dynamic range to display radiographic data in the most meaningful way. High resolution and bright color monitors are also in use and add the capability to use color processing techniques to visualize the radiographic data as well as provide support for text and vector graphic color annotations on images. Ten bit monochrome monitors provide significantly more shades of gray to produce a smoother image and greater appearance of sharpness. 10 bits in a 2048 x 1536 is considered a 3 mega pixel monitor.

6.3.13.2 Storage Systems. Storage for the digital radiographs range from hard drives to magnetic tape systems. Currently CDs are the media of choice, but these are quickly being replaced by DVDs, which hold much more data than a CD. Most digital radiographs opt not to compress their images at all and store the original raw data. It is always recommended a backup copy of digital data is kept at all times.

6.3.13.3 Archival Systems. Archival and retrieval systems are gaining popularity for radiographers that generate large amounts of digital radiographs. These systems are usually comprised of a database and storage mechanism connected over a network. They make searching for an image easy through database commands at the workstation and deliver the image to the viewer upon request with the actual storage media used unknown at times to the radiographer so he or she need never worry about disk space, etc.

6.3.13.4 DICONDE. An emerging standard for industrial digital radiography (and other digital images for nondestructive testing) is known as “DICONDE” – Digital Image Communication for Nondestructive Engineering, and is based upon the already well established DICOM protocol. This standard defines the manner in which image acquisition hardware, software, databases and archival system and printers SHOULD communicate. It also sets standards for data associated with a digital image and a universal file format and protocol so equipment by varying vendors will work with each other.

6.3.13.5 Printing. Digital images allow for the easy replication of hardcopy data either on film or paper. There are several digital film printers available at varying prices so you can produce a hardcopy film from a purely digital image. Some systems use chemicals similar to standard film processors, but more common are the systems which use either dye sublimation or thermal films for the hardcopy output of digital radiographs. Most digital radiographers forego the use of a film printer as in most cases, it is unnecessary in modern digital radiographic labs.

SECTION IV APPLICATION OF RADIOGRAPHIC INSPECTION

6.4 EFFECTIVE RADIOGRAPHIC INSPECTIONS.

6.4.1 Introduction. This section describes the factors that determine whether or not a particular radiographic inspection is sufficiently sensitive to detect small defects. Sensitive radiography requires maximum subject contrast resulting from correct kilovoltage; alignment of the beam with the plane of the likely flaw; a sharp image, due to good geometry and secondary radiation; and finally, optimum density to give good film contrast. Each of these factors is described in turn and, a description is given of quantitative transformations to allow exposure and density changes with a minimum of experimentation.

6.4.2 Factors Affecting Image Quality.

6.4.2.1 Radiation Energy. The radiation energy chosen must be compatible with absorption rate of the subject. For low-absorbing subjects, low-energy radiation produces radiographic images with good contrast. Conversely, for inspection of thick, highly absorbing subjects, the radiation must be capable of sufficient penetration to produce an image within a reasonable period of time. To achieve a high-contrast, 96 to 99-percent of the incident radiation SHOULD be absorbed by the subject. Increasing kilovoltage reduces contrast because the quantity of radiation at any given energy increases and, perhaps more importantly, the proportion of radiation with a short wavelength (high energy) increases disproportionately. These two relationships are in (Figure 6-21). High energy radiation can penetrate the subject more easily, thus, reduces subject contrast. The effect on the final image of low or high contrast is shown (Figure 6-22). The right diagram in (Figure 6-22) shows for a given subject, a doubling of kilovoltage increases transmitted radiation 15 to 30 times. This example shows the disproportionate effect a small kilovoltage change can have upon a particular inspection.

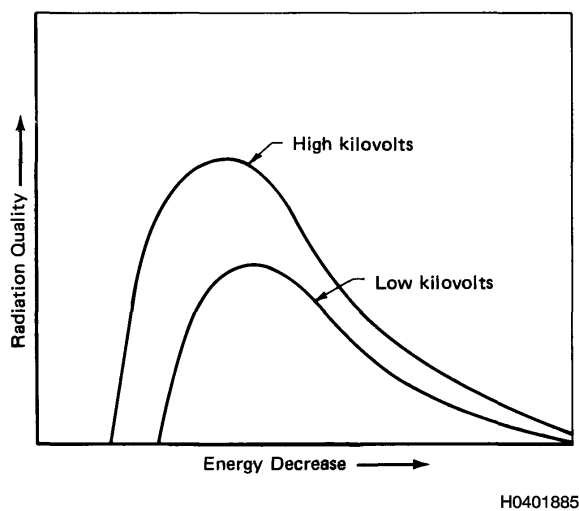


Figure 6-21. Effect of Kilovoltage on Transmitted Radiation Output

- a. 38 kVp, 5 minutes
- b. 80 kVp, 5 seconds

T.O. 33B-1-1

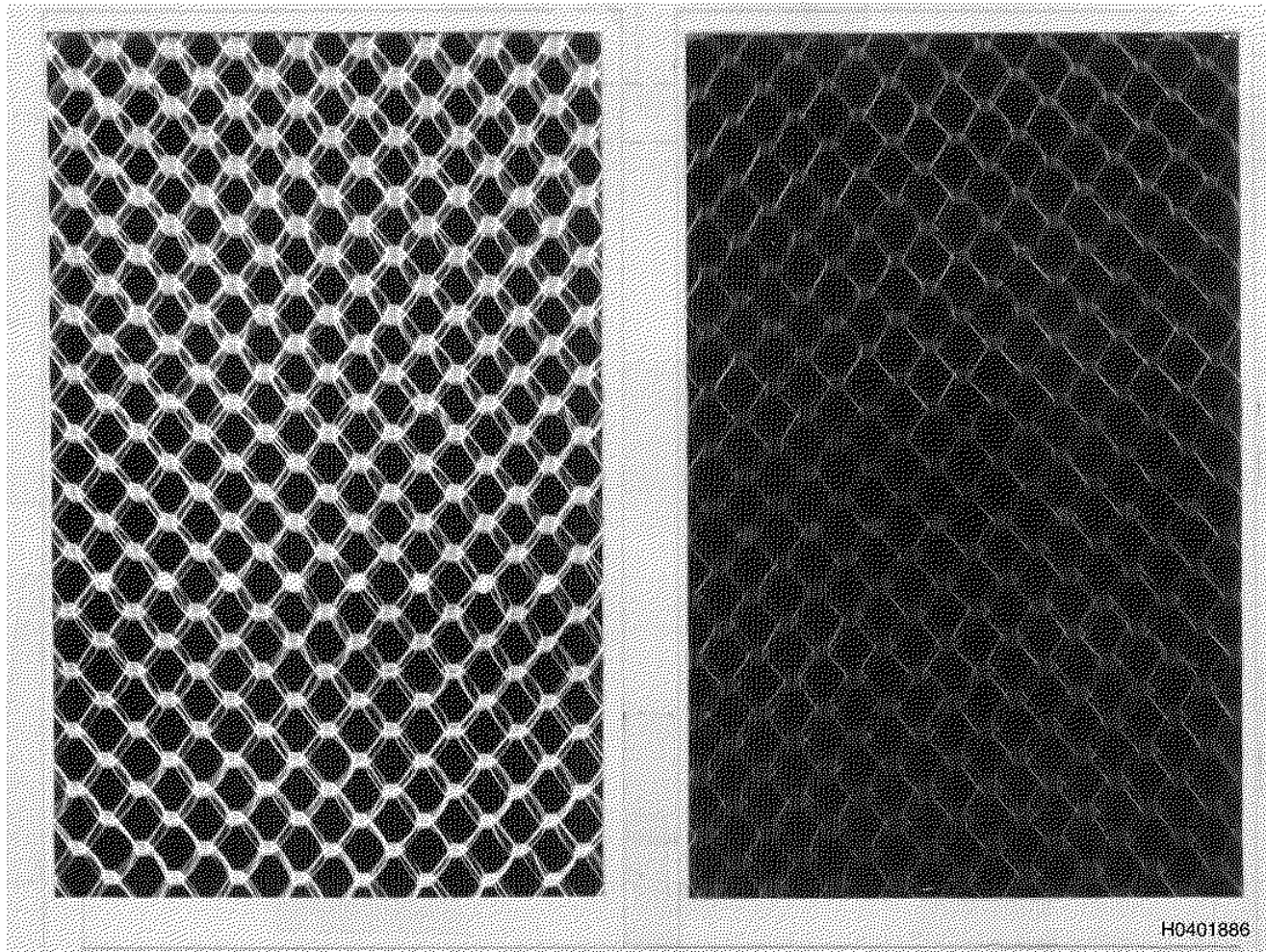


Figure 6-22. Radiographs of Honeycomb Showing Effect of Kilovoltage on Contrast

6.4.2.1.1 If industrial radiographic applications were to use monochromatic radiation, and if there was no scattering to be considered, the radiation absorption could be mathematically calculated with high precision using the classical attenuation equation, however, in normal applications, it is not possible to calculate the right kilovoltage to be used for a particular inspection because this optimum condition does not exist. The best initial approach is to use past experience. Approximate radiation energies compatible with various subjects is indicated in (Table 6-10).

Table 6-10. Approximate Radiation Energies Compatible With Various Absorbers

Radiation Source, kVp	Aluminum or Other Light Metals	Steel
2-25	0.001-0.11 in.	0.001-0.01
25-50	0.1-0.75 in.	0.01-0.125
50-150	0.5-3 in.	0.125-0.75
100-250	2-8	0.125-1.75
150-400	3-12	0.375-3 in.
Ir γ 192		0.625-4 in.
Cs γ 137		0.75-4 in.
1 mev		1.5-5
Co γ 60		1.5-7
8-12 mev		3.12
24 mev		3.18

6.4.2.1.2 It SHOULD be noted, as radiation energy increases, the differences between absorbing materials become less pronounced than at lower energies. Due to photoelectric absorption, the atomic number of an absorber has a large effect upon radiation absorption at energies of 100 kV or less. At high energies, in the 1 MeV range, the material density becomes the major controlling factor in determining radiation absorption. A 10-percent change in radiation energy has a very definite effect at low energies. In MeV energy ranges, this same percent change in energy can hardly be detected in transmission characteristics

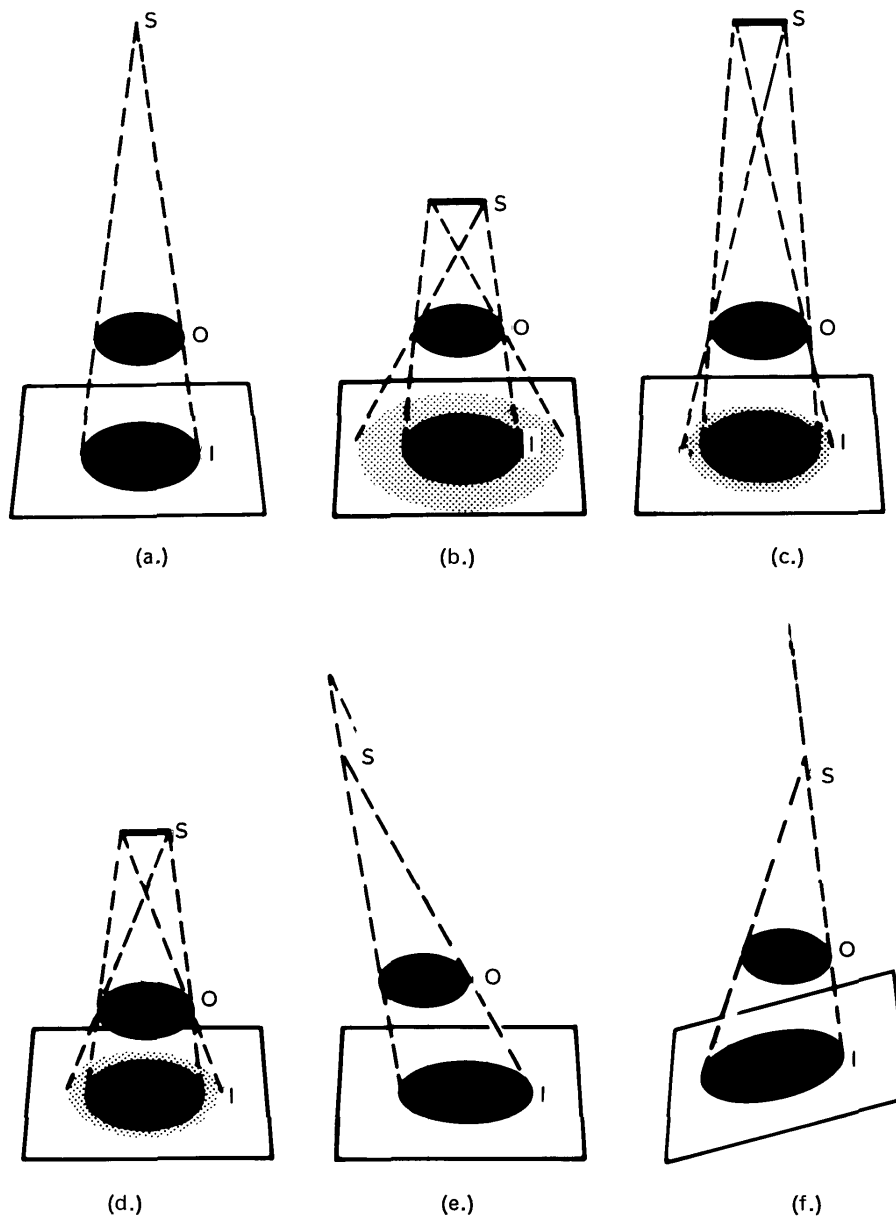
6.4.2.2 Radiation Quantity. An alteration in the filament current (mA), produces a direct change in the quantity of radiation emitted, but has no effect upon the radiation energy. Additionally, filament current (mA) and time are usually interchangeable. That is, the product of milliamperage and time is constant for the same photographic effect, this is known as the "reciprocity law." This law is valid for X- and gamma ray exposures; with or without lead screens; and over the range of radiation intensities and exposure times used in industrial radiography. There is one exception, which is the use of fluorescent screens, discussed in (paragraph 6.3.8.9). For very low or high intensities, the reciprocity law fails because of changes in the efficiency of the response of the film emulsion to unit radiation. If high production radiography is required, a source with a high radiation output would be economical. Usually, the high-output equipment requires a source with a comparatively large focal spot therefore, rate of radiation output is often directly related to focal spot size. The resulting unsharpness, due to geometry can become detrimental to image quality.

6.4.2.3 Exposure Geometry. The geometrical setup used to produce a radiographic image is an important factor that contributes to final image quality. Geometrical relationships affect the image sharpness and help control image distortion.

6.4.2.4 Image Distortion. For the best radiograph, the source beam SHOULD be aligned perpendicular to the part, and the film SHOULD be located on the same plane as the part. This positioning projects the image of the part upon the film in the true shape of the object with minimal distortion. Any deviation from these relative positions of source, object, and film, will produce an image with some degree of distortion. This alignment is particularly critical for crack detection. Since discontinuities revealed in radiographic images are usually identified by their shape; images free of distortion are very important in radiographic interpretation. Where complex structures are encountered in aircraft inspection, it is often impossible to locate the various parts in the most desirable positions, and sometimes an inspection MAY be facilitated by planned distortions. Interpretation of distorted images is not impossible, but the film reader must mentally visualize the geometry of the object under evaluation, and how the exposure would project the distorted image onto the film. This ability requires practice and experience.

6.4.2.5 Image Unsharpness. This is the term applied recognizing there will always be unsharpness of the image to some degree, and perfect image sharpness is unattainable. The amount of geometric image unsharpness is due to size of the source of radiation and relative distances as shown in (Figure 6-23). The distance on the film over which an edge is spread is known as the penumbral shadow or the geometrical unsharpness, U_g . The value of U_g does not enter into other computations; it sets the upper limit for Ft/d . The value must be determined experimentally. The equation to determine unsharpness is located in (paragraph 6.7.7).

T.O. 33B-1-1

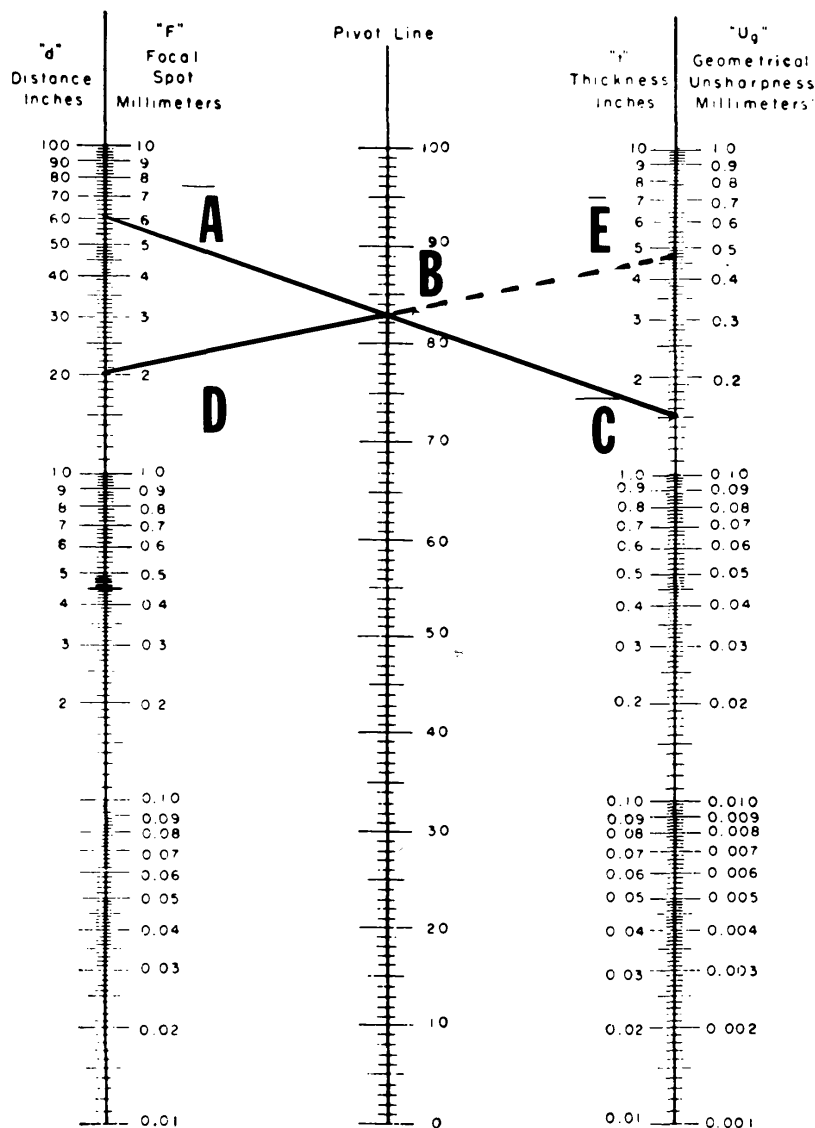


S REPRESENTS THE SOURCE, O REPRESENTS THE OBJECT BEING RADIOGRAPHED, AND I IS THE IMAGE PLANE. (a) OPTIMUM GEOMETRIC FIDELITY CONDITION. (b) EFFECT OF POOR F/d RATIO WITH LARGE PENUMBRA SHADOW, (c) CONDITION IMPROVED BY INCREASING SOURCE-TO-OBJECT DISTANCE. (d) SAME CONDITION ACHIEVED BY DECREASING PART THICKNESS OR DISTANCE FROM OBJECT TO FILM. (e) AND (f) ILLUSTRATE THE EFFECT OF GEOMETRICAL MISALIGNMENT.

H0401887

Figure 6-23. Possible Geometric Distortions

6.4.2.5.1 In considering geometrical unsharpness, recognize the value of new microfocus X-ray sources and the potential for geometric magnification. A nomogram is used to assist in solving this equation for various geometrical conditions (Figure 6-24), note 3 out of 4 terms in the equation must be known before it can be used.



H0401888

Figure 6-24. Nomogram to Assist in Solving Equation $U_g = Ft/d$

6.4.2.5.2 Suppose a specimen having a maximum thickness of 1.5-inches (t) is to be radiographed at 20-inch source-to-film distance (SFD) (d) using a source of effective focal size 6mm. The need is to establish an approximate value for U_g . The steps in using the nomogram are:

- Plot the points A and C that represent the known value of F and t . The pivot line is intersected at B.
- Plot a line joining point D (the value of d) and B. The extension of this line at E gives the value of U_g (0.47mm).

6.4.2.5.3 Remember unsharpness of the radiographic image is also affected by the characteristics of the X-ray film. Therefore, the total image sharpness MAY be controlled by either “geometrical unsharpness,” or “film unsharpness.” The greater of these two values will control the total unsharpness of the image. In any given situation, the geometric unsharpness, which can be tolerated most, will set the lower limit for the adjustable parameter. Additional demands on image sharpness are paid for in intensity of the image. Image unsharpness is inversely proportional to the source-to-object distance, whereas the intensity is inversely proportional to the square of this distance. Therefore, the trade-off of intensity for sharpness is not an equitable one. In many cases, this uneven exchange is necessary because it is very important to achieve good geometric

T.O. 33B-1-1

definition. The basic principles of shadow formation SHALL be given primary consideration to ensure satisfactory sharpness and low distortion of radiographic images. Distortion cannot be entirely eliminated since some of the test object may be further away from the film than other parts, and radiation from all sources cannot be made ideally parallel; images will always be less than perfect. In summary, five general rules can be stated which promote quality assurance from geometric considerations.

- a. Use as small a focal spot as possible, as the considerations will allow.
- b. The distance between the source and the object SHOULD be as great as practical.
- c. The film SHOULD be as close as possible to the object being radiographed.
- d. Central beam SHOULD be as near to perpendicular with the film as possible.
- e. As far as the shape will allow, planes within the specimen plane of interest SHOULD be parallel with the film.

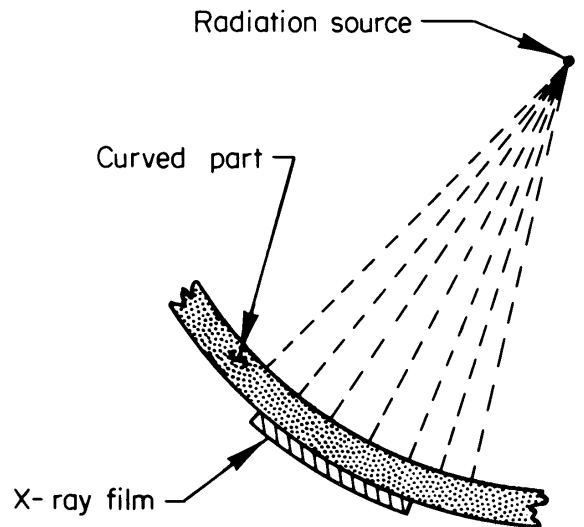
6.4.2.6 Film Placement. After the film and film holder have been chosen, consideration SHALL be given to the position of the film in relation to the part. In radiography of small parts, this could be a simple matter of laying the part on the film. With complex structures involved, film positioning is not quite as simple. A few rules can be of assistance in such inspection situations:

- a. Always position the film as close as possible to the area of interest.
- b. Attempt to locate the film so the plane of the area of interest and the film are perpendicular to the radiation beam. This is to prevent distortion in the final image.

6.4.2.6.1 When positioning the film, care SHALL be used to prevent sharp bends in the film or applying pressures to the film holder that can produce pressure marks or crimp marks (artifacts) on the final image. In radiography of curved surfaces, the source and film SHOULD be positioned, if possible, to take the best advantage of the inverse square law and to prevent as much distortion as possible. Flexible film holders SHOULD be used in order to place the film as near as possible to the surface of the test object. It may be noted in (Figure 6-25) the distance from source to the entire surface of the film is nearly constant and the thickness of the test object is also a constant to the path of radiation. This preferred positioning is not always possible, but it SHOULD be used when practical.

NOTE

The part undergoing inspection will always be between the source and the film.



H0401889

Figure 6-25. Preferred Geometry for Radiography of Curved Surfaces

6.4.2.7 Focal Spot Size. The ideal focal spot would have a pinpoint source of radiation. Though microfocus tubes approach this ideal, in actual practice this is impossible. Radiation sources have finite dimensions. The actual focal spot size in an X-ray tube is the projected area being bombarded by electrons from the heated filament; in gamma radiography, it is the radioactive pellet. To reduce the apparent size, the X-ray target is positioned at a small angle, and from the position of the X-ray film, this area appears as the projection of this focal spot on the film plane. This projection is referred to as the effective focal spot. Focal spot sizes must increase with increasing kilovoltage rating to prevent melting of the target material. Radiation is being emitted from the entire area of the effective focal spot. This radiation is projected at different angles through the test object and spreads the image of a sharp edge over a finite distance on the film. Examples of the formation of shadow projections are shown (Figure 6-23). What has been said about focal spot size in X-ray tubes also applies to gamma radiography where the pellet of radioactive material functions as the focal spot. The relatively large size of the pellets accounts for the inferior definition obtained with gamma radiographs.

6.4.2.8 Source-to-Film Distance (SFD). The sharpest image would be formed by having a SFD so great that the radiation would be parallel at the film plane (Figure 6-23). However, since radiation intensity or quantity is diminished in relationship to the inverse square of the distance, the radiation quantity available to expose the film would be very small, and exposure times would become impractical. Due to this, economics and practicability must be considered when producing a radiographic image. It is recommended the longest practical SFD be used for critical exposures to improve image sharpness. If the source-to-film distance is changed, the formula (paragraph 6.7.3) can be used to correct the exposure. Because an increase in distance causes a decrease in beam intensity, only the intensity is changed. The kilovoltage SHALL NOT be changed when correcting for SFD changes.

6.4.2.9 Inverse Square Law. When the X-ray tube output is held constant, or when a particular radioactive source is used, the radiation intensity reaching the specimen is governed by the distance between the tube (source) and the specimen, varying inversely with the square of this distance. The explanation below is in terms of X-rays and visible light, but applies with equal force to gamma rays as well. Since X-rays conform to the laws of light, they diverge when they are emitted from the anode and cover an increasing larger area with lessened intensity as they travel from their source. This principle is illustrated by (Figure 6-26).

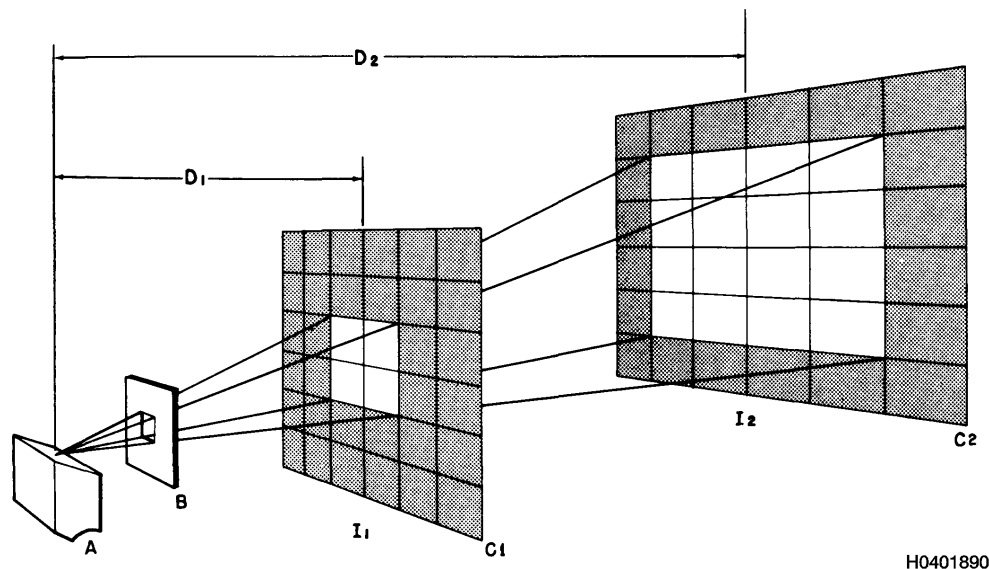


Figure 6-26. Inverse Square Law Diagram

6.4.2.9.1 In this example, it is assumed the intensity of the X-rays emitted at the anode (A) remains constant, and the X-rays passing through the aperture (B), cover a 4-square-inch area upon reaching and recording surface (C1), which is 12-inches (D_1) from (A). If the recording surface (C1) is moved 12-inches farther from the anode to (C2), so the distance between (A) and (C2) is 24-inches (D_2) or twice the distance between (A) and (C1); the X-rays will cover 16-square-inches, an area four-times as great as at (C1). Therefore, the radiation-per-square-inch on the surface at (C2) is only one-quarter that at (C1). Thus the exposure that would be adequate at (C1) must be increased four-times in order to produce a radiograph at (C2) of equal

T.O. 33B-1-1

density. In practice, this is done by increasing either the time, or milliamperage. Mathematically the inverse square law is expressed as follows: (paragraph 6.7.2).

$$\frac{I_1}{I_2} = \frac{(D_2)^2}{(D_1)^2}$$

where I_1 and I_2 are the intensities at distances D_1 and D_2 respectively.

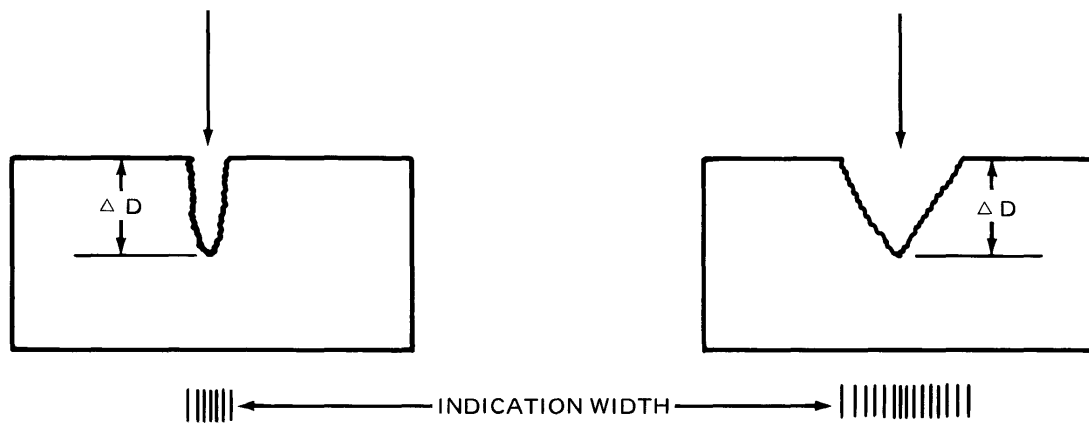
Example: An intensity of 2 mR/hr was measured at 40-inches from the source. What would be the intensity reading at 30-inches, and at 20-inches? Do not forget to take the square of the predetermined value for D_2 when determining unknown distances.

6.4.2.10 Source/Defect Orientation. Radiography can be used quite reliably to detect cracks, provided certain stringent criterion is met. It is very easy to produce an apparently high quality radiograph that does not show an existing crack, or with a crack indication so faint it can barely be seen. The resolution of a crack depends upon total density change, and film/subject contrast. The human eye can detect density changes of 0.02 H & D units, however, to detect cracks, a density change of

0.05 H & D units is more reasonable. There are several factors that produce density changes on X-ray film. The primary factor in the case of crack detection is a change in thickness or mass between the crack and part being inspected. A general rule is the crack must be at least 2-percent of the parts thickness if it is to produce a readable indication. This rule has variables that influence film density changes, and in some cases a change of as little as a 1-percent thickness will produce a visible indication. In other instances, a crack exceeding 5-percent of the part thickness MAY NOT produce a readable change in density. Regardless of total density change across an indication, if the contrast is not high, crack indications can be missed.

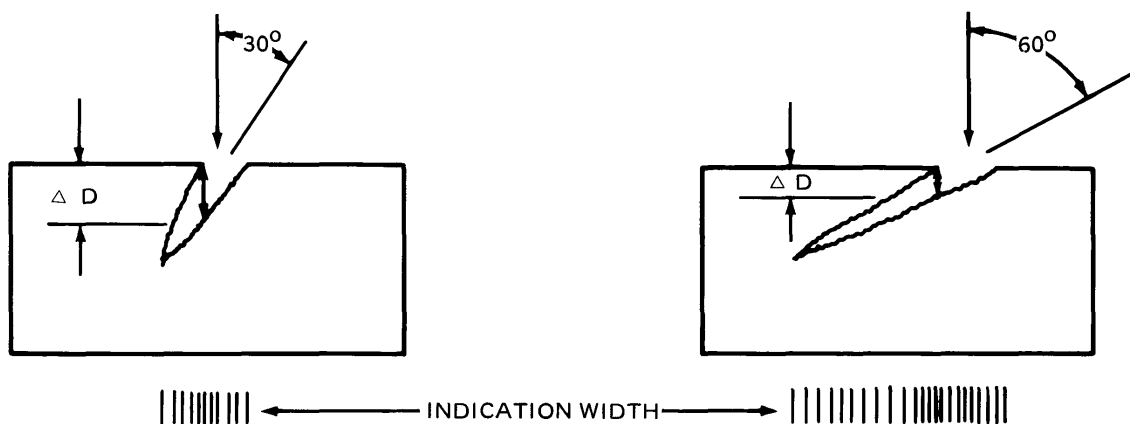
Example: A change in density of 0.05 H & D units can be easily seen if it is an abrupt change. Conversely, a change of 0.25 H & D units (5 times 0.05) is difficult to see if it is a gradual change over an area (e.g., a gradual increase over 1/2-inch width as opposed to a 1/8-inch width).

6.4.2.10.1 When an X-ray tube focal spot is centered directly over a crack with a depth parallel to the beam (X-ray beam and crack plane coincide), the film density change will be a function of the ratio of crack depth to metal thickness. Indications of narrow cracks with parallel sides will appear as fine dark lines with high contrast. Wide cracks with sloping sides will result in broader indications of lower contrast. A sketch illustrating the film density changes between two different width cracks when the X-ray tube is centered over the crack origin is shown in (Figure 6-27). The stress on a part will affect crack width. Example: compressive stress in the lower wing surface of an aircraft on the ground tends to reduce crack width. This compressive stress is due to the weight of the structure, engines, ordnance pylons, etc. Jacking the aircraft, to place the lower surface in neutral stress or in tension is frequently done to enhance detection of small cracks. One general characteristic of a crack and its indication, is the tendency for it to curve or deviate from a straight line. An apparent exception is a very short crack or a crack between two adjacent fasteners, but even here, when the indication is examined under magnification, there will be some edge jaggedness or change in edge appearance.



a. NARROW VERSUS WIDE CRACK INDICATION

NOTE
 ΔD IS EFFECTIVE DEPTH OR MAX
 DENSITY CHANGE.



b. SIMILAR WIDTH AND DEPTH CRACKS AT TWO DIFFERENT X-RAY BEAM TO CRACK PLANE ANGLES.

H0401892

Figure 6-27. Density Changes Due to Varying Crack Widths and Intersection Angles

6.4.2.10.2 Obtaining parallelism between the X-ray beam and the crack plane is difficult to achieve. Cracks do not always initiate at the expected origin, and often are not perpendicular to the part surface. When the X-ray beam passes through a crack at any angle other than directly along the crack plane, both the width of the crack and the intersect angle determine the density change and indication contrast. Two cracks, of approximately the same width and depth, but with differing angles to the X-ray beam and the crack plane intersection are shown (Figure 6-27). As the angle between the X-ray beam and crack plane increases, both film density change and contrast decreases. The film indication becomes broad and more diffuse until it blends into the background and is no longer discernible.

6.4.2.10.3 Detection of cracks depends upon crack width, depth, total metal thickness, and angle of intersection. When only the intersection angle varies, it becomes a matter of statistics or probability. The probability of detecting a crack at various intersect angles is reflected (Table 6-11). This table indicates the probability of detecting a crack with an intersect angle of 9° is 75-percent. Conversely, the chances of missing a crack with a 9° intersect angle is 25-percent or 1 out of 4. When

T.O. 33B-1-1

developing X-ray procedures to detect cracks, the maximum angle of intersection is 5° , which corresponds to an 85-percent probability of detection. The preferred limit is $2\ 1/2^\circ$ corresponding to 90-percent detection probability.

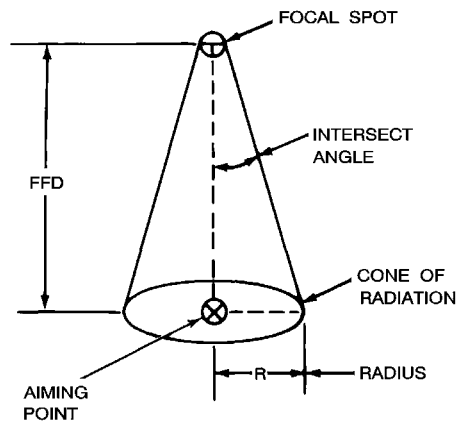
Table 6-11. Correlation Between Beam Divergence and Crack Detectability

Beam to Crack Angle (Degree)	Probability of Crack Detection (Percent)
0	96
3	89
6	82
9	75
15	48
21	30
27	23
45	4

6.4.2.10.4 An X-ray beam with a $2\ 1/2^\circ$ or 5° intersect angle, will not project over the surface of a 14-inch by 17-inch piece of film at normal focal-spot-to-film distances (FFDs). The entire film will be exposed, but only a small cone of radiation will be within the desired intersect angle limits. The radiation cone coverages at various intersect angles and FFDs is reflected in (Table 6-12). This table can be used to determine the necessary FFD when developing procedures. Example: A 12-inch long splice plate must be inspected for cracks. A 72-inch FFD is required (Table 6-11), to be within the 5° intersect angle limit, (6.3-inches on either side of the aiming point). Cracks occurring farther than 6.3-inches from the aiming point will produce indications with reduced film contrast and density change, meaning there is a greater chance of not detecting them. This emphasizes the need for information on probable crack location and orientation before developing an X-ray procedure. It also demonstrates the requirement for accurate tube head alignment during equipment setup.

Table 6-12. Radiation Cone Radii at Various Intersect Angles and FFDs

FFD	RADIUS of CONE (inches)				Intersect Angle
	$2\ 1/2^\circ$	5°	$7\ 1/2^\circ$	10°	
36"	1.57	3.15	4.74	6.35	
48"	2.10	4.2	6.32	8.46	
60"	2.62	5.25	7.9	10.58	
72"	3.14	6.3	9.48	12.7	
84"	3.67	7.35	11.06	14.8	



H0401893

6.4.2.11 Scatter Radiation. Whenever X-rays interact with material, one or more of the following will occur; absorption, scattering, or penetration. In industrial radiography, scatter radiation (paragraph 6.2.8) can present a problem since it has the ability to expose the X-ray film without contributing to image information. Exposure of the film from scatter radiation is referred to as fog, and substantially reduces image contrast. Scatter radiation can have three different sources; reflected scatter, back scatter, and forward scatter (Figure 6-28). Reflected scatter comes from the area around any objects that might be in the radiation beam (e.g., the part under test, tube head stand or a wall). Back scatter is scatter radiation, which comes from objects behind the film (e.g., the floor). Forward scatter is the third source of scatter radiation, and is caused by the test object itself. This scatter can obliterate an object's edges on the film, referred to as "undercutting." The amount of scatter radiation is affected by the radiation energy and the atomic number of the element causing the scatter. The lower the atomic number of a material, the greater the degree of scatter radiation. Materials with a high atomic number will cause less scatter.

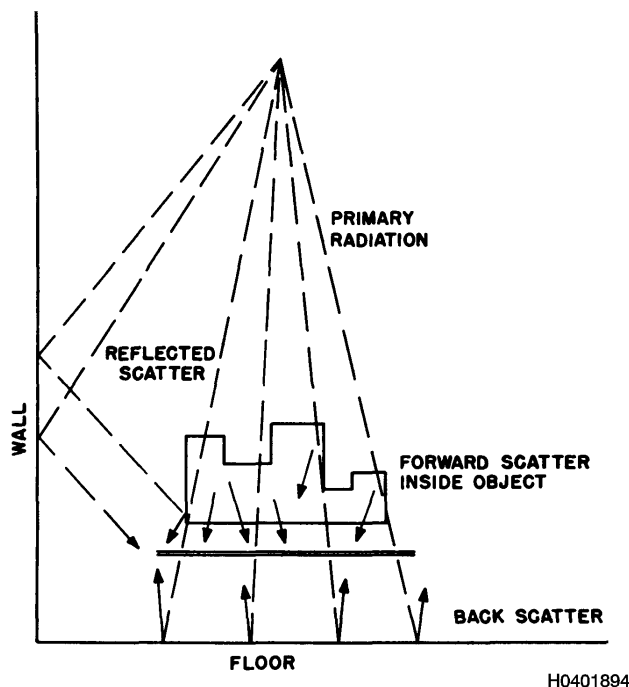


Figure 6-28. Sources of Scatter Radiation

6.4.2.11.1 Several techniques can be used to reduce scatter radiation. Radiographic cones or masks made of lead or other high absorbing materials will reduce the radiation area to only the area necessary for exposure. Lead in many different forms can be placed behind the X-ray film and test object to reduce excessive backscatter. Lead foil MAY be placed between the test object and the X-ray film to absorb some of the scatter radiation before the film is exposed. The lead foil acts as scatter filters since it permits the higher energy image forming radiation to be transmitted to the film, and at the same time absorbs the lower energy scattered radiation. A note of caution; filters in this position will reduce subject contrast. In some cases, the scatter problem can be of such a magnitude special techniques must be applied. Masking the part is often required because of large variations in part thickness, thus differences in absorption will lead to scatter from excessive amounts of radiation being transmitted through thin sections. Look at (Figure 6-29) to understand how a lead sheet could be used for masking. In this case, the object is a steel hub. Without the lead sheet (1/8 inch thick) definition would be poor due to internal scatter.

T.O. 33B-1-1

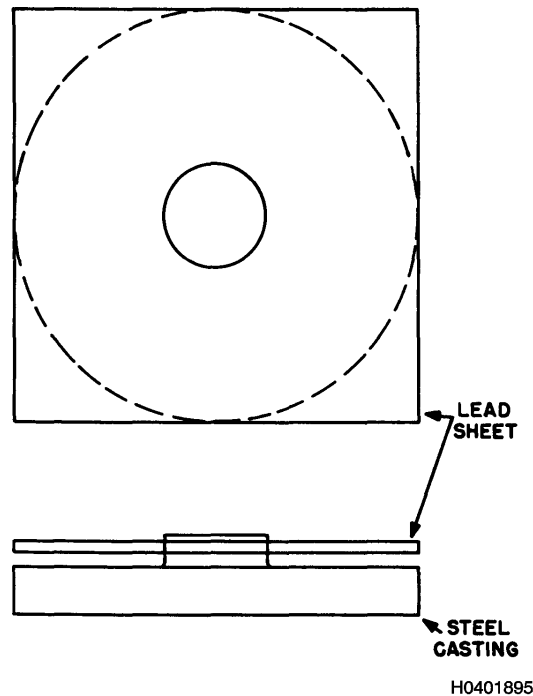


Figure 6-29. Masking to Avoid Scatter

6.4.2.11.2 Controlling scatter radiation requires common sense and ingenuity. A concrete, wood, or composition floor will generate enough back-scattered radiation to fog a film. Film holders **SHOULD** always be laid on, or backed with a sheet of 1/8-inch lead. The backing **SHOULD** be as large as possible to match the primary radiation field. This thickness of lead is enough for radiation generated up to 300 kVp, except when fluorescent screens are in use, in which case a 1/4-inch sheet **SHOULD** be used. The “Potter-Bucky Grid” is a device constructed to specifically absorb object-scatter-radiation. This grid is made somewhat like a Venetian blind; it consists of strips of material, comparatively transparent to radiation, and strips of lead. The strips of lead absorb object scatter radiation at angles other than the direct beam. To prevent the lead strips from being revealed in the image, the grid is moved during exposure so the image of the lead strips is actually distributed over the entire image, but will not show detail. These grids are usually used in industry for radiography of low atomic materials where scatter is a problem of considerable proportions, especially in the medical field.

6.4.2.12 Effects of Processing. Processing variables, especially development time, also affect density and film contrast through their effect upon the slope of the characteristic curve. Tests with a typical industrial film showed as development time was reduced, the effect was to produce a family of characteristic curves displaced to the right. This means, the log relative exposure needed to produce a standard density, increased as development time decreased. There were other effects too. Optimum development time maximized the slope of the characteristic curve (and thus film contrast) at only slight cost in fogging (Figure 6-30).

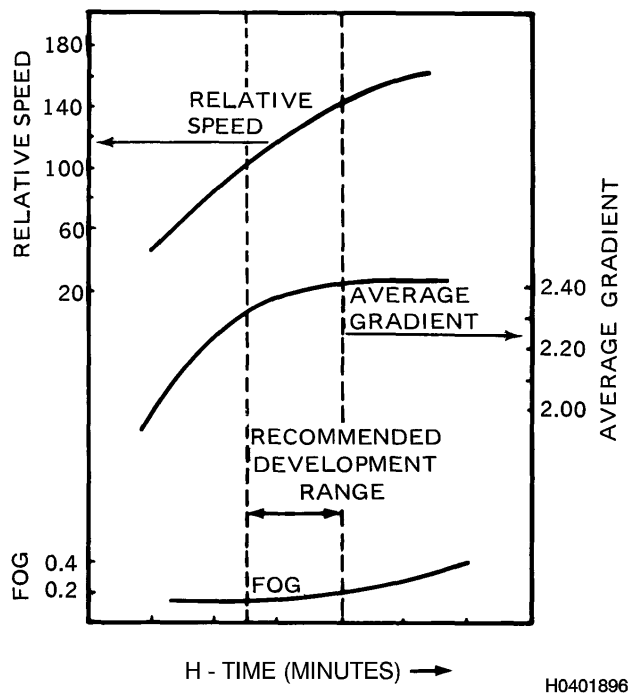


Figure 6-30. Effect of Development Time Upon Film Speed, Contrast, and Fogging

6.4.3 Radiographic Sensitivity. The following affects radiographic sensitivity:

6.4.3.1 Exposure Factor. The exposure factor is a quantity that combines milliamperage (X-ray) or source strength (gamma rays), with time and distance. Radiographic techniques are sometimes given in terms of kilovoltage and exposure factor, or radioactive isotope and exposure factor. In such cases, it is necessary to multiply the exposure factor by the square of the distance to be used to find, for example, the milliamperere-minutes or millicurie hours required.

6.4.3.2 Radiographic Contrast. Contrast in a radiograph is the difference in the resultant density, produced for a given change of X-ray or gamma ray absorption. It is affected by many factors, some of which must be compromised, thus, operator judgment becomes important. The choice of X-ray equipment is one of the most important considerations. The shorter the effective wavelength of X-rays, the greater the penetrating power. Also consider the higher the kilovoltage used, the shorter the effective wavelength of the generated radiation. As a result, the higher the x-ray tube voltage, the greater the penetrating power of X-rays generated. This is true for steel, with X-rays generated below 8 to 10 MeV, for aluminum, up to 20 to 22 MeV, and for lead, up to only 2 to 3 MeV (Table 6-13).

Table 6-13. Relative Absorption of Materials Material Kilovoltage Exposure

Material	Kilovoltage	Exposure Time	Thickness
Lead	200 kVp	1 min	1/16 inch
Copper	200 kVp	1 min	1/2 inch
Steel	200 kVp	1 min	3/4 inch
Titanium	200 kVp	1 min	1 inch
Aluminum	200 kVp	1 min	4 inches
Magnesium	200 kVp	1 min	5 inches

6.4.3.2.1 If the penetrating power of the radiation is great, each increment of thickness in the object will absorb less of the total than it would if the penetrating power of the radiation is lower. Conversely, if low kilovoltage is utilized, less of the total

T.O. 33B-1-1

radiation will be transmitted through the object. Each small change in absorption due to thickness of material will then cause a relatively large change in transmission, thus, the lower the voltage used, the greater the radiographic contrast. Therefore, kilovoltage **MAY** be lowered to perform an inspection, but **SHALL NOT** be increased above the level prescribed in the specific inspection instructions without approval from the responsible engineering authority.

6.4.3.3 Subject Contrast. Subject or object contrast **SHALL** also be considered by the radiographer. At X-ray voltages from 30 kVp to 5 MeV, aluminum has a lower absorption rate per unit thickness than steel. Therefore, it takes a greater thickness change of aluminum to cause the same given change you would notice with steel. Hence, aluminum has less object contrast than steel. The change in thickness versus the change in transmitted radiation is graphically shown ([Figure 6-31](#)). During the radiographic process, the differences in object contrast are, however, partially compensated for because lower energy radiation (longer wavelength), can be used to examine a given thickness of aluminum compared to the same thickness of steel, (e.g., a 1-percent thickness change, will produce sufficient density change on film to be visible when viewed on most metal subjects, but with magnesium and lighter metals, it is difficult to record 2-percent thickness change). Object contrast is a somewhat limiting factor in light metals and material with both low density and atomic number. The relations between X-ray absorption of steel, aluminum and magnesium are shown in ([Figure 6-32](#)).

NOTE

It is recommended on light materials, the radiographer **SHOULD** use lower kilovoltage, and consequently, longer exposure time than he would on heavier materials.

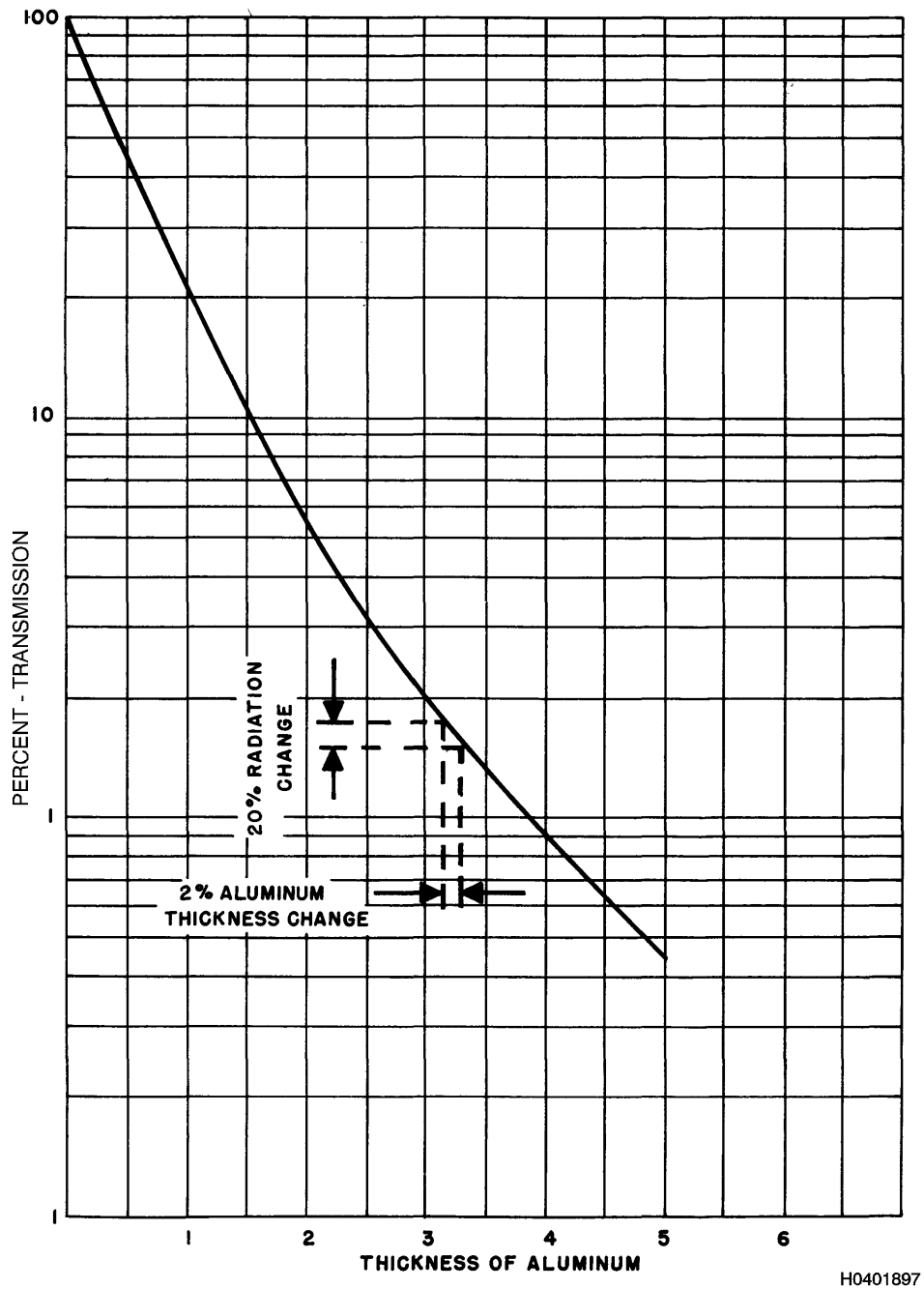
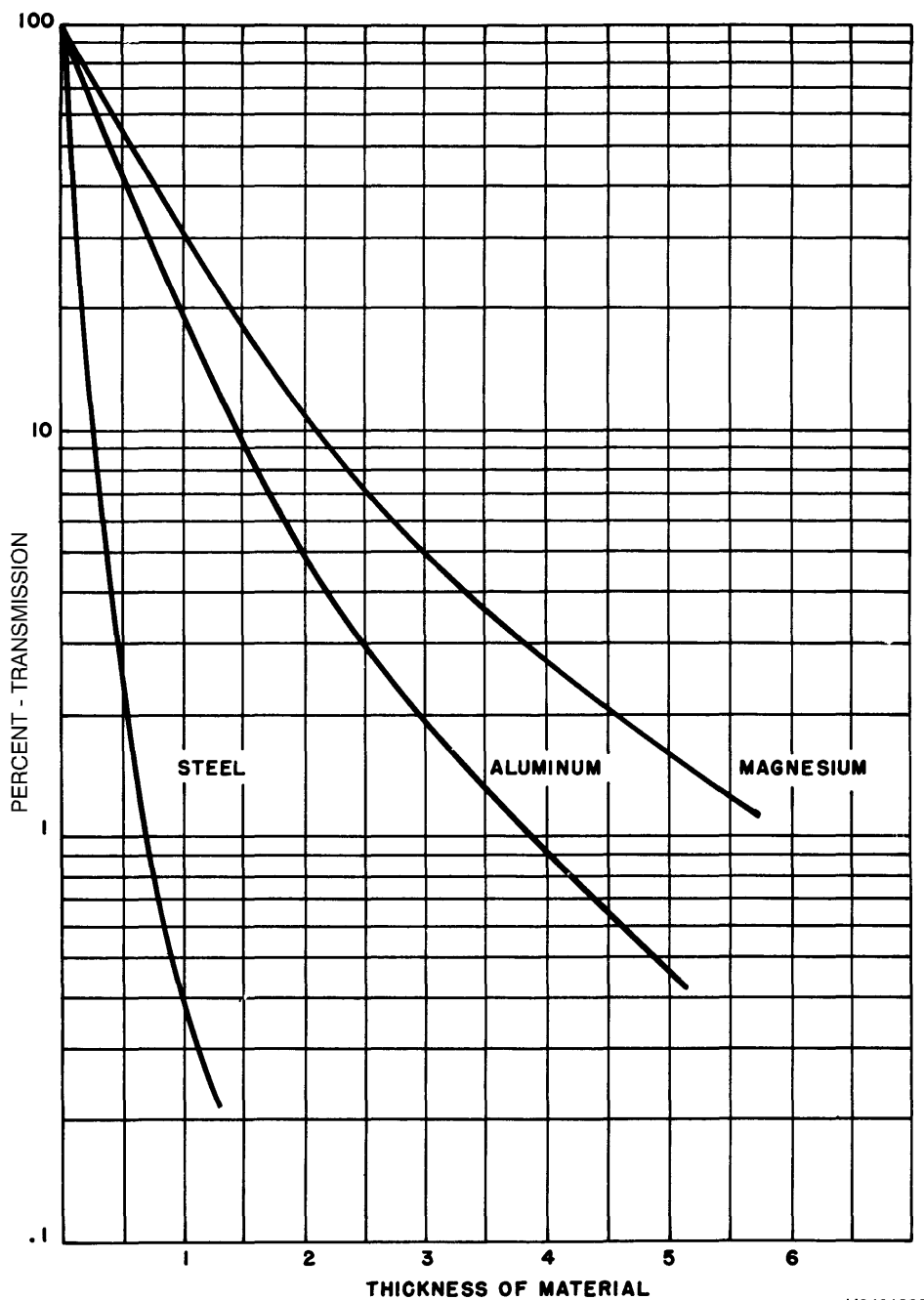


Figure 6-31. Radiation Transmission Versus Thickness of Aluminum at 150 kVp

T.O. 33B-1-1



H0401898

Figure 6-32. Radiation Transmission Versus Thickness for Various Densities at 150 kVp.

6.4.3.3.1 For materials of approximate uniform thickness, where the range of transmitted X-ray intensities is small, the technique producing high contrast will show all portions of the area of interest with an increased radiographic sensitivity; however, if the part radiographed transmits a wide range of X-ray intensities, a technique producing lower contrast will be necessary to record the detail in all portions of the radiograph, probably with some decrease in radiographic sensitivity. In cases where an extreme range of intensities is transmitted, high radiographic contrast MAY be obtained by double-loading the film holder with two high-contrast films of different speeds. The kilovoltage and exposure are so chosen that the thick portions of the object be satisfactorily recorded on the faster film and the thin portions on the slower film.

6.4.3.4 Film Contrast. Film of the no-screen type generally give higher contrast with or without lead screens than screen type films with or without lead screens. Screen type films with calcium tungstate screens, however, produce maximum contrast with sacrifice of detail due to the grain size of the screens. The contrast of a film can be seen from the slope of the characteristic curves.

6.4.3.5 Film Latitude. The film characteristic reverse of contrast is film latitude; the higher the film contrast, the smaller the film latitude; and the lower the film contrast, the greater the film latitude. Film latitude is the range of radiation intensities a film is capable of recording.

6.4.4 Improving Radiographic Sensitivity.

6.4.4.1 Using Quality Indicators. Earlier, we discussed the equipment (paragraph 6.3.7). Now we will discuss their use.

6.4.4.1.1 Contrast Sensitivity. The penetrameter material thickness is added to the thickness of the test object. This increase in thickness causes more radiation to be absorbed, and the penetrameter outline is seen on the final image as a less dense area. This change in film density due to the additional radiation absorption is a measure of the image contrast. The human eye is normally used as a detector in reading radiographic images, and the eye responds to differences in the quantity of light being transmitted through the film due to the density differences. It is assumed under practical industrial film inspection conditions, the human eye is capable of just detecting density differences of $LD = 0.02$, which corresponds to a light transmission difference of 4.72-percent. Since density differences of 0.02 are considered just barely discernible, good practice is to strive for a density difference of 0.08 to assure good visualization of discontinuities.

6.4.4.1.2 Detail Sensitivity.

CAUTION

Penetrameters SHALL always be removed from the specimen after inspection on aircraft.

Detail sensitivity of the radiographic image is revealed by the capability of visualizing the penetrameter holes. When the 2-percent penetrameter is used on the test object, it is usually required the 2T penetrameter hole is visible on the radiograph. If the 2T hole can be seen, the image is said to have 2-percent radiographic sensitivity. The film reader can then assume the capability of seeing any discontinuity that represents a 2-percent dimensional change of the object total thickness. The 1T hole, DOES NOT represent 1-percent image sensitivity because the thickness of the penetrameter has not been reduced to 1-percent of the test object thickness. Calculations reveal visualization of the 1T hole in a 2-percent penetrameter actually reveals 1.4-percent image sensitivity. Resolution of the holes in the penetrameter is a combined measure of image sharpness and contrast, and is thus a measure of the image quality, but note the regular and expected outline of the holes is more readily seen than a crack line. The penetrameter SHALL NOT be placed over an area of interest, since the penetrameter or the lead identification numbers could hide discontinuities. In some cases, the penetrameter cannot be placed on the actual test specimen. In these instances, it is acceptable to place the penetrameter on a separate block of the same material and of the same thickness as the specimen. Remember, when placing an IQI, the purpose of the penetrameter is to reveal image quality to the film reader, therefore, place it in the least disruptive position. Also remember, when placing the IQI, the density SHOULD NOT vary more than +30 or -15-percent from the area of interest. Plaque penetrameters suffer from a number of disadvantages, the most serious of which is the minimum thickness of 0.005 inches. ASTM E1742 provides additional information on the use of penetrameters. The preceding actions have shown effective radiographic inspection requires techniques that have optimum geometry, film choice, contrast, and density. Subsequent paragraphs explain how characteristic curves and technique charts can provide quantitative data to permit precise adjustments.

6.4.4.2 Screens. The radiation reaching the film may be, in part, caused by the use of intensifying screens to reduce the exposure time. The intensification factor for lead or calcium tungstate screens depends on the energy converted to either electrons or light to which the screen is sensitive. This factor varies with kilovoltage and type of film. The film SHALL be selected to achieve the highest efficiency of energy conversion from the screens used. The use of screens is covered more thoroughly in (paragraph 6.3.8.9).

6.4.4.3 Technique Charts. The characteristics of X-ray equipment SHALL be known to properly operate the unit and obtain maximum results. The utilization of X-ray equipment with the least amount of lost time requires a set of technique charts, which show the exposure times required for various thicknesses of material under stated conditions. These charts are generally available from the manufacturers of X-ray machines (Figure 6-33). Due to the differences between individual

T.O. 33B-1-1

equipment, it MAY be necessary or desirable to prepare additional technique charts for the specific purposes and conditions for which the equipment will be applied. If published technique charts are available, they can be used as a guide in preparing the detailed charts.

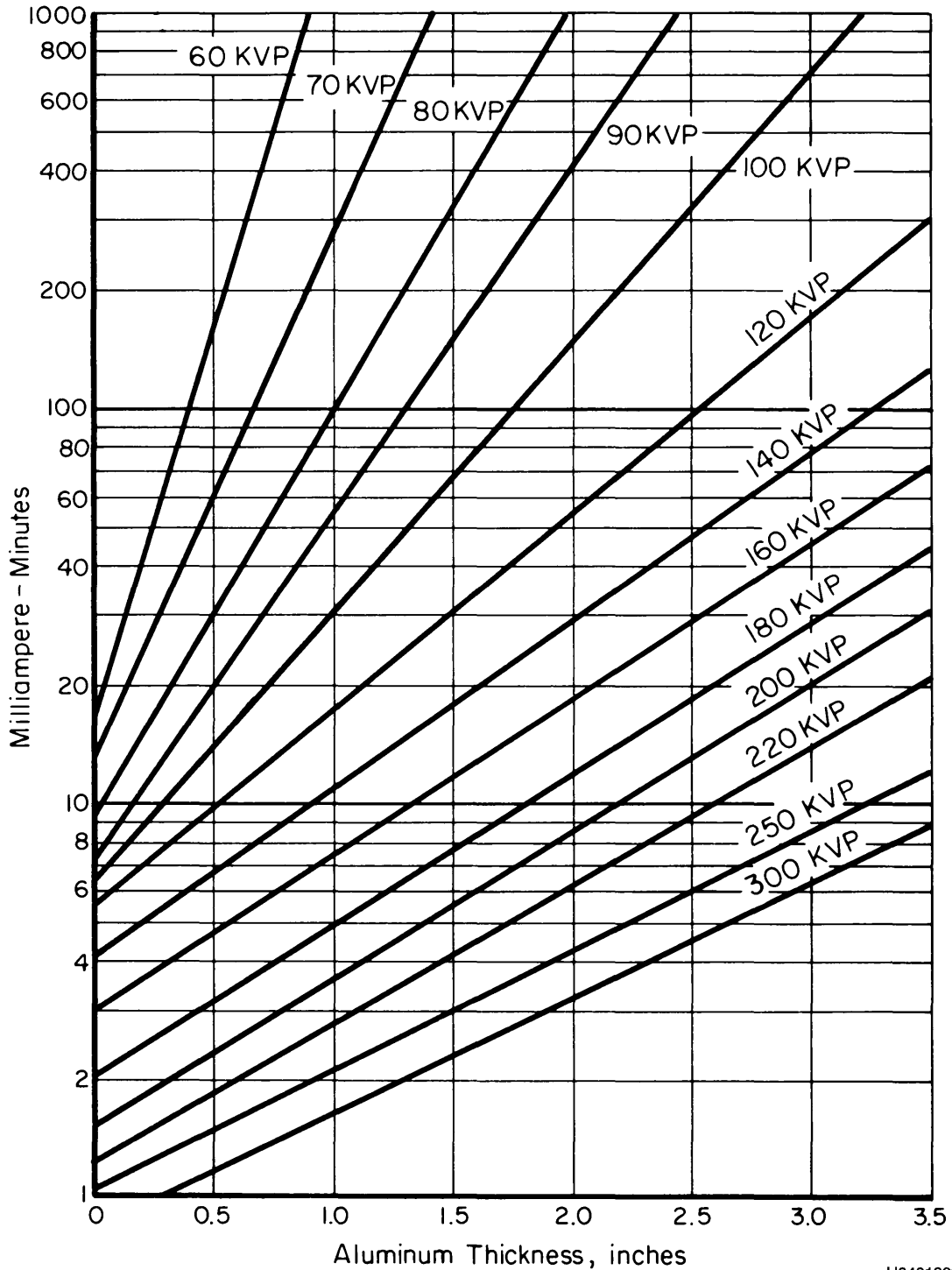


Figure 6-33. A Typical X-ray Exposure Technique Chart

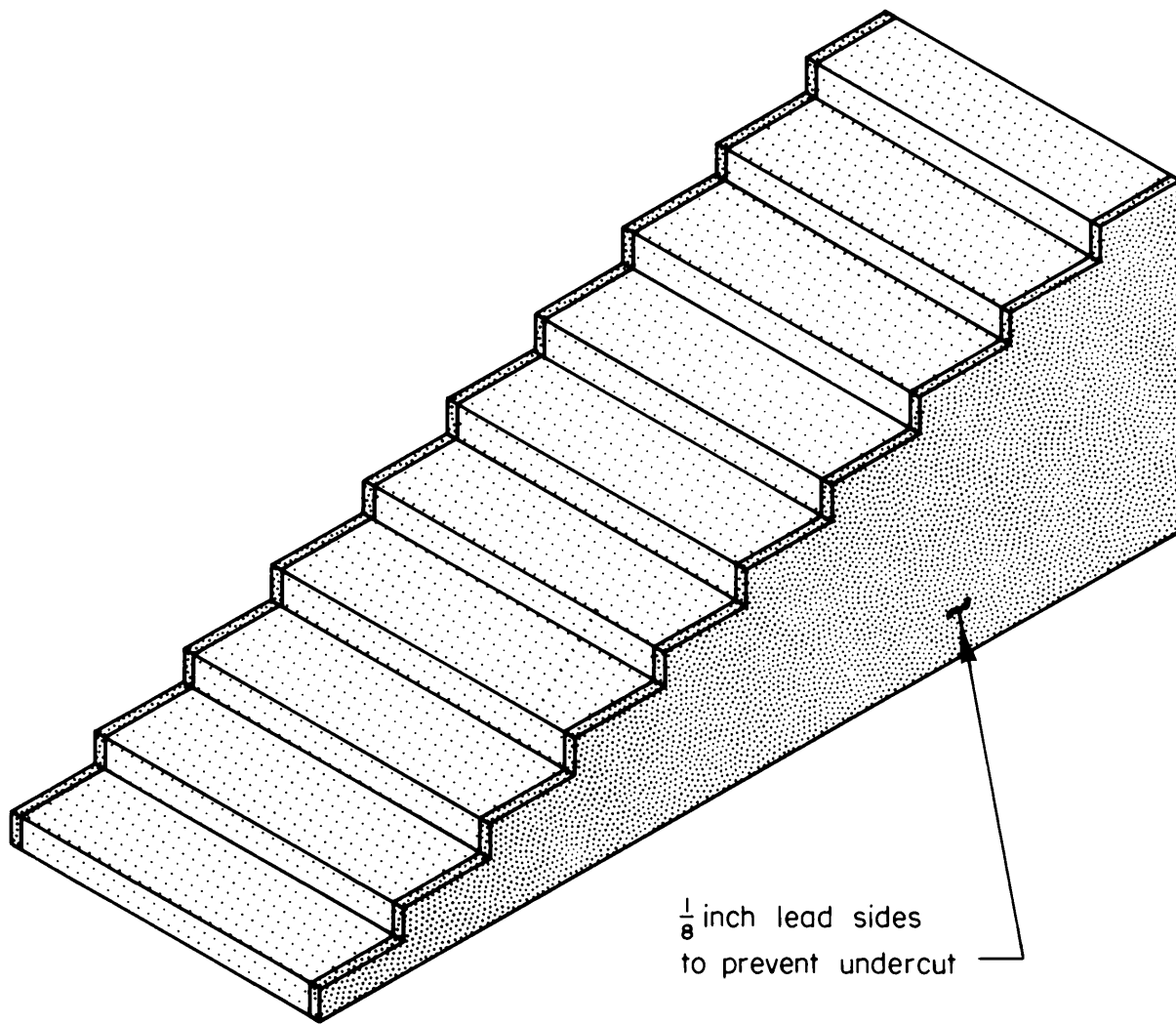
6.4.4.3.1 Identification of Technique Charts. The following items must be recorded to adequately identify technique charts:

- Type of unit.
- Material (type and thickness).
- Film type.
- Quality Enhancers (screens).
- Kilovoltage.
- Current and exposure time.
- Source-to-film distance.
- Film processing factors (temperature, method, etc.).
- Density of radiograph desired.

6.4.4.4 Step Wedge Radiographs. A step wedge MAY either be a solid block, or made up from plates of the same material used as the object being radiographed ([Figure 6-34](#)). A radiograph of the step wedge will give a symmetrical shadow picture of varying densities corresponding to the steps on the wedge. Make a series of radiographs of the step wedge at different exposures while keeping other radiographic factors constant (including subsequent processing). Preparation of the technique chart requires the following steps:

- a. Select an estimated exposure for the thinnest section of the step wedge, based on exposures for similar material in the middle of the voltage range, or a trial exposure on this material. In planning the exposures, pick out a series in an approximate geometrical progression. For example, a series of 120 MAS, 220 MAS, 320 MAS and so on might be chosen.
- b. Expose the step wedge under the conditions previously selected, at the times calculated for the mid-voltage point.
- c. Process the radiographs using fresh solutions, mixed according to manufacturer's directions.

T.O. 33B-1-1



H0401900

Figure 6-34. Sketch of Desirable Stepped Block for Radiation Measurements

6.4.4.5 Plotting the Data.

6.4.4.5.1 Constant Exposure Chart.

NOTE

The “Constant Exposure Chart” is used to plot data for a single kilovoltage setting. Additional curves for other kilovoltages can be made by repeating the procedure at any desired kilovoltage.

Make density measurements of each step on each of the radiographs with a densitometer and record this data in a table. The final table **SHOULD** show a density for each step thickness at each exposure. Now plot this data on semi-logarithmic graph paper with density and object thickness as the coordinates. This will give a set of curves, one for each exposure. This is a Constant-exposure chart and is only one type of technique chart.

6.4.4.5.2 Constant Density Chart. It is more common to plot technique charts in the form shown in (Figure 6-35). This is a constant-density chart for three different kilovoltages. To prepare this type of technique chart, it is necessary only to plot points taken from the graph prepared in (paragraph 6.4.4.3). Record and plot the points for each thickness at the intersection

of the selected density and exposure curves. This will result in a single curve on the constant density chart for one kilovoltage.

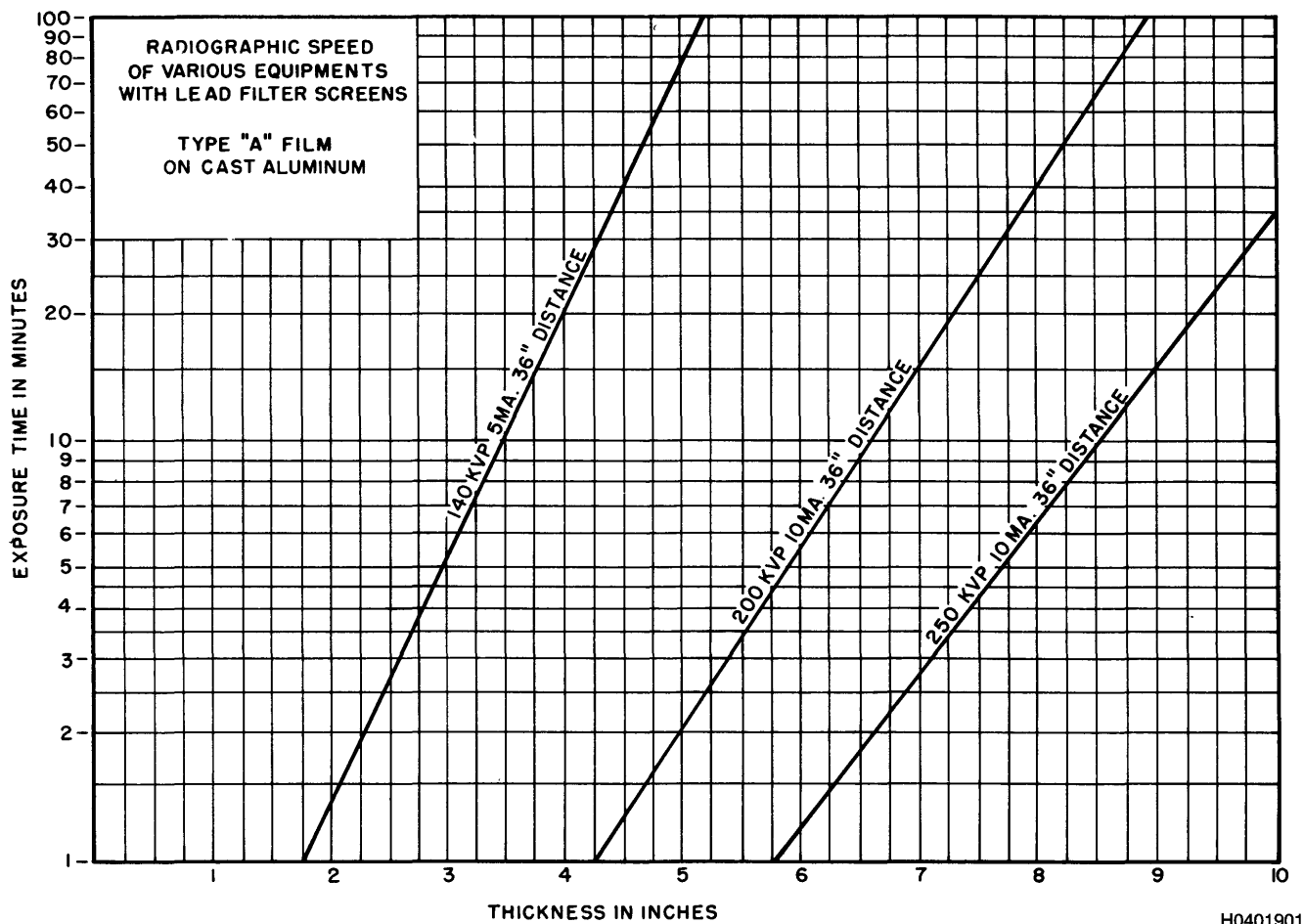


Figure 6-35. Typical Technique Constant-Density Chart

6.4.4.5.2.1 Constant-density charts MAY also be prepared directly from the radiographs if a set of constant exposure charts is not desired. To do this, proceed as follows:

- Select the exposure and thickness of the step wedge that will produce the desired density.
- Plot this exposure of time versus the thickness of material on a sheet of semi-logarithmic graph paper, and label this line with the kVp used for this series of exposures.
- Repeat the above procedure for a series of voltages through the voltage range of the equipment.

6.4.4.6 Logarithms (log). The use of logarithms is discussed further (paragraph 6.7.5).

6.4.4.6.1 Since logarithms are used a great deal in the interpretation of radiographs, a brief discussion of them is included here. A more detailed treatment will be found in (paragraph 6.7.5) and some handbooks and intermediate algebra texts. Before discussing logarithms, it will be necessary to define the term "power." The "power of a number" is the product obtained when it is multiplied by itself a given number of times, thus $10^3 = 10 \times 10 \times 10 = 1,000$ and $5^2 = 5 \times 5 = 25$. In the first example, 1,000 is the third power of 10; in the second, 25 is the second power of 5, or 5 raised to the second power. The figure 2 is known as the exponent. Fractional exponents are used to denote roots.

6.4.4.6.2 Negative exponents indicate reciprocals of powers, thus the base 10 logarithm of a number is the exponent, or the power to which ten must be raised to give the number in question. For example, the log of 100 is 2. The log of 316 = 2.50;

T.O. 33B-1-1

the log of 1,000 is 3. It is also said that 1,000 is the antilogarithm (antilog) of 3. Logarithms consist of two parts: a decimal, which is always positive, called the mantissa; and an integer, which MAY be positive or negative, called the characteristic. In the case of $\log 316 = 2.50$, "0.50 is the mantissa" and "2 is the characteristic." No matter what the location of the decimal point might be, the logarithms of all numbers having the same figures in the same order have the same mantissa. The characteristic of the logarithm is determined by the location of the decimal point in the number. If the number is greater than "1," the characteristic is positive, and its value is one less than the number of digits to the left of the decimal point. If the number is less than "1" (e.g., a decimal fraction), the characteristic is negative, and has a numerical value of one greater than the number of zeros between the decimal point and the first integer. Example, a negative characteristic of, 3, would be written 3...o indicate that only the characteristic is negative, or 7...-10. When a series of numbers increases by a constant factor (e.g., the series 20, 40, 80, 160, or the series 20, 200, 2000, 20,000), their logarithms have a constant difference, in these cases, 0.30 and 1.00 respectively. In other words, a constant increase in the logarithm of a number means a constant percentage increase in the number itself.

6.4.5 Darkroom Design. A dark room is required to process exposed film. Dark rooms provide a space to open exposed radiographs under safe conditions. Darkroom space SHOULD be determined by work volume, but in general, a high efficiency operation can be achieved when the space allows two to three persons to work together at the same time. The darkroom SHALL be completely protected against radiation and visible light. The walls of the darkroom SHALL be painted a light color which best reflects light from the safelight. A ventilator SHOULD be used to keep the air moving from the dry side to the wet side of the room and out. The darkroom SHOULD have an antechamber type entrance that makes an efficient light trap.

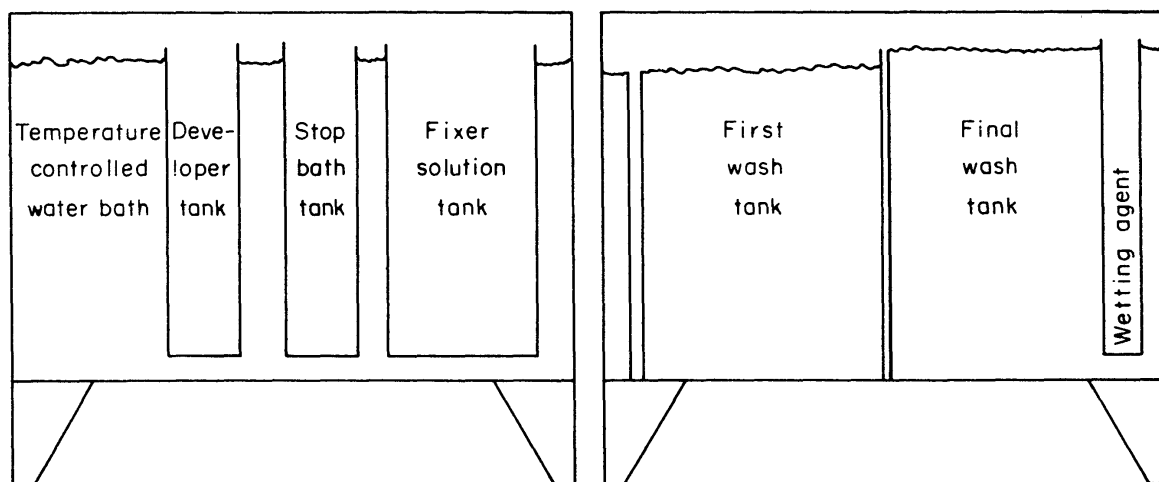
6.4.5.1 Preferably there SHOULD be a film loading darkroom and a processing darkroom. If film loading, unloading, and processing are to be carried out in the same darkroom, the wet area SHALL be in a position opposite the dry area. The following precautions SHALL be observed, when the darkroom area is large enough for loading darkroom and a processing darkroom.

6.4.5.1.1 Darkroom Loading (Dry Area). The loading darkroom is to be provided with film containers, cassette and film holder storage, and a loading bench. The loading darkroom SHALL always be kept clean, and free of water and chemicals.

6.4.5.1.2 Darkroom Processing (Wet Area). The processing tanks, washing tanks, hangar racks, and work benches SHALL be arranged to facilitate film processing. Since the air is readily contaminated in a hot and humid processing darkroom, forced ventilation SHALL be used. An air conditioner MAY also be necessary to keep the air dry.

6.4.5.1.2.1 A dark room, which is used for other types of film processing, MAY be used for processing radiographs unless the various activities interfere with each other.

6.4.5.1.3 Arrangement for Manual Processing. Suggested arrangement of manual processing tanks is shown in (Figure 6-36). The chemicals SHOULD be arranged as shown in the sketch in sequential steps of the process and traversing from left to right. This arrangement is used with the assumption most people are right-handed.



H0401903

Figure 6-36. Suggested Arrangement of Manual Film Processing Tank

6.4.5.1.3.1 Assuming a developing time of 5-minutes, a single 5-gallon tank will develop 30 films an hour. The stop bath tank **SHOULD** have a capacity equal to the developing tank. The capacity of the fixing bath tank **SHOULD** be double the developing tank. The wash tank **SHOULD** hold from 20 to 25 gallons. Install the wash tank so films are placed in the tank at the outlet end. If dark room volume requirements must be greater, use the above relationships to plan the additional facilities. The finish of the benches, walls, and floor adjacent to the tanks **SHOULD** be adequate to protect against the action of chemical solutions and water that might be spilled on them.

6.4.5.1.3.2 Film bins are desirable since they are light-tight and close automatically. The boxes of film can be stored here in perfect safety and are readily available. For the mixing of chemicals, enamel pails, several funnels and stirring rods must be provided. Where films must be dried rapidly, film drying cabinets are necessary. These dryers **SHOULD** have a filtered air intake, film racks, exhaust fan, and heating element. It is best to wire the fan and heating elements on the same circuit so the heating element cannot be turned on without the fan.

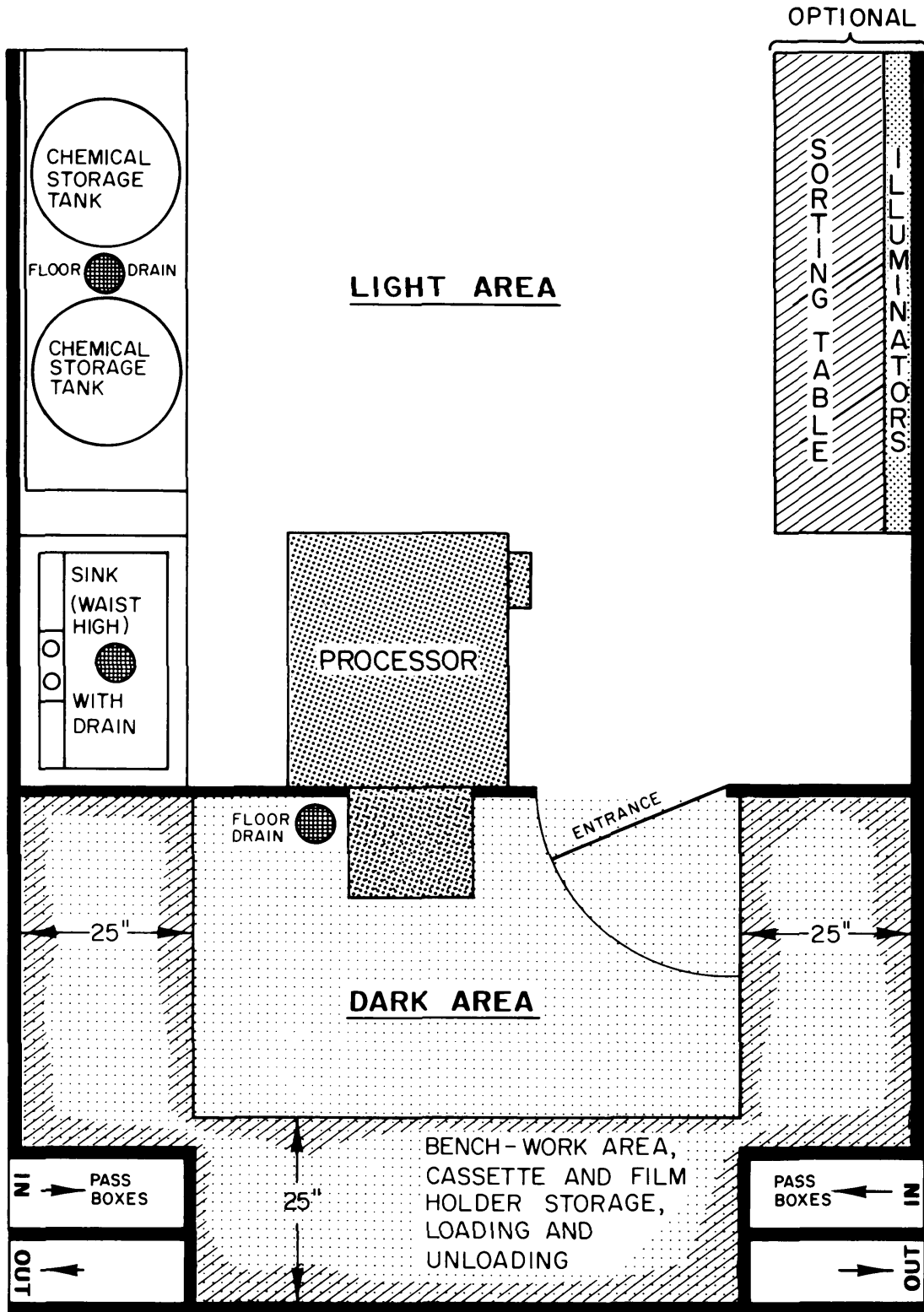
6.4.5.1.4 Arrangement for Automatic Processing.

CAUTION

There might be a time when film jams within the processor. In this situation, the processor lid **MAY** need to be removed, exposing any undeveloped film to light. Care **SHALL** be taken to prevent exposure to undeveloped film by working under safelight.

The general arrangement of a darkroom, where an automatic processor is used, is illustrated in [Figure 6-37](#). The loading end of the processor is located in the dry area of the darkroom and is under safelight illumination. The output end of the processor is generally located on the outside of the darkroom wall under ambient illumination. When processing film in the automatic processor, the film is unloaded from the cassette film holder as in manual processing. However, it is then immediately fed into the loading end of the processor. After processing is completed, the film exits the other end of the processor. At this point, the film is ready for interpretation and filing as required. Cleanliness in automatic processing is essential. Lint and other contaminants, if they are allowed to enter the processor, can cause many spots as they collect on rollers and affect subsequent films.

T.O. 33B-1-1



H0401904

Figure 6-37. Typical Arrangement of Through-the-Wall Automatic Processing Darkroom

6.4.5.2 Safelight.

CAUTION

Keep exposed film a minimum of 1-meter away from the direct light of the safelight; exposed films are more sensitive to illumination from safelights than are unexposed films. Screen-type films are more sensitive to fogging than non-screen film. In addition, emulsions are less sensitive when wet, so they can be exposed to safelights for longer periods after immersion in the developing solution.

Light having spectral qualities outside the region in which sensitive materials are affected is to be used for safelight illumination. A safelight filter, colored dark reddish orange or equivalent is recommended for use in the darkroom. Industrial X-ray films SHALL be handled at a distance of at least 4 feet from a safelight. The safelight MAY be turned on under normal conditions for 10 to 15-minutes without any detrimental effect on X-ray film. Safelights require process control which is located in (paragraph 6.6.3.3).

6.4.5.3 Processing Tanks. Processing solutions are either alkaline or acidic, therefore, the processing tanks must be alkali or acid resistant. Suitable materials include: stainless steel, plastics, and enamelware.

6.4.5.3.1 Plastics have such low thermal conductivity, that plastic containers are suitable for keeping processing solutions warm, but the contents of such containers cannot be rapidly heated or cooled from the outside. Stainless steel which provides adequate protection against corrosion and provides easy temperature control is widely used.

6.4.5.4 Dark Room Cleanliness.

NOTE

If spilled chemicals settle on film and evaporate, they may cause spotting.

Due to the sensitivity of X-ray film, cleanliness is very important. Work areas and any accessories (e.g., film hangers, funnels, stirring rods, and thermometer) SHALL be washed thoroughly after use to avoid contaminating film. Processing tanks SHALL be scrubbed clean before filling with fresh solution. It is advisable to sterilize the tanks periodically with a 5-percent solution of sodium hypochlorite (bleach). Allow the sterilizing solution to remain in the tank overnight and then drain and rinse thoroughly. If any solution is spilled, wipe it up immediately.

6.4.6 Radiographic Film.

6.4.6.1 Film Comparisons. Manufacturer's literature generally provides speed, contrast, and processing data pertinent only to the films and chemicals they produce. Presentation of the data differs greatly from one manufacturer to another, as do their methods for developing this data. Historically, when faced with the necessity to substitute one manufacturer's film with another manufacturer's film, the radiographer would compare manufacturer's literature and then perform trial exposures with the new film. Using the first radiograph as a basis, the radiographer would modify the exposure parameters and try again. Often this procedure would have to be repeated several times, depending on the experience of the radiographer, and difficulty of subject, before an acceptable radiograph was produced. We even find the process used by manufacturers to make the film, varies, to such an extent that the different film emulsions will have different effects on different processing techniques and chemicals. This iterative process involves considerable expenditure of time and significant cost in supplies. When evaluating a new film, the radiographer SHOULD contact the responsible engineering authority for that weapon system and request current information on how each manufacturer's film works for that specific application.

6.4.6.2 Care of Radiographs. The final radiograph represents a considerable investment of time and money; great care SHOULD be taken to preserve the final image. Unexposed X-ray films are highly sensitive to, and adversely affected by, chemicals, heat, moisture, mechanical pressure, visible light, and radiation such as X- and gamma rays. Utmost care therefore SHOULD be taken in the handling of such films and in the selection of storage locations.

6.4.6.3 Handling of Radiographs. The radiographs SHOULD NOT be handled with bare hands, and always handle the film at the extreme edges. The emulsion layer is scratched when strongly rubbed, so black streaks appear in the processed radiograph. A low density shadow, looking like a crescent mark or "flare," is seen in the radiograph when the film is folded or flexed. Generally, the crease made in a film before exposure has a lower density than one made after exposure. Mechanical

T.O. 33B-1-1

pressure also influences the film likewise. The film SHOULD NOT be crimped or sharply bent. Soft, white, cotton gloves SHOULD be used to handle all radiographs between the time they are processed and the time they are disposed of. Thin, soft, cotton gloves SHOULD be worn to avoid marks resulting from contact with fingers contaminated with body oil, lotion, or processing chemicals. The use of gloves made of synthetic fibers or gloves of synthetic fibers blended with cotton SHOULD be avoided, since they could cause static marks. Foreign substances such as water, coffee, or other materials SHOULD NOT be allowed to contact the emulsion surfaces. The films SHOULD always be picked up carefully, never sliding them across surfaces that could be dirty or have some gritty substances that can introduce scratches on the emulsion surfaces. If the film is interleaved the interleaving paper SHOULD be left on the film when it is placed on the work bench before exposure, as it protects the film from dirt, iron powder, moisture, chemicals, and other undesirable matter. When attempting to interpret high-density film areas with high-intensity illuminators, care SHOULD be used to prevent overheating of the radiograph. White cotton gloves can be ordered through the supply system.

6.4.6.3.1 Good uniform contact between the screens and the film is very important. If they are in poor contact, the image sharpness will be adversely affected. Particular care SHOULD be used to obtain good contact between the screens and the film, when the cassettes are of the flexible type. When removing the film from a film holder, remove the film by opening the screens, therefore, avoiding friction between screens and film.

6.4.7 Film Handling Problems.**6.4.7.1 Problems Associated with Storage.****6.4.7.1.1 Fogging from Light.**Phenomenon:

The radiograph is fogged in the same pattern as the interleaving paper texture.

Problem Cause:

The film has been exposed to light while yet covered with interleaving paper.

Corrective Action:

1. Check the darkroom for light leaks.
2. Check the X-ray film storage box for light leaks.
3. Before turning on the normal room lights, make it a rule to ensure no film is on the work bench.
4. Be sure to seal the X-ray film case after use.

6.4.7.1.2 Fogging from Radiation.Phenomenon:

The shadow of an unexpected object or the head foil as embedded in the X-ray film case appears in the radiograph.

Problem Cause:

The film has been exposed to X- or gamma rays during storage.

Corrective Action:

Keep X-ray films in a lead foil coated X-ray film storage box and store in a radiation free environment.

6.4.7.2 Problems Associated with the Safelight.**6.4.7.2.1 Fogging from Safelight.**Phenomenon:

The radiograph has a fog on one side or shows letter form shadows.

Problem Cause:

1. White light is leaking from a slit in the safelight box.
2. The film has been allowed to stand under safelight illumination for too long a time or placed too near the safelight.
3. A lamp having a higher capacity than standard rating is used as the safelight source.

Corrective Action:

1. Check the safelight filter periodically (every six months to once a year) and replace it if faded.
2. Observe safelight requirements, such as the prescribed lamp wattage and safelight-to-film distance, and complete work under safelight illumination as quickly as possible.
3. Periodically check to ensure the safelight is functioning under normal prescribed conditions.

6.4.7.3 Problems Associated with Handling Before Development.**6.4.7.3.1 Dirt Deposits or Stains on the Screen.**Phenomenon:

The radiograph has irregular shaped light spots.

Problem Cause:

There are dirt deposits or stains on the intensifying screens.

Corrective Action:

1. Keep the surfaces of intensifying screens clean and dry at all times.
2. Wipe the surfaces of intensifying screens with cleaner from time-to-time.

6.4.7.3.2 Spots on the Radiograph.Phenomenon 1:

The radiograph has dark spots of a relatively low density.

Problem Cause:

Water was splattered on the film.

Phenomenon 2:

The radiograph has dark spots of high density

Problem Cause:

Developer solution was splattered on the film.

Phenomenon 3:

The radiograph has light and dark spots of a relatively low density.

Problem Cause:

Stop bath solution was splattered on the film.

Phenomenon 4:

The radiograph has light spots which are barely developed.

Problem Cause:

Fixer solution was splattered on the film.

T.O. 33B-1-1

Corrective Action:

Handle the films at such a distance from the processing area that water and processing solutions cannot affect them.

6.4.7.4 Problems Associated with Loading and Unloading.

6.4.7.4.1 Film Adhesion.

Phenomenon:

The radiograph has irregular shaped spot-like marks.

Problem Cause:

The film loaded in the cassette adhered to the intensifying screen.

Corrective Action:

1. Do not leave film in a cassette for a long period of time during hot, wet seasons or in a hot place.
2. When the cassette is wet, leave it to dry in the shade choosing a place where there is a good draft.

6.4.7.4.2 Static Marks.

Phenomenon:

The radiograph has tree-like or branching marks.

Problem Cause:

Static marks result from the contact, peeling, or friction of foreign matter caused by static electricity. They are apt to occur when the air is dry.

Corrective Action:

1. Keep the darkroom air at the proper humidity levels (60 to 70-percent RH).
2. Any materials of rubber or synthetic fibers, which are easily charged with static electricity, SHOULD not be used near the film.
3. Handle the film gently.
4. Ground the darkroom workbench.

6.4.7.4.3 Kink Marks.

Phenomenon:

The radiograph has light or dark marks which are crescent shaped or irregular.

Problem Cause:

The film was broken locally or sharply bent during handling. Dark marks appear when the film is sharply bent before exposure while sharp bending of an exposed area may become the cause of light marks.

Corrective Action:

1. Carefully hold the edge of the film and avoid bending it.

6.4.7.5 Problems Associated with Post-Development Processing.

6.4.7.5.1 Uneven Fixing.

Phenomenon:

The radiograph has light, irregular shaped marks, or streaks.

Problem Cause:

Fixing proceeded locally.

Corrective Action:

1. Agitate the film in the fixer solution at frequent intervals, especially in the early course of fixing.
2. Replace the fixer solution with a fresh one before it is exhausted beyond use.

6.4.7.5.2 Uneven Drying.Phenomenon:

The radiograph has light, blurred lines, or irregular shaped marks of film surface luster.

Problem Cause:

Draining was incomplete and uneven so the drying speed differed from one area to the other.

Corrective Action:

1. Use a wetting agent to drain the film evenly.
2. When hot air is used, gradually heat the air that is blown over the film.

6.4.8 Preparation for Manual Processing.

- a. To place the film on the film hanger, grasp one upper corner between the thumb and index finger and fasten it to the hanger with one of the bottom hanger clips.
- b. Fasten the other bottom clip and finally the two top clips.
- c. The film **SHOULD** be flat and taut with the punched number (if any) at the bottom of the hanger to prevent streaking due to developer flow through the holes when processing. If it is not, repeat the procedure.

6.4.9 Storage of Radiographs. Industrial film **SHOULD NOT** be stored near a radiation source. Precautions **SHALL** be taken to ensure unexposed radiographic film is protected from exposure to radiation by storing film in a lead lined container or in a room removed from x-ray operations. If an exposure is suspected, perform a fog test on a sample film processed with all safelights off. Background density shall not exceed 0.30 density units total. If the film fails the fog test it **SHALL** be used for training or clearing only.

6.4.9.1 Industrial X-ray films are quite sensitive to heat and moisture, therefore, a cool dry place **SHOULD** be chosen for storage. Storage temperatures **SHOULD** be maintained in the 40 to 75°F (5 to 23°C) range. Once film is removed from the envelope, the emulsion will absorb moisture until it attains equilibrium with the moisture content of the surrounding air. On the other hand, excessive dryness is not suitable to the storage of industrial X-ray films, because in such locations films might change with static electricity, resulting in plus-density marks on the radiographs. When X-ray film is not allowed to stabilize at room temperature moisture may condense on the film when it is removed from its protective envelope.

6.4.9.2 Industrial X-ray films could develop fog when exposed to polished metal surfaces, painted surfaces, hydrogen peroxide, coal gas, hydrogen sulfide, ammonia gas, mercury vapor, formalin, engine exhaust gases, acetylene, and terpene. Provisions **SHALL** be made to prevent this kind of fog, which is referred to as a false sensitometric effect

6.4.9.3 The final radiographs **SHOULD** be placed in film filing envelopes for final storage. These envelopes are constructed of heavy paper to protect the films. The envelope **SHOULD** be identified as to the radiographs it contains and filed in a systematic manner to facilitate retrieval if and when necessary. Envelopes **SHOULD** be marked prior to insertion of the film to prevent pressure marks. Films **SHOULD NOT** be stored in high humidity areas. Film filing cabinets are available for film storage. Ordinary filing cabinets are not sufficiently strong to withstand the heavy loads of filed film. X-ray films present no greater fire hazard in storage than an equal quantity of paper records. There is no necessity for expensive vaults equipped with elaborate fire protection devices. The storage area must be kept clean.

6.4.9.4 The disposition for industrial radiographs is referenced in AFMAN 37-123, AFI 37-138, and WebRIMS at “<http://webrims.amc.af.mil>.” Specific inspection instructions and TO 00-20-1 **SHALL** be consulted to determine which

T.O. 33B-1-1

inspection radiographs SHALL become part of official aircraft/support equipment records. All radiographs SHALL be disposed of according to AFMAN 23-110.

6.4.10 Processing Chemicals.**CAUTION**

Manufacturers material data sheet SHALL always be followed when using their chemicals.

Liquid and powdered chemistry in concentrate form are available for manual and automatic processing. When mixed with appropriate quantities of water, these solutions are then ready for the processing sequence of industrial X-ray films.

6.4.10.1 Chemicals for Manual Processing.

6.4.10.1.1 Developer. When radiographic film is exposed to ionizing radiation, an invisible image (called a latent image) is formed in the emulsion layer of the film. The process of converting the latent image to a visible image is called development, and a developer solution is used in this process.

6.4.10.1.1.1 Developer Composition. Chemically, “development” refers to the reducing action of a chemical. It is necessary to reduce only the silver compound deposited in the latent image of exposed film during exposure to metallic silver to form a visible image. The chemical which is chosen to reduce the exposed silver compound to metallic silver is called a developing agent. The developing agent is not used alone, but in combination with other ingredients which perform special functions. They include the accelerator which activates the developing agent, the preservative which reduces the aerial oxidation of the developer, the restrainer which prevents development fog by restraining the action of the developer on the unexposed silver compound, and other additives used to harden the gelatin and soften the water among other things.

6.4.10.1.1.2 Many developers are kept alkaline by the accelerator. The more alkaline the developer or the greater the quantity of accelerator added to the developer, the stronger the action of the developer. The developer for X-ray film contains more ingredients than the developers for conventional black-and-white films, because a larger quantity of silver halide is used in X-ray film.

6.4.10.1.1.2 Stop Bath. The silver image becomes too dense to serve the intended purpose unless the action of the developer is stopped at a proper time. If, in the case of manual processing, the film is directly transferred from the developer to the fixer, uneven fixation could occur. To stop the action of the developer and prevent uneven fixation, a 3-percent solution of acetic acid is used. If the stop bath is not used, the developer carried over with the film not only increases the exhaustion of the fixer, but it might cause reduced processing uniformity or stain formation in the radiograph.

6.4.10.1.1.3 Fixer. After development and stop bath neutralization, the emulsion still contains unreduced non-image forming silver halide, which is detrimental, especially to the radiograph as viewed by transmitted light. The fixer is used to remove the unreduced silver halide.

6.4.10.1.3.1 The most common fixing baths are solutions of sodium thiosulfate. Ammonium thiosulfate is also used when quick fixation is required. These chemicals possess activity that converts silver halides to soluble compounds. The emulsion which is softened by the developer is hardened by the fixer. Almost all fixers in use today are of this acid hardening type.

6.4.10.1.4 Wash Accelerator or Quick Washing Agent. Film removed from the fixing bath retains not only the fixer ingredients, but also other compounds that were formed in dissolving the silver halides. To remove these, the film is washed in running water for 20-minutes or more. Some manufacturers offer an agent to reduce the washing time to one-third or one-fifth the time required without its use.

6.4.10.1.5 Wetting Agent. After the wash step, water adheres to the film in streaks and drops. If the film is dried in this condition, not only will the drying time be extended, but water marks will be left on the surface of the radiograph.

6.4.10.1.6 Other Processing Chemicals. In addition to the chemicals discussed above, certain chemicals MAY also be used on finished radiographs to alter densities. When the density of the silver image is too high, a chemical solution called a reducer is used to reduce it. When the density of the silver is too low, a chemical called an intensifier is used to increase it.

6.4.10.2 Chemicals for Automatic Processing.

CAUTION

Medical automatic processing chemicals are formulated to function at high temperatures, but are not capable of producing acceptable industrial radiographic results. Only development chemicals formulated to be used to develop industrial radiographic film SHALL be used in industrial radiographic film processors.

The composition of chemicals formulated for use in automatic processors differs somewhat from chemicals used in hand processing. The most pronounced difference is automatic processing chemicals protect the film against mechanical pressure and roller stains. The developing solution contains a hardener, in addition to its constituents, to inhibit excessive softening of the emulsion. Softening of the emulsion interferes with the transport of the film through the processor. Automatic processing chemicals are specially designed for use at high temperatures. Chemicals for use in automatic processor are supplied in concentrated liquid form, and a starter system is adopted for ease of use.

6.4.10.2.1 Automatic Processing Chemical Requirements. Let us now go over the major requirements, which automatic processor chemicals must meet.

6.4.10.2.1.1 Rapid Reaction and Activity Recovery. In automatic processing, development and fixing must each be completed within the time frame of 1 to 2.5 minutes. To give constant results, processing solutions must provide for quick recovery of working strength, when replenished at rates proportional to the quantity of film processed.

6.4.10.2.1.2 Suitability for High Temperature Processing. As processing solutions are maintained at high temperatures, they must be formulated so performance will not be adversely affected by elevated temperatures.

6.4.10.2.1.3 Extended Performance Maintenance. Processing solutions are generally used in automatic processors over a long period of time without being replaced. Throughout this period, the processing solutions must show constant performance, without harming the tanks, racks, and films.

6.4.10.2.2 Automatic Processing Developer. In the roller transport type automatic processors for industrial X-ray films, processing solutions are used at higher temperatures (e.g., 86°F or (30°C)) than in manual processing in order to speed the process. Many transport rollers are used to squeegee the film and remove the exhausted solutions from the surfaces. Developers used in automatic processors are specifically formulated to be suitable for processing at high temperatures and include special chemicals which adjust the contrast and fog. A hardener is included to harden the emulsion, thus, providing sufficient resistance to the forced roller squeegee effect.

6.4.10.2.3 Automatic Processing Fixer. The fixer used in roller transport type automatic processors is especially formulated to produce a greater emulsion-hardening effect than with the fixer used in manual processing. Developer tank transport rollers reduce the amount of developer carryover to the fixer. This extends the life of the fixer, although the primary function of the rollers is to move the film through the processor.

6.4.10.2.4 Chemicals NOT Required in Automatic Processing.

6.4.10.2.4.1 Stop Bath – The stop bath is not used in roller transport type automatic processors, because the rollers adequately remove developer solution from the surfaces of the film. This prolongs the life of the fixer to a far greater extent than in manual processing.

6.4.10.2.4.2 Wash Accelerator – In roller transport type automatic processors, the fixer tank rollers efficiently remove fixer from the film surfaces and wash tank rollers provide for continual turnover of fresh water on the film surface; therefore, the necessity of a wash accelerator is not required.

6.4.10.2.4.3 Wetting Agent – In roller transport type automatic processors the rollers effectively remove the wash water clinging to the surfaces of the film so a wetting agent is not needed.

6.4.10.3 Mixing Radiographic Chemicals. All mixing vessels SHALL be made of either polypropylene, enamelware, stainless steel, glass, hard rubber, or glazed earthenware. Metal containers such as aluminum, iron, and zinc will contaminate the solutions and result in fogging on the developed radiograph and therefore, SHALL NOT be used. Chemicals SHALL be mixed thoroughly in accordance with the manufacturer's instructions.

T.O. 33B-1-1

6.4.11 Processing Radiographic Film. This section will deal with manual processing first and automatic processing second.

6.4.11.1 Manual Film Processing.

6.4.11.1.1 Developer.

6.4.11.1.1.1 Developer Solution.

CAUTION

Developer solution SHALL NOT be allowed to drain back into the developer solution tank. The developer solution that is draining becomes oxidized and reduces the useful life of the working bath.

Manufacturers make developers in standard powder and liquid forms. These developers commonly use three reducing agents, metol, phenodone, and hydroquinone. A combination of these ingredients produces all of the steps of grays and jet black, bringing out the best possible results.

6.4.11.1.1.1.1 Metol or phenodone and hydroquinone will not develop when used alone. To produce any density on the film also requires an alkaline solution. The alkali in effect “opens the door” and permits the developing agents to enter the pores of the emulsion. The speed with which the “door opens” is determined by the amount and potency of the alkali. If too much alkali is present, the developer will tend to produce chemical fog. But, if too little is used, developing will be retarded. Within these limits, the stronger the alkali, the more rapidly development will be completed. Some of the alkalis used in developing solutions are sodium hydroxide, potassium hydroxide, sodium carbonate, potassium carbonate, and borax.

6.4.11.1.1.1.2 Developing solutions containing only the developing agents and alkali would rapidly be exhausted by oxidation from the air. The life of all developing agents is limited by: 1) the reduction of silver bromide to metallic silver, and 2) the amount of oxygen absorbed by the developing agents from the air. There is, however, a chemical whose inclusion in developing solutions extends its useful life. This chemical, sodium sulfite, along with oxygen, have a natural attraction for each other. The affinity is so great when added to a developing solution, sodium sulfite actually prevents oxidation by air of the other components for limited periods of time. To assist in reducing oxidation of developing and fixing solutions the following SHALL apply:

- Use a replenishment tank with a floating lid, which matches the general configuration of the container. The floating lid SHALL be manufactured from a material that will not react with the processing chemistry. It SHOULD also have a specific gravity less than the chemistry so it will float naturally. One material that has these characteristics is “polypropylene.” The floating lid SHALL be used in conjunction with the dust cover lid that fits over the top opening of the container.
- Only enough chemical that WILL be consumed within a one-week period SHALL be mixed.
- Developing solutions which are not mixed for use or replenishment SHOULD be maintained in their sealed, original manufacturer’s containers.
- Developing solutions SHALL NOT be used two-years past the date of their manufacture.

6.4.11.1.1.1.3 As stated earlier, all developing agents have a tendency to deposit silver in the unexposed parts of the film emulsion after a certain period of time. This tendency may be retarded or restrained if bromide is added to the solution, in-other-words, this may slow development. The proportion of bromide in an X-ray developer SHOULD be just enough to prevent chemical fog without materially reducing the activity of the solution. Remember, bromide is removed from the film emulsion during development; therefore, since bromide is a restrainer, it SHOULD be evident as each piece of film is developed, more restrainer is being added to the solution. Additionally, developing agents gradually lose potency as they age and/or are used. Consequently, as each piece of film is processed, developing time for the next film must be theoretically increased. The most important characteristic of any developing formula is its ability to produce and reproduce a certain degree of film blackening for a particular quantity of absorbed X-ray energy. Consistency and stability can only be secured by maintaining constant developer activity. To achieve the stability required, the developing solution SHALL be tested and replenished per process control requirements and manufacturer’s instructions.

NOTE

Whenever process control requirements and manufacturer's instructions are in conflict, the process control requirements within this technical manual SHALL take precedence.

6.4.11.1.1.2 Developer Temperature.**NOTE**

For consistent results, the various parameters of development must be kept constant.

The image density and contrast of a radiograph are influenced by development temperature and time. It is necessary to keep the developer at a specified temperature (normally 68°F/(20°C) for manual processing) and carry out development during a specified time. When the temperature of the developer is higher than normal, the sensitivity, resolution, and contrast of the developed film will be reduced similar to the results obtained by extending the development time, and vice versa. With the reduction of these preferred qualities latitude and fog level will increase; decreasing the usefulness of inspection results. In any case, it is important the temperature of the developer be kept within a range from 64.4° to 73.4°F (18° to 23°C). Because development time varies with each brand of developer, the instructions given by the manufacturer SHALL be followed.

6.4.11.1.1.3 Development Time. The sensitometric properties of X-ray film change when the development time is changed while maintaining constant levels for other conditions, such as temperature and agitation. X-ray film speed and contrast increase to a certain extent with increasing development time, but contrast could fail due to fog or other causes. The graininess might become coarser when development time needs to be extended to increase speed and contrast, a maximum limit of 8-minutes SHOULD NOT be exceeded at a developer temperature of 68°F/(20°C) (Figure 6-38). Film SHALL NOT be left in the developer solution any longer than the prescribed time for its specific temperature (Table 6-14). Uncontrolled time and temperature during film development will cause under or over development, which reduces or eliminates useful information from being discernible on the radiograph. Developing solutions, which pass their useful life, SHALL be disposed of properly. Check state and local regulations to determine proper method of disposal.

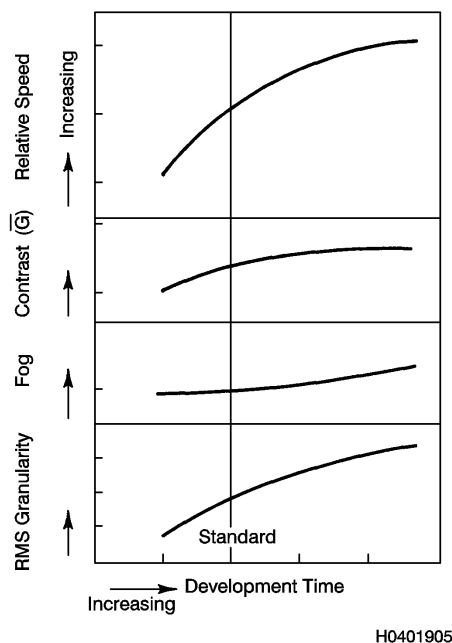


Figure 6-38. Development Time Related Photographic Properties of X-ray Film

T.O. 33B-1-1

Table 6-14. Developing Time Versus Temperature

Time (Minutes)		Temperature
Normal	Maximum	
3-1/4	6-1/4	80
3-3/4	6-3/4	76
4	7	72
4-1/2	7-1/2	70
5	8	68 (Recommended)
5-1/2	8-1/2	65
6	9	63

6.4.11.1.1.4 **Developer Agitation.** During development, the developer solution or the hanger loaded with exposed film is agitated at frequent intervals in order to keep the emulsion in contact with fresh solutions at all times, thus accomplishing even development. If films are allowed to develop without any movement, there is a tendency for each area of the film to affect the development of the areas immediately below it. This is because the products of development have a higher specific gravity than the developer. The greater the film density from which the reaction products flow, the greater is the restraining action upon the development of lower portions of the film. The solution in contact with high density areas of the film will be locally exhausted so development of those areas stops, while the solution in contact with low density areas is exhausted to a lesser extent so development proceeds. As a result, such a radiograph will show low contrast. Thorough and even agitation of the film during development is very important. When tray processing is used, care SHALL be taken to assure radiographs do not cling to one another, and the tray SHALL be rocked to provide continual mixing and redistribution of the solution.

6.4.11.1.1.5 **Developer Exhaustion and Replenishment.** If the water volume is not accurately measured in the preparation of developer solutions, the resulting properties will vary from the original specifications and fog could result. Accurate measurement of water volume is therefore important, however, it SHOULD be remembered the development capacity of even an accurately prepared developer solution decreases as it is used. It is necessary to check the developer solution for exhaustion by maintaining records of the sizes and quantities of X-ray films processed and the number of days the developer has been used.

6.4.11.1.1.5.1 To obtain uniform radiographic results over a period of time, it is necessary to check the activity of the developer solution and add developer replenisher in proportion to quantity of film processed or at regular intervals. The extent to which the developer replenisher influences the sensitometric properties of X-ray film is demonstrated in (Figure 6-39). The rate of replenishment varies with the size and quantity of films and their average density. The developing power of the developer decreases with increasing density or film size, and vice versa. The relative areas of various size films as determined by assigning the value 1 to the reference size 10 x 12 inches (25.4 x 30.5 cm) are shown (Table 6-15).

NOTE

In order to reduce variations in developer solution activity and achieve uniform radiographic results, replenisher SHALL be added in small quantities and at frequent intervals.

Table 6-15. Film Size Versus Relative Area

Film Size	Relative Area
35.6 x 43.2 cm (14 x 17 in.)	2
25.4 x 30.5 cm (10 x 12 in.)	1
11.4 x 43.2 cm (4-1/2 x 17 in.)	0.6
8.5 x 30.5 cm (3-1/3 x 12 in.)	0.3

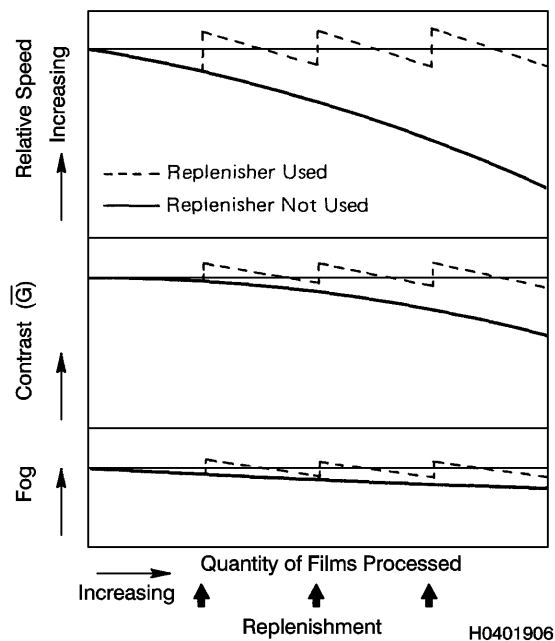


Figure 6-39. Effects of the Developer Replenisher on the Properties of X-ray Films

6.4.11.1.1.6 Developer Aging.

NOTE

It is recommended radiographic inspection facilities use the replenishment method while performing the manual film development process.

As films are developed without replenishment, the developing solution becomes exhausted chemically until no developing action can take place. For a given quality of developer, without considering the effects of oxidation, levels of bromide, hardener, and contamination, the development time must be increased for successive films to fully develop them. It is estimated a five-gallon tank of developer will develop 140 films, size 14 x 17 inches, satisfactorily without excessive increase in development time. It is convenient to divide the total number of films that can be developed by 5-gallons of developer into seven groups of 20 films each. As each group of 20 films, 14 x 17 inches, or equivalent film area is developed, the development time must be increased 1/4-minute, assuming a normal time of 5-minutes at 68°F (20°C). Even when drained, each film carries about 1-1/2-ounces of developer with it, so developer must be added to keep the tank at the 5-gallon level. When the specified number of films has been developed, discard the solution. This method is known as the exhaustion method of developing.

6.4.11.1.1.6.1 Another method of processing is the replenisher method. By adding replenisher solution periodically, the activity of the developer is kept at the same level. In this method, films must be removed from the tank quickly without allowing the excess developer to drain off the film back into the tank. Approximately 1-gallon of replenisher SHOULD be added for every 40 films, 14 x 17 inches, or equivalent film area (based on 5-gallons of developer). If this amount of developer cannot be added at the specified time, too much developer is draining back into the tank. In this case, enough developer must be drained from the tank so the replenisher can be added. For dense radiographs it MAY be necessary to increase the quality of replenisher added. In this case, it is also desirable to add replenisher at shorter intervals to keep the level of developer activity more nearly constant.

NOTE

The developer solution SHALL be discarded when the replenisher used equals four times the original quantity of developer solution, when it fails the process control requirements or at each two month period, whichever occurs first.

T.O. 33B-1-1

6.4.11.1.1.6.2 Fresh developer is referred to as “wild” and will often result in excessive contrast on the first few films. This is apparently due to the lack of equilibrium between the developer and the reaction products. It is sometimes recommended a small quantity of old developer be mixed with the fresh developer to temper the solution.

6.4.11.1.2 Stop Bath.6.4.11.1.2.1 Stop Bath Solution.

WARNING

Glacial acetic acid SHALL be handled with adequate ventilation, and great care SHALL be used to avoid injury to the skin or clothing. Glacial acetic acid SHALL always be slowly added to water, while stirring constantly. Water SHALL NOT be added to the acid, since this may cause boiling, splattering acid, causing burns to the hands or face.

The stop-bath consists of a mild glacial acetic acid solution, designed to neutralize the alkali of the developer. Developer solution will contaminate the stop-bath, but much of this contamination can be eliminated by allowing the radiograph to drain for one or two seconds prior to placing it in the stop-bath.

NOTE

Stop-bath SHOULD be used during hand developing radiographic film, when allowed by the operational environment.

6.4.11.1.2.2 Stop Bath Function. The function of the stop bath is to nullify the action of the developer through the use of acetic acid. It stops development in the shortest period of time, to prevent uneven development and subsequent streaking on the film. Therefore, it is important to assure the action of the developer is terminated over the entire surface of the film. The stop-bath also protects the fixing solution, which is slightly acidic, from the alkalis of the developer, thereby extending its useful life.

6.4.11.1.2.3 Stop Bath Temperature. Care SHALL be exercised to prevent a rapid change in the extent of swelling in the emulsion layer. To meet these requirements, the stop bath SHALL be maintained at a constant temperature close to that of the developer solution. If the temperature of the developing solution is 68°F (20°C), the temperature of the stop bath SHALL be maintained with a range of from 59° to 68°F/(15° to 20°C). If sodium carbonate is used to formulate the stop-bath, it SHALL be used between 65°F (18°C) and 70°F (21°C); otherwise, it will cause carbon dioxide blisters to form in the film's emulsion.

6.4.11.1.2.4 Stop Bath Agitation. After the film is placed in the stop bath, it SHALL be continuously agitated for about 15-seconds to prevent uneven development. Ensure films do not cling to one another, and immerse films in the stop bath for 1 – 2 minutes, agitating about every 30-seconds.

6.4.11.1.2.5 Stop Bath Exhaustion and Replenishment. The stop bath is checked for exhaustion with a pH meter or litmus paper. When the pH of the stop bath exceeds 6.0, its neutralizing power has decreased to such an extent it no longer is able to perform its proper function. Make it a rule to replace the stop bath when its pH value is close to the critical level of 5.5. If a stop bath cannot be prepared for one reason or another, a fresh running water rinse MAY be used in place of the acetic acid stop bath.

6.4.11.1.3 Fixer.

6.4.11.1.3.1 Fixer Solution. There are only two chemicals in common use that will act as clearing agents by dissolving the undeveloped silver bromide in thin film emulsion. These are 1) sodium thiosulfate (hypo) and 2) ammonium thiosulfate. Weight-for-weight, ammonium thiosulfate has approximately three-times the fixing power of sodium thiosulfate. It is the clearing agent in liquid high-speed fixing concentrates, while hypo is used in regular-speed formulas.

6.4.11.1.3.1.1 When a solution of ammonium thiosulfate is used as a fast action fixer, not only is the film cleared in a shorter time, but twice the fixing capacity of ordinary fixer solutions is made available. The fixing capacity limit is likely to be exceeded more easily with fast acting fixer solutions because the time to clear is short, even when twice the fixing time

needed by a fresh solution is required. Fast acting type fixers are not recommended for general use because they could cause discoloration or image fading. Clearing times and fixing capacities for ordinary and fast-acting fixers are compared in (Figure 6-40).

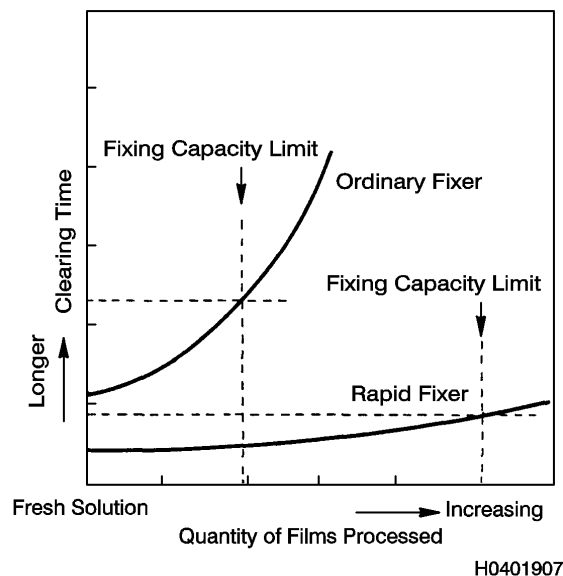


Figure 6-40. Clearing Time and Fixing Capacity of Fixers

6.4.11.1.3.1.2 It is essential the fixing solution neutralize the alkaline developer adhering to the film. In other words, development must stop before fixing can begin. The neutralizer is an acid; the most suitable of which are acetic and sulfuric acid in weak concentration. If a fixing bath is to be used for a long period of time, a large quantity of acid is necessary to neutralize the alkalinity of the developer. Fixing is accomplished by means of the thiosulfate only.

6.4.11.1.3.2 **Fixer Function.** After development, the emulsion contains all of the unexposed and undeveloped grains of silver. A permanent image cannot be retained in the exposed and developed X-ray film unless it is treated with the fixer. The undeveloped silver must be removed from the emulsion if the image is to be permanent. Fixing conditions greatly influence the degree of radiographic permanency. Therefore, control of these conditions as described below, needs to be addressed.

6.4.11.1.3.3 **Fixer Temperature and Fixer Time.** The fixer temperature does not influence the fixing speed to the same extent the developer temperature affects development time, but generally, fixing time decreases with an increase in fixer temperature. The relationship between the fixer temperature and the fixing time is shown in (Figure 6-41). The fixer temperature SHALL be adjusted to be in close range of the developer temperature to avoid related detrimental effects on the emulsion.

6.4.11.1.3.3.1 As a general rule, fixing requires twice the time that elapses from the moment the film is immersed in the fixer solution to the time the milky emulsion becomes completely transparent. If the fixing time is inadequate, the film retains some insoluble salts (complex silver thiosulfate compounds). If they are allowed to remain, they will react with the environment and degrade the image, causing it to discolor and fade. Even if the fixing exceeds twice the clearing time, the quality of the processed radiographs will not be adversely affected. On the other hand, if the film is allowed to remain in the fixer solution for too long a time, the density of the image will decrease and the film will acquire a brown color. Granularity might also be affected depending on the circumstances. Films SHALL NOT be left in the fixing bath for an excessive period of time.

T.O. 33B-1-1

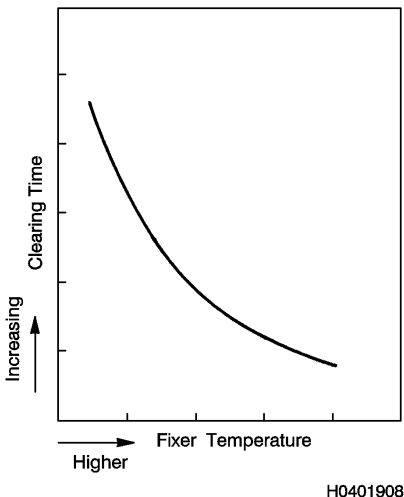


Figure 6-41. Fixer Temperature-Time Curve

6.4.11.1.3.4 Fixer Agitation. When the film is first transferred from the stop bath into the fixing bath, it SHALL be agitated continuously for 10-seconds and thereafter occasional agitation is to be employed. Ensure films do not cling to one another. If the stop bath is unavoidably skipped (the skipping of the stop bath SHALL be avoided to prevent uneven development), and the film is directly transferred from the developer solution into the fixing bath, or if the film is rinsed after development and transferred into the fixing bath, it SHALL be agitated vigorously in the fixer for about 30-seconds. If agitation is not vigorous enough, uneven fixation may result and dichroic fog and stains may occur when the fixer solution is exhausted. Dichroic fog is likely to start from the presence of traces of developer in the fixing bath. When viewed by transmitted light, film with dichroic fog has yellowish to brownish stains. These stains are of a bluish, greenish, or yellowish metallic luster when viewed by reflected light.

6.4.11.1.3.5 Fixer Capacity. In general practice, the fixer solution is not replenished and, thus, is used until fully exhausted. As it is used, its fixing capacity decreases to a point at which the time required for the film to clear is increased by twice the time required with fresh fixer solution. When this critical state has been reached, the fixer solution SHALL be replaced. If this limit is exceeded, proper fixation will not be accomplished even if the film remains in the fixer solution longer than twice the clearing time. Such practice will further result in image discoloration or fading.

6.4.11.1.3.5.1 During use, films carry the processing solution into the fixing bath. The amount of processing solution carried on the film has a significant effect on the strength of the fixer solution exhausting it over time. The smaller the carry-over, the less the fixer solution will be degraded. If film is to be drained thoroughly, it must be held out of solution for a long period of time, and such exposure to air brings with it the risk of discoloration. Films, wet with any of the processing solutions, SHALL NOT be allowed to remain in contact with the air for longer than 10-seconds.

6.4.11.1.3.5.2 When films are repeatedly transferred directly from the developer solution into the fixing bath, or rinsed and transferred into the fixing bath without using the stop bath, the hardening capacity of the fixer solution decreases rapidly so films are easily scratched or longer than normal drying times are required after washing. Furthermore, under these conditions, development MAY proceed even in the fixing bath, thus leading to dichroic fog and uneven fixation. In such cases, it is necessary to replace the fixer solution even before complete exhaustion has taken place.

6.4.11.1.3.6 Hardening. Because X-ray film is handled frequently, and is subject to more abuse than photographic negatives, it is customary to use a hardening agent. This hardening agent or "hardener" tans and toughens the emulsion. Some of the common hardeners are "alum" and "aluminum and chloride" for high-speed fixers. One distinct advantage of the hardener used in high-speed fixers is the production of a hardened film, which will not melt in water as hot as 175°F (85°C) after the film is dried.

6.4.11.1.3.7 Clearing Action. When a film is removed from the developing solution, the undeveloped areas are swollen and yellow in appearance. Sometime after immersion in the fixer, this yellow becomes transparent; this change MAY be observed and recorded. The time required for this change is known as the "clearing time." To adequately fix a film, it

SHALL be immersed in the fixer at least twice as long as it took to clear. This period SHALL NOT exceed fifteen minutes. For example, if the clearing time is two-minutes then the fixing time is four-minutes. The fixing solution will become deficient with each use. This deficiency is insidious, and MAY be overcome by adjusting the fixing time up, to the maximum fifteen-minute time period. The cause of the fixer degradation may be due to one or more of the following:

6.4.11.1.3.7.1 The accumulation of soluble silver salts will gradually prevent the fixer from dissolving unexposed silver halide from the film emulsion, therefore, making the fixer incapable of properly clearing the radiographic film.

6.4.11.1.3.7.2 The loss of chemical activity is evident when long periods of time are required to clear a radiograph. This situation will cause colored stains on the radiograph, swelling of the emulsion that inhibits hardening and results in long drying times, and reticulation or sloughing during drying.

6.4.11.1.3.7.3 Reduction of activity caused by dilution of the fixer solution when stop bath, rinse water, and developer solution are carried over by the film being processed. The effects of this dilution/contamination are reduced by allowing the radiograph to drain into the stop bath prior to being put in the fixer. Care SHALL be taken to not contaminate the developer solution.

6.4.11.1.4 **Washing.** Thorough washing is necessary to remove the processing solutions and complex silver salts (complex silver thiosulfate compounds). If such salts are allowed to remain after washing, they will gradually decompose and cause the image to discolor or fade. Because hardeners are used in X-ray fixing solutions, it is difficult to remove small quantities of the fixer retained by the gelatin.

6.4.11.1.4.1 **Wash Water Flow Rate and Temperature.** The faster the flow of water in contact with the emulsion, the faster the undesired compounds are removed and the shorter the washing time becomes. The wash water temperature SHOULD preferably be slightly lower than the fixer temperature to avoid adverse conditions in emulsion. In practice, however, considerable capacity is required to maintain adequate control of wash water temperature. Ideally, the developer temperature SHOULD be 68°F/(20°C) and the wash water temperature varies greatly with the season. If such variations are present, there is no alternative but to make slight changes in the stop bath and fixer temperatures in favor of the wash water temperature, as shown in (Table 6-16).

Table 6-16. Examples of Temperature Adjustments for Processing Solutions

	Developer	Stop Bath	Fixer	Wash Water
Summer	20°C (68°F)	22 to 25°C (71.6 to 77.0°F)	25 to 28°C (77.0 to 82.4°F)	30°C (86°F)
Winter	20°C (68°F)	18 to 15°C (64.4 to 59.0°F)	16 to 13°C (60.5 to 55.4°F)	10°C (50°F)

6.4.11.1.4.2 **Wash Time.** The speed of washing is determined by the speed with which the clearing agent diffuses out of the film into the water. The quantity of clearing agent remaining in the gelatin is continually halved in the same period of time as washing continues. For example, if a film gives up one-half its clearing agent in 1-minute, then after 2-minutes one-quarter remains, after 3-minutes one-eighth, in 4-minutes one-sixteenth, and so on, provided the film is continually exposed to fresh water. Washing will never remove all traces of fixer. The object of washing is to remove enough fixer so the film MAY be maintained without fading for any given period of time. The processed film SHOULD be washed in running water at 68°F (20°C) for 50 minutes or more. For most practical purposes, X-ray film will be washed sufficiently in 30-minutes if the water changes at the rate of four to eight-times per hour (Table 6-17). The wash water temperature SHOULD be between 65°F and 80°F. Regardless of the type of fixer used, if the film is allowed to fix twice the required time, three times a normal washing time is required.

T.O. 33B-1-1

Table 6-17. Manual Washing of Radiographic Film

Manual Approximate Film-Washing Times at 68°F		
Class of Film	Rate of Water Change	Washing Time
I	4 times per hr.	35 minutes
I	8 times per hr.	20 minutes
II	4 times per hr.	35 minutes
II	8 times per hr.	20 minutes
III	8 times per hr.	35 minutes
IV	4 times per hr.	35 minutes
IV	8 times per hr.	20 minutes

6.4.11.1.4.2.1 If the temperature of the wash water falls below 50°F, it is not possible to adequately remove the fixer from the emulsion in the above length of time. Washing takes three-times as long when the temperature is between 50 to 60°F as it does at 70 to 75°F. Thus, the rule for washing time for X-ray film is true only when the wash water is relatively warm. If the film has been over fixed, and then washed at 50°F, there is no practical way to remove enough fixer to prevent fading of the image. In addition, if the temperature difference between fixer and wash water exceeds 15°F, there is a possibility of unequal swelling of the emulsion known as reticulation.

6.4.11.1.4.3 Wetting Agent Action. The use of a wetting agent between the washing and drying operations is highly recommended. When the film is removed from the wash tank, small drops of water will cling to the emulsion. Areas under these drops will dry more slowly and cause distortion of the gelatin, changing the density of the silver. These are frequently visible and can be troublesome in film interpretation. Most water also contains large amounts of solid material in the form of calcium and other chemicals, which will remain on the film as a white residue after the water drops have evaporated. Such “water-spots” can be prevented by immersing the washed film in a wetting agent for one to two-minutes before transfer into the drying cabinet. Various detergents or commercial wetting agents can be used.

6.4.11.1.5 Drying. The final step in processing is drying of the X-ray film. Film SHALL be dried immediately after washing. Water streaks and drops adhere to film surfaces and if they are not removed prior to drying, the areas lying underneath will dry more slowly than the surrounding areas thus, changing the density of the silver image and resulting in spots. Such uneven drying can be prevented by gently wiping the film with a sponge or accelerated if the film is immersed in a wetting agent solution following washing. In addition to speeding drying time, this technique also prevents the formation of watermarks or streaking on the emulsion. Hang up the films in a dry rack where the film hangers can be suspended. Where a large number of films must be handled, special equipment may be necessary. The forced air dryer SHOULD have a filter over the air inlet with the unit providing 104 to 122°F (45 to 50°C) hot air movement over the film.

6.4.12 Manual Film Processing Procedure.

6.4.12.1 Preparation.

- a. Be sure all films are placed on hangers properly.
- b. Check the temperature of all processing solutions using a bimetallic thermometer (Table 6-17).
- c. Agitate the developing chemicals and make sure they are at the proper level; replenish if necessary.
- d. Be sure wash water flow is adequate.

6.4.12.2 Step-by-Step Manual Processing Procedure (Figure 6-42).

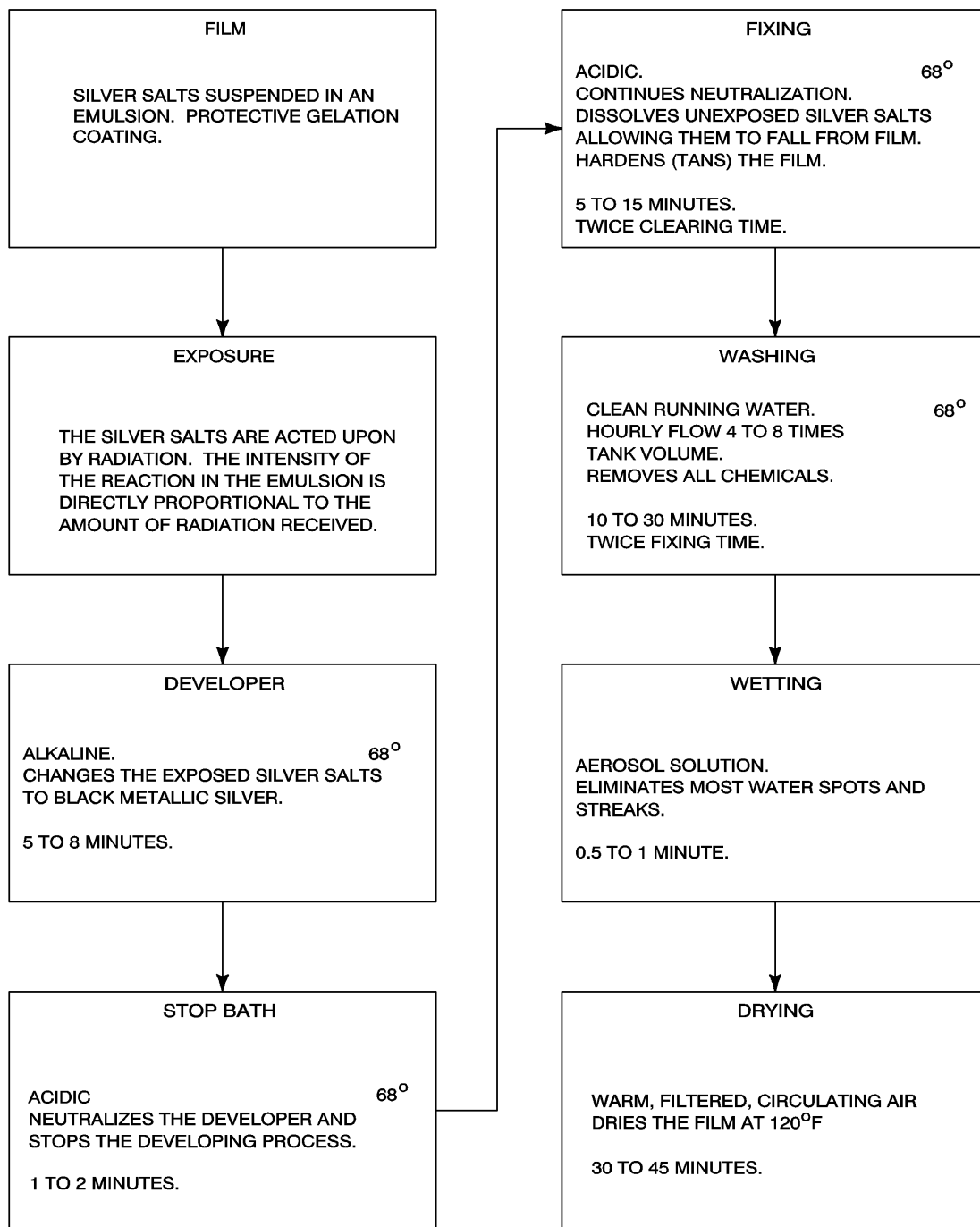
CAUTION

Films SHALL NOT be allowed to remain out of solutions for more than 10 seconds since this will cause uneven development.

NOTE

Drain the films and hangers for several seconds between operations to prevent carryover of chemicals from one tank to another.

T.O. 33B-1-1



H0401909

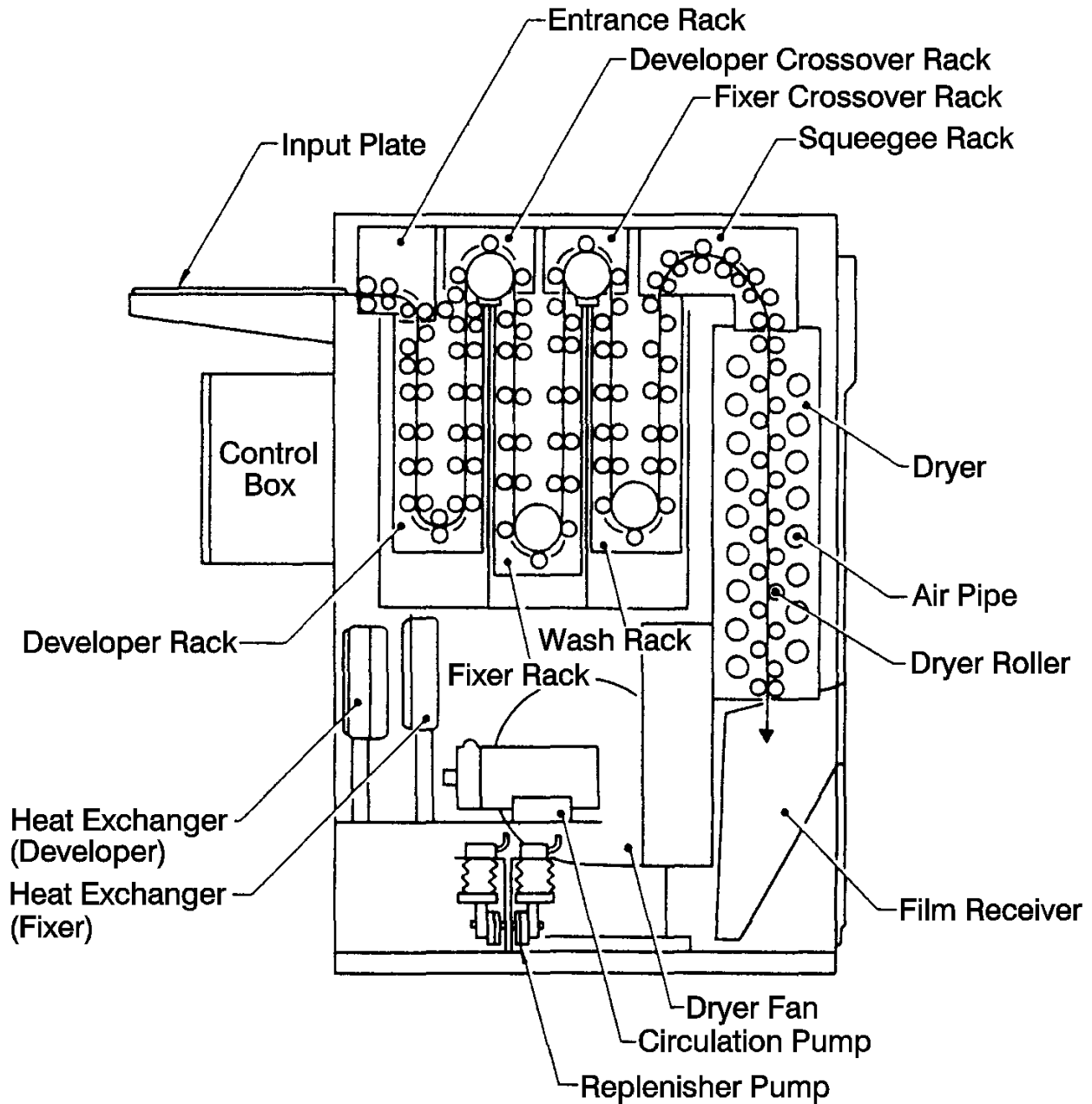
Figure 6-42. Manual Film Processing

- a. Immerse the films (and hanger) in the developing solution. Agitate the hangers by hand at 30-second intervals. This SHALL be done during the entire developing time.
- b. Remove the films from the developer and immerse in stop bath for approximately 1 - 2 minutes.

- c. Remove the films from the stop bath solution and immerse in the fixing solution. The total “clearing time” SHALL be determined according to (paragraph 6.4.11.1.3.7).
- d. Remove the films from the fixing bath and immerse in the wash water for the recommended period.
- e. Dry the films.
- f. Remove the films from the film hangers.

6.4.13 Automatic Film Processing. A system of rollers is generally employed as the transport mechanism in automatic processors, as shown in one manufacturer’s sectional view ([Figure 6-43](#)). These state-of-the-art, automatic processors, decreases dry-to-dry processing time from approximately one-hour, in a manual hand tank system, down to 5 to 13-minutes ([Table 6-18](#)). Furthermore, the automatic processor reduces variations in radiographic quality. However, the processor alone cannot produce these effects unless combined with suitable film and processing chemicals.

T.O. 33B-1-1



H0401910

Figure 6-43. Sectional View of Fuji FIP 4000 Processor

Table 6-18. Conditions for Manual and Automatic Processing

	Development	Stop Bath	Fixing	Washing	Finishing Bath	Drying	Total
Manual Processing	20°C/68°F	20°C/68°F	20°C/68°F	20°C/68°F	20°C/68°F	40°C/104°F	
	5 min.	30 sec.	5 min.	50 min.	30 sec.	30 min.	91 min.
Fuji Fip 4000 Processor	30°C/86°F	–	31°C/88°F	31°C/88°F	–	About 45°C/113°F	
	1 min. 35 sec.	–	1 min. 30 sec.	1 min. 30 sec.	–	50 sec.	5 min. 25 sec.

6.4.13.1 Advantages of Automatic Film Processing. In addition to eliminating the variations in radiographic quality, and reducing processing time by 3/4, automatic film processors also take up less space within the darkroom, help to keep the room cleaner and are easily installed. Automatic processing is particularly advantageous when large volumes of film need to be processed. Automatic processing also provides for greater uniformity of development, thus providing more consistent results. The quality level of these results is determined by chemical and equipment condition, and conscientiousness of the operator. However, because the cycle is faster and the chemical temperatures are higher in automatic processing than they are with manual processing, the use of automatic processing will produce a more narrow (high) latitude radiograph and has a noticeable effect on the radiographic technique. Therefore, apparent film characteristics will be significantly altered by the use of automatic processing. As a result, film quality, when automatic processing is used, is generally lower than that which is obtainable with manual processing. However, the advantages of speed of processing, lower manpower requirements, and consistency of development generally are felt to be more important in the decision to use automatic processing.

6.4.13.2 Rapid Access to Finished Radiographs. The following methods are employed in automatic processing to gain rapid access to finished radiographs.

6.4.13.2.1 Raising Processing Solution Temperatures. The chemical reactions are facilitated by applying relatively high temperatures in processing solutions.

6.4.13.2.2 Reinforcing Chemical Solution Supply to Film Surfaces. A fine spray or processing jet is continuously applied to the film surfaces, as solutions are forced to circulate in the processing tanks, keeping them well mixed and maintaining them in agitated contact with the film surfaces. Such methods facilitate chemical reactions between the emulsion and the processing chemicals.

6.4.13.2.3 Increasing Chemical and Film Interaction through Transport Roller Pressure. The film is brought into direct contact with the transport rollers so the rollers not only squeegee the film, but force processing solutions against the film surfaces, thus facilitating chemical reactions.

6.4.13.3 Care in Automatic Processing. In automatic processing, it is very important certain processing conditions be kept constant as indicated in (Table 6-18). Processing control SHALL be rigidly practiced by making periodic measurements to avoid variations in solution temperatures, replenishment rates, and wash water flow rates.

6.4.13.4 X-ray Film Requirements for Automatic Processing. Industrial X-ray films designed for automatic processing SHALL meet the following requirements.

6.4.13.4.1 Increased Adaptability to Rapid Processing. In spite of satisfactory development, the radiographic image could discolor and fade with time, if fixing, washing, and/or drying are not adequate. Films, which are processed in automatic processors, SHALL therefore meet special requirements that manually processed industrial X-ray films need not comply with. For instance, the emulsion layer must be thinner and the emulsion must react with processing chemicals more rapidly.

6.4.13.4.2 Increased Strength of the Emulsion Layer. Rapid processing will serve no purpose if the resulting quality is inferior to hand processing. When solution temperatures are increased, softening and swelling of the emulsion layer is also increased subjecting the film to severe physical conditions and roller pressure. For automatic processing, the emulsion layer of industrial X-ray film must therefore be strong enough to withstand such severe processing conditions.

T.O. 33B-1-1

6.4.13.4.3 Adoption to a Polyester Based Film. It has been many years since flammable cellulose nitrate film base was replaced first with inflammable cellulose acetate then with polyester base materials. Polyester base materials are advantageous because they provide flatness and great strength. Little expansion and contraction take place and the material is not hygroscopic. These advances in a polyester film base are indispensable to rapid film transport in automatic processors.

6.4.13.4.4 Adoption to Chemicals Used in Automatic Processing. The composition of chemicals formulated for use in automatic processors differs somewhat from that of chemicals used in hand processing. For details on chemicals used in automatic processors (paragraph 6.4.10.2).

6.4.14 Silver Recovery. The value and scarcity of silver makes recovery of it economically feasible. Approximately 80-percent of the silver in the film emulsion is transferred to the fixer solution; the remaining 20-percent forms the radiographic image. Here we will discuss methods used to recover the silver from both the fixer and the film.

6.4.14.1 Recovering Silver from Fixer. The unexposed and undeveloped silver halides in the film emulsion are removed by the fixer solution. Therefore, the exhausted fixer becomes rich in silver content. There are three basic methods of silver recovery from the fixer solution. These are by electrolysis, metallic replacement, and chemical precipitation.

6.4.14.1.1 Electrolysis Recovery Method. When electric current is passed between two electrodes immersed in the silver-bearing fixer, the silver is electronically deposited upon the cathode. This silver can be stripped from the cathode and refined. This method permits re-use of the fixer.

6.4.14.1.2 Metallic Replacement. This method consists of replacing the metallic silver with a less valuable base metal such as iron, zinc, or copper. As an example, if steel wool is inserted into the exhausted fixer solution, the silver in solution is replaced by the iron, and the silver accumulates on the bottom of the container in the form of sludge. The sludge is removed and refined to reclaim the silver. The fixer SHALL be discarded after silver recovery by this method.

6.4.14.1.3 Chemical Precipitation. Silver can be reclaimed from fixer by the addition of certain chemicals to the exhausted fixer. The silver is precipitated out of the solution in the form of a sludge that can be recovered and refined. The chemical reaction generates obnoxious fumes and odors, and separate facilities are recommended for this method of silver recovery. The fixer SHALL be discarded after silver recovery by this method.

6.4.14.2 Recovering Silver from Film. There are two methods used to recover silver from obsolete films: stripping or burning. It is usually more economical to simply market used or obsolete film than to attempt silver reclamation from film on a small scale. Detailed information on silver recovery is provided in AFMAN 23-110 Vol 6.

6.4.14.2.1 Stripping. A chemical or mechanical means is used in this method to strip the silver bearing emulsion from the film base. The emulsion is then refined to reclaim the silver.

6.4.14.3 Burning. The second method is burning the film in an incinerator that controls the burning process and the fly ash. The residual ashes are then processed to obtain the silver content.

6.4.15 Film Reproduction Technique. Often duplicate radiographs are required. If it is known that in advance duplicate films are required, it is quicker and more economical to expose two films simultaneously in the original exposure. If lead screen techniques are being used, slight increases in exposure will be required.

6.4.15.1 If multiple copies of an existing radiograph are required, they can be reproduced by contact printing techniques. The duplicate radiograph can be made on a direct-positive film that produces a duplicate-tone facsimile of the original. The film gradient of the duplicating film is -1.0, which means density differences in the original image are faithfully reproduced in the duplicate image. Duplicating film cannot reproduce radiographic density ranges equivalent to originals. But by varying exposure, the density differences can be recorded accurately.

6.4.15.1.1 If duplicating film is not available, it is possible to use medical film designed for use with fluorescent screens. These duplicates are also produced by the direct printing method. However, these films have a special property. While not a positive film, they do undergo reversal with large exposures. That is, they increase in density up to a saturation point after which time they decrease in density with exposure, and thus reverse. It is necessary to expose these films such that reversals occur, and the original image is duplicated. If the original radiograph has a high density, exposures of as much as two-minutes to a photoflood lamp MAY be required. These exposure requirements must be generated for each specific situation; generalization here is not practical.

6.4.16 Film Artifacts. An artifact is the product of human error and in the case of film is usually due to mishandling the film in some step in the radiographic process. Here we will discuss some typical artifacts you may run across.

6.4.16.1 Processing Artifacts. Chemical spots can occur if any chemicals are splashed, contacted, or transferred by wet fingers to the undeveloped film. Dark spots indicate either water or developer on the film before processing. Light or undeveloped spots indicate the stop bath or fixer has been allowed to contact the film before processing. Stains caused by chemical reactions, over development, or underdevelopment are processing artifacts. Streaks from contaminated hangers are quite common as well as streaks from lack of agitation during the development period.

6.4.16.2 Handling Artifacts. Many artifacts are introduced by film handling. Crowfoot static marks can be caused by sliding the film over surfaces, creating an electrical discharge of static electricity, particularly under very dry atmospheric conditions. Half-moon-shaped marks (either dark or light) can be caused by crimping the film, particularly with the thumb, these are often referred to as thumb crimps, handle X-ray film as if it were a piece of wet paper. Scratching of the emulsion when the film is wet and the emulsion is soft is a common artifact.

6.4.16.3 Exposure Artifacts. The most common exposure artifacts are caused by excessive pressure applied to the film before, during, or after exposure. Either heavy parts or excessive bending of the film can apply sufficient pressures to the film emulsion as to render it insensitive to exposure. These artifacts usually appear as unexposed areas on the film.

6.4.16.4 Manufacturing Artifacts. Artifacts due to the manufacturing process are comparatively rare. On occasion exposed spots or other manufacturing artifacts, such as roller marks or foreign material may occur on the emulsion surface. Artifacts which are commonly encountered, their cause, and any remedial action which SHOULD be taken are shown (Table 6-19).

Table 6-19. Description of Film Artifacts

Condition	Cause	Remedy
1. Pressure Marks	White or dark areas as result of pressure on emulsion.	Handle film carefully, avoid bending when placing in cassette. Do not place heavy objects on exposure holder.
2. Exposure to light	Usually dark areas on film of shadow pattern.	Light leaks in corners of exposure holders. Test film by developing without exposure to X-rays.
3. Static pattern	Black, sharp chicken-track type pattern. The result of rapid removal of film from paper cover of film box.	Handle film properly.
4. Paper pattern	Mottled effect over complete area on film.	Remove paper from film when exposing with screens.
5. Moisture on screen	Spots on radiograph.	Do not allow film to remain in lead screen exposure holders overnight in humid atmosphere.
6. Mottle pattern	Processing streaks.	Use adequate short-stop and agitate film during processing.
7. Film reversal	X-ray image reversed; light areas dark, dark areas light.	Extremely excessive exposure to radiation. Reduce exposure.
8. Either dark or light areas on film, depending where in the process this occurs.	Films stuck together during processing.	Agitate film during processing to assure solution penetrates emulsion.
9. Water spots	Result of splashing water on films after they are dried.	Handle film in dry area of darkroom. Completely remove from processing section. Do not remove film from hangers until dry under clips.
10. Developer scum	Surface on developer clings to surface of films in developer.	Mix solutions thoroughly before processing films.

T.O. 33B-1-1

Table 6-19. Description of Film Artifacts - Continued

Condition	Cause	Remedy
11. Lead screen patterns	Streaking on film due to alloy segregation of lead.	Examine lead screens visually before use.
12. Lead screen scratches	Normally appear as dark sharp lines on radiograph.	Discard all lead screens having scratches.
13. White dots on film	Unclean screens.	Clean lead screens with steel wool and soap periodically.
14. Fuzzy image	Can be lack screen contact with film.	Clamp exposure holder or cassette together securely. Avoid using film holder in vertical direction because of screen and film sag.
15. Grainy image	Can be grain pattern of some high-temperature alloys.	Certain high temperatures are associated with grain pattern at voltage range of 150 to 250 kVp. This condition is eliminated at higher voltages.
16. Surface of film is discolored when viewed by reflected light	Dichroic (chemical) fog.	Change developer and short-stop since this condition is usually the result of exhausted solutions.
17. Film scratches	Emulsion scratched by mishandling.	Handle films on smooth surfaces at all times.
18. Illuminator dirt	Spots on illuminator appear as dark areas on radiograph.	Wipe illuminators periodically with damp cloth.
19. Surface conditions	Can appear as internal discontinuities.	Examine castings or welds for visible surface conditions before reading.
20. Unexplained shadowed area on film	Non-uniform light pattern from illuminator.	Change lamps to correct filament pattern and select fluorescent lamps to match in light response.
21. Unexplained pattern of hinges	Back scatter pattern of cassettes.	Back up cassette with lead blocking to prevent scatter from cassette or other surfaces.
22. Foggy films	Use of film beyond expiration or inadvertent exposure to radiation.	Protect films from radiation by lead-lined film chest. Use film before expiration. If questionable, check film by processing before exposure.
23. Puckered or net-like linkages	Reticulation. Film processed through extreme temperature changes.	Maintain all processing solutions and wash water at approximately same temperature, 68°F.
24. Blisters	Reaction between alkaline developer and acid-fixing bath.	Maintain correct solutions by following manufacturer's directions.
25. Water on screens	White blotches on film.	Dry screens. Do not use for 24 hours.
26. Dark areas on film	Exposure to light.	Light leaks in corners of exposure holders. Test film by developing without exposure to X-rays.
27. Spots on radiograph	Moisture on screen.	Do not allow film to remain in lead screen exposure holders overnight in humid atmosphere.

6.4.17 Special Radiographic Techniques.

6.4.17.1 Introduction. The previous sections of this chapter have primarily been concerned with conventional film radiography. While film radiography offers a versatile tool for the detection and identification of material discontinuities, there are a variety of special radiographic techniques that MAY be employed to extend the capabilities of conventional radiography. Special radiographic techniques are placed into two broad categories.

6.4.17.1.1 Special Purpose Techniques. This category relates to radiographic techniques which require the capabilities of an inspection method to extend beyond normal parameters for a specific objective. This category includes such techniques as “multi-thickness,” “multiple film,” “triangulation,” “thickness measurement,” “stereo (three-dimensional),” and “geometric magnification.”

6.4.17.1.2 Special Imaging Methods. This second category relates to special methods, such as: “radioscopy,” “image intensifiers,” “X-ray vidicon,” “stereo radioscopy,” “photo-radiography,” “Polaroid radiography,” “photothermographic film,” “computed tomography (CT),” and “neutron radiography.” Special radiographic methods not included in authorized inspection manuals, SHALL NOT be used without written approval of the appropriate depot engineering activity.

6.4.17.2 Special Purpose Techniques.

6.4.17.2.1 Multi Thickness Techniques. Many situations require radiography of parts with varying thicknesses, and sometimes these may be made of two or more materials. If concentration on one area, with a nearly constant thickness is all that is required, optimization of image density is straightforward. However, it may be necessary to obtain an acceptable exposure for two or more varying thicknesses using the same radiographic image. For example, small thickness variations, of 0.8 to 0.6 inches, can lead to large variation in density ranging from 1.2 to 1.7 respectively. The goal is to ensure all areas of interest have densities not so low as to lose film contrast, and not so high they cannot be evaluated. An acceptable range of densities is 1.0 to 3.5. The procedure recommended during technique development is to identify the thickest area of interest, and then, from exposure charts and trial-and-error, determine the exposure and kilovoltage that provides a density of 1.0. A trial exposure will then show the density of the image of the thinnest area of interest. There are three possible courses of action an inspector can take:

6.4.17.2.1.1 If the density of the thinnest section of the image is approximately 3.5, and the image can be satisfactorily interpreted, the technique is optimized.

6.4.17.2.1.2 If this density is too low, the exposure SHOULD be increased to raise the average density of thick and thin areas.

6.4.17.2.1.3 If the density of the thinnest section is too high, the range of thicknesses is too great for satisfactory imaging. One possible solution is to raise the kilovoltage substantially, as this reduces contrast of thin areas. A better (and more common) solution is to load the cassette with two films of different speed and expose them simultaneously. This technique is commonly known as “multi-film or double-loading.” In the latter case, care is required to ensure that an acceptable image density is obtained for all areas of interest.

6.4.17.2.2 Multiple Film Techniques. Multiple film techniques (commonly known as double-loading) permit the inspection of parts with multiple thicknesses using a single radiographic exposure. Since a major expense associated with radiographic inspection can be attributed to setup, it may be desirable to expose a multi-thickness component in a single exposure, rather than set up an exposure for each cross section of the component. Using multiple film techniques allow this to be achieved.

6.4.17.2.2.1 An example of this technique is to load a cassette with both a Class 1 and a Class 3 film to provide wide latitude. The faster Class 3 film provides a readable density film for the thicker sections of the component, while the slower Class 1 film provides the appropriate film density for the thinner sections of the component. Thus, in a single radiographic exposure, two images with varying density will be generated covering the required latitude for the inspection of a multi-thickness component.

6.4.17.2.2.1.1 If a part has even more complexities than what was described in the previous paragraph, it is possible to use three classes of films and cover even wider latitudes.

6.4.17.2.2.2 Technique Parameters. Several parameters must be considered when choosing a multiple film technique. In addition to the exposure parameters always of concern in radiographic inspection, the radiographer must be concerned with the choice of film to be used and the combination of these films with various screens.

T.O. 33B-1-1

6.4.17.2.2.2.1 Film Choice. The film combination selected is based on the range of thicknesses that must be covered in a single exposure. The simplest multiple film techniques employ two different films, such as a Class 1 and a Class 2 film, to cover the range of densities for the inspection of an object. An exposure must then be determined which best provides the combination of contrast and sensitivity in the two films.

6.4.17.2.2.2.2 Film Positioning. When film is double-loaded, realize the film nearest the X-ray source acts as an absorber and the film furthest from the source will receive less exposure. This absorption effect is of considerable magnitude at low kilovoltages and decreases with increased radiation energies. The choice of film position will affect the range of material thickness that can be visualized in a single exposure. Typically, the slowest film is placed nearest to the source, while the faster film would be placed farthest from the source. Pre-packaged double-loaded film will normally be marked "source-side" by the manufacturer to make positioning easier. Once a technique has been established, care SHALL be taken to assure the same film is always placed in the same position for the exposure. If the positions of the films are inadvertently switched, the resulting densities in the final images will be different than expected.

6.4.17.2.2.2.3 Multiple Film Techniques with Lead Screens. Lead screens have a definite effect on the quality of a radiographic image. Lead screens are very dense, and preferentially absorb the lower energy scattered radiation. This reduces the fog on the final image and allows a higher contrast, higher quality image. Also, at energies above 125 kVp, lead screens provide a definite intensification. This intensification is due to the efficient conversion of X-ray photons into electrons in lead foils. These electrons in turn expose the X-ray film and thus provide intensification in the final image. These properties of lead screens MAY be useful in developing a multiple film technique.

6.4.17.2.2.2.3.1 As discussed earlier, combinations of films can be used for radiography of multi-thickness materials, but the optimum image quality MAY NOT be achieved. Therefore, the use of lead screens MAY be introduced to help regulate the relative speeds of the films used. As an example, assume the combination of a Class 1 and a Class 2 film could not provide the required latitude for a given component. Lead screens can be used to increase the latitude of the total exposure.

6.4.17.2.2.2.3.2 Most lead screens consist of thin lead foils backed on one side by cardboard, rubber, or vinyl. With this configuration, lead screens have a filtration effect on the films beneath them, and an intensification effect on films facing the foil-coated side. If a combination of a Class 1 and a Class 2 film is used, and insufficient latitude is provided, the latitude MAY be increased by placing the faster Class 2 film nearest the source with a backed 0.005-inch lead screen between the two films with the lead screen in contact with the Class 2 film. This increases the latitude through two effects. First, the lead foil intensifies the near Class 2 film, and second, the lead acts as a filter, slowing the response of the Class 1 film. Thus, over all the latitude of the exposure is increased.

6.4.17.2.2.2.3.3 On the other hand, if the latitude was excessive with the two films using no screens, the opposite effect can be achieved by placing the slower film nearest the source and the faster film farthest the source, with lead screens in between facing the slower film. This combination speeds up the slower film by intensification and slows down the faster film by filtration. Thus, the total latitude is reduced.

6.4.17.2.2.2.3.4 When only a slight increase in latitude is required, two sheets of the same film class may be employed, and lead screens MAY be used as described above to achieve a relative speed difference between the two films.

6.4.17.2.2.2.3.5 There is no end to the combinations that may be employed in multiple film radiography. Using the principles outlined above, any capable radiographer SHOULD be able to accommodate a wide variety of complex components with a multiple film exposure. Experience provides the required proficiency.

6.4.17.2.3 Triangulation Technique. In some cases, it is desirable to know the location of a given discontinuity relative to one of the plane surfaces of the object. If repairs are to be made, it is desirable to know from which surface the repair SHOULD be started. A single radiograph MAY NOT reveal this information. This information can be obtained by making a double exposure with suitable markers placed on the object. These markers are placed on both the source side and on the film side. Either two exposures can be made on one film where discontinuity is very prominent; or two separate films can be used and later be superimposed. These radiographs can be used for measurement purposes to obtain the desired information (Figure 6-44).

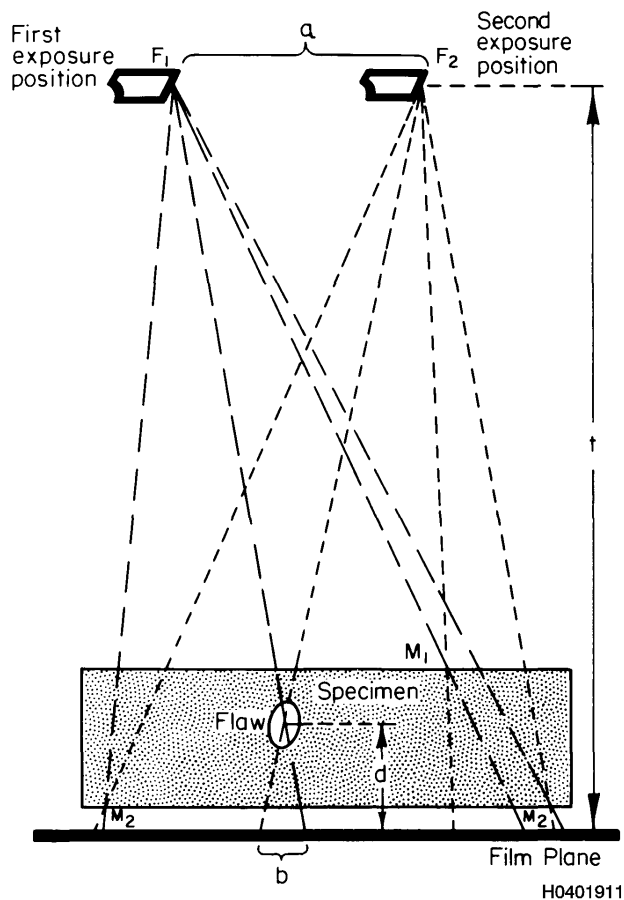


Figure 6-44. Triangulation Technique Used to Determine Flaw Depth in an Object

6.4.17.2.3.1 In this technique, small lead markers, usually in the form of triangles, are attached to the two surfaces of the object, one set of three or four markers on the source side and one set on the film side. If two separate exposures are to be made, each film SHALL be carefully aligned with the object so both films occupy the same position. After the markers are positioned, one exposure is made with the normal source, object, and film position. A second exposure is made with all conditions the same between the object and film with the exception that the source is shifted 10° to 45° from the initial position. The greater this shift, the greater the accuracy of determining the position of a given discontinuity from one of the object's surfaces.

6.4.17.2.3.2 If the discontinuity is sufficiently prominent, both exposures MAY be made on the same film. In either case, the distance of the discontinuity above the film is given by the following expression:

$$d = \frac{bt}{a+b}$$

H0401912

Where:

d = distance of discontinuity above film plane

a = distance of the source shift

b = change in position of discontinuity image on radiographs

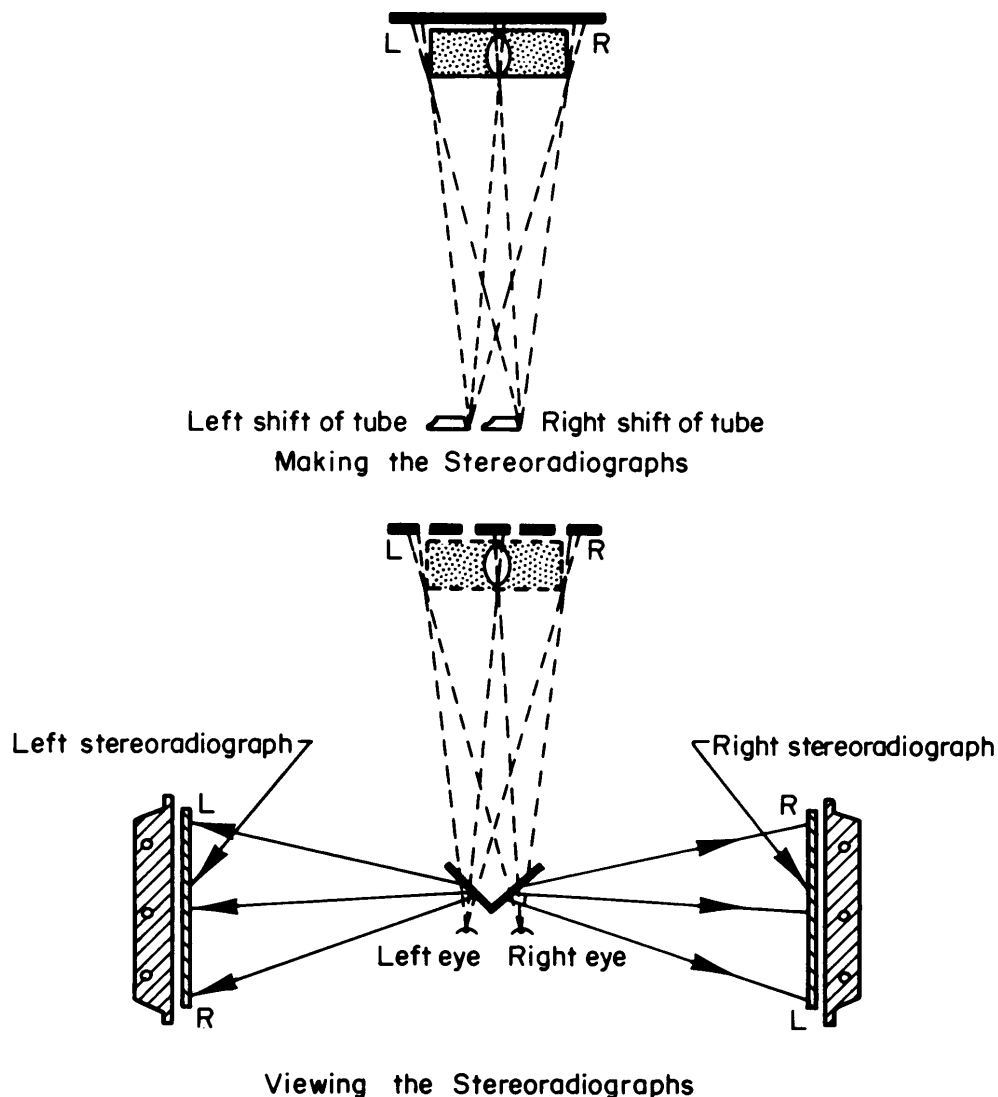
T.O. 33B-1-1

t = source film distance

6.4.17.2.3.3 It is good to know which of the two surfaces of the object is nearest to the discontinuity. In this case, the shift of the discontinuity and marker images is measured. If the shift of the discontinuity image is less than one-half the shift of the markers on the source side of the object, then the discontinuity is nearer to the film. If the shift is greater than one-half, the discontinuity is nearer the markers on the source side of the object.

6.4.17.2.4 Thickness Measurement. Sometimes it is impossible to determine the thickness of an object using conventional mechanical measurement techniques. In these instances, a special radiographic technique for the measurement of material thickness MAY be employed. Although the mathematical development of a relationship between film density and the thickness of an absorber is too complex for practical use, an empirical method of thickness measurement has proven useful. By exposing the object of interest and a step wedge of the same material on a single film, it is possible to obtain a good estimate of the thickness of the material section. It is imperative the composition and structure of the step wedge be the same as the material being measured if any accuracy is to be achieved. Thickness is determined by measuring the resultant film density and finding the step on the wedge is that nearest to the same density. For best results, the section of interest and the step wedge SHOULD be placed as close to one another as possible to avoid variations in the uniformity of the radiation beam. This technique MAY also be employed to measure void dimensions (parallel to the beam direction).

6.4.17.2.5 Stereo (Three Dimensional). Normally, objects appear in their true perspective and correct spatial relationship because of a property of the eyes, called stereoscopic vision. That is, each eye receives a slightly different view and the two images are combined by interpretation to give the impression of three-dimensions. A single radiographic image does not possess this perspective; therefore it does not give the impression of depth. However, some estimate of depth can be judged from detail observed by an experienced radiographer. The mechanics of stereoradiography are relatively simple. Two radiographs are made from two positions of the X-ray tube. These positions can be thought of as the "left eye" and the "right eye." As a matter of fact, the two positions represent the distance between the eyes. A so-called stereoscope is used to view the images (Figure 6-45). Each eye sees only one image but the brain blends these two images into one.



H0401913

Figure 6-45. Sketch Showing Procedure for Making and Viewing Stereo Radiographs

6.4.17.2.5.1 Remember the radiographic image produced does not define the surfaces of the object as in a photo or by direct vision. This is because no radiation is reflected from the surface as under normal optical means. Therefore, in order to obtain apparent depth, it is usually necessary to define the surfaces of an industrial object by means of an X-ray attenuating marker such as a very coarse, high-absorption mesh or grid. These grids can be easily constructed by using 1/16-inch solid lead solder. Such grids, especially on objects with plane surfaces, SHOULD be placed on both the source and the film side.

6.4.17.2.5.2 It is important when taking the radiographs for the distance of shift of the source to be approximately one-tenth the focal film distance. Also, in viewing the resultant radiographs, each film must be positioned so as to duplicate the exact conditions of exposure. That is, the eyes of the viewer SHOULD be in the same relative position as the focal spot of the X-ray tube or source. This positioning is facilitated by placing a different lead marker on each of the two films. The eyes will then see a true representation of the part just as the X-ray tube saw the actual part.

6.4.17.2.5.3 Stereoradioscopic methods can also be used to present stereo images when using realtime radiography.

6.4.17.2.6 Geometric Magnification. For some applications, it is desirable to magnify the radiographic image. This can be done optically after the radiograph has been taken, or it can be done during the radiographic process by using geometric magnification. This is particularly effective when X-ray sources with small focal spots are used (e.g., the mini-focus and

T.O. 33B-1-1

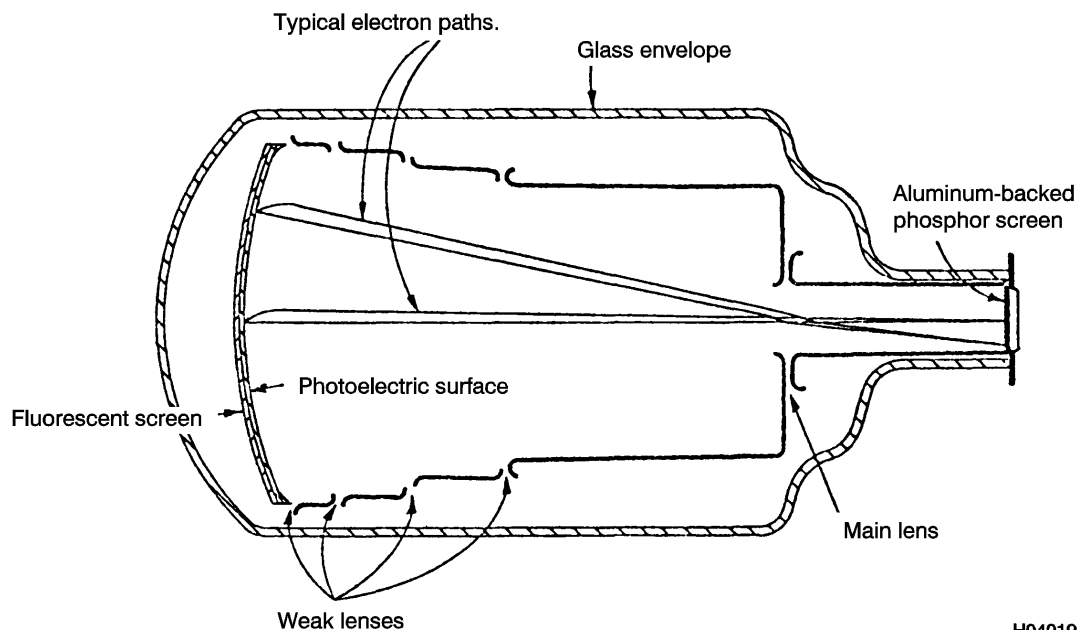
micro-focus sources) as described in (paragraph 6.3.3.2.3). Geometric enlargement can be realized by moving the radiographic object away from the detector, toward the radiation source. Moving their inspection object halfway between the X-ray source and detector produces a magnification factor of two. If the object is closer to the X-ray source (say 1/10th of the source-detector distance) then the magnification is ten times. Useful radiographic images have been produced with small micro-focus sources with geometric magnifications of 10X or more. Although this discussion has covered geometric magnification using only a film detector, this special method can be used with any imaging detector, including radioscopic detectors. Recognize as magnification increases the inspected volume of the object decreases. Therefore, more radiographic views MAY be needed for a complete inspection.

6.4.17.3 Special Imaging Methods. Conventional film radiography has its own capabilities and its own limitations. The capabilities of film radiography have been covered thoroughly in the previous sections. Consider some of the limitations of film radiography. Film takes a long time to process, and the results of the inspection cannot be known until the film is processed. Therefore, in some situations, a need exists to provide a more rapid means of imaging. There are many alternatives to the use of conventional film for recording radiographic images. These include the use of “radioscopy,” “image intensifiers,” “X-ray vidicon,” “stereo radioscopy,” “photo-radiography,” “Polaroid radiography,” “photothermographic film,” “computed tomography,” “neutron radiography,” and computed “digital” radiography. The following paragraphs discuss the advantages and capabilities of these imaging systems. Most provide for more rapid imaging than is available using conventional film radiography. However, each of these methods also has its own limitations. Special imaging methods not included in authorized inspection manuals SHALL NOT be used without written approval of the appropriate depot engineering authority.

6.4.17.3.1 Radioscopy. The oldest non-film imaging method involves the use of fluorescent screens to produce a visible image. These phosphor screens fluoresce (emit visible light) in proportion to the amount of radiation striking them. Thus, an instantaneous visible image is produced, and the results may be instantly read using a now outdated method called fluoroscopy. Modern, prompt-view, or real-time radioscopy systems make use of closed-circuit television systems to bring these images out to a safe viewing location, where a bright television image can be viewed. Radioscopy is defined in ASTM standards as “the electronic production of a radiological image that follows very closely the changes with time of the object being imaged.”

6.4.17.3.2 Fluorescent Screens. The light-emitting fluorescent screen can be viewed directly to see the prompt X-ray image. However, this method is rarely used now because closed-circuit television methods can provide a safer, more efficient environment to view the low-light level signal from the fluorescent screen. The fluorescent screen light signal can be detected by sensitive television cameras, such as the image orthicon. In some systems, the weak light signal from the fluorescent screen is amplified by using a light-image intensifier tube between the fluorescent screen and the television camera.

6.4.17.3.3 Image Intensifiers. Image intensifiers are specially designed, evacuated electronic tubes, which intensify the image on fluorescent screens with very fine grains. The input signal, fine grain screens used in image intensifiers, do not produce sufficient light to be viewed and employed for direct fluoroscopy. Therefore, an image intensification system is employed as shown in (Figure 6-46). The fluorescent screen is backed by a photo-emissive layer that produces electrons in proportion to the number of visible light photons emitted by the fluorescent screen. A series of focusing and accelerating electrodes propel these electrons toward a second and much smaller fluorescent screen, which has very high detail resolution. This screen is typically viewed by a light-sensitive vidicon or other television camera and displayed on a television monitor. The image intensifier provides the immediate imaging capability of the fluorescent screen, while providing higher brightness and detail resolution in a safe area remote from the radiation. However, resolution is still less than obtained with Class 4 radiographic films. There is also no permanent record provided unless a photograph or video tape is made. The X-ray image intensifier is widely used as part of a radioscopy X-ray inspection system.



H0401914

Figure 6-46. Typical Image Intensifier Tube

6.4.17.3.4 X-ray Vidicon. The X-ray vidicon system consists of a specially designed television camera directly sensitive to X-rays. It has a specially coated face capable of imaging X-radiation, because its electrical resistance changes with radiation, a phenomenon called photoconductivity. This small area coating provides very fine resolution. The results of this type of inspection are displayed on a television monitor. The sensitive area of the television vidicon tube is generally very small, on the order of 3/8 by 1/2-inch. When this small area is viewed on a 17-inch television monitor, a magnification of 30 times results, thus, very high detail resolution is accomplished. These systems are used primarily for the inspection of very fine detail, such as in the inspection of microelectronic circuits. This system is capable of resolving wires as small as 0.001 inch in diameter.

6.4.17.3.5 Stereoradioscopy. Stereo imaging can be done in real-time, using microfocus X-ray sources, geometric magnification, and radioscopy systems. The stereo pair images can be obtained using only minimal movement of the microfocus X-ray source when geometric magnification is used. This stereo pair imaging can be done by magnetic movement of the X-ray tube electron beam. The two stereo views, obtained at TV field rates (1/60 second), can be combined electronically into a stereo pair image for 30-frames/second viewing. An observer, wearing special polarizing glass and looking at the television stereo image through a 1/60 second changing polarizing filter, will see a stereo, radioscopy image.

6.4.17.3.6 Photoradiography. Photo radiography is a combination of radioscopy and photography. In this method, the image of a fluoroscopic or image intensifier output screen is photographed by a conventional camera on small or miniature-type film rather than by direct contact. This method has the advantage over fluoroscopy in the film has the property to integrate and react to the total light emitted by the screen during the time of exposure, whereas the integration time of the eye is relatively short. Furthermore, the resultant film can be viewed with transmitted light and the photographic process can be used to enhance the contrast of the fluorescent image. This method has been used to limited extent for the examination of propellant grains, die and precision castings, and similar parts and assemblies when a large number of parts of the same configuration and size are inspected. Airframes have been inspected for component shift and material changes by using photoradiography. The system has limitations since all fluorescent screens commonly used are grainy. In addition, there is loss of definition through the lens of the camera. The main advantage of the system is that it is less expensive because of the use of smaller sized film. The image can be enlarged for viewing by a magnifying system or by projection. In general, this system permits radiographic sensitivity of about four to five-percent. The photoradiography accessory is available as an assembly and usually consists of a light-tight hood, a fluorescent screen or image intensifier assembly, and the camera. Various type cameras are available, some, of which employ sheet film and others using 70-mm roll film.

T.O. 33B-1-1

6.4.17.3.7 Polaroid Radiograph. If a convenient, permanent image is needed and the time required for conventional film radiography is prohibitive, an alternate MAY be radiography with other film. An example of this is Polaroid radiography. Just as Polaroid photography facilitates very rapid development of photographic images, there are available Polaroid X-ray films which provide the same advantages. These require the special Polaroid film holders and a film processor if the larger sizes are used. In some cases the typical Polaroid 4 by 5-inch adapter can be used. Polaroid radiographic films are used just as regular films are used in conventional film radiography. They have their own characteristic curves and an appropriate exposure technique SHOULD be used. However, after the exposure has been made, rather than process the films by conventional techniques, they are dry developed as a Polaroid photograph, and results are available after about one minute. Currently, available Polaroid films provide for either viewing by reflected or transmitted light. Polaroid radiographs provide nearly instant interpretation and a permanent image. However, Polaroid radiographs are low in contrast and detail resolution compared to conventional film. Polaroid radiographs can be made to establish the geometrical alignment of the X-ray beam with the part before a typical film radiograph is exposed. This technique is useful in those cases where critical alignment is required.

6.4.17.3.8 Photothermographic Film. The photothermographic process uses a special “dry silver” film which is heat processed, eliminating the need for chemical processing. The film is sensitive to visible green light. Therefore, to produce the image, phosphor intensifying screens are placed in intimate contact with the film. When struck by X-rays, the screens fluoresce, forming an image on the film. Because film itself is insensitive to X-rays, care SHALL be taken to assure the coated side of the film is in direct contact with the coated side of the screen during the exposure. Since this film is dependent upon the screens for forming the latent image, only screens approved by the film’s manufacturer SHALL be used. To aid in maintaining the necessary contact, vacuum cassettes SHALL be used for holding the film and screens, unless an approved procedure states otherwise. Photothermographic film is less sensitive than Class 4 films; therefore, it is not suitable for most critical applications and SHALL NOT be used for critical crack detection. Photothermographic film is processed by exposing the film to heat in a special thermal processor. The heat causes the latent image in the silver halide grains to form in the reducible silver salts. This process is very fast; typically requiring 20-seconds to process a 14 by 17-inch film. During this process the radiograph is also stabilized, requiring no additional processing. The image produced SHOULD remain stable for years under normal storage conditions. However, exposure of the film to bright light for several days could cause some discoloration of the white background.

6.4.17.3.9 Computed Tomography (CT). Computed Tomography (CT) is a radiation inspection method that can provide quantitative density and geometric images of thin cross sections of an inspection object. The method, adapted for nondestructive testing after extensive use in medical radiology, employs a computer to reconstruct an image of a cross-sectional plane through the object. CT inspection of a tree, for example, would look very much like the surface of a tree stump, showing the varying density of the winter and summer wood rings and an accurate representation of the tree growth rings. CT information is derived from a large number of observations of radiation intensity over many different viewing angles. Using CT, one can, in effect, slice open the test object, examine its internal features, perform dimensional inspections and identify any material or structural anomalies that may exist. As compared to conventional radiography, a major advantage of CT inspection is internal structures are not hidden or shadowed by other structures that might be in the beam path. Also CT inspection can provide quantitative information about density variations and spatial locations within the inspected material. An obvious disadvantage is that currently used CT image reconstruction methods require full access to the inspected part; full 180-degrees of data must be collected by the scanner. Also, the inspection object must be small enough to fit in the CT handling and scanning system. Systems large enough to handle missiles up to 9-feet in diameter are in use.

6.4.17.3.10 Neutron Radiography.

6.4.17.3.10.1 Description. Neutrons are useful for radiography because the attenuation of thermal neutrons is very different from that of X-rays. In general terms, the attenuation pattern is reversed, as many light materials (e.g., hydrogen, lithium, boron) have high attenuation of thermal neutrons while many heavy materials (e.g., bismuth, lead) are relatively transparent. Therefore, in this sense, neutron radiography can serve as a complementary inspection technique to X radiography. The advantages of thermal neutron radiography include excellent sensitivity to materials containing low atomic number elements (particularly hydrogen, lithium, and boron), some additional high attenuation materials (examples include silver, cadmium, indium, and gold), and rare earth elements (particularly samarium, gadolinium, and dysprosium).

6.4.17.3.10.2 Applications. Sensitivity to low atomic number materials opens up neutron inspection to a variety of applications involving water, explosives, fluids, rubber, plastics, and corrosion products (usually a hydroxide). An example of this type of inspection is neutron radiography of small explosive devices in metal cases to assure the presence of the explosives. Lead-covered explosive lines represent such an example. Inspection applications involving materials like cadmium have been demonstrated in the nuclear industry for cadmium reactor control materials. Cadmium plating inspection

can also be considered. A major application involving rare earth materials is the inspection of investment-cast turbine blades to detect residual ceramic core left in cooling passages after leaching.

6.4.17.3.10.3 Disadvantages. Disadvantages of neutron radiography include the relatively high cost and additional radiation safety problems. Where high volume applications exist, for example turbine blade inspection, cost need not be a prohibitive factor. The additional radiation safety issues arise mainly from the generation of radioactivity in the inspection sample. These problems are rare and where they exist they are usually easily handled by shielding and/or short waiting-time periods for the radioactivity in the sample to decay.

6.4.18 Digital Radiographic Techniques.

6.4.18.1 Transition from Film to Filmless. Making the transition from film to filmless is a simple process, usually requiring only a few test exposures to optimize the technique. Phosphor plate systems have such a wide dynamic range that over-exposure and under-exposure situations are rare. Direct capture systems like amorphous silicon or amorphous selenium also increase the dynamic range. The time lag from exposure to seeing the result for all of these systems is so short that developing a technique is much easier and faster than with traditional film based inspection methods.

6.4.18.2 Phosphor Plate Imaging. The dynamic range of a phosphor imaging plate is approximately five times that of radiographic film. This means a single exposure using a phosphor system is similar to a triple load (or greater) film technique. The result of this phenomenon is the ability to successfully image parts with a wide range of subject contrast. Thick and thin sections, previously not viewable with film, can now be captured without multi-film or multi-exposure techniques. This also allows for more flexibility in the time/ma combination, which allows for drastic reductions in time of exposure. Some applications have dropped exposure times by as much as 95-percent, which greatly improves productivity, reduces personnel exposure to radiation, and increases X-ray tube life. Further refinements in software allow for the use of a battery operated, pulse X-ray source, rather than a traditional X-ray tube.

6.4.18.2.1 Phosphor plate imaging can be used from 20 kV up to 15 MeV with excellent results. Since the response of the phosphor is different than from film, kV can also be adjusted favorably. Typical kV reductions for X-ray are approximately 15-percent. The lower kV will increase image quality while again lowering personnel exposure and increase tube life.

6.4.18.2.2 The sensitivity of the phosphor plate leads to another effect. Since the phosphor can produce an image with less radiation, the radiographer now has the flexibility to choose an X-ray tube with a smaller focal spot, which again increases definition and sharpness. Micro-focus X-ray tubes are smaller, lighter, and easier to handle making radiography simpler and safer again.

6.4.18.2.3 As in all X-ray systems, image quality is affected by signal-to-noise ratio. This means longer exposure times will increase image quality. Lower exposure times can be used when inspecting for foreign objects, water, core damage, and foam adhesion. This is due to the relatively low image requirements of these inspections. The contrast sensitivity of the phosphor systems makes water intrusion detection better than with film. For crack detection, longer exposure times will be required, but will still be less than for film. Fatigue cracks and stress-corrosion cracks can be imaged using phosphor plate systems. All of these applications still require the use of a procedure to standardize the inspections and to assure reliable results.

6.4.18.3 Phosphor Plate Handling. Another drastic change from a film system to a phosphor system is the handling of the phosphor media. The plates are flexible and can be used in a conventional film cassette. They are positioned and exposed in a similar fashion to film. With proper handling and care, the plates are capable of many thousands of re-use before replacement.

6.4.18.4 Direct Capture Systems. Amorphous silicon and amorphous selenium systems have the capability of producing filmless images in a very short time, with no mechanical moving parts. The image acquisition time is usually fixed at 5 to 10-seconds, leaving the dose to be controlled by adjusting the ma. The optimum kV will be 5 to 10-percent less than film.

6.4.18.4.1 These systems are excellent choices for factory and laboratory environments where handling of the panel is kept to a minimum in an X-ray cabinet or vault. Positioning these devices on aircraft is difficult and cumbersome. The risk of damage to the panel is high, making these devices impractical for field use. Exposure to temperature and humidity extremes further deters their use on the flight line. Portable versions of these devices have been used on aircraft, but their small field of view and low resolution make them unreliable for crack detection.

SECTION V INTERPRETATION OF RADIOGRAPHIC INSPECTION

6.5 RADIOGRAPHIC INTERPRETATION.

6.5.1 General. The recording of an X-ray image pattern on a film is called radiography. This film, when processed, is called a radiograph. Its interpretation is called radiographic inspection. To obtain the greatest value from this procedure, characteristics of the radiograph must be understood and properly applied. It is possible to make erroneous deductions based on radiography that could result in improper disposition of the material. It is the duty of the radiographer to continually guard against this possibility. The interpretation and correlation of this information is affected by a number of characteristics in the process that ultimately are reflected in the radiograph. The characteristics of the radiograph are reviewed and discussed in the following paragraphs.

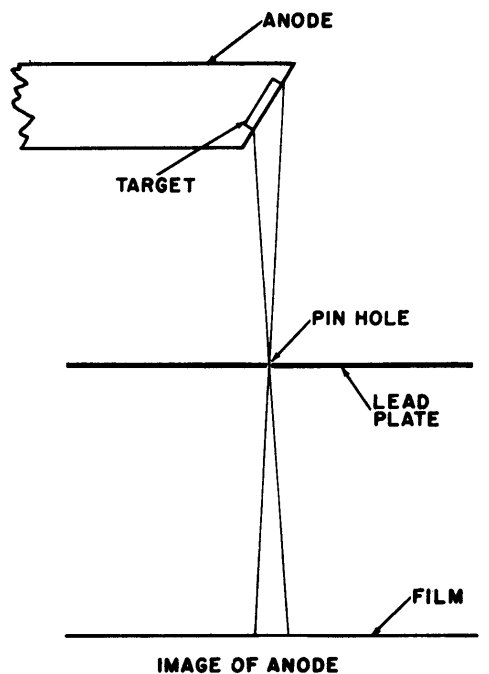
6.5.2 Radiographic Image Quality. Radiographic interpretation cannot be performed without knowledge of the image quality. Knowledge of the image quality tells the film reader the minimum size of discontinuities they can expect to visualize.

6.5.3 Sensitivity. Radiographic sensitivity is defined as the differential in thickness, in terms of percentage of total thickness recorded by radiography. This sensitivity is a result of X-ray image contrast, film contrast, image sharpness, image distortion, and image density obtained in the radiograph. In normal radiographic practice no attempt is made to record the ultimate radiographic sensitivity in each radiograph. However, it is required that a certain quality of radiography be attained to assure satisfactory inspection. To assure this quality of inspection by radiography, penetrameters (image quality indicators) are used. The application of penetrameters is discussed in an earlier section.

6.5.3.1 Examination of the penetrameter image on the radiograph will indicate the sensitivity. Correct radiographic procedure will show the image details of the penetrameter sharply defined. However, the penetrameter sensitivity is a gauge of a certain standard of sensitivity. It cannot actually measure the sensitivity in percent. This idea of penetrameter sensitivity has several limitations that **SHOULD** be kept in mind:

- The eye is limited in resolution.
- Discontinuities are detectable only in the direction of primary radiation.
- Variations in material density are not considered.
- Definition or sharpness of transition between densities is not considered.
- Actual defects are usually irregular in shape while penetrameters have a definite size and shape.

6.5.4 Definition or Detail. Definition or detail in radiography is the sharpness of the image outline reproduced on the film. The size of the focal spot, the physical condition of exposure, and the film resolution determine the definition. If a screen is used, then the screen resolution will also affect the definition. In addition to the focal spot size, the object-to-film distance is an important factor in the sharpness of shadow picture ([Figure 6-47](#)). The resolution of the film is a function of grain size.



H0401915

Figure 6-47. Pinhole Picture of Focal Spot

6.5.4.1 Since the radiograph is a shadow picture, the geometrical interrelationship between the elements of the radiographic system is important. Ideal X-ray focal spots and radioisotope sources **SHOULD** be pinpoints. With such sources, we would obtain sharp images under all conditions. All our radiation sources have finite size since X-ray tube focal spots must be large enough to withstand the energy dissipated as heat to prevent melting and target destruction. The radioactive activity of an isotope is proportional to the source strength in curies, so the smaller the size, the lower the intensity.

6.5.4.1.1 To better understand geometrical relationship (Figure 6-48), which illustrates various conditions true to X-ray and light shadow formations. Diagram "A" in (Figure 6-48) shows the size of the shadow is to the size of the object as the distance of the light to the card is to the distance of the light to object. This image is a true projection. If the source has finite size, the shadows cast will not be perfect projections, but will have surrounding areas out of register, producing a gray cast of unsharpness, which is, called penumbra. Diagrams "B" through "D" in (Figure 6-48) show the effect of changing source size, altering the relative position of source, object and recording surface. From these examples, it will be seen that the following conditions are desirable to produce sharp shadow images:

- The X-ray source **SHOULD** be as small as possible.
- The X-ray source **SHOULD** be as far from the object as possible.
- The recording surface **SHOULD** be as close to the object as possible.

T.O. 33B-1-1

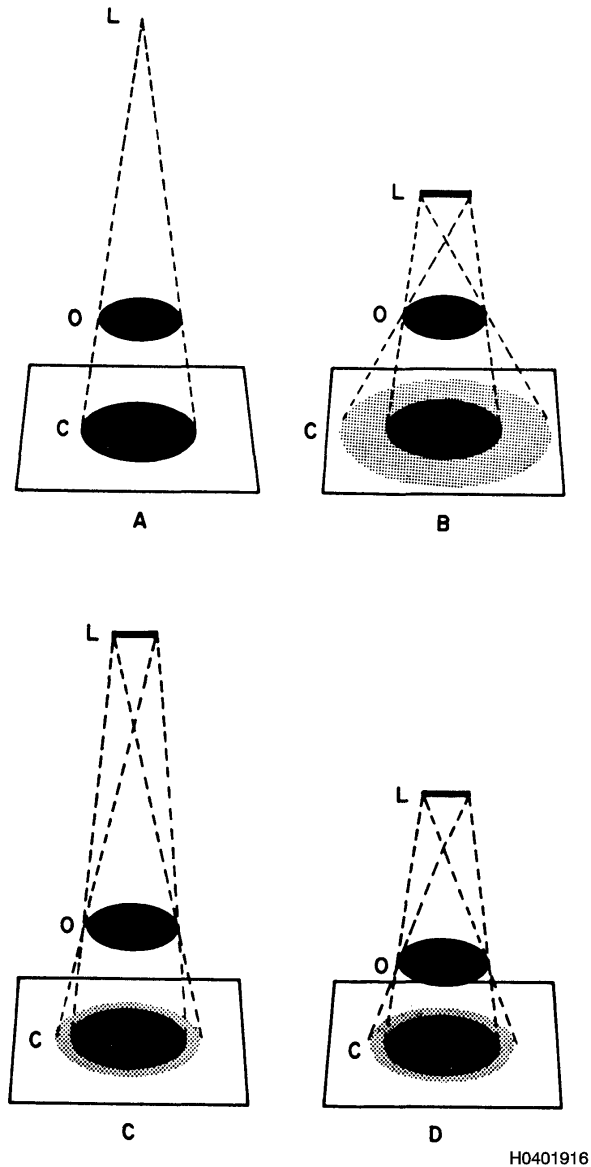


Figure 6-48. Geometrical Factors

6.5.4.1.2 There are other factors affecting detail. They include motion, screens, film, and scatter. If the source, object, or film move independently of each other or are not in phase, blurring will result. Rigid supports for all three elements must be used to prevent this blurring. Since characteristics and conditions of film, screens, and scatter are also related to film contrast and density, they will be discussed later in subsequent paragraphs.

6.5.5 **Density.** Radiographic density is the blackening or darkening produced on the radiograph resulting from the metallic silver deposits remaining on the film after exposure and processing. Density is measured in terms of visible light transmission. The accepted scale of density measurement is the logarithm of the ratio of incident light to transmitted light as given by the following equation: (paragraph 6.7.5.)

$$D = \log \frac{I_0}{I_t}$$

H0401917

Where:

D = density

I_0 = intensity of incident light

I_t = intensity of transmitted light

6.5.5.1 Measurement of radiographic density SHALL be done with electronic direct-reading type densitometers capable of measuring the light transmitted through a radiograph with a film density up to 4.0 with a density unit resolution of 0.02 (paragraph 6.3.12.1). The electronic direct-reading type densitometer is more accurate than the visual type. The densitometer SHALL be calibrated with reference density strip, traceable to the National Institute of Standards and Technology (NIST), prior to determining the density of a radiograph (paragraph 6.3.12.1.1). These calibrated density strips SHALL be replaced whenever they are physically damaged (e.g., scratched, crimped, or become wet by any fluid) to such an extent it might influence their effectiveness. The carbon, dot printed, etc. density strips SHALL NOT be used even though they MAY be NIST traceable. These strips are not able to correlate the densitometer directly to Air Force radiographic needs. Each type of calibrated reference density strip will calibrate the densitometer to a different standard level. The restrictive use of only the photographic or radiographic calibration reference density strip will better enable the standardization of all densitometers to a single calibration value establishing a common (H and D units) density for a given radiographic inspection. The aperture of the densitometer SHALL be black in color. If it is not, it MAY be darkened with a black magic marker or other indelible ink.

6.5.5.1.1 While performing the densitometer calibration procedure, the following SHALL apply:

- a. Follow manufacturer's instructions, substituting the calibration strip supplied with the instrument with the NIST traceable radiographic calibration reference density strip.
- b. The calibration reference density strip SHALL be removed from its protective cover during the calibration procedure, and maintained in its protective cover when not in use.
- c. The calibration reference density strip SHALL NOT be pulled or slid when it is between the aperture and stage diffuser. The aperture SHALL be raised so it is not in contact with the density strip when the strip is being repositioned or removed from the densitometer.
- d. Calibrated reference density strip measurements SHALL be determined from the center of the steps used for the calibration procedure.

6.5.5.1.2 The density of a radiograph is important. Densities less than 0.5 show very little of the object due to three factors: (1) the density of the emulsion base, (2) the basic "fog" of the film and (3) the lack of uniform response of the film at low radiation exposures. Special illuminators are required to view radiographs with a density of 3 to 4. Radiographs with a density over 4 are extremely difficult to "read." A density of 2 to 3 is recommended for all radiographs.

6.5.6 **Contrast.** Maximum contrast is achieved in radiography when the maximum X-ray image contrast is coupled with the maximum available film contrast. High-density radiographs viewed with high intensity illuminators provide the best radiographic contrast. As one of the factors that affect sensitivity, contrast SHOULD be high. Some of the general rules regarding contrast are as follows:

- Contrast increases as kVp decreases.
- Contrast increases as film development increases.
- Contrast increases as film speed decreases.
- Contrast decreases as kVp increases.
- Contrast decreases as film development decreases.
- Contrast decreases as film speed increases.

6.5.7 **Fog.** Fog is the darkening of radiographic emulsion caused by humidity, heat, cosmic radiation, certain chemicals, out of control development chemicals, scatter radiation, and bad development practices. It is defined as the darkening of the film emulsion by an inadvertent cause. The fog level of film brings no useful information to the film and merely creates a

T.O. 33B-1-1

high background that reduces contrast and image visibility. The faster the speed of the film, the more susceptible it will be to fogging.

6.5.8 Distortion and Magnification. Some of the factors that cause distortion and magnification are discussed in other areas of this manual. However, distortion can also be caused by improper alignment of the X-ray machine and/or film in relation to the object. If distortion is so excessive areas are obscured, it may be necessary to radiograph the object at a different angle. The total distortion or magnification tolerated on a radiograph will depend upon the desired sensitivity and the geometry of the object itself.

6.5.9 Kilovoltage and Processing. Any attempt to evaluate a radiograph must take into consideration the conditions under which the radiograph was made. The effects of different kilovoltages and processing techniques cause a variation in contrast and latitude.

6.5.10 Viewing Radiographs. Viewing the radiograph is the final step in the radiographic inspection procedure. The radiographer must be aware of the various factors that can influence his decision. Some factors are density of the film, artifacts on films as a result of handling and processing, level of illumination for viewing radiographs, response of human eye to differences in light intensity, and the acuity of vision.

6.5.10.1 Viewing Conditions. Reading large numbers of radiographs is a strain on the eyes and fatiguing to the film interpreter. The environment of a film reading area **SHOULD** be pleasant and **SHALL** be free of objectionable background light, which **MAY** cause reflection on the radiographic film. Two and one-half foot-candles of ambient light measured at the viewer is optimum for viewing. This light level will aid the film interpreter by accommodating the eye so they are more sensitive to light. When attempting film interpretation, the radiographer **SHOULD** wait at least three (3) minutes before reading film, when coming into the viewing room from ordinary artificial room light. When coming from full sunlight, the interpreter **SHOULD** allow 5-minutes for dark adaptation before viewing. If the eyes are subject to the full brightness of the illuminator during changes of the radiographs, at least 30-seconds re-adaptation is necessary (Figure 6-49). The film reading illuminator or illuminators **SHOULD** transmit at least 2-foot-candles of light through the film at the viewing surface of the film. This quantity of light is sufficient to view radiographs with a density of 3-H and D units. There **SHOULD** also be a high intensity illuminator with a variable light intensity capable of transmitting the required light through densities in the order of 4 to 4.5-H and D units for interpreting these high densities. All film viewers **SHALL** be of the type that provides a uniform level of illumination over the entire viewing surface.

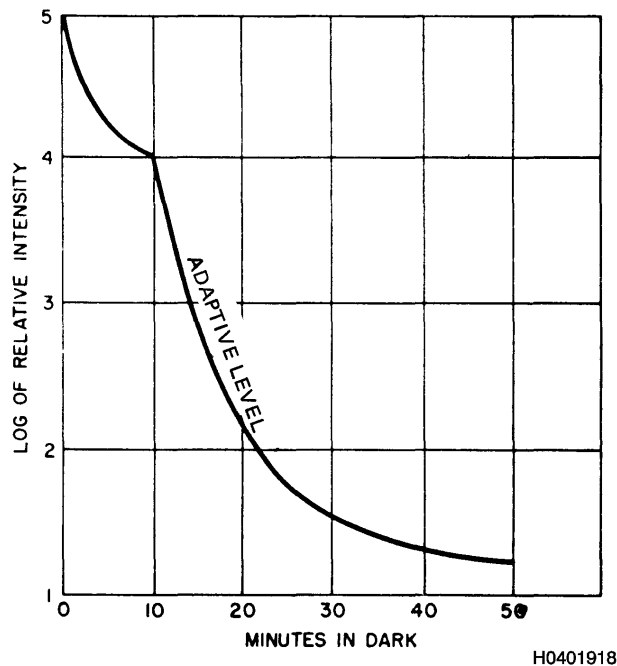


Figure 6-49. Dark Adaptation Diagram

6.5.10.2 Limitations of Eye. The eye is the evaluation medium in radiography. Visual accuracy varies considerably from one individual to another. Oddly enough, a perfect eye does not necessarily mean a perfect visual system. Certain “defects” can be present. Vision must not only record shapes and sizes, but also the variation of light intensities. In this area the eye is especially unreliable. The relative brightness of two light sources, for example, can be gauged only approximately. And even such approximate evaluation is possible only when the light sources are close to the same order of brightness. For example, a bright object or area appears brighter when viewed against a dark field. Conversely, the object will appear darker than it really is when the surrounding area is comparatively brighter.

6.5.10.3 Visual Size. In any task requiring critical examination, we are usually more conscious of size than anything else. The minimum size of an object seen under a given set of conditions is called the threshold size. This varies greatly depending on brightness-contrast between the immediate background and the detail being examined. It also varies with the level of brightness. The physical size of an object can easily be measured, but it is difficult for most individuals to interpret physical size into visual size. The type in which this is printed has a definite physical size measured in points, a point being about 1/72 of an inch. The visual size, however, depends on the distance from the page to the eye. The visual size of the letters at two feet is only one-half that obtained for a page-to-eye distance of one foot. The visual size is the angle subtended at the eye by an object at a distance. The threshold size of a critical detail (such as this black print on a white background) is about one-minute (1/60 of one degree) for persons of normal vision. An individual with sub-normal vision will be able to pick up an object of just about twice the visual size required for normal vision. The relation of a visual size of one-minute of a degree to physical size for different viewing distances is given in (Table 6-20).

Table 6-20. Visual Size Versus Physical Size

Viewing Distance (inches)	Physical Size (inches)
10	0.0029
12	0.0035
15	0.0044
20	0.0058
24	0.0070

6.5.10.3.1 For a given viewing distance the visual size is the maximum when the line of sight is perpendicular to the plane in which the object lies. Referring again to this printed page, this means a line from the eye perpendicular to the page. As the page is inclined (to decrease the angle between the line of sight and the page), the visual size of the print is decreased until at 45° the type size is only 70-percent of what it was at 90°. For a 45° angle, assuming an object of fixed physical size and fixed viewing distance, visibility equal to 90° can be had only by increasing the illumination level by 2-1/2 times. An aid in reading radiographic film is the pocket comparator with graduated reticules having linear and circular scales. They are able to measure the size of discontinuities and/or defects depicted on this film.

6.5.10.4 Visual Contrast. A certain level of contrast is desirable between small detail and its immediate surroundings. However, a high degree of contrast between those immediate surroundings and any large area outside the field in which the detail lies is unfavorable. The contrast between this print and the page is favorable, but a high contrast between the page and the desk on which it lies is detrimental to good vision. For each contrast there is a threshold size, and, conversely, for each threshold size there is a minimum contrast if the object is to be just visible. If the eye is to detect a difference as the brightness level decreases, the difference in brightness levels must be greater and greater. It is evident the eye must have considerable time to adjust to low levels of light intensity.

6.5.10.5 Speed of Sight. Sight is not instantaneous, it takes time to see. We do not see when the eyes are in motion. In reading this line, the eyes focus on a point called the point of fixation. This point of fixation is then moved along the line in a series of jumps. The eyes come to a dead stop several times, about three times usually in reading a line of this print. What we do is read a portion of the line during each fixation period. The time of one of the fixation periods varies between 0.07 and 0.3-second. Hence, these times become the limiting periods in seeing. As a visual task increases in difficulty, these fixation periods become longer. Involved, too, is the problem of reaction time, that is, the time that elapses between seeing and acting. Any task involving sight becomes a series of complex time intervals. The time for seeing is naturally greatly influenced by experience, mental reaction time, brightness level, contrast-brightness, and visual size. The rapidity with which any visual examination can be carried out is a relation between these factors and the necessary accuracy or exactness of the examination.

T.O. 33B-1-1

6.5.10.6 Illuminators/Viewers. The illuminator must provide sufficient light to transmit adequate light for the observer to distinguish areas easily. Since the human eye has greater visual acuity and contrast visualization at given levels of light, the illuminator must provide control of light levels to adjust for optimum visual response of observer. The accepted differential of density detectable by the average individual is 0.02. Thus, a 2-percent change in thickness must result in density change of 0.02 or more. The contrast sensitivity of the human eye is greatest when light reaching the eye comes from one source. Therefore radiographs **SHOULD** be read in areas of subdued light to avoid reflection and glare. The eye responds best if all the light reaching it is approximately the same brightness.

6.5.10.6.1 Opaque masks to suit the size of radiographs being viewed and to isolate areas of interest **SHALL** be used to avoid brightness around edges of film, excess light from low density areas of no interest and reduce light intensity from the illuminator when changing radiographs. This prevents the eye from continually adjusting itself to the changing light levels that cause fatigue. At normal light levels, the eye can see the differences in light brightness of 2-percent. As light reaching the eye decreases, the percentage increases.

NOTE

Radiographs having great ranges of density and complicated image patterns **SHOULD** be viewed on high intensity, 14 x 17 illuminators having adjustable diaphragms and variable light intensity to assure best eye response.

6.5.11 Reading (Interpreting) Radiographs. Interpretation of radiographic images cannot be translated into mathematical formulas or routine procedures. The wide variety of test objects and the various fabrication processes by which they have been made makes radiographic interpretation a complex subject. Radiographic inspection is conducted to assure a material or part has the required integrity to reliably perform the function for which it was designed. This does not mean perfection. All parts, materials, and processes are imperfect. Therefore, the purpose of radiography is to determine the degree of imperfection. The effects of discontinuities or manufacturing deviations must be correlated with the function of the part. Specifications are usually used to spell out the discontinuities that could be considered detrimental to the function of the part and the acceptable magnitudes of the discontinuities. It is the duty of the film interpreter to recognize the various discontinuities, their magnitudes, and be capable of relating them to the particular specification required. The responsibility and capability of the radiographic interpreter cannot be over emphasized. Often, many human lives and investments of millions of dollars are depending on the judgment of the radiographic interpreter. Any information that can be of assistance in making a judgment of discontinuities **SHOULD** be fully utilized. Interpretation of the shadow images visible in the radiograph is an acquired skill, and there is no substitute for experience. Experience aids the film reader in recognizing discontinuities and in identifying where they can be expected to occur in a particular part or structure. The mistakes in radiographic interpretation most often are a result of misreading film artifacts. There are a number of density patterns that resemble welding and casting defects that are often unjustified causes for rejects. A good check is to look at the surface of the film by reflected light to observe any unusual patterns.

6.5.11.1 The inspector reading the radiographs, **SHOULD** be acquainted with the exposure technique used, material radiographed, conditions of processing, and the geometry of the exposure setup. In this way they can judge more accurately the radiographs produced and interpret the discontinuities more accurately. To determine if the part is rejectable or acceptable they will generally consult with the structural or design engineer unless standards have been established.

6.5.12 Typical Use of Radiography. The radiographic inspection method is expensive when compared to other nondestructive inspection methods, and **SHOULD** be used for evaluation of internal discontinuities that cannot be evaluated by more economical methods. Therefore surface discontinuities considered detrimental to the function of the part, **SHOULD** be evaluated by visual inspection or other NDI methods more economical than radiography. The major use of radiography is to reveal internal discontinuities. We will now discuss some of the various ways radiography is used to locate discontinuities in castings, welds, and during in-service inspections.

6.5.13 Castings. The process of forming various shapes of metal by pouring molten metals into molds accounts for a considerable share of the critical components of an aircraft. These castings are made by melting ferrous and nonferrous alloys and casting them into useable shapes. The majority of castings encountered requiring X-ray inspections are made of light alloys; that is, aluminum and magnesium alloys. There are a number of inherent difficulties in this manufacturing technique which plague the foundry. Since the molten metal occupies a larger space than the same material after it freezes or cools, precautions **SHALL** be taken to prevent the metal from shrinking too rapidly and forming voids which are called shrinkage or from rupturing the metal to cause hot cracks. The molten metal also traps considerable gases from the air. These can result in tiny regular shaped bubbles in the solid metal casting. Some metals, such as aluminum, accumulate gas on the surface of the molten metal. This may be trapped in the casting if adequate precautions are not taken to prevent pouring the gas into the

mold. In addition, sand can wash from the walls of the mold into the casting forming inclusions that reduce the strength of the castings.

6.5.13.1 It is necessary to control the quality of the casting process to assure reliability of the castings. Radiographic inspection is a satisfactory quality control since the conditions likely to make the casting unacceptable are readily detected by this inspection. For the purpose of inspection, airframe castings can be divided into classes based on their function and on their margins of safety for design loading conditions. These classes are defined in SAE-AMS-STD-2175 “*Castings, Classification and Inspection Of*” and are basically as follows:

- Class 1. A casting, which the single failure of, would cause significant danger to operating personnel or would result in a significant operational penalty. In the case of missiles, aircraft, and other vehicles, this includes loss of major components, loss of control, unintentional release or inability to release armament stores, or failure of weapon installation components. Class 1 castings SHALL be further classified under Class 1A and Class 1B below.
 - Class 1A. A Class 1 casting, which the single failure of, would result in the loss of a missile, aircraft, or other vehicle. These castings receive 100-percent radiographic inspection.
 - Class 1B. Class 1 casting, which are not included in Class 1A. Radiographic inspection is accomplished in accordance with sampling Table 1 of SAE-AMS-STD-2175.
- Class 2. All castings not classified, as Class 1. Class 2 castings SHALL be further classified under Class 2A and Class 2B below.
 - Class 2A. Castings have a margin of safety of 200-percent or less. Radiographic inspection is accomplished in accordance with Table 11 of SAE-AMS-STD-2175.
 - Class 2B. Castings have a margin of safety greater than 200-percent, or for which no stress analysis is required. All target drone castings and aerospace ground support equipment fall in this category, except for such critical parts, the failure of which would make the equipment unsatisfactory and cause the vehicles which they are intended to support, to become inoperable. Radiographic inspection is not required.

6.5.13.1.1 Radiographic examination is ideally suited to the inspection of castings because the most common casting discontinuities are three-dimensional and are, therefore, almost independent of angle of inspection. Exceptions in some cases include fine cracks, cold shuts, unfused chills, and chaplets. To reveal these, the radiation must be at or near the same parallel plane as the discontinuity. Hairline surface cracks such as those produced by grinding are seldom, if ever, revealed by radiography.

6.5.13.1.2 In most cases, it is possible to identify radiographic images with the common types of discontinuities, which are inherent in the casting process. This information is valuable to the foundry in procedure development work that may be necessary to meet a standard of quality. Although the discontinuities commonly encountered in aluminum and magnesium castings are similar to those in ferrous metals, a group of irregularities called “dispersed defects” may frequently be present. These “defects,” prevalent in light alloy castings, consist of tiny voids scattered throughout part or all of a casting. Gas porosity and shrinkage porosity in aluminum alloys are examples of dispersed defects. On radiographs of sections more than one-half inch thick, it is difficult to distinguish images corresponding to the individual voids. Instead, dispersed defects may appear on film deceptively as mottling, dark streaks, or other irregularities.

6.5.13.1.3 Radiographic studies of new casting produced by the foundry reveal the type and location of internal discontinuities. This aids the foundry to change the casting technique by altering the gating, relocating chills, changing the pouring temperatures, repositioning, increasing or decreasing the risers or altering the size, correcting a faulty sand condition, or increasing the venting in the mold. After developing an acceptable casting procedure the casting can be duplicated with assurance of a quality part.

6.5.13.1.4 In general, castings are irregular in shape and can vary considerably in cross section thickness from area to area. Therefore, it is important to utilize equipment of adequate capacity to penetrate the section thickness and kind of material under consideration with a technique giving inherent wide latitude with adequate sensitivity. In some instances, even when radiographing light alloys castings, lead filter screens MAY be employed.

6.5.13.1.5 Correct radiographic procedure requires the selection of the lowest voltage that will do the job in a reasonable exposure time. Where many castings are examined, a convenient technique is to establish a reasonable exposure time and select the voltage required for the thickness of the particular section being radiographed. Good practice normally requires exposures be longer than 1-minute. When castings, with great differences in thickness must be radiographed in one exposure,

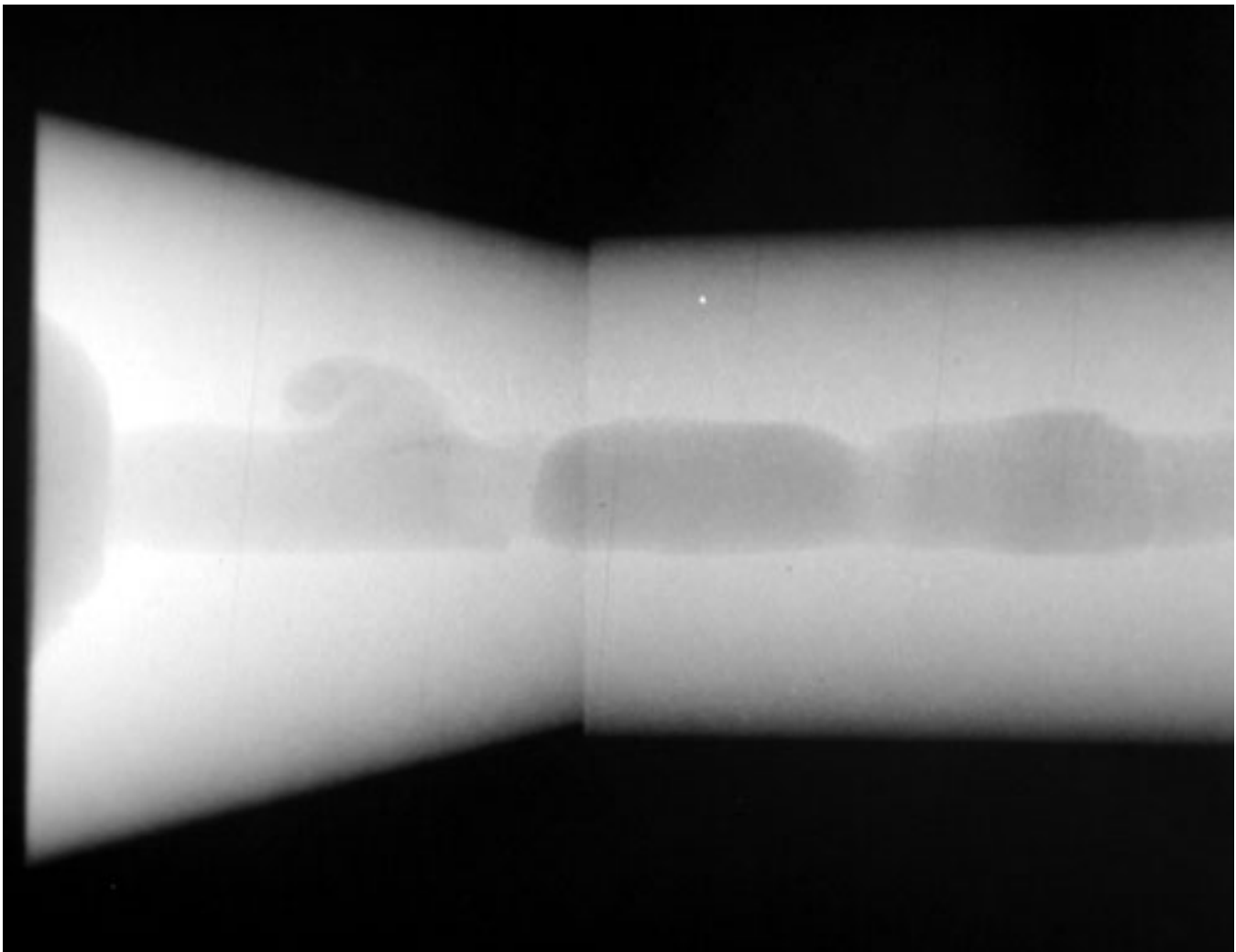
T.O. 33B-1-1

an increase in voltage will provide wider latitude, as well as, shorter exposure time; however, contrast is reduced. If other factors remain constant, the most desirable combinations of voltage and exposure time for a specific part being examined may be governed largely by the acceptable radiographic sensitivity.

6.5.14 Casting Defects.

6.5.14.1 Shrinkage. Shrinkage is a form of discontinuity that appears as dark spots on the radiograph. Shrinkage assumes various forms but in all cases it occurs because molten metal shrinks as it solidifies, in all portions of the final casting. Shrinkage is avoided by making sure that the volume of the casting is adequately fed by risers which sacrificially retain the shrinkage. Shrinkage can be recognized in a number of characteristic by varying appearances on radiographs. There are at least four types: (1) cavity; (2) dendritic; (3) filamentary; and (4) sponge types. Some documents designate these types by numbers, without actual names, to avoid possible misunderstanding.

6.5.14.2 Cavity Shrinkage. Cavity shrinkage appears as areas with distinct jagged boundaries. It may be produced when metal solidifies between two original streams of melt, coming from opposite directions to join a common front; cavity shrinkage usually occurs at a time when the melt has almost reached solidification temperature and there is no source of supplementary liquid to feed possible cavities.



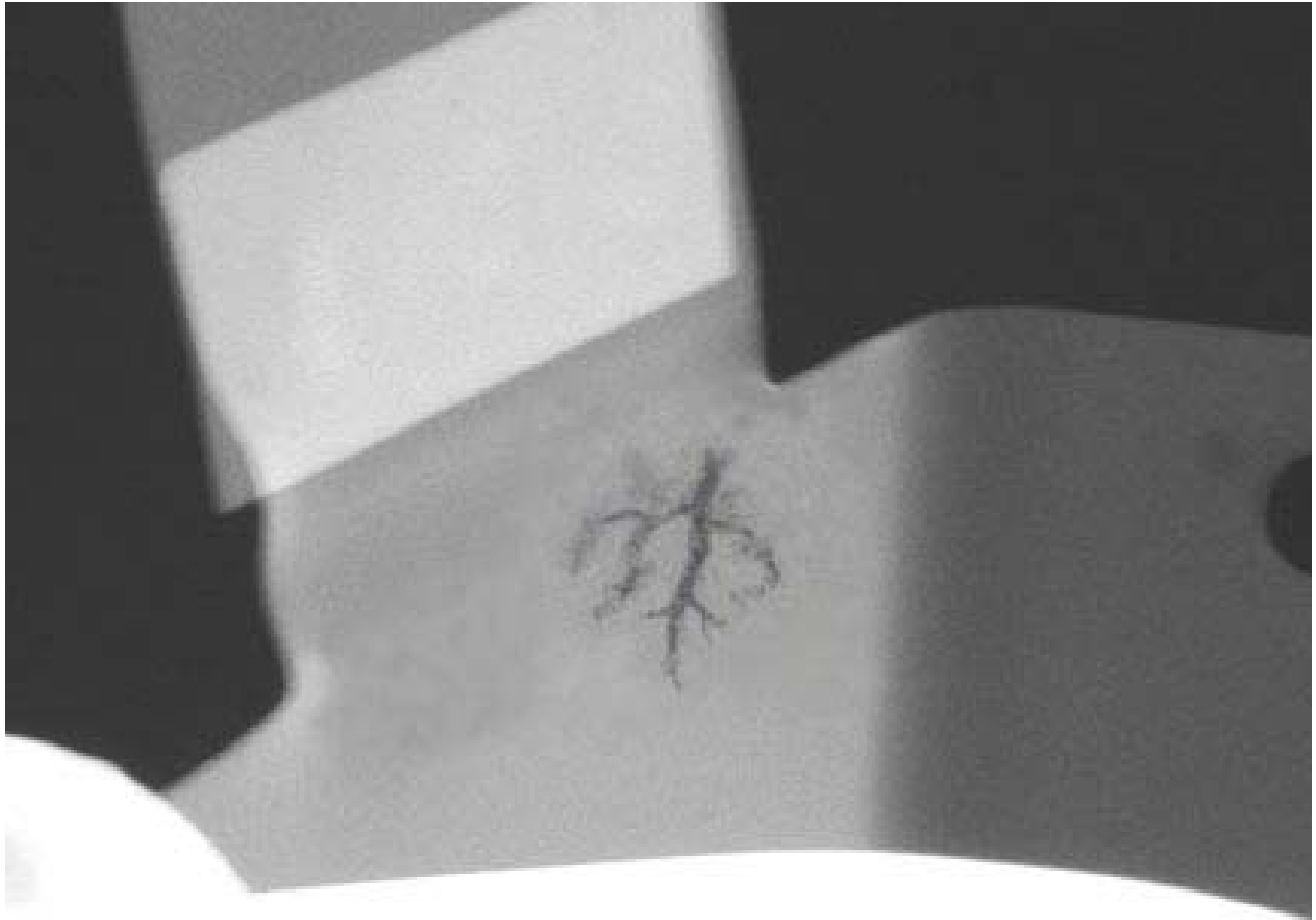
H0703463

Figure 6-50. Cavity Shrinkage

6.5.14.3 Dendritic Shrinkage. Dendritic shrinkage is a distribution of very fine lines or small elongated cavities that may vary in density and are usually unconnected.

6.5.14.4 Filamentary Shrinkage. Filamentary shrinkage usually occurs as a continuous structure of connected lines or branches of variable length, width and density, or occasionally as a network.

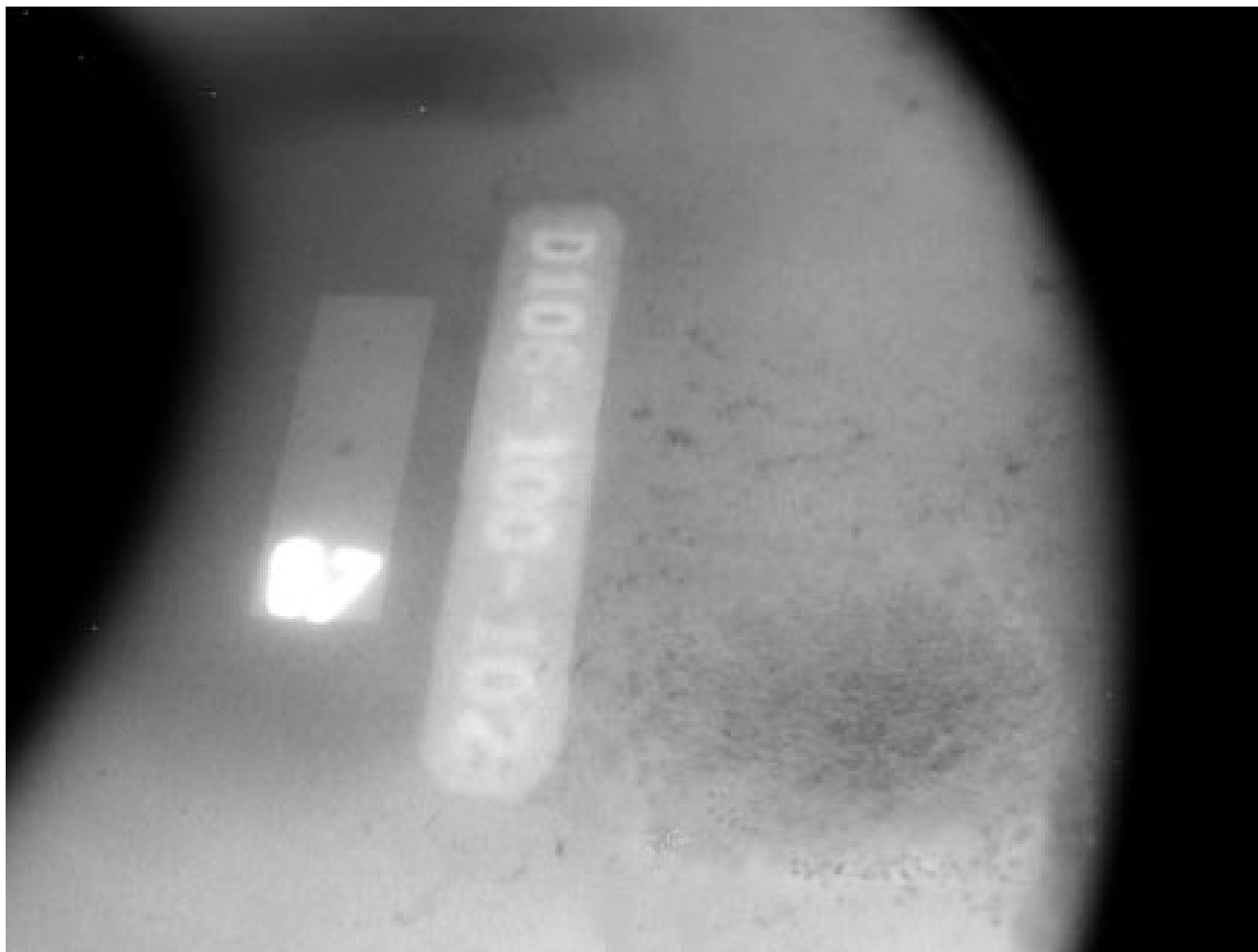
T.O. 33B-1-1



H0703464

Figure 6-51. Filamentary Shrinkage

6.5.14.5 Sponge Shrinkage. Sponge shrinkage shows itself as areas of lacy texture with diffuse outlines, generally toward the mid-thickness of heavier casting sections. Sponge shrinkage may be dendritic or filamentary shrinkage; filamentary sponge shrinkage appears more blurred because it is projected through the relatively thick coating between the discontinuities and the film surface.

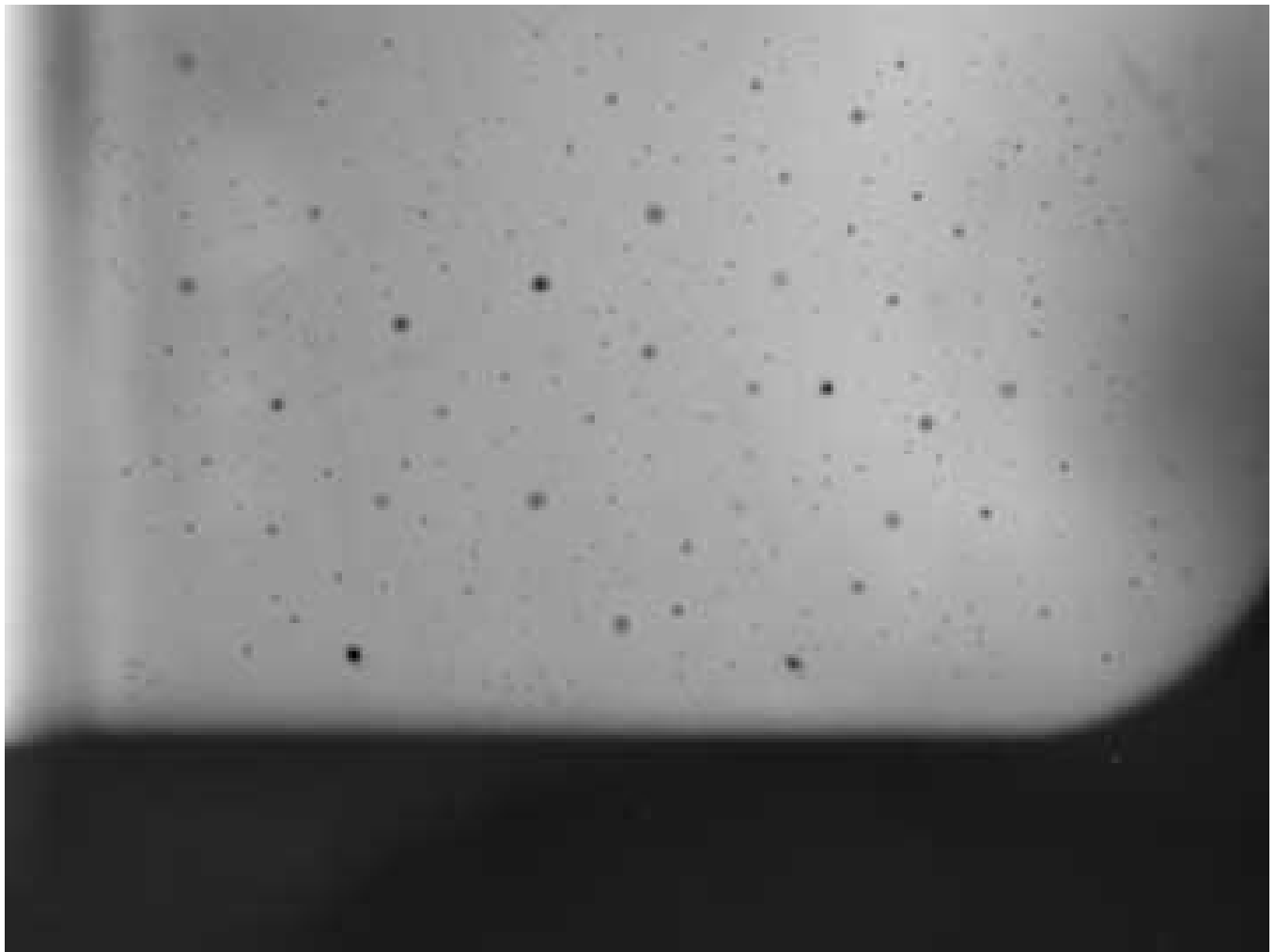


H0703465

Figure 6-52. Sponge Shrinkage

6.5.14.6 Gas Porosity or Blow Holes. Gas porosity or blow holes are caused by accumulated gas or air which is trapped by the metal. These discontinuities are usually smooth-walled rounded cavities of a spherical, elongated or flattened shape. If the sprue is not high enough to provide the necessary heat transfer needed to force the gas or air out of the mold, the gas or air will be trapped as the molten metal begins to solidify. Blows can also be caused by sand that is too fine, too wet, or by sand that has a low permeability so that gas can't escape. Too high a moisture content in the sand makes it difficult to carry the excessive volumes of water vapor away from the casting. Another cause of blows can be attributed to using green ladles, rusty or damp chills and chaplets.

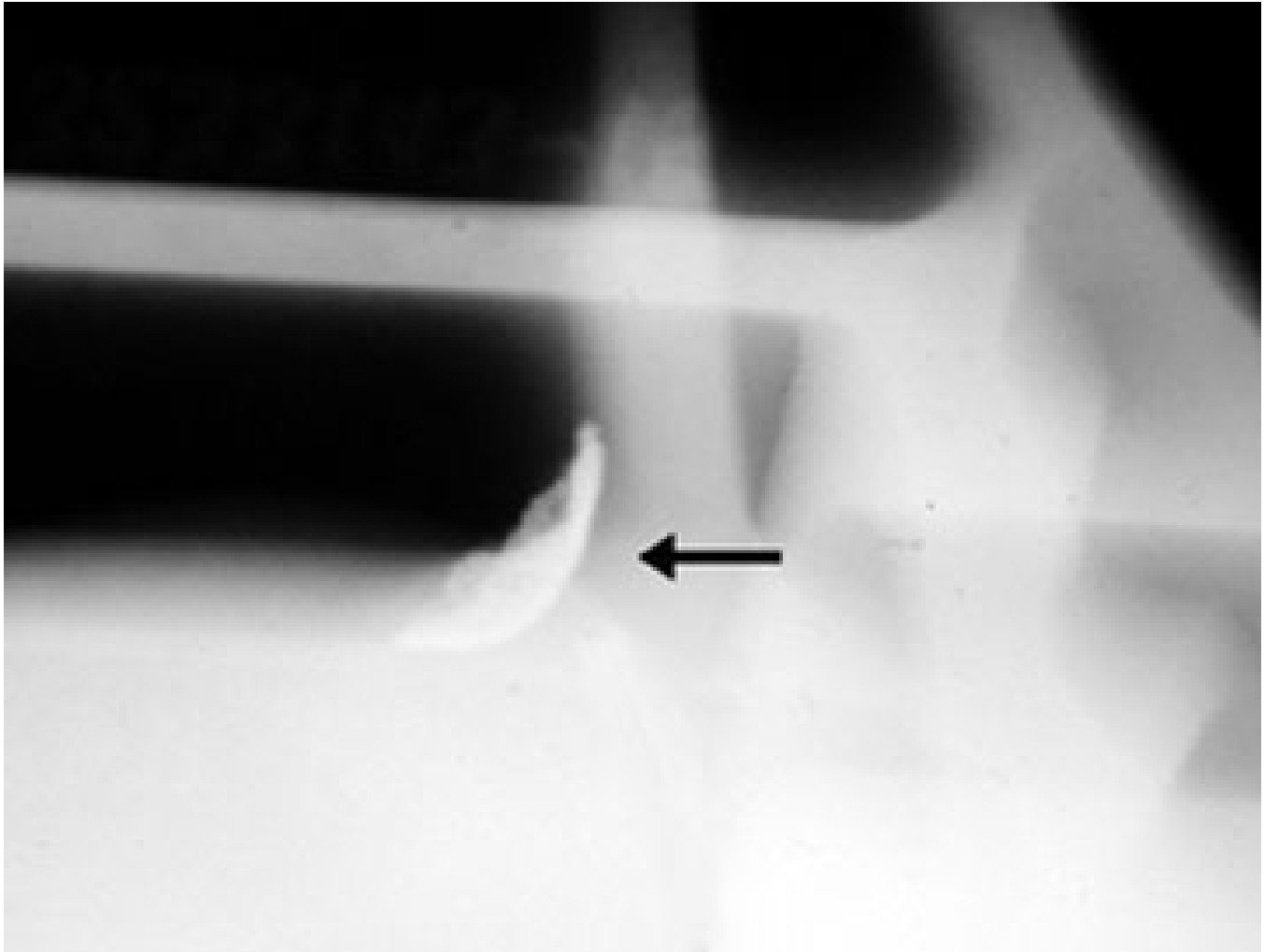
T.O. 33B-1-1



H0703466

Figure 6-53. Gas Porosity

6.5.14.7 Inclusions. Inclusions are nonmetallic materials in a supposedly solid metallic matrix. They may be less or more dense than the matrix alloy and will appear on the radiograph, respectively, as darker or lighter indications. The latter type is more common in light metal castings.

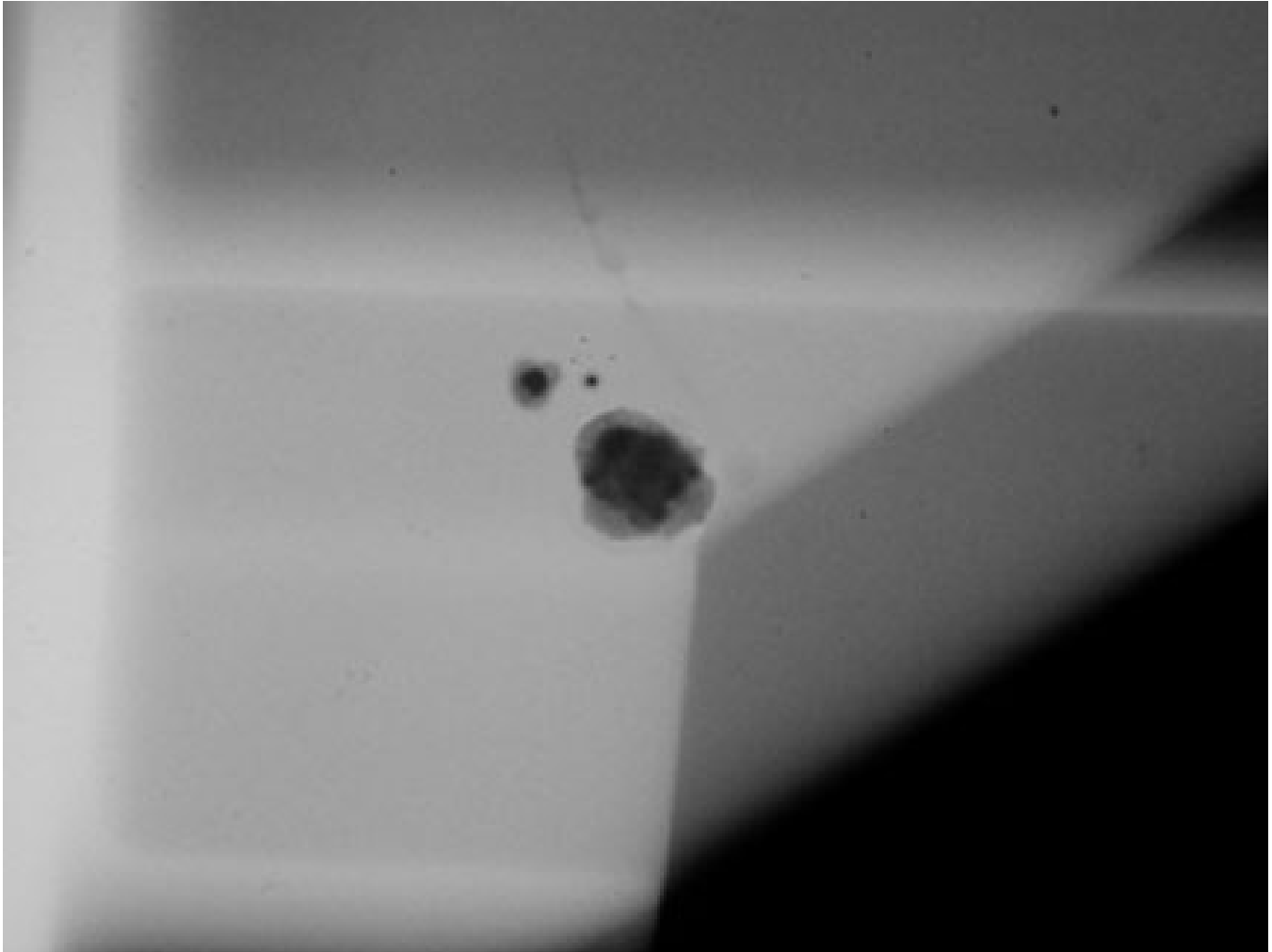


H0703467

Figure 6-54. Inclusions

6.5.14.8 Sand Inclusions and Doss. Sand inclusions and doss are nonmetallic oxides, appearing on the radiograph as irregular, dark blotches. These come from disintegrated portions of mold or core walls and/or from oxides (formed in the melt) which have not been skimmed off prior to introduction of the metal into the mold gates. Careful control of the melt, proper holding time in the ladle and skimming of the melt during pouring will minimize or obviate this source of trouble.

T.O. 33B-1-1



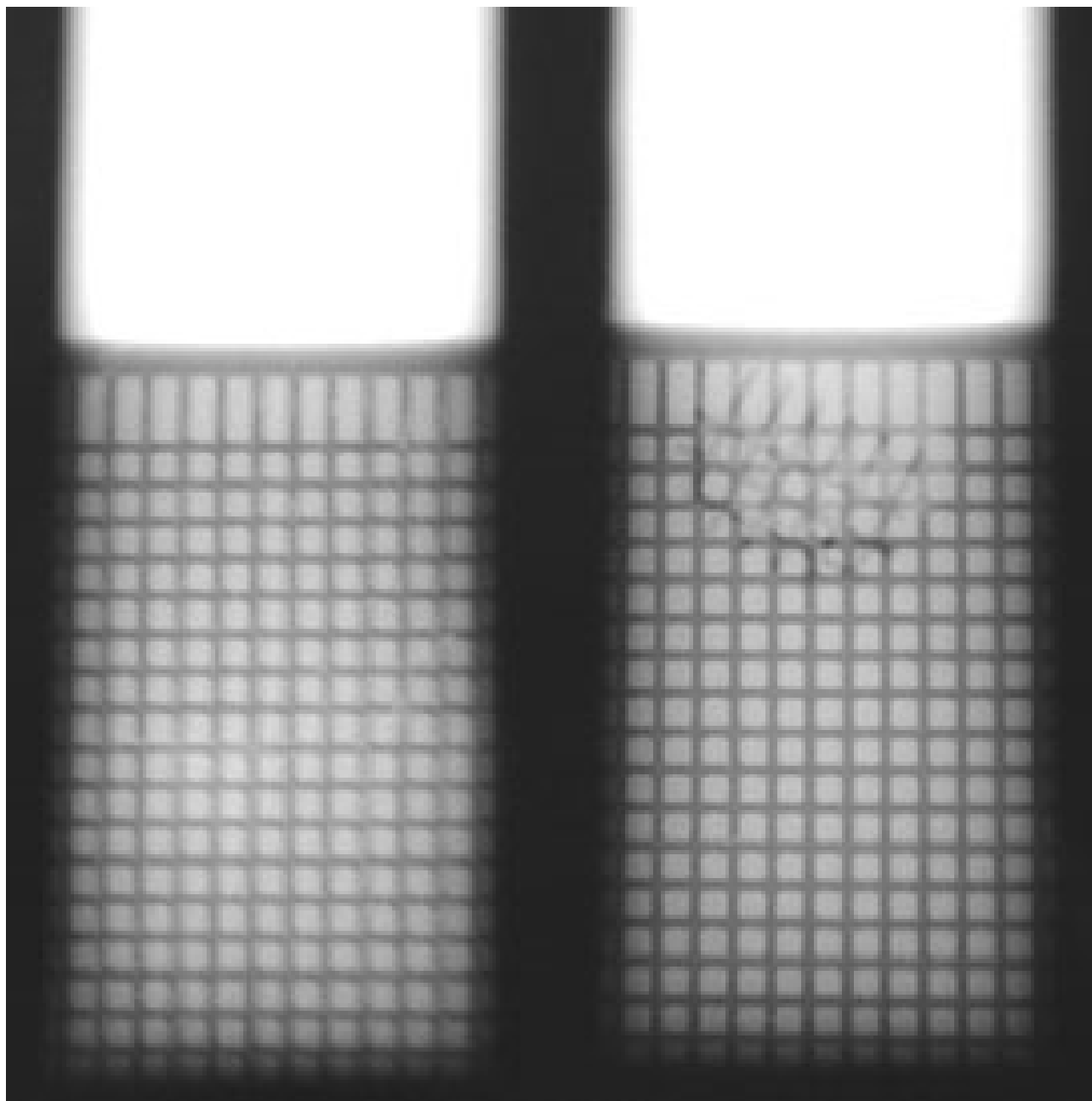
H0703468

Figure 6-55. Sand Inclusions

6.5.14.9 Cracks. Cracks are thin (straight or jagged) linearly disposed discontinuities that occur after the melt has solidified. They generally appear singly and originate at casting surfaces.

6.5.14.10 Cold Shuts. Cold shuts generally appear on or near a surface of cast metal as a result of two streams of liquid meeting and failing to unite. They may appear on a radiograph as cracks or seams with smooth or rounded edges.

6.5.14.11 **Core Shift.** Core shift may be detected when it is possible to angle the radiation or rotate the piece in a manner that would make it possible to measure the deviation of a specified wall thickness. Core shifts may be caused by jarring the mold, insecure anchorage, or omission of chaplets.



H0703470

Figure 6-56. Core Shifts

6.5.14.12 **Hot Tears.** Hot tears are linearly disposed indications that represent fractures formed in a metal during solidification because of hindered contraction. The latter may occur due to overly hard (completely unyielding) mold or core walls. The effect of hot tears, as a stress concentration, is similar to that of an ordinary crack; hot tears are usually systematic flaws. If flaws are identified as hot tears in larger runs of a casting type, they may call for explicit improvements in technique.

T.O. 33B-1-1

6.5.14.13 Misruns. Misruns appear on the radiograph as prominent dense areas of variable dimensions with a definite smooth outline. They are mostly random in occurrence and not readily eliminated by specific remedial actions in the process.

6.5.14.14 Mottling. Mottling is a radiographic indication that appears as an indistinct area of more or less dense images. The condition is a diffraction effect that occurs on relatively vague, thin-section radiographs, most often with austenitic stainless steel. Mottling is caused by interaction of the object's grain boundary material with low-energy X-rays (300 kV or lower). Inexperienced interpreters may incorrectly consider mottling as indications of unacceptable casting flaws. Even experienced interpreters often have to check the condition by re-radiography from slightly different source-film angles. Shifts in mottling are then very pronounced, while true casting discontinuities change only slightly in appearance.

6.5.15 Welds. Metal may be joined together by welding to form many shapes and structures required in aircraft. This fabrication procedure, when carefully controlled, will provide a joint equal in strength to the parent materials. There must be just enough heat to produce fusion and adequate penetration, but not too much, which would cause porosity, cracks, or undercutting.

6.5.15.1 Most weld discontinuities can be readily detected by radiographic inspection since they consist of a change in material homogeneity. Cracks in welds are often detectable since they will usually occur in the direction of the thickness of the plate and will be parallel to the X-ray beam. Stresses created in the metal by welding and not accompanied by a physical separation of material will not be detected by radiography, and cracks not properly oriented may also be missed. Oxides created by the molten metal may become trapped in the weld and result in reduced strength.

6.5.15.1.1 In tungsten inert gas (TIG) welding, tungsten electrode inclusions can occur. These appear as nearly clear specks in a radiograph due to the very high absorption of the radiation by tungsten. These inclusions usually appear in clusters of two or more. A single tungsten inclusion is unusual.

6.5.15.1.2 Foreign material whose density is approximately the same as the weld metal may not be detected. In the inspection of weldments, radiography is an indispensable tool for the location of internal discontinuities. It is the oldest and best known nondestructive means for this purpose. It is used to establish welding procedures, to qualify welders, to inspect welded fabrications, and for quality control of welded parts. For routine inspection, test welds made periodically in process on production welding MAY be inspected by X-ray to supplement destructive tests where results are in doubt. When quality has been established, an occasional X-ray exposure can be made on routine work. All X-ray shadow images are geometric projections of the actual size of conditions in or on the weld. There may be some slight distortion depending on angle of X-ray beam and distance of the weld from the film. Density, in general, is some indication of the depth magnitude of the weld discontinuity.

6.5.16 Welding Defects and Conditions.

6.5.16.1 Inadequate Weld Reinforcement. Inadequate weld reinforcement is an area of a weld where the thickness of weld metal deposited is less than the thickness of the base material. It is very easy to determine by radiograph if the weld has inadequate reinforcement, because the image density in the area of suspected inadequacy will be more (darker) than the image density of the surrounding base material.

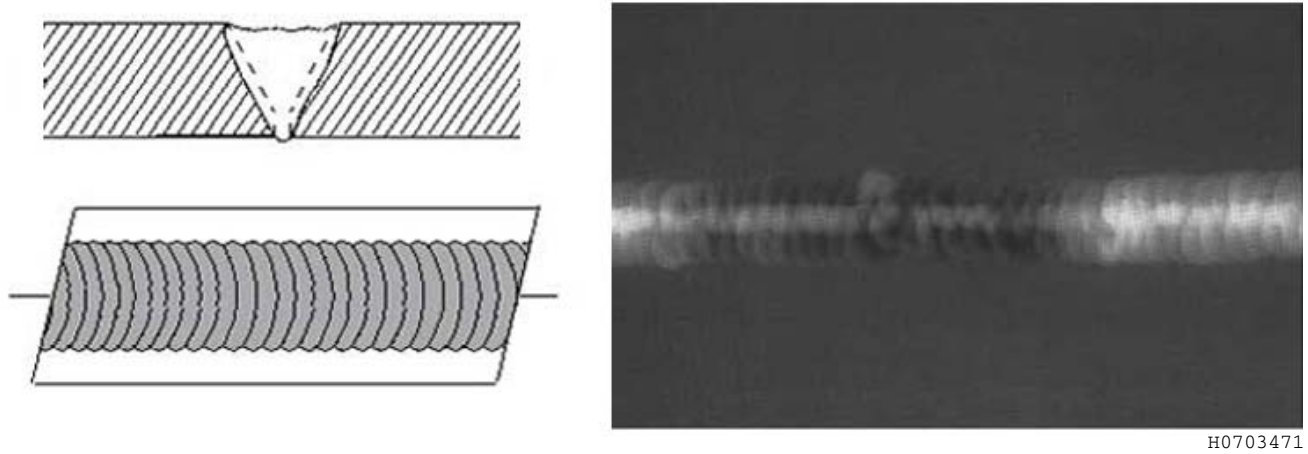
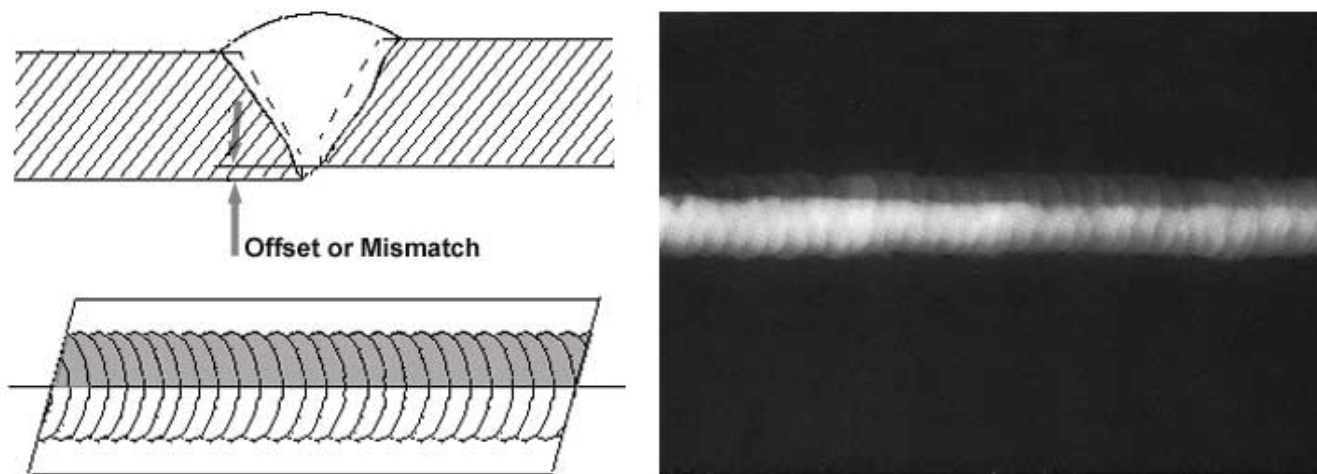


Figure 6-57. Inadequate Weld Reinforcement

6.5.16.2 Offset. Offset or mismatch are terms associated with a condition where two pieces being welded together are not properly aligned. The radiographic image is a noticeable difference in density between the two pieces. The difference in density is caused by the difference in material thickness. The dark, straight line is caused by failure of the weld metal to fuse with the land area.

T.O. 33B-1-1



H0703476

Figure 6-58. Offset

6.5.16.3 Excessive Reinforcement. Excess weld reinforcement is an area of a weld that has weld metal added in excess of that specified by engineering drawings and codes. The appearance on a radiograph is a localized, lighter area in the weld. A visual inspection will easily determine if the weld reinforcement is in excess of that specified by the engineering requirements.

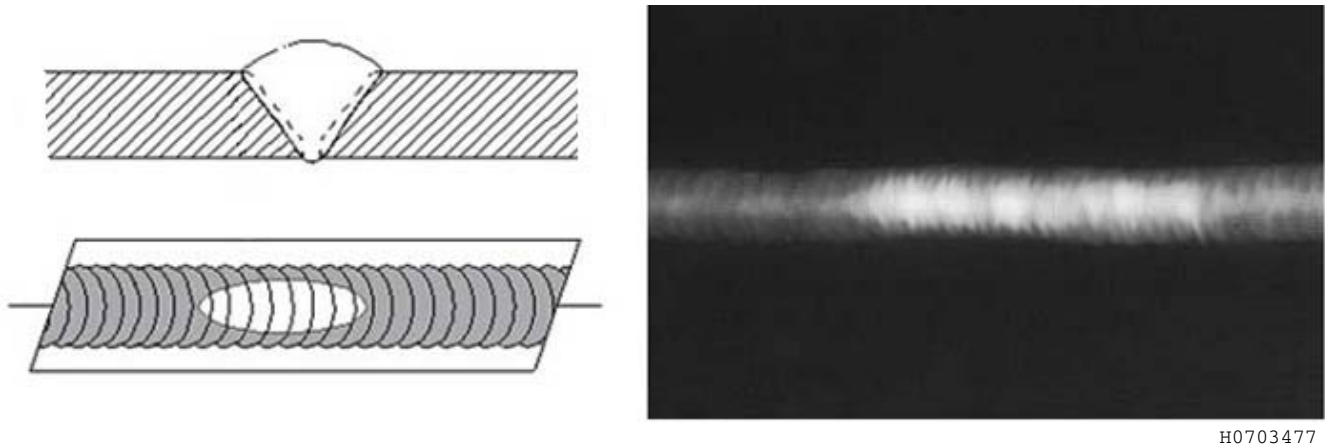


Figure 6-59. Excessive Reinforcement

6.5.16.4 Undercutting. Internal or root undercut is an erosion of the base metal next to the root of the weld. In the radiographic image it appears as a dark irregular line offset from the centerline of the weldment. Undercutting is not as straight edged as lack of penetration because it does not follow a ground edge.

T.O. 33B-1-1

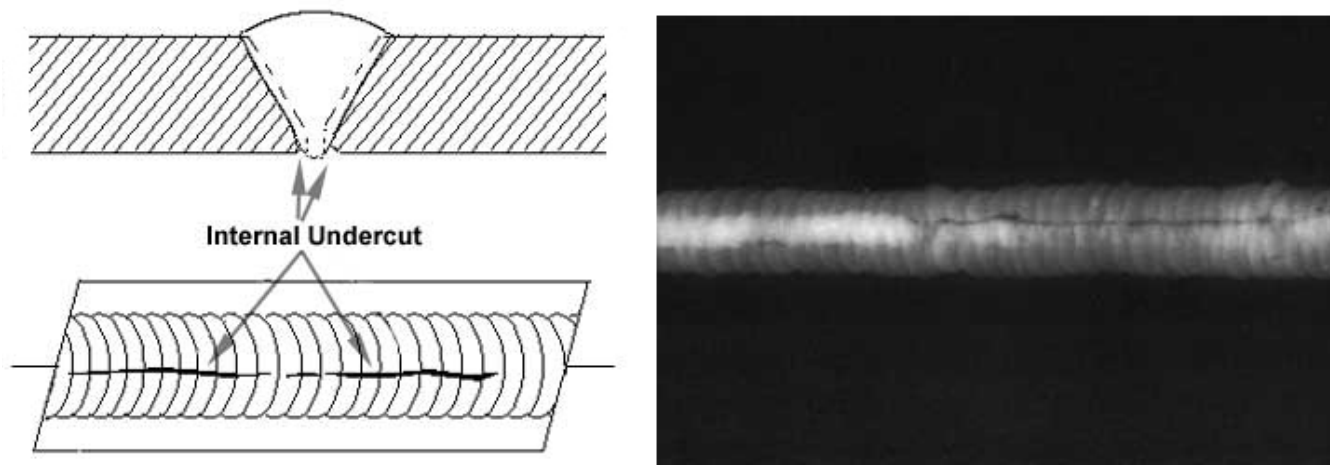


Figure 6-60. Internal Undercutting

6.5.16.5 External Undercut. External or crown undercut is an erosion of the base metal next to the crown of the weld. In the radiograph, it appears as a dark irregular line along the outside edge of the weld area.

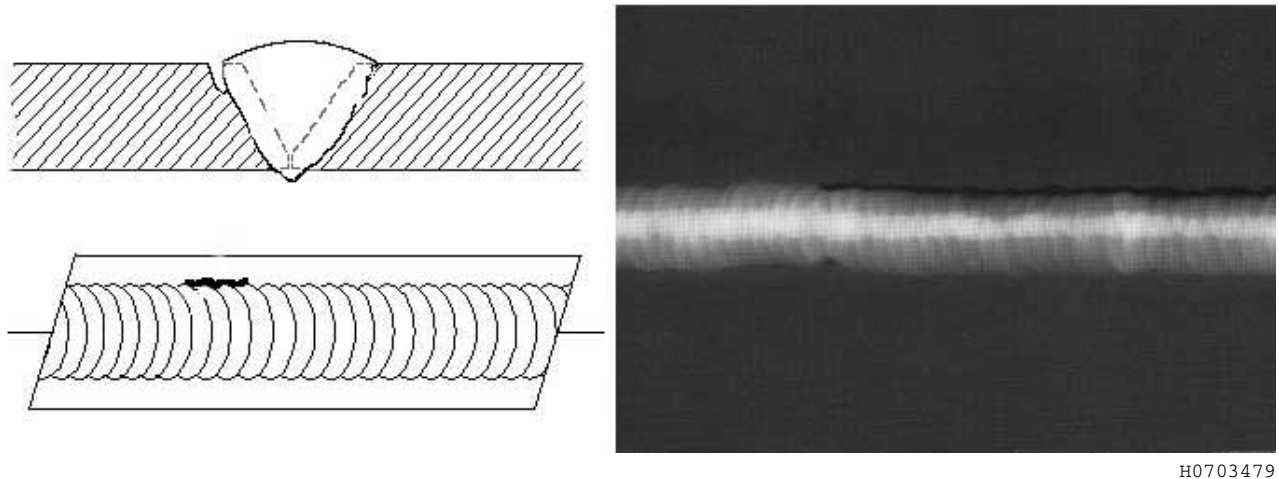


Figure 6-61. External Undercutting

6.5.16.6 Suck Back. Internal concavity or suck back is condition where the weld metal has contracted as it cools and has been drawn up into the root of the weld. On a radiograph it looks similar to lack of penetration but the line has irregular edges and it is often quite wide in the center of the weld image.

T.O. 33B-1-1

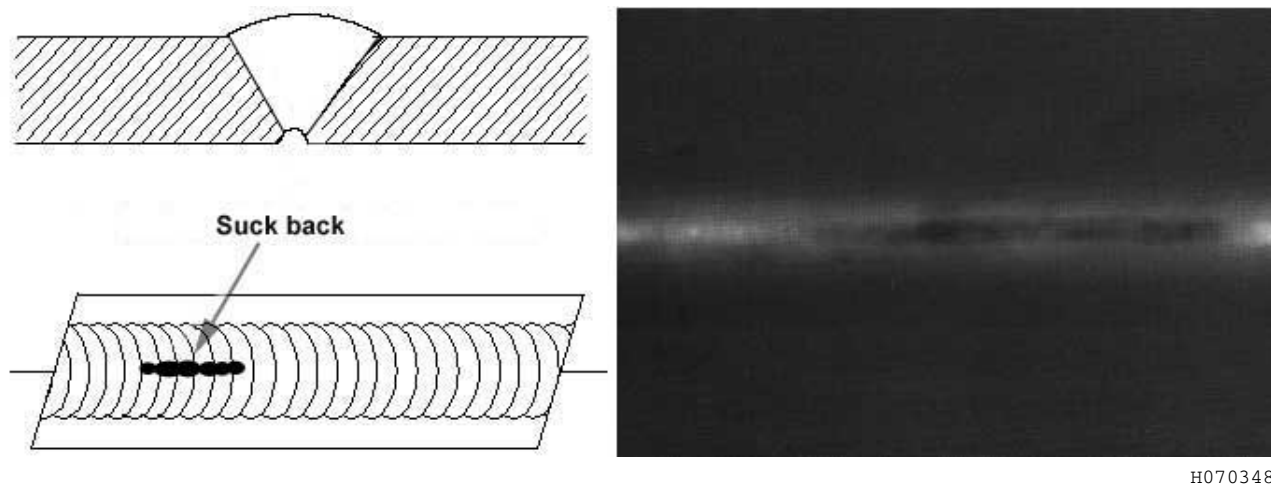
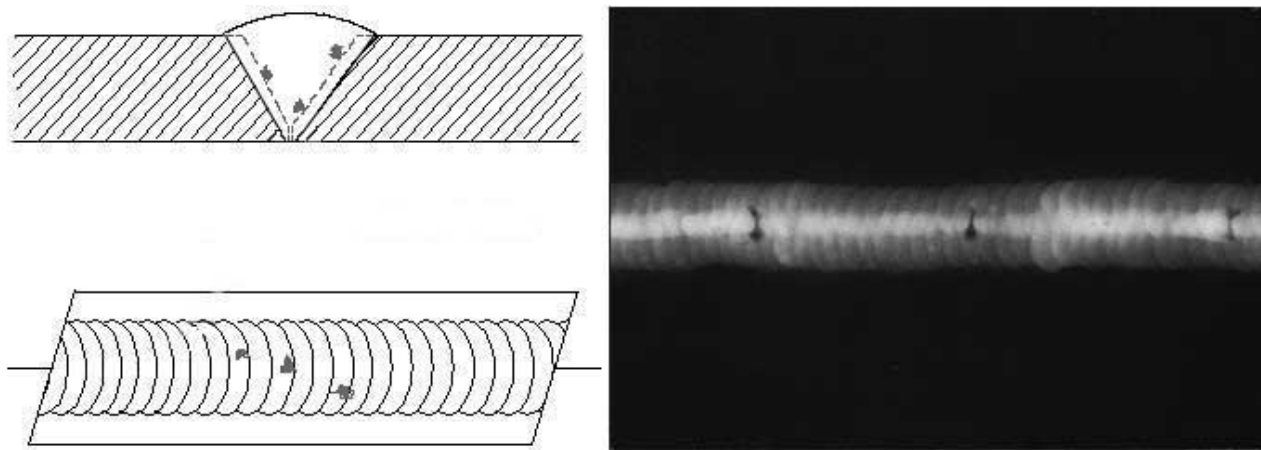


Figure 6-62. Suck Back

6.5.16.7 **Slag.** Slag inclusions are nonmetallic solid material entrapped in weld metal or between weld and base metal. In a radiograph, dark, jagged asymmetrical shapes within the weld or along the weld joint areas are indicative of slag inclusions.

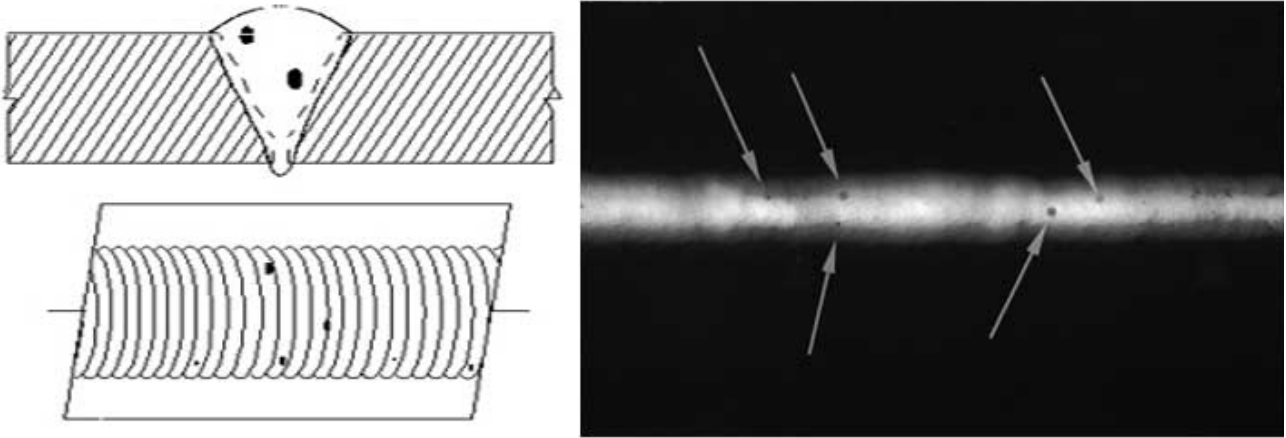


H0703481

Figure 6-63. Slag Inclusions

6.5.16.8 Porosity. Porosity is the result of gas entrapment in the solidifying metal. Porosity can take many shapes on a radiograph but often appears as dark round or irregular spots or specks appearing singularly, in clusters or rows. Sometimes porosity is elongated and may have the appearance of having a tail. This is the result of gas attempting to escape while the metal is still in a liquid state and is called wormhole porosity. All porosity is a void in the material; it will have a radiographic density more than the surrounding area.

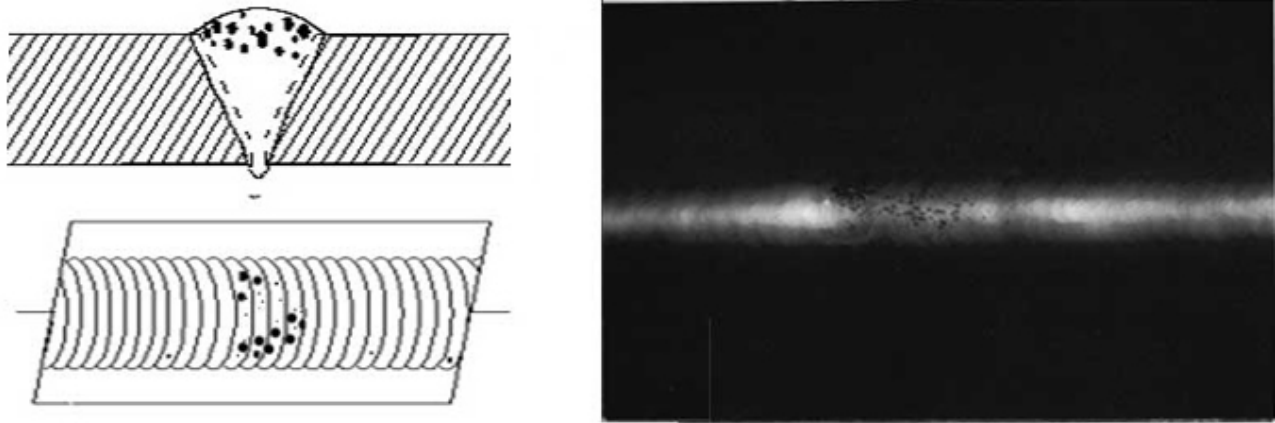
T.O. 33B-1-1



H0703482

Figure 6-64. Porosity

6.5.16.9 Cluster Porosity. Cluster porosity is caused when flux coated electrodes are contaminated with moisture. The moisture turns into gases when heated and becomes trapped in the weld during the welding process. Cluster porosity appear just like regular porosity in the radiograph but the indications will be grouped close together.

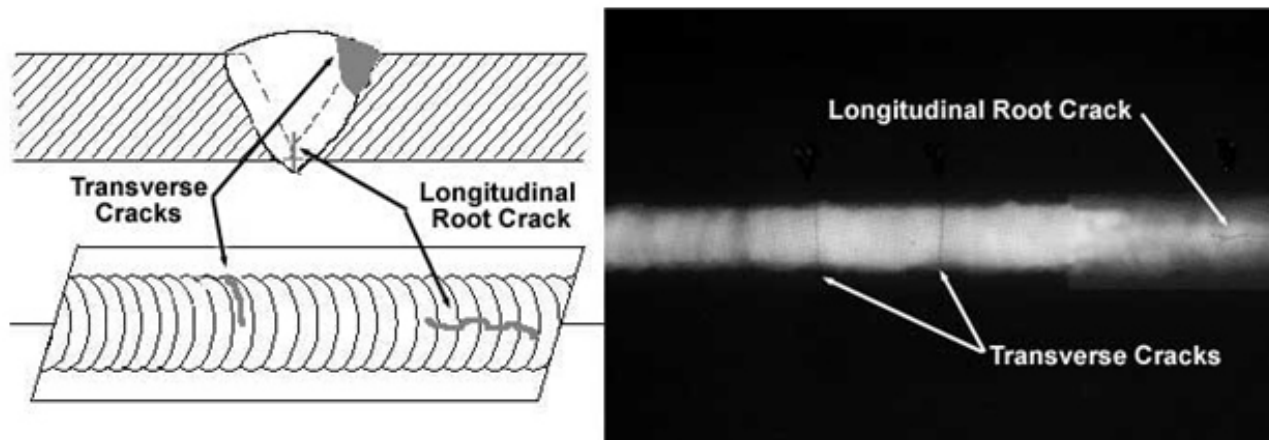


H0703483

Figure 6-65. Cluster Porosity

6.5.16.10 Cracks. Cracks can be detected in a radiograph only when they are propagating in a direction that produces a change in thickness that is parallel to the X-ray beam. Cracks will appear as jagged and often very faint irregular lines. Cracks can sometimes appear as “tails” on inclusions or porosity.

T.O. 33B-1-1



H0703472

Figure 6-66. Cracks

6.5.16.11 Incomplete Penetration. Incomplete penetration may occur in a fillet weld. This will show on a radiograph as dark lines along one side of weld image.

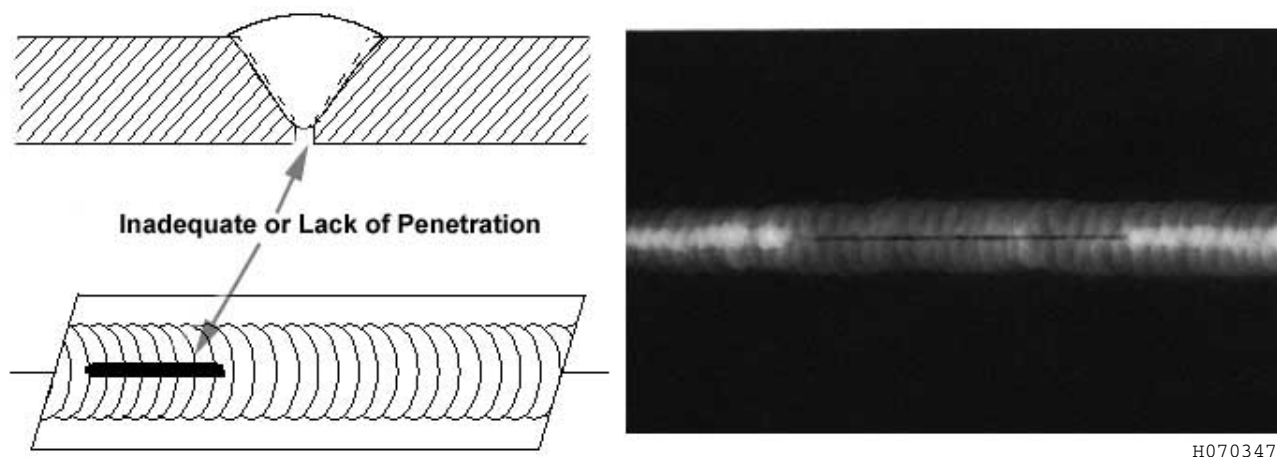


Figure 6-67. Cracks

6.5.16.12 Lack of Fusion. Incomplete fusion is a condition where the weld filler metal does not properly fuse with the base metal. Appearance on radiograph: usually appears as a dark line or lines oriented in the direction of the weld seam along the weld preparation or joining area.

T.O. 33B-1-1

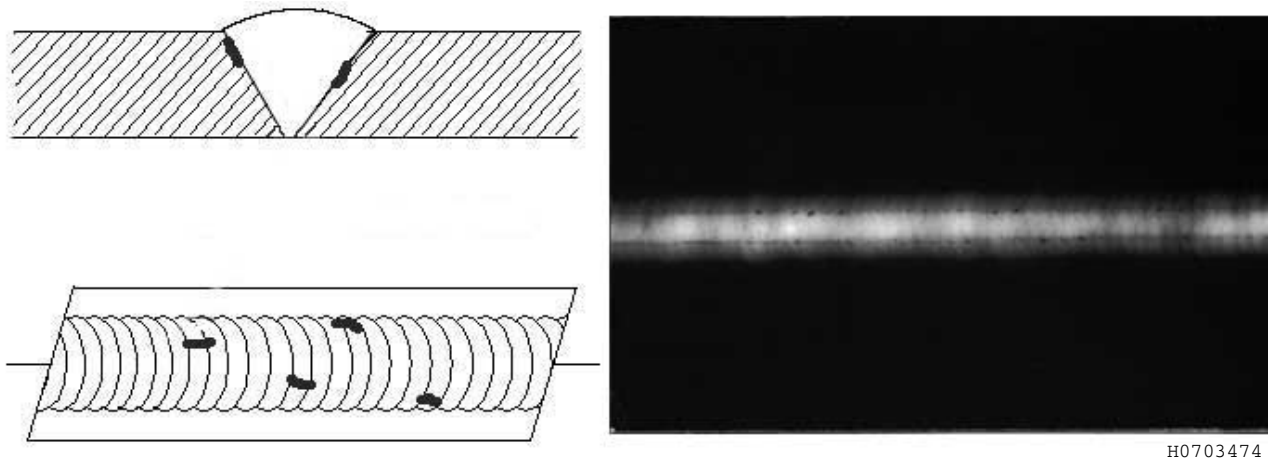


Figure 6-68. Lack of Fusion

6.5.16.13 Cold Lap. Cold Lap is a condition where the weld filler metal does not properly fuse with the base metal or the previous weld pass material (interpass cold lap). The arc does not melt the base metal sufficiently and causes the slightly molten puddle to flow into base material without bonding.

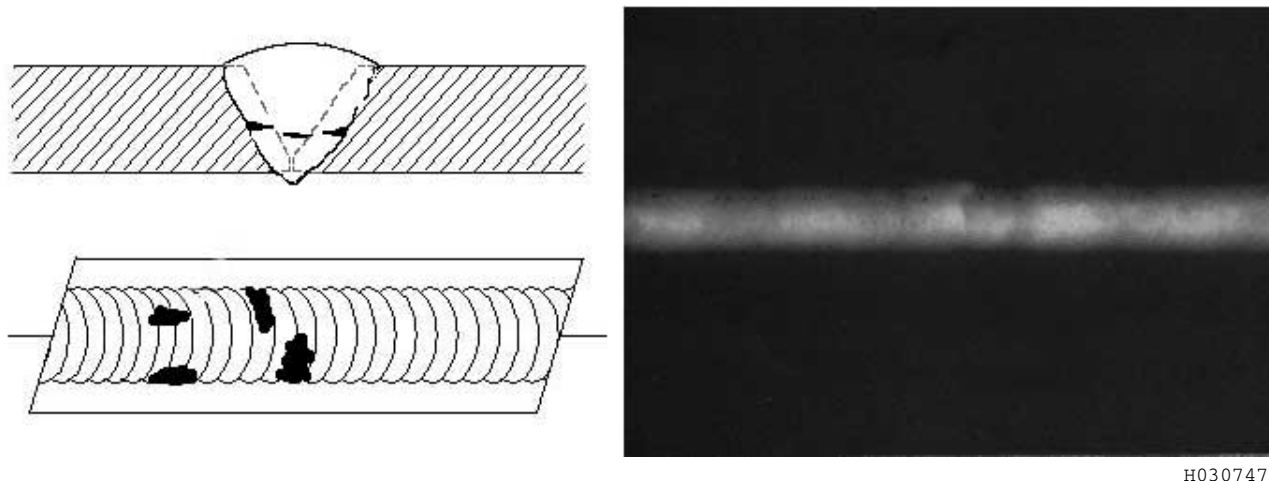
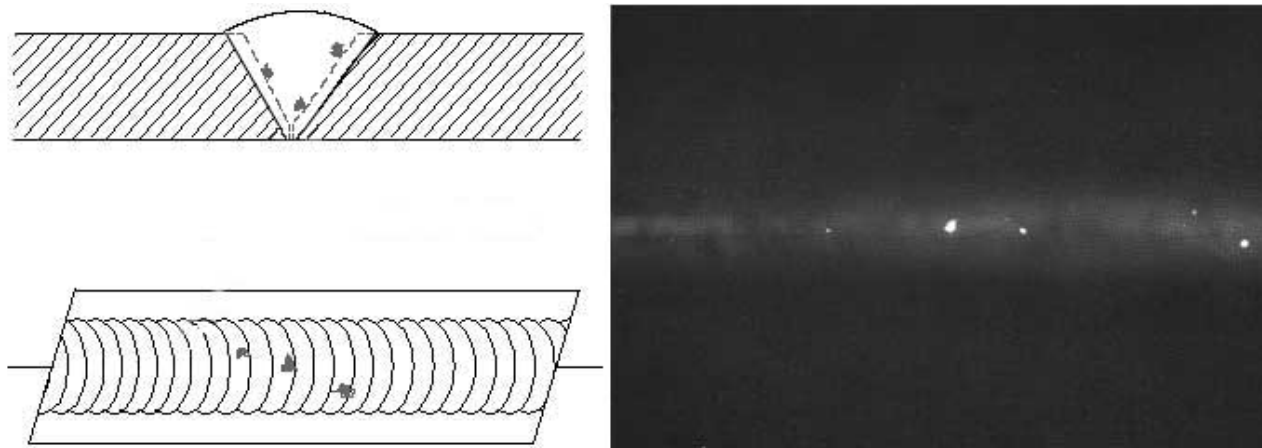


Figure 6-69. Cold Lap

6.5.16.14 TIG Weld Discontinuities. The following discontinuities are peculiar to the TIG welding process. These discontinuities occur in most metals welded by the process including aluminum and stainless steels. The TIG method of welding produces a clean homogeneous weld which when radiographed is easily interpreted.

6.5.16.15 Tungsten Inclusions. Tungsten is a brittle and inherently dense material used in the electrode in tungsten inert gas welding. If improper welding procedures are used, tungsten may be entrapped in the weld. Radiographically, tungsten is more dense than aluminum or steel; therefore, it shows as a lighter area with a distinct outline on the radiograph.

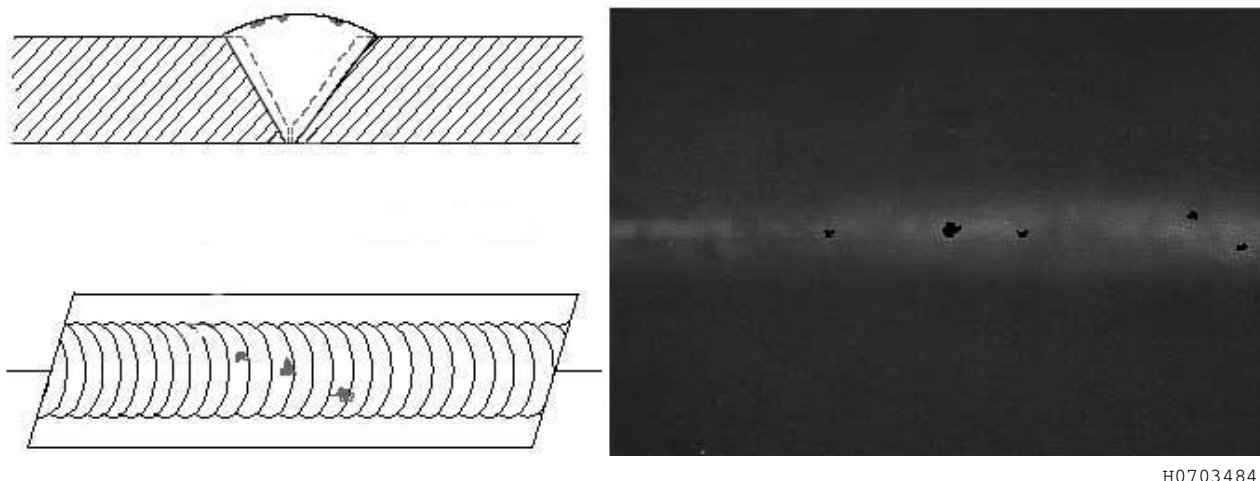
T.O. 33B-1-1



H0703488

Figure 6-70. Tungsten Inclusions

6.5.16.16 Oxide Inclusions. Oxide inclusions are usually visible on the surface of material being welded (especially aluminum). Oxide inclusions are less dense than the surrounding materials and, therefore, appear as dark irregularly shaped discontinuities in the radiograph.



H0703484

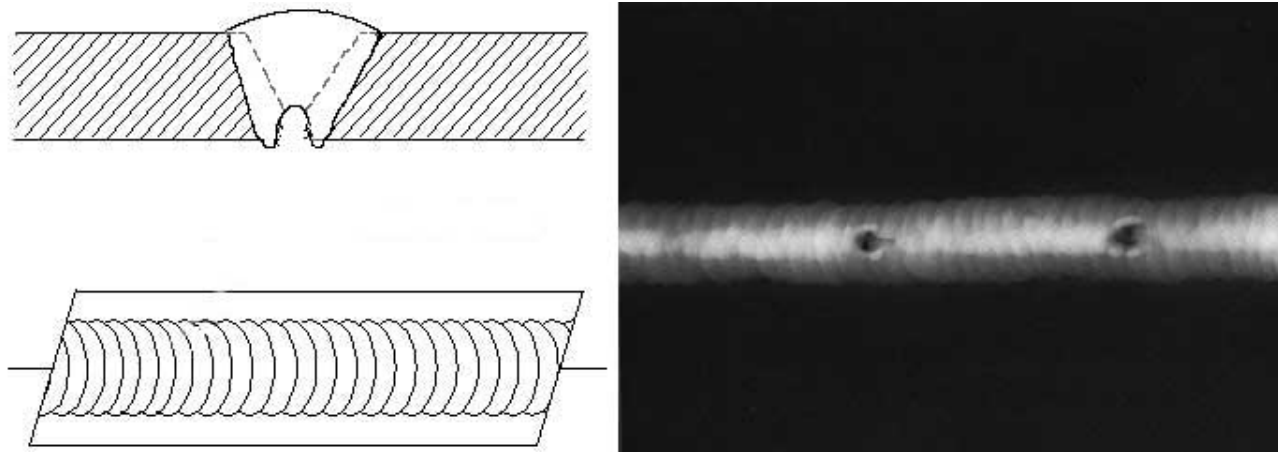
Figure 6-71. Oxide Inclusions

6.5.16.17 Discontinuities in Gas Metal Arc Welds (GMAW). The following discontinuities are most commonly found in GMAW welds.

6.5.16.17.1 Whiskers. Whiskers are short lengths of weld electrode wire, visible on the top or bottom surface of the weld or contained within the weld. On a radiograph they appear as light, “wire like” indications.

6.5.16.17.2 Burn-Through. Burn-through results when too much heat causes excessive weld metal to penetrate the weld zone. Often lumps of metal sag through the weld creating a thick globular condition on the back of the weld. These globs of metal are referred to as icicles. On a radiograph, burn through appears as dark spots, which are often surrounded by light globular areas (icicles).

T.O. 33B-1-1



H0703485

Figure 6-72. Burn-Through

6.5.16.18 Aluminum and Magnesium Welds. Radiographic technique and equipment for examining welds in aluminum and magnesium alloys are no different than methods used for steel welds. The discontinuities produced by fusion welding of aluminum and revealed on film by radiography include:

- Entrapped gas, ranging from fine gas porosity to large gas holes. The porosity may be in line or at random.
- Inclusions of tungsten particles, foreign materials, flux, and oxide. Since the density of oxide films is nearly the same as aluminum, they will not produce a detailed indication on a radiograph unless present in large quantities.
- Inadequate penetration.
- Incomplete fusion.
- Cracks.
- Surface irregularities.

6.5.16.19 Spot Welds. A special exposure technique is necessary for the inspection of spot welds. The welded areas are X-rayed with a low-voltage, high-intensity, beryllium-window X-ray tube on extremely fine grained films. Spot welds and seam welds produce X-ray images of aluminum and its alloys entirely different from those of any other welding technique. Because of the rather large percentage of radiographically dense alloying constituents that produce informative patterns, some of the high strength aluminum alloys are well suited for spot weld radiography. The images show positive indications of the following:

- Variations in weld nugget shape (oversize, undersize, absence, misshapen, doughnut, and crescent shaped).
- Extrusion and expulsion of metal from nugget.
- Cracks.
- Foreign materials (for example, tip pickup).
- Porosity.
- Segregation of the alloying elements.
- Electrode impressions.

6.5.16.19.1 Flash Welds. Produce heat by creating an arc between the pieces to be joined and pressure welding, done by applying pressure to suitably prepared surfaces at temperatures lower than the melting point of the parts. Flash welds are seldom radiographically inspected. When performed, the inspection is usually made to detect cracks produced in welding procedure.

6.5.16.19.2 Incomplete Fusion. Incomplete fusion at the interfaces between weld and parent metal has certain factors in common with a crack. However, the plane of incomplete fusion is rarely normal to the plate surface, and for this reason is not always revealed. Where such a discontinuity is suspected, additional exposures at various angles may reveal the lack of fusion.

6.5.17 In-Service Inspections. When materials are utilized fully as required in the design of modern aircraft, there is occasional failure due to fatigue. These failures are results of over-stress of the material due to unusual operating conditions or deterioration of the material, such as wear, corrosion, cracks, or crack like discontinuities, water in honeycomb, foreign objects, and assembly issues. This type of material change may be the most difficult to detect due to the very nature of the changes and the inaccessibility of the areas in which these changes are most likely to occur in an aircraft. Radiography has been used to detect these conditions when they occur in inaccessible areas and are not available for visual inspection.

6.5.17.1 Wear. Rivets and bolts may wear the skin, spar, and frame holes so there is not a correct fit in the holes for adequate strength in joints or attachments of a wing section. This can occur due to continued flexing of components from use or because of severe stress due to unusual operating conditions in turbulent weather or an adverse landing. This condition may also result in radial cracks from bolt holes. This type of failure is extremely difficult to detect by radiography. Any angle of exposure results in superimposition of bolt or nut over crack. Loose bolts and rivets have been detected satisfactorily when occurring in a position to be located. Elongation of rivet holes caused by bearing failure or sheared rivets **SHOULD NOT** be confused with elongation of holes from drilling. If fatigue is suspected in a riveted joint, the half moon indications **SHOULD** all be on the same side of the rivet and the rivets in the joint **SHOULD** show similar indications of failure. Intermittent indications would normally be considered fabrication tolerance.

6.5.17.2 Corrosion. Corrosion may occur in aircraft materials, which reduces its strength and expedites the possible failure. This deterioration of the metal may be due to electrolytic action, moisture, chemicals, or gases which attack the metals, intergranular action due to improper heat treatment at the time of manufacture, or other factors. This condition usually occurs on internal surfaces of such components as tubular supports or housings. Since corrosion represents a change of material and occurs in all directions it is easily detected by a proper radiographic exposure. If corrosion has proceeded to this point, the support is appreciably reduced in strength and may experience failure.

6.5.17.3 Cracks and Crack-Like Discontinuities. Cracks and other crack-like discontinuities are found in numerous parts and structures. This is particularly true where structures are subjected to vibration or fatigue loading, due to propagation of these crack-like discontinuities. Cracks are very dangerous discontinuities and are the most difficult service type failure to detect by radiography, since these crack separations are usually not associated with other detectable conditions that give a clue to their presence. Crack-like discontinuities will appear in a radiograph as very straight and sharply outlined dark or black lines. Cracks may also appear as diffused jagged lines; in some cases they have a tree-like pattern. Scatter radiation from the sides of a crack can act as an amplifier of the crack image in a radiograph. Crack-like discontinuities oriented at any angle other than 90-degrees to the X-ray film and not parallel with the X-ray beam produce very little change to the radiation transmission and may not be visible in the radiographic image. Radiography can only be depended on to reveal crack-like discontinuities that are aligned within approximately 7-degrees of the X-ray beam. This depends on the thickness and width of the crack. Normally cracks that are easily detectable by X-ray are visible to the naked eye. Radiography **MAY** be used to determine extent of cracks, or other conditions detected visually, or by magnetic particle or penetrant methods of inspection.

6.5.17.3.1 In castings, crack-like discontinuities can be due to shrinkage, hot tears, cold shuts, or other sources typical of the casting process. The forging process can introduce cracks, laps, and seams that appear crack-like in radiographic images. In weldments, longitudinal or transverse cracks may be found. Lack of weld penetration produces a crack-like discontinuity.

6.5.17.4 Water in Honeycomb. A typical condition that occurs in honeycomb structures is the formation of water in the cores. Entrapped water causes corrosion of both face sheet and core material. This entrapped water will also freeze and expand at high altitudes. This expansion distorts the cells and can break the bonds between core and facing sheets. When this condition exists, vibration of the face sheet can occur, causing failure of adjacent bonds and propagation of bond failure. Radiographic inspection is conducted to evaluate core damage and water content as a maintenance inspection. Entrapped water in honeycomb cells usually appears as a smooth, consistent, light density area that does not have a grainy or porous appearance. The lightest area (more dense substance) indicates greater amounts of water.

T.O. 33B-1-1

6.5.17.4.1 Epoxy in honeycomb cells appears grainy, non-homogeneous. If the cell is not spotty and completely filled, the epoxy will be located around the periphery of each cell.

6.5.17.4.2 Radiographic inspection for moisture detection can be made with the honeycomb core cell walls in either the vertical or horizontal plane. The preferred method is with the core cell walls in the horizontal plane because core cells which are partially filled with moisture are more readily identifiable (less easily confused with solid adhesive).

6.5.17.4.3 If practical, confirmation of partially filled cells with water can be made by repeating the radiographic procedure with the honeycomb cell walls in the opposite plane.

6.5.17.4.4 Radiographic exposures indicating filled core cells are not always conclusive for moisture detection and SHOULD be confirmed by other means if possible.

6.5.17.5 Foreign Objects. Radiography is an excellent method to locate and evaluate foreign objects. Foreign objects MAY be free rivets, bolts, or other objects that could be detrimental to the function of the part or assembly.

6.5.17.6 Workmanship. Radiographic inspections, after completion of repair, assure quality of workmanship. On occasion components are misassembled. In some areas it is not possible to check dimension by physical or visual means. Radiography MAY be used if precautions are taken to assure proper geometrical relation to determine dimension of internal spacing.

6.5.18 Assemblies. Radiography has found wide use in the reevaluation of various assemblies to determine status or condition. If the use of the assembly produces changes in it, which are recordable by an X-ray beam, then radiography may be useful in supplying confirming evidence of the suspected condition. Radiographic inspection of oil coolers has resulted in an inspection method that can detect foreign material in the cooler.

6.5.19 Radiographic Standards. It is inherent to good practice, in many cases, that castings or weldments are thicker in cross section than required for the necessary strength of the part. For this reason, some flaws in the casting can be tolerated with no detrimental effect to the aircraft. In order to determine what castings or weldments are acceptable for use in an aircraft, standards of acceptability are prepared as a guide to the radiographer. There are two general types of standards prepared the specific standard applicable to only one particular part and the general standard.

6.5.19.1 A specific standard for a part is prepared by X-raying the part and then destructively testing the part by applying force of the same type and direction as would be expected in actual service. If the yielding force is greater than the design load, the X-ray film of the part MAY be used as a standard. These types of standards are normally used by foundries and copies of these standards are limited in supply since the part is destroyed by testing and additional retakes cannot be made.

6.5.19.1.1 General standards are prepared by an engineering society, company, or government agency as a guide in determining if the casting and weldments are sound. These standards are based on experience and engineering judgment to provide a casting and weldment generally acceptable for normal use. Radiographic standards prepared by the American Society for Testing and Materials (ASTM) International, 100 Barr Harbor Dr., P.O. Box C700, West Conshohocken, PA 19428-2959 are approved for use.

6.5.19.1.2 Paints, sealants, and adhesives used in fabricating structures often build up to thicknesses readily observed on radiographs. Radiographic indications of these materials can result in obliterating the area of concern and/or cause misinterpretation of the radiograph. The method of application and the built up thickness causes a very rough surface of widely varying thicknesses. The radiographic indication often appears similar to a radiograph of a weld bead. The materials in the liquid or gel state can entrap foreign particles, such as metal chips or gas bubbles. These cause radiographic indications similar to inclusions or porosity. During curing, drying, or service, the organic material can form crack patterns. Radiographic indications of the cracks can appear as dry mud cracks, dendrites (tree branches), or one or two very wide cracks. The indications are difficult to interpret and require substantial experience to evaluate. Cracks in coating materials are normally recognized by the crack pattern and the fact that the crack will exceed normal or usual metal crack width. The best method of confirming these indications is to remove the paint, sealant, or adhesive and to X-ray again. Unfortunately, limited access does not always permit coating removal. Triangulation can be used to define the location of the indication as being on top of the structure.

6.5.20 Digital Radiographic Image Analysis.

NOTE

Digital radiographic image processing scanning index SHALL be 100 microns or less.

6.5.20.1 Processing and Analysis. Image processing and analysis or enhancing can help determine the quality of an existing digital image, and provide hints as to correct problems in the image. Additionally, enhancement and processing make digital images easier to interpret than traditional film-only based radiographic methods.

6.5.20.2.1 Group Processing Techniques. Group processing of pixels is a mathematical process that changes a pixel's value based on the values of neighboring pixels. This mathematical process is known as a convolution, and the application of the process on an image is called applying a convolution filter to the image. Some examples of convolution filters are noise filtering, image sharpening, image blurring, and edge enhancement. There are many more filters used in digital imaging, but these are the most commonly accepted in digital radiography.

6.5.20.2.1.1 Noise Filtering. Random patterns of noise in an image can be removed to some degree by applying a noise removing convolution filter. The most common of these in use for digital radiography is known as a "median filter." The median filter works by examining the pixels surrounding a given pixel, and sorting them in order of magnitude. The median value is then used to replace the pixel being examined. This tends to remove small noise spikes in an image while leaving the information containing portion of an image relatively untouched.

6.5.20.2.1.2 Image Sharpening. Image sharpening improves the sharpness of an image and is usually executed by the means of a high pass or related convolution filter. The high pass filter accentuates high spatial frequency changes in an image making the image sharper. This filter type is used frequently in digital radiography because it enhances areas of high contrast change making indication more easily seen and measured.

6.5.20.2.1.3 Image Blurring. Image blurring can help the viewing of noisy images by blending the noise into the background image when a median filter either introduces too many artifacts, or just unable to eliminate the type of noise in the image. Frequently, a blurred image is processed again by a sharpening filter to help create an "edge enhancement" effect. Blurring is most frequently executed through the use of a low pass filter which attenuates areas of high contrast change.

6.5.20.2.1.4 Edge Enhancement. Edge enhancement convolution filters help define the edges of contrast change within an image, making them easier to see. Edge enhancement filters can frequently change the size of an indication (usually making it appear slightly larger than it actually is) so caution SHALL be exercised in its use.

6.5.20.2.2 Frame Processing Techniques. Frame processing techniques manipulate the image by changing the locations of pixels within an image. "Image rotation" and "image scaling" are common frame processing techniques.

6.5.20.2.2.1 Image Rotation. Sometimes a digital image is not in the orientation we would like to view it, so the image MAY be rotated to adjust it. Rotation of digital images SHOULD be performed only in 90° increments to avoid having to produce interpolated or extrapolated pixel values for areas of the image that do not fall exactly on a pixel boundary.

6.5.20.2.2.2 Image Scaling. Image scaling is the magnification or reduction of apparent image size on a monitor or printing device. In digital radiography it is common to not use interpolation or extrapolation methods that alter the actual pixels of the image except to make them either smaller or larger. Other scaling methods try to guess at what a pixel value SHOULD be based on the pixels surrounding it during magnification routines.

6.5.20.2.2.3 Other Frame Processing Techniques. Other frame processing techniques include transforms, which map image data into another space or domain and operate on it there, frequently with a convolution filter or another frame processing technique. Examples include Fourier transforms and YCC photo CD color space conversions. Some compression algorithms rely on domain transforms as well.

6.5.20.3 Compression. Image compression techniques for digital images fall into two main categories, "lossless" and "lossy" compression.

6.5.20.3.1 Lossless Compression. Lossless compression techniques are the only compression styles universally accepted by the industrial digital radiography community. In a lossless compression algorithm, the original raw data can always be reconstructed exactly as it was before compression. Because there is no loss of the original information; it is just coded in a way that is smaller for storage.

T.O. 33B-1-1

6.5.20.3.2 Lossy Compression. Lossy compression techniques sacrifice some of the image data to create even smaller file sizes while trying to maintain the overall quality of an image. The amount of loss can vary in most techniques, and is determined by the quality factor used in the compression algorithm. Lossy compression techniques degrade an image over each subsequent compression from a decompressed image in a manner similar to making a noisy copy of an analog cassette tape, then making a copy of a copy, using the same equipment. The original raw data is lost and irretrievable in a lossy compression technique. Examples of lossy compression include: “Discrete Cosine transform” compression, standard “JPEG” compression, and “wavelet” compression methods. Of these, wavelet compression tends to produce the highest quality copy with a high compression ratio and low image loss.

NOTE

Lossy compression is not recommended for anything but copies of digital radiographs.

SECTION VI PROCESS CONTROL OF RADIOGRAPHIC INSPECTION

6.6 RADIOGRAPHIC PROCESS CONTROL.

6.6.1 Scope and Purpose. Process control of radiography or any of the other NDI methods means variables involving materials, equipment, personnel, and documentation are well defined and maintained. This means that the features which are significant in terms of process reliability be identified so controls can be put in place.

6.6.2 Radiographic Process Control Requirements. Although the entire X-ray process must be closely controlled to produce the expected results, this requirement centers on film processing. The novice might think X-ray is a cure all, but to the informed it is a very costly and sometimes inaccurate NDI method. X-ray procedures SHOULD be followed precisely. Proper beam alignment, the correct film, source focal spot size, and correct exposure parameters are critical. This radiographic process has many factors that affect the quality of the final product.

6.6.2.1 During radiographic inspection/exposure perimeters requiring control include: variations in the radiation source, voltage, current, heat removal, geometry factors (i.e., focal spot size, shape, and location), beam collimation and direction, source-to-object, source to film/detector distances, and object to film detector distances.

6.6.2.2 Variables to be controlled during radiographic film storage include: handling, and processing the film, screens, cassettes, and chemicals. For the most part, process control of these variables is dependent on the radiographer and the care the inspector uses in setting up all these features. Good record keeping of the entire process is important in maintaining reliability.

6.6.3 Process Control in the Darkroom. Darkroom design is discussed in (paragraph 6.4.5), but the design is critical toward controlling the radiographic process. The darkroom SHALL be completely protected against radiation and visible light. For efficiency and reducing the possibility of damaging radiographic film, two distinct areas SHOULD be established within the darkroom. One area SHOULD be designated the "dry area" and the other the "wet area." The dry area is where film is unloaded and placed on hangers, prepared to be loaded in the automatic film processor, loaded in cassettes, or cut to support special inspections. Liquids or materials that could damage unprotected film SHOULD NOT be allowed in this area. The wet area is where development chemicals are mixed and hand development is accomplished. Wet hangers and other wet equipment SHOULD NOT be permitted out of this area of the darkroom. These two areas SHOULD be physically separated to prevent the wet chemicals from being accidentally transferred to the film loading areas, causing spots or other artifacts on the parts. Most dark room equipment such as the processing tanks, dryers, and hangers are manufactured of stainless steel or other non-corrosive materials. The fixer solution is particularly corrosive, and most other metals are readily attacked.

6.6.3.1 If possible, the dark room SHOULD adjoin the X-ray room or radiographic work area. A film-transfer cabinet SHOULD be installed in the separating wall, particularly if a large volume of work is done. Film can be handled efficiently without interfering with darkroom processing. The film-transfer cabinet SHALL be lead lined if it adjoins the X-ray room.

6.6.3.2 Ventilation. Proper ventilation of the darkroom SHALL be determined by Bioenvironmental. The circulation of clean fresh air will reduce fatigue and provide a healthier atmosphere for personnel. Light-tight ventilators SHALL be installed and the number will depend on the size of the darkroom. Ventilators SHOULD keep the air moving from the dry side to the wet side of the room and out of the building.

6.6.3.3 Safelights. To minimize the fogging of undeveloped radiographic film by the safelights in the darkroom, the following provisions apply:

- General illumination SHALL be indirect.
- Safelights SHOULD be suspended from the ceiling and SHALL be at least four feet from undeveloped/exposed film.
- Only the minimum level of safelights needed to perform darkroom operations SHALL be allowed.
- Only safelight filters (6B or equivalent) designated for use with industrial radiographic film SHALL be allowed.
- The manufacturer's recommended bulb wattage SHALL NOT be exceeded
- The darkroom walls SHALL be painted a light color, which best reflects light from the safelight. The darkroom SHOULD have an antechamber type entrance that makes an efficient light trap
- During the development and preparation of uncovered, undeveloped radiographic film, ambient light SHALL NOT exist in the darkroom.

6.6.3.3.1 Why Test Safelights. The level of safelight present in the darkroom SHALL be the minimum required to perform undeveloped film preparation/development operations. Safelights for darkroom operation, contribute to unwanted

T.O. 33B-1-1

densities (fog) on radiographic film. To overcome this problem, the length of time undeveloped industrial radiographic film can safely be exposed to the level of safelight within a specific darkroom SHALL be understood. This time period is much shorter for exposed film than for unexposed film. The reason for this time difference is exposed film is approximately five-times more susceptible to fog caused by safelights than unexposed film.

6.6.3.3.1.1 The safelight fog evaluation procedure consists of two tests: the individual safelight test and the periodic collective safelight test. These tests have a requirement to be performed separately or jointly depending upon the circumstances. Both of these tests SHALL be performed during initial safelight evaluation for a new or in-use darkroom facility whenever the periodic collective safelight test results are unacceptable.

6.6.3.3.2 Individual Safelight Testing. Circumstances when this test SHALL be performed on a single, or if required on all safelights are 1) initial test which includes all safelights, 2) on newly installed safelights, 3) whenever any changes are made to existing lights such as replacing entire units, bulbs, filters, or changing the position (e.g. reflecting versus direct lighting), 4) whenever filters are suspected of fading, 5) to determine the adverse effects of crazing, scratches, and cracks, or 6) whenever a safelight is suspect of producing excessive safelight fog.

6.6.3.3.3 Periodic Collective Safelight Testing. Safelight filters deteriorate during use. This rate of deterioration is dependent on their age, amount of use, and amount of heat generated by the bulb. Therefore, a periodic schedule SHALL be established to collectively test safelights to prevent film fog, dependent upon their use. Circumstances, which determine when this test SHALL be performed, are 1) during the periodic test cycle, which SHALL NOT exceed one-year, and 2) repositioning safelights, 3) when reestablishing an undeveloped film handling area, and 4) when installing additional safelights. The collective safelight test film SHALL be maintained on file for one year or replaced when the test is performed again.

6.6.3.3.4 Safelight Fog Evaluation Procedure. There are three different requirements for using this procedure to establish the maximum safelight exposure period 1) initial evaluation, 2) individual evaluation, and 3) periodic collective evaluation. The procedures are as follows:

CAUTION

It is extremely important that the film used for these tests never be exposed to safelight prior to the test. Do not open film envelopes before their intended use. If a film cassette is used, it SHALL be loaded in total darkness.

6.6.3.3.4.1 Initial Safelight Evaluation Procedure.

- a. During the initial safelight evaluation, expose an individual sheet of Class 4 radiographic film to X-ray for each safelight in the dark room, plus an additional sheet to approximately a 1.5 (± 0.2) HD units overall constant density. (e.g., if there are three safelights in the darkroom, expose four separate sheets of film individually.)
- b. During this evaluation, each safelight SHALL be tested both individually and collectively.
- c. Turn off all of the safelights and ensure the darkroom is void of all ambient light.
- d. While all safelights are off, and in total darkness, remove the exposed film from its envelope/cassette. Position the exposed film in direct line and perpendicular with the safelight's filter, at a maximum distance of four-feet unless the distance between the normal working level and safelight is greater than four-feet, in which case the test film SHOULD be placed at this measurement.
- e. Cover the entire test film with an opaque material, such as cardboard.
- f. During individual tests, turn-on only the safelight to be tested. During collective tests, turn on all safelights.

- g. Expose six equal sections of the test film, which was exposed to X-ray, to the safelight by sliding the opaque material the length of the film in 6-minute, 3-minute, 1-minute, 30-seconds, 15-seconds, and 0-second intervals, (this last section is left unexposed to the safelight). This will result in six test film sections, each with a different safelight exposure consisting of the following: 10-minutes and 45-seconds, 4-minutes and 45-seconds, 1-minute and 45-seconds, 45-seconds, 15-seconds and 0-seconds.
- h. Cover the entire test film with the opaque material, taking care not to lift the mask off of the test film, as this would result in the 0-second section being exposed to the safelight.
- i. Turn off the safelight(s) being tested.
- j. Develop the film in total darkness.
- k. Upon completing the initial individual safelight test for each safelight, perform the periodic collective safelight test. The initial and periodic collective safelight test is similar to the individual safelight test with the exception of the following:
 - (1) All safelights SHALL be turned on during the safelight time interval exposures.
 - (2) The radiographically exposed test film SHALL be positioned in the usual area where normal undeveloped radiographically exposed film is handled. This area SHALL NOT be less than four-feet from any safelight source.
- l. After all test films have been developed in total darkness, read the densities of the five safelight exposed sections comparing them to the sixth section on their respective test film. The section with the least amount of safelight exposure that has a measurable density increase is the maximum time an undeveloped radiographic film SHALL be allowed to be exposed to safelight in the darkroom.
- m. If this time restriction is 4-minutes and 45-seconds or less, or not suitable for operational needs, one or more of the following actions SHALL be taken:
 - (1) Replace safelight filters that are faded, cracked, are not designated for industrial radiographic film, crazed, do not fit properly, or scratched.
 - (2) Replace safelight bulbs exceeding the wattage recommended by the manufacturer.
 - (3) Replace safelights unserviceable, such as emitting ambient light.
 - (4) Eliminate or reconfigure uncontrollable ambient light sources such as doorways, ventilating and heating ducts/vents, faulty film pass through box, building structural cracks, and holes around pipes and electrical wiring.
 - (5) In the event the individual safelight tests are all within an acceptable tolerance, but the collective safelight test is unacceptable, investigate the validity of the individual safelight test and when, in fact, the results of these tests are correct, reduce the number of safelights in the darkroom.

NOTE

The maximum time undeveloped film can be exposed to safelight shall be posted in the darkroom in an area clearly visible to all radiographers.

6.6.3.3.4.2 Individual Safelight Evaluation Procedure.

- a. In the case where only the individual safelight test is being performed, only expose the number of films to X-ray that correspond to the number of safelights to be tested.
- b. Each film exposed, to perform the individual safelight tests, SHALL be identified so as to identify the specific safelight it was used to test or if it was used to perform the collective safelight test.
- c. To perform the individual safelight test, turn off or remove the bulbs from all the safelights with the exception of the safelight to be tested.
- d. Turn off the safelight to be tested and ensure the darkroom is void of all ambient light.
- e. While all safelights are off, and in total darkness, remove the exposed film from its envelope/cassette. Position the exposed film in direct line and perpendicular with the safelight's filter, at a maximum distance of four feet unless the distance between the normal working level and safelight is greater than four feet, in which case the test film SHOULD be placed at this measurement.
- f. Cover the entire test film with an opaque material, such as cardboard.

T.O. 33B-1-1

- g. Turn on the safelight to be tested.
- h. Expose six equal sections of the test film, which was exposed to X-ray, to the safelight by sliding the opaque material the length of the film in 6-minute, 3-minute, 1-minute, 30-seconds, 15-seconds, and 0-second time intervals, (the last section is left unexposed to the safelight). This will result in six test film sections, each with a different safelight exposure consisting of the following: 10-minutes and 45-seconds, 4-minutes and 45-seconds, 1-minute and 45-seconds, 45-seconds, 15-seconds and 0-seconds.
- i. Cover the entire test film with the opaque material, taking care not to lift the mask off of the test film, as this would result in the 0-second section being exposed to the safelight.
- j. Turn off the safelight being tested.
- k. Develop the film as you would normally, with the exception of being performed in total darkness.
- l. Repeat the individual safelight test procedure for each safelight, if required. Great care must be taken to not unintentionally expose the test film to safelight. Undeveloped test film SHALL be maintained in a light tight container prior to it being developed and not being used to perform a safelight test.
- m. After all test films have been developed in total darkness, read the densities of the five safelight exposed sections comparing them to the sixth section on their respective test film. The section with the least amount of safelight exposure that has a measurable density increase is the maximum time an undeveloped radiographic film SHALL be allowed to be exposed to safelight in the darkroom.
- n. If this time restriction is 4-minutes and 45-seconds or less, or not suitable for operational needs, one or more of the following actions SHALL be taken:
 - (1) Replace safelight filters that are faded, cracked, are not designated for industrial radiographic film, crazed, do not fit properly, or scratched.
 - (2) Replace safelight bulbs exceeding the wattage recommended by the manufacturer.
 - (3) Replace safelights unserviceable, such as emitting ambient light.
 - (4) Eliminate or reconfigure uncontrollable ambient light sources such as doorways, ventilating and heating ducts/vents, faulty film pass through box, building structural cracks, and holes around pipes and electrical wiring.
 - (5) In the event the individual safelight tests are all within an acceptable tolerance, but the collective safelight test is unacceptable, investigate the validity of the individual safelight test and if the results of these tests are correct, reduce the number of safelights in the darkroom.

6.6.3.3.4.3 Periodic Collective Safelight Evaluation Procedure.

- a. If only the collective test is to be performed, only expose one film to X-ray.
- b. The film exposed, to perform the collective safelight tests, SHALL be identified so as to identify the specific safelight it was used to test or if it was used to perform the collective safelight test.
- c. Turn off all safelights and ensure the darkroom is void of all ambient light.
- d. While all safelights are off, and in total darkness, remove the exposed film from its envelope/cassette. Position the exposed film in direct line and perpendicular with the safelight's filter, at a maximum distance of four-feet unless the distance between the normal working level and safelight is greater than four-feet, in which case the test film SHOULD be placed at this measurement.
- e. Cover the entire test film with an opaque material, such as cardboard.
- f. Turn on all safelights to be tested.
- g. Expose six equal sections of the test film which was exposed to X-ray to the safelight by sliding the opaque material the length of the film in 6-minute, 3-minute, 1-minute, 30-seconds, 15-seconds, and 0-second time intervals, (the last section is left unexposed to the safelight). This will result in six test film sections, each with a different safelight exposure consisting of the following: 10-minutes and 45-seconds, 4-minutes and 45-seconds, 1-minute and 45-seconds, 45-seconds, 15-seconds and 0-seconds.
- h. Cover the entire test film with the opaque material, taking care not to lift the mask off of the test film, as this would result in the 0-second section being exposed to the safelight.
- i. Turn off all safelights being tested.

- j. Develop the film as you would normally, with the exception of being performed in total darkness.
- k. The initial and periodic collective safelight test is similar to the individual safelight test with the exception of the following:
 - (1) All safelights SHALL be turned on during the safelight time interval exposures.
 - (2) The radiographically exposed test film SHALL be positioned in the usual area where normal undeveloped radiographically exposed film is handled. This area SHALL NOT be less than four-feet from any safelight source.
- l. After all test films have been developed in total darkness, read the densities of the five safelight exposed sections comparing them to the sixth section on their respective test film. The section with the least amount of safelight exposure that has a measurable density increase is the maximum time an undeveloped radiographic film SHALL be allowed to be exposed to safelight in the darkroom.
- m. If this time restriction is 4-minutes and 45-seconds or less, or not suitable for operational needs, one or more of the following actions SHALL be taken:
 - (1) Replace safelight filters that are faded, cracked, are not designated for industrial radiographic film, crazed, do not fit properly, or scratched.
 - (2) Replace safelight bulbs exceeding the wattage recommended by the manufacturer.
 - (3) Replace safelights unserviceable, such as emitting ambient light.
 - (4) Eliminate or reconfigure uncontrollable ambient light sources such as doorways, ventilating and heating ducts/vents, faulty film pass through box, building structural cracks, and holes around pipes and electrical wiring.
 - (5) In the event the individual safelight tests are all within an acceptable tolerance, but the collective safelight test is unacceptable, investigate the validity of the individual safelight test if the results of these tests are correct, reduce the number of safelights in the darkroom.

6.6.3.4 Safelight Filters. Filter may discolor and fade in time or be damaged by accident or mishandling. A visual inspection of safelight filters SHALL be performed at 30-day intervals and when individual or collective safelight tests are accomplished. Replace filters that are cracked, chipped, scratched, faded, or discolored.

6.6.4 Controlling the Development Process.

6.6.4.1 Control Strip. A major variable in the radiographic process is the processing of the film. The chemical concentration levels, contaminants, and temperature are important variables which affect the process. A method of monitoring changes during film processing involves periodically processing many control-exposed films to detect changes in film density and/or contrast. This SHOULD be accomplished by radiographing a step wedge at time zero at the beginning of each month. The film exposed to all the various gray levels from the step wedge can be cut into strips, with each strip being processed at various times after identical exposures. For example, strip No. 1 would be processed immediately, as the control film. Densities and contrast between selected steps SHALL be measured with a densitometer. Once a week, another film strip SHALL be processed and the densities and contrasts compared to those of the control film. Major variations in the densities of the films SHOULD lead to further examination of the film processing procedure. Although small variations MAY be tolerated, variations in excess of 0.3 density units from anticipated film density values would be considered a major variation (a factor of 2 in transmitted brightness). Over several months, this procedure SHOULD provide enough scatter data the radiographer will recognize the acceptable criteria. The last strip in the control exposure SHOULD be processed with the control film of the new batch to maintain continued control from month to month. In cases where films from one manufacturer are processed in another film manufacturer's recommended solutions, the period between control tests may need to be shortened.

6.6.4.1.1 The radiographic inspector SHALL use the control strip to detect changes in the radiographic process. If the inspector ensures the equipment is properly maintained, takes care to use the equipment in a repeatable manner, maintains good records, and maintains the repeatability of film processing, then the radiographic inspection process will remain in good control.

6.6.4.2 Manual Processing Chemicals.

6.6.4.2.1 Testing Developer Activity. The success of this method of compensating for the gradual decrease of developer activity will depend upon the use of an adequate system for testing this activity. Since there is no simple direct physical or chemical test of developer activity, the easiest way of making the test is to process, at frequent intervals, film strips exposed in some standard manner, and to compare the densities obtained with an identical film strip processed in the fresh solution. The standard strips are cut from a sheet film, 8x10 inches or larger, which has been exposed to direct X-rays through a test object. The most suitable form of test object is a stepped wedge made up of a number of sheets of any convenient metal. The

T.O. 33B-1-1

wedge SHOULD have about 15 steps and be large enough to cover completely the largest cassette or film holder used. When given the proper exposure this SHOULD produce series of densities extending over the density range used in practice. It is essential all strips used in testing a batch of developer receive identical exposures. For this reason, no screens of any kind are used and all the sheets of film required SHOULD be exposed simultaneously in the same cassette. For instance, at 80 kilovolts, using an aluminum step tablet, three sheets MAY be exposed in the same cassette without introducing significant differences in the densities of the top and bottom films. At 180 kilovolts, using a steel tablet, five sheets MAY be exposed at once. At 1000 kilovolts, a steel tablet having steps 1/4- to 1/2- inches high can be used, and five sheets of film exposed at once. When this penetrating radiation is used, two extra films are included, and the top and bottom films are discarded after exposure. The exposed films SHOULD be stored in a cool/dry place (ideally, at 70°F and 50-percent relative humidity, or below). Exposed film, which is not used at the end of two to three weeks, SHOULD be discarded. When manually processing test strips, they SHOULD be developed dark end down on regular film-processing hangers in the center of the tank and be given the same development time and agitation used in practice. When using automatic processing, process the film lengthwise to avoid losing the film in the rollers. When a new batch of developer is put into use, one or more strips are processed and preserved as the standard for comparison throughout the useful life of the developer. Thereafter, a strip SHOULD be processed, after every 50, 14x17-inch films, or equivalent, processed per 5-gallons of developer. If the densities of the test strip are less than those of the strip processed in the fresh solution, the rate of addition of replenisher SHOULD be increased. On the other hand, if the densities of the test strips are too high, the rate of addition of replenisher SHOULD be decreased. The stepped wedge method of testing developer activity is also useful in cases where the temperature of the processing solutions cannot be exactly controlled. Strips are developed for a series of times, and the development time that a strip matching the one developed at 68°F in the fresh solution is used for routine work.

6.6.4.2.2 Stop Bath Acidity. The stop bath acidity is not as critical as developer activity, but a check can be made with litmus paper to assure the bath is acidic and capable of neutralizing the alkaline developer.

6.6.4.2.3 Fixer Bath Activity. The diminished activity of the fixer solution with use in manual processing can be readily noted by the extended time required for clearing of the film emulsion. Fixer time can be increased to compensate for deterioration of the chemicals or chemicals MAY be replenished by addition of the chemical constituents of the fixer.

6.6.4.3 Automatic Processing Chemicals.

6.6.4.3.1 Control of Processing Solutions. It is rare when chemicals manufactured under exactly the same conditions possess precisely the same properties. In actuality, differences exist. Accordingly, it is unavoidable, X-ray films processed in automatic processors show some degree of variation in quality. Radiographic quality is affected by the following factors, making it necessary to minimize such variations in the control of processing solutions.

6.6.4.3.2 Developer Control. As in manual processing, the activity level of the developer solution used in automatic processing is kept constant by the addition of replenisher. The degree of exhaustion of the active components may differ from case-to-case depending on the type of processor, the average density of the radiographs, and the water quality even if the quantities of film processed remain constant.

6.6.4.3.2.1 Even when the same replenishment rates are used in different facilities, the activity of the developer solutions differs over time from one situation to another. The developer solution SHOULD therefore be controlled in a manner suited to the specific conditions of the particular facility. Developer solution is controlled in several ways, but in radiography the "sensitometric" and "densitometric" methods are in general use as control procedures.

6.6.4.3.2.1.1 Sensitometric Method. This method provides the highest control accuracy. A control strip which is exposed to visible light or X-rays in step fashion is developed under predetermined conditions and a characteristic curve is derived from this control strip. The characteristic values (of speed, contrast, and fog) obtained from the characteristic curve are graphically represented. If the characteristics of the control strip deviate from normal, corrective action is taken to bring the developer solution into control. In practice, the characteristics obtained from fresh developer are used as the standard and a control strip is processed after processing a certain number of films or at the beginning of each work shift (at the time processing conditions are stabilized following processor preparation). The results obtained with control if they are observed shifts from the standard.

6.6.4.3.2.1.2 Densitometric Method. The densitometric method also uses control strips. The density of a specific step of relatively high density is used to plot a control chart. The control film is processed at the same specified time as indicated for the sensitometric control method.

6.6.4.3.3 Fixer Control. An exhausted fixer solution will produce adverse effects relative to the permanency of radiographs. It is necessary to check the fixer solution for exhaustion once per month, or when regular processor maintenance is performed. Fresh chemicals are metered into the processor as film is processed and it is this replenishment that keeps the solution active. The normal replenishment rates for auto-fixers are 170 to 190 ml per 14x17 film processed. While checking replenishment rate, circulation in the fixer should also be verified and if the processor has a fixer filter, it should also be checked and cleaned.

SECTION VII RADIOGRAPHIC INSPECTION EQUATIONS

6.7 RADIOGRAPHIC EQUATIONS.

6.7.1 General. The following are a list of equations normally used to perform radiographic inspections.

6.7.2 Inverse Square Law. When the X-ray tube output is held constant, or when a particular radioactive source is used, the radiation intensity reaching the specimen is governed by the distance between the tube (source) and the specimen, varying inversely with the square of this distance. The explanation below is in terms of X-rays and visible light, but applies with equal force to gamma rays as well. Since X-rays conform to the laws of light, they diverge when they are emitted from the anode and cover an increasing larger area with lessened intensity as they travel from their source. This principle is illustrated by (Figure 6-26).

6.7.2.1 In this example, it is assumed the intensity of the X-rays emitted at the anode (A) remains constant, and the X-rays passing through the aperture (B), cover a 4-square-inch area upon reaching and recording surface (C1), which is 12-inches (D_1) from (A). If the recording surface (C1) is moved 12-inches farther from the anode to (C2), so the distance between (A) and (C2) is 24-inches (D_2) or twice the distance between (A) and (C1); the X-rays will cover 16-square-inches, an area four-times as great as that at (C1). Therefore, the radiation-per-square-inch on the surface at (C2) is only one-quarter that at (C1). Thus the exposure that would be adequate at (C1) must be increased four-times in order to produce a radiograph at (C2) of equal density. In practice this is done by increasing either the time, or milliamperage. Mathematically the inverse square law is expressed as follows:

$$\frac{I_1}{I_2} = \frac{(D_2)^2}{(D_1)^2}$$

where I_1 and I_2 are the intensities at distances D_1 and D_2 respectively.

Example: An intensity of 2 mR was measured at 40" from the source. What would be the intensity reading at 30-inches, and at 20-inches? Do not forget to take the square of the predetermined value for D_2 when determining unknown distances.

6.7.3 Source-to-Film Distance (SFD). The sharpest image would be formed by having a SFD so great the radiation would be parallel at the film plane (Figure 6-23), however, since radiation intensity or quantity is diminished in relationship to the inverse square of the distance, the radiation quantity available to expose the film would be very small, and exposure times would become impractical. Consequently, economics and practicability must be considered when producing a radiographic image. It is recommended the longest practical SFD be used for critical exposures to improve image sharpness. If the source-to-film distance is changed, the following formula can be used to correct the exposure. Because an increase in distance causes a decrease in beam intensity, only the intensity is changed. The kilovoltage SHALL NOT be changed when correcting for SFD changes.

$$\text{The formula is: } \frac{T_2}{(D_2)^2} = \frac{T_1}{(D_1)^2} \quad T_2 = T_1 \left(\frac{D_2}{D_1} \right)^2 \quad \text{or} \quad \frac{T_1 (D_2)^2}{(D_1)^2}$$

Where:

T_1 = Original Exposure (MAS).

T_2 = New Exposure (MAS).

D_1 = Original Distance (SFD).

D_2 = New Distance (SFD).

For example, if a technique calls for exposing a part at 36-inches using 300 MAS, but the tube head must be moved to make a 48-inch SFD, what would the new exposure be?

Substituting:

Cross multiplying gives $(T_2) * (1296) = (300) * (2304)$ or $T_2 = (300 * 2304)/1296$.

Solving, $T_2 = 533$ MAS, which would be our new exposure.

T.O. 33B-1-1

6.7.4 Film Density. In photographic terms, density is a measure of the degree of blackening or darkening produced on the radiograph, caused by exposure to radiation and resulting from the metallic silver deposits remaining on the film after exposure and processing. Density is measured in terms of visible light transmission with test strips. The accepted scale of film density measurement is the logarithm of the reciprocal of the fraction of incident light to transmitted light as given by the following equation:

$$D = \log \frac{I_0}{I_t}$$

H0401920

Where:

D = film image density.

I_0 = original light intensity falling upon one surface of film.

I_t = light intensity transmitted through the film.

For example, an increase in the amount of blackening from one area of a particular film to another, reduces the proportion of the incident light transmitted from 50 to 25-percent would cause the film density to change from 0.3 to 0.6.

6.7.4.1 More examples of typical relationships between light transmission and density are in (Table 6-3). A typical density used in practical radiography is 2.0 and represents 1-percent transmittance. Density is measured with densitometers and test strips (paragraph 6.5.5.1).

6.7.5 Logarithms for Density and Exposure Calculations. Logarithms are used extensively in X-ray exposure calculations and in the measurement of X-ray film density. Radiographers SHALL be sufficiently familiar with logarithms so they can perform some simple calculations. A brief review of logarithms and their use is therefore included here. More detail can be found in various handbooks and intermediate mathematics texts. Logarithms are used because they provide a convenient method of handling very large ranges of numbers, and they reduce calculations involving multiplication and division to addition and subtraction. The logarithm is the power (or exponent) to which the base must be raised to give the original number. Logarithms MAY be taken from any base; however, most calculations in radiography involve either the base 10 or the base e (2.718). Logarithms to the base 10 are indicated by "log x," and logarithms to the base e are denoted by "ln x." For the moment, let us consider logarithms to the base 10: $\log 100 = 2$, because $10^2 = 100$. Similarly, the logarithm of 1,000 is 3 or: $\log 1,000 = 3$, since $10^3 = 1,000$. The logarithms of all numbers that are integer powers of 10 (e.g., 10, 100, 1,000, etc.) are whole numbers (1, 2, 3, etc.). Logarithms of other numbers are decimal numbers and are found in tables of logarithms or calculated on some hand calculators. A table of four-place logarithms to the base 10 is given in (Table 6-22). The logarithm is made up of two basic parts, the "characteristic," which is the number before the decimal point and the "mantissa," which is the number after the decimal point. The characteristic indicates the order of magnitude of the number x; for example, numbers 10 through 99 have a characteristic of 1. Characteristics for other ranges are given in (Table 6-21). The digits of the number determine the mantissa. In (Table 6-22), the mantissa of 328, for example, find by going to the number 32 along the left hand side and looking across that row under the column marked "8." We see in the table the mantissa of 328 is given as 5159. What is the logarithm of 328? It can be seen the characteristic of 328 would be 2 (Table 6-21). Therefore, $\log 328$ is equal to 2.5159.

Table 6-21. Characteristics of Logarithms

Number	Characteristic
1	0
10	1
100	2
1,000	3
10,000	4

NOTE

The value of the characteristic is one less than the number of digits in the number.

Table 6-22. Four-Place Logarithms to the Base 10

N	0	1	2	3	4	5	6	7	8	9	0	1	2	3	4	5	6	7	8	9	
10	0000	0043	0086	0128	0170	0212	0253	0294	0334	0374	55	7404	7412	7419	7427	7435	7443	7451	7459	7466	7474
11	0414	0453	0492	0531	0569	0607	0645	0682	0719	0755	56	7482	7490	7497	7505	7513	7520	7528	7536	7543	7551
12	0792	0828	0864	0899	0934	0969	1004	1038	1072	1106	57	7559	7566	7574	7582	7589	7597	7604	7612	7619	7627
13	1139	1173	1206	1239	1271	1303	1335	1367	1399	1430	58	7634	7642	7649	7657	7664	7672	7679	7686	7694	7701
14	1461	1492	1523	1553	1584	1614	1644	1673	1703	1732	59	7709	7716	7723	7731	7738	7745	7752	7760	7767	7774
15	1761	1790	1818	1847	1875	1903	1931	1959	1987	2014	60	7782	7789	7796	7803	7810	7818	7825	7832	7839	7846
16	2041	2048	2095	2122	2148	2175	2201	2227	2253	2279	61	7853	7860	7868	7875	7882	7889	7896	7903	7910	7917
17	2304	2330	2355	2380	2405	2430	2455	2480	2504	2529	62	7924	7931	7938	7945	7952	7959	7966	7973	7980	7987
18	2553	2577	2601	2625	2648	2672	2695	2718	2742	2765	63	7993	8000	8007	8014	8021	8028	8035	8041	8048	8055
19	2788	2810	2833	2856	2878	2900	2923	2945	2967	2989	64	8062	8069	8075	8082	8089	8096	8102	8109	8116	8122
20	3010	3032	3054	3075	3096	3118	3139	3160	3181	3201	65	8129	8136	8142	8149	8156	8162	8169	8176	8182	8189
21	3222	3243	3263	3284	3304	3324	3345	3365	3385	3404	66	8195	8202	8209	8215	8222	8228	8235	8241	8248	8254
22	3424	3444	3464	3483	3502	3522	3541	3560	3579	3598	67	8261	8267	8274	8280	8287	8293	8299	8306	8312	8319
23	3617	3636	3655	3674	3692	3711	3729	3747	3766	3784	68	8325	8331	8338	8344	8351	8357	8363	8370	8376	8382
24	3802	3820	3838	3856	3874	3892	3909	3927	3945	3962	69	8388	8395	8401	8407	8414	8420	8426	8432	8439	8445
25	3979	3997	4014	4031	4048	4065	4082	4099	4116	4133	70	8451	8457	8463	8470	8476	8482	8488	8494	8500	8506
26	4150	4166	4183	4200	4216	4232	4249	4265	4281	4298	71	8513	8519	8525	8531	8537	8543	8549	8555	8561	8567
27	4314	4330	4346	4362	4378	4393	4409	4425	4440	4456	72	8573	8579	8585	8591	8597	8603	8609	8615	8621	8627
28	4472	4487	4502	4518	4533	4548	4564	4579	4594	4609	73	8633	8639	8645	8651	8657	8663	8669	8675	8681	8686
29	4624	4639	4654	4669	4683	4698	4713	4728	4742	4757	74	8692	8698	8704	8710	8716	8722	8727	8733	8739	8745
30	4771	4786	4800	4814	4829	4843	4857	4871	4886	4900	75	8751	8756	8762	8768	8774	8779	8785	8791	8797	8802
31	4914	4928	4942	4955	4969	4983	4997	5011	5024	5038	76	8808	8814	8820	8825	8831	8837	8842	8848	8854	8859
32	5051	5065	5079	5092	5105	5119	5132	5145	5159	5172	77	8865	8871	8876	8882	8887	8893	8899	8904	8910	8915
33	5185	5198	5211	5224	5237	5250	5263	5276	5289	5302	78	8921	8927	8932	8938	8943	8949	8954	8960	8965	8971
34	5315	5328	5340	5353	5366	5378	5391	5403	5416	5428	79	8976	8982	8987	8993	8998	9004	9009	9015	9020	9025
35	5441	5453	5465	5478	5490	5502	5514	5527	5539	5551	80	9031	9036	9042	9047	9053	9058	9063	9069	9074	9079
36	5563	5575	5587	5599	5611	5623	5635	5647	5658	5670	81	9085	9090	9096	9101	9106	9112	9117	9122	9128	9133
37	5682	5694	5705	5717	5729	5740	5752	5763	5775	5786	82	9138	9143	9149	9154	9159	9165	9170	9175	9180	9186
38	5798	5809	5821	5832	5843	5855	5866	5877	5888	5899	83	9191	9196	9201	9206	9212	9217	9222	9227	9232	9238
39	5911	5922	5933	5944	5955	5966	5977	5988	5999	6010	84	9243	9248	9253	9258	9263	9269	9274	9279	9284	9289
40	6021	6031	6042	6053	6064	6075	6085	6096	6107	6117	85	9294	9299	9304	9309	9315	9320	9325	9330	9335	9340
41	6128	6138	6140	6160	6170	6180	6191	6201	6212	6222	86	9345	9350	9355	9360	9365	9370	9375	9380	9385	9390
42	6232	6243	6253	6263	6274	6284	6294	6304	6314	6325	87	9395	9400	9405	9410	9415	9420	9425	9430	9435	9440
43	6335	6345	6355	6365	6375	6484	6493	6503	6513	6522	89	9494	9499	9504	9509	9513	9518	9523	9528	9533	9538
45	6532	6542	6551	6561	6571	6580	6590	6599	6609	6618	90	9542	9547	9552	9557	9562	9566	9571	9576	9581	9586
46	6628	6637	6646	6656	6665	6675	6684	6693	6702	6712	91	9590	9595	9600	9605	9609	9614	9619	9624	9628	9633
47	6721	6730	6739	6749	6758	6767	6776	6785	6794	6803	92	9638	9643	9647	9652	9657	9661	9666	9671	9675	9680
48	6812	6821	6830	6839	6848	6857	6866	6875	6884	6893	93	9685	9689	9694	9699	9703	9708	9713	9717	9722	9727
49	6902	6911	6920	6928	6937	6946	6955	6964	6972	6981	94	9731	9736	9741	9745	9750	9754	9759	9763	9768	9773
50	6990	6998	7007	7016	7024	7033	7042	7050	7059	7067	95	9777	9782	9786	9791	9795	9800	9805	9809	9814	9818
51	7076	7084	7093	7101	7110	7118	7126	7135	7143	7152	96	9823	9827	9832	9836	9841	9845	9850	9854	9859	9863
52	7160	7168	7177	7185	7193	7202	7210	7218	7226	7235	97	9868	9872	9877	9881	9886	9890	9894	9899	9903	9908
53	7243	7251	7259	7267	7275	7284	7292	7300	7308	7316	98	9912	9917	9921	9926	9930	9934	9939	9943	9948	9952
54	7324	7332	7340	7348	7356	7364	7372	7380	7388	7396	99	9956	9961	9965	9969	9974	9978	9983	9987	9991	9996
N	0	1	2	3	4	5	6	7	8	9	N	0	1	2	3	4	5	6	7	8	9

*Interpolation in this section of the table is inaccurate.

H0401921

Table 6-23. Antilogarithms

	0	1	2	3	4	5	6	7	8	9		0	1	2	3	4	5	6	7	8	9
.00	1000	1002	1005	1007	1009	1012	1014	1016	1019	1021	.50	3162	3170	3177	3184	3192	3199	3206	3214	3221	3228
.01	1023	1026	1028	1030	1033	1035	1038	1040	1042	1045	.51	3236	3243	3251	3258	3266	3273	3281	3289	3296	3304
.02	1047	1050	1052	1054	1057	1059	1062	1064	1067	1069	.52	3311	3319	3327	3334	3342	3350	3357	3365	3373	3381
.03	1072	1074	1076	1079	1081	1084	1086	1089	1091	1094	.53	3388	3396	3404	3412	3420	3428	3436	3443	3451	3459
.04	1096	1099	1102	1104	1107	1109	1112	1114	1117	1119	.54	3467	3475	3483	3491	3499	3508	3516	3524	3532	3540
.05	1122	1125	1127	1130	1132	1135	1138	1140	1143	1146	.55	3548	3556	3565	3573	3581	3589	3597	3606	3614	3622
.06	1148	1151	1153	1156	1159	1161	1164	1167	1169	1172	.56	3631	3639	3648	3656	3664	3673	3681	3690	3698	3707
.07	1175	1178	1180	1183	1186	1189	1191	1194	1197	1199	.57	3715	3724	3733	3741	3750	3758	3767	3776	3784	3793
.08	1202	1205	1208	1211	1213	1216	1219	1222	1225	1227	.58	3802	3811	3819	3828	3837	3846	3854	3863	3872	3881
.10	1259	1262	1265	1268	1271	1274	1276	1279	1282	1285	.60	3981	3990	3999	4009	4018	4027	4036	4046	4055	4064
.11	1288	1291	1294	1297	1300	1303	1306	1309	1312	1315	.61	4074	4083	4093	4102	4111	4121	4130	4140	4150	4159
.12	1318	1321	1324	1327	1330	1334	1337	1340	1343	1346	.62	4169	4178	4188	4198	4207	4217	4227	4236	4246	4256
.13	1349	1352	1355	1358	1361	1365	1368	1371	1374	1377	.63	4266	4276	4285	4295	4305	4315	4325	4335	4345	4355
.14	1380	1384	1387	1390	1393	1396	1400	1403	1406	1409	.64	4365	4375	4385	4395	4406	4416	4426	4436	4446	4457
.15	1413	1416	1419	1422	1426	1429	1432	1435	1439	1442	.65	4467	4477	4487	4498	4508	4519	4529	4539	4550	4560
.16	1445	1449	1452	1455	1459	1462	1466	1469	1472	1476	.66	4571	4581	4592	4603	4613	4624	4634	4645	4656	4667
.17	1479	1483	1486	1489	1493	1496	1600	1503	1507	1510	.67	4677	4688	4699	4710	4721	4732	4742	4753	4764	4775
.18	1514	1517	1521	1524	1528	1531	1535	1538	1542	1545	.68	4786	4797	4808	4819	4831	4842	4853	4864	4875	4887
.19	1549	1552	1556	1560	1563	1567	1570	1574	1578	1581	.69	4898	4909	4920	4932	4943	4955	4966	4977	4989	5000
.20	1585	1589	1592	1596	1600	1603	1607	1611	1614	1618	.70	5012	5023	5035	5047	5058	5070	5082	5093	5105	5117
.21	1622	1626	1629	1633	1637	1641	1644	1648	1652	1656	.71	5129	5140	5152	5164	5176	5188	5200	5212	5224	5236
.22	1660	1663	1667	1671	1675	1679	1683	1687	1690	1694	.72	5248	5260	5272	5284	5297	5309	5321	5333	5346	5358
.23	1698	1702	1706	1710	1714	1718	1722	1726	1730	1734	.73	5370	5383	5395	5408	5420	5433	5445	5458	5470	5483
.24	1738	1742	1746	1750	1754	1758	1762	1766	1770	1774	.74	5495	5508	5521	5534	5546	5559	5572	5585	5598	5610
.25	1778	1782	1786	1791	1795	1799	1803	1807	1811	1816	.75	5623	5630	5649	5662	5675	5689	5702	5715	5728	5741
.26	1820	1824	1828	1832	1837	1841	1845	1849	1854	1858	.76	5754	5768	5781	5794	5808	5821	5834	5848	5861	5875
.27	1862	1866	1871	1875	1879	1884	1888	1892	1897	1901	.77	5888	5902	5916	5929	5943	5957	5970	5984	5998	6012
.28	1905	1910	1914	1919	1923	1928	1932	1936	1941	1945	.78	6026	6039	6053	6067	6081	6095	6109	6124	6138	6152
.29	1950	1954	1959	1963	1968	1972	1977	1982	1986	1991	.79	6166	6180	6194	6209	6223	6237	6252	6266	6281	6295
.30	1995	2000	2004	2009	2014	2018	2023	2028	2032	2037	.80	6310	6324	6339	6353	6368	6383	6397	6412	6427	6442
.31	2042	2046	2051	2056	2061	2065	2070	2075	2080	2084	.81	6457	6471	6486	6501	6516	6531	6546	6561	6577	6592
.32	2089	2094	2099	2104	2109	2113	2118	2123	2128	2133	.82	6607	6622	6637	6653	6668	6683	6699	6714	6730	6745
.33	2138	2143	2148	2153	2158	2163	2168	2173	2178	2183	.83	6761	6776	6792	6808	6823	6839	6855	6871	6887	6902
.34	2188	2193	2198	2203	2208	2213	2218	2223	2228	2234	.84	6918	6934	6950	6966	6982	6998	7015	7031	7047	7063
.35	2239	2244	2249	2254	2259	2265	2270	2275	2280	2286	.85	7079	7096	7112	7129	7145	7161	7178	7194	7211	7228
.36	2291	2296	2301	2307	2312	2317	2323	2328	2333	2339	.86	7244	7261	7278	7295	7311	7328	7345	7362	7379	7396
.37	2344	2350	2355	2360	2366	2371	2377	2382	2388	2393	.87	7413	7430	7447	7464	7482	7499	7516	7534	7551	7568
.38	2399	2404	2410	2415	2421	2427	2432	2438	2443	2449	.88	7586	7603	7621	7638	7656	7674	7691	7709	7727	7745
.39	2455	2460	2466	2472	2477	2483	2489	2495	2500	2506	.89	7762	7780	7798	7816	7834	7852	7870	7889	7907	7925
.40	2512	2518	2523	2529	2535	2541	2547	2553	2559	2564	.90	7943	7962	7980	7998	8017	8035	8054	8072	8091	8110
.41	2570	2576	2582	2588	2594	2600	2606	2612	2618	2624	.91	8128	8147	8166	8185	8204	8222	8241	8260	8279	8299
.42	2630	2636	2642	2649	2655	2661	2667	2673	2679	2685	.92	8318	8337	8356	8375	8395	8414	8433	8453	8472	8492
.43	2692	2698	2704	2710	2716	2723	2729	2735	2742	2748	.93	8511	8531	8551	8570	8590	8610	8630	8650	8670	8690
.44	2754	2761	2767	2773	2780	2786	2793	2799	2805	2812	.94	8710	8730	8750	8770	8790	8810	8831	8851	8872	8892
.45	2818	2825	2831	2838	2844	2851	2858	2864	2871	2877	.95	8913	8933	8954	8974	8995	9016	9036	9057	9078	9099
.46	2884	2891	2897	2904	2911	2917	2924	2931	2938	2944	.96	9120	9141	9162	9183	9204	9226	9247	9268	9290	9311
.47	2951	2958	2965	2972	2979	2985	2992	2999	3006	3013	.97	9333	9354	9376	9397	9419	9441	9462	9484	9506	9528
.48	3020	3027	3034	3041	3048	3055	3062	3069	3076	3083	.98	9550	9572	9594	9616	9638	9661	9683	9705	9727	9750
.49	3090	3097	3105	3112	3119	3126	3133	3141	3148	3155	.99	9772	9795	9817	9840	9863	9886	9908	9931	9954	9977

Table 6-24. Effect of Relative Exposure on Film Sensitivity

Change in Relative Exposure	Change in Density
0.5 to 1.0	0.3 to 0.7
1.0 to 1.5	0.7 to 1.5
1.5 to 2.0	1.5 to 3.0

6.7.5.1 Logarithms provide a convenient method of multiplying and dividing. To multiply two numbers, you take the logarithms of both numbers and add them to get the logarithm of the product. To obtain the product, you then take the antilogarithm of this sum. The antilog is the inverse function of the log. In other words, the antilog of x is equal to 10^x . The antilogs for mantissas of 0.000 to 0.999 are listed in (Table 6-23). The value of x is then obtained by properly placing the decimal point according to the characteristic of the sum of the logarithms.

Example: Multiply 20 times 8 using logarithms.

- (1) Take the log of 20: $\log 20 = 1.3010$
- (2) Take the log of 8: $\log 8 = 0.9031$
- (3) Take the sum of these logarithms: $1.301 + 0.9031 = 2.2041$
- (4): Take the antilog of the sum:

The antilog of 0.2041 = 1600

The characteristic of 2 indicates a number between 100 and 999.

Therefore the answer is 160.

In this example, the regular mathematical calculation is simple, however, with very large numbers, the use of logarithms significantly simplifies calculation.

6.7.5.1.1 Division is accomplished by taking the difference between the logs of the two numbers.

Example: $6/73 = \text{antilog}(\log 6 - \log 73)$.

6.7.5.2 In radiography, logarithms find particular use in the preparation of exposure charts and in film characteristic curves which plot film density against relative exposure. Logarithms to the base 10 MAY be converted to natural logarithms by the equation $\ln x = 2.3 \log x$.

6.7.6 **Material Contrast Factor.** In consideration to radiation absorption, the most important variable that can be controlled by the radiographer in industrial X-ray inspection is the kilovoltage. The amount of radiation absorbed by the part being inspected depends on the atomic number, density, and thickness of the material. The radiographer cannot change these factors, but can change the energy of radiation in the attenuation equation:

$$\ln(-\mu x) = I_T/I_0$$

we see the linear attenuation coefficient (μ) can be changed by changing radiation energy. This in turn will change the ratio I_T/I_0 , or the percent radiation transmitted through a part of thickness, x . In industrial radiographic applications, the difference in thickness (often due to discontinuities) is the actual parameter from which interpretation is made. Therefore, the greater the change in the radiation transmitted due to a particular change in material thickness, the more obvious is the thickness change revealed in the final image. This radiation difference due to material thickness change is called the material contrast. The material contrast is a function of the absorption characteristics of the part being inspected and the radiation energy level. When measurements have been made and a numerical value has been established, it is called the material contrast factor.

6.7.7 **Image Unsharpness.** This is the term applied recognizing there will always be unsharpness of the image to some degree, and perfect image sharpness is unattainable. The amount of geometric image unsharpness is due to size of the source of radiation and relative distances as shown in (Figure 6-23). The distance on the film over which an edge is spread is known as the penumbral shadow or the geometrical unsharpness, U_g . The value of U_g does not enter into other computations; it sets the upper limit for F/d . The value must be determined experimentally. The equation to determine unsharpness is:

$$\text{where: } U_g = Ft/d$$

H0401923

T.O. 33B-1-1

F = maximum dimension of the focal spot

t = distance from the source side of the test object to the film

d = distance from the source to object

6.7.7.1 In considering geometrical unsharpness, recognize the value of new microfocus X-ray sources and the potential for geometric magnification. A nomogram is used to assist in solving this equation for various geometrical conditions (Figure 6-24), note that 3 out of 4 terms in the equation must be known before it can be used.

6.7.7.2 Suppose a specimen having a maximum thickness of 1.5-inches (t) is to be radiographed at 20-inch source-to-film distance (SFD) (d) using a source of effective focal size 6mm. The need is to establish an approximate value for U_g . The steps in using the nomogram are:

- Plot the points A and C that represent the known value of F and t . The pivot line is intersected at B.
- Plot a line joining point D (the value of d) and B. The extension of this line at E gives the value of U_g (0.47mm).

6.7.8 **Heel Effect.** For simplicity's sake, most literature states the intensity of radiation of the primary beam is constant, this is not quite correct. There is a variation in intensity due to the angle at which X-rays are emitted from the focal spot. This variation in intensity is called the heel effect (Figure 6-12).

6.7.8.1 The intensity of the beam diminishes rapidly from the central ray toward the anode side and increases slightly toward the cathode side. In general practice the heel effect is not evident, provided the maximum lateral dimension of the object to be radiographed is less than half the source-to-film distance (SFD). In other words, coverage of a 14 x 17-inch film requires an SFD of approximately 36-inches to provide a field intensity of plus or minus 12-percent over the entire film. This is based upon using part of the radiation field within a cone having a 30-degree included angle. Remember, the source for an X-ray tube is the focal spot. For a single exposure of larger areas requiring multiple films, the SFD must be increased. For example, to determine the SFD to cover an area that fits within a circle, which has a diameter of 56-inches, do the following calculation:

$$SFD = \frac{R}{\tan\theta}$$

H0401924

θ equals the half-angle of the cone = 15-degrees

$\tan 15 = 0.268$

R = one-half the diameter = 28-inches

$$\text{Therefore, SFD} = \frac{28}{0.268} = 104.5\text{-inches}$$

If the SFD is limited, the radius of beam coverage can be calculated by rearranging the formula:

$$R = \tan\theta \times SFD$$

Using the same cone half-angle of 15-degrees, $\tan\theta = 0.268$

Assume the SFD is limited to 60-inches

$$R = 0.268 \times 60 = 17\text{-inches}$$

If the radiographer must radiograph an area larger than a 34-inch diameter circle, more than one setup must be used.

SECTION VIII RADIOGRAPHIC INSPECTION SAFETY

6.8 SCOPE AND PURPOSE OF RADIATION PROTECTION.

6.8.1 General.

NOTE

Each branch of service has specific requirements governing radiation safety. You will see each branch called out (e.g., ARMY, NAVY, AIR FORCE, or ALL) in parenthesis to signify the following paragraph pertains to that branch of service.

6.8.1.1 This section is intended to serve as a guide to the safe use of X-ray and sealed gamma-ray sources for industrial radiographic purposes. It provides guidance to persons who use these sources and to others who may have a responsibility for their use. It recommends operational procedures, personnel controls, and radiation protection practices to eliminate needless exposure of personnel to ionizing radiation. In addition, it provides criteria for the guidance of qualified personnel for the design or modification of industrial radiographic X-ray and sealed gamma-ray installations.

6.8.1.2 The word "SHALL" identifies requirements necessary to meet the standards of protection of this section. The word "SHOULD" indicates advisory recommendations to be applied when practical.

6.8.1.3 (ARMY & AIR FORCE) The provisions of this section incorporate provisions of Title 10, Code of Federal Regulations, Parts 19-21, and 34, for the Air Force: Air Force Instructions (AFIs) 48-125 and 48-148, and miscellaneous policy statements, and for the Army: Army Regulations (ARs) 40-5, and 11-9. Although the provisions incorporated herein are correct at the time of issuance, users SHOULD review these federal, Air Force and Army regulations periodically to assure compliance with current regulations. This section is based in part on recommendations contained in National Institute of Standards and Technology (NIST) (formerly National Bureau of Standards) Handbook 114, *General Safety Standard for Installations Using Non-Medical X-ray and Sealed Gamma Source, Energies up to 10 MeV*, and in National Council on Radiation Protection and Measurement (NCRP) Report No. 116, *Limitation of Exposure to Ionizing Radiation*, and NCRP Report No. 51, *Radiation Protection Design Guidelines for 0.1-100 MeV Particle Accelerator Facilities*. Exposure limits specified herein are derived from those specified in federal regulations, particularly Title 10, 10 CFR Part 20. In the event of conflict, the more restrictive limits apply.

6.8.1.4 (NAVY) In accordance with OPNAVINST 4790.2G Naval Aviation Maintenance Procedures, Chapter 11.11 Nondestructive Testing and Inspection Program, the NAVSEA S0420-AA-RAD-010 (RAD-010) Radiological Affairs Support Program (RASP) Manual takes precedence over radiation safety procedures contained in NAVAIR 01-1A-16 (T.O. 33B-1-1). For U.S. Navy and Marine Corp radiographic operations, all radiation safety content of this manual is for information only. NAVSEA S0420-AA-RAD-010 (RAD-010) governs and takes precedence.

6.8.2 Responsibilities.

6.8.2.1 (AIR FORCE Only).

6.8.2.1.1 Base Radiation Safety Officer (RSO). The Base RSO is responsible for initiation, supervision, and execution of the base radiation protection program. This program provides for routine health physics surveillance of all operations involving the use of ionizing radiation to ensure safe practices. Consultant services of qualified individuals are available at the following locations to assist the Base RSO with the radiation protection program:

(1) CONUS: AFIOH/SDR
2350 Gillingham Drive
Brooks City-Base, TX 78235-5103
DSN 240-3486

Commercial (210) 536-3486
ESOH Service Center (888) 232-3764

(2) USAFE: 86 CRG/EMF
Unit 4095, Box 25
APO AE 09136-9525 (Sembach AB, Germany)
DSN 314 496-6782

(3) PACAF: Det 3, AFIOH/CDR
Unit 5213 Box 10
APO AP 96368-5213 (Kadena AB, Japan)

T.O. 33B-1-1

DSN 315 634-2636

6.8.2.1.1.1 The Base RSO annually performs a comprehensive assessment of all aspects of the radiation safety program and operational procedures. The RSO will determine the need for additional surveys, safety precautions, administrative or physical controls. The RSO will document findings, recommendations, and restrictions and forward copies to the Unit Commander and the radiography supervisor.

6.8.2.1.1.2 The Base RSO provides As Low As Reasonably Achievable (ALARA) training in accordance with 10 CFR 19 and 29 CFR 1910.

6.8.2.1.1.3 The Base RSO annually assesses exposures in controlled and uncontrolled areas.

6.8.2.1.1.4 The Base RSO assists in any investigations of overexposures, abnormal exposures, or incidents involving radiation exposures resulting from NDI operations.

6.8.2.1.1.5 The Base RSO assures contract radiography services are conducted in accordance with applicable state and federal regulations, and the requirement of this technical order.

6.8.2.1.1.6 The Base RSO establishes appropriate action levels for personnel dosimetry results, such that, if this level is exceeded an investigation will result to assess the cause and minimize future occurrences.

6.8.2.1.2 Maintenance Supervisor. The Maintenance Supervisor is responsible for the Nondestructive Inspection Laboratory, Industrial Radiography Section, and its radiation protection program. Personnel will ensure the requirements of this publication are fulfilled.

6.8.2.1.3 NDI Laboratory Supervisor. The NDI Laboratory Supervisor will normally be delegated the responsibility for administering all industrial radiography operations and ensuring compliance with all aspects of the radiation protection program. Normally, this individual is appointed by the unit commander/maintenance chief as the Shop Radiation Safety Officer (RSO). This person will:

6.8.2.1.3.1 Determine the competency of industrial radiographers.

6.8.2.1.3.2 Maintain control of all industrial radiographic equipment.

6.8.2.1.3.3 Develop and maintain current radiological safety operating and emergency procedures approved by the Base RSO. A copy of the radiological safety operating and emergency procedures SHALL be maintained with the radiation producing equipment during all radiographic operations. The emergency procedures SHALL specify, but not be limited to the following:

- Individuals to contact in the event of a suspected overexposure. As a minimum, list the NDI Laboratory supervisor, Shop RSO (if not the lab supervisor), Base RSO, and the Unit Safety Officer/NCO.
- Forms to be completed (e.g., AF Form 190, AFTO 125 or equivalent).
- Where to take the individual for treatment/observation.
- How to approximate the degree of exposure.
- What to do with direct reading dosimeters/TLDs.

6.8.2.1.3.4 Maintain, as a minimum, two utilization log books; one for shielded areas and the other for unshielded areas. The unshielded log SHALL be subdivided to clearly identify each unshielded area and include its own set of utilization forms (AFTO Form 115 and AFTO Form 125 or equivalent). Utilization log books SHALL contain as a minimum:

1. Current radiation protection survey.
2. Operating and Emergency procedures approved by RSO.
3. AFTO forms 125, 125A, and 115.
4. Other applicable information for the local job site.

6.8.2.1.3.5 Procure and maintain adequate radiation survey instruments and establish a survey instrument calibration program.

6.8.2.1.3.6 Maintain exposure devices, radiography facilities, and associated equipment.

6.8.2.1.3.7 Establish and maintain a personnel-monitoring program in conjunction with the Base RSO.

6.8.2.1.3.8 Assume control and institute corrective actions in emergency situations.

6.8.2.1.3.9 Investigate, in coordination with the base RSO, the cause of incidents that result in suspected overexposures and unnecessary radiation exposures and determine necessary action to prevent recurrence and maintain all radiation exposures "As Low As Reasonably Achievable" (ALARA).

6.8.2.1.3.10 Assure compliance with the requirements of 10 CFR 34 when conducting or overseeing contract operations involving sealed sources.

6.8.2.1.4 Radiographer in Charge. The radiographer in charge is a qualified radiographer and SHALL be identified prior to performing the inspection. This person is normally senior in grade and will ensure all radiation safety monitors and radiation safety monitor assistants understand their duties while performing the inspection. Duties include:

- Supervision of radiation safety monitors and assistants to ensure a safe inspection.
- Follow all mandatory operating procedures as established in this T.O., all locally generated safety operating instructions, and radiation protection survey.
- Ensure utilization logs are filled out.

6.8.2.1.5 Radiation Safety Monitors. Radiation safety monitors are qualified radiographers who work under the direct supervision of the radiographer in charge. Duties include:

- Operate radiation survey meters.
- Establish location of radiation barriers.
- Set up personnel barriers.
- Prevent unauthorized personnel from entering a radiation area.
- Record radiation intensity reading at barriers.
- Record doses from direct reading dosimeters.
- Utilize dosimetry devices as specified by the Radiation Safety Officer.
- Perform other duties as directed by the radiographer in charge.

6.8.2.1.6 Radiation Safety Monitor Assistants. Radiation Safety Monitor Assistants are those persons who assist the radiographer and/or the Radiation Safety Monitor in preventing unauthorized access into radiographic inspection areas. Safety assistants SHALL NOT be authorized inside the radiation area during irradiation. Assistants will be stationed outside the radiation area, but in such a location as to allow them to monitor the barrier and prevent barrier penetration. Assistants SHOULD always be in direct vision or contact with the safety monitor or radiographers to effect radiation termination if required. If this is not possible, adequate means of communication SHALL be specified by the Base RSO during a survey of the radiographic inspection area and operation. Adequate means of communication MAY include, but not limited to two-way radios, whistles, electronic/propellant activated noise alarms, or ultrasonic/infrared intrusion barriers. Assistants will receive their instructions directly from the Radiographer in Charge or the Radiation Safety Monitor, but not from another assistant. Duties include:

- Operate radiation survey meters.
- Assist with setting up personnel barriers.
- Prevent unauthorized personnel from entering a radiation area.
- Wear a TLD or film badge only if specified by the Base Radiation Safety Officer.

6.8.2.2 (ARMY Only).

6.8.2.2.1 Commander. The Commander of each organization/installation using radiation sources or X-ray machines for industrial radiography SHALL:

6.8.2.2.1.1 Establish, in writing, a formal radiation safety program consistent with Federal and Army Regulations and with Status of Forces Agreements and assure adequate resources (personnel, materiel, and funding) are provided to implement and maintain an effective program (AR 11-9). This program will include a comprehensive standing operating procedure to provide personnel with clear and specific requirements and actions to assure no person, to include members of the public, receives a dose in excess of the radiation exposure standards specified in AR 11-9 and that radiation exposure is maintained "As Low As Reasonably Achievable" (ALARA). Special consideration SHALL be given to the potential impact on adjacent operations including those operations conducted near boundaries of military control or in leased facilities.

6.8.2.2.1.2 Implement and enforce compliance with the provisions incorporated herein (AR 40-5, paragraph 9-9a(2)(a)).

6.8.2.2.1.3 Appoint a qualified Radiation Safety Officer (RSO) and Alternate to perform those functions specified in AR 40-5, AR 11-9 and 10 CFR (AR 40-5, paragraph 9-4b). The authority of the RSO to immediately halt unsafe operations and directly access the Commander SHALL be clearly stated. The training and experience of the Radiation Safety Officer will be commensurate with the hazards and will include a basic understanding of radiation protection principles and practices. As a minimum, the formal training of the Radiation Safety Officer will be successful completion of the Radiological Safety Course presented by the US Army Chemical School or its equivalent. (Training required for a RSO to serve as the Radiation Safety Officer for radiography sources licensed by the NRC MAY be much more comprehensive). (Equivalency will be determined by:

Commander
AMCOM, ATTN: AMSAM-SF

T.O. 33B-1-1

5300 Sparkman Center
Redstone Arsenal, AL 35898-5000

pursuant to (AR 11-9), or by the MAJCOM Radiation Control Officer). Organizationally, the RSO must be in a position to effectively advise the commander and radiography personnel on matters of radiation protection. Generally, it is not desirable the RSO be an operator, supervisor of operators, or under the supervision of such individuals. To provide continuity of operation, an alternate Radiation Safety officer SHALL also be appointed. Minimum training of Alternate RSOs SHALL be the same as for the RSO. (Personnel from other services or MAJCOMs such as Health Physicists, Health Physics Technicians, USAF Bioenvironmental Engineers, or 4B071's, can, pursuant to Memorandums of Understanding or Inter-service Support Agreements, be authorized to provide radiation safety support for Army units).

6.8.2.2.1.4 Implement a radiation dosimetry program in accordance with AR 11-9. As an integral part of the dosimetry program an individual SHALL be designated, in writing, to serve as the dose record custodian to be responsible for preparing and maintaining the records of occupational exposure to ionizing radiation.

6.8.2.2.1.5 Appoint a Radiation Control Committee (RCC) and institute administrative procedures for its operations. (Pursuant to AR 11-9, an RCC is required for all operations such as portable X-rays, where radiation exposures are sufficiently high to mandate dosimetry use).

6.8.2.2.1.6 Assure review and approval of plans and specifications for construction of new X-ray facilities or modification of existing X-ray facilities by a qualified expert prior to construction/modification. (NRC licensees must also assure prior NRC approval of all construction and modification activities) Upon completion of construction/modification assure that a comprehensive radiation safety survey is accomplished by a qualified expert prior to operation of the facility (AR 40-5, paragraph 9-9b(10) and (11), and AR 11-9).

6.8.2.2.1.7 Assure procedures to be followed when an accident or incident occurs are defined, that individuals are designated (in writing) to receive notice in the event of emergencies and that radiation accidents and incidents are reported as specified by AR 385-40 and 10 CFR.

6.8.2.2.1.8 Ensure only qualified individuals operate radiographic equipment. A qualified individual is someone who has completed training to qualify for Additional Skill Identifier (ASI) "N2" or attended equivalent training courses conducted by industry or civilian institutions. Qualified individuals SHALL be able to demonstrate competence performing radiographic operations and operating related equipment to include radiation survey instruments. Also ensure operators perform "daily preoperational, operational, and post operational checks or surveys to ensure proper radiation safety" (AR 40-5, paragraph 9).

6.8.2.2.1.9 Ensure health and safety instrumentation is calibrated in accordance with AR 750-43, TB 43-180, TB 750-25 and TB 9-6665-285, and 10 CFR. IAW AR 40-5, paragraph 9-8, U.S. Army X-ray survey instruments are only to be calibrated by:

Commander
US Army Aviation Missile Command
ATTN: AMSAM-TMD-SR
Bldg. 5417
Redstone Arsenal, AL 35898-5000

NOTE

Be sure to notify TMDE personnel the survey instruments are used for industrial X-ray to ensure proper calibration.

6.8.2.2.1.10 Perform, and document in writing, an annual quality assurance audit/self-assessment of the organization's Radiation Protection Program. A quality audit checklist is available upon request from:

Commander
ATCOM, ATTN: AMSAM-SF
5300 Sparkman Center
Redstone Arsenal, AL 35898-5000

6.8.2.2.1.11 Designate in writing, a qualified radiographer, generally the OIC or NCOIC, to serve as "Radiography Supervisor" overseeing industrial radiography operations, and assuring compliance with all aspects of the radiation protection program.

6.8.2.2.1.12 Assure radiography operations are not conducted on non-Army property without verification, such operation is properly licensed by and in full compliance with applicable state and local regulations and laws.

6.8.2.2.1.13 Consultant services of qualified individuals are available from the respective MAJCOM Headquarters and from the following to assist with the Radiation Protection Program:

- US Army Aviation and Missile Command
ATTN: AMSAM-SF-RP
5300 Sparkman Center
Redstone Arsenal, AL 35898-5000
- US Army Center for Health Promotion and Preventive Medicine
ATTN: MCHB-MR-HI
Aberdeen Proving Ground, MD 21010
Commercial (910) 671 3502; DSN 584-3502

6.8.2.2.2 Radiation Control Committee (RCC). The Radiation Control Committee SHALL perform functions outlined in AR 40-5, AR 11-9, and any applicable NRC license.

6.8.2.2.3 Radiation Safety Officer (RSO). The Radiation Safety Officer SHALL establish and manage the radiation protection program. Specific duties of the RSO, as defined in AR 405, AR 11-9, include (but are not limited to):

6.8.2.2.3.1 Provide advice and assistance to the Commander in formulating policies, programs, and procedures pertaining to radiation protection that complies with applicable regulations and directives. Advise the Commander in writing of any unsafe practices, defects, or noncompliance's under 10 CFR 21.

6.8.2.2.3.2 Evaluate and document hazards. "Radiation protection surveys will be performed periodically by the RSO to determine the exposure or exposure rate in the environment during operation of the equipment" as necessary to evaluate and control the potential radiation hazard. This evaluation includes physical measurements or calculations of radiation levels present; a prediction of potential hazards resulting from changes in materials or operations and proposed corrective actions. (Surveys SHALL be accomplished by a health physicist or Nuclear Medicine Science Officer before placing equipment in routine operation for all new or modified industrial radiographic operations.) Consistent with NRC quality audit criteria, surveys SHALL be accomplished at least annually by the local RSO in conjunction with audit of the local radiation safety program. Care SHALL be taken to assure radiation levels are adequately controlled in areas such as roofs, and in rooms and outdoor areas adjacent to X-ray operations.

6.8.2.2.3.3 Develop emergency procedures and assure all actual or alleged overexposures to ionizing radiation are investigated and reported in accordance with AR 385-40 and 10 CFR 20.

6.8.2.2.3.4 Calculate the collective exposure to ionizing radiation of all persons for which a DD Form 1141 (or equivalent) is maintained and report quarterly to the radiation control committee and commander, as applicable, on the collective, average, and highest exposure.

6.8.2.2.3.5 Instruct personnel in safe working practices, emergency procedures, harmful effects of radiation overexposures, and other topics as mandated by 10 CFR 19 and 29 CFR 1910. Records of these instructions will be maintained by the RSO and will include a brief outline of the instructions and a list of persons who received these instructions.

6.8.2.2.3.6 Establish and maintain a personnel dosimetry program in accordance with AR 40-14 to include obtaining personnel exposure histories and providing personnel with reports of radiation exposures as required.

6.8.2.2.3.7 Assign administrative radiation doses.

6.8.2.2.3.8 Manage Department of the Army (DA) Radiation Permit program (AR 11-9; 32 CFR 655).

6.8.2.2.4 Radiography Supervisor. This individual SHALL supervise overall industrial radiography operations and assure compliance with all aspects of the radiation protection program. Personnel SHALL:

6.8.2.2.4.1 Control and maintain all industrial radiographic equipment to include assuring the X-ray tube head, cables, consoles and gamma radiography shielding, and shutters (and the associated safety equipment for each) are checked for obvious defects prior to the first use at the beginning of each shift.

6.8.2.2.4.2 Develop and maintain current radiological safety operating and emergency procedures approved by the Radiation Safety Officer and Commander. Safety procedures will specifically address checklists for periodic inspection and reliability testing of safety systems to include interlocks, audible and visual warning devices, use of radiation monitoring equipment, and "daily pre-operational, operational, and post-operational checks or surveys to ensure proper radiation safety" (AR 40-5, paragraph 9-9). Emergency procedures SHALL include but are not limited to the following:

- Individuals to contact in the event of overexposure. Include name, office symbol, telephone number (duty and non-duty hours), and duty title.
- Notifications required by 10 CFR and/or AR 385-40 and accident incident form to be completed pursuant to AR 385-40, as supplemented.

T.O. 33B-1-1

- Where to take the individual for treatment.
- How to approximate the degree of exposure.
- What to do with dosimetry devices.
- A copy of the radiation safety operating and emergency procedures must be maintained with radiation producing equipment during all radiographic operations. These procedures must ensure required warning signs and notices are properly posted and warning signals (beacon lights and audible alarms) and safety switches are functioning properly (AR 40-5, paragraph 9-9a(2)(d)).

6.8.2.2.4.3 Establish and maintain personnel monitoring program in conjunction with the Radiation Safety Officer and assure proper use and storage of personnel monitoring devices.

6.8.2.2.4.4 Ensure the availability, calibration, and proper maintenance of radiation survey instruments.

6.8.2.2.4.5 Utilization logs SHALL be maintained. Ensure detailed procedures are implemented for maintaining an operational log for each piece of equipment that will identify when interlocks and other control or warning devices are bypassed or overridden (AR 40-5, paragraph 9-9(b)5).

6.8.2.2.4.6 Assume control and institute corrective actions in the event of an emergency.

6.8.2.2.4.7 Investigate, in coordination with the RSO, the cause of accidents and incidents to include suspected overexposures and unnecessary radiation exposures, and determine necessary action to prevent recurrence of accidents and incidents. Maintain all radiation exposures "As Low As Reasonably Achievable" (AR 385-40 and AR 11-9).

6.8.2.2.4.8 Verify the competence of radiographers to include ensuring only qualified personnel with ASI "N2" identifier or other acceptable qualifying credentials perform X-ray operation or use X-ray equipment and only individuals authorized by the applicable NRC license use gamma radiography sources.

6.8.2.2.4.9 Ensure all radiation workers are subjected to medical surveillance in accordance with AR 11-9.

6.8.2.2.5 Radiation Safety Monitors. Radiation safety monitors are qualified radiographers who work under the direct supervision of the radiographer in charge. Duties are the same as identified (paragraph 6.8.2.1.5).

6.8.2.2.6 Radiation Safety Monitor Assistants. Radiation Safety Monitor Assistants are those persons who assist the radiographer and/or the Radiation Safety Monitor in preventing unauthorized access into radiographic inspection areas. Duties are the same as identified (paragraph 6.8.2.1.6).

6.8.2.3 (NAVY Only).

6.8.2.3.1 Responsibilities. Navy and Marine Corps Commanding Officers and officers in charge of all Naval Marine Corps commands (ashore and afloat) possessing ionizing radiation sources are controlled by the Radiological Affairs Support Program (RASP). The RASP requires protection of personnel and the environment by complying with the provisions of NAVSEA S0420-AA-RAD-010 (RAD-010) Radiological Affairs Support Program Manual and other pertinent Navy directives and federal regulations. Technical issues requiring clarification MAY be addressed to NAVSEADET RASO by telephone or in writing. On-site technical assistance beyond the scope of local resources MAY be obtained by written request via the submitting activities chain of command to: Officer in Charge, Naval Seas Systems Command Detachment, Radiological Affairs Support Office (NAVSEADET RASO), P.O. Drawer 260, NWS Yorktown, VA 23691-5098 or by phone: (757) 887-4692, DSN 593-4692. Naval Message address is NAVSEA Det. RASO Yorktown VA.

6.8.3 (ALL) Qualifications of Civilian Industrial Radiographers. NAS-410, Nondestructive Testing Personnel Qualification and Certification, as amended, defines the minimum qualifications for radiography personnel (including recertification requirements).

6.8.3.1 (AIR FORCE Only). Qualifications MAY be through the USAF Nondestructive Inspection Course conducted by the Air Education and Training Command at NAS Pensacola, FL, or through equivalent training courses conducted by industry or civilian institutions. For this training to be considered equivalent to that provided by the Air Education and Training Command NDI Course, approval by the Air Force NDI Office (AFRL/MLS-OL, 4750 Staff Dr., Tinker AFB, OK 73145-3317; DSN 339-4931) is required. The use of any radiation producing equipment is prohibited until written approval of equivalency is received by requester.

6.8.3.2 (ARMY Only). Qualifications MAY be through the USAF Nondestructive Inspection Course conducted by the Air Education and Training Command at NAS Pensacola, FL, the U.S. Navy Radiographic Operator Course (A-701-0032) or through equivalent training courses conducted by industry or civilian institutions. To be considered equivalent to training mandated for American Society of Nondestructive Testing for the Industrial Radiography Radiation Safety Personnel (IRRSP) Certification Program, the initial training SHALL include 40-hours of training in radiation safety topics which includes those topics listed in Appendix A of 10 CFR 34. Equivalency SHALL be reviewed and approved by TRADOC or the Army NDI Program Manager, PM AGSE, SFAE-AV-AS-AG, Bldg. 5308, Redstone Arsenal, AL 35898. The use of any radiation producing equipment is prohibited until written approval of equivalency is received by requester.

6.8.3.3 (RETRAINING ARMY). Each radiographer SHALL receive retraining each time there is a change in equipment, operating procedures or regulations, and annual retraining. Annual retraining of at least an eight-hour duration (FR Vol. 56, No. 53, page 11505) SHALL be conducted or arranged by the RSO or his/her designated representative and documented. This training SHALL include the following:

6.8.3.4 (NAVY Only). Policy guidance in OPNAV Instruction 4790.2 SHALL take precedence over the policy contained within this manual.

6.8.3.5 Documentation.

6.8.3.5.1 (AIR FORCE Only). Job qualification/proficiency for military personnel SHALL be documented per CFETP and filed in the individual's AF Form 623, On-the-job Training Record Folder.

6.8.3.5.2 (ARMY Only). MOS qualification SHALL be documented in accordance with Army Regulations.

6.8.3.5.3 (NAVY Only). Policy guidance in OPNAV Instruction 4790.2 SHALL take precedence over the policy contained within this manual.

6.8.4 (ALL) Industrial Radiographic Safety Training.

6.8.4.1 Initial Training. All industrial radiographers SHALL complete an approved course of instruction in the use of industrial X-ray equipment, which includes radiation hazards control, and demonstrate an understanding of acceptable practice. As a minimum, each radiographer SHALL be instructed in those portions of the following subjects, which applies to industrial radiographic operations and demonstrate understanding thereof.

6.8.4.1.1 Fundamentals of Radiation Safety.

6.8.4.1.1.1 Characteristics of X-ray and Gamma Radiation.

- Electromagnetic Spectrum.
- Properties of X-ray and Gamma Radiation.

6.8.4.1.1.2 Interaction of Radiation with Matter.

- Ionization.
- Photoelectric Effect.
- Compton Effect.
- Pair Production.

6.8.4.1.1.3 Attenuation of Radiation.

- Exponential Function.
- Half-Value Layer (HVL) and Tenth-Value Layer (TVL).
- Filtration.
- Shielding.

6.8.4.1.1.4 Inverse Square Law.

6.8.4.1.1.5 Radiation Scattering.

- Secondary.
- Sky Shine.

6.8.4.1.1.6 Units of Radiation Measurement.

- Roentgen.
- Radiation Absorbed Dose (rad), Roentgen Equivalent Man (rem).
- Gray (Gy), 1 Gy = 100 rad; Sievert (Sv), 1 Sv = 100 rem.
- Exposure Rate and Dose Rate.

6.8.4.1.1.7 Quantity of Radiation.

- Curie, Becquerel; 1 Curie (Ci) = 3.7×10^{10} Becquerel (Bq).

6.8.4.1.2 Hazards of Exposure to Radiation.

6.8.4.1.2.1 Naturally Occurring Radiation.

T.O. 33B-1-1

6.8.4.1.2.2 Biological Effects.

- Mechanism of Tissue Damage.
- Variables Influencing Radiation Doses.
- Somatic and Genetic Effects.
- Occupational Dose Limits.
- Non-Occupational/Public Exposure Limits.

6.8.4.1.3 Radiation Exposure Records.

- Prior Exposure History.
- Reports of Radiation Exposures.

6.8.4.1.4 Radiation Measurement.

6.8.4.1.4.1 Principles of Radiation Measurement.

- Energy Dependence.
- Response Time.
- Ionization Chamber Instruments.
- Geiger-Mueller Instruments.

6.8.4.1.4.2 Direct Reading Dosimetry.

- Use of TLD (or film) Badges.
- Pocket Ion Chambers (Pocket Dosimeters).
- Electronic Dosimeters (Indications and Alarms).

6.8.4.1.4.3 Survey Meters.

- Meter Differences.
- Meter Operation and Calibration.
- Meter Capabilities and Limitations.
- Survey Techniques.

6.8.4.1.5 Radiation Protection.

6.8.4.1.5.1 Control of Radiation Dose.

- Dose Rate Factors (X-ray and/or Gamma Radiation).
- Exposure Time.
- Exposure Distance.
- Shielding.

6.8.4.1.5.2 Safety Equipment for Unshielded Operations.

6.8.4.1.5.3 Safety Equipment for Shielded Operations.

6.8.4.1.6 Practical Application Requirements.

6.8.4.1.6.1 Choosing Radiographic Equipment to Use.

6.8.4.1.6.2 Radiation Exposure in Shielded Operations.

- Accidental Exposure.
- Beam Orientation.
- Location of Operating Controls.
- Checkout of Safety Devices.

6.8.4.1.6.3 Radiation Exposure in Unshielded Operations.

- High (and very high) Radiation Areas.
- Placement of Barriers.
- Measurement of Exposure Rates.

6.8.4.1.7 Inspection and Maintenance Performed by Radiographers.

- Interlocks.
- Warning Devices.
- Radiography Equipment/Facilities.

6.8.4.1.8 Emergency Procedures.

6.8.4.1.9 Case Histories of Radiography Accidents.

6.8.4.1.10 Regulations.

- Applicable Military Service.
- Federal.
- State.
- Local.

6.8.4.2 (NAVY Only) Initial Training. The C-603-3191 Aircraft Nondestructive Inspection (NDI) Class C2 Training Course, located at NATTC, Pensacola, FL, provides NDI technician training for both military and DoD civilian personnel. Career NDI designated Aviation Structural Mechanic (AMS) Navy, and structures mechanics Marine Corps, of E-4 and above, and civil service personnel are eligible for the course. NDI technicians successfully completing the C-603-3191 course are assigned NEC 7225/MOS 6044 and are qualified and certified to perform liquid penetrant, magnetic particle, eddy current, ultrasonic, and radiographic methods of NDI. NDI operator training in liquid penetrant, magnetic particle and eddy current methods, refresher training, and recertification of NDI technicians is provided by Naval Aviation Depots (NAVAVNDEPOT) and Aircraft Controlling Custodian (ACC) and Type Commander (TYCOM) designated NDI Specialists. NDI operators are trained and qualified to perform only specific inspections with ACC/TYCOM authorization when NDI technicians are not available. OPNAVINST 4790.2G, Vol. 1, Sect. 10.2.1 refers and takes precedence. OPNAVINST 4790.2G can be accessed at: www.nalda.navy.mil/4790/.

6.8.4.3 (ALL) Annual/Refresher Training. Annual/refresher radiation safety training SHALL include the items identified below. Note if personnel do not use, possess, or provide direct contract oversight of gamma emitting radiographic sources, 10 CFR training requirements are not required.

6.8.4.3.1 Topics specified in 10 CFR 19.12 (e.g., proper storage, transfer, and use of radiation sources, public health problems associated with use of the radiation sources, precautions, or procedures to minimize radiation exposure and the purposes and functions of protective devices employed, the responsibility to promptly report any condition which may lead to unnecessary radiation exposure, actions to take in the event of malfunction of protective devices or other emergency conditions, and exposure reports which workers may request).

6.8.4.3.2 Deficiencies identified during periodic quality audits of the radiation protection program and unit training inspections.

6.8.4.3.3 Review of accidents and unusual events.

6.8.4.3.4 Review of dosimetry results (emphasizing dose reduction and ALARA).

6.8.4.3.5 Review of basic radiation safety principles, operations, emergency procedures, new safety regulations, license requirements, and other pertinent information.

6.8.4.3.6 If a radiographer or a radiographer's assistant has not participated in a radiographic operation for more than three-months since the last training inspection, that individual's performance SHALL be observed and recorded the next time the individual participates in a radiographic operation.

6.8.4.3.7 Retain the training inspection records of the performance of radiographers and radiographer's assistants (for RSO compliance inspection purposes) for three-years.

6.8.4.4 (ALL) Training for Radiation Safety Monitor Assistants. Assistants SHALL receive, as a minimum, radiation safety training covering the following items: properties of X- and gamma radiation, hazards of excessive exposure to radiation, methods of measuring radiation, radiation protection, and operation of specific measurement devices that will be used. This training SHALL be conducted by a qualified radiographer, Bioenvironmental Engineer or Radiation Safety Officer and documented in the individual's training record or the Maintenance Management Information Control System (MMICS). Refresher training SHALL be conducted annually.

6.8.5 (ALL) Radiation Protection.

6.8.5.1 As Low As Reasonably Achievable (ALARA). All exposures SHALL be kept "As Low As Reasonably Achievable." Exposure to radiation, even at very low dose rates, is permissible only when the benefit derived from such exposure exceeds the risk incurred. Each individual SHALL strive at all times to maintain all radiation exposures "As Low As Reasonably Achievable." Individuals SHALL NOT ever knowingly expose themselves, or cause others to be unnecessarily exposed to radiation.

6.8.5.2 Radiation Dose Limits.

T.O. 33B-1-1**6.8.5.2.1 Occupational Dose Limits.**

6.8.5.2.1.1 Dose Limits for Occupationally Exposed Adults. The annual peacetime ionizing radiation dose received by occupationally exposed adults SHALL NOT exceed the following:

6.8.5.2.1.1.1 An annual limit, which is the more limiting of:

- The total effective dose equivalent (TEDE) of 5 rem (50 mSv); or
- The sum of the deep dose equivalent from external sources and the committed dose equivalent to any individual organ or tissue, other than the lens of the eye, of 50 rem (500 mSv).

6.8.5.2.1.1.2 The annual limits to the lens of the eye, to the skin, and to the extremities, which include:

- An eye-lens dose equivalent of 15 rem (150 mSv); and
- Shallow-dose equivalent to the skin or to any extremity of 50 rem (500 mSv).

6.8.5.2.1.2 Dose Limit for Minors. The annual occupational dose limits for minors (less than 18-years of age) are 10% of the annual occupational dose limits specified for adults.

6.8.5.2.1.3 Dose Limits for Pregnant Females (Embryo/Fetus).

6.8.5.2.1.3.1 (AIR FORCE Only). The radiation dose to the embryo/fetus of an occupationally exposed pregnant female SHALL NOT exceed 0.5 rem (5 mSv) for the entire pregnancy. Additionally, efforts SHOULD be made to maintain the exposures ALARA and relatively uniform, that is, free of substantial dose rate variations above monthly exposure rates. Refer to AFI 48-125 for details.

6.8.5.2.1.3.2 (ARMY Only). The radiation dose to the embryo/fetus of an occupationally exposed pregnant female SHALL NOT exceed 0.5 rem (5 mSv) for the entire pregnancy. Additionally, efforts SHOULD be made to maintain the exposures ALARA and relatively uniform that is, free of substantial dose rate variations above monthly exposure rates.

6.8.5.2.1.3.2.1 A formal declaration of pregnancy is the prerogative of each pregnant female. A female occupationally exposed to radiation does not fall under the lower dose limit until she formally declares her pregnancy in a written statement:

“I hereby make notification that I am occupationally exposed to radiation in the course of my normal job duties, and that I am now pregnant. My estimated date of conception is _____. I understand that by declaring my pregnancy, my occupational exposure to ionizing radiation will be controlled as prescribed by DA Pam 40-18.”

NOTE

If the dose to the embryo/fetus exceeds 0.5 rem (5 mSv) or is within 0.05 rems (0.5 mSv) of this dose at the time the woman declares the pregnancy to the RSO, the organization SHALL be considered in compliance with the limit prescribed above provided any additional dose to the embryo/fetus does not exceed 0.05 rems (0.5 mSv) during the remainder of pregnancy.

6.8.5.2.1.3.2.2 The declaration SHALL be made on a SF 600 (Health Record--Chronological Record of Medical Care), signed and dated by the woman and placed in the woman's health record. A copy SHALL also be provided to the RSO.

6.8.5.2.2 (ALL) Dose Limits for Individual Members of the Public. The total effective dose equivalent to members of the public SHALL NOT exceed 100 mrem (1 mSv) in a year, above background, from all radiation sources under control of the installation activity commander. Additionally, the dose in any unrestricted area from external radiation sources such as industrial X-rays SHALL NOT exceed 2 mrem (0.02 mSv) in any one-hour.

6.8.5.2.3 Multiple Sources of Radiation. When any individual is likely to be exposed to radiation from more than one source simultaneously, or at different times, the protection associated with each source SHALL be increased so the total dose received by any one person from all sources SHALL NOT exceed applicable exposure limits. Additionally, the TEDE limits, the sum of external and internal radiation exposure, requires special consideration be given to ensure the combination of internal and external exposure does not exceed limits.

6.8.5.2.4 Medical, Dental Diagnostic, or Therapeutic, and Naturally Occurring Radiation.

CAUTION

Occupationally exposed personnel SHALL NOT wear their dosimetry devices while undergoing medical or dental X-ray procedures.

Radiation exposures resulting from necessary medical, dental diagnostic, or therapeutic radiation procedures SHALL NOT be included in the determination of the radiation exposure status of the individual concerned. Similarly, exposures resulting from naturally occurring sources or from sources in consumer products, SHALL NOT be included in determining an individual's dose.

6.8.5.3 Personnel Monitoring Devices. TLDs are the primary dosimetry device and have generally replaced film badges as the legal record of radiation exposure in the Army and Air Force.

6.8.5.3.1 Thermoluminescent Dosimeter (TLD).

6.8.5.3.1.1 Theory of Operation. TLDs are well suited for personnel and environmental monitoring of X-ray and gamma radiation. TLDs are special materials which, when exposed to ionizing radiation, results in raising the electrons of the detector material to temporary higher energy states. When these materials are later heated, the electrons fall back to their normal energy states and in the process emit light. The amount of light emitted is directly related to the amount of radiation dose the TLD received. By measuring this light, the dose received by the individual wearing the dosimeter can be assessed. Although a number of materials can be used as TLDs, "lithium fluoride," "lithium borate," and "calcium sulfate" are the most common material used for personnel dosimetry.

6.8.5.3.1.2 The Control Device (TLD/Film Badge). To accurately measure personnel dose, each radiography area will have at least one device designated as a "Control Device" (TLD/Film Badge). It is used to measure radiation exposure received by personnel monitoring devices (primarily from naturally occurring background radiation) while badges are in storage and transit.

6.8.5.3.1.2.1 The control device SHALL be stored in the same area as the personnel TLD/Film Badges, away from sources of radiation in a temperature and humidity controlled area. The control device SHALL NOT be removed from this area.

6.8.5.3.1.2.2 The control device SHALL NOT be worn by any individual.

6.8.5.3.2 Dosimetry Services (TLD/Film Badge).

6.8.5.3.2.1 (AIR FORCE Only). Dosimetry service for Air Force installations is provided by AFIOH/SDR 2350 Gillingham Dr., Brooks City-Base, TX 78235, through the base RSO, in accordance with the provisions of AFI 48-125, *USAF Personnel Dosimetry Program*. Bioenvironmental Engineering is responsible for the dosimeter program at base level and will receive all routine reports issued by the AFIOH/SDR. The Base Radiation Safety Officer SHALL investigate all dose reports which exceed predetermined action levels, and ensures all records of radiation dosage are properly maintained for each individual on the program.

6.8.5.3.2.2 (ARMY Only). DA (and DLA) activities, including reserve forces, are required to use the Army dosimetry service provided by the US Army Ionizing Radiation Dosimetry Center (AIRDC), TMDE Activity:

Commander
US Army Aviation Missile Command
ATTN: AMSAM-TMD-SR-D (AIRDC)
Bldg. 5417
Redstone Arsenal, AL 35898-5000

Organizations initiating industrial radiography operations SHOULD contact AIRDC in advance to assure receipt of dosimeters prior to the date on which such operations are scheduled to commence prior.

6.8.5.3.2.3 (NAVY Only). The requirements of NAVMEDP-5055, [Chapter 6](#) SHALL be followed for use of thermoluminescent dosimeters.

6.8.5.4 (ALL) Personnel Radiation Monitoring Requirements.

6.8.5.4.1 Criteria.

NOTE

A monthly wearing period SHALL be implemented for thermoluminescent dosimeters (TLD) issued to minors and to pregnant women. Criteria requiring individual dosimetry are defined in: (ALL) Title 10, Code of Federal Regulation, Parts 20 and 34; (AIR FORCE) AFI 48-125; and (ARMY) AR 11-9 and the supporting DA Pamphlet. Use of personnel monitoring devices is mandatory for each individual who MAY be exposed to ionizing radiation during the normal course of their duties or occupation according to the following criteria:

T.O. 33B-1-1

- Occupationally exposed adults who may reasonably be expected to receive an annual dose in excess of 500 mrem (5 mSv).
- Occupationally exposed adults entering any high or very high radiation area (regardless of the anticipated magnitude of exposure).
- TLDs are the primary dosimetry device and have generally replaced film badges as the legal record of radiation exposure in the Army and Air Force. For more information (paragraph 6.8.5.3.1).
- Declared pregnant women, who may be expected to receive a radiation dose exceeding 500 mrem (5 mSv) to the whole body/fetus for the entire period of pregnancy.
- All minors who may reasonably be expected to receive an annual radiation dose in excess of 500 mrem (5 mSv) total effective dose equivalent (TEDE) to the whole body.
- Other individuals as necessary for the effective management of the ALARA program, such as radiation safety monitors supporting unshielded radiography operations who do not otherwise require dosimetry devices, will be provided with dosimetry devices to include TLDs if their radiation dose would reasonably be expected to exceed the general public exposure limit of 100 mrem (1 mSv) TEDE per year or 2 mrem in one hour, above background.
- Individuals not meeting any of the criteria contained herein SHOULD NOT be enrolled in, or be needlessly continued in the dosimetry program except on a case-by-case basis. If in doubt, RSOs SHOULD enroll individuals in the dosimetry program for a limited duration, and base continued use of dosimetry on actual exposures received.

6.8.5.4.2 Wear of Whole-Body Dosimeters. TLD badges, used to provide a permanent record of the cumulative exposure to the whole body, SHALL be worn on the trunk (below the shoulders and above the hips) outside of clothing, on the portion or area of the body nearest the radiation source. The dosimeter window SHALL face out from the body.

6.8.5.4.3 Wearing Additional Dosimeters. If radiation exposure to the eyes, extremities, or skin is likely to be significantly different from whole body exposure, additional TLDs (collar, wrist, ring, etc.) SHALL be worn to document the actual exposure received by these areas. (Note: If eye protection providing at least 700 milligram per square centimeter thickness is used, the base RSO SHALL annotate this fact on the dosimetry issue listing beside the individual's name so the correct eye exposure can be noted.)

6.8.5.4.4 Storage of Monitoring Devices. TLD badges and dosimeters SHALL be centrally stored, located in a low background radiation area, in an environment free from excessive temperature and humidity. The TLD badges and pocket dosimeters SHALL be returned to the rack at the end of each work period.

6.8.5.4.5 Recording Readings of Direct Reading and Electronic Dosimeters. Direct reading dosimeters SHALL be read and doses recorded daily. Record of these exposures SHALL be maintained for 3-years after the record is made. Air Force units will document dosimeter readings on AFTO Form 115.

6.8.5.5 Dose Reporting and Recording Procedures.

6.8.5.5.1 Dose Record Custodian. Commanders SHALL designate in writing an individual to serve as the dose record custodian to be responsible for preparing and maintaining the records of occupational exposure to ionizing radiation. This individual MAY be the medical/health records custodian, RSO, or another individual who prepares the dosimetry report and controls dosimeter issuance and recovery.

6.8.5.5.2 (ARMY Only) Automated Dosimetry Record (ADR). Completed forms will be maintained on file for a minimum of one year from the date of last entry. It provides a complete occupational dose history for each occupationally exposed individual (upon written request from the RSO), calendar year-to-date updates of radiation exposures (on a quarterly basis), and includes dose records of whole-body and skin of the whole-body, head and neck, hands and forearms, feet and ankles, and lens of the eye, as applicable. The RSO verifies all ADR related information is contained in the ADR, takes action to correct errors, signs, and dates the ADR to certify the information as the occupationally-exposed individual's official dose record. The RSO also reviews and certifies each of the AIRDC updates and adds them to each individual's dosimetry record. (Updates for previous quarters during that calendar year need not be retained.)

6.8.5.5.3 (Army Only) Personnel Termination. Period and employment termination dose reports will be provided to occupationally exposed individuals in accordance with AR 40-14.

6.8.5.6 (ALL) Emergency Situations and Suspected Exposures Above Limits.

6.8.5.6.1 Emergency Situations. An exposure above occupational limits shall be suspected, and an emergency situation shall be considered to exist, when:

- (AIR FORCE Only): A direct reading dosimeter (EPD, DAD/PAD, Ion Chamber, etc.) registers 500 mrem (5 mSv) or more (10 CFR 34.47) or any individuals' direct reading pocket dosimeters exceed maximum scale.
- (ARMY Only): A direct reading dosimeter indicates an exposure which exceeds defined exposure action limits specified in AR 11-9 or local ALARA exposure guidelines.

- The radiography supervisor, regardless of dosimeter readings, believes an overexposure has occurred, either to another radiographer or any person(s) not directly involved in the radiographic operation.

NOTE

Pocket dosimeters determined to exceed maximum scale reading, or drift, prior to the first actual X-ray production of the shift, SHALL be considered defective. These dosimeters SHALL be withdrawn from service and turned into the servicing TMDE or PMEL calibration facility for evaluation.

6.8.5.6.2 (ALL) Actions for Emergency Situations and Suspected Exposures Above Limits.

NOTE

- (ARMY Only) If the RSO cannot be notified, contact the MAJCOM Radiation Control Officer and the US Army Ionizing Radiation Dosimetry Center (AIRDC) immediately by telephone, and promptly send the TLD badge(s) of all affected individuals, together with the appropriate control badge, by the most expeditious means to:

Commander
US Army Aviation Missile Command
ATTN: AMSAM-TMD-SR-D (AIRDC)
Bldg. 5417
Redstone Arsenal, AL 35898-5000

- (TLDs suspected of having received a potential overexposure SHALL be annotated as such, in writing, when they are shipped to the AIRDC for processing.)

NOTE

(AIR FORCE Only) In those instances where the base Bioenvironmental Engineering services cannot be notified, or is not locally available, the control TLD and the TLD of the suspected overexposed individual SHOULD be sent via "AIR MAIL" from overseas or "FIRST CLASS" from CONUS to: AFIOH/SDR, 2350 Gillingham Drive, Brooks City-Base TX, 78235-5103, DSN 240-3486

(ALL) If an exposure above occupational limits is suspected, an emergency situation SHALL be considered to exist. The following actions SHALL be taken ((ARMY): Consult 10 CFR 20, AR 385-40, AR 11-9 and applicable supplements):

- a. Immediately cease all radiography operations and report the incident to the: (Army) Unit Commander or the: (Air Force) Immediate Supervisor.
- b. Obtain the name, social security number, and organization of all personnel suspected of overexposure.
- c. Notify the base RSO or Bioenvironmental Engineering Services of the suspected overexposure. Prepare to turn in the affected individual's TLD badge and the control badge for immediate processing, as directed. The occupational health physician in consultation with the RSO, will determine the need for medical treatment.
- d. Read and record direct reading dosimeters.
- e. Determine and record exact position and duration of exposure.
- f. Update the Industrial Utilization Log as needed. Make sure the detailed sketch of the area includes the positions of personnel suspected of being overexposed. Record all other pertinent data about the incident.
- g. Obtain a signed statement from the exposed individual(s) of actions resulting in (or contributing to) the exposure.
- h. After completion of the above phase of the investigation and in the case of non-monitored personnel being exposed, the following procedure can be used by the RSO or radiographers to quantify personnel exposure:
 - (1) Re-establish the exact position(s) of all objects at the time of the accident.
 - (2) Place suitable dosimetry devices at the position of the exposed individuals.

T.O. 33B-1-1**WARNING**

Survey meters SHALL NOT be used, unless they have an integrate mode, or remote cameras are available to observe the instruments, since personnel using them will be unnecessarily exposed to radiation.

- (3) Expose the dosimeters, operating the gamma-ray or X-ray apparatus at the same technique as occurred during the incident, with the time of the exposure equal to the time personnel indicated they were present in the area or enclosure.

NOTE

If personnel were moving within the enclosure during the accident exposure, the dosimeters SHALL be placed at the position closest to the X-ray apparatus and at various points of his travel.

- i. (AIR FORCE Only): A complete report of the incident SHALL be prepared by the NDI Laboratory Supervisor and the unit RSO with signed statements from all operators and personnel exposed indicating their concurrence with the report. A copy of this report SHALL be provided to the Base Radiation Safety Officer for review and filing in the industrial workplace case file. Additionally, copies will be forwarded to Air Force NDI Office, AFRL/MLS- OL, 4750 Staff Dr., Tinker AFB, OK 73145-3317; DSN 339-4931, and to AFIOH/SDR, 2350 Gillingham Dr., Brooks City-Base, TX 78235, DSN: 240-3486.
- j. (ARMY Only): Upon return receipt of TLD results confirming personnel overexposures (or after validation of exposure dose to non-monitored personnel), the RSO SHALL complete accident investigations as specified in paragraph below and report the accident pursuant to 10 CFR 20, AR 385-40 and AR 11-9, as applicable.
- k. (ALL) Assure a new control badge is obtained, and designated as a replacement for the control badge submitted for analysis.

6.8.5.6.3 (Army Only) External Potential Overexposure Criteria and Investigations. Upon the detection of a potential overexposure, the following investigations SHALL be made (DA PAM 40-18, paragraph 4-10).

- a. The US Army Ionizing Radiation Dosimetry Center (AIRDC) SHALL promptly report to the RSO any dosimeter that exceeds the applicable Level II values found in (Table 6-25). AIRDC also reports the results from dosimeters which indicate exposure exceeding criteria found in (Table 6-26) to the RSO, to the Office of the Surgeon General, and to Headquarters, Army Materiel Command.

Table 6-25. Investigation Levels (Extract of Table 2-1, DA PAM 40-18*)

	Quarterly Monitoring (mrem)	
	Level I	Level II
Whole body	125	375
Lens of the eye	375	1125
Other	1250	3750
* DA PAM 40-18 is the companion DA Pamphlet to AR 11-9		

Table 6-26. Dosimeter Results Require Notification of OTSG (Extract of Table 4-1, DA PAM 40-18)

	Quarterly Monitoring (mrem)	Monthly Monitoring (mrem)
Whole body	125	375
Lens of the eye	375	1125
Other	1250	3750
* As used above, "Other" includes doses to the skin or to any extremity or to any individual organ or tissue other than lens of the eye.		

- b. For dosimeters used for industrial X-ray operations, which were potentially overexposed at a rate exceeding limits in (Table 6-25), the RSO SHALL:
- (1) Conduct an investigation.
 - (2) Determine the cause, time frame, and circumstances surrounding the apparent potential overexposure.
 - (3) Take action or recommend to the commander corrective actions to prevent recurrence.
 - (4) Determine whether or not the dosimeter was actually worn by the occupationally exposed individuals during the dosimeter wear period.
 - (5) Report the overexposure in accordance with 10 CFR 20 and AR 385-40 (as applicable) if it was determined the badge was actually worn.
 - (6) Fully document the investigation and maintain investigation records as a permanent file per AR 25-400-2. Copies of the final investigation report including any to the individual also are provided to the individual concerned and to the individual's medical records custodian for inclusion in the individual's health or medical records. The written investigation report SHALL contain:
 - (a) A copy of the affected occupationally exposed individual's ADR covering the previous 12-months, if available.
 - (b) Result of any bioassay and medical examinations.
 - (c) Statements from supervisors or other knowledgeable personnel.
 - (d) A statement from the affected occupationally-exposed individual stating, "To the best of my knowledge and belief I (did) (did not) receive this dose because _____."
 - (e) Procedures describing corrective actions.
 - (7) Review the ALARA program to reduce the likelihood of recurrence and minimize future radiation doses.
 - (8) Remove overexposed individuals from duties that could lead to additional radiation exposures pending completion of the overdose investigation.
 - (9) Refer any occupationally-exposed individual who sustains an actual overexposure to the supporting occupational health physician. (The occupational health physician in consultation with the RSO will determine the appropriate medical examinations (if any) and plan appropriate medical care.)

6.8.5.6.4 (ARMY/AIR FORCE) Administrative Assessment of Dose. If a dosimeter is lost, damaged, or if the occupationally-exposed individual's TEDE or CEDE cannot otherwise be determined, the base RSO SHALL determine and assign an administrative dose pursuant to ((ARMY) AR 11-9, paragraph 4-13) or ((AIR FORCE) AFI 48-125), and report the assigned dose to ((ARMY) US Army Ionizing Radiation Dosimetry Center), ((AIR FORCE) AFIOH/SDR) for inclusion in the individual's permanent dosimetry file.

6.8.5.7 (ALL) Radiation Surveys.

6.8.5.7.1 Definition. As used in this section, radiation protection survey means an evaluation of potential radiation hazards associated with the use of industrial X- and gamma-ray equipment, under specified conditions, when used in (AIR FORCE) - shielded and/or unshielded installations, or (ARMY) - protective, enclosed and/or unshielded locations. (ALL) When appropriate, such evaluation includes inspection of equipment, examination of its location with reference to controlled and uncontrolled areas in the immediate environment, and measurements of exposure levels.

T.O. 33B-1-1

6.8.5.7.2 Shielded and Protective Installations. A radiation protection survey of all new shielded and protective X-ray installations, or new equipment in existing installations, SHALL be made by a fully qualified Health Physicist, Bioenvironmental Engineer, Nuclear Medicine Science Officer, or qualified Radiological Health Technician before the installation is placed into routine operation. The installation SHALL be inspected to verify adequacy of shielding, radiation protective devices and operational procedures.

6.8.5.7.2.1 Consultant Assistance. Consultant services of qualified health physicists can be obtained through command channels: (AIR FORCE) – from those organizations listed in (paragraph 6.8.2.1.1, step a); (ARMY) -- from MAJCOM Headquarters or from those organizations listed in (paragraph 6.8.2.2.1, step m).

6.8.5.7.2.2 Local RSO Involvement. An assessment of shielded installations SHALL be made by, or under the direction of the local Base RSO initially before use. Assessments shall also be used before changes are made in shielding, operation, workload, equipment ratings or occupancy of adjacent areas when these changes, in the opinion of the RSO, can adversely affect radiation protection. If supplementary shielding is installed as a result of the radiation protection survey or re-evaluation, another survey SHALL be made to confirm the adequacy of the shielding after the modification.

6.8.5.7.2.3 Survey Methodology. When surveying shielded installations, the radiation exposure measurements SHALL be made in all adjacent areas accessible to personnel. The measurements SHALL be made under facility design conditions of operation that will result in the greatest exposure at the point of interest. X-ray apparatus SHALL be operated at the maximum kilovoltage specified in the design criteria for the facility and at its maximum milliamperage for continuous operation at that voltage. High energy equipment (e.g., linear accelerators, betatrons, etc.) SHOULD be operated at maximum output.

6.8.5.7.2.3.1 Survey Conditions. In evaluating the results of the survey, consideration SHALL be given to actual operating conditions, including workload, use factor, occupancy factor, and attenuation of the useful beam provided by objects permanently in the path of the useful beam.

NOTE

The use of engineering design controls, such as additional shielding, SHALL take precedence over operational (administrative) controls.

6.8.5.7.2.3.2 Compliance in Uncontrolled Areas. Whenever, in the opinion of the RSO or the radiographer, there is a reasonable probability a person in an uncontrolled area, adjacent to any type of radiation installation, may receive more than 2 mrem (0.02 mSv) in any one hour, or 100 mrem (1 mSv) in any calendar year, above background, then one or more of the following courses of action as determined by the RSO SHALL be taken to ensure no person will receive exposure in excess of the basic radiation protection standard:

- Use personnel or area monitoring devices to estimate the exposure received by occupants of the area, applying appropriate occupancy factors for each assessed location (AIR FORCE personnel must coordinate with AFIOH/SDR, 2350 Gillingham Drive, Brooks City-Base, TX, 78235-5103, DSN 240-5573 or 3486).
- Add supplementary shielding to the protective barriers to ensure conformity with protective barrier recommendations contained in this publication.
- Restrict use of the equipment (workload (on-time), kVp, or use factor).
- Restrict occupancy of the area.

6.8.5.7.2.3.3 Identification of Radiation Hazards. Radiation hazards found in the course of a survey of any type installation SHALL be eliminated before the installation is used routinely. If the design and/or approved use of a shielded installation depend upon restrictions on the use factor of any primary barrier, it must be verified these restrictions are actually observed.

6.8.5.7.2.3.4 Inspection of Safety and Warning Devices.

WARNING

All interlock, “ON/OFF” beam control mechanisms, safety and warning devices, remote monitoring systems, etc., SHALL be inspected for proper operation PRIOR to initial operation, on each shift, when X-ray equipment will be used. Interlocks SHALL be subjected to detailed operational testing at intervals not to exceed six-months. A log initialed by the person making these inspections SHALL be maintained. Any malfunctioning devices SHALL be appropriately serviced prior to use and reinspected to verify proper operation.

6.8.5.7.3 Unshielded Installations. Upon initial use, or use with new equipment, a detailed radiation protection survey of all unshielded installations SHALL be conducted by a fully qualified Health Physicist, Bioenvironmental Engineer, Nuclear Medicine Science Officer or qualified radiological health technician. Unshielded installations SHALL be actively surveyed

by radiographers during each subsequent operation. Initial surveys SHALL include radiation exposure measurements to establish, or verify safe operating conditions as established by the applicable standard operating procedures.

6.8.5.7.3.1 Pulsed X-ray. The RSO or their representative SHALL evaluate each area to ensure that the restricted area is setup IAW (paragraph 6.8.8.3.3). Additionally, all workers, working in close proximity to pulsed X-ray operations SHALL be briefed on safety procedures and SHALL NOT enter the established restricted area.

6.8.5.7.4 Report of Radiation Protection Survey.

CAUTION

Existing installations SHALL NOT be assumed to conform to the provisions of this publication, unless a valid radiation protection survey has been made by a qualified expert and a report has been placed on file at the installation.

6.8.5.7.5 Distribution and Retention of Survey Reports.

6.8.5.7.5.1 (ARMY Only) Survey Report Distribution. The written survey report of new or modified fixed radiography facilities SHALL be forwarded by the individual conducting the survey, through command channels to the owning organization, with an information copy to the address below. A statement of corrective action(s) taken by the owning organization, if required, SHOULD be submitted to the MAJCOM Safety Office with information copy to:

Commander
US Army Aviation and Missile Command
AMSAM-SF-RP
5300 Sparkman Center
Redstone Arsenal, AL 35898-5000

Survey reports SHALL include recommendations for any corrective measures and SHOULD indicate if a further survey is necessary after corrections have been made.

6.8.5.7.5.1.1 Report Retention Requirements. Survey reports for fixed radiography facilities SHALL be retained by the Radiation Safety Officer and the organization performing industrial radiography (together with a record of corrective actions taken to address deficiencies) until such reports are superseded or radiography operations are permanently discontinued. All records of surveys performed (including those performed by radiographers and RSOs) SHALL be maintained for a minimum period of 5-years, and then transferred to ARMIS.

6.8.5.7.5.2 (AIR FORCE Only) Survey Report Distribution. The written survey report (with attachments) SHALL be forwarded by the individual conducting the survey to the organization surveyed with an information copy to the AFIOH/SDR 2350 Gillingham Dr., Brooks City-Base, TX, 78235. If the survey is performed by an organization other than the AFIOH/SDR, a copy of the survey report SHALL be submitted for review. A statement of corrective action(s) taken, if required, SHOULD be submitted by the NDI supervisor, to the organization that performed the survey with information copies to the Base Bioenvironmental Engineering office and AFIOH/SDR. The report SHALL include recommendations for any corrective measures and SHOULD indicate if a further survey is necessary after corrections have been made.

6.8.5.7.5.2.1 Report Retention Requirements. Reports of all radiation protection surveys SHALL be retained by the local Bioenvironmental Engineering Services and the NDI supervisor together, with a record of the actions taken, with respect to the recommendations the survey contains.

6.8.5.7.5.3 (ALL) Survey Report Contents.

6.8.5.7.5.3.1 Identification of the radiation source(s), and location of each by suitable means, e.g., serial number, room number, and building number or name.

6.8.5.7.5.3.2 The radiation output (kVp/mA) of the radiographic device (The radiation output of the device will be the level specified by the manufacturer or obtained from remote survey readings. Unnecessary radiation exposure SHALL NOT be incurred to obtain such information.)

- X-ray source -- in roentgens per minute (R/min), at one-meter, at maximum kVp and mA, (under shielding conditions indicative of normal operation). The potential and current at which the X-ray tube was operated during the test will be specified if less than the system operating limits.
- Gamma-ray source -- in roentgens per minute (R/min) at one meter or specific activity remaining (curies or Becquerel) and calibration date.

T.O. 33B-1-1

6.8.5.7.5.3.3 Identification of the radiation survey instruments used, including its serial number and the date calibrated.

6.8.5.7.5.3.4 The location of the source, and the orientation of the useful beam in relation to each exposure measurement.

6.8.5.7.5.3.5 Exposure rates in all adjacent areas accessible to personnel. The location of exposure rate measurements SHALL be in accordance with applicable criteria and SHALL be suitably identified by drawings when appropriate.

6.8.5.7.5.3.6 An assessment of whether the measured exposure rates will result in uncontrolled areas having a total exposure of greater than 2 mrem (0.02 mSv) in any one hour, or greater than 100 mrem (1 mSv) in a year, above background, using the expected workloads, use factors and occupancy factors for the facility. The occupancy factor SHALL NOT be used to determine compliance with the 2 mrem (0.02 mSv) in any one-hour limit.

6.8.5.7.5.3.7 A description of the existing mechanical and electrical limiting devices and safety devices that restrict the orientation of the useful beam and position of the source or otherwise support radiation protection efforts.

6.8.5.7.5.3.8 A statement indicating the appropriate classification of the installation (paragraph 6.8.7) and the radiological design criteria for which it was designed, if available.

6.8.5.7.5.3.9 A statement of what controls are required, if exposures are estimated to exceed 100 mR in a year or 2 mR in any one-hour in uncontrolled areas. Engineering controls (e.g., additional shielding, physical barriers, etc.), SHALL always take precedence over administrative controls (e.g., restrictions on workload).

6.8.5.7.5.3.10 Identification of the individual conducting the survey, to include parent organization (plus the MOS or GS series for Army), and the date the survey was accomplished.

6.8.5.7.5.3.11 A statement of facility compliance/non-compliance with the following directives.

- If an installation does not comply with this publication, it SHALL be stated what action must be taken to ensure compliance.
- If a resurvey is required, it SHALL be so stated. The time frame as to when the resurvey is required, and whether or not operations are permitted prior to the resurvey SHALL be included.

6.8.5.7.6 **Annual Radiation Assessment.** A radiation assessment SHALL be made by the Base RSO or his/her representative, as an integral part of the annual quality assurance audit of the Radiation Protection Program. Assessments SHALL verify the adequacy of operating procedures, the presence and proper use of radiation warning signs and signals, and other necessary equipment. Annual ALARA training and assessment of worker dose to radiation SHALL also be verified and conducted if necessary. A formal report SHALL be generated to document the assessment findings and revalidate operating procedures and initial survey results and restrictions.

6.8.5.7.6.1 Annual assessment SHALL document the following:

- a. Review all radiation exposure records and surveys.
- b. Evaluate the content and effectiveness of the ALARA training program.
- c. Review existing facility designs for compliance with this document and other applicable instructions.
- d. Verify proper location and operation of interlocks, warning signs, and beacons/lights.
- e. Evaluate new X-ray equipment.
- f. Assess impact of new facility modifications if any.
- g. Verify all required forms are correctly completed.
- h. (AIR FORCE Only) Generate a formal report of assessment findings and deliver it to the Unit Commander, Laboratory supervisor, and the Air Force NDI Program Office at Tinker AFB, OK.

6.8.5.7.7 **NDI Radiography Inspections.** The radiographer-in-charge SHALL ensure a comprehensive radiation protection check is performed before an X-ray operation begins. All radiographers SHALL ensure each exposure is adequately controlled IAW base RSO survey and assessment parameters. Personnel SHALL check radiation levels with a survey meter prior to re-entry into a radiation area to ensure the radiation source has terminated.

6.8.5.8 Measuring Exposure Rates: Survey Meters (Ionization Chamber).

6.8.5.8.1 Basic Operating Principle. Radiation exposure, at the energies used for industrial radiography, is most accurately measured with ionization chamber type survey instruments. These detectors use an air filled chamber across which an electric field is applied. When X-ray or gamma radiation interacts with the air in the chamber, it creates positive and negative ions that drift apart under the influence of the electric field. As the ions are collected on the electrodes within the chamber, a small current is generated which is measured by the instrument and directly related to the radiation exposure rate in air.

6.8.5.8.2 Characteristics. Radiation exposure measurement instrumentation SHALL have a range suitable for the conditions of use. Accordingly, all survey instruments used for industrial radiography "SHALL be capable of measuring a range from 2 mrem/hr (0.02 mSv/hr) through 1 rem/hr (0.01 Sv/hr), as a minimum" (10 CFR 34.25).

6.8.5.8.2.1 Environmental Interference. Portable survey instruments are affected by such factors as ambient temperature, configuration of radiation source (e.g., round, square, rectangular, etc.), isotope source, atmospheric pressure and relative humidity, direction of radiation beam, radiation quality (effective energy or radiation spectra), and instrument susceptibility to radio frequency radiation (RFR). Instrument response variations due to temperature and pressure usually do not exceed $\pm 5\%$ for survey instruments. Instrument directional dependence is negligible when the instrument's sensitive volume is pointed in the direction of the radiation origin. Instrument susceptibility to RFR MAY significantly affect ionizing radiation measurements in the presence of RFR. If RFR interference is suspected, it can often be confirmed by placing a piece of leaded (Pb) rubber or similar shielding material over the ionization chamber of the instrument to filter out the gamma or X-ray, while observing the instrument reading. If no change is noticed in the instrument response, when the lead is placed over the chamber, the previous instrument response can be primarily attributed to RFR interference.

6.8.5.8.2.2 Survey Meter Response to a Spectrum of Energies. An X-ray machine, operating at a given tube potential (kVp), produces a spectrum of X-ray energies. Since industrial X-ray machines do not contain primary beam filtration (except the x-ray tube window), the X-ray spectrum contains a relatively large portion of low energy X-rays (below 50 keV) regardless of the tube potential (kVp) setting employed. Therefore, it is important that the survey instrument used in determining the exposure rate produced by such X-ray machines be energy independent or, in other words, capable of accurately measuring the exposure rate over a wide range of X-ray energies.

6.8.5.8.3 Recommended Instruments for Exposure Measurements. Several instruments are suitable for measuring exposure rates resulting from NDI operations.

WARNING

Geiger-Mueller (GM) tube type instruments, such as the AN/PDR-27, AN/PDR-77, ADM-300, and AN/VDR-2, SHALL NOT be used during X-ray operations or X-ray radiation protection surveys. The response of GM-type instruments, to the relatively low effective energies typical of X-ray operations is extremely variable. This extreme variability coupled with inadequate response to low X-ray energies MAY lead to serious personnel radiation overexposures. For example, at 32 keV the AN/PDR-27 measures only 1-percent of the true exposure rate.

6.8.5.8.4 Common Instruments (Models 440, SM400, and VR-10 Survey Meters).

CAUTION

The VR-10 survey meter MAY reflect a false reading when in the presence of RFR environments. Interference MAY be the result of stray RFR energy being generated by the X-ray control panel components at exposure levels that do not present hazards to personnel. Caution SHALL be exercised using these meters at this location; however, the aforementioned does not preclude its use.

The Victoreen Model 440, Nuclear Research Corporation SM400, and the Heat Pipe Model VR-10 survey meters have been standard instruments authorized for use in the Air Force as noted in AS-455 for industrial radiography. These instruments are no longer available from the manufacturer. Suitable replacement instruments include Victoreen models 440RF/D, 450, 450B, 450-CHP, and 450P, ThermoEberline models SHP-400 and RPO-20, Inovision Radiation Measurements models 451B and 451P survey meters. Other survey instruments (Ion chambers) MAY also be considered providing that they have been approved by the local Base RSO and AFIOH/SDR (AIR FORCE).

6.8.5.8.5 Calibration of Radiation Survey Instruments. Radiation survey meters, used for X-ray radiography SHALL be calibrated as follows:

T.O. 33B-1-1

- (AIR FORCE Only) - Radiation survey meters SHALL be calibrated at intervals determined by TO 33K-1-100-CD- 1.
- (ARMY Only) - Radiation survey meter calibration SHALL be in accordance with TB 43-180.
- (NAVY Only) - Radiation survey meter calibration SHALL NOT exceed six-months.

Calibration of radiation survey meters, used with source radiography, SHALL NOT exceed three-month intervals. In addition, all meters, SHALL be calibrated after each instrument servicing. A record SHALL be maintained of the results of each instrument for 3-years after the date of calibration (10 CFR 34.24).

6.8.5.8.5.1 User Operational Check. The survey meter SHALL be checked by the user with a radiation check source prior to the first monitoring operation of the day, and at two-week intervals for instruments not in daily use. Annotate battery condition and source check reading information on AFTO Form 140.

6.8.5.8.5.2 Test Measurement and Diagnostic Equipment (TMDE) Calibration Requirements. (ARMY Only): Consult AR 750-43 (Army Test Measurement and Diagnostic Equipment Program), TB 750-25 (TMDE Calibration and Repair Support Program) and TB 43-180 (Calibration and Repair Requirements for the Maintenance of Army Materiel) for detailed information on the calibration and repair programs. X-ray survey instrumentation can only be calibrated by the US Army TMDE Activity:

US Army TMDE Activity
ATTN: AMSAM-TMD-SR
Bldg 5417
Redstone Arsenal, AL 35898-5000

(To preclude unnecessary delays, instruments SHOULD be shipped direct without regard to local TMDE activities.)

6.8.5.8.5.2.1 (AIR FORCE Only): Reference TO 33K-1-100-CD-1.

6.8.5.8.5.2.2 (NAVY Only): Consult OPNAVINST 4790.2G, Volume V, Chapter 19.1 and NAVSEA SE700-AA-MAN-210 Radiac Policy and Procedures Manual (Vol. II, Part 2). Ensure radiac equipment is calibrated and repaired per the NAVSEA SE700-AA-MAN-210. Radiac interval extension is addressed in paragraph 19.5f.

6.8.5.8.6 Handling and Use of Radiation Survey Instruments.

6.8.5.8.6.1 Handling Survey Meters. Survey meters are delicate instruments, therefore, they SHALL be handled with care. Most survey instruments are not waterproof and SHALL be protected from wet weather conditions. If it rains when working outdoors, a clear, plastic bag will have no appreciable effect on the radiation and will not hamper the operating of the control switches. If the components of the survey meter become wet, the instrument MAY have to be serviced and recalibrated. When survey meters are transported in vehicles, they SHOULD be placed in the driver's compartment with adequate support and restraint to prevent damage during transit.

6.8.5.8.6.2 Guidelines for Use. Whenever radiographic operations are performed, at least one calibrated and operable radiation survey instrument SHALL be available at shielded installations, and at least two operable radiation survey instruments SHALL be available at unshielded installations. The instrument(s) SHALL be turned ON and available for immediate use by the radiographer during all radiographic operations. The instrument(s) SHALL have an adequate instrument response for the range of radiation energies encountered. When entering the area after deactivation of the radiation source, radiographers SHALL use a suitable, calibrated survey meter to assure the source has returned to its "off" position or that X-rays are no longer being produced.

6.8.5.8.6.2.1 Due to the response time of electrical components, survey meters will not instantly indicate the maximum exposure rate. Typically, survey meters have a response time ranging from 2 to 15-seconds, with longer response times being required for lower dose rates. Therefore, prior to use, turn survey meters on for several minutes, and allow them to stabilize. (The Victoreen/Inovision 450, 450B, 450P, 451B, 450-CHP, and 451P Models' response time is required to reach 90% of true value ranges from 3 to 8-seconds and from 3 to 5-seconds respectively.) Thus, in order to accurately measure the actual dose rate present, the operator must hold the survey meter in a set position for a period of time longer than the specified response time. Survey meter response times are published in the instrument instruction manual.

6.8.5.8.7 Survey Instruments Battery Check. If a battery indicator is located on the survey meter, it SHALL be checked each time the instrument is turned on. Some survey meters do not have a battery indicator. However, if the instrument can be zeroed with a zero control, sufficient battery power is available.

NOTE

The zero will constantly shift on some survey meters, so personnel using these meters SHALL continually recheck the zero control and adjust the meter as necessary.

6.8.6 Industrial Radiographic Operations.

6.8.6.1 System Types. There are two primary types of industrial radiographic systems; a sealed gamma emitting radioactive source, typically referred to as a gamma camera, and machine generated X-ray devices. Air Force and Army radiographic operations primarily use machine generated X-ray systems. No gamma emitting sources are currently used or are in the Air Force and Army inventory.

6.8.6.1.1 Sealed Gamma Ray Sources.



Sealed sources used in radiography, usually contain multi-curie quantities of gamma emitting radioactive material and are extremely hazardous if not used properly. Therefore, each radiographer and radiographer's assistant must meet minimum training and experience requirements. A thorough understanding of the hazards and proper procedures for safe handling and use of radiography sources is a fundamental requirement for any individual who is to assume the duties and responsibilities of a radiographer.

6.8.6.1.1.1 Use of Sealed Gamma Ray Sources.

6.8.6.1.1.1.1 (AIR FORCE Only).

6.8.6.1.1.1.1.1 Activities SHALL NOT obtain, possess, or use radioactive material sources (gamma cameras), without a USAF Radioactive Material Permit, in accordance with AFI 40-201, *Managing Radioactive Materials in the USAF*. Application for this permit SHOULD be made through the base RSO to AFMSA/SGPR, 110 Luke Avenue, Room 400, Bolling AFB, DC 20332-7050.

6.8.6.1.1.1.1.2 Approval by the Base RSO is required before contractor personnel are permitted to use radioactive materials on any Air Force installations. The Base RSO SHALL be consulted for current procedures to obtain that approval. Additionally, in cases where contractor requests assistance in performing gamma radiation inspections under this license, the NDI lab supervisor, or assistant in his/her absence, SHALL contact the Base RSO to ensure proper authorization has been granted and proper procedures are followed.

6.8.6.1.1.1.2 (ARMY Only).

6.8.6.1.1.1.3.1 Activities SHALL NOT procure or use gamma sources (by-product material), until formally licensed to do so by the U.S. Nuclear Regulatory Commission (NRC). Application for NRC licenses is made by the RSO in accordance with AR 11-9 through Command channels.

6.8.6.1.1.1.3.2 In cases where a contractor requests approval to perform X-ray inspections or gamma radiography (under the contractor's NRC or agreement state license) on federal property, the contractor WILL submit NRC Form 241 to Base RSO and the RSO will verify the validity of applicable licenses and initiate action pursuant to AR 11-9 and 32 CFR 655.10 to obtain and/or issue a DA Radiation Permit. (RSOs SHOULD also ensure reciprocity notification has been provided to the applicable NRC Regional Office if the contractor is an agreement state licensee.) Although responsibility for safe use of sealed sources remains with the contractor pursuant to the contractor's license, RSOs SHALL review operating procedures to verify compliance with applicable regulations and to assure that Army personnel and property are protected.

6.8.7 Industrial Radiographic Installation Classifications.

6.8.7.1 (AIR FORCE Only) NDI Installation Classifications. The Air Force classifies two types of installations shielded and unshielded.

6.8.7.1.1 Shielded Installation. A facility designed with sufficient shielding to meet exposure limit requirements. The Air Force describes a shielded installation as any enclosed radiographic facility designed to limit exposures on the outside of the facility to less than 2 mrem (0.02 mSv) in any one-hour and less than 100 mrem (1 mSv) in a year, above background. The shielding design incorporates the energy of the X- or gamma ray source to be used, as well as the expected workload, use factors, and occupancy factors of installation. Occupancy factor SHALL be considered only for the 100 mrem (1 mSv) in a year limit.

6.8.7.1.2 Unshielded Installation. Applies where fixed shielding cannot be used (e.g., flight line, open hangars make-shift buildings, etc.).

6.8.7.2 (ARMY Only) NDI Installation Classifications. The Army classifies three types of installations: protective, enclosed, and unshielded. This ensures certain minimum standards of protection without needless expenditures.

T.O. 33B-1-1

6.8.7.2.1 Protective Installation. Provides the highest level of inherent safety; exposure limit requirements are met. This class provides the highest degree of inherent safety because the protection does not depend on compliance with any operating limitations. This type also has the advantage of not requiring restriction in occupancy outside the enclosure; the built-in shielding is generally sufficient to meet the maximum permissible dose requirements for the general public.

6.8.7.2.1.1 The allowable usage exposure level for personnel on the dosimetry program, limits exposures to the lesser of 0.5mrem (0.005 mSv) in any one hour or 2 mrem (0.02 mSv) per week (when corrected for workload, utilization, and type of occupancy) for this class of installation necessitates a higher degree of inherent shielding. The limit of 0.1 mrem (0.001 mSv) in one-hour ensures with reasonable probability that under practical conditions of occupancy and use, the dose received by individuals outside the enclosure will not exceed the annual limit of 100 mrem (1 mSv) per year for members of the general public. For radiation sources of lower energies, and for smaller enclosures such as cabinets, the initial extra cost of the increased shielding is usually insignificant compared with the operational advantage.

6.8.7.2.1.2 At higher energies, as in the megavolt region with high workloads, the required additional shielding will usually make the use of this class extremely expensive compared with the enclosed installation.

6.8.7.2.2 Enclosed Installation. This installation provides fixed shielding for low use and low radiation levels. ("Protective" radiographic facilities generally will be used within the Army rather than "Enclosed" facilities.) This class usually offers the greatest advantage for fixed installations with low use and low occupancy factors. This is particularly true for high-energy sources where the reduction in shielding may result in significant savings. The shielding requirements are considerably lower than for the protective installations, as much as 4.3 half-value layers (HVL) less; yet, the inherent protection is such that the possibility of significant overexposure is remote. With proper supervision, this class of installation offers a degree of protection similar to the protective installation.

6.8.7.2.3 Unshielded Installation. Applies where fixed shielding cannot be used (e.g., flight line, open hangers, make-shift buildings, etc.). This class SHALL NOT be selected unless operational requirements prevent the use of either of the other classes. For radiography, its use SHOULD be limited mainly to mobile and portable equipment where fixed shielding cannot be used. Fluoroscopy SHALL be done only by remote observation, such as by closed circuit television.

6.8.7.2.3.1 The protection of personnel and public depends almost entirely on strict adherence to safe operating procedures. With this adherence, unshielded installations may provide a degree of protection similar to the other classes.

6.8.7.2.3.2 The lack of inherent shielding necessarily increases the importance of an effective ALARA program. Additionally, lack of interlock and engineered access to high radiation areas increases the importance of unauthorized use of devices.

6.8.7.3 (ALL) Requirements for Shielded and Protective Facilities. An installation SHALL be classified as "shielded" or "protective" when it conforms to all of the following mandatory requirements:

NOTE

Each of the following SHALL be provided (except where specifically noted) without regard to the size and/or configuration of the enclosure:

6.8.7.3.1 Shielding requirements will limit radiation exposure as identified (paragraph 6.8.9.1 and paragraph 6.8.9.2).

6.8.7.3.1.1 No person, either within the controlled area or in the environs of "Protective" ("Shielded") installations SHALL receive radiation exposures exceeding the total effective dose equivalent limits for members of the public.

6.8.7.3.2 The radiation source and all objects to be exposed are within a permanent enclosure, and no person is permitted to remain within during irradiation.

6.8.7.3.3 Each entrance used for personnel access to the enclosure/high-radiation area SHALL have both visible and audible warning signals. These signals include: warning signs, beacons, and audible alarms, the latter two are tied to and discussed under "interlock system."

6.8.7.3.3.1 Warning Signs.

6.8.7.3.3.1.1 IAW 10 CFR 20.1902, the interior of the exposure room SHALL be posted with "Caution, High Radiation Area" or "Danger, High Radiation Area" or "Grave Danger, Very High Radiation Area" signs so they are visible from any location. The interior of a cabinet installation SHALL be posted with an identical sign that SHALL be visible with the access door open.

6.8.7.3.3.1.2 The entrance to the exposure room, or cabinet for cabinet type installations, housing X-ray equipment SHALL be posted with radiation marking signs, either "Caution, High Radiation Area," "Danger, High Radiation Area," or "Grave Danger, Very High Radiation Area," as applicable. In addition, gamma radiography sources and cabinet type installations containing a radioactive source SHALL have a "Caution, Radioactive Materials" sign attached to the outside and a label or sign "Caution, Produces X-rays when energized" (or equivalent) SHALL be affixed to the X-ray tube head.

6.8.7.3.3.2 Interlock System. The visible and audible warning beacons/signals SHALL be tied to an interlock system. The interlock system SHALL be placed on each door to interrupt power to the control box/tube head, stopping the irradiation process, when unauthorized access is attempted. A time delay/interlock MAY be locally fabricated or purchased in order to meet this requirement. The wiring harnesses are similar to the harnesses used with X-ray Interlock Assembly. All time delay interlock systems installed SHALL be compatible with all X-ray units commonly available. The following paragraphs list items, which SHALL all be tied to the interlock system.

6.8.7.3.3.2.1 Pre-start switch. SHALL be located inside the enclosure, so if irradiation is interrupted by opening a safety interlock, resumption of operation can only be accomplished after the pre-start switch has been reactivated. This ensures a thorough search, for personnel working within the enclosure, is conducted prior to activation the source. A pre-start switch SHALL NOT be required if:

- The tube head is deenergized (or gamma shutter is closed) when an interlock is tripped.
- The X-ray tube (or gamma shutter) can not be re-energized by merely closing the interlock. To re-energize the X-ray tube, the entire time delay interlock system must be reinitiated at the X-ray machine control panel.

6.8.7.3.3.2.2 Pre-exposure Audible Alarm. A pre-exposure audible alarm, SHALL be used within the enclosure and must be actuated at least 20-seconds before irradiation starts. Audible alarms SHALL cease when radiation is started, but the visible warning signal SHALL remain actuated during irradiation. The audible signal SHALL be of a frequency, or capable of producing a sound pressure level so it can be heard over background noise that may be present. Audible alarms are not required if the enclosure is so small it cannot be entered by an individual. An example of such an enclosure is a cabinet X-ray system that has a small opening into which the part to be radiographed is placed, but into which an individual could not walk or even crawl without difficulty.

6.8.7.3.3.2.3 Warning Beacons. Rotating or flashing strobe-type visible warning beacons SHALL be used at all entrances to the enclosure. These must be activated at least 20-seconds before irradiation starts. These beacons SHALL be located so they are visible to an individual entering, or already inside of the facility, and will be operational when X-rays are being produced. An adequate sign SHALL be displayed near the lights to explain their function. Red warning beacons SHALL be located within the enclosure, and red beacons SHALL be used outside all entrances to the enclosure. Low intensity, flashing, warning lights SHALL NOT be used unless special circumstances occur. The Base RSO SHALL be the only approval for these special circumstances.

6.8.7.3.3.2.4 Entrance/Exit. A suitable means of exit SHALL be provided so any person, who accidentally may be shut inside, can leave the enclosure without delay. This door SHALL be tied to the interlock, so if it is accidentally opened during exposure, it will automatically turn the exposure off.

6.8.7.3.3.2.5 Emergency Shut-off Switch. Emergency shut-off switch(s) SHALL be provided within the facility, and labeled with a sign stating "EMERGENCY SHUT-OFF" in red letters on a white background. Sufficient number of signs and switches SHALL be placed where they are visible and readily activated from any portion of the interior of the shielded/protective installation. The emergency shut-off switch SHALL NOT be obstructed. The area directly in front of and two feet on either side of the emergency shut-off shall remain clear at all times. An emergency shut-off switch SHALL NOT be required if the enclosure is so small that it cannot be entered by an individual. An example of such an enclosure is a cabinet X-ray system.

6.8.7.3.4 The shielded/protective facility SHALL NOT be used for excessive storage. All radiation warning signs and shut-off switches SHALL be at eye level (approx 5 feet from ground) with no obstructions. Excessive clutter may interfere with accurate survey measurements and cause an unsafe condition should an emergency shut-off and egress from the facility become necessary.

6.8.7.4 (ARMY Only) Requirements for Enclosed Installations. An installation SHALL be classified as "enclosed" when it conforms to all of the following mandatory requirements:

6.8.7.4.1 The source of radiation and all objects exposed thereto are within a permanent enclosure, within which no person is permitted to remain during irradiation.

6.8.7.4.2 Each entrance used for personnel access to the enclosure/high-radiation area SHALL have both visible and audible warning signals to warn of the presence of radiation. The visible signal SHALL be actuated by radiation whenever the source is exposed/in operation. The audible signal SHALL be actuated when an attempt is made to enter the enclosure while radiation is being produced (10 CFR 34.29(b)). In addition, reliable dual independent interlocks are desirable on each door to prevent access to the enclosure during irradiation. A single interlock system on each door to prevent access to the enclosure during irradiation is a mandatory requirement.

6.8.7.4.3 Each of the following SHALL be provided (except where specifically noted) without regard to the size and/or configuration of the enclosure.

T.O. 33B-1-1**NOTE**

A time delay interlock MAY be locally fabricated in order to meet this requirement. The suggested design is optional and not mandatory since numerous design approaches can be used. The wiring harnesses are similar to the harnesses used with X-ray interlock assembly, NSN 6635-00-292-7637. All time delay interlock systems installed SHALL be compatible with all X-ray units commonly available.

6.8.7.4.3.1 Pre-exposure audible alarms and rotating red visible warning signals within the enclosure that must be actuated at least 10-seconds before irradiation can be started. A sign SHALL be displayed near these devices to explain their function. Audible alarms will cease when radiation is started, but visible warning signal will continue throughout exposure.

6.8.7.4.3.2 Suitable means of exit, so any person who accidentally may be shut in can leave the enclosure without delay.

6.8.7.4.3.3 An emergency shut-off switch SHALL be provided within the facility labeled by a sign "EMERGENCY SHUT-OFF" in red letters on a white background. Sufficient number of signs and switches SHALL be placed such that they are visible and readily activated from any portion of the interior of the enclosed installation. If only one emergency shut-off switch is provided, it SHOULD NOT be adjacent to personnel exit door since the door itself can act as an emergency shut-off device. The switch SHOULD be located as far from the door as practical.

6.8.7.4.3.4 Red, rotating, or flashing strobe-type visible warning beacons SHALL be used on the perimeter and positioned at the X-ray source (low-intensity flashing warning lights SHALL NOT be used). Rotating or flashing strobe-type warning lights SHALL be used, red inside the enclosure and red or yellow outside all entrances to the enclosure. These lights SHOULD be located at approximately eye level and SHALL be operational. An adequate sign SHALL be displayed near the lights to explain their function. If:

- The shielding provided by the roof is less than provided by the walls, or
- There is direct access from the roof into the exposure room, then one of the following SHALL be provided:
 - Low intensity, flashing, warning lights SHALL NOT be used. A rotating or flashing strobe-type red or yellow light on the roof with an explanatory sign adjacent to it along with the appropriate radiation warning sign, or
 - An appropriate radiation warning sign and sign indicating "Restricted Area, Contact (name, extension) Before Entering," on all permanent accesses to the roof and on the roof itself so it will be visible to anyone attempting to climb onto the roof. Ideally, there will also be a rope barrier provided across the entryway.

6.8.7.4.3.4.1

- A pre-start switch, located inside the enclosure, such that if irradiation is interrupted by the opening of a safety interlock, resumption of operation can only be accomplished after the pre-start switch has been reactivated. A pre-start switch is not required provided that:
 - The tube head is deenergized (or gamma shutter is closed) when an interlock is tripped.
 - The X-ray tube CANNOT be re-energized by merely closing the interlock. To re-energize the X-ray tube, the entire time delay interlock system must be re-initiated at the X-ray machine control panel. (Comparably, the gamma shutter cannot be opened without proceeding through the standard system setup/initiation procedures.)

6.8.7.4.4 The exposure at any accessible and occupied area one-foot (30 cm) from the outside surface of the enclosure does not exceed 2 mrem (0.02 mSv) in any one-hour and the exposure at any accessible and normally unoccupied area one-foot (30 cm) from the outside surface of the enclosure does not exceed 20 mrem (0.2 mSv) in any one hour. (Access to normally unoccupied areas in which doses could exceed 2 mrem (0.02 mSv) in any one-hour or result in exposures to members of the public exceeding 100 mrem (1 mSv) per year, above background, must be secured or continuously monitored to preclude personnel entry.)

6.8.7.4.4.1 For X-ray installations, these exposure limitations SHALL be met for any X-ray tube to be used in the enclosure and operated at any specified mA and kVp rating within the manufacturers published recommendations.

6.8.7.4.4.2 Beam limiting devices or filters SHALL NOT be used during these tests unless such devices and filters are permanently attached to the X-ray tube or gamma exposure device and the unit cannot be operated without their use. The radiation source and beam direction SHALL be positioned and oriented such that the highest exposure rate will be encountered in the area under test provided that such positioning and orientation will serve a practical purpose in normal usage.

6.8.7.4.5 All enclosed installations SHALL display suitable Warning signs as given below:

6.8.7.4.5.1 IAW 10 CFR 20.1902, the interior of the exposure room SHALL be posted with sufficient “Danger, High Radiation Area” or “Grave Danger, Very High Radiation Area” signs as applicable, and visible from any location in the room. The interior of a cabinet installation SHALL be posted with an identical sign which SHALL be visible with the access door open.

6.8.7.4.5.2 IAW 10 CFR 20.1902, the entrance to the exposure room and cabinet of cabinet type installations housing X-ray equipment SHALL be posted with radiation marking signs, either “Caution, Radiation Area,” “Danger, High Radiation Area” or “Grave Danger, Very High Radiation Area,” as applicable. In addition, gamma radiography sources and cabinet type installations containing a radioactive source SHALL; have a “Caution, Radioactive Materials” sign attached to the outside and a label or sign “Caution, Produces X-rays when energized” (or equivalent) SHALL be affixed to the X-ray tube head.

6.8.7.4.5.3 The area accessible to personnel where radiation doses could exceed 5 mrem (0.05 mSv) in any one hour SHALL be posted with a “Caution, Radiation Area” sign. For purposes of ensuring no member of the public receives an exposure exceeding 100 mrem (1 mSv) in one year above background, the barrier to the area where the radiation dose rate could exceed 5 mrem (0.05 mSv) in any one hour SHOULD be posted at 2 mrem/hr (0.02 mSv).

6.8.7.4.6 No person, either within the controlled area or in the environs of the installation, is exposed to more than the radiation protection standard applicable to members of the public unless exposure is approved in writing, in advance, by the Radiation Safety Officer.

Table 6-27. Radiation Area Definitions (ALL)

Area	Definition
Radiation Area	An area where an individual located 30 centimeters from any source of radiation could receive greater than 5 mrem (0.05 mSv) in one hour.
High Radiation Area	An area where an individual located 30 centimeters from any source of radiation could receive greater than 100 mrem (1 mSv) in one hour.
Very High Radiation Area	An area where an individual located 100 centimeters from any source of radiation could receive greater than 500 rads (5 Gy) in one hour.

6.8.7.5 (ALL) Unshielded Installations. An installation SHALL be classified as “unshielded” if due to operational requirements it cannot be provided with the inherent degree of protection specified for either Army “protective” or “enclosed” and Air Force shielded installations. Such installations include fenced or “roped-off” areas located either in the open, or inside buildings such as hangar bays. Unshielded installations SHALL conform to all of the following requirements:

NOTE

High Radiation Area boundaries SHALL be calculated only. Surveys SHALL NOT be performed unless such surveys can be accomplished (using devices such as those, which integrate dose) without additional, unnecessary exposure to personnel.

- a. (ARMY Only). A second perimeter delineating a “Radiation Area” SHALL be calculated, posted with sufficient “Caution, Radiation Area” signs so as to be conspicuous from any direction of approach, and radiation levels verified by radiation surveys. Such radiation surveys SHALL be documented in operating logs and SHALL include a minimum of two readings for each side of the radiation boundary. (A “Radiation Area” is defined as any area accessible to individuals in which ionizing radiation dose rate levels could result in an individual receiving a dose in excess of 5 mrem (0.05 mSv) one-hour at 30-centimeters (one-foot) from the radiation source or from any source that the radiation penetrates.)
- b. (ALL). Compliance with radiation dose limits applicable to the general public and to occasionally exposed individuals requires that access to areas in which radiation doses could exceed 2 mrem (0.02 mSv) in any one-hour or 100 mrem (1 mSv) in a year, above background, SHALL be restricted. “Radiation Area” postings SHALL be extended out from the X-ray tube such as to encompass such areas, or alternative arrangements made to restrict access to this area.
- c. If the beam orientation or technique factors change between exposures, the radiation area boundaries SHALL be reestablished and the boundaries of radiation areas reverified.

T.O. 33B-1-1

- d. Red, rotating, or flashing strobe-type visible warning beacons SHALL be used on the perimeter and positioned at the X-ray source (low-intensity flashing warning lights SHALL NOT be used). The beacon, positioned at the source SHALL be rotating/flashing only when the source is energized.
- e. An X-ray interlock or gamma shutter, as applicable, SHALL be installed between the control unit and the rotating/flashing strobe-type X-ray (or gamma) "on" beacon. The interlock assembly enables electrical power to the "X-ray On" power circuits only after the rotating/flashing strobe type "X-ray On" warning beacon is attached. X-/gamma radiography interlocks SHALL be inspected by radiographers each day, prior to use of the X-ray equipment to verify proper operation. The interlock SHALL be tested every 6-months by verifying it does indeed de-energize the X-ray tube head when the exposure is complete, the circuit is tripped or it is manually shut off by the operator. For units using the PCAMS system add the interlock check at 180 day intervals.
- f. Bioenvironmental radiation surveys for shielded and unshielded locations SHALL be used for set-up instructions and manning requirements. Deviations to set-up procedures or location and number of radiographers, safety monitors, or safety monitor assistants SHALL be approved by the RSO prior to X-ray operations. If the perimeter is of such a size or is so arranged the operator cannot readily determine whether the radiation area is unoccupied, a sufficient number of radiographers and/or radiation safety monitors and/or safety monitor assistants SHALL be strategically located to provide adequate visual surveillance over the entire area. These personnel SHALL have in their possession an adequate and properly calibrated, operable survey meter. The requirement for additional monitors MAY not be necessary if: the radiographic procedures are to be accomplished fenced-in, or in a locked area to which access is controlled by the radiographer. In addition, there SHALL NOT be less than one radiation safety monitor. (X-ray and gamma ray controls SHOULD be placed so all monitors, for the entire perimeter of the barrier, can be seen and heard by the radiographer-in-charge. If this is not possible, a hand held battery powered communication device SHALL be used.
- g. The radiation source and equipment, essential to the use of the source, SHALL be made inaccessible to unauthorized use, tampering or removal while not in use. This SHALL be accomplished by such means as a locked enclosure.
- h. Two qualified radiographers, and as many radiation safety monitor assistants as needed, SHOULD be used. If two qualified radiographers are not available, at least one qualified radiographer and as many radiation safety monitor assistants (paragraph 6.8.2.2.6) as required to prevent radiation barrier penetration, SHALL be present for radiographic operations. Training for radiation safety monitor assistants SHALL be conducted IAW (paragraph 6.8.4.4). This applies to constant potential industrial X-ray systems only.
- i. If the unshielded installation is in a remote area, and if entry into the enclosed area can be absolutely prevented during irradiation, the source and all objects exposed SHALL be within a conspicuously posted perimeter that limits the area in which the exposure can exceed 100 mR/hr (1 mSv/hr) in an hour provided:
 - The perimeter is posted with a sufficient number of "Caution, Radiation Area" signs so as to be conspicuous from any direction of approach.
 - The boundary of the restricted area can be determined where applicable.
 - The requirements of this (paragraph 6.8.7.5) can be met.
- j. Personnel, SHALL NOT be exposed to more than the dose limits prescribed in ARMY ONLY or (paragraph 6.8.5.2) of this T.O.
- k. When entering the area after deactivation of the radiation source, radiographers SHALL use a suitable calibrated survey meter to assure the source has returned to its "off" position or that X-rays are no longer being produced.

6.8.7.5.1 Unshielded (Pulsed X-ray). For details regarding pulsed operations, (paragraph 6.8.8.4).

6.8.7.6 New Facilities. New radiation facilities SHALL be constructed to meet the requirements of one of these classes of installations. The classes differ in the relative dependence on the "inherent shielding," "operating restrictions," and "supervision" necessary to secure the required degree of protection. In addition, each class has certain advantages and limitations. The above referenced paragraphs contain details of the respective installation classes.

6.8.7.7 High Radiation Areas. Each of the types of installations specified herein involves the creation of "High Radiation Areas." Access to all high radiation areas created by radiographic operations with sealed sources SHALL be controlled in accordance with 10 CFR 20.1601. 10 CFR 20.1601 also states controls WILL NOT prevent an individual from leaving a high radiation area. To ensure high levels of safety, these rules will also be applied to radiographic operations performed with X-ray sources. Requirements include one or more of the following features:

- Control devices that, upon entry into the area, cause the level of radiation to be reduced (below that level at which an individual might receive a deep-dose equivalent of 100 mrem (1 mSv) in 1 hour at 30-centimeters from the source (or from any surface that the radiation penetrates).
- Control devices that energize a conspicuous visible or audible alarm such the individual entering the area, and the supervisor of the activity, are made aware of the entry.

- Entries that are locked, except during periods when access to the areas is required, with positive control over each entry.
- Continuous direct or electronic surveillance capable of preventing unauthorized entry.

6.8.7.8 Very High Radiation Areas. A “Very High Radiation Area” is an area in which radiation levels could be encountered at 500 rads (5 gray) per hour at one-meter from a radiation source or from any surface that the radiation penetrates (10 CFR 20.1602). Additional measures SHALL be instituted to ensure that an individual is not able to gain unauthorized or inadvertent entry into a “Very High Radiation Area.” The requirements of 10 CFR 20.1603 SHALL be implemented for all radiation sources, including X-ray machines, which create very high radiation areas.

6.8.8 Mandatory Operating Procedures.

6.8.8.1 (ALL) Operating Procedures for Protected and Shielded Installation. The following are mandatory operating procedures that SHALL be adhered to in “protective” and “shielded” installations:

6.8.8.1.1 (ARMY Only) Protective Installations. No restrictions SHALL be imposed on the mode of operation (kVp, mA, workload, or adjacent operations) for protective installations.

6.8.8.1.2 (AIR FORCE Only) Shielded Installations. Facilities for shielded operations are designed to limit the exposure at the exterior surface of facilities to 2 mrem (0.02 mSv) in one-hour and 100 mrem (1 mSv) in a year, above background. Since such designs incorporate expected workloads, use factors and occupancy factors, these “design” parameters serve as administrative limits for the operations of shielded installations. When the operating conditions have changed such that there is a probability that the exposure of any person may be increased, a radiation protection resurvey or evaluation SHALL be conducted. If in doubt, a health physicist or nuclear medicine science officer SHALL be consulted.

6.8.8.1.3 (ALL). A thorough search for personnel working within the enclosure SHALL be conducted prior to activating the source.

6.8.8.1.4 The installation SHALL be inspected by the radiographers each day the facility is to be used to verify the proper operation of audible and visible warning signals, interlock, delay switches, and other exercises that have a bearing on radiation protection. Interlocks SHALL be subject to detailed testing at intervals not to exceed six-months to assure that they function as designed. A general purpose or AFTO form 135 initialed by the individual making the inspection SHALL be maintained.

6.8.8.1.5 A qualified radiographer SHALL be present at the control panel during all radiographic exposures and will be the only person authorized to operate radiographic equipment. At least one, operational, calibrated, survey instruments SHALL be available for immediate use by the radiographer during all radiographic operations.

6.8.8.1.6 Except when performing safety checks or in emergencies, door interlocks SHALL NOT be used as a means of terminating the exposure. The exposure SHALL be terminated at the control panel.

6.8.8.1.7 When radiographic exposures have been completed, the safety-switch key SHALL be removed from the control panel. The radiation-producing equipment and power safety-switch key SHALL be placed in secure areas separate from one another. Only radiographers specifically authorized by the Commander SHALL have access to the storage areas.

6.8.8.1.8 When entering the exposure room after deactivation of the radiation source, radiographers SHALL use a calibrated survey meter to ensure the source has returned to its “off” position (X-rays are no longer being produced).

6.8.8.2 (ARMY Only) Enclosed Installation Operating Procedures. The following are mandatory operating instructions that SHALL be adhered to for enclosed installations.

6.8.8.2.1 Since the safe operation of an “enclosed” installation is based on the normal operating conditions specified in the applicable radiation protection survey report, the equipment SHALL be operated only within the indicated limits. A copy of the survey report SHALL be readily available during radiographic exposures.

6.8.8.2.2 When the operating conditions have changed so there is a probability the exposure of any person may be increased, a radiation protection resurvey or evaluation SHALL be conducted. When in doubt, a health physicist or nuclear medicine science officer SHALL be consulted.

6.8.8.2.3 Personnel access to areas where radiography is in progress SHALL be limited to that which is absolutely required. All entries into the enclosure SHALL be monitored.

6.8.8.2.4 A thorough search for personnel working within the enclosure SHALL be conducted prior to activating the source.

6.8.8.2.5 The tube head, or gamma radiography source, as applicable, SHOULD be placed as close as possible to the center of the room. Whenever possible the beam SHOULD be directed toward the floor, and a piece of 1/8-inch thick lead plate SHOULD be placed on the floor to interrupt the entire primary beam in order to reduce scatter radiation.

T.O. 33B-1-1

6.8.8.2.6 The installation SHALL be inspected by the radiographers each day the facility is to be used to verify the proper operation of audible alarms, red visible warning signals, interlocks, delay switches, and other devices that have a bearing on radiation protection. Interlocks SHALL be tested by verifying they do indeed de-energize the tube head when tripped. Interlocks will be subjected to detailed testing at a frequency not to exceed 6-months. A log, initialed by the individual making the inspection, SHALL be maintained.

6.8.8.2.7 A qualified radiographer SHALL be present at the console panel during all radiographic exposures and will be the only person authorized to operate radiography equipment. A calibrated survey instrument SHALL be available for immediate use by the radiographer during all radiographic operations.

6.8.8.2.8 Except when conducting daily verification of safety interlock operation and in emergencies, door interlocks SHALL NOT be used to terminate the exposure. The exposure SHALL be terminated at the control panel.

6.8.8.2.9 When radiographic exposures have been completed, the power safety-switch key SHALL be removed from the control panel. The radiation-producing equipment and power safety-switch key SHALL be placed in secure areas separate from one another. Only radiographers authorized by the Unit Commander SHALL have access to the storage area.

6.8.8.2.10 When entering the exposure room after inactivation of the radiation source, radiographers SHALL use a calibrated survey meter to ensure the source has returned to its "off" position (X-rays are no longer being produced).

6.8.8.3 (ALL) Unshielded Operating Procedures. The following are minimum requirements that SHALL be adhered to when performing radiographic inspection operations in "unshielded" areas:

6.8.8.3.1 General. Industrial X-ray or sealed gamma-ray sources will be used in unshielded areas by only qualified radiographers and with written approval of the Radiation Safety Officer. (ARMY: Devices generating "Very High Radiation" areas SHALL NOT be used in unshielded areas without prior written approval from the applicable MAJCOM Headquarters.)

6.8.8.3.2 Required Equipment. In addition to the radiation producing equipment, the following equipment SHALL be used at the site selected for radiographic purposes.

6.8.8.3.2.1 At least two serviceable, properly calibrated, radiation survey meters, authorized for use with X-ray or gamma radiography operations. One instrument SHALL be placed near the operator's console, and the other, utilized for surveys of the perimeter as appropriate.

6.8.8.3.2.2 TLDs are the primary dosimetry device and have generally replaced film badges as the legal record of radiation exposure in the Army and Air Force. For more information (paragraph 6.8.5.3.1). Each Radiographer SHALL wear one DAD/PAD/EPD or two pocket ion chamber dosimeters.

6.8.8.3.2.3 An interlock assembly designed to prevent irradiation unless a properly functioning warning light is connected in the circuit.

6.8.8.3.2.4 At least two, 250-foot coils of rope with sufficient supporting stands (recommended).

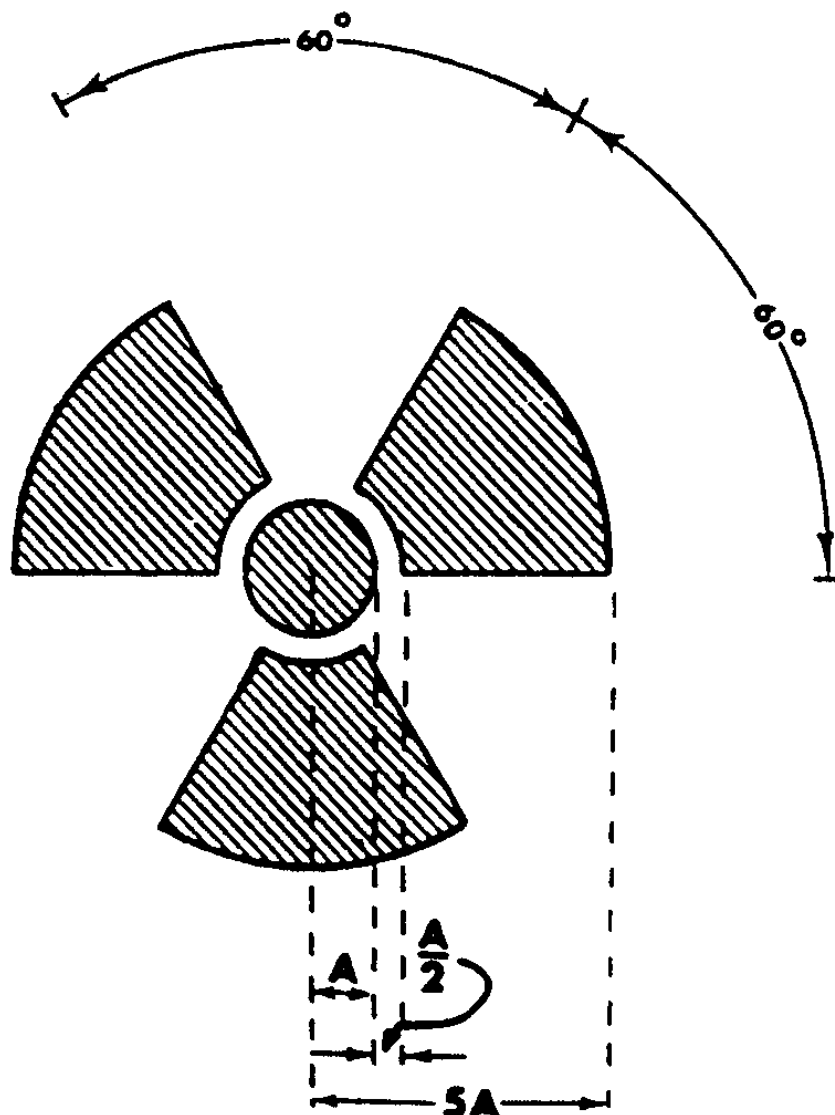
6.8.8.3.2.5 Radiation warning signs: sufficient quantity of each required type, e.g., "Caution, Radiation Area" and Caution, or "Danger" "High Radiation Area."

6.8.8.3.2.6 For X-ray equipment, at least 75-feet of power cable and coolant hose; or as required by the radiation survey.

6.8.8.3.2.7 A red, rotating/flashing strobe-type beacon (low intensity, blinking, warning lights SHALL NOT be used) and in some situations, as specified by the Base RSO, a radiation warning sign stating "X-ray ON" (or "SHUTTER OPEN" for gamma radiography), when the light is lit. The rotating/flashing strobe-type red beacon SHALL be as close to the radiation source as possible, and still be visible from all angles of approach, and SHALL be connected to the control circuit in such a manner the light will be ON when the radiation source is activated. An "X-ray ON" light is typically used at entrance locations to an unshielded facility and is lit during irradiation.

6.8.8.3.2.8 For night radiographic operations, sufficient lighting equipment to illuminate the area.

6.8.8.3.2.9 A minimum of 500-feet (150-meters) of commercially available barrier material, which states "CAUTION RADIATION AREA" (bright yellow background with magenta letters and radiation symbol) and self-supporting stands MAY be used to cordon off the affected area.



H0402941

Figure 6-73. Radiation Symbol

6.8.8.3.3 **Establishment of Restricted Area.** Radiographic operations in unshielded facilities require an initial evaluation of the exposure area to determine the bounds of the area to be restricted during exposure.

6.8.8.3.3.1 A restricted area means: "any area to which access is controlled by the individual in charge of radiation protection for the purpose of protection of individuals from exposure to radiation and radioactive materials." This implies a restricted area is one that requires control of access, occupancy, and working conditions for radiation protection purposes.

6.8.8.3.3.2 The dose limit in any unrestricted area from external radiation sources SHALL NOT exceed 2 mrem (0.02 mSv) in any one-hour. In addition, operations SHALL be conducted so radiation exposure to individual members of the public SHALL NOT exceed 100 mrem (1 mSv) in a year, above background. It SHALL be noted the definition does not limit the radiation exposure to a particular rate (such as 4 mR/hr), but permits higher exposure rates PROVIDING that the total quantity of radiation in any unrestricted area during any one-hour does not exceed 2 mrem (0.02 mSv) and during any calendar year considering occupancy factors, does not exceed 100 mrem (1 mSv) to any single individual. Occupancy factor SHOULD be considered for determining compliance with the annual limit.

6.8.8.3.3.3 Special consideration SHALL be given to ensure restricted areas are of sufficient size to preclude adverse impact on adjacent operations. When in doubt, ensure qualified experts are consulted prior to initiation of operations.

6.8.8.3.3.4 Summary data, comparing the measured exposure rate with the maximum allowable on-time (in minutes per hour) of the radiation source so the total dose in any one hour does not exceed 2 mrem is provided (Table 6-28).

T.O. 33B-1-1

Table 6-28. Maximum Permissible Dose Rate Versus Hourly Duty Cycle

Measured Exposure Rate (mrem/hr)	Total Time X-ray is Operated During a One-Hour Period (minutes)
30	4
24	5
20	6
17	7
15	8
13	9
12	10
8	15
6	20
5	24
4	30
2	60

6.8.8.3.4 Operations. Once the restricted area is identified, it SHALL be adequately posted to ensure against inadvertent entry. In some buildings, it may be feasible to lock appropriate doors, or limit access to very large work areas as a simple means of radiation area control. In other locations it MAY be necessary to establish boundaries by roping off, or barricading passageways at appropriate locations. In any event, sufficient control in the form of posting, use of safety monitors and use of access limiting devices SHALL be in place to guarantee no individual can enter the area inadvertently.

- a. In general, when radiographic operations are conducted without benefit of shielding it is often necessary to erect a rope barrier around X-ray tube head at a distance of 70-meters (230-feet) or more for vertical beam orientation. For exposures requiring near horizontal or horizontal beams, the barrier MAY have to be extended in the direction of the beam for more than a hundred meters to achieve exposure rates at the barrier less than or equal to the maximum limits. (Fixed or portable shielding SHOULD be used whenever practicable to reduce the size of area which must be controlled.) All entrances into the isolated area SHALL be secured and posted, and any uncontrolled area must not contain exposure rates that would allow personnel to receive in excess of 2 mrem (0.02 mSv) in any one-hour. All positions around the barrier SHALL be in view of one of the radiographers or radiation monitors during exposures.
- b. Place radiation warning signs along the barrier so at least one can be seen from any direction of approach.
- c. Extend the power cable from the tube head to the controls so the operator is located as far as possible from the radiation source, usually at least 75-feet (23-meters). Place the controls so all monitors, or the entire perimeter of the barrier, can be seen by the radiographer. If this is not possible, either a consultant health physicist, or Nuclear Medicine Science Officer, or other qualified individual SHALL specify adequate means of communication during a survey of the unshielded operation. Adequate means of communications MAY include two-way radios, whistles, electronic/propellant-activated noise alarms or ultrasonic infrared intrusion barriers, but need not be limited to these methods.
- d. Place the red, rotating/flashing strobe-type (X-ray warning) beacon, near the X-ray tube and connect to the X-ray interlock circuit.
- e. Illuminate the area for night operation.
- f. Ensure no one is inside, on top, or below the object being radiographed.
- g. Prior to making an exposure, the area SHALL be surveyed by the radiographers to establish pattern of any radiation fields that could be present and to determine the adequacy of rope barrier placement.
- h. Upon completion of the survey and modification of the barrier, if needed, put the film in place and proceed with the radiographic exposure.
- i. If the barrier is penetrated by anyone during the exposure, the radiation source SHALL be immediately turned off, detain the individual, secure the area, and the incident reported to the radiography supervisor. Begin emergency procedures.
- j. The radiographic apparatus SHALL NOT be left unattended when operating and unauthorized personnel SHALL NOT operate it. This equipment SHALL always be stored in a secure area. A key lock SHALL be installed on all radiographic unit consoles. While in storage or unattended by an authorized radiographer, the power safety-switch

key SHALL be removed from the console and securely maintained separate from the apparatus. Only radiographers authorized by the Unit Commander SHALL have access to the industrial radiographic unit power safety-switch key storage areas.

- k. In the case of multiple exposures in an open area in which the beam direction, intensity (kVp, mA) or attenuating materials are significantly altered, the barrier perimeter SHALL be re-established as necessary.

WARNING

Bioenvironmental engineering will approve all Laser pointers prior to use and personnel will be trained in accordance with AFOSH Standard 48-139, *Laser Radiation Protection Program*. The Lorad Class IIIa Laser Pointer SHALL NOT be directed above the horizon near the flight line, as this may be dangerous to flight operations. The laser will have a warning affixed to it, and it SHALL only be in the on position when aligning the tubehead and off at all other times. The laser will be treated as a dangerous tool and SHALL not be pointed at any individual.

- l. All information required on the utilization log SHALL be recorded by the radiographer in charge. The completed form will be maintained on file for three years. If a suspected overexposure occurs, any other documents generated during the subsequent investigation SHALL be filed with the respective utilization log. When a log is completed, the radiography supervisor (lab chief) will sign the log. (ARMY - If a suspected overexposure has occurred, (paragraph 6.8.5.6) for instructions.)

6.8.8.4 (ALL) Unshielded (Pulsed X-ray) Operating Procedures. The following are minimum mandatory requirements that SHALL be adhered to when performing pulsed radiographic operations in “unshielded” areas. Requirements are based on the current pulsed X-ray systems used, approved operations and techniques, and a study completed by AFIOH/SDRH. If new pulsed X-ray systems are acquired with an X-ray tube head output greater than 3.5 mR/pulse at one-foot from the tube head and/or a tube current rating greater than 0.5 mA, contact AFIOH/SDRH ((AIR FORCE) paragraph 6.8.2.1.1, step a (1)) or organizations located at ((ARMY) paragraph 6.8.2.2.1, step m) for additional guidance.

6.8.8.4.1 General. Industrial X-ray operations involving pulsed X-rays will only be accomplished by qualified radiographers and with written approval of the Base RSO.

6.8.8.4.2 Required Pulsed X-ray Equipment. In addition to the radiation producing equipment, the following equipment SHALL be readily available for use at the site selected for radiographic purposes.

- A minimum of one TLD badge for each radiographer involved in the radiography operations. Two low energy pocket ion chambers SHALL be worn by each individual radiographer. Dosimeter range SHOULD not exceed 500 mR.

NOTE

The electronic personal dosimeters (EPD), personal alarming dosimeter (PAD) and Digital Alarming Dosimeter (DAD) do not accurately measure radiation in short-pulsed (60-nanosecond) X-ray environments.

- At least 75-foot of rope with sufficient supporting stands (recommended).
- Radiation warning signs: sufficient quantity (minimum of least two) stating “Caution, Radiation Area.”
- For X-ray equipment, at least 12-foot X-ray tube head activation cord.
- The tube-head SHALL provide visual and audio indication of tube activation and require key activation.
- For night radiographic operations, sufficient lighting equipment to illuminate the area.
- A minimum of 75-feet of commercially available barrier material which states “CAUTION RADIATION AREA” (bright yellow background with magenta letters and radiation symbol) and self-supporting stands MAY be used to cordon off the affected area.

6.8.8.4.3 Establishment of Restricted Area for Pulsed X-ray. The radiation scatter and primary beam footprint for pulsed X-ray operations is minimal. Additionally, low energy pulsed X-ray scatter radiation is difficult to accurately measure. Therefore, restricted area requirements are defined below to ensure compliance with the general public exposure limits identified in (paragraph 6.8.5.2.2). Assumptions used for this determination included a total workload of 30,000 images per year, 27 pulses per image and up to 40 images per hour. An occupancy factor of 0.5 was used for determining compliance with the yearly limit.

6.8.8.4.3.1 For vertical image projections, a 16-foot radius around the tube head is required. Additionally, the primary beam SHALL be controlled to 28-feet. For the occasional horizontal image projections, a 16-foot area SHALL be controlled to the sides and back of the tube head. On the target end of the tube head a 28-foot area must be controlled. The unit has a radiation cone angle of approximately 40-degrees.

6.8.8.4.3.2 Trained NDI personnel SHALL always maintain a minimum distance of 12-feet from the tube head, and stay out of the primary X-ray beam to ensure radiation dose is ALARA.

T.O. 33B-1-1**6.8.8.4.4 Pulsed X-ray Operations.**

- a. Once the restricted area is identified, it SHALL be adequately posted to assure against inadvertent entry. In some buildings, it MAY be prudent to lock appropriate doors, or limit access to work areas as a simple means of radiation area control. In other locations it MAY be necessary to establish boundaries by roping off or barricading passageways at appropriate locations. In any event, sufficient control in the form of posting, use of safety monitors and use of access limiting devices SHALL be in place to guarantee no individual can enter the area inadvertently.
- b. All positions around the barrier SHALL be in view of at least one of the radiographers or radiation monitors during exposures.
- c. Place radiation warning signs along the barrier so at least one can be seen from any direction of approach.
- d. Place the controls so the entire perimeter of the barrier can be seen by the radiographer. If this is not possible, either a consultant health physicist or Nuclear Medicine Science Officer or other qualified individual SHALL specify adequate means of communication during a survey of the unshielded operation. Adequate means of communications MAY include two-way radios, whistles, electronic/propellant-activated noise alarms, or ultrasonic infrared intrusion barriers, but need not be limited to these methods.
- e. Illuminate the area for night operation.
- f. Ensure no one is inside or on top of the object being radiographed.
- g. Educate personnel who may be in close proximity to radiation, on safely procedures. (The controlled area SHALL NOT be entered during X-ray procedures.)
- h. If the barrier is penetrated by anyone during the exposure, the radiation source SHALL be turned off immediately and the incident reported to the radiography supervisor.
- i. If the barrier is penetrated by anyone during the exposure, the radiation source SHALL be turned off immediately and the incident reported to the radiography supervisor.
- j. In the case of multiple exposures in an open area in which the beam direction, number of X-ray pulses or attenuating materials are significantly altered, the barrier perimeter SHALL be re-established as necessary.
- k. All information required on the utilization log (AFTO form 125 and 125a) SHALL be recorded by the radiographer. The completed form SHALL be maintained on file for three years from the date of last entry. If a suspected abnormal exposure occurs, any other documents generated during the subsequent investigation SHALL be filed with the respective utilization log. When a log is completed, the radiography supervisor will sign the log. (ARMY - if a suspected overexposure has occurred (paragraph 6.8.5.6.2) for requirements.)

6.8.8.5 Utilization Log. The Industrial Radiography Utilization Log, AFTO Form 125 and 125a, SHALL be completed for all shielded, unshielded inspections and suspected overexposures of personnel. The following information SHALL be recorded:

- a. Facility Location: Identify building number, street address, and room number if applicable.
- b. Organization: Enter maintenance organization radiographers are assigned to.
- c. Aircraft: Identify model number of aircraft that part or component is attached to or removed from, as applicable.
- d. Part/Component: Identify part nomenclature to be radiographed. Similar part/components may be grouped as a series as long as the general X-ray beam orientation does not change.
- e. Date: Enter date of inspection.
- f. Supervisor or radiographer-in-charge: Enter the name and rank of radiographer-in charge. A new entry is required if the radiographer-in-charge changes.
- g. Shift: Enter the duty shift of the operation. A new entry is required if the operation covers multiple shifts.
- h. Number of Exposures: Enter the number of exposures performed to complete a specific radiographic inspection. Multiple exposures are only authorized if the exposure series parameters do not change e.g., wing inspections will have multiple exposures with the same beam direction.
- i. KVP: Enter highest KVP used to radiograph the part/component.
- j. MA: Enter highest mA used to radiograph the part/component.

- k. Time: Enter individual exposure time used to radiograph the part/component. (On series shots, enter the time of the longest single exposure.)
- l. Radiation Level: Enter highest recorded survey meter reading from predetermined points around the barrier. One monitor can observe survey meter readings from various locations. Refer to sketch drawing to determine where the readings will be observed and recorded. Each number on the radiation level block used in the operation SHOULD correlate with a number in the sketch.
- m. Sketch of Restricted Area: Prepare a detailed sketch in accordance with the base RSO's survey and assessment determinations to identify the following:
- Aircraft/part orientation or position, as applicable.
 - Tubehead location, position, and beam direction.
 - Control console position. (SHALL also be radiographer-in-charge position and correlates with the number one position in the radiation level block.)
 - Barrier position.
 - Exposure rates in mr/hr at predetermined radiation survey points on the barrier.
 - Locations of monitors and assistants during the exposure.

6.8.8.5.1 The completed form SHALL be maintained on file for three years. If a suspected overexposure occurs, any other documents generated during the subsequent investigation SHALL be filed with the respective utilization log. When a log is completed, the radiography supervisor (lab chief) will sign the log.

6.8.9 NDI Facility Design and Modification.

6.8.9.1 Determining Shielding Requirements. The structural shielding requirements of any new installation or of an existing one in which changes are contemplated, MAY be decided by a Health Physicist, Radiological Physicist, Nuclear Medicine Science Officer, or a qualified Bioenvironmental Engineer, provided it is approved by the appropriate MAJCOM Headquarters.

6.8.9.2 Data Required for Determining Shielding Requirements. To adequately determine shielding requirements, the following data concerning the source of radiation SHALL be provided:

- Type of radiation source (e.g., X- or gamma-ray).
- Maximum and average tube potential (kilovoltage) or the energy of the radiation source.
- Maximum and average tube current (milliamperage) or the source output in roentgens (R) per minute at one meter (R/min) from the source.
- The expected workload in milliamperere minutes (mA-min) per week.
- The use factors for each wall, floor, and ceiling as appropriate. This is the fraction of the workload during which the useful beam is pointed in the direction under consideration (Table 6-29).
- The type of occupancy of all areas which might be affected by the installation (Table 6-30).
- The structural details of the building. This will include a dimensioned drawing of the facility, with notation of the typical distances from the X-ray source to each barrier of the facility, as well as the expected construction materials for the facility.
- Location of doors, windows, and ventilation systems.

Table 6-29. Use Factors (U)*

Installation Use	Enclosed or Shielded	
	Collimated Sources	Open Sources
Floors	1	1
Walls	1/4	1
Ceilings	1/16	1
*For use as a guide in planning shielding when complete data are not available		
¹ Film speed numbers should be compared only within a single manufacturer.		

Table 6-30. Occupancy Factors (T)

Full Occupancy (T = 1)

X-ray control space and waiting space, darkrooms, film reading areas, workrooms, shops, offices, and corridors large enough to hold desks, living quarters, children's play areas, occupied space in adjoining buildings.

T.O. 33B-1-1

Table 6-30. Occupancy Factors (T) - Continued

Partial Worker Occupancy (T = 1/4) Worker restrooms, occupational use corridors too narrow for desks.
Partial Occupancy (T = 1/8) Public corridors too narrow for desks, utility rooms, employee lounges.
Occasional Public Occupancy (T = 1/20) Rest rooms or bathrooms, storage rooms, vending areas, outdoor areas with seating.
Rare Occupancy (T=1/40) Outside areas used only for pedestrians or vehicular traffic, unattended parking lots, attics or crawl spaces, stairways, unattended elevators, janitors closets.
* For use as a guide in planning shielding where adequate occupancy data are not available.

6.8.9.3 Direction of Useful Beam. Although the cost of shielding MAY be reduced significantly by arranging the installation so the useful beam is not directed toward occupied areas, the cost of shielding SHALL NOT override potential safety concerns. However, since weapon system requirements can change during the useful life of a facility, shielding SHALL be adequate enough for any future requirements, which may occur.

6.8.9.3.1 Devices that permanently restrict the direction and cross section of the useful beam MAY reduce the area requiring primary barriers.

6.8.9.4 Radiation Energy, Output, and Workload. The shielding for each occupied area SHALL be determined on the basis of the expected maximum use kilovoltage or energy, mA or R/min, workload, use factor, and occupancy factor affecting it. Consideration SHOULD be given to the possibility the values of these parameters MAY increase in the future. It MAY be more economical to provide a higher degree of protection initially than to add to it later.

6.8.9.5 Structural Details of Protective Barriers. Shielding for radiographic installations is normally provided by installation of sheet lead, or concrete. Facilities where high workloads and gamma-ray sources are used, MAY use a combination of these materials, or use concrete loaded with high iron content aggregate to improve shielding efficiency. The half-value layers of lead and concrete (the thickness of each material necessary to reduce the exposure intensity by a factor of two) for various energy X-rays and gamma rays is shown in (Table 6-31).

Table 6-31. Peak Voltage (kVp)

Half-Value and Tenth-Value Layers						
Peak Voltage kVp	Attenuation Material					
	Lead (mm) HVL	TVL	Concrete (cm) HVL	TVL	Steel (cm) HVL	TVL
70	0.17	0.52	0.84	2.8		
100	0.27	0.88	1.6	5.3		
125	0.28	0.93	2.0	6.6		
150	0.30	0.99	2.24	7.4		
200	0.52	1.7	2.5	8.4		
250	0.88	2.9	2.8	9.4		
300	1.47	4.8	3.1	10.4		
400	2.5	8.3	3.3	10.6		
500	3.6	11.9	3.6	11.7		
1,000	7.9	26	4.4	14.7		
2,000	12.5	42	6.4	21		
3,000	14.5	48.5	7.4	24.5		
4,000	16	53	8.8	29.2	2.7	9.1
6,000	16.9	56	10.4	34.5	3.0	9.9
Cesium-137	6.5	21.6	4.8	15.7	1.6	5.3

Table 6-31. Peak Voltage (kVp) - Continued

Half-Value and Tenth-Value Layers						
Peak Voltage kVp	Attenuation Material					
	Lead (mm) HVL	TVL	Concrete (cm) HVL	TVL	Steel (cm) HVL	TVL
Cobalt-60	12	40	6.2	20.6	2.1	6.9

6.8.9.6 Quality of Protective Material. All shielding materials SHALL be of assured quality, uniformity, and permanency.

6.8.9.7 Lead Barriers. Lead barriers SHALL be mounted in such a manner they will not cold-flow because of their own weight and SHALL be protected against mechanical damage. Additionally, lead sheets at joints SHOULD be in contact with a lap of at least one-half inch, or twice the thickness of the sheet, whichever is greater. Welded or burned lead seams are permissible provided the lead equivalent of the seams is not less than the minimum requirement.

6.8.9.8 Joints Between Different Materials or Structures. Joints between different kinds of protective materials SHALL be constructed so the overall protection of the barrier is not impaired. Additionally, joints at the floor and ceiling SHALL be constructed so the overall protection is not impaired.

6.8.9.9 Shielding of Openings in Protective Barriers. In the planning of an installation, careful consideration SHOULD be given to reducing the number and size of all perforations of protective barriers and openings into the protected areas. Protection for all such openings SHALL be provided by means of suitable protective baffles.

6.8.9.9.1 Perforations. Provision SHALL be made to ensure nails, rivets, or screws which perforate lead barriers are covered and give protection equivalent to the unperforated barrier.

6.8.9.9.2 Openings for Pipes, Ducts, Conduits, Louvers, etc. Holes in barriers for pipes, ducts, conduits, louvers, etc., SHALL be provided with baffles to ensure the overall protection afforded by the barrier is not impaired. These holes SHOULD be located outside the range of possible orientations of the useful beam.

6.8.9.9.3 Doors and Observation Windows. The lead equivalent of doors and observation windows of exposure rooms, cubicles, and cabinets SHALL NOT be less than required for the walls or barrier in which they are located.

6.8.9.10 General Requirements for Doors.

6.8.9.10.1 Location of Doors. Where practical, doors into exposure rooms SHOULD be located so the operator has control of access to the room.

6.8.9.10.2 Interlock Switches for Doors. All door(s) and panel(s) opening into an X-ray exposure room or cabinet (except those opened or removed only with tools) SHALL be provided with single interlocking switches preventing irradiation unless the door or panel is closed. Double doors SHALL have interlock switches that operate independently of each other.

6.8.9.10.3 Resumption of Operation. If the opening of a door or panel to a: "Shielded," "Protective," or "Enclosed" Installation has interrupted the operation of any radiation source, it SHALL NOT be possible to resume operation by merely closing the door or panel in question. To resume operation, it SHALL be necessary to re-energize the source at the console, and this procedure SHALL cause the time delay interlock system to be reinitiated. It SHALL NOT be possible to resume operation by merely re-engaging the interlock.

6.8.9.10.4 Escape or Interruption of Irradiation from Inside Exposure Room. The exposure room SHALL include at least one means of exit that MAY be rapidly opened from the inside. A suitable means SHALL be provided to quickly interrupt irradiation from inside the room. The means of accomplishing this SHALL be explained to all personnel and a sign explaining its use SHALL be conspicuously posted inside the exposure room. Preferably, the beam SHOULD NOT be directed toward the door or interrupting device.

6.8.9.10.5 Threshold Baffle for Door Sill. A door baffle or threshold will generally be required for radiography sources and for installations operating above 125 kVp, if the discontinuity can be struck by the useful beam.

6.8.9.10.6 Lap of Doorjamb. The protective lead covering of any door leading to an exposure room or cabinet SHALL overlap the doorjamb and lintel so as to reduce the radiation passing through clearance spaces to the allowable limit for the door itself.

GLOSSARY

A

ABSOLUTE (ET):	Refers to measurements made without a direct reference in contrast to differential measurements. Absolute measurements are affected by any change in electromagnetic properties; differential measurements are affected only by differences between the test area and a comparative standard.
ABSOLUTE PROBE:	A probe containing a coil that responds to all electromagnetic properties of the test part.
ABSOLUTE SIGNAL:	The value of the amplitude of a signal without consideration of its relative phase, frequency or waveform.
ABSORBED DOSE:	The energy imparted by ionizing radiation per unit mass of irradiated material. The units of absorbed dose are the rad and the gray (Gy).
ABSORPTION:	The process whereby the particles or quanta (see PHOTON) in a beam of radiation are reduced in number or energy as they pass through some medium. The particles lose energy by interaction with either the nucleus (core) or electrons (shell) of the atoms of the medium.
ABSORPTION COEFFICIENT (RT):	A fraction expressing the decrease in the intensity of a beam of radiation per unit thickness (linear absorption coefficient), or per atom (atomic absorption coefficient of the medium through which the radiation is passing).
ABSORPTION COEFFICIENT, LINEAR (UT):	The fractional decrease in transmitted intensity per unit of absorber material thickness. It is designated by the symbol (μ) and is expressed in units of cm ⁻¹ .
ABSORPTION (PT):	The process of one material (liquid, solid, or gas) merging with a second material by penetration into the particles of the second material... as opposed to adsorption where the material coats and is retained on the surface of the particles of the second material.
ABSORPTION (RT):	The process whereby the particles or quanta (see PHOTON) in a beam of radiation are reduced in number or energy as they are passed through some medium. The particles lose energy by interaction with either the nucleus (core) or electron (shell) of the atoms of the medium.
ADSORPTION (PT):	The process of one material (liquid, solid, or gas) merging with a second material by coating and being retained on the surface of the particles (and interstices) of the second material... as opposed to absorption where the material penetrates into the particles of the second material.
AC (ALTERNATING CURRENT):	Electric current that reverses its direction of flow at regular intervals.
ACCELERATOR:	A device that accelerates charged atomic particles to high energies. An X-ray machine or a betatron is an accelerator.
ACCEPTANCE NUMBER:	The term used to designate the allowable number of defects in a statistical quality control sample.
ACID EMBRITTLEMENT:	A form of hydrogen embrittlement that may be induced in some metals by acid treatment.
ACOUSTIC IMPEDANCE (UT):	A material property, which determines the product of the velocity of sound in a material and the density of the material used in determining the reflection characteristics of interfaces.
ACTIVATION:	The process by which neutrons bombard stable atoms to make them radioactive.
ACTIVITY:	A measure of how radioactive a particular radioisotope is. Activity is calculated by the number of atoms disintegrating per unit of time. Its unit of measurement is the curie. See SPECIFIC ACTIVITY.
ACUTE RADIATION SYNDROME (RT):	The immediate effects of a short-term whole-body over exposure of a person to ionizing radiation. These effects include nausea and vomiting, malaise increased temperature, and blood changes.

T.O. 33B-1-1

ADDED FILTER:	Filter added to the inherent filtration.
ADDITIVE, ABSORPTIVE (RT):	See CONTRAST AGENT.
ADHERENCE:	The extent to which a coating bonds to a substrate.
ADHERENCE INDEX:	The measure of the adherence of porcelain enamel and ceramic coatings to sheet metal (ASTMC-313).
ADHESION:	The adhering or sticking together of substances in contact with each other.
AERIAL IMAGE (RT):	The representation (in relief) of the distribution of the intensity of the radiation in the plane of the radiograph (plane of the film).
AFTERGLOW (RT):	The persistence of light emission from an intensifying screen or fluorescent screen after an exposure. It is a form of phosphorescent radiation.
AGE HARDENING:	Increasing the hardness and possible strength of an alloy by a relatively low-temperature heat treatment that causes precipitation of components or phases of the alloy from the supersaturated solid solution. Also known as precipitation hardening.
AGGLOMERATION (PT) (MT):	An indiscriminately formed mass. A cluster of disparate elements.
AGING:	A metallurgical change in a metal alloy resulting in an increase in mechanical properties. This change can occur in some instances at room temperatures. More often its effects are increased by holding for specified lengths of time at elevated temperatures. Also known as precipitation hardening.
AIR-COOLED TUBE (RT):	An X-ray tube for which the principal method of cooling is dissipation of heat into surrounding air.
AIRCRAFT QUALITY STEEL:	Steel produced in such a way as to be as nearly free of discontinuities as possible.
AIR GAP (MT):	When a magnetic circuit contains a small gap that the magnetic flux must cross, the space is referred to as an air gap. Cracks produce small air gaps on the surface of a magnetized part.
AIR HOLE:	A hole in a casting caused by air or gas trapped in the metal during solidification; also, Gas Hole.
AIR SCATTER (RT):	Ionizing radiation that, because of a scattering interaction with air, arrives at a point by way of an indirect route instead of arriving directly from the source.
ALARA:	(acronym for "as low as is reasonably achievable") means making every reasonable effort to maintain exposures to radiation as far below dose limits as is practical consistent with the purposes for which the radiation exposure is received, taking into account the state of technology, the economics of improvements in relation to benefits to the public health and safety, and other societal and socioeconomic considerations, and in relation to utilization of radiation in the public interest.
ALCLAD ALUMINUM:	A term applied to aluminum alloy sheet and wire products to which a thin coating of high purity aluminum or aluminum alloy of different composition has been bonded for corrosion protection.
ALLOY:	A metal composed of two or more chemical elements at least one of which is a metal.
ALLOY STEEL:	Steel that has had sufficient quantities of alloying elements added to produce desired changes in the mechanical or physical properties.
ALLOY SYSTEM:	A complete series of compositions produced by mixing in all proportions any group of two or more components, at least one of which is a metal.
ALLOYING ELEMENT:	An element added to a metal to create a desired change in its properties.
ALPHA PARTICLE (RT):	A positively charged particle emitted by certain radioactive materials. It is made up of two neutrons and two protons; hence it is identical with the nucleus of a helium atom.

ALPHA "RAY" (RT):	A stream of fast moving helium nuclei. This is a strongly ionizing radiation with very weak penetration.
ALPHA ROCKWELL HARDNESS:	The index of the resistance of a plastic to surface penetration by a specified indenter under a specified load applied with a tester. Higher values indicate higher resistance to indentation (ASTMD- 785).
ALTERNATING CURRENT (AC):	Alternating current is current that reverses its direction of flow at regular intervals. Such current is frequently referred to as AC
ALUMINUM EQUIVALENT (RT, UT):	The thickness of aluminum having a specified purity, affording the same attenuation, under specified conditions, as the material in question.
AMPERAGE:	The strength of a current of electricity measured in amperes.
AMPERE:	This is the unit of electrical current. One ampere is the current that flows through a conductor having a resistance of one ohm, at a potential of one volt.
AMPERE TURNS (MT):	This term refers to the product of the number of turns in a coil and the number of amperes of current flowing through it. This is a measure of the magnetizing or demagnetizing strength of the coil. For example: 800 amperes in a 6 turn coil = $800 \times 6 = 4800$ ampere turns.
AMPLIFIERS:	Circuit components that increase the magnitude of an electronic signal.
AMPLITUDE:	The extent of vibratory movement measured from the mean position to an extreme; the maximum departure of alternating voltage or current from the average value; indicated by vertical height on an A-scan presentation.
AMPLITUDE ECHO (UT):	The total vertical or pulse height of the received signal indicated by "A" scan presentation.
AMPLITUDE RESPONSE:	That property of the test system whereby the amplitude of the detected signal is measured without regard to phase.
AMU:	Atomic mass unit.
ANGLE BEAM (UT):	A sound beam traveling at some angle other than normal to the surface of the test object. Measured from normal incidence.
ANGLE OF INCIDENCE (UT):	The angle defined by the direction of propagation of refracted wave and the normal to the interface at the point of incidence.
ANGLE OF REFLECTION (UT):	The angle defined by the direction of propagation of refracted wave and the normal to the interface at the point of incidence.
ANGLE TRANSDUCER (UT):	A transducer used in angled testing in which the sound beam is set to some predetermined angle to achieve a special effect, e.g., setting up shear or surface waves in the tested piece.
ANGSTROM (A):	Unit of length usually reserved for the expression of wavelength. One Angstrom equals 10^{-8} cm. Under the standard system of units, the Angstrom will be replaced by the nanometer ($1.0 \text{ A} = 0.10 \text{ nm}$). This is the standard unit for measuring wavelengths of light.
ANNEAL:	Heating metal to above its critical temperature range, then slowly cooling to remove stresses, induce softness, remove gases, alter ductility, induce toughness, or modify electrical, magnetic or other physical properties.
ANODE (TARGET) (RT):	The positive terminal of an X-ray tube. It is a high atomic number, high melting point element, and receives the electron bombardment from the cathode or negative terminal.
ANODE CORROSION:	The dissolution of a metal acting as an anode.
ANODE CURRENT (RT):	See TUBE CURRENT.
ANODE STEM (RT):	The metallic rod on which the target is mounted, and which is sealed to the envelope of the Xray tube.
ANODIZING:	Forming a coating on a metal surface by anodic oxidation; most frequently on aluminum.

T.O. 33B-1-1

ANTINODE:	Point in a standing wave where some characteristics of the wave field has a maximum amplitude.
ANTI-SCATTER GRID (RT):	An array of X-ray opaque and transparent sections of materials placed between the specimen and the film to minimize the effect of scattered radiation on the radiographic image, e.g., a Potter-Bucky diaphragm.
APPLICATION TIME (PT):	The period of time wherein parts are immersed in a bath of liquid penetrant, plus the time the liquid penetrant remains on the surface of the part, i.e., soak time and dwell time.
ARC STRIKE:	A burned area where the weld or adjacent surface is marred by the slight addition or loss of metal usually caused by inadvertent contact with the welding electrode.
AREA MONITORING (RT):	The continued measurement of ionizing radiation exposure or dose levels in an area for the purpose of radiation protection.
AREA OF INTEREST (RT):	The specific portion of the specimen image on the radiograph that is to be evaluated.
ARTIFACT (RT):	Film blemishes produced during the manufacture, packaging, handling, or processing of film which are not associated with the actual condition of the material tested. They appear as white or black crescents, fogging, staining, etc.
A-SCAN (UT):	A data presentation method by which intelligence signals from a signal object located are displayed. As generally applied to pulse echo ultrasonics, the horizontal and vertical sweeps are proportional to time or distance and amplitude or magnitude respectively. Thus the location and magnitude of acoustical interface are indicated as to depth below the transducer.
ASTM:	Abbreviation for American Society for Testing and Materials.
ASTM BLOCK:	Specific type of reference standard, cylindrically shaped and having a specified size FBH at a specified metal travel distance from the top of the block. See ASTM.
ASTM HARDNESS NUMBER:	The depth (in thousandths of an inch) of penetration of an indenter into a rubber specimen under loads and conditions specified in ASTM D-314. While suited for most common grades of rubber, ASTM hardness number is not applicable to extremely hard or soft rubbers.
ATOM:	The smallest particle of an element that can enter into a chemical combination. All chemical compounds are formed of atoms, the difference between compounds being attributable to the nature, number and arrangement of their constituent atoms.
ATOMIC MASS UNIT (AMU):	1.66 x 10 ⁻²⁴ grams. Arbitrarily defined as 1/12th of a carbon-12 atom. An AMU is approximately the mass of a proton (1.0073 AMU) or a neutron (1.0087 AMU).
ATOMIC NUMBER:	An integer that expresses the positive charge of the nucleus in multiples of the fundamental electronic charge. In present theory, it is the number of protons in the nucleus.
ATOMIC WEIGHT:	The relative weight of the atom of an element, referred to some element taken as a standard. An atomic weight of 16 for oxygen is the one usually adopted as a basis for reference.
ATTENUATION (RT):	Reduction in the intensity of a beam of ionizing radiation due to passage through matter.
ATTENUATION (UT):	Loss of energy caused by scattering of the sound beam within a material or at an interface or an electronic device in or attached to the instrument.
ATTENUATION COEFFICIENT (RT):	Average rate that a beam of radiation changes as it passes through a body.
ATTENUATOR:	A device that causes a known loss in energy of a beam that is passed through it. It may be calibrated in decibels.
AUGER ELECTRON (RT):	An orbital electron emitted by an atom, instead of a photon of characteristic radiation, when a vacancy in an inner electron shell is filled.
AUSTENITIC STEELS:	Steels whose constituents remain in solution with each other at room temperature and are, therefore, non-magnetic and corrosion resistant.

AUTORADIOGRAPH (RT):	The image of an object obtained on a photographic emulsion by means of radiation emitted by the object itself.
AUTORADIOGRAPHY (RT):	A test in which the object being inspected is radioactive, or made radioactive, and the inherent radiation so produced is used to produce the image on a film.
AUTOTRANSFORMER (RT):	A special type of transformer in which the output voltage can be easily varied. The autotransformer is thus employed to adjust the primary voltage applied to the step-up transformer that produces the high voltage applied to the X-ray tube.
AVERAGE GRADIENT (RT):	(of a film) The steepness of the characteristic curve of a film. Usually measured as average gradient between two levels of density; e.g., the average gradient between a density of 0.25 and a density of 2.0 is the slope of a straight line connecting these points. Most x-ray films have a gradient of 2.5 to 4.0, and any film with a gradient over 1.0 amplifies the subject contrast.
AVERAGE LIFE (MEAN LIFE) (RT):	The arithmetic mean value of the lives of the atoms of a radioactive nuclide. It is the reciprocal of the decay constant.

B

BACKGROUND (PT, MT):	The surface of the test part upon which the indication is viewed. It may be the natural surface of the test part, or it may be the developer coating on the surface. This background may contain traces of unremoved penetrant, fluorescent or visible, which if present, can interfere with the visibility of the indication.
BACKGROUND FLUORESCENCE (PT):	Fluorescent residues observed over the general surface of the part during fluorescent penetrant inspection. It is usually due to poor emulsification or rinsing of the fluorescent penetrant, or due to excessive roughness of the surface causing entrapment of the fluorescent penetrant.
BACKGROUND NOISE (UT):	Extraneous signals caused by signal sources within the ultrasonic testing system, including the material in test.
BACKGROUND RADIATION (RT):	Radiation coming from sources other than the radioactive material or X-ray machines used in making an exposure. Such radiation is primarily due to cosmic radiation from outside the earth's atmosphere and leakage from nearby sources.
BACK REFLECTION (UT):	Signal from the far boundary of the test part.
BACKSCATTER (RT):	Secondary radiation that is deflected at angles greater than 90 degrees with respect to the original direction of motion. Such radiation should be filtered from the film, as they bring no information to the film and cause a reduction in contrast due to an increase in noise.
BAND PASS FILTER:	An electronic circuit which allows flow of signals of a specific frequency range but suppresses signals of both greater and smaller rates of response.
BANDED STRUCTURE:	A segregated structure of nearly parallel bands aligned in the direction of working.
BACKING RING:	A metal ring placed inside pipe for butt welding, to assure complete weld penetration and a smooth internal surface.
BANDWIDTH:	The range of a band of different frequencies; the number of hertz between the maximum frequency of the range and the minimum frequency of the range, usually measured between points of equal and stated amplitude levels.
BANKING CONCEPT (RT):	An idea or model used to facilitate the explanation of radiation exposure permitted in a lifetime.
BARIUM CLAY (RT):	A molding clay blocking material containing barium used to eliminate or reduce the amount of scattered or secondary radiation reaching the film.
BARIUM CONCRETE (RT):	Concrete containing a high portion of barium compounds, used for radiation protection purposes.
BARIUM PLASTER (RT):	Plaster containing a high proportion of barium compounds, used for radiation protection purposes.

T.O. 33B-1-1

BARIUM TITANATE TRANSDUCER (UT):	(Polycrystalline Barium Titanate BaTiO ₃). A ceramic material composed of many individual crystals fired together, and polarized by the application of a D.C. field for use as a transducer.
BARK:	The decarburized layer just beneath the scale that results from heating steel in an oxidizing atmosphere.
BARN (RT):	A very small unit of area used in measuring the cross sections of atoms, nuclei, electrons, and other particles. One barn is equal to 10 ⁻²⁴ square centimeter. The term is a measure of the probability that a given nuclear reaction will occur.
BARRIER (PROTECTIVE) (RT):	Barrier of attenuating materials used to reduce radiation exposure.
BASE DENSITY (RT):	The slight density that is due only to the film base and the blue dye in it. It is measured with the emulsion layer removed, or on a film which has been fixed without prior development.
BASE PLUS FOG (RT):	The density of a film's base material plus the darkening of its emulsion caused by fog. The base plus fog level brings no useful information to the film and merely creates a high background that reduces contrast and image visibility.
BASELINE (UT):	The horizontal trace across the A-scan CRT display for a no signal condition.
BATH (colloquial) (PI, MT):	(1) The liquid penetrant inspection materials (penetrant, emulsifier, developer) into which parts are immersed during the inspection process. (2) Penetrant materials retained in bulk in immersion tanks intended for re-use. (3) Term used to designate a suspension of ferromagnetic particles with oil or water.
BEAM:	A directed flow of energy into space or matter.
BEAM ANGLE (RT):	The smallest angle between the central axis of the radiation beam and the plane of the radiographic film.
BEAM DIVERGENCE (RT):	The solid angle of the beam of radiation as it emerges from the X-ray tube or gamma-ray exposure device.
BEAM QUALITY (RT):	An expression used to describe the penetrating power (energy spectrum) of a beam of radiation. The quality of an X-ray beam is usually expressed in terms of the half-value layer of some reference material, such as aluminum or copper.
BEAM SPREAD (UT):	Divergence of a sound beam as it travels through material.
BERNOULLI EFFECT (PT):	A law of hydrodynamics: a liquid will flow through a conduit at a constant velocity governed by the pressure. When a section of the conduit is decreased in size, the velocity of the liquid flow in the reduced section is increased. If a small opening is placed in the reduced section, a vacuum or suction will be created at the opening.
BETA PARTICLE (RT):	An electron or positron emitted from a nucleus during decay. The term "beta particle" is reserved for electrons and positrons.
BETA "RAY" (RT):	A stream of high speed electrons that is of nuclear origin. This radiation is more penetrating than alpha radiation, but it ionizes less strongly.
BETATRON (RT):	A circular electron accelerator that is a source of either high energy electrons or X-rays. The electrons are injected by periodic bursts into a region of an alternating magnetic field. After acceleration, the electrons are brought out directly or directed against a target to produce X-rays.
BLACK LIGHT (PT, MT):	The term given to electromagnetic radiation having wavelengths from 320-400 nm. Typical units used in penetrant inspection provide an intensity of 100 to 150 foot-candles at 15 inches from the face of the filter and are used to excite fluorescent materials in a range visible to the eye.
BLACK LIGHT INTENSITY (PT, MT):	The amount of properly filtered black light measured at the surface of the part being inspected.
BLACK LIGHT FILTER (PT, MT):	A filter that transmits ultraviolet light (320-400-nm wavelength) while suppressing the transmission of visible light of the longer wavelengths.

BLEED OUT (PT):	The action by which the penetrant exudes out of the discontinuities onto the surface of a component, due primarily to “capillary action” and to “blotting” or “soaking up” effect of the developer.
BLISTER:	A defect in metal on or near the surface, resulting from the expansion of gas in a subsurface zone. Very small blisters are called “pinheads” or “pepper blisters.”
BLOCKING:	See MASKING.
BLOCKING MEDIUM (RT):	Material of appropriate radiation opacity for applying to an object, either around the edges or as a filling for holes, to reduce the effect of scattered radiation and to shield portions of the film which would otherwise be overexposed (e.g., radiographic putty).
BLOTTING (PT):	The action of the developer in soaking up the penetrant from the surface of the discontinuity, so as to cause maximum bleed out of the dye penetrant for increased contrast and sensitivity.
BLOWHOLE:	A hole in a casting or a weld caused by gas entrapped during solidification. See POROSITY.
BLUR (RT):	See UNSHARPNESS; PENUMBRA.
BODY (PT):	The term used to describe the ability of a penetrant vehicle to maintain an adequate suspension of visible or fluorescent dye material.
BODY BURDEN:	The amount of radioactive material present in the body of man or animals.
BOLTHOLE PROBE (ET):	A probe coil(s) assembly used for electromagnetically inspecting the walls of fastener holes or other small holes of limited length.
BOLTHOLE SCANNER (ET):	An eddy current device designed to provide automatic, uniform inspection of walls of fastener holes.
BOTTOM ECHO (UT):	See BACK REFLECTION.
BOUNDARY ECHO (UT):	A reflection of an ultrasonic wave from an interface.
BOUNDARY WAVELENGTH (QUANTUM LIMIT) (RT):	The shortest wavelength present in a continuous X-ray spectrum. It is inversely proportional to the peak voltage applied to the X-ray tube.
BRAZING:	Joining of metals and alloys by fusion of nonferrous alloys that have melting points above 800°F, but lower than melting points of materials being joined.
BREMSTRAHLUNG (RT):	Electromagnetic radiation emitted by charged particles when they are slowed down by electric fields in their passage through matter. Literally, “braking radiation” in German.
BRIDGE CIRCUIT (ET):	An electrical circuit designed to pass only the changes in voltage or current flow through a system while eliminating the larger steady state component. Such circuits in eddy current inspection reflect the changes in the electromagnetic variables while eliminating the larger current from the readout.
BRIGHTNESS AMPLIFIER (RT):	See IMAGE INTENSIFIER.
BRINELL HARDNESS:	A measure of the hardness of a metal, as determined by pressing a hard steel ball into the smooth surface under standard conditions. For aluminum, the steel ball is 10 millimeters in diameter and total load is 500 kilograms. Results are calculated as the ratio of applied load to total surface area of indentation and are referred to in terms of Brinell Hardness Number or BHN.
BRITTLE CRACK PROPAGATION:	A very sudden propagation of a crack with the absorption of no energy except that stored elastically in the body. Microscopic examination may reveal some deformation even though it is not noticeable to the unaided eye.
BRITTLE FRACTURE:	Fracture with little or no plastic deformation.
BRITTLENESS:	The quality of a material that leads to crack propagation without appreciable plastic deformation.

T.O. 33B-1-1

BROAD-BANDED (UT):	Having a relatively large bandwidth; used to describe instruments having an initial pulse with a relatively wide bandwidth and an amplifier with response to a relatively wide range of frequencies; opposite of narrow-banded or tuned.
BROAD BEAM (RT):	An uncollimated beam containing scattered radiation as well as the primary beam.
BROAD-BEAM ABSORPTION (RT):	Absorption measured under conditions in which scattered radiation is not excluded from the measuring apparatus.
B-SCAN (UT):	A data presentation method generally, applied to pulse echo techniques which yields a two dimensional view of a cross-sectional plane through the test piece. The horizontal sweep is proportional to the test piece, with the vertical sweep proportional to distance, showing the front and back surfaces and discontinuities between.
BUBBLER (UT):	See WATER DELAY COLUMN.
BUILD-UP (RT):	An increase in radiation transmitted through material because of forward scatter.
BUILD-UP FACTOR (RT):	In the passage of radiation through a medium, the ratio of the total value of a specified radiation quantity at any point to the contribution to that value from radiation reaching the point without having undergone a collision.
BUNSEN-ROSCOE RECIPROCALITY LAW (RT):	States that the end result of a photochemical reaction is dependent only on the product of the radiation intensity (I) and the duration of the exposure (t), and is independent of absolute values of either quantity. This implies that the resultant density of a film would depend only on the products of the radiation intensity reaching the film and the exposure time.
BURNING:	Extreme overheating makes grains excessively large and causes the more fusible constituents of steel to melt and run into the grain boundaries, or it may leave voids between the grains.
BURST:	Fissures or ruptures caused by rolling or forging improperly or at improper temperatures.
BY-PRODUCT MATERIAL (RT):	In atomic energy law, any radioactive material (except source or fissionable material) obtained in the process of producing or using source or fissionable material. Includes fission products and many other radioisotopes produced in nuclear reactors.

C

CALCIUM TUNGSTATE (RT):	A fluorescent chemical compound which emits visible blue-violet light when activated by either X- or gamma radiation.
CALIBRATION:	The standardization of the instrument, prior to test, to a known reference value.
CALIBRATION STANDARD:	See REFERENCE STANDARD.
CANNON TUBE SHIELD (RT):	A tube shield in the form of a long cylinder generally supported in cantilever fashion. The X-ray beam emerges through an aperture in the lead-lined wall of the cylinder, at right angles to its axis.
CAPILLARY ACTION (PT):	The tendency of certain liquids to travel or climb when exposed to small openings, cracks, fissure, etc., due to factors such as surface tension, cohesion, adhesion and viscosity.
CARBON STEEL:	Steel that does not contain significant amounts of alloying elements other than carbon. Also known as straight carbon, ordinary steel or plain carbon steel contains carbon up to 2%, also termed plain carbon steel or ordinary steel.
CARBURIZE:	To produce surface hardness on low carbon steels by heating above the critical range while in contact with a suitable material containing carbon.
CARRIER FLUID (MT):	A term used colloquially to designate the liquid used to carry the magnetic substance for the wet process.
CASCADE TUBE (RT):	A high voltage X-ray tube of cylindrical form divided into sections, the potential difference across each of which is a fraction of the voltage applied to the whole tube. The electron stream is accelerated to its maximum energy in stages.

CASE:	In a ferrous alloy, the outer portion that has been made harder than the inner portion, or core, by CASE HARDENING.
CASE HARDENING:	Hardening a ferrous alloy so that the outer portion, or case, is made substantially harder than the inner portion, or core. Typical processes used for case hardening are carburizing, cyaniding, carbonitriding, nitriding, induction hardening and flame hardening.
CASSETTE (RT):	A lightproof container used for holding the radiographic films in position during the radiographic exposure. These holders may or may not contain intensifying and/or filter screens.
CASTING:	(1) An object at or near finished shape obtained by solidification of a substance in a mold. (2) Pouring molten metal into a mold to produce an object of desired shape.
CASTING SHRINKAGE:	(1) "Liquid shrinkage" - the reduction in volume of liquid metal as it cools to the liquidus. (2) "Solidification shrinkage" the reduction in volume of metal from the beginning to ending of solidification. (3) "Solid shrinkage" - the reduction in volume of metal from the solidus to room temperature. (4) "Total shrinkage" - the sum of the shrinkage in parts (1), (2) and (3).
CASTING STRAINS:	Strains in a casting caused by casting stresses that develop as the casting cools.
CASTING STRESSES:	Stressed set up in a casting because of geometry and casting shrinkage.
CAST-WELD ASSEMBLY:	An assembly formed by welding one casting to another.
CATHODE (RT):	The negatively biased electrode of an X-ray tube from which the electrons are emitted to be accelerated to the anode.
CATHODE RAY (UT, RT):	A stream of electrons emitted by a heated filament and projected in a more or less confined beam under the influence of a magnetic and/or electric field.
CATHODE RAY TUBE (UT):	A vacuum tube, containing a screen, upon which signals are displayed; basic display device for an A-scan. Abbreviation is CRT.
CENTISTOKE:	A unit of kinematic viscosity. Water has a viscosity of about one centistoke.
CENTRAL CONDUCTOR (MT):	A conductor made of copper, aluminum, steel or flexible cable that is passed into or through an opening in a cylindrically-shaped part or other shapes when applicable for the purpose of establishing a circular field on the inside diameter.
CENTRIFUGAL CASTING:	A casting made in a mold (sand, plaster, or permanent mold) which rotates while the metal solidifies under the pressure developed by centrifugal force.
CERMET (PT):	A strong alloy of a heat-resistant compound and a metal.
CERTIFIED DENSITY (RT):	See STEP-WEDGE CALIBRATION FILM.
CESIUM-137:	A radioactive isotope of the element cesium having a half-life of 80 years, plus or minus three years.
CESIUM-137 (RT):	A radioactive nuclide of the element cesium having a half-life of 30 years, and photon energy of 882 KeV (which is 0.862 MeV).
CHAIN REACTION:	A reaction that stimulates its own repetition. In a fission chain reaction, a fission nucleus absorbs a neutron and fissions, releasing more than one additional neutron. These in turn can be absorbed by other fissionable nuclei, releasing more neutrons. A fission chain reaction is self-sustaining when the number of neutrons released in a given time interval equals or exceeds the number of neutrons absorbed.
CHALK TEST:	The forerunner of modern penetrant methods. A method of locating cracks by applying oil to a part and then removing the excess from the surface, which is then coated with whiting or chalk. After a short period of time the oil seeps out of the cracks into the whiting, or chalk, causing an appreciable difference in whiteness. This method has been replaced with more advanced penetrant methods for most applications.
CHARACTERISTIC CURVE (RT):	A curve which expresses film density as a function of log relative exposure. These curves are useful in determining exposure correction factors and to define the gamma characteristics of the film.

T.O. 33B-1-1

CHARACTERISTIC RADIATION (RT):	X-radiation consisting of discrete wavelengths which are characteristic of the emitting material.
CHARPY:	The name of an impact-testing machine that tests a specimen by striking it with a swinging hammer. The specimen is placed against anvil supports that are 40 millimeters apart.
CHATTER:	In machining or grinding, (1) A vibration of the tool, wheel or workpiece producing a wavy surface on the work. (2) The finish produced by such vibration.
CHECKS (CHECK MARKS):	Numerous, very small cracks in metal or other material caused in processing.
CHEMICAL FOG (AERIAL FOG) (RT):	Fog caused by unwanted chemical reactions during processing of film.
CHILL:	(1) A metal insert imbedded in the surface of a sand mold or core or placed in a mold cavity to increase the cooling rate at that point. (2) White iron occurring on a gray iron casting, such as the "chill" in the wedge test. (3) (Unfused chaplets) A uniform line or band outlining the object and indicating the lack of fusion between the metal and the casting.
CHLORINATION:	The process of passing dry chlorine gas through molten aluminum alloys to remove trapped oxides and dissolved gases.
CINE-FLUOROGRAPHY (RT):	Cine-radiography of images produced on a fluorescent screen.
CINE-RADIOGRAPHY (RT):	The production of a series of radiographs that can be viewed rapidly in sequence, thus creating an illusion of continuity.
CIRCULAR MAGNETISM (MT):	When an electric current is passed through a solid magnetic conductor, a circular magnetic field is developed not only around the conductor, but also within the conductor.
CLADDING:	A process wherein a metallic coating is applied to a base metal by simultaneously rolling the base metal and the cladding material.
CLEAN:	Free of solid or liquid contamination from the surface or in the voids of the flaw that may interfere with the penetration of the dye penetrant into the flaws, or with the occurrence of the inspection process.
CLEARANCE:	(1) The gap or space between two mating parts. (2) Space provided between the relief of a cutting tool and the surface cut.
CLEARING TIME (RT):	The time required for the first stage of fixing during which the whiteness (opaqueness) of the film disappears.
CLEAVAGE:	The splitting (fracture) of a crystal on a crystallographic plane of low index.
CLEAVAGE FRACTURE:	A fracture, usually of a polycrystalline metal, in which most of the grains have failed by cleavage, resulting in bright reflecting facets. It is one type of crystalline fracture. Contrast with SHEAR FRACTURE.
COALESCENCE (PT):	The merging of two or more particles of a liquid, gas, or solid into a single larger particle: The uniting by growth in one body.
COBALT-60:	A radioisotope of the element cobalt.
COBALT-60 (RT):	A radionuclide of the element cobalt, emitting gamma rays with energies of 1.33 and 1.17 MeV, with a half-life of 5.3 years.
COEFFICIENT OF THERMAL EXPANSION:	The linear expansion or contraction per unit length per degree Fahrenheit between specified lower and upper Fahrenheit temperatures. If aluminum is involved, such values are multiplied by one million for easier reading.
COERCIVE FORCE (MT):	The value of the reversing magnetizing force necessary to bring the flux density back to near zero.

COHERENT SCATTER:	The result of Compton scattering in which the electron receives none of the energy from the primary radiation. The resultant scattered radiation is of the same energy as the incident beam.
COHESION:	Molecular attraction by which the particles of a solid are held together.
COIL (ET, MT):	One or more turns of conductor wound to produce a magnetic field when current passes through the conductor.
COIL IMPEDANCE (ET):	The total opposition to current flow through a coil and is represented by the ratio of the coil voltage to the coil current. This impedance is affected by the material within the magnetic field generated by the coil and is sometimes used to measure eddy current response.
COIL SHOT (MT):	A term used colloquially to indicate a shot of magnetizing current passed through a solenoid or coil surrounding a part, for the purpose of establishing a longitudinal field.
COIL SIZE (ET, MT):	The geometry or dimension of a coil; for example, length or diameter.
COIL SPACING:	The axial distance between two encircling coils in a different system.
COLD CRACKS:	Appear as a straight line, usually continuous throughout its length and generally exist singly. These cracks start at the surface.
COLD SHORT:	A condition of brittleness existing in some metals at temperatures below the recrystallization temperature.
COLD SHUT:	(1) A discontinuity that appears on the surface of cast metal as a result of two streams of liquid meeting and failing to unite. (2) A portion of the surface of a forging that is separated, in part, from the main body of metal by oxide.
COLD WORKS:	Permanent strain produced by an external force in a metal below its recrystallization temperature.
COLD WORKING:	Deforming metal plastically at a temperature lower than the recrystallization temperature.
COLLIMATOR (RT):	A device used to limit the size, shape, and direction of the primary radiation beam.
COLLIMATOR (UT):	A lens assembly attachment designed to reduce the ultrasonic beam spread.
COLLIMATION:	The process by which a divergent beam of energy or particles is converted into a parallel beam.
COLLOIDAL (MT):	A liquid suspension of solid particles in which the particles will not settle on standing.
COLLOIDAL SUSPENSION (MT, PT):	An intimate mixture of two substances, one of which, called the dispersed phase (or colloidal), is uniformly distributed in a finely divided state through the second substance, called the dispersion medium (or dispersing medium); the dispersion medium or dispersed phase may be gas, liquid, or solid. Also known as colloidal dispersion; colloidal system.
COLOR-CONTRAST DYE (PT):	A dye which can be used in a penetrant to impart sufficient color intensity to give good color contrast in indications against the background of the surface being tested, when viewed under white light.
COLOR-CONTRAST PENETRANT:	A penetrant incorporating a dye - usually nonfluorescent - sufficiently intense to give good visibility to flaw indications under white light.
COLUMNAR STRUCTURE:	A coarse structure of parallel columns of grains, having the long axis perpendicular to the casting surface.
COMBINATION DIE (DIE-CASTING):	A die having two or more different cavities for different castings.
COMBINATION SCREENS (RT):	A pair of intensifying screens in which the front screen (to be placed on the tube side of the film) is usually thinner than the back screen.
COMBINED STRESSES:	Any state of stress that cannot be represented by a single component of stress; that is, one that is more complicated than simple tension, compression or shear.
COMMERCIAL SOLVENTS:	A liquid containing no emulsifiers and having chemical properties similar to those exhibited by solvents conforming to Government Specifications TT-N-97 and A-A-2904.

T.O. 33B-1-1

COMPARATIVE TEST BLOCK (see REFERENCE STANDARD):	An intentionally cracked metal block having two separate but adjacent areas for the application of different penetrants so that a direct comparison of their relative effectiveness can be obtained. Can also be used to evaluate penetrant test techniques or test conditions, or both.
COMPENSATOR:	An electrical matching network to compensate for circuit impedance differences.
COMPLETE FUSION:	Fusion that has occurred over the entire base-metal surfaces exposed for welding.
COMPOSITE FILTER (RT):	A filter of two or more materials chosen so that the longer wavelengths of a beam are readily absorbed, and within this range undesirable radiation transmission is avoided. The materials are usually arranged so that the second material filters secondary radiation produced in the first material and so on. A particular example is the "Thoraeus Filter" which consists of 0.44 mm of tin, 0.25 mm of copper and 1 mm of aluminum in this order in the beam of radiation.
COMPOSITE PLATE:	An electrodeposit consisting of layers of at least two different compositions.
COMPOUND:	A chemical combination of elements.
COMPRESSIONAL WAVE (UT):	Waves in which the particle motion or vibration is in the same direction as the propagated wave. Same as longitudinal wave. See LONGITUDINAL WAVES.
COMPRESSIVE STRENGTH:	The maximum stress developed in a material when located in compression. For practical purposes, the compressive yield strength is considered as the maximum compressive strength, particularly in the case of wrought metals.
COMPTON ABSORPTION (COMPTON EFFECT) (RT):	The reduction of the energy of an incident photon by its interaction with an electron. Part of the photon energy is transferred to the electron (Compton electron or recoil electron) and part is redirected as a photon of reduced energy.
COMPTON EFFECT (RT):	The glancing collision of an X-ray or gamma ray with an electron resulting in a gain of energy for the electron.
COMPTON SCATTERING (RT):	A process in which a photon transfers a portion of its energy to an orbital electron in matter and a lower energy photon is scattered at an angle to the original photon path.
COMPUTED TOMOGRAPHY (RT):	A method by which a radiograph of a predetermined interior plane of a thick material is obtained through the use of a computer. The images resulting from a series of exposures at different angles are stored and reconstructed into a single image by the computer.
CONCAVE:	Curved or rounded and hollow as the outer boundary of a spherical or circular form viewed from within; opposite of convex.
CONCENTRATE (MT):	A term used colloquially to designate the dry magnetic materials used to prepare a suspension. Also called Dry Concentrate.
CONCENTRATION TEST (MT):	The method used to determine the quantity of magnetic material in the suspension at any given time. Also known as settling test.
CONDENSER IONIZATION CHAMBER (RT):	An ionization chamber which, having been charged to a certain potential, can be irradiated and subsequently attached to an electrometer to measure the residual charge, whereby the exposure is determined.
CONDUCTIVITY:	This is the inverse of resistance, and refers to the ability of a conductor to carry current.
CONDUCTIVITY REFERENCE STANDARD (ET):	Sections of metallic materials with accurately measured electrical conductivity values in percent IACS. These standards are used to calibrate conductivity measuring eddy current instruments.
CONE (RT):	A lead diaphragm or cone placed on the tube head to limit the X-ray beam to a volume defined by a cone.
CONSTANT-POTENTIAL CIRCUIT:	A circuit, which is so, arranged to apply and maintain a substantially constant potential across an X-ray tube.
CONSTANT VOLTAGE (CONSTANT POTENTIAL) (RT):	A unidirectional voltage of essentially constant magnitude.

CONSTRAINT:	Any restriction that occurs to the transverse contraction normally associated with a longitudinal tension, and that hence causes a secondary tension in the transverse direction.
CONTACT HEAD (MT):	Electrode assembly used to clamp and support a part to facilitate passage of electrical current through the part for circular magnetization.
CONTACT METHOD (UT):	The inspection method in which the search unit face makes direct contact with the test part and ultrasonic energy is transmitted through a thin film of couplant.
CONTACT PADS (MT):	Replaceable metal pads, usually copper braid, placed on the contact heads to give good electrical contact, thereby reducing the possibility of damage to the part by arcing or burning.
CONTACT TESTING (UT):	Testing with transducer assembly in direct contact with material through a thin layer of couplant.
CONTACT TRANSDUCER:	A transducer that is coupled to a test surface either directly or through a thin film of couplant.
CONTAINER, GAMMA-RAY SOURCE (RT):	A device for housing radionuclides and giving a required degree of protection against radiation. (This may take the form of an exposure device or a storage container.)
CONTAMINATION (PT, MT):	Any material in the wet suspension other than the liquid vehicle and the magnetic material being used. This could be shop dust, lint, soil from improperly cleaned parts, oil, etc.
CONTAMINATION (RT):	The presence of unwanted radioactive matter, or the "Soiling" of object or materials with "Radioactive Dirt."
CONTINUOUS METHOD (MT):	The method in which the inspection medium is applied while the magnetizing current is on.
CONTINUOUS SPECTRUM (RT):	The characteristic radiation pattern that exhibits energies for an unbroken series of frequencies over a wide range.
CONTINUOUS WAVE (UT):	Steady generation of ultrasonic energy; opposite of pulsed.
CONTINUOUS WEDGE (RT):	A wedge, the thickness of which varies continuously.
CONTRACTED SWEEP (UT):	A contraction of the horizontal sweep line or time axis on the viewing screen of the ultrasonic instrument. A contraction of this sweep permits viewing defect or back reflection occurring over a greater length of time.
CONTRAST AGENT (RT):	Any suitable substance, solid, liquid, or gas, applied to a material being radiographed, to enhance its contrast in total or in part.
CONTRAST RATIO (PT, MT):	The relative amount of light emitted or reflected as between an indication and its background.
CONTRAST RATIO (RT):	The relative amount of light emitted or reflected as between an indication and its background.
CONTRAST (MT, PT, RT):	The difference in visibility between an indication and the surrounding surface.
CONTRAST, FILM (RT):	Change in density that results from a given change in incident radiation. Determined from the slope of the characteristic curve. See FILM GAMMA.
CONTRAST, RADIOGRAPHIC (RT):	The difference in density between an image and its immediate surroundings on a radiograph.
CONTRAST, SUBJECT (RT):	The ratio (or logarithm of the ratio) of the radiation intensities transmitted by selected portions of the specimen.
CONTROL ECHO (UT):	Reference signal from constant reflecting surface, such as the back reflection from a smooth, regular back surface.
CONTROL PANEL (RT):	A console or unit that contains the controls necessary to operate a radiation source and any ancillary equipment used for radiography.

T.O. 33B-1-1

CONTROLLED AREA (RT):	A defined area in which the occupational exposure of personnel to radiation or to radioactive material is under the supervision of an individual in charge of radiation protection. (This implies that a controlled area is one that requires control of access, occupancy, and working conditions for radiation protection purposes.)
CONVEX:	Curved or rounded as the exterior of a spherical or circular form viewed from without; opposite of concave.
COOLIDGE TUBE (RT):	An X-ray tube in which the source of the bombarding electrons is a heated filament in the cathode.
COOLING CRACK:	See CRACKS, COOLING.
COOLING STRESSES:	Residual stresses resulting from non-uniform distribution of temperature during cooling.
CORE (MT):	In reference to an electromagnetic inspection, it is a laminated steel conductor located within the electrical winding of a hand-held yoke or probe. Also, laminated steel conductor used in conjunction with a magnetizing coil to produce a stronger collapsing field in induced current magnetization of ring-shaped parts.
CORNER EFFECT (UT):	The strong reflection obtained when an angle beam is directed normal to the intersection of two perpendicular reflectors.
CORONA:	In spot welding, an area sometimes surrounding the nugget at the faying surfaces, contributing slightly to overall and strength.
CORROSION:	The deterioration of a metal by chemical or electrochemical reaction with its environment or other material.
CORROSION EMBRIT- TLEMENT:	The severe loss of ductility of a metal, resulting from corrosive attack, usually intergranular and often not visually apparent.
CORROSION FATIGUE:	Effect of the application of repeated or fluctuating stresses in a corrosive environment characterized by shorter life than would be encountered as a result of either the repeated or fluctuating stresses alone or the corrosive environment alone.
COULOMB:	A unit of electric charge in the "practical" system of units. It contains 3×10^9 electrostatic units (see ESU) of charge.
COUPLANT (UT):	A substance (usually liquid) used between the search unit and test part to permit or improve transmission of ultrasonic energy into the test part.
COUPLING (ET):	An interaction between systems or between properties of a system.
CRACK:	A discontinuity that has a relatively large cross-section in one direction and a small or negligible crosssection when viewed in a direction perpendicular to the first.
CRACKS COLD:	A crack, which occurs in a casting after solidification, due to excessive strain generally resulting from non-uniform cooling.
CRACK CONTAMINANT:	Material which fills a crack and which may prevent penetrants from entering.
CRACKS COOLING:	In bars of alloy or tool steels, are the result of uneven cooling after rolling and usually are deep in a longitudinal direction, but are not straight.
CRACKS, FATIGUE:	Progressive cracks which develop in the surface caused by the repeated loading and unloading of the part, or by what is called reverse bending.
CRACKS, FORGING:	Cracks developed in the forging operation due to forging at too low a temperature, resulting in rupturing of the steel.
CRACKS, GRINDING:	Thermal cracks due to local over-heating of the surface being ground, generally caused by lack of coolant, improper coolant, dull wheel, too rapid a feed, or too heavy a cut.
CRACKS, HEAT TREAT- ING:	See CRACKS, QUENCHING.
CRACKS, HOT:	Same as CRACKS, COLD, but developing before the casting has completely cooled.
CRACKS, MACHINING:	A surface defect generally called machining tear and caused by too heavy a cut, a dull tool, chatter, or dragging the tool over the metal when not cutting cleanly.

CRACKS, NOT OPEN:	Indications which are difficult to discern or prove upon the use of contrast penetrant inspection techniques.
CRACKS, OPEN:	Those flaws which can be detected by contrast penetrant inspection techniques.
CRACKS, PICKLING:	Cracks caused by the release of internal stresses due to metal removal by immersion in acid or chemical solutions.
CRACKS, PLATING:	A crack developed by the plating process, usually occurring in parts having high internal stresses.
CRACKS, QUENCHING:	Ruptures produced in the tempering of metal, due to uneven cooling and contracting of one portion of a part.
CRACKS, SERVICE:	Ruptures that occur on a part after all fabrication has been completed and the part placed in service. Failure may be due to fatigue, corrosion, overstressing, or undetected processing discontinuities.
CRATER:	(1) In machining, a depression in a cutting tool face eroded by chip contact. (2) In arc welding, depressions at the termination of a bead or in the weld pool beneath the electrode.
CREEP:	Time-dependent strain occurring under stress. The creep strain occurring at a diminishing rate is called primary creep; that occurring at a minimum and almost constant rate, secondary creep; that occurring at an accelerating rate, tertiary creep.
CREEP STRENGTH:	(1) The constant nominal stress that will cause a specified quantity of creep in a given time at constant temperature. (2) The constant nominal stress that will cause a specified creep rate at constant temperature.
CREVICE CORROSION:	A type of concentration cell corrosion; corrosion of a metal that is caused by the concentration of dissolved salts, metal ions, oxygen or other gases, and such, in crevices or pockets remote from the principal fluid stream, with a resultant building up of differential cells that ultimately cause deep pitting.
CRITICAL ANGLE (UT):	The angle of the incident sound beam with respect to the normal to an interface, beyond which a given mode of refracted beam will not exist.
CRITICAL SIZE:	The established flaw size deemed to be detrimental to the serviceability of the product criteria. The acceptance/rejection levels established by design engineering required limits to meet design performance.
CROSS TALK (UT):	The signal leakage (acoustical or electrical) across an intended barrier, such as signal leakage between the transmitting and receiving transducer elements of a dual search unit.
CRT:	Abbreviation for cathode ray tube.
CRYSTAL (UT):	See TRANSDUCER ELEMENT.
CRYSTAL MOSAICS (UT):	Two or more crystals mounted in the same plane in one holder and connected so as to cause all crystals to vibrate as one unit.
CRYSTALS (X-CUT) (UT):	Section cut so that its thickness is parallel to the X-axis of the crystal. A thickness-extensional mode of vibration occurs when excited.
CRYSTALS (Y-CUT) (UT):	Section cut so that its thickness is parallel to the Y-axis of the crystal. A thickness-shear mode of vibration occurs when excited.
CRYSTALS (Z-CUT) (UT):	Section cut so that its thickness is parallel to the Z-axis of the crystal. Piezoelectric effect is restricted to the X and Y-axis; therefore mode of vibration is width-extensional.
C-SCAN (UT):	A data presentation method generally applied to pulse echo techniques yielding a two dimensional plan view of the scanned surfaces of the part. Through gating, only echoes arising from the interior of the test object are indicated. In the C-scan no indication is given of the echo depth.
CUMULATIVE DOSE (RADIATION) (RT):	The total dose resulting from repeated exposure to radiation of the same region or of the whole body.

T.O. 33B-1-1

CUPOLA:	A cylindrical vertical furnace for melting metal, especially gray iron, by having the charge come in contact with the hot fuel, usually metallurgical coke.
CURIE (RT):	A unit of measure to express the rate at which a radioactive material decays. It is defined as that quantity of any radioactive material in which 3.7×10^{10} disintegrations per second are occurring. Under the new International System (SI) of Units, the curie will be replaced by disintegrations per second (1 Curie = 3.70×10^{10} disintegrations per second).
CURIE POINT (MT):	The temperature at which ferromagnetic materials become nonmagnetic and can no longer be magnetized by outside sources. The range of temperatures is 1200°F-1600°F.
CURRENT:	The flow of electrons through a conductor. It is measured in amperes, milliamperes or microamperes.
CURRENT FLOW METHOD (MT):	See CIRCULAR MAGNETIZATION.
CURRENT INDUCTION METHOD (MT):	See INDUCED CURRENT MAGNETIZATION.
CYANIDING:	Introducing carbon and nitrogen into a solid ferrous alloy by holding above Acl in contact with molten cyanide of suitable composition. The cyanided alloy is usually quench hardened.
CYCLOTRON:	A particle accelerator in which the atomic particles are whirled around in a spiral between the ends of a huge magnet gaining speed with each rotation. The cyclotron is normally used for nuclear research but the particles can be made to collide with a target to produce X-rays.

D

D:	Symbol for diameter.
d:	Symbol for distance.
d/t RATIO:	The working distance for the X-ray tube in relation to the film distance. The working distance, d, and the specimen thickness, t, are both measured with reference to the source side of the specimen.
DAC:	Abbreviation for distance amplitude correction; also used to denote electronic distance amplitude correction on some instruments.
DAMPING:	Hindering or decreasing the time of vibrations or oscillations in the motion of a body or in an electrical system subjected to influences which are capable of causing vibration or oscillation. Compare with attenuation.
DAMPING (UT):	Limiting the duration of and/or decreasing the amplitude of vibrations, as in damping of a transducer element; also designates a bond inspection method in which good bonds are verified by damping ultrasonic energy transmitted to the back surface.
DAMPING CAPACITY:	The ability of a metal to absorb vibration (cyclical stresses) by internal friction converting the mechanical energy into heat.
DAMPING MATERIAL (UT):	Material contained within a search unit in back of the transducer element and used for damping.
DARK ADAPTION:	The ability of the eye to adjust so that objects, lights, or colors can be seen in darkened areas. This is important when performing a fluorescent penetrant, fluorescent magnetic particle inspections or when interpreting radiographic film.
dB:	Abbreviation for decibel.
DC (DIRECT CURRENT):	An electrical current that flows continually in one direction through a conductor.
DEAD ZONE:	Zone in the test part directly underneath the sound entry surface where discontinuities cannot be detected; caused by the finite length of the initial pulse, ringing time of the transducer element, and/or electronic characteristics of the instrument.

DECALESCENCE:	A phenomenon, associated with the transformation of alpha iron to gamma iron on the heating (superheating) of iron or steel, revealed by the darkening of the metal surface owing to the sudden decrease in temperature caused by the fast absorption of the latent heat or transformation.
DECARBURIZATION:	The loss of carbon from the surface of a ferrous alloy as a result of heating in a medium that reacts with the carbon at the surface.
DECAY (MT):	The falling off to zero of the current in an electrical circuit. Magnetic fields can also decay in a similar manner. This is important in demagnetization.
DECAY (RT):	Spontaneous change of a nucleus with emission of a particle or a photon. For a definite quality of a nuclide, the rate of decay is usually expressed in terms of half-life.
DECAY CURVE (RT):	A graph showing radioactive strength in curies as a function of time for an isotope. Such curves are used in radiography to determine the compensation or correction for exposure time in selecting exposure conditions.
DECIBEL:	Logarithmic expression of a ratio of two amplitudes; abbreviation is dB. $\text{dB} = 20 \log_{10} (A_2/A_1)$, where A_1 and A_2 are amplitudes.
DECONTAMINATION (RT):	The removal of radioactive contaminants from surfaces by cleaning and washing with chemicals.
DECONTAMINATION FACTOR (RT):	The ratio of the amount of radioactive contaminant initially present to the amount remaining after a suitable processing step has been completed. A factor referring to the reduction of the gross measurable radioactivity.
DEEP-DOSE EQUIVALENT:	Applies to whole-body exposure, is the dose equivalent at a tissue depth of 1 cm (1000 mg/cm ²)
DEEP ETCHING:	Severe etching of a metallic surface for examination at a magnification of ten diameters or less to reveal gross features such as segregation, cracks, porosity or grain flow.
DEFECT:	A discontinuity that interferes with the usefulness of a part. A fault in any material or part detrimental to its serviceability. Note that all cracks, seams, laps, etc. are not necessarily defects as they may not affect serviceability of the part in which they exist.
DEFECT DETECTION SENSITIVITY (RT):	See SENSITIVITY, DEFECT.
DEFECT ORIENTATION (PT, MT):	The position of the defect in relation to the inspection surface and the magnetic or penetrant indication.
DEFECT REFLECTION (UT):	The oscilloscope presentation of the energy returned by a rejectable flaw in the material.
DEFECT RESOLUTION:	A property of a test system which enables the separation of signals due to defects in the test specimen that are located in close proximity to each other.
DEFINITION, RADIOGRAPHIC (RT):	Measure of sharpness in outline in the radiographic image of an object. Radiographic definition is a function of the types of screens, exposure geometry, radiation energy, and the film characteristics.
DEFINITION (RT):	A general and qualitative term that refers to the degree of distinctness of image details in a radiograph, photographic reproduction, or viewing-screen image.
DEGREASING FLUID:	Solvents or cleaners employed to remove oil and grease from the surface of components before the penetrant liquid is applied.
DELAY (UT):	See SWEEP DELAY.
DELAY COLUMN (UT):	See WATER DELAY COLUMN.
DELAY LINE (UT):	Material (liquid or solid) placed in front of the search unit to cause a time delay between the initial pulse and front surface signal.
DELAYED SWEEP (UT):	An A-scan or B-scan presentation in which an initial part of the time scale is not displayed.
DELTA EFFECT:	Acoustic energy re-radiated by a discontinuity.

T.O. 33B-1-1

DEMAGNETIZATION (MT):	The reduction in the degree of residual magnetism in ferromagnetic materials to an acceptable level.
DENDRITE:	A crystal that has a tree-like branching pattern being most evident in cast metals slowly cooled through the solidification range.
DENSITOMETER:	Instrument utilizing the photoelectric principle to determine the degree of darkening of developed photographic film. Measures optical density of films.
DENSITOMETRY (RT):	The measurement of the degree of darkening of a developed photographic/radiographic film, providing one measure of the quality of the film. Measuring the optical density of films.
DENSITY COMPARISON STRIP (RT):	Alternative term for step-wedge comparison film.
DENSITY, FILM (RT):	The degree of blackening of a film is density. Film blackening or density is usually expressed in terms of the H & D curve (Hurter & Driffield) which is defined as the logarithm of the reciprocal of the transparency of the film. $D = \log_{10} \frac{I_0}{I}$ where D density, I_0 = Light incident on the film, and I = Light intensity transmitted.
DENSITY GRADIENT:	The change in density of a radiographic film at a particular film density per unit change in the logarithm of the exposure received by the film. The maximum density gradient of a film is usually called gamma.
DEOXIDIZER:	A substance that can be added to molten metal to remove either free or combined oxygen.
DEOXIDIZING:	(1) The removal of oxygen from molten metals by use of suitable deoxidizers. (2) Sometimes refers to the removal of undesirable elements other than oxygen by the introduction of elements or compounds that readily react with them. (3) In metal finishing, the removal of oxide films from metal surfaces by chemical or electrochemical reaction.
DEPTH OF FUSION:	The depth to which the base metal melted during welding.
DEPTH OF PENETRATION (MT, EC):	The depth at which the magnetic field or induced eddy currents has decreased to a specified percentage of its surface value or has reached the limit of its effectiveness. The depth of penetration is an exponential function of the frequency of the signal and the conductivity and permeability of the material.
DESCALING:	Removing the thick layer of oxides formed on some metals at elevated temperatures.
DESENSITIZATION (RT):	An effect on the emulsion of a radiographic film caused by pressure of any type exerted on the emulsion prior to exposure. A desensitized area on a film is characterized by low density in the affected area.
DETAIL:	See DEFINITION, RADIOGRAPHIC.
DETAIL SENSITIVITY (RT):	The radiographic definition or sharpness of detail as indicated by the drilled holes in a penetrometer. It is expressed by a number x-yT, where x is the thickness of the penetrometer expressed as a percentage of the nominal subject thickness, and y is the diameter of the hole expressed as a multiple of the penetrometer thickness T.
DETECTOR (RT):	A device that determines the presence of ionizing radiation.
DETERGENT REMOVER (PT):	A penetrant remover that is a solution of a detergent in water.
DEUTERIUM:	The isotope of hydrogen having one proton, one neutron, one electron, and an AMU of two.
DEVELOPER DRY (PT):	A light fluffy dry absorbent powder, applied to the part being penetrant inspected after the excess surface penetrant has been removed and the part has been dried. The "Dry" developer adheres primarily to the flaw openings wetted by the penetrant liquid, to obtain increased bleed out of the penetrant and provide sharp flaw delineations.
DEVELOPER (PT):	Material, wet or dry, which will draw or absorb penetrant from a surface crack or defect to the extent the defect will be visible under natural, artificial, or black light, as applicable. Developers also control the background of the high contrast penetrant color system.
DEVELOPER (RT):	A chemical solution that reduces exposed silver halide crystals to metallic silver.

DEVELOPER, NONAQUEOUS (PT):	Absorbent powdered materials suspended in a non-aqueous liquid, used to provide a white background for maximum color contrast, and to enhance the bleed out of the penetrant from the flaw cavity to obtain increased accuracy of penetrant inspection.
DEVELOPER, SOLUBLE (PT):	A developer completely soluble in its carrier, not a suspension of powder in a liquid, which dries to an absorptive coating.
DEVELOPER, SOLVENT:	A developer consisting of fine particles suspended in a volatile solvent. The volatile solvent helps dissolve the penetrant out of the discontinuity and bring it to the surface.
DEVELOPER, WET (PT):	An absorbent powder supplied in the dry form to be mixed and suspended in water for application to the part being penetrant inspected, after the excess surface penetrant has been removed. The "Wet" developer, on drying, provides an absorbent white background to the part for maximum color contrast, and enhances the bleed out of the penetrant from the flaw cavity to obtain increased inspection accuracy.
DEVELOPING AGENT (RT):	The constituent of a developer that reduces sufficiently exposed silver halide grains to metallic silver at a greater rate than unexposed or insufficiently exposed grains.
DEVELOPING TIME (PT):	The elapsed time necessary for the applied developer to bring out indications from penetrant entrapments. Usually one-half the penetrant dwell time.
DEVELOPMENT (RT):	The conversion of a latent image into a visible image by treatment of the film emulsion with a suitable chemical solution (developer).
DEZINCIFICATION:	Corrosion of some copper-zinc alloys involving loss of zinc and formation of a spongy porous copper.
DIAMAGNETIC:	A material that has less magnetic permeability than a vacuum. Although diamagnetic materials have relative magnetic permeabilities slightly less than 1, the amount of difference is insignificant in eddy current testing and diamagnetic material are classified as nonmagnetic with a relative permeability of 1.
DICHROIC FOG (RT):	Fog caused by the deposition of a very thin layer of finely divided silver on an emulsion, which when examined in white light, appears in two colors, red by transmission and green by reflection.
DIE:	Various tools used to impart shape to material primarily because of the shape of the tool itself. Examples are blanking dies, cutting dies, drawing dies, forging dies, punching dies, and threading dies.
DIE CASTING:	(1) A casting made in a die. (2) A casting process where molten metal is forced under high pressure into the cavity of a metal mold.
DIE FORGING:	A forging whose shape is determined by impressions in specially prepared dies.
DIE LINES:	Lines or markings on formed, drawn or extruded metal parts caused by imperfections in the surface of the die.
DIFFERENTIAL COILS (ET):	Two or more coils electrically connected in series opposition such that any electromagnetic condition which is not common to the areas of the specimen being tested or the test specimen and the standard will produce an unbalance in the system and thereby be detected.
DIFFERENTIAL MOTTLING (RT):	Minor irregularities in the distribution of density over the whole of the radiograph.
DIFFERENTIAL SENSING:	A method of measuring eddy current response in which two coils are used to determine relative variations between two sections of material. These two sections may be two separate pieces of material (one a standard, the other the test material).
DIFFRACTION (RT):	The scattering of incident radiation from the regularly spaced atoms in crystals or complex molecules such that interference between the scattered waves results in a pattern of maxima and minima in the intensity of the scattered radiation.
DIFFRACTION (UT):	The deflection of a wave front when passing the edges of an obstacle.

T.O. 33B-1-1

DIFFRACTION MOTTLE (RT):	A superimposed mottle or pattern on an image due to diffraction of certain wavelengths in the incident beam, caused by tile size and orientation of the crystals of the material through which they have passed.
DIFFRACTION MOTTLING:	A diffuse diffraction pattern on a radiograph resulting from X-raying thin sections of crystalline material.
DIFFUSE INDICATIONS (MT):	Indications of some sub-surface indications that are broad, fuzzy, feathery and are not clearly defined.
DIFFUSE REFLECTION (UT):	Rough surface or associate interface reflection of ultrasonic waves from irregularities of the same order of magnitude or greater than the wavelength.
DIFFUSION:	(1) Spreading of a constituent in a gas, liquid or solid, tending to make the composition of all parts uniform. (2) The spontaneous movement of atoms or molecules to new sites within a material.
DIGGING:	A sudden erratic increase in cutting depth or in the load of a cutting tool caused by unstable conditions in the machine setup. Usually, the machine is stalled or either the tool or the workpiece is destroyed.
DIMENSIONAL STABILITY:	Refers to the ability of an alloy to remain unchanged in size or shape after aging.
DIMPLING:	(1) Stretching a relatively small, shallow indentation into sheet metal. (2) In aircraft, stretching metal into a conical flange for the use of a countersunk head rivet.
DIP RINSE (PT):	A means of removing excess penetrant in which the test parts are dipped into an agitated tank of water or remover.
DIRECT CURRENT:	Electric current flowing continuously in one direction through a conductor. Such current is frequently referred to as DC.
DIRECT FILM (RT):	See NON-SCREEN FILM.
DIRECTIONAL PROPERTIES:	Properties whose magnitude varies depending on the relation of the test axis to the specific direction within the metal. The variation results from preferred orientation or from fibering of constituents or inclusions.
DISCERNABLE IMAGE:	Image capable of being recognized by sight without the aid of magnification; corrected vision excepted.
DISCONTINUITY:	An interruption in the normal physical structure or configuration of a part such as cracks, laps, seams, inclusions, porosity. A discontinuity may or may not affect the usefulness of a part. See DEFECT.
DISINTEGRATION, NUCLEAR:	A spontaneous nuclear transformation (radioactivity) characterized by the emission of energy and/or mass from the nucleus.
DISLOCATION:	A linear defect in a crystal or lattice of a material. The two basic types are edge and screw.
DISPERSANT (PT):	A substance for promoting the formation and stabilization of dispersed particles of one substance in another.
DISPERSION, SOUND:	Scattering of rays of an ultrasonic beam as a result of reflection from a highly irregular incident surface above that normally associated with a particular transducer.
DISTANCE AMPLITUDE CORRECTION (UT):	Compensation for variance in amplitude from equal reflectors at different sound travel distances. The abbreviation is DAC. Also used to denote electronic change of amplification to provide equal amplitude from equal reflectors at different sound travel distances. Other designations for this electronic change of amplification are Swept Gain (SG), Time Corrected Gain (TCG), Time Variable Gain (TVG) and Sensitivity Time Control (STC).
DISTORTED FIELD (MT):	The direction of a magnetic field in a symmetrical object will be substantially uniform if produced by a uniformly applied magnetizing force, as in the case of a bar magnetized in a solenoid. But if the piece being magnetized is irregular in shape, the field is distorted and does not follow a straight path or have a uniform distribution.

DOSE OR RADIATION DOSE:	A generic term that means absorbed dose, dose equivalent, etc. And represents the total amount of radiation received during the applicable period of exposure.
DOSE EQUIVALENT:	The product of the absorbed dose in tissue, quality factor, and all other necessary modifying factors at the location of interest. The units of dose equivalent are the rem and Sievert (Sv).
DROSS:	The scum that forms on the surface of molten metals largely because of oxidation but sometimes because of the rising of impurities to the surface.
DRY DEVELOPER (PT):	A developer powder that is applied as a dust without a liquid carrier.
DRYING OVEN (PT):	An oven used for drying rinse water from test pieces.
DRYING TIME (PT):	The time during which a washed or wet-developed part is in the hot air drying oven.
DRY METHOD (MT):	Magnetic particle inspection in which the particles are applied in a dry powder form.
DRY POWDER (MT):	Finely divided ferromagnetic particles suitably selected and prepared for magnetic particle inspection. Colors employed are usually red, gray, yellow or black.
DUAL SEARCH UNIT (UT):	A single search unit containing two transducer elements; one used as a transmitter of ultrasonic energy, the other used as a receiver of ultrasonic energy.
DUCTILE CRACK PROPAGATION:	Slow crack propagation that is accompanied by noticeable plastic deformation and requires energy to be supplied from outside the body.
DUCTILITY:	The ability of a material to deform plastically without fracturing, being measured by elongation or reduction of area in a tensile test, by height of cupping in an Erichsen test or by other means.
DUPLITIZED FILM (RT):	Radiographic film that consists of a coating of photosensitivity emulsion on both sides of the tinted polyester base.
DWELL TIME (PT):	The period of time wherein the liquid penetrant remains on the surface of the part. For the immersion techniques, the period subsequent to soak and prior to wash, i.e., draining process is considered dwell time.
DYE:	The chemical component added to a penetrant vehicle to provide a characteristic color to the penetrant.
DYE PENETRANT:	Penetrant with dye added that makes it readily visible in light.
DYE STUFFS (MT, PT):	A natural or synthetic coloring matter whether soluble or insoluble that is used to color materials usually from a solution or fine dispersion and sometimes with the aid of a chemical (mordant) that serves to fix a dye in or on a substance.
DYNAMIC CREEP:	Creep that occurs under conditions of fluctuating load or fluctuating temperature.
DYNAMIC RANGE (UT):	The ratio of maximum to minimum reflective areas that can be distinguished on the cathode ray tube at a constant gain setting.

E

ECHO:	Signal of reflected ultrasonic energy.
EDDY CURRENTS:	Currents caused to flow in an electrical conductor by the time and/or space variation of an applied magnetic field.
EDDY CURRENT INSPECTION OR TESTING:	A nondestructive inspection method in which eddy current flow is induced in the test object. Changes in the flow caused by the variations in the specimen are reflected into a nearby coil or coils for subsequent analysis by suitable instrumentation and techniques.
EDDY-SONIC (UT, ET):	Describes a process in which sonic or ultra-sonic energy is produced in a test part by coil on or near the surface of the test part. The coil is used to produce eddy currents in the test part. Vibrations in the test part result from the interaction of the magnetic field from the eddy currents in the test part with the magnetic field of the coil.
EDGE EFFECT (ET):	The effect on the magnetic field caused by the geometric boundaries of the test specimen. The effect is large in magnitude and similar in phase to a large crack. Also called END EFFECT.

T.O. 33B-1-1

EFFECTIVE DEPTH OF PENETRATION:	The depth within a material, under test, where the transmitted or induced energy is sufficient to detect discontinuities (determine condition of interest). EDP is approximately equal to three times standard DOP.
EFFECTIVE FOCAL SPOT (RT):	An elongated, rectangular electron focus so angled that the focal spot size, as viewed along the X-ray beam axis, is smaller and approximately square, thereby permitting increased total area loading of the target for a given focal spot size.
ELASTIC AFTER-EFFECT:	A lagging elastic recovery, of minor proportions, following a decrease in or removal of the load.
ELASTIC CONSTANTS:	Modulus of elasticity, either in tension, compression or shear, and Poisson's ratio.
ELASTIC DEFORMATION:	Change of dimensions accompanying stress in the elastic range, original dimensions being restored upon release of stress.
ELASTIC LIMIT:	The maximum stress to which a material may be subjected without any permanent strain remaining upon complete release of stress.
ELASTICITY:	That property of a material by virtue of which it tends to recover its original size and shape after deformation.
ELECTRICAL NOISE:	Extraneous signals caused by externally radiated electrical signals or from electrical interferences within the ultrasonic instrumentation.
ELECTROCHEMICAL CORROSION:	Corrosion that occurs when current flows between cathodic and anodic area on metallic surfaces.
ELECTRODE SKID:	In spot, seam or projection welding, the sliding of an electrode along the surface of the work.
ELECTROGALVANIZING:	The process of electroplating zinc on iron or steel.
ELECTROMAGNET:	A soft iron core surrounded by a coil of wire. The iron core becomes magnetic when an electric current flows through the wire.
ELECTROMAGNETIC INSPECTION OR TESTING (ET):	A nondestructive test method for engineering materials including magnetic materials, which use electromagnetic energy having frequencies less than those of visible light to yield information regarding the quality of test material. This term includes both eddy current testing and magnetoinductive testing.
ELECTROMAGNETIC RADIATION (RT):	Radiation consisting of electric and magnetic waves that travel at the speed of light. Examples: light, radio waves, gamma rays, X-rays. All can be transmitted through a vacuum.
ELECTROMAGNETIC SPECTRUM:	The wavelength range of the various forms of electromagnetic radiation.
ELECTROMOTIVE FORCE (EMF):	The work or energy that causes the flow of an electric current. Expressed as volts. It should be noted that the term "force" is a misnomer. However, the term is so well established that its use continues in spite of its being incorrect.
ELECTRON:	One of the fundamental constituents of atoms. The electron is a very small negatively charged particle with a rest mass of approximately 1/1836 that of the hydrogen atom, or 9.107×10^{-28} gm. It has an electric charge of 4.802×10^{-10} statcoulomb (the electrostatic unit of charge). Electrons appear to be uniform in mass and charge.
ELECTRON CAPTURE (RT):	A mode of radioactive decay in which a bound electron is captured by the nucleus of the same atom, producing a vacancy in an inner emission of characteristic X-rays or auger electrons.
ELECTRON FOCUS (RT):	The surface of the intersection of the electron beam and the anode of the X-ray tube.
ELECTRON GUN (RT):	A device in which electrons (usually liberated from a hot filament) are focused and accelerated, and from which they are emitted as a narrow beam.
ELECTRON PAIR (RT):	An electron and a positron resulting from pair production.
ELECTRON RADIOGRAPHY (RT):	The process whereby a photographic image of an object is produced by electron radiation that has penetrated through the object.

ELECTRON VOLT:	A unit of energy commonly used to express the energy of X-rays. One electron volt is the energy gained by an electron when it is accelerated by a potential difference of 1 volt ($1 \text{ eV} = 1.60210 \times 10^{-19} \text{ joule - SI}$).
ELECTROPLATING:	Electrodepositing metal in an adherent method upon a metal object serving as a cathode. Examples would be nickel chromium and cadmium deposits. Thicknesses under 0.005 do not interfere with magnetic particle inspection.
ELECTROSTATIC SPRAYING (PT):	A technique of spraying wherein the material being sprayed is given a high electrical charge, while the test piece is grounded.
ELEMENT:	One of the 103 known chemical substances that cannot be divided into simpler substances by chemical means. Examples: hydrogen, lead, and uranium.
ELEMENTARY PARTICLE:	Originally a term applied to any particle that could not be further subdivided; now applied only to protons, electrons, neutrons, antiparticles, and strange particles, but not to alpha particles and deuterons.
ELONGATION:	In tensile testing, the increase in the gage length, measured after fracture of the specimen within the gage length, usually expressed as a percentage of the original gage length.
EMBRITTLEMENT:	Reduction in the normal ductility of a metal due to a physical or chemical change.
EMBRYO/FETUS:	The developing human organism, from conception until the time of birth.
EMISSIVITY:	The energy emission rate usually expressed as r/c/hr @ 1 ft or mR/mc/hr @ 1 ft.
EMULSIFICATION (PT):	The process of dispersing one liquid in a second immiscible liquid; the largest group of emulsifying agents are soaps, detergents, and other compounds, whose basic structure is a paraffin chain terminating in a polar group.
EMULSIFICATION TIME (PT):	The time allowed for the emulsifier to act on the penetrant before the part is washed, after emulsifier is applied as a separate step.
EMULSIFIER (PT):	A liquid agent that must be applied to the non-water washable penetrant after the proper dwell time has elapsed to permit water rinsing. This requires an additional step and a period of time must be allowed for the combining to occur. A suspension of one liquid phase in another.
EMULSIFIER-REMOVER (PT):	A type of solvent that can be rinsed off with water after it is applied or used as a solvent wipe remover.
EMULSIFICATION TIME (PT):	Time required for the emulsifying agent to combine with the penetrant. This is critical as insufficient time will result in failure to remove the penetrant and lead to false indications, and too long a time may remove the penetrant from the flaws. Emulsification time usually ranges from 30 seconds to 5 minutes.
EMULSION (RT):	The gelatinous substance in which fine grains of silver halides are dispersed. The emulsion is coated on a base, usually polyester, and contains the image forming substance of a radiographic film.
EMULSION FOG (RT):	The slight density in an unexposed area of the film due to a small number of silver bromide crystals developing spontaneously. Film speed and improper processing or storage will affect emulsion fog. Safelight, white light, or radiation fog is not considered part of emulsion fog.
ENCAPSULATION:	The process of sealing radioactive materials to prevent contamination.
ENCIRCLING COIL (MT, ET):	Coil(s) or coil assembly which surrounds the part to be tested. Coils of this type are also referred to as annular, circumferential, or feed-through coils.
END EFFECT (ET, MT):	The effect on the magnetic field caused by the geometric boundaries of the test specimen that makes it impractical to apply electromagnetic test methods to the associated regions of the test specimen; also called EDGE EFFECT.
ENDURANCE LIMIT:	A value used to measure the load-carrying ability of a metal subjected to infinitely repeated loading. It is determined from the S-N curve as the stress at which the curve becomes parallel to the N axis, i.e.; it projects to an infinite number of cycles of stress without failure.

T.O. 33B-1-1

ENDURANCE RATIO:	Same as FATIGUE RATIO.
ENERGY, RADIOGRAPHIC (RT):	The energy of X-radiation is generally expressed in multiples of the electron volt (1,000,000 eV = 1,000 KeV = 1 MeV).
EQUIAXED GRAIN STRUCTURE:	A structure in which the grains have approximately the same dimensions in all directions.
EQUI-OPAQUE SUBSTANCE (RT):	A material having radiation absorption similar to that of the specimen, applied along its edges or in its cavities in order to obtain homogeneous absorption and thereby avoid local overexposure of the film.
EQUIVALENT PENETRATOR SENSITIVITY (RT):	The thickness of penetrometer, expressed as a percentage of the part thickness, in which the 2T hole would be visible under the same radiographic conditions.
EROSION:	Destruction of metals or other materials by the abrasive action of moving fluids usually accelerated by the presence of solid particles or matter in suspension. When corrosion occurs simultaneously, the term erosion-corrosion is often used.
ET:	Symbol for eddy current method of nondestructive testing/inspection.
ETCH CRACKS:	Shallow cracks in hardened steel, containing high residual surface stresses, produced on etching in an embrittling acid.
ETCHING:	Subjecting the surface of a metal to preferential chemical or electrolytic attack in order to reveal structural details.
EUTECTIC ALLOY:	The composition in a binary alloy system that melts at the lowest temperature. More than one eutectic composition may occur in a given alloy system consisting of more than two metals.
EUTECTIC MELTING:	Melting of localized micro areas whose composition corresponds to that of the eutectic in the system.
EVALUATION:	The process of deciding as to the severity of the condition after the indication has been interpreted. Evaluation leads to the decision as to whether the part must be rejected, salvaged or may be accepted for use.
EXFOLIATION:	A type of corrosion that progresses approximately parallel to the outer surface of the metal, causing layers of the metal to be elevated by the formation of corrosion product.
EXPANDED SWEEP (UT):	An expansion of the horizontal sweep line or time axis on the viewing screen of the ultrasonic instrument. This permits, when used in conjunction with the sweep delay, to more closely scrutinize any portion of the pattern.
EXPOSURE (RT):	The product of the X-ray intensity as measured by filament current in milliamperes and time in seconds or minutes for X-rays, or the product of source strength in curies and time in seconds or minutes for gamma rays. The exposure factor determines the degree of film blackening as long as the reciprocity law is valid. See RECIPROCITY LAW and RECIPROCITY LAW FAILURE.
EXPOSURE CHART (RT):	A graph showing the relation between material thickness, kilovoltage, and exposure. It is only adequate for determining exposure time for a uniform thickness of material.
EXPOSURE DEVICE (RT):	A shield in the form of a package designed to contain and allow the controlled use of one or more sealed sources for the purpose of making radiographic exposures.
EXPOSURE FACTOR (RT):	A quantity that combines milliamperage or source strength, time, and distance. Numerically, the exposure factor is the product of milliamperage and time divided by distance squared for X-rays and the product of curies and time divided by distance squared for gamma rays.
EXPOSURE FOG (RT):	Fog caused by any unwanted exposure of a film to ionizing radiation or light, at any time between manufacture and final fixing.
EXPOSURE LATITUDE (RT):	The range of thickness of a specified material that corresponds to the range of useful film densities.
EXPOSURE METER (RT):	An instrument for measuring exposure (radiation quantity).

EXPOSURE RATE (RADIATION QUANTITY) (RT):	The exposure unit time. Special unit: roentgens per second.
EXPOSURE RATE METER (RT):	An instrument for measuring exposure rate (radiation quantity).
EXPOSURE TABLE (RT):	A table giving the radiographic exposures suitable for the different thicknesses of a specified material.
EXTERNAL DISCONTINUITIES:	Surface irregularities that cause density variations on a radiograph. These are observable with the naked eye.
EXTERNAL DOSE:	The portion of the dose equivalent received from radiation sources outside the body.
EXTREMITY:	means hand, elbow, and arm below the elbow; foot, knee, and leg below the knee.
EXTRUSION:	Conversion of a billet into lengths of uniform cross section by forcing the plastic metal through a die orifice of the desired cross-sectional outline.
EXTRUSION DEFECT:	A defect of flow in extruded products caused by the oxidized outer surface of the billet flowing into the center of the extrusion. It normally occurs in the last 10 to 20% of the extruded bar. Also called "pipe" or "core."
EXUDED (PT):	To ooze out slowly in small drops through openings; to flow slowly out.
EYE DOSE EQUIVALENT:	applies to the external exposure of the lens of the eye and is taken as the dose equivalent at a tissue depth of 0.3 centimeters (300-mg/ cm ²).

F

f:	Symbol for frequency.
FALSE INDICATIONS:	See NON-RELEVANT INDICATIONS.
FALSE INDICATIONS (MT):	An indication of magnetic particles on the part held by gravity or surface roughness. It is neither caused nor held in place by leakage field.
FAMILY CONCEPT (PT):	See SYSTEM CONCEPT. The term "Family Concept" has been changed to "System Concept" to comply with DOD standardization requirements. The two terms have the same meaning.
FAMILY (PT):	A family of materials refers to the entire series of materials supplied by one manufacturer, necessary to perform a specific type or process of inspection.
FAR FIELD (UT):	Sound beam zone in which equal reflectors give signals of exponentially decreasing amplitude with increasing distance; zone beyond the near field; also known as the FRAUNHOFER ZONE.
FAST FILM:	Radiographic film that has inherent graininess characteristics of a coarse nature intended to increase the relative film speed.
FATIGUE:	The progressive fracture of a material that begins at a defect and increases under repeated cycles of stress. Fatigue fractures are progressive, beginning as minute cracks that grow under the action of the fluctuating stress.
FATIGUE CRACKS:	See CRACKS, FATIGUE.
FATIGUE LIFE:	The number of cycles of stress than can be sustained prior to failure for a stated test condition.
FATIGUE LIMIT:	The maximum stress below which a material can presumably endure an infinite number of stress cycles. If the stress is not completely reversed, the value of the mean stress, the minimum stress or the stress ratio should be stated.
FATIGUE RATIO:	The ratio of the fatigue limit for cycles of reversed flexural stress to the tensile strength.
FATIGUE STRENGTH:	Maximum stress that a metal will withstand without failure for a specified number of cycles of stress.
FATIGUE STRENGTH REDUCTION FACTOR (Kf):	The ratio of the fatigue strength of a member or specimen with no stress concentration to the fatigue strength with stress concentration. Kf has no meaning unless the geometry, size and material of the member or specimen and stress range are stated.

T.O. 33B-1-1

FAYING SURFACE:	The surface of a piece of metal (or a member) in contact with another to which it is or is to be joined.
FBH:	Abbreviation for flat bottom hole.
FERRITE BANDING:	Parallel bands of free ferrite aligned in the direction of working. Sometimes referred to as ferrite streaks.
FERROMAGNETIC MATERIAL:	Materials that are strongly attracted by a magnetic field. Iron, steel, nickel, and cobalt are included in this category. Permeability is much greater than one, and is effected by the applied magnetic field. Such materials exhibit hysteresis behavior.
FERROUS METALS:	Containing iron, such as steel, stainless steel and cast iron.
FFD (RT):	Film focal distance; distance between film and tube target.
FIBER (FIBRE):	(1) The characteristic of wrought metal that indicates Directional Properties and is revealed by the etching of a longitudinal section or is manifested by the fibrous or woody appearance of a fracture. It is caused chiefly by the extension of the constituents of the metal, both metallic and nonmetallic, in the direction of working. (2) The pattern of preferred orientation of metal crystals after a given deformation process, usually wire-drawing.
FIBROUS FRACTURE:	A fracture where the surface is characterized by a dull gray or silky appearance. Contrast with crystalline fracture.
FIBROUS STRUCTURE:	(1) In forgings, a structure revealed as laminations, not necessarily detrimental, on an etched section or as a ropy appearance on a fracture. It is not to be confused with the "silky" or "ductile" fracture of a clean metal. (2) In wrought iron, a structure consisting of slag fibers embedded in ferrite. (3) In rolled steel plate stock, a uniform, fine-grained structure on a fractured surface, free of laminations or shale-type discontinuities. As contrasted with part (1) above, it is virtually synonymous with "silky" or "ductile" fracture.
FIELD, BIPOLAR (MT):	A longitudinal field within a part having two poles.
FIELD, CIRCULAR (MT):	The magnetic field surrounding any magnetic conductor or part resulting from the current being passed through a central conductor or the part.
FIELD COIL (ET):	The coil generating the magnetic field that produces eddy currents in the part being tested.
FIELD INDICATOR (MT):	A device for indicating the amount of magnetism in a part.
FIELD, LEAKAGE (MT):	The field that leaves or enters the surface of a part at a discontinuity or change in section configuration.
FIELD, LONGITUDINAL (MT):	A field created by a coil shot or cable wrap and in which the flux lines traverse the part essentially parallel with its longitudinal axis. A localized field, on the surface of a part, traversing from one leg of a yoke or probe to the other.
FIELD, MAGNETIC (MT):	The space within and surrounding a magnetized part or a conductor carrying current in which magnetic lines of force exists.
FIELD, RESIDUAL (MT):	The magnetism that remains in a piece of magnetizable material after the magnetizing force has been removed.
FIELD, RESULTANT (MT):	The magnetic field resulting when two or more magnetizing forces, operating in different directions, are applied to ferromagnetic materials.
FILAMENT (RT):	The source of electrons in a hot-cathode tube. It is usually a heated wire.
FILAMENT TRANSFORMER (RT):	A transformer supplying power to heat the filament of a hot-cathode. The primary and secondary windings must be sufficiently insulated to withstand the peak potential difference between the cathode and earth.
FILLED CRACK:	A crack-like discontinuity, open to the surface, but filled with some foreign material - oxide, grease, etc. - which tends to prevent penetrants from entering.
FILLET:	Radius imparted to the inside of two meeting surfaces.

FILL FACTOR (MT):	The square of the ratio of the diameter of a part to the diameter of one encircling coil(s). The square of the ratio of the internal coil diameter to the bore diameter for internal probes. The fill factor is a measure of coupling between the encircling or internal coil and the test object.
FILM BADGE (RT):	A piece of masked radiographic film worn in the form of a badge that is used to measure exposure. The amount of exposure is determined from the degree of film blackening.
FILM BASE (RT):	A flexible, transparent, or translucent material that is coated with a photosensitive emulsion.
FILM CLEARING TIME (RT):	See CLEARING TIME.
FILM CONTRAST (RT):	See CONTRAST, FILM.
FILM DENSITY (RT):	See DENSITY, FILM.
FILM GAMMA (RT):	Term used to describe the amplification factor of a radiographic film, equal to the absolute slope of the characteristic curve.
FILM GRAININESS (DIRECT X-RAY EXPOSURES) (RT):	The visual impression of irregularity of density, in areas where exposure is macroscopically uniform, due to the random spatial distribution of X-ray quanta absorbed in the film. In general, fast films exhibit greater graininess than slow films.
FILM HOLDER (RT):	A light-tight carrier for films and screens.
FILM ILLUMINATOR (RT):	A device incorporating a suitable source of illumination for viewing radiographs or other transparencies.
FILM LATITUDE (RT):	Latitude refers to the exposure range within which a satisfactory radiograph is produced. Films which have the widest latitude are those which have the lowest film gradient and therefore the lowest film contrast.
FILM PROCESSING (RT):	See PROCESSING, FILM.
FILM, RADIOGRAPHIC (RT):	A photographic film that is usually coated on both sides with an emulsion designed for use with X-rays and gamma rays.
FILM SPEED (RT):	A measure of the rate at which a film responds to a given amount of radiation. Slower films require a longer period of time to reach the same film density than a fast film under the same exposure conditions.
FILM UNSHARPNESS (RT):	See UNSHARPNESS.
FILM VIEWER (RT):	See FILM ILLUMINATOR.
FILTER (RT):	A layer of absorptive material which is placed in the beam of radiation for the purpose of absorbing rays of long wavelengths to control the quality of the radiograph.
FILTERS (UT, ET):	Filters are electrical circuits designed to eliminate various frequencies from a circuit output or input. Filter may be low pass (high frequencies suppressed), high pass (low frequencies suppressed) or band pass (frequencies outside a specified range suppressed).
FILTRATION:	See INHERENT FILTRATION.
FILTRATION (RT):	The use of a filter to alter the characteristics of a radiation beam.
FINE CRACK:	A discontinuity in a solid material with a very fine opening to the surface, but possessing length and depth greater than the width of this opening; usually depth is many times the width.
FINISH:	(1) Surface condition, quality or appearance of a metal. (2) Stock on a forging to be removed when finish machined.
FIRE SCALE:	Oxide subscale formed just under the surface of certain alloys when they are annealed in air.
FISH EYES:	Areas on a fractured steel surface having a characteristic white crystalline appearance.

T.O. 33B-1-1

FISSION:	The splitting of a heavy nucleus into two roughly equal parts (which are nuclei of lighter elements) accompanied by the release of a relatively large amount of energy and frequently one or more neutrons. Fission can occur spontaneously, but usually it is caused by the absorption of gamma rays, neutrons, or other particles.
FISSION PRODUCTS:	Nuclei formed by the fission of heavy elements. They are of medium atomic weight, and almost all are radioactive. Examples: strontium-90, cesium-137.
FISSIONABLE MATERIAL:	Any material readily fissioned by slow neutrons, for example, uranium-235 and plutonium-239.
FIT:	The amount of clearance or interference between mating parts.
FIXER (RT):	A chemical solution that removes unexposed silver halide crystals from film emulsion.
FIXING (RT):	The procedure used in film processing that removes all of the undeveloped silver salts of the emulsion from the surface of the film, thus leaving only the developed latent image.
FLAME HARDENING:	A method of hardening where the surface layer is heated by a high temperature torch and then quenched.
FLAKES:	Short discontinuous internal fissures in ferrous metals attributed to stresses produced by localized transformation and decreased solubility of hydrogen during cooling after hot working. In a fractured surface, flakes appear as bright silvery areas; on an etched surface they appear as short, discontinuous cracks. Also called "shatter cracks and snowflakes."
FLANGE:	The projecting annular rim around a cylinder that is used for strengthening, fastening, or positioning.
FLANGE RADIUS:	The radius formed at the junction of a flange and the wall of a casting.
FLASH:	(1) In forging, the excess metal forced between the upper and lower dies. (2) In die casting, the fin of metal that results from leakage between the mating die surfaces. (3) In resistance butt welding, a fin formed perpendicular to the direction of applied pressure.
FLASH LINE:	The line of location of flash formed around a forging.
FLASH MAGNETIZATION (MT):	Magnetization by a current flow of very brief duration.
FLASH POINT:	The lowest temperature at which a substance will decompose to a flammable gaseous mixture. The temperature at which the vapor air mixture first ignites is the flash point. This temperature can be determined by raising the temperature of the liquid in accordance with the pre-determined schedule, and periodically introducing a flame or other ignition means immediately above the surface.
FLASH TUBE (RT):	An X-ray tube designed for use in flash radiography.
FLASH X-RAY:	Term used to describe the technique in which a tube capable of producing very short (10 to 100 nanoseconds) high intensity pulses of radiation are used for special radiographic inspections.
FLAT BOTTOM HOLE (UT):	A type of reflector commonly used in reference standards. Abbreviation is FBH.
FLAW:	An imperfection in an item or material that may or may not be harmful. See DISCONTINUITY.
FLAW SENSITIVITY (RT):	See SENSITIVITY, DEFECT.
FLOW LINES:	A fiber pattern frequently observed in wrought metals, which indicates the manner in which the metal flows during deformation. The pattern is made more visible by acid etching.
FLOW STRESS:	The uniaxial true stress required to cause plastic deformation at a particular value of strain.

FLUORESCENT (RT):	The emission of electromagnetic radiation by a substance as the result of the absorption of electromagnetic or corpuscular radiation having greater unit energy than that of the fluorescent radiation. Fluorescence is characterized by the fact that it occurs only so long as the stimulus responsible for it is maintained. The characteristic X-radiation emitted, as a result of absorption of X-rays of higher frequency is a typical example of fluorescence. Property of emitting visible light as the result of and only during, the absorption of radiant energy from some other source (i.e., black light).
FLUORESCENT DYE PENETRANT (PT):	A highly penetrating liquid which fluoresces when subjected to ultra-violet or black light, used to produce luminous indications of surface flaws or discontinuities.
FLUORESCENT MAGNETIC PARTICLE INSPECTION (MT):	The inspection process employing magnetic materials which have been coated with a material that fluoresces when activated by light of suitable wavelength.
FLUORESCENT SCREEN (Salt Screen) (RT):	Intensifying screens composed of fluorescent all, such as calcium tungstate, which emit a visible blue-violet electromagnetic radiation when activated by the absorption of the primary rays, thereby reducing the exposure time.
FLUORESCENT SCREENS (RT):	Intensifying screens composed of fluorescent salts which emit a visible blue-violet electromagnetic radiation when activated by the absorption of the primary rays, thereby reducing the exposure time.
FLUOROGRAPHY (RT):	The use of photography to record fluoroscopic images on film.
FLUOROMETALLIC SCREEN (RT):	A screen consisting of a metal foil (usually lead) coated with a material that fluoresces when exposed to ionizing radiation. It combines the properties of the fluorescent and metal screen.
FLUOROSCOPY (RT):	The visual observation on a fluorescent screen of the image of an object that has been exposed to penetrating, ionizing radiation.
FLUX:	A fusible salt mixture or gas used to purify molten metal by removing suspended oxides or dissolved gas.
FLUX (NEUTRON):	The intensity of neutron radiation. It is expressed as the number of neutrons passing through I square centimeter in 1 second.
FLUX DENSITY (MT):	The number of magnetic flux lines per unit of area taken at right angles to the direction of magnetic field flow. This is a measure of field strength.
FLUX LINES (MT):	Also called lines of force, magnetism or induction. Imaginary lines used as means of explaining the distribution and potential of magnetic fields.
FLUX, MAGNETIC LEAKAGE:	See FIELD, LEAKAGE.
FLUX PENETRATION (MT):	The depth to which magnetic flux is effective in a part.
FOCAL-FILM DISTANCE (FFD) (RT):	The distance in inches between the focal spot of the X-ray tube, or gamma source, and the film.
FOCAL SPOT (RT):	The area on the target that receives the bombardment of electrons and emits the primary radiation necessary to produce an image of the object on a radiographic film. The spot at which the sound beam from a focused search unit converges to maximum intensity.
FOCUSED BEAM (UT):	Sound beam that converges to a focal spot.
FOCUSED TRANSDUCER (UT):	A transducer with a concave face which converges the acoustic beam to a focal point or line at a definite distance from the face. Also known as a focused search unit.
FOCUSING:	Concentration or convergence of energy into a small beam.
FOCUSING (RT):	Concentration or convergence of energy into a narrow beam.
FOD (RT):	Film object distance; distance from film to object being radiographed.
FOG (RT):	A general term used to denote any increase in the optical density of a processed film caused by anything other than the direct action of image-forming radiation.

T.O. 33B-1-1

FOG DENSITY (RT):	See FOG.
FOG THRESHOLD (RT):	The minimum uniform density inherent in a processed emulsion without prior exposure.
FOIL:	Metal in sheet from less than 0.006 inches in thickness.
FOLD:	See LAP.
FOREIGN MATERIALS:	They may appear as isolated, irregular, or elongated variations of film density not corresponding to variations in thickness of material or to cavities. May be sand, slag, oxide or dross, or metal of different density, included in the material being examined.
FORGING:	Working metal into a desired shape by hammer, upsetting, or pressing, either hot or cold, or by a combination of these processes.
FORGING CRACKS:	See CRACKS, FORGING.
FORGING RANGE:	Temperature range in which a metal can be forged successfully.
FORGING STRAIN:	Internal strains in the metal set up by the forging operation.
FORGE WELD:	Uniting metal by heat and pressure during forging.
FORMABILITY:	The relative ease with which a metal can be shaped through plastic deformation.
FORMING:	Making a change, with the exception of shearing or blanking, in the shape or contour of a metal part without intentionally altering the thickness.
FORWARD SCATTER:	Radiation scattered in approximately the same direction of the primary beam.
FOUNDRY:	A commercial establishment or building where metal castings are produced.
FRACTOGRAPHY:	Descriptive treatment of fracture, especially in metals, with specific reference to photographs of the fracture surface. Macrofractography involves photographs at low magnification; microfractography, at high magnification.
FRACTURE:	A break, rupture, or crack large enough to cause a full or partial partition of a casting.
FRACTURE STRESS:	(1) The maximum principal true stress at fracture. Usually refers to unnotched tensile specimens. (2) The (hypothetical) true stress which will cause fracture without further deformation at any given strain.
FRACTURE TEST:	Breaking a specimen and examining the fractured surface with the unaided eye or with a lowpower microscope to determine such things as composition, grain size, case depth, soundness, or presence of defects.
FRAGMENTATION:	The subdivision of a grain into small discrete crystallites outlined by a heavily deformed network or intersecting slip as a result of cold working. These small crystals or fragments differ from one another in orientation and tend to rotate to a stable orientation determined by the slip systems.
FRAUNHOFER ZONE (UT):	See FAR FIELD.
FREE CARBON:	The part of the total carbon in steel or cast iron that is present in the elemental form as graphite or temper carbon.
FREQUENCY:	Frequency in uniform circular motion or in any periodic motion is the number of revolutions or cycles completed in unit time. The International Systems of Units expresses frequency in Hertz (1 Hz = 1 cycle per second).
FREQUENCY (FUNDAMENTAL) (UT):	In resonance testing, the frequency at which the wavelength is twice the thickness of the examined material.
FREQUENCY (INSPECTION) (UT):	Effective peak ultra-sonic wave frequency used to inspect the test part.
FREQUENCY (PULSE REPETITION) (UT):	The number of pulses per second.
FRESNEL ZONE (UT):	See NEAR FIELD.
FRETTING (FRETTING CORROSION):	Action that results in surface damage, especially in a corrosive environment, when there is relative motion between solid surfaces in contact under pressure.

FRILLING (RT):	See SLOUGHING.
FULL-WAVE RECTIFIED SINGLE-PHASE AC:	This is rectified alternating current for which the rectifier is so connected that the reverse half of the cycle is “turned around,” and fed into the circuit flowing in the same direction as the first half of the cycle. This produces pulsating D.C., but with no interval between the pulses. Such current is also referred to as single-phase full-wave D.C. It is also known as unidirectional current, single phase.
FULL-WAVE RECTIFIED THREE-PHASE AC:	When three-phase alternating current is rectified the full-wave rectification system is used. The result is D.C. with very little pulsation - in fact only a ripple of varying voltage distinguishes it from straight D.C. It is also known as unidirectional current, three phase.
FURRING (MT):	Buildup or bristling of magnetic particles due to excessive magnetization of the component under examination resulting in a furry appearance.
FUSION:	The process by which two light nuclei combine to form a heavier nucleus.

G

GADOLINIUM-153:	A radioisotope of the element gadolinium.
GAIN:	See SENSITIVITY.
GALVANIC CORROSION:	Corrosion consisting of two dissimilar conductors in an electrolyte, or two similar conductors in dissimilar electrolytes.
GAMMA, FILM (RT):	See GRADIENT.
GAMMA INFINITY (RT):	The maximum gamma that can be achieved by prolonged development of a photographic film.
GAMMA RADIOGRAPHY (RT):	The process whereby a photographic image of an object is produced by gamma radiation that has penetrated through the object.
GAMMA RADIOGRAPHY SYSTEM (RT):	All components necessary to make radiographic exposures with gamma radiation, including the exposure device, source assembly, control, and other components associated with positioning the source such as source guide tubes, exposure head, and collimators, if used.
GAMMA-RAY SOURCE (RT):	A quantity of a radionuclide that emits gamma radiation suitable for radiography.
GAMMA-RAY SOURCE CONTAINER (RT):	See CONTAINER, GAMMA-RAY SOURCE.
GAMMA RAYS:	The electromagnetic radiation of high frequency or short wavelength emitted by the nucleus of an atom during a nuclear reaction. Gamma rays are undeflected by electric or magnetic fields. They are identified in nature and properties to X-rays of the same wavelength, and differ only in their manner of production.
GAS HOLES:	Blow holes, channels, or porosity produced by gas evolution, usually during solidification.
GAS HOLES (RT) (ON RADIOGRAPH):	Appear as round or elongated, smooth-edged dark spots, occurring individually, in clusters, or distributed throughout the casting.
GAS POROSITY:	Refers to porous sections in metal that appear as round or elongated dark spots corresponding to minute voids usually distributed through the entire casting.
GAS POROSITY (RT) (ON RADIOGRAPH):	Represented by round or elongated dark spots corresponding to minute voids usually distributed through the entire casting.
GATE (UT):	Electronic device to monitor signals in a selected segment of the distance trace on an A-scan display.
GAUSS:	This is the unit of flux density or induction. The strength of field induced in a ferromagnetic body is described as being so many Gauss. It is usually designated by the letter “B.” Numerically, one Gauss is one line of flux per square centimeter of area.
GEIGER COUNTER:	A radiation detection and measuring instrument. It contains a gas-filled tube that discharges electrically when ionizing radiation passes through it. Discharges are counted to measure the radiation’s intensity.

T.O. 33B-1-1

GENETIC EFFECTS OF RADIATION:	Effects that produce changes in those cells of organisms which give rise to egg or sperm cells and therefore affect offspring of the exposed individuals.
GEOMETRIC FACTORS (RT):	General term used to describe the factors in radiographic exposures that account for distortion and/or enlargement. Some of the more common geometric factors include focal spot size, specimen thickness, and source-to-film distance.
GEOMETRIC UNSHARPNESS (RT):	See UNSHARPNESS.
GHOST (UT):	An indication that has no direct relation to reflected pulses from discontinuities in the materials being tested.
GRADIENT (RT):	The slope of a characteristic curve at a specified density. Symbol: G. Note: The term "gamma" is used for the slope of the approximately straight portion of the curve.
GRAININESS (RT):	A film characteristic which consists of the grouping or clumping together of the countless small silver grains into relative large masses visible to the naked eye or with slight magnification.
GRAIN BOUNDARY:	An interface separating two grains when the orientation of the lattices changes from that of one grain to that of another. When the orientation change is very small, the boundary is sometimes referred to as subboundary.
GRAIN FLOW:	See FLOW LINES.
GRAINS:	Individual alloy crystals that form the structure of the metal.
GRAIN SIZE:	Size of the crystals in metal when compared with a standard. Usually referred to as being fine, medium or coarse.
GRAIN SIZE (RT):	The average size of the silver halide particles in a photographic emulsion.
GRAPHITIZATION:	Formation of graphite in iron or steel. Where graphite is formed during solidification, the phenomenon is called "primary graphitization"; where formed later by heat treatment, "secondary graphitization."
GRAY (Gy):	The SI unit of absorbed dose. One gray is equal to an absorbed dose of 1 Joule/kilogram (or 100 rads).
GRID (RT):	An assembly of strips of metal, opaque to X-rays, assembled edgewise and interleaved with material of low absorption, to be placed between the object and the screen or film, in order to reduce the effects of scattered radiation from the object.
GRID RATIO (RT):	The ratio of the depth of the opaque strips of a grid, measured in the direction of the primary beam, to the spacing between them.
GRINDING CRACKS:	See CRACKS, GRINDING.
GRINDING STRESS:	Residual stress, generated by grinding, in the surface layer of work. It may be tensile, compressive, or both.
GRIT BLAST:	See SANDBLAST.
GROSS POROSITY:	In weld metal or in a casting, pores, gas holes or globular voids that are larger and in greater number than obtained in good practice.

H

H AND D CURVE (RT):	See CHARACTERISTIC CURVE.
HAIRLINE SEAM:	See SEAM.
HALATION (RT):	The fogging of a film emulsion due to reflection and dispersion of the radiation within the emulsion. This is generally apparent at locations of heavy exposure.
HALF-LIFE (RT):	The time in which half the atoms in a radioactive substance disintegrate. Half-lives vary from millionths of a second to billions of years.
HALF-LIFE (BIOLOGICAL):	The time required for a biological system, such as a man or an animal, to eliminate, by natural processes, half the amount of a substance that has entered it.

HALF-VALUE LAYER (RT):	The thickness of a material that transmits 50 percent of the radiation incident upon it. In exponential attenuation, the half-value layer is related to the linear attenuation coefficient and the mean free path.
HALF-VALUE PERIOD (RT):	See HALF-LIFE.
HALF-WAVE RECTIFIED AC (MT):	Alternating current which passes through a rectifier in such a manner that the reversing half of the cycle (negative) is blocked out completely. It is pulsating unidirectional current. It differs from full-wave.
HALL DEVICE (MT):	An element composed generally of a semiconductor material which exhibits a relatively large output voltage across the edges of the element in a directional mutually perpendicular to current flowing through the material and a magnetic field at right angles to the current flow.
HALL EFFECT (MT):	The phenomenon wherein a voltage is generated across the opposite edges of an electrical conductor carrying current and placed in a magnetic field. The generated voltage differential is mutually perpendicular to the direction of current flow and the applied magnetic field.
HAMMER FORGING:	Forging in which the work is deformed by repeated blows. Compare with press forging.
HARDENABILITY:	In a ferrous alloy, the property that determines the depth and distribution of hardness induced by quenching.
HARDENER (RT):	An agent incorporated into the fixer solution to harden the emulsion during the fixing process. The acid hardener prevents the swelling of the emulsion and facilitates the drying process.
HARDENING:	Heating metal to within its critical range as in annealing, followed by rapid cooling as in quenching.
HARD FACING:	Depositing filler metal on a surface by welding, spraying or braze welding, for the purpose of resisting abrasion, erosion, wear, galling and impact.
HARDNESS:	Resistance of metal to plastic deformation, usually by indentation. However, the term may also refer to stiffness or temper or to resistance to scratching, abrasion or cutting.
HARDNESS TESTING:	By means of instruments such as Brinell, Rockwell, Scleroscope, Vickers, etc.
HARD RADIATION (RT):	A term used to describe qualitatively the more penetrating types of radiation.
HARDWARE FINISH:	Refers to an especially smooth, as cast, surface which requires a minimum of preparation for plating.
“HARD” X-RAYS:	A term used to express the quality or penetrating power of X radiation. Hard X-rays are very penetrating.
HARMONICS (UT):	Those vibrations that are integral multiples of the fundamental frequency; used in resonance testing.
HASH:	Numerous, small indications appearing on the viewing screen of the ultrasonic instrument indicative of many small inhomogeneities in the material and/or background noise; also known as grass.
HEADING:	Upsetting wire, rod or bar stock in dies to form parts having some of the cross-sectional area larger than the original. Examples are bolts, rivets, and screws.
HEADS:	The clamping contacts on a stationary magnetizing unit.
H & D CURVE (HURTER AND DRIFFIELD) (RT):	See CHARACTERISTIC CURVE.
HEADSHOT (MT):	A term used colloquially to designate the magnetizing current passing through a part or a central conductor while clamped between the head contacts of a stationary magnetizing unit for the purpose of circular magnetization.
HEALTH PHYSICS:	A term in common use for that branch of radiological science dealing with the protection of personnel from harmful effects of ionizing radiation.

T.O. 33B-1-1

HEAT (MELT) OF METAL:	A quantity of metal manufactured from one melt.
HEAT-AFFECTED ZONE:	That portion of the base metal which was not melted during brazing, cutting or welding, but whose microstructure and physical properties were altered by the heat.
HEAT CHECK:	A pattern of parallel surface cracks that are formed by alternate rapid heating and cooling of the extreme surface metal, sometimes found on forging dies and piercing punches. There may be two sets of parallel cracks, one set perpendicular to the other.
HEAT CHECKING:	The crazing of a die surface, especially when the die is subjected to alternate heating and cooling by molten metal; the resulting fine cracks produce corresponding veins on castings.
HEAT TINTING:	Coloration of a metal surface through oxidation by heating to reveal details of the microstructure.
HEAT TREAT:	Heating and cooling of a metal or alloy in the solid state for the purpose of obtaining certain desirable conditions or properties.
HEAT TREAT CRACKS:	See CRACKS, QUENCHING.
HEAT TREATMENT:	Exposure of a metal to predetermined temperatures beyond the range of normal atmospheric conditions for a specific time to obtain a specific range of mechanical properties.
HERTZ:	One cycle per second; a unit for frequency. Abbreviation is Hz.
HETEROGENEOUS RADIATION (RT):	Radiation consisting of particles or photons that have a broad spectrum of energies.
HIGH-CONDUCTIVITY COPPER:	Copper that, in the annealed condition, has a minimum electrical conductivity of 100% IACS as determined in accordance with ASTM methods of test.
HIGH RADIATION AREA:	Means an area, accessible to individuals, in which radiation levels could result in an individual receiving a dose equivalent in excess of 0.1 rem (1 mSv) in 1 hour at 30 centimeters from the radiation source or from any surface that the radiation penetrates.
HOMOGENIZING:	Holding at high temperature to eliminate or decrease chemical segregation by diffusion.
HOMOGENIZING TREATMENT:	A heat treatment of an alloy intended to make it uniform in composition by eliminating coring and concentration gradients.
HOODED ANODE (RT):	A type of anode, in medium or high voltage X-ray tubes, in which the target is recessed in a metal hood that intercepts electrons. The hood may also incorporate a filter to absorb unwanted radiation.
HORIZONTAL LINEARITY (UT):	Constant relationship between the incremental horizontal displacement of vertical indications on an A-scan presentation and the incremental time required for reflected waves to pass through a known length in a uniform transmission medium.
HORSESHOE MAGNET:	A bar magnet, bent into the shape of a horseshoe so that the two poles are adjacent. Usually the term applies to a permanent magnet.
HOT-CATHODE TUBE (RT):	An X-ray tube in which the cathode is electrically heated to provide electrons.
HOT CELL:	A heavily shielded enclosure in which radioactive materials can be handled remotely through the use of manipulators and viewed through shielded windows so that there is no danger to personnel.
HOT CRACKS:	See CRACKS, HOT.
HOT FORMING:	Working operations, such as bending, drawing, forging, piercing, pressing and heading performed above the recrystallization temperature of the metal.
HOT SHORTNESS:	Brittleness in metal in the hot forming range.
HOT SPOT:	The point of retarded solidification caused by an increased mass of metal at the juncture of two sections. It frequently results in shrinkage and inferior mechanical properties at this location.

HOT TEAR:	A fracture formed in a metal during solidification because of hindered contraction. Usually on the surface of the part.
HOT WORKING:	Deforming metal plastically at such a temperature and rate that strain hardening does not occur. The low limit of temperature is the recrystallization temperature.
HYDROGEN EMBRITTLEMENT:	A condition of low ductility in metals resulting from the absorption of hydrogen.
HYDROMETER:	An instrument used to determine specific gravity and hence the strength. It consists of a sealed, graduated tube, weighted at one end, that sinks in a fluid to a depth used as a measure of the fluid's specific gravity.
HYDROPHILIC (PT):	Having an affinity for, attracting, adsorbing, or absorbing water. A substance soluble in water.
HYDROPHILIC REMOVER (PT):	A water compatible remover used with standard penetrants. Provides for improved control of the emulsification step process. It requires different processing steps than the standard Lipophilic emulsifiers.
HYSTERESIS (MT):	A retardation or lagging of the magnetic effect when the magnetizing forces acting upon a ferromagnetic body are changed.
Hz:	Abbreviation for hertz.
I	
IACS (ET):	International Annealed Copper Standard is an international standard of electrical conductivity. It is based on a high purity grade of copper designated as 100 percent.
ICICLES (BURN THROUGH):	A coalescence of metal beyond the root of the weld.
IIW:	Abbreviation for International Institute of Welding.
IIW BLOCK:	Specific type of reference standard used for angle beam, straight beam, and surface wave methods. See IIW.
IMAGE AMPLIFIER (RT):	A device that enhances a radiographic image for the purpose of decreasing interpretation time or increasing image detail.
IMAGE CONTRAST (RT):	See CONTRAST, FILM.
IMAGE DEFINITION (RT):	See DEFINITION, RADIOGRAPHIC.
IMAGE INTENSIFIER (RT):	A device used in fluoroscopy to produce an image brighter than that, which would be produced by the unaided action of the X-ray beam on a fluorescent screen.
IMAGE QUALITY INDICATOR (IQI) (PENETRAMETER) (RT):	A device used to determine from the appearance of its image in a radiograph, the overall quality of that radiograph. It is not intended for use in judging size nor establishing acceptance limits for discontinuities.
IMAGE QUALITY LEVEL (RT):	See RADIOGRAPHIC QUALITY LEVEL.
IMMERSION METHOD (UT):	The inspection method in which the search unit and the test part are submerged in a fluid, usually water, which acts as the coupling medium.
IMMISCIBLE (PT):	Pertaining to liquids that will not mix with each other.
IMPACT ENERGY (IMPACT VALUE):	The amount of energy required to fracture a material, usually measured by means of an Izod or Charpy test.
IMPACT STRENGTH:	The ability to resist shock, as measured by an impact testing machine.
IMPACT TEST:	A test to determine the behavior of materials when subjected to high rates of loading, usually in bending, tension or torsion. The quantity measured is the energy absorbed in breaking the specimen by a single blow, as in the Charpy or Izod tests.
IMPEDANCE:	This term is used to refer to the total opposition to the flow of current represented by the combined effect of resistance, inductance and capacitance of a circuit.

T.O. 33B-1-1

IMPEDANCE (ACOUSTIC):	Resistance to flow of ultrasonic energy in a medium. Impedance is a product of particle velocity and material density.
IMPEDANCE PLANE DIAGRAM:	A graphical representation of the locus of points indicating the variations in the impedance of a test coil as a function of basic test parameters such as electrical conductivity, magnetic permeability, test frequency, thickness and magnetic coupling.
IMPEDANCE TESTING:	A term generally applied to eddy current testing which measures the overall change in impedance caused by variations in electromagnetic properties as differentiated from phase analysis testing which measures changes in phase.
IMPURITIES:	Elements or compounds whose presence in a material is undesired.
INCLUSION:	Particles of impurities, usually oxides, sulphides, silicates, and such, which are retained in the metal during solidification or which are formed by subsequent reaction of the solid metal.
INCOMPLETE FUSION:	Fusion that is less than complete. Failure of weld metal to fuse completely with the base metal or preceding bead.
INCOMPLETE JOINT PENETRATION (LACK OF FUSION):	Appears as elongated darkened lines of varying length and width that may occur in any part of the welding groove.
INCOMPLETE PENETRATION:	Root penetration that is less than complete or failure of a root pass and a backing pass to fuse with each other.
INDENTATION:	In a spot, seam or projection weld, the depression on the exterior surface of the base metal.
INDENTATION HARDNESS:	The resistance of a material to indentation. This is the usual type of hardness test, in which a pointed or rounded indenter is pressed into a surface under a substantially static load.
INDICATION:	In nondestructive inspection, a response or evidence of a response, that requires interpretation to determine its significance.
INDICATION (MT):	This term refers to any magnetically held magnetic particle pattern on the surface of a part being tested.
INDICATION (PT):	The visible evidence of penetrant which has come out of a discontinuity, indicating to the inspector that some sort of surface opening is present.
INDICATION (UT):	The signal displayed on the ultrasonic equipment.
INDIVIDUAL MONITORING DEVICES:	Devices designed to be worn by a single individual for assessment of dose equivalents. Although they may include film badges, thermoluminescent dosimeters (TLDs), pocket ionization chambers and personal air sampling devices, their use within the Army is usually limited to TLDs.
INDUCED CURRENT MAGNETIZATION (MT):	A special technique used to establish a circular field for the detection of circumferential discontinuities in ring-shaped parts without making direct contact with the surface of the part. Sometimes referenced as Induced Field.
INDUCED RADIOACTIVITY:	Radioactivity that is created by bombarding a substance with neutrons in a reactor or with charged particles produced by particle accelerators.
INDUCED RADIOACTIVITY (RT):	Radioactivity resulting from irradiation of matter.
INDUCTANCE:	A property of a circuit that opposes any change in the existing current. Inductance is present only when the current is changing. A coil is a source of inductance.
INDUCTION:	Magnetic induction is the magnetism induced in a ferromagnetic body by some outside magnetizing force.
INDUCTION HARDENING:	Quench hardening in which the heat is generated by electrical induction.

INDUCTIVE REACTANCE:	This is the opposition, independent of resistance, of a coil to the flow of an alternating current.
INDUSTRIAL RADIOLOGY (RT):	That branch of radiology covering industrial applications of ionizing radiation.
INGATE:	Same as GATE.
INGOT:	A casting suitable for working or remelting.
INHERENT DEFECTS:	Defects introduced into steel at the time it originally solidifies from the molten state.
INHERENT FILTRATION (RT):	The filtration exhibited by the walls and other materials of a radiation source through which the radiation must pass before it is utilized. Inherent filtration affects the spectral distribution of the radiation, and thus, the quality of the final radiograph.
INHERENT UNSHARPNESS (RT):	See UNSHARPNESS.
INHIBITOR:	A substance that retards some specific chemical reaction such as rusting.
INITIAL PULSE (UT):	Electrical pulse generated by the ultrasonic instrument; used to excite a search unit in order to produce ultrasonic energy. Sometimes called the main bang.
IN-MOTION RADIOGRAPHY:	A method in which either the object being radiographed or the source of radiation is in motion during the exposure.
IRRELEVANT INDICATION:	See GHOST.
INSPECTION:	Process of examining for possible defects or for deviation from established standards.
INSPECTION (MT):	Visually observing, or looking at the surface of a part after it has been magnetized and magnetic particles applied to assure that the part is free of discontinuities.
INTENSIFYING SCREEN (RT):	A layer of material that, when placed in contact with a photographic film, improves the efficiency of the photographic action of ionizing radiation on the film emulsion. The increased rate of absorption of radiation energy by the emulsion enables reduction of exposure time.
INTENSITY, RADIATION (RT):	The amount of energy passing per unit time per unit area at a point in a beam of radiation, the area being perpendicular to the direction of propagation.
INTERACTION (RT):	Any process in which all or part of the energy of incident radiation is transferred to the electrons or nuclei of the atoms that constitute matter, or in which only the direction of the incident particle is altered.
INTERFACE:	The physical boundary between two adjacent surfaces.
INTERGRANULAR CORROSION:	Corrosion occurring preferentially at grain boundaries.
INTERLOCK (RT):	A device for precluding access to an area of radiation hazard either by preventing entry or by automatically removing the hazard.
INTERMEDIATE LAYER METHOD (ET):	A method of liftoff compensation where the same eddy current indication is obtained from bare metal and at a predetermined distance from the bare metal using a nonconductive shim (intermediate layer).
INTERNAL COIL (ET):	A coil wound upon a bobbin and having a cross-sectional configuration close to that of the internal bore or passage of the test object.
INTERNAL CONVERSION (RT):	The transfer of nuclear energy directly to a bound electron in the same atom, which causes the electron to be ejected from the atom. Subsequent filling of the vacancy thus created results in the emission of characteristic X-rays or auger electrons.
INTERNAL STRESSES:	Unseen forces existing within a part. These are forces that exist without the part being subjected to a working load.
INTERPRETATION (Evaluation):	The determination of the cause of an indication or the evaluation of the significance of discontinuities from the standpoint of whether they are detrimental defects or superficial blemishes.

T.O. 33B-1-1

INTERPRETATION (MT):	The determination of what condition in the part has caused the magnetic particle pattern.
INTERSTITIAL SOLID SOLUTION:	An alloy in which small atoms of alloying elements including carbon, nitrogen or hydrogen assume positions between the lattice sites normally occupied by the base metal.
INVERSE SQUARE LAW (RT):	At constant kilovoltage or source strength, the intensity of the radiation reaching the object is governed by the distance between the focal spot or radioactive source and the object, varying inversely with the square of the distance.
INVERSE VOLTAGE (RT):	A voltage that may appear across an X-ray tube or rectifier during one half-cycle of an alternating current and that reverses the polarity of the electrodes relative to the previous half-cycle.
INVESTMENT CASTING:	(1) Casting metal into a mold produced by surrounding (investing) in expendable pattern with a refractory slurry that sets at room temperature after which the wax, plastic or frozen mercury pattern is removed through the use of heat. Also called precision casting or lost-wax process. (2) A casting made by the process.
ION (RT):	An ion is an atom or group of atoms that is not electrically neutral but instead carries a positive or negative electric charge. Positive ions are formed when neutral atoms or molecules lose valence electrons; negative ions are those which have gained electrons.
ION PAIR (RT):	A positive ion and a negative ion or electron having charges of the same magnitude, and formed simultaneously from a neutral atom or molecule with energy supplied by radiation or any other suitable source.
ION PAIRS:	A positive ion and a negative ion or electron having charges of the same magnitude, and formed from a neutral atom or molecule by the action of radiation or by any other agency that supplies energy.
ION SOURCE (ION GUN) (RT):	A device by which gaseous ions are produced, focused, and accelerated, and are emitted as a narrow beam.
IONIC (RT, PT):	Relating to, existing in the form of, or characterized by ions.
IONIZATION:	The process of adding electrons to, or knocking electrons from, atoms or molecules, thereby creating ions. High temperatures, electrical discharges, and nuclear radiation can cause ionization.
IONIZATION CHAMBER:	An instrument that detects and measures ionizing radiation by observing the electrical current created when radiation ionizes gas in the chamber, making it a conductor of electricity.
IONIZING RADIATION:	Any radiation that directly or indirectly displaces electrons from the outer domains of atoms. Examples: alpha, beta, and gamma radiation.
IQI SENSITIVITY (RT):	The sensitivity (quality level) of a radiographic process, as determined by the use of an image quality indicator (IQI). Properly called radiographic sensitivity.
IRIDIUM-192:	A radioactive isotope of the element Iridium that has a half life of 75 days. It is used extensively as a source of gamma radiation.
IRRADIATION:	Exposure to radiation, as in a nuclear reactor.
ISOMER:	One or two or more nuclides having the same atomic number, but existing for measurable time intervals in different quantum states, with different energies and radioactive properties.
ISOMER (RT):	One of two or more nuclides that are both isotopes (same atomic number) and isobars (same mass number) of each other, but which have some measurably different physical property, such as half life.
ISOMERIC TRANSITION (RT):	The transition of an isomer to a lower energy state. It is accompanied by the emission of gamma radiation that may be internally converted.

ISOTOPE (RT):	One of several nuclides having the same number of protons in their nuclei, and hence belonging to the same element, but differing in the number of neutrons, and therefore in mass number. Small quantitative differences in chemical properties exist between elements and isotopes. Isotopes may or may not be unstable. Unstable isotopes undergo transitions to other isotopes or elements with a loss of energy. Such energy is usually given off in the form of electromagnetic or particle radiation. Isotopes are used as source of radiation for radiography.
ISOTROPY:	Quality of having identical properties in all directions.
ITEMS:	An item is one of the compounds necessary to make up a family of penetrant materials. For example: penetrant, emulsifier, remover, or developer.
IZOD TEST:	A pendulum-type of single-blow impact test in which the specimen, usually notched is fixed at one end and broken by a falling pendulum. The energy absorbed, as measured by the subsequent rise of the pendulum, is a measure of impact strength or notch toughness.

J

JIG:	A fixture or template employed to insure exact location of one part in relation to another.
JOINT EFFICIENCY:	The strength of a welded joint expressed as a percentage of the strength of the unwelded base metal.
JOINT PENETRATION:	The distance weld metal and fusion extend into a joint.

K

K-ELECTRON CAPTURE:	Electron captured by a nucleus of an electron from the "K" or innermost shell of electrons surrounding it. Also loosely used to designate any orbital electron captured.
KEY SWITCH (RT):	A device that requires a Key for making and breaking electrical connections.
KHz:	Abbreviation for kilohertz.
KILLED STEEL:	Steel deoxidized with a strong deoxidizing agent such as silicon or aluminum in order to reduce the oxygen content to such a level that no reaction occurs between carbon and oxygen during solidification.
KILOHERTZ:	Unit of frequency equal to 1,000 Hz. Abbreviation is kHz.
KILOVOLT:	Unit of electromotive force or potential equal to 1,000 volts.
KILOVOLT PEAK:	The crest value of electromotive force or potential, in kilovolts, of a pulsating source of electric potential.

L

L_o :	Symbol for near field length.
LACK OF FUSION:	Two-dimensional defect due to lack of union between weld metal and parent metal..A casting made in a mold (sand, plaster, or permanent mold) which rotates while the metal solidifies under the pressure developed by centrifugal force.
LAMB WAVE (UT):	A complex type of ultrasonic wave propagated in metal sheets up to a few wavelengths thick. Their propagation characteristics are dependent upon the properties of the material and its thickness, along with the frequency of the incident wave. These vibrations occur throughout the thickness of the material and consist of two basic types, symmetrical and asymmetrical. Each of these types may have an infinite number of modes, which are determined, by the wave's incident angle. They can be very effective for detecting laminar discontinuities, but, because of their complexity, practical application can be difficult.
LAMBDA (λ):	Symbol for wavelength; the eleventh letter of the Greek alphabet.
LAMINATE:	(1) A composite metal, usually in the form of sheet or bar, composed of two or more metal layers so bonded that the composite metal forms a structural member. (2) To form a metallic product of two or more bonded layers.
LAMINATIONS:	Discontinuities in plate, sheet or strip caused by pipe, inclusions, or blowholes in the original ingot; after rolling they are usually flat and parallel to the outside surface.

T.O. 33B-1-1

LAMINOGRAPHY:	A special form of tomography which is used for limiting an inspection to a single plane in the material; images of the condition along the plane of interest are brought into sharp focus while other images are smeared or blurred.
LAP:	A surface defect, appearing as a seam, caused by folding over hot metal, fins or sharp corners and then rolling or forging them into the surface, but not welding them.
LATENT IMAGE (RT):	The metallic silver image of the material radiographed brought out by the developing process.
LATITUDE (RT):	Latitude, most closely aligned with contrast, is the range of thickness that can be transferred or recorded on a radiograph within the useful reading range of film density. A high contrast has little latitude whereas a low contrast film will have great latitude.
LATTICE:	The repetitive three-dimensional arrangement of atoms in a solid.
LAW:	Liquid Active Waste.
LAW OF RECIPROCITY,	PHOTOGRAPHIC (RT): See RECIPROCITY LAW.
LD (RT):	See MEDIAN LETHAL DOSE.
LEAD EQUIVALENT (RT):	The thickness of lead affording the same attenuation of radiation under specified conditions, as the material in question.
LEAD GLASS (RT):	Glass containing a high proportion of lead compounds, used as a transparent shielding material.
LEAD RUBBER (RT):	Rubber containing a high proportion of lead compounds. It is used as a flexible shielding material.
LEAD-RUBBER GLOVES (PROTECTIVE GLOVES) (RT):	Gloves incorporating lead rubber as a shielding material.
LEAD SCREENS:	See SCREENS, LEAD.
LEAK:	A hole or void in the wall of an enclosure, capable of passing liquid or gas from one side to the other under action of a pressure or concentration difference existing across the wall.
LEAKAGE (RT):	The undesired release of radioactive material from a sealed source.
LEAKAGE FIELD:	See FIELD, LEAKAGE.
LEAKAGE RADIATION (RT):	Radiation other than the useful beam emitted from an X-ray tube assembly or source housing.
LEAKAGE RATE:	The quantity of gas per unit time at a given temperature and pressure, that flows through a leak or leaks; normally expressed in standard cubic centimeters per second (STD. cm ³ /s).
LEAK TEST (RT):	A method capable of detecting the leakage of radioactive material from a sealed source.
LEAK TESTING (PT):	Method of applying penetrant to one surface and developer to the opposite side of a structure to detect flaws that extend entirely through the structure.
LEAKER-PENETRANT:	The type of penetrant especially designed for leak detection.
LENGTH/DIAMETER RATIO (MT):	A ratio of the length and diameter of a part for the purpose of calculating the amperes required for longitudinal magnetization.
LICENSED MATERIAL:	Source material, special nuclear material, or by-product material received, possessed, used, or transferred under a general or special license issued by the Atomic Energy Commission.
LICENSED MATERIAL (RT):	Source material, special nuclear material, or byproduct material received, possessed, used, or transferred under a general or special license issued by the Nuclear Regulatory Commission or an Agreement State.
LIFT-OFF (ET):	A measure of the gap between the face of a surface probe and the surface being inspected. It is a measure of the coupling between the probe and the material being inspected.

LIFT-OFF COMPENSATION (LIFT-OFF ADJUSTMENT) (ET):	Procedures for instrument adjustments whereby impedance variations caused by a variable gap between an eddy current surface and the test part are suppressed. This adjustment is designed to provide a better signal-to-noise ratio for eddy current inspection.
LIFT-OFF EFFECT (ET):	The effect observed in the test system output due to a change in magnetic coupling between a test specimen and a probe coil whenever the distance of separation between them is varied.
LIGHT METAL:	One of the low-density metals such as aluminum, magnesium, titanium, beryllium or their alloys.
LIGHT METER (MT, PT):	A device used to measure the light intensity of a black light in foot candles or micro-watts per square centimeter, whichever is appropriate.
LIMIT FREQUENCY:	A mathematically derived frequency value used to establish impedance diagrams.
LINDEMANN GLASS (RT):	Glass of low X-ray absorption containing lithium, boron and beryllium.
LINEAR ABSORPTION COEFFICIENT:	See ABSORPTION COEFFICIENT, LINEAR.
LINEAR ACCELERATOR:	An apparatus used to accelerate electrons to high velocities by means of a high frequency electrical wave traveling along a tube in the linear direction of the electron beam.
LINEAR DISCONTINUITIES:	Ragged lines of variable width. May appear as a single jagged line or exist in groups. They may or may not have a definite line of continuity.
LINEAR ENERGY TRANSFER (LET) (RT):	The energy lost by a charged particle per unit distance of material traversed. It can be expressed as electron volts per meter, or some convenient multiple or submultiple, such as KeV per millimeter.
LINEAR INDICATIONS:	An indication having length three or more times its width.
LINEARITY:	See VERTICAL LINEARITY and HORIZONTAL LINEARITY.
LINE FOCUS (RT):	See EFFECTIVE FOCAL SPOT.
LINE FOCUS PRINCIPLE (RT):	The process of making the angle between the anode face and the central ray such that the effective focal spot is small in relation to the actual spot size.
LINE-FOCUS TUBE (RT):	An X-ray tube in which the electron focus is approximately a rectangle and the focal spot size is approximately a square.
LINES OF FORCE (MT):	Imaginary lines used to visualize the magnetic field.
LIMITS (dose limits):	The permissible upper bounds of radiation doses.
LIPOPHILIC (PT):	An oil based liquid used in penetrant inspection to make penetrant oil water-washable.
LIQUID VEHICLE (MT):	The liquid in which the magnetic particles are suspended to facilitate their application.
LOCALIZING CONE (COLLIMATING CONE) (RT):	A cone that limits the divergence of a beam of radiation.
LONGITUDINAL MAGNETIZATION (MT):	Magnetization of a material in such a way that the magnetic lines of force are essentially parallel to the test parts longitudinal axis.
LONGITUDINAL WAVE (UT):	A type of wave in which the particle motion of the material is essentially in the same direction as the wave propagation.
LOSS OF BACK REFLECTION (UT):	Absence of an indication of the far surface of the article being inspected.
LUDERS' LINES:	Lines that are produced on the surface of low carbon steel by deforming the metal just past the yield point.
LUMEN (PT, MT):	A measure of the brightness of light. A unit of luminous flux equal to the light emitted in a unit solid angle by uniform point source of one candle.
LUMINESCENCE (RT):	A phenomenon in which the absorption of radiation by a substance gives rise to the emission of light characteristic of the substance.

T.O. 33B-1-1**M**

MACHINEABILITY:	Refers to the ease and speed with which a metal may be cut (with free chip removal) to produce a reasonably smooth surface.
MACHINED SURFACE:	The metal surface left by the cutting tool.
MACHINING:	Removing material, in the form of chips, from work, usually through the use of a machine.
MACHINING STRESS:	Residual stress caused by machining.
MACRO-ETCH:	Etching of a metal surface for accentuation of gross structural details and defects for observation by the unaided eye or at magnifications not exceeding ten diameters.
MACROGRAPH:	A graphic reproduction of the surface of a prepared specimen at a magnification not exceeding ten diameters. When photographed, the reproduction is known as a photomacrograph.
MACRO INSPECTION:	Utilizes deep etch and examination under low magnification up to 10 diameters. It reveals flow lines, etc.
MACROPOROSITY (PT):	Voids or gas pockets in metals that are large enough to be seen at magnification of less than 10 diameters.
MACROSCOPIC:	Visible at magnifications from one to ten diameters.
MACROSCOPIC STRESSES:	Residual stresses which vary from tension to compression in a distance (presumably many times the grain size) which is comparable to the gage length in ordinary strain measurements, hence, detectable by X-ray or dissection methods.
MACROSTRUCTURES:	The structure of metals, as revealed by the eye or at a magnification of less than 10 diameters.
MAGNET:	Materials that show the power to attract iron and other substances to themselves, and that exhibit polarity, are called magnets.
MAGNET, PERMANENT:	A highly retentive metal that has been strongly magnetized; for example, the alloy Alnico.
MAGNETIC COUPLING (MT):	A term designating the interaction of a magnetic field with an adjoining test part.
MAGNETIC DISCONTINUITY (MT):	This refers to a break in the magnetic uniformity of the part - a sudden change in permeability. A magnetic discontinuity may not be related to any actual physical break in the metal, but it may produce a magnetic particle indication.
MAGNETIC FIELD (MT):	The space around a source of magnetic flux in which the effects of magnetism can be determined.
MAGNETIC FIELD STRENGTH (MT):	The intensity of the magnetic field surrounding the magnetized part measured in GAUSS.
MAGNETIC FLUX:	The total number of magnetic lines existing in a magnetic circuit is called "magnetic flux."
MAGNETIC FORCE:	In magnetic particle inspection the magnetizing force is considered to be the total force tending to set up a flux in a magnetic circuit. It is usually designated by letter "H."
MAGNETIC HYSTERESIS:	See HYSTERESIS.
MAGNETIC LOOP:	If a conductor carrying an electric current is bent in a loop, the magnetic lines of force enter on one side of the loop and leave at the other, and the space within the loop is found to contain a magnetic field which has very definite directional properties. Polarity is created within the coil with one end being a north pole and the opposite end a south pole. The space enclosed by the loop is longitudinally magnetized.
MAGNETIC MATERIALS:	Materials are affected by magnets in two general ways. Some of them are attracted by a magnetic force, while others exert a repellent force. The first is called "paramagnetic" and the latter "diamagnetic." In magnetic particle inspection we are not ordinarily concerned with either of the two classes, but with what may be termed a subdivision of the first class called "ferromagnetic materials."

MAGNETIC PARTICLE INSPECTION (MT):	A method for detecting discontinuities on or near the surface in suitably magnetized materials, which employ finely divided magnetic particles that tend to congregate in regions of the magnetic non-uniformity, i.e., along cracks, over inclusions, voids, etc.
MAGNETIC PERMEABILITY (MT):	A term indicating the ease with which a magnetic field can be established in a material. It is determined by the ratio of the strength of the resultant magnetic force to the applied magnetic force.
MAGNETIC POLES:	The ability of a magnet to attract or repel is not uniform over its surface, but is concentrated at local areas called "poles." Each magnet has at least two poles, one of which is attracted by the earth's North Pole and is called the north pole of the magnet, and the other which is attracted by the earth's South Pole and is called the south pole of the magnet. Magnetic leakage occurs at poles.
MAGNETICALLY HARD ALLOY:	A ferromagnetic alloy capable of being magnetized permanently because of its ability to retain induced magnetization and magnetic poles after removal of externally applied fields; an alloy with high coercive force. The name is based on the fact that the quality of the early permanent magnets was related to their hardness.
MAGNETICALLY SOFT ALLOY:	A ferromagnetic alloy that becomes magnetized readily upon application of a field and that returns to practically a nonmagnetic condition when the field is removed; an alloy with the properties of high magnetic permeability, low coercive force and low magnetic hysteresis loss.
MAGNETIC RUBBER INSPECTION (MT):	An inspection process involving the use of a formulation of magnetic particles dispersed in a room temperature curing rubber. An extension of the magnetic particle method used for detection of flaws in problem areas such as bolt holes, tubes, etc.
MAGNETIC SATURATION (MT):	The degree of magnetization when increasing the magnetizing force upon a part no longer increases the magnetic flux density (permeability) in the part.
MAGNETIC WRITING (MT):	A form of nonrelevant indications, sometimes caused when the surface of a magnetized part comes into contact with another piece of ferromagnetic material.
MAGNETISM (MT):	The ability of matter to attract other matter to itself and exhibit polarity.
MAGNETIZING CURRENT (MT):	The flow of either alternating, rectified AC or direct current used to induce magnetism into the part.
MAGNETIZING FORCE:	For the purpose of this discussion, magnetizing force is considered to be the total force tending to set up a magnetic flux in a magnetic circuit. It is usually designated by the letter "H" and the unit is the "Oersted."
MAGNETOGRAPH:	A magnetograph is a picture of a magnetic field made by the use of iron powder under conditions that allow it to arrange itself into the pattern of the field.
MAGNETROSTRUCTIVE (MT):	The property of changing dimension with changing magnetic field.
MAIN BANG (UT):	See INITIAL PULSE.
MAINTENANCE INSPECTION:	Inspecting any tooling, machines, or equipment periodically, or during rebuilding to prevent future in-service failure.
MALLEABILITY:	That property which allows a material to be permanently deformed, by compression, without rupture.
MALLEABLE CAST IRON:	A cast iron made by a prolonged anneal of white cast iron in which decarburization or graphitization, or both, take place to eliminate some or all of the cementite. The graphite is in the form of temper carbon.
MANIPULATOR (UT):	A device used for orientation of the transducer assembly. As generally applied to immersion techniques provides either angular or normal sound wave path.
MAP:	Locating the boundaries of a discontinuity.
MARKERS:	A series of square waves, or other beam deflections displayed on the cathode-ray tube screen of the ultrasonic equipment used to determine the distance from the test surface of the article being inspected to a subsequent discontinuity or boundary.

T.O. 33B-1-1

MAS:	Milliampere seconds, utilized to standardize radiographic exposures. Example: 5 MA X 60 seconds = 300 MAS.
MASKING (RT):	Surrounding specimens or covering thin sections with absorptive material to eliminate scatter and halation on the film image.
MASS ABSORPTION COEFFICIENT (RT):	A numerical expression of the absorption characteristics of a given material. The mass absorption coefficient is different for different materials, and is dependent on kilovoltage. It is equal to the Linear Absorption Coefficient divided by the mass density.
MASS ATTENUATION COEFFICIENT (RT):	The fraction of uncharged ionizing particles that experience interactions in traversing a unit distance in a material of density.
MASS NUMBER:	The sum of the neutrons and protons in a nucleus. The mass number of uranium-235 is 235. It is the nearest whole number to the atom's actual atomic weight.
MATERIAL NOISE:	Extraneous signals caused by the structure of the material being tested.
MAXIMUM PERMISSIBLE DOSE (MPD):	That dose of ionizing radiation which competent authorities have established as the maximum that can be absorbed without undue risk to human health.
MEAN FREE PATH:	Average distance a particle travels between collisions.
MEAN LIFE:	The average time during which an atom or other system exists in a particular form.
MEAN STRESS:	(1) In fatigue testing, the algebraic mean of the maximum and minimum stress in one cycle. Also called the steady stress component. (2) In any multiaxial stress system, the algebraic mean of three Principal Stresses; more correctly called mean normal stress.
MECHANICAL PROPERTIES:	The properties of a material that reveal its elastic and in-elastic behavior where force is applied, thereby indicating its suitability for mechanical applications; for example, modulus of elasticity, tensile strength, elongation, hardness, and fatigue limit.
MEDIAN LETHAL DOSE (RT):	The whole-body dose, resulting from a single short exposure (minutes or hours), that will cause the death, within a specified period of time, of 50 percent of the individuals irradiated. The dose sufficient to cause death to 50 percent of the individuals within 30 days is indicated as LD and is on the order of 300 rads.
MEGACYCLE:	One million cycles; often used to express one million cycles per second. Abbreviation is mc.
MEGAHERTZ:	Unit of frequency equal to one million Hertz. Abbreviation is MHz.
METAL SCREEN (RT):	A screen consisting of a foil of dense metal (usually lead) that emits secondary electrons when exposed to X- or gamma radiation. It also reduces the undesirable effects of scattered radiation.
METALLOGRAPH:	An optical instrument designed for both visual observation and photomicrography of prepared surfaces of opaque materials at magnifications ranging from about 25 to about 1500 diameters.
METALLOGRAPHY:	The science dealing with the constitution and structure of metals and alloys as revealed by the unaided eye or by such tools as low-powered magnification, optical microscope, electron microscope and diffraction or X-ray techniques.
METALLURGY:	The science and technology of metals.
MeV:	One million electron volts.
MHz:	Abbreviation for megahertz.
MICRO:	A prefix that divides a basic unit by one million.
MICROFISSURE:	A crack of microscopic proportions.
MICROGRAPH:	A graphic reproduction of the surface of a prepared specimen, usually etched, at a magnification greater than ten diameters. If produced by photographic means it is called a photomicrograph (not a microphotograph).
MICROHARDNESS:	The hardness of microscopic areas or of the individual microconstituents in a metal, as measured by such means as Tukon, Knoop or scratch methods.

MICRO-INSPECTION:	Utilizes a mild etch and high magnification (up to 1000 diameters) for examination of specifically prepared polished samples.
MICRO-SHRINKAGE:	Irregular feathery cavities occurring in the grain boundaries. (Occurs predominantly in magnesium alloys.)
MICROPOROSITY:	Porosity visible only with the aid of a microscope.
MICROSCOPIC STRESS-ES:	Residual stresses which vary from tension to compression in a distance (presumably approximating the grain size) which is small compared to the gage length in ordinary strain measurements. Hence not detectable by dissection methods, they can sometimes be measured by X-ray line shift.
MICROSECOND:	Unit of the time equivalent to 10 ⁻⁶ second or 0.000001 second.
MICRORADIOGRAPHY:	A technique used to examine very small objects or minute detail through the use of low voltage X-rays and an ultrafine grain film emulsion which is examined with the aid of optical enlargement.
MICROSHRINKAGE (ON RADIOGRAPH):	Cracks that appear as dark feathery streaks, or irregular patches that indicate cavities in the grain boundaries.
MICROSTRUCTURE:	The structure of polished and etched metals as revealed by a microscope at a magnification greater than ten diameters.
MILLI:	A prefix that divides a basic unit by one thousand.
MILLIAMPERAGE (RT):	Milliamperage is a measure of the current flowing between the cathode and the anode in an X-ray tube, and is a measure of the intensity of the emitted radiation.
MILLIAMPERE (RT):	A unit of electrical current equal to one thousandth of an ampere.
MILLIAMPERE-SECONDS (RT):	A term used to quantify radiographic exposures made with X-rays. It is the product of tube current in milliamperes and exposure time in seconds. Abbreviation: mAs.
MILLICURIE-HOUR (RT):	A term used to quantify radiographic exposures made with a gamma-ray source. It is the product of the activity of the source in millicuries and the exposure time in hours.
MILLIROENTGEN (mR):	One-thousandth of a roentgen.
MINIATURE ANGLE BEAM BLOCK (UT):	Specific type of reference standard primarily used for the angle beam method, but also used for the straight beam and surface wave methods.
MINIATURE-FILM RADIOGRAPHY (MASS MINIATURE RADIOGRAPHY) (RT):	Fluorography using miniature photographic film.
MISCIBLE (PT):	The tendency of capacity of two or more liquids to form a uniform blend, that is, to dissolve in each other; degrees are total miscibility, partial miscibility, and immiscibility.
MISRUN:	A casting not fully formed, resulting from the metal solidifying before the mold is filled.
MISRUNS (RADIOGRAPHIC):	Appears as prominent darkened areas of variable dimensions with a definite smooth outlines.
MOBILITY (MT):	The ease with which magnetic particles move over the surface of a magnetized part and accumulate at a discontinuity exhibiting polarity.
MODE:	The manner in which acoustic energy is propagated through a material as characterized by the particle motion of the wave.
MODE CONVERSION (UT):	Changing from one mode of vibration to another; caused by retraction at an interface.
MODE OF VIBRATION (UT):	Type of wave motion; e.g., longitudinal, transverse, etc. Three common modes of vibration used in ultrasonic inspection are longitudinal, transverse, and surface wave modes.
MODULATION ANALYSIS (ET):	An instrumentation method used in eddy current testing which separates responses based on their frequency or rate of response. For instance, slow responses from gradual dimension changes can be separated from rapid responses from a crack.

T.O. 33B-1-1

MODULUS OF ELASTICITY:	The ration of stress to the corresponding strain within the limit of elasticity.
MODULUS OF RUPTURE:	Nominal stress at fracture in a bend test or torsion test.
MOLD:	A form or cavity into which molten metal is poured to produce a desired shape. Molds may be made of sand, plaster or metal and frequently require the use of cores and inserts for special applications.
MOLECULE:	The smallest unit quantity of matter that can exist by itself and retain all the properties of the original substance. Molecules are formed by the chemical combination of atoms.
MONITORING (RT):	Periodic or continuous determination of the amount of ionizing radiation or radioactive contamination present in an occupied region.
MONOCHROMATIC:	(Homogeneous) of the same wavelength.
MOTTLING (RT):	Large graininess effect on a radiograph that may be due to diffraction by large grain structures in materials, or can be caused by the use of fluorescent screens. Mottling is readily distinguishable from film graininess because of its coarse appearance and lack of definition.
MOVEMENT UNSHARPNESS (RT):	See UNSHARPNESS.
MT:	Symbol for the magnetic particle method of nondestructive testing/inspection.
MULTIAXIAL STRESSES:	Any stress state in which two or three principal stresses are not zero.
MULTIDIRECTIONAL MAGNETIZATION:	Two separate fields, having different directions, cannot exist in a part at the same time. But two or more fields in different directions can be imposed upon a part sequentially in rapid succession. When this is done magnetic particle indications are formed when discontinuities are located favorably with respect to the directions of each of the fields, and will persist as long as the rapid alternations of field direction continue. This, in effect, does constitute two or more fields in different directions at the same time, and enables the detection of defect oriented in any direction in one operation.
MULTIPLE REFLECTIONS (UT):	Successive echoes of ultrasonic energy between two surfaces.

N

NANOMETER (PT):	A unit of length equal to one billionth of a meter, or 10 ⁻⁹ meter. The Nanometer has replaced the angstrom unit as a measurement of short wave length, electromagnetic radiation where 1 nm = 10 angstroms.
NANOSECOND:	(10 ⁻⁹) one billionth of a second.
NARROW-BANDED (UT):	Having a relatively narrow bandwidth; opposite of broad-banded; see TUNED.
NEAR FIELD (UT):	The region of the ultrasonic beam adjacent to the search unit, having complex beam profiles; also known as the Fresnel zone. The length of the near field extends from the face of the search unit to the point at which the far field begins and is given by the equation: $L_o = D^2f / 4v$ where: L_o = near field length - inches. D = the major dimensions of the search unit element - inches. For circles, D = the diameter. For rectangles or squares, D = diagonal. f = ultrasonic frequency - hertz v = ultrasonic velocity - inches per second.
NEIGHBORHOOD EFFECT (RT):	The name given to various effects arising from the diffusion of developer which has become locally exhausted or loaded with oxidation products by its action on a heavily exposed region of an emulsion. Typical examples are developer streaks and abnormal density variations near the edges of regions of high density.
NET DENSITY (RT):	Total film density less the base plus fog density.

NETWORK STRUCTURE:	A structure in which one constituent occurs primarily at the grain boundaries, thus partially or completely enveloping the grains of the other constituents.
NEUTRON:	An uncharged elementary particle with a mass nearly equal to that of the proton. The isolated neutron is unstable and decays with a half-life of about 13 minutes into an electron, proton, and neutrino. Neutrons sustain the fission chain reaction in a nuclear reactor. Neutron radiograph is a technique in which neutrons are used as a penetrating radiation to produce a radiograph.
NEUTRON RADIOGRAPHY (RT):	The process whereby a photographic image of an object is produced by neutron radiation that has penetrated through the object.
NITRIDING:	Introducing nitrogen into a solid ferrous alloy by holding at a suitable temperature (below A ₁ for ferritic steels) in contact with a nitrogenous material, usually ammonia or molten cyanide of appropriate composition. Quenching is not required to produce a hard case.
NOBLE METAL:	A metal whose potential is highly positive relative to hydrogen electrode. A metal with a marked resistance to chemical reaction.
NODE:	A point in a standing wave where some characteristic of the wave field has essentially zero amplitude.
NODULAR CAST IRON:	A cast iron that has been treated while molten with a master alloy containing an element such as magnesium or cerium to give primary graphite in the spherulitic form.
NOISE (UT, ET):	Any undesired signal that tends to interfere with normal reception or processing of the desired signal. Origin may be electrical or from small reflectors in a material.
NONAQUEOUS DEVELOPER:	See SOLVENT DEVELOPER.
NONDESTRUCTIVE INSPECTION (NDI):	A method used to check the soundness of a material or a part without impairing or destroying the serviceability of the part.
NONFERROMAGNETIC MATERIAL (NONMAGNETIC):	A material that is not magnetizable and hence, essentially not affected by magnetic fields. This would include paramagnetic materials having a magnetic permeability slightly greater than that of a vacuum and approximately independent of the magnetizing force and diamagnetic materials having permeability less than a vacuum. Some metals free from iron are zinc, tin, aluminum, brass, copper and pot metal.
NON-METALLIC INCLUSION:	Inclusions (or stringers) are impurities in the metal as a mechanical mixture. They may be stretched out and broken up during rolling or forging and are at various depths from the surface.
NON-RELEVANT INDICATIONS:	An indication due to misapplied or improper inspection. Also, an indication caused by an actual discontinuity in the material that does not affect the usefulness of the part (such as a change of section).
NONRELEVANT INDICATION (MAGNETIC PARTICLE INSPECTION):	A magnetic particle indication due to a weak leakage field caused by some condition other than a discontinuity but does not affect the usefulness of the part; such as a keyway, dissimilar parts, etc.
NON-SCREEN FILM (RT):	X-ray film designed for use with or without metal screens, but not intended for use with salt screens. It may be of relatively high speed and coarse grain (ordinary non-screen film) or of lower speed and finer grain (fine grain non-screen film).
NON-STOCHASTIC EFFECT:	Means health effects, the severity of which varies with the dose and for which a threshold is believed to exist (below which there are no effects). Radiation-induced cataract formation is an example of a non-stochastic effect.
NORMALIZE:	Heating steel to above its critical range, as in annealing, and then cooling it in still air at ordinary room temperature.
NOTCH BRITTLINESS:	Susceptibility of a material to brittle fracture at points of stress concentration.
NOTCH SENSITIVITY:	A measure of the reduction in strength of a metal caused by the presence of stress concentration. Values can be obtained from static, impact or fatigue tests.

T.O. 33B-1-1

NOZZLE:	The outlet end of a gooseneck, or the fitting that joins the gooseneck to the sprue hole of the die.
NUCLEAR REACTION:	A reaction involving an atom's nucleus, such as fission, neutron capture, radioactive decay, or fusion, as distinct from a chemical reaction, which is limited to changes in the electron structure surrounding the nucleus.
NUCLEAR REACTOR:	A device by means of which a fission chain reaction can be initiated, maintained, and controlled. Its essential component is a core with fissionable fuel. It usually has a moderator, a reflector, shielding, and control mechanisms.
NUCLEAR TRANSITION (RT):	A change in the energy state or level of an atomic nucleus which may, or may not, result in the emission of radiation.
NUCLEUS:	The heavy central part of an atom in which most of the mass and the total positive electric charge is concentrated. With the exception of the nucleus of hydrogen, nuclei are composed of protons and neutrons. The charge of the nucleus, an integral multiple of the charge of the electron, is the essential factor that distinguishes one element from another chemically.
NUCLIDE:	Any species of atom that exists for a measurable length of time. A nuclide can be distinguished by its atomic weight, atomic number, and energy state. The term is used synonymously with isotope. A radionuclide is a radioactive nuclide.
NUCLIDE (RT):	A species of atom characterized by its mass number, atomic number, and nuclear energy state, and that has a measurable mean life.

O

OBJECT-TO-FILM DISTANCE (RT):	The distance from the tube or source side of the irradiated specimen to the film surface, i.e., inclusive of specimen thickness. Abbreviation: ofd.
OCCUPANCY FACTOR (RT):	The factor by which the workload should be multiplied to correct for the degree or type of occupancy of the area in question. Symbol: T.
OCCUPATIONAL DOSE:	The dose received by an individual in a restricted area or in the course of employment in which the individual's assigned duties involve exposure to radiation. Occupational dose does not include dose received from background radiation, as a patient from medical practices, from voluntary participation in medical research programs, or a member of the general public.
OERSTED (MT):	A unit of field strength that produces magnetic induction designated by the letter "H." The Oersted is numerically equal in air or in a vacuum. Oersted (H) refers to the magnetizing force tending to magnetize an unmagnetized body, and Gauss refers to the field (B) so induced in the body.
OHM:	The ohm is the unit of electrical resistance. It is the value of a resistance that will pass one ampere of current at a potential of one volt.
OIL-COOLED TUBE (RT):	An X-ray tube in which the heat produced is dissipated, directly or indirectly, by means of oil.
OIL-IMMERSED TUBE (RT):	An X-ray tube designed for operation in oil.
OPERATING STRESS:	The stress to which a structural unit is subjected in service.
OPTICAL DENSITY (RT):	See DENSITY.
OPTICAL PYROMETER:	A temperature measuring optical device used to compare the incandescence of a heated object with that of an electrically heated filament whose brightness can be regulated.
OPTIMUM FREQUENCY (ET, UT):	That frequency, which provides the highest signal-to-noise ratio obtainable for the detection of an individual property such as conductivity, crack, or inclusion of the test specimen. Each type of defect in a given material may have its own optimum frequency.
ORANGE-PEEL EFFECT:	A surface roughening in the form of a grain pattern where a metal of unusually coarse grain is stressed beyond its elastic limit. Also called pebbles and alligator skin.

ORBITAL ELECTRON (SHELL ELECTRON) (RT):	An electron in the extra-nuclear structure of an atom.
ORIENTATION:	Position of a discontinuity or part or surface in relation to the test surface of the article or ultrasonic beam.
ORIENTATION (CRYSTAL):	Arrangement in space of the axes of a crystal with respect to a chosen reference or coordinate system.
OSCILLATOR (ET):	A component of an electrical circuit that provides a source of current that varies in magnitude and direction with time. In eddy current testing, the oscillator provides a source of alternating current to establish a varying magnetic field.
OSCILLOGRAM (UT):	Common term for photograph of data displayed on CRT.
OVER-DEVELOPMENT (RT):	Development that is greater than that required to produce the optimum results in a particular radiograph. It may arise from development for too long a time, or at too high a temperature, and may give rise to excessive graininess and lack of contrast.
OVERHEATED:	Steel subjected to such high temperatures that coarse grains are produced without destroying the stock as in burning. This may be corrected by suitable heat treat.
OVERLAP:	Protrusion of weld metal beyond the bond at the toe of the weld.
OVERLOAD INTERLOCK, X-RAY UNIT (RT):	An X-ray machine in which the presetting of voltage, current, and time are interlinked in such a way that if their product (i.e., the energy to be applied) exceeds the permissible loading of the X-ray tube, the latter cannot be energized.
OVERSTRESSING:	In fatigue testing, cycling at a stress level higher than that used at the end of the test.
OXIDATION:	The reaction of an element to oxygen or an oxygen containing compound.
OXIDATION FOG (RT):	Fog caused by exposure of a film to air during development.

P

PAIR PRODUCTION (RT):	The conversion of very high-energy photons, when absorbed in matter, by a process wherein the photon is converted in the electrical field of a nucleus into an electron (negative charge) and a positron (equal but opposite positive charge).
PARALLEL MAGNETIZATION:	A magnetic field induced in a piece of magnetizable material that is placed parallel to a conductor carrying an electric current.
PARAMAGNETIC (MT):	Materials in which the magnetic permeability is slightly greater than one. These materials are classified as nonmagnetic with a permeability of one for purposes of eddy current inspection. A material which can be slightly magnetized, but not sufficiently to permit magnetic particle inspection.
PART:	A term used to refer to a manufactured article that is being inspected.
PARTICLE:	A minute constituent of matter with a measurable mass, such as a neutron, proton, or meson.
PARTICLE MOTION (UT):	Movement of particles in an article brought about by the action of a transducer.
PARTICLE (RT):	A minute constituent of matter with a measurable mass, such as an electron, neutron, proton, or meson.
PARTICULATE RADIATION (RT):	Radiation consisting of charged or uncharged atomic particles.
PARTING LINE:	The line along which a pattern is divided for molding or along which the sections of a mold separate.
PASTE (MAGNETIC):	Finely divided, ferromagnetic particles in paste form used in preparing wet suspensions magnetic particle inspection.
PEAK VOLTAGE (RT):	The maximum value achieved by a varying voltage.
PENETRABILITY (PT):	The property of a penetrant that causes it to find its way into very fine openings, such as cracks.

T.O. 33B-1-1

PENETRAMETER (RT):	A device employed to obtain evidence on a radiograph that the technique used was satisfactory. It is not intended for use in judging the size of discontinuities nor for establishing acceptance limits for materials or products.
PENETRAMETER SENSITIVITY (RT):	See SENSITIVITY, RADIOGRAPHIC.
PENETRANT (PT):	A liquid of high surface tension and high capillary action which is a vehicle for a colored or a fluorescent dye, used to penetrate into the defect and detect surface discontinuities.
PENETRANT INDICATION:	Readings that mark or denote the presence of material defects.
PENETRANT, POST EMULSIFIABLE (PT):	A penetrant that requires the application of a separate emulsifier to render the surface penetrant water-washable.
PENETRANT REMOVER (PT):	A penetrant remover is a solvent-type liquid used to clean penetrants from the surface of a material.
PENETRANT SENSITIVITY (PT):	Penetrant sensitivity is the ability of the penetrant, processing technique, and developer to detect surface-connected discontinuities and provide an indication visible to the unaided eye.
PENETRANT, VISIBLE (PT):	A penetrant that is characterized by an intense visible color, usually red, that allows it to give contrasting indications on a white developer background.
PENETRANT, WATER-WASHABLE (IT):	See WATER-WASHABLE.
PENETRATION:	The maximum depth from which indications can be measured in a material.
PENETRATION (RT):	A qualitative term used to describe the degree to which radiation is capable of penetrating a given object. Penetration is usually a function of the applied tube voltage in X-rays or equivalent voltage in isotope radiography.
PENETRATION TIME (PT):	The time allowed for the penetrant to enter into surface discontinuities, i.e., the length of time elapsing between the application of the penetrant to the part and removal of penetrant.
PENUMBRA (RT):	The shadow cast when the incident radiation is partly, but not wholly, cut off by an intervening body; the space of partial illumination between the umbra, or perfect shadow, on all sides and the full light. A marginal region of borderland of partial obscurity.
PERSONNEL MONITORING EQUIPMENT (RT):	Devices designed to be worn or carried by an individual for the purpose of measuring the dose received (e.g., film badges, pocket chambers, pocket dosimeters, film rings, etc.)
PERIODIC TABLE:	A tabular arrangement of elements according to their properties.
PERMEABILITY (MT):	The ease with which a material can become magnetized. It is the relationship between field strength and the magnetizing force.
PERMEABILITY (MT):	The ease with which a magnetic field or flux can be set up in a magnetic circuit. It is not a constant value for a given material, but is a ratio. At any given value of magnetizing force, permeability is B/H the ratio of flux density, B , to magnetizing force H .
PERMANENT MAGNETS:	A body that possesses the ability to retain or hold a large amount of the applied magnet field after the active power of the field is removed.
PERMANENT MOLD:	A metal mold (other than an ingot mold) of two or more parts that is used repeatedly for the production of many castings of the same form. Liquid metal is poured in by gravity.
PERMANENT SET:	Plastic deformation that remains upon releasing the stress that produces the deformation.
PHASE:	In periodic changes of any magnitude varying according to a simple harmonic law (as ultrasonic vibrations, alternating electric currents, etc.), the point or stage in the period to which the variation has advanced, considered in its relation to a standard position; can be expressed in degrees.
PHASE ANALYSIS:	An instrumentation technique which discriminates between variables in the test part by the different phase angle changes which these conditions produce in the test signal.

PHASE ANGLE:	The angular equivalent of the time displacement between corresponding points on two sine waves of the same frequency.
PHASE SHIFT:	A change in the phase relationship between two alternating quantities of the same frequency.
PHI (ϕ):	Symbol for the sound beam angle as measured from the normal to a sound entry or sound reflecting surface; the Greek letter Phi.
PHOTOELECTRIC ABSORPTION (RT):	A process by which electromagnetic radiation imparts energy to matter.
PHOTOGRAPHIC EMULSION (RT):	See EMULSION.
PHOTOGRAPHIC FOG (RT):	Fog caused solely by the properties of an emulsion and the processing conditions, i.e., the total effect of inherent fog and chemical fog.
PHOTOGRAPHIC INTENSIFICATION (RT):	Chemical treatment of a processed emulsion, usually with an oxidizing agent, to lessen the density. There may be a change of contrast, depending on the process used.
PHOTOGRAPHIC TRANSMISSION DENSITY (RT):	See DENSITY.
PHOTON (RT):	An electromagnetic packet of radiation. It has a dual character, acting sometimes like a particle and at other times like a wave. Photons all have equal velocity (the speed of light), have no electric charge, and have no mass.
PHOTO-SENSITIVITY (RT):	A property of a photographic emulsion by virtue of which electromagnetic or particulate radiation may produce chemical or physical changes in the emulsion.
PHOTOTHERMOGRAPHIC FILM (RT):	A blue/green sensitive "dry silver" film used in conjunction with special fluorescent screens in vacuum cassettes which can serve as an alternative to X-ray film for noncritical applications. The principle advantage of this film is that it is processed thermally, eliminating the need for wet chemicals.
PHYSICAL PROPERTIES:	The properties, other than mechanical properties, that pertain to the physics of a material; for example, density, electrical conductivity, heat conductivity, thermal expansion.
PHYSICAL TESTING:	Determination of Physical Properties.
PICKLE:	Using acid or other chemicals with suitable inhibitors to remove scale or smeared metal without affecting the sound metal.
PICKLE PATCH:	A tightly adhering oxide or scale coating not properly removed during the pickling process.
PICKLE STAIN:	Discoloration of metal due to chemical cleaning without adequate washing and drying.
PICKLING CRACKS:	Cracks caused by internal stresses being released as the pickling acid eats away the surface of the material.
PIEZOELECTRIC (UT):	That ability of a material to convert electrical energy into mechanical energy and vice versa.
PIG:	A cast slab of primary metal that must be remelted before use.
PINHOLES:	Very small holes; sometimes found as a type of porosity in a casting because of microshrinkage or of gas evolution during solidification.
PINHOLE (RT):	A through hole of small diameter in a sheet of material opaque to radiation.
PINHOLE POROSITY:	Porosity, in either castings or metal formed by electrodeposition, resulting from numerous small holes distributed throughout the metal.
PIPE:	(1) The central cavity formed by contraction in metal, especially ingots, during solidification. (2) The defect in wrought or cast products resulting from such a cavity. (3) An Extrusion Defect due to the oxidized surface of the billet flowing toward the center of the rod at the back end. (4) A tubular metal product, cast or wrought.
PITCHBLEND:	An ore that contains uranium.

T.O. 33B-1-1

PITCH-CATCH (UT):	Used to describe an inspection method in which the ultrasonic energy is emitted by one transducer element and received by another on the same or adjacent surface.
PITTING:	Forming small sharp cavities in a metal surface by nonuniform electrodeposition or by corrosion.
PLANCK'S CONSTANT (RT):	A fundamental physical constant; the ratio of the energy of a photon to its frequency.
PLASTIC DEFORMATION:	Working of a material beyond its elastic limit to produce a permanent change in dimensions.
PLASTIC FLOW:	Same as PLASTIC DEFORMATION.
PLASTICITY:	The ability of a metal to deform nonelastically without rupture.
PLATE PENETRATOR (STRIP PENETRATOR) (RT):	A plate of material similar to the specimen under examination, having a thickness of 1 or 2 percent of the specimen thickness, and having holes of different diameters.
PLATED CRYSTAL:	Crystal on which metallic surfaces are deposited for protection and/or to give surfaces on which the electrical potential can be impressed.
PLATEN:	That part of a casting machine against which die sections are fastened, or presses against which trim dies are fastened.
PLATING:	Forming an adherent layer of metal upon an object.
PLATING CRACK:	See CRACK, PLATING.
PLATE WAVE:	See LAMB WAVE.
POINT OF INCIDENCE (UT):	Designates the point at which the center of the sound beam leaves the wedge from an angle beam search unit.
POLARITY:	The quality of having two opposite magnetic poles, one north and one south.
POLE (MT):	The area on a magnetized part from which the magnetic field leaves or enters the part.
POROSITY:	Random pits or holes in the object.
POSITRON:	A fundamental particle of nature having a mass equal to that of the electron and possessing a positive charge equal to the negative charge of the electron. The mass of the positron is therefore 9.107×10^{-28} gm; the electrical charge carried by the positron is equal to 4.802×10^{-10} statcoulomb (electrostatic unit of charge).
POST-CLEANING (PT):	The removal of residual penetrant and/or developer from the item after the inspection operation.
POST-EMULSIFICATION (PT):	The technique wherein a separate emulsifying step is required to facilitate water rinse removal of the surface penetrant.
POTTER-BUCKY DIAPHRAGM (RT):	A device incorporating an anti-scatter grid that is kept in motion during the time of a radiographic exposure so as to avoid grid images on the radiograph.
POTTER-BUCKY GRID (RT):	See POTTER-BUCKY DIAPHRAGM.
POWDER, DRY (MT):	Finely divided ferromagnetic particles suitably selected and prepared for magnetic particle inspection.
PRECIPITATE (MT):	The separating of the magnetic particles from the liquid vehicle. Used primarily for checking concentration of magnetic particles in the vehicle.
PRECIPITATION HARDENING:	The process by which a metal is hardened by the formation of small particles of secondary composition from a solid solution. This process is usually performed at an elevated temperature considerably below the temperature of solution heat treating.
PRECIPITATION HEAT TREATMENT:	Artificial aging in which a constituent precipitates from a supersaturated solid solution.

PRE-CLEANING:	The cleaning of a part before testing so that it is free from all foreign material (paint, grease, oil, rust, scale, layout dye, wax crayon markings, etc.) which may cover a surface discontinuity and thereby inhibit the entrance of the penetrant liquid, or absorb the penetrant and render an "irrelevant indication."
PRESENTATION:	The method used to show ultrasonic wave information. May include A, B, or C scans displayed either on various types of recorders or cathode ray instrumentation's.
PRESERVATIVE, DEVELOPER (RT):	A constituent (e.g., sodium sulfate) that minimizes the exhaustion of a developer caused by aerial oxidation, and serves to remove oxidation products which might retard development or produce stain.
PRESSURE MARK (RT):	An effect produced by pressure on a film which after developing results in areas of either increased or decreased density. The crescent-shaped pressure mark due to severe local bending of a film is often called a crimp mark.
PRIMARY MAGNETIC FIELD (ET):	In eddy current inspection, the field produced by the test coil or coils as differentiated from the magnetic field produced by the eddy current or the resultant field.
PRIMARY RADIATION (RT):	Radiation coming directly from the source of radiation that has undergone no physical process changing its character.
PROBE (ET, MT, UT):	An assembly containing a small coil or coils designed for eddy current inspection of small areas immediately adjacent to the coil and an electromagnet producing magnetic fields for magnetic inspection. The unit has two jointed laminated pole pieces permitting adjustment to varying surfaces configuration. Also the device contains a microphone used with an ultrasonic leak detector to receive ultrasonic energy resulting from leakage. See SEARCH UNIT.
PROBE WOBBLE (ET):	The change in angular orientation between a surface probe and the inspection surface. Probe wobble results in lift-off variations.
PROCESS ANNEALING:	In the sheet and wire industries, heating a ferrous alloy to a temperature close to, but below, the lower limit of the transformation range and then cooling, in order to soften the alloy for further cold working.
PROCESS ATTAINMENT (ABILITY):	The ultimate ability of a process to find a defect of minute size at the current state-of-the-art, usually defined as the ability to detect defects as small... See SENSITIVITY.
PROCESS CAPABILITY:	The ability of a process to repeatedly find a defect under the influence of normal day-to-day variations of process, people, materials, environment and other influences normally tied to a confidence level.
PROCESS CONTROL:	Is a general term used to encompass the actions and documentation, as required by official directives or logic, that are necessary for a NDI method to be effective in detecting conditions of interest (e.g., cracks, foreign objects, corrosion, alignment of parts, thickness of parts/coating and pressure/vacuum leaks).
PROCESSING DEFECTS:	Defects occurring in the material during any of the processing stages from molten metal to the finished product.
PROCESSING, FILM (RT):	A series of operations, such as developing, fixing, and washing, associated with the conversion of a latent image into a stable visible image.
PROCESSING UNIT (RT):	A series of tanks forming a single unit for holding chemical solutions used during processing.
PROCESS INSPECTION:	To establish correct manufacturing procedure by inspection methods, and then by periodic inspection to insure that the process continues to operate correctly.
PRODS (MT):	Hand held electrodes attached to cables to transmit the magnetizing current from the source to the part being inspected.
PROGRESSIVE AGING:	Aging by increasing the temperature in steps or continuously during the aging cycle.
PROGRESSIVE FORMING:	Sequential forming at consecutive stations either with a single die or with separate dies.
PROJECTOR (RT):	See exposure device.

T.O. 33B-1-1

PROOF LOAD:	A predetermined load, generally some multiple of the service load, to which a specimen or structure is submitted before acceptance for use.
PROOF STRESS:	(1) The stress that will cause a specified small permanent set in a material. (2) A specified stress to be applied to a member or structure to indicate its ability to withstand service loads.
PROPAGATION:	Advancement of a wave through a medium.
PROPORTIONAL LIMIT:	The maximum stress at which strain remains directly proportional to stress.
PROTECTIVE APRON (RT):	Apron made of attenuating materials, used to reduce radiation exposure.
PROTECTIVE MATERIAL (RT):	Shielding material used for the purpose of radiation protection.
PROTON:	An elementary particle with a single positive electrical charge and a mass approximately 1847 times that of the electron. The atomic number of an atom is equal to the number of protons in its nucleus.
PSIGG:	Pounds per square inch; gauged air pressure gauged by a regulator.
PT:	Symbol for the liquid penetrant method of nondestructive testing/inspection.
PUBLIC DOSE:	The dose received by a member of the public from exposure to radiation.
PULL CRACKS:	In a casting, cracks that are caused by residual stresses produced during cooling, and that result from the shape of the object.
PULSE (UT):	A series of vibrations or oscillations having a brief duration.
PULSE-ECHO METHOD (UT):	An inspection method in which the presence and position of a discontinuity is indicated by the echo amplitude and time position; also designates a method of inspecting bonded honeycomb structures by monitoring the echoes from the far side of the core.
PULSE LENGTH (UT):	A measure of the duration of a pulse, expressed in time or number of cycles.
PULSE REPETITION RATE (UT):	See FREQUENCY, PULSE REPETITION.
PULSE TUNING (UT):	Control, on some instruments, used to optimize the response of the search unit and cable.
PYROMETER:	Any device used for determining temperatures over a wide range, including extremely high temperatures.

Q

QUALITY CONTROL INDICATOR (RT):	See PENETRAMEETER.
QUALITY FACTOR (RT):	The linear-energy-transfer-dependent factor by which absorbed doses are to be multiplied to obtain, for radiation protection purposes, a quantity (i.e., dose equivalent) that expresses on a common scale for all ionizing radiation the irradiation incurred by exposed persons. The quality factor weights the absorbed dose for the biological effectiveness of the particular type of radiation producing the absorbed dose. Symbol: Q.
QUALITY LEVEL (RT):	See RADIOGRAPHIC QUALITY LEVEL.
QUALITY OF RADIATION (RT):	The quality of a radiation determines its degree of penetration, and is related to the energy of the radiation.
QUANTUM:	If the magnitude of a quantity is always an integral multiple of a definite unit, then that unit is called the quantum of the quantity. The photon is a quantum of the electromagnetic field and the meson is considered to be the quantum of the nuclear field.
QUANTUM (RT):	A discrete amount of radiation energy. The quantum energy is $E=hu$, where u is the frequency of the radiation and h is Planck's constant.
QUENCH AGING:	Aging induced by rapid cooling after Solution Heat Treatment.
QUENCH ANNEALING:	Annealing an austenitic ferrous alloy by Solution Heat Treatment.
QUENCH CRACKS:	See CRACKS, QUENCHING.

QUENCH HARDENING:	Hardening a ferrous alloy by austenitizing and then cooling rapidly enough so that some or all of the austenite transforms to martensite. The austenitizing temperature for hypoeutectoid steels is usually above Ac ₃ and for hypereutectoid steels usually between Ac ₁ and Accm.
QUENCHING:	Rapid cooling. When applicable, the following more specific terms should be used: direct quenching, fog quenching, hot quenching, interrupted quenching, selective quenching, spray quenching, and time quenching.
QUICK-BREAK:	Sometimes called "FAST BREAK." The sudden breaking of a direct current causes a transient current to be induced in the part by the rapid collapse of the magnetic field. In magnetic particle testing, fast breaking of the magnetizing current is used to generate a transient current in a part which is favorable for finding transverse defects at the ends of longitudinally magnetized bars. Such defects are often concealed by the strong polarity at the bar ends. At such locations the lines of force of the longitudinal field are leaving the bar in a direction normal to the surface, which prevents them from intercepting transverse defects in those areas. The field induced by the transient current does intercept such discontinuities.
QUENCHING OF FLUORESCENCE (MT, PT):	The extinction of fluorescence by causes other than removal of the black light (the exciting radiation).
R	
RAD:	The special unit of absorbed dose. One rad is equal to an absorbed dose of 100 ergs/gram or 0.01 Joule/kilogram (0.01 gray).
RADIATION (RT):	The propagation of energy through matter or space in the form of waves. In atomic physics the term has been extended to include fast-moving particles (alpha and beta rays, free neutrons, etc.). Gamma rays and Xrays, of particular interest in atomic physics, are electromagnetic radiation in which energy is propagated in packets called photons.
RADIATION AREA:	An area, accessible to individuals, in which radiation levels could result in an individual receiving a dose equivalent in excess of 5 mrem (0.05 mSv) in any one hour at 30 centimeters from the radiation source or from any surface that the radiation penetrates.
RADIATION BURN (RT):	A burn caused by overexposure to radiant energy.
RADIATION DAMAGE (RT):	A general term for the alteration of properties of a material arising from radiation exposure to X-rays, gamma rays, neutrons, heavy-particle radiation or fission fragments in nuclear fuel material.
RADIATION DETECTOR (RT):	See DETECTOR.
RADIATION HAZARD (RT):	A situation or condition that represents potential danger to health as the result of exposure to ionizing radiation.
RADIATION MAZE (RT):	An indirect route of access to a room that contains a radiation source. It is designed to allow easy access when the source is turned off or is fully shielded, and to reduce radiation intensity outside the room to acceptable levels when the source is turned on or exposed. Reduction of radiation intensity is achieved through multiple scattering from walls and application of the inverse square law.
RADIATION METER (RT):	An instrument consisting of one or more radiation detectors, associated electronics, and an indicator of the magnitude of the measured radiation quantity.
RADIATION MONITOR (RT):	A radiation meter that is designed and used to keep track of radiation levels in a specific area, and to record those levels, or to provide an audible or visual signal when a predetermined level is exceeded.
RADIATION PROTECTION GUIDE:	The total amounts of ionizing radiation dose over certain periods of time which may safely be permitted to exposed industrial groups. These standards, established by the Federal Radiation Council, are equivalent to what was formerly called the "maximum permissible exposure."

T.O. 33B-1-1

RADIATION PROTECTION (RT):	A branch of the physical, biological, and chemical sciences applying to the prevention of the risks presented by exposure of persons to ionizing radiation.
RADIATION PROTECTION SURVEY (RT):	Evaluation of the radiation hazards in and around an area where a radiation source is used or stored. It customarily includes an examination of the arrangement and use of the source and related equipment, and measurements of exposure rates under expected operating conditions.
RADIATION QUALITY (RT):	See BEAM QUALITY.
RADIATION SAFETY INTERLOCK (RT):	A device for precluding access to an area of radiation hazard either by preventing entry or by automatically removing the hazard.
RADIATION SAFETY OFFICER:	An individual engaged in the practices of providing radiation protection. He is the representative appointed by the licensee for liaison with the Atomic Energy Commission.
RADIATION SICKNESS (RT):	See ACUTE RADIATION SYNDROME.
RADIATION SOURCE (RT):	A machine or a material emitting, or capable of emitting, ionizing radiation.
RADIATION SURVEY (RT):	See RADIATION PROTECTION SURVEY.
RADIATION TRAP (RT):	See RADIATION MAZE.
RADIOACTIVE:	Atoms that are energetically unstable and decay to a stable condition by emitting radiation are said to be radioactive.
RADIOACTIVE CONTAMINATION:	Deposition of any radioactive material in any place where it is not desired, particularly where it may be harmful.
RADIOACTIVE DECAY (RT):	The spontaneous nuclear disintegration of a material. It occurs on an atomic scale by the loss of subatomic particles (i.e., protons, neutrons, electrons, etc.). See HALF-LIFE.
RADIOACTIVE MATERIAL:	Includes any such material whether or not subject to licensing control by the Commission.
RADIOACTIVE SERIES (RT):	A sequence of radionuclides formed by successive nuclear transitions until a stable (non-radioactive) nuclide, the end product, is reached.
RADIOACTIVE SOURCE (RT):	A radiation source consisting of radioactive material.
RADIOACTIVE WASTE:	Equipment and materials (from nuclear operations) which are radioactive and for which there is no further use.
RADIOACTIVITY:	Spontaneous nuclear disintegration with emission of corpuscular or electromagnetic radiation. The principal types of radioactivity are alpha disintegration, beta decay (electron emission, positron emission, and electron capture) and isomeric transition.
RADIOACTIVITY CONCENTRATION GUIDE:	The concentration of radioactivity in an environment which results in doses equal to those in the radiation protection guide. This Federal Radiation Council term replaces the former "maximum permissible concentration."
RADIOBIOLOGY:	The study of the scientific principles, mechanisms, and effects of the interaction of ionizing radiation with living matter.
RADIOGRAPH (RT):	A permanent visible image on a recording medium produced by penetrating radiation passing through the material being tested.
RADIOGRAPHER:	Any individual who performs or who, in attendance at the site where the sealed source or sources are being used, personally supervises radiographic operations and who is responsible to the licensee for assuring compliance with the requirements of these regulations and the conditions of the licenses.

RADIOGRAPHER'S ASSISTANT:	Any individual who under the personal supervision of a radiographer, uses radiographer exposure devices, sealed sources or related handling tools, or survey instruments in radiography.
RADIOGRAPHER'S EXPOSURE DEVICE:	Any instrument containing a sealed source fastened or contained therein, in which the sealed source or shielding thereof may be moved, or otherwise changed, from a shielded to unshielded position for purposes of making a radiographic exposure.
RADIOGRAPHIC CODE:	A code for specifying minimum standards related to radiographic practices.
RADIOGRAPHIC EXPOSURE DEVICE (RT):	See EXPOSURE DEVICE.
RADIOGRAPHIC FILM (RT):	See FILM, RADIOGRAPHIC.
RADIOGRAPHIC PAPER (RT):	White paper coated on one side with emulsion, suitable for some purposes as an alternative to X-ray film.
RADIOGRAPHIC PROJECTION METHOD (RT):	A method whereby image magnification is achieved by projection.
RADIOGRAPHIC QUALIFICATION TEST:	A procedure for determining the optimum value of the d/t ratio, or the proper working distance of an X-ray tube or a radioactive source.
RADIOGRAPHIC QUALITY LEVEL (RT):	An expression of the quality (sensitivity) of a radiograph in terms of an image quality indicator (penetrameter). When a standard hole-type penetrameter is used, quality level is stated as a-bT, where a is the penetrameter thickness, expressed as a percentage of the maximum thickness of the specimen, and b is the diameter of the smallest discernible hole, expressed as a multiple of penetrameter thickness, T. For example, the 3- 2T quality level means that the penetrameter thickness equals 3 percent of maximum specimen thickness, and the smallest discernible penetrameter hole has a diameter equal to twice the penetrameter thickness.
RADIOGRAPHIC RANGE (RT):	See EXPOSURE LATITUDE.
RADIOGRAPHIC SCREEN (RT):	See INTENSIFYING SCREEN.
RADIOGRAPHIC SCREENS:	Metallic or fluorescent sheets used to intensify the radiation effect on films.
RADIOGRAPHIC SENSITIVITY (RT):	See SENSITIVITY, RADIOGRAPHIC.
RADIOGRAPHICALLY SIMILAR MATERIAL (RT):	A material or alloy that has approximately the same radiation absorption as the material being radiographed.
RADIOGRAPHIC CONTRAST (RT):	See CONTRAST, RADIOGRAPHIC.
RADIOGRAPHIC DEFINITION (RT):	See DEFINITION, RADIOGRAPHIC.
RADIOGRAPHIC ENERGY (RT):	See ENERGY, RADIOGRAPHIC.
RADIOGRAPHIC EQUIVALENCE FACTOR (RT):	The factor by which the thickness of a material must be multiplied in order to determine what thickness of a standard material (often steel) will have the same absorption.
RADIOGRAPHIC INSPECTION (RT):	The use of X-rays or nuclear radiation or both to detect discontinuities in material, and to present their images on a recording medium.
RADIOGRAPHIC INTERPRETATION (RT):	The identification of subsurface discontinuities indicated on the radiograph. The evaluation as to the acceptability or rejectability of the material is based upon the judicious application of the radiographic specifications and standards governing the material.

T.O. 33B-1-1

RADIOGRAPHIC TECHNIQUE (RT):	The selection of those radiographic factors such as kilovoltage, milliamperage, type of film and screen, distance, and exposure time as to render the best possible radiographic sensitivity.
RADIOGRAPHY (RT):	A nondestructive testing method wherein a source of X-rays or gamma rays, is utilized to indicate the subsurface condition of opaque materials. A permanent record of the soundness characteristics is generally made on a specially prepared film called the radiograph.
RADIOISOTOPE:	An unstable isotope of an element that decays or disintegrates spontaneously, emitting radiation. More than 1300 natural and artificial radioisotopes have been identified.
RADIOLOGY:	That branch of medicine that uses ionizing radiation for diagnosis and therapy.
RADIONUCLIDE (RT):	A nuclide that is radioactive.
RADIUM:	A radioactive element with the atomic number 88 and an atomic weight of 226. In nature, radium is found associated with uranium, which decays to radium, by a series of alpha and beta emissions. Radium is used as a radiation source.
RANGE (UT):	The maximum ultrasonic path length that can be displayed; see SWEEP.
RANGE MARKERS:	See MARKERS.
RAREFACTION:	The thinning out, or moving apart of the particles in a material as an ultrasonic wave is propagated. Opposite in its effect to compression. The sound wave is composed of alternate compressions and rarefactions of the material.
RATE METER (RT):	A device designed to measure radiation per unit time, as in milliroentgens per hour. It is used for detecting radiation fields and measuring the exposure rate.
RAY:	A beam of energy of small cross section.
RAYLEIGH WAVE (UT):	See SURFACE WAVE.
RBE DOSE:	RBE stands for relative biological effectiveness. An RBE dose is the dose measured in rems. (This is discussed in the report of the International Commission on Radiological Units and Measurements, 1956, NBS Handbook 62, p. 7).
READOUT (ET):	The method by which eddy current information is presented or displayed. Readout includes meters, recorders and CRTs (cathode ray tubes).
REAL-TIME RADIOGRAPHY (RT):	A type of radiography in which an image is not produced photographically, but is instead produced on a fluorescent screen viewed by a video camera. The image may be intensified or enhanced before display on a television monitor. This enables radiographic interpretation concurrent with irradiation of a specimen, and lends itself to remote rapid inspection of items on an assembly line. A video recorder may be used to record the image.
RECARBURIZE:	(1) To increase the carbon content of molten cast iron or steel by adding carbonaceous material, high-carbon pig iron or a high-carbon alloy. (2) To carburize a metal part to return surface carbon lost in processing.
RECEIVER (UT):	Search unit or transducer element, used to receive ultrasonic energy from a test part.
RECESS:	A groove or depression in a surface.
RECIPROCITY LAW (RT):	Law that states that the film blackening is determined by the product of the milliamperage or source strength and the time of exposure. See RECIPROCITY LAW FAILURE.
RECIPROCITY LAW FAILURE (RT):	A term used to describe situations in which the reciprocity law is not applicable. For very short or very long exposures, problems with film response time can cause the reciprocity law to fail.
RECORDING MEDIUM (RT):	A photographic film or other material that converts radiation energy into a permanent visible image.
RECOVERY TIME:	The time required for a test system to return to its original state after it has received a signal.

RECRYSTALLIZATION:	(1) The change from one crystal structure to another, as occurs on heating or cooling through a critical temperature. (2) The formation of a new, strain-free grain structure from that existing in cold worked metal, usually accomplished by heating.
RECTIFICATION:	Any method by which a unidirectional voltage can be obtained from an alternating supply.
RECTIFIED ALTERNATING CURRENT:	By means of a device called a rectifier, which permits current to flow in one direction only, alternating current can be converted to direct or unidirectional current. This differs from direct current in that the current value varies from a steady level. This variation may be extreme, as in the case of half-wave rectified single-phase AC or slight, as in the case of three-phase rectified AC.
RECTIFIER:	A tube or circuit capable of converting the high voltage alternating waveform into a usable unidirectional voltage waveform.
REDUCTION:	(1) In cupping and deep drawing, a measure of the percentage decrease from blank diameter to cup diameter or of diameter reduction in redraws. (2) In forging, rolling and drawing, either the ratio of the original to final cross-sectional area or the percentage decrease in cross-sectional area.
REDUCTION FACTOR:	Dose rate without a shield divided by the dose rate with a shield interposed between a source and a point at which radiation is measured.
REDUCTION OF AREA:	(1) Commonly, the difference expressed as a percentage of original area, between the original cross-sectional area of a tensile test specimen and the minimum cross-sectional area measured after complete separation. (2) The difference expressed as a percentage of original area, between original cross-sectional area and that after straining the specimen.
REFERENCE BLOCKS:	A block or series of blocks of material containing artificial or actual discontinuities of one or more reflecting areas at one or more distances from the test surface, which are used for reference in defining the size and distance of defective areas in materials.
REFERENCE NUMBER:	A mathematical value established to summarize the combined effects of conductivity, magnetic permeability, test frequency, coil radius and thickness for use in impedance diagrams.
REFERENCE RADIOGRAPHS:	A group of radiographs containing images of discontinuities. These can be used as comparison "standards" for acceptability of materials.
REFERENCE STANDARD:	A piece of material, part, or piece from a part, containing an artificial discontinuity of known size; provides a means of producing a reflection of known characteristics; used to establish a measurement scale. Also, a known size discontinuity used to produce a reflection of known characteristics. References are constructed for thickness measurement, conductivity measurement or flaw detection.
REFLECTION (UT):	An indication that has arisen as a result of an incident sound beam being reflected at the boundary of two materials of dissimilar acoustic impedance.
REFLECTION DENSITY (RT):	The common logarithm of the ratio of the brightness of a non-absorbing perfect diffuser to that of the sample, both being illuminated at an angle of 45 degrees to the surface, the direction of measurement being normal to the surface.
REFLECTOGRAM:	A picture of recording of the indications presented on the cathode ray tube of the ultrasonic instrument.
REFLECTOGRAPH:	A recording or chart made of either the signals transmitted through a part or reflected back from defects within a part, or both.
REFLECTOR (UT):	An interface at which an ultrasonic beam reflects.
REFRACTED BEAM (UT):	The beam that occurs in the second medium when an ultrasonic beam passes obliquely from one medium to another when each medium has different sound velocities.
REFRACTION (UT):	Change in direction of an ultrasonic beam as it passes obliquely through the interface between two materials with different acoustic velocity; see SNELL'S LAW.

T.O. 33B-1-1

REFRACTIVE INDEX (UT):	The ratio of the velocity of a wave in one medium to the velocity of the wave in a second medium is the refractive index of the second medium with respect to the first. It is a measure of the amount a wave will be refracted when it enters the second medium after leaving the first.
REFRACTORY:	(1) A material of very high melting point with properties that make it suitable for such uses as furnace linings and kiln construction. (2) The quality of resisting heat.
REFRACTORY ALLOY:	(1) A heat-resistant alloy. (2) An alloy having an extremely high melting point. See REFRACTORY METAL. (3) An alloy difficult to work at elevated temperatures.
REFRACTORY METAL:	A metal having an extremely high melting point. In the broad sense, it refers to metals having melting points above the range of iron, cobalt and nickel.
REINFORCEMENT OF WELD:	(1) In a butt joint, weld metal on the face of the weld that extends out beyond a surface plane common to the members being welded. (2) In a fillet weld, weld metal that contributes to convexity. (3) In a flash, upset or gas pressure weld, the original diameter or thickness.
REJECT (SUPPRESSION) (UT):	A control used for minimizing or eliminating low amplitude signals (electrical or material "noise") so that larger signals are emphasized. Use of this control can reduce the vertical linearity of the amplifier.
REJECTION LEVEL (UT):	The setting of the signal level above or below which all parts are rejectable as, in an automatic system, at which objectionable parts will actuate the reject mechanism of the system.
RELATIVE BIOLOGICAL EFFECTIVENESS (RBE):	The relative effectiveness of a given kind of ionizing radiation in producing a biological response as compared with 250,000 electron volt gamma rays.
RELATIVE EXPOSURE:	Exposure expressed relative to a standard exposure that is arbitrarily assigned the value of 1.0.
RELATIVE SPEED (RT):	The exposure time of any radiographic film relative to one particular type of film whose speed is arbitrarily assigned the value of 100.
RELEVANT DISCONTINUITY:	Discontinuity that is detrimental to the intended use of a part or material.
RELUCTANCE:	The degree of difficulty with which the magnetic flux is produced within a material. Material of high permeability has low reluctance.
REM:	The special unit of any of the quantities expressed as dose equivalent. The dose equivalent in rems is equal to absorbed dose in rads multiplied by the quality factor (1 rem = 0.01 sievert).
REMNANT MAGNETISM:	This is the term applied to the magnetism remaining in a magnetic circuit after the magnetizing force is removed.
REMOVER (PT):	See PENETRANT REMOVER.
REP:	Roentgen equivalent physical. An obsolete unit of radiation dosage now superseded by the rad.
REPETITION RATE (UT):	The rate at which the individual pulses of acoustic energy are generated; also PULSE RATE.
REPLENISHER (RT):	A modified form of the original developer which, when added to partially exhausted developer, restores its efficiency.
RESIDUAL ELEMENTS:	Elements present in an alloy in small quantities, but not added intentionally.
RESIDUAL FIELD (MT):	See FIELD, RESIDUAL.
RESIDUAL MAGNETISM (MT):	The magnetic field remaining in a part after the current has been removed.
RESIDUAL METHOD (MT):	Bath is applied after current has been shut off; that is, the indicating particles are on the part when residual (remaining) magnetic field is present.
RESIDUAL STRESS:	Stress present in a body that is free of external forces or thermal gradients.

RESILIENCE:	(1) The amount of energy per unit volume released upon unloading. (2) The capacity of a metal, by virtue of high yield strength and low elastic modulus, to exhibit considerable elastic recovery upon release of load.
RESISTANCE:	Resistance is the opposition to the flow of an electrical current through a conductor. Its unit is the ohm.
RESOLUTION (RT):	The smallest distance between adjacent distinguishable images on a radiograph or viewing screen. It may be expressed as the number of lines (or line parts) per millimeter that can be seen as discrete images.
RESOLVING POWER (UT):	The measure of the capability of an ultrasonic system to separate in time two discontinuities at slightly different distances or to separate the multiple reflections from the back surface of flat plates.
RESONANCE (UT):	The condition in which the frequency of the forced vibration (ultrasonic wave) is the same as the natural frequency of the body (test piece) which results in abnormally large amplitudes of vibration.
RESONANCE METHOD:	A technique in which continuous ultrasonic waves are varied in frequency to identify resonant characteristics in order to discriminate some property of a part as thickness, stiffness, or bond integrity.
RESONANT FREQUENCY:	The frequency at which a body will vibrate freely after being set in motion by some outside force.
RESTRAINER (RT):	The constituent (e.g., potassium bromide) that reduces the activity of the developing agent but enhances its preferential action by reducing the rate of development of unexposed grains to a greater extent than it does that of exposed grains. It thus tends to reduce chemical fog.
RESTRICTED AREA:	Any area access to which is controlled by the licensee.
RESTRIKING:	(1) Striking a trimmed but slightly misaligned or otherwise faulty forging one or more blows to improve alignment, improve surface, maintain close tolerance, increase hardness or to effect other improvements. (2) A sizing operation in which coining or stretching are utilized to correct or alter profiles and to counteract distortion.
RESULTANT (VECTOR FIELD) (MT):	When two or more magnetizing forces operating in different directions are simultaneously applied to a ferromagnetic material, a resultant field is produced, having a direction which is determined by the relative strengths and directions of the applied magnetizing forces. Such a field is also referred to as a vector field. If either or both of the applied magnetizing forces are themselves varying in direction or amount, the resultant field is moving or swinging in direction and strength. Such a moving resultant field is sometimes referred to as a "swinging field."
RESIDUAL METHOD (MT):	The method in which magnetic particles are applied to the material after the magnetizing current has been discontinued.
RESIDUAL STRESS:	Internal stress remaining in a piece of metal following some processing operation, such as hardening, cold working, etc.
RESISTANCE:	The opposition to the flow of an electrical current through a conductor or circuit that does not include inductive or capacitive elements. It can be expressed as the ratio of the applied voltage to the current.
RESOLUTION, DEFECT:	A property of a test system that enables the separation of indication due to defects in a test specimen that are located in close proximity to each other.
RESONANCE METHOD:	A method that varies the frequency of continuous ultrasonic waves to excite standing waves in a body generally used for thickness measurement.
RETENTIVITY (MT):	The ability of a material to retain magnetism after the current has been removed.
RETICULATION (RT):	The swelling of film emulsion because of sudden change of temperature, in excess of 15°F during processing.
REVERSAL (RT):	The production of a positive instead of a negative image in an emulsion or vice versa.

T.O. 33B-1-1

RF DISPLAY (UT):	A CRT signal display that is not rectified. Displayed signals are both above and below the sweep or base line.
RIGGING:	The engineering design, layout, and fabrication of pattern equipment for producing castings; including a study of the casting solidification program, feeding and gating, risering, skimmers, and fitting flasks.
RIMMED STEEL:	A low-carbon steel containing sufficient iron oxide to give a continuous evolution of carbon monoxide while the ingot is solidifying, resulting in a case or rim of metal virtually free of voids. Sheet and strip products made from the ingot have very good surface quality.
RINGING METHOD (UT):	A bonded structure inspection method in which unbonds are indicated by increased amplitude ringing signals.
RINGING SIGNALS (UT):	Closely spaced multiple signals can be caused by multiple reflections in a thin material or continued vibration of a transducer element.
RINGING TIME (UT):	The time that the mechanical vibrations of a transducer element continue after the electrical pulse has stopped.
RIPPLE (RT):	The periodic variation in the potential differences between the cathode and anode of an X-ray tube, resulting from rectification of an alternating current. As the ripple is decreased by the use of filtering circuits, a constant potential is more nearly approached.
RINSE (PT):	In penetrant inspection, the operation by which the excess surface penetrant is removed from the part. Sometimes also referred to as the WASH.
RISER:	A reservoir of molten metal connected to the casting to provide additional metal to the casting, required as the result of shrinkage before and during solidification.
R-METER:	An ionization-type instrument designed to measure radiation dose.
ROCKWELL HARDNESS TEST:	A test for determining the hardness of a material based upon the depth of penetration of a specified penetrator into the specimen under certain arbitrarily fixed conditions of test.
ROD-ANODE TUBE (RT):	A special type of X-ray tube in which the target is situated at the outer end of a long tubular anode. It usually produces panoramic radiation.
ROENTGEN (R)(RT):	The international unit of the quantity of X or gamma radiation which cause the emission of ions carrying 1 electrostatic unit quantity of charge per 0.001293 grams of air. It is usually employed to express the radiation output of a given source in terms of roentgens per hour at one meter (Rhm). Under the International System of Units this will be expressed in coulombs/kilogram ($1 \text{ r} = 2.579560 \times 10^{-4} \text{ C/kg}$).
ROENTGENS PER HOUR AT ONE METER (RT):	A specification of the output of a source of X- or gamma radiation in terms of the exposure rate, in roentgens per hour, measured in air at a distance of one meter from the source. Abbreviation: Rhm.
ROLL BENDING:	Curving sheets, bars and sections by means of rolls.
ROLL FLATTENING:	Flattening of sheets, that have been rolled in packs, by passing them separately through a two-high cold mill, there being virtually no deformation. Not to be confused with roller leveling.
ROLL FORGING:	Forging with rotating dies that are not full round, the desired shape, either straight or tapered, being produced by a groove in the dies.
ROLL FORMING:	Metal forming by the use of power-driven rolls whose contour determines the shape of the product. Sometimes used to denote power spinning.
ROLL STRAIGHTENING:	Straightening of metal stock of various shapes by passing it through a series of staggered rolls, the rolls usually being in horizontal and vertical planes.
ROLLING:	Reducing the cross-sectional area of metal stock, or otherwise shaping metal products, through the use of rotating rolls.
ROOT CRACK:	A crack in either the weld or heat-affected zone at the root of a weld.
ROOT OF JOINT:	The location of closest approach between parts of a joint to be welded.

ROOT PENETRATION:	The depth to which weld metal extends into the root of a joint.
ROTATING-ANODE TUBE (RT):	An X-ray tube in which the anode can rotate. The axis of rotation is offset from the axis of the electron beam, so that the focus lies on a circle on the rotating surface.
ROUGHNESS:	Relatively finely spaced surface irregularities, the height, width and direction of which establish the predominant surface pattern.
ROUGHNESS HEIGHT RATING:	Quantitative expression of the roughness of a surface; arithmetical average, normally expressed in microinches, of the absolute values of surface height deviation from the mean surface height. Abbreviation is rhr.
RT:	Symbol for the radiographic method of nondestructive testing/inspection.
RUPTURED METAL:	See BURSTS.
RUST:	A corrosion product consisting of hydrated oxides of iron. Applied only to ferrous alloys.

S

SAFELIGHT (RT):	A special lamp used in the darkroom to provide working visibility without affecting the photosensitive emulsion of the radiographic film.
SALT SCREEN (RT):	See INTENSIFYING SCREEN.
SALVAGE INSPECTION:	Inspection for salvage parts that can be repaired.
SAMARIUM-145:	A radioisotope of the element samarium.
SAMPLING INSPECTION:	Inspecting a random sample from a lot of parts to determine the lot quality, the sample size having been chosen in accordance with statistical methods.
SAND:	A granular material resulting from the disintegration of rock. Foundry sands are mainly silica. "Bank sands" are found in sedimentary deposits and contain less than 5% clay. "Dune" sand occurs in wind blown deposits near large bodies of water and is very high in silica content. "Moulding sand" contains more than 5% clay; usually between 10 and 20%. "Silica sand" is a granular material containing at least 95% silica and often more than 99%. "Sand core" is nearly pure silica. "Miscellaneous sand" includes zircon, olivine, calcium carbonate, lava, and titanium minerals.
SAND BLAST:	(Grit Blast) The use of sand or grit at high velocity through air pressure to clean surfaces.
SAPONIFICATION (PT):	The process of converting chemicals into soap; involves the alkaline hydrolysis of a fat or oil, or the neutralization of a fatty acid.
SATURATION (MT):	The point in the magnetization of a magnetizable object at which an increase in the magnetizing force produced no increase in the magnetic field within the part. See VERTICAL SATURATION (SCOPE) (UT): A term used to describe an indication of such a size as to reach full scope amplitude (100%). Beyond this point there is no visual display to estimate the actual real height of the response signal unless the equipment is provided with dB readout.
SCAB:	A defect consisting of a flat volume of metal joined to a casting through a small area. It is usually set in a depression, a flat side being separated from the metal of the casting proper by a thin layer of sand.
SCALE:	Oxide formed on metal by chemical action of the surface metal with oxygen from the air.
SCALE PIT:	Shallow surface depression in metal, caused by scale.
SCALING:	(1) Forming a thick layer of oxidation products on metals at high temperatures. (2) Depositing water-insoluble constituents on a metal surface, as in cooling tubes and water boilers.
SCANNING (ET, UT):	Relative movement of the search unit over a test part.
SCARFING:	Cutting surface areas of metal objects, ordinarily by using a gas torch. The operation permits surface defects to be cut from ingots, billets or the edges of plate that is to be beveled for butt welding.

T.O. 33B-1-1

SCATTER (RT):	One of the causes of haziness or fog. Some of the incident radiation is scattered by atomic electrons of the object being radiographed much as light is dispersed by fog. Any material, whether specimen, cassette, tabletop walls, floors, etc., receiving direct radiation, is a source of scattered radiation.
SCATTER UNSHARPNESS (RT):	See UNSHARPNESS.
SCATTERED ENERGY (UT):	Energy that is reflected in a random fashion by small discontinuities in the path of a sound beam.
SCATTERED RADIATION (RT):	Radiation that, as the result of interaction with matter, has had its direction changed and, for some interactions, its energy decreased.
SCATTERING (RT):	A change of direction, and possibly reduction of energy, of an incident particle or photon as the result of interaction with an atom, nucleus, or other particle.
SCATTERING ANGLE (RT):	The angle between the directions of propagation of the incident and scattered radiation.
SCHLIEREN SYSTEM (UT):	An optical system used to visually display an ultrasonic beam passing through a transparent medium.
SCHWARZCHILD EXPOSURE (RT):	A mathematical index that may be applied to one of the variables in order to correct for the failure of the reciprocity law over a limited range.
SCINTILLATION (RT):	A localized flash of light caused by a particle or photon of ionizing radiation incident on a fluorescent material.
SCINTILLATION COUNTER:	A device for counting atomic particles by means of tiny flashes of light (scintillations) which the particles produce when they strike certain crystals.
SCINTILLATOR (RT):	A substance that emits a localized flash of light when excited by an incident particle or photon of ionizing radiation.
SCLEROSCOPE TEST:	A hardness test where the loss in kinetic energy of a falling metal "tup," absorbed by indentation upon impact of the tup on the metal being tested, is indicated by the height of rebound.
SCORING:	(1) Marring or scratching of any formed part by metal pickup on the punch or die. (2) Reducing the thickness of a material along a line to weaken it purposely along that line.
SCOTCH TAPE TRANSFER (MT):	The use of colorless tape to lift a magnetic particle indication from a part.
SCRATCH:	A shallow mark or injury produced by abrasion.
SCRATCH HARDNESS:	The hardness of a metal determined by the width of a scratch made by a cutting point drawn across the surface under a given pressure.
SCREEN (RT):	Alternative term for intensifying screen.
SCREENS, FLUORESCENT (RT):	See FLUORESCENT SCREENS.
SCREENS, INTENSIFYING (RT):	See INTENSIFYING SCREENS.
SCREENS, LEAD (RT):	Layers of lead foil, used in intimate contact with the film during exposure. They act to improve radiographic quality or to decrease exposure time, or both.
SCREEN MOTTLE (RT):	(Fluorescent Screen Exposures) The visual impression of irregularity of density, in areas where the exposure is macroscopically uniform, due to the random spatial distribution of X-ray quanta absorbed in the screens. Screen mottle is much larger in scale and "softer" in outline than film graininess. See FILM GRAININESS.
SCREEN-TYPE FILM (RT):	A radiographic film produced specially to be used with fluorescent screens. This type of film has high sensitivity to the fluorescent light emitted by such screens under the effect of ionizing radiation. (Improperly called screen film.)

SCREEN UNSHARPNESS (RT):	See UNSHARPNESS.
SEALED SOURCE:	Any by-product material that is encased in a capsule designed to prevent leakage or escape of the by-product material.
SEALING:	(1) Closing pores in anodic coatings to render them less absorbent. (2) Plugging leaks in a casting by introducing thermosetting plastics into porous areas and subsequently setting the plastic with heat.
SEAM:	A discontinuity caused by a void or crack in rolled material parallel to the axis of the material which although closed is not welded. A line of junction; a line, groove, ridge, or interstice formed by or between two contracting edges.
SEARCH UNIT (UT):	A device for generating and/or receiving ultrasonic energy; may contain one or more transducer elements or, in the case of the Harmonic Bond Tester, a microphone and coil.
SEASON CRACKING:	Cracking resulting from the combined effects of corrosion and internal stress. A term usually applied to stress-corrosion cracking of brass.
SECONDARY MAGNETIC FIELD (ET):	In eddy current testing, the magnetic field produced by the eddy currents in the test material. The secondary field opposes the primary field.
SECONDARY RADIATION (RT):	Radiation other than primary radiation emerging from irradiated matter.
SEEABILITY (PT, MT):	The characteristic of an indication that enables an observer to see it against the conditions of background, outside light, etc.
SEGREGATION:	Where a metallic constituent which cools last, forms a final brittle film between crystals. It may also be a concentration of non-metallic impurities. Segregations may occur at the center or be grouped in some regular form about the center.
SELF-ABSORPTION:	Gamma ray emission from large sources wherein the gamma radiation emitted from the center of the source will be appreciably absorbed by the outer layers of the source material.
SELF-EMULSIFIABLE (PT):	(Water-Washable) Self-emulsifiable material is an oil base material containing an emulsifying agent that forms an emulsion when rinsed with water.
SELF-RECTIFYING TUBE (RT):	Any hot-cathode X-ray tube that permits current to flow only from the cathode to the anode, when the anode is kept cool.
SEMI-KILLED STEEL:	Steel that is incompletely deoxidized and contains sufficient dissolved oxygen to react with the carbon to form carbon monoxide to offset solidification shrinkage.
SEMIPERMANENT MOLD:	A permanent mold in which sand or plastic cores are used.
SENSITIVITY (MT, ET, RT, PT, UT):	The capacity or degree of responsiveness to magnetic particle inspection. The ability of an ultrasonic system to detect a very small discontinuity. The ability of a penetrant to detect surface defects. Higher sensitivity indicates finer cracks can be detected.
SENSITIVITY, DEFECT (RT):	The minimum dimension of a discontinuity, considered to be a defect, that can be detected in a radiograph under specified conditions.
SENSITIVITY, IQI (RT):	See IQI SENSITIVITY.
SENSITIVITY (PERCENT-AGE):	A ratio of the smallest detectable thickness difference divided by the thickness of material being examined.
SENSITIVITY, RADIO-GRAPHIC:	The ratio of the smallest difference in thickness that is detectable on the radiograph to the thickness of the specimen. It may be expressed as a percentage, and is an indication of ability to detect a small discontinuity. In practice, it is determined by the use of an image quality indicator (penetrameter).
SENSITIVITY, SPECTRAL (RT):	The variation in radiographic exposure, as a function of X-ray energy, required to produce a given film density.

T.O. 33B-1-1

SENSITOMETRIC CURVE (RT):	See CHARACTERISTIC CURVE.
SENSITOMETRY (RT):	A quantitative measurement of the response of a film to exposure and development.
SEPARATION ANGLE:	The angle on the impedance plane between the thickness change curve and the lift-off curve for a specific material.
SETTLING TEST (MT):	See CONCENTRATION TEST.
SG:	Swept gain. See DISTANCE AMPLITUDE CORRECTION.
SHADOW (UT):	A region in a body, which cannot be reached by ultrasonic energy, traveling in a given direction; caused by the geometry of the body or a discontinuity in it.
SHALLOW DISCONTINUITY:	A discontinuity open to the surface of a solid object which possesses little depth in proportion to the width of this opening. A scratch or nick may be a "shallow discontinuity" in this sense.
SHALLOW-DOSE EQUIVALENT:	As it applies to external exposure of the skin or an extremity, is taken as the dose equivalent at a tissue depth of 0.007 centimeters (7 mg/cm ²) averaged over an area of 1 square centimeter.
SHARPNESS (RT):	See definition RADIOGRAPHIC (RT).
SHEAR:	That type of force which causes or tends to cause two contiguous parts of the same body to slide relative to each other in a direction parallel to their plane of contact.
SHEAR FRACTURE:	A fracture in which a crystal (or a polycrystalline mass) has separated by sliding or tearing under the action of shear stresses.
SHEAR LIP:	A narrow, slanting (hence "shear") ridge along the edge of a fracture surface. The term sometimes also denotes a narrow, often crescent-shaped, fibrous region at the edge of an otherwise cleavage fracture, even though this fibrous region is in the same plane as the rest of the fracture surface.
SHEAR STRENGTH:	The stress required to produce fracture in the plane of cross-section, the conditions of loading being such that the directions of force and of resistance are parallel and opposite although their paths are offset a specified minimum amount.
SHEAR WAVE (UT):	A type of wave in which the particle motion is perpendicular to the direction of propagation.
SHEET:	A flat-rolled metal product of some maximum thickness and minimum width arbitrarily dependent on the type of metal. It is thinner than plate.
SHEET SEPARATION:	In spot, seam or projection welding, the gap which exists between faying surfaces surrounding the weld, after the joint has been welded.
SHIELD:	A layer or mass of material used to reduce the passage of ionizing radiation.
SHOCK-PROOF (RT):	A term applied to those components of the high-voltage circuit of X-ray equipment which are entirely surrounded by grounded metal enclosures, e.g., shock-proof tube, shock-proof cable.
SHOCKPROOF TUBE (RT):	An X-ray tube surrounded by a grounded conducting enclosure.
SHOE (UT):	Device used to adapt a straight beam search unit for use in a specific type of inspection such as inspection of a curved surface, angle beam or surface wave inspection, inspection around a fastener hole, etc. Also, see WEDGE.
SHORTNESS:	A form of brittleness in metal. It is designated as "cold," "hot," and "red," to indicate the temperature range in which the brittleness occurs.
SHOT PEENING:	Cold working the surface of a metal by metal-shot impingement.
SHRINK MARK:	A surface depression on a casting that sometimes occurs next to a thick section that cools more slowly than adjacent sections.
SHRINKAGE CAVITIES:	Cavities in castings caused by lack of sufficient molten metal as the casting cools.

SHRINKAGE CAVITY (ON RADIOGRAPH):	A small bubble in metal that appears as a dendritic, filamentary, or jagged darkened area on a radiograph film.
SHRINKAGE CRACKS:	Hot tears associated with shrinkage cavities.
SHRINKAGE POROSITY OR SPONGE:	(NONFERROUS ALLOYS).
SHRINKAGE POROSITY OR SPONGE (NONFERROUS ALLOYS, RADIOGRAPHIC):	A localized lacy, or honeycombed, darkened area on a film that indicates porous metal.
SHUTTER (RT):	A device that incorporates a movable shield used to block the useful beam emitted from an X-ray tube assembly or source housing.
SIDE LOBE ENERGY (UT):	Ultrasonic energy emitted from a search unit to the sides of the main sound beam.
SIEVERT (Sv):	SIEVERT (Sv): The SI unit of any of the quantities expressed as dose equivalent. The dose equivalent in sieverts is equal to the absorbed dose in grays multiplied by the quality factor (1 Sv = 100 rems).
SIGNAL (UT):	Vertical deflection from the base line on an A-scan.
SIGNAL-TO-NOISE RATIO (UT):	The ratio of the signal from the variable of interest (flaw, thickness change or conductivity change) to signals from variables which are of no interest (lift-off, geometry and finish changes and electronic components).
SILKY FRACTURE:	A metal fracture in which the broken metal surface has a fine texture usually dull in appearance. Characteristic of tough and strong metals.
SILVER HALIDE (RT):	A compound of silver with one of the halogen elements, e.g., silver bromide.
SINGLE-PHASE ALTERNATING CURRENT:	This term refers to a simple current, alternating in direction. Commercial single-phase current follows a sine wave. Such a current requires only two conductors for its circuit. Most common commercial frequencies are 25, 50 and 60 cycles per second.
SKIN EFFECT (MT, EC):	The phenomenon that causes current to flow along the surface of a conductor. As frequency increase, skin depth decreases.
SKIP DISTANCE (UT):	In angle beam testing, the distance from the sound entry point to the first reflection point on the same test surface; also sometimes called V-Path.
SKY SHINE (RT):	Scatter radiation caused by interaction of the X-ray photons with the atoms in the air molecules, or structures in the vicinity, and radiates back toward the earth. Skyshine can be detected at considerable distance from the source, therefore, it should be considered when establishing barriers, etc.
SLAG:	A non-metallic residue that forms on molten metal as a result of the combining of impurities.
SLAG INCLUSIONS:	Nonmetallic solid material entrapped in weld metal or between weld metal and base metal.
SLAG LINES:	Elongated cavities containing slag or other foreign matter.
SLIP LINES:	(Slip Bands) Traces of slip planes observed at low magnifications on the polished surface of a crystal which has been deformed after polishing.
SLIP PLANES:	In a given metal, slip occurs most easily along certain crystallographic planes. Hence, these planes are termed slip planes.
SLOUGHING (RT):	The loosening of an emulsion from its base, commencing at the edges. It is usually caused by prolonged immersion in a liquid at too high a temperature or of unsuitable chemical composition.
SLUGGING (STUBBING):	The addition of a separate piece or pieces of material in a joint before or during welding.
S-N DIAGRAM:	A plot showing the relationship of stress, S, and the number of cycles, N, before failure in fatigue testing.

T.O. 33B-1-1

SNELL'S LAW (UT):	Law that defines the angle of incidence and angle of refraction or mode conversion; expressed as: $\sin\theta_1$ divided by $\sin\theta_2 = V_1$ divided by V_2
where:	θ_1 = angle (measured from the normal to the interface surface) of the incident sound beam. θ_2 = angle (measured from the normal to the interface surface) of the refracted or mode converted beam. V_1 = velocity of incident sound beam. V_2 = velocity of refracted or mode converted sound beam.
SOAKING:	Prolonged holding at a selected temperature.
SOAK TIME (PT):	The period of time wherein parts are immersed in a bath of liquid penetrant.
SOD (RT):	Source to object distance. The distance between x-ray tube or radioisotope and the object being radiographed.
SOFT RADIATION (RT):	A qualitative term used to describe the relatively less penetrating types of ionizing radiation.
SOFT X-RAYS:	A term used to express the quality or penetrating power of X radiation; their penetrating power is relatively light.
SOLARIZATION (RT):	The instances decreased (photographic) density produced by exposure additional to that required to give maximum density. This may result in reversal.
SOLDER EMBRITTLEMENT:	Reduction in mechanical properties of a metal as a result of local penetration of solder along grain boundaries.
SOLDERING:	Sticking or adhering of metal to portions of the die.
SOLENOID:	A solenoid is a coil consisting of a number of loops of wire or cable to carry electric current. It may be used for both magnetizing and demagnetizing purposes.
SOLIDIFICATION SHRINKAGE:	The decrease in volume of a metal during solidification.
SOLUBLE (PT):	The amount of a substance that will dissolve in a given amount of another substance and is typically expressed as the number of parts by weight dissolved by 100 parts of solvent at a specified temperature and pressure or as a percent by weight or by volume.
SOLUTION HEAT TREATMENT:	A heat treatment in which an alloy is heated to a sufficiently high temperature to permit many or all of the alloying elements to become randomly dispersed throughout the metal.
SOLVENT ACTION:	The dissolution of a fluid or solid by another material.
SOLVENT CLEANING (PT):	The process of removing the excess penetrant from the surface of a part by washing or wiping with a solvent for the penetrant.
SOLVENT DEVELOPER (PT):	A developer in which the developing powder is applied as a suspension in a quickdrying solvent.
SOURCE (RT):	The origin of radiation; an X-ray tube or radioisotope.
SOURCE ASSEMBLY (RT):	A component of a gamma radiography exposure device to which the sealed source is affixed or in which the sealed source is contained. The source assembly includes the sealed source.
SOURCE CAPSULE (RT):	The immediate container that, along with the contained radioactive material, constitutes a sealed source of ionizing radiation.
SOURCE-FILM DISTANCE (SFD) (RT):	The distance between the focal spot of an X-ray tube or radiation source and the film generally expressed in inches.
SOURCE GUIDE TUBE (CONDUIT) (RT):	A flexible or rigid tube for guiding the sealed source from the exposure device to the exposure head.
SOURCE HOUSING (RT):	An enclosure for a sealed source that provides attenuation for the radiation emitted by the source. The enclosure may have an aperture through which the useful beam is emitted or through which the source is extracted.

SOURCE MATERIAL:	In atomic energy law, any material, except special nuclear material, which contains 0.05% or more of uranium, thorium, or any combination of the two.
SOURCE MATERIAL (RT):	Any material, except special nuclear material, which contains 0.05 percent or more of uranium, thorium, or any combination of the two.
SOURCE-SHIFT RADIOGRAPHY (RT):	See TRIANGULATION.
SOURCE SIZE, EFFECTIVE:	The apparent dimensions, as viewed along the beam axis, of that portion of the source from which ionizing radiation are emitted. For the purpose of calculating geometric unsharpness, the effective dimensions must always be used.
SPALL:	Cracking off, or flaking off of small particles of metal, usually in thin layers, from the surface.
SPECIFIC ACTIVITY (RT):	Specific activity is a measure of the activity per unit weight generally measured in curies per gram (SI) dis/sec-dm (See CURIE).
SPECIAL NUCLEAR MATERIAL:	In atomic energy law, includes plutonium, uranium-233, uranium containing more than the natural abundance of uranium-235, or any material artificially enriched by any of these substances.
SPECIFIC ACOUSTIC IMPEDENCE (UT):	A factor that determines the amount of reflection that occurs at an interface and represents the product of the density of the medium in which the wave is propagating and the wave velocity.
SPECIFIC ACTIVITY (RT):	Total radioactivity of a given isotope per gram of element.
SPECIFIC HEAT:	The number of British thermal units required to raise the temperature of 1 pound of metal 1°F.
SPECIFIC IONIZATION:	Number of ion pairs per unit length of path of the ionizing particle in a medium, e.g., per cm of air per micron of tissue.
SPECTRAL SENSITIVITY (RT):	The areas of the EMR spectrum to which a film is sensitive. Silver bromide films are all sensitive to ultraviolet and blue light as well as X-rays. Screen-type medical X-ray films are designed to be particularly sensitive to blue light and ultraviolet radiation from fluorescent screens, but some X-ray films are designed to be used without screens and are particularly sensitive to direct exposure from X-rays.
SPECTRUM:	An orderly array of the components of a beam of electromagnetic waves according to their frequency, wavelength, or energies.
SPEED EFFECT (ET):	The phenomenon in electromagnetic testing of which the evidence is a change in the signal voltage resulting from EMFs produced by the relative motion between a specimen and test coil assembly. These EMFs cause eddy currents that result in a space redistribution of the magnetic field.
SPEED, FILM (RT):	See FILM SPEED.
SPHEROIDIZING:	Heating and cooling to produce a spheroidal or globular form of carbide in steel.
SPELL:	The accidental release of radioactive liquids.
SPINNING:	Shaping of seamless hollow cylindrical sheet-metal parts by the combined forces of rotation and pressure.
SPLIT GATE:	A gate having the sprue axis in the die parting.
SPOT EXAMINATION:	Local examination of welds or castings
SPRINGBACK:	(1) The elastic recovery of metal after stressing. (2) The degree to which metal tends to return to its original shape or contour after undergoing a forming operation.
STABILIZER (RT):	A device that automatically compensates for variation of main voltage and/or frequency in an electric circuit. An example is the stabilization of filament heating current, and therefore the anode current, in an X-ray tube.
STABILIZING TREATMENT:	Any treatment intended to stabilize the structure of an alloy or the dimensions of a part.

T.O. 33B-1-1

STABLE ISOTOPE:	A nuclide that does not undergo radioactive decay.
STABLE ISOTOPE (RT):	A non-radioactive nuclide of a particular element.
STACKED CRYSTAL:	Several crystals cemented together with the faces of the same polarity in the same direction.
STAMPING:	A general term covering almost all press operation. It includes blanking, shearing, hot or cold forming, drawing, bending, coining.
STANDARD:	(1) A reference used as a basis for comparison or calibration. (2) A concept that has been established by authority, custom, or agreement to serve as a model or rule in the measurement of quantity or the establishment of a practice or procedure.
STANDARD CUBIC CENTIMETER PER SECOND:	Unit of leakage rate equivalent to one cubic centimeter at atmospheric pressure (14.7 pounds per square inch) and standard temperature (77°F) leaking each second. Abbreviation is STD.cm ³ /s.
STANDARD DEPTH OF PENETRATION (ET):	The depth at which the eddy current field has fallen to 1/e, or 37 percent, of its strength at the surface. In practice, it is generally used to define the sensing limit of the eddy current field.
STANDING WAVES (UT):	Waves that exist in a body when the thickness of the body is equal to an integral number of 1/2 wave lengths (thickness equal to 1/2, 1, 1 1/2, 2, or 2 1/2, etc., wave lengths); used with the resonance method.
STATIONARY GRID (RT):	A grid in which the opaque strips are so thin and so close together that it can remain stationary during exposure without causing images of the strips that would interfere with interpretation of the radiograph (e.g., Lysholm grid).
STATISTICAL INSPECTION:	The inspection of a proportion of the number of parts (such as 5 to 10%) as predetermined by probability analysis. This method does not provide complete assurance of the lot quality.
STC:	See DISTANCE AMPLITUDE CORRECTION.
STD. cm ³ /s:	Abbreviation for standard cubic centimeters per second.
STEP-WEDGE CALIBRATION FILM (RT):	A step-wedge comparison film, the densities of which are traceable to a nationally recognized standardizing body. It is used for reference when determining the density or densities of a radiograph.
STEP-WEDGE COMPARISON FILM (RT):	A strip of processed film carrying a stepwise array of increasing photographic density.
STEP-WEDGE PENETRATOR (STEP PENETRATOR):	A penetrometer of similar material to the specimen under examination, having steps ranging usually from 1 to 5 percent of the specimen thickness. Each step may contain one or more drilled holes for the assessment of definition.
STEPPED WEDGE (RT):	A device that is used, with appropriate penetrometers on each step, for the inspection of parts having great variations in thickness or a complex geometry. The stepped wedge must be made of material radiographically similar to that being radiographed.
STEREOFLUOROSCOPY (RT):	The production of a pair of radiographs suitable for stereoscopic viewing.
STEREORADIOGRAPHY (RT):	The process of finding the position and dimensions of details within a specimen by measurements made on radiographs taken from different directions.
STEREOSCOPIC (RT):	A type of viewing that employs an optical instrument (stereoscope) to combine the images of two radiographs taken from slightly different angles, thus achieving a three-dimensional effect.
STEREOSCOPY (RT):	The three-dimensional visual effect resulting from binocular vision.
STIFFNESS:	The ability of a metal or shape to resist elastic deflection. For identical shapes, the stiffness is proportional to the modulus of elasticity.

STOCHASTIC EFFECTS:	The health effects that occur randomly and for which the probability of the effect occurring, rather than its severity, is assumed to be a linear function of dose without threshold. Hereditary effects and cancer incidence are examples of stochastic effects.
STOP BATH (RT):	A chemical solution (or clean running water) used for arresting the activity of the developer remaining in the film emulsion.
STORAGE FOG (RT):	Fog caused by storing film in a high humidity/temperature environment.
STRAIGHT BEAM (UT):	A vibrating pulse wave train traveling normal to the test surface.
STRAIN:	The change per unit of length in a linear dimension of a stressed body. It may be thought of as the deformation caused by an applied load and is measured in inches of change per inch of stressed length, or in percentage of dimensional change of a specified stressed length.
STRAIN AGING:	Aging induced by cold working.
STRAIN ENERGY:	(1) The work done in deforming a body. (2) The work done in deforming a body within the elastic limit of the material. It is more properly elastic strain energy and can be recovered as work rather than heat.
STRAIN HARDENING:	An increase in hardness and strength caused by plastic deformation at temperatures lower than the recrystallization range.
STRAY RADIATION (RT):	Radiation other than the useful beam. It includes leakage, secondary, and scattered radiation.
STRESS:	Force per unit area, often thought of as force acting through a small area within a plane.
STRESS CONCENTRATION FACTOR (Kt):	The ratio of the greatest stress, in the region of a notch or other stress raiser as determined by advanced theory, photo-elasticity or direct measurement of elastic strain, to the corresponding nominal stress.
STRESS-CORROSION CRACKING:	Failure by cracking under combined action of corrosion and stress, either external (applied) or internal (residual). Cracking may be either intergranular or transgranular, depending on metal and corrosive medium.
STRESS RAISERS:	Changes in contour of discontinuities in structure that cause local increases in stress.
STRESS RELIEVING:	Heating to a suitable temperature, holding long enough to reduce residual stresses and then cooling slowly enough to minimize the development of new residual stresses. See TEMPER.
STRESS RUPTURE TEST:	A tension test performed at constant load and constant temperature, the load being held at such a level as to cause rupture. Also known as "creep-rupture test."
STRETCH FORMING:	Shaping of a sheet or part, usually of uniform cross-section, by first applying suitable tension or stretch and then wrapping it around a die of the desired shape.
STRETCHER LEVELING:	Leveling where a piece of metal is gripped at each end and subjected to a stress higher than its yield strength to remove warp and distortion. Sometimes called "patent leveling."
STRETCHER STRAIGHTENING:	A process for straightening rod, tubing and shapes by the application of tension at the ends of the stock. The products are elongated a definite amount to remove warpage.
STRETCHER STRAINS:	Elongated markings that appear on the surface of some materials when deformed just past the yield point. These markings lie approximately parallel to the direction of maximum shear stress and are the result of localized yielding. Same as Luders Lines.
STRIKING:	Electrodepositing, under special conditions, a very thin film of metal which will facilitate further plating with another metal or with the same metal under different conditions.
STRINGER:	In wrought materials, an elongated configuration of microconstituents or foreign material aligned in the direction of working. Commonly, the term is associated with elongated oxide or sulfide inclusions in steel.
STRIPPING EMULSION (RT):	A photographic emulsion, for use in autoradiography, which can be removed from its base and placed in contact with a specimen containing radioactive material.
SUBJECT CONTRAST:	See CONTRAST, SUBJECT.

T.O. 33B-1-1

SUBJECT CONTRAST (RT):	The ratio (or the logarithm of the ratio) of the radiation intensities transmitted by selected portions of the specimen.
SUBJECT RANGE (RT):	The range of thickness or radiation opacity of material in a specimen.
SUBJECTIVE CONTRAST (RT):	A qualitative estimate of the contrast in a radiograph or fluorescent screen reproduction.
SUBSTITUTIONAL SOLID SOLUTION:	An alloy composed of two or more chemical elements in which both metals are randomly distributed at equivalent lattice positions throughout the metal.
SUBSTRATE:	Layer of metal underlying a coating, regardless of whether the layer is basis metal.
SUBSURFACE CORROSION:	Formation of isolated particles of corrosion products beneath the metal surface. This results from the preferential reaction of certain alloy constituents by inward diffusion of oxygen, nitrogen and sulfur.
SUB-SURFACE DEFECT:	Any defect which does not break the surface of the part in which it exists.
SUBSURFACE INDICATION:	Any indication that does not open onto the surface of the part in which it exists.
SUPERFICIAL ROCKWELL HARDNESS TEST:	Form of Rockwell Hardness Test using relatively light loads, which produce minimum penetration. Used for determining surface hardness or hardness of thin sections or small parts, or where large hardness impression might be harmful.
SUPPRESSION (UT):	See REJECT.
SURFACE FINISH:	(1) Condition of a surface as a result of a final treatment. (2) Measured surface profile characteristics, the preferred term being ROUGHNESS.
SURFACE INDICATION:	Any indication that is open onto the surface of the part in which it exists.
SURFACE IRREGULARITY:	An image on a radiograph film that corresponds to an irregularity visible on the surface of an object being tested.
SURFACE IRREGULARITY (RT):	An image on a radiograph that corresponds to an irregularity visible on the surface of a specimen.
SURFACE IRREGULARITIES:	Any change in material surface that renders the specimen unserviceable.
SURFACE TENSION (PT):	That property due to molecular forces, by which the surface of all liquids tends to bring the contained volume into a form having the least superficial area.
SURFACE WAVE (UT):	A type of wave which travels along a surface; characterized by elliptical particle motion having effective penetration less than one wave length.
SURFACTANT (PT):	(Surface active agent) A soluble compound that reduces the surface tension of liquids, or reduces interfacial tension between two liquids or a liquid and a solid.
SURGE METHOD (MT):	Inspection by first employing a high surge of magnetizing force, followed by a reduced magnetic field during application of a finely divided ferromagnetic inspection medium.
SURGE SUPPRESSOR:	A device that automatically reduces abnormally high voltage or current transients to acceptable levels.
SURVEY:	An evaluation of the radiological conditions and potential hazards incident to the presence of radiation. When appropriate, such an evaluation includes a physical survey of the location and measurements or calculations of the levels of radiation.
SURVEY METER (RT):	A portable instrument that measures dose rate of exposure or radiation intensity.
SUSPENSION (MT):	The correct term applied to the liquid bath in which is suspended the ferromagnetic particles used in the wet magnetic particle inspection method.
SWAGING:	Forming a taper or a reduction on metal products such as rod and tubing by forging, squeezing or hammering.
SWEEP (UT):	The uniform and repeated movement of an electron beam across the CRT.

SWEEP DELAY (UT):	See DELAYED SWEEP. A delay in time, after the initial pulse, of starting the sweep presentation; also used to denote the control used for adjusting the time of starting the sweep presentation.
SWEEP LENGTH (UT):	Length of time or distance represented by the horizontal base line on an A-scan.
SYSTEM CONCEPT (PT):	A combination of penetrant and emulsifier supplied by one manufacturer and intended to perform a specific type or process of inspection. The term "Family Concept" has been changed to "System Concept" to comply with DOD standardization requirements.

T

TARGET (RT):	The area on the anode of an X-ray tube on which the electron stream impinges and from which the primary beam of X-rays is emitted.
TARNISH:	Surface discoloration of a metal caused by formation of a thin film of corrosion product.
TCG:	See DISTANCE AMPLITUDE CORRECTION.
TEAR, HOT:	Same as CRACK, HOT; but developing before the casting has completely solidified.
TEAR, MACHINING:	See CRACKS, MACHINING.
TECHNIQUE CHART (RT):	See EXPOSURE CHART.
TEMPER:	(1) In heat treatment, reheating hardened steel or hardened cast iron to some temperature below the eutectoid temperature for the purpose of decreasing the hardness and increasing the toughness. The process also is sometimes applied to normalized steel. (2) In tool steels, "temper" is sometimes used, but inadvisedly, to denote the carbon content. (3) In nonferrous alloys and in some ferrous alloys (steels that cannot be hardened by heat treatment), the hardness and strength produced by mechanical or thermal treatment, or both, and characterized by a certain structure, mechanical properties, or reduction in area during cold working.
TEMPER BRITTLENESS:	Brittleness that results when certain steels are held within, or are cooled slowly through, a certain range of temperature below the transformation range. The brittleness is revealed by notched- bar impact tests at or below room temperature.
TEMPERATURE ENVELOPE (PT):	The temperature range over which a particular penetrant inspection test will operate.
TEMPERING:	Reheating a quench-hardened or normalized ferrous alloy to a temperature below the transformation range and then cooling at any rate desired.
TEMPLATE:	A guide, gage or pattern for checking dimensions or locations.
TEMPORARY MAGNETS:	A body of normally soft steel or piece iron which is readily magnetized but retains only a very small field after the active power of the external magnetic field is removed.
TENSILE STRENGTH:	The maximum stress that a material is capable of withstanding without breaking under a gradually and uniformly applied load. Other terms commonly used to express the same thing are ultimate tensile strength and, less accurately, breaking strength.
TENTH-VALUE LAYER (TVL) (RT):	The thickness of the layer of a specified substance which, when introduced into the path of a given narrow beam of radiation, reduces the intensity of this radiation to one-tenth the original value.
TEST BLOCK:	See REFERENCE STANDARD.
TEST FREQUENCY:	The number of complete input cycles per unit time of a periodic quantity such as alternating current employed for a specified inspection. The test frequency is always considered to be the fundamental whenever harmonics are generated in the process of testing certain materials such as ferromagnetic materials.
TEST PART:	A part, material, or assembly being inspected.
TEST SURFACE:	The test part surface through which the ultrasonic energy used for inspection initially enters the test part.

T.O. 33B-1-1

THERMAL ANALYSIS:	A method for determining transformations in a metal by noting the temperatures at which thermal arrests occur. These arrests are manifested by changes in slope of the plotted or mechanically traced heating and cooling curves. When such data are secured under nearly equilibrium conditions of heating and cooling, the method is commonly used for determining certain critical temperatures required for the construction of equilibrium diagrams.
THERMAL CAPACITY:	A measure of the amount of heat that can be obtained in a given mass of material.
THERMAL FATIGUE:	Fracture resulting from the presence of temperature gradients which vary with time in such a manner as to produce cyclic stresses in a structure.
THERMAL FOCUS (RT):	That part of the anode of an X-ray tube submitted to direct heating by the electron beam.
THERMAL SHOCK:	The development of a steep temperature gradient and accompanying high stresses within a structure.
THERMAL STRESSES:	Stresses in metal, resulting from non-uniform temperature distribution.
THERMIONIC EMISSION (RT):	The emission of electrons from the surface of a heated material by virtue of their thermal energy.
THERMOLUMINESCENCE (RT):	The property possessed by certain crystals, of emitting light when heated after having been exposed to ionizing radiation.
THERMOLUMINESCENCE DOSIMETER (TLD) (RT):	A dosimeter, commonly used as a personnel monitor that uses thermoluminescent material. The total amount of light emitted upon heating of the material is proportional to the amount of radiation energy absorbed.
THETA (θ):	Symbol for the half angle of beam spread; the Greek letter Theta.
THORIATED TUNGSTEN FILAMENT (RT):	A vacuum-tube filament consisting of tungsten mixed with thorium oxide to give improved electron emission. Also known as thoriated emitter.
THORIUM:	A heavy malleable, radioactive metal used in the manufacture of thoriated tungsten target material in the X-ray tube head.
THREE-PHASE ALTERNATING CURRENT:	Commercial, electricity is commonly transmitted as three single phase currents, that is, three separate currents following separate sine curves, each at 60 cycles (or other frequency) per second, but with the peaks of their individual curves one-third of a cycle apart. At least three (sometimes four) conductors are required for three-phase alternating current.
THRESHOLD:	In reference to currents or magnetic fields, the minimum strength necessary to create a looked-for effect is called the threshold value. For example, the minimum current necessary to produce a readable indication at a given defect, is the threshold value of current for that purpose.
THRESHOLD DOSE (RT):	The minimum absorbed dose or dose equivalent that will produce a specified effect.
THROUGH TRANSMISSION METHOD (UT):	An inspection method in which ultrasonic energy is generated by one search unit and received by another at the opposite surface of the test part.
3-2T RADIOGRAPHY:	Quality level of radiography in which the finished radiograph displays a discernible image or a penetrameter hole that has a diameter equal to twice the penetrameter thickness. The penetrameter thickness equals 3 percent of the material thickness.
THULIUM-170:	A radioisotope of the element thulium.
TIME DELAY (UT):	See SWEEP DELAY.
TLD (RT):	See THERMOLUMINESCENCE DOSIMETER.
TOE CRACK:	A base-metal crack at the Toe of Weld.
TOE OF WELD:	The junction between the face of a weld and the base metal.
TOLERANCE:	The specified permissible deviation from a specified nominal dimension, or the permissible variation in size of a part.
TOMOGRAPH (RT):	A radiograph of a specified plane of a deep structure.
TOMOGRAPHY (RT):	The radiography of a predetermined interior plane of a thick material. In one method the X-ray tube and the film are moved simultaneously in opposite directions about a pivotal point in the plane of the layer.

TORSION:	A twisting action resulting in shear stresses and strains.
TOUGHNESS:	Ability of a metal to absorb energy and deform plastically before fracturing. It is usually measured by the energy absorbed in a notch impact test, but the area under the stress-strain curve in tensile testing is also a measure of toughness.
TOXIC:	The quality of certain materials being proportionally poisonous, as indicated by jeopardy to life, health or comfort.
TRACER:	An element or compound that has been made radioactive so that it can be easily followed (traced) in biological and industrial processes. Radiation emitted by the radioisotope pinpoints its location.
TRANSDUCER:	Any device that is capable of converting energy from one form to another.
TRANSDUCER (UT):	An electroacoustical device for converting electrical energy into acoustical energy and vice versa.
TRANSDUCER ELEMENT (UT):	A piezoelectric element in a search unit.
TRANSFER:	Compensation for differences in signal amplitude from equivalent reflectors in a test part and the reference standard used in an inspection.
TRANSIENT CURRENTS:	These currents are of short duration, generated by sudden changes in the electrical or magnetic conditions existing in an electrical or magnetic circuit.
TRANSMISSION ANGLE (UT):	The incident angle of the transmitted ultrasonic beam. It is zero degrees when the ultrasonic beam is perpendicular to the test surface.
TRANSMISSION CHARACTERISTICS (UT):	Test part characteristics that influence the transmitting and receiving of ultrasonic energy in an inspection; includes surface effects and internal effects.
TRANSMISSION TARGET (RT):	A relatively thin target so arranged that the X-ray beam emerges from the surface opposite that on which the electron stream is incident.
TRANSMITTER (UT):	Search unit or transducer element, used to generate ultrasonic energy to be transmitted into a test part.
TRANSVERSE:	Literally, "across," usually signifying a direction or plane perpendicular to the direction of working.
TRANSVERSE WAVE (UT):	See SHEAR WAVE.
TREES:	Visible projections of electrodeposited metal formed at sites of high current density.
TREPPANNING:	A type of boring where an annular cut is made into a solid material with the coincidental formation of a plug or solid cylinder.
TRITIUM:	A radioactive isotope of hydrogen with two neutrons and one proton in the nucleus. It is heavier than deuterium (heavy hydrogen). Tritium is used in industrial thickness gages, as a label in tracer experiments, and in controlled fusion experiments.
TUBE CURRENT (RT):	The current flowing between the cathode and anode during the generation of radiation by an X-ray tube.
TUBE DIAPHRAGM (RT):	An adjustable device, normally attached to a tube housing, that limits the cross section of the emergent X-ray beam.
TUBE FILTER (RT):	A filter that can be attached to the X-ray tube housing.
TUBE HOUSING (RT):	An enclosure that contains an X-ray tube and has a port through which the useful beam is emitted. The tube housing may also contain transformers and other appropriate components.
TUBE RATING (RT):	The maximum electrical power (in watts) that can be safely applied to an X-ray tube for a specified period.
TUBE SHIELD (RT):	The housing of an X-ray tube that normally provides protection against electric shock and affords a degree of protection against radiation.

T.O. 33B-1-1

TUBE-SHIFT RADIOGRAPHY (RT):	See TRIANGULATION.
TUBE SHUTTER (RT):	A device attached to a tube housing, generally of lead and usually remotely operated, used to permit or to prevent the emergence of the X-ray beam.
TUBE STAND (RT):	A support, often in the form of one or more vertical pillars with adjustable attachments, for holding an X-ray tube in position for use.
TUBE WINDOW (RT):	The relatively thin section of the X-ray tube through which the useful beam emerges. (Materials have different absorption properties, and thus some "Windows" are designated by their material, e.g., "Beryllium Window".)
TUNED:	Having a relatively narrow bandwidth; used to describe instruments having an initial pulse with a relatively narrow bandwidth and/or an amplifier with response to a relatively narrow range of frequencies.
TUNGSTEN ALLOY (HEAVY ALLOY) (RT):	A shielding material containing tungsten, copper, and nickel, and having a density about 50 percent greater than that of lead.
TUNGSTEN INCLUSIONS:	Inclusions in welds resulting from particles or splinters of tungsten welding electrodes.
TURBIDITY (PT, MT):	The state of being turbid, characterized by being cloudy, muddy, dully, impure or polluted.
TVG:	See DISTANCE AMPLITUDE CORRECTION.
TWO-CRYSTAL METHOD (UT):	Use of two transducers for sending and receiving. May be send-receive or through-transmission method.
TWO-FILM TECHNIQUE (RT):	A procedure wherein two films of different relative speeds are used simultaneously to radiograph both the thick and the thin sections of an item.
2-2T RADIOGRAPHY:	Quality level of radiography in which the finished radiograph displays a discernible image of a penetrometer hole that has a diameter equal to twice the penetrometer thickness. The penetrometer thickness equals 2 percent of the material thickness.
TYPE A PACKAGING (RT):	The name given, in the regulations concerning the transport of radioactive materials, to packaging capable of preventing any loss or dispersion of the radioactive contents and of maintaining its function of shielding against radiation in normal transport conditions.
TYPE B PACKAGING (RT):	The name given, in the regulations concerning the transport of radioactive materials, to packaging capable of resisting not only normal transport conditions like type A packaging but also a serious accident.

U

UMBRA (RT):	A region behind an object in a beam of radiation such that a straight line drawn from any point in this region to any point in the source passes through the object. The umbra is sometimes referred to as the region of total shadow.
ULTIMATE COMPRESSIVE STRENGTH:	The maximum compressive stress that a material can withstand under a gradually and uniformly applied load.
ULTIMATE STRENGTH:	The maximum conventional stress, tensile, compressive or shear, that a material can withstand.
ULTRA-BLUE LIGHT (PT):	Monochromatic blue light of approximately 4300 AU wavelength used to cause certain dye penetrants to fluoresce.
ULTRASONIC (UT):	Pertaining to mechanical vibrations having a frequency greater than approximately 20,000 hertz.
ULTRASONIC ABSORPTION:	A dampening of ultrasonic vibrations that occurs when the wave transverses a medium.
ULTRASONIC SPECTRUM:	The frequency span associated with elastic waves greater than the highest audible frequency, generally regarded as being higher than 2.0×10^4 cycles per second, to approximately 109 cps.

ULTRASONIC TESTING:	A nondestructive method of testing materials by transmitting high frequency sound waves through them.
UNDERBEAD CRACK:	A subsurface crack in the base metal near the weld.
UNDERCUT (RT):	A depression or groove adjoining the toe of a weld in a metal object. Appears on a radiograph as a dark area.
UNDERCUT (RT):	Undercut is a term that is used to describe the excessive radiation intensity that may be found at the edge of an object. Such undercutting is usually associated with scattered radiation.
UNDER-DEVELOPMENT (RT):	Development that is less than that required to produce the optimum results in a particular radiograph. It may arise from development for too short a time, or at too low a temperature, or from the use of exhausted developer.
UNDERFILL:	Storage of metal so that the true shape is not completely filled.
UNIAXIAL STRESS:	A state of stress in which two of the three principal stresses are zero.
UNIDIRECTIONAL:	Having one direction only.
UNIDIRECTIONAL VOLTAGE:	A voltage of which the polarity, but not necessarily the magnitude is constant.
UNIFORM STRAIN:	The strain occurring prior to the beginning of localization of strain (necking); the strain to maximum load in the tension test.
UNRESTRICTED AREA (RT):	Any area to which access is not controlled for purposes of radiation protection.
UNSHARPNESS (RT):	Unsharpness is a term used to describe the lack of definition of an edge due to geometric factors related to the source size and the source-to-film distance.
UPSETTING:	Working metal so that the cross-sectional area of a portion or all of the stock is increased.
USE FACTOR (RT):	The fraction of the workload during which the useful beam is pointed in the direction under consideration when designing shielding. Symbol: U.
USEFUL BEAM (RT):	All radiation that emerges from a source housing or an X-ray tube assembly through a port, diaphragm, or cone.
USEFUL DENSITY RANGE (RT):	The range of density over which the gradient is adequate for the recognition of image details. The upper density limit is determined mainly by the brightness available in the film illuminator, and the lower density limit by the sensitivity required.
UT:	Symbol for the ultrasonic method of nondestructive testing/inspection.

V

v:	Symbol for velocity.
V-PATH:	See SKIP DISTANCE.
VACUUM DEPOSITION:	Condensation of thin metal coatings on the cool surface of work in a vacuum.
VACUUM MELTING:	Melting in a vacuum to prevent contamination from air, as well as to remove gases already dissolved in the metal; the solidification may also be carried out in a vacuum or at low pressure.
VAN DE GRAAF GENERATOR:	An electrostatic type X-ray generator in the million and multi-million volt category.
VECTOR FIELD (MT):	See FIELD, RESULTANT.
VELOCITY (UT):	The distance an ultrasonic wave travels in unit time.
VERTICAL LIMIT (UT):	The maximum readable level of vertical indications, determined either by an electrical or a physical limit of an A-scan presentation.
VERTICAL LINEARITY (UT):	Constant relationship between the amplitude of the indications on an A-scan display and the corresponding magnitudes of the reflected ultrasonic waves from reflectors of known size.

T.O. 33B-1-1

VERY HIGH RADIATION AREA:	An area, accessible to individuals, in which radiation levels could result in an individual receiving an absorbed dose in excess of 500 rads (5 grays) in 1 hour 1 meter from a radiation source or from any surface that the radiation penetrates.
NOTES:	At very high doses received at high dose rates, unit of absorbed dose (e.g., rads and grays) are appropriate, rather than units of dose equivalent (e.g., rems and sieverts). The maximum dose rate 1 meter from the aperture of the Lorad LPX-160A Industrial X-ray Unit is 2.4 grays (240 RDAs) per minute at 0.5 meters thus the maximum dose received in one hour would equate to about 0.6 grays (60 RDAs) per minute. As such, "Very High Radiation" areas can exist for this and comparable radiation sources.
VIBRATION MODE (UT):	See MODE OF VIBRATION.
VICKERS HARDNESS TEST:	Same as diamond pyramid hardness test.
VIDEO PRESENTATION (UT):	A CRT presentation in which rectified signals are displayed.
VIEWING MASK (RT):	A device for limiting the field of examination of the radiograph.
VISCOSITY:	Quality, state or degree of being viscous. That property of a body by virtue of which, when flow occurs inside it, forces arise in such a direction as to oppose the flow.
VISCOSITY:	A measurement of a liquids resistance to change of shape or flow. Also referred to as flow resistance.
VISIBLE:	Capable of being discerned by the eye.
VISIBLE DYE PENETRANT (PT):	An intensely colored (usually red) highly penetrating liquid which will provide maximum contrast with the white developer when used for detection of surface discontinuities under normal light.
VISIBILITY (MT):	The ability of magnetic particles to be seen against a contrasting background.
VOID:	Discontinuities in which there is a physical separation between opposite walls.
VOLTAGE:	The unit of electromotive force that tends to cause an electric current to flow through a conductor.
VOLTAGE REGULATOR:	A device that automatically compensates for variations in line-power voltage, thus maintaining nearly constant voltage on the electrical circuit.

W

WATER-BREAK (MT):	A method of testing the water suspension for the proper amount of wetting agent. The inability of the rinse water to cover the entire surface in an unbroken film.
WATER-COOLED TUBE (RT):	An X-ray tube for which the principal method of cooling is dissipation of heat, directly or indirectly, by means of water.
WATER DELAY COLUMN (UT):	A hollow column filled with water and attached to a search unit; causes a time delay between the initial pulse and front surface signal.
WATER PATH (UT):	In immersion inspection or inspection using a water column delay, the distance from the search unit face to the test part front surface.
WATER TOLERANCE (IT):	The amount of water that a penetrant or emulsifier can absorb before its effectiveness is impaired.
WATER TRAVEL (UT):	In immersion testing the distance from the face of the search unit to the entry surface of the material under test.
WATER WASHABLE (PT):	A water-washable penetrant is an oil-like material containing an emulsifying agent that makes it washable by water rinsing.
WATER-WASHABILITY (PT):	The property of a penetrant that permits it to be cleaned from the surface of a part by washing with water.
WAVE FRONT (UT):	In a wave disturbance, a continuous surface drawn through the most forward points which have the same phase.

WAVE INTERFERENCE (UT):	The production of a series of maxima and minima of sound pressure, as a consequence of the superimposition of waves having different phases.
WAVELENGTH:	The distance between two points having the same phase in two consecutive cycles of a periodic wave, along a line in the direction of propagation.
WAVELENGTH (UT):	The distance between two corresponding points of the periodic pattern of particle motion that is a characteristic of ultrasonic energy propagation.
WAVE TRAIN (UT):	Succession of ultrasonic waves arising from the same source, having the same characteristics, and propagating along the same path.
WEAR FACE (UT):	A device attached to the face of a search unit to prevent wear of the transducer element.
WEDGE (RT):	See STEP WEDGE.
WEDGE (UT):	A device used to direct ultrasonic energy into a test part at an angle; also, see SHOE.
WEDGE FILTER (RT):	A filter so constructed that its thickness varies continuously or in steps from one edge to the other. Wedge filters may be used to increase the uniformity of radiation in certain types of exposures.
WELD BEAD:	A deposit of filler metal from a single welding pass.
WELD CRACK:	A crack in weld metal.
WELDING STRESS:	Residual stress caused by localized heating and cooling during welding.
WELD LINE:	The junction of the weld metal and the base metal, or the junction of the base-metal parts when filler metal is not used.
WELD METAL:	That portion of a weld which has been melted during welding.
WELD NUGGET:	The weld metal in spot, seam or projection welding.
WELD STRUCTURES:	The micro-structures of a weld deposit and heat affected base metal.
WET CONTINUOUS PROCESS (MT):	The method of applying the wet suspension to the inspection surfaces just prior to applying the magnetizing current.
WET DEVELOPER (IT):	A developer in which the developing powder is applied as a suspension or solution in a liquid, usually water.
WET METHOD (MT):	The magnetic particle inspection method employing ferromagnetic particles suspended in a liquid bath.
WETTING ACTION (MT):	The ability of a solution to adhere to the surface of an object.
WETTING AGENT (RT, MT):	In film processing, a chemical additive to the final water rinse to promote complete wetting of the film, thus assuring adequate washing away and neutralization of the prior processing solutions and prevention of water spots during the drying cycle. In magnetic particle inspection a material added to liquid that enables it to wet and cover surfaces that the liquid itself would ordinarily not wet.
WHEEL SEARCH UNIT (UT):	Ultrasonic device which couples ultrasonic energy to a test part through the rolling contact area of a wheel containing a liquid and one or more transducer elements.
WHITE CAST IRON:	Cast iron that gives a white fracture because the carbon is in a combined form.
WHOLE BODY:	Means, for purposes of external exposure, head, trunk (including male gonads), arms above the elbow or legs above the knee.
WIRE PENETRAMETER (RT):	An image quality indicator incorporating a series of wires that are graded in diameter and usually of similar material to the specimen under examination.
WOBBULATION (ET):	An effect which produces variations in an output signal of a test system and arises from variations in coil spacing due to lateral motion of the test specimen in passing through an encircling coil.
WORK HARDENING:	Same as STRAIN HARDENING.
WORKLOAD (RT):	The output of a radiation machine or a radioactive source integrated over a suitable time and expressed in appropriate units.
WROUGHT IRON:	A commercial iron consisting of slag (iron silicate) fibers entrained in a ferrite matrix.

T.O. 33B-1-1**X**

X-RADIATION (RT):	See X-RAYS.
X-RADIOGRAPHY (RT):	The process of producing radiographs using X-rays.
X-RAYS (RT):	A form of radiant energy resulting from the bombardment of a suitable target by electrons produced in a vacuum by the application of high voltages. X-rays have wavelengths between 10-11 cm and 10-6 cm.
X-RAY FILM (RT):	A film base that is coated (usually on both sides) with an emulsion designed for use with X-rays.
X-RAY PAPER (RT):	White paper coated on one side with emulsion for use with or without an intensifying screen. It is suitable for use with X-rays.
X-RAY SPECTROMETER (RT):	An instrument used to determine the wavelengths of X-rays and the relative intensities of different wavelengths in an X-ray beam.
X-RAY SPECTROSCOPY (RT):	The study of X-ray spectrums and their interpretation.
X-RAY TUBE:	A glass vacuum tube that decelerates the high velocity electrons, and produces X-rays.
X-RAY TUBE (RT):	A vacuum tube intended for the production of X-rays by bombarding the anode with a beam of electrons accelerated under a difference of potential between anode and cathode.
X-RAY TUBE ASSEMBLY (RT):	A tube housing with the tube installed. It may include high voltage and filament transformers and other appropriate elements when they are contained within the tube housing.
XERO-RADIOGRAPHY (RT):	A process using the photoconductive property of amorphous selenium to produce a radiological image, instead of photographic film.

Y

YIELD POINT:	The load (in psig) at which a marked increase in deformation occurs without an increase in load.
YIELD STRENGTH:	The stress at which a material exhibits a specified deviation from proportionality of stress and strain. An offset of 0.2% is used for many metals.
YOKE (MT):	A "C" shaped piece of soft magnetic material either solid or laminated, around which is wound a coil carrying the magnetizing current.
YOKE MAGNETIZATION (MT):	A longitudinal magnetic field induced in a part, or in an area of a part, by means of an external electromagnet shaped like a yoke.

Z

Z:	Symbol for acoustic impedance.
ZIRCON SAND:	A highly absorptive material used as a blocking or masking medium for drilled holes, slots and highly irregular geometric parts to reduce or eliminate scattered radiation.
ZONE MELTING:	Highly localized melting, usually by induction heating, of a small volume of an otherwise solid piece. By moving the induction coil along the rod, the melted zone can be transferred from one end to the other. In a binary mixture where there is a large difference in composition on the liquidus and solidus lines, high purity can be attained by concentrating one of the constituents in the liquid as it moves along the rod.