

~~SECRET~~

UNCLASSIFIED

M-U 43947-5  
C. 2

NOTICE: This material may be protected by copyright law (Title 17 U.S. Code)

AIR UNIVERSITY LIBRARY  
3 9349 00553 4991

# Aerial Attack

NOTICE: This material may be protected by copyright law. (Title 17 U.S. Code)

AIR UNIVERSITY LIBRARY  
MAXWELL AIR FORCE BASE  
ALABAMA

## Study

50-10-6c

Revised 11 August 1964

THE CONTENTS OF THIS DOCUMENT ARE CLASSIFIED SECRET UNDER THE PROVISIONS OF PARAGRAPH 3-5b(3) OF AFR 205-1A, DATED 1 NOVEMBER 1963.

Classified by \_\_\_\_\_  
Declassify on \_\_\_\_\_

By: JOHN R. BOYD  
CAPT. USAF

~~SECRET~~ UNCLASSIFIED

Downgraded at 12 Year Intervals; Not Automatically Declassified. DOD Dir 5200.10

WTL 2/5/81

Done 4-8-81  
WTL

10294862

[REDACTED]

TABLE OF CONTENTS

	PAGE
Table of Contents	i
Statement of Review	iv
Introduction	v
 Part I - Fighter vs Bomber	
Basic Limitations of the Disturbed Sight and 20mm Cannon	1
Basic Limitations of the AIM-9B Missile against a Non-Maneuvering Target	1
IR Pattern	2
Range	4
G	6
Lambda	7
Mechanics of the Pursuit Curve	11
Limitations of Our Weapons System in a Pursuit Curve Attack	16
The AIM-9B Missile	17
Types of Pursuit Curve Attack	17
The High-side Attack	18
The Overhead Attack	19
Underside Attack	21
Nose-quarter Attack	22
The Best Type of Attack against a Non-Maneuvering Target with AIM-9B	22
Overhead Attack	22
High-side Attack	24
Six-O'Clock Attack	25
Underside Attack	25
Best Type of Attack against a Non-Maneuvering Target with the 20mm Cannon	27
Maneuvering for the Attack	31
Flight Tactics	35

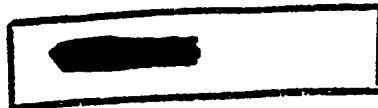

NOTICE: This material may be  
protected by copyright law  
(Title 17 U.S. Code)

# PART I

---

# FIGHTER

# VS

# BOMBER

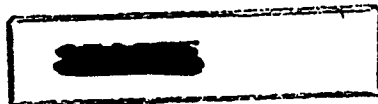



## INTRODUCTION

Tactics - fighter-versus-bomber, fighter-versus fighter, or even ground attack - are developed according to the performance capabilities or limitations of the weapons or weapons systems used. In other words, effective tactics reflect the best way to employ a given weapon against a given enemy with known or estimated capabilities. Assuming this to be true, tactics are functional - that is, they reflect the capabilities and limitations of the opponent's weapons as well as our own. Therefore, in our discussion of aerial attack, we must determine the operating envelopes of our weapons systems (this includes the aircraft and its associated armament). After having learned these envelope parameters, the discussion will center on how to best employ our weapons systems in a given fighter-versus-fighter or fighter-versus-bomber situation, in which we assume that our opponent has comparable capabilities.

Fighter-versus-bomber tactics will be covered first. In this phase, we assume that a maneuvering fighter attacks a non-maneuvering target; whereas in the fighter-versus-fighter phase, we assume that a maneuvering fighter attacks a maneuvering target. Since the fighter-versus-bomber situation has only one variable - the maneuvering fighter - a more exact technical analysis can be accomplished on it. In addition, fighter-versus-bomber theory is a fundamental departure point for fighter-versus-fighter combat.

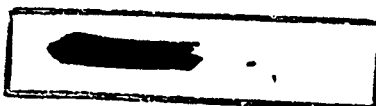



TABLE OF CONTENTS

	PAGE
Table of Contents	i
Statement of Review	iv
Introduction	v
Part I - Fighter vs Bomber	
Basic Limitations of the Disturbed Sight and 20mm Cannon	1
Basic Limitations of the AIM-9B Missile against a Non-Maneuvering Target	1
IR Pattern	2
Range	4
G	6
Lambda	7
Mechanics of the Pursuit Curve	11
Limitations of Our Weapons System in a Pursuit Curve Attack	16
The AIM-9B Missile	17
Types of Pursuit Curve Attack	17
The High-side Attack	18
The Overhead Attack	19
Underside Attack	21
Nose-quarter Attack	22
The Best Type of Attack against a Non-Maneuvering Target with AIM-9B	22
Overhead Attack	22
High-side Attack	24
Six-O'Clock Attack	25
Underside Attack	25
Best Type of Attack against a Non-Maneuvering Target with the 20mm Cannon	27
Maneuvering for the Attack	31
Flight Tactics	35



	PAGE
Summary	38
Part II - Fighter vs Fighter	
Introduction	41
Basic Limitations of AIM-9B against a Maneuvering Target	42
Fighter Maneuvers	49
Defensive Turn	51
Procedures for the Defensive Turn	53
Adverse Yaw	53
The Scissors Maneuver	55
Procedures for the Scissors Maneuver	56
Countering the Scissors Maneuver	58
Procedures for Countering the Scissors Maneuver	61
Procedures for Maneuvering against a Scissors Counter	61
The Attack	62
Procedures for the Initial Attack	63
High-Speed Yo-Yo	64
Procedures for the High-Speed Yo-Yo	70
Procedures for Countering the High-Speed Yo-Yo	72
Barrel-Roll Attack	73
Procedures for the Barrel-Roll Attack	77
Procedures for Countering the Barrel-Roll Maneuver	78
The Low-Speed Yo-Yo	79
Procedures for the Low-Speed Yo-Yo	83
Procedures for Countering the Low-Speed Yo-Yo	84
Countering the Overhead Attack with a Negative Delta Mach	84
Procedures for Countering the Overhead Attack with a Negative Delta Mach	87
Maneuvering from an Overhead Attack with a Negative Delta Mach	89
Procedures for Maneuvering from an Overhead Attack with a Negative Delta Mach	92
The Vertical Rolling Scissors	93
Procedures for the Vertical Rolling Scissors	96
Procedures for Countering the Vertical Rolling Scissors	96
The High-G Barrel-Roll	97
The High-G Barrel-Roll over the Top	98
The High-G Roll Underneath	101



	PAGE
	103
Procedures for the High-G Barrel-Roll over the Top	105
Procedures for the High-G Roll Underneath	105
Maneuvering from a Nose-Quarter Attack	110
Procedures for the Nose-Quarter Attack	111
Procedures for Countering the Nose-Quarter Attack	112
Tactical Formation	119
Procedures for Flying Element Formation	119
Flying the Position of Wingman in Patrol Formation	119
Flying the Fighting Position as a Wingman in Element Formation	120
Procedures for Flying the Fluid Four Patrol	120
Flying Position of Fluid Element Leader	120
Flying Position of Wingman in Fluid Four Patrol	121
Slight Tactics	122
Two Attacking Two	122
Procedures for Maneuvering against a Defensive Split	127
Defending Two when Attacked by Two	129
Procedures for Employing the Defensive Split	136
Performing the Defensive Split	136
Executing the Defensive Split when the Attacker Selects the Low Defender	137
Executing the Defensive Split when the Attacker Selects the High Defender	137
Playing the Defensive Split when the Attacking Element Splits	137
Executing the Defensive Split when the Attack Switches from Low Defender to High Defender	138
Attacking Four with Two	138
Attacking a Flight of Four with Four	139
Procedures for Attacking Four with Two	142
Procedures for Attacking Four with Four	142
Defending Four when Attacked by Two	144
Defending Four when Attacked by Four	144
Procedures for Defending Four when Attacked by Two	144
Procedures for Defending Four when Attacked by Four	146
Summary	146
Bibliography	147

**STATEMENT OF REVIEW**

1. In accordance with AFR 5-5 and in compliance with AFR 5-5/Wing Supplement-1, Nellis Air Force Base, dated 21 March 1960, this publication has been thoroughly reviewed by the undersigned officers, and:
  - a. Is considered essential for the following reasons:
    - (1) It satisfies a Tactical Air Command need for GAR-8 employment information.
    - (2) It provides a complete and authoritative analysis of Aerial Tactics for use by all fighter units within TAC.
    - (3) It will be used as a reference work in support of Course No. 111505B, and by units undergoing training in the Academic Section of the USAF Fighter Weapons School.
  - b. It has been determined to be an original work which does not duplicate any similar publication.
  - c. It does not contain any matter which might be considered objectionable or subject to ridicule.
  - d. No further coordination is deemed necessary.

Dorman C. Garris, Major

Billie R. Cotton, Major

Oliver S. Nelson, Major





### BASIC LIMITATIONS OF THE DISTURBED SIGHT AND THE 20MM CANNON

To adequately employ the disturbed sight and the 20mm cannon, we must understand the limitations of this equipment in any tactical situation.

The operating range of the ASG-17 disturbed sight is from 600 to 6000 feet. It will compute the proper prediction angle for a target throughout that range, from the ground up to 50,000 feet and from zero to nine G, if the pilot can track the target properly. However, it is improbable that a pilot would be able to deliver a lethal burst of fire at a range greater than 3000 feet because of the difficulty in tracking beyond that range.

To accurately predict the lead requirement, any disturbed sight requires the following basic information: range and target angular velocity. In the disturbed sight, range is provided by the ranging radar, and target angular velocity information is acquired by tracking the target aircraft. Since the pilot is forced to turn his aircraft at a certain rate, this rate of turn is a representation of target motion and is directly proportional to target speed. The angular velocity of the attacking aircraft is set into the sight through gyro action. The information is then married to the input from the radar and the proper prediction angle is computed by placing an electrical restraint (stiffness current) on the gyros. At long ranges, little restraint is applied, while at short ranges a great amount of restraint is applied. At ranges beyond 3,000 feet, little restraint is applied, thus producing a tracking index which is quite loose and difficult to control. Since the pilot's responses are not precise enough, results are usually poor, even though the equipment may be working properly.

Another limitation is the cone of dispersion of the 20mm cannon. For the M-39, harmonization criteria specifies that 80% of all rounds fired must impact in a 4-mil cone. As we increase firing range, bullet density will be decreased by a function of the square (if range doubles, bullet density quarters). At 3,000 feet, bullet density will be decreased to 1/9 that at 1,000 feet. As a result, an attacker must fire over a longer time span in order to deliver a lethal burst. At the same time, he must track a target smaller in perspective. Since it is extremely difficult to track with the disturbed sight at ranges greater than 3,000 feet, and the 20mm cone of dispersion causes loss of effective bullet density at this range, we consider our maximum range for the disturbed sight/20mm cannon as 3,000 feet.

### BASIC LIMITATIONS OF THE AIM-9B (GAR-8) MISSILE AGAINST A NON-MANEUVERING TARGET

AIM-9B is a supersonic infra-red-homing missile, launched in the target's tail cone on a pursuit course, using the fixed sight. After launch, the missile maneuvers to establish a collision course with

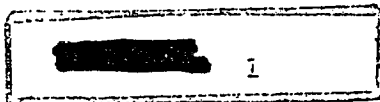

[REDACTED]

the target. In other words, the missile determines where the target is going and heads for that point in space. To successfully employ Sidewinder in a given tactical situation, you must be within its firing envelope. This firing envelope is determined by: (1) The radiation pattern of the target and (2) The performance envelope of the missile. The radiation pattern of a particular target is the area in which you can detect its IR radiation. The performance envelope is determined by: Range of the missile, number of G which the missile can pull and lambda (look-angle) limitations. Thus, the basic limitations of the missile, against a non-maneuvering target, are determined by: Infra-red pattern, range, G and lambda. Since tactics are developed according to the performance capabilities or limitations of the weapons used, discussion of the limitations is in order.

### IR Pattern

The missile gyro-seeker locks onto the strongest point-source of IR radiation. For a target in military power, the strongest point-source is the hot metal of the jet's tailpipe. Approximately 85% of the IR signal generated comes from this hot metal and the remaining 15% comes from the hot jet exhaust. For a target operating in afterburner, the primary source of radiation is the hot exhaust flame. Approximately 60% of the signal generated comes from flame and 40% is generated by the hot metal of the tailpipe. In the discussion of radiation patterns, it is necessary to keep in mind the shape of the pattern. In aircraft with shielded tailpipes, radiation patterns are generally long and relatively narrow; whereas, in aircraft which do not have shielded tailpipes, the patterns are long and wide. In fighter-type aircraft, the radiation pattern is generally long and relatively narrow since the geometry of the aircraft shields the tailpipe. This applies in military power only. In afterburner power, naturally, the pattern is long and wide, since the flame of the afterburner is not shielded by the jet's aft fuselage. In both English and Soviet bomber-type airplanes, in the horizontal plane, the jet tailpipe is shielded by the sweep-back of the wings, thus presenting a long narrow pattern. In the vertical plane, however, the pattern is long and wide, since the wings do not shield the hot metal and the jet exhaust. USAF bomber-type aircraft, on the other hand, present long and wide horizontal patterns, since the engine nacelles are suspended below the wing, providing the gyro-seeker a relatively unrestricted view of the jet exhaust. In the overhead vertical plane, the pattern is long and narrow, since the wing shields the IR radiation from the gyro-seeker. Radiation patterns vary with tailpipe temperature as well as with area of the source. In other words, the greater the temperature, the greater the radiation pattern; and, logically, the larger the source, the greater the radiation pattern. To illustrate: A bomber with 8 engines in military power, as compared to a fighter with one engine in military power, would generate a much larger radiation pattern because the area of the source is much greater.

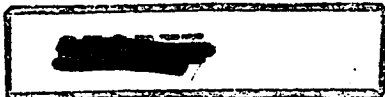

Background IR sources are significant factors affecting the size and shape of radiation patterns. Important background IR sources are (1) Sun, (2) Clouds, (3) Water, (4) Snow and (5) Terrain.

(1) Sun: The sun is the strongest source of infra-red energy known. You cannot fire Sidewinder at targets flying directly between you and the sun, since the sun's radiation will decoy the missile away from the target. Therefore, do not fire at a target which is within  $25^{\circ}$  of the sun. Also, do not continuously point the missile directly at the sun for more than ten seconds, or the lead sulphide detector may be permanently damaged.

(2) Clouds: Clouds reflect IR radiation from the sun - particularly cumulus clouds. If you must fire at a target which is framed against a bright cloud background, in all probability you will be forced to reduce your slant range to 6,000 or 8,000 feet (AFMDC ADJ S8-845) to obtain proper signal discrimination. If the target is hidden by clouds, the clouds will confuse the target signal so that the missile will not home. The signal which you receive will be the background radiation reflected by the clouds. A good rule-of-thumb for flying in clouds or against a cloud background is: diminish range until it is possible to discriminate between the background and the target signal.

(3) Water: Water, like clouds, reflects IR energy from the sun. Calm water is a tremendous background radiator when the sun's image can actually be seen in the water. Rough or choppy water, on the other hand, reflects IR radiation in all directions and the attacker need not be in a position where he can see the image of the sun on the water. As when operating against a cloud background, diminish range until you can achieve proper signal discrimination.

(4) Snow: Snow, like water and clouds, reflects the sun's IR energy. When firing against a snow background, as compared to a water or cloud background, you will have to diminish your slant range much more in order to get proper signal discrimination. There is a good possibility that you will be forced inside the missile's minimum range, thereby precluding a missile attack.

(5) Terrain: Terrain background reduces maximum missile range, as do clouds and other previously mentioned backgrounds. Light terrain in particular, such as dry lakes and sand, provides maximum background radiation. When firing against the three previously mentioned backgrounds, under an overcast, max range is not diminished nearly as much as when firing under CAVU conditions, since the clouds act as a device for shielding out the sun's IR radiation.

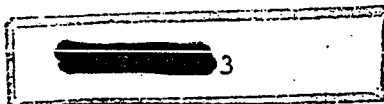

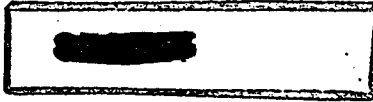

Range:

AIM-9B has both minimum and maximum range restrictions. Basic minimum range for launching is 3,000 feet. This is determined by three factors: (1) Time for the influence fuze to arm, (2) Time for the missile to set up a collision course, and (3) Delta Mach. To be assured of a kill, all three of these factors must be considered.

First, time for the influence fuze to arm: It has been proven through empirical testing, that approximately 85% of the kills achieved have been through influence fuze action. Since it takes the influence fuze about two seconds to arm - at rocket motor burn-out - a minimum range must be considered.

Second, time for the missile to set up a collision course: After launching, the missile does not begin to guide until it clears the launch aircraft. This delay lasts for about 1/2 second, at the end of which time the missile receives its first guidance command and starts to set up a collision course.

Third, Delta Mach (rate of closure): At rocket motor burn-out, the missile is traveling about 1.7 Mach above the speed of the launch aircraft. If the launch aircraft has a high rate of closure, the missile has a faster airspeed relative to the target. Since it takes a definite time for the influence fuze to arm, and a definite time for the missile to set up a collision course, the missile must travel a greater distance, relative to the target, before either one of these occurs.

Missile firing range can be determined by use of the following formula: Minimum range is equal to  $3000 \pm (\text{Delta Mach} \times 3000)$ . To illustrate: If the launch aircraft is traveling at 1.2 Mach and the target aircraft at .8 Mach, we have a Delta Mach of .4. Applying this to the formula, we see that minimum range is equal to  $3000 + (.4 \times 3000)$ , or 4200 feet. The general "rule-of-thumb" for minimum range, co-air-speed, co-altitude, however, is 3000 feet.

Maximum Range: Maximum range is determined by three factors - guidance time, air density and delta Mach. Missile guidance time is approximately 18 seconds, which is a constant value applied to both air density and Delta Mach. Air density is an important factor, in that the higher the air density the greater the aerodynamic drag, thus the shorter the range over an 18-second time period. Delta Mach is important in that the faster the launch aircraft, the faster the missile in relation to the target; thus, over an 18-second time period, the greater the distance the missile will travel. Many max-range charts have been developed by both the Air Force and the Navy to depict the maximum range at various altitudes, airspeeds, and Delta Mach relationships; however, it is virtually impossible to remember all these relationships.

The following "rules-of-thumb" may be used by the pilot to determine max range:

(1) For co-speed attacks against trans-sonic bombers - one mile for altitudes below 10,000 feet, add one-half mile range for each additional 10,000 feet increase in altitude.

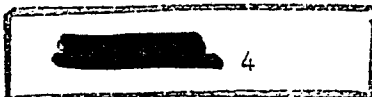

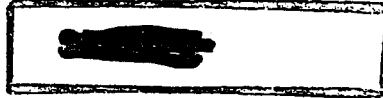

(2) For co-speed attacks against supersonic targets - one mile range for altitudes below 20,000 feet and add one-half mile for each additional 10,000-foot increase in altitude. In applying the rules-of-thumb we can see that Sidewinder's max-effective range against a sub-sonic target at 30,000 feet would be two miles, or, roughly 10,000 feet slant range. Against a supersonic target at 30,000 feet, the maximum slant range would be approximately one and one-half mile, or, roughly 7800 feet.

(3) Delta Mach "rule-of-thumb": Add one thousand feet for each .1 Delta Mach when above 30,000 feet altitude. To illustrate: A .8-Mach target, at 30,000 feet, is being attacked by a 1.2-Mach fighter at the same altitude. Applying the sub-sonic rule-of-thumb, we find that the max-effective range at which we can launch the missile is 10,000 feet, or approximately 2 miles, for a co-speed condition. Adding 4000 feet for .4 Delta Mach, we compute a new max-effective range of 14,000 feet.

The only problem now is range estimation. When in the cockpit of an attacking fighter, at minimum ranges, there is no problem, since we may use the ASG-17 radar to determine range. At max range, however, we are beyond the capability of the radar and must use another means of determining our approximate range from a given target. For normal missile firing ranges, fairly accurate range estimation can be accomplished by comparing a known aircraft wingspan with the sight reticle radius, or with pipper diameter. Applying the formula,  

$$X = \frac{WS \times 1000}{S}$$

where X = size of the target in mils  
 WS = wingspan of the target in feet  
 S = range of the attacking fighter from the target

we can determine the size of the target, in relation to the 70-mil-diameter reticle or 2-mil pipper.

Examples:

1. Size of Badger (wingspan 116') in mils when range is 10,000'

$$X = \frac{116 \times 1000}{10,000} = 11.6 \text{ or approximately } \underline{12 \text{ mils}}$$

This means that at 10,000 feet, the Badger wingspan will subtend 1/3 of a reticle radius (35 mils). At 20,000 feet the Badger span will be 6 mils and will subtend 3 pipper widths. At 5,000 feet the Badger span will be 23 mils and will subtend 2/3 of a reticle radius.



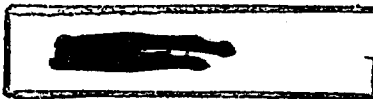

2. Size of F-100 (wingspan 39') in mils when range is 10,000 feet

$$X = \frac{39 \times 1000}{10,000} = 3.9 \text{ or approximately } \underline{4 \text{ mils}}$$

At 10,000 feet the F-100 wingspan will subtend 2 pipper widths. At 20,000 feet it will subtend 1 pipper width, and at 5000 feet, 4 pipper widths or approximately 1/5 of the radius.

### G

AIM-9B can pull approximately 10 G at sea level and approximately 3.5 G at 50,000 feet. The 10 G maximum at sea level extends almost all the way to 30,000 feet. From that altitude upward, the capability decreases until, at 50,000 feet the missile can pull approximately 3.5 G. In other words, Sidewinder can pull 10 G from sea level to 30,000 feet and approximately 3.5 G at 50,000 feet. Maximum fighter G, when launching, is approximately 2 G below 40,000 feet and 1.6 G above 40,000 feet. The G-capability of the missile determines the G-limit on the fighter at launch. To illustrate: The rate of turn of the fighter in a pursuit curve is dependent on target speed, angle off, and range, as indicated by the following formula:

$$W = \frac{V_t \times \text{Sin}\theta}{\text{Range}}$$

where W = Rate of turn in radians per second  
 V<sub>t</sub> = Target velocity in feet per second  
 Sinθ = Sine of the angle-off

By examining the formula we can see that the rate of turn (W) increases any time target velocity or angle-off increases, and decreases as range increases. The number of G which the fighter pulls, at a given rate of turn, is directly proportional to fighter speed, and may be represented by the following formula:

$$W = \frac{32.2 N}{V_f}$$

where N = Number of radial G  
 V<sub>f</sub> = Fighter velocity in feet per second  
 W = Rate of turn in radians per second

We can see from the formula that any time fighter velocity increases, we must also increase G (N), in an effort to maintain a given turn rate.

Rate of turn required for the missile to set up a collision course is dependent upon five factors: (1) target speed, (2) angle-off,

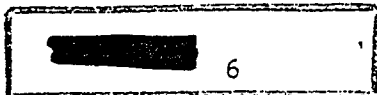

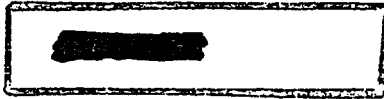

(3) range, (4) enabling time, and, (5) the navigational constant. The number of G which the missile pulls, for a given rate of turn, is directly proportional to missile speed. The higher the speed, the higher the G. If the missile is launched from a Mach 1 fighter pulling 2 G, how many G must the missile pull in order to maintain the same rate of turn as the launching fighter? As shown by the formula ( $N = \frac{V_f \times W}{V}$ ), since the missile (V) is going 1.7 Mach above the launch

32.2

aircraft's velocity, or 2.7 Mach, it must pull 5.4 G, in order to maintain the same rate of turn as the launching fighter. Why, then, are we committed to pull a maximum of 2 G when the missile can pull 10 G, an amount considerably greater than the 5.4 G which we just computed? AIM-9B does not begin to guide until 1/2 second after launch, at which time it receives its first guidance signal to set up a collision course. During this enabling period (1/2 second) the missile has the characteristics of an ordinary rocket. Because of this, an additional rate of turn is necessary to set up its collision course. To set up the collision course Sidewinder turns 3 1/2 times the rate of turn of the gyro-seeker - this is a navigational constant. Because of this, the rate of turn generated by the missile, in the first maneuver, is greater than the rate of turn of the launching fighter. Since the number of G pulled by the missile and fighter is equated to rate of turn and velocity, it is obvious that the 2 G limitation of the fighter at launch is tied to the 10 G limitation of the missile. If more than 2 G is pulled, the tracking rate of the gyro-seeker is exceeded by the line-of-sight rate, thus the seeker loses the target.

Another means of exceeding the tracking rate of the gyro-seeker is to launch the missile with an angle-of-attack in excess of 12° (the angle between the missile's longitudinal axis and the launch aircraft's flight path). For the F-100, since the missile launcher line is aligned 2° below the fuselage reference line, the maximum aircraft angle of attack is 14°. If launched with a greater angle of attack, Sidewinder will jump toward flight path, causing the tracking rate of the gyro-seeker to be exceeded by the line-of-sight rate, consequently the gyro-seeker will lose the target. When this happens, the missile goes ballistic. To avoid exceeding a 14° angle of attack, the F-100 should not be flown at less than 170 knots in a 1 G condition and 230 knots in a 2 G condition.

Lambda (look angle of seeker)

Lambda limit is simply the max look-angle between the axis of the gyro-seeker and the longitudinal axis of the missile - a 25-degree cone with its center along the longitudinal axis of the missile. Why are we interested in this lambda limitation? It is possible for a pilot to satisfy the conditions of IR, range, and G, yet be outside the lambda capability of the missile. Lambda limit may be exceeded by a combination of two factors: low missile velocity and high angle-off.

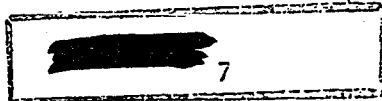

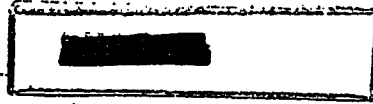

(1) Low Missile Velocity: One-half second after launch, Sidewinder turns to establish a collision course with the target. Two seconds after launch, it has a velocity 1.7 Mach greater than that of the launch aircraft. To establish a collision course, Sidewinder turns  $3\frac{1}{2}$  times the rate of the gyro-seeker axis to reduce the line of sight rate to zero, or establish a constant angular relationship between the missile and the target. After rocket motor burn-out, the missile begins to slow down. In order to maintain a collision course after deceleration, the gyro-seeker must look farther and farther to the side as it nears the target. In other words, as illustrated by figures 1 and 2, as the missile slows down, the lambda angle increases until collision occurs.

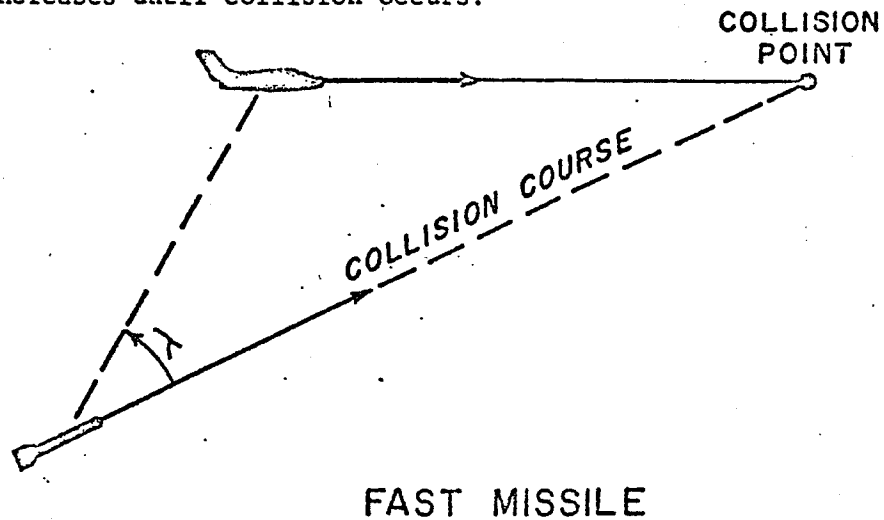

Figure 1

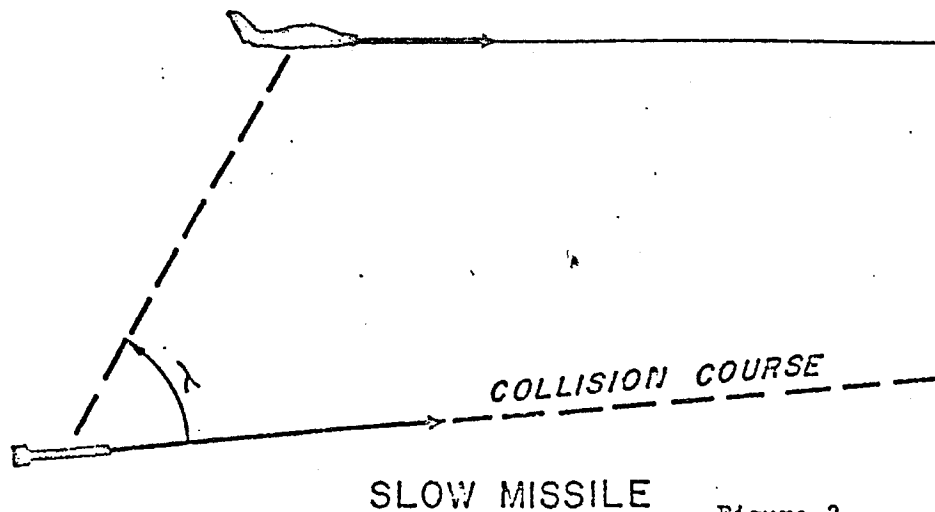
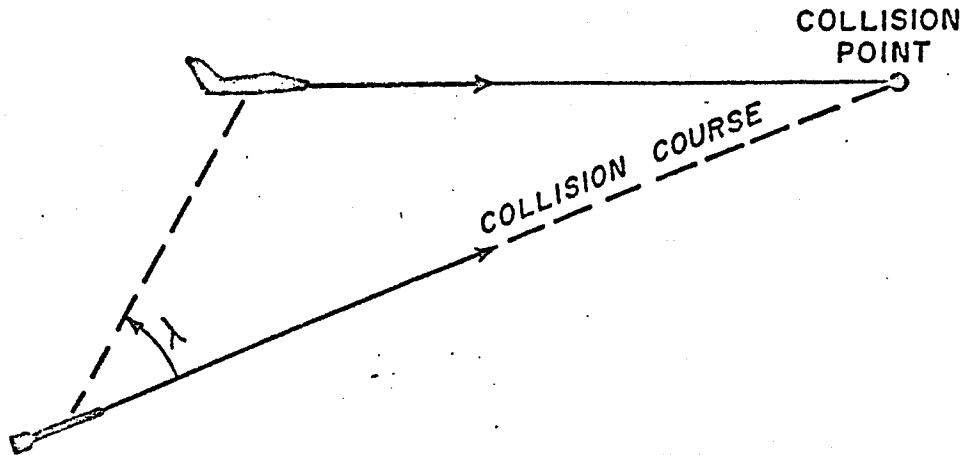

Figure 2



(2) High Angle-Off, the other basic cause of lambda-limiting is understood by considering a missile which, immediately upon launching, could turn onto the collision course. The line-of-sight angle would remain constant and the gyro-seeker would thus remain with its axis along the initial pursuit heading. It can be seen in figures 3 and 4 that the collision course for launching well off the tail differs in direction from the initial heading much more than does the collision course for launching slightly off the tail.



LARGE INITIAL ANGLE  
OFF

Figure 3

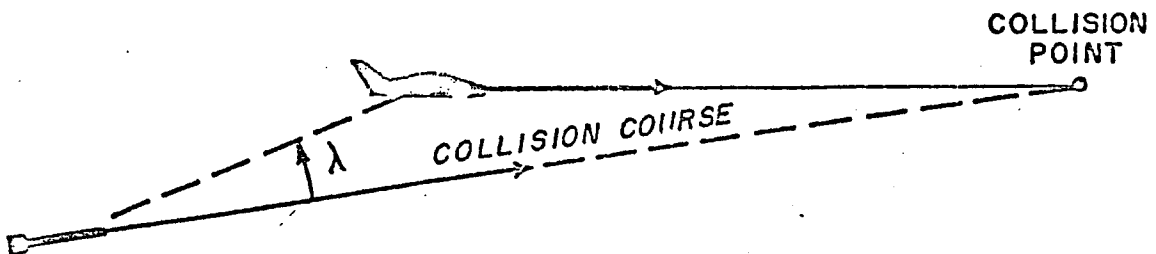

SMALL INITIAL ANGLE  
OFF

Figure 4

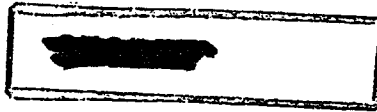

Consequently, the higher the angle-off, the greater the lambda angle. At long range (within max missile range) lambda limitation occurs at smaller angles-off, because of the effect of lambda-limitation on decreasing missile velocity. At short range, lambda limitation is caused by the sharp turn which the missile must perform. You will recall that if an attacker fires with any appreciable angle-off at short range, he will be very near his 2 G limitation, or near the 10 G limitation of the missile itself. This means that the missile is turning sharply to set up its collision course. The sharper the turn, the higher the missile angle of attack. As shown in figure 5, the angle of attack adds to the lambda angle so that lambda limit is reached. When lambda limit is exceeded, the gyro-seeker bumps against a mechanical stop, slows the gyro to a halt and the missile goes ballistic. Since we have no instrumentation available to measure lambda limit, we provide an artificial means to represent this lambda limitation - do not fire at angles-off greater than  $30^{\circ}$ . At 40,000 feet and above,

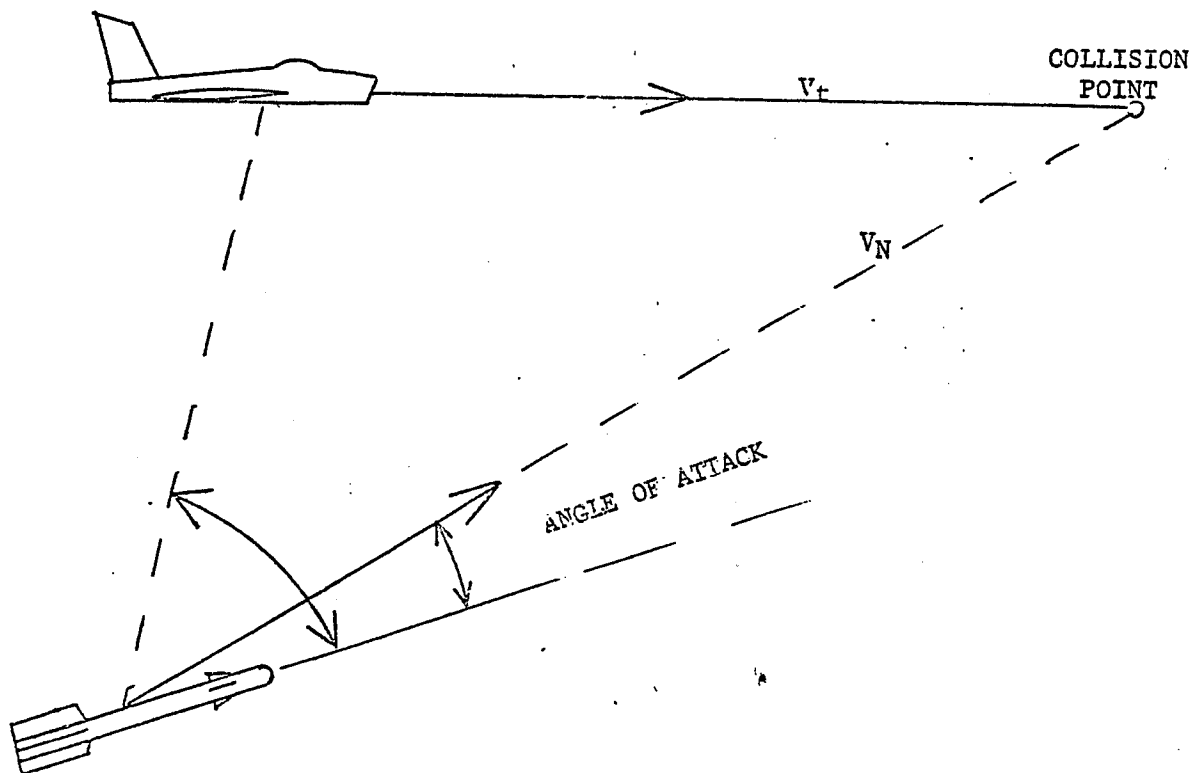
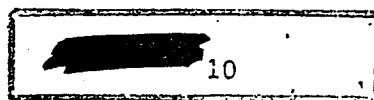
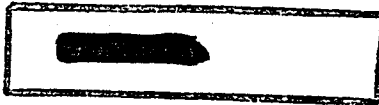

Figure 5 -- SHORT RANGE LAMBDA LIMITATION





do not exceed  $10^\circ$  angle-off - this is primarily because of servo-bias (poor burning of powder). This will preclude the possibility of an attacking pilot exceeding the lambda limitation of his missile.

In order to kill with Sidewinder, you must be within the firing envelope as defined by the infra-red, range, G and lambda limitations. If a pilot exceeds any one of these limits, kill-probability drops drastically. For practical purposes, we can define the missile firing envelope as a  $60^\circ$  cone emanating from the tail of the target aircraft, with its length dependent upon altitude and rate of closure (Delta Mach). For future use, we will describe this cone as an angular velocity cone or a cone of maximum performance.

#### MECHANICS OF THE PURSUIT CURVE

To fully comprehend the limitations of our weapons system, so that we may develop effective tactics, we need to know something of the nature of the attack in which we will be employing Sidewinder - the pursuit curve attack. A pursuit curve attack is basically an attack in which the flight path of the attacking fighter is continuously pointed at a moving target. To provide an insight into this type of attack, we will employ the following formula.

$$S = \frac{V_f \times V_t \times \sin\theta}{32.2N}$$

where S = Range

V<sub>f</sub> = Fighter velocity in feet per second

V<sub>t</sub> = Target velocity in feet per second

Sinθ = Sine of the angle-off of the attacking fighter

N = Number of radial Gs pulled by the attacker

With the above formula, we can compute the range for a given G and angle-off for any combination of target and fighter speeds. It should be noted however, that the formula does not consider lead for target motion, nor does it represent the flight path of the attacking aircraft. Instead it represents distance/bearing relationships for a given set of values at a specific point in space.

Despite the above limitations, the formula is still valid, in that it provides an insight into the problems associated with the pursuit curve. Study of the formula reveals:

1. The area of vulnerability is a narrow cone emanating from the tail of the target aircraft. This can be amply illustrated in the formula above by analyzing figure 6.

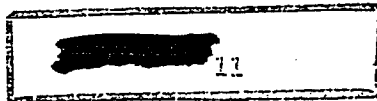

$$V_f = 1.2M = 693 \text{ KTAS} = 1,170' / S$$

$$V_t = .8M = 463 \text{ KTAS} = 782' / S$$

$$S = \frac{V_f V_t \sin\theta}{32.2N} = \frac{28,450 (\sin\theta)}{N}$$

	$\theta$	$S$
$S = 9,480 \sin\theta$	$15^\circ$	$= 2,460'$
$N = 3$	$20^\circ$	$= 3,240'$
	$25^\circ$	$= 4,010'$
	$30^\circ$	$= 4,740'$

$S = 8,130 \sin\theta$	$15^\circ$	$= 2,110'$
$N = 3.5$	$20^\circ$	$= 2,780'$
	$25^\circ$	$= 3,440'$
	$30^\circ$	$= 4,060'$

Figure 6

As shown in figure 6, the cone becomes narrower at firing ranges if the fighter velocity and/or target velocity is increased. In other words, the attacking fighter will be forced to fire at smaller angles-off if he does not wish to increase his firing range. Reducing angle-off against bomber-type targets places the attacking fighter in the bomber's effective cone of fire. Therefore, if the velocities of the target and fighter increase, and we do not reduce angle-off, the range must, of necessity, increase. The increase in range will be in proportion to the velocity increase of the fighter or the target. If both target and fighter velocities are increased, the increase in range will be a multiple of the increases of the fighter and target velocities (for example - if  $V_f$  and  $V_t$  are doubled, the range will be quadrupled).

2. The cone becomes narrower with an increase in altitude (the formula is a function of fighter velocity,  $G$ , and angle-off). It is a recognized fact that the available  $G$  of the fighter decreases with an increase in altitude and, as shown in the formula, any such decrease in  $G$  will be accompanied by an increase in range.

In a curve of pursuit, the rate of turn necessary to track a given target is determined by range, angle-off and target velocity. This rate of turn may be expressed by the following formula:

$$W = \frac{V_t \times \sin\theta}{\text{Range}}$$

where  $W$  = Radians per second  
 $V_t$  = Target velocity in feet per second  
 $\sin\theta$  = Sine of the angle-off

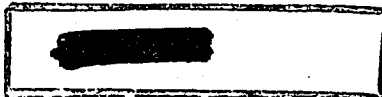

On the basis of the formula, if angle-off diminishes more rapidly than the range, the rate of turn will decrease (this will occur in some part of the pursuit curve when the fighter velocity is less than twice the velocity of the target). If range diminishes more rapidly than angle-off, throughout the curve, the rate of turn or G will increase (this will occur when the fighter velocity is more than twice as great as the velocity of the target). To find the parts of the curve where we will achieve these increases or decreases in rates of turn, we can use the following formula:

$$\text{CoSin of the angle-off where maximum G occurs} = \frac{V_f}{2xV_t}$$

where  $V_f$  = Fighter velocity  
 $V_t$  = Target velocity

NOTE: These two velocities may be expressed in knots, miles per hour, feet per second, or any other appropriate unit, as long as  $V_f$  and  $V_t$  are expressed in like values.

This formula will enable us to determine the point on the pursuit curve where maximum G will be encountered. For example: If we have a fighter with a velocity of 1.2 Mach attacking a target with a velocity of .8 Mach, the point of max-G will be about 41.4° angle-off. Therefore, in effect, we are saying that at angles greater than 41.4°, the rate of turn (or G) is increasing. At angles of less than 41.4° the rate of turn is decreasing. To further illustrate - if we have a fighter traveling at twice or greater than twice the speed of the target, the max-G point will occur at zero-degrees angle-off. In other words, there will be a G build-up or an increase in the rate of turn throughout the entire pass.

In pursuit attacks with today's fighter-bomber velocities, a fighter is forced to fire under conditions where its velocity is less than twice that of the target. In this type of attack, the fighter is not only forced to fire at longer ranges, but also to fire where his rate of turn is decreasing. We can see from studying figure 7 that the attacker's rate of turn is not only decreasing, but it is decreasing at an increasing rate. In other words, the attacker is being "sucked" or forced in-trail. As illustrated in figure 7, the attacker loses .19 G/sec at 30° angle-off. At 25° angle-off he loses .27 G/sec and so on until at 10° angle-off he loses .45 G/sec.

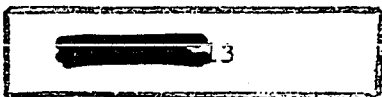

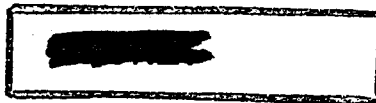

$$\begin{array}{l} V_f = 1.2 \text{ Mach} \\ V_t = .8 \text{ Mach} \end{array} \left. \vphantom{\begin{array}{l} V_f \\ V_t \end{array}} \right\} 35-80,000'$$

$$\text{Angle of Max-G} = 41.4^\circ$$

$$N_r = 4 @ 41.4^\circ$$

$\theta$	N	$\dot{N}$	S
$41.4^\circ$	4	0	4620
$30^\circ$	3.83	.19	3660
$25^\circ$	3.64	.27	3260
$20^\circ$	3.36	.35	2850
$15^\circ$	2.97	.41	2440
$10^\circ$	2.49	.46	1960

Figure 7

If the attacker decreases his G at the max-G point (with the same fighter velocities as shown in figure 8, he will be able to diminish his rate of G bleed-off. However, this will force him to fire at longer ranges. Naturally an attacker does not want to do this, because, as range increases, his bullet density decreases by a function of the square (if range doubles, bullet density quarters). As a result, an attacker must fire over a longer time span to deliver a lethal burst. At the same time, he must track a target smaller in perspective. Under these conditions, it becomes quite difficult to deliver an effective burst.

$$\begin{array}{l} V_f = 1.2 \text{ Mach} \\ V_t = .8 \text{ Mach} \end{array} \left. \vphantom{\begin{array}{l} V_f \\ V_t \end{array}} \right\} 35-80,000'$$

$$\text{Angle of Max-G} = 41.4^\circ$$

$$N_r = 3 @ 41.4^\circ$$

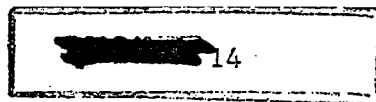

$\theta$	N	$\dot{N}$	S
$41.4^\circ$	3	0	6180
$30^\circ$	2.88	.11	4870
$25^\circ$	2.74	.16	4330
$20^\circ$	2.53	.20	3790
$15^\circ$	2.23	.23	3250
$10^\circ$	1.87	.26	2600

Figure 8

If the attacker increases his G at the max-G point, as shown in figure 9, he will be able to fire at shorter ranges. However, if he does this, his G bleed-off will become even more rapid than originally shown.

$$\begin{array}{l} V_f = 1.2 \text{ Mach} \\ V_t = .8 \text{ Mach} \end{array} \left. \vphantom{\begin{array}{l} V_f \\ V_t \end{array}} \right\} 35-80,000'$$

$$\text{Angle of Max G} = 41.4^\circ$$

$$N_r = 5 @ 41.4^\circ$$

$$\dot{N} = \text{Rate of change of } G/\text{sec}^2$$

$\theta$	N	$\dot{N}$	S
$41.4^\circ$	5	0	3710
$30^\circ$	4.80	.30	2920
$25^\circ$	4.56	.43	2600
$20^\circ$	4.21	.55	2280
$15^\circ$	3.72	.63	1950
$10^\circ$	3.12	.72	1560

Figure 9

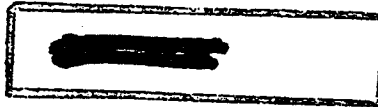

### LIMITATIONS OF OUR WEAPONS SYSTEM IN A PURSUIT CURVE ATTACK

To accurately predict the lead requirement (prediction angle) any sight requires the following basic information: range and target angular velocity. In the disturbed sight, range is provided by the ranging radar and target angular velocity information is acquired by tracking the target aircraft. Since the pilot is forced to turn his aircraft at a certain rate, this rate of turn is a representation of target motion and is directly proportional to target speed. The angular velocity of the attacking aircraft is fed into the sight through gyro action. This information is then married to the input from the radar and the proper prediction angle is computed by placing an electrical restraint (stiffness current) on the gyros. At long ranges, little restraint is applied, while at short ranges, great restraint is applied. In other words, the disturbed sight is directly tied to the responses of the pilot and to the dynamics of the aircraft when computing for target motion.

In an attack where the fighter velocity is less than twice that of the target, the following occurs:

1. The rate of turn necessary to track the target diminishes as the range decreases.
2. The stiffness current to the gyros in the sight increases as the range decreases.

Because of these two conditions, a pilot closing for the attack experiences a sensation that the pipper is drifting in front of the target. To correct for this, he relaxes back-pressure to reduce his turn rate. This, in turn, creates a lower rate input to the sight gyros, which causes the pipper to be repositioned to match the new turn rate. So, once again, the pilot must change his turn rate to reposition his tracking index, which again repositions his pipper and so on. Yet, for the attacker to have the proper prediction angle, he must continually make these corrections and also track the target one-half to two-thirds the time of flight of the bullet, to allow for sight solution time. As we can see, a pilot may nullify this effect of chasing the pipper by firing at lower G. However, if he does, he will be forced to fire at longer range. His sight will have even less restraint and his target will be smaller in perspective. If he fires at higher G (shorter range), his sight will have more restraint, but the prediction angle will continuously change in greater magnitude. As a result, the attacker has very little choice as to the type of pass he may execute. He is forced into a narrow attack cone to avoid either extreme.

To solve this problem of G bleed-off, we must refer back to the mechanics of the pursuit curve. You will recall that if an attacker's



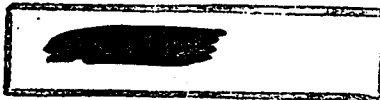

velocity is twice or more than twice that of a target, there will be an increase in rate of turn. In attacks of this nature, a different situation exists.

1. The rate of turn necessary to track a target increases as the range decreases.
2. The stiffness current to the sight gyros increases as the range decreases.

In an attack where these conditions exist, the pipper tends to remain on the target because the forward drift of the pipper is cancelled by the demand for greater G as range diminishes. In this attack, as the prediction angle is changing less in magnitude, the pilot has a more stable tracking index, and consequently, is more able to track for the required time to achieve sight solution. Naturally, this would be the ideal attack for us to perform; however, this is impossible, because the disproportionate increase in fighter and target velocities has not only pushed the firing range out, but has also created conditions where the sight prediction angle is continuously changing in considerable magnitude. These conditions seriously impair our ability to destroy a non-maneuvering target with a gun attack.

#### AIM-9B Missile

Sidewinder is not affected by the limitations of a computing sight because, in a missile attack, the pilot uses a 70-mil tracking cone with a fixed sight. This allows him to track the target quite successfully. The G bleed-off characteristics of today's pursuit attacks actually help the attacker to position himself within the 60° launch cone behind the target aircraft, since the attacker is being forced into the trail position - behind his respective target - with a G bleed-off.

#### TYPES OF PURSUIT CURVE ATTACKS

Until now, we have made a general analysis of the type of attack we will be performing against high-speed targets. Now, we will discuss specific types of pursuit curve attacks and see if one or more of these attacks offers advantages over the others. There are four basic types of pursuit attack:

1. The High-side or Level Attack
2. The Overhead Attack
3. The Underside Attack
4. The Nose-quarter Attack

[REDACTED]

### The High-Side Attack

In any attack, the rate of turn which an attacker needs to track a target may be expressed as radial G, and can be shown by the following formula:

$$N = \frac{V_f \times V_t \times \sin\theta}{32.2S}$$

The radial G expressed here represents the lateral acceleration of the fighter in the horizontal plane. It does not represent the total G on the aircraft, since it neglects the pull of gravity (1G). Total G is the resultant of radial G and 1 G pull of gravity acting through the vertical axis of the aircraft. This total G determines angle of attack - the angle between the mean chord line and the relative wind. Since total G determines angle of attack, the aircraft stalls on total G. In view of this fact, and because our previous formula considered only radial G, we must determine the exact relationship between total and radial G. It may be expressed as follows:

$$G_t^2 = G_r^2 + 1$$

where  $G_t$  = Total G

$G_r$  = Radial G

1 = 1 G gravity

We can see, by the formula, that total G will always be greater than radial G. This is a disadvantage, because the rate of turn which an attacker needs to track a target, or the range to which an attacker can approach a target is dependent upon radial G, not total G. This disadvantage becomes less at higher G values because the difference between total and radial G is less. Example:

$$\text{If } G_t = 4$$

$$G_r = \sqrt{G_t - 1} = \sqrt{16 - 1} = 3.87$$

$$\text{If } G_t = 2$$

$$G_r = \sqrt{G_t - 1} = \sqrt{4 - 1} = 1.73$$

The difference between 2 and 1.73 = .27 whereas the difference between 4 and 3.87 = .13.

Since a greater difference exists between  $G_t$  and  $G_r$  at lower G values, the rate of turn is reduced not only because less total G is available, but also because an even greater loss of radial G is experienced.

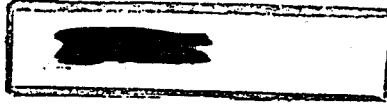

### The Overhead Attack

The overhead attack, as compared to the high-side or level attack, has the apparent advantage of maintaining airspeed and G because the thrust vector and gravity act together to provide a greater total force. However, to determine whether or not there is a real advantage, let's examine the difference between rate of turn (GR) and total G. To digress, let's assume that an aircraft is in straight-and-level flight. How many G will show on the G-meter? One G. Now, let's assume that an aircraft is in straight-and-level flight, but upside down. How many G will show on the G-meter? One negative G. Now remembering these relationships, let's note the total and radial G relationships at four points around a loop - the pullup, the 90° point, the 180° point, and the 270° point. For example: let's assume that the aircraft is pulling 4 total G at the pullup as illustrated in figure 10. How many radial G is it pulling? Three. Then, in effect, we have added 3 G to the 1 G needed for straight-and-level flight, to give us 4 total G at pullup. At the 90° point, when pulling 4 total G, we will also be pulling 4 radial G. At this point, gravity is 90° from our vertical axis, thereby exerting no pull along this axis - instead, it is a drag factor action 180° from the aircraft line of flight. At the 180° point, when we are pulling 4 total G, we will have 5 radial G, thereby giving us a turn rate - at a given airspeed - greater than at any other point on the loop. In other words, as compared to the pullup, gravity (1 G) acts in the opposite direction, therefore gravity must add to, rather than subtract from total G, to provide a greater radial G. At the 270° point, once again, total G equals radial G except that gravity acts in the same direction as the aircraft line of flight. From the 270° point on, radial G diminishes in relation to total G until the pullup point is reached. At this point we again have 1 G difference between total and radial G.

In an overhead attack, to determine the difference between total and radial G, we may use the following formula:

$$G_t = G_r + \text{Cos}\theta$$

where  $G_t$  = Total G  
 $G_r$  = Radial G  
 $\text{Cos}\theta$  = CoSine of the angle-off

It is obvious, from the formula, that the relationship between total and radial G is considerably different from that experienced in a high-side pass. Example:

In a Level Pass where  $G_t = 4$ ,

$$G_r = \sqrt{16 - 1} = \underline{3.87}$$

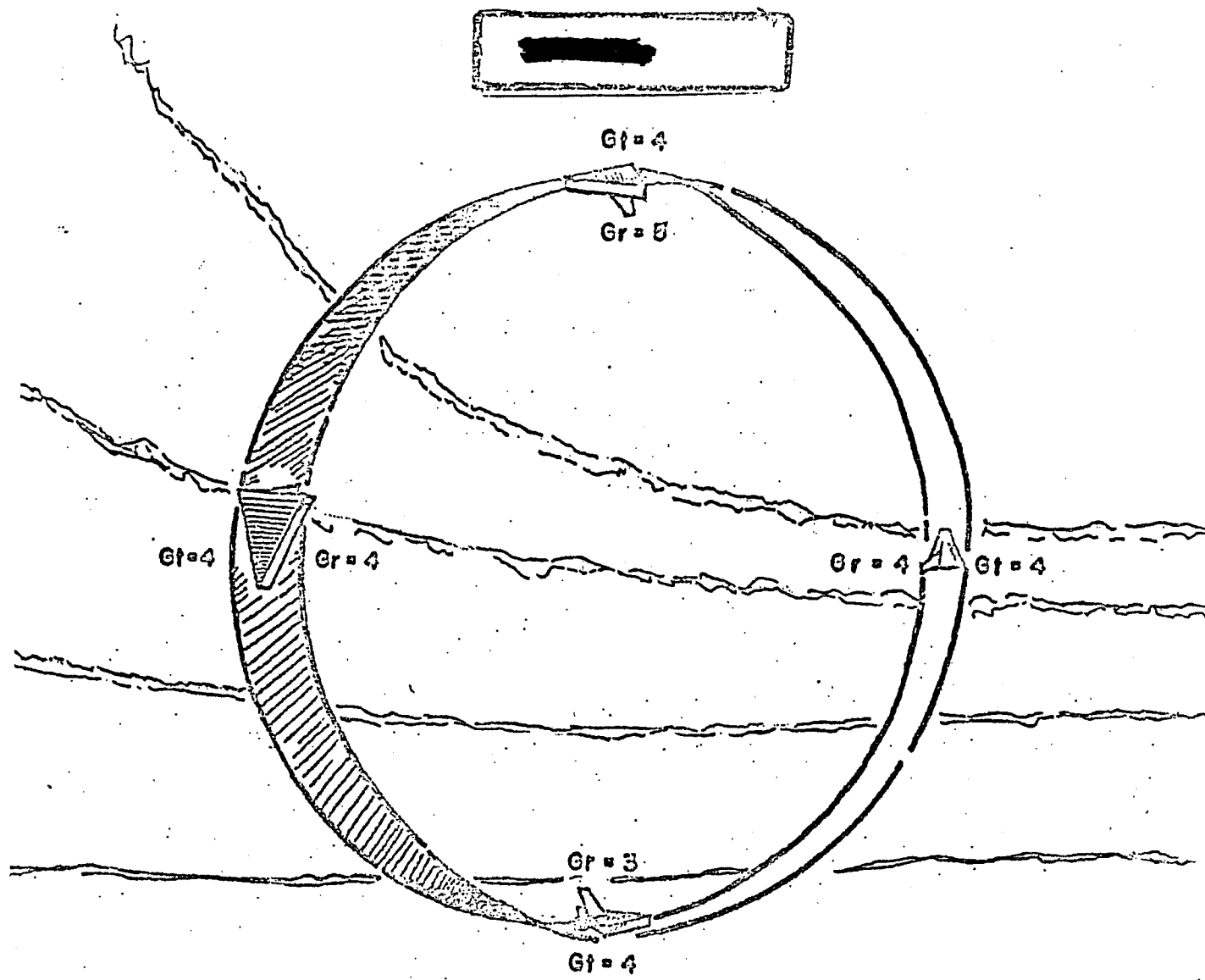
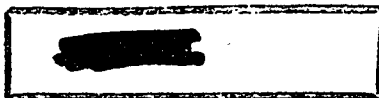

Figure 10



In an Overhead Pass at  $30^\circ$  angle-off where  $G_t = 4$ ,

$$G_r = G_t - \text{Cos}\theta \text{ or } G_r = 4 - .866 = \underline{3.14}$$

As shown in the example above, if an attacker is forced to fire inside an opponent's maximum performance cone - at angles of less than  $30^\circ$  - this means that from .866 to 1 more G, above radial G, is necessary to track a given target. Thus, as compared to a high-side attack, even though an attacker may have an apparent advantage in maintaining higher G, it is largely wiped out by the greater difference between radial and total G. The important thing to keep in mind here is that the overhead attack offers no significant advantages over the high-side attack.

#### Underside Attack

The Underside Attack provides an effect just opposite that illustrated in the overhead pass. Here, an attacker generates a radial G higher than total G upon his aircraft (you will recall that in the top half of the loop, radial G is greater than total G) and may be expressed by the following formula:

$$G_t = G_r - \text{Cos}\theta$$

If we assume the same attack conditions as illustrated in the overhead pass -  $30^\circ$  angle-off, 4 total G - we get the following results:

$$G_r = 4 + .866 \text{ or}$$

$$G_r = 4.866$$

In terms of G, this attack seems to provide an apparent advantage, however this does not always hold true. For example: If an attacker performed an underside attack in an F-100, he would experience a rapid speed decay, because of gravity as well as induced drag. As a result, since speed determines G available, the attacker would have much less total G. In addition, because of airspeed decay, the attacker would diminish the fighter-target ratio. As a consequence, the attacker's max-G point would be forced farther out - in angle-off, and range - causing a further reduction in both total and radial G. As a result, the F-100 would not gain appreciably by this attack, since total G available is reduced sufficiently to cancel out the advantage of a higher radial G. However, if this same attack were executed in an aircraft with a very high power-to-weight ratio and a low-drag profile - such as the F-104 - the attack could be invaluable, since high speed decay and G bleed-off would not occur.

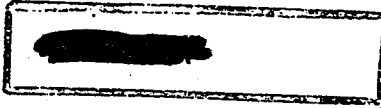

### Nose-Quarter Attack

A nose-quarter attack is ineffective for the following two reasons:

1. We cannot launch the AIM-9B missile from this position, because of the missile's IR limitations.
2. In a gun attack from a nose-quarter position, we can avoid the defensive-fire coverage of a given bomber. However, in this type attack, the rate of closure becomes so high that an attacker cannot deliver an effective burst and avoid a collision with a target. For these two reasons, we will not consider this attack further.

### THE BEST TYPE ATTACK AGAINST A NON-MANEUVERING TARGET WITH AIM-9B

To determine the best type attack to employ with the missile, let's first examine the possible attacks which we may employ with this equipment. There are four basic sidewinder attacks which we may employ.

1. Overhead Attack
2. The High-side Attack
3. The Six-O'clock Attack
4. The Underside Attack

### Overhead Attack

The Overhead Attack has two basic disadvantages - IR and G. As you will recall, IR tone contrast against sunlight-reflective backgrounds - clouds, and ground - forces us to diminish our effective slant range, until we are approximately 6000' to 8000' from our target. This IR limitation, combined with the 2G limitation, allows an attacker to fire only at low angles off. To illustrate, by figure 11, if an attacker pulls 2 G inside an opponent's cone of max performance - angular velocity cone - he will generate a radial G considerably different than the total G on the G meter. For example, at 30° angle off, applying the formula  $G_t = G_r + \text{Cos}\theta$ , we find that the attacker is only able to generate 1.134 Gr.

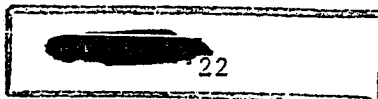

$$\begin{aligned} V_f &= .9 \text{ Mach} = 873' / \text{S} \\ V_t &= .9 \text{ Mach} = 873' / \text{S} \\ G_t &= 2 \\ \theta &= 10^\circ, 20^\circ, 30^\circ \end{aligned} \quad \left. \begin{array}{l} \\ \\ \\ \end{array} \right\} 35 - 80,000'$$

$$\begin{aligned} Gr @ 10^\circ &= 2 - .985 = 1.015 \\ Gr @ 20^\circ &= 2 - .94 = 1.06 \\ Gr @ 30^\circ &= 2 - .866 = 1.134 \end{aligned}$$

$$S = \frac{V_f V_t \sin \theta}{32.2GR} = \frac{23700 \sin \theta}{Gr}$$

$$S = \frac{23,700 \times .174}{1.015} = 4.060$$

$$\theta = 10^\circ$$

$$S = \frac{23,700 \times .342}{1.06} = 7.650$$

$$\theta = 20^\circ$$

$$S = \frac{23,700 \times .5}{1.134} = 10.450$$

$$\theta = 30^\circ$$

Figure 11

At 20° angle-off, applying the same formula, we find that the attacker can generate 1.06 Gr. At 10° angle-off, he can generate only 1.015 Gr. Now let's assume that the fighter making this attack is going .9 Mach against a .9 Mach target at 35,000'. Applying the formula:

$$S = \frac{V_f V_t \times \sin \theta}{32.2N}$$

$$\text{where } V_f = .9 \text{ Mach or } 873' / \text{S}$$

$$V_t = .9 \text{ Mach or } 873' / \text{S}$$

$$\sin \theta @ 30^\circ = .5$$

$$N = 1.134$$

we find that, at 30° angle-off, an attacker can get no closer than 10,450'. At 20° angle-off - where  $\sin \theta = .342$  and  $N = 1.06$  - we find that an attacker can get no closer than 7,650'. At 10° angle-off, using the same procedure, we find that an attacker can get no closer than 4,060'. Since an attacker cannot receive proper IR discrimination at ranges greater than 6000' to 8000' feet, he will be forced to launch his missile inside 20 degrees angle-off in order to secure a kill. Certainly this poses no great problem, as the

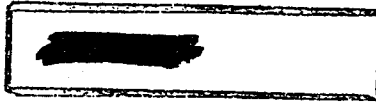

attacker will be forced in-trail since the fighter/target ratio is much less than 2 to 1. However, despite this aid from a low fighter/target ratio, the overhead attack is the poorest possible for employment of AIM-9B. (This will become especially apparent when we discuss fighter-versus-fighter tactics.)

### High-Side Attack

In a High-side Attack, IR tone contrast will not be adequate at longer missile ranges because of background reflections; however, when compared to an overhead attack, IR range is somewhat better. G presents no significant limitation, as illustrated by figure 12.

$$\begin{aligned}
 V_f &= .9 \text{ Mach} = 873' / \text{S} \\
 V_t &= .9 \text{ Mach} = 873' / \text{S} \\
 G_t &= 2 \text{ Gr} = 1.73 \\
 G_t &= 1.6 \text{ Gr} = 1.25 \\
 S &= \frac{V_f V_t \sin \theta}{32.2 \text{ Gr}} = \frac{23,700 \sin \theta}{\text{Gr}} \\
 S &= 13,700 \sin \theta \quad 10^\circ = 2380 \\
 \text{Gr} &= 1.73 \quad 20^\circ = 4680 \\
 &\quad 30^\circ = 6840 \\
 S &= 19,000 \sin \theta \quad 10^\circ = 3300 \\
 \text{Gr} &= 1.25 \quad 20^\circ = 6490 \\
 &\quad 30^\circ = 9480
 \end{aligned}$$

Figure 12

This figure discloses that when below 40,000 feet and pulling 2 G, we will be generating 1.73 radial G. Applying this figure to our cone of max performance (our angular velocity cone) we find that at 30° angle-off, we can close to a range of 6,840 feet and at 10° angle-off, 2,380 feet, but the important thing to remember is that we cannot get inside the ranges specified at 30°, 20° and 10° angle-off without exceeding the 2-G limitation. At 40,000 feet, when we are pulling 1.6 total G, we will be generating 1.25 radial G. In terms of distance, we will be at the range specified in the figure above. Once again, if we attempt to get inside the specified range at a given angle-off, we will exceed our 1.6-G limitation.

We can see, by comparing the high-side attack with the overhead attack, that the high-side is better, because of less limitations in IR and G. In other words, we have greater freedom of maneuver to successfully launch Sidewinder.



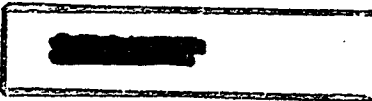

### Six-O'clock Attack

In a six-o'clock attack, IR tone contrast occurs at greater ranges because the horizon does not reflect as much background IR radiation. Since we are at  $0^\circ$  angle-off, there will be no G or lambda limitation, therefore we can fire Sidewinder from any range between maximum and minimum. In view of these facts, the six-o'clock attack is the best so far, because AIM-9B is not forced to operate near its limiting parameters. In addition, because of our position in relation to the target, we achieve an element of surprise.

### Underside Attack

The underside or six-o'clock-low attack, is the best possible attack we can execute, as we acquire advantages in:

1. IR
2. G
3. Surprise
4. Aircraft Performance

IR Tone contrast is maximum against a blue-sky background. Here, the lead sulphide cell can discriminate between the hot metal of the jet's tailpipe and the blue sky. At ranges of 20,000 feet and greater, the IR pattern becomes longer than the range of the missile. The G limitation, in relation to missile range and IR tone contrast, is almost non-existent. (see figure 13).

$$\begin{aligned} V_f &= .9 \text{ Mach} = 873' / \text{s} \\ V_t &= .9 \text{ Mach} = 873' / \text{s} \end{aligned} \quad \left. \begin{array}{l} \\ \\ \end{array} \right\} 35 - 80,000'$$

$$\begin{aligned} G_t &= 2 \\ \theta &= 10^\circ, 20^\circ, 30^\circ \\ Gr @ 10^\circ &= 2 + .985 = 2.985 \\ Gr @ 20^\circ &= 2 + .94 = 2.94 \\ Gr @ 30^\circ &= 2 + .866 = 2.866 \end{aligned}$$

$$S = \frac{V_f V_t \sin \theta}{32.2 Gr} = \frac{23,700 \sin \theta}{Gr}$$

$$S = \frac{23,700 \times .174}{2.985} = \underline{1,380'}$$

$$\theta = 10^\circ$$

$$S = \frac{23,700 \times .342}{2.94} = \underline{2,760'}$$

$$\theta = 20^\circ$$

$$S = \frac{23,700 \times .5}{2.866} = \underline{4,130'}$$

$$\theta = 30^\circ$$

Figure 13

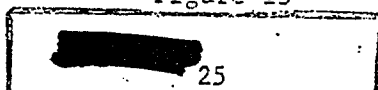

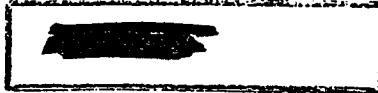

This figure shows that, as we approach our cone of maximum performance, we find that we can generate 2.866 radial G while pulling 2 total G. Applying this value to the figure above, we find that we can launch Sidewinder at a range as near as 4,130 feet at  $30^\circ$  angle-off without exceeding our 2-G limitation. At  $20^\circ$  angle-off, while generating 2.94 radial G, we find that we can launch as near as 2,760 feet without exceeding the 2-total-G limitation. At  $10^\circ$  angle-off, we can launch at a range as close as 1,380 feet. To put it another way, when we launch our missile against a target from an underside attack, the missile must turn in the direction of gravity to set up its collision course - thus, gravity, acting in the direction of the missile's turn, actually causes the missile to fall toward the target. In other words, the missile has a maneuvering advantage, since it generates a radial G greater than its total G. This advantage we have already considered in the previous illustration. Surprise, the third major advantage, is greatest when attacking a target from underneath, or from six-o'clock-low, since this is the target's blind area. Aircraft Performance, the fourth major advantage, can be understood by referring to figure 14.

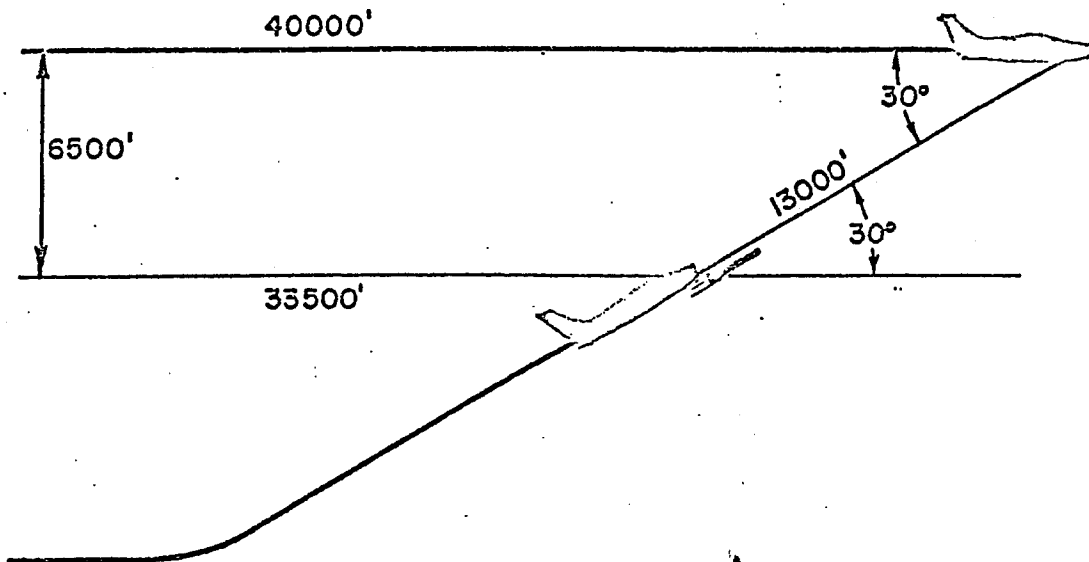

#### UNDERSIDE ATTACK

Figure 14

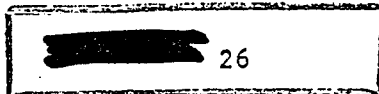

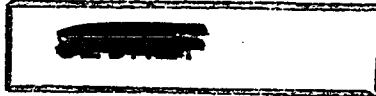

Here, we are an attacker ready to launch AIM-9B against a target travelling .9 Mach at 40,000 feet. Applying a rule-of-thumb for co-air-speed, we see that the fighter can launch from a max range of about 13,000'. Now, if the attacker sets himself up to launch from 30° angle-off, this means that he can launch from a position 6,500 feet below the target. To achieve this launch position, an attacker may start his attack at even a lower altitude - the distance below dependent upon his airspeed. For example: An F-100 at 1.1 Mach may start his attack with an altitude differential of at least 10,000 feet - in this case, at 30,000 feet altitude. From this illustration, we can see that AIM-9B gives an attacker an additional performance capability, in that the attacker is not required to attain the target's altitude.

In summary, since the underside attack provides the greatest advantages - IR, G, surprise and performance - we should employ this attack whenever possible. As you will see later, this holds true for both fighter-versus-bomber and fighter-versus-fighter. When compared with a gun attack, AIM-9B is far superior, since the range of the missile allows us to get into an effective cone of fire.

BEST TYPE OF ATTACK AGAINST A NON-MANEUVERING TARGET WITH THE 20MM CANNON

As you will recall, because of the characteristics of the pursuit curve, our fire control system limitations, and the capabilities of our opponent's defensive fire, we consider the pursuit curve a poor attack at best, when using the 20mm cannon. It does not matter whether we are in an overhead, a high-side or an underside attack. The problem now is, how are we going to attack a non-maneuvering target if we do not choose to use the pursuit curve as illustrated previously. The solution we propose: Plan an attack in which we combine the characteristics of the pursuit curve and the collision course. To explain: On a collision course attack, the target will be allowed to fly right through our bullet stream. The bullet stream itself will have no angular velocity as generated in a pursuit curve type attack. A 100-foot target with a speed of 800 feet per second, at 30,000 feet will require approximately 1/8 of a second to fly through our bullet stream. Assuming that we can fire 6,000 rounds per minute - the combined rate of fire of 4 M-39 cannon - this means we fire at a rate of approximately 100 rounds per second. If the target requires 1/8 of a second to pass through our bullet stream, we can expect about 12 hits if we set up a perfect attack. This is not acceptable. In a pursuit curve attack, we do not have this problem, because the angular velocity of our bullet stream matches the angular velocity of our target. In other words, our bullet stream is constantly superimposed against the target which is being tracked. The only disadvantage of this attack is that it forces us into our opponent's defensive cone of fire. To counter the disadvantages of the pursuit curve and the collision course, we assume attack conditions against an imaginary target and

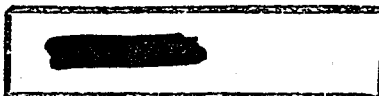

apply them against a real target. To illustrate: We set up an attack so that the angular velocity of our bullet stream matches that of a target going slower than .8 Mach - say .5 Mach. This allows us to fire at a higher angle-off, at a given range, because of the slower target. Then we apply this imaginary attack - against a .5-Mach target - to the .8-Mach target. To do this, we place our reticle in front of the .8-Mach target, generating the G necessary to track a .5-Mach target which means our real target (.8) closes upon our bullet stream (.5) with a delta Mach of .3 which, at 30,000 feet, is 300 feet per second. Firing 100 rounds per second, this allows us to put approximately 33 holes in the target with a perfect pass, as compared to 12 in a collision course.

Our only requirement is to figure the amount of lead necessary, when firing. To determine lead, we need to know three components:

1. Lead for target motion.
2. Lead for gravity drop.
3. Trajectory shift.

If we use a fixed sight, we will have to determine all three components. If we use radar, or keep the sight pegged at the range from which we plan to fire, gravity drop and trajectory shift will be completely computed and lead for target motion partially computed. We'll use pegged sight, to simplify our lead problem. Radar is not applicable because the overlead needed to set up the attack takes us out of our radar tracking cone. To determine the additional lead we need to enable our pegged sight to indicate the bullet impact area, we use the following formula:

$$\text{Lead} = \frac{V_t \times \sin\theta \times 1000}{V_p}$$

where  $V_t$  = rate of closure of the target, in feet per second toward the bullet stream

$\sin\theta$  = Sine of the angle-off.

$V_p$  = average projectile velocity (dynamic gravity drop tables)

Lead = additional lead in mils

The lead in mils which we acquire from the above formula is placed in the sight reticle, so that the outer diamond indicates the bullet impact area as the target passes through the reticle. To compute the lead for insertion into our sight reticle we use the following formula:

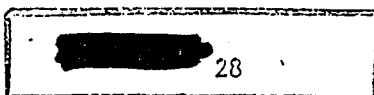

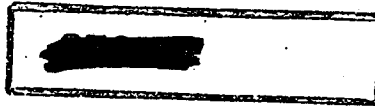

$$\frac{WS}{\text{Firing Range}} = \frac{2 \times \text{lead in mils}}{1000}$$

In order to solve for both additional lead and reticle size, we need to know the firing range and the angle-off at which we'll be firing. Assume that we attack a target which is traveling .8 Mach (at 35,000 feet) at .9 Mach with 3 Gr.

### Step I

To find the firing range and angle-off, we assume a .5-Mach target and solve in the following manner:

$$\begin{array}{l} V_f = .9 \text{ Mach} = \\ V_t = .5 \text{ Mach} = \end{array} \left. \begin{array}{l} \\ \\ \end{array} \right\} 35,000$$

$$\begin{array}{l} N = 3 \\ \theta = 30^\circ, 25^\circ, 20^\circ \end{array}$$

$$S = \frac{V_f V_t \sin \theta}{32.2N} = \frac{873' \times 485 (\sin \theta)}{96.6} = 4380 (\sin \theta)$$

$$30^\circ$$

$$S = 4380 (.5) = \underline{2190'}$$

$$25^\circ$$

$$S = 4380 (.423) = \underline{1850'}$$

$$20^\circ$$

$$S = 4380 (.342) = \underline{1500'}$$

### Step II

To find the additional lead (in mils) needed against a .8-Mach target we solve in the following manner:

$$l = \frac{V_t (\sin \theta) 1000}{V_p}$$

$$30^\circ$$

$$l = \frac{291' (.5) 1000}{3840} = \underline{38 \text{ mils}}$$

$$25^\circ$$

$$l = \frac{291' (.423) 1000}{3880} = \underline{32 \text{ mils}}$$

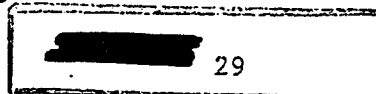

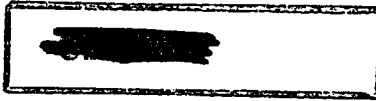

20°

$$1 = \frac{291 (.342) 1000}{3920} = 25.5 \text{ mils}$$

## Step III

To determine the additional lead to be incorporated into the sight reticle we solve in the following manner:

At 30° angle-off

$$\frac{\text{WS}}{\text{Firing Range}} = \frac{2 (\text{lead in mils})}{1000}$$

$$\frac{\text{WS}}{2190} = \frac{76}{1000}$$

$$\text{WS} = \underline{166}$$

At 25° angle-off

$$\frac{\text{WS}}{1850} = \frac{64}{1000}$$

$$\text{WS} = \underline{118}$$

At 20° angle-off

$$\frac{\text{WS}}{1500} = \frac{51}{1000}$$

$$\text{WS} = \underline{76}$$

From Step III we can see that it will be impossible to set up the additional lead by placing the wingspan lever on 166 since 120 is the maximum setting. This means that we can either fire at 1850', 25° angle-off (steps I and II with the wingspan lever at 118 or at 1500', 20° angle-off with the wingspan lever at 76. Since we want to fire at max angle-off, we'll set the wingspan lever at 118 and fire at 1850', 25° angle-off.

Now to perform the attack. We do not use the conventional pursuit curve approach, as this does not allow us to determine target speed and direction, and we need these factors to apply the attack we have just computed. To apply this attack correctly, we use a barrel-roll type of attack. To set it up, we fly in the same direction as the target and about 3,000 to 4,000 feet above it. From there we turn about 10° from his line of flight, barrel-roll - in the direction of

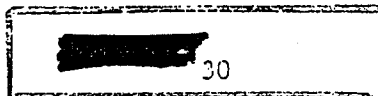

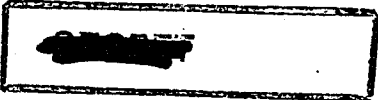

the turn - down to a key point, trying to maintain an almost constant angular relationship between us and the target. See figure 15. From here, we place the sight reticle well out in front of the target, in line with his flight path, and pull the G necessary to track the imaginary target. As we close to our firing range and angle-off, the target will move toward our sight reticle. As the target starts to cross the outer diamond, we depress the gun trigger and hold it down until the tail of the target passes through the outer diamond. From there we recover and set up another attack by kicking in afterburner and rolling back to the same position on top of the target..

This attack has definite advantages: It allows the attacker to fire at a higher angle-off than in a pure pursuit curve attack. It allows the attacker to fly through the target's defensive cone of fire at a faster rate than is possible in a normal pursuit curve attack. Since he is flying a combination of a pursuit curve and a collision course, another and probably the most important advantage is that the attacker finds it easy to reposition himself for consecutive attacks. This is possible because the attacker is always close enough to the target to judge relative positioning. The big disadvantage of the barrel-roll attack - as we employ it - is that it provides the attacker less time for lethal fire. However, in view of the fact that a fighter can perform more consecutive attacks than in a normal pursuit curve, this disadvantage does not appear to be too restrictive.

In summary, we do not advocate the barrel-roll attack as a cure-all for fire control problems encountered when firing against bomber-type aircraft. Instead, we consider it somewhat of a "Rube Goldberg" affair designed to surmount the problems associated with today's normal pursuit curve attack, when using guns as the means for ordnance delivery. Although it appears difficult to perform, pilots are able, with just a minimum of practice, to set themselves up quite successfully.

#### MANEUVERING FOR THE ATTACK

Success, in air-to-air combat, depends on the ability of a pilot to place himself in a position from which he can deliver his fire power. In fighter-versus-bomber combat, time is important also and can be considered a measurement of success. To illustrate: If we have a bomber attempting to destroy a given target, we must not only position ourselves to deliver our fire power, but must also expedite our positioning before the bomber reaches "bombs away" point. Since timing is so critical, we must use the very best method by which we can position ourselves for this attack. As we have shown, the best weapon in terms of performance and ease of delivery, is AIM-9B. The best attack with this weapon and our aircraft, is the underside attack. Positioning for this attack depends upon the space relationship between you and the target. Considering this relationship, GCI may provide a set-up from three possible positions.

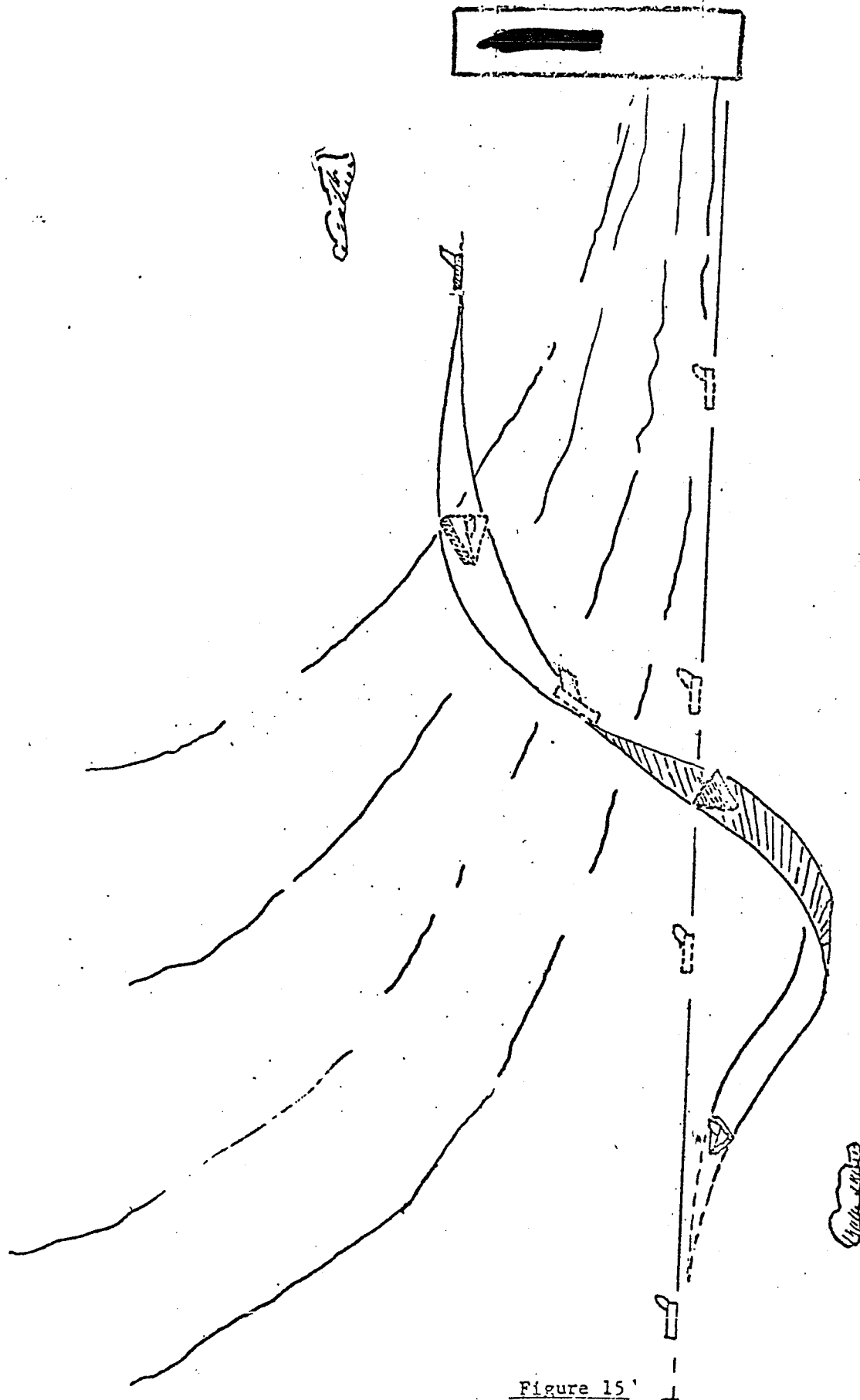

ROLL-SLIDE ATTACK

Figure 15'



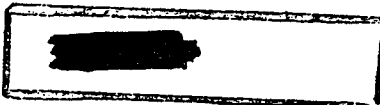

1. Nose-quarter
2. Abeam, or 90°
3. Tail-quarter

Assuming VFR conditions, it will be the responsibility of each attacker - upon visually acquiring the target - to maneuver from any one of these set-ups to the firing envelope behind the target. To get into this position quickly, an attacker must maneuver in a three-dimensional field to acquire the maximum benefits from airspeed and turn. If the attacker does not understand three-dimensional maneuvering, he will be little more effective than GCI in maneuvering from a setup or approach, to a final firing position (GCI will place him in the firing envelope through the use of two-dimensional maneuvers).

The Nose-Quarter Attack: In performing the nose-quarter attack, we do not choose to approach our target from a direct head-on position. If we do, we will be forced to perform a 180° change of direction by executing a level or a climbing turn (high-speed yo-yo) to approach our target from a six-o'clock position. The time consumed in a level turn allows the target to generate a great amount of longitudinal separation. This allows the target aircraft to make considerable penetration of a defense area before the attacker can set up a missile attack. The climbing turn or high-speed yo-yo allows the attacker to complete his change of direction in less time; however, at the end of this maneuver, the attacker will find himself with considerable longitudinal separation in relation to the target, since his airspeed has decayed considerably below that of the target. Once again, the target aircraft will effect considerable penetration before the attacker can position himself to launch AIM-9B. If the attacker is directed by GCI for a nose-quarter attack, he should request GCI to set him up on an anti-parallel course to an offset point 15,000 feet to one side of the target's line of flight. When the attacker visually acquires the target, or when GCI indicates that he is ten miles from the target, the attacker should apply full afterburner power. At the same time, he should dive to an altitude about 5,000 feet below the target, so he will be offset in both the vertical and horizontal planes. This provides the attacker with maneuvering airspeed and a position from which to execute a Chandelle followed by a low speed yo-yo (a dive behind and below the target) to the attack cone behind the target. See figure 16. Compared to a level turn, this maneuver allows the attacker to complete his 180° change of direction more rapidly. In addition, since the attacker is turning through both the vertical and horizontal planes, his horizontal turning component is reduced. As a result of these two factors - fast turn rate and small turn radius - the attacker will be in a position much nearer the target's attack cone. To prevent the target from penetrating the defense area excessively, the attacker must dive behind and below the target at the completion of 90°

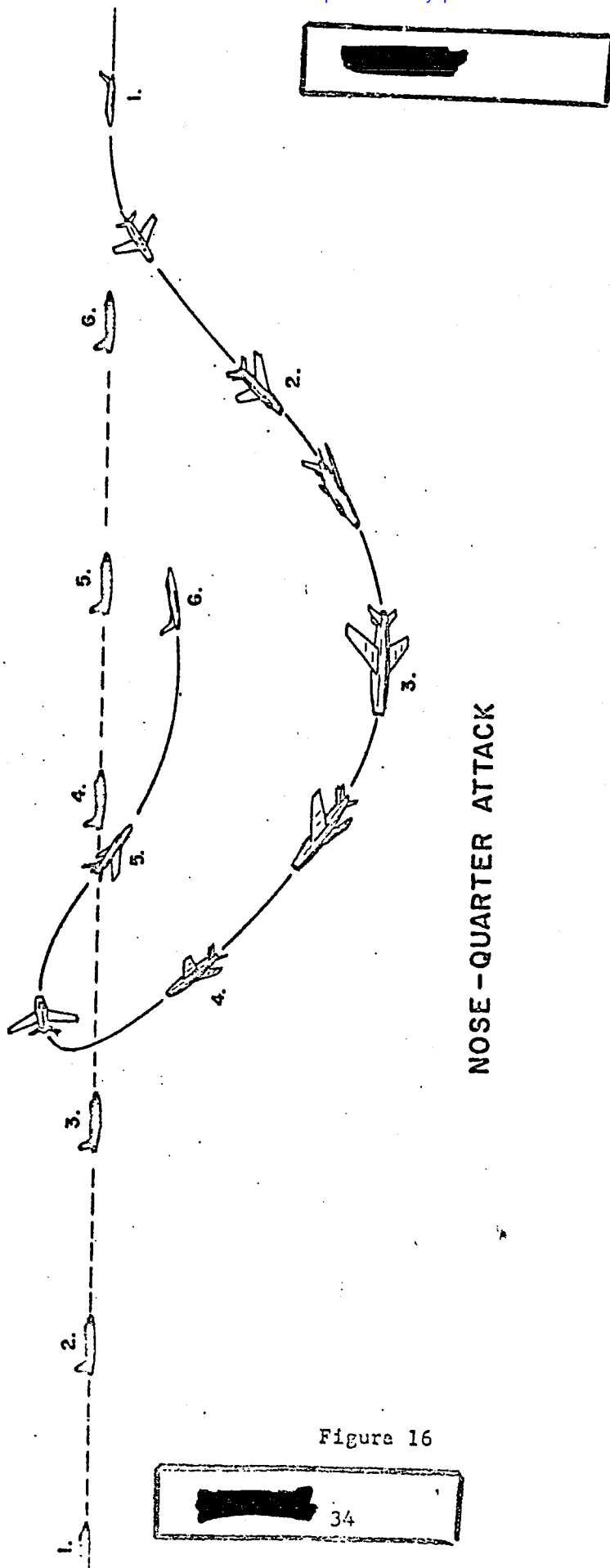

NOSE-QUARTER ATTACK

Figure 16



of turn. This will aid the attacker in recouping the speed lost in the chandelle. Also, it allows him to turn inside the target's line of flight, because he is able to reduce his horizontal turning component by maneuvering through both the vertical and horizontal planes. Result: The attacker quickly positions himself - at six-o'clock-low - to launch Sidewinder.

The Beam or 90° Approach: In a beam approach, our problem remains essentially the same as that in a nose-quarter attack. That is, we must quickly place the attacker in a launch position, to reduce penetration time. The best means by which to accomplish this, upon visually acquiring the target, is to use afterburner and perform a diving turn, below and behind the target's line of flight. Once again, afterburner, coupled with a descending turn, will increase rate of closure, because of rapid acceleration. At the same time, since the turn is through both the vertical and horizontal planes, a cutoff is easily effected. Result: the attacker is quickly set up for a missile attack from six-o'clock-low. If the beam attack starts from a high position, the same procedures should still be used. Remember, the attacker wants to reduce the target's penetration time. At the same time, he wants to set up for the best possible attack. A diving turn or low-speed yo-yo will satisfy both of these conditions. If a beam attack is initiated from a low position, the previous procedures still apply, since the attacker is trying to reduce target penetration time by rapid closure and a cutoff inside the target's line of flight.

In a tail-quarter attack, the problem of defense area penetration is most critical. To reduce this penetration time and to allow the attacker to position himself for the best possible missile attack, he must accomplish a dive below and inside his opponent's line of flight, up to an attack position (inside yo-yo). Since penetration time is so critical, the procedure will remain the same whether the attack starts from a high or low position.

#### FLIGHT TACTICS

Tactical formation, hence flight tactics, are designed primarily to provide maximum mutual support and visual cross cover and retain maximum maneuverability for any air-to-air operation. In other words, tactical formations must provide both defensive and offensive capabilities. To provide these capabilities, a compromise between maximum mutual support and maximum maneuverability must be accomplished. The extent of the compromise will depend upon the type of mission flown. Though our mission - fighter-versus-bomber - emanates from a defensive situation, it is offensive in nature, in that the fighter is trying to destroy the bomber aircraft and is not primarily interested in providing security for himself.

The present concept of weapons employment (nuclear weapons) indicates that a given enemy will employ saturation-type tactics rather than a concentration of his force over a given target area. In other



of turn. This will aid the attacker in recouping the speed lost in the chandelle. Also, it allows him to turn inside the target's line of flight, because he is able to reduce his horizontal turning component by maneuvering through both the vertical and horizontal planes. Result: The attacker quickly positions himself - at six-o'clock-low - to launch Sidewinder.

The Beam or 90° Approach: In a beam approach, our problem remains essentially the same as that in a nose-quarter attack. That is, we must quickly place the attacker in a launch position, to reduce penetration time. The best means by which to accomplish this, upon visually acquiring the target, is to use afterburner and perform a diving turn, below and behind the target's line of flight. Once again, afterburner, coupled with a descending turn, will increase rate of closure, because of rapid acceleration. At the same time, since the turn is through both the vertical and horizontal planes, a cutoff is easily effected. Result: the attacker is quickly set up for a missile attack from six-o'clock-low. If the beam attack starts from a high position, the same procedures should still be used. Remember, the attacker wants to reduce the target's penetration time. At the same time, he wants to set up for the best possible attack. A diving turn or low-speed yo-yo will satisfy both of these conditions. If a beam attack is initiated from a low position, the previous procedures still apply, since the attacker is trying to reduce target penetration time by rapid closure and a cutoff inside the target's line of flight.

In a tail-quarter attack, the problem of defense area penetration is most critical. To reduce this penetration time and to allow the attacker to position himself for the best possible missile attack, he must accomplish a dive below and inside his opponent's line of flight, up to an attack position (inside yo-yo). Since penetration time is so critical, the procedure will remain the same whether the attack starts from a high or low position.

#### FLIGHT TACTICS

Tactical formation, hence flight tactics, are designed primarily to provide maximum mutual support and visual cross cover and retain maximum maneuverability for any air-to-air operation. In other words, tactical formations must provide both defensive and offensive capabilities. To provide these capabilities, a compromise between maximum mutual support and maximum maneuverability must be accomplished. The extent of the compromise will depend upon the type of mission flown. Though our mission - fighter-versus-bomber - emanates from a defensive situation, it is offensive in nature, in that the fighter is trying to destroy the bomber aircraft and is not primarily interested in providing security for himself.

The present concept of weapons employment (nuclear weapons) indicates that a given enemy will employ saturation-type tactics rather than a concentration of his force over a given target area. In other

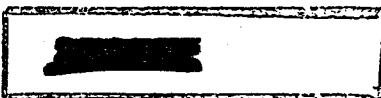

words, we may expect an attack force composed of single bombers dispersed over a wide area to strike at many targets. To counter this at all points, with four-ship scrambles, is not the answer, for we need a defense force numbering four times that of the strike force. We will be providing unnecessary security for the attacking fighters, as well as violating the dictum, "economy of force!" The problem remains - how shall we tactically deploy our fighters? A single fighter against a single bomber may appear the obvious answer, however, this is not so. When employing single fighters against a saturation-type raid, we would be assuming that each fighter would intercept its respective target without exception. There would be no ground aborts, air aborts, and/or possible fire control malfunctions. Result: some attacking bombers would get through our defenses. To preclude this possibility, we recommend a two-ship flight, as the basic unit, in a given fighter-versus-bomber intercept. The two-ship flight will be composed of a leader and his wingman.

In patrol position - prior to visually acquiring the bomber - the wingman should fly approximately 10 to 20 degrees back and approximately 1500 feet out. If he flies in much closer, too much time will be spent in flying forward and not enough in covering the leader and aiding him in visually acquiring the target. Flying too far out reduces maneuverability and may cause the wingman to become separated from his leader. When maneuvering, the wingman will play the outside as well as the inside of the turn, as a means of maintaining position. To do this effectively, he must maneuver through both the horizontal and vertical planes. This will allow him to reduce his horizontal turning component and thus maintain his relative position more easily. Procedure: When on the outside of a turn, the wingman should lower his nose and cross to the inside. If on the inside of the turn, and sliding forward, he should cross to the outside, slide high and fly in the plane of the leader. In other words, a wingman will fly a partial extended-low position, on the inside of the turn, and an extended-high position - in the plane of the leader's wing - on the outside of the turn. One thing for the wingman to remember: He must not cross in front of the leader. Instead, he should always maintain nose-tail separation, thus precluding the possibility of getting in the way of his leader.

To reduce the bomber's defense-area penetration, the flight must quickly maneuver from the approach to the best attack position. To do this, the flight must maneuver at max performance through both the vertical and horizontal planes. Under these circumstances, it would be quite difficult for the wingman to maintain the patrol position defined above. To enable the wingman to maintain a relative position during these maneuvers, we place him in a new position - the fighting position. Position: The wingman will fly within a 60° cone behind the leader at a distance of about 1000 feet. See figure 17. While flying in this cone, the wingman will maneuver through both the horizontal and

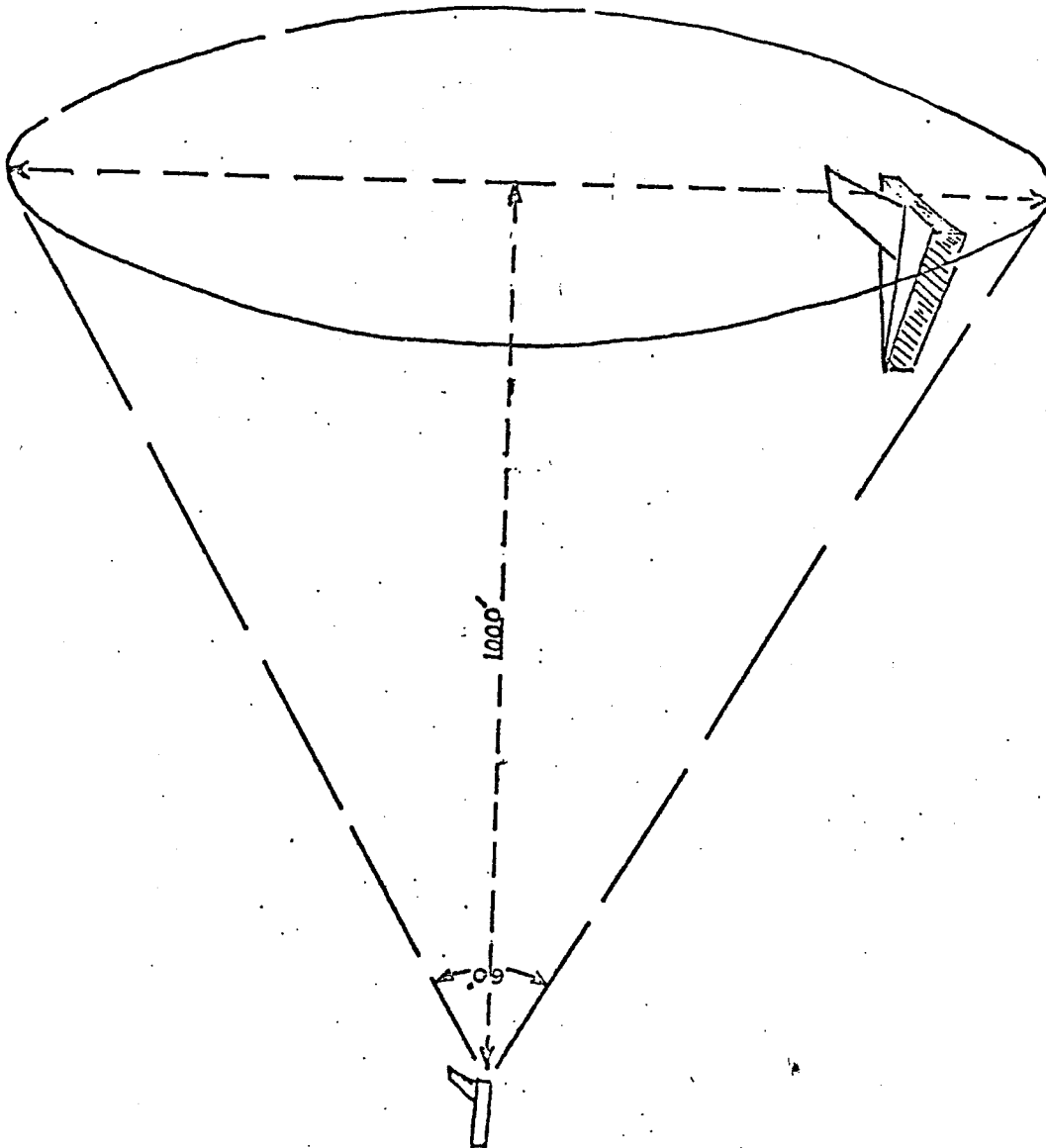

FIGHTING POSITION

Figure 17

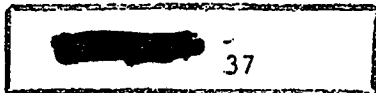

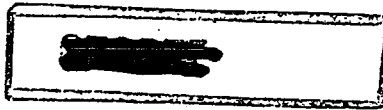

vertical planes to maintain position. He will slide high when overshooting, and drop low to the inside when falling back. In other words, the maneuvering technique is basically the same as that of the patrol position.

If the leader is unable to deliver a successful attack against a bomber aircraft, the wingman will take over the lead position and initiate the attack. If neither the wingman nor the leader can deliver a successful missile attack, they will press in - with afterburner - and zoom above the target aircraft. From this position, they can execute coordinated barrel-roll attacks against the bomber aircraft. When the leader comes out of his roll, and into the firing position, the wingman may start down. When the leader slides to a new high position on the target, the wingman will be in the firing cone, and the cycle just repeats itself.

If the bomber is too high to permit successful employment of the barrel-roll attack, the fighters have no recourse. They will be forced to approach the target from below and from the six-o'clock position. If this tactic must be employed, it behooves the fighters to fire at the extreme range of the fire control system. Since the bomber is much larger, as compared to the fighter, their opportunity to secure a lethal burst is certainly as good - if not better - than that of the defending bomber. The important thing to remember: the bomber must be destroyed, regardless of the tactics used, or the weapon employed.

#### SUMMARY

In our discussion of Aerial Attack, we stated that tactics were developed according to the performance capabilities or limitations of the weapons systems used - our weapons as well as the opponent's. Recognizing this, we set about to determine the performance parameters of our weapons systems - the F-100 equipped with AIM-9B and the 20mm cannon. Study revealed: To successfully employ AIM-9B, it must be launched within a given firing envelope. The firing envelope is determined by the radiation pattern of the target and the performance envelope of the missile. The parameters of this envelope are determined by, (1) the size of the target's infra-red pattern, (2) the range of the missile, (3) G-capability of the missile, and, (4) AIM-9B lambda limitation. To successfully employ the 20mm cannon, the pilot must be within the theoretical capability of the fire control system, and have control responses precise enough to control this equipment.

We then applied the information provided by this study - the limitations of AIM-9B and the 20mm cannon - to the pursuit curve, to find the best attack envelope for each system. We found that the best attack envelope for AIM-9B is an underside or a six-o'clock-low attack. For 20mm cannon, we found that the best attack would have to be a



barrel-roll attack, combining the characteristics of the pursuit curve and the collision course. Comparing this information revealed that AIM-9B is a far superior weapon for a fighter-versus-bomber intercept, since its firing envelope and resultant attack cone is much greater than is possible when employing the 20mm cannon. Sidewinder's main disadvantage, in a fighter-versus-bomber intercept, is its inability to discriminate target IR radiation from background IR clutter. This disadvantage can easily result in the attacker being forced to use the 20mm cannon attack. NOTE: Keep in mind that the advantage which AIM-9B enjoys over ordinary armament, in a fighter-versus-bomber attack, is not near as great in a fighter-versus-fighter situation. (We will elaborate on this in Part II of this manual.)

Since AIM-9B provides a larger attack cone and a greater capability, tactics will be predicated upon this advantage. Whether an attacker approaches the target from the nose-quarter, beam or tail-quarter position, he will set up to deliver AIM-9B. If conditions preclude missile delivery, he will press in and employ 20mm cannon. Before the attacker reaches this weapon delivery point, he must maneuver through both the vertical and horizontal planes as it is his responsibility to provide positive guarantee that individual bombers in a saturation-type strike will be intercepted. Two-ship scrambles will be employed. If more than two aircraft are used, the fighter defense is spread too thin. Simply stated, the dictum, "economy of force" would be violated with little gain in effective combat potential.



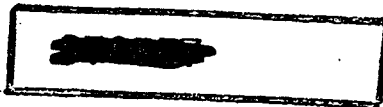

PART II

FIGHTER

VS

FIGHTER



## INTRODUCTION

In our discussion of fighter-versus-bomber tactics, you will recall, we determined the capabilities and limitations of our weapons systems. On having learned these parameters, we then developed our fighter-versus-bomber tactical doctrine. In our discussion of fighter-versus-fighter tactics, we will employ this same procedure. The order of discussion will be as follows:

1. Basic Limitations of AIM-9B Against a Maneuvering Target
2. Fighter Maneuvers
3. Tactical Formation
4. Flight Tactics

When analyzing fighter-versus-fighter tactics, by way of the four major phases above, we will employ the case system - a plan whereby we examine possible hypothetical situations which the pilot may encounter in fighter-versus-fighter combat.



CHAPTER I

BASIC LIMITATIONS OF AIM-9B AGAINST A MANEUVERING TARGET

In discussing the employment of AIM-9B against a non-maneuvering target, we indicated that the missile has four basic limitations - IR, range, G, and lambda - and that these limitations forced us to deliver the missile in a cone  $60^\circ$  wide, emanating from the tail of the target aircraft. It was also shown that the length of this cone would vary according to altitude and delta Mach. At high altitude, with a positive delta Mach, the cone (envelope) will be considerably longer than at low altitude. In our discussion of fighter-versus-bomber tactics, we defined this cone in terms of angular velocity (max performance cone). By angular velocity, cone, we mean an envelope in which the attacking fighter may deliver AIM-9B without exceeding its maneuvering limitations. We can see, by applying this angular velocity cone to any fighter-versus-bomber or fighter-versus-fighter situation, that the purpose of any tactics which we develop will be to place us in this cone. On the other hand, when in a defensive situation, we will attempt to rotate this cone away from a given opponent. By doing this, we prevent him from securing a firing position.

When employing AIM-9B against a maneuvering target, the cone not only diminishes in size, it also changes in shape. In other words, the geometric shape of the maneuvering envelope will be considerably different than a non-maneuvering envelope. To illustrate: When discussing the non-maneuvering envelope, we found that its basic shape was determined by four factors - IR, range, G and lambda. We noted that these envelopes were rather symmetrical in shape. Maneuvering envelopes, on the other hand, are not so symmetrical. The lambda and G-limitations are primarily responsible for this change in shape. The reason for this: Lambda limitation may be exceeded because of a combination of low missile velocity and high angle off. If we launch AIM-9B from long range - within the effective range of the missile - at a maneuvering target, we can expect the target to turn into the attack. His objective is, of course, to rotate his angular velocity cone away from the launch aircraft. By doing this, the defender can force the missile to exceed its lambda limit, because the missile is not only slowing down as it approaches the target, but the angle-off is increasing, since the defender is turning into the missile's line of flight. In other words, the angular velocity generated by the defender forces AIM-9B to turn farther and farther in front of the target to maintain its collision course. This, of course, increases the resultant lambda angle. In addition, the missile is forced to turn even farther in front of the target, because of its continuous decrease in velocity after rocket motor burn-out, producing an extremely large lambda angle. If AIM-9B is launched near its max-effective range and the target turns into the attack, the combination of increasing angle off and missile deceleration can easily cause the missile to exceed its lambda limitation. If

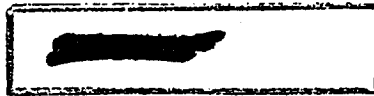

this occurs, the gyro seeker rubs against its mechanical stops, which stops the gyro and the missile loses guidance.

The attacker can do two things to avoid exceeding lambda limitation: (1) Reduce his range before launch, which results in a higher missile velocity in relation to the target, and therefore, a smaller resultant lambda angle, and (2) reduce angle off. The smaller the angle off, the lower the resulting lambda angle. It is now obvious that the best attack can be initiated from the six-o'clock position at a reduced range. It is also obvious that lambda is the greatest missile limitation against a maneuvering target. To illustrate the magnitude of this limitation, let's examine figures 18 and 19.

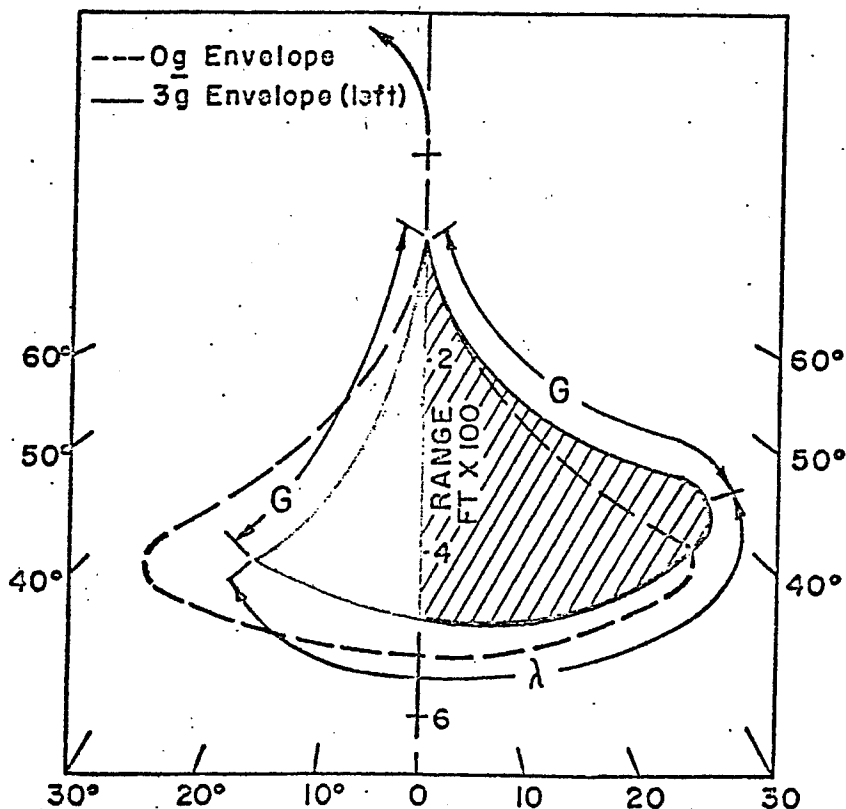

TGT-.8 MACH  
ATTACK-.8 MACH  
ALTITUDE - SEA LEVEL  
MANEUVER 3g LEFT TURN

Figure 18

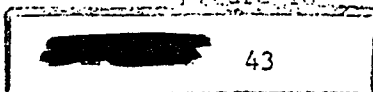

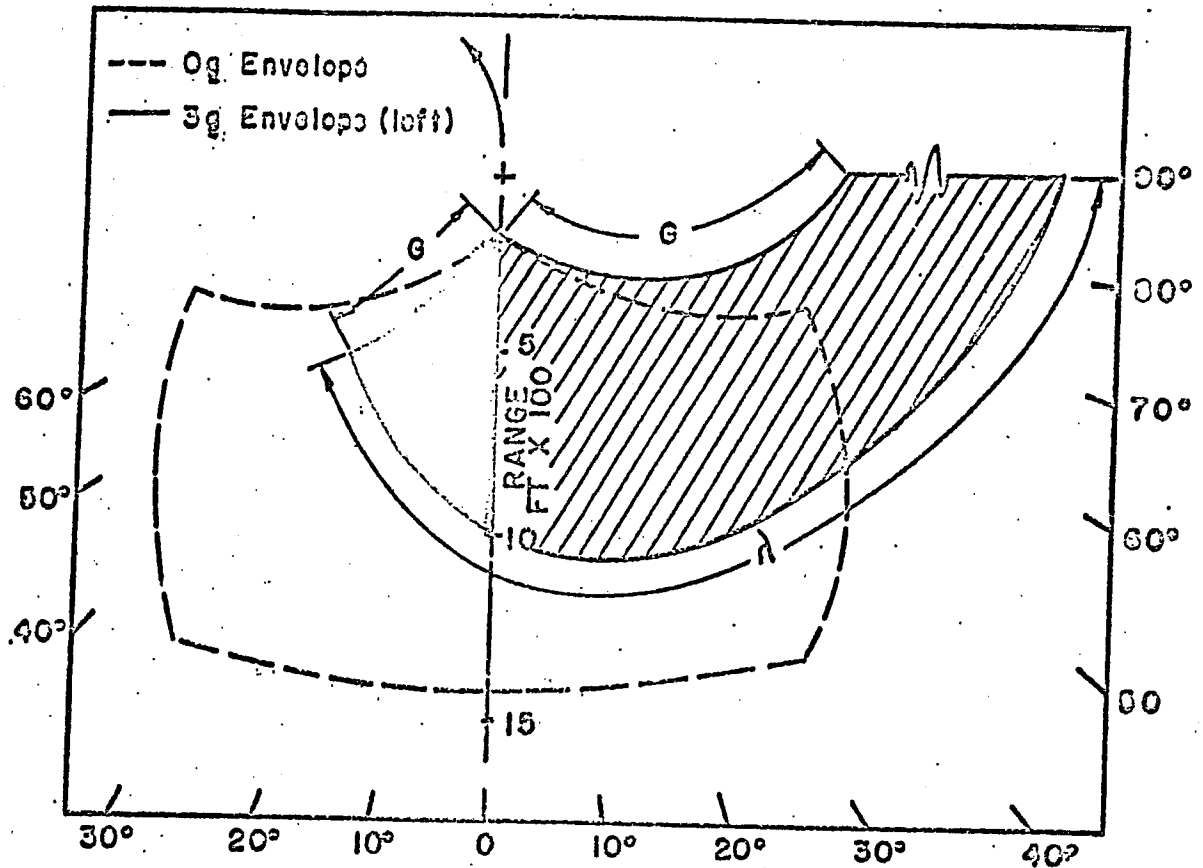

TGT - 1.0 MACH  
 ATTACK - 1.0 MACH  
 ALTITUDE - 35000'  
 TGT MANEUVER - 3g LEFT TURN

Figure 19

When AIM-9B is launched from a .8 Mach attacker against a .8 Mach maneuvering target which is performing a 3-G turn into the attack, we note (from figure 18) that effective missile range is somewhat less than that available against a non-maneuvering target. We also note that max angle off from which AIM-9B may be launched is less than 20°. The reduction in range is necessary because of the 25° lambda limit, while the reduced angle off is caused by a combination of lambda and G-limitations (G-limitations will be discussed later). If the target pulls more than 3 G, the maneuvering envelope will become even smaller.

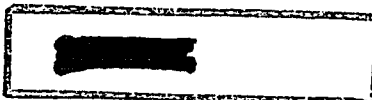

At 6 G, there will be no point from which the attacker can fire the missile and achieve a kill. In other words, there will be no maneuvering envelope at all. If AIM-9B is launched from a Mach-1 attacker against a Mach-1 target, at 35,000 feet, we note the following: When the target performs a 3-G turn into the attack, at missile launch, the attacker must reduce his range by approximately one-third when firing from a six-o'clock position (see figure 19). If the attacker launches at 30° angle-off, he must reduce his range by approximately one-half - as compared to a non-maneuvering target - if he expects to get a kill. Once again, the reason for this reduction in range is lambda limitation. The attacker must reduce his range, by a greater magnitude, at 30° angle-off because missile lambda angle is increased by both high angle off and increased range. When the angle off is increased, range must be reduced to preclude exceeding lambda limit, hence the difference in range reduction between a zero-degree angle off and a high-angle-off shot against a maneuvering target. Once again, if the target increases G, the maneuvering envelope diminishes in size. At 6-G, there will be no maneuvering envelope, therefore, the attacker cannot achieve a successful launch and kill against a target pulling 6 G.

In our discussion of the delta Mach envelope, we assume that there has been no deceleration of target speed in any of his maneuvers. If speed decay occurs, the attack conditions will change and the attack will no longer be one-speed. As a result, missile velocity will be higher in relation to the target, and the resultant lambda angle will be smaller, since velocity varies inversely with lambda angle (at a given range and angle off). This means that if the attacker has a positive delta Mach, rather than a one-speed relationship, he can launch at a greater range without exceeding lambda limitation. On the other hand, if the attacker is forced to launch against a maneuvering target which is traveling faster than the speed of missile velocity, in relation to the target, is smaller. Result: The attacker must launch at a shorter range to preclude lambda limitation.

In view of the above relationships, we can see that the best attack is one in which the attacker has a positive delta Mach and a low angle-off on his initial approach to the target. This will provide greater freedom of maneuver and the opportunity to launch at longer ranges. On the other hand, the worst possible attack is one in which the attacker has a negative delta Mach and a high angle-off. This will restrict his freedom of maneuver and force him into a position from which the target can easily defend against this attack.

If AIM-9B is launched from an attack executed in the vertical plane - overhead or underside attack - the maneuvering target will be forced to turn into the attack. Once again, by turning into the plane of the attack, the target will generate max angular velocity and force the missile to operate near its limiting parameters. In an overhead attack, this means that the attacker will not only be concerned with

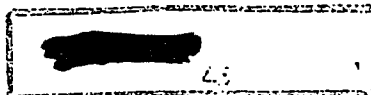

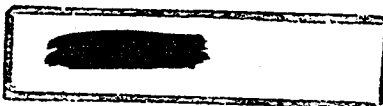

lambda limitation, but also with the same limitations encountered in an attack against a non-maneuvering target - IR and G. These limitations force the attacker to diminish his range until he can discriminate between IR background clutter and target signal and/or avoid exceeding the lambda limitation. This means that in a .9 Mach co-speed attack against a maneuvering target, the attacker will be forced to fire at less than  $20^\circ$  angle-off, otherwise, he will exceed his 2G limitation. (see figure 20). Remember, in an overhead attack, the difference between total and radial G is considerably less than in the high-side or the underside attack ( $G_t = G_r + \cos\theta$ ), therefore, to stay within the 2G limitation, the attacker must launch from longer ranges (at a given angle-off). For example, if an attacker performs an overhead .9-Mach co-speed attack - to prevent himself from exceeding the 2G launch limitation at  $30^\circ$  angle-off - he must launch from a range of at least 10,450 feet. Under the same conditions, he can launch from a range of 6,840 feet at  $30^\circ$  angle off in a high-side or level attack. In an underside attack, he can launch as near as 4,130 feet at  $30^\circ$  angle-off and still be within the 2G launch limitation.

From the above analysis, it is apparent that the overhead attack is the worst possible because of the limitations imposed by IR, G and lambda. Unlike an overhead attack against a non-maneuvering target, the attacker will find it difficult to acquire the low angle-off necessary for launch. Instead, since the target is turning into the attack, the angle off will increase and the opportunity to launch will be lost. On the other hand, there is a slight advantage since the target is forced to turn into the attack - he will be forced to pull up and will consequently experience speed decay. The attacker will have a positive delta Mach and a higher missile velocity in relation to the target, and, therefore, a greater range from which he can launch AIM-9B before lambda limit is reached. This advantage is not a real advantage however, because the attacker can still be forced to exceed the IR and G parameters. We know, from our study of AIM-9B, that if we force the missile to exceed any one of the four parameters - IR, range, G or lambda - a kill will be unlikely. From a tactics standpoint, while on the defensive, the attack most easy to defend against is an overhead attack with a negative delta Mach. In this situation, we force the attacker to exceed a greater number of his limiting parameters than in any other attack.

The underside, or six-o'clock-low attack is the best possible attack which we can execute against a maneuvering target. It was noted in our analysis of this attack against a non-maneuvering target that we acquired advantages in IR, G, surprise, and performance. When attacking a maneuvering target, we retain these advantages, but acquire a disadvantage from lambda limitation. The lambda disadvantage is, however, overridden by the advantages. This is true because the advantages of IR and G allow the attacker to launch at relatively shorter ranges at high angles-off, without exceeding the 2G launch

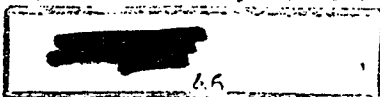

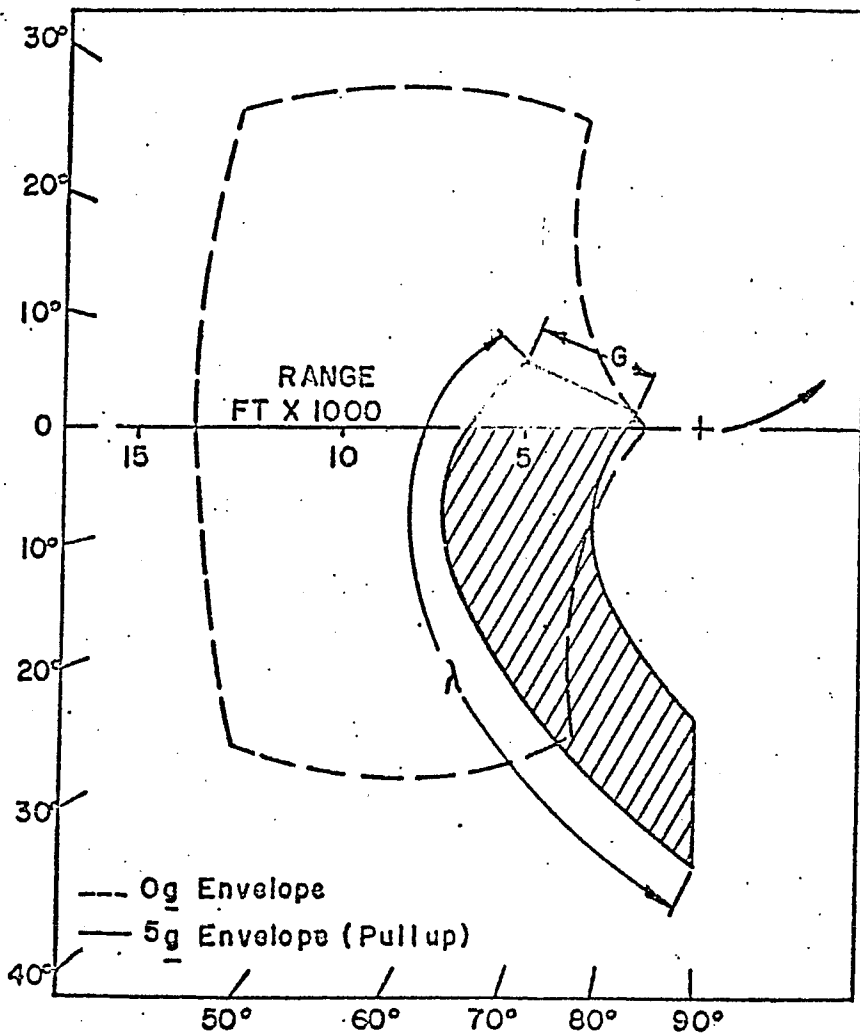
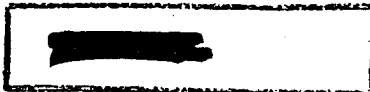

TGT - .9 MACH  
ATTACK - .9 MACH  
ALTITUDE - 35000  
TGT MANEUVER - 5g PULL UP

Figure 20



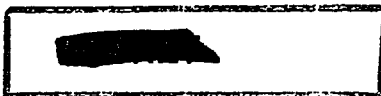

limitation. (Remember, in an underside attack, radial G is greater than total G.) In other words, the attacker receives the benefit of 1G gravity, thus allowing him to position himself closer to the target at a higher angle off without exceeding his 2G limitation (total G). This means that the attacker can reduce his range to stay within the lambda limitation and still be within his 2G launch limitation. In effect, the attacker is provided greater freedom of maneuver to successfully launch AIM-9B. In an underside attack, this freedom of maneuver is greater than in any other attack. From the defender's viewpoint, it is certainly the most difficult attack to defend against. In summary we may say: The best attack for AIM-9B is the underside attack and the worst attack is the overhead attack - especially if the attacker has a negative delta Mach.

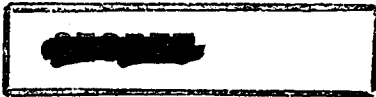
  
CHAPTER IIFIGHTER MANEUVERS

To acquire an understanding of the science of fighter-versus-fighter combat, a complete knowledge of the spatial relationships involved in this form of aerial combat, is necessary. Before he can achieve this understanding, any tactician must be able to define or imagine a frame of reference, within which he must operate. In addition, he must know the basic tools which he may employ in this frame of reference. Simply stated, this means that the pilot must understand the geometric space relationships and how to apply this insight to a given fighter-versus-fighter situation. Our purpose, in fighter maneuvers, will be two-fold: (1) To define and present geometric relationships needed for fighter-versus-fighter combat, and (2) to show how to properly apply these relationships in fighter maneuvers.

In discussing fighter-versus-fighter combat, it is evident that many pilots believe there are an infinite number of situations and solutions in a given tactical encounter. Such is not the case! The field in which a fighter pilot must operate is three-dimensional and finite. The size and shape of the field is determined by the pull of 1G gravity and the performance limitations of the aircraft and its pilot. We can imagine this field to be spherical in shape, with a flattened northern hemisphere and an elongated southern hemisphere. See figure 21. The spherical shape is generated by a maneuvering fighter's turn and velocity operating through three dimensions. The elongation results from the effect of 1G gravity on the fighter in this three-dimensional field of maneuver. Turn, speed and the force of gravity determine the operating envelopes and we need only understand spatial relationships presented by these factors to develop effective fighter maneuvers. To know how to secure an advantage over an opponent, an attacker need only visualize turn, velocity and G projected onto this spheroid shape. He has no control over the force of gravity, of course, but he can exercise complete control over aircraft turn and velocity. As a result, he can maneuver in a manner to effectively use the pull of gravity in a given tactical situation. Thus, in a fighter-versus-fighter situation, the pilot can do two things to gain an advantage over an opponent: Change turn and/or velocity, in respect to his opponent. He can accomplish either or both by maneuvering through both the vertical and horizontal planes by employing either a two-dimensional maneuver through three-dimensional space, or a three-dimensional maneuver (barrel roll).

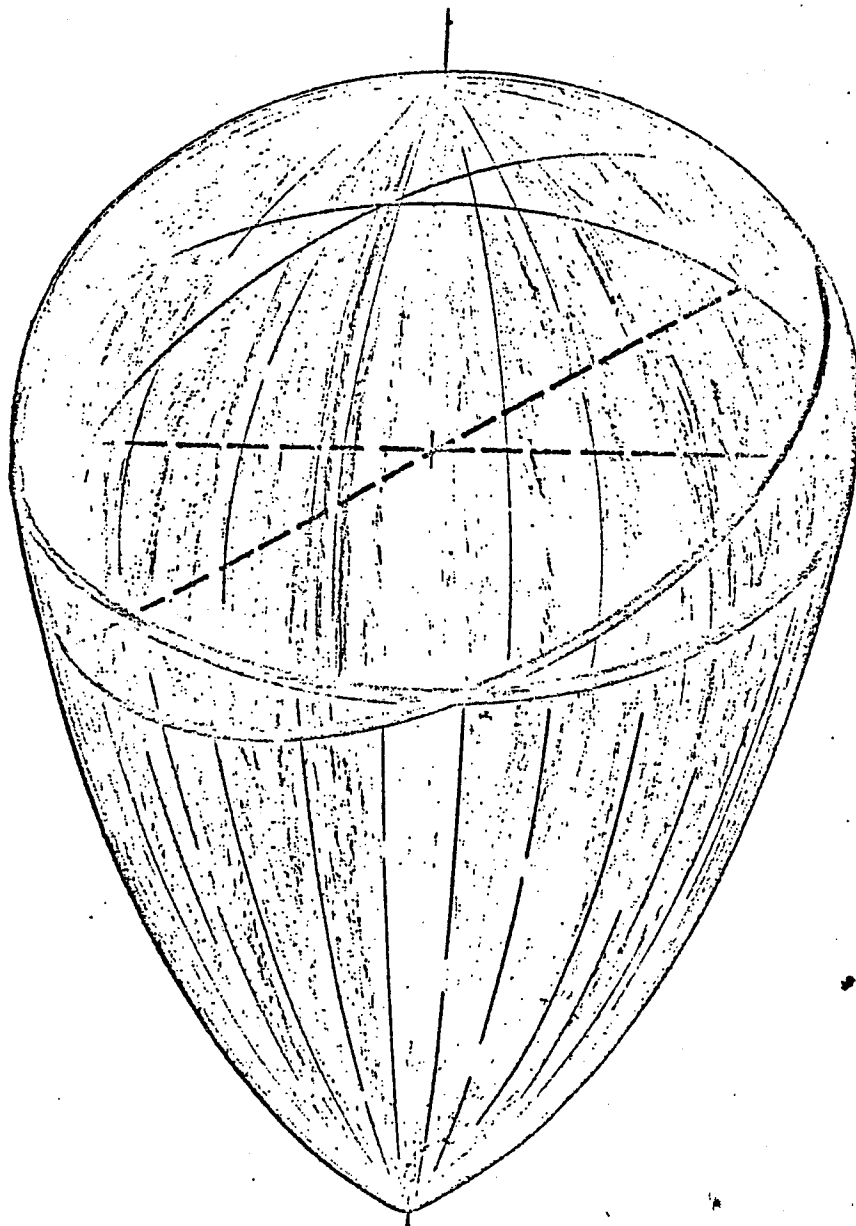
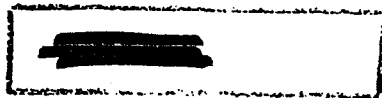

FIELD OF MANEUVER

Figure 21

[REDACTED]

To apply these principles correctly, we need only recall what we determined previously in regard to weapons capability. We determined that to successfully employ AIM-9B or the 20mm cannon, we must attain a launch or firing position in the angular velocity cone emanating from the tail of our opponent. Applying the three-dimensional concept of turn and velocity, this means that we must reduce one or both of these factors in order to secure an advantage. Employing these spatial relationships against a given opponent will provide insight as to the type of maneuver which we must employ to defeat him.

In our discussion of fighter maneuvers, we will keep in mind this concept of turn and velocity within a three-dimensional field. As stated earlier, we will use the case system to determine not only what maneuver to employ, but also how to employ it to acquire maximum benefit. In discussing fighter-versus-fighter tactics, our first maneuver for discussion will be the defensive turn. We choose to start with this maneuver because it is the basic maneuver by which the defender tries to nullify an attacker's advantage. This may cause our approach to appear to be defensive in nature, however; we feel that this is necessary since any offensive action is directly dependent on the precise maneuver which the defendant chooses to execute. If the defender's knowledge is limited in scope, the attacker's corresponding maneuvers will reflect this limitation.

#### Defensive Turn

The purpose of the defensive turn is to prevent an opponent from achieving a launch or firing position. As stated earlier, the objective of this maneuver is to rotate our angular velocity cone away from the attacker. The best way to achieve this is to turn into the plane of the attack. This means that in an overhead attack, we will pull up into the attack; in an underside attack, we will dive into the attack; and if the attack is from six-o'clock, we will turn in whichever direction provides the greatest tactical advantage. Assuming that an attacker armed with an IR missile is approaching our angular velocity cone from six-o'clock, how would we defend against this attack? First, perform a hard turn with a slight dive. This turn should not be a break or maximum performance maneuver. If so, we will experience high speed-decay and loss of maneuvering potential, eventually diminishing our angular velocity. As a result we will probably successfully defend against the missile attack, but our attacker will be in position for a follow-up gun attack. If we employ the hard turn and the slight dive, we generate enough angular velocity to preclude a missile launch at long range, and at the same time, we retain future maneuvering potential. As range diminishes, the attacker will be looking for an opportunity to launch a missile; however, since he is in a pursuit curve attack, his rate of turn is a function of target speed, angle-off and range. At long range the rate of turn required for the attacker to track is considerably less than ours. Consequently, the attacker's

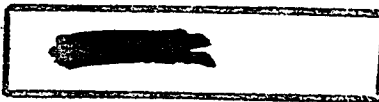

angle-off and rate of closure will increase. The increase in angle-off demands a further reduction in range before the attacker can successfully launch without exceeding the lambda limitation. This forces the attacker to get closer and, since he is on a curve of pursuit, his angle-off is continuing to increase as his range decreases. The rate of turn formula ( $\omega = \frac{V_t \times \sin\theta}{\text{Range}}$ ) indicates that

rate of turn will increase if angle-off increases ( $\sin\theta$ ) and range decreases on an attack against a maneuvering target. Both of these conditions occur. This means that the attacker generates a rapid build-up in his rate of turn, and by the time he reaches the point at which he can launch without exceeding lambda limit, he exceeds the 2G launch limitation. With a .9-Mach co-speed attack at 35,000 feet, this will occur at a range of about 7,000 feet from the target. If the attacker gets closer, he must forego a missile attack and attempt to set up a 20mm cannon attack. This is necessary because when attacking a maneuvering target, once the G-limit is exceeded, G cannot be reduced - it will continue to build up as range diminishes.

As a defender, we are now forced to nullify our opponent's subsequent gun attack. To accomplish this, let us once again analyze our relative positions: The attacker, noting that he has lost the opportunity to deliver a missile, will attempt to reduce his angle-off and slide into our six-o'clock position. To prevent this, we must increase G and rotate our angular velocity cone away from our opponent. Our concern now is to acquire a smaller turn radius than the attacker. This will force him outside our turn and prevent him from achieving a tracking solution. To accomplish this objective, we must play the turn in respect to the attacker. The moment we notice his attempt to diminish angle-off, we increase our G, to prevent him from diminishing his angle-off and sliding toward our six-o'clock position. If he continues to press the attack, tighten the turn to prevent him from staying on the inside of the turn. In effect, we are trying to place him on the other side of our angular velocity cone. If we play this maneuver correctly, he will be unable to match our turn radius. The formula for turn radius:

$$R = \frac{V_f^2}{32.2N}$$

where R = Turn radius in feet  
 V<sub>f</sub> = Fighter velocity in feet/second  
 N = Number of radial G

indicates that the fighter with the lower velocity and/or greater G has a smaller turn radius. In this situation, the attacker's speed and G are directly dependent upon the defender's action and if we pull a certain number of G, the attacker cannot pull the same amount. If he does, his rate of turn will equal ours, and, at the end of a

[REDACTED]

180° turn, the attacker becomes the defender and we the attacker. Of course this will not occur, because the attacker will be forced to play his turn in respect to our position. This means that his G will be less, and as a result, his speed decay will not be as rapid as ours. As is shown by the above formula, the attacker will have a greater turn radius for two reasons: (1) higher speed, and (2) lower G. As a result, if the attacker continues to press the attack in the plane of our turn, he must overshoot. This provides the attacker little opportunity to track the target and places him, geometrically, on the other side of our flight path. Of course, this presupposes that we, as the defender, are turning near or at maximum rate. If not, the attacker would be able to slide toward 6-o'clock, pull a higher G, diminish airspeed and avoid an overshoot. As we will see later, the lateral separation provided by this overshoot is a "must" for the defender's subsequent actions.

#### Procedures for the Defensive Turn

1. Estimate range and angle-off of the attacking aircraft.
2. Perform a hard turn if the attacker is near AIM-9B launch range. This is a planned maneuver to preclude a successful missile launch.
3. Do not make an instantaneous max-performance turn. This will kill off airspeed very rapidly and reduce future angular velocity as well as maneuvering potential.
4. Play the turn to maintain the attacker at a high angle-off. This will force him to diminish his range and exceed the 2-G launch limit, at about the time when he is within lambda limit.
5. Increase rate of turn steadily to maximum performance as the attacker approaches gun-firing range. This will prevent him from acquiring a tracking solution and sliding toward your six-o'clock position.

#### Adverse Yaw

Adverse yaw is defined as the tendency of the aircraft to yaw or roll away from the intended turn. In the F-100, this condition is present in the sub-sonic speed range, and is especially noticeable in high-angle-of-attack maneuvering. If proper technique is not employed to counteract adverse yaw in high-angle-of-attack maneuvers, aircraft maneuverability is seriously compromised. In fighter-versus-fighter combat, since maneuverability is a key to success, inability to handle adverse yaw will produce disastrous results. We can see this upon examining the defensive turn. In defending against an AIM-9B attack, the speed and G which we were pulling produced a low angle of attack. Defending against a follow-up gun attack, however, produced a high

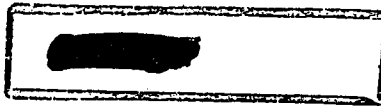

angle of attack. If conventional technique is attempted when max performance is necessary, the result will not be maximum performance. To preclude performance degradation, the pilot must develop two entirely different techniques to control the F-100 under low-angle-of-attack and high-angle-of-attack conditions.

In low-angle-of-attack maneuvers, conventional technique will be employed. That is, ailerons will be primary control for directional change, in either a turn or a roll, and rudder will be secondary. It will be used to counter the small amount of adverse yaw to keep the turn or roll coordinated. Back pressure will be employed to control the rate of turn or the intensity of the roll.

In high-angle-of-attack maneuvers, the following techniques will be employed: Rudder will be used to control directional change. Ailerons will be moved to the neutral position and back pressure will be employed to control the rate of turn or intensity of the roll. In a high-angle-of-attack situation, if the pilot employs aileron as primary for directional change, he will induce a roll-off in the direction away from the intended turn. The more aileron he applies, the faster the roll-away. This is true because, in a turn, the induced drag on the inboard wing is less than that on the outboard wing. If aileron is employed, the inboard aileron is deflected up and the outboard aileron is deflected down. This condition imposes an additional increment of drag upon the outboard wing. As a result, the aircraft yaws toward the high-drag area, or in a direction away from the intended turn. In low-angle-of-attack maneuvers, this yaw can be corrected by applying rudder until the ball is centered. In a high-angle-of-attack maneuver with the F-100, this technique is not satisfactory. As the angle of attack increases, the amount of adverse yaw generated by the induced drag and deflected ailerons increases. The yaw increase causes the outboard wing to meet the relative wind at a velocity less than the inboard wing. The decrease in velocity, plus the downward deflection of the outboard aileron, causes the aileron to stall out, consequently, there will be less lift over the outboard wing. The aircraft will roll in the direction of the yaw. If additional aileron is applied to correct this roll-off, the rate of roll will increase and the adverse yaw and stall conditions will be magnified. If rudder is employed - along with aileron - the adverse yaw generated may be cancelled by the favorable yaw induced by the rudder. However, as the angle of attack builds up, the adverse yaw generated by induced drag and deflected aileron becomes greater than the favorable yaw generated by the rudder. Thus, a roll-off will still occur, however, at a slightly higher angle of attack. On the other hand, if we neutralize aileron and employ rudder as primary for directional control, we can generate a maximum performance turn without a subsequent roll-off.

To determine whether we should use conventional techniques or the rudder technique, we need only recognize the "feel" of the aircraft. The moment the outboard wing appears to be heavy, the pilot should

[REDACTED]

neutralize aileron and apply rudder to control the turn or roll. Full rudder should not be employed, otherwise the pilot will experience a loss of directional control. Instead, apply rudder smoothly and as needed to maintain directional control. If this is accomplished, the ball will be centered and a max-performance maneuver is possible. Do not arbitrarily use full rudder and opposite aileron to achieve a max-performance turn. If this is accomplished, a large amount of favorable yaw will be generated and a snap-roll or spin will probably occur.

### The Scissors Maneuver

The scissors is a defensive maneuver in which a series of turn reversals is executed in an attempt to achieve offensive potential after an overshoot by an attacker. To successfully employ the scissors, the defender needs an initial turn overshoot. In a defensive turn, if an attacker attempts to position himself in his opponent's angular velocity cone by remaining in the plane of his turn, the defender is provided the opportunity to generate an overshoot. The overshoot places the attacker on the opposite side of the defender's angular velocity cone. If the defender continues to turn in the same direction after the overshoot, the attacker will be presented the opportunity to maneuver toward his opponent's six-o'clock position, simply because the defender will be turning away from the attack. To prevent this, the defender must initiate a turn reversal as the attacker passes through his flight path. The decision as to when to execute this reversal will depend upon the attacker's rate of overshoot and his angle-off. A good "rule-of-thumb" is: rapid turn overshoot, early reversal; slow turn overshoot, late reversal. The turn reversal will rotate the defender's angular velocity cone away from the attacker. This will place the attacker at a high angle-off and will cause him, once again, to cross the defender's flight path. See figure 22. The defender has now forced the attacker into a scissors maneuver.

We can see - by geometric inspection - that the aircraft which has the shorter turn radius and the lower velocity, will force the other to the 12-o'clock position. In this maneuver, the defender has the advantage. By virtue of forcing the attacker to overshoot, he has lower velocity and if he employs the proper technique, he can easily place the attacker at 12-o'clock. To accomplish this, each turn reversal should be a rudder reversal, at max-performance. If aileron is applied, the defender will roll off in the wrong direction, or be forced to release back-pressure to execute the reversal. This, of course, will increase turn radius. A nose-high attitude accomplishes two things: (1) It reduces the defender's horizontal turning component, and (2) It reduces the defender's vector velocity in the horizontal plane. The reduction in the horizontal turning component and vector velocity is a result of maneuvering through both the vertical and horizontal planes. In other words, we are employing the pull of



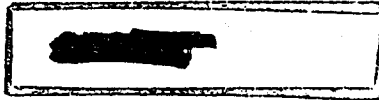

one-G gravity to provide a greater radial G and a lower velocity. Maximum power should be used in this maneuver, because its force vector opposes the one-G gravity and is directed toward the inside of the turning circle. This provides the defender the opportunity to maneuver through the vertical plane, and thereby diminish his horizontal turning component. In addition, since power provides a lower stall speed, it allows the defender to tighten his turn radius at a given airspeed as well as reduce airspeed to the lowest possible point. This means that if the defender performs a nose-high rudder reversal with power on, he will reduce his turn and velocity components to their smallest state and, if the attacker doesn't counter in like manner, he will be quickly forced to the 12-o'clock position. The defender now becomes the attacker.

If the attacker counters effectively, and forces the defender below him, the defender should maneuver in phase with the attacker. This provides the attacker a visual disadvantage since the defender will be directly beneath him. In an attempt to maneuver, in relation to the defender, the attacker will be forced to roll excessively in one direction or the other. This increases his stall speed and forces him forward and down toward his opponent's flight path. The moment the attacker notices this, he probably will reduce his bank and maneuver as smoothly as the defender, with a resultant standoff. If, and when, this occurs, the defender must employ afterburner, relax G and dive 180° away from his opponent. He should initiate this maneuver immediately after the attacker has made his last observation, when the attacker does not have visual contact. This affords the defender the opportunity to gain considerable longitudinal separation and places the attacker in an overhead attack with a negative delta Mach. The defender will be out of gun range and the attacker will be provided the worst possible situation for a missile launch. (NOTE: Tactical analysis of the dive-away will be discussed later.)

When employing the scissors maneuver, a pilot should attempt to secure an advantage as quickly as possible - certainly by the second turn reversal. If not, he will lose airspeed rapidly, therefore maneuverability, and will be prevented from ever acquiring an advantage. Instead, he will find himself in a standoff, with marginal control - an easy set-up for another attacker (or his immediate opponent, if the opponent has a superior aircraft).

#### Procedures for the Scissors Maneuver

1. Increase rate of turn into the attack until the attacker overshoots or moves outside the turn.
2. Execute a nose-high rudder reversal with power on as the attacker passes your tail. Remember the "rule-of-thumb" for turn-reversal: Rapid turn overshoot, early reversal; slow turn overshoot, late reversal.

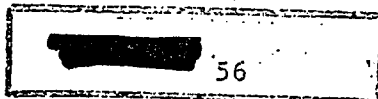

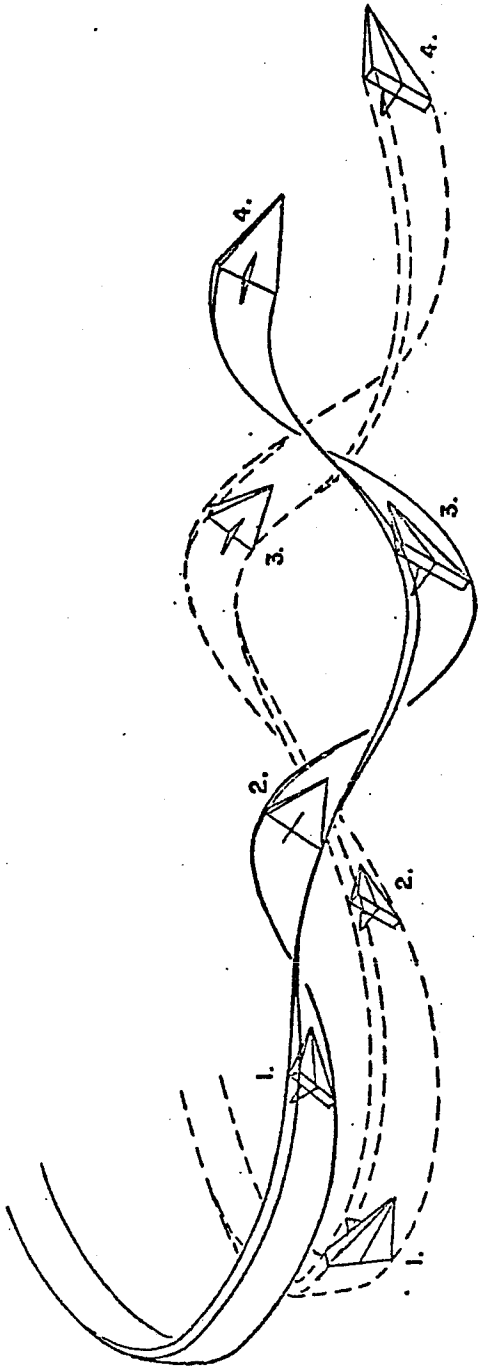

SCISSORS

Figure 22

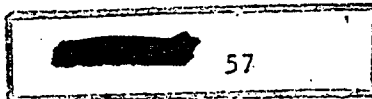

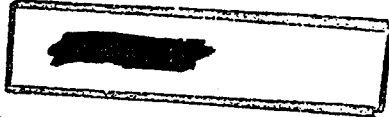

3. Repeat a nose-high reversal each time your opponent slides through your flight path to the outside of the turn. If you pass nose-high above your opponent, he will begin to slide forward.
4. Perform a roll-off or "S" down to the six-o'clock position, after you obtain a position above and behind your opponent.
5. Place yourself in phase with your opponent if you are underneath him; then, at the earliest possible moment, perform the 180° dive-away.

Countering the Scissors Maneuver

In our discussion of the scissors maneuver, we stated that it is a defensive maneuver designed to take advantage of an attacker's overshoot. We then proceeded to show how the defender would react to gain this advantage. The implication is clear - an attacker places himself in a very serious position if he misjudges the defender's turn and overshoots. To prevent this, it is suggested that the attacker employ the high-speed yo-yo any time he believes his rate of closure may be sufficient to cause a turn overshoot. In this manner, the attacker can retain his offensive advantage, however, we will still have the problem: What can an attacker do in the event he misjudges his opponent's turn and is forced into an overshoot? The purpose in discussing maneuvers after a turn overshoot is to point out an effective counter to the scissors and, by means of this counter, show that the scissors is highly over-rated as an easy method by which to achieve an offensive advantage.

To know how to counter a scissors maneuver, we must first determine the attacker's maneuvering potential in respect to the defender: The attacker has a significant disadvantage in terms of velocity; however, this disadvantage can be converted to an advantage if the attacker knows how to employ it properly. Maneuvering into a nose-high scissors is not proper employment, as this will place him forward or above his opponent in a stalemate condition. On the other hand, if the attacker employs this velocity in the vertical plane, in a zoom maneuver, he can generate a significant advantage. How can this advantage be gained? As the attacker notes that he is overshooting his opponent's turn, he should relax G and deliberately slide around the outside of the turn. Relaxing G serves a two-fold purpose: (1) It reduces induced drag, thereby allowing the attacker to maintain an airspeed advantage, and (2) It increases lateral separation on the overshoot. This reduces the attacker's velocity component along the axis of his opponent's flight path, thus allowing the attacker to maintain nose-tail separation. The defender, observing the overshoot, will be enticed to execute a nose-high reversal in an attempt to gain offensive advantage. If the defender continues the turn, the attacker can play the maneuver and, once again, slide into the defender's angular velocity cone. In

[REDACTED]

view of this, a reversal is almost a sure thing. As the defender reverses, the attacker rolls wings-level and zooms, at a max-rotation-angle, through the vertical plane. See figure 23. The defender will be unable to match the attacker's rotation angle and subsequent zoom because of his airspeed disadvantage. This means that the attacker, even though he has a higher airspeed, may reduce his horizontal vector velocity to a smaller value than that of his opponent. As a result, the attacker will be on top with nose-tail separation, and the defender will have dissipated his airspeed, with a consequent loss of maneuvering potential. The attacker need only roll off to the defender's six-o'clock position.

If the defender pulls up into a banked attitude, toward the attacker's rotation, the height of his pull-up will be even less. This is the result of two factors: (1) The defender's pull-up is only a component of a straight pull-up - his rotation angle is through both the vertical and horizontal planes. Since he is in a banked attitude, this means that his rotation angle in the vertical plane must be less than a straight pull-up. (2) The defender's stall speed is higher. In a banked attitude, stall speed increases because less lifting surface is available to counter the pull of gravity. Higher stall speed causes the rotation component in the vertical plane to be even less. As a result of these two factors, the defender's rotation angle is reduced. This means that the height of the zoom in the vertical plane is less and vector velocity in the horizontal plane is increased. This forces the defender to turn below, in front of and across the attacker's line of flight. The attacker need only roll off in a direction opposite his opponent's turn and move toward the six-o'clock position. The roll-off increases nose-tail separation and prevents a possible overshoot by the attacker.

To maneuver against the attacker's counter, the defender simply cannot refuse to reverse and continue his defensive turn. If he does, the attacker will not be obligated to roll wings-level and zoom in the vertical plane. The defender will turn away and place his angular velocity cone in front of the attacker's flight path. As a consequence, the attacker will simply play his opponent's turn and maneuver toward the six-o'clock position. If the defender cannot pull up and turn into, or away, how then will he maneuver against the attacker's counter? As the attacker overshoots his turn, the defender will execute a nose-high reversal. This will force the attacker to roll wings-level, rotate through a large angle in the vertical plane and zoom for altitude. This action is designed to reduce vector velocity in the horizontal plane to a value less than the defender's velocity. If the attacker fails to generate this large rotation, his vector velocity will be greater, and he will be forced toward the defender's twelve-o'clock-high position. So we see, the attacker has no choice, he must rotate through a large vertical angle when the defender executes his nose-high attitude and provides considerable vertical displacement in respect to the defender. Having placed the attacker in this position, the defender turns 180°

COUNTERING A SCISSORS MANEUVER

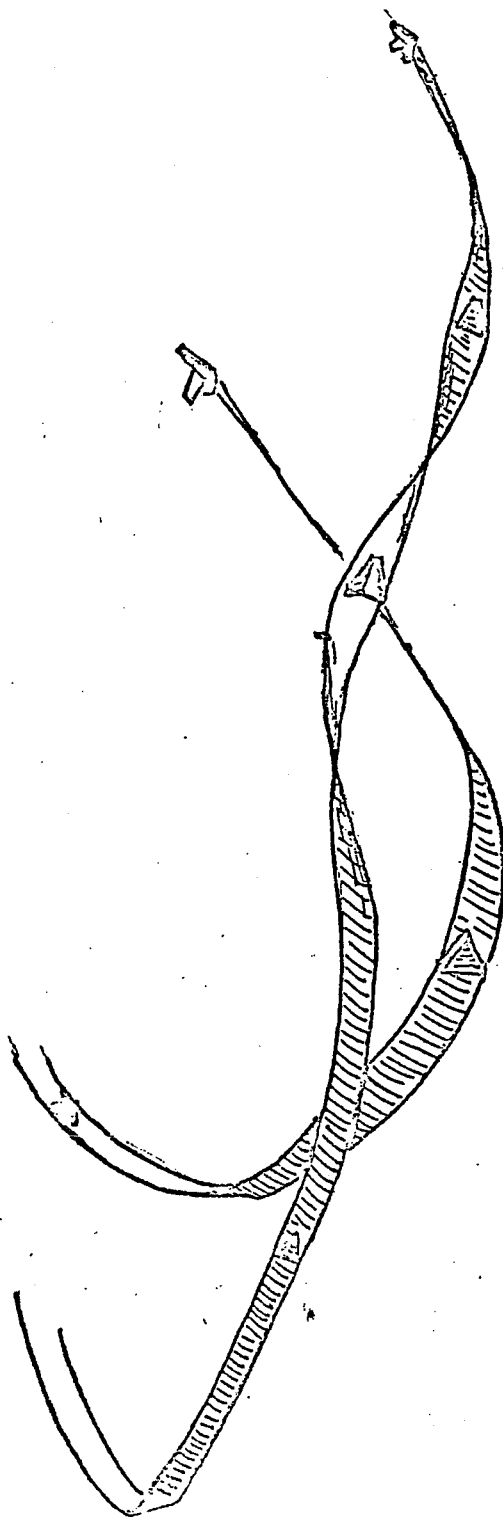
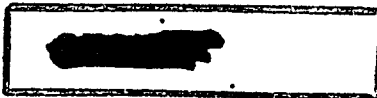

Figure 23



in the vertical plane, relaxes G, lights afterburner and dives for separation. (The defender must accomplish his turn before dissipating too much airspeed and acquiring an extreme nose-high condition.) Noting the dive for separation, the attacker must turn - from an extreme nose-high position -  $180^{\circ}$  in the vertical plane to regain an offensive position at six-o'clock. The pull of one-G gravity causes the attacker to dissipate considerable airspeed, thus placing him in an overhead attack with a negative delta Mach outside of gun range.

Remember: The counter to the scissor maneuver is nothing more than a high-speed yo-yo initiated after a turn overshoot. The only difference is that the attacker relaxes G, rolls wings-level and zooms in the vertical plane, so that he may regain nose-tail separation.

#### Procedures for Countering the Scissors Maneuver

1. Realize that you are overshooting your opponent's turn and can no longer effect a yo-yo maneuver.
2. Do not attempt to pull into the target's radius of turn. This will impose high G-loads, and possible buffet or stall will occur. All airspeed advantage will be lost.
3. Relax G, slide around the outside of the turn, and thereby maintain an airspeed advantage.
4. Roll level, and zoom up (wings-level) as your opponent reverses into you. When your opponent reverses, he will be unable to match your zoom, because he will have killed some of his airspeed on the reversal, besides having less airspeed to begin with.
5. Continue to pull up, wings-level, and force your opponent forward and below your line of flight. If he pulls up into a banked attitude, he cannot counter your maneuver, since: (a) His stall speed is higher, and (b) His pull-up is only a component of a straight pull-up. If your opponent pulls up wings-level, he cannot match our rotation, because of your airspeed advantage. In any case, your rotation in the vertical plane will be greater than your opponent's. This will place him below and forward of your line of flight. You will have nose-tail separation.
6. Roll off - roll in a direction away from your opponent's turn if he is in a banked attitude - and move into his six-o'clock position. The roll-off will provide additional nose-tail separation and will prevent a possible overshoot.

#### Procedures for Maneuvering Against a Scissors Counter

1. Play the defensive turn in an attempt to force the attacker to overshoot your flight path.

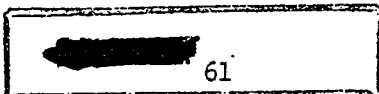

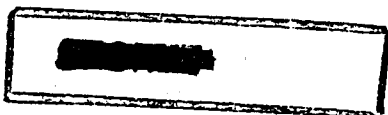

2. Reverse nose-high, as you observe your opponent overshooting your turn radius. Remember: A decision as to when to reverse will depend upon how rapidly the attacker is sliding to the outside - rapid turn overshoot, early reversal; slow turn overshoot, late reversal.
3. Determine if your opponent rolls wings-level, rotates and zooms in the vertical plane or commits himself to the scissors maneuver. If he zooms in the vertical plane, follow the procedures below; otherwise employ the procedures specified for the scissors maneuver.
4. Force your opponent into an extreme nose-high attitude and a high resulting zoom, by pulling nose-high toward his line of flight. The attacker must rotate nose-high and zoom for considerable altitude to counter your nose-high pull-up. His purpose is, of course, to reduce his vector velocity in the horizontal plane in order to maintain nose-tail separation.
5. Turn 180° in a vertical plane, relax G, light afterburner and dive for separation. This maneuver should be initiated prior to dissipating too much airspeed - otherwise, it will be difficult to gain separation. If done properly, the attacker will be placed in an overhead attack with a negative delta Mach outside gun range.

The Attack

The purpose of the attack is to position ourselves in the defender's angular velocity cone, so that we may deliver our ordnance and effect a kill. Since the angular velocity cone of AIM-9B is considerably greater than the 20mm cone, we will first try for a set-up to launch a missile. Knowing AIM-9Bs capabilities, we will try to attack our target from six-o'clock low. If the defender notes our position, we can expect him to perform a defensive turn into the attack so as to rotate his angular velocity cone away from us. If he accomplishes this, we will be unable to successfully launch a missile because of its lambda limitation. Instead, we will be forced to diminish range until we reach a point where lambda limit will not be exceeded. If we attempt to fly a pursuit curve attack - track the target with our fixed sight-- to this point, our angle-off will increase and a further reduction in range will be required before launch. By the time we reach the range at which we can launch without exceeding lambda limit, we will have exceeded the missile's 2G launch limitation. As we get closer, G will continue to build up and the opportunity to employ AIM-9B will be lost. We are now forced to initiate a gun attack.

Our position is not satisfactory for a gun attack: In our pursuit curve approach, we built up a substantial angle-off, but now we are faced with the prospect of diminishing this angle-off in order to reduce our angular velocity to enable us to track the target. As we attempt to accomplish this, we can expect the defender to tighten his



turn to prevent us from doing so. We, in turn, will be forced to counter. Result: If we continue the attack, in the plane of our opponent's turn, we will slide through his flight path and to the opposite side of the angular velocity cone. Under the circumstances, we can expect the defender to counter with a scissors maneuver. To prevent this, we have to employ a different technique in the initial attack.

In the initial missile attack, the worst error which we can commit is to fly a pursuit curve attack - in other words, continuously track the target with our fixed sight in an attempt to launch AIM-9B. This forces us to continuously increase our angle-off and prevents us from ever launching. It also prevents us from salvaging the situation by initiating a gun attack. At the same time, the pursuit curve causes a turn overshoot and sets up the defender for a successful scissors maneuver. To prevent the defender from generating these favorable relationships, we should not fly our gunsight (pursuit curve) after the defender initiates his defensive turn. Instead, we should attempt to generate a rate of turn almost equal to that of the defender. (We must not match his rate of turn, for if we do, he will have rotated into the position of attacker at the end of 180° of turn.) By doing this, we keep our flight path or fuselage in the same relative direction as the defender. In other words, we prevent the large increase in angle-off. This prevents us from launching AIM-9B; however, as we approach gun range, this positions us at a smaller angle-off and much nearer our opponent's angular velocity cone. To counter, the defender is forced to tighten up his turn much sooner than in a pursuit curve attack. This means that the defender is forced to maintain a max-performance turn for a longer time period, in an attempt to generate an overshoot. This causes a greater speed decay, a loss of angular velocity and a loss of future maneuvering potential as we enter gun firing range. As a result, the defender has a more difficult time generating an overshoot and a subsequent scissors. If he exercises poor judgment and is lacking in stick and rudder technique, he may never effect the overshoot. The result is obvious: We simply shoot him down. On the other hand, if his judgment and stick and rudder technique are excellent, we will still be forced to overshoot if we continue to press the attack in the plane of his turn.

To prevent an overshoot, we should zoom or yo-yo off the defender if we are unable to stay inside his turn radius.

#### Procedures for the Initial Attack

1. Stalk your target in an attempt to position yourself for a six-o'clock-low missile attack.
2. Do not attempt to track or launch AIM-9B at max-effective range, if the defender turns into the attack. Instead, position the gunsight reticle ahead of the target.



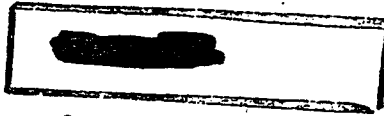

3. Check that your fuselage is pointing in the same relative direction as the defender's fuselage. This will help prevent overshoot.
4. Continue the cutoff to close upon the target. However, attempt to gradually reduce angle-off as range diminishes, in an effort to launch a missile. If this is impossible, disregard the missile and continue the cutoff to set up for a gun attack.
5. Play the cutoff, in an effort to reduce angle-off and slide inside the defender's 20mm angular velocity cone.
6. Press the attack until you realize it will be impossible to stay inside the defender's turn radius. At this point, zoom or yo-yo off the target to prevent overshoot and a subsequent scissors maneuver.

### High-Speed Yo-Yo

The high-speed yo-yo is an offensive tactic in which the attacker maneuvers through both the vertical and horizontal planes to prevent an overshoot in the plane of the defender's turn. See figure 24. From this definition, the purpose of the maneuver is obvious: To maintain an offensive advantage by keeping nose-tail separation between the attacker and defender. In other words, the high-speed yo-yo is a counter for the defensive turn and the scissors maneuver. As an attacker, when it becomes apparent that it will be impossible to stay inside the defender's turn radius, employ the high-speed yo-yo.

To perform the maneuver correctly, timing is essential. To illustrate: If an attacker is conservative and yo-yo's high early, he can expect the defender to lower his nose and dive for separation. The defender, noting the early yo-yo, realizes it will be foolhardy to continue his turn or to pull up into the attack. If he continues the turn, the defender will dissipate his airspeed and his angular velocity. Consequently, the attacker will be permitted to reduce range and slide down into the defender's angular velocity cone. If the defender pulls up into the attack, he dissipates airspeed and angular velocity even more rapidly. Again, the attacker is provided the opportunity to diminish range and roll or slide into his opponent's angular velocity cone. The defender cannot counter, because he has no further maneuvering potential.

In view of the above, the defender's best maneuver is to dive away and gain separation. By doing this, he places the attacker out of gun range and in an overhead attack with a negative delta Mach - the worst possible attack with AIM-9B.

If the attacker yo-yo's late, it will be difficult for him to maintain nose-tail separation. He will either be directly on top of the

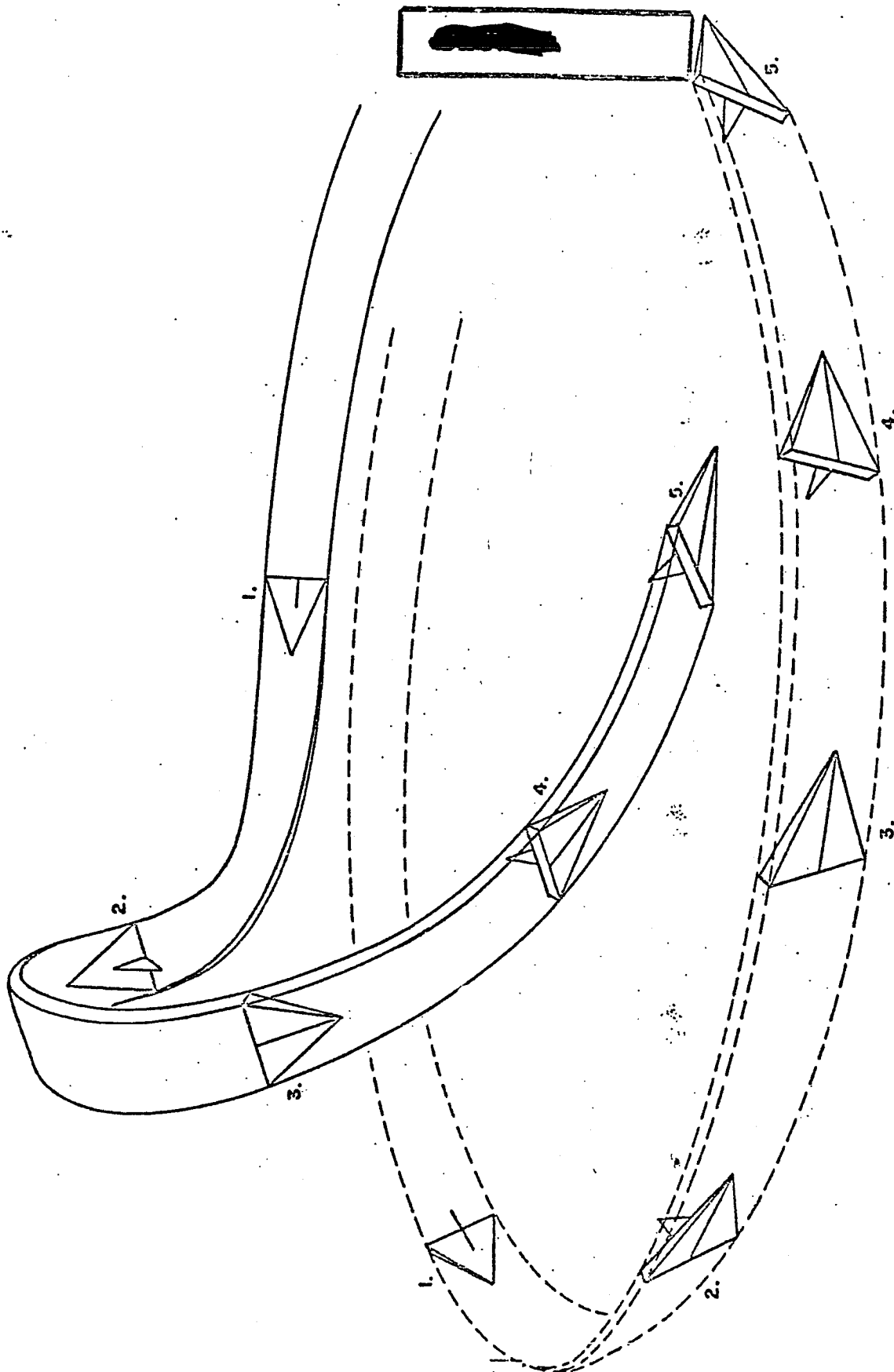

HIGH-SPEED YO-YO

Figure 24

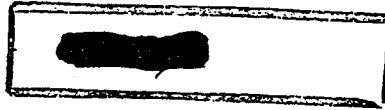

defender or will slide to the defender's twelve-o'clock-high position. If this occurs, we can expect the defender to reverse and pull up into the attacker. By doing this, he will dissipate his air-speed and reduce his vector velocity along the horizontal axis, thus giving the defender the opportunity to maneuver toward the attacker's six-o'clock-low position. The attacker now becomes the defender.

We can see that to maintain offensive advantage, the attacker must not be too conservative and yo-yo early nor too aggressive and yo-yo late. Rather, he must play the yo-yo for a middle position in order to prevent the defender from diving away or pulling up into the attack. Excellent timing and skillful stick and rudder technique are required to attain this position.

The moment the attacker realizes that he will be unable to stay inside his opponent's turn radius, he should roll away from the defender's turn and pull his nose through the vertical plane. The purpose of this action is to diminish his turning component and vector velocity in the plane of the defender's turn. To acquire max effectiveness, the attacker must maintain back pressure and employ rudder as primary control for directional change in the vertical plane. For proper perspective, this means that the attacker rolls toward the vertical plane just enough to provide him an angle of bank smaller than that of his opponent. This forces the attacker's flight path to describe an arc through both the vertical and horizontal planes (we assume that the defender is turning, more or less, through the horizontal plane). As a result, the attacker's turning component and vector velocity are diminished in respect to the defender's turning and velocity components in the plane of the defender's turn. This allows the attacker to maintain nose-tail separation while turning inside his opponent. At the same time, the control technique employed - back pressure and rudder as primary control for the maneuver - not only allows the attacker to reduce his turn and velocity components to their smallest value, but also reduces his yo-yo apex. This provides the defender very little maneuvering freedom with which to counter the high-speed yo-yo. If the attacker does not use rudder as primary control for the roll into the yo-yo he will be forced to relax back pressure. His turn radius and velocity will increase and his induced drag will decrease. So, to maintain nose-tail separation and prevent a turn overshoot, the attacker will be forced to yo-yo to a higher apex point. This provides the defender the option of diving away to gain separation and, of course, places the attacker in an over-head attack with a negative delta Mach. If the attacker attempts to employ ailerons and maintain back pressure, adverse yaw will preclude the yo-yo maneuver. As a result, the attacker will probably be forced to overshoot his opponent and will be caught in a scissors maneuver.

If the attacker employs the high-speed yo-yo correctly, the effect of one-G gravity on turn and velocity will provide nose-tail separation



with little vertical displacement - low yo-yo apex. The attacker need only roll or slide down to his opponent's six-o'clock position. The attacker should employ roll if he has little nose-tail separation. The roll reduces his vector velocity along the axis of the roll. This provides the attacker separation and thus prevents a possible overshoot. To perform the roll successfully, the attacker should continuously release back pressure as he rolls from  $90^\circ$  up to the inverted position -  $180^\circ$  - then gradually increase back-pressure as he approaches the  $270^\circ$  point and continue the increase of back pressure until the  $360^\circ$  point. From the  $180^\circ$  through to the  $360^\circ$  point, the attacker should employ top rudder. If the attacker fails to employ this stick and rudder technique, he will roll underneath his opponent in an obvious overshoot - his offensive advantage seriously compromised. From our discussion of the high-speed yo-yo, we may have implied that this maneuver is the ultimate in countering a perfectly-executed defensive turn with a follow-up scissors. This is not the case. If the attacker yo-yo's too far behind or too high, the defender can relax G, light afterburner and dive away for separation. This places the attacker in an overhead attack with a negative delta Mach. If the attacker yo-yo's high and maintains very little nose-tail separation, the defender can pull up into the attack and secure a six-o'clock-low position. If the attacker perfectly executes the high-speed yo-yo, the defender still has an out if he exercises excellent judgment and skillful technique.

To counter the high-speed yo-yo, the defender must first play the attack in an attempt to force an overshoot. Naturally, we can expect the attacker to yo-yo-high to maintain his advantage. The defender must now determine the attacker's relative position and attitude before making the next move. If the attacker generates extreme vertical separation, the defender must immediately relax G, light afterburner, and dive  $180^\circ$  away. If the attacker executes the high-speed yo-yo properly, the defender has little opportunity to dive away. If the defender pulls up, he will only position himself at 12-o'clock, and if he maintains his turn, he will dissipate his airspeed and angular velocity. The attacker will then merely slide down to his six-o'clock position and finish him off. To understand the counter which the defender must employ, let's examine the spatial relationship of the attacker in respect to the defender. The attacker, although in a most favorable position with his nose-tail separation and low yo-yo apex, is not set up in the defender's angular velocity cone to deliver his weapons at this instant. However, if the defender takes no action, the attacker will assume the proper position for weapons delivery. The defender, realizing this, knows his salvation lies in maneuverability - airspeed and angular velocity. Therefore, the defender must relax G when the attacker yo-yo's off and, at the same time, he should maintain his angle of bank. As a result, his nose will drop slightly below the horizon, thus helping him to keep his maneuvering airspeed. Also, as we shall see, it forces the attacker to commit himself. Upon observing the greater turn radius and the nose-down condition, the

[REDACTED]

attacker has the option of maintaining his yo-yo apex or committing himself to an attack against the descending defender. It is obvious that the attacker is committed to press his advantage. If not, the defender will increase separation and place the attacker in an undesirable overhead position with a negative delta Mach. Knowing this, the attacker drops his nose and attempts to set up for a missile launch or 20mm attack. The defender, observing this commitment, employs top rudder and back pressure to pull up into the attack. He has approximately two seconds to start this maneuver - the amount of time which the attacker needs to successfully delivery an IR missile or to initiate a 20mm cannon attack. If the defender waits for the commitment and counters correctly, the attacker will be placed in a nose-low condition, while the defender has a nose-high attitude. The attacker's airspeed, in respect to the defender, will be increased and his rate of turn will be less. (If the attacker's rate of turn were the same or greater than that of the defender, he would block out the defender and slide in front.) At the same time, since the attacker is approaching the horizontal position and the defender the vertical position, the attacker's radial G, in respect to his total G, is less as compared to the defender's radial G in respect to his total G. Since the attacker's airspeed is greater, his rate of turn is less, and because he has a lower radial G relationship, his radius of turn must be greater (radius of turn = Fighter velocity squared divided by rate of turn). The result is obvious: The attacker will be forced into an overshoot, below and forward of the defender's line of flight. See figure 25. To gain the offensive, the defender need only roll or slide down to the attacker's six-o'clock position. Once again, if the defender has little nose-tail separation, and enough vertical displacement, he should employ the roll in order to achieve an advantage.

To successfully maneuver against a defender's countering pull-up, the attacker must keep in mind the relationships involved: The pull of one-G gravity causes the attacker's airspeed and turn radius to increase in respect to the defender. Therefore, the attacker's advantage lies not in turn, but in airspeed in respect to the defender. We stated that the purpose of the high-speed yo-yo was to maintain nose-tail separation and that it was acquired by turning through the vertical plane as the defender turns through a plane intersecting the plane of the defender's turn. Result: The attacker's line of flight provides nose-tail separation, along with some lateral separation in the vertical plane. Nose-tail separation prevents a possible reverse by the defender.

In our present situation, the attacker has the same problems of trying to maintain nose-tail separation, however, he can maintain this separation by turning in a plane away from the defender's turn. The attacker merely rolls one quarter away from the defender's line of flight at the instant he observes the defender's rolling pull-up. At the same time, he begins a smooth pull-up behind the defender's line

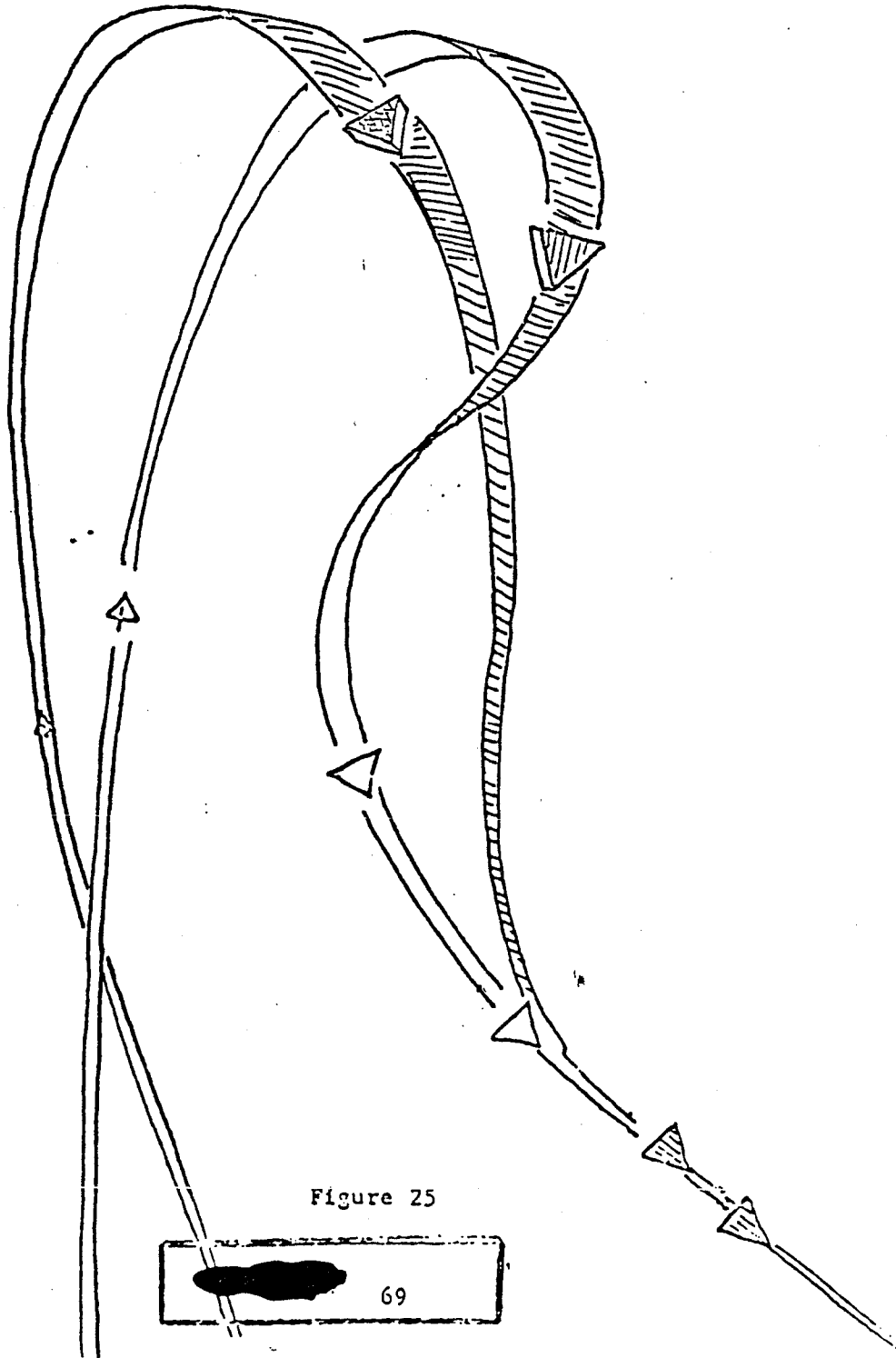
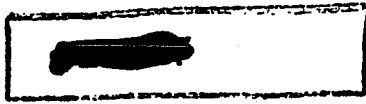
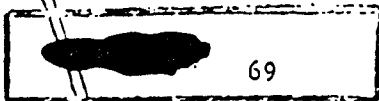
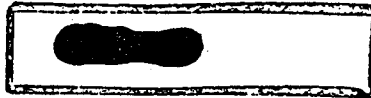

Figure 25



COUNTERING THE HIGH SPEED YO-YO



of flight. See figure 26. The attacker plays his pull-up so that he does not overshoot the defender's original altitude. (An overshoot here would be the same as an overshoot in the horizontal plane before executing a high-speed yo-yo). Since the attacker starts from a high position, his airspeed at the bottom of the pull-up will be greater than his opponent's at that same level, with a consequent advantage. If the defender continues his pull-up, the attacker zooms above and rolls behind the defender - the attacker's airspeed advantage pays off. If the defender attempts to dive away, the attacker cuts off through the horizontal plane and moves into the defender's six-o'clock position.

The defender can counter the attacker's one-quarter roll-away. When the attacker is near the bottom of his pull-up, his airspeed is max; while the defender, near the top of the zoom, has minimum airspeed. The attacker has not only generated nose-tail separation but also lateral separation in the vertical plane. To counter this situation, the defender must rotate his angular velocity cone away from the attacker. In other words, he turns from a nose-high to a nose-low position, through the vertical plane, into the attack. This places the defender in a nose-low, nose-quarter attack, with the defender's airspeed increasing and the attacker's airspeed decreasing. The defender now relaxes G, lights afterburner and dives for separation. Meanwhile, the attacker must turn 180° through the vertical plane, to acquire a six-o'clock position. During this maneuver, the attacker continues to dissipate airspeed. By the time he completes the maneuver, he is placed in an overhead attack with a negative delta Mach, well outside 20mm cannon range. The defender can easily frustrate a possible missile launch.

#### Procedures for the High-Speed Yo-Yo

1. Attempt to reduce angle-off and stay on the inside of the turn as range diminishes.
2. Maintain back-pressure, employ top rudder and roll away from the turn, up through the vertical plane, when you can no longer stay inside your opponent's turn radius. As the pipper slides behind the target - you are no longer matching your opponent's turn - you must zoom off to prevent an overshoot. In other words, any time it becomes impossible to maintain parallel-fuselage with your opponent, your angle-off will be too great and you must zoom into a high-speed yo-yo.
3. Play the zoom so as to maintain nose-tail separation and yet retain a low yo-yo apex. If proper stick and rudder technique is employed, this is easily accomplished.
4. Roll, or slide down to your opponent's six-o'clock position. Employ the roll, if you have nose-tail separation, to acquire a six-o'clock advantage.

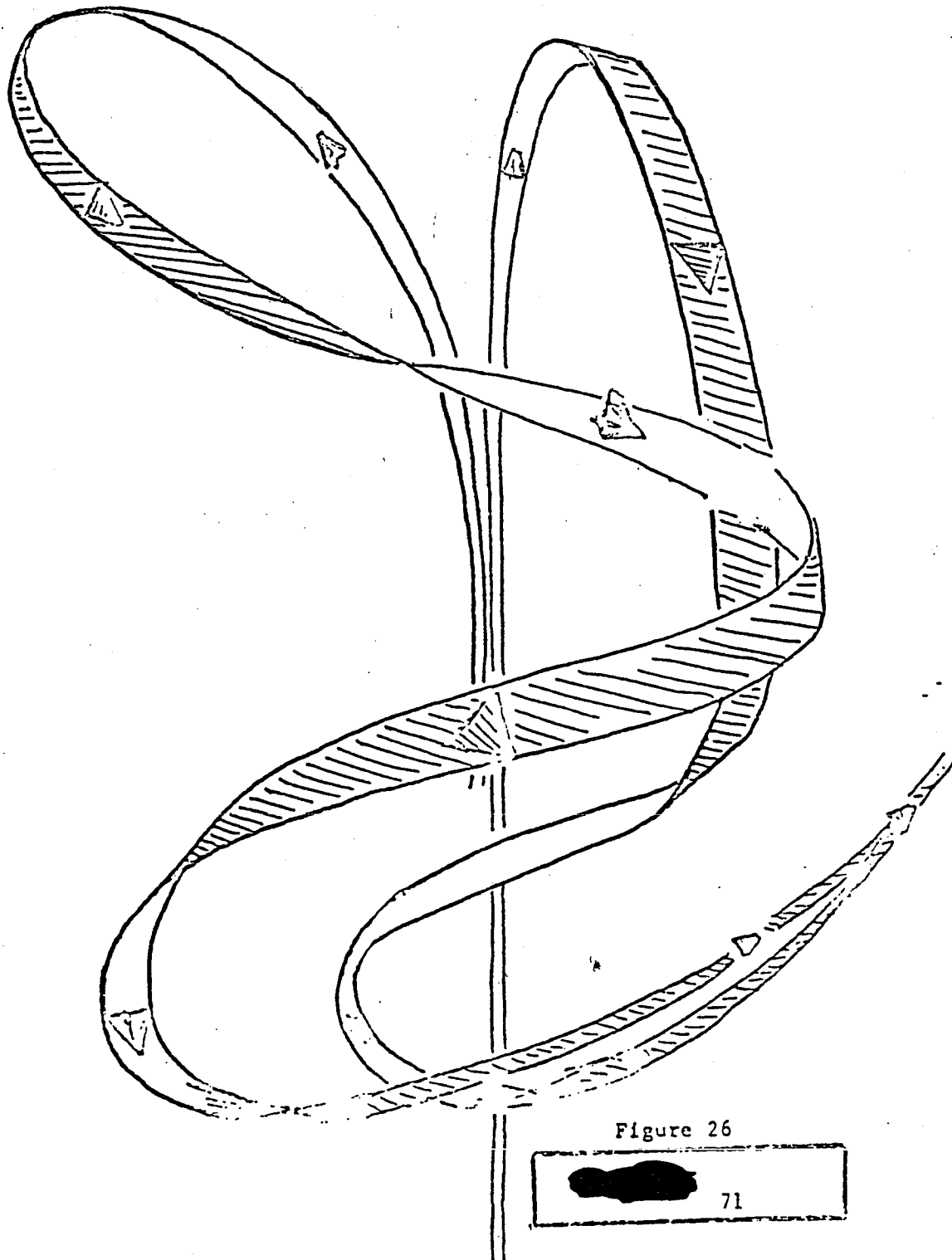
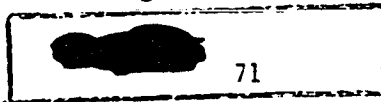

Figure 26



COUNTERING THE DEFENDER'S PULLUP





5. Use extreme caution when dropping down to your opponent's six-o'clock position. Do not acquire a steep nose-down attitude, otherwise your opponent may reverse up into you. This is a difficult situation to recover from. However, if it does occur, employ the following procedures.

6. Roll one-quarter turn away from your opponent's line of flight, the instant your opponent begins a pull-up, and you recognize a steep nose-low attitude as you approach tracking range. This maneuver will provide nose-tail separation and lateral separation in the vertical plane.

7. Initiate a smooth pull-up - after the quarter-roll - without overshooting your opponent's original altitude, continue the pull-up, turn and zoom toward his six-o'clock position. If your opponent attempts to dive away, cut off in the horizontal plane and slide toward his six-o'clock position.

#### Procedures for Countering the High-Speed Yo-Yo

1. Play the attack in an attempt to force your opponent to overshoot. This will force him to counter with a yo-yo maneuver, in order to maintain his offensive advantage.

2. Determine whether or not the attacker is going high and to the rear. If he has an extremely high rate of closure, he may be forced into extreme altitude separation. If so, employ the dive-away for separation and place the attacker in an overhead attack with a negative delta Mach. If the attacker maintains nose-tail separation, and a low yo-yo apex, employ the procedures outlined below:

3. Maintain angle of bank and relax G, as your opponent slides high. This will place you in a slight descent and will allow you to maintain airspeed for future maneuvering potential. At the same time, it will force your opponent to commit himself to a nose-low attack. Continue to maneuver until he does so.

4. Perform a hard-rolling reversal - with rudder and back pressure - up into the attack. This will cause your opponent to overshoot below and forward of your line of flight, or force him to employ the quarter roll-away. If he overshoots below, simply roll or "S" down toward his six-o'clock position. If he employs the quarter roll-away, employ the procedures below.

5. Continue to zoom, and turn through the vertical plane down toward your opponent as he crosses your flight path and begins his zoom toward your angular velocity cone.



6. Relax G, light afterburner and dive for separation. This forces the attacker to perform a  $180^\circ$  turn through the vertical plane to get back into your six-o'clock position. By the time this is accomplished, you will have placed him out of 20mm cannon range and in an overhead attack with a negative delta Mach.

#### Barrel-Roll Attack

The high-speed yo-yo appears to be an excellent offensive maneuver to use any time an attacker has a rate of closure and cannot match an opponent's defensive turn. Generally, this is true; however, in a situation in which an attacker approaches a defender at high angle-off ( $40^\circ$  or more) and long range (10,000 feet or more) the high speed yo-yo has questionable value. Under these circumstances an attacker would have to yo-yo to an extremely high apex to maintain nose-tail separation and stay inside his opponent's turn radius. Naturally, if this occurs, we can expect the defender to immediately dive for separation and airspeed. The attacker is placed in an overhead attack with a negative delta Mach. This means that he must initiate a new attack. Noting this, the defender turns into the attack and generates a high angle-off at long range, and forces the attacker into another yo-yo with high vertical displacement. Once again, the attacker performs a new attack and the process repeats itself. The result is obvious: If the defender counters each attack successfully, the attacker gains little additional advantage and a stalemate exists. The purpose of the barrel-roll attack is to prevent this stalemate from developing.

Geometric examination of this situation - high angle-off, long-range attack - reveals that the attacker would not prefer to execute the yo-yo in this manner. Instead, he would appreciate the opportunity to reduce his angle-off and slide into the defender's angular velocity cone, without the defender being able to gain longitudinal separation. In other words, the attacker would like to reduce his velocity, cut off, and turn inside his opponent, then regain his velocity after he diminishes his angle-off, and slide toward his opponent's six-o'clock position. Is this possible? Yes, if we know how to correctly apply the three-dimensional concept of turn and velocity. As previously stated in the introduction to fighter maneuvers, it is possible to reduce turn and velocity by two methods: (1) Through both the vertical and horizontal planes by employing a two-dimensional maneuver (yo-yo) or (2) Maneuver through both the vertical and horizontal planes by employing a three-dimensional maneuver (barrel-roll). Thus far, our emphasis has been on the first method. Now, we will employ both methods to solve our present dilemma - to reduce airspeed and angle-off, then regain airspeed to prevent longitudinal separation.

How do we apply this three-dimensional concept? If the attacker attempts to barrel-roll, in the plane of the opponent's turn, he will reduce his vector velocity along the axis of the roll. However, the

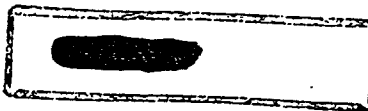

roll will provide a line of flight tangent to his intended turn, which will increase his angle-off and improve the possibility of an overshoot. If the roll is conducted in the vertical plane - combined with a high-speed yo-yo - there is a different result: (1) There is less vertical displacement than in an ordinary yo-yo, because vector velocity along the axis of the roll, in the vertical plane, is diminished, (2) Component velocity, in the plane of the defender's turn, is diminished as a result of the yo-yo and the roll, (3) Aircraft velocity is greater, as a result of the lower yo-yo apex and the shortening effect which the roll has on the velocity vector in the plane of the defender's turn. The shortening effect allows the attacker to diminish his rotation angle through the vertical planes. This provides less speed decay, hence greater aircraft velocity, and (4) There will be no overshoot, as a result of the roll, since the roll is not conducted in the plane of the defender's turn. Upon further examination, we can see that if the attacker is able to initiate this yo-yo with a roll, from below his opponent, he increases his opportunity to gain a favorable position. By initiating the maneuver from an inside-low position, the attacker lowers the apex of the maneuver. This provides the defender less opportunity to gain separation. The only problem now is that the attacker must be able to apply this concept of turn and velocity against his opponent.

To set up the maneuver, the attacker must dive below and inside his opponent's defensive turn. We assume that the attacker has the range/angle-off relationship specified above, and a dive below will provide the attacker some additional airspeed. However, this will not increase his vertical displacement above his opponent, since he can easily kill airspeed upon his forthcoming rotation through the vertical plane. If the attacker approaches the target from below and at a high angle-off, he continues to cut off, in an attempt to reduce angle-off, until he reaches his pull-up point. The attacker pulls up on the inside of his opponent's defensive turn, then barrel-rolls in a direction away from his opponent's turn. If his opponent's defensive turn is toward the left, he rolls right; if the turn is toward the right, he rolls left. The roll is not a high-G barrel-roll (the attacker is trying to kill vector velocity, not aircraft velocity). As the attacker rolls nose-high through the inverted position, he plays back-pressure and kicks bottom rudder to obtain a nose-low  $270^\circ$  change of direction. See figure 27. During this portion of the maneuver - from the inverted position to the  $270^\circ$  point of the roll - the attacker receives the benefit of 1G gravity which assists him in gaining a rapid change of direction toward the defender's six-o'clock position. If the attacker has played the entire maneuver - from pull-up through the roll - on the inside of the opponent's defensive turn, he will find himself above, at a reduced angle-off and in a position to dive below his opponent's line of flight for a six-o'clock-low position. Longitudinal separation will not be great, for two reasons: (1) Vector velocity is reduced, but a higher aircraft velocity is retained, and, (2) The entire maneuver

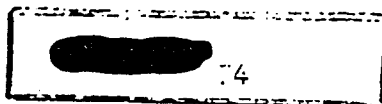

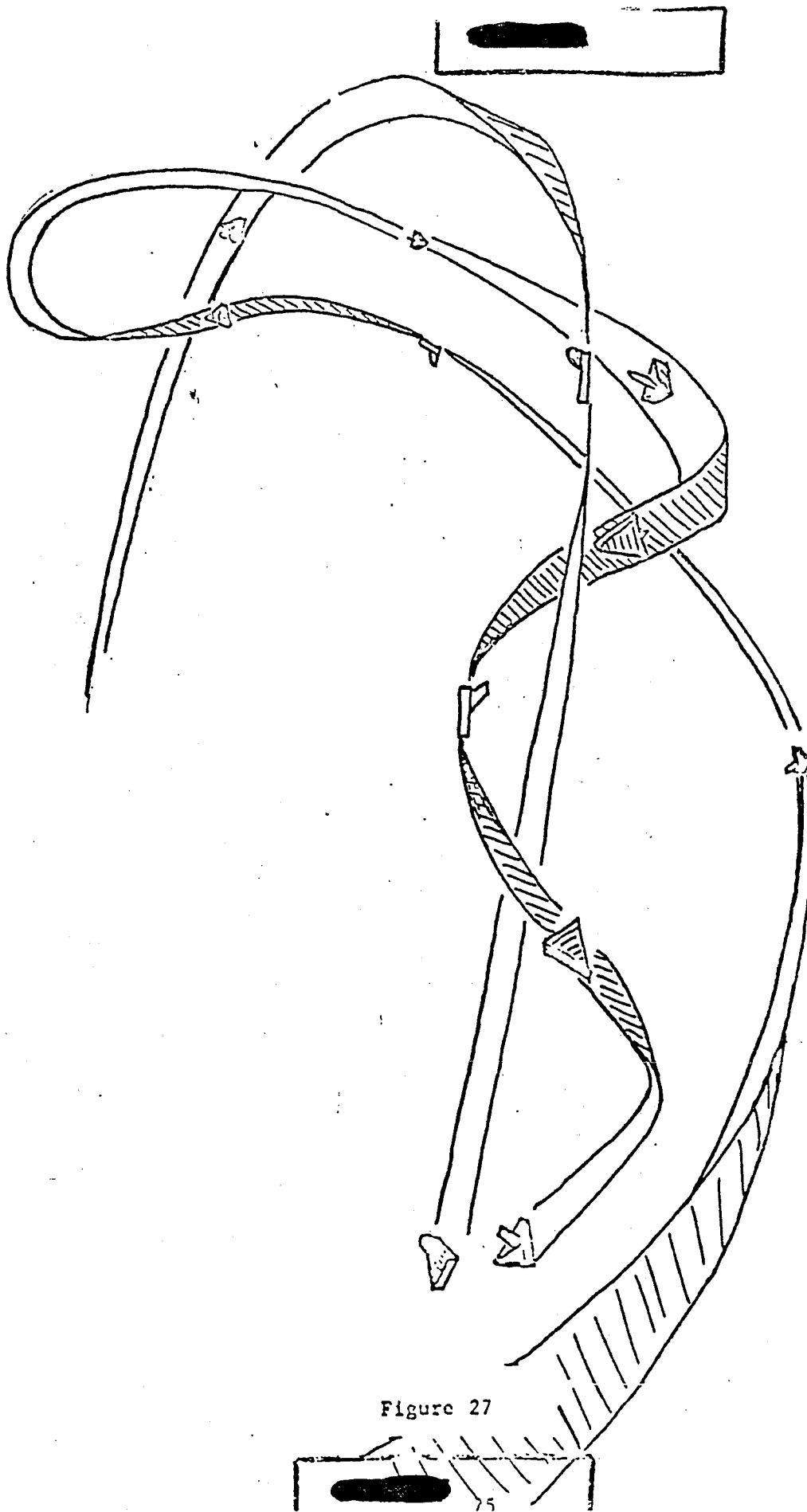

Figure 27

BARREL-ROLL ATTACK

[REDACTED]

is performed inside the defender's turn radius. The offensive roll-away places the attacker outside of gun range, but inside AIM-9B range at six-o'clock low. Whether the attacker can launch or not, depends on how his opponent plays the defensive turn. If the defender tightens his turn and attempts to counter the maneuver, he will experience high speed decay, his angular velocity will be reduced and the attacker will find it easy to set up for a missile launch. On the other hand, if the defender does not tighten his turn, his airspeed and angular velocity will be greater and the attacker will have to maneuver further, if the defender tightens his turn as the attacker attempts to launch. In any case, we can see that the roll-away provides an effective method by which to reduce angle-off, prevent separation and get into an opponent's angular velocity cone. It is tailored to the performance of the AIM-9B.

To counter the barrel-roll attack there may appear to be certain alternatives such as a high-G roll by the defender when the attacker performs his  $270^\circ$  change of direction, or a pull-up (under the same circumstances). The high-G roll is ineffective because this will cause the defender's line of flight to be tangent to his defensive turn. In addition, his vector velocity will be reduced. As a result, the attacker can easily play his maneuver to slide toward his opponent's six-o'clock position and have less longitudinal separation, since his opponent reduced his vector velocity. The pull-up is ineffective, since the attacker is not committed to a nose-low position by employing bottom rudder. Instead, he may employ top rudder when rolling from the inverted position. At the same time, the defender must roll away from his defensive turn to execute a pull-up. This provides the attacker with sufficient longitudinal separation and time to play his top rudder. Result: The attacker rolls toward his opponent's six-o'clock position, with his opponent framed against blue sky - a perfect set-up for a missile launch. The only effective counter for a properly executed roll-away is a dive for separation and airspeed. The moment the attacker initiates his pull-up, the defender should turn nose-low toward the pull-up, relax G, light afterburner and dive for separation. This forces the attacker, even though he may use the roll-away, to perform a  $180^\circ$  change of direction in the vertical plane. If the attacker pulls considerable G in acquiring this change of direction, he diminishes airspeed considerably in respect to the defender. If the attacker plays the maneuver with less G, his vertical displacement is greater. No matter which action he employs, he will be placed in an overhead attack with a negative delta Mach.

To maneuver against this counter, an attacker may employ some deception. The purpose of the deception is to prevent the defender from employing the dive for separation. Instead of pulling up inside the defender's turn, from an inside-low position, the attacker will pull-up to the outside of his opponent's turn, thus maintaining nose-tail separation. To the defender, this will appear as an overshoot. Therefore, we can expect him to reverse nose-high, in an effort to scissor the

[REDACTED]

attacker forward. However, if the attacker plays the maneuver properly - overshoot and zoom - this will be impossible. The attacker has a three-fold advantage in terms of airspeed, nose-tail separation, and a high rotation angle in the vertical plane. This means that the attacker may zoom above and behind, but outside his opponent's turn. The defender will be unable to match the attacker's zoom. If the defender reverses (he most likely will) this will place the attacker above, behind and to the inside of his opponent's turn. The attacker need only roll off in a direction away from his opponent's turn. This will reduce vector velocity, provide nose-tail separation and thus allow the attacker to roll down toward his opponent's six-o'clock position. The defender will be in a poor position to counter, since he has diminished airspeed and angular velocity as a result of his turn and nose-high reversal. Should he attempt to pull up into the attacker, the attacker need only employ top rudder on his roll-off toward the defender's six-o'clock position. If the defender dives away, the attacker employs bottom rudder on his roll-off to prevent separation. In either case, the attacker will be in a favorable position to fire the 20mm cannon or launch a missile. More than likely he will be set up for a 20mm cannon attack. If the defender does not react with a reversal, to counter the overshoot and roll-off, but instead dives away for separation, he will place the attacker in an overhead attack with a negative delta Mach. The separation from this barrel-roll attack will be greater than from the one conducted on the inside of the turn. It is difficult to determine which attack is best. However, if the defender's conditioned reflexes are oriented toward a scissors maneuver in the event of an overshoot - the attacker should employ the outside method; if not he should employ the inside method.

The barrel-roll attack, or roll-off maneuver, need not be limited to the conditions specified above. It may be employed at shorter ranges and lower angle-off. The purpose is to reduce rate of closure and angle-off and provide the defender little opportunity to gain separation. As stated earlier, this is an especially good maneuver by which to slide into an opponent's AIM-9B angular velocity cone, since it provides the attacker a better opportunity to launch against a maneuvering target.

#### Procedures for the Barrel-Roll Attack

1. Stalk your target and attempt to reduce angle-off as much as possible. If this is impossible, employ the procedures outlined below:
2. Dive below and inside your opponent's turn radius, maintaining nose-tail separation throughout the maneuvers. The dive below should be initiated far enough out so the forthcoming zoom may be played inside or outside the defender's turn.



3. Pull up and zoom inside your opponent's turn radius if you feel he is not strongly oriented toward the scissors maneuver (sometimes this is difficult to determine).

4. Barrel-roll, nose-high, in a direction away from your opponent's turn. If he turns right, barrel-roll left, and vice versa. The roll will reduce vector velocity and the height of the yo-yo apex, while maintaining a higher aircraft velocity.

5. Continue the roll and employ bottom rudder as the aircraft comes through the nose-high inverted position. This will provide a 270° change of direction and place you with longitudinal separation,, at a reduced angle-off above your opponent, diving toward a six-o'clock-low position. The longitudinal separation will be less than that acquired from an ordinary yo-yo.

6. Do not employ bottom rudder if your opponent rolls away from the turn and pulls up into the attack. Instead, employ top rudder and continue the roll from the inverted position. This will place you in a nose-high attitude at six-o'clock-low - a perfect set-up for a missile launch.

7. Pull up and zoom to the outside of your opponent's turn radius if you feel you can sucker him into a turn-reversal. If he reverses, continue with the following procedures.

8. Roll in a direction opposite your opponent's turn-reversal. This will reduce your vector velocity and help maintain longitudinal separation.

9. Play top or bottom rudder, according to whether your opponent pulls up or dives away after the reversal. If he pulls up, employ top rudder. This will allow you to roll nose-high toward a six-o'clock-low position. If he dives away, employ bottom rudder. This will allow you to roll nose-low and prevent your opponent from obtaining extreme longitudinal separation.

#### Procedures for Countering the Barrel-Roll Maneuver

1. Play the attack in an attempt to generate angle-off and prevent your opponent from setting up for a missile launch. If your opponent counters with a dive below and to the inside of your turn radius, continue with the procedures outlined below.

2. Turn, nose-low toward the attack, as your opponent initiates his pull-up from an inside-low position. This will increase his angle-off, since you are turning into the plane of attack.

[REDACTED]

3. Relax G, light afterburner and dive for separation. This will force the attacker to turn  $180^\circ$  in the vertical plane toward your line of flight. During this maneuver, he will be dissipating airspeed while you will be increasing airspeed. As a result, at the end of this  $180^\circ$  turn, he will be placed in an overhead attack with a negative delta Mach, beyond gunfire range and in a poor position to launch a missile.

#### The Low-Speed Yo-Yo

Until now, our central theme in discussing tactics has been the problem of overshoot. The defender's maneuvers have been predicated upon rate of closure. He needs rate of closure to generate an overshoot in order to nullify an attack and gain an offensive advantage. On the other hand, the attacker attempts to counter rate of closure, by maneuvering through both the vertical and horizontal planes. Discussing these maneuvers - by the attacker and defender - we assumed that the attacker has a definite rate of closure. Now let us investigate an area in tactics in which an attacker does not have an initial rate of closure. Assume an attacker is at six-o'clock, outside missile range. How would he gain position to launch a missile or deliver a 20mm cannon attack?

To gain position quickly, the attacker must light afterburner and dive below his opponent's flight path. In other words, trade altitude for airspeed. After reaching an altitude of no more than 10,000 feet below his opponent, he should level out and press the attack from a six-o'clock-low position. The airspeed gained in this maneuver will allow the attacker to quickly close upon his opponent. In addition, it places him in the defender's blind spot, with the possibility that the defender will not maneuver to protect himself. If he does not, the attacker simply closes the distance, executes a pull-up inside missile range and launches.

If he has no missile, the attacker moves in closer and executes a gradual pull-up and positions himself for a gun attack. The entire maneuver depicted here - a dive for airspeed and a pull-up for position - we define as a yo-yo. It may be employed in a running battle or in a turning fight any time an attacker has insufficient rate of closure.

In a turning fight, an attacker may find himself in a circular tail-chase unable to close upon an opponent. If he tightens his turn, his opponent counters in like manner and the attacker's position remains unchanged. The result is a lufbery maneuver - a stalemate in which the attacker and defender bleed off airspeed and altitude. If the attacker attempts a high-speed yo-yo in an attempt to break the stalemate and gain a more favorable position, he will break the stalemate but will lose rather than gain a more favorable position. To employ the high-speed yo-yo, the attacker must roll away from the circular





tail-chase and zoom in the vertical plane. The roll-away decreases turn rate and increases turn radius, whereas the zoom dissipates airspeed and also decreases turn rate. The defender now has an airspeed and rate-of-turn advantage. Result: He moves around the lubbery circle away from the attacker's nose, toward his tail.

To gain a more favorable position, the attacker must be able to cut off and close upon his opponent. The purpose of a low-speed yo-yo is to provide cut-off and rate of closure. To employ the low-speed yo-yo when in a turning fight, the attacker simply maintains his bank and lowers his nose to the inside of the turn (see figure 28). He is now turning through both the vertical and horizontal planes. The pull of gravity increases aircraft velocity, thus increasing turn radius through the vertical and horizontal planes; however, in the horizontal plane - the plane of the defender's turn - his turn radius is decreased (in this plane, turn radius is only a component of actual turn). As a result, the attacker turns below and inside his opponent. The attacker's angle-off and airspeed increase and his distance - in respect to his opponent - decreases along the horizontal plane. To prevent an overshoot, the attacker must roll wings-level, pull up and zoom toward the defender's six-o'clock position. The entire maneuver must be accomplished prior to reaching the defender's line-abreast position. If done correctly, the attacker will find himself at a reduced angle-off and at a diminished range. If he is still not in a lethal position, he need only repeat the process. The attacker gains an advantage in employing this maneuver, because airspeed loss is less than the airspeed lost by the defender. When the attacker dives to the inside, he increases airspeed and reduces angle of attack. The increased airspeed provides greater airflow mass to the engine, hence the engine generates more thrust. The decrease in angle of attack reduces induced drag and as a result, in the dive portion of the maneuver, the attacker not only has an airspeed advantage, but also a thrust advantage. On the pull-up to the horizon, angle of attack and induced drag increase. This prevents any further increase in airspeed. However, at this point, the attacker still has a considerable airspeed advantage. In the zoom portion of the maneuver, the pull of one-G gravity starts to diminish airspeed, the loss of airspeed starts to increase angle of attack; however, angle of attack is less than the defender's because of the greater radial G available in the vertical and horizontal plane as compared to the horizontal plane alone. Because of this, the loss of airspeed in a low-speed yo-yo is less than the loss of airspeed in a horizontal turn through the same distance. Therefore, the attacker gains a more favorable position even though he goes through a greater distance.

If the attacker employs afterburner, he will find the maneuver even more effective, even though his opponent may counter in like manner. The afterburner is essentially a ramjet tandem to a turbo engine, therefore, its thrust, like a ramjet, multiplies enormously

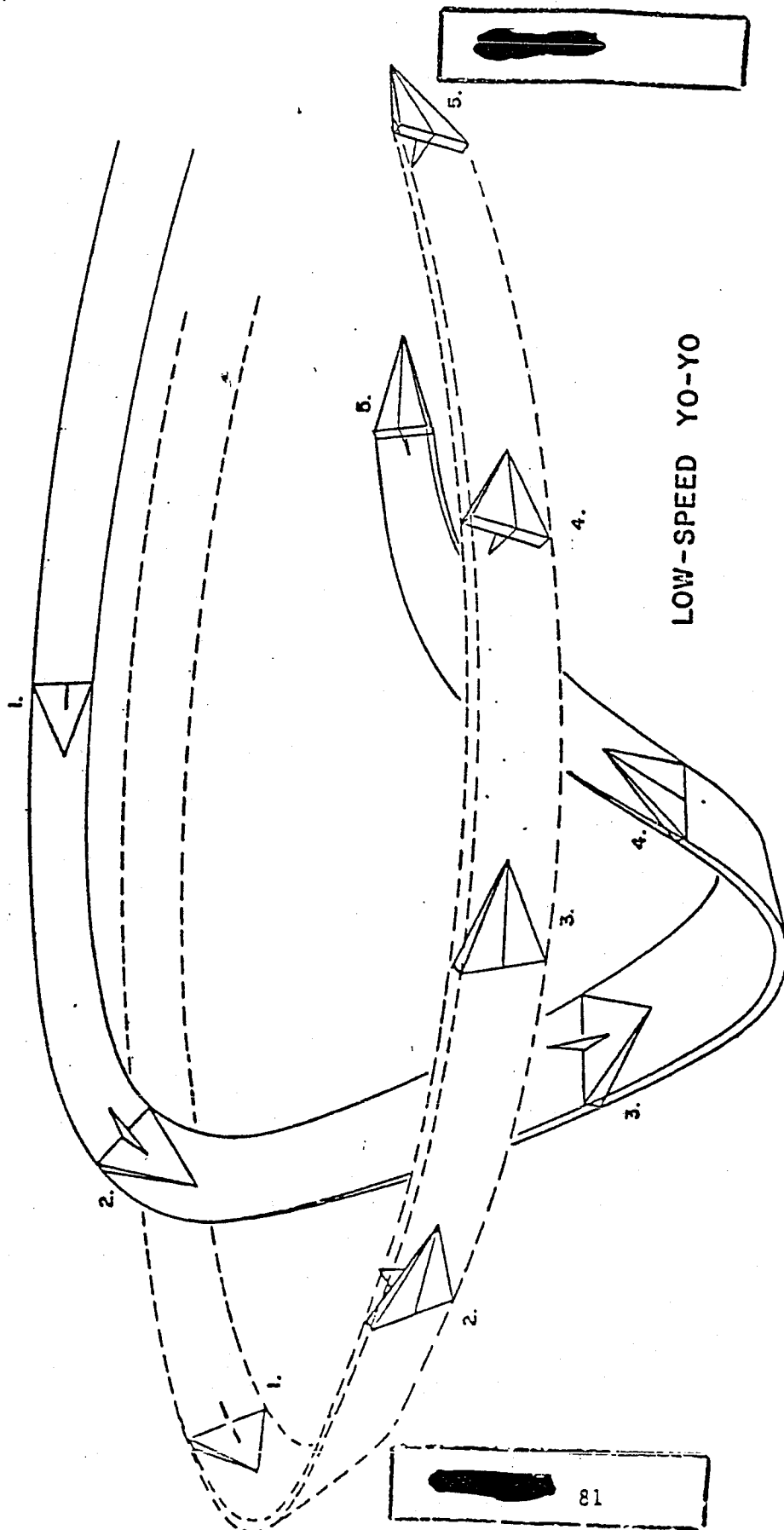
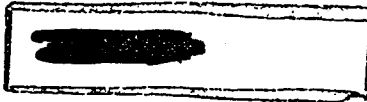

Figure 28



as speed increases. Because of the additional speed thus generated, the attacker need only employ the yo-yo one time in order to gain a favorable position. The afterburner can best be used during the descent and zoom portion of the yo-yo, not during the pull-up to the horizon. If afterburner is used from pull-up to the horizon, the component of afterburner thrust acts in the same direction as the pull of gravity. Unlike max power in a horizontal turn, this causes the attacker to describe a wider arc during the pull-up. This may reduce the effectiveness of the maneuver. On the other hand, if considerable longitudinal separation exists, and the low-speed yo-yo may be performed inside the defender's turn, employ afterburner throughout the entire maneuver. This will enable the attacker to quickly reduce range and zoom into his opponent's angular velocity cone.

A defender cannot effectively counter a properly-executed low-speed yo-yo by tightening his turn, initiating a reversal, or performing a high-G barrel-roll. If the defender tightens his turn, he dissipates his airspeed rapidly to a point where he reduces his angular velocity and increases his turn radius. The attacker then has no great problem in zooming up toward his opponent's six-o'clock position. The attacker may even play the zoom - out of a low-speed yo-yo - so that he will overshoot his opponent's flight path in the horizontal plane. If the defender reverses, the attacker rolls off in a direction opposite the defender's turn toward his six-o'clock position. If the defender initiates a reversal as the attacker starts into his low-speed yo-yo, the defender will be turning away from the attack, hence rotating his angular velocity cone toward the attacker. The attacker simply pulls up on the inside of the reversal and maneuvers toward his opponent's six-o'clock position. The reversal allows the attacker to reduce more G than is possible against a tight turn, and as a result, his rate of closure increases to enable him to gain a favorable position more rapidly. If the defender executes a high-G roll, out of his turn, he reduces vector velocity and flies tangent to the intended turn, thus permitting the attacker to zoom out of his low-speed yo-yo and quickly secure a six-o'clock position. The defender will be in a poor position to counter, since the roll kills his airspeed and maneuvering potential.

To counter a low-speed yo-yo, the defender must rotate his angular velocity cone away from his opponent. In other words, he must turn into the plane of the attack. From this explanation, an obvious counter-measure appears to be a diving turn the instant an attacker begins his low-speed yo-yo. This rotates the defender into the plane of the attack and cancels a possible low-speed yo-yo. Of course the two antagonists will be forced to the deck rather quickly. If the defender rolls out of the turn his opponent will be positioned at six-o'clock. Thus the defender receives only a respite from a stalemate situation. We can see from this illustration that a defender must not only rotate his angular velocity cone away but also do it in such a manner as to completely nullify his opponent's low-speed yo-yo. He

[REDACTED]

can accomplish this in the following manner: the defender allows the attacker to dive below and inside his turn until a pull-up is begun. At this point the defender is in no immediate danger, since the attacker is diving away from his angular velocity cone. As the attacker begins his pull-up, from a nose-low attitude, the defender rolls away from his turn and zooms in the vertical plane in a banked attitude. By this action, the defender rotates his angular velocity cone toward the attacker's line of flight. Observing this, the attacker continues his pull-up in an effort to move toward the defender's six-o'clock-low position. By the time the attacker's nose reaches the horizon on his pull-up, the defender will be nose-high in a bank toward the attacker with considerably less airspeed than the attacker. At this point the defender rotates his angular velocity cone away from the attacker by turning, from a nose-high to a nose-low position, through the vertical plane into the attack. This places the defender in a nose-low, nose-quarter attack with the defender's airspeed increasing and the attacker's airspeed decreasing. The defender now plays his action according to the attacker's intentions. If the attacker continues his zoom and turns 180° through the vertical plane, without cutting off, the defender relaxes G, lights afterburner and dives for separation. This places the attacker in an overhead attack with a negative delta Mach. On the other hand, if the attacker cuts off and overshoots his opponent in the vertical plane, the defender may employ a different counter - the vertical rolling scissors.

#### Procedures for the Low-Speed Yo-Yo

1. Dive below and inside your opponent's turn, if you are in a circular tail-chase, and have little or no rate of closure. This maneuver will increase airspeed, diminish your horizontal turning component, and allow you to set up a rate of closure and maneuver inside your opponent's turn.
2. Employ afterburner in the descent and in the zoom portions of the maneuver. Do not employ afterburner during the pull-up from the nose-low to a nose-level position. The use of afterburner in the descent and zoom portion of the maneuver increases and helps to maintain rate of closure. When afterburner is employed during the pull-up, a wider arc is described, possibly ruining the effectiveness of the maneuver.
3. Do not burble the aircraft, otherwise drag is increased, airspeed is decreased and consequently, zoom capability is diminished.
4. Shallow out your turn and begin a pull-up toward your opponent's six-o'clock position. This should be accomplished from an inside-low position before you reach a position line-abreast of your opponent.

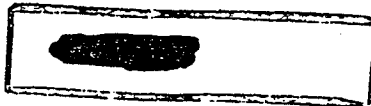

5. Employ afterburner as your nose comes through the horizon and zoom toward your opponent's six-o'clock position.
6. Repeat the low-speed yo-yo - if necessary - until a launch or firing position is reached.

Procedures for Countering the Low-Speed Yo-Yo

1. Continue to turn and observe your opponent's dive below and to the inside until a pull-up is begun. You are attempting to gain lateral separation in the vertical plane before initiating your counter-maneuver.
2. Roll away from the turn and zoom in a banked attitude toward your opponent as he begins his pull-up. This will diminish airspeed and rotate your angular velocity cone toward your opponent. He will maneuver in an attempt to gain position inside this cone at six-o'clock low. As his nose reaches the horizon, in this attempt, maneuver as outlined below.
3. Turn, from a nose-high to a nose-low attitude, through the vertical plane into the attack. This will place you in a nose-low, nose-quarter attack with your airspeed increasing. Your attacker will be in a zoom with airspeed decreasing.
4. Relax G, light afterburner and dive for separation if your opponent does not cut off and overshoot your flight path. If he attempts to cut off and overshoots your flight path, employ the vertical rolling scissors.

Countering the Overhead Attack with a Negative Delta Mach

In our discussion of previous maneuvers, we have encountered many situations in which the defender had to dive for separation in an effort to gain maneuvering airspeed and to provide the attacker the worst possible position for a missile attack - an overhead attack with a negative delta Mach. We will now discuss possible counters to this attack.

In an overhead attack, with a negative delta Mach, the attacker is in the worst possible position to launch an IR missile. The attacker must not only consider IR background clutter, but the lambda and G limitations of his missile. The lambda limit is especially important because of the attacker's negative rate of closure in respect to the target. If the defender performs any defensive maneuver at all, a low relative missile velocity will be combined with an increasing angle-off. As a result, the defender can easily prevent a successful missile launch. G is significant because the attacker must maneuver against one-G gravity. This means he will easily exceed the two-G launch

[REDACTED]

limitation and/or the angle-of-attack limitation against a maneuvering defender. To elude an attacker, the defender need only rotate his angular velocity cone away from the attacker's line of flight. In an overhead attack with a negative delta Mach, he may accomplish this in two ways: (1) Pull up to the horizon, wings level, and perform a defensive turn left or right (the direction dependent upon whether the attacker is high to the left or high to the right). Let's discuss each alternative in detail. First the pull-up and zoom in the vertical plane.

The moment the defender observes his opponent lining up for a possible missile shot, he pulls up and zooms in the vertical plane. During the pull-up - from nose-low to nose-level - he does not employ afterburner. As his nose hits the horizon, he lights afterburner and zooms in the vertical plane. The attacker, faced with this counter, has one of two alternatives: (1) Cut off, in an attempt to secure a six-o'clock-low position as the defender zooms through the vertical plane, or, (2) Do not cut off but fly the same relative flight path as the defender. In all probability, the attacker will be enticed into a cut-off, because he thinks the cut-off will quickly position him for a missile launch. This, however, is what the defender is actually hoping and waiting for. If the attacker cuts off, he will not take advantage of the pull of gravity to build up his airspeed. Therefore, at the bottom of his pull-out, he will generate a lower airspeed than did the defender when the defender was at the bottom of his pull-out. The cut-off and lower airspeed force the attacker to reduce his rotation angle in the vertical plane in respect to the defender. This means that he will be unable to secure a six-o'clock position. Instead, he will be forced to accept a smaller rotation angle, hence a flight path overshoot in the vertical plane (see figure 29). Meanwhile, the defender with his airspeed margin, can pull toward or past the vertical and execute a roll-off - not a loop - down toward the attacker's six-o'clock position. To counter, the attacker will attempt to complete his zoom and roll-off; however, the attacker will lose out because of his initial lower airspeed on his first cut-off and his smaller rotation angle. As a result, the defender will quickly gain an advantage and move toward the attacker's six-o'clock position. If the attacker had not cut off on the initial pull-up and zoom, but had pulled up and zoomed through the same arc as the defender, he would not have lost his advantage. As the defender reached the near vertical, the attacker would be near six-o'clock. This means the defender would be unable to successfully roll off and gain a six-o'clock advantage, since he would not have an overshoot in the vertical plane. If he did, the attacker would simply follow and gain a more favorable position. To prevent this, the defender must turn 180° through the vertical plane and once again relax G and dive for separation. The attacker, noting this, will be faced with the choice of attempting to cut-off or zoom past the defender through the same turning point to complete a 180° change of direction toward the defender's six-o'clock position. If the attacker attempts to cut off and overshoots his

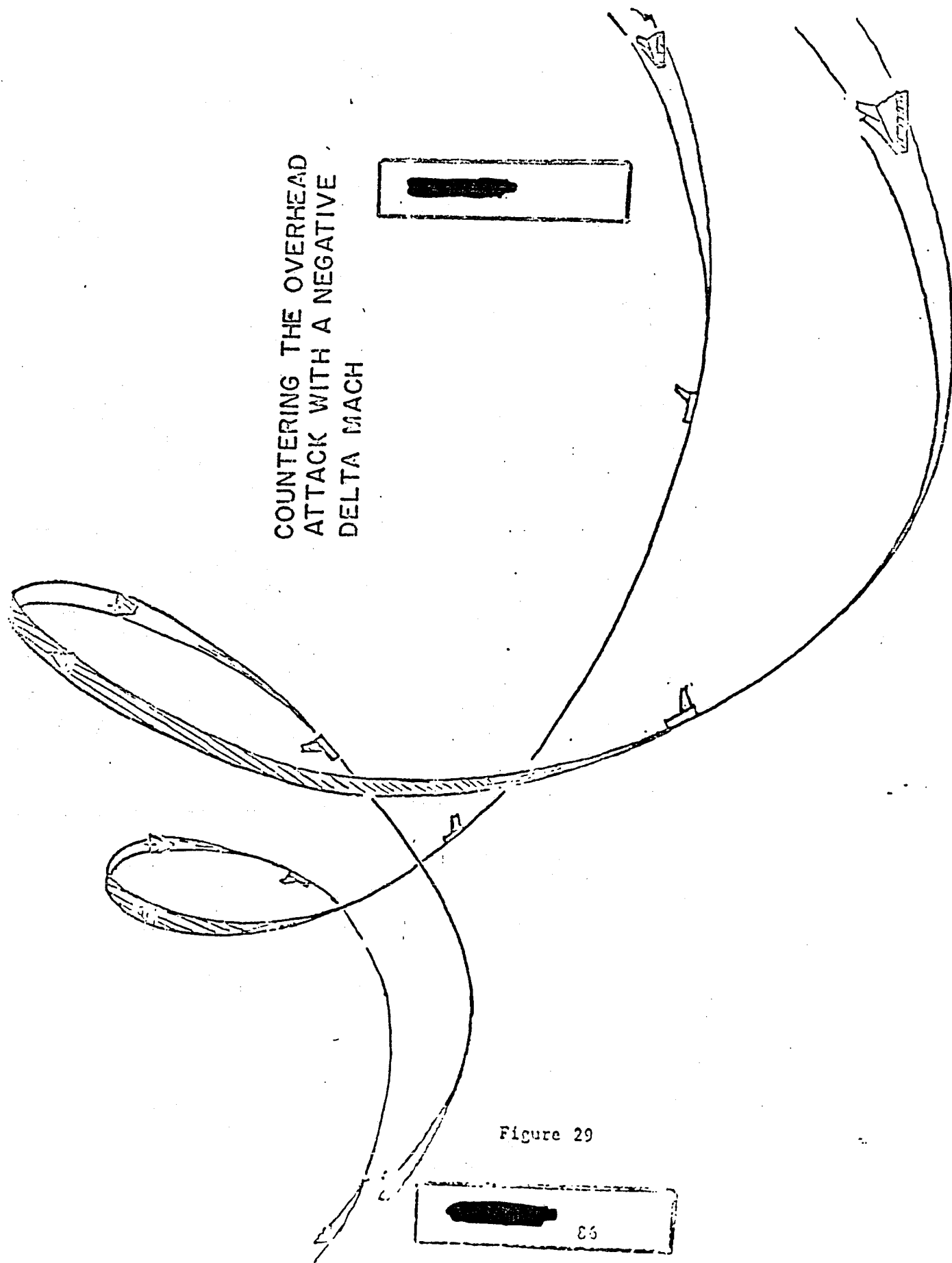

[REDACTED]

opponent in the vertical plane, the defender may employ the vertical rolling scissors as a counter. On the other hand, if the attacker does not cut off, the overhead attack with a negative delta Mach will be repeated once again. To counter this second attempt, the defender may execute the second alternative - a pull-up to the horizon and a defensive turn, left or right. If the attacker is to the rear and off to the left, the defender will turn left, and vice versa. If the attacker presses the attack, in a curved plane intercepting the defender's turn, he will describe a nose-low spiral. As range diminishes, the attacker's airspeed and G will build up. The defender, observing his opponent's attack, will tighten up his defensive turn as the attacker's range diminishes. If the attack is continued, the nose-low spiral forces the attacker into an overshoot below the defender. The result is obvious: The defender simply rolls off and maneuvers toward the attacker's six-o'clock position. If the attacker attempts to yo-yo out of this nose-low spiral - before overshooting below his opponent's flight path - he must roll wings-level in order to pull up and zoom in the vertical plane. This maneuver provides nose-tail separation for the attacker; however, it also provides lateral separation for the defender. In this instance, the defender has taken the advantage. After rolling wings-level the attacker has a nose-low attitude while the defender has a nose-level attitude. This means that the attacker must pull from this attitude to nose-level before he can zoom in the vertical plane. During the process, the attacker increases his horizontal velocity component. This causes him to overshoot the defender's flight path before he can execute his zoom. If, during the pull-up and zoom by the attacker, the defender counters with a nose-high reversal, he will diminish his horizontal component. The result is obvious: The attacker is forced out front by his pull-up and zoom. The defender will be in position, at six-o'clock low, for a missile attack.

Procedures for Countering the Overhead Attack with a Negative Delta Mach

1. Determine if an attacker is in position to execute an overhead attack with a negative delta Mach. This can be accomplished by observing the attacker's previous maneuvers and his present relative position. If he is in a proper position, employ the following procedures.
2. Pull up from a nose-low attitude and zoom in the vertical plane (wings level). This should be accomplished the moment the defender observes his opponent flying up for a possible missile shot.
3. Employ afterburner during the dive and zoom portions of the maneuver. Do not employ afterburner during the pull-up from nose-low to nose-level. Use of the afterburner during the dive and zoom portions of the maneuver and not during the pull-up allows the defender



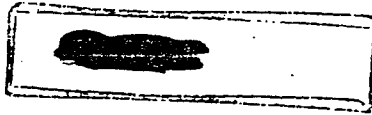

to generate sufficient angular velocity and, at the same time, maintain a substantial zoom capability.

4. Observe and determine if your opponent attempts a cut-off in an effort to secure advantage. If he does, he will not take advantage of the force of gravity to build up his airspeed. Therefore, in the bottom of his pull-out, he will have a lower airspeed, hence a lower zoom potential as well as a reduced rotation angle.

5. Roll off, as you approach the vertical, and maneuver down toward your opponent's six-o'clock position. This should be accomplished as your opponent starts in the zoom portion of his maneuver. This will prevent him from getting near your six-o'clock position. At the same time, it allows you to gain toward his six-o'clock position.

6. Repeat the process. This means that you will dive toward the attacker's six-o'clock position from your roll-off. This will place you at the bottom half of the maneuver. Your attacker, attempting to complete his zoom, will roll off toward your six-o'clock position. However, you will gain on him because of his initial lower airspeed when he performs his first cut-off.

7. Do not attempt the roll-off if the attacker does not cut off on the initial maneuver. Instead, turn  $180^\circ$  to the vertical plane, relax G and dive for separation. If the attacker does not cut off, he will be near your six-o'clock position as you reach the near-vertical. To provide him little advantage, you must turn  $180^\circ$  into the attack, dive for separation, and once again place him in an overhead attack with a negative delta Mach.

8. Determine, once again, when the attacker is in an overhead attack with a negative delta Mach, then get ready to employ the second alternative.

9. Pull up to the horizon with wings level, then perform a defensive turn left or right (the direction is dependent upon whether the attack is high to the left or high to the right). If the attacker counters the first alternative, he will meet the second in an effort to gain an advantage.

10. Continue the turn and observe the attacker. If he presses the attack in a curved plane intercepting your turn, proceed as follows:

11. Tighten up the turn, as the attacker's range diminishes, and attempt to force him below your line of flight, or attempt to force him into a yo-yo out to the side. If he continues the attack, he will be forced into an overshoot below you.



12. Roll off and maneuver toward the attacker's six-o'clock-low position if the attacker continues the attack and is forced into an overshoot below you. If he yo-yo's out to the side, employ the following procedures.

13. Reverse nose-high to force the attacker below and out front. Since the attacker must pull up before he can zoom, his horizontal velocity will carry him below and forward.

14. Roll off and maneuver toward the attacker's six-o'clock-low position as he completes his pull-up and proceeds in the zoom portion of his maneuver.

#### Maneuvering from An Overhead Attack with a Negative Delta Mach

You will recall, from our previous discussions of the overhead attack with a negative delta Mach, that an attacker may expect two possible counters to his attack: (1) A pull-up from a nose-low attitude, followed by a zoom in the vertical plane, or (2) A pull-up to the horizon, wings level, followed by a defensive turn left or right. Our purpose in discussing the overhead attack with a negative delta Mach is to point out maneuvers which can be used against either one of these counters.

To maneuver against the first alternative - pull-up from a nose-low attitude with a zoom in the vertical plane - we stated that the attacker should not cut off and pull-up and zoom. Instead, he should fly the same relative flight path as the defender. By doing this, the attacker would force the defender to turn 180° in the vertical plane in an attempt to gain longitudinal separation. We can see, by geometrically examining this situation, that the attacker has an apparent choice of either cutting off his opponent in the vertical plane, or zooming past the defender through the same turning point to complete a 180° change of direction toward the defender's six-o'clock position. If the attacker attempts to cut off and over-shoots his opponent's descending flight path in the vertical plane, he can expect the defender to counter with the vertical rolling scissors. This will cost him his offensive advantage. On the other hand, if he does not cut off, the overhead attack with a negative delta Mach will be repeated once again, and he will gain little additional advantage. To prevent either situation from occurring, the attacker need only employ a barrel-roll (roll-away) in the vertical plane, as he starts to move past the descending defender. This will reduce the apex of his zoom, because his vector velocity (along the axis of the roll) in the vertical plane is diminished. As a result, the attacker will roll away through a 180° change of direction to position himself at his opponent's six-o'clock-low position, in the vertical plane, with much less longitudinal separation. If the defender repeats the pull-up and zoom, followed by a 180° turn in

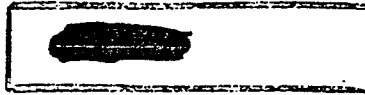

the vertical plane, the attacker need only repeat the process to gain an even more favorable position. He may then set up for a missile or 20mm cannon attack.

To counter this roll-away, the defender need only add back-pressure and roll toward the roll-away, or dive for whatever longitudinal separation he can get to employ his second alternative. If the defender rolls toward the roll-away, this will place the attacker at a high angle-off in the vertical plane, as shown in figure 30. To maneuver out of this position, the attacker must roll 180° toward the defender's flight path. Meantime, the defender can relax G, dive for separation and attempt his second alternative.

To maneuver against the second alternative - a pull-up to the horizon, wings-level, with a defensive turn left or right - the attacker must not launch an overhead attack in a curved plane against the rim of the defender's horizontal turn. This means that if the attack is pressed, the attacker has the option of descending outside his opponent's turning circle or descending inside the turning circle. If the attacker descends outside his opponent's turning circle, his rate of turn will be less than the defender's. This means the defender will be turning away from the attacker's nose, toward his tail, as the attacker approaches the defender's line of flight. As a result, the defender will maneuver toward the attacker's six-o'clock position. On the other hand, if the attacker descends inside the turning circle, he is not committed to generate a turn rate less and a turn radius greater than his opponent, as would be the case if he initiated a pursuit curve attack, in a curved plane (either intercepting the defender's horizontal turn or descending outside his turning circle). By descending inside the horizontal circle, the attacker describes a nose-low spiral, in which his rate of turn, along the horizontal axis, is governed by his spiral or roll rate along the vertical axis. His radius of turn along the horizontal axis is governed by the slope of his descending spiral. If the attacker increases his roll rate (in the spiral) and steepens the spiral, he increases his horizontal turn rate and decreases his horizontal turn radius. In effect, the attacker will be pinwheeling down the axle of the defender's horizontal turn. This, of course, will cause the attacker to build up excessive velocity for his forthcoming maneuver unless he reduces power. As the attacker pulls well inside and below the defender's turning circle, he rolls out of the spiral and executes a pull-up and zoom toward the defender's six-o'clock position. (In other words, he employs a variation of the low-speed yo-yo.) If the attacker's aimpoint is excessive and it appears that the resulting zoom may force him too high and/or to the outside of the defender's turning circle, the attacker simply employs the barrel-roll attack in an effort to secure a launch or firing position.

To counter the nose-low maneuver (the low-speed yo-yo or the barrel-roll attack) out of the overhead attack with a negative delta

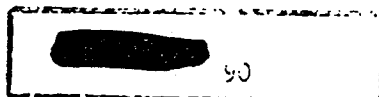

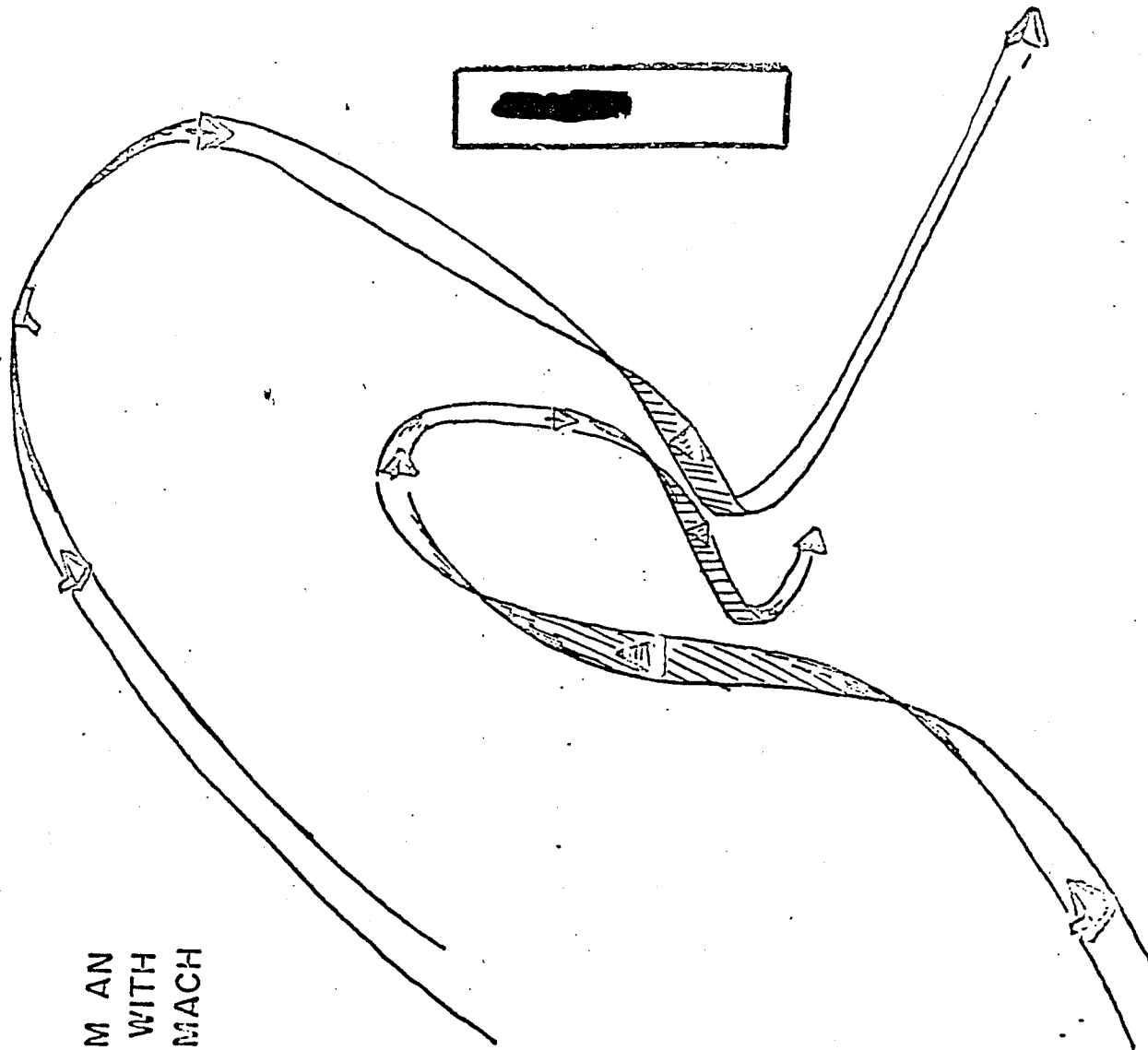

MANEUVERING FROM AN  
OVERHEAD ATTACK WITH  
A NEGATIVE DELTA MACH

Figure 30

 91

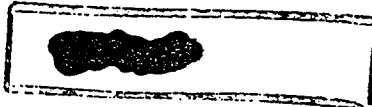

Mach, the defender need only employ the counters suggested for a low-speed yo-yo and/or for the barrel-roll attack.

Procedures for Maneuvering from an Overhead Attack with a Negative Delta Mach

1. Observe your opponent and determine if he employs alternative 1 - a pull-up from a nose-low attitude and a zoom in the vertical plane - or alternative 2 - a pull-up to the horizon, wings-level, and a defensive turn left or right. If he employs the first alternative, use the following procedures.
2. Do not cut off as your opponent begins his pull-up for a zoom in the vertical plane. A cut-off now will provide you a lower airspeed and a smaller rotation angle for your forthcoming zoom.
3. Dive - A/B on-- and initiate a pull-up and zoom through the same arc which the defender described. This technique will enable you to generate a high rotation angle in your zoom, hence, prevent a flight-path overshoot, in the vertical plane.
4. Determine if your opponent counters with a roll-off or a 180° turn through the vertical plane in an effort to maneuver you out of his six-o'clock position. If he employs the roll-off, simply roll with him and maneuver toward his six-o'clock position. If he employs a 180° turn through the vertical plane in an effort to gain separation, employ the following procedures.
5. Initiate a barrel-roll (roll-away) as you begin to zoom past your descending opponent. A roll-away will reduce your vector velocity in the vertical plane; hence, provide your opponent less longitudinal separation.
6. Complete the barrel-roll (roll-away) and maneuver toward your opponent's six-o'clock position in the vertical plane. Your opponent will now either repeat the pull-up and zoom or proceed to his second alternative. If he repeats his previous maneuver, simply repeat your roll-off and gain position for a missile or 20mm cannon shot. If he employs the second alternative, use the following procedures.
7. Do not press the attack in a curved plane intercepting the rim of the defender's turn. This will force you to either overshoot below your opponent or to yo-yo out to the side in a nose-low attitude. In either case, he will gain an advantage (see section on countering the overhead attack with a negative delta Mach).
8. Spiral inside your opponent's horizontal turn to match his turn and to cut him off. This may be accomplished by adjusting your rate of spiral and the slope of the spiral.

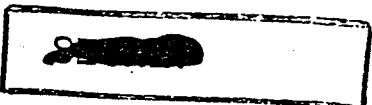

9. Continue the spiral, inside your opponent's turn, until you start to move below and inside his line of flight.
10. Roll wings-level, pull-up inside your opponent's turn and zoom toward his six-o'clock position. If you have excess airspeed or are not spiraling well inside your opponent's horizontal turn, you may be forced to pull up and zoom outside his turning circle. In this case, employ the following procedures.
11. Zoom outside your opponent's horizontal turning circle - if you are unable to complete your pull-up inside his horizontal turn radius-- then turn back toward him if he continues to turn or attempts to dive away.
12. Zoom to the outside and barrel-roll (roll-away) toward your opponent's six-o'clock position, if he attempts a reversal to counter your zoom to the outside.

The Vertical Rolling Scissors

The vertical rolling scissors is what the name implies - a defensive, descending, rolling maneuver in the vertical plane. The purpose of this maneuver is to gain an offensive advantage if an opponent overshoots a defender's flight path, and slides through his angular velocity cone while descending in the vertical plane. See figure 31. The following situations may be used to set the stage for employing the maneuver:

- (1) At high altitude, when the defender has a high Mach with a low indicated airspeed. In this case, the defender will be forced to perform a descending defensive turn to maintain future maneuvering potential. If the attacker with a fair rate of closure, thinks that his opponent is attempting to gain separation, he may cut off in an effort to prevent him from doing so. With his higher airspeed, his radius of turn during the cut-off will be greater than the defender's. As a result, he can be easily forced to overshoot the defender's descending flight path.
- (2) In a zoom-maneuver in which the attacker is attempting to approach a zooming defender's six-o'clock position. The defender, observing the attacker's position, uses the pull of gravity and executes a 180° turn through the vertical plane in an effort to gain separation and thus place the attacker in an overhead attack with a negative delta Mach. In an effort to prevent this, the attacker cuts off. During the cut-off, his radius of turn is greater than the defender's because of this higher airspeed, and as a result, he overshoots the defender's descending flight path.
- (3) A six-o'clock-low missile attack, in which an attacker is approaching his pull-up point for launch. The defender, observing the attacker, may execute one of two maneuvers: An immediate defensive turn down into the attack, or a pull-up and zoom followed by a 180° turn, in the vertical plane, down into the zooming attacker (this is the same procedure used as a counter to the low-speed yo-yo). In either of these cases, if the attacker attempts a substantial cut-off he can be forced to overshoot his opponent's descending flight path.

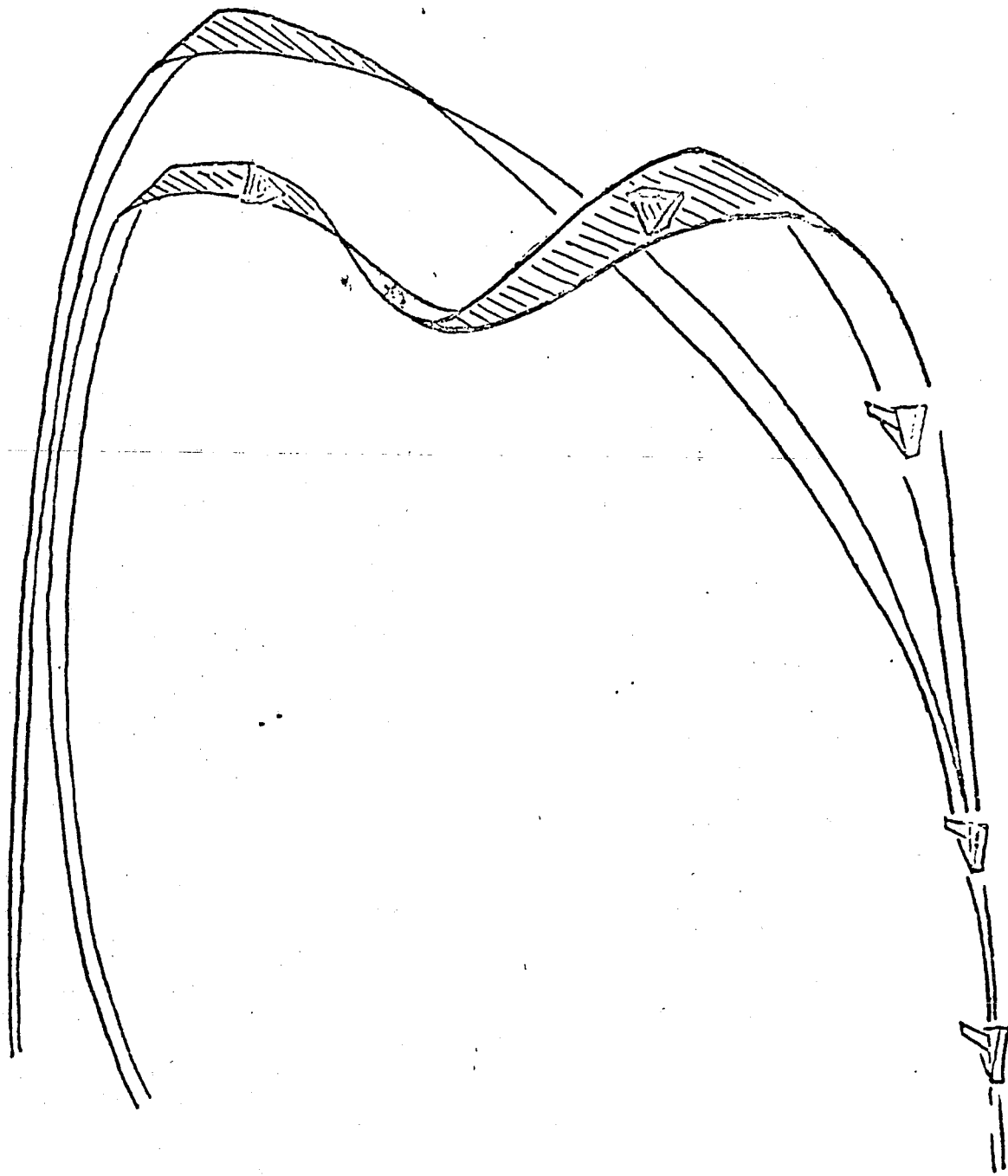

VERTICAL ROLLING SCISSORS

Figure 31

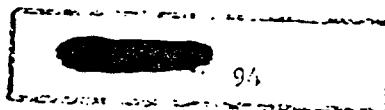

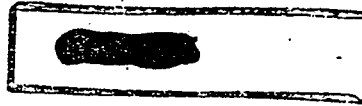

With the stage set, we can now discuss the mechanics of the vertical rolling scissors. Let's assume that we have a defender zooming in the vertical plane, with an attacker initiating a pull-up in an effort to maneuver toward the zooming defender's six-o'clock position. The defender, observing his opponent's position, turns  $180^\circ$  through the vertical plane, down into the attack in an apparent attempt to gain separation. Observing this maneuver, the attacker decides he can either cut off, or zoom and turn  $180^\circ$  through the defender's turning circle. Since he knows that a turn through the defender's turning circle will place him in an overhead attack with a negative delta Mach, he elects to cut-off. Observing the cut-off, the defender knows that the attacker will be performing his  $180^\circ$  turn through the vertical plane at a higher airspeed. Therefore, the attacker's turn radius will be greater; hence, he will overshoot the defender's descending flight path. Understanding this, the defender reduces power to slow his rate of descent (he may deceive the attacker in this power reduction by momentarily lighting afterburner, then reducing power, to make it more apparent that the defender is trying to dive for separation) then waits until the attacker overshoots his flight path and is committed to a nose-low attitude. At this instant, the defender comes in with back pressure and reverse-rolls into the overshooting attacker. This will place the defender below the attacker and  $180^\circ$  out of phase, with a less nose-low attitude; hence, a lower vector velocity along the vertical axis. The attacker, noting that he is out of phase, and is descending more rapidly than the defender, will attempt to roll  $180^\circ$  toward the defender's descending flight path. Observing the attacker's action, the defender rolls in the same direction. This prevents the attacker from flying into his opponent's six-o'clock position. At the same time, it prevents him from reducing his nose-low attitude. As a result, the attacker, with his higher vertical vector velocity, has rolled  $180^\circ$  out of phase, down and below the defender. The defender now has the advantage and he need only roll into the attacker's six-o'clock position.

To counter the vertical rolling scissors, a zooming attacker should not attempt to cut off a descending defender when he has a substantial airspeed advantage. Instead, he should roll away or barrel-roll to reduce his ascending vertical vector velocity, hence his yo-yo apex. In an effort to prevent the defender from gaining longitudinal separation, the attacker need only initiate his roll-away as he starts to ascend past the diving defender. This will allow him to complete his  $180^\circ$  change of direction with less vertical displacement and will position him at the diving defender's six-o'clock position with less longitudinal separation and less negative rate of closure. To maneuver for a launch or firing position, the attacker need only maneuver against any forthcoming counters by the defender. If the defender has none, the attacker moves in for the kill.



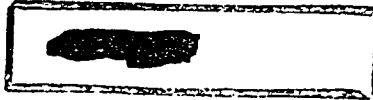

### Procedures for the Vertical Rolling Scissors

1. Observe the attacker's position. If he is in a six-o'clock-low position, perform the following procedures.
2. Pull up and zoom in the vertical plane, or perform an immediate descending defensive turn. If your opponent has not set up a zoom for a launch or firing position, you may employ the pull-up and zoom. If he has, immediately employ the descending defensive turn.
3. Turn  $180^\circ$  through the vertical plane, if you zoom, or continue the dive if forced to perform a descending defensive turn.
4. Observe your opponent to determine whether or not he will cut off. If he cuts off, employ the following procedures.
5. Reduce power to slow rate of descent.
6. Reverse-roll, toward your opponent, when you observe his overshoot and nose-low commitment. A reverse-roll should be accomplished with back-pressure and rudder (high-angle-of-attack maneuver) to reduce your nose-low attitude and your vertical vector velocity.
7. Do not allow your opponent to roll toward your flight path - keep him  $180^\circ$  out of phase. To accomplish this, roll in the same direction as your opponent if he attempts to acquire your six-o'clock position.
8. Continue this rolling maneuver, with your opponent out of phase, until he rolls down and below you. He will be forced into this position because his vertical vector velocity is greater than yours.
9. Roll into your opponent's six-o'clock position and maneuver for the kill.

### Procedures for Countering the Vertical Rolling Scissors

1. Do not attempt to cut off as a zooming attacker against a descending defender if you have a substantial airspeed advantage. Under these conditions, a cut-off will force you to overshoot your opponent's descending flight path.
2. Roll away or barrel-roll as you move vertically past your descending opponent. This maneuver will reduce your zooming vector velocity, hence vertical displacement, in your zoom.
3. Continue the roll-away to acquire a  $180^\circ$  change of direction and a six-o'clock-low position against your diving opponent. This prevents your opponent from gaining a considerable longitudinal separation and at the same time reduces your negative rate of closure.

4. Maneuver against any forthcoming counter thrown at you by your opponent.

#### The High-G Barrel-Roll

There may come a time, in a tactical situation, in which you find that you can nullify a missile attack, but have less success in counter- ing a follow-up 20mm cannon attack. You will recall that a defender can frustrate a missile attack by exceeding the missile's lambda and/or G-capabilities. The maneuvers needed to accomplish this are not too demanding, providing the defender has visual contact with the attacker. On the other hand, a much higher degree of skill - in respect to man- euvering - is needed to counter an aggressive, skillfully-executed follow-up gun attack. Under these circumstances even the most profi- cient defender may find himself in a serious defensive position, with an attacker at six-o'clock inside gun firing range. To get out of this situation, any defender knows he must force the attacker to overshoot his flight path. In other words, he must rotate his angular velocity cone in such a manner as to acquire lateral separation. Turn and velo- city, married to the pull of gravity, determine his field of maneuver, and his ability to rotate his angular velocity cone. He must employ these factors in proper perspective to gain an overshoot. In this sit- uation, this means that the defender must reduce his turn and velocity more quickly than his opponent if he is to force his opponent out of his six-o'clock position. From our previous discussions, it is obvious that a barrel-roll type maneuver offers the best opportunity to quickly change direction and reduce vector velocity. In this case, since the attacker is at six-o'clock inside gun firing range, the defender must perform a max-performance or a high-G barrel-roll to prevent his oppo- nent from matching his change of direction and reduction of vector velocity. Before initiating the maneuver, his only remaining problem is to determine in which direction the high-G barrel-roll should be executed. To answer this, let's assume that the defender is in a defensive turn with an attacker at six-o'clock under the conditions specified above.

In an attempt to force the attacker to overshoot, the defender can either execute a barrel-roll over the top or a barrel-roll underneath out of his defensive turn. If the attacker is at high speed - 300 knots or more in the F-100 - and he performs a high-G barrel-roll underneath, the pull of gravity will act in the same direction as his thrust vector. This means that he will experience considerable diffi- culty in reducing his vector velocity more quickly than his opponent. On the other hand, if he performs a high-G barrel-roll over the top, his thrust vector acts in a direction opposite the pull of gravity. This means that he will reduce his vector velocity much more rapidly in respect to his opponent. To illustrate both situations: If the defender rolls underneath, he must execute the maneuver first, since the attacker is maneuvering in respect to him. This means that the pull of gravity will act in the same direction as the defender's thrust

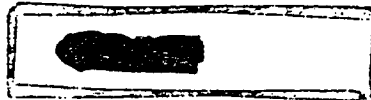

and velocity, before it acts on the attacker. As a result, the defender will experience difficulty in reducing his vector velocity more rapidly than his opponent. On the other hand, if the defender rolls over the top, once again he must execute the maneuver first, since the attacker is maneuvering in respect to him. In this case, the defender can reduce his vector velocity more rapidly than his opponent since the pull of gravity acts against his thrust and velocity, before it acts against the attacker's thrust and velocity. It is obvious from this discussion that if a defender, at high speed in a defensive turn, has an attacker at six-o'clock inside gun firing range, he should execute the high-G barrel-roll over the top, rather than underneath, in order to gain an overshoot.

If a defender does not have the necessary speed to execute the high-G roll over the top, he should not attempt to do so, because the high angle of attack required to successfully accomplish the maneuver and the pull of gravity will cause his speed to decay very rapidly. If the defender attempts to roll over the top, this means that he will stall out and be unable to complete the maneuver, and the attacker will set up at a six-o'clock position for an easy kill. To prevent this, the defender with insufficient speed to execute a roll over the top, should perform a high-G roll underneath (in the F-100, this maneuver should be initiated with an airspeed of 250 knots or less). In this situation, a defender needs the pull of gravity to successfully complete the maneuver. He will be maneuvering with a high angle of attack. The induced drag generated by this angle of attack will provide a deceleration greater than the acceleration generated by the pull of gravity. Hence, if the defender executes a high-G roll underneath, he can still change direction and reduce velocity more rapidly than his opponent. Why? Because the attacker must still maneuver in respect to the defender. The attacker's rate of turn and vector velocity are dependent upon his angle of attack, which, in turn, is dependent upon his rate of turn, which is dependent upon the defender's velocity, angle-off and range  $(W = \frac{Vt \times \sin \theta}{\text{Range}})$ .

Now that we understand the need for the high-G barrel-roll - both over the top and underneath - and when it should be employed, let's discuss the mechanics of each maneuver.

#### The High-G Barrel-Roll over the Top

As indicated above, the high-G barrel-roll over the top is designed for use against an attacker at six-o'clock inside gun firing range, when the defender is in a defensive turn and is unable to shake the attacker. More specifically, the attacker should be in fairly close - a range of around 1500 feet or less. If the attacker is at a range much greater than this, the high-G barrel-roll, because of its rapid reduction of the defender's velocity, will only serve to bring him closer toward the defender's six-o'clock position. In other words, this maneuver should not be employed at the longer gun firing ranges or as a defence



against a missile attack. If so, the attacker will simply play the maneuver to reduce longitudinal separation to move into position for a kill. The defender will be in a poor position to counter, since he will have killed all his maneuvering velocity.

With these conditions in mind, the moment the defender realizes he is unable to shake his opponent, he should start to execute the roll (see figure 32). He should not delay, otherwise the attacker may make the kill. To execute the maneuver properly, a defender should maintain back-pressure and start his roll over the top without releasing any G. This means that he must exercise proper rudder and aileron control; otherwise adverse yaw will prevent him from performing the maneuver (some aileron may be required during the start of the roll, however, as the roll progresses, his angle of attack increases and more rudder will be needed). As the defender comes through the inverted position, he should maintain back-pressure and increase his roll rate. If he fails to maintain back-pressure, he will not reduce vector velocity rapidly enough, and will not force his opponent around the outside of the roll. If he fails to increase his roll rate, he will not successfully complete it, since rapid airspeed decay is reducing his maneuvering potential. As the defender reaches the 270° point - the opposite side of the roll - he should play top rudder to prevent dish-out, and visually ascertain the attacker's position. If, in an effort to secure a kill, the attacker has followed the defender around the roll, he will be forced outside the defender's roll. This means that at the 270° point he will be high, toward the rear and outside the roll (if the attacker has not reduced very much of his velocity during the roll, he will simply be high and to the outside). If, while the attacker is in this position the defender continues his roll-out - holding top rudder to maintain a nose-high attitude - it forces the attacker to slide below and forward in an obvious overshoot. The defender then simply increases his nose-up attitude and rolls or S's toward the attacker's six-o'clock position.

To counter the high-G roll, the attacker may attempt to yo-yo out the top of the roll or reverse-roll out of the top in an effort to secure a six-o'clock position. If the attacker yo-yo's out the top, the intent is obvious - he is attempting to reduce his vector velocity along the axis of the roll by yo-yoing in the vertical plane. In this way he can maintain a six-o'clock-high position after the defender completes the roll. If the attacker reverse-rolls, he will roll through a wider arc in the opposite direction. If he maintains back pressure while doing this, he can reduce vector velocity along the axis of the defender's roll more rapidly than the defender. As a result, upon completion of the roll by the defender, the attacker will be at six-o'clock. To maneuver against either of these counters, the defender must ascertain the attacker's position as he approaches the 270° point in his roll. He will be unable to determine the attacker's position prior to this, since the yo-yo out, or the reverse-roll, places the

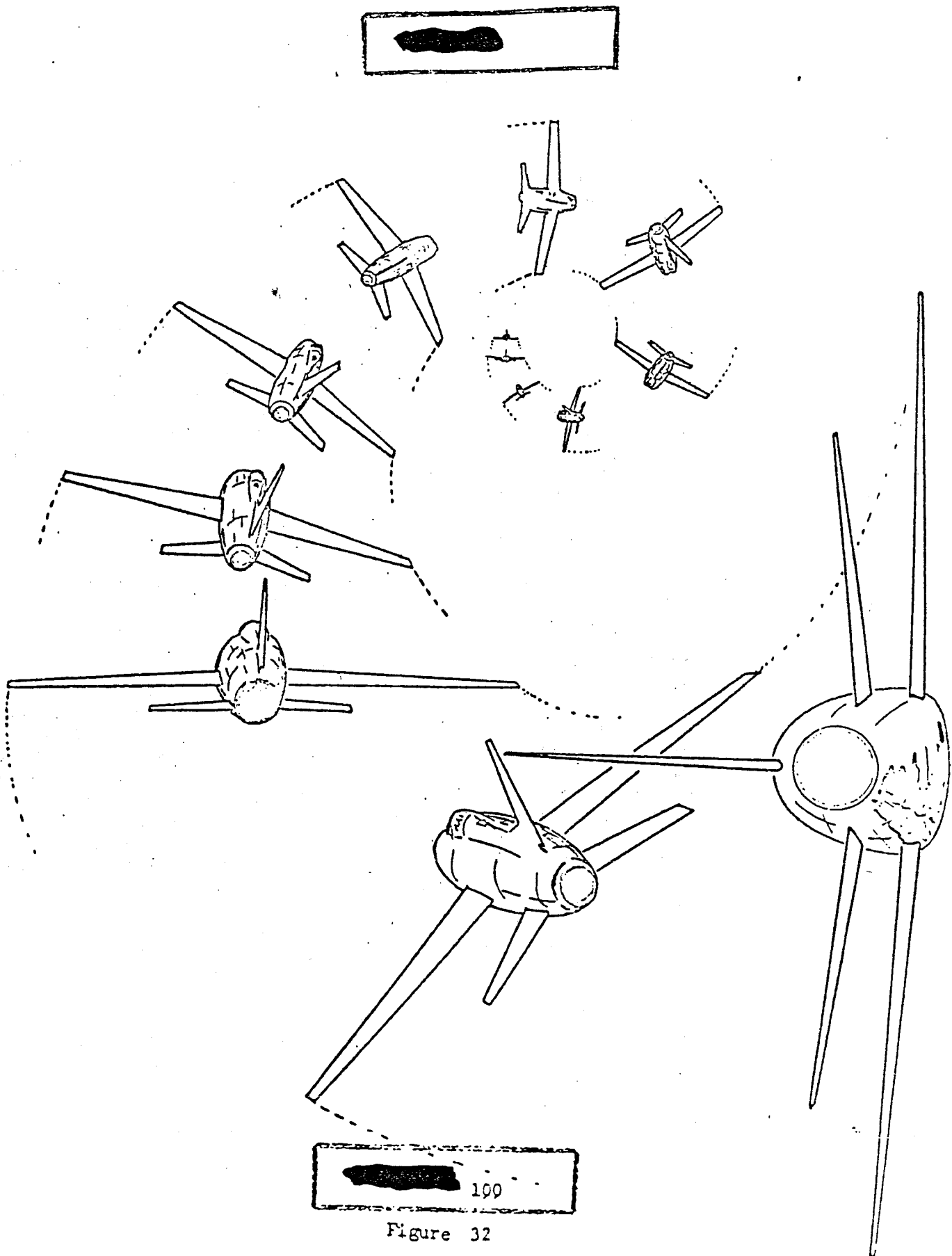

VIEW A HARRY NOT WITH THE TAB

100

Figure 32

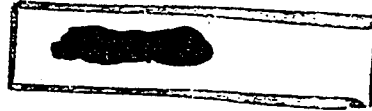

attacker in the defender's blind spot - toward the underside of his aircraft. At the 270° point, if the defender notes the attacker's position as being toward the rear, at the top of his canopy (by "top of the canopy", we mean that the attacker will be in the horizontal plane when the defender is at the 270° point of his roll) the attacker has performed a reverse roll. If the attacker is in this position, the defender does not complete the roll. Instead, he performs a horizontal turn into the attacker and forces him to overshoot, and dives for separation to gain airspeed and place the attacker in an overhead attack with a negative delta Mach (the defender does not attempt a scissors, since he does not have the airspeed after performing the high-G roll). At the 270° point, if the defender observes the attacker to be high and to the rear (off the left side of the canopy in a high-G roll to the left, and off the right side of the canopy in a high-G roll to the right by the defender). The defender turns 180° through the vertical plane, under the attacker, relaxes G and dives for separation. To follow, the attacker must run out of his nose-high yo-yo toward the diving defender's six-o'clock position. This allows the defender to gain lateral separation and places the attacker in an overhead attack with a negative delta Mach.

#### The High-G Roll Underneath

In discussing the high-G roll underneath, let's assume that we have a defender in a defensive turn with an attacker at six-o'clock inside gun firing range. If the defender does not have the necessary airspeed to execute a high-G roll over the top, he will be committed to a high-G roll underneath. In the F-100, this means that if the defender's airspeed has dropped below 300 knots, he should not attempt the high-G roll over the top. However, before executing the roll underneath, he should maintain G, and allow his speed to dissipate to 250 knots or less. With these conditions prevailing, the defender should immediately start the high-G roll underneath in an effort to shake his attacker. He should not delay, otherwise he will experience considerable speed decay, and will encounter considerable difficulty in executing the maneuver. To execute the roll underneath, the defender maintains back pressure, employs rudder in the direction of the roll - bottom rudder - all the way around the roll. If done properly, the maneuver will describe a barrel-roll underneath. To the attacker, just after the maneuver has started, it will appear as a split-S. This illusion is created by the high angle of attack generated in performing the maneuver (this deception will cause the attacker to cut off in an effort to counter his opponent's apparent dive for separation. The cut-off will place the attacker in a steep nose-down attitude). As the defender rolls past the inverted, near-vertical position, to the completion of the maneuver - a wings-level and a near-nose-level attitude - the attacker will overshoot below the defender's line of flight at a higher relative airspeed. See figure 33. The attacker is forced into this overshoot because his steep nose-down attitude combined with his rate

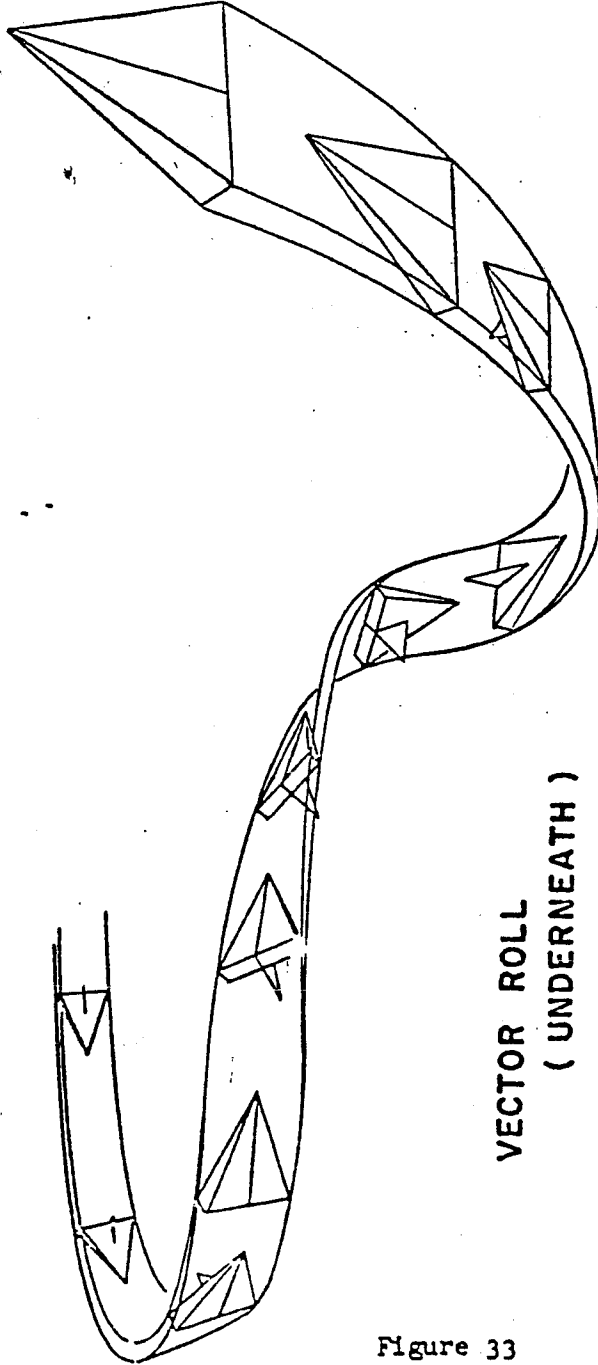
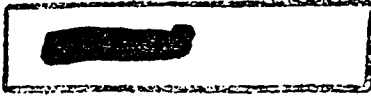

VECTOR ROLL  
( UNDERNEATH )

Figure 33

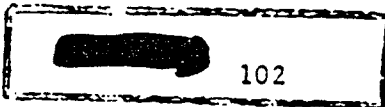



of roll and/or turn - which is dependent upon the defender's rate of roll and turn - forces him below his opponent with a higher vector velocity along the axis of the high-G roll. As a result, upon completion of the maneuver, the defender will be above and somewhat toward the rear of his opponent. To gain a firing position, the defender need only roll off or "S" down to the attacker's six-o'clock position.

To counter the high-G roll underneath, it is obvious that the attacker must not generate a steep nose-low attitude, then attempt to follow the maneuver. In other words, he must not interpret the roll underneath as an apparent dive for separation. To determine whether the maneuver is a roll underneath or a dive for separation, the attacker need only observe the dynamics of the defender's initial move down and out of the defensive turn. If the defender appears to fly through his longitudinal axis, he is in a dive for separation. If he appears to pivot or rotate around his longitudinal axis, he is performing the high-G roll underneath. The attacker must observe the defender very carefully to catch this difference. If he does, and notes that the defender is rotating around his longitudinal axis, he should not cut off. Instead, he can pull up, delay momentarily, then follow the defender around the roll. This will provide the attacker the opportunity to play the maneuver, hence prevent an overshoot below the defender. As a second alternative, the attacker can pull off and roll in the opposite direction. By doing this, he is not dependent upon a G and rate of roll governed by the defender's velocity, angle off and range. Instead, the attacker can pull the G necessary to play his rate of roll to reduce vector velocity and prevent an overshoot below the defender. If done properly, the reverse-roll will place the attacker at the defender's six-o'clock position. At completion of the defender's roll underneath the defender can move against either one of these counters, by observing the attacker's actions. If the attacker pulls off to initiate either counter, the defender does not complete the maneuver. Instead, he relaxes G and dives for separation. If the attacker is pulling off and up in either case, this will place him in an overhead attack with a negative delta Mach. However, the separation gained in this situation is not as great as in the other overhead attacks with a negative delta Mach. Therefore, a great deal more pressure is exerted on the defender, unless he can deceive the attacker into following his high-G barrel-roll underneath. On the other hand, the high-G roll underneath has an advantage over the high-G roll over the top because the defender can observe the attacker throughout most of the maneuver, whereas in a roll over the top, he cannot. This means that if the attacker counters with a roll underneath, the defender can take immediate action, whereas in a roll over the top, he is forced to the 270° point before he can observe the attacker's counter.

#### Procedures for the High-G Barrel-Roll over the Top

1. Perform a defensive turn, in an effort to force your attacker to overshoot. If he does not, and is within gun firing range at six o'clock (out 1500 feet or less) use the following procedures.



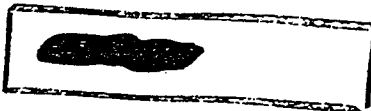

2. Barrel-roll over the top without relaxing any G forces. This requires extreme rudder control and very little aileron movement (see section describing adverse yaw). This maneuver will give you a rapid reduction in vector velocity and will provide a deceleration advantage because your line of flight will describe an arc above the horizon, prior to your opponent's. Your opponent will be forced to barrel-roll around the outside of your roll. Remember, you must have the necessary airspeed (300 knots or more in the F-100) before starting the maneuver.
3. Observe your opponent's position. When coming through the 270° point or down the opposite side of the roll, keep "coming in" with top rudder and get him committed into a nose-low attitude.
4. Continue rolling and keep adding top rudder to increase your nose-up attitude. This will force your opponent to slide below and in front of you.
5. Continue maneuvering to gain the advantage as your opponent slides below and forward. Either roll off or "S" down into his six-o'clock position.
6. Try to keep your opponent in sight throughout the maneuver. Be sure you have him in sight as you reach the 270° point. If he is at the top of your canopy, and to the rear, maneuver as outlined below.
7. Discontinue your roll-out at the 270° point and turn through the horizontal plane into the attack. Your opponent, having accomplished a reverse roll-off, will be at an angle-off, in the horizontal plane, when you are at the 270° point. To counter the reverse roll-off, you must turn into the attack at this point.
8. Force your opponent into an overshoot in the horizontal plane then relax G, light afterburner and dive for separation. If the attacker attempts to turn in behind you, he will be placed in an overhead attack with a negative delta Mach. Do not attempt a scissors maneuver after your opponent overshoots. You will not have enough maneuvering airspeed to successfully employ it.
9. If your opponent is nose-high in a yo-yo maneuver (with nose-tail separation) at the 270° point, turn 180° through the vertical plane, relax G, light afterburner and dive for separation. If the attacker attempts to follow, he will be placed in an overhead attack with a negative delta Mach.
10. At the 270° point, continue your roll if your opponent does not yo-yo out into an extreme nose-high attitude. Since he has failed to zoom sufficiently in the vertical plane, his vector velocity, along the axis of the roll, will be greater than yours. This will force him forward and will place you to the rear and below him.



11. Maneuver (low-speed yo-yo) for a firing position.

#### Procedures for the High-G Roll Underneath

1. Perform a defensive turn, in an effort to force your attacker into an overshoot. If you are unable to do so, and you are within the speed requirement for the high-G roll underneath (250 knots or less in the F-100) employ the following procedures.
2. Roll underneath without releasing any G force. This will prevent any subsequent increase in airspeed and will tend to deceive your opponent into thinking you are attempting a dive for separation.
3. Hold rudder in the direction of the roll all the way around the roll and play power to deceive your opponent. By holding rudder, you will successfully perform the high-G roll underneath without falling out into a steep nose-low spiral and a subsequent easy tracking solution. If your opponent was deceived into cutting off, he will be forced below you in an obvious overshoot. If this occurs, maneuver as outlined below.
4. Complete the roll to a wings-level, nose-level attitude. The attacker will be in a nose-low attitude below your line of flight with a higher vector velocity.
5. Bring your aircraft to a nose-high attitude, then roll off toward the attacker's six-o'clock position.
6. If the attacker is not deceived into cutting off and following you, after you initiate the roll, employ the following procedures.
7. Discontinue the roll, relax G, light afterburner and dive for separation, when you observe your opponent pulling up to delay, or to reverse-roll. This will place the attacker in an overhead attack with a negative delta Mach. However, separation will not be great, therefore prepare to counter any subsequent action.

#### Maneuvering from a Nose-Quarter Attack

Until now, our interest has been directed to the offensive and defensive tactics involved in rear-hemisphere attacks. Now we will concern ourselves with forward-hemisphere attacks. From experience, we know many fighter-versus-fighter engagements start with the opposing fighters approaching each other's nose-quarter position. Since this is the case, it behooves us, as fighter pilots, to understand the tactics needed to gain an advantage from this position. Hence, the remainder of our discussion, in fighter maneuvers, will be concerned with the nose-quarter attack. This will complete the maneuvering aspect of fighter-versus-fighter combat and will prepare us for



the other elements of fighter-versus-fighter operations — Tactical Formation and Flight Tactics.

To understand how we must gain an advantage from a nose-quarter attack, let's refer back to our concept of turn and velocity. As previously stated there are only two basic things that an attacker or a defender can do in order to gain an advantage - change direction (turn) and/or velocity. Applying these principles in a nose-quarter attack, we know that a given attacker must maneuver into the angular velocity cone in the rear hemisphere of his opponent to successfully launch a missile or deliver an effective 20mm cannon burst. This means that in a nose-quarter attack, an attacker will need a substantial rate of turn, a small turn radius and a closing velocity to gain his opponent's six-o'clock position. If the attacker fails to maneuver so that he acquires all three of these factors, he may never gain an advantage. Worse yet, he may provide his opponent an advantage. With this in mind, let's assume that an attacker notes that he is approaching an opponent from a nose-quarter position. The moment the attacker visually acquires his target, he should dive and light afterburner to gain an airspeed advantage. The distance he dives will depend upon the aircraft's acceleration and zoom capabilities (in the F-100, he can dive from 5,000 to 10,000 feet below his target). The airspeed gained from this maneuver will provide the attacker a greater forthcoming zoom than if he had maintained straight-and-level flight. The zoom will provide him freedom of maneuver in the vertical plane, so that he may effectively use the pull of gravity to increase his rate of turn and reduce his turn radius along the horizontal axis. Another advantage acquired by this dive maneuver is the element of surprise. The dive frames his opponent against blue sky and frames the attacker against the ground (assuming that the opponent does not counter with a like maneuver). From experience, we know it is generally more difficult to maintain visual contact with an adversary framed against the ground. In view of this, the opponent may fail to maintain visual contact (especially at long range before the dive maneuver is executed). The possible lack of visual contact enables the attacker to set up the next stage of his maneuver - a turn for an offset in the horizontal plane. If the defender fails to maintain visual contact, the attacker will easily generate this offset. To the attacker this is the first indication of whether or not the defender actually has contact (if not the defender will fail to turn, therefore fail to prevent the attacker from achieving his offset point). Assuming that the defender fails to counter, this places the attacker below and off to one side of his opponent, on an anti-parallel course. The attacker, with an airspeed advantage, is now in position to execute a turn through the vertical and horizontal plane toward the rear hemisphere of his opponent. Since the attacker is below his opponent, he may start the maneuver before the defender reaches his line-abreast position. See figure 34. The attacker will then execute a chandelle-type maneuver (high-speed zoom) toward his opponent. The chandelle

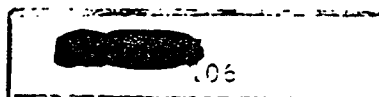

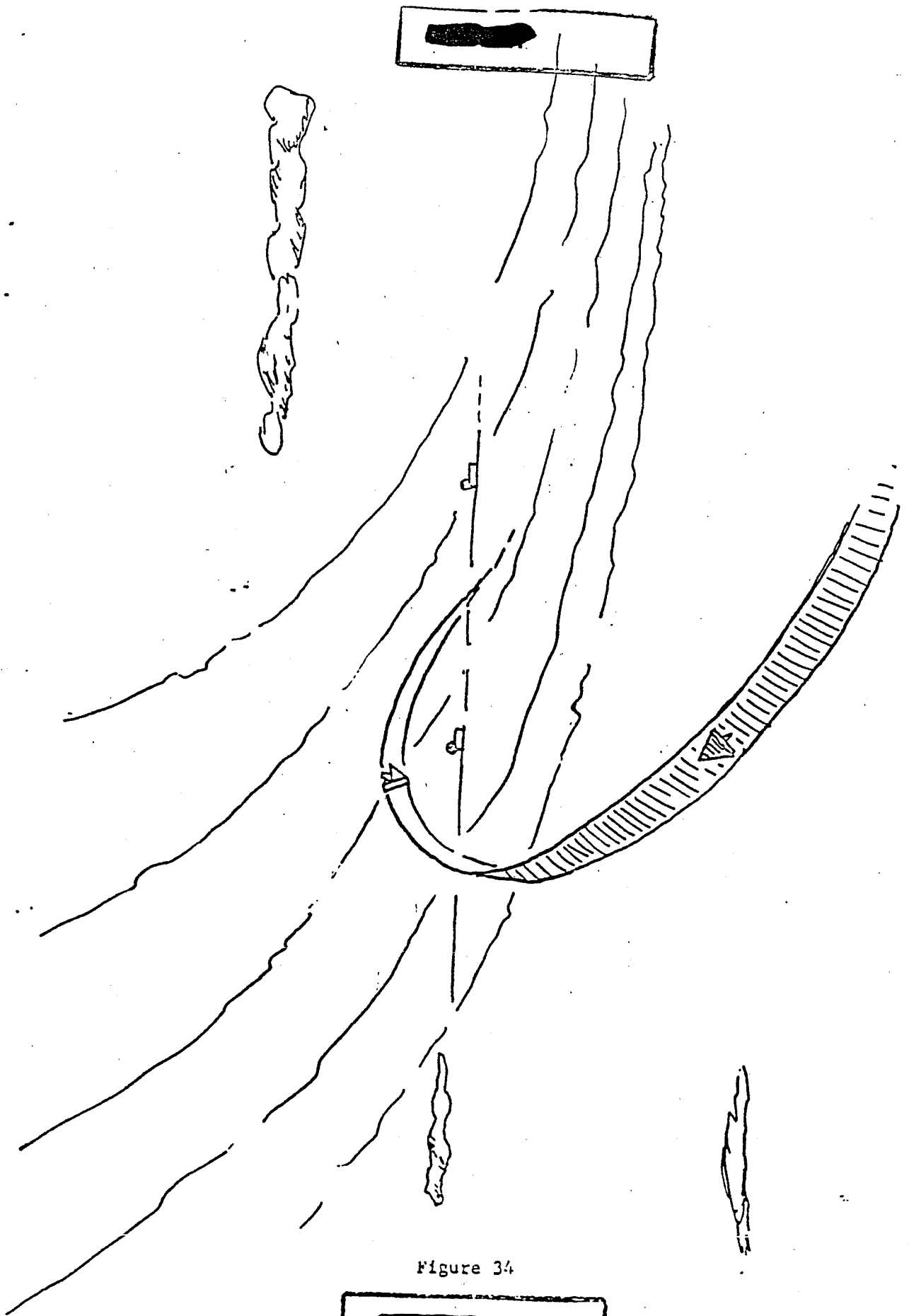
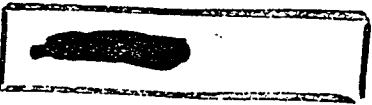

Figure 34

ME 30 2A FC RTT ATTK



diminishes airspeed and reduces horizontal turn radius. This will prevent an overshoot, however, it will reduce his rate of turn and diminish his closing velocity, as he approaches the defender's rear hemisphere. To prevent the defender from achieving considerable longitudinal separation, and to increase the attacker's turn rate toward the defender's six-o'clock position, the attacker should turn down through the vertical plane (low-speed yo-yo) toward the defender's six-o'clock-low position. See figure 35. The turn down through the vertical plane enables the attacker to effectively use the pull of gravity in achieving an increase in airspeed and turn rate and a decrease in turn radius. If the defender fails to counter, the attacker need only drive in underneath him, and set up for a missile attack. If the defender counters with a turn or pull-up, after the attacker has initiated his chandelle from his offset point, the attacker still has the advantage. He need only shallow out his chandelle and zoom more through the vertical plane. This will enable him to play his opponent's counter and diminish his horizontal turn radius. However, once again, this will decrease his airspeed, hence decrease his turn rate as long as he remains in the zoom. Therefore, to gain airspeed and a more rapid change of direction (turn rate) than his opponent, he should use the pull of gravity to turn down through the vertical plane into a low-speed yo-yo below his opponent's line of flight. This will place him inside his opponent's turn at a reduced angle-off with a higher airspeed. To further reduce angle-off and longitudinal separation, the attacker need only repeat the zoom and dive below his opponent's line of flight, or zoom and perform the barrel-roll attack (a roll-away maneuver) toward his opponent's six-o'clock-low position. Even if the defender countered in like manner, after the attacker started to zoom from below and out to the side, the attacker would eventually gain the advantage, since his initial dive for airspeed and his offset give him a maneuvering advantage. The dive for airspeed provides an airspeed and rate of turn advantage. The offset below provides an initial maneuvering advantage.

To effectively counter a nose-quarter attack of this nature, the defender must decide whether he is trying to avoid a fight or to gain a kill. In either case, when the attacker starts to dive for airspeed and a possible offset, the defender should counter in like manner. This will prevent the attacker from gaining an airspeed advantage. It will also prevent him from attempting an offset, since such a maneuver under these conditions would be the same as reducing the defender's angle-off. This will provide the defender some advantage. Now if the attacker approaches and starts to move past the defender, he must decide if he is trying to avoid a fight or not. If he is attempting to avoid a fight, he should push over and dive for separation, as the attacker attempts to zoom, turn and dive for a six-o'clock position. This maneuver by the defender will place the attacker in an overhead attack with a negative delta Mach, with extreme longitudinal separation. The attacker will be unable to close for a missile attack. On the other hand, if the defender decides to stay and fight, he should

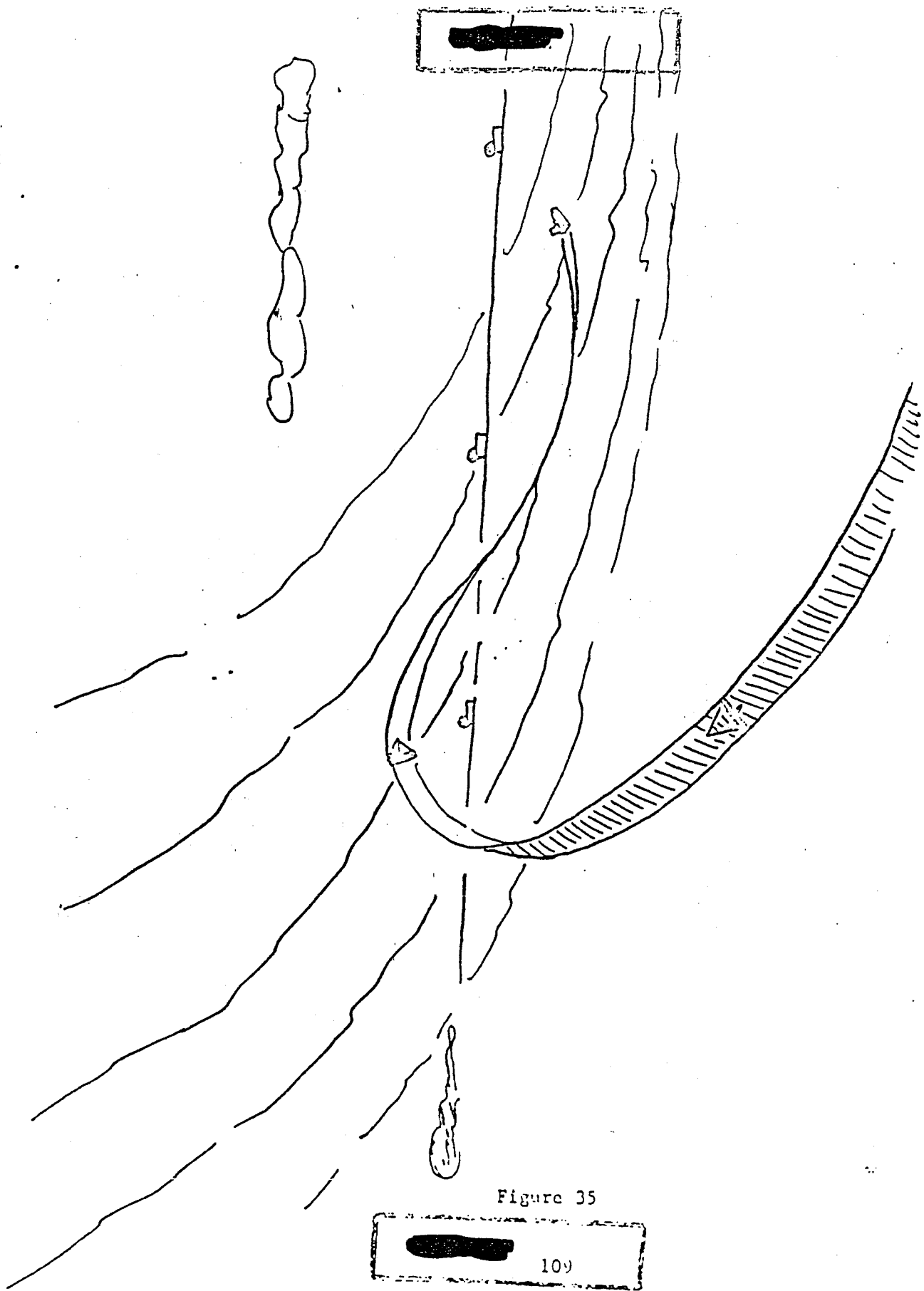



zoom and dive in the manner just discussed in an effort to gain an advantage. If the attacker is as skillful as the defender in employing this technique, this might not be a wise decision.

If the defender desires to counter an attacker who has already offset below and to the side, for his forthcoming zoom and dive, the defender should turn toward the offset and dive for separation. Since the attacker must perform a  $130^\circ$  change of direction, this will place him in an overhead attack with a negative delta Mach, with extreme longitudinal separation. If the defender attempts to stay and fight, instead of diving for separation, the attacker will eventually gain the advantage because of his higher airspeed and better position (in this situation, we assume that the attacker will employ the proper zoom and dive techniques to gain an advantage).

#### Procedures for the Nose-Quarter Attack

1. Light afterburner and dive immediately below your opponent to gain energy for your forthcoming zoom and maneuverability in the vertical plane. A dive below will also provide you the element of surprise needed for your next move.
2. Turn to an offset point in the horizontal plane. This will place you below and out to the side of your opponent on an anti-parallel course. If your opponent fails to counter, you will have a maneuvering advantage in terms of position as well as airspeed. In this event employ the following procedures.
3. Start a chandelle toward your opponent, so that you will be near the  $90^\circ$  point of the chandelle when you are approximately  $90^\circ$  angle-off from your opponent. This maneuver will reduce your turn radius and decrease your airspeed.
4. Turn through the vertical plane out of the chandelle, inside and below your opponent's line of flight, toward his six-o'clock-low position. A turn through the vertical plane enables you to gain your opponent's six-o'clock-low position without extreme longitudinal separation and a possible flight path overshoot in the horizontal plane, since you increase your airspeed and turn rate, and at the same time, further reduce your turn radius. To gain maximum effect, a turn through the vertical plane should be initiated as you pass the  $90^\circ$  point of your chandelle.
5. Accelerate below your opponent for an AIM-9B attack from six-o'clock-low. If your opponent counters with a defensive turn or a pull-up against your dive toward a six-o'clock-low position, employ the following procedures.
6. Pull up and zoom from your inside-low position and repeat the zoom-dive technique to gain an advantage, or barrel-roll (roll-away)

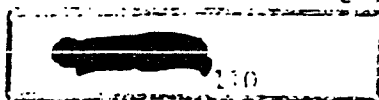

[REDACTED]

out of the zoom toward your opponent's six-o'clock-low position. Generally, the roll-away will enable you to gain your opponent's six-o'clock-low position more quickly. However, the zoom-dive technique may be more appropriate if you horizontally overshoot your opponent's flight path on the zoom, and he dives for separation after the overshoot.

Procedures for Countering the Nose-Quarter Attack

1. Dive the instant your opponent dives, to prevent him from gaining an airspeed and a possible offset advantage.
2. Do not allow your opponent to offset. If he attempts to do so, turn toward the direction of the offset. This will reduce your angle-off toward his six-o'clock position, and will give you a slight advantage if he offsets (under these circumstances, he most likely will not attempt it).
3. Decide whether you will avoid a fighter-versus-fighter engagement or stay and fight. If you wish to avoid the engagement, simply push over and dive for separation as your opponent moves past you on an anti-parallel course. Since your opponent must perform a 180° change of direction, this will provide you extreme longitudinal separation outside missile range. If you wish to stay and fight, employ the following procedures.
4. Pull up and zoom, in the vertical plane, toward your opponent - as your opponent starts to move past your line-abreast position on an anti-parallel course - to reduce your horizontal turn radius. While in the zoom, your airspeed and turn rate will decrease. Therefore, to acquire a rapid change of direction and to accelerate toward your opponent's six-o'clock position, employ the procedures outlined in the following paragraph.
5. Dive out of your zoom, below your opponent's line of flight, in an attempt to gain a six-o'clock-low position. If your opponent fails to emulate your zoom-dive technique, you will gain an advantage by reducing angle-off and moving toward his six-o'clock position. From this position, you need only repeat the process or employ the barrel-roll attack to move in for the kill. If your opponent emulates your zoom-dive technique, you will be stalemated. If this is the situation, you must use your own judgment to determine whether you should continue to fight or break off the engagement.



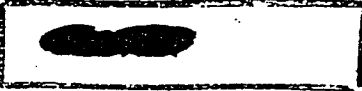

CHAPTER II

TACTICAL FORMATION

In air-to-air combat, the primary purpose of tactical formation is two-fold: (1) To provide security against attacks by enemy fighters, and (2) To conduct offensive operations against enemy bombers and/or fighters. To gain security, any formation must be able to detect the attack and maneuver against it before the attackers achieve a lethal position. This means that the formation must be so constructed that attacking fighters with air-to-air missiles can be detected before they are within launch range. At the same time, this formation must possess characteristics of maneuverability and mutual support so that it can counter the attack as well as see it. These same characteristics are necessary in conducting offensive air-to-air operations.

To gain maximum lookout security against a rear-hemisphere attack, the flight must be so constructed that visual cross-cover is the maximum attainable. Two means by which a formation can increase its visual cross-cover are: (1) Increase the number of aircraft within the basic maneuvering formation, and (2) Place these aircraft line-abreast at definite intervals to increase the field of cross-cover. By increasing the number of aircraft, we provide more flight members covering the rear hemisphere. If we stack the flight line-abreast, we provide greater cross-cover, thus increasing the probability of detecting a rear-hemisphere attack. This means that we increase look-out security, but at the same time we decrease maneuverability. To maximize maneuverability, a flight must consist of as few members as possible (a single aircraft is more maneuverable than any formation consisting of more than one aircraft) with these members stacked in-trail. From experience we know that when the number within the flight is reduced, it becomes easier for the members to keep track of and avoid one another during any maneuvering engagement. Experience also indicates it is much easier to maneuver in-trail as opposed to line-abreast formation.

In order to acquire security and maneuverability, we must compromise between maximum look-out security and maximum maneuverability. The extent of the compromise needed will determine the type formation flown in a fighter-versus-fighter engagement. The increased range of AIM-9B, as opposed to the 20mm cannon, forces us to construct a formation in which the compromise favors look-out security. This means that the formation will be flown very nearly line-abreast at a specified interval to pick up a missile attack at ranges of greater than 15,000 feet. To maintain maneuverability and mutual support, the size of the formation must be restricted to no more than four aircraft. If a number greater than four is employed, maneuverability and mutual support become difficult and complicated. On the other hand, if less than two aircraft are employed, the look-out capability is reduced and mutual support becomes impossible. Therefore, to provide look-out

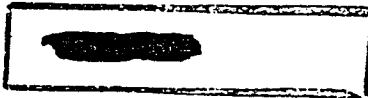

security and maneuverability, a formation of two, three or four aircraft must be employed.

The three-ship flight, with a leader and two wingmen, has been evaluated many times throughout the history of fighter aviation. In spite of many attempts to propose a three-ship flight as a combat formation, it has never been extensively employed. The reason is that a three-ship flight, with flanking wingmen, provides excellent look-out capability in the rear hemisphere on a combat air patrol; however, when this formation detects an attack and maneuvers against it, the result has always been the same - chaos. The wingmen cannot keep track of and avoid one another while maneuvering in respect to their leader and their attackers. As a result, one or the other of the wingmen is forced out of the formation and flight integrity is broken. The attackers simply drive in and take the single, then maneuver after the element after having destroyed the single or having forced him out of the fight. On the attack, where hard combat maneuvering is necessary, flight integrity disappears just as it did when maneuvering on the defensive.

As indicated previously, the two-ship formation would be more maneuverable than any other type we may employ. Our problem in using this type formation is to provide extensive look-out security in order to detect a possible missile attack. If we stack the formation line-abreast, we must provide sufficient interval so the element can detect a missile attack at ranges greater than 15,000 feet. In order that this may be accomplished, the flight must spread about 2500 feet apart. A disadvantage of a spread of this magnitude is quickly apparent. Initial maneuverability is reduced after detecting the attack in the rear hemisphere. When the missile's limitation is known, this maneuverability disadvantage is not as great as it appears (remember, to defend against a missile attack at long range, we need angular velocity plus airspeed, not a small turn radius and a low airspeed). This means that maneuverability is not required to the same extent as in gun tactics. With this in mind, we can safely accept an initial maneuverability restriction; however, the real disadvantage of the two-ship flight concerns look-out security. With only two ships, the leader of this formation must spend a great deal of time looking to the rear, rather than looking for enemy targets. In terms of look-out capability, this means a loss in offensive potential. If this loss can be accepted, along with reduced initial maneuverability, the two-ship flight may be employed as a basic maneuvering formation.

To employ the element correctly, without sacrificing maneuverability beyond initial maneuverability, the wingman must know how to position himself during all maneuvers. On patrol, prior to initial contact, the wingman will maintain the position specified above - line-abreast and about 2500 feet out. During turns, the wingman will play the outside as well as the inside of the turn, in order to maintain position.

[REDACTED]

This will not be too difficult because the maneuvers executed, prior to contact, will not be of the maximum-performance variety. To allow the wingman to easily maintain his position and to provide adequate rearward coverage, the wingman must maneuver through both the horizontal and vertical planes. If the leader performs a turn away from the wingman, the wingman lowers his nose and cuts to the inside. This procedure allows the wingman to reduce his horizontal turning component and, at the same time, provides him a rate of closure so he will not be straggling behind his leader. As the wingman moves inside and low toward the leader's line-abreast position, he should play his crossover so that he does not cross in front of his leader. He should cross to the outside, slide high and fly in the plane of the leader. If this crossover technique is employed during all turns, the wingman will describe a circular movement in the plane of the leader's aircraft, see figure 36. On the outside of this circle the wingman will lose airspeed and slide to the rear. On the inside, the wingman will gain airspeed and move forward. In effect, the wingman is employing the low-speed and the high-speed yo-yo as a means of maintaining position, and providing sufficient visual cross-coverage. At the same time, this maneuver will enable the leader to cover his wingman, whether he be on the outside or on the inside of the turn. If the initial turn by the leader is toward the wingman, the wingman will be unable to cross over behind and underneath his leader. In this situation, the wingman must pull up, play the leader's turn and cross to the outside, above and behind the plane of the leader's aircraft. After the initial crossover, the wingman employs the techniques specified above for the remainder of his crossovers..

When maneuvers approach maximum performance, the wingman will be unable to maintain the loose position implied in patrol formation. He will be forced into a fighting position, in a narrow cone, behind the leader's aircraft. In order to remain with the leader and, at the same time, provide rearward coverage he will be forced to assume a position closer to the tail of the leader's aircraft. As we define it, the fighting position is any place within a 60° cone with the wingman approximately 1000 feet behind the leader. To maintain position in this cone, the wingman employs the same maneuvering techniques which he used in patrol formation. (He maneuvers through both the vertical and horizontal planes). During max maneuvers, if the wingman attempts to maneuver very much outside the confines of this cone, he will find it difficult to maintain position and also provide rearward visual coverage. The primary duty of the wingman while in fighting position is to provide visual coverage to the rear, while the leader is concentrating on maneuvering for an advantage. This is of extreme importance if the enemy is equipped with air-to-air missiles. Considering all factors, a two-ship is better than a three-ship formation. Although a two-ship element has an initial look-out disadvantage, while in patrol formation, it has a distinct maneuvering advantage, and a somewhat better look-out advantage while fighting as a basic formation.

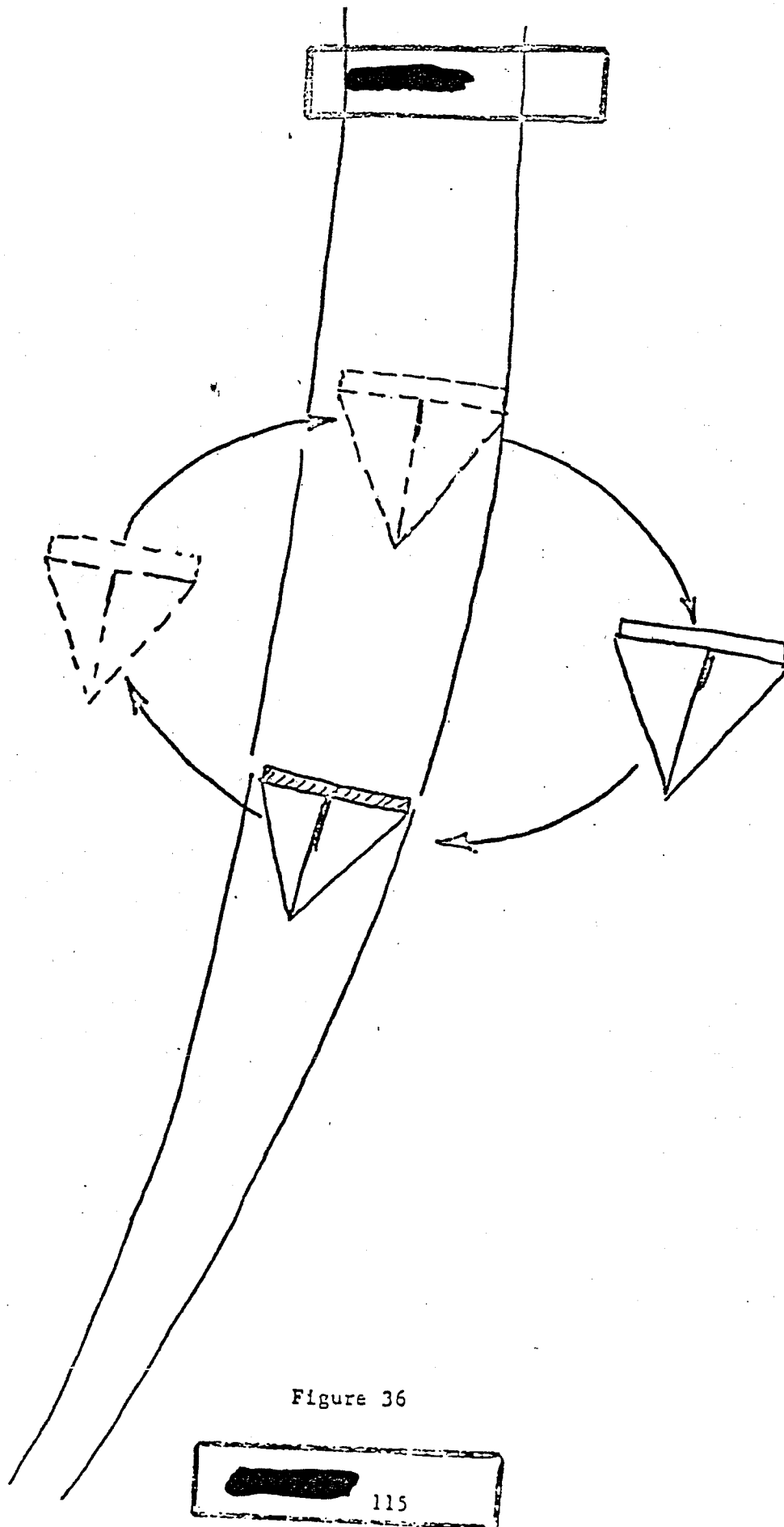



Figure 36

MANEUVERING IN THE FIGHTING POSITION

[REDACTED]

When employed properly, the four-ship flight will give us all-around advantages in look-out, maneuverability and mutual support. To acquire these advantages without sacrificing one for the other, a flight of four must consist of two mutually-supporting elements. When on patrol, the elements should fly line-abreast from five to seven thousand feet apart. The wingmen should maintain a position from line-abreast to no more than 20° back, at approximately 1500 feet out from their respective element leaders. A formation spread in this manner provides excellent look-out capability, because the wingmen can provide mutual crosscover at ranges in excess of 15,000 feet. Maneuverability in this formation is somewhat restricted. When the lead element turns away from the second element, the second element will experience considerable difficulty in regaining a line-abreast position, unless the turn is held for almost 180°. If the lead element turns into the second element, the second element will be forced to pull up and cross above the lead element. If this is not done, the second element will be forced to cross in front of the lead. In either case, if the turn is less than 90°, the second element will experience considerable difficulty in regaining a line-abreast position. To provide more maneuverability and flexibility, the second element must be given a greater field of maneuver. This field of maneuver should enable the second element to easily position itself, no matter what type of turn is performed by the lead element. A method of providing this freedom of maneuver is to spread the second element in both the vertical and horizontal planes. When this is done, if the lead element turns away, the second element can lower its nose, cut across the inside and quickly reposition itself, even though the lead element does not perform 90° or 180° turns. On turns into the second element, the second element can maneuver well above the lead element without fear of dragging the wingmen through one another (remember, wingmen will be maneuvering through both the vertical and horizontal planes to maintain position on their respective leaders). The freedom of maneuver provided the second element leader enables him to devote less time to flying formation and more time to looking for prospective kills. At the same time, during turns, it allows the wingman to provide better rearward coverage, because the elements will not be strung out in extended-train. The only real objection to this formation is that, in straight-away flight, the second element must look through a greater distance to detect a missile attack against the lead element. Although this is true, it can be mathematically demonstrated that the additional distance through which both elements must look, is insignificant. (Less than 300' against a six-o'clock attacker if the fluid element is stacked vertically less than 3000' above the lead element). If the attack is directed from six-o'clock-low, the additional distance through which the second element must look is somewhat greater. However, the attackers must get in considerably closer along the horizontal plane before initiating a pull-up into an underside attack. This means that the second element will be afforded more of a plan view of the attackers, thus a larger target in perspective even though the additional distance is somewhat greater. Another reason cited for not



using the high element is the fact that the aircraft wing covers a considerable portion of the highly vulnerable six-o'clock-low attack area. This is true for both the high element and the level-stacked element. To surmount this difficulty, wingmen simply dip their wings occasionally to enable them to cover the vulnerable rear area.

In view of the maneuverability advantage offered by the fluid-four type formation (the formation in which the second element is stacked both horizontally and vertically) without significant look-out disadvantage, we consider it the best combat patrol formation. In fluid-four, the second or fluid element should be line-abreast, 5,000 to 7,000 feet out, and approximately 2,000 feet above the lead element. As in a normal tactical formation, the wingman will maintain a position from line-abreast to 20° back and 1500 feet out to the side opposite the other element, see figure 37. As indicated in the two-ship flight, the wingmen will fly the vertical as well as the horizontal plane in order to maintain their respective positions. On patrol, the fluid element leader will maintain position on the lead element by flying through the vertical and horizontal plane during all turns and maneuvers. For a fighting position, the fluid element must operate as an independent unit during violent maneuvers in flight-versus-flight engagements (the reason for this will become apparent when we discuss flight tactics).

If the tactical situation indicates that not enough aircraft are available for area saturation with four-ship flights do not employ the fluid-four formation. Instead, use individual elements as basic patrol formations and as basic fighting formations. Although not as decisive as the four-ship flight in terms of look-out capability, maneuverability and mutual support, the two-ship flight will be much more effective than the three-ship flight. The only real advantage which a flight of four has over an element is initial look-out capability and initial mutual support. After the engagement is entered, the fluid-four, or the four-ship flight will become nothing more than individual fighting elements. If suitable tail-warning radar devices were available, four-ship flights would enjoy very little advantage over individual fighting elements in terms of combat capability. The dictum, "economy of force" would most certainly prevail. Tactical formation in fighter-versus-fighter engagements would probably be dominated by the element or even possibly the single ship. Without this needed radar gear, a four-ship flight is the best all-around tactical formation.

Three factors to consider when employing either the fluid-four or the element in combat or on a combat patrol are: (1) look-out capability, (2) maneuverability, and (3) fuel management. In the era of missile-equipped supersonic fighters with afterburner, these factors determine the best altitude for patrol in order to enter a given fighter-versus-fighter engagement. If the patrol is conducted at extreme altitudes (40,000 feet or above) the look-out problem becomes a liability which increases as altitude increases. The advantage of

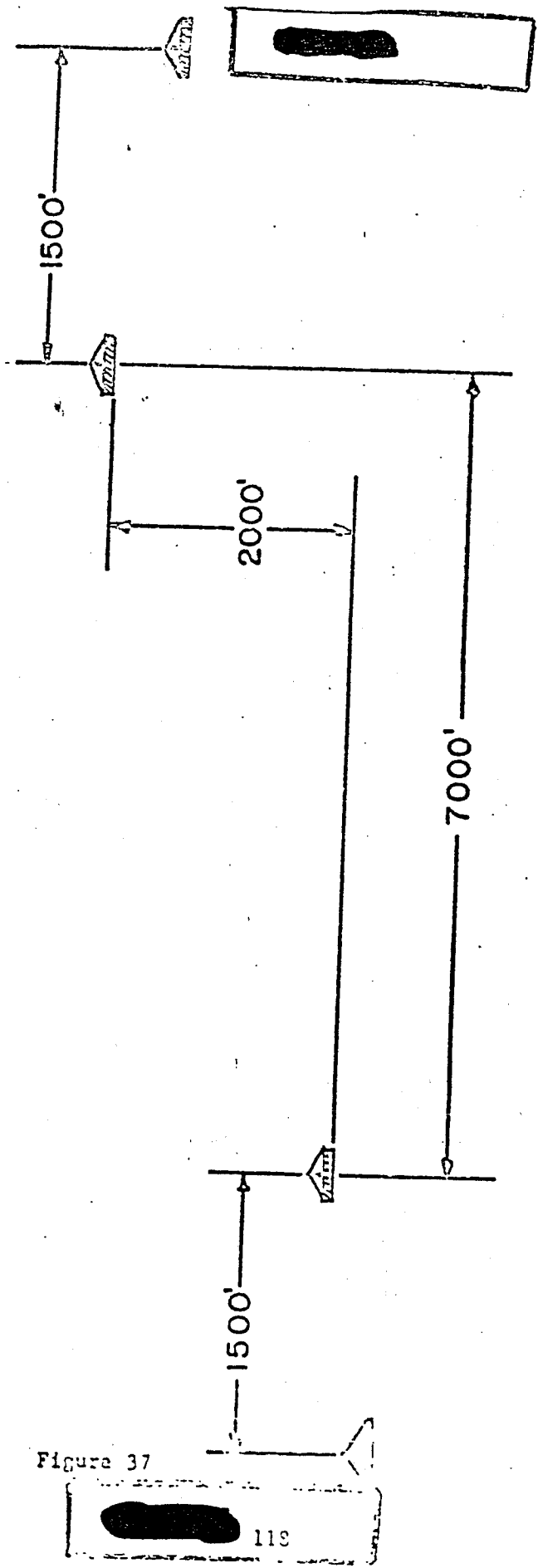

Figure 37

FLUID FOUR FORMATION

[REDACTED]

firing an air-to-air missile at greater range against a given defender is nullified by the possibility of an enemy attacker enjoying the same advantage. In addition, extreme altitude provides a maneuverability disadvantage in terms of indicated maneuvering airspeed. At extreme altitude, fuel management may be an advantage in some aircraft while in others (F-100) it can be a disadvantage. If the patrol is conducted at very low altitudes (10,000 feet or below) the look-out problem is considerably reduced and maneuverability, in terms of maneuvering airspeed, is certainly increased. However, this maneuverability is nullified somewhat by the fact that maneuvering becomes more restricted to the horizontal plane as opposed to the vertical plane. At very low altitudes, good fuel management is not possible with present-day jet engines and afterburners. The optimum altitudes, considering all three factors - look-out capability, maneuverability and fuel management - for patrolling and entering a fighter-versus-fighter engagement are the middle altitudes between 25,000 and 35,000 feet (even this is open for argument if one considers the possibility of surface-to-air missiles). The exact altitudes will depend upon look-out capability and maneuverability of the fighters employed. In the F-100, the best all-around altitude seems to be approximately 30,000 feet. At this altitude, maneuverability and fuel management are excellent. At the same time the look-out problem can be easily handled by a flight of four and handled adequately by an element. If the tactical situation dictates that elements must be employed, an altitude somewhere between 25,000 and 30,000 feet might be more appropriate to reduce the look-out problem. In any case, the medium altitudes provide a position from which an attack may be launched against aircraft at very high or very low altitudes.

#### Procedures for Flying Element Formation

1. Flying the Position of Wingman in Patrol Formation.
  - a. Maintain a patrol position off the leader's wing by flying line-abreast at approximately 2,500 feet out when in straight-and-level flight. If you fly closer, look-out capability will be sacrificed. If you fly further out, initial maneuverability as well as final maneuverability will be sacrificed after initial contact with the enemy.
  - b. Play the outside as well as the inside of the turn for mutual coverage. If an attempt is made to stay on the inside of the turn without a crossover, you will only fall back when the leader rolls out of his turn.
  - c. Maneuver through both the vertical and horizontal planes in order to fly a relative position off the leader. While on the inside of the turn, you will be in an extended-low position. On the outside of the turn, you will be in an extended-high position in the plane of the leader's aircraft.





d. Lower your nose and cross to the inside if you are on the outside of the turn. If you are on the inside, sliding forward, cross to the outside then slide high and fly in the plane of the leader. If the initial turn is into you, pull up, cross over and behind your leader, then cross from outside to inside and vice versa in the manner just discussed. This technique will cause you to describe a circular movement in the plane of the leader's aircraft. You will be moving forward in the bottom half of the circle and backward in the top half. This will enable you to easily maintain position and provide mutual coverage during the entire turn.

e. Do not cross in front of your leader. Always maintain nose-tail separation.

## 2. Flying the Fighting Position as a Wingman in Element Formation

a. Fly in a 60° cone, in a fighting position, about 1,000 feet back.

b. Maneuver through both the horizontal and vertical planes to maintain position. Slide high when overshooting and drop low when falling back, in order to maintain position on the leader.

c. Attempt to keep your fuselage aligned with your leader's during all maneuvers. This will enable you to match your leader's maximum performance and will prevent you from becoming separated.

d. Attempt to stay out of the in-trail position as much as possible. By doing this, the leader may cover you more adequately.

## Procedures for Flying the Fluid-Four Patrol

### 1. Flying Position of Fluid Element Leader

a. Position the element, line-abreast, about 5,000 to 7,000 feet out and approximately 2,000 feet above the lead element.

b. Maintain a relative position to your leader during turns. If you are on the outside of the turn, drop your nose and cross to the other side when you find yourself losing out and falling back. When being turned into, and you find yourself creeping forward, slide high and/or cross to the outside of the turn to maintain position. In other words, play the vertical as well as the horizontal plane in order to maintain supporting position.

c. Lower your nose to gain airspeed and position when you find yourself too far back after rolling out of a turn. When you regain your forward position you may pull back to the original fluid position.

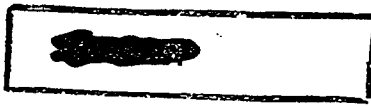

d. Pull your nose up and kill off airspeed if you find yourself too far forward after rolling out of a turn. You may also retard throttle, however this is not advised when at altitude. When you regain your correct relative position, lower the nose to maintain proper vertical separation. All maneuvers must be smooth to prevent over-correction.

e. Bank from side to side and look below when crossing from the inside high to the outside of the lead element. This will prevent you from losing the lead element during crossovers.

f. Cover the forward hemisphere, along with the flight leader, as primary responsibility in an effort to visually acquire a target so that an attack may be launched against it. As a secondary responsibility, cover the rear hemisphere behind the lead element in order to detect a possible missile attack.

## 2. Flying Position of Wingman in Fluid-Four Patrol

a. Maintain a position from line-abreast to  $20^{\circ}$  back and 1500 feet out on the side opposite the element.

b. Maneuver through both the horizontal and vertical planes to maintain position during turns. Fly high when overshooting and drop low to the inside when falling back.

c. Cover the rear hemisphere, behind the other element, at all times. This is your responsibility and your coverage is necessary to detect any possible missile attacks. Your opposite number in the other element, will be providing you the same coverage.

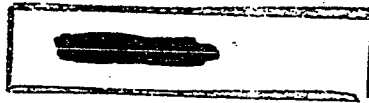

## CHAPTER IV

FLIGHT TACTICS

To employ a flight of four or an element of two in a fighter-versus-fighter engagement, only a few new basic maneuvers must be mastered. The previous maneuvers we have learned still apply in flight tactics. With this in mind, we will now concern ourselves with tactics when operating as a flight of four and/or as an element of two. We will objectively analyze offensive and defensive situations in which we have element-versus-element (two-versus-two) element versus a flight of four (two-versus-four) and a flight of four versus a flight of four (four-versus-four). For our first engagement, let's assume that we have an element of two attacking another element of two.

Two Attacking Two

To attack an element with an element, the maneuvers and procedures learned in the section on Fighter Maneuvers and Tactical Formation will be employed to gain an advantage. The attacking element will attempt to set up for a missile attack. The defending element will counter with a defensive turn in an effort to preclude this attack. The attackers will maneuver for a follow-up gun attack by cutting off or yo-yoing to the defender's angular velocity cone, or they will attempt to deliver a missile in a secondary attack by employing the roll-off or the barrel-roll attack. If the attackers are unable to set up for a missile launch but are able to set up for a 20mm cannon attack, the defenders will be placed in a precarious position. If the defending element continues to maneuver as a single element - without being able to shake the attacking element - the attacking element will simply move in and shoot down the wingman, then the leader. To prevent this possibility, the defending element may attempt a defensive split. This split may be executed so that the leader and the wingman turn in opposite directions through the vertical and horizontal plane or in the same direction with horizontal or vertical separation.

If the defensive split is executed with the defending leader and wingman turning away from one another, the attacking element can split and continue the attack as individual fighting units, or maintain element integrity and continue the attack on one member of the splitting element. If the attackers split, they retain offensive advantage against the splitting defenders. However, they incur a defensive advantage, in terms of look-out capability, against an attack from another enemy element. To maintain an offensive capability in terms of maneuverability, and a defensive capability in terms of look-out, the attackers should maintain element integrity. To continue the attack against one member of this splitting element, the attackers may select either member if the split is in the horizontal plane. The

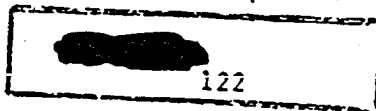

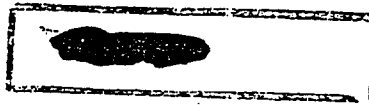

defender not selected must then continue the turn or reverse in an effort to provide his teammate mutual support. If the free defender continues the turn, he will meet his teammate and the attacking element from a nose-quarter position and will be in a poor position to provide effective support. If the free defender reverses he will be in a better position; however, he will still be unable to provide effective mutual support. The distance generated by splitting in opposite directions, plus the time needed to execute the reversal, will place the free defender at too high an angle-off to launch a missile and beyond effective range to deliver a 20mm cannon attack. The attacking element should select the high trailing defender if the split in opposite directions is conducted through both the vertical and horizontal planes. If the low, forward defender were selected, the free high defender would be able to roll off and move inside the attacking element's angular velocity cone for a 20mm cannon attack. On the other hand, if the high trailing defender is selected, the low free defender has the same problems in supporting his teammate as did the free defender in the horizontal split. By geometric inspection, we can see that a defensive split in opposite directions is not effective, because a permanent separation of the defenders is achieved with the free defender unable to drive the attacking element off his teammate.

If the defensive split is conducted with one defender executing a max-performance turn in the horizontal plane (or slightly nose-down in the vertical plane) and the other defender turning in the same relative direction, nose-high at less than maximum performance, the attacking element is faced with a defensive split difficult to contend with. See figure 38. In this split - with the defenders turning in the same relative direction, but separated in the horizontal and vertical planes - the free defender can more easily maneuver to support his teammate, since he will not be out of range, nor out of phase in terms of angular velocity. To maneuver against a split of this nature, the attacking element may employ one of five possible options: (1) Dive in and attack the low-inside defender, (2) Attack the high outside defender, (3) Split and continue the attack against each individual defender, (4) Initiating an attack against the low defender, and switch the attack to the high defender after the low defender is well committed in a defensive turn, and (5) Perform a fluid separation to drive the low defender out of the fight, then regain element integrity and continue the attack against the high defender.

If the attacking element drives in after the low-inside defender (option 1) the high defender will be in position to launch an attack against the attacking element's six-o'clock position. The attacking element will be sandwiched between the two defenders with an obvious loss of offensive potential, and a possible sacrifice of a wingman in an effort to destroy the low defender. If the attacking element attacks the high defender, the high defender can reverse-roll or roll underneath,

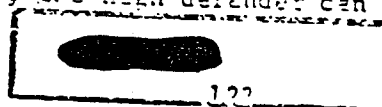

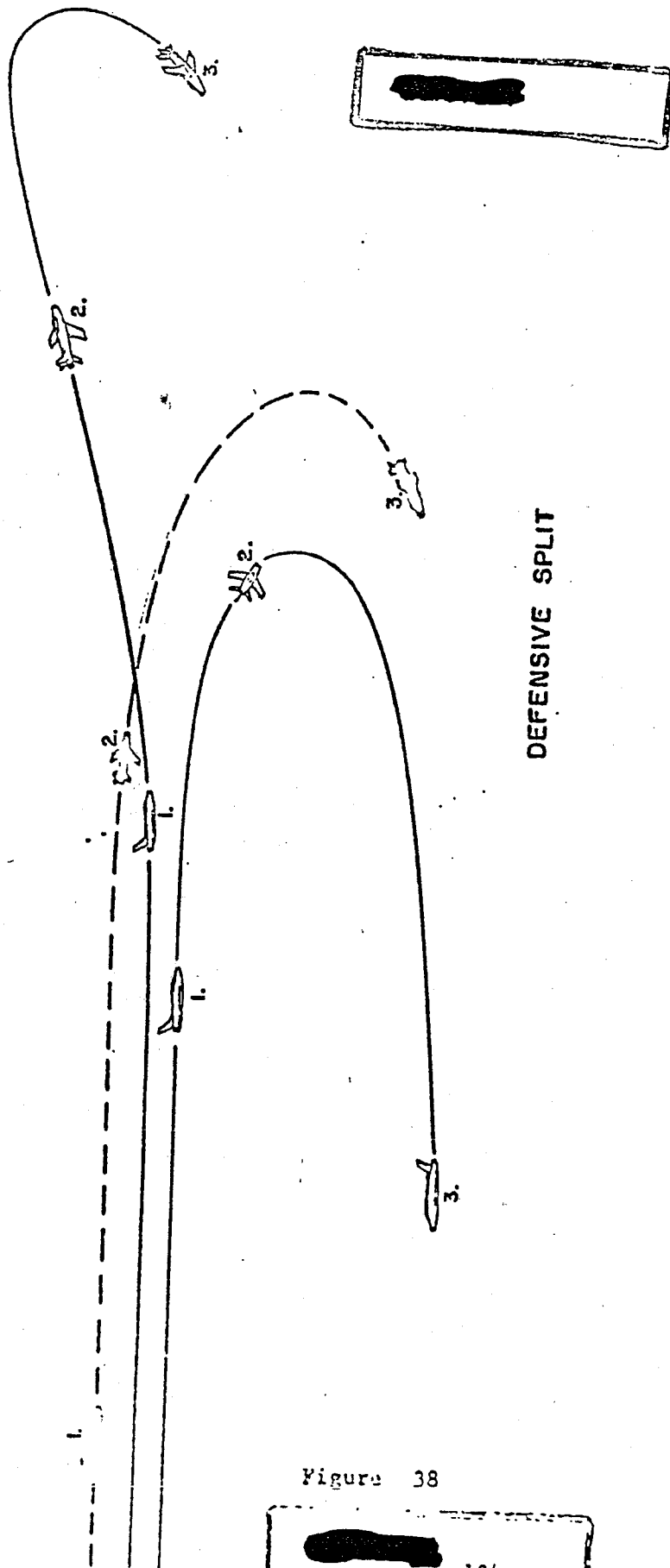
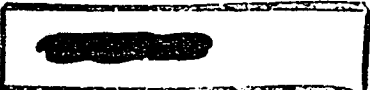
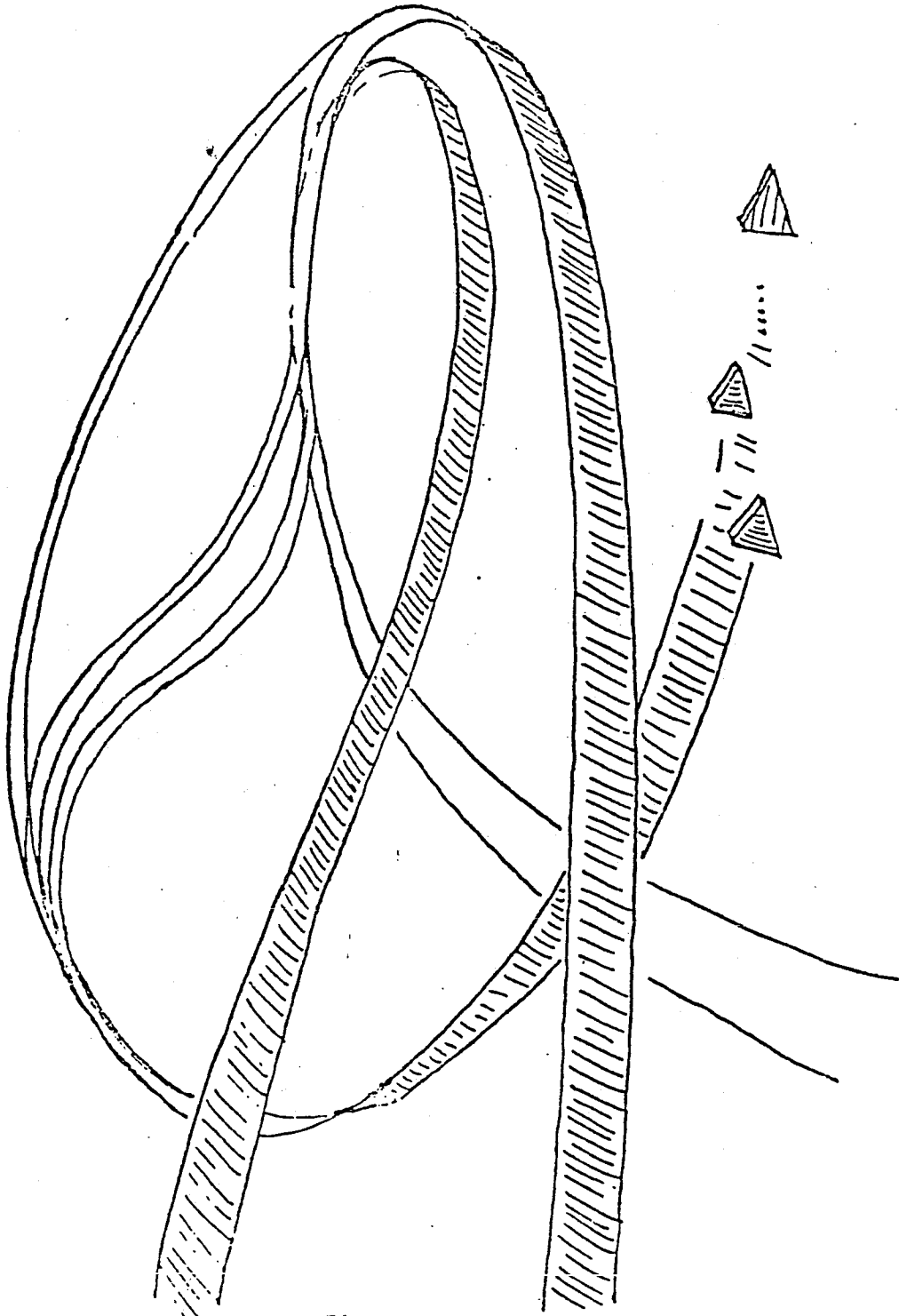

Figure 38



down and away from his teammate. The free defender can then simply reverse-roll and sandwich the attacking element between the two defenders. Once again, the attacking element's wingman will be placed at a severe disadvantage if this attack is continued. If the attacking element splits and continues the attack against each individual defender, the attackers have an immediate advantage since the defending element will be unable to effect mutual support. However, this advantage can be short-lived if the split attacking element is, in turn, attacked by another enemy. The attacking element will have sacrificed look-out capability and mutual support, thus becoming an easy set-up for the new enemy. For this reason, we do not advocate an offensive split as a means of countering the defensive split. If the attacking element initiates an attack against the low defender in a defensive split, then switches the attack to the high defender, the attacking element can maintain its offensive advantage without needlessly sacrificing a wingman. See figure 39. To employ this course of action correctly, the attacking element should drive in and select the low defender. When the low defender observes this action, he will be forced to tighten his turn to prevent himself from becoming an easy target. This action by the low defender will cause him to be driven further from his teammate, with reduced maneuvering potential. If the attacking element handles this initial maneuver correctly, the low defender may be driven completely out of the fight. The attacking element should switch the attack to the high man after the low defender is well committed in his defensive turn. The switch should be performed before reaching the high defender's line-abreast position and before zoom potential is sacrificed. If the attack against the low defender is prolonged, the attacking element will experience airspeed decay, hence a loss in zoom potential when the switch is made against the high defender. If airspeed decay reduces zoom to the extent where the high defender can counter with a zoom through a greater angle, the attacking element will be forced out front and below the high defender. A nose-high reversal by the low defender at this point will sandwich the attacking element in the vertical plane. To preclude this possibility, the attacking element should switch and zoom soon enough to force the high defender to turn into the attack. During the switch, the attacking wingman should closely observe the low defender's subsequent actions, to determine whether he is out of the fight or is reverse-rolling in an effort to maneuver into the attacking element's six-o'clock position. If the low defender is out of the fight, the attacking element can continue to engage the high defender. If the low defender is still a threat and reverse-rolls, the attacking element should disengage the high defender, roll wings-level and zoom in the vertical plane, while it still enjoys the airspeed advantage. As shown in our discussion of Fighter Maneuvers, a zoom under these conditions enables the attacking element to reduce its horizontal velocity component in relation to the defender. As a result, the defender is forced below and forward and the attacking element need only roll off and maneuver toward the trailing defender's six-o'clock position. During the roll-off, once again,



SWITCHING THE ATTACK TO THE HIGH DEFENDER

Figure 39

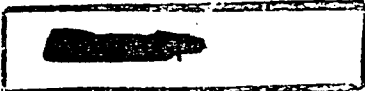

the attacking wingman must observe the actions of the defender not under attack to determine whether or not he will be a threat.

Another tactic that can be used to successfully counter the defensive split is the fluid separation. See figure 40. In a fluid separation, the attacking element initially drives after the low-inside defender. After this initial feint, the leader then resumes the attack against the high defender. Meanwhile, the attacking wingman performs a fluid separation to force the low defender down and out of the fight. The attacking wingman does not split from his leader to initiate a one-versus-one engagement. Instead, he simply checkmates a possible counter-move by the low defender, while providing the attacking leader visual cross-coverage during the entire maneuver. When the low defender has been definitely committed out of the fight, the attacking wingman rejoins the leader at normal interval. At the same time, he visually observes the down-and-out defender for a possible threat. After rejoining, the attacking element presses the attack with a two-against-one advantage over the high defender. To make the fluid separation a successful tactic, the attacking wingman must play the separation so that he is able to rejoin the leader after forcing the low defender out of the fight. If the attacking leader has an experienced wingman, and one whom he can trust not to split, the fluid separation is the best counter for a defensive split. If the wingman is inexperienced or lacks talent, the best tactic would be to maintain element integrity, attack the low defender (in an effort to drive him out of the fight) then switch and continue the attack against the high defender.

#### Procedures for Maneuvering Against a Defensive Split

1. Attempt to force the low defender down and out of the fight. You are trying to force the weakest man out of the fight to give you a two-to-one advantage. Normally the wingman will be the low defender with the least experience.
2. Do not prolong your attack on the low defender. This may kill off too much airspeed and result in a loss of offensive advantage when you attempt to zoom behind the high defender.
3. Switch the attack to the high defender. This maneuver should be performed before you lose too much airspeed and before the high defender reaches your line-abreast position.
4. Perform a fluid separation and allow your wingman to force the low defender down and out of the fight. This maneuver should be performed only if the wingman is fairly experienced. He should not attempt to destroy the low defender, but should force him down and out of the fight as quickly as possible, while maintaining a visual look-out on the leader. If your wingman is relatively inexperienced,



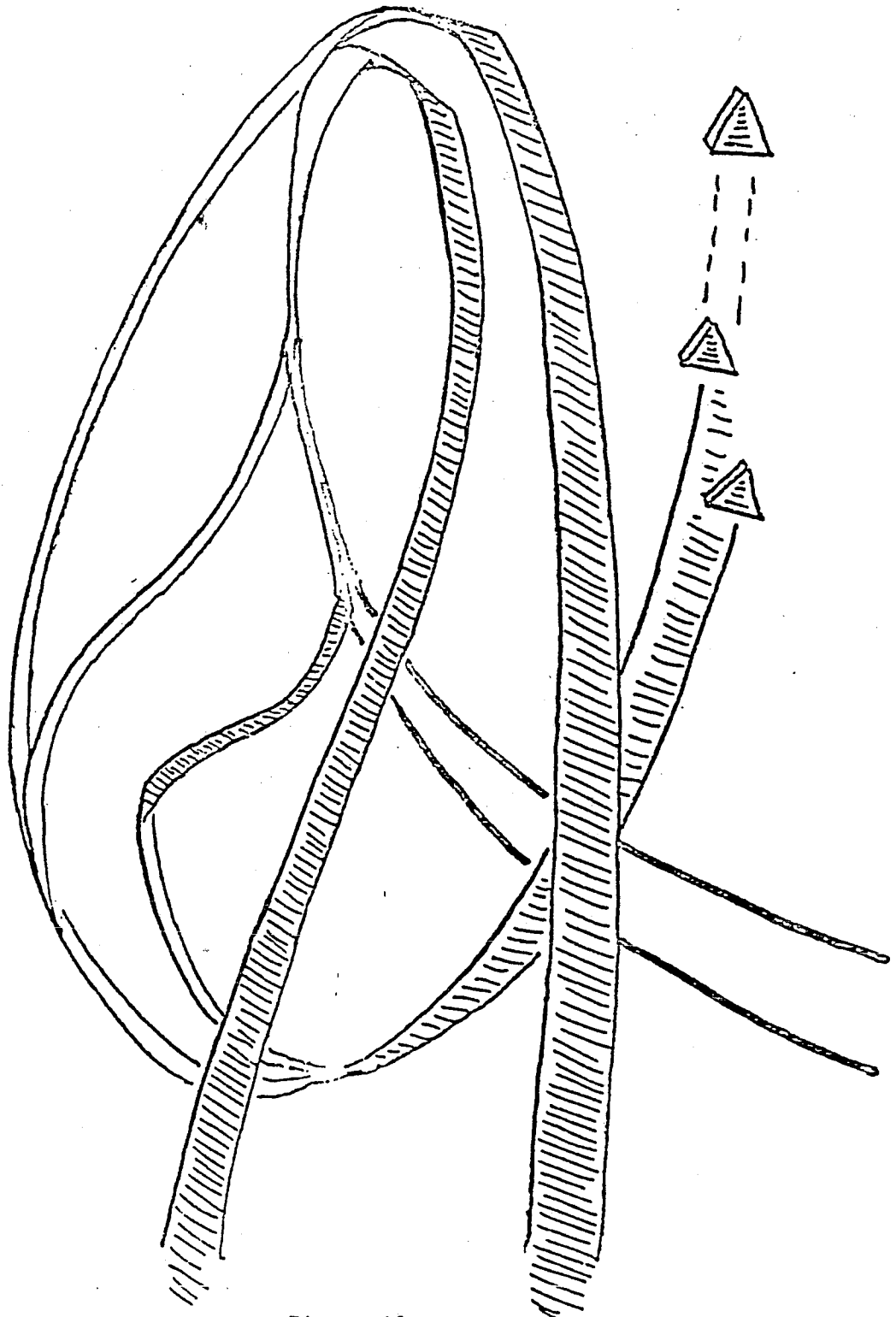
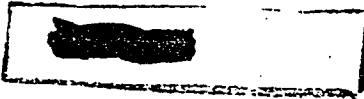

PERFORMING A FLUID SEPARATION

Figure 40

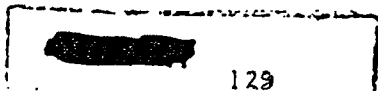

(and/or untrustworthy) you should maintain close element integrity and simply switch from low to high defender.

5. Rejoin the leader as soon as the low defender has been definitely committed out of the fight. Do not follow the low defender too far or element integrity and all mutual support will be sacrificed.

6. Complete the attack with a two-against-one advantage. The wingman should continue to closely observe the low defender to prevent any counter-attack.

#### Defending Two when Attacked by Two

The defending element should maneuver as a single unit to counter a missile launch and a follow-up 20mm cannon attack. The tactics illustrated in fighter maneuvers apply equally as well with an element as with a single aircraft. The defensive split should not be employed to counter the missile attack. To successfully deliver AIM-9B against a maneuvering defending element, requires a launch at ranges in excess of 5,000 feet. A launch under these conditions can be easily nullified by generating angular velocity. A split is not necessary. If employed, the defending element will be forced into a permanent separation, without the necessary mutual support to counter the follow-up gun attack. The attacking element, at its leisure, may move in for the kill against one defender without interference from his teammate. The defensive split should be employed when there is no possibility of shaking the attackers as they approach gun firing range (3,000 feet). To set it up, the defending leader should declare the split. On signal, the inside defender (usually the wingman) should tighten up his turn in the plane of the attack. The other defender (usually the leader) should maintain his turn and spread out, as well as up, to effect the split. If the split is conducted in the horizontal plane, this means that the inside defender will be turning level or in a slight nose-down attitude, while his teammate will be turning in the horizontal plane and also up through the vertical plane. See figure 41. At the time the split is declared, certain responsibilities exist between the inside and outside defenders. The inside defender no longer provides visual cross-coverage to his teammate. Instead, he devotes his entire attention to the attackers in order that he may play the attack and determine the attackers' subsequent action. The high-outside defender, on the other hand, determines the magnitude of the split by playing his position in respect to his teammate as well as to the attacking element. Confronted with the split, the attacking element must now make a decision as to whether to attack the low-inside defender, attack the high-outside defender, or split and continue the attack against each defender. In considering these three possibilities, the attacking element can initiate one of five possible courses of action: (1) Attack the low defender, (2) Attack the high defender, (3) Split and attack each individual defender, (4) Initiate or feint an attack against the

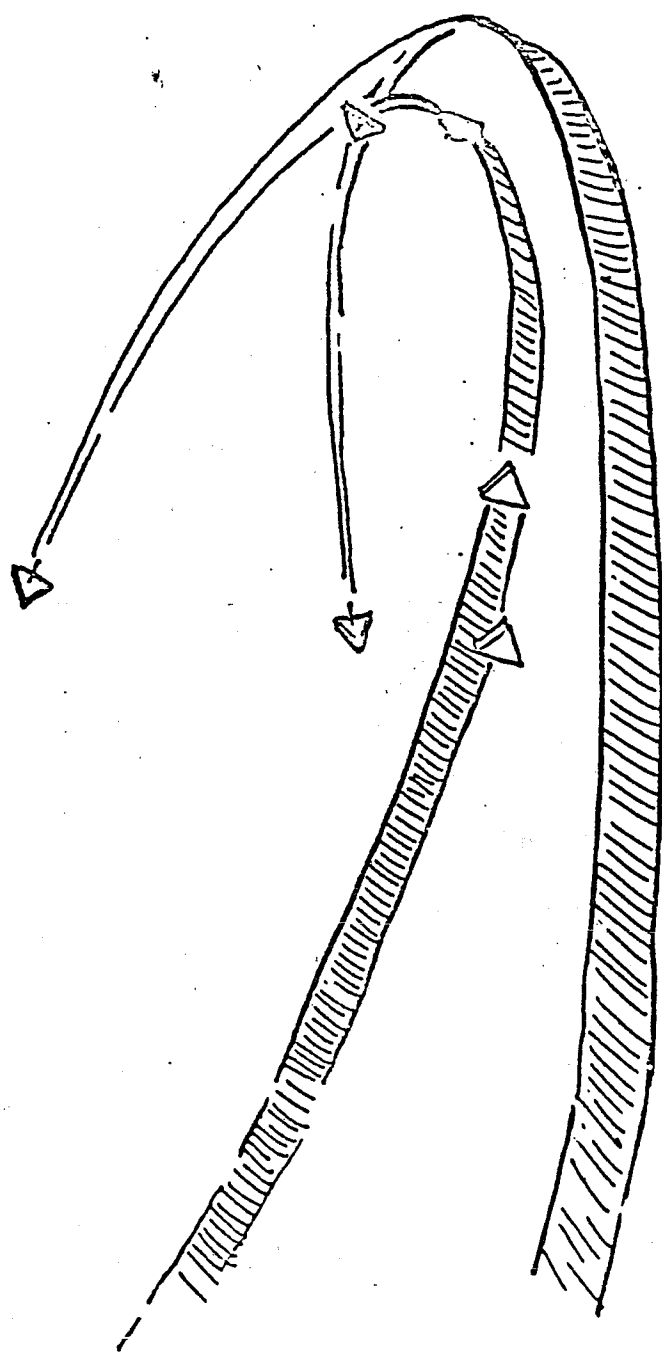
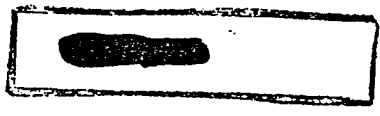

DEFENSIVE SPLIT

Figure 41

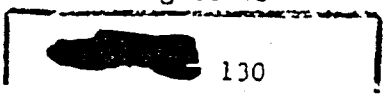

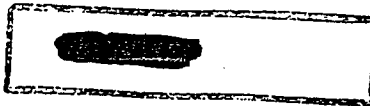

low-inside defender, then switch and continue the attack against his high-outside teammate, or (5) Initiate an attack against the low defender and perform a fluid separation in which the attacking leader selects the high defender while the attacking wingman drives the low defender out of the fight, then rejoins the leader on the attack against the high defender.

If the attacking element drives in after the low defender (figure 42), the low defender fights as a single aircraft in an effort to gain an offensive advantage. At the same time, the high defender drives in after the attacking element in an effort to force them to break off the attack. During this process, the low defender does not compromise his position to set up his teammate in the attacking element's six-o'clock position. It is the high defender's responsibility to gain an offensive advantage without a compromising assist from the low defender. If the low defender can achieve an immediate offensive advantage against the attacking element, the high defender should immediately clear his teammate and allow him to set up for the kill. Mutual support of this nature enables the defending element to exploit any advantage with dispatch.

If the attacking element attacks the high-outside defender, the high-outside defender should immediately play the attack in an effort to acquire an offensive advantage. Once again, the defender under attack (high defender) should not compromise his position to set up his teammate to gain an advantage. This means that the high defender must force the attackers to overshoot. The overshoot may be generated by executing a max-performance turn into the attack or by employing the high-G roll underneath, see figure 43. Considering the geometric position of the two defenders, the high-G roll underneath would be the better maneuver. The roll underneath will not compromise the high defender's position, yet it will make it easier for the low defender to move into the attacking element's vulnerable six-o'clock position, because the final portion of the roll will be away from the low defender. The moment the inside-low defender observes the attacking element driving after his high teammate, he should pull out of his defensive turn and drive toward the attacker's six-o'clock position. If the high defender performs a high-G roll underneath, the low defender can achieve a lethal position by executing a simple reversal or a roll-off maneuver. (See figure 43) If the high defender turns down into the attack, toward the low defender, the low defender will be forced to execute a nose-high reversal followed by a roll-off to move into the attacking element's six-o'clock position within 2000m cannon range. In this position, the low defender either forces the attackers to break off or he clears his leader, in the event his leader gains an offensive position.

If the attacking element splits (each attacker taking a defender) to counter a defensive split the defenders must break element integrity and fight as single aircraft in an effort to elude the attackers.

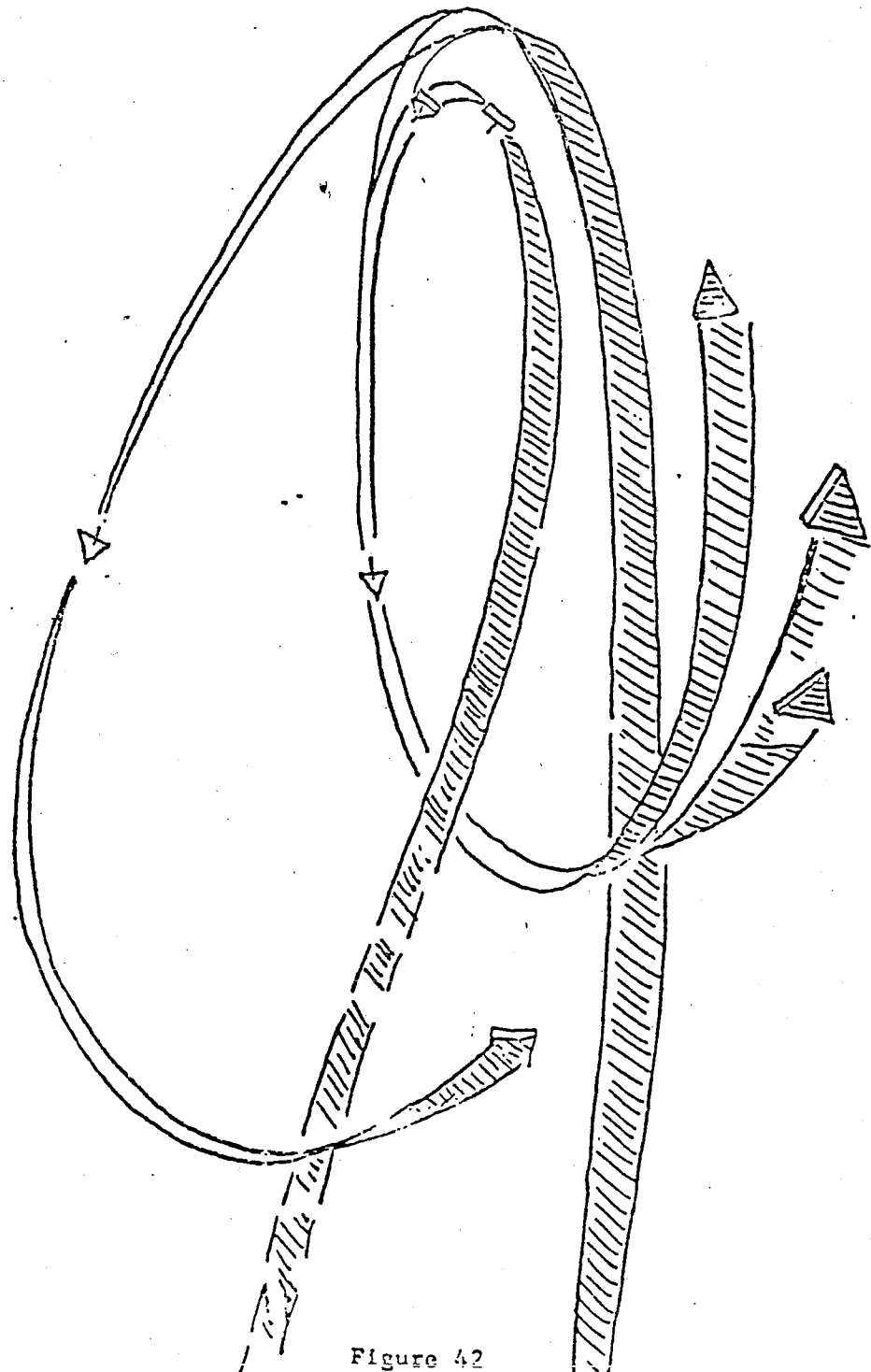
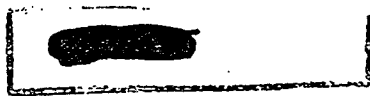

SANDWICHING THE ATTACKERS IF THEY SELECT A LOW DEFENDER

Figure 42

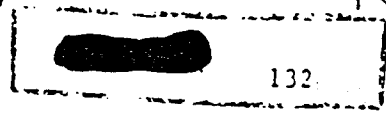

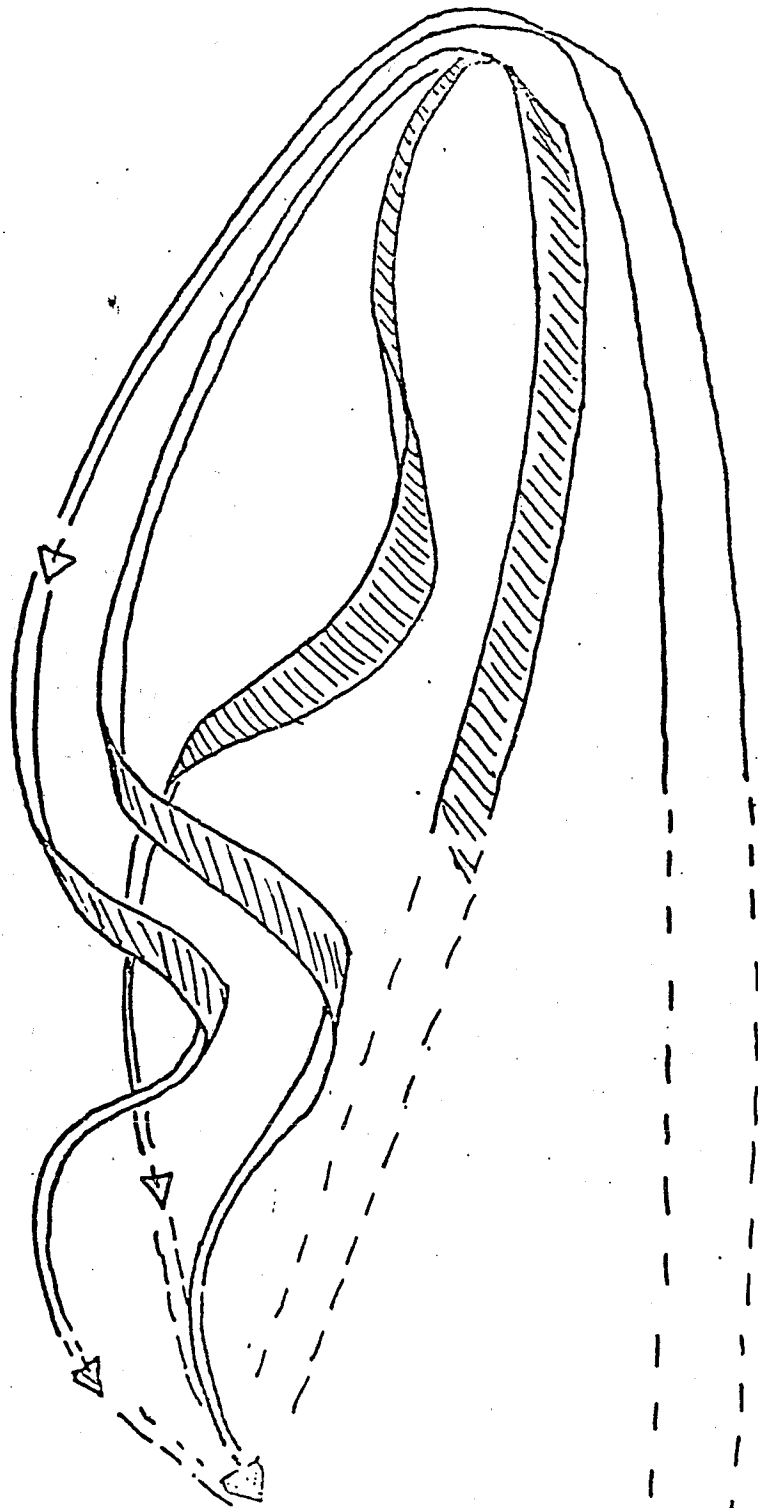

GAINING THE ADVANTAGE IF THE ATTACKER SELECTS THE HIGH DEFENDER

Figure 43

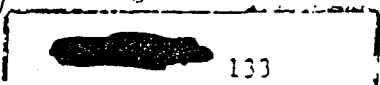

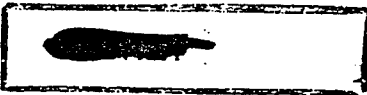

During this portion of the engagement, each defender must disregard his teammate's actions until he is able to successfully evade his opponent. The purpose of this action is to prevent the defenders from compromising their respective defensive position. The first defender able to elude his attacker should maneuver to support his teammate as soon as possible. If the attacker is an especially aggressive type, this may be impossible until the defender destroys him. The one-versus-one fight caused by the attackers' split is the only engagement which causes a permanent split of the defensive element. However, this is necessary to preclude loss of both members of the defending element.

If the attacking element initiates or feints an attack against the low defender (in an effort to drive him out of the fight) then switches the attack to the high defender, (figure 44) the defending element must maneuver initially as though the attack were directed against the low defender. During the initial portion of this engagement - before the switch is attempted - the high defender should note whether or not the attacking element attempts to prolong the attack against the low defender. To stay with the low defender too long means that the attacking element will experience considerable airspeed decay. If the high defender observes this sort of action by the attacking element, he should not turn or roll down into the attack when the switch occurs. Instead, he should roll wings-level and zoom in the vertical plane. Since the attackers have dissipated their maneuvering airspeed they will be unable to match the high defender's rotation angle and subsequent zoom (see section on Maneuvering after a Turn Overshoot, in Fighter Maneuvers): The attacking element will be forced below and in front of the high defender. During the switch, if the low defender has rolled nose-high out of his defensive turn, he will move toward the attacker's six-o'clock-low position and the attacking element will be caught, with little or no maneuvering airspeed, in a vertical sandwich in front of both the high and low defenders. If they remain in this position, the high defender need only execute a roll-off toward the attacker's six-o'clock position. If the attackers attempt to dive away, they will position themselves in front of the low defender. In either case, the defending element now has the advantage. If the attacking element does not bleed off airspeed - by prolonging the attack against the low defender - prior to executing a switch, the high defender must turn down into the attack or perform a high-G roll underneath, to counter the switch. See figure 45. Although the high defender is provided less opportunity to gain an advantage by this action, the low defender is provided a greater opportunity. The reason for the low defender's greater opportunity is that he will not be forced to stay in his max-performance turn so long. This means that he will have more maneuvering airspeed, hence a greater opportunity to maneuver into the attacker's six-o'clock position after they perform the switch. As a result, the low defender can clear his teammate, in the event he gains an advantage, or he can quickly provide mutual support and force the attacker to break off his attack on the high defender.

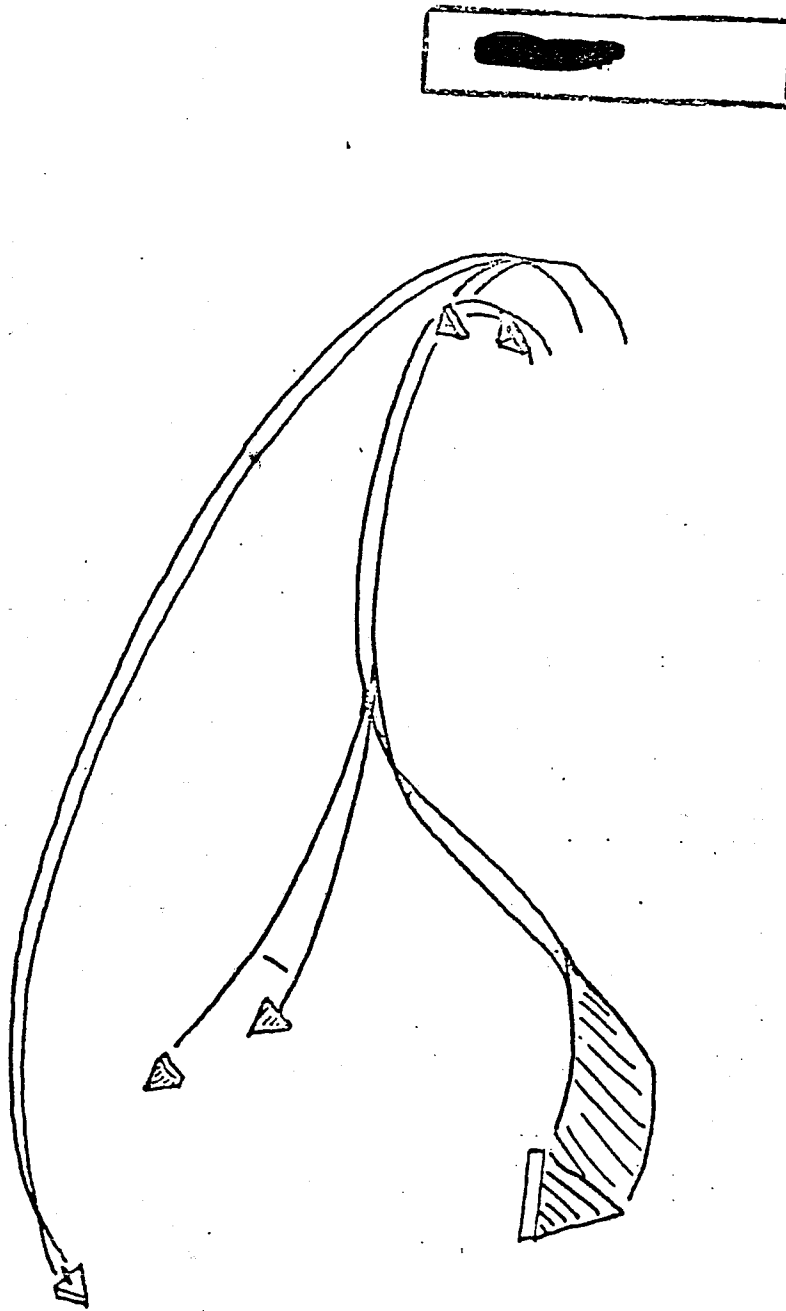

SWITCHING THE ATTACK TO THE HIGH DEFENDER

Figure 44





If the attackers perform a "fluid separation" as a means of countering the defensive split, the defenders will be hard-pressed. To them, a fluid separation will appear as an offensive split. Therefore, they will be forced to initially treat this tactic as a split, and maneuver accordingly. The first indication that the tactic is a fluid separation, rather than a split, will be when the attacking wingman breaks off the inside defender and rejoins the leader in an attack against the high defender. The moment the attacking wingman breaks off and attempts to regain normal element integrity with his leader, the low defender discontinues the defensive turn. He will reverse-roll, nose-high and maneuver toward the attacking wingman's six-o'clock position. Meanwhile, the high defender should be turning down through the vertical plane into the attacking leader. A high-G roll underneath may or may not be performed, depending upon the circumstances. If there is considerable separation between the attacking leader and his wingman, a roll underneath may force the attacking leader to overshoot. However, because of the separation, it can easily place the attacking wingman at the high defender's six-o'clock position. To preclude this possibility, the high defender should turn down through the vertical plane to counter the attacking leader and let his teammate provide mutual support by driving in after the attacking wingman. If there is not considerable separation between the attacking leader and his wingman, the high defender may employ the high-G roll underneath in an effort to drive the attackers forward. At the same time, this will enable the low defender to more easily clear or provide mutual support. If the fluid separation is performed correctly, a great deal of pressure is exerted against the defensive split. The defending element must exercise skillful maneuvering technique along with excellent judgment and timing to counter the attacking element's advantage. It can be accomplished, but it demands a maximum in team coordination.

#### Procedures for Employing the Defensive Split

1. Performing the Defensive Split.
  - a. Perform a defensive split if unsuccessful in eluding an opponent by all other maneuvers. This split should be initiated when the attackers are approximately 3000 feet to the rear.
  - b. Declare the split to the wingman so that he may turn to the inside and play the attack.
  - c. Slide high and to the outside when maneuvering as a leader. You should play the pull-up to maintain a supporting position upon the wingman.
  - d. Do not kill off airspeed by abrupt or violent maneuvers. You are attempting to force the attackers to concentrate their efforts

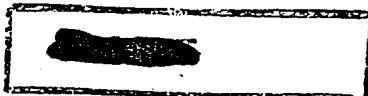

on one defender, therefore you must maintain sufficient airspeed for future maneuvering.

2. Executing the Defensive Split when the Attacker Selects the Low Defender.

a. Continue a level or slightly nose-low maximum turn when maneuvering as the low defender (wingman). A low defender should not lower his nose excessively, since the attacking element is trying to force him down and out of the fight.

b. Attempt to sandwich the attacking element when maneuvering as the high defender. While you are performing this maneuver, the low defender will attempt to generate an overshoot and gain offensive potential.

c. Play the low defender's evasive maneuvering to achieve a firing position. If the low defender maneuvers onto the offense, you should support the attack.

3. Executing the Defensive Split when the Attacking Element Selects the High Defender.

a. Perform a hard turn into the attack or a high-G roll underneath when maneuvering as the high defender. This will prevent your attacker from being able to position for a kill.

b. Call the low defender to reverse and pull up after the attackers. The low defender should be alert and execute the reversal the instant the attackers select the high defender. This will force the attacking element into a sandwich.

c. Continue evasive action in an effort to gain an offensive advantage. If, as high defender, you gain this advantage, the low defender will support your attack.

d. Play the high defender's evasive action (when maneuvering as low defender) to achieve a firing position, if he is unable to elude the attackers.

4. Playing the Defensive Split when the Attacking Element Splits

a. Split into a one-versus-one situation.

b. Maneuver as necessary to elude your opponent (see section covering Fighter Maneuvers).

c. Disregard your teammate's actions until you are able to successfully evade your opponent. By doing this, you will not compromise your defensive position.

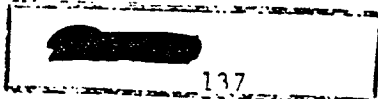



d. Attempt to rejoin and support one another as soon as possible. You may be forced to destroy your opponent before effecting a rejoin.

5. Executing the Defensive Split when the Attack Switches from Low Defender to High Defender.

a. Maneuver initially as outlined in the Section describing the attack on the low defender.

b. Observe to determine whether or not the attackers prolong their attack on the low defender. If the attackers attempt to stay with the low defender too long, they will lose airspeed very rapidly. If this condition prevails, the high defender should roll wings-level when the attackers execute their switch. If the attacking element has killed its airspeed, it will be unable to match the high defender's rotation angle and will be forced below and forward. During the switch the low defender should perform a nose-high reversal to catch the attackers in a vertical sandwich.

c. Turn down into the attack or execute a high-G roll underneath when maneuvering as a high defender, if the attackers do not decrease airspeed prior to executing the switch.

d. Execute an immediate roll-out when maneuvering as a low defender. This maneuver should be initiated after the switch to the high defender.

e. Play the high defender's subsequent action in order to gain a firing position or to support any offensive action taken by the high defender.

#### Attacking Four with Two

To gain maximum advantage, an attacking element should strike at six-o'clock-low in an effort to deliver AIM-9B. If the flight of four fails to detect the attack the attacking element should pick out the nearest target and launch a missile. If the flight of four wheels around in an effort to nullify the attack, the attacking element should re-position behind the defending trailing element. From here, the attacking element should drive in and set up for a secondary missile attack - by employing the barrel-roll attack - or a follow-up 20mm cannon attack, in the event it is impossible to reposition for AIM-9B. If the flight of four splits into two separate fighting elements, the attacking element should switch to the outside trailing element and continue its attack. During the switch, the attacking wingman should closely observe the defending element to determine if it will provide mutual support to the element under attack. If the free element can provide mutual support, the attacking element should roll wings-level.

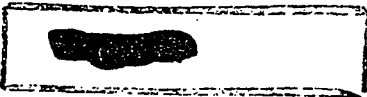

zoom in the vertical plane, and once again reposition behind the trailing element. See figure 46. When the defending elements are no longer able to provide mutual support, the attacking element should move in for the kill behind the trailing defending element.

#### Attacking a Flight of Four with Four

To attack a flight of four, AIM-9B-equipped attacking elements should maneuver into the defender's blind area in an effort to set up for a missile attack without being detected. If successful in this endeavor, each attacking element should line-up behind a respective defending element in the flight of four. On signal, the attacking element leaders should launch their missiles. If the defenders fail to maneuver, they will lose two aircraft (one out of each element) and be set up as individual defenders with a two-to-one disadvantage against their respective attacking elements. In describing this type of attack, a better method may appear obvious: To have each individual attacker launch AIM-9B against the individual defenders. This may be accomplished, however the coordination and timing needed before the defenders execute a counter-maneuver, make it appear unlikely. In addition, this tactic destroys the attacking element's look-out capability.

If the defending elements detect the attack and maneuver against it, the attacking elements will be unable to maneuver line-abreast and launch their missiles simultaneously. Instead, the attacking elements will be forced in-train (element behind element) to attack as a flight of four against one of the defending elements, or to attack as individual elements against the respective defending elements. If the attacking elements maneuver as a flight of four, against one of the defending elements, the free defending element will be provided an opportunity to maneuver behind the flight of four. If each attacking element selects a defending element, mutual support becomes almost impossible, since each defending element must maneuver against its respective attacker to counter a possible missile launch. Considering AIM-9B, this means that the defending elements can no longer maneuver in respect to one another, but must maneuver in respect to their individual attackers. As a result, the four-versus-four engagement becomes two individual two-versus-two engagements, with each attacking element attempting to set up for a missile attack or a follow-up 20mm cannon attack. If the attackers are forced in-train and the two defending elements attempt to separate for mutual support, the lead attacking element should attempt to drive the inside defending element into a permanent separation. Before the lead attacking element compromises his position and diminishes his airspeed, he should switch the attack to the high-outside trailing defending element. See figure 47. At the same time, the second attacking element should drive after the inside defending element. This double switch by the attacking element counters the defenders' possibility of setting up an effective sandwich on the lead element and the fight ends up in an element-versus-element engagement.

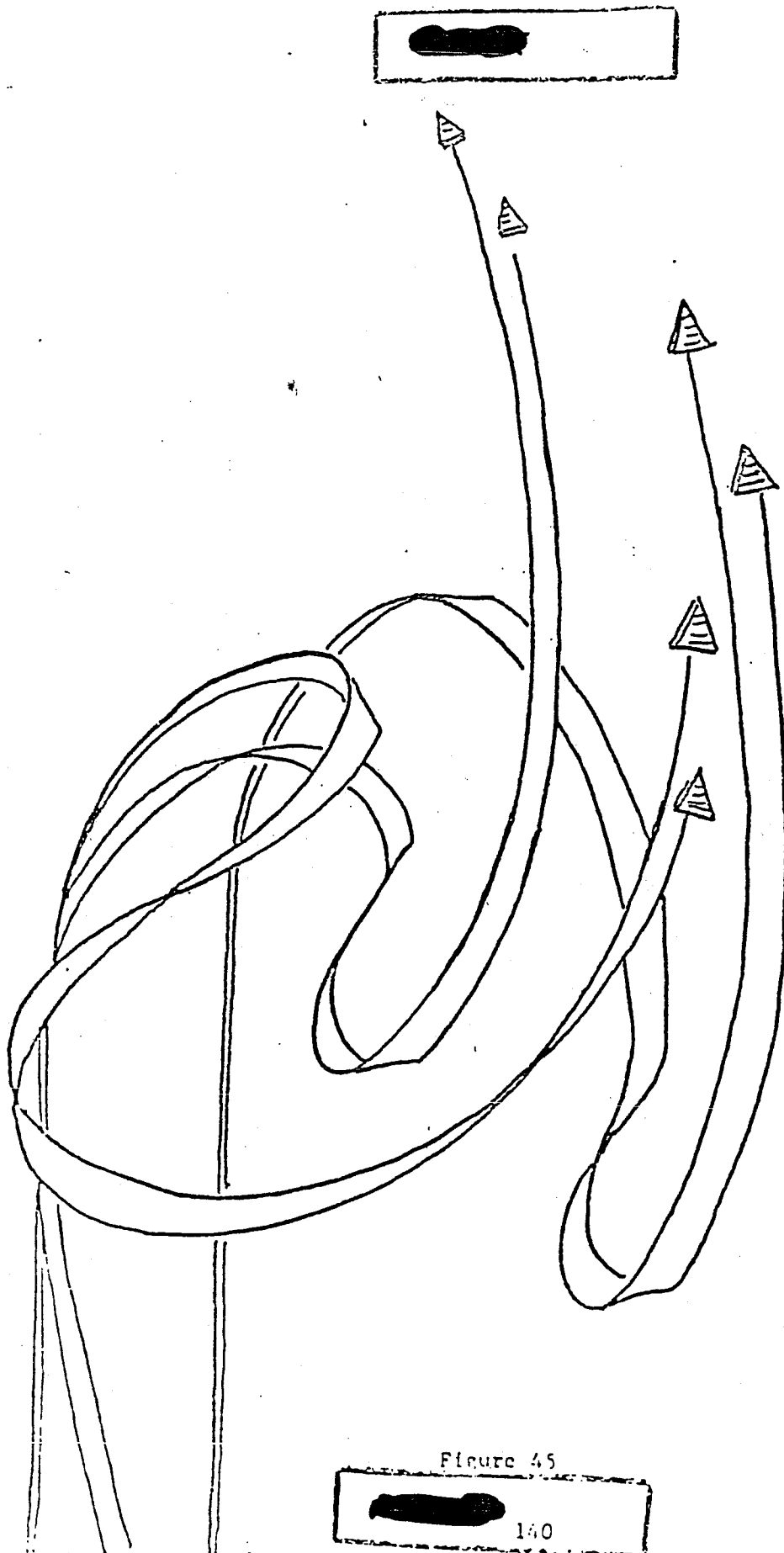

SELECTING THE OUTSIDE TRAILING ELEMENT

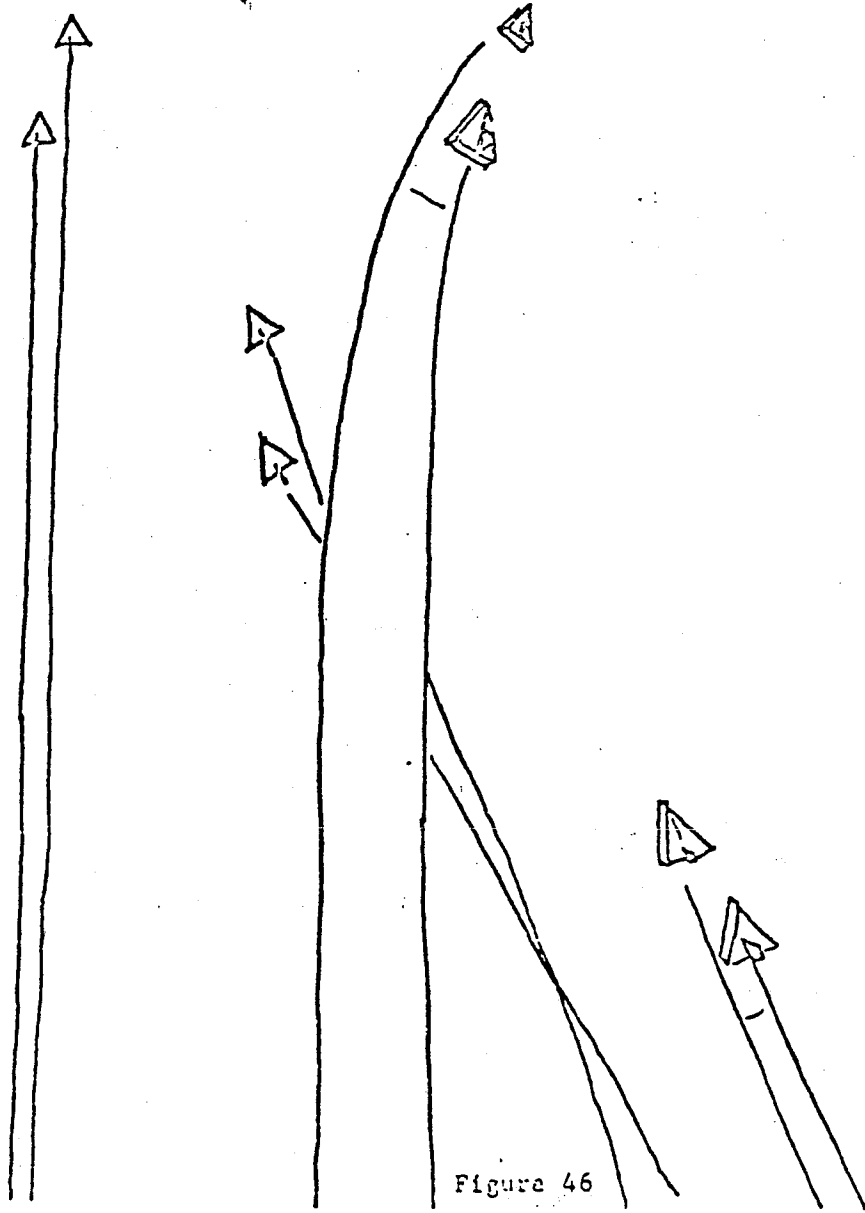
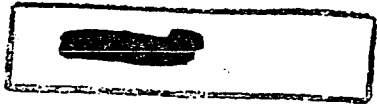
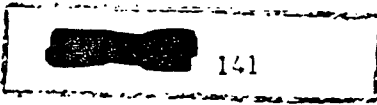
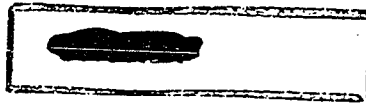

Figure 46



ATTACKING IN TRAIN



with the attacking elements enjoying the advantage. See figure 48. If the defenders maneuver as a flight of four, the attacking elements simply drive in after the trailing defending element, destroy it, then continue the action against the lead defending element.

#### Procedures for Attacking Four with Two

1. Begin your attack on the high element. If possible, at six-o'clock-low. This will position you in your opponent's blind area.
2. Switch your attack to the lead element after the high element is well committed in a defensive maneuver. If the high element should reverse, pull high and position yourself behind the trailing element while you still have an airspeed advantage.
3. Drive in again and attack the trailing element. If the defenders attempt (and are able) to provide mutual support, slide high once again behind the trailing element.
4. Continue this procedure until the defending elements are unable to provide mutual support, then drive in and attain a firing position behind the trailing element. Your wingman should keep you informed as to the whereabouts of the free element, to prevent any possible counter-attack.

#### Procedures for Attacking Four with Four

1. Attempt to maneuver your flight into the defender's blind area without being detected. If successful in this endeavor, line up each attacking element behind a defending element. On signal, the attacking element leaders will launch missiles to eliminate two of the defenders. If the defending elements observe this attack and maneuver to counter it, employ the following procedures.
2. Continue the attack, element against element, in an effort to prevent the defending elements from setting up a mutual-support situation. If the defending elements' maneuvers force you to attack in-train, they may separate the elements and attempt mutual support. To counter this tactic, employ the following procedures.
3. Drive in (as lead attacking element) after the inside defending element, in an effort to force the defending elements into a permanent separation.
4. Switch your attack to the high outside defending element before you compromise your position and diminish your airspeed. At the same time, switch your fluid element (second element) behind the defender's free element. This double switch prevents the defenders from setting up mutual support in order to sandwich the lead attacking element.

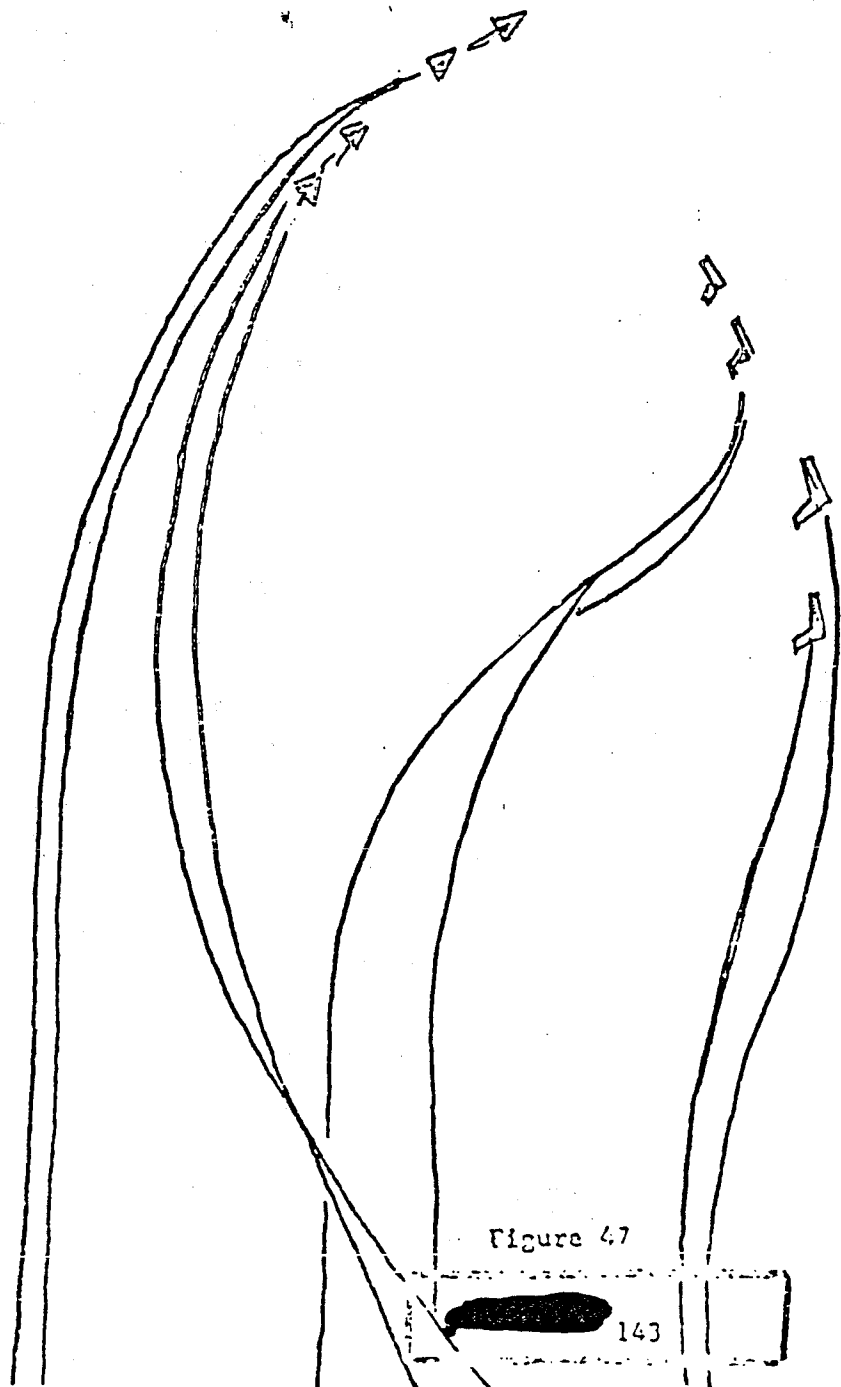
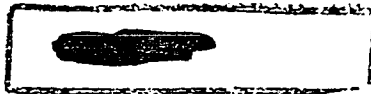
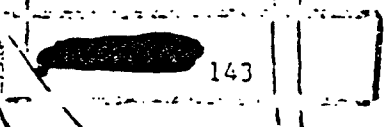

Figure 47



143

ELEMENT VS ELEMENT AFTER AN ATTACK IN TRAIN



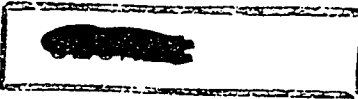

5. Press the attack as separate elements. This allows each element to take advantage of its superior position. Also, it prevents the defenders from effecting a re-join and subsequent mutual support.

6. Maneuver behind the trailing element if you have the whole flight breaking in the same direction.

#### Defending Four when Attacked by Two

To successfully defend a flight of four, the defenders must detect the attack and determine the number executing the attack. If the defenders are certain there is only one element performing the attack, their course of action is simple. The moment they pick up the attacking element, they must determine against which defending element the attack is being executed. The element being attacked turns away from its supporting element. This means that if the attack is directed against the high element, it turns down and away from the lead element. If the attacking element continues to press its attack against the fluid element, the lead element simply rolls in behind the attackers. If the attacking element switches its attack to the lead element, the lead element turns into the attack and the free defending element reverses nose-high, then follows through with a roll-off to move into the attacking element's six-o'clock position. See figure 49. The attacking element, caught in a sandwich, will now be forced to maneuver against the attacking defending element or face the possibility of being destroyed.

#### Defending Four when Attacked by Four

If the attacking elements drive in and line up behind each defending element, the defending elements must fight separate element-versus-element engagements. If mutual support is attempted, one of the defending elements will be forced to maneuver in respect to the other defending element. Such a tactic, with an attacking element in lethal position, would be disastrous. If the attacking elements maintain flight integrity, mutual support may be initiated. The element under attack turns away from its supporting element. If the attackers continue this attack, the supporting or fluid element drives in and sandwiches the flight of four. During the attempt for mutual support, if the attacking lead element switches the attack to the outside defending element, and the attacking fluid element drives in after the inside defending element, the defending elements must maneuver as separate elements.

#### Procedures for Defending Four when Attacked by Two

1. Check to be sure there is only one element performing the attack.

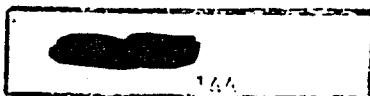

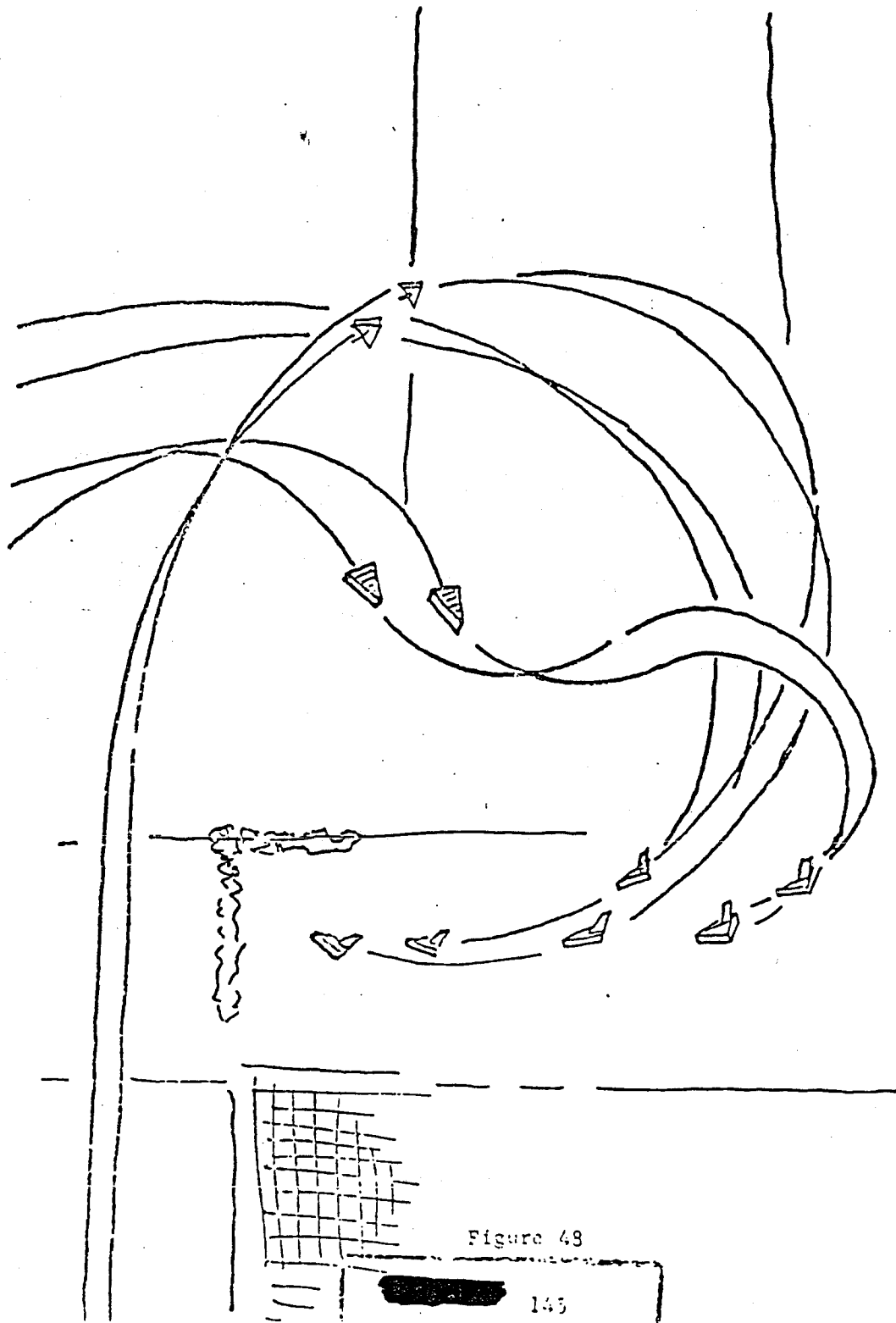
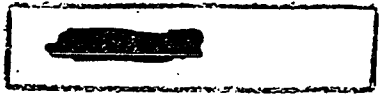
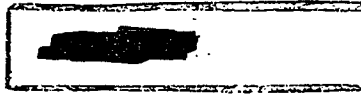

Figure 48

ROLLING OFF BEHIND THE ATTACKING FREE ELEMENT



2. Turn the element under attack away from the supporting element.
3. Turn the supporting element in on the attackers, if the attack switches to the supporting element. The attackers are sandwiched once again, but in reverse order.

Procedures for Defending Four when Attacked by Four

1. Fight as separate elements, if the attacking elements initiate simultaneous attacks against each defending element. Mutual support, attempted against this tactic, will only compromise the position of one of the defending elements.
2. If the attackers maintain flight integrity and attack either one of the defending elements, employ mutual support and sandwich the flight of four.
3. If the attacking lead element switches the attack to the supporting element, and the attacking fluid element drives in after the inside defending element, maneuver as separate elements.

SUMMARY

In discussing fighter-versus-fighter combat we have emphasized the importance of turn and velocity during all maneuvers. A pilot under attack will not be able to simply outrun his opponent - he must generate sufficient angular velocity to prevent a successful missile launch and/or a 20mm cannon attack. This means that "high-speed tactics" cannot be distinguished from "low-speed tactics" since the entire field of maneuver and capability must be considered. As long as fighter pilots are committed to rear-hemisphere attacks, the concept depicted in this study will hold true. New weapons such as the F-104 and F-105 aircraft and the AIM-9B missile may change the maneuvers per se, however the principles involved will remain the same.

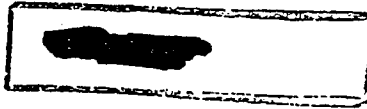

BIBLIOGRAPHY

1. Evaluation Report on F-104A/GAR-8 Weapons System, 1 Feb 58.
2. Project Report 58-4 TR&D, Nellis AFB, Nevada.
3. NAVORD OD 12663, 21 Jan 58.
4. Interim Report 51-1 TR&D, Nellis AFB, Nevada
5. CTAF Manual, 51-1, 26 Nov 56.
6. Fighter Weapons Newsletter, Jun 57.
7. Fighter Weapons Newsletter, Mar 59.
8. Final Engineering Report on Sidewinder System Studies - Westinghouse Electric Corporation, 14 Feb 58.
9. NAVORD Report 5808, 2 Dec 57.
10. NOTS 1739..
11. NAVORD Report 4914, Jan 58.
12. AFM 335-25.
13. TF Project 19234 Storyboard, 23 Apt 58.