

7

AD-A157 596

AFWAL-TR-85-4049



EFFECT OF MANUFACTURING PROCESS ON  
STRUCTURAL ALLOWABLES

University of Dayton Research Institute  
300 College Park Avenue  
Dayton, Ohio 45469

May 1985

Final Report for Period February 1983 - November 1984

Approved for public release; distribution unlimited.

DTIC FILE COPY

MATERIALS LABORATORY  
AIR FORCE WRIGHT AERONAUTICAL LABORATORIES  
AIR FORCE SYSTEMS COMMAND  
WRIGHT-PATTERSON AIR FORCE BASE, OHIO 45433

DTIC  
ELECTE  
JUL 19 1985  
S D  
G

## NOTICE

When Government drawings, specifications, or other data are used for any purpose other than in connection with a definitely related Government procurement operation, the United States Government thereby incurs no responsibility nor any obligation whatsoever; and the fact that the government may have formulated, furnished, or in any way supplied the said drawings, specifications, or other data, is not to be regarded by implication or otherwise as in any manner licensing the holder or any other person or corporation, or conveying any rights or permission to manufacture use, or sell any patented invention that may in any way be related thereto.

This report has been reviewed by the Office of Public Affairs (ASD/PA) and is releasable to the National Technical Information Service (NTIS). At NTIS, it will be available to the general public, including foreign nations.

This technical report has been reviewed and is approved for publication.

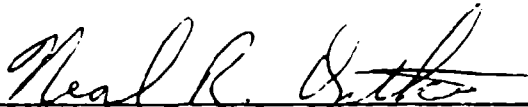

NEAL R. ONTKO  
Project Engineer  
Materials Engineering Branch

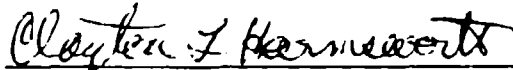

CLAYTON L. HARMSWORTH  
Technical Manager for  
Engineering & Design Data  
Materials Engineering Branch

FOR THE COMMANDER



THEODORE J. REINHART, Chief  
Materials Engineering Branch  
Systems Support Division  
Materials Laboratory

Accession For	
NTIS GRA&I	<input checked="" type="checkbox"/>
DTIC TAB	<input type="checkbox"/>
Unannounced	<input type="checkbox"/>
Justification	
By _____	
Distribution/ _____	
Availability Codes	
Avail and/or	
Dist	Special
A1	



"If your address has changed, if you wish to be removed from our mailing list, or if the addressee is no longer employed by your organization please notify MLSE, W-PAFB, OH 45433 to help us maintain a current mailing list".

Copies of this report should not be returned unless return is required by security considerations, contractual obligations, or notice on a specific document.

Unclassified

SECURITY CLASSIFICATION OF THIS PAGE

## REPORT DOCUMENTATION PAGE

1a. REPORT SECURITY CLASSIFICATION Unclassified		1b. RESTRICTIVE MARKINGS	
2a. SECURITY CLASSIFICATION AUTHORITY		3. DISTRIBUTION/AVAILABILITY OF REPORT Approved for public release; distribution unlimited.	
2b. DECLASSIFICATION/DOWNGRADING SCHEDULE			
4. PERFORMING ORGANIZATION REPORT NUMBER(S) UDR-TR-84-133		5. MONITORING ORGANIZATION REPORT NUMBER(S) AFWAL-TR-85-4049	
6a. NAME OF PERFORMING ORGANIZATION University of Dayton Research Institute	6b. OFFICE SYMBOL (If applicable)	7a. NAME OF MONITORING ORGANIZATION Engineering and Design Data Materials Engineering Branch	
6c. ADDRESS (City, State and ZIP Code) 300 College Park Ave. Dayton, Ohio 45469		7b. ADDRESS (City, State and ZIP Code) Air Force Wright Aeronautical Laboratories Materials Laboratory (AFWAL/MLSE) Wright-Patterson Air Force Base, Ohio 45433	
8a. NAME OF FUNDING/SPONSORING ORGANIZATION Materials Laboratory	8b. OFFICE SYMBOL (If applicable) AFWAL/MLSE	9. PROCUREMENT INSTRUMENT IDENTIFICATION NUMBER F33615-82-C-5102	
8c. ADDRESS (City, State and ZIP Code) Air Force Wright Aeronautical Laboratories Materials Laboratory Wright-Patterson Air Force Base, Ohio 45433		10. SOURCE OF FUNDING NOS.	
11. TITLE (Include Security Classification) Effect on Manufacturing Processes on Structural Allowables		PROGRAM ELEMENT NO. 78011F	PROJECT NO. MTP1
12. PERSONAL AUTHOR(S) Philip E. Doepker		TASK NO. 06	WORK UNIT NO. 65
13a. TYPE OF REPORT Final	13b. TIME COVERED FROM Feb. 83 TO Nov 84	14. DATE OF REPORT (Yr., Mo., Day) 85 May	15. PAGE COUNT 185
16. SUPPLEMENTARY NOTATION			
17. COSATI CODES		18. SUBJECT TERMS (Continue on reverse if necessary and identify by block number)	
FIELD	GROUP	SUB. GR.	Tensile yield strength, tensile ultimate strength, compressive ultimate strength, fatigue properties, shear properties, bearing properties, (cont'd on back)
11	06		
19. ABSTRACT (Continue on reverse if necessary and identify by block number) This report documents the results from tests to determine mechanical property data for materials having various manufacturing processes. The materials tested were: 15-5 PH (H1025) Stainless Steel Alloy Hot Rolled Plate, 7175-T736 Aluminum Alloy Hand Forging and 7050-T736511 Aluminum Alloy Extrusion. Tensile, compression, shear and bearing properties were obtained for all three materials. Fatigue (notched and unnotched) properties were determined for the Stainless Steel Plate and the 7175-T736 Aluminum Hand Forging.			
20. DISTRIBUTION/AVAILABILITY OF ABSTRACT UNCLASSIFIED/UNLIMITED <input checked="" type="checkbox"/> SAME AS RPT <input type="checkbox"/> DTIC USERS <input type="checkbox"/>		21. ABSTRACT SECURITY CLASSIFICATION Unclassified	
22a. NAME OF RESPONSIBLE INDIVIDUAL Neal E. Ontko		22b. TELEPHONE NUMBER (Include Area Code) 255-5063	22c. OFFICE SYMBOL AFWAL/MLSE

UNCLASSIFIED

SECURITY CLASSIFICATION OF THIS PAGE

18. (Continued)

15-5 PH (H1025) Stainless Steel, 7050-T736511 Aluminum Alloy, 7175-T736  
Aluminum Alloy, Aluminum Hand Forging, Aluminum Extrusion, Stainless Steel  
Hot Rolled Plate.

UNCLASSIFIED

SECURITY CLASSIFICATION OF THIS PAGE

## FOREWORD

This project was conducted by the University of Dayton Research Institute under Contract No. F33615-82-C-5102 over the period from 25 February 1983 to 30 November 1984. Mr. Neal R. Ontko, Engineering and Design Data, Materials Engineering Branch was the technical monitor for the Air Force Wright Aeronautical Laboratories/Materials Laboratory (AFWAL/ML), Air Force Systems Command, Wright-Patterson Air Force Base, Ohio.

The author wishes to express his appreciation to Messers. G. Roth., C. Williams, and R. Glett for their efforts during this project.

## TABLE OF CONTENTS

	<u>Page</u>
INTRODUCTION . . . . .	1
TEST PROCEDURE . . . . .	2
Tension Tests . . . . .	3
Compression Tests . . . . .	3
Bearing Tests . . . . .	3
Shear Tests . . . . .	3
Fatigue Tests . . . . .	4
15-5 PH (H1025) PRECIPITATION HARDENING STAINLESS STEEL PLATE. . . . .	5
Background. . . . .	5
Material Description. . . . .	5
Specimen Numbering Sequence . . . . .	5
Test Results. . . . .	6
Tension . . . . .	7
Compression . . . . .	7
Shear . . . . .	7
Bearing . . . . .	8
Fatigue . . . . .	8
Summary of Mechanical Properties. . . . .	8
7175-T736 ALUMINUM ALLOY HAND FORGING . . . . .	54
Background . . . . .	54
Material Description. . . . .	54
Specimen Numbering Sequence . . . . .	55
Test Results. . . . .	56
Tension . . . . .	56
Compression . . . . .	56
Shear . . . . .	56
Bearing . . . . .	57
Fatigue . . . . .	57
Summary of Mechanical Properties. . . . .	57
ALUMINUM EXTRUSION - 7050-T736511. . . . .	98
Material Description. . . . .	98
Specimen Numbering Sequence . . . . .	99
Test Results. . . . .	99
Tension . . . . .	99
Compression . . . . .	99
Shear . . . . .	100
Bearing . . . . .	100
Summary of Mechanical Properties. . . . .	100

TABLE OF CONTENTS (CONTINUED)

	<u>Page</u>
APPENDIX A - SPECIMEN DRAWINGS . . . . .	139
APPENDIX B -- DATA SHEETS . . . . .	153
15-5 PH (H1025) Stainless Steel Alloy Hot Rolled Plate . . . . .	157
7175-T736 Aluminum Alloy Hand Forging . . . . .	161
7050-T736511 Aluminum Alloy Extrusion . . . . .	165

## LIST OF FIGURES

<u>Figure</u>		<u>Page</u>
1a	Specimen Layout for Plates 1 and 10.	10
1b	Specimen Layout for Plates 2 through 5.	11
1c	Specimen Layout for Plate 6.	12
1d	Specimen Layout for Plate 7.	13
1e	Specimen Layout for Plate 8.	14
1f	Specimen Layout for Plate 9.	15
2	Typical Stress-Strain Curve in Tension at Room Temperature for 15-5 PH (H1025).	21
3	Tensile Ultimate Stress as a Function of Plate Thickness for 15-5 PH.	22
4	Tensile Yield Stress as a Function of Plate Thickness for Various Plate Thicknesses for 15-5 PH.	23
5	Typical Stress-Strain Curve in Compression at Room Temperature for 15-5 PH (H1025).	29
6	Compressive Yield Stress vs. Plate Thickness for 15-5 PH.	30
7	Ultimate Shear Stress vs. Plate Thickness for 15-5 PH.	33
8	Typical Stress - Deflection Curve in Bearing for 15-5 PH (H1025).	38
9a	Bearing Ultimate Stress vs. Plate Thickness for $e/D = 1.5$	39
9b	Bearing Yield Stress vs. Plate Thickness for $e/D = 1.5$ .	40
9c	Bearing Ultimate Stress vs. Plate Thickness for $e/D = 2.0$ .	41
9d	Bearing Yield Stress vs. Plate Thickness for $e/D = 2.0$ .	42
10	Axial Load Fatigue Band for Unnotched 15-5 PH Stainless Steel (H1025, Longitudinal, $K_t=1.0$ ).	49



LIST OF FIGURES  
(CONTINUED)

<u>Figure</u>		<u>Page</u>
11	Axial Load Fatigue Band for Notched 15-5 PH Stainless Steel (H1025, Longitudinal, $K_t=3.0$ ).	50
12	Axial Load Fatigue Data of Unnotched 15-5 PH Stainless Steel (H1025, Long Transverse, $K_t=1.0$ ).	51
13	Axial Load Fatigue Data of Notched 15-5 PH Stainless Steel (H1025, Long Transverse, $K_t=3.0$ ).	52
14a	Material 7175-T736 AL Specimen Layout Hand Forgings, 3 Replicates from Each Forging.	59
14b	Material 7175-T736 AL Specimen Layout Hand Forgings.	60
15	Typical Stress-Strain Curve in Tension for 7175-T736 Aluminum Hand Forging.	66
16a	Tensile Ultimate Stress as a Function of Forging Thickness.	67
16b	Tensile Yield Stress as a Function of Forging Thickness.	68
17	Typical Compressive Stress-Strain Curve for 7175-T736 Aluminum Hand Forging.	72
18	Compressive Yield Stress as a Function of Forging Thickness.	73
19	Typical Shear Stress vs. Deflection for 7175-T736 Aluminum Hand Forging.	76
20	Ultimate Shear Strength as a Function of Forging Thickness for Both Amsler and RIVET Specimens.	77
21	Typical Bearing Stress vs. Deflection Curve for 7175-T736 Aluminum Hand Forging.	84
22a	Bearing Ultimate Stress as a Function of Forging Thickness $e/D = 1.5$ .	85
22b	Bearing Yield Stress as a Function of Forging Thickness $e/D = 1.5$ .	86

LIST OF FIGURES  
(CONTINUED)

<u>Figure</u>		<u>Page</u>
23a	Bearing Ultimate Stress as a Function of Forging Thickness $e/D = 2.0$ .	87
23b	Bearing Yield Stress as a Function of Forging Thickness $e/D = 2.0$ .	88
24	Axial Load Fatigue Data (Multiple Heats) $K_t = 1.0$ .	93
25	Axial Load Fatigue Data (Multiple Heats) $K_t = 3.0$ .	94
26	Axial Load Fatigue Data (One Heat Only) $K_t = 1.0$ .	95
27	Axial Load Fatigue Data (One Heat Only) $K_t = 3.0$ .	96
28a	Specimen Layout for Extrusion 105.	101
28b	Specimen Layout for Extrusion 107.	102
28c	Specimen Layout for Extrusion 110.	103
28d	Specimen Layout for Extrusion 112.	104
28e	Specimen Layout for Extrusion 114.	105
28f	Specimen Layout for Extrusion 115.	106
28g	Specimen Layout for Extrusion 122.	107
28h	Specimen Layout for Extrusion 124.	108
28i	Specimen Layout for Extrusion 126.	109
28j	Specimen Layout for Extrusion 127.	110
28k	Specimen Layout for Extrusion 128.	111
28l	Specimen Layout for Extrusion 703.	112
29	Typical Stress-Strain Curve in Tension for 7050-T736511 Aluminum Extrusion.	118

LIST OF FIGURES  
(CONTINUED)

<u>Figure</u>		<u>Page</u>
30a	Tensile Ultimate and Yield as a Function of Extrusion Section Thickness for Longitudinal Samples.	119
30b	Tensile Ultimate and Yield as a Function of Extrusion Section Thickness for Long Transverse Samples.	120
31	Typical Stress-Strain Curve in Compression for 7050-T736511 Aluminum Extrusion.	123
32	Compressive Yield Strength as a Function of Extrusion Section Thickness for 7050-T736511 Aluminum Extrusion.	124
33	Shear Stress vs. Deflection Curve for 7050-T736511 Aluminum Extrusion.	126
34	Ultimate Shear Strength as a Function of Extrusion Thickness.	127
35	Pin Bearing Stress vs. Displacement for 7050-T736511 Aluminum Extrusion.	132
36	Bearing Ultimate Stress as a Function of Extrusion Thickness for $e/D = 1.5$ .	133
37	Bearing Yield Stress as a Function of Extrusion Thickness for $e/D = 1.5$ .	134
38	Bearing Ultimate Stress as a Function of Extrusion Thickness for $e/D = 2.0$ .	135
39	Bearing Yield Stress as a Function of Extrusion Thickness for $e/D = 2.0$ .	136

## LIST OF TABLES

<u>Table</u>		<u>Page</u>
1	CHEMICAL COMPOSITION OF 15-5 PH (H1025) STAINLESS STEEL	6
2	GEOMETRY AND HEAT NUMBER FOR 15-5 PH (H1025) STAINLESS STEEL PLATES	9
3	TEST GRID FOR (15-5 PH STAINLESS STEEL)	16
4A	TENSILE TEST RESULTS FOR 15-5 PH (H1025) (RECTANGULAR - LONGITUDINAL)	17
4B	TENSILE TEST RESULTS FOR 15-5 PH (H1025) (ROUND - LONGITUDINAL)	18
4C	TENSILE TEST RESULTS FOR 15-5 PH (H1025) (RECTANGULAR - LONG TRANSVERSE)	19
4D	TENSILE TEST RESULTS FOR 15-5 PH (H1025) (ROUND - LONG TRANSVERSE)	20
5A	COMPRESSION TEST RESULTS FOR 15-5 PH (H1025) (RECTANGULAR - LONGITUDINAL)	24
5B	COMPRESSION TEST RESULTS FOR 15-5 PH (H1025) (ROUND - LONGITUDINAL)	25
5C	COMPRESSION TEST RESULTS FOR 15-5 PH (H1025) (RECTANGULAR - LONG TRANSVERSE)	26
5D	COMPRESSION TEST RESULTS FOR 15-5 PH (H1025) (ROUND - LONG TRANSVERSE)	27
5E	COMPRESSION TEST RESULTS 15-5 PH (H1025) (ROUND - SHORT TRANSVERSE)	28
6A	DOUBLE RIVET SHEAR RESULTS FOR 15-5 PH (H1025)	31
6B	TENSION SINGLE SHEAR RESULTS FOR 15-5 PH (H1025)	32
7A	PIN BEARING RESULTS FOR 15-5 PH (H1025) (e/D = 1.5, LONGITUDINAL)	34
7B	PIN BEARING RESULTS FOR 15-5 PH (H1025) (e/D = 1.5, LONG TRANSVERSE)	35
7C	PIN BEARING RESULTS FOR 15-5 PH (H1025) (e/D = 2.0, LONGITUDINAL)	36

LIST OF TABLES  
(CONTINUED)

<u>Table</u>		<u>Page</u>
7D	PIN BEARING RESULTS FOR 15-5 PH (H1025) (e/D = 2.0, LONG TRANSVERSE)	37
8A	FATIGUE TEST RESULTS FOR 15-5 PH (H1025) (FLAT, UNNOTCHED, LONGITUDINAL)	43
8B	FATIGUE TEST RESULTS FOR 15-5 PH (H1025) (ROUND, UNNOTCHED, LONGITUDINAL)	44
8C	FATIGUE TEST RESULTS FOR 15-5 PH (H1025) (FLAT, NOTCHED, LONGITUDINAL)	45
8D	FATIGUE TEST RESULTS FOR 15-5 PH (H1025) (ROUND, NOTCHED, LONGITUDINAL)	46
8E	FATIGUE TEST RESULTS FOR 15-5 PH (H1025) (ROUND, UNNOTCHED, LONG TRANSVERSE)	47
8F	FATIGUE TEST RESULTS FOR 15-5 PH (H1025) (ROUND, NOTCHED, LONG TRANSVERSE)	48
9	SUMMARY OF MECHANICAL PROPERTIES FOR 15-5 PH (H1025) STAINLESS STEEL PLATE	53
10	CHEMICAL COMPOSITION OF 7175 ALUMINUM ALLOY	54
11	GEOMETRY AND HEAT NUMBER FOR 7175-T736 ALUMINUM ALLOY HAND FORGINGS	58
12	TEST GRID FOR 7175-T736 ALUMINUM HAND FORGING	61
13A	TENSILE RESULTS FOR ALUMINUM HAND FORGING (7175-T736) (LONG, ROUND, LONGITUDINAL)	62
13B	TENSILE RESULTS FOR ALUMINUM HAND FORGING (7175-T736) (LONG, ROUND, LONG TRANSVERSE)	63
13C	TENSILE RESULTS FOR ALUMINUM HAND FORGING (7175-T736) (LONG, ROUND, SHORT TRANSVERSE)	64
13D	TENSILE RESULTS FOR ALUMINUM HAND FORGING (7175-T736) (SHORT, ROUND, SHORT TRANSVERSE)	65
14A	COMPRESSION RESULTS FOR ALUMINUM HAND FORGING (7175-T736) (ROUND, LONGITUDINAL)	69

LIST OF TABLES  
(CONTINUED)

<u>Table</u>		<u>Page</u>
14B	COMPRESSION RESULTS FOR ALUMINUM HAND FORGING (7175-T736) (ROUND, LONG TRANSVERSE)	70
14C	COMPRESSION RESULTS FOR ALUMINUM HAND FORGING (7175-T736) (ROUND, SHORT TRANSVERSE)	71
15A	DOUBLE RIVET SHEAR RESULTS FOR ALUMINUM HAND FORGING (7175-T736)	74
15B	AMSLER DOUBLE SHEAR RESULTS FOR ALUMINUM HAND FORGING (7175-T736)	75
16A	PIN BEARING RESULTS FOR ALUMINUM HAND FORGING (7175-T736) (e/D = 1.5, LONGITUDINAL)	78
16B	PIN BEARING RESULTS FOR ALUMINUM HAND FORGING (7175-T736) (e/D = 1.5, LONG TRANSVERSE)	79
16C	PIN BEARING RESULTS FOR ALUMINUM HAND FORGING (7175-T736) (e/D = 1.5, SHORT TRANSVERSE)	80
16D	PIN BEARING RESULTS FOR ALUMINUM HAND FORGING (7175-T736) (e/D = 2.0, LONGITUDINAL)	81
16E	PIN BEARING RESULTS FOR ALUMINUM HAND FORGING (7175-T736) (e/D = 2.0, LONG TRANSVERSE)	82
16F	PIN BEARING RESULTS FOR ALUMINUM HAND FORGING (7175-T736) (e/D = 2.0, SHORT TRANSVERSE)	83
17A	FATIGUE TEST RESULTS FOR HAND FORGED ALUMINUM (7175-T736) (ROUND, UNNOTCHED, LONGITUDINAL)	89
17B	FATIGUE TEST RESULTS FOR HAND FORGED ALUMINUM (7175-T736) (ROUND, NOTCHED, LONGITUDINAL)	90
17C	FATIGUE TEST RESULTS FOR HAND FORGED ALUMINUM (7175-T736) (ROUND, UNNOTCHED, LONG TRANSVERSE)	91
17D	FATIGUE TEST RESULTS FOR HAND FORGED ALUMINUM (7175-T736) (ROUND, NOTCHED, LONG TRANSVERSE)	92
18	SUMMARY OF MECHANICAL PROPERTIES FOR 7175-T736 ALUMINUM HAND FORGINGS	97

LIST OF TABLES  
(CONCLUDED)

<u>Table</u>		<u>Page</u>
19	CHEMICAL COMPOSITION OF 7050-T736511 ALUMINUM EXTRUSIONS	98
20	TEST GRID FO. 7050-T736511 ALUMINUM EXTRUSION	113
21A	TENSILE RESULTS FOR ALUMINUM EXTRUSION (7050-T736511) (LONG, RECTANGULAR, LONGITUDINAL)	114
21B	TENSILE RESULTS FOR ALUMINUM EXTRUSION (7050-T736511) (LONG, RECTANGULAR, LONG TRANSVERSE)	115
21C	TENSILE RESULTS FOR ALUMINUM EXTRUSION (7050-T736511) (SHORT, ROUND, LONG TRANSVERSE)	116
21D	TENSILE RESULTS FOR ALUMINUM EXTRUSION (7050-T736511) (SHORT, RECTANGULAR, LONG TRANSVERSE)	117
22A	COMPRESSION RESULTS FOR ALUMINUM EXTRUSION (7050-T736511) (RECTANGULAR, LONGITUDINAL)	121
22B	COMPRESSION RESULTS FOR ALUMINUM EXTRUSION (7050-T736511) (RECTANGULAR, LONG TRANSVERSE)	122
23	AMSLER DOUBLE SHEAR RESULTS FOR ALUMINUM EXTRUSION (7050-T736511)	125
24A	PIN BEARING RESULTS FOR ALUMINUM EXTRUSION (7050-T736511) (e/D = 1.5, LONGITUDINAL)	128
24B	PIN BEARING RESULTS FOR ALUMINUM EXTRUSION (7050-T736511) (e/D = 1.5, LONG TRANSVERSE)	129
24C	PIN BEARING RESULTS FOR ALUMINUM EXTRUSION (7050-T736511) (e/D = 2.0, LONGITUDINAL)	130
24D	PIN BEARING RESULTS FOR ALUMINUM EXTRUSION (7050-T736511) (e/D = 2.0, LONG TRANSVERSE)	131
25	SUMMARY OF MECHANICAL PROPERTIES FOR ALUMINUM EXTRUSION 7050-T736511	137

## INTRODUCTION

The properties of a number of materials of interest to the United States Air Force and in particular to the Materials Laboratory at the Air Force Wright Aeronautical Laboratories are contained in Military Handbook 5 (MIL-HDBK-5). Over the years extensive evaluations have provided the basic properties of many aerospace materials. On a continuing basis this data base has been expanded to include not only new materials being considered for aerospace applications but also to supplement the properties of materials presently in the handbook. The purpose of the project reported herein was to determine the effect of various manufacturing processes on the properties of two aluminum alloys and one steel alloy. In particular the materials tested were:

15-5PH (H1050)	steel plate
7175-T736	aluminum hand forging
7050-T736511	aluminum extrusion

A summary of the test results was provided in the data sheets issued earlier and contained in Appendix B.



## TEST PROCEDURE

Where possible, accepted standard test samples and procedures were used in determining the properties of the materials in this program. However, in several instances it was necessary to design test specimens which would conform to the structural shape of the material provided (plate, forging, or extrusion). Prior to testing, the specimen geometry was approved by the contracting agency. The specimen geometries for all tests are contained in Appendix A.

A summary of the test methods used for each of the materials is contained in the following table.

	Stainless Steel 15-5 PH	Aluminum 7175-T736 Hand Forging	Aluminum 7050-T736511 Extrusion
Tensile Tests	ASTM E8-81 Round Rectangular	ASTM E8-81 Round Short Round	ASTM E8-81 Rectangular Short Flat Short Round Tensile
Compression Tests	ASTM E9-77 Rectangular Round	ASTM E9-77 Round	ASTM E9-77 Rectangular
Bearing	ASTM E238-68 Pin Bearing	ASTM E238-68 Pin Bearing	ASTM E238-68 Pin Bearing
Shear	Double Rivet AIAA-ARTC-13-S-1 Tension Single Shear (Sheet) AIAA-ARTC-13-S-1	Double Rivet AIAA-ARTC-13-S-1 Amsler Double Shear	Amsler Double Shear
Fatigue	Notched $K_t=3.0$ Round Flat Unnotched $K_t=1.0$ Round Flat	Notched $K_t=3.0$ Round Flat Unnotched $K_t=1.0$ Round Flat	N.A.

### Tension Tests

The standard E8-81 specimen for sheet type material was utilized for both longitudinal (L) and long transverse (LT) directions. The E8-81 standard 0.50-inch diameter round tensile specimen was used whenever possible for non-sheet material forms. When it was not possible to use this specimen design shorter specimens were used as shown in Appendix A. The tensile ultimate and yield strengths, 0.2-percent offset, elongation, modulus, and reduction in area were measured and calculated using the ASTM specifications.

### Compression Tests

The standard E9-77 specimen (both round and rectangular) were utilized for these tests. The ends of the specimens were ground flat and parallel to within 0.0002 inch to minimize bending and buckling within the specimen. Also, an anti-buckling fixture was utilized, which provided high lateral constraint with minimum axial constraint.

### Bearing Tests

Bearing tests were conducted per the ASTM Standard Method E238-68 (Pin-type Bearing Test of Metallic Materials). Specimens were of various thicknesses and were tested with e/D ratios of 1.5 and 2.0. Results obtained included both bearing yield strength and bearing ultimate strength.

### Shear Tests

The shear test specimen designs were a function of material thickness. For thicknesses less than 0.25 inch (sheet material) the tension-shear pin loaded specimen of AIAA Standard Test Procedure ARTC-13-S-1 was utilized. These were used in testing the Stainless Steel 15-5 PH alloy only. For thicknesses greater than 0.25 inch a pin-type double shear-test specimen was used. Both the pin-type double shear specimen (AIAA ARTC-13-S-1) and the Amsler Pin Shear specimen were tested in this effort to

evaluate potential differences in data generated by each method. The ultimate shear strength is reported for each test.

#### Fatigue Tests

Fatigue tests were conducted for Stainless Steel (15-5 PH) as well as for the Aluminum Hand Forging (7175-T736) in accordance with ASTM E 466-76. No fatigue tests were performed for the Aluminum Extrusion (7050-T736511). Four types of specimens were used; notched and unnotched, round and flat. See Appendix A. The stress concentration for the notched samples was 3.0. Fatigue test frequency did not exceed 30 Hz. The stress ratio (R) for all fatigue tests was 0.1.

15-5PH (H1025)  
PRECIPITATION HARDENING STAINLESS STEEL PLATE

Background

Selected properties of 15-5 PH Condition A (annealed) stainless steel bars, forgings, and rings are available in MIL-Handbook HDBK-5. Since precipitation hardenable stainless steels offer many unique properties such as high transverse-notch-toughness and good forging characteristics it is desirable to expand the data base for the mechanical properties of this material. Good fracture toughness and impact properties are obtained when the H1025 heat treatment is used (hardening treatment at 1025°F, four hours and then air cooled). The 15-5 PH (H1025) stainless steel alloy plates used for this project were received in thicknesses from 0.215 to 2.579 inches, widths varying from 10 to 16 inches, and lengths varying from 35 to 78 inches.

Material Description

The average chemical composition of the 15-5 PH (H1025) tested was as shown in Table 1.

The geometry and heat number of plates used for fabrication of test samples is shown in Table 2. Each plate was heat treated separately to the H1025 condition. It should also be noted that plate number 8 has a larger dimension in the width direction than in the length direction. This alloy was obtained as hot rolled plate that was solution annealed and pickled.

Figures 1a thru 1f shows the layout of the specimens in each of the plates. Figures 1c thru 1f are for plates 6 through 9 respectively. Samples were taken from two planes in plates 8 and 9 and require auxiliary views to show the specimens in two layers.

Specimen Numbering Sequence

A sample specimen numbering sequence is shown as follows:

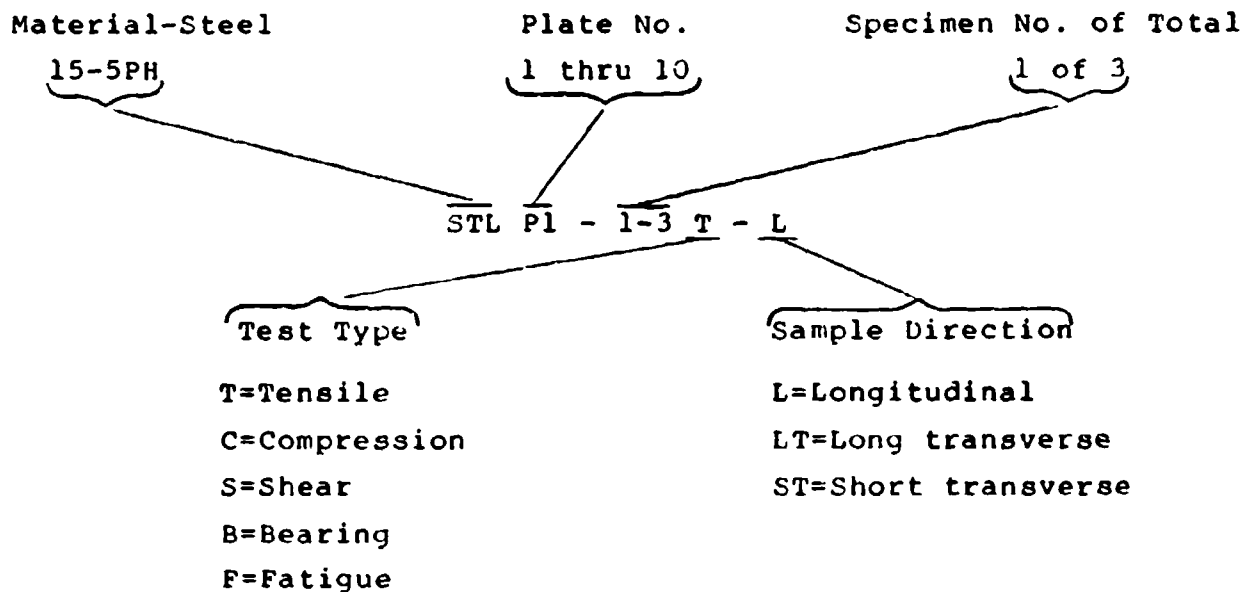

TABLE 1

## CHEMICAL COMPOSITION OF 15-5 PH (H 1025) STAINLESS STEEL

<u>Chemical Composition</u>	<u>Percent Weight</u>
Carbon	0.037
Manganese	0.32
Phosphorus	0.023
Sulfur	0.004
Silicon	0.43
Chromium	14.59
Nickel	4.73
Copper	3.27
Columbium	0.23
Tantalum	0.01
Iron	Balance

Thus the specimen shown is for 15-5 PH steel taken from plate 1, it is the first of three tensile samples in the longitudinal direction. Table 3 shows the test matrix for the 15-5 PH stainless steel.

Test Results

Tension, compression, shear, bearing, and fatigue tests were performed on this material. The results from these tests are reported in the following paragraphs and the associated tables

and figures. Appendix A contains the specimen geometries for each of the test types performed. Data sheets generated during the source of this program are in Appendix B.

Tension. The results of the tensile tests are presented in Table 4. Table 4a shows the tensile properties for samples in the longitudinal direction obtained from rectangular specimens. Tables 4b thru 4d contain the results from long transverse-rectangular, longitudinal-round, and long transverse-round specimens. A typical stress-strain curve for this material is shown in Figure 2. Figures 3 and 4 show graphically the tensile ultimate and tensile yield stress as a function of plate thickness range. The data points in Figures 3 and 4 were taken from the condensed data of Table 9. This table provides the mechanical properties for ranges of plate thickness. Thus, the data points of mechanical property as a function of thickness are plotted for thickness "brackets" of 0.2 inch to 0.6 inch, 0.6 to 1.0 inch, 2.0 to 2.5 inches, and 2.5 to 3.0 inches. For example, the data points in Figure 3 for  $F_{tu}$  of 172 ksi at a thickness of approximately 0.4 inch represents the range of specimens having plate thicknesses of 0.215 inch, 0.269 inch, 0.277 inch, 0.394 inch and 0.524 inch. The remaining figures in this section which provide mechanical property data as a function of plate thickness are also provided for the same ranges on "brackets".

Compression. Table 5 contains the yield strength and compression modulus results from compression tests on the 15-5PH (H1025). Tables 5a thru 5e are for compressive samples that are rectangular-longitudinal, rectangular-long transverse, round-longitudinal, round-long transverse, and round-short transverse. Figure 5 is a typical stress-strain curve for this material in compression. Figure 6 shows the compressive yield stress for various plate thickness ranges.

Shear. Two different specimen geometries were used to determine the shear properties of 15-5PH (H1025). Shear results were obtained from the pin-type double shear specimen (83-EDD-A-062 in Appendix A). The results for this specimen are shown in

Table 6a. Table 6b provides the results of the shear testing for the tension single-shear type specimens (Drawing No. 83-EDD-A-068 in Appendix A). A graphical representation of ultimate shear stress as a function of plate thickness range is shown in Figure 7.

Bearing. Pin-bearing test results are reported for  $e/D$  of 1.5 and 2.0 in Table 7. The ratio of the distance between the centerline of the hole in the bearing specimen (83-EDD-A-065 in Appendix A) and the edge of the specimen ( $e$ ) to the diameter of the bearing hole ( $D$ ) is  $e/D$ . Tables 7a and 7b present the results for an  $e/D=1.5$  for longitudinal and long transverse grain orientations. Tables 7c and 7d are for an  $e/D$  of 2.0. A typical stress-strain curve is shown in Figure 8. Figures 9a through 9d present bearing ultimate and bearing yield respectively as a function of plate thickness range and the  $e/D$  ratio.

Fatigue. Axial load fatigue tests were performed at room temperature to determine the number of cycles to failure at a given maximum stress. The ratio ( $R$ ) of minimum to maximum stress was 0.1. Both notched and unnotched specimens were tested. Tables 8a through 8f present the results for fatigue tests conducted using round and flat samples. Figures 10 through 13 depict SN curves of the axial load fatigue data for notched ( $K_t=3.0$ ) and unnotched ( $K_t=1.0$ ) in both longitudinal and long transverse grain orientations. Note the large scatter band formed can be directly related to original plate thickness.

#### Summary of Mechanical Properties

Curves for each of the above material properties (tension, compression, etc.) as a function of plate thickness range have been presented. These results are summarized in Table 9 which provide mechanical properties in the plate thickness ranges shown. In general, the properties are greater for the thinner and thicker plates but there is not a significant deviation.

TABLE 2

GEOMETRY AND HEAT NUMBER FOR 15-5PH (H 1025)  
STAINLESS STEEL PLATES

Plate Number	Heat Number	Plate Thickness (inches)	Width (inches)	Length (inches)
1	7B11-1FA1	0.215	10	64
2	B159-4DB1	0.277	10	36
3	8B110-2F1	0.394	10	49
4*	8B110-2F1	0.394	10	49
5	A496-411	0.524	10	78
6	2B005-211	0.808	10	59
7*	2B005-211	0.808	10	59
8	7B241-1B1	2.024	10	61
9	0B113-4C1	2.579	35	16
10	8A782-2F	0.269	12	60

\*Heat treated separately



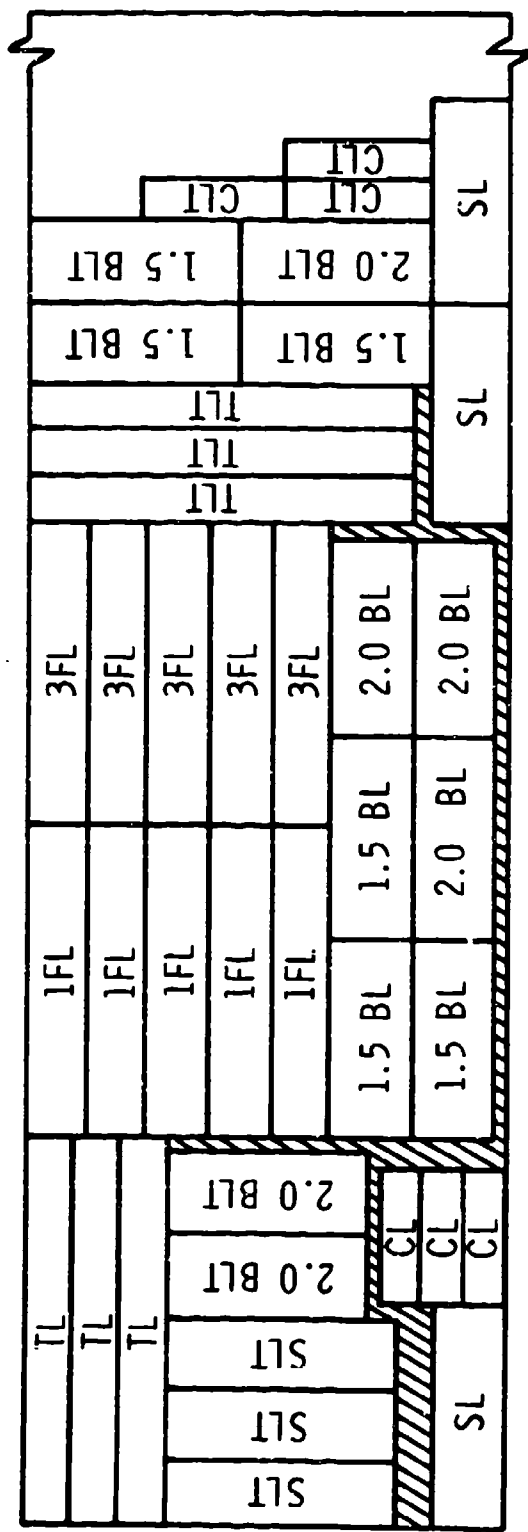

	MATERIAL	15-5PH
PLATE 1	HEAT NO.	7B110-1FA1
	THICKNESS	0.215"
PLATE 10	HEAT NO.	8A782-2F
	THICKNESS	0.269"

Figure 1a. Specimen Layout for Plates 1 and 10.

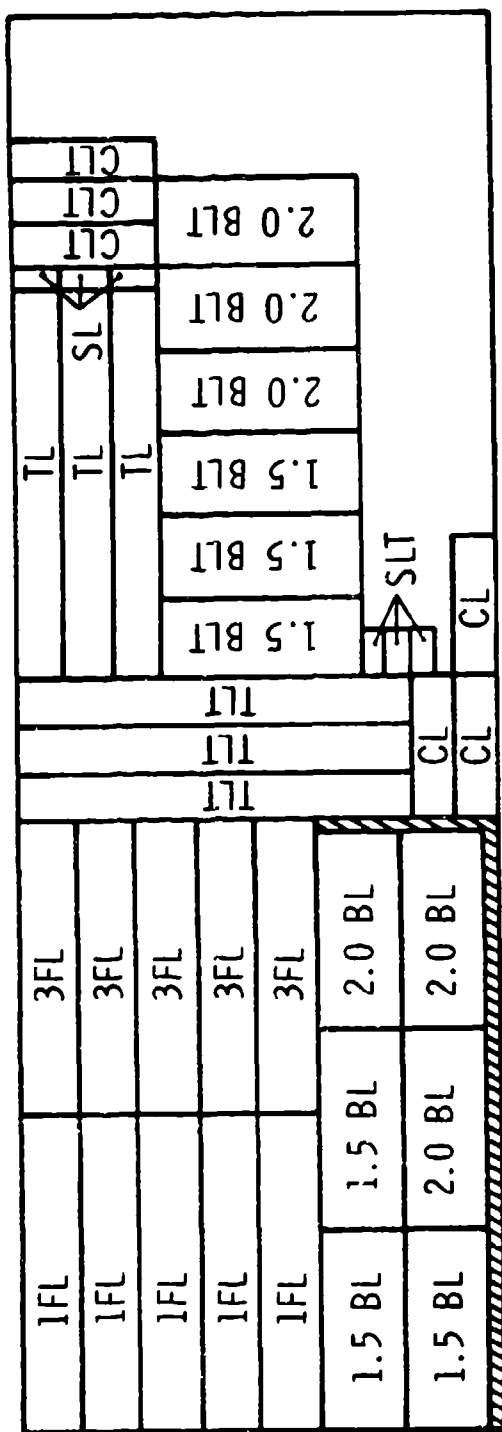

	MATERIAL	15-5PH
PLATE 2	HEAT NO.	0B159-40B1
	THICKNESS	0.277
PLATE 3	HEAT NO.	8B110-2F1
	THICKNESS	0.394
PLATE 4	HEAT NO.	8B110-2F1
	THICKNESS	0.394
PLATE 5	HEAT NO.	0A496-411
	THICKNESS	0.524

Figure 1b. Specimen Layout for Plates 2 through 5.

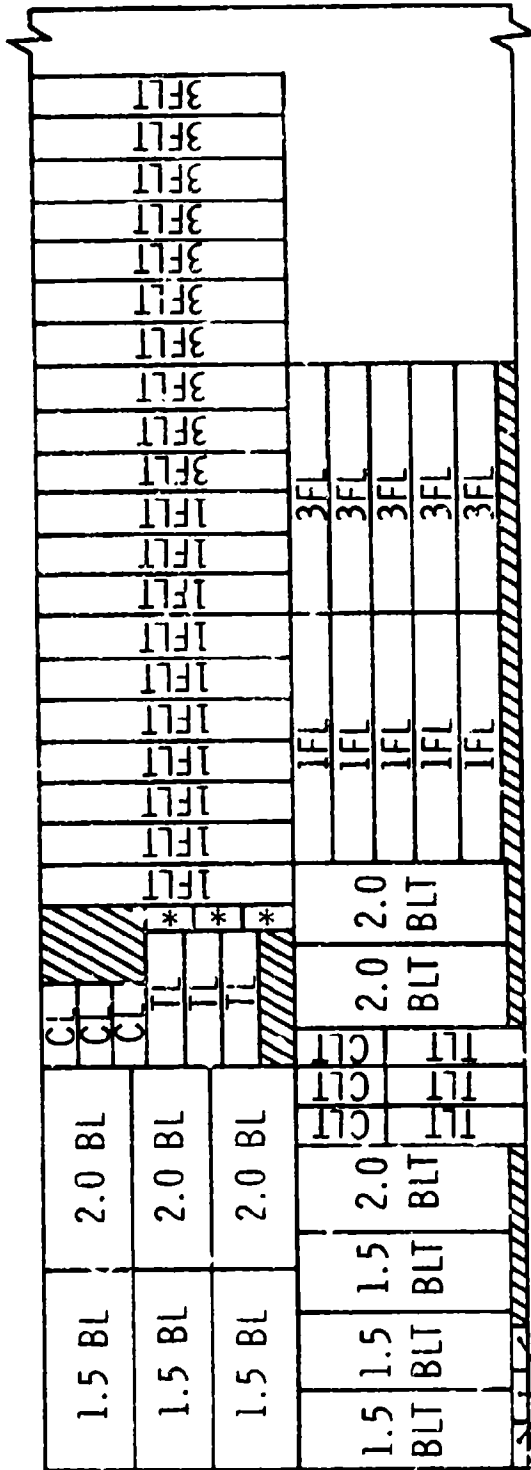

MATERIAL 15-5PH  
 HEAT NO. 2B005-211  
 THICKNESS 0.808"

Figure 1c. Specimen Layout for Plate 6.

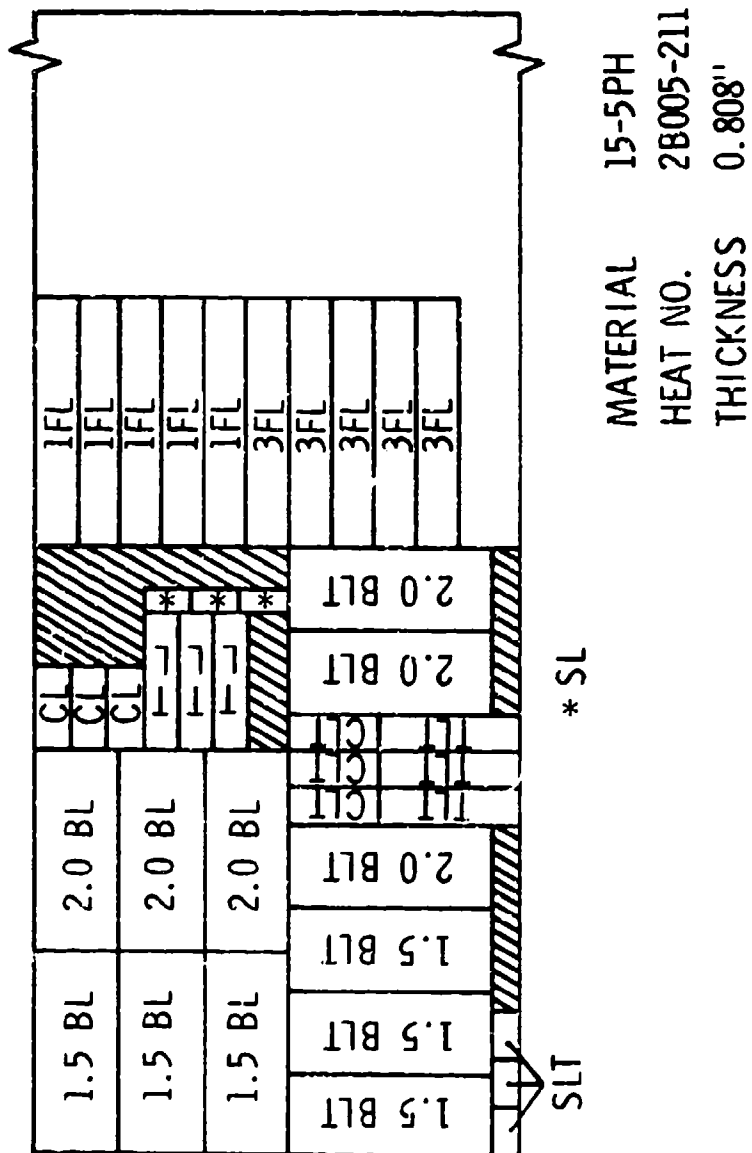

Figure 1d. Specimen Layout for Plate 7.

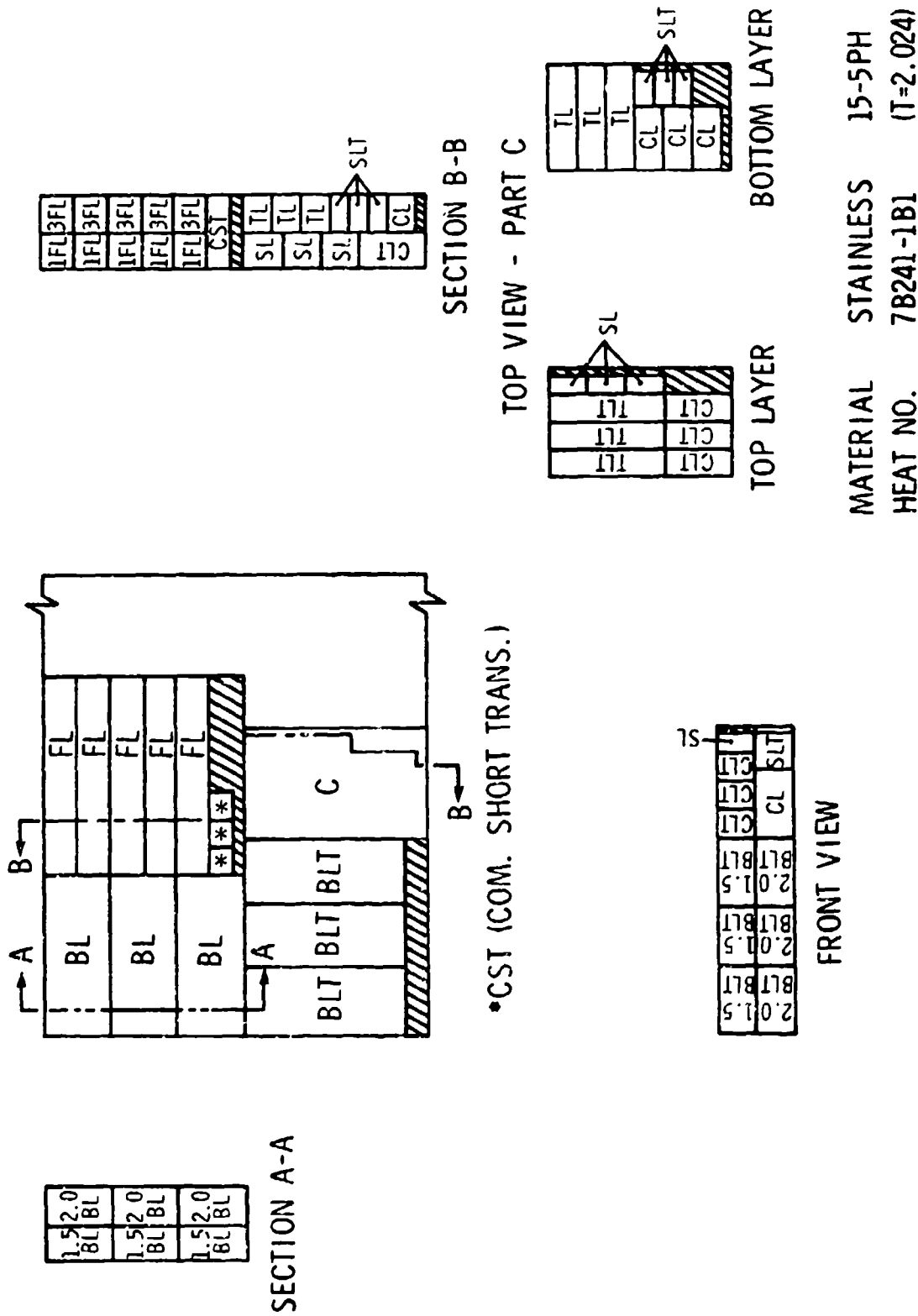

Figure 1e. Specimen Layout for Plate 8.

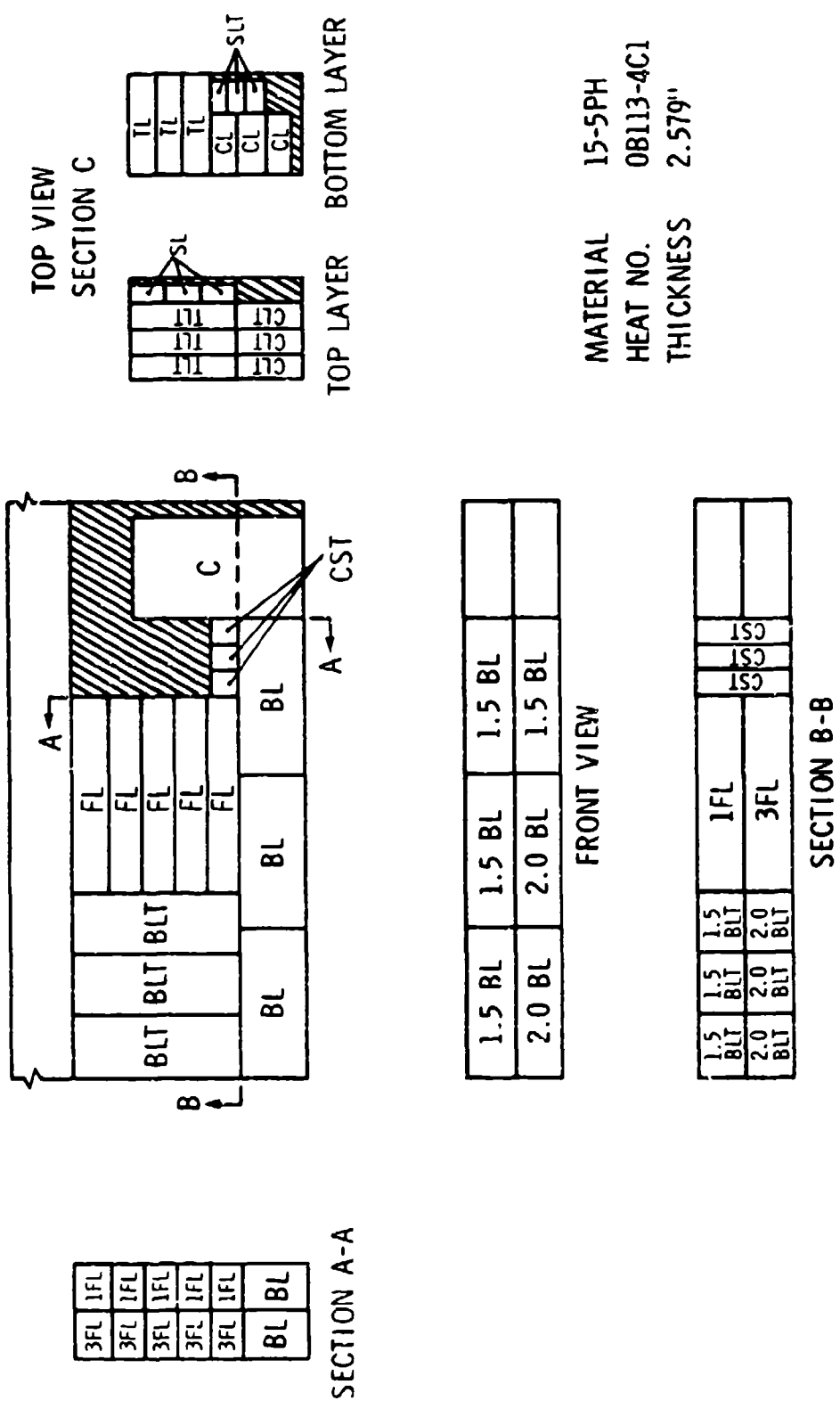

Figure 1f. Specimen Layout for Plate 9.

TABLE 3  
TEST GRID FOR 15-5 PH STAINLESS STEEL

PLATE NUMBER	1	2	3	4	5	6	7	8	9	10
HEAT	78110- 1FAL	08159- 4DB1	08110- 2F1	08110- 2F1	0A496- 411	28005- 211	28005- 211	78241- 1B1	08113- 4C1	8A782- 2F
PLATE THICKNESS in (mm)	0.215 (5.46)	0.277 (7.04)	0.394 (10.0)	0.394 (10.0)	0.524 (13.3)	0.608 (20.5)	0.608 (20.5)	2.024 (51.4)	2.579 (65.5)	0.269 (6.83)
TENSION	Sheet (L) Sheet (LT) Round (L) Round (LT)	3 3 3 3	3 3 3 3	3 3 3 3	3 3 3 3	3 3 3 3	3 3 3 3	3 3 3 3	3 3 3 3	3 3 3 3
COMPRESSION	Rectangular (L) Rectangular (LT) Round (L) Round (LT) Round (ST)	3 3 3 3 3	3 3 3 3 3	3 3 3 3 3	3 3 3 3 3	3 3 3 3 3	3 3 3 3 3	3 3 3 3 3	3 3 3 3 3	3 3 3 3 3
SHEAR	Pin Shear (L) Pin Shear (LT) Tension (L) Tension (LT)	3 3 3 3	3 3 3 3	3 3 3 3	3 3 3 3	3 3 3 3	3 3 3 3	3 3 3 3	3 3 3 3	3 3 3 3
BEARING	e/D = 1.5 Pin Bearing (L) Pin Bearing (LT) e/D = 1.5 Pin Bearing (L) Pin Bearing (LT)	3 3 3 3 3	3 3 3 3 3	3 3 3 3 3	3 3 3 3 3	3 3 3 3 3	3 3 3 3 3	3 3 3 3 3	3 3 3 3 3	3 3 3 3 3
FATIGUE	Unnotched Flat (L) Unnotched Round (L) Unnotched Round (LT) Notched Flat (L) Notched Round (L) Notched Round (LT)	5 5 5 5 5 5	5 5 5 5 5 5	5 5 5 5 5 5	5 5 5 5 5 5	5 5 5 5 5 5	5 5 5 5 5 5	5 5 5 5 5 5	5 5 5 5 5 5	5 5 5 5 5 5

TABLE 4A

TENSILE TEST RESULTS FOR 105 (H 1025)  
(RECTANGULAR - LONG L)

SPECIMEN ID.	ULTIMATE TENSILE STRENGTH Ksi (MPa)	0.2 PERCENT OFFSET YIELD STRENGTH Ksi (MPa)	ELONG. IN 2 IN. (50.8) PERCENT	REDUCT. IN AREA PERCENT	TENSILE MODULUS Ksi (GPa)
<u>LONG, RECTANGULAR, LONGITUDINAL</u>					
STLP1-1-3T-L	173.4 (1196)	165.4 (1141)	11.62	58.60	27540 (189.9)
STLP1-2-3T-L	173.2 (1194)	166.4 (1147)	12.42	52.75	30470 (210.1)
STLP1-3-3T-L	173.0 (1193)	166.8 (1150)	11.65	51.35	28820 (198.6)
STLP2-1-3T-L	174.0 (1200)	168.4 (1161)	12.25	51.37	28670 (197.7)
STLP2-2-3T-L	172.2 (1187)	167.2 (1153)	11.75	52.91	29340 (202.3)
STLP2-3-3T-L	173.1 (1194)	168.2 (1160)	12.05	51.61	28570 (197.0)
STLP3-1-3T-L	176.4 (1216)	168.7 (1163)	16.55	58.87	28240 (194.7)
STLP3-2-3T-L	176.2 (1215)	166.6 (1149)	16.25	57.59	29020 (200.1)
STLP3-3-3T-L	176.7 (1218)	168.3 (1160)	16.00	55.27	28390 (195.7)
STLP4-1-3T-L	178.5 (1231)	170.5 (1176)	16.10	56.34	28010 (193.1)
STLP4-2-3T-L	178.2 (1229)	170.3 (1174)	16.25	55.35	28340 (195.4)
STLP4-3-3T-L	178.2 (1229)	170.2 (1173)	15.85	55.86	28570 (197.0)
STLP5-1-3T-L	165.8 (1143)	161.7 (1115)	18.40	63.63	28480 (196.4)
STLP5-2-3T-L	166.0 (1145)	161.0 (1110)	18.50	62.87	28300 (195.1)
STLP5-3-3T-L	165.1 (1139)	161.7 (1115)	18.75	62.51	28980 (199.8)
STLP10-1-3T-L	163.4 (1126)	158.9 (1095)	14.82	57.30	29360 (202.4)
STLP10-2-3T-L	163.6 (1128)	159.2 (1098)	14.72	57.80	29590 (204.0)
STLP10-3-3T-L	163.2 (1125)	158.9 (1095)	14.49	57.84	29090 (200.6)
AVERAGE	171.7 (1184)	165.5 (1141)	14.91	56.12	28760 (198.3)



TABLE 4B

TENSILE TEST RESULTS FOR 15-5PH (H 1025)  
(ROUND - LONGITUDINAL)

SPECIMEN ID.	ULTIMATE TENSILE STRENGTH Ksi (MPa)	0.2 PERCENT OFFSET YIELD STRENGTH Ksi (MPa)	ELONG. IN 2.0 IN. ( 50.8 mm) PERCENT	REDUCT. IN AREA PERCENT	TENSILE MODULUS Ksi (GPa)
<u>LONG, ROUND, LONGITUDINAL</u>					
STLP6-1-3T-L	169.0 (1166)	165.7 (1143)	16.25	65.87	28870 (199.1)
STLP6-2-3T-L	169.0 (1166)	165.7 (1143)	15.75	64.93	28910 (199.3)
STLP6-3-3T-L	168.5 (1162)	164.8 (1136)	15.75	65.47	28780 (198.5)
STLP7-1-3T-L	168.9 (1165)	164.6 (1135)	15.15	63.98	28500 (196.5)
STLP7-2-3T-L	168.3 (1161)	164.3 (1133)	15.70	64.29	27720 (191.1)
STLP7-3-3T-L	168.3 (1161)	164.6 (1135)	15.75	64.29	28150 (194.1)
STLP8-1-3T-L	168.6 (1162)	163.9 (1130)	14.85	59.87	28870 (199.1)
STLP8-2-3T-L	168.3 (1161)	163.6 (1128)	15.00	59.62	28280 (195.0)
STLP8-3-3T-L	169.2 (1167)	164.5 (1134)	14.40	58.78	28340 (195.4)
STLP9-1-3T-L	173.0 (1193)	168.6 (1162)	14.55	60.38	28250 (194.8)
STLP9-2-3T-L	174.2 (1201)	169.8 (1171)	14.20	58.53	28780 (198.4)
STLP9-3-3T-L	173.0 (1193)	168.3 (1161)	14.40	59.37	28810 (198.6)
AVERAGE	169.9 (1172)	165.7 (1143)	15.15	62.12	28520 (196.7)

TABLE 4C

TENSILE TEST RESULTS FOR 15-5PH (H 1025)  
(RECTANGULAR - LONG TRANSVERSE)

SPECIMEN ID.	ULTIMATE TENSILE STRENGTH Ksi (MPa)	0.2 PERCENT OFFSET YIELD STRENGTH Ksi (MPa)	ELONG. IN 2 IN. (50.8) PERCENT	REDUCT. IN AREA PERCENT	TENSILE MODULUS Ksi (GPa)
<u>LONG, RECTANGULAR, LONG TRANSVERSE</u>					
STLP1-1-3T-LT	176.0 (1214)	169.6 (1169)	11.16	52.59	28760 (198.3)
STLP1-2-3T-LT	176.4 (1217)	169.1 (1166)	12.00	52.83	28480 (196.3)
STLP1-3-3T-LT	174.9 (1206)	168.2 (1159)	11.51	43.17	28700 (197.9)
STLP2-1-3T-LT	175.1 (1207)	170.9 (1178)	13.07	53.21	29320 (202.1)
STLP2-2-3T-LT	174.6 (1204)	169.0 (1165)	12.77	53.69	29170 (201.1)
STLP2-3-3T-LT	175.4 (1209)	169.9 (1171)	12.84	52.90	28630 (197.4)
STLP3-1-3T-LT	174.3 (1202)	167.5 (1155)	14.75	68.82	28310 (195.2)
STLP3-2-3T-LT	173.8 (1199)	165.7 (1142)	17.10	59.31	28640 (197.4)
STLP3-3-3T-LT	173.8 (1199)	166.7 (1149)	16.85	59.24	28730 (198.1)
STLP4-1-3T-LT	177.6 (1225)	169.3 (1167)	17.15	56.61	28620 (197.3)
STLP4-2-3T-LT	178.6 (1231)	169.3 (1167)	16.65	57.81	28260 (194.8)
STLP4-3-3T-LT	178.3 (1230)	169.7 (1170)	17.10	56.65	28520 (196.7)
STLP5-1-3T-LT	166.1 (1145)	162.0 (1117)	17.80	58.34	28720 (198.0)
STLP5-2-3T-LT	165.0 (1137)	160.5 (1107)	17.50	58.67	29500 (203.4)
STLP5-3-3T-LT	165.7 (1143)	161.5 (1114)	17.30	59.64	28610 (197.3)
STLP10-1-3T-LT	164.7 (1136)	159.6 (1101)	13.55	48.28	29080 (200.5)
STLP10-2-3T-LT	164.9 (1137)	160.4 (1106)	12.05	48.97	28790 (198.5)
STLP10-3-3T-LT	164.6 (1135)	159.6 (1101)	13.60	50.05	28920 (199.4)
AVERAGE	172.2 (1188)	166.0 (1145)	14.71	55.04	28760 (198.3)

TABLE 4D

TENSILE TEST RESULTS FOR 15-5PH (H 1025)  
(ROUND - LONG TRANSVERSE)

SPECIMEN ID.	ULTIMATE TENSILE STRENGTH Ksi (MPa)	0.2 PERCENT OFFSET YIELD STRENGTH Ksi (MPa)	ELONG. IN 2.0 IN. ( 50.8 mm) PERCENT	REDUCT. IN AREA PERCENT	TENSILE MODULUS Ksi (GPa)
LONG, ROUND, LONG TRANSVERSE					
STLP6-1-3T-LT	168.9 (1164)	165.3 (1140)	15.40	65.09	28630 (197.4)
STLP6-2-3T-LT	168.9 (1164)	165.8 (1143)	15.80	65.33	29010 (200.0)
STLP6-3-3T-LT	169.1 (1166)	165.3 (1140)	15.60	64.38	29050 (200.3)
STLP7-1-3T-LT	168.6 (1163)	165.5 (1141)	15.80	64.38	28170 (194.3)
STLP7-2-3T-LT	168.5 (1162)	165.2 (1139)	15.40	61.96	29320 (202.2)
STLP7-3-3T-LT	168.3 (1160)	164.6 (1135)	15.70	64.69	28440 (196.1)
STLP8-1-3T-LT	169.3 (1167)	164.9 (1137)	14.85	60.50	28560 (196.9)
STLP8-2-3T-LT	169.3 (1167)	164.7 (1135)	14.52	59.84	27890 (192.3)
STLP8-3-3T-LT	169.5 (1169)	164.5 (1135)	15.20	60.47	28630 (197.4)
STLP9-1-3T-LT	174.2 (1201)	169.0 (1165)	13.97	57.01	28970 (199.7)
STLP9-2-3T-LT	174.2 (1201)	170.0 (1172)	14.05	55.64	28520 (196.6)
STLP9-3-3T-LT	173.8 (1199)	168.9 (1164)	14.17	57.66	28700 (197.9)
AVERAGE	170.2 (1174)	166.1 (1146)	15.04	61.41	28660 (197.6)

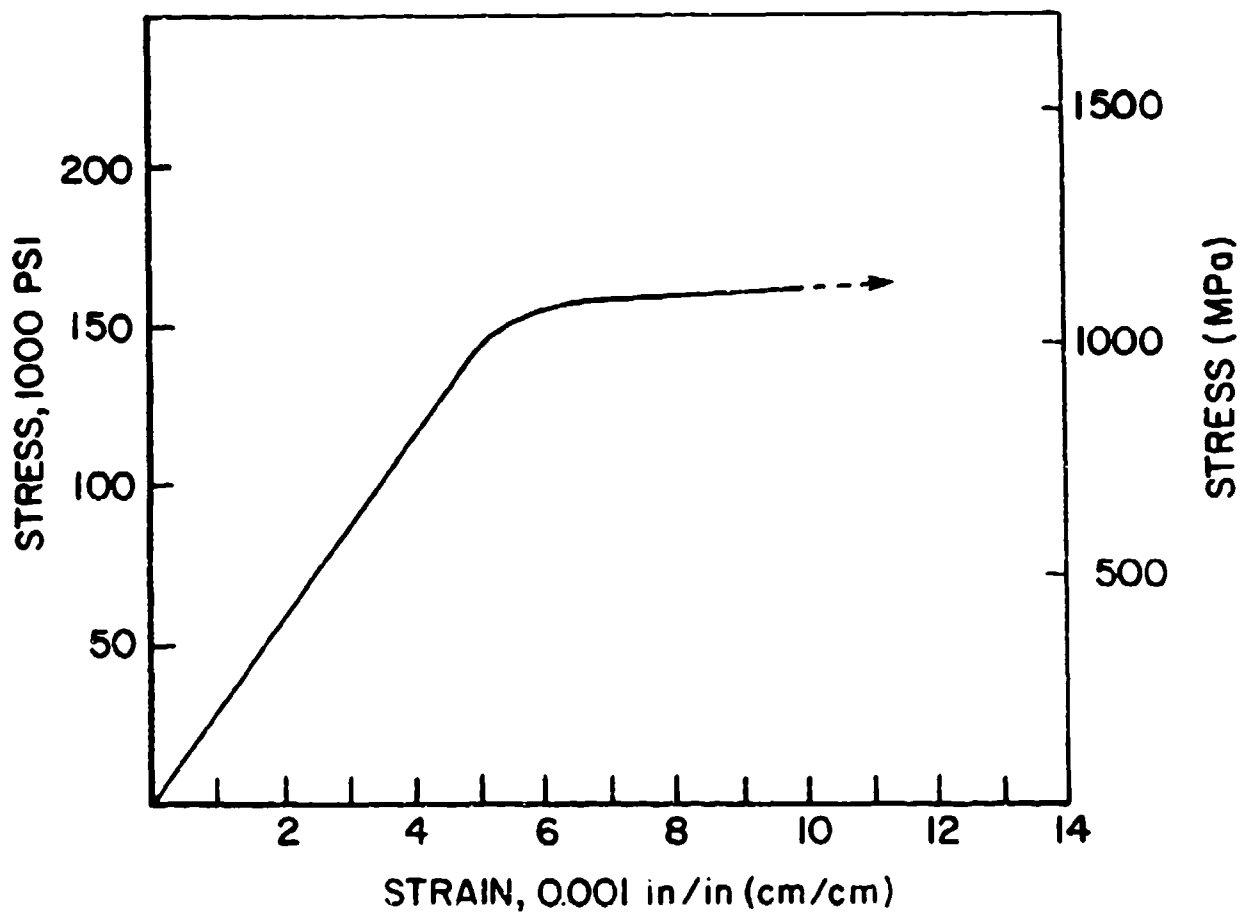

Figure 2. Typical Stress Strain Curve in Tension at Room Temperature for 15-5PH (H1025).

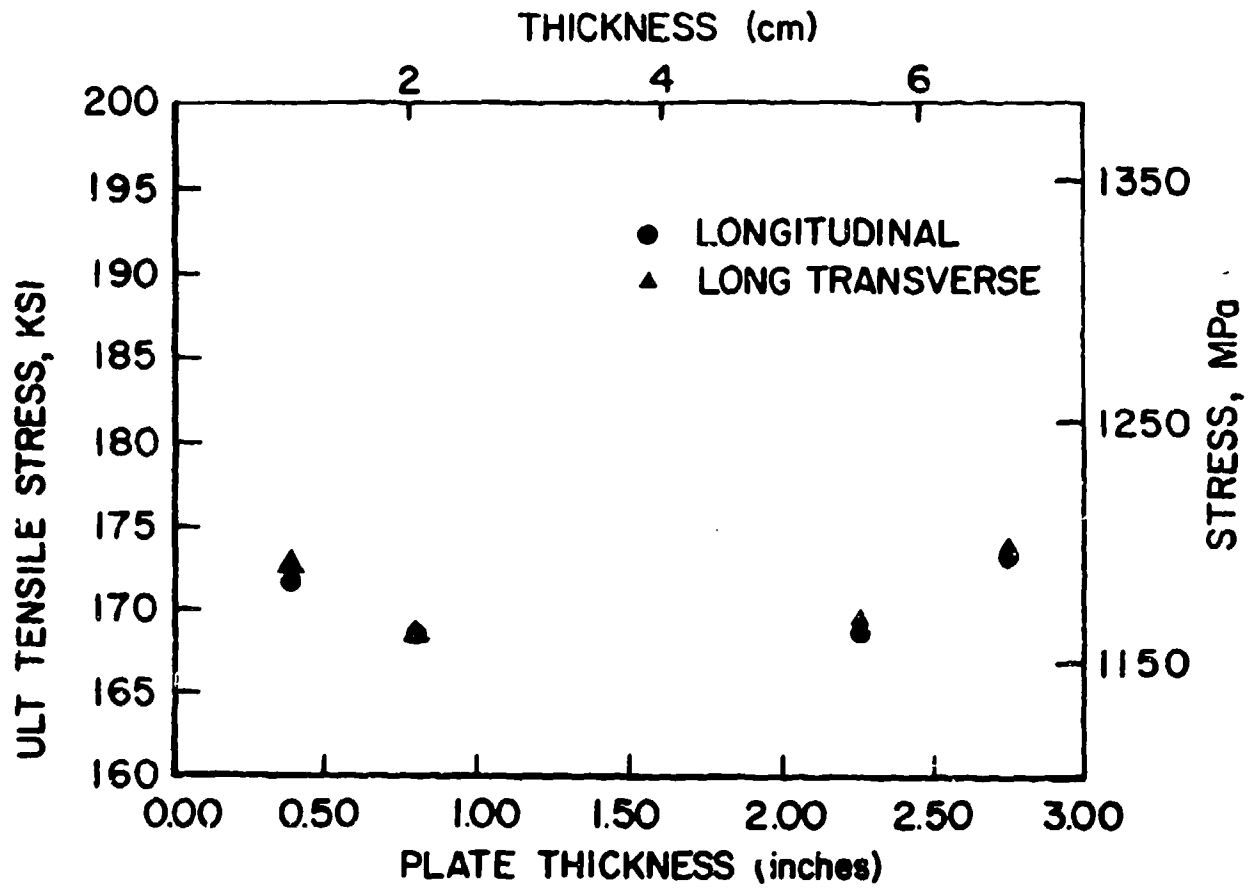

Figure 3. Tensile Ultimate Stress as a Function of Plate Thickness Range for 15-5PH.

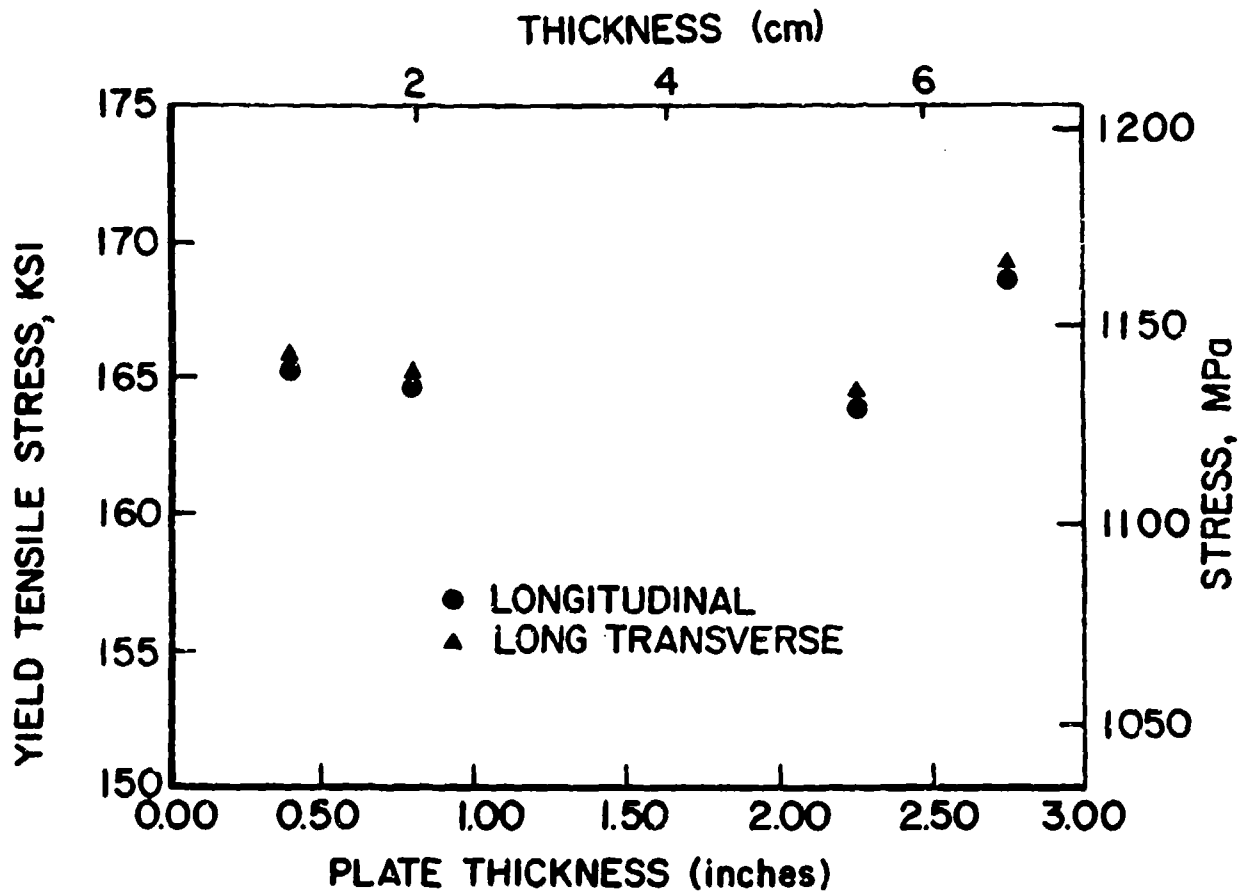

Figure 4. Tensile Yield Stress as a Function of Plate Thickness for Various Plate Thicknesses for 15-5PH.

TABLE 5A

COMPRESSION TEST RESULTS FOR 15-5PH (H 1025)  
(RECTANGULAR, LONGITUDINAL)

SPECIMEN IDENTIFICATION	0.2 PERCENT OFFSET YIELD STRENGTH		COMPRESSIVE MODULUS	
	Ksi	(MPa)	Ksi	(GPa)
	<u>RECTANGULAR, LONGITUDINAL</u>			
STLP1-1-3C-L	179.7	(1239)	29750	(205.1)
STLP1-2-3C-L	174.2	(1201)	29940	(206.5)
STLP1-3-3C-L	180.2	(1243)	29220	(201.5)
STLP2-1-3C-L	183.3	(1264)	28730	(198.1)
STLP2-2-3C-L	183.5	(1265)	29990	(206.8)
STLP2-3-3C-L	184.3	(1271)	30680	(211.5)
STLP3-1-3C-L	182.3	(1257)	30260	(208.7)
STLP3-2-3C-L	178.4	(1230)	29700	(204.8)
STLP3-3-3C-L	179.6	(1239)	29490	(203.3)
STLP4-1-3C-L	182.3	(1257)	30500	(210.3)
STLP4-2-3C-L	183.6	(1266)	30520	(210.4)
STLP4-3-3C-L	181.8	(1254)	29100	(200.6)
STLP10-1-3C-L	168.1	(1159)	28920	(199.4)
STLP10-2-3C-L	168.4	(1161)	30310	(209.0)
STLP10-3-3C-L	167.5	(1155)	29340	(202.3)
AVERAGE	178.5	(1231)	29760	(205.2)

TABLE 5B  
 COMPRESSION TEST RESULTS FOR 15-5PH (H 1025)  
 (ROUND, LONGITUDINAL)

SPECIMEN IDENTIFICATION	0.2 PERCENT OFFSET YIELD STRENGTH	COMPRESSIVE MODULUS
	Ksi (MPa)	Ksi (GPa)
<u>ROUND, LONGITUDINAL</u>		
STLP6-1-3C-L	171.8 (1185)	30150 (207.9)
STLP6-2-3C-L	174.1 (1200)	30980 (213.6)
STLP6-3-3C-L	174.4 (1203)	29840 (205.8)
STLP7-1-3C-L	172.6 (1190)	30640 (211.3)
STLP7-2-3C-L	173.2 (1195)	29830 (205.7)
STLP7-3-3C-L	173.3 (1195)	29630 (204.3)
STLP8-1-3C-L	173.1 (1194)	30280 (208.8)
STLP8-2-3C-L	173.7 (1198)	30160 (208.0)
STLP8-3-3C-L	174.1 (1200)	29650 (204.4)
STLP9-1-3C-L	175.4 (1210)	30210 (208.3)
STLP9-2-3C-L	174.9 (1206)	29430 (202.9)
STLP9-3-3C-L	174.1 (1201)	29290 (201.3)
AVERAGE	173.7 (1198)	30010 (206.9)



TABLE 5C

COMPRESSION TEST RESULTS FOR 15-5PH (H 1025)  
(RECTANGULAR, LONG TRANSVERSE)

SPECIMEN IDENTIFICATION	0.2 PERCENT OFFSET YIELD STRENGTH		COMPRESSIVE MODULUS	
	Ksi	(MPa)	Ksi	(GPa)
<u>RECTANGULAR, LONG TRANSVERSE</u>				
STLP1-1-3C-LT	178.3	(1230)	30510	(210.3)
STLP1-2-3C-LT	179.6	(1238)	30560	(210.7)
STLP1-3-3C-LT	178.3	(1229)	30180	(208.1)
STLP2-1-3C-LT	182.2	(1256)	29240	(201.6)
STLP2-2-3C-LT	181.3	(1250)	29690	(204.7)
STLP2-3-3C-LT	176.5	(1217)	29900	(206.1)
STLP3-1-3C-LT	182.2	(1257)	29290	(202.0)
STLP3-2-3C-LT	179.7	(1239)	29340	(202.3)
STLP3-3-3C-LT	182.2	(1256)	29230	(201.6)
STLP4-1-3C-LT	176.9	(1220)	29690	(197.8)
STLP4-2-3C-LT	181.1	(1248)	29520	(203.5)
STLP4-3-3C-LT	179.5	(1238)	30400	(209.6)
STLP5-1-3C-LT	169.7	(1170)	30400	(209.6)
STLP5-2-3C-LT	170.4	(1175)	30250	(208.6)
STLP5-3-3C-LT	169.8	(1171)	30140	(207.8)
STLP10-1-3C-LT	169.7	(1170)	30100	(207.5)
STLP10-2-3C-LT	170.1	(1173)	29790	(205.4)
STLP10-3-3C-LT	170.2	(1174)	29830	(205.4)
AVERAGE	176.5	(1217)	29840	(205.7)

TABLE 5D

COMPRESSION TEST RESULTS FOR 15-5PH (H1025)  
(ROUND, LONG TRANSVERSE)

SPECIMEN IDENTIFICATION	0.2 PERCENT OFFSET YIELD STRENGTH		COMPRESSIVE MODULUS	
	Ksi	(MPa)	Ksi	(GPa)
	<u>ROUND, LONG TRANSVERSE</u>			
STLP6-1-3C-LT	174.6	(1204)	29830	(205.7)
STLP6-2-3C-LT	173.4	(1196)	29690	(204.7)
STLP6-3-3C-LT	174.5	(1203)	29370	(202.5)
STLP7-1-3C-LT	171.9	(1185)	29930	(206.3)
STLP7-2-3C-LT	172.9	(1192)	29940	(206.5)
STLP7-3-3C-LT	172.1	(1186)	29460	(203.1)
STLP8-1-3C-LT	172.4	(1188)	30180	(208.1)
STLP8-2-3C-LT	172.1	(1187)	29900	(206.2)
STLP8-3-3C-LT	173.4	(1196)	29880	(206.0)
STLP9-1-3C-LT	175.1	(1207)	29580	(204.0)
STLP9-2-3C-LT	175.4	(1210)	30100	(207.6)
STLP9-3-3C-LT	175.4	(1210)	30060	(207.3)
AVERAGE	173.6	(1197)	29830	(205.7)

TABLE 5E

COMPRESSION TEST RESULTS 15-5PH (1025)  
(ROUND, SHORT TRANSVERS)

SPECIMEN IDENTIFICATION	0.2 PERCENT OFFSET YIELD STRENGTH	COMPRESSIVE MODULUS
	Ksi (MPa)	Ksi (GPa)
	<u>ROUND, SHORT TRANSVERSE</u>	
STLP8-1-3C-ST	173.4 (1196)	30240 (208.5)
STLP8-2-3C-ST	172.7 (1191)	30340 (209.2)
STLP8-3-3C-ST	173.1 (1194)	30160 (207.9)
STLP9-1-3C-ST	176.4 (1216)	29700 (204.8)
STLP9-2-3C-ST	177.3 (1222)	30170 (208.0)
STLP9-3-3C-ST	176.3 (1216)	29500 (204.0)
AVERAGE	174.9 (1206)	30030 (207.1)

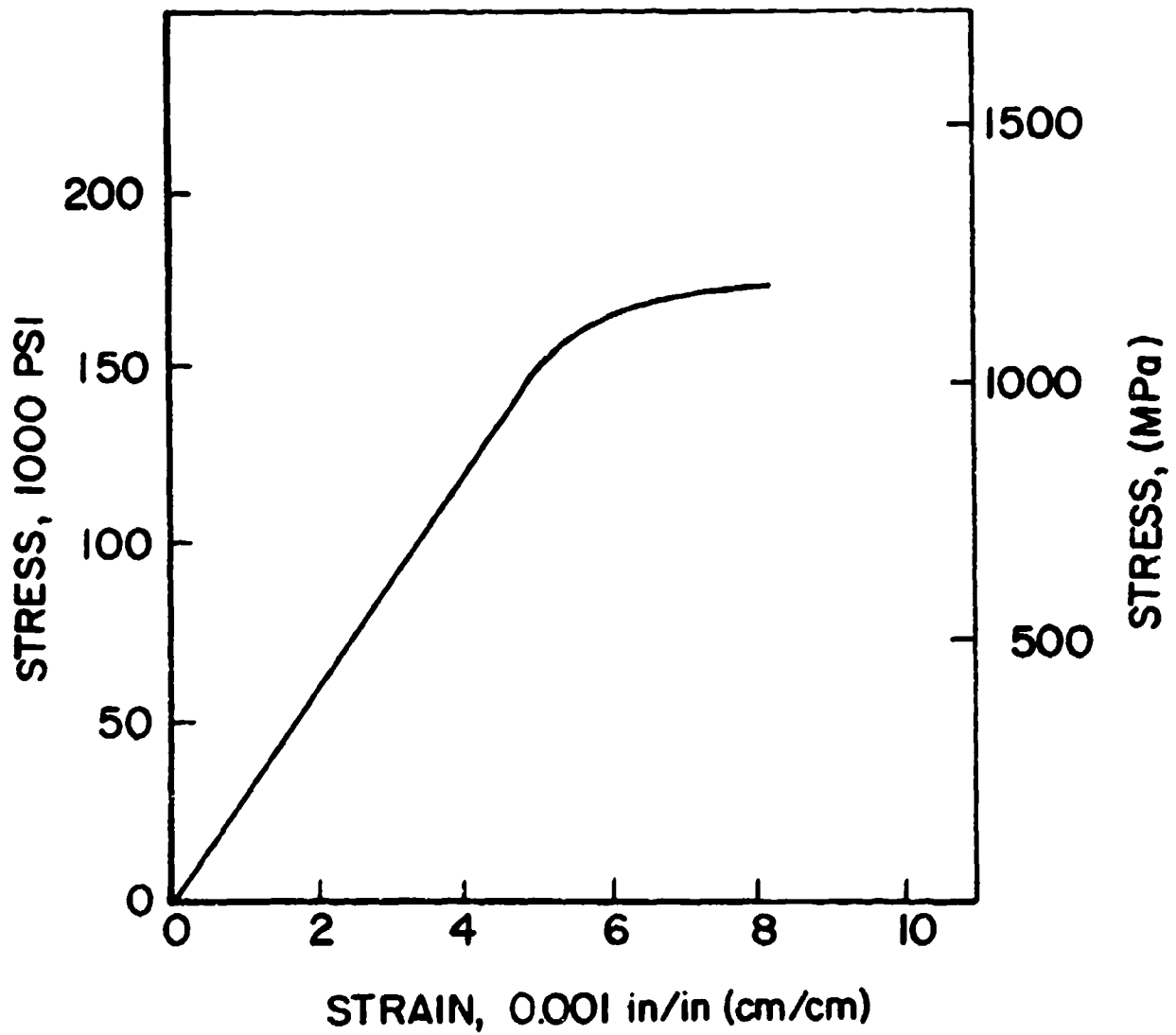

Figure 5. Typical Stress Strain Curve in Compression at Room Temperature for 15-5PH (H 1025).

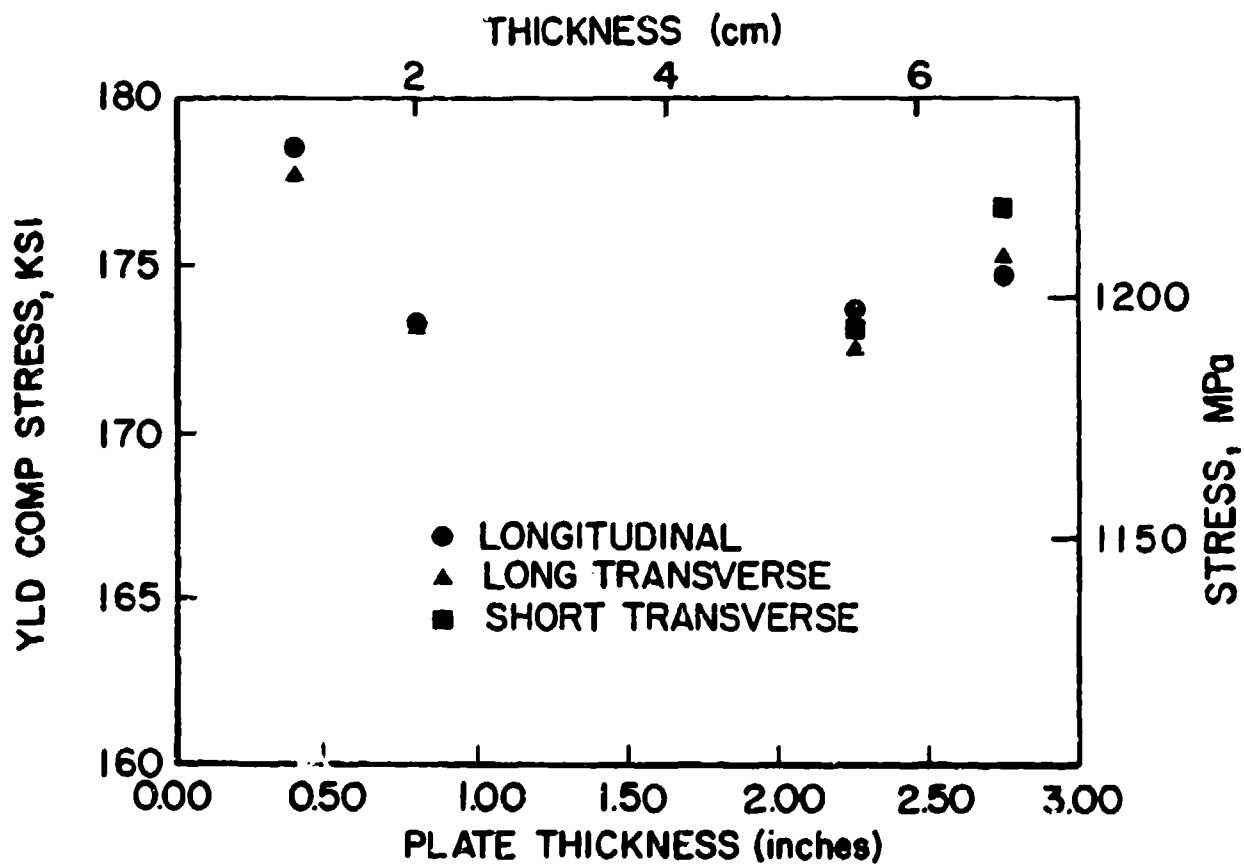

Figure 6. Compressive Yield Stress vs. Plate Thickness for 15-5PH.

TABLE 6A

## DOUBLE RIVET SHEAR RESULTS FOR 15-5PH (H 1025)

SPECIMEN IDENTIFICATION	ULTIMATE SHEAR STRENGTH Ksi (MPa)	SPECIMEN IDENTIFICATION	ULTIMATE SHEAR STRENGTH Ksi (MPa)
<u>LONG TRANSVERSE</u>			
STLP3-1-3S-LT	111.9 (771.5)	STLP4-1-3S-LT	113.5 (782.6)
STLP3-2-3S-LT	112.1 (773.1)	STLP4-2-3S-LT	113.3 (781.2)
STLP3-3-3S-LT	112.4 (774.7)	STLP4-3-3S-LT	113.6 (783.4)
STLP5-1-3S-LT	104.5 (720.8)	STLP6-1-3S-LT	108.6 (748.7)
STLP5-2-3S-LT	104.5 (720.8)	STLP6-2-3S-LT	108.5 (748.4)
STLP5-3-3S-LT	104.7 (722.0)	STLP6-3-3S-LT	108.1 (745.5)
STLP7-1-3S-LT	106.6 (735.2)	STLP8-1-3S-LT	108.3 (747.0)
STLP7-2-3S-LT	106.6 (734.9)	STLP8-2-3S-LT	108.0 (745.0)
STLP7-3-3S-LT	106.6 (734.9)	STLP8-3-3S-LT	107.8 (743.0)
STLP9-1-3S-LT	109.9 (757.9)		
STLP9-2-3S-LT	110.1 (758.8)		
STLP9-3-3S-LT	109.8 (757.1)		
AVERAGE		109.0 (751.7)	
<u>LONGITUDINAL</u>			
STLP3-1-3S-L	112.7 (777.2)	STLP4-1-3S-L	106.8 (736.7)
STLP3-2-3S-L	113.2 (780.8)	STLP4-2-3S-L	107.9 (744.1)
STLP3-3-3S-L	114.3 (788.4)	STLP4-3-3S-L	107.3 (740.0)
STLP5-1-3S-L	103.0 (709.9)	STLP6-1-3S-L	111.7 (770.3)
STLP5-2-3S-L	103.0 (710.1)	STLP6-2-3S-L	112.3 (774.2)
STLP5-3-3S-L	102.8 (709.0)	STLP6-3-3S-L	112.2 (774.0)
STLP7-1-3S-L	106.5 (734.3)	STLP8-1-3S-L	106.6 (735.2)
STLP7-2-3S-L	106.1 (731.5)	STLP8-2-3S-L	106.6 (735.2)
STLP7-3-3S-L	106.0 (730.9)	STLP8-3-3S-L	106.3 (732.9)
STLP9-1-3S-L	107.3 (739.6)		
STLP9-2-3S-L	108.6 (749.1)		
STLP9-3-3S-L	108.3 (746.7)		
AVERAGE		108.1 (745.2)	

TABLE 6B

## TENSION SINGLE SHEAR RESULTS FOR 15-5PH (H 1025)

SPECIMEN IDENTIFICATION	ULTIMATE SHEAR STRENGTH Ksi (MPa)	SPECIMEN IDENTIFICATION	ULTIMATE SHEAR STRENGTH Ksi (MPa)
<u>LONG TRANSVERSE</u>			
STLP1-1-3S-LT	115.4 (795.7)	STLP2-1-3S-LT	115.5 (796.4)
STLP1-2-3S-LT	114.3 (788.4)	STLP2-2-3S-LT	113.7 (783.6)
STLP1-3-3S-LT	115.8 (798.4)	STLP2-3-3S-LT	111.6 (769.4)
STLP10-1-3S-LT	109.7 (756.1)		
STLP10-2-3S-LT	110.3 (760.8)		
STLP10-3-3S-LT	112.7 (777.0)		
AVERAGE		113.2 (780.6)	
<u>LONGITUDINAL</u>			
STLP1-1-3S-L	115.3 (795.2)	STLP2-1-3S-L	115.6 (796.9)
STLP1-2-3S-L	115.1 (793.4)	STLP2-2-3S-L	116.9 (806.0)
STLP1-3-3S-L	116.7 (805.0)	STLP2-3-3S-L	115.7 (797.7)
STLP10-1-3S-L	111.2 (766.4)		
STLP10-2-3S-L	109.7 (756.4)		
STLP10-3-3S-L	112.1 (773.0)		
AVERAGE		114.3 (787.8)	

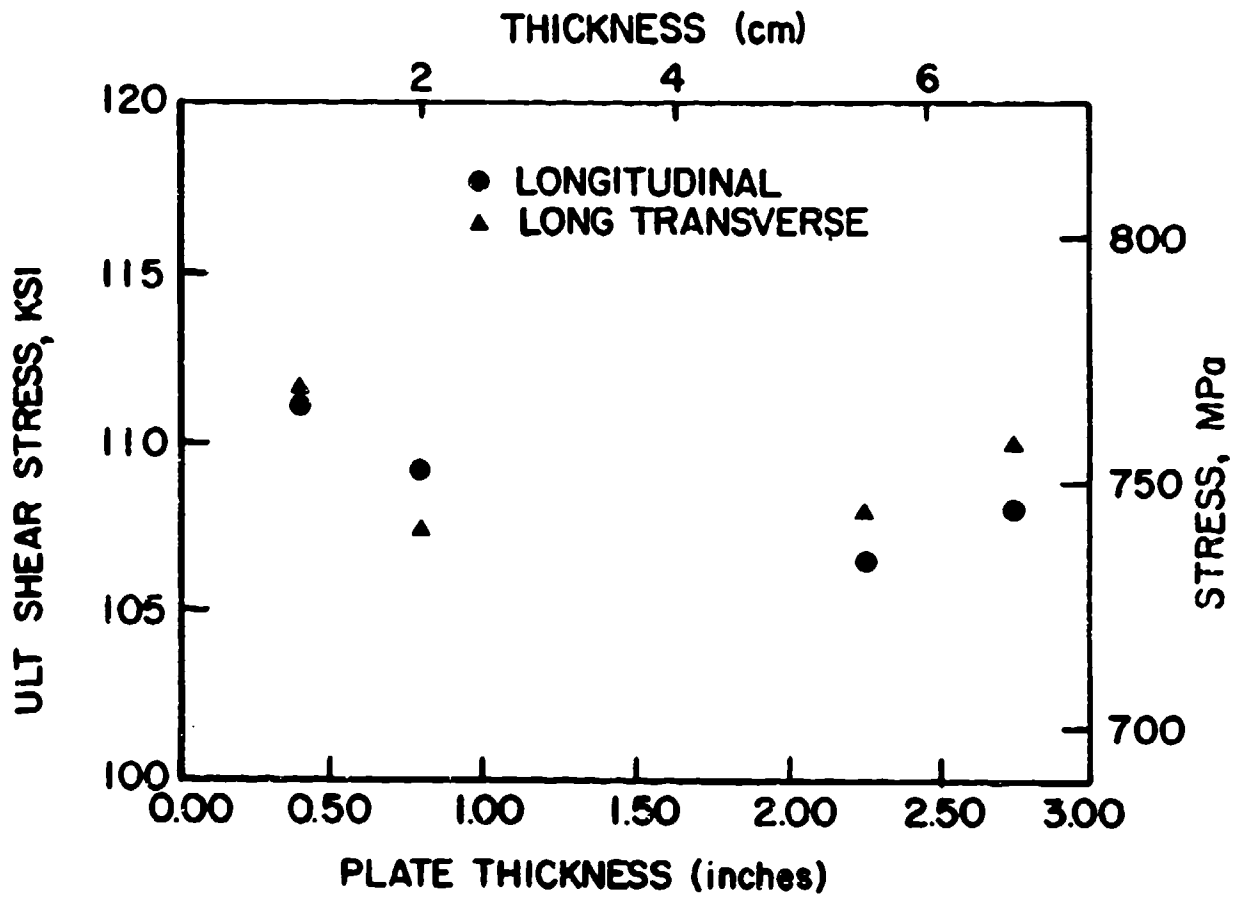

Figure 7. Ultimate Shear Stress vs. Plate Thickness for 15-5PH.



TABLE 7A

PIN BEARING RESULTS FOR 15-5PH (H 1025)  
(e/D = 1.5, LONGITUDINAL)

SPECIMEN IDENTIFICATION	BEARING YIELD STRENGTH		BEARING ULTIMATE STRENGTH	
	Ksi	(MPa)	Ksi	(MPa)
<u>e/D = 1.5, LONGITUDINAL</u>				
STLP1-1-3B-L	237.9	(1640)	283.3	(1953)
STLP1-2-3B-L	261.7	(1804)	297.5	(2051)
STLP1-3-3B-L	254.6	(1755)	295.1	(2035)
STLP2-1-3B-L	263.1	(1814)	298.1	(2055)
STLP2-2-3B-L	258.5	(1782)	297.8	(2053)
STLP2-3-3B-L	260.0	(1792)	296.4	(2043)
STLP3-1-3B-L	250.1	(1724)	293.7	(2025)
STLP3-2-3B-L	249.3	(1719)	293.6	(2025)
STLP3-3-3B-L	242.4	(1672)	284.3	(1960)
STLP4-1-3B-L	259.6	(1790)	301.2	(2076)
STLP4-2-3B-L	255.6	(1763)	303.7	(2094)
STLP4-3-3B-L	261.2	(1801)	303.5	(2093)
STLP5-1-3B-L	230.9	(1592)	267.3	(1843)
STLP5-2-3B-L	237.2	(1635)	268.9	(1854)
STLP5-3-3B-L	232.2	(1601)	272.6	(1879)
STLP6-1-3B-L	240.7	(1660)	287.8	(1984)
STLP6-2-3B-L	249.5	(1721)	285.0	(1965)
STLP6-3-3B-L	238.7	(1646)	285.5	(1968)
STLP7-1-3B-L	244.1	(1683)	281.3	(1940)
STLP7-2-3B-L	244.4	(1685)	284.0	(1958)
STLP7-3-3B-L	239.7	(1652)	280.1	(1932)
STLP8-1-3B-L	248.5	(1713)	288.6	(1990)
STLP8-2-3B-L	245.8	(1695)	283.6	(1955)
STLP8-3-3B-L	244.6	(1686)	288.6	(1990)
STLP9-1-3B-L	242.1	(1669)	287.6	(1983)
STLP9-2-3B-L	246.2	(1697)	288.5	(1989)
STLP9-3-3B-L	244.4	(1685)	288.4	(1988)
STLP10-1-3B-L	230.9	(1592)	276.4	(1906)
STLP10-2-3B-L	233.7	(1611)	276.5	(1906)
STLP10-3-3B-L	234.1	(1614)	279.6	(1928)
AVERAGE	246.1	(1696)	287.3	(1981)

TABLE 7B

PIN BEARING RESULTS FOR 15-5PH (H 1025)  
( $e/D = 1.5$ , LONG TRANSVERSE)

SPECIMEN IDENTIFICATION	BEARING YIELD STRENGTH Ksi (MPa)		BEARING ULTIMATE STRENGTH Ksi (MPa)	
<u><math>e/D = 1.5</math>, LONG TRANSVERSE</u>				
STLP1-1-3B-LT	245.0	(1689)	289.1	(1994)
STLP1-2-3B-LT	251.7	(1736)	293.9	(2026)
STLP1-3-3B-LT	254.5	(1755)	292.5	(2017)
STLP2-1-3B-LT	253.9	(1751)	292.9	(2020)
STLP2-2-3B-LT	251.4	(1733)	296.2	(2042)
STLP2-3-3B-LT	262.5	(1810)	299.6	(2066)
STLP3-1-3B-LT	232.9	(1606)	276.4	(1906)
STLP3-2-3B-LT	249.1	(1717)	298.6	(2059)
STLP3-3-3B-LT	246.0	(1696)	297.2	(2049)
STLP4-1-3B-LT	260.0	(1793)	302.6	(2087)
STLP4-2-3B-LT	257.2	(1773)	302.8	(2088)
STLP4-3-3B-LT	262.9	(1813)	305.4	(2106)
STLP5-1-3B-LT	232.5	(1603)	277.6	(1914)
STLP5-2-3B-LT	240.0	(1655)	277.1	(1911)
STLP5-3-3B-LT	235.0	(1620)	275.2	(1898)
STLP6-1-3B-LT	248.5	(1714)	283.2	(1953)
STLP6-2-3B-LT	239.2	(1649)	283.4	(1954)
STLP6-3-3B-LT	246.8	(1702)	283.5	(1955)
STLP7-1-3B-LT	238.3	(1643)	280.0	(1930)
STLP7-2-3B-LT	241.1	(1662)	281.4	(1940)
STLP7-3-3B-LT	246.6	(1700)	280.6	(1935)
STLP8-1-3B-LT	247.7	(1708)	284.2	(1960)
STLP8-2-3B-LT	240.2	(1656)	283.0	(1951)
STLP8-3-3B-LT	244.3	(1684)	283.2	(1953)
STLP9-1-3B-LT	249.6	(1721)	289.7	(1997)
STLP9-2-3B-LT	253.4	(1747)	288.8	(1991)
STLP9-3-3B-LT	245.6	(1693)	288.7	(1990)
STLP10-1-3B-LT	238.2	(1642)	276.7	(1908)
STLP10-2-3B-LT	234.7	(1618)	275.9	(1902)
STLP10-3-3B-LT	239.3	(1650)	275.6	(1901)
AVERAGE	246.3	(1698)	287.2	(1980)

TABLE 7C

PIN BEARING RESULTS FOR 15-5PH (H 1025)  
( $e/D = 2.0$ , LONGITUDINAL)

SPECIMEN IDENTIFICATION	BEARING YIELD STRENGTH Ksi (MPa)		BEARING ULTIMATE STRENGTH Ksi (MPa)	
<u><math>e/D = 2.0</math>, LONGITUDINAL</u>				
STLP1-1-3B-L	291.2	(2008)	378.9	(2613)
STLP1-2-3B-L	288.5	(1989)	375.6	(2590)
STLP1-3-3B-L	291.9	(2013)	373.1	(2573)
STLP2-1-3B-L	293.6	(2024)	377.3	(2602)
STLP2-2-3B-L	296.0	(2041)	375.7	(2591)
STLP2-3-3B-L	277.3	(1912)	375.9	(2592)
STLP3-1-3B-L	284.2	(1960)	376.4	(2595)
STLP3-2-3B-L	299.4	(2064)	373.5	(2575)
STLP3-3-3B-L	290.6	(2003)	366.4	(2526)
STLP4-1-3B-L	311.7	(2149)	389.1	(2683)
STLP4-2-3B-L	304.2	(2098)	390.5	(2693)
STLP4-3-3B-L	311.5	(2148)	388.1	(2676)
STLP5-1-3B-L	276.9	(1909)	348.4	(2402)
STLP5-2-3B-L	273.2	(1884)	347.8	(2398)
STLP5-3-3B-L	273.6	(1886)	348.8	(2405)
STLP6-1-3B-L	291.0	(2006)	364.7	(2514)
STLP6-2-3B-L	290.0	(1999)	366.2	(2525)
STLP6-3-3B-L	286.2	(1974)	368.7	(2542)
STLP7-1-3B-L	268.4	(1850)	363.1	(2503)
STLP7-2-3B-L	273.2	(1884)	363.7	(2507)
STLP7-3-3B-L	278.7	(1922)	363.0	(2503)
STLP8-1-3B-L	292.0	(2014)	370.6	(2555)
STLP8-2-3B-L	273.8	(1888)	366.1	(2524)
STLP8-3-3B-L	285.7	(1970)	367.2	(2532)
STLP9-1-3B-L	285.7	(1970)	366.5	(2527)
STLP9-2-3B-L	294.1	(2028)	368.2	(2539)
STLP9-3-3B-L	291.8	(2012)	369.0	(2544)
STLP10-1-3B-L	275.6	(1900)	356.0	(2455)
STLP10-2-3B-L	274.1	(1890)	355.9	(2454)
STLP10-3-3B-L	276.7	(1908)	357.3	(2464)
AVERAGE	286.7	(1977)	368.4	(2540)

TABLE 7D

PIN BEARING RESULTS FOR 15-5PH (H 1025)  
(e/D = 2.0, LONG TRANSVERSE)

SPECIMEN IDENTIFICATION	BEARING YIELD STRENGTH Ksi (MPa)		BEARING ULTIMATE STRENGTH Ksi (MPa)	
<u>e/D = 2.0, LONG TRANSVERSE</u>				
STLP1-1-3B-LT	294.0	(2027)	373.4	(2574)
STLP1-2-3B-LT	283.7	(1956)	378.6	(2610)
STLP1-3-3B-LT	292.5	(2017)	376.3	(2594)
STLP2-1-3B-LT	293.0	(2020)	378.2	(2608)
STLP2-2-3B-LT	297.2	(2049)	379.7	(2618)
STLP2-3-3B-LT	296.6	(2045)	379.4	(2616)
STLP3-1-3B-LT	295.5	(2037)	384.6	(2652)
STLP3-2-3B-LT	292.8	(2019)	381.1	(2628)
STLP3-3-3B-LT	295.0	(2034)	378.3	(2609)
STLP4-1-3B-LT	305.2	(2104)	385.2	(2656)
STLP4-2-3B-LT	298.2	(2056)	389.5	(2685)
STLP4-3-3B-LT	305.9	(2109)	384.0	(2647)
STLP5-1-3B-LT	350.0	(2413)	296.9	(2047)
STLP5-2-3B-LT	273.6	(1886)	357.6	(2466)
STLP5-3-3B-LT	277.8	(1916)	353.7	(2439)
STLP6-1-3B-LT	280.8	(1936)	367.2	(2532)
STLP6-2-3B-LT	283.3	(1954)	365.4	(2520)
STLP6-3-3B-LT	285.1	(1966)	364.7	(2514)
STLP7-1-3B-LT	285.3	(1967)	359.1	(2476)
STLP7-2-3B-LT	275.3	(1898)	362.5	(2499)
STLP7-3-3B-LT	281.0	(1937)	359.7	(2480)
STLP8-1-3B-LT	283.3	(1953)	366.3	(2526)
STLP8-2-3B-LT	283.1	(1952)	363.3	(2505)
STLP8-3-3B-LT	277.7	(1915)	365.7	(2521)
STLP9-1-3B-LT	290.8	(2005)	368.1	(2538)
STLP9-2-3B-LT	288.1	(1987)	369.5	(2547)
STLP9-3-3B-LT	278.5	(1920)	372.0	(2565)
STLP10-1-3B-LT	273.8	(1888)	359.5	(2479)
STLP10-2-3B-LT	278.9	(1923)	359.4	(2478)
STLP10-3-3B-LT	277.3	(1912)	355.5	(2451)
AVERAGE	289.1	(1993)	367.8	(2536)

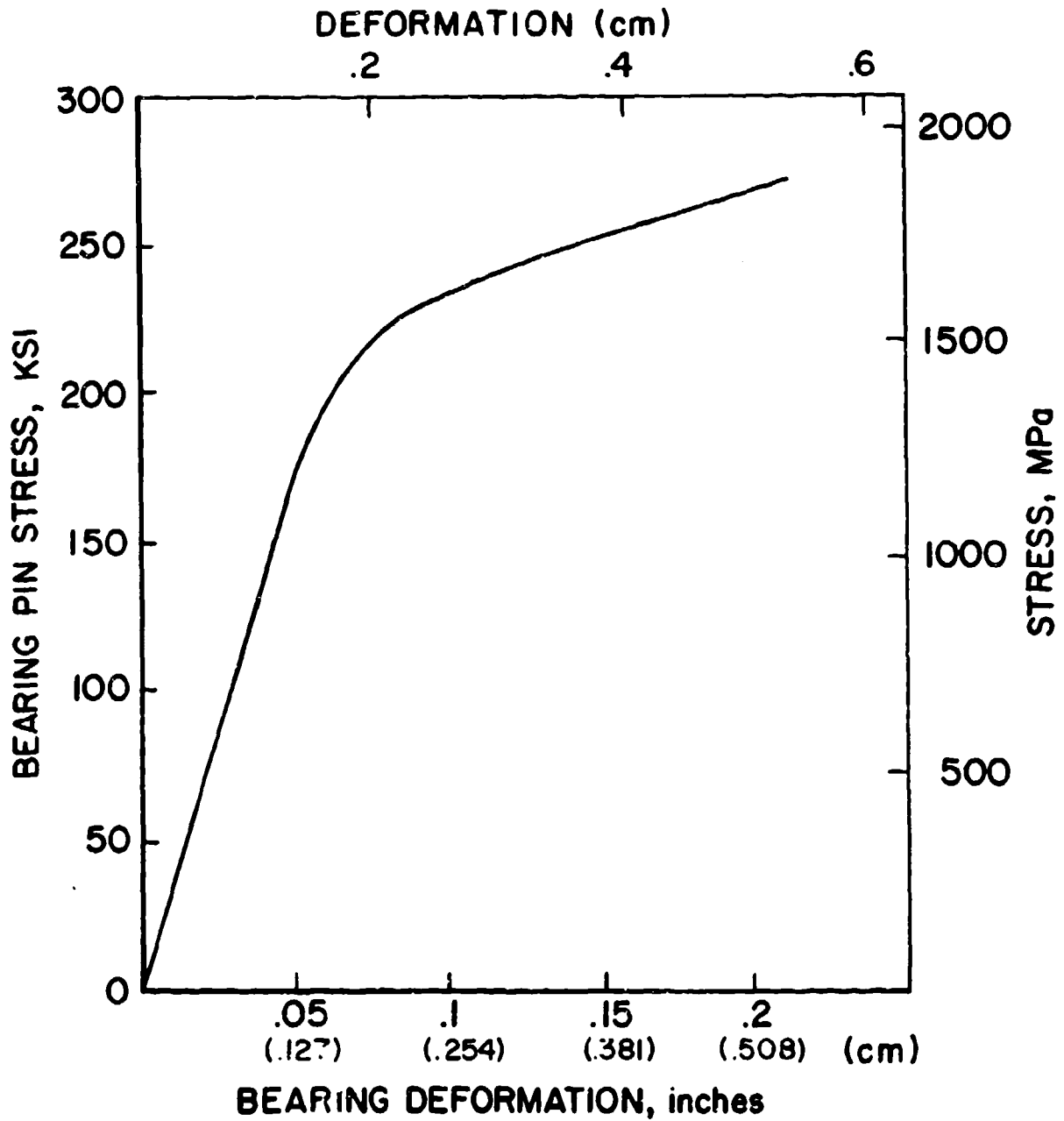

Figure 8. Typical Stress - Deflection Curve in Bearing for 15-5PH (H 1025), ( $e/D = 1.5$ ,  $D = 0.251$ , thickness = 0.999 in).

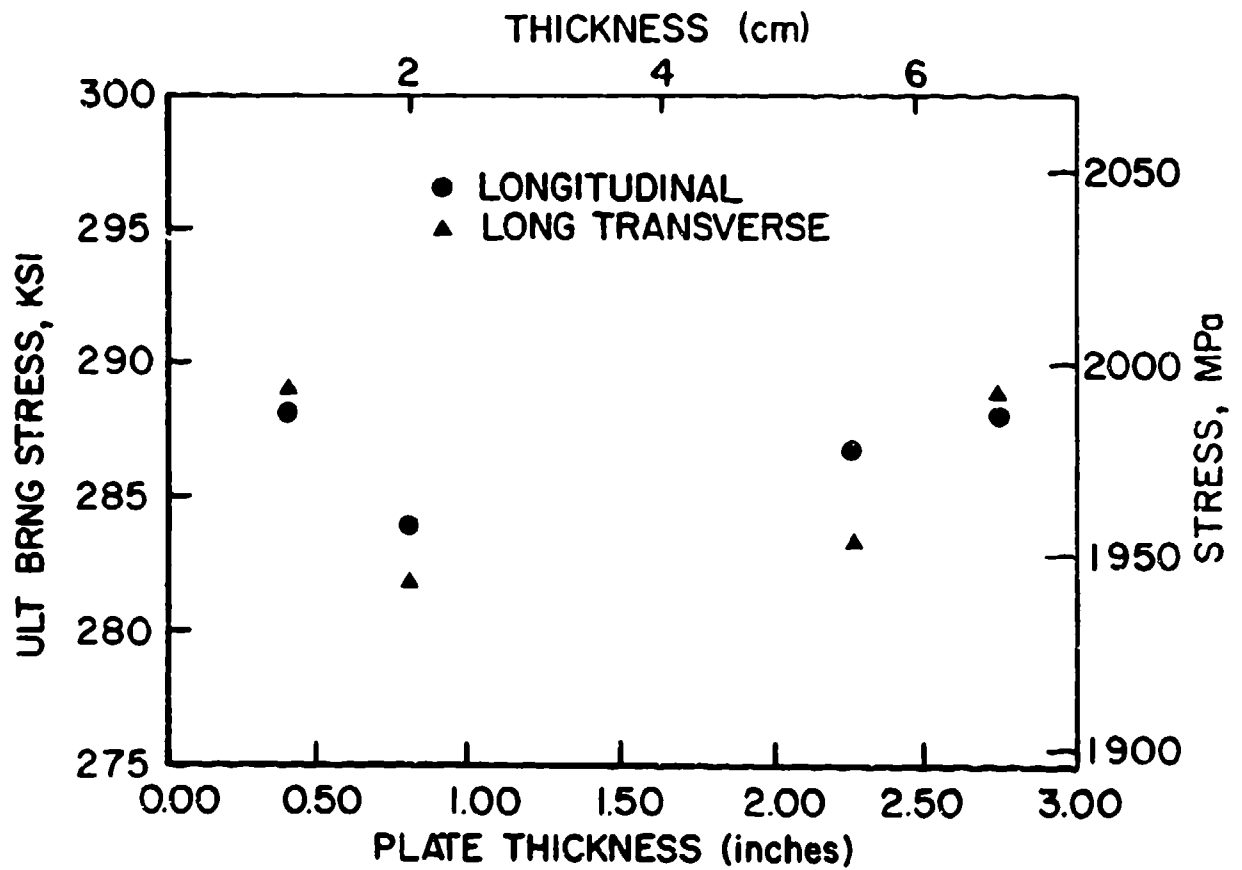

Figure 9a. Bearing Ultimate Stress vs. Plate Thickness Range for  $e/D = 1.5$ .

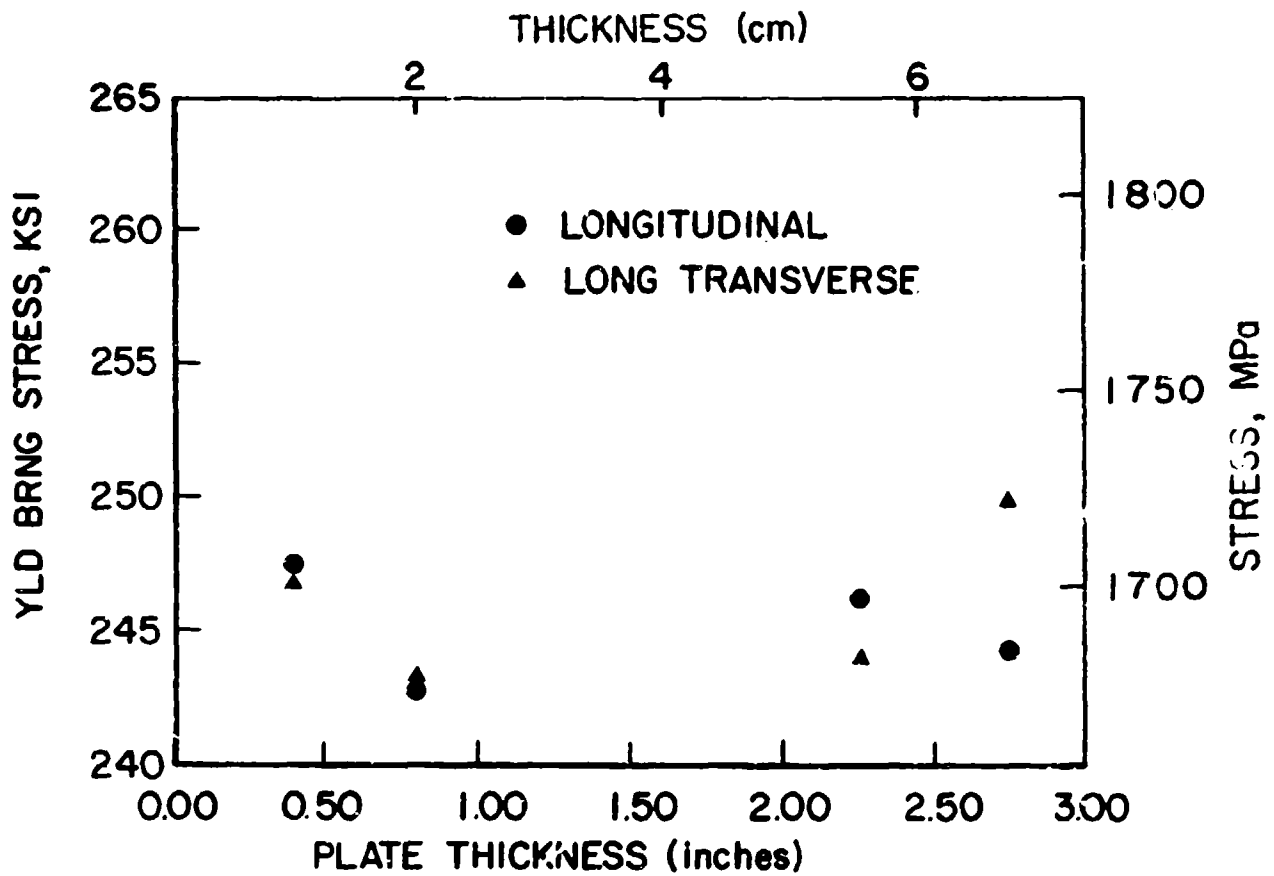

Figure 9b. Bearing Yield Stress vs. Plate Thickness for  $e/D = 1.5$ .

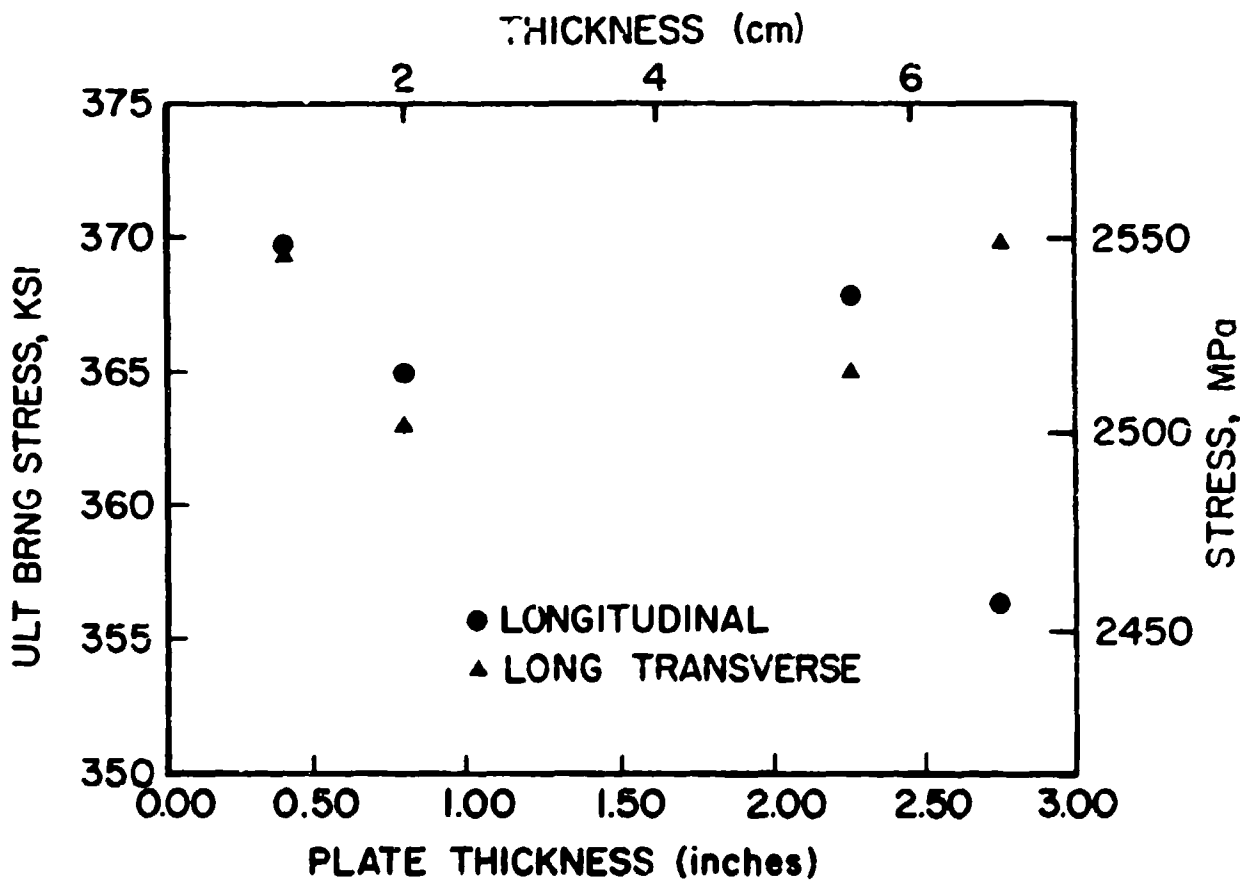

Figure 9c. Bearing Ultimate Stress vs. Plate Thickness Range for  $e/D = 2.0$ .



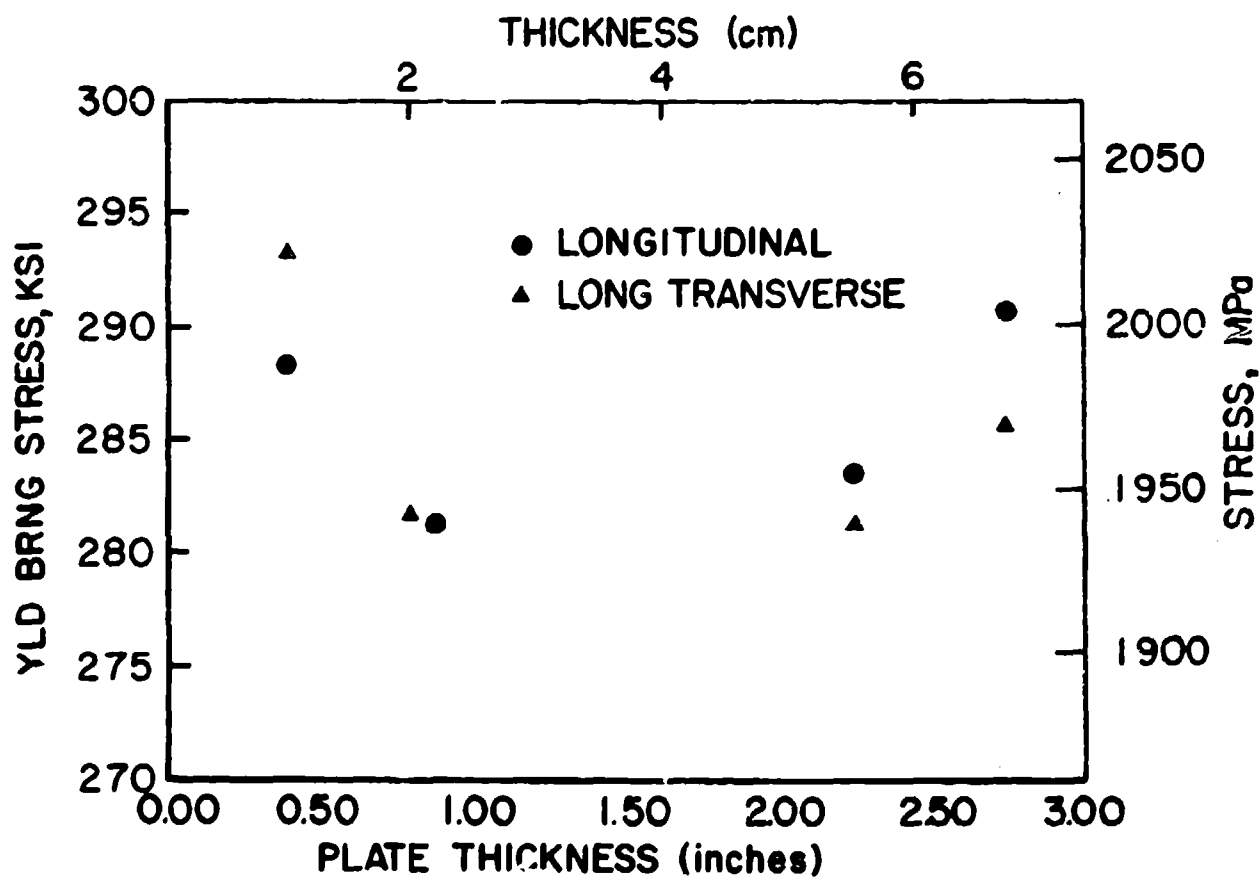

Figure 9d. Bearing Yield Stress vs. Plate Thickness Range for  $e/D = 2.0$ .

TABLE 8A

FATIGUE TEST RESULTS FOR 15-5PH (H 1025)  
(FLAT, UNNOTCHED, LONGITUDINAL)

$$K_t = 1.0$$

Specimen Identification	Maximum Stress ksi (MPa)	Cycles to Failure	Remarks
Flat, Unnotched, Longitudinal			
STLP1-5-5FL	160. (1241.1)	N.A.	Broke first cycle
STLP3-1-5FL	175. (1206.6)	28,100	
STLP4-5-5FL	175. (1206.6)	30,300	
STLP2-1-5FL	172.5 (1189.4)	26,800	
STLP3-5-5FL	170. (1172.2)	23,000	
STLP2-5-5FL	167.5 (1154.9)	25,500	
STLP1-4-5FL	165. (1137.7)	75,500	
STLP5-2-5FL	162.5 (1120.4)	15,400	
STLP10-4-5FL	160. (1103.2)	23,100	
STLP4-1-5FL	155. (1068.7)	199,900	
STLP10-5-5FL	152.5 (1051.5)	197,600	
STLP1-2-5FL	150. (1034.3)	132,500	
STLP5-5-5FL	147.5 (1017.0)	85,000	
STLP3-4-5FL	145. ( 999.8)	10,000,000	Runout
STLP4-2-5FL	142.5 ( 982.5)	322,400	
STLP10-2-5FL	140. ( 965.3)	1,574,000	Invalid-broke in grip
STLP10-3-5FL	140. ( 965.3)	88,200	
STLP1-3-5FL	137.5 ( 984.1)	113,000	
STLP4-4-5FL	135. ( 930.8)	65,400	
STLP5-3-5FL	132.5 ( 913.6)	353,500	
STLP2-2-5FL	130. ( 896.4)	138,300	
STLP3-3-5FL	127.5 ( 879.1)	87,700	
STLP5-4-5FL	127.5 ( 879.1)	10,000,000	Runout
STLP10-1-5FL	125. ( 861.9)	92,200	
STLP4-3-5FL	125. ( 861.9)	133,700	
STLP3-2-5FL	122.5 ( 844.6)	10,000,000	Runout
STLP1-1-5FL	120. ( 827.4)	10,000,000	Runout
STLP2-3-5FL	120. ( 827.4)	345,200	
STLP5-1-5FL	117.5 ( 810.2)	10,000,000	Runout
STLP2-4-5FL	105. ( 724.0)	10,000,000	Runout

\*Note: Specimens were taken from plates 1, 2, 3, 4, 5, 10.

TABLE 8B

FATIGUE TEST RESULTS FOR 15-5PH (H 1025)  
(ROUND, UNNOTCHED, LONGITUDINAL)

$$K_t = 1.0$$

Specimen Identification	Maximum Stress ksi (MPa)	Cycles to Failure	Remarks
Round, Unnotched, Longitudinal			
STLP7-3-5FL	180. (1241.1)	N.A.	Failed below 180 ksi
STLP9-4-5FL	177.5 (1223.9)	24,600	
STLP6-3-5FL	175. (1206.6)	30,800	
STLP8-3-5FL	172.5 (1189.4)	55,100	
STLP9-5-5FL	172.5 (1189.4)	43,800	
STLP7-4-5FL	172.5 (1189.4)	27,900	
STLP9-2-5FL	170. (1172.2)	84,600	
STLP6-4-5FL	170. (1172.2)	52,700	
STLP8-2-5FL	167.5 (1154.9)	67,500	
STLP8-4-5FL	167.5 (1154.9)	51,200	
STLP6-1-5FL	165. (1137.7)	137,200	
STLP7-5-5FL	165. (1137.7)	105,500	
STLP8-5-5FL	165. (1137.7)	3,676,700	
STLP9-3-5FL	162.5 (1120.4)	174,400	
STLP6-5-5FL	162.5 (1120.4)	2,806,700	
STLP7-1-5FL	160. (1103.2)	529,900	
STLP6-2-5FL	157.5 (1086.0)	2,676,900	
STLP8-1-5FL	155. (1068.7)	2,125,400	
STLP7-2-5FL	152.5 (1051.5)	10,000,000	Runout
STLP9-1-5FL	150. (1034.3)	9,765,700	

\*Note: Specimens were taken from plates 6, 7, 8, 9.

TABLE 8C

FATIGUE TEST RESULTS FOR 15-5PH (H 1025)  
(FLAT, NOTCHED, LONGITUDINAL)

Specimen Identification	Maximum Stress ksi (MPa)	Cycles to Failure	Remarks
Flat, Notched, Longitudinal			
STLP5-1-5FL	110. (758.45)	10,400	
STLP4-2-5FL	105. (723.98)	9,100	
STLP2-4-5FL	100. (689.50)	11,300	
STLP3-2-5FL	95. (655.03)	15,600	
STLP5-2-5FL	92.5 (637.79)	20,100	
STLP1-3-5FL	90. (620.55)	20,600	
STLP10-4-5FL	85. (586.08)	37,000	
STLP4-3-5FL	82.5 (568.84)	32,200	
STLP2-1-5FL	80. (551.60)	52,700	~56 ksi @ to 27400 cy
STLP3-3-5FL	77.5 (534.36)	49,500	
STLP10-5-5FL	75. (517.13)	58,300	
STLP5-3-5FL	75. (517.13)	30,600	
STLP10-2-5FL	72. (496.44)	30,000	
STLP1-2-5FL	70. (482.65)	39,800	
STLP4-5-5FL	70. (482.65)	59,700	
STLP1-5-5FL	67.5 (465.41)	43,800	
STLP5-4-5FL	67.5 (465.41)	60,400	
STLP3-5-5FL	65. (448.10)	54,800	
STLP2-3-5FL	64. (441.20)	132,300	
STLP10-3-5FL	62.5 (430.94)	95,000	
STLP2-2-5FL	60. (413.70)	242,400	
STLP3-4-5FL	57.5 (396.46)	134,800	
STLP1-4-5FL	55. (379.23)	125,000	
STLP4-4-5FL	55. (379.23)	8,417,100	
STLP3-1-5FL	52.5 (361.99)	184,500	
STLP5-5-5FL	52.5 (361.99)	117,000	
STLP10-1-5FL	50. (344.75)	403,800	
STLP4-1-5FL	50. (344.75)	1,620,700	
STLP2-5-5FL	47.5 (327.51)	10,000,000	Runout
STLP1-1-3FL	40. (275.80)	10,000,000	Runout

\* Note: Specimens were taken from plates 1, 2, 3, 4, 5, 10.

TABLE 8D

FATIGUE TEST RESULTS FOR 15-5PH (H 1025)  
(ROUND, NOTCHED, LONGITUDINAL)

$$K_t = 3.0$$

Specimen Identification	Maximum Stress ksi (MPa)	Cycles to Failure	Remarks
Round, Notched, Longitudinal			
STLP6-1-5FL	100. (689.50)	13,400	
STLP9-2-5FL	95. (655.03)	11,700	
STLP8-3-5FL	95. (655.03)	18,700	
STLP7-1-5FL	90. (620.55)	19,400	
STLP8-4-5FL	87.5 (603.31)	18,300	
STLP9-4-5FL	87.5 (603.31)	19,900	
STLP6-3-5FL	85. (586.00)	40,000	
STLP9-5-5FL	82.5 (568.04)	18,900	
STLP6-4-5FL	82.5 (568.04)	21,100	
STLP8-1-5FL	80. (551.60)	33,300	
STLP6-5-5FL	77.5 (534.36)	28,400	
STLP7-2-5FL	72.5 (499.09)	49,600	
STLP9-1-5FL	70. (482.65)	83,300	
STLP7-5-5FL	67.5 (465.41)	437,800	
STLP6-2-5FL	65. (448.18)	92,800	
STLP8-5-5FL	62.5 (430.94)	105,500	
STLP7-3-5FL	62.5 (430.94)	201,200	
STLP7-4-5FL	60. (413.70)	111,300	
STLP8-2-5FL	60. (413.70)	164,300	
STLP9-3-5FL	57.5 (396.46)	10,000,000	Runout

\* Note: Specimens were taken from plates 6, 7, 8, 9.

TABLE 8E

FATIGUE TEST RESULTS FOR 15-5PH (H 1025)  
(ROUND, UNNOTCHED, LONG TRANSVERSE)

$$K_t = 1.0$$

Specimen Identification	Maximum Stress ksi (MPa)	Cycles to Failure	Remarks
<u>Round, Unnotched, Long Transverse</u>			
STLP6-7-10FLT	180. (1241.1)	400	
STLP6-4-10FLT	177.5 (1223.9)	23,100	
STLP6-5-10FLT	175. (1206.6)	24,400	
STLP6-1-10FLT	170. (1172.2)	36,000	
STLP6-9-10FLT	167.5 (1154.9)	62,000	
STLP6-6-10FLT	167.5 (1154.9)	N.A.	Invalid: wrong loads
STLP6-2-10FLT	165. (1137.7)	525,600	
STLP6-8-10FLT	162.5 (1120.4)	55,700	Invalid: spec twisted
STLP6-10-10FLT	162.5 (1120.4)	6,945,500	
STLP6-3-10FLT	160. (1103.2)	N.A.	Invalid: wrong loads

\* Note: Specimens were taken from plate 6.

TABLE 8F

FATIGUE TEST RESULTS FOR 15-5PH (H 1025)  
(ROUND, NOTCHED, LONG TRANSVERSE)

$$K_t = 3.0$$

Specimen Identification	Maximum Stress ksi (MPa)	Cycles to Failure	Remarks
<u>Round, Notched, Long Transverse</u>			
STLP6-9-10FLT	90. (620.55)	16,600	
STLP6-4-10FLT	85. (586.08)	20,000	
STLP6-1-10FLT	80. (551.60)	34,200	
STLP6-5-10FLT	75. (517.13)	29,000	
STLP6-2-10FLT	70. (482.65)	52,900	
STLP6-6-10FLT	65. (448.18)	61,000	
STLP6-3-10FLT	60. (413.70)	116,000	
STLP6-7-10FLT	55. (379.23)	124,500	
STLP6-10-10FLT	52.5 (361.99)	162,100	
STLP6-8-10FLT	50. (344.75)	10,000,000	Runout

\*Note: Specimens were taken from plate 6.

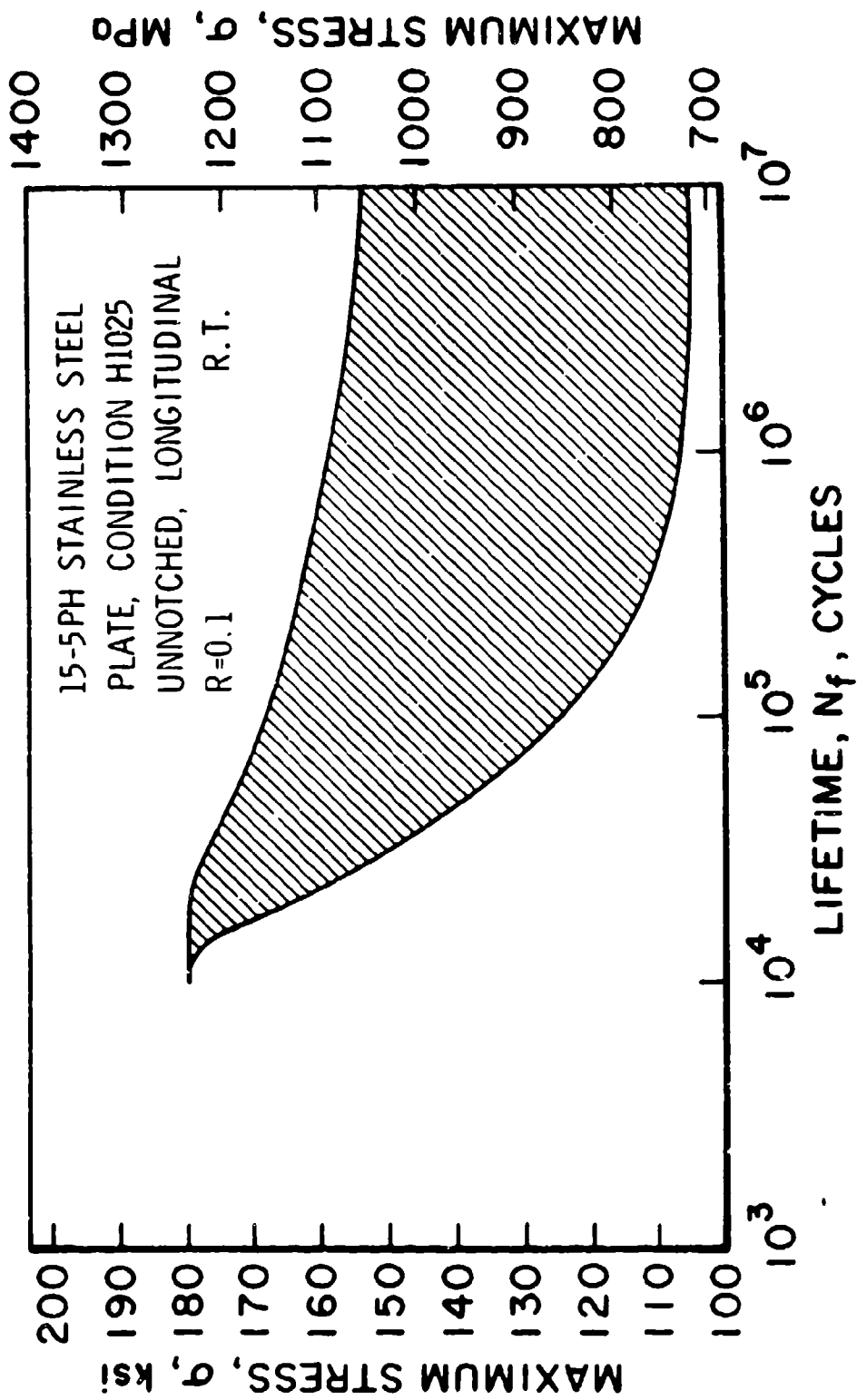

Figure 10. Axial Load Fatigue Band for Unnotched 15-5PH Stainless Steel (H1025, Longitudinal,  $K_t = 1.0$ ).



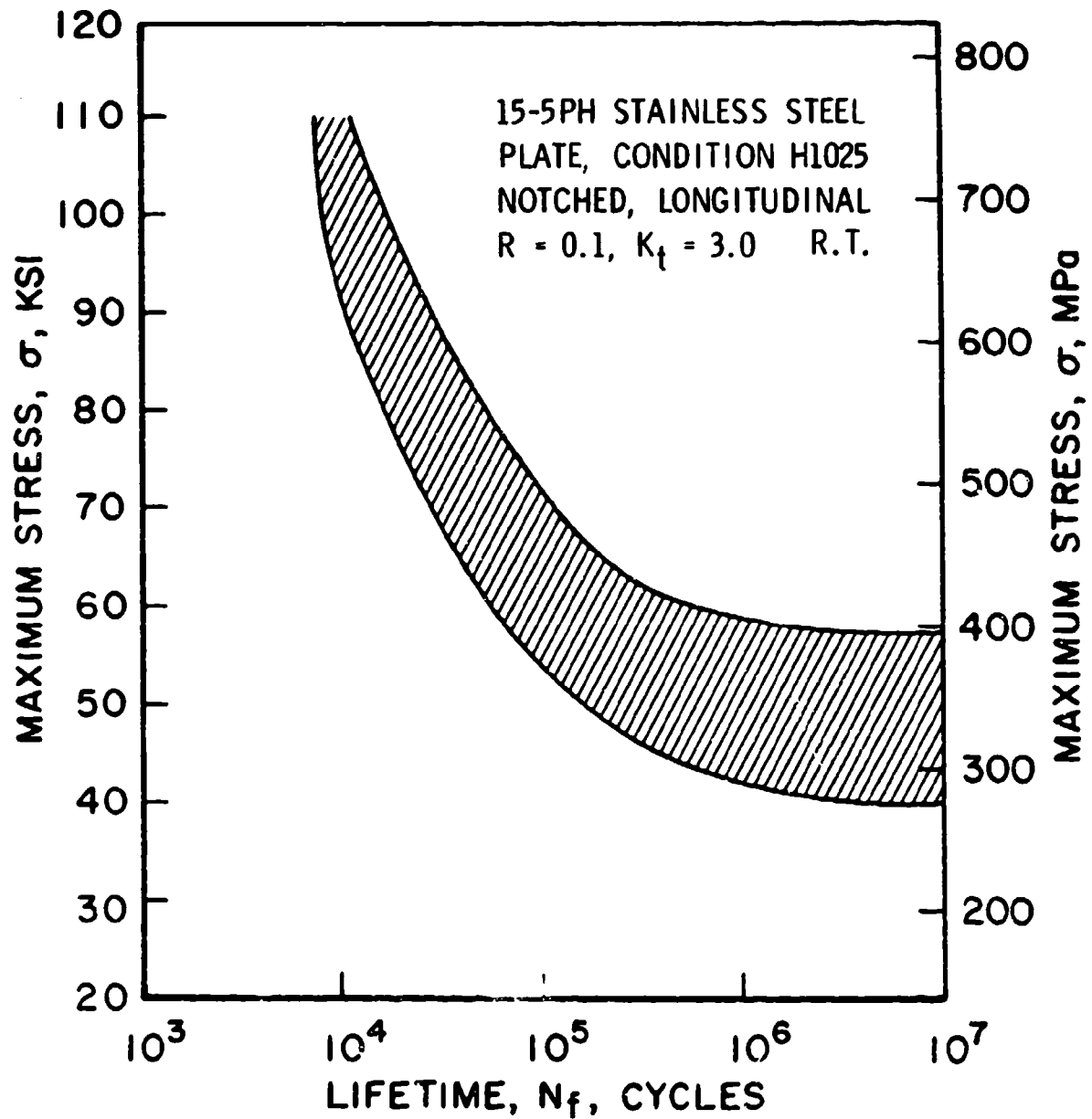

Figure 11. Axial Load Fatigue Band for Notched 15-5PH Stainless Steel (H1025, Longitudinal,  $K_t = 3.0$ ).

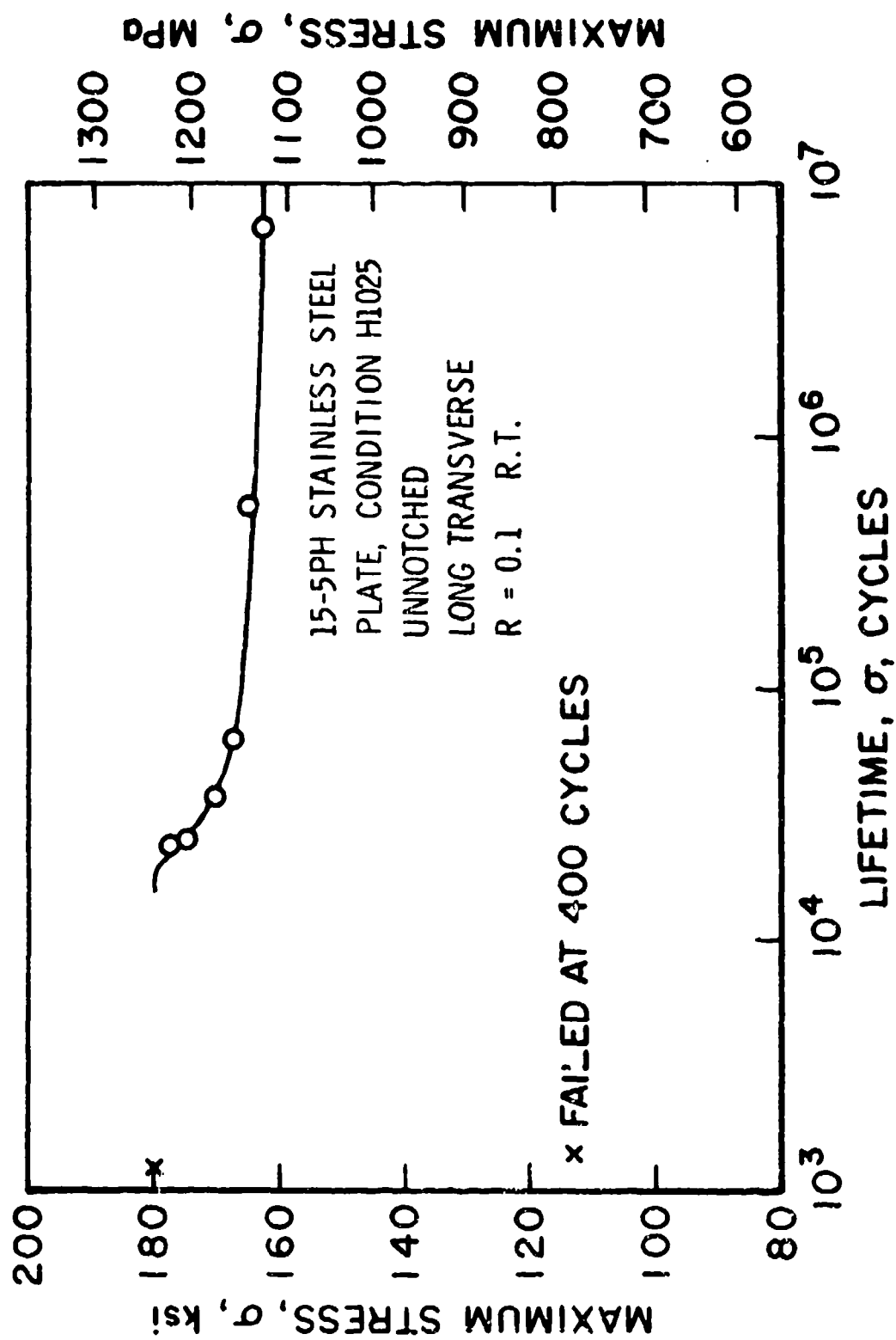

Figure 12. Axial Load Fatigue Data of Unnotched 15-5PH Stainless Steel (H 1025, long Transverse,  $K_t = 1.0$ ).

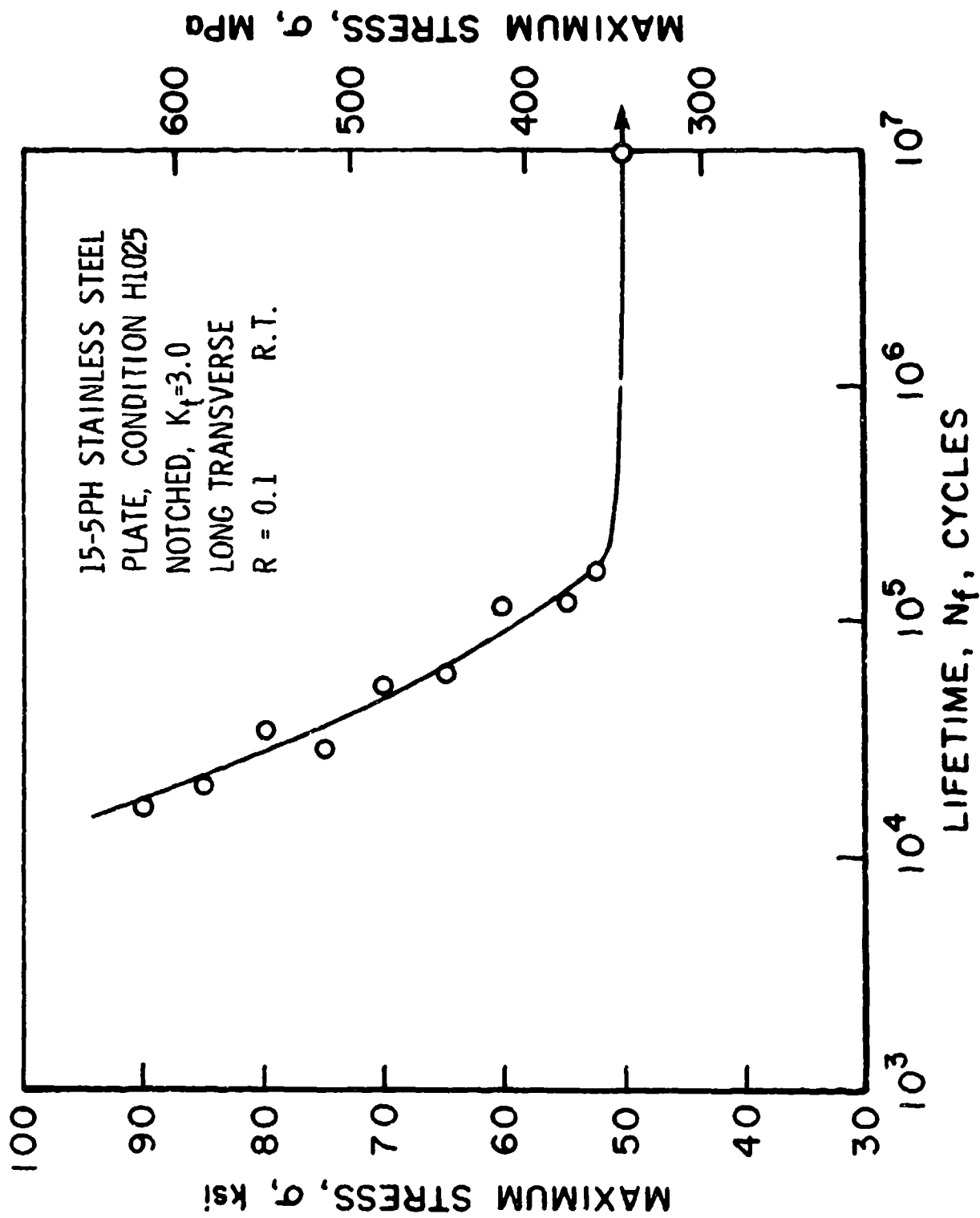

Figure 13. Axial Load Fatigue Data of Notched 15-5PH Stainless Steel (H 1025, Long Transverse,  $K_t = 3.0$ ).

TABLE 9  
SUMMARY OF MECHANICAL PROPERTIES FOR 15-5 PH (H1025) STAINLESS STEEL PLATE

Specification		15-5 PH (H1025)			
Form		Plate			
Condition		H1025	H1025	H1025	H1025
Thickness, in (mm)		0.2-0.6 (5.08-15.24)	0.6-1.0 (15.24-25.4)	2.0-2.5 (50.8-63.5)	2.5-3.0 (63.5-76.2)
<b>Mechanical Properties</b>					
$F_{tu}$ , Ksi (MPa)		L 171.7 (1183)	168.7 (1173)	164.7 (1162)	173.4 (1195)
		LT 172.2 (1187)	168.7 (1163)	169.4 (1167)	174.1 (1200)
$F_{ty}$ , Ksi (MPa)		L 165.5 (1141)	164.9 (1137)	164.0 (1130)	168.9 (1164)
		LT 166.0 (1144)	165.3 (1139)	164.7 (1135)	169.3 (1167)
$F_{cy}$ , Ksi (MPa)		L 178.5 (1230)	173.23 (1194)	173.6 (1197)	174.8 (1205)
		LT 177.8 (1226)	173.23 (1194)	172.6 (1190)	175.3 (1208)
		ST	173.1 (1193)	176.7 (1218)	
$F_{su}$ , Ksi (MPa)		L 111.1 (766)	109.1 (752)	106.5 (734)	108.1 (745)
		LT 111.6 (769)	107.5 (741)	108.0 (744)	110.0 (758)
$F_{bru}$ , Ksi (MPa)		L 288.3 (1986)	284.0 (1957)	286.9 (1977)	288.2 (1986)
	(e/D=1.5)	LT 289.2 (1993)	282.0 (1944)	283.5 (1954)	289.1 (1993)
	(e/D=2.0)	L 369.7 (2548)	364.9 (2515)	367.9 (2536)	356.4 (2457)
		LT 369.5 (2546)	363.1 (2502)	365.1 (2517)	369.9 (2550)
$F_{bry}$ , Ksi (MPa)		L 247.5 (1706)	242.9 (1674)	246.3 (1697.7)	244.2 (1683)
	(e/D=1.5)	LT 247.0 (1703)	243.4 (1678)	244.1 (1682.5)	250.0 (1723)
	(e/D=2.0)	L 288.3 (1987)	281.3 (1939)	283.6 (1955)	290.5 (1999)
		LT 293.4 (2022)	281.9 (1942)	281.4 (1940)	285.8 (1970)
e, percent		L 14.91	15.73	14.75	14.38
		LT 14.71	15.62	14.86	14.06
$E, 10^3$ Ksi (GPa)		28.8 (198.6)	28.6 (197.1)	28.4 (195.8)	28.6 (197.1)
$E_c, 10^3$ Ksi (GPa)		29.8 (205.5)	29.9 (206.1)	30.0 (206.8)	29.8 (205.4)

## 7175-T736 ALUMINUM ALLOY HAND FORGING

Background

There is very little information on the mechanical properties of 7175-T736 aluminum. Section 3.7.4 in Mil-Handbook HDBK-5 has been reserved for this material but to date none is presented.

Material Description

This 7175 Aluminum Alloy, heat-treated to the T736 temper, was produced by ALCOA as a hand forging. Six forgings were received in thicknesses ranging from 2 to 6.25 inches, widths ranging from 12 to 16 inches, and lengths of either 30 or 31 inches.

The average chemical composition of the six heats is shown in Table 10.

TABLE 10  
CHEMICAL COMPOSITION OF 7175 ALUMINUM ALLOY

<u>Chemical Composition</u>	<u>Percent Weight</u>
Silicon	0.078
Manganese	0.010
Magnesium	2.1
Iron	0.089
Copper	1.3
Zinc	5.3
Titanium	0.021
Chromium	0.190
Aluminum	Balance

The 7175 aluminum alloy was processed into rectangular shapes by hand forging. The alloy plates were heat treated to the T736 temper. The geometry and heat number of the forging used for fabrication of the sample is shown in Table 11.

Figure 14 shows the layout of the specimens in the forging. The specimens are grouped around the centerline as shown. This grouping was replicated three times from each forging. Specimens 1.5B-ST, AS-ST and T-ST (also denoted with an \*) were not included when the sample thickness was not large enough to provide an adequate specimen. Also, the specimens were centered on the forging thickness. Fatigue samples in the long transverse (LT) direction were obtained from forging 4 only. The nomenclature for the sample is as follows:

- |      |   |                     |  |                     |
|------|---|---------------------|--|---------------------|
| AS   | - | Amsler Shear        |  | -L Longitudinal     |
| 1.5B | - | Bearing (e/D = 1.5) |  | -LT Long Transverse |
| C    | - | Compression         |  | -ST Short           |
- Transverse
- |                   |   |                   |  |  |
|-------------------|---|-------------------|--|--|
| 1K <sub>t</sub> F | - | Unnotched Fatigue |  |  |
| 3K <sub>t</sub> F | - | Notched Fatigue   |  |  |
| S                 | - | Double Shear      |  |  |

Specimen Numbering Sequence

A sample specimen numbering sequence is shown as follows:

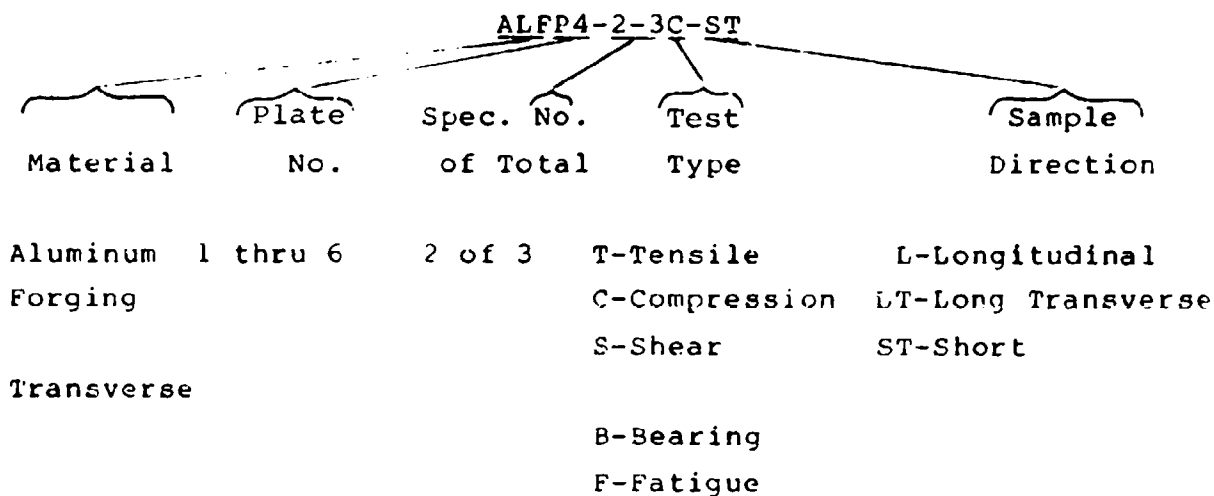

For the specimen shown above the material is for 7175-T736, and comes from forging number 4 (3 3/4"), is the second of three compression specimens in the short transverse direction.

## Test Results

As can be seen from Table 12, specimens were obtained for all types of tests, in all three directions (L, LT, ST). Fatigue samples were obtained for the L and LT directions. Plates 5 and 6 were not thick enough from which to obtain shear and bearing samples in the ST direction. The geometry of the specimen used for each type of test is contained in Appendix A. Appendix B contains the data sheets previously published for this material.

Tension. The results of the tension tests are shown in Table 13. The longitudinal and long transverse results were obtained from long, round tensile specimens. The short transverse were obtained from both long and short round specimens. Only forging number 2 was thick enough to permit obtaining a long specimen. Forgings 1, 3, 4, and 5 required the use of short round specimens. Forging 6 was not thick enough to obtain a sample. A typical stress-strain curve in tension for this material is shown in Figure 15. Tensile ultimate and tensile yield stress are plotted as a function of forging thickness in Figures 16a and 16b respectively. As can be seen these values increase for thinner forgings.

Compression. Compression results were obtained for all six forgings in all three directions. Results are presented in Table 14. Table 14a contains the results for the longitudinal samples. Long transverse and short transverse results are in Tables 14b and 14c respectively. A typical stress-strain curve for this material is shown in Figure 17. Compressive ultimate and compressive yield strengths are plotted as a function of forging thickness in Figure 18.

Shear. Two specimen types were used to determine the shear properties of 7175-T736 aluminum hand forgings: double-rivet shear and Amsler shear. Table 15 provides the results from these tests. Table 15a is for the double-rivet shear and Table 15b is for the Amsler shear. The ultimate shear strengths established using the Amsler-shear fixture were from 2.6 percent

to 11.4 percent higher depending on specimen orientation and forging thickness. The Amsler-shear fixture is an extremely rigid fixture and seems to better restrain bending over the length of the test specimen producing higher data. Results of a typical shear test are shown graphically in Figure 19. Figure 20 plots the combined ultimate shear strength as a function of forging thickness.

Bearing. Pin-Bearing Test results are reported for  $e/D$  of 1.5 and 2.0 for all three directions (L, LT, and ST) in Table 16. The ratio,  $e/D$ , is the ratio of the distance between the centerline of the hole in the bearing specimen and the edge of the specimen ( $e$ ) to the diameter of the bearing hole ( $D$ ). Tables 16a through 16c are for an  $e/D$  of 1.5. Tables 16d through 16f are for an  $e/D$  of 2.0. A typical stress-deflection curve in bearing is presented in Figure 21. The bearing ultimate and yield strengths are plotted as a function of forging thickness for  $e/D$  of 1.5 in Figures 22a and 22b respectively. Figures 23a and 23b present similar results for  $e/D=2.0$ .

Fatigue. Axial load fatigue tests were performed at room temperature to determine the number of cycles to failure at a given maximum stress. The ratio of minimum to maximum stress was 0.1. Both notched and unnotched round samples in the longitudinal and long transverse direction were tested. Tables 17a through 17d present the results from tests of these samples. Figures 24 through 27 graphically summarize the results of these tests for the geometries and orientation identified above.

#### Summary of Mechanical Properties

A summary of the individual material properties for various ranges of forging thicknesses is given in Table 18 for the aluminum hand forging (7175-T736).



TABLE 11

GEOMETRY AND HEAT NUMBER FOR 7175-T736 ALUMINUM ALLOY  
HAND FORGINGS

Plate Number	Heat Number	Plate Thickness (inches)	Width (inches)	Length (inches)
1	56648-01 701403	4 3/4	12 1/4	30 1/4
2	56648-01 701403	6 1/4	12	29 1/2
3	56640-01 701402	5 1/4	15	30 1/4
4	56642-01 701402	3 3/4	15.5	30 1/2
5	56657-01 701403	2 3/4	13 1/2	23 1/4
6	56644-01	2	16 3/8	26 1/2

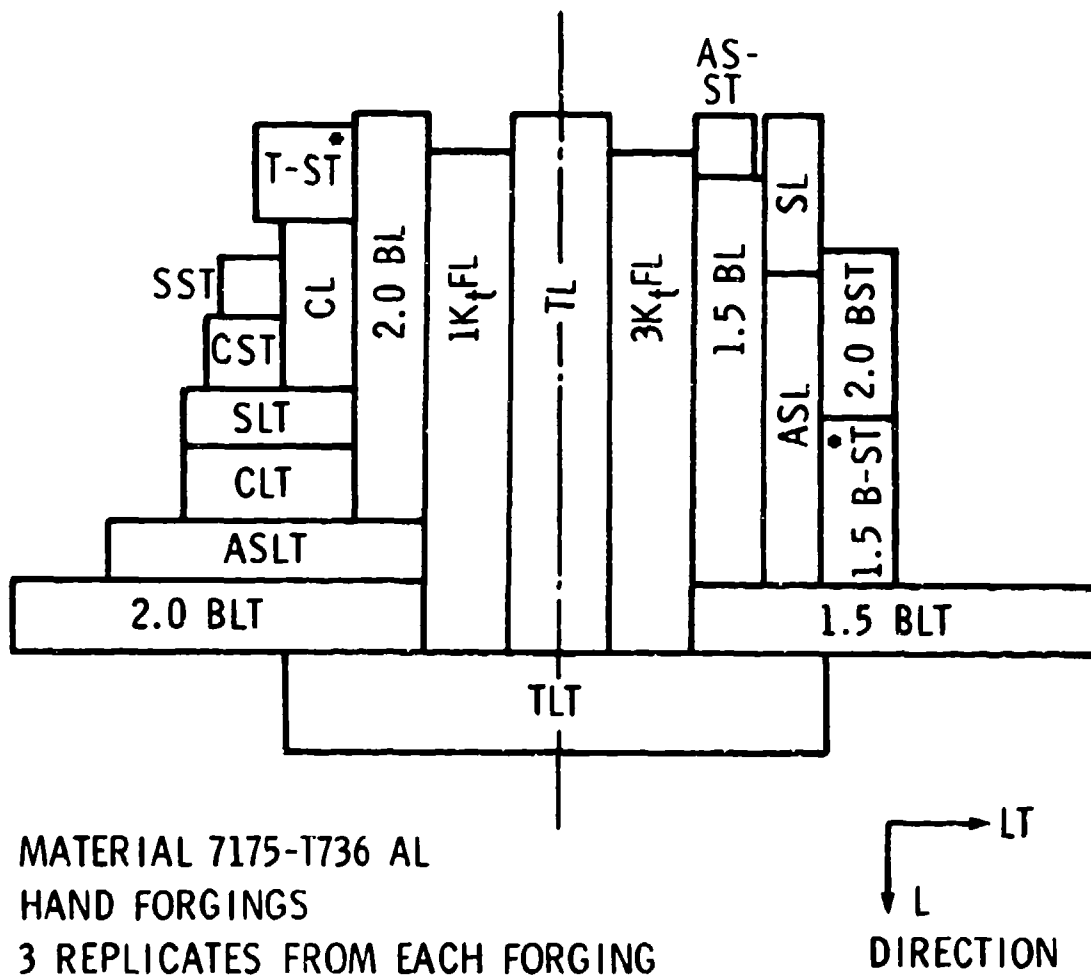
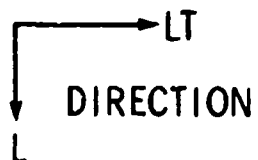

Figure 14a. Material 7175-T736 AL Specimen Layout Hand Forgings, 3 Replicates from Each Forging.

1K <sub>t</sub> F-LT	3K <sub>t</sub> F-LT
1K <sub>t</sub> F-LT	3K <sub>t</sub> F-LT
1K <sub>t</sub> F-LT	3K <sub>t</sub> F-LT
1K <sub>t</sub> F-LT	3K <sub>t</sub> F-LT
1K <sub>t</sub> F-LT	3K <sub>t</sub> F-LT
1K <sub>t</sub> F-LT	3K <sub>t</sub> F-LT
1K <sub>t</sub> F-LT	3K <sub>t</sub> F-LT
1K <sub>t</sub> F-LT	3K <sub>t</sub> F-LT
1K <sub>t</sub> F-LT	3K <sub>t</sub> F-LT
1K <sub>t</sub> F-LT	3K <sub>t</sub> F-LT
1K <sub>t</sub> F-LT	3K <sub>t</sub> F-LT
1K <sub>t</sub> F-LT	3K <sub>t</sub> F-LT
1K <sub>t</sub> F-LT	3K <sub>t</sub> F-LT
1K <sub>t</sub> F-LT	3K <sub>t</sub> F-LT
1K <sub>t</sub> F-LT	3K <sub>t</sub> F-LT



MATERIAL 7175-T736 AL  
HAND FORGINGS

Figure 14b. Material 7175-T736 AL Specimen Layout Hand Forgings.

TABLE 12  
TEST GRID FOR 7175-T736 ALUMINUM HAND FORGING

PLATE NUMBER	1	2	3	4	5	6
HEAT NUMBER	56648-01 701403	56646-01 701403	56640-01 701402	56642-01 701402	56657-01 701403	56644-01 701402
PLATE THICKNESS in (mm)	4.75 (121)	6.25 (159)	5.25 (133)	3.75 (95.2)	2.75 (69.8)	2.00 (50.8)
Tension	Long (L) 3 Long (LT) 3 Long (ST) 3 Short (ST) 3	3 3 3 3	3 3 3 3	3 3 3 3	3 3 3 3	3 3 3 3
Compression	Round (L) 3 Round (LT) 3 Round (ST) 3	3 3 3 3	3 3 3 3	3 3 3 3	3 3 3 3	3 3 3 3
Shear	Double Rivet (L) 3 Double Rivet (LT) 3 Double Rivet (ST) 3 Angler Shear (L) 3 Angler Shear (LT) 3 Angler Shear (ST) 3	3 3 3 3 3 3 3 3 3	3 3 3 3 3 3 3 3 3	3 3 3 3 3 3 3 3 3	3 3 3 3 3 3 3 3 3	3 3 3 3 3 3 3 3 3
Bearing	e/D = 1.5 Pin Bearing (L) 3 Pin Bearing (LT) 3 Pin Bearing (ST) 3 e/D = 2.0 Pin Bearing (L) 3 Pin Bearing (LT) 3 Pin Bearing (ST) 3	3 3 3 3 3 3 3 3 3 3 3	3 3 3 3 3 3 3 3 3 3 3	3 3 3 3 3 3 3 3 3 3 3	3 3 3 3 3 3 3 3 3 3 3	3 3 3 3 3 3 3 3 3 3 3
Fatigue (Round)	Unnotched (L) 3 Unnotched (LT) 3 Notched (L) 3 Unnotched (LT) 3	3 3 3 3 3 3 3	3 3 3 3 3 3 3	3 12 3 12	3 3 3 3	3 3 3 3

TABLE 13A

TENSILE RESULTS FOR ALUMINUM HAND FORGING (7175-T736)  
(LONG, ROUND, LONGITUDINAL)

SPECIMEN ID.	ULTIMATE TENSILE STRENGTH Ksi (MPa)	0.2 PERCENT OFFSET YIELD STRENGTH Ksi (MPa)	ELONG. IN 2.0 IN. ( 50.8 mm) PERCENT	REDUCT. IN AREA PERCENT	TENSILE MODULUS Ksi (GPa)
<u>LONG, ROUND, LONGITUDINAL</u>					
ALFP1-1-3T-L	69.17 (476.9)	58.16 (401.0)	22.50	39.99	10010 (69.05)
ALFP1-2-3T-L	69.98 (482.5)	59.28 (408.7)	22.90	40.30	10330 (71.23)
ALFP1-3-3T-L	67.98 (468.7)	56.77 (391.4)	23.60	39.73	9992 (68.90)
ALFP2-1-3T-L	65.89 (454.3)	53.85 (371.3)	23.50	37.39	9890 (68.19)
ALFP2-2-3T-L	66.45 (458.1)	54.14 (373.3)	23.90	37.66	10600 (73.09)
ALFP2-3-3T-L	65.71 (453.1)	53.30 (367.5)	23.10	40.85	10810 (74.56)
ALFP3-1-3T-L	68.63 (473.2)	56.17 (387.3)	22.50	36.88	9982 (68.83)
ALFP3-2-3T-L	70.60 (486.8)	59.48 (410.1)	19.40	38.27	10450 (72.07)
ALFP3-3-3T-L	68.06 (469.3)	55.83 (384.9)	22.90	36.42	10140 (69.91)
ALFP4-1-3T-L	73.29 (505.4)	62.70 (432.3)	22.40	36.51	10270 (70.78)
ALFP4-2-3T-L	71.67 (494.2)	61.02 (420.7)	22.60	40.59	10280 (70.88)
ALFP4-3-3T-L	72.55 (500.2)	61.89 (426.7)	22.30	43.34	9932 (68.48)
ALFP5-1-3T-L	77.72 (535.9)	69.12 (476.6)	21.80	37.15	10220 (70.49)
ALFP5-2-3T-L	78.19 (539.1)	69.13 (476.7)	23.00	37.02	10330 (71.23)
ALFP5-3-3T-L	76.56 (527.9)	67.82 (467.6)	17.30	38.92	10300 (71.01)
ALFP6-1-3T-L	80.03 (551.8)	71.49 (492.9)	22.40	37.78	10230 (70.54)
ALFP6-2-3T-L	80.12 (552.4)	71.69 (494.3)	22.00	37.34	10240 (70.63)
ALFP6-3-3T-L	78.78 (543.2)	69.52 (479.3)	20.20	37.98	10170 (70.15)
AVERAGE	72.30 (498.5)	61.74 (425.7)	22.13	38.56	10230 (70.56)

TABLE 13B

TENSILE RESULTS FOR ALUMINUM HAND FORGING (7175-T736)  
(LONG, ROUND, LONG TRANSVERSE)

SPECIMEN ID.	ULTIMATE TENSILE STRENGTH Ksi (MPa)	0.2 PERCENT OFFSET YIELD STRENGTH Ksi (MPa)	ELONG. IN 2.0 IN. (50.8 mm) PERCENT	REDUCT. IN AREA PERCENT	TENSILE MODULUS Ksi (GPa)
LONG, ROUND, LONG TRANSVERSE					
ALFP1-1-3T-LT	70.93 (489.1)	59.96 (413.4)	9.02	14.89	10300 (71.03)
ALFP1-2-3T-LT	68.92 (475.2)	56.35 (388.6)	14.50	19.00	10170 (70.89)
ALFP1-3-3T-LT	69.36 (478.2)	56.82 (391.8)	15.00	19.49	10300 (71.03)
ALFP2-1-3T-LT	66.24 (456.7)	51.63 (356.0)	13.90	18.64	10130 (69.86)
ALFP2-2-3T-LT	65.93 (454.6)	51.71 (356.5)	13.80	17.65	9978 (68.80)
ALFP2-3-3T-LT	66.45 (458.1)	51.96 (358.3)	13.90	17.95	10200 (70.32)
ALFP3-1-3T-LT	67.70 (466.8)	54.27 (374.2)	15.40	18.68	10340 (71.31)
ALFP3-2-3T-LT	67.57 (465.9)	53.77 (370.7)	15.00	18.31	10160 (70.02)
ALFP3-3-3T-LT	67.14 (463.0)	52.94 (365.0)	12.90	17.42	9882 (68.14)
ALFP4-1-3T-LT	71.37 (492.1)	59.97 (413.5)	15.80	24.61	10040 (69.24)
ALFP4-2-3T-LT	71.59 (493.6)	59.84 (412.6)	15.40	19.00	10070 (69.41)
ALFP4-3-3T-LT	71.67 (494.2)	60.51 (417.2)	18.10	25.93	10180 (70.17)
ALFP5-1-3T-LT	76.48 (527.3)	67.17 (463.1)	17.50	28.23	10580 (72.97)
ALFP5-2-3T-LT	76.13 (524.9)	66.80 (460.6)	16.90	22.56	10040 (69.24)
ALFP5-3-3T-LT	76.88 (530.1)	67.86 (467.9)	17.60	24.31	9983 (68.83)
ALFP6-1-3T-LT	78.00 (537.8)	68.73 (473.9)	16.00	22.21	10010 (69.05)
ALFP6-2-3T-LT	77.94 (537.4)	69.60 (479.9)	19.60	32.43	10520 (72.52)
ALFP6-3-3T-LT	77.69 (535.7)	70.04 (482.9)	19.70	36.00	10310 (71.09)
AVERAGE	71.55 (493.4)	60.00 (413.7)	15.56	22.07	10180 (70.17)

TABLE 13C

TENSILE RESULTS FOR ALUMINUM HAND FORGING (7175-T736)  
(LONG, ROUND, SHORT TRANSVERSE)

SPECIMEN ID.	ULTIMATE TENSILE STRENGTH	0.2 PERCENT OFFSET YIELD STRENGTH	ELONG. IN 2.0 IN. ( 50.8 mm)	REDUCT. IN AREA	TENSILE MODULUS
	Ksi (MPa)	Ksi (MPa)	PERCENT	PERCENT	Ksi (GPa)
	<u>LONG, ROUND, SHORT TRANSVERSE</u>				
ALFP2-1-3T-ST	66.90 (461.3)	53.92 (371.8)	10.90	11.31	10490 (72.33)
ALFP2-2-3T-ST	67.08 (462.5)	53.75 (370.6)	12.20	12.24	10340 (71.32)
ALFP2-3-3T-ST	68.18 (470.1)	55.41 (382.0)	13.60	14.82	9801 (67.58)
AVERAGE	67.39 (464.6)	54.36 (374.8)	12.23	12.79	10210 (70.41)

TABLE 13D

TENSILE RESULTS FOR ALUMINUM HAND FORGING (7175-T736)  
(SHORT, ROUND, SHORT TRANSVERSE)

SPECIMEN ID.	ULTIMATE	0.2 PERCENT	ELONG.	REDUCT.	TENSILE
	TENSILE	OFFSET YIELD	IN 1.0 IN.		
	STRENGTH	STRENGTH	( 25.4 mm)	IN AREA	MODULUS
	Ksi (MPa)	Ksi (MPa)	PERCENT	PERCENT	Ksi (GPa)
<u>SHORT, ROUND, SHORT TRANSVERSE</u>					
ALFP1-1-3T-ST	70.11 (483.4)	58.67 (404.5)	6.10	9.44	10150 (70.02)
ALFP1-2-3T-ST	70.37 (485.2)	58.31 (402.1)	9.00	26.61	10090 (69.58)
ALFP1-3-3T-ST	68.61 (473.1)	57.28 (394.9)	7.00	16.16	10130 (69.85)
ALFP3-1-3T-ST	78.02 (538.0)	67.47 (465.2)	7.40	13.14	10120 (69.81)
ALFP3-2-3T-ST	68.62 (473.2)	54.58 (376.3)	7.90	12.32	10130 (69.83)
ALFP3-3-3T-ST	68.55 (472.6)	54.76 (377.6)	8.50	16.36	10020 (69.12)
ALFP4-1-3T-ST	72.05 (496.8)	59.81 (412.4)	9.30	19.00	9848 (67.90)
ALFP4-2-3T-ST	71.60 (493.7)	61.26 (422.4)	9.10	20.50	10040 (69.20)
ALFP4-3-3T-ST	72.28 (498.4)	60.96 (420.3)	8.80	16.30	9864 (68.01)
ALFP5-1-3T-ST	76.05 (524.4)	66.02 (455.2)	8.10	13.35	9803 (67.59)
ALFP5-2-3T-ST	78.25 (539.5)	68.48 (472.2)	8.40	13.74	9846 (67.89)
ALFP5-3-3T-ST	75.16 (518.2)	67.11 (462.8)	9.20	17.75	10040 (69.19)
AVERAGE	72.47 (499.7)	61.23 (422.2)	8.233	16.22	10010 (69.00)



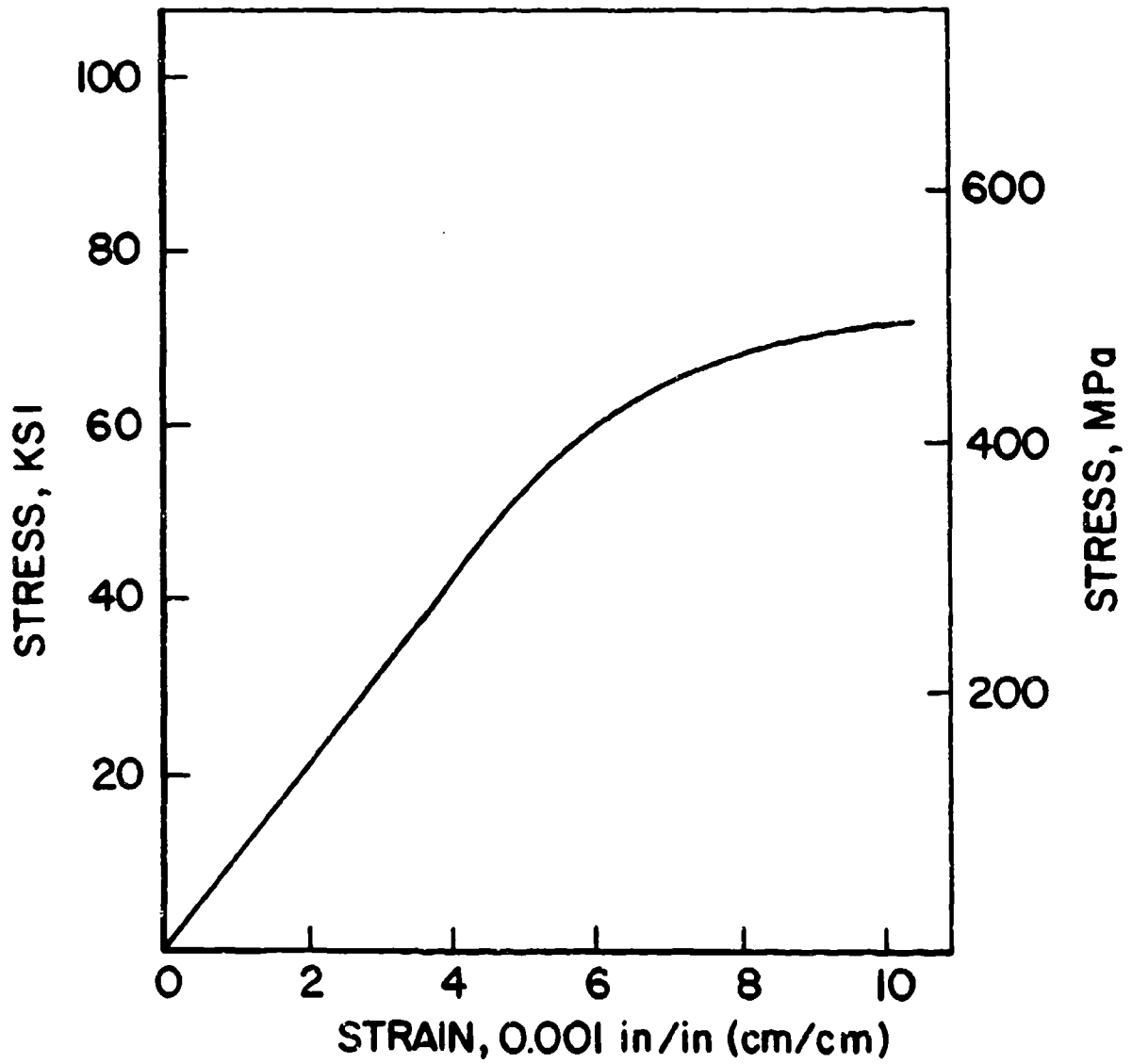

Figure 15. Typical Stress-Strain Curve in Tension for 7175-T736 Aluminum Hand Forging.

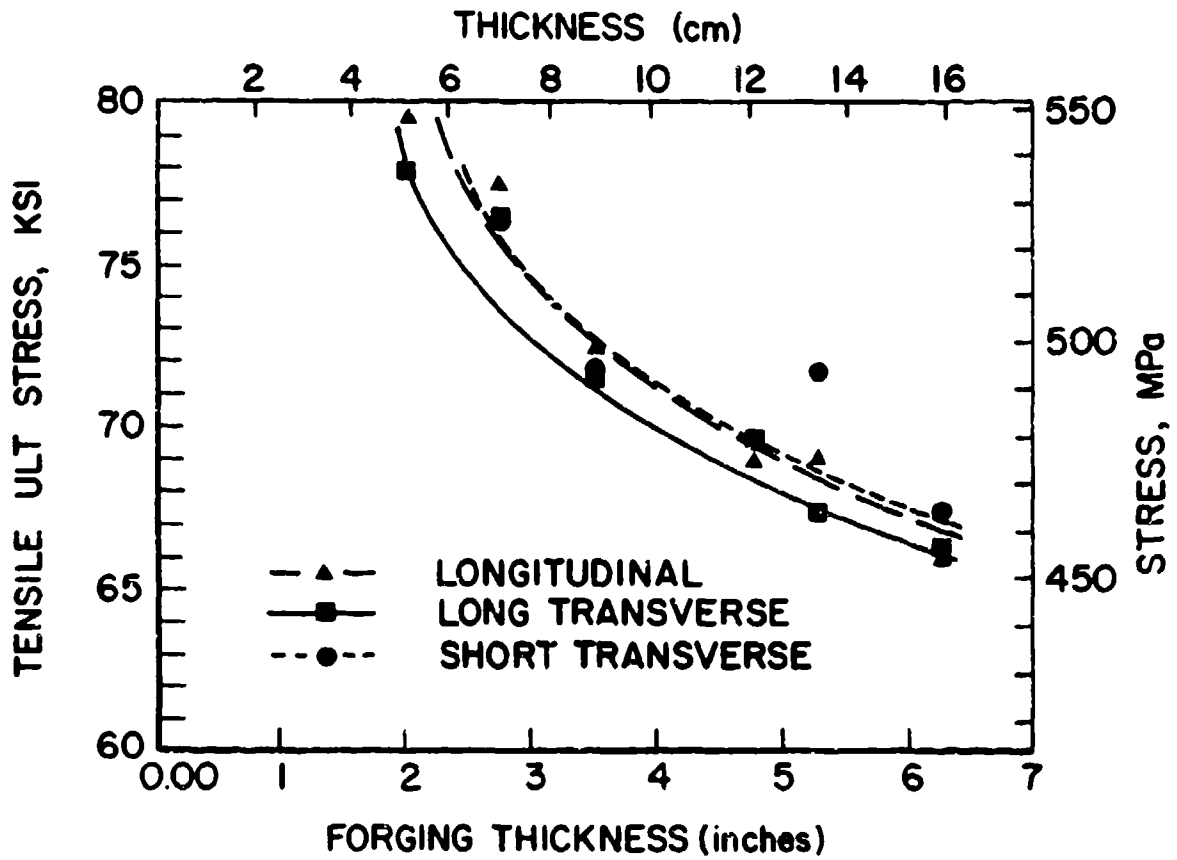

Figure 16a. Tensile Ultimate Stress as a Function of Forging Thickness.

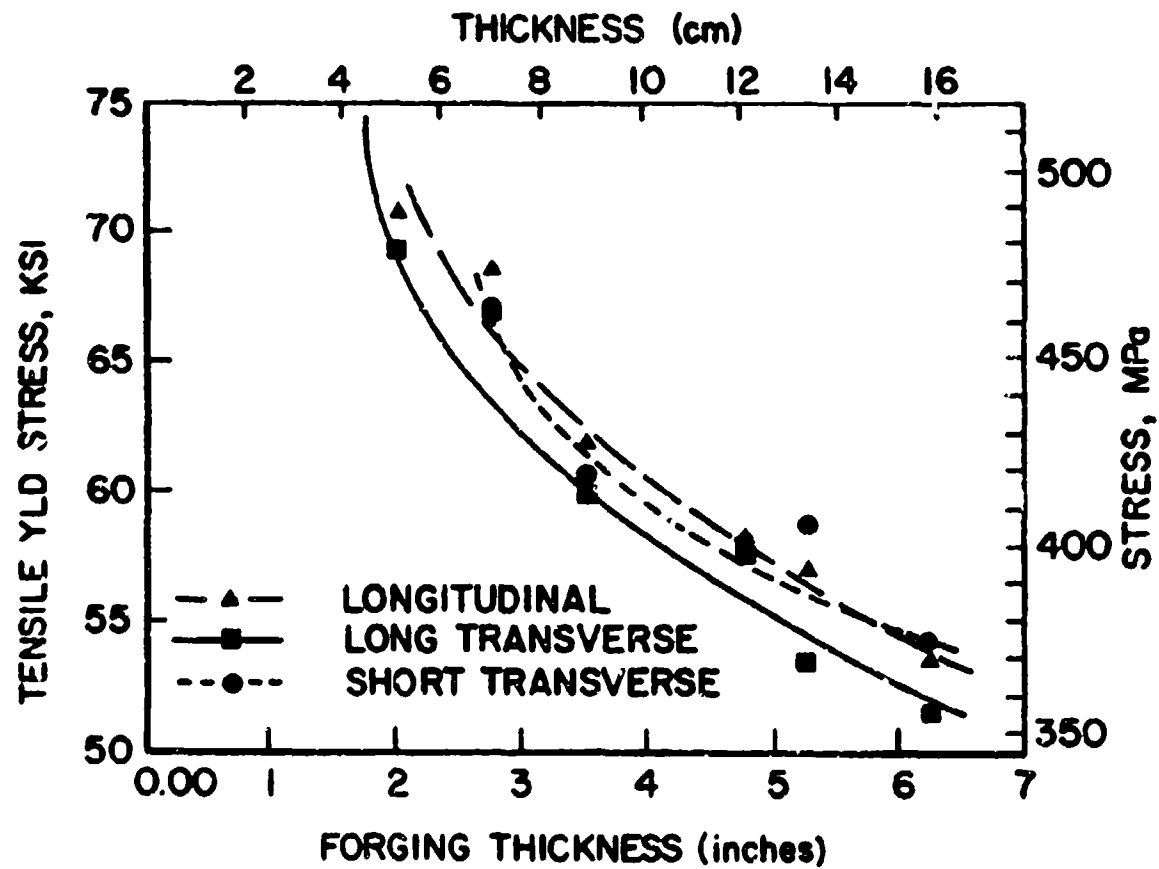

Figure 16b. Tensile Yield Stress as a Function of Forging Thickness.

TABLE 14A

COMPRESSION RESULTS FOR ALUMINUM HAND FORGING (7175-T736)  
(ROUND, LONGITUDINAL)

SPECIMEN IDENTIFICATION	0.2 PERCENT OFFSET YIELD STRENGTH		COMPRESSIVE MODULUS
	Ksi	(MPa)	Ksi (GPa)
<u>ROUND, LONGITUDINAL</u>			
ALFP1-1-3C-L	60.56	(417.6)	10210 (70.41)
ALFP1-2-3C-L	60.26	(415.5)	10270 (70.84)
ALFP1-3-3C-L	62.78	(432.9)	10360 (71.46)
ALFP2-1-3C-L	56.64	(390.5)	10170 (70.10)
ALFP2-2-3C-L	57.74	(398.2)	10370 (71.53)
ALFP2-3-3C-L	57.84	(398.8)	10490 (72.36)
ALFP3-1-3C-L	57.85	(398.8)	10550 (72.73)
ALFP3-2-3C-L	59.01	(406.9)	10540 (72.70)
ALFP3-3-3C-L	64.16	(442.4)	10610 (73.18)
ALFP4-1-3C-L	64.63	(445.6)	10610 (73.13)
ALFP4-2-3C-L	64.48	(444.6)	10670 (73.59)
ALFP4-3-3C-L	65.25	(449.9)	10620 (73.20)
ALFP5-1-3C-L	71.04	(489.8)	10610 (73.19)
ALFP5-2-3C-L	71.67	(494.2)	10770 (74.23)
ALFP5-3-3C-L	71.14	(490.5)	10650 (73.43)
ALFP6-1-3C-L	74.21	(511.7)	10690 (73.73)
ALFP6-2-3C-L	75.51	(520.7)	10750 (74.13)
ALFP6-3-3C-L	73.62	(507.6)	10690 (73.73)
AVERAGE	64.91	(447.6)	10540 (72.65)

TABLE 14B

COMPRESSION RESULTS FOR ALUMINUM HAND FORGING (7175-T736)  
(ROUND, LONG TRANSVERSE)

SPECIMEN IDENTIFICATION	0.2 PERCENT OFFSET YIELD STRENGTH		COMPRESSIVE MODULUS	
	Ksi	(MPa)	Ksi	(GPa)
<u>ROUND, LONG TRANSVERSE</u>				
ALFP1-1-3C-LT	61.63	(424.9)	11060	(76.29)
ALFP1-2-3C-LT	61.01	(420.6)	10980	(75.72)
ALFP1-3-3C-LT	61.53	(424.3)	10980	(75.73)
ALFP2-1-3C-LT	57.44	(396.1)	11030	(76.05)
ALFP2-2-3C-LT	56.84	(391.9)	11020	(76.01)
ALFP2-3-3C-LT	56.27	(388.0)	10910	(75.19)
ALFP3-1-3C-LT	58.34	(402.3)	10880	(75.03)
ALFP3-2-3C-LT	59.37	(409.3)	10980	(75.68)
ALFP3-3-3C-LT	58.03	(400.1)	10930	(75.36)
ALFP4-1-3C-LT	64.97	(448.0)	11120	(76.66)
ALFP4-2-3C-LT	63.25	(436.1)	10960	(75.55)
ALFP4-3-3C-LT	63.95	(441.0)	10940	(75.42)
ALFP5-1-3C-LT	70.86	(488.6)	11060	(76.25)
ALFP5-2-3C-LT	71.18	(490.8)	11100	(76.56)
ALFP5-3-3C-LT	70.83	(488.4)	11020	(75.98)
ALFP6-1-3C-LT	74.40	(513.0)	11100	(76.53)
ALFP6-2-3C-LT	74.21	(511.7)	11060	(76.23)
ALFP6-3-3C-LT	73.63	(507.6)	11150	(76.88)
AVERAGE	64.32	(443.5)	11020	(75.95)

TABLE 14C

COMPRESSION RESULTS FOR ALUMINUM HAND FORGING (7175-T736)  
(ROUND, SHORT TRANSVERSE)

SPECIMEN IDENTIFICATION	0.2 PERCENT OFFSET YIELD STRENGTH		COMPRESSIVE MODULUS
	ksi	(MPa)	Ksi (GPa)
<u>ROUND, SHORT TRANSVERSE</u>			
ALFP1-1-3C-ST	60.96	(420.3)	10970 (75.64)
ALFP1-2-3C-ST	60.76	(418.9)	10960 (75.54)
ALFP1-3-3C-ST	60.67	(418.3)	10860 (74.91)
ALFP2-1-3C-ST	56.87	(392.1)	10920 (75.27)
ALFP2-2-3C-ST	56.81	(391.7)	10890 (75.08)
ALFP2-3-3C-ST	57.69	(397.8)	10970 (75.61)
ALFP3-1-3C-ST	56.93	(392.5)	10960 (75.56)
ALFP3-2-3C-ST	57.32	(395.2)	10900 (75.14)
ALFP3-3-3C-ST	61.33	(422.9)	10950 (75.50)
ALFP4-1-3C-ST	63.35	(436.8)	10950 (75.51)
ALFP4-2-3C-ST	62.75	(432.6)	10910 (75.25)
ALFP4-3-3C-ST	63.22	(435.9)	10920 (75.30)
ALFP5-1-3C-ST	70.47	(485.9)	10920 (75.31)
ALFP5-2-3C-ST	71.00	(489.6)	10890 (75.09)
ALFP5-3-3C-ST	70.32	(484.9)	10870 (74.95)
ALFP6-1-3C-ST	72.30	(499.1)	10840 (74.76)
ALFP6-2-3C-ST	73.28	(505.3)	10940 (75.45)
ALFP6-3-3C-ST	73.07	(503.8)	10860 (74.86)
AVERAGE	63.84	(440.2)	10920 (75.26)

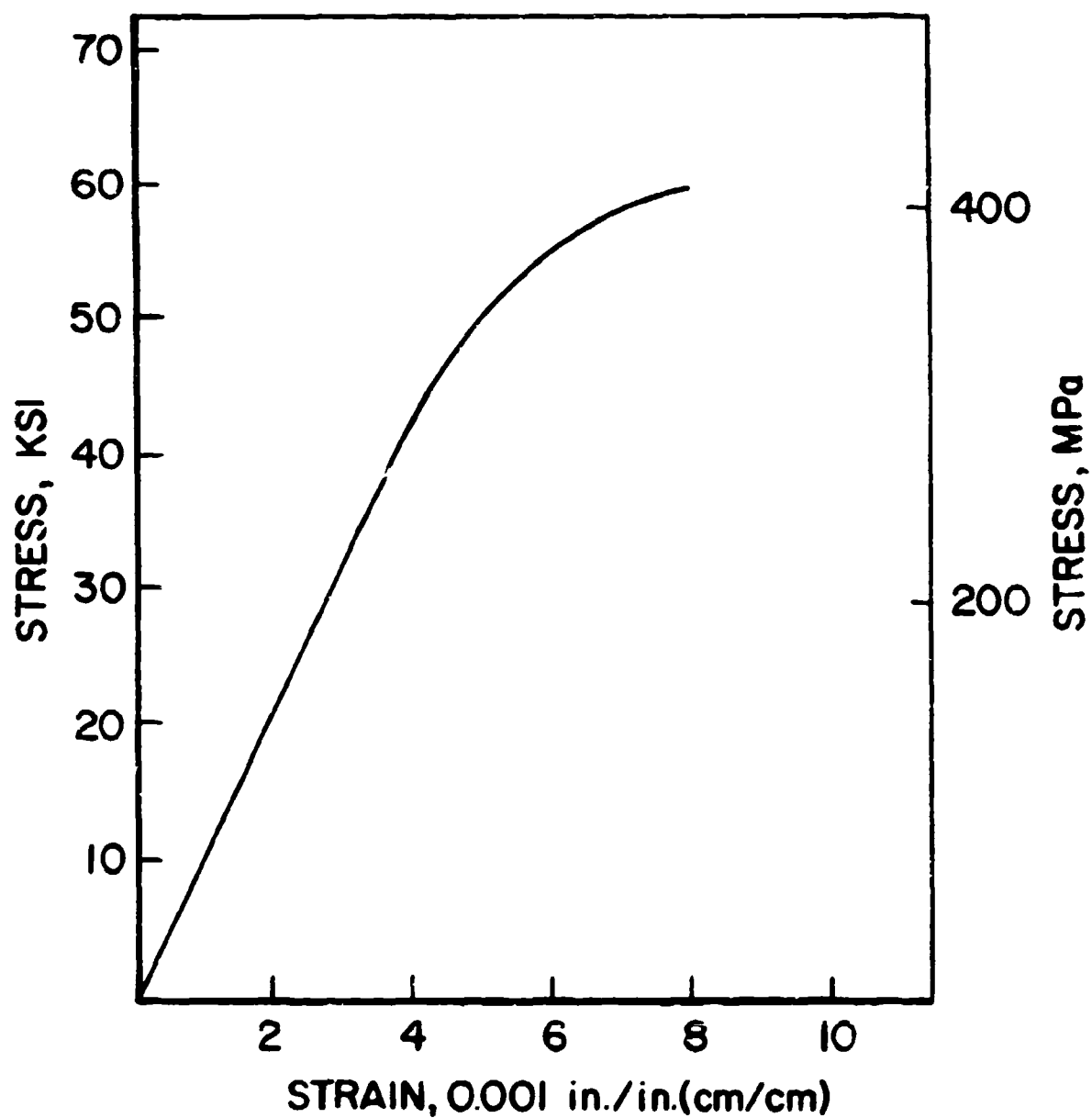

Figure 17. Typical Compressive Stress-Strain Curve for 7175-T736 Aluminum Hand Forging.

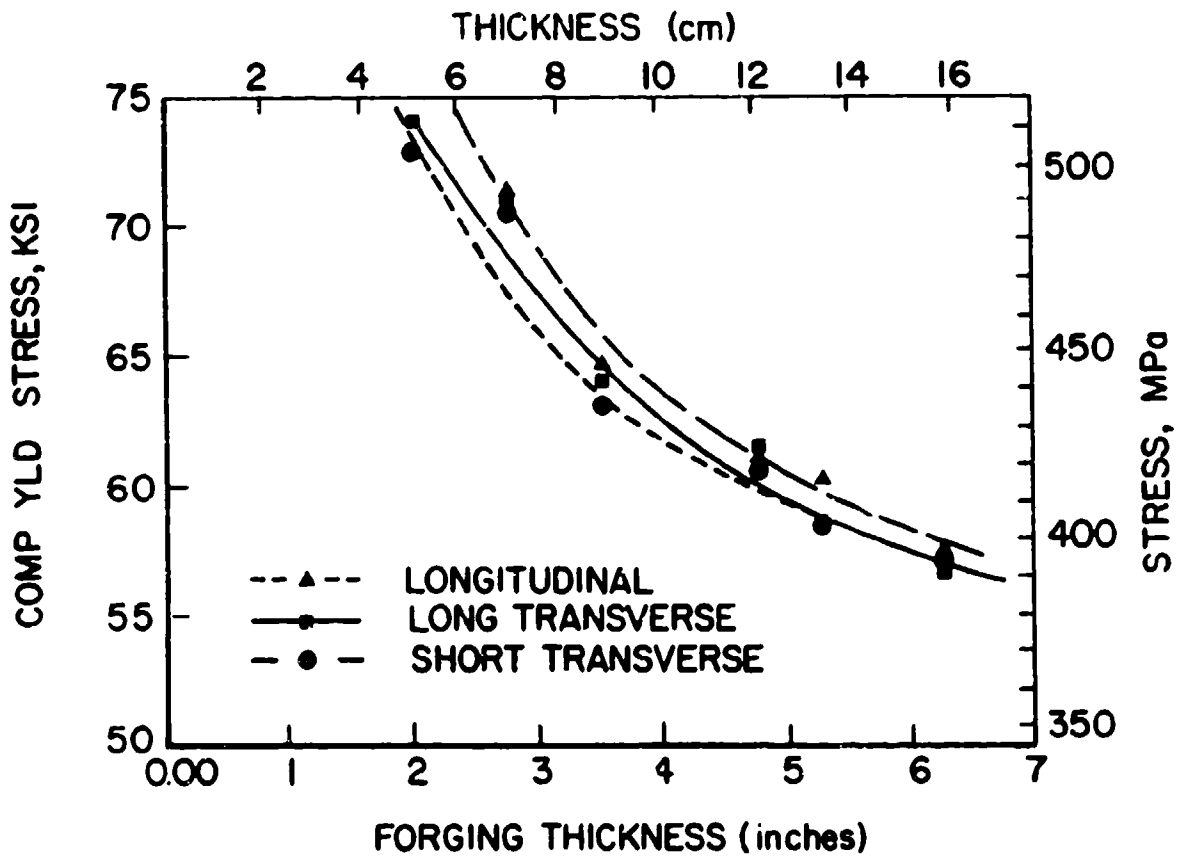

Figure 18. Compressive Yield Stress as a Function of Forging Thickness.



TABLE 15A

DOUBLE RIVET SHEAR RESULTS FOR ALUMINUM HAND FORGING (7175-T736)

SPECIMEN IDENTIFICATION	ULTIMATE SHEAR STRENGTH Ksi (MPa)		SPECIMEN IDENTIFICATION	ULTIMATE SHEAR STRENGTH Ksi (MPa)	
<u>SHORT TRANSVERSE</u>					
ALFP1-1-3S-ST	38.89	(268.1)	ALFP2-1-3S-ST	40.78	(281.2)
ALFP1-2-3S-ST	40.29	(277.8)	ALFP2-2-3S-ST	41.16	(283.8)
ALFP1-3-3S-ST	39.56	(272.7)	ALFP2-3-3S-ST	37.93	(261.5)
ALFP3-1-3S-ST	41.44	(285.8)	ALFP4-1-3S-ST	40.33	(278.1)
ALFP3-2-3S-ST	38.53	(265.7)	ALFP4-2-3S-ST	40.56	(279.6)
ALFP3-3-3S-ST	39.64	(273.3)	ALFP4-3-3S-ST	39.95	(275.5)
ALFP5-1-3S-ST	42.17	(290.7)	ALFP6-1-3S-ST	40.97	(282.5)
ALFP5-2-3S-ST	44.96	(310.0)	ALFP6-2-3S-ST	43.89	(302.7)
ALFP5-3-3S-ST	39.96	(275.5)	ALFP6-3-3S-ST	43.97	(303.2)
	AVERAGE		40.83	(281.5)	
<u>LONG TRANSVERSE</u>					
ALFP1-1-3S-LT	38.49	(265.4)	ALFP2-1-3S-LT	37.95	(261.7)
ALFP1-2-3S-LT	38.69	(266.7)	ALFP2-2-3S-LT	37.63	(259.4)
ALFP1-3-3S-LT	38.34	(264.3)	ALFP2-3-3S-LT	38.04	(262.3)
ALFP3-1-3S-LT	38.28	(264.0)	ALFP4-1-3S-LT	39.91	(275.1)
ALFP3-2-3S-LT	38.85	(267.8)	ALFP4-2-3S-LT	39.35	(271.3)
ALFP3-3-3S-LT	37.32	(257.3)	ALFP4-3-3S-LT	40.37	(278.4)
ALFP5-1-3S-LT	41.62	(287.0)	ALFP6-1-3S-LT	43.80	(302.0)
ALFP5-2-3S-LT	41.68	(287.4)	ALFP6-2-3S-LT	43.33	(298.8)
ALFP5-3-3S-LT	41.91	(289.0)	ALFP6-3-3S-LT	44.01	(303.5)
	AVERAGE		39.98	(275.6)	
<u>LONGITUDINAL</u>					
ALFP1-1-3S-L	41.47	(285.9)	ALFP2-1-3S-L	41.14	(283.7)
ALFP1-2-3S-L	42.22	(291.1)	ALFP2-2-3S-L	40.18	(277.0)
ALFP1-3-3S-L	41.38	(285.3)	ALFP2-3-3S-L	40.35	(278.2)
ALFP3-1-3S-L	40.73	(280.8)	ALFP4-1-3S-L	42.17	(290.7)
ALFP3-2-3S-L	44.62	(307.6)	ALFP4-2-3S-L	42.93	(296.0)
ALFP3-3-3S-L	40.49	(279.2)	ALFP4-3-3S-L	42.44	(292.6)
ALFP5-1-3S-L	45.53	(314.0)	ALFP6-1-3S-L	45.96	(316.9)
ALFP5-2-3S-L	43.70	(301.3)	ALFP6-2-3S-L	46.17	(318.4)
ALFP5-3-3S-L	44.70	(308.2)	ALFP6-3-3S-L	45.92	(316.7)
	AVERAGE		42.89	(295.8)	

TABLE 15B

AMSLER DOUBLE SHEAR RESULTS FOR ALUMINUM HAND FORGING (7175-T736)

SPECIMEN IDENTIFICATION	ULTIMATE SHEAR STRENGTH Ksi (MPa)	SPECIMEN IDENTIFICATION	ULTIMATE SHEAR STRENGTH Ksi (MPa)
<u>SHORT TRANSVERSE</u>			
ALFP1-1-3S-ST	42.56 (293.5)	ALFP2-1-3S-ST	41.52 (286.3)
ALFP1-2-3S-ST	43.45 (299.6)	ALFP2-2-3S-ST	42.50 (293.0)
ALFP1-3-3S-ST	43.99 (303.3)	ALFP2-3-3S-ST	41.61 (286.9)
ALFP3-1-3S-ST	43.71 (301.4)	ALFP4-1-3S-ST	43.75 (301.7)
ALFP3-2-3S-ST	41.27 (284.6)	ALFP4-2-3S-ST	42.97 (296.3)
ALFP3-3-3S-ST	46.47 (320.4)	ALFP4-3-3S-ST	43.61 (300.7)
AVERAGE		43.12 (297.3)	
<u>LONG TRANSVERSE</u>			
ALFP1-1-3S-LT	45.26 (312.1)	ALFP2-1-3S-LT	41.04 (282.9)
ALFP1-2-3S-LT	41.59 (286.7)	ALFP2-2-3S-LT	41.26 (284.5)
ALFP1-3-3S-LT	41.88 (288.8)	ALFP2-3-3S-LT	43.34 (298.8)
ALFP3-1-3S-LT	41.41 (285.5)	ALFP4-1-3S-LT	42.95 (296.1)
ALFP3-2-3S-LT	41.54 (286.4)	ALFP4-2-3S-LT	42.68 (294.3)
ALFP3-3-3S-LT	41.61 (286.9)	ALFP4-3-3S-LT	43.32 (298.7)
ALFP5-1-3S-LT	45.28 (312.2)	ALFP6-1-3S-LT	46.65 (321.6)
ALFP5-2-3S-LT	44.96 (310.0)	ALFP6-2-3S-LT	46.20 (318.5)
ALFP5-3-3S-LT	44.91 (309.6)	ALFP6-3-3S-LT	46.72 (322.1)
AVERAGE		43.48 (299.8)	
<u>LONGITUDINAL</u>			
ALFP1-1-3S-L	45.00 (310.3)	ALFP2-1-3S-L	42.71 (294.5)
ALFP1-2-3S-L	43.15 (297.5)	ALFP2-2-3S-L	42.71 (294.5)
ALFP1-3-3S-L	43.09 (297.1)	ALFP2-3-3S-L	42.48 (292.9)
ALFP3-1-3S-L	43.89 (302.7)	ALFP4-1-3S-L	44.50 (306.8)
ALFP3-2-3S-L	42.53 (293.3)	ALFP4-2-3S-L	44.70 (308.2)
ALFP3-3-3S-L	42.60 (293.7)	ALFP4-3-3S-L	45.12 (311.1)
ALFP5-1-3S-L	46.38 (319.8)	ALFP6-1-3S-L	48.60 (335.1)
ALFP5-2-3S-L	46.86 (323.1)	ALFP6-2-3S-L	48.15 (332.0)
ALFP5-3-3S-L	46.30 (319.2)	ALFP6-3-3S-L	48.18 (332.2)
AVERAGE		44.83 (309.1)	

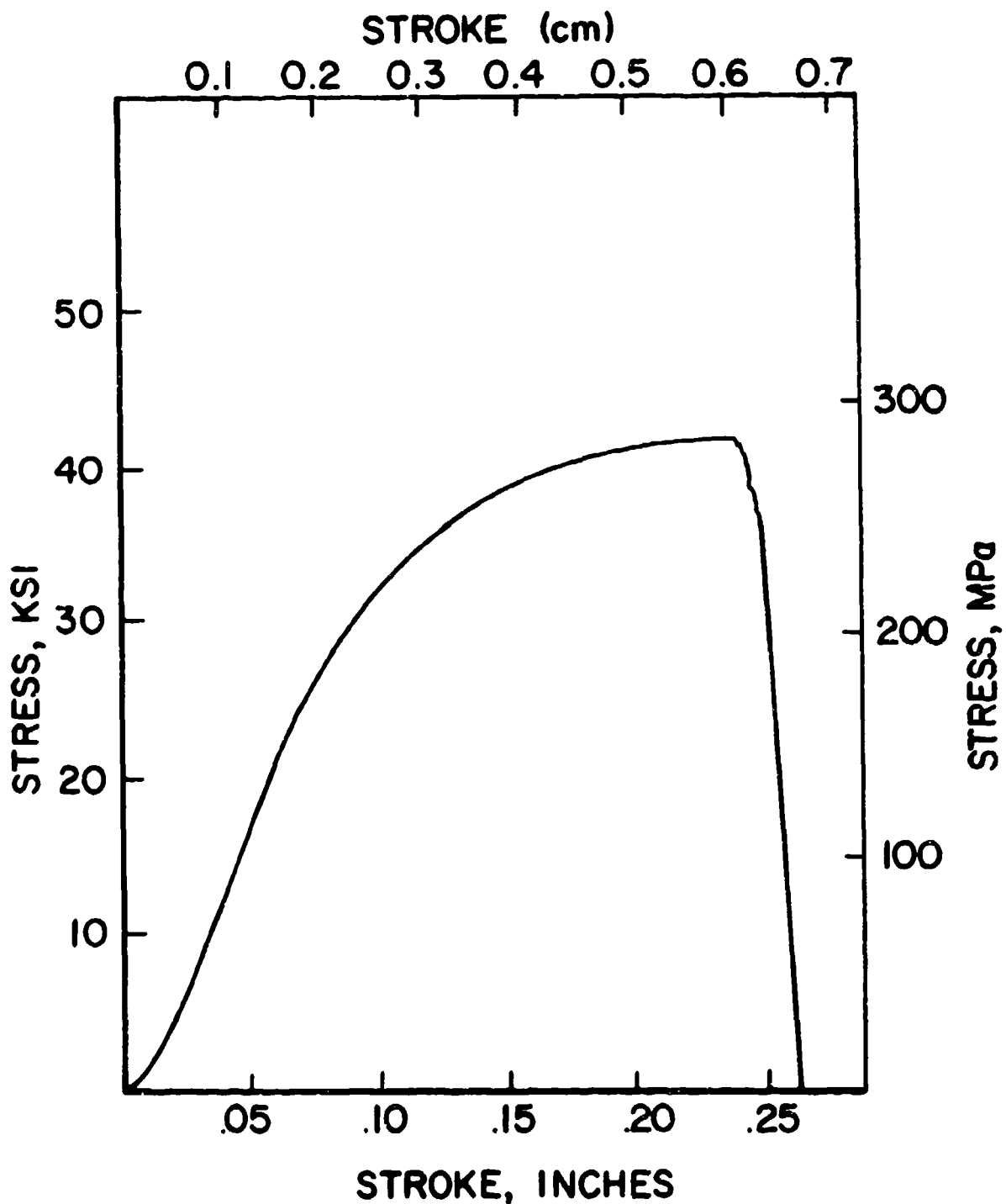

Figure 19. Typical Shear Stress vs. Deflection for 7175-T736 Aluminum Hand Forging.

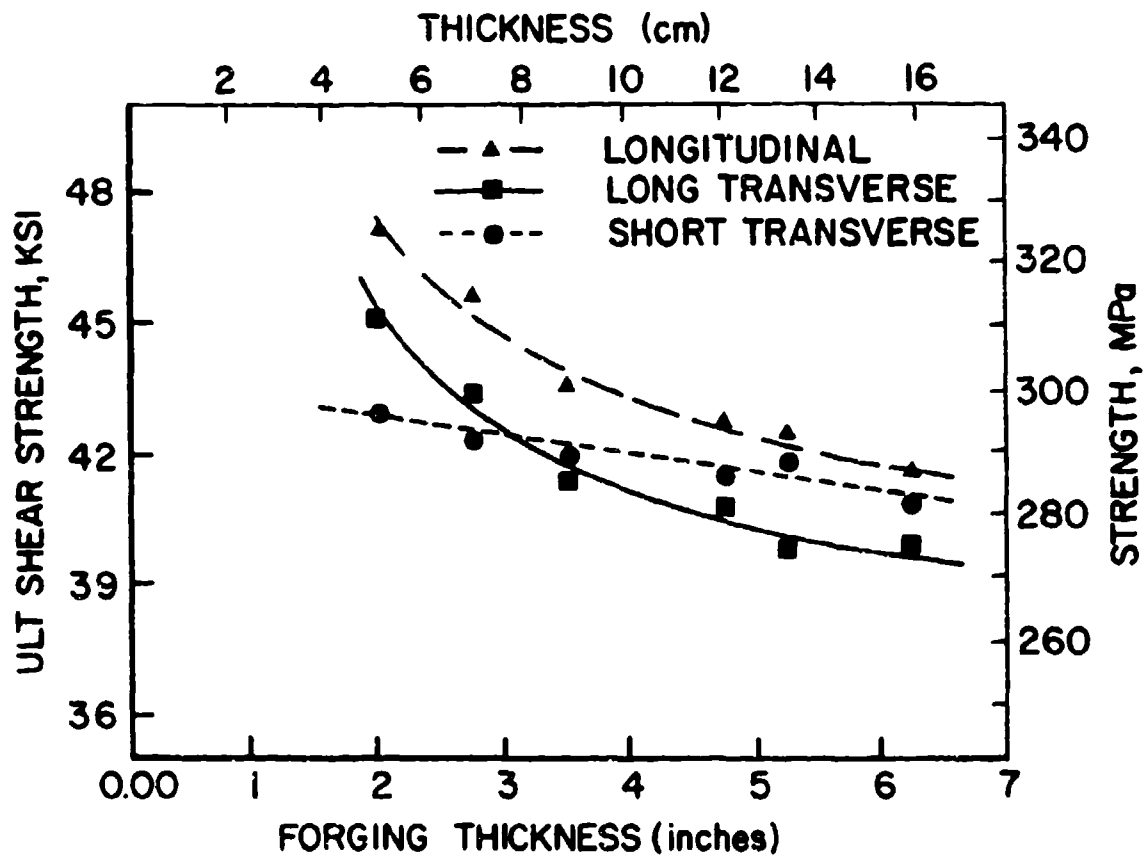

Figure 20. Ultimate Shear Strength as a Function of Forging Thickness for both Amsler and Rivet Specimens.

TABLE 16A

PIN BEARING RESULTS FOR ALUMINUM HAND FORGING (7175-T736)  
(e/D = 1.5, LONGITUDINAL)

SPECIMEN IDENTIFICATION	BEARING YIELD STRENGTH		BEARING ULTIMATE STRENGTH	
	Ksi (MPa)		Ksi (MPa)	
<u>e/D = 1.5, LONGITUDINAL</u>				
ALFP1-1-3B-L	89.24	(615.3)	109.20	(753.2)
ALFP1-2-3B-L	91.61	(631.7)	113.20	(780.6)
ALFP1-3-3B-L	88.94	(613.2)	121.60	(838.5)
ALFP2-1-3B-L	83.83	(578.0)	107.30	(739.8)
ALFP2-2-3B-L	88.46	(609.9)	109.10	(752.4)
ALFP2-3-3B-L	85.37	(588.7)	108.70	(749.4)
ALFP3-1-3B-L	84.75	(584.4)	108.80	(750.5)
ALFP3-2-3B-L	89.70	(618.5)	110.40	(761.1)
ALFP3-3-3B-L	84.35	(581.6)	108.80	(750.1)
ALFP4-1-3B-L	91.78	(632.8)	113.50	(782.8)
ALFP4-2-3B-L	94.86	(654.1)	112.50	(775.7)
ALFP4-3-3B-L	90.90	(626.7)	113.80	(784.9)
ALFP5-1-3B-L	96.44	(665.0)	114.60	(789.9)
ALFP5-2-3B-L	99.47	(685.9)	119.30	(822.4)
ALFP5-3-3B-L	100.90	(695.7)	119.40	(823.4)
ALFP6-1-3B-L	105.90	(730.5)	123.80	(853.5)
ALFP6-2-3B-L	98.69	(680.5)	119.30	(822.3)
ALFP6-3-3B-L	107.80	(743.3)	127.60	(879.6)
AVERAGE	92.94	(640.9)	114.50	(789.5)

TABLE 16B

PIN BEARING RESULTS FOR ALUMINUM HAND FORGING (7175-T736)  
(e/D = 1.5, LONG TRANSVERSE)

SPECIMEN IDENTIFICATION	BEARING YIELD STRENGTH		BEARING ULTIMATE STRENGTH	
	Ksi	(MPa)	Ksi	(MPa)
<u>e/D = 1.5, LONG TRANSVERSE</u>				
ALFP1-1-3B-LT	85.59	(590.1)	106.50	(734.2)
ALFP1-2-3B-LT	84.46	(582.3)	105.60	(727.9)
ALFP1-3-3B-LT	83.72	(577.3)	105.70	(728.9)
ALFP2-1-3B-LT	82.04	(565.7)	103.30	(712.6)
ALFP2-2-3B-LT	81.95	(565.1)	103.40	(713.0)
ALFP2-3-3B-LT	81.91	(564.8)	103.20	(711.8)
ALFP3-1-3B-LT	81.38	(561.1)	104.90	(723.0)
ALFP3-2-3B-LT	81.71	(563.4)	104.80	(722.5)
ALFP3-3-3B-LT	83.29	(574.3)	104.00	(717.1)
ALFP4-1-3B-LT	89.24	(615.3)	110.10	(759.0)
ALFP4-2-3B-LT	87.53	(603.5)	110.30	(760.5)
ALFP4-3-3B-LT	88.36	(609.2)	110.10	(759.4)
ALFP5-1-3B-LT	96.09	(662.5)	115.30	(795.0)
ALFP5-2-3B-LT	95.43	(658.0)	116.90	(805.7)
ALFP5-3-3B-LT	95.70	(659.9)	115.90	(799.2)
ALFP6-1-3B-LT	102.40	(706.0)	122.50	(844.6)
ALFP6-2-3B-LT	99.38	(685.2)	122.00	(841.5)
ALFP6-3-3B-LT	99.02	(682.8)	120.50	(830.6)
AVERAGE	88.84	(612.6)	110.30	(760.4)

TABLE 16C

PIN BEARING RESULTS FOR ALUMINUM HAND FORGING (7175-T736)  
( $e/D = 1.5$ , SHORT TRANSVERSE)

SPECIMEN IDENTIFICATION	BEARING YIELD STRENGTH		BEARING ULTIMATE STRENGTH	
	Ksi	(MPa)	Ksi	(MPa)
<u><math>e/D = 1.5</math>, SHORT TRANSVERSE</u>				
ALFP1-1-3B-ST	95.63	(659.3)	116.20	(800.9)
ALFP1-2-3B-ST	97.78	(674.2)	113.00	(779.2)
ALFP1-3-3B-ST	94.32	(650.3)	111.70	(770.4)
ALFP2-1-3B-ST	85.44	(589.1)	109.70	(756.2)
ALFP2-2-3B-ST	88.71	(611.6)	109.80	(757.1)
ALFP2-3-3B-ST	99.43	(685.6)	122.10	(841.7)
ALFP3-1-3B-ST	104.30	(719.2)	118.30	(815.6)
ALFP3-2-3B-ST	88.49	(610.1)	109.20	(752.6)
ALFP3-3-3B-ST	91.71	(632.3)	108.80	(750.3)
ALFP4-1-3B-ST	101.80	(702.0)	119.60	(824.8)
ALFP4-2-3B-ST	98.73	(680.8)	120.00	(827.5)
ALFP4-3-3B-ST	104.00	(717.4)	124.00	(855.3)
AVERAGE	95.86	(661.0)	115.20	(794.3)

TABLE 16D

PIN BEARING RESULTS FOR ALUMINUM HAND FORGING (7175-T736)  
( $e/D = 2.0$ , LONGITUDINAL)

SPECIMEN IDENTIFICATION	BEARING YIELD STRENGTH		BEARING ULTIMATE STRENGTH	
	Ksi (MPa)		Ksi (MPa)	
<u><math>e/D = 2.0</math>, LONGITUDINAL</u>				
ALFP1-1-3B-L	108.90	(750.8)	141.00	(972.3)
ALFP1-2-3B-L	109.10	(752.1)	142.90	(985.2)
ALFP1-3-3B-L	107.60	(742.0)	141.50	(975.5)
ALFP2-1-3B-L	106.00	(730.7)	139.10	(959.1)
ALFP2-2-3B-L	100.60	(693.9)	138.20	(953.1)
ALFP2-3-3B-L	105.90	(729.9)	138.30	(953.7)
ALFP3-1-3B-L	98.54	(679.4)	139.90	(964.7)
ALFP3-2-3B-L	104.50	(720.4)	142.80	(984.4)
ALFP3-3-3B-L	104.50	(720.6)	139.10	(959.1)
ALFP4-1-3B-L	111.20	(767.0)	145.80	(1006.0)
ALFP4-2-3B-L	110.70	(763.0)	145.80	(1005.0)
ALFP4-3-3B-L	115.30	(794.8)	147.60	(1018.0)
ALFP5-1-3B-L	120.60	(831.8)	154.90	(1068.0)
ALFP5-2-3B-L	121.10	(835.0)	153.80	(1060.0)
ALFP5-3-3B-L	118.40	(816.6)	153.90	(1061.0)
ALFP6-1-3B-L	127.80	(880.9)	162.60	(1121.0)
ALFP6-2-3B-L	117.60	(811.0)	156.70	(1080.0)
ALFP6-3-3B-L	114.20	(787.3)	158.60	(1094.0)
AVERAGE	111.30	(767.1)	146.80	(1012.0)



TABLE 16E

PIN BEARING RESULTS FOR ALUMINUM HAND FORGING (7175-T736)  
( $e/D = 2.0$ , LONG TRANSVERSE)

SPECIMEN IDENTIFICATION	BEARING YIELD STRENGTH		BEARING ULTIMATE STRENGTH	
	Ksi	(MPa)	Ksi	(MPa)
<u><math>e/D = 2.0</math>, LONG TRANSVERSE</u>				
ALFP1-1-3B-LT	104.90	(723.5)	139.20	( 959.9)
ALFP1-2-3B-LT	102.70	(708.2)	137.70	( 949.4)
ALFP1-3-3B-LT	100.30	(691.8)	136.80	( 943.3)
ALFP2-1-3B-LT	98.83	(681.4)	135.30	( 932.9)
ALFP2-2-3B-LT	96.56	(665.8)	133.50	( 920.5)
ALFP2-3-3B-LT	99.10	(683.3)	134.80	( 929.7)
ALFP3-1-3B-LT	104.10	(717.7)	136.10	( 938.3)
ALFP3-2-3B-LT	100.90	(695.7)	136.10	( 938.1)
ALFP3-3-3B-LT	96.19	(663.2)	134.70	( 928.8)
ALFP4-1-3B-LT	108.00	(744.7)	143.30	( 987.7)
ALFP4-2-3B-LT	109.20	(752.6)	143.00	( 985.8)
ALFP4-3-3B-LT	114.80	(791.4)	143.50	( 989.2)
ALFP5-1-3B-LT	94.57	(652.0)	147.80	(1019.0)
ALFP5-2-3B-LT	104.20	(718.7)	150.90	(1040.0)
ALFP5-3-3B-LT	114.60	(789.9)	150.60	(1038.0)
ALFP6-1-3B-LT	125.60	(865.7)	158.40	(1092.0)
ALFP6-2-3B-LT	123.80	(853.5)	158.50	(1093.0)
ALFP6-3-3B-LT	126.30	(870.6)	157.40	(1085.0)
AVERAGE	106.90	(737.2)	143.20	( 987.3)

TABLE 16F

PIN BEARING RESULTS FOR ALUMINUM HAND FORGING (7175-T736)  
( $e/D = 2.0$ , SHORT TRANSVERSE)

SPECIMEN IDENTIFICATION	BEARING YIELD STRENGTH		BEARING ULTIMATE STRENGTH	
	Ksi	(MPa)	Ksi	(MPa)
$e/D = 2.0$ , SHORT TRANSVERSE				
ALFP1-1-3B-ST	110.30	(760.4)	145.00	(1000.0)
ALFP1-2-3B-ST	111.20	(766.5)	143.90	(992.3)
ALFP1-3-3B-ST	108.50	(748.1)	144.20	(994.5)
ALFP2-1-3B-ST	107.50	(741.4)	141.70	(977.2)
ALFP2-2-3B-ST	106.00	(736.3)	141.40	(975.1)
ALFP2-3-3B-ST	107.40	(740.3)	141.30	(974.4)
ALFP3-1-3B-ST	109.60	(755.4)	143.70	(991.1)
ALFP3-2-3B-ST	106.30	(732.9)	140.90	(971.6)
ALFP3-3-3B-ST	107.00	(737.9)	142.30	(980.8)
ALFP4-1-3B-ST	117.90	(812.7)	149.80	(1033.0)
ALFP4-2-3B-ST	113.90	(785.0)	146.50	(1010.0)
ALFP4-3-3B-ST	110.00	(758.5)	140.00	(965.3)
AVERAGE	109.70	(756.3)	143.40	(988.8)

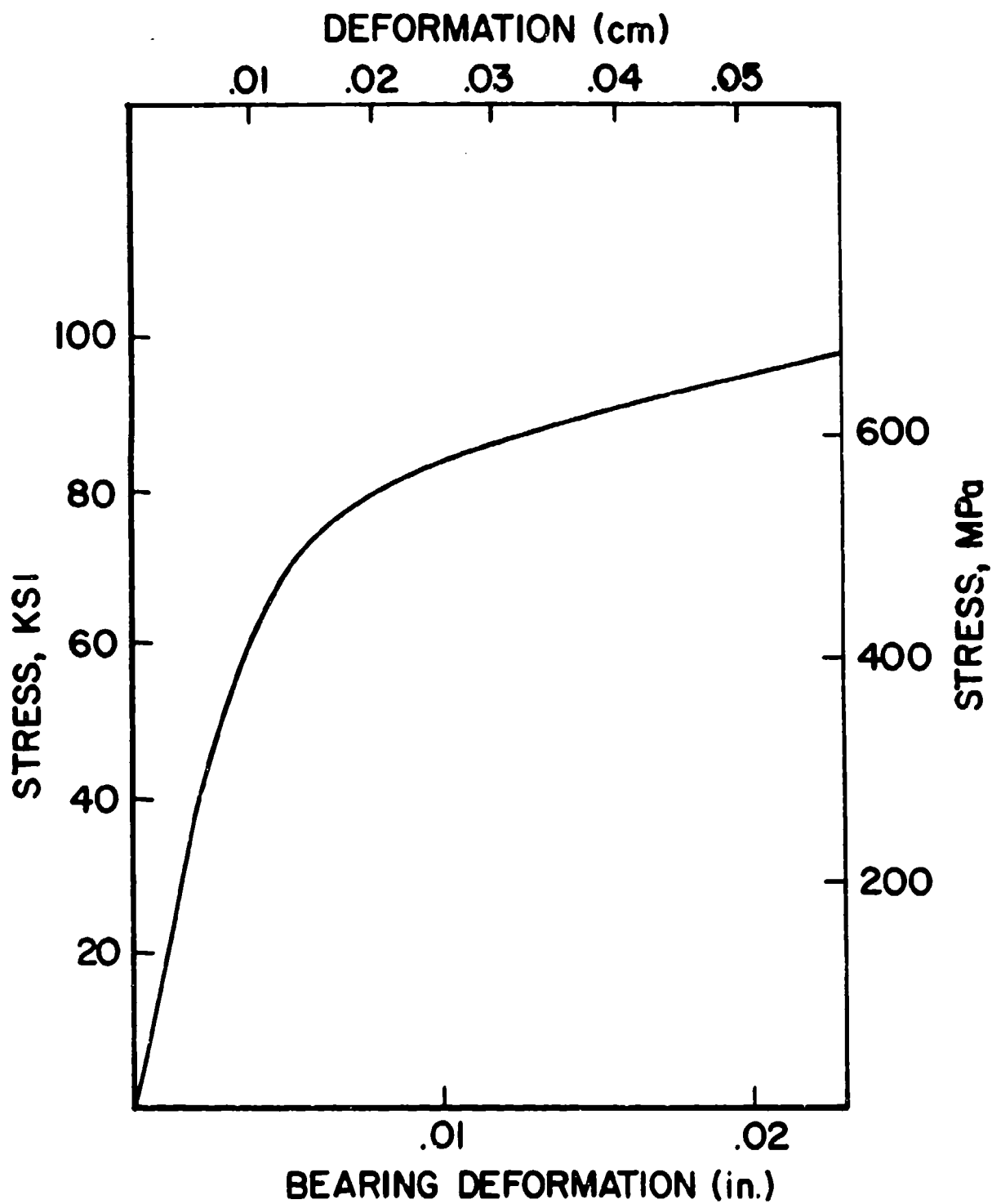

Figure 21. Typical Bearing Stress vs. Deflection Curve for 7175-T736 Aluminum Hand Forging.

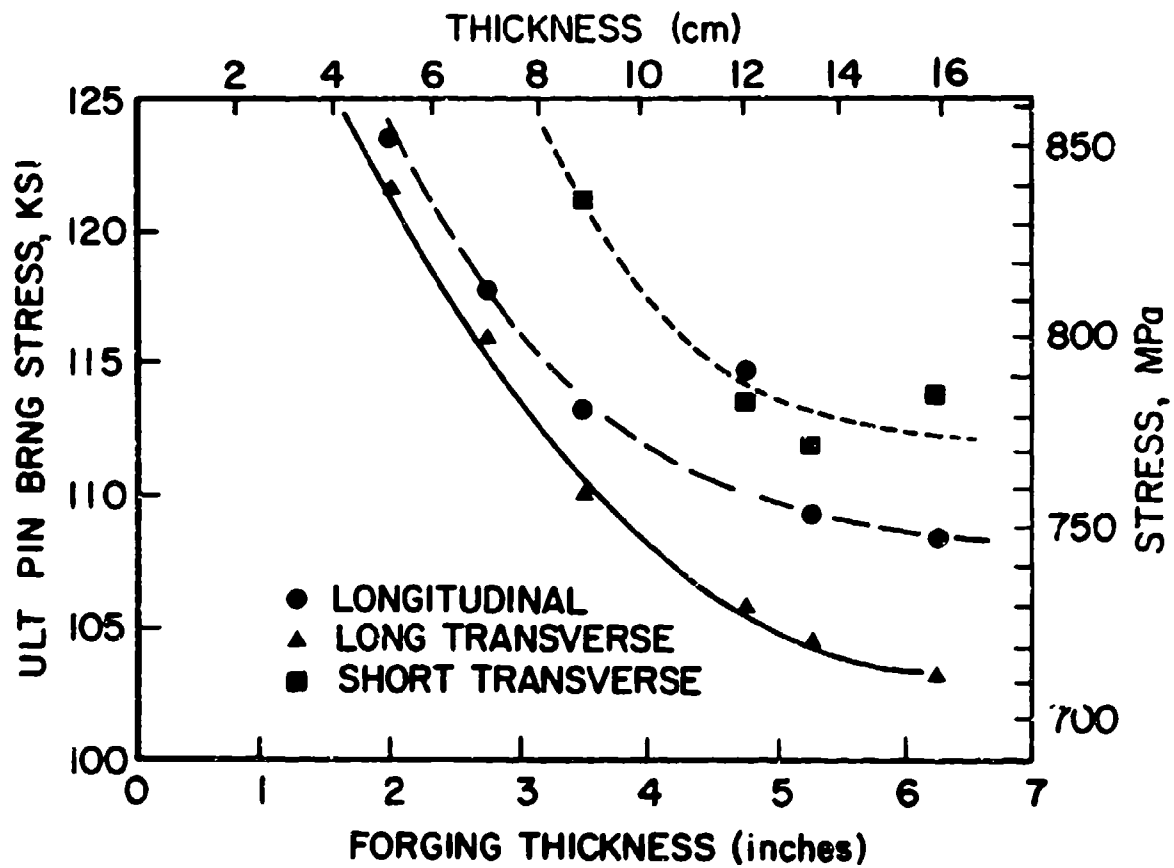

Figure 22a. Bearing Ultimate Stress as a Function of Forging Thickness  $e/d = 1.5$ .

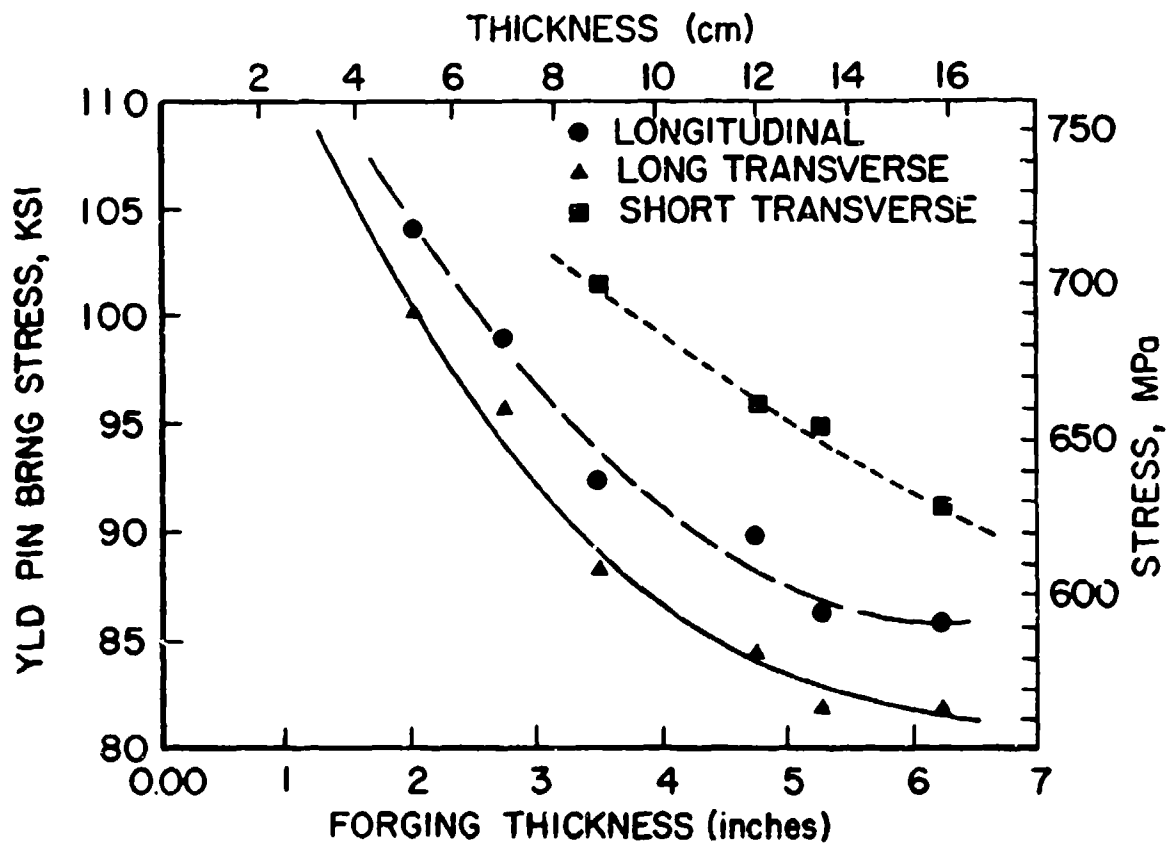

Figure 22b. Bearing Yield Stress as a Function of Forging Thickness  $e/d = 1.5$ .

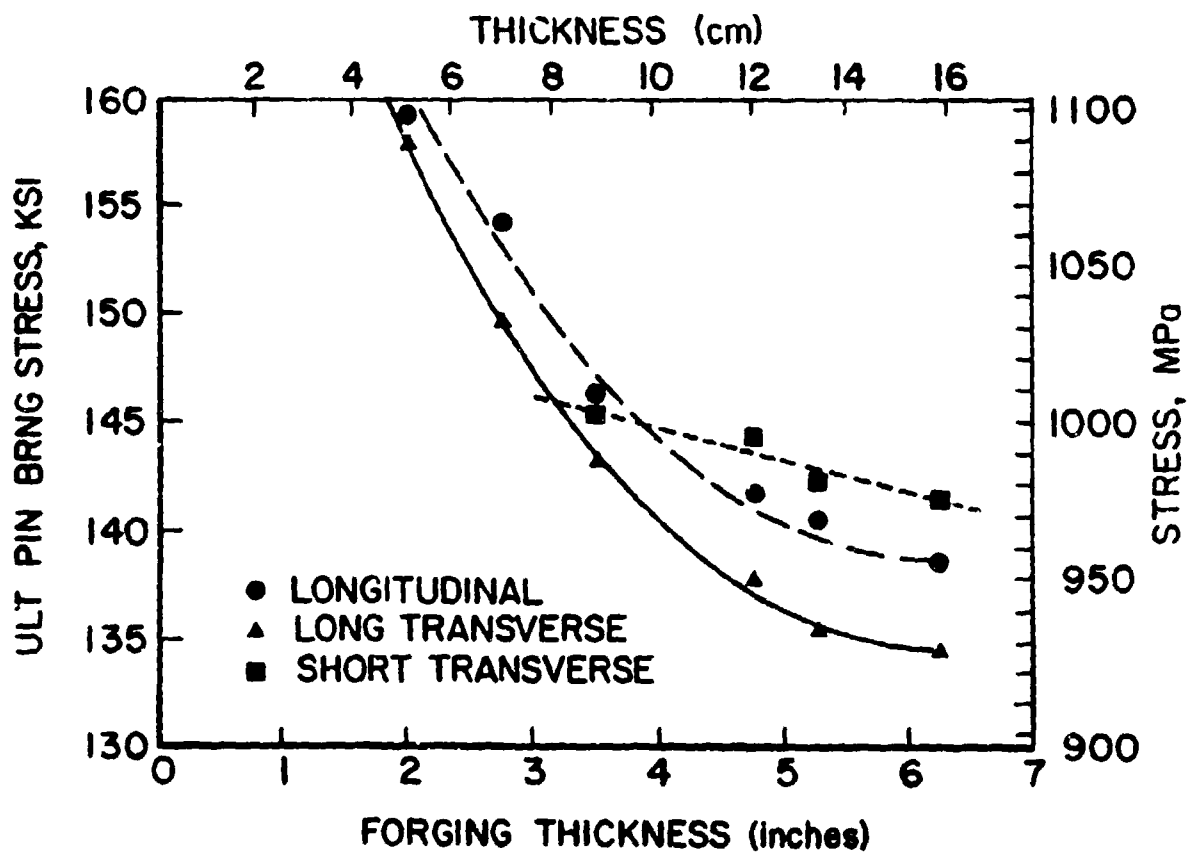

Figure 23a. Bearing Ultimate Stress as a Function of Forging Thickness  $e/D = 2.0$ .

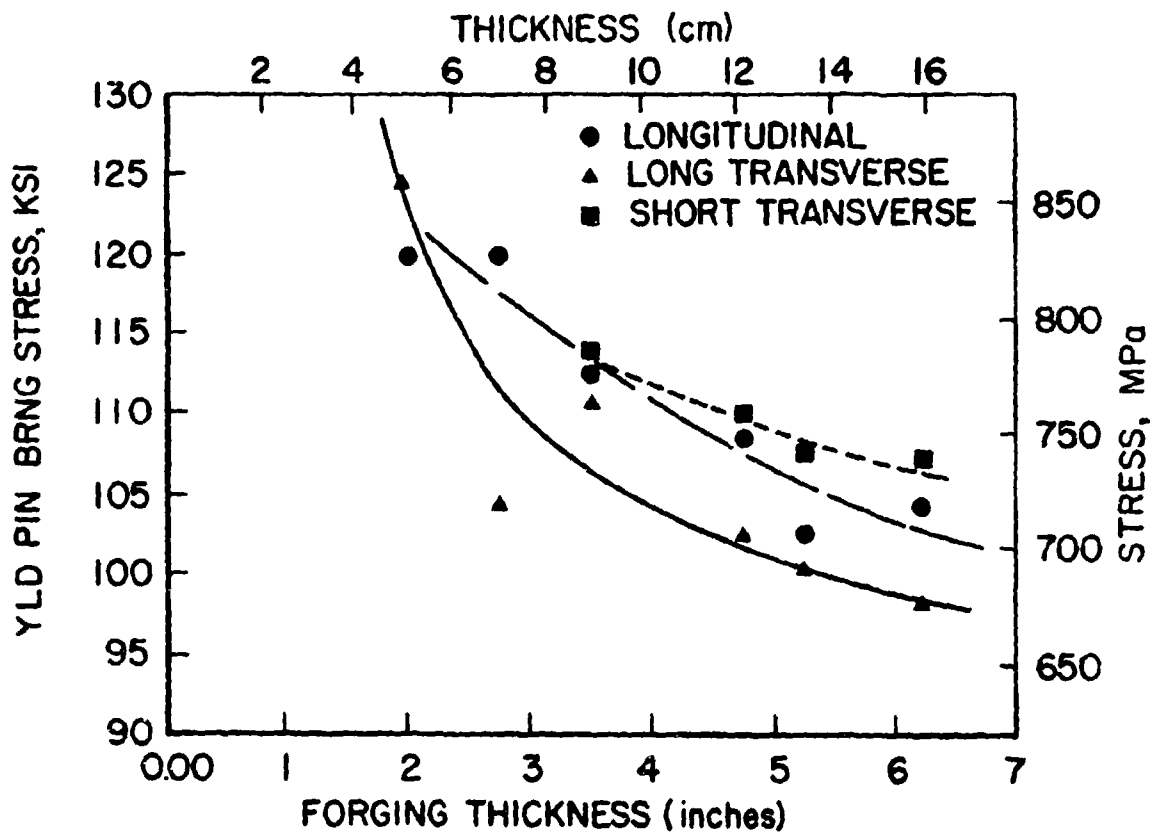

Figure 23b. Bearing Yield Stress as a Function of Forging Thickness  $e/D = 2.0$ .

TABLE 17A

FATIGUE TEST RESULTS FOR HAND FORGED ALUMINUM (7175-T736)  
(ROUND, UNNOTCHED, LONGITUDINAL)

$$K_t = 1.0$$

Specimen Identification	Maximum Stress ksi (MPa)	Cycles to Failure	Remarks
<u>Round, Unnotched, Longitudinal</u>			
ALFP4-3-3FL	72.5 (499.89)	6,700	
ALFP2-3-3FL	70. (482.65)	N.A.	Failed below 70 ksi
ALFP6-2-3FL	67.5 (465.41)	32,300	
ALFP2-2-3FL	65.0 (448.18)	10,600	
ALFP1-3-3FL	65. (448.18)	16,900	
ALFP3-2-3FL	62.5 (430.94)	20,500	
ALFP4-1-3FL	60. (413.70)	29,700	
ALFP6-3-3FL	60. (413.70)	74,400	
ALFP5-2-3FL	57.5 (396.46)	118,900	
ALFP1-1-3FL	56. (386.12)	N.A.	Failure from overload
ALFP1-2-3FL	56. (386.12)	46,300	
ALFP3-3-3FL	55. (379.23)	38,100	
ALFP6-1-3FL	52.5 (361.99)	42,600	
ALFP2-1-3FL	50. (344.75)	135,500	
ALFP7-3-5FL	50. (344.75)	10,000,000	Runout
ALFP5-1-3FL	47.5 (327.51)	337,100	
ALFP3-1-3FL	45. (310.28)	10,000,000	Runout
ALFP4-2-3FL	42.5 (293.04)	10,000,000	Runout



TABLE 17B

FATIGUE TEST RESULTS FOR HAND FORGED ALUMINUM (7175-T736)  
(ROUND, NOTCHED, LONGITUDINAL)

$$K_t = 3.0$$

Specimen Identification	Maximum Stress ksi (MPa)	Cycles to Failure	Remarks
<u>Round Notched, Longitudinal</u>			
ALFP2-2-3FL	50. (344.75)	2,400	
ALFP4-1-3FL	45. (310.28)	3,600	
ALFP3-2-3FL	42.5 (293.04)	1,100	
ALFP1-1-3FL	40. (275.80)	4,700	
ALFP6-2-3FL	37.5 (258.56)	8,800	
ALFP5-1-3FL	35. (241.33)	9,800	
ALFP4-2-3FL	32.5 (224.09)	9,400	
ALFP2-1-3FL	30. (206.85)	14,800	
ALFP5-2-3FL	27.5 (189.61)	19,000	
ALFP6-1-3FL	25. (172.38)	20,700	
ALFP3-3-3FL	22.5 (155.14)	45,200	
ALFP5-3-3FL	22.5 (155.14)	60,900	
ALFP3-1-3FL	20. (137.90)	72,900	
ALFP4-3-3FL	20. (137.90)	114,600	
ALFP1-3-3FL	17.5 (120.66)	138,600	
ALFP2-3-3FL	17.5 (120.66)	200,600	
ALFP6-3-3FL	15. (103.43)	10,000,000	Runout
ALFP1-2-3FL	15. (103.43)	10,000,000	Runout

TABLE 17C

FATIGUE TEST RESULTS FOR HAND FORGED ALUMINUM (7175-T736)  
(ROUND, UNNOTCHED, LONG TRANSVERSE)

$$K_t = 1.0$$

Specimen Identification	Maximum Stress ksi (MPa)	Cycles to Failure	Remarks
<u>Round, Unnotched, Long Transverse</u>			
ALFP4-8-12FLT	70. (482.65)	6,900	
ALFP4-1-12FLT	67.5 (465.41)	9,100	
ALFP4-2-12FLT	65. (448.18)	18,600	
ALFP4-3-12FLT	62.5 (430.94)	16,600	
ALFP4-4-12FLT	60. (413.70)	22,300	
ALFP4-5-12FLT	57.5 (396.46)	36,800	
ALFP4-6-12FLT	55. (379.23)	31,300	
ALFP4-7-12FLT	52.5 (361.99)	45,400	
ALFP4-11-12FLT	50. (344.75)	38,100	
ALFP4-12-12FLT	47.5 (327.51)	6,096,000	
ALFP4-9-12FLT	45. (310.28)	76,800	
ALFP4-10-12FLT	40. (275.80)	10,000,000	Runout

TABLE 17D

FATIGUE TEST RESULTS FOR HAND FORGED ALUMINUM (7175-T736)  
(ROUND, NOTCHED, LONG TRANSVERSE)

$$K_t = 3.0$$

Specimen Identification	Maximum Stress ksi (MPa)	Cycles to Failure	Remarks
<u>Round, Notched, Long Transverse</u>			
ALFP4-11-12FLT	45. (310.28)	2,900	
ALFP4-7-12FLT	40. (275.80)	4,500	
ALFP4-8-12FLT	37.5 (258.56)	6,200	
ALFP4-9-12FLT	35. (241.33)	8,800	
ALFP4-10-12FLT	32.5 (224.09)	8,200	
ALFP4-1-12FLT	30. (206.85)	12,500	
ALFP4-4-12FLT	27.5 (189.61)	16,800	
ALFP4-2-12FLT	25. (172.39)	22,000	
ALFP4-5-12FLT	22.5 (155.14)	31,700	
ALFP4-3-12FLT	20. (137.90)	48,100	
ALFP4-6-12FLT	17.5 (120.66)	137,400	
ALFP4-12-12FLT	12.5 ( 86.19)	364,200	

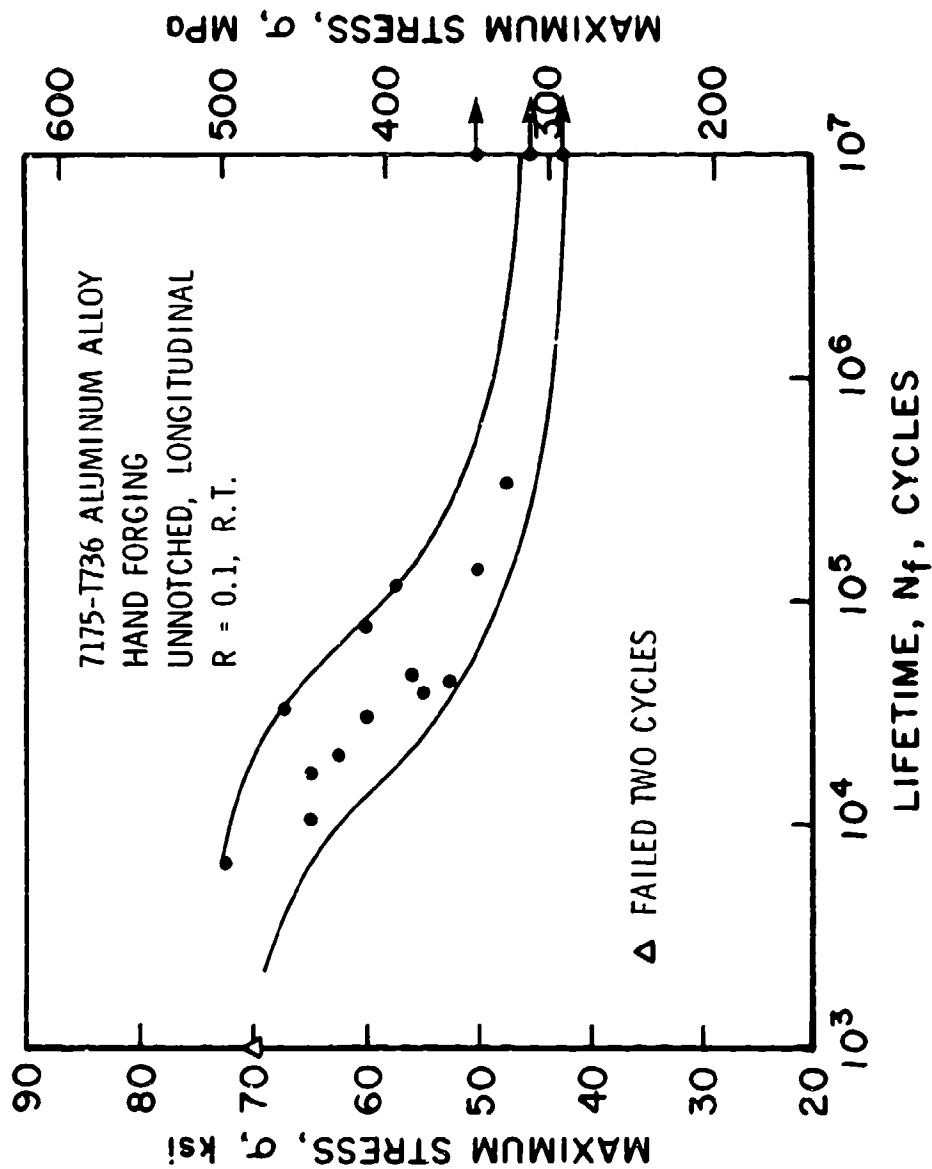

Figure 24. Axial Load Fatigue Data (Multiple Heats)  $K_t = 1.0$ .

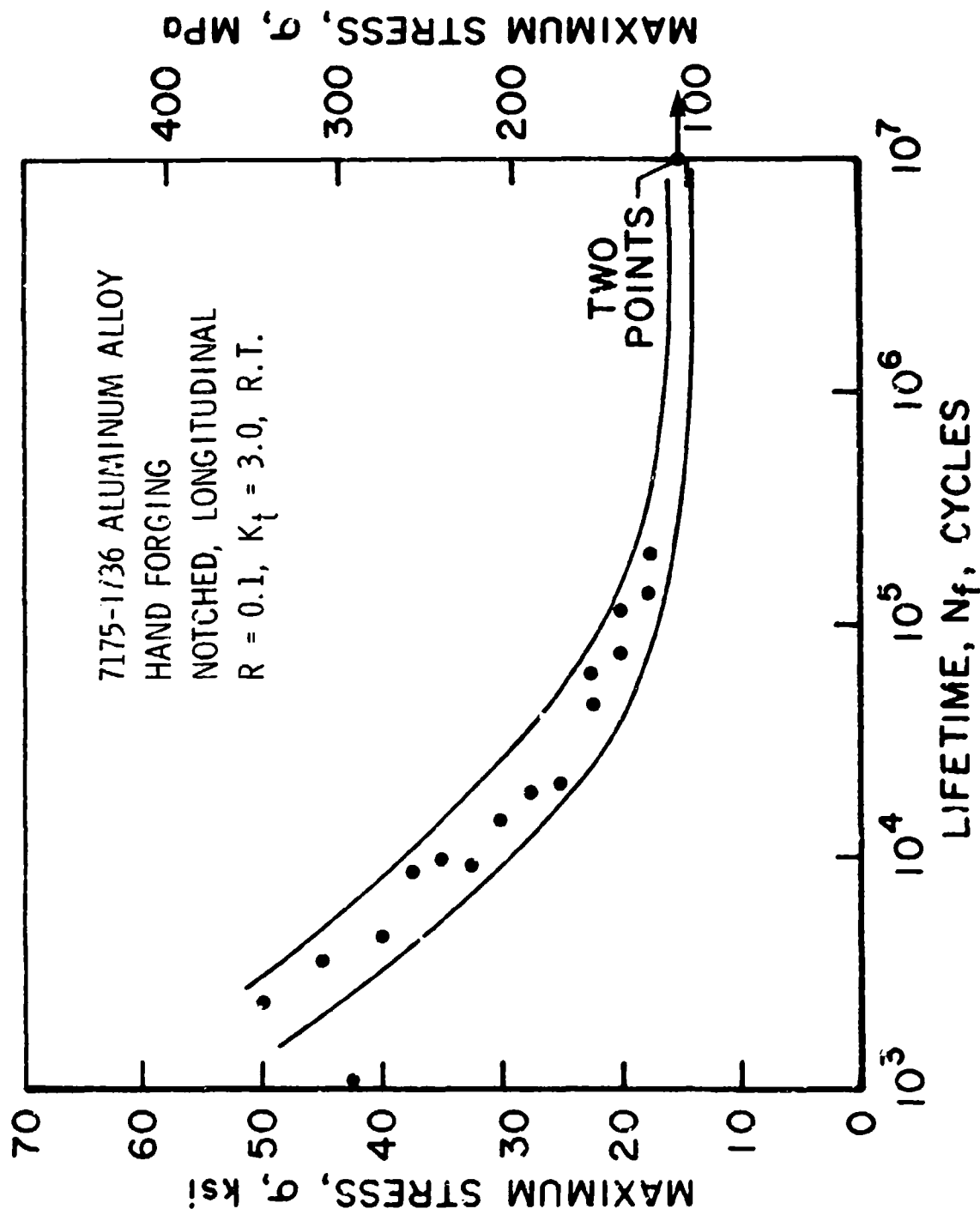

Figure 25. Axial Load Fatigue Data (Multiple Heats)  
 $K_t = 3.0$ .

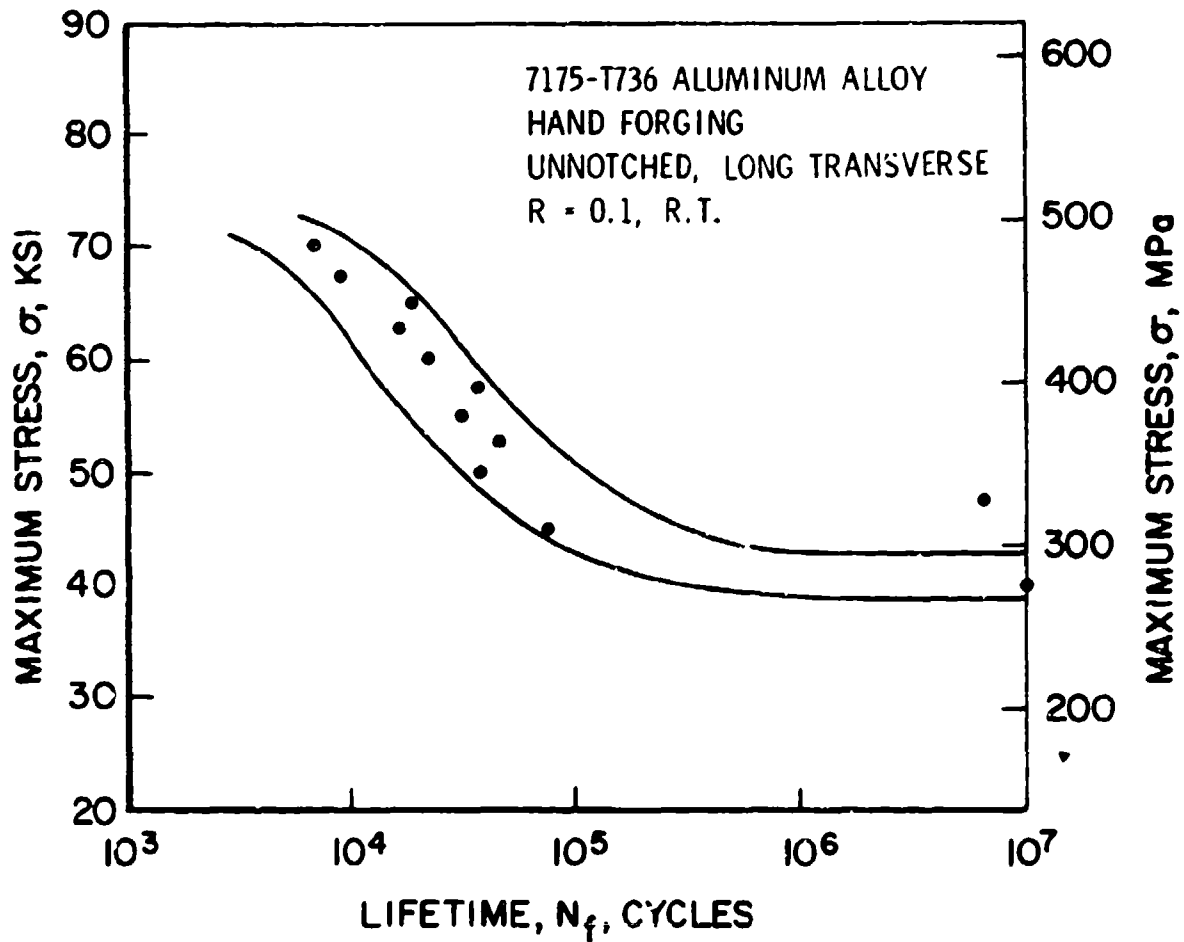

Figure 26. Axial Load Fatigue Data (One Heat Only)  $K_t = 1.0$ .

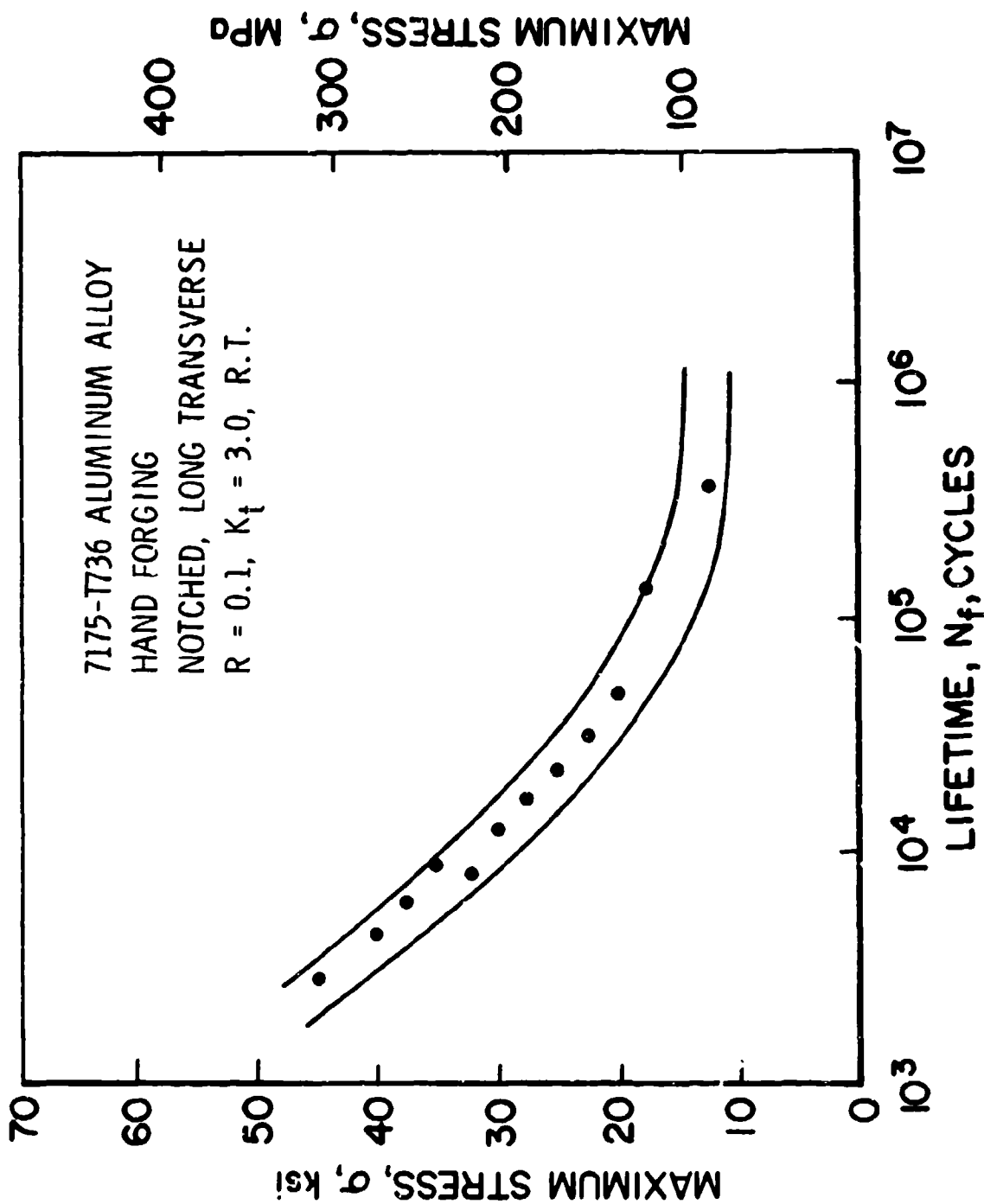

Figure 27. Axial Load Fatigue Data (One Heat Only)  
 $K_t = 3.0$ .

TABLE 18  
SUMMARY OF MECHANICAL PROPERTIES FOR 7175-T736 ALUMINUM

Specification Form	Aluminum (7175-T736)						
	2.0-3.0 (50.8-76)		3.0-4.0 (76-102)		Hand Forging		
Thickness, in (mm)					4.0-5.0 (102-127)	5.0-6.0 (127-152)	6.0-7.0 (152-178)
<b>Mechanical Properties</b>							
$F_{tu}$ , ksi (MPa)	L	78.56 (541.5)	72.50 (499.7)	69.04 (475.9)	69.10 (476.3)	66.02 (455.1)	
	Lt	77.19 (523.1)	71.54 (493.1)	69.74 (480.7)	67.47 (465.1)	66.21 (456.4)	
	St	76.49 (527.2)	71.80 (495.0)	69.70 (480.4)	71.73 (494.4)	67.39 (464.5)	
$F_{ty}$ , ksi (MPa)	L	69.79 (481.1)	61.87 (426.5)	58.07 (400.3)	57.16 (394.0)	53.76 (370.6)	
	Lt	68.37 (471.3)	60.11 (414.4)	57.71 (397.8)	53.66 (369.9)	51.77 (365.8)	
	St	67.20 (463.2)	60.68 (418.3)	58.09 (400.4)	58.94 (406.3)	54.36 (374.7)	
$F_{cy}$ , ksi (MPa)	L	72.86 (502.2)	64.79 (446.6)	61.20 (421.8)	60.34 (415.9)	57.41 (395.7)	
	Lt	72.52 (499.9)	64.06 (441.6)	61.39 (423.2)	58.58 (403.8)	56.85 (391.9)	
	St	71.75 (494.6)	63.11 (435.0)	60.80 (419.1)	58.53 (403.4)	57.12 (393.7)	
$F_{au}$ , ksi (MPa)	L	46.37 (319.7)	43.6 (300.8)	42.72 (294.5)	42.46 (292.8)	41.60 (286.7)	
	Lt	44.25 (305.0)	42.43 (285.6)	40.71 (280.6)	39.84 (274.6)	39.88 (274.9)	
	St	42.65 (294.0)	41.86 (288.5)	41.46 (285.8)	41.84 (288.4)	40.92 (282.1)	
$F_{bru}$ , ksi (MPa)	L	120.7 (832.0)	113.3 (781.0)	114.7 (790.6)	109.3 (753.4)	108.4 (747.2)	
	Lt	118.8 (818.9)	110.2 (759.6)	105.9 (730.0)	104.6 (731.0)	103.3 (712.0)	
	St	121.2 (835.4)	113.6 (783.0)	112.1 (772.7)	112.1 (772.7)	113.9 (785.1)	
$(\sigma/D=2.0)$	L	156.7 (1080)	146.4 (1009)	141.8 (977.4)	140.6 (969.2)	138.5 (954.7)	
	Lt	153.9 (1061)	143.3 (987.7)	137.9 (950.5)	135.6 (934.7)	134.5 (927.1)	
	St	145.4 (1002)	144.4 (995.4)	142.3 (980.9)	142.3 (980.9)	141.5 (957.4)	
$F_{bry}$ , ksi (MPa)	L	101.5 (699.6)	92.51 (637)	89.93 (619.9)	86.27 (594.7)	85.89 (592.0)	
	Lt	98.02 (657.6)	88.38 (609.2)	84.59 (583.1)	82.13 (566.1)	81.97 (565.0)	
	St	101.5 (699.6)	95.91 (661.1)	94.83 (653.6)	94.83 (653.6)	91.19 (628.6)	
$(\sigma/D=2.0)$	L	120.0 (827.2)	112.4 (774.7)	108.5 (747.9)	102.5 (706.5)	104.2 (718.3)	
	Lt	114.8 (791.3)	110.7 (763.0)	102.6 (707.2)	100.4 (692.1)	98.20 (676.9)	
	St	113.9 (785.1)	110.0 (758.2)	110.0 (758.2)	107.6 (741.6)	107.2 (738.9)	
$\epsilon$ , percent	L	21.11	22.43	23.00	21.60	23.50	
	Lt	17.88	16.43	12.84	14.43	13.87	
	St	8.57	9.07	7.37	7.93	12.23	
$E, 10^3$ ksi (GPa)		10.2 (70.3)	10.1 (69.6)	10.2 (70.3)	10.1 (69.6)	10.2 (70.3)	
$E, 10^3$ ksi (GPa)		10.9 (75.1)	10.9 (75.1)	10.7 (73.7)	10.6 (74.4)	10.6 (74.4)	



## ALUMINUM EXTRUSION - 7050-T736511

Material Description

This 7050 Aluminum Extrusion was heat treated to the T736511 temper. The material is now produced and commonly referred to as T74511. They were produced as extrusions by Martin Marietta. Twelve extrusions in total were used in obtaining samples for this test program. The average chemical composition is shown in Table 19.

TABLE 19

## CHEMICAL COMPOSITION OF 7050-T736511 ALUMINUM EXTRUSION

<u>Chemical Composition</u>	<u>Percent Weight</u>
Silicon	0.05
Iron	0.11
Copper	2.24
Magnesium	2.29
Nickel	0.01
Zinc	6.38
Titanium	0.03
Lead	0.01
Zirconium	0.10

Figure 28 shows the layout of the specimens as they were obtained from the extrusions. The various shapes and location of the specimens are shown in Figures 28A through 28L. This grouping was replicated three times for each extrusion. The nomenclature for the samples is as follows: B-bearing, FC-flat compression, FT-flat tension, SFT-shot flat tension, SRT-short round tension, AS-Amsler Shear, SB-shot bearing.

The direction from which the sample has been taken is indicated as: -L longitudinal, -LT longitudinal transverse, -ST short transverse. Precise specimen location was performed in accordance with ASTM B 557.

### Specimen Numbering Sequence

The sample specimen number in sequence is shown as follows:

ALEE 105 - 1 - 3B - L

The specimen designation is broken down as follows:

ALE - aluminum extrusion  
 E105 - from extrusion 105  
 -1 - first sample of 3  
 -3 - three samples from this extrusion  
 B - a bearing sample  
 L - longitudinal sample

For the specimens shown above, the material is for aluminum extrusion 7050-T736511 and comes from extrusion number 105, the first of three bearing samples in the longitudinal direction.

### Test Results

From Table 20, it can be seen that specimens were obtained for all types of tests from nearly all extrusions. As noted previously the geometry of the specimen used for each type of test is contained in Appendix A. Appendix B contains the data sheets previously published for this material.

Tension. Results of the tension tests are shown in Table 21. Longitudinal and long transverse results were obtained from flat, short flat, and short round samples. A typical stress versus strain curve in tension for this material is shown in Figure 29. Tension ultimate and tension yield stress is also plotted as a function of plate thickness in Figure 30.

Compression. Compression results were obtained from all 12 extrusions from both the longitudinal and transverse directions. The results from this test in compression are shown in Table 22. Table 22a contains the results of the longitudinal samples. Long transverse results are presented in Table 22b. A typical compression stress-strain curve for this material is shown in

Figure 31. Compressive yield strength is plotted as a function of plate thickness in Figure 32.

Shear. The Amsler Shear specimen was used to determine the shear properties of this aluminum extrusion. Table 23 provides the results from these tests. The lower part of the table is for the Amsler Shear in the longitudinal direction while the top part is for the Amsler Shear in the long transverse direction. Figure 33 is a typical plot of the shear as a function of displacement during the shear test. Figure 34 plots the ultimate shear strength as a function of specimen thickness for the Amsler Shear Test.

Bearing. Pin-bearing test results are reported for  $e/D$ 's of 1.5 and 2.0 for longitudinal and long transverse directions in Table 24. The ratio,  $e/D$ , is the ratio of the distance between the central line of the hole in the bearing specimen and the edge of the specimen ( $e$ ) to the diameter of the bearing hole ( $D$ ). Tables 24A and 24B are for the  $e/D$ 's of 1.5 with longitudinal and transverse orientations respectively. Tables 24C and 24D are for  $e/D$ 's of 2.0 in the longitudinal and long transverse orientations. A typical stress versus deflection curve in bearing is presented in Figure 35. Figure 36 presents the yield and ultimate bearing strengths as a function of plate thickness for an  $e/D$  of 1.5. Figure 37 presents similar results for an  $e/D$  of 2.0.

#### Summary of Mechanical Properties

A summary of the test results in tension, compression, shear and bearing is shown in Table 25. Values are given for each extrusion and each section thickness. These values were used in plotting the property versus specimen thickness curves in this section.

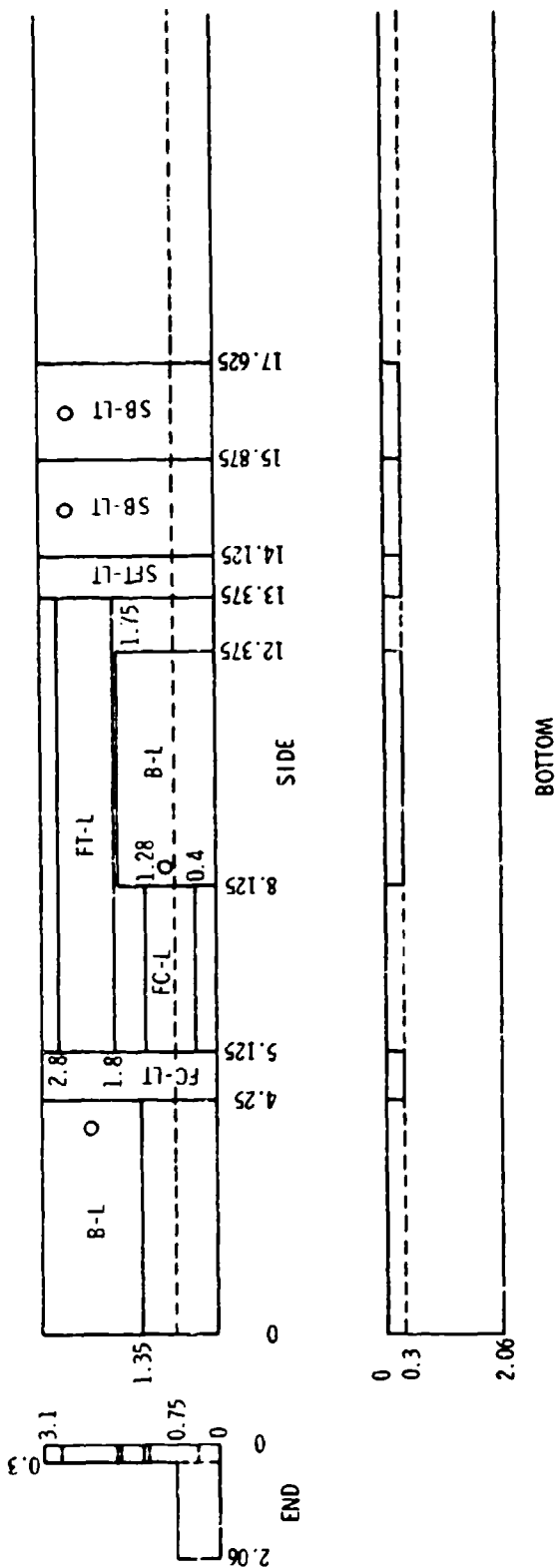

\*Note: All dimensions in inches.

Figure 28a. Specimen Layout for Extrusion 105.

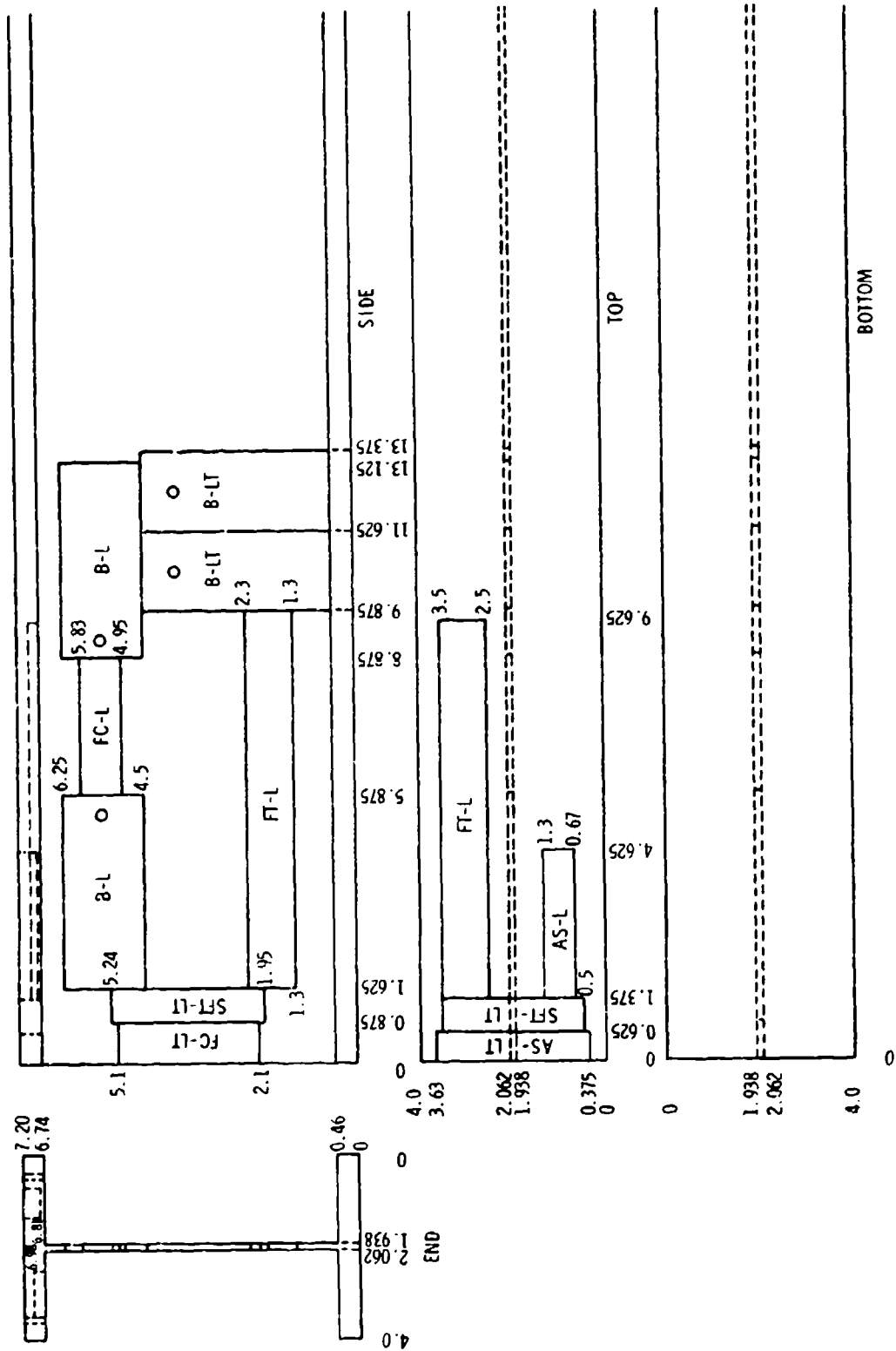

\*Ncte: All dimensions in inches.

Figure 28b. Specimen Layout for Extrusion 107.

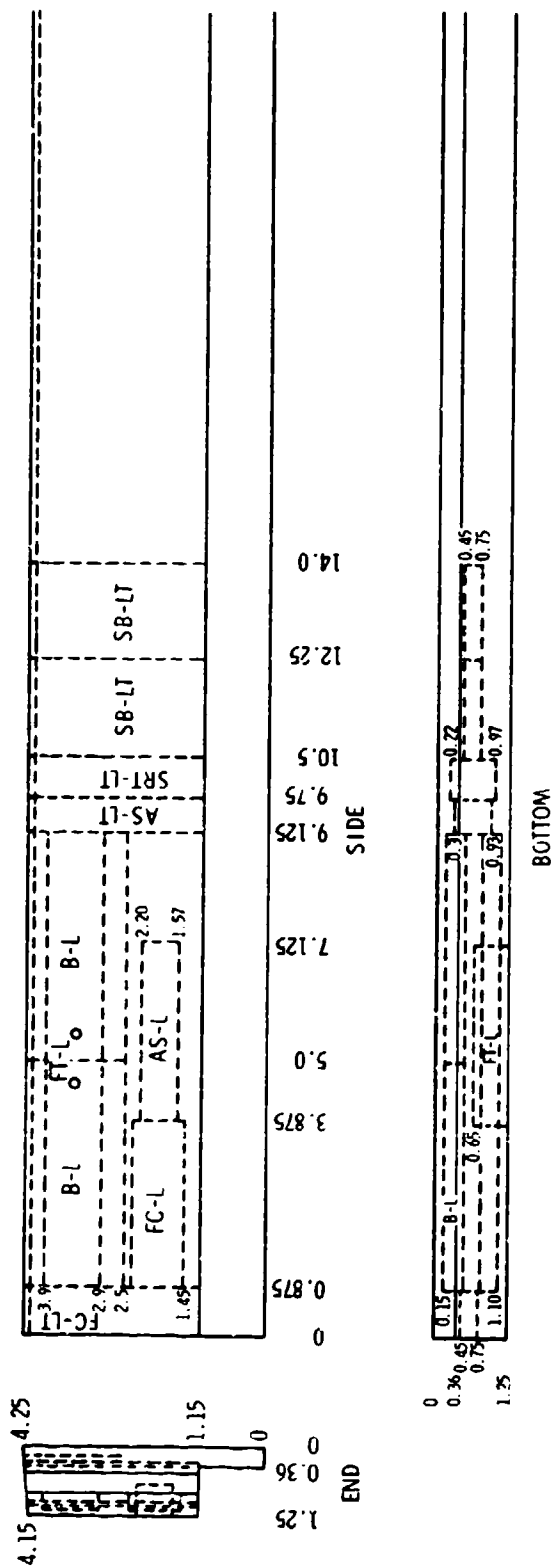

\*Note: All dimensions in inches.

Figure 28c. Specimen Layout for Extrusion 110.

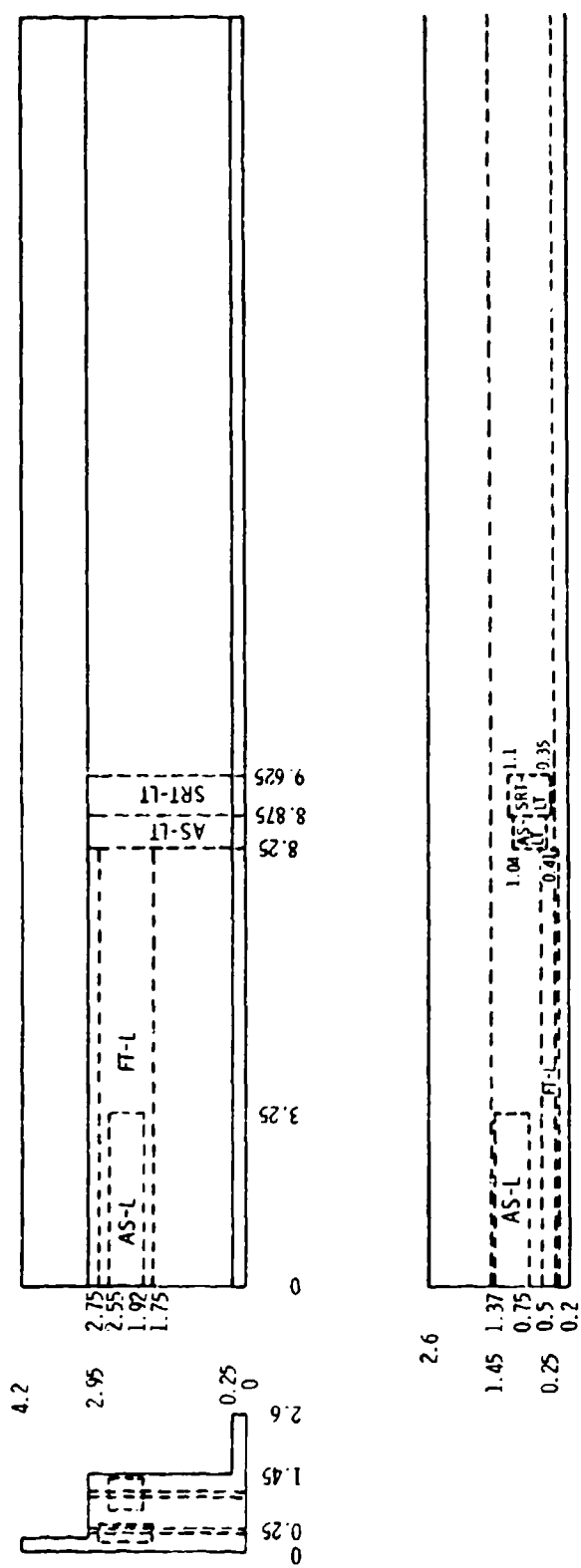

SCALE 1/2' = 1"

\*Note: All dimensions in inches.

Figure 28d. Specimen Layout for Extrusion 112.

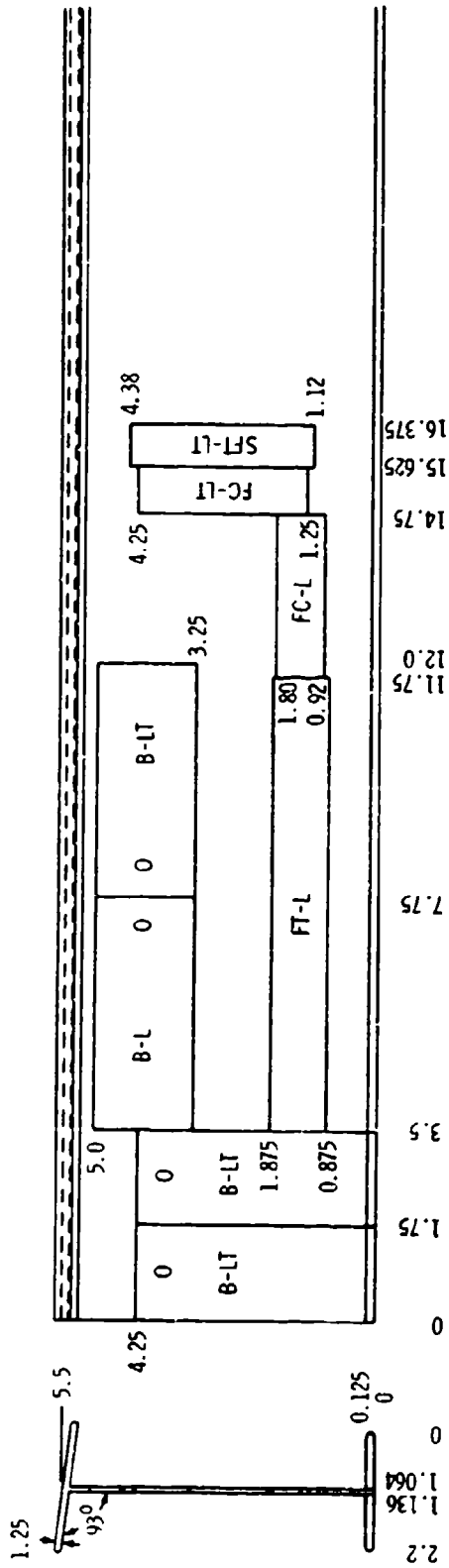

\*Note: All dimensions in inches.

Figure 28e. Specimen Layout for Extrusion 114.



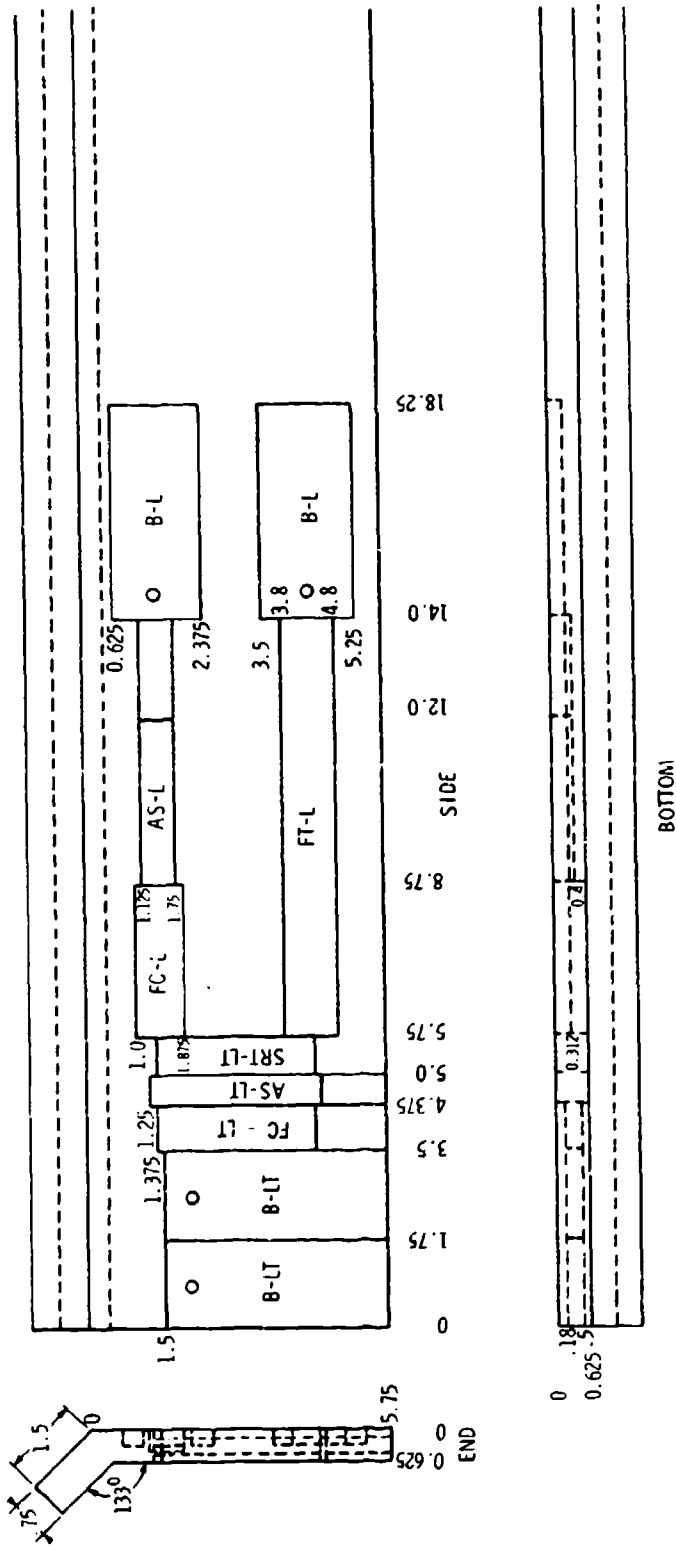

\*Note: All dimensions in inches.

Figure 28f. Specimen Layout for Extrusion 115.

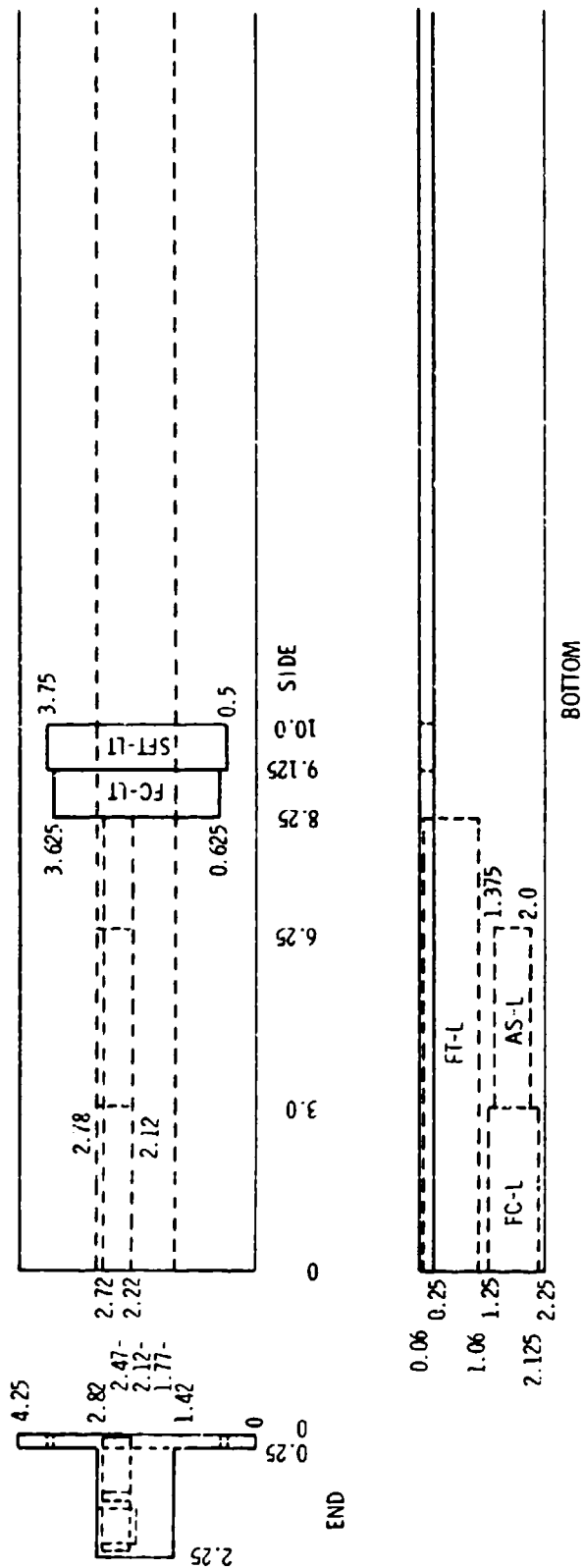

SCALE 1/2" = 1"

\*Note: All dimensions in inches.

Figure 28g. Specimen Layout for Extrusion 122.

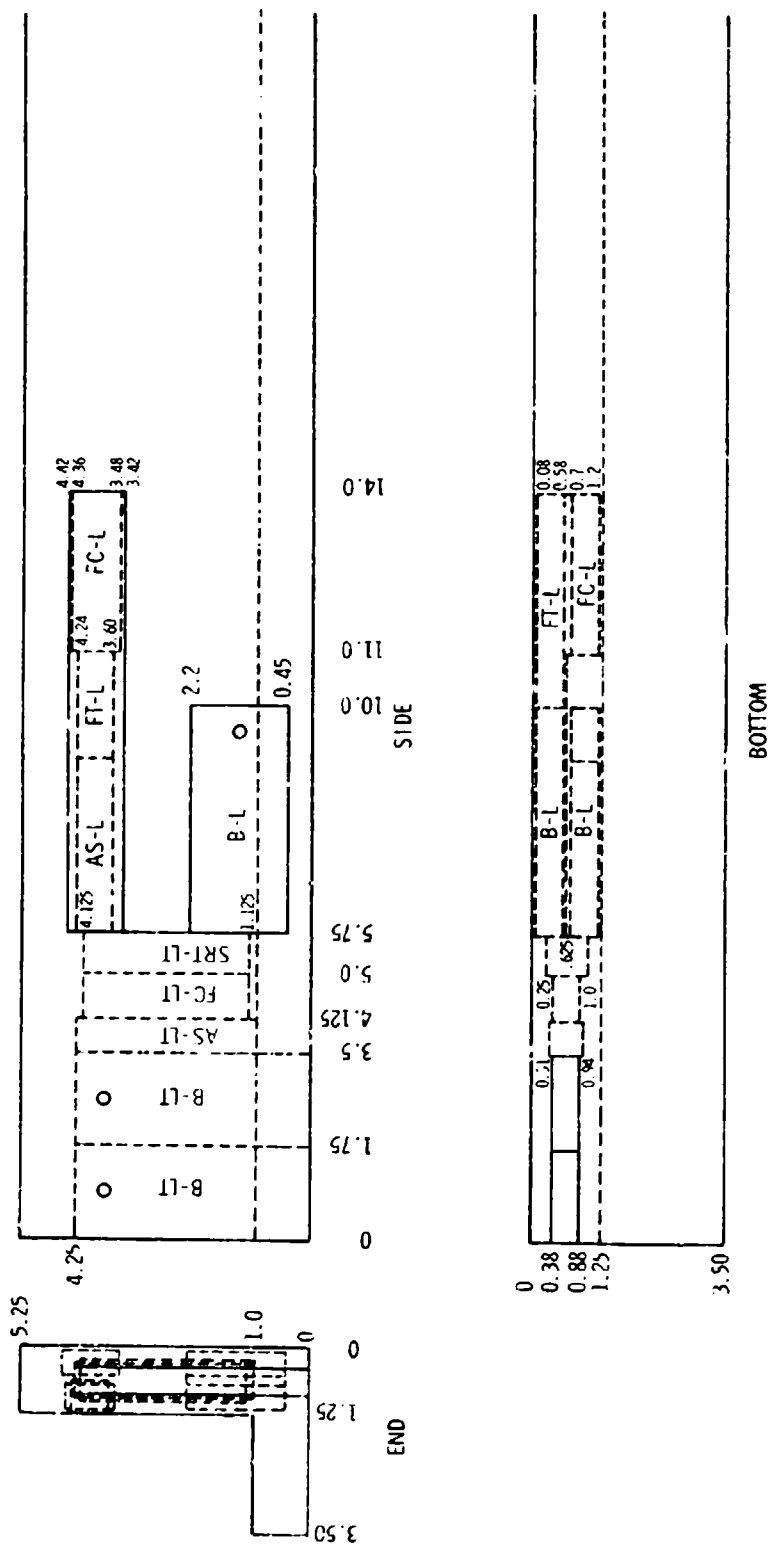

\*Note: All dimensions in inches.

Figure 28h. Specimen Layout for Extrusion 124.

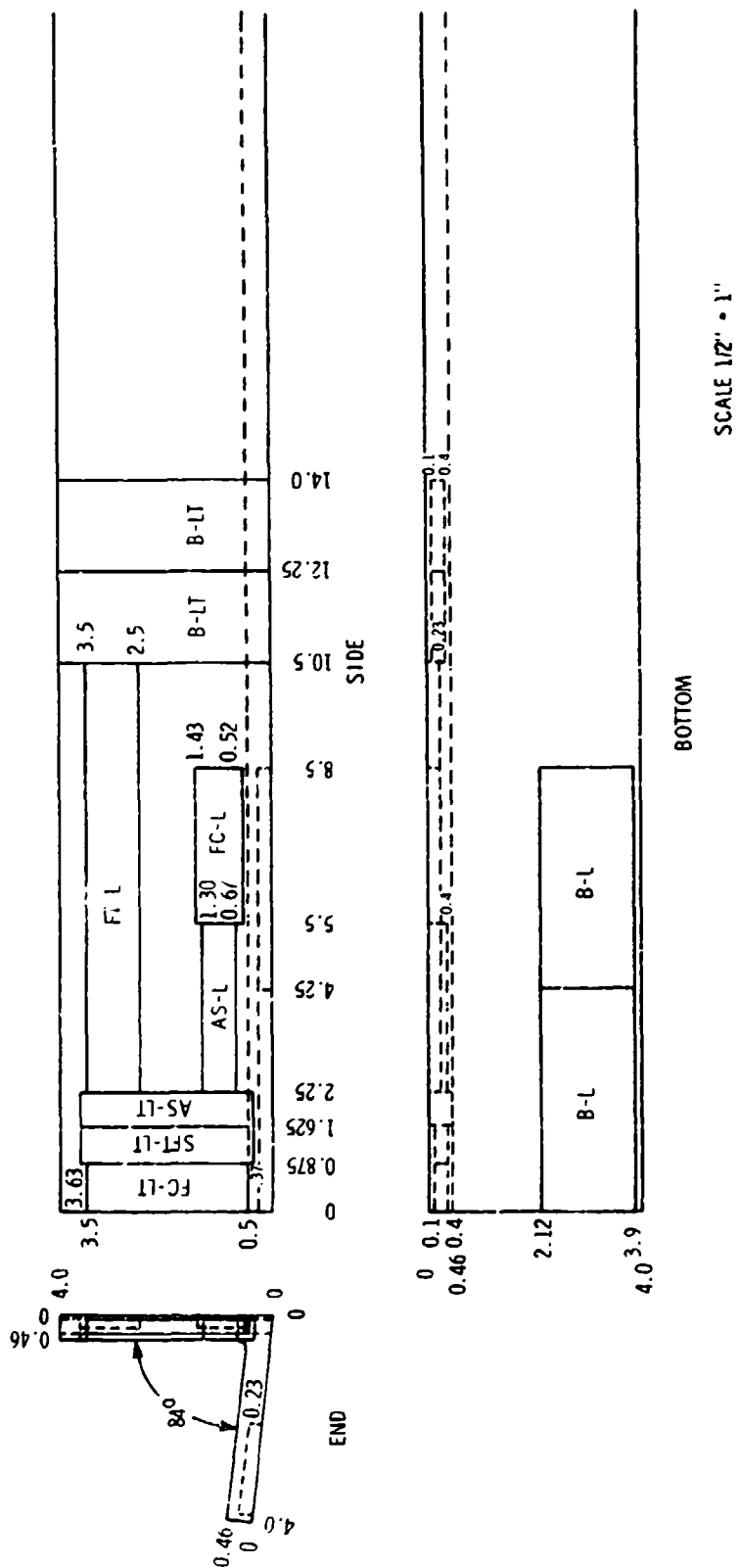

\*Note: All dimensions in inches.

Figure 28i. Specimen Layout for Extrusion 126.

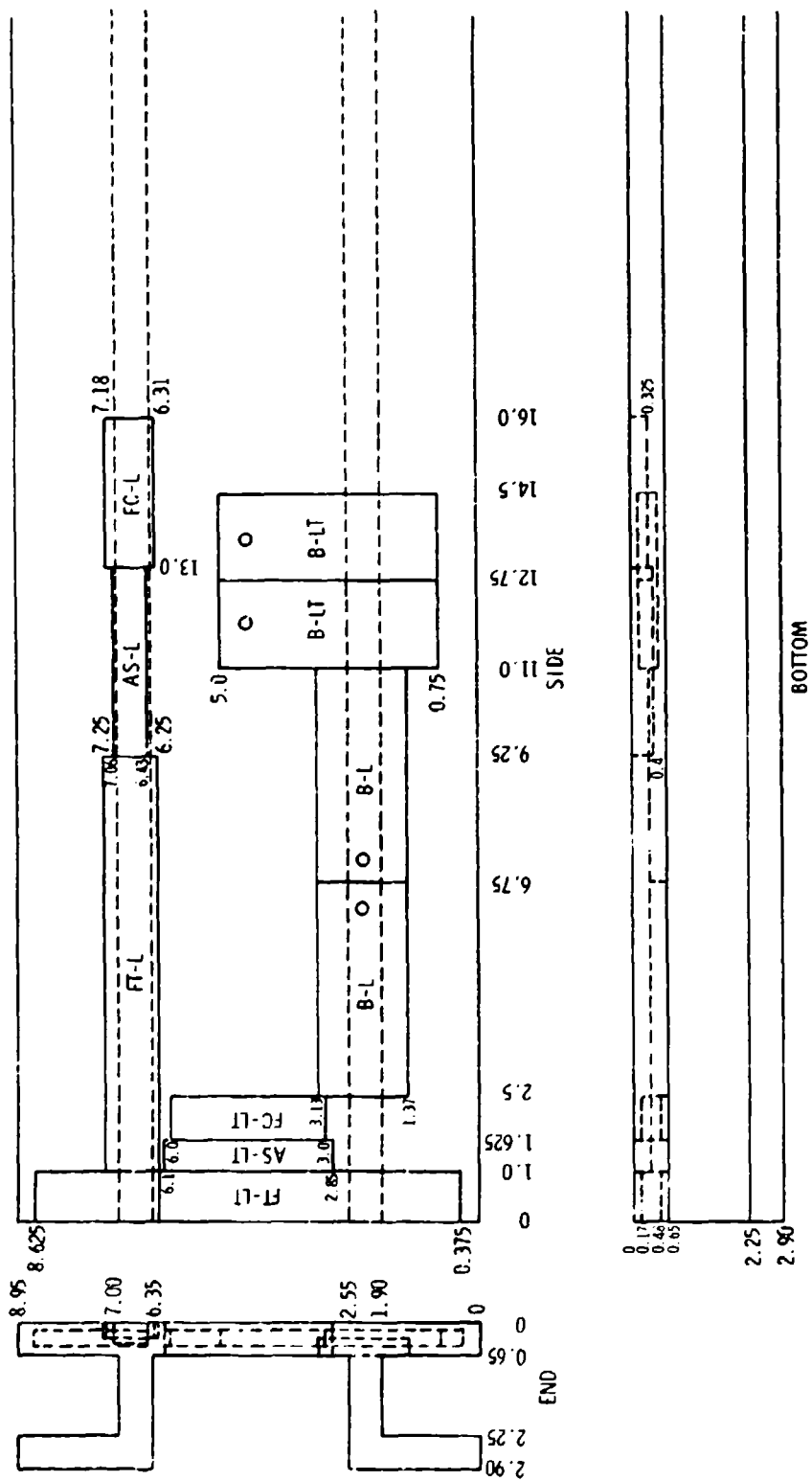

\*Note: All dimensions in inches.

Figure 28j. Specimen Layout for Extrusion 127.

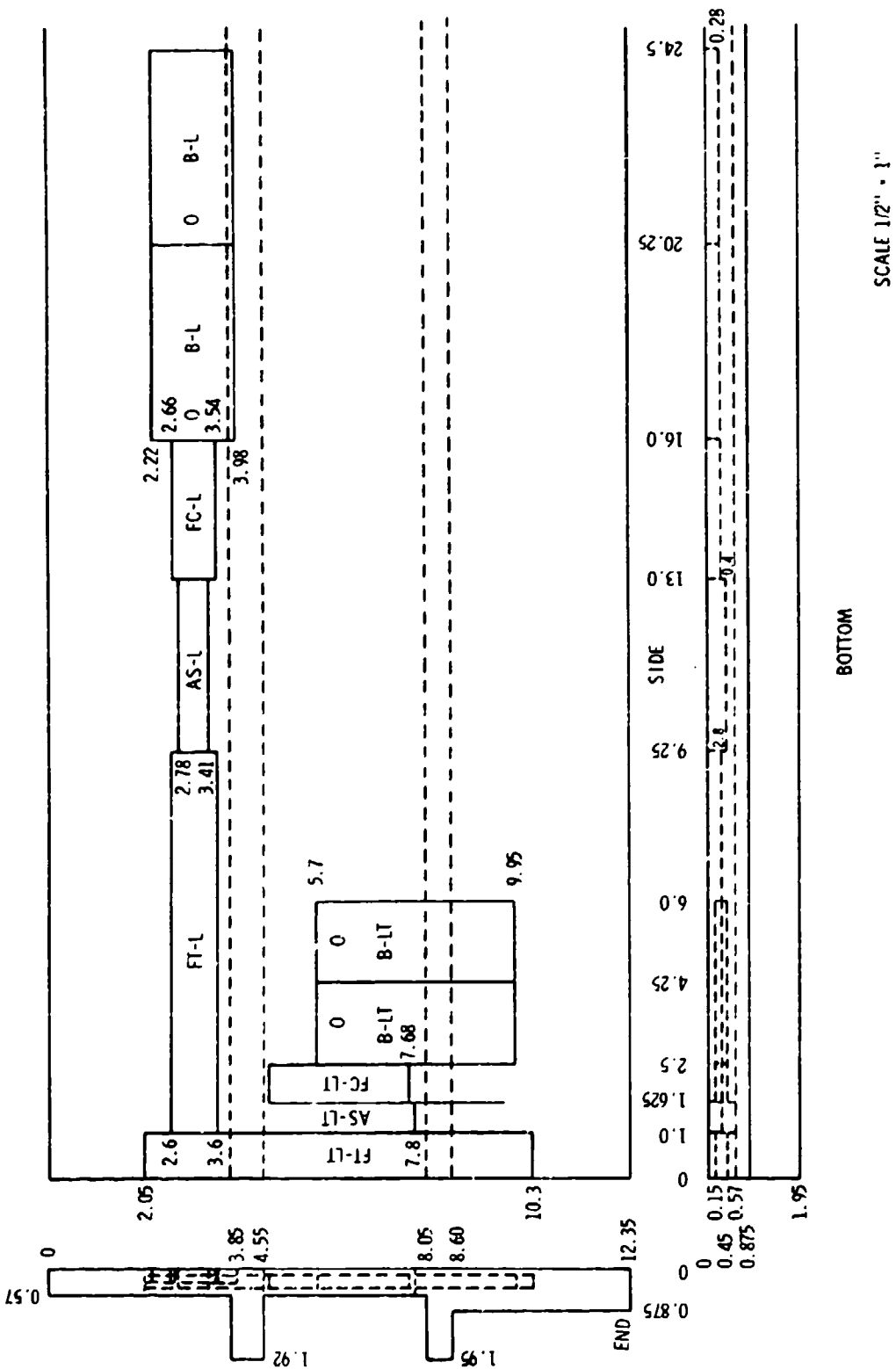

\*Note: All dimensions in inches.

Figure 28k. Specimen Layout for Extrusion 128.

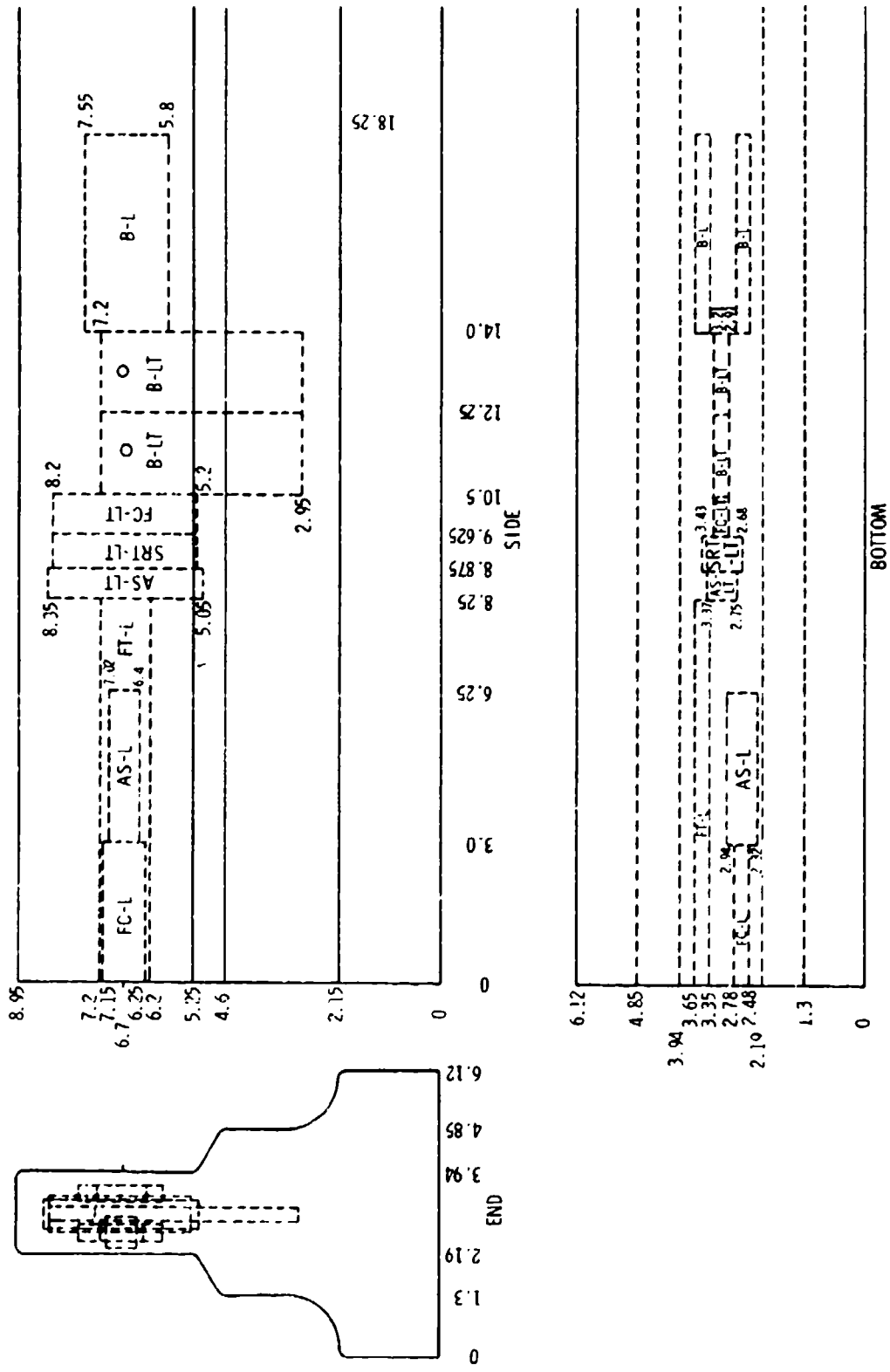

\*Note: All dimensions in inches.

Figure 28e. Specimen Layout for Extrusion 703.

TABLE 20  
TEST GRID FOR 7050-T736511 ALUMINUM EXTRUSION

EXTRUSION NUMBER	105	107	110	112	114	115	122	124	126	127	128	703
TENSILE SPECIMEN THICKNESS in (mm)	0.295 (7.49)	0.13/0.27 (3.3/6.9)	0.52 (13.2)	0.53 (13.4)	0.07 (1.78)	0.30 (7.6)	0.5 (12.7)	0.52 (13.2)	0.22 (5.6)	0.35 (8.9)	0.32 (8.1)	0.35 (8.9)
EXTRUSION SECTION THICKNESS in (mm)	0.3 (7.6)	0.46, 0.124 (11.7, 3.1)	1.25 (31.7)	1.45 (36.8)	0.072 (1.82)	0.625 (15.8)	1.40, 0.25 (35.5, 6.35)	1.25 (31.75)	0.46 (11.7)	0.65 (16.5)	0.57 (14.5)	1.75 (44.4)
Tension	3	6	3	3	3	3	3	3	3	3	3	3
Flat (L)												
Flat (LT)												
Short Flat (L)												
Short Flat (LT)	3	6			3		3		3			
Short Round (L)												
Short Round (LT)			3	3		3	3	3				3
Compression												
Flat (L)	3	3	3	3	3	3	3	3	3	3	3	3
Flat (LT)	3	3	3	3	3	3	3	3	3	3	3	3
Flat (ST)												
Shear												
Angle Shear (L)	3	3	3	3	3	3	3	3	3	3	3	3
Angle Shear (LT)	3	3	3	3	3	3	3	3	3	3	3	3
Bearing												
e/D = 1.5												
Pin Bearing (L)	3	3	3	3	3	3	3	3	3	3	3	3
Pin Bearing (LT)	3	3	3	3	3	3	3	3	3	3	3	3
e/D = 2.0												
Pin Bearing (L)	3	3	3	3	3	3	3	3	3	3	3	3
Pin Bearing (LT)	3	3	3	3	3	3	3	3	3	3	3	3



TABLE 21A

TENSILE RESULTS FOR ALUMINUM EXTRUSION (7050-T736511)  
(LONG, RECTANGULAR, LONGITUDINAL)

SPECIMEN ID.	ULTIMATE TENSILE STRENGTH Ksi (MPa)	0.2 PERCENT OFFSET YIELD STRENGTH Ksi (MPa)	ELONG. IN 2.0 IN. (50.8 mm) PERCENT	REDUCT. IN AREA PERCENT	TENSILE MODULUS Ksi (GPa)
LONG, RECTANGULAR, LONGITUDINAL					
ALEE105-1-3T-L	78.89 (544.0)	69.21 (477.2)	12.97	28.75	10360 (71.42)
ALEE105-2-3T-L	78.79 (543.3)	68.94 (475.4)	12.95	29.10	10370 (71.49)
ALEE105-3-3T-L	79.13 (545.6)	69.30 (477.8)	13.47	29.99	10500 (72.39)
ALEE107-1-6T-L	79.69 (549.4)	69.69 (480.5)	10.40	23.59	10630 (73.27)
ALEE107-2-6T-L	79.07 (545.2)	68.85 (474.7)	10.42	30.37	9985 (68.84)
ALEE107-3-6T-L	79.38 (547.3)	69.14 (476.7)	11.12	23.94	10090 (69.54)
ALEE107-4-6T-L	79.86 (550.7)	70.11 (483.4)	14.00	31.22	10670 (73.57)
ALEE107-5-6T-L	79.82 (550.3)	69.68 (480.4)	12.65	28.99	10470 (72.18)
ALEE107-6-6T-L	79.58 (548.7)	69.54 (479.5)	13.30	27.20	10330 (71.23)
ALEE110-1-3T-L	81.42 (561.4)	74.00 (510.2)	15.50	31.90	10250 (70.69)
ALEE110-2-3T-L	81.14 (559.4)	73.63 (507.7)	15.55	31.58	10450 (72.08)
ALEE110-3-3T-L	81.20 (559.9)	73.64 (507.7)	16.27	32.21	10360 (71.45)
ALEE112-1-3T-L	79.10 (545.4)	70.00 (488.2)	16.60	33.81	10370 (71.53)
ALEE112-2-3T-L	78.67 (542.4)	70.15 (483.7)	15.45	33.41	10460 (72.10)
ALEE112-3-3T-L	78.47 (541.1)	69.99 (482.6)	15.92	31.21	10370 (71.50)
ALEE114-1-3T-L	77.08 (531.5)	66.79 (460.5)	9.10	15.37	10570 (72.89)
ALEE114-2-3T-L	76.85 (529.9)	66.36 (457.5)	10.62	13.39	10260 (70.77)
ALEE114-3-3T-L	76.86 (530.0)	66.82 (460.7)	9.67	19.08	10140 (69.90)
ALEE115-1-3T-L	77.32 (533.1)	67.52 (465.6)	14.15	32.19	10380 (71.55)
ALEE115-2-3T-L	76.96 (530.6)	67.10 (462.7)	13.97	32.65	10430 (71.89)
ALEE115-3-3T-L	76.77 (529.3)	66.52 (458.7)	12.62	23.36	10360 (71.44)
ALEE122-1-3T-L	85.02 (586.2)	77.87 (536.9)	13.42	26.16	10550 (72.71)
ALEE122-2-3T-L	84.70 (584.0)	77.74 (536.0)	13.52	26.52	10480 (72.26)
ALEE122-3-3T-L	84.51 (582.7)	77.32 (533.1)	14.42	31.22	10470 (72.21)
ALEE124-1-3T-L	78.26 (539.6)	68.29 (470.9)	16.90	34.08	10470 (72.20)
ALEE124-2-3T-L	78.44 (540.8)	68.71 (473.8)	16.35	37.80	10270 (70.81)
ALEE124-3-3T-L	78.21 (539.2)	68.43 (471.8)	16.80	38.25	10270 (70.82)
ALEE126-1-3T-L	78.39 (540.5)	67.82 (467.6)	13.17	28.71	10360 (71.45)
ALEE126-2-3T-L	78.73 (542.9)	68.35 (471.2)	11.57	25.15	10480 (72.29)
ALEE126-3-3T-L	78.35 (540.2)	67.88 (468.0)	11.75	25.19	10370 (71.51)
ALEE127-1-3T-L	78.30 (539.9)	69.73 (480.8)	13.00	27.58	10470 (72.19)
ALEE127-2-3T-L	78.62 (542.1)	69.93 (482.1)	13.85	31.13	10450 (72.04)
ALEE127-3-3T-L	78.71 (542.7)	69.89 (481.9)	14.30	30.00	10466 (72.16)
ALEE128-1-3T-L	76.01 (524.1)	65.66 (452.7)	13.17	30.32	10370 (71.49)
ALEE128-2-3T-L	75.73 (522.2)	65.60 (452.3)	14.52	32.30	10210 (70.42)
ALEE128-3-3T-L	76.38 (526.7)	65.87 (454.2)	13.35	30.14	10320 (71.17)
ALEE703-1-3T-L	78.57 (541.7)	68.78 (474.3)	13.40	28.47	10290 (70.93)
ALEE703-2-3T-L	78.40 (540.6)	68.40 (471.6)	13.65	27.96	10290 (70.98)
ALEE703-3-3T-L	78.79 (543.3)	69.06 (476.2)	13.15	27.58	10230 (70.53)
AVERAGE	78.98 (544.6)	69.57 (479.7)	13.53	28.77	10370 (71.54)

TABLE 21B

TENSILE RESULTS FOR ALUMINUM EXTRUSION (7050-T736511)  
(LONG, RECTANGULAR, LONG TRANSVERSE)

SPECIMEN ID.	ULTIMATE TENSILE STRENGTH Ksi (MPa)	0.2 PERCENT OFFSET YIELD STRENGTH Ksi (MPa)	ELONG. IN 2.0 IN. ( 50.8 mm) PERCENT	REDUCT. IN AREA PERCENT	TENSILE MODULUS Ksi (GPa)
<u>LONG, RECTANGULAR, LONG TRANSVERSE</u>					
ALEE127-1-3T-LT	77.57 (534.9)	68.19 (470.2)	13.22	25.19	10570 (72.89)
ALEE127-2-3T-LT	77.21 (532.4)	67.62 (466.2)	12.62	26.95	10520 (72.52)
ALEE127-3-3T-LT	77.28 (532.9)	67.87 (468.0)	13.60	26.20	10590 (73.08)
ALEE128-1-3T-LT	76.10 (524.7)	66.08 (455.6)	13.17	28.22	10650 (73.44)
ALEE128-2-3T-LT	76.18 (525.2)	66.02 (455.2)	13.57	28.78	10410 (71.79)
ALEE128-3-3T-LT	76.31 (526.2)	65.94 (454.7)	15.72	30.63	10340 (71.26)
AVERAGE	76.78 (529.4)	66.95 (461.7)	13.65	27.66	10510 (72.48)

TABLE 21C

TENSILE RESULTS FOR ALUMINUM EXTRUSION (7050-T736511)  
(SHORT, ROUND, LONG TRANSVERSE)

SPECIMEN ID.	ULTIMATE TENSILE STRENGTH	0.2 PERCENT OFFSET YIELD STRENGTH	ELONG. IN 1.0 IN. ( 25.4 mm)	REDUCT. IN AREA	TENSILE MODULUS
	Ksi (MPa)	Ksi (MPa)	PERCENT	PERCENT	Ksi (GPa)
<u>SHORT, ROUND, LONG TRANSVERSE</u>					
ALEE110-1-3T-LT	77.23 (532.5)	68.97 (475.5)	12.95	32.76	10030 (69.15)
ALEE110-2-3T-LT	77.19 (532.2)	69.24 (477.4)	12.25	28.48	9983 (68.83)
ALEE110-3-3T-LT	76.62 (528.3)	68.63 (473.2)	11.25	29.27	9983 (68.28)
ALEE112-1-3T-LT	75.90 (523.3)	66.95 (461.6)	11.45	23.40	9840 (67.85)
ALEE112-2-3T-LT	76.15 (525.1)	66.90 (461.3)	10.45	23.34	9999 (68.94)
ALEE112-3-3T-LT	75.54 (520.8)	65.83 (453.9)	12.10	20.79	9819 (67.70)
ALEE115-1-3T-LT	74.16 (511.4)	63.59 (438.5)	12.30	31.28	10090 (69.57)
ALEE115-2-3T-LT	75.98 (523.9)	65.29 (450.1)	13.65	32.76	10160 (70.08)
ALEE115-3-3T-LT	76.12 (524.9)	65.43 (451.2)	13.70	33.14	10120 (69.80)
ALEE124-1-3T-LT	75.68 (521.8)	65.64 (452.6)	14.10	29.55	10040 (69.20)
ALEE124-2-3T-LT	75.58 (521.1)	65.22 (449.7)	13.45	28.71	9959 (68.67)
ALEE124-3-3T-LT	75.73 (522.2)	65.57 (452.1)	14.15	30.06	10040 (69.22)
ALEE703-1-3T-LT	75.87 (523.1)	65.53 (451.8)	9.65	18.34	10190 (70.24)
ALEE703-3-3T-LT	75.97 (523.8)	66.13 (456.0)	10.20	17.26	9962 (68.69)
ALEE703-3-3T-LT	76.15 (525.0)	65.63 (452.5)	10.75	19.91	10120 (69.79)
AVERAGE	75.99 (524.0)	66.30 (457.2)	12.16	26.60	10020 (69.07)

TABLE 21D

TENSILE RESULTS FOR ALUMINUM EXTRUSION (7050-T736511)  
(SHORT, RECTANGULAR, LONG TRANSVERSE)

SPECIMEN ID.	ULTIMATE TENSILE STRENGTH Ksi (MPa)	0.2 PERCENT OFFSET YIELD STRENGTH Ksi (MPa)	ELONG. IN 0.5 IN. ( 12.7 mm) PERCENT	REDUCT. IN AREA PERCENT	TENSILE MODULUS Ksi (GPa)
SHORT, RECTANGULAR, LONG TRANSVERSE					
ALEE105-1-3T-LT	75.56 (521.0)	66.27 (456.9)	20.20	30.88	10572 (72.89)
ALEE105-2-3T-LT	76.57 (527.9)	65.76 (453.4)	20.00	30.17	10311 (71.89)
ALEE105-3-3T-LT	77.31 (533.1)	66.02 (455.2)	20.60	29.75	10542 (72.69)
ALEE107-1-6T-LT	76.46 (527.2)	66.16 (456.2)	18.80	28.46	10292 (70.96)
ALEE107-2-6T-LT	76.46 (527.2)	65.90 (454.4)	20.60	27.70	10443 (72.00)
ALEE107-3-6T-LT	76.61 (528.2)	65.52 (451.8)	19.10	26.39	10252 (70.69)
ALEE107-4-6T-LT	80.88 (557.7)	69.53 (479.4)	17.20	26.60	10558 (72.80)
ALEE107-5-6T-LT	81.25 (560.2)	70.31 (484.8)	18.40	28.11	10603 (73.11)
ALEE107-6-6T-LT	81.25 (560.2)	71.09 (490.2)	19.60	27.27	10470 (72.19)
ALEE114-1-3T-LT	80.53 (555.3)	69.52 (479.3)	14.30	9.39	10588 (73.00)
ALEE114-2-3T-LT	80.65 (556.1)	69.89 (481.9)	16.90	16.39	10919 (75.29)
ALEE114-3-3T-LT	79.57 (548.6)	67.17 (463.1)	15.60	15.09	11141 (76.82)
ALEE122-1-3T-LT	81.49 (561.9)	72.94 (502.9)	18.00	23.25	10191 (70.27)
ALEE122-2-3T-LT	81.33 (560.8)	72.79 (501.9)	18.70	25.90	10361 (71.44)
ALEE122-3-3T-LT	80.88 (557.7)	72.29 (498.4)	10.10	25.46	10331 (71.23)
ALEE126-1-3T-LT	76.57 (528.0)	64.26 (443.1)	20.00	29.72	10311 (71.89)
ALEE126-2-3T-LT	76.26 (525.8)	64.14 (442.2)	20.80	30.12	10232 (70.55)
ALEE126-3-3T-LT	76.41 (526.8)	64.63 (445.6)	20.90	28.88	10441 (71.99)
AVERAGE	78.67 (542.4)	68.01 (468.9)	18.77	25.53	10480 (72.23)

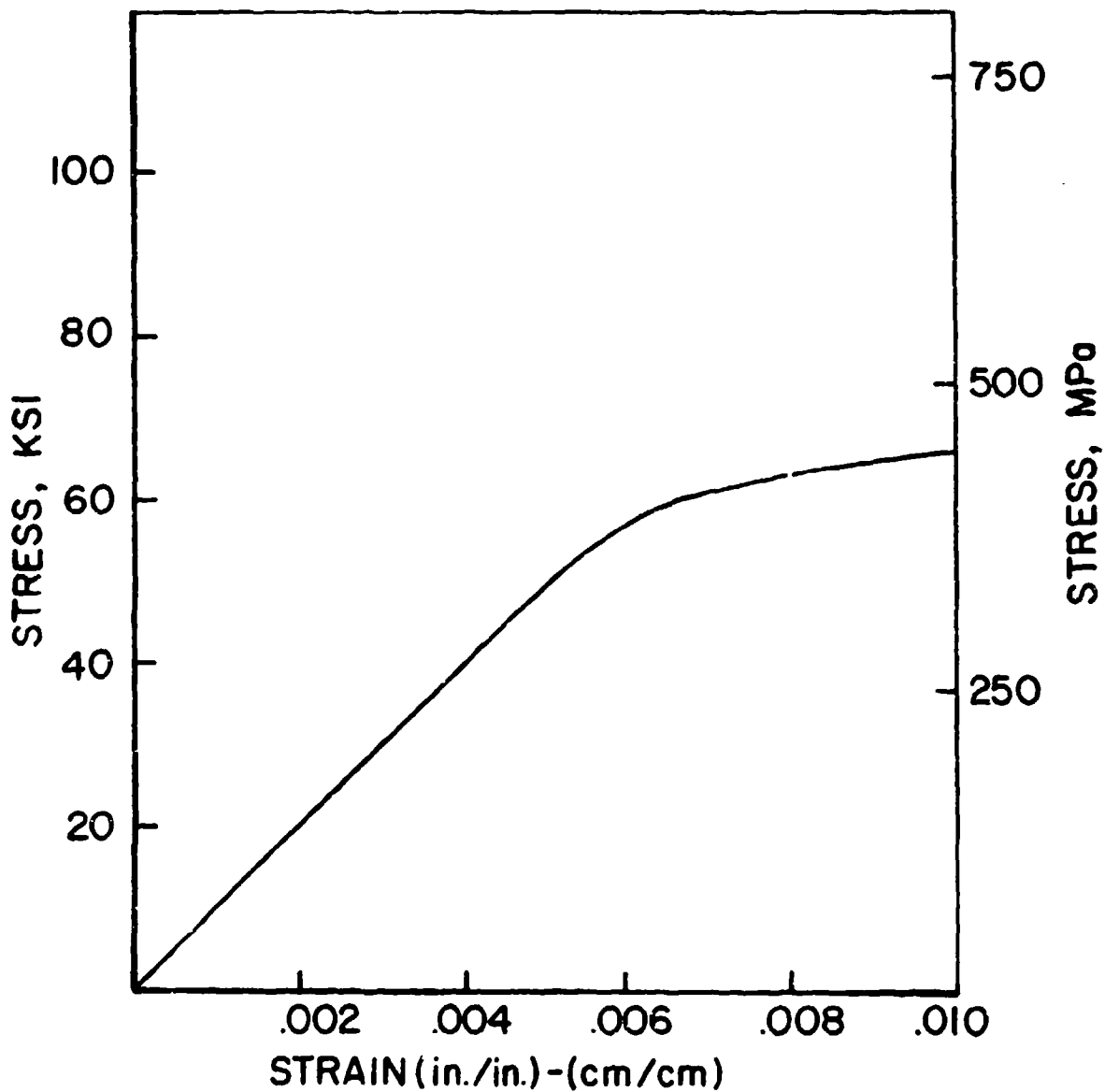

Figure 29. Typical Stress-Strain Curve in Tension for 7050-T736511 Aluminum Extrusion.

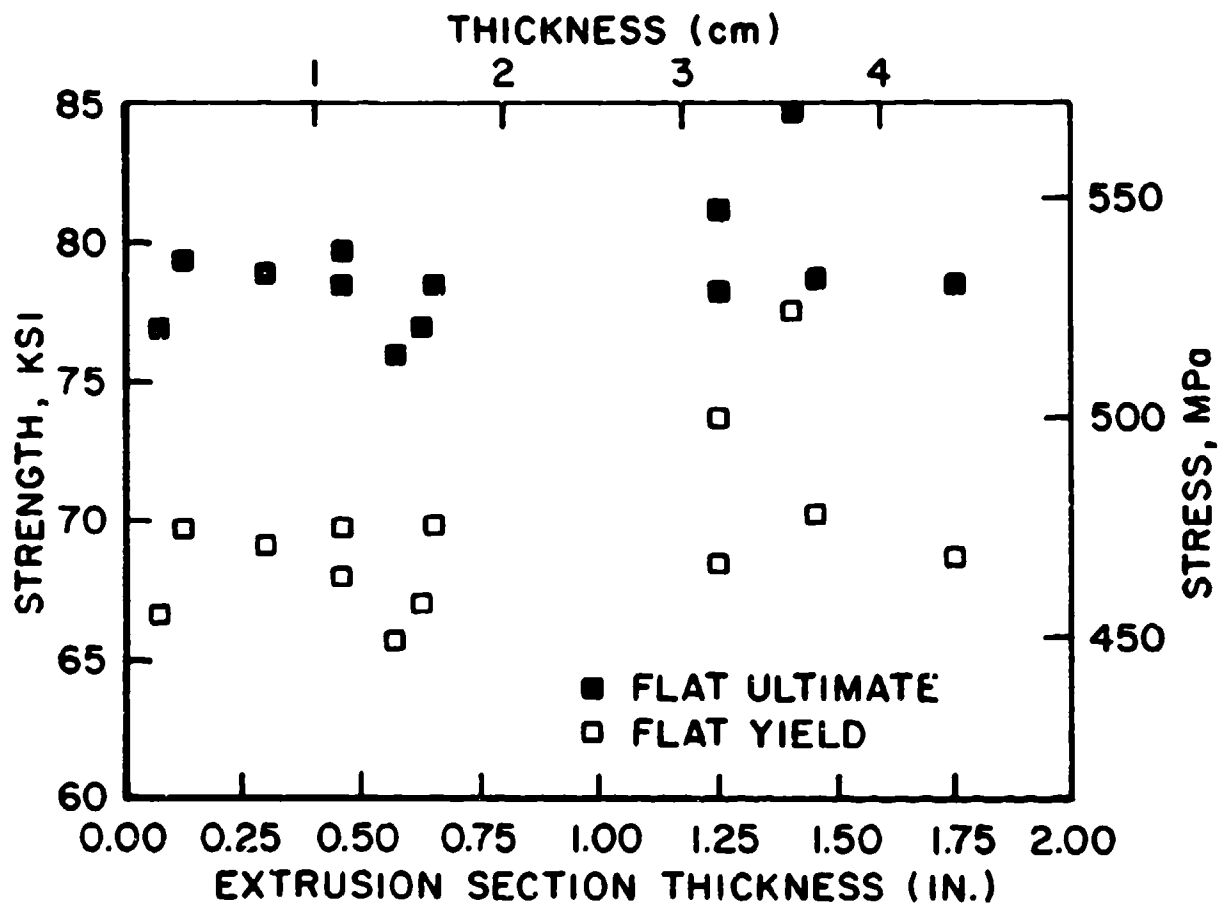

Figure 30a. Tensile Ultimate and Yield as a Function of Extrusion Section Thickness for Longitudinal Samples.

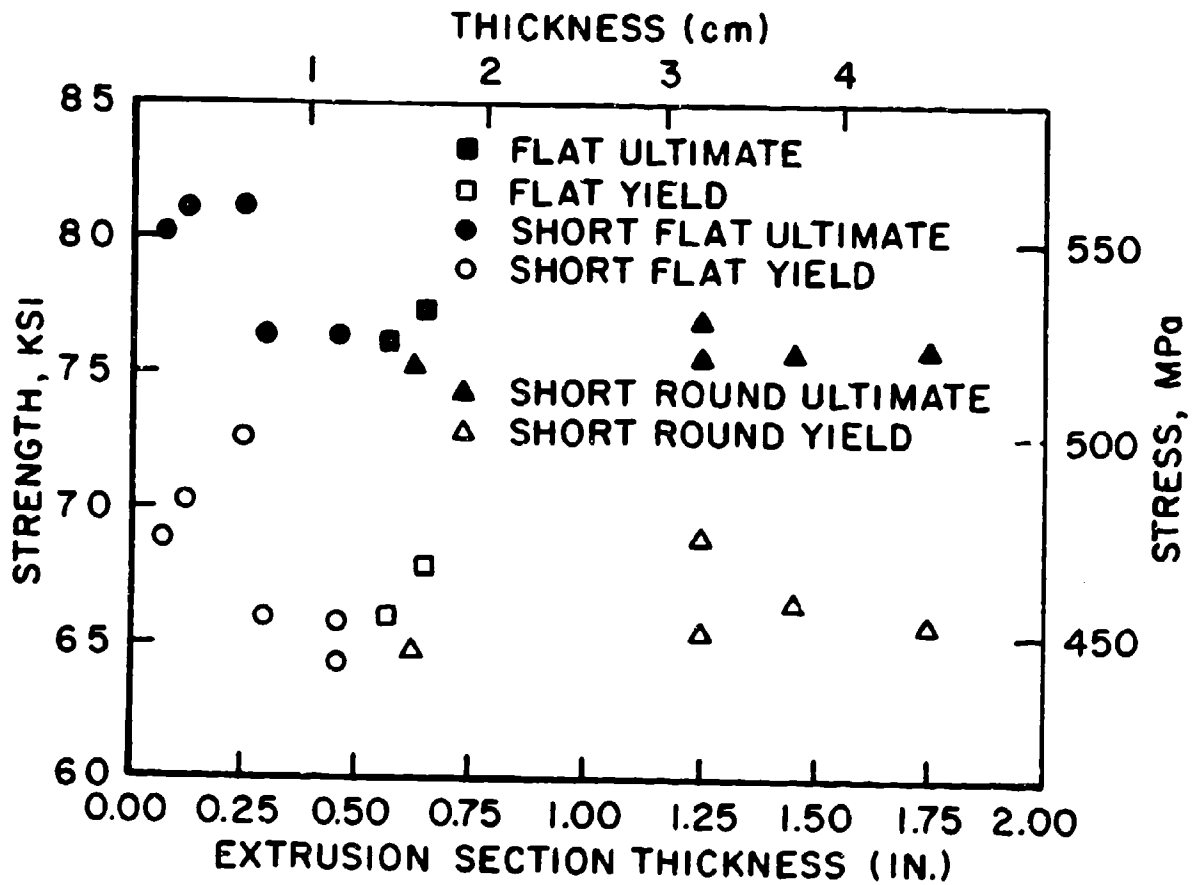

Figure 30b. Tensile Ultimate and Yield as a Function of Extrusion Section Thickness for Long Transverse Samples.

TABLE 22A

COMPRESSION RESULTS FOR ALUMINUM EXTRUSION (7050-T736511)  
(RECTANGULAR, LONGITUDINAL)

SPECIMEN IDENTIFICATION	0.2 PERCENT OFFSET YIELD STRENGTH		COMPRESSIVE MODULUS
	Ksi	(MPa)	Ksi (GPa)
<u>RECTANGULAR, LONGITUDINAL</u>			
ALEE105-1-3C-L	70.33	(484.9)	10570 (72.91)
ALEE105-2-3C-L	69.60	(479.9)	10370 (74.95)
ALEE105-3-3C-L	70.10	(483.4)	10500 (72.40)
ALEE107-1-3C-L	68.74	(474.0)	10530 (72.60)
ALEE107-2-3C-L	68.93	(475.3)	10580 (72.93)
ALEE107-3-3C-L	68.88	(474.9)	10600 (73.06)
ALEE110-1-3C-L	75.15	(518.2)	10540 (73.38)
ALEE110-2-3C-L	75.64	(521.5)	10640 (73.34)
ALEE110-3-3C-L	77.54	(534.6)	10650 (73.41)
ALEE114-1-3C-L	66.59	(459.1)	10710 (73.87)
ALEE114-2-3C-L	66.00	(455.1)	10620 (73.21)
ALEE114-3-3C-L	66.50	(458.5)	10450 (72.05)
ALEE115-1-3C-L	66.67	(459.7)	10620 (73.25)
ALEE115-2-3C-L	67.40	(464.7)	10720 (73.92)
ALEE115-3-3C-L	68.24	(470.5)	10730 (73.96)
ALEE122-1-3C-L	82.22	(566.9)	10680 (73.63)
ALEE122-2-3C-L	82.08	(565.9)	10560 (72.84)
ALEE122-3-3C-L	80.88	(557.6)	10740 (74.04)
ALEE124-1-3C-L	69.78	(481.2)	10770 (74.27)
ALEE124-2-3C-L	68.91	(475.2)	10650 (73.44)
ALEE124-3-3C-L	68.97	(475.6)	10590 (73.03)
ALEE126-1-3C-L	67.66	(466.5)	10430 (71.94)
ALEE126-2-3C-L	68.84	(474.7)	10570 (72.88)
ALEE126-3-3C-L	67.82	(467.6)	10490 (72.32)
ALEE127-1-3C-L	71.74	(494.6)	10700 (73.78)
ALEE127-2-3C-L	70.01	(482.7)	10570 (72.91)
ALEE127-3-3C-L	71.48	(492.9)	10660 (73.51)
ALEE128-1-3C-L	65.35	(450.6)	10520 (72.53)
ALEE128-2-3C-L	66.35	(457.5)	10470 (72.18)
ALEE128-3-3C-L	66.12	(455.9)	10400 (71.71)
ALEE703-1-3C-L	68.92	(475.2)	10570 (72.85)
ALEE703-2-3C-L	68.92	(475.2)	10520 (72.55)
ALEE703-3-3C-L	69.12	(476.6)	10570 (72.87)
AVERAGE	70.35	(485.1)	10600 (73.11)



TABLE 22B

COMPRESSION RESULTS FOR ALUMINUM EXTRUSION (7050-T736511)  
(RECTANGULAR, LONG TRANSVERSE)

SPECIMEN IDENTIFICATION	0.2 PERCENT OFFSET YIELD STRENGTH	COMPRESSIVE MODULUS
	Ksi (MPa)	Ksi (GPa)
<u>RECTANGULAR, LONG TRANSVERSE</u>		
ALEE105-1-3C-LT	69.27 (477.6)	10560 (72.82)
ALEE105-2-3C-LT	69.73 (480.8)	10540 (72.67)
ALEE105-3-3C-LT	68.46 (472.0)	10570 (72.89)
ALEE107-1-3C-LT	73.22 (504.8)	10300 (74.46)
ALEE107-2-3C-LT	73.68 (508.1)	10950 (75.49)
ALEE107-3-3C-LT	73.94 (509.8)	10880 (75.01)
ALEE110-1-3C-LT	73.21 (504.8)	10690 (73.70)
ALEE110-2-3C-LT	73.01 (503.4)	10630 (73.30)
ALEE110-3-3C-LT	72.67 (501.1)	10750 (74.10)
ALEE114-1-3C-LT	72.68 (501.1)	11050 (76.20)
ALEE114-2-3C-LT	73.62 (507.5)	11110 (76.61)
ALEE114-3-3C-LT	73.72 (508.3)	11040 (76.14)
ALEE115-1-3C-LT	67.79 (467.4)	10900 (75.17)
ALEE115-2-3C-LT	68.25 (470.6)	10740 (74.04)
ALEE115-3-3C-LT	68.77 (474.2)	10770 (74.26)
ALEE122-1-3C-LT	77.22 (532.4)	10970 (75.63)
ALEE122-2-3C-LT	77.42 (533.8)	10530 (72.63)
ALEE122-3-3C-LT	78.04 (538.1)	10850 (74.78)
ALEE124-1-3C-LT	69.20 (477.2)	10880 (74.99)
ALEE124-2-3C-LT	50.83 (350.5)	11010 (75.50)
ALEE124-3-3C-LT	68.20 (470.2)	10990 (75.79)
ALEE126-1-3C-LT	67.91 (468.2)	11000 (75.87)
ALEE126-2-3C-LT	67.72 (466.9)	10750 (74.09)
ALEE126-3-3C-LT	67.34 (464.3)	10790 (74.38)
ALEE127-1-3C-LT	69.94 (482.2)	10920 (75.30)
ALEE127-2-3C-LT	69.68 (480.4)	10790 (74.40)
ALEE127-3-3C-LT	54.75 (377.5)	11070 (76.35)
ALEE128-1-3C-LT	69.09 (476.4)	10800 (74.46)
ALEE128-2-3C-LT	69.54 (473.5)	10830 (74.68)
ALEE128-3-3C-LT	69.45 (473.3)	10950 (75.50)
ALEE703-1-3C-LT	69.78 (481.1)	10770 (74.28)
ALEE703-2-3C-LT	70.41 (485.5)	10890 (75.09)
ALEE703-3-3C-LT	70.01 (482.7)	11060 (76.23)
AVERAGE	69.96 (482.3)	10840 (74.76)

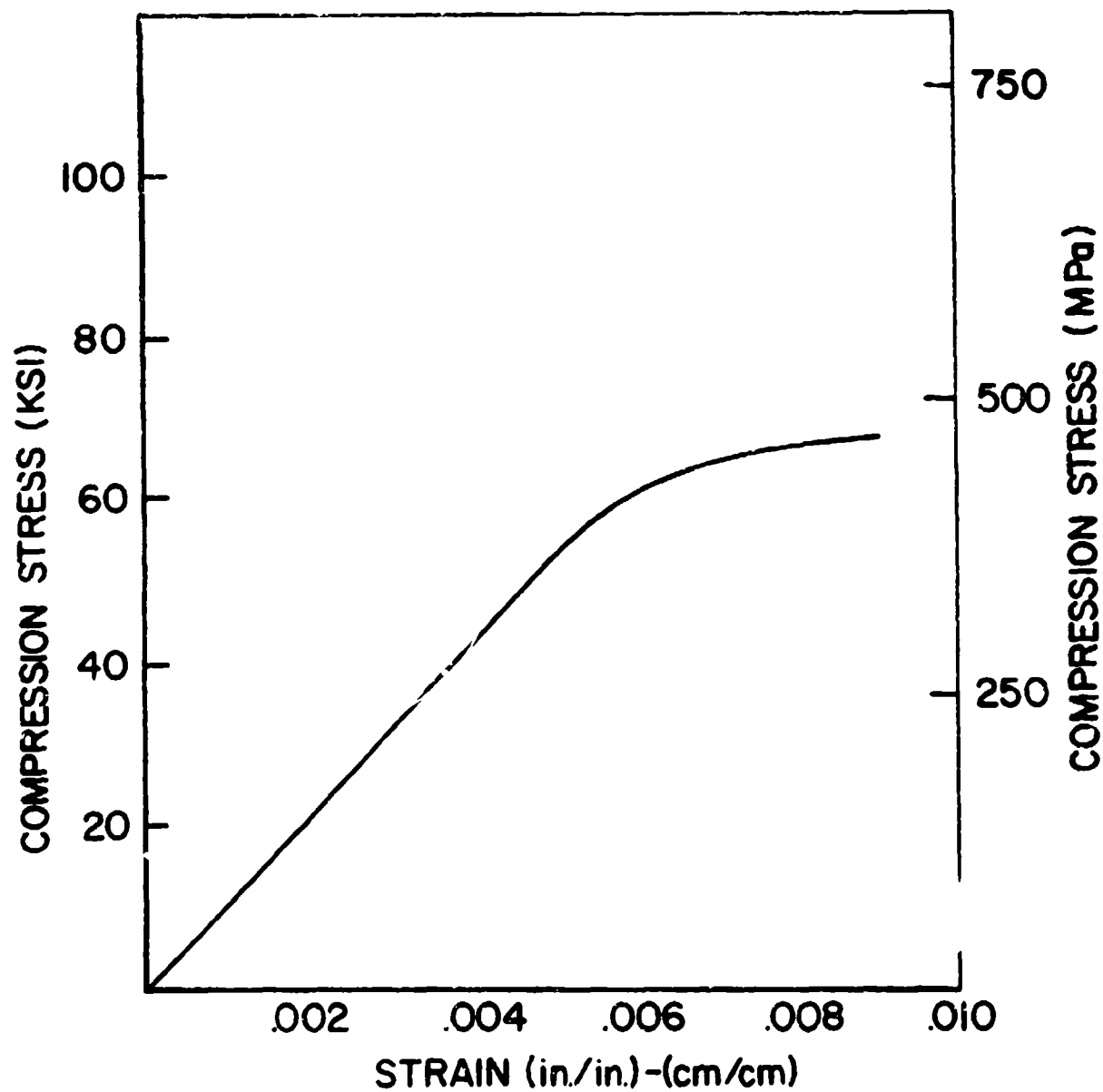

Figure 31. Typical Stress-Strain Curve in Compression for 7050-T736511 Aluminum Extrusion.

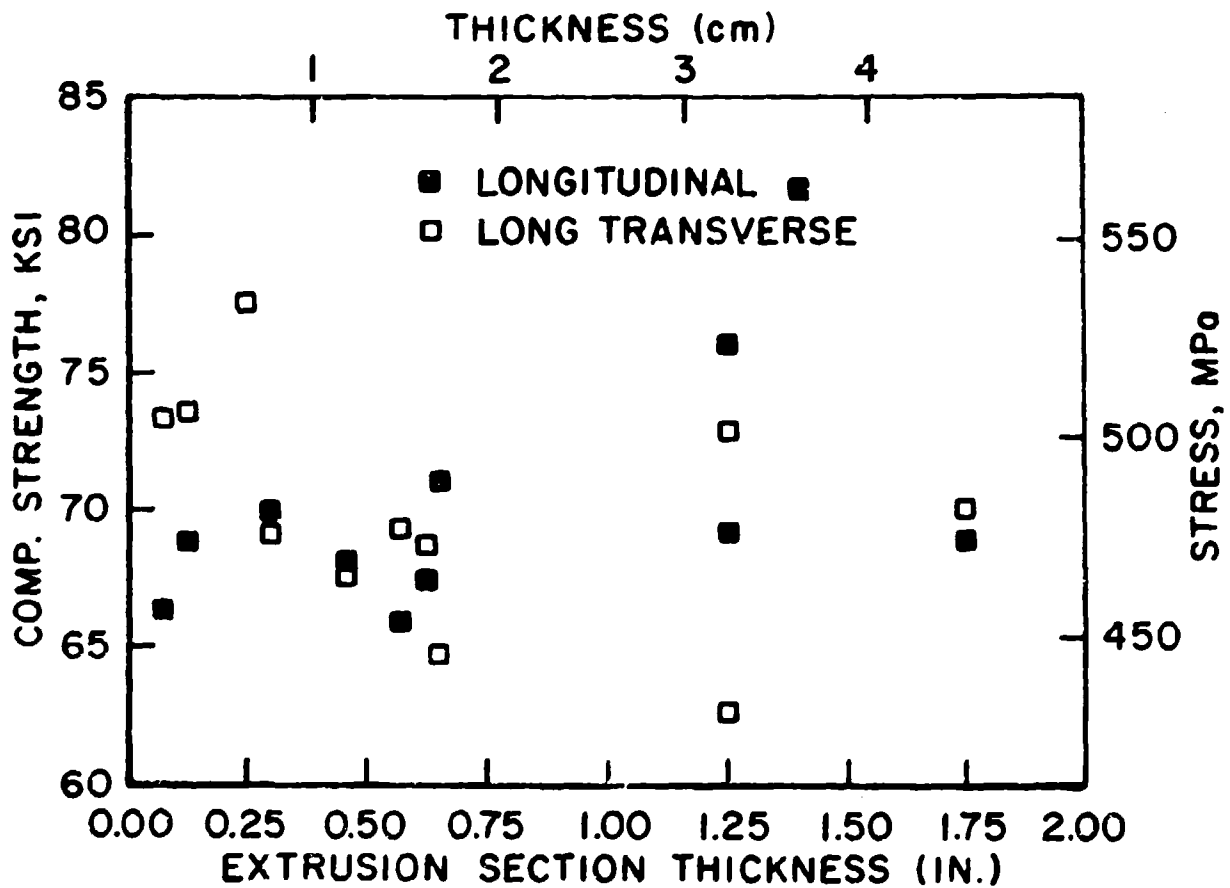

Figure 32. Compressive Yield Strength as a Function of Extrusion Section Thickness for 7050-T736511 Aluminum Extrusion.

TABLE 23

AMSLER DOUBLE-SHEAR RESULTS FOR ALUMINUM EXTRUSION (7050-T736511)

SPECIMEN IDENTIFICATION	ULTIMATE SHEAR STRENGTH Ksi (MPa)	SPECIMEN IDENTIFICATION	ULTIMATE SHEAR STRENGTH Ksi (MPa)
<u>LONG TRANSVERSE</u>			
ALEE107-1-3S-LT	44.75 (308.5)	ALEE110-1-3S-LT	45.80 (315.8)
ALEE107-2-3S-LT	44.91 (309.7)	ALEE110-2-3S-LT	45.65 (314.8)
ALEE107-3-3S-LT	44.77 (308.7)	ALEE110-3-3S-LT	45.82 (315.9)
ALEE112-1-3S-LT	45.08 (310.8)	ALEE115-1-3S-LT	43.82 (302.1)
ALEE112-2-3S-LT	45.42 (313.2)	ALEE115-2-3S-LT	43.36 (298.9)
ALEE112-3-3S-LT	45.10 (311.0)	ALEE115-3-3S-LT	43.25 (298.2)
ALEE124-1-3S-LT	44.32 (305.6)	ALEE126-1-3S-LT	44.18 (304.6)
ALEE124-2-3S-LT	44.10 (304.1)	ALEE126-2-3S-LT	43.97 (303.2)
ALEE124-3-3S-LT	47.29 (326.1)	ALEE126-3-3S-LT	44.66 (307.9)
ALEE127-1-3S-LT	44.62 (307.6)	ALEE128-1-3S-LT	44.66 (307.9)
ALEE127-2-3S-LT	46.70 (322.0)	ALEE128-2-3S-LT	43.95 (303.0)
ALEE127-3-3S-LT	44.58 (307.4)	ALEE128-3-3S-LT	44.56 (307.3)
ALEE703-1-3S-LT	44.57 (307.3)		
ALEE703-2-3S-LT	44.56 (307.3)		
ALEE703-3-3S-LT	44.85 (309.3)		
AVERAGE		44.79 (308.8)	
<u>LONGITUDINAL</u>			
ALEE107-1-3S-L	47.88 (330.1)	ALEE110-1-3S-L	49.05 (338.2)
ALEE107-2-3S-L	47.47 (327.3)	ALEE110-2-3S-L	49.20 (339.3)
ALEE107-3-3S-L	46.31 (319.3)	ALEE110-3-3S-L	47.77 (329.4)
ALEE112-1-3S-L	46.99 (324.0)	ALEE115-1-3S-L	44.39 (306.1)
ALEE112-2-3S-L	45.61 (314.5)	ALEE115-2-3S-L	44.34 (305.7)
ALEE112-3-3S-L	46.90 (323.4)	ALEE115-3-3S-L	47.66 (328.2)
ALEE122-1-3S-L	48.88 (337.0)	ALEE124-1-3S-L	44.53 (307.0)
ALEE122-2-3S-L	47.97 (330.8)	ALEE124-2-3S-L	47.16 (325.2)
ALEE122-3-3S-L	48.53 (334.6)	ALEE124-3-3S-L	46.94 (323.6)
ALEE126-1-3S-L	46.00 (317.2)	ALEE127-1-3S-L	44.36 (305.9)
ALEE126-2-3S-L	45.03 (310.5)	ALEE127-2-3S-L	44.78 (308.8)
ALEE126-3-3S-L	44.74 (308.5)	ALEE127-3-3S-L	44.64 (307.8)
ALEE128-1-3S-L	45.19 (311.6)	ALEE703-1-3S-L	46.09 (317.8)
ALEE128-2-3S-L	45.15 (311.3)	ALEE703-2-3S-L	45.38 (312.9)
ALEE128-3-3S-L	45.26 (312.1)	ALEE703-3-3S-L	44.89 (309.5)
AVERAGE		46.30 (319.3)	

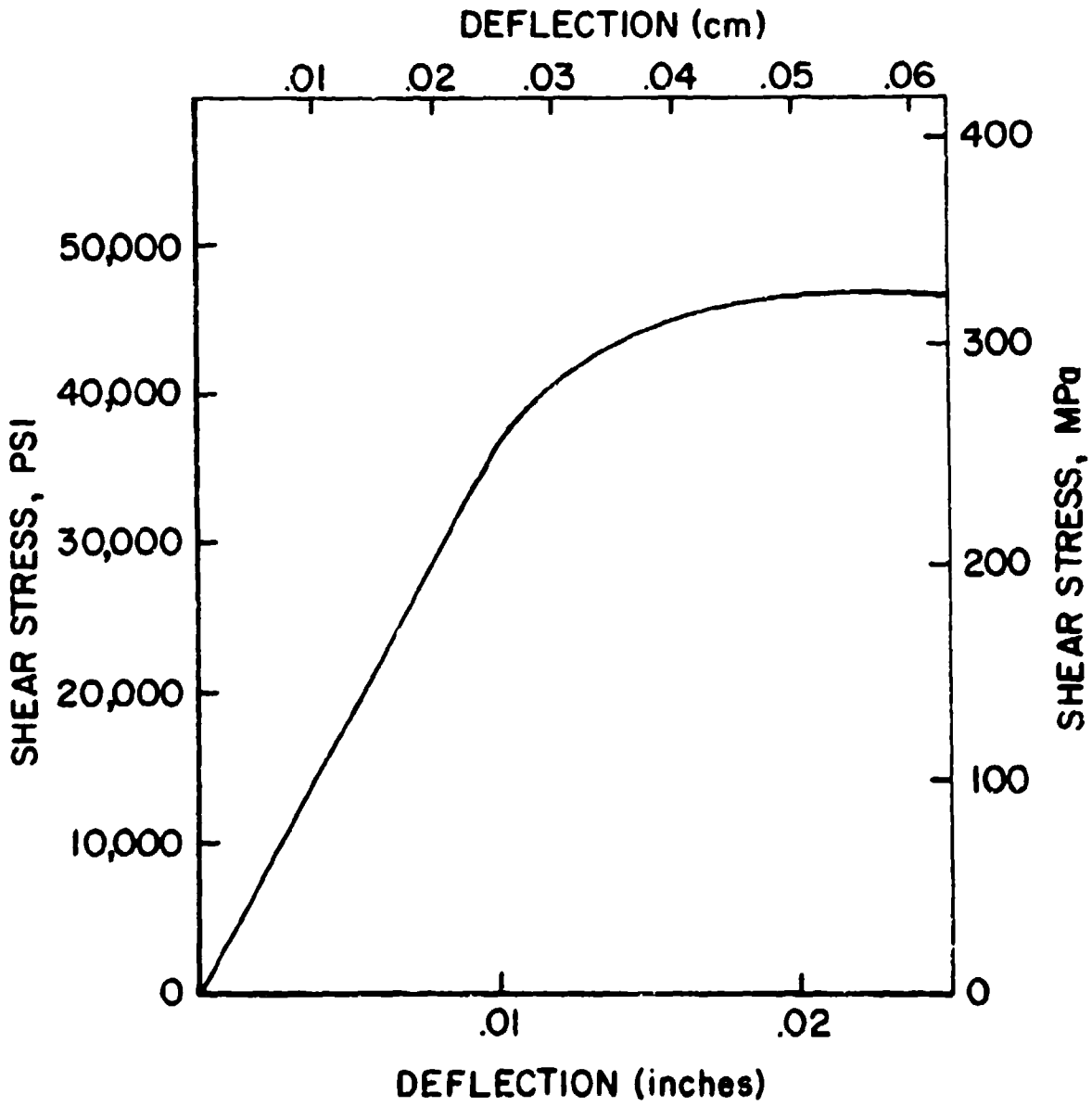

Figure 33. Shear Stress vs. Deflection Curve for 7050-T736511 Aluminum Extrusion.

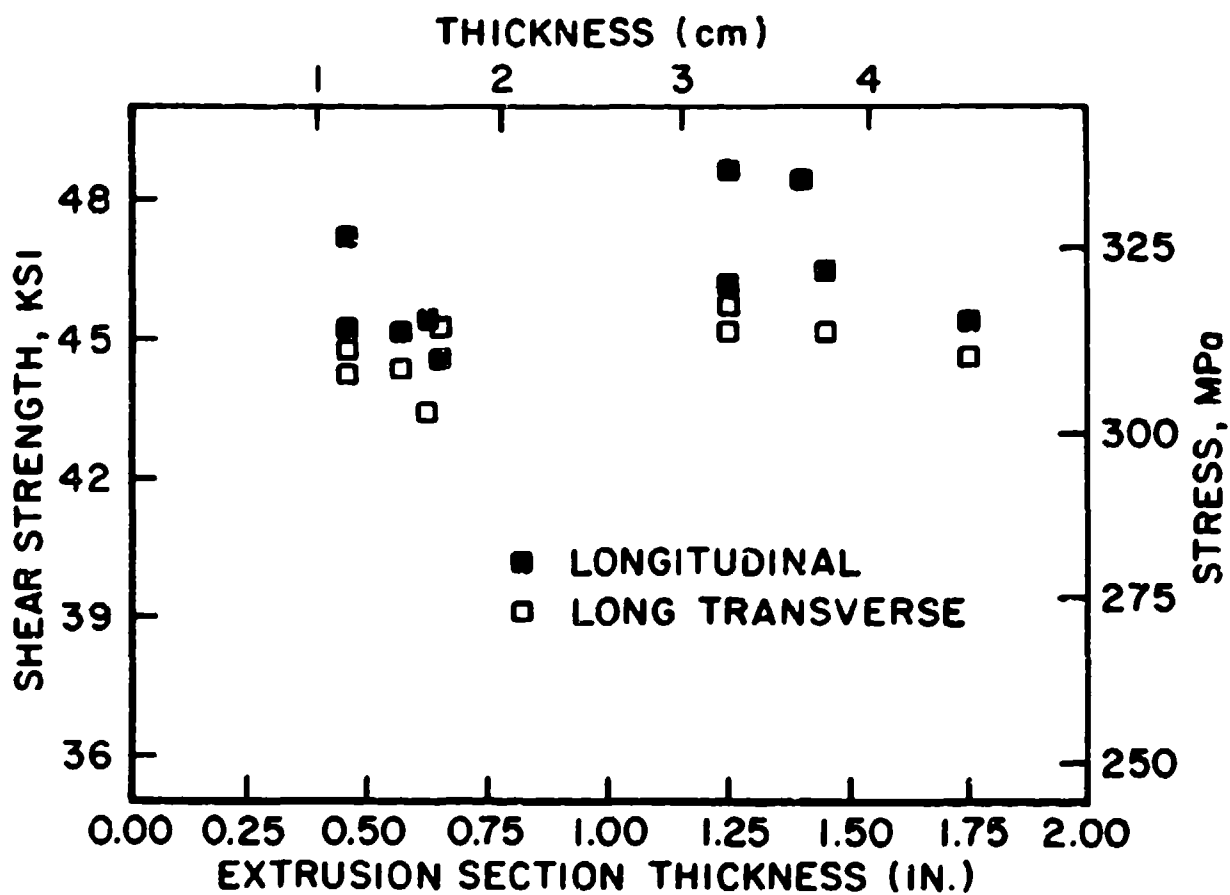

Figure 34. Ultimate Shear Strength as a Function of Extrusion Thickness.

TABLE 24A

PIN-BEARING RESULTS FOR ALUMINUM EXTRUSION (7050-T736511)  
(e/D = 1.5, LONGITUDINAL)

SPECIMEN IDENTIFICATION	BEARING YIELD STRENGTH		BEARING ULTIMATE STRENGTH	
	Ksi	(MPa)	Ksi	(MPa)
<u>e/D = 1.5, LONGITUDINAL</u>				
ALEE105-1-3B-L	96.43	(664.9)	120.70	(832.5)
ALEE105-2-3B-L	97.31	(671.0)	121.00	(834.3)
ALEE105-3-3B-L	97.29	(670.8)	118.90	(819.9)
ALEE107-1-3B-L	99.05	(683.0)	122.60	(845.4)
ALEE107-2-3B-L	97.24	(670.5)	122.70	(846.1)
ALEE107-3-3B-L	98.59	(679.8)	123.50	(851.8)
ALEE110-1-3B-L	101.90	(702.7)	126.90	(875.3)
ALEE110-2-3B-L	102.70	(708.0)	126.10	(869.5)
ALEE110-3-3B-L	101.60	(700.7)	126.90	(874.8)
ALEE114-1-3B-L	93.44	(644.3)	117.70	(811.6)
ALEE114-2-3B-L	95.25	(656.7)	118.20	(815.1)
ALEE114-3-3B-L	95.38	(657.7)	118.10	(814.1)
ALEE115-1-3B-L	92.60	(638.5)	116.40	(802.5)
ALEE115-2-3B-L	93.20	(642.6)	115.90	(799.2)
ALEE115-3-3B-L	92.14	(635.3)	116.30	(802.2)
ALEE124-1-3B-L	96.05	(662.3)	120.50	(831.2)
ALEE124-2-3B-L	92.82	(640.0)	116.70	(804.4)
ALEE124-3-3B-L	94.59	(652.2)	120.30	(829.3)
ALEE126-1-3B-L	93.59	(645.3)	118.50	(816.8)
ALEE126-2-3B-L	93.68	(645.9)	118.80	(819.3)
ALEE126-3-3B-L	93.79	(646.7)	117.90	(812.7)
ALEE127-1-3B-L	91.58	(631.4)	114.10	(786.9)
ALEE127-2-3B-L	93.91	(647.5)	116.90	(805.7)
ALEE127-3-3B-L	91.44	(630.5)	115.90	(799.2)
ALEE128-1-3B-L	97.31	(671.0)	121.20	(836.0)
ALEE128-2-3B-L	93.79	(646.7)	120.60	(831.6)
ALEE128-3-3B-L	97.71	(673.7)	120.10	(827.8)
ALEE703-1-3B-L	96.14	(662.9)	119.00	(820.8)
ALEE703-2-3B-L	94.68	(652.8)	118.30	(815.7)
ALEE703-3-3B-L	94.76	(653.4)	120.30	(829.6)
AVERAGE	95.67	(659.6)	119.70	(825.4)

TABLE 24B

PIN-BEARING RESULTS FOR ALUMINUM EXTRUSION (7050-T736511)  
(e/D = 1.5, LONG TRANSVERSE)

SPECIMEN IDENTIFICATION	BEARING YIELD STRENGTH Ksi (MPa)	BEARING ULTIMATE STRENGTH Ksi (MPa)
<u>e/D = 1.5, LONG TRANSVERSE</u>		
ALEE105-1-3B-LT	95.17 (656.2)	119.60 (824.6)
ALEE105-2-3B-LT	95.95 (661.6)	118.60 (817.8)
ALEE105-3-3B-LT	94.37 (650.7)	118.00 (813.3)
ALEE107-1-3B-LT	101.20 (697.9)	125.00 (867.3)
ALEE107-2-3B-LT	100.40 (692.5)	124.00 (860.6)
ALEE107-3-3B-LT	100.50 (692.6)	125.00 (861.7)
ALEE110-1-3B-LT	97.90 (675.0)	119.20 (822.2)
ALEE110-2-3B-LT	99.00 (688.6)	119.20 (821.8)
ALEE110-3-3B-LT	98.71 (688.6)	121.20 (835.5)
ALEE114-1-3B-LT	94.09 (648.8)	119.60 (824.7)
ALEE114-2-3B-LT	94.85 (654.0)	119.30 (822.4)
ALEE114-3-3B-LT	94.97 (654.8)	120.20 (828.9)
ALEE115-1-3B-LT	90.30 (623.2)	115.60 (796.8)
ALEE115-2-3B-LT	93.81 (646.8)	117.00 (811.9)
ALEE115-3-3B-LT	92.34 (636.7)	116.30 (802.2)
ALEE124-1-3B-LT	94.07 (654.2)	117.50 (810.3)
ALEE124-2-3B-LT	91.19 (628.8)	115.30 (795.0)
ALEE124-3-3B-LT	94.28 (650.1)	118.30 (816.0)
ALEE126-1-3B	93.50 (644.7)	114.60 (790.3)
ALEE126-2-3B-LT	91.95 (634.0)	115.20 (794.1)
ALEE126-3-3B-LT	94.58 (652.1)	116.70 (804.4)
ALEE127-1-3B-LT	93.81 (646.8)	117.00 (811.9)
ALEE127-2-3B-LT	94.00 (654.2)	119.20 (822.1)
ALEE127-3-3B-LT	93.23 (642.8)	116.60 (803.8)
ALEE128-1-3B-LT	96.24 (663.6)	122.90 (847.3)
ALEE128-2-3B-LT	98.40 (678.4)	123.00 (848.1)
ALEE128-3-3B-LT	97.61 (673.0)	120.70 (832.5)
ALEE703-1-3B-LT	92.73 (639.4)	115.20 (794.1)
ALEE703-2-3B-LT	92.92 (640.7)	117.30 (809.0)
ALEE703-3-3B-LT	92.55 (638.1)	114.70 (791.0)
AVERAGE	95.24 (656.7)	118.00 (819.4)



TABLE 24C

PIN-BEARING RESULTS FOR ALUMINUM EXTRUSION (7050-T736511)  
( $e/D = 2.0$ , LONGITUDINAL)

SPECIMEN IDENTIFICATION	BEARING YIELD STRENGTH		BEARING ULTIMATE STRENGTH	
	Ksi (MPa)		Ksi (MPa)	
<u><math>e/D = 2.0</math>, LONGITUDINAL</u>				
ALEE105-1-3B-L	116.80	(805.2)	154.50	(1066.0)
ALEE105-2-3B-L	112.50	(775.7)	153.10	(1065.0)
ALEE105-3-3B-L	117.50	(819.9)	154.10	(1063.0)
ALEE107-1-3B-L	115.50	(796.7)	154.10	(1063.0)
ALEE107-2-3B-L	119.70	(825.1)	155.00	(1069.0)
ALEE107-3-3B-L	116.80	(805.2)	155.90	(1075.0)
ALEE110-1-3B-L	125.40	(851.1)	162.00	(1117.0)
ALEE110-2-3B-L	118.60	(817.5)	159.30	(1098.0)
ALEE110-3-3B-L	123.00	(847.8)	162.00	(1117.0)
ALEE114-1-3B-L	111.70	(770.5)	147.60	(1018.0)
ALEE114-2-3B-L	113.60	(783.0)	149.40	(1030.0)
ALEE114-3-3B-L	115.67	(797.2)	149.80	(1033.0)
ALEE115-1-3B-L	112.27	(772.4)	148.90	(1027.0)
ALEE115-2-3B-L	112.70	(777.0)	147.40	(1017.0)
ALEE115-3-3B-L	108.00	(744.5)	146.70	(1012.0)
ALEE124-1-3B-L	114.20	(787.3)	153.10	(1056.0)
ALEE124-2-3B-L	114.40	(788.5)	149.80	(1033.0)
ALEE124-3-3B-L	112.70	(777.4)	154.00	(1062.0)
ALEE126-1-3B-L	116.60	(804.2)	150.30	(1036.0)
ALEE126-2-3B-L	114.00	(785.8)	151.10	(1042.0)
ALEE126-3-3B-L	113.10	(779.6)	150.00	(1034.0)
ALEE127-1-3B-L	115.10	(793.3)	150.10	(1035.0)
ALEE127-2-3B-L	113.60	(783.3)	150.20	(1035.0)
ALEE127-3-3B-L	115.70	(797.6)	148.70	(1025.0)
ALEE128-1-3B-L	112.60	(776.4)	152.40	(1050.0)
ALEE128-2-3B-L	113.00	(779.1)	152.40	(1050.0)
ALEE128-3-3B-L	113.20	(780.2)	152.20	(1049.0)
ALEE703-1-3B-L	114.80	(791.8)	153.10	(1056.0)
ALEE703-2-3B-L	112.00	(772.5)	152.60	(1052.0)
ALEE703-3-3B-L	115.60	(797.1)	153.30	(1057.0)
AVERAGE	114.90	(792.4)	152.40	(1051.0)

TABLE 24D

PIN-BEARING RESULTS FOR ALUMINUM EXTRUSION (7050-T736511)  
( $e/D = 2.0$ , LONG TRANSVERSE)

SPECIMEN IDENTIFICATION	BEARING YIELD STRENGTH		BEARING ULTIMATE STRENGTH	
	Ksi	(MPa)	Ksi	(MPa)
<u><math>e/D = 2.0</math>, LONG TRANSVERSE</u>				
ALEE105-1-3B-LT	113.20	(780.2)	151.90	(1048.0)
ALEE105-2-3B-LT	117.10	(807.6)	152.60	(1052.0)
ALEE105-3-3B-LT	116.10	(800.5)	152.30	(1050.0)
ALEE107-1-3B-LT	118.80	(819.4)	157.90	(1089.0)
ALEE107-2-3B-LT	121.20	(835.4)	158.00	(1090.0)
ALEE107-3-3B-LT	118.30	(816.0)	158.10	(1090.0)
ALEE110-1-3B-LT	118.80	(819.3)	156.70	(1081.0)
ALEE110-2-3B-LT	124.20	(856.4)	155.70	(1074.0)
ALEE110-3-3B-LT	125.40	(864.9)	158.00	(1090.0)
ALEE114-1-3B-LT	117.20	(807.9)	152.80	(1054.0)
ALEE114-2-3B-LT	116.40	(802.7)	153.80	(1051.0)
ALEE114-3-3B-LT	116.30	(802.0)	154.00	(1052.0)
ALEE115-1-3B-LT	117.20	(808.3)	151.80	(1047.0)
ALEE115-2-3B-LT	114.50	(789.5)	150.90	(1041.0)
ALEE115-3-3B-LT	118.30	(815.9)	151.40	(1044.0)
ALEE124-1-3B-LT	114.00	(786.0)	150.90	(1041.0)
ALEE124-2-3B-LT	117.30	(809.1)	151.90	(1047.0)
ALEE124-3-3B-LT	114.40	(789.0)	151.30	(1043.0)
ALEE126-1-3B-LT	111.60	(769.6)	150.50	(1038.0)
ALEE126-2-3B-LT	114.00	(785.7)	151.10	(1042.0)
ALEE126-3-3B-LT	113.70	(784.3)	150.40	(1037.0)
ALEE127-1-3B-LT	115.90	(799.1)	152.60	(1052.0)
ALEE127-2-3B-LT	120.00	(827.1)	154.30	(1064.0)
ALEE127-3-3B-LT	115.40	(795.9)	152.40	(1051.0)
ALEE128-1-3B-LT	116.20	(800.9)	156.10	(1076.0)
ALEE128-2-3B-LT	119.10	(820.9)	155.70	(1074.0)
ALEE128-3-3B-LT	113.40	(781.9)	152.30	(1050.0)
ALEE703-1-3B-LT	113.50	(782.7)	147.30	(1016.0)
ALEE703-2-3B-LT	*	*	152.00	(1048.0)
ALEE703-3-3B-LT	110.50	(761.9)	147.80	(1019.0)
AVERAGE	116.60	(804.1)	153.10	(1056.0)

\* NO DATA DUE TO PROBLEMS DURING TESTING

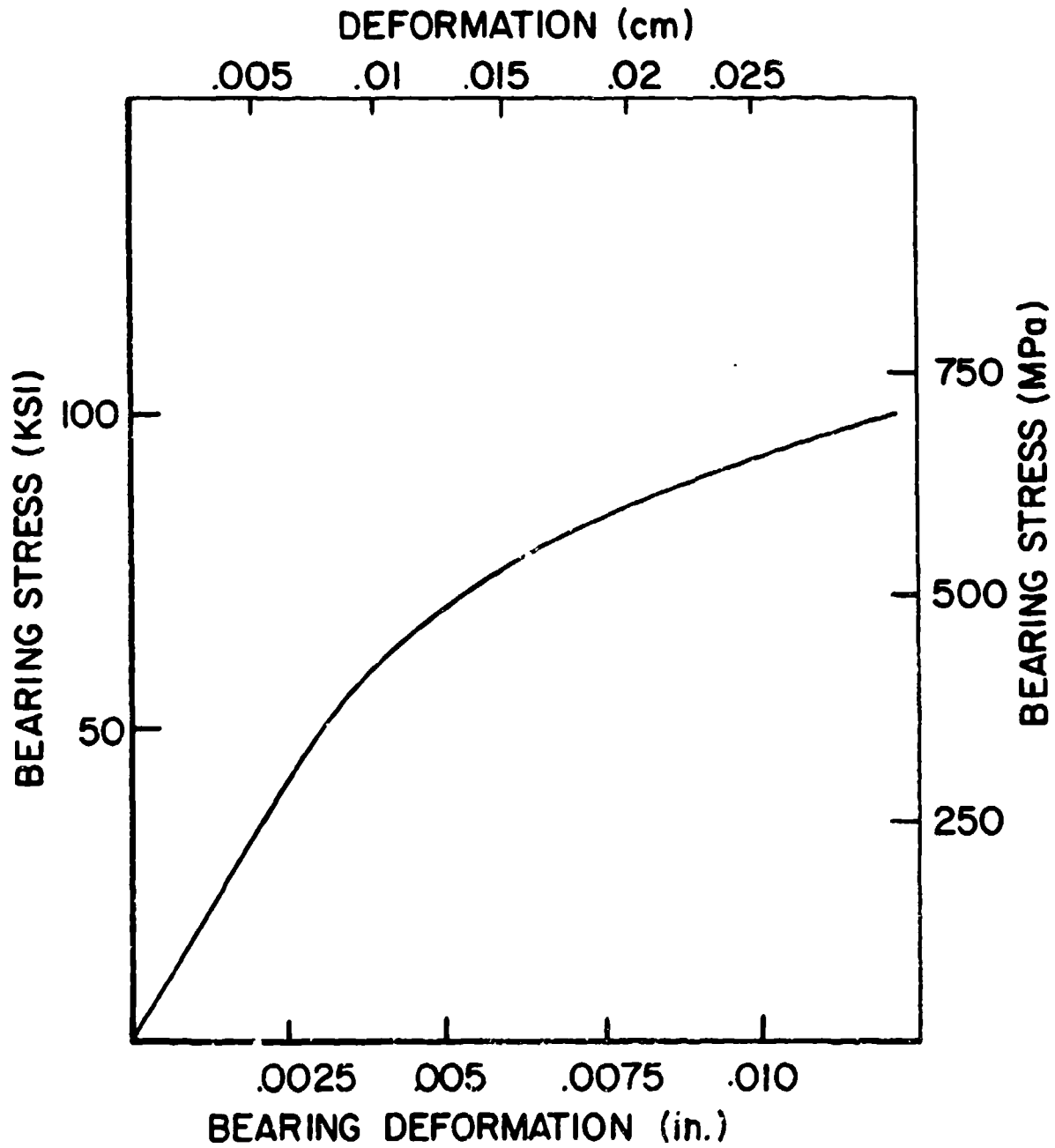

Figure 35. Pin-Bearing Stress vs. Displacement for 7050-T736511 Aluminum Extrusion.

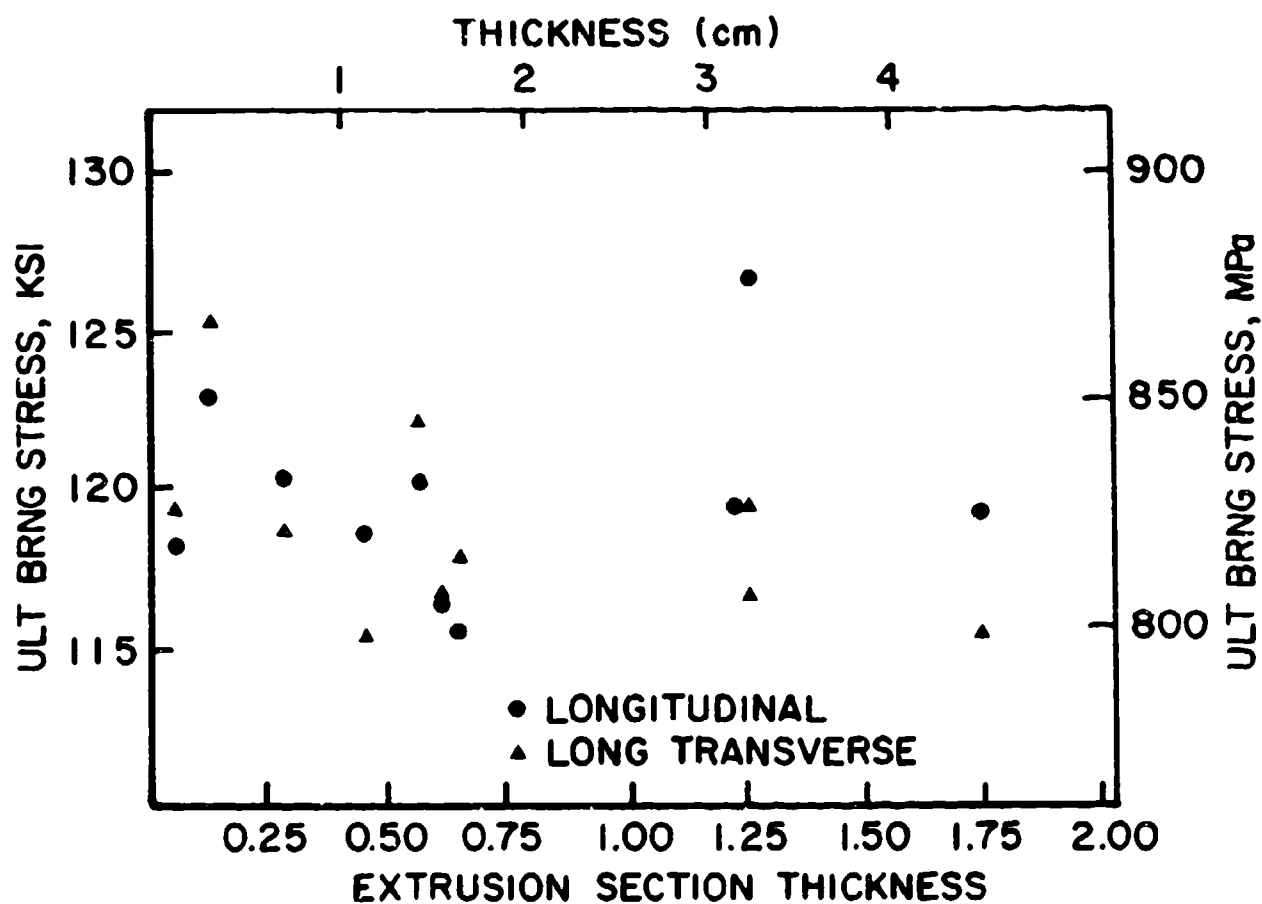

Figure 36. Bearing Ultimate Stress as a Function of Extrusion Thickness Range for  $e/D = 1.5$ .

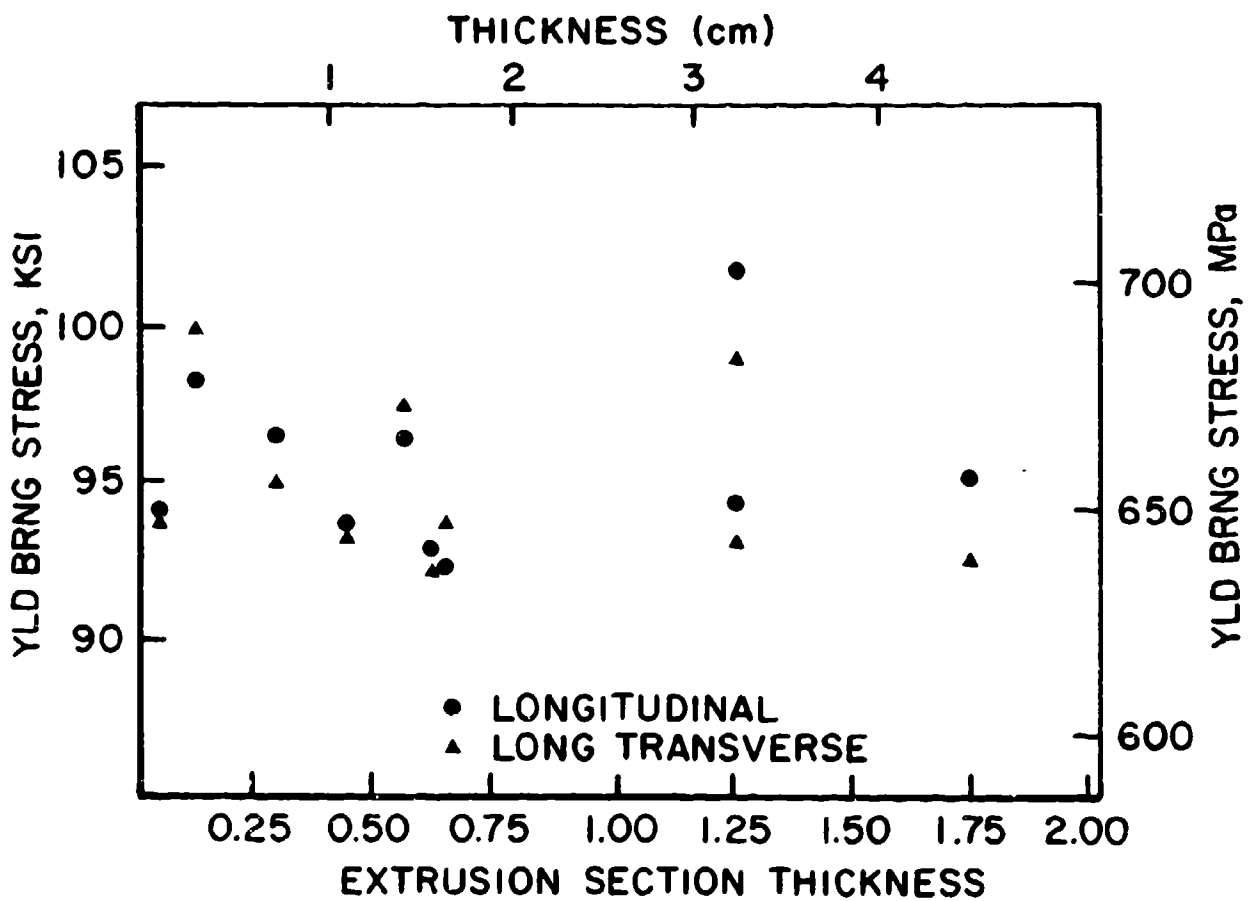

Figure 37. Bearing Yield Stress as a Function of Extrusion Thickness Range for  $e/D = 1.5$ .

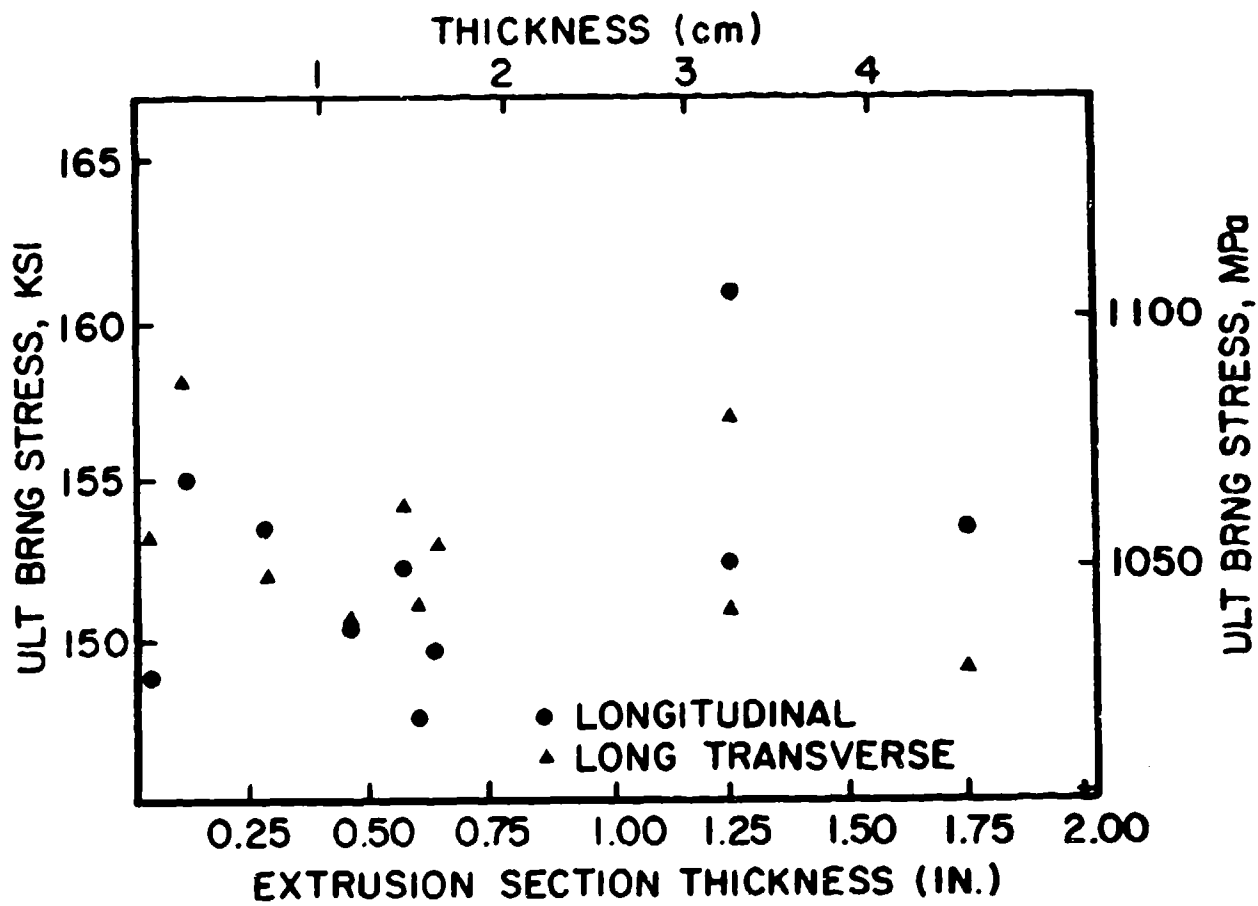

Figure 38. Bearing Ultimate Stress as a Function of Extrusion Thickness for  $e/D = 2.0$ .

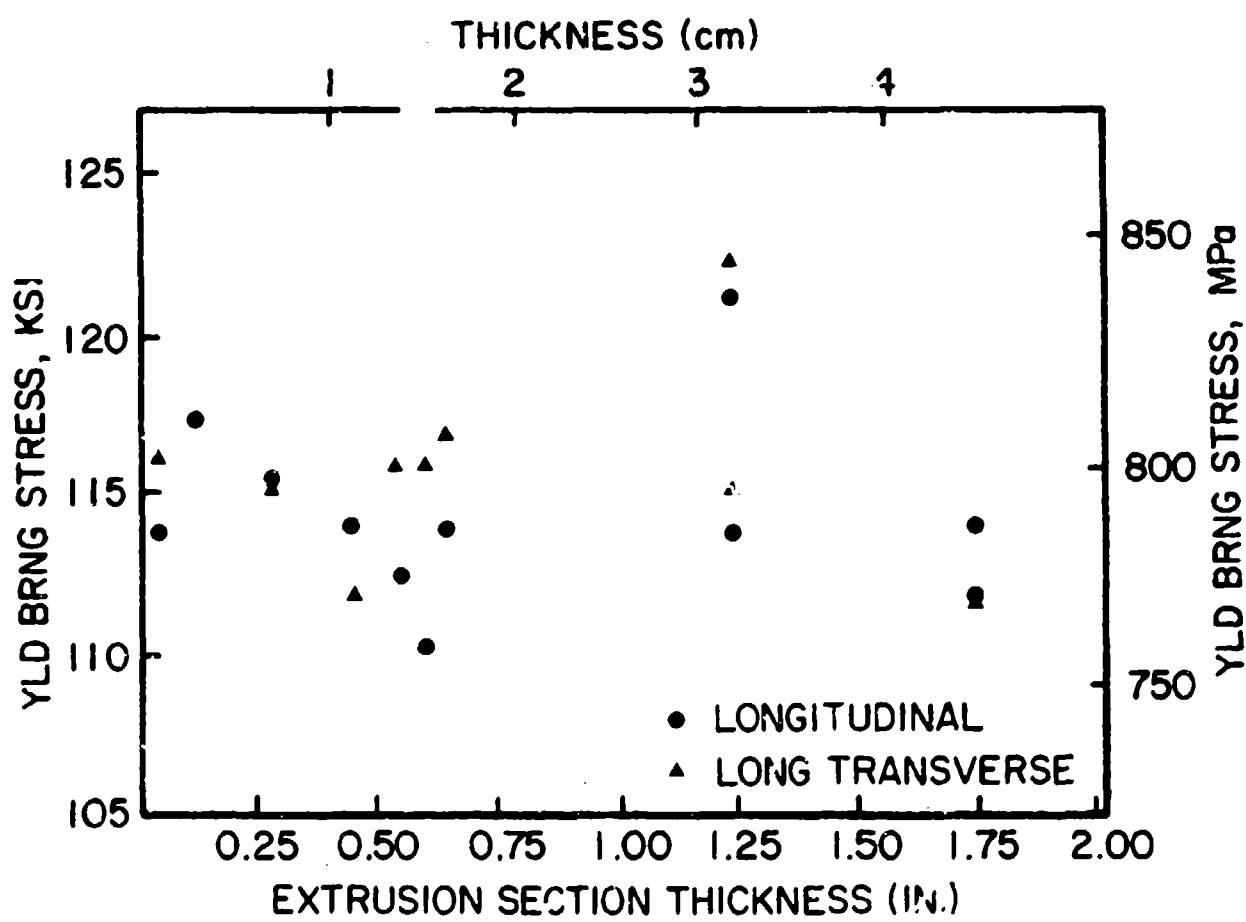

Figure 39. Bearing Yield Stress as a Function of Extrusion Thickness for  $e/D = 2.0$ .

TABLE 25  
SUMMARY OF MECHANICAL PROPERTIES FOR ALUMINUM EXTRUSION 7050-T73511

Specification		Aluminum 7050-T73511			
Form		Extrusion			
Section Thickness, in (mm)		0.072-0.5 (1.82-12.7)	0.5-1.00 (12.7-25.4)	1.00-1.5 (25.4-38.1)	1.5-2.0 (38.1-50.8)
Mechanical Properties					
$F_{tu}$ , Ksi (MPa)	L	78.70 (542)	77.20 (532)	80.76 (557)	78.59 (542)
	LT	78.66 (542)	76.32 (526)	76.17 (525)	76.00 (524)
$F_{ty}$ , Ksi (MPa)	L	68.57 (473)	67.53 (465)	72.54 (500)	68.75 (473)
	LT	68.01 (469)	66.22 (456)	66.86 (461)	65.76 (467)
$F_{cy}$ , Ksi (MPa)	L	68.33 (471)	68.15 (469)	75.68 (522)	68.99 (475)
	LT	72.26 (498)	67.64 (466)	67.85 (468)	70.10 (483)
$F_{su}$ , Ksi (MPa)	L	46.24 (319)	45.07 (311)	47.46 (327)	45.45 (313)
	LT	44.54 (307)	44.38 (306)	45.40 (313)	44.66 (308)
$F_{bru}$ , Ksi (MPa) ( $e/D=1.5$ )	L	119.9 (826)	117.5 (810)	122.9 (847)	119.2 (822)
	LT	119.8 (826)	118.9 (819)	118.4 (816)	115.7 (796)
	L	152.1 (1048)	149.9 (1033)	156.7 (1080)	153.0 (1055)
	LT	153.62 (1059)	153.1 (1055)	154.1 (1062)	149.0 (1027)
$f_{bry}$ , Ksi (MPa) ( $e/D=1.5$ )	L	95.92 (661)	93.74 (646)	98.29 (677)	95.15 (656)
	LT	95.96 (661)	94.52 (652)	96.14 (662)	92.73 (639)
	L	115.3 (795)	112.9 (778)	117.7 (811)	114.1 (786)
	LT	116.2 (801)	116.7 (804)	119.0 (820)	112.0 (772)
e, percent	L	11.81	13.74	15.56	13.4
	LT	18.77	13.5	13.9	10.2
$E_{c,10^3}$ , Ksi (GPa)	L	28.8 (198.6)	28.6 (197.1)	28.4 (195.8)	28.6 (197.1)
	LT	29.8 (205.4)	29.9 (206.1)	30.0 (206.8)	29.8 (205.4)



APPENDIX A  
SPECIMEN DRAWINGS

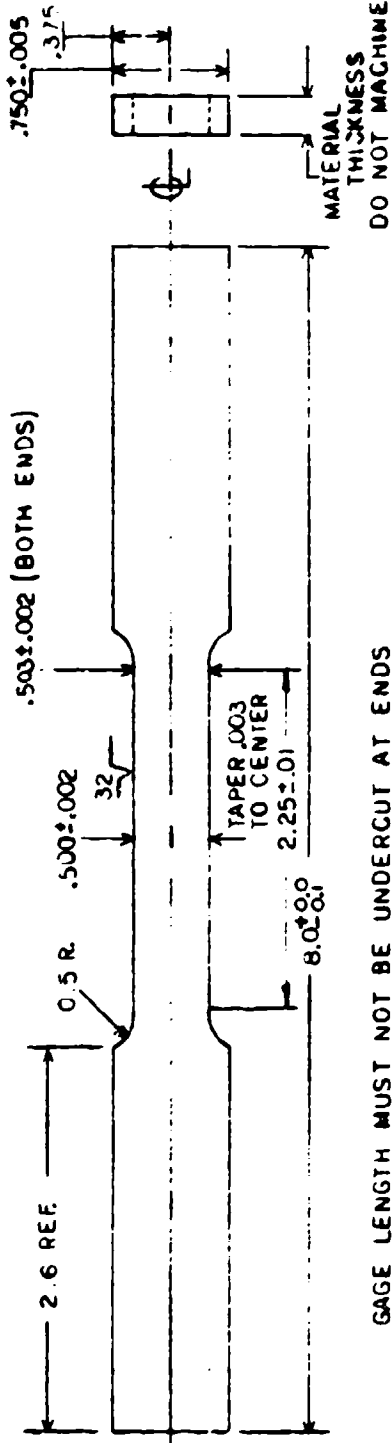

GAGE LENGTH MUST NOT BE UNDERCUT AT ENDS  
AND MUST BE FREE OF SCRATCHES.

SHEET TYPE MATERIAL TENSILE TEST SPECIMEN.  
MATERIAL THICKNESSES FROM 0.062 TO 0.53.

ASTM E8-81

All dimensions are inches.

UNIVERSITY OF DAYTON RESEARCH INSTITUTE ENGINEERING DESIGN AND DEVELOPMENT			
TITLE SHEET TYPE TENSILE TEST			
MATERIAL	NO. REQ'D.	TOLERANCES	
SCALE 1:1	SHEET 1 OF 1	DECIMAL ±	FRACTIONS ±
CONTRACT	DATE	ANGLES ±	
DRAFTSMAN JG	DETAIL NO. 83-EDD-A-066		

PREVIOUS PAGE IS BLANK

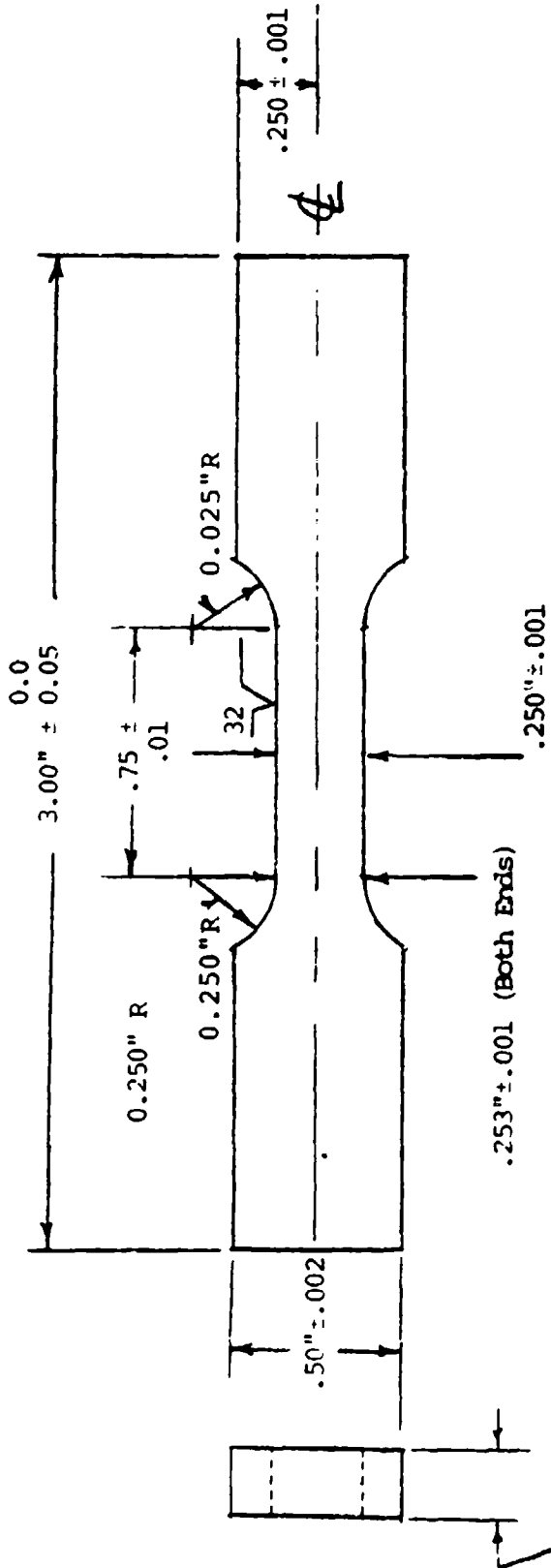

MACHINE THICKNESS ONLY IF SURFACES HAVE BEEN ROUGH SAW CUT OR THICKNESS EXCEEDS 0.200". THEN CENTER IN THICKNESS OF BLANK.

0.003 TAPER TO CENTER FROM ENDS OF 0.75 SECTION. GAGE LENGTH MUST NOT BE UNDERCUT AT ENDS AND MUST BE FREE OF SCRATCHES.

All dimensions are inches.

UNIVERSITY OF DAYTON RESEARCH INSTITUTE ENGINEERING DESIGN AND DEVELOPMENT			
TITLE SHORT FLAT TENSILE SAMPLE			
MATERIAL	NO. REQ'D.	TOLERANCES	
SCALE 1" = 1/2"	SHEET OF	DECIMAL ±	FRACTIONS ±
CONTRACT	DATE	ANGLES ±	
DRAFTSMAN RG	DETAIL NO. 83-EDD-A-300		

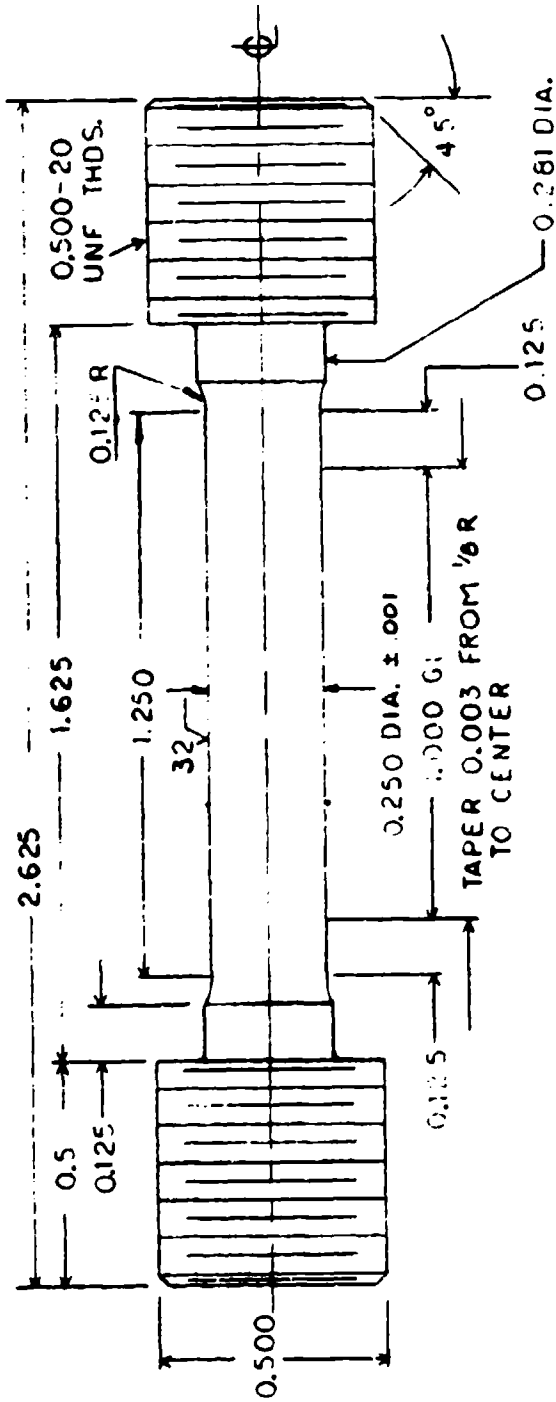

1. THREADS TO BE CONCENTRIC WITH CENTRAL AXIS TO 0.001
2. GAGE LENGTH MUST NOT BE UNDERCUT AT ENDS.
3. GAGE LENGTH MUST BE FREE OF CIRCUMFERENTIAL SCRATCHES.

ROUND TENSILE SPECIMEN, MATERIAL THICKNESS > 0.53 in.

All dimensions are inches.

<b>UNIVERSITY OF DAYTON RESEARCH INSTITUTE ENGINEERING DESIGN AND DEVELOPMENT</b>			
<b>TITLE</b> ROUND TENSILE SPECIMEN			
<b>MATERIAL</b>	<b>NO. REQ'D.</b>	<b>TOLERANCES</b>	
		<b>DECIMAL ±</b>	<b>FRACTIONS ±</b>
<b>SCALE</b> 3:1	<b>SHEET 1 OF 1</b>		<b>ANGLES ±</b>
<b>CONTRACT</b>	<b>DATE</b>		
<b>DRAFTSMAN</b> JG	<b>DETAIL NO.</b>	83-EDD-A-067	

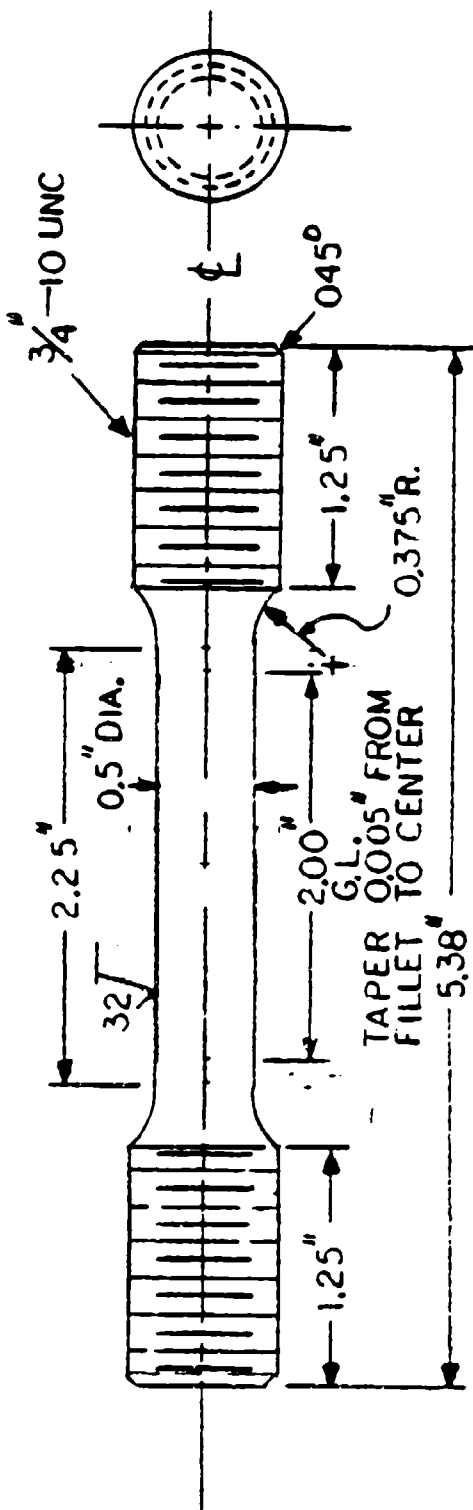

1. THREADS TO BE CONCENTRIC WITH TEST SECTION AXIS TO 0.001."
2. NO UNDERCUTS BETWEEN STRAIGHT SECTION AND FILLETS.
3. GAGE LENGTH MUST BE FREE OF CIRCUMFERENTIAL SCRATCHES.
4. ROUND TENSILE SPECIMEN, MATERIAL THICKNESS >0.75 in.

All dimensions are inches.

UNIVERSITY OF DAYTON RESEARCH INSTITUTE  
ENGINEERING DESIGN AND DEVELOPMENT

TITLE		STANDARD ASTM LONG TENSILE SPEC.	
MATERIAL	NO. REQ'D	TOLERANCES XXX + .01 DECIMAL ± .005 FRACTIONS ± ANGLES ±	
SCALE	SHEET 1 OF 1	DATE	
CONTRACT	DATE	DRAFTSMAN	
DRAFTSMAN		JG	DETAIL NO. 83-EDD-A-074

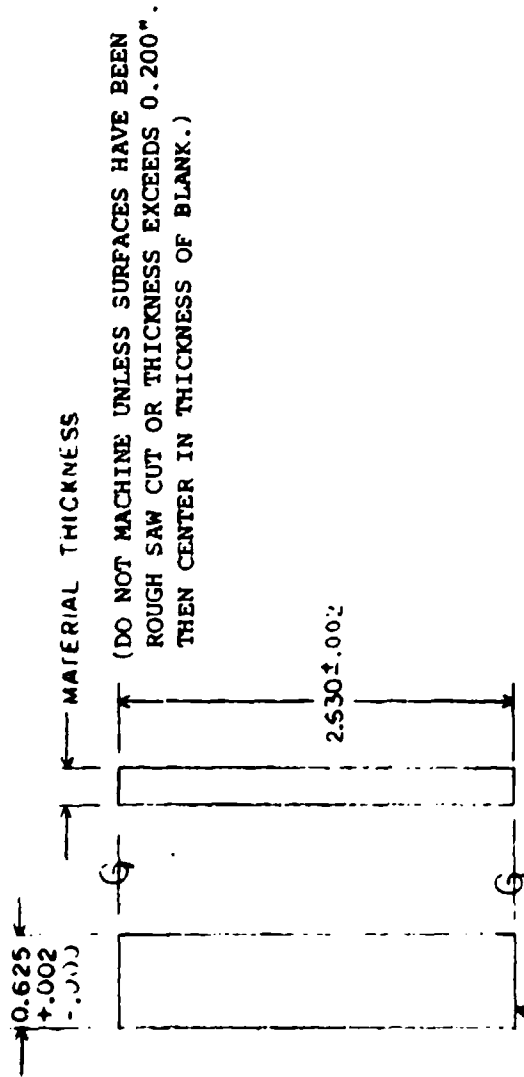

(DO NOT MACHINE UNLESS SURFACES HAVE BEEN ROUGH SAW CUT OR THICKNESS EXCEEDS 0.200". THEN CENTER IN THICKNESS OF BLANK.)

ENDS OF SPECIMEN TO BE PARALLEL WITHIN 0.002 INCH AND  $\perp$  TO THE SIDES WITHIN 0.25 DEGREE.

REMOVE ALL BURRS.

SHEET TYPE MATERIAL COMPRESSION TEST SPECIMEN.

MATERIAL THICKNESS 0.030 TO 0.55 IN. ASTM E9-77

All dimensions are inches.

<b>UNIVERSITY OF DAYTON RESEARCH INSTITUTE ENGINEERING DESIGN AND DEVELOPMENT</b>			
<b>TITLE</b> SHEET MATERIAL COMPRESSION TEST			
<b>MATERIAL</b>	<b>NO.</b>	<b>TOLERANCES</b>	
	<b>REQ'D.</b>	.XX ± .01	
<b>SCALE</b>	<b>SHEET</b> 1 <b>OF</b> 1	DECIMAL ± .002	
<b>CONTRACT</b>	<b>DATE</b>	FRACTIONS ±	
<b>DRAFTSMAN</b>	<b>JG</b>	<b>ANGLES ±</b>	
		<b>DETAIL NO.</b>	
		83-EDD-A-063	

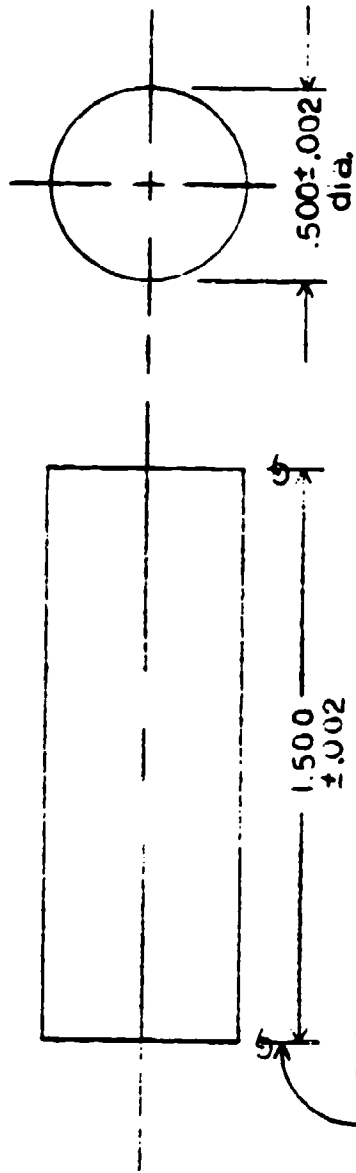

ENDS OF SPECIMENS TO BE FLAT AND PARALLEL WITHIN 0.0002 INCH. ENDS OF SPECIMEN SHALL BE PERPENDICULAR TO AXIS OF SPECIMEN WITHIN 0.25 DEGREE.

REMOVE ALL BURRS.

CYLINDRICAL COMPRESSION TEST SPECIMEN. MEDIUM LENGTH, ASTM E9-77.

All dimensions are inches.

UNIVERSITY OF DAYTON RESEARCH INSTITUTE ENGINEERING DESIGN AND DEVELOPMENT			
TITLE CYLINDRICAL COMPRESSION TEST			
MATERIAL	NO.	TOLERANCES .xx ± .01 DECIMAL ± .xxx ± .002 FRACTIONS ±	
SCALE 2:1	SHEET 1 OF 1	REQ'D.	
CONTRACT	DATE	ANGLES ±	
DRAFTSMAN JG	DETAIL NO. 83-EDD-A-064		

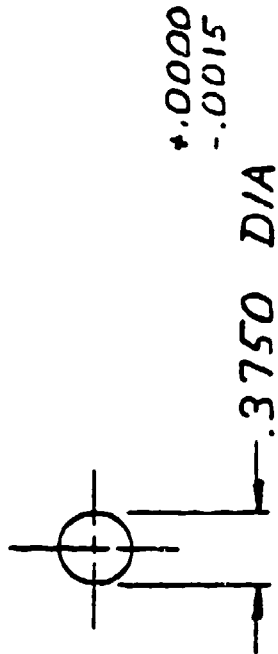
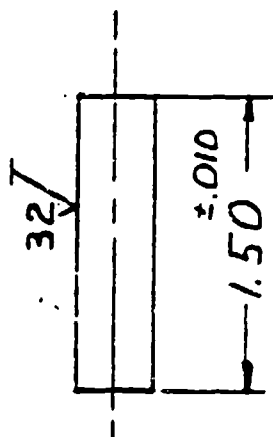

AS PER AIAA ARTC-13-S-1  
 MATERIAL THICKNESS > 0.375  
 All dimensions are inches.

<b>UNIVERSITY OF DAYTON RESEARCH INSTITUTE ENGINEERING DESIGN AND DEVELOPMENT</b>			
TITLE PIN-TYPE DOUBLE SHEAR SPECIMEN (3/8)			
MATERIAL	NO. REQ'D.	TOLERANCES	
		DECIMAL ±	FRACTIONS ±
SCALE FULL	SHEET 1 OF 1	ANGLES ±	
CONTRACT	DATE	DETAIL NO.	
DRAFTSMAN RI	83-EDD-A-1-RIVET		

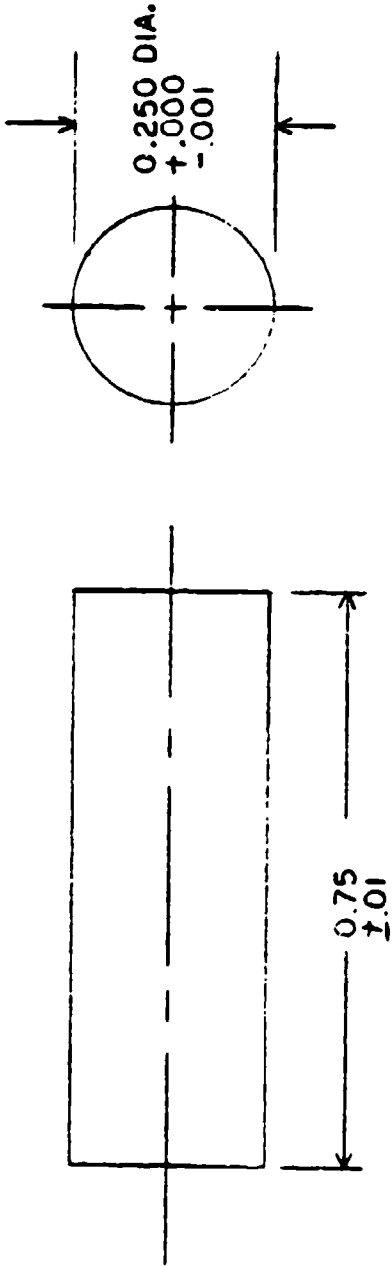

PIN-TYPE DOUBLE SHEAR TEST SPECIMEN  
 AIAA ARTC-13-S-1  
 MATERIAL THICKNESS > 0.25 INCH.

All dimensions are inches.

<b>UNIVERSITY OF DAYTON RESEARCH INSTITUTE ENGINEERING DESIGN AND DEVELOPMENT</b>			
PIN-TYPE DOUBLE SHEAR TEST			
TITLE	MATERIAL	NO.	TOLERANCES
		REQ'D.	DECIMAL ± FRACTIONS ± ANGLES ±
SCALE	4:1	SHEET 1 OF 1	DATE
CONTRACT		DRAFTSMAN	
JG		DETAIL NO. 83-EDD-A-062	



#2 CENTER - 60°  
BOTH ENDS

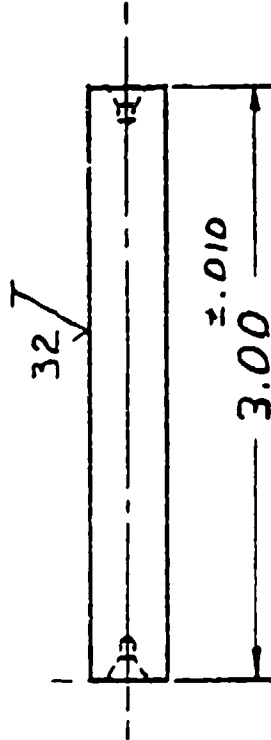

$\frac{.3730}{.3720}$  DIA

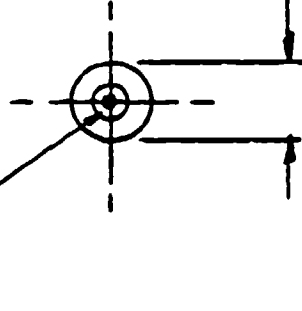

All dimensions are inches.

UNIVERSITY OF DAYTON RESEARCH INSTITUTE ENGINEERING DESIGN AND DEVELOPMENT			
TITLE AMSLER PIN SHEAR SPECIMEN (3/8)			
MATERIAL	NO. REQ'D.	TOLERANCES	
		DECIMAL ±	FRACTIONS ±
SCALE FULL	SHEET 1 OF 1	ANGLES ±	
CONTRACT	DATE	DRAFTSMAN RI	
DETAIL NO. 83-EDD-2-AMSLER			

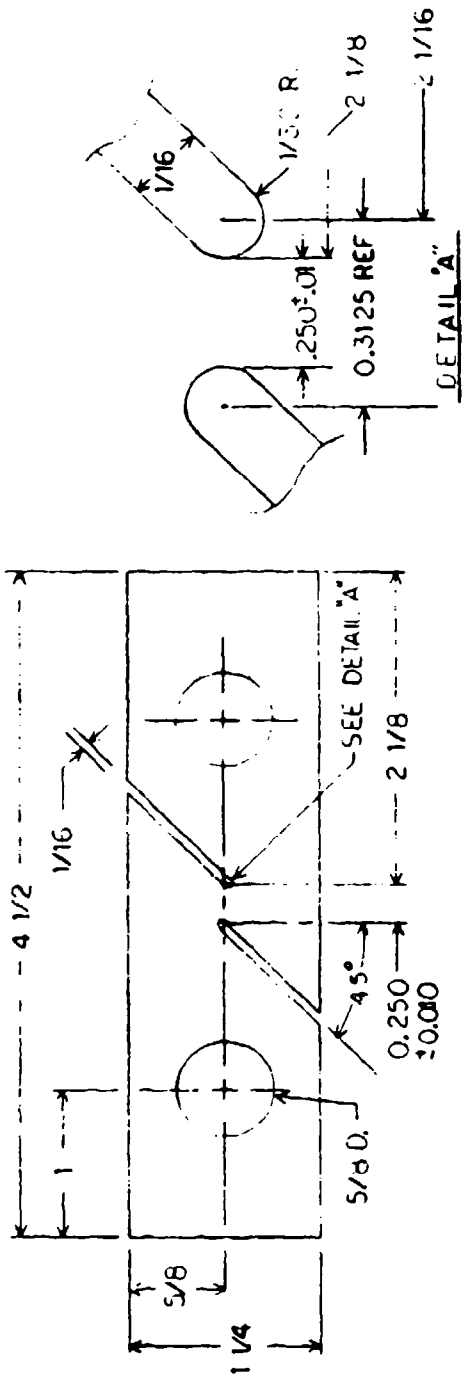

NOTE: ALL DIMENSIONS IN INCHES.  
 MATERIAL THICKNESS < 0.25 INCH.  
 DO NOT MACHINE THICKNESS.

TENSION-TYPE SHEAR TEST SPECIMEN.

AIAA ARTC-13-S-1

<b>UNIVERSITY OF DAYTON RESEARCH INSTITUTE ENGINEERING DESIGN AND DEVELOPMENT</b>			
TENSION-TYPE SHEAR TEST SPECIMEN			
MATERIAL	NO.	TOLERANCES	
	REQ'D.	DECIMAL ±	FRACTIONS ±
SCALE	SHEET 1 OF 1	ANGLES ±	
CONTRACT	DATE		
DRAFTSMAN	JG	DETAIL NO.	
		83-EDD-A-068	

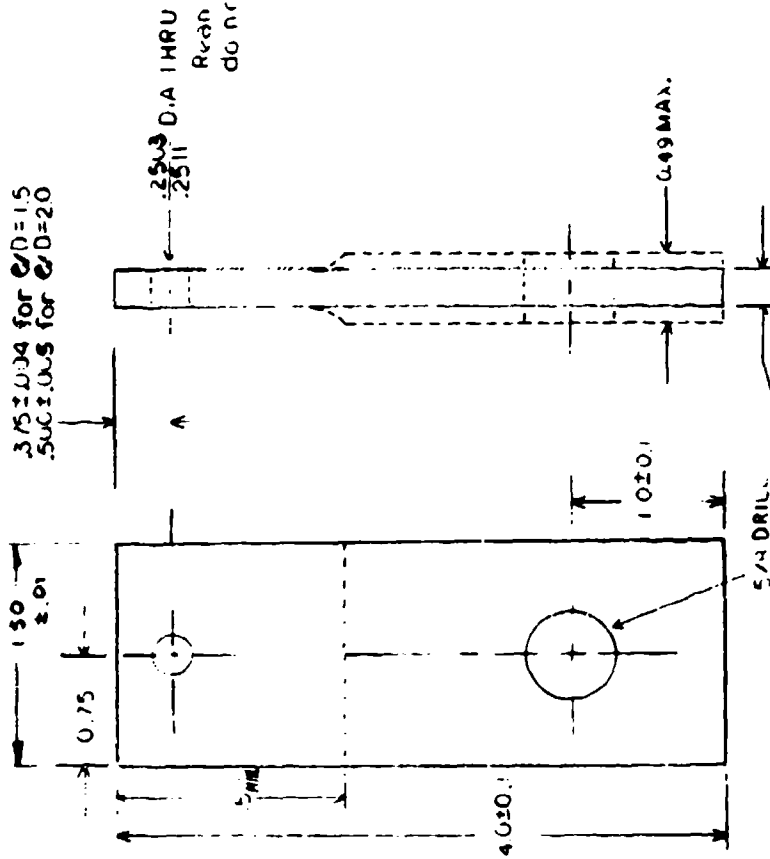

Rebar of 4-grind finished diameter, do not burr. Hole to be ± 0.0001 in.

For material thicknesses in the range of 0.070 to 0.125 inches, do not machine thick. For materials in excess of 0.125 inches thick, machine to 0.100 thickness by removing equal amounts of material on both sides. Optional configuration shown is acceptable for thick materials.

All dimensions are inches.

<b>UNIVERSITY OF DAYTON RESEARCH INSTITUTE ENGINEERING DESIGN AND DEVELOPMENT</b>			
TITLE PIN-TYPE BEARING TEST ASTM E238-58 SPECIMEN			
MATERIAL	NO.	TOLERANCES .XX ± .01 DECIMAL ± FRACTIONS ± ANGLES ±	
SCALE	1:1	SHEET 1 OF 1	REQ'D.
CONTRACT		DATE	
DRAFTSMAN	JG	DETAIL NO. 83-EDD-A-065	

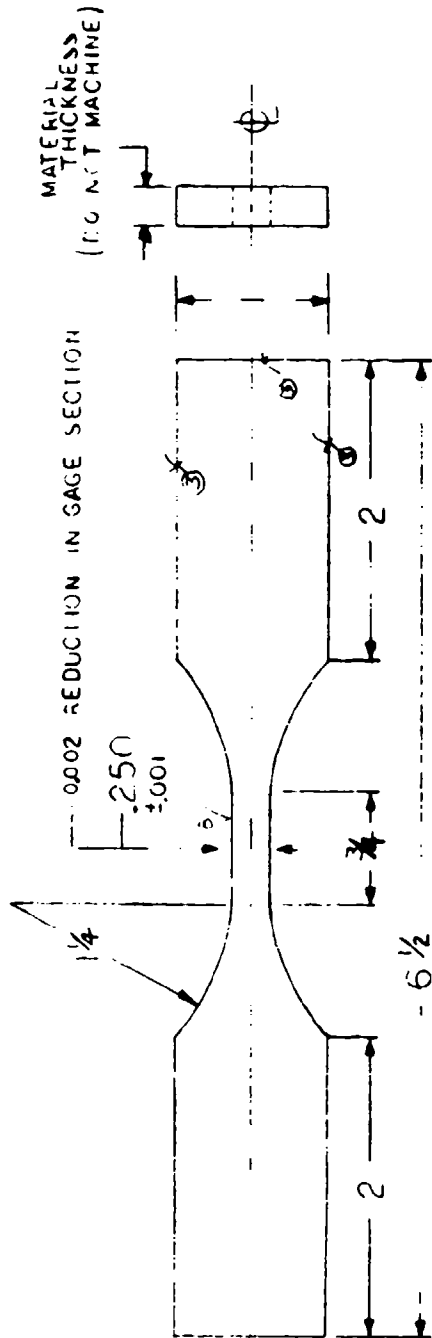

FINISH: GROUND-EXCEPT (3) SMOOTH MACHINE.

All dimensions are inches.

UNIVERSITY OF DAYTON RESEARCH INSTITUTE ENGINEERING DESIGN AND DEVELOPMENT	
TITLE AXIAL LOADING FLAT FATIGUE SPEC.	
MATERIAL	NO. REQ'D.
SCALE 1:1	SHEET 1 OF 1
CONTRACT	DATE
TOLERANCES	
DECIMAL ±	
FRACTIONS ± 1/64	
ANGLES ±	
DRAFTSMAN JG	DETAIL NO. 83-EDD-A-071

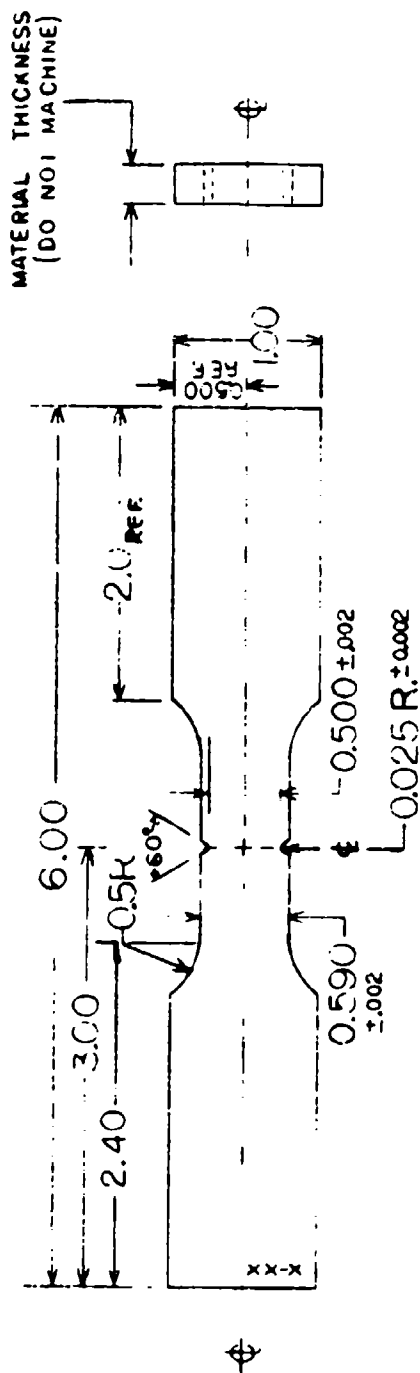

NOTCHES TO BE CENTERED TO WITHIN 0.002 OF SPECIMEN  $\phi$ .  
 NOTCH SECTION FINISH 32 RMS OR BETTER, 64 RMS ELSEWHERE.  
 ALL DIMENSIONS  $\pm 0.005$  EXCEPT WHEN TOLERANCE GIVEN.

All dimensions are inches.

<b>UNIVERSITY OF DAYTON RESEARCH INSTITUTE ENGINEERING DESIGN AND DEVELOPMENT</b>	
<b>TITLE</b> NOTCHED FATIGUED, FLAT, $KT_t = 3.0$	
<b>MATERIAL</b>	<b>NO. REQ'D.</b>
<b>SCALE</b> 1:1	<b>SHEET 1 OF 1</b>
<b>CONTRACT</b>	<b>DATE</b>
<b>DRAFTSMAN</b> JG	<b>DETAIL NO.</b> 83-EDD-A-070
<b>TOLERANCES</b>	
<b>DECIMAL <math>\pm</math></b>	
<b>FRACTIONS <math>\pm</math></b>	
<b>ANGLES <math>\pm</math></b>	

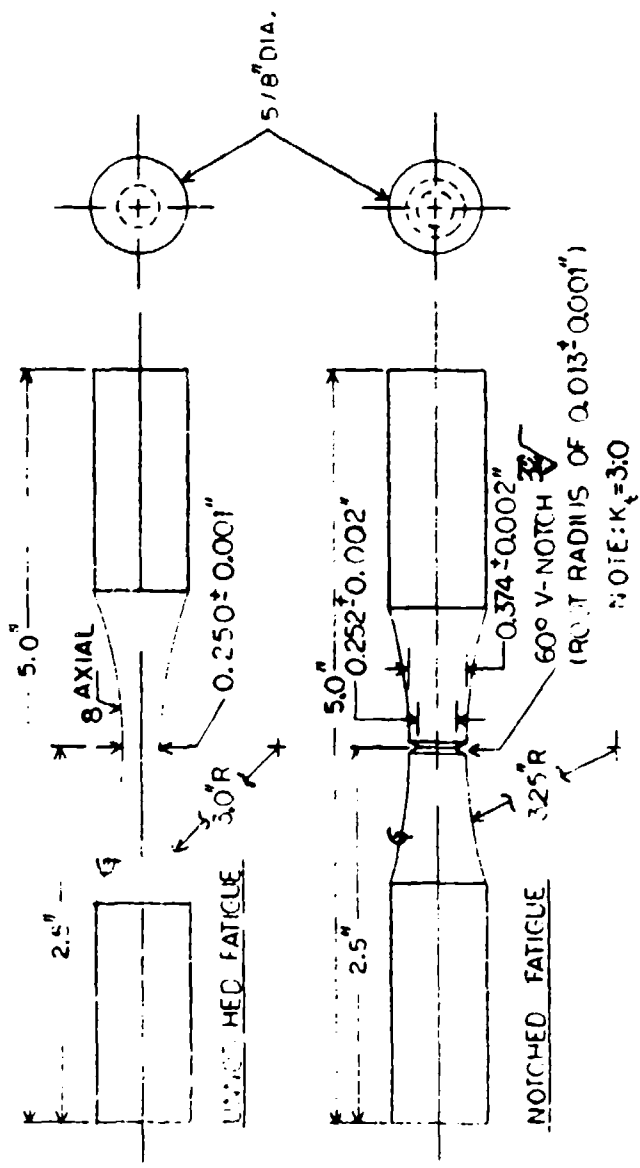

All dimensions are inches.

<b>UNIVERSITY OF DAYTON RESEARCH INSTITUTE ENGINEERING DESIGN AND DEVELOPMENT</b>			
TITLE ROUND FATIGUE SPECIMENS; $K_t = 1 + K_f = 3$			
MATERIAL	NO. REQ'D.	TOLERANCES	
SCALE 1:1	SHEET 1 OF 1	DECIMAL ±	FRACTIONS ±
CONTRACT	DATE	ANGLES ±	
DRAFTSMAN JG	DETAIL NO. 83-EDD-A-069		

UDR-TM-84-14

APPENDIX B  
MECHANICAL PROPERTY  
DATA SHEETS

Prepared by:  
UNIVERSITY OF DAYTON  
Research Institute  
Dayton, Ohio 45469

F33615-82-C-5102

This data sheet was prepared by the University of Dayton Research Institute under Contract No. F33615-82-C-5102, under the direction of the Air Force Wright Aeronautical Laboratories, Materials Laboratory, Mr. Neal Ontko, MLSA, Technical Monitor.

### Notices

When Government drawings, specifications, or other data are used for any purpose other than in connection with a definitely related Government procurement operation, the United States Government thereby incurs no responsibility nor any obligation whatsoever; and the fact that the Government may have formulated, furnished, or in any way supplied the said drawings, specifications, or other data, is not to be regarded by implication or otherwise as in any manner licensing the holder or any other person or corporation, or conveying any rights or permission to manufacture, use, or sell any potential invention that may be in any way related thereto.

Approved for public release; distribution unlimited.

Copies of this report should not be returned unless return is required by security considerations, contractual obligations, or notice on a specific document.

PREVIOUS PAGE  
IS BLANK



UDR-TM-84-14  
May 1984

15-5PH (H1025) Stainless Steel Alloy Hot-Rolled Plate

Material Description

This 15-5PH Stainless Steel Alloy, heat-treated to the H1025 condition was provided by G. O. Carlson, Thorndale, Pennsylvania. The plates were received in thicknesses from 0.215 to 2.579 inches, widths varying from 10 to 16 inches, and lengths varying from 35 to 78 inches.

The average chemical composition of this lot is as follows:

<u>Chemical Composition</u>	<u>Percent Weight</u>
Carbon	0.037
Manganese	0.32
Phosphorus	0.023
Sulfur	0.004
Silicon	0.43
Chromium	14.59
Nickel	4.73
Copper	3.27
Columbium	0.23
Tantalum	0.01
Iron	Balance

Processing and Heat Treating

The 15-5PH stainless steel alloy was obtained as hot-rolled plate that was solution annealed and pickled. Each plate was heat-treated separately to the H1025 condition.

Results

The average values for each property are listed in Table 1 by plate direction. Due to the large numbers of data points (50 each from multiple heats for notched and unnotched specimens), only fatigue bands are presented in Figures 1 and 2. The long transverse fatigue data were generated from one heat only and are presented as curves in Figures 3 and 4.

PREVIOUS PAGE  
IS BLANK

Table B-1  
15-5PH Stainless Steel Plate  
Condition: H1025<sup>(a)</sup>

R.T.

Properties	Plate Direction		
	Longitudinal	Long Transverse	Short Transverse
<b>Tension</b>			
TUS, ksi (MPa)	171.0 (1179)	171.4 (1182)	--
TYS, ksi (MPa)	165.6 (1142)	166.0 (1145)	--
RA, percent	58.5	57.6	--
e, percent in 2 in. (50.8 mm)	15.0	14.8	--
E, 10 <sup>3</sup> ksi (GPa)	28.66 (197.6)	28.72 (198)	--
<b>Compression</b>			
CYS, ksi (MPa)	175.6 (1210.8)	175.3 (1208.7)	174.9 (1206) <sup>(b)</sup>
E <sub>c</sub> , 10 <sup>3</sup> ksi (GPa)	29.85 (205.8)	29.84 (205.7)	30.03 (207.1) <sup>(b)</sup>
<b>Shear</b>			
SUS, ksi (MPa) <sup>(c)</sup>	114.3 (788)	113.2 (781)	--
SUS, ksi (MPa) <sup>(d)</sup>	108.1 (745)	109.0 (752)	--
<b>Bearing</b>			
e/D = 1.5			
BUS, ksi (MPa)	287.3 (1981)	287.2 (1980)	--
BYS, ksi (MPa)	246.1 (1696)	246.3 (1698)	--
e/D = 2.0			
BUS, ksi (MPa)	368.4 (2540)	367.8 (2536)	--
BYS, ksi (MPa)	286.7 (1977)	289.1 (1993)	--

- (a) Values are average of triplicate room temperature tests conducted at the University of Dayton Research Institute under the subject contract.
- (b) Compression tests in short transverse direction conducted for two heats, the plate thicknesses of which were greater than 1.5 inches.
- (c) Full thickness tensile shear tests from three heats (plates), the plate thicknesses of which were less than 0.3 inch.
- (d) 0.25 inch diameter double pin shear tests from seven heats (plates), the plate thicknesses of which were greater than 0.3 inch.

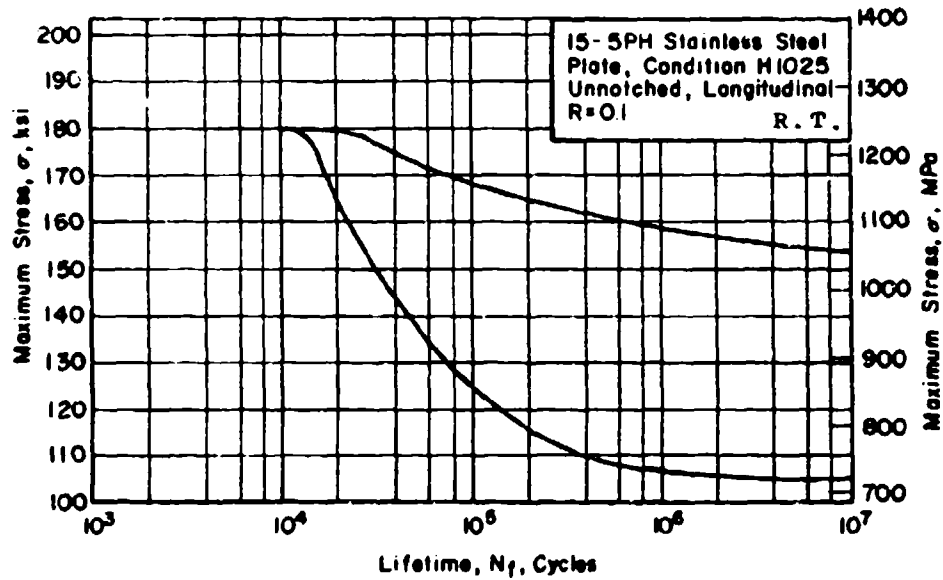

Figure B-1. Axial load fatigue data of unnotched 15-5PH stainless steel (H1025, longitudinal).

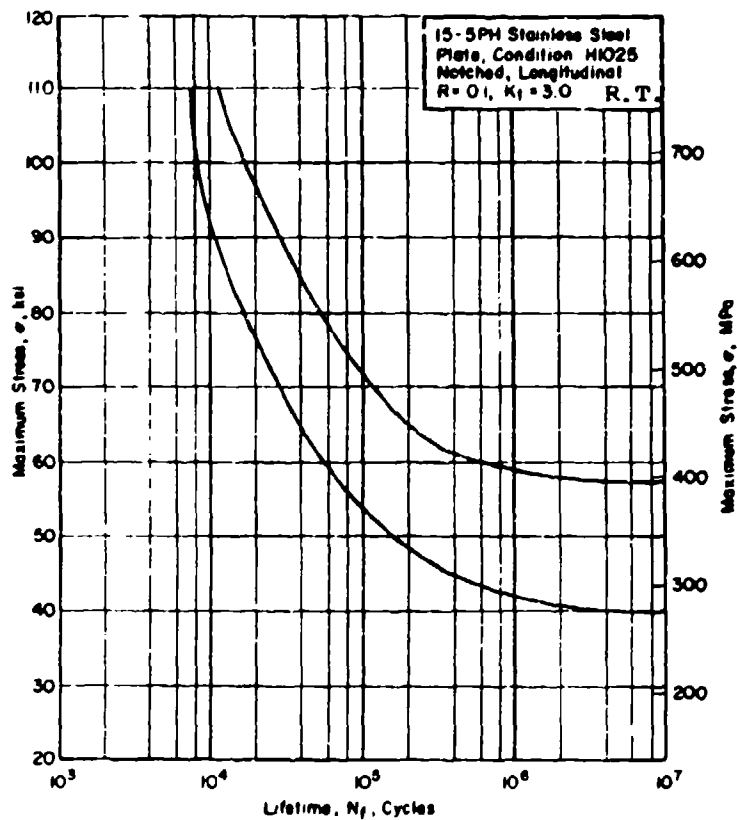

Figure B-2. Axial load fatigue data of notched 15-5PH stainless steel (H1025, longitudinal).

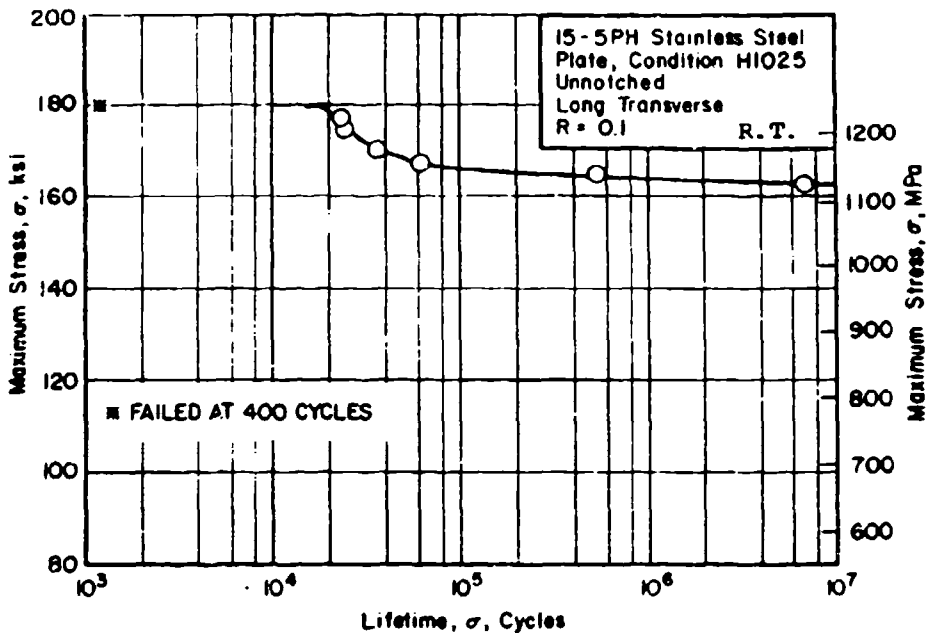

Figure B-3. Axial load fatigue data of unnotched 15-5PH stainless steel (H1025, long transverse).

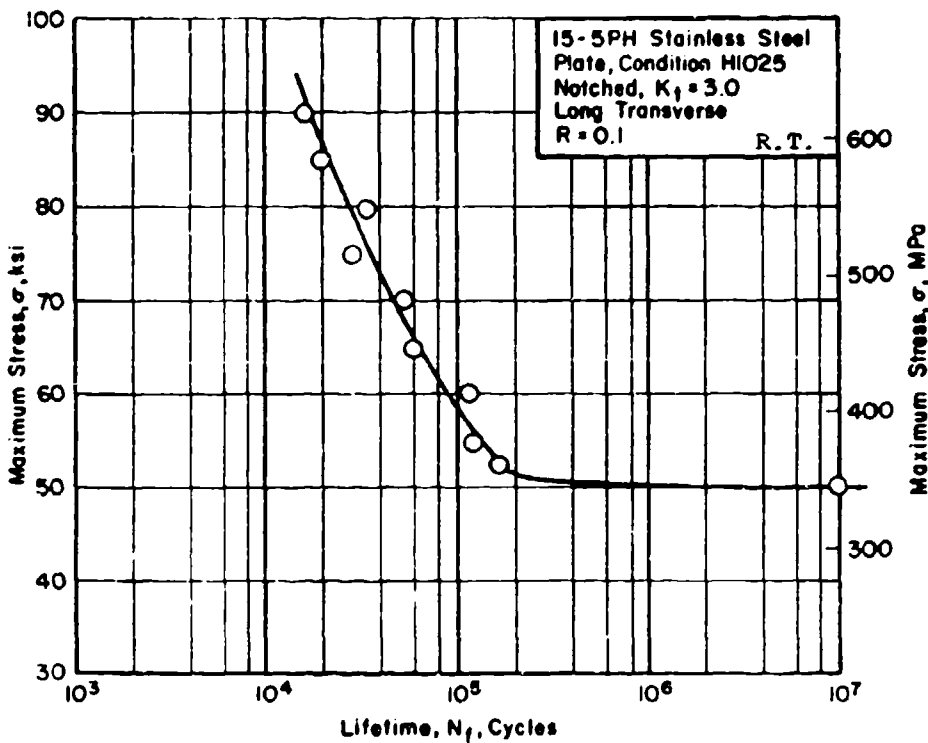

Figure B-4. Axial load fatigue data of notched 15-5PH stainless steel (H1025, long transverse).

UDR-TM-84-20  
June 1984

## 7175-T736 Aluminum Alloy Hand Forging

### Material Description

This 7175 Aluminum Alloy, heat-treated to the T736 temper, was produced by ALCOA as a hand forging. Six plates were received in thicknesses ranging from 2 to 6.25 inches, widths ranging from 12 to 16 inches, and lengths of either 30 or 31 inches. This report contains data generated only from these six plates (heats).

The average chemical composition of the six heats is as follows:

<u>Chemical Composition</u>	<u>Percent Weight</u>
Silicon	0.078
Manganese	0.010
Magnesium	2.1
Iron	0.089
Copper	1.3
Zinc	5.3
Titanium	0.021
Chromium	0.190
Aluminum	Balance

### Processing and Heat Treating

The 7175 aluminum alloy was processed into rectangular shapes by hand forging. The alloy plates were heat treated to the T736 temper.

### Results

Only data from the six plates tested are included in this report. The average values for each property are listed in Table 1 by plate direction. The fatigue data and bands for the data are presented in Figures 1 and 2 for the longitudinal direction (notched and unnotched from multiple heats) and in Figures 3 and 4 for the long transverse direction from one heat only.

Table B-2  
7175-T736 Aluminum Alloy Hand Forging<sup>(a)</sup>  
R.T.

Properties	Plate Direction		
	Longitudinal	Long Transverse	Short Transverse
<b>Tension</b>			
TUS, ksi (MPa)	72.3 (498.5)	71.6 (493.4)	71.6 (493.4)
TYS, ksi (MPa)	61.7 (425.7)	60.0 (413.7)	60.1 (414.4)
RA, percent	38.6	22.1	15.6
e, percent in 2 in. (50.8 mm)	22.1	15.6	8.9
E, 10 <sup>3</sup> ksi (GPa)	10.23 (70.6)	10.18 (70.2)	10.04 (69.2)
<b>Compression</b>			
CYS, ksi (MPa)	64.9 (447.6)	64.3 (443.3)	63.8 (439.6)
E <sub>c</sub> , 10 <sup>3</sup> ksi (GPa)	10.54 (72.7)	11.02 (76.0)	10.92 (75.3)
<b>Shear</b>			
SUS, ksi (MPa) <sup>(b)</sup>	42.9 (295.7)	40.0 (275.8)	40.8 (281.3)
SUS, ksi (MPa) <sup>(c)</sup>	44.8 (308.9)	43.5 (299.9)	43.1 (297.2)
<b>Bearing</b>			
e/D = 1.5			
BUS, ksi (MPa)	114.5 (789.5)	110.3 (760.5)	115.2 (794.3) <sup>(d)</sup>
BYS, ksi (MPa)	92.9 (640.5)	88.8 (612.3)	95.9 (661.2) <sup>(d)</sup>
e/D = 2.0			
BUS, ksi (MPa)	146.8 (1012.2)	143.2 (987.4)	143.4 (988.7) <sup>(d)</sup>
BYS, ksi (MPa)	111.3 (767.4)	106.9 (737.1)	109.7 (756.4) <sup>(d)</sup>

- (a) Values are average of triplicate room temperature tests conducted on six plates (heats) at the University of Dayton Research Institute under the subject contract.
- (b) Double "rivet" pin shear tests conducted on all six heats for all three directions using 3/8 inch diameter x 1.5 inch long double "rivet" shear specimens.
- (c) "Amsler" double pin shear tests conducted on all six heats for L and LT directions and on four heats (with thicknesses above 3.0 inches), using 3/8 inch diameter x 3.0 inch long specimens.
- (d) Bearing tests in the short transverse direction were only conducted on 4 heats which had thicknesses of 3.75 inches and greater.

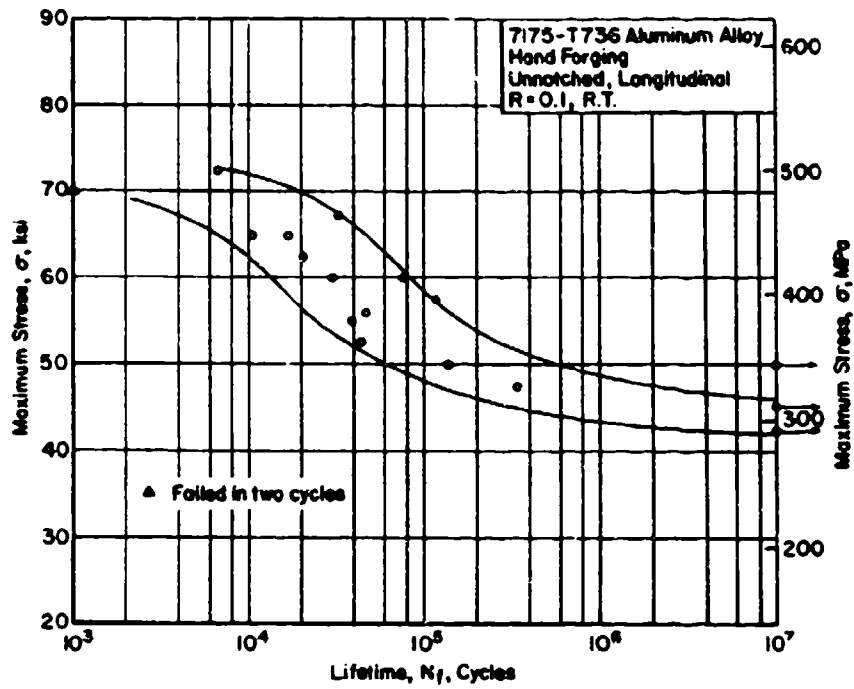

Figure B-5. Axial load fatigue data (multiple heats).

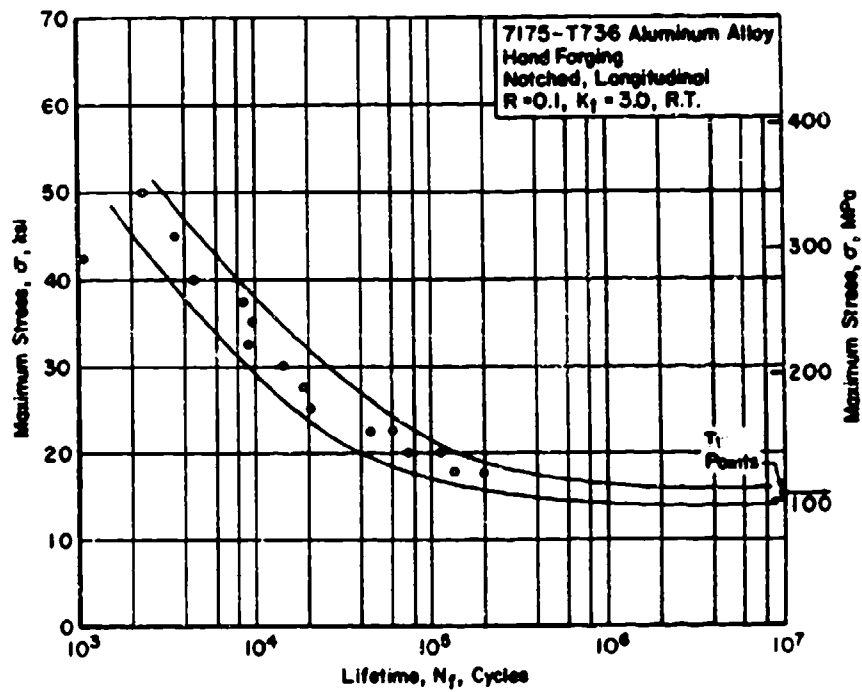

Figure B-6. Axial load fatigue data (multiple heats).

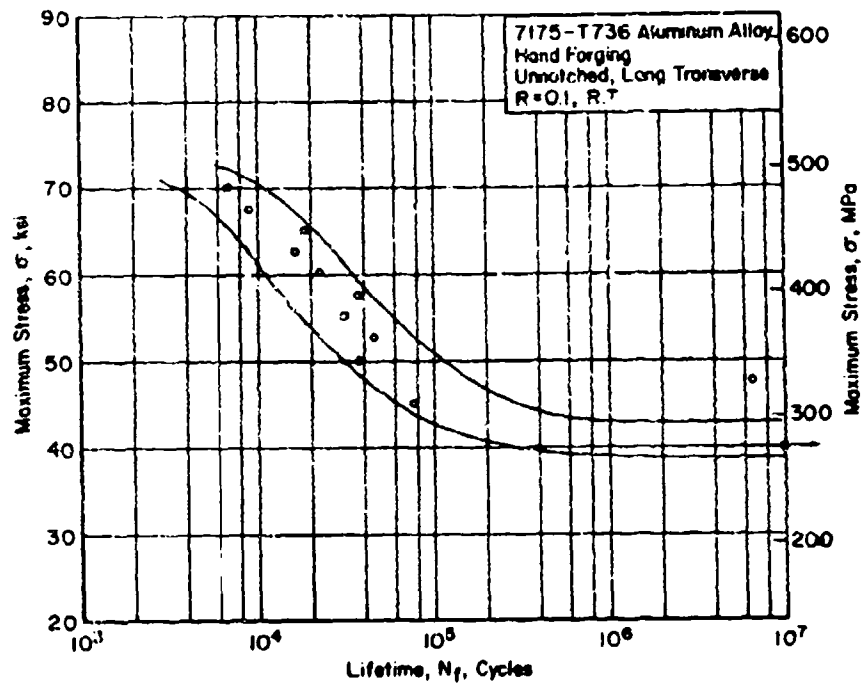

Figure B-7. Axial load fatigue data (one heat only).

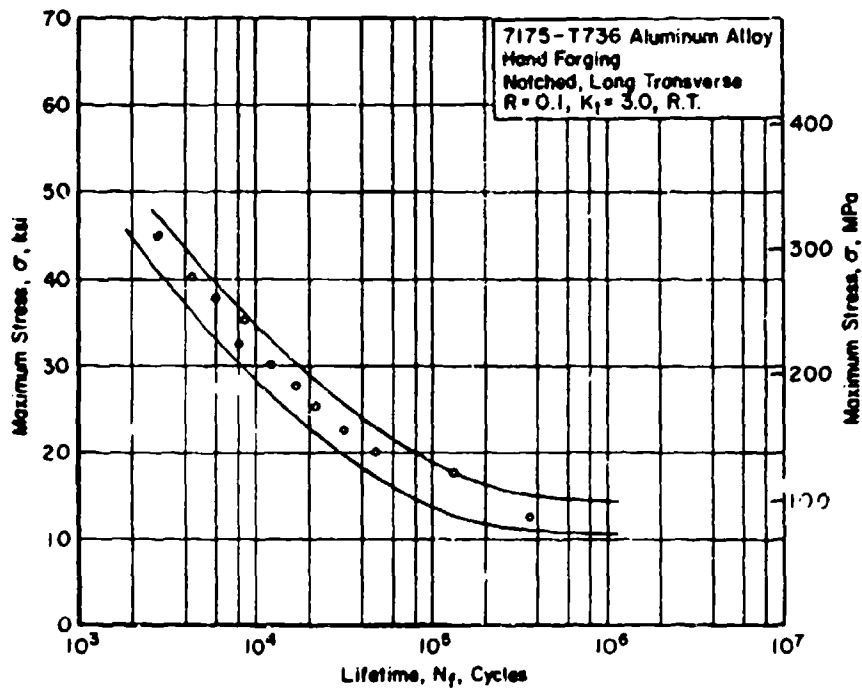

Figure B-8. Axial load fatigue data (one heat only).



UDR-TM-84-35  
October 1984

7050-T736511 Aluminum Alloy Extrusion

Material Description

This 7050 Aluminum Alloy was produced by Martin Marietta in the form of extrusions and heat treated to the T736511 temper. Twelve extrusions were used in obtaining samples for this test program. Due to the large variation in the geometry of the extrusions some variation in test sample length and thickness was required. This is most evident with the tensile samples in the long transverse direction in which both long and short as well as rectangular and round samples were used.

The average chemical composition of these extrusions is as follows:

<u>Chemical Composition</u>	<u>Percent Weight</u>
Silicon	.05
Iron	.11
Copper	2.24
Magnesium	2.29
Nickel	.01
Zinc	6.38
Titanium	.03
Lead	.01
Zirconium	.10
Aluminum	Balance

Processing and Heat Treating

The 7050 Aluminum Alloy was processed and formed into various shapes by extrusion. These extrusions were heat treated to the T736511 temper.

Results

Data from samples of the 12 extrusions are included in this report. The average values for tension, compression, shear and bearing are listed in Table 1 by specimen direction. The elongation data presented was generated from long rectangular samples

only. The shear results were obtained from the "Amsler" double pin shear fixture.

TABLE B-3  
ALUMINUM EXTRUSION (7050-T736511)<sup>(a)</sup>  
R.T.

Properties	Plate Direction	
	Longitudinal	Long Transverse
<u>Tension</u>		
TUS, Ksi (MPa)	78.98 (544.6)	77.35 (533.3)
TYS, Ksi (MPa)	69.57 (479.7)	67.19 (463.3)
RA, percent	28.77	26.04
$E$ , $10^3$ Ksi (GPa)	10.37 (71.54)	10.31 (71.05)
$\epsilon$ , percent in 2 in <sup>(b)</sup> (50.8 mm)	13.53	13.65
<u>Compression</u>		
CYS, Ksi (MPa)	70.35 (485.1)	69.96 (482.3)
$E_c$ , $10^3$ Ksi (GPa)	10.6 (73.1)	10.64 (74.76)
<u>Shear</u>		
SUS, Ksi (MPa) <sup>(c)</sup>	46.30 (319.3)	44.79 (308.8)
<u>Bearing</u>		
$e/D = 1.5$		
BUS, Ksi (MPa)	119.7 (825.4)	118.80 (819.4)
BYS, Ksi (MPa)	95.69 (659.6)	95.24 (656.7)
$e/D = 2.0$		
BUS, Ksi (MPa)	152.4 (1051.0)	153.10 (1056.0)
BYS, Ksi (MPa)	114.90 (792.4)	116.60 (804.1)

(a) Values are average of triplicate room temperature test conducted on 12 extrusions at the University of Dayton Research Institute under the subject contract.

(b) Elongation values from long, rectangular samples. Twelve extrusions in longitudinal direction, two extrusions in long transverse direction. Gage section: 2 in long x .5 in wide.

(c) "Amsler" Double pin shear test conducted on 10 extrusions in the longitudinal direction and 9 extrusions in the long transverse direction.