

AFRL-ML-WP-TR-2001-4027

**PRELIMINARY MATERIAL PROPERTIES
HANDBOOK**

Volume 2: SI Units

**Jana Jackson
Richard Rice**

**Battelle
505 King Avenue
Columbus, OH 43201-2693**

JULY 2000

FINAL REPORT for 01 November 1998 - 01 July 2000

Approved for public release; distribution unlimited



This material may be reproduced by or for the U.S. Government pursuant to the copyright license under the clause at DFARS 252.227-7013, Oct. 88.

**MATERIALS & MANUFACTURING DIRECTORATE
AIR FORCE RESEARCH LABORATORY
AIR FORCE MATERIEL COMMAND
WRIGHT-PATTERSON AIR FORCE BASE OH 45433-7750**

NOTICE

USING GOVERNMENT DRAWINGS, SPECIFICATIONS, OR OTHER DATA INCLUDED IN THIS DOCUMENT FOR ANY PURPOSE OTHER THAN GOVERNMENT PROCUREMENT DOES NOT IN ANY WAY OBLIGATE THE US GOVERNMENT. THE FACT THAT THE GOVERNMENT FORMULATED OR SUPPLIED THE DRAWINGS, SPECIFICATIONS, OR OTHER DATA DOES NOT LICENSE THE HOLDER OR ANY OTHER PERSON OR CORPORATION; OR CONVEY ANY RIGHTS OR PERMISSION TO MANUFACTURE, USE, OR SELL ANY PATENTED INVENTION THAT MAY RELATE TO THEM.

THIS REPORT IS RELEASABLE TO THE NATIONAL TECHNICAL INFORMATION SERVICE (NTIS). AT NTIS, IT WILL BE AVAILABLE TO THE GENERAL PUBLIC, INCLUDING FOREIGN NATIONS.

THIS TECHNICAL REPORT HAS BEEN REVIEWED AND IS APPROVED FOR PUBLICATION.



Steven R Thompson
Materials Test & Evaluation
Acquisition Systems Support Branch

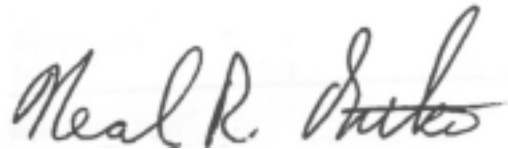

Neal R Ontko, Team Lead
Materials Test & Evaluation
Acquisition Systems Support Branch



Edward E. Hermes, Chief
Acquisition Systems Support Branch
Systems Support Division

FOR THE COMMANDER

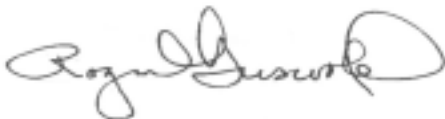

Roger D. Griswold, Chief
Systems Support Division
Materials and Manufacturing Directorate

Do not return copies of this report unless contractual obligations or notice on a specific document requires its return.

REPORT DOCUMENTATION PAGE			Form Approved OMB No. 0704-0188
Public reporting burden for this collection of information is estimated to average 1 hour per response, including the time for reviewing instructions, searching existing data sources, gathering and maintaining the data needed, and completing and reviewing the collection of information. Send comments regarding this burden estimate or any other aspect of this collection of information, including suggestions for reducing this burden, to Washington Headquarters Services, Directorate for information Operations and Reports, 1215 Jefferson Davis Highway, Suite 1204, Arlington, VA. 22202-4302, and to the Office of Management and Budget, Paperwork Reduction Project (0704-0188), Washington, DC 20503.			
1. AGENCY USE ONLY (Leave blank)	2. REPORT DATE July, 2000	3. REPORT TYPE AND DATES COVERED Final Technical 11/01/1998 – 07/01/2000	
4. TITLE AND SUBTITLE Preliminary Material Properties Handbook Volume 2: SI Units		5. FUNDING NUMBERS C: F33615-97-C-5647 PE: 62301F PR: 4349 TA: S2 WU: 02	
6. AUTHOR(S) Jana Jackson Richard Rice			
7. PERFORMING ORGANIZATION NAME(S) AND ADDRESS(ES) Battelle 505 King Avenue Columbus, Ohio 43201-2693		8. PERFORMING ORGANIZATION REPORT NUMBER	
9. SPONSORING/MONITORING AGENCY NAME(S) AND ADDRESS(ES) Materials & Manufacturing Directorate Air Force Research Laboratory Air Force Material Command Wright Patterson AFB, Ohio 45433-7750 POC: Neal R. Ontko, AFRL/MLSC, (937) 656-9134		10. SPONSORING/MONITORING AGENCY REPORT NUMBER AFRL-ML-WP-TR-2001-4027	
11. SUPPLEMENTARY NOTES Contains Copyright Material.			
12a. DISTRIBUTION/AVAILABILITY STATEMENT Approved for public release; distribution unlimited		12b. DISTRIBUTION CODE	
13. ABSTRACT (Maximum 200 Words) The Emerging Materials program provides the aerospace industry with typical properties of emerging materials and other materials of interest that have not met all the criteria for inclusion in the MIL-HDBK-5. Materials included in this report are standardized with regard to composition and processing methods and are described by industry, government, or company specifications.			
14. SUBJECT TERMS Emerging Materials, Typical Properties, International Metals		15. NUMBER OF PAGES 293	
		16. PRICE CODE	
17. SECURITY CLASSIFICATION OF REPORT Unclassified	18. SECURITY CLASSIFICATION OF THIS PAGE Unclassified	19. SECURITY CLASSIFICATION OF ABSTRACT Unclassified	20. LIMITATION OF ABSTRACT SAR

TABLE OF CONTENTS

	<u>Page</u>
Chapter 1. General	
1.1 Purpose, Procurement, and Use of Document	1-1
1.2 Symbols, Abbreviations, and Systems of Units	1-1
1.3 Basic Principles and Definitions	1-1
Chapter 2. Steel	2-1
Chapter 3. Aluminum	
3.1 General	3-1
3.2 2000 Series Wrought Alloys	3-10
3.3 3000 Series Wrought Alloys	3-24
3.4 4000 Series Wrought Alloys	3-24
3.5 5000 Series Wrought Alloys	3-24
3.6 6000 Series Wrought Alloys	3-24
3.7 7000 Series Wrought Alloys	3-24
3.8 200.0 Series Cast Alloys	3-39
3.9 300.0 Series Cast Alloys	3-41
References	3-41
Chapter 4. Magnesium Alloys	4-1
Chapter 5. Titanium	
5.1 General	5-1
5.2 Unalloyed Titanium	5-3
5.3 Alpha and Near-Alpha Titanium Alloys	5-3
5.4 Alpha-Beta Titanium Alloys	5-8
5.5 Beta, Near-Beta, and Metastable Titanium Alloys	5-21
References	5-29
Chapter 6. Heat-Resistant Alloys	
6.1 General	6-1
6.2 Iron-Chromium-Nickel-Base Alloys	6-3
6.3 Nickel-Base Alloys	6-3
6.4 Cobalt-Base Alloys	6-37
6.5 Other Alloys	6-37
References	6-45

CONTENTS (Continued)

	<u>Page</u>
Chapter 7. Miscellaneous Alloys and Hybrid Materials	
7.1 General	7-1
7.2 Aluminum Beryllium Alloys	7-1
7.3 Optical Grade Beryllium	7-15
Chapter 8. Structural Joints	8-1
Chapter 9. Statistical and Data Presentation Guidelines	
9.0 Summary	9-1
9.1 General	9-3
9.2 Room-Temperature Properties	9-6
9.3 Graphical Mechanical Property Data	9-12
9.4 Miscellaneous Properties	9-12
9.5 Statistical Procedures and Tables	9-12
Appendix A	
A.0 Glossary	A-1
A.1 Abbreviations	A-1
A.2 Symbols	A-4
A.3 Definitions	A-4
A.4 Conversion of U.S. Units of Measure used in PMP HDBK to SI Units	A-14
Appendix B	
B.0 Alloy Index	B-1
Appendix C	
C.0 Specification Index	C-1
Appendix D	
D.0 Additional Information	D-1
D.1 Comparison of ASTM E8-95A and Russian GOST 1497-84 Standard	D-1
D.2 Presentation of Russian OST 1 90148-74 Standard Shear Test	D-7

LIST OF FIGURES

<u>Figure</u>		<u>Page</u>
3.2.2.0(a)	Effect of temperature on specific heat of 2224A-T351	3-16
3.2.2.0(b)	Effect of temperature on thermal conductivity of 2224A-T351	3-16
3.2.2.0(c)	Effect of temperature on coefficient of thermal expansion of 2224A-T351	3-17
3.2.3.0(a)	Cycle stress-strain and strain-life curves for 2297-T8R85, 101.6 mm plate	3-21
3.2.3.0(b)	Fatigue-crack propagation data for 101.6-mm thick 2297-T8R87 aluminum alloy plate	3-23
3.7.1.0(a)	Effect of temperature on tensile strength of 7040-T7451	3-30
3.7.2.0	Crack Propagation of 7449-T7651	3-34
3.7.3.0(a)	Effect of temperature on specific heat of 7249-T76511	3-38
5.4.2.0(a)	Effect of temperature on specific heat of VT-16	5-15
5.4.2.0(b)	Effect of temperature on thermal expansion of VT-16	5-15
5.5.1.1(a)	Effect of temperature on specific heat of <i>TIMETAL</i> ® 21S aged at 593°C for 8 hours (Single Aged)	5-27
5.5.1.1(b)	Effect of temperature on thermal conductivity of <i>TIMETAL</i> ® 21S aged at 593°C for 8 hours (Single Aged)	5-27
5.5.1.1(c)	Effect of temperature on coefficient of thermal expansion of <i>TIMETAL</i> ® 21S aged at 593°C for 8 hours (Single Aged)	5-28
6.3.1.0(a)	Effect of temperature on thermal conductivity of AEREX 350	6-8
6.3.1.0(b)	Effect of temperature on specific heat of AEREX 350	6-8
6.3.1.0(c)	Effect of temperature on coefficient of thermal expansion of AEREX 350	6-9
6.3.1.0(d)	Effect of temperature on electrical resistivity of AEREX 350	6-9
6.3.1.0(e)	Stress rupture properties of AEREX 350 at 649°C and 732°C	6-10
6.3.2.0(a)	Effect of temperature on specific heat of HAYNES® 230® alloy	6-16
6.3.2.0(b)	Effect of temperature on thermal conductivity of HAYNES® 230® alloy	6-16
6.3.2.0(c)	Effect of temperature on coefficient of thermal expansion of HAYNES® 230® alloy	6-17
6.3.2.0(d)	Effect of temperature on tensile properties of HAYNES® 230® alloy plate	6-18
6.3.2.0(e)	Effect of temperature on tensile properties of HAYNES® 230® alloy bar	6-18
6.3.3.0(a)	Effect of temperature on elastic modulus of HAYNES® HR-120® alloy	6-24
6.3.3.0(b)	Effect of temperature on specific heat of HAYNES® HR-120® alloy	6-24
6.3.3.0(c)	Effect of temperature on thermal conductivity of HAYNES® HR-120® alloy	6-25
6.3.3.0(d)	Effect of temperature on coefficient of thermal expansion of HAYNES® HR-120® alloy	6-25
6.3.4.0(a)	Effect of temperature on Young's Modulus for textured and untextured bar	6-28
6.3.4.0(b)	Effect of temperature on specific heat of MA754 textured bar	6-28
6.3.4.0(c)	Effect of temperature on thermal conductivity of MA754 textured bar	6-29
6.3.4.0(d)	Effect of temperature on coefficient of thermal expansion of MA754 textured bar	6-29
6.3.4.0(e)	Effect of temperature on TUS and TYS in the L direction of MA754 alloy	6-30
6.3.4.0(f)	Effect of temperature on TUS and TYS in LT direction of MA754 alloy	6-30
6.3.4.0(g)	Isothermal stress rupture curves for MA754 textured bar, longitudinal orientation	6-31

FIGURES (Continued)

<u>Figure</u>		<u>Page</u>
6.3.4.0(h)	Isothermal stress rupture curves for MA754 textured bar, transverse orientation	6-32
6.3.5.0(a)	Effect of temperature on specific heat of EP741NP superalloy	6-35
6.3.5.0(b)	Effect of temperature on thermal conductivity of EP741NP superalloy	6-36
6.3.5.0(c)	Effect of temperature on coefficient of thermal expansion for EP741NP superalloy	6-36
6.5.1.0(a)	Effect of temperature on thermal conductivity of C-103 Niobium alloy	6-41
6.5.1.0(b)	Effect of temperature on coefficient of thermal expansion of C-103 Niobium alloy	6-41
6.5.1.0(c)	Effect of temperature on TUS and TYS of C-103 Niobium alloy	6-42
6.5.1.0(d)	Average isothermal creep curves to 1% strain for C-103 Niobium alloy when annealed for 1 hour at 1327°C	6-43
6.5.1.0(e)	Average isothermal creep curves to 1% strain for C-103 Niobium alloy when annealed for 3 hours at 1593 - 1649°C	6-44
7.2.2.0(a)	Effect of temperature on thermal conductivity of Beralcast® 363, HIPed	7-9
7.2.2.0(b)	S/N curves for Beralcast® 363 HIPed	7-10
7.2.2.0(c)	S/N curves for Beralcast® 363 HIPed, at 505°K	7-12
9.2.6	Format for room temperature property table	9-11

LIST OF TABLES

<u>Table</u>	<u>Page</u>	
3.1	Basic Designation for Wrought and Cast Aluminum Alloys	3-1
3.1.1	Aluminum Alloy Index	3-2
3.1.2	Temper Designation System for Aluminum Alloys	3-3
3.2.1.0(a)	Material Specifications for 2026-T3511	3-10
3.2.1.0(b)	Typical Mechanical and Physical Properties of 2026-T3511 Aluminum Alloy Extruded Bars, Rods, and Profiles	3-11
3.2.2.0(a)	Material Specifications for 2224A-T351	3-14
3.2.2.0(b)	Typical Mechanical and Physical Properties of 2224A-T351 (Russian Alloy 1163-T7) Plate	3-15
3.2.3.0(a)	Material Specifications for 2297-T8R85 Aluminum Alloy	3-18
3.2.3.0(b)	Typical Mechanical and Physical Properties of 2297-T8R85, Plate	3-19
3.2.3.0(c)	Typical Fracture Toughness Properties of 2297-T8R85 Plate	3-20
3.7.1.0(a)	Material Specifications for 7040-T7451 Alloy Plate	3-25
3.7.1.0(b)	Typical Mechanical Properties of 7040-T7451 Plate	3-26
3.7.1.0(c)	Typical Modulus and Physical Properties of 7040-T7451 Plate	3-29
3.7.1.0(d)	Typical Fracture Toughness Properties of 7040-T7451 Plate	3-29
3.7.2.0(a)	Material Specifications for 7449-T7651	3-31
3.7.2.0(b)	Typical Mechanical and Physical Properties of 7449-T7651 Plate	3-32
3.7.2.0(c)	Typical Fracture Toughness Properties of 7449-T7651 Plate	3-33
3.7.3.0(a)	Material Specifications for 7249-T76511	3-35
3.7.3.0(b)	Typical Mechanical and Physical Properties of 7249-T76511 Aluminum Alloy Extruded Bars, Rods, Shapes, and Tubing	3-36
3.7.3.0(c)	Typical Fracture Toughness Properties of 7249-T76511 Aluminum Alloy Extruded Bars, Rods, Shapes, and Tubing	3-38
3.8.1.0(a)	Material Specifications for A206 Aluminum Alloy	3-39
3.8.1.0(b)	Typical Mechanical and Physical Properties of A206 Castings	3-40
3.8.1.0(c)	Typical Mechanical and Physical Properties of A206 Cast Appendages	3-40
5.1	Titanium Alloys Index	5-1
5.3.1.0(a)	Material Specifications for <i>TIMETAL</i> ® 834	5-4
5.3.1.0(b)	Typical Mechanical and Physical Properties of <i>TIMETAL</i> ® 834 Forging Stock	5-5
5.3.1.0(c)	Typical Creep Properties of <i>TIMETAL</i> ® 834 Bars, Forging, and Forging Stock	5-6
5.3.1.0(d)	Typical Mechanical and Physical Properties of <i>TIMETAL</i> ® 834 Forging Stock at Elevated Temperature	5-7
5.4.1.0(a)	Material Specifications for <i>TIMETAL</i> ® 550	5-9
5.4.1.0(b)	Typical Mechanical and Physical Properties of <i>TIMETAL</i> ® 550 Forging Stock	5-10
5.4.1.0(c)	Thermal Expansion for <i>TIMETAL</i> ® 550	5-10
5.4.1.0(d)	Typical Mechanical and Physical Properties of <i>TIMETAL</i> ® 550 Plate	5-11
5.4.1.0(e)	Typical Mechanical and Physical Properties of <i>TIMETAL</i> ® 550 Bar	5-12

TABLES (Continued)

<u>Table</u>		<u>Page</u>
5.4.2.0(a)	Material Specifications for Ti-3Al-5Mo (VT-16) Rod	5-13
5.4.2.0(b)	Typical Mechanical and Physical Properties of Ti-3Al-5Mo (VT-16) Rod	5-14
5.4.3.0(a)	Material Specifications for Ti-6-22-22S	5-16
5.4.3.0(b)	Typical Mechanical and Physical Properties of Ti-6-22-22S Sheet	5-17
5.4.3.0(c)	Typical Mechanical and Physical Properties of Ti-6-22-22S Plate	5-18
5.4.3.0(d)	Fracture Toughness Properties of Ti-6-22-22S Plate	5-20
5.5.1.0	Material Specifications for <i>TIMETAL</i> ® 21S	5-22
5.5.1.1(a)	Typical Mechanical and Physical Properties of <i>TIMETAL</i> ® 21S Strip and Sheet	5-23
5.5.1.1(b)	Typical Mechanical and Physical Properties of <i>TIMETAL</i> ® 21S at 600°C Elevated Temperature	5-24
5.5.1.2(a)	Typical Mechanical and Physical Properties of <i>TIMETAL</i> ® 21S Strip and Sheet	5-25
5.5.1.2(b)	Typical Mechanical and Physical Properties of <i>TIMETAL</i> ® 21S Strip and Sheet at Elevated Temperatures	5-26
6.1.1	Heat-Resistant Alloys Index	6-1
6.3.1.0(a)	Material Specifications for AEREX 350	6-5
6.3.1.0(b)	Typical Mechanical and Physical Properties of AEREX 350 Bar	6-6
6.3.1.0(c)	Typical Stress Rupture Properties of AEREX 350 at Elevated Temperatures	6-7
6.3.2.0(a)	Material Specifications for HAYNES® 230® Alloy Wrought	6-11
6.3.2.0(b)	Typical Mechanical and Physical Properties of HAYNES® 230® Alloy Sheet	6-12
6.3.2.0(c)	Typical Mechanical and Physical Properties of HAYNES® 230® Alloy Plate	6-14
6.3.2.0(d)	Typical Mechanical and Physical Properties of HAYNES® 230® Alloy Bar	6-15
6.3.3.0(a)	Material Specifications for HAYNES® HR-120® Alloy Wrought Products	6-19
6.3.3.0(b)	Typical Mechanical and Physical Properties of HAYNES® HR-120® Alloy Bar	6-20
6.3.3.0(c)	Typical Mechanical and Physical Properties of HAYNES® HR-120® Alloy Sheet	6-21
6.3.3.0(d)	Typical Mechanical and Physical Properties of HAYNES® HR-120® Alloy Wrought Sheet	6-23
6.3.4.0(a)	Material Specifications for MA754	6-26
6.3.4.0(b)	Typical Mechanical and Physical Properties of MA754 Textured Bar	6-27
6.3.5.0(a)	Material Specifications for EP741NP	6-33
6.3.5.0(b)	Typical Mechanical and Physical Properties of PM EP741NP Discs	6-34
6.3.5.0(c)	Fatigue and Stress Rupture Properties of PM EP741N Discs at 650°C	6-35
6.5.1.0(a)	Material Specifications for C-103	6-38
6.5.1.0(b)	Typical Mechanical and Physical Properties of C-103 Niobium Alloy Bar, Tube, and Sheet	6-39
6.5.1.0(c)	Typical Mechanical and Physical Properties of C-103 Niobium Alloy Sheet at Elevated Temperatures	6-40
7.1.1	Miscellaneous Alloys Index	7-1
7.2.1.0(a)	Material Specifications for AM162	7-2

TABLES (Continued)

<u>Table</u>		<u>Page</u>
7.2.1.0.(b)	Typical Mechanical and Physical Properties of AM162 HIPed	7-3
7.2.1.0.(c)	Typical Mechanical and Physical Properties of AM162 Extruded	7-4
7.2.1.0.(d)	Typical Mechanical and Physical Properties of AM162 Sheet and Plate	7-5
7.2.2.0(a)	Material Specifications for Beralcast® Alloys	7-6
7.2.2.0(b)	Typical Mechanical and Physical Properties of Beralcast® Alloy Casting . .	7-7
7.2.2.0(c)	Typical Mechanical and Physical Properties of Beralcast® Alloy Casting, Plate, Bar, and Tube	7-8
7.2.2.0(d)	Typical Mechanical Properties of Beralcast® 363 Casting at -55°C	7-11
7.2.2.0(e)	Typical Mechanical Properties of Beralcast® 363 Casting at 110°C	7-11
7.2.3.0(a)	Material Specifications for AMIC 910	7-13
7.2.3.0.(b)	Typical Mechanical and Physical Properties of AMIC 910 Investment Cast .	7-14
7.3.1.0(a)	Material Specifications for O-30-H Grade Beryllium	7-15
7.3.1.0.(b)	Typical Mechanical and Physical Properties of O-30-H Grade Beryllium, HIPed	7-16
9.1.4.2	Definitions of Heat, Melt, and Cast	9-4
9.2.2.2	Mechanical Property Terms	9-7
9.2.5	Units and Symbols Used to Present Physical Property Data and ASTM Test Procedures	9-9

This page intentionally blank.

Preliminary Material Properties Handbook

FOREWORD

This final technical report covers the work performed under Contract F33615-97-C-5647 from November 1998 to July 2000 by Battelle. The program was administered under the technical direction of Mr. Neal R. Ontko, Air Force Research Laboratory, Wright-Patterson Air Force Base, Ohio 45433-7718. Mr. Steven R. Thompson was the lead engineer for emerging materials and the Preliminary Material Properties Handbook effort.

Battelle performed the work with the input of various aerospace industry companies. Mr. Richard Rice was the Program Manager, Ms. Jana Jackson was the Principal Investigator.

The program manager wishes to acknowledge input from the following companies: Russian Interstate Aviation Committee, Moscow, Russia; Pechiney Rhenalu, Issoire, France; Pechiney Rolled Products, U.S.A.; Hitchcock Industries, U.S.A.; Timet, U.K.; Timet, U.S.A.; HAYNES International, U.S.A.; SPS Technologies, U.S.A.; Brush Wellman, U.S.A.; Starmet, U.S.A.; and Pratt-Whitney, U.S.A.; Special Metals, U.S.A.; WahChang, U.S.A.; Aluminum Company of America, U.S.A.; McCook, U.S.A.; Universal Alloy, U.S.A.; and RMI Titanium, U.S.A.

Preliminary Material Properties Handbook

This page intentionally blank.

CHAPTER 1

GENERAL

1.1 PURPOSE, PROCUREMENT, AND USE OF DOCUMENT

1.1.1 INTRODUCTION — This handbook contains emerging materials and other materials which are of interest to the aerospace industry but have not met all the criteria for inclusion into MIL-HDBK-5 “Metallic Materials and Elements for Aerospace Vehicle Structures”. The data presented in this handbook is designed to give aerospace designers preliminary material properties for consideration in aerospace applications. As new quantities of material are produced, subsequent data can be added to the existing database.

1.1.2 SCOPE OF DOCUMENT — This document is intended primarily as a source of summarized test data for the transition of emerging materials new to the aerospace industry. A list of the alloys included in this document is in Appendix B. Data are summarized by providing the average, standard deviation and skewness factor, including the test sample size and number of lots, for design analysis. Where physical property data are included from other sources, a notation is made.

The materials included in this document are standardized with regard to composition and processing methods and are described by industry, government, or company specifications. Copies of company specifications are included in Appendix C.

Where available, applicable references are listed at the end of each chapter. The reference numbers correspond to the paragraph to which they most generally apply. References are provided for guidance to further information on a particular subject.

1.2 SYMBOLS, ABBREVIATIONS, AND SYSTEMS OF UNITS

1.2.1 SYMBOLS AND ABBREVIATIONS — The symbols, abbreviations, and conversion factors used in this document are defined in Appendix A. The metric units used in this document are listed in Table 1.2.1.

Table 1.2.1. SI Units

Property	SI Unit	SI Symbol
Stress	Megapascal	MPa
Modulus	Gigapascal	GPa
Density	Megagram/meter ³	Mg/m ³
Specific heat	Joule/(gram Kelvin)	J/(g °K)
Thermal conductivity	Watt/(meter Kelvin)	W/m °K
Thermal expansion	Meter/(meter Kelvin)	m/m °K
Stress intensity factor	Megapascal meter ^{0.5}	MPa m ^{0.5}
Crack growth rate	Millimeters/cycle	mm/cycle

1.3 BASIC PRINCIPLES AND DEFINITIONS

1.3.1 GENERAL — It is assumed that engineers using this document are thoroughly familiar with the basic principles of strength of materials. Lists of abbreviations, definitions, and symbols are located in Appendix A. The typical mechanical-property values of various metals and elements are provided in the tables in each chapter.

A copy of MIL-HDBK-5 can be requested by mail or FAX from the Defense Area Printing Service, Philadelphia, PA, on company letterhead, showing the complete mailing address and point of contact. Assistance in ordering may be obtained by calling (215) 697-2179/2667 or sending a FAX to (215) 697-1462. Their mailing address is:

DODSSP
700 Robbins Avenue Bldg 4D
Philadelphia, PA 19111-5094

Additional copies of this report may be requested by mail on company letterhead, showing the complete mailing address and point of contact. Mail requests to:

AFRL/MLSC
Building 652, Room 122
2179 12th Street
Wright-Patterson AFB, OH 45433-7718

CHAPTER 2

STEEL

Data on emerging steels designed for use in aircraft and missile structural applications were not submitted for inclusion in this handbook.

This page intentionally blank.

CHAPTER 3

ALUMINUM

This chapter contains the engineering properties and related characteristics of wrought and cast aluminum alloys used in aircraft and missile structural applications.

General comments on engineering properties and the considerations relating to alloy selection are presented in Section 3.1. Mechanical and physical property data and characteristics pertinent to specific alloy groups or individual alloys are reported in the following sections.

3.1 GENERAL

Aluminum is a lightweight, corrosion-resistant structural material that can be strengthened through alloying and, depending upon composition, further strengthened by heat treatment and/or cold working [Reference 3.1(a)]. Among its advantages for specific applications are: low density, high strength-to-weight ratio, good corrosion resistance, ease of fabrication and diversity of form.

Wrought and cast aluminum and aluminum alloys are identified by a four-digit numerical designation assigned by the Aluminum Association, the first digit of which indicates the alloy group as shown in Table 3.1. The second digit indicates modifications of the original alloy or impurity limits. For structural wrought aluminum alloys the last two digits identify the aluminum alloy. For cast aluminum and aluminum alloys the second and third digits identify the aluminum alloy or indicate the minimum aluminum percentage. The last digit, which is to the right of the decimal point, indicates the product form: XXX.0 indicates castings, and XXX.1 and XXX.2 indicate ingot.

Table 3.1. Basic Designation for Wrought and Cast Aluminum Alloys
[Reference 3.1(b)]

Alloy Group	Major Alloying Elements	Alloy Group	Major Alloying Groups
	Wrought Alloys		Cast Alloys
1XXX	99.00 percent minimum aluminum	1XX.0	99.00 percent minimum aluminum
2XXX	Copper	2XX.0	Copper
3XXX	Manganese	3XX.0	Silicon with added copper and/or
4XXX	Silicon	4XX.0	magnesium
5XXX	Magnesium	5XX.0	Silicon
6XXX	Magnesium and Silicon	6XX.0	Magnesium
7XXX	Zinc	7XX.0	Unused Series
8XXX	Other Elements	8XX.0	Zinc
9XXX	Unused Series	9XX.0	Tin
			Other Elements

3.1.1 ALUMINUM ALLOY INDEX — The alloys are listed in the index, shown in Table 3.1.1**Table 3.1.1. Aluminum Alloy Index**

Section	Alloy Designation
3.2	2000 series wrought alloys
3.2.1	2026-T3511
3.2.2	2224A-T351 (Russian alloy 1163-T7)
3.2.3	2297-T8R85
3.3	3000 series wrought alloys
3.4	4000 series wrought alloys
3.5	5000 series wrought alloys
3.6	6000 series wrought alloys
3.7	7000 series wrought alloys
3.7.1	7040-T7451
3.7.2	7449-T7651
3.7.3	7249-T76511
3.8	200.0 series cast alloys
3.8.1	A206 cast
3.9	300.0 series cast alloys

3.1.2 MATERIAL PROPERTIES — The properties of the aluminum alloys are determined by the alloy content and method of fabrication. Some alloys are strengthened principally by cold work, while others are strengthened principally by solution heat treatment and precipitation hardening [Reference 3.1(a)]. The temper designations, shown in Table 3.1.2 (which is based on Reference 3.1.2), are indicative of the type of strengthening mechanism employed.

The number of test samples and number of lots are presented in the mechanical property tables for each alloy. Data on the effect of temperature on properties are presented graphically when available. Comments on the effect of temperature on properties are given in Sections 3.1.2.1.3; and comments on the effects of manufacturing practices on these properties are given in Section 3.1.3.

It should be recognized not all combinations of stress and environment have been investigated, and it is necessary to evaluate an alloy under the specific conditions involved for certain critical applications.

Table 3.1.2. Temper Designation System for Aluminum Alloys

Temper Designation System^{ab}	
<p>The temper designation system is used for all forms of wrought and cast aluminum and aluminum alloys except ingot. It is based on the sequences of basic treatments used to produce the various tempers. The temper designation follows the alloy designation, the two being separated by a hyphen. Basic temper designations consist of letters. Subdivisions of the basic tempers, where required, are indicated by one or more digits following the letter. These designate specific sequences of basic treatments, but only operations recognized as significantly influencing the characteristics of the product are indicated. Should some other variation of the same sequence of basic operations be applied to the same alloy, resulting in different characteristics, then additional digits are added to the designation.</p>	<p>the period of natural aging is indicated: for example, W ½ hr.</p>
Basic Temper Designations	<p>T thermally treated to produce stable tempers other than F, O, or H. Applies to products which are thermally treated, with or without supplementary strain-hardening, to produce stable tempers. The T is always followed by one or more digits.</p>
<p>F as fabricated. Applies to the products of shaping processes in which no special control over thermal conditions or strain-hardening is employed. For wrought products, there are no mechanical property limits.</p>	<p>Subdivisions of H Temper: Strain-hardened.</p> <p>The first digit following H indicates the specific combination of basic operations, as follows:</p>
<p>O annealed. Applies to wrought products which are annealed to obtain the lowest strength temper, and to cast products which are annealed to improve ductility and dimensional stability. The O may be followed by a digit other than zero.</p>	<p>H1 strain-hardened only. Applies to products which are strain-hardened to obtain the desired strength without supplementary thermal treatment. The number following this designation indicates the degree of strain-hardening.</p>
<p>H strain-hardened (wrought products only). Applies to products which have their strength increased by strain-hardening, with or without supplementary thermal treatments to produce some reduction in strength. The H is always followed by two or more digits.</p>	<p>H2 strain-hardened and partially annealed. Applies to products which are strain-hardened more than the desired final amount and then reduced in strength to the desired level by partial annealing. For alloys that age-soften at room temperature, the H2 tempers have the same minimum ultimate tensile strength as the corresponding H3 tempers. For other alloys, the H2 tempers have the same minimum ultimate tensile strength as the corresponding H1 tempers and slightly higher elongation. The number following this designation indicates the degree of strain-hardening remaining after the product has been partially annealed.</p>
<p>W solution heat-treated. An unstable temper applicable only to alloys which spontaneously age at room temperature after solution heat-treatment. This designation is specific only when</p>	<p>H3 strain-hardened and stabilized. Applies to products which are strain-hardened and whose mechanical properties are stabilized either by a low temperature thermal treatment or as a result</p>

a From reference 3.1.2.

b Temper designations conforming to this standard for wrought aluminum and wrought aluminum alloys, and aluminum alloy castings may be registered with the Aluminum Association provided: (1) the temper is used or is available for use by more than one user, (2) mechanical property limits are registered, (3) characteristics of the temper are significantly different from those of all other tempers which have the same sequence of basic treatments and for which designations already have been assigned for the same alloy and product, and (4) the following are also registered if characteristics other than mechanical properties are considered significant: (a) test methods and limits for the characteristics or (b) the specific practices used to produce the temper.

Table 3.1.2. Temper Designation System for Aluminum Alloys — Continued

of heat introduced during fabrication. Stabilization usually improves ductility. This designation is applicable only to those alloys which, unless stabilized, gradually age-soften at room temperature. The number following this designation indicates the degree of strain-hardening remaining after the stabilization treatment.

The digit following the designations H1, H2, and H3 indicates the degree of strain hardening. Numeral 8 has been assigned to indicate tempers having an ultimate tensile strength equivalent to that achieved by a cold reduction (temperature during reduction not to exceed 120°F) of approximately 75 percent following a full anneal. Tempers between O (annealed) and 8 are designated by numerals 1 through 7. Material having an ultimate tensile strength about midway between that of the O temper and that of the 8 temper is designated by the numeral 4; about midway between the O and 4 tempers by the numeral 2; and about midway between 4 and 8 tempers by the numeral 6. Numeral 9 designates tempers whose minimum ultimate tensile strength exceeds that of the 8 temper by 2.0 ksi or more. For two-digit H tempers whose second digit is odd, the standard limits for ultimate tensile strength are exactly midway between those of the adjacent two digit H tempers whose second digits are even.

NOTE: For alloys which cannot be cold reduced an amount sufficient to establish an ultimate tensile strength applicable to the 8 temper (75 percent cold reduction after full anneal), the 6 temper tensile strength may be established by a cold reduction of approximately 55 percent following a full anneal, or the 4 temper tensile strength may be established by a cold reduction of approximately 35 percent after a full anneal.

The third digit^c, when used, indicates a variation of a two-digit temper. It is used when the degree of control of temper or the mechanical properties or both differ from, but are close to, that (or those) for the two-digit H temper designation to which it is

added, or when some other characteristic is significantly affected.

NOTE: The minimum ultimate tensile strength of a three-digit H temper must be at least as close to that of the corresponding two-digit H temper as it is to the adjacent two-digit H tempers. Products of the H temper whose mechanical properties are below H₁ shall be variations of H₁.

Three-digit H Tempers

H₁₁ Applies to products which incur sufficient strain hardening after the final anneal that they fail to qualify as annealed but not so much or so consistent an amount of strain hardening that they qualify as H₁.

H₁₂ Applies to products which may acquire some temper from working at an elevated temperature and for which there are mechanical property limits.

Subdivisions of T Temper: Thermally Treated

Numerals 1 through 10 following the T indicate specific sequences of basic treatments, as follows.^d

T1 cooled from an elevated temperature shaping process and naturally aged to a substantially stable condition. Applies to products which are not cold worked after cooling from an elevated temperature shaping process, or in which the effect of cold work in flattening or straightening may not be recognized in mechanical property limits.

T2 cooled from an elevated temperature shaping process, cold worked and naturally aged to a substantially stable condition. Applies to products which are cold worked to improve strength after cooling from an elevated temperature shaping process, or in which the effect of

c Numerals 1 through 9 may be arbitrarily assigned as the third digit and registered with The Aluminum Association for an alloy and product to indicate a variation of a two-digit H temper (see footnote b).

d A period of natural aging at room temperature may occur between or after the operations listed for the T tempers. Control of this period is exercised when it is metallurgically important.

Table 3.1.2. Temper Designation System for Aluminum Alloys — Continued

cold work in flattening or straightening is recognized in mechanical property limits.	artificially aged after solution heat-treatment to provide dimensional and strength stability.
T3 solution heat-treated^e, cold worked, and naturally aged to a substantially stable condition. Applies to products which are cold worked to improve strength after solution heat-treatment, or in which the effect of cold work in flattening or straightening is recognized in mechanical property limits.	T8 solution heat-treated^e, cold worked, and artificially aged. Applies to products which are cold worked to improve strength, or in which the effect of cold work in flattening or straightening is recognized in mechanical property limits.
T4 solution heat-treated^e and naturally aged to a substantially stable condition. Applies to products which are not cold worked after solution heat-treatment, or in which the effect of cold work in flattening or straightening may not be recognized in mechanical property limits.	T9 solution heat-treated^e, artificially aged, and cold worked. Applies to products which are cold worked to improve strength.
T5 cooled from an elevated temperature shaping process and artificially aged. Applies to products which are not cold worked after cooling from an elevated temperature shaping process, or in which the effect of cold work in flattening or straightening may not be recognized in mechanical property limits.	T10 cooled from an elevated temperature shaping process, cold worked, and artificially aged. Applies to products which are cold worked to improve strength, or in which the effect of cold work in flattening or straightening is recognized in mechanical property limits.
T6 solution heat-treated^e and artificially aged. Applies to products which are not cold worked after solution heat-treatment or in which the effect of cold work in flattening or straightening may not be recognized in mechanical property limits.	Additional digits ^f , the first of which shall not be zero, may be added to designations T1 through T10 to indicate a variation in treatment which significantly alters the product characteristics ^g that are or would be obtained using the basic treatment.
T7 solution heat-treated^e and overaged/stabilized. Applies to wrought products that are artificially aged after solution heat-treatment to carry them beyond a point of maximum strength to provide control of some significant characteristic. Applies to cast products that are	The following specific additional digits have been assigned for stress-relieved tempers of wrought products: Stress Relieved by Stretching
	T_51 Applies to plate and rolled or cold-finished rod and bar when stretched the indicated amounts after solution heat-treatment or after cooling from an elevated temperature shaping process. The products receive no further straightening after stretching.

- e Solution heat treatment is achieved by heating cast or wrought products to a suitable temperature, holding at that temperature long enough to allow constituents to enter into solid solution and cooling rapidly enough to hold the constituents in solution. Some 6000 series alloys attain the same specified mechanical properties whether furnace solution heat-treated or cooled from an elevated temperature shaping process at a rate rapid enough to hold constituents in solution. In such cases the temper designations T3, T4, T6, T7, T8, and T9 are used to apply to either process and are appropriate designations.
- f Additional digits may be arbitrarily assigned and registered with the Aluminum Association for an alloy and product to indicate a variation of tempers T1 through T10 even though the temper representing the basic treatment has not been registered (see footnote b). Variations in treatment which do not alter the characteristics of the product are considered alternate treatments for which additional digits are not assigned.
- g For this purpose, characteristic is something other than mechanical properties. The test method and limit used to evaluate material for this characteristic are specified at the time of the temper registration.

Table 3.1.2. Temper Designation System for Aluminum Alloys — Continued

<p>Plate 1½ to 3% permanent set. Rolled or Cold-Finished Rod and Bar 1 to 3% permanent set. Die or Ring Forgings and Rolled Rings 1 to 5% permanent set.</p>	<p>The following temper designations have been assigned for wrought product test material heat-treated from annealed (O, O1, etc.) or F temper.^h</p>
<p>T₅₁₀ Applies to extruded rod, bar, shapes and tube and to drawn tube when stretched the indicated amounts after solution heat-treatment or after cooling from an elevated temperature shaping process. These products receive no further straightening after stretching.</p> <p>Extruded Rod, Bar, Shapes and Tube 1 to 3% permanent set. Drawn Tube ½ to 3% permanent set.</p>	<p>T42 Solution heat-treated from annealed or F temper and naturally aged to a substantially stable condition.</p>
<p>T₅₁₁ Applies to extruded rod, bar, shapes and tube and to drawn tube when stretched the indicated amounts after solution heat-treatment or after cooling from an elevated temperature shaping process. These products may receive minor straightening after stretching to comply with standard tolerances.</p>	<p>T62 Solution heat-treated from annealed or F temper and artificially aged.</p>
<p>Stress Relieved by Compressing</p>	<p>Temper designations T42 and T62 may also be applied to wrought products heat-treated from any temper by the user when such heat-treatment results in the mechanical properties applicable to these tempers.</p>
<p>T₅₂ Applies to products which are stress-relieved by compressing after solution heat-treatment or cooling from an elevated temperature shaping process to produce a set of 1 to 3 percent.</p>	<p>Variations of O Temper: Annealed</p>
<p>Stress Relieved by Combined Stretching and Compressing</p>	<p>A digit following the O, when used, indicates a product in the annealed condition have special characteristics. NOTE: As the O temper is not part of the strain-hardened (H) series, variations of O temper shall not apply to products which are strain-hardened after annealing and in which the effect of strain-hardening is recognized in the mechanical properties or other characteristics.</p>
<p>T₅₄ Applies to die forgings which are stress relieved by restriking cold in the finish die.</p>	<p>Assigned O Temper Variations</p>
<p>NOTE: The same digits (51, 52, 54) may be added to the designation W to indicate unstable solution heat-treated and stress-relieved treatment.</p>	<p>The following temper designation has been assigned for wrought products high temperature annealed to accentuate ultrasonic response and provide dimensional stability.</p>
	<p>O1 Thermally treated at approximately same time and temperature required for solution heat treatment and slow cooled to room temperature. Applicable to products which are to be machined prior to solution heat treatment by the user. Mechanical Property limits are not applicable.</p>
	<p>Designation of Unregistered Tempers</p> <p>The letter P has been assigned to denote H, T and O temper variations that are negotiated between manufacturer and purchaser. The letter P immediately follows the temper designation that</p>

^h When the user requires capability demonstrations from T-temper, the seller shall note "capability compliance" adjacent to the specified ending tempers. Some examples are: "-T4 to -T6 Capability Compliance as for aging" or "-T351 to -T4 Capability Compliance as for resolution heat treating."

Table 3.1.2. Temper Designation System for Aluminum Alloys — Continued

most nearly pertains. Specific examples where such designation may be applied include the following:	The test conditions (sampling location, number of samples, test specimen configuration, etc.) are different from those required for registration with the Aluminum Association.
The use of the temper is sufficiently limited so as to preclude its registration. (Negotiated H temper variations were formerly indicated by the third digit zero.)	The mechanical property limits are not established on the same basis as required for registration with the Aluminum Association.

3.1.2.1 Mechanical Properties — Comments on the mechanical properties represented in this Handbook are included in this section.

3.1.2.1.1 Strength (Tension, Compression, Shear, Bearing) — The average strength properties at room temperature are presented in a table near the beginning of each alloy's section covering the properties of that alloy. The effect of temperature on these properties is indicated in figures which follow the tables.

Tensile and compressive strengths are given for the longitudinal, long-transverse, and short-transverse directions wherever data are available. Short-transverse strengths may be relatively low, and transverse properties should not be assumed to apply to the short-transverse direction unless so stated. In those instances where the direction in which the material will be used is not known, the lesser of the applicable longitudinal or transverse properties should be used.

Bearing strengths are given without reference to direction and may be assumed to be about the same in all directions, with the exception of plate, die forging, and hand forging. Bearing data are tested in accordance with ASTM E 238 which requires clean pins and specimens. See Reference 3.1.2.1.1 for additional information. Designers should consider a reduction factor in applying these values to structural analyses.

Shear strengths also vary to some extent with plane of shear and direction of loading but the differences are not so consistent [Reference 3.1.2.1.1]. The standard test method for the determination of shear strength of aluminum alloy products, 3/16 inch and greater in thickness, is contained in ASTM B 769.

Shear strength values are presented without reference to grain direction, except for hand forgings. For hand forgings, the shear strength in short-transverse direction may be significantly lower than for the other two grain directions. Consequently, the shear strength for hand forgings is presented for each grain direction.

3.1.2.1.2 Elongation — Elongation values are included in the tables of room-temperature mechanical properties. Short-transverse elongations may be relatively low, and long-transverse values should not be assumed to apply to the short-transverse direction.

3.1.2.1.3 Elevated Temperatures — In general, the strengths of aluminum alloys decrease and toughness increases with increase in temperature and with time at temperature above room temperature; the effect is generally greatest over the temperature range from 212 to 400°F. Exceptions to the general trends are tempers developed by solution heat treatment without subsequent aging, for which the initial elevated temperature exposure results in some age hardening and reduction in toughness; further

time at temperature beyond that required to achieve peak hardness results in the aforementioned decrease in strength and increase in toughness [Reference 3.1.2.1.3].

3.1.2.2 Physical Properties — Where available from the literature, the average values of certain physical properties are included in the room-temperature tables for each alloy. These properties include density, ω , in lb/in.³; the specific heat, C , in Btu/(lb)(°F); the thermal conductivity, K , in Btu/[(hr)(ft²)(°F)/ft]; and the mean coefficient of thermal expansion, α , in in./in./°F. Where more extensive data are available to show the effect of temperature on these physical properties, graphs of physical property as a function of temperature are presented for the applicable alloys. Where available from test data, the number of tests and lots are indicated along with their mean average, standard deviation, and skewness.

3.1.2.3 Corrosion Resistance — Currently no data is included on stress-corrosion cracking or exfoliation for aluminum materials in this Handbook.

3.1.3 MANUFACTURING CONSIDERATIONS

3.1.3.1 Avoiding Stress-Corrosion Cracking — In order to avoid stress-corrosion cracking, practices, such as the use of press or shrink fits; taper pins; clevis joints in which tightening of the bolt imposes a bending load on female lugs; and straightening or assembly operations, which result in sustained surface tensile stresses (especially when acting in the short-transverse grain orientation), should be avoided in these high-strength alloys such as: 2014-T451, T4, T6, T651, T652; 2024-T3, T351, T4; 7075-T6, T651, T652; 7150-T6151, T61511; and 7475-T6, T651.

Where straightening or forming is necessary, it should be performed when the material is in the freshly quenched condition or at an elevated temperature to minimize the residual stress induced. Where elevated temperature forming is performed on 2014-T4 T451, or 2024-T3 T351, a subsequent precipitation heat treatment to produce the T6 or T651, T81 or T851 temper is recommended.

It is good engineering practice to control sustained short-transverse tensile stress at the surface of structural parts at the lowest practicable level. Thus, careful attention should be given in all stages of manufacturing, starting with design of the part configuration, to choose practices in the heat treatment, fabrication, and assembly to avoid unfavorable combinations of end grain microstructure and sustained tensile stress. The greatest danger arises when residual, assembly, and service stress combine to produce high sustained tensile stress at the metal surface. Sources of residual and assembly stress have been the most contributory to stress-corrosion-cracking problems because their presence and magnitude were not recognized. In most cases, the design stresses (developed by functional loads) are not continuous and would not be involved in the summation of sustained tensile stress. It is imperative that, for materials with low resistance to stress-corrosion cracking in the short-transverse grain orientation, every effort be taken to keep the level of sustained tensile stress close to zero.

3.1.3.2 Cold-Formed Heat-Treatable Aluminum Alloys — Cold working such as stretch forming of aluminum alloy prior to solution heat treatment may result in recrystallization or grain growth during heat treatment. The resulting strength, particularly yield strength, may be significantly below the specified minimum values. For critical applications, the strength should be determined on the part after forming and heat treating including straightening operations. To minimize recrystallization during heat treatment, it is recommended that forming be done after solution heat treatment in the as-quenched condition whenever possible, but this may result in compressive yield strength in the direction of stretching being lower than design allowables for user heat treat tempers.

3.1.3.3 Dimensional Changes — The dimensional changes that occur in aluminum alloy during thermal treatment generally are negligible, but in a few instances these changes may have to be considered in manufacturing. Because of many variables involved, there are no tabulated values for these dimensional changes. In the artificial aging of alloy 2219 from the T42, T351, and T37 tempers to the T62, T851, and T87 tempers, respectively, a net dimensional growth of 0.0010 to 0.0015 in./in. may be anticipated. Additional growth of as much as 0.0010 in./in. may occur during subsequent service of a year or more at 300°F or equivalent shorter exposures at higher temperatures. The dimensional changes that occur during the artificial aging of other wrought heat-treatable alloys are less than one-half that for alloy 2219 under the same conditions.

3.1.3.4 Welding — The ease with which aluminum alloys may be welded is dependent principally upon composition, but the ease is also influenced by the temper of the alloy, the welding process, and the filler metal used. Also, the weldability of wrought and cast alloys is generally considered separately.

Several weldability rating systems are established and may be found in publications by the Aluminum Association, American Welding Society, and the American Society for Metals. Handbooks from these groups can be consulted for more detailed information. The Aluminum Association has published a paper on welding of aluminum alloys (Reference 3.1.3.4), in which weldability is rated by alloy, temper, and welding process (arc or resistance).

When heat-treated or work-hardened materials of most systems are welded, a loss of mechanical properties generally occurs. The extent of the loss (if not reheat treated) will have to be established for each specific situation.

3.2 2000 SERIES WROUGHT ALLOYS

Alloys of the 2000 series contain copper as the principal alloying element and are strengthened by solution heat treatment and aging. As a group, these alloys are noteworthy for their excellent strengths at elevated and cryogenic temperatures, and creep resistance at elevated temperatures.

3.2.1 2026-T3511

3.2.1.0 COMMENTS AND PROPERTIES — 2026 is a 4.0Cu-1.3Mg-0.60Mn aluminum alloy used for extrusion of bars, rods, and profiles. These extrusions have been used typically for parts subject to excessive warpage during machining processes and for parts requiring high strength and damage tolerance, where fabrication does not normally involve welding.

Manufacturing Considerations — Certain processing procedures may cause these extrusions to become susceptible to stress-corrosion cracking; ARP823 (Reference 3.2.1.0) recommends practices to minimize such conditions.

Heat Treatment — Extruded, solution heat treated and stress-relieved by stretching to produce a nominal permanent set of 1.5%, but not less than 1% nor more than 3%, to the T3511 temper. Solution heat treatment shall be performed in accordance with AMS 2772.

Specifications and Properties — Material specifications are shown in Table 3.2.1.0(a). Room temperature mechanical and physical properties are shown in Table 3.2.1.0 (b).

Table 3.2.1.0(a). Material Specifications for 2026-T3511

Specification	Form
Draft Specification for AMS	Extruded bars, rods, and profiles

Table 3.2.1.0(b). Typical Mechanical and Physical Properties of 2026-T3511 Aluminum Alloy Extruded Bars, Rods, and Profiles

Specification	Draft Specification for AMS (see Appendix C)							
Form	Extrusion							
Condition (or Temper)	T3511							
Thickness, mm.	<6.35				6.35 - 12.6			
	n / lots/ heats ^a	Avg.	Std. Dev.	Skew	n / lots/ heats ^a	Avg.	Std. Dev.	Skew
Mechanical Properties:								
<i>TUS</i> , MPa								
L	59/9/3	504	12	-0.20	46/3/3	520	13	0.69
LT	—	—	—	—	4/1	455	5	-0.55
<i>TYS</i> , MPa								
L	59/9/3	374	10	-0.10	46/3/3	384	10	0.70
LT	—	—	—	—	4/1	333	4	-1.14
<i>CYS</i> , MPa								
L	22/6	330	13	0.62	4/1	351	3	0.16
LT	—	—	—	—	4/1	354	3	-1.77
<i>SUS</i> , MPa								
L	22/6	291	8	0.01	4/1	282	3	-1.73
LT	—	—	—	—	—	—	—	—
<i>BUS</i> , MPa:								
(e/D = 1.5) L	22/6	693	18	0.32	4/1	699	16	1.96
LT	—	—	—	—	—	—	—	—
(e/D = 2.0) L	22/6	874	16	-0.88	4/1	866	12	1.45
LT	—	—	—	—	—	—	—	—
<i>BYS</i> , MPa:								
(e/D = 1.5) L	22/6	494	25	-0.18	4/1	502	6	-0.27
LT	—	—	—	—	—	—	—	—
(e/D = 2.0) L	22/6	605	29	0.44	4/1	611	16	-1.93
LT	—	—	—	—	—	—	—	—
<i>elong.</i> , percent								
L	58/9/3	16.3	1.4	-0.43	46/3/3	18.0	0.6	0.05
LT	—	—	—	—	—	—	—	—
<i>Red. of Area</i> , percent								
E, GPa	—	—	—	—	—	—	—	—
E _c , GPa	22/6	74	1	-0.30	—	74 ^b	—	—
G, GPa	28 ^c							
μ	0.33 ^c							

a *n* represents the number of data points, *lots* represent the number of lots, *heats* represent the number of heats. Refer to Section 9.1.3 for definitions.

b Test value from <0.250 thickness range.

c Reported value.

Table 3.2.1.0(b) Continued. Typical Mechanical and Physical Properties of 2026-T3511 Aluminum Alloy Extruded Bars, Rods, and Profiles

Specification	Draft Specification for AMS (see Appendix C)							
	Extrusion							
	T3511							
	12.7 - 38.0				38.1 - 57.1			
	n / lots/ heats ^a	Avg.	Std. Dev.	Skew	n / lots/ heats ^a	Avg.	Std. Dev.	Skew
Mechanical Properties:								
<i>TUS</i> , MPa								
L	85/23/8	541	10	-0.72	70/17/4	532	9	0.09
LT	38/7/3	486	8	0.58	6/1/1	469	2	-0.91
<i>TYS</i> , MPa								
L	85/23/8	403	12	0.28	70/17/4	405	10	0.46
LT	28/7/3	344	8	-0.12	6/1/1	335	2	-0.51
<i>CYS</i> , MPa								
L	28/7	369	15	0.31	4/1	368	4	-0.44
LT	24/6	364	9	0.12	4/1	354	3	1.01
<i>SUS</i> , MPa								
L	28/7	254	4	0.24	4/1	248	2	0.00
LT	24/6	250	4	-0.17	4/1	238	7	1.90
<i>BUS</i> , MPa:								
(e/D = 1.5) L	28/7	694	11	-0.38	4/1	690	2	0.00
LT	20/5	680	14	-0.23	4/1	662	6	-0.00
(e/D = 2.0) L	28/7	865	18	-0.33	4/1	857	14	0.68
LT	20/5	845	14	0.27	4/1	810	10	-1.62
<i>BYS</i> , MPa:								
(e/D = 1.5) L	28/7	484	11	-0.33	4/1	481	4	-0.20
LT	20/5	475	11	-0.54	4/1	468	11	0.68
(e/D = 2.0) L	28/7	604	11	0.21	4/1	594	2	0.89
LT	20/5	599	14	-0.20	4/1	577	13	1.22
<i>elong.</i> , percent								
L	84/23/8	16.3	1.8	-0.52	70/17/4	15.6	1.2	0.15
LT	35/7/3	20.1	1.6	-1.03	6/1/1	18.5	1.0	0.90
<i>Red. of Area</i> , percent								
L	—	—	—	—	—	—	—	—
LT	—	—	—	—	—	—	—	—
<i>E</i> , GPa								
					—			
<i>E_c</i> , GPa								
					74 ^b			
<i>G</i> , GPa								
					28 ^c			
μ								
					0.33 ^c			

a *n* represents the number of data points, *lots* represent the number of lots, *heats* represent the number of heats. Refer to Section 9.1.3 for definitions.

b Test value from Table 3.2.1.0(b₁).

c Reported value.

Table 3.2.1.0(b) Continued. Typical Mechanical and Physical Properties of 2026-T3511 Aluminum Alloy Extruded Bars, Rods, and Profiles

Specification	Draft Specification for AMS (see Appendix C)			
	Extrusion			
	T3511			
	57.2 - 82.6			
Form				
Condition (or Temper)				
Thickness, mm				
	n / lots/ heats ^a	Avg.	Std. Dev.	Skew
Mechanical Properties:				
<i>TUS</i> , MPa				
L	51/5/3	542	11	-0.08
LT	35/5/3	448	11	0.57
<i>TYS</i> , MPa				
L	51/5/3	407	10	0.08
LT	35/5/3	316	11	0.53
<i>CYS</i> , MPa				
L	18/5	379	11	-1.63
LT	18/5	331	6	0.75
<i>SUS</i> , MPa				
L	18/5	252	4	-0.06
LT	18/5	244	4	0.70
<i>BUS</i> , MPa:				
(e/D = 1.5) L	18/5	692	13	0.41
LT	18/5	638	10	-1.18
(e/D = 2.0) L	18/5	863	21	0.80
LT	18/5	796	13	0.70
<i>BYS</i> , MPa:				
(e/D = 1.5) L	18/5	478	9	1.02
LT	18/5	467	8	2.13
(e/D = 2.0) L	18/5	595	13	1.62
LT	18/5	582	11	-0.84
<i>elong.</i> , percent				
L	51/5/3	15.5	1.2	-0.47
LT	35/5/3	15.3	1.7	-0.16
<i>Red. of Area</i> , percent				
L	—	—	—	—
LT	—	—	—	—
<i>E</i> , GPa			—	
<i>E_c</i> , GPa			74 ^b	
<i>G</i> , GPa			28 ^c	
<i>μ</i>			0.33 ^c	

a *n* represents the number of data points, *lots* represent the number of lots, *heats* represent the number of heats. Refer to Section 9.1.3 for definitions.

b Test value from Table 3.2.1.0(b₁).

c Reported value.

3.2.2 2224A-T351 (AL-CU-MG) (RUSSIAN ALLOY 1163-T7)

3.2.2.0 Comments and Properties — Aluminum alloy 2224A-T351 is the assigned aluminum number for the Russian alloy 1163-T7. Chemical composition is similar to 2124 aluminum, with reduced upper limits for copper, magnesium and manganese, and reduced levels of iron and silicon. Physical properties are also similar to 2124/2224.

Manufacturing Considerations — Produced in plate form, can be spot and roller welded.

Environmental Considerations — Corrosion resistance is similar to 2124/2224 aluminum.

Heat Treatment — 2224A-T351 is full annealed at 380 - 420°C (716 - 788°F) for 10 to 60 minutes, cooled no more than 30°C (86°F) per hour to 260°C (500°F), then air cooled. During hot rolling, the alloy is heated to between 300 and 470°C (572 and 878°F) and allowed to air cool.

Specifications and Properties — Material specifications are shown in Table 3.2.2.0(a).

Table 3.2.2.0(a). Material Specifications for 2224A-T351 (Russian alloy 1163-T7)

Specification	Form
Russian TU 1-92-81-87	Plate

Room temperature mechanical and physical properties are shown in Table 3.2.2.0 (b). Refer to Appendix D for a comparison of Russian test methods to ASTM test methods.

Table 3.2.2.0(b). Typical Mechanical and Physical Properties of 2224A-T351 (Russian Alloy 1163-T7) Plate

Specification	Russian TU-1-92-81-87 (See Appendix C)			
Form	Plate			
Condition (or Temper) ...	Hot-rolled, quenched and naturally aged			
Thickness, mm	30 - 38			
	n / lots ^a	Avg.	Std. Dev.	Skew
Mechanical Properties:				
<i>TUS</i> , MPa:				
L	724/724	493	16	-0.00
LT (or T)	335/335	471	11	0.16
<i>TYS</i> , MPa:				
L	721/721	379	20	0.35
LT (or T)	341/341	341	15	0.43
<i>CYS</i> , MPa	—	—	—	—
<i>SUS</i> , MPa	—	—	—	—
<i>BUS</i> , MPa:				
(e/D = 1.5)	—	—	—	—
(e/D = 2.0)	—	—	—	—
<i>BYS</i> , MPa:				
(e/D = 1.5)	—	—	—	—
(e/D = 2.0)	—	—	—	—
<i>elong.</i> , percent:				
L	725/725	16.5	2.8	0.48
LT (or T)	340/340	17.0	1.9	-0.09
<i>Red. of Area</i> , percent ..	—	—	—	—
<i>E</i> , GPa	—			
<i>E_c</i> , GPa	—			
<i>G</i> , GPa	—			
<i>μ</i>	—			
Physical Properties:				
<i>ω</i> , Mg/m ³	2.768			
<i>C</i> , J/(g°K)	See Figure 3.2.2.0(a)			
<i>K</i> , W/(m°K)	See Figure 3.2.2.0(b)			
<i>α</i> , 10 ⁻⁶ m/m°K)	See Figure 3.2.2.0(c)			

^a *n* represents the number of data points, *lots* represents the number of lots. Refer to Section 9.1.3 for definitions.

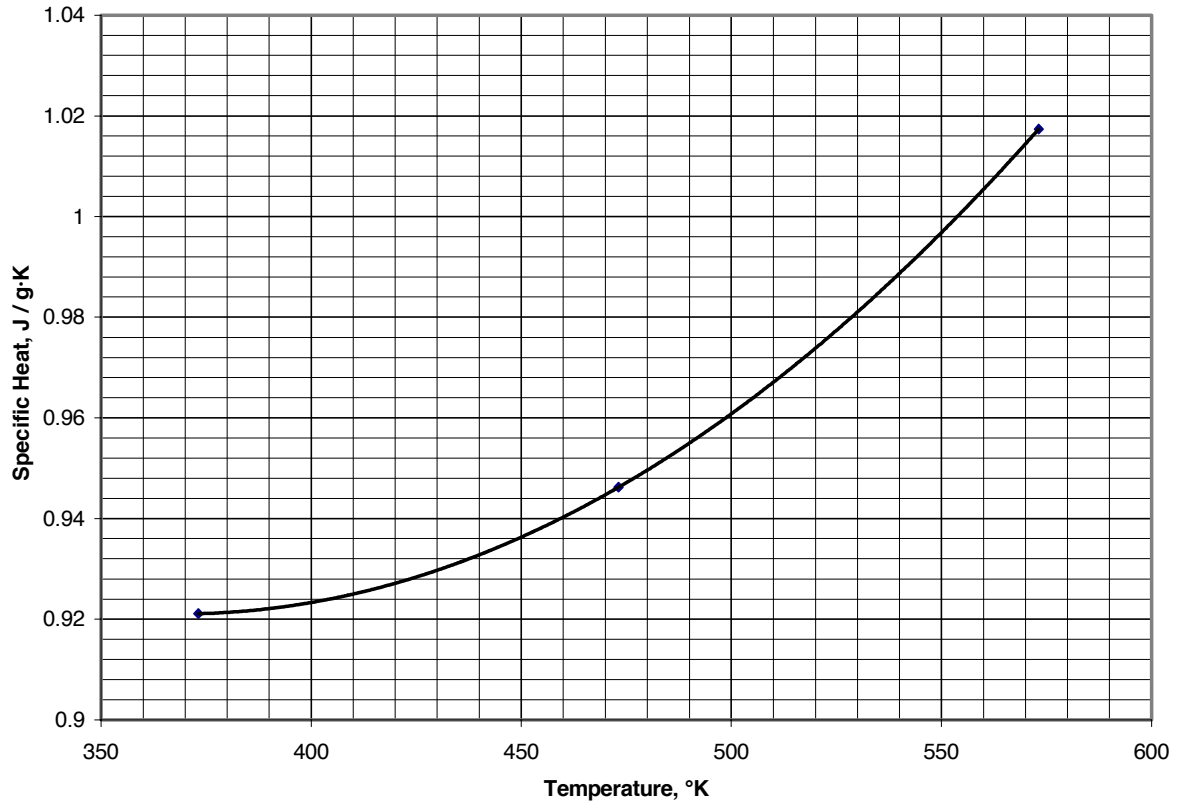

Figure 3.2.2.0(a). Effect of temperature on specific heat of 2224A-T351.

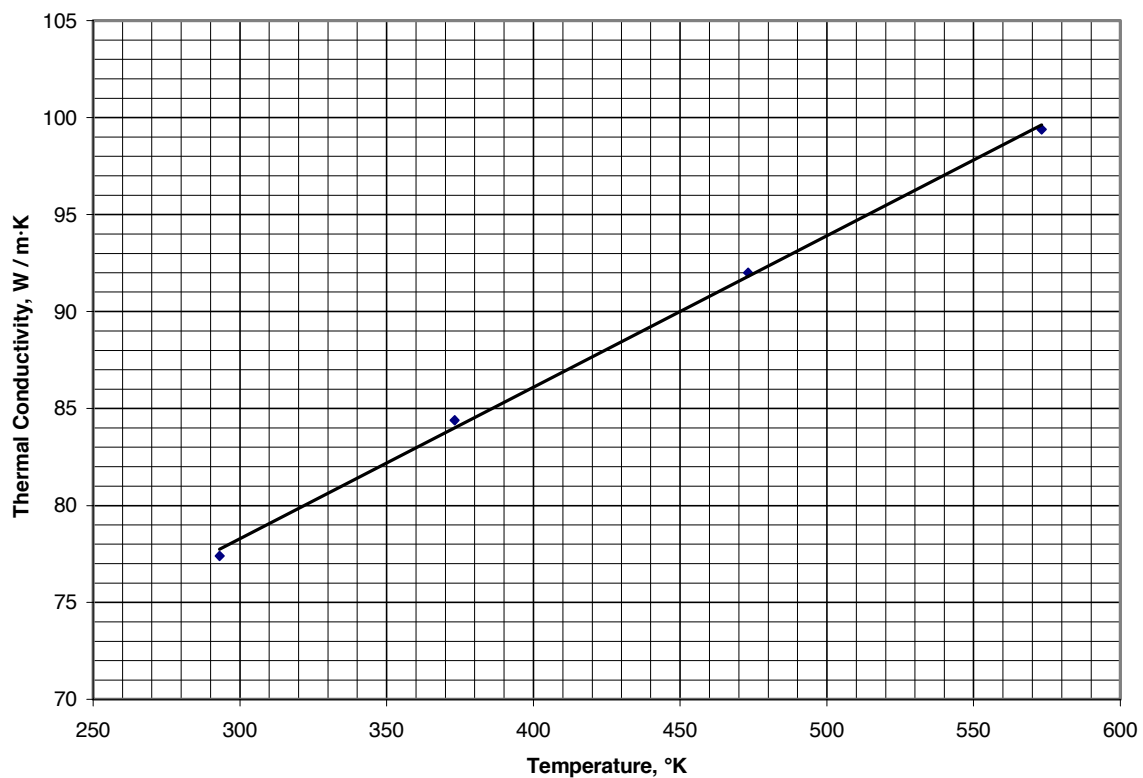

Figure 3.2.2.0(b). Effect of temperature on thermal conductivity of 2224A-T351.

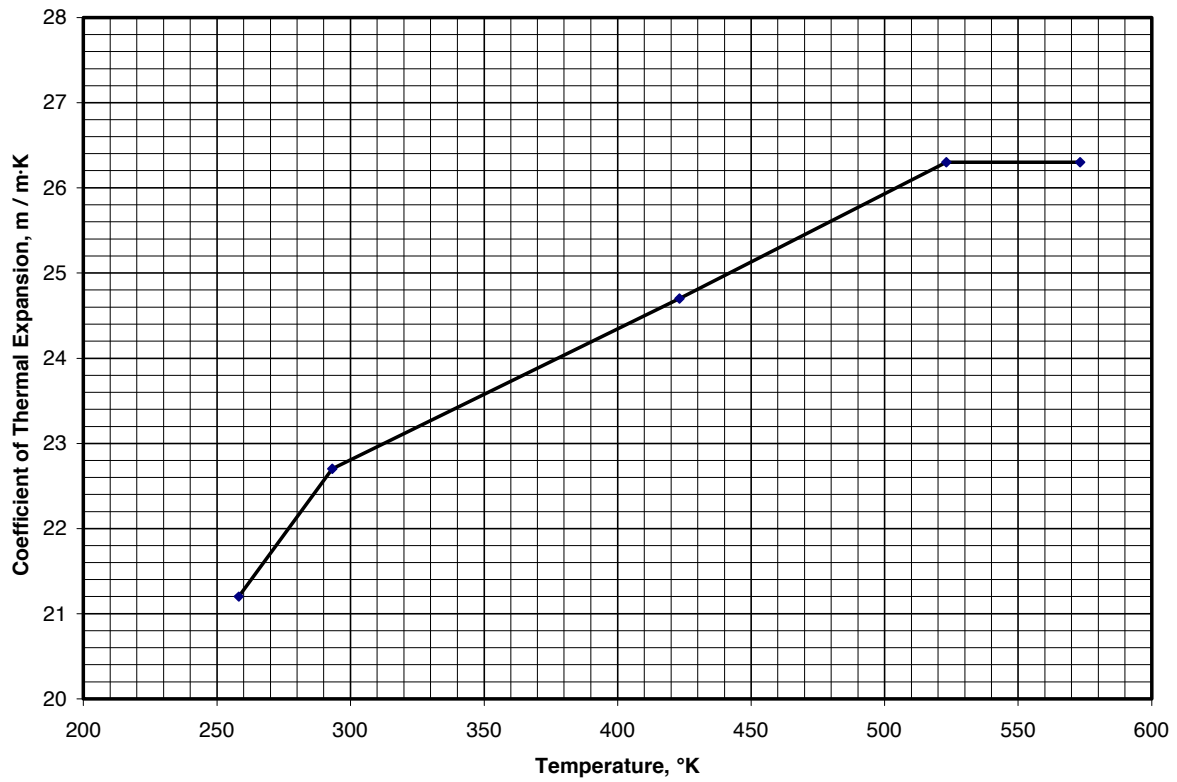

Figure 3.2.2.0(c). Effect of temperature on coefficient of thermal expansion of 2224A-T351.

3.2.3 2297-T8R85

3.2.3.0 COMMENTS AND PROPERTIES — 2297 is an Al-Cu-Li-Mn-Zr plate alloy for damage tolerant and durability applications. The alloy shows excellent fracture toughness and ductility in all test directions including short longitudinal (S-L) direction with excellent stress-corrosion cracking resistance. An additional attribute of this alloy that makes it suitable for bulkhead applications is its isotropic mechanical properties. Tensile properties for this alloy were isotropic in all three in-plane test directions (i.e., L, LT, and 45 degree direction) in regards to the original rolling direction.

Environmental Considerations — 2297-T8R85 has an EA EXCO rating.

Heat Treatment — 2297 aluminum alloy is solution-heat treated by holding at heat for a time commensurate with section thickness, and rapid cooling in a suitable quenching medium. It is stretched to produce a nominal permanent set of 2.75% but not more than 6.75%. It is artificially aged to T8R87 as required to meet minimum property requirements.

Specifications and Properties — Material specifications are shown in Table 3.2.3.0 (a). Room temperature mechanical and physical properties are shown in Table 3.2.3.0 (b). Fracture toughness properties are shown in Table 3.2.3.0(c). Cyclic stress-strain and strain-life curves are shown in Figure 3.2.3.0(a). Fatigue crack propagation is shown in Figure 3.2.3.0(b).

**Table 3.2.3.0(a). Material Specifications for
2297-T8R85 Aluminum Alloy**

Specification	Form
AMS D-00AE (Draft)	Plate

Table 3.2.3.0(b). Typical Mechanical and Physical Properties of 2297-T8R85 Plate

Specification	AMS D-00AE (Draft) (see Appendix C)			
Form	Plate			
Condition (or Temper) . . .	T8R85			
Thickness or diameter, mm	102 - 127			
	n / lots ^a	Avg.	Std. Dev.	Skew
Mechanical Properties:				
<i>TUS</i> , MPa:				
L	115/46	446	12	1.07
LT	115/46	452	9	0.39
ST	174/46	438	10	-0.20
<i>TYS</i> , MPa:				
L	115/46	412	11	1.01
LT	115/46	409	9	0.43
ST	174/46	386	9	0.30
<i>CYS</i> , MPa:	—	—	—	—
<i>SUS</i> , MPa:	—	—	—	—
<i>BUS</i> , MPa:				
(e/D = 1.5)	—	—	—	—
(e/D = 2.0)	—	—	—	—
<i>BYS</i> , MPa:				
(e/D = 1.5)	—	—	—	—
(e/D = 2.0)	—	—	—	—
<i>elong.</i> , percent:				
L	115/46	11.6	1.0	-0.84
LT	115/46	8.0	0.8	0.17
ST	174/46	5.2	0.9	0.22
<i>Red. of Area</i> , percent: . .	—	—	—	—
<i>E</i> , GPa			—	
<i>E_c</i> , GPa			—	
<i>G</i> , GPa			—	
μ			—	

a *n* represents the number of data points, *lots* represent the number of lots. Refer to Section 9.1.3 for definitions.

Table 3.2.3.0(c). Typical Fracture Toughness Properties of 2297-T8R85 Plate

Specification	AMS D-00AE (Draft) (See Appendix C)			
Form	Plate			
Condition (or Temper) ...	T8R85			
Thickness or diameter, mm	102 to 127			
	n / lots ^a	Avg.	Std. Dev.	Skew
Mechanical Properties:				
<i>K_{Ic}</i> , MPa·m				
L-T	46/46	42	4	0.19
T-L	46/46	34	2	0.20
S-L	47/46	27	2	-0.10

a *n* represents the number of data points, *lots* represent the number of lots. Refer to Section 9.1.3 for definitions.

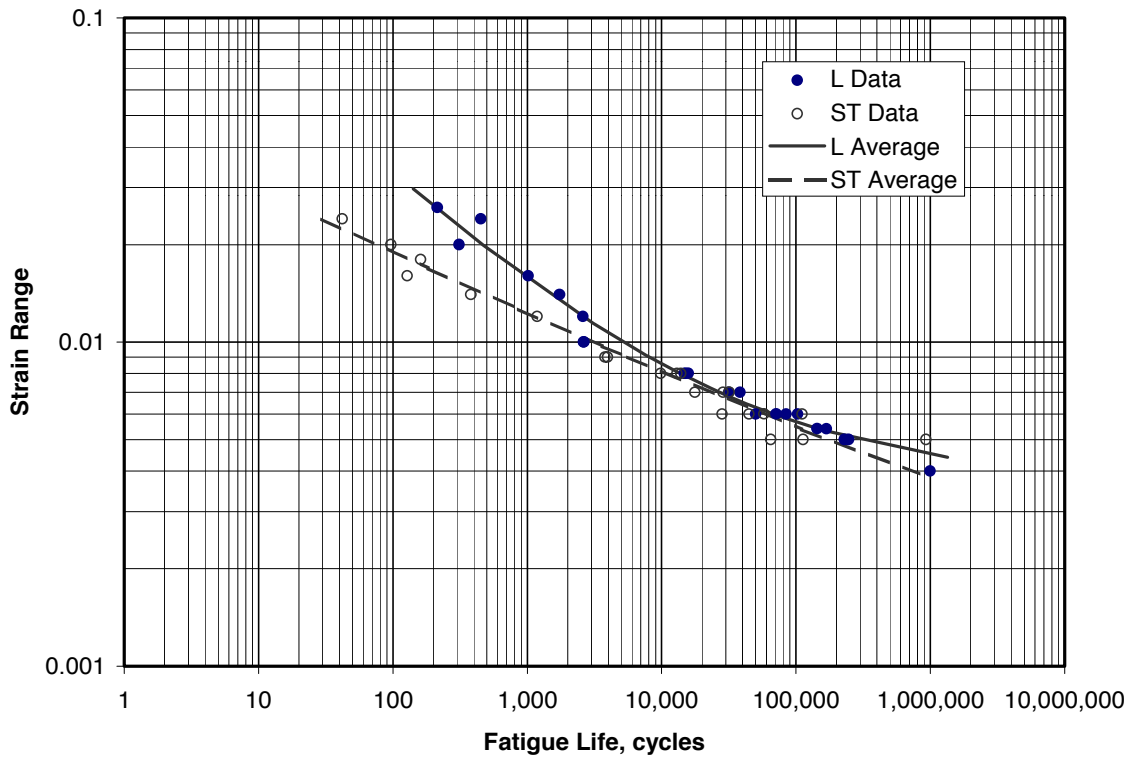
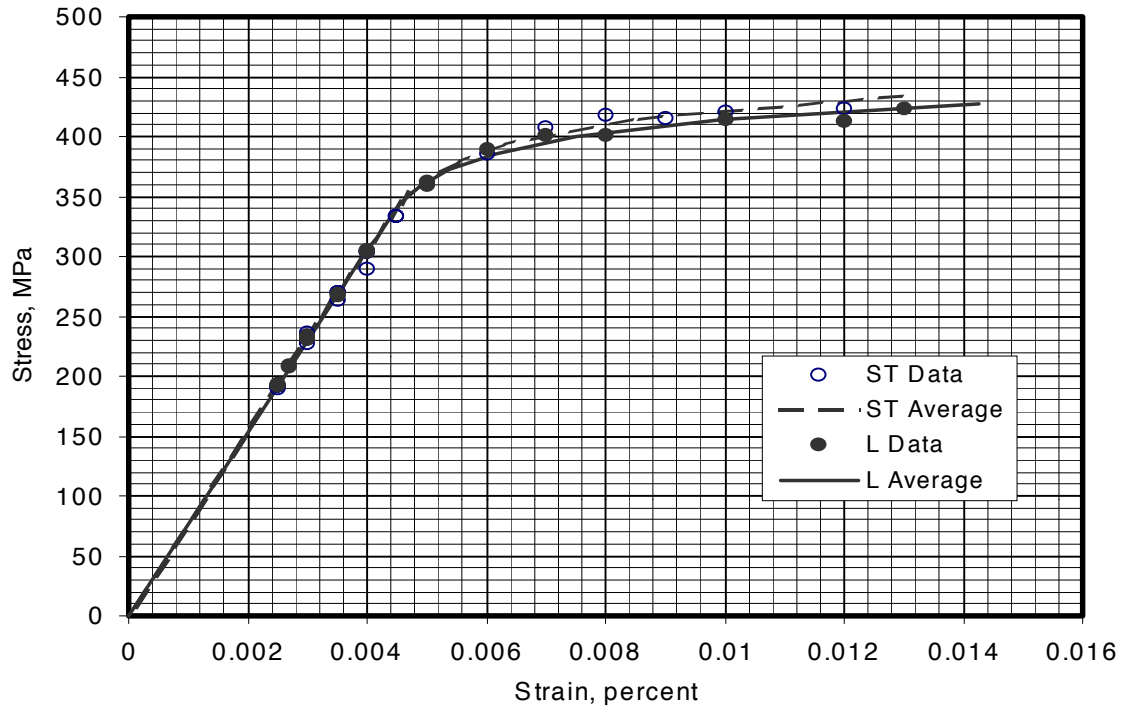

Figure 3.2.3.0(a). Cyclic stress-strain and strain-life curves for 2297-T8R85, 101.6 mm plate.

Correlative Information for Figure 3.2.3.0(a)

Product Form: Plate, 101.6 mm thick

<u>Properties:</u>	<u>TUS, MPa</u>	<u>TYS, MPa</u>	<u>Temp., °F</u>
ST	438	386	RT
L	446	412	RT

Specimen Details:

Uniform gage test section
6.35-mm diameter

Surface Condition: Machined and polished along the length of the specimen using a commercial metal polishing paste called POL Metal Polish. The specimens had a mirror-like finish, estimated as an RMS of 4.

Reference: 3.2.3.0

Test Parameters:

Frequency - 0.5 - 5 Hz. (Higher frequencies typically used for the longer tests at the lower strains.)

Temperature - RT

Environment - Lab Air (approx. 50% relative humidity)

No. of Heats/Lots: 1

Strain Ratio = -1

Stress-Strain Equations:

ST Direction

$(\Delta\epsilon)/2 = \sigma/E + \epsilon_p$ where

$E = 77.91 \text{ GPa}$ (reported),

$\epsilon_p = 1.33 \times 10^{-12} \sigma^{3.187}$ for $\sigma < 351 \text{ MPa}$, and

$\epsilon_p = 2.82 \times 10^{-49} \sigma^{17.598}$ for $\sigma > 351 \text{ MPa}$.

L Direction

$(\Delta\epsilon)/2 = \sigma/E + \epsilon_p$ where

$E = 77.91 \text{ GPa}$ (reported),

$\epsilon_p = 160\sigma^{3.566}$ for $\sigma < 345 \text{ MPa}$, and

$\epsilon_p = 24.99 \times 10^{-54} \sigma^{19.478}$ for $\sigma > 345 \text{ MPa}$.

Equivalent Strain Equations:

ST Direction

$\text{Log } N_f = -6.66 - 4.96 \log(\epsilon_t - 0.001)$

Standard Error of Estimate = 0.249

Standard Deviation in Life = 0.864

$R^2 = 96 \%$

Sample Size = 21

L Direction

$\text{Log } N_f = -1.88 - 2.54 \log(\epsilon_t - 0.0037)$

Standard Error of Estimate = 0.141

Standard Deviation in Life = 0.722

$R^2 = 98 \%$

Sample Size = 21

Specimen Thickness: 12.7 mm

Environment: > 90% Rel. Humidity

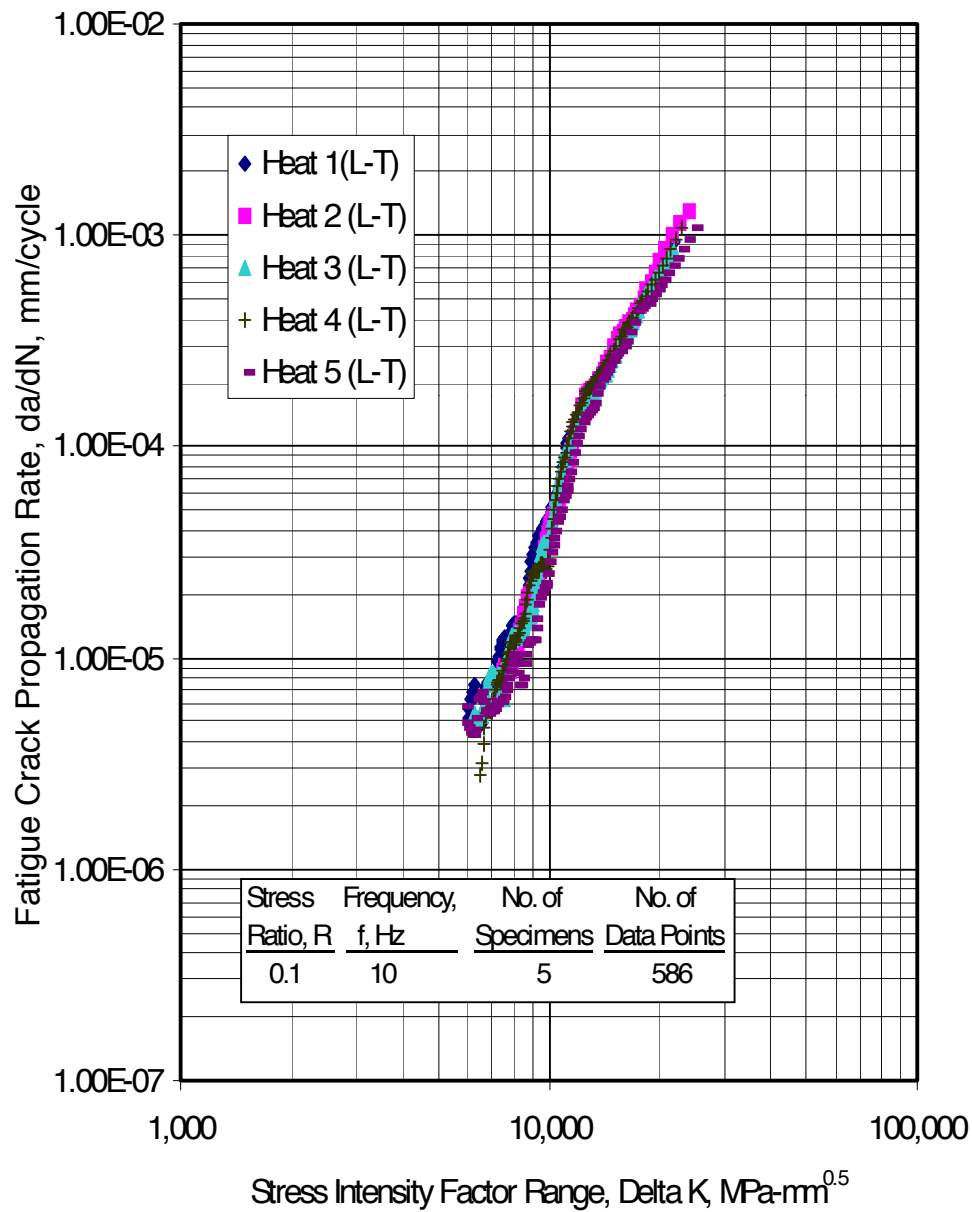

Figure 3.2.3.0(b). Fatigue-crack propagation data for 101.6 mm thick 2297-T8R85 aluminum alloy plate.

Specimen Width: 76.2 mm
 Specimen Type: C(T)

Temperature: RT
 Orientation: L-T

3.3 3000 SERIES WROUGHT ALLOYS

3.4 4000 SERIES WROUGHT ALLOYS

3.5 5000 SERIES WROUGHT ALLOYS

3.6 6000 SERIES WROUGHT ALLOYS

3.7 7000 SERIES WROUGHT ALLOYS

The 7000 series of wrought alloys contain zinc as the principal alloying element and magnesium and copper as other major elements. They are available in a wide variety of product forms. They are strengthened principally by solution heat treatment and precipitation hardening, and are among the highest strength aluminum alloys.

3.7.1 7040-T7451

3.7.1.0 *Comments and Properties* — 7040 alloy is an Al-Mg-Zn-Cu-Zr alloy developed to provide a higher strength/toughness compromise than the currently available 7010 and 7050 alloys, in particular in heavy gauge plates up to 8.5 inch (215 mm) thickness. The use of a desaturated chemical composition in Mg and Cu together with a very close control of the Zr content and impurities, provide 7040 with a much lower quench sensitivity than that of 7050, resulting in high strength and toughness properties in very thick sections.

7040-T7451 plates are particularly suited for structures in which high strength, high toughness and good corrosion resistance are the major requirements. Parts such as integrally machined spars, ribs and main fuselage frames can benefit from this outstanding property combination.

7040 is available in the form of plates, in the thickness range 3.0 to 8.5 inches (76.2 to 215 mm).

Manufacturing Considerations — Due to tight control of residual stress level, the 7040 plates exhibit a superior dimensional stability, thus offering a cost-efficient alternative to rolled or forged parts which require distortion corrections after machining.

Heat Treatment — solution heat treatment shall be performed by heating to 880 to 895°F (470 to 480°C) and holding at least for a time commensurate with section thickness. It should be followed by rapid cooling in a suitable quenching medium.

T7451 temper is obtained through a conventional two-stage heat treatment, proprietary to the producer and available upon request.

Specifications and Properties — Material specifications are shown in Table 3.7.1.0(a).

**Table 3.7.1.0(a). Material Specifications for
7040-T7451 Alloy Plate**

Specification	Form
AMS D-99AA (draft)	Plate

Room temperature mechanical and physical properties are shown in Table 3.7.1.0(b) and (c). Fracture toughness properties are shown in Table 3.7.1.0(d). Figure 3.7.1.0(a) shows the effect of temperature on tensile properties.

Table 3.7.1.0(b). Typical Mechanical Properties of 7040-T7451 Plate^a

Specification	AMS D-99AA (Draft) (See Appendix C)							
	Plate							
	T7451							
	77 to 102				103 to 127			
	n / lots ^b	Avg.	Std. Dev.	Skew	n / lots ^b	Avg.	Std. Dev.	Skew
Mechanical Properties:								
<i>TUS</i> , MPa:								
L	32/5	508	4	-0.20	36/3	502	2	-0.45
LT	41/4	522	3	0.94	36/3	511	1	-0.30
ST	33/5	500	8	1.29	48/3	488	3	0.64
<i>TYS</i> , MPa:								
L	32/5	458	3	0.02	36/3	450	3	-0.97
LT	41/4	460	4	1.20	36/3	448	3	-0.33
ST	33/5	436	8	-0.14	48/3	429	4	0.35
<i>CYS</i> , MPa:								
L	6/3	444	2	1.13	—	—	—	—
LT	6/3	481	3	-0.64	—	—	—	—
ST	6/3	474	1	1.65	—	—	—	—
<i>SUS</i> , MPa:								
L								
L-S	6/3	332	2	-0.94	—	—	—	—
L-T	6/3	338	3	0.80	—	—	—	—
LT								
T-L	6/3	336	4	0.53	—	—	—	—
T-S	6/3	329	3	-1.11	—	—	—	—
ST								
S-L	8/4	282	11	-1.35	—	—	—	—
S-T	8/4	288	7	-0.62	—	—	—	—
<i>BUS</i> , MPa:								
($\epsilon/D = 1.5$)								
L	6/3	832	10	1.08	—	—	—	—
LT (or T)	6/3	831	7	-1.52	—	—	—	—
($\epsilon/D = 2.0$)								
L	6/3	1068	6	-0.78	—	—	—	—
LT (or T)	6/3	1067	4	-0.02	—	—	—	—
<i>BYS</i> , MPa:								
($\epsilon/D = 1.5$)								
L	6/3	701	6	-1.03	—	—	—	—
LT (or T)	6/3	703	5	0.44	—	—	—	—
($\epsilon/D = 2.0$)								
L	6/3	850	14	0.82	—	—	—	—
LT (or T)	6/3	864	8	0.63	—	—	—	—
L	32/5	13.1	1.0	0.58	36/3	12.3	0.5	0.06
LT (or T)	41/4	10.0	0.7	0.31	36/3	9.6	0.4	0.46
L	32/5	6.8	2.0	-0.00	48/3	7.2	0.9	-0.09
LT (or T)								
ST	6/3	34.8	3.7	0.17	—	—	—	—
<i>Red. of Area</i> , percent:								
L	33/4	17.4	2.4	-0.51	—	—	—	—
LT (or T)	6/3	11.7	2.4	-0.67	—	—	—	—
ST								

^a Modulus properties and Physical properties are on Table 3.7.1.0(c).

Table 3.7.1.0(b) Continued. Typical Mechanical Properties of 7040-T7451 Plate^a

Specification	AMS D-99AA (Draft) (See Appendix C)							
	Plate							
	T7451							
	128 to 153				154 to 178			
	n / lots ^b	Avg.	Std. Dev.	Skew	n / lots ^b	Avg.	Std. Dev.	Skew
Mechanical Properties:								
<i>TUS</i> , MPa:								
L	48/4	504	3	0.37	42/5	493	5	2.19
LT	31/5	515	4	0.80	46/8	498	7	0.15
ST	45/4	493	6	1.21	31/5	479	7	0.18
<i>TYS</i> , MPa:								
L	48/4	460	4	0.92	42/5	443	4	-0.24
LT	31/5	458	5	1.21	46/8	436	7	0.57
ST	45/4	435	6	1.34	31/5	417	8	1.73
<i>CYS</i> , MPa:								
L	4/2	448	2	-0.44	—	—	—	—
LT	4/2	482	2	1.20	—	—	—	—
ST	4/2	475	1	0.00	—	—	—	—
<i>SUS</i> , MPa:								
L								
L-S	4/2	328	4	0.00	—	—	—	—
L-T	4/2	335	2	-0.48	—	—	—	—
LT								
T-L	4/2	332	2	0.76	—	—	—	—
T-S	4/2	325	1	0.00	—	—	—	—
ST								
S-L	6/3	290	8	-0.83	—	—	—	—
S-T	6/3	302	5	0.27	—	—	—	—
<i>BUS</i> , MPa:								
(e/D = 1.5)								
L	4/2	813	12	-0.83	—	—	—	—
LT (or T)	4/2	820	9	1.20	—	—	—	—
(e/D = 2.0)								
L	4/2	1042	7	1.94	—	—	—	—
LT (or T)	4/2	1048	4	-0.68	—	—	—	—
<i>BYS</i> , MPa:								
(e/D = 1.5)								
L	4/2	692	12	-0.67	—	—	—	—
LT (or T)	4/2	693	5	-0.90	—	—	—	—
(e/D = 2.0)								
L	4/2	853	9	-0.70	—	—	—	—
LT (or T)	4/2	854	4	-0.77	—	—	—	—
LT (or T)	48/4	11.9	0.9	0.52	42/5	11.4	1.3	-0.13
<i>elong.</i> , percent:	30/5	8.4	1.1	0.09	46/8	8.3	0.9	0.13
L	45/4	6.7	0.9	1.28	31/5	6.0	1.3	0.37
LT (or T)								
ST	4/2	25.4	0.8	-0.51	—	—	—	—
<i>Red. of Area</i> , percent:	23/3	12.7	1.0	-0.84	—	—	—	—
L	4/2	9.3	1.5	-0.43	—	—	—	—
LT (or T)								
ST								

^a Modulus properties and Physical properties are on Table 3.7.1.0(c).

Table 3.7.1.0(b) Continued. Typical Mechanical Properties of 7040-T7451 Plate^a

Specification	AMS D-99AA (Draft) (See Appendix C)							
	Plate							
	T7451							
	179 to 204				205 to 229			
	n / lots ^b	Avg.	Std. Dev.	Skew	n / lots ^b	Avg.	Std. Dev.	Skew
Mechanical Properties:								
<i>TUS</i> , MPa:								
L	36/3	484	2	1.17	32/5	507	7	-1.13
LT	36/3	488	2	0.25	56/5	502	12	-0.38
ST	33/3	465	4	0.24	38/5	484	7	-0.19
<i>TYS</i> , MPa:								
L	36/3	430	3	-0.21	32/5	460	9	-1.19
LT	36/3	423	3	-1.00	56/5	446	13	-0.27
ST	33/3	399	3	0.28	38/5	429	10	-0.45
<i>CYS</i> , MPa:								
L	—	—	—	—	4/2	444	10	0.04
LT	—	—	—	—	4/2	455	4	0.23
ST	—	—	—	—	4/2	450	6	-0.11
<i>SUS</i> , MPa:								
L								
L-S	—	—	—	—	4/2	305	5	0.77
L-T	—	—	—	—	4/2	311	3	-0.37
LT								
T-L	—	—	—	—	4/2	315	3	-1.50
T-S	—	—	—	—	4/2	304	4	0.46
ST								
S-L	—	—	—	—	4/2	288	11	0.14
S-T	—	—	—	—	4/2	296	7	-1.18
<i>BUS</i> , MPa:								
(e/D = 1.5)								
L	—	—	—	—	4/2	766	9	1.12
LT (or T)	—	—	—	—	4/2	766	9	0.65
(e/D = 2.0)								
L	—	—	—	—	4/2	981	12	1.85
LT (or T)	—	—	—	—	4/2	988	11	-0.83
<i>BYS</i> , MPa:								
(e/D = 1.5)								
L	—	—	—	—	4/2	661	16	0.56
LT (or T)	—	—	—	—	4/2	652	14	0.17
(e/D = 2.0)								
L	—	—	—	—	4/2	810	12	0.37
LT (or T)	—	—	—	—	4/2	812	11	-1.18
L	36/3	10.8	0.6	0.67	32/5	9.3	0.8	-0.68
LT (or T)	36/3	7.6	0.4	-0.54	56/5	6.0	0.9	-0.66
L	33/3	7.8	1.0	0.29	37/5	5.4	0.8	0.78
LT (or T)	—	—	—	—	4/2	14.8	2.4	-0.02
ST	—	—	—	—	4/2	14.8	2.4	-0.02
<i>Red. of Area</i> , percent:								
L	—	—	—	—	20/2	9.6	1.2	0.01
LT (or T)	—	—	—	—	4/2	10.4	1.7	-1.86
ST	—	—	—	—	4/2	10.4	1.7	-1.86

^a Modulus properties and Physical properties are on Table 3.7.1.0(c).

Table 3.7.1.0(c). Typical Modulus and Physical Properties of 7040-T7451 Plate

Specification	AMS D-99AA (Draft) (See Appendix C)			
Form	Plate			
Condition (or Temper)	T7451			
Thickness, mm	77 to 229			
	n / lots ^a	Avg.	Std. Dev.	Skew
E , GPa	114/11	70	2	0.16
E_c , GPa	36/9	74	2	0.43
G , GPa	–	–	–	–
μ	–	–	–	–
Physical Properties:				
ω , Mg/m ³	2.823 (calculated)			
C , J/(g°K)	–			
K , W/(m°K)	–			
α , m/m°K	–			

a n represents the number of data points, $lots$ represents the number of lots. Refer to Section 9.1.3 for definitions.

Table 3.7.1.0(d). Typical Fracture Toughness Properties of 7040-T7451 Plate

Specification	AMS D-99AA (Draft) (See Appendix C)							
Form	Plate							
Condition (or Temper) ..	T7451							
Thickness, mm	77 to 102				103 to 127			
	n / lots ^a	Avg.	Std. Dev.	Skew	n / lots ^a	Avg.	Std. Dev.	Skew
Mechanical Properties:								
K_{Ic} , MPa-m ^{0.5}								
L-T	16/4	40	2	-0.90	17/3	35	1	0.05
T-L	16/4	33	1	-1.31	17/3	29	0	0.02
S-L	14/2	34	1	-0.87	17/3	29	1	0.68
	128 to 153				154 to 1778			
Mechanical Properties:								
K_{Ic} , MPa-m ^{0.5}								
L-T	17/4	35	1	-0.93	21/5	37	2	0.19
T-L	14/4	28	1	2.03	21/5	30	1	-0.39
S-L	16/4	29	1	0.90	21/5	32	1	-0.06
	179 to 204				205 to 229			
Mechanical Properties:								
K_{Ic} , MPa-m ^{0.5}								
L-T	18/3	35	1	-0.40	17/5	34	2	0.35
T-L	16/3	30	1	-0.17	13/5	26	1	0.74
S-L	13/3	32	1	-1.65	17/5	28	1	-0.34

a n represents the number of data points, $lots$ represents the number of lots. Refer to Section 9.1.3 for definitions.

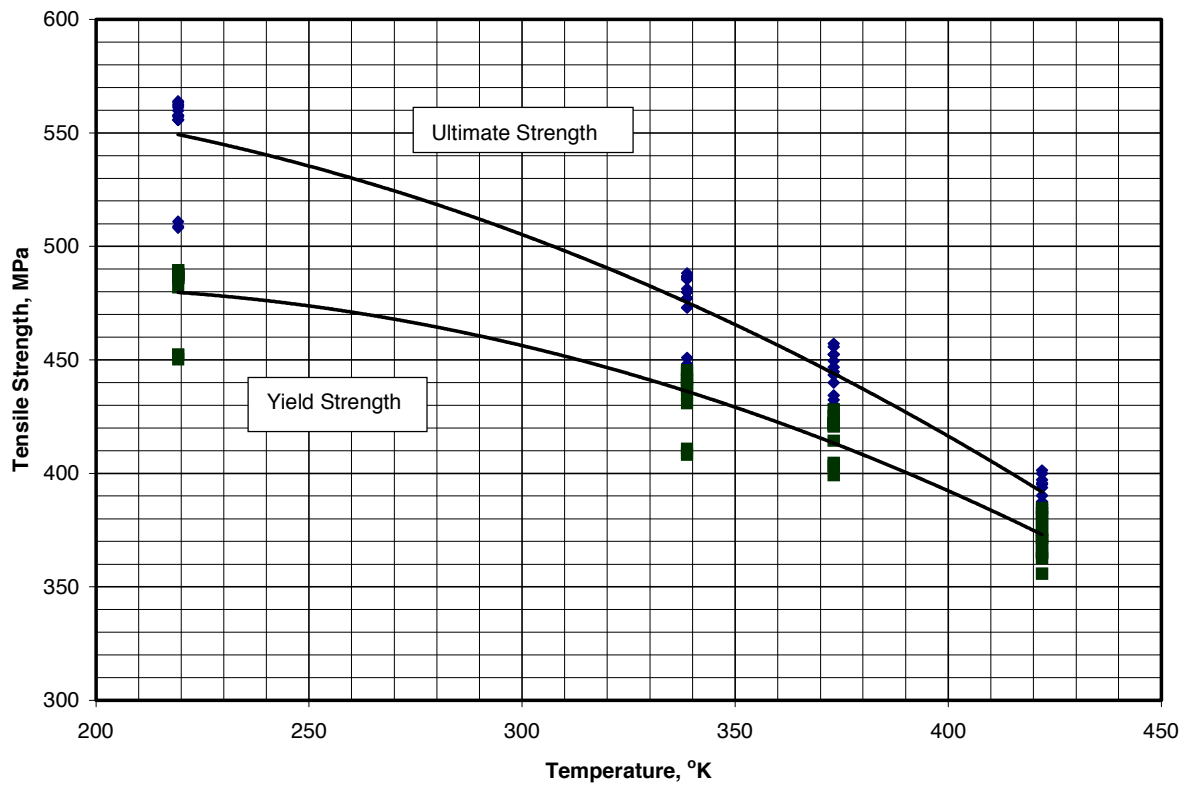

Figure 3.7.1(a). Effect of temperature on tensile strength of 7040-T7451.

3.7.2 7449-T7651

3.7.2.0 COMMENTS AND PROPERTIES — 7449 aluminum alloy is an Al-Mg-Zn-Cu-Zr alloy developed to provide higher strength and corrosion resistance than currently available with 7150. The over-aged T7651 temper has been specially designed for superior corrosion resistance, associated with a high level of mechanical strength and fracture toughness. 7449-T7651 is available in the form of fully stress-relieved plates, in thicknesses up to 2.5 inches. It is particularly suited for corrosion critical areas of compression dominated structures, such as upper wing skin panels.

Manufacturing Considerations — Due to optimized conventional two-stage ageing treatment, 7449-T7651 exhibits outstanding age-forming capability, enabling formed structures with superior dimensional tolerances at lower cost.

Heat Treatment — Solution heat treatment is performed by heating to 465 - 475°C (870°F to 890°F) and holding for a time commensurate with section thickness. It is followed by rapid cooling in a suitable quenching medium.

T7651 temper is obtained through a conventional two-stage heat treatment, proprietary to the producer.

Specifications and Properties — Material specifications are shown in Table 3.7.2.0(a). Room temperature mechanical and physical properties are shown in Table 3.7.2.0(b). Fracture toughness properties are shown in Table 3.7.2.0(c). Crack propagation data is shown in Figure 3.7.2.0.

Table 3.7.2.0(a). Material Specifications for 7449-T7651

Specification	Form
AMS D-99AE (Draft)	Plate

Table 3.7.2.0(b). Typical Mechanical and Physical Properties of 7449-T7651 Plate

Specification	AMS D-99AE (Draft) (See Appendix C)							
Form	Plate							
Condition (or Temper)	T7651							
Thickness, mm	6 to 38				39 to 64			
	n / lots ^a	Avg.	Std. Dev.	Skew	n / lots ^a	Avg.	Std. Dev.	Skew
Mechanical Properties:								
<i>TUS</i> , MPa:								
L	88/23	601	7	0.04	35/5	596	3	0.72
LT (or T)	109/25	597	5	-0.16	35/5	597	3	0.49
ST	6/2	578	2	0.00	35/5	583	5	-0.02
<i>TYS</i> , MPa:								
L	88/23	568	10	0.10	35/5	556	4	0.76
LT (or T)	109/25	566	8	-0.04	35/5	559	5	0.72
ST	6/2	508	3	0.39	35/5	530	5	1.12
<i>CYS</i> , MPa:								
L	78/19	569	13	-0.21	18/5	553	5	-0.04
LT (or T)	23/7	586	5	2.19	18/5	580	4	-0.21
<i>SUS</i> , MPa:								
L	4/3	-	-	-0.89	-	-	-	-
LT (or T)	4/3	-	-	1.52	-	-	-	-
<i>BUS</i> , MPa:								
(e/D = 1.5)								
L	20/10	849	17	0.76	6/2	840	12	1.11
LT (or T)	20/10	858	10	0.28	6/2	840	12	0.29
(e/D = 2.0)								
L	20/10	1103	20	-0.53	6/2	1098	13	-0.50
LT (or T)	20/10	1117	24	-1.34	6/2	1106	10	-1.13
<i>BYS</i> , MPa:								
(e/D = 1.5)								
L	20/10	706	18	-0.07	6/2	680	7	0.38
LT (or T)	20/10	710	18	-0.26	6/2	683	8	0.40
(e/D = 2.0)								
L	20/10	813	28	-0.70	6/2	770	11	0.29
LT (or T)	20/10	834	32	0.71	6/2	791	10	-0.24
<i>elong.</i> , percent:								
L	88/23	11.6	1.0	0.69	35/5	11.2	1.6	-0.09
LT (or T)	109/25	10.7	0.8	0.88	35/5	11.0	1.0	0.33
ST	6/2	7.4	0.9	0.54	35/5	6.5	1.1	-0.37

^a *n* represents the number of data points, *lots* represents the number of lots. Refer to Section 9.1.3 for definitions.

Table 3.7.2.0(b) Continued. Typical Mechanical and Physical Properties of 7449-T7651 Plate

Specification	AMS D-99AE (Draft) (See Appendix C)							
	Plate							
	T7651							
	6 to 38				39 to 64			
	n / lots ^a	Avg.	Std. Dev.	Skew	n / lots ^a	Avg.	Std. Dev.	Skew
Mechanical Properties Continue:								
E , GPa	—	—	—	—	—	—	—	—
E_c , GPa								
L	63/19	72	1	1.35	18/5	72	0	1.24
LT (or T)	23/7	74	2	1.10	18/5	74	0	0.26
G , GPa		27 ^b				27 ^b		
μ		0.33 ^b				0.33 ^b		
Physical Properties:								
ω , Mg/m ³		2.85 ^b				2.85 ^b		
C , J/(g°K)		—				—		
K , W/(m°K)		156 ^b				156 ^b		
α , 10 ⁻⁶ m/m°K		—				—		
Electrical conductivity, % IACS .	10/10	39.1	0.3	0.25	3/3	37.7	0.1	-1.73

a n represents the number of data points, $lots$ represents the number of lots. Refer to Section 9.1.3 for definitions.

b Values calculated by Pechiney

Table 3.7.2.0(c). Typical Fracture Toughness Properties of 7449-T7651 Plate

Specification	AMS D-99AE (Draft) (See Appendix C)			
	Plate			
	T7651			
	0.750 to 2.500			
	n / lots ^a	Avg.	Std. Dev.	Skew
Mechanical Properties:				
K_{Ic} , MPa-m ^{0.5}				
L-T	25/12	30	2	-0.11
T-L	25/12	27	1	0.34

a n represents the number of data points, $lots$ represents the number of lots. Refer to Section 9.1.3 for definitions.

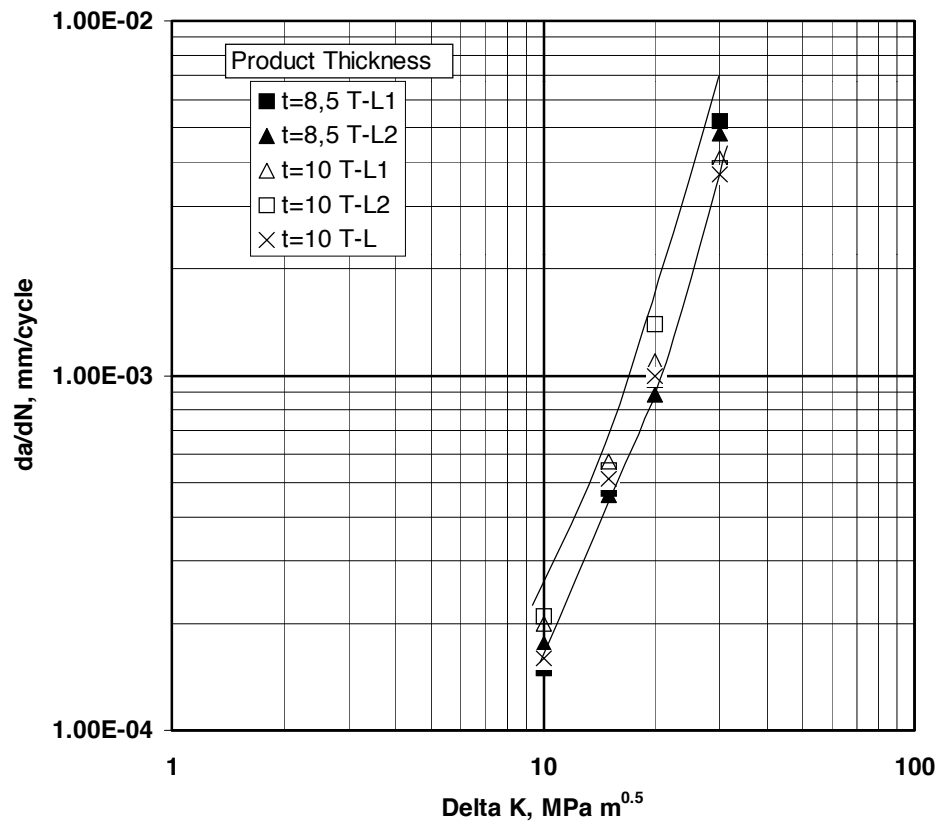

Figure 3.7.2.0. Crack propagation of 7449-T7651.

Correlative Information for Figure 3.7.2.0

Product Form: Plate

Test Parameters:

Specimen Details:

Temperature - RT
Environment - Air

M(T) Specimen

W = 160 mm, t = 5 mm

L-T direction

Initial notch = 3 mm

Preliminary fatigue up to a notch length
of 5 mm

No. of Heats/Lots: 3

Sample Size = 5

Reference: ASTM E647

3.7.3 7249-T76511

3.7.3.0 COMMENTS AND PROPERTIES — 7249 is an Al-Zn-Mg-Cu alloy with the composition adjusted to enhance corrosion resistance and toughness. The thermal mechanical processing has been optimized to maintain a high level of strength and high toughness, while providing for superior corrosion resistance.

The material has been used in structural applications requiring combinations of high tensile strength, fracture toughness, and good corrosion resistance. The alloy has been utilized in airframes generally as narrow extrusions for stringer, rib and spar caps, longerons, etc.; however, intended applications also include wide extrusions for wing panels, horizontal stabilizers, and struts. The alloy has comparable mechanical properties to 7075-T6511 with superior corrosion resistance and superior fracture toughness and is an alternative for 7075-T6511.

The alloy is available in extruded form up to 1.5 inches in thickness.

Heat Treatment — Solution heat treatment is performed by heating at 465 - 475°C and holding for a time commensurate with section thickness. It is followed by rapidly cooling in a suitable quenching medium. The T76511 temper is obtained through a tightly controlled conventional two step precipitation aging treatment.

Specifications and Properties — Material specifications are shown in Table 3.7.3.0(a). Room temperature mechanical and physical properties are shown in Table 3.7.3.0(b). Fracture toughness properties are shown in Table 3.7.3.0(c).

Table 3.7.3.0(a). Material Specifications for 7249-T76511

Specification	Form
AMS D-00AA (Draft)	Extruded bars, rods, shapes and tubing

Table 3.7.3.0(b). Typical Mechanical and Physical Properties of 7249-T76511 Aluminum Alloy Extruded Bars, Rods, Shapes, and Tubing

Specification	AMS D-00AA (Draft) (see Appendix C)							
	Extruded Bars, Rods, Shapes, and Tubing							
	T76511							
	2.03				2.54 - 10.80 ^b			
	n / heats ^a	Avg.	Std. Dev.	Skew	n / heats ^a	Avg.	Std. Dev.	Skew
Mechanical Properties:								
<i>TUS</i> , MPa								
L	31/3	595	11	1.14	61/5	585	7	0.60
LT	—	—	—	—	20/2	597	7	-0.06
<i>TYS</i> , MPa								
L	31/3	542	12	0.68	61/5	538	10	-0.73
LT	—	—	—	—	20/2	555	10	-0.02
<i>CYS</i> , MPa								
L	—	—	—	—	—	—	—	—
LT	—	—	—	—	—	—	—	—
<i>SUS</i> , MPa								
L	—	—	—	—	—	—	—	—
LT	—	—	—	—	—	—	—	—
<i>BUS</i> , MPa:								
(e/D = 1.5)	—	—	—	—	—	—	—	—
(e/D = 2.0)	—	—	—	—	—	—	—	—
<i>BYS</i> , MPa:								
(e/D = 1.5)	—	—	—	—	—	—	—	—
(e/D = 2.0)	—	—	—	—	—	—	—	—
<i>elong.</i> , percent								
L	31/3	11.5	1.7	0.10	61/5	13.2	1.8	0.48
LT	—	—	—	—	20/2	13.1	1.5	-0.20
<i>Red. of Area</i> , percent								
L	—	—	—	—	—	—	—	—
LT	—	—	—	—	—	—	—	—
E, GPa	—							
E _c , GPa	—							
G, GPa	—							
μ	—							
Physical Properties:								
ω , Mg/m ³	2.82 ^c							
C, J/(g°K)	Figure 3.7.3.0(a) ^c							
K, W/m°K	147 (at 25°C) ^c							
α , 10 ⁻⁶ m/m°K	22.14 (21 to 100°C) ^c							

a *n* represents the number of data points, *lots* represent the number of lots, *heats* represent the number of heats. Refer to Section 9.1.3 for definitions.

b Data for LT direction is within the 4.57 to 6.35-mm thickness range.

c Reported.

Table 3.7.3.0(b) Continued. Typical Mechanical and Physical Properties of 7249-T76511 Aluminum Alloy Extruded Bars, Rods, Shapes, and Tubing

Specification	AMS D-00AA (Draft) (see Appendix C)							
Form	Extruded Bars, Rods, Shapes, and Tubing							
Condition (or Temper)	T76511							
Thickness, mm	19.05				25.4 - 31.75			
	n / heats ^a	Avg.	Std. Dev.	Skew	n / heats ^a	Avg.	Std. Dev.	Skew
Mechanical Properties:								
<i>TUS</i> , MPa								
L	10/2	596	10	-0.59	111/21	582	10	-0.53
LT	10/2	571	4	-0.40	110/21	554	9	0.41
<i>TYS</i> , MPa								
L	10/2	552	7	0.84	111/21	534	12	-0.06
LT	10/2	521	6	0.06	110/21	503	9	0.26
<i>CYS</i> , MPa								
L	6/2	589	8	1.75	60/20	582	13	-0.43
LT	6/2	599	7	0.55	60/20	580	12	-0.38
<i>SUS</i> , MPa								
L	4/2	355	7	-0.03	38/20	341	10	-0.52
LT	—	—	—	—	2/1	356	4	—
<i>BUS</i> , MPa:								
(e/D = 1.5) L	4/2	855	12	1.18	38/19	857	21	-0.04
LT	2/1	901	1	—	—	—	—	—
(e/D = 2.0) L	4/2	1134	14	1.09	38/19	1130	16	-0.03
LT	2/1	1156	9	—	—	—	—	—
<i>BYS</i> , MPa:								
(e/D = 1.5) L	4/2	688	4	1.54	38/19	692	20	0.79
LT	2/1	720	3	—	—	—	—	—
(e/D = 2.0) L	3/2	849	13	-1.14	36/19	849	23	0.56
LT	2/1	873	0	—	—	—	—	—
<i>elong.</i> , percent								
L	10/2	11.9	0.6	1.02	111/21	11.9	0.9	-0.90
LT	10/2	14.5	0.3	-0.20	110/21	13.7	0.8	0.67
<i>Red. of Area</i> , percent								
L	10/2	25.1	3.5	0.99	100/20	32.9	3.7	-0.47
LT	10/2	33.0	0.6	0.63	100/20	30.3	3.2	0.33
<i>E</i> , GPa								
L	10/2	74	2	0.26	100/20	72	2	-0.56
LT	10/2	79	4	-1.12	100/20	76	4	0.18
<i>E_c</i> , GPa								
L	6/2	66	2	0.26	60/20	72	3	0.35
LT	6/2	75	2	-1.10	60/20	73	2	0.01
<i>G</i> , GPa								
	—	—	—	—	—	—	—	—
<i>μ</i>								
	—	—	—	—	—	—	—	—

a *n* represents the number of data points, *lots* represents the number of lots, *heats* represents the number of heats. Refer to Section 9.1.3 for definitions.

b Data for LT direction is within the 4.57 to 6.35-mm thickness range.

Table 3.7.3.0(c). Typical Fracture Toughness Properties of 7249-T76511 Aluminum Alloy Extruded Bars, Rods, Shapes, and Tubing

Specification	AMS D-00AA (Draft) (see Appendix C)			
Form	Extruded Bars, Rods, Shapes, and Tubing			
Condition (or Temper) . .	T76511			
Thickness, mm	25.4 - 31.75			
	n / heats ^a	Avg.	Std. Dev.	Skew
Mechanical Properties:				
K_{Ic} , MPa-m ^{0.5}				
L-T	9/3	35	1	-0.52
T-L	9/3	27	1	0.26
S-L	—	—	—	—

a n represents the number of data points, *lots* represent the number of lots, *heats* represent the number of heats. Refer to Section 9.1.3 for definitions.

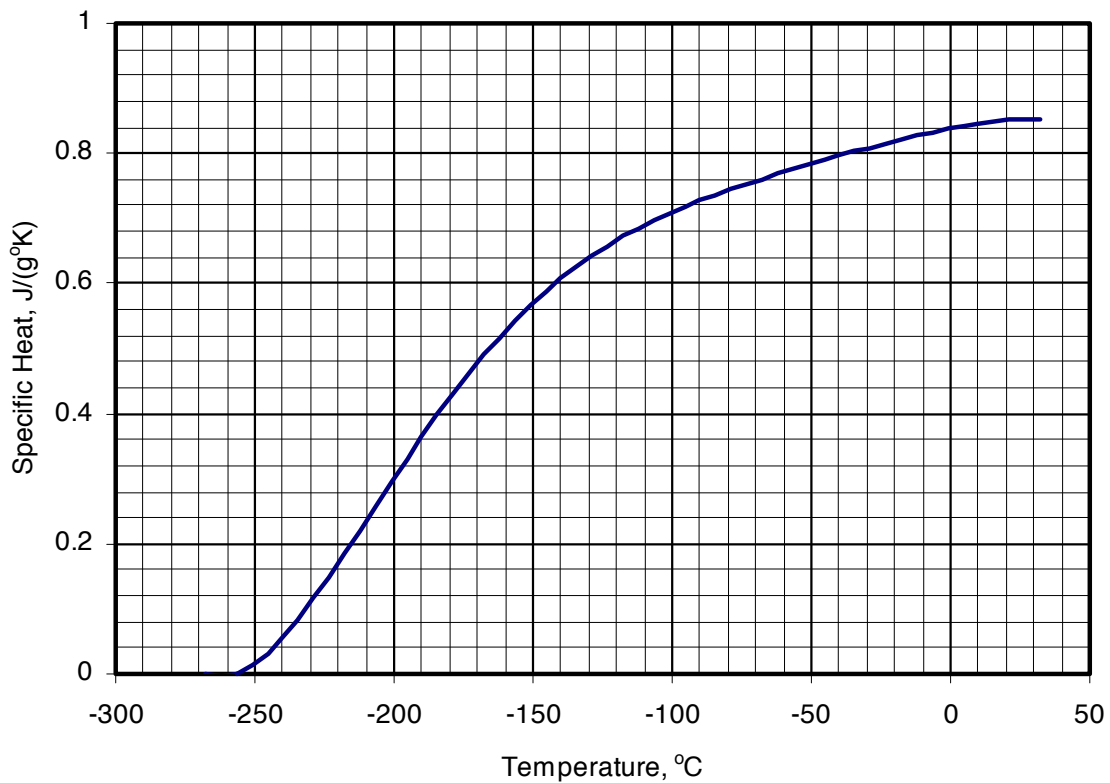

Figure 3.7.3.0(a). Effect of temperature on specific heat of 7249-T76511.

3.8 200.0 SERIES CAST ALLOYS

Alloys of the 200 series contain copper as the principal alloying element, and are particularly useful for elevated temperature applications.

3.8.1 A 206

3.8.1.0 *Comments and Properties* — The primary alloying additions of A206 are copper and manganese. A206 is used in applications where high tensile and yield strength with moderate elongation are needed. It has good fracture toughness characteristics and maintains high strength properties at elevated temperatures.

Manufacturing Considerations — Welding repair characteristics are fair.

Environmental Considerations — May be subject to corrosion due to the copper content.

Heat Treatment — Solution heat treat at 529°C for a minimum of 8 hours and quench, followed by precipitation aging at 188°C for 5 hours and air cool. Solution heat treatment will vary for rapid solidifying (thin wall) castings and slow solidifying (thick wall) castings. See AMS 4235.

Specifications and Properties — Material specifications are shown in Table 3.8.1.0 (a).

Table 3.8.1.0(a). Material Specifications for A206 Aluminum Alloy

Specification	Form
AMS 4235	Cast

Room temperature mechanical and physical properties of castings are shown in Table 3.8.1.0.(b). Room temperature properties of appendages are shown in Table 3.8.1.0.(c).

The test sample appendages were cast as integral parts of castings. The intent of an appendage is to validate that the properties of the casting meet the required specification. Chills were made around the appendages to reflect the critical areas of the casting.

Table 3.8.1.0.(b). Typical Mechanical and Physical Properties of A206 Castings

Specification	AMS 4235			
Form	Cast			
Condition (or Temper) ...	Aged 5 - 7 hours			
Location within casting ..	Casting			
	n / lots ^a	Avg.	Std. Dev.	Skew
Mechanical Properties:				
<i>TUS</i> , MPa:	99/3	409	26	-0.21
<i>TYS</i> , MPa:	99/3	326	27	0.31
<i>elong.</i> , percent:	99/3	8.8	3.6	0.31
Physical Properties:				
ω , Mg/m ³		2.80		
<i>C</i> , J/(g°K)		0.92 (373°K)		
<i>K</i> , W/(m°K)		121.3		
α , 10 ⁻⁶ m/m°K		19.26 (293 to 373°K)		

a *n* represents the number of data points, *lots* represents the number of lots. Refer to Section 9.1.3 for definitions.

Table 3.8.1.0.(c). Typical Mechanical and Physical Properties of A206 Cast Appendages

Specification	AMS 4235			
Form	Cast Appendages			
Condition (or Temper) ...	Aged 5 - 7 hours			
Location within casting ..	Integral Test Specimens			
Basis	n / lots ^a	Avg.	Std. Dev.	Skew
Mechanical Properties:				
<i>TUS</i> , MPa:	30/21	437	13	-0.23
<i>TYS</i> , MPa:	30/21	361	17	-0.08
<i>elong.</i> , percent:	30/21	10.1	1.6	-0.24
Physical Properties:				
ω , Mg/m ³		2.80		
<i>C</i> , J/(g°K)		0.92 (373°K)		
<i>K</i> , W/(m°K)		121.3		
α , 10 ⁻⁶ m/m°K		19.26 (293 to 373°K)		

a *n* represents the number of data points, *lots* represents the number of lots. Refer to Section 9.1.3 for definitions.

3.9 300.0 SERIES CAST ALLOYS

No alloys included at this time.

REFERENCES

- 3.1(a) Aluminum, Vol. I, "Properties, Physical Metallurgy and Phase Diagrams," Vol. II, "Design and Application," Vol. III, "Fabrication and Finishing," American Society for Metals (1967).
- 3.1(b) Aluminum Standards and Data, The Aluminum Association.
- 3.1.2 ANSI/ASC H35.1—1988, "American National Standard Alloy and Temper Designation Systems for Aluminum."
- 3.1.2.1.1 Stickley, G. W., and Moore, A. A., "Effects of Lubrication and Pin Surface on Bearing Strengths of Aluminum and Magnesium Alloys," *Material Research & Standards*, Vol. 2, No. 9, pp. 747 (September 1962).
- 3.1.2.1.3 Holt, M., and Bogardus, K. O., "The 'Hot' Aluminum Alloys," *Product Engineering* (August 16, 1965).
- 3.1.3.4 "Welding Aluminum: Theory and Practice," Aluminum Association, 3rd Edition, November 1997, IFBN 89-080539, AA code WATP-23-516146.
- 3.2.1.0 SAE Publication, ARP 823, "Minimizing Stress-Corrosion Cracking in Wrought Heat-Treatable Aluminum Alloy Products."
- 3.2.3.0 Unpublished data supplied by A. Cho of McCook Metals, (May, 2000) (MIL-HDBK-5 Source M895).

This page intentionally blank.

CHAPTER 4

MAGNESIUM ALLOYS

Data on emerging magnesium alloys designed for use in aircraft and missile structural applications were not submitted for inclusion in this handbook.

This page intentionally blank.

CHAPTER 5

TITANIUM

This chapter contains the engineering properties and related characteristics of titanium and titanium alloys used in aircraft and missile structural applications.

General comments on engineering properties and the considerations relating to alloy selection are presented in Section 5.1. Mechanical and physical property data and characteristics pertinent to specific alloy groups or individual alloys are reported in the following sections.

5.1 GENERAL

Titanium is a relatively lightweight, corrosion-resistant structural material that can be strengthened greatly through alloying and, in some of its alloys, by heat treatment. Among its advantages for specific applications are: good strength-to-weight ratio, low density, low coefficient of thermal expansion, good corrosion resistance, good oxidation resistance at intermediate temperatures, good toughness, and low heat-treating temperature during hardening, and others.

5.1.1 TITANIUM INDEX — The alloys are listed in the index, shown in Table 5.1.

Table 5.1. Titanium Alloys Index

Section	Alloy Designation
5.2	Unalloyed Titanium
5.3	Alpha and Near-Alpha Titanium Alloys
5.3.1	Ti-5.8Al-4Sn-3.5Zr-0.7Nb-0.5Mo-0.35Si-0.06C (<i>TIMETAL</i> ®*834)
5.4	Alpha-Beta Titanium Alloys
5.4.1	Ti-4Al-4Mo-2Sn-0.5Si (<i>TIMETAL</i> ® 550)
5.4.2	Ti-3Al-5Mo (Russian alloy VT-16)
5.4.3	Ti-6Al-2Sn-2Zr-2Mo-2Cr-Si
5.5	Beta, Near-Beta, and Metastable Titanium Alloys
5.5.1	Ti-15Mo-3Al-3Nb (<i>TIMETAL</i> ®21S)

* *TIMETAL* is a registered trademark of TIMET.

5.1.2 MATERIAL PROPERTIES — The material properties of titanium and its alloys are determined mainly by their alloy content and heat treatment, both of which are influential in determining the allotropic forms in which this material will be bound. Under equilibrium conditions, pure titanium has an “alpha” structure up to 882°C (1620°F), above which it transforms to a “beta” structure. The inherent properties of these two structures are quite different. Through alloying and heat treatment, one or the other or a combination of these two structures can be made to exist at service temperatures, and the properties of the material vary accordingly. References 5.1.2(a) and (b) provide general discussion of titanium microstructures and associated metallography.

Titanium and titanium alloys of the alpha and alpha-beta type exhibit crystallographic textures in sheet form in which certain crystallographic planes or directions are closely aligned with the direction of prior working. The presence of textures in these materials lead to anisotropy with respect to many mechan-

ical and physical properties. Poisson's ratio and Young's modulus are among those properties strongly affected by texture. Wide variations experienced in these properties both within and between sheets of titanium alloys have been qualitatively related to variations of texture. In general, the degree of texturing, and hence the variation of Young's modulus and Poisson's ratio, that is developed for alpha-beta alloys tends to be less than that developed in all alpha titanium alloys. Rolling temperature has a pronounced effect on the texturing of titanium alloys which may not in general be affected by subsequent thermal treatments. The degree of applicability of the effect of textural variations discussed above on the mechanical properties of products other than sheet is unknown at present. The values of Young's modulus and Poisson's ratio listed in this document represent the usual values obtained on products resulting from standard mill practices. References 5.1.2(c) and (d) provide further information on texturing in titanium alloys.

5.1.2.1 Mechanical Properties —

5.1.2.1.1 Fracture Toughness — The fracture toughness of titanium alloys is greatly influenced by such factors as chemistry variations, heat treatment, microstructure, and product thickness, as well as yield strength. For fracture critical applications, these factors should be closely controlled.

5.1.3 MANUFACTURING CONSIDERATIONS — Comments relating to formability, weldability, and final heat treatment are presented under individual alloys. These comments are necessarily brief and are intended only to aid the designer in the selection of an alloy for a specific application. In practice, departures from recommended practices are very common and are based largely on in-plant experience. Springback is nearly always a factor in hot or cold forming.

5.1.4 ENVIRONMENTAL CONSIDERATIONS — Comments relating to temperature limitations in the application of titanium and titanium alloys are presented under the individual alloys.

Below approximately 150°C (300°F), as well as above approximately 370°C (700°F), creep deformation of titanium alloys can be expected at stresses below the yield strength. Available data indicate that room-temperature creep of unalloyed titanium may be significant (exceed 0.2 percent creep-strain in 1,000 hours) at stresses that exceed approximately 50 percent F_{ty} , room-temperature creep of Ti-5Al-1.5Sn ELI may be significant at stresses above approximately 60 percent F_{ty} , and room-temperature creep of the standard grades of titanium alloys may be significant at stresses above approximately 75 percent F_{ty} .

The use of titanium and its alloys in contact with either liquid oxygen or gaseous oxygen at cryogenic temperatures should be avoided, since either the presentation of a fresh surface (such as produced by tensile rupture) or impact may initiate a violent reaction [Reference 5.1.4(a)]. Impact of the surface in contact with liquid oxygen will result in a reaction at energy levels as low as 10 ft-lb. In gaseous oxygen, a partial pressure of about 50 psi is sufficient to ignite a fresh titanium surface over the temperature range from -157°C (-250°F) to room temperature or higher.

Titanium is susceptible to stress-corrosion cracking in certain anhydrous chemicals including methyl alcohol and nitrogen tetroxide. Traces of water tend to inhibit the reaction in either environment. However, in N_2O_4 , NO is preferred and inhibited N_2O_4 contains 0.4 to 0.8 percent NO. Red fuming nitric acid with less than 1.5 percent water and 10 to 20 percent NO_2 can crack the metal and result in a pyrophoric reaction.

Titanium alloys are also susceptible to stress corrosion by dry sodium chloride at elevated temperatures. This problem has been observed largely in laboratory tests at 232 to 260°C (450 to 500°F) and higher and occasionally in fabrication shops. However, there have been no reported failures of titanium components in service by hot salt stress corrosion. Cleaning with a nonchlorinated solvent (to remove salt deposits, including fingerprints) of parts used above 232°C (450°F) is recommended.

In laboratory tests, with a fatigue crack present in the specimen, certain titanium alloys show an increased crack propagation rate in the presence of water or salt water as compared with the rate in air. These alloys also may show reduced sustained load-carrying ability in aqueous environments in the presence of fatigue cracks. Crack growth rates in salt water are a function of sheet or section thickness. These alloys are not susceptible in the form of thin-gauge sheet, but become susceptible as thickness increases. The thickness at which susceptibility occurs varies over a visual range with the alloy and processing. Alloys of titanium found susceptible to this effect include some from alpha, alpha-beta, and beta-type microstructures. In some cases, special processing techniques and heat treatments have been developed that minimize this effect.

Under certain conditions, titanium, when in contact with cadmium, silver, mercury, or certain of their compounds, may become embrittled. Refer to MIL-HDBK-1568 [Reference 5.1.4(b)] for restrictions concerning applications with titanium in contact with these metals or their compounds.

5.2 UNALLOYED TITANIUM

5.3 ALPHA AND NEAR-ALPHA TITANIUM ALLOYS

5.3.1 *TIMETAL*® 834 (Ti-5.8Al-4Sn-3.5Zr-0.7Nb-0.5Mo-0.35Si-0.06C)

5.3.1.0 *Comments and Properties* — *TIMETAL*® 834 is a near alpha titanium alloy with increased tensile strength and creep resistance up to 600°C and better fatigue strength when compared to *TIMETAL*® 685 and *TIMETAL*® 829.

Forging Considerations — Hot-working should be done in the alpha + beta phase to develop an equiaxed structure. Forging stock is supplied in the alpha + beta processed condition. The preferred furnace pre-heat is 1010°C and experience has shown that the alloy forges satisfactorily from this temperature.

Heat Treatment — *TIMETAL*® 834 has a more gradual change in alpha phase content with temperature as compared to *TIMETAL*® 829 and *TIMETAL*® 685. Thus, the alloy may be heat treated in the high alpha + beta field to produce the predominantly transformed beta structure required for optimum creep and crack propagation resistance, but with beta grain size controlled for improved fatigue performance.

Time at solution-treatment temperature has little effect on tensile properties at room temperature, but does affect creep performance at 600°C with significant improvement in creep resistance as time is increased from ½ hour to 2 hours. Fast cooling of approximately 200-400°C/min from solution-treatment temperature much improves creep resistance.

Specifications and Properties — Material specifications are shown in Table 5.3.1.0(a). Room temperature mechanical and physical properties are shown in Table 5.3.1.0(b). Elevated temperature properties are shown in Table 5.3.1.0(c).

Table 5.3.1.0(a). Material Specifications for *TIMETAL*® 834

Specification	Form
Rolls Royce - MSRR8679	Forging stock
Aerospace Manufacturer Specification	Bars, Forgings, and Forging stock

Table 5.3.1.0(b). Typical Mechanical and Physical Properties of TIMETAL® 834 Forging Stock

Specification	Rolls-Royce MSRR8679				Aerospace Manufacturer Specification			
	Forging Stock				Bars, forgings, and forging stock			
Form	Solution heat treated, oil quench. Aged, air cool. ^a				Solution heat treated, oil quench. Aged, air cool. ^b			
Test piece condition (or temper)	≤260 mm				Typically material of 175 - 250 mm is used to manufacture forgings of up to 75 mm section.			
Limiting ruling diameter, in.	A transverse billet slice is 3:1 upset forged to 13 mm at 1010°C							
Test piece thickness, mm	n / heats ^c	Avg.	Std. Dev.	Skew	n / heats ^c	Avg.	Std. Dev.	Skew
Mechanical Properties:^d								
<i>TUS</i> , MPa	370/185	1065	14	-0.10	53/53	1059	14	0.03
<i>TYS</i> , MPa	370/185	944	12	-0.12	53/53	945	12	0.05
<i>CYS</i> , MPa	—	—	—	—	—	—	—	—
<i>SUS</i> , MPa	—	—	—	—	—	—	—	—
<i>BUS</i> , MPa:								
(e/D = 1.5)	—	—	—	—	—	—	—	—
(e/D = 2.0)	—	—	—	—	—	—	—	—
<i>BYS</i> , MPa:								
(e/D = 1.5)	—	—	—	—	—	—	—	—
(e/D = 2.0)	—	—	—	—	—	—	—	—
<i>elong.</i> , percent ^e	370/185	11.8	1.4	0.18	53/53	11.5	1.6	-0.13
<i>Red. of Area</i> , percent ...	370/185	21.1	3.0	0.13	53/53	21.4	3.8	-0.36
<i>Creep</i> , percent strain ^f ...	370/185	0.070	0.01	0.08	See Table 5.3.1.0(c).			
<i>E</i> , GPa	—							
<i>E_c</i> , GPa	—							
<i>G</i> , GPa	—							
<i>μ</i>	—							
Physical Properties:								
<i>ω</i> , Mg/m ³	4.5 ^g							
<i>C</i> , J/(gK)	—							
<i>K</i> , W/m ² K	—							
<i>α</i> , 10 ⁻⁶ m/m ² K	19.1 (19.8 at 600°C, 20.3 at 1000°C) ^g							

a Solution heat treated at a temperature calculated to produce 5% -25% primary alpha for a minimum of 2

hours, followed by an oil quench. Aged at 700°C for 2 hours followed by an air cool.

b Solution heat treated at a temperature calculated to produce 5% -25% primary alpha for a minimum of 2 hours, followed by an oil quench. Aged at 704°C for 2 hours followed by an air cool.

c *n* represents the number of data points, *heats* represents the number of heats. Refer to Section 9.1.3 for definitions.

d Tensile test specification PR EN 2002-1.

e Elongation gage length is 5.65 times the square root of the test piece area.

f Total plastic strain after 100 hours at 600°C and 150 MPa. Creep test specification ASTM E139.

g From Timet brochure.

Table 5.3.1.0(c). Typical Creep Properties of *TIMETAL*® 834 Bars, Forging, and Forging Stock

Specification	Aerospace Manufacturer Specification			
Form	Bars, forging, and forging stock			
Test piece condition	Solution-heat treated, oil quench. Aged, air cool ^a			
Test piece thickness, mm	A transverse billet slice is 3:1 upset forged to 13 mm at 1010°C			
Creep test parameters	566°C ± 3 and 241 MPa			
	n/ heats ^b	Avg.	Std. Dev.	Skew
<i>Creep</i> , percent strain ^c :				
after 35 hours, %	5/5	0.073	0.0330	0.66
after 50 hours, %	45/45	0.091	0.0222	0.76
after 75 hours, %	5/5	0.156	0.01212	0.10
Time to 0.15% strain, hrs	7/7	77.0	23.52	1.72

^a Solution heat treated at a temperature calculated to produce 5-25% primary alpha for a minimum of 2 hours, followed by an

oil quench. Age at 704°C for 2 hours followed by an air cool.

^b *n* represents the number of data points, *heats* represents the number of heats. Refer to Section 9.1.3 for definitions.

^c Creep test specification ASTM E139.

Table 5.3.1.0(d). Typical Mechanical and Physical Properties of *TIMETAL*® 834 Forging Stock at Elevated Temperature

Specification	Rolls-Royce MSRR8679				Aerospace Manufacturer Specification			
Form	Forging Stock				Bars, forgings, and forging stock			
Test piece condition (or temper)	Solution heat treated, oil quench. Aged, air cool. ^a				Solution heat treated, oil quench. Aged, air cool. ^b			
Temperature, °C	600°C				510°C ± 5.5			
Limiting ruling diameter, in.	≤260 mm				Typically material of 175 - 250 mm is used to manufacture forgings of up to 75 mm section			
Test piece thickness, mm	A transverse billet slice is 3:1 upset forged to 13 mm at 1010°C							
	n / heats ^c	Avg.	Std. Dev.	Skew	n / heats ^c	Avg.	Std. Dev.	Skew
Mechanical Properties:^d								
<i>TUS</i> , MPa	370/185	683	11	0.15	53/53	727	14	0.17
<i>TYS</i> , MPa	370/185	529	12	0.57	53/53	570	12	0.25
<i>CYS</i> , MPa	—	—	—	—	—	—	—	—
<i>SUS</i> , MPa	—	—	—	—	—	—	—	—
<i>BUS</i> , MPa:								
(e/D = 1.5)	—	—	—	—	—	—	—	—
(e/D = 2.0)	—	—	—	—	—	—	—	—
<i>BYS</i> , MPa:								
(e/D = 1.5)	—	—	—	—	—	—	—	—
(e/D = 2.0)	—	—	—	—	—	—	—	—
<i>elong.</i> , percent ^e	370/185	18.3	2.2	0.45	53/53	15.8	1.6	0.03
<i>Red. of Area</i> , percent	370/185	54.9	3.2	-0.45	53/53	45.5	2.8	0.34
<i>E</i> , GPa	—							
<i>E_c</i> , GPa	—							
<i>G</i> , GPa	—							
<i>μ</i>	—							
Physical Properties:								
<i>ω</i> , Mg/m ³	4.5 ^f							
<i>C</i> , J/(g°K)	—							
<i>K</i> , W/m°K	—							
<i>α</i> , m/m°K	19 (19.8 at 600°C, 20.3 at 1,000°C) ^f							

a Solution heat treated at a temperature calculated to produce 5% -25% primary alpha for a minimum of 2 hours, followed

by an oil quench. Aged at 700°C for 2 hours followed by an air cool.

b Solution heat treated at a temperature calculated to produce 5% -25% primary alpha for a minimum of 2 hours, followed by an oil quench. Aged at 704°C for 2 hours followed by an air cool.

c *n* represents the number of data points, *heats* represents the number of heats. Refer to Section 9.1.3 for definitions.

d Tensile test specification PR EN 2002-1.

e Elongation gage length is 5.65 times the square root of the test piece area.

f From Timet brochure.

5.4 ALPHA-BETA TITANIUM ALLOYS

The alpha-beta titanium alloys contain both alpha and beta phases at room temperature. The alpha phase is similar to that of unalloyed titanium but is strengthened by alpha stabilizing additions (e.g., aluminum). The beta phase is the high-temperature phase of titanium but is stabilized to room temperature by sufficient quantities of beta stabilizing elements as vanadium, molybdenum, iron, or chromium. In addition to strengthening of titanium by the alloying additions, alpha-beta alloys may be further strengthened by heat treatment. The alpha-beta alloys have good strength at room temperature and for short times at elevated temperature. They are not noted for long-time creep strength. With the exception of annealed Ti-6Al-4V, these alloys are not recommended for cryogenic applications. The weldability of many of these alloys is poor because of the two-phase microstructure. Most alpha-beta alloys can be fusion welded, and all can be welded by solid state processes. Titanium and most of its more common alloys can be easily welded, but contamination with air and carbonaceous materials poses the biggest threat to successful fusion welding, so the area to be welded must be clear and protected by inert gas while hot.

5.4.1 Ti-4Al-4Mo-2Sn-0.5Si (*TIMETAL*®* 550)

5.4.1.0 Comments and Properties — Ti-4Al-4Mo-2Sn-0.5Si also known as *TIMETAL*® 550, is a medium strength, forgeable alpha beta alloy notable for its improved tensile and fatigue properties in the solution treated and aged condition, over those of Ti-6Al-4V. Additionally, it exhibits good elevated temperature tensile and creep properties up to 400°C (750°F) making it useful in aerospace applications such as compressor discs, flap tracks, engine components and airframe components. Product forms include plate, bar, and billet.

Forging Considerations — As with most high-strength titanium alloys, *TIMETAL*® 550 should be given at least 75% reduction in the alpha + beta field in order to develop optimum mechanical properties and grain structure. A preheating temperature of 900°C (1650°F) is recommended.

Some forgers like to balance heat loss by radiation and conduction during forging with the internal heat generated by the plastic deformation. Care must however be taken to ensure that the internal heat generated does not cause local temperatures in excess of the recommended 900°C (1650°F). Forging should also be stopped when the face temperature has fallen below approximately 750°C (1380°F), when the low ductility may give rise to surface cracking.

On occasions it may be permissible to carry out roughing operations at appreciably higher temperatures, possible even in the beta field provided that all relevant parts of the forging are later given the necessary 75% reduction at the lower temperature indicated above.

Joining — Ti-4Al-4Mo-2Sn-0.5Si may be welded using laser welding or electron beam techniques. Slow welding speeds and cooling rates are required to ensure strong weld properties.

Heat Treatment — The recommended heat treatment for Ti-4Al-4Mo-2Sn-0.5Si consists of a solution treatment at 900°C (1650°F) for 1 hour per 25 mm (inch) of section thickness, followed by air cooling and ageing at 500°C (930°F) for 24 hours followed by air cooling.

When sections thinner than 12.5 mm (0.5-inch) are air cooled (or when thicker sections are water-quenched or oil-quenched) higher tensile strengths can be developed on ageing, but only at the expense of

* *TIMETAL* is a registered trademark of TIMET.

ductility and creep strength. It is therefore better to slow-cool thin sections such as compressor blades - in a refractory-filled box, for example - to avoid the undesirable effects of an excessive cooling rate.

It may sometimes be desirable to give a stress-relieving treatment at an intermediate stage of manufacture; 650°C (1200°F) for 2 hours, followed by air cooling, will give properties similar to those of solution-treated material, but without the full ageing response of the 900°C (1650°F) solution treatment.

Environmental Considerations — **TIMETAL® 550** has a generally good resistance to corrosion. It exhibits excellent resistance to attack from SKYDROL hydraulic fluids, primarily due to the molybdenum content.

Specifications and Properties — Material specifications are shown in Table 5.4.1.0(a). Room temperature mechanical and physical properties are shown in Table 5.4.1.0(b) through (e).

Table 5.4.1.0(a). Material Specifications for *TIMETAL® 550*

Specification	Form
Rolls Royce - MSRR8663	Forging stock
British Standard TA 57	Plate
Rolls Royce - MSRR8626	Bar
Rolls Royce - MSRR 8642	Bar

Table 5.4.1.0.(b). Typical Mechanical and Physical Properties of *TIMETAL*® 550 Forging Stock

Specification	Rolls Royce MSRR8663 (See Appendix C)			
Form ^a	Forging Stock (transverse slice, upset forged at 900°C)			
Test Piece Condition	Solution Heat Treated, 900°C for ≥20 min., Air cool, Aged, 500°C for 24 hr, Air cool			
Thickness or diameter, mm	280 ^a (11.023 in)			
	n / lots ^b	Avg.	Std. Dev.	Skew
Mechanical Properties:^a				
<i>TUS</i> ^c , MPa	214/107	1157	24	-0.50
<i>TYS</i> ^c , MPa	214/107	1026	25	-0.23
<i>CYS</i> , MPa	—	—	—	—
<i>SUS</i> , MPa	—	—	—	—
<i>BUS</i> , MPa				
(e/D = 1.5)	—	—	—	—
(e/D = 2.0)	—	—	—	—
<i>BYS</i> , MPa				
(e/D = 1.5)	—	—	—	—
(e/D = 2.0)	—	—	—	—
<i>elong.</i> , percent	214/107	12.7	1.5	0.30
<i>Red. of Area</i> , percent	214/107	38.1	4.8	0.02
<i>Creep</i> , percent strain ^d	214/107	0.063	0.009	0.497
<i>E</i> , GPa	110 - 120 ^e			
<i>E_c</i> , GPa	—			
<i>G</i> , GPa	—			
<i>μ</i>	—			
Physical Properties:				
<i>ω</i> , Mg/m ³	4.59 ^e			
<i>C</i> , J/(g°K)	0.628 ^e			
<i>K</i> , W/(m°K)	7.53 ^e			
<i>α</i> , 10 ⁻⁶ m/m°K	see Table 5.4.1.0(c) ^e			

a Properties were obtained from material treated as follows; transverse billet slice is 3:1 upset forged at 900°C (1652°F) followed by solution heat treatment of 900°C/1hr/air cooled and aged 500°C/24 hrs/air cooled.

b *n* represents the number of data points, *lots* represents the number of lots. Refer to Section 9.1.3 for definitions.

c Tensile test specifications, PR EN 2002-1.

d Total plastic strain after 100 hours at 400°C (750°F) and 465 MPa (67.4 ksi). Test specification ASTM E139.

e From TIMET® brochure on *TIMETAL*® 550 Alloy.

Table 5.4.1.0(c). Thermal Expansion for *TIMETAL*® 550^a

Temperature	m/m°K
20 - 100°C (68 - 240°F)	8.6 x 10 ⁶
20 - 500°C (68 - 930°F)	9.7 x 10 ⁶

a From TIMET® brochure on *TIMETAL*® 550 Alloy

Table 5.4.1.0(d). Typical Mechanical and Physical Properties of **TIMETAL® 550 Plate**

		British Standard TA 57 (See Appendix C)											
		Plate											
		Solution Heat Treated, 900°C for ≥20 min., Air cool, Aged, 500°C for 24 hr, Air cool											
		0 to 25.4				26 to 50.8				51 to 66			
Specification	Form	n/ lots ^a	Avg.	Std. Dev.	Skew	n / lots ^a	Avg.	Std. Dev.	Skew	n/ lots ^a	Avg.	Std. Dev.	Skew
Temper	Thickness, mm	14/10 15/10	1123 1155	28 51	-0.36 0.96	96/60 97/61	1102 1108	18 17	-0.02 0.15	12/8 12/8	1089 1088	18 23	0.31 0.04
Mechanical Properties ^b :													
TUS, MPa:													
L		14/10	999	15	-0.70	96/60	996	21	0.40	12/8	985	16	0.42
T		15/10	1042	37	0.92	97/61	1011	20	-0.16	12/8	994	27	-0.09
TYS, MPa:													
L		—	—	—	—	—	—	—	—	—	—	—	—
T		—	—	—	—	—	—	—	—	—	—	—	—
CYS, MPa													
SUS, MPa		—	—	—	—	—	—	—	—	—	—	—	—
BUS, MPa:													
(e/D = 1.5)		—	—	—	—	—	—	—	—	—	—	—	—
(e/D = 2.0)		—	—	—	—	—	—	—	—	—	—	—	—
BYS, MPa:													
(e/D = 1.5)		—	—	—	—	—	—	—	—	—	—	—	—
(e/D = 2.0)		—	—	—	—	—	—	—	—	—	—	—	—
elong., percent:													
L		14/10	13.7	2.0	-0.27	96/60	12.8	1.6	-0.09	12/8	12.2	1.8	-0.34
T		15/10	13.9	1.7	-0.62	97/61	12.7	1.4	-0.52	12/8	12.8	1.3	0.05
Red. of Area., percent:													
L		14/10	42.4	7.7	0.01	96/60	36.1	5.7	0.11	12/8	40.2	5.6	-0.16
T		15/10	43.4	5.8	-0.16	97/61	36.7	5.1	0.18	12/8	38.1	6.1	-0.36
E , GPa		110 - 120 ^c											
E_c , GPa		—											
G , GPa		—											
μ		—											
Physical Properties:													
ω , Mg/m ³		4.59 ^c											
C , J/(g°K)		0.628 ^c											
K , W/(m°K)		7.53 ^c											
α , m/m°K		see Table 5.4.1.0(c) ^c											

^a n represents the number of data points, $lots$ represents the number of lots. Refer to Section 9.1.3 for definitions.

^b Tensile test specification PR EN 2002-1.

^c From TIMET® brochure on **TIMETAL® 550 Alloy**.

Table 5.4.1.0(e). Typical Mechanical and Physical Properties of *TIMETAL*®550 Bar

Specification	Rolls Royce MSRR8626				Rolls Royce MSRR8642			
	Bar							
Form	Solution Heat Treated, 900°C for ≥20 min., Air cool, Aged, 500°C for 24 hr, Air cool							
Condition (or Temper) . . .	16 to 31.75				28 to 50			
Diameter, mm	n/ lots ^a	Avg.	Std. Dev.	Skew	n/ lots ^a	Avg.	Std. Dev.	Skew
Mechanical Properties^b:								
<i>TUS</i> , MPa:								
L	46/17	1187	44	0.57	31/26	1153	38	0.51
LT or T	—	—	—	—	—	—	—	—
<i>TYS</i> , MPa:								
L	46/17	1020	43	0.60	31/26	1002	36	-0.03
LT or T	—	—	—	—	—	—	—	—
<i>CYS</i> , MPa:								
—								
<i>SUS</i> , MPa								
—								
<i>BUS</i> ,MPa:								
(e/D = 1.5)	—	—	—	—	—	—	—	—
(e/D = 2.0)	—	—	—	—	—	—	—	—
<i>BYS</i> , MPa:								
(e/D = 1.5)	—	—	—	—	—	—	—	—
(e/D = 2.0)	—	—	—	—	—	—	—	—
<i>elong.</i> , percent:								
L	46/17	13.0	2.1	0.04	28/23	13.8	2.1	-0.52
LT or T	—	—	—	—	—	—	—	—
red. of area, percent :								
L	46/17	46.7	3.3	-1.86	31/27	47.7	2.3	-0.17
LT or T	—	—	—	—	—	—	—	—
<i>Creep</i> , percent strain ^c :								
22/15	0.05	0.01	0.468	27/26	0.06	0.01	0.672	
<i>E</i> , GPa								
110 - 120 ^d								
<i>E_c</i> , GPa								
—								
<i>G</i> , GPa								
—								
μ								
—								
Physical Properties:								
ω , Mg/m ³								
4.59 ^d								
<i>C</i> , J/(g°K)								
0.628 ^d								
<i>K</i> , W/(m°K)								
7.53 ^d								
α , m/m°K								
see Table 5.4.1.0(c) ^d								

^a *n* represents the number of data points, *lots* represents the number of lots. Refer to Section 9.1.3 for definitions.

^b Tensile test specifications PR EN 2002-1.

^c Total plastic strain after 100 hours at 400°C (750°F) and 465 MPa (67.4 ksi). Creep test specification ASTM E139.

^d From TIMET® brochure on *TIMETAL*® 550 Alloy.

5.4.2 Ti-3Al-5Mo (Russian Alloy VT-16)

5.4.2.0 Comments and Properties — Ti-3Al-5Mo, also known as Russian alloy VT-16 is an $\alpha+\beta$ -titanium alloy, with a β -phase stability coefficient of 0.8 ($K\beta$). The characteristic feature of the alloy is its high ductility in the cold state (at the level of β -titanium alloys) and high cyclic loading resistance, typical of $\alpha+\beta$ alloys. Its effective strengthening during the cold plastic deformation without the significant decrease in ductility makes it useful for the production of fasteners in the deformation-strengthened state.

Manufacturing Considerations — VT-16 is supplied in the form of hot-rolled, turned calibrated bars in the annealed state. The phase transformation of $\alpha+\beta\Rightarrow\alpha''+\beta$ takes place during cold deformation with the degree of more than 20%, which gives a possibility to avoid the cold working and to ensure the optimum ratio of strength and ductility characteristics for fasteners.

Environmental Considerations — For a titanium alloy, VT-16 exhibits good corrosion resistance in atmospheric and salt water conditions.

Heat Treatment — VT-16 is heated to 700 - 1000°C (1292 - 1832°F), annealed at 780°C (1436°F), furnace cooled to 400°C (752°F) at 2 - 3°C (36 - 37°F) per minute, then air cooled. The alloy is then strengthened by heating it to 780 - 820°C (1436 - 1508°F) within 8 to 12 hours and water quenching.

Specifications and Properties — Material specifications are shown in Table 5.4.2.0(a). Room temperature mechanical and physical properties are shown in Table 5.4.2.0(b). Refer to Appendix D for a comparison of Russian test methods to ASTM test methods.

Table 5.4.2.0(a). Material Specifications for Ti-3Al-5Mo (VT-16) Rod

Specification	Form
Russian Federation TU 1-809-987-92	Rod

Table 5.4.2.0(b). Typical Mechanical and Physical Properties of Ti-3Al-5Mo (VT-16) Rod

Specification	Russian Federation TU 1-809-987-92 (See Appendix C)											
	Rod											
	Annealed and Cold Deformed											
Form	4.10				6.50				8.50			
Condition	n/lots ^a	Avg.	Std. Dev.	Skew	n/lots ^a	Avg.	Std. Dev.	Skew	n/lots ^a	Avg.	Std. Dev.	Skew
Diameter, mm	150/50	901	28	0.02	150/50	884	25	1.28	150/50	884	18	0.73
Mechanical Properties^b:												
<i>TUS</i> , MPa	—	—	—	—	—	—	—	—	—	—	—	—
<i>TYS</i> , MPa	—	—	—	—	—	—	—	—	—	—	—	—
<i>CYS</i> , MPa	150/50	656	15	0.05	150/50	647	13	1.22	150/50	647	10	0.77
<i>SUS</i> , MPa	—	—	—	—	—	—	—	—	—	—	—	—
<i>BUS</i> , MPa:	—	—	—	—	—	—	—	—	—	—	—	—
(<i>e/D</i> = 1.5)	—	—	—	—	—	—	—	—	—	—	—	—
(<i>e/D</i> = 2.0)	—	—	—	—	—	—	—	—	—	—	—	—
<i>BYS</i>, MPa:	—	—	—	—	—	—	—	—	—	—	—	—
(<i>e/D</i> = 1.5)	—	—	—	—	—	—	—	—	—	—	—	—
(<i>e/D</i> = 2.0)	150/50	20.1	1.6	0.45	150/50	21.0	1.4	3.88	150/50	19.6	1.2	-0.32
<i>elong.</i> , percent:	150/50	66.3	3.7	-3.02	150/50	67.0	2.0	-0.14	150/50	66.9	1.6	0.45
<i>Red. of Area</i> , percent												
<i>E</i> , GPa	—	—	—	—	—	—	—	—	—	—	—	—
<i>G</i> , GPa	—	—	—	—	—	—	—	—	—	—	—	—
<i>μ</i>	—	—	—	—	—	—	—	—	—	—	—	—
Physical Properties:												
<i>ω</i> , Mg/m ³	—	—	—	—	—	—	—	—	—	—	—	—
<i>C</i>	—	—	—	—	—	—	—	—	—	—	—	—
<i>K</i>	—	—	—	—	—	—	—	—	—	—	—	—
<i>α</i>	—	—	—	—	—	—	—	—	—	—	—	—

^a *n* represents the number of data points, *lots* represents the number of lots. Refer to Section 9.1.3 for definitions.

^b Tensile testing per GOST 1497-84 Russian Standard, Shear testing per OST 1 90148-74 Russian Standard (in Appendix D)

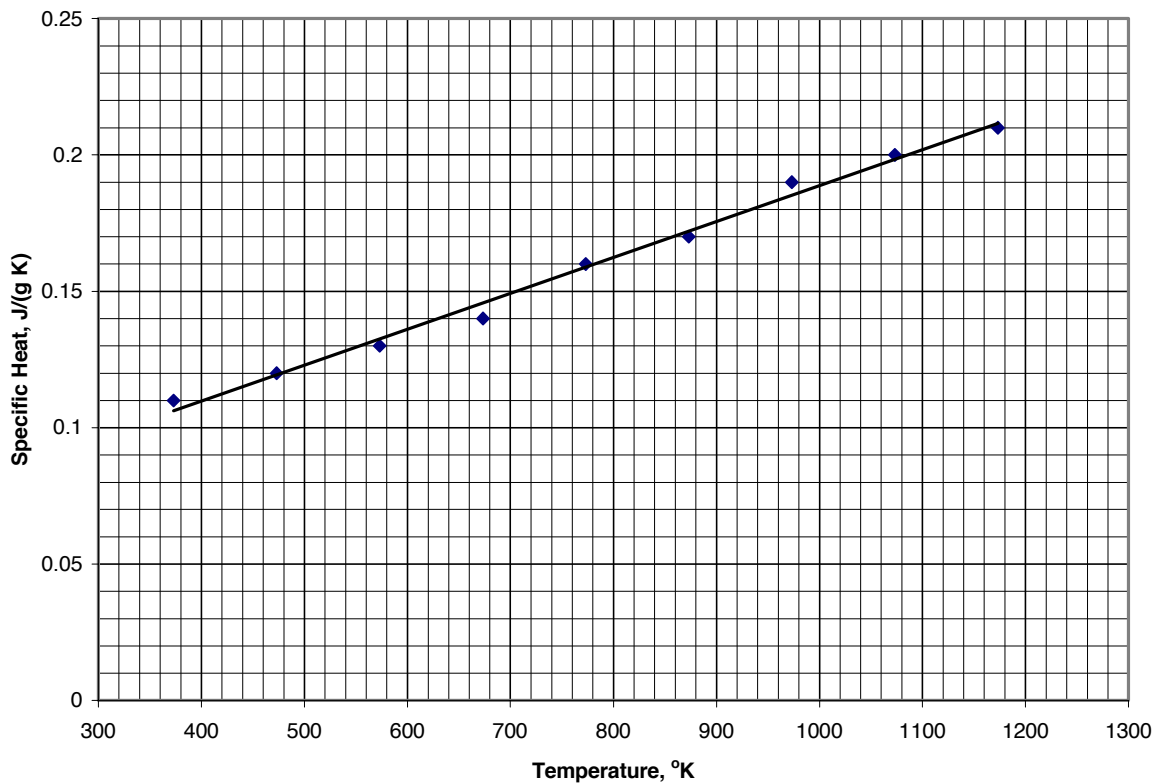

Figure 5.4.2.0(a). Effect of temperature on specific heat of VT-16.

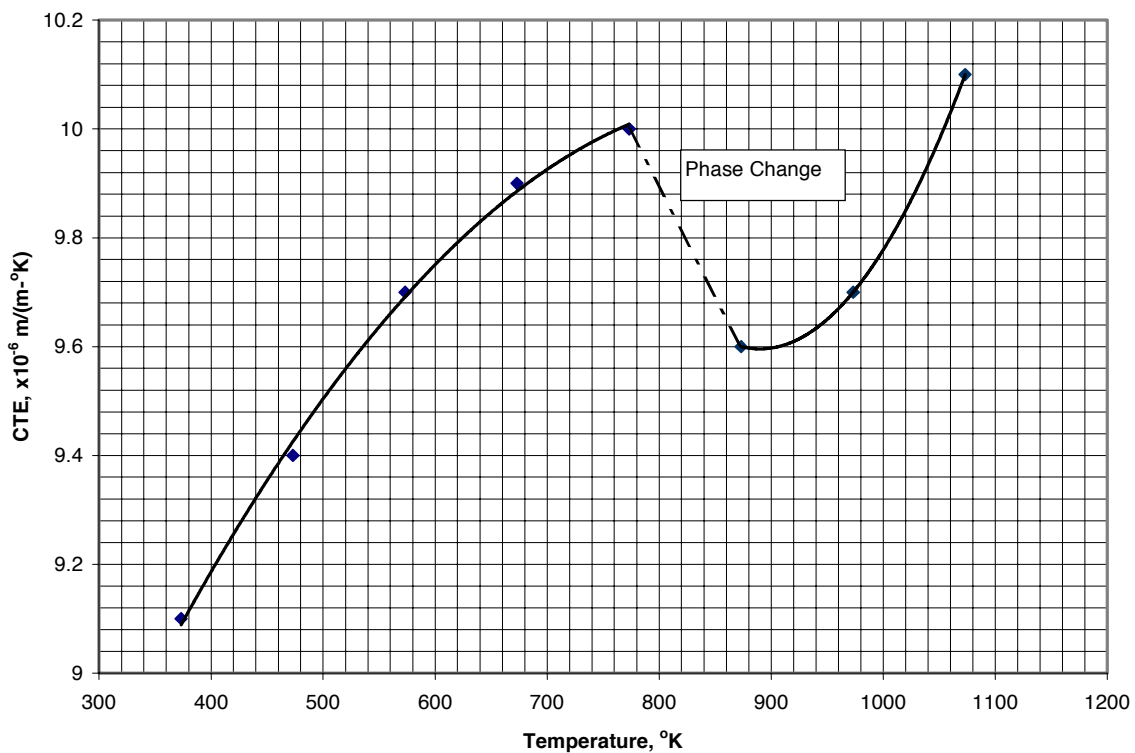

Figure 5.4.2.0(b). Effect of temperature on thermal expansion of VT-16.

5.4.3 Ti-6Al-2Sn-2Zr-2Mo-2CR-Si (Ti-6-22-22S)

5.4.3.0 Comments and Properties — Ti-6-22-22S provides high strength in heavy sections with good fracture toughness and retains its strength up to moderate temperatures due to the addition of silicon. Ti-6-22-22S has improved strength and damage tolerance over Ti-6Al-4V.

Thermomechanical Process Considerations — The Ti-6-22-22S alloy can be fabricated into all forging product types, although closed die and precision forgings predominate. Ti-6-22-22S is commercially fabricated on all types of forging equipment under a range of processing temperatures.

Ti-6-22-22S is a reasonably forgeable alloy with comparable unit pressures (flow stress), forgability, and crack sensitivity to Ti-6Al-4V. Thermomechanical processes for the alloy use combinations of conventional (subtransus) and/or Beta (supra-transus) forging followed by subtransus and/or supra-transus thermal treatments to fulfill critical mechanical property criteria.

Conventional Forging Considerations — Conventional subtransus ($\alpha + \beta$) forging thermomechanical processes followed by a triplex β heat treatment are the most widely used in commercial forging manufacture. To achieve conventional equiaxed α structures in preparation for final β heat treatment, subtransus reductions of at least 50 to 75%, accumulated through one or more forging steps are required. Supra-transus β forging may be used in the early forging operations such as upsetting or pre-forming. However, higher temperature initial forging operations must be followed by sufficient subtransus reduction to achieve an equiaxed α structure prior to heat treatment.

Rolling, Forming, and Machining Considerations — The rolling, forming, and machining behavior of Ti-6-22-22S are similar to those employed for processing of Ti-6Al-4V.

Heat Treatment — Ti-6-22-22S can be supplied in a number of heat-treated conditions depending on the mechanical property requirements. A list of potential heat treatments are shown below.

Mill Anneal	732 – 899°C (15 Minutes to 2 hours)
Solution Treat and Age (STA)	871 – 927°C 15 to 60 Minutes AC or Faster, Age 482 – 538°C 8 to 12 Hrs
Triplex Heat Treatment	($\beta_T + 10^\circ\text{C}$) 30 Min. AC + ($\beta_T - 10^\circ\text{C}$) 1 Hr. AC + 538°C 8 Hrs. AC

Specifications and Properties — Material specifications are shown in Table 5.4.3.0(a). Room temperature mechanical and physical properties are shown in Table 5.4.3.0(b) and (c). Fracture toughness properties are shown in Table 5.4.3.0(d).

Table 5.4.3.0(a). Material Specifications for Ti-6-22-22S

Specification	Form
AMS 4898	Sheet
Boeing 5PTM7T01 (Proprietary)	Plate

Table 5.4.3.0(b). Typical Mechanical and Physical Properties of Ti-6-22-22S Sheet

Specification	AMS 4898											
	Sheet											
	Annealed						STA					
	0.4 to 0.9			1 to 3			0.8 to 1.6					
n/heats/ lots ^a	Avg.	Std. Dev.	Skew	n/heats/ lots ^a	Avg.	Std. Dev.	Skew	n/heats/ lots ^a	Avg.	Std. Dev.	Skew	
Mechanical Properties:												
TUS, MPa:												
L	16/4/4	1137	30	-0.83	30/6/14	1143	22	-0.25	18/2/7	1344	21	-0.36
T	16/4/4	1143	29	-0.44	30/6/14	1175	31	-0.11	18/2/7	1314	42	0.28
TYS, MPa:												
L	16/4/4	1091	35	-0.45	30/6/14	1102	20	0.03	18/2/7	1264	31	1.71
T	16/4/4	1103	33	-0.04	30/6/14	1157	34	0.25	18/2/7	1235	38	0.48
CYS, MPa	-	-	-	-	-	-	-	-	-	-	-	-
SUS, MPa	-	-	-	-	-	-	-	-	-	-	-	-
BUS, MPa:												
(e/D = 1.5)	-	-	-	-	-	-	-	-	-	-	-	-
(e/D = 2.0)	-	-	-	-	-	-	-	-	-	-	-	-
BYS, MPa:												
(e/D = 1.5)	-	-	-	-	-	-	-	-	-	-	-	-
(e/D = 2.0)	-	-	-	-	-	-	-	-	-	-	-	-
<i>elong.</i> , percent:												
L	16/4/4	9.2	1.8	-1.10	30/6/14	10.6	1.2	-0.64	18/2/7	7.9	1.1	-0.53
T	16/4/4	8.7	1.4	-1.10	30/6/14	10.9	1.4	0.53	18/2/7	7.6	1.1	-0.03
<i>Red. of Area.</i> , percent:												
E, 10 ³ GPa	-	-	-	-	-	-	-	-	-	-	-	-
E _c , 10 ³ GPa	-	-	-	-	-	-	-	-	-	-	-	-
G, 10 ³ GPa	-	-	-	-	-	-	-	-	-	-	-	-
Physical Properties:												
ω, Mg/m ³	-	-	-	-	-	-	-	-	-	-	-	-
C, J/g·K	-	-	-	-	-	-	-	-	-	-	-	-
K, W/m ² ·K	-	-	-	-	-	-	-	-	-	-	-	-
α, 10 ⁻⁶ m/m·°K	-	-	-	-	-	-	-	-	-	-	-	-

a n represents the number of data points, *heats* represent the number of heats, *lots* represent the number of lots. Refer to Section 9.1.3 for definitions.

Table 5.4.3.0(c). Typical Mechanical and Physical Properties of Ti-6-22-22S Plate

Specification	Boeing specification 5PTM7T01 (Proprietary)							
	Plate							
	Triplex							
	< 25.4				25.4 up to 50.8			
Thickness, mm	n /heats /lots ^a	Avg.	Std. Dev.	Skew	n /heats /lots ^a	Avg.	Std. Dev.	Skew
Mechanical Properties:								
<i>TUS</i> , MPa								
L	12/5/6	1184	41	-0.35	64/20/34	1138	33	-0.05
T	12/5/6	1151	36	0.77	64/20/34	1144	32	-0.39
<i>TYS</i> , MPa								
L	12/5/6	1046	33	0.00	64/20/34	995	37	-0.14
T	12/5/6	1019	22	-0.06	64/20/34	1004	34	-0.10
<i>CYS</i> , MPa								
L	—	—	—	—	—	—	—	—
T	—	—	—	—	—	—	—	—
<i>SUS</i> , MPa								
L	—	—	—	—	—	—	—	—
T	—	—	—	—	—	—	—	—
<i>BUS</i> , MPa:								
(e/D = 1.5)	—	—	—	—	—	—	—	—
(e/D = 2.0)	—	—	—	—	—	—	—	—
<i>BYS</i> , MPa:								
(e/D = 1.5)	—	—	—	—	—	—	—	—
(e/D = 2.0)	—	—	—	—	—	—	—	—
<i>elong.</i> , percent								
L	12/5/6	9.2	1.0	0.14	64/20/34	9.0	1.6	1.35
T	12/5/6	9.0	1.0	-0.57	64/20/34	8.8	1.7	1.32
<i>Red. of Area</i> , percent								
L	12/5/6	11.7	1.0	0.13	64/20/34	12.9	2.4	0.83
T	12/5/6	13.8	3.5	0.06	64/20/34	13.6	2.4	0.68
E, GPa ^b	1/1/1	118	—	—	9/7/9	121	1.6	-0.68
E _c , GPa	—							
G, GPa	—							
μ	—							
Physical Properties:								
ω, Mg/m ³	—				4.54	—		
C, J/(g°K)	—							
K, W/m°K	—							
α, m/m°K	—							

a n represents the number of data points, *heats* represent the number of heats, *lots* represent the number of lots. Refer to Section 9.1.3 for definitions.

b Per ASTM E111-97.

Table 5.4.3.0(c) Continued. Typical Mechanical and Physical Properties of Ti-6-22-22S Plate

Specification	Boeing specification 5PTM7T01 (Proprietary)							
	Plate							
	Triplex							
	50.8 up to 76.2				76.2 - 101.6 (incl.)			
	n /heats /lots ^a	Avg.	Std. Dev.	Skew	n /heats /lots ^a	Avg.	Std. Dev.	Skew
Mechanical Properties:								
<i>TUS</i> , MPa								
L	72/25/36	1123	22	0.49	86/36/42	1108	28	0.02
T	72/25/36	1128	23	0.16	86/36/42	1109	22	-0.11
<i>TYS</i> , MPa								
L	72/25/36	982	22	0.65	86/36/42	970	23	0.22
T	72/25/36	992	24	0.00	86/36/42	974	21	0.41
<i>CYS</i> , MPa								
L	—	—	—	—	—	—	—	—
T	—	—	—	—	—	—	—	—
<i>SUS</i> , MPa								
L	—	—	—	—	—	—	—	—
T	—	—	—	—	—	—	—	—
<i>BUS</i> , MPa:								
(e/D = 1.5)	—	—	—	—	—	—	—	—
(e/D = 2.0)	—	—	—	—	—	—	—	—
<i>BYS</i> , MPa:								
(e/D = 1.5)	—	—	—	—	—	—	—	—
(e/D = 2.0)	—	—	—	—	—	—	—	—
<i>elong.</i> , percent								
L	72/25/36	9.5	1.8	0.40	86/36/42	9.2	1.9	0.26
T	72/25/36	9.4	1.8	0.27	86/36/42	9.0	1.7	0.35
<i>Red. of Area</i> , percent								
L	72/25/36	14.0	2.4	0.22	86/36/42	14.0	2.3	-0.01
T	72/25/36	13.6	2.2	0.15	86/36/42	13.7	2.3	0.04
E, GPa ^b	8/6/8	121	1.3	-0.41	18/15/17	120	1.2	-0.31
E _c , GPa	—							
G, GPa	—							
μ	—							
Physical Properties:								
ω, Mg/m ³	4.54							
C, J/(g °K)	—							
K, W/m °K	—							
α, m/m °K	—							

a *n* represents the number of data points, *heats* represent the number of heats, *lots* represent the number of lots. Refer to Section 9.1.3 for definitions.

b Per ASTM E111-97.

Table 5.4.3.0(d). Fracture Toughness Properties of Ti-6-22-22S Plate

Specification	Boeing specification 5PTM7T01 (Proprietary)							
Form	Plate							
Condition (or Temper) ..	Triplex							
Thickness, mm	< 25.4				25.4 up to 50.8			
	n /heats /lots ^a	Avg.	Std. Dev.	Skew	n /heats /lots ^a	Avg.	Std. Dev.	Skew
Mechanical Properties: K_{Ic} , MPa-m ^{0.5} T-L	7/5/6	107	9	1.14	35/20/31	98	9	-0.27
Thickness, mm	50.8 up to 76.2				76.2 - 101.6 (incl.)			
	n /heats /lots ^a	Avg.	Std. Dev.	Skew	n /heats /lots ^a	Avg.	Std. Dev.	Skew
Mechanical Properties: K_{Ic} , MPa-m ^{0.5} T-L	38/25/34	96	8	-0.62	49/36/40	96	6	-0.22

a *n* represents the number of data points, *heats* represent the number of heats, *lots* represent the number of lots. Refer to Section 9.1.3 for definitions.

5.5 BETA, NEAR-BETA, AND METASTABLE TITANIUM ALLOYS

There is no clear-cut definition for beta titanium alloys. Conventional terminology usually refers to near-beta alloys and metastable-beta alloys as classes of beta titanium alloys. A near-beta alloy is generally one which has appreciably higher beta stabilizer content than a conventional alpha-beta alloy such as Ti-6Al-4V, but is not quite sufficiently stabilized to readily retain an all-beta structure with an air cool of thin sections. For such alloys, a water quench even of thin sections is required. Due to the marginal stability of the beta phase in these alloys, they are primarily solution treated below the beta transus to produce primary alpha phase which in turn results in an enriched, more stable beta phase. This enriched beta phase is more suitable for aging. The Ti-10V-2Fe-3Al alloy is an example of a near-beta alloy.

On the other hand, the metastable-beta alloys are even more heavily alloyed with beta stabilizers than near-beta alloys and, as such, readily retain an all-beta structure upon air cooling of thin sections. Due to the added stability of these alloys, it is not necessary to heat treat below the beta transus to enrich the beta phase. Therefore, these alloys do not normally contain primary alpha since they are usually solution treated above the beta transus. These alloys are termed “metastable” because the resultant beta phase is not truly stable—it can be aged to precipitate alpha for strengthening purposes. Alloys such as Ti-15-3, B120VCA, Beta C, and Beta III are considered metastable-beta alloys.

Unfortunately, the classification of an alloy as either near-beta or metastable beta is not always obvious. In fact, the “metastable” terminology is not precise since a near-beta alloy is also metastable—i.e., it also decomposes to alpha plus beta upon aging.

There is one obvious additional category of beta alloys—the stable beta alloys. These alloys are so heavily alloyed with beta stabilizers that the beta phase will not decompose to alpha plus beta upon subsequent aging. There are no such alloys currently being produced commercially. An example of such an alloy is Ti-30Mo.

The interest in beta alloys stems from the fact that they contain a high volume fraction of beta phase which can be subsequently hardened by alpha precipitation. Thus, these alloys can generate quite high-strength levels (in excess of 1379 MPa) with good ductilities. Also, such alloys are much more deep hardenable than alpha-beta alloys such as Ti-6Al-4V. Finally, many of the more heavily alloyed beta alloys exhibit excellent cold formability and as such offer attractive sheet metal forming characteristics.

5.5.1 Ti-15Mo-3Al-3Nb (*TIMETAL*®21S)

5.5.1.0 Comments and Properties— Ti-15Mo-3Al-3Nb-0.2Si, also known as *TIMETAL*®21S is a metastable beta titanium alloy that offers a unique combination of high strength, good elevated temperature properties, and extraordinary environmental degradation resistance. Among the alloy’s unique properties are a high resistance to attack by commercial aircraft hydraulic fluids at all temperatures. Creep resistance is excellent for a metastable beta alloy, though still less resistant to creep than near alpha alloys.

Manufacturing Considerations — Ti-15Mo-3Al-3Nb-0.2Si is usually supplied in the solution heat treated condition. In this condition, the alloy has a single phase (beta) structure and hence, is readily cold formed. After cold forming, the alloy can be aged to the desired strength level. Cold reductions greater than 80% are possible in most compressive operations, including rolling, spinning, and swaging. *TIMETAL*®21S has a relatively low work hardenability, allowing maximum tensile deformations when strains are uniform such as in hydro-forming and bulge-forming. Machining should only be performed after aging to avoid a brittle surface that can result from the enhanced aging response of the machining-induced severely cold worked layer. Surface contamination (alpha case), when present, must always be removed prior to forming.

Environmental Considerations — **TIMETAL®21S** has excellent corrosion resistance. Unaged material should not be used for long term exposures above about 204°C (400°F) because the potential exists for embrittlement by the precipitation of omega phase or very fine alpha.

Heat Treatment — This alloy is solution heat treated at 816-899°C (1500-1650°F) for 3-30 minutes. For service temperatures less than 427°C (800°F), **TIMETAL® 21S** is usually aged at 593°C (1100°F) for 8 hours. For elevated temperature applications, a duplex age of 690°C (1275°F) for 8 hours plus 649°C (1200°F) for 8 hours is used. For the 593°C (1100°F) age, care should be used to avoid heating too slowly, because this can result in very high strength with concomitant low ductility.

Single Aged: 593°C (1100°F) for 8 hours

Duplex Aged: 690°C (1275°F) for 8 hours plus 649°C (1200°F) for 8 hours

Specifications and Properties — Material specifications are shown in Table 5.5.1.0.

**Table 5.5.1.0. Material Specifications for
TIMETAL® 21S**

Specification	Form
AMS 4897	Sheet, strip, and plate

5.5.1.1 Single-Aged Condition — Room temperature mechanical and physical properties are shown in Table 5.5.1.1(a). Elevated temperature properties are shown in Table 5.5.1.1(b).

5.5.1.2 Duplex-Aged Condition — Room temperature mechanical and physical properties are shown in Table 5.5.1.2(a). Elevated temperature properties are shown in Table 5.5.1.2(b).

Table 5.5.1.1(a). Typical Mechanical and Physical Properties of *TIMETAL*® 21S Strip and Sheet

Specification	AMS 4897			
Form	Strip and Sheet			
Condition (or Temper) . . .	Aged at 593 °C for 8 hours (Single Aged)			
Thickness or diameter, mm	0.4 to 3.2			
	n / lots ^a	Avg.	Std. Dev.	Skew
Mechanical Properties:				
<i>TUS</i> , MPa:				
L	99/6	1166	59	0.83
LT	116/10	1174	82	-0.81
<i>TYS</i> , MPa:				
L	99/6	1076	68	0.67
LT	116/10	1090	84	-0.38
<i>CYS</i> , MPa:				
L	21/7	1108	88	-1.30
LT	13/5	1180	140	-1.71
<i>SUS</i> , MPa:				
L	24/8	780	30	0.73
LT	15/5	791	39	-0.09
<i>BUS</i> , MPa:				
L (e/D = 1.5)	15/5	1842	81	-0.27
LT (e/D = 1.5)	15/5	1834	69	-0.01
L (e/D = 2.0)	24/8	2278	112	1.66
LT (e/D = 2.0)	15/5	2268	75	-0.36
<i>BYS</i> , MPa:				
L (e/D = 1.5)	12/5	1668	130	-0.72
LT (e/D = 1.5)	11/5	1707	93	-0.29
L (e/D = 2.0)	21/8	1876	178	0.75
LT (e/D = 2.0)	14/5	1959	38	0.17
<i>elong.</i> , percent:				
L	99/6	11.0	2.1	-0.37
LT	116/10	10.0	2.2	0.11
<i>E</i> , GPa:				
L	19/5	109	10	2.14
LT	27/6	113	9	0.33
<i>E_c</i> , GPa:				
L	12/4	114	5	0.56
LT	13/5	117	6	-0.95
<i>G</i> , GPa	—			
<i>μ</i>	—			
Physical Properties:				
<i>ω</i> , Mg/m ³	4.93			
<i>C</i> , J/(g °K)	see Figure 5.5.1.1(a)			
<i>K</i> , W/(m °K)	see Figure 5.5.1.1(b)			
<i>α</i> , 10 ⁻⁶ m/m °K	see Figure 5.5.1.1(c)			

^a *n* represents the number of data points, *lots* represents the number of lots. Refer to Section 9.1.3 for definitions.

Table 5.5.1.1(b). Typical Mechanical and Physical Properties of *TIMETAL*® 21S at 315°C Elevated Temperature

Specification	AMS 4897			
Form	Strip and Sheet			
Condition (or Temper) ...	Aged at 593°C for 8 hours (Single Aged)			
Thickness, mm	1 to 2			
	n / lots ^a	Avg.	Std. Dev.	Skew
Mechanical Properties at 315°C:				
<i>TUS</i> , MPa:	9/3	938	12	-0.13
LT				
<i>TYS</i> , MPa:	9/3	810	14	-1.10
LT				
<i>CYS</i> , MPa:	9/3	898	80	-1.19
L				
<i>SUS</i> , MPa:	9/3	592	7	1.17
L				
<i>BUS</i> , MPa:	9/3	1851	30	-0.42
L ($\epsilon/D = 2.0$)				
<i>BYS</i> , MPa:	9/3	1464	83	0.12
L ($\epsilon/D = 2.0$)				
<i>elong.</i> , percent:	9/3	9.2	1.5	-0.78
LT				

a *n* represents the number of data points, *lots* represents the number of lots. Refer to Section 9.1.3 for definitions.

Table 5.5.1.2(a). Typical Mechanical and Physical Properties of TIMETAL® 21S Strip and Sheet

Specification	AMS 4897			
Form	Strip and Sheet			
Condition (or Temper) ..	Aged at 690°C for 8 hours and 649°C for 8 hours (Duplex Aged)			
Thickness, mm	0.4 to 3.2			
Basis	n / lots ^a	Avg.	Std. Dev.	Skew
Mechanical Properties:				
<i>TUS</i> , MPa:				
L	78/12	975	32	-0.70
LT	65/11	995	50	1.68
<i>TYS</i> , MPa:				
L	77/12	902	45	-1.24
LT	64/11	939	52	0.84
<i>CYS</i> , MPa:				
L	23/7	969	49	1.47
LT	14/5	1021	29	-0.09
<i>SUS</i> , MPa:				
L	24/7	698	37	0.17
LT	15/5	691	16	-0.40
<i>BUS</i> , MPa:				
L (e/D = 1.5)	14/5	1664	34	-0.65
LT (e/D = 1.5)	15/5	1654	44	-0.28
L (e/D = 2.0)	23/7	2042	164	-3.03
LT (e/D = 2.0)	14/5	2054	70	0.27
<i>BYS</i> , MPa:				
L (e/D = 1.5)	12/5	1391	60	0.31
LT (e/D = 1.5)	15/5	1392	56	0.19
L (e/D = 2.0)	23/7	1630	108	-0.36
LT (e/D = 2.0)	13/5	1696	90	-0.32
<i>elong.</i> , percent:				
L	78/12	14.1	2.8	-0.48
LT	65/11	13.5	3.0	-0.68
<i>E</i> , GPa:				
L	56/12	107	12	0.70
LT	43/11	113	13	0.39
<i>E_c</i> , GPa:				
L	14/5	106	3	2.05
LT	14/5	111	4	-0.65
<i>G</i> , GPa	—			
<i>μ</i>	—			
Physical Properties:				
<i>ω</i> , Mg/m ³	4.93			
<i>C</i> , J/(g°K)	—			
<i>K</i> , W/(m°K)	—			
<i>α</i> , 10 ⁻⁶ m/m°K	—			

a *n* represents the number of data points, *lots* represents the number of lots. Refer to section 9.1.3 for definitions.

Table 5.5.1.2(b). Design Mechanical and Physical Properties of *TIMETAL® 21S* Strip and Sheet at Elevated Temperatures

Specification	AMS 4897			
Form	Strip and Sheet			
Condition (or Temper) ..	Aged at 690°C for 8 hours and 649°C for 8 hours (Duplex Aged)			
Thickness, mm	1 to 2			
Basis	n / lots ^a	Avg.	Std. Dev.	Skew
Mechanical Properties at 593°C				
<i>TUS</i> , MPa				
L	9/3	485	12	-0.04
LT	9/3	496	13	-0.78
<i>TYS</i> , MPa				
L	9/3	428	23	0.55
LT	9/3	443	25	-0.04
<i>elong.</i> , percent:				
L	9/3	39.0	8.2	0.12
LT	9/3	37.2	6.3	-0.44
Mechanical Properties at 315°C				
<i>CYS</i> , MPa				
L	8/3	588	80	1.54
<i>SUS</i> , MPa				
L	9/3	383	8	0.06
<i>BUS</i> , MPa				
L ($\epsilon/D = 2.0$)	9/3	981	86	-2.43
<i>BYS</i> , MPa				
L ($\epsilon/D = 2.0$)	9/3	873	88	-1.49

a *n* represents the number of data points, *lots* represents the number of lots. Refer to section 9.1.3 for definitions.

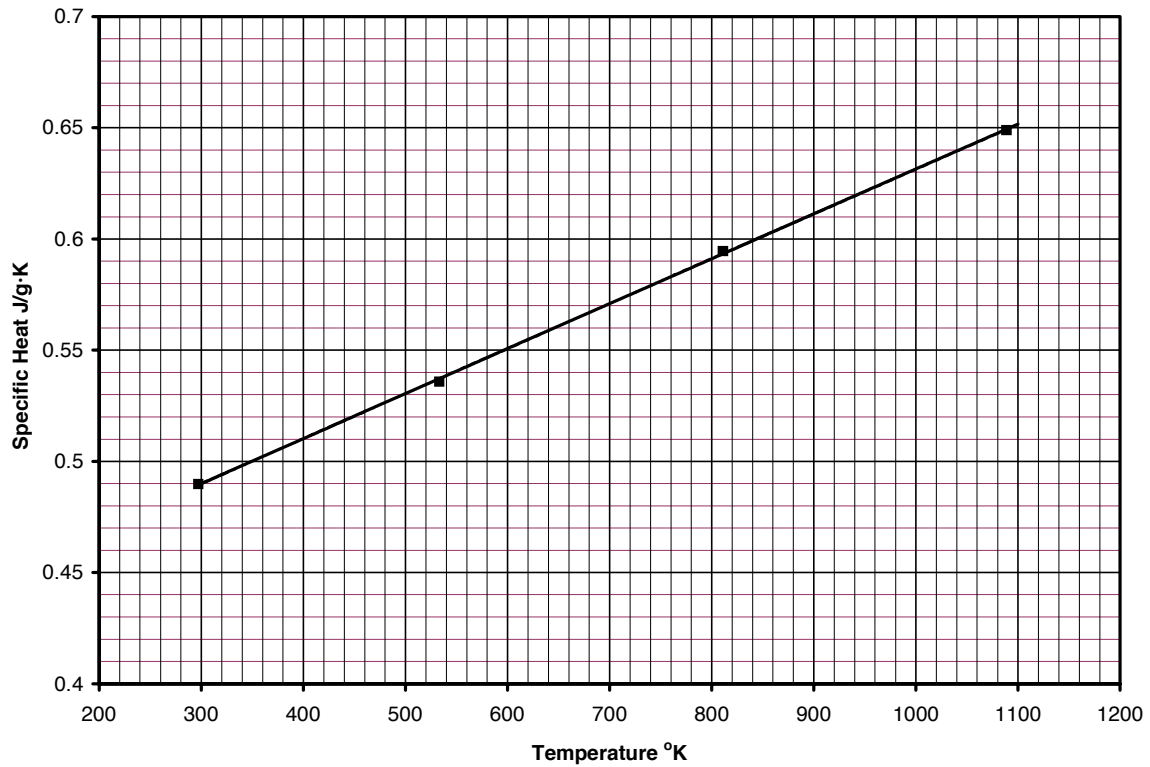

Figure 5.5.1.1(a). Effect of temperature on specific heat of *TIMETAL*® 21S aged at 593°C for 8 hours (Single Aged).

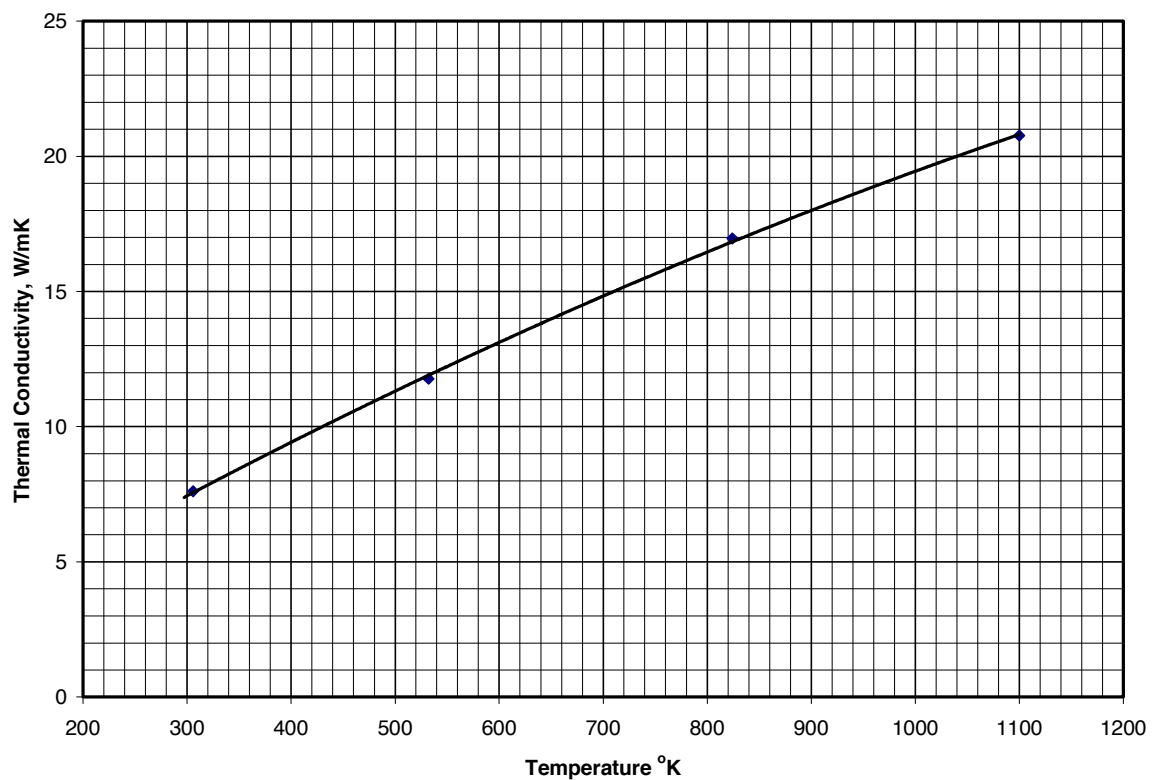

Figure 5.5.1.1(b). Effect of temperature on thermal conductivity of *TIMETAL*® 21S aged at 593°C for 8 hours (Single Aged).

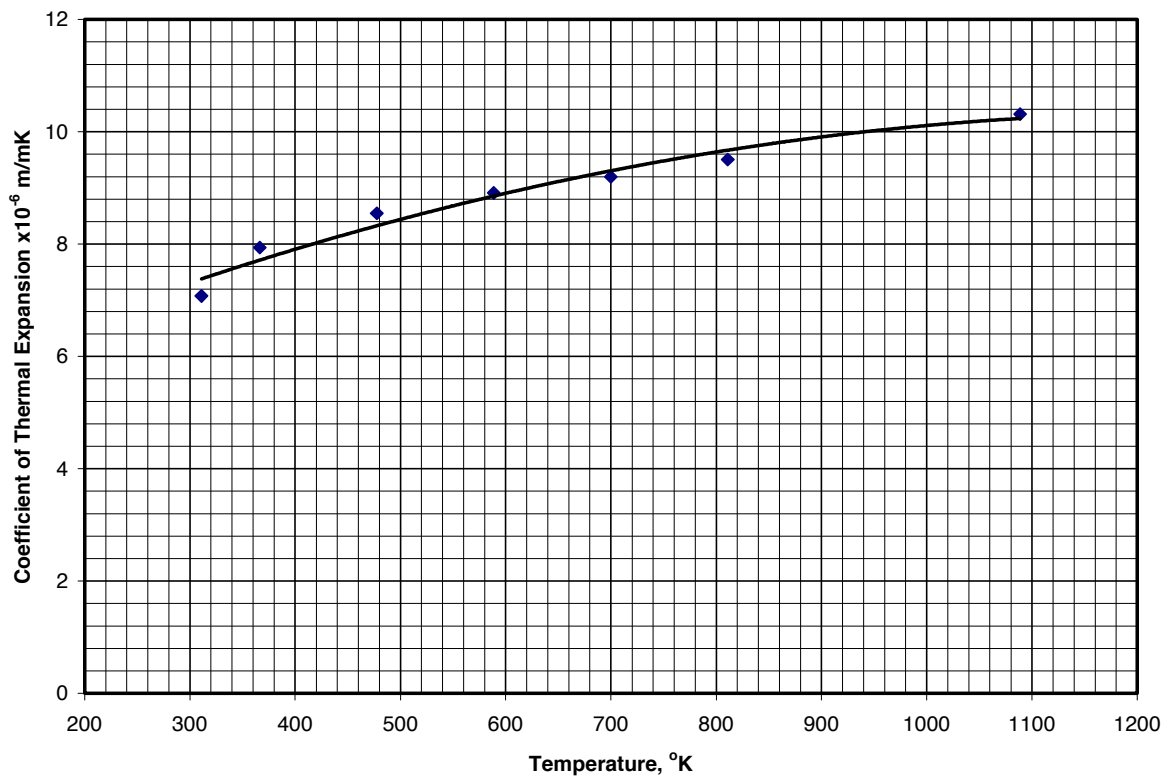

Figure 5.5.1.1(c). Effect of temperature on coefficient of thermal expansion of *TIMETAL*® 21S aged at 593°C for 8 hours (Single Aged).

REFERENCES

- 5.1.2(a) Jaffe, R. I., "The Physical Metallurgy of Titanium Alloys," *Progress in Metal Physics*, Vol. 7, Pergamon Press, Oxford, England, pp 65-167 (1958).
- 5.1.2(b) "Aircraft Designer's Handbook for Titanium and Titanium Alloys," AFML-TR-67-142 (March 1967).
- 5.1.2(c) Larson, F. R., "Anisotropy in Titanium Sheet in Uniaxial Tension," *ASM Transactions*, **57**, pp 620-631 (1964).
- 5.1.2(d) Larson, F. R., "Textures in Titanium Sheet and Its Effects on Plastic Flow Properties," Army Materials Research Agency, AMRA-TR-65-24 (October 1965).
- 5.1.4(a) White, E. L., and Ward, J. J., "Ignition of Metals in Oxygen," DMIC Report 224, Defense Metals Information Center, Battelle Memorial Institute, Columbus, Ohio (February 1, 1966).
- 5.1.4(b) MIL-HDBK-1568, "Materials and Processes for Corrosion Prevention and Control in Aerospace Weapons Systems" (July 1998). (Replaces MIL-STD-1568.)
- 5.5.1.0 Fanning, J. C., "Timetal® 21S Property Data," TIMET (February 1993).

This page intentionally blank.

CHAPTER 6

HEAT-RESISTANT ALLOYS

Heat-resistant alloys are arbitrarily defined as iron alloys richer in alloy content than the 18 percent chromium, 8 percent nickel types, or as alloys with a base element other than iron and which are intended for elevated-temperature service. These alloys have adequate oxidation resistance for service at elevated temperatures and are normally used without special surface protection. So-called “refractory” alloys that require special surface protection for elevated-temperature service are included in Section 6.5.

This chapter contains strength properties and related characteristics of wrought heat-resistant alloy products used in aerospace vehicles. The strength properties are those commonly used in structural design, such as tension, compression, bearing, and shear. The effects of elevated temperature are presented. Factors such as metallurgical considerations influencing the selection of metals are included in comments preceding the specific properties of each alloy or alloy group. Data on creep, stress-rupture, and fatigue strength, as well as crack-growth characteristics, are presented when available in the applicable alloy section.

6.1 GENERAL

There is no standardized numbering system for the alloys in this chapter. For this reason, each alloy is identified by its most widely accepted trade designation.

6.1.1 HEAT-RESISTANT INDEX — The alloys are listed in the index, shown in Table 6.1.1.

Table 6.1.1. Heat-Resistant Alloys Index

Section	Designation
6.2	Iron-Chromium-Nickel-Base Alloys
6.3	Nickel-Base Alloys
6.3.1	AEREX® 350 alloy
6.3.2	HAYNES® 230® alloy
6.3.3	HAYNES® HR-120® alloy
6.3.4	Inconel alloy MA754
6.3.5	EP741NP (Russian Powder Material)
6.4	Cobalt-Base Alloys
6.5	Other Alloys
6.5.1	C-103 (Niobium-Hafnium-Titanium)

The heat treatments applied to the alloys in this chapter vary considerably from one alloy to another. For uniformity of presentation, the heat-treating terms are defined as follows:

Stress-Relieving — Heating to a suitable temperature, holding long enough to reduce residual stresses, and cooling in air or as prescribed.

Annealing — Heating to a suitable temperature, holding, and cooling at a suitable rate for the purpose of obtaining minimum hardness or strength.

Solution-Treating — Heating to a suitable temperature, holding long enough to allow one or more constituents to enter into solid solution, and cooling rapidly enough to hold the constituents in solution.

Aging, Precipitation-Hardening — Heating to a suitable temperature and holding long enough to obtain hardening by the precipitation of a constituent from the solution-treated condition.

The actual temperatures, holding times, and heating and cooling rates used in these treatments vary from alloy to alloy and are described in the applicable specifications.

6.1.2 MATERIAL PROPERTIES

6.1.2.1 Mechanical Properties — The mechanical properties of the heat-resistant alloys are affected by relatively minor variations in chemistry, processing, and heat treatment. Consequently, the mechanical properties shown for the various alloys in this chapter are intended to apply only to the alloy, form (shape), size (thickness), and heat treatment indicated.

Strength Properties — Room-temperature strength properties for alloys in this chapter are based primarily on tensile test data. The variation of properties with temperature and other data of interest are presented in figures or tables, when available.

The strength properties of the heat-resistant alloys generally decrease with increasing temperatures or increasing time at temperature. There are exceptions to this statement, particularly in the case of age-hardening alloys; these alloys may actually show an increase in strength with temperature or time, within a limited range, as a result of further aging. In most cases, however, this increase in strength is temporary and, furthermore, cannot usually be taken advantage of in service.

At cryogenic temperatures, the strength properties of the heat-resistant alloys are generally higher than at room temperature, provided some ductility is retained at the low temperatures. For additional information on mechanical properties at cryogenic temperatures, other references, such as the Cryogenic Materials Data Handbook (Reference 6.1.2.1), should be consulted.

Ductility — Specified minimum ductility requirements are presented for these alloys in the room-temperature property tables. The variation in ductility with temperature is somewhat erratic for the heat-resistant alloys. Generally, ductility decreases with increasing temperature from room temperature up to about 1200 to 1400°F, where it reaches a minimum value, then it increases with higher temperatures. Prior creep exposure may also affect ductility adversely. Below room temperature, ductility decreases with decreasing temperature for some of these alloys.

Creep — Data covering the temperatures and times of exposure and the creep deformations of interest are included when available in individual material sections. These presentations are in the form of creep stress-lifetime curves for various deformation criteria as specified in Chapter 9.

Fatigue — Fatigue S/N curves for unnotched and notched specimens at room temperature and elevated temperatures are shown when available in each alloy section.

6.1.2.2 Physical Properties — Selected physical-property data are presented for these alloys. Processing variables and heat treatment have only a slight effect on these values; thus, the properties listed are applicable to all forms and heat treatments.

6.2 IRON-CHROMIUM-NICKEL-BASE ALLOYS

6.3 NICKEL-BASE ALLOYS

6.3.0 GENERAL COMMENTS — Nickel is the base element for most of the higher temperature heat-resistant alloys. While it is more expensive than iron, nickel provides an austenitic structure that has greater toughness and workability than ferritic structures of the same strength level.

6.3.0.1 Metallurgical Considerations —

Composition — The common alloying elements for nickel are cobalt, iron, chromium, molybdenum, titanium, and aluminum. Cobalt, when substituted for a portion of the nickel in the matrix, improves high-temperature strength; small additions of iron tend to strengthen the nickel matrix and reduce the cost; chromium is added to increase strength and oxidation resistance at very high temperatures; molybdenum contributes to solid solution strengthening. Titanium and aluminum are added to most nickel-base heat resistant alloys to permit age-hardening by the formation of Ni₃ (Ti, Al) precipitates; aluminum also contributes to oxidation resistance.

The nature of the alloying elements in the age-hardenable nickel-base alloys makes vacuum melting of these alloys advisable, if not mandatory. However, the additional cost of vacuum melting is more than compensated for by the resulting improvements in elevated-temperature properties.

Heat Treatment — The nickel-base alloys are heat treated with conventional equipment and fixtures such as would be used with austenitic stainless steels. Since nickel-base alloys are more susceptible to sulfur embrittlement than are iron-base alloys, it is essential that sulfur-bearing materials such as grease, oil, cutting lubricants, marking paints, etc., be removed before heat treatment. Mechanical cleaning, such as wire brushing, is not adequate and if used should be followed by washing with a suitable solvent or by vapor degreasing. A low-sulfur content furnace atmosphere should be used. Good furnace control with respect to time and temperature is desirable since overheating some of the alloys as little as 2°C (35°F) above the set point impairs strength and corrosion resistance.

When it is necessary to anneal the age-hardenable-type alloys, a protective atmosphere (such as argon) lessens the possibility of surface contaminations or depletion of the precipitation-hardening elements. This precaution is not so critical in heavier sections since the oxidized surface layer is a smaller percentage of the cross section. After solution annealing, the alloys are generally quenched in water. Heavy sections may require air cooling to avoid cracking from thermal stresses.

In stress-relief annealing of a structure or assembly composed of an aluminum-titanium hardened alloy, it is vitally important to heat the structure rapidly through the age-hardening temperature range, 649 to 760°C (1200 to 1400°F) which is also the low ductility range) so that stress relief can be achieved before any aging takes place. Parts which are to be used in the fully heat-treated condition would have to be solution treated, air cooled, and subsequently aged. In this case, the stress-relief treatment would be conducted in the solution-temperature range. Little difficulty has been encountered with distortion under rapid heating

conditions, and distortion of weldments of substantial size has been less than that observed with conventional slow heating methods.

6.3.0.2 *Manufacturing Considerations*

Forging — All of the alloys considered, except for the casting compositions, can be forged to some degree. The matrix-strengthened alloys can be forged with proper consideration of cooling rates, atmosphere, etc. Most of the precipitation-hardenable grades can be forged, although heavier equipment is required and a smaller range of reductions can be safely attained.

Cold Forming — Almost all of the wrought-nickel-base alloys in sheet form are cold formable. The lower strength alloys offer few problems, but the higher strength alloys require higher forming pressures and more frequent anneals.

Machining — All of the alloys in this section are readily machinable, provided the optimum conditions of heat treatment, type of tool speed, feed, depth of cut, etc., are achieved. Specific recommendations on these points are available from various producers of these alloys.

Welding — The matrix-strengthening-type alloys offer no serious problems in welding. All of the common resistance- and fusion-welding processes (except submerged arc) have been successfully employed. For the age-hardenable type of alloy, it is necessary to observe some further precautions:

- (1) Welding should be confined to annealed material where design permits. In full age-hardened material, the hazard of cracking in the weld and/or the parent metal is great.
- (2) If design permits joining some portions only after age hardening, the parts to be joined should be “safe ended” with a matrix-strengthened-type alloy (with increased cross section) and then age hardened; welding should then be carried out on the “safe ends.”
- (3) Parts severely worked or deformed should be annealed before welding.
- (4) After welding, the weldment will often require stress relieving before aging.
- (5) Material must be heated rapidly to the stress-relieving temperature.
- (6) In a number of the age-hardenable alloys, fusion welds may exhibit only 70 to 80 percent of the rupture strength of the parent metal. The deficiency can often be minimized by design, such as locating welds in areas of lowest temperature and/or stress. The use of special filler wires to improve weld-rupture properties is under investigation.

Brazing — The solid-solution-type chromium-containing alloys respond well to brazing, using techniques and brazing alloys applicable to the austenitic stainless steels. Generally, it is necessary to braze annealed material and to keep stresses low during brazing, especially when brazing with low melting alloys, to avoid embrittlement. As with the stainless steels, dry hydrogen, argon, or helium atmospheres (-62°C [-80°F] dew point or lower) are used successfully, and vacuum brazing is now receiving increasing attention.

The aluminum-titanium age-hardened nickel-base alloys are difficult to braze, even using extremely dry reducing- and inert-gas atmospheres, unless some method of fluxing, solid or gaseous, is used. An alternative technique which is commonly used is to preplate the areas to be brazed with ½ to 1 mil of nickel. For some metal combinations, a few fabricators prefer to apply an iron preplate. In either case, the plating prevents the formation of aluminum or titanium oxide films and results in better joints.

Most of the high-temperature alloys of the nickel-base type are brazed with Ni-Cr-Si-B and Ni-Cr-Si types of brazing alloy. Silver brazing alloys can be used for lower temperature applications. However, since the nickel-base alloys to be brazed are usually employed for higher temperature applications, the higher melting point, stronger, and more oxidation-resistant brazing alloys of the Nicrobraz type are generally used. Some of the gold-base and palladium-base brazing alloys may be useful under some circumstances in intermediate-temperature applications.

6.3.1 AEREX® 350*

6.3.1.0 Comments and Properties — AEREX® 350 is a Ni-Co-Cr precipitation-hardening superalloy similar to MP159, but with more gamma prime formers to allow even higher temperature capability (Ref. 6.3.1.0 (a) and (b)). AEREX 350 was designed for high temperature fastener applications such as bolts for gas turbine engines and may be used in a continuous application at 732°C (1350°F). It has excellent creep and stress rupture resistance at high temperatures ranging from 620-760°C (1150 to 1400°F) and a coefficient of thermal expansion similar to conventional nickel base superalloys. As a result of its attractive ambient temperature properties, AEREX 350 is also expected to be used as a structural fastener alloy in airframe applications.

Manufacturing Considerations — AEREX 350 is strengthened through a combination of cold work and thermal treatments. Thermal treatments during manufacturing lead to the more conventional gamma prime particle strengthening. Cold deformation promotes a martensitic transformation which hinders dislocation and leads to strengthening. Machinability is fair, as with other nickel-based superalloys.

Environmental Considerations — The corrosion resistance of AEREX 350 is similar to many nickel-chromium based superalloys. Oxidation, sulfidation and hot salt corrosion resistance are comparable to that of Waspaloy. When used with aluminum joints, AEREX 350 (as with other nickel base superalloys), requires a compatible coating or plating to prevent galvanic corrosion of the joint material.

Heat Treatment — Following the required cold working for strengthening, a stabilization heat treatment of 885°C (1625°F) for 2 hours is required for precipitation of additional intergranular eta phase, and some coarse gamma prime. This is followed by age hardening at 760°C (1400°F) for 4 hours to precipitate fine gamma prime which is responsible for elevated temperature strength.

Specifications and Properties — Material specifications are shown in Table 6.3.1.0(a).

Table 6.3.1.0(a). Material Specifications for AEREX 350

Specification	Form
Proprietary SPS Technology Spec. SPS-M-746	Bar

Room temperature mechanical and physical properties are shown in Table 6.3.1.0(b). Stress rupture properties are shown in Table 6.3.1.0(c) and Figure 6.3.1.0(e).

* AEREX is a registered trademark of SPS Technologies, Inc.

Table 6.3.1.0(b). Typical Mechanical and Physical Properties of AEREX® 350 Bar

Specification	Proprietary SPS Technology Spec. SPS-M-746			
Form	Bar			
Condition (or Temper)	Cold Worked and Aged			
Diameter, mm	5.334			
	n / lots/ heats ^a	Avg.	Std. Dev.	Skew
Mechanical Properties:				
<i>TUS</i> , MPa	65/6/3	1653	35	0.40
<i>TYS</i> , MPa	65/6/3	1423	59	-0.12
<i>CYS</i> , MPa	—	—	—	—
<i>SUS</i> , MPa	—	—	—	—
<i>BUS</i> , MPa:				
($\epsilon/D = 1.5$)	—	—	—	—
($\epsilon/D = 2.0$)	—	—	—	—
<i>BYS</i> , MPa:				
($\epsilon/D = 1.5$)	—	—	—	—
($\epsilon/D = 2.0$)	—	—	—	—
<i>elong.</i> , percent	65/6/3	20.5	2.6	-0.63
<i>Red. of Area</i> , percent	65/6/3	31.7	3.3	-0.32
<i>E</i> , GPa	216 ^b			
<i>E_c</i> , GPa	—			
<i>G</i> , GPa	83.8 ^b			
μ	0.287 ^b			
Physical Properties:				
ω , Mg/m ³	8.62 ^b			
<i>K</i> , W/m ^{°K}	see Figure 6.3.1.0 (a) ^b			
<i>C</i> , J/(g ^{°K})	see Figure 6.3.1.0 (b) ^b			
α , 10 ⁻⁶ m/m ^{°K}	see Figure 6.3.1.0 (c) ^c			
<i>Electrical Resistivity</i> , ohm-in x10 ⁻⁸	see Figure 6.3.1.0 (d) ^b			

^a *n* represents the number of data points, *lots* represents the number of lots, *heats* represents the number of heats. Refer to

Section 9.1.3 for definitions.

^b From SPS Technologies brochures.

Table 6.3.1.0(c). Typical Stress Rupture Properties of AEREX® 350 at Elevated Temperatures

Specification		Proprietary SPS Technology Spec. SPS-M-746											
Form		Bar											
Condition		Cold Worked and Aged											
Diameter, mm		5.334											
Property		Rupture Life, hrs				Elongation, %				Reduction of Area, %			
		n/lots/ heats ^a	Avg.	Std. Dev.	Skew	n/lots/ heats ^a	Avg.	Std. Dev.	Skew	n/lots/ heats ^a	Avg.	Std. Dev.	Skew
Stress Rupture at 649 °C:													
896 MPa (130 ksi)		8/3/3	225.2	46.6	-0.03	8/3/3	34.2	7.4	-1.75	8/3/3	51.0	6.4	0.95
931 MPa (135 ksi)		8/3/3	137.6	45.3	0.14	8/3/3	34.2	4.9	-1.47	8/3/3	51.6	4.3	-0.02
965 MPa (140 ksi)		7/3/3	83.0	28.1	0.99	7/3/3	33.7	5.3	-0.96	7/3/3	53.7	3.6	-0.20
1014 MPa . (147.1 ksi)		3/1/1	21.9	4.2	-1.60	3/1/1	39.3	1.2	-1.73	3/1/1	50.3	3.7	1.73
1093 MPa . (158.5 ksi)		3/1/1	6.1	0.4	1.15	3/1/1	31.3	5.0	-0.58	3/1/1	30.3	15.5	0.26
Stress Rupture at 732 °F:													
620 MPa (90 ksi)		8/3/3	61.3	12.6	0.62	8/3/3	41.0	5.8	1.02	8/3/3	60.9	5.9	0.66
655 MPa (95 ksi)		45/3/5	59.5	22.8	0.63	45/3/5	34.2	6.8	0.33	8/3/3	62.2	2.7	-0.67
690 MPa (100 ksi)		9/3/3	27.0	8.3	1.30	9/3/3	40.9	5.0	-1.26	9/3/3	60.4	3.0	-0.23

^a *n* represents the number of data points, *lots* represents the number of lots, *heats* represents the number of heats. Refer to Section 9.1.3 for definitions.

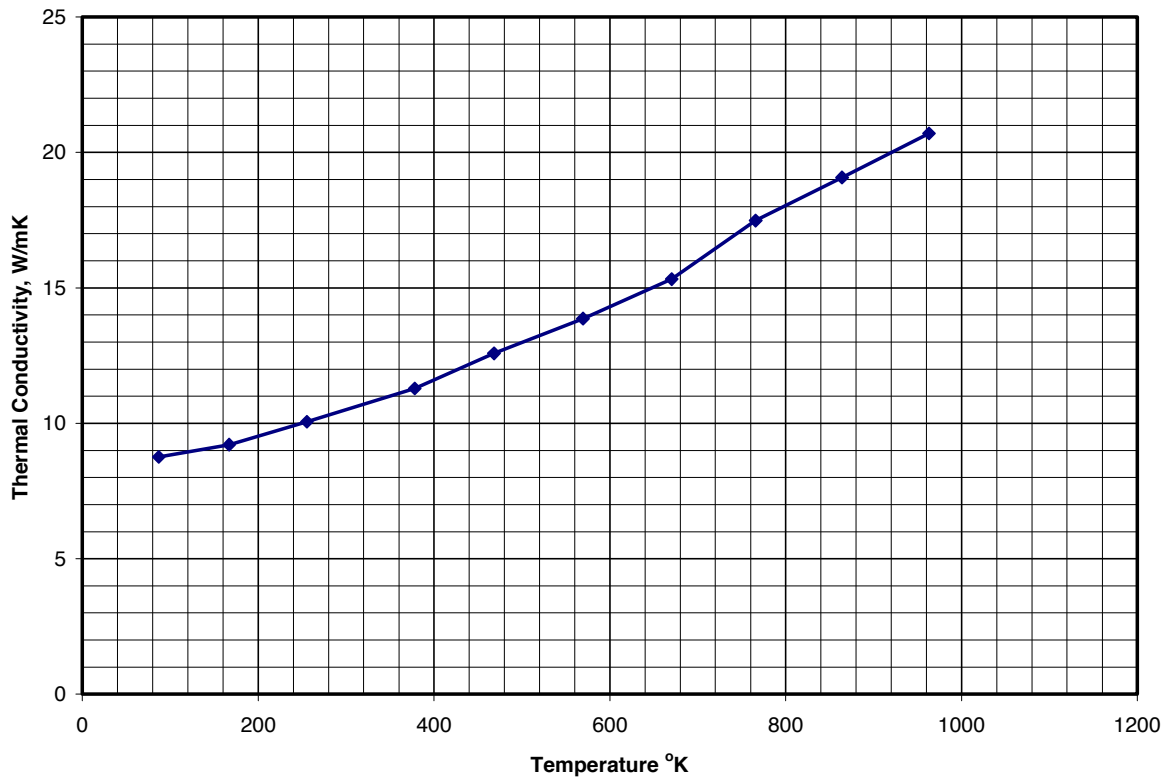

Figure 6.3.1.0(a). Effect of temperature on thermal conductivity of AEREX 350.

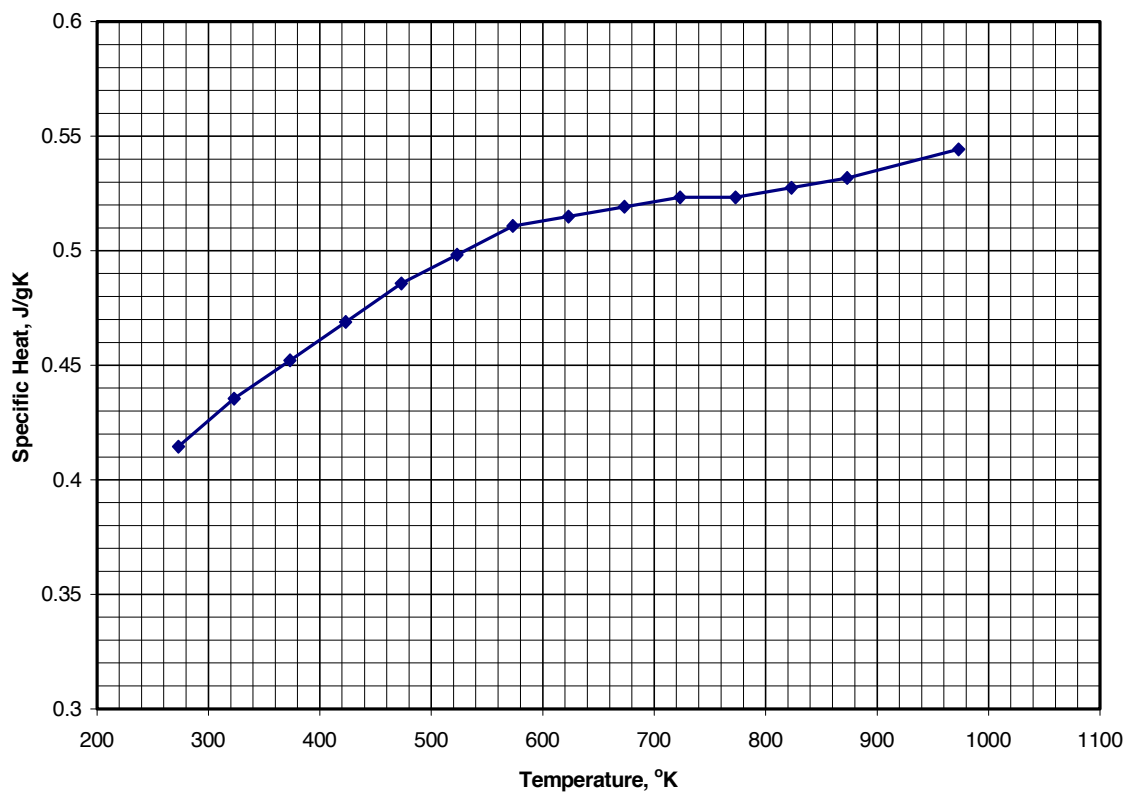

Figure 6.3.1.0(b). Effect of temperature on specific heat of AEREX 350.

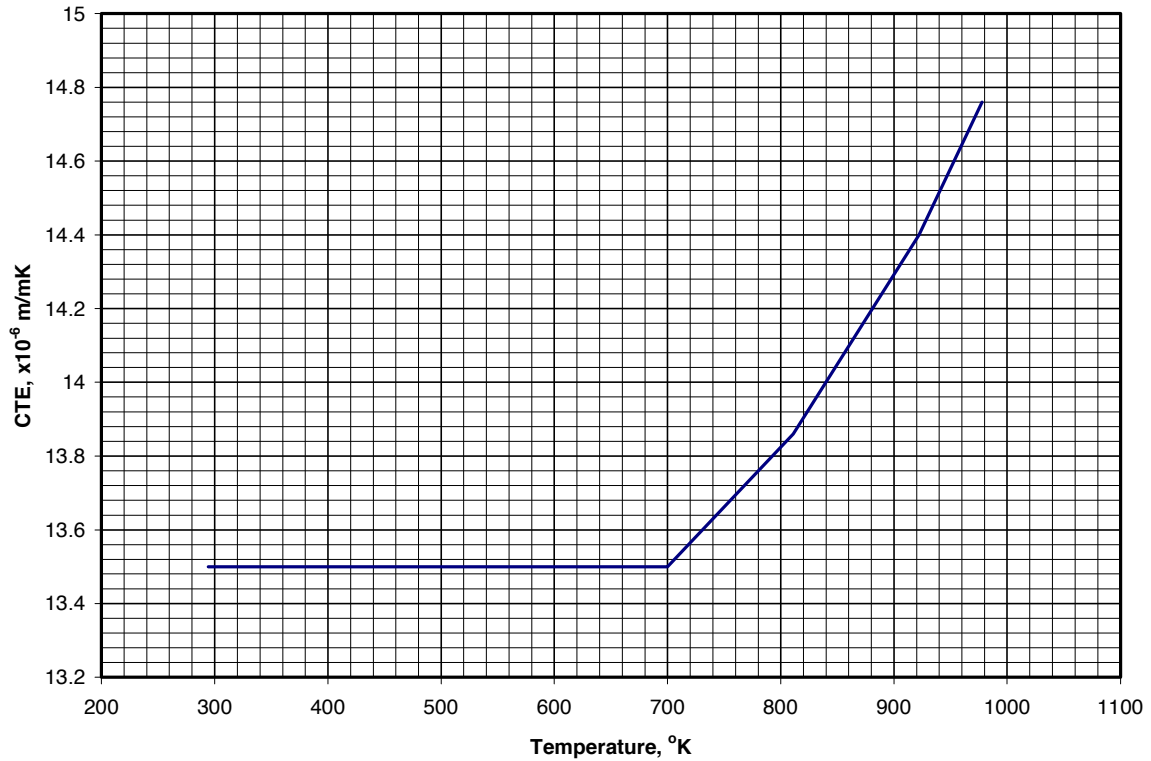

Figure 6.3.1.0(c). Effect of temperature on coefficient of thermal expansion of AEREX® 350.

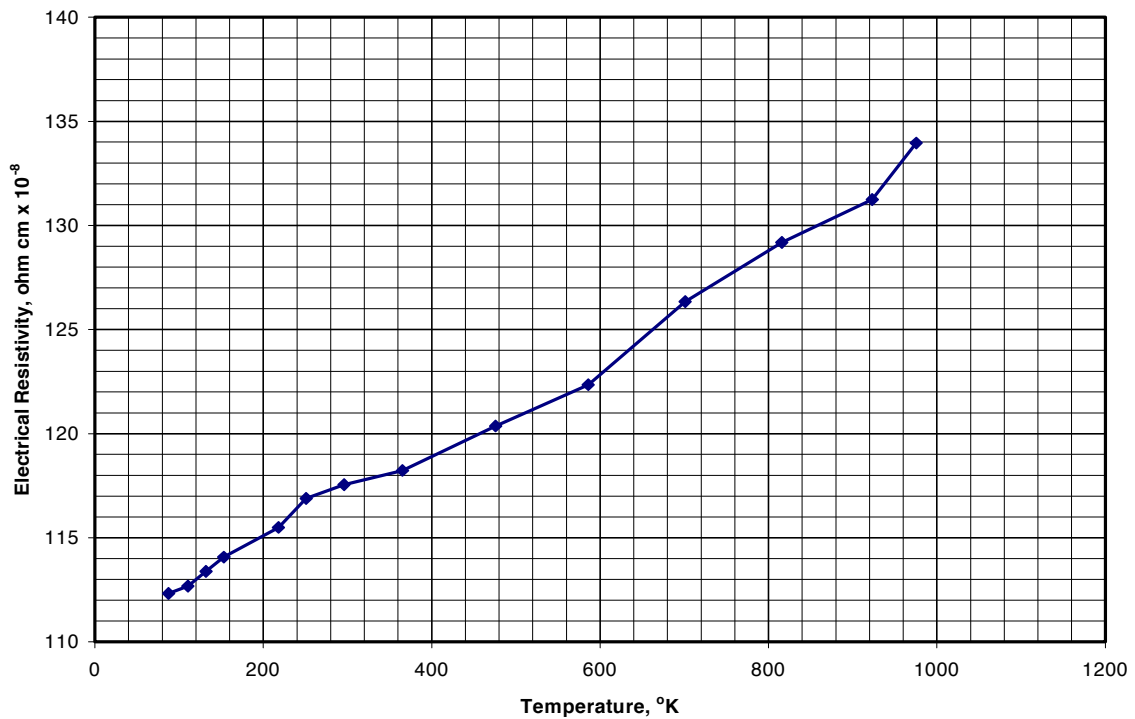

Figure 6.3.1.0(d). Effect of temperature on electrical resistivity of AEREX® 350.

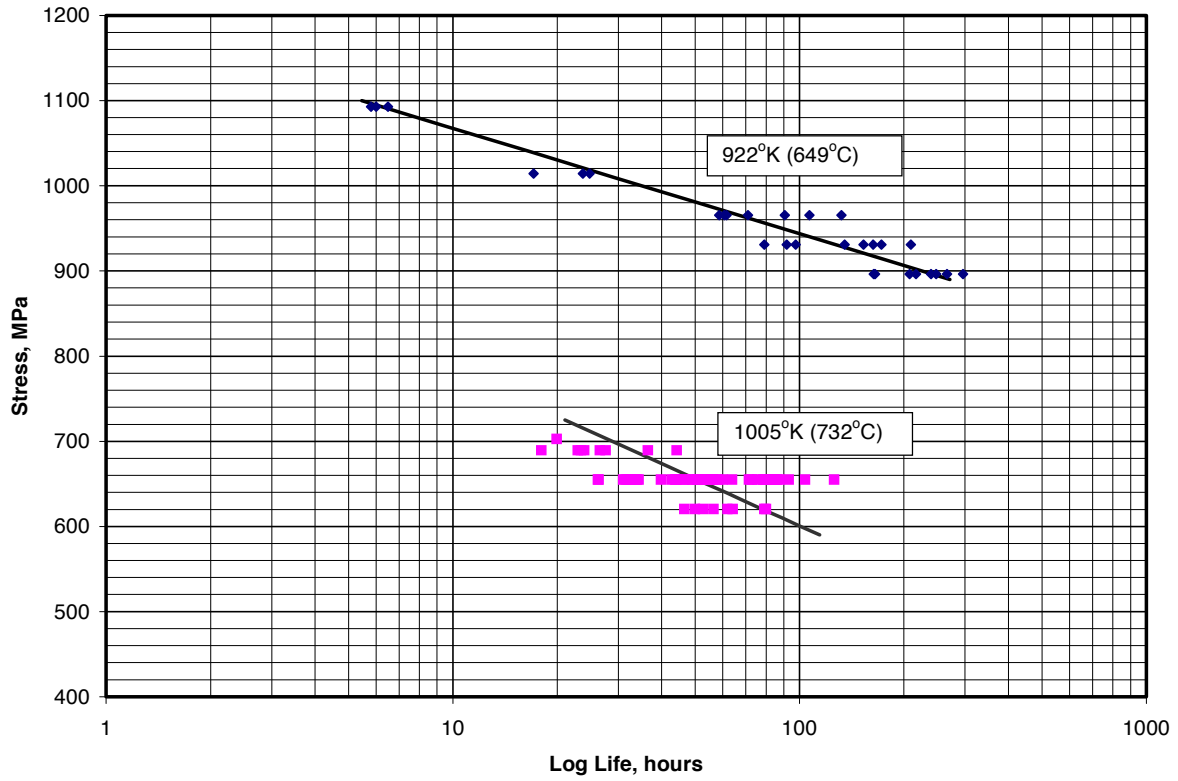

Figure 6.3.1.0(e). Stress rupture properties of AEREX® 350 at 649°C and 732°C.

6.3.2. HAYNES® 230®*

6.3.2.0. Comments and Properties — HAYNES® 230® alloy provides excellent oxidation resistance up to 2100°F for prolonged exposures with superior long term stability, high temperature strength and good fabricability. It is produced in the form of plate, sheet, strip, foil, billet, bar, wire welding products, pipe, tubing, remelt bar, and may be cast using traditional air-melt sand mold or vacuum-melt investment foundry techniques. Products are used for gas turbine components in the aerospace industry, catalyst grid supports in the chemical process industry, and various other high-temperature applications.

Environmental Considerations — HAYNES® 230® alloy has excellent corrosion resistance to both air and combustion gas oxidizing environments. It also exhibits excellent nitriding resistance and good resistance to carburization and hydrogen embrittlement.

Machining — HAYNES® 230® alloy has similar machining characteristics to other solid-solution-strengthened nickel-based alloys. This group of materials is classified moderate to difficult to machine, however, they can be machined using conventional methods at satisfactory rates. They work-harden rapidly, requiring slower speeds and feeds with heavier cuts than would be used for machining stainless steels. See HAYNES® publication H-3159 (Reference 6.3.2.0) for more detailed information.

Joining — HAYNES® 230® alloy has excellent forming and welding characteristics similar to HASTELLOY® X. It is readily welded using GTAW (Gas Tungsten-Arc Welding), GMAW (Gas Metal-Arc Welding), SMAW (Shielded Metal-Arc Welding), and resistance techniques. HAYNES® 230-W™ alloy is the recommended filler metal.

Heat Treatment — This alloy is normally final solution heat-treated between 1176°C and 1246°C (2150°F and 2275°F). Annealing during fabrication can be performed at slightly lower temperatures, but a final subsequent solution heat treatment followed by rapid cooling is needed to produce optimum properties and structure.

Specifications and Properties — Material specifications are shown in Table 6.3.2.0(a).

Table 6.3.2.0(a). Material Specifications for HAYNES® 230® Alloy Wrought

Specification	Form
AMS 5878	Plate, sheet, and strip
AMS 5891	Bar, and forging

Room temperature mechanical and physical properties are shown in Tables 6.3.2.0(b) through (d). Elevated temperature mechanical properties are shown in Figures 6.3.2.0(d) and (e).

*HAYNES® and HASTELLOY® are registered trademarks of HAYNES International.

Table 6.3.2.0(b). Typical Mechanical and Physical Properties of HAYNES® 230® Alloy Sheet

Specification	AMS 5878							
	Cold Rolled Sheet							
	Annealed at 1232°C (2250°F)							
	0 to 2.5				2.6 to 4			
	n / lots ^a	Avg.	Std. Dev.	Skew	n / lots ^a	Avg.	Std. Dev.	Skew
Mechanical Properties:								
<i>TUS</i> , MPa:								
L	—	—	—	—	—	—	—	—
LT or T	458/137	844	24	0.48	81/61	835	18	-0.04
<i>TYS</i> , MPa:								
L	—	—	—	—	—	—	—	—
LT or T	458/137	414	33	0.31	80/60	398	28	0.34
<i>CYS</i> , MPa								
—								
<i>SUS</i> , MPa								
—								
<i>BUS</i> , MPa:								
(e/D = 1.5)	—	—	—	—	—	—	—	—
(e/D = 2.0)	—	—	—	—	—	—	—	—
<i>BYS</i> , MPa:								
(e/D = 1.5)	—	—	—	—	—	—	—	—
(e/D = 2.0)	—	—	—	—	—	—	—	—
<i>elong.</i> , percent:								
L	—	—	—	—	—	—	—	—
LT or T	458/137	45.5	2.2	-0.03	81/61	48.1	1.9	0.25
red. of area, percent:								
L	—	—	—	—	—	—	—	—
LT or T	—	—	—	—	—	—	—	—
<i>E</i> , GPa								
—								
<i>E_c</i> , GPa								
—								
<i>G</i> , GPa								
—								
<i>μ</i>								
—								
Physical Properties:								
<i>ω</i> , Mg/m ³	0.324 ^b							
<i>C</i> , J/(g°K)	see Figure 6.3.2.0(a) ^b							
<i>K</i> , W/m°K	see Figure 6.3.2.0(b) ^b							
<i>α</i> , m/m°K	see Figure 6.3.2.0(c) ^b							

a *n* represents the number of data points, *lots* represents the number of lots. Refer to Section 9.1.3 for definitions.

b Converted to metric from HAYNES® brochure H-3000F on HAYNES® 230® alloy

Table 6.3.2.0(b). Cont. Typical Mechanical and Physical Properties of HAYNES® 230® Alloy Sheet

Specification	AMS 5878							
	Cold Rolled Sheet				Hot Rolled Sheet			
	Annealed at 1204°C (2200°F)							
	0 to 4				3 to 5			
	n / lots ^a	Avg.	Std. Dev.	Skew	n / lots ^a	Avg.	Std. Dev.	Skew
Mechanical Properties:								
<i>TUS</i> , MPa:								
L	—	—	—	—	—	—	—	—
LT or T	35/25	847	24	0.46	90/57	852	20	-0.24
<i>TYS</i> , MPa:								
L	—	—	—	—	—	—	—	—
LT or T	35/25	410	36	1.02	90/57	420	30	0.04
<i>CYS</i> , MPa	—	—	—	—	—	—	—	—
<i>SUS</i> , MPa	—	—	—	—	—	—	—	—
<i>BUS</i> , MPa:								
(e/D = 1.5)	—	—	—	—	—	—	—	—
(e/D = 2.0)	—	—	—	—	—	—	—	—
<i>BYS</i> , MPa:								
(e/D = 1.5)	—	—	—	—	—	—	—	—
(e/D = 2.0)	—	—	—	—	—	—	—	—
<i>elong.</i> , percent:								
L	—	—	—	—	—	—	—	—
LT or T	35/25	46.2	3.1	-0.22	90/57	46.2	1.9	0.22
red. of area, percent:								
L	—	—	—	—	—	—	—	—
LT or T	—	—	—	—	—	—	—	—
<i>E</i> , GPa				—				
<i>E_c</i> , GPa				—				
<i>G</i> , GPa				—				
<i>μ</i>				—				
Physical Properties:								
<i>ω</i> , Mg/m ³				8.968 ^b				
<i>C</i> , J/(g°K)				see Figure 6.3.2.0(a) ^b				
<i>K</i> , W/m°K				see Figure 6.3.2.0(b) ^b				
<i>α</i> , 10 ⁻⁶ m/m°K				see Figure 6.3.2.0(c) ^b				

a *n* represents the number of data points, *lots* represents the number of lots. Refer to Section 9.1.3 for definitions.

b Converted to metric from HAYNES® brochure H-3000F on HAYNES® 230® alloy.

Table 6.3.2.0(c). Typical Mechanical and Physical Properties of HAYNES® 230® Alloy Plate

Specification	AMS 5878											
	Plate											
	Anneal at 1177 °C (2150 °F)				Anneal at 1204 °C (2200 °F)				Anneal at 1204 °C (2200 °F)			
	19 to 51		5 to 26		27 to 51		5 to 26		27 to 51		27 to 51	
	n / lots ^a	Avg.	Std. Dev.	Skew	n / lots ^a	Avg.	Std. Dev.	Skew	n / lots ^a	Avg.	Std. Dev.	Skew
Thickness, mm												
Mechanical Properties:												
TUS, MPa:												
L	6/3	835	19	-0.50	396/125	850	19	-0.20	54/41	826	23	0.35
LT												
TYS, MPa:												
L	6/3	384	21	0.51	396/125	403	29	0.13	54/41	389	20	0.37
LT												
CYS, MPa												
SUS, MPa												
BUS, MPa:												
(e/D = 1.5)												
(e/D = 2.0)												
BYS, MPa:												
(e/D = 1.5)												
(e/D = 2.0)												
<i>elong.</i> , percent:												
L	6/3	42.7	2.4	0.08	396/125	46.4	2.6	0.10	54/41	45.7	3.0	0.05
LT	6/3	39.8	3.9	0.41	113/66	46.0	3.6	0.56	48/38	42.3	3.9	-0.42
<i>Red. of Area.</i> , percent ..												
<i>E</i> , GPa												
<i>E_t</i> , GPa												
<i>G</i> , GPa												
<i>μ</i>												
Physical Properties:												
<i>ω</i> , Mg/m ³												
<i>C</i> , J/(g °K)												
<i>K</i> , W/m °K												
<i>α</i> , 10 ⁻⁶ m/m °K												

8,968^b
see Figure 6.3.2.0(a)^b
see Figure 6.3.2.0(b)^b
see Figure 6.3.2.0(c)^b

^a *n* represents the number of data points, *lots* represents the number of lots. Refer to Section 9.1.3 for definitions.
^b Converted to metric from HAYNES® brochure H-3000F on HAYNES® 230® alloy.

Table 6.3.2.0(d). Typical Mechanical and Physical Properties of HAYNES® 230® Alloy Bar

Specification		AMS 5891											
		Bar											
Form		Anneal at 1232°C (2250°F)											
Temper		< 51				52 to 102				103 to 152			
Diameter, mm		n / lots ^a	Avg.	Std. Dev.	Skew	n / lots ^a	Avg.	Std. Dev.	Skew	n / lots ^a	Avg.	Std. Dev.	Skew
Mechanical Properties:													
TUS, MPa:		104/29	845	22	-0.29	39/23	829	21	-0.29	20/14	803	21	1.18
L		-	-	-	-	-	-	-	-	-	-	-	-
LT		-	-	-	-	-	-	-	-	-	-	-	-
TYS, MPa:		104/29	397	31	1.72	39/23	400	21	-0.32	20/14	382	23	1.22
L		-	-	-	-	-	-	-	-	-	-	-	-
LT		-	-	-	-	-	-	-	-	-	-	-	-
CYS, MPa		-	-	-	-	-	-	-	-	-	-	-	-
SUS, MPa		-	-	-	-	-	-	-	-	-	-	-	-
BUS, MPa:		-	-	-	-	-	-	-	-	-	-	-	-
(e/D = 1.5)		-	-	-	-	-	-	-	-	-	-	-	-
(e/D = 2.0)		-	-	-	-	-	-	-	-	-	-	-	-
BYS, MPa:		-	-	-	-	-	-	-	-	-	-	-	-
(e/D = 1.5)		-	-	-	-	-	-	-	-	-	-	-	-
(e/D = 2.0)		-	-	-	-	-	-	-	-	-	-	-	-
elong., percent:		-	-	-	-	-	-	-	-	-	-	-	-
L		104/29	50.5	2.1	-0.28	39/23	50.5	2.6	-0.21	20/14	50.2	3.0	-0.11
LT		-	-	-	-	-	-	-	-	-	-	-	-
Red. of Area., percent:		-	-	-	-	-	-	-	-	-	-	-	-
L		104/29	56.0	2.8	0.47	39/23	52.1	2.6	-0.65	20/14	47.4	3.9	-0.98
LT		-	-	-	-	-	-	-	-	-	-	-	-
E, GPa		-	-	-	-	-	-	-	-	-	-	-	-
E ₀ , GPa		-	-	-	-	-	-	-	-	-	-	-	-
G, GPa		-	-	-	-	-	-	-	-	-	-	-	-
μ		-	-	-	-	-	-	-	-	-	-	-	-
Physical Properties:													
ω, Mg/m ³		-	-	-	-	-	8.968 ^b	-	-	-	-	-	-
C, J/(g°K)		-	-	-	-	-	see Figure 6.3.2.0(a) ^b	-	-	-	-	-	-
K, W/m°K		-	-	-	-	-	see Figure 6.3.2.0(b) ^b	-	-	-	-	-	-
α, 10 ⁻⁶ m/m°K		-	-	-	-	-	see Figure 6.3.2.0(c) ^b	-	-	-	-	-	-

^a *n* represents the number of data points, *lots* represents the number of lots. Refer to Section 9.1.3 for definitions.

^b Converted to metric from HAYNES® brochure H-3000F on HAYNES® 230® alloy.

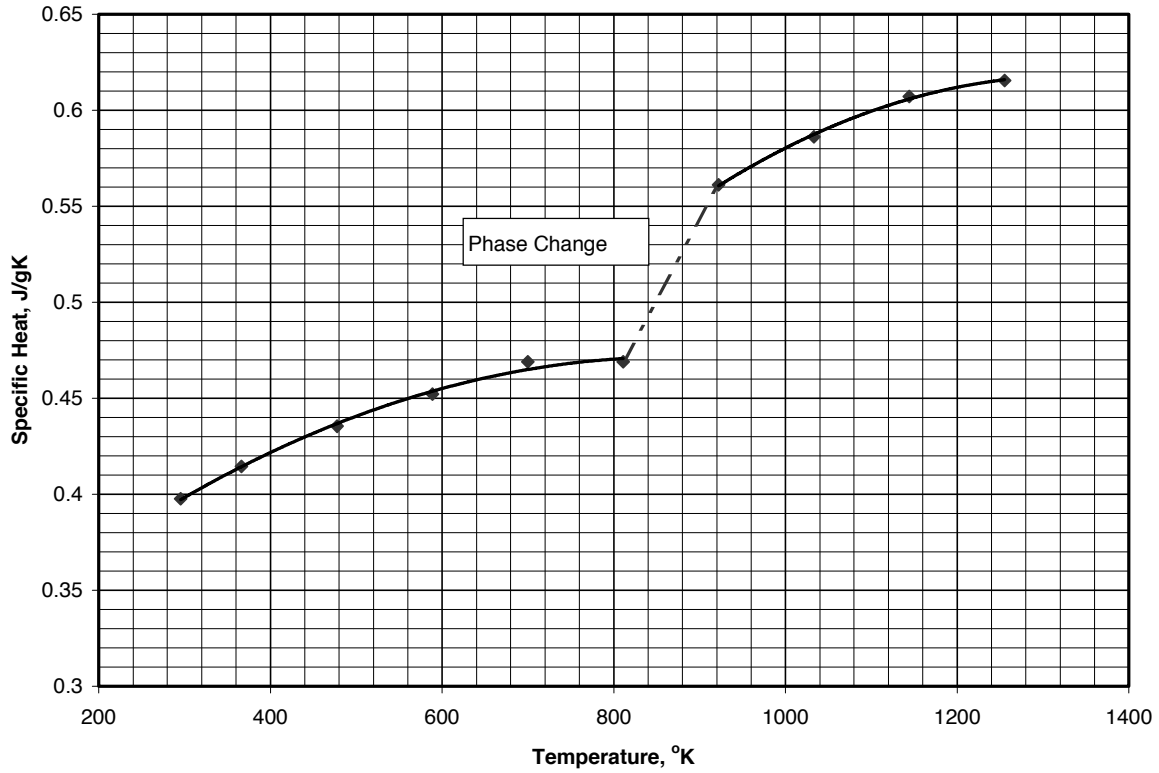

Figure 6.3.2.0(a). Effect of temperature on specific heat of HAYNES® 230® alloy.

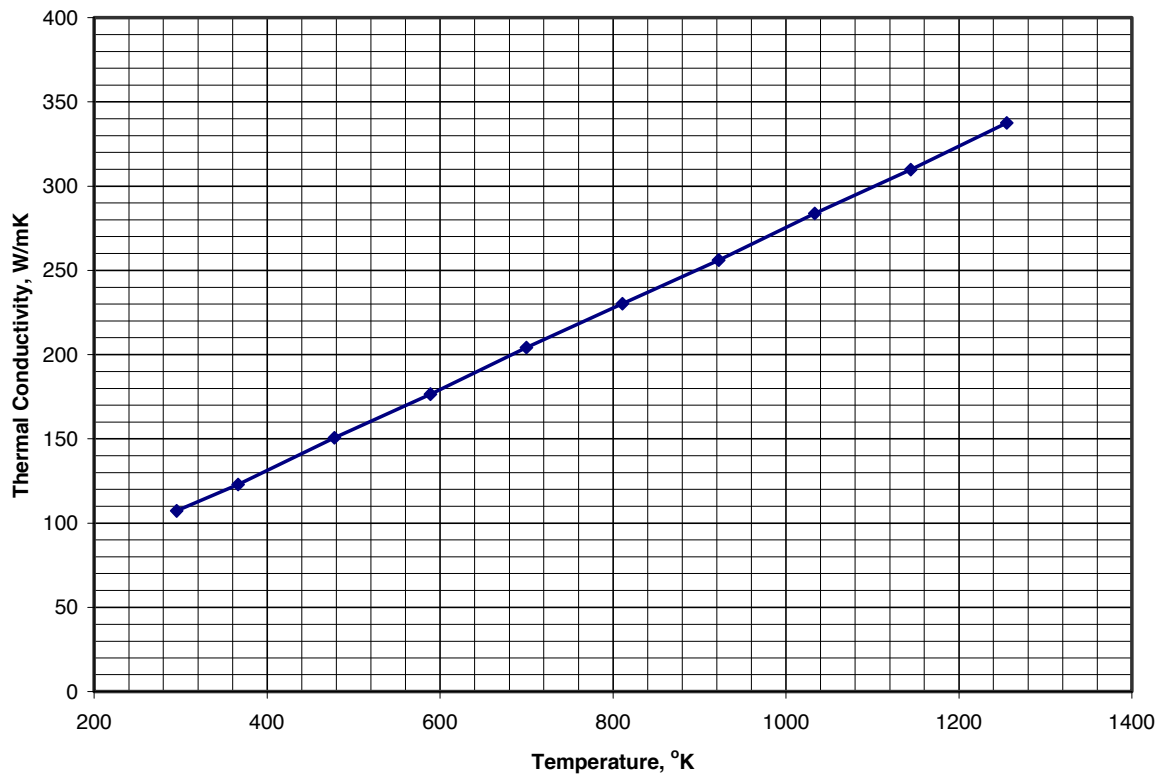

Figure 6.3.2.0(b). Effect of temperature on thermal conductivity of HAYNES® 230® alloy.

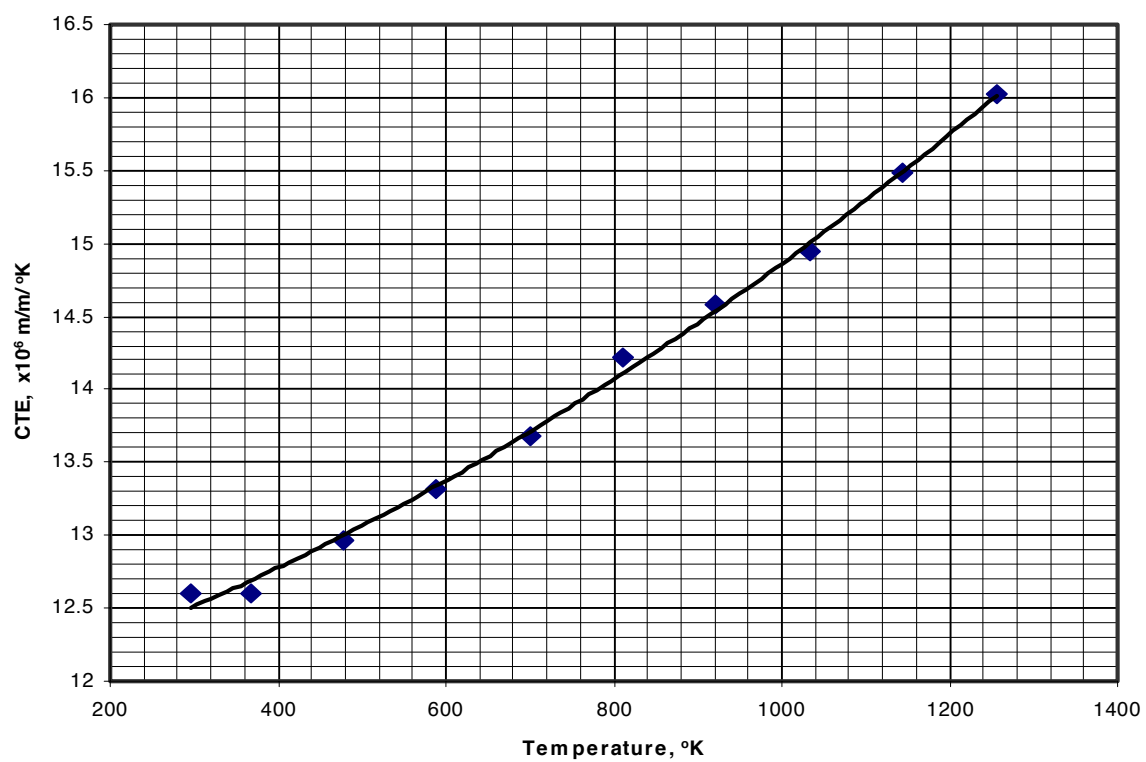

Figure 6.3.2.0(c). Effect of temperature on coefficient of thermal expansion of HAYNES® 230® alloy.

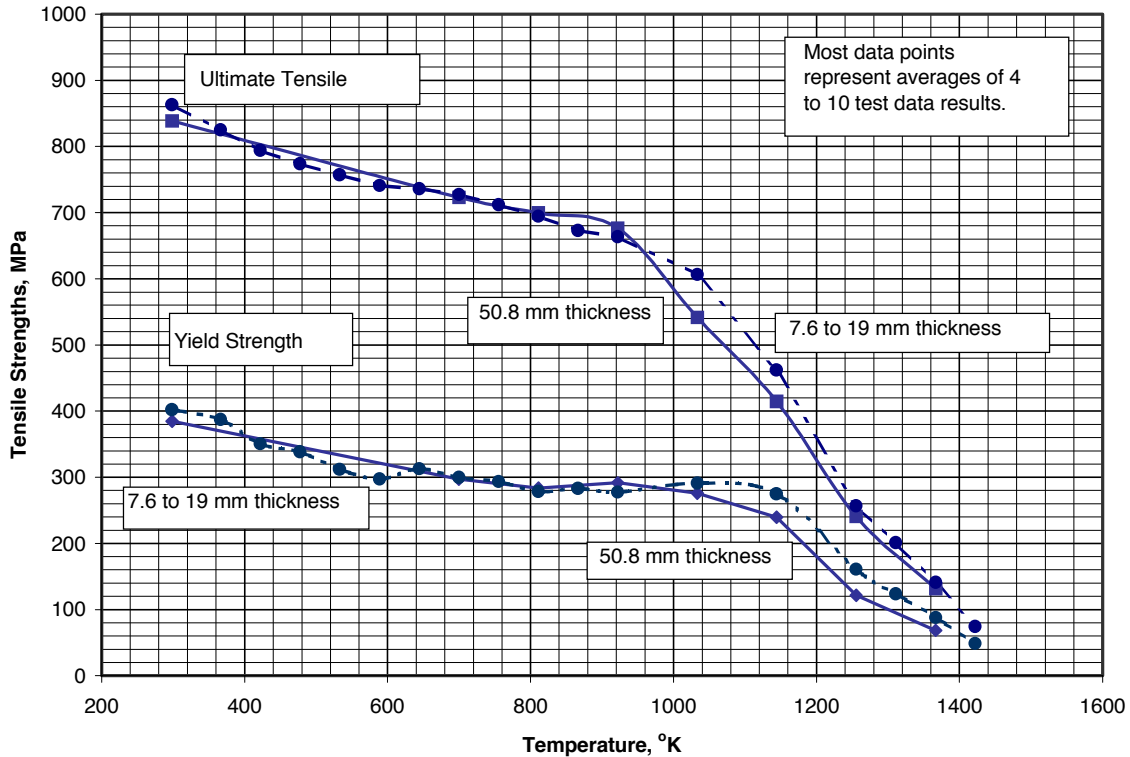

Figure 6.3.2.0(d). Effect of temperature on tensile properties of HAYNES® 230® alloy plate. The strain rate to determine TYS was 0.005 mm/mm/min of gage length. The crosshead rate to determine UTS from beyond yield strength was 12.7 mm/min of reduced section length.

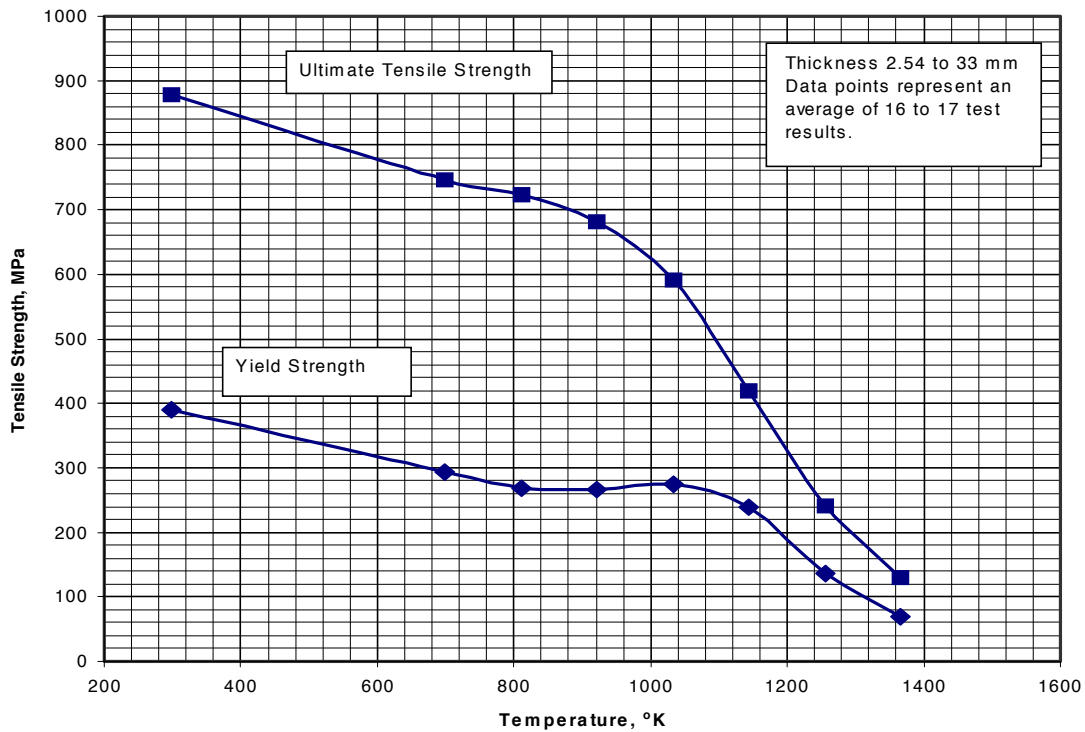

Figure 6.3.2.0(e). Effect of temperature on tensile properties of HAYNES® 230® alloy bar. The strain rate to determine TYS was 0.005 mm/mm/min of gage length. The crosshead rate to determine UTS from beyond yield strength was 12.7 mm/min of reduced section length.

6.3.3 HAYNES® HR-120®*

6.3.3.0 Comments and Properties— HAYNES® HR-120® alloy is a solid-solution strengthened Fe-Ni-Cr alloy with excellent high temperature strength, very good resistance to carburizing and sulfiding environments, and readily formed hot or cold.

Environmental Considerations — HAYNES® HR-120® alloy has very good sulfide and carburization resistance. Oxidation resistance is comparable to other Fe-Ni-Cr materials such as alloys 330 and 800H, yet with a greater strength at temperatures up to 2000°F.

Machining — This alloy is readily machinable using conventional practices similar to those for 300 series austenitic stainless steels. Minor adjustments may be required to yield optimum results. See HAYNES publication H-3125B for more detailed information.

Joining — Welding characteristics are similar to the HASTELLOY® alloys. The alloy is readily welded using GTAW (Gas Tungsten-Arc Welding), GMAW (Gas Metal-Arc Welding), and SMAW (Shielded Metal-Arc Welding) techniques. HAYNES® 556™ alloy is the recommended filler wire (AMS5831) for GTAW and GMAW processes. Multimet® alloy covered electrode (AMS 5795) is recommended for SMAW processes. HASTELLOY® X alloy filler wire (AMS 5798) and covered electrode (AMS 5799) may also be used.

Heat Treatment — This alloy is solution annealed between 1177 and 1232°C (2150 and 2250°F) and rapidly cooled.

Specifications and Properties — Material specifications are shown in Table 6.3.3.0(a).

Table 6.3.3.0(a). Material Specifications for HAYNES® HR-120® Alloy Wrought Products

Specification	Form
ASTM B 408	Bar
ASTM B 409	Sheet and plate
AMS5891	Bar, Forging

Room temperature mechanical and physical properties are shown in Tables 6.3.3.0(b).

* HAYNES® and HASTELLOY® are registered trademarks of HAYNES International.

Table 6.3.3.0(b). Typical Mechanical and Physical Properties of HAYNES® HR-120® Alloy Bar

Specification	ASTM B 408							
	Bar							
	Annealed at 1204°C (2200°F)							
	7 to 20				21 to 40			
	n / lots ^a	Avg.	Std. Dev.	Skew	n / lots ^a	Avg.	Std. Dev.	Skew
Mechanical Properties:								
<i>TUS</i> , MPa:								
L	54/26	727	17	-0.55	13/8	706	10	0.17
LT or T	—	—	—	—	—	—	—	—
<i>TYS</i> , MPa:								
L	54/26	320	28	0.73	13/8	321	16	1.78
LT or T	—	—	—	—	—	—	—	—
<i>CYS</i> , MPa	—	—	—	—	—	—	—	—
<i>SUS</i> , MPa	—	—	—	—	—	—	—	—
<i>BUS</i> , MPa:								
(<i>e/D</i> = 1.5)	—	—	—	—	—	—	—	—
(<i>e/D</i> = 2.0)	—	—	—	—	—	—	—	—
<i>BYS</i> , MPa:								
(<i>e/D</i> = 1.5)	—	—	—	—	—	—	—	—
(<i>e/D</i> = 2.0)	—	—	—	—	—	—	—	—
<i>elong.</i> , percent:								
L	54/26	48.5	2.0	0.42	13/8	50.1	2.0	-0.12
LT or T	—	—	—	—	—	—	—	—
red. of area, percent :								
L	54/26	65.5	4.4	-1.97	13/8	63.3	2.0	0.29
LT or T	—	—	—	—	—	—	—	—
<i>E</i> , GPa	see Figure 6.3.3.0(a) ^b							
<i>E_c</i> , GPa	—							
<i>G</i> , GPa	—							
<i>μ</i>	—							
Physical Properties:								
<i>ω</i> , Mg/m ³	8.055 ^b							
<i>C</i> , J/(g°K)	see Figure 6.3.3.0(b) ^b							
<i>K</i> , W/m°K	see Figure 6.3.3.0(c) ^b							
<i>α</i> , 10 ⁻⁶ m/m°K	see Figure 6.3.3.0(d) ^b							

a *n* represents the number of data points, *lots* represents the number of lots. Refer to Section 9.1.3 for definitions.

b Converted to metric from HAYNES® brochure H-3125B on HAYNES® HR-120® alloy.

Table 6.3.3.0(c). Typical Mechanical and Physical Properties of HAYNES® HR-120® Alloy Sheet

Specification	ASTM B 409							
	Cold Rolled Sheet				Hot Rolled Sheet			
	Annealed at 1204°C (2200°F)				Annealed at 1232°C (2250°F)			
	1 to 4				3 to 5			
	n / lots ^a	Avg.	Std. Dev.	Skew	n / lots ^a	Avg.	Std. Dev.	Skew
Mechanical Properties:								
<i>TUS</i> , MPa:								
L	—	—	—	—	—	—	—	—
LT	40/26	717	14	0.78	16/10	690	15	0.27
<i>TYS</i> , MPa:								
L	—	—	—	—	—	—	—	—
LT	40/26	318	15	1.31	16/10	319	22	1.30
<i>CYS</i> , MPa	—	—	—	—	—	—	—	—
<i>SUS</i> , MPa	—	—	—	—	—	—	—	—
<i>BUS</i> , MPa:								
(e/D = 1.5)	—	—	—	—	—	—	—	—
(e/D = 2.0)	—	—	—	—	—	—	—	—
<i>BYS</i> , MPa:								
(e/D = 1.5)	—	—	—	—	—	—	—	—
(e/D = 2.0)	—	—	—	—	—	—	—	—
<i>elong.</i> , percent:								
L	—	—	—	—	—	—	—	—
LT	40/26	45.6	2.1	0.05	16/10	50.4	2.6	0.46
red. of area, percent:								
L	—	—	—	—	—	—	—	—
LT	—	—	—	—	—	—	—	—
<i>E</i> , GPa	see Figure 6.3.3.0(a) ^b							
<i>E_c</i> , GPa	—							
<i>G</i> , GPa	—							
<i>μ</i>	—							
Physical Properties:								
<i>ω</i> , Mg/m ³	8.968 ^b							
<i>C</i> , J/(g°K)	see Figure 6.3.3.0(b) ^b							
<i>K</i> , W/m°K	see Figure 6.3.3.0(c) ^b							
<i>α</i> , 10 ⁻⁶ m/m°K	see Figure 6.3.3.0(d) ^b							

a *n* represents the number of data points, *lots* represents the number of lots. Refer to Section 9.1.3 for definitions.

b Converted to metric from HAYNES® brochure H-3125B on HAYNES® HR-120® alloy.

Table 6.3.3.0(c). Cont. Typical Mechanical and Physical Properties of HAYNES® HR-120® Alloy Sheet

Specification	ASTM B 409							
	Hot Rolled Sheet							
	Annealed at 1204 °C (2200°F)							
	1 to 3.1				3.2 to 5			
	n / lots ^a	Avg.	Std. Dev.	Skew	n / lots ^a	Avg.	Std. Dev.	Skew
Mechanical Properties:								
<i>TUS</i> , MPa:								
L	—	—	—	—	—	—	—	—
LT	8/7	720	26	-0.85	38/27	716	15	0.38
<i>TYS</i> , MPa:								
L	—	—	—	—	—	—	—	—
LT	8/7	309	12	0.79	38/27	342	18	0.75
<i>CYS</i> , MPa	—	—	—	—	—	—	—	—
<i>SUS</i> , MPa	—	—	—	—	—	—	—	—
<i>BUS</i> , MPa:								
(e/D = 1.5)	—	—	—	—	—	—	—	—
(e/D = 2.0)	—	—	—	—	—	—	—	—
<i>BYS</i> , MPa:								
(e/D = 1.5)	—	—	—	—	—	—	—	—
(e/D = 2.0)	—	—	—	—	—	—	—	—
<i>elong.</i> , percent:								
L	—	—	—	—	—	—	—	—
LT	8/7	43.1	5.1	-2.34	38/27	46.4	1.7	0.73
red. of area, percent:								
L	—	—	—	—	—	—	—	—
LT	—	—	—	—	—	—	—	—
<i>E</i> , GPa	see Figure 6.3.3.0(a) ^b							
<i>E_c</i> , GPa	—							
<i>G</i> , GPa	—							
<i>μ</i>	—							
Physical Properties:								
<i>ω</i> , Mg/m ³	8.968 ^b							
<i>C</i> , J/(g°K)	see Figure 6.3.3.0(b) ^b							
<i>K</i> , W/m°K	see Figure 6.3.3.0(c) ^b							
<i>α</i> , 10 ⁻⁶ m/m°K	see Figure 6.3.3.0(d) ^b							

a *n* represents the number of data points, *lots* represents the number of lots. Refer to Section 9.1.3 for definitions.

b Converted to metric from HAYNES® brochure H-3125B on HAYNES® HR-120® alloy.

Table 6.3.3.0(d). Typical Mechanical and Physical Properties of HAYNES® HR-120® Alloy Wrought Sheet

Specification	ASTM B 409												
	Plate												
	Annealed at 1204 °C (2200°F)				15 to 40				Annealed at 1232 °C (2250°F)				
Form	4 to 14				15 to 40				6 to 10				
Condition (or Temper)	n / lots ^a	Avg.	Std. Dev.	Skew	n / lots ^a	Avg.	Std. Dev.	Skew	n / lots ^a	Avg.	Std. Dev.	Skew	
Thickness, mm													
Mechanical Properties:													
TUS, MPa:													
L	93/43	-	12	-	14/10	708	12	-	14/9	696	24	-	
LT	-	720	-	0.34	-	-	-	-0.98	-	-	-	-0.78	
TYS, MPa:													
L	93/43	-	16	-	14/10	319	15	0.43	14/9	331	21	-	
LT	-	345	-	-0.44	-	-	-	-	-	-	-	-0.50	
CYS, MPa	-	-	-	-	-	-	-	-	-	-	-	-	
SUS, MPa	-	-	-	-	-	-	-	-	-	-	-	-	
BUS, MPa:													
(e/D = 1.5)	-	-	-	-	-	-	-	-	-	-	-	-	
(e/D = 2.0)	-	-	-	-	-	-	-	-	-	-	-	-	
BYS, MPa:													
(e/D = 1.5)	-	-	-	-	-	-	-	-	-	-	-	-	
(e/D = 2.0)	-	-	-	-	-	-	-	-	-	-	-	-	
elong., percent:													
L	93/43	48.1	2.1	0.77	14/10	49.2	1.7	0.30	14/9	50.4	2.4	0.33	
LT	-	-	-	-	-	-	-	-	-	-	-	-	
red. of area, percent:													
L	-	-	-	-	-	-	-	-	-	-	-	-	
LT	-	-	-	-	14/10	60.7	1.3	0.13	-	-	-	-	
E, GPa													
E_c, GPa													
G, GPa													
μ													
									see Figure 6.3.3.0(a) ^b				
Physical Properties:													
ω, Mg/m³													
C, J/(g °K)													
K, W/m °K													
α, 10⁻⁶ m/m °K													

^a *n* represents the number of data points, *lots* represents the number of lots. Refer to Section 9.1.3 for definitions.

^b Converted to metric from HAYNES® brochure H-3125B on HAYNES® HR-120® alloy.

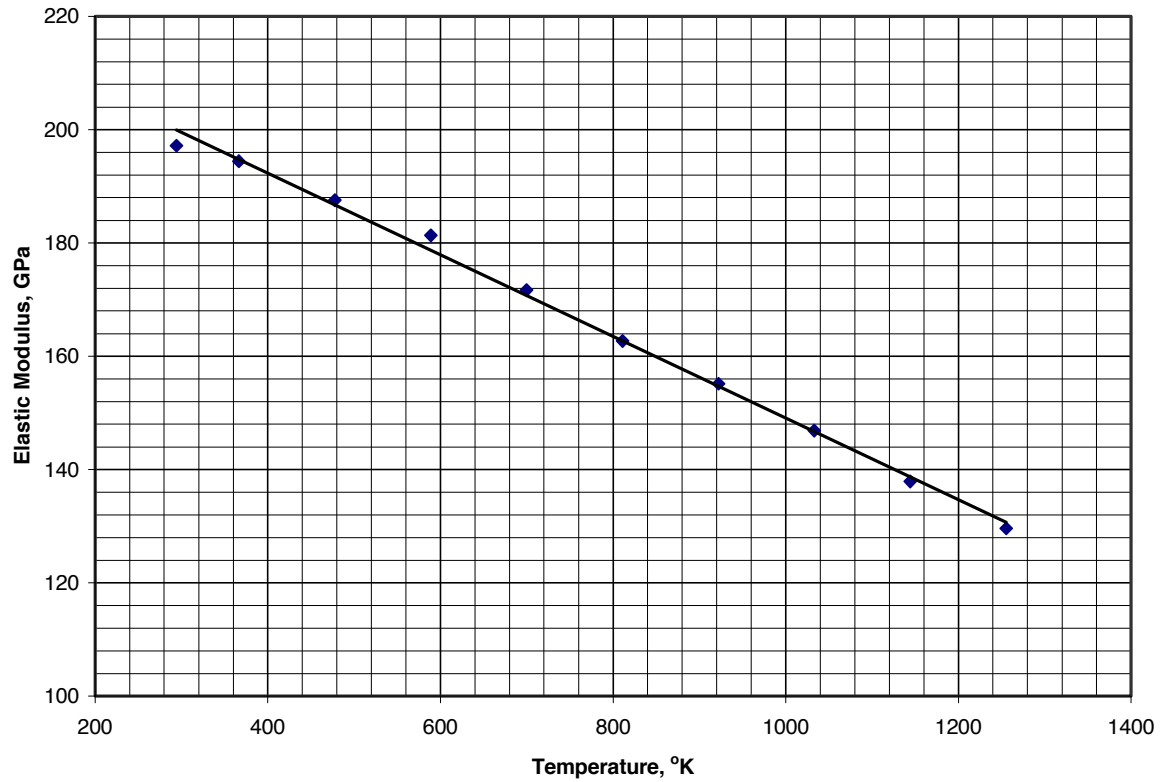

Figure 6.3.3.0(a). Effect of temperature on elastic modulus of HAYNES® HR-120® alloy.

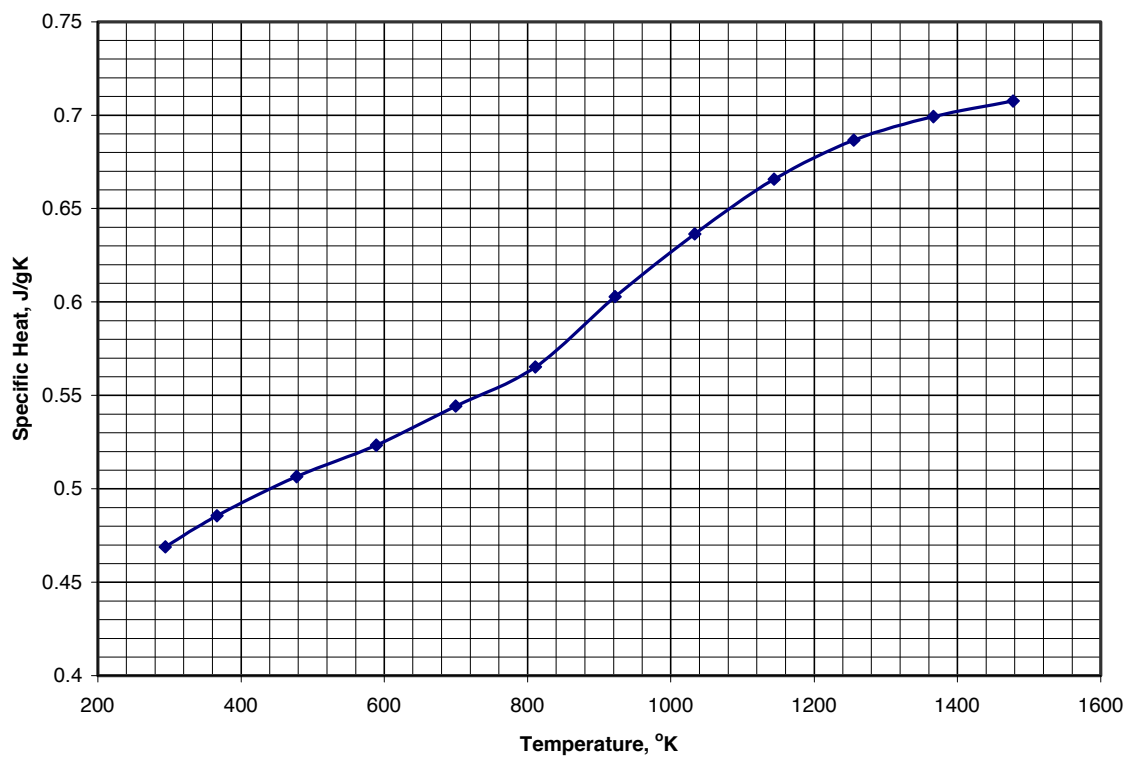

Figure 6.3.3.0(b). Effect of temperature on specific heat of HAYNES® HR-120® alloy.

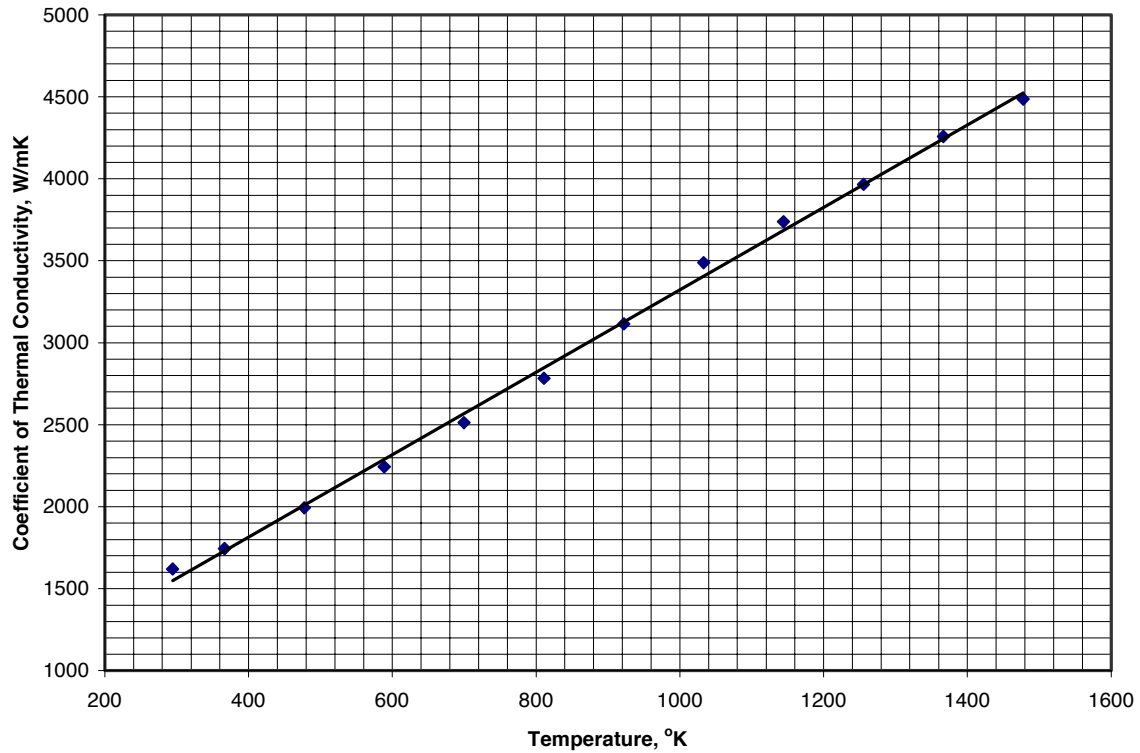

Figure 6.3.3.0(c). Effect of temperature on thermal conductivity of HAYNES® HR-120® alloy.

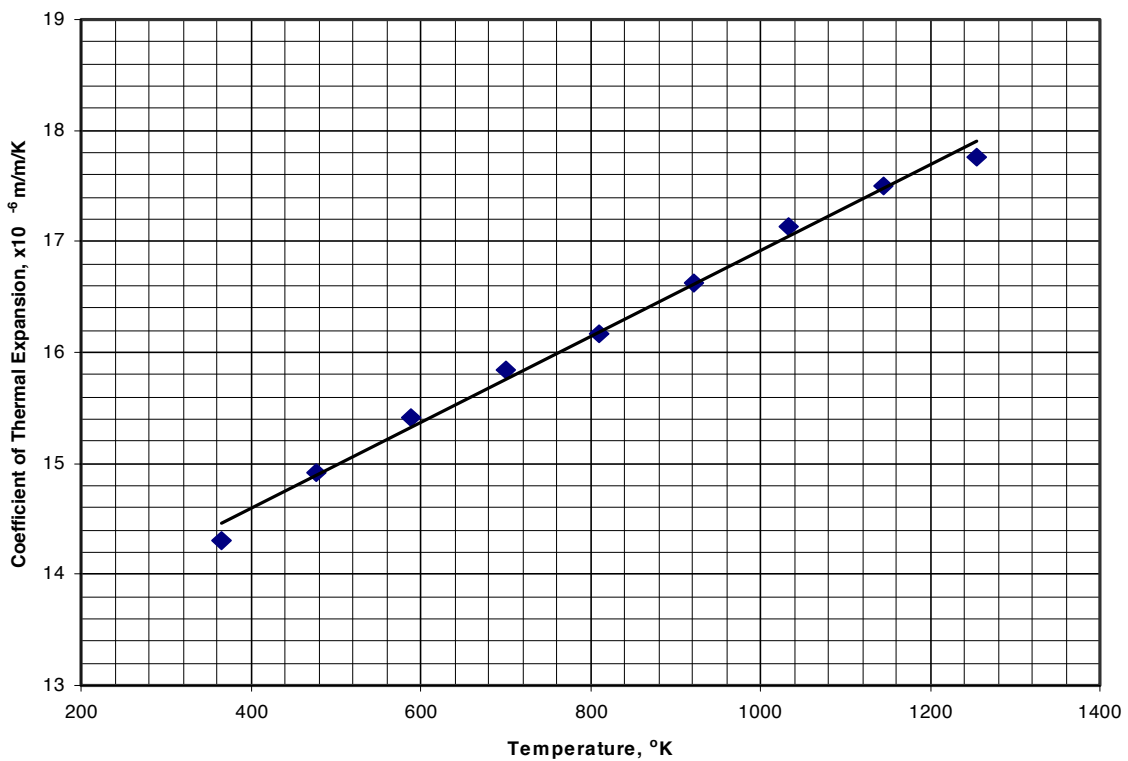

Figure 6.3.3.0(d). Effect of temperature on coefficient of thermal expansion of HAYNES® HR-120® alloy.

6.3.4 INCONEL ALLOY MA754

6.3.4.0 Comments and Properties — INCONEL alloy MA754 is a nickel-chromium alloy strengthened by yttrium oxide dispersion. It has exceptional high temperature strength and creep resistance. Aerospace applications include gas-turbine components and other extreme-service parts. Optimum high temperature strength is controlled through thermo-mechanical processing designed to create a stable, recrystallized grain structure that is coarse and highly elongated in the direction of hot working. A high-temperature recrystallization treatment is required to develop the desired grain structure. For thermal fatigue applications, such as gas-turbine vanes, the alloy is given a strong texture parallel to the working direction, resulting in a low modulus of elasticity in the longitudinal direction. The low modulus improves resistance to thermal fatigue by lowering stresses for given thermal strains. This highly directional structure leads to anisotropic mechanical properties.

Manufacturing Considerations — INCONEL alloy MA754 is produced as hot-rolled, solution-annealed bars, sheets, or plates.

Heat Treatment — To produce the desired grain structure, the alloy is typically heat treated at 1316°C for 1 hour followed by air cooling.

Specifications and Properties — Material specifications are shown in Table 6.3.4.0(a).

Table 6.3.4.0(a). Material Specifications for MA754

Specification	Form
Aerospace Manufacturer Specification	Textured Bar

Room temperature mechanical and physical properties are shown in Table 6.3.4.0(b). Elevated temperature tensile properties are shown in Figures 6.3.4.0(e) and (f). Stress rupture properties are shown in Table 6.3.4.0(g) and (h).

Table 6.3.4.0(b). Typical Mechanical and Physical Properties of MA754 Textured Bar

Specification	Aerospace Manufacturer Specification (see Appendix C)			
	Textured Rectangular Bar			
	Annealed			
	25.4 to 41.275			
	n / heats ^a	Avg.	Std. Dev.	Skew
Mechanical Properties:				
<i>TUS</i> , MPa				
L	14/4	966	6	-0.92
LT	9/4	840	12	-0.01
<i>TYS</i> , MPa				
L	14/4	589	11	0.01
LT	9/4	564	13	-0.58
<i>CYS</i> , MPa				
L	—	—	—	—
LT	—	—	—	—
<i>SUS</i> , MPa				
L	—	—	—	—
LT	—	—	—	—
<i>BUS</i> , MPa:				
(e/D = 1.5)	—	—	—	—
(e/D = 2.0)	—	—	—	—
<i>BYS</i> , MPa:				
(e/D = 1.5)	—	—	—	—
(e/D = 2.0)	—	—	—	—
<i>elong.</i> , percent				
L	14/4	21	1.5	0.55
LT	9/4	27	1.4	-0.56
<i>Red. of Area</i> , percent				
L	14/4	33	5.3	-0.18
LT	9/4	29	2.2	-0.42
<i>E</i> , GPa	149 ^b			
<i>E_c</i> , GPa	—			
<i>G</i> , GPa	—			
<i>μ</i>	—			
Physical Properties:				
<i>ω</i> , Mg/m ³	—			
<i>C</i> , J/(g°K)	see Figure 6.3.4.0(b)			
<i>K</i> , W/m°K	see Figure 6.3.4.0(c)			
<i>α</i> , m/m°K	see Figure 6.3.4.0(d)			
<i>Electrical Resistivity</i> , ohm·10 ⁻⁷ m ²	see Figure 6.3.4.0(e)			

a *n* represents the number of data points, *lots* represent the number of lots, *heats* represent the number of heats. Refer to Section 9.1.3 for definitions.

b Figure 6.3.4.0(a) shows effect of temperature on Young's Modulus for textured and untextured bar.

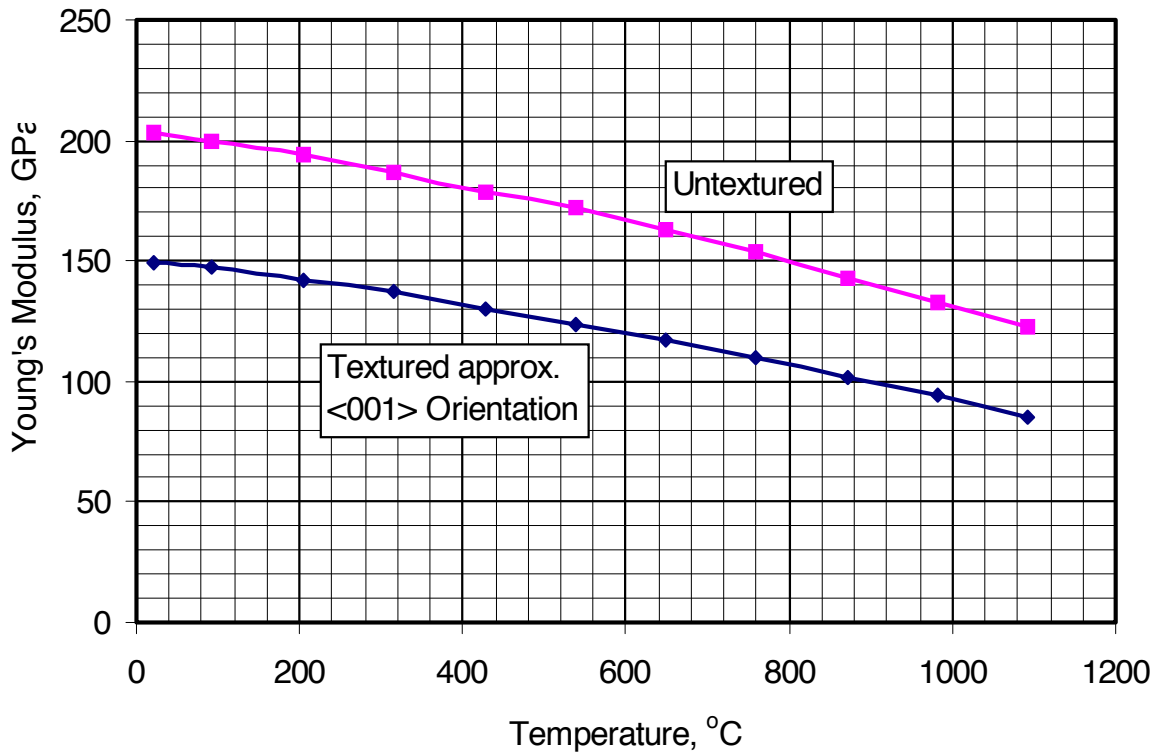

Figure 6.3.4.0(a). Effect of temperature on Young's Modulus for textured and untextured bar.

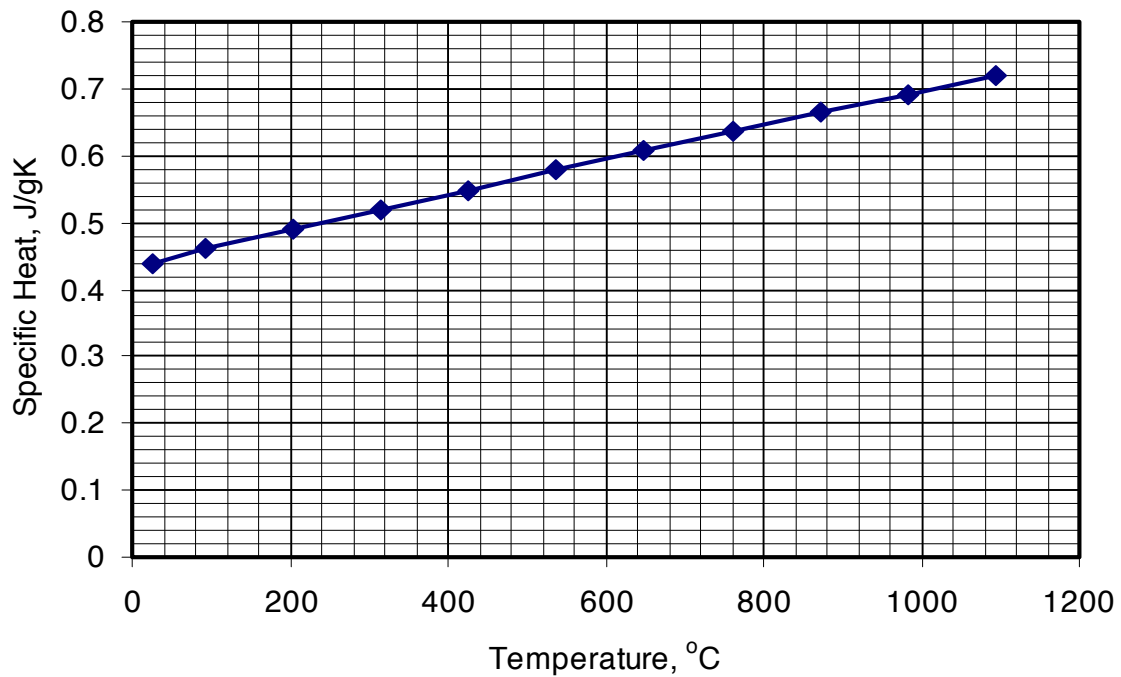

Figure 6.3.4.0(b). Effect of temperature on specific heat of MA754 textured bar.

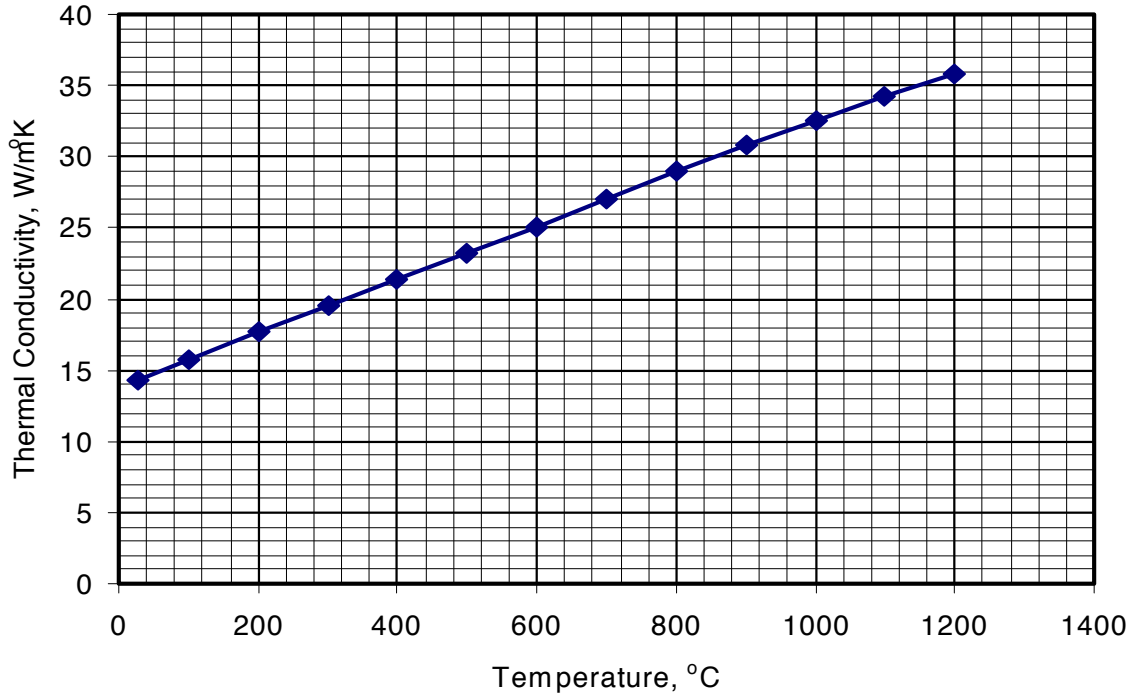

Figure 6.3.4.0(c). Effect of temperature on thermal conductivity of MA754 textured bar.

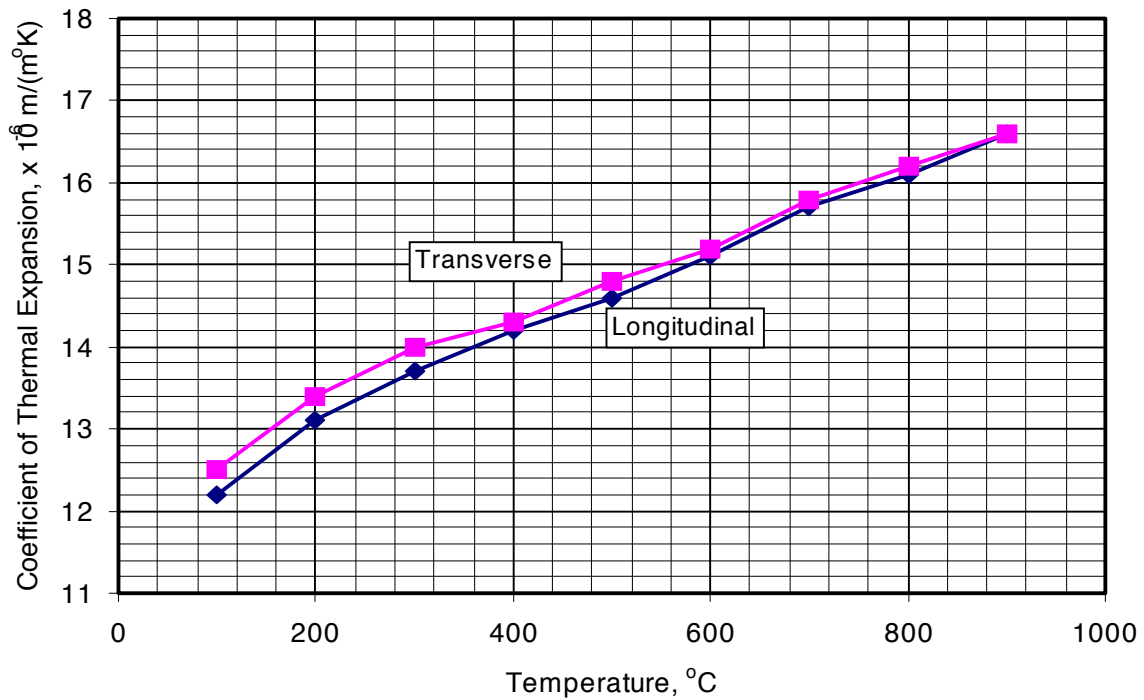

Figure 6.3.4.0(d). Effect of temperature on coefficient of thermal expansion of MA754 textured bar.

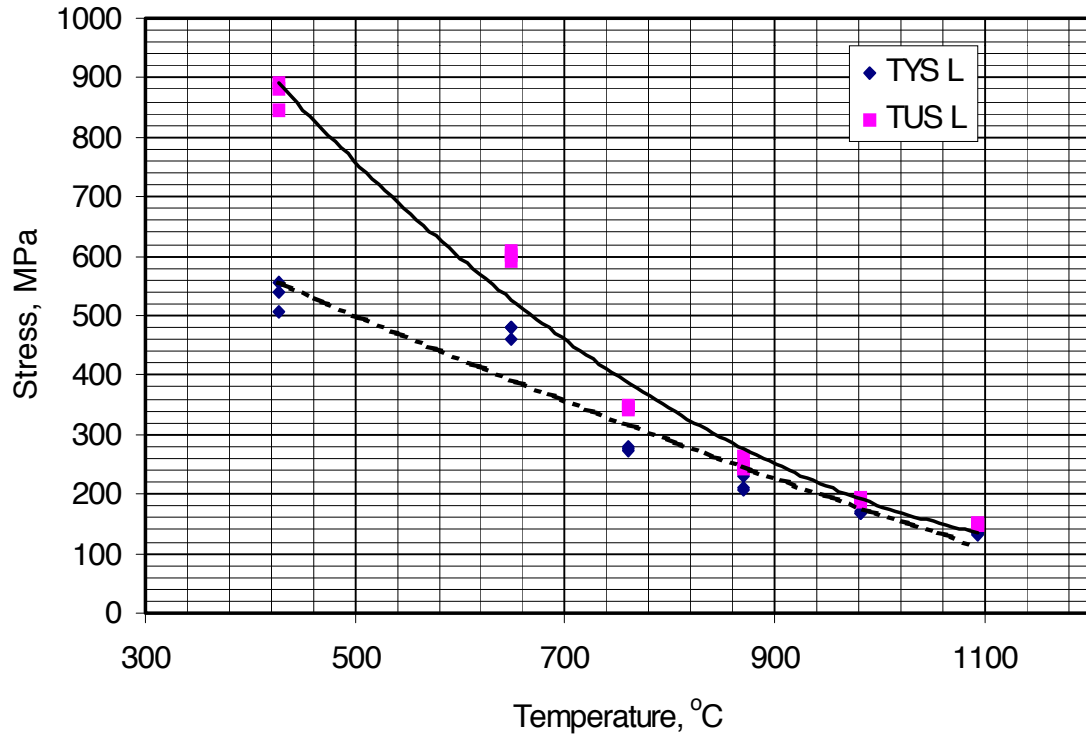

Figure 6.3.4.0(e). Effect of temperature on TUS and TYS in the L direction of MA754 alloy.

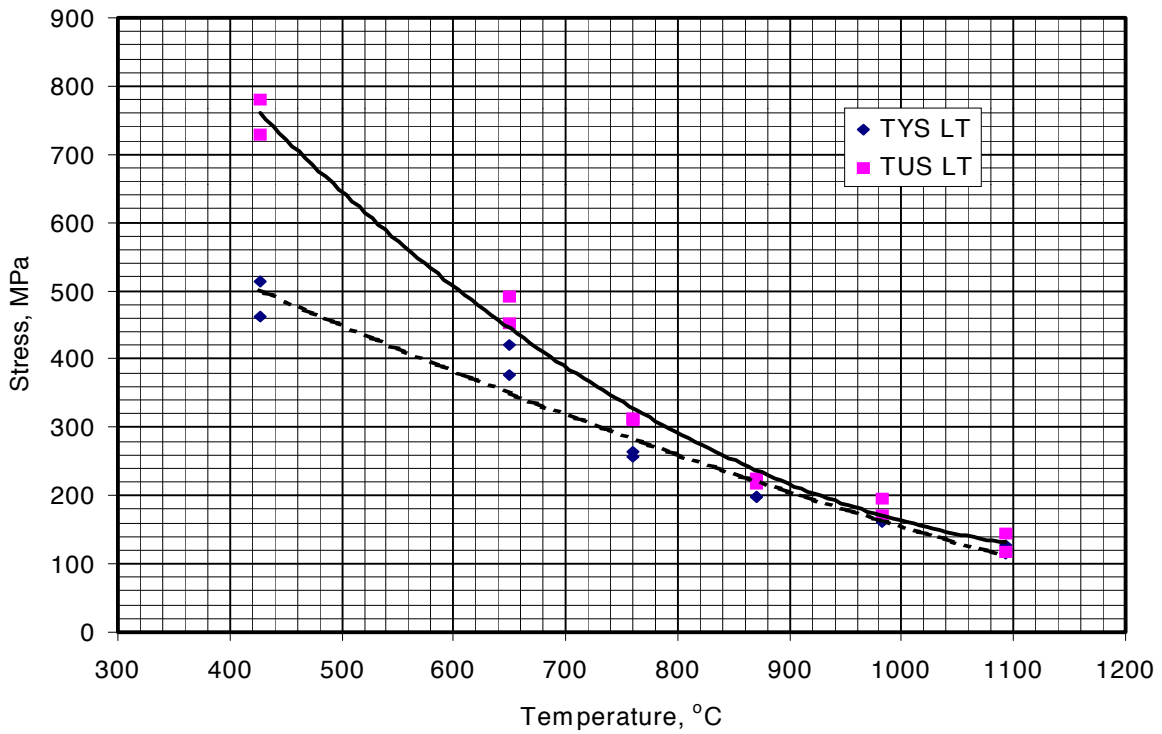
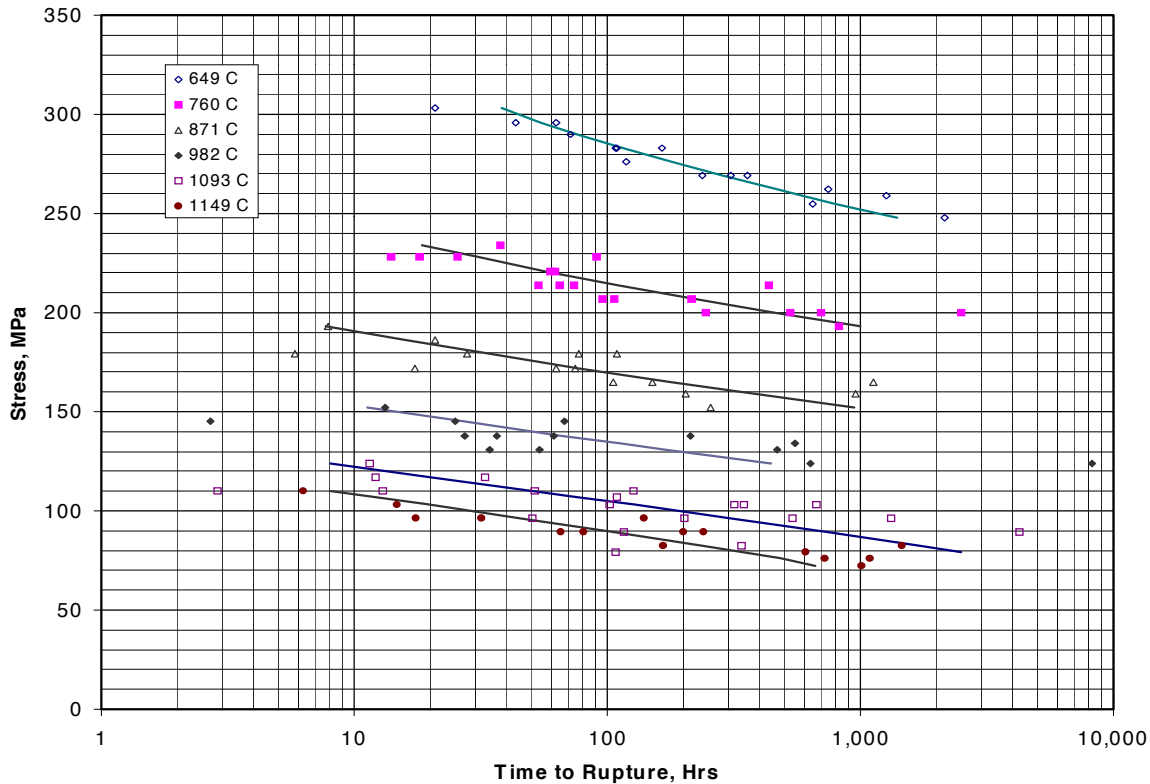

Figure 6.3.4.0(f). Effect of temperature on TUS and TYS in the LT direction of MA754 alloy.



Correlative Information for Figure 6.3.4.0(g)

Makeup of Data Collection:

Heat Treatment: 1316 °C for 1 hour
 followed by air cooling.
 Number of Vendors = one
 Number of Lots = 20
 Number of Test laboratories = one
 Number of Tests = 98

Specimen Details:

Type - Round
 Gage Length - NA
 Gage Diameter - 6.4 mm
 Test - ASTM E139

Stress Rupture Creep Equation:

$$\text{Log } t = c + b_1/T + b_2X/T + b_3X^2/T + b_4X^3/T$$

T = °R
 X = log (stress, MPa)
 $c = -18.764 \times 10^1$
 $b_1 = -6.5211 \times 10^5$
 $b_2 = 1.0305 \times 10^6$
 $b_3 = -4.8627 \times 10^5$
 $b_4 = 7.3497 \times 10^4$

Analysis Details:

Standard Deviation = 0.57
 Standard Error of Estimate = 0.45

[Caution: The equivalent stress model may provide unrealistic life predications for stress ratios beyond those represented above.]

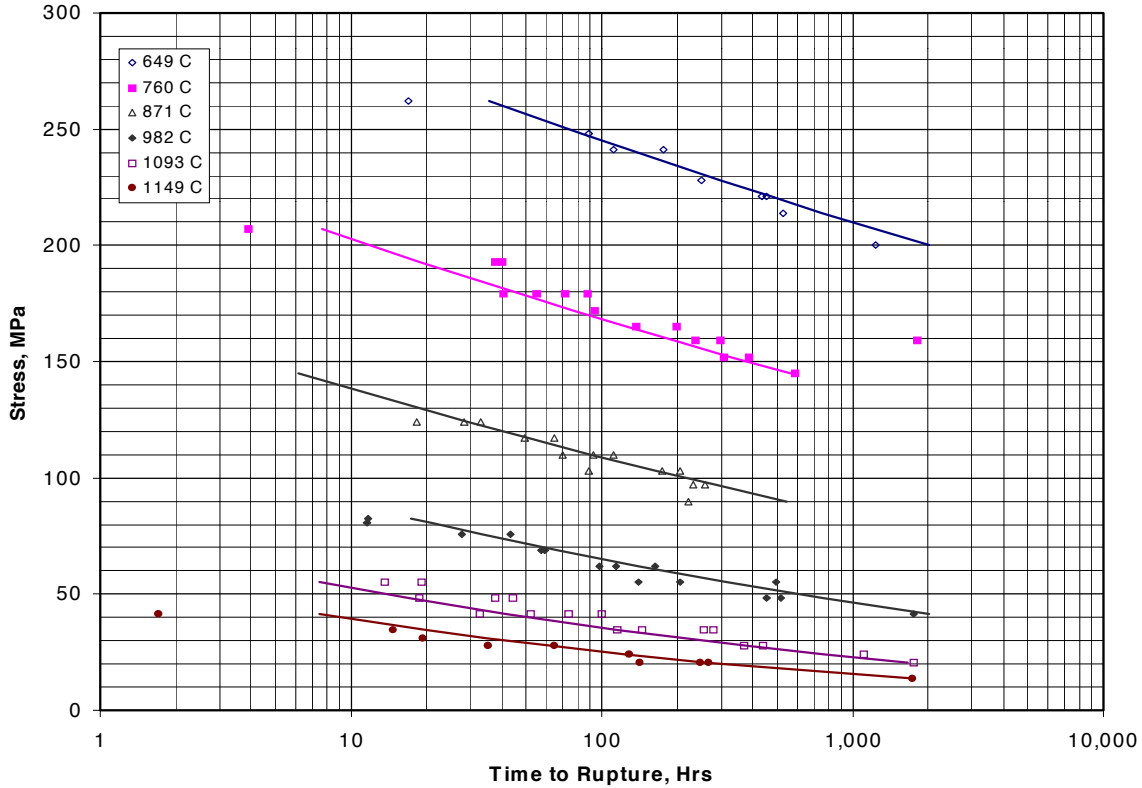

Correlative Information for Figure 6.3.4.0(h)

Makeup of Data Collection:

Heat Treatment: 1316 °C for 1 hour
 followed by air cooling.
 Number of Vendors = one
 Number of Lots = 17
 Number of Test laboratories = one
 Number of Tests = 82

Specimen Details:

Type - Round
 Gage Length - NA
 Gage Diameter - 6.4 mm
 Test - ASTM E139

Stress Rupture Creep Equation:

$$\text{Log } t = c + b_1/T + b_2X/T + b_3X^2/T + b_4X^3/T$$

T = °R
 X = log (stress, MPa)
 $c = -1.7422 \times 10^1$
 $b_1 = 7.0900 \times 10^4$
 $b_2 = -2.3145 \times 10^4$
 $b_3 = 9.7098 \times 10^3$
 $b_4 = -2.8439 \times 10^3$

Analysis Details:

Standard Deviation = 0.49
 Standard Error of Estimate = 0.26

[Caution: The equivalent stress model may provide unrealistic life predications for stress ratios beyond those represented above.]

6.3.5 EP741NP (RUSSIAN POWDER MATERIAL)

6.3.5.0 Comments and Properties — Powder material (PM) nickel-base superalloy EP741NP is used for manufacturing the high-stressed parts working at the temperature range from -196°C to 750°C in gas turbine engines for aerospace and power applications. High performances (including long-term rupture strength and low cycle fatigue resistance) are achieved due to optimum alloying and heat treatment to assure a homogeneous fine-grained structure and uniform distribution of strengthened gamma prime-phase particles.

Hot Isostatic Pressing (HIP) is carried out in an argon atmosphere at the temperature above gamma prime-phase and pressure not less than 18.85 ksi.

Heat Treatment — Heat treatment includes annealing from the temperature 20-30°C higher than the gamma prime temperature combined with the hardening at the temperature 10-20°C lower than gamma prime temperature in calm air or with the forced air cooling and one stage ageing at 870°C.

Environmental Considerations — At the operating temperatures the alloy is gas corrosion resistant and no protection is required.

Specifications and Properties — Material specifications are shown in Table 6.3.5.0(a).

Table 6.3.5.0(a). Material Specifications for EP741NP

Specification	Form
Russian specification TU 1-809-941-98	Powder material HIPed Discs

Room temperature mechanical and physical properties are shown in Table 6.3.5.0(b). Fatigue life and stress rupture are shown in Table 6.3.5.0(c).

Table 6.3.5.0(b). Typical Mechanical and Physical Properties of PM EP741NP Discs

Specification	Russian specification TU 1-809-941-98 (see Appendix C)			
Form	Discs			
Condition (or Temper)	HIPed, annealed, and hardened			
Diameter, mm	278 - 750			
	n / lots ^a	Avg.	Std. Dev.	Skew
Mechanical Properties^b:				
<i>TUS</i> , MPa	174/87	1430	19	-0.12
<i>TYS</i> , MPa	174/87	936	20	-0.08
<i>CYS</i> , MPa	—	—	—	—
<i>SUS</i> , MPa	—	—	—	—
<i>BUS</i> , MPa:				
(e/D = 1.5)	—	—	—	—
(e/D = 2.0)	—	—	—	—
<i>BYS</i> , MPa:				
(e/D = 1.5)	—	—	—	—
(e/D = 2.0)	—	—	—	—
<i>elong.</i> , percent	174/87	26.1	2.1	-1.07
<i>Red. of Area</i> , percent	174/87	25.0	1.9	-0.79
<i>Impact Strength^c</i> ,				
kJ/m ²	174/87	84	8	-1.76
<i>Brinell Hardness^d</i> (Diam.),				
5mm/ 7350N	174/87	1.62	0.02	-0.13
<i>E</i> , GPa	190			
<i>E_c</i> , GPa	—			
<i>G</i> , GPa	—			
<i>μ</i>	—			
Physical Properties:				
<i>ω</i> , Mg/m ³	8.5			
<i>C</i> , J/(g°K)	see Figure 6.3.5.0(a)			
<i>K</i> , W/m°K	see Figure 6.3.5.0(b)			
<i>α</i> , 10 ⁻⁶ m/m°K	see Figure 6.3.5.0(c)			

^a *n* represents the number of data points, *lots* represent the number of lots. Refer to Section 9.1.3 for definitions.

^b

^b Tensile test per GOST 1492.

^c Impact test per GOST 9454.

^d Brinell Hardness tested by 5-mm diameter steel ball at 7350N (750 kg) load per GOST 9012.

Table 6.3.5.0(c). Fatigue and Stress Rupture Properties of PM EP741 NP Discs at 650°F

Specification	Russian specification TU 1-809-941-98 (see Appendix C)			
	Discs			
	HIPed, annealed, and hardened			
	278- 750			
	n / lots ^a	Avg.	Std. Dev.	Skew
Fatigue Properties ^b : cycles to failure at 986 MPa, 1Hz, cycles	33/NA	28,430	11,400	1.611
Stress Rupture Properties ^c : at 993 MPa, hrs	128/NA	217 ^d	85.8	1.80
at 1034 MPa, hrs	128/NA	129	41.5	1.02

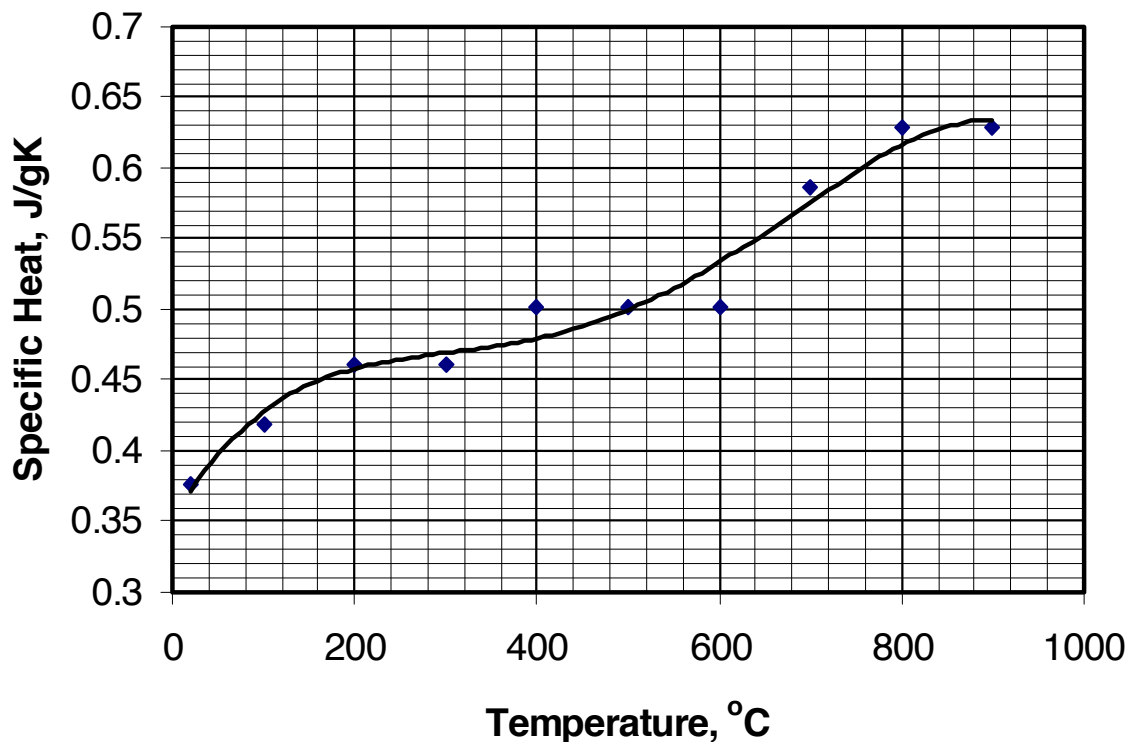
**Figure 6.3.5.0(a). Effect of temperature on specific heat of EP741 NP superalloy.**

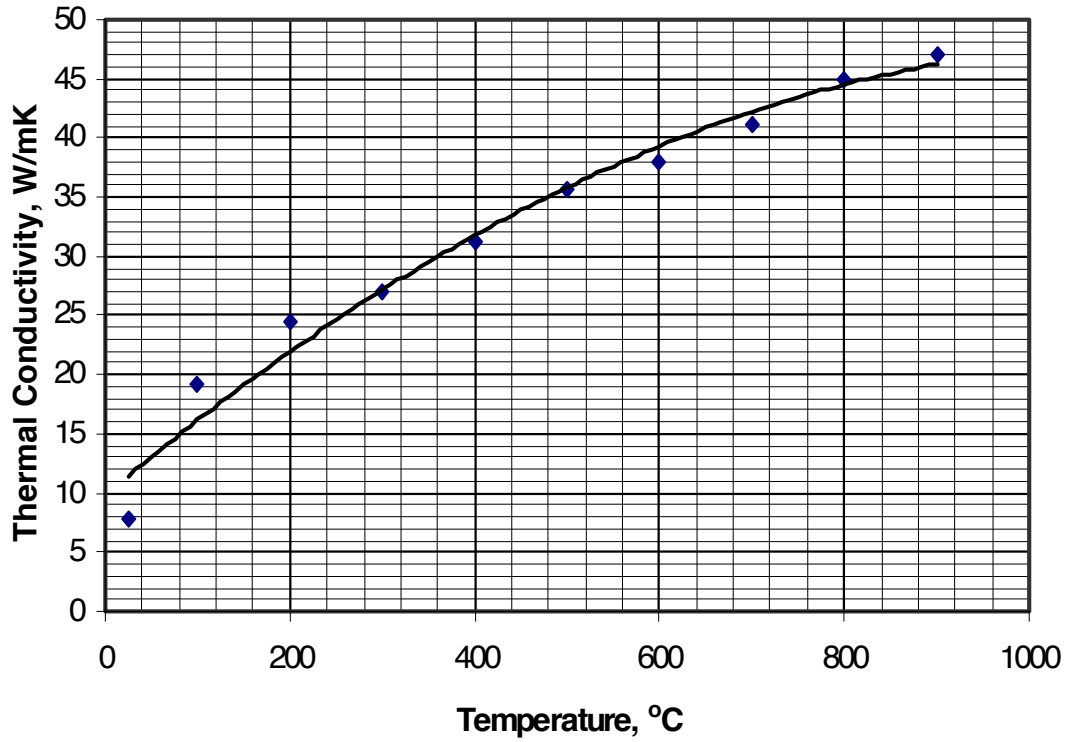

Figure 6.3.5.0(b). Effect of temperature on thermal conductivity of EP741NP superalloy.

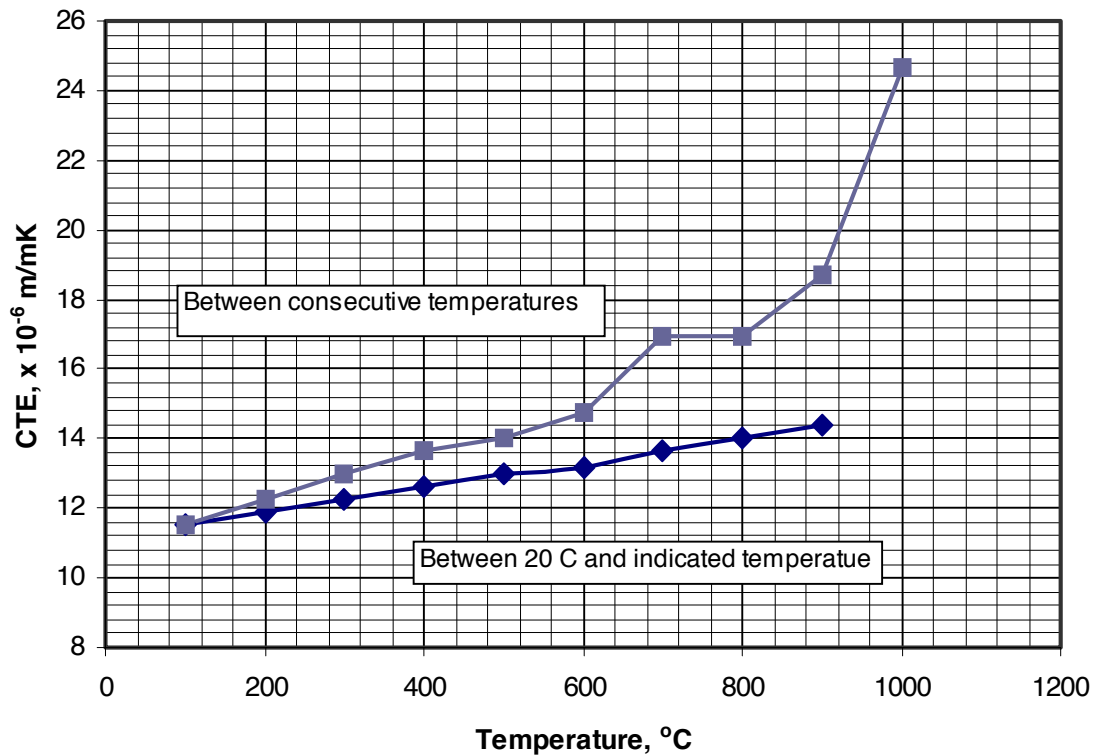

Figure 6.3.5.0(c). Effect of temperature on coefficient of thermal expansion for EP741NP superalloy.

6.4 COBALT-BASE ALLOYS

No alloys included at this time.

6.5 OTHER ALLOYS

6.5.1 C-103 (NIOBIUM- HAFNIUM-TITANIUM)

6.5.1.0 Comments and Properties — C-103 is a Niobium-based alloy (Nb-10Hf-0.7 to 1.3Ti) used for elevated temperature applications with high-stress levels, such as rocket engine applications with temperatures up to 132°C. C-103 also has a low ductile-to-brittle transition temperature allowing it to withstand high frequency vibrations at cryogenic temperatures.

Fabrication Considerations — C-103 is readily fabricable when following design guidelines. Before fabrication the materials must be fully re-crystallized and have a minimum grain size of ASTM 5. Because Niobium can be embrittled by interstitial contamination, the following maximum levels should be held throughout processing; 225 ppm oxygen, 10 ppm hydrogen, 150 ppm carbon, and 150 ppm nitrogen. To insure these lower levels through all fabrication processes the material must be chemically cleansed before and after welding, heat treating, and before coating.

C-103 can be formed into complex shapes by drawing, spinning, or bulge forming. Thin wall tubing can be drawn from sheet product. Bell contour configurations, such as nozzle extensions, can be roll-formed, welded and sized with no intermediate heat treatment requirements.

Machining — Machinability of C-103 may be compared to 316 stainless steel in reference to tool wear due to heat buildup, and to copper in reference to tool geometry. However, Niobium is highly ductile, soft, stringy and tends to gall, tear, and weld to the face of the cutting tool. Chip breakers have not proven practical because the chip is not easily broken due to its tough, stringy nature, and the tool forces are greatly increased. To reduce cratering and abrasive wear, high positive rake angles should be employed and a water soluble coolant with good lubricity and wetting characteristics. During grinding, care must be taken to prevent the metal surface from heating up to prevent surface hydrogen pickup.

Welding — Because Niobium alloys can be severely embrittled by high interstitial content, extreme care must be taken during the welding process not to increase the carbon, nitrogen, oxygen, and hydrogen of the weldment over that of the material. A pickling operation should be conducted before and after welding as well as before and after heat treating.

Welding can be accomplished by both TIG and electron beam processes. Material over 2.54-mm thick should be welded by electron beam process. It is recommended that all copper tooling have a hard chrome plating of approximately 0.05-mm thick over a nickel strike to prevent copper contamination (which causes brittle welds). For GTA, properly designed trailer shields and backup grooves with adequate gas flow can give weldments a quality equal to welds made with electron beam equipment. High purity certified argon or helium is required.

Generally, GTA welding is accomplished without weld wire because of the high cleanliness requirements for welding; the weld wire often has slight serrations and laps making it difficult to clean, unless acid pickled. In addition, the high melting point of Niobium causes the wire to deflect and give an uneven weld bead and incomplete penetration. To eliminate these problems and still get a weld with an adequate crown and root on thin gage material, the mating edges to be welded are rolled up to form a “burned-down

flange”. The material is then welded with back-up gas and a trailer shield at a fast welding speed. Heavier gage sheet can be efficiently welded manually or with mechanically step fed wire using a pulsed arc.

It is also possible to electron beam seam weld or braze Titanium to Niobium that has been given certain aluminide and silicide Niobium coatings, providing specialized weld joints and equipment setups are employed.

Coatings — Aluminide coating can be applied to Niobium and exhibit 100 hour life in air at 1316°C. Silicide coatings can last in excess of 4000 operating hours in jet engine afterburner applications at 1204°C.

Specifications and Properties — Material specifications are shown in Table 6.5.1.0(a).

Table 6.5.1.0(a). Material Specifications for C-103

Specification	Form
ASTM B654-92	Foil, Sheet, Strip, and Plate
ASTM B655-96	Bar, Rod, and Wire

Room temperature mechanical and physical properties are shown in Table 6.5.1.0(b). Elevated temperature properties are shown in Table 6.5.1.0(c) and Figure 6.5.1.0(c). Average isothermal creep curves are shown in Figures 6.5.1.0(d) and (e).

Table 6.5.1.0(b). Typical Mechanical and Physical Properties of C-103 Niobium Alloy Bar, Tube, and Sheet

	ASTM B655-96			ASTM B654-92								
	Bar			Tube			Sheet					
	Annealed											
Diameter or Thickness, mm	25.4 - 101.6			25.4 - 101.6			< 3.175					
	n/ heats ^a	Avg.	Std. Dev.	Skew	n / lots ^a	Avg.	Std. Dev.	Skew	n / lots ^a	Avg.	Std. Dev.	Skew
Mechanical Properties:												
TUS, MPa:	88/14	411	10	0.20	12/2	413	6	0.52	54/12	402	8	0.33
TYs, MPa:	88/14	284	12	1.75	12/2	289	6	0.72	54/12	288	12	1.08
CYS, MPa:	-	-	-	-	-	-	-	-	-	-	-	-
SUS, MPa:	-	-	-	-	-	-	-	-	-	-	-	-
BUS, MPa:	-	-	-	-	-	-	-	-	-	-	-	-
(e/D = 1.5)	-	-	-	-	-	-	-	-	-	-	-	-
(e/D = 2.0)	-	-	-	-	-	-	-	-	-	-	-	-
BYS, MPa:	-	-	-	-	-	-	-	-	-	-	-	-
(e/D = 1.5)	-	-	-	-	-	-	-	-	-	-	-	-
(e/D = 2.0)	-	-	-	-	-	-	-	-	-	-	-	-
elong., percent:	88/14	40.8	2.4	-0.35	12/2	34.7	3.9	1.12	54/12	41.4	3.4	-0.21
Red. of Area., percent:	-	-	-	-	-	-	-	-	-	-	-	-
E, GPa												
E _r , GPa												
G, GPa												
μ												
Physical Properties:												
ω, Mg/m ³											8.86 ^b	
C, J/(g/°K)											0.34 ^b	
K, W/m ² °K												
α, m/m ² °K												

^a n represents the number of data points, *heats* represent the number of heats. Refer to Section 9.1.3 for definitions.

^b From Wah Chang brochure.

see Figure 6.5.1.0(a)^b
see Figure 6.5.1.0(b)^b

Table 6.5.1.0(c). Typical Mechanical and Physical Properties of C-103 Niobium Alloy Sheet at Elevated Temperatures

Specification	ASTM B654-92							
Form	Sheet							
Condition (or Temper)	Annealed							
Thickness, mm	< 3.175							
Temperature, °C	1093				1316			
	n / heats ^a	Avg.	Std. Dev.	Skew	n / heats ^a	Avg.	Std. Dev.	Skew
Mechanical Properties:^b								
<i>TUS</i> , MPa	31/17	209	30	-3.34	4/2	102	7	0.82
<i>TYS</i> , MPa	31/17	145	18	-2.19	4/2	84	10	1.05
<i>CYS</i> , MPa	—	—	—	—	—	—	—	—
<i>SUS</i> , MPa	—	—	—	—	—	—	—	—
<i>BUS</i> , MPa:								
(e/D = 1.5)	—	—	—	—	—	—	—	—
(e/D = 2.0)	—	—	—	—	—	—	—	—
<i>BYS</i> , MPa:								
(e/D = 1.5)	—	—	—	—	—	—	—	—
(e/D = 2.0)	—	—	—	—	—	—	—	—
<i>elong.</i> , percent	31/17	44.0	3.6	0.46	4/2	126.0	11.9	-1.03
<i>Red. of Area</i> , percent	—	—	—	—	—	—	—	—
<i>E</i> , GPa	64 (1200 °C) ^c							
<i>E_c</i> , GPa	—							
<i>G</i> , GPa	—							
<i>μ</i>	—							
Physical Properties:								
<i>ω</i> , Mg/m ³	—							
<i>C</i> , J/(g °K)	—							
<i>K</i> , W/m °K	—							
<i>α</i> , m/m °K	—							

a *n* represents the number of data points, *lots* represent the number of lots, *heats* represent the number of heats. Refer to Section 9.1.3 for definitions.

b All elevated temperature tensile tests are performed in a vacuum..

c From Wah Chang brochure.

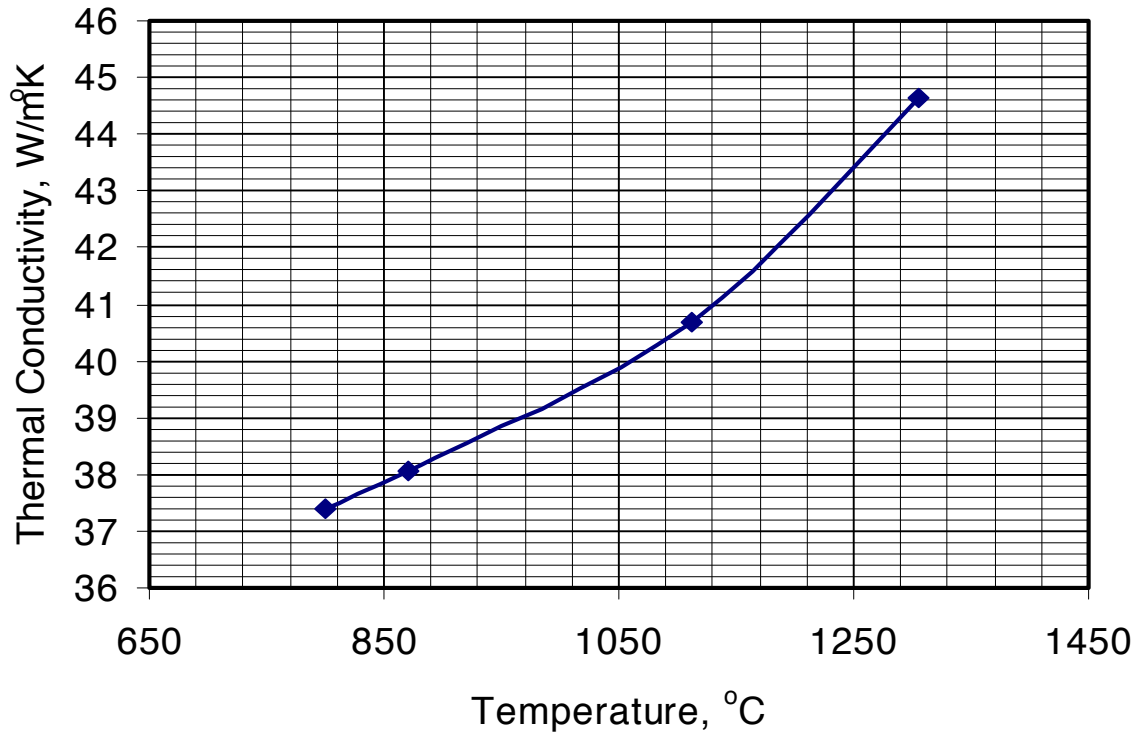

Figure 6.5.1.0(a). Effect of temperature on thermal conductivity of C-103 Niobium alloy.

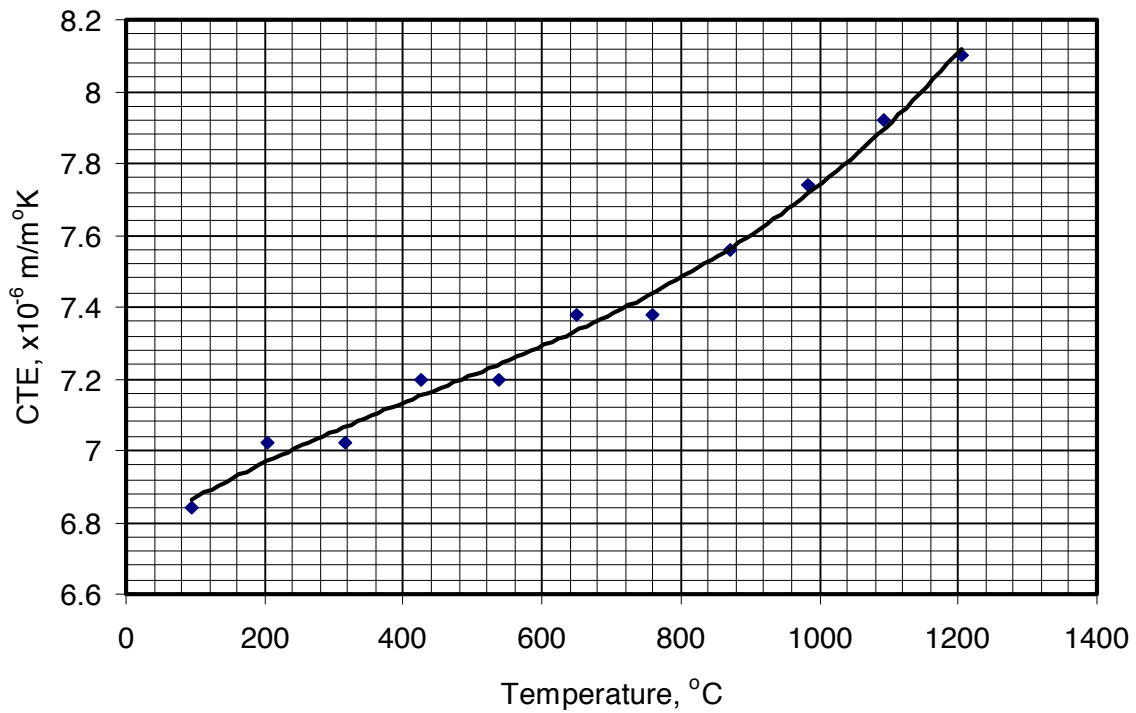

Figure 6.5.1.0(b). Effect of temperature on coefficient of thermal expansion of C-103 Niobium alloy.

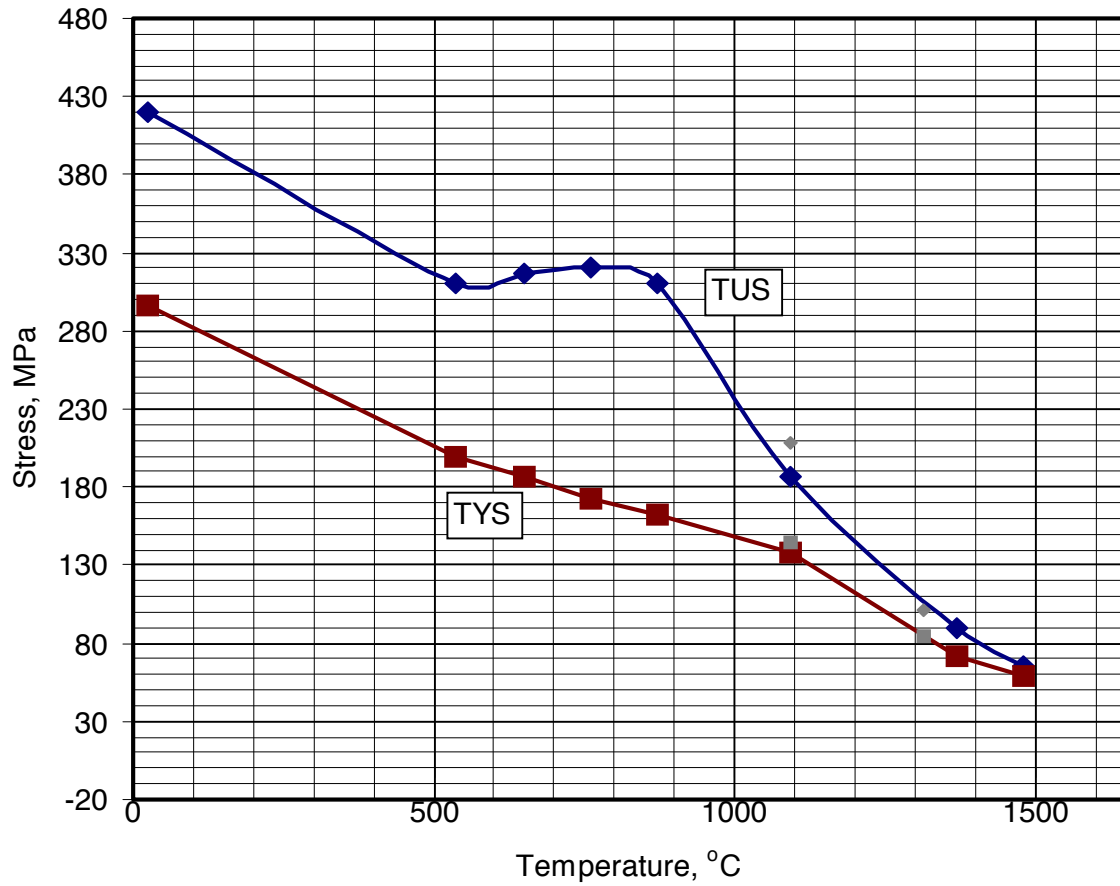

Figure 6.5.1.0(c). Effect of temperature on TUS and TYS of C-103 Niobium alloy.^a

^a From Wah Chang brochure. More recent data points from Table 6.5.1.0(c) are also shown in a lighter shade and as smaller points for temperatures of 1093°C and 1316°C.

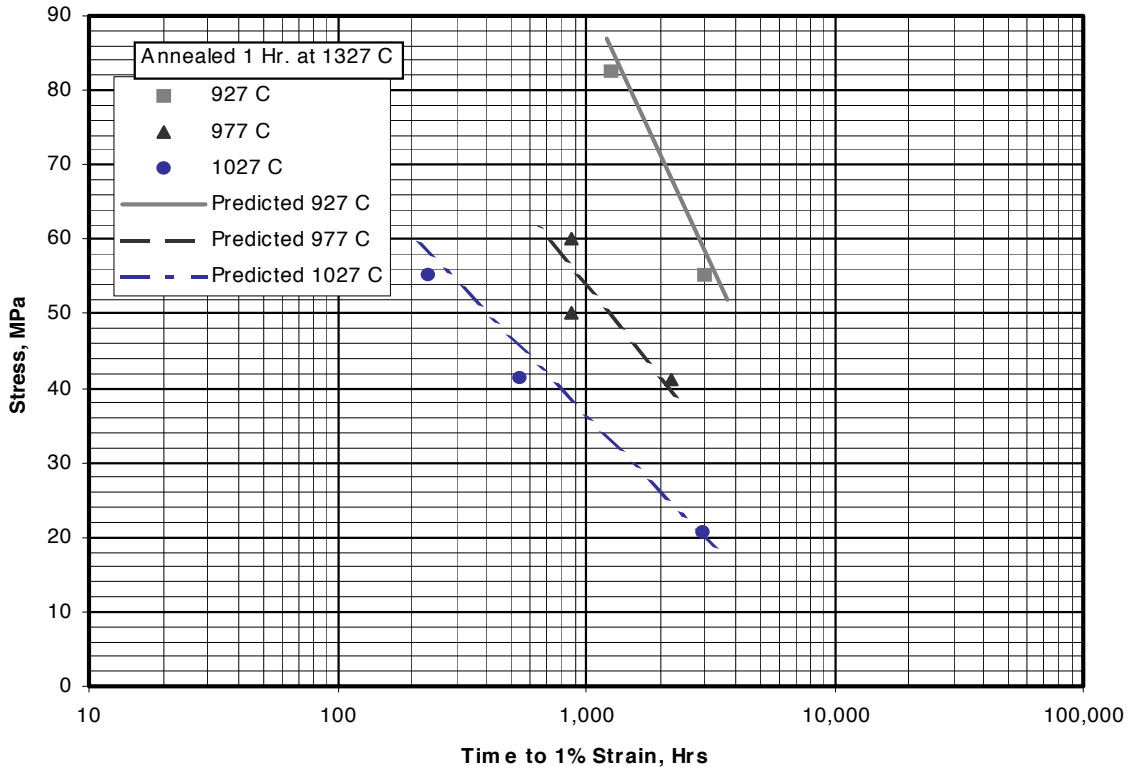

Figure 6.5.1.0(d). Average isothermal creep curves to 1% strain for C-103 Niobium alloy when annealed for 1 hour at 1327°C.

Correlative Information for Figure 6.5.1.0(d)

Test Data: Reference 6.5.1.0

Specimen Description:

Sheet Thickness – 7.62 mm

Gage Dimensions – 6.35mm (w) x 25.4mm (l)

Test Conditions:

Annealing - Degreased, rinsed in distilled water and alcohol, wrapped in tantalum foil, and annealed in a vacuum of 10^{-10} Pa for 1 hour at 1327°C.

Heating Rate – NA

Soak Time – NA

Atmosphere - Began at 10^{-10} Pa and decreased into the 10^{-12} Pa range after several hundred hours.

Strain Measurement –Frequent optical readings of fiducial marks in the reduced gage section.

Temperature Measurement – NA

Heating System – Radiant heat with Tantalum heating elements and heat shields. Entire specimen located in hot zone of furnace.

Creep Equation^a:

$$\text{Log } t = c + b_1/T + b_2X/T + b_3X^2/T + b_4X^3/T$$

$$T = \text{°R}$$

$$X = \text{Log stress}$$

$$c = -1.0838 \times 10^4$$

$$b_1 = -1.1503 \times 10^4$$

$$b_2 = 9.4449 \times 10^4$$

$$b_3 = -6.2999 \times 10^4$$

$$b_4 = 1.3074 \times 10^4$$

Analysis Details:

$$R^2 = 97\%$$

$$\text{Standard Error of Estimates} = 0.09$$

$$\text{Observations} = 8$$

^a To convert from °R to °K, divide °R by 1.8.

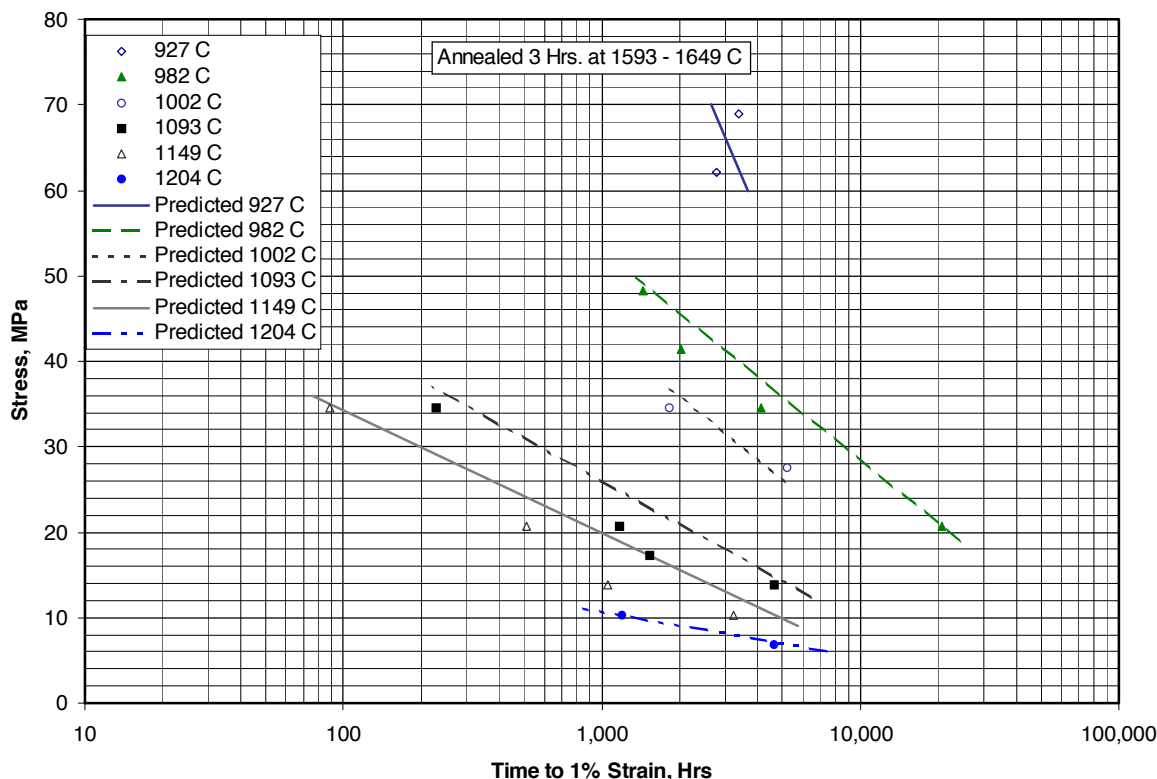

Figure 6.5.1.0(e). Average isothermal creep curves to 1% strain for C-103 Niobium alloy when annealed for 3 hours at 1593 - 1649°C.

Correlative Information for Figure 6.5.1.0(e)

Test Data: Reference 6.5.1.0

Specimen Description:

Sheet Thickness – 7.62 mm

Gage Dimensions – 6.35 mm (w) x 25.4 mm (l)

Test Conditions:

Annealing - Degreased, rinsed in distilled water and alcohol, wrapped in tantalum foil, and annealed in a vacuum of 10^{-10} Pa for 3 hours at 2900-3000°F.

Heating Rate – NA

Soak Time – NA

Atmosphere – Began at 10^{-10} Pa and decreased into the 10^{-12} Pa range after several hundred hours.

Strain Measurement – Frequent optical readings of fiducial marks in the reduced gage section.

Temperature Measurement – NA

Heating System – Radiant heat with Tantalum heating elements and heat shields. Entire specimen located in hot zone of furnace.

Creep Equation^a:

$$\text{Log } t = c + b_1/T + b_2X/T + b_3X^2/T + b_4X^3/T$$

$$T = \text{°R}$$

$$X = \text{Log stress}$$

$$c = -1.0330 \times 10$$

$$b_1 = 4.5827 \times 10^4$$

$$b_2 = -1.0416 \times 10^4$$

$$b_3 = -5.7995 \times 10^2$$

$$b_4 = 8.0842 \times 10^2$$

Analysis Details:

$$R^2 = 98\%$$

$$\text{Standard Error of Estimates} = 0.09$$

$$\text{Observations} = 18$$

^a To convert from °R to °K, divide °R by 1.8.

REFERENCES

- 6.1.2.1 "Cryogenic Materials Data Handbook," Air Force Materials Laboratory, Wright-Patterson Air Force Base, Ohio, AFML-TDR-64-280, 1970.
- 6.3.1.0(a) Buzolits, S. R. and Lawler, M. J., "AEREX® 350 Alloy: A 220 ksi Minimum Tensile Strength Fastener Alloy for Service up to 1350°F," ASM 2nd International Conference on Heat-Resistant Materials, 11-14 September, 1995.
- 6.3.1.0(b) SPS Technologies brochure, 1998.
- 6.3.2.0 H-3159, "Fabrication of HAYNES® and HASTELLOY® Solid-Solution Strengthened High-Temperature Alloy," 1992.
- 6.5.1.0 Titran, Robert H. and Klopp, William D. "Long-Time Creep Behavior of the Niobium Alloy C-103", NASA Technical Paper 1727, October 1980.

This page intentionally blank.

CHAPTER 7

MISCELLANEOUS ALLOYS AND HYBRID MATERIALS

This chapter contains the engineering properties and related characteristics of miscellaneous alloys and hybrid materials.

Mechanical and physical property data and characteristics pertinent to specific alloy groups or individual alloys are reported in the following sections. Due to the nature of this chapter, the major sections are not the same alloy sections used in MIL-HDBK-5.

7.1 GENERAL

In addition to the usual properties, some characteristics relating to the special uses of these alloys are described, such as the toxicity of particles of beryllium and its compounds.

7.1.1 MISCELLANEOUS ALLOY INDEX — The alloys are listed in the index, shown in Table 7.1.1.

Table 7.1.1 Miscellaneous Alloys Index

Section	Designation
7.2	Aluminum Beryllium Alloys
7.2.1	AM162
7.2.2	Beralcast® 363, 191, and 310
7.2.3	AMIC 910
7.3	Optical Grade Beryllium Alloys
7.3.1	O-30-H

7.2 ALUMINUM BERYLLIUM ALLOYS

7.2.0 General Comments — This section contains properties and characteristics of aluminum beryllium alloys used in aerospace applications. These alloys exhibit high modulus of elasticity, low density, good thermal conductivity, and low thermal expansion.

Environmental Considerations — Particles of beryllium and its compounds, such as beryllium oxide, are toxic, so special precautions to prevent inhalation must be ensured. Please review MSDS (Material Safety Data Sheet) before use.

Manufacturing Considerations — Precautions must be taken to control beryllium chips or fines caused when machining. Otherwise, machining is similar to that of aluminum. Tool wear is increased due to the abrasiveness of the beryllium.

7.2.1 AM162

7.2.1.0 Comments and Properties — These materials are typically used for parts requiring high thermal conductivity, low density, and high modulus of elasticity. Bars, rods, tubing, and shapes are consolidated from powder by either HIP or extrusion. Sheets and plate are consolidated from powder by extrusion and subsequently rolled.

Machining — Precautions must be taken to control beryllium chips or fines caused when machining. Depending on machining operation, cutting speeds and feeds are 5 - 50 percent slower than used with 6061-T6 aluminum.

Joining — Joining materials can be performed by vacuum and dip brazing, electron beam, and TIG welding. Joint design varies from that of aluminum joint design due to the increased stiffness of the AM162 material.

Surface Treatment — Typical aluminum protective coatings from Chemfilm (Alodine) to cadmium over nickel can be used. For seawater environments, anodizing, electroless nickel plating or cadmium plating over nickel can be used.

Specifications and Properties — Material specifications are shown in Table 7.2.1.0(a).

Table 7.2.1.0(a). Material Specifications for AM162

Specification	Form
AMS 7911	HIPed bar, rod, tubing or shapes
AMS 7912	Extruded bar, rod, tubing or shapes
AMS 7913	Extruded and rolled sheet and plate

Room temperature mechanical and physical properties are shown in Tables 7.2.1.0.(b), (c), and (d).

Table 7.2.1.0.(b). Typical Mechanical and Physical Properties of AM162 HIPed

Specification	AMS 7911			
Form	HIPed into Bar, Rod, Tubing or Shapes			
Condition (or Temper) ...	593 °C (1100 °F) for 24 hours			
	n / lots ^a	Avg.	Std. Dev.	Skew
Mechanical Properties:				
<i>TUS</i> , MPa	111/29	305	5	0.97
<i>TYS</i> , MPa	111/20	226	17	0.29
<i>CYS</i> , MPa	—	—	—	—
<i>SUS</i> , MPa	—	—	—	—
<i>BUS</i> , MPa:				
(e/D = 1.5)	—	—	—	—
(e/D = 2.0)	—	—	—	—
<i>BYS</i> , MPa:				
(e/D = 1.5)	—	—	—	—
(e/D = 2.0)	—	—	—	—
<i>elong.</i> , percent:	111/29	4.7	0.9	0.19
red. of area, percent : ...	—	—	—	—
<i>E</i> , GPa			—	
<i>E_c</i> , GPa			—	
<i>G</i> , GPa			—	
<i>μ</i>			—	
Physical Properties:				
<i>ω</i> , Mg/m ³	5/5	2.1	.005	-0.850
<i>C</i> , J/(g °K)			—	
<i>K</i> , W/m °K			—	
<i>α</i> , 10 ⁻⁶ m/m °K			—	

a *n* represents the number of data points, *lots* represents the number of lots. Refer to Section 9.1.3 for definitions.

Table 7.2.1.0.(c). Typical Mechanical and Physical Properties of AM162 Extruded

Specification	AMS 7912			
Form	Extruded Bar, Rod, Tubing or Shape			
Condition (or Temper) ...	Annealed at 593°C (1100°F) for 24 hours			
Thickness or diameter, mm	12 to 38			
	n / lots ^a	Avg.	Std. Dev.	Skew
Mechanical Properties:				
<i>TUS</i> , MPa:				
L	203/99	452	28	-0.43
LT (or T)	91/28	388	26	0.45
ST	—	—	—	—
<i>TYS</i> , MPa:				
L	204/99	324	22	0.86
LT (or T)	91/28	315	18	-0.66
ST	—	—	—	—
<i>CYS</i> , MPa:				
L	—	—	—	—
LT (or T)	—	—	—	—
ST	—	—	—	—
<i>SUS</i> , MPa				
—	—	—	—	—
<i>BUS</i> , MPa:				
(e/D = 1.5)	—	—	—	—
(e/D = 2.0)	—	—	—	—
<i>BYS</i> , MPa:				
(e/D = 1.5)	—	—	—	—
(e/D = 2.0)	—	—	—	—
<i>elong.</i> , percent:				
L	203/99	11.0	2.7	-0.70
LT (or T)	91/28	5.1	2.2	1.48
ST	—	—	—	—
red. of area, percent:				
L	—	—	—	—
LT (or T)	—	—	—	—
ST	—	—	—	—
<i>E</i> , GPa				
—	—	193 ^b	—	—
<i>E_c</i> , GPa				
—	—	—	—	—
<i>G</i> , GPa				
—	—	—	—	—
<i>μ</i>				
—	—	0.17 ^b	—	—
Physical Properties:				
<i>ω</i> , Mg/m ³				
—	—	2.071 ^b	—	—
<i>C</i> , J/(g°K)				
—	—	1506 ^b	—	—
<i>K</i> , W/m°K				
—	—	210 ^b	—	—
<i>α</i> , 10 ⁻⁶ m/m°K				
—	—	13.9 ^b	—	—

^a *n* represents the number of data points, *lots* represents the number of lots. Refer to Section 9.1.3 for definitions.

^b From Brush Wellman brochure "Beryllium Metal Matrix Composite Avionics Materials".

Table 7.2.1.0.(d). Typical Mechanical and Physical Properties of AM162 Sheet and Plate

Specification	AMS 7913			
	Extruded and Rolled Sheet and Plate			
	Annealed at 593°C (1100°F) for 24 hours			
	1.6 to 9			
	n / lots ^a	Avg.	Std. Dev.	Skew
Mechanical Properties:				
<i>TUS</i> , MPa:				
L	209/131	428	16	-0.40
LT (or T)	195/111	431	16	-0.10
ST	—	—	—	—
<i>TYS</i> , MPa:				
L	209/131	314	15	-0.17
LT (or T)	195/111	318	15	0.17
ST	—	—	—	—
<i>CYS</i> , MPa:				
L	—	—	—	—
LT (or T)	—	—	—	—
ST	—	—	—	—
<i>SUS</i> , MPa				
—	—	—	—	—
<i>BUS</i> , MPa:				
(e/D = 1.5)	—	—	—	—
(e/D = 2.0)	—	—	—	—
<i>BYS</i> , MPa:				
(e/D = 1.5)	—	—	—	—
(e/D = 2.0)	—	—	—	—
<i>elong.</i> , percent:				
L	209/131	8.7	1.8	-0.34
LT (or T)	195/111	8.6	1.9	-0.24
ST	—	—	—	—
red. of area, percent:				
L	—	—	—	—
LT (or T)	—	—	—	—
ST	—	—	—	—
<i>E</i> , GPa				
—	—	—	—	—
<i>E_c</i> , GPa				
—	—	—	—	—
<i>G</i> , GPa				
—	—	—	—	—
<i>μ</i>				
—	—	—	—	—
Physical Properties:				
<i>ω</i> , Mg/m ³				
—	—	—	—	—
<i>C</i> , J/(g°K)				
—	—	—	—	—
<i>K</i> , W/m°K				
—	—	—	—	—
<i>α</i> , 10 ⁻⁶ m/m°K				
—	—	—	—	—

^a *n* represents the number of data points, *lots* represents the number of lots. Refer to section 9.1.3 for definitions.

7.2.2 Beralcast®* Alloys

7.2.2.0 Comments and Properties — The Beralcast® alloys are used primarily for precision cast, high-strength structural applications. They offer low density, low coefficient of thermal expansion (CTE), good thermal conductivity, high modulus of elasticity, and improved damping characteristics.

Machining — Starmet provides technical data sheets for machining of Beralcast®363 and 191 investment castings. Precautions are necessary for handling chips or fines. If coolants are used, they must be treated as a beryllium contaminated hazardous waste. Aluminum/(61-68%) Beryllium materials are not as prone to edge build up during machining as many aluminum alloys and recommended starting speeds are 20% - 40% less. Starmet recommends that most Beralcast® products that undergo any rough machining (significant surface removal) operations undergo thermal stress relief per NMI-PR-BER3 Processing Standard for Thermal Stress Relief of Beralcast® Investment Castings.

Post Treatment — Cast products may be HIPed.

Surface Treatment — Various coatings may be used for environmental protection, wear resistance, and electrical and/or thermal conductivity. These include anodize chromate conversion, electroless nickel, aluminum plating, and organic finishes.

Specifications and Properties — Material specifications are shown in Table 7.2.2.0(a).

Table 7.2.2.0(a). Material Specifications for Beralcast® Alloys

Specification	Form
Starmet PRS-001	Investment cast
Lockheed 78001709	Extruded plate, bar and tubing

Room temperature mechanical and physical properties of castings and extruded plate, bar, and tubing are shown in Table 7.2.2.0(b) and (c). Figure 7.2.2.0(b) provides S/N fatigue curves for room temperature samples. Lower temperature mechanical properties of HIPed castings are shown in Table 7.2.2.0(d). Elevated temperature mechanical properties of HIPed castings are shown in Table 7.2.2.0(e) and an elevated temperature S/N fatigue curve is shown in Figure 7.2.2.0(c).

* Beralcast is a registered trademark of Starmet.

Table 7.2.2.0(b). Typical Mechanical and Physical Properties of Beralcast® Alloy Casting

Specification	Starmet PRS-001 (See Appendix C)							
Form	Investment Cast							
Trade name	Beralcast® 363							
Condition (or Temper)	As-Cast				HIPed			
Location	Primarily from casting							
Thickness or diameter, mm .	5 to 13							
	n/ lots ^a	Avg.	Std. Dev.	Skew	n/ lots ^a	Avg.	Std. Dev.	Skew
Mechanical Properties:								
<i>TUS</i> , MPa	20/5	275	11	-0.54	91/15	276	11	-0.11
<i>TYS</i> , MPa	20/5	220	16	-1.96	91/15	220	14	-2.56
<i>CYS</i> , MPa	—	—	—	—	22/9	228	11	-0.97
<i>SUS</i> , MPa	—	—	—	—	21/9	246	13	-0.15
<i>BUS</i> ,MPa:								
(e/D = 1.5)	—	—	—	—	13/8	467	22	0.13
(e/D = 2.0)	20/4	625	24	-1.9	13/9	618	13	0.41
<i>BYS</i> , MPa:								
(e/D = 1.5)	—	—	—	—	13/8	407	17	-0.18
(e/D = 2.0)	20/4	466	26	0.55	13/9	483	19	0.51
<i>elong.</i> , percent	20/5	1.8	1.0	1.89	91/15	3.4	2.1	0.97
<i>E</i> , GPa	202 ^b				12/12	209	7	-0.03
<i>E_c</i> , GPa	—				—	—	—	—
<i>E_b</i> , GPa (bending) T. . . .	—				18/6	174	8	-0.06
<i>G</i> , GPa	—				—	—	—	—
<i>μ</i>	0.20 ^b				18/6	0.20	0.0	0.24
Physical Properties:								
<i>ω</i> , Mg/m ³	2.16 ^b				2.16 ^b			
<i>C</i> , J/(g °K)	1.5 ^b				3/1	1.5	0.05	1.73
<i>K</i> , W/m °K	105.5 ^b				See Figure 7.2.2.0(a)			
<i>α</i> , 10 ⁻⁶ m/m °K for -55 °C to 110 °C . . .	4/4	14.7	0.1	0.85	11/5	14.9	1.12	0.20

a *n* represents the number of data points, *lots* represents the number of lots. Refer to Section 9.1.3 for definitions.

b Starmet's Beralcast® Advantage brochure.

Table 7.2.2.0(c). Typical Mechanical and Physical Properties of Beralcast® Alloy Casting, Plate, Bar, and Tube

Specification	Starmet PRS-001				Lockheed 778001709			
	Investment Cast				Extruded Plate, Bar, and Tube			
Form	Beralcast® 191				Beralcast® 310			
Trade name	Solution Quenched and Aged				none			
Condition (or Temper)	appendages to casting				NA			
Location	5 to 13				5 to 6.3			
Thickness or diameter, mm .	n/ lots ^a	Avg.	Std. Dev.	Skew	n/ lots ^a	Avg.	Std. Dev.	Skew
Mechanical Properties:								
<i>TUS</i> , MPa:	67/65	226	13	0.07	22/5	406	23	0.41
L					22/5	320	15	-0.08
<i>TYS</i> , MPa:	67/65	159	9	-0.62				
L					8/3	318	6	0.91
<i>CYS</i> , MPa:	–	–	–	–	7/2	300	10	-0.54
L								
<i>SUS</i> , MPa	–	–	–	–	2/2	492	31	–
<i>BUS</i> , MPa:					3/1	606	33	-1.57
(e/D = 1.5)	–	–	–	–				
(e/D = 2.0)	–	–	–	–	2/2	471	13	–
<i>BYS</i> , MPa:					3/1	566	9	-0.12
(e/D = 1.5)	–	–	–	–				
(e/D = 2.0)	–	–	–	–				
<i>elong.</i> , percent	67/65	3.3	1.2	0.63	22/5	10.9	3.7	-0.04
L					22/5	12.1	5.3	0.22
<i>Red. of Area</i> , percent	–	–	–	–				
<i>E</i> , GPa		202 ^b			5/3	221	8	-1.48
<i>E_b</i> , GPa (bend mod) T ...		–			7/2	179	18	-2.23
<i>E_c</i> , GPa		–						
<i>G</i> , GPa		–						
<i>μ</i>		0.20 ^b						
Physical Properties:								
<i>ω</i> , Mg/m ³		2.16 ^b			11/6	2.086	0.0	0.54
<i>C</i> , J/(g°K)		180 ^b				180 ^b		
<i>K</i> , W/m°K		1423.5 ^b				1423.5 ^b		
<i>α</i> , 10 ⁻⁶ m/m°K		13.4 ^b			3/2	7.3	0.3	1.66

a *n* represents the number of data points, *lots* represents the number of lots. Refer to Section 9.1.3 for definitions.

b Starmet's Beralcast® Advantage brochure.

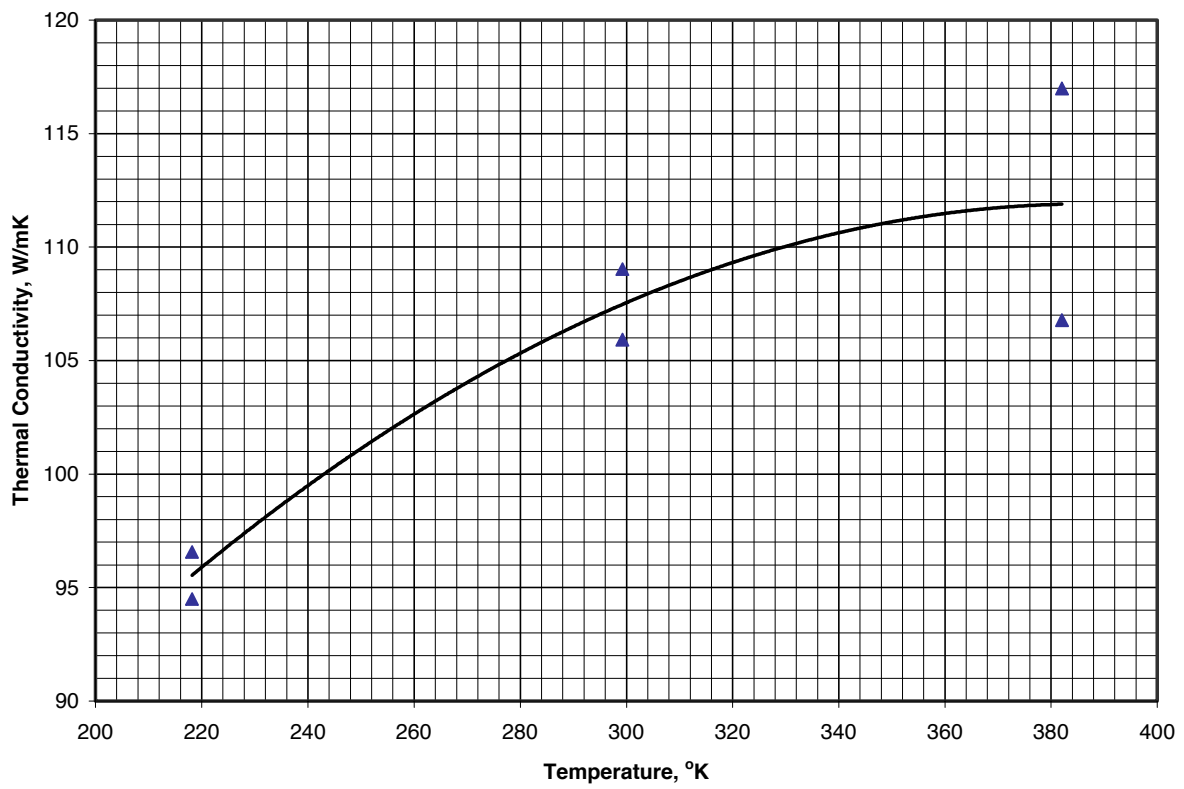

Figure 7.2.2.0(a). Effect of temperature on thermal conductivity of Beralcast® 363 HIPed.

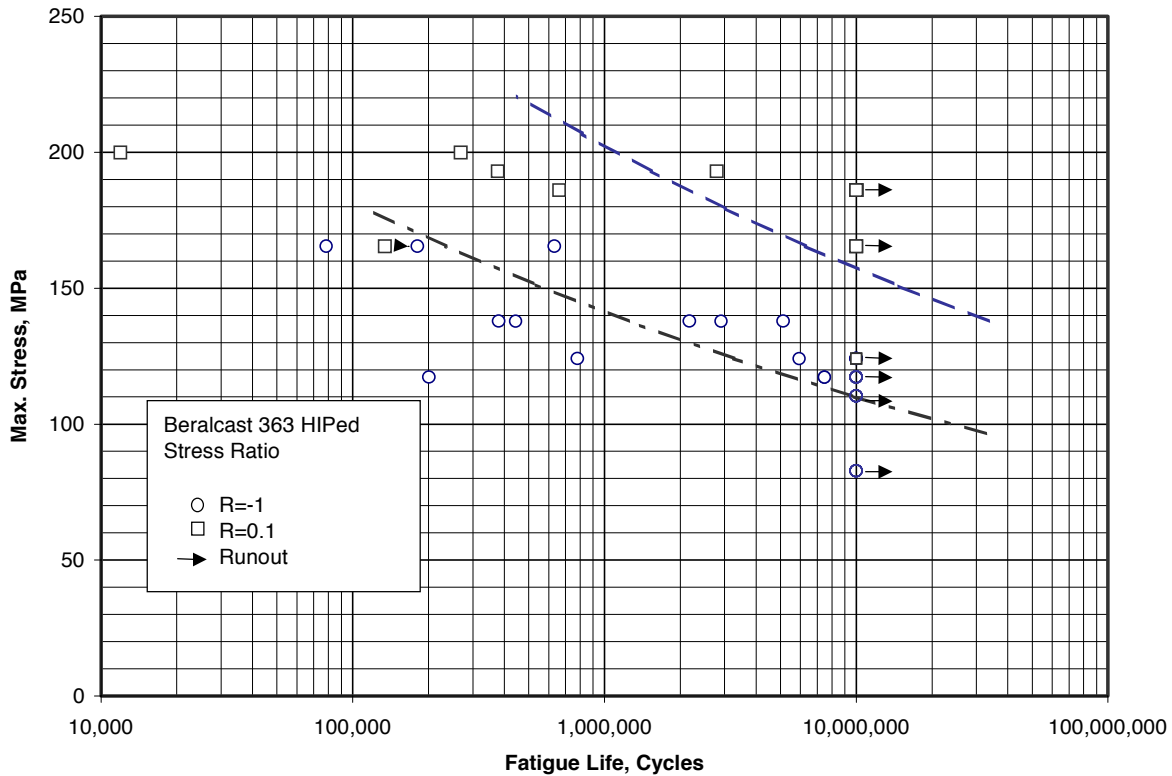

Figure 7.2.2.0(b). S/N curves for Beralcast® 363 HIPed.

Correlative Information for Figure 7.2.2.0(b)

Product Form: Investment cast, HIPed

Properties: TUS, MPa TYS, MPa Temp., °K

276 220 RT

Specimen Details:

Flat
127 mm total length
Gage section:
6.35 mm (w) x 38 mm (l) x 3.175 mm (t)

Surface Condition: Machined and polished to RMS 24 or better on gage and blended sections and RMS 64 or better on remaining specimen

Reference: 7.2.2.0.
ASTM E466-82

Test Parameters:

Loading - Axial
Frequency - 1200 - 3600 cpm
Temperature - RT
Environment - Air

No. of Heats/Lots: 12

Equivalent Stress Equation:

$\log N_f = 19.25 - 9.16 \log (S_{eq})$
 $S_{eq} = S_{max} (1-R)^{0.45}$
Standard Error of Estimate = 0.736
Standard Deviation in Life = 0.821
 $R^2 = 22\%$

Sample Size = 31

[Caution: The equivalent stress model may provide unrealistic life predictions for stress ratios beyond those represented above.]

Table 7.2.2.0(d). Typical Mechanical Properties of Beralcast® 363 Casting at -55°C

Specification	Starmet PRS-001			
Form	Investment Cast			
Condition (or Temper) ...	HIPed			
Location	Primarily from casting			
Thickness or diameter, mm	5 to 13			
	n / lots ^a	Avg.	Std. Dev.	Skew
Mechanical Properties:				
<i>TUS</i> , MPa	5/3	288	13	0.07
<i>TYS</i> , MPa	5/3	253	9	-0.07
<i>elong.</i> , percent	5/3	2.0	0.6	0.46

a *n* represents the number of data points, *lots* represents the number of lots. Refer to Section 9.1.3 for definitions.

Table 7.2.2.0(e). Typical Mechanical Properties of Beralcast® 363 Casting at 110°C

Specification	Starmet PRS-001			
Form	Investment Cast			
Condition (or Temper) ...	HIPed			
Location	Primarily from casting			
Thickness or diameter, mm	5 to 13			
	n / lots ^a	Avg.	Std. Dev.	Skew
Mechanical Properties:				
<i>TUS</i> , MPa	6/4	230	6	-0.19
<i>TYS</i> , MPa	6/4	207	7	-2.26
<i>elong.</i> , percent	6/4	4.9	1.1	0.86

a *n* represents the number of data points, *lots* represents the number of lots. Refer to Section 9.1.3 for definitions.

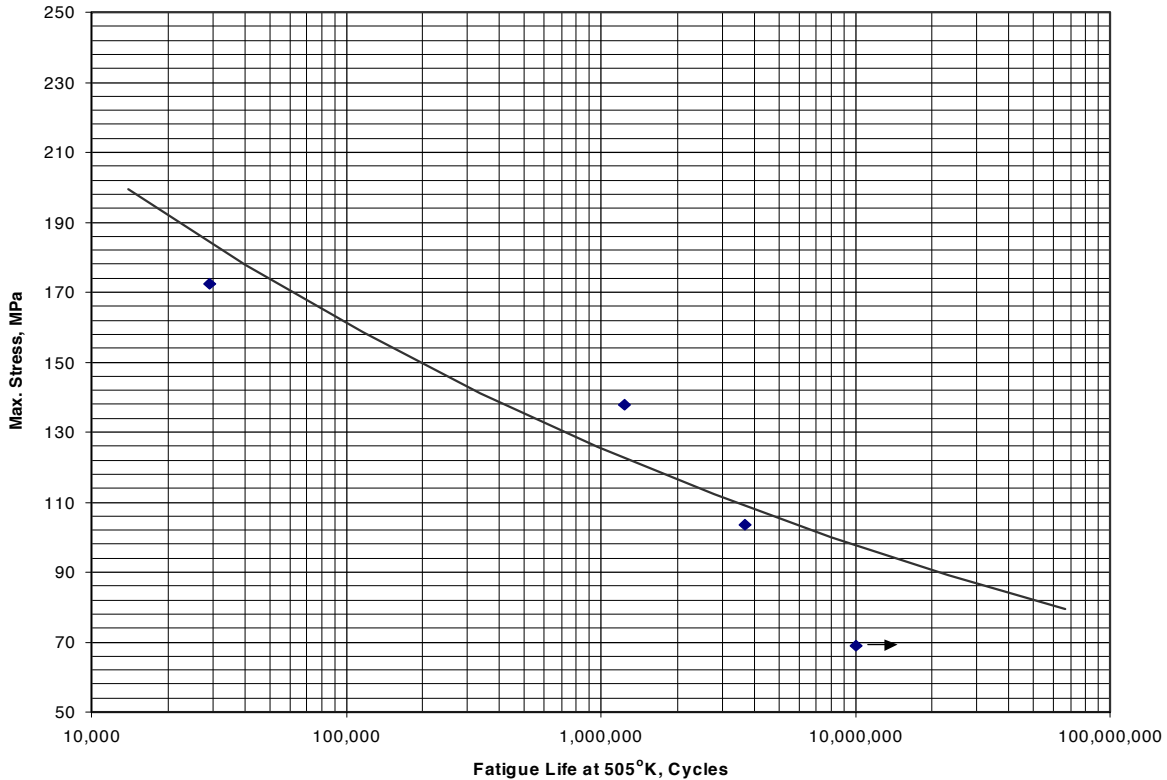

Figure 7.2.2.0(c). S/N curves for Beralcast® 363 HIPed, at 505°K.

Correlative Information for Figure 7.2.2.0(c)

Product Form: Investment cast, HIPed

Test Parameters:

<u>Properties:</u>	<u>TUS, MPa</u>	<u>TYS, MPa</u>	<u>Temp., °K</u>
	276	220	RT
	230	208	383

Loading - Axial
 Frequency - 1800 cpm
 Temperature - 505°K
 Environment - Air

Specimen Details:

Flat
 127 mm total length
 Gage section:
 6.35 mm (w) x 38 mm (l) x 3.175 mm (t)

No. of Heats/Lots: unknown

Equivalent Stress Equation:

$\log N_f = 17.59 - 9.20 \log (S_{eq})$
 Standard Error of Estimate = 0.581
 Standard Deviation in Life = 1.103
 $R^2 = 86\%$

Surface Condition: Machined and polished to RMS 24 or better on gage and blended sections and RMS 64 or better on remaining specimen.

Sample Size = 3

Reference: 7.2.2.0.
 ASTM E466-82

[Caution: The equivalent stress model may provide unrealistic life predictions for stress ratios beyond those represented above.]

7.2.3 AMIC 910 alloy

7.2.3.0 Comments and Properties — This alloy is used for investment casting of aluminum beryllium products.

Environmental Considerations — Particles of beryllium and its compounds, such as beryllium oxide, are toxic, so special precautions to prevent inhalation must be taken.

Machining — Precautions must be taken to control beryllium chips or fines caused when machining. Otherwise, machining is similar to that of aluminum. Depending on machining operations, cutting speeds and feeds are 5 - 50% slower than used with 6061T6 aluminum. Tool wear is increased due to the abrasiveness of the beryllium.

Joining — Joining materials can be performed by vacuum and dip brazing, electron beam, and TIG welding. Joint design varies from that of aluminum joint design due to the increased stiffness of the AM162 material.

Surface Treatment — Typical aluminum protective coatings from Chemfilm (Alodine) to Cadmium over nickel can be used. For seawater environments, anodizing, electroless nickel plating or cadmium plating over nickel can be used.

Specifications and Properties — Material specifications are shown in Table 7.2.3.0(a).

Specification	Form
(Brush Wellman) AlBeCast™ : AMIC 910 Investment Castings	Investment cast

Room temperature mechanical and physical properties are shown in Tables 7.2.3.0.(b).

Table 7.2.3.0.(b). Typical Mechanical and Physical Properties of AMIC 910 Investment Cast

Specification	AlBeCast™ : AMIC 910 (see Appendix C)			
Form	HIPed into Bar, Rod, Tubing or Shapes			
Condition (or Temper) . . .	593 °C for 24 hours			
	n / lots ^a	Avg.	Std. Dev.	Skew
Mechanical Properties:				
<i>TUS</i> , MPa	50/50	201	22	-0.30
<i>TYS</i> , MPa	50/50	159	18	-0.06
<i>CYS</i> , MPa	—	—	—	—
<i>SUS</i> , MPa	—	—	—	—
<i>BUS</i> , MPa:				
(<i>e/D</i> = 1.5)	—	—	—	—
(<i>e/D</i> = 2.0)	—	—	—	—
<i>BYS</i> , MPa:				
(<i>e/D</i> = 1.5)	—	—	—	—
(<i>e/D</i> = 2.0)	—	—	—	—
<i>elong.</i> , percent	50/50	3.9	2.2	2.59
red. of area, percent . . .	—	—	—	—
<i>E</i> , GPa	—			
<i>E_c</i> , GPa	—			
<i>G</i> , GPa	—			
<i>μ</i>	—			
Physical Properties:				
<i>ω</i> , Mg/m ³	—			
<i>C</i> , J/(g°K)	—			
<i>K</i> , W/m°K	—			
<i>α</i> , 10 ⁻⁶ m/m°K	—			

^a *n* represents the number of data points, *lots* represents the number of lots. Refer to Section 9.1.3 for definitions.

7.3 OPTICAL GRADE BERYLLIUM

7.3.1 O-30-H

7.3.1.0 Comments and Properties — This is a pure beryllium material made by HIPing (Hot Isostatic Pressing) of spherical beryllium powder. These materials are typically used for parts requiring superior optical properties and/or support structures requiring isotropic properties and a low coefficient of thermal expansion.

Environmental Considerations — Particles of beryllium and its compounds, such as beryllium oxide, are toxic, so special precautions to prevent inhalation must be taken.

Machining — Precautions must be taken to control beryllium chips or fines caused when machining. Tool wear is increased due to the abrasiveness of the beryllium.

Joining — Joining materials can be performed by vacuum and dip brazing, electron beam, and TIG welding. Joint design varies from that of aluminum joint design due to the increased stiffness of the O-30-H material.

Surface Treatment — Typical aluminum protective coatings from Chemfilm (Alodine) to Cadmium over nickel can be used. For seawater environments, anodizing, electroless nickel plating or cadmium plating over nickel can be used.

Specifications and Properties — Material specifications are shown in Table 7.3.1.0(a).

Table 7.3.1.0(a). Material Specifications for O-30-H Grade Beryllium

Specification	Form
Brush Wellman O-30-H Optical Grade Beryllium	HIPed bar, rod, tubing or shapes

Room temperature mechanical and physical properties are shown in Tables 7.3.1.0.(b).

Table 7.3.1.0.(b). Typical Mechanical and Physical Properties of O-30-H Grade Beryllium, HIPed

Specification	Brush Wellman O-30-H Optical Beryllium (see Appendix C)			
	HIPed into Bar, Rod, Tubing or Shapes			
	Condition (or Temper) . . .			
	Thickness or diameter, mm			
	n / lots ^a	Avg.	Std. Dev.	Skew
Mechanical Properties:				
<i>TUS</i> , MPa	20/2	427	9	0.36
<i>TYS</i> , MPa	20/2	329	19	1.36
<i>CYS</i> , MPa	—	—	—	—
<i>SUS</i> , MPa	—	—	—	—
<i>BUS</i> , MPa:				
(e/D = 1.5)	—	—	—	—
(e/D = 2.0)	—	—	—	—
<i>BYS</i> , MPa:				
(e/D = 1.5)	—	—	—	—
(e/D = 2.0)	—	—	—	—
<i>elong.</i> , percent	20/2	2.05	0.4	-0.24
red. of area, percent . . .	—	—	—	—
PEL ^b , MPa	9/1	26.5	2.7	-0.65
<i>E</i> , GPa			—	
<i>E_c</i> , GPa			—	
<i>G</i> , GPA			—	
<i>μ</i>			—	
Physical Properties:				
<i>ω</i> , Mg/m ³			—	
<i>C</i> , J/(g°K)			—	
<i>K</i> , W/m°K			—	
<i>α</i> , 10 ⁻⁶ m/m°K	3/1	21	0.13	-0.82

a *n* represents the number of data points, *lots* represents the number of lots. Refer to Section 9.1.3 for definitions.

b Precision elastic limit or micro-yield stress; the stress necessary to produce 6.4516 cm³/cm. plastic deformation.

CHAPTER 8

STRUCTURAL JOINTS

Data on emerging structural joints or fastener materials designed for use in aircraft and missile structural applications were not submitted for inclusion in this handbook.

This page intentionally blank.

CHAPTER 9

STATISTICAL AND DATA PRESENTATION GUIDELINES

This chapter includes guidelines for the collection, statistical analysis and presentation of data in the Preliminary Material Properties (PMP) Handbook.

The following index should be helpful in locating sections of these Guidelines that describe data analysis methods applicable to specific material properties:

Section	Subject	Page
9.0	Summary	9-1
9.1	General	9-3
9.1.1	Introduction	9-3
9.1.2	Documentation Requirements	9-3
9.1.3	Symbols and Definitions	9-3
9.1.4	Data Requirements for Introducing a New Product	9-3
9.1.5	Procedure for the Submission of Mechanical Property Data	9-5
9.2	Room-Temperature Design Properties	9-6
9.2.1	Introduction	9-6
9.2.2	Designations and Symbols	9-6
9.2.3	Computation of Properties	9-8
9.2.4	Modulus of Elasticity and Poisson's Ratio	9-8
9.2.5	Physical Properties	9-8
9.2.6	Presentation of Room-Temperature Design Properties	9-9
9.3	Graphical Mechanical Property Data (refer to MIL-HDBK-5)	9-12
9.4	Miscellaneous Properties (refer to MIL-HDBK-5)	9-12
9.5	Statistical Procedures and Tables	9-12

9.0 SUMMARY

The objective of this summary is to provide an overview of Chapter 9 without defining specific statistical details. It will be most helpful to those unfamiliar with the statistical procedures used in the PMP Handbook and to those who would like to learn more about the philosophy behind these guidelines.

Chapter 9 is the "rule book" for the PMP Handbook. It is based on the MIL-HDBK-5 guidelines, which were first defined in 1966. By comparison to MIL-HDBK-5, the PMP guidelines allow for the presentation of data as typical values identifying the number of tests and lots, mean average, standard deviation, and skewness. Recommended changes in these guidelines are presented to the Guidelines Task Group (GTG) and later the entire coordination committee.

Chapter 9 is divided into 6 subchapters, similar to MIL-HDBK-5, that cover the analysis methods used to define room and elevated temperature properties. The room temperature mechanical properties are tensile, compression, bearing, shear, fatigue, fracture toughness, elongation and elastic modulus. The elevated temperature properties are the same, with the addition of creep and stress rupture properties. Analysis procedures for fatigue crack growth rate data are also included since this data is commonly used in aircraft design. The presentation of these data varies depending upon the data type. For instance, the

room temperature mechanical properties (tensile, compression, bearing, shear, elongation and elastic modulus) are provided in a tabular format, while the fatigue, elevated temperature properties, and typical stress strain curves are presented in graphical format. The PMP handbook refers to the MIL-HDBK-5 for analysis procedures and presentation of graphical properties.

Before an alloy can be considered for inclusion in the PMP Handbook, it must be covered by a publicly available specification (developed by a domestic or foreign agency, an industry group, individual company, or government) available in the English language and reviewed by the MIL-HDBK-5 coordination committee (see Section 9.1.4.1). The reason for this is to insure that the alloy, and its method of manufacture, has been "reduced to standard practice".

The majority of the data in the PMP Handbook are room temperature typical properties: including tensile (TUS, TYS), shear (SUS), compression (CYS), bearing strengths (BUS, and BYS), elongation and elastic modulus. Room temperature properties are the primary focus in the Handbook since most material specifications include only room temperature property requirements, and for comparison with similar materials properties. Data at operational temperatures for air vehicle, turbine engine, or spacecraft applications should be submitted if available.

Mechanical properties tabulated in the PMP Handbook are calculated by standard statistical procedures. A minimum of 30 observations is preferred, including data from at least 3 heats, castings or melts (as defined in the next paragraph). The number of samples and heats are indicated with the average, standard deviation, and skewness for each property. Compression, bearing and shear strength properties may have fewer samples.

A heat of material, in the case of batch melting, is all of the material that is cast at the same time from the same furnace charge and is identified with the same heat number. In the case of continuous melting, a single heat of material is generally poured without interruption. The exception is for ingot metallurgy wrought aluminum products, where a single heat is commonly cast in sequential aluminum ingots, which are melted from a single furnace charge and poured in one or more drops without changes in the processing parameters (see Table 9.1.6.2). A lot represents all of the material of a specific chemical composition, heat treat condition or temper, and product form that has passed through all processing operations at the same time. Multiple lots can be obtained from a single heat.

Many mechanical property tables in the PMP Handbook include data for specific grain directions and thickness ranges. This is done to better represent anisotropic materials, such as wrought products, that often display variations in mechanical properties as a function of grain direction and/or product thickness.

Effect of temperature and thermal exposure curves are also included in the PMP Handbook. The creep rupture plots are shown as typical isothermal curves of stress versus time. The physical properties are shown as a function of temperature for each property i.e. specific heat, thermal conductivity etc. Physical properties are reported as average actual values, not a percentage of a room temperature value.

In addition to the mechanical properties, statistically based mean S/N fatigue curves may be provided in the PMP Handbook, since many structures experience dynamic loading conditions. The statistical procedures are fairly rigorous and defined in detail in MIL-HDBK-5. For example, the procedure describes how to treat outliers and run-outs (discontinued tests), and which models to use to best-fit a specific set of data. Each fatigue figure includes relevant information such as K_f , R value, material properties, sample size and equivalent stress equation. Each figure should be closely examined by the user to properly identify the fatigue curves required for a particular design.

9.1 GENERAL

This section of the Guidelines covers general information. Information specific to individual properties can be found in pertinent sections.

9.1.1 INTRODUCTION — Properties in the PMP Handbook are used to determine preliminary design of aerospace structures and elements. Thus, it is important that the values presented in the PMP Handbook reflect as accurately as possible the actual properties of the products covered.

9.1.2 DOCUMENTATION REQUIREMENTS — The purpose of requiring adequate documentation of proposals submitted to the MIL-HDBK-5 Coordination Group is to permit an independent evaluation of proposals by each interested attendee and to provide a historical record of actions of the Coordination Group. For this reason, supporting data and a description of analytical procedures employed must be made available to attendees, either as an integral portion of an attachment to the agenda or minutes, or by reference to other documents that may reasonably be expected to be in the possession of the attendees. Due to the nature of the PMP Handbook, in which many of the alloys are emerging materials, some data may be considered company sensitive data. In those cases, the raw data will not be presented to the Coordination Group.

9.1.3 SYMBOLS AND DEFINITIONS —

- heat — All material identifiable to a single molten metal source. (All material from a heat is considered to have the same composition. A heat may yield one or more ingots. A heat may be divided into several lots by subsequent processing.)
- lot — All material from a heat or single molten metal source of the same product type having the same thickness or configuration, and fabricated as a unit under the same conditions. If the material is heat treated, a lot is the above material processed through the required heat-treating operations as a unit.
- n — Number of individual measurements.

9.1.4 DATA INPUT FOR INTRODUCTION OF A NEW PRODUCT — This section includes requirements for the incorporation of a new product into the PMP Handbook. These requirements are applicable to each alloy, product form, and heat treat condition or temper. Sections 9.1.4.2 through 9.1.4.7 delineate requirements for the determination of mechanical property data.

9.1.4.1 *Material Specification* — To be considered for inclusion in the PMP Handbook, a product should normally be covered by a publicly available industry or company specification that is available in an English translation for review by the MIL-HDBK-5 coordination committee. If a public specification for the product is not available, action should be initiated to prepare a draft specification. Standard manufacturing procedures must be established for the fabrication and processing of production material before a draft specification is prepared. The draft specification must describe a product which is commercially available on a production basis.

9.1.4.2 *Material* — Production material must be used for the determination of typical values for incorporation into the PMP Handbook. The material must have been produced using production facilities and standard fabrication and processing procedures. If a test program to determine requisite mechanical properties is initiated before a public specification describing this product is available precautionary measures must be taken to ensure that the product supplied for the test program conforms to the specification, when published, and represents production material.

Material from at least three production heats, casts or melts should be tested for each product form and heat treat condition to determine mechanical properties by direct computational procedures. For

definitions of heat, melt, and cast as it applies to various materials, see Table 9.1.4.2. (This is not a mandatory requirement, as any substantial data collection will be considered for inclusion.)

A lot is defined as all material of a specific chemical composition, heat treat condition or temper, and product form which has been processed at the same time through all processing operations. Different sizes and configurations from a heat, cast or melt can be considered different lots. Thicknesses of the lots to be tested should span the thickness range of the product form covered by the material specification (or for the thickness range for which design values are to be established).

Dimensionally discrepant castings or special test configurations may be used, providing these castings meet the requirements of the applicable material specification. Typical values for separately cast test specimens must be indicate.

Table 9.1.4.2. Definitions of Heat, Melt, and Cast

Material	Heat, Melt, or Cast
Ingot Metallurgy Wrought Products Excluding Aluminum Alloys	A heat is material which, in the case of batch melting, is cast at the same time from the same furnace and is identified with the same heat number; or, in the case of continuous melting, is poured without interruption.
Ingot Metallurgy Wrought Aluminum Alloy Products	A cast consists of the sequential aluminum ingots which are melted from a single furnace charge and poured in one or more drops without changes in the processing parameters. (The cast number is for internal identification and is not reported.)
Powder Metallurgy Wrought Products Including Metal-Matrix Composites	A heat is a consolidated (vacuum hot pressed) billet having a distinct chemical composition.
Cast Alloy Products Including Metal-Matrix Composites	A melt is a single homogeneous batch of molten metal for which all processing has been completed and the temperature has been adjusted and made ready to pour castings. (For metal-matrix composites, the molten metal includes unmelted reinforcements such as particles, fibers, or whiskers.)

9.1.4.3 Test Specimens — Test specimens must be located within the cross section of the product in accordance with the applicable material specification, or applicable sampling specification, such as AMS 2355, AMS 2370, and AMS 2371. Subsize specimens may be used if necessary.

Test specimens must be excised in longitudinal, long transverse, and short transverse (when applicable) grain directions. Mechanical properties should also be obtained in the 45° grain direction for materials that have significantly different properties in this direction than the standard grain directions. For some product configurations, it may be impractical to obtain transverse bearing specimens. For aluminum die forging, the longitudinal grain direction is defined as orientations parallel, within ± 15°, to

the predominate grain flow. The long transverse grain direction is defined as perpendicular, within $\pm 15^\circ$, to the longitudinal (predominate) grain direction and parallel, within $\pm 15^\circ$, to the parting plane. (Both conditions must be met.) The sort transverse grain direction is defined as perpendicular, within $\pm 15^\circ$, to the longitudinal (predominate) grain direction and perpendicular, within $\pm 15^\circ$, to the parting plane. (Both conditions must be met.)

9.1.4.4 Test Procedures — The pin shear testing of aluminum alloys is covered by ASTM B 769. Grain orientations and loading directions for shear specimens are also specified in ASTM B 769. Shear testing standards for aluminum alloy sheet, strip, or thin extrusions or for products from other alloy systems are tested per ASTM B 831. Bearing tests for products from all alloy systems must be conducted in accordance with ASTM E 238, using "clean pin" test procedures. For aluminum alloy plate, bearing specimens are oriented flatwise and for aluminum alloy die and hand forgings, bearing specimens are oriented edgewise, as described in Section 3.1.2.1.1 of MIL-HDBK-5.

9.1.4.5 Mechanical Properties — Tensile (ASTM E8), compression (ASTM E9), shear (ASTM B769 and ASTM B831), and bearing tests (ASTM E238) must be conducted at room temperature to determine tensile yield and ultimate strengths, compressive yield strength, shear ultimate strength, and bearing yield and ultimate strengths for $e/D = 1.5$ and $e/D = 2.0$ for each grain direction and each lot of material. All data must be identified by lot, or heat, or melt. Data should be submitted for the useful temperature range of the product. For data requirements of elevated temperature curves, see the section on Data Requirements in the MIL-HDBK-5.

9.1.4.6 Modulus of Elasticity Data — Tensile and compressive modulus of elasticity values must be determined for at least three lots of material. Elastic modulus values are those obtained using a Class B-1 or better extensometer. A method of determining or verifying the classification of extensometers is identified in ASTM E 83. ASTM E 111, is the standard test method for the determination of Young's Modulus, tangent modulus, and chord modulus of structural materials. A modulus value must also be obtained for the 45 degree grain orientation for materials that are anticipated to have significantly different properties in this direction than the standard grain directions.

9.1.4.7 Other Data — Room temperature, tensile and compressive load-deformation curves or stress-strain data for each grain direction may be provided. Room temperature, full-range, tensile load deformation curves or stress-strain data for each grain direction may also be provided. For heat resistant materials for which elevated temperature data for tensile yield and ultimate strengths are presented, room and elevated temperature stress-strain data are requested. For materials designated for cryogenic applications and used at cold temperatures, for which cold temperature tensile yield and ultimate strength data are presented, room and cold temperature stress-strain data are requested. For all materials, a precise density value in pounds per cubic inch is requested. Although not required, physical property data for coefficient of expansion, thermal conductivity, and specific heat should be submitted, when available. Also, information regarding manufacturing (fabrication and processing), environmental effects (corrosion resistance), heat treat condition and applicable specification must be provided so that a comments and properties section can be prepared. Data for creep, stress rupture, fatigue crack propagation, fatigue and fracture toughness properties should be submitted whenever possible, especially when applicable specifications contain minimum property requirements, such as minimum fracture toughness values.

9.1.5 SUBMISSION OF DATA — Data should be supplied in an PC format spreadsheet. It may be sent electronically or on a disk. Along with the floppy disk, provide a hard (paper) copy of the data contained on the disk and any other supporting documentation such as specimen dimensions, gage length, physical properties, comments on the material, etc. This information will be stored in the MIL-HDBK-5 archives for future reference. Use the format described in the MIL-HDBK-5 as a guideline.)

9.2 ROOM-TEMPERATURE PROPERTIES

9.2.1 INTRODUCTION — This section contains detailed procedures for the determination of typical room-temperature properties.

9.2.2 DESIGNATIONS AND SYMBOLS — Designations and Symbols presented in this section are applicable throughout the PMP Handbook, but are particularly pertinent to computation and presentation of room-temperature mechanical properties.

9.2.2.1 Data Basis — Room-temperature mechanical properties included in the PMP Handbook are based on typical property values.

All available original test data for current material that is produced and supplied to the appropriate government, industry, or equivalent company specifications are included in calculating values. (However, to be considered for inclusion in the PMP Handbook, a material must be covered by a publicly available specification per Section 9.1.6.) Only positive proof of improper processing or testing is cause for exclusion of original test data.

9.2.2.2 Mechanical-Property Terms — Mechanical properties that are presented as room-temperature properties are listed in Table 9.2.2.2. The absence of a directionality symbol implies that the property value is applicable to each of the grain directions when the product dimensions exceed approximately 2.5 inches.

The listed mechanical property symbols should be followed by one of the following additional symbols for wrought alloys, not castings.

- L — Longitudinal direction; parallel to the principal direction of flow in a worked metal.
- T — Transverse direction; perpendicular to the principal direction of flow in a worked metal; may be further defined as LT or ST.
- LT — Long-transverse direction; the transverse direction having the largest dimension, often called the "width" direction.
- ST — Short-transverse direction; the transverse direction having the smallest dimension, often called the "thickness" direction.

Values of *BUS* and *BYS* should indicate the appropriate edge distance/hole diameter (e/D) ratio. Typical properties are presented for two such ratios: $e/D = 1.5$ and $e/D = 2.0$.

Data for use in establishing these properties should be based on ASTM or equivalent standard testing practices. The test practice and any deviations should be reported.

Table 9.2.2.2. Mechanical Property Terms

Property	Units	Symbol
		Room-Temperature Typical Value
Tensile Ultimate Strength	MPa	TUS
Tensile Yield Strength	MPa	TYS
Compressive Yield Strength	MPa	CYS
Shear Ultimate Strength	MPa	SUS
Shear Yield Strength ^a	MPa	SYS
Bearing Ultimate Strength	MPa	BUS
Bearing Yield Strength	MPa	BYS
Elongation	percent	elong.
Total Strain at Failure ^a	percent	strain at failure
Reduction of Area	percent	red. of area
Number of samples	number	n
Mean Average		Avg.
Standard Deviation		Std. Dev.
Skew		Skew

a As applicable.

9.2.2.3 Statistical Terms — Proper use of the following statistical terms and equations will alleviate misunderstanding in the presentation of data analyses:

Population — All potential measurements having certain independent characteristics in common, i.e., "all possible TUS(L) measurements for 17-7PH stainless steel sheet in TH1050 condition."

Sample — A finite number of observations drawn from the population.

Sample mean — Average of all observed values in the sample. It is an estimate of population mean. A mean is indicated by a bar over the symbol for the value observed. Thus, the mean of n observations of TUS would be expressed as:

$$\overline{\text{TUS}} = \frac{\text{TUS}_1 + \text{TUS}_2 + \dots + \text{TUS}_n}{n} = \frac{\sum_{i=1}^n (\text{TUS}_i)}{n}$$

Sample standard deviation — An estimate of the population standard deviation; the square root of the sample variance, or

$$s_{\text{TUS}} = \sqrt{\frac{\sum_{i=1}^n (X_i - \bar{X})^2}{(n-1)}}$$

Skewness — The degree of asymmetry of a distribution, or

$$\gamma = \frac{n}{(n-1)(n-2)} \sum_{i=1}^n \left(\frac{X_i - \bar{X}}{S} \right)^3$$

9.2.3 COMPUTATION OF PROPERTIES —

9.2.3.1 Treatment of Grain Direction — Mechanical properties are usually listed according to grain direction in material specifications although some specifications do not indicate a grain direction, which implies isotropy. For the PMP Handbook, it is recommended that mechanical properties be shown for each grain direction for wrought materials. When the material is shown to be isotropic, then the same properties should be shown for each direction.

9.2.3.2 Proposals — Proposals should include (1) proposed new or revised table of room-temperature properties, (2) raw data used in the analysis (unless it is considered company confidential), and (3) analysis for the proposed design values.

9.2.4 MODULUS OF ELASTICITY AND POISSON'S RATIO — The following room-temperature elasticity values are presented in the room-temperature property tables as typical values:

Property	Units	Symbol	Recommended ASTM Test Procedures
Modulus of Elasticity			
In tension	GPa	E	E 111
In compression	GPa	E_c	E 111
In shear	GPa	G	E 143
Poisson's Ratio	(Dimensionless)	μ	E 132

If the material is not isotropic, the applicable test direction must be specified. Deviations from isotropy must be suspected if the experimentally determined Poisson's ratio differs from the value computed by the formula

$$\mu = \frac{E}{2G} - 1 \quad [9.2.4(a)]$$

where E is the average of E and E_c .

Given E , E_c , and G , μ may be computed by this equation. Likewise, given E , E_c , and μ , G may be computed from the equation:

$$G = \frac{E}{2(\mu + 1)} \quad [9.2.4(b)]$$

In the event E_c is not available, E may be substituted for E in the above equations to provide an estimate of either μ or G .

9.2.5 PHYSICAL PROPERTIES — Density, specific heat, thermal conductivity, and mean coefficient of thermal expansion are physical properties normally included in the PMP Handbook. Physical properties are presented in the room-temperature property table if they are not presented in

effect-of-temperature curves (see Section 9.3.1.4). Table 9.2.5 displays units and symbols used in the PMP Handbook, and also recommended ASTM test procedures for measuring these properties. Since other procedures are employed in measuring physical properties, methods used to develop the values proposed for inclusion in the PMP Handbook should be reported in the supporting data proposal. For specific heat and thermal conductivity values reported in the room temperature property table, the reference temperature of measurement is also shown (for example, for A206 aluminum the specific heat is shown as “0.92 (373°K)”). For tabulated values of mean thermal expansion, temperature range of the coefficient is shown (for example “19.26 (293 to 373°K)”). The reference temperature of 294°K (70°F) is established as standard for mean coefficient of thermal expansion curves.

Table 9.2.5. Units and Symbols Used to Present Physical Property Data and ASTM Test Procedures

Property	Unit	Symbol	Recommended ASTM Test Procedures
Density	Mg/m ³	ω	C 693
Specific heat	J/(g°K)	C	D 2766
Thermal conductivity	W/m°K	K	C 714 ^a
Mean coefficient of thermal expansion	10 ⁶ m/mK	α	E 228

a ASTM C 714 is a test for thermal diffusivity from which thermal conductivity can be computed.

9.2.6 PRESENTATION OF ROOM-TEMPERATURE VALUES — The proposal for the incorporation of data into the PMP Handbook must contain supporting data and computations for all typical properties. Depending on quantity and availability, data may be tabulated, plotted, or referenced (to readily available technical reports, specifications, etc.). Computations should indicate adequately the manner in which values were computed and must be presented in an orderly manner. Nonproprietary data sources must be identified.

The table of room-temperature typical values must be presented in the format indicated in Figure 9.2.6 for conventional metallic materials. The following instructions should be followed for the items located in the table:

- (1) Table number: If this is a revision of an existing table, use the same table number; otherwise, use a new table number in the proper sequence.
- (2) Material designation: Use a numeric designation where available (for example, 7075 aluminum alloy). Avoid the use of trade names. Include products following the material designation, except products may be omitted from the title if there are many products covered by the table.
- (3) Specification: Refer to a publicly available specification (industry, Military, or Federal), followed by a type or class designation, if appropriate. Include a copy of the industry specification, whether from the producer or user of the material, in Appendix C. Do not refer to proprietary specifications.
- (4) Condition: Use a standard temper designation where applicable. Otherwise, use an easily recognized description, including pertinent details if these are not available in the reference specification. Examples: T651, TH1050, Aged 760 C (1400 F), Mill Annealed.
- (5) Cross-sectional area: Use only when applicable.

- (6) Location within casting: Applicable only to castings. Specify "Non-designated area," or "Designated area," as applicable.
- (7) Typical values must be presented only for the thicknesses covered in the material specification.
- (8) Grain direction: Show typical values for grain directions "L, LT, and ST" or for grain directions "L and T" for the properties *TUS*, *TUY*, *CYS*, *elong.*, and *red. of area*. For anisotropic materials, present values for grain directions "L, 45°, and LT" for *TUS*, *TYS*, and *CYS*. Grain directions are not applicable to castings.

The T grain direction should be footnoted with the definition used in the specification identified at the top of the mechanical property table. For example, the T grain direction for aluminum die forgings covered in MIL, Federal and some AMS specifications should read as follows: "For die forgings, T indicates any grain direction not within ± 15 degrees of being parallel to the forging flow lines." For the AMS specifications with the narrow definition for the T grain direction, the footnote should read as follows: "For die forgings, T indicates a grain direction within ± 15 degrees of being perpendicular to forging flow lines." Specimens to test the transverse properties should be located as close to the short transverse direction as possible.

Transverse *CYS* values for aluminum die forgings must be shown as *CYS(T)*. If the values are based upon short transverse or long transverse test data, add this information to the above footnote.

- (9) Missing values: For table entries that are missing or not applicable, show a dash aligned with the numbers in that column.
- (10) Physical properties: Include a section for physical properties even if properties are not available. If physical property data are presented in an effect-of-temperature curve, use table entry, "See Figure X.X.X.0" to refer to the illustration.
- (11) Footnotes: Use footnotes to indicate anything unusual or restrictive concerning the property description, properties, or individual values; to present supplementary values; or to reference other tables or sections of text.

Table ①. Typical Mechanical and Physical Properties of (material designation) ② (products)

Specification	③			
Form				
Condition (or Temper)	④			
Cross-sectional area, in. ²	⑤			
Location within casting	⑥			
Thickness or diameter, in.	⑦			
	n / lots	Avg.	Std. Dev.	Skew
Mechanical Properties:				
<i>TUS</i> , MPa:				
L	12/4	120	2.5	
LT (or T)⑧	-	-	-	
ST		⑨		
<i>TUY</i> , MPa:				
L				
LT (or T)				
ST				
<i>CYS</i> , MPa:				
L				
LT (or T)				
ST				
<i>SUS</i> , MPa				
<i>BUS</i> ,MPa:				
(e/D = 1.5)				
(e/D = 2.0)				
<i>BUY</i> , MPa:				
(e/D = 1.5)				
(e/D = 2.0)				
<i>elong.</i> , percent (S-basis):				
L				
LT (or T)				
ST				
red. of area, percent :				
L				
LT (or T)				
ST				
<i>E</i> , GPa				
<i>E_c</i> , GPa				
<i>G</i> , GPa				
<i>μ</i>				
Physical Properties:				
<i>ω</i> , Mg/m ³		⑩		
<i>C</i> , J/(g°K)				
<i>K</i> , W/m°K				
<i>α</i> , 10 ⁻⁶ m/m°K				

⑪ (footnotes)

Figure 9.2.6. Format for room temperature property table.

9.3 GRAPHICAL MECHANICAL PROPERTY DATA —

The analysis methods and presentation methods defined in MIL-HDBK-5 are used for all graphical data such as for elevated temperature curves, typical stress-strain curves, compression, fatigue, fatigue crack propagation, creep and creep-rupture.

9.4 MISCELLANEOUS PROPERTIES —

The analysis and presentation methods defined in MIL-HDBK-5 are used for miscellaneous properties such as fracture toughness.

9.5 STATISTICAL PROCEDURES AND TABLES —

No statistical tables are required for the room temperature data analysis for the PMP handbook. Procedures are defined in section 9.2. For graphical data, the procedures and tables are those used in MIL-HDBK-5.

APPENDIX A

A.0 GLOSSARY

A.1 ABBREVIATIONS (also see Section 9.2.2, and Sections 9.3.4.3, 9.3.6.2, 9.4.1.2, 9.5.1.2, 9.6 of MIL-HDBK-5).

a	— Amplitude; crack or flaw dimension; measure of flaw size, inches.
a_c	— Critical half crack length.
a_o	— Initial half crack length.
A	— Area of cross section, square inches; ratio of alternating stress to mean stress; subscript “axial”; “A” ratio, loading amplitude/mean load; or area.
A_e	— Strain “A” ratio, strain amplitude/mean strain.
AMS	— Aerospace Materials Specification (published by Society of Automotive Engineers, Inc.).
Ann	— Annealed.
AN	— Air Force-Navy Aeronautical Standard.
ASTM	— American Society for Testing and Materials.
b	— Width of sections; subscript “bending”.
br	— Subscript “bearing”.
B	— Biaxial ratio (see Equation 1.3.2.8)
Btu	— British thermal unit(s).
BUS	— Individual or typical bearing ultimate strength.
BYS	— Individual or typical bearing yield strength.
c	— Fixity coefficient for columns; subscript “compression”.
cpm	— Cycles per minute.
C	— Specific heat; Celsius; Constant.
C(T)	— Compact tension.
CYS	— Individual or typical compressive yield strength.
d	— Mathematical operator denoting differential.
D or d	— Diameter, or Durbin Watson statistic; hole or fastener diameter; dimpled hole.
df	— Degrees of freedom.
e	— Elongation in percent, a measure of the ductility of a material based on a tension test; unit deformation or strain; subscript “fatigue or endurance”; the minimum distance from a hole, center to the edge of the sheet; Engineering strain.
e_e	— Elastic strain.
e_p	— Plastic strain.
e/D	— Ratio of edge distance (center of the hole to edge of the sheet) to hole diameter (bearing strength).
E	— Modulus of elasticity in tension or compression; average ratio of stress to strain for stress below proportional limit.
E_c	— Modulus of elasticity in compression; average ratio of stress to strain below proportional limit.
E_s	— Secant modulus of elasticity, Eq. 9.3.2.5b.
E_t	— Tangent modulus of elasticity.
ELI	— Extra low interstitial (grade of titanium alloy).
ft	— Foot: feet.
F	— Design stress; Fahrenheit; Ratio of two sample variances.
g	— Gram(s).
G	— Modulus of rigidity (shear modulus).

GPa	— Gigapascal(s).
hr	— Hour(s).
H	— Subscript “hoop”.
HIP	— Hot isostatically pressed.
i	— Slope (due to bending) of neutral plane of a beam, in radians (1 radian = 57.3 degrees).
in.	— Inch(es).
I	— Axial moment of inertia.
J	— Torsion constant (= I_p for round tubes); Joule.
k	— Tolerance limit factor for the normal distribution and the specified probability, confidence, and degrees of freedom; Strain at unit stress.
ksi	— Kips (1,000 pounds) per square inch.
K	— A constant, generally empirical; thermal conductivity; stress intensity; Kelvin; correction factor.
K_{app}	— Apparent plane stress fracture toughness or residual strength.
K_c	— Critical plane stress fracture toughness, a measure of fracture toughness at point of crack growth instability.
K_f	— Fatigue notch factor, or fatigue strength reduction factor.
K_{Ic}	— Plane strain fracture toughness.
K_N	— Empirically calculated fatigue notch factor.
K_t	— Theoretical stress concentration factor.
lb	— Pound.
ln	— Natural (base e) logarithm.
log	— Base 10 logarithm.
L	— Length; subscript “lateral”; longitudinal (grain direction).
LT	— Long transverse (grain direction).
m	— Subscript “mean”; metre; slope.
mm	— Millimeter(s).
M	— Applied moment or couple, usually a bending moment.
Mg	— Megagram(s).
MIG	— Metal-inert-gas (welding).
MPa	— Megapascal(s).
MS	— Military Standard.
M.S.	— Margin of safety.
M(T)	— Middle tension.
n	— Number of individual measurements or pairs of measurements; subscript “normal”; cycles applied to failure; shape parameter for the standard stress-strain curve (Ramberg-Osgood parameter); number of fatigue cycles endured.
N	— Fatigue life, number of cycles to failure; Newton; normalized.
N_f	— Fatigue life, cycles to failure.
N_i^*	— Fatigue life, cycles to initiation.
N_t^*	— Transition fatigue life where plastic and elastic strains are equal.
NAS	— National Aerospace Standard.
p	— Subscript “polar”; subscript “proportional limit”.
psi	— Pounds per square inch.
P	— Load; applied load (total, not unit, load); exposure parameter; probability.
P_a	— Load amplitude.
P_m	— Mean load.
P_{max}	— Maximum load.
P_{min}	— Minimum load.

* Different from ASTM.

Pu	— Test ultimate load, pounds per fastener.
Py	— Test yield load, pounds per fastener.
q	— Fatigue notch sensitivity.
Q	— Static moment of a cross section.
Q&T	— Quenched and tempered.
r	— Radius; root radius; reduced ratio (regression analysis); ratio of two pair measurements; rank of test point within a sample.
\bar{r}	— average ratio of paired measurements.
R	— Load (stress) ratio, or residual (observed minus predicted value); stress ratio, ratio of minimum stress to maximum stress in a fatigue cycle; reduced ratio.
R _b	— Stress ratio in bending.
R _c	— Stress ratio in compression; Rockwell hardness - C scale.
R _e	— Strain ratio, $\epsilon_{\min}/\epsilon_{\max}$.
R _s	— Stress ratio in shear or torsion; ratio of applied load to allowable shear load.
R _t	— Ratio of applied load to allowable tension load.
RA	— Reduction of area.
R.H.	— Relative humidity.
RMS	— Root-mean-square (surface finish).
RT	— Room temperature.
s	— Estimated population standard deviation; sample standard deviation; subscript “shear”.
s ²	— Sample variance.
S	— Shear force; nominal engineering stress, fatigue
S _a	— Stress amplitude, fatigue.
S _e	— Fatigue limit.
S _{eq} *	— Equivalent stress.
S _f	— Fatigue limit.
S _m	— Mean stress, fatigue.
S _{max}	— Highest algebraic value of stress in the stress cycle.
S _{min}	— Lowest algebraic value of stress in the stress cycle.
S _r	— Algebraic difference between the maximum and minimum stresses in one cycle.
S _y	— Root mean square error.
SAE	— Society of Automotive Engineers.
SCC	— Stress-corrosion cracking.
SEE	— Estimate population standard error of estimate.
SR	— Studentized residual.
ST	— Short transverse (grain direction).
STA	— Solution treated and aged.
SUS	— Individual or typical shear ultimate strength.
SYS	— Individual or typical shear yield strength.
t	— Thickness; subscript “tension”; exposure time; elapsed time; tolerance factor for the “t” distribution with the specified probability and appropriate degrees of freedom.
T	— Transverse direction; applied torsional moment; transverse (grain direction); subscript “transverse”.
T _F	— Exposure temperature.
TIG	— Tungsten-inert-gas (welding).
TUS	— Individual or typical tensile ultimate strength.
TYS	— Individual or typical tensile yield strength.
u	— Subscript “ultimate”.

* Different from ASTM.

U	— Factor of utilization.
W	— Width of center-through-cracked tension panel; Watt.
\bar{x}	— Distance along a coordinate axis.
x	— Sample mean based upon n observations.
X	— Value of an individual measurement; average value of individual measurements.
y	— Deflection (due to bending) of elastic curve of a beam; distance from neutral axis to given fiber; subscript “yield”; distance along a coordinate axis.
Y	— Nondimensional factor relating component geometry and flaw size. See Reference 1.4.12.2.1(a) for values.
z	— Distance along a coordinate axis.
Z	— Section modulus, I/y.

A.2 SYMBOLS (also see Section 9.2.2, and Sections 9.3.4.3, 9.3.6.2, 9.4.1.2, 9.5.1.2, and 9.6 of MIL-HDBK-5).

α	— (1) Coefficient of thermal expansion, mean; constant. (2) Significance level; probability [risk of erroneously rejecting the null hypothesis (see Section 9.6.2)].
β	— Constant.
$\Delta\varepsilon$ or ε_r^*	— strain range, $\varepsilon_{\max} - \varepsilon_{\min}$.
$\Delta\varepsilon_e$	— Elastic strain range.
$\Delta\varepsilon_p$	— Plastic strain range.
ΔS (S_r) [*]	— Stress range.
$\Delta\sigma$	— True or local stress range.
ε	— True or local strain.
ε_{eq}^*	— Equivalent strain.
ε_m	— Mean strain, $(\varepsilon_{\max} + \varepsilon_{\min})/2$.
ε_{\max}	— Maximum strain.
ε_{\min}	— Minimum strain.
ε_t	— Total (elastic plus plastic) strain at failure determined from tensile stress-strain curve.
δ	— Deflection.
Φ	— Angular deflection.
ρ	— Radius of gyration; Neuber constant (block length).
μ	— Poisson’s ratio.
σ	— True or local stress; or population standard deviation.
σ_x	— Population standard deviation of x.
σ_x^2	— Population variance of x.
ω	— Density; flank angle.
∞	— Infinity.
Σ	— The sum of.
'	— Superscript that denotes value determined by regression analysis.

A.3 DEFINITIONS (also see Sections 9.1.5, 9.1.6.2, 9.2.2, and Sections 9.3.6.2, 9.4.1.2, 9.5.1.2 and 9.6 of MIL-HDBK-5).

Alternating Load.— See Loading Amplitude.

* Different from ASTM.

Cast.—Cast consists of the sequential ingots which are melted from a single furnace charge and poured in one or more drops without changes in the processing parameters. (The cast number is for internal identification and is not reported.) (See Table 9.1.4.2).

Casting.—One or more parts which are melted from a single furnace charge and poured in one or more molds without changes in the processing parameters. (The cast number is for internal identification and is not reported.) (See Table 9.1.4.2). Designated areas of the casting are those areas used for testing as prescribed by qualification requirements. Non-designated areas are any other areas.

Constant-Amplitude Loading.—A loading in which all of the peak loads are equal and all of the valley loads are equal.

Constant-Life Fatigue Diagram.—A plot (usually on Cartesian coordinates) of a family of curves, each of which is for a single fatigue life, N —relating S , S_{\max} , and/or S_{\min} to the mean stress, S_m . Generally, the constant life fatigue diagram is derived from a family of S/N curves, each of which represents a different stress ratio (A or R) for a 50 percent probability of survival. NOTE—MIL-HDBK-5 no longer presents fatigue data in the form of constant-life diagrams.

Creep.—The time-dependent deformation of a solid resulting from force.

Note 1—Creep tests are usually made at constant load and temperature. For tests on metals, initial loading strain, however defined, is not included.

Note 2—This change in strain is sometimes referred to as creep strain.

Creep-Rupture Curve.—Results of material tests under constant load and temperature; usually plotted as strain versus time to rupture. A typical plot of creep-rupture data is shown in Figure 9.3.6.2. The strain indicated in this curve includes both initial deformation due to loading and plastic strain due to creep.

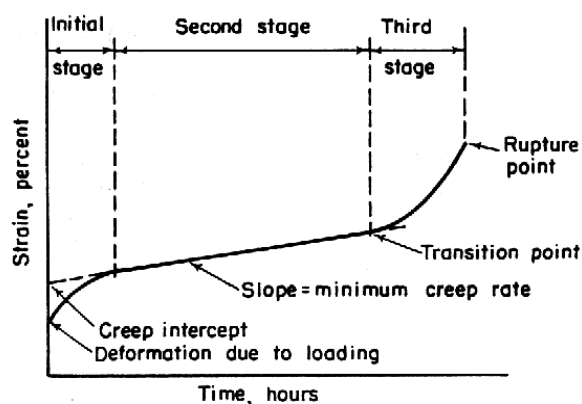

Figure A.1. Typical creep-rupture curve.

Creep-Rupture Strength.—Stress that will cause fracture in a creep test at a given time, in a specified constant environment. Note: This is sometimes referred to as the stress-rupture strength.

Creep-Rupture Test.—A creep-rupture test is one in which progressive specimen deformation and time for rupture are measured. In general, deformation is much larger than that developed during a creep test.

Creep-Strain.—The time-dependent part of the strain resulting from stress, excluding initial loading strain and thermal expansion.

Creep Strength.—Stress that causes a given creep in a creep test at a given time in a specified constant environment.

Creep Stress.—The constant load divided by the original cross-sectional area of the specimen.

Creep Test.—A creep test has the objective of measuring deformation and deformation rates at stresses usually well below those which would result in fracture during the time of testing.

Critical Stress Intensity Factor.—A limiting value of the stress intensity factor beyond which continued flaw propagation and/or fracture may be expected. This value is dependent on material and may vary with type of loading and conditions of use.

Cycle.—Under constant-amplitude loading, the load varies from the minimum to the maximum and then to the minimum load (see Figure 9.3.4.3). The symbol n or N (see definition of fatigue life) is used to indicate the number of cycles.

Deformable Shank Fasteners.—A fastener whose shank is deformed in the grip area during normal installation processes.

Degree of Freedom.—Number of degrees of freedom for n variables may be defined as number of variables minus number of constraints between them. Since the standard deviation calculation contains one fixed value (the mean) it has $n - 1$ degrees of freedom.

Degrees of Freedom.—Number of independent comparisons afforded by a sample.

Discontinued Test.—See Runout.

Elapsed Time.—The time interval from application of the creep stress to a specified observation.

Fatigue.—The process of progressive localized permanent structural change occurring in a material subjected to conditions that produce fluctuating stresses and strains at some point or points, and which may culminate in cracks or complete fracture after a sufficient number of fluctuations. NOTE—fluctuations in stress and in time (frequency), as in the case of “random vibration”.

Fatigue Life.— N —the number of cycles of stress or strain of a specified character that a given specimen sustains before failure of a specified nature occurs.

Fatigue Limit.— S_f —the limiting value of the median fatigue strength as N becomes very large. NOTE—Certain materials and environments preclude the attainment of a fatigue limit. Values tabulated as “fatigue limits” in the literature are frequently (but not always) values of S_N for 50 percent survival at N cycles of stress in which $S_m = 0$.

Fatigue Loading.—Periodic or non-periodic fluctuating loading applied to a test specimen or experienced by a structure in service (also known as cyclic loading).

*Fatigue Notch Factor**.—The fatigue notch factor, K_f (also called fatigue strength reduction factor), is the ratio of the fatigue strength of a specimen with no stress concentration to the fatigue strength of a specimen with a stress concentration at the same number of cycles for the same conditions. NOTE—In specifying K_f , it is necessary to specify the geometry, mode of loading, and the values of S_{max} , S_m , and N for which it is computed.

Fatigue Notch Sensitivity.—The fatigue notch sensitivity, q , is a measure of the degree of agreement between K_f and K_t . NOTE—the definition of fatigue notch sensitivity is $q = (K_f - 1)/(K_t - 1)$.

Heat.—All material identifiable to a single molten metal source. (All material from a heat is considered to have the same composition. A heat may yield one or more ingots. A heat may be divided into several lots by subsequent processing.)

Heat.—Heat is material which, in the case of batch melting, is cast at the same time from the same furnace and is identified with the same heat number; or, in the case of continuous melting, is poured without interruption. (See Table 9.1.6.2)

Heat.—Heat is a consolidated (vacuum hot pressed) billet having a distinct chemical composition. (See Table 9.1.6.2)

Hysteresis Diagram.—The stress-strain path during a fatigue cycle.

Isostrain Lines.—Lines representing constant levels of creep.

Isothermal Lines.—Lines of uniform temperature on a creep or stress-rupture curve.

*Interrupted Test**.—Tests which have been stopped before failure because of some mechanical problem, e.g., power failure, load or temperature spikes.

Loading Amplitude.—The loading amplitude, P_a , S_a , or ϵ_a represents one-half of the range of a cycle (see Figure 9.3.4.3). (Also known as alternating load, alternating stress, or alternating strain.)

Loading Strain.—Loading strain is the change in strain during the time interval from the start of loading to the instant of full-load application, sometimes called initial strain.

Loading (Unloading) Rate.—The time rate of change in the monotonically increasing (decreasing) portion of the load-time function.

Load Ratio.—The load ratio, R , A , or R_{ϵ} , A_{ϵ} , or R_{σ} , A_{σ} , is the algebraic ratio of the two loading parameters of a cycle; the two most widely used ratios are

$$R = \frac{\text{minimum load}}{\text{maximum load}} = \frac{P_{\min}}{P_{\max}}$$

or

* Different from ASTM.

$$R_{\sigma} = \frac{S_{\min}}{S_{\max}}$$

or

$$R_{\epsilon} = \epsilon_{\min}/\epsilon_{\max}$$

and

$$A = \frac{\text{loading amplitude}}{\text{mean load}} = \frac{P_a}{P_m} \text{ or } \frac{S_a}{S_M}$$

$$A_{\epsilon} = \frac{\text{strain amplitude}}{\text{mean strain}} = \frac{\epsilon_a}{\epsilon_M} \text{ or } \frac{\epsilon_{\max} - \epsilon_{\min}}{\epsilon_{\max} + \epsilon_{\min}} .$$

NOTE—load ratios R or R_{ϵ} are generally used in MIL-HDBK-5.

Longitudinal Direction.—Parallel to the principal direction of flow in a worked metal. For die forgings this direction is within $\pm 15^{\circ}$ of the predominate grain flow.

Long-Transverse Direction.—The transverse direction having the largest dimension, often called the “width” direction. For die forgings this direction is within $\pm 15^{\circ}$ of the longitudinal (predominate) grain direction and parallel, within $\pm 15^{\circ}$, to the parting plane. (Both conditions must be met.)

Lot.—All material from a heat or single molten metal source of the same product type having the same thickness or configuration, and fabricated as a unit under the same conditions. If the material is heat treated, a lot is the above material processed through the required heat-treating operations as a unit.

Master Creep Equation.—An equation expressing combinations of stress, temperature, time and creep, or a set of equations expressing combinations of stress, temperature and time for given levels of creep.

Master Rupture Equation.—An equation expressing combinations of stress, temperature, and time that cause complete separation (fracture or rupture) of the specimen.

Maximum Load.—The maximum load, P_{\max} , S_{\max} , ϵ_{\max} is the load having the greatest algebraic value.

Mean Load.—The mean load, P_m , is the algebraic average of the maximum and minimum loads in constant-amplitude loading:

$$P_m = \frac{P_{\max} + P_{\min}}{2}, \text{ or}$$

$$S_m = \frac{S_{\max} + S_{\min}}{2}, \text{ or}$$

$$\epsilon_m = \frac{\epsilon_{\max} + \epsilon_{\min}}{2},$$

or the integral average of the instantaneous load values.

Median Fatigue Life.—The middlemost of the observed fatigue life values (arranged in order of magnitude) of the individual specimens in a group tested under identical conditions. In the case where an even number of specimens are tested, it is the average of the two middlemost values (based on log lives in MIL-HDBK-5). NOTE 1—The use of the sample median instead of the arithmetic mean (that is, the average) is usually preferred. NOTE 2—In the literature, the abbreviated term “fatigue life” usually has meant the median fatigue life of the group. However, when applied to a collection of data without further qualification, the term “fatigue life” is ambiguous.

Median Fatigue Strength at N Cycles.—An estimate of the stress level at which 50 percent of the population would survive N cycles. NOTE—The estimate of the median fatigue strength is derived from a particular point of the fatigue-life distribution, since there is no test procedure by which a frequency distribution of fatigue strengths at N cycles can be directly observed. That is, one can not perform constant-life tests.

Melt.—Melt is a single homogeneous batch of molten metal for which all processing has been completed and the temperature has been adjusted and made ready to pour castings. (For metal-matrix composites, the molten metal includes unmelted reinforcements such as particles, fibers, or whiskers.) (See Table 9.1.6.2)

Minimum Load.—The minimum load, P_{\min} , S_{\min} , or ϵ_{\min} , is the load having the least algebraic value.

Nominal Hole Diameters.—Nominal hole diameters for deformable shank fasteners shall be according to Table 9.4.1.2(a). When tests are made with hole diameters other than those tabulated, hole sizes used shall be noted in the report and on the proposed joint allowables table.

Nominal Shank Diameter.—Nominal shank diameter of fasteners with shank diameters equal to those used for standard size bolts and screws (NAS 618 sizes) shall be the decimal equivalents of stated fractional or numbered sizes. These diameters are those listed in the fourth column of Table 9.4.1.2. Nominal shank diameters for nondeformable shank blind fasteners are listed in the fifth column of Table 9.4.1.2. Nominal shank diameters for other fasteners shall be the average of required maximum and minimum shank diameters.

Nondeformable Shank Fasteners.—A fastener whose shank does not deform in the grip area during normal installation processes.

*Outlier.**—An experimental observation which deviates markedly from other observations in the sample. An outlier is often either an extreme value of the variability in the data, or the result of gross deviation in the material or experimental procedure.

* Different from ASTM.

Peak.—The point at which the first derivative of the load-time history changes from a positive to a negative sign; the point of maximum load in constant-amplitude loading (see Figure 9.3.4.3).

Plane Strain.—The stress state in which all strains occur only in the principal loading plane. No strains occur out of the plane, i.e., $\epsilon_z = 0$, and $\sigma_z \neq 0$.

Plane Stress.—The stress state in which all stresses occur only in the principal loading plane. No stresses occur out of the plane, i.e., $\sigma_z = 0$, and $\epsilon_z \neq 0$.

Plastic Strain During Loading.—Plastic strain during loading is the portion of the strain during loading determined as the offset from the linear portion to the end of a stress-strain curve made during load application.

Plane-Strain Fracture Toughness.—A generic term now generally adopted for the critical plane-strain stress intensity factor characteristic of plane-strain fracture, symbolically denoted K_{Ic} . This is because in current fracture testing practices, specification of the slowly increasing load test of specimen materials in the plane-strain stress state and in opening mode (I) has been dominant.

Plane-Stress and Transitional Fracture Toughness.—A generic term denoting the critical stress intensity factor associated with fracture behavior under nonplane-strain conditions. Because of plasticity effects and stable crack growth which can be encountered prior to fracture under these conditions, designation of a specific value is dependent on the stage of crack growth detected during testing. Residual strength or apparent fracture toughness is a special case of plane-stress and transitional fracture toughness wherein the reference crack length is the initial pre-existing crack length and subsequent crack growth during the test is neglected.

Population.—All potential measurements having certain independent characteristics in common; i.e., “all possible TUS(L) measurements for 17-7PH stainless steel sheet in TH1050 condition”.

*Precision.**—The degree of mutual agreement among individual measurements. Relative to a method of test, precision is the degree of mutual agreement among individual measurements made under prescribed like conditions. The lack of precision in a measurement may be characterized as the standard deviation of the errors in measurement.

Primary Creep.—Creep occurring at a diminishing rate, sometimes called initial stage of creep.

Probability.—Ratio of possible number of favorable events to total possible number of equally likely events. For example, if a coin is tossed, the probability of heads is one-half (or 50 percent) because heads can occur one way and the total possible events are two, either heads or tails. Similarly, the probability of throwing a three or greater on a die is 4/6 or 66.7 percent. Probability, as related to design allowables, means that chances of a material-property measurement equaling or exceeding a certain value (the one-sided lower tolerance limit) is 99 percent in the case of a A-basis value and 90 percent in the case of a B-basis value.

Range.—Range, ΔP , S_r , $\Delta\epsilon$, ϵ_r , $\Delta\sigma$ is the algebraic difference between successive valley and peak loads (positive range or increasing load range) or between successive peak and valley loads (negative range or decreasing load range), see Figure 9.3.4.3. In constant-amplitude loading, for example, the range is given by $\Delta P = P_{\max} - P_{\min}$.

* Different from ASTM.

Rate of Creep.—The slope of the creep-time curve at a given time determined from a Cartesian plot.

*Residual.**—The difference between the observed fatigue (log) life and the fatigue (log) life estimated from the fatigue model at a particular stress/strain level.

*Runout.**—A test that has been terminated prior to failure. Runout tests are usually stopped at an arbitrary life value because of time and economic considerations. NOTE—Runout tests are useful for estimating a pseudo-fatigue-limit for a fatigue data sample.

Sample.—A finite number of observations drawn from the population.

Sample.—The number of specimens selected from a population for test purposes. NOTE—The method of selecting the sample determines the population about which statistical inferences or generalization can be made.

Sample Average (Arithmetic Mean).—The sum of all the observed values in a sample divided by the sample size (number). It is a point estimate of the population mean.

Sample Mean.—Average of all observed values in the sample. It is an estimate of population mean. A mean is indicated by a bar over the symbol for the value observed. Thus, the mean of n observations of TUS would be expressed as:

$$\overline{\text{TUS}} = \frac{\text{TUS}_1 + \text{TUS}_2 + \dots + \text{TUS}_n}{n} = \frac{\sum_{i=1}^n (\text{TUS}_i)}{n}$$

Sample Median.—Value of the middle-most observation. If the sample is nearly normally distributed, the sample median is also an estimate of the population mean.

Sample Median.—The middle value when all observed values in a sample are arranged in order of magnitude if an odd number of samples are tested. If the sample size is even, it is the average of the two middlemost values. It is a point estimate of the population median, or 50 percentile point.

Sample Point Deviation.—The difference between an observed value and the sample mean.

*Sample Standard Deviation.**—The standard deviation of the sample, s , is the square root of the sample variance. It is a point estimate of the standard deviation of a population, a measure of the "spread" of the frequency distribution of a population. NOTE—This value of s provides a statistic that is used in computing interval estimates and several test statistics.

*Sample Variance.**—Sample variance, s^2 , is the sum of the squares of the differences between each observed value and the sample average divided by the sample size minus one. It is a point estimate of the population variance. NOTE—This value of s^2 provides both an unbiased point estimate of the population variance and a statistic that is used on computing the interval estimates and several test statistics. Some texts define s^2 as "the sum of the squared differences between each observed value and the sample average divided by the sample size", however, this statistic underestimates the population variance, particularly for small sample sizes.

* Different from ASTM.

Sample Variance.—The sum of the squared deviations, divided by $n - 1$, and, based on n observations of TUS, expressed as

$$S_{\text{TUS}}^2 = \frac{\sum_{i=1}^n (\text{TUS}_i - \overline{\text{TUS}})^2}{n - 1} = \frac{n \sum_{i=1}^n (\text{TUS}_i)^2 - \left(\sum_{i=1}^n \text{TUS}_i \right)^2}{n(n - 1)}$$

Secondary Creep.—Creep occurring at a constant rate, sometimes called second stage creep.

Short-Transverse Direction.—The transverse direction having the smallest dimension, often called the “thickness” direction. For die forgings this direction is within $\pm 15^\circ$ of the longitudinal (predominate) grain direction and perpendicular, within $\pm 15^\circ$, to the parting plane. (Both conditions must be met.) When possible, short transverse specimens shall be taken across the parting plane.

Significance Level (As Used Here).—Risk of concluding that two samples were drawn from different populations when, in fact, they were drawn from the same population. A significance level of $\alpha = 0.05$ is employed through these Guidelines. (This is appropriate, since a confidence level of $1 - \alpha = 0.95$ is used in establishing A and B-values.)

Significance Level.—The stated probability (risk) that a given test of significance will reject the hypothesis that a specified effect is absent when the hypothesis is true.

Significant (Statistically Significant).—An effect or difference between populations is said to be present if the value of a test statistic is significant, that is, lies outside of predetermined limits. NOTE—An effect that is statistically significant may not have engineering importance.

Skewness— The degree of asymmetry of a distribution, or

$$\gamma = \frac{n}{(n - 1)(n - 2)} \sum_{i=1}^n \left(\frac{X_i - \bar{X}}{S} \right)^3$$

*S/N Curve for 50 Percent Survival.**—A curve fitted to the median values of fatigue life at each of several stress levels. It is an estimate of the relationship between applied stress and the number of cycles-to-failure that 50 percent of the population would survive. NOTE 1—This is a special case of the more general definition of S/N curve for P percent survival. NOTE 2—In the literature, the abbreviated term “S/N Curve” usually has meant either the S/N curve drawn through the mean (averages) or through the medians (50 percent values) for the fatigue life values. Since the term “S/N Curve” is ambiguous, it should be used only when described appropriately. NOTE 3—Mean S/N curves (based on log lives) are shown in MIL-HDBK-5.

S/N Diagram.—A plot of stress against the number of cycles to failure. The stress can be S_{max} , S_{min} , or S_a . The diagram indicates the S/N relationship for a specified value of S_m , A, or R and a specified probability of survival. Typically, for N, a log scale (base 10) is used. Generally, for S, a linear scale is used, but a log scale is used occasionally. NOTE— S_{max} -versus-log N diagrams are used commonly in MIL-HDBK-5.

* Different from ASTM.

Standard Deviation.—An estimate of the population standard deviation; the square root of the variance, or

$$S_{TUS} = \sqrt{\frac{\sum_{i=1}^n (TUS_i - \overline{TUS})^2}{n - 1}} = \sqrt{\frac{n \sum_{i=1}^n (TUS_i)^2 - \sum_{i=1}^n (TUS_i)^2}{n(n - 1)}}$$

Stress Intensity Factor.—A physical quantity describing the severity of a flaw in the stress field of a loaded structural element. The gross stress in the material and flaw size are characterized parametrically by the stress intensity factor,

$$K = f\sqrt{a} Y, \text{ ksi} - \text{in.}^{1/2} \quad [9.5.1.2]$$

Stress-Rupture Test.—A stress-rupture test is one in which time for rupture is measured, no deformation measurement being made during the test.

Tertiary Creep.—Creep occurring at an accelerating rate, sometimes called third stage creep.

Theoretical Stress Concentration Factor (or Stress Concentration Factor).—This factor, K_t , is the ratio of the nominal stress to the greatest stress in the region of a notch (or other stress concentrator) as determined by the theory of elasticity (or by experimental procedures that give equivalent values). NOTE—The theory of plasticity should not be used to determine K_t .

Tolerance Interval.—An interval computed so that it will include at least a stated percentage of the population with a stated probability.

Tolerance Level.—The stated probability that the tolerance interval includes at least the stated percentage of the population. It is not the same as a confidence level, but the term confidence level is frequently associated with tolerance intervals.

Tolerance Limits.—The two statistics that define a tolerance interval. (One value may be “minus infinity” or “plus infinity”.)

Total Plastic Strain.—Total plastic strain at a specified time is equal to the sum of plastic strain during loading plus creep.

Total Strain.—Total strain at any given time, including initial loading strain (which may include plastic strain in addition to elastic strain) and creep strain, but not including thermal expansion.

*Transition Fatigue Life.**—The point on a strain-life diagram where the elastic and plastic strains are equal.

Transverse Direction.—Perpendicular to the principal direction of flow in a worked metal; may be defined as T, LT or ST.

Typical Basis.—A typical property value is an average value and has no statistical assurance associated with it.

* Different from ASTM.

Waveform.—The shape of the peak-to-peak variation of a controlled mechanical test variable (for example, load, strain, displacement) as a function of time.

A.4 Conversion of SI Units of Measure used in PMP HDBK to U.S. Units

Quantity or Property	To Convert To U. S. Unit	Divide by ^a	SI Unit ^b
Area	in. ²	645.16 ^c	Millimeter ² (mm ²)
Force	lb	4.4482	Newton (N)
Length	in.	25.4 ^c	Millimeter (mm)
Stress	ksi	6.895	Megapascal (MPa) ^d
Stress intensity factor	ksi $\sqrt{\text{in.}}$	1.0989	Megapascal $\sqrt{\text{meter}}$ (MPa $\cdot \text{m}^{1/2}$) ^d
Modulus	10 ³ ksi	6.895	Gigapascal (GPa) ^d
Temperature	°F	$\frac{F + 459.67}{1.8}$	Kelvin (K)
Temperature	°F	5/9(F-32)	Centegrade (c)
Temperature	°F	F + 459.67	Rankine (R)
Density (ω)	lb/in. ³	27.680	Megagram/meter ³ (Mg/m ³)
Specific heat (C)	Btu/lb·F (or Btu·lb ⁻¹ ·F ⁻¹)	4.1868 ^c	Joule/(gram·Kelvin) (J/g·K) or (J·g ⁻¹ ·K ⁻¹)
Thermal conductivity (K)	Btu/[(hr)(ft ²)(F)/ft] (or Btu·hr ⁻¹ ·ft ⁻² ·F ⁻¹ ·ft)	1.7307	Watt/(meter·Kelvin) W/(m·K) or (W·m ⁻¹ ·K ⁻¹)
Thermal expansion (α)	in./in./F (or in.·in. ⁻¹ ·F ⁻¹)	1.8	Meter/meter/Kelvin m/(m·K) or (m·m ⁻¹ ·K ⁻¹)

a Conversion factors to give significant figures are as specified in ASTM E 380, NASA SP-7012, second revision. NBS Special Publication 330, and *Metals Engineering Quarterly*. Note: Multiple conversions between U.S. and SI units should be avoided because significant round-off errors may result.

b Prefix	Multiple	Prefix	Multiple
giga (G)	10 ⁹	milli (m)	10 ⁻³
mega (M)	10 ⁶	micro (μ)	10 ⁻⁶
kilo (k)	10 ³		

c Conversion factor is exact.

d One Pascal (Pa) = one Newton/meter².

APPENDIX B

B.0 Alloy Index

Alloy Name	Form	Specification	Section
2026-T3511	Extruded Bars, Rods, and Profiles	Draft Spec. for AMS	3.2.1
2297-T8R85	Plate	AMS D-00AE (Draft)	3.2.3
2224A-T351	Plate	Russian Federation TU 1-92-81-87	3.2.2
7040-T7451	Plate	AMS D-99AA (Draft)	3.7.1
7249-T76511	Extruded Bars, Rods, Shapes, and Tubing	AMS D-00AA (Draft)	3.7.3
7449-T7651	Plate	AMS D-99AE (Draft)	3.7.2
A206	Casting	AMS 4235	3.8.1
AEREX®350	Bar	SPS Technologies SPS-M-746	6.3.1
AM 162	HIPed Bar, Rod, Tubing, or Shapes	AMS 7911	7.2.1
AM 162	Extruded and Rolled	AMS 7913	7.2.1
AM 162	Extruded Bar, Rod, Tubing, or Shapes	AMS 7912	7.2.1
AMIC 910	Investment Casting	(Brush Wellman) AlBeCast™ : AMIC 910 Investment Castings	7.2.3
Beralcast® 191	Investment Casting	Starmet PRS-001	7.2.2
Beralcast® 310	Extruded Sheet, Plate, Bar, and Tubing	Lockheed 78001709	7.2.2
Beralcast® 363	Investment Casting	Starmet PRS-001	7.2.2
C-103	Foil, Sheet, Strip, and Plate	ASTM B654-92	6.5.1
C-103	Bar, Rod, and Wire	ASTM B655-96	6.5.1
EP741NP	Discs	Russian Federation TU 1-809-941-98	6.3.5
HAYNES®230®	Plate, Sheet, Strip	AMS 5878	6.3.2
HAYNES®230®	Bar, Forging	AMS 5891	6.3.2
HAYNES®HR-120®	Sheet	ASTM B 409	6.3.3
HAYNES®HR-120®	Bar	ASTM B 408	6.3.3
Inconel MA754	Textured Bar	Aerospace Manufacturer Specification	6.3.4
O-30-H	HIPed Bar, Rod, Tubing, or Shapes	Brush Wellman O-30-H Optical Grade Beryllium	7.3.1
Ti-6-22-22S	Sheet	AMS 4898	5.4.3
Ti-6-22-22S	Plate	Boeing 5PTM7T01	5.4.3
TIMETAL® 550	Forging Stock	Rolls Royce MSRR8663	5.4.1
TIMETAL® 550	Plate	British Standard TA 57	5.4.1
TIMETAL® 550	Bar	Rolls Royce MSRR8626	5.4.1
TIMETAL® 550	Bar	Rolls Royce MSRR8642	5.4.1
TIMETAL®21S	Sheet, Strip, and Plate	AMS 4897	5.5.1
TIMETAL® 834	Forging Stock	Rolls Royce MSRR8679	5.3.1
TIMETAL® 834	Bars, Forging, and Forging Stock	Aerospace Manufacturer	6.3.1
VT-16	Rod	Russian Federation TU 1-809-987-92	5.4.2

This page intentionally blank.

APPENDIX C

C.0 Specification Index

Specification	Alloy Name	Form/Application	Section	Page*
AMS 4235	A206	Casting	3.8.1	
AMS 4897	TIMETAL ®21S	Sheet, Strip, and Plate	5.5.1	
AMS 4898	Ti-6-22-22S	Sheet	5.4.3	
AMS 5878	HAYNES®230®	Plate, Sheet, Strip	6.3.2	
AMS 5891	HAYNES®230®	Bar, Forging	6.3.2	
AMS 7911	AM 162	HIPed Bar, Rod, Tubing, or Shapes	7.2.1	
AMS 7912	AM 162	Extruded Bar, Rod, Tubing, or Shapes	7.2.1	
AMS 7913	AM 162	Extruded and Rolled	7.2.1	
AMS D-00AA (Draft)	7249-T76511	Extruded Bars, Rods, Shapes, and Tubing	3.7.3	C-3
AMS D-00AE (Draft)	2297-T8R85	Plate	3.2.3	C-11
AMS D-99AA (Draft)	7040-T7451	Plate	3.7.1	C-19
AMS D-99AE (Draft)	7449-T7651	Plate	3.7.2	C-27
ASTM B 408	HAYNES®HR-120®	Bar	6.2.1	
ASTM B 409	HAYNES®HR-120®	Sheet	6.2.1	
ASTM B654-92	C-103	Foil, Sheet, Strip, and Plate	6.5.1	
ASTM B655-96	C-103	Bar, Rod, and Wire	6.5.1	
Aerospace Manufacturer Spec.	Inconel MA754	Textured Bar	6.3.4	C-33
Aerospace Manufacturer Spec.	TIMETAL ® 834	Bars, Forgings, and Forging Stock	5.3.1	Proprietary
Boeing 5PTM7T01	Ti-6-22-22S	Plate	5.4.3	Proprietary
British Standard TA 57	TIMETAL ® 550	Plate	5.4.1	C-39
(Brush Wellman) AlBeCast™ : AMIC 910 Investment Castings	AMIC 910	Investment Casting	7.2.3	C-43
Brush Wellman O-30-H Optical Grade Beryllium	O-30-H	HIPed Bar, Rod, Tubing, or Shapes	7.3.1	C-49
Draft Spec. for AMS	2026-T3511	Extruded Bars, Rods, and Profiles	3.2.1	C-55
Lockheed 78001709	Beralcast® 310	Extruded Sheet, Plate, Bar, and Tubing	7.2.2	Proprietary
Rolls Royce MSRR8626	TIMETAL ® 550	Bar	5.4.1	C-61
Rolls Royce MSRR8642	TIMETAL ® 550	Bar	5.4.1	C-65
Rolls Royce MSRR8663	TIMETAL ® 550	Forging Stock	5.4.1	C-67
Rolls Royce MSRR8679	TIMETAL ® 834	Forging Stock	5.3.1	C-71
Russian Federation TU1-809-941-98	EP741NP	Discs	6.3.5	C-73
Russian Federation TU 1-809-987-92	VT-16	Rod	5.4.2	C-87
Russian Federation TU 1-92-81-87	2224A-T351	Plate	3.2.2	C-93
SPS Technologies SPS-M-746	AEREX®350	Bar	6.3.1	Proprietary
Sarmet PRS-001	Beralcast® 363, 191	Investment Casting	7.2.2	C-99

* Copies of company or producer specifications are included on the page indicated unless marked proprietary. Copies of AMS and ASTM specifications are not included (unless it is a draft copy) as these are generally available to the public.

This page intentionally blank.

ALUMINUM ALLOY EXTRUSIONS
7.9Zn-1.6Cu-2.2Mg-0.16Cr (7249-T76511)
Solution Heat Treated, Stress-Relieved, Straightened, and Overaged

1. SCOPE:

1.1 Form:

This specification covers an aluminum alloy procured in the form of extruded bars, rods, shapes, and tubing.

1.2 Application:

These extrusions have been used typically for structural applications requiring a combination of high tensile strength, fracture toughness, good corrosion resistance and minimum distortion during machining. Usage of these extrusions, however, is not limited to such applications.

2. APPLICABLE DOCUMENTS

The issue of the following documents in effect on the date of the purchase order forms a part of this specification to the extent specified herein. The supplier may work to a subsequent revision of a document unless a specific document issue is specified. When the referenced document has been canceled and no superseding document has been specified, the last published issue of that document shall apply.

2.1 SAE Publications:

Available from SAE, 400 Commonwealth Drive, Warrendale, PA 15096-0001.

AMS 2355 Quality Assurance Sampling and Testing, Aluminum Alloys and Magnesium Alloys, Wrought Products, Except Forging Stock, and Rolled, Forged, or Flash Welded Rings

MAM 2355 Quality Assurance Sampling and Testing, Aluminum Alloys and Magnesium Alloys, Wrought Products, Except Forging Stock, and Rolled, Forged, or Flash Welded Rings, Metric (SI) Units

AMS 2772 Heat Treatment of Aluminum Alloy Raw Materials

2.2 ASTM Publications:

Available from ASTM, 100 Barr Harbor Drive, West Conshohocken, PA 19428-2959.

ASTM B594 Ultrasonic Inspection of Aluminum-Alloy Wrought Products for Aerospace Applications

ASTM B645 Standard Practice for Plane-Strain Fracture Toughness Testing of Aluminum Alloys

ASTM B660 Standard Practices for Packaging/Packing of Aluminum and Magnesium Products

ASTM B666/B666M Identification Marking of Aluminum and Magnesium Products

ASTM E399	Standard Test Method for Plane-Strain Fracture Toughness of Metallic Materials
ASTM E1004	Standard Test Method for Electromagnetic (Eddy-Current) Measurements of Electrical Conductivity
ASTM G34	Exfoliation Corrosion Susceptibility in 2XXX and 7XXX Series Aluminum Alloys (EXCO Test)
ASTM G47	Standard Test Method for Determining Susceptibility to Stress-Corrosion Cracking of High-Strength Aluminum Alloy Products

2.3 ANSI Publications:

Available from ANSI, 11 West 42nd Street, New York, NY 10036-8002

ANSI H 35.1	Alloy and Temper Designation System for Aluminum
ANSI H35.2	Dimensional Tolerances for Aluminum Mill Products
ANSI H35.2	Dimensional Tolerances for Aluminum Mill Products (Metric)

3. TECHNICAL REQUIREMENTS:

3.1 Composition:

Shall conform to the percentages by weight shown in Table 1, determined in accordance with AMS 2355 or MAM 2355.

TABLE 1 – Composition

Element	min	max
Silicon	--	0.10
Iron	--	0.12
Copper	1.3	1.9
Manganese	--	0.10
Magnesium	2.0	2.4
Chromium	0.12	0.18
Zinc	7.5	8.2
Titanium	--	0.06
Other Impurities, each	--	0.05
Other Impurities, total	--	0.15
Aluminum	remainder	

3.2 Condition:

Extrusions shall be solution heat treated, stress relieved by stretching after solution treatment to produce a nominal permanent set of 2 percent, but not less than 1.5 percent or more than 3 percent, and overaged to the -T76511 temper.

- 3.2.1 Extrusions may receive minor straightening, after stretching, of an amount necessary to meet tolerance requirements of 3.6.
- 3.2.2 Extrusions shall be supplied with an as-extruded surface finish; light polishing to remove minor surface imperfections is permissible provided such imperfections can be removed within specified dimensional tolerances.
- 3.2.3 For extrusion legs or features greater than or equal to 0.120 inches (3.048 mm) in thickness, as-extruded recrystallized surface structure, as determined by a cross-sectional examination, shall not exceed a depth of 0.060 inches (1.524 mm) per surface of the section thickness. At the corners of the section where two surfaces meet, the as-extruded recrystallized surface structure shall not exceed a depth of 0.090 inches (2.286 mm), unless otherwise specified on the Engineering drawings.

3.3 Heat Treatment:

Shall be performed in accordance with the requirements of AMS 2772 for aluminum 7149 product forms, except that overaging shall be performed at the necessary times and temperatures as required to meet the requirements of 3.4 (see 8.2).

3.4 Properties:

Extrusions shall conform to the following requirements, determined in accordance with AMS 2355 or MAM 2355:

- 3.4.1 Extrusion profiles, bars, and rods 1.500 inches (38.10 mm) and under in thickness or nominal diameter, and tubes with least wall thickness of 1.500 inches (38.10 mm) with a maximum cross-sectional area of 20 square inches (129 cm²) and a maximum circle size of 10 inches (254 mm) shall have properties as specified in Table 2. Extrusions exceeding the above limits shall have properties as agreed upon by purchaser and vendor.

TABLE 2A – Minimum Tensile Properties, Inch/Pound Units

Nominal Diameter or Least Thickness (bars, rods, wire, profiles) or Nominal Wall Thickness (tubing) Inches	Specimen Orientation	Tensile Strength (ksi, min.) F_{tu}	Yield Strength At 0.2% Offset (ksi, min.) F_{ty}	Elongation in 2 Inches or 4D (% min.) e
0.049 – 0.099	Longitudinal	xx	xx	x
	Long-Transverse	xx	xx	x
0.100 – 1.500	Longitudinal	xx	xx	x
	Long-Transverse	xx	xx	x

TABLE 2B – Minimum Tensile Properties, SI Units

Nominal Diameter or Least Thickness (bars, rods, wire, profiles) or Nominal Wall Thickness (tubing) Millimeters	Specimen Orientation	Tensile Strength (MPa, min.) F_{tu}	Yield Strength At 0.2% Offset (MPa, min.) F_{ty}	Elongation in 2 Inches or 4D (% min.) e
1.245 – 2.515	Longitudinal	xx	xx	x
	Long-Transverse	xx	xx	x
2.516 – 38.10	Longitudinal	xx	xx	x
	Long-Transverse	xx	xx	x

3.4.2 Corrosion Resistance:

3.4.2.1 Exfoliation-Corrosion Resistance: Specimens, cut from extrusions, shall not exhibit exfoliation corrosion, at a T/10 plane, greater than that exhibited by Photo B, Figure 2 of ASTM G34-72.

3.4.2.2 Stress-Corrosion Cracking: When specified, specimens cut from extrusions 0.750 inches (19.05 mm) and over in diameter or thickness shall show no evidence of stress corrosion cracking when stressed in the short-transverse direction (perpendicular to grain flow) to 25.0 ksi (172 MPa) for a minimum 20 day exposure, as determined in accordance with ASTM G47.

3.4.3 Fracture Toughness: When specified by the Engineering drawing, plane-strain fracture toughness (K_{IC}) per ASTM E399 for the thickness range 0.750 to 1.500 inches (19.05 to 38.10 mm) shall be as specified in Table 3.

TABLE 3A – Fracture Toughness

Test Direction	K_{IC} ksi $\sqrt{\text{in}}$ (1)
L-T	31
T-L	23

TABLE 3B – Fracture Toughness

Test Direction	K_{IC} MPa $\sqrt{\text{m}}$ (1)
L-T	34.1
T-L	25.3

- (1) If an invalid K_{IC} result is obtained from testing to ASTM E399, it should be interpreted according to ASTM B645. A meaningful K_Q value as defined by ASTM B645 is acceptable when the K_Q value equals or exceeds the minimum K_{IC} requirement.

3.4.4 Electrical Conductivity (EC): Electrical conductivity shall be equal to or greater than 38 percent and less than or equal to 44 percent IACS (International Annealed Copper Standard), and testing shall be performed in accordance with ASTM E1004.

3.4.4.1 Extrusions with electrical conductivities less than 38% IACS may receive additional precipitation heat treatment. If, upon completion of such treatment, they meet the property and conductivity requirements as specified in paragraphs 3.4.1 and 3.4.4, they shall be acceptable.

3.5 Quality:

As received by the purchaser, extrusions shall be uniform in quality and condition, sound, and free from foreign material and from imperfections detrimental to their use. Any internal defects found during the customer's manufacturing process are subject to rejection.

3.5.1 When specified, bars, rods, wire, and profiles shall be subjected to ultrasonic inspection in accordance with ASTM B594.

3.5.1.1 Extrusions, 0.500 to 1.500 inches (12.70 to 38.10 mm), inclusive, in nominal thickness, not exceeding 600 pounds (272 kg) in weight per piece, or a 10 to 1 width-to-thickness ratio, shall meet ultrasonic Class B.

3.5.1.2 Extrusions, 1.500 inches (38.10 mm) and over in nominal thickness, not exceeding 600 pounds in weight (272 kg), or a 10 to 1 width-to-thickness ratio, shall meet ultrasonic Class A.

3.6 Tolerances:

Shall conform to all applicable requirements of ANSI H35.2 or ANSI H35.2M.

4. QUALITY ASSURANCE PROVISIONS:

4.1 Responsibility for Inspection:

The vendor of extrusions shall supply all samples for vendor's tests and shall be responsible for the performance of all required tests. Purchaser reserves the right to sample and to perform any confirmatory testing deemed necessary to ensure that the extrusions conform to specified requirements.

4.2 Classification of Tests:

4.2.1 Acceptance Tests: Composition (3.1), tensile testing (3.4.1), electrical conductivity (3.4.4), tolerances (3.6), fracture toughness (3.4.3) (when specified), and ultrasonic inspection (3.5.1) (when specified) are acceptance tests and, except for composition, shall be performed on each lot.

4.2.2 Periodic Tests: Tests for exfoliation-corrosion resistance (3.4.2.1), stress-corrosion cracking resistance (3.4.2.2), and fracture toughness (3.4.3) (when specified) are periodic tests and shall be performed at a frequency selected by the vendor unless frequency of testing is specified by the purchaser.

4.3 Sampling and Testing:

Shall be in accordance with AMS 2355 or MAM 2355.

4.4 Reports:

The vendor of extrusions shall furnish with each shipment a report stating that the extrusions conform to the chemical composition, ultrasonic inspection (when specified), and tolerances and showing the numerical results of tests on each inspection lot to determine conformance to the other acceptance test requirements. This report shall include the purchase order number, inspection lot number, AMS ????, size or section identification number, and quantity.

4.5 Resampling and Retesting:

Shall be in accordance with AMS 2355 or MAM 2355.

5. PREPARATION FOR DELIVERY:

5.1 Identification:

Shall be in accordance with ASTM B666/B666M

5.2 Packaging:

Extrusions shall be prepared for shipment in accordance with commercial practice and in compliance with applicable rules and regulations pertaining to the handling, packaging, and transportation of the product to ensure carrier acceptance and safe delivery.

5.3 Preservation:

Extrusions shall be oiled with a preservative meeting the requirements of ASTM B660, or equivalent.

5.4 Hazardous Materials:

Materials referenced in this specification may be hazardous. Refer to the Material Safety Data Sheets (MSDS) and/or contact safety operations for safe use conditions and proper personal protective equipment (PPE).

6. ACKNOWLEDGMENT:

A vendor shall mention this specification number and its revision letter in all quotations and when acknowledging purchase orders.

7. REJECTIONS:

Extrusions not conforming to this specification, or to modifications authorized by purchaser, will be subject to rejection.

8. NOTES:

- 8.1 A change bar (2) located in the left margin is for the convenience of the user in locating areas where technical revisions, not editorial changes, have been made to the previous issue of this specification. An (R) symbol to the left of the document title indicates a complete revision of the specification, including technical revisions. Change bars and (R) are not used in original publications, nor in specifications that contain editorial changes only.
- 8.2 Actual overaging heat treatments may be proprietary.
- 8.3 Terms used in AMS are clarified in ARP 1917.
- 8.4 Dimensions and properties in inch/pound units are primary; dimensions and properties in SI units are shown as the approximate equivalents of the primary units and are presented only for information.
- 8.5 Procurement documents should specify not less than the following:
- AMS ????
- Form and size or section identification number of extrusions desired
- Quantity of extrusions desired.
- 8.6 Key Words:
- Bars, rods, wire, profiles, tubing

This page intentionally blank.

SAE AEROSPACE MATERIAL SPECIFICATION Prepared by McCook Metals L.L.C.	SAE	AMS D-00 AE (Draft)						
	Issued Revised							
Aluminum Alloy, Plate (2297-T8R87) 2.8 Cu – 1.5 Li - .30Mn - .25Mg Solution Heat Treated, Stretched, and Artificially Aged								
<p>1. SCOPE</p> <p>1.1 Form:</p> <p style="padding-left: 40px;">This specification covers an aluminum alloy in the form of plate.</p> <p>1.2 Application:</p> <p style="padding-left: 40px;">These products are primarily for use in aerospace applications where low density is needed in combination with moderate strength, high fatigue resistance, good stress corrosion properties, and improved stiffness.</p> <p>2 APPLICABLE DOCUMENTS:</p> <p style="padding-left: 40px;">The following publications form a part of this specification to the extent specified herein. The latest issue of SAE publication shall apply. The applicable issue of other publications shall be the issue in effect on the date of the purchase order.</p> <p>2.1 SAE Publications:</p> <p style="padding-left: 40px;">Available from SAE, 400 Commonwealth Drive, Warrendale, PA 15096-0001.</p> <table style="width: 100%; border: none;"> <tr> <td style="padding-left: 40px;">AMS 2355</td> <td>Quality Assurance Sampling and Testing of Aluminum Alloys and Magnesium Alloys Wrought Products (Except Forging Stock) and Flash Welded Rings</td> </tr> <tr> <td style="padding-left: 40px;">MAM 2355</td> <td>Quality Assurance Sampling and Testing of Aluminum Alloys and Magnesium Alloys Wrought Products (Except Forging Stock) and Flash Welded Rings, Metric (SI) Units</td> </tr> <tr> <td style="padding-left: 40px;">AMS 2772</td> <td>Heat Treatment of Aluminum Alloys</td> </tr> </table>			AMS 2355	Quality Assurance Sampling and Testing of Aluminum Alloys and Magnesium Alloys Wrought Products (Except Forging Stock) and Flash Welded Rings	MAM 2355	Quality Assurance Sampling and Testing of Aluminum Alloys and Magnesium Alloys Wrought Products (Except Forging Stock) and Flash Welded Rings, Metric (SI) Units	AMS 2772	Heat Treatment of Aluminum Alloys
AMS 2355	Quality Assurance Sampling and Testing of Aluminum Alloys and Magnesium Alloys Wrought Products (Except Forging Stock) and Flash Welded Rings							
MAM 2355	Quality Assurance Sampling and Testing of Aluminum Alloys and Magnesium Alloys Wrought Products (Except Forging Stock) and Flash Welded Rings, Metric (SI) Units							
AMS 2772	Heat Treatment of Aluminum Alloys							

AMS D-00 AE (Draft)**SAE****AMS D-00 AE (Draft)**

2.2 ASTM Publications

Available from ASTM, 100 Barr Harbor Drive, West Conshohocken, PA 19428-2959.

ASTM B 557	Standard Methods of Tension Testing Wrought and Cast Aluminum- and Magnesium-Alloy Products
ASTM B 594	Standard Method for Ultrasonic Inspection of Aluminum Alloy Wrought Products for Aerospace Applications
ASTM B 645	Standard Practice for Plane-Strain Fracture Toughness Testing of Aluminum Alloys
ASTM E 399	Standard Method of Tests for Plane-Strain Fracture Toughness of Metallic Materials
ASTM E 1251	Standard Test Method for Optical Emission Spectrometric Analysis of Aluminum and Aluminum Alloys by the Argon Atmosphere, Point-to-Plane, Unipolar Self-Initiating Capacitor Discharge
ASTM G 34	Standard Test Method for Exfoliation Corrosion Susceptibility in 2XXX and 7XXX Series Aluminum Alloys (EXCO Test)
ASTM G 47	Standard Test Method for Determining Susceptibility to Stress-corrosion Cracking of 2XXX and 7XXX Aluminum Alloy Products

2.3 ANSI Publications:

Available from (ANSI), 11 West 42nd Street, New York, NY 10036-8002.

ANSI H35.2	Dimensional tolerances for Aluminum Mill Products
ANSI H35.2	Dimensional tolerances for Aluminum Mill Products (Metric)

3. TECHNICAL REQUIREMENTS:

3.1 Composition:

Shall conform to the percentages by weight shown in Table 1, determined in accordance with ASTM E1251.

Table 1 - Composition

Element	min	max
Copper	2.50	3.10
Lithium	1.10	1.80
Manganese	0.10	0.50
Magnesium	--	0.25
Zirconium	0.08	0.15
Zinc	--	0.15
Titanium	--	0.12
Silicon	--	0.10
Iron	--	0.10
Others, each	--	0.05
Other, Total	--	0.15
Aluminum	remainder	

AMS D-00 AE (Draft)

SAE

AMS D-00 AE (Draft)

3.2 Condition:

Solution heat treated by holding at heat for a time commensurate with section thickness, and rapid cooling in a suitable quenching medium. Stretched to produce a nominal permanent set of 2.75% but not more than 6.75%. Artificial aging to T8R87 shall be performed at a temperature, for a time as required to meet requirements of 3.3.

3.2.1 Plate shall receive no further straightening operations after stretching.

3.3 Properties:

Plate shall conform to the following requirements, determined in accordance with ASTM B557, and ASTM B 645.

3.3.1 Tensile Properties: Shall be as specified in Table 2.

3.3.2

Table 2 – Minimum Tensile Properties (Inch/Pound Units)

Temper	Thickness (inches)	Grain Direction	Ultimate Tensile Strength (ksi)	Yield Strength 0.2% offset (ksi)	% Elongation in 2 inches or 4D
T8R87	1.800- 2.000	L	65.0	60.0	7
		LT	65.0	60.0	5
		ST	64.0	57.0	2
	2.001-3.000	L	63.0	58.0	6
		LT	63.0	58.0	4
		ST	63.0	56.0	2
	3.001-4.000	L	62.0	57.0	5
		LT	62.0	57.0	4
		ST	59.0	54.0	1.5
	4.001- 5.000	L	61.0	56.0	5
		LT	61.0	56.0	4
		ST	58.0	52.0	1.5
5.001-6.000	L	60.0	55.0	5	
	LT	60.0	55.0	4	
	ST	57.0	52.0	1.5	

AMS D-00 AE (Draft)

SAE

AMS D-00 AE (Draft)

- 3.3.2 Corrosion-Resistance: Two forms of testing are required to show corrosion resistance. Exfoliation Corrosion and Stress-Corrosion Resistance are required for qualification. SCC shall be considered a surveillance test unless otherwise specified by the customer.
- 3.3.2.1 Stress-Corrosion Resistance: Direct tension specimens machined and tested in accordance with ASTM G 47, shall show no evidence of stress corrosion failure when stressed in the short-transverse direction at 30,000 psi (207 MPa) and exposed for 30 days to test conditions of ASTM G 47.
- 3.3.2.2 Exfoliation Corrosion Resistance: Specimens from plate shall show exfoliation corrosion equal to or better than EB when tested at the T/10 plane per ASTM G 34.
- 3.3.2.3 Plate not meeting the requirements of 3.3.2.1 or 3.3.2.2 may be given additional precipitation heat treatment. After such treatment, if all specified properties are met, the plate is acceptable.
- 3.3.2.4 Fracture Toughness: Plate shall meet the requirements for K_{Ic} specified in Table 3. For L-T and T-L test directions, use specimens with 1.5 inch minimum thickness. For the S-L test direction, use specimens with thickness maximized to the nearest $\frac{1}{4}$ inch. L-T, T-L and S-L specimens shall be centered at T/2 for plate 3.000 inches and under in nominal thickness and centered at T/4 for plate over 3.000 inches in nominal thickness. If a valid K_{Ic} or meaningful K_Q cannot be obtained due to insufficient specimen thickness or crack length, then the fracture toughness (K_Q) of the specimen will be acceptable for lot acceptance if the following conditions are met:
- 3.3.2.4.1 The B dimension of the specimen tested was the maximum possible up to 2.5 inches for the given plate thickness.
- 3.3.2.4.2 The specimen centerline location was maintained at the specified plate thickness location.
- 3.3.2.4.3 All fracture toughness validity checks except specimen thickness, crack length or P_{max}/P_Q meet either the criteria of ASTM E399 or ASTM B645.
- 3.3.2.4.4 If the only invalidity with $B=1.5$ inches is P_{max}/P_Q , test result is acceptable for lot acceptance.

AMS D-00 AE (Draft)

SAE

AMS D-00 AE (Draft)

Table 3 – Minimum Fracture Parameters, Inch/Pound Units

Temper	Thickness (inches)	Specimen Orientation	Required Minimum Plane-Strain Fracture Toughness, K_{Ic} (ksi-in ^{1/2})
T8R87	1.800-2.000	L-T	34
		T-L	28
		S-L	23
	2.001-3.000	L-T	32
		T-L	27
		S-L	21
	3.001-4.000	L-T	31
		T-L	27
		S-L	20
	4.001- 5.000	L-T	30
		T-L	26
		S-L	18
	5.001-6.000	L-T	29
		T-L	25
		S-L	18

3.4 Quality:

Plate, as received by the purchaser, shall be uniform in quality and condition, sound, and free from foreign materials and from imperfections detrimental to usage of the plate. Light scratches and discoloration streaking shall not be reason for rejection.

- 3.4.1 Each shall be ultrasonically inspected in accordance with ASTM B 594 and shall meet the requirements of Class A.

3.5 Tolerances:

Shall conform to all applicable requirements of ANSI H35.2 or H35.2M.

4. QUALITY ASSURANCE PROVISIONS:

4.1 Responsibility for Inspection:

The vendor of plate shall supply all samples for vendor's tests and shall be responsible for the performance of all required tests. Purchaser reserves the right to sample and to perform any confirmatory testing deemed necessary to ensure that the plate conforms to the specified requirements.

4.2 Classification of Tests:

4.2.1 Acceptance Tests: Composition (3.1), Tensile Properties (3.3.1), Fracture Toughness (3.3.2.4), and Ultrasonic Inspection (3.4.1) are acceptance tests and shall be performed on each lot.

4.2.2 Periodic Tests: Stress-Corrosion Resistance (3.3.2.1) is a periodic test and shall be performed at a frequency selected by the vendor unless frequency of testing is specified by purchaser. Exfoliation Corrosion Resistance Testing (3.3.2.2) shall only be performed when required by the customer for qualification testing.

4.3 Sampling and Testing:

4.3.1 Each parent plate shall be sampled by removing material for one set of three tensile specimens from the center width location on one end and one set of two tensile specimens from the center width location on the other end. The set of three tensile specimens shall consist of one longitudinal, one long transverse and one short transverse specimen and the set of two tensile specimens shall consist of one long transverse and one short transverse specimen.

4.3.2 Fracture toughness specimens shall be taken from each parent plate at the center width location on the end from which the set of three tensile specimens is removed.

4.4 Reports:

The vendor shall furnish with each shipment a report stating that the plate conforms to the chemical composition and tolerances (and ultrasonic inspection when required) showing the numerical results of tests on each inspection lot to determine conformance to the other acceptance test requirements. This report shall include the purchase order number, inspection lot number, AMS ____ size, and quantity.

4.5 Resampling and Retesting: Shall be in accordance with ASTM B 557.

5. PREPARATION FOR DELIVERY:

5.1 Identification:

Plate shall be stenciled in green ink around the plate perimeter on one side of the plate. The marking shall include plate producer, alloy and temper, plate lot number and gauge.

AMS D-00 AE (Draft)**SAE****AMS D-00 AE (Draft)****5.2 Packaging:**

5.2.1 Plate shall be prepared for shipment in accordance with commercial practice and in compliance with applicable rules and regulations pertaining to the handling, packaging, and transportation of the plate to ensure carrier acceptance and safe delivery.

5.2.2 Packaging shall be in accordance with ASTM B 660.

6. ACKNOWLEDGEMENT:

A vendor shall mention this specification number and its revision letter in all quotations and when acknowledging purchase orders.

7. REJECTIONS:

Plate not conforming to this specification, or to modifications authorized by purchaser, will be subject to rejection.

8. NOTES:

8.1 The change bar (I) located in the left hand margin is for the convenience of the user in locating areas where technical revisions, not editorial changes, have been made to the previous issue of this specification. An (R) symbol to the left of the document title indicates a complete revision of the specification.

8.2 Dimensions and properties in inch/pound units and the Fahrenheit temperatures are primary; dimensions and properties in SI units and Celsius temperatures are shown as the approximate equivalents of the primary units and are presented only for information.

8.3 Procurement documents should specify not less than the following:

AMS _____
Size of plate desired
Quantity of plate desired

8.4 Key Words:

Aluminum alloy, plate, solution heat treated, aging, 2297-T8R87.

This page intentionally blank.

AEROSPACE MATERIAL SPECIFICATION

Submitted for recognition as an
American National Standard

AMS # D99AA Draft

Issued
XXX 1999

Aluminum Alloy, Plate
6.2Zn - 1.9Cu - 2.1Mg - 0.09Zr (7040-T7451)
Solution Heat Treated, Stress Relieved, and Overaged

UNS A97040

SCOPE :

1.

1.1 From :

This specification covers an aluminum alloy in the form of plate.

1.2 Application :

This plate has been used typically for parts requiring a high level of mechanical properties and good resistance to stress-corrosion cracking, but usage is not limited to such applications.

2. APPLICABLE DOCUMENTS :

The following publications form a part of this specification to the extent specified herein. The latest issue of SAE publications shall apply. The applicable issue of other publications shall be the issue in effect on the date of the purchase order.

2.1 SAE Publications :

Available from SAE, 400 Commonwealth Drive, Warrendale, PA 15096-0001.

AMS 2355 Quality Assurance Sampling and Testing of Aluminum Alloys and Magnesium Alloys, Wrought Products (Except Forging Stock) and Flash Welded Rings

MAM 2355 Quality Assurance Sampling and Testing of Aluminum Alloys and Magnesium Alloys, Wrought Products (Except Forging Stock) and Flash Welded Rings, Metric (SI) Units

AMS 2772 Heat Treatment of Aluminum Raw Material

AS 1990 Aluminum Alloy Tempers

2.2 ASTM Publications :

Available from ASTM, 100 Barr Harbor Drive, West Conshohocken, PA 19428-2959.

ASTM B 666/B 666M	Identification Marking of Aluminum and Magnesium Products
ASTM B 594	Ultrasonic Inspection of Aluminum-Alloy Products for Aerospace Applications
ASTM B 660	Packing/Packaging of Aluminum and Magnesium Products
ASTM E 466	Conducting Constant Amplitude Axial Fatigue Tests of Metallic Materials
ASTM G 34-72	Exfoliation Corrosion Susceptibility In 2XXX and 7XXX Series Aluminum Alloys (EXCO Test)
ASTM G47	Standard Test Method for Determination Susceptibility to Stress-Corrosion Cracking of High-Strength Aluminium Alloy Products

2.3 ANSI Publications :

Available from ANSI, 11 West 42nd Street, New York, NY 10036-8002.

ANSI H35.1 Alloy and Temper Designation Systems for Aluminum

Dimensional Tolerances for Aluminum Mill Products

ANSI H35.2

ANSI H35.2M Dimensional Tolerances for Aluminum Mill Products (Metric)

3. TECHNICAL REQUIREMENTS :

3.1 Composition :

Shall conform to the percentages by weight shown in Table 1, determined in accordance with AMS 2355 or MAM 2355.

TABLE 1 - Composition

Element	min	max
Silicon	--	0.10
Iron	--	0.13
Copper	1.5	2.3
Manganese	--	0.04
Magnesium	1.7	2.4
Chromium	--	0.04
Zinc	5.7	6.7
Titanium	--	0.06
Zirconium	0.05	0.12
Other Impurities, each	--	0.05
Other impurities, total	--	0.15
Aluminum	remainder	

3.2 Condition :

Solution heat treated, stretched to produce a nominal permanent set of 2% but not less than 1-1/2 % nor more than 3 %, and precipitation heat treated to the T7451 temper. Solution and precipitation heat treatment shall be performed in accordance with AMS 2772 with the following aging treatment : 6-12 hours at 250(+10,-10)F 121(+5,-5)°C followed by 15-21 hours at 330(+10,-10)F 166(+5,-5)°C

3.2.1 Plate shall receive no further straightening operations after stretching.

3.3 Properties :

Plate shall conform to the following requirements, determined in accordance with AMS 2355 or MAM 2355 and as specified herein.

3.3.1 Tensile Properties :

Shall be as specified in Table 2.

TABLE 2A - Minimum Tensile Properties, Inch/Pound Units

Nominal Thickness Inches	Specimen Orientation	Tensile Strength ksi	Yield Strength at 0.2 % Offset ksi	Elongation in 2 inches or 4D
Over 3.001 to 4.000, incl	Longitudinal	72.0	62.0	9
	Long Trans.	72.0	62.0	6
	Short Trans.	69.0	59.0	3
Over 4.001 to 5.000, incl	Longitudinal	71.0	62.0	9
	Long Trans.	71.0	62.0	5
	Short Trans.	68.0	58.0	3
Over 5.001 to 6.000, incl	Longitudinal	70.0	62.0	8
	Long Trans.	70.0	61.0	4
	Short Trans.	68.0	58.0	3
Over 6.001 to 7.000, incl	Longitudinal	69.0	62.0	7
	Long Trans.	69.0	60.0	4
	Short Trans.	66.0	57.0	3
Over 7.001 to 8.000, incl	Longitudinal	68.0	61.0	6
	Long Trans.	68.0	60.0	4
	Short Trans.	66.0	57.0	3
Over 8.001 to 8.500, incl	Longitudinal	68.0	61.0	6
	Long Trans.	68.0	59.0	4
	Short Trans.	66.0	56.0	3

TABLE 2B - Minimum Tensile Properties, SI Units

Nominal Thickness Millimeters	Specimen Orientation	Tensile Strength MPa	Yield Strength at 0.2% Offset MPa	Elongation in 50.8 mm or 4D %	Elongation in 50.8 mm or 5D %
Over 76 to 102, incl	Longitudinal	496	427	-	8
	Long Trans.	496	427	-	5
	Short Trans.	476	407	-	2
Over 102 to 127, incl	Longitudinal	490	427	-	8
	Long Trans.	490	427	-	5
	Short Trans.	469	400	-	2
Over 127 to 152, incl	Longitudinal	483	427	-	7
	Long Trans.	483	421	-	4
	Short Trans.	469	400	-	2
Over 152 to 178, incl	Longitudinal	476	427	-	6
	Long Trans.	476	414	-	3
	Short Trans.	455	393	-	2
Over 178 to 203, incl	Longitudinal	469	421	-	5
	Long Trans.	469	414	-	3
	Short Trans.	455	393	-	2
Over 202 to 216 incl	Longitudinal	469	421	-	5
	Long Trans.	469	407	-	3
	Short Trans.	455	386	-	2

3.3.2 Corrosion-Resistance :

Resistance to stress-corrosion cracking and to exfoliation-corrosion shall be acceptable if the plate conforms to the requirements of 3.3.2.1 and 3.3.2.2.

3.3.2.1 Electrical Conductivity :

Shall be not lower than 39.0 % IACS (International Annealed Copper Standard) (22.6 MS/m), determined on the surface of the tensile coupon.

3.3.2.2 Stress-Corrosion Susceptibility Factor (SCF):

Shall be not greater than 32.0 (220), determined by subtracting the electrical conductivity, AA.A% IACS (12 times BB.B MS/m) from the long-transverse yield strength, XX.X ksi (YYY MPa).

Examples: For 4.0 inches (102 mm) nominal thickness

Inch/Pound Units		73.1 ksi - 39.6%
IACS = 33.5	unacceptable	
		68.8 ksi - 40.2%
IACS = 28.6	acceptable	
SI Units		504 MPa - 12 x 23
MS/m = 232	unacceptable	
		474 MPa - 12 x
23.3		
MS/m = 194	acceptable	

3.3.2.3 Plate not meeting the requirements of 3.3.2.1 be given additional precipitation heat treatment or reheat treated. After such treatment, if all specified properties are met, the plate is acceptable.

3.3.3 Exfoliation-Corrosion Test :

Plate shall not exhibit exfoliation-corrosion greater than that illustrated by Photo B, Figure 2, of ASTM G 34-72.

3.3.4 Stress-Corrosion Test :

Specimens shall show no evidence of stress-corrosion cracking when stressed in the short-transverse direction at 35.0 ksi (241 MPa) for 20 days.

3.3.5 Fracture Toughness :

When specified, plate shall meet the values for K_{1c} specified in Table 3. For T-L and L-T test directions on plate over 3 to 4 inches (76 to 102 mm), inclusive, in nominal thickness, use specimens 2-inch (51-mm) minimum thickness centered at T/2; and for plate over 4 inches (102 mm) in nominal thickness, use specimens 2-inch (51-mm) minimum thickness centered at T/4. For the S-L test direction, the test specimen shall be centered at T/2. Required specimen orientation(s) shall be specified by purchaser.

TABLE 3A - Minimum Fracture Toughness Parameters, Inch/Pound Units

Nominal Thickness, Inches	L-T ksi	T-L ksi	S-L ksi
Over 3.000 to 4.000, incl	31	26	24
Over 4.000 to 5.000, incl	30	25	24
Over 5.000 to 6.000, incl	29	23	24
Over 6.000 to 7.000, incl	27	22	23
Over 7.000 to 8.000, incl	26	22	23
Over 8.000 to 8.500, incl	26	22	22

TABLE 3B - Minimum Fracture Toughness Parameters, SI Units

Nominal Thickness, Millimeters	L-T MPa	T-L MPa	S-L MPa
Over 76.20 to 101.60, incl	34	28	26
Over 101.60 to 127.00, incl	33	27	26
Over 127.00 to 152.40, incl	32	25	26
Over 152.40 to 177.80, incl	30	24	25
Over 177.80 to 203.20, incl	28	24	25
Over 203.20 to 216.00, incl	28	24	24

3.3.6 Fatigue Resistance :

When specified, 4 to 8.5 inch (102 to 216 mm) thick plate shall meet the values for fatigue life specified in table 4. Two fatigue specimens from each end of the plate shall be sampled in the long transverse grain direction. These specimens are to be removed from the T/2, W/2 location. Fatigue testing shall be conducted in air at 70°F + 5 (21°C + 3) in accordance with ASTM E 466. They are to be tested at an R-ratio of 0.1, at a maximum stress of 35.0 ksi (241 MPa) and shall meet the fatigue requirements shown in Table 4.

TABLE 4 - Fatigue Life Requirements

Minimum cycles per test	90,000 cycles
Average of 4 tests	120,000 cycles
Runout	300,000 cycles

3.4 Quality :

Plate, as received by purchaser, shall be uniform in quality and condition, sound, and free from foreign materials and from imperfections detrimental to usage of the plate.

3.4.1 Each plate shall be ultrasonically inspected in accordance with ASTM B 594 and shall meet the requirements of 3.4.1.1 or 3.4.1.2 as applicable.

3.4.1.1 Plates weighing 2000 pounds (907 kg) and under shall meet the requirements for ultrasonic class A for plate 3.001 to 8.000 inches (76 to 203.20 mm) in nominal thickness.

3.4.1.2 The ultrasonic class for plates weighing over 2000 pounds (907 kg) or over 8.000 inches (203.20 mm) in nominal thickness shall be as agreed upon by purchaser and vendor.

3.5 Tolerances :

Shall conform to all applicable requirements of ANSI H35.2 or H35.2M.

4. QUALITY ASSURANCE PROVISIONS :

4.1 Responsibility for Inspection :

The vendor of plate shall supply all samples for vendor's tests and shall be responsible for the performance of all required tests. Purchaser reserves the right to sample and to perform any confirmatory testing deemed necessary to ensure that the plate conforms to the specified requirements.

4.2 Classification of Tests :

Acceptance Tests :

4.2.1

Composition (3.1), tensile properties (3.3.1), corrosion resistance (3.3.2), tolerances (3.5), ultrasonic soundness (3.4.1) and, when specified, fracture toughness (3.3.5) and fatigue (3.3.6) are acceptance tests and shall be performed on each inspection lot.

4.2.2 Periodic Tests :

Tests for exfoliation corrosion resistance (3.3.3) and stress-corrosion resistance (3.3.4) are periodic tests and shall be performed at a frequency selected by the vendor unless frequency of testing is specified by purchaser.

4.3 Sampling and Testing :

Shall be in accordance with AMS 2355 or MAM 2355 and the following:

4.3.1 Tensile specimens shall be taken with axis of specimens parallel to each applicable grain flow direction specified in Table 2.

4.3.2 When fracture toughness testing is specified, specimens shall be taken from the center width of at least one plate in each lot for each specimen orientation specified by purchaser.

4.3.3 When fatigue testing is specified, specimen shall be taken from at least one plate in each lot, at the location given in 3.3.6.

4.4 Reports :

The vendor of the product shall furnish with each shipment a report stating that the plate conforms to the chemical composition, tolerances, and ultrasonic inspection showing the numerical results of tests on each inspection lot to determine conformance to the other acceptance test requirements. This report shall include the purchase order number, inspection lot number, AMS #, size, and quantity.

The report shall also identify the producer, the producer form and the size of the mill product.

Resampling and Retesting :

4.5

Shall be in accordance with AMS 2355 or MAM 2355.

5. PREPARATION FOR DELIVERY :

5.1 Identification :

Shall be in accordance with ASTM B666/B666M.

5.2 Packaging :

Plate shall be prepared for shipment in accordance with commercial practice and in compliance

5.2.1

with applicable rules and regulations pertaining to the handling, packaging, and transportation of the plate to ensure carrier acceptance and safe delivery.

5.2.2

Packaging shall be in accordance with ASTM B 660.

6. ACKNOWLEDGMENT :

A vendor shall mention this specification number and its revision letter in all quotations and when acknowledging purchase orders.

7. REJECTIONS :

Plate not conforming to this specification, or to modifications authorized by purchaser, will be subject to rejection.

8. NOTES :

8.1 Terms used in AMS are clarified in ARP1917.

8.2 Dimensions and properties in inch/pound units are primary; dimensions and properties in SI units are shown as the approximate equivalents of the primary units and are presented only for information.

8.3 Procurement documents should specify not less than the following :

AMS #

Size of plate desired

Quality of plate desired

Fracture toughness testing (if required) and specimen orientation (See 3.3.5)

Fatigue testing (if required)

8.4 Key Words :

Aluminum alloy, plate, solution heat treated, stress relieved, and overaged, 7040-T7451, UNS A97040.

PREPARED UNDER THE JURISDICTION OF AMS COMMITTEE "D"

AEROSPACE MATERIAL SPECIFICATION

Submitted for recognition as an
American National Standard

AMS # D99AE

Issued
XXX 1999

Aluminum Alloy, Plate
(7449-T7651)
Solution Heat Treated, Stress Relieved, and Overaged

UNS A97449

1.0 SCOPE:

1.1 Form:

This specification covers an aluminum alloy in the form of plate.

1.2 Application:

This plate has been used typically for structural applications requiring a combination of high tensile strength and compressive properties and good exfoliation corrosion resistance, but usage is not limited to such applications.

2.0 APPLICABLE DOCUMENTS:

The issue of the following documents in effect on the date of the purchase order form a part of this specification to the extent specified herein. The supplier may work to a subsequent revision of a document unless a specific document issue is specified, when the referenced document has been canceled and no superseding document has been specified, the last published issue of that document shall apply.

2.1 SAE Publications:

Available from SAE, 400 Commonwealth Drive, Warrendale, PA 15096-0001.

AMS 2355 Quality Assurance Sampling and Testing, Aluminum Alloys and Magnesium Alloys, Wrought Products, Except Forging Stock, and Rolled, Forged, or Flash Welded Rings

MAM 2355 Quality Assurance Sampling and Testing, Aluminum Alloys and Magnesium Alloys, Wrought Products, Except Forging Stock, and Rolled, Forged, or Flash Welded Rings, Metric (SI) Units

2.2 ASTM Publications:

Available from ASTM, 100 Barr Harbor Drive, West Conshohocken, PA 19428-2959.

ASTM B 666/B 666M Identification Marking of Aluminum and Magnesium Products

ASTM B 594	Ultrasonic Inspection of Aluminum-Alloy Products for Aerospace Applications
ASTM B 660	Packing/Packaging of Aluminum and Magnesium Products
ASTM G 34-72	Exfoliation Corrosion Susceptibility in 2XXX and 7XXX Series Aluminum Alloys (EXCO Test)
ASTM G47	Standard Test Method for Determination Susceptibility to Stress-Corrosion Cracking of High-Strength Aluminum Alloy Products
ASTM E9	Compressive Testing of Metallic Materials at Room Temperature

2.3 U.S. Government Publications:

Available from DODSSP, Subscription Order Desk, Building 4D, 700 Robbins Avenue, Philadelphia, PA 1911-5094.

MIL-H-6088 Heat Treatment of Aluminum Alloys

2.4 ANSI Publications:

Available from ANSI, 11 West 42nd Street, New York, NY 10036-8002

ANSI H35.2 Dimensional Tolerances for Aluminum Mill Products

ANSI H35.2M Dimensional Tolerances for Aluminum Mill Products (Metric)

3.0 TECHNICAL REQUIREMENTS:

3.1 Composition:

Shall conform to the percentages by weight shown in Table 1, determined in accordance with AMS 2355 or MAM 2355.

Table 1. Composition

Element	min	max
Silicon	–	0.12
Iron	–	0.15
Copper	1.4	2.1
Manganese	–	0.20
Magnesium	1.8	2.7
Zinc	7.5	8.7
Titanium + Zirconium	–	0.25
Other Elements, each	–	0.05
Other Elements, total	–	0.15
Aluminum	Remainder	

3.2 Condition:

Solution heat treated, stretched to produce a nominal permanent set of 2% but not less than 1-1/2% nor more than 3%, and precipitation heat treated to the T7651 temper.

3.2.1 Heat Treatment:

Plate shall be solution heat treated by heating to 870° to 890°F (465° to 475°C), holding at heat for a time commensurate with section thickness, and rapid cooling in a suitable quenching medium: overaging shall be performed at a temperature, for a time, and cooling as required to meet requirements of 3.4. Furnace surveys and calibration of temperature recorders and controllers shall be in accordance with MIL-H-6088.

3.3 Properties:

Plate shall on the mill produced size conform to the following requirements, determined in accordance with AMS 2355 or MAM 2355 and as specified herein.

3.3.1 Tensile Properties:

Shall be as specified in Table 2.

Table 2A. Minimum Tensile Properties, Inch/Pound Units

Nominal Thickness Inches	Specimen Orientation	Tensile Strength, ksi	Yield Strength at 0.2% Offset, ksi	Elongation in 2 inches or 4D, %
0.250 to 1.500, incl	Longitudinal	84.0	78.0	8
	Long Trans.	84.0	77.0	8
Over 1.500 to 2.500, incl	Longitudinal	82.0	76.0	7
	Long Trans.	82.0	75.0	6
	Short Trans.	77.0	67.0	3

Table 2B. Minimum Tensile Properties, SI Units

Nominal Thickness Millimeters	Specimen Orientation	Tensile Strength, MPa	Yield Strength at 0.2% Offset, MPa	Elongation in 50.8 mm or 4D, %
6.35 to 38.10, incl.	Longitudinal	579	538	8
	Long Trans.	579	531	8
Over 38.10 to 63.50, incl	Longitudinal	565	524	7
	Long Trans.	565	517	6
	Short Trans.	531	482	3

3.3.2 Comprehensive Yield Strength:

When specified, the compressive strength, determined in accordance with ASTM E9, shall be as shown in Table 3.

Table 3. Minimum Compressive Yield Strength, Inch/Pound and SI Units

Nominal Thickness Inches	Nominal Thickness Millimeters	Specimen Orientation	Compressive Yield Strength ksi	Compressive Yield Strength MPa
0.250 to 1.500, incl.	6.35 to 38.10, incl.	Longitudinal	77.0	531
		Long Trans.	81.0	559
Over 1.500 to 2.500, incl		Longitudinal	75.0	517
		Long Trans.	79.0	545

3.4.3 Corrosion-Resistance:

3.3.3.1 Exfoliation Corrosion Resistance:

When specified, specimens from plate shall show exfoliation corrosion equal to or better than EB when tested at the T/10 plane.

3.3.3.2. Stress-Corrosion Cracking

3.3.3.2.1. When specified, specimens cut from plate 0.750 inch (19.05 mm) and over in nominal thickness, shall show no evidence of stress-corrosion cracking when stressed in the short-transverse direction of 25 ksi (172 MPa).

3.3.3.2.2 When specified, specimens cut from plate 0.250 inch (6.35 mm) and over in nominal thickness, shall show no evidence of stress-corrosion cracking when stressed in the long-transverse direction to 58 ksi (400 MPa).

3.3.4 Fracture Toughness:

When specified, plan-strain fracture toughness (K_{Ic}) for the L-T and T-L specimen orientations shall not be lower than the values specified in Table 4 for plate 0.750 to 2.500 inches (19.05 to 63.5 mm) in nominal thickness.

Table 4. Minimum Fracture Toughness Parameters

Nominal Thickness Inches	Nominal Thickness Millimeters	Specimen Orientation	K_{Ic} ksi $\sqrt{\text{in}}$	K_{Ic} MPa $\sqrt{\text{m}}$
0.750 to 2.500, incl.	19.05 to 63.5, incl.	L-T	22.0	24.2
		T-L	20.0	22.0

3.3.5 Electrical Conductivity:

Should not be lower than 36.0% IACS (International Annealed Copper Standard) (20.9 MS/m), except that electrical conductivity shall be determined and reported but shall not be cause for rejection of the plate.

3.4 Quality:

Plate, as received by purchaser, shall be uniform in quality and condition, sound, and free from foreign materials and from imperfections detrimental to usage of the plate.

3.4.1 Each plate 0.500 inch (12.70 mm) and over in nominal thickness shall be ultrasonically inspected in accordance with ASTM B594 and shall meet Ultrasonic Class A requirements.

3.5 Tolerances:

Shall be in accordance with ANSI H35.2 or ANSI H35.2M.

4.0 QUALITY ASSURANCE PROVISIONS:

4.1 Responsibility for Inspection:

The vendor of plate shall supply all samples for vendor's tests and shall be responsible for the performance of all required tests. Results of such tests shall be reported to the purchaser as required by 4.4. Purchaser reserves the right to sample and to perform any confirmatory testing deemed necessary to ensure that the plate conforms to the specified requirements.

4.2 Classification of Tests:

Composition (3.1), long-transverse tensile properties (3.3.1), ultrasonic soundness (3.4.1), tolerances (3.5), and when specified, exfoliation corrosion resistance (3.3.3.1), longitudinal and short-transverse tensile properties (3.3.1), stress-corrosion cracking (3.3.3.2) and, fracture toughness (3.3.4) are acceptance tests and except for composition shall be performed on each lot.

4.3 Sampling and Testing:

Shall be in accordance with AMS 2355 of MAM 2355.

4.4 Reports

The vendor of plate shall furnish with each shipment a report stating that the plate conforms to the chemical composition, tolerance and ultrasonic inspection and showing the numerical results of tests on each inspection lot to determine conformance to the other acceptance test requirements. This report shall include the purchase order number, inspection lot number(s), AMS____, size and quantity. The report shall also identify the producer, the product form, and the size of the mill product.

4.5 Resampling and Retesting:

Shall be in accordance with AMS 2355 or MAM 2355.

5.0. PREPARATION FOR DELIVERY

5.1 Identification

Shall be in accordance with ASTM B 666/B 666M

5.2 Packaging

5.2.1 Plate shall be prepared for shipment in accordance with commercial practice and in compliance with applicable rules and regulations pertaining to the handling, packaging, and transportation of the plate to ensure carrier acceptance and safe delivery. Packaging shall conform to carrier rules and regulations applicable to the mode of transportation.

5.2.2 Packaging shall be in accordance with ASTM B660.

6.0 ACKNOWLEDGEMENT:

A vendor shall mention this specification number in all quotations and when acknowledging purchase orders.

7.0 REJECTIONS:

Plate not conforming to this specification, or to modifications authorized by purchaser, will be subject to rejection.

8.0 NOTES:

8.1 A change bar (I) located in the left margin is for the convenience of the user in locating areas where technical revisions, not editorial changes, have been made to the previous issue of a specification. An (R) symbol to the left of the document title indicates a complete revision of the specification, including technical revision. Change bars and (R) symbols are not used in original publications, nor in specifications that contain editorial changes only.

8.2 Dimensions and properties in inch/pound units and the Fahrenheit temperatures are primary; dimensions and properties in SI units and the Celsius temperatures are shown as the approximate equivalents of the primary units and are presented only for information.

8.3 Terms used in AMS are clarified in ARP1917.

8.4 Procurement documents should specify not less than the following:

AMS: _ _ _ _

Size of plate desired

Quality of plate desired

When specified, fracture toughness testing and specimen orientation (see 3.3.4)

Additional tests required (see 4.2).

Prepared Under Jurisdiction of SAE-AMS Committee "D".

EXCERPT FROM AEROSPACE MANUFACTURER'S SPECIFICATION:
NICKEL-CHROMIUM-YTTRIA BARS AND FORGINGS (MA754)

1. SCOPE

1.1 Scope. This specification presents requirements for yttria dispersion strengthened nickel-chromium hot rolled and fully heat treated bars, hot rolled bars, and fully heat treated forgings from hot rolled bar.

1.1.1 Classification. This specification contains the following class(es). Unless otherwise specified, the requirements herein apply to all classes.

CLASS A: Heat Treated Bar
CLASS B: Inactive for new design
CLASS C: Hot Rolled Bar
CLASS D: Forged Shapes

2. APPLICABLE DOCUMENTS

2.1 Issues Of Documents. The following documents form a part of this specification to the extent specified herein. Unless otherwise indicated, the latest issue shall apply.

AEROSPACE MATERIAL SPECIFICATIONS

AMS 2269	Chemical Check Analysis Limits - Wrought Nickel Alloys and Cobalt Alloys
----------	--

AMERICAN SOCIETY FOR TESTING AND MATERIALS

ASTM E 3	Preparation of Metallographic Specimens
ASTM E 139	Conducting Creep, Creep-Rupture and Stress-Rupture Tests of Metallic Materials

PHOTOGRAPHS

C7702057	Acceptable Inclusion Limits
C7702058	Acceptable Inclusion Limits
C7702059	Unacceptable Inclusion Limits
8509015	Acceptable Macrostructure
8509016	Unacceptable Macrostructure

3. REQUIREMENTS

3.1 Manufacture. Material shall be manufactured from powder that has been nitrogen attrited or ball milled and processed through canning, extrusion, hot rolling, and de-canning.

3.1.1 Condition. Condition shall be as follows:

CLASSES A and B: Bar shall be hot rolled, heat treated, descaled and straightened.

CLASS C: Bar shall be hot rolled, descaled and straightened.

CLASS D: Shapes shall be hot forged and heat treated.

3.2 Chemical Composition, Weight Percent. Material supplied to this specification shall have the following composition:

Chromium -----	19.00-23.00	Carbon -----	0.10 Max.
Titanium -----	0.70 Max.	Sulfur -----	0.015 Max.
Aluminum -----	0.50 Max.	Oxygen -----	0.35-0.50
Yttria -----	0.4-0.8 (1)	Nickel -----	Remainder
Iron -----	2.50 Max.		

NOTES: (1) Yttria shall be determined as Yttrium and reported as Yttria.

3.2.1 Chemical Analysis. The analysis made by the Supplier to determine the percentages of elements required by this specification shall conform to the requirements of 3.2 and shall be reported in the certificate of test specified herein.

3.3 Heat Treatment. Material shall be supplied in one of the following conditions as specified on the purchase order.

CLASSES A, B, and D: Heat treated at a metal temperature of $2400^{\circ}\text{F} \pm 25$ ($1316^{\circ}\text{C} \pm 14$) for a minimum of one hour and a maximum of four hours. (The heat up rate shall achieve the macrostructure requirements of Table II.)

CLASS C: Hot Rolled

3.4 Mechanical Properties. Each Lot and Forge/Heat Treat Lot shall meet the mechanical properties of this specification.

3.4.1 Stress Rupture. Material after full heat treatment in accordance with 3.3 shall meet the stress rupture requirements of Table I at 2000°F (1093°C):

TABLE I
Stress Rupture of 2000°F (1093°C)

TEST DIRECTION	CLASS	STRESS	LIFE HOURS
In the Hot rolled or forged direction	A, B, C, D	12,000 psi (85 MPa)	20
Long transverse to direction of hot rolling	A and C	4,000 psi (30 MPa)	20
	B	5,500 psi (40 MPa)	20
Short transverse to direction of hot rolling	A and C	2,300 psi (15 MPa)	20
	B	4,000 psi (30 MPa)	20

3.4.2 Dynamic Modulus. The dynamic modulus of the material shall be determined at room temperature. Modulus of CLASSES A, B, and D material and CLASS C after heat treatment shall be not greater than 25.0×10^6 psi (172.4 GPa) in the hot rolled or forging direction.

3.5 Metallographic Inspection

3.5.1 Macroexamination. Macroexamination of a section transverse within 10° to the hot rolled direction or forging flow direction shall reveal a dull matte appearance when viewed at 5° to 20° from a line perpendicular to the section.

3.5.1.1 Macrostructure. Allowable level of mistextured grains shall be as specified in Table II.

TABLE II
Macrostructure Requirements

REQUIREMENT	PHOTOGRAPH	PART LOCATION
Acceptable	8509015	ALL
Unacceptable	8509016	ALL

3.5.2 Inclusion Level Requirements. Examples of acceptable inclusion levels are shown in Photo No. C7702057 (Level I) and Photo No. C7702058 (Level II). Unacceptable inclusion level is shown in Photo No. C7702059 (Level III). Failure to meet these requirements shall be cause for rejection of all hot rolled and hot rolled and fully heat treated bars from that extrusion.

3.5.2.1 Microstructure Requirements. Material shall be recrystallized before examination.

4. QUALITY ASSURANCE PROVISIONS

4.1 Chemical Analysis. Chemical analysis shall be performed on each master powder blend at the consolidated product stage in accordance with ASTM standards or methods approved by the Purchaser.

4.1.1 Chemical Analysis Limits. Chemical check analysis limits shall be in accordance with AMS 2269. Variation limits for yttria shall be ± 0.10 weight percent.

4.2 Mechanical Properties

4.2.1 Test Specimens

4.2.1.1 Test Block. Test blocks for stress rupture and dynamic modulus specimens shall be taken as follows:

CLASSES A, B, and C: Cut from the front end of a hot rolled bar taken from the front end of an extrusion from each lot.

CLASS D: Cut from shapes as specified by the Purchaser. Frequency of testing shall be approved by the Purchaser.

4.2.3 Stress Rupture Testing. Stress rupture test specimens shall be tested in air in accordance with the applicable requirements of ASTM E 139.

4.2.4 Dynamic Modulus Testing. Dynamic modulus shall be determined by methods as approved by the Purchaser.

4.3 Metallographic Inspection

4.3.1 Macro Examination. Examination shall be by a method suitable for examining macro grain structure and using a magnification of up to 10X. Examination shall be performed on immersion etched macro surface specimens. Before etching, the surfaces to be examined shall be polished in accordance with ASTM E 3, except that the final polishing shall be with a 300 grit or finer media. Examination shall be as follows:

CLASSES A and B: Both ends of each bar

CLASS C: Both ends of each hot rolled bar after heat treatment of a sample piece in accordance with 3.3, CLASS A.

CLASS D: One heat treated forging from each Forge/Heat Treat Lot.

4.3.2 Micro Examination, Inclusions. The metallographic micro inspection for inclusion shall be performed on heat treated and as-polished micro-surface specimens taken from the front and rear of each extrusion as follows:

CLASSES A and B: Specimen from the extruded and hot rolled bar.

CLASS C: Specimen from the extruded and hot rolled test block.

5. PACKAGING

5.1 Packing. All material shall be packed to prevent damage, loss or contamination during handling, shipping or storage.

5.2 Marking. Each shipment shall be identified with purchase order number, Supplier's name, lot and part number, and the specification number, class and issue number.

This page intentionally blank.



TA 57: May 1974

UDC 629.7.02.669.295.5'71'28'6'782-413

British Standard: Aerospace Series

Specification for

Plate of titanium-aluminum-molybdenum-tin-silicon alloy

(Tensile strength 1030-1220 Mpa)

(Maximum thickness 65 mm)

NOTE: Other forms of material of similar composition are covered by British Standards as listed in Appendix A.

1. Inspection and testing procedure

This British Standard shall be used in conjunction with Sections 1 and 6 of British Standard TA 100.

2. Manufacture

The material shall be made from ingots produced, by consumable electrode melting, from materials having a total carbon content of not more than 0.08%

3. Chemical composition

The chemical composition of the material shall be:

Element	%	
	min.	max.
Aluminum	3.0	5.0
Molybdenum	3.0	5.0
Tin	1.5	2.5
Silicon	0.3	0.7
Iron	–	0.20
Hydrogen	–	0.0125
Oxygen	–	0.25
Nitrogen	–	0.05
Titanium	–	Remainder

4. Condition

Unless otherwise agreed between the manufacturer and the purchaser and stated on the drawing, order or Inspection Schedule, the material shall be supplied heat treated and subsequently descaled and pickled, ground and pickled or machined.

TA 57: May 1974

UDC 629.7.02.669.295.571'28'6782-413

5. Heat treatment

The material and test samples shall be heat treated as follows:

- (1) heat at a temperature of $900 \pm 10^\circ\text{C}$ and hold for 1 h per 25 mm of section, with a minimum of 20 min;
- (2) cool in air;
- (3) heat at a temperature of $500 \pm 5^\circ\text{C}$ and hold for 24 h;
- (4) cool in air.

6. Mechanical properties

6.1 Tensile test at room temperature. The mechanical properties obtained from test pieces selected, prepared and tested in accordance with the relevant requirements of British Standard TA 100 shall be:

Nominal thickness		Direction	0.2% proof stress	Tensile strength		Elongation	Reduction of area
			min.	min.	max.	min.	min.
mm			MPa (=N/mm ²)	MPa (=N/mm ²)	MPa (=N/mm ²)	%	%
Over	Up to and including	{ Longitudinal Long transverse	900	1030	1220	9	—
			920	1050	1220	9	—
5	10	{ Longitudinal Long transverse	900	1030	1220	9	20
			920	1050	1220	9	20
10	25	{ Longitudinal Long transverse	900	1030	1220	9	20
			920	1050	1220	9	20
25	65	{ Longitudinal Long transverse Short transverse	900	1030	1220	7	20
			920	1050	1220	9	20

Gr 2

British Standards Institution

Telephone 01-629 9000

Telex 266933

• 2 Park Street •

London W1A 2BS

TA 57: May 1974

UDC 629.7.02.669.295.5'71'28'6'782-413

Appendix A

British Standards covering other forms of material of similar composition

Tensile strength (Mpa = N/mm ²)	min.	1100	1050	1050	1050	1000
	max.	1280	1220	1220	1200	1200
Limiting ruling section (mm)	Over		25			100
	Up to an including	25	100	100	100	150
Form	British Standard					
Bar and section for machining Forging Stock Forgings	TA 45	TA 46	TA 47	TA 48	TA 49 TA 50 TA 51	

AMD 3757

BSI

Amendment Slip No. 1
published and effective from 30 September 1981
to British Standard TA 57 : 1974
(Aerospace Series)

Plate of titanium-aluminum-molybdenum-
tin-silicon alloy
(Tensile strength 1030– 1220 Mpa)
(Maximum thickness 65 mm)

Revised text

AMD 3757
September 1981

Clause 4. Condition
In line 2, after 'ground' insert 'and pickled'.

This page intentionally blank.

Cercast Brush Wellman

Engineered Materials
14710 West Portage River South Road, Elmore Ohio 43416
Phone 419-862-2745 FAX 419-862-4341

AlBeCast™ : AMIC 910 Investment Castings

Effective January 1, 199X

1. Scope:

1.1 Specification:

This specification defines requirements for Aluminum-Beryllium alloy investment castings and follows the general format and content of ASTM B618-95; Standard Specification for Aluminum-Alloy Investment Castings.

1.2 Revisions:

This is a preliminary specification and is expected to be modified and improved with program history and casting data.

1.3 Application:

These castings are used for applications requiring light weight, high specific stiffness, and good thermal properties.

2. Applicable Documents:

2.1 SAE Publications

AMS 2360 Room Temperature Tensile Properties Castings
AMS 2771 Heat Treatment of Aluminum Alloy Castings
AMS 2804 Identification, Castings

2.2 ASTM Publications

ASTM B 557 Tension Testing of Wrought and Cast Aluminum and Magnesium Alloy Products
ASTM B 618 Standard Specification for Aluminum-Alloy Investment Castings
ASTM E 94 Guide for Radiographic Testing
ASTM E 155 Reference Radiographs for Inspection of Aluminum and Magnesium Castings
ASTM E 165 Test Method for Liquid Penetrant Examination
ASTM E 192 Reference Radiographs of Investment Steel Castings of Aerospace Applications
ASTM E 433 Standard Reference Photographs for Liquid Penetrant Inspection

2.3 U.S. Government Publications

MIL-STD-453 Inspection, Radiographic
MIL-STD-2175 Casting, Classification and Inspection of
MIL-STD-6866 Inspection, Liquid Penetrant

3. Technical Requirements

3.1 Chemical Composition:

The chemical composition shall conform to the values shown in Table 3.1 All values determined by wet chemical, spectrochemical, or radiochemical analysis.

Table 3.1 AMIC 910 Composition limits		
Element	Weight % Minimum	Weight % Maximum
Beryllium	56.0	63.0
Nickel	2.4	3.2
Silicon		0.50
Iron		0.30
Other Metallics, each		0.20
Other Metallics, total		0.50
Aluminum		Remainder

3.2 Casting:

Castings shall be produced from a melt conforming to section 3.1. Furnace and late-ladle grain-refining additions are acceptable. Chemical samples will be obtained from a representative melt sample or a section of a casting tree, including using tension test specimens or chemistry bars representative of the castings.

3.2.1 A melt shall be all of the material contained in the crucible at one time without recharging, other than grain refiners, within the limits of section 3.2. A melt may have a maximum weight limit of 500 pounds.

3.2.2 A lot shall be all castings poured from the melt.

3.3 Density:

Casting density is not generally checked. When checked, the bulk density of the castings shall range between two values listed in **Table 3.3**.

Table 3.3		
Material	Density (g/cm ³) Minimum	(lbs/in ³) Maximum
AMIC 910	2.07 (0.075)	2.18 (0.078)

3.3.1 Density shall be determined by water immersion of cast specimens. Only one cast sample from a lot need be tested.

AlbeCast™ 10 Specification

2/1/97/fcg

3.3.2 Density standards and test plan, where applicable, shall be as agreed upon by purchaser and vendor at the time of order.

3.4 Heat Treatment:

AMIC910 is not currently heat treatable.

3.5 Tensile Properties:

Tensile properties are verified by testing integrally Cast to Size “CTS” test bars, buttons, coupons, or similar shape attached to the gating/rising system. Test bars may also be prepared from material cut from a representative section of the casting and machined into test bars.

3.5.1 Minimum tensile properties at room temperature for integrally Cast to Size “CTS” test bars, buttons, coupons are shown in Table 3.5.1.

Table 3.5.1 Tensile Properties (integrally cast to size bars)	
Property	AMIC910
Ultimate Strength MPa (Ksi)	178 (26)
Yield Strength MPa (Ksi)	124 (18)
% Elongation	3

3.5.2 Minimum tensile properties at room temperature for machined test bars, buttons, coupons are shown in Table 3.5.2.

Table 3.5.2 Tensile Properties (Machined bars)	
Property	AMIC910
Ultimate Strength MPa (Ksi)	178 (26)
Yield Strength MPa (Ksi)	124 (18)
% Elongation	2

3.6 Quality:

The castings shall be uniform in quality and free of defects detrimental to usage.

3.6.1 Castings shall have smooth surfaces and be well cleaned.

3.6.2 Castings shall be produced under radiographic control consisting of examination in accordance with the procedures and requirements of MIL-STD-453. Inspection shall continue until foundry control for the part is established and the part is qualified per section 5.3 and a quality maintenance plan to ensure satisfactory quality is developed and approved.

AlbeCast™ 10 Specification

2/1/97/fcg

- 3.6.2.1 Penetrameters will not be used for certification of radiographic films.
- 3.6.3 ASTM E155 and ASTM E192 shall be used to define radiographic acceptance standards in accordance with MIL-STD-453.
- 3.6.4 When specified, castings shall be subjected to fluorescent penetrant inspection in accordance with MIL-STD-6866 or to other non-destructive inspection techniques acceptable to the purchaser. No etching is required when using MIL-STD-6866 or other inspection techniques acceptable to the customer.
- 3.6.5 Radiographic, fluorescent penetrant, and other quality standards shall be as agreed upon by purchaser and vendor.
- 3.6.6 When permitted, castings may be repaired by welding after removal of the defects. Welding requirements and allowable locations will be negotiated between vendor and supplier.
- 3.6.7 Surface defects may be repaired by peening and/or aluminum plating. Surface repairs shall be negotiated between vendor and supplier.

4.0 Tolerances

Casting tolerances are calculated using the Cercast *Casting Design Guide* for non-ferrous investment castings. Copies are available upon request.

5.0 Quality Assurance Provisions

5.1 Responsibility for Inspection:

Unless otherwise specified in the contract or order, the supplier shall be responsible for the performance of all acceptance provisions. The supplier may utilize his own facilities or nay commercial laboratory acceptable to the customer. The customer reserves the right to request test material and perform any test set forth in this specification to verify conformance with requirements.

5.2 Qualification Inspection:

Demonstration of conformance with all requirements of this specification shall be required to qualify a new part or requalify a product to this in specification. Any material or process changes by Brush Wellman/Cercast subsequent to qualification shall constitute basis for requalification unless such requalificaion is waived in writing by the customer.

Table 5.2 Qualification Inspection Requirements			
Requirement	Acceptance	Qualification	Test Method
Chemical Composition	Test CTS Bars each Melt	Test Qual CTS Bars each Melt	Paragraph 8.4.1
Density	Test CTS Bars each Melt	Test Qual Casting	Paragraph 4.4.3 and ASTM B311
Mechanical Properties	Test CTS Bars each Melt	Test Qual Casting	ASTM B557
Surface Defects/Finish	Inspect Each Casting	Inspect Qual Casting	MIL-STD-6866
X-ray	Inspect Each Casting	Inspect Qual Casting	MIL-STD-2175

Note: 1. CTS Bars are Cast to Size bars integral to castings.

5.3 Qualification lot Acceptance:

Conformance to the inspection requirements of Table 5.2 shall be verified prior to acceptance of castings to this specification. Acceptance testing shall be performed on each casting of the qualification lot.

5.4 Test Methods:

Test methods shall conform to Table 5.2 and the methods identified as follows:

5.4.1 Composition:

Chemical composition shall be determined from integrally cast test bars and performed by wet chemistry methods, spectrochemical methods or other methods approved by the customer. Analytical methods used for qualification testing shall also be used for inspection.

5.4.2 Mechanical Testing Methods:

Tensile tests shall be performed upon integrally cast test bars. A minimum of two specimens shall be tested with each melt. The location of the integrally cast specimens shall not be changed with respect to the qualification castings without the consent of the customer. Integrally cast specimens shall be, as a minimum, of sufficient size to accommodate ASTM B557 sub-size round or flat tensile specimens. If any of the requirements of table 5.2 are not met, then the castings from that melt may be heat-treated, HIPed, or otherwise processed to meet the requirements with approval of the customer. Brush Wellman/Cercast may also request approval of additional processing if the initial test results are judged to be marginal. In either case, the results of the second test shall be the basis for the acceptance of the melt under considerations.

5.4.3 Density:

Density shall be measured for each melt utilizing integrally cast test bars, buttons, or coupons. Measurements shall be performed in accordance with ASTM B311.

5.4.4 Surface Finish:

Cast surfaces shall be determined by visual comparison to the cited standard.

AlbeCast™ 10 Specification

2/1/97/fcg

5.4.5 Radiographic:

Radiographic procedures and standards as defined for aluminum castings in MIL-STD-2175 shall be used to interpret the quality of the castings.

5.4.6 Casting Repair:

Repaired areas shall be inspected for the casting quality requirements of Table 5.2.

5.5 Approval:

Sample castings from new or reworked patterns shall be approved by the customer before castings for production use are supplied, unless such approval be waived by the customer. One preproduction casting of each part number shall be dimensionally inspected and the results and the castings submitted for approval.

5.6 Reports:

Brush Wellman/Cercast shall furnish a certification with each inspection lot showing the results of tests performed and records of casting repairs. This report shall include the customer purchase order number, lot number, specification number, part number(s) and quantity.

6.0 Packaging and Marking**6.1 Packaging:**

The materials shall be packaged in accordance with the manufacturers commercial practice to insure safe delivery by common carrier.

6.2 Marking:

Each lot of material shipped to the customer will be appropriately identified, tagged, packaged and labeled to include the following:

Brush Wellman, Inc. - Cercast Group Lot Number Specification Number Purchase Order Number Patent Numbers Warning Beryllium

Additional markings are available at the customers' request.

7.0 Notes**7.1 Definitions:**

7.1.1 A Casting shall be the metal from a single shell and may include multiple parts.

7.1.2 A Lot shall be all castings poured from a single melt.

7.1.3 A Melt shall be a single homogeneous batch of molten metal.

7.1.4 An Inspection Lot shall consist of all castings from a single lot as defined in submitted for inspection at one time.

BRUSHWELLMAN

ENGINEERED MATERIALS

O - 30H OPTICAL GRADE BERYLLIUM

Effective Date: April 30, 1998

1. Scope

1. This specification establishes the material requirements for an optical grade of hot isostatically pressed (HIP) beryllium, suitable for low scatter optical applications which is designated O-30H.

This is a high density, high purity, low oxide material with good polishing characteristics. It is more isotropic than other grades of beryllium with 45,000 psi typical yield strength and 4,000 psi typical micro yield strength.

2. Chemical Composition

1. The chemical composition shall conform to the following:

Beryllium Assay, % minimum (1)	99.0	
Beryllium Oxide, % maximum (2)	0.50	
Aluminum, % maximum (3)	0.07	
Carbon, % maximum (4)	0.12	
Iron, % maximum (3)	0.12	
Magnesium, % maximum (3)	0.07	
Silicon, % maximum (3)		0.07
Other Metallic Impurities, each, % maximum (3)	0.04	

- Note: (1) Difference (i.e. 100%-other elements)
 (2) Leco Inert Gas Fusion
 (3) DC Plasma Emission Spectrometry
 (4) Leco Combustion

3. Density

- 3.1 The actual bulk density shall be equal to or greater than 99.7% of the Theoretical Density, after the material has been stress relieved.

- 3.2 The theoretical density is to be calculated using the following formula:

$$\text{Theoretical Density} = \frac{100}{\frac{100 - \% \text{ BeO}}{1.8477 \text{ gm/cc}} + \frac{\% \text{ BeO}}{3.009 \text{ gm/cc}}} \text{ gm/cc}$$

- 3.3 Density shall be determined using the water displacement method.

4. Thermally Induced Porosity (TIP) Resistance

- 4.1 Sample material shall be subjected to a TIP test consisting of a heat treatment in inert atmosphere at a temperature of 1450°F (788°C).
- 4.2 The minimum material density allowed following the TIP heat treatment shall be 99.7% of the Theoretical Density, calculated as shown in Section 3.2. The maximum drop in the density due to the TIP Resistance Test is to be 0.20%.

5. Tensile Properties

- 5.1 Minimum tensile properties for the material at room temperature, as determined per ASTM E-8 and MAB-205M, shall be:

Ultimate Tensile Strength	345 Mpa (50 Ksi) Minimum
Tensile Yield Strength	207 Mpa (30 Ksi) Minimum
Elongation	2.0% Minimum
Micro-Yield Strength	21 Mpa (3 Ksi) Minimum

- 5.2 Federal Test Method Standard No. 151 is applicable.

6. Coefficient of Thermal Expansion

The linear Coefficient of Thermal Expansion (CTE) will be measured in three orthogonal directions for each pressing produced to this specification. The overall average CTE from 5 °C (41°F) to 65°C (149°F) will be reported for each direction. (Typically 11.2-11.3 ppm/°C).

7. Penetrant Inspection

- 7.1 Penetrant and Visual Acceptance Criteria

A. Cracks are not permissible.

B. Pores (as determined by penetrant):

1. The size of an individual indication on the surface may not exceed 0.050" (1.27 mm).
2. A maximum of 3 indications (of the size of 0.003" (0.08 mm) to 0.050" (1.27 mm)) per square inch (650 mm²) of the surface is acceptable.
3. No restrictions to size or number if they do not hold Zygo.

- 7.2 Penetrant inspection shall be performed per ASTM E-1417, using penetrants and a dry developer conforming to MIL-1-25135, Type 1, Level 2, Method B, Form A.

8. Radiographic Inspection

- 8.1 Radiographic inspection to a penetrameter sensitivity of 2% shall be performed in accordance with MIL-STD-453, however exceptions are taken to the penetrameter contrast requirement and applicable area of penetrameter density ranges of +30% or -15% from the density at penetrameter location(s).

Note: Due to the nature of radiographic inspection, it is pointed out that the sensitivity of the inspection method decreases with the increasing material thickness.

8.2 Radiographic indications (voids and/or inclusions) shall conform to the requirements as established and defined in 8.2.1.

8.2.1 Requirements

Material shall conform to the following requirements, as defined in 8.2.2.

8.2.2	Maximum Dimension 0.050 inch	Maximum Average Dimension 0.030 Inch	Total Combined Volume per Cubic Inch Sphere 0.050 inch diameter
	Maximum Dimension 1.27 mm	Maximum Average Dimension 0.076 mm	Total Combined Volume per Cubic Inch Sphere 1.27 mm diameter

8.2.2.1 Maximum Dimension of any Indication.

Any dimension of any indication measured in the plane of the radiograph shall not exceed the indicated size.

8.2.2.2 Maximum Average of any Indication.

The average dimension of an indication shall be the arithmetic average of the maximum and minimum dimensions measured in the plane of the radiograph. The average dimension of an indication shall not exceed the indicated average.

8.2.2.3 Total Combined Volume Per Cubic Inch of all Indications.

The total combined volume per cubic inch (16.4 cm) of all indications with an average dimension larger than 0.001 inch (0.025 mm) shall not exceed the volume of a sphere of the indicated volume.

8.2.2.4 The minimum detectable size of voids and inclusions will increase as the section thickness increases, due to the decrease sensitivity referred to in paragraph 8.1

8.2.2.5 Part Density Uniformity.

The terms variable density areas, banding or striations shall denote relatively large areas of a radiograph, which vary in density as compared to the surrounding area. These areas shall not vary in radiographic density by more than 5% as compared to the surrounding area of comparable section thickness.

8.2.2.6 Light high density indications or areas in material 1.000" (25.4 mm) thick or less, which are 5% or less in radiographic density compared to the surrounding material, are radiographically acceptable.

9. Grain Size

- 9.1 The average grain size shall be determined in accordance with ASTM E-112, using the Intercept method at 500 magnification.
- 9.2 The average grain size shall not exceed 15 microns.

10. Tolerances

- 10.1 Materials furnished under this specification shall conform to the dimensions and dimensional tolerances as established by the purchase order and applicable drawings. If tolerances are not specified by purchase order, the following standard tolerances shall apply employing ANSI Y 14.5M:

Diameter, Width or Thickness, Inches	Tolerance
Up to 3, inclusive	-0 + 1/64
Over 3 to 20, inclusive	-0 + 1/16
Over 20	-0 + 1/4

Length, Inches	Tolerance
Up to 20, inclusive	-0 + 1/8
Over 20	-0 + 1/4

Diameter, Width or Thickness, Inches	Tolerance
Up to 76, inclusive	-0 + 0.40
Over 76 to 508, inclusive	-0 + 1.58
Over 508	-0 + 6.35

Length, Inches	Tolerance
Up to 508, inclusive	-0 + 3.18
Over 20	-0 + 6.35

11. Surface Finish

- 11.1 The material shall be furnished with a machined surface. The standard surface finish shall be 125 microinches ms. (Approximately = 110 Ra) maximum, employing ASME/ANSI B46.1.

12. Reports

- 12.1 Certification of Compliance with this specification will be furnished on request and, when specified, actual test results will be certified. Testing in accordance with individual customer instructions will be performed, if mutually acceptable and actual test results will be certified.

Note: The reported density and tensile properties shall be representative of the shapes in the as-HIP'd and stress relieved condition.

13. Marking

- 13.1 Surface permitting, each part shall be legibly marked employing and electroetching technique or tagging if insufficient area is available.

13.2 Marking is to include the following:

Brush Wellman Inc. (BWI)
Lot and/or Part Number
Serial Number
Specification Number
X-Ray Number
Purchase Order Number
Warning beryllium

14. Procedures

14.1 Detailed analytical and test procedures used by Brush Wellman Inc. are available upon request.

15. Health and Safety

Beryllium containing materials may pose a health risk if recommended safe handling procedures are not followed. Inhalation of airborne beryllium may cause a serious lung condition in susceptible individuals. The Occupational Safety and Health Administration (OSHA) has set mandatory limits on occupational respiratory exposures. Read and follow the guidance in the respective Material Safety Data Sheet (MSDS) before working with this material. For more information on safe handling practices or technical data contact your Brush Wellman Inc. representative.

This page intentionally blank.

ALUMINUM ALLOY, EXTRUSIONS
4.0Cu - 1.3Mg - 0.60Mn (2026-T3511)
Solution Heat Treated, Stress-Relieved by Stretching, and Straightened

UNS A92026

1. SCOPE:

1.1 Form:

This specification covers an aluminum alloy in the form of extruded bars, rods, and profiles.

1.2 Application:

These extrusions have been used typically for parts subject to excessive warpage during machining processes and for parts requiring high strength and damage tolerance, where fabrication does not normally involve welding.

1.2.1 Certain processing procedures may cause these extrusions to become susceptible to stress-corrosion cracking; ARP823 recommends practices to minimize such conditions.

2. APPLICABLE DOCUMENTS:

The issue of the following documents in effect on the date of the purchase order form a part of this specification to the extent specified herein. The supplier may work to a subsequent revision of a document unless a specific document issue is specified. When the referenced document has been canceled and no superseding document has been specified, the last published issue of that document shall apply.

2.1 SAE Publications:

Available from SAE, 400 Commonwealth Drive, Warrendale, PA 15096-0001.

AMS 2355	Quality Assurance Sampling and Testing, Aluminum Alloys and Magnesium Alloys, Wrought Products, Except Forging Stock and Rolled, Forged, or Flash Welded Rings
MAM 2355	Quality Assurance Sampling and Testing, Aluminum Alloys and Magnesium Alloys, Wrought Products, Except Forging Stock, and Rolled, Forged, or Flash Welded Rings, Metric (SI) Units
AMS 2772	Heat Treatment of Aluminum Alloy Raw Material
ARP823	Minimizing Stress-Corrosion Cracking in Wrought Heat-Treatable Aluminum Alloy Products

2.2 ASTM Publications:

Available from ASTM, 100 Barr Harbor Drive, West Conshohocken, PA 19428-2959.

ASTM B 594	Ultrasonic Inspection of Aluminum-Alloy Wrought Products for Aerospace Applications
ASTM B 666/B 666M	Identification Marking of Aluminum and Magnesium Products

2.3 ANSI Publications:

Available from ANSI, 11 West 42nd Street, New York, NY 10036-8002.

ANSI H 35.2	Dimensional Tolerances for Aluminum Mill Products
ANSI H 35.2M	Dimensional Tolerances for Aluminum Mill Products (Metric)

3. TECHNICAL REQUIREMENTS:

3.1 Composition:

Shall conform to the percentages by weight shown in Table 1, determined in accordance with AMS 2355 or MAM 2355.

TABLE 1 - Composition

Element	min	max
Silicon	–	0.05
Iron	–	0.07
Copper	3.6	4.3
Manganese	0.30	0.80
Magnesium	1.0	1.6
Zinc	–	0.10
Titanium	–	0.06
Zirconium	0.05	0.25
Other impurities, each	–	0.05
Other impurities, total	–	0.15
Aluminum	remainder	

3.2 Condition:

Extruded, solution heat treated and stress-relieved by stretching to produce a nominal permanent set of 1.5%, but not less than 1% nor more than 3%, to the T3511 temper. Solution heat treatment shall be performed in accordance with AMS 2772.

3.2.1 Product shall be supplied with an as-extruded surface finish; light polishing to remove minor surface conditions is permissible provided such conditions can be removed within specified dimensional tolerances.

3.2.2 Product may receive minor straightening, after stretching, of an amount necessary to meet the requirements of 3.5.

3.3 Properties:

Product shall conform to the following requirements, determined in accordance with AMS 2355 or MAM 2355:

3.3.1 Tensile properties of extrusions with a maximum cross-sectional area of 25 square inches (161 cm²) and a maximum circle size of 12 inches (305 mm) shall meet the following requirements:

3.3.1.1 Longitudinal: Shall be as shown in Table 2.

3.3.1.2 Long-Transverse: Shall be as shown in Table 3.

TABLE 2A - Minimum Longitudinal Tensile Properties, Inch/Pound Units

Nominal Thickness Inches	Tensile Strength ksi	Yield Strength at 0.2% Offset ksi	Elongation in 2 Inches or 4D %
Up to 0.249, incl	66.0	48.0	11
Over 0.249 to 0.499, incl	70.0	52.0	12
Over 0.499 to 1.499, incl	72.0	53.0	11
Over 1.499 to 2.249, incl	73.0	54.0	11
Over 2.249 to 3.250, incl	73.0	54.0	10

TABLE 2B - Minimum Longitudinal Tensile Properties, SI Units

Nominal Thickness Millimeters	Tensile Strength MPa	Yield Strength at 0.2% Offset MPa	Elongation in 50.8 mm or 4D %
Up to 6.34, incl	455	331	11
Over 6.34 to 12.68, incl	483	359	12
Over 12.68 to 38.09, incl	496	365	11
Over 38.09 to 57.14, incl	503	372	11
Over 57.14 to 82.54, incl	503	372	10

TABLE 3A - Minimum Long-Transverse Tensile Properties, Inch/Pounds Units

Nominal Thickness Inches	Tensile Strength ksi	Yield Strength at 0.2% Offset ksi	Elongation in 2 Inches or 4D %
Over 0.499 to 1.499, incl	66.0	46.0	8
Over 1.499 to 2.249, incl	64.0	44.0	8
Over 2.249 to 3.250, incl	61.0	42.0	8

TABLE 3B - Minimum Long-Transverse Tensile Properties, SI Units

Nominal Thickness Millimeters	Tensile Strength MPa	Yield Strength at 0.2% Offset MPa	Elongation in 50.8 mm or 4D %
Over 12.68 to 38.09, incl	455	317	8
Over 38.09 to 57.14, incl	441	303	8
Over 57.14 to 82.54, incl	421	290	8

3.4 Quality:

Products, as received by purchaser, shall be uniform in quality and condition, sound, and free from foreign materials and from conditions detrimental to usage of the extrusions.

- 3.4.1 When specified, each extrusion shall be subjected to ultrasonic inspection in accordance with ASTM B 594. Extrusions 0.50 inch (12.7 mm) and over in nominal diameter or least distance between parallel sides, weighing 600 pounds (272 kg) and under, and having a maximum width-to-thickness ratio of 10:1 shall meet ultrasonic Class B requirements, as described in ASTM B594.

3.5 Tolerances:

Shall conform to all applicable requirements of ANSI H35.2 or ANSI H35.2M except that surface roughness tolerances shall be twice those specified therein.

4. QUALITY ASSURANCE PROVISIONS:

4.1 Responsibility for Inspection:

The vendor of the products shall supply all samples for vendor's tests and shall be responsible for the performance of all required tests. Purchase reserves the right to sample and to perform any confirmatory testing deemed necessary to ensure that the products conform to specified requirements.

4.2 Classification of Tests:

4.2.1 Acceptance Tests: Composition (3.1), longitudinal tensile properties (3.3.1.1), ultrasonic inspection when specified (3.4.1), and tolerances (3.5) are acceptance tests and, except for composition, shall be performed on each inspection lot.

4.2.2 Periodic Tests: Long-transverse tensile properties (3.3.1.2) are periodic tests and shall be performed at a frequency selected by the vendor unless frequency of testing is specified by purchaser.

4.3 Sampling and Testing:

Shall be in accordance with AMS 2355 or MAM 2355.

4.4 Reports:

The vendor of products shall furnish with each shipment a report stating that the product conforms to the chemical composition, ultrasonic inspection when required, and tolerances and showing the numerical results of tests on each inspection lot to determine conformance to the other acceptance test requirements and stating that the final product conforms to the other technical requirements. This report shall include the purchase order number, inspection lot number, AMS XXXX, size or section identification number, and quantity.

4.5 Resampling and Retesting:

Shall be in accordance with AMS 2355 or MAM 2355.

5. PREPARATION FOR DELIVERY:

5.1 Identification:

Shall be in accordance with ASTM B 666/B 666M.

5.2 Packaging:

Products shall be prepared for shipment in accordance with commercial practice and in compliance with applicable rules and regulations pertaining to the handling, packaging, and transportation of the product to ensure carrier acceptance and safe delivery.

6. ACKNOWLEDGMENT:

A vendor shall mention this specification number and its revision letter in all quotations and when acknowledging purchase orders.

7. REJECTIONS:

Products not conforming to this specification, or to modifications authorized by purchaser, will be subject to rejection.

8. NOTES:

8.1 A change bar (I) located in the left margin is for the convenience of the user in locating areas where technical revisions, not editorial changes, have been made to the previous issue of this specification. An (R) symbol to the left of the document title indicates a complete revision of the specification, including technical revisions. Change bars and (R) are not used in original publications, nor in specifications that contain editorial changes only.

8.2 Extrusions produced to this specification exhibit high fracture toughness and a thin recrystallized surface layer relative to other high-strength 2xxx alloys. Limits on the thickness of the recrystallized surface layer can be guaranteed for specific purposes.

8.3 Terms used in AMS are clarified in ARP1917.

8.4 Dimensions and properties in inch/pound are primary, dimensions and properties in SI units are shown as the approximate equivalent of the primary units and are presented only for information.

8.5 Procurement documents should specify not less than the following:

AMS XXXX

Form and size or section identification number of extrusions desired

Quantity of extrusions desired

Whether ultrasonic inspection of extrusions is required (See 3.4.1).

8.6 Key Words:

Bar, rods, profiles

Excerpt from Rolls Royce Specification MSRR 8626

Material Specification Ti - 4Al - 4Mo - 2Sn - 0.5Si ALLOY BARS FOR MACHINING, FORGING STOCK AND FORGINGS	DATE April '98
Composition	

Constituent	Value	Constituent	Value
C	≤0.08 %_wt	Mo	3.0 to 5.0 %_wt
The total carbon (C) content of the raw material shall be not more than 0.08%		N	≤0.03 %_wt
		O+2N	≤0.27 %_wt
Si	0.30 to 0.70 %_wt	Sn	1.5 to 2.5 %_wt
Al	3.0 to 5.0 %_wt	Y	≤50 ppm_wt
Fe	≤0.20 %_wt	TITANIUM	REMAINDER
H	≤0.010 %_wt		

Unless otherwise agreed with the Rolls-Royce Laboratories, each forging designated by the order or drawing as a critical part component shall be analyzed for hydrogen (H).

The procedure used for the selection and preparation of test pieces for hydrogen determination and the stage in manufacture at which samples are taken on individual forgings, shall be stated in the relevant Method of Manufacture Data Sheet.

The hydrogen (H) content shall not exceed 0.0125% max for bars for machining, 0.010% max for forging stock and 0.015% max for forgings.

Hydrogen determination shall be carried out on equipment approved by the Rolls-Royce Laboratories.

The testing frequency may be reduced provided that the following can be demonstrated, to the Rolls-Royce Laboratories process capability, control and that the property requirements will be met.

Method of Manufacture
MVAR

MATERIAL MANUFACTURE: Form Limit Dimensions	Bars/Finished Parts/Section RS=<100 mm
See Chemical Composition for hydrogen content for bars.	
SUPPLY: Condition and Material Processing	SOLUTION TREAT:900Cel/⇒20min/AC (a) PRECIPITATION TREAT:500Cel/24h/AC CENTERLESS GRIND or MACHINE ETCH:TO RPS675 (b)
<p>(a) The time at temperature shall be 1h per 25 mm of section, with minimum of 20 minutes. When agreed with the Rolls-Royce Laboratories and stated in the Method of Manufacture Data Sheet, a forced air cool may be utilized.</p> <p>(b) (1) RPS675 Procedure A. (2) The maximum amount of dressing allowed to be agreed between the material manufacturer and the forger. Dressed areas shall be faired smoothly into the surrounding materials such that the bottom radius of the dressed areas is equal to at least three times the depth of defect. On completion of local dressing, the dressed areas shall be etched and inspected to ensure that the defects have been completely removed and that no overheating or other surface imperfection has occurred.</p>	
FINAL USE: Condition and Material Processing	As condition of supply

NON-DESTRUCTIVE TESTING	To the relevant Method of Manufacture Data Sheet
MACRO EXAMINATION	<p>No harmful defects</p> <p>During etch examination of machining bar for forging billet and (where required by the drawing), forgings, detection of any of the following will be cause for rejection.</p> <p>(i) Porosity (ii) Beta Segregation (iii) Evidence of overheating (iv) Unselaed ingot cavity (v) Cracks or laps (vi) Hard alpha defects of dense metal inclusions</p> <p>Standards for sealed ingot cavity and soft alpha segregation shall be agreed between the manufacturer and the Rolls-Royce Laboratories.</p>

TEST MATERIAL: Condition and Material Processing Sampling	As condition of supply BS.TA100
Continued on next page	

TEST MATERIAL NUMBER (Continued)				
BATCH TENSILE MSRR9968	DUCTILITY	DUCT_TYPE	ELONGATION	>=9 %
		GAUGE_LENGTH	5.65_ROOT(A)	
		TEMPERATURE	20 Cel	
		DUCT_TYPE	RED_OF_AREA	>= 20%
	GAUGE_LENGTH	5.65_ROOT(A)		
	TEMPERATURE	20 Cel		
	PROOF_STRESS	LOADING	TENSION	>=920 MPa
		STRAIN	0.2%	
	TEMPERATURE	20 Cel		
ULT_STRENGTH	CONC_FACTOR	1	1100 to 1280 MPa	
	LOADING	TENSION		
	TEMPERATURE	20 Cel		
BATCH CREEPSTRAIN	PLAS_STRAIN	STRESS	465 MPa	<=0.1 % ⁽¹⁾
		TEMPERATURE	400 Cel	
		TIME	100 h	

This page intentionally blank.

Excerpt from Rolls Royce Specification MSRR 8642

MATERIAL SPECIFICATION (1) Ti - 4 AL - 4Mo - 2Sn - 0.5Si ALLOY (8) BARS FOR MACHINING AND COMPRESSOR BLADE FORGINGS (LIMITING RULING SECTION - BARS FOR MACHINING 75 MM, FORGING STOCK 112 MM)										DATE May '83	CODE TDS			
1	Chemical Composition % or (ppm) *See Note 2 **See Note 3		Element	C*	Al	Mo	Fe	Si	Sn	H ₂	Ti			
			Minimum	-	3.00	3.00	-	0.30	1.50	-	REM			
			Maximum	0.10	5.00	5.00	0.30	0.70	2.50	**				
			Element											
			Minimum											
			Maximum											
2	Method of Melting and Manufacturing		Consumable electrode vacuum arc melting.											
3	Inspection and Testing Procedures		BS.TA100 Sections 1, 2, 3 and 4 unless this specification overrides.											
5	1		2											
6	Form Method of production Limit dimensions		Bars for machining											
7	Condition and Heat treatment	Supply	Solution treated and precipitation treated, descaled and, when required, etched to RPS.196 900°C/≥20 mins. (See Note 4)/Air cool + 500°C/24h/Air cool											
8	Condition and Heat treatment	Use	As supplied											
9	Test Piece: Heat treatment Sampling		As condition of use BS.TA100											
11	Direction of Sample		Longitudinal					Transverse						
12	Tensile (5)	Temperature	°C	RT					RT					
13		0.2% Proof Stress	MPa	≥920					≥920					
14		Tensile Strength	MPa	1050 - 1200					1050 - 1200					
15		Elongation	%	≥9					≥7					
16		Reduction of Area	%	≥20					≥20					
17	Hardness		-											
18	Bend		-											
19	Impact		-											
20	Creep /Rupture (5)	Temperature	°C	-										
21		Stress	Mpa	-										
22		Time	h	-										
23		Total plastic strain	%	-					-					
24		Elongation	%	-					-					

© Rolls-Royce pic

The information in this document is the property of Rolls-Royce pic and may not be copied or communicated to a third party for any purpose other than that for which it is supplied without the express written authority of Rolls-Royce pic.

	MSRR.8642 Page 2	
	1	2
26	Non-Destructive Testing	To relevant QAS
29	Macro Examination	Standard to be agreed
30	Micro Examination	Standard to be agreed

Notes

Information on SI units is given in BS.3763 "The International System of Units" and BS.350 "Conversion Factors and Tables".

- (1) This specification replaces BSEM 594
- (2) The carbon content shall be determined on raw materials
- (3) Hydrogen Content

Forging Stock

The hydrogen content of forging stock shall not exceed 0.008% (80 ppm).

Bars for Machining

The hydrogen content of bars for machining shall not exceed 0.0125% (125 ppm).

Hydrogen Determination

Hydrogen determination shall be carried out on equipment approved by the Controlling Laboratory.

In addition, the procedure used for the selection and preparation of test pieces and the stage in manufacture at which samples shall be taken, shall be stated in the relevant Method of Manufacture Data Sheet.

- (4) On solution treatment, the 'time at temperature' shall be determined as follows:
1 hour per 25 mm of section.

Excerpt from Rolls Royce Specification MSRR 8663

MATERIAL SPECIFICATION (1) TI - 4 AL - 4MO - 2SN - 0.5SI ALLOY FOR FORGING STOCK AND FORGINGS										DATE April '88		
1	Chemical Composition % or (ppm)		Element	C*	Si	Al	Fe	H ₂	Mo	N ₂	O ₂	O ₂ +(2x N ₂)
			Minimum	–	0.30	3.0	–	–	3.0	–	–	–
	*See Note 3		Maximum	0.08	0.70	5.0	0.20	*	2.50	(300)	0.25	0.27
			Element	Sn	Y	Ti						
			Minimum	1.5	–	REM						
			Maximum	2.5	(10)	REM						
2	Method of Melting and Manufacturing		Triple consumable electrode vacuum are melted.									
5	1		2									
6	Form Method of production Limit dimensions		Forging stock Forged or rolled ≤ 280 mm φ									
7	Condition and Heat treatment	Supply	As manufactured, machined, and arched (4)									
8	Condition and Heat treatment	Final Use	Refer to Columns 3 and 4									
9	Test Piece: Heat treatment Sampling		900°C/≥20 mins (7) / Air cool + 500°C/24/Air cool									
10	Direction Concerned		–									
11	Direction of Sample		Transverse									
12	Tensile	Temperature	°C	Room Temperature								
13		0.2% Proof Stress	MPa	≥960								
14		Tensile Strength	MPa	1100 - 1280								
15		Elongation	%	≥7								
16		Reduction of Area	%	≥20								
17	Hardness		–									
18	Bend		–									
19	Impact (IZOD)		ft lbf	–								
20	Creep /Rupture	Temperature	°C	400								
21		Stress	Mpa	465								
22		Time	h	100								
23		Total plastic strain	%	≤ 0.10								
24		Elongation at Rupture	%	–								

MSRR.8663 Page 2						
For lines 1-4 see page 1						
5	1		3		4	
6	Form Method of Production Limit Dimensions		Forgings Forged or ring rolled from products supplied to Column 2		Forgings Forged or ring rolled from products supplied to Column 2	
7	Condition and Heat Treatment } Supply		<u>Solution Treated:</u> 900°C/ ≥ 20 mins (7) / Air cool + <u>Precipitation Treated:</u> 500°C/ 24h/Air cool + Rectilinear machined (5) and etched		Solution Treated: 900°C/ ≥ 20 mins (7) / Air cool + Precipitation Treated: 500°C/ 24h/Air cool + Rectilinear machined (5) and etched	
8	Condition and Heat Treatment } Final Use		As condition of supply		As condition of supply	
9	Test Place: Heat Treatment Sampling		As condition of supply		As condition of supply	
10	Dimensions Concerned		-		--	
11	Direction of Sample		Longitudinal	Transverse and Tangential	Longitudinal	Transverse and Tangential
12	Tensile	Temperature	°C	RT	RT	RT
13		0.2% Proof Stress	MPa	≥ 920	≥ 920	≥ 920
14		Tensile Strength	MPa	1050-1200	1050-1200	1050-1200
15		Elongation	%	≥9	≥7	≥9
16		Reduction of Area	%	≥20	≥20	≥20
17	Hardness		-		-	
18	Bend		-		-	
19	Impact (IZOD)		ft lbf		-	
20	Creep/Rupture	Temperature	°C	-		400
21		Stress	MPa	-		465
22		Time	h	-		100
23		Total Plastic Strain	%	-		≤ 0.10
24		Elongation at Rupture	%	-		-
				AGREED BY SUPPLY:		

Notes

Information on SI units is given in BS.3763 "The International System of Units" and BS.350 "Conversion Factors and Tables".

(1) This specification shall be interpreted in accordance with MSRR0000

(2) Material codes are as follows:

TFA - material to column 3

TGP - material to column 4

(3) Hydrogen Determination

Forging Stock: The hydrogen content of forging stock carried out at a frequency of not less than one per batch shall be agreed between the material manufacturer and the forger.

Forgings:

(a) The hydrogen content of finally heat treated forgings shall not exceed 150 ppm.

(b) Frequency of Determination

The test frequency may be reduced to one per forging batch per heat treatment batch provided that the Supply Responsible Laboratory can demonstrate process capability to the Design Responsible Laboratory.

(4) Forging stock shall have a surface finish not exceeding 3.8 micrometers when all processing has been completed.

This page intentionally blank.

Excerpt from Rolls Royce Specification MSRR 8679

Material Specification Ti-5.8Al - 4Sn - 3.8Zr - 0.7Nb - 0.5Mo - 0.06C ALLOY DISCS AND ASSOCIATED ROTATING COMPONENTS LIMITED RULING SECTION: 30 MM	MSRR8679 PAGE 1 OF 14 PAGES DATE 16-NOV-99 ISSUED ISSUE 4
Method of Manufacture	
TVAR	

Property Notes
1 Transverse: TEST_ANGLEXY=90 deg means a test direction of TRANSVERSE.

MATERIAL NUMBER	20
Material Name: (DF) Ti834 stock (not HT)	Material Code: NBW

Composition

Constituent	Value	Constituent	Value
C	0.04 to 0.08%_wt	N	<=100 ppm_wt
Si	0.28 to 0.44%_wt	Nb	0.68 to 0.75%_wt
Al	5.5 to 5.35%_wt	O	750 to 1500 ppm_wt
B	<=50 ppm_wt	Sn	3.7 to 4.2%_wt
Fe	<=150 ppm_wt	Y	<=10 ppm_wt
H	<=60 ppm_wt	Zr	3.3 to 4.0%_wt
Mo	0.45 to 0.57%_wt	Others Each	<=0.08%_wt
		Others Total	<=0.20%_wt
		TITANIUM	REMAINDER

MATERIAL MANUFACTURE: Form Method of Production Limit Dimensions	Forging Stock Forged and/or rolled =<280 mm billet diameter
SUPPLY: Condition and Material Processing	MACHINE (a)
(a) Surface machine.	
FINAL USE: Condition and Material Processing	Refer to Material 30

This material has 1 test material (see below)	
TEST MATERIAL NUMBER	21 (Tests for Material Number 20)
Material Name: Ti834: (DF: TVAR)	Material Code: THW

TEST MATERIAL:	
Condition and Material Processing	SOLUTION TREAT (a)
Sampling	MSRR9987
Limit Dimensions	13 mm test section

(a) (1) Material shall be solution treated for a minimum time of two hours at temperature following which the material shall be oil quenched from the solution treatment temperature. On oil quenching from solution treatment the delay between removal from the furnace and transfer to the quenching media shall not exceed 30 seconds unless specifically agreed in the Method of Manufacture Data Sheet.

(2) The solution treatment temperature for each cast shall be established by alpha approach curve analysis, i.e., estimation of the alpha content at a series of temperatures up to the cast beta transus temperature. The solution treatment temperature shall be that which produces between 5% and 25% volume fraction primary alpha in the microstructure.

BATCH TENSILE	DUCTILITY	DUCT_TYPE	ELONGATION	>=6%
		GAUGE_LENGTH	5.88_ROOT(A)	
		TEMPERATURE	20 Cel	
		TEST_ANGLEXY	90 deg (1)	
	DUCTILITY	DUCT_TYPE	RED_OF_AREA	>=14%
		TEMPERATURE	20 Cel	
		TEST_ANGLEXY	30 deg (1)	
		DUCT_TYPE	ELONGATION	>=9%
	DUCTILITY	GAUGE_LENGTH	5.65_ROOT(A)	
		TEMPERATURE	600 Cel	
TEST_ANGLEXY		90 deg (1)		
DUCT_TYPE		RED_OF_AREA	>=30%	
DUCTILITY	TEMPERATURE	600 Cel		
	TEST_ANGLEXY	90 deg (1)		
	PROOF_STRESS	LOADING	TENSION	>=905 MPa
		STRAIN	0.2%	
TEMPERATURE		20 Cel		
TEST_ANGLEXY		90 deg (1)		
PROOF_STRESS	LOADING	TENSION	>=476 MPa	
	STRAIN	0.2%		
	TEMPERATURE	600 Cel		
	TEST_ANGLEXY	50 deg (1)		
ULT_STRENGTH	LOADING	TENSION	>=1025 MPa	
	TEMPERATURE	20 Cel		
	TEST_ANGLEXY	90 deg (1)		
	LOADING	TENSION	>=630 MPa	
ULT_STRENGTH	TEMPERATURE	600 Cel		
	TEST_ANGLEXY	90 deg (1)		
	BATCH CREEPSTRAIN	PLAS_STRAIN	STRESS	150 MPa
		PLAS_STRAIN	TEMPERATURE	600 Cel
TIME			100 h	
				<=0.1% (2)
BATCH Transition Temperature	BETA TRANSUS	The estimated temperature difference between ingot top to bottom approach curves in the range of 12% to 17% primary alpha shall not exceed 12 Cel.		

RUSSIAN FEDERATION

SPECIFICATION

TU 1-809-941-98

PM EP741NP NICKEL-BASE SUPERALLOY DISCS

**Manufacturer
/Supplier/**

All-Russia Institute of Light Alloys (VILS)

2 Gorbunov St., Moscow, 121596, Russia

Developer

All-Russia Institute of Light Alloys (VILS)

2 Gorbunov St., Moscow, 121596, Russia

Moscow, 1998

1. SCOPE

1.1 The present Specification cover Powder Material EP741NP nickel-base superalloy discs made from particles by hot isostatic pressing, in conformity Manufacturing Instruction No. DTI 50-7/4-86.

2. TECHNICAL REQUIREMENTS

2.1 The discs shall be made from EP741NP nickel-base superalloy powder (particle size is +50 -140 μm) in accordance with requirements of the present Specifications and agreed drawings and according to manufacturer's production documentation approved in an established order.

2.2 Main parameters and dimensions

2.2.1 Code, disc configuration, dimensions and their tolerance limit as well as location of stock left for cutting-out of specimens for testing of mechanical properties shall meet requirements of drawings agreed between supplier and customer.

2.3 Chemical composition of the alloy shall meet requirements specified by OST I 92111-85 Standard (Table 1).

Table 1. Chemical Composition of EP741NP Alloy, wt. %

<i>Element</i>	<i>min</i>	<i>max</i>
Carbon	0.02	0.05
Chromium	8.0	10.0
Cobalt	15.0	16.5
Molybdenum	3.5	4.2
Aluminium	4.8	5.3
Titanium	1.6	2.0
Tungsten	5.2	5.9
Niobium	2.4	2.8
Hafnium	0.1	0.4
Zirconium	—	0.015
Magnesium	—	0.02
Boron	—	0.015
Cerium	—	0.01
Silicon	—	0.5
Manganese	—	0.5
Iron	—	0.5
Sulphur	—	0.009
Phosphorous	—	0.015
Nickel	balance	

2.3.1 The discs shall be supplied in the as-heat-treated conditions after machining. Heat-treatment of the discs shall be carried out in accordance with supplier's operating conditions agreed with a customer.

2.3.2 Surface roughness parameter of the discs shall meet requirements specified in the drawings. Disc surface shall not have visual cracks, non-metallic inclusions and porosity. It shall not also have scratches, guide marks, compression marks with a depth of more than 0.33% of the real machining allowance.

2.3.3 Disc surface shall be free from metal continuity disturbances revealed by luminescent method. Individual luminous spots, occurred due to the presence of non-metallic inclusions shall not be a reason for rejection.

2.3.4 The discs shall be free from defects revealed by ultrasonic testing (see Instruction MK 266-40-78) if echo signal amplitudes exceed those of reference flat-bottom holes of 0.8 mm dia. for rim and 1.2 mm dia. for web and hub when the depth of the defects and the references is the same.

Non-homogeneity of structure shall be defined based on ultrasonic test Instruction MK 308-40-87.

2.3.5 Mechanical properties at room temperature, low-cycle fatigue resistance and long-term tensile strength of the discs in the as-delivered condition, determined on specimens cut from the stock left for specimens shall meet requirements specified by Tables 2, 3 and 4.

2.3.6 After testing, fracture surface of impact specimens shall be free from interparticle fracture (Appendix 1 - "a" and "b" check specimens). The presence of unbroken particles in the intraparticle fracture structure in accordance with "c", "d", "e" and "f" check specimens shall be allowable.

Table 2. Mechanical Properties at Room Temperature

Tensile properties, (guaranteed min.)					Brinell hardness (indentation diameter) 5 mm/7350N
Ultimate tensile strength, MPa (<i>ksi</i>)	Yield strength, MPa (<i>ksi</i>)	Elongation, %	Reduction in area, %	Impact strength, kJ/m ² (<i>in-lb/in²</i>)	
1372 (200)	931 (136)	13	15	390 (2227)	1.50-1.75

Table 3. Long-Term Tensile Strength

Testing temperature, °C	Constant applied stress, MPa (<i>ksi</i>)	Time to failure, h (minim.), combined specimens
650	980 (143)	100

Table 4. Low-Cycle Fatigue Resistance

Testing temperature, °C	Maximum cycle stress, MPa (<i>ksi</i>)	Frequency of applied stress, Hz	Number of cycles to failure, N _C (minim.)
650	980 (143)	1	5000

2.3.7 A macrostructure of disc etching surfaces in the as-delivered condition shall be free from visual porosity, cracks. Maximum macrograin size shall not exceed 1.5 mm. During disc macrostructure examination at manufacturer's or customer's site the presence of not more than three non-metallic inclusions up to 0.25 mm in size along the whole etching surface shall be allowable. A disc macrostructure shall be free from residual microporosity (Appendix 2), microporosity occurred due to overheating (Appendix 3), visual powder particle boundaries (Appendix 4 - "a" check specimen). A microstructure with the presence of individual powder particle boundaries shall be allowable (Appendix 4 - "b" and "c" check specimens). In this case a number of powder particles indicated by boundaries in the microstructure shall not be prescribed. A disc microstructure having intraparticle microporosity specified by Appendix 5 (from the first /a, b/ to the fifth /a, b/ scale numbers) shall be allowable. Not more than six aggregates or six individual micropores of the fifth degree shall be allowable along 2.5 cm² area microslice surface.

3. ACCEPTANCE CRITERIA

3.1 The EP741NP superalloy discs shall be produced in lots up to 36 pieces of any codes and in any combination of them.

3.2 The discs shall be submitted for acceptance by the piece.

3.3 The discs shall be put to acceptance tests to determine conformity to the requirements of Part 2 of the present Specifications.

3.4 Acceptance tests

3.4.1 During the acceptance test it shall be tested:

a) for every disc

- chemical composition (in accordance with supplier's sampling technique);
- dimensions;
- surface quality.

Disc surface roughness shall not be tested but conformance of this parameter shall be assured by disc machining technique:

- the discs shall be free from internal defects;
- mechanical properties at room temperature shall meet specified requirements;
- long-term tensile strength and low-cycle fatigue resistance shall meet specified requirements.

Mechanical property test specimens shall be made of a ring cut out from a stock left for sampling of a disc. Ring cutting out location shall be indicated in the drawing of a disc. Specimens shall be cut out in accordance with supplier's technique;

- surface fracture type of impact specimens;
- macro- and microstructure, macrograin dimensions;
- packing and disc marking.

b) packaging.

3.4.2 If the results of any tests fail to conform to the requirements prescribed in Tables 2, 3 and 4, twice number of additional specimens shall be cut out from the same disc and retested. If the results of repeated tests fail to conform to the specified requirements the disc shall be rejected.

3.4.3 If the results of disc surface quality inspection made by visual or luminescent method after machining as well as after macrostructure examination fail to conform to the specified requirements, repeated surface quality inspection shall be permitted after additional machining or local grinding within the limits of disc size tolerance in as-delivered condition.

3.5 Periodic (comprehensive) tests

3.5.1 Disc comprehensive tests shall be used to evaluate production process stability and disc quality in zones which are not inspected during acceptance tests. For comprehensive testing a disc of any code, which meets all requirements of the present Specifications shall be selected from the first four discs in the first hot isostatic pressing charge.

3.5.2 Specimens for comprehensive testing shall be made in accordance with techniques approved by customer.

3.5.3 The following parameters shall be determined during disc comprehensive tests:

- mechanical properties at room temperature and low-cycle fatigue resistance;
- long-term strength;
- hardness;
- macro- and microstructure;
- fracture type.

3.5.4 If test results are not meet the requirements prescribed in Tables 1, 2 and 3, twice number of additional specimens shall be cut from the same area of a disc, where the failed specimen was, and retested. One non-metallic inclusion not more than 0.2 mm in size, found in disc macrostructure section shall not be a reason for rejection.

3.5.5 If the results of repeated tests or primary results of macro- and/or microstructure examination fail to conform to the specified requirements, two more discs shall be chosen for additional comprehensive testing in accordance with items 3.5.2 - 3.5.3 of the present Specifications.

3.5.6 If the results of disc test fail to conform to the specified requirements even in the case of one of two discs, the problem of the use of the given lot shall be jointly solved by supplier and customer after additional testing of the discs in accordance with approved programme.

3.5.7 On the basis of comprehensive test results, findings shall be worked out and sent to customer.

4. TEST METHODS

4.1 Disc dimensions shall be inspected by measuring tools which assure accuracy specified in the agreed drawings.

4.2 EP741NP alloy chemical composition shall be analysed in accordance with the supplier's technique. Chemical analysis of powder shall be permitted too, but in this case chemical composition of the alloy shall conform to the requirements of item 2.3 of the present Specifications.

4.3 Etched and non-etched surface quality of the discs shall be visually inspected without the use of magnification devices in accordance with the supplier's testing procedure.

4.4 Disc surface metal discontinuities shall be controlled by luminescent method in accordance with the supplier's testing procedure.

4.5 Disc internal defects shall be revealed in accordance with MK 226-40-78 and MK 308-40-87 supplier's testing procedures.

4.6 Disc mechanical properties shall be inspected during:

a) Tensile test at room temperature of two specimens 5 mm in dia. and with design length $l_0=5.65\sqrt{F_0}$ in accordance with GOST 1492 Standard requirements;

b) Impact strength test of two specimens belonged to Type I in accordance with GOST 9454 Standard requirements;

c) Brinell hardness test of two specimens tested by 5 mm dia. steel ball at 7350N (750 kg) load in accordance with GOST 9012 Standard requirements;

d) Long-term strength test of two complex specimens with smooth and notched parts in accordance with GOST 10145 Standard requirements with regard for MK 1.3.10-37 testing procedure. Shapes and dimensions of the complex specimens shall conform to parameters prescribed in Figure I;

e) Low-cycle fatigue test of two smooth 5 mm. dia cylindrical specimens (Type II) in accordance with GOST 25.502 Standard requirements.

4.7 Disc fracture surface behaviour shall be inspected after impact strength test with a x6 or more level of magnification in accordance with supplier's procedure by comparison with reference specimens shown in Appendix 1 of the present Specifications.

4.8 A macrostructure of disk etched surface shall be visually inspected in accordance with supplier's procedure. Macrograin and non-metallic inclusion dimensions shall be inspected by measuring tool exhibiting an error of up to 0.1 mm in accordance with supplier's procedures.

4.9 A disc microstructure shall be inspected by microscope using non-etched metallographic specimens by comparison with reference specimens prescribed in item 2.3.8 of the present Specifications with a x100 level of magnification in accordance with supplier's procedures. If it is necessary to obtain more

specific information about microporosity effect, the presence of microporosity resulted from overheating shall be inspected using metallographic specimens exposed to electrolytical etching (Appendix 3 of the present Specifications).

4.10 Disc marking and packing shall be controlled visually.

5. PACKING, MARKING, TRANSPORTATION

5.1 Each disc shall be marked by a stamp or by an electrical marker to show an alloy, a code, an ordinal number and an acceptance stamp. Location of the stamp shall be indicated in the disc drawing.

5.2 The discs shall be delivered without preservation in wood boxes or in supplier's reusable containers in such a manner as to prevent damage during transportation. Gross weight of a container with discs shall not exceed 350 kg.

5.3 The discs in the wood boxes or in reusable containers shall be carried by any transport facilities.

5.4 Each box shall be marked with customer's and supplier's names, alloy, disc code, a number of discs and their original numbers.

5.5 Transportation and storage of the discs shall be carried out in accordance with GOST 7566 Standard requirements.

5.6 Each box with discs shall be accompanied with a quality document (certificate) signed by a head of quality control department, certified that the discs conform to the requirements of the present Specifications. The certificate shall include the following:

- a) supplier's name;
- b) customer's name;
- c) alloy and composition;
- d) disc code, a number of the discs and their ordinal numbers;
- e) net weight of the discs;
- f) results of all tests specified by the present Specifications;
- g) designation of the present Specification.

Referenced Documents

OST I 92111-85 Standard	PM Nickel-Base Superalloys. Grades.
GOST 1497-84 Standard	Metals. Tensile Test Methods.
GOST 9012-59 Standard	Metals. Test Methods. Brinell Hardness Test.
GOST 9454-78 Standard	Metals. Method of Impact Bending Test at Lowered, Room and Elevated Temperatures.
GOST 10145-81 Standard	Metals. Long-Term Strength Test Method.
MK 266-40-78 Testing Procedure	Ultrasonic Inspection of Pancakes and Turned Turbine and Compressor Discs Made from Superalloys and Titanium Alloys.
MK 308-40-87 Testing Procedure	Ultrasonic Inspection of Structure Heterogeneity of PM Nickel-Base Superalloy Discs.
MK 1.3.10-37-89 Testing Procedure	Long-Term Strength Test and Notch Sensitivity Test of Complex Specimen.
GOST 25.502-79 Standard	Metal Mechanical Testing Methods. Fatigue Test Methods.

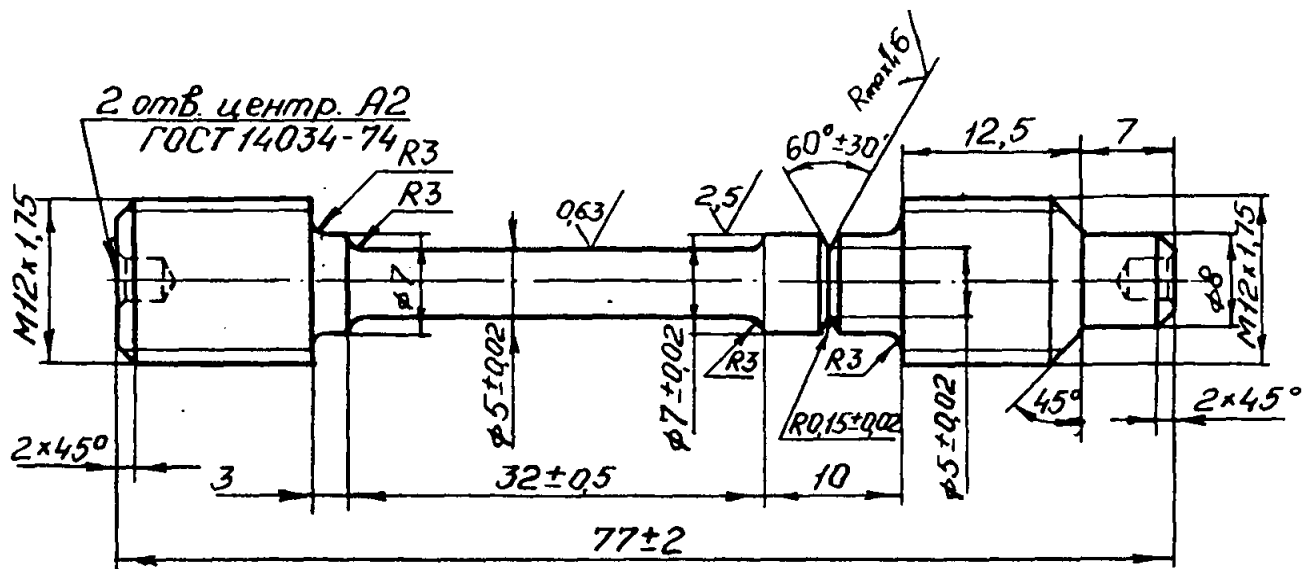

Figure 1^a.

Complex specimen for long-term strength test in accordance with GOST 10145-81 Standard and MK 1.3.10-37-89 Testing Procedure requirements.

(Unshown limiting deviations shall meet requirements specified by OST 1 76253-78 Standard).

^a Drawing units of Figure 1 are in mm.

TYPES OF FRACTURE SURFACE OF IMPACT SPECIMENS (x7)

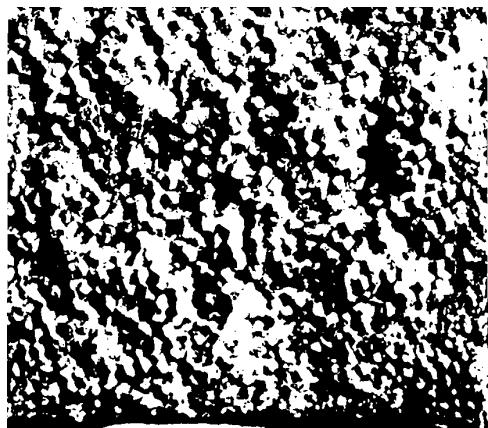

a

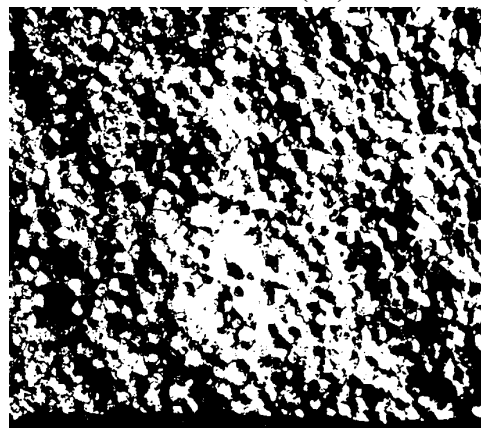

b

a and b - unallowable interparticle fracture



c



d

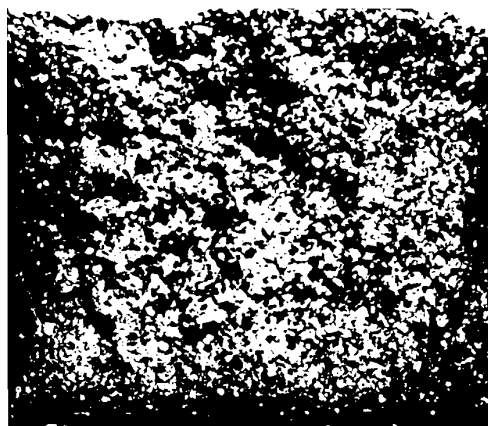

e



f

c, d and e - allowable intraparticle fracture with the presence of unbroken particles

f - allowable intraparticle fracture

Scale of a microstructure with residual microporosity (six levels) (x100)^b



a



b



c

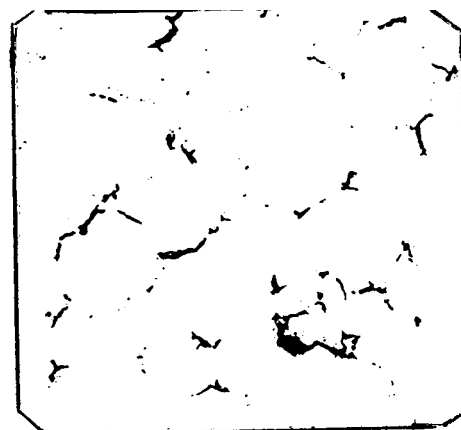

d

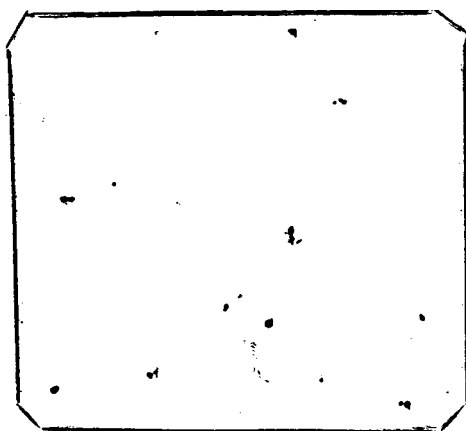

e

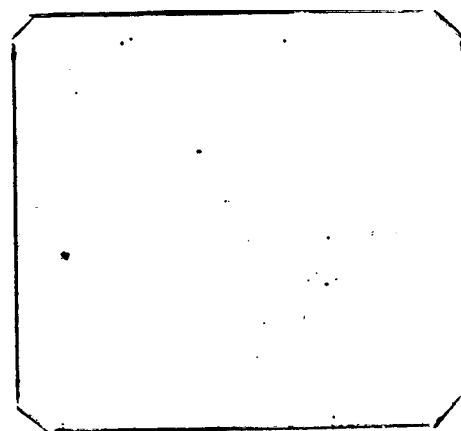

f

^b Figures are best available at time of print.

Types of a microstructure with unallowable microporosity occurred due to overheating (x100)^a

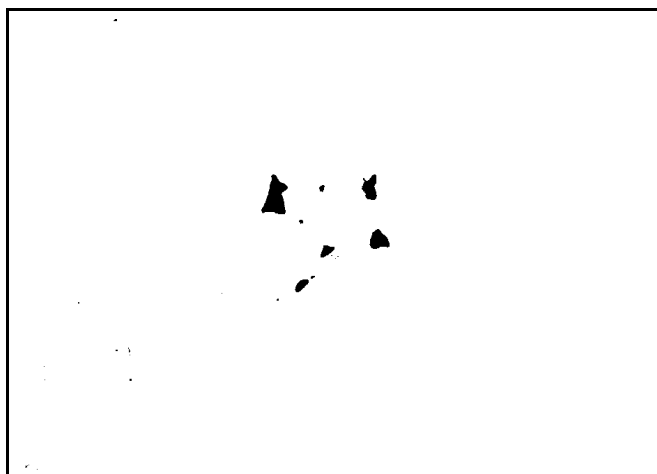

Prior to electrolytic etching

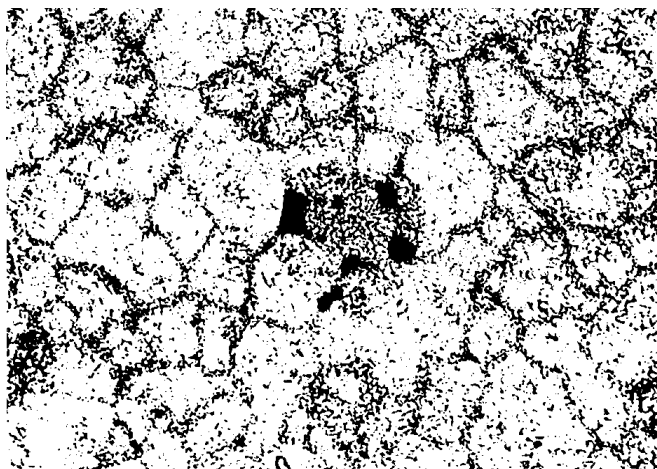

After electrolytic etching

^a Figures are best available at time of print.

Types of a microstructure with a powder particle boundaries (x100)^a

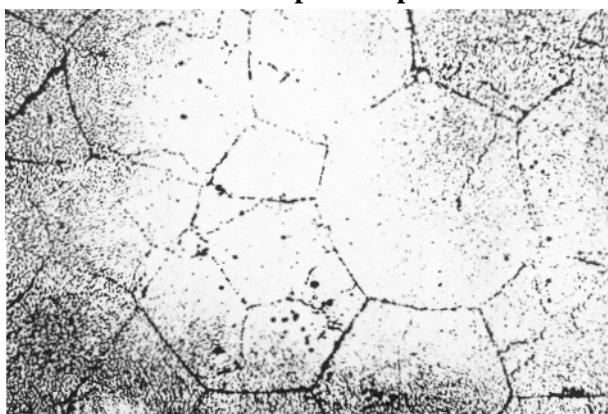

a

a – an unallowable microstructure with the presence of a visual powder particle boundaries

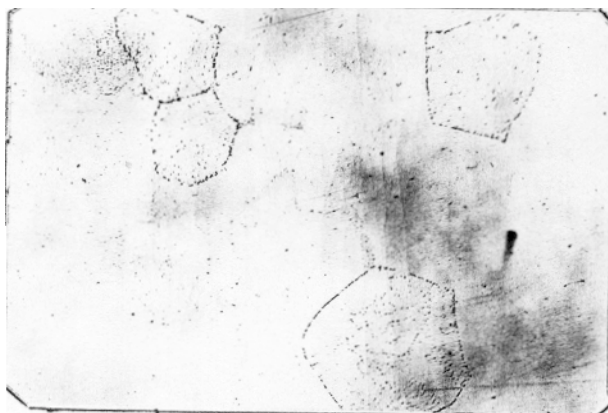

b

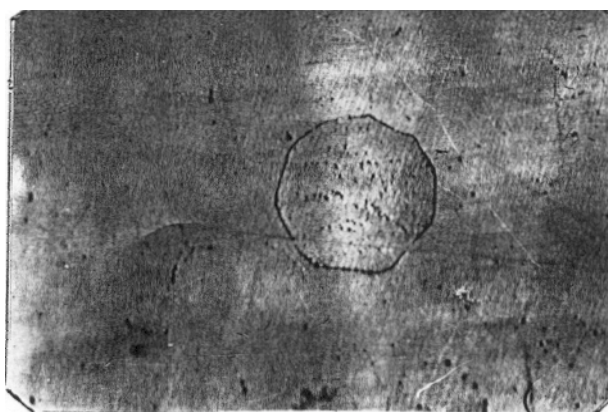

c

b, c - an allowable microstructure with the presence of individual powder particle boundaries

A number of powder particles adjoining to each other shall not exceed three.

^a Figures are best available at time of print.

Intraparticle porosity scale (x100)^a

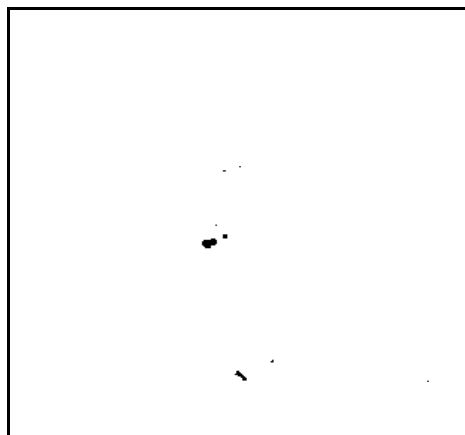

a

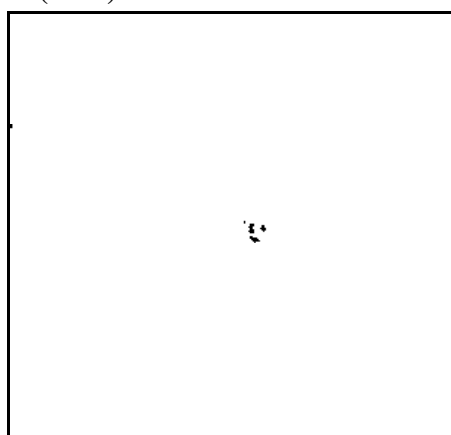

b

Scale number I

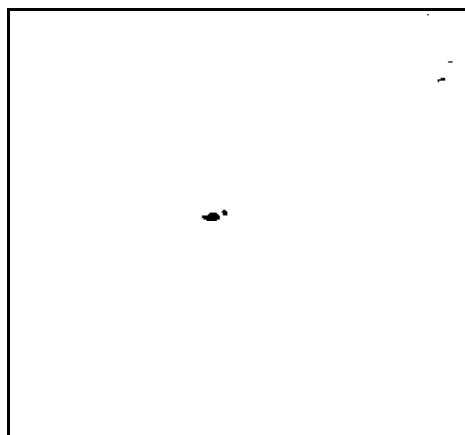

a

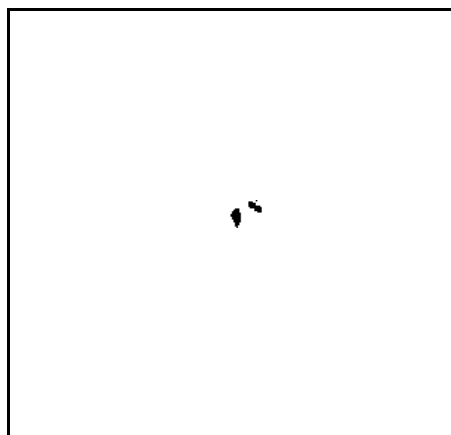

b

Scale number II

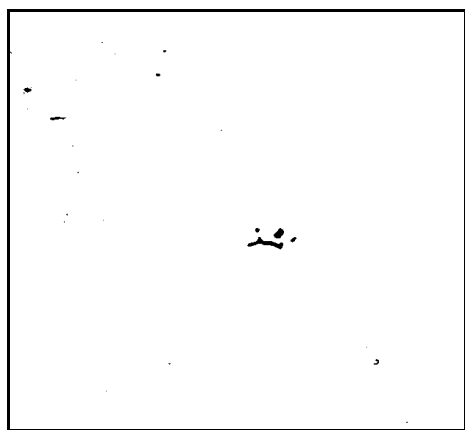

a

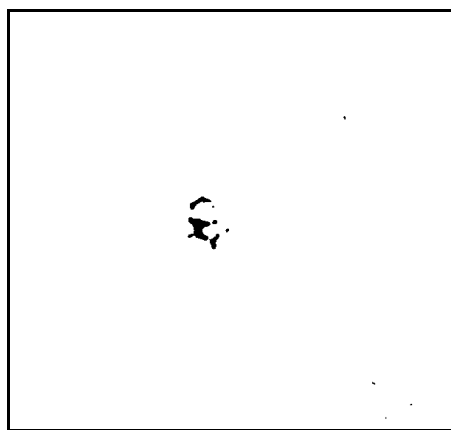

b

Scale number III

^a Figures are best available at time of print.

Appendix 5
(Continued from the previous page)

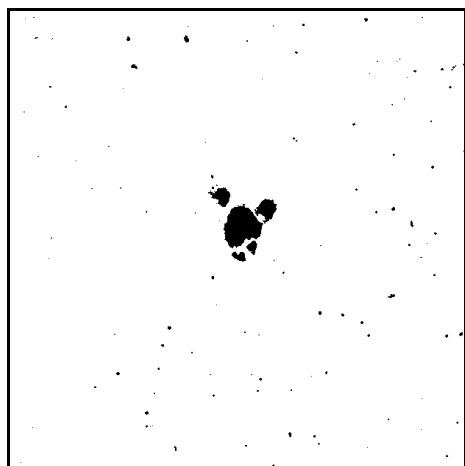

a

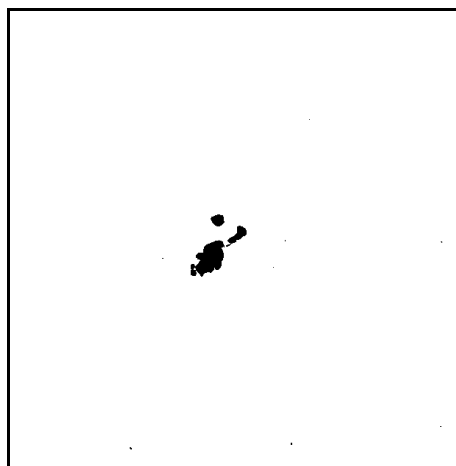

b

Scale number VI



a

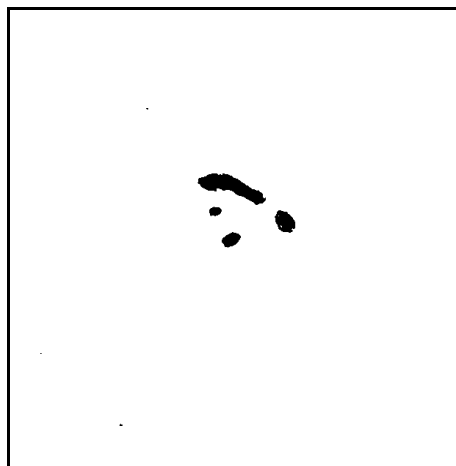

b

Scale number V

RUSSIAN FEDERATION
SPECIFICATIONS TU 1-809-987-92

VT16 TITANIUM ALLOY RODS MACHINED FOR COLD UPSET

Manufacturer:

All-Russian Institute of Light Alloys (VILS)
2 Gorbunov St., Moscow, 121596, Russia

Designer

All-Russian Institute of Aviation Materials (VIAM)
17 Radio St., Moscow, 107005, Russia

All-Russian Institute of Light Alloys (VILS)
2 Gorbunov St., Moscow, 121596, Russia

1998

This specifications cover VT16 titanium alloy rods intended for manufacture of cold upset fasteners.

1 RANGE OF SIZES

1.1 Rod diameters and allowable deviations from them shall meet the requirements shown in Table 1.

Table 1. Diameters of VT16 titanium alloy machined rods and allowable deviations from them

Rod diameters, mm	Allowable deviations from diameters, mm
4.0	-0.040
4.1	
4.5	
4.85	
5.5	
6.5	
8.5	

1.2 Ovality of rods shall not exceed allowable deviations from diameters.

1.3 The length of rods in the as-received condition is 0.8-3.0 m, allowable deviation from straight is 2 mm in one running metre for 4.0-6.5 mm dia rods and 3 mm in one running metre for 6.6-6.5 mm dia rods.

2. TECHNICAL REQUIREMENTS

2.1 Chemical composition of VT16 alloy shall meet the requirements of OST 1 90013-81 Standard (Table 2).

Table 2. Chemical composition of VT16 alloy, wt. %

Element	min	max
<i>Aluminum</i>	1.8	3.8
<i>Molybdenum</i>	4.5	5.5
<i>Vanadium</i>	4.0	5.0
<i>Carbon</i>	-	0.10
<i>Iron</i>	-	0.25
<i>Silicon</i>	-	0.15
<i>Zirconium</i>	-	0.3
<i>Oxygen</i>	-	0.15
<i>Nitrogen</i>	-	0.05
<i>Hydrogen</i>	-	0.012
<i>Others, Total</i>	-	0.30
<i>Titanium</i>	balance	

- 2.2 Rods are supplied as-vacuum annealed followed by machining.
- 2.3 Annealing: annealing temperature is 779-790°C, cooling down to 500°C in a vacuum furnace and then in air.
- 2.4 Rod surfaces shall be free from fins, cracks, exfoliations, laps, rough marks from machining, cavities.
- 2.5 Small scratches, hollows, prick marks, fine traces of machining are allowed on rod surfaces if control grinding of surfaces is within allowable deviation from diameters.
- 2.6 Roughness parameters (Rz) of rods shall be \leq 10 mm (?) in the specified length of 0.8 mm (V6) according to GOST 2789-73 Standard.
- 2.7 Mechanical properties of rods in the as-received condition shall meet the requirements shown in Table 3.

Table 3. Mechanical properties of VT16 titanium alloy rods

UTS <i>ksi</i>	Shear strength <i>ksi</i>	<i>e, %</i>	<i>RA, %</i>
		<i>not less than</i>	
119-136 (830-950 MPa)	90 (630 MPa)	14	65

Notes: Supply of 4.1 and 4.85 mm dia rods with shear strength not less than 86 ksi and intended to manufacture screws is allowed.

- 2.8 Microstructure shall comply with 1-3 types of 5-types of 5-type scale. Macrostructure shall not be more than the 3rd number in 10 number scale according to OST 1 90201-75 Standard.
- 2.9 Rods are not additionally tested for oxygen and hydrogen content. Hydrogen and oxygen content are taken into account in terms of their content in an ingot.
- 2.10 Rods shall withstand test for cold upset till one fourth of initial height of the specimen upset. The upset specimens shall be free from surface tears and cracks.
- 2.11 In the process of ultrasonic tests of rods areas having echo signal amplitudes equal or more than amplitudes of echo signals from flat bottom holes are not allowed. The type of flat-bottom holes is a cross mark 0.2 mm deep.
3. ACCEPTANCE INSTRUCTION
- 3.1 Acceptance of rods is carried out in lots. Every lot shall include rods of the same alloy, heat and diameter.
- 3.2 Notes: Rods 4.1 and 4.85 mm dia intended to manufacture crews are sorted into separate lots.
- 3.3 Rod diameter and surface quality are controlled in every rod and coil.
- 3.4 Rods are subject to 100 % nondestructive ultrasonic testing.

- 3.5 To control mechanical properties failure, shearing and upsetting tests are carried out using two specimens for each type of tests. The specimens are cut out from two rods (one from each rod), and one specimen from each end of a coil is cut out. Specimens under control are taken from every rolled billet (rod bundle, coil). In case of unsatisfactory results tests are repeated using a double number of specimens. The results of repeat tests are considered to be final.
- 3.6 Shearing tests are conducted according to OST 90148-74 Standard.
- 3.7 Control of macrostructure is conducted on two specimens taken from two coils.
- 3.8 Control of microstructure is conducted on one specimen taken from every bundle (coil).
- 3.9 In case of unsatisfactory test results for macro- and microstructure tests are repeated using a double number of specimens taken from the same rods (coils). The results of repeat tests of microstructure are considered to be final.
- 3.10 Roughness of rod surfaces is assured by manufacturing technology. In case of disagreement surface roughness is determined on two specimens from a lot in accord with GOST 2789-73 Standard.

4. TEST METHODS

- 4.1 Tensile tests are conducted immediately on rods at a calculated specimen length of 5d according to GOST 1497-84 Standard.
- 4.2 Shearing tests are conducted according to OST 90148-74 Standard and Table 4.
- 4.3 Upsetting tests are conducted in a cold state according to GOST 9817-82 Standard. The height of an upsetting specimen shall be equal to two diameters. Speed of upsetting tests under load shall be 100 mm/min.
- 4.4 Ultrasonic test of rods is conducted using supplier's method. Ultrasonic test is carried out at a speed of rod movement in one direction (from one end of a rod) which is up to 0.5 m/s.
- 4.5 Control of rod straightness and ovality is carried out according to GOST 26877-91 Standard.

5. MARKING, PACKING AND EXECUTION OF DOCUMENTATION

- 5.1 Marking, packing, execution of documentation for rods are carried out according to OST 1 90201-75 Standard.
- 5.2 In a certificate for rods intended for screws their purpose shall be also pointed out, i.e., "Rods for screws".

6. REFERENCES

- OST 1 90013-81 Standard “Titanium and Titanium Wrought Alloys. Grades”
- GOST 1497-84 Standard “Metals Method of Tensile Test”.
- GOST 2789-73 Standard “ESKD. Surface Roughness. Designation of Surface Roughness”.
- GOST 26877-91 Standard “Metal Products Methods of Measurements of Form Deviation”.
- TU 1 -92-3-74 Standard “VT16 Alloy Rods for Cold Upset”.
- OST 1 90201-75 Standard “Titanium Alloy grinded Rods and sized by machining”.
- OST 1 90148-74 Standard “Metals. Method of Shearing test”.
- GOST 8817-82 Standard “Metals. Method of Upsetting Test”.

This page intentionally blank.

TU1-92-81-87

Technical Conditions

Long-length plates from 1163, B954₀₄ (in Russian) (V95och-very high purity) and B95_{n4} (n Russian) (V95pch-higher purity) aluminum alloys for aviation
(Manufacturer - BKMPO, Belaya Kalitva Metallurgical Production Association, Rostov region, 347005, Russia)

The present standard is applied to the plate delivery from 1163, V95och and V95pch aluminum alloys which are designed for primary structural parts of aircraft.

1.0 Classification

1.1 As for material condition the plates are divided into:

- quenched and naturally aged - T(1163T);
- hot-rolled in accordance with special regime, quenched and naturally aged T7 (1163T7); technological parameters are related to “Know-how”;
- quenched and artificially aged - T2 (V95ochT2 and V95pchT2).

2.0 Range of Products

2.1 Dimensions of plates must satisfy the requirements presented in Table 1.

Table 1. **Dimensions, mm**

Alloy, temper	Thickness	Width	Length
V95ochT2, V95pchT2	20-40	1150, 1450	6000-25000
	30	1900, 2000	6000-25000
	30	2150	6000-24000
1163T7	20-40	1150, 1450	6000-25000
	30	1900, 2000	6000-25000
	30	2150	6000-24000
	32-40	1950	6000-25000
1163T	20-40	1150, 1450	6000-25000
	30	1900, 2000	6000-25000
	32-40	1900	6000-25000

2.2 Dimensional tolerances must be corresponded to requirements of GOST 17232-79. In some cases (cross rolling) width tolerance increases by 50 mm. Intermediate dimensions of plates in thickness and width are set by agreement between Manufacturing and Customer.

2.3 Plate dimensions and alloy tempers are specified in the contract.

2.4 Examples of conventional designation:

Plate from 1163 aluminum alloy, quenched and naturally aged, thickness - 30 mm, width - 2000 mm, length - 25000 mm, delivered in accordance with TU1-92-81-87;

Plate 1163T, 30x2000x25000, TU1-92-81-87

Also hot-rolled in accordance with special regime, quenched and naturally aged, delivered in accordance with TU1-92-81-87;

Plate 1163T7, 30x2000x25000, TU1-92-81-87

Plate from V95och aluminum alloy, quenched and artificially aged in accordance with T2 regime, thickness - 30 mm, width - 2000 mm, length - 25000 mm, delivered in accordance with TU1-92-81-87;

Plate V95ochT2, 30x2000x25000, TU1-92-81-87.

3.0 Technical Requirements

3.1 Chemical composition of the plates from V95och and V95pch aluminum alloys must satisfy the requirements of OST1 90026-80, as for the chemical composition of the plates from 1163 aluminum alloy, it must satisfy the requirements of OST1 90048-77 (Table 2).

Table 2. **1163 Alloy Composition**

Element	Min	Max
Copper	3.8	4.5
Magnesium	1.2	1.6
Manganese	0.40	0.80
Titanium	0.01	0.07
Iron	–	0.15
Silicon	–	0.10
Nickel	–	0.05
Zinc	–	0.01
Other impurities, each	–	0.05
Other impurities, total	–	0.10
Aluminum	Remainder	

3.2 Hydrogen content in metal must not exceed 0.25 cm³ per 100 g of metal.

3.3 T7 condition consists of the process of hot rolling in accordance with the specific regime, quenching, stretching and natural aging.

3.4 Plates from 1163T, V95ochT2, and V95pchT2 alloys are subjected to stretching in a as-quenched condition with residual deformation of 1.5-3.0%.

3.4.1 The stretching of plates after hot rolling by tension at the value of residual deformation no more than 0.8% is allowed.

3.5 Plate surface quality and allowable deviation from flat shall comply with GOST 17232-79.

Additional flex leveling with the use of a special roller leveler is allowed. The total degree of strain during stretcher and flex leveling of a particular plate shall not be more than that specified by the present specifications for stretcher leveling.

Interval between quenching and leveling shall not be more than 6 hours.

3.6 Mechanical properties in longitudinal and transverse directions should comply with the requirements of Table 3.

Table 3. **Mechanical Properties**

Alloy	Test Direction	The Temper of Tested Specimens	Thickness of Plates, mm	Tensile Properties, not less than		
				UTS	YS	Elongation
				Mpa (kgs/mm ²)		%
1163	Longitudinal	T	20-25	430 (44)	295 (30)	12
	Transverse			430 (44)	295 (30)	10
	Longitudinal		26-40	440 (45)	315 (32)	12
	Transverse			420 (43)	285 (29)	10
	Longitudinal	T7	20-25	450 (46)	330 (34)	12
	Transverse			430 (44)	295 (30)	10
	Longitudinal		26-40	460 (47)	340 (35)	12
	Transverse			420 (43)	285 (29)	10
V95och, pch	Longitudinal	T2	20-40	510-580 (52-59)	430-510 (44-52)	7
	Transverse			490-580 (50-59)	410-500 (42-51)	7

3.7 Plates microstructure shouldn't be overheated.

3.8 Plates should be subjected to ultrasonic testing, for this echo signals are recovered from defects, which are equal or exceed echo signals by amplitude from control reflector with the diameter of 2-4 mm. Total amount of defects in each square meter, measured along the plate width beginning from one of the plate ends at the discretion of manufacturer, shouldn't exceed 5 pieces, including defects, equivalent to reflector with the diameter range of 3.2 - 4.0 mm, no more, than 1 piece in number. The distance between the recorded defects shouldn't be less, than 25 mm.

- 3.8.1 Under agreement between the sides, depending on defects location in produced component, the supply of plates with defects, exceeded standards, specified in point 3.8, is allowed.
- 3.9 The value of specific conductivity of the plates from V95ochT2 and V95pchT2 alloys, defining the level of corrosion resistance on quenched and artificial aged specimens, should be not less, than 20,7 MSm/m, at more lower values of the specific conductivity the additional aging of plates is allowed or the direct cracking corrosion tests should be conducted on ring specimens with orientation SL at stress = $0.75 \cdot 0.2\% \text{ YS}$ during 20 days. If the plates withstood the direct cracking corrosion tests, it is allowed to get them with lower electrical conductivity. After additional aging the plates are only subjected to tensile and conductivity tests.
- 3.10 Fracture toughness K_{cY} for specimen in longitudinal direction must be not less than:
- If specimen's width equal 200 mm:
 - for V95ochT2, V95pchT2 - $78 \text{ Mpa}\cdot\text{m}^{1/2}$ ($250 \text{ kgs}/\text{mm}^{3/2}$)
 - for 1163, T7 - $78 \text{ Mpa}\cdot\text{m}^{1/2}$ ($250 \text{ kgs}/\text{mm}^{3/2}$)
 - If specimen's width equal 750 mm:
 - for V95ochT2, V95pchT2 - $125 \text{ Mpa}\cdot\text{m}^{1/2}$ ($400 \text{ kgs}/\text{mm}^{3/2}$)
 - for 1163, T7 = $155 \text{ Mpa}\cdot\text{m}^{1/2}$ ($470 \text{ kgs}/\text{mm}^{3/2}$)
- 3.11 Low cycles fatigue N_{LCF} , that is determined for typical flat longitudinal specimens with central hole (stress concentration factor $K_t = 2.6$) at pulse cycle with $f=3 \text{ Hz}$, $\sigma_{\max}=155 \text{ Mpa}$ ($16 \text{ kgs}/\text{mm}^2$), must be not less than:
- for 1163T, T7 - 200 000 cycles;
 - for V95ochT2, V95pchT2 - 140 000 cycles.
- 3.12 All the rest of standard must satisfy OST1 90124-74.

4.0 The rules of acceptance.

- 4.1 The plates are subjected to acceptance inspection piece-by-piece.
- 4.2 Every plate is subjected to inspection of surface quality, dimensions, and nonflatness.
- 4.3 Every melting is subjected to inspection of chemical composition including hydrogen content.
- 4.4. Tensile tests are carried out on each plate using specimens cut from middle layers in two directions from both ends of plate and from the middle part across width:
- on two samples in longitudinal direction;
 - one sample in long transverse direction.
- 4.5 Each plate is subjected to ultrasonic inspection for controlling compliance with requirements of acting standards (TU). The defects taking place in 50 mm zone across the plate edge are left out of account.
- 4.6 Corrosion cracking evaluation by electroconductivity is carried out in plane TL of billets intended for mechanical tests.

- 4.7 Specimens of K_C^Y test shall be cut from the middle layers of one plate end (from the bottom part of an ingot) in longitudinal direction. K_C^Y test shall be carried out on 15x200x650 and 15x500x1200 mm specimens (2 pcs of each dimensions) and on 15x750x2250 mm specimen (1 pc) taken from each 20th plate.
- 4.8 The overheating inspection is carried out for each plate.
- 4.9 All the rest of the requirements for acceptance rules must meet OST1 90124-74.
- 4.10 Each plate must be supplied with a traveling passport. Covering passport form is attached to this TU.

5.0 Test Methods

- 5.1 Tensile tests are carried out by GOST 1497-84. On determining yield strength by a graphic method diagrams scale in deformation axis must be not less than 50:1, it is assumed to determine the yield strength by the diagrams with scale 10:1.
- 5.2 Hydrogen content is defined on solid sample by GOST 21132.1-81. It is assumed to determine hydrogen content at the manufacturer by the first bubble method GOST 21132.0-81.
- 5.3 The evaluation of corrosion resistance by electroconductivity is performed according to MK 251–35-83.
- 5.4 Ultrasonic inspection of the plates is carried out by hand according to MK 52-40-81 or automated method according to MK 129-40-79.
- 5.5 The fracture toughness evaluation is carried out in accordance with OST-I 90356-84.
- 5.6 The low cycles fatigue evaluation is carried out according to method agreed by TsAGI, VIAM and VILS.
- 5.7 The inspection of plate overheating is carried out by a metallographical method MK 266-31-38.
- 5.8 All the rest of the requirements for test methods must meet the requirements OST1 90124-74 and GOST 17232-79.

6.0 Identification, packing and transportation.

- 6.1 Every accepted plate must have the following identification: alloy mark, heat treatment type, plate number, designation in letters, corresponding to head and bottom parts of the plate “JI”-head part of ingot for rolling of the plate, “II”-bottom part of ingot for rolling of the plate, stamp of the control department.
- 6.2 The requirements on the plates preservation, packing and transportation are in accordance with the GOST 9.011-79.
- 6.3 All other requirements on the plates identification, packing and transportation are in accordance with the GOST 17232-79.

References

1. GOST 1497-84 "Metal. Tensile test method."
2. GOST 17 232-79 "Plates from aluminum and aluminum alloys."
3. GOST 21132.0-81 "Aluminum alloys. Hydrogen content determination methods."
4. GOST 21132.1-81 "Aluminum alloys. Hydrogen content determination methods."
5. OST1 90026-80 "Aluminum improved purity wrought alloys. Marks."
6. OST1 90048-77 "Aluminum wrought alloys. Marks."
7. OST1 90124-74 "Aviation plates from the aluminum alloys."
8. OST1 90356-84 "Metals. Static crack resistance fracture toughness determination method for the lining materials in the plane stressed state."
9. TY 1-92-81-87 "Long-length aviation plates from the 1163 and V95 purity aluminum alloys."
10. MK 52-40-81 "Ultrasonic test of the large-scale forgings, die forgings, plates, extruded shapes from the aluminum alloys and parts manufactured from them."
11. MK 251-35-83 "Aluminum alloys semiproducts corrosion resistance evaluation by means of measuring the electrical conductivity using the eddy currents."
12. MK 266-31-83 "Metallographical method for determination of the overheating in the aluminum wrought alloys semiproducts."
13. MK 129-40-79 "Ultrasonic testing rolled plates, flat ingots and extruded shapes."

STARMET

Metallurgical Excellence

Specification for Beralcast[®] Investment Castings

1.0 SCOPE

- 1.1 This specification defines material requirements for Beralcast[®] 363 and Beralcast[®] 191 investment cast products produced from a wax pattern.
- 1.2 Cast products produced from rapid prototype manufacture methods shall be supplied in accordance with this procedure except that they will be subject to the grade requirements specified in paragraphs 3.2.3, radiographic acceptance and 3.2.5, penetrant acceptance.
- 1.3 Safety: While beryllium and beryllium alloys are hazardous materials and required special precautions and procedures in their manufacture and use, this specification does not address the specific hazards which may be involved in the production and use of beryllium containing materials. It is the sole responsibility of the user to ensure familiarity with the safe use and proper precautions involved with these materials and to take the necessary measures to ensure the health and safety of all personnel involved according to any federal, state, and local regulations that may be applicable.

2.0 APPLICABLE DOCUMENTS

- 2.1 The following documents form part of this specification to the extent specified herein. The applicable issue of these documents shall be the issue in effect on the date of the purchase order.
- 2.2 Government
 - 2.2.1 MIL-STD-453, Inspection, Radiographic
 - 2.2.2 MIL-STD-6866, Inspection, Liquid Penetrant
 - 2.2.3 MIL-STD-129, Marking for Shipment and Storage
 - 2.2.4 MIL-STD-2175, Castings, Classification and Inspection of
- 2.3 American Society for testing and materials (ASTM)
 - 2.3.1 ASTM E8, Standard Test Methods of Tension Testing of metallic Materials
 - 2.3.2 ASTM E155, Standard Reference Radiographs for inspection of Aluminum and Magnesium Castings
 - 2.3.3 ASTM E29, Standard Practice for Using Significant Digits in Test Data to Determine Conformance with Specifications

2.4 International Organization for Standardization

2.4.1 ISO 10012, Quality Assurance Requirements for Measuring Equipment

2.5 Starmet Corporation

2.5.1 IP-1214, Reference Radiographs for Beralcast™ Castings

2.5.2 IP-1644, The Determination of the chemical Composition of Beryllium-Aluminum Alloys

2.5.3 IP-2200, Nondestructive Testing personnel Qualification and Certification

2.5.4 IP-3000, Liquid Penetrant Testing

2.5.5 IP-3001, Radiographic Testing

2.5.6 NMI-PR-BER-10, Weld Repair of Beralcast™ Castings

2.6 Definitions

2.6.1 Casting: The metal from a single ceramic mold, which may include multiple parts.

2.6.2 Melt: A single batch of molten metal on which all processing has been completed.

2.6.3 Lot: All castings poured from a single melt.

3.0 TECHNICAL REQUIREMENTS

3.1 Material Requirements

3.1.1 Beralcast™ material shall conform to the percentages by weight shown in Table 1.

TABLE 1
Composition by Weight Percent

Element	363 Alloy		191 Alloy	
	Min.	Max.	Min.	Max.
Beryllium	61.1	68.6	61.1	68.6
Aluminum	Bal.	Bal.	27.5	34.5
Silicon	N/A	1000 ppm	1.65	2.5
Silver	2.65	3.35	1.65	2.35
Cobalt	0.65	1.35	N/A	N/A
Germanium	0.55	0.95	N/A	N/A
Iron	N/A	2000 ppm	N/A	2000 ppm
Other (Total)	N/A	3000 ppm	N/A	2500 ppm

 **STARMET**

3.1.2 Beralcast" material shall conform to the mechanical properties shown in Table 2.

TABLE 2
Minimum Ambient Temperature Mechanical Properties of Beralcast" Alloys

	Alloy and Condition				
	363				191
Property	Grade A	Grade B	Grade C	Grade D	Heat Treated
Ultimate tensile Strength (ksi)	35.0	35.0	31.0	30.0	28.5
0.2% Offset Yield Strength (ksi)	28.0	27.0	26.0	26.0	20.0
% Elongation	2.5	2.0	0.8	0.5	1.5

Unless otherwise specified, 363 alloy castings shall be delivered in the "As Cast" condition.

- 3.1.3 Mechanical properties shall be determined by testing in accordance with ASTM E8.
- 3.1.4 Tensile test specimens shall be cast from the same melt as the castings they represent.
- 3.1.5 In the event that post-casting conditioning of the castings is performed (e.g. HIP or heat treatment) the mechanical test specimens shall be conditioned with the castings.

3.2 Casting Requirements

- 3.2.1 Castings, as received by purchaser, as a minimum, shall meet the requirements of this specification.
- 3.2.2 Radiographic inspection shall be performed in accordance with IP-3001, Radiographic testing.
- 3.2.3 The radiographic acceptance standard for areas not otherwise specified shall be Grade C as defined by IP-1214 Reference Radiographs for Beralcast" Castings.
- 3.2.4 Castings shall be subject to fluorescent penetrant inspection in accordance with IP-3000, Liquid Penetrant Testing unless otherwise specified. Liquid Penetrant Testing shall be Type 1, Method A, at a sensitivity level of 1, unless otherwise specified.
- 3.2.5 The penetrant acceptance standard shall be MIL-STD-2175, Grade C, unless otherwise specified.
- 3.2.6 Castings may be repaired by welding in accordance with NMI-PR-BER-10, when not restricted by the customer.

4.0 QUALITY ASSURANCE PROVISIONS

- 4.1 Starmet Corporation shall be responsible for coordinating all acceptance testing unless otherwise specified.
- 4.2 Acceptance Tests: Tests for composition, tensile properties, radiography, and liquid penetrant shall be performed in accordance with Table 3 on each casting, melt, or lot as applicable per paragraph 4.3.

STARMET

Table 3
Test Specifications

Test	Specification(s)
Tensile	ASTM E8
Radiography	IP-3001, IP-1214 (ASTM E155, MIL-STD-453, MIL-STD-2175)
Fluorescent Penetrant	IP-3000 (MIL-STD-6866, MIL-STD-2175)
Chemical Composition	IP-1644

^{2&3} Government specifications contained within parentheses are referenced within the governing specification.

4.3 Sampling shall be in accordance with the following as a minimum.

4.3.1 One chemical analysis specimen in accordance with paragraph 3.1.1 from each melt

4.3.2 One tensile test shall be performed in accordance with 3.1.2 on each lot.

4.3.3 Radiography and fluorescent penetrant testing shall be in accordance with paragraph 3.2.

4.4 Reports: A certificate of conformance shall be supplied to document acceptance of each casting by serial number. These reports shall include the purchase order number, lot number, specification number, part number, and quantity.

5.0 PREPARATION FOR DELIVERY

5.1 Part Identification shall be in accordance with MIL-STD-129.

5.1.1 All parts from a casting shall be identified with a part number and a serial number.

5.1.2 All parts from a casting accepted by radiographic inspection shall be marked in accordance with MIL-STD-453, inspection, Radiographic.

5.1.3 All parts from a casting accepted by penetrant inspection shall be marked in accordance with MIL-STD-6866, Inspection, Liquid Penetrant.

5.2 Packaging: Castings shall be prepared for shipment in accordance with commercial practice and in compliance with applicable rules and regulations pertaining to the handling, packaging, and transportation of the casting to ensure carrier acceptance and safe delivery.

STARMET

APPENDIX D

D.0 ADDITIONAL INFORMATION

D.1 COMPARISON OF ASTM E8-95A AND RUSSIAN GOST 1497-84 STANDARD

COMPARISON OF US ASTM E8-95a AND RUSSIAN GOST 1497-84 STANDARDS

Compared parameters		ASTM E8-95a	GOST 1497-84	Degree of distinction						
Scope		All main types of semiproducts	All main types of semiproducts except pipes and wire	Insignificant						
Types and sizes of specimens	Cylindrical	Standard specimen: Diameter $d_o = 0.5$ in. (12.7 mm) Calculated length = $4 d_o$ Specimens of smaller diameter, proportional to standard one: $d_o = 0.35; 0.25; 0.16; 0.113$ in. (8.89; 6.35; 4.06; 2.87 mm)	Specimen diameter: $d_o = 25; 20; 15; 10; 8; 6; 5; 4; 3$ mm $l_o = 5d_o; 10d_o$. In the case of cast and brittle specimens it is allowed the usage of specimens with $l_o = 2.83 \sqrt{F_o}$	1 Distinction in l_o has no effect on YS and UTS properties. 2 For $l_o = 4 d_o$ and $l_o = 5 d_o$, distinction between elongation values is insignificant 3 For $l_o = 10 d_o$, elongation values can be lower than those for $l_o = 4 d_o$ and $l_o = 5 d_o$.						
	Flat	<table border="1" style="margin-left: auto; margin-right: auto;"> <thead> <tr> <th>Width, in. (mm)</th> <th>l_o in. (mm)</th> </tr> </thead> <tbody> <tr> <td>$1\frac{1}{2}^{+1}_{-1}$ (38,1^{3,17;-6,35})</td> <td>8.0(203.2)</td> </tr> <tr> <td>$\frac{1}{2}$(12,7)</td> <td>2.0(50.8)</td> </tr> <tr> <td>$\frac{1}{4}$(6,35)</td> <td>1.0(25.4)</td> </tr> </tbody> </table>	Width, in. (mm)		l_o in. (mm)	$1\frac{1}{2}^{+1}_{-1}$ (38,1 ^{3,17;-6,35})	8.0(203.2)	$\frac{1}{2}$ (12,7)	2.0(50.8)	$\frac{1}{4}$ (6,35)
Width, in. (mm)	l_o in. (mm)									
$1\frac{1}{2}^{+1}_{-1}$ (38,1 ^{3,17;-6,35})	8.0(203.2)									
$\frac{1}{2}$ (12,7)	2.0(50.8)									
$\frac{1}{4}$ (6,35)	1.0(25.4)									
Accuracy of measurement of geometrical sizes		Measurements are conducted in the centre of the working part of the length. The error is not more than (0.1÷0.5) % and up to 1 % of measurements in the case of sizes above 0.5 mm and below 0.5 mm respectively.	Measurements are conducted in three cross-sections within the working part of a specimen. When F_o is calculated, the lowest value is adopted. The error is not more than ± 0.5 % of measurement.	Insignificant						

Compared parameters	ASTM E8-95a	GOST 1497-84	Degree of distinction
Thinning of the working part of a specimen in diameter and width from the ends to the middle	It is recommended up to 1 % to ensure specimen failure within the calculated length	–	Insignificant
Specimen surface condition (roughness)	–	$R_o < 1.25 \mu\text{m}$ for cylindrical specimens $R_z < 20 \mu\text{m}$ for side surfaces of the working part of flat specimens	Insignificant
Techniques used to secure specimens on a testing machine	Various types of clamps are used to avoid slipping, crushing or deformation of specimen heads and eccentricity in application of load	Similar to ASTM E8-95a	No distinction
Rate of stress application and strain	When performing a test to determine yield properties, rate of stress application is 10000÷100000 Psi/min (1.15÷11.5 N/mm ² sec) When determining the tensile strength, the speed of the testing machine may be increased to correspond to a strain rate between 0.05-0.5 in/in/min	When performing a test to determine yield properties, for metals showing Young's modulus $E \leq 1.5 \cdot 10^5$ N/mm ² , the rate of stress application is 1÷10 N/mm ² sec For metals showing $E > 1.5 \cdot 10^5$ N/mm ² , the rate of stress application is 3÷30 N/mm ² sec When determining the tensile strength, the rate of strain may be increased but not more than 0.5 l_o mm/min	Insignificant
Technique used for control of strain during plotting of diagrams	With the usage of the extensometer	1 With the usage of the extensometer in the case of certification 2 In terms of the movement of the crosshead of the testing machine	Insignificant

Compared parameters	ASTM E8-95a	GOST 1497-84	Degree of distinction
Accuracy of load measurement	$\pm 1 \%$	$\pm 1 \%$	No distinction
Accuracy of strain measurement during 0.2 % YS determination	$\pm 1 \%$ (ASTM E83-94)	Not more than 0.05 % of the initial calculated length against the extensometer	Insignificant
UTS determination	$UTS = \frac{P_{max}}{F_0}$	$UTS = \frac{P_{max}}{F_0}$	No distinction
0.2 % YS determination	$0.2 \% YS = \frac{P_{0.2}}{F_0}$ Measurement of strain in the case of $P_{0.2}$ determination is carried out with the help of the extensometer or with some other device located on the working part of a specimen.	$0.2 \% YS = \frac{P_{0.2}}{F_0}$ Measurement of strain in the case of $P_{0.2}$ determination is carried out with the help of the extensometer or with some other device which controls the movement of the crosshead of the testing machine	Insignificant
EI determination	$EI = \frac{l_k - l_0}{l_0} \cdot 100\%$ For $EI > 3 \%$, the error of measurement of l_k is not more than 0.01 in. (0.25 mm) if the calculated length is more than 2 in. (50.8 mm) and 0.5 % of the calculated length if the calculated length exceeds 2 in. (50.8 mm). For $EI \leq 3 \%$, the error of measurement of l_k is not more than 0.002 in. (0.005 mm). It is not admissible to determine EI if a specimen fails out of the limits of the two middle quarters of the calculated length l_0 .	$EI = \frac{l_k - l_0}{l_0} \cdot 100\%$ It is not admissible to determine EI if a specimen fails out of the limits of the calculated length l_0 .	Insignificant

Compared parameters	ASTM E8-95a	GOST 1497-84	Degree of distinction															
RA determination	<p>Determination is carried out for cylindrical and flat specimens.</p> $RA = \frac{(F_s - F_k) \cdot 100}{F_s}$ $F_k = \frac{\pi d_1 d_2}{4}$ <p>d_1 and d_2 are the largest and the least diameters in the failed cross-section respectively</p>	<p>Determination is carried out for cylindrical specimens only</p> $RA = \frac{(F_s - F_k) \cdot 100}{F_s}$ $F_k = \frac{\pi(d_1 + d_2)^2}{4}$	Insignificant															
Rejection of test results	<p>Reasons of rejection:</p> <ol style="list-style-type: none"> 1 Specimen surface is machined badly. Specimen size falls off from the desired size. 2 Specimen properties changed because of machining. 3 Incorrect test technique. 4 Specimen failed out of the limits of the calculated length. 5 When determining elongation, failure occurred out of the limits of the two middle quarters of the calculated length. 6 Malfunction of the testing equipment. 	<p>Reasons of rejection:</p> <ol style="list-style-type: none"> 1 A specimen failed along marks limiting the calculated length of this specimen and one of the characteristics did not meet requirements specified by standard documentation on metal products. 2 A specimen failed within areas covered with the clamps of the testing machine or out of the limits of the calculated length. 3 A specimen failed across defects occurred during metallurgical production. 	Insignificant															
Reproducibility of tests	<p>Coefficient of variation (cv), %:</p> <p>a) in-laboratory and b) inter-laboratory</p> <table border="1"> <thead> <tr> <th>cv</th> <th>UTS</th> <th>0.2%YS</th> <th>EI</th> <th>RA</th> </tr> </thead> <tbody> <tr> <td>a</td> <td>0.9</td> <td>1.4</td> <td>2.8</td> <td>2.8</td> </tr> <tr> <td>b</td> <td>1.3</td> <td>2.3</td> <td>5.4</td> <td>4.6</td> </tr> </tbody> </table>	cv	UTS	0.2%YS	EI	RA	a	0.9	1.4	2.8	2.8	b	1.3	2.3	5.4	4.6	-	-
cv	UTS	0.2%YS	EI	RA														
a	0.9	1.4	2.8	2.8														
b	1.3	2.3	5.4	4.6														

**COMPARISON OF THE RESULTS OF TENSILE TESTS CARRIED OUT ACCORDING TO RUSSIAN GOST 1497-84
AND US ASTM E8-95A STANDARDS**

**Material: titanium alloy Grade 2 (Unalloyed titanium)
Semiproduct: bars, d = 16 mm and d = 20 mm**

Bar diameter, mm	Standard	Number of specimens, pc.	Specimen size, mm	Strain rate, mm/min	Mechanical properties, mean values			
					0.2 % YS, KSi	UTS, KSi	El, %	RA, %
16	GOST 1497-84	4	d _o = 5.0 mm l _o = 5d _o	V ₁ = V ₂ = 1.5	46,9	54,3	57.2	76.9
	ASTM-95a	4	d _o = 6.35 mm l _o = 4d _o	V ₁ = 0.22* V ₂ = 1.5	45,0	54,3	54.2	76.0
20	GOST 1497-84	4	d _o = 5.0 mm l _o = 5d _o	V ₁ = V ₂ = 1.5	43,7	55,7	43.2	73.6
	ASTM-95a	4	d _o = 12.7 mm l _o = 4d _o	V ₁ = 0.35* V ₂ = 2.35	38,6	55,7	43.0	67.1

* According to ASTM Designation B 348-83 "Standard Specification for Titanium and Titanium Alloy Bars and Billets".

D.2 PRESENTATION OF RUSSIAN OST 1 90148-74 STANDARD SHEAR TEST

••	Heading of the standard	Content of the heading
1	2	3
1	Scope	Determining shear strength of wire and bar, bolts and rivets from ferrous and non-ferrous metals over 2 through 25 mm at a temperature of $20\pm 5^{\circ}\text{C}$.
2	Properties to be determined	Shear strength when testing : - double shear $F_{su} = 2P/\pi d^2$ (1) - single shear $F_{su} = 4P/\pi d^2$ (2), where P - maximum load, d - initial diameter.
3	Requirements for specimens	Wire, bars, bolts, rivets are to be tested without surface conditioning.
4	Requirements for apparatus and equipment	<ol style="list-style-type: none"> 1. Shear test is to be performed using machines designed for tensile and reduction tests. 2. Double shear tests are carried out on devices applying both tensile stress and compressive force. 3. Single shear tests are carried out on devices applying tensile stress.
5	Testing conditions	<ol style="list-style-type: none"> 1. The setting to zero of the dynamometer of the testing machine is accomplished with devices fitted into it for shear testing. 2. The displacement rate of the knife relative to the device cheek-pieces when shear testing should not exceed 10 mm/min maximum.

This page intentionally blank.