

NASA SP-8092

**NASA
SPACE VEHICLE
DESIGN CRITERIA
(ENVIRONMENT)**

*Approved for Release
by NSA on 08-21-2013
 pursuant to E.O. 13526*

**ASSESSMENT AND CONTROL
OF SPACECRAFT
ELECTROMAGNETIC INTERFERENCE**



JUNE 1972

NATIONAL AERONAUTICS AND SPACE ADMINISTRATION

FOREWORD

NASA experience has indicated a need for uniform design criteria for space vehicles. Accordingly, criteria are being developed in the following areas of technology:

Environment

Structures

Guidance and Control

Chemical Propulsion

Individual components are issued as separate monographs as soon as they are completed. A list of monographs published in this series can be found on the last page.

These monographs are to be regarded as guides to design and not as NASA requirements except as may be specified in formal project specifications. It is expected, however, that the monographs will be used to develop requirements for specific projects and be cited as the applicable documents in mission studies, or in contracts for the design and development of space vehicle systems.

This monograph was prepared under the cognizance of the NASA Goddard Space Flight Center (GSFC) by Robert Lyle, Pericles Stabekis, and Robert Stroud of Exotech Systems, Inc., Washington, D.C. Scott Mills and John Sweeney of GSFC were program coordinators. Grobowski & Associates did preliminary work on some sections.

David S. Hepler of GSFC served as chairman of the Advisory Panel which provided guidance as to the monograph's scope and technical content. The following individuals served as panel members:

Joseph G. Bastow	Jet Propulsion Laboratory
Earl H. Dilley	GSFC
Gary D. Harris	GSFC
George D. Hogan	GSFC
Joseph McKenzie	NASA Manned Spacecraft Center
Charles N. Smith	GSFC
Ralph E. Taylor	GSFC
Philip Yaffee	GSFC

Comments concerning the technical content of these monographs will be welcomed by the National Aeronautics and Space Administration, Goddard Space Flight Center, Systems Reliability Directorate, Greenbelt, Maryland 20771.

June 1972

CONTENTS

1.	INTRODUCTION	1
2.	STATE OF THE ART	1
2.1	Flight Experience	1
2.2	Sources of EMI	4
2.2.1	Functional Sources	4
2.2.2	Incidental Sources	6
2.3	Transmission of Electromagnetic Interference	6
2.3.1	Conducted Interference	7
2.3.2	Radiated Interference	7
2.4	Susceptible Equipment	9
2.5	Factors in Electromagnetic Environment	9
2.6	Design Procedure	10
2.7	Electromagnetic Interference Control Techniques	11
2.8	Testing	12
2.8.1	Setups	12
2.8.2	Types of Tests	12
2.8.3	Measurement of Radiated Interference	12
2.8.4	Measurement of Conducted Interference	13
3.	CRITERIA	14
3.1	Management Procedures for EMI Control	14
3.2	Assessment of EMI	15
3.2.1	Sources of Electromagnetic Interference (EMI)	15
3.2.2	Susceptible Equipment	16
3.3	Design Procedures	16
3.4	Testing	17
4.	RECOMMENDED PRACTICES	18
4.1	Interference Control Program	18

4.2	Assessment of Spacecraft Requirements for Electromagnetic Compatibility (EMC)	18
4.2.1	Initial System Design	19
4.2.2	Selection of Equipment	19
4.2.3	System Integration	19
4.2.4	System Compatibility	20
4.3	Interference Control Analysis	20
4.4	Interference Control Techniques	21
4.4.1	Shielding	21
4.4.2	Grounding	21
4.4.3	Bonding	23
4.4.4	Filtering	23
4.4.5	Wire Treatment and Routing	23
4.5	Control of EMI Sources	24
4.6	Protection of Susceptible Equipment	24
4.6.1	Relays	25
4.6.2	Conductors	25
4.6.3	Tubes	26
4.6.4	Connectors	26
4.6.5	Semi-Conductor and Integrated Circuit Devices	26
4.7	Testing	26
	REFERENCES	27
	NASA SPACE VEHICLE DESIGN CRITERIA MONOGRAPHS	29

ASSESSMENT AND CONTROL OF SPACECRAFT ELECTROMAGNETIC INTERFERENCE

1. INTRODUCTION

Electromagnetic interference (EMI) is any electromagnetic signal or disturbance, natural or man-made, that can degrade or inhibit the operation of electrical devices aboard space vehicles. Some of the more important operations that are subject to disturbance are guidance, sequence stage firing, command communications, tracking, experiment data collection, and telemetering. The frequency span of greatest concern ranges from 30 Hz to 10 GHz but may extend to higher frequencies in special cases.

Electromagnetic interference may arise from an onboard source or from an external source such as radio frequency (RF) transmission from Earth (ref. 1). This design criteria monograph provides guidance for assessing the EMI possibilities from onboard sources and establishing requisite control in spacecraft design, development, and testing. A related monograph (NASA SP-8037) gives guidance for assessment and control of spacecraft magnetic fields.

2. STATE OF THE ART

Electromagnetic interference problems, widely encountered in aerospace programs from the beginning, have become increasingly serious because of (1) the increased number of electronic devices that are required to operate within constrained spatial and spectral environments, (2) the high power levels of energy sources, and (3) the increased sensitivity of equipment. Numerous approaches for controlling EMI have been developed including design and test specifications for onboard electronic equipment, testing techniques, design concepts, and project management procedures.

2.1 FLIGHT EXPERIENCE

It is a matter of record that a large number of flight delays and failures have resulted from EMI. The launch of the Beacon Explorer 3 spacecraft was delayed when interference was belatedly discovered after the spacecraft had been attached to the launch vehicle, and it is believed that both channels on the Ranger 6 TV camera were burned out through an unscheduled triggering of the equipment 67 seconds after launch (ref. 2).

On several spacecraft it has been necessary to resort to sequential operation of the experiments because of interference between them. Until 1968 that was the case for all of the OGO spacecraft in which each experiment was given its own on/off power command.

Weight restraints prevented installation of such switching devices on Ariel 3. Consequently, measurements taken on the concentration of molecular oxygen became confused with data collected on the absolute values of cosmic noise; the value of both experiments was greatly reduced (ref. 3).

Lack of adequate grounding on Mariner 2 and the resultant shorting of one of the solar panels contributed to a very large change in the magnetic field of that spacecraft. The change was on the order of 100 gamma, several hundred times the sensitivity limit of the magnetometer sensor. Fortunately, the sensor was built with two ranges and measurements were obtained with the upper range. The sensitivity of the instrument was reduced greatly, however. The large field change, never completely explained, may have resulted from location of the magnetometer sensor and an omnidirectional antenna on the same support. The support was carrying currents, and the lack of adequate grounding forced the spacecraft structure to carry part of the return. When one of the panels shorted, the change in paths of the currents flowing near the magnetometer sensor may have caused the large field change (ref. 3).

Special precautionary steps must be taken when new electronic equipment is introduced into an existing spacecraft. For example, a VHF/UHF dual-channel receiver was added to the Mariner Venus 67 spacecraft to determine the electron density in space. The determination was to be made by the transmission of two modulated, coherent carriers from the ground at 49.8 and 423.3 MHz. From the relative phase of the received carriers and their sidebands the electron density could be inferred. When a compatibility check was made between the dual frequency receiver and an S-Band transponder, it was found that the S-Band transmitter frequency was entering the UHF channel of the dual receiver and causing generation of S-Band frequencies that would exit from the 423.3 MHz receiver and enter the S-Band receiver. These frequencies, in turn, would cause the phase lock loop to jam and be driven out of lock with the required signal (ref. 4). On the basis of the compatibility check, it was recommended that RF filters be installed at the input of each dual frequency receiver channel. This was particularly desirable because the dual frequency receiver did not have any preselector filters. It was further recommended that an antenna range perform coupling tests between each of the antennas on the spacecraft. From these tests, it was determined that the coupling between the S-Band transmitter antenna and the UHF antennas was only marginal and that installation of the filters would provide adequate isolation. The final filters selected were a lowpass filter for the UHF channel and a bandpass filter for the VHF channel.

The possible consequence of uncontrolled stray-wiring capacity was illustrated by residual voltage on the Mariner Mars 69 Pyro Control Unit (ref. 5). The Pyro Control Unit was powered by an ac power supply and activated with a single pole switch remote from both units, as illustrated in figure 1. Inside the Pyro Control Unit, power is rectified for charging capacitor banks that store the energy required to fire squibs. A residual 0.5 volt was detected on the capacitors even with the switch open. Although the investigation proved that the residual voltage was not a technical or safety problem (the normal firing voltage is 40 volts), there was initial concern because the origin and cause were unknown. The confirmed equivalent circuit and a graph of the capacitor voltage vs coupling capacitance are shown in figures 2 and 3, respectively. It can be seen that the problem would have been considerably worse if the distance to the switch had been greater.

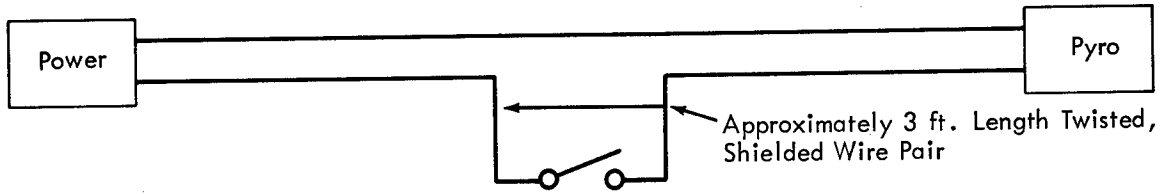

Figure 1. - Block diagram of pyro-power configuration.

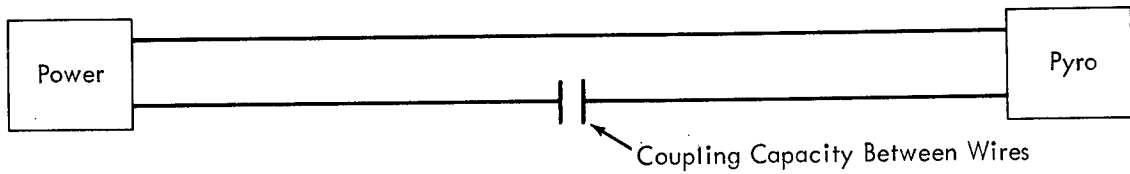

Figure 2. - Equivalent circuit of pyro-power configuration.

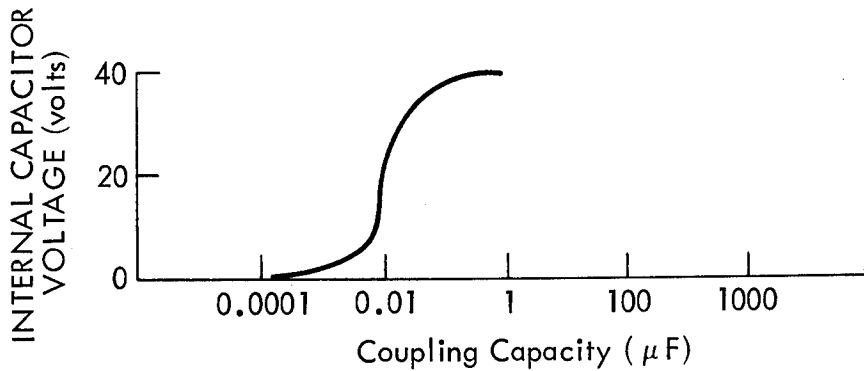

Figure 3. - Coupling capacity vs capacitor firing bank voltage.

The foregoing example illustrates that stray parameters, such as the wiring coupling capacity that may appear insignificant at first, can have a large influence on parameters that are significant - in this case, the capacitor bank voltage. The solution was to route both wires into the Pyro Unit together and switch them both (ref. 5).

2.2 SOURCES OF EMI

Electromagnetic interference in spacecraft has been traced to two sources: RF transmission from Earth, aircraft, or other spacecraft; and electromagnetic energy from companion components or systems on the spacecraft. Most EMI problems for the spacecraft in its flight arise from onboard sources rather than from distant transmission; the internal sources are the main concern of this monograph, so will be treated in some detail.

The onboard components or systems generating the interference may be functional or incidental. Functional sources are those designed for the specific purpose of generating electromagnetic energy, such as oscillators, multipliers, mixers, beacons, and transmitters. Incidental sources are those not designed to generate electromagnetic energy, such as power converters, motors, switches, relays, solenoids, and parasitic oscillators. Unlike functional sources, onboard incidental sources can often be circumvented or suppressed without impairing system or subsystem functions.

EMI may be narrowband or broadband in nature. Narrowband interference consists of interference signals that are present at only one frequency or over a narrow range of frequencies. It generally results from a functional source. In the case of communication or radar transmitters, the functional signal is normally accompanied by spurious output that may be harmonically related to the fundamental output. Broadband interference involves undesired signals that are present over a wide range of frequencies such as noise or impulses and are generally produced by incidental sources.

Whereas the average value of narrowband frequency signals is close to their amplitude, impulse type of broadband signals typically have much higher peak values than average values. Table I, supplied by A. Whittlesey of JPL, presents the effect of receiver bandwidth on signal to noise (S/N) ratio as a function of various signals.

2.2.1 Functional Sources

The simplest form of a functional signal is the single-frequency sine wave. However, even though equipment containing oscillators, multipliers, and amplifiers are designed to produce single-frequency sine waves, such equipment has instabilities and nonlinear circuits and elements.* As a result energy is present in a narrowband around the fundamental and at harmonic and spurious frequencies during operation. Stabilizing the operation of the equipment and reducing the effects of the nonlinearity can control the energy bandwidth and the harmonic or spurious output from these sine wave sources.

*Nonlinear circuits are those in which voltage and current are not directly proportional over the operating range. With nonlinear circuits, the theory of superposition does not apply. Consequently, frequencies are produced in the circuit other than those that have been externally impressed.

Table I

EFFECT OF RECEIVER BANDWIDTH ON S/N RATIO
AS A FUNCTION OF VARIOUS SIGNALS*

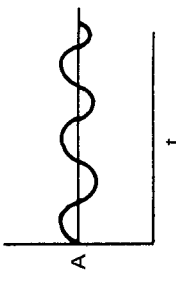
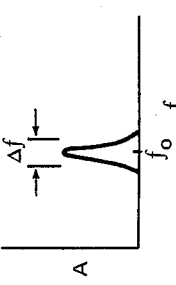
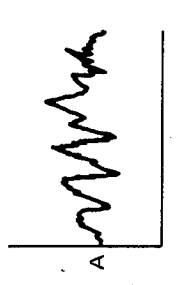
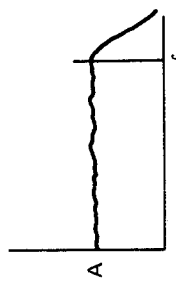
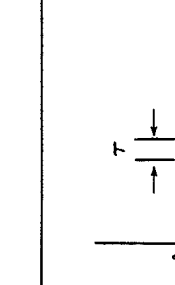
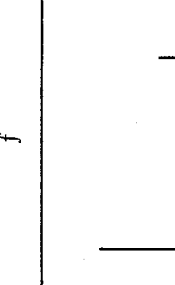
Signal	Time Description	Frequency Description	Detector Response to Receiver Internal Noise	Detector Response to Signal	Effect of Bandwidth on S/N Ratio	Notes
CW Continuous Wave (Narrowband)			Amplitude and phase are random; voltages add in an RMS manner. Noise Power \propto BW	Signal Power, once in Receiver BW, is no longer increased. Signal Power = K	$S/N \propto \frac{1}{BW}$	$BW > \Delta f$ f_0 in BW
Random (Broadband)			Noise Power \propto BW	Amplitude and phase are random Noise Power \propto BW	$S/N = K$	$f_0 + \frac{BW}{2} < f_c$ $f_0 - \frac{BW}{2} > 0$
Impulse (Usually Broadband)			Noise Power \propto BW	Phase is coherent; Signal Voltage \propto BW, Signal Power \propto BW ²	$S/N \propto BW$	$f_0 + \frac{BW}{2} < f_c$ $f_0 - \frac{BW}{2} > 0$ $f_c \approx \frac{1}{T}$

*Key to symbols: BW Bandwidth
 f_0 Mean (center) frequency
 f_c Critical frequency

T Impulse duration
 Δf Frequency band

In the case of more complex sources such as communication, telemetry, or radar transmitters, the generation of the functional signal is normally accompanied by the generation of undesired electromagnetic energy. For example, transmitters (particularly their traveling wave tubes) generate spurious outputs at frequencies other than the operating frequency. These spurious outputs are not needed for the operation of the equipment and, therefore, should be eliminated or their amplitude reduced as much as possible. The level of the broadband noise radiated by transmitters is generally low, but in some cases, it is high enough to cause desensitization or interference to nearby receivers. This noise is not easily recognizable because it does not produce a characteristic output from the receiver and it is almost identical in form to the characteristic receiver noise.

Another form of interference associated with functional sources is radiation of RF energy from the case of a transmitter or other high-frequency generator. This radiation can seriously affect the performance of colocated equipment. It is usually eliminated by grounding, bonding, shielding, and proper wire separation and treatment techniques.

2.2.2 Incidental Sources

The interfering energy from incidental sources occurs over a wide range of frequencies and is broadband. Broadband interference can be further classified as either random or impulsive.

2.2.2.1 Random Interference

Thermal agitation can produce interference having random amplitudes. Atmospheric interference, cosmic and solar noise, and corona also are considered random because the impulses are frequent and overlap with a number of sharp peaks exceeding the average level. Other types of interference that consist of impulses which follow each other rapidly and are not individually distinguishable also may be considered random.

2.2.2.2 Impulsive Interference

Impulse interference is made up of one or more sharp pulses that may be periodic or aperiodic. The characteristics of this type of interference are determined by the shape and repetition frequency of the pulses. Attitude control thrusters, torquers, turn-on transients, clock and digital pulses, and other pulse-type electrical disturbances are typical sources of impulse interference.

2.3 TRANSMISSION OF ELECTROMAGNETIC INTERFERENCE

Interference can be transmitted from a source to a susceptible component or system by conduction or radiation. Conducted interference involves introduction of electromagnetic energy through external connections. Radiated interference is electromagnetic energy that is introduced into equipment from external sources without external connections. A quantitative description of transmission by conduction requires circuit theory (ref. 2), and description of transmission by radiation requires field theory (ref. 6).

2.3.1 Conducted Interference

There are several modes by which circuit components can generate interference in other circuits or components. The most common is conduction via direct electrical connections such as cables. Frequently, it is necessary to transmit power and operational signals via cables, and it is possible to conduct interference with the desired signal, particularly in the case of long cables.

Magnetic flux linkage is probably the predominant mode of interference transfer other than direct conduction in high current circuits, whereas capacitive coupling is dominant in high voltage circuits. A magnetic field generated by steady alternating current or transiently changing current will produce an interfering voltage proportional to the rate of change of flux. Therefore, high frequency, high power currents, such as in radar equipment, and currents in multiturn coils are sources of interference. Likewise, devices that produce a high rate of change of current, such as switches, can generate strong pulses capable of producing interference.

The source of interference on a circuit could be a signal on another wire that is coupled to the circuit by capacitance, inductance, or a common impedance and results in crosstalk (ref. 5). Capacitive coupling depends on a rapid voltage change (dv/dt) that is coupled to an adjacent circuit through a coupling capacity (cc) as shown in figure 4. The magnitude of the coupled voltage V_2 depends on the dv/dt of circuit No. 1 and the relative values of cc , the load resistance, and the shunt capacity to ground. This situation often occurs because of adjacent wiring or circuitry. Interference in inductive coupling is also caused by a rapid waveform change. In this case, however, it is the change in current (di/dt) that causes the effect (fig. 5). The di/dt in the first circuit creates a proportionate voltage in circuit No. 2, as does a transformer; an increase of the common circuit area can also cause an increase in the coupled voltage (ref. 5). Inductive coupling is less of a problem in spacecraft circuits than capacitive coupling because of the small currents generally present.

Common impedance coupling occurs when several circuits share a common return with significant impedance. In such case, current in one circuit can create significant voltage differentials that will react unfavorably on another circuit. Also, the combined effect of several circuits operating together may cause interference with another circuit. For more detail on this effect, see NASA SP-3067 (Taylor, R. E., ed., "Radio Frequency Interference Handbook," 1971).

Noise voltages or currents may appear because of component defects. For example, high resistance may inadvertently occur at contacts, such as the operative contact of relays, pressure and soldered connections, and connectors. Also, insulation failures may occur causing accidental shorts and grounds. These defects do not necessarily cause direct failures or faulty operation of the related equipment, but they may degrade or destroy its operation by reason of noise or polarization inserted into the system by the defective component.

2.3.2 Radiated Interference

Radiated interference, e.g., from a dipole, can cause bias to appear across diodes, transistors, tube grids, and other nonlinear circuits. Nonlinear circuits susceptible to radiated interference can generate sum and difference frequencies between the interference and the signal frequencies in the circuit and can also generate harmonic frequencies of the interfering signal.

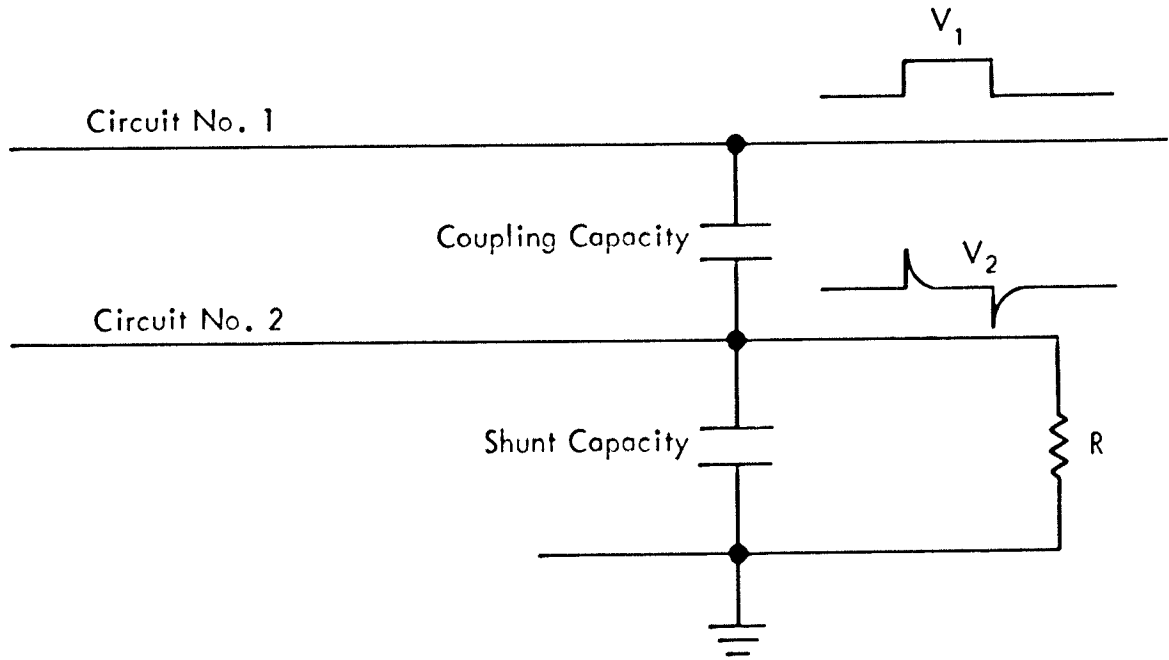

Figure 4. - Capacitive coupling.

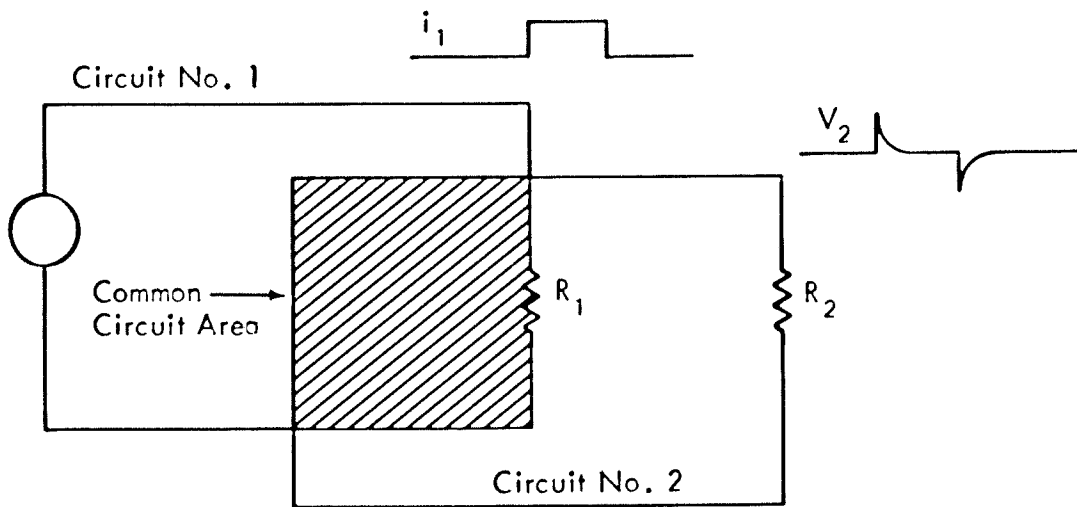

Figure 5. - Inductive coupling.

2.4 SUSCEPTIBLE EQUIPMENT

Scientific spacecraft have introduced a new dimension to achievement of electromagnetic compatibility because many of the scientific instruments are attempting to measure signals in the natural space environment that are masked by the spacecraft noise. Therefore, existing EMI specifications are not adequate to cope with ultra-sensitive, extremely-broadband signals. Special efforts are required to ensure that each experiment can accomplish its scientific mission.

Common mode interference is frequently encountered in instrumentation amplifiers because of high gains and sensitivity. This problem requires increased attention to bandwidth requirements and grounding configurations. Printed circuit board sometimes have excessive ground-path routing and insufficient conductor cross-section (ref. 7).

Because of low-humidity test environments, and other clean room requirements, static discharges on sensitive microcircuits have caused component breakdowns when adequate preventive measures have not been taken.

In many cases, circuits are designed with unnecessary sensitivity. For example, a switching circuit whose normal command is a pulse of 6 volts for 75 to 125 milliseconds duration was found to be triggered by 2 volt spikes with a duration of 4 to 5 microseconds. There is a tendency to overdesign for reliability of operation at the expense of increased susceptibility to interference.

2.5 BASIC FACTORS IN ELECTROMAGNETIC ENVIRONMENT

Each spacecraft has its peculiar electromagnetic environment which is determined by five interrelated factors:

- Spacecraft configuration
- Spacecraft stabilization
- Electronic and electrical systems
- Orbit and trajectory
- Scientific mission requirements

Spacecraft configuration, by affecting distances between components, systems, and the length and routing of wiring harnesses, influences the overall electromagnetic environment. The intensity of interference from magnetic flux linkage, capacitive coupling, and radiation increases with decreasing distance between the source and susceptible system. Therefore, if there is less physical separation between the sources and systems more stringent requirements on equipment are necessary. Further complications arise with weight restrictions that limit the extent and type of shielding and filtering devices that may be used.

The stabilization method chosen for the spacecraft is a factor in determining spacecraft configuration and thus, indirectly, EMI possibilities. Spacecraft stabilization predetermines the basic type and placement of receiving and transmitting antennas, which in turn influence the electromagnetic environment. The omnidirectional, low-gain antennas appropriate to spin-stabilized spacecraft, for example, require higher transmitter power or greater receiver sensitivity than directional antennas in order to perform as effectively (ref 8).

Each additional electrical or electronic system added to the spacecraft multiplies the problem of electromagnetic interference analysis and control because all systems (including power supplies) must be evaluated with respect to all other systems. This complicates consideration of frequency allocations, bandwidths, orientation of systems, sensitivity of antenna-terminated systems, sensor characteristics, and grounding systems.

The fourth factor, orbit and trajectory is concerned with signals that originate externally such as those from Earth and radiation belts. Over different geographical regions the spacecraft may be exposed to many signals that are unrelated to the mission, but which are close to frequencies used for the mission.* Consequently, such signals may be accepted by the spacecraft receiver because of its input bandwidth and sensitivity characteristics. This may occur even though Earth transmitters supporting the mission are providing the desired energy levels to the spacecraft at properly-allocated frequencies.

Scientific instruments impose special requirements such as very low frequencies, no discrete signals within the bandwidth of the instrument, and higher sensitivities.

2.6 DESIGN PROCEDURES

Three current state-of-the-art design approaches for control of EMI are summarized below.

The first design approach involves a thorough study of all EMI possibilities. Such study leads to development of EMI control and test requirements that are tailored to the particular spacecraft. However, it should be noted that despite such studies there has been a tendency to adhere to standardized EMI test specifications. Because standardized tests may be stricter in some areas than required for a particular spacecraft, this approach can lead to overdesign and consequent cost and weight penalties.

Another design approach relies almost entirely on compliance with EMI test specifications developed by NASA or the military (refs. 9 and 10). The military specifications, which are stringent, generally assure compliance with space system integration and mission requirements but have the disadvantage of being expensive and not designed to the specific needs of the individual spacecraft. Component substitution to effect miniaturization and weight-saving in filters and the shielding of compartments may compromise electromagnetic compatibility (EMC).

*Mann, H. J. and Blakely, S.W.: "Analysis of Unexpected Spacecraft Status Changes", NASA Goddard Space Flight Center, Aug. 1970 (working paper).

The third design approach is usually applied to spacecraft with new and sophisticated equipment. In such cases, the design of subsystems and experiments takes into account the particular RF and EMI situation with little reference to existing EMI specifications.

In recent years, attempts have been made to adapt computer analysis to electromagnetic compatibility problems. A survey of three computer-aided intrasystem EMC prediction programs is given in reference 11. One of these programs has been applied to the Pioneer program. This is apparently the first project for which this approach to EMC has been utilized over the full course of a design development and test cycle (ref. 12).

2.7 ELECTROMAGNETIC INTERFERENCE CONTROL TECHNIQUES

Electromagnetic interference analysis is used on the system level to evaluate the system compatibility and to reveal specific areas where interference problems are likely to arise. Once the analysis has revealed problem areas, there are several techniques available to control or reduce interference. These techniques, however, contain inherent disadvantages such as added cost and increased weight so compromise is usually necessary. The following techniques are among those available to establish compatibility.

Grounding consists of establishing an electrical conductive path between circuits to some reference point. The basic purpose is to maintain all parts of the system at the same potential so that unwanted excess electromagnetic energy will equalize throughout the system. To provide good grounding, the connections should not present any more opposition to the electric current than it encounters when it passes through the conductor up to the point of connection.

Electrical bonding is the process of mechanically connecting certain metal parts so that they will make a good low-resistance contact. Welding, soldering, and pressure connection are used according to the required quality of the bond.

Another effective way to reduce interference is through the use of shielding. Shielding is used to contain interference generated from a source or protect susceptible equipment by attenuating the interfering signal. However, certain discontinuities are necessary in the shield to permit input and output connections. The shield design must accommodate these discontinuities without substantially diminishing the overall shielding effectiveness.

Interference reduction filters provide another means for establishing compatibility. Filters are often used in conjunction with shielding to attenuate interference that may enter or leave through breaks in the shield for wiring.

Care in routing wires and cables can also assist in control of interference. Routing includes physical separation, cable placement, and sorting into bundles. In bundling, wires and cables are segregated into compatible groups which are shielded. Interference from inductive and capacitive coupling resulting from proximity of wire pairs within a bundle, can be significantly reduced by twisting of the transmitting or receiving pair. This has the effect of reducing the common circuit area between the two twisted circuits.

2.8 TESTING

The field of interference measurements, including both susceptibility and emanation, employs many of the same methods and equipment used for other radio frequency measurements. Peculiar to interference measurements, however, is the wide range of frequencies and signal levels that must be considered. Consequently, some of the equipment and techniques used to provide signal sources, receivers, and antennas, as well as to perform the measurements, have been specially devised for interference work.

2.8.1 Setups

There is a wide variety of test setups corresponding to the wide variety of equipment that may require interference tests. In many instances, tests are performed in some form of shielded enclosure with the test specimen placed on a bench, if it is small enough, or in a rack or cabinet, if larger. When equipment is tested aboard spacecraft or in simulated conditions, the environment external to the immediate area of the test may cause interference.

Setup difficulties often arise when auxiliary units, which are not to be tested, are required to operate the unit under test, monitor its performance, or note susceptibility to interference. These auxiliary units include power supplies, signal generators, monitoring equipment and loads. It is necessary to ensure that the auxiliary units do not add to the EMI environment, and that they substantially duplicate the "in-flight" operation and configuration of the equipment under test.

2.8.2 Types of Tests

Most commonly performed tests are system compatibility tests to determine the ability of individual spacecraft subsystems to operate simultaneously without causing degradation of performance. In addition to the system compatibility testing, the following two subsystem tests have been included in certain programs: (1) subsystem interference tests to measure the magnitude of undesired interfering signals emanating from individual spacecraft or support equipments; and (2) subsystem susceptibility tests to determine whether individual spacecraft or support equipments will satisfactorily operate when subjected to undesired external signals.

In general, interference and susceptibility testing includes "radiated" and "conducted" measurements.

2.8.3 Measurement of Radiated Interference

Radiated interference measurements performed in testing are primarily near-field measurements (ref. 3). In the near field, the magnetic (H) and electric (E) components of the field are measured separately because they do not have the simple time, space, and amplitude relationship that they have in the far field. The H field is measured by a loop antenna, and the E field by a rod or dipole.

In the actual performance of radiated interference tests, the appropriate antenna is set up at a distance of one to three feet from the unit under test, and connected to a frequency selective voltmeter (FSVM). The frequency range of interest is scanned with readings taken where signals are noted. The FSVM is calibrated at each frequency as the gain varies with frequency because of characteristics of transmission lines, room dimensions, and the antenna factor (ref. 9).

Radiated susceptibility tests are performed in a similar manner. In this case the signal source is connected to the antenna, and a means is provided for monitoring the power or voltage supplied to the test antenna. Further descriptions are included in references 9 and 13.

2.8.4 Measurement of Conducted Interference

For conducted interference measurements in testing of power lines and signal lines, two different pickup devices are used; line impedance stabilization networks (LISN) and current probes. The LISN method has been used for a long time to measure interference, but now several specifications stipulate LISN in conjunction with the clamp-on current probe.

The LISN, whose schematic diagram is shown in figure 6, is a device which provides an artificial, but known, impedance in the power line and a convenient method of connecting the interference measurement equipment. Above 25 MHz the impedance of the network varies so unpredictably that it is unusable (ref. 9).

The current probe furnishes a current measurement. In general it requires no alteration of the cables to be tested unless individual leads must be separated for separate measurements. Although it normally will not affect the circuit to be measured, caution is required when the current probe is used on sensitive signal lines of low impedance because the series impedance of the probe may appreciably change the overall circuit impedance.

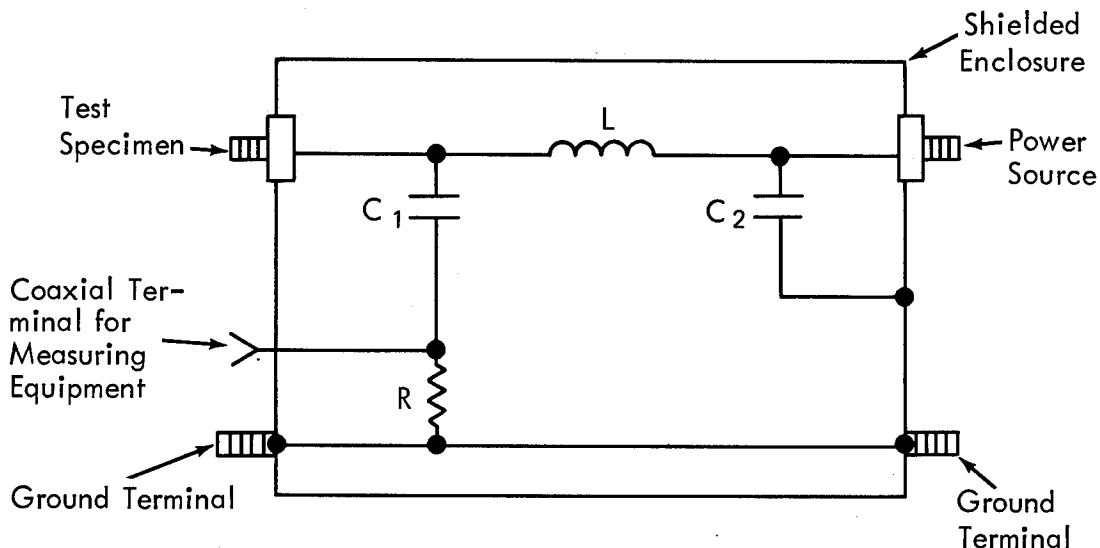

Figure 6. - Line impedance stabilization network.

An advantage of the current probe, besides its requiring no insertion into the circuit, is its wide frequency range (from 30 Hz to 1 GHz in several designs), which permits measurements well beyond the 25 MHz limit of the LISN.

The susceptibility tests for conducted interference may be divided into two areas, RF and audio. The RF test is the simpler of the two and uses the foregoing LISN as the coupling device from the signal source to the power line. Susceptibility limits are usually specified as a voltage or power level. From 5 to 25 MHz, the LISN is assumed to be a 50 ohm load. Below 5 MHz, the impedance decreases to as low as approximately 5 ohms at 150 KHz (ref. 2). Because all LISN's have this characteristic, meaningful and repeatable tests are possible in spite of the mismatch.

The audio test is a more complex but also a better-designed test. The test signal is coupled to the power line through a specially-designed current transformer. Enough signal current must be coupled into the line to cause a drop of several volts across the input of the test sample to the exact level given by the particular specification. To accomplish this, an audio amplifier of about 50 watts output is used to drive the current transformer. The signal voltage is monitored by an oscilloscope.

Reference 9 suggests a useful device to aid in monitoring the signal voltage on an ac line. It is a variable phase shifter so arranged in the test circuit as to null out the line frequency insofar as the monitoring device is concerned. This permits a direct measurement of the audio signal voltage on the face of the oscilloscope.

One principle followed by most electromagnetic interference specifications concerns the method of operating the unit under test, i.e., the unit shall be operated so as to produce the highest levels of interference or maximum susceptibility. This approach is valuable in situations in which the number of variables in the operation of a unit would require an unreasonably high number of interference or susceptibility tests. The identifiable effects of each variable are considered in the test planning stage and are selected to produce the maximum interference or susceptibility. Then, only those variables whose effects are uncertain must be examined experimentally during the interference and susceptibility tests.

Because of the extensive use of digital signals on spacecraft circuits, the measurement of transient interference has increased in test programs. In addition, transients are being injected into interface circuits to determine their susceptibility.

3. CRITERIA

Consideration of the electromagnetic interference arising from both functional and incidental sources is essential to satisfactory design of the spacecraft. A control program for electromagnetic interference should be instituted in the early design phases of a spacecraft program to suppress unwanted interference and ensure proper design of equipment or systems so that they will operate compatibly with the other electronic and electrical devices in the operating environment.

3.1 MANAGEMENT PROCEDURES FOR EMI CONTROL

The key element of an effective EMI control program is recognition by management and design engineers of the importance of electromagnetic compatibility (EMC) to mission success.

The cornerstone of the EMI program is an EMI Control Plan. This plan should provide explicit directions as to what should be done.

The table of contents of the control plan might contain the following sections:

1.0 Scope	4.1 Organization
2.0 Applicable Documents	4.2 Responsibilities
3.0 Requirements	4.3 Schedules
3.1 Preliminary Analysis of Design	4.4 EMI Control Program Reviews
3.2 Design Requirements	4.5 Quality Assurance Provisions
3.3 Documentation Requirements	5.0 Appendices
3.4 Test Requirements	5.1 Definitions
4.0 Management Plan	5.2 Design Guidelines

3.2 ASSESSMENT OF EMI

A review should be made of all the proposed sensitive equipment to be carried on the spacecraft and all the potential sources of electromagnetic interference expected to be included in the spacecraft design to identify EMI possibilities and associated conflicting requirements. The required level of interference control is determined by mission objectives and spacecraft operational requirements. Acceptable signal levels for functionally-and incidentally-generated electromagnetic energy should be established accordingly.

3.2.1 Sources of Electromagnetic Interference (EMI)

EMI generated by the spacecraft, Earth transmissions, and by natural sources should be considered. The functional and incidental sources of EMI on the spacecraft should be identified and their characteristics and transmission modes evaluated.

Functional sources arise from equipment designed to radiate electromagnetic energy. Major functional sources that should be considered are:

Oscillators	Signal generators
Radar transmitters	Beacons
Communication transmitters	Transponders
Telemetry transmitters	

Incidental sources arise from equipment not designed to radiate electromagnetic energy. Major incidental sources that should be considered are:

Power systems and distribution	Switches
Solenoids	Relays
Motors	Gyros

The primary natural sources to be considered are:

Galactic noise
 Terrestrial noise
 Cosmic noise

3.2.2 Susceptible Equipment

Any device capable of responding to electrical signals, or to fields associated with these signals, is vulnerable to interference. These devices should be identified and their sensitivities determined. Such equipment includes but is not limited to the following types:

Experiments	Field effect devices
Receivers	Sensors (optical and thermal)
Pyrotechnic devices	Preamplifiers
Electrical switches	Infrared detectors
Recording devices	

3.3 DESIGN PROCEDURES

After identification and evaluation of EMI sources and susceptible equipment and potential coupling modes, a control program should be established. Its objective should be operational compatibility commensurate with mission requirements of spacecraft subsystems. Compatibility can be achieved by interference suppression, a proper grounding scheme, and attention to good EMC design practices. Interference should be suppressed at its source whenever possible since a single source may effect many susceptible components or systems. The difficulty involved in interference suppression at the source, however, generally depends on whether the source is functional or incidental. When the interfering signal is an intentionally-generated carrier of useful information from a functional source, reduction of interference at the transmitter must rely on techniques for modifying signal strength,

frequency, and operational schedule. In some cases, interference must be suppressed at the susceptible equipment. Still other alternatives to suppression at the sources of intentionally-generated signals are:

Re-allocation of the intentionally-generated signal frequency.

Relocation and reorientation of either the susceptible device or the transmitting device to minimize impingement of interference signals.

Design of a time-sharing operations plan based on the priorities of mission requirements for operation of the transmitting system and the interference-susceptible device.

Additional shielding and filtering.

3.4 TESTING

A series of interference and susceptibility tests should be used to ascertain that EMI characteristics of the spacecraft equipment comply with requirements of the control plan. Overall system integration tests should be applied to establish overall compatibility of the spacecraft's equipment. Interference and susceptibility tests that may be required for EMI control programs include:

Radiated interference measurements

Antenna-conducted spurious emanation measurements

Powerline conducted interference measurements

Signal-line and powerline conducted transient interference measurements

Signal-line magnetic field susceptibility measurements

Electromagnetic compatibility qualification tests

Radiated susceptibility measurements

Receiver input rejection and cross-modulation measurements

Low-power transmitter cross-modulation susceptibility measurements

Receiver intermodulation measurements

Tests for spurious transmitter emissions.

4. RECOMMENDED PRACTICES

4.1 INTERFERENCE CONTROL PROGRAM

It is important that serious interference possibilities be foreseen as early as possible in the spacecraft program to allow time for effective and economical action. Therefore, an interference control program should be established in the preliminary design phase of spacecraft development to identify EMI problems systematically and implement control measures.

The control program should be based on the particular mission and spacecraft rather than on generalized requirements of electromagnetic interference specifications.

The primary objective of the control measures is to prevent any subsystem from having an adverse effect on the operation of any other subsystem. Thus, the compatibility of the spacecraft system should be continually analyzed and evaluated throughout system design and development, and specific interference control techniques should be designated for the compatibility problems likely to be encountered. Engineering and management milestones should be established that do not affect the overall mission schedule adversely.

The control program should describe as quantitatively as possible acceptability standards for interference sources and susceptible systems, outline appropriate interference tests and evaluation procedures, and present methods for treatment of identified problems.

4.2 ASSESSMENT OF SPACECRAFT REQUIREMENTS FOR ELECTROMAGNETIC COMPATIBILITY (EMC)

The spacecraft requirements for EMC are determined by mission objectives and the associated requirements for equipment susceptible to EMI and potential EMI sources. These considerations are prerequisites to the design and implementation of a control program which will operate throughout design, development, and all flight preparations to ensure that EMI does not degrade performance in the mission. In addition to onboard systems, the assessment of EMC requirements should include a critical evaluation of launch vehicle systems and ground support equipment because of possible effects on spacecraft design.

Launch vehicle considerations are primarily important in telemetering and command functions in which separately-powered equipment is mounted on both the vehicle and the spacecraft. Couplings between antennas, frequency allocation management, operational timing plans for vehicle and spacecraft are of concern.

Ground support equipment operating away from the immediate test and launch areas is not necessarily subject to the overall electromagnetic interference control program. It should be given careful consideration because of the potential interference hazards, however. Ground support equipment that is closely associated with the spacecraft during test and launch should be checked carefully for proper grounding, bonding, and cable shielding. It should be noted that ground support equipment, unlike the spacecraft, are not weight-limited and so can be shielded heavily.

From the standpoint of interference control and reduction techniques, the system design is divided basically into four stages: (1) the initial stage when the basic design concepts are formulated and the system parameters are specified, (2) the selection of the equipments or subsystems that will be used in the system, (3) the combination of the selected equipments or subsystems into a system, and (4) the performance of compatibility tests and final adjustments on the complete system to minimize the risk of performance degradation as a result of electromagnetic interference. In each of these stages there are usually trade-off relationships that should be evaluated by the designer. EMI considerations should be evaluated in the perspective of mission objectives, project schedule, and budget to determine the measures that will optimize electromagnetic compatibility of spacecraft systems without compromising other requirements.

4.2.1 Initial System Design

During the initial stage of system design, electromagnetic compatibility should be considered as a requirement of candidate subsystems and their elements so that proper attention is given to EMI in evaluating the various trade-off relationships considered by the designer. Frequency assignment, transmitter power levels, receiver sensitivity levels, switching levels of digital circuits, and operational schedules are a few examples of subsystem characteristics and parameters that have a significant effect on electromagnetic compatibility. The wide variety of operational requirements and compatibility problems make it impossible to present specific recommendations for designing an optimum system for any generalized set of mission requirements. Each subsystem should be examined individually as to functional requirements and associated boundary conditions (electromagnetic interfaces with other parts of the spacecraft and the mission environment) and the system parameters should be selected accordingly.

4.2.2 Selection of Equipment

The next stage of the system design involves the selection of equipment that will be used in the system to perform the required functions, e.g., electrical power source, transmitters, and receivers. At this point, electromagnetic compatibility should be considered in specifying equipment-operating characteristics, in testing equipment to ensure that they conform to specifications, and in modifying the design or operating schedule to accommodate residual compatibility problems.

4.2.3 System Integration

When the selected equipment and subsystems are combined into a spacecraft system, interface and grounding problems may require attention. Interface problems can be corrected or improved by re-routing cables, relocating or reorienting equipment, filtering of input and output leads, and shielding potential EMI sources and susceptible equipment. For grounding the system, it is desirable to provide a single dc ground for all subsystems to minimize the risk of common currents. (For larger spacecraft, a number of grounds may be necessary, however, to handle all the subsystems). Bonding also should be considered on a system basis.

4.2.4 System Compatibility

Finally, the system components and equipments should be subjected to applicable interference tests to uncover residual problems. Care should be taken that test equipment and breakout boxes including associated long leads do not alter the grounding configuration or induce or generate interference. The system designer should assist in the preparation of the overall system compatibility tests to ensure that the complete system will perform according to the requirements established for the mission.

4.3 INTERFERENCE CONTROL ANALYSIS

The first phase of the interference analysis is to identify potential sources of electromagnetic interference and define their interference characteristics. For the purpose of this analysis the amplitude versus frequency and the amplitude versus time characteristics are specified for each source. This information is generally obtained from equipment manuals and schematics, from the designers of the equipment, and from the results of measurements performed.

After identification of the sources, all susceptible equipment and their sensitivity characteristics should be identified and defined. Basically, the types of signals to which the susceptible equipment will respond are established, and the susceptibility versus frequency (or any other important parameters for each type of signal that can produce interference) is defined. Sensitivity, selectivity, and response characteristics are obtained from schematics, equipment designers, or from results of interference measurements performed on the equipment.

After definition of possible EMI sources and susceptible equipment, the next phase of analysis is to determine situations in which EMI problems are likely to occur. In general, potential problems are evaluated by using the transmission loss to modify the source function so that the resulting function represents the interference level at the susceptible equipment. This resulting function is then compared to the equipment susceptibility function (as shown in figure 7) to determine whether the amplitude of the potentially interfering signal is sufficient to cause an undesirable response in the susceptible equipment. In figure 7, it is seen that a compatibility problem is likely to result from a source function at frequency f_1 (ref. 2). In general, if an undesired response is produced by a signal, then its effect on the operation of the susceptible equipment is assessed for interference.

Besides evaluating the interference effect of specific sources, the total electromagnetic environment resulting from the operation of all the onboard electric and electronic subsystems is also evaluated. Each equipment susceptibility characteristic is then compared to the environment levels to determine whether the equipments are compatible with the electromagnetic environment in which they are required to operate.

The final phase of the system interference analysis is to define the amount of interference reduction necessary to eliminate the compatibility problems and to determine the techniques to be applied to subsystem designs to ensure compatibility.

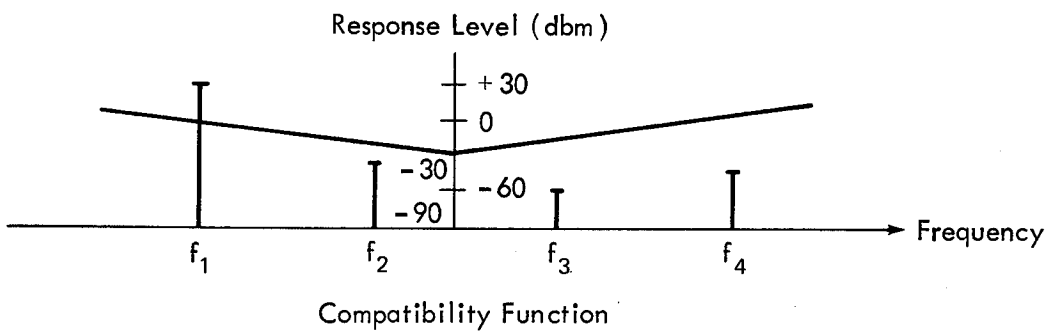
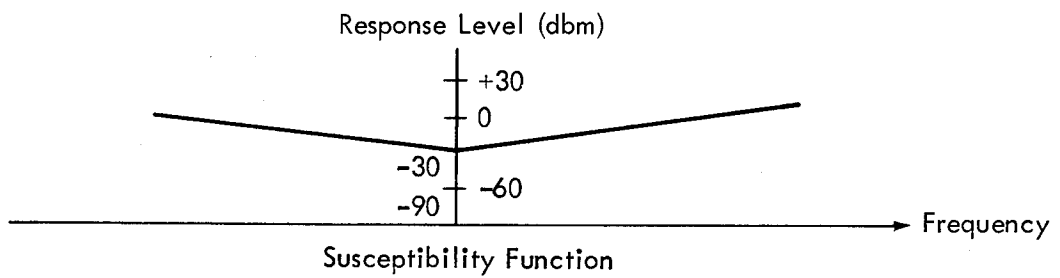
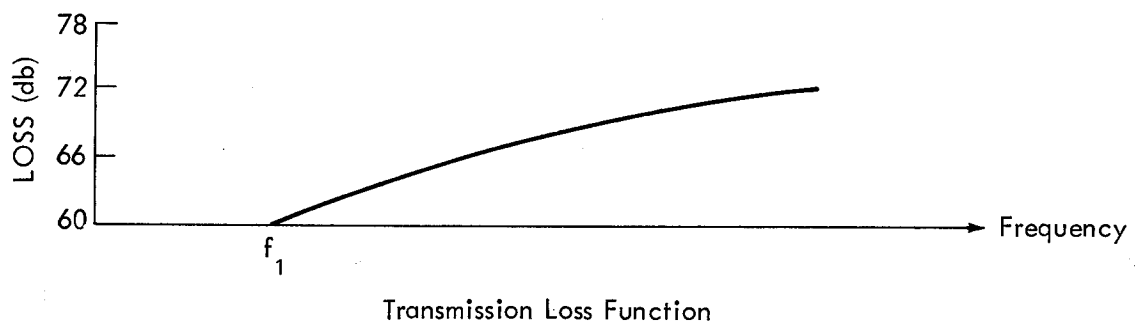
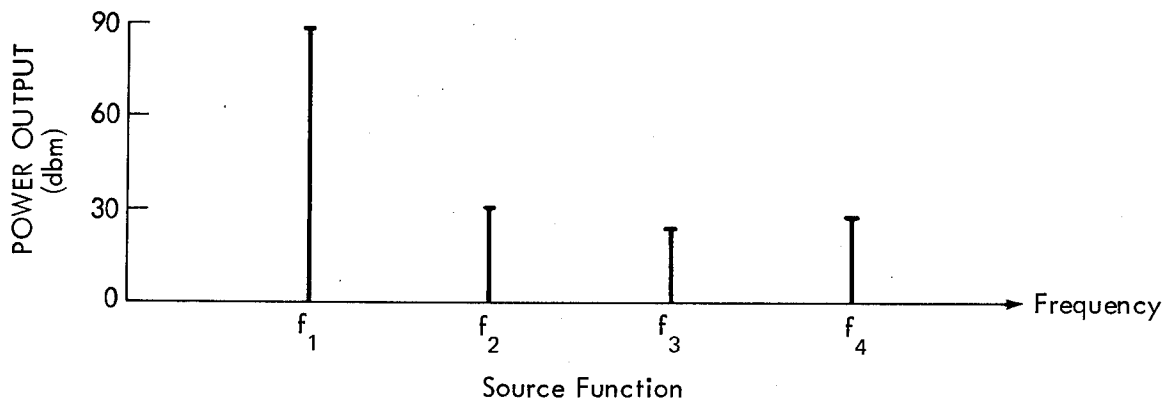

Figure 7. - Elements of electromagnetic compatibility analysis.

4.4 INTERFERENCE CONTROL TECHNIQUES

The basic hardware techniques for minimizing electromagnetic interference are shielding, grounding, wire treatment and routing, and filtering.

4.4.1 Shielding

Shielding is used to enclose equipment so that spurious signals generated by the equipment or those interfering with the equipment are completely excluded. The type of material used for shielding is usually determined by the lowest frequencies at which a given shielding effectiveness is required. High conductivity metals, such as copper and aluminum, offer good shielding efficiency for electric fields generally associated with high impedance circuits. Magnetic fields, generally associated with low impedance circuits, are more difficult to shield. With decreasing frequency, the losses in reflection and absorption for nonmagnetic materials such as aluminum steadily decrease. Thus, it is exceedingly difficult to shield against magnetic fields using non-magnetic materials. At low frequencies (below 150 KHz), it is necessary to use a high-permeability material, such as Mu-metal or Permalloy, to provide satisfactory shielding efficiency to magnetic fields. The attenuation and reflection of a shield are the two parameters that determine the shield effectiveness. When a shield is used to contain interference, the attenuation (absorption) losses are significant, whereas reflection losses become more important when shielding is used to exclude interference at susceptible equipment. Reference 14 includes tables giving absorption and reflection losses for copper and iron for frequencies ranging from 60 Hz to 10,000 MHz. Investigation of shielding efficiency and theoretical expressions for predicting shielding effectiveness are included in references 15, 16, and NASA SP-3067.

4.4.2 Grounding

To suppress interference by an effective grounding system, all the spacecraft system's electrical and structural components must be maintained at the same reference potential. This is usually accomplished by setting up separate grounding systems for the structural and the electrical parts of the system and combining them at one common reference point or plane.

Grounding systems include the static and structural grounds which take in all conductive parts of the spacecraft that are not designed to carry current; ac and dc power grounds; and shield grounding.

In general, for effective grounding, the galvanic action, the electromotive force valence potentials, the oxidation rate, and mating materials should be considered as possible sources of performance degradation. Any of these may cause additional spurious frequencies to be generated so the equipment will in a short time assume a potential other than ground and operate as an antenna to receive or transmit energy. This may cause or contribute to malfunction of the equipment. Shields should not be used on cables serving as ground return paths.

4.4.3 Bonding

Bonding is defined as a fixed union between two metallic conductors that show a uniform resistance to a current passing through it. Bonds must be made so that no additional potential gradients will develop which can contribute to interference. Good bonding depends on the degree of contact as determined by contact area, pressure, and the condition of the surfaces that are joined. If it is necessary to join metals of different chemical composition, care must be taken to avoid the development of corrosion. The physical size of the bond is important because of its effect on the RF impedance. Impedance increases linearly with the length of the bonding strap and decreases inversely with the cross-sectional area. Also the tendency of current to flow along the outside layers of the bond (the skin effect) becomes increasingly important as the frequency under consideration increases. It results in an increase of the effective resistance as a function of frequency and a slight increase in the inductance of conductors. To reduce these effects to tolerable levels, bonding straps with a length to width ratio of 5 or less are used (ref. 17).

4.4.4 Filtering

After interference reduction by grounding and shielding, the residual conducted and radiated interference can be further suppressed by filters. A filter is an electrical circuit or network designed to have specific capability for attenuation of various frequencies applied to it. The required attenuation is usually a function of the amplitude of the unwanted or spurious signals and of either the susceptibility limits of adjacent equipment or the limit requirements of the applicable EMI specifications. It is generally difficult to reduce spurious energy at susceptible equipments since noise potentials can enter by conduction, radiation, or a combination of both. Therefore, it is preferable to use filters at the source of electromagnetic interference to eliminate or minimize extraneous signals or limit the bandwidth of required functional signals.

Filtering of a signal can increase the rise and fall times of digital pulses, thus reducing dv/dt noise (ref. 5). Filtering also helps reduce harmonic frequencies of a pulse train.

There are several types of filters; the simplest is a shunt capacitor that connects the conductor carrying the spurious noise voltages to ground. Ferrite beads are frequently used as filters. They are effective in reducing the amplitude of the high frequency components of a signal. The apparent effect reduces the rise time of the amplitude and oscillations at the leading edge of the waveform.

4.4.5 Wire Treatment and Routing

To assess the possibility of adverse interaction between circuits and subsystems, it is necessary to analyze intra- and intersystem wiring for its interference and susceptibility characteristics and categorize the interconnecting cabling and wiring accordingly. On the basis of this analysis, twisting, shielding, bundling, referencing, and grounding can be used to eliminate or reduce interaction (ref. 13).

Circuits normally are classified for treatment on the basis of susceptibility, signal level, and frequency. Pyrotechnic circuitry is normally isolated to comply with the applicable test

range requirements. Power circuits often are considered separately as cables. (Cable segregation and shielding and twisting criteria are prescribed in the EMI Control Plan.)

Circuits typically might be classified as follows:

Power-

- DC primary and secondary power distribution
- AC power distribution

Quiet circuits-

- Sensitive circuits
- Low level signal circuits
- High impedance circuits

Noisy circuits-

- Control circuits
- High level signal circuits

Pyrotechnic firing circuits

4.5 CONTROL OF EMI SOURCES

The techniques for suppressing interference from a functional source are primarily those of (1) filtering of spurious signals, (2) substituting a more compatible signal-generating method, (3) relocating or reorienting signal generators to take advantage of nulls in the emission field, (4) increasing the control of frequencies allocated to functional sources, (5) controlling the time-sharing of operations to provide electromagnetically quiet intervals for the operation of interference-susceptible equipment, and (6) minimizing the use of nonlinear circuits.

When the source of interference is incidental such as motors or electrical switches, suppression can usually be applied at the signal source by several techniques. For example, bonding can be used to eliminate arcing which may occur between rotating machinery and its enclosure. Grounding and shielding can be effective for reduction of undesired signals. For elimination of an undesired signal, a new device sometimes can be substituted for the generating equipment that is responsible.

4.6 PROTECTION OF SUSCEPTIBLE EQUIPMENT

Analysis of the interference at the susceptible equipment usually begins by examining the various paths that may be used by the interfering signal. Usually, the more paths, the more

vulnerable the system is and the greater the need for interference control techniques. The normal input paths of interfering signals are:

- Input power leads
- Interconnecting cables of system
- Case enclosure (penetration)
- Antenna

Interfering signals may be coupled to an inductor by mutual inductance. If an inductor is located near another inductor, a resistor, a conductor, or any circuit element carrying a varying current, the resulting magnetic flux will induce a voltage in the inductor. This voltage may interfere with the current desired at the inductor. To minimize the effect of interference by inductive coupling, the inductor should be shielded or oriented to minimize coupling to sources of interference.

4.6.1 Relays

The enclosures, cabinets, or consoles used for relay circuitry should be designed and constructed to provide the maximum practicable isolation. Possible sources of EMI such as power or signal leads must be isolated or shielded to avoid coupling, and filters should be used as necessary on leads at their points of entry into the enclosure.

Relays used in areas where interference is likely should have their own metal enclosure without mechanical discontinuities. Solid state relays, as well as other EMI sensitive electronic components, should be protected by means of a signal ground. This ground is a low-impedance circuit used to minimize introduction of spurious voltages into the signal circuitry. Single-point grounding is used for low-frequency currents and multiple grounding for high frequencies. In the former, twisted circuit leads will help eliminate low frequency magnetic field interference. In multiple grounding, currents flow in the ground reference and cause magnetic fields. A combination of single and multiple grounding is possible.

4.6.2 Conductors

An electromagnetic force is produced in any single conductor when it is exposed to either an electric or non-parallel, varying magnetic field. If a conductor, however, were positioned in a varying magnetic field so that the field lines of flux did not link the conductor, no emf would be generated. Therefore, particularly in chassis wiring, an attempt should be made to lay out conductors which are potentially susceptible to this type of interference at right angles to each other. At the least, parallel conductors should be kept to a minimum.

The susceptibility of conductors to induced signals can be reduced by shielding in conjunction with appropriate techniques for grounding the shield and, in the case of conductive pairs, by twisting. Bundling of compatible conductors is recommended to minimize shielding requirements.

4.6.3 Tubes

Electron tubes such as photomultipliers and vidicon tubes, especially those with high gain, are susceptible to interference. If an undesired signal appears on the grid of a tube, it is amplified along with the desired signal and thereby causes interference in the output. This is further complicated by the nonlinear characteristics of the tube, i.e., if two signals appear on the grid of the tube, the waveform of the alternating anode current contains the applied frequencies and their harmonics plus frequencies equal to the sum and differences of the applied frequencies and their harmonics. The use of shielded wires in the grid circuit is recommended for this problem.

Electron tubes can pick up interfering signals through their envelope, especially when operating near an RF field, but the use of tube shields solves this problem. Mechanical vibrations affect electron tubes by causing the generation of microphonics; therefore, ruggedized tubes should be used whenever possible to minimize this effect. Also, electron tubes are affected by nuclear radiation, which causes a change in tube characteristics, but the use of ceramic tubes reduces this problem.

4.6.4 Connectors

Connectors can provide easy entrance to interference from RF transmission unless properly protected by appropriate means of shielding. Many shielding techniques are employed to suppress EMI. All connectors used as a conducting path for functional transmissions should be physically bonded (welded, bolted, or clamped) across an interface to the static ground. The maximum bonding resistance should not exceed about 10 milliohm.

Crosstalk effects in connectors can be minimized by proper connector-pin assignments. Reference 18 defines a set of criteria that can be used for making pin assignments and develops a valuable technique for making initial critical signal-pin assignments.

4.6.5 Semi-Conductor and Integrated Circuit Devices

Semi-conductor and integrated circuit devices are sensitive to momentary overload which can cause burnout of the semi-conductor material or the fine wires. Small amounts of RF energy can change the bias and operation of integrated circuits by rectification of the RF at the junctions which act like diodes.

To prevent susceptibility of semi-conductors and integrated circuits to EMI, leads should be filtered as necessary and the modules or enclosures appropriately shielded. When impulse type of interference on power leads is difficult to filter, voltage regulators can often be used for protection.

4.7 TESTING

The control plan should outline and describe tests which have a direct bearing on design measures for solving electromagnetic interference problems. Typical tests, some of which are listed in section 3.4, should be modified on the basis of the specific requirements of the spacecraft and the parameters under test.

The test sites should provide a low-noise, adequately protected environment such as a screen room or shielded enclosure which attenuates to a high degree all outside signals and serves to contain to the same degree all inside signals. However, as spacecraft systems become larger and testing includes associated ground equipment, the controlled environment approach may become impractical. In this event the ambient interference level of the particular test environment should be determined and tests modified accordingly. The ambient environment may be evaluated directly, by tests, or analytically by examining the sources in the area.

REFERENCES

1. Anon.: Description of Electromagnetic Environment for High Altitude Satellite Tests. Report by Jansky & Bailey Division, prepared under NASA Contract NAS 5-3157 with Atlantic Res. Corp., Alexandria, Va. June 1963.
2. Anon.: Electromagnetic Compatibility Principles and Practices NASA Handbook NHB 5320.3, Oct. 1965.
3. Smith, E.J.: Noisy Spacecraft "I Have Known". NASA Tech. Memo 33-402 (Proceedings of the Spacecraft Electromagnetic Interference Workshop at JPL, Feb 6-8 1968). Dec. 1968, pp. 101-109.
4. Case, R.K.; and Keeler, L.H.: Electromagnetic Interference Aspects of Integrating a UHF/VHF Receiver Onboard Mariner V. Jet Propulsion Laboratory Technical Report 32-1315, Nov. 1, 1968.
5. Whittlesey, A.C.: An Introduction to Electromagnetic Interference, its Causes and Prevention. Jet Propulsion Laboratory Report 900-328 (Rev. A), Nov. 1969.
6. Anon.: "Electromagnetic Compatibility", AFSC Design Handbook DHI-4, Series 1-0, General, 1st ed. Air Force Systems Command, Wright-Patterson AF Base, Ohio, Jan. 10, 1969.
7. Burdick, E.E. and Frankos, D.T.: Mariner Mars '69 EMC Problem Failure Report Study for Updating Mariner '71 Design Constraints. Jet Propulsion Laboratory Final Report, February 6, 1970.
8. Anon.: Quarterly Progress Report (ART/SRT) Research & Advanced Technological Development Activities, Systems Reliability Directorate, NASA Goddard Space Flight Center, Greenbelt, Maryland, Sept. 1967.
9. Anon.: Electromagnetic Compatibility (MSFC-SPEC-279). NASA Marshall Space Flight Center, June 1, 1964.
10. Anon.: MIL-STD-826 and 826 A, Electromagnetic Interference Test Requirements and Test Methods. U.S. Air Force, Jan. 1964 and June 1966.
11. Paul, C.R.; and Edwards, J.H.: Computer Aided Compatibility Prediction. IEEE International Electromagnetic Compatibility Symposium Record, Philadelphia Pa. July 13-15, 1971, pp. 210-214.
12. Biber, K.W.; and Thomas, A.K.: Computer Assisted EMC Program on Pioneer F and G. IEEE International Electromagnetic Compatibility Symposium Record, Philadelphia, Pa. July 13-15, 1971, pp. 294-298.

13. Pearlston, C.B., Jr.: Electromagnetic Compatibility Requirements for Space Systems. Report TOR-1001 (2307)-4, Reissue A, Contract AF 04(695)-1001, Engr. Sci. Operations, Aerospace Corp. (El Segundo, Calif.), July 1969.
14. Pearlston, C.B., Jr.: Case and Cable Shielding, Bonding and Grounding Considerations in Electromagnetic Interference. IRE Transactions on Radio Frequency Interference, vol. RFI-4, no. 3, pp. 1-16, October 1962.
15. Anon.: Investigation of Shielding Efficiency. Report 9, Final Development Report, Contract NObsr-49161, Breeze Corp., Newark, N.J., Nov. 1952. (Available from Federal Clearinghouse, AD 662-416).
16. Banister, P.R.: New Theoretical Expressions for Predicting Shielding Effectiveness for the Plane Shield Case. Report USL 851, U.S. Navy Underwater Sound Lab., (New London, Conn.), Nov. 1967 (Available from Federal Clearinghouse, AD 663-104).
17. Anon.: MIL-STD 461 and 462, Electromagnetic Interference Characteristics, Requirements for Dept. of Defense, Aug. 1968 and July 1967.
18. Craig, R.D.: Optimization of Connector-Pin Assignments in Electrical/Electronic Wiring Systems. Proceedings of Eighth Reliability and Maintainability Conference, Denver, Colorado, July 1969, pp. 334-340.

NASA SPACE VEHICLE DESIGN CRITERIA MONOGRAPHS

ENVIRONMENT

- | | |
|---------|---|
| SP-8005 | Solar Electromagnetic Radiation, revised May 1971 |
| SP-8010 | Models of Mars Atmosphere (1967), May 1968 |
| SP-8011 | Models of Venus Atmosphere (1968), December 1968 |
| SP-8013 | Meteoroid Environment Model—1969 (Near Earth to Lunar Surface), March 1969 |
| SP-8017 | Magnetic Fields—Earth and Extraterrestrial, March 1969 |
| SP-8020 | Mars Surface Models (1968), May 1969 |
| SP-8021 | Models of Earth's Atmosphere (120 to 1000 km), May 1969 |
| SP-8023 | Lunar Surface Models, May 1969 |
| SP-8037 | Assessment and Control of Spacecraft Magnetic Fields, September 1970 |
| SP-8038 | Meteoroid Environment Model—1970 (Interplanetary and Planetary), October 1970 |
| SP-8049 | The Earth's Ionosphere, March 1971 |
| SP-8067 | Earth Albedo and Emitted Radiation, July 1971 |
| SP-8069 | The Planet Jupiter (1970), December 1971 |
| SP-8084 | Surface Atmospheric Extremes (Launch and Transportation Areas), May 1972 |
| SP-8085 | The Planet Mercury (1971), March 1972 |

STRUCTURES

- | | |
|---------|--|
| SP-8001 | Buffeting During Atmospheric Ascent, revised November 1970 |
|---------|--|

SP-8002	Flight-Loads Measurements During Launch and Exit, December 1964
SP-8003	Flutter, Buzz, and Divergence, July 1964
SP-8004	Panel Flutter, July 1964
SP-8006	Local Steady Aerodynamic Loads During Launch and Exit, May 1965
SP-8007	Buckling of Thin-Walled Circular Cylinders, revised August 1968
SP-8008	Prelaunch Ground Wind Loads, November 1965
SP-8009	Propellant Slosh Loads, August 1968
SP-8012	Natural Vibration Modal Analysis, September 1968
SP-8014	Entry Thermal Protection, August 1968
SP-8019	Buckling of Thin-Walled Truncated Cones, September 1968
SP-8022	Staging Loads, February 1969
SP-8029	Aerodynamic and Rocket-Exhaust Heating During Launch and Ascent, May 1969
SP-8031	Slosh Suppression, May 1969
SP-8032	Buckling of Thin-Walled Doubly Curved Shells, August 1969
SP-8035	Wind Loads During Ascent, June 1970
SP-8040	Fracture Control of Metallic Pressure Vessels, May 1970
SP-8042	Meteoroid Damage Assessment, May 1970
SP-8043	Design -Development testing, May 1970
SP-8044	Qualification testing, May 1970
SP-8045	Acceptance testing, April 1970
SP-8046	Landing Impact Attenuation For Non-Surface-Planing Landers, April 1970
SP-8050	Structural Vibration Prediction, June 1970

- SP-8053 Nuclear and Space Radiation Effects on Materials, June 1970
- SP-8054 Space Radiation Protection, June 1970
- SP-8055 Prevention of Coupled Structure-Propulsion Instability (Pogo), October 1970
- SP-8056 Flight Separation Mechanisms, October 1970
- SP-8057 Structural Design Criteria Applicable to a Space Shuttle, January 1971
- SP-8060 Compartment Venting, November 1970
- SP-8061 Interaction with Umbilicals, and Launch Stand, August 1970
- SP-8062 Entry Gasdynamic Heating, January 1971
- SP-8063 Lubrication, Friction, and Wear, June 1971
- SP-8066 Deployable Aerodynamic Deceleration Systems, June 1971
- SP-8068 Buckling Strength of Structural Plates, June 1971
- SP-8072 Acoustic Loads Generated by the Propulsion System, June 1971
- SP-8077 Transportation and Handling Loads, September 1971
- SP-8079 Structural Interaction with Control Systems, November 1971
- SP-8082 Stress-Corrosion Cracking in Metals, August 1971

GUIDANCE AND CONTROL

- SP-8015 Guidance and Navigation for Entry Vehicles, November 1968
- SP-8016 Effects of Structural Flexibility on Spacecraft Control Systems, April 1969
- SP-8018 Spacecraft Magnetic Torques, March 1969
- SP-8024 Spacecraft Gravitational Torques, May 1969

SP-8026	Spacecraft Star Trackers, July 1970
SP-8027	Spacecraft Radiation Torques, October 1969
SP-8028	Entry Vehicle Control, November 1969
SP-8033	Spacecraft Earth Horizon Sensors, December 1969
SP-8034	Spacecraft Mass Expulsion Torques, December 1969
SP-8036	Effects of Structural Flexibility on Launch Vehicle Control Systems, February 1970
SP-8047	Spacecraft Sun Sensors, June 1970
SP-8058	Spacecraft Aerodynamic Torques, January 1971
SP-8059	Spacecraft Attitude Control During Thrusting Maneuvers, February 1971
SP-8065	Tubular Spacecraft Booms (Extendible, Reel Stored), February 1971
SP-8070	Spaceborne Digital Computer Systems, March 1971
SP-8071	Passive Gravity-Gradient Libration Dampers, February 1971
SP-8074	Spacecraft Solar Cell Arrays, May 1971
SP-8078	Spaceborne Electronic Imaging Systems, June 1971

CHEMICAL PROPULSION

SP-8025	Solid Rocket Motor Metal Cases, April 1970
SP-8041	Captive-Fired Testing of Solid Rocket Motors, March 1971
SP-8048	Liquid Rocket Engine Turbopump Bearings, March 1971
SP-8051	Solid Rocket Motor Igniters, March 1971
SP-8052	Liquid Rocket Engine Turbopump Inducers, May 1971