



**NASA TECHNICAL
STANDARD**

**NASA-STD-8739.1A
With Change 1**

National Aeronautics and Space Administration
Washington, DC 20546

Approved: 2008-03-04
Change 1 Approved: 2009-07-23
Expiration Date: 2013-03-04

**WORKMANSHIP STANDARD FOR POLYMERIC
APPLICATION ON ELECTRONIC ASSEMBLIES**

**Measurement System Identification:
Metric (English)**

APPROVED FOR PUBLIC RELEASE – DISTRIBUTION IS UNLIMITED

NASA-STD 8739.1A with Change 1

This page intentionally left blank.

NASA-STD 8739.1A with Change 1

DOCUMENT HISTORY LOG

Status	Document Revision	Approval Date	Description
-	Baseline	1999-08-06	Initial Release
Update/Revise	Revision A	2008-03-04	Technical corrections and addition of sections covering bonding and encapsulation.
Change 1 (Editorial Errata)	--	2009-07-23	Editorial errata to paragraphs 2.1.2, 2.1.3, 4.1.4, 4.5.2.a, 5.1.3, 5.2.1, 5.5.1, 6.2.2, 6.3.1.1, 6.5.1.a, 6.6.1.b, 6.6.2.b, 6.8.1.2, Table 6-1, 8.1.3, 8.4.4, Table 8-1 Notes 2/4, 9.1.2.3, 9.1.2.4, 9.1.3.f, 9.1.4.3.c/d/e/f/g, 9.2.1.2, Figures 9-1/2/3/4/5/6/7/10, 10.2.5, 10.2.7.f, Figure 10-3, Table 10-1, 12.3, 12.3.2/3/6/8, Figures 12-1/2, 13.2.2.a, 13.3.g, 13.6.2.d/i thru p, 13.6.3.b/g, 13.7.2.a, 13.7.3.d/e, 13.8.1, 13.9.2.j, 13.10.3, 13.11.3.c/d

JWL4

NASA-STD 8739.1A with Change 1

This page intentionally left blank.

NASA-STD 8739.1A with Change 1**FOREWORD**

This NASA Standard (NASA-STD) is published by the National Aeronautics and Space Administration (NASA) to provide uniform engineering and technical requirements for processes, procedures, practices, and methods that have been endorsed as standard for NASA programs and projects, including requirements for selection, application, and design criteria of an item. Use of this NASA-STD is the responsibility of the user as required by NASA Policy Directive (NPD) 8730.5, NASA Quality Assurance Program Policy.

This NASA-STD is approved for use by NASA Headquarters and NASA Centers, including Component Facilities. This NASA-STD may be applied on contracts for spacecraft, instrument, or launch vehicle contractors per contractual documentation.

The requirements herein prescribe NASA's technical requirements, procedures, and documenting requirements for staking, conformal coating, bonding, and encapsulation of printed wiring boards and electronic assemblies. These may be tailored to the program applications to obtain the most cost effective, best quality product. These requirements describe basic considerations necessary to ensure reliable staking, conformal coating, bonding, and encapsulation of printed circuit boards and electronic assemblies. Included are requirements which establish the responsibility for documenting fabrication and inspection procedures to be used for NASA work including supplier innovations, special processes, and changes in technology. For the purpose of this document, the term "supplier" is defined as in-house NASA, NASA contractors, and subtier contractors.

Requests for information, corrections, or additions to this NASA-STD can be submitted via "Feedback" in the NASA Technical Standards System at <http://standards.nasa.gov>. This NASA-STD was developed by the NASA Headquarters Office of Safety and Mission Assurance, Safety and Assurance Requirements Division and the NASA Workmanship Technical Committee which is managed by NASA Goddard Space Flight Center.

s/ Bryan O'Connor

Bryan O'Connor
Chief, Safety and Mission Assurance

March 4, 2008

Approval Date

NASA-STD 8739.1A with Change 1

This page intentionally left blank.

NASA-STD 8739.1A with Change 1

TABLE OF CONTENTS

DOCUMENT HISTORY LOG	3
FOREWORD	5
TABLE OF CONTENTS	7
LIST OF FIGURES	9
LIST OF TABLES	10
1. SCOPE.....	11
1.1 Purpose.....	11
1.2 Applicability	11
1.3 Special Requirements.....	11
1.4 Approval of Departures from this Standard.....	11
2. APPLICABLE DOCUMENTS	12
2.1 Applicable Documents.....	12
2.1.1 General.....	12
2.1.2 Government Documents	12
2.1.3 Non-Government Documents	12
3. ACRONYMS AND DEFINITIONS	13
3.1 Acronyms.....	13
3.2 Definitions.....	14
4. GENERAL REQUIREMENTS	18
4.1 General.....	18
4.2 Documentation.....	18
4.3 Rework and Repair	18
4.4 Electrostatic Discharge Requirements	19
4.5 Selection and Approval Requirements for Polymeric Materials	19
5. TRAINING AND CERTIFICATION PROGRAM.....	22
5.1 General.....	22
5.2 Vision Requirements.....	22
5.3 Personnel Certification Levels.....	23
5.4 Training Program Requirements.....	23
5.5 Documentation.....	24

NASA-STD 8739.1A with Change 1

5.6	Maintenance of Certification Status.....	24
5.7	Training Resources	25
6.	FACILITIES, TOOLS, AND MATERIALS.....	26
6.1	Safety	26
6.2	Facility Cleanliness.....	26
6.3	Environmental Conditions	26
6.4	Silicone Operations.....	27
6.5	Tool and Equipment Control	27
6.6	Material Storage and Records Retention	28
6.7	Inspection Optics	29
6.8	In-Process Storage and Handling.....	29
6.9	Solvents.....	29
7.	CLEANLINESS REQUIREMENTS.....	31
7.1	General.....	31
7.2	Cleanliness Testing.....	31
7.3	Test Limits	32
7.4	Resistivity of Solvent Extract	32
7.5	Sodium Chloride Salt Equivalent Ionic Contamination Test.....	32
8.	PREPARATION FOR POLYMERIC APPLICATIONS.....	34
8.1	Surface Preparation.....	34
8.2	Masking.....	34
8.3	Priming.....	34
8.4	Material Preparation.....	36
8.5	Test Specimen.....	38
8.6	Conformal Coating Specimens	38
9.	STAKING	39
9.1	Requirements	39
9.2	Fastener Staking.....	47
9.3	Torque Striping.....	49
10.	CONFORMAL COATING	50
10.1	Purpose.....	50
10.2	Conformal Coating Application.....	50
10.3	Curing	53
10.4	Cleanup.....	53
10.5	Touchup/Rework.....	53

NASA-STD 8739.1A with Change 1

11. BONDING	58
11.1 General.....	58
11.2 Bonding.....	58
12. ENCAPSULATION	60
12.1 General.....	60
12.2 Pre-cure Examination.....	60
12.3 Post-cure Inspection.....	60
12.4 Potting Connectors used with Shielded Cable	62
12.5 Cleanup	62
13. QUALITY ASSURANCE.....	63
13.1 General.....	63
13.2 Documentation Verification.....	63
13.3 Documentation Authorization.....	64
13.4 Verification of Tools, Equipment, and Materials	64
13.5 General Inspection Methods for Polymeric Applications.....	64
13.6 Acceptance/Rejection Criteria for Staking	65
13.7 Acceptance/Rejection Criteria for Fastener Staking and Torque Striping.....	67
13.8 Inspection Methods for Conformal Coating	68
13.9 Acceptance/Rejection Criteria for Conformal Coating.....	68
13.10 Acceptance/Rejection Criteria for Bonding.....	69
13.11 Acceptance/Rejection Criteria for Encapsulation.....	70
APPENDIX A. CONFORMAL COATING PROBLEMS	72
A.1 Conformal Coating Thickness	72
A.2 Coverage – Points and Edges.....	72
A.3 Bubbles	72

LIST OF FIGURES

Figure 9-1: Default Staking for Horizontally-Mounted Sleeveless Cylindrical Part.....	42
Figure 9-2: Default Staking for Horizontally-Mounted Sleeved Cylindrical Parts	42
Figure 9-3: Default Staking of a Single Vertically-Mounted Rectangular Part.....	43
Figure 9-4: Default Staking for an Array of Vertically-Mounted Rectangular Parts	43
Figure 9-5: Staking for Radial Lead Components	44
Figure 9-6: Staking for Radial Multi-lead Rectangular Components	44
Figure 9-7: Wire Bundle Staking.....	45
Figure 9-8: Single Wire Staking	45
Figure 9-9: Toroid Staking.....	46

NASA-STD 8739.1A with Change 1

Figure 9-10: Vibration Dampening Staking	47
Figure 9-11: Locking of Screws and Bolts with Nuts.....	48
Figure 9-12: Thread Locking of Blind Screw	49
Figure 9-13: Torque Striping Methods	49
Figure 10-1: Spray Application	51
Figure 10-2: Conformal Coating – Bubbles.....	54
Figure 10-3: Conformal Coating – Scratches	55
Figure 10-4: Conformal Coating - Lifting and Peeling	56
Figure 10-5: Conformal Coating – Coverage Defects	57
Figure 11-1: Component Bonding - Excess Bonding Material	59
Figure 12-1: Encapsulating Wires at Connector.....	61
Figure 12-2: Module Encapsulation.....	62

LIST OF TABLES

Table 6-1: Solvent and Cleaners	30
Table 7-1: Cleanliness Test Values.....	33
Table 8-1: Demoisturizing Schedules for Polymeric Applications Surface Preparation.....	35
Table 10-1: Conformal Coating Thickness.....	52

NASA-STD 8739.1A with Change 1

1. SCOPE

This standard prescribes NASA's technical requirements, procedures, and documentation requirements for polymeric applications for electrical and electronic assemblies. These requirements may be tailored to the program applications via the engineering documentation (See Sections 1.3, 1.4 and 4.1.3).

1.1 Purpose

This publication sets forth requirements for staking, conformal coating, bonding, and encapsulation of components used in electronic hardware.

1.2 Applicability

This publication is applicable to NASA programs involving polymeric applications for flight hardware, mission critical ground support equipment, and elements thereof and wherever invoked contractually.

1.3 Special Requirements

Special requirements may exist that are not in conformance with the requirements of this publication. Engineering documentation shall contain the details for such requirements, including modifications to existing equipment, and shall take precedence over appropriate portions of this publication when approved in writing by the procuring NASA Center (*Requirement*).

1.4 Approval of Departures from this Standard

1.4.1 Minor departures from this standard require written approval from the cognizant NASA contracting officer. The supplier is responsible for assuring that any departures from this publication are evaluated by, coordinated with, and submitted to the procuring NASA Center for approval prior to use or implementation. Departures which reduce the requirements herein may warrant a request for waiver of associated requirements in NPD 8730.5, per NASA Procedural Requirements (NPR) 8715.3, NASA General Safety Program Requirements.

1.4.2 For in-house NASA projects, this publication requires written approval by the in-house NASA project management to deviate from the provisions herein.

NASA-STD 8739.1A with Change 1**2. APPLICABLE DOCUMENTS****2.1 Applicable Documents**

2.1.1 General

The documents listed in this section contain provisions that constitute requirements of this NASA-STD. The latest issuance of cited documents is to be used unless otherwise approved by the assigned Technical Authority. The applicable documents are accessible via the NASA Online Directives Information System at <http://nodis3.gsfc.nasa.gov/>, the NASA Technical Standards website at <http://standards.nasa.gov/>, or directly from the Standards Developing Organizations (SDOs) or other document distributors.

2.1.2 Government Documents

27 CFR 21.35	Code of Federal Regulations, Title 27, Alcohol, Tobacco and Firearms, Part 21, Formulas for Denatured Alcohol and Rum, Subpart D, Specially Denatured Spirits Formulas and Authorized Uses, Formula No. 3-A
O-M-232	Methanol (Methyl Alcohol)
NASA-STD-6001	Flammability, Odor, Offgassing and Compatibility Requirements and Test Procedures for Materials in Environments that Support Combustion
NPD 8730.5	NASA Quality Assurance Program Policy
OSHA Standards	Occupational Safety and Health Administration (OSHA), Title 29, Code of Federal Regulations (CFR), Part 1910, Occupational Safety and Health Standards.
TT-I-735A	Specification for Isopropyl Alcohol

2.1.3 Non-Government Documents

ANSI/NCSL Z540.1	Requirements for the Calibration of Measuring and Test Equipment
ASTM-D-1007	Standard Specification for sec-Butyl Alcohol
ASTM-D-2240	Standard Test Method for Rubber Property – Durometer Hardness
ASTM-E-595	Standard Test Method for Total Mass Loss and Collected Volatile Condensable Materials From Outgassing in a Vacuum Environment
ANSI/ESD S20.20	Standard for Electrostatic Discharge Control (Excluding Electrically Initiated Explosive Devices)

NASA-STD 8739.1A with Change 1**3. ACRONYMS AND DEFINITIONS****3.1 Acronyms**

CFR	Code of Federal Regulations
CTE	Coefficient of Thermal Expansion
CVCM	Collected Volatile Condensable Material
CVD	Chemical Vapor Deposition
DIP	Dual-In-Line Package
DOT	Department of Transportation
EEE	Electrical, Electronic, and Electromechanical
EPA	Environmental Protection Agency
ESD	Electrostatic Discharge
GSFC	Goddard Space Flight Center
JPL	Jet Propulsion Laboratory
MSDS	Material Safety Data Sheet
NASA	National Aeronautics and Space Administration
NASA-STD	NASA Standard
NPD	NASA Policy Directive
NPR	NASA Procedural Requirements
SDO	Standards Developing Organizations
OSHA	Occupational Safety and Health Administration
OSMA	Office of Safety and Mission Assurance
PRT	Platinum Resistance Thermometer
PWA	Printed Wiring Assembly
PWB	Printed Wiring Board
QPL	Qualified Products List
RH	Relative Humidity
TML	Total Mass Loss
UV	Ultraviolet

NASA-STD 8739.1A with Change 1

3.2 Definitions

Accelerator: A compounding material used in small amounts with a curing agent to increase the cure rate.

Area Array Package: A package with an X-Y grid interconnect pattern on the under-surface (i.e., ball grid array, column grid array, land grid array, pin grid array).

Batch: That quantity of material that was subjected to unit chemical processing or physical mixing, or both, designed to produce a product of substantially uniform characteristics.

Blister: Undesirable rounded elevation of the surface of a polymer, whose boundaries may be more or less sharply defined.

Bonding: Bonding refers to fastening parts or materials to a substrate or assembly using a polymer sandwich construction.

Catalyst: A substance that changes the rate of a chemical reaction without undergoing permanent change in its composition; a substance that markedly speeds up the cure of a compound when added in minor quantity as compared to the amount of primary reactants.

Certification of Personnel: The act of verifying and documenting that personnel have completed the required training and have demonstrated specified proficiency and have met other specified requirements.

Coefficient of Thermal Expansion (CTE): The measure of the fractional change in dimension per unit change in temperature.

Conductor: A lead or wire, solid, stranded, or printed wiring path serving as an electrical connection.

Conformal Coating: A thin electrically nonconductive protective coating that conforms to the contours of the printed wiring assembly (PWA) or electronic assemblies.

Conformal Coating Specimen: A representative sample of the conformal coating process that is created simultaneously with the same materials, at the same time, and with the same processes as used to coat the finished item.

Contaminant: An impurity or foreign substance present in a material that affects one or more properties of the material. A contaminant may be either ionic or nonionic. An ionic, or polar, compound forms free ions when dissolved in water, making the water a more conductive path. A nonionic substance does not form free ions, nor increase the water's conductivity. Ionic contaminants are usually processing residue such as flux activators, fingerprints, and etching or plating salts.

Cure: A chemical reaction that hardens and changes the physical properties of a material(s).

Deterioration: (as in the context of the condition of stored polymer materials) A change in the material that can be observed prior to its use, or during use, that indicates it no longer meets its performance requirements. Deteriorated in this context includes degraded or separated.

NASA-STD 8739.1A with Change 1

Dielectric: A material with a high resistance to the flow of electrical current, and which is capable of being polarized by an electrical field.

Dielectric Strength: The maximum voltage that a dielectric can withstand under specified conditions without resulting in a voltage breakdown, usually expressed as volts per unit dimension.

Diluent: Any material that reduces the concentration of the fundamental resin; usually a liquid added to the resin to afford lower viscosity.

Embedment: The complete encasement of a component or module in a resin. Equivalent to “encapsulation.”

Encapsulation: The complete encasement of a component or module in a resin. Encapsulation is equivalent to “potting,” “embedment,” and “molding.”

Engineering Documentation: Drawings and specifications which provide instructions, design features, requirements, acceptance criteria, and other documentation to invoke and/or modify requirements.

Filler: A material added to polymers in order to reduce cost or modify physical properties.

Fillet: A smooth, generally concave, buildup of material between two surfaces (e.g., a buildup of conformal coating material between a part and the printed wiring board (PWB)).

Flatpack: A part with two straight rows of leads (normally on 1.27mm (0.050 inch) centers) that are parallel to the part body.

Flux: A chemically-active compound which, when heated, removes minor surface oxidation, minimizes oxidation of the basis metal, and promotes the formation of an intermetallic layer between solder and basis metal.

Gelling: Formation of a semi-solid system consisting of a network of solid aggregates in which liquid is held; the initial gel-like solid phase that develops during the formation of a resin from a liquid.

Glass Transition Temperature (T_g): The approximate midpoint of the temperature range over which the glass transition takes place. The glass transition is a reversible change in an amorphous polymer or in amorphous regions of a partially crystalline polymer from (or to) a viscous or rubbery condition to (or from) a hard and relatively brittle one. Not only do hardness and brittleness undergo rapid changes in this temperature region, but other properties, such as dissipation factor, thermal expansibility, and specific heat, also change rapidly. The glass transition has its origin in short scale segmental motion involving intramolecular rotation of the main chain, and, if present, side chains or pendant groups. Moreover, the observed transition temperature can vary significantly depending on the specific property chosen for observation and on details of the experimental technique (for example, rate of heating, frequency). Therefore, the observed T_g should be considered only an estimate.

Impregnation: An encapsulation process that results in complete saturation of the unit with the insulating material to include penetration and filling of every void replacing all air and gasses.

Lifting: Any separation of conformal coating from the PWA.

NASA-STD 8739.1A with Change 1

Measling: A condition at the interface of the conformal coating and base material, in the form of whitish spots or patches which reveal a separation of the conformal coating from the surface of the printed wiring board or from the surface of attached components or from both.

Mix Record: A record of the procedure followed for mixing the polymeric compounds.

Module: A separable unit in a packaging scheme.

Molding: The complete encasement of a component or module in a resin. Equivalent to “encapsulation.”

Offgassing: Deaeration or other gaseous emission from a liquid or solid material when exposed to reduced pressure, heat, or both that may affect crew members. Reference NASA-STD-6001.

Outgassing: Gaseous emission from a liquid or solid material when exposed to reduced pressure, heat, or both.

Part Lead: The conductor attached to a part.

Peeling: The separation of conformal coating from the PWA, usually due to improper preparation or abrasion. Peeling is distinguished from lifting in that the layer of conformal coating is not continuous.

Polymer: A compound of high molecular weight that is derived from either the joining together of many small similar or dissimilar organic molecules or by the condensation of many small molecules by the elimination of water, alcohol, or a solvent.

Potting: The complete encasement of a component or module in a resin. Equivalent to “encapsulation.”

Printed Wiring Assembly (PWA): The PWA consists of the PWB, components, and associated hardware and materials.

Printed Wiring Board (PWB): A pattern of conductors printed (screened) onto the surface of an insulating base to provide interconnection for parts.

Repair(ing): The act of restoring the functional capability of a defective article in a manner that precludes compliance of the article with applicable drawings or specifications.

Resin: Generally, any synthetic organic material produced by polymerization.

Rework: The act of reprocessing noncomplying articles, through the use of original or alternate equivalent processing, in a manner that assures compliance of the article with applicable drawings or specifications.

Shall: Signifies a requirement statement herein.

Should: Signifies statement of a recommended practice herein.

Squeeze-out: The resin and/or reinforcement that is visible at the edges of a bond.

Staking: The process of bonding and securing components or parts to PWB's and electronic assemblies by means of an adhesive material.

NASA-STD 8739.1A with Change 1

Staking Compound: An electrically nonconductive adhesive material used for additional support.

Stress Relief: The formed portion of a conductor that provides sufficient length to minimize stress between terminations.

Substrate: That surface upon which an adhesive is spread for any purpose, such as coating; a broader term than “adherent.”

Supplier: In-house NASA, NASA contractors, and subtier contractors.

Test Specimen: A sample of the same material processed using the same method, at the same time, and under the same conditions as the original end item product. It used as a quality record of the hardness and cure achieved with the particular material batch and the operations performed.

Traceability Code: The code uniquely identifying the production lot by the manufacturer, equivalent to batch code, lot code, or date code.

Transmissivity: The fractional quantity of incident radiation transmitted by matter.

Viscosity: A measure of the resistance of a material to flow under stress.

NASA-STD 8739.1A with Change 1

4. GENERAL REQUIREMENTS

4.1 General

4.1.1 Implementation. NASA quality assurance personnel will advise and assist suppliers, NASA personnel, and delegated agencies in the proper and effective implementation of the provisions of this publication. Effective implementation includes establishing a system that will identify each inspection point and provide records.

4.1.2 Changes in Requirements. When related requirements or changes in requirements are specified, NASA quality assurance personnel will assure that the Government agency delegated to inspect at the supplier's site of fabrication has received full instructions so that the work will be inspected to actual contract requirements.

4.1.3 Nonstandard Processes, Materials, or Parts. When the supplier intends to use processes, materials, or parts not covered by this standard, the supplier shall document the details of fabrication and inspection, including acceptance and rejection criteria, and provide the documentation along with appropriate test data to the procuring NASA Center for approval prior to use (*Requirement*).

4.1.4 Proactive Work Stoppages. If at any time during any phase of polymeric applications, a condition should arise that any responsible party, including the operator, inspector, or manager, feels may damage or in any way affect the reliability of the hardware, the work shall be halted until that condition has been reviewed and resolved (*Requirement*).

4.1.5 Requirement Flow Down. The prime contractors are responsible for delegating the requirements herein to their subtier suppliers as required (*Requirement*).

4.2 Documentation

4.2.1 The supplier shall document the methods and procedures proposed to incorporate the requirements of this standard into the design, fabrication, and inspection of staking, conformal coating, bonding, and encapsulation applications involved in the contract or purchase order (*Requirement*).

4.2.2 Staking material shall be applied as defined herein unless exceptions or additions are documented on the engineering drawings. In this case, the engineering drawing takes precedence. Instructions for staking on the engineering drawings include, as a minimum, the staking material and the locations to be staked (*Requirement*).

4.2.3 Documents required herein, except as specified by paragraph 4.1.3, shall be submitted to the procuring NASA Center, or its designated representative, as required by the contract or purchase order (*Requirement*).

4.2.4 Applicable supplier polymeric applications program documents, or portions thereof, accepted on other NASA contracts shall be included to avoid duplication of effort (*Requirement*).

4.3 Rework and Repair

4.3.1 Rework. Rework is permissible unless excluded by other provisions of the contract.

NASA-STD 8739.1A with Change 1

4.3.1.1 All rework shall meet the requirements of this publication and approved engineering documentation (*Requirement*).

4.3.1.2 The discrepancies shall be documented before rework is performed (*Requirement*).

4.3.1.3 Rework procedures shall be approved prior to performing rework by the procuring NASA Center or its designated representative (*Requirement*).

4.3.2 Repair.

4.3.2.1 Repairs shall be made only in compliance with applicable contractual requirements and after authorization for each incident by the procuring NASA Center (*Requirement*).

4.3.2.2 Repairs shall be accomplished using documented procedures previously approved by the procuring NASA Center (*Requirement*).

4.3.2.3 For in-house NASA projects, repairs shall be authorized for each incident by the Project Office and the Project quality technical lead (*Requirement*).

4.3.2.4 Repair is not rework.

4.4 Electrostatic Discharge Requirements

Electrostatic Discharge (ESD) requirements shall be in accordance with ANSI/ESD S20.20 (*Requirement*).

4.5 Selection and Approval Requirements for Polymeric Materials

4.5.1 Minimum Criteria for Material Selection. The polymeric material(s) shall be selected in accordance with the following:

a. Workable using the processes described herein such that the intended performance of the polymer is realized in the application. This includes continuous and consistent coverage for conformal coating, material volume control for staking material, and bond line control for bonding materials (*Requirement*).

b. Suitable to the complexity of the assembly and the mission lifetime defined by the project (*Requirement*).

c. Compatible with, and adheres to, the intended substrates (including the PWB, electrical, electronic, and electromechanical (EEE) parts, jumper wires, cable ties, metal brackets, enclosure surfaces) (*Requirement*).

d. Stable with respect to moisture exposure, the project's test, operating, and storage temperature range, and vacuum conditions (including thermal-vacuum). Other environmental conditions may be applicable such as ionizing radiation and UV radiation (*Requirement*).

e. In vacuum or low-pressure compartments, does not release greater than 1.0 percent total mass loss (TML) and 0.1 percent collected volatile condensable material (CVCM) when tested in accordance with ASTM-E-595 and Project requirements (*Requirement*).

NASA-STD 8739.1A with Change 1

- f. In habitable areas of spacecraft, stowed equipment, and experiments, is evaluated for flammability, odor, and offgassing characteristics in accordance with NASA-STD-6001 and Project requirements (*Requirement*).
- g. Selected to conform to the project contamination control requirements plan (*Requirement*).
- h. Noncorrosive to the electronic assembly for which it is selected (*Requirement*).
- i. Curable under temperature conditions compatible with the assembly on which it is located (*Requirement*).
- j. Shall be selected to enable the finished assembly to meet all mechanical, thermal, electrical, and optical requirements associated with test and mission use, with consideration given to the following characteristics: dielectric constant, permittivity, dielectric withstanding voltage, tensile modulus over temperature range, coefficient of thermal expansion (CTE), glass transition temperature (T_g), viscosity and transmissivity, and Project-specific requirements (*Requirement*).
- k. Allow repair and rework as needed without damaging the assembly or other elements (*Requirement*).

4.5.2 Qualification and Acceptance of Polymeric Materials. Materials proposed for use in accordance with this standard shall be validated, approved, and accepted using the following as a minimum:

- a. When required by the procuring NASA Center, verification tests shall be conducted to establish confidence in the reliability of the completed assembly (*Requirement*).
 - (1) A test plan shall be submitted to the procuring NASA Center, or its designated representative, for approval (*Requirement*).
 - (2) The test plan shall detail the test environment, test duration, test assembly design, and failure criteria based on life and mission requirements (*Requirement*).
- b. The suppliers have established a consistent record of supplying lots which have been verified to meet their datasheet characteristics and are homogeneous on a lot-to-lot basis (*Requirement*).
- c. Materials are traceable to a production lot identifier and manufacturing date (*Requirement*).
- d. Procurements are made from the original manufacturer or their authorized distributors (*Requirement*).
- e. A certificate of compliance from the supplier is required for each purchase certifying compliance with 4.5.2.c and 4.5.2.d above (*Requirement*).

4.5.3 Special Design Elements for Staking Material. Additional minimum design elements when staking are the following:

- a. Staking material shall be electrically insulative (*Requirement*).
- b. The mechanical support provided by staking shall extend to worst case application of thermal, shock, and vibration conditions (*Requirement*).
- c. Staking shall not negate stress relief (*Requirement*).

NASA-STD 8739.1A with Change 1

d. Through-hole solid tantalum capacitors and jumper wires in excess of 25 mm (1 inch) shall be staked (*Requirement*).

4.5.4 Special Design Elements for Conformal Coating. Additional minimum design elements for conformal coating are the following:

- a. The conformal coating process and material shall be capable of continuously and uniformly covering the PWA (*Requirement*).
- b. To facilitate examination for coverage, conformal coating materials with a fluorescent indicator are preferred.

CAUTION: ULTRAVIOLET (UV) SENSITIVE EQUIPMENT MAY BE ADVERSELY AFFECTED BY USING FLUORESCENT INDICATORS.

c. The following shall be identified in the engineering documentation:

- i. Maskant material and areas to be masked (*Requirement*)
- ii. Conformal coat material (*Requirement*)

4.5.5. Special Design Elements for Bonding. The minimum design elements to assure reliable bonding are:

- a. Fixturing or other methods for controlling device placement during bonding and cure may be required.
- b. The following shall be identified in the engineering documentation:
 - i. Bonding material (*Requirement*)
 - ii. Locations of the items to be bonded (*Requirement*)
 - iii. Bond line thickness requirements if applicable (*Requirement*)

4.5.6. Special Design Elements for Encapsulation. The minimum design elements to assure reliable encapsulation are:

- a. Shall extend to worst case application electrical, thermal, and mechanical conditions (*Requirement*).
- b. Shall prevent damaging stress during processing (*Requirement*).
- c. Shall identify the following in the engineering documentation:
 - i. The encapsulation material (*Requirement*)
 - ii. The items to be encapsulated (*Requirement*)

4.5.7 Underfill of Area Array Interconnect Packages. Underfill of area array interconnect packages shall require qualification using the identical material, application process, PWA configuration, and operating environment(s) for the intended mission (*Requirement*).

NASA-STD 8739.1A with Change 1

5. TRAINING AND CERTIFICATION PROGRAM

5.1 General

5.1.1 The supplier is responsible for maintaining a documented training program that meets the requirements of this standard.

5.1.2 The supplier shall assure that design personnel are familiar with the requirements of this standard, staking, conformal coating, bonding and encapsulation techniques, and other pertinent requirements of the contract (Requirement).

5.1.3 The supplier shall implement and document a training program that provides the necessary training of polymeric applications fabrication and inspection personnel in techniques, use of equipment, and procedures pertinent to their responsibilities in performance of the contract requirements (Requirement).

5.1.4 The supplier shall certify and maintain the certification of each individual who fabricates, inspects, or instructs (Requirement).

5.1.5 Operators, inspectors, and instructors shall be qualified to fulfill all requirements of this standard involved in their assigned tasks (Requirement).

5.1.6 Demonstration of proficiency and understanding of the requirements is a requisite for certification and recertification, and evidence of certification status shall be maintained in the work area (Requirement).

5.2 Vision Requirements

5.2.1 The supplier is responsible for ensuring that all personnel who perform or inspect staking or conformal coating applications meet vision test requirements as a prerequisite to training, certification, and recertification (Requirement). The vision requirements may be met with corrected vision (personal eyeglasses).

5.2.2 The vision tests shall be administered every 2 years by a qualified eye examiner, accepted by the procuring supplier, using standard instruments and techniques (Requirement).

5.2.3 Results of the visual examinations shall be maintained and available for review (Requirement).

5.2.4 The following are minimum vision requirements:

- a. Far Vision. Snellen Chart 20/50 (Requirement).
- b. Near Vision. Jaeger 1 at 355.6 mm (14 inches), or reduced Snellen 20/20, or equivalent (Requirement).
- c. Color Vision. Ability to distinguish red, green, blue, and yellow colors as prescribed in Dvorine Charts, Ishihara Plates, or AO-HRR Tests (Requirement).

NASA-STD 8739.1A with Change 1

<p>NOTE: <i>A PRACTICAL TEST, USING COLOR CODED WIRES AND/OR COLOR CODED ELECTRICAL PARTS, AS APPLICABLE, IS ACCEPTABLE FOR COLOR VISION TESTING.</i></p>

5.3 Personnel Certification Levels

5.3.1 Level A NASA instructors are certified by the NASA Training and Certification Board. Level A NASA instructors have the authority to train Level B instructors, operators, and inspectors. Upon successful course completion, a certificate shall be issued by the instructor (*Requirement*).

5.3.2 Certification of Level B instructors shall be provided by the supplier based on successful completion of training by a Level A NASA instructor (*Requirement*). Level B instructors are authorized to train operators and inspectors employed at their organization and subcontractors.

5.3.3 Certification of inspectors shall be provided by the supplier based on successful completion of training by a Level A NASA instructor or Level B supplier instructor (*Requirement*). An inspector is trained and certified to inspect for conformance with the requirements of this standard.

5.3.4 Certification of operators shall be provided by the supplier based on successful completion of training by a Level A NASA instructor or Level B supplier instructor (*Requirement*).

5.3.5 An operator is trained and certified to apply polymeric materials in conformance with the requirements of this standard. When operators are certified to perform limited operations or processes, the limitation(s) shall be stated on the certification card (*Requirement*).

5.4 Training Program Requirements

5.4.1 The supplier is responsible for training and certification of operators and inspectors in the staking, conformal coating, bonding, and encapsulation processes and associated processing equipment (*Requirement*).

5.4.2 The supplier shall submit training program documentation to the procuring NASA Center as directed by the contract (*Requirement*).

5.4.3 The training program shall:

- a. Identify the criteria for qualification and certification of Level B instructors, inspectors, and operators (*Requirement*).
- b. Document the methods and procedures proposed to fulfill the requirements of this standard (*Requirement*).
- c. Utilize visual standards consisting of satisfactory work samples or visual aids that clearly illustrate the quality characteristics of polymeric applications applicable to the contract (*Requirement*).

NASA-STD 8739.1A with Change 1

d. Utilize applicable illustrations in this standard, supplemented as necessary, for visual standards. Standards of unacceptable conditions may also be used for clarification or comparison (*Requirement*).

e. Make applicable standards readily available (*Requirement*).

5.5 Documentation

5.5.1 The supplier training program documentation shall describe the training and certification program proposed to satisfy the requirements herein for the polymeric applications applications (*Requirement*).

5.5.2 This description shall include the following:

a. Qualification of instructors (*Requirement*).

b. Procedures for training, including who will be trained and for what purpose, (e.g., operator, inspector) (*Requirement*).

c. Lesson plan(s)/student standards (*Requirement*).

d. Hours of instruction (*Requirement*).

e. Procedures for certification and recertification (*Requirement*).

f. Procedures for recording training, recertification, and a method of identifying/recalling trained personnel (*Requirement*).

g. Certification criteria (*Requirement*).

5.5.3 Records of training and certification shall become part of the supplier's quality data and be retained for a minimum of 5 years (*Requirement*).

5.5.4 Evidence of certification status, including limitations, shall be available in the work area (*Requirement*).

5.6 Maintenance of Certification Status

5.6.1 Maintenance of certification for instructors, operators, and inspectors requires continuous proficiency.

5.6.2 Recertification of Level B instructors shall include the successful completion of retraining by a Level A NASA instructor (*Requirement*).

5.6.3 Recertification of operators and inspectors shall include successful completion of retraining by a Level A NASA instructor or a Level B supplier instructor (*Requirement*).

5.6.4 Recertification shall be required when:

a. Proficiency requirements herein are not met (*Requirement*).

i. Instructors - proficiency unacceptable.

ii. Operators - unsatisfactory quality of articles fabricated.

NASA-STD 8739.1A with Change 1

- iii. Inspectors - unsatisfactory quality of inspection.
- iv. Quality/quantitative data demonstrates a need for recertification.
- b. New polymeric applications or inspection techniques have been approved that require different skills (*Requirement*).
- c. Work period interruption of greater than 6 months occurs (*Requirement*).
- d. Two years have elapsed since the last certification (*Requirement*).

5.6.5 Certification shall be revoked when:

- a. Certificate holder fails recertification (*Requirement*).
- b. Certificate holder fails to meet visual acuity requirements of paragraph 5.2 (*Requirement*).
- c. Employment is terminated (*Requirement*).
- d. Supplier training program fails to meet requirements set forth herein or those set forth otherwise in the contract (*Requirement*).

5.7 Training Resources

5.7.1 Training of Level B instructors is available at either the Goddard Space Flight Center (GSFC) or Jet Propulsion Laboratory (JPL). Contact information for these facilities can be found at <http://workmanship.nasa.gov>. The NASA Generic Polymeric Applications Training Plan will be supplied to instructors at the time of course completion.

5.7.2 Suppliers may train operator or inspector personnel in-house for certification or recertification utilizing certified instructors and approved training programs, or arrange for this training at one of the NASA-conducted schools.

5.7.3 A fee is required. Contact the training center at GSFC or JPL for information.

NASA-STD 8739.1A with Change 1**6. FACILITIES, TOOLS, AND MATERIALS****6.1 Safety**

6.1.1 General. Personal protective equipment (such as eye protection, gloves) complies with the requirements of OSHA, 29 CFR Part 1910, Personal Protective Equipment and any state and local regulations shall be provided and used as appropriate to the work being performed (*Requirement*).

6.1.2 Handling of Staking, Conformal Coating, Bonding, and Encapsulating Materials. Staking, conformal coating, bonding, and encapsulating materials may be flammable or contain harmful solvents. No smoking or open flame shall be allowed within 7.6 meters (25 feet) of the polymeric application and storage areas (*Requirement*).

WARNING: ALL SOLVENTS AND CHEMICALS MAY PRESENT HEALTH AND SAFETY PROBLEMS. FOLLOW DOT/EPA/OSHA PRECAUTIONS AND GUIDELINES FOR STORING, HANDLING, TRANSPORTING, STAGING, AND DISPOSAL OF HAZARDOUS WASTE. FOR WORK DONE OFF-SHORE, HOST GOVERNMENT OR COUNTRY REGULATIONS MAY APPLY.

6.1.3 Exposure to Solvents. Personnel exposure to solvents and vapor of solvents shall be minimized and controlled in accordance with OSHA, 29 CFR Part 1910 (*Requirement*).

6.1.4 Exposure to Hazardous Chemicals. Chemical hazards associated with each material shall be known and understood (*Requirement*).

6.1.4.1 The relevant Material Safety Data Sheets (MSDS's) shall be read and understood before work with any material begins.

6.1.4.2 MSDS's shall be available for reference in the work area (*Requirement*).

6.2 Facility Cleanliness

6.2.1 The work area shall be maintained in a clean and orderly condition (*Requirement*).

6.2.2 Smoking, eating, and drinking materials in polymeric applications areas and at individual work stations shall not be permitted (*Requirement*).

6.2.3 Nonessential tools and materials shall not be permitted at the work station (*Requirement*).

WARNING: SMOKING, EATING, AND DRINKING IN AREAS WHERE HAZARDOUS CHEMICALS ARE PRESENT IS HAZARDOUS TO HUMANS AND CAN COMPROMISE HARDWARE QUALITY.

6.3 Environmental Conditions

6.3.1 Controlled Environment.

NASA-STD 8739.1A with Change 1

6.3.1.1 The polymeric applications area shall have a controlled environment that limits the entry of contamination (*Requirement*).

6.3.1.2 The temperature and humidity of this area shall be monitored and maintained to $24\pm 3^{\circ}\text{C}$ ($75\pm 5^{\circ}\text{F}$), 30 percent to 70 percent Relative Humidity (RH) (*Requirement*).

6.3.2 Special Environmental Requirements. Parts, materials, or equipment being processed that require more stringent control of environmental conditions than those stated above shall have these requirements and controls identified and specified on the engineering documentation (*Requirement*).

6.3.3 Field Operations Requirement. In field operations where the required controlled conditions cannot be effectively achieved, special precautions shall be identified in the appropriate documentation and followed to minimize the effects of the uncontrolled environment on the operation being performed on the hardware (*Requirement*).

6.3.4 Lighting Requirements. Light intensity shall be a minimum of 1077 Lumens per square meter (Lm/m^2) (100 foot - candles) on the surface being staked, conformally coated, or inspected (*Requirement*). Supplemental lighting may be used to achieve the required levels.

6.4 Silicone Operations

6.4.1 All silicone processing, including the use of curing ovens, tools, equipment, fixtures, the supplies, and garments used in the operations, shall be segregated from other polymeric material operations (*Requirement*).

6.4.2 Segregation shall be to the degree that ensures no contamination of assemblies, tools, workspaces, and equipment that are not intended for use with silicone materials (*Requirement*).

WARNING: FLIGHT EQUIPMENT CAN BE CONTAMINATED WHEN TOOLS AND EQUIPMENT USED FOR SILICONE PROCESSING ARE NOT RIGOROUSLY SEGREGATED FROM THOSE NOT USED FOR SILICONE PROCESSING.

6.5 Tool and Equipment Control

6.5.1 Each supplier shall:

- a. Select tools to be used in polymeric applications, and in work preparation areas appropriate to their intended function (*Requirement*).
- b. Clean and properly maintain all tools and equipment (*Requirement*).
- c. Examine all elements of tools used in polymeric applications for physical damage (*Requirement*).
- d. Prohibit unauthorized, defective, or uncalibrated tools in the work area (*Requirement*).
- e. Document detailed operating procedures and maintenance schedules for tools and equipment requiring calibration or set up (*Requirement*).
- f. Maintain records of tool and equipment calibration and functional testing (*Requirement*).

NASA-STD 8739.1A with Change 1

6.5.2 The supplier shall have a documented calibration system in accordance with ANSI/NCSL Z540.1 (*Requirement*).

6.5.3 The supplier's process documentation for tool control is subject to review and approval by the procuring NASA Center.

6.6 Material Storage and Records Retention

6.6.1 Shelf Life.

a. Shelf Life Stickers. Material storage shall be controlled (*Requirement*). A standard method used is attaching shelf life stickers to each material container.

b. Expired Shelf Life. Staking, conformal coating, bonding, and encapsulating material shall not be used if the shelf life has expired (*Requirement*). Shelf life extension may be granted on an individualized basis when adequate data is provided by the polymer manufacturer in advance of actual use.

c. Shelf Life. The material shelf life shall be as stated by the manufacturer and in accordance with the manufacturer's specifications governing the usable life of the product (*Requirement*).

d. Material in Use. The staking and conformal coating material shall be free of foreign matter and shall not show any signs of deterioration (*Requirement*).

6.6.2 Storage.

a. Solvents. All cleaning and diluent solvents shall be stored in accordance with applicable regulations (*Requirement*).

b. Polymeric applications Materials. Materials shall be stored in accordance with the manufacturer's recommendations (*Requirement*). All stored containers shall be sealed (*Requirement*).

6.6.3 Records.

a. Purchase Data Recording. Records of manufacturing date, lot number, receiving date, and manufacturer's certification of compliance of each material shipment shall be maintained (*Requirement*).

b. Container Markings. Material containers shall be marked with the following:

i. Manufacturer's identification (*Requirement*).

ii. Manufacturer's product designation (*Requirement*).

iii. Traceability code (if applicable) (*Requirement*).

iv. Storage temperature range (if applicable) (*Requirement*).

v. Expiration date of guaranteed product life or use (*Requirement*).

vi. Caution notes (where applicable) (*Requirement*).

NASA-STD 8739.1A with Change 1

6.7 Inspection Optics

Visual inspection shall be performed using magnification aids conforming to the following:

6.7.1 Inspection magnification aids that permit simultaneous viewing with both eyes are preferred but single eye viewing devices are acceptable.

6.7.2 Magnification aids shall be capable of rendering true colors, proportional dimensions, and adequate resolution at the chosen magnification to perform the specified inspection (*Requirement*).

6.7.3 The light source shall provide shadowless illumination of the area being viewed except when oblique lighting is required (*Requirement*).

6.7.4 Inspection optics shall be capable of 1x to 10x magnification. (See Section 13, Quality Assurance) (*Requirement*).

6.8 In-Process Storage and Handling

6.8.1 Each supplier performing staking, conformal coating, bonding, and encapsulating operations shall develop and implement requirements and procedures that control conditions to prevent damage to and degradation of parts and deliverable items (*Requirement*).

6.8.1.1 Means shall be provided to prevent damage or contamination of printed wiring terminating areas, terminals, connectors, wire ends, and part leads during handling or storage (*Requirement*).

6.8.1.2 Containers shall be compatible with items stored therein (*Requirement*).

6.8.2 When handling metal surfaces, printed wiring terminating areas, terminals, connectors, wire ends, or part leads is unavoidable, clean, particulate free gloves or finger cots shall be used (*Requirement*).

6.9 Solvents

6.9.1 The solvents or aqueous cleaners used to remove grease, oil, dirt, flux, and other debris shall be selected for their ability to remove both ionic and nonionic contamination (*Requirement*).

6.9.2 The solvents or cleaners used shall not degrade the materials or parts being cleaned (*Requirement*).

6.9.3 A list of approved solvents and cleaners is provided in Table 6-1. Cleaners and solvents shall not be used in any manner that will deposit residue on electrical contact surfaces such as those in switches, potentiometers, or connectors (*Requirement*).

6.9.4 Mixtures of the approved solvents may be used. Solvent containers shall be properly labeled (*Requirement*).

6.9.5 The use of any other solvents requires the approval of the procuring NASA Center and shall be identified in the supplier's process documentation (*Requirement*).

NASA-STD 8739.1A with Change 1

6.9.6 MSDS's for solvents and cleaners shall be available for personnel review at the work area (Requirement).

6.9.7 Methyl alcohol and secondary butyl alcohol shall be used only when purchased as a constituent of an already blended solvent (Requirement).

6.9.8 When deionized water is used, forced nitrogen drying or an equivalent method shall be accomplished immediately after its use (Requirement).

6.9.9 Water based saponifier and detergent systems as per Table 6-1 shall require the approval of the procuring NASA Center (Requirement).

6.9.10 Solvent and cleaning systems have the potential of removing marking information from parts. Appropriate marking permanency testing shall be performed as part of the evaluation procedure for any solvent or cleaning system (Requirement).

Table 6-1: Solvent and Cleaners

Solvents and Cleaners	Specification
Ethyl Alcohol	Per Federal Regulation 27 CFR Part 21, Subpart.35, Formula No. 3-A
Isopropyl Alcohol	TT-I-735A
Deionized Water	1 megohm-cm, minimum resistivity (See paragraph 6.9.8)
Detergent cleaners and saponifiers	(See paragraph 6.9.9)

WARNING: TREAT ALL SOLVENTS USED IN THE STAKING AND CONFORMAL COATING PROCESSES AS HAZARDOUS AND VOLATILE UNLESS THEY ARE OTHERWISE RATED ON THE MSDS.

NASA-STD 8739.1A with Change 1**7. CLEANLINESS REQUIREMENTS****7.1 General**

All cleaning procedures shall be specified in the supplier's process documentation (*Requirement*).

7.1.1 Monitoring. The effectiveness of the cleaning process depends upon the proper execution of the approved cleaning procedure. To assure the effectiveness of the cleaning method, a system for monitoring the purity of the cleaning solvents shall be established (*Requirement*).

7.1.2 Compatibility of Solvent With Hardware. The cleaning solvent shall be chemically benign to the hardware and in accordance with Table 6-1 and paragraph 6.9 (*Requirement*). The solvent used shall not degrade the reliability of the hardware being cleaned (*Requirement*).

CAUTION: SOME SOLVENTS OR METHODS OF CLEANING MAY BE DETRIMENTAL TO POLYMERIC MATERIALS.

7.1.3 Protection of Unsealed Parts. Unsealed parts shall not be completely immersed in the cleaning solvent and hardware containing unsealed parts shall be immersed in the solvent only after these parts have been sealed or masked prior to cleaning (*Requirement*).

7.1.4 Ultrasonic Cleaning. Ultrasonic cleaning shall not be used for cleaning assemblies that contain electronic parts (*Requirement*).

7.1.5 Rework Cleaning. The rework area shall be cleaned and dried prior to application of rework staking and conformal coating (*Requirement*). Conformal coated assemblies shall not be immersion cleaned (*Requirement*).

7.1.6 Immersion Cleaning. Immersion cleaning shall not be used for silver-plated copper wire in order to mitigate the risks associated with the propensity for silver-plated copper wire to develop cuprous-oxide corrosion product (red plague) (*Requirement*).

7.1.7 Alternate Cleaning Processes. Alternate cleaning processes and systems, such as plasma systems, shall be supported by objective evidence that their use does not degrade the hardware (*Requirement*). The objective evidence shall be reviewed and approved by the responsible NASA project manager or their designee prior to use (*Requirement*).

7.2 Cleanliness Testing

All PWAs shall be tested prior to conformal coating (*Requirement*).

7.2.1 One of the following tests shall be used to determine the cleanliness level (*Requirement*):

- a. Resistivity of solvent extract in accordance with the limits in paragraph 7.3.1 and the method of paragraph 7.4.
- b. Sodium chloride (NaCl) salt equivalent ionic contamination in accordance with the limits in paragraph 7.3.2 and the method of paragraph 7.5.
- c. Other test methods shall be approved by the responsible NASA project manager prior to use (*Requirement*).

NASA-STD 8739.1A with Change 1

7.2.2 Failed PWAs shall not be recleaned until appropriate corrective actions have been performed on the cleaning system to ensure its correct operation (*Requirement*).

7.3 Test Limits

7.3.1 Resistivity of Solvent Extract. The resistivity of the solvent extract shall have a final value greater than 2,000,000 ohm-cm (*Requirement*).

7.3.2 Sodium Chloride Salt Equivalent Ionic Contamination Test. The final value for this test shall be less than 1.55 micrograms per sq. cm (10 micrograms per square inch) of PWB surface area (*Requirement*).

7.4 Resistivity of Solvent Extract

Solvent extract resistivity shall be measured as follows (also, see Table 7-1):

7.4.1 Prepare a test solution of 75 percent by volume isopropyl alcohol and 25 percent by volume deionized water. Pass this solution through a mixed bed deionizer cartridge. After passage through the cartridge, the resistivity of the solution shall be greater than 6×10^6 ohm-cm (conductivity less than 0.166 micromhos/cm) (*Requirement*).

7.4.2 Clean a funnel, a wash bottle, and a container with a portion of this test solution.

7.4.3 Measure out 1.55 ml for each square centimeter (10 ml for each square inch) of PWA area on both sides of the PWA (*Requirement*).

7.4.4 Slowly, direct the test solution in a fine stream onto both sides of the PWA until all the measured solution is used (*Requirement*).

7.4.5 The resistivity of the solvent extract shall be determined by using a resistivity meter (*Requirement*).

7.5 Sodium Chloride Salt Equivalent Ionic Contamination Test

Sodium chloride salt equivalent ionic contamination shall be measured as follows (also, see Table 7-1):

7.5.1 The sodium chloride salt equivalent ionic contamination test shall use a solution of 75 percent isopropyl alcohol and 25 percent deionized water (*Requirement*).

7.5.2 This solution shall be verified for correct composition upon initial use and every 4 hours during a shift (*Requirement*). The time limit may be extended when the results of data provide definite indications that such actions will not adversely affect the results of the test.

7.5.3 The equipment shall be calibrated using a known amount of sodium chloride standard on the same schedule as the percentage composition verification (*Requirement*).

7.5.4 The starting or reference purity of the solution shall be greater than 20×10^6 ohm-centimeters (0.05 micromhos/centimeter) before each sample is tested (*Requirement*).

NASA-STD 8739.1A with Change 1**Table 7-1: Cleanliness Test Values**

Test Method	Starting Resistivity	Ending Values
Resistivity of Solvent Extract	6×10^6 ohm-cm	Shall be greater than 2×10^6 ohm-cm (Requirement)
Sodium Chloride Salt Equivalent Ionic contamination	20×10^6 ohm-cm	Shall be less than 1.55 micrograms/square centimeter (10.0 micrograms/square inch) (Requirement)

NASA-STD 8739.1A with Change 1**8. PREPARATION FOR POLYMERIC APPLICATIONS****8.1 Surface Preparation**

8.1.1 The PWAs shall be cleaned and demoisturized within 8 hours before any polymeric application (Requirement).

8.1.2 Demoisturizing shall be defined on the engineering documentation (Requirement).

8.1.3 Demoisturizing may be accomplished by an oven bake at $90^{\circ}\text{C} \pm 5.5^{\circ}\text{C}$ ($194^{\circ}\text{F} \pm 10^{\circ}\text{F}$) for a minimum of 4 hours, or by a vacuum bake at a lower temperature (See Table 8-1). The time in and out of the oven or chamber and the temperature shall be recorded (Requirement). The PWAs may be stored for longer periods of time in a controlled moisture free atmosphere.

8.1.4 Surface preparation varies with the type of material and substrate. For materials, substrates, or combinations not specifically addressed in this standard, special instructions shall be generated in accordance with paragraph 1.4 (Requirement).

8.2 Masking

8.2.1 Material.

8.2.1.1 Areas to be kept free of polymeric material shall be masked with approved tape, covers, or other suitable masking material or devices (Requirement).

8.2.1.2 Masking material shall be compatible with the PWA being processed (Requirement).

8.2.1.3 ESD protective tapes containing conductive adhesive shall not be applied over PWB conductor patterns (Requirement).

8.2.1.4 Precautions shall be taken to assure that no residues are left when the masking material is removed (Requirement).

<p><i>CAUTION: TAPES MAY CONTAIN METALLIC OR METALLIZED POLYMERIC MATERIAL THAT CAN CAUSE ELECTRICAL SHORTS OR CORROSION.</i></p>

8.2.2 Masking for Paraxylene Conformal Coating.

8.2.2.1 Unsealed parts and areas not to be coated shall be properly masked to prevent paraxylene vapors from penetrating minute openings (Requirement).

8.2.2.2 Masking materials shall be compatible with the primer and the vacuum deposition system (Requirement).

8.3 Priming

8.3.1 Materials Requiring Primer.

NASA-STD 8739.1A with Change 1

8.3.1.1 When a primer is used, it shall be of a material recommended by the same manufacturer that produced the conformal coating material and be applied and cured in accordance with the manufacturer's instruction (Requirement).

8.3.1.2 Any excess buildup of primer shall be removed (Requirement).

Table 8-1: Demoisturizing Schedules for Polymeric Applications Surface Preparation

Drying Process	Minimum Bake-Out Time (hours) ¹			
	+66°C (+151°F)	+90°C (+194°F)	+100°C (+212°F)	+125°C (+257°F)
Recirculating Oven	6	4	2	1.5 ³
Vacuum Oven ²	2.5	2	1.5	1 ³

Notes:

1. Times specified are recommendations. Actual drying time may be affected by board assembly type, component technology (PTH / SMT / COB, etc.), PWA population density, layer count, ground/power plane(s), PWB thickness, via aspect ratio, cleaning method, cleanliness verification method, or other conditions.
2. Vacuum Oven: Chamber pressure: 3 torr / 3 mm mercury (Hg).
3. Long-term (≥ 24 hrs cumulative) bake-out at +125°C (+257°F) is prohibited, unless specified by engineering documentation. Elevated temperature bake-out may degrade the laminate and components.
4. Oven temperature ramp rate requirements, intended to protect the assembly from thermal shock during the baking process, are established and controlled at the Project level. Refer to engineering documentation for ramp rate control limits and monitoring requirements.
5. A dry nitrogen blanket/purge is recommended to limit the formation of oxidation on solderable surfaces and to accelerate drying. Bake-out at temperatures in excess of +90°C (+194°F) should not exceed 48 hours cumulative, unless specified by engineering documentation.

8.3.2 Re-Priming Requirements. Most primers are effective only for a specified period of time with well-protected storage. If, after priming, subsequent conformal coating has not been applied within the manufacturer's recommended elapsed time, re-priming is mandatory (Requirement).

CAUTION: SOME SURFACE PRIMERS WILL DAMAGE CERTAIN TYPES OF MATERIALS. REFER TO MANUFACTURERS' SPECIFICATIONS FOR THE SPECIFIC TYPE OF SURFACE PRIMER RECOMMENDED FOR USE.

NASA-STD 8739.1A with Change 1

8.4 Material Preparation

8.4.1 Preparation

8.4.1.1 Polymeric materials shall be mixed and prepared according to the manufacturer's instructions or the appropriate process document (*Requirement*).

8.4.1.2 It shall be verified, prior to usage, that materials have not exceeded their shelf life (*Requirement*).

8.4.2 Single-Component Materials. Materials that are supplied as a single part may require stirring because of settling of fillers or other ingredients in the system. Stirring shall be carefully conducted to minimize entrapped air (*Requirement*). High-solid materials or high-viscosity materials may be deaerated to remove entrapped air. Be aware of the possibility of losing the volatile ingredients during the deaeration process.

8.4.3 Multicomponent Materials.

8.4.3.1 Multicomponent materials shall be thoroughly mixed until the mixture is smooth and homogeneous and shall be used within the working life limit (*Requirement*).

8.4.3.2 Mixing shall be carefully conducted to minimize entrapped air (*Requirement*). High-solid materials or high-viscosity materials may be deaerated to remove entrapped air. Be aware of the possibility of losing the volatile ingredients during the deaeration process.

8.4.4 Fillers. Fillers shall be free of moisture (*Requirement*). A bake of at least 4 hours at $100^{\circ}\text{C} \pm 10^{\circ}\text{C}$ ($212^{\circ}\text{F} \pm 18^{\circ}\text{F}$) is suitable for demisting fillers.

8.4.5 Mixing. Mixing shall be carefully conducted to minimize entrapped air (*Requirement*). High-solid materials or high-viscosity materials may be deaerated to remove trapped air. Be aware of the possibility of losing the volatile ingredients, if any, in the deaeration process.

8.4.6 Mix Record.

8.4.6.1 A record of each mix batch date and procedure shall be maintained (*Requirement*). The mix record shall, as a minimum, include:

- a. Hardware traceability identifier (*Requirement*)
- b. Materials used (including manufacturer, part number, traceability code, expiration date) (*Requirement*)
- c. The mix ratio (*Requirement*)
- d. Ambient conditions (temperature, humidity) (*Requirement*)
- e. Time mixed (*Requirement*)
- f. Working life (*Requirement*)
- g. Date (*Requirement*)
- h. Operator (*Requirement*)

NASA-STD 8739.1A with Change 1

- i. Quality assurance inspector (*Requirement*)
- j. Test specimen acceptance test results (*Requirement*)
- k. Manufacturer datasheet range for hardness (*Requirement*)
- l. Any special allowances (*Requirement*).

8.4.6.2 The mix record shall be traceable to the test specimen by serial number or other unique identifier as they may be stored separately (*Requirement*).

8.4.7 Spray Applications.

8.4.7.1 In spray applications, viscosity of conformal coatings shall be closely observed and controlled by adding solvents as necessary to preserve the best sprayable viscosity (*Requirement*).

8.4.7.2 Solvent addition shall not be used to extend the working life of the material (*Requirement*).

8.4.8 Containers.

8.4.8.1 In all mixing operations, nonabsorbent plastic, glass, or metal containers and stirrers shall be used (*Requirement*).

8.4.8.2 Containers with seams and crevices that will trap unmixed materials shall not be used (*Requirement*).

8.4.8.3 The stirrer and container combination shall not introduce contamination to the mix (i.e., from metal stirrers scraping the inside of the container, from coatings dissolving from the inside of the container, or from containers supplied with powdered surfaces) (*Requirement*).

8.4.9 Material Condition.

8.4.9.1 Materials shall not be used that exhibit any evidence of excessive crystallization, surface skinning, or gelling (*Requirement*).

8.4.9.2 The manufacturer's recommendations shall be followed regarding crystallization and residue on the bottom of the container (*Requirement*).

8.4.10 Silicones.

8.4.10.1 All silicone operations shall be segregated from other material operations (*Requirement*).

8.4.10.2 Equipment and workspace used for measuring viscosity, mixing, curing, and applying silicone materials shall not be used for preparing or applying other materials (See 6.4) (*Requirement*).

8.4.11 Working Life. The working life (pot life) of the material shall begin immediately after mixing (*Requirement*).

NASA-STD 8739.1A with Change 1

8.5 Test Specimen

8.5.1 A test specimen shall be prepared and maintained for each mixed batch (*Requirement*).

8.5.2 The test specimen shall be prepared just prior to or at the same time, and under the same conditions as the PWA, and be of a size that is compatible with the test equipment and methods required (*Requirement*).

8.5.3 The dwell time required to fully cure the test specimen may be different than that used for the PWA if it is material that is being used for a conformal coating or bonding application. This test specimen shall be tested in accordance with ASTM 2240 and shall meet the manufacturer's specified hardness range (*Requirement*).

8.5.4 Acceptance of the test specimen shall be indicated on the mix record (*Requirement*).

8.5.5 Preparation and test of the test specimen may be performed prior to its use on the final assembly or may be done in parallel with use of the material on the final assembly. The former is preferred in order to avoid risk associated with non-compliant material. Hardness testing is not a requirement for conformal coating materials.

8.5.6 The test specimen shall be identified and stored under controlled conditions of paragraph 6.3.1 (*Requirement*).

8.5.7 Test specimens shall be maintained for the period specified by the contract or in-house project requirements (*Requirement*).

8.5.8 A test specimen is not required for vacuum deposited coating materials. Cure verification for vacuum deposited coating materials shall be done using the conformal coating test specimen (see paragraph 8.6) (*Requirement*).

8.6 Conformal Coating Specimens

8.6.1 A conformal coating specimen shall be coated concurrently with the regular PWA for the purposes of assessing coating cure and/or thickness (*Requirement*).

8.6.2 The conformal coating specimen shall be used for tests and analyses to avoid damage or destruction of the production boards (*Requirement*).

8.6.3 Each conformal coating specimen shall be traceable to its PWA.

NASA-STD 8739.1A with Change 1

9. STAKING

9.1 Requirements

9.1.1 Application Sequence. Staking shall be performed prior to conformal coating unless it is specifically stated otherwise on the engineering documentation (*Requirement*).

9.1.2 Application.

9.1.2.1 Staking material shall be applied to the parts and areas specified by the approved engineering documentation (*Requirement*). Spatulas and syringes, with or without pressure-control pneumatic dispensers, may be used to apply the material.

9.1.2.2 Staking material shall adhere to all surfaces to be joined (*Requirement*).

9.1.3 Staking Concerns. When staking, the following shall be assured:

- a. The staking compound does not negate stress relief of parts and enclose joints, part leads, or mechanically compromise the reliability of the hardware (*Requirement*).
- b. Staking material is free from contamination (*Requirement*).
- c. Glass-bodied parts are covered with resilient material prior to staking with rigid material, such as epoxy (*Requirement*).
- d. Fastener thread lubricant, if used, is controlled so that it does not inhibit adhesion of the staking (*Requirement*).
- e. Staking material does not enter the inside of mounting holes or cover vent holes (*Requirement*).
- f. Staking material shall not be allowed to bridge between the bottom of ceramic-bodied DIPs or surface mounted parts and the PWB (*Requirement*).

9.1.4 Mandatory Staking.

9.1.4.1 All required staking shall be detailed on the engineering documentation (*Requirement*).

9.1.4.2 Jumper wires in excess of 2.54 cm (1 inch) and axial leaded tantalum capacitors of all case sizes shall be staked.

9.1.4.3 If parts are identified to be staked but staking location or staking dimensions are not specified on the engineering documentation, the following shall be used as default criteria:

- a. Axial leaded component, sleeveless (See Fig. 9-1):
 - i. Fillet location: between the board and the length of the body (*Requirement*)
 - ii. Fillet length $\geq 50\%$ of the body length (*Requirement*)
 - iii. Fillet height $\geq 25\%$ and $\leq 50\%$ of the body diameter (*Requirement*)
 - iv. The top of the component is visible for its entire length (*Requirement*).

NASA-STD 8739.1A with Change 1

- b. Axial leaded component, sleeved (See Fig. 9-2):
 - i. Fillet location: between the board and end faces of the body (*Requirement*)
 - ii. Fillet height $\geq 25\%$ and $\leq 50\%$ of the body diameter, fillet does not enclose the lead, negate stress relief, or contact the lead seal (*Requirement*).
- c. Jumper wires (See Fig. 9-8):
 - i. Fillet location: at intervals of 2.54 cm (1 inch) maximum and at every change of direction beyond the radius of curvature for a radius bend that is shorter than 2.54 cm (1 inch) (*Requirement*).
 - ii. Be in contact around the full circumference of the wire and in contact with the board (*Requirement*).
- d. TO-type packages (See Fig. 9-5):
 - i. At least three fillets, spaced approximately evenly around the periphery of the component (*Requirement*).
 - ii. Fillet height: $\geq 25\%$, extension over the top of the part is controlled by clearance requirements at the next higher level of assembly (*Requirement*).
 - iii. Slight flow under the part is allowed however staking shall not contact lead, enclose the lead, or negate stress relief (*Requirement*).
- e. Radial-leaded square or rectangular packages (See Fig. 9-6)
 - i. Staking shall be used at each corner (*Requirement*).
 - ii. Fillet height: $\geq 25\%$, extension over the top of the part is controlled by clearance requirements at the next higher level of assembly (*Requirement*).
 - iii. Slight flow under the part is allowed however staking shall not contact lead, enclose the lead, or negate stress relief (*Requirement*).
 - iv. Surface mount area array packages require engineering analysis and design instructions to address all necessary polymeric applications and acceptance criteria (*Requirement*).
- f. Radial-leaded component whose height is larger than one of its base dimensions (see Fig. 9-3).
 - i. Fillet required on both sides, fillet height: $\geq 50\%$ to 100%, fillet width: $\geq 50\%$ (*Requirement*)
 - ii. Slight flow under the part is allowed however staking shall not contact lead, enclose the lead, or negate stress relief (*Requirement*).
 - iii. When in an array of between two and four devices, staking material shall connect the tops of the parts in the array for the entire width of each part and connect the end faces of the two parts at each end of the array to the substrate for $\geq 50\%$ to 100% of the height of the parts and $\geq 50\%$ of the width of the parts (*Requirement*).

NASA-STD 8739.1A with Change 1

iv. When in an array of greater than four devices, in addition to the requirements of 9.1.4.3.iii, both outer side surfaces of every other part shall contain a fillet to the board $\geq 25\%$ to 100% of the height of the part (*Requirement*). (See Fig. 9-4).

g. Wire bundles. (See Fig. 9-7) Width of staking stripe shall be a minimum of 1x the diameter of the bundle (*Requirement*).

9.1.5 Curing.

9.1.5.1 Staking material shall be cured in accordance with the manufacturer's recommended cure schedule or as specified in the engineering documentation (*Requirement*).

9.1.5.2 Staking material shall be tack-free when cured (*Requirement*).

NASA-STD 8739.1A with Change 1

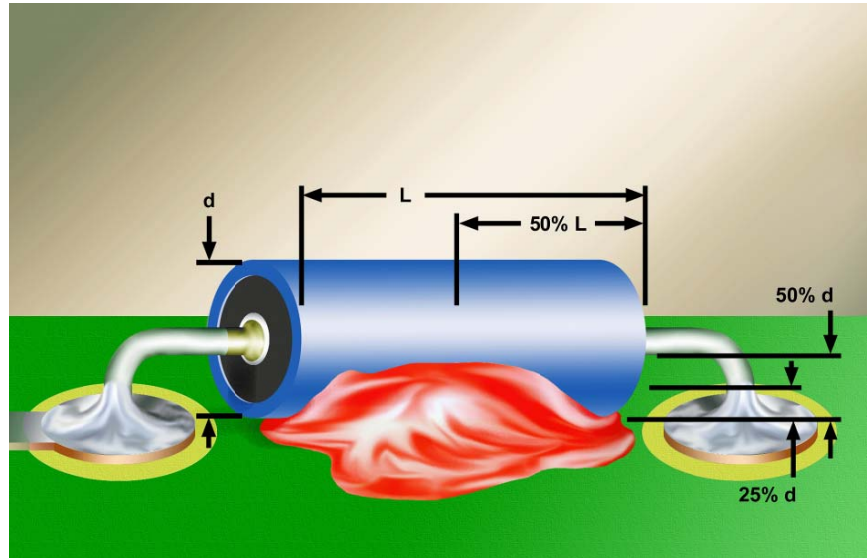

Fillet Length: $\geq 50\%L$ to $100\%L$
Fillet Height: $\geq 25\%d$ to $50\%d$
Top of component is visible for its entire length.

Figure 9-1: Default Staking for Horizontally-Mounted Sleeveless Cylindrical Part

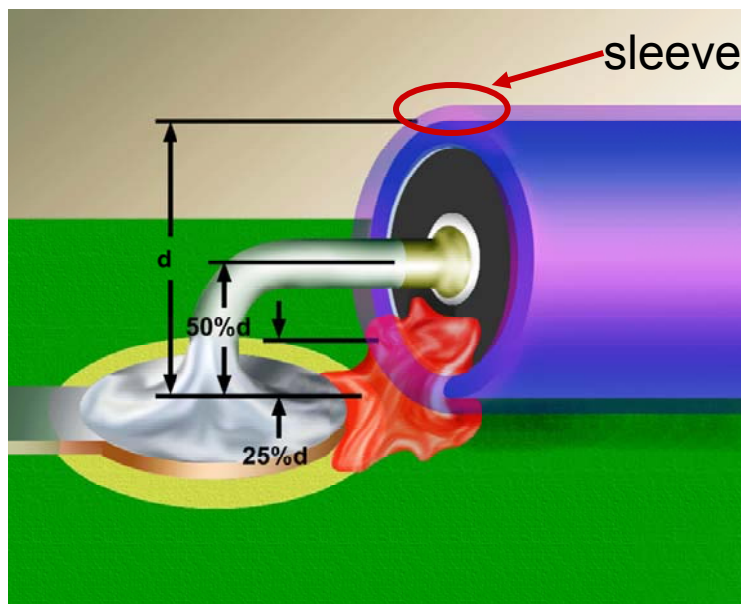

Staking is in contact with both end faces of the component.
Fillet Height: $\geq 25\%d$ to $50\%d$ and does not enclose the lead, negate stress relief, or contact the lead seal.

Figure 9-2: Default Staking for Horizontally-Mounted Sleeved Cylindrical Parts

NASA-STD 8739.1A with Change 1

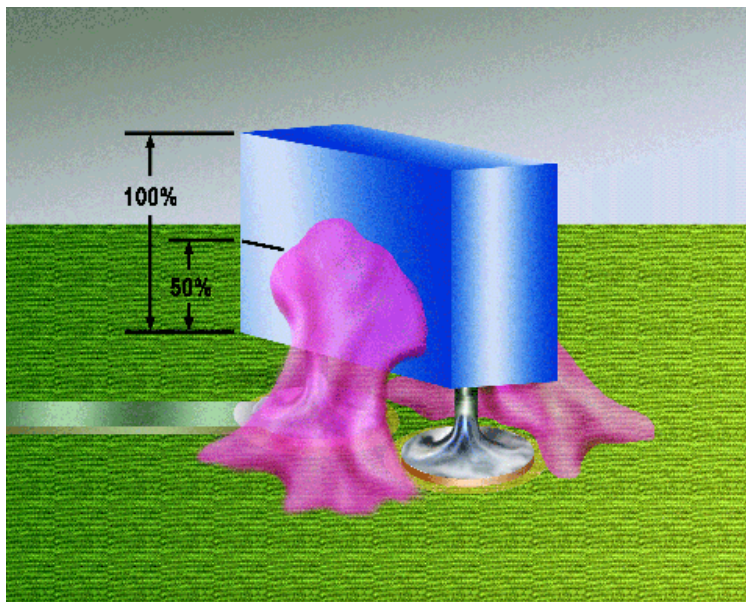

Fillet Height: $\geq 50\% H$ to $100\% H$

Fillet Width: $\geq 50\% W$

Slight flow underneath component, but fillets do not contact lead seals or enclose the lead, or negate stress relief.

Figure 9-3: Default Staking of a Single Vertically-Mounted Rectangular Part

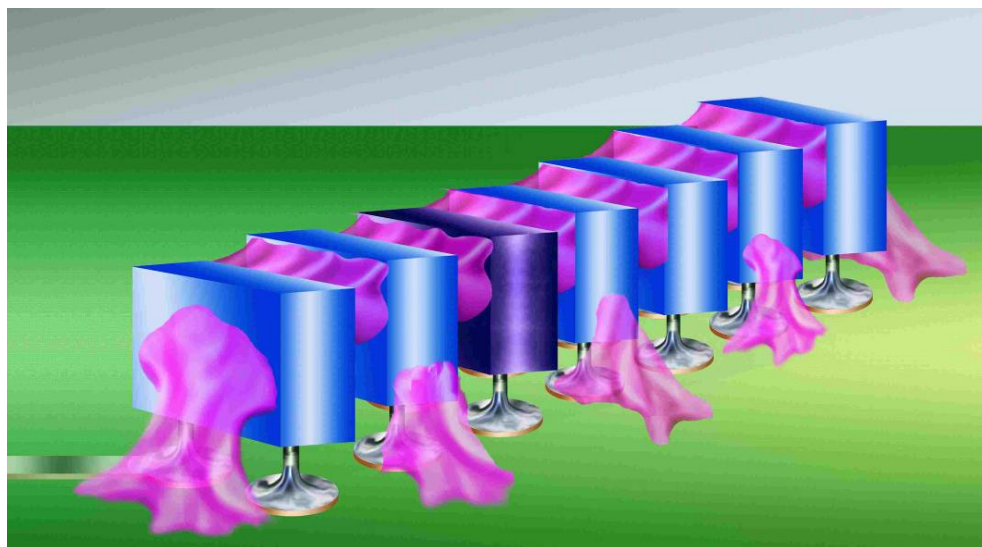

Two outside ends – Fillet Height: $\geq 50\% H$ to $100\% H$

End Fillet : $\geq 50\% W$

Inner surfaces: Fillet is in contact with both surfaces for 100% of component width

Figure 9-4: Default Staking for an Array of Vertically-Mounted Rectangular Parts

NASA-STD 8739.1A with Change 1

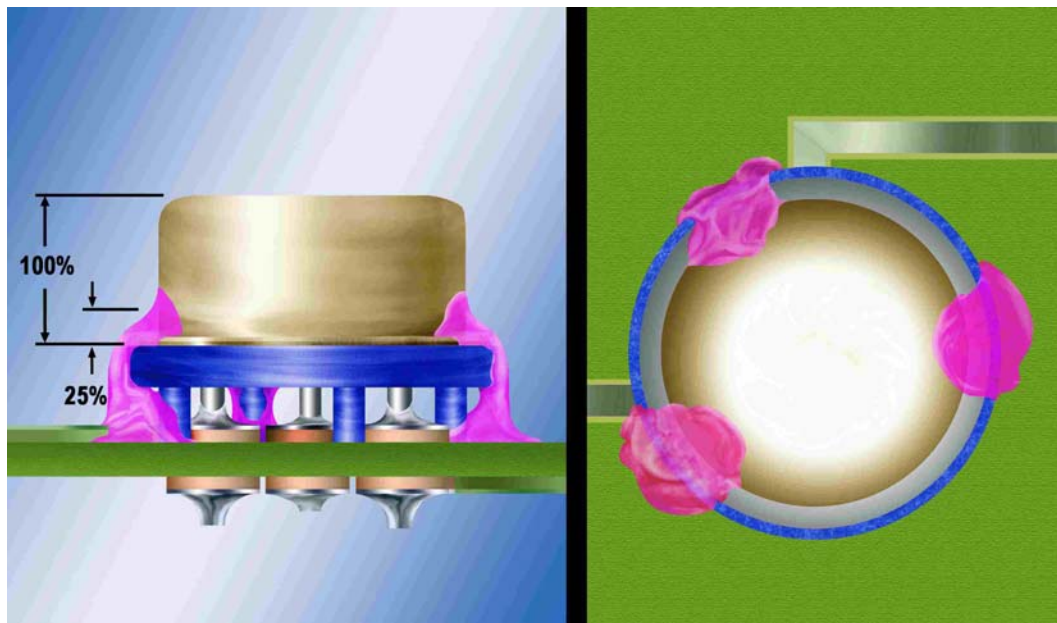

At least three fillets spaced approximately evenly around periphery of the component.
Fillet Height: $\geq 25\%$ to 100% of the component body height
Slight flow underneath component, but fillets do not contact lead seals, enclose the lead, or negate stress relief.

Figure 9-5: Staking for Radial Lead Components

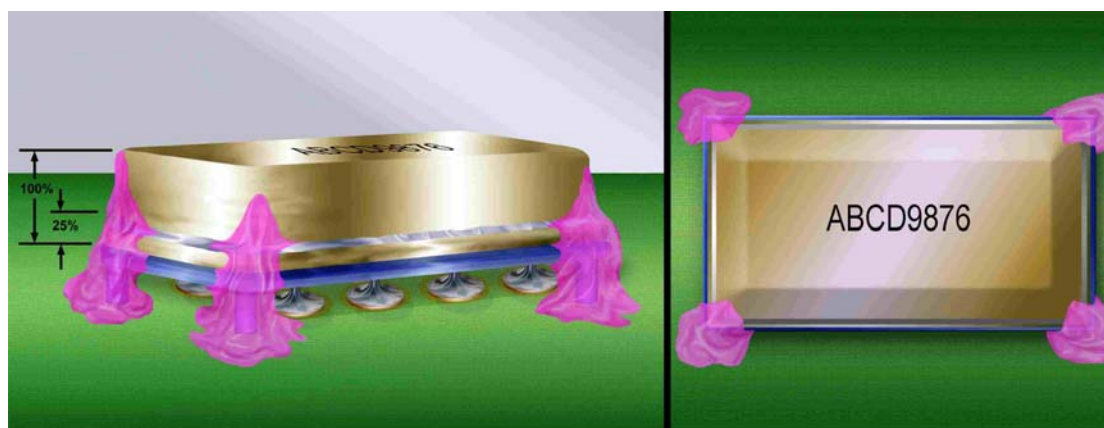

Fillets on all four corners.
Fillet Height: $\geq 25\%$ to 100% of the component body height
Slight flow underneath component, but fillets do not contact lead seals enclose the lead, or negate stress relief.

Figure 9-6: Staking for Radial Multi-lead Rectangular Components

NASA-STD 8739.1A with Change 1

Minimum 1X diameter of wire bundle

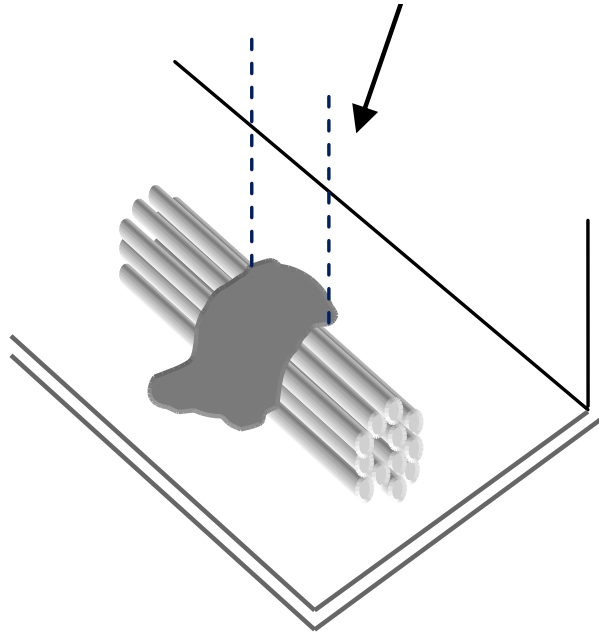

Figure 9-7: Wire Bundle Staking



Figure 9-8: Single Wire Staking

NASA-STD 8739.1A with Change 1

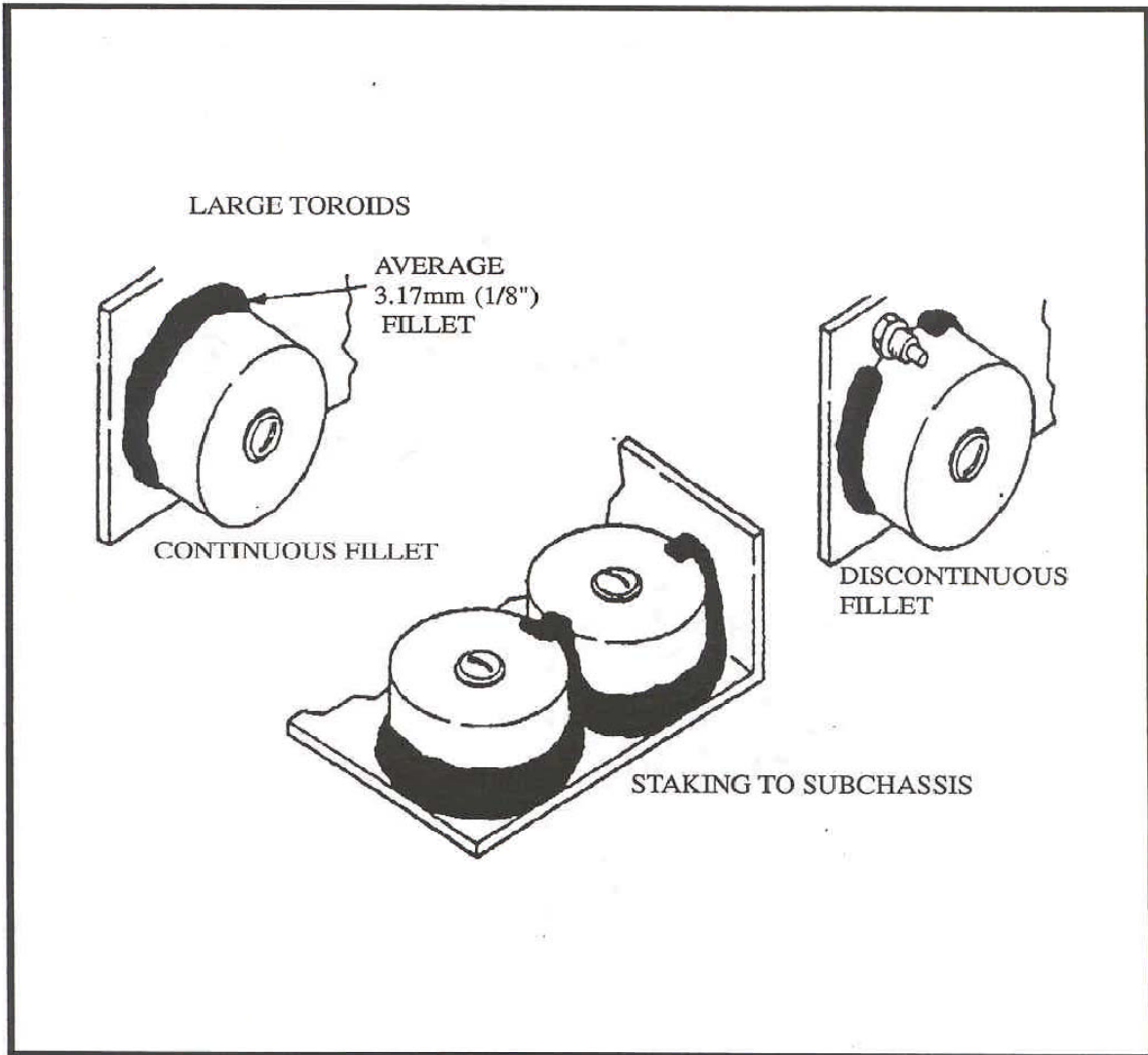

Figure 9-9: Toroid Staking

NASA-STD 8739.1A with Change 1

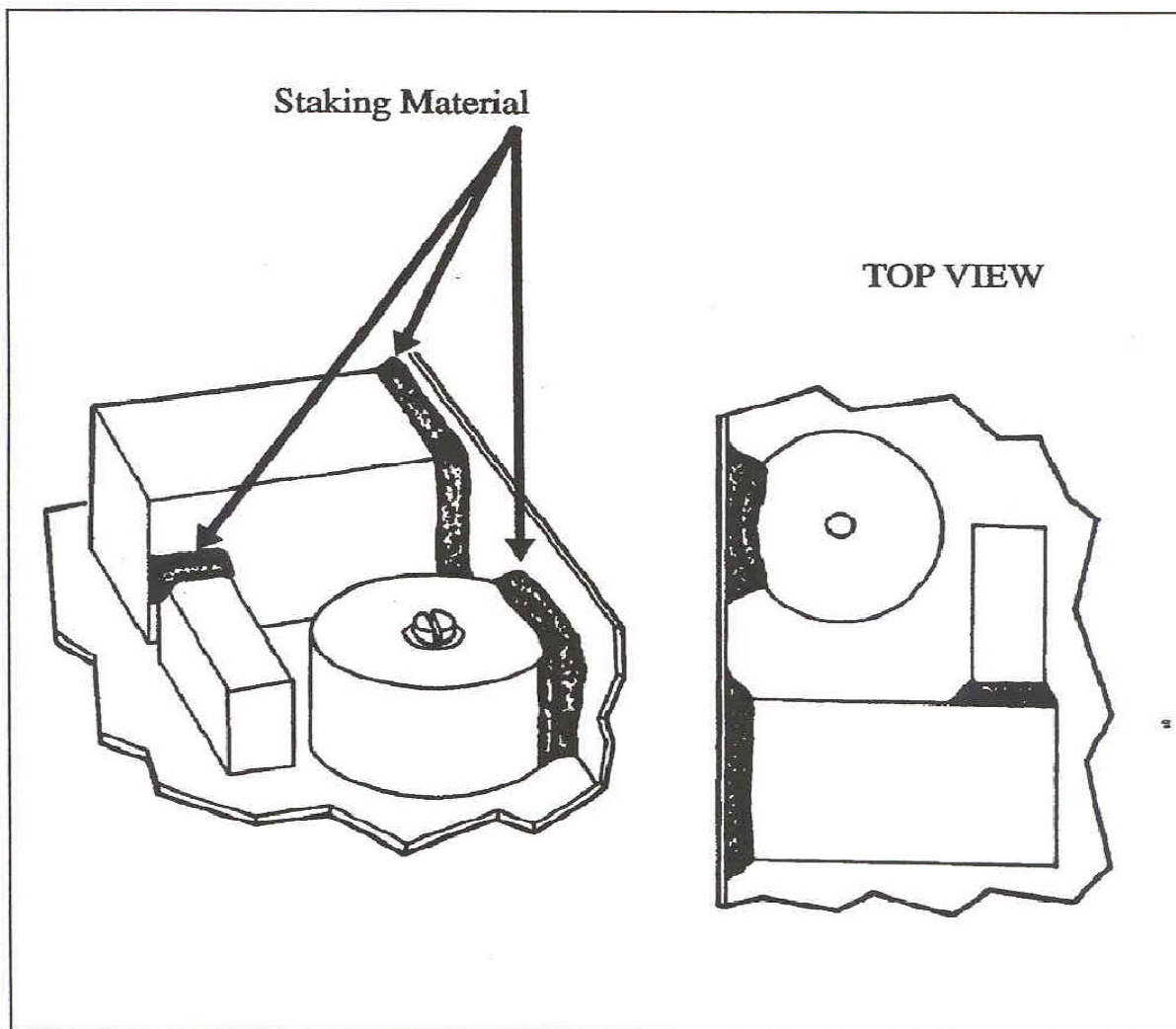

Figure 9-10: Vibration Dampening Staking

9.2 Fastener Staking

9.2.1 General Requirements. The requirements in this section apply only to fasteners on PWAs and are not applicable to structural applications.

9.2.1.1 The staking material used for fastener locking or torque striping shall have good adhesion and no evidence of separation or delamination from the bolt, screw, or washer/nut and the adjacent surfaces (*Requirement*).

9.2.1.2 The staking shall not contain voids or air bubbles larger than 0.635 mm (0.025 inch) in diameter or contaminants (*Requirement*).

9.2.1.3 There shall be no material spillage or residue on adjacent surfaces (*Requirement*).

9.2.2. Fastener Staking Application Requirements

NASA-STD 8739.1A with Change 1

9.2.2.1 Staking is applied to the head of the fastener unless otherwise directed by the engineering documentation (*Requirement*).

9.2.2.2 When the engineering documentation specifies that polymeric material be added to the screw threads, a QA witness shall confirm proper application (*Requirement*).

9.2.2.3 There shall be no evidence that the staking material has been fractured or disturbed at any time after the staking work was completed (*Requirement*).

9.2.2.4 If a nut is part of the fastener combination, the nut shall be spot staked to the bolt and the assembly in one or two places such that 25 percent to 50 percent of the circumference of the nut is covered. Staking of the bolt head is optional (*Requirement*).

9.2.2.5 The staking material shall not enter the internal drive (impede removal of the bolt or screw). (See Figure 9-11) (*Requirement*)

9.2.2.6 If a nut is not used, bolt heads and screw heads shall have 25 percent to 50 percent of the heads' circumference covered with staking (*Requirement*).

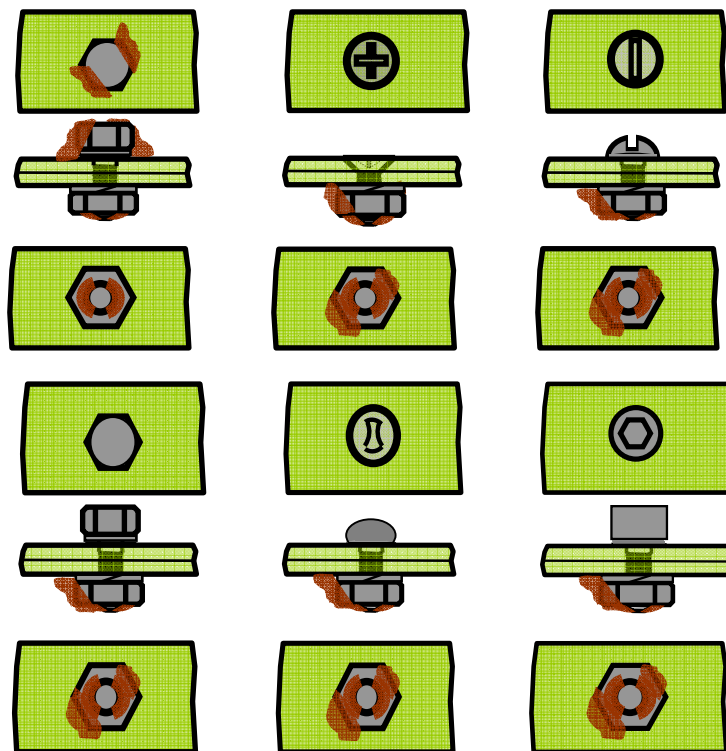

Figure 9-11: Locking of Screws and Bolts with Nuts

NASA-STD 8739.1A with Change 1

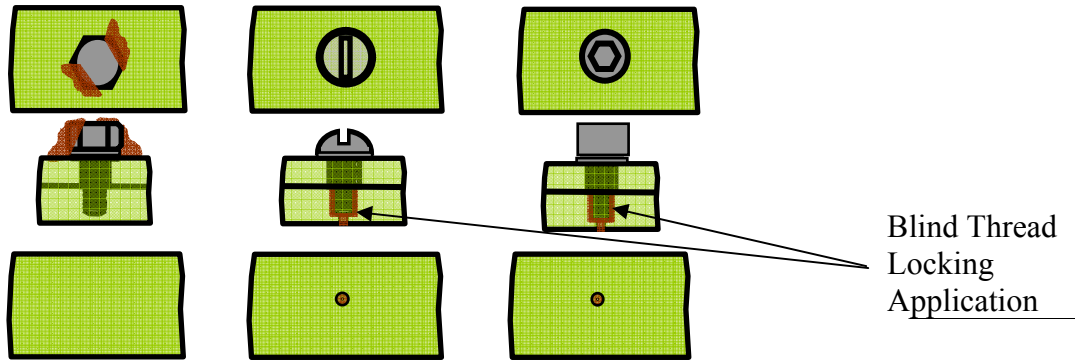

Figure 9-12: Thread Locking of Blind Screw

9.2.3. Fastener Thread Locking

9.2.3.1 Fastener thread locking shall be inspected during the process (*Requirement*).

9.2.3.2 If the application includes a blind hole, a vent hole shall be provided for polymer squeeze-out. (See Figure 9-12) (*Requirement*)

9.3 Torque Striping

(See Figure 9-13)

9.3.1 Torque Striping Application Requirements

9.3.1.1 When used, torque striping shall be applied from the center of the screw or bolt head to at least 3.2 mm (0.126 inch) onto the substrate (*Requirement*).

9.3.1.2 There shall be no evidence that the torque striping material has been fractured or tampered with at any time after the work is completed (*Requirement*).

9.3.1.3 Torque striping material shall not be removed without the expressed approval by the Project or the Quality Engineer (*Requirement*).

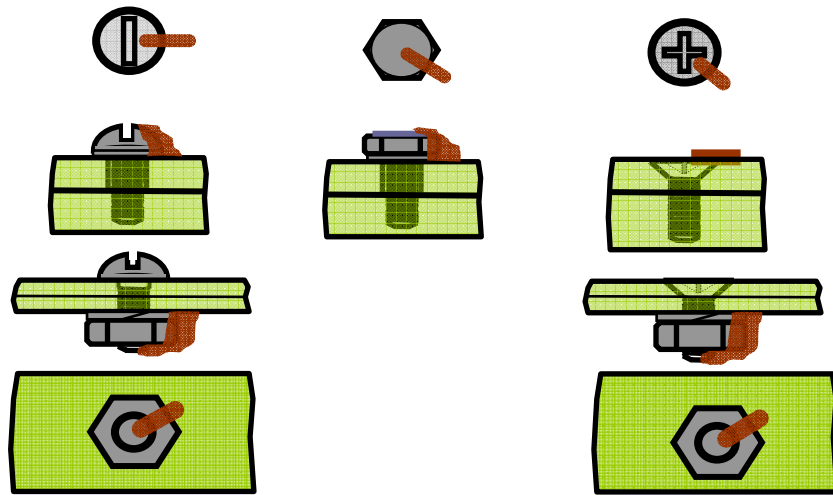

Figure 9-13: Torque Striping Methods

NASA-STD 8739.1A with Change 1**10. CONFORMAL COATING****10.1 Purpose**

Conformal coatings are intended to provide electrical insulation and environmental protection thus minimizing the performance degradation to electronic PWAs by humidity, handling, debris, and contamination. Conformal coating materials may include solvents (diluent), fillers, and catalysts and/or accelerators, in addition to the basic resin. Conformal coating is applied by spraying, brushing, dipping, or vacuum deposition methods and then allowed to cure to provide a uniform, continuous coating over the surface of the PWA or electronic assembly. Vacuum deposition methods involve processes, equipment, and materials that are departures from those applicable to the other application methods. Staking shall be performed prior to conformal coating unless it is specifically stated otherwise on the engineering documentation (*Requirement*).

10.2 Conformal Coating Application

10.2.1 The PWAs shall be cleaned and demoinsturized within 8 hours before conformal coating (*Requirement*).

10.2.2 Demoinsturizing shall be defined on the engineering documentation (*Requirement*). Demoinsturizing may be accomplished by an oven bake or by a vacuum bake as described in Table 8-1.

10.2.3 The time in and out of the oven or chamber and the temperature shall be recorded (*Requirement*).

10.2.4 Conformal coating shall be applied using a method that will yield the intended coverage without excessive filleting or runs (*Requirement*). Common coating application methods include spraying, brushing, dipping, or a combination thereof. Chemical Vapor Deposition (CVD) is the process used for paraxylene.

a. Spraying.

(i) The conformal coatings shall be sprayed onto the PWA using clean dry gas at a pressure sufficient to provide proper atomization (*Requirement*).

(ii) One pass shall be sprayed across the entire surface of the PWA holding the spray gun at an angle of approximately 45° to the PWA (*Requirement*).

(iii) The PWA shall be rotated 90° after each pass, and spraying repeated, so that all four directions are sprayed. See Figure 10-1 (*Requirement*).

b. Brushing.

(i) The material shall be evenly applied without forming excessive fillets and thick areas (*Requirement*).

(ii) Particular attention shall be paid to undersides of parts and lead wires (*Requirement*).

(iii) The brush selected shall provide adequate control for appropriate coverage, be cleaned in a non-reactive solvent, and be thoroughly dried before use (*Requirement*).

NASA-STD 8739.1A with Change 1

c. Dipping.

(i) The entire PWA shall be dipped (*Requirement*). The extraction rate ensures uniform thickness.

(ii) The conformal coated PWA shall be allowed to drain until the conformal coating stops running and minimum part filleting is achieved (*Requirement*).

d. Vacuum Deposition.

(i) Paraxylene conformal coating shall be applied using a special vacuum deposition chamber (*Requirement*).

(ii) The conformal coating shall be thin, uniform, and fillet free (*Requirement*).

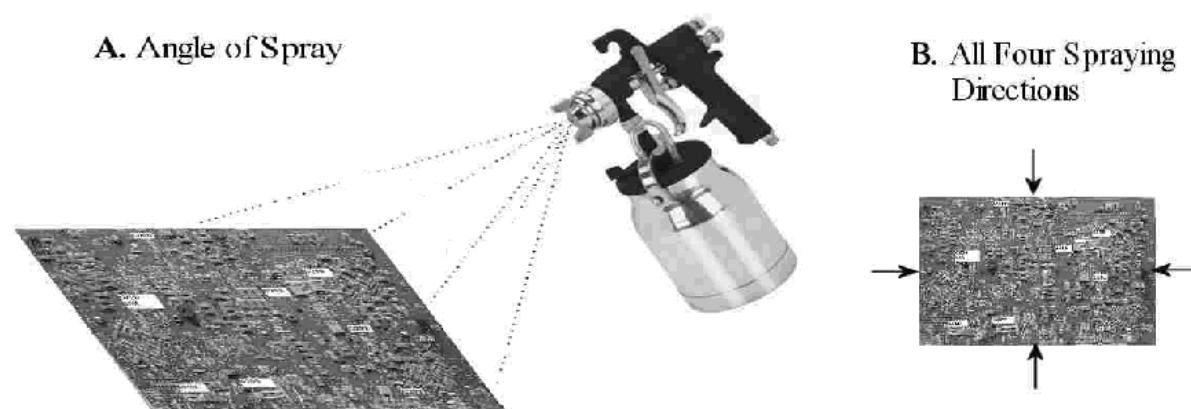

Figure 10-1: Spray Application

10.2.5 Thickness Measurements. Thickness measurements shall be applied to the final cured thickness on conformal coating specimens and shall be in accordance with Table 10-1 (*Requirement*). An in-process wet film thickness measurement may be used provided that it is calibrated to a final cured thickness that meets the values in Table 10-1.

a. Excessive Coating Removal. Excessive coating shall be removed prior to cure (*Requirement*).

b. Thickness requirement for brush coatings. The variances of brushed coating thicknesses may be outside of the limits given in Table 10-1. See engineering documentation for thickness requirements for brushed coatings.

NASA-STD 8739.1A with Change 1

Table 10-1: Conformal Coating Thickness

Type of Coating	Cured Coating [mm (inch)]
ACRYLIC	0.025 – 0.127 (0.001 to 0.005)
URETHANE	0.025 – 0.127 (0.001 to 0.005)
EPOXY	0.025 – 0.127 (0.001 to 0.005)
SILICONE	0.051 – 0.203 (0.002 to 0.008)
PARAXYLENE	0.013 – 0.051 (0.0005 to 0.002)

10.2.6 Pre-Cure Examination. Immediately after material application, the uncured conformal coating shall be examined for:

- a. Bubbles and Air Entrapments. Prior to cure, bubbles and air entrapments shall be broken using locally qualified methods such as piercing with a sharp probe or by vacuum methods (*Requirement*).
- b. Bridging. Conformal coating material shall not be allowed to bridge between the bottom of a leaded surface mount device and the PWB, or between the part lead and the PWB, thereby negating stress relief (*Requirement*).

10.2.7 Post Cure Inspection. After the cure cycle, the conformally coated PWA shall be examined to assure that the following conditions are met. See Figure 10-2 through Figure 10-5 for additional requirements.

- a. Conformal coating is uniform in color, thickness, and texture, tack-free, and shows proper adhesion to all coated surfaces (*Requirement*).
- b. Conformal coating covers all areas as specified on the engineering documentation, has a smooth continuous surface, and follows the contours of the PWA (*Requirement*). Minor pull back from sharp points and edges is permissible unless otherwise specified on engineering documentation.
- c. Conformal coating is free from contamination (*Requirement*).
- d. Terminals are conformal coating encapsulated, including the insulation gap of the wire, unless there is a solder ball type connection (as in a high voltage connection) (*Requirement*). This is normally applied with a brush after the initial conformal coating application.
- e. Conformal coating may bridge between adjacent part leads providing stress reliefs are not negated.
- f. Conformal coating does not exhibit discoloration (due to such things as excessive curing oven temperature or contamination) (*Requirement*). Change of color due to temperature aging during normal exposures to test temperatures or standard rework is allowed. This allowance is not intended to apply to color changes resulting from the use of incorrect or defective material.

NASA-STD 8739.1A with Change 1

10.2.8 When fluorescent conformal coating materials are used, coverage and location shall be verified by Ultraviolet (UV) light illumination.

10.3 Curing

10.3.1 Cure Schedule. The conformal coating material shall be cured in accordance with a specified cure schedule that is compatible with the thermal limitations of the hardware and results in a tack-free finish (*Requirement*).

10.3.2 Multiple Conformal Coatings. When multiple conformal coatings of the same material are employed, each layer may be partially cured before the next layer is applied.

10.3.3 Curing Silicones. Ovens used for curing silicones shall not be used for curing other materials (*Requirement*).

10.3.4 Handling and Storage. After application of the polymeric material, particularly when the material is still wet and tacky (during curing cycle), hardware shall be handled and stored in a manner that minimizes exposure to contamination or handling damage (*Requirement*).

10.4 Cleanup

After the conformal coating process has been completed, the PWAs shall be cleaned to remove any maskant, loose debris, or material that may damage or degrade its performance (*Requirement*).

10.5 Touchup/Rework

10.5.1 Conformally coated assemblies shall be touched up to correct coating coverage deficiencies (*Requirement*).

10.5.2 Touched up areas shall meet the minimum thickness requirement of Table 10-1, but may exceed the maximum thickness limit (*Requirement*).

10.5.3 Removal and replacement of conformal coating is considered rework and the procedures shall be documented (*Requirement*).

NASA-STD 8739.1A with Change 1

	<p>PREFERRED</p> <p>Completed uniform coverage with no visual bubbles.</p>
	<p>ACCEPTABLE</p> <p>Small bubbles, but they do not bridge between non-common conductors, expose a bare conductor surface, or exceed 0.76mm (0.03 inch) in any dimension.</p>
	<p>UNACCEPTABLE</p> <p>Excessive bubbling</p>

Figure 10-2: Conformal Coating – Bubbles

NASA-STD 8739.1A with Change 1

	<p>PREFERRED</p> <p>Smooth, continuous, and without bubbles, scratches or imperfections.</p>
	<p>ACCEPTABLE</p> <p>Scratch does not expose any conductive area.</p>
	<p>UNACCEPTABLE</p> <p>Scratch exposes conductive areas.</p>

Figure 10-3: Conformal Coating – Scratches

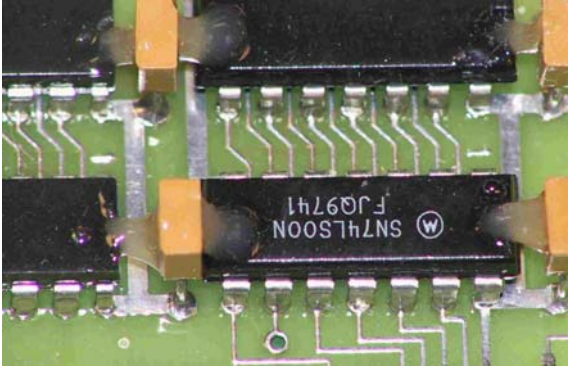
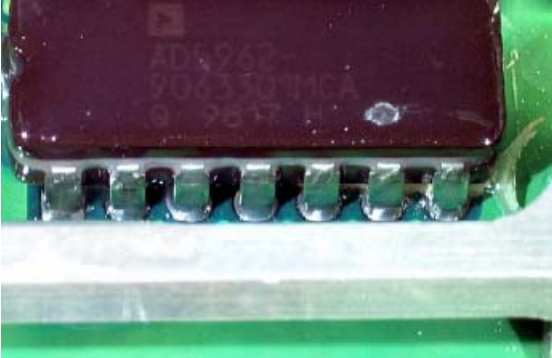
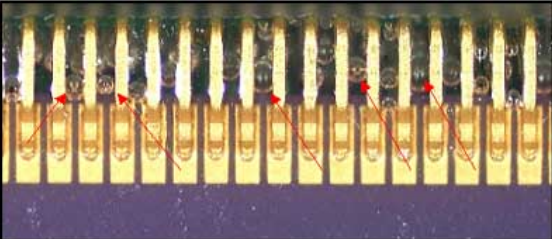
NASA-STD 8739.1A with Change 1

	<p>PREFERRED</p> <p>Uniform color, texture, and thickness with apparent good adhesion on parts and board surface. The coating should show uniform fluorescence under a UV light.</p>
	<p>ACCEPTABLE</p> <p>Some evidence of variation in coating thickness. Minor lifting on nonconductive areas.</p>
	<p>UNACCEPTABLE</p> <p>Excessive lifting and peeling indicating improper surface cleaning or excessive thickness. Any lifting on conductive areas is nonconforming.</p>

Figure 10-4: Conformal Coating - Lifting and Peeling

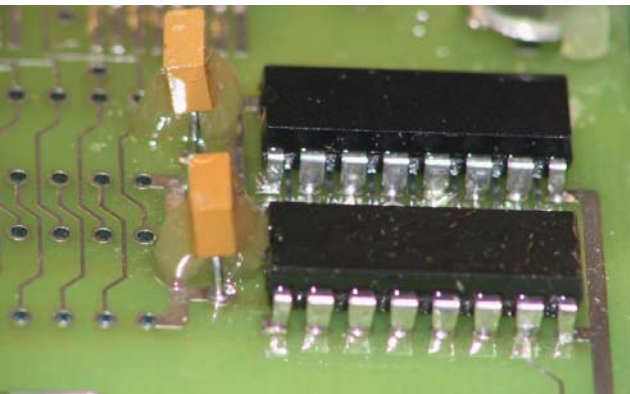
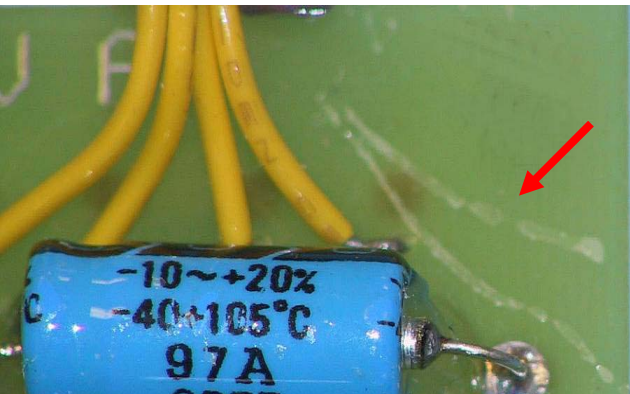
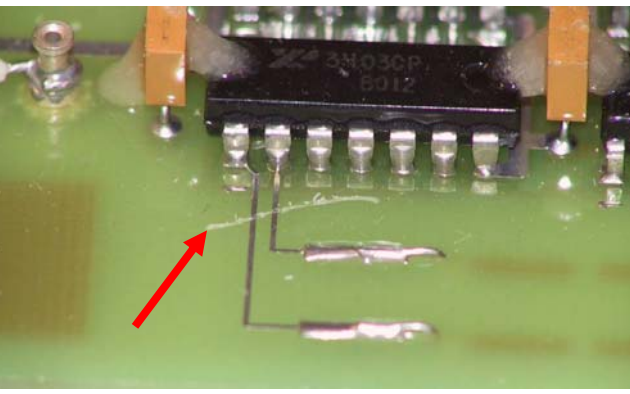
NASA-STD 8739.1A with Change 1

	<p>ACCEPTABLE</p> <p>Not to exceed 5 percent of PWB surface area.</p> <p><u>Runs</u></p>
	<p>ACCEPTABLE</p> <p>Not to exceed 5 percent of PWB surface area.</p> <p><u>Fish Eyes</u></p>
	<p>UNACCEPTABLE</p> <p>Loss of adhesion.</p>

Figure 10-5: Conformal Coating – Coverage Defects

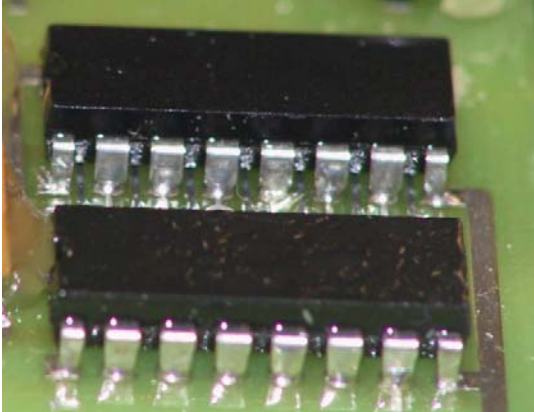
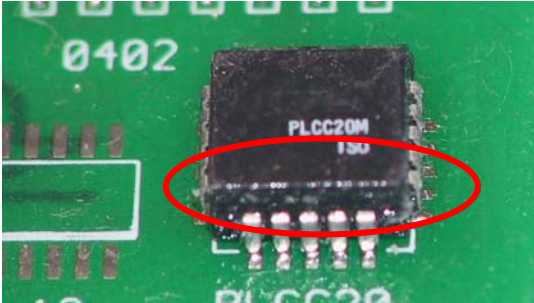
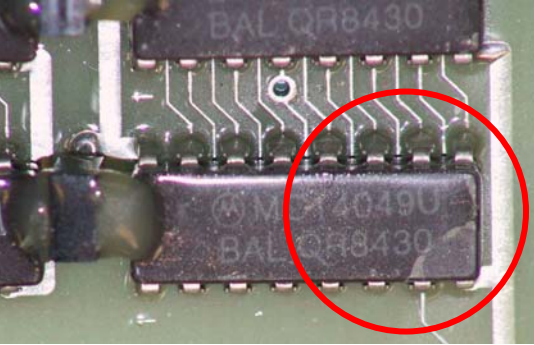
NASA-STD 8739.1A with Change 1

11. BONDING

11.1 General

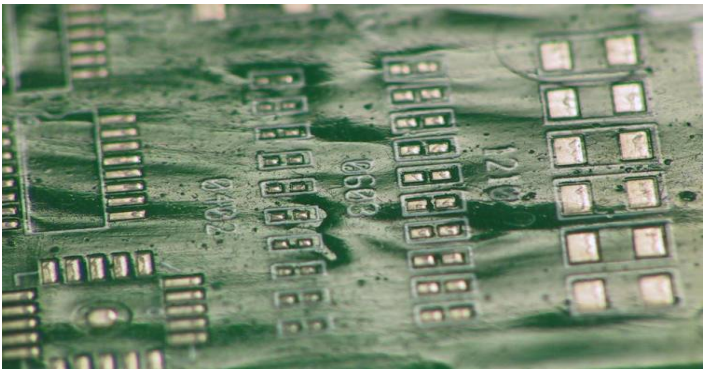
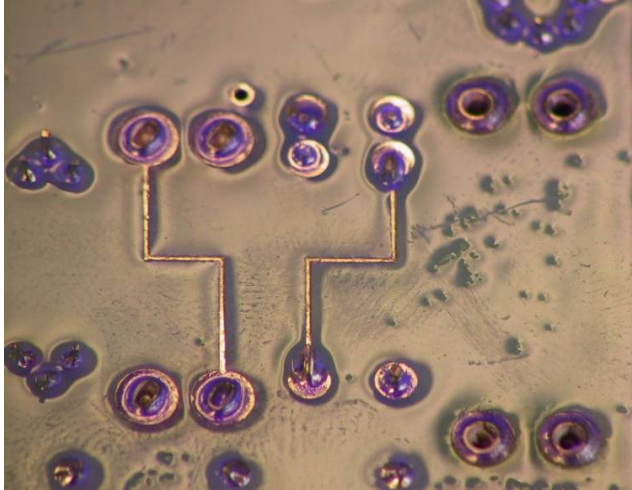
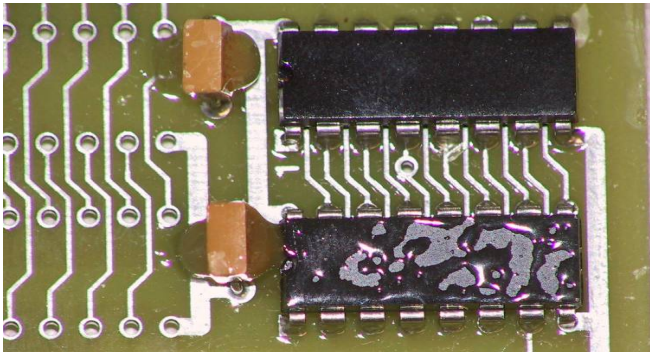
Bonding provides a method for joining surfaces of parts or materials using a polymer rather than fasteners.

11.2 Bonding

11.2.1 Surface Preparation. Surfaces being bonded shall be cleaned and prepared in such a manner as to achieve an acceptable bond between the surface and the adhesive (*Requirement*). When cleaning and priming surfaces, as required, masking may be needed to prevent contamination of adjacent surfaces.

11.2.2 Requirements.

a. Markings shall be clearly visible after completion of bonding processes unless otherwise allowed by the engineering documentation (i.e., dead-bugged parts) (*Requirement*).

b. The bonding material shall adhere to all surfaces to be joined (*Requirement*).

c. For thermistors, PRT, and similar components, at least one lead shall not be embedded in the bonding material (*Requirement*).

(i) The leads of these types of components shall be staked in accordance with the wire run rules in section 9.1.4.3.c above (*Requirement*).

d. Squeeze-out shall be visible on all sides unless sheet adhesive is used (*Requirement*). Squeeze-out should be kept to a minimum while providing enough to confirm via visual inspection.

e. For thermal joints, bond line control and coverage shall be per the engineering documentation and verified by engineering prior to use (*Requirement*).

f. Figure 11-1 shows some examples of acceptable and unacceptable bonding.

11.2.3 Order of Operations. Bonding shall be performed before conformal coating (*Requirement*).

NASA-STD 8739.1A with Change 1

	<p>ACCEPTABLE</p> <p>Markings shall be clearly visible.</p> <p>For thermistors, platinum resistance thermometers (PRT), and similar components, at least one lead shall be free of the bonding material.</p>
	<p>UNACCEPTABLE</p> <p>Excess bonding material applied</p>
	<p>UNACCEPTABLE</p> <p>Excess bonding material applied, squeeze-out negates stress relief.</p>

Figure 11-1: Component Bonding - Excess Bonding Material

NASA-STD 8739.1A with Change 1**12. ENCAPSULATION****12.1 General**

The purpose of encapsulation is to protect the component or assembly against damage and deterioration from electrical, thermal, mechanical, and space environment stresses under service conditions.

12.1.1 Vacuum Degassing.

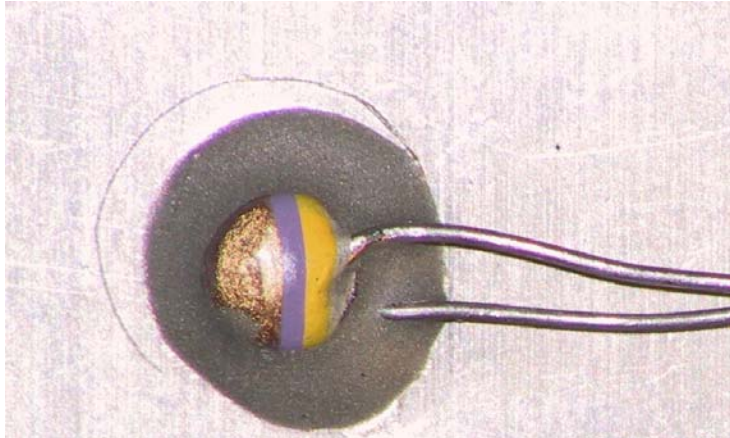
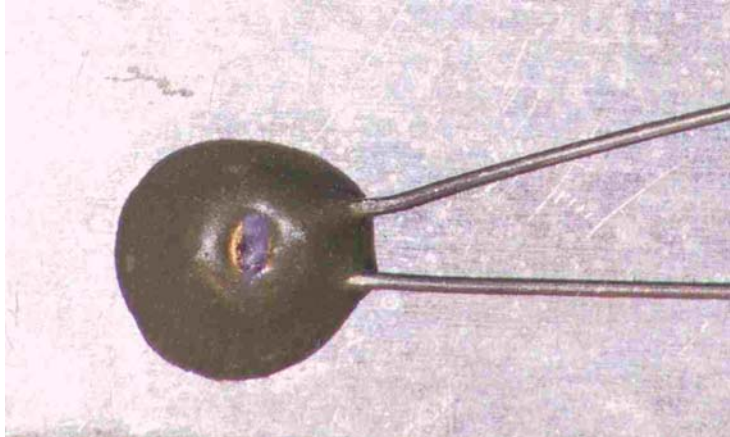
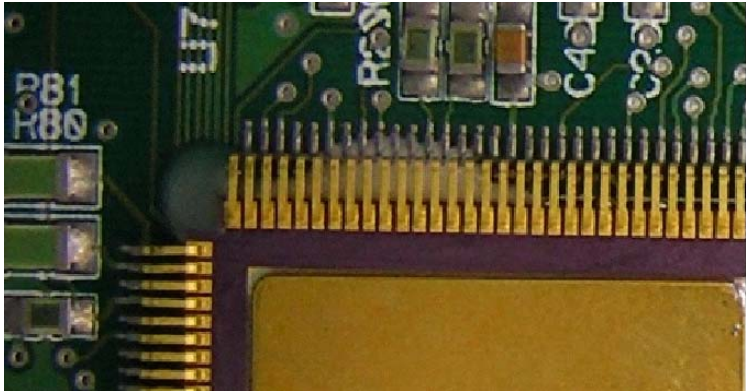
12.1.1.1 Encapsulation material shall be vacuum degassed before application (*Requirement*).

12.1.1.2 Engineering documentation shall specify when vacuum-degassing is also required after application or if it is not appropriate (*Requirement*).

12.2 Pre-cure Examination

12.2.1 The item to be encapsulated shall be free of contamination or residual solvents (*Requirement*).

12.2.2 Masking should be used to minimize material adhesion to the exterior surfaces of the assembly.

12.2.3 When required, underfill of components prior to potting shall be defined in the engineering documentation (*Requirement*).

12.2.4 For high voltage applications, bubbles and/or pinholes shall not be greater than 0.0254 mm (0.001 in) (*Requirement*).

12.3 Post-cure Inspection

12.3.1 The encapsulation material shall be free from contamination (*Requirement*).

12.3.2 The encapsulation material shall fill the required areas completely and shall adhere to all surfaces as intended (See Figs. 12-1 and 12-2) (*Requirement*).

12.3.3 Bubbles or pinholes shall be less than 0.635 mm (0.025 inch) diameter (See Fig. 12-2) (*Requirement*).

12.3.4 Bubbles or a series of bubbles shall not form a continuous path between two electrically conductive elements (*Requirement*).

12.3.5 For high voltage applications, bubbles and/or pinholes shall not be greater than 0.0254 mm (0.001 in) (*Requirement*).

12.3.6 Potting material shall not be present on the exterior surfaces of the encapsulation mold. (Small amount of spillage is allowed if it does not interfere with mounting or markings) (See Fig. 12-2) (*Requirement*).

12.3.7 The encapsulation material shall be free of fracture lines and cracks (*Requirement*).

12.3.8 For connectors, the encapsulation material shall have concave fillets to the encapsulated wires (*Requirement*).

NASA-STD 8739.1A with Change 1

12.3.9 Pins and sockets shall be free of encapsulating material (*Requirement*).



	<p>ACCEPTABLE</p> <p>Wire Encapsulation</p>
	<p>ACCEPTABLE</p> <p>Cable Encapsulation</p>
	<p>UNACCEPTABLE</p> <p>Large void bridging conductors, Improper filling of embedding mold.</p>

Figure 12-1: Encapsulating Wires at Connector

NASA-STD 8739.1A with Change 1

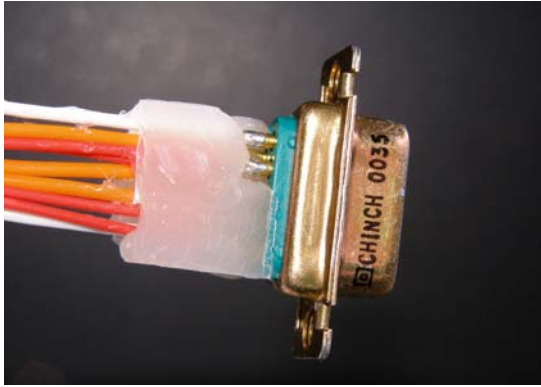

	<p>ACCEPTABLE</p> <p>Bubbles/Cavities <0.635mm (<0.025 inch diameter)</p>
	<p>UNACCEPTABLE</p> <p>Lack of adhesion</p>
	<p>ACCEPTABLE</p> <p>Spillage (A thin film is acceptable provided there is not an interference problem.)</p>
	<p>UNACCEPTABLE</p> <p>Spillage</p>

Figure 12-2: Module Encapsulation

12.4 Potting Connectors used with Shielded Cable

12.4.1 When conductive epoxy is used in place of a connector back shell, the epoxy shall provide electric conductivity between the connector shell mounting and the cable shield (*Requirement*).

12.4.2 All shielding wire end tips shall be captured by the encapsulant to prevent loose wires from causing electrical shorts (*Requirement*).

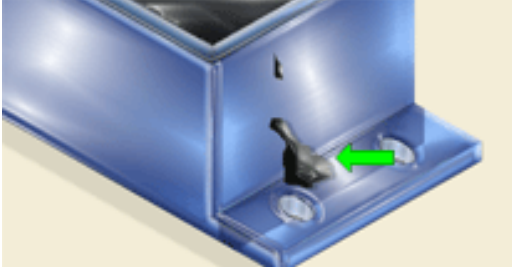
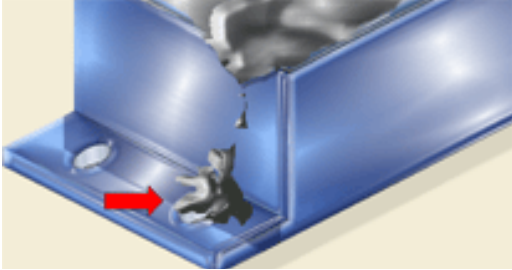
12.5 Cleanup

Encapsulated assemblies shall be cleaned to remove any masking or material that may damage or degrade their performance (*Requirement*).

NASA-STD 8739.1A with Change 1

13. QUALITY ASSURANCE

13.1 General

13.1.1 Workmanship. Workmanship shall be of a level of quality adequate to assure that the processed products meet the performance requirements of the engineering documentation and the criteria delineated herein (*Requirement*).

13.1.2 Inspection.

13.1.2.1 Inspection for acceptability shall be performed on all uses of staking, conformal coating, bonding and encapsulation on PWAs and electronic assemblies to the requirements specified in this Standard (*Requirement*).

13.1.2.2 Parts and conductors shall not be physically disturbed to aid inspection (*Requirement*).

13.1.3 Quality Assurance. The following functions shall be performed:

- a. Verify that all tests, inspections, and measurements specified by this standard have been performed (*Requirement*).
- b. Verify that all personnel who stake, coat, bond, encapsulate, or inspect hardware in accordance with this document have been trained and certified as specified in Chapter 5 (*Requirement*).
- c. Conduct in-process surveillance of all assembly operations to verify that all processes and procedures implementing the requirements of this document are current, approved, adequate, and being accurately utilized (*Requirement*).
- d. Verify that no damage exists on parts and PWBs prior to their being staked, bonded, conformally coated, or encapsulated (*Requirement*).
- e. Verify that the facility cleanliness, environmental conditions, and lighting requirements of Chapter 6 are being met (*Requirement*).

13.2 Documentation Verification

Quality assurance personnel shall verify that all required documentation is current and approved. The documentation shall include:

13.2.1 Records

- a. Results of the visual examination as per paragraph 5.2 (*Requirement*).
- b. Evidence of operator and inspector certification as per paragraph 5.3 (*Requirement*).
- c. Material purchase data as per paragraphs 6.6.3.a and b (*Requirement*).
- d. Mix record as per paragraph 8.4.6 (*Requirement*).
- e. Test Specimen per paragraph 8.5 (*Requirement*).
- f. Conformal coating specimen per paragraph 8.6 (*Requirement*).

NASA-STD 8739.1A with Change 1

g. Demoisturizing as per paragraph 10.2 (*Requirement*).

13.2.2. Procedures

a. Polymeric applications program as per paragraph 4.2 (*Requirement*).

b. Training and certification program as per paragraph 5.1 (*Requirement*).

c. Tooling and equipment operating procedures as per paragraph 6.5.1.e (*Requirement*).

d. Calibration system as per paragraph 6.5.2 (*Requirement*).

e. In-process storage and handling procedures as per paragraph 6.8 (*Requirement*).

f. Cleaning procedures as per paragraph 7.1 (*Requirement*).

13.3 Documentation Authorization

Quality assurance personnel shall verify that the following documentation has been approved by the procuring NASA Center prior to implementation:

a. Special engineering requirements as per paragraph 1.3 (*Requirement*).

b. Special processes, materials, or parts as per paragraph 4.1.3 (*Requirement*).

c. Special documents as per paragraph 4.1.3 (*Requirement*).

d. Departures from requirements as per paragraph 1.4 (*Requirement*).

e. Repairs as per paragraph 4.3 (*Requirement*).

f. Process documentation for special tools as per paragraph 6.5.3 (*Requirement*).

g. Polymeric materials as per paragraph 6.6 (*Requirement*).

h. Special cleanliness test methods as per paragraph 7.2.1.c (*Requirement*).

13.4 Verification of Tools, Equipment, and Materials

13.4.1 Tools and equipment. Tools and equipment shall be verified for conformance to the applicable requirements found in paragraph 6.5 (*Requirement*).

13.4.2 Materials.

13.4.2.1 Materials shall conform to the requirements of paragraph 4.5 (*Requirement*).

13.4.2.2 Controls shall be implemented to assure that only approved and conforming materials are used (*Requirement*).

13.4.2.3 Materials not conforming or not required for the operations involved shall be removed from the work areas or tagged non-usable (*Requirement*).

13.5 General Inspection Methods for Polymeric Applications

13.5.1 Magnification Aids.

NASA-STD 8739.1A with Change 1

13.5.1.1 Requirements shall be verified by visual inspection using 1X to 10X power magnification (*Requirement*).

13.5.1.2 Inspection optics shall conform to the requirements of paragraph 6.7 (*Requirement*). Higher magnification may be used, as necessary, to inspect suspected anomalies or defects.

13.5.2 Tackiness and Adhesion.

13.5.2.1 Gentle finger pressure or a plastic probe shall be used to inspect for tackiness and adhesion (*Requirement*).

13.5.2.2 Lint-free gloves or finger cots shall be worn when finger pressure is used (*Requirement*).

13.5.3 Hardness. When applicable, hardness shall be measured in accordance with ASTM-D-2240 (*Requirement*).

13.6 Acceptance/Rejection Criteria for Staking

13.6.1 Documentation. All acceptance and rejection criteria for staking shall be clearly defined in the application processing document(s) otherwise the criteria herein shall be the default (*Requirement*).

13.6.2 Acceptance Criteria. Staked PWAs shall exhibit, as a minimum, the following workmanship characteristics in order to be judged acceptable (Reference Figures 9-1 through 9-8 for pictorial representations of some of the requirements below):

- a. The staking material shall adhere to the intended surfaces as per paragraph 4.5.1.c (*Requirement*).
- b. Staking material meets the hardness requirement of paragraph 8.5.3 (*Requirement*).
- c. Visual evidence shall indicate that the staking material was applied prior to conformal coating per paragraph 9.1.1 (*Requirement*).
- d. Staking material shall not be allowed to bridge between the bottom of ceramic-bodied DIP's or surface mounted parts and the PWB per paragraph 9.1.2.4 (*Requirement*).
- e. The staking compound shall not negate stress relief of parts or enclose joints or part leads per paragraph 9.1.3.a (*Requirement*).
- f. The staking material shall be free from contamination as per paragraph 9.1.3.b (*Requirement*).
- g. Glass bodied parts shall be covered with resilient material prior to staking with rigid material per paragraph 9.1.3.c (*Requirement*).
- h. All axial lead solid slug tantalum capacitors shall be staked as per paragraph 9.1.4 (*Requirement*).
- i. When required to stake sleeveless axial leaded components: fillet is between the board and the length of the body, fillet length ≥ 50 percent of the body length, fillet height ≥ 25 percent and ≤ 50 percent of the body diameter, and the top of the component is visible for its entire length per paragraph 9.1.4.3.a (*Requirement*).

NASA-STD 8739.1A with Change 1

j. When required to stake sleeved axial leaded components: fillet is between the board and the end faces of the body, fillet height ≥ 25 percent and ≤ 50 percent of the body diameter, fillet does not enclose the lead, negate stress relief or contact the lead seal per paragraph 9.1.4.3.b (*Requirement*).

k. Jumper wires shall be staked a minimum of every 2.54 cm (1 inch) maximum and at every change of direction beyond the radius of curvature for a radius-bend that is shorter than 2.54 cm (1 inch) with staking in contact around the full circumference of the wire and in contact with the board per paragraph 9.1.4.3.c (*Requirement*).

l. When required to stake TO-type packages: at least three fillets spaced approximately evenly around the periphery of the component, fillet height: ≥ 25 percent, slight flow under the part is allowed however staking shall not contact lead seals, enclose the lead, or negate stress relief per paragraph 9.1.4.3.d (*Requirement*).

m. When required to stake radial-leaded square or rectangular packages: staking shall be used at each corner, fillet height: ≥ 25 percent, slight flow under the part is allowed however staking shall not contact lead seals, enclose the lead, or negate stress relief per paragraph 9.1.4.3.e (*Requirement*).

n. When required to stake radial-leaded component whose longest dimension is its height: fillet required on both sides, fillet height ≥ 50 percent to 100 percent, fillet width ≥ 50 percent, slight flow under the part is allowed however staking shall not contact lead seals, enclose the lead, or negate stress relief per paragraph 9.1.4.3.f (*Requirement*).

o. When in an array of between two and four devices, fillets shall connect the tops of the parts in the array for the entire width of each part. Fillets shall also connect the end faces of the two parts at each end of the array to the substrate for $\geq 50\%$ to 100% of the height of the parts and $\geq 50\%$ of the width of the parts (*Requirement*).

p. When in an array of greater than four devices, in addition to 13.6.2.o, both sides of the outer surfaces of every part shall contain a fillet to the board $\geq 25\%$ to 100% of the height of the part (*Requirement*).

q. The staking material shall be tack-free when cured as per paragraph 9.1.5 (*Requirement*).

13.6.3 Rejection Criteria. The following are some characteristics of unsatisfactory conditions, any of which is cause for rejection (*Requirement*).

a. Staking material used after shelf life expiration as per paragraph 6.6.1.b.

b. Staking material bridges between the PWB and the bottom of the DIPs or flatpacks per paragraph 9.1.2.4.

c. Staking material fills the stress relief areas per paragraph 9.1.3.a.

d. Staking material encloses the part lead as per paragraph 9.1.3.a.

e. Rigid staking has been applied directly to glass bodied parts per paragraph 9.1.3.c.

f. Fastener lubricant inhibits the adhesion of staking per paragraph 9.1.3.d.

NASA-STD 8739.1A with Change 1

g. Staking material is found inside of mounting holes or covering vent holes or via's per paragraph 9.1.3.e.

13.7 Acceptance/Rejection Criteria for Fastener Staking and Torque Striping

13.7.1 Documentation. All acceptance and rejection criteria for staking shall be clearly defined in the application processing document(s) (*Requirement*). Reference Figures 9-11 through 9-13 for typical, acceptable fastener staking.

13.7.2 Acceptance Criteria for Fastener Staking. Staked fasteners shall exhibit, as a minimum, the following workmanship characteristics in order to be judged acceptable:

a. Fastener staking material adheres to the intended surfaces per paragraph 4.5.1.c. and 9.2.1.1 (*Requirement*).

b. Fastener staking material meets the hardness requirement of 8.5.3 (*Requirement*).

c. Fastener staking material contains no contaminants, voids, or air bubbles per paragraph 9.2.1.2 (*Requirement*).

d. The nut part of a fastener combination (when used) is spot staked to the bolt and to the assembly in one or two locations, with total coverage of 25 percent to 50 percent of the circumference of the nut per paragraph 9.2.2.4 (*Requirement*).

e. If a nut is not used, bolt heads and screw heads have 25 percent to 50 percent of the heads' circumference covered with staking per paragraph 9.2.2.6 (*Requirement*).

13.7.3 Rejection Criteria for Fastener Staking. The following are some of the characteristics of unsatisfactory conditions; any of which shall be a cause for rejection (*Requirement*).

a. The nut part of a fastener is staked less than 25 percent of the circumference and/or does not contact both the bolt and the assembly surface per paragraph 9.2.2.4.

b. If a nut is not used, bolt heads and screw heads have less than 25 percent of the heads' circumference covered per paragraph 9.2.2.6.

c. Evidence that the fastener staking material has been fractured or tampered with at any time after the thread locking work was completed per paragraph 9.2.2.3.

d. Resin spillage or residue on adjacent substrate surfaces per paragraph 9.2.1.3.

e. The staking material has entered a bolt or screw's internal drive (impede removal of the bolt or screw) when a nut is used per paragraph 9.2.2.5.

f. Thread lock was applied to a blind threaded hole, without a vent hole provided for polymer squeeze-out per paragraph 9.2.3.2.

13.7.4 Acceptance Criteria for Torque Striping.

a. Torque striping material shall adhere to the intended surfaces per paragraph 4.5.1.c (*Requirement*).

b. Torque striping material shall meet the hardness requirement of 8.5.3 (*Requirement*).

NASA-STD 8739.1A with Change 1

c. Torque striping is applied from the center of bolt to at least 3.2 mm (0.126 inch) onto the substrate per paragraph 9.3.1.1 (*Requirement*).

d. Evidence that the torque striping material has been fractured or tampered with at any time after the thread locking work was completed per paragraph 9.3.1.2 (*Requirement*).

13.7.5 Rejection Criteria for Torque Striping. Torque striping shall be rejected if any of the following are formed:

a. No evidence of torque striping on fasteners designated to be torqued on engineering documentation (*Requirement*).

b. Torque striping shows evidence of having been disturbed per paragraph 9.3.1.2 (*Requirement*).

c. Resin spillage or residue on adjacent substrate surfaces (*Requirement*).

13.8 Inspection Methods for Conformal Coating

13.8.1 UV-Light Inspection. When fluorescent conformal coating materials are used, coverage and location shall be determined by UV-light examination per paragraph 10.2.8 (*Requirement*).

13.8.2 Conformal Coating Thickness Inspection. Conformal coating thickness shall be determined using a wet film thickness gauge, micrometer, or other tool on flat surfaces of the PWA or on the conformal coating specimens per paragraphs 10.2.5 and 8.6 (*Requirement*).

13.9 Acceptance/Rejection Criteria for Conformal Coating

13.9.1 Documentation. All acceptance and rejection criteria for conformal coating shall be clearly defined in the application processing document(s) (*Requirement*). Reference Figure 10-2 through Figure 10-5 for conformal coating acceptance and rejection criteria.

13.9.2 Acceptance Criteria. Conformally coated PWAs shall exhibit, as a minimum, the following workmanship characteristics to be acceptable:

a. PWAs were cleaned and demoisturized within 8 hours before conformal coating per paragraph 8.1.1 (*Requirement*).

b. Unless otherwise specified by the approved engineering documentation, the conformal coating, when measured in flat unencumbered areas on the conformal coating specimen, shall have a thickness appropriate for the conformal coating material being used as per paragraph 10.2.5 (*Requirement*).

c. Conformal coating shall be uniform in color and texture per paragraph 10.2.7.a (*Requirement*).

d. Conformal coating shall be tack-free when cured per paragraph 10.2.7.a (*Requirement*).

e. Conformal coating shall adhere to all coated surfaces per paragraph 10.2.7.a (*Requirement*).

f. Conformal coating shall have a smooth continuous surface and follow the contours of the PWA as paragraph 10.2.7.b (*Requirement*).

NASA-STD 8739.1A with Change 1

- g. PWAs were cleaned to remove any maskant per paragraph 10.4 (*Requirement*).
- h. Conformal coating shall be uniform in thickness as specified in Table 10-1 or on engineering documentation except in touched-up areas as per paragraph 10.5 (*Requirement*).
- i. Conformal coating shall cover all areas as specified on the engineering documentation (*Requirement*). Pull back from sharp points and edges shall be permitted unless otherwise specified as per paragraph 10.2.7.b (*Requirement*).
- j. Conformal coating shall be free of contamination as per paragraph 10.2.7.c (*Requirement*).
- k. Each terminal shall be encapsulated with conformal coating to include the insulation gap of the wire as per paragraph 10.2.7.d (*Requirement*).
- l. Conformal coating material that bridges between adjacent part leads is acceptable as per paragraph 10.2.7.e (*Requirement*).

13.9.3 Rejection Criteria. The following are some characteristics of unsatisfactory conditions, any of which is cause for rejection (*Requirement*):

- a. Conformal coating material used after shelf life expiration as per paragraph 6.6.1.b.
- b. Conformal coating bridges stress relief areas thereby negating stress relief as per paragraph 10.2.6.b.
- c. Conformal coating bridges between the PWB and the bottom of DIP's and flatpacks as per paragraph 10.2.6.b.
- d. Conformal coating exhibits tackiness or soft spots as per paragraph 10.2.7.a.
- e. Pinholes, blistering, scratches, whitish spots (measling), wrinkling, or cracking as per paragraph 10.2.7.a and paragraph 10.2.7.b.
- f. Any signs of contamination (e.g., flux, loose particles, or foreign material) as per paragraph 10.2.7.c.
- g. Discolored conformal coating as per paragraph 10.2.7.f.
- h. Bubbles or bare spots bridging two electrically conductive elements as per Figure 10.2.
- i. Bubbles larger than 0.76 mm (0.030 inch) in any dimension as per Figure 10.2.
- j. Conformal coating exhibits lifting or peeling as per Figure 10.4.
- k. Conformal coating exhibits excess runs, fish eyes, or peeling as per Figure 10.5.

13.10 Acceptance/Rejection Criteria for Bonding

13.10.1 Documentation. All other acceptance and rejection criteria for bonding shall be clearly defined in the application processing document(s) (*Requirement*). Reference Figure 11-1 for acceptable and rejected bonding features.

13.10.2 Acceptance Criteria. PWAs and electronics assemblies containing bonded items shall exhibit, as a minimum, the following workmanship characteristics to be acceptable:

NASA-STD 8739.1A with Change 1

- a. The bonding resin witness sample meets the hardness requirement of 8.5.3 (*Requirement*).
- b. The adhesive material shows evidence of squeeze-out around all sides of the part mounting base per paragraph 11.2.2.d (*Requirement*).
- c. The adhesive material has good adhesion and shows no evidence of separation from the substrate surfaces per paragraph 11.2.2.b (*Requirement*).
- d. Bond line control is per the engineering documentation per paragraph 11.2.2.e (*Requirement*).
- e. Bonding is done prior to conformal coating per paragraph 11.2.3 (*Requirement*).

13.10.3 Rejection Criteria. Bonding shall be rejected if any of the following characteristics are found (*Requirement*):

- a. Part markings are not visible, unless allowed by engineering instructions per paragraph 11.2.2.a.
- b. Both leads of PRT, thermistors, and similar parts are fully captured per paragraph 11.2.2.c.
- c. Adhesive material residue or spills on top of the part or the adjacent substrate surfaces, after completion of the work. Excessive squeeze-out around the part per paragraph 11.2.2.d.

13.11 Acceptance/Rejection Criteria for Encapsulation

13.11.1 Documentation. All acceptance and rejection criteria for encapsulated assemblies shall be clearly defined in the application processing document(s) (*Requirement*). Reference figures 12-1 and 12-2 for typical, acceptable encapsulation features.

13.11.2 Acceptance Criteria. Encapsulated assemblies shall exhibit, as a minimum, the following workmanship characteristics in order to be judged acceptable:

- a. The encapsulation material adheres to the intended surfaces per paragraph 12.3.2 (*Requirement*).
- b. The encapsulation polymer shall meet the hardness requirement of 8.5.3 (*Requirement*).
- c. As defined in the engineering documentation, underfill has been installed prior to encapsulation per paragraph 12.2.3 (*Requirement*).
- d. The encapsulation material fills the required areas completely per paragraph 12.3.2 (*Requirement*).
- e. The encapsulation material is free from fracture lines or cracks per paragraph 12.3.7 (*Requirement*).

13.11.3 Rejection Criteria. Encapsulation shall be rejected if any of the following characteristics are found (*Requirement*):

- a. Incomplete fill of the specified areas per paragraph 12.3.2.
- b. Bubbles greater than 0.635mm (0.025 in) diameter or that form a continuous path between two electrically conductive elements per paragraphs 12.3.3 and 12.3.4.

NASA-STD 8739.1A with Change 1

c. For high voltage applications, bubbles and/or pinholes are greater than 0.0254 mm (0.001 in) per paragraph 12.3.5.

d. Material on the exterior surfaces of the encapsulation cup which interferes with markings or mounting holes or can damage or degrade performance per paragraph 12.3.6.

13.11.4 Connector encapsulation Acceptance/Rejection Criteria. In addition to the above encapsulation criteria the following acceptance criteria shall be applied to encapsulated connectors:

a. Connector pins/sockets are clean with no trace of encapsulant per 12.3.6 (*Requirement*).

b. Encapsulation material has concave fillets to the encapsulated wires per paragraph 12.3.8 (*Requirement*).

c. Good adhesion to back of connector per paragraph 12.3.2 (*Requirement*).

d. When conductive epoxy is used in place of a connector back shell, the epoxy shall provide electric conductivity between the connector shell mounting and the cable shield per paragraph 12.4.1 (*Requirement*).

e. All shielding wire end tips are within the encapsulant to prevent loose wires from causing electrical shorts per 12.4.2 (*Requirement*).

NASA-STD 8739.1A with Change 1

APPENDIX A. CONFORMAL COATING PROBLEMS

The following are the major problems encountered in the conformal coating process:

A.1 Conformal Coating Thickness

Conformal coating thickness can be critical to the proper function of a PWA. If a coating is too thin, proper coverage is impossible; if a coating is too thick, it may create excessive stresses on solder joints and components (particularly glass-bodied components). Controlling coating thickness is of special importance with rigid coating materials (e.g., epoxies and some of the urethanes) because the residual stresses associated with an excessively thick application of these materials are much greater than with flexible coating materials (such as silicones and some urethanes).

The thickness of a conformal coating can best be controlled by controlling the material viscosity during application. Where permitted, diluent solvents can be used to control viscosity. A multiple-coating process can also be used to attain more uniform thickness. Excessive filleting of adjacent components, caused by surface tension, may necessitate use of a brush to remove the excess.

Using a wet film gauge after each coating pass in a multiple-coating process helps the operator stay within the required post-cure thickness, that is when the number of passes and wet gauge values have been calibrated and documented in the processing documents with results of cured samples.

A.2 Coverage – Points and Edges

Liquid coatings, because of gravity and their surface energy, tend to pull away from sharp points and edges which are often formed in conductors needing the most coverage. Inadequately protected conductors exposed to atmospheric humidity or condensing moisture can easily develop circuitry malfunctions.

This problem can be alleviated by using a multiple-coat process with some drying between coat applications or by using an initial coat with a filler that will reduce the tendency of the coating to pull away from points and edges better. Vacuum deposition of paraxylylene is the best method for covering points and edges.

Using more than one type of coating method (e.g., brush method followed by spray method) can help accomplish acceptable coverage around difficult-to-cover parts such as transformers, components near a stiffener, components mounted to heat sinks, and closely spaced components which limit line-of-sight spray applications.

A.3 Bubbles

Bubbles normally originate from air trapped underneath components and at solder joints. When bubbles bridge uncommon conductors, entrapped moisture or other contaminants may reduce insulation resistance or cause shorts and possible arcing.

Bubbling may be controlled by various means. The angle at which an assembly is dried, cured, or dipped is important in preventing bubble formation. The best angle for spraying conformal coating is usually 45° to the PWA. The drying and cure schedule can also affect bubble

NASA-STD 8739.1A with Change 1

formation. Sometimes air cure is needed to permit solvent evaporation; sometimes immediate thermal cure is more desirable because of lower material viscosity caused by higher temperature. Spray coating, being more thinly applied, is not as susceptible to bubbling caused by solvent and air entrapment as are dip coating and brush coating. For thicker coating applications, degassing in a vacuum chamber will remove entrapped air.