

**METRIC/INCH-POUND**

**KSC-STD-F-0004E**  
**OCTOBER 24, 2003**

Supersedes  
KSC-STD-F-0004D  
September 14, 1992

**FIRE PROTECTION DESIGN,  
STANDARD FOR**

**SPACEPORT SERVICES DIRECTORATE**

---

National Aeronautics and  
Space Administration

**John F. Kennedy Space Center**



**KSC-STD-F-0004E**  
**OCTOBER 24, 2003**

Supersedes  
KSC-STD-F-0004D  
September 14, 1992

**FIRE PROTECTION DESIGN,  
STANDARD FOR**

Approved by:

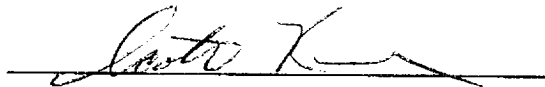
A handwritten signature in black ink, appearing to read "Scott Kerr", is written over a solid horizontal line.

Scott Kerr  
Director of Spaceport Services

**JOHN F. KENNEDY SPACE CENTER, NASA**

## CONTENTS

1.	SCOPE .....	1
1.1	Purpose .....	1
1.2	General .....	1
2.	APPLICABLE DOCUMENTS .....	1
2.1	Governmental .....	1
2.2	Non-Governmental .....	2
3.	DEFINITIONS .....	3
4.	GENERAL REQUIREMENTS .....	5
4.1	Criteria .....	5
4.2	Fire Alarm and Detection Systems .....	6
4.2.1	General .....	6
4.2.2	Facility Fire Alarm Systems .....	6
4.2.2.1	Retrofitting/Expansion of Existing Fire Alarm Systems .....	7
4.2.2.2	Fire Alarm Control Panel Location .....	7
4.2.2.3	Services of a Certified Fire Alarm Specialist .....	8
4.2.3	Annunciators .....	8
4.2.4	FACP Wiring .....	8
4.2.4.1	Circuit Color Coding .....	8
4.2.4.2	Surge Suppression .....	9
4.2.5	Exterior Conduit Requirements .....	9
4.2.5.1	Conduit in Hazardous Locations .....	9
4.2.6	Initiating Devices .....	9
4.2.6.1	Manual Pull Stations .....	10
4.2.6.2	Heat Detectors .....	10
4.2.6.2.1	Line-Type Fixed Temperature Heat Detector .....	10
4.2.6.2.2	Rate-Compensating Heat Detectors .....	10
4.2.6.3	Smoke Detectors .....	10
4.2.6.3.1	Duct Smoke Detectors .....	11
4.2.6.4	Air Sampling Detection Systems (ASDS) .....	12
4.2.6.5	Flame Detectors .....	14
4.2.6.6	Water Flow Devices .....	15
4.2.7	Elevator Recall .....	15
4.2.8	Notification Appliances .....	15
4.2.8.1	Voice Evacuation Systems .....	15
4.2.9	Visual Evacuation Appliances .....	16
4.2.10	Signaling Line Circuits .....	16
4.2.11	Network Reporting Loop Circuits .....	16
4.2.12	Fire Alarm System Reporting .....	16
4.2.12.1	Color Graphics Display .....	17

KSC-STD-F-0004E

October 24, 2003

4.2.12.1.1	General Criteria .....	17
4.2.12.1.2	Minimum Criteria.....	18
4.2.13	Equipment Installation in Hazardous Locations .....	18
4.2.13.1	Weatherproof and Hazardous Locations .....	18
4.2.13.2	Weatherproof Locations.....	19
4.2.14	Architects and Engineers (A&E) Design Drawings.....	19
4.2.15	Fire Alarm System Drawings .....	19
4.2.15.1	Connection Drawings.....	19
4.2.15.2	As-Built Drawings.....	20
4.2.15.3	Fire Service Floor Plans .....	20
4.2.16	Battery Calculations .....	20
4.2.17	Fire Alarm System Acceptance Testing.....	20
4.3	Water-Based Suppression Systems .....	20
4.3.1	General Requirements .....	20
4.3.1.1	Requirements for Automatic Sprinkler Systems.....	21
4.3.1.2	Emergency Disconnecting Means.....	21
4.3.1.3	Water Supply Demands.....	22
4.3.1.4	Drain Systems .....	22
4.3.1.5	Fire Department Connections (FDC) .....	22
4.3.1.6	Control Valves.....	22
4.3.1.7	Hydraulic Calculations, Schematics, and Fabrication Drawings .....	22
4.3.1.8	Services of a Certified Automatic Sprinkler Specialist.....	23
4.3.1.9	Fire Stopping.....	23
4.3.1.10	Painting.....	23
4.3.1.11	Test Procedures .....	23
4.3.1.12	Testing and Acceptance Criteria .....	23
4.3.2	Wet-Pipe Sprinkler Systems .....	24
4.3.3	Dry-Pipe Sprinkler Systems.....	24
4.3.3.1	Compressed Air Supply .....	24
4.3.3.2	Power for Compressed Air Systems .....	24
4.3.4	Preaction Sprinkler System .....	25
4.3.4.1	General .....	25
4.3.4.2	Automatic Operations .....	25
4.3.4.3	Manual Mechanical Activation Stations .....	26
4.3.5	Deluge Systems.....	26
4.3.5.1	General .....	26
4.3.5.2	Testing.....	27
4.3.5.3	Types of Deluge Systems.....	27
4.3.5.4	Deluge System Electrical Controls .....	34
4.3.5.4.1	Type I Deluge Panel Control Circuit Logic .....	35
4.3.5.4.2	Type II Deluge Panel Control Circuit Logic.....	36
4.3.5.5	Deluge Water Control Valves/Manual Shutoff Valves.....	37
4.3.5.6	Deluge Actuation Systems (Mechanical).....	37
4.3.5.7	Deluge Water Control Valve Actuators .....	38

4.3.5.8	Solenoid Valves.....	38
4.3.5.9	Monitoring.....	38
4.3.5.10	Control Lines.....	38
4.3.5.11	Routing.....	38
4.3.6	Standpipes .....	38
4.3.7	Fire Pumps.....	38
4.4	Special Suppression Systems .....	39
4.4.1	Carbon Dioxide Systems.....	39
4.4.2	Wet Chemical Extinguishing Systems .....	39
4.4.3	Foam Extinguishing Systems for Aircraft Hangars .....	39
4.4.4	Halon 1301 and Clean Agent Extinguishing Systems .....	39
APPENDIX A.	GRAPHIC SYMBOLS FOR FIREX AND FIRE ALARM SYSTEMS .....	41

KSC-STD-F-0004E  
October 24, 2003

## FIGURES

Figure 1.	Typical Smoke Detector Mounting .....	11
Figure 2.	Outdoor AHU Duct Detector Housing .....	13
Figure 3.	VESDA Cabinet Mounting .....	14
Figure 4.	Typical Type I Deluge Water System .....	28
Figure 5.	Typical Type II Deluge Water Sprinkler (Mechanical) (Sheet 1 of 2) .....	30
Figure 6.	Typical Type III Deluge Water System .....	33
Figure 7.	Deluge Compressed Air Supply Configuration .....	37

**ABBREVIATIONS AND ACRONYMS**

ac	alternating current
ADA	Americans With Disabilities Act
A&E	architects and engineers (Architects and Engineers)
AHJ	authority having jurisdiction (Authority Having Jurisdiction)
AHU	air handling unit
ASDS	Air Sampling Detection System
AWG	American wire gage
°C	degree Celsius
CCAFS	Cape Canaveral Air Force Station
CDSC	Communications Distribution and Switching Center
CFMS	Central Fire Monitoring System
CFR	Code of Federal Regulations
CO <sub>2</sub>	carbon dioxide
CR	conditional requirements; control relay
CRAC	computer room air conditioning
db	decibel
dc	direct current
e.g.	for example
EMCS	Environmental Monitoring and Control System
°F	degree Fahrenheit
FACP	fire alarm control panel
FATC	fire alarm terminal cabinet
FDC	fire department connections
FED STD	federal standard
ft	foot
FM	Factory Mutual
FPED	Fire Protection Equipment Directory
GP	General Publication
HAD	heat-actuated detector
HVAC	heating, ventilating, and air conditioning
Hz	hertz
i.e.	that is
IMSA	International Municipal Signal Association
in	inch
IR	infrared
kPa	kilopascal
KSC	John F. Kennedy Space Center
LED	light-emitting diode
m	meter
MIL STD	military standard
MLP	Mobile Launcher Platform

KSC-STD-F-0004E

October 24, 2003

mm	millimeter
MPa	megapascal
NASA	National Aeronautics and Space Administration
N.C.	normally closed
NEC	National Electrical Code
NEMA	National Electrical Manufacturers Association
NFC	National Fire Code
NFPA	National Fire Protection Association
NHB	NASA Handbook
NPG	NASA Procedures and Guidelines
NSS	NASA Safety Standard
NIST	National Institute of Standards and Technology
N.O.	normally open
NPG	NASA Procedures and Guidelines
OS&Y	outside stem and yoke
PAWS	Paging and Area Warning System
PCP	preaction control panel
PER	preliminary engineering report
PIV	positional indicator valve
psi	pound per square inch (static pressure)
PVC	polyvinylchloride
SOW	statement of work
STD	standard
TFE	tetrafluoroethylene
UFAS	Uniform Federal Accessibility Standards
UL	Underwriters Laboratories Inc.
UV	ultraviolet
V	volt
VABR	Vehicle Assembly Building Repeater
VRMS	volts root mean square



## **FIRE PROTECTION DESIGN, STANDARD FOR**

### **1. SCOPE**

#### **1.1 Purpose**

This document provides additional fire protection design standards to be used in conjunction with NASA-STD-8719.11, Safety Standard for Fire Protection, for the design or modification of facilities and systems under the design jurisdiction of the John F. Kennedy Space Center (KSC), NASA.

#### **1.2 General**

The minimum basic requirements for the design of a fire protection system shall be in accordance with the applicable provisions of the latest revision of the National Fire Code (NFC) published by the National Fire Protection Association (NFPA). If there are inconsistencies or conflicts between these requirements and other NASA documents, then the contract statement of work (SOW), this standard, and NPG 8715.3 shall take precedence in that order.

The coordination and the resolution of questions and conflicts concerning the application of this standard to a design shall be the responsibility of the NASA Lead Design Engineer, with support from the NASA System Engineer and the NASA KSC authority having jurisdiction (AHJ). Where NASA Handbooks (NHBs), NASA Safety Standards (NSSs), NASA Procedures and Guidelines (NPGs), NFPA codes, etc., refer to the AHJ, the Lead Design Engineer shall coordinate with the NASA Fire Protection Office for an AHJ-related decision.

Monitoring systems installed for monitoring a particular hazard, such as systems using hydrogen and hypergolic fuel leak detectors, are of a specialized nature and are not within the scope of this standard.

### **2. APPLICABLE DOCUMENTS**

The following documents form a part of this document to the extent specified herein. When this document is used for procurement, including solicitations, or is added to an existing contract, the specific revision levels, amendments, and approval dates of said documents shall be specified in an attachment to the Solicitation/Statement of Work/Contract.

#### **2.1 Governmental**

##### Federal

29 CFR, Subpart B,  
Chapter XVII, Part 1910

Occupational Safety and Health Standards

KSC-STD-F-0004E

October 24, 2003

FED STD 595	Colors Used in Government Procurement
<u>John F. Kennedy Space Center (KSC), NASA</u>	
79K32573	Water Deluge Activation Station Standard
GP 435	Engineering Drawing Practices
KSC-STD-E-0002	Hazardproofing of Electrically Energized Equipment, Standard for
SPECSINTACT	NASA KSC Shelf Masters
<u>Military</u>	
MIL-STD-101	Color Code for Pipelines and for Compressed Gas Cylinders
<u>National Aeronautics and Space Administration (NASA)</u>	
NASA-STD-8719.11	Safety Standard for Fire Protection
NPG 8715.3	NASA Safety Manual w/changes through Change 1, 6/19/02

(Copies of specifications, standards, drawings, and publications required by suppliers in connection with specified procurement functions should be obtained from the procuring activity or as directed by the Contracting Officer.)

## 2.2 Non-Governmental

### Factory Mutual

FM P7825	Approval Guide
FM	Loss Prevention Design Data Sheets

(Application for copies should be addressed to the Factory Mutual Research, Inc. 1151 Boston-Providence Turnpike, P.O. Box 9102, Norwood, Massachusetts 02062.)

### National Fire Protection Association (NFPA)

All volumes of NFPA fire codes, including appendices and recommended practices.

(Application for copies should be addressed to the National Fire Protection Association, One Batterymarch Park, Quincy, P.O. Box, 9101, MA 02269-9101.)

National Institute of Standards and Technology (NIST)

NIST TN 1423

Analysis of High Bay Hangar Facilities for Detector Sensitivity and Placement

(Applications for copies should be addressed to the Building and Fire Research Laboratory, National Institute of Standards and Technology (NIST), Gaithersburg, MD 20899.)

Underwriters Laboratories Inc. (UL)

UL FPED

UL Fire Protection Equipment Directory

(Application for copies should be addressed to Underwriters Laboratories Inc., 333 Pfingsten Road, Northbrook, IL 60062.)

American Society of Mechanical Engineers (ASME)

ASME A17.1

Safety Code for Elevators and Escalators

(Application for copies should be addressed to The American Society of Mechanical Engineers, Three Park Avenue, New York, NY 10016.)

American Society for Testing and Materials

ASTM D 6386

Preparation of Zinc (Hot-Dip Galvanized) Coated Iron and Steel Product and Hardware Surfaces for Painting

(Application for copies should be addressed to ASTM International, 100 Barr Harbor Drive, PO Box C700, West Conshohocken, Pennsylvania, USA 19428-2959.)

**3. DEFINITIONS**

For the purpose of this standard, the following definitions shall apply; refer to the specific NFPA standards for further clarification of definitions:

- a. Approved: For equipment items listed for use in fire protection systems by a nationally recognized testing agency, typically Underwriters Laboratory (UL) and/or Factory Mutual (FM). For actions, acceptance by the KSC AHJ, Contracting Officer, and Lead Design Engineer as appropriate to the particular issue under consideration is required.
- b. Authority Having Jurisdiction: The individual responsible for approving equipment, providing resolution to code related issues, and providing code interpretations for fire protection and life safety related issues.

KSC-STD-F-0004E

October 24, 2003

- c. Central Station System: A system or group of systems in which the operations of circuits and devices are transmitted automatically to, recorded in, maintained by, and supervised from a listed central station that has competent and experienced servers and operators who, upon receipt of a signal, take such action as required. Such service is to be controlled and operated by a person, firm, or corporation whose business is the furnishing, maintaining, or monitoring of supervised fire alarm systems.
- d. Compatible Equipment: Equipment that interfaces mechanically or electrically as manufactured without field modification.
- e. Electrical Supervision: Monitors the circuit integrity of interconnecting conductors so when a single open or a single ground condition occurs that would prevent normal operation, the condition is automatically transmitted and indicated at the appropriate location.
- f. Fire Alarm Control Panel (FACP): A system component that receives inputs from automatic and manual fire alarm devices and might supply power to detection devices and to a transponder or off-premises transmitter. The control unit might also provide transfer of power to the notification appliances and transfer of condition to relays or devices connected to the control unit. The fire alarm control unit can be a local fire alarm control unit or a master control unit.
- g. Fire Fighting: The physical deployment of available fixed or portable extinguishing agents for the purposes of aiding escape or rescue, suppression of the fire spreading, and extinguishment.
- h. Fire Prevention: Measures directed towards avoiding the inception of fire.
- i. Fixed Extinguishing System: An engineered arrangement of equipment designed to provide a specified firefighting capability against a particular fire hazard within a specified area (does not include portable fire extinguishers).
- j. Fully Compatible: Shall indicate the ability to communicate in two directions (duplex).
- k. General Fire Protection: Everything relating to the prevention, detection, and extinguishment of a fire and to the reduction of losses by fire, including the safeguarding of human life and the preservation of property.
- l. Heat Detector: A device that detects an abnormally high temperature or rate-of-temperature rise, or both.
- m. Initiating Device: A fire alarm system component that originates transmission of a change-of-state condition, such as in a smoke detector, heat detector, manual pull station, or supervisory switch.

- n. Listed: A product approved for use in fire protection systems by a nationally recognized testing agency (e.g., UL, FM).
- o. Manual Pull Station: A manually operated device used to initiate an alarm signal.
- p. Multiplex Communication Format: A signaling method characterized by simultaneous or sequential transmission, or both, and a reception of multiple signals on a signaling line circuit, including means for positively identifying each signal.
- q. Notification Appliance: A fire alarm system component, such as bell, speaker, strobe, or text display, that provides audible, tactile, or visible outputs or any combination thereof.
- r. Portable Fire Extinguishers: A device containing chemicals, fluids, or gases for extinguishing fires that can be easily moved.
- s. Signaling Line Circuit: A circuit or path between any combination of circuit interfaces, control units, or transmitters, over which multiple system input signals or output signals, or both are carried.
- t. Smoke Detector: A device that actuates if it detects visible or invisible particles of combustion.
- u. Water Deluge System: A sprinkler system employing open sprinklers attached to a piping system that is connected to a water supply through a valve opened by the operation of a detection system or manual activation installed in the same areas as the sprinklers. When this valve opens, water flows into the piping system and discharges from all the attached sprinklers.
- v. Water Spray: An automatic or manually actuated fixed pipe system connected to a water supply and equipped with water spray nozzles designed to provide a specific water discharge and distribution over the protected surfaces or area.

## 4. GENERAL REQUIREMENTS

### 4.1 Criteria

Fire alarm systems shall be designed, installed, tested, and maintained in accordance with the provisions of NFPA 70, 72, 75, 101, 29 CFR Part 1910. A complete fire alarm and detection system shall be required in facilities meeting any of the following conditions:

- a. Subject to 50 or more occupants as determined using the Life Safety Code (NFPA 101) criteria.
- b. Floor area greater than 279 square meters (m<sup>2</sup>) (3,000 square feet [ft<sup>2</sup>]).

KSC-STD-F-0004E

October 24, 2003

- c. A facility with one or more floors above or below the level of exit discharge.
- d. Temporary and permanent sleeping quarters including all access corridors. Smoke detection that includes audible devices shall be provided as a minimum.
- e. Computer rooms and essential electronic equipment areas as designated by the KSC AHJ.
- f. Facilities with partitions that prevent occupants from readily identifying fire effects and the subsequent need to evacuate.
- g. Areas within the facility that require a fixed suppression system and where automatic suppression, flow switches, and tamper switches are required.
- h. Where heating, ventilating, and air conditioning (HVAC) systems are required by NFPA 90A to have duct smoke detectors for air handler shutdown.
- i. Where rooftop air handler units require shutdown and there is no ductwork to allow installation of duct smoke detectors (typical in trailer complexes).
- j. Other instances as determined by the KSC AHJ.

## **4.2 Fire Alarm and Detection Systems**

### **4.2.1 General**

The KSC fire alarm detection and reporting system shall be composed of local systems and a Centerwide proprietary protective signaling system as described in NFPA 72. All system components shall be listed or approved for use by a recognized independent testing laboratory such as UL or FM.

### **4.2.2 Facility Fire Alarm Systems**

The facility fire alarm system shall be a fully addressable, modular-type, microprocessor-based, supervised, noncoded electrical alarm system with NFPA 72, Style D initiating device circuits, auxiliary control circuits, NFPA 72, Style Z notification appliance circuits, and NFPA 72, Style 7 signaling line circuits. All styles of Class A initiating device, signaling line, notification appliance, and control circuits shall use separate raceways in accordance with NFPA 72. The outgoing and return (redundant) circuit conductors shall not be run in the same cable assembly, enclosure, or raceway. The facility fire alarm system shall be addressable-type unless otherwise specified by the AHJ. The system shall be electrically connected to report alarms, silent alarms, troubles, and supervisory signals to the Central Fire Monitoring System; sound the general alarm continuously; and control auxiliary equipment such as dampers, air handling units, magnetic door latches, elevator recall, etc., upon operation of one or more initiating devices. Initiating, notification, signal, and auxiliary control circuits shall be 24 volt (v) direct current (dc). The facility fire alarm system shall also be capable of remote control by the Central Fire Monitoring



System (CFMS) in facilities designated by the KSC AHJ. Fire alarm control panel enclosures shall be dustproof and have a hinged cover and shall be provided with an integral key lock that accepts the KSC-specified Best Company 7-pin lock cylinder.

Fire alarm systems shall be stand-alone systems and shall not be combined with a security system, paging and area warning system (PAWS), energy management and control system, or any other control system. Fire alarm systems may be connected to a security or Environmental Monitoring and Control System (EMCS) for monitoring purposes only but shall not have to rely on these systems to perform any of its operations.

#### **4.2.2.1 Retrofitting/Expansion of Existing Fire Alarm Systems**

During field investigations for planning, studies, preliminary engineering reports (PERs), and designs that require existing fire alarm systems to be modified (i.e., HVAC duct smoke detectors and associated shutdown relays, modifying or adding space to a facility, adding or modifying sprinkler systems), designers shall ensure the existing FACP meets the following guidelines per this section.

- a. Communicate directly with the CFMS.
- b. Ensure the existing FACP has adequate expansion capability.
- c. Ensure there is adequate space to install additional fire alarm terminal cabinets (FATCs) at the designated locations.
- d. Verify the existing secondary power supply is adequate to handle the additional load associated with the modifications.
- e. Determine location and size for any new alternating current (ac) circuits required for new systems (e.g., air sampling system, preaction air compressor, audio amplifiers).
- f. If the new criteria for the retrofitting/expansion of the existing fire alarm system exceed the expansion capabilities of the FACP, a new fire alarm system shall be provided.

#### **4.2.2.2 Fire Alarm Control Panel Location**

The fire alarm control panel shall be installed in an air-conditioned room such as the communication rooms located on the floor of exit discharge. Location of the FACP inside the communication room allows for easier connection to the CFMS. In small facilities the FACP can be installed in the entrance lobby with approval from the KSC AHJ. In multistory buildings the FATC also will need to be installed in an air-conditioned room on each floor level.

KSC-STD-F-0004E

October 24, 2003

#### **4.2.2.3 Services of a Certified Fire Alarm Specialist**

The design agency shall ensure that services of a Certified Fire Alarm Specialist thoroughly experienced in fire detection and alarm work be provided on site to perform or directly supervise the installation, make all necessary adjustments, and perform all tests on the fire alarm system at the site.

#### **4.2.3 Annunciators**

The facility fire alarm system annunciator shall be the addressable type or as otherwise specified by the Lead Design Engineer following consultation with the AHJ. Addressable system annunciators shall be installed in the main lobby entrance or other location that is easily accessible to responding fire department personnel. The minimum functions of the lobby annunciator shall include reporting alarms, silent alarms, troubles, and supervisory signals. Capability to reset the facility fire alarm system from the annunciator panel shall be determined by the Lead Design Engineer following consultation with the AHJ.

#### **4.2.4 FACP Wiring**

Wiring shall be provided in accordance with NFPA 70 and NFPA 72. Conductors shall be solid copper. Wiring shall conform to the requirements of NFPA 70. Fire alarm system circuits shall be installed in a separate raceway system. The 60-hertz (Hz) power circuits shall not enter enclosures containing fire alarm circuits except where required to connect to the fire alarm control panels.

Wiring in fire alarm cabinets and boxes shall be installed in a neat and orderly manner with wire properly grouped, tie-wrapped, or laced parallel and perpendicular to the major axis, supported, and identified. Splices, solder connections, "T" taps, or other type connections are not acceptable. Where continuous wiring is not possible, terminations shall be clearly marked and protected on terminal strips and shall be mounted in junction boxes. All wires entering or leaving control cabinets, boxes, and devices shall be permanently marked and terminated on screw terminals. Marking shall be consistent throughout the fire alarm system and shall be the same as the identification shown on the connection drawings. All circuit conductors shall be identified within each enclosure where a tap, splice, or termination is made. Conductor identification shall be by heat-shrink-type sleeves or other approved method.

Conductors shall be continuous from a terminal point at one device to a terminal point at the next device and from a device to the fire alarm (control) panel. The wires shall be broken at each terminal. Wires shall not be looped over a terminal. Termination of solid wire shall be made on compression or screw-type terminals.

##### **4.2.4.1 Circuit Color Coding**

Conductor colors are listed below. Where modifications are made to existing systems, the new or added conductors shall match the size and color of the existing system.



Conductors for multiplexed communication circuits, speaker audio circuits, remote phone circuits, and remote station signaling circuits shall be marked with circuit designation and consistent color coding for the positive and negative loops and shall be maintained throughout the cable system.

Initiating device circuits shall have the positive loop conductors colored blue and the negative loop conductor colored black.

Power leads from the control panel for product-of-combustion detectors shall have one white positive conductor and one black negative conductor.

Notification appliance circuits shall have the positive conductors colored red and negative conductors colored orange.

Auxiliary control device circuits shall have positive conductors colored yellow and negative conductors colored brown.

Reaction solenoid valve control circuit shall have the positive conductors colored yellow and negative conductors colored violet.

#### **4.2.4.2 Surge Suppression**

Line voltage and low-voltage surge suppression devices to suppress all voltage transients that might damage the fire alarm control panel components shall be provided. Line voltage surge suppressors shall be installed on the incoming lines of the lockable fused disconnect switch and low voltage surge suppressors shall be installed on any circuit entering or leaving a facility.

#### **4.2.5 Exterior Conduit Requirements**

Conduit in exterior (outdoor) unfinished areas shall be painted and shall be installed in a manner that will minimize water intrusion into exterior-mounted devices. Conduit shall enter device junction boxes from the bottom and leave the device junction boxes from the sides. Conduit shall be sloped away from the device junction boxes and towards an automatic or manual drain.

##### **4.2.5.1 Conduit in Hazardous Locations**

Conduit installed in hazardous locations shall conform to the requirements of UL or FM for the hazardous location classification indicated. When the device is not factory sealed, conduit seal-off fittings suitable for the hazardous classification shall be installed at each conduit connection to the explosion proof enclosure in accordance with NFPA 70.

#### **4.2.6 Initiating Devices**

This shall include all devices that initiate an alarm by either manual or automatic means. The automatic devices are designed to respond to measurable quantities of heat, smoke, energy radiation, or other detectable byproducts of fire.

KSC-STD-F-0004E

October 24, 2003

#### **4.2.6.1 Manual Pull Stations**

Manual alarm stations shall be alarm-initiating devices that provide visual indication of operation and are designed for use with automatic/manual fire alarm systems in accordance with UL 38.

Manual alarm stations with a pushbutton, which depends upon a spring loaded device to close the contacts when the handle is pulled, are not acceptable.

A molded polycarbonate, clear protective cover with the provision for a lead seal or plastic supervisory seal shall be provided in all areas open to the general public. The protective cover shall not have an integral warning horn.

#### **4.2.6.2 Heat Detectors**

Heat-actuated detectors (HAD) shall be alarm-initiating devices designed for use with automatic/manual fire alarm systems in accordance with UL 521.

Detectors should be located no closer than 1 meter (m) (3 ft) from any return air diffuser and no closer than 2 m (6 ft) from any supply diffuser. Detectors installed in areas subject to moisture or exterior atmospheric conditions shall be UL listed or FM approved for such locations.

Electronic heat detectors shall only be used in air-conditioned spaces only. Electronic heat detectors should be located no closer than 2 m (6 ft) from a fluorescent light fixture.

##### **4.2.6.2.1 Line-Type Fixed Temperature Heat Detector**

Line-type heat detection cable for the protection of interior and exterior cable trays shall be provided. Cable shall operate on a fixed temperature principle only.

##### **4.2.6.2.2 Rate-Compensating Heat Detectors**

Detectors shall be hermetically sealed and automatically resetting type that will operate when ambient air temperature reaches detector setting regardless of the rate-of-temperature rise. This type of detector is used to protect certain types of hazardous locations in accordance with NFPA 70.

#### **4.2.6.3 Smoke Detectors**

Smoke detectors shall be alarm-initiating devices designed for use with automatic/manual fire alarm systems in accordance with UL 268.

Smoke detectors shall be photoelectric type with field adjustable sensitivity for the percent per foot obscuration level. Detectors shall be listed for use with the fire alarm control panel installed. All detector openings shall be screened to prevent the entry of insects and debris. A light-emitting diode (LED) indicator shall provide a visual indication that the detector is operating properly and distinctively indicate when the detector is in alarm.

Where possible, detectors should be located no closer than 305 mm (12 in) from a fluorescent light fixture. Detectors should be located no closer than 1 m (3 ft) from any return air diffuser and no closer than 2 m (6 ft) from any supply diffuser. Detectors installed in areas subject to moisture or exterior atmospheric conditions shall be UL listed or FM approved for such locations.

In locations where photoelectric-type smoke detectors are installed beneath raised floors, the detectors shall be installed in accordance with Figure 1 utilizing a Z-bracket and centered beneath the floor tile.

#### 4.2.6.3.1 Duct Smoke Detectors

Duct smoke detectors shall be photoelectric type listed by UL Fire Protection Equipment Directory (FPED) or FM approval guide and installed in accordance with NFPA 90A. Activation of duct smoke detectors shall cause annunciation at the fire alarm control panel, transmit a silent alarm to the Central Fire Monitoring Station, and shut down the associated air handling unit via a local fire alarm relay activated by the FACP. Duct smoke detector activation shall not activate the building evacuation notification appliances. Duct smoke detectors shall be addressable type connected to an addressable FACP with ability to perform sensitivity testing in accordance with NFPA 72. A single maintenance bypass switch to isolate each air handling unit duct smoke detector shall be provided. A common bypass switch for multiple air handling units may be used where approved by the KSC AHJ.

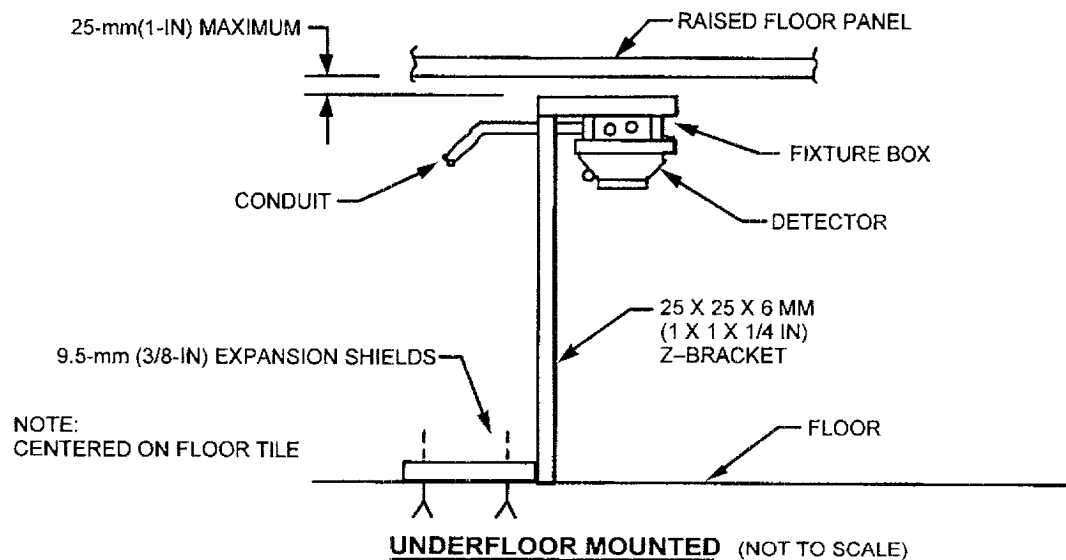

**Figure 1. Typical Smoke Detector Mounting**

KSC-STD-F-0004E

October 24, 2003

Where duct smoke detectors are installed outdoors, in unconditioned mechanical or electrical rooms, or in areas with high ambient temperatures and humidity, the detector housing shall be installed in an additional polyvinylchloride (PVC) enclosure with an additional set of supply and exhaust sampling tubes to prevent condensation from forming within the detector housing (see Figure 2).

A separate remote test/light assembly shall be installed for each duct smoke detector. Where multiple duct smoke detectors are installed, the remote test switches shall be grouped together at a common location.

#### **4.2.6.4 Air Sampling Detection Systems (ASDS)**

An approved Air Sampling Detection System, such as VESDA or equal, shall be installed to provide early detection of smoke in areas where mission-critical and essential electronic equipment is used, or as designated by the AHJ. These systems detect invisible molecules generated during the precombustion stages of an incipient fire. An air sampling network is utilized to continuously draw air from the protected area back to the detection chamber. The sensitivity of these systems is an order of magnitude greater than conventional spot-type smoke detectors and they operate in high airflow environments. This type of smoke detection system shall be installed under raised floors and at the ceiling level. Unique applications, such as clean rooms, may require protection directly above the return air intakes of the computer room air conditioning (CRAC) units and above the false ceiling in locations where combustible materials are present. The air sampling detection systems can be used in conjunction with preaction sprinkler systems, wet pipe sprinkler systems, special suppression systems, or as a stand-alone alarm and detection system. The maximum recommended spacing for sampling ports shall not exceed 23 m<sup>2</sup> (250 ft<sup>2</sup>) per port. See Figure 3 for typical mounting of VESDA cabinets.

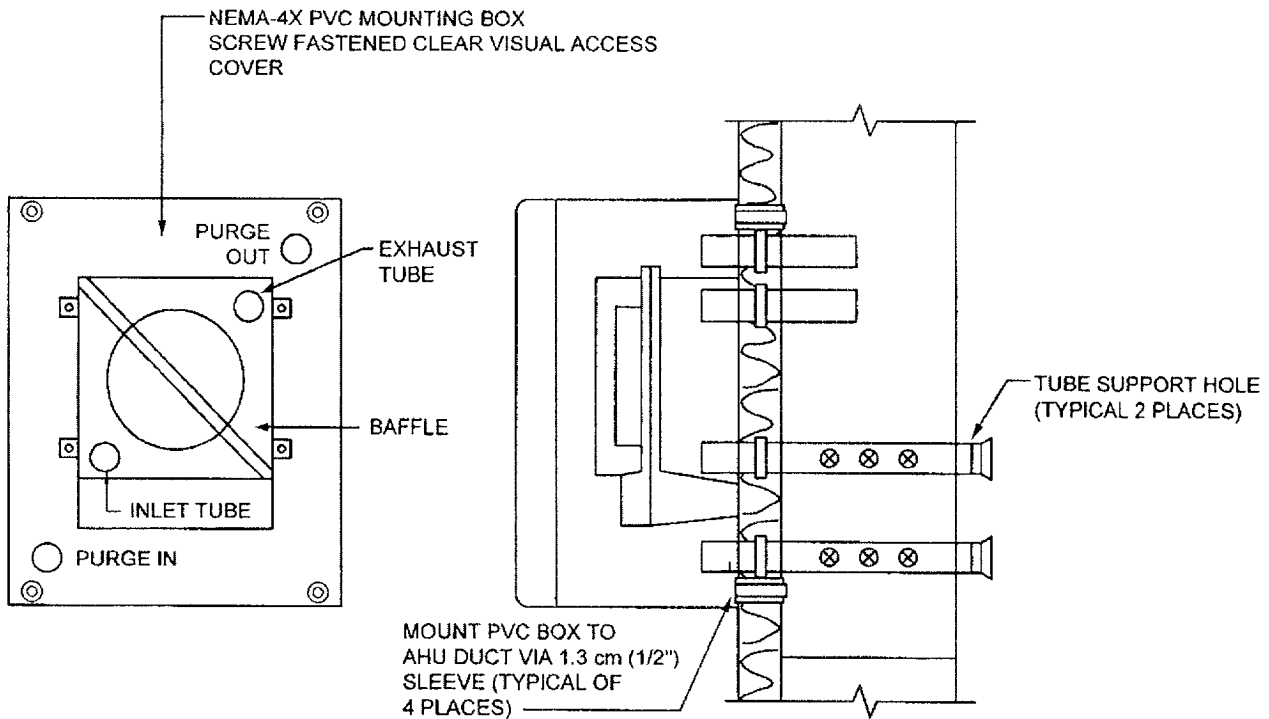

**ELEVATION**  
**NO SCALE**

**SECTION**  
**NO SCALE**

**NOTES:**

1. ALL MANUFACTURERS INSTALLATION RECOMMENDATION PROCEDURES AND TEST METHODS SHALL BE OBSERVED UNLESS OTHERWISE STATED. REFERENCE MANUFACTURERS INSTALLATION INSTRUCTIONS
2. ALL DUCT WORK PENETRATIONS SHALL BE AIR TIGHT AND WATER TIGHT.
3. A DIFFERENTIAL PRESSURE GAUGE SHALL BE USED TO ADJUST THE SAMPLING AND REFERENCE TUBES IN ORDER TO OBTAIN MAXIMUM PRESSURE DIFFERENTIAL.
4. DUCT WORK HOLE PENETRATIONS SHALL BE PER MFG SPECIFICATIONS.
5. 41 cm x 41 cm (16"x16") WATERTIGHT, AIRTIGHT ACCESS DOOR, MATERIAL TO MATCH DUCT MATERIAL, SHALL BE PROVIDED TO BE USED FOR CHECKING AND ADJUSTING AIR SAMPLING TUBES. IT SHALL NOT WEAKEN DUCTWORK.
6. PVC MOUNTING BOX SHALL NOT BE ATTACHED DIRECTLY TO DUCTWORK.

**Figure 2. Outdoor AHU Duct Detector Housing**

KSC-STD-F-0004E

October 24, 2003

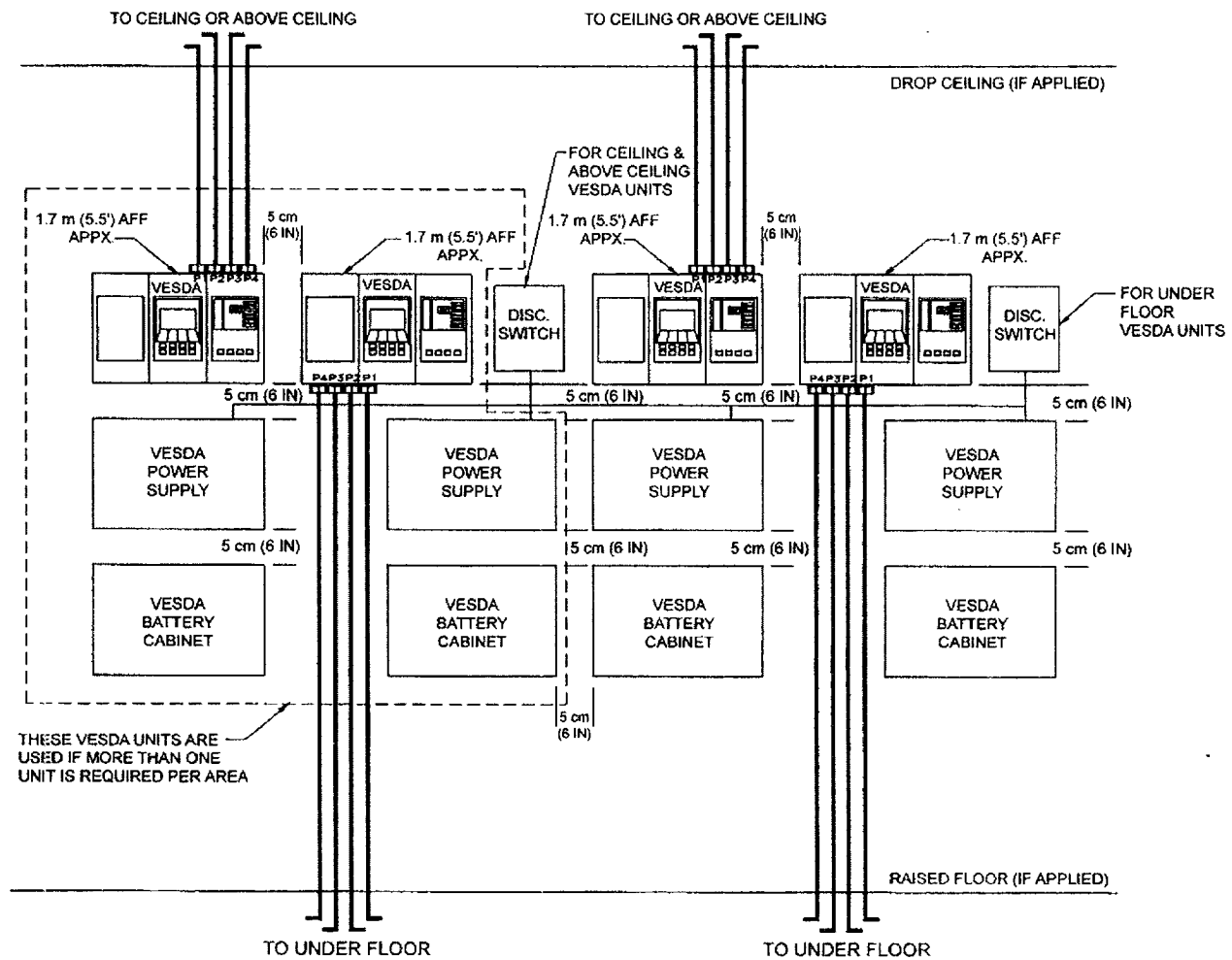

TYPICAL MOUNTING OF VESDA CABINETS

Figure 3. VESDA Cabinet Mounting

#### 4.2.6.5 Flame Detectors

Flame detectors shall be installed in high-bay areas; i.e., ceiling height greater than 9 m (30 ft) and where flight vehicles or payloads are processed, flame detectors shall be individually addressable for both alarm and trouble conditions. In other locations, flame detectors shall include features to readily determine if the individual devices are either in alarm or in trouble. Detectors shall be tested by UL, FM or other acceptable testing laboratory for the fuel detected (i.e., hydrazine, hydrogen, and hydrocarbon fuels).

Triple IR flame detectors shall be a unitized detector incorporating all sensory, signal processing, and alarm system interfacing components to provide fire detection by sensing within the carbon dioxide (CO<sub>2</sub>) emission band for IR radiation. Detector logic shall require IR signal from all three sensors present in the proper spectral signature for an alarm condition to be initiated.

Detectors shall have their own self-test capability and the ability to remotely test the optical integrity of the detector from the fire alarm control panel.

#### **4.2.6.6 Water Flow Devices**

Water flow alarm devices shall conform to UL or FM requirements for the particular type of sprinkler system. A single pole, double throw set of contacts shall be provided with each water flow device. Pressure switches shall depend upon a rise or fall in water pressure to cause activation. Vane-type flow switches shall be activated upon deflection by a volume of flowing water that equals or exceeds the capacity of a single sprinkler. Water flow alarm devices shall be provided with retard or time delay features.

#### **4.2.7 Elevator Recall**

Elevator recall systems shall be designed and installed in accordance with ANSI A17.1 and NFPA 72. The smoke detectors located in elevator lobbies, elevator hoistways, and elevator machine rooms used to initiate fire fighters' service recall shall be connected to the building fire alarm system control panel or to a dedicated fire alarm control panel, which shall be designated as "Elevator Recall Control and Supervisory Panel." Unless otherwise required by the KSC AHJ only elevator lobby, elevator hoistway, and elevator machine room smoke detectors shall be used to recall elevators for fire fighters' service. All smoke detectors for elevator recall shall be the photoelectric type. Where heat detectors are used to shut down elevator power prior to automatic sprinkler operation, the heat detector shall have a lower temperature rating and a higher sensitivity compared to the automatic sprinkler head. The heat detectors shall be installed within 0.61 m (2 ft) of each automatic sprinkler head in accordance with NFPA 13 and 72. Heat detectors shall be of the fixed temperature type. Heat detectors will not be installed in the elevator pit unless required by the KSC AHJ.

#### **4.2.8 Notification Appliances**

The standard evacuation signal at KSC is a temporal three-bell tone. Fire alarm bells shall be red, 254 mm (10 in) vibrating, under-dome, and have notification appliances in accordance with UL 464. Bells shall produce at least 87 dB at 3 m (10 ft) and shall conform to NFPA 72. Audible notification appliance circuits shall have sufficient capacity to operate all devices connected, plus 25 percent minimum spare capacity per circuit.

##### **4.2.8.1 Voice Evacuation Systems**

Voice evacuation systems shall be installed in all facilities required by NFPA 101, NASA-STD-8719.11, Uniform Federal Accessibility Standards (UFAS), Americans With Disabilities Act (ADA), or as required by the KSC AHJ. Speakers shall be UL listed or FM approved for audible signal use and shall be capable of clearly reproducing voice messages and bell tones in a three-pulse temporal pattern over a 400-to-4000-Hz range. Messages shall be a multilingual voice in five languages followed by temporal three-bell tone until silenced. The languages in priority are English, Spanish, French, Japanese, and Russian, or as specified by AHJ.



KSC-STD-F-0004E

October 24, 2003

Generally, multilingual voice announcements shall be provided in public visitor areas. For non-public facilities, English voice messages shall include the facility number, facility name, and reference to evacuation to marshalling areas, followed by temporal three-bell tone.

#### **4.2.9 Visual Evacuation Appliances**

Strobe units shall be notification appliances designed for use with automatic/manual fire alarm systems in accordance with UL 1971.

Unit brightness shall be 15, 30, 75, or 110 candela, in accordance with NFPA 72, producing a minimum flashing frequency of 1 Hz and a maximum flashing frequency of 3 Hz. All strobes shall be synchronized and shall remain flashing until the fire alarm control panel is reset. Units shall be UL listed or FM approved for their intended use. Visual notification appliance circuits shall have sufficient capacity to operate all devices connected, plus 25-percent minimum spare capacity per circuit.

#### **4.2.10 Signaling Line Circuits**

This shall include all circuits where simultaneous or sequential transmissions, or both, are transmitted between circuit interfaces, control devices, addressable modules, fire alarm control panels, and the central fire monitoring system.

#### **4.2.11 Network Reporting Loop Circuits**

Reporting modules shall individually communicate with the Central Fire Monitoring System using multiplexed communication techniques. Communication circuit wiring connections shall be suitable for supervised Style 7 operation. Module power shall be derived from the communication circuit or 24-V dc supervised power supply. Invalid configuration or loss of communication, component failure, or power failure shall initiate a trouble signal at the Central Fire Monitoring System.

#### **4.2.12 Fire Alarm System Reporting**

Fire alarm control panels shall report to the Central Fire Monitoring System through the following cable plant hubs: Vehicle Assembly Building Repeater (VABR), Communications Distribution and Switching Center (CDSC), and Building XY at Cape Canaveral Air Force Station (CCAFS). There are three reporting systems at KSC and CCAFS: the Simplex system, the Siemens system, and the Digitize system. The Simplex and Siemens reporting systems are the main reporting systems utilized for connection of new fire alarm systems. All new fire alarm systems shall be 100% addressable. The following devices and conditions shall be transmitted to the Central Fire Monitoring System via the Simplex or Siemens reporting systems:

- a. Automatic sprinkler systems pressure or flow switches. Each flow or pressure switch shall be individually reported to the facility FACP.



- b. Special suppression systems pressure or flow switches. Each flow or pressure switch shall be individually reported to the facility FACP.
- c. Summary alarm and trouble conditions for the facility fire alarm control panel.
- d. Summary supervisory alarm conditions for the suppression system isolation valves, low air pressure switches, tamper switches, and all other supervisory devices as specified by the KSC AHJ.
- e. Summary alarm and trouble condition for all the water flow devices by floor shall be transmitted to the CFMS. If there are multiple water flow devices on a single floor, any water flow device on that floor will cause a summary alarm or trouble condition to be transmitted to the CFMS.
- f. All addressable devices as specified by the KSC AHJ.
- g. The following alarm conditions shall be transmitted to the CFMS from each air sampling detection system:
  - (1) "Alarm Level 1 (Alert)" – Supervisory Alarm.
  - (2) "Alarm Level 2 (Action)" – Supervisory Alarm.
  - (3) "Alarm Level 3 (Fire 1)" – Silent Alarm.
  - (4) "Alarm Level 4 (Fire 2)" – Alarm.
  - (5) Summary trouble alarms indicating any trouble conditions such as low air flow, high air flow, and malfunctioning circuit board.
  - (6) Air sampling detection system has been bypassed for maintenance.

The network communication shall be by NFPA 72, Style 7, fiber optic or copper signaling line circuits. Fire alarm systems with minimal devices may be hardwired to the summary panels with approval from the AHJ.

#### **4.2.12.1 Color Graphics Display**

##### **4.2.12.1.1 General Criteria**

Color graphic screen development shall be required for the following criteria:

- a. Payload processing facilities
- b. Launch pads
- c. Essential electronic equipment areas

KSC-STD-F-0004E

October 24, 2003

- d. Facilities that have restricted access
- e. Unique facilities as directed by the KSC AHJ

#### **4.2.12.1.2 Minimum Criteria**

The following minimum criteria for the development of the color graphics screens shall be used:

- a. Provide a basic outline of the building indicating the approximate location of the following equipment:
  - (1) Fire alarm control panel
  - (2) Fire alarm annunciator panel
  - (3) Automatic sprinkler system riser
  - (4) Fire department connection
  - (5) Each special suppression system (i.e., preaction, kitchen suppression, CO<sub>2</sub>)
- b. Provide a visual indication for the type of device in alarm or trouble
- c. Provide a visual indication of the floor where the device is located
- d. Provide more elaborate and descriptive color graphic screens as directed by the KSC AHJ

#### **4.2.13 Equipment Installation in Hazardous Locations**

Local fire alarm systems installed in hazardous areas shall comply with NFPA 70 (National Electrical Code [NEC]), Article 500, NFPA 497, and KSC-STD-E-0002.

Equipment installed in hazardous locations will conform to the requirements of UL or FM for the hazardous location classification indicated. When the device is not factory sealed, conduit seal-off fittings suitable for the hazardous location classification shall be installed at each conduit connection to the explosionproof enclosure in accordance with NFPA 70. Explosionproof bell operating current shall not exceed 0.25 amp.

##### **4.2.13.1 Weatherproof and Hazardous Locations**

Equipment mounted in exterior or wet locations shall be weatherproof National Electrical Manufacturers Association (NEMA) 4X and meet the requirements of UL or FM for the hazardous location classification indicated. Equipment shall be protected from corrosion.

#### **4.2.13.2 Weatherproof Locations**

Equipment mounted in exterior or wet locations shall be NEMA 4X. Strobes that are installed in exterior or wet locations shall be made weatherproof by using a neoprene gasket. Equipment shall be protected from corrosion.

#### **4.2.14 Architects and Engineers (A&E) Design Drawings**

Design plan views shall indicate locations of the FACP, FATC's, remote annunciators, and all devices. KSC-approved fire alarm symbols shall be used. Ceiling-mounted devices shall be shown on a reflected ceiling plan. Elevation details shall be provided as required for the fire alarm control panel, fire alarm terminal cabinets, and other associated equipment and cabinets. Riser diagrams indicating all control equipment and devices connected, addressable devices, initiating devices, notification appliances, relays, duct smoke detectors, and connections to special suppression and detection systems shall be provided. Sequence of Operations whenever special suppression systems (i.e., preaction, dry pipe, kitchen suppression, and gaseous suppression) are connected to the facility fire alarm control panel shall be provided. Operational matrix to cover control functions for kitchen suppression, preaction, and elevator recall systems shall be provided.

The following information shall be provided on the drawings for the areas that will be protected by air sampling detection systems. Reflected ceiling plans showing all lights, air conditioning diffusers both supply and return, transfer grilles, PAWS speakers, exit lights, sprinkler heads, heat detectors, etc., to prevent interference with new ceiling air sampling system piping shall be provided. Reflected raised floor plans showing the location of all new and existing essential electronic equipment, desks, work stations, floor diffusers, computer room air conditioning units, etc., to prevent interference with the new underfloor air sampling system piping shall be provided. Plan view of all obstructions within the interstitial space between the true ceiling and the suspended ceiling to include, but not be limited to, HVAC ductwork, chilled water piping drain and sewer lines, and sprinkler system piping, to prevent interference with the new above ceiling air sampling system piping shall be provided.

#### **4.2.15 Fire Alarm System Drawings**

The design agency shall ensure that, as a minimum, the following system drawings be part of the construction contract: connection and as-built drawings, which are required to perform maintenance; and fire service floor plans, which are required to aid the responding fire department personnel. Symbols used on fire alarm system drawings shall be in accordance with GP 435 and Appendix A of this document. Connection drawings, schematics, as-built drawings and fire service floor plans shall be submitted as computer generated drawings in either .DXF or .DWG format.

##### **4.2.15.1 Connection Drawings**

The design agency shall ensure that connection drawings be submitted by the Contractor for approval prior to installation of the Fire Alarm and Detection Systems. Connection drawings shall

KSC-STD-F-0004E

October 24, 2003

consist of point-to-point wiring diagrams of internal and external wiring including, but not limited to, all fire alarm field devices, panel wiring, and interconnection between other building systems and components.

#### **4.2.15.2 As-Built Drawings**

The design agency shall ensure that as-built drawings document final system configuration, indicating all field changes and shall be released into the KSC configuration documentation system to comply with NFPA 72 requirements.

#### **4.2.15.3 Fire Service Floor Plans**

The design agency shall ensure that the contractor provide a fire service floor plan. Floor plan shall indicate the location of the fire alarm control panel, all fire alarm equipment and devices, all automatic suppression system risers, and any special suppression systems. The fire service floor plan shall be located in a place easily accessible to the responding fire department personnel.

#### **4.2.16 Battery Calculations**

The design agency shall ensure that battery calculations be performed to substantiate that the batteries are sized to operate the fire alarm and detection system, including all connected devices in normal supervisory condition for 24 hours and then operate the system in the alarm condition for 5 minutes in accordance with NFPA 72. In situations as directed by the KSC AHJ the batteries shall be sized to operate the Fire Alarm and Detection System in normal supervisory condition for 24 hours and then operate the system in the alarm condition for 10 minutes. For unique systems such as at the pad and Mobile Launcher Platform (MLP), batteries shall operate the systems in their normal supervisory mode for a minimum of 72 hours and shall operate in alarm condition for a period of 15 minutes.

#### **4.2.17 Fire Alarm System Acceptance Testing**

The design agency shall ensure that fire alarm system acceptance testing (both preliminary and final) be incorporated in the construction contract. Incorporation shall include the requirement that pre-approved fire alarm system test procedures be used to perform the acceptance testing. The design agency shall ensure NFPA 72 final inspection and testing forms be provided upon completion of the final acceptance testing.

### **4.3 Water-Based Suppression Systems**

#### **4.3.1 General Requirements**

All water-based suppression systems shall be designed and installed in accordance with NFPA codes, except as specified by this document. The Lead Design Engineer and the AHJ shall determine specific types of systems. Suppression system electrical control and detection design shall be in accordance with the applicable subsections of this standard.

#### 4.3.1.1 Requirements for Automatic Sprinkler Systems

Automatic sprinkler protections shall be provided for all new building/facility construction. Sprinkler protection shall be provided in renovation projects exceeding 232 m<sup>2</sup> (2500 ft<sup>2</sup>) or involving over 50 percent of the building. Small building construction housing only noncombustible materials may not require automatic sprinkler protection if approved by the KSC AHJ.

Riser main drain piping shall be extended full size to discharge outdoors in a location approved by the Lead Design Engineer.

Inspector test valve shall be installed at 1.5 m (5 ft) above the finished floor located at the most hydraulically remote portion of the system. Piping shall extend from valve to discharge outdoors in a location approved by the Lead Design Engineer. For nonpaved areas, a 457-mm (18-in-long) concrete splashblock for inspectors test discharge impingement shall be provided. Inspector test stations shall not be terminated in mop sinks or floor drains.

Piping shall be installed level or sloped back towards the riser or the auxiliary drains to allow for drainage. Where trapped piping is unavoidable, auxiliary drains shall be provided.

Risers shall be provided with a stamped metal tag containing the hydraulic design data. Main drain and inspector test stations shall also be identified using metal nameplates with minimum 51-mm (2-in-high) lettering chained to the valves.

#### 4.3.1.2 Emergency Disconnecting Means

A manually activated emergency disconnect means shall be provided in accordance with NFPA 75 and NFPA 70, Article 645, to disconnect power to all essential electronic equipment. There shall also be a similar means to disconnect the power to all dedicated HVAC systems serving the room and cause all required fire/smoke dampers to close. The control for these disconnecting means shall be grouped and identified and shall be readily accessible at the principal exit doors. A single means to control both the electronic equipment and HVAC systems shall be permitted unless otherwise directed by the Lead Design Engineer. Where a pushbutton is used as a means to disconnect power, pushing the button in shall disconnect the power. Manually activated mushroom push button stations shall be installed within 457 mm (18 in) of the latch side of the exit doors and approximately 1219 mm (48 in) above the finished floor measured from the finished floor to the top of the plastic protective enclosure. Where both a manual pull station and mushroom push button station are required mounting locations shall be approved by the AHJ prior to installation. The protective enclosure shall prevent accidental activation and be capable of accepting a metal wire with lead seal or a plastic integrity seal.

Requirements for automatically activated shunt-trip circuits in areas other than computer and essential electronic equipment rooms shall be specified by the AHJ. Automatically activated shunt-trip circuits shall only be installed in locations approved by the essential electronic equipment owner and the AHJ. Where automatically activated shunt-trip circuits are installed, maintenance bypass provisions shall be provided.

KSC-STD-F-0004E

October 24, 2003

#### **4.3.1.3 Water Supply Demands**

The water supply demand requirements in NFPA 13 are minimum design requirements. The AHJ shall determine the need for increased water supply requirements to provide for occupancy flexibility. The occupancy classification for the design density of a sprinkler system shall be increased by one occupancy classification for light and ordinary (Group 1), as defined by NFPA 13, for all KSC facilities.

#### **4.3.1.4 Drain Systems**

In essential electronic and other areas protected by automatic sprinkler systems that are subject to excessive water damage, floor drain systems with sufficient capacity shall be provided to handle anticipated accumulation of sprinkler system and hose stream discharge.

#### **4.3.1.5 Fire Department Connections (FDC)**

At least one FDC shall be provided for each facility with an automatic sprinkler system and/or standpipe system. The FDC should serve the sprinkler system and interior standpipe system in buildings equipped with both. All standpipes and sprinkler systems shall be interconnected so that each FDC serves all fire protection systems simultaneously.

#### **4.3.1.6 Control Valves**

All control valves installed in these systems shall be the visually indicating outside stem and yoke (OS&Y) type and shall meet NFPA codes. Valve tamper switches shall be installed on all the system isolation valves unless otherwise directed by the Lead Design Engineer, after consultation with the AHJ. The valve tamper switches shall be monitored directly from the facility fire alarm panel as a separate or grouped supervisory.

A system control valve is required at the base of each riser for wet pipe, dry pipe, preaction, and deluge automatic sprinkler systems. A valve tamper switch is required for each automatic sprinkler system isolation valve. In buildings that have a looped main supply system that supplies all the automatic sprinkler systems using isolation valves and flow or pressure switches, tamper switches shall be provided with each isolation valve.

All other capable of isolating all or portions of the system, such as positional indicator valves (PIVs), back flow preventers, fire pump test header and isolation valves, shall be locked with nonfrangible locks and/or provided with tamper switches as directed by the Lead Design Engineer after consultation with the AHJ. Locks shall be provided by the Government. All systems subject to freezing shall have the capability of being isolated and drained for freeze protection or designed to mitigate problems associated with freezing.

#### **4.3.1.7 Hydraulic Calculations, Schematics, and Fabrication Drawings**

The design agency shall ensure that automatic sprinkler and standpipe system fabrication and assembly drawings be submitted for approval by the KSC AHJ or designee. Fabrication draw-



ings shall meet all requirements in NFPA 13, stipulated for "working plans" to include a building cross section. The automatic sprinkler system shall be hydraulically designed to meet density and area of coverage requirements using a UL listed or FM approved hydraulic design program. Systems shall be designed in accordance with NFPA 13.

#### **4.3.1.8 Services of a Certified Automatic Sprinkler Specialist**

The design agency shall ensure that services of a Certified Specialist thoroughly experienced in automatic sprinkler system installations shall be provided on site to perform or directly supervise the installation.

#### **4.3.1.9 Fire Stopping**

Through-penetrations in fire walls, partitions, or any floors to allow passage of cables, ducts, pipes, and conduits shall be sealed with a "fire stopping assembly" that is UL listed or FM approved with a fire-resistance rating equal to the fire resistance rating of the walls, partitions, or floors in accordance with NFPA 251. For sealing purposes all floors shall be considered to have a fire-resistance rating of 2 hours. Openings no longer required shall be sealed with a material of equal or greater fire resistance to that of the walls, partitions, or floors.

#### **4.3.1.10 Painting**

All automatic sprinkler and standpipe system piping, valves, and appurtenances shall be painted red or other color as dictated by AHJ. In locations where hot-dip galvanized piping is specified the automatic sprinkler and standpipe system piping should utilize the duplex system of protection. This system requires both hot dip galvanizing and painting of the galvanized pipe in accordance with ASTM D 6386.

#### **4.3.1.11 Test Procedures**

The design agency shall ensure that a test procedure and test record forms for conducting and recording complete tests on automatic sprinkler and standpipe systems installed in accordance with the hydraulic calculations be used to perform the final acceptance tests. The design agency shall ensure NFPA 13 final inspection and testing forms be provided upon completion of the final acceptance testing.

#### **4.3.1.12 Testing and Acceptance Criteria**

The design agency shall ensure aboveground and underground systems be tested in accordance with NFPA 13 and 24. The design agency shall ensure Pre-approved automatic sprinkler system test procedures be used to perform the acceptance testing. NFPA 13 final inspection and testing forms shall be provided upon completion of the final acceptance testing.

Preaction and dry pipe systems shall require air pressure leakage test at 276 kPa (40 psi). The applied pressure shall be maintained without further addition of test media for not less than 24 hours. Maximum allowable pressure drop shall be 10 kPa (1.5 psi).

KSC-STD-F-0004E

October 24, 2003

### 4.3.2 Wet-Pipe Sprinkler Systems

These systems shall utilize either a riser swing-type check valve with all associated trim including a 51-mm (2-in) main drain connection and flow switch or an OS&Y isolation valve and flow switch.

When wet-pipe sprinkler systems are used in conjunction with air sampling detection systems for the protection of essential electronic equipment, the air sampling systems shall be monitored by the facility fire alarm control panel instead of an auxiliary control panel.

### 4.3.3 Dry-Pipe Sprinkler Systems

Dry-pipe sprinkler systems should be installed only where heat is not adequate to prevent freezing of water in all parts or in sections of the system. Dry-pipe valve sprinkler systems shall be a UL listed or FM approved dry-pipe valve complete with standard accessories and trim necessary to provide alarm, trouble, and supervisory signals. The 51-mm (2-in) main drain connection, pressure gages on the water side of the valve, air side of the valve, and on the compressor shall be provided. Also provisions for testing and draining the system and all necessary water piping, fittings, quick opening devices, and valves for proper operation of the system shall be provided.

The system shall include a supervisory indication alerting of a loss of air pressure.

#### 4.3.3.1 Compressed Air Supply

Riser-mounted compressed air system or independent air compressor mounted on the floor with air compressor, pressure gages, pressure switches, air maintenance devices, desiccant air dryer, and appurtenances shall be provided. The compressed air system shall maintain the manufacturer's specified air pressure on the dry-pipe system piping and comply with the fill-time requirements of NFPA 13. The pressure switch for controlling the compressor shall be field adjustable for both the "on" and "off" pressure settings. The air maintenance device with a by-pass line for fast filling the system shall be provided.

#### 4.3.3.2 Power for Compressed Air Systems

Provide power for the floor-mounted or riser-mounted air compressor from a dedicated circuit breaker. Install an independent, properly fused safety disconnect switch with provisions for locking the operating handle in either the "Power ON" or "Power OFF" positions. The disconnect switch shall be located within 1 m (3 ft) of the compressor. Provide a label on the disconnect switch that indicates what electrical panel and which circuit breaker power is being fed from.



#### 4.3.4 Preaction Sprinkler System

##### 4.3.4.1 General

The system shall be a single or double interlocking type, as directed by the Lead Design Engineer after consultation with the KSC AHJ. The design of preaction sprinkler systems shall provide a new automatic preaction sprinkler system consisting of either a pneumatic/electric double interlocked preaction valve or a pneumatic/electric single interlocked preaction valve with all associated trim, air compressor with air maintenance device, OS&Y isolation valves, floor drains, pressure switches, manual mechanical activation stations located in the riser trim piping, and dry pendant sprinkler heads. The preaction sprinkler system shall be hydraulically designed to meet density and area of coverage requirements. The design, equipment, materials, installation, workmanship, examination, inspection, and testing shall be in strict accordance with the required and advisory provisions of NFPA 13, 24, and 75 except as modified herein. When the facility has multiple essential electronic areas to be protected by preaction sprinkler systems, the control system shall contain a preaction control panel for each operational area affected and shall be separate from the facility FACP. In small facilities with an existing facility fire alarm control panel, an analysis shall be made to determine whether to provide separate panels or to utilize the facility FACP as the preaction control panel. Unique configurations shall be approved by the KSC AHJ prior to installation.

##### 4.3.4.2 Automatic Operations

Preaction sprinkler systems shall utilize an air sampling detection system for automatic actuation in accordance with this standard. The following "Sequence of Operations" shall apply to all automatically operated preaction sprinkler systems:

- a. The following alarm conditions shall be transmitted to the preaction control panel (PCP) from the air sampling detection systems:
  - (1) "Alarm Level 1 (Alert)" – Supervisory alarm
  - (2) "Alarm Level 2 (Action)" – Supervisory alarm
  - (3) "Alarm Level 3 (Fire 1)" – Silent Alarm
  - (4) "Alarm Level 4 (Fire 2)" – Alarm
  - (5) Summary trouble alarms indicating any trouble conditions such as low air flow, high air flow, malfunctioning circuit board, etc.
  - (6) Air sampling detection system has been by-passed for maintenance.
- b. The PCP shall operate the strobes upon receipt of "Alarm Level 3."

KSC-STD-F-0004E

October 24, 2003

- c. The PCP shall operate the preaction system solenoid valve upon receipt of "Alarm Level 4."
- d. The pressure switch shall activate and transmit an alarm to the CFMS through the facility FACP.
- e. The facility notification appliances shall be activated by the facility FACP resulting in evacuation of the facility.
- f. The PCP shall interrupt power to all the fire smoke dampers that are associated with the essential electronic area upon receipt of "Alarm Level 4."
- g. The PCP shall interrupt power to any external AHU that is supplying makeup air to the essential electronic area upon receipt of "Alarm Level 4."
- h. The CRAC units will have their power interrupted by either their respective internal smoke detectors or directly by the PCP upon receipt of "Alarm Level 4." This function may be eliminated when approved by the KSC AHJ.
- i. Items 3, 4, and 5 shall be initiated simultaneously by the PCP.

#### **4.3.4.3 Manual Mechanical Activation Stations**

The activation of the manual activation station shall result in the following actions:

- a. The preaction control valve shall open and precharge the sprinkler system.
- b. The pressure switch shall activate and transmit an alarm to the CFMS through the facility FACP.
- c. The facility notification appliances shall be activated by the facility FACP resulting in evacuation of the facility.

Manual activation shall leave a tell-tale sign of activation (latch or broken seal) and be labeled to indicate open and closed. A manufacturer-approved manual activation valve shall be installed at the riser for manual activation of the preaction system.

#### **4.3.5 Deluge Systems**

##### **4.3.5.1 General**

The general intent of deluge systems is to quickly extinguish a fire yet limit the destruction of the facility and/or contents of the facility during a fire condition. Deluge water on the payload and Shuttle flight hardware may destroy the hardware or cause extensive damage. With this in mind, facilities where deluge systems are required shall have a Type I, Type II, or Type III system as described below. Deluge systems shall be installed with a manual shutoff valve located outside of the hazardous area or as approved by the AHJ.

For deluge systems not protecting payload/flight hardware areas, nozzle systems shall be designed such that all headers can be prefilled. Deluge water control valve stations shall consist of butterfly valves with double-acting pneumatic actuators powered by compressed air or dry nitrogen as specified herein. Design densities shall be as specified in NASA-STD-8719.11, Section 7.8. The schematic drawings contained herein are representative of the requirements for these types of systems; however, modifications and enhancements to these requirements are acceptable on a case-by-case basis, as approved by the AHJ.

#### 4.3.5.2 Testing

A functional test shall be required as a condition of acceptance for all deluge systems. In systems provided with a test branch, flow through the nozzles may not be required.

#### 4.3.5.3 Types of Deluge Systems

One of three types of fixed-deluge water systems shall be used to protect payload/flight hardware. Type I systems should be used in areas where the consequences of inadvertent actuation are not great (e.g., propellant transfer areas). Type II systems should be used where payload or flight hardware is present but no damage would occur due to inadvertent actuation. The Pad A&B Payload Changeout Rooms (PCRs) are examples of Type II systems. Type III systems should be used where payload or flight hardware is susceptible to damage due to inadvertent activation. The type of fixed-deluge water suppression system to be used shall be approved by the KSC AHJ prior to installation. In areas where periodic flow testing of the deluge system cannot be accomplished through its nozzles due to facility operations, a test branch shall be provided that will properly model the flow characteristics of the nozzle system.

- a. Type I Deluge Water Systems – Type I systems shall be configured in accordance with Figure 4. The major components for Type I systems shall consist of a manual cutoff valve, a pneumatically operated butterfly valve with solenoid and position switches, an orifice, a pressure switch, a strainer, and appropriate nozzles. The solenoid shall be housed in a weatherproof enclosure and located adjacent to, but not directly mounted on, the valve assembly. If the system is located in an area requiring explosionproofing, the solenoid shall be installed in accordance with NFPA 70 requirements for explosionproof devices. Type I systems shall have all major components electronically supervised for trouble or position indication within the deluge control panel. Flow/pressure switches shall be monitored by the facility FACP; they may also be monitored by the deluge panel. Type I systems shall be automatically activating where approved by the Lead Design Engineer after consultation with the KSC AHJ. A manual shutoff valve shall be installed outside the processing area (15 to 30 m [50 to 100 ft]) from the facility structure where practical and shall be clearly marked in an open or closed position. The valve shall be positively identifiable as a deluge water system valve through the use of placards, signs, or other methods approved by the Lead Design Engineer after consultation with the KSC AHJ.

KSC-STD-F-0004E  
 October 24, 2003

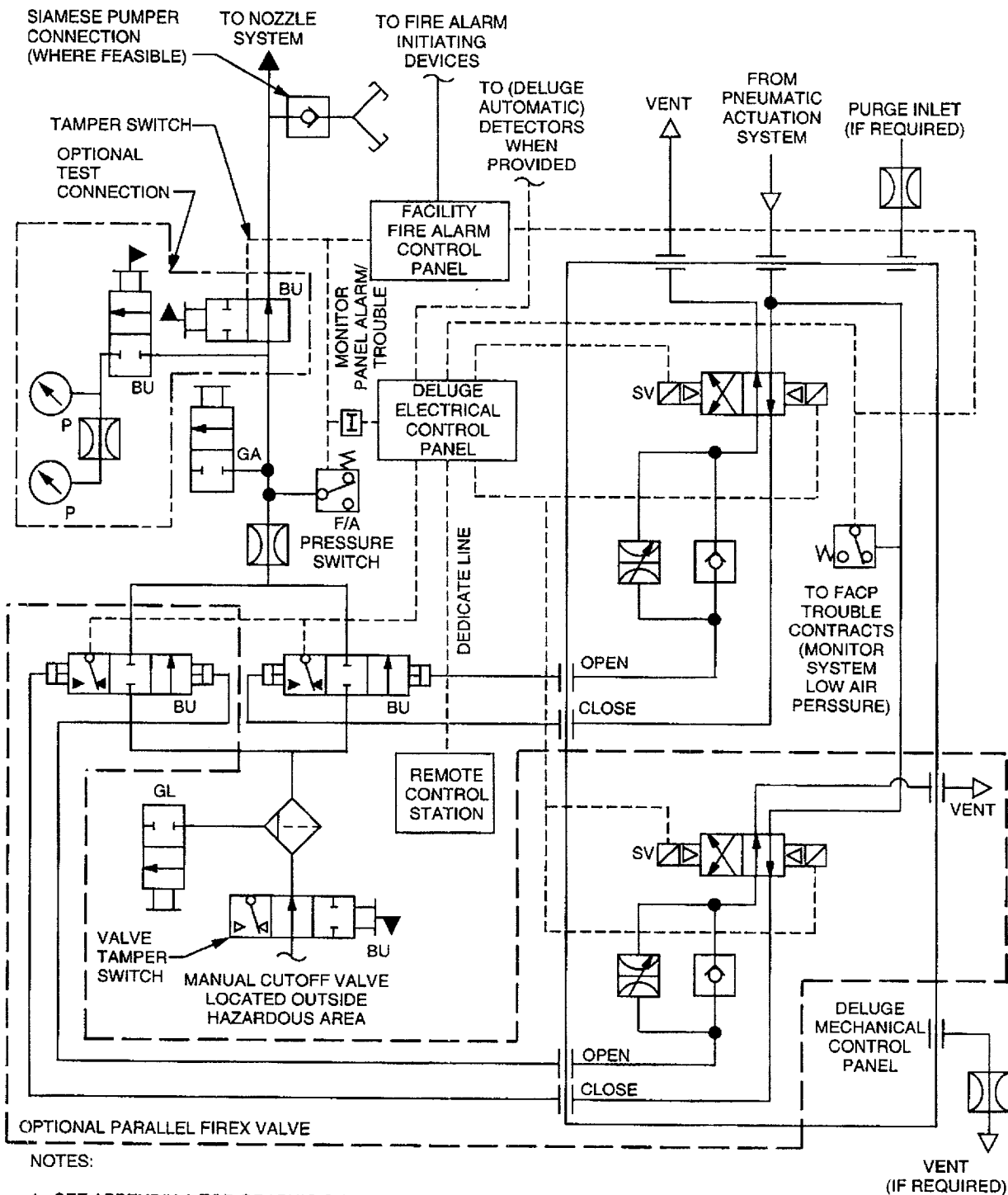

Figure 4. Typical Type I Deluge Water System

- b. Type II Deluge Water Systems – Type II systems shall be configured in accordance with Figure 5. Drawing 80K59233 should be used as a guide in the design and fabrication of solenoid panels for Firex systems. Major system components are the same as Type I except that four butterfly valves are required with two ARM valves on the downstream side of the two Activate valves. The solenoid shall be housed in a weatherproof enclosure and located adjacent to, but not directly mounted on, the valve assembly. If the system is located in an area requiring explosionproofing, the solenoid shall be installed in accordance with NFPA 70 requirements for explosionproof devices. The deluge systems shall be remotely monitored by the facility FACP utilizing supervisory circuits. Flow/pressure switches shall be monitored by the facility FACP; they may also be monitored by the deluge panel. A valve tamper switch shall also be located on the manual shutoff valve located outside the hazardous area (15 to 30 m [50 to 100 ft]) from the facility structure where practical and shall be clearly marked in an open or closed position. The valve shall be positively identifiable as a deluge water system valve through the use of placards, signs, or other methods approved by the Lead Design Engineer in consultation with the KSC AHJ.

KSC-STD-F-0004E  
 October 24, 2003

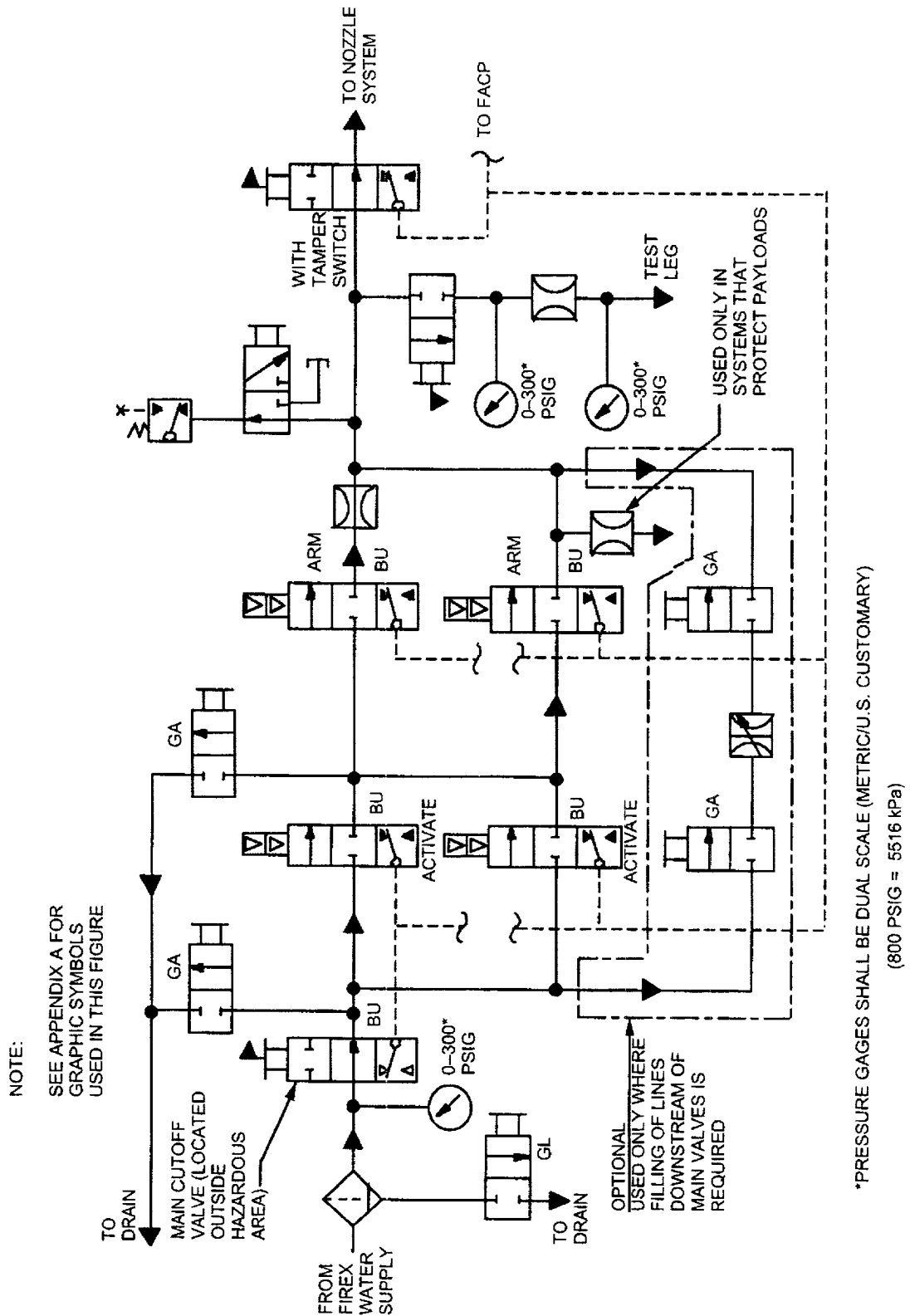
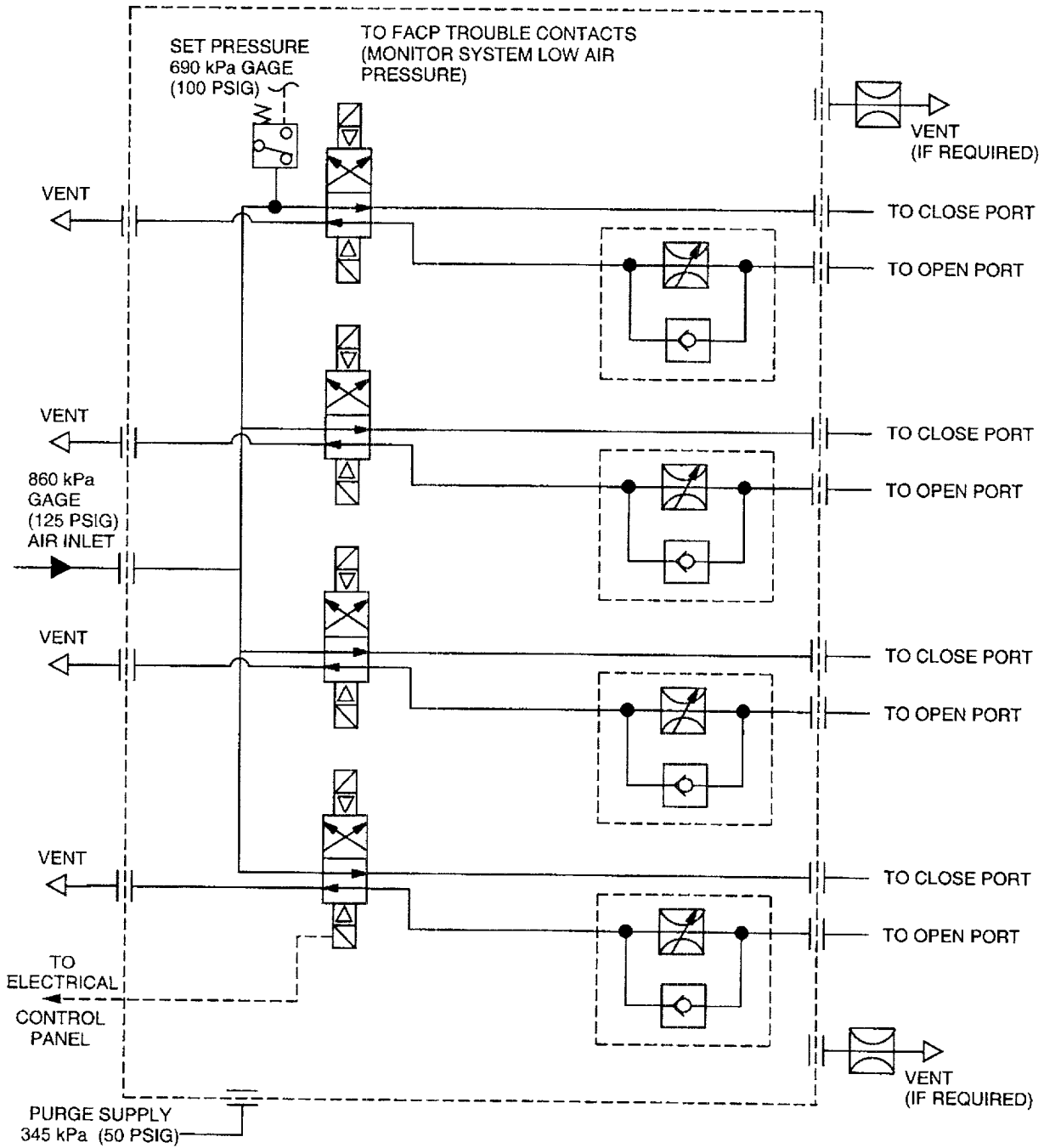

Figure 5. Typical Type II Deluge Water Sprinkler (Mechanical) (Sheet 1 of 2)



**Figure 5. Typical Type II Deluge Activation Panel (Mechanical) (Sheet 2 of 2)**

KSC-STD-F-0004E

October 24, 2003

- c. Type III Deluge Water Systems – Type III systems shall be configured in accordance with Figure 6. Major system components are two series manual activation valves located in an area safe for occupation during hazardous operations (15 to 30 m [50 to 100 ft]) from the facility structure where practical). The valve shall be positively identifiable as a deluge water system valve through the use of placards, signs, or other methods approved by the Lead Design Engineer in consultation with the KSC AHJ. Communication with the test conductor in a remote control room or location shall be provided for granting approval to activate the system. The test conductor shall have video and/or audio communication with the protected facility adequate to provide verification of the need for system activation. The position of both valves shall be monitored. If either valve is opened, a local and remote indication shall be provided. The status of the system shall be monitored independently by the FACP. Opening of either valve shall ring the facility bells and notify the CFMS through the FACP. Where planning, studies, preliminary engineering reports, and/or designs require either the modification, retrofit, or expansion of the existing Type I or Type II deluge water system to a Type III system, an analysis shall be conducted as to the cost effectiveness and the need to remove the Type I or Type II system.



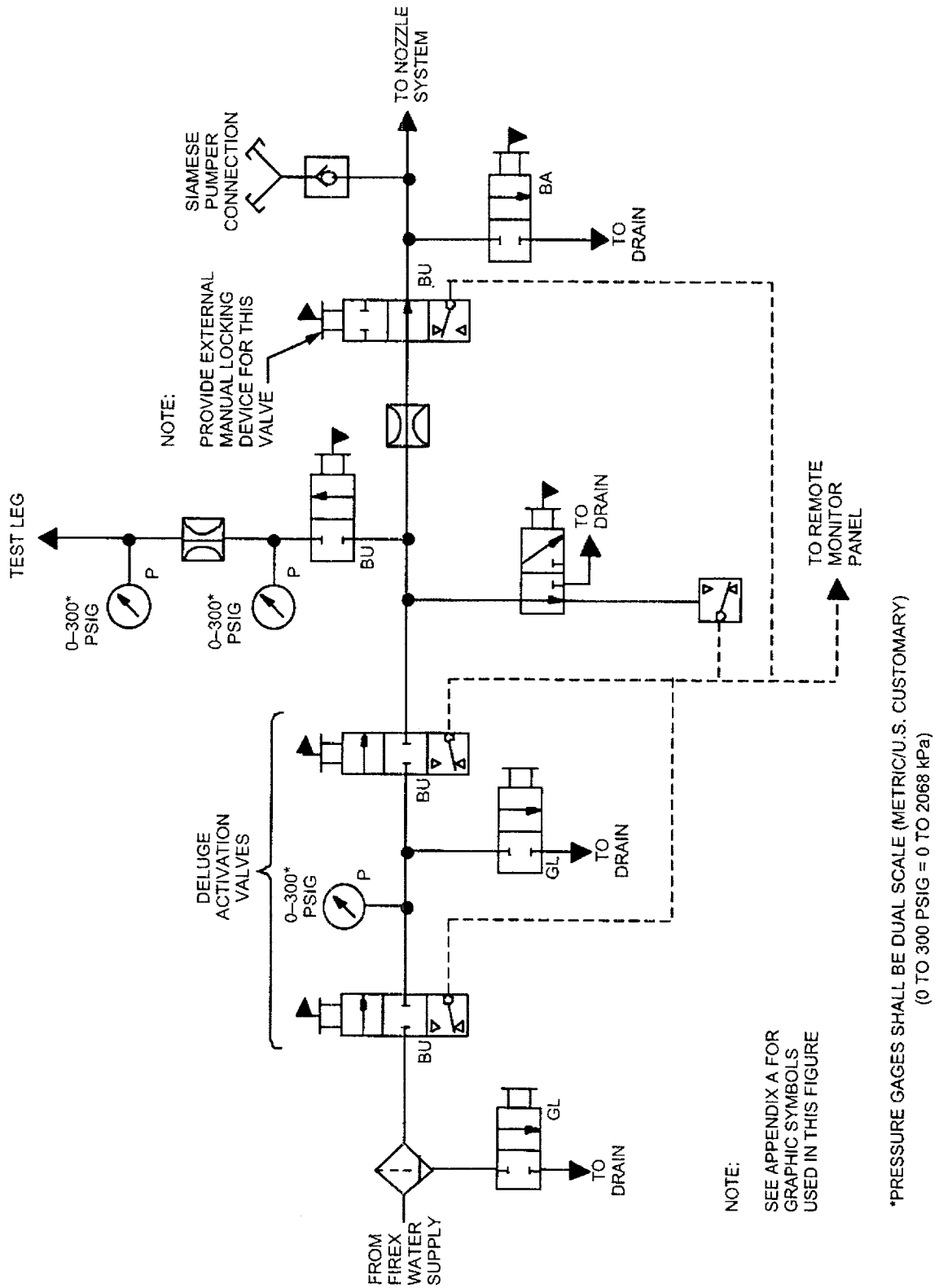

Figure 6. Typical Type III Deluge Water System

KSC-STD-F-0004E

October 24, 2003

#### 4.3.5.4 Deluge System Electrical Controls

Control and monitoring shall be provided utilizing a dedicated deluge control system. All deluge system initiation and activation devices shall be directly connected to the deluge system. Control power for deluge systems shall be dedicated 24 or 28 V dc with automatic battery backup. When the command is given to begin waterflow, latching-type control relays shall keep the circuit energized until the command is given to stop waterflow. Electrical controls for deluge systems shall be configured as identified in this standard. If there are differences between this standard and drawing 79K32573, this standard supersedes drawing 79K32573. Type I and Type II systems shall be controlled by manual dual pushbutton control stations. Drawing 79K32573 should be used as a guide in the design of these control stations. The control stations shall be equipped with protective covers or keylock switches to prevent accidental actuation. The covers shall be designed such that they are not self-closing. Each pushbutton shall have dual contacts. The controls shall require personnel to push two separate buttons in order to initiate waterflow. If the system is not monitored by a continuously manned Firex system console, the initiation shall result in the following:

- a. When either the arm or activate pushbutton is pushed:
  - (1) The horn (if provided) and flashing light at the pushbutton station are activated.
  - (2) A signal is sent to the CFMS through the facility FACP.
- b. When the second pushbutton is pushed, the FACP rings facility bells and shuts down the HVAC where applicable.

A remote control station shall be provided within sight of the area protected but removed from the immediate hazard. This control station shall permit operating personnel to operate the deluge system. The location of all remote control stations shall be as directed by the Lead Design Engineer following consultation with the KSC AHJ. The control wiring should not be routed through communication terminal distribution racks and/or main frames. Separate dedicated wiring should be run for these control circuits.

Three zones or addresses shall be allocated in the facility FACP to monitor the deluge system as required:

- a. Summary of deluge control panel status
- b. Flow or pressure monitoring
- c. Valve tamper-switch monitor

#### 4.3.5.4.1 Type I Deluge Panel Control Circuit Logic

The deluge water valves shall be pneumatically actuated, with actuators controlled by solenoid valves. The solenoid valves shall be operated by pushbutton stations and/or remotely controlled from a Firex console. The following logic shall be executed by the deluge control circuitry:

- a. Pressing the "ARM" pushbutton or sending remote "ARM" commands will energize the "ARM" relays, which will "seal-in," energizing the normally open (N.O.) contacts. The red "ARM" indicating lamps on all local pushbutton stations will illuminate.
- b. Pressing the "ACTIVATE" pushbutton or sending remote "ACTIVATE" commands will energize the "ACTIVATE" relays, which will "seal-in," energizing the N.O. contacts. The red "ACTIVATE" indicating lamps on all local pushbutton stations will illuminate.
- c. When both arming and activating relays are "sealed-in," the corresponding control relays will energize the N.O. contacts, which will in turn energize the "OPEN" coil of the solenoid associated with the deluge butterfly valve, causing the butterfly valve to open.
- d. If the design incorporates a deluge "armed warning horn," it will sound and remain on when either the arming or activating relays have been energized.
- e. The deluge control system will monitor the position of each butterfly valve using limit switches.
- f. When either the "ARM" or "ACTIVATE" pushbuttons have been pushed, the Fire Console in LCC Room 1P10 will receive a "pending deluge activation" alarm, and the red "System Armed" warning light on the valve control station will be illuminated and begin flashing. When any butterfly limit switch does not indicate closed, the Fire Console in LCC Room 1P10 will receive a "pending deluge activation" alarm. The "pending deluge activation" alarms to the LCC Fire Console and the flashing light are not required if the system is monitored by a continuously manned Firex system console.
- g. When water flows to the nozzles, LCC Room 1P10 receives the "Deluge System Activated" alarm via the "Deluge Water Pressure Switch."
- h. A green light shall be illuminated at each control station indicating that power is available.
- i. Pressing the "CLOSE" pushbuttons or sending a remote close command will close the "ACTIVATE" and "ARM" butterfly valves, respectively, and will return the deluge system to "standby" configuration. "CLOSE" pushbuttons are not required to be located at the same location as the local activation stations.

KSC-STD-F-0004E

October 24, 2003

#### 4.3.5.4.2 Type II Deluge Panel Control Circuit Logic

The deluge water valves shall be pneumatically actuated, with actuators controlled by solenoid valves. The solenoid valves shall be operated by pushbutton stations and/or remotely controlled from a Firex console. The following logic shall be executed by the deluge control circuitry:

- a. Pressing the "ARM" pushbutton or sending remote "ARM" commands will energize relays which will in turn energize the "OPEN" coil of the solenoid associated with the "ARM" butterfly valves, causing both "ARM" butterfly valves to open. The relays energizing the solenoids will "seal-in" energizing the normally open (N.O.) contacts. The red "ARM" indicating lamps on all local pushbutton stations will illuminate.
- b. Pressing the "ACTIVATE" pushbutton or sending remote "ACTIVATE" commands will energize relays, which will in turn energize the "OPEN" coil of the solenoid associated with the "ACTIVATE" butterfly valves, causing both "ACTIVATE" butterfly valves to open. The relays energizing the solenoids will "seal-in" energizing the N.O. contacts. The red "ACTIVATE" indicating lamps on all local pushbutton stations will illuminate.
- c. If the design incorporates a deluge "armed warning horn", it will sound and remain on when either the "ARM" or "ACTIVATE" valves have been actuated.
- d. The deluge control system will monitor the position of each butterfly valve using limit switches.
- e. When either the "ARM" or "ACTIVATE" pushbuttons have been pushed, the Fire Console in LCC Room 1P10 will receive a "pending deluge activation" alarm and the red "System Armed" warning light on the valve control station will be illuminated and begin flashing. When any butterfly valve limit switch does not indicate closed, the Fire Console in LCC Room 1P10 will receive a "pending deluge activation" alarm. The "pending deluge activation" alarms to the LCC Fire Console and the flashing light are not required if the system is monitored by a continuously manned Firex system console.
- f. When water flows to the nozzles, 1P10 receives the "Deluge System Activated" alarm via the "Deluge Water Pressure Switch."
- g. A green light shall be illuminated at each control station indicating that power is available.
- h. Pressing the "CLOSE" pushbuttons or sending a remote close command will close the "ACTIVATE" and "ARM" butterfly valves, respectively, and will return the deluge system to "standby" configuration. "CLOSE" pushbuttons are not required to be located at the same location as the local activation stations.

#### 4.3.5.5 Deluge Water Control Valves/Manual Shutoff Valves

Control valves and manual shutoff valves in deluge systems shall be of the butterfly type with an offset shaft and eccentric disk. Both the shaft and disk shall be made of stainless steel. Valve bodies may be of carbon steel when environmental conditions permit. Valve seats shall be made of a single piece of reinforced tetrafluoroethylene (TFE) (type M). Valve shaft seals shall be virgin TFE (type T). Valve orientation shall be such that the upstream pressure tends to hold the valve closed (i.e., installed with the shaft upstream). Deluge water control valves shall be the wafer-sphere design by Jamesbury Corporation or an approved equal. Valves shall be clearly labeled open or closed utilizing a valve position indicator.

#### 4.3.5.6 Deluge Actuation Systems (Mechanical)

Actuation of deluge systems shall be with compressed air or dry nitrogen. Actuation systems compressed air or dry nitrogen supply shall be designed in accordance with Figure 7. The deluge control panel shall monitor pressure in the system.

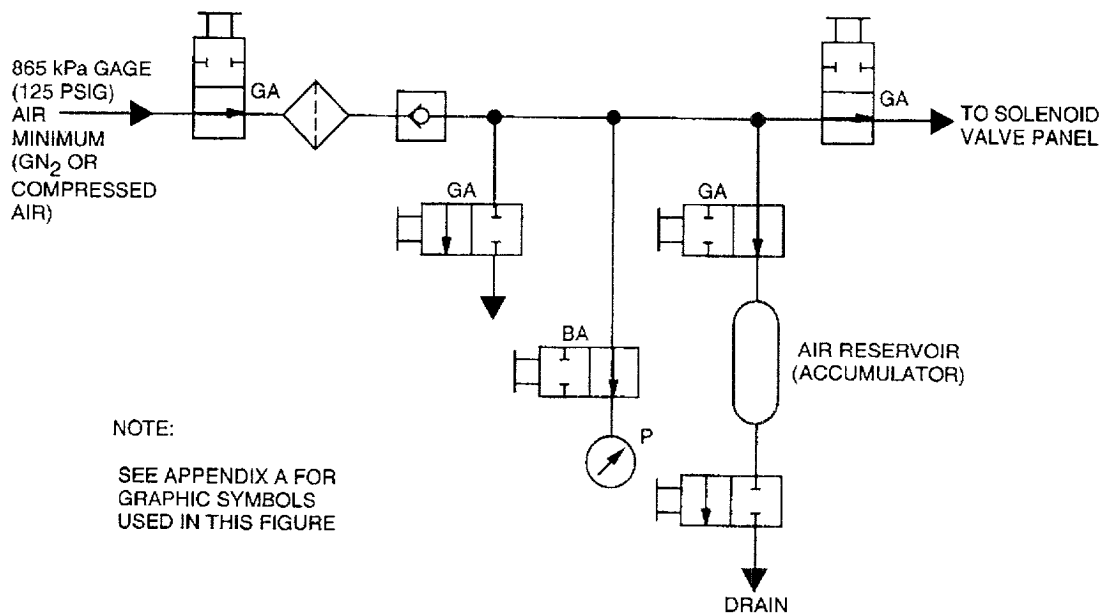

**Figure 7. Deluge Compressed Air Supply Configuration**

Major system components shall consist of an isolation valve, filter check valve, accumulator with an isolation valve and vent valve, flow controller, solenoid valve, pressure switch, pressure gage with an isolation valve, and bleed valve. The accumulator shall be sized to open and close the system control valves not less than three times for a single zone from a fully charged system. Check valves shall be Circle Seal 249B or an approved equal.

KSC-STD-F-0004E

October 24, 2003

#### **4.3.5.7 Deluge Water Control Valve Actuators**

Valve actuators shall be the double-acting type, rated for at least 1.035 MPa (150 psi). They shall be sized to open the butterfly valves under full system pressure with 690 kPa (100 psi) air available. Valve actuators shall be type ST 200 or ST 400 by Jamesbury Corporation or an approved equal. Shutoff valves shall have manual gear actuators clearly marked OPEN and SHUT and shall have electrical supervision tied to the fire alarm system to indicate a SUPERVISORY condition when closed. Valve tamper switches shall be installed on all manual shutoff valves on the critical flow path, where practical. Valve tamper switches shall be monitored directly from the facility FACP as a separate zone (not from the deluge control panel). Tamper switches are typically not required on individual platform isolation valves inside controlled facility spaces (e.g., high bays and cleanrooms).

#### **4.3.5.8 Solenoid Valves**

Solenoid valves shall be four-way with two positions and dual coils. The valves shall be designed to operate on 24 V dc. The deluge control panel shall monitor and annunciate which valve was operated. Additional information and guidance for the fabrication of solenoid panels can be obtained from drawing 80K59233.

#### **4.3.5.9 Monitoring**

Control logic shall be designed so traceability is provided to indicate how the system was activated (i.e., which pushbutton or station was activated). Control logic is shown on drawing 79K32573.

#### **4.3.5.10 Control Lines**

Control functions that require an open/closed path between two wires shall be designed and implemented so that exposed terminals are nonadjacent and are adequately protected. If possible, separate wires with waterproof insulation should be utilized, not telephone audio grade pairs.

#### **4.3.5.11 Routing**

Control wires for arm and activate valves and other critical functions shall not be routed through uncontrolled terminal distributors and frames along with other miscellaneous systems.

#### **4.3.6 Standpipes**

Standpipes shall be provided in accordance NASA-STD-8719.11 and in special applications as directed by the KSC AHJ.

#### **4.3.7 Fire Pumps**

Fire-pump installations shall comply with NFPA 20, with the following exceptions. For extra hazard occupancy areas, as defined by the Lead Design Engineer following consultation with the



KSC AHJ, fire pump installations providing primary fire protection water shall contain not less than two diesel-driven fire pumps or two electric-motor-driven fire pumps with a redundant source of power or one electric fire pump with a redundant diesel-driven backup fire pump of the same size. When multiple fire pumps are needed to meet the demand requirements, the maximum demand (flow and pressure) shall be met without the largest pump running. A single fire pump and driver may be used to provide 100 percent of the system's flow and pressure requirement for light and ordinary hazards. All fire pumps shall be monitored by UL-listed FACPs for condition and status. Existing FACPs or existing CFMS summary panels shall be used.

#### **4.4 Special Suppression Systems**

##### **4.4.1 Carbon Dioxide Systems**

Carbon dioxide systems are most effective against flammable liquid and electrical fires. Carbon dioxide systems shall not be installed in occupied areas. This type of system has been used to protect crawler transporter engine compartments. Carbon dioxide systems shall be designed in accordance with NFPA 12 and the NASA KSC local specifications.

##### **4.4.2 Wet Chemical Extinguishing Systems**

Wet chemical kitchen suppression systems shall be installed for protection of cooking equipment and cooking exhaust hood systems. Normally pre-engineered wet chemical systems shall be installed. The installation and operation of wet chemical extinguishing systems shall conform to NFPA 17A and the NASA KSC local specifications.

##### **4.4.3 Foam Extinguishing Systems for Aircraft Hangars**

Foam extinguishing systems shall be installed for the protection of NASA aircraft and research and development aircraft in specialized aircraft hangars. The installation and operation of foam extinguishing systems shall conform to NFPA 11, NFPA 11A, NFPA 16, and NFPA 409, and the NASA KSC local specifications. Additional design guidance should be obtained from the Factory Mutual Design Data Sheets and the National Institute of Standards and Technology Technical Report NIST TN 1423, Analysis of High Bay Hangar Facilities for Detector Sensitivity and Placement.

##### **4.4.4 Halon 1301 and Clean Agent Extinguishing Systems**

Installation of new Halon 1301 systems is prohibited except by special approval by the KSC AHJ. Installation of new clean agent extinguishing systems shall also require special approval by the KSC AHJ. Clean agent extinguishing systems shall be installed in accordance with NFPA 2001 and the NASA KSC local specifications. Additional design guidance should be obtained from the Factory Mutual Design Data Sheets.

NOTICE. The Government drawings, specifications, and/or data are prepared for the official use by, or on behalf of, the United States Government. The Government neither warrants these Government drawings, specifications, or other data, nor assumes any responsibility or obligation, for



KSC-STD-F-0004E

October 24, 2003

their use for purposes other than the Government project for which they were prepared and/or provided by the Government, or any activity directly related thereto. The fact that the Government may have formulated, furnished, or in any way supplied the said drawings, specifications, or other data is not to be regarded, by implication or otherwise, as licensing in any manner the holder or any other person or corporation nor conveying the right or permission, to manufacture, use, or sell any patented invention that may relate thereto.

Custodian:

NASA – John F. Kennedy Space Center  
Kennedy Space Center, Florida 32899

Preparing Activity:

John F. Kennedy Space Center  
Spaceport Services Directorate



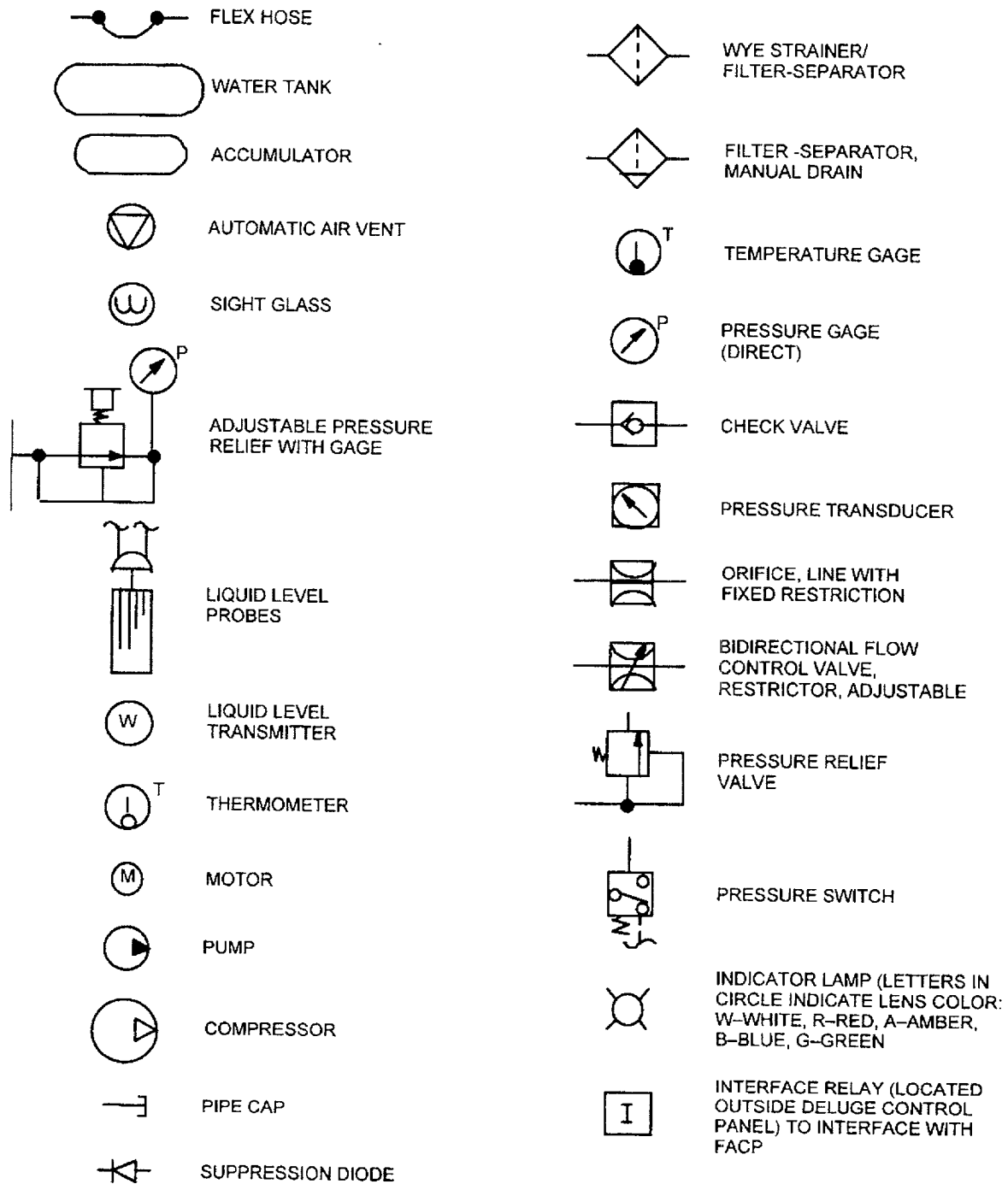



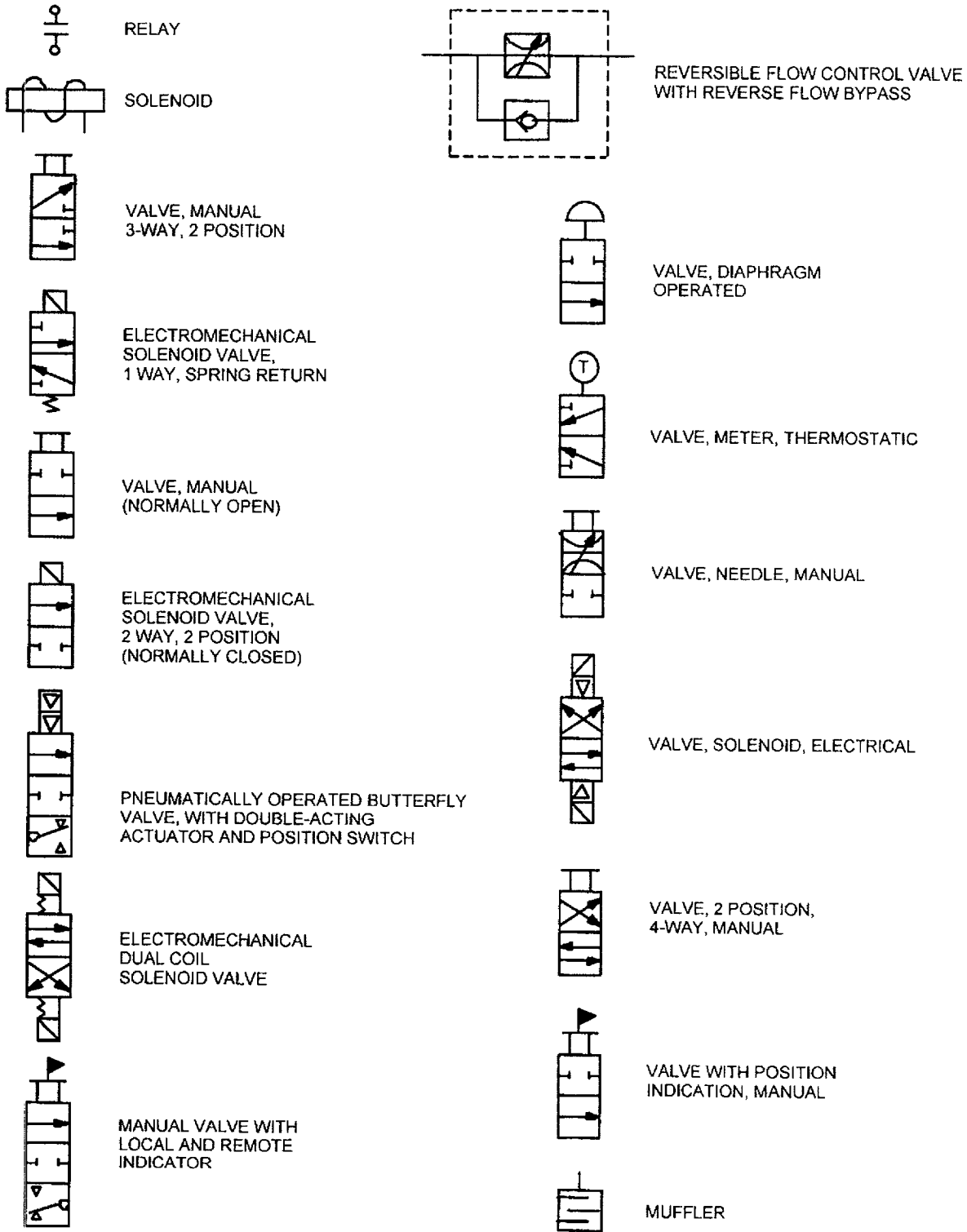



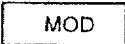

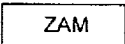

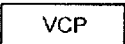
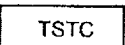















**APPENDIX A. GRAPHIC SYMBOLS FOR FIREX AND FIRE ALARM SYSTEMS**



KSC-STD-F-0004E  
 October 24, 2003











## FIRE ALARM PLAN AND RISERS SYMBOLS:

	CONDUIT ROUTED EXPOSED		FIRE ALARM MODEM CABINET
	HEAT SENSITIVE CABLE		FIRE ALARM ZAM CABINET
	HEAT SENSITIVE CABLE TEST PORT		FIRE ALARM TERMINAL CABINET
TYP.	TYPICAL		FIRE ALARM VOICE CONTROL PANEL
TX/TRANSF	TRANSFORMER		TRANSIENT SURGE TERMINAL CABINET
DISTRIB.	DISTRIBUTION		ULTRA-VIOLET / INFRA-RED DETECTOR TRIPLE INFRA-RED DETECTOR
W/	WITH		PHOTO BEAM TRANSMITTER
W/O	WITH OUT		PHOTO BEAM RECEIVER
	ELECTRICAL GROUND		SIGNAL ZAM
TTB	TELEPHONE TERMINAL BOARD		MONITOR ZAM
AFF	ABOVE FINISHED FLOOR		CONTROL ZAM
A.F.G.	ABOVE FINISHED GRADE		SOLENOID VALVE
WP	WEATHERPROOF		KEY ISOLATE SWITCH
EP	EXPLOSIONPROOF		SUPERVISED IAM
	FIRE ALARM CONTROL PANEL		LOW AIR PRESSURE SWITCH
	FIRE ALARM AUXILIARY CONTROL PANEL		AIR SAMPLING DETECTION SYSTEM
	FIRE ALARM WET CHEMICAL CONTROL PANEL		FIRE SMOKE DAMPERS
	FIRE ALARM PRE-ACTION CONTROL PANEL		TELEPHONE JACK
	HALON CONTROL PANEL		DISCONNECT SWITCH
	CO <sub>2</sub> CONTROL PANEL		ANNUNCIATOR LCD PANEL
	FOAM SYSTEM CONTROL PANEL		REMOTE DUCT DETECTOR TEST SWITCH / LED
			AUXILIARY REMOTE CONTROL RELAY

KSC-STD-F-0004E









October 24, 2003

FIRE ALARM PLAN AND RISERS SYMBOLS:

	FIRE ALARM STROBE LIGHT		FIRE SPEAKER
	COMBINATION FIRE BELL/STROBE		MAGNETIC DOOR HOLDER
	COMBINATION FIRE SPEAKER/STROBE		CODED TRANSMITTER
	FIRE BELL		NOTIFICATION APPLIANCE CABINET

INITIATION DEVICE NOTE:

ALL INITIATION DEVICE SYMBOLS USED ON PLANS SHALL HAVE ZONE INDICATION SUBSCRIPTS. NUMERIC ONLY SUBSCRIPTS (FOR EXAMPLE "1") INDICATE ZONE. THE LETTER "A" FOLLOWED BY A NUMBER (FOR EXAMPLE "A1") INDICATES AN INDIVIDUALLY ADDRESSABLE DEVICE AND GROUPING FOR CENTRAL FIRE MONITOR SYSTEM REPORTING PURPOSES.

	PRESSURE SWITCH		MANUAL PULL STATION
	FLOW SWITCH		PHOTOELECTRIC SMOKE DETECTOR
	TAMPER SWITCH		PHOTOELECTRIC DUCT SMOKE DETECTOR (SUPPLY)
	HEAT-ACTUATED DETECTOR		PHOTOELECTRIC DUCT SMOKE DETECTOR (RETURN)

VALVE TYPES

- BU - BUTTERFLY
- GL - GLOBE
- GA - GATE
- CO - CONE
- BA - BALL
- CL - CLAPPER
- PL - PLUG
- SV - SOLENOID
- F/A - FIRE ALARM

NOTES:

REFERENCE DOCUMENTS:

- 79K09579 OMD BASE LINE NO. 40200
- 79K29921 SYSTEM DOCUMENTATION LIST
- 79K29849 LRU PARTS LIST

SOLENIOD VALVES ARE DEPICTED IN THE DEENERGIZED STATE OTHER SYSTEM VALVES ARE DEPICTED IN POSITION (OPEN, CLOSED, ACTUATED, UNACTUATED) SHOWING THE WATER SYSTEM OPERATIONALLY PRESSURIZED WITH NO FLOWS.

SYMBOLGY IS PER KSC-STD-15-2. (SPECIAL SYMBOLS FOR WATER SYSTEM ADDED AS REQUIRED.)

IN MULTIPLE ENVELOPE SYMBOLS, FLOW CONDITION SHOWN NEAREST A CONTROL SYMBOL TAKES PLACE WHEN THE CONTROL IS CAUSED OR PERMITTED TO ACTUATE.

EXAMPLE

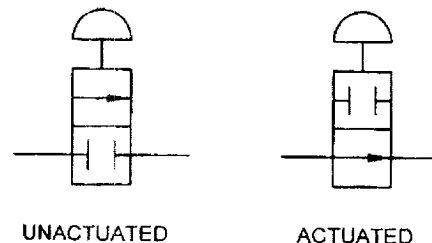

# STANDARDIZATION DOCUMENT IMPROVEMENT PROPOSAL

## INSTRUCTIONS

1. The preparing activity must complete blocks 1, 2, 3, and 8. In block 1, both the document number and revision letter should be given.
2. The submitter of this form must complete blocks 4, 5, 6, and 7.
3. The preparing activity must provide a reply within 30 days from receipt of the form.

NOTE: This form may not be used to request copies of documents, nor to request waivers or clarification of requirements on current contracts. Comments submitted on this form do not constitute or imply authorization to waive any portion of the referenced document or to amend contractual requirements.

**I RECOMMEND A CHANGE:**

1. DOCUMENT NUMBER

KSC-STD-F-0004E

2. DOCUMENT DATE

October 24, 2003

3. DOCUMENT TITLE

Fire Protection Design, Standard for

4. NATURE OF CHANGE *(Identify paragraph number and include proposed rewrite, if possible. Attach extra sheets as needed.)*

5. REASON FOR RECOMMENDATION

6. SUBMITTER

a. NAME *(Last, First, Middle Initial)*

b. ORGANIZATION

c. ADDRESS *(Include Zip Code)*

d. TELEPHONE *(Include Area Code)*

7. DATE SUBMITTED

8. PREPARING ACTIVITY

a. NAME

b. TELEPHONE *(Include Area Code)*

c. ADDRESS *(Include Zip Code)*