

NATIONAL AERONAUTICS and SPACE ADMINISTRATION (NASA)



RELIABILITY CENTERED BUILDING AND EQUIPMENT ACCEPTANCE GUIDE

July, 2004

NASA Reliability Centered Building and Equipment Acceptance Guide

Preface

The purpose of this *NASA Reliability Centered Building and Equipment Acceptance Guide* is to provide acceptance criteria guidelines for equipment associated with new construction, repair or rehabilitation projects. It serves as a technical reference for design engineers, project and program managers, construction managers and inspectors, quality control personnel, and NASA quality assurance staff to help define the required acceptance requirements.

In support of the “forward-thinking” vision that value and cost span the entire life of equipment, NASA embraces the process of Reliability Centered Maintenance (RCM). RCM demonstrates tremendous success in not only identifying where equipment failures potentially occur, but also the actions and technologies that could be used to prevent those failures and mitigate the associated risk. Those technologies, commonly called Predictive Testing and Inspection (PT&I), are integral elements of the RCM philosophy. Those same technologies can be used with equal success during acceptance to identify and eliminate latent manufacturing and installation defects. Equipment with such defects would be significantly detrimental to mission success, personnel safety, and overall cost of operations and maintenance.

This guide promotes the process of RCM as the foundation for developing acceptance criteria. It contains a description of the methodologies of RCM, and it also contains descriptions of the technologies available for acceptance testing. The expected result is a quality and safe installation, reduced premature failures, and reduced life cycle costs.

This Guide *does not*, nor is it intended to, address all aspects of Traditional and Total Building Commissioning as practiced widely in industry. For these, the user is encouraged to refer to the comprehensive and detailed commissioning guides, criteria and standards, such as those published by the American Society of Heating, Refrigerating and Air Conditioning Engineers (ASHRAE).

This Guide supplements the commissioning standards already in place and *does not* replace those standards. The practices and standards contained herein are to be used in conjunction with traditional process parameters to inspect, test and accept facilities and equipment installations prior to the contractor's departure from the site. The equipment examples contained in this Guide are not inclusive of all equipment at NASA nor is it the intention of this guide to comprehensively address all different makes, models and sizes of equipment. The examples contained herein are typical of common equipment, and are intended for NASA personnel to duplicate, imitate or expand upon for their explicit and unique purposes.

This guide is an update to the March 2001 *NASA Reliability Centered Building and Equipment Acceptance Guide*. It contains 46 additional general equipment specifications as well as updates to the glossary and appendices. *SpecsIntact* references have been included in this update.

This page intentionally left blank

Table of Contents

1.	INTRODUCTION TO ACCEPTANCE TESTING AND RELIABILITY CENTERED MAINTENANCE	1
1.1	Purpose of Guide	1
1.2	Integrating Acceptance Testing into NASA’s Commissioning Process.....	2
1.3	Introduction to Reliability Centered Maintenance (RCM).....	4
1.4	Responsibilities.....	8
1.5	Overview of Facilities and Collateral Equipment.....	10
1.6	Reliability Centered Facilities and Equipment Acceptance Intent	11
2	CONTRACT CLAUSES AND SPECIFICATIONS FOR TYPICAL EQUIPMENT ITEMS	13
2.1	PT&I Selection Check List.....	13
2.2	General Equipment Specifications	21
2.3	Batteries (General).....	36
2.4	Battery (Lead-Acid).....	38
2.5	Battery Chargers	41
2.6	Blowers	43
2.7	Boiler.....	47
2.8	Breakers (General)	49
2.9	Breakers- Air Blast.....	52
2.10	Breakers- Air Magnetic.....	54
2.11	Breakers- Oil.....	56
2.12	Breakers-SF6 Gas	59
2.13	Breakers- Vacuum	62
2.14	Cables (General)	64
2.15	Cables- Low Voltage (600V Maximum).....	66
2.16	Cables- Medium Voltage (600V – 33,000V).....	67
2.17	Cables, High Voltage (33,000V Minimum).....	70

NASA Reliability Centered Building and Equipment Acceptance Guide

2.18	Electrical, Capacitor Bank.....	73
2.19	Capacitor, Dry-Type.....	75
2.20	Capacitor, Liquid Filled.....	77
2.21	Compressors.....	79
2.22	Cranes.....	82
2.23	Diesel Engine.....	84
2.24	Diesel Generator.....	88
2.25	Electrical Automatic Transfer Switch (ATS).....	92
2.26	Electric Buss.....	95
2.27	Electrical Control Panel.....	97
2.28	Electrical Distribution Panel.....	100
2.29	Electrical Grounding Grid.....	103
2.30	Electrical Lightning Protection.....	105
2.31	Electrical Power Centers.....	107
2.32	Electrical Power Supplies.....	110
2.33	Electrical Rectifiers.....	113
2.34	Electrical Relays.....	116
2.35	Electrical Starters.....	118
2.36	Electric Switch, Cutouts.....	121
2.37	Electric Switch, Low Voltage Air.....	123
2.38	Electric Switch, Medium & High Voltage Air, Open.....	125
2.39	Electric Switch, Medium Voltage Air, Metal Enclosed.....	127
2.40	Electric Switch, Medium Voltage Oil.....	129
2.41	Electric Switch, Medium Voltage SF6.....	131
2.42	Electric Switch, Medium Voltage Vacuum.....	134
2.43	Electrical Transformer Load Tap Changer.....	136
2.44	Fans.....	139
2.45	Gearboxes.....	142

 NASA Reliability Centered Building and Equipment Acceptance Guide

2.46	Heat Exchanger (General)	144
2.47	Heat Exchange Condenser Air Cooled	146
2.48	Heat Exchange Condenser Water Cooled	148
2.49	Heat Exchange Cooling Tower	150
2.50	HVAC Ducts	152
2.51	Material Handling Conveyor	154
2.52	Miscellaneous Safety Wash	156
2.53	Motor Control Centers	158
2.54	Motors (General)	160
2.55	Motor- Hydraulic	166
2.56	Motor - Pneumatic	169
2.57	Piping Systems	172
2.58	Pumps	175
2.59	Roofs, Walls and Insulation	179
2.60	Steam Traps	183
2.61	Switchgear	184
2.62	Tank and Storage Tank Pressurized	186
2.63	Tank and Storage Tank Unpressurized	188
2.64	Transformers	190
2.65	Turbine Expander	193
2.66	Turbines-Gas	196
2.67	Steam Turbine (ST)	200
2.68	Valves	203
Appendix A: Description of Reliability Centered Maintenance (RCM)		1
Appendix B: Description of Predictive Testing and Inspection (PT&I) Technologies		1
Appendix C: Defining Basic Value – Benefit Terminology		1
Appendix D: Resources		1
Appendix E - Referenced Specifications		1

NASA Reliability Centered Building and Equipment Acceptance Guide

Appendix F - RCM Acceptance Data Sheets.....1

Appendix G - Glossary1

Appendix H – Reference Data Requirements1

Table of Tables

TABLE 1-1: NASA PT&I TECHNOLOGIES	11
TABLE 2-1: PT&I SELECTION CHECKLIST	20
TABLE 2-2. ISO 3945 VIBRATION SEVERITY TABLE.	26
TABLE 2-3. VIBRATION ACCEPTANCE CLASSES	26
TABLE 2-4. MACHINE CLASSIFICATIONS	27
TABLE 2-5. LUBRICANT TESTS	29
TABLE 2-6: SPERRY VICKERS TABLE OF SUGGESTED ACCEPTABLE CONTAMINATION LEVELS FOR VARIOUS HYDRAULIC SYSTEMS	30
TABLE 2-7. TYPICAL PROPERTIES OF TRANSFORMER OILS	31
TABLE 2-8: SPECSINTACT CROSS-REFERENCE	34
TABLE 2-9: SF ₆ GAS TEST	60
TABLE 2-10: EPA NON-ROAD DIESEL ENGINE EMISSION STANDARDS, G/KW•HR (G/BHP•HR)	86
TABLE 2-11: HEAVY DUTY DIESEL EMISSIONS FOR OVER THE ROAD DUTY ENGINES	86
TABLE 2-12: FUEL ANALYSIS LIMITS	86
TABLE 2-13: COOLANT ACCEPTANCE LEVELS	87
TABLE 2-14: EPA NON-ROAD DIESEL ENGINE EMISSION STANDARDS.	90
TABLE 2-15: FUEL ANALYSIS LIMITS	91
TABLE 2-16: COOLANT ACCEPTANCE LEVELS	91
TABLE 2-17: THERMOGRAPHIC SURVEY SUGGESTED ACTIONS BASED ON TEMPERATURE RISE	94
TABLE 2-18: DIELECTRIC WITHSTAND TEST VOLTAGES METAL ENCLOSED BUS	96
TABLE 2-19: SF ₆ GAS TESTS	132
TABLE 2-20: MOTOR BALANCE SPECIFICATIONS	162
TABLE 2-21: MOTOR VIBRATION CRITERIA	162
TABLE 2-22: ACCEPTANCE VIBRATION LIMITS	166
TABLE 2-23: LUBRICATING OIL ANALYSIS LIMITS	167
TABLE 2-24: PUMP VIBRATION LIMITS	176
TABLE A-1: ADVANTAGES AND DISADVANTAGES OF A REACTIVE MAINTENANCE PHILOSOPHY	3
TABLE A-2: ADVANTAGES AND DISADVANTAGES OF A PREVENTIVE MAINTENANCE PHILOSOPHY	3
TABLE A-3 ADVANTAGES AND DISADVANTAGES OF A PT&I MAINTENANCE PHILOSOPHY	4
TABLE B-1: BALANCE QUALITY GRADES FOR VARIOUS GROUPS OF REPRESENTATIVE RIGID ROTORS (IOS 1940/1- 1986)	2
TABLE B-2: TOLERANCES FOR COUPLED SHAFT ALIGNMENTS	4
TABLE B-3: DEFAULT BALANCE CRITERIA	8
TABLE B-4: INFRARED TEMPERATURE CRITERIA	15
TABLE B-5: POWER FACTOR VALUES	18
TABLE B-6: SWITCHGEAR POWER FACTOR VALUES	19
TABLE B-7. ESTIMATED STEAM LOSS	22
TABLE B-8 ISO 2206 FLUID CLEANLINESS CODES	25
TABLE B-9: TYPICAL BASE CLEANLINESS TARGETS	25
TABLE B-10 SPERRY VICKERS TABLE OF SUGGESTED ACCEPTABLE CONTAMINATION LEVELS FOR VARIOUS HYDRAULIC SYSTEMS	27
TABLE B-11: NEW LUBRICATING OIL LIMITS	28
TABLE B-12: DISSOLVED GAS LIMITS FOR NEW INSULATING OIL	29
TABLE B-13: OIL CONDITION TESTS AND LIMITS FOR NEW OIL	31
TABLE B-14: OIL CONDITION TESTS AND LIMITS FOR NEW INSULATING OIL	31
TABLE B-15: INSULATING FLUID MAINTENANCE	32
TABLE B-16: INSULATION RESISTANCE TEST VALUES	35
TABLE B-17: INSULATION RESISTANCE CORRECTION FACTORS	35
TABLE B-18: SWITCHGEAR WITHSTAND TEST VOLTAGES	37
TABLE B-19: MEDIUM VOLTAGE CABLES ACCEPTANCE TEST VALUES	44
TABLE B-20: MEDIUM VOLTAGE CABLE ACCEPTANCE TEST VALUES	45
TABLE B-21: OVERPOTENTIAL TEST VOLTAGES ELECTRICAL APPARATUS OTHER THAN INDUCTIVE EQUIPMENT	45

Table of Figures

FIGURE 1-1: STAGES OF LIFE CYCLE COST COMMITMENT ⁷	6
FIGURE 2-1: TRANSDUCER RESPONSE	23
FIGURE 2-2: BELT DRIVEN BLOWER VIBRATION ENVELOPE OVERALL PER BAND	43
FIGURE 2-3: DIRECT DRIVE BLOWER VIBRATION ENVELOPE OVERALL PER BAND	44
FIGURE 2-4: ACCEPTABLE NOISE LEVELS	85
FIGURE 2-5: ACCEPTABLE NOISE LEVELS	89
FIGURE 2-6: BELT DRIVEN FAN VIBRATION ENVELOPE OVERALL PER BAND	139
FIGURE 2-7: DIRECT DRIVE FAN VIBRATION ENVELOPE OVERALL PER BAND	140
FIGURE 2-8: GEARBOX VIBRATION ENVELOPE OVERALL PER BAND	142
FIGURE 2-9: SMALL MOTOR VIBRATION ENVELOPE OVERALL PER BAND	161
FIGURE 2-10: LARGE MOTOR VIBRATION ENVELOPE OVERALL PER BAND	161
FIGURE 2-11: DRIVE SHAFT DIRECTIONS	168
FIGURE 2-13: POSITIVE DISPLACEMENT AND CENTRIFUGAL PUMP VIBRATION ENVELOPE OVERALL PER BAND	175
FIGURE 2-14: INFRARED IMAGE OF MOISTURE UNDER ROOF	180
FIGURE A-1: COMPONENTS OF AN RCM PROGRAM.....	A-2
FIGURE A-2: RELIABILITY CENTERED MAINTENANCE (RCM) DECISION LOGIC	A-6
FIGURE B-1: BALANCE TEST KEY DIMENSION	B-2
FIGURE B-2: OFFSET AND ANGULAR MISALIGNMENT	B-5
FIGURE B-3: MEASUREMENT SYSTEM FREQUENCY RESPONSE	B-8
FIGURE B-4: TYPICAL VIBRATION MEASUREMENT LOCATIONS	B-11
FIGURE B-5: SOUND DISC DIAGRAM	B-12
FIGURE B-6: SAMPLE GEARBOX DIAGRAM	B-12
FIGURE B-7: INFRARED IMAGE OF A BAD ELECTRICAL CONNECTION AT A MAJOR FEDERAL FACILITY	B-14
FIGURE B-8: INFRARED IMAGE OF BLOCKED DRAIN PIPE UNDER CONCRETE FLOORING	B-14
FIGURE B-9: INFRARED IMAGE OF A 120 VOLT POWER PANEL	B-15
FIGURE B-10: INFRARED IMAGE OF MOTOR/COUPLING	B-16
FIGURE B-11: PHASE RELATIONSHIPS	B-17
FIGURE B-12: TYPICAL POWER FACTOR CONNECTION TO A TRANSFORMER.....	B-20
FIGURE B-13: TYPICAL POWER FACTOR CONNECTION TO A BUSHING	B-20
FIGURE B-14: THE EFFECT OF HYDRAULIC SYSTEM CONTAMINATION	B-24
FIGURE B-15: BEARING LIFE REDUCTION FROM WATER IN OIL ¹³	B-26
FIGURE B-16: TYPICAL BATTERY IMPEDANCE VERSUS AGE.....	B-33
FIGURE B-17: SIMPLIFIED MOTOR CURRENT SIGNATURE	B-40
FIGURE B-18: BREAKER TIMING PLOT	B-42
FIGURE B-19: HI-POT TESTING EXAMPLE	B-43

This page intentionally left blank

1. Introduction to Acceptance Testing and Reliability Centered Maintenance

1.1 Purpose of Guide

This guide is a technical reference for design engineers, project/program managers, construction managers/inspectors, contractor quality control and NASA quality assurance staff, and NASA researchers to use prior to and during the equipment start-up/checkout phase of new construction, repair, or rehabilitation projects. It presents methods for ensuring that building equipment and systems installed by the contractor have been installed properly and contain no identifiable defects that will shorten the design life of the equipment. It identifies these methods and technologies so that they can be incorporated into the design of the equipment and subsequent operation and maintenance phases. These technologies, commonly called Predictive Testing & Inspection (PT&I), will be essential elements in NASA's Quality Control program to test, accept, and maintain building systems and equipment. PT&I technologies have been used by world-class corporations and Malcolm Baldrige Quality Award winners extensively for acceptance testing and condition monitoring because they reduce costs while improving safety and reliability.

This guide is *not* intended to limit the inspection and acceptance process to the use of PT&I techniques. In addition to the comprehensive and detailed commissioning guides, criteria and standards published by subject matter expert organizations such as the American Society of Heating, Refrigerating and Air-Conditioning Engineers (ASHRAE), this guide is designed to complement other NASA documents such as the *Reliability Centered Maintenance Guide for Facilities and Collateral Equipment*¹ and the *NASA Facilities Maintenance Management Handbook*². For ease of use, some information from those documents is included in this guide.

It is also recommended that in conjunction with this guide the user consults other technical and trade publications, such as those issued by the ASHRAE^{3,4} and the Association of Higher Education Facilities Offices (APPA)⁵, which provide general commissioning non-PT&I guidance and may be valuable in planning the Center's commissioning program.

This guide has the following sections:

- Introduction to acceptance testing and reliability centered maintenance (RCM), including a discussion of how to integrate acceptance testing into the project delivery process,
- Sample Contract Clauses, including acceptance guidelines for typical equipment,
- Appendices with support and reference information to describe RCM and PT&I technologies.

¹ *NASA Reliability Centered Maintenance Guide for Facilities and Collateral Equipment*, first published in 1996 and revised in February 2000, available from NASA HQ Code JX.

² NASA NPG 8831.2, *Facilities Maintenance Management Handbook*

³ *Guideline for Commissioning of HVAC Systems*, ASHRAE Guideline 1-1996, American Society of Heating, Refrigerating, and Air-Conditioning Engineers, Inc., Atlanta, GA, 1989

⁴ *The Building Commissioning Process*, ASHRAE Technical Data Bulletin, Volume 9 Number 1, American Society of Heating, Refrigerating, and Air-Conditioning Engineers, Inc., Atlanta, GA, 1989

⁵ Heinz, John A., *The Building Commissioning Handbook*, The Association of Higher Education Facilities Officers, Alexandria, VA 1996

1.2 Integrating Acceptance Testing into NASA's Commissioning Process

It is not unusual to discover equipment operation problems after a construction or major renovation project. Some of those problems are caused by misapplied design, but most of them are caused by latent manufacturing defects, poor installation practices, and damage incurred during transportation and handling. As an example, recent experience with new construction at two NASA Centers and a major facility of another Federal Agency revealed 85 – 100% of the rotating equipment at the acceptance phase to be either misaligned, out-of- balance, or contained defective bearings. In most of the above cases, the faulty equipment would have passed the specified acceptance criteria. This same equipment would most likely experience premature failure during actual operation if the problem conditions were not corrected. Premature failures decrease system safety, reliability, and efficiency, and often disrupt ongoing critical operations. The costs associated with that premature failure not only could have been avoided with better acceptance criteria, but the costs of correcting the problem should be the responsibility of the contractor. To ensure that NASA take advantage of both of those opportunities, better acceptance criteria will help to identify those problems, and will also allow NASA to enforce contractor compliance.

It should also be noted that equipment designs contribute significantly to equipment cost. There is an exceptionally high cost associated with a bad design, either because the equipment is unable to properly satisfy function, equipment life is shortened, or because operations and maintenance cannot be properly performed. Ensuring a good equipment design can overcome many of these issues, as well as overcome premature failure to some extent. Recognize that this practice may cause costs to escalate. Those additional costs must be weighed in relation to the perceived value and benefits achieved. NASA's preferred approach is to eliminate those premature failures and achieve those additional benefits without unnecessarily enhancing the design, and therefore keeping costs to a minimum.

Traditional Commissioning

Traditional Commissioning ensures that the finished facility operates as intended.⁶ It uses a programmed series of design and construction documentation and testing activities that verify the functional operation of the facility. It typically checks operating parameters such as pressure, temperature, minimum and maximum airflow, lighting levels, electrical amperage and voltage, torque, fluid volumes, and other thermodynamic measures to confirm that the design intent has been met.

Traditional Commissioning historically has not included using PT&I technologies to check for latent manufacturing and installation defects. Traditional Commissioning acceptance requirements are met as long as the installation complies with the design intent and reflects the proper process parameters for equipment acceptance. This process does not detect underlying defects, which may result in premature equipment failure. Regardless of whether the failure occurs within or outside of the warranty period, the facility incurs costs associated with correcting the problem or enforcing the contractor's warranty at a later date.

⁶ Heinz, John A., *The Building Commissioning Handbook*, The Association of Higher Education Facilities Officers (APPA), Alexandria, VA 1996.

Total Building Commissioning

Total Building Commissioning, as it has emerged in the public and private sectors, is a cradle-to-grave systematic process of ensuring that facility systems are planned, designed, installed, tested, and capable of being operated and maintained to perform according to the design intent and the owner's needs. The Total Commissioning process is optimally applied to all phases of a construction project - program planning, design, construction/installation, acceptance and post-acceptance/occupancy⁶. Commissioning team involvement begins at the earliest stages of project planning, where expertise in system sizing, code compliance, maintainability, user friendliness, maintainability, product quality and reliability, ergonomics and projected life cycle costs, is applied to the design. The commissioning staff is also involved in monitoring the quality of the construction in terms of workmanship and specification and code compliance throughout all the stages leading up to acceptance. The total building commissioning team continues to monitor all installed systems following acceptance to ensure that there are no latent installation defects, or degradation of system performance. This rigorous commissioning process is intended to provide the following benefits:

- Ensure that a new facility begins its life with systems at optimal productivity.
- Improve the likelihood that the facility will maintain this level of performance.
- Restore an existing facility to high productivity.
- Ensure that facility renovations and equipment upgrades function as designed.

NASA's Approach to Commissioning

NASA's approach to Commissioning conforms rather closely to the Total Building Commissioning concept described above, with the additional commitment to integrate Reliability Centered Maintenance (RCM). RCM is an on-going process that determines the most effective approach to maintenance by assessing equipment function and determining risks of safety and economy should a failure occur.

Traditionally, RCM was considered to be a process which maximizes equipment performance through maintenance actions. It is also a process to ensure that equipment is optimally designed to support the highest level of performance throughout its life. RCM takes a life-cycle view of facilities and collateral equipment, and recognizes:

- New considerations to equipment design as a result of a better understanding of equipment failure consequences,
- New considerations to equipment design to be able to verify specified criteria during acceptance,
- New considerations to equipment design to be able to monitor and assess equipment condition during operation,
- New considerations to equipment design to take advantage of modern testing and inspection technologies.

Design engineers should understand that considerations during design can benefit the later stages of maintenance and operations. They should also understand that enhanced design features may increase the cost of acquisition and installation, so those additional design features should only be included when it is cost effective over the entire life-cycle of the equipment to do so. The acceptance criteria and the associated acceptance documents provide significant benefit toward integrating the design community with the O&M community. These criteria will define what technologies will be required to verify a defect free acceptance, what technologies will be required for equipment condition assessment and maintenance, who will be involved in supporting those technology initiatives, and when during the entire process those technologies will be required.

An additional benefit of rigorous acceptance testing is to generate baseline performance data that can be useful for condition assessment for already in place RCM O&M programs. Although this data is not always directly applicable for O&M, it could possibly eliminate redundant efforts and provide for some cost savings.

While it is understood that RCM based acceptance criteria certainly translates into benefits for the Total Building Commissioning program, this guide concentrates only on the acceptance portion of that program. Any interfaces or relationships between acceptance and the other aspects of commissioning are expected to be defined and described in other NASA initiatives, and this guide complements those comprehensive initiatives.

1.3 Introduction to Reliability Centered Maintenance (RCM)

1.3.1 What is RCM and Why Use it?

What is RCM ?

RCM is an on-going process used to determine the most effective approach to maintenance in support of the mission. It identifies the optimum mix of applicable and effective maintenance tasks needed to realize the inherent design reliability of equipment and preserve safety of systems and personnel at minimal cost. RCM uses a systematic, logic based approach for determining objective evidence for selecting the most appropriate maintenance tasks.

RCM generates sound technical rationale and economic justification on which maintenance decisions are based. The process considers operational experience and failure history to validate and support those decisions.

The RCM approach takes a life-cycle view of facilities and collateral equipment. By comprehensively defining all the possible failure causes of this equipment, steps can be taken at various stages of installation and operation to continually preserve this functionality. A key element in the transition from good design to full operation must include the construction and acceptance phase. If construction and installation practices adhere to sound principles emergent of the RCM philosophy, then there will be improved possibility that equipment will be properly built and installed, latent defects will be eliminated, and the probability of premature failure will be greatly reduced. This guide embraces the RCM philosophy and seeks to ensure that future

equipment specification criteria include not only the traditional items of functional requirements, but also specific performance requirements which can be verified with PT&I technologies.

What is PT&I?

PT&I is the use of advanced technology to assess machinery condition. The analysis of PT&I data will reveal any degradation in equipment performance and provide insight into the rate by which it is degrading. The PT&I data allows for effective planning and scheduling of maintenance or repairs so that consequences from failure can be minimized or eliminated. For PT&I data to be effective, initial baseline data, normally taken at inception, is needed for comparisons and trending. From an equipment acceptance perspective, PT&I tests have become one of the most effective methods for testing new and in-service equipment for hidden defects.

Only imagination and money limit the range and use of potential PT&I technologies. In humans, the fields of medicine and bioengineering are continuously developing ways to non-intrusively monitor the body and detect the onset of problems. Likewise, the machinery monitoring field is continuing to grow as new and cheaper technologies are developed. The technologies identified in this guide under Appendix B are not the only technologies available; however, they provide the most cost-effective approach for NASA facilities and collateral equipment.

For a complete description of the methodologies associated with RCM and PT&I technologies, refer to *the NASA Reliability Centered Maintenance Guide for Facilities and Collateral Equipment*¹. An abbreviated description of RCM can be found in Appendix A. An abbreviated description of PT&I technologies that are referenced elsewhere in this guide can be found in Appendix B.

An expanded description of other NASA criteria associated with reasons for conducting RCM are included in the following paragraphs.

Safety Per NPD 8700.1, *NASA Policy for Safety and Mission Success*, NASA policy is to "Avoid loss of life, personal injury or illness, property loss or damage, or environmental harm from any of its activities and ensure safe and healthful conditions for persons working at or visiting NASA facilities." By its very features, including analysis, monitoring, taking decisive action on systems before they become problematic, and thorough documentation, RCM's view on safety is consistent with the NASA Safety policy.

Reliability RCM places great emphasis on improving system and equipment reliability, principally through the documentation and feedback of initial baseline readings, maintenance experience and equipment condition data to facility planners, designers, maintenance managers, craftsmen, and manufacturers. This information is instrumental for continually upgrading the equipment specifications for increased reliability. The increased reliability that comes from RCM leads to fewer equipment failures and, therefore, greater availability for mission support and lower maintenance costs.

Scheduling The ability of RCM to forecast maintenance requirements, from as early as taking and documenting baseline data during the construction and acceptance phase and then operational data throughout its life, provides time for planning, obtaining replacement parts, and arranging environmental and operating conditions before the

maintenance is done. A principal advantage of RCM is that it obtains the maximum use from equipment. With RCM, decisions for equipment replacement consider condition as well as the calendar. This condition-based approach to maintenance thereby extends the operating life of the facility and its equipment.

Life Cycle Cost The facilities life cycle is often divided into two broad stages: acquisition (planning, design, and construction) and operations. RCM affects all phases of the acquisition and operations stages to some degree.

Decisions made early in the acquisition cycle profoundly affect the life-cycle cost of a facility. Even though equipment expenditures may occur later during the acquisition process, their cost is committed at an early stage. Conceptually as shown in Figure 1-1, planning (including conceptual design) fixes two-thirds of the facility's overall life-cycle costs. The subsequent design and construction phases determine an additional 29% of the life-cycle cost. About 95%, then, of the facility cost is determined by the time the facility is accepted and turned over, leaving only about 5% of the life-cycle cost that can be impacted during the O&M phase.

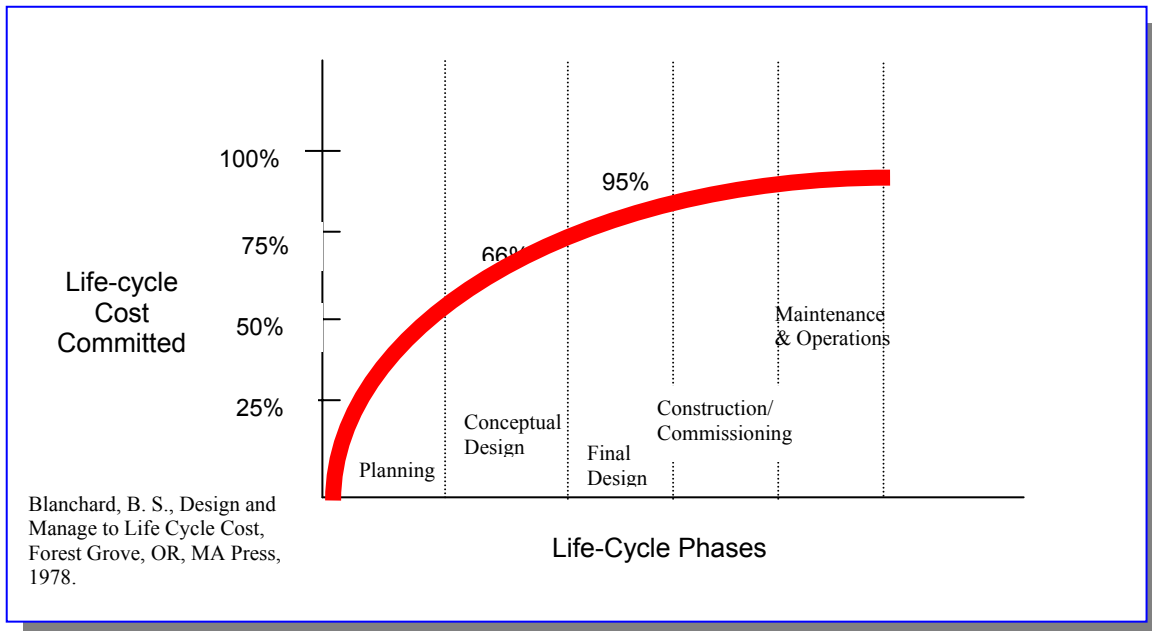

Figure 1-1: Stages of Life Cycle Cost Commitment⁷

Thus, the decision to include a facility in an RCM program, including PT&I, should start as early as the planning phase. These early decisions will have a major impact on equipment life-cycle cost. Ensuring that facilities meet acceptable RCM criteria and obtaining and documenting critical baseline data are extremely important during the construction phase. As RCM decisions are made later in the life cycle, it becomes more difficult to achieve the maximum possible benefit from the RCM program.

1.3.2 Benefits of RCM and PT&I as They Apply to Acceptance

During the acceptance phase of a recent building project for new equipment within NASA, the contractor was tasked with complying with the traditional acceptance criteria. Prior to executing acceptance; however, NASA personnel performed additional PT&I tests for further verification of acceptability of this equipment and discovered that:

- All HVAC pumps were misaligned at installation;
- All HVAC pumps had inadequate shims;
- 90% of the HVAC fans had improper sheaves specified and installed;
- 80% of all fans tested had excessive vibration;
- All fan vibration problems were traceable to balance and/or sheave problems;
- 2 out of 3 vertical pumps had extreme vibration caused by imbalance.

Unfortunately, this example is typical of the kind of results that can be expected from traditional acceptance criteria. None of the above items prevented the equipment from meeting performance criteria as specified in the contract. All of the items; however, would have a significant impact on equipment balance, bearing wear and the life of the bearings. Had vibration testing not been performed, the likelihood that the imbalance would have been detected prior to the occurrence of significant damage and/or a premature failure is slight. As a result of identifying and correcting the above deficiencies, bearings with an ISO 1940-1 Balance Grade of 16 were improved grades of 2.5 or better. In terms of bearing life, this equates toward extending bearing life from three years to eight years. In other words, these tests potentially enabled NASA to reduce the number of bearing replacements by almost a factor of three

None of the above problems are desirable, nor are they satisfactory, yet up until now they were considered acceptable. They were acceptable because NASA did not actively seek out ways to identify these problems and hold the contractor accountable for eliminating them. The contractor's scope of work did not require that these criteria be met, and therefore NASA was unable to enforce these issues during either acceptance or subsequent warranty.

NASA intends to correct this situation, and therefore investigate all possible, cost effective ways to ensure that these issues are addressed.

****** The design engineer must understand; however, that enhanced acceptance criteria may have an impact on contractor cost, and therefore NASA cost. It is not the intent of these acceptance criteria to unnecessarily drive up the cost of equipment installations and contractor work. If the cost of the added inspections and the cost of enhanced equipment designs outweigh their performance and life-cycle value, then obviously requiring overly restrictive acceptance criteria should not be used. The acceptance criteria should define the "minimum" limits essential for a good, quality installation.***

1.4 Responsibilities

1.4.1 Project Manager

During the entire life cycle of a project up through acceptance and up to the point of operation and maintenance, the Project Manager is responsible for ensuring that all aspects of the project are performed in a timely and professional manner. The Project Manager oversees all design efforts, specifications, issues bid documents, evaluates bids, recommends contractors for selection, and verifies that all administration and documentation for the project is completed and approved. The Project Manager also interfaces with the Construction Manager during construction and provides any required documentation requested by the Construction Manager.

The Project Manager is ultimately responsible for the project up through and including acceptance, at which time the equipment becomes the responsibility of the building owners.

1.4.2 Design

The long-term reliability of an installation or refurbishment begins with its initial planning and design. Section 1.4.4 above illustrated that decisions made early in the acquisition cycle profoundly affect the life-cycle cost of a facility with two-thirds⁷ of it fixed during the planning and initial design phase. The subsequent design phase determines an additional 29% of the life-cycle cost. Consequently, the project design determines not only the inherent equipment safety, reliability, maintainability, and supportability but the overall cost of the project. The design must then become a functional part of the facility.

In efforts to improve the reliability of its operational facilities and collateral equipment, NASA is in the process of integrating an RCM philosophy into their SPECSINTACT construction guide specifications and they also place considerable emphasis on executing the most cost-effective maintenance program. This maintenance program will include PT&I requirements; therefore, it is important early in the design process to determine what is required to allow for the proper and efficient testing, monitoring, documentation and maintenance to be accomplished. Addressing safety, accessibility, monitorability, and maintainability in the design process results in the following benefits:

- **Maintainability** – It has been estimated by NASA facility designers that the cost to make a system change, once the system is built, is anywhere from 10 to 1,000 times more than if the change was made during the system design. Retrofitting system maintainability features is therefore often cost prohibitive.
- **Improved Reliability** – The performance of PT&I tasks allows for impending failures to be discovered before the functional failure can occur, thus allowing the process to be coordinated with the customer and repaired when it is most convenient for the operation. In addition, early failure detection and correction prevents additional collateral damage, which could escalate consequences and costs.
- **Reduced Life Cycle Cost (LCC)** – The combination of the above two items is a reduced LCC resulting from reduced O&M costs due to fewer maintenance actions, reduced risk and

⁷ Blanchard, B.S., *Design and Manage to Life Cycle Cost*, Forest Grove OR, MA Press, 1978

consequences impacting mission critical operations, and increased efficiency of the O&M staff due to improved maintainability.

This Guide can assist the design engineer in identifying the appropriate acceptance testing requirements and include them when they are most cost-effective.

1.4.3 Contractor

The Contractor is responsible for the proper installation of the design or refurbishment requirements as specified in the contract. Acceptance testing using both traditional and PT&I technologies should be performed by the contractor as a part of the QC program throughout the installation process and immediately thereafter to verify that the installation is acceptable and to establish the required baselines. Not until this is complete will the equipment or facility be accepted by NASA for turnover.

* Note: NASA may reserve that the performance of certain tests be performed by either NASA personnel or other designated support contractors whenever there is demonstrated benefit to NASA. These benefits can take on the flavor of better quality of testing, better control of the test environment, reduced cost to the contract, better ability to meet schedule requirements, or other similar benefits. These alternate approaches to testing should be defined in the contract.

While it would be highly beneficial for a contractor to understand the NASA RCM process, their requirements are to deliver equipment that meet the terms of the contract and to meet all criteria defined in the contract. That is why it is vital that comprehensive acceptance criteria be clearly defined in the contract by NASA personnel.

Each contractor shall have a quality control plan outlining the intended methods of receiving, testing, and installing equipment, and how the contractor's work practices contribute to maintaining the design reliability. The contractor must use trained and adequately certified personnel in the appropriate acceptance testing PT&I technologies to ensure that the results are accurate. Contractors may retain the services of subcontractors to help them execute their obligations with regard to their quality control plan and acceptance testing.

1.4.4 Construction Manager

During the construction phase, one major concern is the need to monitor the progress and quality of the construction to ensure that the work meets the requirements of the contract documents and is effectively implemented. Throughout this process the Construction Manager oversees the work and acts as the Contracting Officer's representative, approving or disapproving the job, and verifying the required documentation and data are collected.

First, the Construction Manager will verify that the appropriate drawings and documentation are in the possession of the Contractor. Contained in these drawings and documentation should be equipment specifications that include test points meeting PT&I technology and acceptance criteria. It is important that the Construction Manager ensures that the Contractor order the appropriate test equipment for performing the required acceptance tests..

During construction, the Construction Manager will be responsible for ensuring that any interim testing is performed, that the test results meet specifications, that they are properly documented, and that they are included with the final acceptance documentation.

Additionally, it is the Construction Manager's responsibility to ensure that the acceptance testing results are within the required tolerances, and if not, to contact the responsible engineer for direction.

Also, during the construction stage, the Construction Manager should ensure that the appropriate O&M personnel for the system are identified, that training requirements are identified, standard and special operating and maintenance procedures are prepared, safety concerns are addressed, and nameplate and baseline performance data are collected and documented.

When all acceptance criteria have been met, the final responsibility of the Construction Manager will be to collect all of the required documentation, including all manufacturers manuals, drawing redlines, and all acceptance testing and baseline data, and deliver it to the appropriate O&M personnel.

This guide can help the Construction Manager understand the equipment specifications, what acceptance tests are required, when the testing needs to be performed, and what results are acceptable and what needs to be rejected.

1.4.5 Operations and Maintenance

How the facility and its equipment will be operated and maintained must be considered during the planning, design, and construction phases. During these phases O&M needs are best served by carefully and realistically identifying and defining the PT&I and PM requirements. Although the performance of maintenance and operations occurs during the operations stage of the life cycle, some preparatory activities should be conducted during the construction and acceptance stage. These activities can include personnel selection; planning for the training requirements; procedure preparation; review of specifications, design and nameplate data; review of the *NASA Reliability Centered Maintenance Guide for Facilities and Collateral Equipment*; and the collection of baseline performance data from the Construction Manager.

1.5 Overview of Facilities and Collateral Equipment

Facilities contain a myriad of equipment and systems - from the simplest light switch to a computer controlled air conditioning system. While, all equipment can benefit from formal acceptance testing and commissioning in general, it must be understood that even though a reliability centered acceptance test may be available, it is not always cost effective to perform.

This guide contains samples of acceptance criteria for a select number of typical equipment throughout NASA facilities. The equipment selected are generic representations of some of the critical and important equipment items (based on consequence of failure). For these examples, only applicable and cost effective PT&I technologies for those equipment will be included.

Table 1-1 below is a chart listing the PT&I technologies currently in use by NASA and the equipment that each technology has been or can be applied to.

PT&I/Inspection Technology	Vibration Monitoring	Balancing	Alignment	Infrared Thermography	Ultrasonic (Airborne) Tests	Lubricant Analysis	Insulation Power Factor	Dissolved Gas Analysis	Insulating Oil Tests	Battery Impedance Tests	Insulation Resistance	Motor Analysis	Flux Analysis	Contact Resistance	Breaker Timing Tests	High Potential Tests	Turns Ratio Tests	Partial Discharge Analysis	Visual Inspection	Thermodynamic Tests
Batteries				●						●									●	
Boilers				●	●															●
Breakers				●	●		●	●	●		●			●	●	●			●	
Cables					●		●				●					●		●		
Compressors	●	●	●	●		●													●	●
Condensers				●	●														●	●
Cranes	●	●	●	●		●													●	●
Electrical Systems				●	●						●	●							●	●
Fans	●	●	●																●	●
Fluid Piping				●	●														●	●
Gearboxes	●	●	●			●													●	
Heat Exchangers				●	●														●	●
HVAC Ducts				●	●														●	●
MCC Panels & Switchgear				●	●		●				●	●		●	●	●		●	●	
Motors	●	●	●	●		●	●				●	●	●			●		●	●	
Pumps	●	●	●	●	●	●													●	●
Roofs, Walls & Insulation				●															●	
Transformers				●	●		●	●	●		●		●				●	●	●	●
Valves				●	●														●	●

Table 1-1: NASA PT&I Technologies

1.6 Reliability Centered Facilities and Equipment Acceptance Intent

The intent of reliability centered facilities and equipment acceptance is to assure the delivery of systems to NASA that are fully functioning in accordance with all specifications, free of latent defects, and which NASA personnel are fully trained and equipped to operate, maintain and troubleshoot.

This Guide as Guidelines Only

This document provides information to support a successful equipment installation and refurbishments. It is one of many documents, along with SPECSINTACT and NASA Reliability Centered Maintenance Guide For Facilities and Collateral Equipment that is available for helping NASA personnel generate specification and contract documents.

This page intentionally left blank

2 Contract Clauses and Specifications for Typical Equipment Items

Facilities contain a myriad of equipment and systems - from the simplest light switch to a computer controlled air conditioning system. While, all equipment can benefit from formal acceptance testing and commissioning in general, it must be understood that even though a reliability centered acceptance test may be available, it is not always cost effective to perform. The determination to perform reliability centered acceptance testing should be based on the RCM philosophy and techniques presented in *the NASA RCM Guide for Facilities and Collateral Equipment* and NPG 8831.2, *The NASA Facilities Maintenance Management Handbook*.

This section lists equipment items for which sample contract clauses and acceptance criteria are presented. These samples are generic guidelines only, and they were selected because they demonstrate benefits associated with the use of PT&I. They are presented in this format as representative of items within their category, and the reader must understand and recognize that specific brands, varieties, sizes, and manufacturer's of each class will deviate from the sample and it is the responsibility of the reader to adjust for those deviations and select those specifications and technologies that best meet the design requirements.

2.1 PT&I Selection Check List

While the use of a PT&I technology is an *applicable* tool in helping to ensure an acceptable equipment or installation, it may not always be *cost effective*. The costs associated with incorporating a PT&I technology into an acceptance document must be weighed in relation to the perceived value and benefits achieved. While NASA's desire is to eliminate unacceptable installation issues and to eliminate premature failures, this must not come at any cost. The specification of which PT&I technologies to use for specific equipment is difficult to determine in advance since each situation varies in both design and consequences of failure, and it is the design engineer's responsibility to effectively evaluate which situations would be best served by which technologies.

The check list provided in this section includes a list of the equipment that are examples in the rest of this section, and correspondingly includes a list of the PT&I technologies that are applicable for each of those equipment items. When a specific technology is predetermined to be applicable and cost effective, then it will be indicated as a "Highly Suggested" item. All other technologies will be indicated to be optional.

The design engineer should include this check list in their preparations for every project to ensure that they have adequately considered all PT&I requirements for their design.

This checklist, Table 2-1, can be found starting on the next page.

Equipment Item	Highly Suggested PT&I Technologies	Optional PT&I Technologies	Section
Batteries (General)	<input type="checkbox"/> Battery Impedance Test	<input type="checkbox"/> Infrared Thermography	2.3
Batteries (Lead-Acid)	<input type="checkbox"/> Battery Impedance Test <input type="checkbox"/> Contact Resistance Test <input type="checkbox"/> General Battery Tests	<input type="checkbox"/> Airborne Ultrasonic Test <input type="checkbox"/> Infrared Thermography	2.4
Battery Chargers	<input type="checkbox"/> Contact Resistance Test <input type="checkbox"/> General Charger Tests	<input type="checkbox"/> Airborne Ultrasonic Test <input type="checkbox"/> Infrared Thermography	2.5
Blowers	<input type="checkbox"/> Vibration Analysis <input type="checkbox"/> Balance Test and Measurement <input type="checkbox"/> Alignment (Laser preferred) <input type="checkbox"/> Lubrication Oil Tests <input type="checkbox"/> Performance Test		2.6
Boilers	<input type="checkbox"/> Hydrostatic Test <input type="checkbox"/> Airborne Ultrasonic Test <input type="checkbox"/> Thermodynamic Performance Tests	<input type="checkbox"/> Infrared Thermography	2.7
Breakers (General)	<input type="checkbox"/> Contact Resistance Test <input type="checkbox"/> Insulation Resistance Test	<input type="checkbox"/> Airborne Ultrasonic Test <input type="checkbox"/> Power Factor Test <input type="checkbox"/> Insulation Oil Test <input type="checkbox"/> High Voltage Test <input type="checkbox"/> Breaker Timing Test <input type="checkbox"/> Infrared Thermography	2.8
Breakers-Air Blast	<input type="checkbox"/> Contact Resistance Test <input type="checkbox"/> Insulation Resistance Test	<input type="checkbox"/> Airborne Ultrasonic Test <input type="checkbox"/> Power Factor Test <input type="checkbox"/> High Voltage Test <input type="checkbox"/> Breaker Timing Test <input type="checkbox"/> Infrared Thermography	2.9
Breakers-Air Magnetic	<input type="checkbox"/> Contact Resistance Test <input type="checkbox"/> Insulation Resistance Test	<input type="checkbox"/> Airborne Ultrasonic Test <input type="checkbox"/> Power Factor Test <input type="checkbox"/> High Voltage Test <input type="checkbox"/> Breaker Timing Test <input type="checkbox"/> Infrared Thermography	2.10
Breakers-Oil	<input type="checkbox"/> Contact Resistance Test <input type="checkbox"/> Insulation Resistance Test <input type="checkbox"/> Insulation Oil Test	<input type="checkbox"/> Airborne Ultrasonic Test <input type="checkbox"/> Power Factor Test <input type="checkbox"/> High Voltage Test <input type="checkbox"/> Breaker Timing Test <input type="checkbox"/> Infrared Thermography	2.11
Breakers-SF6 Gas	<input type="checkbox"/> Contact Resistance Test <input type="checkbox"/> Insulation Resistance Test <input type="checkbox"/> Vacuum Bottle Integrity	<input type="checkbox"/> Airborne Ultrasonic Test <input type="checkbox"/> Power Factor Test <input type="checkbox"/> High Voltage Test <input type="checkbox"/> Breaker Timing Test	2.12

NASA Reliability Centered Building and Equipment Acceptance Guide

	Test <input type="checkbox"/> SF6 Gas Test Results <input type="checkbox"/> Air Compressor Performance Test <input type="checkbox"/> SF6 Gas Leakage Test	<input type="checkbox"/> Infrared Thermography	
Breakers-Vacuum	<input type="checkbox"/> Contact Resistance Test <input type="checkbox"/> Insulation Resistance Test	<input type="checkbox"/> Airborne Ultrasonic Test <input type="checkbox"/> Power Factor Test <input type="checkbox"/> High Voltage Test <input type="checkbox"/> Breaker Timing Test <input type="checkbox"/> Infrared Thermography	2.13
Cables (General)	<input type="checkbox"/> Insulation Resistance Test	<input type="checkbox"/> Airborne Ultrasonic Test <input type="checkbox"/> Power Factor Test <input type="checkbox"/> High Voltage Test	2.14
Cables-Low Voltage	<input type="checkbox"/> Insulation Resistance Test	<input type="checkbox"/> Airborne Ultrasonic Test	2.15
Cables-Medium Voltage	<input type="checkbox"/> Insulation Resistance Test	<input type="checkbox"/> Airborne Ultrasonic Test <input type="checkbox"/> Power Factor Test <input type="checkbox"/> High Voltage Test	2.16
Cables-High Voltage	<input type="checkbox"/> Insulation Resistance Test	<input type="checkbox"/> Airborne Ultrasonic Test <input type="checkbox"/> Power Factor Test <input type="checkbox"/> High Voltage Test	2.17
Capacitor Banks	<input type="checkbox"/> Capacitor Bank Acceptance Test <input type="checkbox"/> Capacitor Discharge Test	<input type="checkbox"/> Airborne Ultrasonic Test	2.18
Capacitors-Dry Type	<input type="checkbox"/> Insulation Resistance Test <input type="checkbox"/> Overpotential Test <input type="checkbox"/> Capacitor Discharge Test	<input type="checkbox"/> Airborne Ultrasonic Test	2.19
Capacitors-Liquid Filled	<input type="checkbox"/> Insulation Resistance Test <input type="checkbox"/> Insulation Oil Test	<input type="checkbox"/> Airborne Ultrasonic Test	2.20
Compressors	<input type="checkbox"/> Vibration Analysis <input type="checkbox"/> Balance Test and Measurement <input type="checkbox"/> Alignment (Laser preferred) <input type="checkbox"/> Lubricating Oil Test <input type="checkbox"/> Thermodynamic Performance Tests	<input type="checkbox"/> Hydraulic Oil Test	2.21
Cranes	<input type="checkbox"/> Vibration Analysis <input type="checkbox"/> Balance Test and Measurement <input type="checkbox"/> Alignment (Laser preferred) <input type="checkbox"/> Lubricating Oil Test <input type="checkbox"/> Mechanical Performance Tests	<input type="checkbox"/> Insulation Resistance Test <input type="checkbox"/> Hydraulic Oil Test	2.22

NASA Reliability Centered Building and Equipment Acceptance Guide

Diesel Engine	<input type="checkbox"/> Lubricating Oil Test <input type="checkbox"/> Noise Level Acceptance Test <input type="checkbox"/> Exhaust Emissions Test <input type="checkbox"/> Cold Starting Test <input type="checkbox"/> Mechanical Performance Tests <input type="checkbox"/> Vibration Analysis <input type="checkbox"/> Cooling System Evaluation Test		2.23
Diesel Generator	<input type="checkbox"/> Lubricating Oil Test <input type="checkbox"/> Noise Level Acceptance Test <input type="checkbox"/> Exhaust Emissions Test <input type="checkbox"/> Cold Starting Test <input type="checkbox"/> Mechanical Performance Tests <input type="checkbox"/> Vibration Analysis <input type="checkbox"/> Cooling System Evaluation Test		2.24
Electrical Automatic Transfer Switch	<input type="checkbox"/> Contact Resistance Test <input type="checkbox"/> Insulation Resistance Test <input type="checkbox"/> Automatic Transfer Test	<input type="checkbox"/> Airborne Ultrasonic Test <input type="checkbox"/> Power Factor Test <input type="checkbox"/> Infrared Thermography	2.25
Electrical Buss	<input type="checkbox"/> Insulation Resistance Test <input type="checkbox"/> Overpotential Test <input type="checkbox"/> Contact Resistance Test	<input type="checkbox"/> Airborne Ultrasonic Test <input type="checkbox"/> Infrared Thermography	2.26
Electrical Control Panels	<input type="checkbox"/> Contact Resistance Test <input type="checkbox"/> Infrared Thermography <input type="checkbox"/> Airborne Ultrasonic Test	<input type="checkbox"/> Insulation Resistance Test <input type="checkbox"/> Power Factor Test	2.27
Electrical Distribution Panels	<input type="checkbox"/> Contact Resistance Test <input type="checkbox"/> Infrared Thermography <input type="checkbox"/> Airborne Ultrasonic Test	<input type="checkbox"/> Insulation Resistance Test <input type="checkbox"/> High Voltage Test <input type="checkbox"/> Power Factor Test	2.28
Electrical Grounding Grid	<input type="checkbox"/> Fall-of-Potential Test <input type="checkbox"/> Point-to-Point Test		2.29
Electrical Lightning Protection System	<input type="checkbox"/> Continuity Test	<input type="checkbox"/> Insulation Resistance Test	2.30
Electrical Power Centers	<input type="checkbox"/> Contact Resistance Test <input type="checkbox"/> Infrared Thermography <input type="checkbox"/> Airborne Ultrasonic Test	<input type="checkbox"/> Insulation Resistance Test <input type="checkbox"/> High Voltage Test <input type="checkbox"/> Power Factor Test	2.31
Electrical Power Supplies	<input type="checkbox"/> Contact Resistance Test <input type="checkbox"/> Infrared Thermography	<input type="checkbox"/> Insulation Resistance Test <input type="checkbox"/> Power Factor Test	2.32
Electrical Rectifiers	<input type="checkbox"/> Insulation Resistance Test	<input type="checkbox"/> High Voltage Test <input type="checkbox"/> Infrared Thermography	2.33

NASA Reliability Centered Building and Equipment Acceptance Guide

	<input type="checkbox"/> Power Factor Test <input type="checkbox"/> Turns Ratio Test <input type="checkbox"/> Contact Resistance Test	<input type="checkbox"/> Airborne Ultrasonic Test	
Electrical Relays	<input type="checkbox"/> Insulation Resistance Test	<input type="checkbox"/> Contact Resistance Test	2.34
Electrical Starters	<input type="checkbox"/> Airborne Ultrasonic Test <input type="checkbox"/> Infrared Thermography	<input type="checkbox"/> Insulation Resistance Test <input type="checkbox"/> Contact Resistance Test	2.35
Electrical Switches, Cutouts	<input type="checkbox"/> Contact Resistance Test <input type="checkbox"/> Insulation Resistance Test	<input type="checkbox"/> Airborne Ultrasonic Test <input type="checkbox"/> Power Factor Test <input type="checkbox"/> High Voltage Test <input type="checkbox"/> Infrared Thermography	2.36
Electrical Switches, Low Voltage Air	<input type="checkbox"/> Contact Resistance Test <input type="checkbox"/> Insulation Resistance Test	<input type="checkbox"/> Airborne Ultrasonic Test <input type="checkbox"/> Infrared Thermography	2.37
Electrical Switches, Medium and High Voltage Air	<input type="checkbox"/> Contact Resistance Test <input type="checkbox"/> Insulation Resistance Test	<input type="checkbox"/> Airborne Ultrasonic Test <input type="checkbox"/> Power Factor Test <input type="checkbox"/> High Voltage Test <input type="checkbox"/> Infrared Thermography	2.38
Electrical Switches, Medium Voltage Air, Metal Enclosed	<input type="checkbox"/> Contact Resistance Test <input type="checkbox"/> Insulation Resistance Test	<input type="checkbox"/> Airborne Ultrasonic Test <input type="checkbox"/> Power Factor Test <input type="checkbox"/> High Voltage Test <input type="checkbox"/> Infrared Thermography	2.39
Electrical Switches, Medium Voltage Oil	<input type="checkbox"/> Contact Resistance Test <input type="checkbox"/> Insulation Resistance Test <input type="checkbox"/> Insulating Oil Test	<input type="checkbox"/> Airborne Ultrasonic Test <input type="checkbox"/> Power Factor Test <input type="checkbox"/> High Voltage Test <input type="checkbox"/> Infrared Thermography	2.40
Electrical Switches, Medium Voltage SF6	<input type="checkbox"/> Contact Resistance Test <input type="checkbox"/> Insulation Resistance Test <input type="checkbox"/> Vacuum Bottle Integrity Test <input type="checkbox"/> SF6 Gas Test Results	<input type="checkbox"/> Airborne Ultrasonic Test <input type="checkbox"/> Power Factor Test <input type="checkbox"/> High Voltage Test <input type="checkbox"/> Infrared Thermography	2.41
Electrical Switches, Medium Voltage Vacuum	<input type="checkbox"/> Contact Resistance Test <input type="checkbox"/> Insulation Resistance Test <input type="checkbox"/> Vacuum Bottle Integrity Test <input type="checkbox"/> Insulating Oil Test	<input type="checkbox"/> Airborne Ultrasonic Test <input type="checkbox"/> Power Factor Test <input type="checkbox"/> High Voltage Test <input type="checkbox"/> Infrared Thermography	2.42
Electrical Transformer Load Tap Changers	<input type="checkbox"/> Insulation Resistance Test <input type="checkbox"/> Power Factor Test <input type="checkbox"/> Turns Ratio Test <input type="checkbox"/> Contact Resistance Test	<input type="checkbox"/> High Voltage Test <input type="checkbox"/> Infrared Thermography <input type="checkbox"/> Airborne Ultrasonic Test	2.43

NASA Reliability Centered Building and Equipment Acceptance Guide

Fans	<input type="checkbox"/> Vibration Analysis <input type="checkbox"/> Balance Test and Measurement <input type="checkbox"/> Alignment (Laser preferred) <input type="checkbox"/> Lubricating Oil Test <input type="checkbox"/> Thermodynamic Performance Tests		2.44
Gearboxes	<input type="checkbox"/> Vibration Analysis <input type="checkbox"/> Hydraulic Oil Test <input type="checkbox"/> Lubricating Oil Test		2.45
Heat Exchangers (General)	<input type="checkbox"/> Hydrostatic Test <input type="checkbox"/> Airborne Ultrasonic Test <input type="checkbox"/> Thermodynamic Performance Tests	<input type="checkbox"/> Infrared Thermography	2.46
Heat Exchanger Condenser Air Cooled	<input type="checkbox"/> Hydrostatic Test <input type="checkbox"/> Thermodynamic Performance Test	<input type="checkbox"/> Airborne Ultrasonic Test <input type="checkbox"/> Pulse Ultrasonic Test <input type="checkbox"/> Infrared Thermography	2.47
Heat Exchange Condenser Water Cooled	<input type="checkbox"/> Hydrostatic Test <input type="checkbox"/> Thermodynamic Performance Test	<input type="checkbox"/> Airborne Ultrasonic Test <input type="checkbox"/> Pulse Ultrasonic Test <input type="checkbox"/> Infrared Thermography	2.48
Heat Exchange Cooling Tower	<input type="checkbox"/> Vibration Analysis <input type="checkbox"/> Balance Test and Measurement <input type="checkbox"/> Alignment (Laser preferred) <input type="checkbox"/> Lubricating Oil Test <input type="checkbox"/> Performance Test		2.49
HVAC Ducts	<input type="checkbox"/> Operational Test <input type="checkbox"/> Ductwork Leakage Test		2.50
Material Handling Conveyor	<input type="checkbox"/> Vibration Analysis <input type="checkbox"/> Balance Test and Measurement <input type="checkbox"/> Alignment (Laser preferred) <input type="checkbox"/> Lubricating Oil Test <input type="checkbox"/> Performance Test		2.51
Miscellaneous Safety Wash	<input type="checkbox"/> Code and Requirements Verification		2.52
Motor Control Centers	<input type="checkbox"/> Airborne Ultrasonic Test <input type="checkbox"/> Infrared Thermography	<input type="checkbox"/> Insulation Resistance Test	2.53
Motors (General)	<input type="checkbox"/> Vibration Analysis <input type="checkbox"/> Balance Test and Measurement <input type="checkbox"/> Alignment (Laser preferred) <input type="checkbox"/> Power Factor Test	<input type="checkbox"/> Infrared Thermography <input type="checkbox"/> Insulation Resistance Test <input type="checkbox"/> Motor Circuit Evaluation Test <input type="checkbox"/> High Voltage Test	2.54

NASA Reliability Centered Building and Equipment Acceptance Guide

Motors-Hydraulic	<input type="checkbox"/> Vibration Analysis <input type="checkbox"/> Lubricating Oil Test <input type="checkbox"/> Performance Test <input type="checkbox"/> Alignment (Laser preferred)		2.55
Motors-Pneumatic	<input type="checkbox"/> Vibration Analysis <input type="checkbox"/> Noise Level Acceptance Test <input type="checkbox"/> Lubricating Oil Test <input type="checkbox"/> Performance Test		2.56
Piping Systems	<input type="checkbox"/> Hydrostatic Test <input type="checkbox"/> Thermodynamic Performance Tests	<input type="checkbox"/> Airborne Ultrasonic Test <input type="checkbox"/> Pulse Ultrasonic Test <input type="checkbox"/> Infrared Thermography	2.57
Pumps	<input type="checkbox"/> Vibration Analysis <input type="checkbox"/> Balance Test and Measurement <input type="checkbox"/> Alignment (Laser preferred) <input type="checkbox"/> Lubricating Oil Test <input type="checkbox"/> Thermodynamic Performance Tests	<input type="checkbox"/> Hydraulic Oil Test	2.58
Roofs, Walls and Insulation	<input type="checkbox"/> Infrared Thermography	<input type="checkbox"/> Airborne Ultrasonic Test	2.59
Steam Traps	<input type="checkbox"/> Airborne Ultrasonic Test		2.60
Switchgear	<input type="checkbox"/> Airborne Ultrasonic Test <input type="checkbox"/> Insulation Resistance Test <input type="checkbox"/> Infrared Thermography	<input type="checkbox"/> Contact Resistance Test <input type="checkbox"/> High Voltage Test <input type="checkbox"/> Power Factor Test	2.61
Tanks and Storage Tank Pressurized	<input type="checkbox"/> Tank Integrity Test <input type="checkbox"/> Verification of Liquid Level <input type="checkbox"/> Verification of Relief Devices		2.62
Tanks and Storage Tank Unpressurized	<input type="checkbox"/> Tank Integrity Test <input type="checkbox"/> Verification of Liquid Level <input type="checkbox"/> Verification of Relief Devices		2.63
Transformers	<input type="checkbox"/> Airborne Ultrasonic Test <input type="checkbox"/> Power Factor Test <input type="checkbox"/> Insulation Oil Test <input type="checkbox"/> Infrared Thermography <input type="checkbox"/> Turns Ratio Test	<input type="checkbox"/> Contact Resistance Test <input type="checkbox"/> Insulation Resistance Test <input type="checkbox"/> High Voltage Test	2.64
Turbine Expander	<input type="checkbox"/> Vibration Analysis <input type="checkbox"/> Alignment (Laser preferred) <input type="checkbox"/> Lubricating Oil Test <input type="checkbox"/> Performance Test	<input type="checkbox"/> Hydraulic Oil Test	2.65

NASA Reliability Centered Building and Equipment Acceptance Guide

	<input type="checkbox"/> Infrared Thermography <input type="checkbox"/> Borescope Insp. Test		
Turbines-Gas	<input type="checkbox"/> Warranty Test <input type="checkbox"/> Vibration Analysis <input type="checkbox"/> Balance Test <input type="checkbox"/> Alignment (Laser preferred) <input type="checkbox"/> Lubricating Oil Test <input type="checkbox"/> Performance Test <input type="checkbox"/> Airborne Ultrasonic Test <input type="checkbox"/> Power/Output Test <input type="checkbox"/> Exh. Gas Emission Test <input type="checkbox"/> Noise Emission Test <input type="checkbox"/> Infrared Thermography <input type="checkbox"/> Borescope Insp. Test	<input type="checkbox"/> Hydraulic Oil Test	2.66
Turbines-Steam	<input type="checkbox"/> Warranty Test <input type="checkbox"/> Vibration Analysis <input type="checkbox"/> Balance Test <input type="checkbox"/> Alignment (Laser preferred) <input type="checkbox"/> Lubricating Oil Test <input type="checkbox"/> Performance Test <input type="checkbox"/> Airborne Ultrasonic Test <input type="checkbox"/> Power/Output Test <input type="checkbox"/> Infrared Thermography <input type="checkbox"/> Borescope Insp. Test	<input type="checkbox"/> Hydraulic Oil Test	2.67
Valves	<input type="checkbox"/> Hydrostatic Test	<input type="checkbox"/> Airborne Ultrasonic Test <input type="checkbox"/> Thermodynamic Performance Tests <input type="checkbox"/> Infrared Thermography	2.68

Table 2-1: PT&I Selection Checklist

2.2 General Equipment Specifications

This section describes a number of common practices or equipment data that apply to a number of different equipment items. There are also several PT&I technologies that are contained in this section because the technology could be applied generically to a number of different equipment items, and it is easier and more expedient to describe the specific practices in this section than to duplicate this information several times under each equipment item where it applies.

Additional information about these technologies and practices can be found in *the NASA RCM Guide for Facilities and Collateral Equipment* and NPG 8831.2, *The NASA Facilities Maintenance Management Handbook*.

2.2.1 Predictive Testing and Inspection (PT&I) and Acceptance Testing

2.2.1.1 The Contractor shall be responsible to deliver equipment and services that meet the requirements and specifications of their respective contract. NASA desires that all such equipment be free of latent manufacturing and installation defects, and acceptance criteria will be defined to ensure, to the maximum extent possible within economic reason, that these criteria are met. The contractor shall perform acceptance testing as defined in their contract, using both traditional and PT&I technologies. The acceptance criteria, as defined in the contract, may also be used to establish the required baselines for future maintenance. Not until the requirements of acceptance are met will the equipment or facility be accepted by NASA.

Note: At NASA's option, NASA may elect not to have the Contractor perform acceptance testing, but instead the acceptance testing may be performed either by NASA personnel or other designated third party personnel. This option can be exercised on a case-by-case basis. Regardless of who performs the acceptance testing, the requirements of acceptance must still be met by the Contractor.

2.2.1.2 Each machine shall have all nameplate information, all hardware and general condition noted and documented for inclusion in NASA's electronic inventory database.

2.2.1.3 Each contractor shall have a Quality Control plan outlining the intended methods of receiving, testing, and installing equipment. The contractor shall use trained and adequately certified personnel in the appropriate acceptance testing PT&I technologies to ensure that the results are accurate and consistent.

2.2.1.4 Predictive Testing and Inspection (PT&I) involves the use of acceptance and inspection techniques that are non-intrusive and non-destructive in order to avoid introducing problems. It also involves the use of data collection devices, data analysis and computer databases to store and trend information. Typical PT&I technologies used during equipment acceptance include, but are not limited to, vibration analysis, oil and hydraulic fluid analysis, temperature monitoring, airborne ultrasonics, electrical system testing, and fluid flow and process analysis.

2.2.1.5 Preliminary and final acceptance test results, including all data, will be documented. Unless defined otherwise as noted in paragraph 2.2.1.1, these tests shall be performed by the contractor. NASA will observe and monitor the acceptance testing, analysis and documentation as part of NASA's Quality Assurance Program. Preliminary and final acceptance data shall be provided by the contractor to the NASA Contracting Officer. Data shall have a cover letter or sheet clearly marked with the system name, date, and the words "(Preliminary) (Final) Test Data - Forward to the (System Engineer) (Condition Monitoring Office) (Predictive Testing Group) for inclusion in the Maintenance Information Database."

2.2.2 Testing and Measuring Equipment

There are several PT&I technologies that are contained in this section because the technology could be applied generically to a number of different equipment items, and it is easier and more expedient to describe the specific practices in this section than to duplicate this information several times under each equipment item where it applies. These technologies include the following:

- Vibration analysis
- Lubricant and wear particle analysis
- Ultrasonics

2.2.2.1 General Requirements

The following information shall be submitted by the contractor as part of the Quality Control Plan for all required acceptance testing:

- List of all test equipment used, including its manufacturer, model number, calibration date, certificate of calibration, and serial number.
- Certificates of test personnel qualifications and certifications.
- Proof of equivalency if the contractor desires to substitute a test requirement.

2.2.2.2 Vibration Monitoring

The contractor shall use a vibration data collector that has the following minimum requirements:

- A minimum of 400 lines of resolution
- A dynamic range greater than 70dB
- A frequency response of 5Hz-10kHz (300 to 600,000 cpm)
- The capability to perform ensemble averaging
- The use of a Hanning window
- Auto-ranging frequency
- A minimum amplitude accuracy over the selected frequency range of + or – 20% or + or – 1.5dB
- Sensor frequency response shall conform to Figure 2–1.

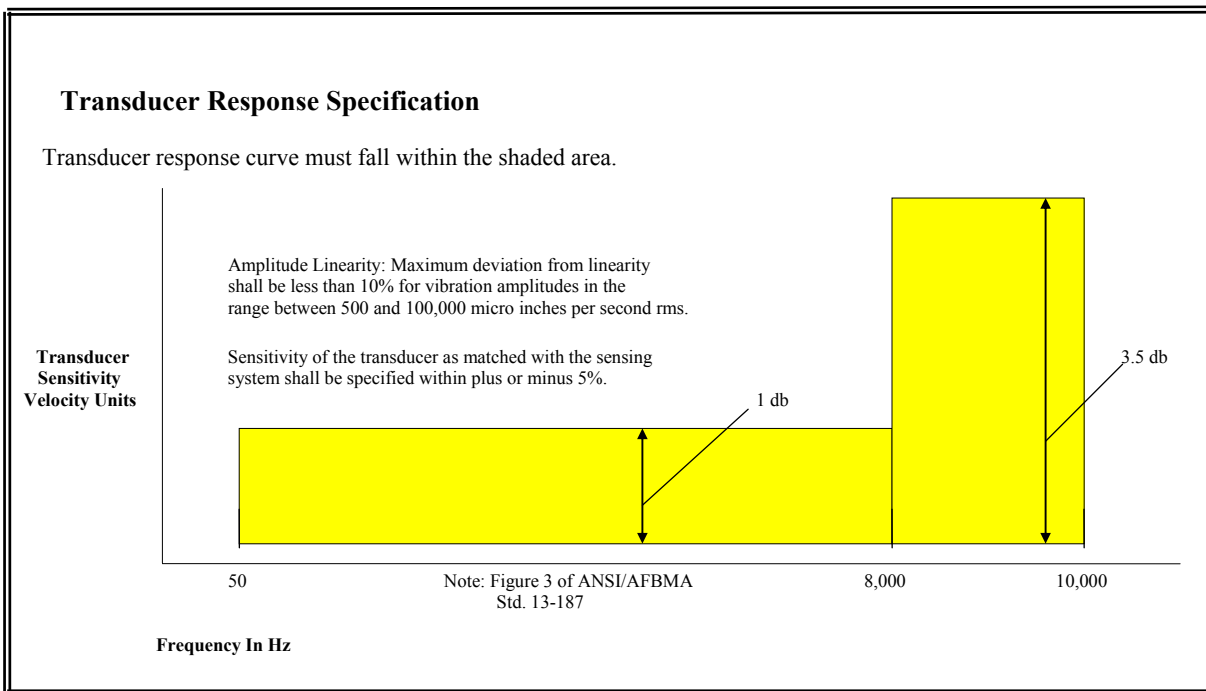

Figure 2-1: Transducer Response

The contractor shall provide to the procuring organization narrow-band spectral vibration data for all machines as follows:

- a. For machines operating at or below 1,800 RPM, the frequency spectrum provided shall be in the range of 5 to 2,500 Hz.
- b. For machines operating greater than 1,800 RPM, the frequency spectrum provided shall be in the range of 5 to 5,000 Hz.
- c. Two narrow-band spectra for each point shall be obtained in the following manner:
 1. For all machines regardless of operating speed, a 5 to 500 Hz spectrum with 400 lines of resolution shall be used to analyze balance, alignment, and electrical line frequency faults.
 2. An additional spectrum of 5 to 2,500 or 5 to 5,000 Hz shall be acquired for machines operating at or below 1800 RPM or greater than 1,800 RPM, respectively. This higher frequency range allows early detection of rolling element bearing, gear rotor and stator problems.
 3. The contractor shall report vibration data in velocity (inches/second). If proximity probes are installed, the contractor shall acquire and analyze vibration and phase data.

4. The contractor shall collect vibration data at normal operating load, temperature, and speed.
5. The contractor shall supply all critical speed calculations. In addition, the contractor shall perform a check for machine resonance following installation and correlated with all known forcing frequencies; i.e., running speed, bearing, gear, impeller frequencies, etc
6. The contractor shall ensure that the equipment provided meets the following acceptable vibration amplitudes for each machine:
 - (a) **Developing Vibration Criteria** - Specific vibration criteria are provided in this guide (see Chapter 5) where possible. Where specific criteria are not provided the following procedure is recommended for the guide user for use in developing the vibration criteria:
 - (1) Obtain nameplate data.
 - (2) Obtain vibration spectra on similar machines. Differences in baseplate stiffness and mass will affect the vibration signature.
 - (3) Calculate all forcing frequencies, i.e., imbalance, misalignment, bearing defect, impeller and/or vane, electrical, gear, belt, etc.
 - (4) Construct a mean vibration signature for the similar machines.
 - (5) Compare this mean vibration signature to the specifications and guidelines provided in this guide.
 - (6) Note any deviations from the guidelines and determine if the unknown frequencies are system related; e.g., a resonance frequency from piping supports.
 - (7) Collect vibration data on the new component at the recommended positions.
 - (8) Compare the vibration spectrum with the mean spectrum determined in step (5) above as well as with the criteria and guidelines provided in this guide.
 - (9) Any new piece of equipment should have a vibration spectrum which is no worse than a similar unit of equipment which is operating satisfactorily.
 - (b) **Vibration Analysis of New Equipment**—For all large or critical pieces of equipment assembled and run at the factory prior to shipment, a

narrow-band vibration spectrum should be acquired at the locations specified in this guide while the equipment is undergoing this factory performance testing. A baseline or reference spectrum should be retained for comparison with the post-installation vibration check. Equipment failing the vibration criteria should be rejected by the procuring organization prior to shipment.

Vibration tests are recommended under the following situations if the equipment fails the initial test and/or if problems are encountered following installation:

- Motor cold and uncoupled.
- Motor hot and uncoupled.
- Motor and machine coupled, unloaded and cold.
- Motor and machine coupled, unloaded and hot.
- Motor and machine coupled, loaded and cold.
- Motor and machine coupled, loaded and hot.

A significant change in the vibration signature could indicate a problem with thermal distortion and/or bearing overloading due to failure of one of the bearings to float.

(c) General Equipment Vibration Standards

- (1) If rolling element bearings are utilized in either the driver or driven component of a unit of equipment (e.g., a pump/motor combination), no discrete bearing frequencies should be detectable. If a discrete bearing frequency is detected, the equipment should be deemed unacceptable.
- (2) For belt-driven equipment, belt rotational frequency and harmonics should be undetectable. If belt rotation and/or harmonics are detectable, the equipment should be deemed unacceptable.
- (3) If no specific criteria are available, the ISO 3945 acceptance Class A guidelines should be combined with the motor criteria contained in Table B-2 and used as the acceptance specification for procurement and overhaul. The vibration acceptance classes and ISO 3945 machine classes are shown in Tables 2-2, 2-3 and 2-4 respectively. Note that the ISO amplitude values are overall measurements in inches/second RMS while the recommended specifications for electric motors are narrow-band measurements in inches/second peak.

Ranges of Radial Vibration Severity			Quality Judgement for Separate Machine Classes			
Range	RMS Velocity in 10-1000 Hz at the Limits mm/sec	in/sec	<i>Class I</i>	<i>Class II</i>	<i>Class III</i>	<i>Class IV</i>
0.28	0.28	0.011	A	A	A	A
0.45	0.45	0.018	A	A	A	A
0.71	0.71	0.028	A	A	A	A
1.12	1.12	0.044	B	A	A	A
1.80	1.80	0.071	B	B	A	A
2.80	2.80	0.110	C	B	B	A
4.50	4.50	0.180	C	C	B	B
7.10	7.10	0.280	D	C	C	B
11.20	11.20	0.440	D	D	C	C
18	18	0.710	D	D	D	C
28	28	1.10	D	D	D	D
71	71	2.80	D	D	D	D

Table 2-2. ISO 3945 Vibration Severity Table.

Class	Condition
A	Good
B	Satisfactory
C	Unsatisfactory
D	Unacceptable

Table 2-3. Vibration Acceptance Classes

Machine Classes for ISO 3945	
Class I	Small size machines to 20 HP
Class II	Medium size machines (20-100 HP)
Class III	Large machines (600-12,000 RPM) 400 HP and Greater Rigid mounting
Class IV	Large machines (600-12,000 RPM) 400 HP and Greater Flexible mounting

Table 2-4. Machine Classifications

The vibration data collector device shall use either a stud mounted or a low mass rare earth magnet mounted accelerometer. Hand-held accelerometers are not acceptable. The mass of the accelerometer and its mounting shall have minimal influence on the frequency response of the system over the selected measurement range.

The contractor shall ensure that all rotating equipment without permanently mounted accelerometers have vibration monitoring disks installed using the following guideline:

- Sound discs shall be a minimum of 1 inch in diameter, manufactured of a magnetic stainless steel, such as alloy 410 or 416, have a surface finish of 32 micro-inches rms, and be attached by stud mounting, or be epoxy glued. The contractor shall have the option of machining the equipment case in order to achieve a flat and smooth spot that meets the same tolerances as the sound disc if the equipment case is manufactured from a magnetic material and the manufactures warranty will allow.
- Sound discs applied to components that will have permanently mounted accelerometers applied shall be stud mounted or epoxy glued. The mounting hole shall be centered on the face of the disc and the disc shall have 3/8-in. available depth.
- If machined flat spots are provided, the spot area shall be free of paint, grease, or other coatings.

The contractor shall ensure that monitoring locations are positioned on structural members. The installation of sound discs on bolted cover plates or other non-rigid members are not acceptable.

2.2.2.3 Lubricant and Wear Particle Analysis

The contractor shall provide to the procuring organization the following information on all lubricants supplied in bulk or contained within equipment supplied under this contract:

a. Liquid Lubricants

Viscosity grade in ISO units

AGMA and/or SAE classification as applicable

Viscosity in Saybolt Universal Seconds (SUS) or centipoise at the standard temperature and at designed normal operating temperature. The following formula should be used to calculate SUS and absolute viscosity:

$$Z = p_t(0.22s-180/s)$$

where: Z = absolute viscosity in centipoise at test temperature

S = SAYBOLT UNIVERSAL SECONDS

p_t = specific gravity at test temperature

t = temperature (deg F)

Changes in density can be calculated by the formula:

$$p_t = p_r - 0.00035(t-60)$$

where: p_r = specific gravity at the reference temperature (normally 60 deg F)

t = temperature (deg F)

b. Grease Lubricants

National Lubrication and Grease Institute (NLGI) Number

Type and percent of thickener

Dropping point

Base oil viscosity range in SUS or centipoise

The following formula shall be used to calculate SUS and absolute viscosity:

$$Z = p_t(0.22s-180/s)$$

where: Z = absolute viscosity in centipoise at test temperature

s = Saybolt Universal Seconds

p_t = specific gravity at test temperature

t = temperature (deg F)

Changes in density can be calculated by the formula:

$$p_t = p_r - 0.00035(t-60)$$

where: p_r = specific gravity at the reference temperature (normally 60 deg F)

t = temperature (deg F)

Lubricant Tests					
Test		Testing for	Indicates	Correlates with	When used
Total Acid No. (TAN) Total Base No.		pH	Degradation, oxidation, contamination	Visual, RBOT	Routine
Rotating Bomb Oxidation Test (RBOT)		Anti-oxidants remaining	Lubricant resistance to oxidation	TAN	Periodic (long term)
Solids		Solids	Contamination or degradation	TAN, RBOT, Spectrometals	Routine and post repair
Visual for color & clarity		Cloudiness or darkening	Presence of water or particulates. Oxidation of lubricant.	TAN	Routine
Spectrometals (IR spectral analysis)		Metals	Presence of contaminants, wear products and additives	Particle count	Routine
Particle count		Particles >10 m	Metal & wear product particles	Spectrometals	Routine
Ferro- graphy	Direct	Ferrous particles up to 250 m	Wear rate	Particle count, Spectrometals	Case basis
	Analytical	Ferrous particles	Microscopic examination. Diagnostic tool.	Particle count, Spectrometals	Case basis
Micro patch		Particles, debris	Microscopic examination. Diagnostic tool	Particle count, Spectrometals, ferrography	Periodic or case basis
Water Content		Water	Degradation, leak, oxidation, emulsion	Visual, RBOT	Routine
Viscosity		Lubricating quality	Contamination, degradation	Water	Routine

Table 2-5. Lubricant Tests

- c. **Lubricant Tests** - The contractor shall perform the lubricant tests listed in Table 2-5 on all lubricants supplied by him and shall submit the results of the tests to the procuring organization.
- d. **Hydraulic Fluids** - All bulk and equipment-installed hydraulic fluids supplied under this contract shall meet the cleanliness guidelines in Table 2-6. The procuring organization will specify System Sensitivity. In Table 2-6, the numbers in the 5 micron and 15 micron columns are the number of particles greater than 5 microns and 15 microns in a 100-milliliter sample.

The particle counting technique utilized shall be quantitative. Patch test results are not acceptable.

Type of System	System Sensitivity	Suggested Maximum Particle Level (Particles per 100 milliliters)		
		5 microns	15 microns	ISO
Silt sensitive control system with very high Reliability. Laboratory or Aerospace	Super critical	4,000	250	13/9
High performance servo and high pressure long life systems. Machine tools	Critical	16,000	1,000	15/11
High quality reliable systems. General machine requirements	Very Important	32,000	4,000	16/13
General machinery and mobile systems. Med. pressure & capacity	Important	130,000	8,000	18/14
Low pressure heavy industrial systems. Long life not critical.	Average	250,000	16,000	19/15
Low pressure systems with large clearances	Main protection	1,000,000	64,000	21/17

Table 2-6: Sperry Vickers Table of Suggested Acceptable Contamination levels for Various Hydraulic Systems

The ISO numbers in the right-hand column of Table 2-6 are based on the concentration of particles greater than 5 microns and greater than 15 microns per 100-milliliter sample. The concentration can then be converted to the ISO number using an ISO Range Number Table which should be available from a hydraulic fluid vendor or lubrication laboratory.

- e. **Insulating Fluids** - The contractor shall identify the type of oil used as an insulating fluid for all oil-filled transformers supplied under the contract. In addition, the contractor shall test the insulating oil using the American Society for Testing Materials (ASTM) test listed in Table 2-7 and provide the results to the Government. Any deviation from the typical properties listed below shall be corrected by the contractor before the Government will accept the transformer.

Test (Units)	Silicone	Mineral	Asakrel
Dielectric Breakdown ASTM D877 (KV)	30+	30+	30+
Power Factor ASTM D924 (%)	0.01	0.05 max	0.05
Neutralization Number ASTM D974 (mg KOH/g)	<0.03	<0.03	<0.03
Interfacial Tension ASTM D2285 (dynes/cm)	N/A	35 min	N/A
Specific Gravity ASTM 1298	0.96	0.88	1.55
Flash Point ASTM D92 ©	>305	160	N/A
Fire Point ASTM D92 ©	360	177	None to Boiling
Pour Point ASTM D97 ©	-55	-51 max	-30 max
Water Content ASTM D1533 (ppm)	30 max	30 max	30 max
Viscosity at 40C ASTM D445 (SUS)	232	57.9	55.8-61.0
Color & Appearance	clear/water like	pale yellow clear	pale yellow clear

Table 2-7. Typical Properties of Transformer Oils

- f. **Sampling Points** -The contractor shall install sampling points and lines in accordance with Method No.1 as recommended by the National Fluid Power Association (NFPA). Method No. 1 is published as NFPA T2.9.1-1972 titled Method for Extracting Fluid Samples from the Lines of an Operating Hydraulic Fluid Power System for Particulate Particle Contamination Analysis as follows:
1. **For Pressurized Systems** - A ball valve is placed in the fully opened position with a downstream capillary tube (ID> 1.25 mm) of sufficient length to reduce downstream pressure and control flow in the desired range. The sampling point shall be located in a turbulent flow region and upstream of any filters.
 2. **For Reservoirs and Non-Pressurized Systems** - A 1/8" stainless steel line and ball valve is placed in the side of the oil sump or tank. The line shall be located as close to the midpoint of the structure as feasible. In addition, the sample line shall extend internally to and as close to the center of the tank as possible.

2.2.2.4 Ultrasonics

Airborne Ultrasonics

The contractor shall perform an airborne ultrasonic survey during the start-up phase of the installation unless the airborne ultrasonic survey is waived by the procuring organization. The contractor shall survey electrical equipment for indications of arcing or electrical discharge, including corona. Piping systems shall be surveyed for indications of leakage.

For switchyards the operator should use a parabolic concentrator, since the minimum distance to any live circuit will be at least 13 feet. A fixed frequency should be used to listen for a crackling sound. When inspecting electrical panels, the operator should use a rubber concentrator, a “bootie”, placed over the receiver to narrow the inspection area and help block out surrounding noises.

Airborne ultrasonics can be subjective and dependent on perceived differences in noises. To maximize the usefulness of this technology, care should be taken when setting test equipment controls for frequency ranges, sensitivity, and scale. Additionally, the operator should be cognizant of the fact that electrical loading and the presence of moisture (high humidity) may effect the ultrasonic signal.

Any defects or exceptions noted by the use of airborne ultrasonics shall be corrected by the contractor at no additional expense to the procuring organization. The contractor shall re-survey repaired areas to assure proper corrective action has been taken.

Pulse Echo Ultrasonics

The contractor shall perform material thickness measurements on a representative sample of all material where a thickness is specified in the contract. Thickness measurements shall be performed at the fabricator’s place of business prior to shipment of any material to the project site. Material which does not meet the specified requirements of the contract shall not be shipped without the prior approval of the procuring organization.

2.2.3 Technical Manuals/Data

2.2.3.1 The contractor shall provide six copies, either hardcopy or electronic CD, of all pertinent operations and maintenance manuals for equipment and systems, which will include an illustrated parts breakdown, sufficiently detailed to allow NASA to obtain replacement parts when required.

2.2.3.2 Where available, the contractor shall provide technical manuals in electronic format. These electronic manuals shall be in Standard Graphics Markup Language. When electronic format publications are provided, only two copies of the document are required.

2.2.3.3 Parts breakdown shall be sufficiently detailed to allow for the identification of all replaceable parts within the equipment being procured. Cut sheets from generic catalogs are not sufficient to meet this requirement. All manuals shall be edited to limit the data to the model(s) and configuration of equipment actually delivered, including any and all options.

2.2.3.4 When systems are procured, the contractor shall provide technical manuals for all constituent components.

2.2.3.5 When measurements or surveys are required by a contract clause, the contractor shall furnish to the NASA Contracting Officer the following information concerning the equipment used to make the specified measurements:

- Test equipment - List of all test equipment used, including its manufacturer, model number, serial number, calibration date, certificate of calibration, and special personnel qualifications required.
- Equivalency - If the contractor uses an equivalent test or procedure to meet the requirements of the contract specification, the contractor shall provide to the procuring organization proof of equivalency.

2.2.4 Equipment Data

2.2.4.1 Bearings

2.2.4.1.1 *Drawings* – The contractor shall provide to the Contracting Officer section drawings that show, for all rotating equipment supplied under the contract, the component arrangement. The section drawings shall depict accurately the bearing support structural arrangement, be drawn to scale, and show the dimensions to the centerline of all rotating shafts.

2.2.4.1.2 *Bearing data* – The contractor shall provide to the Contracting Officer the bearing manufacturer, part number, and National Stock Number (if applicable) for all bearings used in all rotating equipment supplied under this contract. The information shall be included on the sectional drawings of each bearing location.

2.2.4.1.3 *Operating data* - The contractor shall provide to the Contracting Officer required equipment data that includes the operating speed for constant speed units and the normal operating speed range for variable-speed equipment.

2.2.5 Maintainability and Ease of Monitoring

The contractor shall provide for facility and equipment maintainability and ease of monitoring through design. The contractor shall provide documentation to illustrate and support the maintainability and ease of monitoring incorporated by the design.

For example, Mobile industrial equipment shall be equipped with fluid sampling ports on the engine and hydraulic systems. Accessibility to these ports shall facilitate periodic fluid sampling and system monitoring.

2.2.6 Leveling of Equipment Upon Installation

The contractor shall level all installed rotating electrical and mechanical machinery. After installation, the equipment shall not exceed a maximum slope of the base and the frame of 0.001 inch per foot. The contractor shall report to the procuring organization the type and accuracy of the instrument used for measuring the level; e.g., a 12-inch machinist's level graduated to 0.0002 inch per foot.

2.2.7 SPECSINTACT

Where appropriate the contactor shall use the required specifications listed in *NASA SpecsIntact*. These are referenced under each equipment category and listed under the acceptance technologies and criteria section. Table 2-8 provides the applicable SpecsIntact for each equipment item.

Equipment Item	Paragraph	SpecsIntact Reference
Boilers	2.70	<input type="checkbox"/> 15510
Breakers-SF6 Gas	2.12	<input type="checkbox"/> 16328
Cables (General)	2.14	<input type="checkbox"/> 16145
Cables-Medium Voltage	2.16	<input type="checkbox"/> 16124
Compressors	2.21	<input type="checkbox"/> 15610
Electrical Automatic Transfer Switch	2.25	<input type="checkbox"/> 16435
Electrical Distribution Panels	2.28	<input type="checkbox"/> 16446
Electrical Lightning Protection System	2.30	<input type="checkbox"/> 13100
Electrical Switches, Medium Voltage Air, Metal Enclosed	2.39	<input type="checkbox"/> 16326
Electrical Switches, Medium Voltage SF6	2.41	<input type="checkbox"/> 16328
Fans	2.44	<input type="checkbox"/> 15764
HVAC Ducts	2.50	<input type="checkbox"/> 15083
Material Handling Conveyor	2.51	<input type="checkbox"/> 14210 <input type="checkbox"/> 14240
Motor Control Centers	2.53	<input type="checkbox"/> 16345
Motors (General)	2.54	<input type="checkbox"/> 16225
Piping Systems	2.57	<input type="checkbox"/> 15102 <input type="checkbox"/> 15106 <input type="checkbox"/> 15107
Pumps	2.58	<input type="checkbox"/> 15135
Roofs, Walls and Insulation	2.59	<input type="checkbox"/> 07400 <input type="checkbox"/> 07510 <input type="checkbox"/> 07511 <input type="checkbox"/> 07530
Steam Traps	2.60	<input type="checkbox"/> 15125
Switchgear	2.61	<input type="checkbox"/> 16445
Transformers	2.64	<input type="checkbox"/> 16275 <input type="checkbox"/> 16276
Valves	2.68	<input type="checkbox"/> 15110

Table 2-8: SpecsIntact Cross-reference

2.3 Batteries (General)

2.3.1 Required Equipment Information

- Battery Identification (Type)
- Location of Installation
- NASA Identification Number
- Date of Installation (Required or Actual Acceptance Date)
- Applicable NASA reference drawing number(s)

2.3.2 Required Acceptance Documentation

- Layout Drawings
- Test Point Locations
- Manufacturer Data
- Maintenance Manual
- Warranty Information
- Certificates
- Parts List and Recommended Spare Parts List
- Baseline Data from Verification Test
- Acceptance Documentation (Dates and Signatures)

2.3.3 Acceptance Technologies and Criteria

- Battery Impedance Test (Refer to section B.9)

The contractor shall use a battery impedance test to verify an internal short or open condition, and also to verify battery capacity.

The Battery Impedance Test Set shall have all of the following minimum requirements:

- Be able to test battery cells of up to 2,500 amp-hour capacities
- Maximum battery test voltage of 25 volts DC
- Impedance range of 0.0 to 100 milliohms
- Ability to test both lead-acid and nickel-cadmium batteries

Minimum acceptable limits for this test are as follows:

- Voltage within $\pm 5\%$ of manufacturer's specifications
- Battery impedance within $\pm 5\%$ of manufacturer's specifications
- Maximum range of cell impedance within $\pm 10\%$ from each other
- Trickle charge while in standby within $\pm 5\%$ of manufacturer's specifications
- Battery strap impedance < 0.1 ohm.

- Visual Inspection

A visual inspection of the battery shall reveal no abnormalities or defects.

- Infrared Thermography (IRT) (optional) (Refer to section B.4)

The contractor shall use IRT to verify good battery terminal connections, internal connections to the individual cells, and internal operation of the individual cells. Battery loading should be > 50% for performing this test.

The infrared imager shall be a focal plane array camera with all of the following minimum requirements:

- Self contained with a minimum of 2 hours of battery capacity
- Temperature range of $-20\text{ }^{\circ}\text{C}$ to $300\text{ }^{\circ}\text{C}$
- Sensitive to $0.2\text{ }^{\circ}\text{C}$ over all temperature ranges
- Accurate to within $\pm 3\%$
- Must be capable of storing up to 12 images for later use
- Have a video recorder interface

Minimum acceptable limits for this test are as follows:

- Qualitatively verify good battery terminal connections, internal connections to the individual cells, and relative equivalent temperatures of the adjacent cells during operation. Acceptable deviations in temperature will vary with the size and type of the battery, but these limits should not exceed $\pm 5\text{ }^{\circ}\text{C}$. At no time should any of the wiring connections, battery terminal connections or internal connections to the individual cells, display a temperature in excess of 11.3°C greater than ambient.

2.4 Battery (Lead-Acid)

2.4.1 Required Equipment Information

- Battery Type
- Battery Specifications
- Location of Installation
- NASA Identification Number
- Date of Installation (Required or Actual Acceptance Date)
- Applicable NASA reference drawing number(s)

2.4.2 Required Acceptance Documentation

- Material, Equipment and Fixture Lists
- Shop Drawings
 - Connection Diagrams
 - Fabrication Drawings
- Product Data
 - Equipment and Performance Data
 - Manufacturer's Catalog Data
- Test Reports
 - Battery Impedance Test Results
 - Contact Resistance Test Results
 - General Battery Test Results
(Electrolyte, voltage, intercell connection resistances, ohmic measurements, load test)
 - Airborne Ultrasonic Test Results (Optional)
 - Infrared Thermography Test Results (Optional)
- Certificates
- Manufacturer's Instructions
- Operations Manual
- Maintenance Manual
- Warranty Information
- Parts List and Recommended Spare Parts List
- Acceptance Documentation (Dates and Signatures)

2.4.3 Acceptance Technologies and Criteria

*** Note: Based on type, size and number of cells of the battery, the NASA Construction Manager should determine which test(s)/technologies should be performed. Some of the below listed tests/technologies do not apply to every type of switch.

- Battery Impedance Test (Refer to section B.9)

The contractor shall use a battery impedance test to verify an internal short or open condition, and also to verify battery capacity.

The Battery Impedance Test Set shall have all of the following minimum requirements:

- Be able to test battery cells of up to 2,500 amp-hour capacities
- Maximum battery test voltage of 25 volts DC
- Impedance range of 0.0 to 100 milliohms

Minimum acceptable limits for this test are as follows:

- Voltage within $\pm 5\%$ of manufacturer's specifications
- Battery impedance within $\pm 5\%$ of manufacturer's specifications
- Maximum range of cell impedance within $\pm 10\%$ from each other
- Trickle charge while in standby within $\pm 5\%$ of manufacturer's specifications
- Battery strap impedance < 0.1 ohm.

- Contact Resistance Test (Refer to section B.13)
Refer to data set 2 in Appendix H for additional information.
- Verify electrolyte level. Measure electrolyte specific gravity and temperature levels.

Minimum acceptance criteria:

- Better than or equal to manufacturer's specifications

- Measure each cell voltage and total battery voltage with charger energized and in float mode of operation.

Minimum acceptance criteria:

- Charger float and equalize voltage levels shall be in accordance with battery manufacturer's published data. Cell voltages should be within 0.05 volt of each other or in accordance with manufacturer's published data.

- Measure intercell connection resistances.

Minimum acceptance criteria:

- Microhm or millivolt drop values shall not exceed the high levels of the normal range as indicated in the manufacturer's published data. If manufacturer's data is not available, investigate any values which deviate from similar connections by more than 50 percent of the lowest value.

- Perform internal ohmic measurement tests.

Minimum acceptance criteria:

- Cell internal ohmic values (resistance, impedance or conductance) should not vary by more than 25 percent between identical cells that are in a fully charged state.

- Perform a load test in accordance with manufacturer's specifications or ANSI/IEEE 450.

Minimum acceptance criteria:

- Better than or equal to manufacturer's specifications

- Measure the battery system voltage from positive to ground and negative to ground.

Minimum acceptance criteria:

- Positive and negative voltage to ground should be of equal value.

- Airborne Ultrasonic Tests (Optional) (Refer to sections B.6)
Refer to data set 1 in Appendix H for additional information.
- Infrared Thermography (IRT) (Optional) (Refer to section B.4)
Refer to data set 4 in Appendix H for additional information.
- Visual Inspection
A visual inspection of the battery shall reveal no abnormalities or defects.

2.5 Battery Chargers

2.5.1 Required Equipment Information

- Battery Charger Type
- Battery Charger Specifications
- Location of Installation
- NASA Identification Number
- Date of Installation (Required or Actual Acceptance Date)
- Applicable NASA reference drawing number(s)

2.5.2 Required Acceptance Documentation

- Material, Equipment and Fixture Lists
- Shop Drawings
 - Connection Diagrams
 - Fabrication Drawings
- Product Data
 - Equipment and Performance Data
 - Manufacturer's Catalog Data
- Test Reports
 - Contact Resistance Test Results
 - General Battery Charger Test Results
(Voltages, current, load sharing, load test, alarm setpoints)
 - Airborne Ultrasonic Test Results (Optional)
 - Infrared Thermography Test Results (Optional)
- Certificates
- Manufacturer's Instructions
- Operations Manual
- Maintenance Manual
- Warranty Information
- Parts List and Recommended Spare Parts List
- Acceptance Documentation (Dates and Signatures)

2.5.3 Acceptance Technologies and Criteria

*** Note: Based on type, size and number of cells of the battery, the NASA Construction Manager should determine which test(s)/technologies should be performed. Some of the below listed tests/technologies do not apply to every type of switch.

- Contact Resistance Test (Refer to section B.13)
Refer to data set 2 in Appendix H for additional information.
- Verify float voltage; equalize voltage, and high voltage shutdown settings.
Minimum acceptance criteria:
 - Float and equalize voltage settings shall be in accordance with the battery manufacturer's published data.

- Verify current limit.
Minimum acceptance criteria:
 - Current limit shall be within manufacturer's recommended maximum.
- Verify correct load sharing (parallel chargers).
Minimum acceptance criteria:
 - Better than or equal to manufacturer's specifications.
- Verify operation of alarms.
Minimum acceptance criteria:
 - All alarms shall operate as intended by manufacturer.
- Measure and record ac ripple current and/or voltage imposed on the battery.
Minimum acceptance criteria:
 - Ripple current should not exceed battery manufacturer's recommendations.
- Perform a load test in accordance with manufacturer's specifications or ANSI/IEEE 450.
Minimum acceptance criteria:
 - Better than or equal to manufacturer's specifications. Charger shall be capable of manufacturer's specified full load at rated voltages.
- Airborne Ultrasonic Tests (Optional) (Refer to section B.6)
Refer to data set 1 in Appendix H for additional information.
- Infrared Thermography (IRT) (Optional) (Refer to section B.4)
Refer to data set 4 in Appendix H for additional information.
- Visual Inspection
A visual inspection of the battery charger shall reveal no abnormalities or defects.

2.6 Blowers

Blowers are machines used for producing an artificial blast or current of air by pressure, for increasing the draft of a furnace, ventilating a building or shaft. A blower may also be used to convey bulk material or slurry mixtures through pipe systems for processing.

Blowers are defined as all positive displacement air handling units, including, but not limited to, induced draft (ID), forced draft (FD), over-hung, center-hung, centrifugal, vane-axial, and tube-axial.

Natural frequencies of the completely assembled blower unit shall not be exceeded at the operating speed. (Running speed should be at least 25 percent removed from a natural frequency of the system.)

Variable speed or adjustable sheaves shall not be used in the final installation.

The drive sheave and driven sheave should differ in size by 20 percent or more to avoid "beat" vibration.

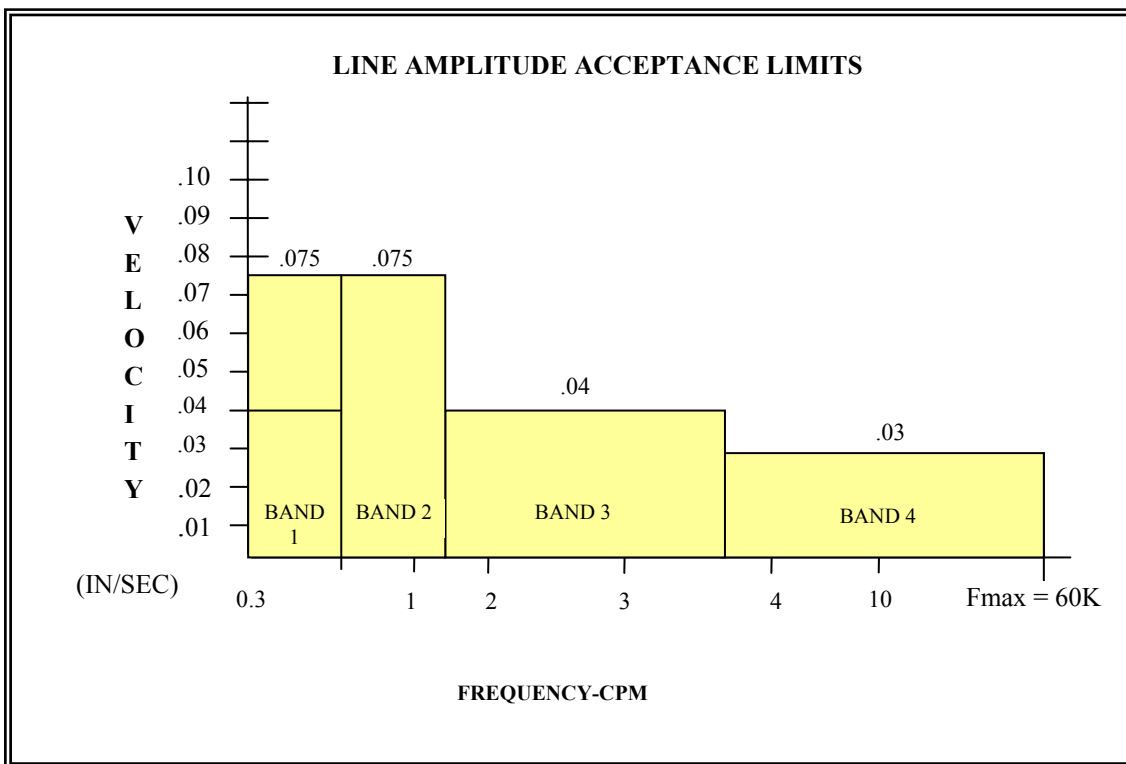

Figure 2-2: Belt Driven Blower Vibration Envelope Overall Per Band

Vibration Standards for Blowers

Vibration limits for blowers are as follows:

- New, rebuilt and repaired blowers shall conform to the vibration limits specified in Figures 2-1 and 2-2 when operating at the specified system volume (cfm) and blower static pressure.
- Acceptance limits for blowers running over 3,600 rpm will be specified by NASA.

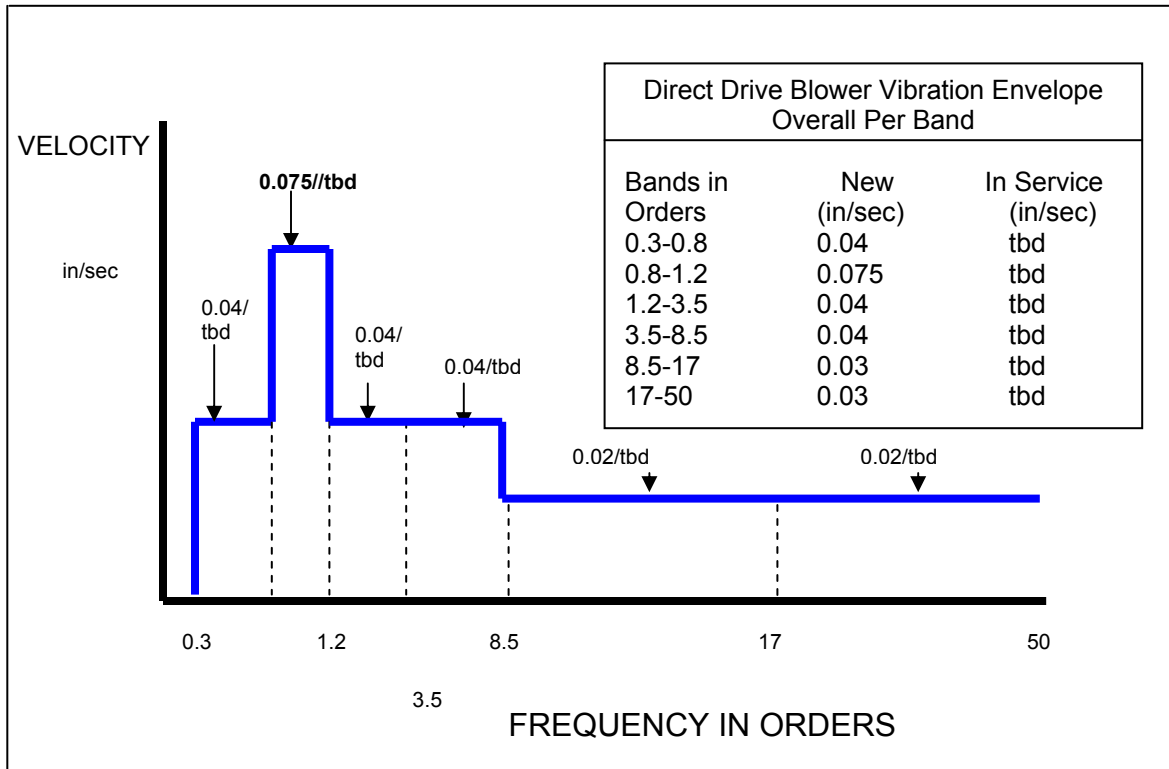

Figure 2-3: Direct Drive Blower Vibration Envelope Overall Per Band

Motors on blowers shall have sound discs installed in the radial and axial directions as previously described. Blower bearings shall be monitored radially in the vertical direction.

2.6.1 Required Equipment Information

- Blower Type
- Blower Specifications
 - Number of rotating vanes
 - Number of stationary vanes
 - Rotating Speed(s)
 - Number of belts (if belt driven)

- Belt lengths – measured at the pitch line (if belt driven)
- Diameter of the drive sheave at the drive pitch line (if belt driven)
- Diameter of the driven sheave at the drive pitch line (if belt driven)
- Location of Installation
- NASA Identification Number
- Date of Installation (Required or Actual Acceptance Date)
- Applicable NASA reference drawing number(s)

2.6.2 Required Acceptance Documentation

- Material, Equipment and Fixture Lists
- Equipment Foundation Data
- Shop Drawings
 - Installation Drawings
 - As-Built Drawings
 - Bearing Layout
- Manufacturer Data
 - Equipment and Performance Data
 - Design Analysis and Calculations
 - Bearing Data
- Test Point Locations
- Test Reports
 - Vibration Analysis Test Results
 - Balance Test and Measurement Results
 - Alignment Measurement Results (Laser Alignment)
 - Lubricating Oil Test Results
 - Performance (Efficiency) Tests
 - Visual Inspection Tests
 - Electrical Inspection Tests
- Certificates
- Manufacturer's Instructions
- Operations Manual
- Maintenance Manual
- Warranty Information
- Parts List and Recommended Spare Parts List
- Acceptance Documentation (Dates and Signatures)

2.6.3 Acceptance Technologies and Criteria

- Vibration Analysis Test (Refer to sections B.3)
Refer to data set 10 in Appendix H for additional information.
- Balance Test and Measurement (Refer to section B.1)
The contractor shall use balance measurement to verify that rotating shafts are balanced and mass and rotational centerlines are coincident.
 - Document key lengths A, B, final length

Minimum Acceptance Criteria: refer to Table B-1

- better than or equal to manufacturer's specifications

- Laser Alignment or Other Alignment Methods (Refer to sections B.2)
Refer to data set 6 in Appendix H for additional information.
- Lubricating Oil Tests (Refer to sections B.7)
Refer to data set 7 in Appendix H for additional information.
- Performance Tests (Refer to section B.18)
Refer to data set 9 in Appendix H for additional information.
- Visual Inspection
A visual inspection of the blower shall reveal no abnormalities or defects.
- Electrical Inspection
Verify that the wiring meets NEC 430 specifications

2.7 Boiler

2.7.1 Required Equipment Information

- Boiler Type
- Location of Installation
- NASA Identification Number
- Date of Installation (Required or Actual Acceptance Date)
- Applicable NASA reference drawing number(s)

2.7.2 Required Acceptance Documentation

- Material, Equipment and Fixture Lists
- Shop Drawings
 - Fabrication Drawings
 - Installation Drawings
 - As-Built Drawings
- Product Data
 - Equipment Foundation Data
 - Equipment and Performance Data
 - Manufacturer's Catalog Data
- Design Data
 - Design Analysis and Calculations
- Test Reports
 - Hydrostatic Test Results
 - Performance Test Results
 - Baseline Data from Verification Test
- Manufacturer's Instructions
- Operations Manual
- Maintenance Manual
- Warranty Information
- Certificates
- Parts List
- Recommended Spare Parts List
- Acceptance Documentation (Dates and Signatures)

2.7.3 Acceptance Technologies and Criteria

- Hydrostatic Test

The contractor shall perform a hydrostatic test at the pressure specified by the Construction Manager.

Minimum acceptable criteria: zero leakage

- Airborne Ultrasonic Tests (Refer to section B.6)
The contractor shall use ultrasonics to verify the integrity of the boiler casing and its associated piping. Using a contact probe, the contractor operator can listen to the internal tubing of the boiler housing.

Minimum acceptable criteria: zero leakage.
- Thermodynamic Performance Tests (Refer to section B.18)
Refer to data set 9 in Appendix H for additional information.
- Visual Inspection (Observations)
A visual inspection of the boiler shall reveal no abnormalities or defects.
- Infrared Thermography (IRT) (optional) (Refer to section B.4)

The contractor shall perform a thermographic survey during the start-up phase of installation of all boilers as a means of determining voids in insulation or refractory materials. The boiler should be operating at > 50% load during this test.

The infrared imager shall be a focal plane array camera with all of the following minimum requirements:
 - Self contained with a minimum of 2 hours of battery capacity
 - Temperature range of -20 °C to 300 °C
 - Sensitive to 0.2 °C over all temperature ranges
 - Accurate to within ± 3%
 - Must be capable of storing up to 12 images for later use
 - Have a video recorder interface
Refer to data set 4 in Appendix H for additional information.
- NASA SpecsIntact Reference: Section 15510 Boilers - Hot water boilers for heating office buildings and other plants where heating with hot water is an acceptable method.

2.8 Breakers (General)

2.8.1 Required Equipment Information

- Breaker Type
- Breaker Specifications (including current transformer ratios)
- Location of Installation
- NASA Identification Number
- Date of Installation (Required or Actual Acceptance Date)
- Applicable NASA reference drawing number(s)

2.8.2 Required Acceptance Documentation

- Material, Equipment and Fixture Lists
- Shop Drawings
 - Connection Diagrams
 - Fabrication Drawings
- Product Data
 - Equipment and Performance Data
 - Manufacturer's Catalog Data
- Test Reports
 - Operation Test Results
 - Dielectric Test Results
 - Performance Test Results
 - Baseline Data from Verification Test
- Certificates
- Manufacturer's Instructions
- Operations Manual
- Maintenance Manual
- Warranty Information
- Parts List and Recommended Spare Parts List
- Acceptance Documentation (Dates and Signatures)

2.8.3 Acceptance Technologies and Criteria

*** Note: Based on type, size and voltage of the breaker, the NASA Construction Manager should determine which test(s)/technologies should be performed. Some of the below listed tests/technologies do not apply to every type of breaker.

- Contact Resistance Test (refer to section B.13)
Refer to data set 2 in Appendix H for additional information.
- Insulation Resistance Test (Refer to sections B.10)
The contractor shall perform the insulation resistance test to determine insulation resistance to ground. Use both the Dielectric Absorption and the Polarization Index.

The insulation resistance test set shall have all of the following minimum requirements:

- Test Voltage increments of 500V, 1000V, 2500V, and 5000V DC
- Resistance range of 0.0 to 500,000 megohms at 500,000V DC
- A short-circuit terminal current of at least 2.5 milliamps
- Test voltage stability of $\pm 0.1\%$
- Resistance accuracy of $\pm 5\%$ at 1 megohm

Minimum acceptance criteria:

- better than or equal to manufacturer's specifications

- Airborne Ultrasonic Tests (Optional) (Refer to sections B.6)

The contractor shall use ultrasonics to verify the non-existence of electrical arcing and other high frequency events.

Minimum acceptance criteria: < TBD based on unit test set

- Power Factor Test (Optional) (Refer to sections B.5)

Refer to data set 8 in Appendix H for additional information.

- Insulation Oil Test (Optional) (Refer to sections B.8)

The contractor shall perform the following tests as appropriate for the type of breaker to verify lack of contaminants and that the necessary inhibitors have been added:

- Dissolved Gas Analysis, ASTM D-3612-90
- Karl Fisher, ASTM D-1533-88
- Dielectric Breakdown Strength Test, ASTM D-877 and D-1816
- Acidity Test, ASTM D-974
- Visualization Examination, ASTM D-1524

Minimum acceptance criteria:

- Dissolved Gas
- Nitrogen (N₂) < 100 ppm
- Oxygen (O₂) < 10 ppm
- Carbon dioxide (CO₂) < 10 ppm
- Carbon Monoxide (CO) < 100 ppm
- Methane (CH₄) none
- Ethane (C₂H₆) none
- Ethylene (C₂H₄) none
- Hydrogen (H₂) none
- Acetylene (C₂H₂) none
- Karl Fisher (<25ppm at 20°C.
- Dielectric Breakdown Strength (> 30kV)
- Neutralization number (< 0.05mg/g)
- Visual Examination (clear)

- High Voltage Test (Optional) (refer to section B.15)

The contractor shall perform the high voltage test to verify the insulation in a new breaker and to ensure that there is no excessive leakage current. This is a potentially destructive test and requires authorization from the NASA Construction Manager.

Minimum acceptance criteria:

- better than or equal to manufacturer's specifications
- limits in accordance with ANSI/IEEE Standard 400

- Breaker Timing Test (Optional) (Refer to sections B.14)

The contractor shall perform a breaker timing test (mechanical) to verify the speed and position of breaker contacts before, during and after an operation. The breaker timing test shall have all of the following minimum requirements:

- Perform contact timing during breaker close, open, open-close, close-open, and open-close-open.
- Have a minimum of three dry contact inputs
- Have a minimum of two wet-input channels to monitor breaker secondary contacts
- Have a minimum resolution of ± 0.0001 seconds over a one-second duration
- Have travel transducers capable of linear and rotary motion
- Be capable of slow close contact point measurement

Minimum acceptance criteria :

- better than or equal to manufacturer's specifications

- Infrared Thermography (IRT) (Optional) (Refer to sections B.4)

Refer to data set 4 in Appendix H for additional information.

- Visual Inspection

A visual inspection of the breaker shall reveal no abnormalities or defects.

2.9 Breakers- Air Blast

2.9.1 Required Equipment Information

- Breaker Type
- Breaker Specifications (including current transformer ratios)
- Location of Installation
- NASA Identification Number
- Date of Installation (Required or Actual Acceptance Date)
- Applicable NASA reference drawing number(s)

2.9.2 Required Acceptance Documentation

- Material, Equipment and Fixture Lists
- Shop Drawings
 - Connection Diagrams
 - Fabrication Drawings
- Product Data
 - Equipment and Performance Data
 - Manufacturer's Catalog Data
- Test Reports
 - Contact Resistance Test Results
 - Insulation Resistance Test Results
 - Airborne Ultrasonic Test Results (optional)
 - Power Factor Test Results (optional)
 - High Voltage Test Results (optional)
 - Breaker Timing Test Results (optional)
 - Infrared Thermography Test Results (optional)
 - Baseline Data from Verification Test
- Certificates
- Manufacturer's Instructions
- Operations Manual
- Maintenance Manual
- Warranty Information
- Parts List and Recommended Spare Parts List
- Acceptance Documentation (Dates and Signatures)

2.9.3 Acceptance Technologies and Criteria

*** Note: Based on type, size and voltage of the breaker, the NASA Construction Manager should determine which test(s)/technologies should be performed. Some of the below listed tests/technologies do not apply to every type of breaker.

- Contact Resistance Test (Refer to section B.13)

Refer to data set 2 in Appendix H for additional information.

- Insulation Resistance Test (Refer to section B.10)
Refer to data set 5 in Appendix H for additional information.
 - Airborne Ultrasonic Tests (Optional) (Refer to section B.6)
Refer to data set 1 in Appendix H for additional information.
 - Power Factor Test (Optional) (Refer to section B.5)
Refer to data set 8 in Appendix H for additional information.
 - High Voltage Test (Optional) (Refer to section B.15)
Refer to data set 3 in Appendix H for additional information.
 - Breaker Timing Test (Optional) (Refer to section B.14)
The contractor shall perform a breaker-timing test (mechanical) to verify the speed and position of breaker contacts before, during and after an operation. The breaker-timing test shall have all of the following minimum requirements:
 - Perform contact timing during breaker close, open, open-close, close-open, and open-close-open.
 - Have a minimum of three dry contact inputs
 - Have a minimum of two wet-input channels to monitor breaker secondary contacts
 - Have a minimum resolution of ± 0.0001 seconds over a one-second duration
 - Have travel transducers capable of linear and rotary motion
 - Be capable of slow close contact point measurement
- Minimum acceptance criteria:
- Better than or equal to manufacturer's specifications
- Infrared Thermography (IRT) (Optional) (Refer to section B.4)
Refer to data set 4 in Appendix H for additional information.
- Visual Inspection
A visual inspection of the breaker shall reveal no abnormalities or defects.

2.10 Breakers- Air Magnetic

2.10.1 Required Equipment Information

- Breaker Type
- Breaker Specifications (including current transformer ratios)
- Location of Installation
- NASA Identification Number
- Date of Installation (Required or Actual Acceptance Date)
- Applicable NASA reference drawing number(s)

2.10.2 Required Acceptance Documentation

- Material, Equipment and Fixture Lists
- Shop Drawings
 - Connection Diagrams
 - Fabrication Drawings
- Product Data
 - Equipment and Performance Data
 - Manufacturer's Catalog Data
- Test Reports
 - Contact Resistance Test Results
 - Insulation Resistance Test Results
 - Airborne Ultrasonic Test Results (optional)
 - Power Factor Test Results (optional)
 - High Voltage Test Results (optional)
 - Breaker Timing Test Results (optional)
 - Infrared Thermography Test Results (optional)
 - Baseline Data from Verification Test
- Certificates
- Manufacturer's Instructions
- Operations Manual
- Maintenance Manual
- Warranty Information
- Parts List and Recommended Spare Parts List
- Acceptance Documentation (Dates and Signatures)

2.10.3 Acceptance Technologies and Criteria

*** Note: Based on type, size and voltage of the breaker, the NASA Construction Manager should determine which test(s)/technologies should be performed. Some of the below listed tests/technologies do not apply to every type of breaker.

- Contact Resistance Test (Refer to section B.13)

Refer to data set 2 in Appendix H for additional information.

- Insulation Resistance Test (Refer to section B.10)
Refer to data set 5 in Appendix H for additional information.
 - Airborne Ultrasonic Tests (Optional) (Refer to section B.6)
Refer to data set 1 in Appendix H for additional information.
 - Power Factor Test (Optional) (Refer to section B.5)
Refer to data set 8 in Appendix H for additional information.
 - High Voltage Test (Optional) (Refer to section B.15)
Refer to data set 3 in Appendix H for additional information.
 - Breaker Timing Test (Optional) (Refer to section B.14)
The contractor shall perform a breaker-timing test (mechanical) to verify the speed and position of breaker contacts before, during and after an operation. The breaker-timing test shall have all of the following minimum requirements:
 - Perform contact timing during breaker close, open, open-close, close-open, and open-close-open.
 - Have a minimum of three dry contact inputs
 - Have a minimum of two wet-input channels to monitor breaker secondary contacts
 - Have a minimum resolution of ± 0.0001 seconds over a one-second duration
 - Have travel transducers capable of linear and rotary motion
 - Be capable of slow close contact point measurement
- Minimum acceptance criteria:
- Better than or equal to manufacturer's specifications
- Infrared Thermography (IRT) (Optional) (Refer to section B.4)
Refer to data set 4 in Appendix H for additional information.
- Visual Inspection
A visual inspection of the breaker shall reveal no abnormalities or defects.

2.11 Breakers- Oil

2.11.1 Required Equipment Information

- Breaker Type
- Breaker Specifications (including current transformer ratios)
- Location of Installation
- NASA Identification Number
- Date of Installation (Required or Actual Acceptance Date)
- Applicable NASA reference drawing number(s)

2.11.2 Required Acceptance Documentation

- Material, Equipment and Fixture Lists
- Shop Drawings
 - Connection Diagrams
 - Fabrication Drawings
- Product Data
 - Equipment and Performance Data
 - Manufacturer's Catalog Data
- Test Reports
 - Contact Resistance Test Results
 - Insulation Resistance Test Results
 - Airborne Ultrasonic Test Results (optional)
 - Power Factor Test Results (optional)
 - Insulation Oil Test Results
 - High Voltage Test Results (optional)
 - Breaker Timing Test Results (optional)
 - Infrared Thermography Test Results (optional)
 - Baseline Data from Verification Test
- Certificates
- Manufacturer's Instructions
- Operations Manual
- Maintenance Manual
- Warranty Information
- Parts List and Recommended Spare Parts List
- Acceptance Documentation (Dates and Signatures)

2.11.3 Acceptance Technologies and Criteria

*** Note: Based on type, size and voltage of the breaker, the NASA Construction Manager should determine which test(s)/technologies should be performed. Some of the below listed tests/technologies do not apply to every type of breaker.

- Contact Resistance Test (Refer to section B.13)
Refer to data set 2 in Appendix H for additional information.
- Insulation Resistance Test (Refer to section B.10)
Refer to data set 5 in Appendix H for additional information.
- Airborne Ultrasonic Tests (Optional) (Refer to section B.6)
Refer to data set 1 in Appendix H for additional information.
- Power Factor Test (Optional) (Refer to section B.5)
Refer to data set 8 in Appendix H for additional information.
- Insulation Oil Test (Optional) (Refer to section B.8)
The contractor shall perform the following tests as appropriate for the type of breaker to verify lack of contaminants and that the necessary inhibitors have been added:
 - Dissolved Gas Analysis, ASTM D-3612-90
 - Karl Fisher, ASTM D-1533-88
 - Dielectric Breakdown Strength Test, ASTM D-877 and D-1816
 - Acidity Test, ASTM D-974
 - Visualization Examination, ASTM D-1524

Minimum acceptance criteria: (Refer to Tables B.x and B.x regarding Oil Condition Tests and Limits for New Oil in section B.8)

 - Nitrogen (N₂) < 100 ppm
 - Oxygen (O₂) < 10 ppm
 - Carbon dioxide (CO₂) < 10 ppm
 - Carbon Monoxide (CO) < 100 ppm
 - Methane (CH₄) none
 - Ethane (C₂H₆) none
 - Ethylene (C₂H₄) none
 - Hydrogen (H₂) none
 - Acetylene (C₂H₂) none
 - Water content using Karl Fisher (<25ppm at 20°C)
 - Neutralization number (< 0.05mg/g)
- High Voltage Test (Optional) (Refer to section B.15)
Refer to data set 3 in Appendix H for additional information.
- Breaker Timing Test (Optional) (Refer to section B.14)
The contractor shall perform a breaker-timing test (mechanical) to verify the speed and position of breaker contacts before, during and after an operation. The breaker-timing test shall have all of the following minimum requirements:
 - Perform contact timing during breaker close, open, open-close, close-open, and open-close-open.
 - Have a minimum of three dry contact inputs

- Have a minimum of two wet-input channels to monitor breaker secondary contacts
- Have a minimum resolution of ± 0.0001 seconds over a one-second duration
- Have travel transducers capable of linear and rotary motion
- Be capable of slow close contact point measurement

Minimum acceptance criteria:

- better than or equal to manufacturer's specifications
- Infrared Thermography (IRT) (Optional) (Refer to section B.4)
Refer to data set 4 in Appendix H for additional information.
 - Visual Inspection
A visual inspection of the breaker shall reveal no abnormalities or defects.

2.12 Breakers-SF6 Gas

2.12.1 Required Equipment Information

- Breaker Type
- Breaker Specifications (including current transformer ratios)
- Location of Installation
- NASA Identification Number
- Date of Installation (Required or Actual Acceptance Date)
- Applicable NASA reference drawing number(s)

2.12.2 Required Acceptance Documentation

- Material, Equipment and Fixture Lists
- Shop Drawings
 - Connection Diagrams
 - Fabrication Drawings
- Product Data
 - Equipment and Performance Data
 - Manufacturer's Catalog Data
- Test Reports
 - Contact Resistance Test Results
 - Insulation Resistance Test Results
 - Airborne Ultrasonic Test Results (optional)
 - Vacuum Bottle Integrity Test Results
 - SF₆ Gas Test Results
 - Power Factor Test Results (optional)
 - High Voltage Test Results (optional)
 - Breaker Timing Test Results (optional)
 - Infrared Thermography Test Results (optional)
 - Air Compressor Performance Test Results
 - SF₆ Gas Leakage Test Results
 - Baseline Data from Verification Test
- Certificates
- Manufacturer's Instructions
- Operations Manual
- Maintenance Manual
- Warranty Information
- Parts List and Recommended Spare Parts List
- Acceptance Documentation (Dates and Signatures)

2.12.3 Acceptance Technologies and Criteria

*** Note: Based on type, size and voltage of the breaker, the NASA Construction Manager should determine which test(s)/technologies should be performed. Some of the below listed tests/technologies do not apply to every type of breaker.

- Contact Resistance Test (Refer to section B.13)
Refer to data set 2 in Appendix H for additional information.
- Insulation Resistance Test (Refer to section B.10)
Refer to data set 5 in Appendix H for additional information.
- Airborne Ultrasonic Tests (Optional) (Refer to section B.6)
Refer to data set 1 in Appendix H for additional information.
- Vacuum Bottle Integrity Test
Perform vacuum bottle integrity (overpotential) test across each vacuum bottle with the contacts in the open position in strict accordance with manufacturer's published data. Do not exceed maximum voltage stipulated for this test. Provide adequate barriers and protection against x-radiation during this test. Do not perform this test unless the contact separation of each interrupter is within manufacturer's tolerance. (Be aware that some dc high-potential test sets are half-wave rectified and may produce peak voltages in excess of the manufacturer's recommended maximum.)
- SF₆ Gas Test
Remove a sample of SF₆ gas if provisions are made for sampling and test in accordance with the following table.

Test	Method	Serviceability Limits ^a
Moisture	Hygrometer	Per manufacturer or ≥ 200 ppm ^b
SF ₆ decomposition byproducts	ASTM D 2685	≥ 500 ppm
Air	ASTM D 2685	≥ 5000 ppm ^c
Dielectric breakdown Hemispherical contacts	0.10 inch gap at atmospheric pressure	11.5 - 13.5 kV ^d

Table 2-9: SF₆ Gas Test

- a. In the absence of consensus standards dealing with SF₆ circuit breaker gas tests, the NETA Standards Review Council suggests the above representative values.
- b. According to some manufacturers.
- c. Dominelli, N. and Wylie, L., Analysis of SF₆ Gas as a Diagnostic Technique for GIS, Electric Power Research Institute, Substation Equipment Diagnostics Conference IV, February 1996.
- d. Per Even, F.E., and Mani, G. Sulfur Fluorides, Kirk, Othmer Encyclopedia of Chemical Technology, 4th ed., 11,428, 1994.
Reference: IEC 61634 High-Voltage Switchgear and Controlgear - Use and Handling of Sulfur Hexafluoride (SF₆) in High-Voltage Switchgear and Controlgear.

- Airborne Ultrasonic Tests (Optional) (Refer to section B.6.5)

Refer to data set 1 in Appendix H for additional information.

- Power Factor Test (Optional) (Refer to section B.5)
Refer to data set 8 in Appendix H for additional information.
- High Voltage Test (Optional) (Refer to section B.15)
Refer to data set 3 in Appendix H for additional information.
- Breaker Timing Test (Optional) (Refer to section B.14)
The contractor shall perform a breaker-timing test (mechanical) to verify the speed and position of breaker contacts before, during and after an operation. The breaker-timing test shall have all of the following minimum requirements:
 - Perform contact timing during breaker close, open, open-close, close-open, and open-close-open.
 - Have a minimum of three dry contact inputs
 - Have a minimum of two wet-input channels to monitor breaker secondary contacts
 - Have a minimum resolution of + 0.0001 seconds over a one-second duration
 - Have travel transducers capable of linear and rotary motion
 - Be capable of slow close contact point measurement

Minimum acceptance criteria:

- Better than or equal to manufacturer's specifications
- Infrared Thermography (IRT) (Optional) (Refer to section B.4)
Refer to data set 4 in Appendix H for additional information.
- Inspect associated air compressor in accordance with the acceptance criteria for "compressors" found in section 2.7.
- Test for gas leaks
A test for gas leaks shall reveal no leakage.
- Visual Inspection
A visual inspection of the breaker shall reveal no abnormalities or defects.
- NASA SpecsIntact Reference: Section 16328 Load Break SF6 GAS Switches - Requirements for 5k through 38 kV, 600A load-break sulphur hexafluoride (SF6) gas switches.

2.13 Breakers- Vacuum

2.13.1 Required Equipment Information

- Breaker Type
- Breaker Specifications (including current transformer ratios)
- Location of Installation
- NASA Identification Number
- Date of Installation (Required or Actual Acceptance Date)
- Applicable NASA reference drawing number(s)

2.13.2 Required Acceptance Documentation

- Material, Equipment and Fixture Lists
- Shop Drawings
 - Connection Diagrams
 - Fabrication Drawings
- Product Data
 - Equipment and Performance Data
 - Manufacturer's Catalog Data
- Test Reports
 - Contact Resistance Test Results
 - Insulation Resistance Test Results
 - Airborne Ultrasonic Test Results (optional)
 - Power Factor Test Results (optional)
 - High Voltage Test Results (optional)
 - Breaker Timing Test Results (optional)
 - Infrared Thermography Test Results (optional)
 - Baseline Data from Verification Test
- Certificates
- Manufacturer's Instructions
- Operations Manual
- Maintenance Manual
- Warranty Information
- Parts List and Recommended Spare Parts List
- Acceptance Documentation (Dates and Signatures)

2.13.3 Acceptance Technologies and Criteria

*** Note: Based on type, size and voltage of the breaker, the NASA Construction Manager should determine which test(s)/technologies should be performed. Some of the below listed tests/technologies do not apply to every type of breaker.

- Contact Resistance Test (Refer to section B.13)

Refer to data set 2 in Appendix H for additional information.

- Insulation Resistance Test (Refer to section B.10)
Refer to data set 5 in Appendix H for additional information.
 - Airborne Ultrasonic Tests (Optional) (Refer to section B.6)
Refer to data set 1 in Appendix H for additional information.
 - Power Factor Test (Optional) (Refer to section B.5)
Refer to data set 8 in Appendix H for additional information.
 - High Voltage Test (Optional) (Refer to section B.15)
Refer to data set 3 in Appendix H for additional information.
 - Breaker Timing Test (Optional) (Refer to section B.14)
The contractor shall perform a breaker-timing test (mechanical) to verify the speed and position of breaker contacts before, during and after an operation. The breaker-timing test shall have all of the following minimum requirements:
 - Perform contact timing during breaker close, open, open-close, close-open, and open-close-open.
 - Have a minimum of three dry contact inputs
 - Have a minimum of two wet-input channels to monitor breaker secondary contacts
 - Have a minimum resolution of + 0.0001 seconds over a one-second duration
 - Have travel transducers capable of linear and rotary motion
 - Be capable of slow close contact point measurement
- Minimum acceptance criteria:
- Better than or equal to manufacturer's specifications
- Infrared Thermography (IRT) (Optional) (Refer to section B.4)
Refer to data set 4 in Appendix H for additional information.
 - Visual Inspection
A visual inspection of the breaker shall reveal no abnormalities or defects.

2.14 Cables (General)

2.14.1 Required Equipment Information

- Power Cable Type
- Location of Installation
- NASA Identification Number
- Date of Installation (Required or Actual Acceptance Date)
- Applicable NASA reference drawing number(s)

2.14.2 Required Acceptance Documentation

- Material, Equipment and Fixture Lists
- Shop Drawings
 - Connection Diagrams
 - Fabrication Drawings
- Manufacturer Data
- Test Reports
 - Dielectric Test Results
 - High Voltage Test Results
 - Radiographic Test Results
- Certificates
- Manufacturer's Instructions
- Operations Manual
- Maintenance Manual
- Warranty Information
- Parts List and Recommended Spare Parts List
- Acceptance Documentation (Dates and Signatures)

2.14.3 Acceptance Technologies and Criteria

- Insulation Resistance Test (Refer to sections B.10)
Refer to data set 5 in Appendix H for additional information.
- Airborne Ultrasonic Tests (Optional) (Refer to sections B.6)
The contractor shall use ultrasonics to verify the non-existence of electrical arcing and other high frequency events.

Minimum acceptance criteria:

< TBD based on unit test set. Limit to be at a level representative of no electrical arcing.

- Power Factor Test (Optional) (Refer to sections B.5)
Refer to data set 8 in Appendix H for additional information.

- High Voltage Test (Optional) (refer to section B.15)
The contractor shall perform the high voltage test to verify the insulation and to ensure that there is no excessive leakage current. This is a potentially destructive test and requires authorization from the NASA Construction Manager.

Minimum acceptance criteria:
 - better than or equal to manufacturer's specifications
 - limits in accordance with ANSI/IEEE Standard 400

- Visual Inspection
A visual inspection of the cable shall reveal no abnormalities or defects.

- NASA SpecsIntact Reference: Section 16145 Standard Wiring Systems - Basic wiring materials and methods applicable to most types of interior electrical construction.

2.15 Cables- Low Voltage (600V Maximum)

2.15.1 Required Equipment Information

- Power Cable Type
- Location of Installation
- NASA Identification Number
- Date of Installation (Required or Actual Acceptance Date)
- Applicable NASA reference drawing number(s)

2.15.2 Required Acceptance Documentation

- Material, Equipment and Fixture Lists
- Shop Drawings
 - Connection Diagrams
 - Fabrication Drawings
- Manufacturer Data
- Test Reports
 - Insulation Resistance Test Results
 - Airborne Ultrasonic Test Results (Optional)
- Certificates
- Manufacturer's Instructions
- Operations Manual
- Maintenance Manual
- Warranty Information
- Parts List and Recommended Spare Parts List
- Acceptance Documentation (Dates and Signatures)

2.15.3 Acceptance Technologies and Criteria

- Insulation Resistance Test (Refer to section B.10)
Refer to data set 5 in Appendix H for additional information.
- Airborne Ultrasonic Tests (Optional) (Refer to section B.6)
The contractor shall use ultrasonics to verify the non-existence of electrical arcing and other high frequency events.

Minimum acceptance criteria:

< TBD based on unit test set. Limit to be at a level representative of no electrical arcing.

- Visual Inspection
A visual inspection of the cable shall reveal no abnormalities or defects.

2.16 Cables- Medium Voltage (600V – 33.000V)

2.16.1 Required Equipment Information

- Power Cable Type
- Location of Installation
- NASA Identification Number
- Date of Installation (Required or Actual Acceptance Date)
- Applicable NASA reference drawing number(s)

2.16.2 Required Acceptance Documentation

- Material, Equipment and Fixture Lists
- Shop Drawings
 - Connection Diagrams
 - Fabrication Drawings
- Manufacturer Data
- Test Reports
 - Insulation Resistance Test Results
 - Airborne Ultrasonic Test Results (Optional)
 - Power Factor Test Results (Optional)
 - High Voltage Test Results (Optional)
- Certificates
- Manufacturer's Instructions
- Operations Manual
- Maintenance Manual
- Warranty Information
- Parts List and Recommended Spare Parts List
- Acceptance Documentation (Dates and Signatures)

2.16.3 Acceptance Technologies and Criteria

- Insulation Resistance Test (Refer to section B.10)
Refer to data set 5 in Appendix H for additional information.
- Airborne Ultrasonic Tests (Optional) (Refer to section B.6)
The contractor shall use ultrasonics to verify the non-existence of electrical arcing and other high frequency events.

Minimum acceptance criteria:

< TBD based on unit test set. Limit to be at a level representative of no electrical arcing.

- Power Factor Test (Optional) (Refer to section B.5)

The contractor shall use the power factor test to verify acceptable dissipation and power loss from the insulation to ground. Measure with Grounded Specimen Test (GST), Ungrounded Specimen Test (UST), and GST with Ground. The power factor test set shall have all of the following minimum requirements:

 - Test voltage range of 500V to 12kV
 - Ability to perform UST, GST, and GST with guard tests
 - Readings for power factor, dissipation factor, capacitance, and watts-loss
 - Power factor/Dissipation factor range of 0 to 200%
 - Capacitance measuring range of 0 to 0.20 picofarads

Minimum acceptance criteria:

 - Power factor must not exceed manufacturer's data. Verify manufacturer's maximum power factor with Table B-5
- High Voltage Test (Optional) (Refer to section B.15)

Refer to data set 3 in Appendix H for additional information.
- Visual Inspection

A visual inspection of the cable shall reveal no abnormalities or defects.

The following is excerpted from *2003 NETA Acceptance Specifications*. Perform an acceptance test on cables, including terminations and joints, after cable system installation and before the cable system is placed into service. In accordance with ANSI/IEEE 400, ICEA S-93-639/NEMA WC 74, ICEA S-94-649 and ICEA S-97-682, testing can be performed by means of direct voltage (dc), alternating voltage (ac), partial discharge (pd), or very low frequency (VLF). The selection can be made only after an evaluation of the alternative methods. Test procedure shall be as follows, and the results for each cable test shall be recorded as specified herein. Test voltages shall not exceed 80 percent of cable manufacturer's factory test value or the maximum test voltage in Table 100.6.

1. Insure that the input voltage to the test set is regulated.
2. Current-sensing circuits in test equipment, when available, shall measure only the leakage current associated with the cable under test and shall not include internal leakage of the test equipment.
3. Record wet- and dry-bulb temperatures or relative humidity and temperature.
4. Test each cable section individually.
5. Test each conductor individually with all other conductors grounded. Ground all shields.
6. Terminations shall be adequately corona-suppressed by guard ring, field reduction sphere, or other suitable method, as necessary.

7. Insure that the maximum test voltage does not exceed the limits for terminators specified in ANSI/IEEE 48, IEEE 386, or manufacturer's specifications.
 8. Raise the conductor to the specified maximum test voltage and hold for 15 minutes. Refer to Table 100.6.
 9. If performed by means of direct voltage (dc), reduce the test set potential to zero and measure residual voltage at discrete intervals.
 10. Apply grounds for a time period adequate to drain all insulation stored charge.
 11. Spliced cables (new to existing)
 1. When new cables are spliced into existing cables, the acceptance test shall be performed on the new cable prior to splicing in accordance with Section 7.3.3.2.
 2. After test results are approved for new cable and the splice is completed, an insulation-resistance test and a shield-continuity test shall be performed on the length of new and existing cable including the splice.
 - *3. After a satisfactory insulation-resistance test, a test in accordance with the types listed in section 7.3.3.2.4 may be performed on the cable utilizing a test voltage acceptable to owner and not exceeding 60 percent of factory test value.
- NASA SpecsIntact Reference: Section 16124 Medium Voltage Cable - Medium voltage cables, including shielded and nonshielded single- and multiple-conductor power cables, portable cables, cable splices and terminations, single- and multiple-conductor potheads, and fireproofing cables in manholes and utility tunnels.

2.17 Cables, High Voltage (33,000V Minimum)

2.17.1 Required Equipment Information

- Power Cable Type
- Location of Installation
- NASA Identification Number
- Date of Installation (Required or Actual Acceptance Date)
- Applicable NASA reference drawing number(s)

2.17.2 Required Acceptance Documentation

- Material, Equipment and Fixture Lists
- Shop Drawings
 - Connection Diagrams
 - Fabrication Drawings
- Manufacturer Data
- Test Reports
 - Insulation Resistance Test Results
 - Airborne Ultrasonic Test Results (Optional)
 - Power Factor Test Results (Optional)
 - High Voltage Test Results (Optional)
- Certificates
- Manufacturer's Instructions
- Operations Manual
- Maintenance Manual
- Warranty Information
- Parts List and Recommended Spare Parts List
- Acceptance Documentation (Dates and Signatures)

2.17.3 Acceptance Technologies and Criteria

- Insulation Resistance Test (Refer to section B.10)
Refer to data set 5 in Appendix H for additional information.
- Airborne Ultrasonic Tests (Optional) (Refer to section B.6)
The contractor shall use ultrasonics to verify the non-existence of electrical arcing and other high frequency events.

Minimum acceptance criteria:
< TBD based on unit test set. Limit to be at a level representative of no electrical arcing.
- Power Factor Test (Optional) (Refer to section B.5)
The contractor shall use the power factor test to verify acceptable dissipation and power loss from the insulation to ground. Measure with Grounded Specimen Test

(GST), Ungrounded Specimen Test (UST), and GST with Ground. The power factor test set shall have all of the following minimum requirements:

- Test voltage range of 500V to 12kV
- Ability to perform UST, GST, and GST with guard tests
- Readings for power factor, dissipation factor, capacitance, and watts-loss
- Power factor/Dissipation factor range of 0 to 200%
- Capacitance measuring range of 0 to 0.20 picofarads

Minimum acceptance criteria:

- Power factor must not exceed manufacturer's data. Verify manufacturer's maximum power factor with Table B-5
- High Voltage Test (Optional) (Refer to section B.15)
Refer to data set 3 in Appendix H for additional information.
 - Visual Inspection
A visual inspection of the cable shall reveal no abnormalities or defects.

The following is excerpted from 2003 NETA Acceptance Specifications. Perform an acceptance test on cables, including terminations and joints, after cable system installation and before the cable system is placed into service. In accordance with ANSI/IEEE 400, ICEA S-93-639/NEMA WC 74, ICEA S-94-649 and ICEA S-97-682, testing can be performed by means of direct voltage (dc), alternating voltage (ac), partial discharge (pd), or very low frequency (VLF). The selection can be made only after an evaluation of the alternative methods. Test procedure shall be as follows, and the results for each cable test shall be recorded as specified herein. Test voltages shall not exceed 80 percent of cable manufacturer's factory test value or the maximum test voltage in Table 100.6.

- Insure that the input voltage to the test set is regulated.
- Current-sensing circuits in test equipment, when available, shall measure only the leakage current associated with the cable under test and shall not include internal leakage of the test equipment.
- Record wet- and dry-bulb temperatures or relative humidity and temperature.
- Test each cable section individually.
- Test each conductor individually with all other conductors grounded. Ground all shields.
- Terminations shall be adequately corona-suppressed by guard ring, field reduction sphere, or other suitable method, as necessary.
- Insure that the maximum test voltage does not exceed the limits for terminators specified in ANSI/IEEE 48, IEEE 386, or manufacturer's specifications.
- Raise the conductor to the specified maximum test voltage and hold for 15 minutes. Refer to Table 100.6.
- If performed by means of direct voltage (dc), reduce the test set potential to zero and measure residual voltage at discrete intervals.
- Apply grounds for a time period adequate to drain all insulation stored charge.

- Spliced cables (new to existing)
 1. When new cables are spliced into existing cables, the acceptance test shall be performed on the new cable prior to splicing in accordance with Section 7.3.3.2.
 2. After test results are approved for new cable and the splice is completed, an insulation-resistance test and a shield-continuity test shall be performed on the length of new and existing cable including the splice.
 3. After a satisfactory insulation-resistance test, a test in accordance with the types listed in section 7.3.3.2.4 may be performed on the cable utilizing a test voltage acceptable to owner and not exceeding 60 percent of factory test value.

2.18 Electrical, Capacitor Bank

2.18.1 Required Equipment Information

- Capacitor Type
- Location of Installation
- NASA Identification Number
- Date of Installation (Required or Actual Acceptance Date)
- Applicable NASA reference drawing number(s)

2.18.2 Required Acceptance Documentation

- Material, Equipment and Fixture Lists
- Shop Drawings
 - Connection Diagrams
 - Fabrication Drawings
- Manufacturer Data
- Test Reports
 - Capacitor Bank Acceptance Test Results
 - Airborne Ultrasonic Test Results (Optional)
 - Capacitor Discharge Test Results
- Certificates
- Manufacturer's Instructions
- Operations Manual
- Maintenance Manual
- Warranty Information
- Parts List and Recommended Spare Parts List
- Acceptance Documentation (Dates and Signatures)

2.18.3 Acceptance Technologies and Criteria

- Capacitor Bank Acceptance Testing
 - The contractor shall perform acceptance testing on each capacitor in the bank in accordance with the applicable acceptance testing guide.

Inspect bolted electrical connections for high resistance using one of the following methods:

1. Use of low-resistance ohmmeter.
 2. Verify tightness of accessible bolted electrical connections by calibrated torque-wrench method in accordance with manufacturer's published data.
- Airborne Ultrasonic Tests (Optional) (Refer to section B.6)
 - The contractor shall use ultrasonics to verify the non-existence of electrical arcing and other high frequency events.

Minimum acceptance criteria:

< TBD based on unit test set. Limit to be at a level representative of no electrical arcing.

- Capacitor Discharge Test

The following is excerpted from 2003 NETA Acceptance Specifications. Confirm automatic discharging in accordance with NFPA 70 National Electrical Code Article 460.

Minimum acceptance criteria :

- Better than or equal to manufacturer's specifications or in the absence of manufacturer's specifications, use NFPA 70 National Electrical Code Article 460, residual voltage of a capacitor shall be reduced to 50 volts after being disconnected from the source of supply

<u>Rated Voltage</u>	<u>Discharge Time</u>
≤ 600 volts	1 minute
> 600 volts	5 minutes

- Visual Inspection

A visual inspection of the capacitor bank shall reveal no abnormalities or defects.

2.19 Capacitor, Dry-Type

2.19.1 Required Equipment Information

- Capacitor Type
- Location of Installation
- NASA Identification Number
- Date of Installation (Required or Actual Acceptance Date)
- Applicable NASA reference drawing number(s)

2.19.2 Required Acceptance Documentation

- Material, Equipment and Fixture Lists
- Shop Drawings
 - Connection Diagrams
 - Fabrication Drawings
- Manufacturer Data
- Test Reports
 - Insulation Resistance Test Results
 - Overpotential Test Results
 - Airborne Ultrasonic Test Results (Optional)
 - Capacitor Discharge Test Results
- Certificates
- Manufacturer's Instructions
- Operations Manual
- Maintenance Manual
- Warranty Information
- Parts List and Recommended Spare Parts List
- Acceptance Documentation (Dates and Signatures)

2.19.3 Acceptance Technologies and Criteria

- Insulation Resistance Test (Refer to section B.10)
Refer to data set 5 in Appendix H for additional information.
- Overpotential Test
AC overpotential test shall not exceed 75 percent of factory test voltage for one-minute duration. DC overpotential test shall not exceed 100 percent of the factory rms test voltage for one-minute duration.

Minimum acceptance criteria:
 - Better than or equal to manufacturer's specifications or in the absence of manufacturer's specifications, the insulation shall withstand the overpotential test voltage applied.
- Airborne Ultrasonic Tests (Optional) (Refer to section B.6)

The contractor shall use ultrasonics to verify the non-existence of electrical arcing and other high frequency events.

Minimum acceptance criteria:

< TBD based on unit test set. Limit to be at a level representative of no electrical arcing.

- Capacitor Discharge Test

The following is excerpted from 2003 NETA Acceptance Specifications. Confirm automatic discharging in accordance with NFPA 70 National Electrical Code Article 460.

Minimum acceptance criteria:

- Better than or equal to manufacturer's specifications or in the absence of manufacturer's specifications, use NFPA 70 National Electrical Code Article 460, residual voltage of a capacitor shall be reduced to 50 volts after being disconnected from the source of supply

<u>Rated Voltage</u>	<u>Discharge Time</u>
≤ 600 volts	1 minute
> 600 volts	5 minutes

- Visual Inspection

A visual inspection of the capacitor shall reveal no abnormalities or defects.

2.20 Capacitor, Liquid Filled

2.20.1 Required Equipment Information

- Capacitor Type
- Location of Installation
- NASA Identification Number
- Date of Installation (Required or Actual Acceptance Date)
- Applicable NASA reference drawing number(s)

2.20.2 Required Acceptance Documentation

- Material, Equipment and Fixture Lists
- Shop Drawings
 - Connection Diagrams
 - Fabrication Drawings
- Manufacturer Data
- Test Reports
 - Insulation Resistance Test Results
 - Airborne Ultrasonic Test Results (Optional)
 - Insulation Oil Test Results
- Certificates
- Manufacturer's Instructions
- Operations Manual
- Maintenance Manual
- Warranty Information
- Parts List and Recommended Spare Parts List
- Acceptance Documentation (Dates and Signatures)

2.20.3 Acceptance Technologies and Criteria

- Insulation Resistance Test (Refer to section B.10)

The contractor shall use the insulation resistance test to detect the presence of contamination or degradation of the insulation. Use both the Dielectric Absorption Index and the Polarization Index. Perform winding-to-ground insulation-resistance tests. Apply voltage in accordance with manufacturer's published data.

Minimum acceptance criteria:

 - Better than or equal to manufacturer's specifications or in the absence of manufacturer's specifications, use the information contained in section B.10 for Insulation Resistance Testing.
- Airborne Ultrasonic Tests (Optional) (Refer to section B.6)

The contractor shall use ultrasonics to verify the non-existence of electrical arcing and other high frequency events.

Minimum acceptance criteria:

< TBD based on unit test set. Limit to be at a level representative of no electrical arcing.

- Insulation Oil Test (Optional) (Refer to section B.8)

The contractor shall perform the following tests as appropriate for the type of capacitor to verify lack of contaminants and that the necessary inhibitors have been added:

- Dissolved Gas Analysis, ASTM D-3612-90
- Karl Fisher, ASTM D-1533-8 (Required on 25 kV or higher voltages and on all silicone-filled units.)
- Dielectric Breakdown Strength Test, ASTM D-877 and D-1816
- Acidity Test, ASTM D-974
- Visualization Examination, ASTM D-1524
- Specific Gravity Test, ASTM D-1298
- Interfacial Tension Test, ASTM D-971 or ASTM D-2285
- Power Factor or Dissipation Factor Test, ASTM D-924
- Color, ASTM D-1500

Minimum acceptance criteria:

- Dissolved Gas
 - Nitrogen (N₂) < 100 ppm
 - Oxygen (O₂) < 10 ppm
 - Carbon dioxide (CO₂) < 10 ppm
 - Carbon Monoxide (CO) < 100 ppm
 - Methane (CH₄) none
 - Ethane (C₂H₆) none
 - Ethylene (C₂H₄) none
 - Hydrogen (H₂) none
 - Acetylene (C₂H₂) none
 - Karl Fisher (<25ppm at 20°C.)
 - Dielectric Breakdown Strength (> 30kV)
 - Neutralization number (< 0.05mg/g)
 - Visual Examination (clear)
- Visual Inspection
 - A visual inspection of the capacitor shall reveal no abnormalities or defects.

2.21 Compressors

Centrifugal

The contractor shall mount sound discs in the horizontal and vertical planes radial to the shaft at the free and coupled ends of the motor and compressor as close to the bearings as possible. Accelerometers shall be mounted to solid structures and not on drip shields or other flexible structures. Mounting locations shall be in line with each other, perpendicular to the compressor discharge, and located at the free end, at the coupled end of the motor and compressor, and in the axial direction on compressor and motor.

Reciprocating

The contractor shall install sound discs radial to the input and output shafts in the horizontal and vertical directions. Additional discs shall be installed in the axial direction as close to the input and output shafts as possible.

Centrifugal compressors may be monitored effectively in this manner. However, reciprocating air compressors shall only be monitored for balance and alignment problems.

2.21.1 Required Equipment Information

- Compressor Type
- Compressor Specifications
 - Number of compressor sections
 - Number of blades per section
 - Number of diffusers
 - Number of gear teeth on drive gear
 - Number of driven shafts
 - Number of gear teeth per driven shaft
 - Rotating speed of each rotor
 - Lubricating Oil information, viscosity grade in ISO units, AGMA or SAE classification and identification of all additives
 - Grease lubricant information, type of base stock, NLGI number, type and percent of thickener, dropping point, and base oil viscosity range in SUS
- Location of Installation
- NASA Identification Number
- Date of Installation (Required or Actual Acceptance Date)
- Applicable NASA reference drawing number(s)

2.21.2 Required Acceptance Documentation

- Material, Equipment and Fixture Lists
- Equipment Foundation Data
- Shop Drawings
 - Installation Drawings
 - As-Built Drawings
 - Bearing Layout

- Manufacturer Data
 - Equipment and Performance Data
 - Design Analysis and Calculations
 - Bearing Data
- Test Point Locations
- Test Reports
 - Vibration Analysis Test Results
 - Alignment Measurement Results (Laser Alignment)
 - Hydraulic Oil Test Results
 - Lubricating Oil Test Results
- Certificates
- Manufacturer's Instructions
- Operations Manual
- Maintenance Manual
- Warranty Information
- Parts List and Recommended Spare Parts List
- Acceptance Documentation (Dates and Signatures)

2.21.3 Acceptance Technologies and Criteria

- Vibration Analysis Test (Refer to sections B.3)
Refer to data set 10 in Appendix H for additional information.

- Balance Test and Measurement (Refer to section B.1)
 - The contractor shall use balance measurement to verify that rotating shafts are balanced and mass and rotational centerlines are coincident.
 - Document key lengths A, B, final length

Minimum Acceptance Criteria: refer to Table B-1

 - Better than or equal to manufacturer's specifications

- Laser Alignment or Other Alignment Methods (Refer to sections B.2)
Refer to data set 6 in Appendix H for additional information.

- Lubricating Oil Tests (Refer to sections B.7)
Refer to data set 7 in Appendix H for additional information.

- Thermodynamic Performance Tests (Refer to section B.18)
Refer to data set 9 in Appendix H for additional information.

- Hydraulic Oil Tests (Optional) (Refer to sections B.7)
The contractor shall use particle counting tests to verify an acceptable level of contamination in the hydraulic oil.

Minimum Acceptance Criteria:
Refer to Sperry Vickers Table, Table B-10.

- Visual Inspection
A visual inspection of the compressor shall reveal no abnormalities or defects
- NASA SpecsIntact Reference: Section 15610 Refrigeration Compressors - Reciprocating, scroll and screw type compressors for refrigerating and air conditioning applications.

2.22 Cranes

2.22.1 Required Equipment Information

- Crane Type, Duty Class and Capacity
- Crane Specifications
 - Operating speeds
 - Hoist lift
 - Number of hoists per crane
- Location of Installation
- NASA Identification Number
- Date of Installation (Required or Actual Acceptance Date)
- Applicable NASA reference drawing number(s)

2.22.2 Required Acceptance Documentation

- Material, Equipment and Fixture Lists
- Equipment Foundation Data
- Shop Drawings
 - Installation Drawings
 - Fabrication Drawings
 - As-Built Drawings
- Manufacturer Data
 - Equipment and Performance Data
 - Design Analysis and Calculations
 - Bearing Data
- Test Reports
 - Vibration Analysis Test Results
 - Alignment Measurement Results (Laser Alignment)
 - Lubricating Oil Test Results
 - Temperature Test Results
 - Mechanical Test Results
 - Dielectric Test Results
 - Voltage Drop and Short Circuit Test Results
 - Continuity Test and Insulation Test Results
- Certificates
- Manufacturer's Instructions
- Operations Manual
- Maintenance Manual
- Warranty Information
- Parts List and Recommended Spare Parts List
- Acceptance Documentation (Dates and Signatures)

2.22.3 Acceptance Technologies and Criteria

- Vibration Analysis Test (Refer to sections B.3)
Refer to data set 10 in Appendix H for additional information.
- Balance Test and Measurement (Refer to section B.1)
The contractor shall use balance measurement to verify that rotating shafts are balanced and mass and rotational centerlines are coincident.
 - Document key lengths A, B, final length

Minimum Acceptance Criteria: refer to Table B-1

 - Better than or equal to manufacturer's specifications.
- Laser Alignment or Other Alignment Methods (Refer to sections B.2)
Refer to data set 6 in Appendix H for additional information.
- Lubricating Oil Tests (Refer to sections B.7)
Refer to data set 7 in Appendix H for additional information.
- Mechanical Performance Tests (Refer to section B.18)
The contractor shall perform mechanical performance tests of the crane to verify that design specifications are met. The required tests and calculations will be specified by the Design Engineer.

Minimum acceptable limits for mechanical performance tests:
± 5% of manufacturer's specifications or as specified by the Design Engineer.
- Insulation Resistance Test (Optional) (Refer to sections B.10)
Refer to data set 5 in Appendix H for additional information.
- Hydraulic Oil Tests (Optional) (Refer to sections B.7)
The contractor shall use particle counting tests to verify an acceptable level of contamination in the hydraulic oil.

Minimum Acceptance Criteria:
Refer to Sperry Vickers Table, Table B-10
- Visual Inspection
A visual inspection of the crane shall reveal no abnormalities or defects

2.23 Diesel Engine

2.23.1 Required Equipment Information

- Engine Type
- Engine Specifications
- Location of Installation
- NASA Identification Number
- Date of Installation (Required or Actual Acceptance Date)
- Applicable NASA reference drawing number(s)

2.23.2 Required Acceptance Documentation

- Material, Equipment and Fixture Lists
- Equipment Foundation Data
- Shop Drawings
 - Installation Drawings
 - As-Built Drawings
 - Bearing Layout
- Manufacturer Data
 - Equipment and Performance Data
 - Design Analysis and Calculations
 - Bearing Data
- Test Point Locations
- Test Reports
 - Lubricating oil test reports
 - Visual inspection reports
 - Noise level test reports
 - Exhaust emissions reports
 - Cold starting analysis reports
 - Performance test reports
 - Vibration analysis reports
 - Cooling system evaluation reports

- Certificates
- Manufacturer's Instructions
- Operations Manual
- Maintenance Manual
- Warranty Information
- Parts List and Recommended Spare Parts List
- Acceptance Documentation (Dates and Signatures)

2.23.3 Acceptance Technologies and Criteria

- Lubricating Oil Tests
Refer to data set 7 in Appendix H for additional information.
- Visual Inspection
 - A visual inspection of the diesel engine shall reveal no abnormalities or defects.
- Noise Level Acceptance
 - Test noise level to ensure the db is within acceptable limits for the application. (see Fig 2.2)

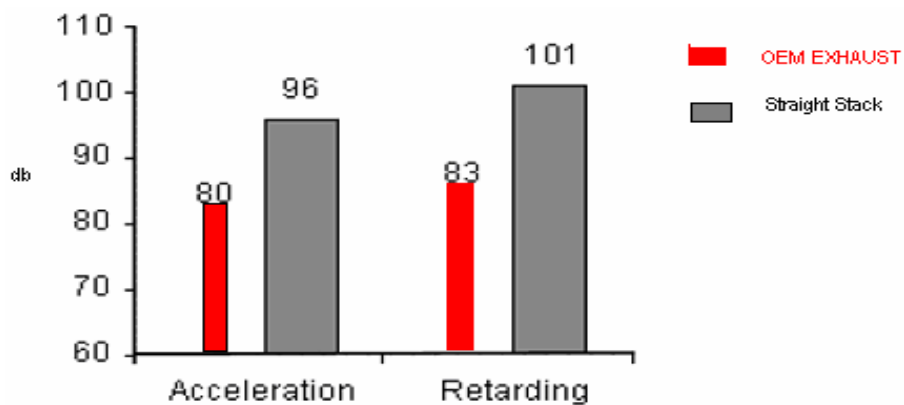

Figure 2-4: Acceptable Noise Levels

- Exhaust Emissions (see Fig 2.9 and Fig 2.10)
 - Test exhaust gas recirculation valve
 - Analyze emissions for Nitrous Oxide, Hydrocarbon, Non-Methane Hydrocarbon+Nitrous Oxide, Carbon, Promethium

EPA Non-Road Diesel Engine Emission Standards, g/kW·hr (g/bhp·hr)					
Engine Power	Nitrous Oxide	Hydro Carbon	Non-Methane Hydro Carbons + Nitrous Oxide	Carbon	Promethium
<8kW	-	-	10.5 (7.8)	8.0 (6.0)	1.0 (0.75)
(<11hp)	-	-	7.5 (5.6)	8.0 (6.0)	0.80 (0.60)
>8 kW <19kW	-	-	9.5 (7.1)	6.6 (4.9)	0.80 (0.60)
(>11hp <25hp)	-	-	7.5 (5.6)	6.6 (4.9)	0.80 (0.60)
>19kW <37kW	-	-	9.5 (7.1)	5.5 (4.1)	0.80 (0.60)
(>25hp <50hp)	-	-	7.5 (5.6)	5.5 (4.1)	0.60 (0.45)
>37kW <75kW	9.2 (6.9)	-	-	-	-
(>50hp <100hp)	-	-	7.5 (5.6)	5.0 (3.7)	0.40 (0.30)
	-	-	4.7 (3.5)	5.0 (3.7)	-*

NASA Reliability Centered Building and Equipment Acceptance Guide

>75kW <130kW (>100hp <175hp)	9.2 (6.9)	-	-	-	-
	-	-	6.6 (4.9)	5.0 (3.7)	0.30 (0.22)
	-	-	4.0 (3.0)	5.0 (3.7)	-*
>130kW <225kW (>175hp <300hp)	9.2 (6.9)	1.3 (1.0)	-	11.4 (8.5)	0.54 (0.40)
	-	-	6.6 (4.9)	3.5 (2.6)	0.20 (0.15)
	-	-	4.0 (3.0)	3.5 (2.6)	-*
>225kW <450kW (>300hp <600hp)	9.2 (6.9)	1.3 (1.0)	-	11.4 (8.5)	0.54 (0.40)
	-	-	6.4 (4.8)	3.5 (2.6)	0.20 (0.15)
	-	-	4.0 (3.0)	3.5 (2.6)	-*
>450kW <560kW (>600hp <750hp)	9.2 (6.9)	1.3 (1.0)	-	11.4 (8.5)	0.54 (0.40)
	-	-	6.4 (4.8)	3.5 (2.6)	0.20 (0.15)
>560kW (>750hp)	9.2 (6.9)	1.3 (1.0)	-	11.4 (8.5)	0.54 (0.40)
	-	-	6.4 (4.8)	3.5 (2.6)	0.20 (0.15)

Table 2-10: EPA Non-Road Diesel Engine Emission Standards, g/kW•hr (g/bhp•hr)

	Hydro Carbon	Carbon	Nitrous Oxide	Promethium
Over the road				
	1.3	15.5	4	0.1
Inside corporation limits				
	1.3	15.5	4	0.07

Table 2-11: Heavy duty diesel emissions for over the road duty engines

- Cold Starting
 - Test start-aid device effectiveness - (i.e. Glow Plugs, Oil Heaters, and Block Heaters)
 - Test fuel blend for cold weather additive packages (Fig 2.4)
 - Test minimum fuel standard quality (Fig 2.5)
 - Analyze oil for proper viscosity
 - Test governor for cold-idle stability
 - Verify cold cranking amps of batteries
 - Adjust fuel injection per altitude

API Gravity (Hydrometer Method)	ASTM D-287
Ash Content	ASTM D-482
Ramsbottom Carbon Residue	ASTM D-524
Cloud Point	ASTM D-2500
Copper Corrosion	ASTM D-130
Sulfur by X-Ray Fluorescence	ASTM D-4294
Distillation	ASTM D-86
Flash Point (Closed Cup)	ASTM D-93
Cetane Number	ASTM D-976
Sediment & Water	ASTM D-1796
Viscosity	ASTM D-445

Table 2-11: Fuel Analysis Limits

- Minimum Fuel Standards
 - Centane number of 40 or more
 - 0.5% sulfur or less by weight
 - 0.05% or less water

- Performance Testing
 - Compression Test
For compression PSI of 3000-4500 psi, variance between cylinders should not exceed 50-75 psi
 - Fuel injector pump and nozzle calibration
 - Fuel pump calibration
 - Governor and timing analysis
 - Valve timing inspection
 - Fuel properties evaluation
 - Evaluation of electronic control systems
 - Turbocharger boost adjustment
 - Filter inspections-air, oil and emissions
 - Air flow test
 - Fuel Flow test
 - Cylinder leakdown test

- Vibration Analysis
 - Torsional vibration analysis

- Cooling system evaluation (Coolant flow and contamination of coolant.)
 - Look for impurities in the coolant, i.e. oil from a leaking cylinder head gasket etc, rust from internal corrosion of the radiator.

ph - ASTM 1287	8.5 - 10.5
reserve alkalinity ASTM D1121	detectable level
% EG/PG	50/50 water glycol
freeze / boiling point	per region
Nitrite, ppm NO ₂	10% of additive level
TDS (total dissolved solids)	5%
Appearance	free from suspended solids

Table 2-13: Coolant Acceptance Levels

2.24 Diesel Generator

A diesel generator is an internal combustion engine used to generate rotation on a shaft to convert mechanical energy into electrical energy. Diesel engines are a compression-ignition piston engine in which fuel is injected directly into the cylinder without pre-mixing with air and is ignited by the heat of the compressed air. Since a diesel engine only compresses air, the compression ratio can be much higher than what would typically be found in a gasoline engine. The higher the compression ratio, the more power is generated.

2.24.1 Required Equipment Information

- Engine Type
- Generator Type
- Engine Specifications
- Location of Installation
- NASA Identification Number
- Date of Installation (Required or Actual Acceptance Date)
- Applicable NASA reference drawing number(s)

2.24.2 Required Acceptance Documentation

- Material, Equipment and Fixture Lists
- Equipment Foundation Data
- Shop Drawings
 - Installation Drawings
 - As-Built Drawings
 - Bearing Layout
- Manufacturer Data
 - Equipment and Performance Data
 - Design Analysis and Calculations
 - Bearing Data
- Test Point Locations
- Test Reports
 - Lubricating oil test reports
 - Visual inspection reports
 - Noise level test reports
 - Exhaust emissions reports
 - Cold starting analysis reports
 - Performance test reports
 - Vibration analysis reports
 - Cooling system evaluation reports
 - Load bank test reports
 - Megger test reports
 - Safety shutdown test reports

- Certificates
- Manufacturer's Instructions
- Operations Manual
- Maintenance Manual
- Warranty Information
- Parts List and Recommended Spare Parts List
- Acceptance Documentation (Dates and Signatures)

2.24.3 Acceptance Technologies and Criteria

- Lubricating Oil Tests
Refer to data set 7 in Appendix H for additional information.
- Visual Inspection
A visual inspection of the diesel engine shall reveal no abnormalities or defects.
- Noise Level Acceptance
Test noise level to ensure the db is within acceptable limits for the application.
(see Fig 1.1)

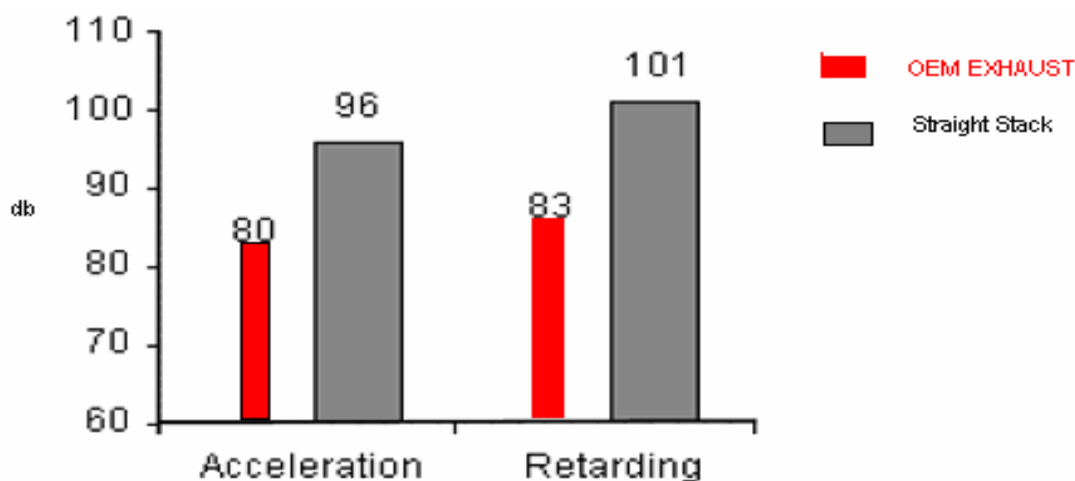

Figure 2-5: Acceptable Noise Levels

- Exhaust Emissions (see Fig 1.2 and Fig 1.3)

Test exhaust gas recirculation (EGR) valve to ensure proper operation of sending exhaust gas back through the turbo or intake to be re-burnt,

Analyze emissions for Nitrous Oxide, Hydrocarbon, Non-Methane Hydrocarbon + Nitrous Oxide, Carbon, and Promethium.

EPA Non-Road Diesel Engine Emission Standards, g/kW·hr (g/bhp·hr)					
Engine Power	Nitrous Oxide	Hydro Carbon	Non-Methane Hydro Carbons + Nitrous Oxide	Carbon	Promethium
<8kW	-	-	10.5 (7.8)	8.0 (6.0)	1.0 (0.75)
(<11hp)	-	-	7.5 (5.6)	8.0 (6.0)	0.80 (0.60)
>8 kW <19kW	-	-	9.5 (7.1)	6.6 (4.9)	0.80 (0.60)
(>11hp <25hp)	-	-	7.5 (5.6)	6.6 (4.9)	0.80 (0.60)
>19kW <37kW	-	-	9.5 (7.1)	5.5 (4.1)	0.80 (0.60)
(>25hp <50hp)	-	-	7.5 (5.6)	5.5 (4.1)	0.60 (0.45)
>37kW <75kW	9.2 (6.9)	-	-	-	-
(>50hp <100hp)	-	-	7.5 (5.6)	5.0 (3.7)	0.40 (0.30)
	-	-	4.7 (3.5)	5.0 (3.7)	-*
>75kW <130kW	9.2 (6.9)	-	-	-	-
(>100hp <175hp)	-	-	6.6 (4.9)	5.0 (3.7)	0.30 (0.22)
	-	-	4.0 (3.0)	5.0 (3.7)	-*
>130kW <225kW	9.2 (6.9)	1.3 (1.0)	-	11.4 (8.5)	0.54 (0.40)
(>175hp <300hp)	-	-	6.6 (4.9)	3.5 (2.6)	0.20 (0.15)
	-	-	4.0 (3.0)	3.5 (2.6)	-*
>225kW <450kW	9.2 (6.9)	1.3 (1.0)	-	11.4 (8.5)	0.54 (0.40)
(>300hp <600hp)	-	-	6.4 (4.8)	3.5 (2.6)	0.20 (0.15)
	-	-	4.0 (3.0)	3.5 (2.6)	-*
>450kW <560kW	9.2 (6.9)	1.3 (1.0)	-	11.4 (8.5)	0.54 (0.40)
(>600hp <750hp)	-	-	6.4 (4.8)	3.5 (2.6)	0.20 (0.15)
>560kW	9.2 (6.9)	1.3 (1.0)	-	11.4 (8.5)	0.54 (0.40)
(>750hp)	-	-	6.4 (4.8)	3.5 (2.6)	0.20 (0.15)

Table 2-14: EPA Non-Road Diesel Engine Emission Standards.

- Cold Starting
 - Test start-aid device effectiveness - (i.e. Glow Plugs, Oil Heaters, and Block Heaters)
 - Test fuel blend for cold weather additive packages (Fig 1.4)
 - Test minimum fuel standard quality (Fig 1.5)
 - Analyze oil for proper viscosity
 - Test governor for cold-idle stability
 - Verify cold cranking amps of batteries
 - Adjust fuel injection per altitude

API Gravity (Hydrometer Method)	ASTM D-287
Ash Content	ASTM D-482
Ramsbottom Carbon Residue	ASTM D-524
Cloud Point	ASTM D-2500
Copper Corrosion	ASTM D-130

Sulfur by X-Ray Fluorescence	ASTM D-4294
Distillation	ASTM D-86
Flash Point (Closed Cup)	ASTM D-93
Cetane Number	ASTM D-976
Sediment & Water	ASTM D-1796
Viscosity	ASTM D-445

Table 2-15: Fuel Analysis Limits

- Minimum Fuel Standards
 - Centane number of 40 or more
 - 0.5% sulfur or less by weight
 - 0.05% or less water

- Performance Testing
 - Compression Test
 - For compression PSI of 3000-4500 psi, variance between cylinders should not exceed 50-75 psi
 - Fuel injector pump and nozzle calibration
 - Fuel pump calibration
 - Governor and timing analysis
 - Valve timing inspection
 - Fuel properties evaluation
 - Evaluation of electronic control systems
 - Turbocharger boost adjustment
 - Filter inspections-air, oil and emissions
 - Air flow test
 - Fuel Flow test
 - Cylinder leakdown test
 - Load bank test
 - Megger test
 - Safety shutdown test

- Vibration Analysis
 - Torsional vibration analysis

- Cooling system evaluation
 - Evaluate for coolant flow and contamination of the coolant.

ph - ASTM 1287	8.5 - 10.5
reserve alkalinity ASTM D1121	detectable level
% EG/PG	50/50 water glycol
freeze / boiling point	per region
Nitrite, ppm NO ₂	10% of additive level
TDS (total dissolved solids)	5%
Appearance	free from suspended solids

Table 2-16: Coolant Acceptance Levels

2.25 Electrical Automatic Transfer Switch (ATS)

2.25.1 Required Equipment Information

Example for ATS:

- ATS Identification (Type)
- Location of Installation
- NASA Identification Number
- Date of Installation (Required or Actual Acceptance Date)
- Applicable NASA reference drawing number(s)

2.25.2 Required Acceptance Documentation

Example for ATS:

- Layout Drawings
- Manufacturer Data
- Maintenance Manual
- Warranty Information
- Test Reports
 - Contact Resistance Test Results
 - Insulation Resistance Test Results
 - Automatic Transfer Test Results
 - Airborne Ultrasonic Tests Results (Optional)
 - Power Factor Test Results (Optional)
 - Verification of Phase Rotation Test Results
 - Infrared Thermography Test Results (Optional)
- Certificates
- Parts List and Recommended Spare Parts List
- Baseline Data from Verification Test
- Acceptance Documentation (Dates and Signatures)

2.25.3 Acceptance Technologies and Criteria

- Contact Resistance Test (Refer to section B.13)
Refer to data set 2 in Appendix H for additional information.
- Insulation Resistance Testing (Refer to section B.10)
The contractor shall perform insulation resistance tests on all control wiring with respect to ground. Applied potential shall be 500 volts dc for 300 volt rated cable and 1000 volts dc for 600 volt rated cable. Test duration shall be one minute. For units with solid-state components or for control devices that cannot tolerate the applied voltage, follow manufacturer's recommendation.

Minimum acceptance criteria:

Better than or equal to manufacturer's specifications or in the absence of manufacturer's specifications, use the information contained in section B.10 for Insulation Resistance Testing.

- **Automatic Transfer Tests:**
Perform a series of automatic transfer tests to verify proper operation of the ATS. While performing these tests, confirm that the switch closes or opens in the proper time as specified by the manufacturer and that the switch stays in the proper position for the minimum time as specified by the manufacturer.
Simulate loss of normal power.
Return to normal power.
Simulate loss of emergency power.
Simulate all forms of single-phase conditions.
- **Airborne Ultrasonic Tests (Optional) (Refer to section B.6)**
Refer to data set 1 in Appendix H for additional information.
- **Power Factor Test (Optional) (Refer to section B.5)**
Refer to data set 8 in Appendix H for additional information.
- **Phase Rotation**
Verify phase rotation, phasing, and synchronized operation as required by the application.
- **Infrared Thermography (IRT) (Optional) (Refer to section B.4)**
Inspect the ATS distribution systems with imaging equipment capable of detecting a minimum temperature difference of 1° C at 30° C.

Minimum acceptance criteria:

- Equipment shall detect emitted radiation and convert detected radiation to visual signal. Thermographic surveys should be performed during periods of maximum possible loading. Refer to ANSI/NFPA 70B, Section 20.17 for reference information. Suggested actions based on temperature rise can be found in the table below.

Temperature difference (ΔT) based on comparisons between similar components under similar loading.	Temperature difference (ΔT) based upon comparisons between component and ambient air temperatures.	Recommended Action
1°C - 3°C	1°C - 10°C	Possible deficiency; warrants investigation
4°C - 15°C	11°C - 20°C	Indicates probable deficiency; repair as time permits
-----	21°C - 40°C	Monitor until corrective measures can be accomplished
>15°C	>40°C	Major discrepancy; repair immediately

Table 2-17: Thermographic Survey Suggested Actions Based on Temperature Rise

Temperature specifications vary depending on the exact type of equipment. Even in the same class of equipment (i.e., cables) there are various temperature ratings. Heating is generally related to the square of the current; therefore, the load current will have a major impact on ΔT . In the absence of consensus standards for ΔT , the values in this table will provide reasonable guidelines.

- Visual Inspection
 - Compare equipment nameplate data with drawings and specifications.
 - Inspect physical and mechanical condition.
 - Inspect anchorage, alignment, grounding, and required clearances.
 - Verify the unit is clean.
 - Lubrication requirements
 - Verify appropriate lubrication on moving current-carrying parts.
 - Verify appropriate lubrication on moving and sliding surfaces.
 - Verify that manual transfer warnings are attached and visible.
 - Verify tightness of all control connections.

- NASA SpecsIntact Reference: Section 16435 Automatic Transfer Switches - Automatic transfer switches for use with engine-generator sets for standby power.

2.26 Electric Buss

2.26.1 Required Equipment Information

- Buss Type
- Buss Specifications (including current and load capacity)
- Location of Installation
- NASA Identification Number
- Date of Installation (Required or Actual Acceptance Date)
- Applicable NASA reference drawing number(s)

2.26.2 Required Acceptance Documentation

- Material, Equipment and Fixture Lists
- Shop Drawings
 - Connection Diagrams
 - Fabrication Drawings
- Product Data
 - Equipment and Performance Data
 - Manufacturer's Catalog Data
- Test Reports
 - Insulation Resistance Test Results
 - Overpotential Test Results
 - Airborne Ultrasonic Test Results (Optional)
 - Infrared Thermography Test Results (Optional)
 - Contact Resistance Test Results
- Certificates
- Manufacturer's Instructions
- Operations Manual
- Maintenance Manual
- Warranty Information
- Parts List and Recommended Spare Parts List
- Acceptance Documentation (Dates and Signatures)

2.26.3 Acceptance Technologies and Criteria

- Insulation Resistance Test (Refer to section B.10)
Refer to data set 5 in Appendix H for additional information.
- Overpotential Test
The contractor shall perform an overpotential test on each busway, phase-to-ground with phases not under test grounded, in accordance with manufacturer's published data. If manufacturer has no recommendation for this test, it shall be in accordance with Table 100.17 of the 2003 NETA Acceptance Specifications. Where no dc test value is shown in Table 100.17, ac value shall be used. The test voltage shall be applied for one minute.

Minimum acceptance criteria:

- Better than or equal to manufacturer's specifications or in the absence of manufacturer's specifications, use the following from table from the 2003 NETA Acceptance Specifications.

Type of Bus	Rated kV	Maximum Test Voltage, kV	
		AC	DC
Isolated Phase for Generator Leads	24.5	37.0	52.0
	29.5	45.0	--
	34.5	60.0	--
Isolated Phase for Other than Generator Leads	15.5	37.0	52.0
	25.8	45.0	--
	38.0	60.0	--
Nonsegregated Phase	0.635	1.6	2.3
	4.76	14.2	20.0
	15.0	27.0	37.0
	25.8	45.0	63.0
	38.0	60.0	--
Segregated Phase	15.5	37.0	52.0
	25.8	45.0	63.0
	38.0	60.0	--
DC Bus Duct	0.3	1.6	2.3
	0.8	2.7	3.9
	1.2	3.4	4.8
	1.6	4.0	5.7
	3.2	6.6	9.3

Table 2-18: Dielectric Withstand Test Voltages Metal Enclosed Bus

Derived from ANSI/IEEE C37.23-1987, Tables 3A, 3B, 3C, 3D and paragraph 6.4.2. The table includes a 0.75 multiplier with fractions rounded down.

NOTE: The presence of the column headed "DC" does not imply any requirement for a dc withstand test on ac equipment. This column is given as a reference only for those using dc tests and represents values believed to be appropriate and approximately equivalent to the corresponding power frequency withstand test values specified for each class of bus.

Direct current withstand tests are recommended for flexible bus to avoid the loss of insulation life that may result from the dielectric heating that occurs with rated frequency withstand testing.

Because of the variable voltage distribution encountered when making dc withstand tests and variances in leakage currents associated with various insulation systems, the manufacturer should be consulted for recommendations before applying dc withstand tests to this equipment.

- Airborne Ultrasonic Tests (Optional) (Refer to section B.6)
Refer to data set 1 in Appendix H for additional information.
- Infrared Thermography (IRT) (Optional) (Refer to section B.4)
Refer to data set 4 in Appendix H for additional information.
- Contact Resistance Test (Refer to section B.13)
Refer to data set 2 in Appendix H for additional information.
- Visual Inspection
A visual inspection of the Electric Buss shall reveal no abnormalities or defects.

2.27 Electrical Control Panel

Electrical Control Panels provide control and/or monitoring of a variety of electrical equipment, such as pumps, valves, compressors, fans, chillers, and other electrically driven equipment. The “control panel” is primarily defined to be the NEMA type enclosure unit that contains components such as fuses, contact relays, power supply transformers, push button switches, contactors, starters, PLC’s, and monitoring/control interface equipment. The “control panel” includes the enclosure and all of the above items, and it also includes the terminal strips or connection points that connect each of these items. Other common and alternate names for a control panel could be operator interface systems, alarm panels, remote panels, pump panels, and controllers.

2.27.1 Required Equipment Information

- Electrical Control Panel Type (NEMA enclosure type)
- Electrical Control Panel Specifications
 - Voltage configuration (120/240 VAC, 12/24 VDC, etc.)
 - Amperage
 - Dimensions, Weight
 - UL certification, EMI levels (if applicable)
- Location of Installation
- NASA Identification Number
- Date of Installation (Required or Actual Acceptance Date)
- Applicable NASA reference drawing number(s)

2.27.2 Required Acceptance Documentation

- Material, Equipment and Fixture Lists
- Shop Drawings
 - Connection Diagrams
 - Fabrication Drawings
 - Installation Drawings
- Product Data
 - Equipment and Performance Data (if applicable)
 - Manufacturer’s Catalog Data
- Test Reports
 - Infrared Thermography Test (IRT) Results
 - Airborne Ultrasonic Test Results
 - Contact Resistance Test Results
 - Insulation Resistance Test Results
 - Power Factor Test Results
 - Baseline Data from Verification Tests
- Certificates
- Manufacturer’s Instructions
- Installation and Operations Manual
- Warranty Information

- Parts List and Recommended Spare Parts List
- Acceptance Documentation (with Dates and Signatures)

2.27.3 Acceptance Technologies and Criteria

* Note: Where some of the tests provide similar condition information, the NASA Construction Manager should determine which test need not be performed based on experience with the type and size of Electrical Control Panel.

- Contact Resistance Test (Refer to section B.13)
Refer to data set 2 in Appendix H for additional information.
- Infrared Thermography (IRT) (Refer to section B.4)
The contractor shall perform a thermographic survey to detect uneven heating indicative of loose or dirty terminal connections, other internal electrical connections to the individual components. This survey may also indicate internal corrosion or other flaws. Localized heating may be indicative of flaws in windings or insufficient ventilation of the surrounding area. Electrical panel loading should be > 50% for performing this test.

The infrared imager shall be a focal plane array camera with all of the following minimum requirements:

- Self contained with a minimum of 2 hours of battery capacity
- Temperature range of $-20\text{ }^{\circ}\text{C}$ to $300\text{ }^{\circ}\text{C}$
- Sensitive to $0.2\text{ }^{\circ}\text{C}$ over all temperature ranges
- Accurate to within $\pm 3\%$
- Must be capable of storing up to 12 images for later use
- Have a video recorder interface

Minimum acceptance criteria:

- Qualitative inspection using predefined relative difference limits, hot and cold spots, and deviations from normal or expected temperature ranges consistent with manufacturer's design data.

Minimum acceptable limits for this test are as follows:

- Qualitatively verify good terminal connections, internal connections to the individual components, and relative equivalent temperatures of the adjacent components during operation. Acceptable deviations in temperature will vary with the size and type of the electrical panel, but these limits should not exceed $\pm 5\text{ }^{\circ}\text{C}$. At no time should any of the terminal connections or internal connections to the individual components display a temperature in excess of $11.3\text{ }^{\circ}\text{C}$ greater than ambient.

- Airborne Ultrasonic Tests (Refer to section B.6)
The contractor shall use ultrasonics to verify the non-existence of electrical arcing and other high frequency events.

Minimum acceptance criteria:

< TBD based on unit test set

- Insulation Resistance Test (Optional) (Refer to section B.10)
Refer to data set 5 in Appendix H for additional information.
- Power Factor Test (Optional) (Refer to section B.5)
Refer to data set 8 in Appendix H for additional information.

Minimum acceptance criteria:

- Power factor must not exceed manufacturer's data.

- Electrical Acceptance Tests
The contractor shall perform electrical continuity tests on current, potential and control circuits.
The contractor shall perform a current test on the remainder of the secondary circuit to detect any open or short-circuit connections.
- Weatherproof Test (if applicable)
The contractor shall perform a weatherproof test in the presence of the Contracting Officer in accordance with IEEE C37.20.1
- Visual Inspection
A visual inspection of the Electrical Control Panel shall reveal no abnormalities or defects.

2.28 Electrical Distribution Panel

Electrical Distribution Panels provide power at designated voltage, current and frequency to a variety of electrical equipment, such as pumps, valves, compressors, fans, chillers and other electrically driven equipment. The “distribution panel” is primarily defined to be the NEMA type enclosure unit that contains components such as buss bars, circuit breakers, step down transformers, automatic/manual transfer switches, and optional monitoring/control equipment, and it also includes the terminal strips or connection points that connect each of these items

The electrical distribution panel as included in this section includes the foundation, enclosure, enclosure access doors, and terminal connection elements. The other components (such as the buss bars, circuit breakers, transformers, etc.) which are physically inside the enclosure, are addressed in other sections of this document.

2.28.1 Required Equipment Information

- Electrical Distribution Panel Type (NEMA enclosure type)
- Electrical Distribution Panel Specifications
 - Voltage configuration (120/240 VAC, 12/24 VDC, etc.)
 - Amperage (panel main bus maximum)
 - Dimensions, Weight
 - UL certification, EMI levels (if applicable)
 - Number of circuit breaker positions (outputs)
 - Electrical Distribution Panel impedance
- Location of Installation
- NASA Identification Number
- Date of Installation (Required or Actual Acceptance Date)
- Applicable NASA reference drawing number(s)

2.28.2 Required Acceptance Documentation

- Material, Equipment and Fixture Lists
- Shop Drawings
 - Equipment Foundation Drawings (if applicable)
 - Connection Diagrams
 - Fabrication Drawings
 - Installation Drawings
- Product Data
 - Equipment Foundation Data (if applicable)
 - Equipment and Performance Data (if applicable)
 - Manufacturer’s Catalog Data
- Test Reports
 - Infrared Thermography Test (IRT) Results
 - Airborne Ultrasonic Test Results
 - Contact Resistance Test Results

- Insulation Resistance Test Results
- Power Factor Test Results
- High Voltage Test Results
- Baseline Data from Verification Tests
- Certificates
- Manufacturer's Instructions
- Installation and Operations Manual
- Maintenance Manual
- Warranty Information
- Parts List and Recommended Spare Parts List
- Acceptance Documentation (with Dates and Signatures)

2.28.3 Acceptance Technologies and Criteria

* Note: Where some of the tests provide similar condition information, the NASA Construction Manager should determine which test need not be performed based on experience with the type and size of Electrical Distribution Panel.

- Infrared Thermography (IRT) (Refer to section B.4)

The contractor shall perform a thermographic survey to detect uneven heating indicative of loose or dirty terminal connections, other internal electrical connections to the individual components, and also uneven heating patterns in the oil and windings of transformers and oil breakers that may be integral to these Panels. This survey may also indicate internal corrosion or other flaws. Localized heating may be indicative of flaws in windings or insufficient ventilation of the surrounding area. A bank of same-type Electrical Distribution Panels with significantly different temperature readings may indicate unbalanced loading or a defective Electrical Distribution Panel. Electrical panel loading should be > 50% for performing this test.

The infrared imager shall be a focal plane array camera with all of the following minimum requirements:

- Self contained with a minimum of 2 hours of battery capacity
- Temperature range of -20 °C to 300 °C
- Sensitive to 0.2 °C over all temperature ranges
- Accurate to within ± 3%
- Must be capable of storing up to 12 images for later use
- Have a video recorder interface

Minimum acceptable limits for this test are as follows:

- Qualitatively verify good terminal connections, internal connections to the individual components, and relative equivalent temperatures of the adjacent components during operation. Acceptable deviations in temperature will vary with the size and type of the electrical panel, but these limits should not exceed ± 5 °C.

Refer to data set 4 in Appendix H for additional information.

- Airborne Ultrasonic Tests (Refer to section B.6)
The contractor shall use ultrasonics to verify the non-existence of electrical arcing and other high frequency events.

Minimum acceptance criteria: < TBD based on unit test set
- Contact Resistance Test (Refer to section B.13)
Refer to data set 2 in Appendix H for additional information.
- Insulation Resistance Test (Optional) (Refer to section B.10)
Refer to data set 5 in Appendix H for additional information.
- High Voltage Test (Optional) (Refer to section B.15)
Refer to data set 3 in Appendix H for additional information.
- Power Factor Test (Optional) (Refer to section B.5)
Refer to data set 8 in Appendix H for additional information.

Minimum acceptance criteria:
 - Power factor must not exceed manufacturer's data.
- Electrical Acceptance Tests
The contractor shall perform electrical continuity tests on current, potential and control circuits.
The contractor shall perform ratio and polarity tests on current and potential transformers (if applicable).
The contractor shall perform a current test on the remainder of the secondary circuit to detect any open or short-circuit connections.
- Weatherproof Test (if applicable)
The contractor shall perform a weatherproof test in the presence of the Contracting Officer in accordance with IEEE C37.20.1
- Visual Inspection
A visual inspection of the Electrical Distribution Panel shall reveal no abnormalities or defects.
- NASA SpecsIntact Reference: Section 16446 Panelboards - Power-distribution panelboards and lighting and appliance branch-circuit panelboards.

2.29 Electrical Grounding Grid

2.29.1 Required Equipment Information

- Grid Identification (Type)
- Location of Installation
- NASA Identification Number
- Date of Installation (Required or Actual Acceptance Date)
- Applicable NASA reference drawing number(s)

2.29.2 Required Acceptance Documentation

- Layout Drawings
- Test Point Locations
- Manufacturer Data
- Maintenance Manual
- Warranty Information
- Test Reports
 - Fall-of-Potential Test Results
 - Point-to-Point Test Results
- Certificates
- Parts List and Recommended Spare Parts List
- Baseline Data from Verification Test
- Acceptance Documentation (Dates and Signatures)

2.29.3 Acceptance Technologies and Criteria

- Fall Of Potential Test

The “fall of potential” test is used to test the grounding resistance of a single grounding electrode or grounding electrode system. The method involves passing a known current through the electrode to be tested (X) and another test electrode (Z) placed a specific distance away. A second test electrode (Y) is placed at a specified distance between the (X) electrode and (Z) electrode. The voltage drop between electrodes (X) and Y is measured by a voltmeter, and the current flow between electrodes (X) and (Z) is measured with an ammeter. The required resistance is calculated by dividing the measured voltage by the known current. Actual (Y) and (Z) distances are obtained from standardized tables.

Minimum acceptance criteria:

 - In accordance with ANSI/IEEE 81 on the main grounding electrode or system. The resistance between the main grounding electrode and ground should be no greater than five ohms for large commercial or industrial systems and 1.0 ohm or less for generating or transmission station grounds unless otherwise specified by the owner.

- Point to Point Resistance Test
 - Perform point-to-point tests to determine the resistance between the main grounding system and all major electrical equipment frames, system neutral, and/or derived neutral points.

Minimum acceptance criteria:

- Investigate point-to-point resistance values, which exceed 0.5 ohm.

2.30 Electrical Lightning Protection

Electrical Lightning Protection provides a designated path for the lightning current to travel. The system neither attracts nor repels a lightning strike, but simply intercepts and guides the current harmlessly to ground. A lightning protection system is made up of several components: Air Terminals (also known as lightning rods), Main Conductors (cables which interconnect the air terminals to grounds), Ground Terminations (typically copper or copper-clad rods driven into the earth a minimum of 10 feet in depth), Bonding Connections (are made to equalize the potential between grounded metal objects), Lightning Arresters (protect wiring from lightning induced damage), and Surge Suppressors (may be added to further protect valuable electronic equipment).

2.30.1 Required Equipment Information

- Electrical Lightning Protection for Type I or II building structures
- Class I Type Structures (Buildings below 75 feet in height)
- Class II Type Structures (Buildings at or above 75 feet in height)
- Class I & Class II Type Structures where the structural steel will be used in lieu of downlead or vertical cables
- Electrical Lightning Protection Specifications
 - UL certification – “Master Label” rating by a UL inspector
- Installation configuration
- NASA Identification Number
- Date of Installation (Required or Actual Acceptance Date)
- Applicable NASA reference drawing number(s)

2.30.2 Required Acceptance Documentation

- Material, Equipment and Fixture Lists
- Shop Drawings
 - Connection Diagrams
 - Fabrication Drawings
 - Installation Drawings
- Product Data
 - Equipment and Performance Data (if applicable)
 - Manufacturer’s Catalog Data
- Test Reports
 - Continuity Test
 - Insulation Resistance Test Results
 - Baseline Data from Verification Tests
- Certificates
- Manufacturer’s Instructions
- Installation and Operations Manual
- Maintenance Manual
- Warranty Information

- Parts List and Recommended Spare Parts List
- Acceptance Documentation (with Dates and Signatures)

2.30.3 Acceptance Technologies and Criteria

* Note: Where some of the tests provide similar condition information, the NASA Construction Manager should determine which test need not be performed based on experience with the type and size of Electrical Lightning Protection.

- Continuity Test (Optional)

The contractor shall perform a continuity test to determine the point to point continuity of an Electrical Lightning Protection circuit where visual observation is not possible. The contractor shall perform electrical continuity tests on current, potential and control circuits. The contractor shall perform a current test on the remainder of the secondary circuit to detect any open or short-circuit connections.

Minimum acceptance criteria:

- No discontinuity.

- Insulation Resistance Test (Optional) (Refer to section B.10)

The contractor shall perform the insulation resistance test to determine insulation resistance to ground. Use both the Dielectric Absorption and the Polarization Index. The insulation resistance test set shall have all of the following minimum requirements:

- Test Voltage increments of 500V, 1000V, 2500V, and 5000V DC
- Resistance range of 0.0 to 500,000 megohms at 500,000V DC
- A short-circuit terminal current of at least 2.5 milliamps
- Test voltage stability of $\pm 0.1\%$
- Resistance accuracy of $\pm 5\%$ at 1 megohm

Minimum acceptance criteria:

The complete ground system shall have no more than 10 ohms of resistance as measured per the IEEE fall of potential method.

Certification that surge protection is installed on the electrical service with a minimum of 160 ka per phase surge capacity.

- Visual Inspection

A visual inspection of the Electrical Lightning Protection shall reveal no abnormalities or defects.

- NASA SpecsIntact Reference: Section 13100 Lighting Protection Systems - Lightning protection, systems and installation.

2.31 Electrical Power Centers

Electrical Power Centers combine electrical distribution equipment [Distribution Panels] and building management controls [Control Panels] into a single factory-assembled and factory-wired integrated system. This approach replaces the traditional method of independently mounting each panel board, lighting control and building management system. These switchboard enclosure units contain the same components as Electrical Distribution and Control Panels. They may also contain lighting control, power and control cable wiring, contactors, and terminal blocks. They may be customized further with the addition of third party components, such as building management systems, automatic transfer switches or power conditioners. Power Centers also describe certain kinds of quality power filtering systems, system protection enclosures, and power distribution systems, but will not be addressed here.

2.31.1 Required Equipment Information

- Electrical Power Centers Type (NEMA enclosure type)
- Electrical Power Centers Specifications
 - Voltage configuration (120/240 VAC, 12/24 VDC, etc.)
 - Amperage (panel main bus maximum)
 - Dimensions, Weight
 - UL certification, EMI levels (if applicable)
 - Number of circuit breaker positions (outputs)
 - Electrical Power Centers impedance
- Location of Installation
- NASA Identification Number
- Date of Installation (Required or Actual Acceptance Date)
- Applicable NASA reference drawing number(s)

2.31.2 Required Acceptance Documentation

- Material, Equipment and Fixture Lists
- Shop Drawings
 - Equipment Foundation Drawings (if applicable)
 - Connection Diagrams
 - Fabrication Drawings
 - Installation Drawings
- Product Data
 - Equipment Foundation Data (if applicable)
 - Equipment and Performance Data (if applicable)
 - Manufacturer's Catalog Data
- Test Reports
 - Infrared Thermography Test (IRT) Results
 - Airborne Ultrasonic Test Results
 - Contact Resistance Test Results
 - Insulation Resistance Test Results

- Power Factor Test Results
- High Voltage Test Results
- Baseline Data from Verification Tests
- Certificates
- Manufacturer's Instructions
- Installation and Operations Manual
- Maintenance Manual
- Warranty Information
- Parts List and Recommended Spare Parts List
- Acceptance Documentation (with Dates and Signatures)

2.31.3 Acceptance Technologies and Criteria

* Note: Where some of the tests provide similar condition information, the NASA Construction Manager should determine which test need not be performed based on experience with the type and size of Electrical Power Centers.

- Infrared Thermography (IRT) (Refer to section B.4)
 - The contractor shall perform a thermographic survey to detect uneven heating indicative of loose or dirty terminal connections, other internal electrical connections to the individual components, and also uneven heating patterns in the oil and windings of transformers and oil breakers that may be integral to these Panels. This survey may also indicate internal corrosion or other flaws. Localized heating may be indicative of flaws in windings or insufficient ventilation of the surrounding area. A bank of same-type Electrical Power Centers with significantly different temperature readings may indicate unbalanced loading or a defective Electrical Power Center. Electrical panel loading should be > 50% for performing this test.

The infrared imager shall be a focal plane array camera with all of the following minimum requirements:

- Self contained with a minimum of 2 hours of battery capacity
- Temperature range of -20°C to 300°C
- Sensitive to 0.2°C over all temperature ranges
- Accurate to within $\pm 3\%$
- Must be capable of storing up to 12 images for later use
- Have a video recorder interface

Minimum acceptance criteria:

- Qualitative inspection using predefined relative difference limits, hot and cold spots, and deviations from normal or expected temperature ranges consistent with manufacturer's design data.

Minimum acceptable limits for this test are as follows:

- Qualitatively verify good terminal connections, internal connections to the individual components, and relative equivalent temperatures of the adjacent components during operation. Acceptable deviations in temperature will vary

with the size and type of the electrical panel, but these limits should not exceed ± 5 °C. At no time should any of the terminal connections or internal connections to the individual components display a temperature in excess of 11.3°C greater than ambient.

- Airborne Ultrasonic Tests (Refer to section B.6)
The contractor shall use ultrasonics to verify the non-existence of electrical arcing and other high frequency events.

Minimum acceptance criteria: < TBD based on unit test set

- Contact Resistance Test (Refer to section B.13)
Refer to data set 2 in Appendix H for additional information.
- Insulation Resistance Test (Optional) (Refer to section B.10)
Refer to data set 5 in Appendix H for additional information.
- High Voltage Test (Optional) (Refer to section B.15)
Refer to data set 3 in Appendix H for additional information.
- Power Factor Test (Optional) (Refer to section B.5)
Refer to data set 8 in Appendix H for additional information.

Minimum acceptance criteria:

- Power factor must not exceed manufacturer's data.

- Electrical Acceptance Tests
The contractor shall perform electrical continuity tests on current, potential and control circuits.
The contractor shall perform ratio and polarity tests on current and potential transformers (if applicable).
The contractor shall perform a current test on the remainder of the secondary circuit to detect any open or short-circuit connections.
- Weatherproof Test (if applicable)
The contractor shall perform a weatherproof test in the presence of the Contracting Officer in accordance with IEEE C37.20.1
- Visual Inspection
A visual inspection of the Electrical Power Centers shall reveal no abnormalities or defects.

2.32 Electrical Power Supplies

Electrical Power Supplies provide a reliable source of power for direct use by a variety of loads to prevent undesired features of the power source such as outages, sags, surges, bad harmonics, etc. The input source is normally from a standard receptacle, (e.g. a wall outlet), and they normally convert power, usually from AC to DC and/or from low current to high current, for direct use by the device (e.g. a computer). These power supplies are physically contained in various types of enclosure units [NEMA enclosures, racks, panels] and contain such components as capacitors, transformers, heat sinks, switching transistors, diodes, fuses, contact relays, toggle switches, cooling fans, and monitoring/control interface equipment. Electrical power supplies are also known by the following alternate names: high voltage power supplies, switching power supplies, AC/DC converters, AC-DC adapters, AC power sources, power inverters (DC to AC), and uninterruptible power supplies (which provide clean and stable power).

2.32.1 Required Equipment Information

- Electrical Power Supply Type
- Electrical Power Supply Specifications
 - DC Output ratings
 - Dimensions, Weight
 - UL certification, EMI levels (if applicable)
 - Electrical Power Supply impedance
- Location of Installation
- NASA Identification Number
- Date of Installation (Required or Actual Acceptance Date)
- Applicable NASA reference drawing number(s)

2.32.2 Required Acceptance Documentation

- Material, Equipment and Fixture Lists
- Shop Drawings
 - Connection Diagrams
 - Fabrication Drawings
 - Installation Drawings
- Product Data
 - Equipment and Performance Data (if applicable)
 - Manufacturer's Catalog Data
- Test Reports
 - Infrared Thermography Test (IRT) Results
 - Contact Resistance Test Results
 - Insulation Resistance Test Results
 - Power Factor Test Results
 - Baseline Data from Verification Tests
- Certificates
- Manufacturer's Instructions
- Installation and Operations Manual

- Maintenance Manual
- Warranty Information
- Parts List and Recommended Spare Parts List
- Acceptance Documentation (with Dates and Signatures)

2.32.3 Acceptance Technologies and Criteria

* Note: Where some of the tests provide similar condition information, the NASA Construction Manager should determine which test need not be performed based on experience with the type and size of Electrical Power Supply.

- Infrared Thermography (IRT) (Refer to section B.4)
The contractor shall perform a thermographic survey to detect uneven heating indicative of loose or dirty terminal connections, and other internal electrical connections to the individual components. This survey may also indicate internal corrosion or other flaws. Localized heating may be indicative of flaws in windings or insufficient ventilation of the surrounding area. Electrical panel loading should be > 50% for performing this test.

The infrared imager shall be a focal plane array camera with all of the following minimum requirements:

- Self contained with a minimum of 2 hours of battery capacity
- Temperature range of $-20\text{ }^{\circ}\text{C}$ to $300\text{ }^{\circ}\text{C}$
- Sensitive to $0.2\text{ }^{\circ}\text{C}$ over all temperature ranges
- Accurate to within $\pm 3\%$
- Must be capable of storing up to 12 images for later use
- Have a video recorder interface

Minimum acceptance criteria:

- Qualitative inspection using predefined relative difference limits, hot and cold spots, and deviations from normal or expected temperature ranges consistent with manufacturer's design data.

Minimum acceptable limits for this test are as follows:

- Qualitatively verify good terminal connections, internal connections to the individual components, and relative equivalent temperatures of the adjacent components during operation. Acceptable deviations in temperature will vary with the size and type of the electrical panel, but these limits should not exceed $\pm 5\text{ }^{\circ}\text{C}$. At no time should any of the terminal connections or internal connections to the individual components display a temperature in excess of 11.3°C greater than ambient.

- Contact Resistance Test (Refer to section B.13)
Refer to data set 2 in Appendix H for additional information.
- Insulation Resistance Test (Optional) (Refer to section B.10)
Refer to data set 5 in Appendix H for additional information.

- Power Factor Test (Optional) (Refer to section B.5)
Refer to data set 8 in Appendix H for additional information.

Minimum acceptance criteria:
 - Power factor must not exceed manufacturer's data.

- Electrical Acceptance Tests
The contractor shall perform electrical continuity tests on current, potential and control circuits.
The contractor shall perform ratio and polarity tests on current and potential transformers (if applicable).
The contractor shall perform a current test on the remainder of the secondary circuit to detect any open or short-circuit connections.

- Weatherproof Test (if applicable)
The contractor shall perform a weatherproof test in the presence of the Contracting Officer in accordance with IEEE C37.20.1

- Visual Inspection
A visual inspection of the Electrical Power Supply shall reveal no abnormalities or defects.

2.33 Electrical Rectifiers

Electrical Rectifiers are defined as electrical circuits that convert an AC signal into a DC signal. Rectifier systems may contain such components as high power thyristors, transformers, cooling units, over voltage protection resistors, pulse amplifiers, heat sink panels, and monitoring/control interface equipment. Sometimes called rectifier diodes, they are electronic devices, which allow current to flow in one direction only. Similarly, Silicon Controlled Rectifiers (SCR) are thyristors for forward bias, unidirectional power switching and control. These rectifier systems can also be described as thyristors, converters, bridge rectifiers, silicon controlled rectifiers (SCR), and diode rectifiers.

2.33.1 Required Equipment Information

- Electrical Rectifier Type (enclosure type)
- Electrical Rectifiers Specifications
 - DC Voltage range (and DC current supply, kA)
 - Thyristor configurations (bridge, double-star, parallel)
 - Pulse number per unit
 - Dimensions, Weight
 - UL certification
- Location of Installation
- NASA Identification Number
- Date of Installation (Required or Actual Acceptance Date)
- Applicable NASA reference drawing number(s)

2.33.2 Required Acceptance Documentation

- Material, Equipment and Fixture Lists
- Shop Drawings
 - Equipment Foundation Drawings (if applicable)
 - Connection Diagrams
 - Fabrication Drawings
 - Installation Drawings
- Product Data
 - Equipment Foundation Data (if applicable)
 - Equipment and Performance Data (if applicable)
 - Manufacturer's Catalog Data
- Test Reports
 - Insulation Resistance Test Results
 - Power Factor Test Results
 - Turns Ratio Test Results
 - Contact Resistance Test Results
 - High Voltage Test Results
 - Infrared Thermography Test (IRT) Results
 - Airborne Ultrasonic Test Results
 - Baseline Data from Verification Tests
- Certificates

- Manufacturer's Instructions
- Installation and Operations Manual
- Maintenance Manual
- Warranty Information
- Parts List and Recommended Spare Parts List
- Acceptance Documentation (with Dates and Signatures)

2.33.3 Acceptance Technologies and Criteria

* Note: Where some of the tests provide similar condition information, the NASA Construction Manager should determine which test need not be performed based on experience with the type and size of Electrical Rectifiers.

- Insulation Resistance Test (Refer to section B.10)
Refer to data set 5 in Appendix H for additional information.
- Power Factor Test (Optional) (Refer to section B.5)
Refer to data set 8 in Appendix H for additional information.

Minimum acceptance criteria:

- Power factor must not exceed manufacturer's data.

- Turns Ratio Test (Refer to section B.16)
The contractor shall verify acceptable turns ratio.

Minimum acceptance criteria: $\pm 2\%$ design specifications

- Contact Resistance Test (Refer to section B.13)
Refer to data set 2 in Appendix H for additional information.
- High Voltage Test (Refer to section B.15)
Refer to data set 3 in Appendix H for additional information.

- Infrared Thermography (IRT) (Optional) (Refer to section B.4)
The contractor shall perform a thermographic survey to detect uneven heating indicative of loose or dirty terminal connections, other internal electrical connections to the individual components. This survey may also indicate internal corrosion or other flaws. Localized heating may be indicative of flaws in windings or insufficient ventilation of the surrounding area. A bank of same-type Electrical Rectifiers with significantly different temperature readings may indicate unbalanced loading or a defective Electrical Rectifiers.

The infrared imager shall be a focal plane array camera with all of the following minimum requirements:

- Self contained with a minimum of 2 hours of battery capacity
- Temperature range of $-20\text{ }^{\circ}\text{C}$ to $300\text{ }^{\circ}\text{C}$

- Sensitive to 0.2 °C over all temperature ranges
- Accurate to within $\pm 3\%$
- Must be capable of storing up to 12 images for later use
- Have a video recorder interface

Minimum acceptance criteria:

- Qualitative inspection using predefined relative difference limits, hot and cold spots, and deviations from normal or expected temperature ranges consistent with manufacturer's design data.

Minimum acceptable limits for this test are as follows:

- Qualitatively verify good terminal connections, internal connections to the individual components, and relative equivalent temperatures of the adjacent components during operation. Acceptable deviations in temperature will vary with the size and type of the electrical panel, but these limits should not exceed ± 5 °C. At no time should any of the terminal connections or internal connections to the individual components display a temperature in excess of 11.3°C greater than ambient.

- Airborne Ultrasonic Tests (Optional) (Refer to section B.6)
The contractor shall use ultrasonics to verify the non-existence of electrical arcing and other high frequency events.

Minimum acceptance criteria: < TBD based on unit test set

- Electrical Acceptance Tests
The contractor shall perform electrical continuity tests on current, potential and control circuits.
The contractor shall perform ratio and polarity tests on current and potential transformers (if applicable).
The contractor shall perform a current test on the remainder of the secondary circuit to detect any open or short-circuit connections.
- Weatherproof Test (if applicable)
The contractor shall perform a weatherproof test in the presence of the Contracting Officer in accordance with IEEE C37.20.1
- Visual Inspection
A visual inspection of the Electrical Rectifiers shall reveal no abnormalities or defects.

2.34 Electrical Relays

Electrical Relays are defined as electromechanical switching devices that open and close electrical contacts to effect the operation of other devices in the same or another electrical circuit. Power relays can be either solid state or microprocessor based relays that are designed to protect the following types of systems: transmission lines, generators, transformers, motors, feeders, bus systems, and distribution systems. Their main components include electromagnets, contacts, armatures and springs. Many times they are part of a larger package that includes protection, metering, monitoring and control. They can be also be described as contact protection circuits, temperature tolerant relays, contactors, latching relays, and power relays. In this guide they are not equivalent to printed circuit board relays, or solid state relays, or specialty [like time delay] relays.

2.34.1 Required Equipment Information

- Electrical Relay Type (NEMA enclosure type)
- Electrical Relay Specifications
 - Voltage configuration
 - Time over current curves (time delay curves)
 - Phase and ground operating curves (shapes)
 - Dimensions, Weight
 - UL certification, EMI levels (if applicable)
 - Number and types of output relays
 - Current loading
- Location of Installation
- NASA Identification Number
- Date of Installation (Required or Actual Acceptance Date)
- Applicable NASA reference drawing number(s)

2.34.2 Required Acceptance Documentation

- Material, Equipment and Fixture Lists
- Shop Drawings
 - Connection Diagrams
 - Installation Drawings
- Product Data
 - Equipment and Performance Data (if applicable)
 - Manufacturer's Catalog Data
- Test Reports
 - Insulation Resistance Test Results
 - Contact Resistance Test Results
- Certificates
- Manufacturer's Instructions
- Installation and Operations Manual
- Warranty Information
- Parts List and Recommended Spare Parts List
- Acceptance Documentation (with Dates and Signatures)

2.34.3 Acceptance Technologies and Criteria

* Note: Where some of the tests provide similar condition information, the NASA Construction Manager should determine which test need not be performed based on experience with the type and size of Electrical Relays.

- Insulation Resistance Test (Refer to section B.10)
Refer to data set 5 in Appendix H for additional information.
- Contact Resistance Test (Optional) (Refer to section B.13)
Refer to data set 2 in Appendix H for additional information.
- Electrical Acceptance Tests
The contractor shall perform electrical continuity tests on current, potential and control circuits.
The contractor shall perform a current test on the remainder of the secondary circuit to detect any open or short-circuit connections.
- Visual Inspection
A visual inspection of the Electrical Relays shall reveal no abnormalities or defects.

2.35 Electrical Starters

Electrical Starters are used in a variety of industrial electric equipment including air conditioning, heating, refrigeration, food processing, agricultural plus numerous other applications. Usually within NEMA type enclosure units they include such components as fuses, overload contact relays, full voltage reversing, non-reversing and multi-speed contactors, PLC's, and monitoring/control interface equipment. They are designed to provide starter control and overload protection of individual motorized components (pumps, valves, compressors, fans, chillers) and other electrically driven equipment or combinations of these. They can be described as motor starters, full or reduced voltage starters, or definite purpose starters.

2.35.1 Required Equipment Information

- Electrical Starter Type (NEMA enclosure type)
- Electrical Starter Specifications
 - Amperage and voltage configuration (25A-60A, <600V and ¼-50HP, etc.)
 - Overload settings
 - Dimensions, Weight
 - UL certification, EMI levels (if applicable)
- Location of Installation
- NASA Identification Number
- Date of Installation (Required or Actual Acceptance Date)
- Applicable NASA reference drawing number(s)

2.35.2 Required Acceptance Documentation

- Material, Equipment and Fixture Lists
- Shop Drawings
 - Connection Diagrams
 - Fabrication Drawings
 - Installation Drawings
- Product Data
 - Equipment and Performance Data (if applicable)
 - Manufacturer's Catalog Data
- Test Reports
 - Infrared Thermography Test (IRT) Results
 - Airborne Ultrasonic Test Results
 - Contact Resistance Test Results
 - Insulation Resistance Test Results
 - Weatherproof Test Results
 - Baseline Data from Verification Tests
- Certificates
- Manufacturer's Instructions
- Installation and Operations Manual
- Warranty Information
- Parts List and Recommended Spare Parts List
- Acceptance Documentation (with Dates and Signatures)

2.35.3 Acceptance Technologies and Criteria

* Note: Where some of the tests provide similar condition information, the NASA Construction Manager should determine which test need not be performed based on experience with the type and size of Electrical Starter.

- Infrared Thermography (IRT) (Refer to section B.4)

The contractor shall perform a thermographic survey to detect uneven heating indicative of loose or dirty terminal connections or other internal electrical connections to the individual components. This survey may also indicate internal corrosion or other flaws. Localized heating may be indicative of flaws in windings or insufficient ventilation of the surrounding area. Electrical panel loading should be > 50% for performing this test.

The infrared imager shall be a focal plane array camera with all of the following minimum requirements:

- Self contained with a minimum of 2 hours of battery capacity
- Temperature range of -20°C to 300°C
- Sensitive to 0.2°C over all temperature ranges
- Accurate to within $\pm 3\%$
- Must be capable of storing up to 12 images for later use
- Have a video recorder interface

Minimum acceptance criteria:

- Qualitative inspection using predefined relative difference limits, hot and cold spots, and deviations from normal or expected temperature ranges consistent with manufacturer's design data.

Minimum acceptable limits for this test are as follows:

- Qualitatively verify good terminal connections, internal connections to the individual components, and relative equivalent temperatures of the adjacent components during operation. Acceptable deviations in temperature will vary with the size and type of the electrical panel, but these limits should not exceed $\pm 5^{\circ}\text{C}$. At no time should any of the terminal connections or internal connections to the individual components display a temperature in excess of 11.3°C greater than ambient.

- Airborne Ultrasonic Tests (Refer to section B.6)

The contractor shall use ultrasonics to verify the non-existence of electrical arcing and other high frequency events.

Minimum acceptance criteria: < TBD based on unit test set

- Contact Resistance Test (Optional) (Refer to section B.13)
Refer to data set 2 in Appendix H for additional information.
- Insulation Resistance Test (Optional) (Refer to section B.10)

Refer to data set 5 in Appendix H for additional information.

- **Electrical Acceptance Tests**
The contractor shall perform electrical continuity tests on current, potential and control circuits.
The contractor shall perform a current test on the remainder of the secondary circuit to detect any open or short-circuit connections.
- **Weatherproof Test (if applicable)**
The contractor shall perform a weatherproof test in the presence of the Contracting Officer in accordance with IEEE C37.20.1
- **Visual Inspection**
A visual inspection of the Electrical Starter shall reveal no abnormalities or defects.

2.36 Electric Switch, Cutouts

2.36.1 Required Equipment Information

- Switch Type
- Switch Specifications
- Location of Installation
- NASA Identification Number
- Date of Installation (Required or Actual Acceptance Date)
- Applicable NASA reference drawing number(s)

2.36.2 Required Acceptance Documentation

- Material, Equipment and Fixture Lists
- Shop Drawings
 - Connection Diagrams
 - Fabrication Drawings
- Product Data
 - Equipment and Performance Data
 - Manufacturer's Catalog Data
- Test Reports
 - Contact Resistance Test Results
 - Insulation Resistance Test Results
 - Airborne Ultrasonic Test Results (Optional)
 - Power Factor Test Results (Optional)
 - High Voltage Test Results (Optional)
 - Infrared Thermography Test Results (Optional)
- Certificates
- Manufacturer's Instructions
- Operations Manual
- Maintenance Manual
- Warranty Information
- Parts List and Recommended Spare Parts List
- Acceptance Documentation (Dates and Signatures)

2.36.3 Acceptance Technologies and Criteria

*** Note: Based on type, size and voltage of the switch, the NASA Construction Manager should determine which test(s)/technologies should be performed. Some of the below listed tests/technologies do not apply to every type of switch.

- Contact Resistance Test (Refer to section B.13)
Refer to data set 2 in Appendix H for additional information.
- Insulation Resistance Test (Refer to section B.10)

Refer to data set 5 in Appendix H for additional information.

- Airborne Ultrasonic Tests (Optional) (Refer to section B.6)
Refer to data set 1 in Appendix H for additional information.
- Power Factor Test (Optional) (Refer to section B.5)
Refer to data set 8 in Appendix H for additional information.
- High Voltage Test (Optional) (Refer to section B.15)
Refer to data set 3 in Appendix H for additional information.

Minimum acceptance criteria:

- The following table and notes are taken from 2003 NETA Acceptance Specifications.

- Infrared Thermography (IRT) (Optional) (Refer to section B.4)
Refer to data set 4 in Appendix H for additional information.
- Visual Inspection
A visual inspection of the switch shall reveal no abnormalities or defects.

2.37 Electric Switch, Low Voltage Air

2.37.1 Required Equipment Information

- Switch Type
- Switch Specifications
- Location of Installation
- NASA Identification Number
- Date of Installation (Required or Actual Acceptance Date)
- Applicable NASA reference drawing number(s)

2.37.2 Required Acceptance Documentation

- Material, Equipment and Fixture Lists
- Shop Drawings
 - Connection Diagrams
 - Fabrication Drawings
- Product Data
 - Equipment and Performance Data
 - Manufacturer's Catalog Data
- Test Reports
 - Contact Resistance Test Results
 - Insulation Resistance Test Results
 - Airborne Ultrasonic Test Results (Optional)
 - Infrared Thermography Test Results (Optional)
- Certificates
- Manufacturer's Instructions
- Operations Manual
- Maintenance Manual
- Warranty Information
- Parts List and Recommended Spare Parts List
- Acceptance Documentation (Dates and Signatures)

2.37.3 Acceptance Technologies and Criteria

*** Note: Based on type, size and voltage of the switch, the NASA Construction Manager should determine which test(s)/technologies should be performed. Some of the below listed tests/technologies do not apply to every type of switch.

- Contact Resistance Test (Refer to section B.13)
Refer to data set 2 in Appendix H for additional information.
- Insulation Resistance Test (Refer to section B.10)
Refer to data set 5 in Appendix H for additional information.

- Airborne Ultrasonic Tests (Optional) (Refer to section B.6)
Refer to data set 1 in Appendix H for additional information.
- Infrared Thermography (IRT) (Optional) (Refer to section B.4)
Refer to data set 4 in Appendix H for additional information.
- Visual Inspection
A visual inspection of the switch shall reveal no abnormalities or defects.

2.38 Electric Switch, Medium & High Voltage Air, Open

2.38.1 Required Equipment Information

- Switch Type
- Switch Specifications
- Location of Installation
- NASA Identification Number
- Date of Installation (Required or Actual Acceptance Date)
- Applicable NASA reference drawing number(s)

2.38.2 Required Acceptance Documentation

- Material, Equipment and Fixture Lists
- Shop Drawings
 - Connection Diagrams
 - Fabrication Drawings
- Product Data
 - Equipment and Performance Data
 - Manufacturer's Catalog Data
- Test Reports
 - Contact Resistance Test Results
 - Insulation Resistance Test Results
 - Airborne Ultrasonic Test Results (Optional)
 - Power Factor Test Results (Optional)
 - High Voltage Test Results (Optional)
 - Infrared Thermography Test Results (Optional)
- Certificates
- Manufacturer's Instructions
- Operations Manual
- Maintenance Manual
- Warranty Information
- Parts List and Recommended Spare Parts List
- Acceptance Documentation (Dates and Signatures)

2.38.3 Acceptance Technologies and Criteria

*** Note: Based on type, size and voltage of the switch, the NASA Construction Manager should determine which test(s)/technologies should be performed. Some of the below listed tests/technologies do not apply to every type of switch.

- Contact Resistance Test (Refer to section B.13)
Refer to data set 2 in Appendix H for additional information.

- Insulation Resistance Test (Refer to section B.10)
Refer to data set 5 in Appendix H for additional information.
- Airborne Ultrasonic Tests (Optional) (Refer to section B.6)
Refer to data set 1 in Appendix H for additional information.
- Power Factor Test (Optional) (Refer to section B.5)
Refer to data set 8 in Appendix H for additional information.
- High Voltage Test (Optional) (Refer to section B.15)
Refer to data set 3 in Appendix H for additional information.
- Infrared Thermography (IRT) (Optional) (Refer to section B.4)
Refer to data set 4 in Appendix H for additional information.
- Visual Inspection
A visual inspection of the switch shall reveal no abnormalities or defects.

2.39 Electric Switch, Medium Voltage Air, Metal Enclosed

2.39.1 Required Equipment Information

- Switch Type
- Switch Specifications
- Location of Installation
- NASA Identification Number
- Date of Installation (Required or Actual Acceptance Date)
- Applicable NASA reference drawing number(s)

2.39.2 Required Acceptance Documentation

- Material, Equipment and Fixture Lists
- Shop Drawings
 - Connection Diagrams
 - Fabrication Drawings
- Product Data
 - Equipment and Performance Data
 - Manufacturer's Catalog Data
- Test Reports
 - Contact Resistance Test Results
 - Insulation Resistance Test Results
 - Airborne Ultrasonic Test Results (Optional)
 - Power Factor Test Results (Optional)
 - High Voltage Test Results (Optional)
 - Infrared Thermography Test Results (Optional)
- Certificates
- Manufacturer's Instructions
- Operations Manual
- Maintenance Manual
- Warranty Information
- Parts List and Recommended Spare Parts List
- Acceptance Documentation (Dates and Signatures)

2.39.3 Acceptance Technologies and Criteria

*** Note: Based on type, size and voltage of the switch, the NASA Construction Manager should determine which test(s)/technologies should be performed. Some of the below listed tests/technologies do not apply to every type of switch.

- Contact Resistance Test (Refer to section B.13)
Refer to data set 2 in Appendix H for additional information.

- Insulation Resistance Test (Refer to section B.10)
Refer to data set 5 in Appendix H for additional information.
- Airborne Ultrasonic Tests (Optional) (Refer to section B.6)
Refer to data set 1 in Appendix H for additional information.
- Power Factor Test (Optional) (Refer to section B.5)
Refer to data set 8 in Appendix H for additional information.
- High Voltage Test (Optional) (Refer to section B.15)
Refer to data set 3 in Appendix H for additional information.

Minimum acceptance criteria:
 - The following table and notes are taken from 2003 NETA Acceptance Specifications.
- Infrared Thermography (IRT) (Optional) (Refer to section B.4)
Refer to data set 4 in Appendix H for additional information.
- Visual Inspection
A visual inspection of the switch shall reveal no abnormalities or defects.
- NASA SpecsIntact Reference: Section 16326 Medium-Voltage Air-Break disconnect Switches - Air-break, single-pole and gang-operated disconnecting/isolating switches 2.4 kilovolts and above.

2.40 Electric Switch, Medium Voltage Oil

2.40.1 Required Equipment Information

- Switch Type
- Switch Specifications
- Location of Installation
- NASA Identification Number
- Date of Installation (Required or Actual Acceptance Date)
- Applicable NASA reference drawing number(s)

2.40.2 Required Acceptance Documentation

- Material, Equipment and Fixture Lists
- Shop Drawings
 - Connection Diagrams
 - Fabrication Drawings
- Product Data
 - Equipment and Performance Data
 - Manufacturer's Catalog Data
- Test Reports
 - Contact Resistance Test Results
 - Insulation Resistance Test Results
 - Airborne Ultrasonic Test Results (Optional)
 - Power Factor Test Results (Optional)
 - High Voltage Test Results (Optional)
 - Insulation Oil Test Results
 - Infrared Thermography Test Results (Optional)
- Certificates
- Manufacturer's Instructions
- Operations Manual
- Maintenance Manual
- Warranty Information
- Parts List and Recommended Spare Parts List
- Acceptance Documentation (Dates and Signatures)

2.40.3 Acceptance Technologies and Criteria

*** Note: Based on type, size and voltage of the switch, the NASA Construction Manager should determine which test(s)/technologies should be performed. Some of the below listed tests/technologies do not apply to every type of switch.

- Contact Resistance Test (Refer to section B.13)
Refer to data set 2 in Appendix H for additional information.
- Insulation Resistance Test (Refer to section B.10)

Perform insulation-resistance tests on all control wiring with respect to ground. Applied potential shall be 500 volts dc for 300 volt rated cable and 1000 volts dc for 600 volt rated cable. Test duration shall be one minute. For units with solid-state components or control devices that cannot tolerate the applied voltage, follow manufacturer's recommendation.

Perform insulation-resistance tests on each pole, phase-to-phase and phase-to-ground with switch closed and across each open pole for one minute. Test voltage shall be in accordance with manufacturer's published data or Table 100.1. Use both the Dielectric Absorption and the Polarization Index. The insulation resistance test set shall have all of the following minimum requirements:

- Test Voltage increments of 500V, 1000V, 2500V, and 5000V DC
- Resistance range of 0.0 to 500,000 megohms at 500,000V DC
- A short-circuit terminal current of at least 2.5 milliamps
- Test voltage stability of $\pm 0.1\%$
- Resistance accuracy of $\pm 5\%$ at 1 megohm

Minimum acceptance criteria:

- Better than or equal to manufacturer's specifications or in the absence of manufacturer's specifications, use the information contained in section B.10 for Insulation Resistance Testing.

- Airborne Ultrasonic Tests (Optional) (Refer to section B.6)
Refer to data set 1 in Appendix H for additional information.
- Power Factor Test (Optional) (Refer to section B.5)
Refer to data set 8 in Appendix H for additional information.
- High Voltage Test (Optional) (Refer to section B.15)
Refer to data set 3 in Appendix H for additional information.
- Insulation Oil Test (Refer to section B.8)
Remove a sample of insulating liquid in accordance with ASTM D 923. Sample shall be tested in accordance with the referenced standard.
 1. Dielectric breakdown voltage: ASTM D 877
 2. Color: ANSI/ASTM D 1500
 3. Visual condition: ASTM D 1524

Minimum acceptance criteria:

- In accordance with tables B.x and B.x, Section B.10 referring to Oil Condition Tests and Limits for New Oil.

- Infrared Thermography (IRT) (Optional) (Refer to section B.4)
Refer to data set 4 in Appendix H for additional information.
- Visual Inspection
A visual inspection of the switch shall reveal no abnormalities or defects.

2.41 Electric Switch, Medium Voltage SF6

2.41.1 Required Equipment Information

- Switch Type
- Switch Specifications
- Location of Installation
- NASA Identification Number
- Date of Installation (Required or Actual Acceptance Date)
- Applicable NASA reference drawing number(s)

2.41.2 Required Acceptance Documentation

- Material, Equipment and Fixture Lists
- Shop Drawings
 - Connection Diagrams
 - Fabrication Drawings
- Product Data
 - Equipment and Performance Data
 - Manufacturer's Catalog Data
- Test Reports
 - Contact Resistance Test Results
 - Insulation Resistance Test Results
 - Vacuum Bottle Integrity Test Results
 - SF₆ Gas Test Results
 - Airborne Ultrasonic Test Results (Optional)
 - Power Factor Test Results (Optional)
 - High Voltage Test Results (Optional)
 - Infrared Thermography Test Results (Optional)
- Certificates
- Manufacturer's Instructions
- Operations Manual
- Maintenance Manual
- Warranty Information
- Parts List and Recommended Spare Parts List
- Acceptance Documentation (Dates and Signatures)

2.41.3 Acceptance Technologies and Criteria

*** Note: Based on type, size and voltage of the switch, the NASA Construction Manager should determine which test(s)/technologies should be performed. Some of the below listed tests/technologies do not apply to every type of switch.

- Contact Resistance Test (Refer to section B.13)

Refer to data set 2 in Appendix H for additional information.

- Insulation Resistance Test (Refer to section B.10)

Perform insulation-resistance tests on all control wiring with respect to ground. Applied potential shall be 500 volts dc for 300 volt rated cable and 1000 volts dc for 600 volt rated cable. Test duration shall be one minute. For units with solid-state components, follow manufacturer's recommendation.

Refer to data set 5 in Appendix H for additional information.

- Vacuum Bottle Integrity Test

Perform vacuum bottle integrity (overpotential) test across each vacuum bottle with the contacts in the open position in strict accordance with manufacturer's published data. **Do not exceed maximum voltage stipulated for this test.** Provide adequate barriers and protection against x-radiation during this test. Do not perform this test unless the contact separation of each interrupter is within manufacturer's tolerance. (Be aware that some dc high-potential test sets are half-wave rectified and may produce peak voltages in excess of the manufacturer's recommended maximum.)

- SF₆ Gas Test

Remove a sample of SF₆ gas if provisions are made for sampling and test in accordance with the following table.

Test	Method	Serviceability Limits ^a
Moisture	Hygrometer	Per manufacturer or ≥ 200 ppm ^b
SF ₆ decomposition byproducts	ASTM D 2685	≥ 500 ppm
Air	ASTM D 2685	≥ 5000 ppm ^c
Dielectric breakdown Hemispherical contacts	0.10 inch gap at atmospheric pressure	11.5 - 13.5 kV ^d

Table 2-19: SF₆ Gas Tests

- In the absence of consensus standards dealing with SF₆ circuit breaker gas tests, the NETA Standards Review Council suggests the above representative values.
- According to some manufacturers.
- Dominelli, N. and Wylie, L., Analysis of SF₆ Gas as a Diagnostic Technique for GIS, Electric Power Research Institute, Substation Equipment Diagnostics Conference IV, February 1996.
- Per Even, F.E., and Mani, G. Sulfur Fluorides, Kirk, Othmer Encyclopedia of Chemical Technology, 4th ed., 11,428, 1994.
Reference: IEC 61634 High-Voltage Switchgear and Controlgear - Use and Handling of Sulfur Hexafluoride (SF₆) in High-Voltage Switchgear and Controlgear.

- Airborne Ultrasonic Tests (Optional) (Refer to section B.6)
Refer to data set 1 in Appendix H for additional information.
- Power Factor Test (Optional) (Refer to section B.5)
Refer to data set 8 in Appendix H for additional information.
- High Voltage Test (Optional) (Refer to section B.15)
Refer to data set 3 in Appendix H for additional information.
- Infrared Thermography (IRT) (Optional) (Refer to section B.4)
Refer to data set 4 in Appendix H for additional information.
- Visual Inspection
A visual inspection of the switch shall reveal no abnormalities or defects.
- NASA SpecsIntact Reference: Section 16328 Load Break SF6 GAS Switches - Requirements for 5k through 38 kV, 600A load-break sulphur hexafluoride (SF6) gas switches.

2.42 Electric Switch, Medium Voltage Vacuum

2.42.1 Required Equipment Information

- Switch Type
- Switch Specifications
- Location of Installation
- NASA Identification Number
- Date of Installation (Required or Actual Acceptance Date)
- Applicable NASA reference drawing number(s)

2.42.2 Required Acceptance Documentation

- Material, Equipment and Fixture Lists
- Shop Drawings
 - Connection Diagrams
 - Fabrication Drawings
- Product Data
 - Equipment and Performance Data
 - Manufacturer's Catalog Data
- Test Reports
 - Contact Resistance Test Results
 - Insulation Resistance Test Results
 - Vacuum Bottle Integrity Test Results
 - Insulating Oil Test Results
 - Airborne Ultrasonic Test Results (Optional)
 - Power Factor Test Results (Optional)
 - High Voltage Test Results (Optional)
 - Infrared Thermography Test Results (Optional)
- Certificates
- Manufacturer's Instructions
- Operations Manual
- Maintenance Manual
- Warranty Information
- Parts List and Recommended Spare Parts List
- Acceptance Documentation (Dates and Signatures)

2.42.3 Acceptance Technologies and Criteria

*** Note: Based on type, size and voltage of the switch, the NASA Construction Manager should determine which test(s)/technologies should be performed. Some of the below listed tests/technologies do not apply to every type of switch.

- Contact Resistance Test (Refer to section B.13)

Refer to data set 2 in Appendix H for additional information.

- Insulation Resistance Test (Refer to sections B.10)
The contractor shall perform insulation-resistance tests on all control wiring with respect to ground. Applied potential shall be 500 volts dc for 300 volt rated cable and 1000 volts dc for 600 volt rated cable. Test duration shall be one minute. For units with solid-state components, follow manufacturer's recommendation.

Refer to data set 5 in Appendix H for additional information.

- Perform vacuum bottle integrity (overpotential) test across each vacuum bottle with the contacts in the open position in strict accordance with manufacturer's published data. **Do not exceed maximum voltage stipulated for this test.** Provide adequate barriers and protection against x-radiation during this test. Do not perform this test unless the contact separation of each interrupter is within manufacturer's tolerance. (Be aware that some dc high-potential test sets are half-wave rectified and may produce peak voltages in excess of the manufacturer's recommended maximum.)
- Perform an Insulating Oil Test by removing a sample of insulating liquid in accordance with ASTM D 923. Sample shall be tested in accordance with the referenced standard.
 1. Dielectric breakdown voltage: ASTM D 877
 2. Color: ANSI/ASTM D 1500
 3. Visual condition: ASTM D 1524

Minimum acceptance criteria:

- In accordance with criteria found in Table 2.x in section B.8.

- Airborne Ultrasonic Tests (Optional) (Refer to section B.6)
Refer to data set 1 in Appendix H for additional information.
- Power Factor Test (Optional) (Refer to section B.5)
Refer to data set 8 in Appendix H for additional information.
- High Voltage Test (Optional) (Refer to section B.15)
Refer to data set 3 in Appendix H for additional information.
- Infrared Thermography (IRT) (Optional) (Refer to section B.4)
Refer to data set 4 in Appendix H for additional information.
- Visual Inspection
A visual inspection of the switch shall reveal no abnormalities or defects.

2.43 Electrical Transformer Load Tap Changer

Electrical Transformer Load Tap Changers (LTC) are mechanical switching devices that are designed to change the tapping connection of a transformer winding while the transformer is energized (on-load) or not energized (off-load). This adjustment of the tap connection provides a capability to maintain downstream voltages at defined levels as a means of compensating for factors that could cause the voltages to vary. The most common example of an on-load tap changer is a voltage regulator. LTCs can be located either inside the transformer main tank or they can be outside in their own compartment. Most LTC's are adjusted manually, and some have remote or automatic actuators. They contain such components as spring drive mechanisms, motor actuators, moving arms, transition resistors/reactors, oil tanks, and monitoring/control interface equipment. LTCs cause more failures and outages than any other component of a power transformer. When occurring early in life, LTC failures are usually mechanical or related to a defect of the moving mechanisms or contact surfaces and connections. After continued use, LTC failures are usually electrical faults associated with carbon buildup due to arcing across contacts, or from mechanical failure due to component load stresses. Other failures may also be associated with transition resistors, and insulation. Another common term for LTC's is automatic voltage regulators.

2.43.1 Required Equipment Information

- Electrical Transformer Load Tap Changer Type (NEMA enclosure type)
- Electrical Transformer Load Tap Changer Specifications
 - Step down voltage configuration (number of positions)
 - Maximum current loading
 - Maximum tapping range (kV)
 - Insulation level (to ground and phase-to-phase)
 - Arcing time
 - Dimensions, Weight
 - Oil capacity
 - UL certification, EMI levels (if applicable)
- Location of Installation
- NASA Identification Number
- Date of Installation (Required or Actual Acceptance Date)
- Applicable NASA reference drawing number(s)

2.43.2 Required Acceptance Documentation

- Material, Equipment and Fixture Lists
- Shop Drawings
 - Connection Diagrams
 - Fabrication Drawings
 - Installation Drawings
- Product Data
 - Equipment and Performance Data (if applicable)

- Manufacturer's Catalog Data
- Test Reports
 - Insulation Resistance Test Results
 - Power Factor Test Results
 - Contact Resistance Test Results
 - High Voltage Test Results
 - Infrared Thermography Test Results
 - Airborne Ultrasonic Test Results
 - Baseline Data from Verification Tests
- Certificates
- Manufacturer's Instructions
- Installation and Operations Manual
- Maintenance Manual
- Warranty Information
- Parts List and Recommended Spare Parts List
- Acceptance Documentation (with Dates and Signatures)

2.43.3 Acceptance Technologies and Criteria

* Note: Where some of the tests provide similar condition information, the NASA Construction Manager should determine which test need not be performed based on experience with the type and size of Electrical Transformer Load Tap Changer.

- Insulation Resistance Test (Refer to section B.10)
Refer to data set 5 in Appendix H for additional information.
- Power Factor Test (Refer to section B.5)
Refer to data set 8 in Appendix H for additional information.

Minimum acceptance criteria:
 - Power factor must not exceed manufacturer's data.
- Contact Resistance Test (refer to section B.13)
Refer to data set 2 in Appendix H for additional information.
- High Voltage Test (Optional) (Refer to section B.15)
Refer to data set 3 in Appendix H for additional information.
- Infrared Thermography (IRT) (optional) (Refer to section B.4)
The contractor shall perform a thermographic survey to detect uneven heating indicative of loose or dirty terminal connections, other internal electrical connections to the individual components, and also uneven heating patterns in the oil and windings of transformers and oil breakers that may be integral to LTCs. This survey may also indicate internal corrosion or other flaws. Localized heating may be indicative of flaws in windings or insufficient ventilation of the surrounding area. A bank of same-type LTCs with significantly different

temperature readings may indicate unbalanced loading or a defective LTC. LTC loading should be > 50% for performing this test.

The infrared imager shall be a focal plane array camera with all of the following minimum requirements:

- Self contained with a minimum of 2 hours of battery capacity
- Temperature range of -20°C to 300°C
- Sensitive to 0.2°C over all temperature ranges
- Accurate to within $\pm 3\%$
- Must be capable of storing up to 12 images for later use
- Have a video recorder interface

Minimum acceptance criteria:

- Qualitative inspection using predefined relative difference limits, hot and cold spots, and deviations from normal or expected temperature ranges consistent with manufacturer's design data.

Minimum acceptable limits for this test are as follows:

- Qualitatively verify good terminal connections, internal connections to the individual components, and relative equivalent temperatures of the adjacent components during operation. Acceptable deviations in temperature will vary with the size and type of the system component, but these limits should not exceed $\pm 5^{\circ}\text{C}$. At no time should any of the terminal connections or internal connections to the individual components display a temperature in excess of 11.3°C greater than ambient.

- Airborne Ultrasonic Tests (optional) (Refer to section B.6)
The contractor shall use ultrasonics to verify the non-existence of electrical arcing and other high frequency events.

Minimum acceptance criteria: < TBD based on unit test set

- Electrical Acceptance Tests
The contractor shall perform electrical continuity tests on current, potential and control circuits.
The contractor shall perform ratio and polarity tests on current and potential transformers (if applicable).
The contractor shall perform a current test on the remainder of the secondary circuit to detect any open or short-circuit connections.
- Weatherproof Test (if applicable)
The contractor shall perform a weatherproof test in the presence of the Contracting Officer in accordance with IEEE C37.20.1
- Visual Inspection
A visual inspection of the Electrical Transformer Load Tap Changer shall reveal no abnormalities or defects.

2.44 Fans

Vibration Standards for Fans

Fans are defined as all non-positive displacement air handling units, including, but not limited to, induced draft (ID) fans, forced draft (FD) fans, over-hung fans, center-hung fans, centrifugal, vane-axial, tube-axial, and blowers.

Natural frequencies of the completely assembled fan unit shall not be excited at the operating speed. (Running speed should be at least 25 percent removed from a natural frequency of the system.)

Variable speed or adjustable sheaves shall not be used in the final installation.

The drive sheave and driven sheave should differ in size by 20 percent or more to avoid "beat" vibration.

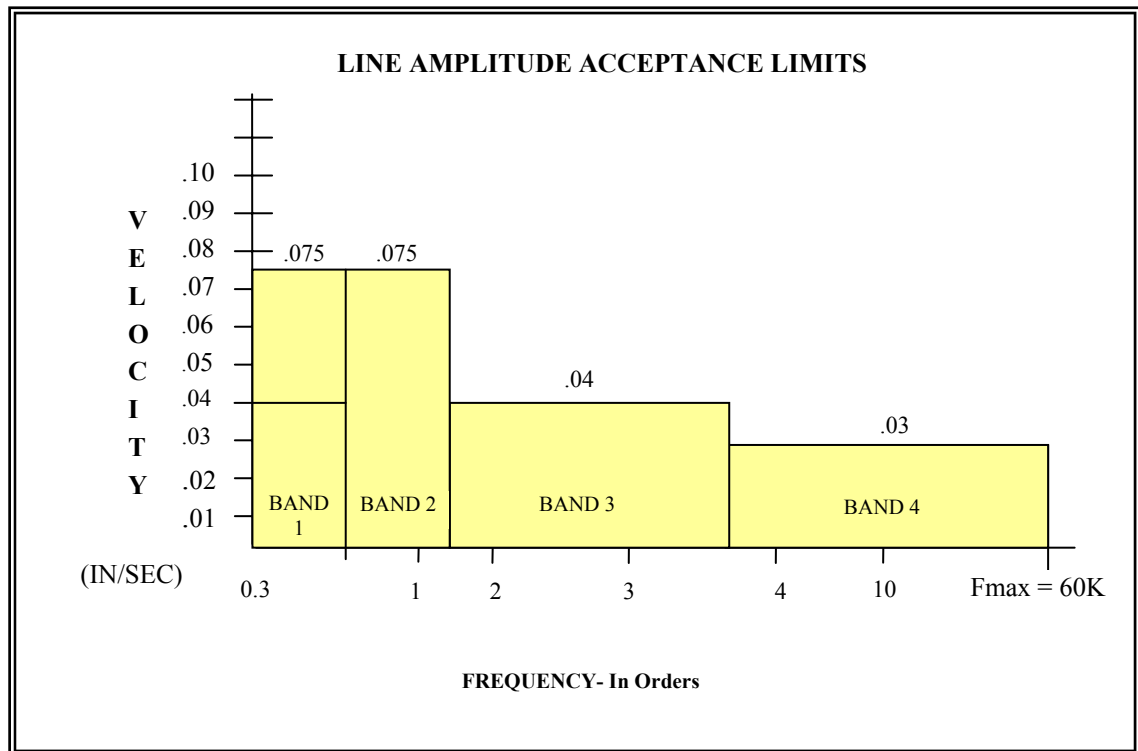

Figure 2-6: Belt Driven Fan Vibration Envelope Overall Per Band

Vibration limits for fans are as follows:

- New, rebuilt and repaired fans shall conform to the vibration limits specified in Figures 2-6 and 2-7 when operating at the specified system volume (cfm) and fan static pressure.
- Acceptance limits for fans running over 3,600 rpm will be specified by NASA.

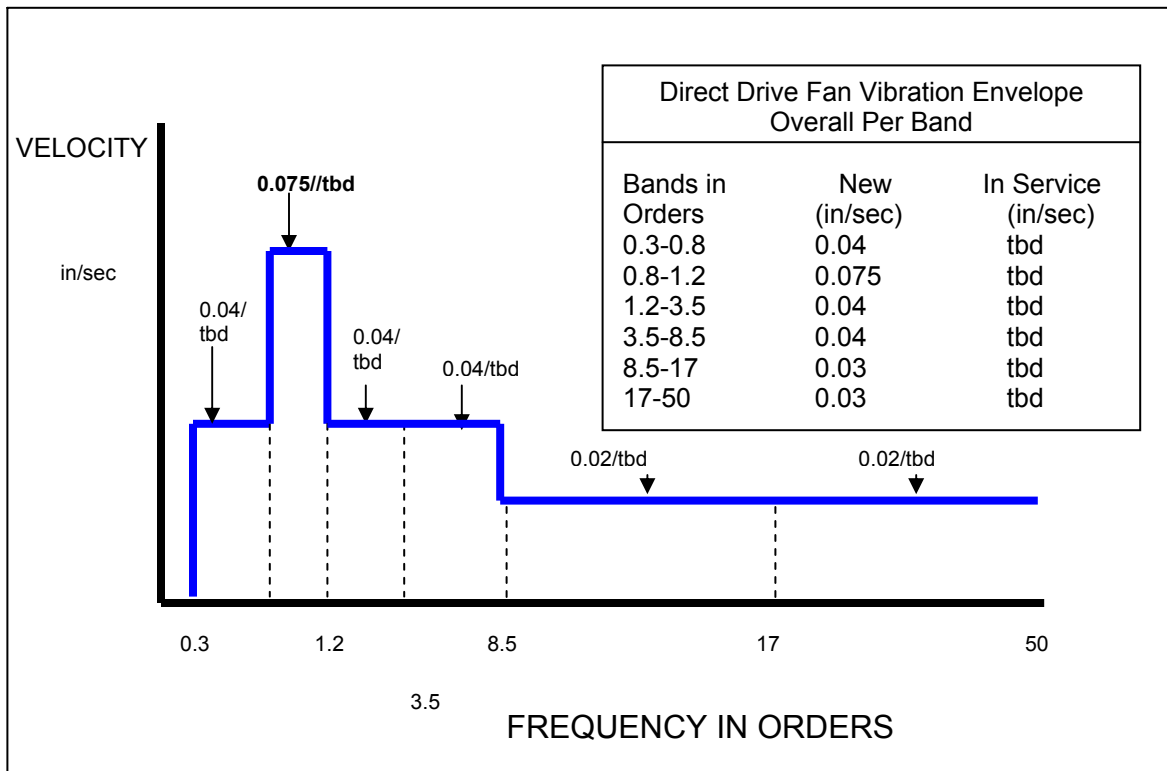

Figure 2-7: Direct Drive Fan Vibration Envelope Overall Per Band

Motors on blowers and fans shall have sound discs installed in the radial and axial directions as previously described. Fan bearings shall be monitored radially in the vertical direction.

2.44.1 Required Equipment Information

- Fan Type
- Fan Specifications
 - Number of rotating fan blades/vanes
 - Number of stationary fan blades/vanes
 - Rotating Speed(s)
 - Number of belts (if belt driven)
 - Belt lengths – measured at the pitch line (if belt driven)
 - Diameter of the drive sheave at the drive pitch line (if belt driven)
 - Diameter of the driven sheave at the drive pitch line (if belt driven)
- Location of Installation
- NASA Identification Number
- Date of Installation (Required or Actual Acceptance Date)
- Applicable NASA reference drawing number(s)

2.44.2 Required Acceptance Documentation

- Material, Equipment and Fixture Lists
- Equipment Foundation Data
- Shop Drawings
 - Installation Drawings

- As-Built Drawings
- Bearing Layout
- Manufacturer Data
 - Equipment and Performance Data
 - Design Analysis and Calculations
 - Bearing Data
- Test Point Locations
- Test Reports
 - Vibration Analysis Test Results
 - Alignment Measurement Results (Laser Alignment)
 - Hydraulic Oil Test Results
 - Lubricating Oil Test Results
- Certificates
- Manufacturer's Instructions
- Operations Manual
- Maintenance Manual
- Warranty Information
- Parts List and Recommended Spare Parts List
- Acceptance Documentation (Dates and Signatures)

2.44.3 Acceptance Technologies and Criteria

- Vibration Analysis Test (Refer to sections B.3)
Refer to data set 10 in Appendix H for additional information.
- Balance Test and Measurement (Refer to section B.1)
 - The contractor shall use balance measurement to verify that rotating shafts are balanced and mass and rotational centerlines are coincident.
 - Document key lengths A, B, final length

Minimum Acceptance Criteria: refer to Table B-1

 - Better than or equal to manufacturer's specifications
- Laser Alignment or Other Alignment Methods (Refer to sections B.2)
Refer to data set 6 in Appendix H for additional information.
- Lubricating Oil Tests (Refer to sections B.7)
Refer to data set 7 in Appendix H for additional information.
- Thermodynamic Performance Tests (Refer to section B.18)
Refer to data set 9 in Appendix H for additional information.
- Visual Inspection
A visual inspection of the fan shall reveal no abnormalities or defects.
- NASA SpecsIntact Reference: Section 15764 Fan-coil Units - Fan-coil units for temperature-control assemblies.

2.45 Gearboxes

Vibration Standards for Gearboxes

Gearboxes shall not exceed the vibration limits specified in Figure 2-8.

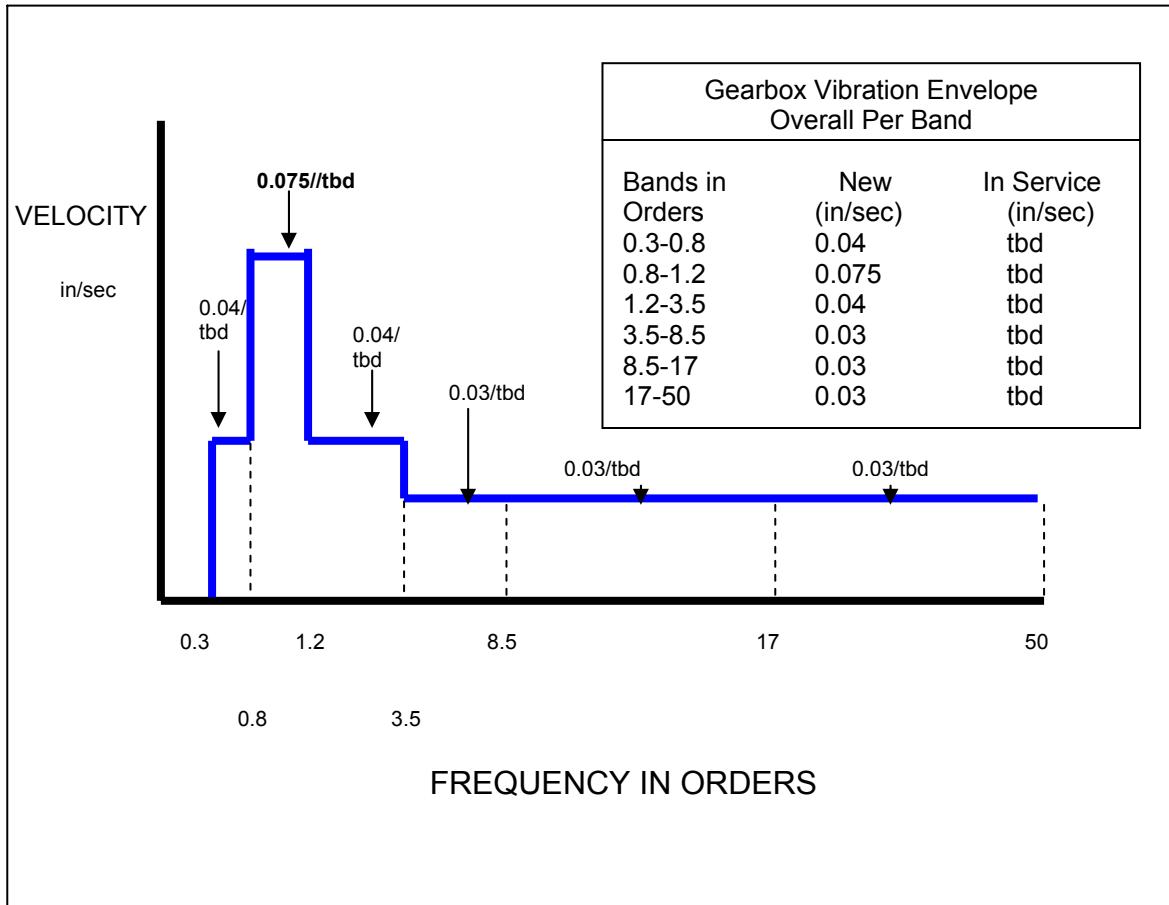

Figure 2-8: Gearbox Vibration Envelope Overall Per Band

The contractor shall install sound discs radial to the input and output shafts in the horizontal and vertical directions. Additional discs shall be installed in the axial direction as close to the input and output shafts as possible.

2.45.1 Required Equipment Information

- Gearbox Type
- Gearbox Nameplate Data / Specifications
 - Type of gear tooth
 - Gear material
 - Number of teeth on each gear
 - Gear ratio
 - Input and output speeds
- Location of Installation

- NASA Identification Number
- Date of Installation (Required or Actual Acceptance Date)
- Applicable NASA reference drawing number(s)

2.45.2 Required Acceptance Documentation

- Material, Equipment and Fixture Lists
- Equipment Foundation Data
- Drawings
 - Installation Drawings
 - Cutaway Drawings (engineering drawing of the gearbox internal structure)
 - Sectional Drawings
 - Bearing Layout
- Manufacturer Data
 - Equipment and Performance Data
 - Design Analysis and Calculations
 - Bearing Data
- Test Point Locations
- Test Reports
 - Vibration Analysis Test Results
 - Hydraulic Oil Test Results
 - Lubricating Oil Test Results
- Certificates
- Manufacturer's Instructions
- Maintenance Manual
- Warranty Information
- Parts List and Recommended Spare Parts List
- Acceptance Documentation (Dates and Signatures)

2.45.3 Acceptance Technologies and Criteria

- Vibration Analysis Test (Refer to sections B.3)
Refer to data set 10 in Appendix H for additional information.
- Hydraulic Oil Tests (Optional) (Refer to sections B.7)
The contractor shall use particle counting tests to verify an acceptable level of contamination in the hydraulic oil.

Minimum Acceptance Criteria: refer to Sperry Vickers Table, Table B-10

- Lubricating Oil Tests (Refer to sections B.7)
Refer to data set 7 in Appendix H for additional information.
- Visual Inspection
A visual inspection of the gearboxes shall reveal no abnormalities or defects.

2.46 Heat Exchanger (General)

2.46.1 Required Equipment Information

- Heat Exchanger Type
- Location of Installation
- NASA Identification Number
- Date of Installation (Required or Actual Acceptance Date)
- Applicable NASA reference drawing number(s)

2.46.2 Required Acceptance Documentation

- Material, Equipment and Fixture Lists
- Shop Drawings
 - Fabrication Drawings
 - Installation Drawings
 - As-Built Drawings
- Product Data
 - Equipment Foundation Data
 - Equipment and Performance Data
 - Manufacturer's Catalog Data
- Design Data
 - Design Analysis and Calculations
- Test Reports
 - Hydrostatic Test Results
 - Performance Test Results
 - Baseline Data from Verification Test
- Manufacturer's Instructions
- Test Point Locations
- Operations Manual
- Maintenance Manual
- Warranty Information
- Certificates
- Parts List
- Recommended Spare Parts List
- Acceptance Documentation (Dates and Signatures)

2.46.3 Acceptance Technologies and Criteria

- Hydrostatic Test

The contractor shall pressurize the system and inspect for leaks. This test can be performed simultaneously with the ultrasonic test. The required tests, pressures, and hold durations will be specified by the Design Engineer.

Minimum acceptable criteria: zero leakage

- Thermodynamic Performance Tests (Refer to section B.18)

Refer to data set 9 in Appendix H for additional information.

Minimum acceptable limits for thermodynamic performance tests:

- Performance (Flow) Test Results > design specifications

- Airborne Ultrasonic Tests (Optional) (Refer to section B.6)

The contractor shall use ultrasonic to verify the integrity of the joints, valves, fittings and its associated piping..

Minimum acceptable criteria: zero leakage.

- Infrared Thermography (IRT) (optional) (Refer to section B.4)

The contractor shall perform a thermographic survey during the start-up phase of installation of all piping systems as a means of determining leakage. For hot water systems verify insulation integrity.

The infrared imager shall be a focal plane array camera with all of the following minimum requirements:

- Self contained with a minimum of 2 hours of battery capacity
- Temperature range of $-20\text{ }^{\circ}\text{C}$ to $300\text{ }^{\circ}\text{C}$
- Sensitive to $0.2\text{ }^{\circ}\text{C}$ over all temperature ranges
- Accurate to within $\pm 3\%$
- Must be capable of storing up to 12 images for later use
- Have a video recorder interface

Minimum acceptable limits for this test are as follows:

- Qualitatively verify that there is no leakage across piping boundaries and isolation components. Design Engineer or manufacturer to provide predefined relative difference limits, hot and cold spots, and deviations from normal or expected temperature ranges consistent with manufacturer's design data

- Visual Inspection (Observations)

A visual inspection of the heat exchanger shall reveal no abnormalities or defects.

2.47 Heat Exchange Condenser Air Cooled

2.47.1 Required Equipment Information

- Condenser Identification (Type)
- Location of Installation
- NASA Identification Number
- Date of Installation (Required or Actual Acceptance Date)
- Applicable NASA reference drawing number(s)

2.47.2 Required Acceptance Documentation

- Layout Drawings
- Test Point Locations
- Manufacturer Data
- Maintenance Manual
- Warranty Information
- Test Reports
 - Hydrostatic Test Results
 - Thermodynamic Performance Test Results
 - Airborne Ultrasonic Test Results (Optional)
 - Pulse Ultrasound Test Results (Optional)
 - Infrared Thermography Test Results (Optional)
- Certificates
- Parts List and Recommended Spare Parts List
- Baseline Data from Verification Test
- Acceptance Documentation (Dates and Signatures)

2.47.3 Acceptance Technologies and Criteria

- Hydrostatic Test
The contractor shall pressurize the system and inspect for leaks. This test can be performed simultaneously with the ultrasonic test. The required tests, pressures, and hold durations will be specified by the Design Engineer.

Minimum acceptable criteria: zero leakage

- Thermodynamic Performance Tests (Refer to section B.18)
Refer to data set 9 in Appendix H for additional information.
- Airborne Ultrasonic Tests (Optional) (Refer to section B.6)
The contractor shall use ultrasonic to verify the integrity of the joints, valves, fittings and its associated piping.

Minimum acceptable criteria: zero leakage.

- Pulse Ultrasound Tests (Optional) (Refer to section B.6)

The contractor shall perform material thickness measurements on a representative sample of material where a thickness is specified in the contract.

Minimum acceptable criteria:

- $\pm 5\%$ design specifications

- Infrared Thermography (IRT) (optional) (Refer to section B.4)

The contractor shall perform a thermographic survey during the start-up phase of installation of all piping systems as a means of determining leakage. For hot water systems verify insulation integrity.

The infrared imager shall be a focal plane array camera with all of the following minimum requirements:

- Self contained with a minimum of 2 hours of battery capacity
- Temperature range of $-20\text{ }^{\circ}\text{C}$ to $300\text{ }^{\circ}\text{C}$
- Sensitive to $0.2\text{ }^{\circ}\text{C}$ over all temperature ranges
- Accurate to within $\pm 3\%$
- Must be capable of storing up to 12 images for later use
- Have a video recorder interface

Minimum acceptable limits for this test are as follows:

- Qualitatively verify that there is no leakage across piping boundaries and isolation components. Design Engineer or manufacturer to provide predefined relative difference limits, hot and cold spots, and deviations from normal or expected temperature ranges consistent with manufacturer's design data

- Visual Inspection (Observations)

A visual inspection of the heat exchanger shall reveal no abnormalities or defects.

2.48 Heat Exchange Condenser Water Cooled

2.48.1 Required Equipment Information

- Condenser Identification (Type)
- Location of Installation
- NASA Identification Number
- Date of Installation (Required or Actual Acceptance Date)
- Applicable NASA reference drawing number(s)

2.48.2 Required Acceptance Documentation

- Layout Drawings
- Test Point Locations
- Manufacturer Data
- Maintenance Manual
- Warranty Information
- Test Reports
 - Hydrostatic Test Results
 - Thermodynamic Performance Test Results
 - Airborne Ultrasonic Test Results (Optional)
 - Pulse Ultrasound Test Results (Optional)
 - Infrared Thermography Test Results (Optional)
- Certificates
- Parts List and Recommended Spare Parts List
- Baseline Data from Verification Test
- Acceptance Documentation (Dates and Signatures)

2.48.3 Acceptance Technologies and Criteria

- Hydrostatic Test

The contractor shall pressurize the system and inspect for leaks. This test can be performed simultaneously with the ultrasonic test. The required tests, pressures, and hold durations will be specified by the Design Engineer.

Minimum acceptable criteria: zero leakage

- Thermodynamic Performance Tests (Refer to section B.18)

Refer to data set 9 in Appendix H for additional information.
- Airborne Ultrasonic Tests (Optional) (Refer to section B.6)

The contractor shall use ultrasonics to verify the integrity of the joints, valves, fittings and its associated piping..

Minimum acceptable criteria: zero leakage.

- Pulse Ultrasound Tests (Optional) (Refer to section B.6)
The contractor shall perform material thickness measurements on a representative sample of material where a thickness is specified in the contract.

Minimum acceptable criteria:

- $\pm 5\%$ design specifications

- Infrared Thermography (IRT) (optional) (Refer to section B.4)
The contractor shall perform a thermographic survey during the start-up phase of installation of all piping systems as a means of determining leakage. For hot water systems verify insulation integrity.

The infrared imager shall be a focal plane array camera with all of the following minimum requirements:

- Self contained with a minimum of 2 hours of battery capacity
- Temperature range of $-20\text{ }^{\circ}\text{C}$ to $300\text{ }^{\circ}\text{C}$
- Sensitive to $0.2\text{ }^{\circ}\text{C}$ over all temperature ranges
- Accurate to within $\pm 3\%$
- Must be capable of storing up to 12 images for later use
- Have a video recorder interface

Minimum acceptable limits for this test are as follows:

- Qualitatively verify that there is no leakage across piping boundaries and isolation components. Design Engineer or manufacturer to provide predefined relative difference limits, hot and cold spots, and deviations from normal or expected temperature ranges consistent with manufacturer's design data

- Visual Inspection (Observations)
A visual inspection of the heat exchanger shall reveal no abnormalities or defects.

2.49 Heat Exchange Cooling Tower

2.49.1 Required Equipment Information

- Cooling Tower Identification (Type)
- Location of Installation
- NASA Identification Number
- Date of Installation (Required or Actual Acceptance Date)
- Applicable NASA reference drawing number(s)

2.49.2 Required Acceptance Documentation

- Layout Drawings
- Test Point Locations
- Manufacturer Data
- Maintenance Manual
- Warranty Information
- Test Reports
 - Vibration Analysis Results
 - Balance Test and Measurement Results
 - Lubricating Oil Test Results
 - Thermodynamic Performance Test Results
- Certificates
- Parts List and Recommended Spare Parts List
- Baseline Data from Verification Test
- Acceptance Documentation (Dates and Signatures)

2.49.3 Acceptance Technologies and Criteria

- Vibration Analysis Test (Refer to sections B.3)
Refer to data set 10 in Appendix H for additional information.
- Balance Test and Measurement (Refer to section B.1)
The contractor shall use balance measurement to verify that rotating shafts are balanced and mass and rotational centerlines are coincident.
 - Document key lengths A, B, final length

Minimum Acceptance Criteria: refer to Table B-1

 - Better than or equal to manufacturer's specifications
- Laser Alignment or Other Alignment Methods (Refer to section B.2)
Refer to data set 6 in Appendix H for additional information.

- Lubricating Oil Tests (Refer to section B.7)
Refer to data set 7 in Appendix H for additional information.
- Thermodynamic Performance Tests (Refer to section B.18)
Refer to data set 9 in Appendix H for additional information.
- Visual Inspection (Observations)
A visual inspection of the cooling tower and piping system shall reveal no abnormalities or defects.

2.50 HVAC Ducts

2.50.1 Required Equipment Information

- Type of Duct Installed
- Location of Installation
- NASA Identification Number
- Date of Installation (Required or Actual Acceptance Date)
- Applicable NASA reference drawing number(s)

2.50.2 Required Acceptance Documentation

- Shop Drawings
 - Connection diagrams
 - Fabrication Drawings
 - installation Drawings
 - As-Built Drawings
- Design Analysis and Calculations
- Samples
- Manufacturer Data
- Operation and Maintenance Manuals
- Warranty Information
- Material, Equipment and Fixture Lists
- Test Reports
 - Operational Tests (Fire Damper Test)
 - Ductwork Leakage Test
- Certificates
- Parts List and Recommended Spare Parts List
- Acceptance Documentation (Dates and Signatures)

2.50.3 Acceptance Technologies and Criteria

- Visual Inspection

The contractor shall visually inspect for structural integrity, moisture, penetrations seals, damage or voids. There shall be no defects or abnormalities.
- Operational Test (Fire Damper Test)

The contractor shall perform a test on each fire damper in the presence of the Contracting Officer by energizing fusible link with localized heat. New links shall be provided and installed after each successful testing. Fire Damper Test shall verify 100% compliance.
- Ductwork Leakage Tests (Refer to section 15950)

The contractor shall perform leakage test in accordance with Section 15950, "Testing, Adjusting and Balancing". Test shall be performed prior to installing ductwork insulation. Results shall meet or exceed specifications.

- NASA SpecsIntact Reference: Section 15083 Duct Insulation - Insulation for round and rectangular ducting and includes materials, adhesives, and tape; 15818 Medium/High Pressure Ductwork - Medium/high pressure ductwork for air conditioning systems.

2.51 Material Handling Conveyor

2.51.1 Required Equipment Information

- Conveyor (Type)
- Location of Installation
- NASA Identification Number
- Date of Installation (Required or Actual Acceptance Date)
- Applicable NASA reference drawing number(s)

2.51.2 Required Acceptance Documentation

- Layout Drawings
- Test Point Locations
- Manufacturer Data
- Maintenance Manual
- Warranty Information
- Test Reports
 - Vibration Analysis Test Results
 - Balance Test and Results
 - Lubricating Oil Test Results
 - Performance Test Results
- Certificates
- Parts List and Recommended Spare Parts List
- Baseline Data from Verification Test
- Acceptance Documentation (Dates and Signatures)

2.51.3 Acceptance Technologies and Criteria

- Vibration Analysis Test (Refer to section B.3)
Refer to data set 10 in Appendix H for additional information.
- Balance Test and Measurement (Refer to section B.1)
The contractor shall use balance measurement to verify that rotating shafts are balanced and mass and rotational centerlines are coincident.
 - Document key lengths A, B, final length

Minimum Acceptance Criteria: refer to Table B-1

 - Better than or equal to manufacturer's specifications
- Laser Alignment or Other Alignment Methods (Refer to sections B.2)
Refer to data set 6 in Appendix H for additional information.

- Lubricating Oil Tests (Refer to sections B.7)
Refer to data set 7 in Appendix H for additional information.
- Performance Test
The contractor shall perform a performance test of the conveyor to verify that design specifications are met. The required tests and calculations will be specified by the Design Engineer.
- Visual Inspection:
A visual inspection of the conveyor shall reveal no abnormalities or defects. As a minimum, the following items shall be verified:
 - Lubricated bearings, universal joints, and pulleys.
 - Proper chain tension and lubrication.
 - Sprocket alignment and screw set.
 - Flat belt tension.
 - V-belt tension.
 - Electrical connections at conveyor.
 - Gearbox lubricant for proper type and proper level.
- NASA SpecsIntact Reference: Sections 14210 Electric Traction Elevators - Electric passenger and freight elevator design and installation, where equipment, material, construction, and installation is provided by the elevator manufacturer; 14240 Hydraulic Elevators - Hydraulic passenger and freight elevators and their installation.

2.52 Miscellaneous Safety Wash

2.52.1 Required Equipment Information

- Identification (Type)
- Location of Installation
- NASA Identification Number
- Date of Installation (Required or Actual Acceptance Date)
- Applicable NASA reference drawing number(s)

2.52.2 Required Acceptance Documentation

- Layout Drawings
- Test Point Locations
- Manufacturer Data
- Maintenance Manual
- Warranty Information
- Test Reports
 - Code & Requirements Verification Results
- Certificates
- Parts List and Recommended Spare Parts List
- Baseline Data from Verification Test
- Acceptance Documentation (Dates and Signatures)

2.52.3 Acceptance Technologies and Criteria

- Visual Inspection (Criteria shown is from ANSI Z358.1 - 1998 Standard for Emergency Showers)
 - Verify proper height of installation.
For plumbed-in and self-contained units the showerhead shall be fitted between 208.3cm (82 inches) and 243.8cm (96inches) in height from the surface on which the user stands.
 - Verify spray pattern.
The Spray pattern shall deliver a minimum of 50.8cm (20 inches) at 152.4cm (60 inches) and the center of the spray pattern shall be located at least 40.6cm (16 inches) from any obstruction.)
 - Verify flow.
The showerhead shall deliver a minimum of 113.6 liters per minute [25 imperial gallons per minute].
With the current spray pattern a flow of 75.7 liters per minute (16.6 imperial gallons is acceptable).
 - Verify operation.

The valve shall be designed so that the water flow remains on without requiring the use of the operator's hands.

The valve shall be designed to remain activated until intentionally shut off.

The valve shall be simple to operate and shall go from "off" to "on" in 1 second or less.

- Verify corrosion resistance

The valve shall be resistant to corrosion from potable water.

- Verify protection from freezing and frost

If freezing conditions exist the showers shall be frost protected.

Additional requirements associated with Eye/face Washes & Drench Hoses

- Self contained eye/face washes shall deliver a minimum of 1.5 liters per minute for 15 minutes.
- Plumbed-in eye/face washes and drench hoses shall deliver a minimum of 11.4 liters per minute (2.5 imperial gallons per minute) for 15 minutes.
- The valve shall be designed so that the water flow remains on without requiring the use of the operator's hands.
- The valve shall be designed to remain activated until intentionally shut off.
- The valve shall be simple to operate and shall go from "off" to "on" in 1 second or less.
- The valve shall be resistant to corrosion from potable water.

If freezing conditions exist eye/face washes and drench hoses shall be frost protected.

2.53 Motor Control Centers

2.53.1 Required Equipment Information

- Motor Control Center Type
- Motor Control Center Specifications
- Location of Installation
- NASA Identification Number
- Date of Installation (Required or Actual Acceptance Date)
- Applicable NASA reference drawing number(s)

2.53.2 Required Acceptance Documentation

- Material, Equipment and Fixture Lists
- Shop Drawings
 - Connection Diagrams
 - Fabrication Drawings
- Product Data
 - Manufacturer's Catalog Data
- Test Reports
 - Airborne Ultrasonic Test Results
 - Infrared Thermography Test (IRT) Results
 - Insulation Resistance Test Results
- Certificates
- Manufacturer's Instructions
- Operations Manual
- Maintenance Manual
- Warranty Information
- Parts List and Recommended Spare Parts List
- Acceptance Documentation (Dates and Signatures)

2.53.3 Acceptance Technologies and Criteria

- Airborne Ultrasonic Tests (Optional) (Refer to sections B.6.5)
The contractor shall use ultrasonics to verify the non-existence of electrical arcing and other high frequency events.

Minimum acceptance criteria: < TBD based on unit test set

- Infrared Thermography (IRT) (Refer to sections B.4)
Refer to data set 4 in Appendix H for additional information.
- Insulation Resistance Test (Optional) (Refer to sections B.10)

Refer to data set 5 in Appendix H for additional information.

- **Visual Inspection**
A visual inspection of the motor control center shall reveal no abnormalities or defects.
- **NASA SpecsIntact Reference: Section 16345 Motor Control - Motor-control centers for the grouped control of motors.**

2.54 Motors (General)

Vibration Criteria for Electric Motors

All motor vibration spectra should be analyzed at the following forcing frequencies:

- One times running speed (1X) for imbalance.
- Two times running speed (2X) for misalignment.
- Multiples of running speed (NX) for looseness, resonance, plain bearing defects.
- Electric line frequency and harmonics (60 or 120 Hz for AC motors) for stator and rotor problems.
- The following is a list of rolling element bearing frequencies:
 - Outer race defect frequency
 - Inner race defect frequency
 - Ball defect (ball spin frequency)
 - Fundamental train frequency
- Plain or journal bearings indicate faults at harmonics of running speed and at the frequency corresponding to 0.4-0.5 of running speed.
- Other sources of vibration in motors are dependent on the number of motor rotor bars and stator slots, the number of cooling fan blades, the number of commutator bars and brushes, and on the SCR firing frequencies for variable speed motors.
- Broken rotor bars will often produce sidebands spaced at two times the slip frequency. The presence of broken rotor bars can be confirmed through the use of electrical testing.

Vibration Standards for Electric Motors

Alternating-current motors will be tested at rated voltage and frequency, and no load. Single-speed alternating-current motors will be tested at synchronous speed. A multi-speed alternating-current motor will be tested at all of its rated synchronous speeds. Direct-current motors will be tested at their highest rated speed. Series and universal motors will be tested at operating speed.

All electrical motors defined by NEMA Standard MG-1-1993 Section I, *Classification According to Size*, shall meet the following requirements:

- The velocity amplitude (inch/sec-peak) of any line of resolution, measured at bearing locations in any direction shall not exceed the line-amplitude band limit values specified in Figures 2-9 and 2-10 for small and large motors, respectively.
- The acceleration overall amplitude (g's peak) at bearing locations in any direction shall not exceed the band-limited overall amplitude acceptance limit appropriate for the motor being tested.

For electrical motor certification, the amplitude of vibration at bearing locations in any direction shall not exceed the values listed in Figures 2-9 and 2-10 for small and large motors, respectively. Vibration signatures of velocity and acceleration, and a listing of the maximum peak velocity in each band for vibration measurements taken at position 1 horizontal, position 2 vertical, and position 3 axial shall be submitted as part of the motor

certification. The data shall be identified with the motor serial number, frame number, model number, horsepower, and synchronous speed.

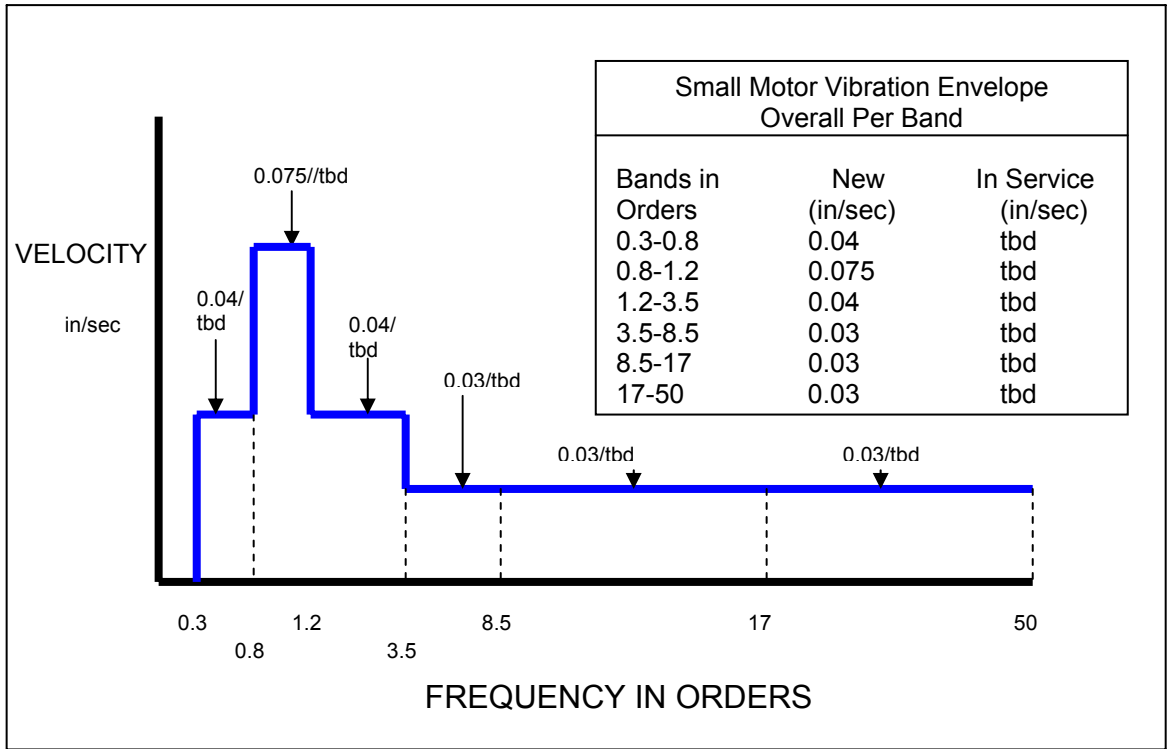

Figure 2-9: Small Motor Vibration Envelope Overall Per Band

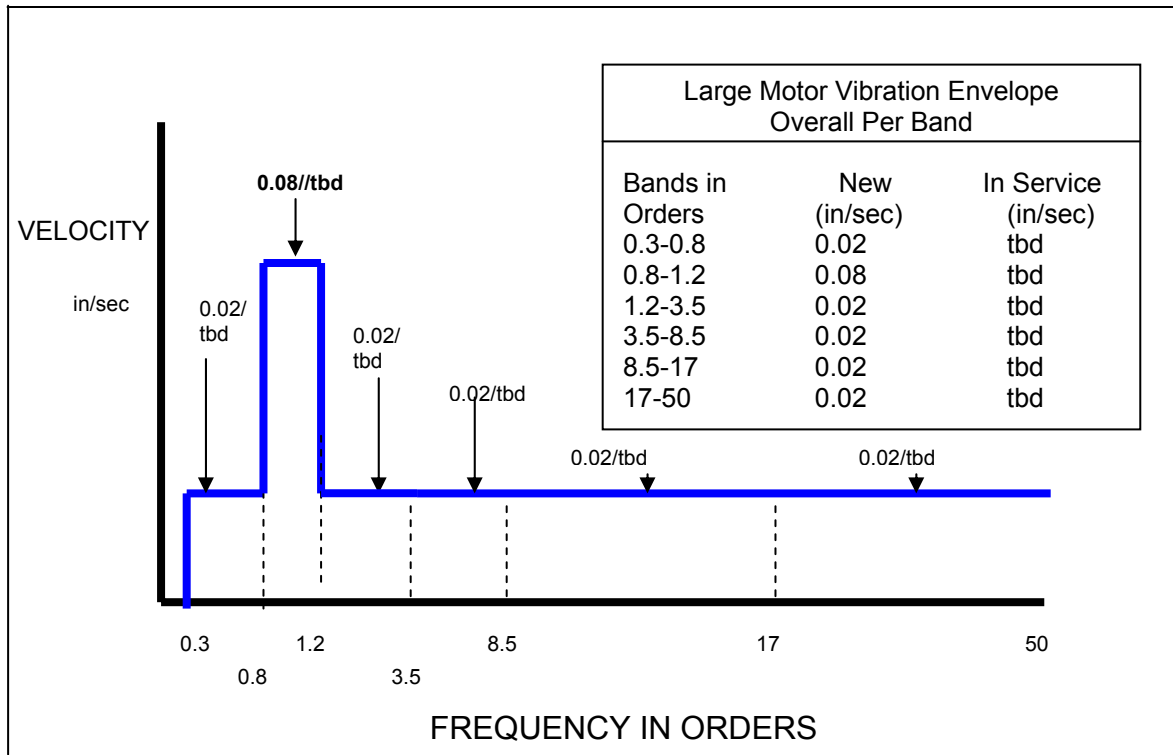

Figure 2-10: Large Motor Vibration Envelope Overall Per Band

Balance

The vibration criteria listed in Table 2–8 are for the vibration amplitude at the fundamental rotational frequency or one times running speed (1X). This is a narrow-band limit. An overall reading is not acceptable.

Additional Vibration Criteria

All testing should be conducted at normal operating speed under full load conditions. Suggested motor vibration criteria are provided in Table 2–9. Appendix E of the *NASA RCM Guide* also contains criteria for common machines and an example of how to calculate criteria.

Motor Speed (RPM)	Maximum Vibration (in/sec, Peak)	Maximum Displacement (mils, Peak-to-Peak)
900	0.02	0.425
1200	0.026	0.425
1800	0.04	0.425
3600	0.04	0.212

Table 2-20: Motor Balance Specifications

Frequency (X RPM) Motor Component	Maximum Amplitude (in/sec Peak)
0.4 - 0.5	Not detectable
1X	See Motor Balance Specifications
2X	0.02
Harmonics (NX)	Not detectable
Roller Element Bearings	Not detectable
Side Bands	Not detectable
Rotor Bar/Stator Slot	Not detectable
Line Frequency (60 Hz)	Not detectable
2X Line Frequency (120 Hz)	0.02

Table 2-21: Motor Vibration Criteria

Rewound Electric Motors

Due to the potential of both rotor and/or stator damage incurred during the motor rewinding process (usually resulting from the bake-out of the old insulation and subsequent distortion of the pole pieces) a rewind electrical motor should be checked both electrically and mechanically. The mechanical check consists of post-overhaul vibration measurements at the same location as for new motors. The vibration level at each measurement point should not exceed the reference spectrum for that motor by more than 10%. In addition, vibration amplitudes associated with electrical faults such as slip, rotor bar, and stator slot should be noted for any deviation from the reference spectrum.

2.54.1 Required Equipment Information

- Motor Type
- Motor Specifications
 - Bearing information
 - Frame size
 - Motor class
 - Full load and locked rotor current
 - Winding resistance
 - Winding inductance
 - Cooling fan blades
 - Number of rotor bars
 - Number of stator slots
 - SCR firing sequence
- Location of Installation
- NASA Identification Number
- Date of Installation (Required or Actual Acceptance Date)
- Applicable NASA reference drawing number(s)

2.54.2 Required Acceptance Documentation

- Material, Equipment and Fixture Lists
- Equipment Foundation Data
- Shop Drawings
 - Installation Drawings
 - As-Built Drawings
 - Bearing Layout
- Manufacturer Data
 - Equipment and Performance Data
 - Design Analysis and Calculations
 - Bearing Data
- Test Point Locations
- Test Reports
 - Vibration Analysis Test Results
 - Infrared Thermography Test (IRT) Results
 - Power Factor Test Results

- Insulation Resistance Test Results
- Motor Circuit Evaluation Test Results
- High Voltage Testing Results
- Start-up Test Results
- Certificates
- Manufacturer's Instructions
- Operations Manual
- Maintenance Manual
- Warranty Information
- Parts List and Recommended Spare Parts List
- Acceptance Documentation (Dates and Signatures)

2.54.3 Acceptance Technologies and Criteria

- Vibration Analysis Test (Refer to sections B.3)
Refer to data set 10 in Appendix H for additional information.
- Balance Test and Measurement (Refer to section B.1)
 - The contractor shall use balance measurement to verify that rotating shafts are balanced and mass and rotational centerlines are coincident.
 - Document key lengths A, B, final length

Minimum Acceptance Criteria: refer to Table B-1

 - Better than or equal to manufacturer's specifications
- Laser Alignment or Other Alignment Methods (Refer to sections B.2)
Refer to data set 6 in Appendix H for additional information.
- Power Factor Test (Refer to sections B.5)
Refer to data set 8 in Appendix H for additional information.

Minimum acceptance criteria:

 - Power factor must not exceed manufacturer's data.
- Infrared Thermography (IRT) (Optional) (Refer to sections B.4)
Abnormal hot spots on the body may indicate flaws in the stator winding.
Refer to data set 4 in Appendix H for additional information.
- Insulation Resistance Test (Optional) (Refer to sections B.10)
Refer to data set 5 in Appendix H for additional information.
- High Voltage Test (Optional) (refer to section B.15)
The contractor shall perform the high voltage test to verify the insulation in a motor and to ensure that there is no excessive leakage current. This is a potentially destructive test and requires authorization from the NASA Construction Manager.

Minimum acceptance criteria:

- better than or equal to manufacturer's specifications
- limits in accordance with ANSI/IEEE Standard 400

- Motor Circuit Evaluation Test (Refer to section B.11)

The contractor shall perform the motor circuit evaluation test to determine the condition of the complete motor circuit. The motor shall be loaded at 75% or greater.

Minimum acceptance results:

- Resistive imbalance < 2%
- Inductive imbalance < 10%
- Resistance, inductance and capacitance with \pm 5% of manufacturer specifications

- Start-up Test

The contractor shall determine the coast-down time and the peak starting current.

- Visual Inspection

A visual inspection of the motor shall reveal no abnormalities or defects.

- NASA SpecsIntact Reference: Section 16225 Motors - Alternating current fractional and integral horsepower/wattage motors rated up to 250 hp/190 kilowatt when used on a 120-, 208- or 240-volt, single-or three-phase, 60-hertz power source and up to 300 hp/225 kilowatt when used on a 480-volt and 600-volt, three-phase, 60-hertz power source.

2.55 Motor- Hydraulic

Standards for Hydraulic Motors

Hydraulic motors are used to convert hydraulic pressure into rotary mechanical motion. It is very similar to a pump, except that the operating principle is reversed. Instead of rotating a drive shaft which draws fluid into one port and forces it out the other under pressure, the hydraulic motor directs fluid already under pressure into the inlet port which forces the shaft to rotate. A hydraulic motor, when powered by a mechanical source, can rotate in a reverse direction and act as a pump.

Typical applications for a hydraulic motor: provides power to winches on cranes, drives conveyors on ditching machines, and is used in other applications where mechanical drives are impractical.

Vibration limits for hydraulic motors are as follows:

- New, rebuilt and repaired motors shall conform to the vibration limits specified in Table 2-21

Vibration Value (in/sec)	Condition Assessment
< .10	Good operating condition
.10 to .20	Satisfactory
.20 to .35	Correct to extend life
.35 to .50	Unsatisfactory - mechanical wear
> .50	Severe wear - correct ASAP

Table 2-22: Acceptance Vibration Limits

Source: <http://www.elongo.com/pdfs/MotorVibration990514.pdf>

2.55.1 Required Equipment Information

- Hydraulic Type
- Hydraulic Motor Specifications
 - Number (if any)
 - Stamped on direction of rotation
 - Shaft size & type
 - Type of mounting flange
 - Port size & type
 - Gear diameter & width
- Location of Installation
- NASA Identification Number
- Date of Installation (Required or Actual Acceptance Date)
- Applicable NASA reference drawing number(s)

2.55.2 Required Acceptance Documentation

- Material, Equipment and Fixture Lists
- Equipment Foundation Data
- Shop Drawings
 - Installation Drawings
 - As-Built Drawings

- Bearing Layout
- Manufacturer Data
 - Equipment and Performance Data
 - Design Analysis and Calculations
 - Bearing Data
- Test Point Locations
- Test Reports
 - Vibration Analysis Test Results
 - Lubricating Oil Test Results
 - Visual Inspection Results
 - Performance (Efficiency) Tests
 - Alignment Measurement Results (Laser Alignment)
- Certificates
- Manufacturer's Instructions
- Operations Manual
- Maintenance Manual
- Warranty Information
- Parts List and Recommended Spare Parts List
- Acceptance Documentation (Dates and Signatures)

2.55.3 Acceptance Technologies and Criteria

- Vibration Analysis Test (Refer to sections B.3)
Refer to data set 10 in Appendix H for additional information.
- Lubricating Oil Tests Fig 1.2
Refer to data set 7 in Appendix H for additional information.

PHYSICAL PROPERTIES		
TEST	REQUIREMENT	METHOD
Viscosity @ 100 deg. F.	150 SSU Minimum	D88
Viscosity @ 210 deg. F.	42 SSU Minimum	D88
Viscosity index	95-125	D2270
Gravity, API	28.9-31.0	D287
Zinc	.08% Minimum	By Weight
Corrosion at 212 deg. F. Maximum	1	D130
Emulsion at 130 deg. F.	30	D1401
Flash point deg. F. Minimum	380	D92
Foam Test:		
Tendency @ 75 deg. F., M1, Maximum	75	D892-IP146
Stability @ 75 deg. F., M1, Maximum		
Pour Point deg. F., Minimum*	-20	D97
Rust Test	-Pass	D665
Minimum Hours to reach Acid No.2	2,000	D943

Table 2-23: Lubricating Oil Analysis Limits

- Visual Inspection

A visual inspection of the hydraulic motor shall reveal no abnormalities or defects. Verify proper installation as in (Fig 1.3)

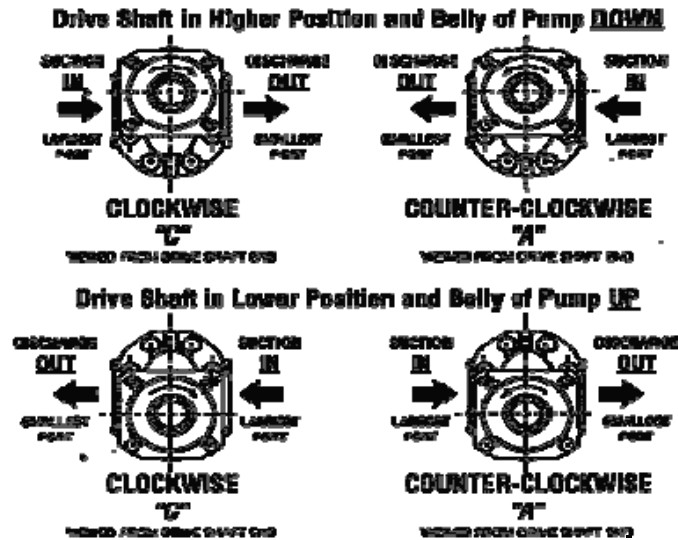

Figure 2-11: Drive Shaft Directions

- Performance Tests

Verify gallons per minute (GPM) is within required limits. (Fig 1.4)

Document and graph performance of motor, include GPM parameters versus power output.

Compare performance graph to manufacture specifications.

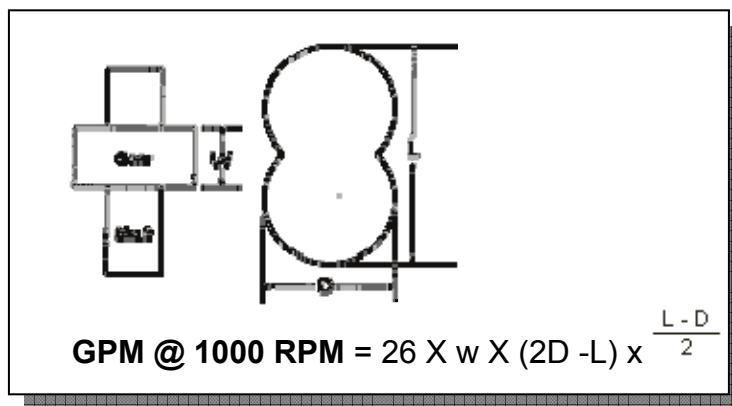

Figure 2-12: Figuring Gear Pump G.P.M.

- Alignment Tests

Verify alignment of couplings using laser technology.

Inspect shaft run-out using laser or dial indicator

2.56 Motor - Pneumatic

Standards for Pneumatic Motor

Air motors produce rotational power developed at an output shaft when compressed air is supplied to an inlet port. The objective of an air motor is to produce enough power to overcome a specified torque level and operate at a desired rpm range. The amount of torque a motor can produce is determined by its integrated gearing. Spur gears are used for simplicity, but planetary gearing is also offered on some models. Variable rpm and power is attained by simply throttling inlet air. Air motor models are designed to run slower with higher torque loads, and faster with lower torque loads. This characteristic is a major advantage in many applications. Matching the motor's speed range with its available torque allows for consistently reliable high starting and running efficiencies. Air motors generally fall into one of three types.

Rotary Vane Air Motors

- Smooth power, with maximum torque reached when load on motor reduces RPM to $\frac{1}{2}$
- Can operate at temperatures approaching 200 deg. F
- Air line lubrication is needed for long, trouble-free service

Axial Piston Air Motors

- Ideal for close quarters applications
- Rugged construction and precision manufacturing contribute to long life with minimum maintenance
- High starting torque output is ideal for applications with heavy starting loads
- Smooth, even torque and full power in either rotational direction
- Should be operated under load and horizontally
- Not recommended for operation at speeds greater than 75% of free speed
- Can be operated at temperatures of up to 200 deg. F
- Grease fittings provided for lubrication, plus air filter and air lubricator recommended for incoming compressed air

Radial Piston Air Motors

- High starting torque is ideal for heavy starting loads
- Smooth, even torque and full power in either rotational direction
- Should be operated under load and horizontally
- Not recommended for operation at speeds greater than 75% of free speed
- Can be operated at temperatures of up to 200 deg. F
- Air filter and air lubricator recommended for incoming compressed air
- A slinger distributes oil to all moving parts within motor

2.56.1 Required Equipment Information

- Motor Type
- Pneumatic Motor Specifications
 - Number (if any) stamped on pump
 - Direction of rotation
 - Shaft size & type
 - Type of mounting flange
 - Port size & type
 - Gear diameter & width

- Location of Installation
- NASA Identification Number
- Date of Installation (Required or Actual Acceptance Date)
- Applicable NASA reference drawing number(s)

2.56.2 Required Acceptance Documentation

- Material, Equipment and Fixture Lists
- Equipment Foundation Data
- Shop Drawings
 - Installation Drawings
 - As-Built Drawings
 - Bearing Layout
- Manufacturer Data
 - Equipment and Performance Data
 - Design Analysis and Calculations
 - Bearing Data
- Test Point Locations
- Test Reports
 - Lubricating Oil Test Results
 - Visual inspection test reports
 - Noise level acceptance test
 - Performance test reports
- Certificates
- Manufacturer's Instructions
- Operations Manual
- Maintenance Manual
- Warranty Information
- Parts List and Recommended Spare Parts List
- Acceptance Documentation (Dates and Signatures)

2.56.3 Acceptance Technologies and Criteria

- Lubricating Oil Tests

The contractor shall use the following tests to verify an acceptable quality of the lubricating oil:

 - Total Acid number testing for pH balance
 - Visual testing for cloudiness
 - IR Spectral Analysis testing for metal particles
 - Particle Count testing for number and size of particles
 - Water Content testing for the presence of water
 - Viscosity testing for lubricating quality

Minimum Acceptance Criteria: refer to Table B-11

- Total Acid Number < 0.05 gm KOH/ml
- Visual – Non cloudy

- IR Spectral Analysis – No presence of metals
 - Particle count < 100 for particles > 10 um
 - Water content < 25 ppm @ 20 °C
 - Viscosity as per manufacturer's specification
-
- Visual Inspection
 - A visual inspection of the motor shall reveal no abnormalities or defects.

 - Noise Level Acceptance
 - Test noise level to ensure the db is within acceptable limits for the application.

 - Performance Test
 - Test run the pneumatic motor and graph performance outputs at various operating speeds.
 - Verify operation in accordance with manufacturer specifications.

2.57 Piping Systems

Industry standard commissioning tests for water, plumbing and air systems first require a pressure test of all piping and fittings. During this test, an ultrasonic scan should be performed on all accessible above ground piping to help discover any leaks.

For hot water systems, after the standard pressure and hydro tests are completed and after the piping insulation has been installed, the system should be charged with hot water. An infrared scan should then be performed to verify insulation integrity.

2.57.1 Required Equipment Information

- Type of Piping System Installed
- Location of Installation
- Quantity of Installation
- NASA Identification Number
- Date of Installation (Required or Actual Acceptance Date)
- Applicable NASA reference drawing number(s)

2.57.2 Required Acceptance Documentation

- Material, Equipment and Fixture Lists
- Shop Drawings
 - Fabrication Drawings
 - Installation Drawings
 - As-Built Drawings
- Product Data
 - Manufacturer's Catalog Data
- Design Data
 - Design Analysis and Calculations
- Test Reports
 - Hydrostatic Test Results
 - Airborne Ultrasonic Test Results
 - Pulse Ultrasound Test Results
 - Performance (Flow) Test Results
 - Infrared Thermography Test (IRT) Results
- Manufacturer's Instructions
- Maintenance Manual
- Warranty Information
- Certificates
- Parts List
- Recommended Spare Parts List
- Acceptance Documentation (Dates and Signatures)

2.57.3 Acceptance Technologies and Criteria

- Hydrostatic Test

The contractor shall pressurize the system and inspect for leaks. This test can be performed simultaneously with the ultrasonic test.

Minimum acceptable criteria: zero leakage

- Thermodynamic Performance Tests (Refer to section B.18)
Refer to data set 9 in Appendix H for additional information.

Minimum acceptable limits for thermodynamic performance tests:

- Performance (Flow) Test Results > design specifications

- Airborne Ultrasonic Tests (Optional) (Refer to section B.6)
The contractor shall use ultrasonics to verify the integrity of the joints, valves, fittings and its associated piping.

Minimum acceptable criteria: zero leakage.

- Pulse Ultrasound Tests (Optional) (Refer to sections B.6)
The contractor shall material thickness measurements on a representative sample of material where a thickness is specified in the contract.

Minimum acceptable criteria:

- $\pm 5\%$ design specifications

- Infrared Thermography (IRT) (optional) (Refer to section B.4)

The contractor shall perform a thermographic survey during the start-up phase of installation of all piping systems as a means of determining leakage. For hot water systems verify insulation integrity.

The infrared imager shall be a focal plane array camera with all of the following minimum requirements:

- Self contained with a minimum of 2 hours of battery capacity
- Temperature range of $-20\text{ }^{\circ}\text{C}$ to $300\text{ }^{\circ}\text{C}$
- Sensitive to $0.2\text{ }^{\circ}\text{C}$ over all temperature ranges
- Accurate to within $\pm 3\%$
- Must be capable of storing up to 12 images for later use
- Have a video recorder interface

Minimum acceptable limits for this test are as follows:

- Qualitatively verify that there is no leakage across piping boundaries and isolation components. Design Engineer or manufacturer to provide predefined relative difference limits, hot and cold spots, and deviations from normal or expected temperature ranges consistent with manufacturer's design data

- Visual Inspection (Observations)
A visual inspection of the piping system shall reveal no abnormalities or defects.

- NASA SpecsIntact Reference: Sections 15102 Plumbing - General requirements, equipment, materials, installation, and testing of plumbing systems; 15106 Ferrous Pipe and Fittings - Steam and condensate systems (150 and 350 pounds per square inch (psi)/(1034 and 2413 kilopascal) and high-pressure compressed air systems(2,000 and 6,000 psi)/(15 and 41 megapascal); 15107 Plastic Pipe and Fittings - Polyvinylchloride (PVC), polyethylene (PE), acrylonitrile-butadiene-styrene (ABS), and chlorinated polyvinylchloride (CPVC) pipe and pipe fittings for general use; 15108 Stainless Steel Pipe and Fittings - High-pressure compressed-air systems.

2.58 Pumps

Vibration Standards for Pumps

Pumps are defined in two (2) categories:

- Positive displacement—including, but not limited to, piston, gear, and vane
- Centrifugal

Vibration readings should be taken under the following operating conditions:

- Non-cavitating, non-separating condition.
- No piping strain.
- Shaft coupling aligned.
- Suction pipe to pump conforms to the Hydraulic Institute standard for required straight run.

Certification shall be performed while the pumps are operating within design specifications.

The vibration limits for positive displacement and centrifugal pumps are shown in Figure 2-13. For the purposes of line amplitude evaluations, a "pumping frequency" (PF) band will be established. The PF band will be centered on the pumping frequency (the number of pumping elements X pump RPM). The band will extend +2 lines of resolution on either side of the line of resolution containing the pumping frequency (i.e., Bandwidth = 5 lines of Resolution).

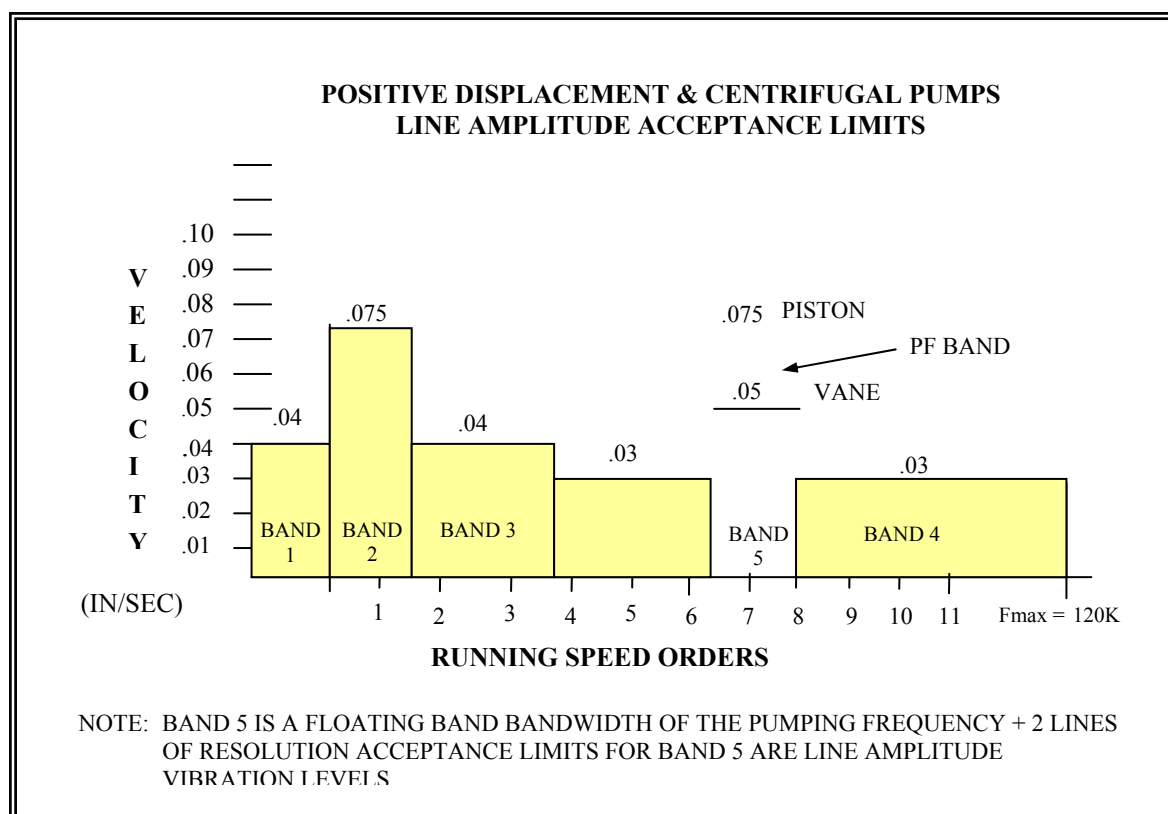

Figure 2-13: Positive Displacement and Centrifugal Pump Vibration Envelope Overall Per Band

Excluding the lines of resolution contained in the PF band, the velocity amplitude (in/sec-peak) of any line of resolution, measured at bearing locations in any direction of a positive displacement or centrifugal pump shall not exceed the line amplitude band limit values specified in Figure 2-13.

Specific Equipment—Use the criteria shown in Table 2-23 on boiler feedwater, split case, and progressive cavity pumps:

Frequency Band	Maximum Vibration Amplitude (in/sec Peak)
Overall (10-1000 Hz)	0.06
1X RPM	0.05
2X RPM	0.02
Harmonics	0.01
Bearing Defect	Not detectable

Table 2-24: Pump Vibration Limits

Centrifugal Pumps, Vertically Mounted

Sound discs shall be mounted in the radial direction as close to the bearings as possible. Accelerometers shall be mounted to solid structures and not on drip shields or other flexible structures. Mounting locations shall be in line with each other, perpendicular to the pump discharge, and located at the free end, at the coupled end of the motor and pump, and in the axial direction on the pump and motor, if possible.

Centrifugal Pumps, Horizontally Mounted

Sound discs shall be mounted in the horizontal and vertical planes radial to the shaft at the free and coupled ends of the motor and pump as close to the bearings as possible. Accelerometers shall be mounted to solid structures and not on drip shields or other flexible structures. Mounting locations shall be in line with each other, perpendicular to the pump discharge and located at the free and coupled end of the motor and pump, and in the axial direction on the motor and pump, if possible.

Positive Displacement Pumps

Sound discs shall be mounted in the horizontal and vertical planes radial to the shaft at the free and coupled ends of the motor and pump as close to the bearings as possible. Accelerometers shall be mounted to solid structures and not on drip shields or other flexible structures. Mounting locations shall be in line with each other, perpendicular to the pump discharge, and located at the free end, coupled end of the motor and pump, and in the axial direction on the pump and motor. An exception may be granted if the pump is sump mounted.

2.58.1 Required Equipment Information

- Pump Type
- Pump Specifications
 - Number of stages
 - Number of vanes per stage
 - Number of gear teeth on each pump gear
 - Type of impeller or gear
 - Rotating speed
 - Number of volutes
 - number of diffuser vanes
- Location of Installation
- NASA Identification Number
- Date of Installation (Required or Actual Acceptance Date)
- Applicable NASA reference drawing number(s)

2.58.2 Required Acceptance Documentation

- Material, Equipment and Fixture Lists
- Equipment Foundation Data
- Shop Drawings
 - Installation Drawings
 - As-Built Drawings
 - Bearing Layout
- Manufacturer Data
 - Equipment Foundation Data
 - Equipment and Performance Data
 - Design Analysis and Calculations
 - Bearing Data
- Test Point Locations
- Test Reports
 - Hydraulic Tests (Factory Report)
 - Performance (Efficiency) Tests
 - Vibration Analysis Test Results
 - Alignment Measurement Results (Laser Alignment)
 - Lubricating Oil Test Results
- Certificates
- Manufacturer's Instructions
- Operations Manual
- Maintenance Manual
- Warranty Information
- Parts List and Recommended Spare Parts List
- Acceptance Documentation (Dates and Signatures)

2.58.3 Acceptance Technologies and Criteria

- Vibration Analysis Test (Refer to sections B.3)

Refer to data set 10 in Appendix H for additional information.

- Balance Test and Measurement (Refer to section B.1)
 - The contractor shall use balance measurement to verify that rotating shafts are balanced and mass and rotational centerlines are coincident.
 - Document key lengths A, B, final length

Minimum Acceptance Criteria: refer to Table B-1

- Better than or equal to manufacturer's specifications

- Laser Alignment or Other Alignment Methods (Refer to sections B.2)
Refer to data set 6 in Appendix H for additional information.

- Lubricating Oil Tests (Refer to sections B.7)
Refer to data set 7 in Appendix H for additional information.

- Thermodynamic Performance Tests (Refer to section B.18)
Refer to data set 9 in Appendix H for additional information.

- Hydraulic Oil Tests (Optional) (Refer to sections B.7)
The contractor shall use particle counting tests to verify an acceptable level of contamination in the hydraulic oil.

Minimum Acceptance Criteria: refer to Sperry Vickers Table, Table B-10

- Visual Inspection
A visual inspection of the pumps shall reveal no abnormalities or defects.
- NASA SpecsIntact Reference: Section 15135 Centrifugal pumps.

2.59 Roofs, Walls and Insulation

The most common concerns associated with structures in addition to structural integrity, are temperature and environmental relationships. The facility must keep the "outside" out, and the "inside" in. Infrared thermography (IRT) is a technology that can be very useful in determining temperature deviations across structural boundaries. IRT can be used to locate wet insulation in roofs, insulation voids in walls, and leaks in HVAC systems.

Roofs

Because roofs normally are constructed layer by layer, and because they are comprised of many different types of materials, the inspection of roofs must be a continuous process. Since moisture ingress and contamination is the major failure pattern, moisture must not be allowed to enter the roof structure or materials during the construction phase. Any trapped moisture within the roof system will remain there for the life of the roof. Trapped moisture will eventually degrade the roof and structure and can cause a premature failure of the roofing system.

Traditional roof inspections are usually looking for the *effects* of leaks. IRT instead looks for wet insulation caused by improper installation or roof boundary failures. During the course of a day, the temperature of a roof will increase due to solar loading. However, wet insulation changes temperature at a different (slower) rate than dry insulation, so as the roof cools in the evening there is the opportunity to take advantage of this temperature difference and locate any wet insulation. The reverse process occurs in the morning and offers a similar, but more limited, opportunity to identify a temperature difference.

Roof inspections using IRT typically have a small thermal "window" of opportunity to see this temperature difference. Factors to contend with are winds, dew, and ambient temperature. Eventually, the entire roof surface will reach equilibrium and the IRT inspection from that point becomes ineffective - the "window" is closed until the next temperature swing.

Most moisture problems in new roofs are often due to improper installation (e.g., insulation materials become wet before the layers are sealed) or breeches around flashings and penetrations. Leaks caused by the latter can sometimes be quite a distance away from the actual breach. Different insulation types will produce different IRT images. Some will appear as straight lines, indicating that there is moisture in the seams. Others will appear as puddles with free forming edges due to the wicking of the moisture. Any anomalies found must be turned over to the contract administrator for repair by the roofing contractor. Figure 2-14 is an IRT image of a wet roofing system. The moisture pattern is evident.

Built-up Roofs

The first inspection should be a visual one, after all roof penetrations are complete. The inspection should be thorough enough to ensure that there is a good, weatherproof seal on all penetrations and that the surface is free of moisture and contamination before allowing the base layer to be installed.

After the final layers are completed, the entire roof should again be inspected visually. All penetrations and flashing should be watertight at the roof penetration. Additionally, all insulation materials and their locations must be identified and documented for future reference. This information should be provided to the Construction Manager for forwarding to the

appropriate maintenance organization, i.e., Systems Engineer, Condition Monitoring Office, Predictive Testing Group, etc. and inclusion in the maintenance database.

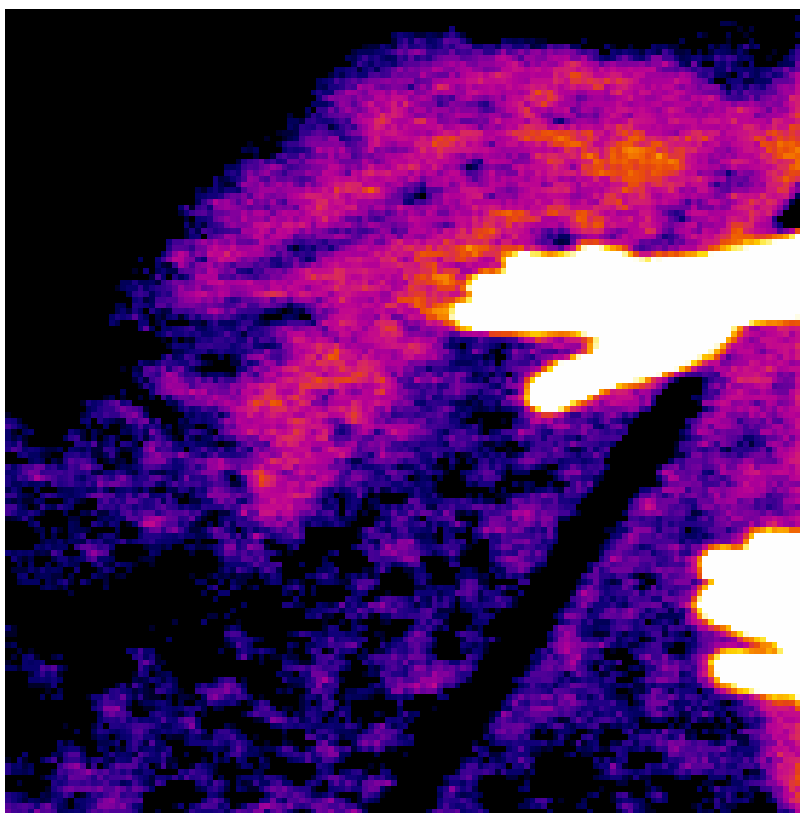

Figure 2-14: Infrared Image of Moisture Under Roof⁸

Membrane Roofs

As with built-up roofs, the first inspection should take place after all roof penetrations are complete. The inspection should be thorough enough to ensure that there is a good, weatherproof seal on all penetrations and that the surface is free of moisture and contamination before allowing the base layer to be installed.

After its installation, the outer membrane should be inspected for the proper seam overlap and connection. All penetrations and flashings should be watertight. All insulation materials and their locations must be identified and documented for future reference.

Following a minimum of 90 days operation (or installation), but no later than one year, and having let nature take its course, the appropriate maintenance organization (i.e., Systems Engineer, Condition Monitoring Office, Predictive Testing Group, etc.) should inspect the installation using advanced monitoring technologies such as IRT or Ultrasonic mapping. Although it is recognized that facility acceptance has already taken place, these technologies can identify insulation voids, insulation settling, and areas of moisture intrusion that could have been overlooked during the initial inspections and for which the contractor is still responsible under the terms of the construction contract warranty.

⁸ Image provided by Kennedy Space Center (SGS))

Metal Roofs

Unlike built-up and membrane roofs, metal roofs have no insulation. They are normally single layer, overlapped corrugated galvanized steel or aluminum sheeting. Consequently, inspections will consist of verifying that the proper material has been used and ensuring that the construction is watertight and properly anchored.

Insulation/Building Envelope

As with roofs, building insulation is installed during construction, but in most cases, prior to the building being completed. Consequently, acceptance inspections of the envelope insulation must occur before the walls and ceilings are completed.

On completion of the insulation installation, a construction detail showing the insulation material type, amount, and location shall be generated and submitted by the contractor. This information should be provided to the Construction Manager for forwarding to the appropriate maintenance organization, i.e., Systems Engineer, Condition Monitoring Office, Predictive Testing Group, etc. and inclusion in the maintenance database.

Summary

For all structures (except possibly metal roofs) following a minimum of 90 days operation (or installation), but no later than one year, and having let nature take its course, the appropriate maintenance organization (i.e., Systems Engineer, Condition Monitoring Office, Predictive Testing Group, etc.) should inspect the installation using advanced monitoring technologies such as IRT or Ultrasonic mapping. Although it is recognized that facility acceptance has already taken place, these technologies can identify insulation voids, insulation settling, and areas of moisture intrusion that could have been overlooked during the initial inspections and for which the contractor is still responsible under the terms of the construction contract warranty.

The contractor shall perform a thermographic survey of the building envelope as part of the pre-beneficial occupancy to check for voids in insulation and/or the presence of wetted insulation. In addition, the presence of air gaps in building joints such as seams, door frames, window frames, etc., shall be checked via thermographic survey using an appropriate procedure and specifications described in the following:

ASTM C1060-90	<i>Thermographic Inspection of Insulation in Envelope Cavities In Wood Frame Buildings.</i>
ASTM C1153-90	<i>Standard Practice for the Location of Wet Insulation in Roofing Systems Using Infrared Imaging.</i>
ISO 6781	<i>Thermal Insulation-Qualitative Detection of Thermal Irregularities in Building Envelopes-Infrared Method.</i>
ASTM E1186-87	<i>Standard Practices for Air Leakage Site Detection in Buildings.</i>

The contractor shall clearly identify all voids or gaps noted during the thermographic scan by photographs, scale drawings, and/or by description.

For areas where the moisture content of the insulation or building envelope is questionable, the contractor shall use either destructive or non-destructive testing techniques that confirm the amount of moisture. Specific testing procedures to be used shall be proposed by the contractor and approved by the procuring organization.

2.59.1 Required Equipment Information

- Type of Roofing System or Insulation System Installed
- Location of Installation
- NASA Identification Number
- Date of Installation (Required or Actual Acceptance Date)
- Applicable NASA reference drawing number(s)

2.59.2 Required Acceptance Documentation

- Layout Drawings
- Fabrication Drawings
- Samples
- Manufacturer Data
- Maintenance Manual
- Warranty Information
- ID of Materials and Location
- Certificates
- Parts List and Recommended Spare Parts List
- Acceptance Documentation (Dates and Signatures)

2.59.3 Acceptance Technologies and Criteria

- Infrared Thermography (IRT) (Refer to sections B.4)
Refer to data set 4 in Appendix H for additional information.
- Airborne Ultrasonic Tests (Optional) (Refer to sections B.6.5)
The contractor shall perform airborne ultrasonic tests to detect uneven heating indicative of moisture as a result of leaks or trapped moisture from installation.

Minimum acceptance criteria: < TBD based on unit test set

- Visual Inspection
The contractor shall visually inspect for structural integrity, moisture, penetrations seals, damage or voids.
- NASA SpecsIntact Reference: Sections 07400 Roofing and Siding Panels - Aluminum and steel roofing and siding, single-sheet uninsulated and insulated metal panels, and fire-rated metal walls; 07510 Built-up Bituminous Roofing - Asphalt and coal-tar built-up roofing systems and nonmetallic flashing systems; 07511 Built-up Asphalt Roofing - Asphalt and coal-tar built-up roofing systems and nonmetallic flashing systems; 07530 Single Ply Membrane Roofing - Elastic roofing sheet-applied for application directly on decks and insulation.

2.60 Steam Traps

2.60.1 Required Equipment Information

- Type of Steam Trap Installed
- Location of Installation
- NASA Identification Number
- Date of Installation (Required or Actual Acceptance Date)
- Applicable NASA reference drawing number(s)

2.60.2 Required Acceptance Documentation

- Material, Equipment and Fixture Lists
- Shop Drawings
 - Installation Drawings
- Product Data
 - Manufacturer's Catalog Data
- Design Data
 - Design Analysis and Calculations
- Test Reports
 - Airborne Ultrasonic Test Results
- Manufacturer's Instructions
- Maintenance Manual
- Warranty Information
- Certificates
- Parts List
- Recommended Spare Parts List
- Acceptance Documentation (Dates and Signatures)

2.60.3 Acceptance Technologies and Criteria

- Airborne Ultrasonic Tests (Refer to sections B.6.5)
The contractor shall use ultrasonics to verify the integrity of the joints, valves, fittings and its associated piping.

Minimum acceptance criteria: < TBD based on unit test set

- Visual Inspection
The contractor shall visually inspect for abnormalities or defects.
- NASA SpecsIntact Reference: Section 15125 – Steam Traps.

2.61 Switchgear

2.61.1 Required Equipment Information

- Switchgear Type
- Switchgear Specification Data (Voltage Rating)
- Location of Installation
- NASA Identification Number
- Date of Installation (Required or Actual Acceptance Date)
- Applicable NASA reference drawing number(s)

2.61.2 Required Acceptance Documentation

- Material, Equipment and Fixture Lists
- Shop Drawings
 - Connection Diagrams
 - Switchgear Assemblies
 - Fabrication Drawings
- Product Data
 - Equipment and Performance Data
 - Equipment Foundation Data
 - Manufacturer's Catalog Data
- Test Reports
 - Airborne Ultrasonics Test
 - Power Factor Test
 - Infrared Thermography Test (IRT)
 - Insulation Resistance Test
 - High Voltage Test
 - Weatherproof Test
 - Contact Resistance Test
- Certificates
- Manufacturer's Instructions
- Operations Manual
- Maintenance Manual
- Warranty Information
- Parts List and Recommended Spare Parts List
- Acceptance Documentation (Dates and Signatures)

2.61.3 Acceptance Criteria

- Airborne Ultrasonic Tests (Optional) (Refer to sections B.6)
The contractor shall use ultrasonics to verify the non-existence of electrical arcing and other high frequency events.

Minimum acceptance criteria: < TBD based on unit test set

- Insulation Resistance Test (Refer to sections B.10)
Refer to data set 5 in Appendix H for additional information.
- Infrared Thermography (IRT) (Optional) (Refer to sections B.4)
Refer to data set 4 in Appendix H for additional information.
- Contact Resistance Test (Optional) (refer to section B.13)
Refer to data set 2 in Appendix H for additional information.
- Power Factor Test (Optional) (Refer to sections B.5)
Refer to data set 8 in Appendix H for additional information.

Minimum acceptance criteria:
 - Power factor must not exceed manufacturer's data.
- High Voltage Test (Optional) (refer to section B.15)
The contractor shall perform the high voltage test to verify the insulation in a new switchgear and to ensure that there is no excessive leakage current. This is a potentially destructive test and requires authorization from the NASA Construction Manager.

Minimum acceptance criteria:
 - better than or equal to manufacturer's specifications
 - limits in accordance with ANSI/IEEE Standard 400
- Visual Inspection
A visual inspection of the Switchgear shall reveal no abnormalities or defects.
- Electrical Acceptance Tests
The contractor shall perform electrical continuity tests on current, potential and control circuits.
The contractor shall perform ratio and polarity tests on current and potential transformers.
The contractor shall perform a current test on the remainder of the secondary circuit to detect any open or short-circuit connections.
- Weatherproof Test
The contractor shall perform a weatherproof test in the presence of the Contracting Officer in accordance with IEEE C37.20.1
- NASA SpecsIntact Reference: Section 16445 Switchgear Assemblies - Switchgear and switchboards of special design or configuration.

2.62 Tank and Storage Tank Pressurized

2.62.1 Required Equipment Information

- Tank Identification (Type)
- Volume
- Location of Installation
- NASA Identification Number
- Date of Installation (Required or Actual Acceptance Date)
- Applicable NASA reference drawing number(s)

2.62.2 Required Acceptance Documentation

- Layout Drawings
- Manufacturer Data
- Maintenance Manual
- Warranty Information
- Test Reports
 - Tank Integrity Test Results
 - Verification of Liquid Level Indication Results (If applicable)
 - Verification of Relief Device Results
- Certificates
- Parts List and Recommended Spare Parts List
- Baseline Data from Verification Test
- Acceptance Documentation (Dates and Signatures)

2.62.3 Acceptance Technologies and Criteria

- Integrity Testing

Conduct integrity testing in accordance with recognized industry standards. Integrity testing may include the following:

 - non-destructive shell testing
 - hydrostatic testing
 - radiographic testing
 - ultrasonic examination (UE) testing
 - acoustic emissions (AE) testing.

The type of testing should be determined by the NASA Construction Manager with considerations for the type of liquid to be stored in the tank and also whether the tank is to be above or below ground.

If airborne ultrasonic leak detection is specified, then it can be used with an ultrasonic tone generator to verify vessel seals prior to hydrotesting. Testing in this manner is subjective. The tone generator is set to a specific frequency within

the ultrasonic frequency band and the detector is set to monitor for that frequency. Any indication of that frequency is a sign of a leak and will need to be corrected.

If ultrasonic examination (UE) thickness testing is specified to verify tank wall material thickness, then check certified design drawings to find the specified material thickness for the vessel wall to be tested.

Below ground, steel tanks may require additional consideration for ground induced corrosion and cathodic protection. Testing for these issues may be found in another section of this document.

Integrity testing of the valves and piping are considered in other sections of this document.

- **Verification of Liquid Level Indication**

The contractor shall perform appropriate tests to verify the accuracy of the liquid level indication. Depending on various factors associated with construction of the tank, temperature of the liquid contained in the tank, and the type of instrumentation, the methods used to verify the accuracy of this indication is to be determined by the NASA Construction Manager.

Some of the possible methods that may be used for this verification may include:

- Infrared Thermography (Refer to section B.4)
- Sounding Tape
- Sight glass (if installed)

- **Verification of Safety Relief Devices**

The contractor shall perform appropriate tests to verify that if there are any safety relief devices installed on the tank, that they will perform their relief function at the appropriate pressure or vacuum.

- **Visual Inspection**

A visual inspection of the gaskets and fasteners to verify correct materials used during installation.

A visual inspection for any abnormalities prior to any liquid being introduced into the tank.

Visual inspections to assure all components are installed properly.

2.63 Tank and Storage Tank Unpressurized

2.63.1 Required Equipment Information

- Tank Identification (Storage Solution)
- Volume in US Gallons
- Location of Installation
- NASA Identification Number
- Date of Installation (Required or Actual Acceptance Date)
- Applicable NASA reference drawing number(s)

2.63.2 Required Acceptance Documentation

- Layout Drawings
- Test Point Locations
- Manufacturer Data
- Maintenance Manual
- Warranty Information
- Test Reports
 - Tank Integrity Test Results
 - Verification of Liquid Level Indication Results
 - Verification of Relief Device Results
- Certificates
- Parts List and Recommended Spare Parts List
- Baseline Data from Verification Test
- Acceptance Documentation (Dates and Signatures)

2.63.3 Acceptance Technologies and Criteria

- Integrity Testing

For tanks with capacities greater than 6,000 gallons, conduct integrity testing in accordance with recognized industry standards. Integrity testing may include the following:

 - non-destructive shell testing
 - hydrostatic testing
 - radiographic testing
 - ultrasonic examination (UE) testing
 - acoustic emissions (AE) testing.

The type of testing should be determined by the NASA Construction Manager with considerations for the type of liquid to be stored in the tank and also whether the tank is to be above or below ground.

Below ground, steel tanks may require additional consideration for ground induced corrosion and cathodic protection. Testing for these issues may be found in another section of this document.

Integrity testing of the valves and piping are considered in other sections of this document.

- **Verification of Liquid Level Indication**

The contractor shall perform appropriate tests to verify the accuracy of the liquid level indication. Depending on various factors associated with construction of the tank, temperature of the liquid contained in the tank, and the type of instrumentation, the methods used to verify the accuracy of this indication is to be determined by the NASA Construction Manager.

Some of the possible methods that may be used for this verification may include:

 - Infrared Thermography (Refer to section B.4)
 - Sounding Tape
 - Sight glass (if installed)

- **Verification of Safety Relief Devices**

The contractor shall perform appropriate tests to verify that if there are any safety relief devices installed on the tank, that they will perform their relief function at the appropriate pressure or vacuum. Not all atmospheric tanks will include such items.

- **Visual Inspection**

A visual inspection of the gaskets and fasteners to verify correct materials used during installation.

A visual inspection for any abnormalities prior to any liquid being introduced into the tank.

A visual inspection for leaks once filled with acceptable liquid.

2.64 Transformers

2.64.1 Required Equipment Information

- Transformer Type
- Transformer Specifications
 - Winding resistances
 - Current transformer ratios
 - Transformer impedance
 - Load loss at rated voltage and current
 - Current loading
- Location of Installation
- NASA Identification Number
- Date of Installation (Required or Actual Acceptance Date)
- Applicable NASA reference drawing number(s)

2.64.2 Required Acceptance Documentation

- Material, Equipment and Fixture Lists
- Shop Drawings
 - Equipment Foundation Drawings
 - Connection Diagrams
 - Fabrication Drawings
 - Installation Drawings
- Product Data
 - Equipment Foundation Data
 - Equipment and Performance Data
 - Manufacturer's Catalog Data
- Test Reports
 - Airborne Ultrasonic Test Results
 - Power Factor Test Results
 - Insulation Oil Test Results
 - Infrared Thermography Test (IRT) Results
 - Insulation Resistance Test Results
 - Turns Ratio Test Results
 - High Voltage Test Results
 - Temperature Rise Test Results
 - Baseline Data from Verification Tests
- Certificates
- Manufacturer's Instructions
- Operations Manual
- Maintenance Manual
- Warranty Information
- Parts List and Recommended Spare Parts List
- Acceptance Documentation (Dates and Signatures)

2.64.3 Acceptance Technologies and Criteria

* Note: Where some of the tests provide similar condition information, the NASA Construction Manager should determine which test need not be performed based on experience with the type and size of transformer.

- Airborne Ultrasonic Tests (Optional) (Refer to sections B.6)
 - The contractor shall use ultrasonics to verify the non-existence of electrical arcing and other high frequency events.
 - Minimum acceptance criteria: < TBD based on unit test set
- Power Factor Test (Optional) (Refer to sections B.5)
 - Refer to data set 8 in Appendix H for additional information.
- Insulation Oil Test (Optional) (Refer to sections B.8)
 - The contractor shall perform the following tests as appropriate for the type of transformer to verify lack of contaminants and that the necessary inhibitors have been added:
 - Dissolved Gas Analysis, ASTM D-3612-90
 - Karl Fisher, ASTM D-1533-88
 - Dielectric Breakdown Strength Test, ASTM D-877 and D-1816
 - Acidity Test, ASTM D-974
 - Visualization Examination, ASTM D-1524

Minimum acceptance criteria:

- Dissolved Gas
 - Nitrogen (N₂) < 100 ppm
 - Oxygen (O₂) < 10 ppm
 - Carbon dioxide (CO₂) < 10 ppm
 - Carbon Monoxide (CO) < 100 ppm
 - Methane (CH₄) none
 - Ethane (C₂H₆) none
 - Ethylene (C₂H₄) none
 - Hydrogen (H₂) none
 - Acetylene (C₂H₂) none
 - Karl Fisher (<25ppm at 20°C.
 - Dielectric Breakdown Strength (> 30kV)
 - Neutralization number (< 0.05mg/g)
 - Visual Examination (clear)
- Infrared Thermography (IRT) (Refer to sections B.4)
 - The contractor shall perform a thermographic survey to detect uneven heating indicative of loose or dirty connections, and also uneven heating patterns in transformer oil and windings. This survey may also indicate internal corrosion or other flaws. Localized heating may be indicative of flaws in windings or insufficient ventilation of the surrounding area. Temperature variations in cooling fins or tubes may indicate internal cooling problems, such as a loss of coolant or

plugging. A bank of same-type transformers with significantly different temperature readings may indicate unbalanced loading or a defective transformer.

Minimum acceptance criteria:

- qualitative inspection using predefined relative difference limits, hot and cold spots, and deviations from normal or expected temperature ranges consistent with manufacturer's design data

- Turns Ratio Test (Refer to Section B.16)
The contractor shall verify acceptable turns ratio.

Minimum acceptance criteria: $\pm 2\%$ design specifications

- Temperature Rise Test
The contractor shall verify that the transformer does not exceed temperature limits when the transformer is delivering rated kVA output at rated secondary voltage

Minimum acceptance criteria : in accordance with IEEE C57.12.00

- Contact Resistance Test (Optional) (refer to section B.13)
Refer to data set 2 in Appendix H for additional information.

- Insulation Resistance Test (Optional) (Refer to sections B.10)
Refer to data set 5 in Appendix H for additional information.

- High Voltage Test (Optional) (refer to section B.15)
The contractor shall perform the high voltage test to verify the insulation in a transformer and to ensure that there is no excessive leakage current. This is a potentially destructive test and requires authorization from the NASA Construction Manager.

Minimum acceptance criteria:

- better than or equal to manufacturer's specifications
- limits in accordance with ANSI/IEEE Standard 400

- Visual Inspection
A visual inspection of the transformers shall reveal no abnormalities or defects.

- NASA SpecsIntact Reference: Sections 16275 Distribution Transformers - Single- and three-phase dry-type and oil-insulated transformers; 16276 Station Class Power Transformers - Station power transformers, single- and three-phase.

2.65 Turbine Expander

The term “Turbine Expander” is often used interchangeably with “power turbine” or “free turbine.” The suppliers, OEMs, of power turbines have multiple names for the various equipment and in accepting certain guarantees/warranties, an exact understanding of what they should be providing is imperative.

The turbine expander typically consists of 2 or 3 stages and expands gases received from the hot exhaust of a stationary-mounted jet engine. The jet engine is often referred to as an aeroderivative type gas turbine (see 2.X for explanation). The gases are expanded through the turbine creating power to drive a generator, compressor, pump, etc. through the power turbine’s shaft.

2.65.1 Required Equipment Information

- Power Turbine Type
- Power Turbine Specifications
 - Manufacturer / PT Model Number
 - Major component list
 - Number of turbine stages with speed, blades per each row
 - Coupling type and information
 - Baseplate supports
 - Lube Oil System
 - Exhaust System
 - Control & Data Output Systems
 - Vibration System
 - Fire/Gas/Extinguishing System
 - Water Wash System
- Performance Test by OEM with customer verification/1-yr HR-Output
- Warranty Information
- Location of Installation
- NASA Identification Number
- Actual Acceptance Date by Customer
- Applicable NASA reference drawing numbers

2.65.2 Required Acceptance Documentation

- Manufacturer’s Data
 - Equipment & Performance Data
 - Design analysis & calculations
 - Bearing data (support and thrust)
- Material, equipment, and fixture lists
- Equipment Foundation data
- Equipment/Shop Drawings

- Installation drawings along with final red line drawings/signatures and dated before customer accepts responsibility
- Completed As-Built Drawings (part of retainer released)
- Bearing and fiber optic ports layouts
- All Test point locations
- Test Reports (part of retainer released when received and accepted by customer)
 - Vibration analysis test results
 - Laser alignment test results
 - Lubricating oil test results
 - Thermodynamic performance test results (GT efficiency)
 - Hydraulic oil test results (optional)
 - Infrared thermography test results
 - Borescope inspection test results
- Certificates
- Manufacturer's Instructions
- Operations and Maintenance Manuals
- Warranty Information
- Parts list and recommended spare parts list
- Acceptance documentation with dates and signatures

2.65.3 Acceptance Technologies and Criteria

- Vibration Analysis Test (Refer to section B.3)
Refer to data set 10 in Appendix H for additional information.
- Balance Test and Measurement (Refer to section B.1)
- The contractor shall use balance measurement to verify that rotating shafts are balanced and mass and rotational centerlines are coincident.
 - Document key lengths A, B, final length

Minimum Acceptance Criteria: refer to Table B-1

- Better than or equal to manufacturer's specifications

- Laser Alignment or Other Alignment Methods (Refer to section B.2)
Refer to data set 6 in Appendix H for additional information.
- Lubricating Oil Tests (Refer to section B.7)
Refer to data set 7 in Appendix H for additional information.
- Thermodynamic Performance Tests (Refer to section B.18) (ASME PTC22)

The contractor shall perform thermodynamic performance tests of the power turbine to verify that design specifications are met. The required tests and calculations will be specified by the Design Engineer.

Minimum acceptable limits for thermodynamic performance tests:

± 2% of manufacturer's specifications or as specified by the Design Engineer.

- Hydraulic Oil Tests (Optional) (Refer to section B.7)
The contractor shall use particle counting tests to verify an acceptable level of contamination in the hydraulic oil.

Minimum Acceptance Criteria: refer to Sperry Vickers Table, Table B-10

- Infrared Inspection (refer to sections B.4)
During acceptance tests, contractor will conduct full scan of the power turbine unit looking for hot spots on casings, bearing areas, connections, etc. for indications of any abnormalities. This will be accomplished with an Infrared camera that has video tape capabilities which will serve as a signature for full load, steady condition of the PT. Any future taping may indicate discrepancies when compared to the bas tape.
- Borescope Inspection (refer to sections B.20)
When the PT is set in place and acquisition is possible to the casing's borescope or fiber optic inspection ports, the contractor will accomplish a complete internal visual diagnostic inspection of the power turbine to verify no damage, corrosion or deformation has occurred. This will be detailed in a final acceptance test report with accompanying video tapes to verify the conditions and serve as a original signature to the new unit. This will be required during maintenance activities during the life of the PT as specified in the OEM's scheduled and unscheduled O&M activities.
- Visual Inspection
A visual inspection of the compressor shall reveal no abnormalities or defects.

2.66 Turbines-Gas

A gas turbine is an engine which converts heat energy from fossil fuels into mechanical (rotating) energy. There are two distinct types of gas turbines in the marketplace. Their applications and basic characteristics may be the same, however, size, weight, and design considerations offer specific advantages of one type over the other. It must be noted that the designation “gas turbine” is interchangeable with “combustion turbine” and also another type of engine called, “aeroderivative”. The suppliers and OEMs of gas turbines have multiple names for various equipment and in accepting certain guarantees/warranties, an exact understanding of what they should be providing is imperative.

Combustion Turbines (CT)

The typical combustion turbine is the industrial, or heavy duty type of turbine; that is, very large in physical size, has thick/horizontal split casings with heavy rotors that weigh in the tons. They are designed for stationary applications such as drivers for power generators, mechanical drives, compressors, etc. They are not limited in power output and have grown increasingly larger over the past 20 years. The CT has a basic design which comprises a single shaft usually rotating around 3600 rpm, an axial compressor, a combustion section, and a hot expansion turbine section. It typically has two bearings, only at the front and the back, which should have sound discs mounted in the horizontal and vertical planes radial to the shaft on the turbine supports at each end. These accelerometer pick up points must be in line with each other and data taken from the same location. It takes 20-30 minutes from a cold start to reach full load and over an hour to reach steady state thermal conditions prior to any testing.

Aeroderivative Type (AT)

The aeroderivative type of combustion turbine is a light weight aircraft engine (also called a gas generator) mounted on stationary supports to either discharge its exhaust into a power turbine (also called an expansion turbine and drives similar devices as CT). It also can be directly coupled from its compressor end through a gear drive system to drive various equipment. They are limited in size and output and are made of thin walled cylindrical casings. The AT’s design is typically dual shafted with a low pressure compressor/turbine (speed at about 6000 rpm) and a high compressor/turbine (9000 rpm) setup. It has a centralized combustion zone like the CT. It has multiple bearings and there are mounting supports where sound discs need to be installed. It takes 5-10 minutes to reach full load from a cold start and less than 30 minutes to achieve steady state thermal conditions. No acceptance performance data signatures should be acquired until this condition has been achieved.

2.66.1 Required Equipment Information

- Gas Turbine Type
- Site Design Conditions
- Gas Turbine Specifications
 - Manufacturer/ GT Model Number
 - Major Component List

- Number of compressor/turbines with speeds, blades per each row
- Number of combustors and number of fuel nozzles per each combustor
- Gear box, drive, turbine cycle descriptions
- Fuel type(s) along with combustion system info to control emissions
- Baseplate supports
- Acoustic enclosure – noise control
- Air inlet information – with filtration details
- Starting system
- Lube oil system
- Exhaust system
- Control and data output systems
- Vibration system
- Emergency power system along with DC battery and controls info
- Fire/gas/extinguishing system
- Water wash system
- Performance Test Criteria by OEM with Customer Verification-1 yr. HR/Output Warranty
- Location Installation
- NASA Identification Number
- Actual Acceptance Date by Customer
- Applicable NASA Reference Drawing Numbers

2.66.2 Required Acceptance Documentation

- Manufacturer's Data
 - Equipment & Performance Data
 - Design Analysis & Calculations
 - Bearing Data (support and thrust)
- Material, Equipment and Fixture Lists
- Equipment Foundation Data
- Equipment/Shop Drawings
 - Sets of installation drawings along with final red lines drawings/signatures/dated
 - Completed as-built drawings (part of retainer released)
 - Bearing and fiberoptic ports layout
- All test point locations
- Test Reports (part of retainer released when received and accepted by customer)
 - Warranty test for heat rate and output (part of retainer released at acceptance) (one year verification test – last part of retainer if meets contractual points)
Note: Customer will do parallel testing with supplier both times to verify results
 - Vibration analysis test results
 - Balance test and measurement results
 - Laser alignment or other alignment method results
 - Lubricating oil test results
 - Thermodynamic performance test results (GT efficiency)

- Hydraulic oil test results (optional)
- Ultrasonic airborne test results
- Power/output test results
- Exhaust gas emissions test results
- Noise level emission test results
- Infrared inspection test results
- Borescope inspection test results
- Visual inspection test results
- Certificates
- Manufacturer's Instructions
- Operation and Maintenance Manuals
- All warranty information
- Parts list and recommended spare parts list
- Acceptance documentation with dates and signatures (base cost minus retainer)

2.66.3 Acceptance Technologies and Criteria

- Vibration Analysis Test (Refer to section B.3) (According to API 670 & 678)
Refer to data set 10 in Appendix H for additional information.
- Balance Test and Measurement (Refer to section B.1)
 - The contractor shall use balance measurement to verify that rotating shafts are balanced and mass and rotational centerlines are coincident.
 - Document key lengths A, B, final length

Minimum Acceptance Criteria: refer to Table B-1

- Better than or equal to manufacturer's specifications

- Laser Alignment or Other Alignment Methods (Refer to section B.2)
Refer to data set 6 in Appendix H for additional information.
- Lubricating Oil Tests (Refer to section B.7)
Refer to data set 7 in Appendix H for additional information.
- Thermodynamic Performance Tests (Refer to section B.18) (ASME PTC22)
Refer to data set 9 in Appendix H for additional information.
- Hydraulic Oil Tests (Optional) (Refer to section B.7)
The contractor shall use particle counting tests to verify an acceptable level of contamination in the hydraulic oil.

Minimum Acceptance Criteria: refer to Sperry Vickers Table, Table B-10

- Ultrasonics – Airborne Tests (Refer to section B.6)
The contractor shall perform UT (optional) refer to sections B6.5) to verify no leakage occurs at the GT's horizontal joints and at any of the pipe connections to the GT.

- **Power/Output Tests (According to IEC 34.1 & ASME PTC22)**

The gas turbine will be full-load tested at the factory to verify power, fuel efficiency, and mechanical integrity. Test report will be included with GT delivery to customer's site.

The supplier will conduct a site load test of the GT at the contractual power point & the contractor, as a verification to the customer, will operate its own test equipment at the same time. The result's of the power output and the GT's heat rate will be within + or -1% of supplier/contractor comparative analysis based on output of exit thermocouples. Retainer will be held by the customer for one year when the acceptance test will be rerun. To verify guaranteed power output and heat rate. Any losses will not be greater than 2%.
- **Exhaust Gas Emissions Test**

EPA designated test procedure for GT emissions will be conducted by the Contractor to verify the emissions and any other designated pollutants are within acceptable limits as specified in the certificate for the site. This is for NO_x, CO, PM₁₀ and UHC emissions.
- **Noise Level Emissions (According to ANSI B133.8, S1.2, & S1.13)**

Specified in site certificate for operations, set of dB noise level indications will be obtained to meet acceptable noise levels at site perimeters and in close proximity to GT where operators will conducting inspections while the unit is in service.
- **Infrared Inspections (Refer to section B.4)**

During acceptance tests, contractor will conduct a full scan of gas turbine looking for hot spots on casings, bearing, connections, etc. for indications of abnormalities. This will be accomplished with an Infrared camera that has video capabilities which serves as signature for GT steady-state conditions. Any future taping may indicate discrepancies when compared to the base signature tape at this full load point.
- **Borescope Inspection (Refer to section B.20)**

When the GT is set in place and acquisition is possible to the casing's borescope or fiber optic inspection ports, the contractor will accomplish an investigation to complete internal visual diagnostic inspections of the GT compressor, combustion area and turbine to verify no damage, corrosion or deformation has occurred. This will be detailed in a report with accompanying video tapes to verify the conditions and serve as a original signature to the new unit. This will be required during maintenance activities during the life of the GT as specified in the OEM's scheduled and unscheduled O&M activities.
- **Visual Inspection**

A visual inspection of the GT shall reveal no abnormalities or defects.

2.67 Steam Turbine (ST)

A steam turbine converts heat energy into mechanical (rotating) energy. Steam turbines may be classified as to:

- (1) steam supply, whether its low, intermediate (medium), high or mixed pressure
- (2) exhaust arrangement, which be of extraction, condensing, non-condensing or back pressure types
- (3) physical arrangement of shaft or shafts – single, tandem or compound
- (4) driven equipment, mechanical equipment or generators
- (5) connection to drive unit, geared or direct

They come in multiple sizes from very small to huge rotors weighing tons that have several bearings, very sophisticated cooling and sealing systems. It is imperative to comprehend its application & classification.

2.67.1 Required Equipment Information

- Steam Turbine Type
- Design Conditions
- Steam Turbine Specifications
 - Manufacturer/ ST Model Number
 - Major Component List
 - Pressure sections , turbines with speed, blades per each row
 - Bearings/gear box, drive, turbine cycle descriptions
 - Baseplate supports
 - Steam conditions at various locations – flow/pressure/temperature – heat balance diagram
 - Lube oil system
 - Starting system/emergency power system
 - Control and data output systems
 - Vibration system
 - Fire/gas/extinguishing system
 - Water wash system
- Location Installation
- NASA Identification Number
- Actual Acceptance Date by Customer
- Applicable NASA Reference Drawing Numbers

2.67.2 Required Acceptance Documentation

- Manufacturer's Data
 - Equipment & Performance Data
 - Design Analysis & Calculations
 - Bearing Data (support and thrust)
- Material, Equipment and Fixture Lists
- Equipment Foundation Data
- Equipment/Shop Drawings

- Sets of installation drawings along with final red lines drawings/signatures/dated
- Completed as-built drawings (part of retainer released)
- Bearing and fiber optic ports layout
- All test point locations
- Test Reports (part of retainer released when received and accepted by customer)
 - Warranty test for heat rate and output (part of retainer released at acceptance) (one year verification test – last part of retainer if meets contractual points)
Note: Customer will do parallel testing with supplier both times to verify results
 - Vibration analysis test results
 - Balance test and measurement test results
 - Laser alignment or other alignment method results
 - Lubricating oil test results
 - Thermodynamic performance test results (GT efficiency)
 - Hydraulic oil test results (optional)
 - Ultrasonic airborne test results
 - Infrared inspection test results
 - Borescope inspection test results
 - Visual inspection test results
- Certificates
- Manufacturer's Instructions
- Operation and Maintenance Manuals
- Warranty information
- Parts list and recommended spare parts list
- Acceptance documentation with dates and signatures (base cost minus retainer)

2.67.3 Acceptance Technologies and Criteria

- Vibration Analysis Test (Refer to section B.3) (According to API 670 & 678)
Refer to data set 10 in Appendix H for additional information.
- Balance Test and Measurement (Refer to section B.1)
 - The contractor shall use balance measurement to verify that rotating shafts are balanced and mass and rotational centerlines are coincident.
 - Document key lengths A, B, final length

Minimum Acceptance Criteria: refer to Table B-1

- Better than or equal to manufacturer's specifications
- Laser Alignment or Other Alignment Methods (Refer to section B.2)
Refer to data set 6 in Appendix H for additional information.
- Lubricating Oil Tests (Refer to section B.7)
Refer to data set 7 in Appendix H for additional information.

- Thermodynamic Performance Tests (Refer to section B.18) (ASME PTC22)
Refer to data set 9 in Appendix H for additional information.
- Hydraulic Oil Tests (Optional) (Refer to section B.7)
The contractor shall use particle counting tests to verify an acceptable level of contamination in the hydraulic oil.

Minimum Acceptance Criteria: refer to Sperry Vickers Table, Table B-10

- Ultrasonics – Airborne Tests (Refer to section B.5)
The contractor shall perform UT (optional) refer to sections B6.5) to verify no leakage occurs at the ST's horizontal joints and at any of the pipe connections to the GT.

Infrared Inspections (Refer to section B.4)

During acceptance tests, contractor will conduct a full scan of the ST looking for hot spots on casings, bearing, connections, etc. for indications of abnormalities. This will be accomplished with an Infrared camera that has video capabilities which serves as signature for steady-state conditions. Any future taping may indicate discrepancies when compared to the base signature tape at this full load point.

- Borescope Inspection (refer to section B.20)
When the ST is set in place and acquisition is possible to the casing's borescope or fiber optic inspection ports, the contractor will accomplish an investigation to complete internal visual diagnostic inspections turbine to verify no damage, corrosion or deformation has occurred. This will be detailed in a report with accompanying video tapes to verify the conditions and serve as a original signature to the new unit. This will be required during maintenance activities during the life of the ST as specified in the OEM's scheduled and unscheduled O&M activities.
- Visual Inspection
A visual inspection of the ST shall reveal no abnormalities or defects.

2.68 Valves

2.68.1 Required Equipment Information

- Type of Valve
- Location of Installation
- NASA Identification Number
- Date of Installation (Required or Actual Acceptance Date)
- Applicable NASA reference drawing number(s)

2.68.2 Required Acceptance Documentation

- Material, Equipment and Fixture Lists
- Shop Drawings
 - Fabrication Drawings
 - Installation Drawings
 - As-Built Drawings
- Product Data
 - Manufacturer's Catalog Data
- Design Data
 - Design Analysis and Calculations
- Test Reports
 - Hydrostatic Test Results
 - Airborne Ultrasonic Test Results
 - Performance (Flow) Test Results
 - Performance (Position Indication) Test Results
 - Infrared Thermography Test (IRT) Results
- Manufacturer's Instructions
- Maintenance Manual
- Warranty Information
- Certificates
- Parts List
- Recommended Spare Parts List
- Acceptance Documentation (Dates and Signatures)

2.68.3 Acceptance Technologies and Criteria

- Hydrostatic Test

The contractor shall pressurize the valve and inspect for leaks. This test can be performed simultaneously with the ultrasonic test.

Minimum acceptable criteria: zero leakage
- Airborne Ultrasonic Tests (Optional) (Refer to section B.6)

The contractor shall use ultrasonics to verify the integrity of the joints, valves, fittings and its associated piping.

Minimum acceptable criteria: zero leakage.

- Thermodynamic Performance Tests (Optional) (Refer to section B.18)

Refer to data set 9 in Appendix H for additional information.

Minimum acceptable limits for thermodynamic performance tests:

- Performance (Flow) Test Results > design specifications
- Performance (Position Indication) Test results \pm 5% actual position

- Infrared Thermography (IRT) (optional) (Refer to section B.4)

The contractor shall perform a thermographic survey during the start-up phase of installation of all valves piping systems as a means of determining leakage.

The infrared imager shall be a focal plane array camera with all of the following minimum requirements:

- Self contained with a minimum of 2 hours of battery capacity
- Temperature range of -20 °C to 300 °C
- Sensitive to 0.2 °C over all temperature ranges
- Accurate to within \pm 3%
- Must be capable of storing up to 12 images for later use
- Have a video recorder interface

Minimum acceptable limits for this test are as follows:

- Qualitatively verify that there is no leakage across piping boundaries and isolation components. Design Engineer or manufacturer to provide predefined relative difference limits, hot and cold spots, and deviations from normal or expected temperature ranges consistent with manufacturer's design data

- Visual Inspection (Observations)

A visual inspection of the piping system shall reveal no abnormalities or defects.

- NASA SpecsIntact Reference: Section 15110 Valves - Valves for steam and condensate systems.

Appendix A: Description of Reliability Centered Maintenance (RCM)

1. Introduction to Reliability Centered Maintenance

Reliability Centered Maintenance (RCM) is an on-going process used to determine the most effective approach to maintenance in support of the mission. It identifies the optimum mix of applicable and effective maintenance tasks needed to realize the inherent design reliability and safety of systems, equipment and personnel at minimal cost. RCM uses a systematic, logic based approach for determining objective evidence for selecting the most appropriate maintenance tasks.

RCM generates sound technical rationale and economic justification on which maintenance decisions are based. The process considers operational experience and failure history to validate and support those decisions.

2. Historical Evolution of RCM

The early development of RCM concepts can primarily be attributed to maintenance policy events in the airline industry in the late 1960's and early 1970's. In an attempt to maximize the safety of airplane passengers and maximize the reliability of airplane equipment, a task group was formed to investigate maintenance practices and to challenge the traditional concepts of successive overhauls. This traditional concept promoted the belief that every item on a piece of degrades over time, and that a specified age can be defined where overhauling that equipment will ensure safety and operating reliability. The resultant work of this task group demonstrated that a strong correlation between age and failure rate did not exist and that the basic premise of time based maintenance was false for the majority of equipment. The results of this task group can be summarized in the following three significant discoveries:

- Scheduled overhaul had little effect on the overall reliability of equipment unless the item has a dominant failure mode and the maintenance action directly addresses that dominant failure mode
- There were many items for which there is no effective form of scheduled maintenance.
- Cost reductions in maintenance could be achieved with no decrease in reliability. A better understanding of the failure process in complex equipment has actually improved reliability when some maintenance actions were eliminated.

The principles and applications of RCM as they evolved in these early developments are documented in Nowlan and Heap's publication, *Reliability-Centered Maintenance*⁹.

3. A Description of the Philosophies That Comprise RCM

⁹ Nowlan, F. Stanley and Heap, Howard F., *Reliability Centered Maintenance*, Dolby Access Press, 1978

RCM is not a new strategy by which organizations embrace maintenance, but rather it is a combination of three distinct philosophies. Those three individual philosophies are best described as:

- Reactive Maintenance, which consists of repair actions after failure,
- Preventive Maintenance (PM) maintenance strategy, also known as “time-directed” maintenance, which consists primarily of health restorative actions prior to failure,
- Predictive Maintenance, also known as Predictive Testing & Inspection (PT&I) or Condition Based Maintenance (CBM), which consists of monitoring actions that allow predictive of failure.

Each of these philosophies has many advantages and disadvantages. The challenge of RCM is to exploit the advantages of each while overcoming or eliminating the disadvantages. As the industry became more experienced with recognizing failures and understanding the relationships between their actions and failure, a fourth philosophy was created which contained the elements to continually improve the total maintenance program.

- Proactive Maintenance, which consists of such elements as Root Cause Failure analysis (RCFA), Age exploration, the developments of Failure Modes and Effects Analyses (FMEA), and incorporating this knowledge into new design in order to continually improve performance and extent equipment life.

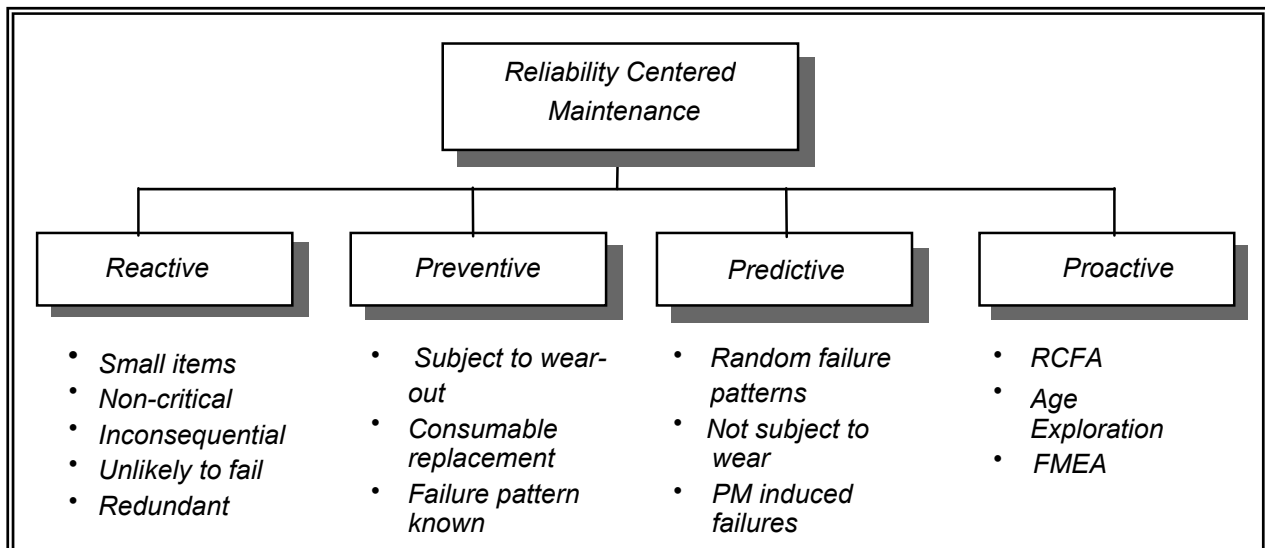

Figure A-1: Components of an RCM Program

Reactive Maintenance Strategy

A Reactive maintenance strategy is corrective in nature, and maintenance isn't performed until equipment performance is unacceptable. It minimizes the amount of down time for maintenance, and is easily understood by most staff personnel. As long as the equipment is performing its

function, it is left alone. Reactive maintenance allows for a lower skill set, as the failures are well defined and there is no need to second guess equipment condition or to train personnel on expensive predictive technologies.

<u>Advantages</u>	<u>Disadvantages</u>
<ul style="list-style-type: none"> • No downtime between failures • Traditionally accepted by maintenance personnel • Easy to justify to outside groups 	<ul style="list-style-type: none"> • Large spare parts inventory • Quick response required from trained personnel • Unscheduled work outages • Longer restoration time • Higher restoration costs • Low manageability of budget, personnel and parts • Disregards safety • Possible collateral damage

Table A-1: Advantages and Disadvantages of a Reactive Maintenance Philosophy

A negative aspect of reactive maintenance is that failures often occur unexpectedly, severely disrupting operations. Emergency repairs can be expensive; labor, parts and supplies may not be immediately available; costs for returning the equipment back to service may be high; and operational impacts can be far more significant than the mere cost to repair the system. Another disadvantage is that have an overly extensive spare parts program because they want to be prepared for any possible failure.

Preventive Maintenance (PM) Strategy

A PM maintenance strategy consists of restorative type maintenance actions that are intended to improve equipment condition and prevent or delay failure. PM applies experience and failure history to identify a pattern of degradation, then attempts to apply specific maintenance actions to return equipment to a desirable level of performance. PM tasks include lubrication, servicing and overhaul. It also includes inspections that require that the equipment be shutdown. PM is successful in reducing the risk of catastrophic failures and also in extending the interval between failures. It helps to maintain equipment at high performance levels and overcomes to some extent some of the disadvantages of a reactive strategy.

The largest disadvantage of PM is that improper execution of maintenance tasks often create more problems than if the maintenance were never performed. Even if the maintenance was done correctly, statistics show that when restorative action is performed to bring equipment back to an as new condition, 72% of the time those actions will have a probability of imposing “infant mortality” on that equipment¹⁷. Infant mortality is defined as failures very early in life, either on newly installed equipment or immediately following restorative maintenance. This is why so many problems exist immediately after returning equipment into service following maintenance. PM maintenance should be performed only if the benefit of restoration outweighs the risk and consequence of infant mortality.

<u>Advantages</u>	<u>Disadvantages</u>
<ul style="list-style-type: none"> • Reduces risk of catastrophic failure • Prevents equipment failure • Overcomes, to some extent, the disadvantages of reactive maintenance 	<ul style="list-style-type: none"> • Operating time per cycle is reduced • Costly unneeded maintenance is performed • Operational restrictions result in deferred maintenance • Frequency intervals based on limited data and vendor recommendations

Table A-2: Advantages and Disadvantages of a Preventive Maintenance Philosophy

One negative aspect of PM is that equipment availability is reduced by intentionally taking equipment off-line in order to perform many of the PM actions. PM strategies also tend to perform more maintenance than the other type of strategies, which in turn increases the requirements for labor, spare parts and supplies. Another disadvantages of a PM strategy is that execution requires very good coordination between “operations” and “maintenance” departments. Before equipment can be removed from service for maintenance, the operational schedule must be able to support that period of unavailability. If such periods of unavailability are not immediately obtainable (i.e. operations demands that the equipment continue running), then the maintenance is deferred. For complex equipment, it is difficult to assess the impact of deferred maintenance.

Predictive Maintenance Strategy

***** Note: Also called Predictive Testing & Inspection (PT&I) *****

A PT&I maintenance strategy monitors equipment performance to recognize the onset of failure, determine degradation rate, and forecast failure. Maintenance actions can be performed at the optimum time before failure. Although PT&I has nearly none of the disadvantages of the RTF and PM strategies, and is effective at recognizing degradation before failure, it may be expensive to implement. PT&I requires skilled technicians, and therefore increased training. PT&I program costs include the one-time costs of acquiring the PT&I equipment (i.e. infrared camera, vibration analysis equipment, borescope, computers, software, on-line sensors, etc.), and the initial and annual costs to train technicians and use this equipment.

Advantages

- Provides for continuous risk assessment
- Integrates with total resource planning
- Overcomes most of the disadvantages of Reactive and Preventive maintenance

- High acquisition and implementation costs
- High training and certification requirements
- Additional maintenance on testing equipment
- May be limited due to non-standard equipment

Disadvantages**Table A-3 Advantages and Disadvantages of a PT&I Maintenance Philosophy****4. Proactive Maintenance Strategy**

As should be noted from the above three tables, there are advantages to each of the three philosophies of reactive maintenance, preventive maintenance, and PT&I. The tremendous power of RCM is that it seeks the optimal mix of PT&I actions, preventive maintenance based actions, and corrective maintenance actions to form a totally comprehensive program. The methodology used in RCM to determine this optimum blend of maintenance actions is based on employing these additional proactive maintenance techniques:

- Failure Mode and Effects Analysis (FMEA)
- Root Cause Failure Analysis (RCFA)
- Age Exploration
- Enhanced specifications and acceptance criteria for new/rebuilt equipment
- Precision rebuild and installation, verified with certification
- Failed part analysis
- Reliability engineering
- Recurrence control

These techniques improve maintenance through better design, installation, maintenance procedures, workmanship, and scheduling. All combined, they form what is commonly called Proactive Maintenance. For a complete description of the techniques, please refer to the NASA Reliability Centered Maintenance Guide for Facilities and Collateral Equipment. The characteristics of proactive maintenance are:

- Using feedback and communications to ensure that changes in design or procedures are rapidly made available to designers and managers.
- Employing a life-cycle view of maintenance and supporting functions.
- Ensuring that nothing affecting maintenance occurs in isolation.
- Employing a continuous process of improvement.
- Optimizing and tailoring maintenance techniques and technologies to each application.

NASA Reliability Centered Building and Equipment Acceptance Guide

- Integrating functions that support maintenance into maintenance program planning.
- Using root-cause failure analysis and predictive analysis to maximize maintenance effectiveness.
- Adopting an ultimate goal of fixing the equipment forever.
- Periodic evaluation of the technical content and performance interval of maintenance tasks (PM and PT&I).

A proactive maintenance program is the capstone of the RCM philosophy, and the most essential element is a thorough understanding of the failure modes associated with a system or equipment failure, and accurately assessing the effects or consequences should such a failure occur.

NASA uses a standard decision logic tree to support consistent analysis and determination of the types of maintenance action that are the best solution for any general situation. This decision logic tree is shown below.

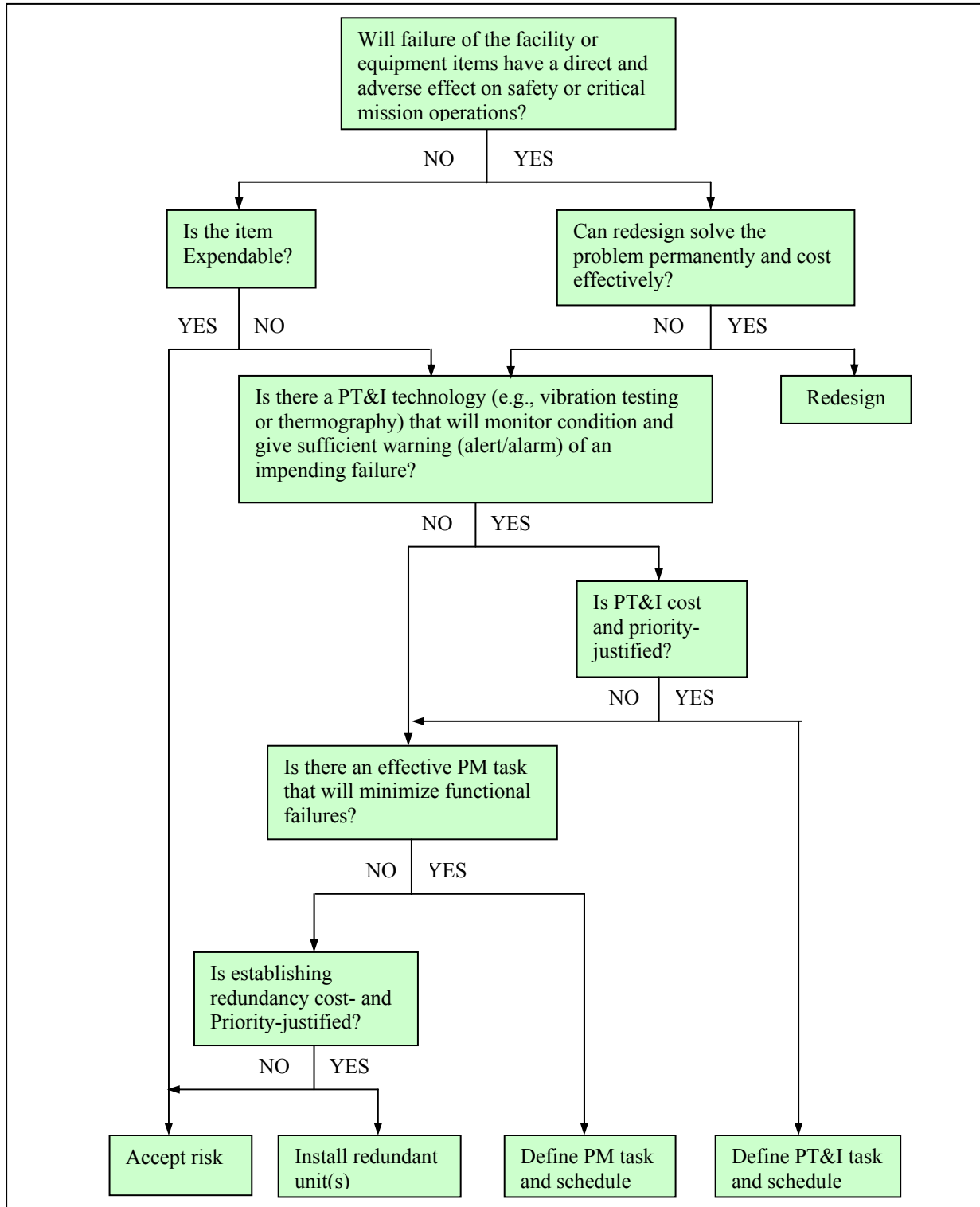

Figure A-2: Reliability Centered Maintenance (RCM) Decision Logic

Failure modes and failure effects are usually determined by performing a failure modes and effects analysis (FMEA). In such an analysis, each function of the system or equipment is translated into a functional failure, which are descriptions of the various ways that the functional requirements will not be met. Each functional failure is then broken down into dominant failure modes, which are observations by which the functions will not be met. Then each dominant failure mode is analyzed to determine specific reasons, or failure causes, that will lead to an occurrence of the dominant failure mode. While dominant failure modes only address overall observations without identifying specific failure mechanisms, failure causes will address the failure mechanisms. For a complete description of failure modes and effects, please refer to the NASA Reliability Centered Maintenance Guide for Facilities and Equipment.

Examples of functional failures (FF), dominant failure modes (DFM), and failure causes (FC) would include the following:

FMEA EXAMPLE #1 (Cooling Water System)

- FF: Total loss of flow
- DFM: Motor for pump does not start
 - FC: Switch/contact broken and will not close
 - FC: Cable from MCC to motor shorted out
 - FC: Bad cable connection at motor
- DFM: Pipe rupture
 - FC: Corrosion
 - FC: Excess stress from adjacent pump vibration

FMEA EXAMPLE #2 (Oil Filtering System)

- FF: Oil is contaminated
- DFM: Filter not removing solid particles
 - FC: Filter element is full and cannot remove more
 - FC: Channeling due to filter element damage
- DFM: Oil being added is contaminated or wrong
 - FC: Bad practices during addition of oil introduces contamination
 - FC: Wrong grade of oil
- FF: Inadequate flow
- DFM: Obstruction
 - FC: Foreign material left in pipe after installation or maintenance
 - FC: Expanded, plugged or collapsed filter element

5. The Link From RCM to Design

RCM is an on-going process which continuously generates performance information to measure the success and effectiveness of the program. There must be a constant effort to evaluate the effectiveness of the current maintenance program, and continually make changes to improve as knowledge and experience about the equipment failures grow. RCM is often defined as a “living program” to recognize that continuous adjustments are made to incorporate lessons learned.

RCM increases the probability that a machine or component will function as required over its design life cycle. The maintenance decisions must be based on function requirements supported by sound technical and economic justification. In other words, an expensive maintenance task (i.e. infrared thermography or vibration analysis) should not be performed if there is little to no consequence associated with the failure it is designed to prevent. Maintenance actions must be both applicable and cost effective.

When maintenance actions are neither applicable nor cost effective toward eliminating a failure, then the risks associated with that failure can only be mitigated by investigating the design. Any collected knowledge and lessons learned from these adjustments and design considerations can and should be incorporated into new designs. When an organization proactively integrates RCM with the design process, then they have effectively bridged the gap between design and O&M to create an optimum solution for system productivity.

This page intentionally left blank

Appendix B: Description of Predictive Testing and Inspection (PT&I) Technologies

B.1 Balance

This section describes quality guidelines for the balance of new and rebuilt rotating machinery.

Equipment is considered to be “balanced” when the mass centerline and the rotational centerline of a rotor are coincident. The act of “balancing” provides for adjusting the radial mass distribution of a rotor by adding or removing weight, so that the mass centerline approaches the rotor geometric centerline. Rotors that are balanced demonstrate less vibration amplitude at rotational speed, and measurements and limits of vibration are commonly used as a measure of balance. Refer to section B.3 of this guide for vibration limits.

Table B-1 provides the ISO1940/1-1986 balance quality grades for various groups of representative rigid rotors. For more detailed information on these balance grades and for determination of the balance grade calculations, refer to The RCM Guide and the complete ISO 1940/1 –1986 table.

Balance Quality Grade	Product of The Relationship ($e_{\text{per}} \times \omega$) ^{1,2} mm/s	Rotor Types—General Examples
G100	100	Crankshaft/drives of rigidly mounted fast diesel engines with six or more cylinders ⁴ Complete engines (gas or diesel) for cars, trucks, and locomotives ⁵
G40	40	Car wheels, wheel rims, wheel sets, drive shafts Crankshaft/drives of elastically mounted fast four-cycle engines (gas or diesel) with six or more cylinders Crankshaft/drives of engines of cars, trucks, and locomotives
G16	16	Drive shafts (propeller shafts, cardan shafts) with special requirements Parts of crushing machines Parts of agricultural machinery Individual components of engines (gas or diesel) for cars, trucks and locomotives Crankshaft/drives of engines with six or more cylinders under special requirements
G6.3	6.3	Parts of process plant machines Centrifuge drums Fans Flywheels Pump impellers General machinery parts Medium and large electric armatures (of electric motors having at least 80 mm shaft height) without special requirements Small electric armatures, often mass produced, in vibration insensitive

Balance Quality Grade	Product of The Relationship ($e_{\text{per}} \times \omega$) ^{1,2} mm/s	Rotor Types—General Examples
		applications and/or with vibration isolating mountings Individual components of engines under special requirements
G2.5	2.5	Rigid turbo-generator rotors Turbo-compressors Medium and large electric armatures with special requirements Small electric armatures not qualifying for one or both of the conditions specified for small electric armatures of balance quality grade G6.3 Turbine-driven pumps
G1	1	Grinding-machines drives Small electric armatures with special requirements
G0.4	0.4	Spindles, disc, and armatures of precision grinders Gyroscopes

Table B-1: Balance Quality Grades for Various Groups of Representative Rigid Rotors (IOS 1940/1-1986)

B.1.1 Standard Key

For rotating machines and machine components with a keyed shaft, balancing will be achieved by using a standard one-half key in the key seat in accordance with ISO 8821-1989. If a “full key,” corresponding to the half key used for balancing, is not provided with the rotating machine, a tag, as shown in Figure B-1, will be attached to the machine to indicate the dimension of the key used to perform the balance test.

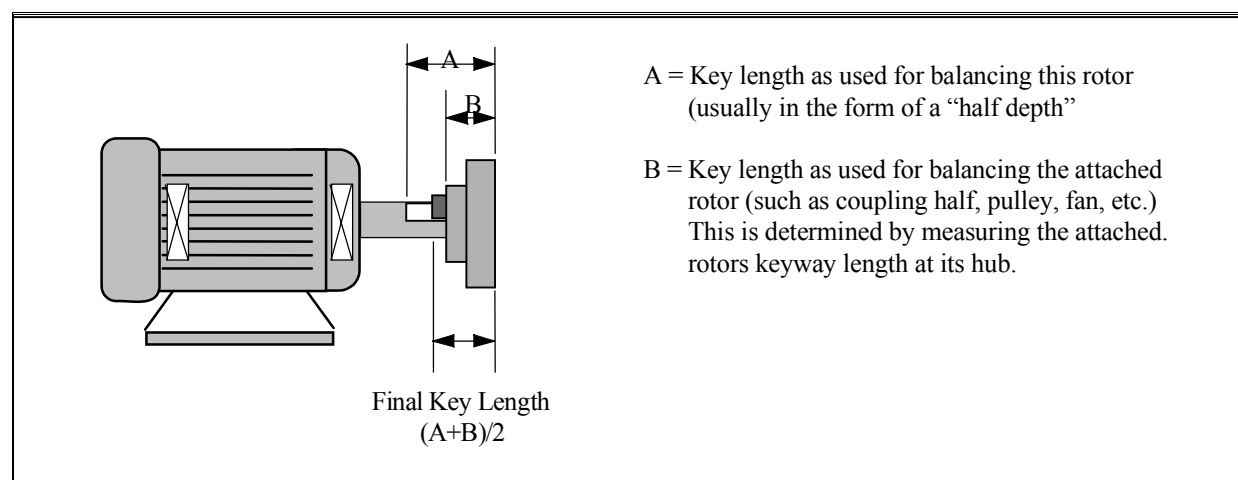

Figure B-1: Balance Test Key Dimension

Permanently attached balancing weights must be secured by welding, bolting, or pop-riveting, or they must be of a “clip-on” design. If bolted, a hardened bolt must be used in conjunction with a mechanical locking device (e.g., lock washer or lock nut). Clip-on balancing weights can be used only on centrifugal-type fans and must be located and attached on the ID pitch of the blades such that the rotational motion of the fan creates a positive seating of the clip-on weight against the fan blade.

Balancing weights and the method of their attachment must be stable at the equipment operating temperature and manufactured of a material that is compatible with the parent material of the fan to which the balancing weight is attached.

NOTE: THE USE OF STICK ON LEAD WEIGHTS IS NOT ACCEPTABLE.

Any parent metal removed to achieve a dynamic or static balance shall be drilled out in a manner that will maintain the structural integrity of the rotor or sheave.

B.1.3 Measurement Requirements For Machine Certification

Taking and documenting balance measurements are the responsibility of the contractor unless specified otherwise by NASA. The measurements must be performed by a technically qualified person who is trained and experienced in machinery balancing. The technical qualifications of the person doing the balance certification shall be submitted to the Construction Manager as a part of the machine balance certification data.

Balance quality for machine certification shall be measured prior to “run-off” at the vendor’s facility. NASA will have the option to verify the balance quality of the equipment during machine “run-off” at the vendor’s test site prior to shipment or at the NASA Center prior to final acceptance authorization.

Where it is impractical to set up and test a complete machine at the vendor’s facility, arrangements shall be made to perform the test at the NASA Center. Under this circumstance, the shipment of the equipment does not relieve the Contractor of the responsibility for meeting the specified balance quality.

B.2 Alignment

This section describes laser alignment guidelines for the inclusion of all new and rebuilt machines. The laser alignment system used for coupled shaft alignment shall use either a combined laser emitter and laser target detector unit or separate units for its laser emitter and laser target detector.

B.2.1 Shaft Alignment Tolerances

All shaft-to-shaft centerline alignments shall be within the tolerances specified in Table B-2 unless more precise tolerances are specified by the machine manufacturer or by the purchasing engineer for special applications. The tolerances specified in Table B-2 are the maximum allowable deviations from zero-zero specifications or alignment target specifications (i.e., an intention targeted offset and/or angularity). Acknowledging that machines often move after startup because of thermal growth, dynamic load shifts, etc., the alignment parameters shall be measured and adjusted for operating conditions.

Laser alignment will be performed at the NASA Center on all shaft-coupled machines during installation of the equipment. When verifying the alignment of coupled shafts, the contractor

must document and provide the following data for each set of coupled shafts at the time of functional checkout:

- Alignment tolerances used
- Soft Foot
- Vertical angularity (pitch) at the coupling point (Refer to Figure B-2)
- Vertical offset at the coupling point.
- Horizontal angularity (yaw) at the coupling point.
- Horizontal offset at the coupling point.

	RPM	Tolerance Specification	
Soft Foot	All	<0.002 inch (0.0508 mm) at each foot	
	RPM	Horizontal Parallel Offset	and Vertical Angularity/Gap Inch/10 (Mm/254 Mm) Inch
Short Couplings			
	<1000	0.005 in. (1.2700 mm)	0.015 in. (0.3810 mm)
	1200	0.004 in. (1.0160 mm)	0.010 in. (0.2540 mm)
	1800	0.003 in. (0.7620 mm)	0.005 in. (0.1270 mm)
	3600	0.002 in. (0.5080 mm)	0.003 in. (0.0762 mm)
	7200	0.001 in. (0.2540 mm)	0.0025 in. (0.0635 mm)
		Horizontal Parallel Per Inch of Spacer Length	and Vertical Offset of (25.4 Mm)
Couplings			
with	<1000	0.0020 in. (0.0508 mm)	
Spacers	1200	0.0015 in. (0.0381 mm)	
	1800	0.0010 in. (0.0254 mm)	
	3600	0.0005 in. (0.0127 mm)	
	7200	0.0003 in. (0.0076 mm)	

Table B-2: Tolerances for Coupled Shaft Alignments

Piping must be fitted, supported, and sufficiently flexible such that soft foot due to movement caused by tightening pipe flanges does not exceed 0.002 in. (0.051 mm). Piping must not restrict the minimum 180-degree rotation requirement of the laser alignment system.

Shims shall meet the following specifications:

- Shims shall be commercially die-cut.
- Shims shall be made of corrosion- and crush-resistant stainless steel, which is dimensionally stable when subjected to high compression over long periods of time.
- Shims shall be consistent over the whole shim area, without seams or folds from bending.

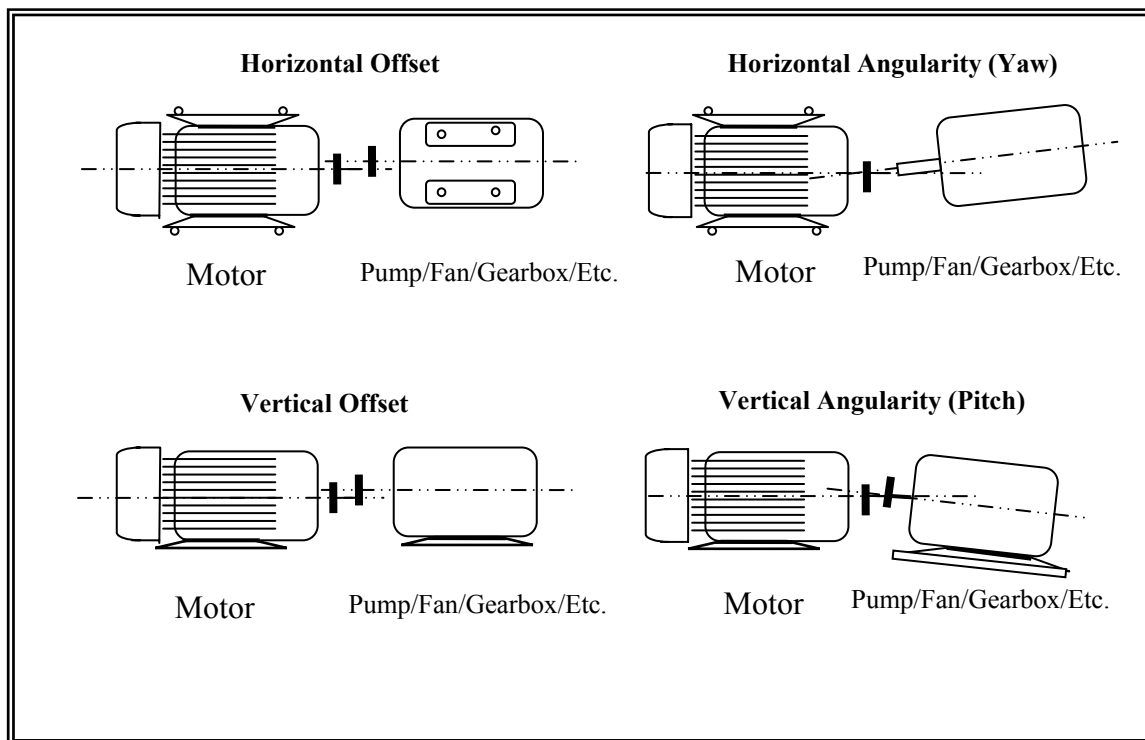

Figure B-2: Offset and Angular Misalignment

- Shims shall be clean, free from burrs, bumps, nicks, and dents of any kind.
- Size numbers or trademarks shall be etched (not printed or stamped) into the shim.
- The smallest commercial shim that will fit around the hold down bolts without binding shall be used.
- The overall shim pack shall not exceed a total of five (5) shims.
- Shims must rest on bare metal, not on paint or other coatings.

All machines shall be installed with a minimum of 0.125-inch (3.0-mm) dimensionally stable shims under each surface mounting point for vertical mobility.

Original Equipment Manufacturers (OEMs) must use only the couplings specified by NASA unless otherwise agreed to by NASA. During the alignment process, coupling play or backlash must be eliminated to accomplish a precision shaft alignment.

Axial shaft play or end play must be no greater than 0.125 inch (3.175 mm). The accommodation of end movement must be done without inducing abnormal loads in the connecting equipment.

B.2.2 Alignment Of Belt-Driven Machines

Motors will be provided with adjustable motor bases unless otherwise specified. Motors of over 5,600 watts of power will be provided with adjustable, pivoted motor bases. The base will have enough adjustment to allow for belt replacement without stretching the new belts. The adjustment method will be by the use of two adjusting bolts.

After sheaves are installed on the motor and driven shafts, the sheaves will be checked to ensure that they are true on the shaft. Run-out on the sheaves shall not exceed 0.002 in. (0.0580 mm).

Unless otherwise specified, drive and driven sheaves will be aligned by the four-point method. If the sheave web thickness is not the same on the drive and driven sheave, shims of the appropriate thickness will be used on the narrower sheave for the alignment. The thickness of the shims will be recorded and supplied with the machine information to the NASA Construction Manager for forwarding to the appropriate maintenance organization, i.e., Systems Engineer, Condition Monitoring Office, Predictive Testing Group, etc. and inclusion in the maintenance database.

B.3 Vibration Monitoring

Vibration monitoring and analysis is the most common PT&I test used by NASA facilities maintenance organizations and by industry to verify balance and alignment. Vibration monitoring helps determine the condition of rotating equipment and structural stability in a system. The techniques involved in vibration monitoring include examining the vibration signature, either the frequency spectrum or time wave, to identify equipment conditions. Vibration monitoring also aids in the identification and localization of airborne noise sources.

Machinery and system vibration is the periodic motion of a body about its equilibrium position. The technique measures machinery movement (vibration) through the use of either an accelerometer for equipment with roller element bearings or with a proximity probe for large equipment with journal bearings. The proximity probe measures distance out of round and is primarily used for slower speed equipment. In either case, the vibration spectrum is analyzed to identify and trend frequencies related to the electrical and mechanical components of interest. These frequencies, known as "forcing frequencies", are associated with the machine design, regardless of its condition. The amplitude of the forcing frequency determines the condition or severity of the defect. These forcing frequencies would provide indication of the following typical types of conditions:

wear, imbalance, misalignment, mechanical looseness, bearing damage, belt flaws, sheave and pulley flaws, gear damage, flow turbulence, cavitation, structural resonance, fatigue, electrical health of contacts and rotor bars, etc.

Studies by the U.S. Navy have found probabilities of detection in the range of 0.76 up to 0.92, which would indicate that vibration monitoring is an excellent source of failure detection. The corresponding false alarm rate was found to be 0.08. Selecting proper monitoring intervals and alarm criteria will increase the probability of detection.

The different types of vibration analysis include the following:

- Overall vibration
- Spectrum Analysis and Waveform Analysis
- Torsional Vibration
- Multi-Channel Vibration Analysis
- Shock Pulse Analysis

Overall vibration measurement is the sum of all vibration energy produced across a filtered bandwidth. It provides an easy indicator that a vibration problem exists, but it does not identify the specific cause of the vibration. This technique is used frequently as the trigger to perform additional, more specific tests which will require specialized instruments and certified, trained personnel. A modern maintenance program will not depend solely on an overall measurement approach to vibration analysis.

Spectrum analysis of the frequency domain is the most commonly employed analysis method for machinery diagnostics. The spectrum analysis is used to identify the majority of all rotating equipment failures (due to mechanical degradation) prior to failure. Waveform analysis, or time domain analysis, is another extremely valuable analytical tool. While not employed as regularly as spectrum analysis, the waveform often aids the analyst in a more correct diagnosis of the machine problem.

Torsional vibration analysis is often utilized to detect the vibration associated with gear vibration and shaft torque. It proves most helpful in situations where, due to transmission path attenuation, the casing vibration signal has a signal-to-noise ratio insufficient to detect the problem. Torsional vibration measurement is especially effective in situations where unsteady forces excite the resonance of the structure or housing. Torque is measured by using pairs of matched sensors spaced at an interval. This is done to take advantage of the phase difference in the signals due to shaft twisting, which is a function of shaft stiffness and load.

Multi-channel vibration analysis offers several extremely powerful methods for machinery analysis such as force-response analysis, cross-coupling phase analysis, analysis of resonance mode characteristics, and multi-plane balancing. Additionally, coherence functions offered by multi-channel analyzers allow for checking the quality and linearity of data collected with typical data loggers.

Shock pulse analysis is used to detect impacts caused by contact between the surfaces of the ball or roller and the raceway during rotation of anti-friction bearings. The magnitude of these pulses depends on the surface condition and the angular velocity of the bearing (RPM and diameter). Spike energy is similar in theory to shock pulse.

Vibration limits various equipment items will be identified in Chapter 4 of this document where appropriate. If a limit is not provided, the vibration criteria listed in Table B-3 will be used for acceptability of the machine in question. These should be narrow-band limits. An overall reading is not acceptable.

Frequency Range (CPM)	Vibration Limit (inch/sec)
0.3xRPM to 0.8xRPM	0.04
0.8xRPM to 1.2xRPM	0.075
1.2xRPM to 3.5xRPM	0.04
3.5xRPM to 120,000CPM	0.03

Table B-3: Default Balance Criteria

B.3.1 Instrumentation Requirements for Acceptance Testing

When making vibration measurements for acceptance testing, they should be made with a Fast Fourier Transform (FFT) analyzer. The FFT analyzer shall be capable of a line resolution bandwidth $\Delta f = 300$ cpm for the frequency range specified for machine certification, unless this restriction would result in less than 400 lines of resolution. In that case, the requirement defaults to 400 lines of resolution. (Higher resolution may be required to resolve “side bands,” or in Band 1 to resolve machine vibration between 0.3X and 0.8X running speed.)

The dynamic range shall be a minimum of 72 dB.

The FFT analyzer shall be capable of applying a Hanning window, be capable of linear non-overlap averaging, and shall have anti-aliasing filters.

The measurement system (FFT analyzer, cables, transducer, and mounting) used to take vibration measurements for machine certification and acceptance shall have a measurement system amplitude accuracy over the selected frequency range as follows (see Figure B-3):

- For displacement and velocity measurements, $\pm 10\%$ or ± 1 dB
- For acceleration measurements, $\pm 20\%$ or ± 1.5 dB

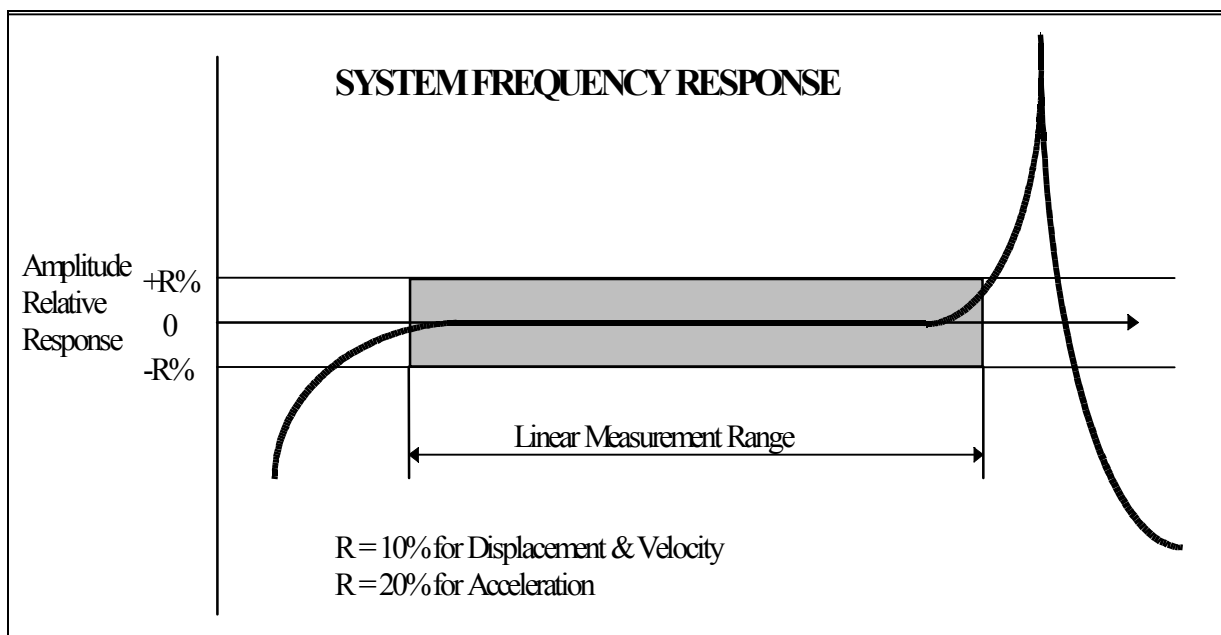

Figure B-3: Measurement System Frequency Response

The vibration equipment (transducer, preamplifier, FFT analyzer, recorder, and connecting cable) used to take vibration measurements for machine certification and acceptance must be calibrated by a qualified instrumentation laboratory in accordance with Sections 5.1 and 5.2 of ANSI S2.17-1980, *Technique of Machinery Vibration Measurement*, within one (1) year prior to use.

The calibration shall be traceable to the National Institute of Standards and Technology (NIST) in accordance with ISO 10012-1/1992, *Quality Assurance Requirements for Measuring Equipment—Part 1: Meteorological Confirmation Systems for Measuring Equipment*.

B.3.2 Vibration Transducers

An accelerometer shall be used in the collection of data for machine certification and acceptance. The accelerometer must be selected and attached to the machine in such a way that the minimum frequency (F_{\min}) and maximum frequency (F_{\max}) are within the usable frequency range of the transducer and can be accurately measured (reference manufacturer recommendations and/or Section 6.3, ANSI S2.17-1980).

The mass of the accelerometer and its mounting shall have minimal influence on the frequency response of the system over the selected measurement range. (A typical mass of accelerometer and mounting should not exceed 10 percent of the dynamic mass of the structure upon which the accelerometer is mounted.)

B.3.3 Vibration Measurement Locations

The required measurement positions and orientations on the surface of a machine at which vibration measurements are to be taken shall be determined by mutual agreement between NASA and the contractor, and shall meet the following requirements:

- If an obstruction or safety consideration prevents locating a transducer as specified, locate it as close as possible to the standardized position.
- Measurement locations used for machine certification and acceptance shall be identified on the machine layout drawing and/or physically on the machine, as mutually agreed upon by NASA and the contractor.
- Vibration measurement locations shall be on a rigid member of the machine, as close to each bearing as feasible. Bearing housings, bearing pedestals, machine casings, or permanently mounted pickup mounting blocks are examples of suitable mounting locations.
- The vibration measurement location shall NOT be on a flexible cover or shield, such as the fan cover on an electric motor or a sheet-metal belt guard.
- Any guarding must be designed to allow accessibility to all measurement locations.

If vibration monitoring points are rendered inaccessible after the machine is built or access to the measurement points presents a safety problem during measurement, the NASA Construction Manager shall be contacted to determine if permanently mounted transducers are to be installed.

B.3.4 Transducer And Machine Mounting Conditions

In order to monitor vibration, the housing or measuring point must have a smooth surface. For motors, there must be available in the vertical, horizontal, and axial directions at each bearing

housing, suitable for attaching a magnet-mounted accelerometer. See Figure B-4 for typical vibration measurement locations. The surface shall be on the bearing housing, with a finish of 63 micro-inch minimum. The axial surface will be as close to the centerline as possible. The diameter of the finished surface shall be 2-inch minimum and must be corrosion resistant.

As an option, sound disks can be used to meet the smooth surface requirement. As illustrated in Figure B-5, the disk shall have a minimum thickness of 3/8 inch. The disc or surface face must be level to prevent the magnet from rocking and the surface must be level within 1 degree or .001 inch. Good frequency response is more directly related to placing the magnet on a clean surface with a lubricant between the magnet and the disc than on a highly polished disc surface. If an adhesive is used to attach the sound disk, the upper frequency limit of the transducer shall be reduced by 20 percent of the manufacturer's stated resonance for "hard" adhesives, and by 50 percent of the manufacturer's stated resonance for "soft" adhesives. The transducer manufacturer's specifications should be consulted.

For a stud-mounted transducer, the surface of the machine at which vibration measurements are to be taken shall be in accordance with that specified by the transducer manufacturer (torque, grease, etc.). The designated transducer type will be specified by NASA.

B.3.5 Machine Certification and Acceptance

The following are the measurement requirements for machine certification. Vibration measurements shall:

- Be the responsibility of the Contractor unless specified otherwise by NASA.
- Be performed by a technically qualified person who is trained and experienced in vibration measurement. The technical qualifications of the person doing the vibration certification shall be submitted as a part of the machine vibration certification data.
- Be taken with the machine operating as specified. Where "no load" is specified, no actual work is to be taking place during collection of machine vibration data. Where "rated load" is specified, rated operating load, either actual or simulated, will be applied during the collection of machine vibration data.
- Prior to vibration measurements, the machine will be "run in" until it reaches operating speed and thermal stability.
- Vibration signatures shall be submitted to the NASA Construction Manager before the acceptance of the machinery or equipment being purchased will be authorized.
- Narrow-band vibration data for machine certification shall be measured during "run off" at the vendor's facility. A baseline or reference spectrum should be provided for comparison with post-installation vibration checks. Equipment failing the vibration criteria should be rejected by the procuring organization prior to shipment. Where it is impractical to set up and test a complete machine at the vendor's facility, arrangements shall be made to perform the test at the NASA Center. Under this circumstance, shipment of the equipment does not relieve the contractor of the responsibility for meeting the specified vibration-level limits.
- NASA will have the option to verify the equipment vibration data during machine "run off" at the vendor's test site prior to shipment or at the NASA Center prior to final acceptance authorization.

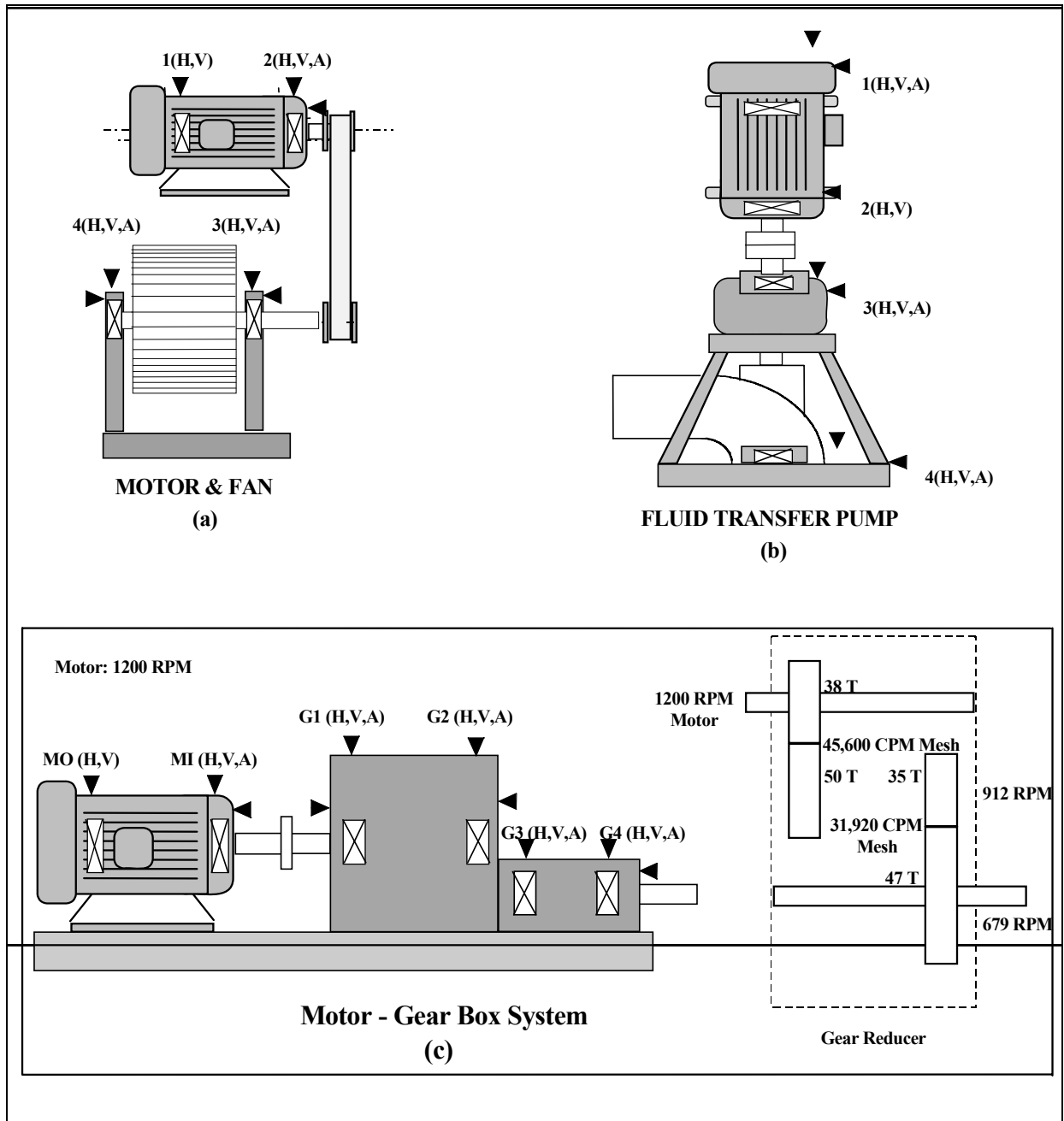

Figure B-4: Typical Vibration Measurement Locations

- The machine layout drawings shall be submitted as a part of the Machine Vibration Certification. Vibration measurement locations on the surface of the machine at which vibration measurements are taken shall be designated on the drawing. At NASA's option, shaft speeds (rpm), gear type and number of gear teeth, gear mesh frequencies (cpm), bearing manufacturer's name, and bearing type number and class shall be identified on the machine layout drawing. Where gearboxes are involved, an insert similar to the one illustrated in Figure B-6 shall be included on the machine layout drawing.

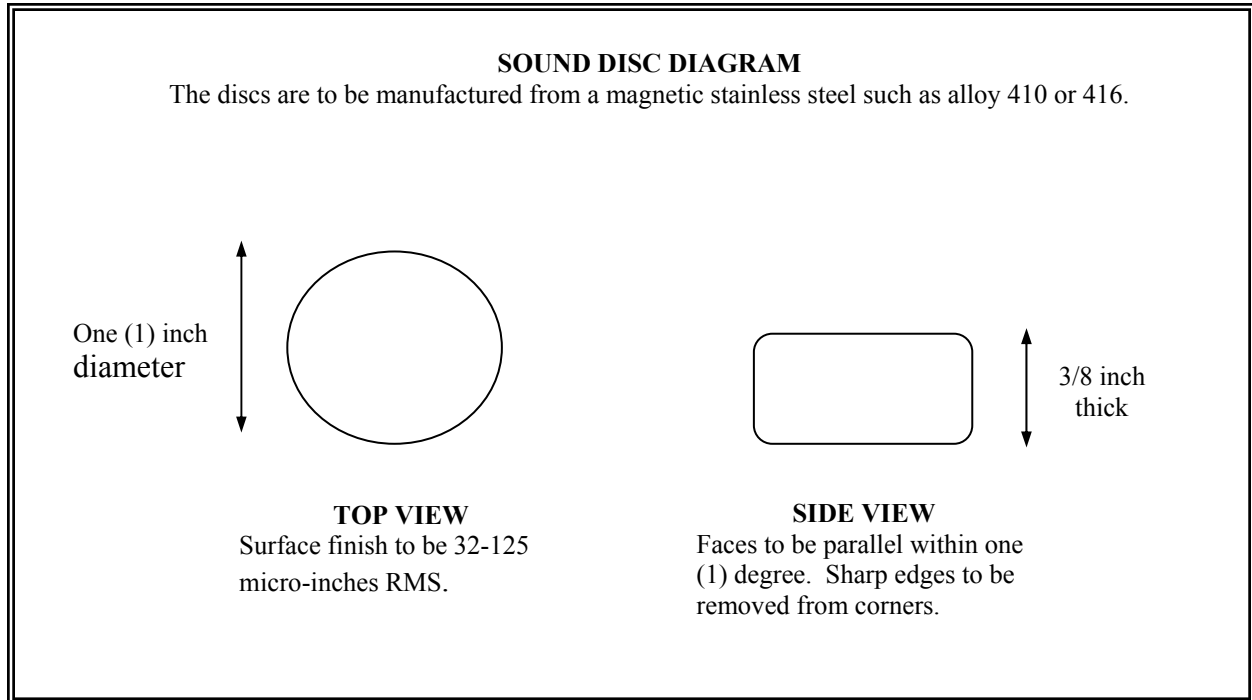

Figure B-5: Sound Disc Diagram

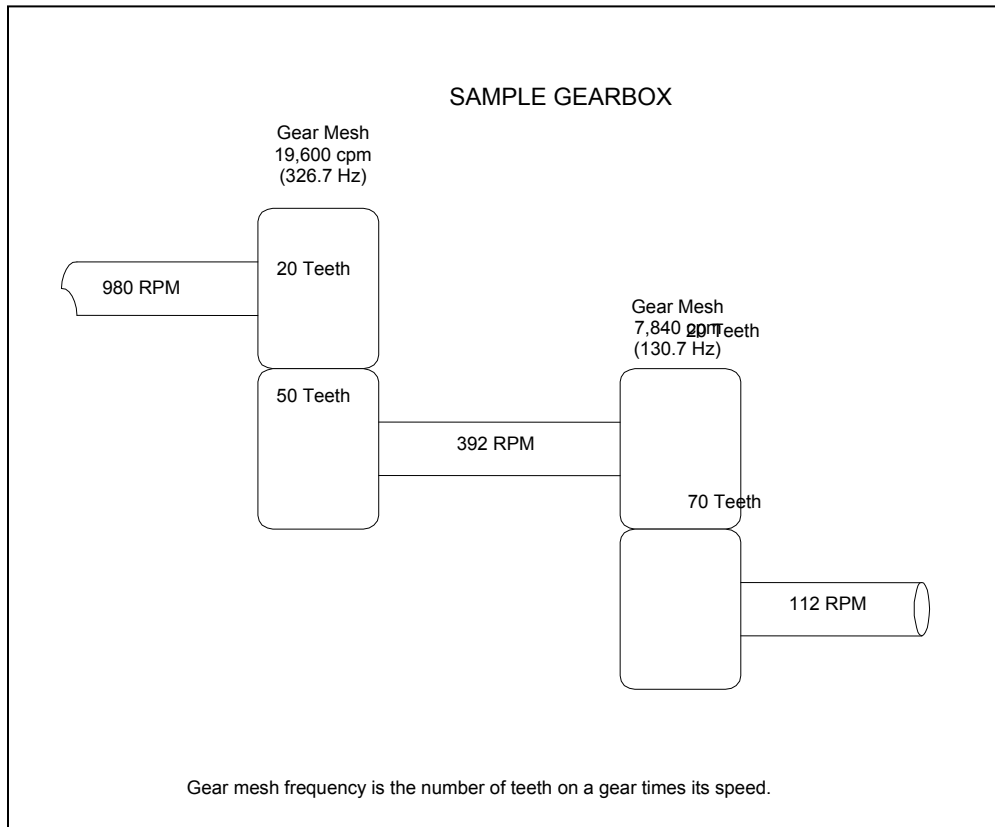

Figure B-6: Sample Gearbox Diagram

Vibration tests are recommended under the following situations if the equipment fails the initial test and/or if problems are encountered following installation:

- Motor cold and uncoupled.
- Motor hot and uncoupled.
- Motor and machine coupled, unloaded and cold.
- Motor and machine coupled, unloaded and hot.
- Motor and machine coupled, loaded and cold.
- Motor and machine coupled, loaded and hot.

A significant change in the vibration signature under each scenario could indicate a problem with thermal distortion and/or bearing overloading due to the failure of one of the bearings to float.

Authorization for machine and equipment acceptance based on vibration limits requires a signature by the NASA Construction Manager. This information along with all other test documentation should be provided to the Construction Manager for forwarding to the appropriate maintenance organization, i.e., Systems Engineer, Condition Monitoring Office, Predictive Testing Group, etc. and inclusion in the maintenance database.

B.4 Infrared Thermography (IRT)

Infrared Thermography (IRT) is the application of infrared detection instruments to identify temperature differences (thermogram) in equipment. The test instruments used are non-contact, line-of-sight, thermal measurement and imaging systems. Because IRT is a non-contact technique, it is especially attractive for identifying hot and cold spots in energized electrical equipment, large surface areas such as roofs and building walls, and other areas where stand off temperature measurement is necessary.

IRT inspections are identified as either qualitative or quantitative. The quantitative inspection is interested in the accurate measurement of the temperature of the item of interest. The qualitative inspection identifies relative differences, hot and cold spots, and deviations from normal or expected temperature ranges. Qualitative inspections are significantly less time-consuming than quantitative because the thermographer is not concerned with highly accurate temperature measurement. What the thermographer does identify is highly accurate temperature differences between like components. For example, a typical motor control center will supply three-phase power through a circuit breaker and controller to a motor. Current flow through the three-phase circuit should be uniform, which means that the components within the circuit should have similar temperatures, one to the other. As illustrated in Figure B-7, any uneven heating (perhaps due to dirty or loose connections) would quickly be identified with the IRT imaging system.

IRT can be used to identify installation defects, latent manufacturing defects, and safety hazards in electrical systems such as transformers, motor control centers, switchgear, switchyards, or power lines. It should be noted that for meaningful infrared data to be recorded the loading of the circuit should be at least 50%. In mechanical systems, IRT can identify blocked flow conditions in heat exchanges, condensers, transformer cooling radiators, and pipes. It can also be used to verify the fluid level in large containers, such as fuel storage tanks, and identify improper installation of refractory in boilers and furnaces. Figure B-8 is an actual infrared image taken at

a major Federal installation of a blocked drain pipe under a concrete floor. By looking at the thermal contrast, the Contractor is able to take corrective action while minimizing the excavation area.

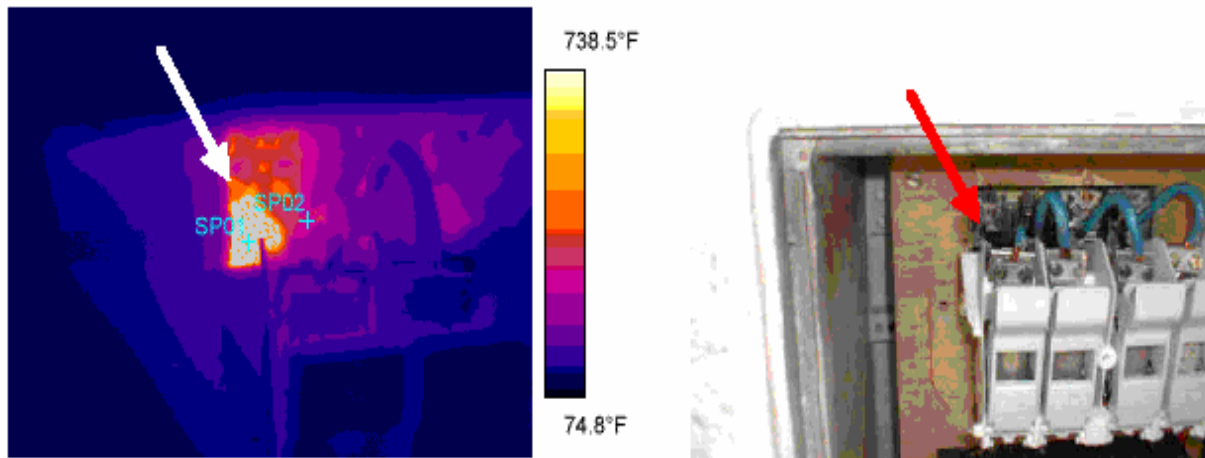

Figure B-7: Infrared Image of a bad Electrical Connection at a Major Federal Facility

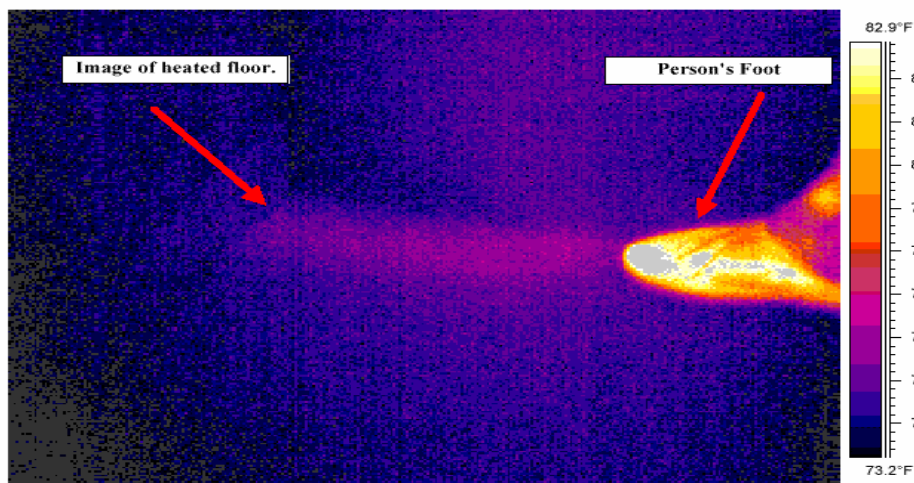

Figure B-8: Infrared Image of Blocked Drain Pipe Under Concrete Flooring

For new or rebuilt electrical equipment, an infrared inspection by the appropriate maintenance organization (i.e., Systems Engineer, Condition Monitoring Office, Predictive Testing Group, etc.) should also be accomplished within 90 days of system/facility turnover. Although it is recognized that facility acceptance would have already taken place, this will allow for any initial anomalies for which the contractor is still responsible under the terms of the construction contract warranty to develop and become apparent to the inspector.

To be effective in facilities applications, the IRT instruments must be portable, sensitive to within 0.2°C over a range of -10°C to $+300^{\circ}\text{C}$, and accurate to within 2%. Additionally, the instrument must be capable of storing an image of the thermogram for later use and analysis.

Table B-4 shows typical temperature differences relative to a given baseline (delta T) criteria used in both industry and the military for in-service electrical equipment. For new equipment, any temperature rise over the reference temperature should be investigated and repaired.

It should be noted that the indicated values are for equipment at 50% loading or greater. As the loading becomes less, the delta T values become less.

Figure B-9 is an infrared image of a 120-volt power panel. Note the relative temperature differentials indicative of a poor connection. Figure B-10 is an infrared image of a defective Motor/coupling.

Criticality	Temperature above reference, Mil Spec	Temperature above reference, Industry	Condition
Nominal	10 to 25C°	0 to 10C°	Nominal possibility of permanent damage, repair next maintenance period.
Intermediate	25 to 40C°	10 to 20C°	Possibility of permanent damage, repair soon.
Serious	40 to 70C°	20 to 40C°	Probability of permanent damage to item and surrounding area, repair immediately.
Critical	Over 70C°	over 40C°	Failure imminent

Table B-4: Infrared Temperature Criteria

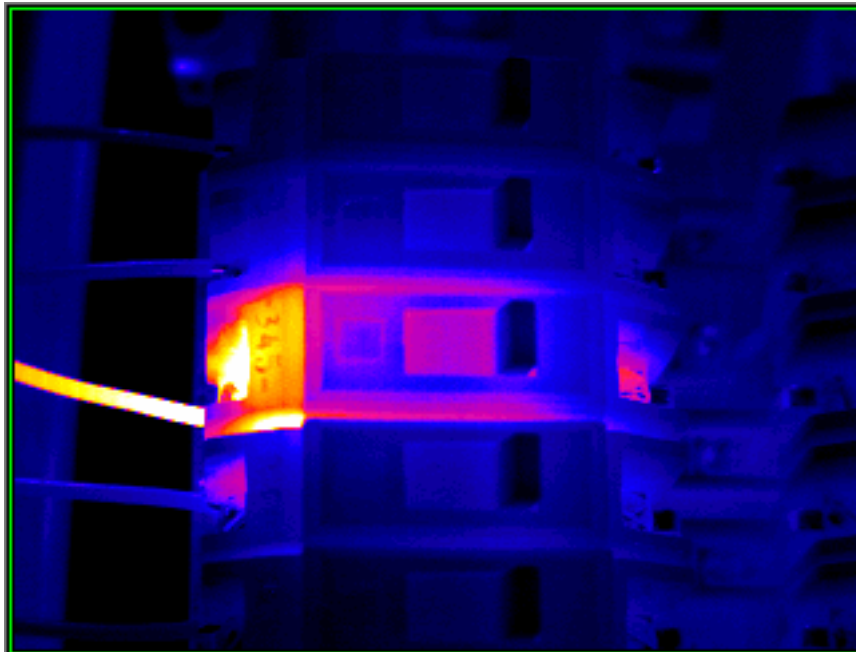

Figure B-9: Infrared Image of a 120 Volt Power Panel¹⁰

¹⁰ Figure provided by Michoud Assembly Facility (Lockheed Martin)

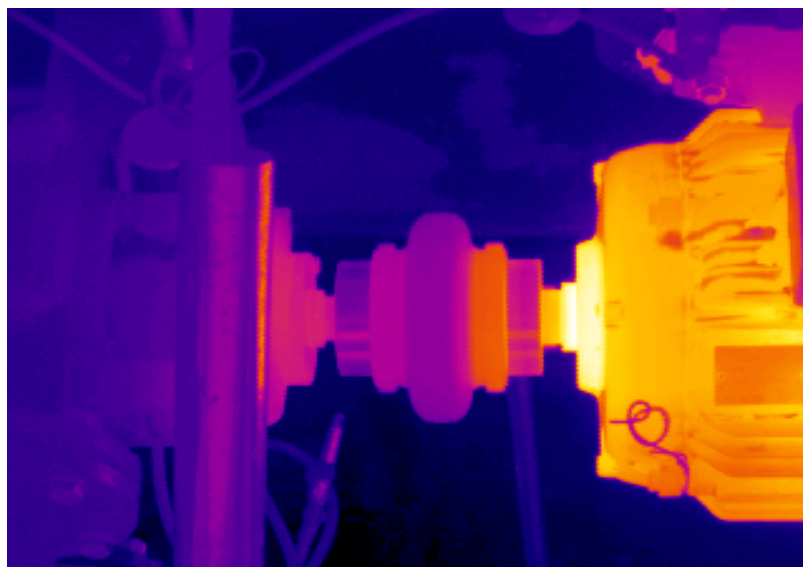

Figure B-10: Infrared Image of Motor/coupling¹¹

B.5 Insulation Power Factor Testing

Power Factor, sometimes referred to as "dissipation factor", is the measure of the power loss through the insulation system to ground. It is a dimensionless ratio that is expressed as a percent of the resistive current flowing through an insulation relative to the total current flowing. To measure this value, a known voltage is applied to the insulation, and the resulting current and current/voltage phase relationship is measured. Figure B-11 shows the phase relationships of the resulting currents. I_R is the resistive current, I_C is the capacitive current, I_T is the resultant, or total current, and V is the applied voltage. This test is non-destructive, will not deteriorate or damage insulation, and is recommended for inclusion in any commissioning program.

Usually, I_R is very small compared to I_T because most insulation is capacitive in nature. As a comparison, the reader should consider the similarities between a capacitor and a piece of electrical insulation. A capacitor is two current carrying plates separated by a dielectric material. An electrical coil, such as that found in a transformer or motor, is a current carrying conductor with an insulation material protecting the conductor from shorting to ground. The conductor of the coil and ground is similar to the two conducting plates in the capacitor. The insulation of the coil is like the dielectric material of the capacitor. The dielectric material prevents the charge on each plate from "bleeding through" until such time when the voltage level of the two plates exceeds the voltage capacity of the dielectric. The coil insulation prevents the current from flowing to ground, until the voltage level exceeds the voltage capacity of the insulation.

¹¹ Figure provided by Kennedy Space Center (SGS)

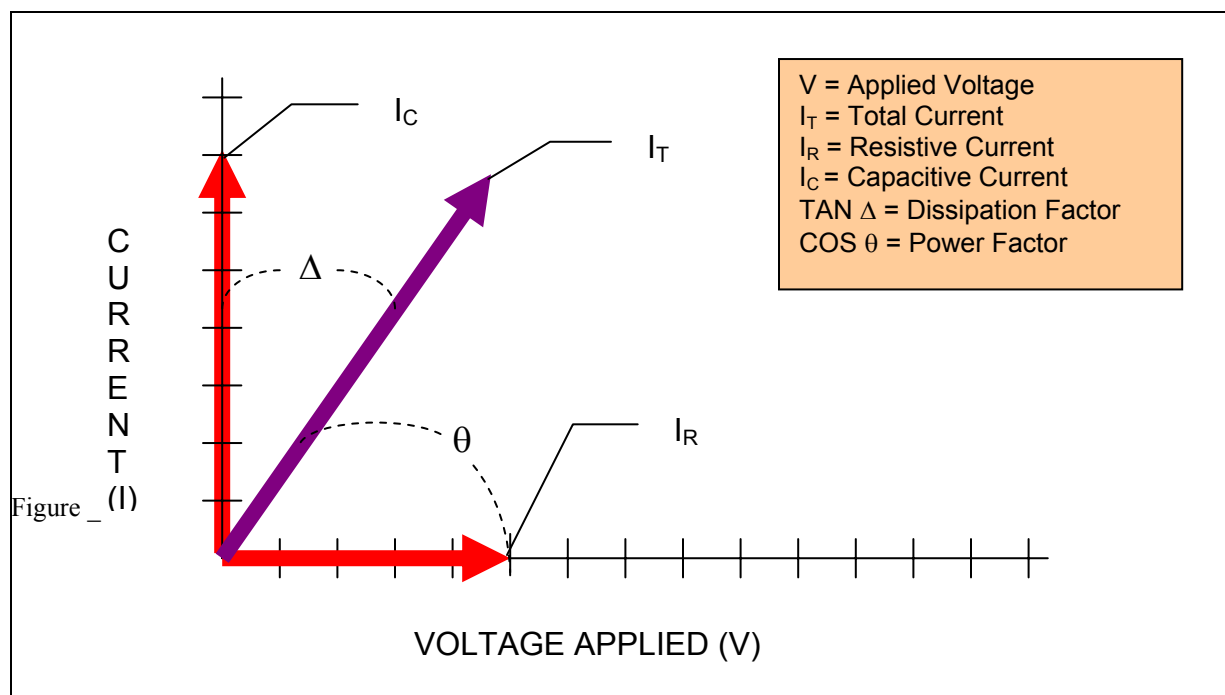

Figure B-11: Phase Relationships

Referring back to Figure B-11, it can be seen that I_R is in phase with the applied voltage V , and I_C is leading the voltage by a phase angle of 90 degrees. The total current is the resultant combination of both I_R and I_C . The tangent of the angle between the applied voltage and resultant current is called the "dissipation factor", and the cosine of the angle between the resultant current and the capacitive current is called the "power factor".

As the impedance of the insulation changes due to physical damage, insulation shorts, moisture, contamination, or aging the ratio between I_C and I_R will become less. The resulting phase angle between the applied voltage and resultant current then becomes less, and the power factor will rise. Consequently, the power factor test is used for making routine comparisons of the condition of an insulation system and for acceptance testing to verify that the equipment had been manufactured and installed properly. The test is non-destructive, and regular follow-on maintenance testing will not deteriorate or damage the insulation.

The power factor can be measured in three ways:

- Grounded Specimen Test (GST) – A voltage is applied to the circuit under test and all leakage current flowing through the insulation to ground is detected. Grounding leads are provided for the return path. This test provides a good overall test of the circuit.
- Ungrounded Specimen Test (UST) – A voltage is applied to the circuit under test and a direct measurement on only a portion of the circuit can be accomplished. Any currents flowing to ground are not measured. This test is good for isolating a reading for troubleshooting.

- GST with Guard – A voltage is applied to the circuit under test and all leakage current flowing through the insulation to ground is detected. However, an additional lead is attached to the circuit and any leakage current up to that part of the circuit will be bypassed by the measuring circuit. This test is good for troubleshooting.

Table B-5 contains typical insulation power factor values of electrical equipment. All power factor test results must be corrected to 20°C for comparison purposes. Test set manufacturers' instruction manuals should be consulted for the appropriate correction tables.

Limitations – Power factor readings should not be taken under the following conditions:

- High humidity – humid conditions over 75% can result in excessive surface leakage currents on exposed surfaces.
- Freezing ambient temperatures – power factor tests are very sensitive to moisture; however, frozen water becomes non-conducting and defects or degradation can remain hidden. This temperature limitation does not apply to insulation oils.
- Dirty or contaminated surfaces – poor surface conditions result in excessive leakage currents that will be added to the losses and may give a false impression of the test.

Equipment Type	% PF at 20°C
Oil Filled Transformer: New, high-voltage	0.25 to 1.0
15 year old, high-voltage	0.75 to 1.5
Medium-voltage distribution	1.5 to 5.0
Dry type transformer (>600V)	1.0 to 7.0
Oil Circuit Breakers (5KV and up)	0.5 to 2.0
Air Circuit Breakers (5KV and up)	0.5 to 2.0
Oil-Paper Cables: solid (up to 27KV) new condition	0.5 to 1.5
High-voltage oil-filled or pressurized (to 69KV)	0.2 to 0.5
Rotating machines stator windings, 2KV to 13.8KV	2.0 to 8.0
Capacitors (resistor out of circuit)	0.2 to 0.5
Bushings: Solid or dry	3.0 to 10.0
Compound filled up to 15KV	5.0 to 10.0
Compound filled 15KV to 46KV	2.0 to 5.0
Oil-filled below 110KV	1.5 to 4.0
Oil-filled 110KV and up	0.3 to 3.0

Table B-5: Power Factor Values

Authorization for electrical system acceptance based on insulation power factor testing requires a signature by the NASA Construction Manager. This information along with all test data should be provided to the Construction Manager for forwarding to the appropriate maintenance organization, i.e., Systems Engineer, Condition Monitoring Office, Predictive Testing Group, etc. and inclusion in the maintenance database.

B.5.1 Circuit Breakers (Above 600 Volts)

Circuit breakers should first be power factored in the open position using the Grounded Specimen Test. The porcelain surface of bushings should be clean and dry prior to beginning the test. The load and line side of each phase should read within 10% of each other and the factory test results. See Table B-5 for the maximum power factor values along with the appropriate test voltages. Any larger difference should be investigated and repaired prior to acceptance. The

breaker should then be closed, the load and line side bushings tied together, and then power factored. As before, each phase should be within 10% of the other two phases, and anything greater should be investigated and repaired. The manufacturer's instructions and factory test data should be consulted for comparisons.

Circuit Breakers rated 15KV and above should also have their bushings power factored. Breaker bushings rated 69KV and above should have the factory power factor and capacitance values stamped on the bushing base.

B.5.2 Motors (Tip-Up)

A motor should be tested using a GST test. Ideally, each phase should be tested individually, so this test must be accomplished prior to terminating the motor at the terminal box.

B.5.3 Switchgear And Motor Control Centers

For switchgear rated 5KV and above the bus should be power factored to the values shown in Table B-6.

Power Factor Values		
Voltage Rating (Volts)	Test Voltage (Volts)	Maximum Reading
5000	5000	2%
7000	5000	2%
15,000	10,000	2%
35,000	10,000	2%

Table B-6: Switchgear Power Factor Values

B.5.4 Transformers

Insulation Power factor is applicable to transformers with at least one winding rated 5KV or higher. (Low voltage transformers have not been shown to benefit from insulation power factor testing.) Both the high voltage and low voltage windings of a transformer should be power factored. The results of this test should be compared to the factory test to confirm that no damage occurred to the unit during shipping and installation. Additionally, these results should be used for the unit's initial baseline for condition monitoring purposes.

Insulation power factor is typically performed at rated voltage up to a maximum of 10KV. Manufacturer's instruction manuals and IEEE Standard 62-95, *IEEE Guide for Diagnostic Field Testing of Electrical Apparatus – Part 1: Oil Filled Power Transformers, Regulators, and Reactors*, or IEEE Standard C57.12.91-1995, *IEEE Standard Test Code for Dry Type Distribution and Power Transformers*. Typical connection diagrams are shown in Figures B-12 for transformers and B-13 for bushings.

For new oil and gas filled units the insulation power factor should not exceed 1.0%. Any values obtained over this value should be investigated and the unit not energized until a reason for the excessive reading is found. For dry type units, power factor standards have not been established due to the hydroscopic characteristics of the windings. Consequently, the most useful method of evaluation is comparison with the factory test results.

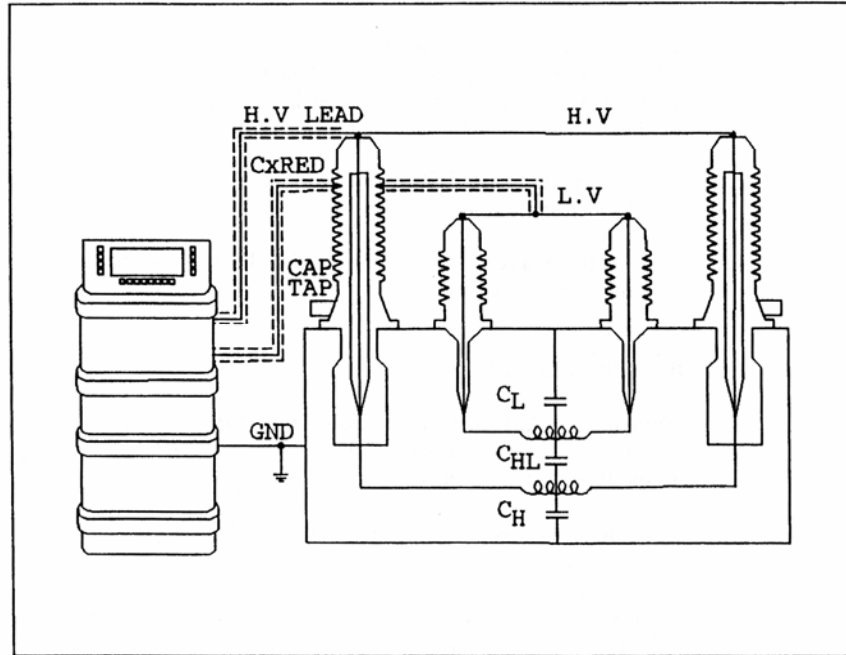

Figure B-12: Typical Power Factor Connection to a Transformer

The condition of the core and turn insulation can be monitored using an excitation current test. This test uses a simple measurement of a single-phase current on one side, usually the high voltage side of a transformer with the other side left floating (ungrounded). The test should be performed at the highest possible voltage level without exceeding the rating of the windings. For effective comparisons, the same voltage should be used for subsequent tests. Units with load tap changers should have readings taken at the neutral tap position and one position both higher and lower.

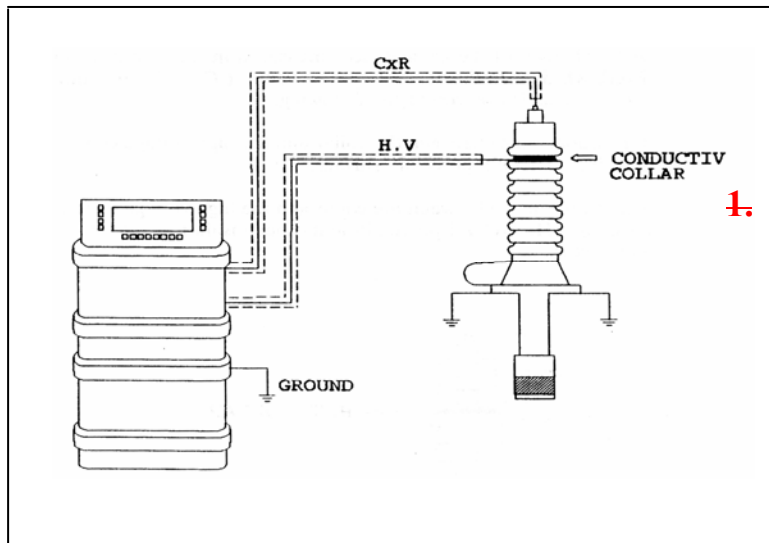

Figure B-13: Typical Power Factor Connection to a Bushing

The best approach to the analysis is to compare the results with the factory tests or with other identical units. For three phase units the normal pattern is two similar high readings on the outer phases and one lower reading on the center phase. The relationship between outer and center phases should remain the same as a percentage at all tap changer positions.

B.6 Airborne Ultrasonic Tests

A relatively inexpensive device called an ultrasonic noise detector can be used to locate liquid and gas (pressure and vacuum) leaks. When a fluid or gas moves from a high-pressure region to a low-pressure region it produces ultrasonic noise, due to turbulent flow. The detector translates the ultrasonic noise in the frequency range of 20kHz to 100kHz to the audible range, allowing an inspector to identify the source of the leak. In addition, electrical arcing and discharges create sounds in the ultrasonic frequency ranges, sometimes long before a catastrophic failure occurs. Corona discharge is normally associated with high voltage distribution systems and is produced as a result of a poor connection or insulation problem. Corona discharges, loose switch connections, and internal arcing in dead-front electrical connections are conditions that can all be discovered using ultrasonic test devices.. For electrical systems, ultrasonic tests are often used in conjunction with the IRT, since corona occurs in the ultraviolet region of the spectrum. Even though this is a subjective test, i.e., results are not quantifiable, it is recommended for use on compressed gas, steam, and vacuum systems as well as on high voltage electrical components.

Ultrasonic test kits generally consist of a receiver “gun” with variable frequency select, a set of ear-isolation headphones, various contact probes, and various tone generators for placement into heat exchangers, boilers, etc. The following applications apply to all airborne ultrasonic devices.

B.6.1 Heat Exchangers

The contractor may test heat exchangers by either of the following methods:

- Warble Tone Generator—An ultrasonic source is placed inside the area to be tested (one tone generator is required for each 4,000 cubic feet of volume), the instrument is set on scanning mode, log position, and fixed band. The tone generator can be attached to an adapter at the end of a pipe to flood the pipe, heat exchanger shell, or tube bundle. A scan is then performed on the pipe or tubes.
- Differential Pressure Method—Equitable gas is inserted between the inspection area and the scanning location. A general scan of the area is then performed. When checking the tubes, the tubes are blocked, one at a time, and the differences in readings noted. Any tubes suspected of leakage should then be marked.

A general scan of the equipment is performed with the sensitivity set to maximum in the fixed band mode. As the search area is reduced, the rubber probe is attached to narrow the pickup area and reduce the equipment’s sensitivity.

Ultrasonic reading results (data) and signatures of the contractor and of the NASA Construction Manager must be obtained before acceptance of the heat exchanger will be authorized. Defective heat exchangers shall be rejected. This information should be provided to the Construction Manager for forwarding to the appropriate maintenance organization, i.e., Systems Engineer, Condition Monitoring Office, Predictive Testing Group, etc. and inclusion in the maintenance database.

B.6.2 Boilers

The contractor shall use ultrasonics to verify the integrity of the boiler casing and its associated piping. Using a contact probe, the contractor operator can listen to the internal tubing of the boiler housing.

Ultrasonic reading results (data) and signatures of the contractor and of the NASA Construction Manager must be obtained before acceptance of the boiler will be authorized. Defective boilers shall be rejected. This information should be provided to the Construction Manager for forwarding to the appropriate maintenance organization, i.e., Systems Engineer, Condition Monitoring Office, Predictive Testing Group, etc. and inclusion in the maintenance database.

B.6.3 Steam Traps

Steam traps must be monitored on the downstream side of the trap. The contact probe should be attached to the sensor and the sensor set at or near the 25kHz band. Most steam traps produce intermittent sounds from opening and closing. Most traps found with continuous flows or no flows whatsoever should be checked for proper operation. The five types of steam traps are as follows:

- Intermittent Traps—The operator will hear an open and closing sound. The trap normally fails in the open position, producing a continuous, rushing sound.
- Inverted Bucket—A normal trap sounds as if it is floating; a failed trap sinks, producing a continuous flow noise.
- Thermostatic—Ultrasonic testing results of this type of trap vary. The noise produced by these traps can be continuous or intermittent and will produce different sounds accordingly.
- Float and Thermostatic (Continuous Load)—Flow and noise associated with these traps are usually modulated. Failed traps are normally cold and silent.
- Continuous Flow—This type of trap, when operating normally, produces the sound of condensate flow only. If it has failed in the open position, a continuous flow sound should be heard.

The use of ultrasound to detect steam leaks both in new and existing installations can have substantial economical benefit for the Center. Table B-7 provides an estimate of the monthly steam loss resulting from various size leaks. When all applicable costs associated with each pound of steam are calculated, the result is a budgetary burden the Center can ill-afford.

Leak Diameter (inches)	Steam Loss per Month (lb/m)
1/64	3,300
1/32	6,650
1/16	13,300
1/8	52,200
1/4	209,000
1/2	833,000

Table B-7. Estimated Steam Loss

Ultrasonic reading results (data) and signatures of the contractor and of the NASA Construction Manager must be obtained before acceptance of the steam traps will be authorized. Defective steam traps shall be rejected. This information should be provided to the Construction Manager for forwarding to the appropriate maintenance organization, i.e., Systems Engineer, Condition Monitoring Office, Predictive Testing Group, etc. and inclusion in the maintenance database.

B.6.4 Piping Systems

Traditional and Total Building commissioning tests for water, plumbing and air distribution systems first require a pressure test of all piping, seals and fittings. During this test, an ultrasonic scan should be performed on all accessible piping and distribution systems to help discover any leaks. Additionally:

- For hot water systems, after the pressure and hydro tests are completed and after piping insulation has been installed, the system should be charged with hot water and an infrared scan performed to verify insulation integrity.
- For steam systems ultrasonic scans should be performed on steam traps.
- For process/vacuum systems ultrasonic scans should be performed on all connections and fittings.

Ultrasonic reading results (data) and signatures of the contractor and of the NASA Construction Manager must be obtained before acceptance of the piping system will be authorized. Defective piping, joints, seals and related components shall be rejected. This information should be provided to the Construction Manager for forwarding to the appropriate maintenance organization, i.e., Systems Engineer, Condition Monitoring Office, Predictive Testing Group, etc. and inclusion in the maintenance database.

B.6.5 Bearings

Airborne ultrasonics can be used to detect bearing problems, but it is not the preferred method. Vibration analysis is recommended.

B.7 Lubricant and Wear Particle Tests

For new facilities and collateral equipment, oil analysis will confirm that the specified lubricants are being used and that the system is free of construction and other contamination. Figure B-14 illustrates the effects that hydraulic oil contamination has on life expectancy of a machine.

ISO 4406 establishes the relationship between particle counts and cleanliness in hydraulic fluids (although by common practice this has been extended to other lubricants). The ISO 4406 codes are provided in Table B-8. Codes are written in either 2- or 3-parts. The 2-part code refers to particle counts in the 5 and 15 micron size ranges, while the 3-part code refers to particle counts in the 2, 5 and 15 micron size ranges. For example, the ISO code 16/13 indicates that in one ml of lubricant there are between 32 - 640 particles greater than 5 microns and between 40 - 80 particles greater than 15 microns. The ISO code 17/14/12 indicates that the sample has between

640 - 1300 particles greater than 2 microns, 80 - 160 particles greater than 5 microns and 20 - 40 particles greater than 15 microns.

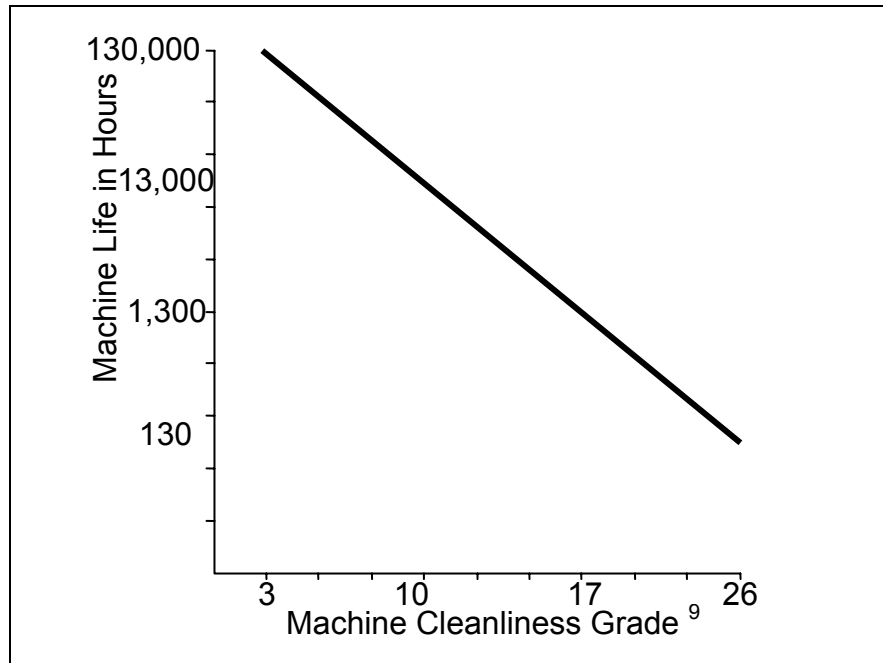

Figure B-14: The Effect of Hydraulic System Contamination¹²

ISO CODE	MINIMUM*	MAXIMUM*
-	-	-
10	5	10
11	10	20
12	20	40
13	40	80
14	80	160
15	160	320
16	320	640
17	640	1300
18	1300	2500
19	2500	5000
20	5000	10000
21	10000	20000
22	20000	40000
23	40000	80000

¹² "Extending Hydraulic Component Life at Alumax of South Carolina", J. Mayo and D. Troyer, *Reliability Magazine*, Jan 1995

ISO CODE	MINIMUM*	MAXIMUM*
-	-	-
		* Particles per mL

Table B-8 ISO 2206 Fluid Cleanliness Codes

Studies of "new" turbine oils, crankcase oils, hydraulic oils, hydraulic fluids and bearing oils delivered to customers indicate varying degrees of cleanliness, with ISO codes from a low of 14/11, to a high of 23/20.¹³ Drum-delivered products were generally found to be cleaner than bulk-delivered products. Improper storage and handling procedures can contribute additional contamination to the lubricant. When considering Figure B-14 in light of this information, the need to check the cleanliness of lubricants at the time of facility and equipment acceptance is all the more evident. Table B-9 provides the typical base cleanliness targets for various mechanical systems.

MACHINE/ELEMENT	ISO TARGET
Roller Bearing	16/14/12
Journal Bearing	17/15/12
Industrial Gearbox	17/15/12
Mobile Gearbox	17/16/13
Diesel Engine	17/16/13
Steam Turbine	18/15/12

Table B-9: Typical Base Cleanliness Targets

Water is another major factor in lubricant degradation. Depending on the storage and handling practices, it is often detected in the lubricants found in new systems, components and lubricant deliveries. Its adverse effects in oil include:

- Lubricant breakdown, through oxidation and additive precipitation;
- Changes in viscosity, affecting the ability of the lubricant to maintain the film thickness necessary to protect the component;
- Corrosion; and
- Accelerated fatigue of lubricated surfaces.

¹³ "Clean Up Your Oil and Keep It Clean!", Dave Whitefield, *Orbit*, 4th Qtr 1999 (A Publication of Bently Nevada Corporation)

The effect that water has on the life of a roller element bearing is shown in Figure B-15.

In new operating systems, then, lubricating oil analysis is performed for three reasons:

- Determine the machine mechanical wear condition
- Determine the lubricant condition
- Determine if the lubricant has become contaminated.

There are a wide variety of tests that will provide information regarding one or more of these areas. The test used will depend on the test results sensitivity and accuracy, the cost, and the machine construction and application. A comprehensive test will usually monitor the conditions of most interest. At a minimum, testing should be done for:

- Viscosity - Tests oil flow rate at a specified temperature. Viscosity index should also be performed
- Water - Water in lubricating oil and hydraulic fluid can contribute to corrosion, the formation of acids and changes in viscosity.
- Solids - Metallic and non-metallic material contaminants that can lead to premature machinery failure. These Contaminants may result from external contamination (construction, processing, storage and handling debris) or as a result of abnormal, premature wear.

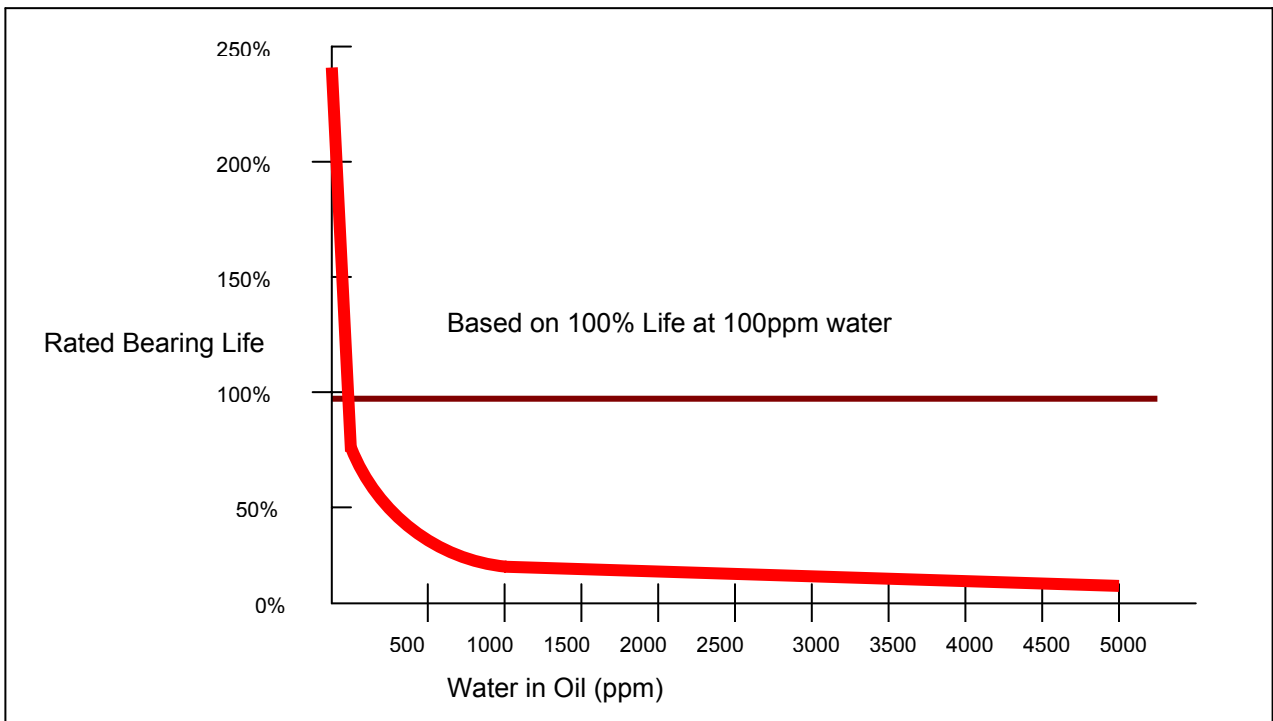

Figure B-15: Bearing Life Reduction from Water in Oil¹³

B.7.1 Hydraulic Oils

Type of System	System Sensitivity	Maximum Particle Level (particles per 100 milliliters)		
		5 microns	15 microns	ISO
Silt-sensitive control system with very high reliability	Super critical	4000	250	13/9
High-performance servo and high-pressure long-life systems	Critical	16,000	1000	15/11
High-quality reliable systems	Very important	32,000	4000	16/13
General machinery and mobile systems	Important	130,000	8000	18/14
Low-pressure heavy industrial systems	Average	250,000	16,000	19/15
Low-pressure systems with large clearances	Main protection	1,000,000	64,000	21/17

Table B-10 Sperry Vickers Table Of Suggested Acceptable Contamination Levels For Various Hydraulic Systems

All bulk and equipment-installed hydraulic fluids supplied shall meet the cleanliness guidelines in Table B-10. NASA will specify the system sensitivity.

The particle counting technique used must be quantitative. Patch test results are not acceptable.

B.7.2 Lubrication Oils

The contractor must provide to NASA the following information on all lubricants supplied in bulk or contained within equipment supplied under this contract:

Liquid Lubricants

- Viscosity grade in ISO units
- AGMA and/or SAE classification as applicable
- Complete identification of all additive package compounds

Grease Lubricants

- Type of base stock
- NLGI Number
- Type and percent of thickener
- Dropping point
- Base oil viscosity range in SUS or centipoise

The contractor must identify all lubricants and perform the lubricant tests listed in Table B-11 on all lubricants supplied by the contractor. The results of the tests shall be submitted to the NASA Construction Manager for forwarding to the appropriate maintenance organization, i.e., Systems Engineer, Condition Monitoring Office, Predictive Testing Group, etc. and inclusion in the maintenance database.

Lubricant Tests	Testing For	Limits
Total Acid Number	pH balance	<.05 gm KOH/ml
Visual	Cloudiness	Non-cloudy
IR Spectral Analysis	Metals	None
Particle Count	Particles >10um	< 100
Water Content	Water	< 25ppm @ 20°C
Viscosity	Lubricating Quality	Per Spec.

Table B-11: New Lubricating Oil Limits

B.8 Insulation Oil Tests

Insulation oil testing is done to confirm that the specified oil is installed and is free from contamination and/or degradation. High and medium voltage transformers, some high and medium voltage breakers, and some medium voltage switches are supplied with mineral oil as an insulation medium. Performing oil tests by the Contractor prior to turnover is needed to ensure that the proper oil is installed and that the necessary inhibitors have been added. The two groupings of testing required of the contractor for facility and equipment acceptance are Dissolved Gas Analysis and oil condition tests, which include Color, Karl Fischer (water in oil), Acidity level (Neutralization Number), Power Factor, Interfacial Tension, and Electrical Dielectric.

Authorization for electrical system acceptance based on insulation oil testing requires a signature by the NASA Construction Manager. This information should be provided along with all test data to the Construction Manager for forwarding to the appropriate maintenance organization, i.e., Systems Engineer, Condition Monitoring Office, Predictive Testing Group, etc. and inclusion in the maintenance database.

B.8.1. Dissolved Gas Analysis

Dissolved gas analysis, also called "gas-in-oil analysis", is probably the best predictive test for oil filled transformers. As transformers age, small amounts of combustible gases are formed. However, when insulation systems are subjected to stresses, such as fault currents and overheating, combustible gas generation can change dramatically. In most cases, these stresses can be detected early on; the presence and quantity of the individual gases can be measured and the results analyzed to indicate the probable cause of the gas generation. The primary causes of these gases are thermal, mechanical, and electrical stresses in the windings. Consequently, it is

important that the contractor checks to make sure that the new oil has no contaminants, especially combustible gases.

Using ANSI Standard D-3613, the contractor shall draw a small oil sample (50cc) from the transformer with a glass syringe. To obtain a reliable reading, this must be accomplished with the unit energized. As a transformer cools after being taken off-line, dissolved gases in the oil migrate into the windings so any sample taken after cool-down will not be representative of the true “on-line” condition.

The oil is then analyzed using ASTM D-3612-90, *Standard Test Method for Analysis of Gases Dissolved in Electrical Insulating Oil by Gas Chromatography*. While there are over 200 gasses present in insulating oils, there are only nine that are of concern. They are:

- Nitrogen (N₂)
- Oxygen (O₂)
- Carbon Dioxide (CO₂)
- Carbon Monoxide (CO)
- Methane (CH₄)
- Ethane (C₂H₆)
- Ethylene (C₂H₄)
- Hydrogen (H₂)
- Acetylene (C₂H₂)

Standards for gas-in-oil are listed in Table B-12.

Dissolved Gas Limits For New Insulating Oil	
Nitrogen (N ₂)	< 100 ppm
Oxygen (O ₂)	< 10 ppm
Carbon Monoxide (CO)	< 10 ppm
Carbon Dioxide (CO ₂)	< 100 ppm
Methane (CH ₄)	None
Ethane (C ₂ H ₆)	None
Ethylene (C ₂ H ₄)	None
Hydrogen (H ₂)	None
Acetylene (C ₂ H ₂)	None

Table B-12: Dissolved Gas Limits for New Insulating Oil

B.8.2 Insulation Oil Condition

Below is a list of the available tests, their ASTM standard number, and a brief description of what each test reveals.

- *Karl Fisher, ASTM D-1533-88.* Tests for water in insulating fluids. This test reveals the total water content in oil, both dissolved and free. High readings could indicate a leak in the equipment housing or insulation breakdown.
- *Dielectric Breakdown Strength, ASTM D-877 and D-1816.* Tests for conductive contaminants, such as metallic cuttings, fibers, or free water, present in the oil.
- *Acidity Test and Neutralization Number, ASTM D-974.* Commonly called the "acid number", this measurement shows the amount of acid in the oil. The acidity is a result of oxidation of the oil caused by the release of water into the oil from insulation material due to aging, overheating, or operational stresses such as internal or through faults. The acidity is measured as the number of milligrams of potassium hydroxide (KOH) it takes to neutralize the acid in one gram of oil. An increase in the acidity indicates a deterioration of the oil. This process causes the formation of sludge within the windings, which in turn can result in premature failure of the unit.
- *Interfacial Tension (IFT), ASTM D-971.* Measures the tension at the interface between two liquids, oil and water. It is expressed in dynes/centimeter. This test is extremely sensitive to oil decay products and contamination from solid insulating materials. Good oil will have an IFT of 40 to 50 dynes/cm and will normally "float" on top of water. As transformer and breaker insulation ages, contaminants such as Oxygen and free water are released into the oil. The properties that allow the oil to "float" on top of the oil then begin to break down and the result is a lower IFT. Along with the neutralization number, the IFT can reveal the presence of sludge in insulating oils.
- *Color, ASTM D-1524.* As insulating oils in electrical equipment age, the color of the oil tends to gradually darken. A marked color change from one year to the next indicates a problem.
- *Sediment, ASTM D-1698.* Indicates deterioration and/or contamination of the oil.
- *Power Factor, ASTM D-924.* Taken at 25 degrees C, this test can reveal the presence of moisture, resins, varnishes, or other products of oxidation or foreign contaminants, such as motor oil and fuel oil. The power factor of new oil should always be below .05%.
- *Visual Examination, ASTM D-1524.* Good oil is clear and sparkling, not cloudy and dull. Cloudiness indicates the presence of moisture or other contaminants. This is a good, "quick look" field test; however a Karl Fisher or a Dielectric Breakdown test is much more definitive.

Acceptable values are listed in Table B-13, B-14, and B-15.

Oil Condition Tests and Limits for New Oil	
Color	<3.0 on the ASTM D-1524 color scale
Dielectric Breakdown	>30 kV
Power Factor	<0.15 at 25°C
Karl Fischer (Water in the Oil)	<25 ppm at 20°C
Interfacial Tension	>40 dynes/cm
Acidity (Neutralization Number)	<.05mg KOH per gram oil

Table B-13: Oil Condition Tests and limits for New Oil

Test Limits for New Insulating Oil Received in New Equipment					
Mineral Oil					
Test	ASTM Method	≤ 69 kV and Below	>69 kV - < 230 kV	≥230 kV - < 345 kV	≥345 kV and Above
Dielectric breakdown, kV minimum	D877	30	30	30	
Dielectric breakdown, kV minimum @ 1mm (0.04") gap	D1816	25	30	32	35
Dielectric breakdown, kV minimum @ 2 mm (0.08") gap	D1816	45	52	55	60
Interfacial tension mN/m minimum	D971 or D2285	38	38	38	38
Neutralization number, mg KOH/g maximum	D974	0.015	0.015	0.015	0.015
Water content, ppm maximum	D1533	20	10	10	10
Power factor at 25° C, %	D924	0.05	0.05	0.05	0.05
Power factor at 100° C, %	D924	0.40	0.40	0.30	0.30
Color	D1500	1.0	1.0	1.0	0.5
Visual condition	D1524	Bright and clear	Bright and clear	Bright and clear	Bright and clear

Table B-14: Oil Condition Tests and Limits for new Insulating Oil

ANSI/IEEE C57.106-2002, *Guide for Acceptance and Maintenance of Insulating Oil in Equipment*,

Typical Values for Less-Flammable Hydrocarbon Insulating Liquid Received in New Equipment		Results		
ASTM Method	Test	Minimum	Maximum	
D1816	Dielectric breakdown voltage for 0.08 in gap, kV	40	34.5 kV class and below	-----
		50	Above 34.5 kV class	
		60	Desirable	
D1816	Dielectric breakdown voltage for 0.04 in gap kV	20	34.5 kV class and below	-----
		25	Above 34.5 kV class	
		30	Desirable	
D974	Neutralization number, mg KOH/g	-----	0.03	
D877	Dielectric breakdown voltage Kv	30	-----	
D924	AC loss characteristic (dissipation factor), % 25° C 100° C	-----	0.1	
		-----	1	

D1533B	Water content, ppm	-----	25	
D1524	Condition-visual	Clear		
D92	Flash point (° C)	275	-----	
D92	Fire point (° C)	300 ^a	-----	
D971	Interfacial tension, mN/m, 25° C	38	-----	
D445	Kinematic viscosity, mm ² /s, (cSt), 40° C	1.0 X 10 ² (100)	1.3 X 10 ² (130)	
D1500	Color	-----	L2.5	

Table B-15: Insulating Fluid Maintenance

ANSI/IEEE C57.121-1998, *IEEE Guide for Acceptance and Maintenance of Less Flammable Hydrocarbon Fluid in Transformers*, Table 3.

The test limits shown in this table apply to less-flammable hydrocarbon fluids as a class. Specific typical values for each brand of fluid should be obtained from each fluid manufacturer.

- a. If the purpose of the HMWH installation is to comply with the NFPA 70 *National Electrical Code*, this value is the minimum for compliance with NEC Article 450.23.

B.9 Battery Impedance Tests

A battery impedance test set injects an AC signal between the terminals of the battery. The resulting voltage is measured and the impedance then calculated. This measurement can be accomplished without removing the battery from service since the AC signal is low level and "rides" on top of the DC of the battery. Two comparisons are then made: first, the impedance is compared with the last reading for that battery; and second, the reading is compared with other batteries in the same bank. Each battery should be within 10% of the others and 5% of its' last reading. A reading outside of these values indicates a cell problem or capacity loss. If a battery has

an internal short, the impedance tends to go to zero; if an open exists, the impedance will approach infinity.

As the battery ages and begins to lose capacity, its internal impedance rises. This is the parameter that can be trended - comparing the current value with the original value and also with the last previous reading. Figure B-16 shows a typical battery impedance versus age graph. The internal impedance increases as the battery ages. Additionally, if the battery has an internal short the impedance tends to go to zero; if there is an "open" the impedance will approach infinity, and premature aging due to excessive heat or discharges will cause the impedance to rise quickly.

A battery impedance test set injects an AC signal between the terminals of the battery. The resulting voltage is measured and the impedance is then calculated. This measurement can be accomplished without having to remove the battery from service since the AC signal is low level and "rides" on top of the DC of the battery. Two comparisons are then made: first, the impedance is compared with the last previous reading for that battery; and, second, the reading is compared with other batteries in the same bank. Each battery should be within 10% of the others and 5% of its last reading. A reading outside of these values indicates a cell problem or capacity loss. It should be noted that there are no set guidelines and limits for this test. Each type, style, and configuration of battery will have its own impedance, so it is important to take these measurements early in a battery's life, preferably at installation. It should take less than an hour to perform this test on a battery bank of 60 cells.

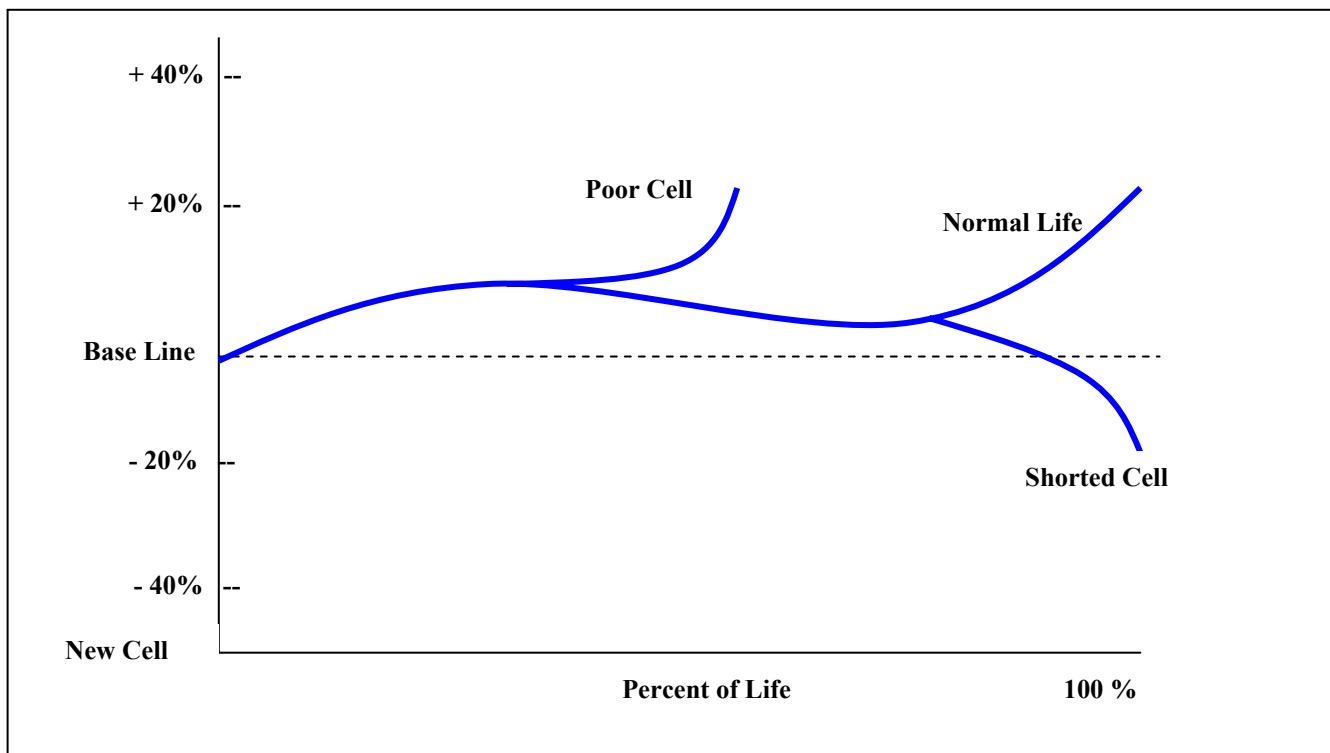

Figure B-16: Typical Battery Impedance Versus Age

Battery Impedance baseline data must be provided to the Construction Manager for forwarding to the appropriate maintenance organization, i.e., Systems Engineer, Condition Monitoring

Office, Predictive Testing Group, etc. and inclusion in the maintenance database. Defective batteries found at this time are to be replaced by the contractor prior to system acceptance.

B.10 Insulation Resistance Testing

An Insulation Resistance test is a non-destructive direct current (DC) test used to determine insulation resistance to ground. A DC voltage is applied to the equipment under test, resulting in a small current flow. The test set then calculates the resistance. The insulation resistance is generally accepted as a reliable indication of the presence of contamination or degradation; however, test results vary greatly due to environmental conditions, specifically temperature. All readings must be corrected to 20°C for comparisons to be accurate. Under ideal conditions, modern insulation systems can be expected to have life cycles in excess of 100,000 operating hours.¹⁴

The total current through and along the insulation is made up of three components:

- The Capacitance Charging Current - This current is actually “charging” the insulation up to the applied voltage, just like a capacitor, hence the term “Capacitance Charging”. This current starts high and very rapidly falls off to zero after the insulation has been fully charged.
- The Dielectric Absorption Current - This current results from absorption within imperfections in the insulation. These imperfections cause voltage polarization, the most predominant being interfacial types found at the interfaces between different materials, such as the insulation paper and the copper coil found in the windings of transformers. This current starts high and decreases rapidly with time.
- The Leakage Current - The leakage current is the most important component of the insulation resistance test when attempting to evaluate the condition of the insulation under test. The path of this current can be either through the insulation itself to ground, or over leakage surfaces. While the other two currents are essentially temporary charging currents, this current actually represents a current loss. Theoretically, the leakage current should be constant with time for any single voltage value. This is an indication that the insulation under test can withstand the voltage being applied. However a steady increase in the leakage current with time at the same applied voltage indicates an abnormality in the insulation, and the test should be stopped and the equipment examined.

In the absence of consensus standards dealing with insulation-resistance tests, the NETA Standards Review council suggests the following representative values:

Table B-16 provides a listing of insulation resistance test values

¹⁴ Hodowance and Bezesky, Field Motor Testing: Limiting Risk, *IEEE Industry Applications Magazine*, May/June 1999

Nominal Rating of Equipment in Volts	Minimum Test Voltage, DC	Recommended Minimum Insulation Resistance in Megohms
250	500	25
500	1,000	100
1,000	1,000	100
2,500	1,000	500
5,000	2,500	1,000
8,000	2,500	2,000
15,000	2,500	5,000
25,000	5,000	20,000
34,500 and above	15,000	100,000

Table B-16: Insulation Resistance Test Values

Actual test results are dependent on the length of the conductor being tested, the temperature of the insulating material, and the humidity of the surrounding environment at the time of the test. In addition, insulation resistance tests are performed to establish a trending pattern and a deviation from the baseline information obtained during maintenance testing enabling the evaluation of the insulation for confined use.

To correct reading to 20 °C, the following temperature correction factors should be used.

Temperature		Multiplier	
° C	° F	Apparatus Containing Immersed Oil Insulations	Apparatus Containing Solid Insulations
0	32	0.25	0.40
5	41	0.36	0.45
10	50	0.50	0.50
15	59	0.75	0.75
20	68	1.00	1.00
25	77	1.40	1.30
30	86	1.98	1.60
35	95	2.80	2.05
40	104	3.95	2.50
45	113	5.60	3.25
50	122	7.85	4.00
55	131	11.20	5.20
60	140	15.85	6.40
65	149	22.40	8.70
70	158	31.75	10.00
75	167	44.0	13.00
80	176	63.50	16.00

Table B-17: Insulation Resistance Correction Factors

Taking the insulation resistance test a step further, the resistance readings can be recorded at 15-, 30-, 45-, and 60-seconds, and at 1-minute intervals up to 10 minutes. These readings can then be plotted on log-log graph paper. The resulting curves should have a smooth rise over the test time.

For condition monitoring purposes, the best application for the insulation resistance test is the Polarization Index (PI) or the Dielectric Absorption Ratio (DAR). The PI is the ratio of the ten-minute resistance to the one-minute resistance, and the DAR is the 30-sec reading divided by the one minute reading. The resulting values are dimensionless and do not need any temperature correction. They are purely numeric and offset the fact that previous test information might not be available. Leakage current increases faster in insulation with the presence of moisture or contamination. The PI and DAR ratios will be lower for insulation that is in poor condition. In a condition monitoring program using insulation resistance, the PI is the value that is trended.

Authorization for electrical system acceptance based on insulation resistance testing requires a signature by the NASA Construction Manager. This information along with the test data should be provided to the Construction Manager for forwarding to the appropriate maintenance organization, i.e., Systems Engineer, Condition Monitoring Office, Predictive Testing Group, etc. and inclusion in the maintenance database.

B.10.1 Motors

On motors 200HP and above, the contractor is to perform an Insulation Resistance test and Polarization Index test on each phase of the motor prior to terminating the motor to the feeder cable. On motors below 200HP, an Insulation Resistance and DAR test should be performed. On motors where the phases can not be separated, all three phases are to be tested together. Insulation tests on motors up to 2,400 volts shall be conducted using 2,500 volts DC. Insulation tests on motors rated above 2,400 volts shall be conducted using 5,000 volts DC.

Data recorded shall be megohm readings relative to time. Readings shall be taken at 15-, 30-, 45- seconds and in 1-minute increments thereafter up to 10 minutes. Megohm readings shall not be less than 25 megohms for each phase, and each phase reading shall be within 10% of the other two.

The polarization index of each phase shall be calculated by dividing the 10-minute reading by the 1-minute reading. The polarization index shall be greater than 1.25. Any values lower than 1.25 shall be rejected and the motor not accepted by NASA.

The DAR of each phase is to be calculated by dividing the 30-second reading by the 1-minute reading. The DAR shall be greater than 1.25. Any values lower than 1.25 shall be rejected and the motor not accepted by NASA.

B.10.2 Switchgear And Motor Control Centers

Bus insulation for both switchgear and motor control centers should be measured with the insulation resistance limits displayed in Table B-16.

Readings below the minimum values are indicative of improperly installed or wet insulation or loose bus connections and should be resolved prior to continuing testing and commissioning.

In addition to the insulation resistance tests, the integrity of the connected cable installations associated with switchgear and motor control centers can also be tested by impressing a high voltage, commonly called a “withstand test voltage.” The following table of test voltages was extracted from 2003 NETA Acceptance Specifications.

Type of Switchgear	Rated Maximum Voltage (kV) (rms)	Maximum Test Voltage kV	
		AC	DC
Low-Voltage Power Circuit Breaker Switchgear	.254/.508/.635	1.6	2.3
Metal-Clad Switchgear	4.76	14	20
	8.25	27	37
	15.0	27	37
	27.0	45	†
	38.0	60	†
Station-Type Cubicle Switchgear	15.5	37	†
	38.0	60	†
	72.5	120	†
Metal Enclosed Interrupter Switchgear	4.76	14	20
	8.25	19	27
	15.0	27	37
	15.5	37	52
	25.8	45	†
	38.0	60	†

Table B-18: Switchgear Withstand Test Voltages

Derived from ANSI/IEEE C37.20.1-1993, Paragraph 5.5, *Standard for Metal-Enclosed Low-Voltage Power Circuit-Breaker Switchgear*, C37.20.2-1993, Paragraph 5.5, *Standard for Metal-Clad and Station-Type Cubicle Switchgear* and C37.20.3-1987 (R1992), Paragraph 5.5, *Standard for Metal-Enclosed Interrupter Switchgear*, and includes 0.75 multiplier with fraction rounded down.

The column headed “DC” is given as a reference only for those using dc tests to verify the integrity of connected cable installations without disconnecting the cables from the switchgear. It represents values believed to be appropriate and approximately equivalent to the corresponding power frequency withstand test values specified for voltage rating of switchgear. The presence of this column in no way implies any requirement for a dc withstand test on ac equipment or that a dc withstand test represents an acceptable alternative to the low-frequency withstand tests specified in these specifications, either for design tests, production tests, conformance tests, or field tests. When making dc tests, the voltage should be raised to the test value in discrete steps and held for a period of one minute.

† Because of the variable voltage distribution encountered when making dc withstand tests, the manufacturer should be contacted for recommendations before applying dc withstand tests to the switchgear. Voltage transformers above 34.5 kV should be disconnected when testing with dc. Refer to ANSI/IEEE C57.13-1993 (*IEEE Standard Requirements for Instrument Transformers*) paragraph 8.8.2.

B.10.3 Circuit Breakers

Insulation Resistance (Megger) values, measured for each phase, should be over 25 megohms for molded case breakers and over 100 megohms for all others.

B.10.4 Transformers

Insulation resistance measurements are to be performed by the contractor to verify that the state of dryness of the winding insulation and the core is acceptable. Insulation resistance tests can also reveal information about concealed damage to bushings that can occur during shipment and/or storage. Measurements normally are performed on transformers at rated voltage up to a maximum of 5,000 volts. It is very important for the temperature of the insulation system to be known when performing the test. Insulation resistance is very sensitive to temperature and varies inversely with temperature. Insulation resistance measurements must be corrected to 20 degrees C for comparison purposes. When the test is performed, the core should be grounded and the windings under test short-circuited. Those windings that are not being tested should be grounded, and all bushings should be cleaned prior to beginning the test.

The minimum resistance values depend on the voltage and capacity of the unit under test. For acceptance tests, the minimum value should be determined using the following equation:

$$R = \frac{CE}{\sqrt{kVA}}$$

Where: R = Minimum resistance corrected to 20°C

C = Constant (0.8 for oil transformers, 16 for dry type)

E = Voltage rating of the winding under test

kVA = Rated capacity of winding under test

The results of the test should also be compared with the factory results and should be within 5% of the factory readings after correction to 20°C.

Large transformers can sometimes have long charging times due to the absorption current. When this is the case, the polarization index (PI) can be used. PI is a ratiometric test that will help identify the condition of the insulation even if the charging currents have not diminished to zero. The test lasts for 10 minutes. The one-minute and 10-minute insulation resistance readings are recorded. The PI is the 10-minute reading divided by the one-minute reading. For a new transformer, the PI should be greater than 2.

B.11 Motor Analysis

Motor analysis consists of various technologies to determine the condition of both the motor itself and motor circuitry.

The total impedance of a motor is the sum of its resistance, capacitance, and inductance. Any impedance imbalances in a motor will result in a voltage imbalance. Voltage imbalances result in higher operating current and temperatures, which will weaken the insulation and shorten the motor's life. For resistance, the maximum allowable percentage imbalance is 2%. For inductance the maximum allowable percentage is 10%. The percent imbalance is calculated as follows:

$$\% \text{ imbalance} = \frac{(R^{\text{high}} - R^{\text{ave}})}{R^{\text{ave}}} \text{ times } 100$$

$$\text{Where } R^{\text{ave}} = \frac{R1 + R2 + R3}{3}$$

The formula is the same for impedance imbalance. The capacitance value is used for trending purposes and indicates wet or dirty windings.

B.11.1 Motor Circuit Analysis

Motor Circuit Analysis is a technology designed to monitor the condition of the complete motor circuit. The test device measures the basic electrical characteristics, conductor phase resistance, conductor phase inductance, and resistance to ground as well as capacitance to ground. The root causes of motor failure in AC three-phase motor stators are frequently found outside the motor.¹⁵ The most common cause is found somewhere after the power supply enters the facility, including (in order of decreasing frequency):

- Distribution transformer defects;
- Uneven loads on individual phases; and
- Deterioration of individual conductor paths.

Checking three-phase motor circuits for resistive balance can be important to assuring long motor operating life. In each three-phase motor circuit the resistance of each conductor path should be as close to equal as possible. Small values of resistive imbalance (up to 2-3%) can be tolerated for short periods without much loss. However, resistive imbalance beyond 5% will begin to reduce life expectancy radically.

Similarly, it is important for inductive balance to be checked. At some point above 15% inductive imbalance, electrically induced mechanical vibrations will occur. When a rotor has a defect, such as broken bars and/or end rings, it has the effect of highly variable imbalance as the rotor position changes relative to the stator windings. During equipment acceptance, the lower the initial imbalance, the longer will be the expected motor life from both electrical and mechanical standpoints.

Motor circuit analysis also evaluates motor circuit capacitance and resistance to ground. The capacitance indicates the amount of dirt and moisture present on the outside of the motor winding insulation, which first, have the effect of helping current "leak" through defective insulation to ground through the motor frame, and second interfere with the motor's designed capability to dissipate heat. From a baseline condition of low capacitance (to ground) this parameter can be trended

Test equipment is portable and computer based, which provides for automated test performance and data collection.

B.11.2 Motor Current Signature Analysis (MCSA)

MCSA detects:

- Broken Rotor Bars
- Defective Shorting Rings
- Rotor Porosity, and
- Air Gap Eccentricity

¹⁵ Jack R. Nicholas Jr., PE, *Motor Circuit and Current Signature Analysis*, AIPE Facilities, July/August 1994

The main indicator of rotor problems is the difference in height, measured in decibels, between the spike at the line frequency and the spike at the pole pass frequency of the motor current signature. (See Figure B-17.) As the difference decreases, it indicates increased severity of damage to the rotor bars and end rings that make up the rotor cage.

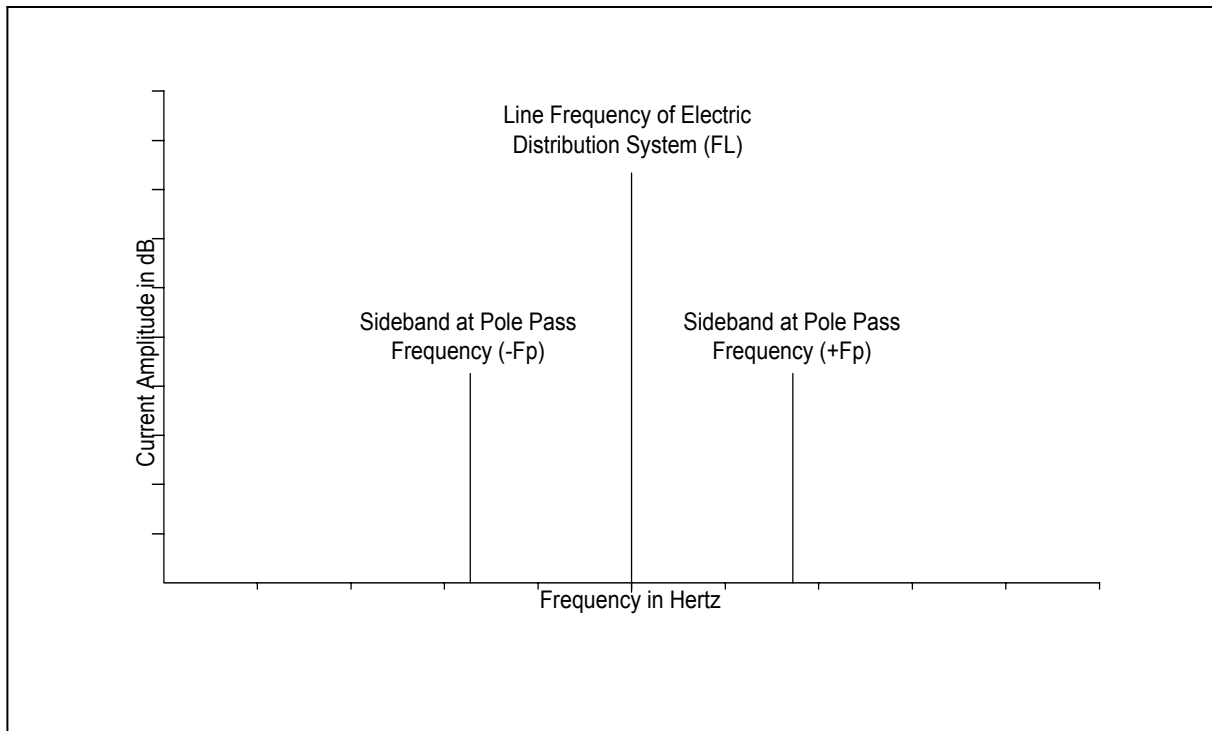

Figure B-17: Simplified Motor Current Signature

MCSA takes advantage of the fact that an electrical motor is a reliable transducer of mechanically induced loads. Variations in motor load modulate the current flowing through the motor stator windings¹⁶. These variations in the motor load are due to the non-symmetrical magnetic field in the motor and mechanical feedback due to variations in system response. Spikes are present at or near the one at the pole pass frequency that are induced by other mechanical faults, mainly those in the machinery that the motor is driving. The motor current is filtered to remove line frequency harmonics and transformed to the frequency domain by performing a Fast Fourier Transform (FFT).

B.11.3 Electrical Signal Analysis

Electrical Signature Analysis is an on-line technology where all currents and voltages of a motor circuit are measured, conditioned, and displayed as time domain and frequency spectral data. The technology allows for the diagnosis of conditions of the power system, motor, and driven component. Data collected includes voltage and current balance, power quality, impedance balance and current sequence data.

¹⁶ Roger Carr, P/PM Technology, Volume 8, Issue 3 – June 1995, p. 50.

B.12 Flux Analysis

Flux analysis is a diagnostic technique involving the measurement and analysis of the magnetic leakage flux field around a motor. The technology is designed to detect faults in rotor bars, stator turn to turn shorts, and phase to phase faults. The analysis is similar to that of motor current signature analysis.

2.63.3 Contact Resistance Tests

This test is used to determine the contact condition on a breaker or switch without visual inspection. Most manufacturers of high and medium voltage circuit breakers will specify a maximum contact resistance for both new contacts and in-service contacts. The contact resistance is dependent on two things - the quality of contact area and the contact pressure. The contact quality can degrade if the breaker is called upon to open under fault conditions. The contact pressure can lessen as the breaker's springs fatigue due to age or a large number of operations.

To measure the contact resistance, a DC current, usually 10 or 100 amps, is applied through the contacts. The voltage across the contacts is measured, and the resistance is calculated using Ohms law. This value can be trended and compared with maximum limits issued by the breaker or switch manufacturer. It should be noted that for oil filled breakers, using a 100 amp test set is best because oil tends to glaze on contact surfaces and in some cases 10 amps is not enough to "punch through" the glaze.

Authorization for electrical system acceptance based on contact resistance testing requires a signature by the NASA Construction Manager. This information should be provided by the contractor with the test data to the Construction Manager for forwarding to the appropriate maintenance organization, i.e., Systems Engineer, Condition Monitoring Office, Predictive Testing Group, etc. and for inclusion in the maintenance database.

Inspection and testing technologies are those tests that give results that can be used for acceptance criteria but are not normally used for trending. Most tests in this category can be classified as a go/no-go test, i.e., either the equipment passes or fails the test.

B.14 Breaker Timing Tests

A Breaker Timing Test is a mechanical test that shows the speed and position of breaker contacts before, during, and after an operation.

The first timing devices were called Drop-Bar Recorders and recorded their results on a rotating drum. They were developed in the late 1930s and were the instrument of choice until the coming of rotary motion, vacuum, and high-speed breakers in the mid 1970s.

In 1972 the Doble Engineering Company introduced their first breaker timer which used the light-beam recorder technology. This method used light sensitive paper that was etched using a light source and a mirror that modulated with the breaker contact travel. The main drawbacks to this technology is the fragility of the test set (mirrors go out of alignment very easily) and the amount of paper required (since the paper was etched real-time).

Today, there are two general types of timers in use - digital contact timers and digital contact and breaker travel analyzers. The digital contact timers are only good for timing contacts where no travel time is required and is really only applicable for new breakers prior to being put into service.

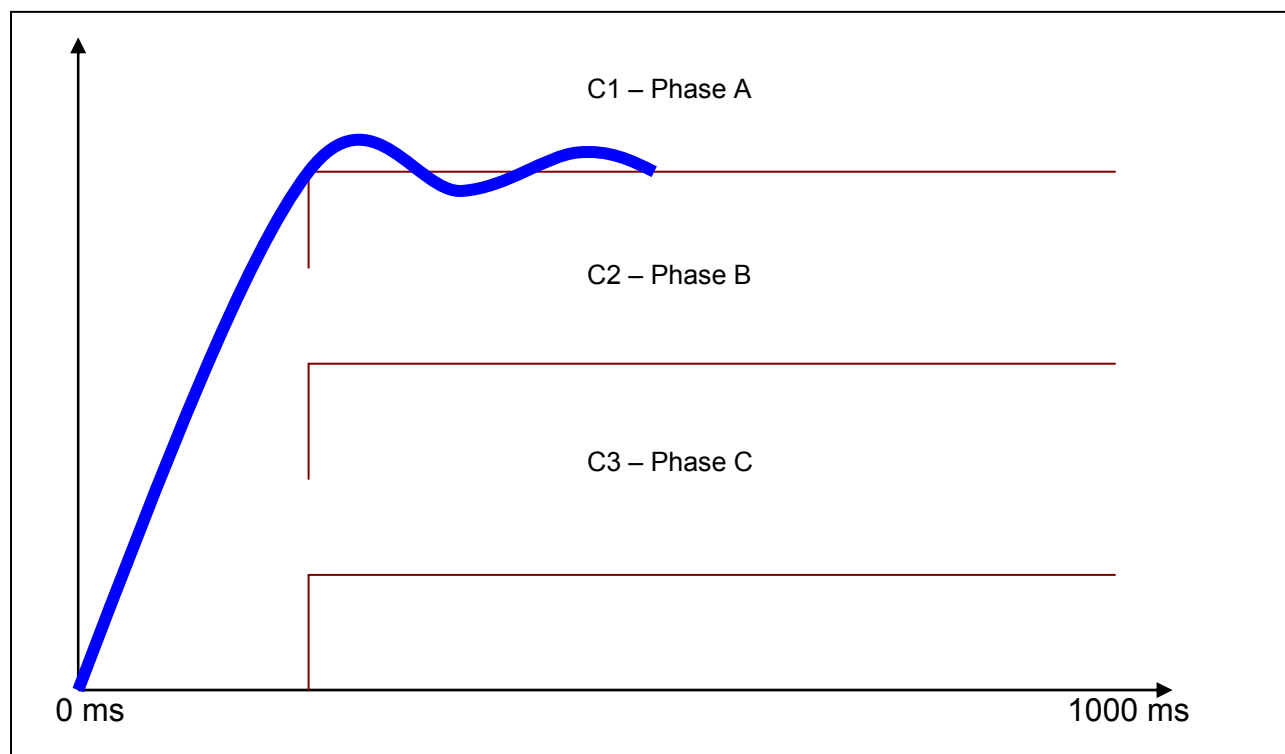

Figure B-18: Breaker Timing Plot

A digital contact and breaker analyzer measures the contact velocity, travel, over-travel, bounce back, and acceleration to give the user a good idea of the breaker operating mechanism condition. A voltage is applied to the breaker contacts, and a motion transducer is attached to the operating mechanism. The breaker is then closed and opened, and the test set measures the timeframe of voltage changes and plots the voltage changes over the motion waveform produced by the motion transducer. Figure B-18 is an example of a motion plot. The three square waves, C1, C2, and C3 are the contacts, and the curve is the motion of the mechanism. The “wiggle” at the top of the motion waveform shows the amount of over-travel, bounce back, at seating depth of the contacts. The numbers are normally printed out from the test set, and the chart is stored in memory for downloading into a computer. This test is not applicable to molded case breakers or low voltage breakers.

Authorization for electrical system acceptance based on breaker timing testing requires a signature by the NASA Construction Manager. This information should be provided with the test data to the Construction Manager for forwarding to the appropriate maintenance organization, i.e., Systems Engineer, Condition Monitoring Office, Predictive Testing Group, etc. and inclusion in the maintenance database. Analyzing and trending this information will indicate if adjustments to the breaker operating mechanism are necessary.

B.15 High Potential Tests

Hi-Pot testing, illustrated in Figure B-19, is a high voltage DC test that shows excessive leakage current in equipment. It is also used to verify that insulation systems in new equipment can withstand designed voltage levels. Consequently, it is a good acceptance test for new and repaired electrical transmission and distribution equipment. In repaired equipment, if the leakage current continues to increase at a constant test voltage, this indicates that the repair is not to the proper standard and will probably fail prematurely. For new equipment, if the equipment will not withstand the appropriate test voltage, it indicates that the insulation system or construction method is inadequate for long term service reliability. Since DC Hi-Pot testing is a potentially destructive test, it is a standard acceptance test, especially for new or rewound motors, but normally it is not used for periodic testing.

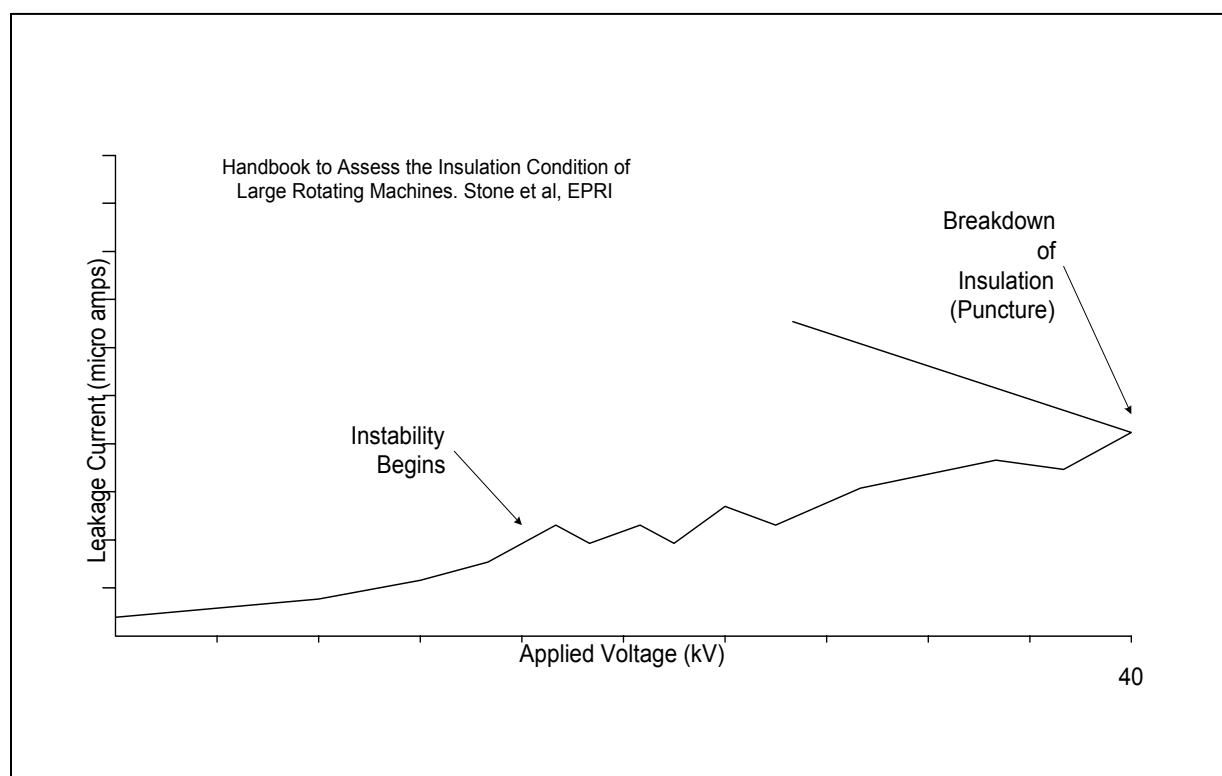

Figure B-19: Hi-Pot Testing Example

Authorization for electrical system acceptance based on High Voltage Withstand testing requires a signature by the NASA Construction Manager. This information should be provided by the contractor with the test data to the Construction Manager for forwarding to the appropriate maintenance organization, i.e., Systems Engineer, Condition Monitoring Office, Predictive Testing Group, etc. and for inclusion in the maintenance database.

When performing these tests, the following tables provide recommended field test voltages.

DC Test Voltages						
Rated Voltage Phase-to-Phase kV	Conductor Size AWG or kcmil (mm)	Nominal Insulation Thickness		Maximum DC Test Voltages, Field kV		
		100% Insulation Level	133% Insulation Level	100% Insulation Level	133% Insulation Level	
5	8-1000 (8.4-507) Above 1000 (507)	90 (2.29)	115 (2.92)	28	36	
		140 (3.56)	140 (3.56)	28	36	
8	6-1000 (13.3-507) Above 1000 (507)	115 (2.92)	140 (3.56)	36	44	
		175 (4.45)	175 (4.45)	36	44	
15	2-1000 (33.6-507) Above 1000 (507)	175 (4.45)	220 (5.59)	56	64	
		220 (5.59)	220 (5.59)	56	64	
25	1-2000 (42.4-1013)	260 (6.60)	320 (8.13)	80	96	
28	1-2000 (42.4-1013)	280 (7.11)	345 (8.76)	84	100	
35	1/0-2000 (53.5-1013)	345 (8.76)	420 (10.7)	100	124	
46	4/0-2000 (107.2-1013)	445 (11.3)	580 (14.7)	132	172	
69	4/0-2000 (107.2-1013)		650		195	

Table B-19: Medium Voltage Cables Acceptance Test Values

Tables derived from ANSI/ICEA S 93-639/NEMA WC 74-2000, *5-46 kV Shielded Power Cable for Use in the Transmission and Distribution of Electric Energy*; ANSI/ICEA S-94-649-2000, *Standard for Concentric Neutral Cables Rated 5,000 - 46,000 Volts*; ANSI/ICEA S-97-682-2000, *Standard for Utility Shielded Power Cables Rated 5,000 - 46,000 Volts*; and The Okonite Company, *High-Voltage Proof Testing*.

DC test voltages are applied to discover gross problems such as incorrectly installed accessories or mechanical damage.

The dc field test voltages listed above are intended for cable designed in accordance with ICEA specifications. When older cables or other types/classes of cables or accessories are connected to the system, voltages lower than those shown may be necessary. Consult the manufacturers of the cables and/or accessories before applying the test voltage.

NASA Reliability Centered Building and Equipment Acceptance Guide

AC Test Voltages					
Rated Voltage Phase-to-Phase kV	Conductor Size AWG or kcmil	Nominal Insulation Thickness		AC Test Voltage, kV	
		100% Insulation Level	133% Insulation Level	100% Insulation Level	133% Insulation Level
5 kV	8-1000 1001-3000	90 (2.29) 140 (3.56)	115 (2.92) 140 (3.56)	18 28	23 28
8 kV	6-1000 1001-3000	115 (2.92) 175 (4.45)	140 (3.56) 175 (4.45)	23 35	28 35
15 kV	2-1000 1001-3000	175 (4.45) 220 (5.59)	220 (5.59) 220 (5.59)	35 44	44 44
25 kV	1-3000	260 (6.60)	320 (8.13)	52	64
28 kV	1-3000	280 (7.11)	345 (8.76)	56	69
35 kV	1/0-3000	345 (8.76)	420 (10.7)	69	84
46 kV	4/0-3000	445 (11.3)	580 (14.7)	89	116

Table B-20: Medium Voltage Cable Acceptance Test Values

Tables derived from ANSI/ICEA S 93-639/NEMA WC 74-2000, *5-46 kV Shielded Power Cable for Use in the Transmission and Distribution of Electric Energy*; ANSI/ICEA S-94-649-2000, *Standard for Concentric Neutral Cables Rated 5,000 - 46,000 Volts*; ANSI/ICEA S-97-682-2000, *Standard for Utility Shielded Power Cables Rated 5,000 - 46,000 Volts*.

All ac voltages are rms values.

Nominal System Voltage ^a (kV)	Insulation Class	AC Factory Test (kV)	Maximum Field Applied AC Test (kV)	Maximum Field Applied DC Test (kV)
1.2	1.2	10	6.0	8.5
2.4	2.5	15	9.0	12.7
4.8	5.0	19	11.4	16.1
8.3	8.7	26	15.6	22.1
14.4	15.0	34	20.4	28.8
18.0	18.0	40	24.0	33.9
25.0	25.0	50	30.0	42.4
34.5	35.0	70	42.0	59.4
46.0	46.0	95	57.0	80.6
69.0	69.0	140	84.0	118.8

Table B-21: Overpotential Test Voltages Electrical Apparatus other than Inductive Equipment

In the absence of consensus standards, the NETA Standards Review Council suggests the above representative values.

- a. Intermediate voltage ratings are placed in the next higher insulation class.

B.16 Turns Ratio Tests (TTR)

This test measures the turns-ratio of a transformer and is mainly used as an acceptance test. It can also be used as a trouble-shooting tool when other electrical tests reveal a possible problem. For acceptance tests, a TTR is performed to identify short-circuited turns, incorrect tap settings, mislabeled terminals, and functional failure in tap changers.

To perform a turns ratio test, a voltage is applied to the primary and the induced voltage on the secondary is measured. The ratio is then calculated and compared to the nameplate data. A turns ratio measurement can show that a fault exists but can not determine the reason or location of the fault.

Because the TTR does not give information that has value for trending, and because a Power Factor Excitation test will also show a shorted turn condition, the TTR test is not an effective PT&I test for maintenance.

Authorization for electrical system acceptance based on turns ratio testing requires a signature by the NASA Construction Manager. This information should be provided by the contractor with the test data to the Construction Manager for forwarding to the appropriate maintenance organization, i.e., Systems Engineer, Condition Monitoring Office, Predictive Testing Group, etc. and for inclusion in the maintenance historical database.

B.17 Partial Discharge (PD) Analysis

Partial Discharge Analysis is an on-line technology designed to monitor the condition of insulation in machines and cables above 4,000VAC. A partial discharge is an incomplete, or partial, electrical discharge that occurs between insulation and either other insulation, or a conductor. These discharges create a high frequency signal that PD monitoring systems are designed to detect. PD typically is performed for very large power generation equipment and large drive units, such as those associated with wind tunnel operations.

B.18 Thermodynamic Performance Tests

Thermodynamic tests are used to verify that systems meet the required levels of functional performance in terms of heating, cooling, utility service delivery and power consumption. These types of tests directly measure pressure, temperature, flow, voltage, current, and power consumption and indirectly measure heat transfer characteristics, system capacity performance, energy efficiency, and control system response.

The performance of thermodynamic tests is essential if system and facility functionality is to be confirmed and base-lined. These types of tests typically use installed sensors, supplemented by temporary sensors, for measuring flow.

B.19 Operational Checks

Operational checks are performed to ensure that systems and facilities respond to changes in demand per design. For example, changes in outside temperature will effect the percentage of make-up air used by the ventilation system. Furthermore, ventilation systems have different operating modes. For example, in a normal operating configuration dampers and supply and exhaust fans will operate in one mode, but during a fire or heavy atmospheric contamination a different mode will be required.

Operational checks test the functionality of the control systems by varying the inputs (i.e., room temperature and humidity) and observing the response of variable speed drives (air handlers and pumps), flow control valves, chiller load, and ventilation dampers.

B.20 Borescoping (Fiber Optics)

Internal damage can occur to turbomachinery such as gas turbines, compressors, power turbines, gear boxes, and steam turbines as a result of factory assembly, machinery storage, delivery, installation, operation and repairs. With the equipment in its final installation location, borescope (also known as fiberscope) instrumentation and procedures can be used to determine if such internal problems have occurred.

By using a fiberscope or borescope, it is possible to see any internal machine deformations or defects which are visible on the surface without having to disassemble the unit. This instrument is an optical device consisting of an objective lens, a series of relay lenses, eyepiece lens and an illumination system all contained within a rigid (borescope) or a flexible (fiberscope) tube. It is inserted into the machinery's designed access ports or access gained by removing igniters, fuel lines, etc.

The image formed by the lenses is called an aerial image because it is formed in the air between the lenses. By including a focus adjustment at the eyepiece, this aerial image can be shifted in and out so that a great depth of field can be obtained. This focus adjustment is also a diopter adjustment to correct differences in the inspector's eyesight. Within the tube or sheath, the scopes contain a fiberoptic light guide bundle around or running parallel to the lens system. When connected to an external light guide cable, light can be transmitted from a light source to illuminate the machinery's internal cavity being inspected.

Any existing corrosion, material buildup, coating breakup, clearance problems or cracks in surfaces can be identified on new, used or repaired machinery. These surface defects are resultant of the effects of heat, corrosion, contamination buildup, hot oxidation, sulfidation, and other operating. This can cause performance deterioration, potential future failure of parts, and damage to other parts as well as cooling and/or seal blockage.

These tests should be performed by trained engineer or certified technicians as part of the quality assurance inspection program. The inspection results will provide the basis for a "go / no go" acceptance decision.

This page intentionally left blank

Appendix C: Defining Basic Value – Benefit Terminology

What is Value ?

When determining the value of your car, your answer is most likely either what you paid for it or what you can sell it for. Ask the same question for a valve that leaked gas into a building that caused several people to require medical attention, the answer is no longer confined to the cost of the valve. The answer now includes the additional costs of medical attention, the costs of lost productivity, and also the costs of legal risks. It stops being a \$ 75 valve.

Value is a combination of actual out-of-pocket costs and all the possible costs associated with the function of the equipment.

What are Normal Costs ?

The costs of any equipment are what it costs to have it installed in operating condition and then to keep it running. The absolute minimum cost is to buy it, install it, run it until it wears out, and then replace it. Any additional costs such as lubrication, balancing or overhauls is done either to improve its operation, extend its life, or because it is more cost effective than replacement. Total replacement is seldom the most cost effective maintenance practice and should be avoided.

In the normal lifetime of any equipment, the total lifetime costs would include the following :

- Initial cost, includes original purchase price, cost of installation, and cost of acceptance and operational verification
- Costs of routine servicing (lubrication, adjustments, etc.)
- Costs of overhauls

Risks – The Reasons for Performing Maintenance

Because we recognize that failure of an equipment item is not translated merely to be the cost of the item, we must understand how to generate value for the item. This perceived value is usually determined by the risks associated with that item. Some of those risks can be classified as follows:

- Risk to production (lost revenue)
- Risk to mission schedule (lost opportunity)
- Risk to mission schedule (prolonged costs)
- Risk to personnel safety and/or environment
- Risk to additional damage to collateral equipment

Risks or the avoidance of risk is the primary reason for performing maintenance other than correcting failures that have already occurred. Knowing how to measure risk in terms of dollars is an important activity that will allow relative scaling and comparison of equipment items so that the maintenance team can effectively determine which risks are not acceptable, and then rank those risks in order of priority so that they can be effectively managed.

By measuring risks in terms of dollars we can judge the effectiveness of maintenance activities, and we can judge the effectiveness of monitoring activities. Dollars at risk should never be confused with actual costs. It is real dollars that are spent purchasing plant equipment, real dollars to operate and maintain equipment, and real dollars to monitor their health. Risk dollars are potential costs that would occur based on predefined scenarios that usually represent “worst-case” situations. The likelihood of these events occurring are an important consideration when calculating risk.

Cost Savings

When reviewing an equipment’s maintenance strategy, any maintenance costs that can be eliminated without impacting the equipment’s performance or reliability can be called a cost savings. Basically, it means that a specific action in the existing program is either unnecessary or can be performed in a more cost effective way. Consider the following examples:

Example #1: Vibration analysis on a total of 50 motors performed monthly over the last year has not revealed any irregularities or degradation. Consider relaxing the frequency to every other month and cut the cost of performing the vibration analysis by 50%.

Example #2: A heat exchanger is opened and inspected every year for internal condition. For the last three years, no irregularities or fouling was discovered. Consider installing thermocouples at the inlet and outlet of the heat exchanger, and perform internal inspections only when the delta temperature exceeds a predefined limit

There are many opportunities for cost savings. Some typical examples would be:

- Decrease the frequency of an existing task
- Eliminate a task than is not effective
- Substitute technologies that are more cost effective
- Substitute condition monitoring tasks for preventive maintenance actions

Cost Avoidance

Cost avoidance is determined by estimating the total costs that would have been incurred as a result of a failure, but did not occur because of actions taken in advance of the failure. These costs would include such things as repair or replacement costs to the equipment with the failure, repair costs to collateral equipment, and other costs associated with restoring function. Calculations for cost avoidance will usually complete the following statement:

“We could have avoided having to spend _____ dollars had we done _____.”

Appendix D: Resources

Equipment

The following is a list of manufacturers of PT&I and acceptance testing equipment and services. This list is intended to serve as a starting point only and is by no means complete, as changes in industry are occurring constantly.

Infrared Imaging

AGEMA Infrared Systems Inc. 550 County Avenue Secaucus, NJ 07094 Phone: 201-867-5390; Fax: 201-867-2191	Computational Systems Inc. (CSI) 835 Innovation Way Knoxville, TN. 37932 Phone: 423-675-2400; Fax: 423-675-4726 www.compsys.com
Flir Systems (FSI) 16505 SW 72 nd Ave. Portland, OR 97224 Phone: 503-684-3731; Fax: 503-684-3207	Inframetrics Inc. 16 Esquire Road N. Bellrica, MA 01862 Phone: 508-670-5555; Fax: 508-677-2702

Vibration Analysis, Ultrasonic, and Alignment

Bently-Nevada Corporation 1617 Water Street Minden, Nevada 89423 Phone: 800-227-5514	Computational Systems Inc. (CSI) 835 Innovation Way Knoxville, TN. 37932 Phone: 423-675-2400; Fax: 423-675-4726 www.compsys.com
Entek/IRD International 1700 Edison Way Milford, OH. 45150 Phone: 513-576-6151, Fax: 513-576-6104 www.entekird.com	Ludeca Inc. 1527 NW 89 th Court Miami, FL. 33172 Phone: 305-591-8935; Fax: 305-591-1537 Email: info@ludeca.mhs.compuserve.com
Predict/DLI 9555 Rockside Road Cleveland, OH 44125 Phone: 800-543-8786 www.predictDLI.com	VibraMetrics 1014 Sherman Avenue Hamden, CT. 06514 Phone: 888-225-9572 www.vibrametrics.com

UE Systems
12 W. Main St.
Elmsford, N.Y. 10523
Phone: 914-592-1220

Oil Services

Computational Systems Inc. (CSI)
835 Innovation Way
Knoxville, TN. 37932
Phone: 423-675-2400; Fax: 423-675-4726
www.compsys.com

Insight Services
12703 Triskett Road
Cleveland, OH 44111
Phone: 800-TEST OIL
<http://insight.insight.cleveland.oh.us/tribo>

Predict/DLI
9555 Rockside Road
Cleveland, OH 44125
Phone: 800-543-8786
www.predictDLI.com

TriboMetrics Inc.
2475 4th Street
Berkeley, CA, 94710
Phone: 510-540-1247; Fax: 510-527-7247

Electrical Testing

AVO International
4555 Westmoreland Way
Dallas, TX. 75237
Phone: 214-330-3522; Fax: 214-333-0104
www.avo.com

Computational Systems Inc. (CSI)
835 Innovation Way
Knoxville, TN. 37932
Phone: 423-675-2400; Fax: 423-675-4726
www.compsys.com

PdMA Corporation
5909-C Hampton Oaks Parkway
Tampa, FL 33610
Phone: 800-476-6463
www.PdMA.com

SAVO Electronics
P.O. Box 1373
Corallis, OR 97339
Phone: 503-758-7235

Technical Diagnostic Services, Inc.
4300 Beltway Place, Suite 120
Arlington, TX 76018
Phone: 817-465-9494; Fax: 817-465-9573
www.technicaldiagnostic.com

2. Training & Certifications

Listed below are the organizations that offer training and certification in PT&I technologies and reliability. This list is intended to serve as a starting point only and is by no means complete, as changes in industry are occurring constantly.

AVO International Training Institute (*All Electrical Certifications*)
4555 Westmoreland Way
Dallas, TX. 75237
Phone: 214-330-3522; Fax: 214-333-0104
www.avo.com

Bently-Nevada Corporation
1617 Water Street
Minden, Nevada 89423
Phone: 800-227-5514

Computational Systems Inc. (CSI) (*Vibration I, II & III, and IRT I & II*)
835 Innovation Way
Knoxville, TN. 37932
Phone: 423-675-2400; Fax: 423-675-4726
www.compsys.com

Diagnetics Inc. (*Vibration I, II & III*)
5410 S. 94E Ave.
Tulsa, OK 74145
Phone: 800-788-9774

EPRI M&D Center (*Electrical Testing Training*)
3 Industrial Highway
Eddystone, PA 19022
Phone: 800-745-9982

Flir Systems (FSI) (*IRT level I, II & III*)
16505 SW 72nd Ave.
Portland, OR 97224
Phone: 503-684-3731; Fax: 503-684-3207

Inframetrics Inc. (*IRT level I, II & III*)
16 Esquire Road
N. Billerica, MA 01862
Phone: 508-670-5555; Fax: 508-677-2702

Ludeca Inc. (*Alignment Training*)
1527 NW 89th Court
Miami, FL. 33172
Phone: 305-591-8935; Fax: 305-591-1537
Email: info@ludeca.mhs.compuserve.com

PdMA Corporation (*Motor Testing Training*)
5909-C Hampton Oaks Parkway
Tampa, FL 33610
Phone: 800-476-6463
www.PdMA.com

Predict/DLI (*Vibration level I, II & III, Oil and Tribology*)
9555 Rockside Road
Cleveland, OH 44125
Phone: 800-543-8786
www.predictDLI.com

Technical Diagnostic Services, Inc. (*All Electrical Certifications*)
4300 Beltway Place, Suite 120
Arlington, TX 76018
Phone: 817-465-9494; Fax: 817-465-9573
www.technicaldiagnostic.com

Update International Inc. (*Vibration level I, II & III*)
2103 Wadsworth Blvd.
Denver, CO 80227-2400
Phone: 303-986-6761; Fax: 303-985-3950

Vibration Institute (*Vibration level I, II & III*)
6262 S. Kingery Highway, Suite 212
Willowbrook, IL 60514
Phone: 630-654-2254; Fax: 630-654-2271
www.vibinst.org

VibraMetrics, (*Vibration level I, II & III*)
1041 Sherman Ave.
Hamden, CT 06514
Phone: 800-873-6748; Fax: 203-288-4937

Appendix E - Referenced Specifications

1. Organizations

There are many technical organizations that develop standards applicable in the facilities area. Most are listed below. Standards can be researched using internet search engines. In addition, the NASA Technical Standards Program has a web page at standards.nasa.gov. At most Centers, the technical library has a subscription service that continually updates standards from the major standards organizations.

ABMA	American Bearing Manufacturers Association 1200 19th Street, NW, Suite 300 Washington, DC 20036-2422 Phone: 202-429-5155, Fax: 202-828-6042 www.abma-dc.org
ABMA	American Boiler Manufacturers Association 950 N. Glebe Rd., Suite 160 Arlington, VA 22203 Phone: 703-522-7350, Fax: 703-522-2665
AGMA	American Gear Manufacturers Association 1500 King St., Suite 201 Alexandria, VA 22314-2730 Phone: 703-684-0211, Fax: 703-684-0242 www.agma.org
AIA	Aerospace Industries Association of America 1250 Eye St. NW, Suite 1200 Washington, DC 20005 Phone: 202-371-8400, Fax: 202-371-8470 www.aia-aerospace.org
AIAA	American Institute of Aeronautics and Astronautics 1801 Alexander Bell Drive, Suite 500 Reston, VA 20191 Phone: 800-639-2422, 703-264-7500, Fax: 703/264-7657 www.aiaa.org
ANSI	American National Standards Institute 11 West 42nd Street 13th floor New York, N.Y. 10036 Phone: 212-642-4900, Fax 212-398-0023 web.ansi.org

- API American Petroleum Institute
1220 L Street, NW Washington, DC 20005
Phone: 202-682-8000
www.api.org
- ARI Air-Conditioning and Refrigeration Institute
4301 North Fairfax Drive, Suite 425
Arlington, Virginia 22203
Phone: 703-524-8800, Fax: 703-528-3816
www.ari.org
- ASA Acoustical Society of America
500 Sunnyside Blvd
Woodbury, NY 11797-2999
Phone: 516-576-2360, Fax: 516-576-2377
asa.aip.org
- ASCE American Society of Civil Engineers
1801 Alexander Bell Drive
Reston, Virginia 20191-4400
Phone: 703-295-6300, Fax: 703-295-6222
www.asce.org
- ASHRAE American Society of Heating, Refrigerating and Air-Conditioning Engineers
1791 Tullie Circle, N.E.
Atlanta, GA 30329
Phone: 404-636-8400, Fax: 404-321-5478
www.ashrae.org
- ASME American Society of Mechanical Engineers
Three Park Avenue
New York, NY 10016-5990
800-843-2763
www.asme.org
- ASNT American Society for Nondestructive Testing
PO Box 28518
1711 Arlingate Lane
Columbus, OH 43228-0518
Phone: 800-222-2768, 614-274-6003, Fax: 614-274-6899
www.asnt.org

- ASQ
American Society for Quality
(formerly American Society of Quality Control)
611 East Wisconsin Avenue
P.O. Box 3005
Milwaukee, WI 53201-3005
Phone: 800-248-1946, 414-272-8575, Fax: 414-272-1734
www.asqc.org
- ASSE
American Society of Sanitary Engineering
28901 Clemens Road, Suite 100
Westlake, OH 44145
Phone: 440-835-3040, Fax: 440-835-3488
www.asse-plumbing.org
- ASTD
American Society for Training and Development
1640 King Street
PO Box 1443
Alexandria, Virginia, 22313-2043
Phone: 703-683-8100, Fax: 703-683-8103
www.astd.org
- ASTM
American Society for Testing and Materials
100 Barr Harbor Drive
West Conshohocken, Pennsylvania 19428-2959
Phone: 610 832-9585, Fax: 610 832-9555
www.astm.org
- CGA
Compressed Gas Association
1725 Jefferson Davis Highway
Suite 1004
Arlington, Virginia 22202-4102
Phone: 703-412-0900, Fax: 703-412-0128
www.cganet.com
- CSI
The Construction Specifications Institute
601 Madison Street
Alexandria, Virginia 22314-1791
Phone: 800-689-2900, 703-684-0300, Fax: 703-684-046
www.csinet.org
- EASA
Electrical Apparatus Service Association
1331 Baur Boulevard
St. Louis, Missouri 63132
Phone: 314-993-2220, Fax: 314-993-1269

- IEEE Institute of Electrical and Electronics Engineers
445 Hoes Lane, PO Box 459
Piscataway, NJ 08855-0459
Phone: 800-678-4333
www.ieee.org
- IES The Illuminating Engineering Society of North America
120 Wall Street, Fl 17
New York, NY 10005
phone: (212) 248-5000
fax: (212) 248-5017/18
www.iesna.org
- ISA Instrument Society of America
67 Alexander Drive
PO Box 12277
Research Triangle Park, NC 27709
Phone: 919-549-8411, Fax: 919-549-828
www.isa.org
- ISO International Organization for Standardization
1, rue de Varembe
Case postale 56
CH-1211 Genève 20
Switzerland
Phone: +41 22 749 01 11, Fax: +41 22 733 34 3
www.iso.ch
The US Member is the American National Standards Institute, see ANSI
- NACE National Association of Corrosion Engineers
P.O. Box 218340
Houston, TX 77218
713-492-0535
- NBBI National Board of Boiler and Pressure Vessel Inspectors
1055 Crupper Avenue
Columbus, Ohio 43229-1183
Phone: 614-888-8320; FAX: 614-847-5542
www.nationalboard.org
- NEBB National Environmental Balancing Bureau
8575 Grovemont Circle
Gaithersburg, MD 20877
Phone: 301-977-3698
<http://www.nebb.org>

- NEMA National Electrical Manufacturers Association
1300 North 17th Street
Suite 1847
Rosslyn, VA 22209
Phone 703-841-3200,
www.nema.org
- NETA InterNational Electrical Testing Association
106 Stone St.
P.O. Box 687
Morrison, CO 80465
Phone 303-697-8441
www.netaworld.org
- NFPA National Fire Protection Association
1 Batterymarch Park
Quincy, MA 02269-9101 USA
Phone: 617-770-3000, Fax: 617-770-0700
www.nfpa.org
- NFPA National Fluid Power Association
3333 N. Mayfair Road
Milwaukee, WI 53222-3219
Phone: 414-778-3344, Fax: 414-778-3361
www.nfpa.com
- NLGI National Lubricating Grease Institute
4635 Wyandotte Street, Suite 202
Kansas City, Missouri, 64112-1596
Phone: 816-931-9480, Fax: 816-753-5026
www.nlgi.com
- NSSB National Skill Standards Board
1441 L Street NW Suite 9000 Washington, DC 20005 - 3512
Phone: 202-254-8628 Fax: 202-254-8646
www.nssb.org
- OSHA Occupational Safety and Health Administration
U.S. Department of Labor
Occupational Safety and Health Administration (OSHA)
200 Constitution Avenue, N.W.
Washington, D.C. 2021
www.osha.gov

SAE	Society of Automotive Engineers 400 Commonwealth Drive Warrendale, PA 15096-0001 Phone: 724-776-4841, Fax: 724-776-576 www.sae.org
SFPE	Society of Fire Protection Engineers 7315 Wisconsin Avenue, Suite 1225W Bethesda MD 20814-0001 Phone: 301-718-2910, Fax: 301-718-2242 www.wpi.edu/Academics/Depts/Fire/SFPE
STLE	Society of Tribologists and Lubrication Engineers 840 Busse Highway Park Ridge, IL 60068-2376 Phone: 847-825-5536, Fax: 847-825-1456 www.stle.org

2. Condition Monitoring (PT&I) Information

The machinery condition monitoring technologies are being developed and refined continuously. The cost of computer systems has been a key factor in making many approaches available to monitor facilities and collateral equipment. The information provided in this section should be considered as only a starting point for researching the latest technologies and most appropriate applications.

In addition to publishing their own professional journals, many of the organizations listed below serve as clearing houses for textbooks, technical papers, presentations and other publications that are available at a reasonable cost. The magazines and groups listed below usually have advertisements and articles related to condition monitoring technologies. Some of the magazines are free to “qualified” individuals while others are only available to members.

AFE Facilities Engineering Journal
Association for Facilities Engineering (AFE)
8180 Corporate Park Drive, Suite 305
Cincinnati, OH 45242
Phone: 888-222-0155, Fax: 513-247-7422
www.afe.org

IEEE Spectrum

Institute for Electrical and Electronic Engineers (IEEE)

455 Hoes Lane

P.O. Box 459

Piscataway, N.J. 08855-0459

Phone: 800-678-4333, Fax: 723-981-9667

www.ieee.org*Maintenance Technology*

Applied Technology Publications, Inc.

1300 S. Grove Ave., Suite 205

Barrington, IL 60010

Phone: 847-382-8100 Fax 847-304-8603

www.mt-online.com*Plant and Facilities Engineer's Digest*

Adams/ Huebcore Publishing, Inc.

29100 Aurora Road, Suite 200

Cleveland, OH 44139

Phone: 440-248-1125, Fax: 440-248-0187

www.engineersdigest.com*P/PM Technology*

SC Publishing Div.

Second Childhood Inc.

P.O. Box 2770

Minden, NV 89423

Phone: 702-267-3970

Reliability Magazine

Industrial Communications, Inc.

1704 Natalie Nehs Dr

Knoxville, TN 37931-4554

Phone: 423-531-2193/2194, Fax: 423-531-2459

www.reliability-magazine.com

Society for Machinery Failure Prevention Technology (MFPT)

4193 Sudley Road

Haymarket, VA 20169-2420

Phone: 703-754-2234, Fax: 703-754-9743

www.mfpt.org

Society for Maintenance & Reliability Professionals (SMRP)

401 N. Michigan Ave.

Chicago, IL 60611-4267

Phone: 800-950-7354 or 312-321-5190, Fax: 312-527-665

www.smrp.org

The International Society for Optical Engineering
(Thermosense Working Group)
1000 20th St.
Bellingham WA 98225-6705
Phone: 360-676-3290, Fax: 360-647-1445
www.spie.org

Vibration Institute
6262 S. Kingery Highway, Suite 212
Willowbrook, IL 60514
Phone: 630-654-2254; Fax: 630-654-227
www.vibinst.org

Appendix F - RCM Acceptance Data Sheets

The sample RCM Acceptance Data Sheets on the following pages are provided as examples and guides for preparing similar data sheets that are customized to the specific NASA Center. These examples are prepared for several of the different PT&I technologies so that users can “cut and paste” these examples in accordance with the determination of which PT&I technologies are desired.

PT&I Technology / Test	Section
Airborne Ultrasonics Test	F-1
Balance – Keyed Shaft	F-2
Alignment	F-3
Battery Impedance Test	F-4
Breaker Timing Test	F-5
Contact Resistance Test	F-6
High Voltage Test	F-7
Hydraulic Oil Test	F-8
Infrared Thermography Test (IRT)	F-9
Insulation Oil Test	F-10
Insulation Resistance Test	F-11
Lubrication Oil Test	F-12
Motor Circuit Evaluation Test	F-13
Power Factor Test	F-14
Turns Ratio Test	F-15
Vibration Analysis Test	F-16
Borescope / Fiberscope Test	F-17

These examples are prepared in a matrix format that documents the following information associated with each item:

Item	Date of Inspection	Acceptable Limit	Actual Value	Inspector Initials	PASS	FAIL	Comments
xxx	12/12/2000	< 100 ppm	85 ppm	DGD	X		
xxx	12/28/2000	< 100 ppm	125 ppm	DGD		X	xxxxxxxxxxxxxxxxxxxxxxxx

F-1 Airborne Ultrasonic Criteria

Item	Date of Inspection	Acceptable Limit	Actual Value	Inspector Initials	PASS	FAIL	Comments
Airborne Ultrasonics							
Warble Tone Generator							
Differential Pressure Method							
Contact Probe Method							
Frequency Range Set							
Sensitivity Level Set							
Scale Set							
System Loading (%)							
Results:							

F-2 Balance – Keyed Shaft Criteria

Item	Date of Inspection	Acceptable Limit	Actual Value	Inspector Initials	PASS	FAIL	Comments
Balance - Keyed Shaft							
Key Length A							
Key Length B							
Final Key Length							
Results:							

F-3 Alignment Criteria

Item	Date of Inspection	Acceptable Limit	Actual Value	Inspector Initials	PASS	FAIL	Comments
Alignment							
RPM							
Soft Foot Actual (in)							
Soft Foot Tolerance							
Vert angularity at coupling - Actual							
Vert offset at coupling - Actual							
Vert angularity at coupling - Actual							
Vert offset at coupling - Actual							
Axial Shaft Play							
Shims							
Shim Type							
Shim Condition							
Number of Shims in Pack							
Thickness							
Sheaves							
True to Shaft							
Runout (in.)							
Results:							

F-4 Battery Impedance Test Criteria

Item	Date of Inspection	Acceptable Limit	Actual Value	Inspector Initials	PASS	FAIL	Comments
Battery Impedance Test							
Battery Age							
Applied Voltage							
Read Voltage							
Delta							
Impedance							
Compare vs. Previous Reading (< 5% difference)							
Compare vs. Similar Batteries (< 10% difference)							
Results:							

F-5 Breaker Timing Test Criteria

Item	Date of Inspection	Acceptable Limit	Actual Value	Inspector Initials	PASS	FAIL	Comments
Breaker Timing Test							
Voltage Applied							
C1 – Phase A							
C2 – Phase B							
C3 – Phase C							
Results:							

F-6 Contact Resistance Test Criteria

Item	Date of Inspection	Acceptable Limit	Actual Value	Inspector Initials	PASS	FAIL	Comments
Contact Resistance Test							
DC Current Applied							
Measured Voltage							
Calculated Resistance							
Manufacturer Resistance							
Results:							

F-7 High Voltage Test Criteria

Item	Date of Inspection	Acceptable Limit	Actual Value	Inspector Initials	PASS	FAIL	Comments
High Voltage Test							
DC High Voltage Applied							
Leakage Current							
Results:							

F-8 Hydraulic Oil Test Criteria

Item	Date of Inspection	Acceptable Limit	Actual Value	Inspector Initials	PASS	FAIL	Comments
Hydraulic Oil Test							
System Sensitivity							
Actual Particle Level (part/100ml)							
Results:							

F-9 Infrared Thermography Test (IRT) Criteria

Item	Date of Inspection	Acceptable Limit	Actual Value	Inspector Initials	PASS	FAIL	Comments
Infrared Thermography Test Kit (IRT)							
Sensitivity							
Accuracy							
Results:							

F-10 Insulation Oil Test Criteria

Item	Date of Inspection	Acceptable Limit	Actual Value	Inspector Initials	PASS	FAIL	Comments
Insulation Oil Test							
Dissolved Gas Analysis							
Nitrogen (N ₂)		< 100 ppm					
Oxygen (O ₂)		< 10 ppm					
Carbon Dioxide (CO ₂)		< 10 ppm					
Carbon Monoxide (CO)		< 100 ppm					
Methane (CH ₄)		None					
Ethane (C ₂ H ₆)		None					
Ethylene (C ₂ H ₄)		None					
Hydrogen (H ₂)		None					
Acetylene (C ₂ H ₂)		None					
Karl Fisher (@ 20 Deg C)		< 25 ppm					
Dielectric Breakdown Strength		> 30 kV					
Neutralization Number		< 0.05 mg/g					
Interfacial Tension		>40 dynes/cm					
Color (ASTM D-1524)		< 3.0					
Sediment		clear					
Power Factor		< 0.05%					
Sediment / Visual Examination		clear					
Results:							

F-11 Insulation Resistance Test Criteria

Item	Date of Inspection	Acceptable Limit	Actual Value	Inspector Initials	PASS	FAIL	Comments
Insulation Resistance Test							
Capacitance Charging Current							
Dielectric Absorption Current							
Leakage Current							
Temperature Correction Factor							
Polarization Index							
Dielectric Absorption Ratio							
Minimum Resistance Value							
Results:							

F-12 Turns Ratio Test Criteria

Item	Date of Inspection	Acceptable Limit	Actual Value	Inspector Initials	PASS	FAIL	Comments
Turns Ratio Test							
Voltage Applied							
Induced Voltage							
Calculated Ratio							
Nameplate Data Ratio							
Certification							
Other							
Submitted							
Results:							

F-13 Lubrication Oil Test Criteria

Item	Date of Inspection	Acceptable Limit	Actual Value	Inspector Initials	PASS	FAIL	Comments
Lubrication Oil Test							
Liquids							
Viscosity Grade (ISO Units)							
AGMA/SAE Classification							
Additives							
Grease							
Type of Base Stock							
NLGI Number							
Type/% of thickener							
Dropping Point							
Base Oil Viscosity (SUS)							
Total Acid Number							
Visual Observation (Cloudiness)							
IR Spectral Analysis – Metal Count							
Particle Count							
Water Content							
Viscosity							
Results:							

F-14 Motor Circuit Evaluation Test Criteria

Item	Date of Inspection	Acceptable Limit	Actual Value	Inspector Initials	PASS	FAIL	Comments
Motor Circuit Evaluation Test							
Resistance							
Resistance Imbalance		< 2%					
Inductance							
Inductance Imbalance		< 10%					
Capacitance							
Total Impedance							
Impedance Imbalance							
Motor Current Analysis							
Results:							

F-15 Power Factor Test Criteria

Item	Date of Inspection	Acceptable Limit	Actual Value	Inspector Initials	PASS	FAIL	Comments
Power Factor Test							
Grounded Specimen Test – GST							
Ungrounded Specimen Test – UST							
GST with Guard							
Environment Humidity							
Environment Temperature							
Surface Cleanliness							
Phase I							
Applied Voltage							
Total Current							
Capacitive Current							
Dissipation Factor							
Power Factor							
Normal Power Factor							
Phase II							
Applied Voltage							
Total Current							
Capacitive Current							
Dissipation Factor							
Power Factor							
Normal Power Factor							
Phase III							
Applied Voltage							
Total Current							
Capacitive Current							
Dissipation Factor							
Power Factor							
Normal Power Factor							
Results:							

F-16 Vibration Analysis Test Criteria

Item	Date of Inspection	Acceptable Limit	Actual Value	Inspector Initials	PASS	FAIL	Comments
Vibration Analysis Test							
Test Instrumentation							
FFT Analyzer							
Type							
Model							
Serial Number							
Last Calibration Date							
Line Resolution Bandwidth							
Dynamic Range							
Hanning Window							
Linear Non-overlap Averaging							
Anti-aliasing Filters							
Amplitude Accuracy							
Sound Disk Thickness							
Adhesive (hard/soft)							
Vibration Readings							
1H							
1V							
1A							
2H							
2V							
2A							
Velocity Amplitude (in/sec-peak)							
Running Speed Order							
Acceleration Overall Amp (g-peak)							
Vibration Signatures (H,V,A)							
Frequency (CPM)							
Balanced Condition							
Balance Wt. Type							
Results:							

F-17 Borescope / Fiberscope Test Criteria

Item	Date of Inspection	Acceptable Limit	Actual Value	Inspector Initials	PASS	FAIL	Comments
Equipment Information							
Model Number							
Scope Serial Number							
Manufacturer							
Date Purchased							
Diameter							
Working Length							
Test Information / Results							
Direction of View							
Degrees Direct							
Degrees Foreoblique							
Degrees Side							
Degrees Retro							
Field of View							
Degrees Focusing							
Degrees Fixed Focus							
Depth of Field (Distance)							
Min (cm)							
Max (cm)							
Special Instructions/Notes:							
Results:							

Appendix G - Glossary¹⁷

Note: The following are terms that are widely used in the Reliability Centered Maintenance philosophy and methodologies. Because of the likelihood that the reader will encounter the terms while doing Reliability Centered Acceptance, they are listed as a ready reference for better understanding. Additional terms and explanations can be found in the *NASA Reliability Centered Maintenance Guide for Facilities and Collateral Equipment*.

Acceleration - The time rate of change of velocity. Typical units are ft/sec² and g's (1 g = 32.17 ft/sec² = 386 in/sec² = 9.81 meter/sec²). Acceleration measurements are made with accelerometers.

Accelerometer - Transducer where the output is directly proportional to acceleration. Most commonly used are mass loaded piezoelectric crystals to produce an output proportional to acceleration.

Accessible- The ability to fully reach, adjust and maintain the equipment. Consideration should be given to confined space restrictions, removing guards, bushing plates, hydraulic lines, lubrication lines, electric lines etc. Also, on a broader scale, the ability to gain access to the equipment due to security, safety and other restrictions.

Age Exploration - The process of determining the most effective intervals for maintenance tasks. Its called age exploration because it is often associated with identifying age related maintenance actions such as overhaul and discard tasks and then extending the interval between tasks.

Alignment Target Specifications - Desired intentional offset and angularity at coupling center to compensate for thermal growth and/or dynamic loads. Most properly specified as an OFFSET, and an angle in two perpendicular planes, horizontal and vertical.

Amplitude - A measure of the severity of vibration. Amplitude is expressed in terms of peak-to-peak, zero-to-peak (peak), or rms. For pure sine waves only:

- Peak (P) = 1.414 x RMS
- Peak-to-Peak = 2 x Zero-to-Peak (Peak)

Amplitude Limits - The total vibration level "A" in a band, as defined by the following equation, shall not exceed the Overall Amplitude Acceptance Limit specified for the Band

$$A = \sqrt{\frac{\sum_{i=1}^N A_i^2}{W}}$$

A	=	Overall vibration level in the Band
A _i	=	Amplitude in the i th line of resolution in the Band
(i = 1)	=	The first line of resolution in the Band
(i=N)	=	The last line of resolution in the Band
N	=	The number of lines of resolution in the Band
W	=	Window Factor (W = 1.5 for a Hanning Window)

¹⁷ The reference for many of the definitions in this Glossary is the Glossary from Hewlett Packard's Publication *Effective Machinery Measurements Using Dynamic Signal Analyzers*, Application Note 243.1.

Angular Error - A misalignment condition characterized by the angular error between the desired centerline and the actual centerline. This misalignment condition may exist in planes both horizontal and vertical to the axis of rotation.

Angularity - The angle between the rotational centerlines of two shafts. Angularity is a "slope" expressed in terms of a rise (millimeters or thousandths of an inch) over a run (meter or inches).

Anti-Aliasing Filter - A low-pass filter designed to filter out frequencies higher than 1/2 the sample rate in order to prevent aliasing.

Availability - (1) Informally, the time a machine or system is available for use. (2) From the Overall Equipment Effectiveness calculation, the actual run time of a machine or system divided by the scheduled run time. Note that Availability differs slightly from Asset Utilization (Uptime) in that scheduled run time varies between facilities and is changed by factors such as scheduled maintenance actions, logistics, or administrative delays.

Axial Play - Shaft axial movement along its centerline caused by axial forces, thermal expansion or contraction, and permitted by journal bearings, sleeve bearings and/or looseness. Also Axial Float, End Float.

Balance - When the mass center line and rotational center line of a rotor are coincident.

Balancing - A procedure for adjusting the radial mass distribution of a rotor by adding or removing weight, so that the mass centerline approaches the rotor geometric centerline achieving less vibration amplitude at rotational speed.

Band-Limited Overall Amplitude - For vibration level limits specified in terms of "Band-Limited Overall Reading."

Band Limited Overall Reading - The vibration severity amplitude measured over a frequency range defined by a F_{MIN} and a F_{MAX} .

Beats - Periodic variations in the amplitude of an oscillation resulting from the combination of two oscillations of slightly different frequencies. The beats occur at the difference frequency. ISO 2041 (1990).

Beat Frequency - The absolute value of the difference in frequency of two oscillations of slightly different frequencies. ISO 2041 (1990)

Blade Pass Frequency - A potential vibration frequency on any bladed machine (turbine, axial compressor, fan, pump, etc.). It is represented by the number of fan blades or pump vanes times shaft rotating frequency. Also Pumping Frequency.

Borescoping - A borescope, or fiberscope, is an optical instrument that allows internal inspection of machinery through port holes without equipment disassembly. It is a condition monitoring technique to verify that the internal parts are in satisfactory shape and if potential failures exist, to what extent have they developed.

Building Commissioning - The systematic process for achieving, verifying, and documenting that the performance of NASA Facilities and Collateral Equipment meets the design intent. The process extends through all phases of a project and culminates with occupancy and operation. The process includes the testing and accepting of new or repaired building, system or component parts to verify proper installation.

Calibration - A test to verify the accuracy of measurement instruments. For vibration, a transducer is subjected to a known motion, usually on a shaker table, and the output readings are verified or adjusted.

Co-Linear - Two lines that are positioned as if they were one line. Co-linear as used in alignment means two or more centerlines of rotation with no offset or angularity between them. Two or more lines are co-linear when there is no offset or angularity between them (i.e. they follow the same path).

Complete Machine - A complete machine is defined as the entire assembly of components, sub-components, and structure, which is purchased to perform a specific task(s). On a Complete Machine Assembly with all individual components operating in their normal operating condition, mode, and sequence, the Component Vibration Level Limits for the complete machine acceptance are the same as when the component is tested individually.

Coplanar - The condition of two or more surfaces having all elements in one plane. (per ANSI Y14.5)

Cost Effective - An economic determination of the Maintenance Approach and entails the evaluation of maintenance costs, support costs, and consequences of failure.

Coupling Point - The phrase "COUPLING POINT" in the definition of SHAFT ALIGNMENT is an acknowledgment that vibration due to misalignment originates at a the point of power transmission, the coupling. The shafts are being aligned and the coupling center is just the measuring point.

Critical Failure - A failure involving a loss of function or secondary damage that could have a direct adverse effect on operating safety, on mission, or have significant economic impact.

Critical Failure Mode - A failure mode that has significant mission, safety or maintenance effects that warrant the selection of maintenance tasks to prevent the critical failure mode from occurring.

Critical Speed - The speed of a rotating system corresponding to a system resonance frequency.

Decibel (Db) - A logarithmic representation of amplitude ratio, defined as 20 times the base ten logarithm of the ratio of the measured amplitude to a reference. dBV readings, for example, are referenced to 1 volt rms. dB amplitude scales are required to display the full dynamic range of an F Analyzer.

Displacement - The distance traveled by a vibrating object. For purposes of this document, displacement represents the total distance traveled by a vibrating part or surface from the maximum position of travel in one direction to the maximum position of travel in the opposite direction (Peak-to-Peak) and is measured in the unit mil (1 mil = 0.001 inch).

Dominant Failure Mode - A single failure mode that accounts for a significant portion of the failures of a complex item.

Dynamic Mass - To determine if the mass of the transducer is effecting the measurement, perform the following steps:

- (a) Make the desired measurement with the accelerometer.
- (b) Place a mass equivalent to the mass of the accelerometer adjacent to the measuring accelerometer.
- (c) Repeat the measurement.
- (d) Compare data from (a) and (c)
- (e) If any differences (i.e. shift in frequencies) between (a) and (c) exist, then a less massive transducer should be used in a.

Dynamic Range - The difference between the highest measurable signal level and the lowest measurable signal level that is detectable for a given Amplitude Range setting. Dynamic Range is usually expressed in decibels, typically 60 to 90 dB for modern instruments.

Failure - A cessation of proper function or performance; the inability to meet a standard; nonperformance of what is requested or expected.

Failure Effect - The consequences of failure.

Failure Mode - The manner of failure. For example, the motor stops is the failure - the reason the motor failed was the motor bearing seized which, is the failure mode.

Failure Modes and Effects Analysis (FMEA) - Analysis used to determine what parts fail, why they usually fail, and what effect their failure has on the systems in total.

FFT (Fast Fourier Transform) - A calculation procedure which converts a time domain signal into a frequency domain display.

FFT Analyzer - Vibration analyzer that uses the Fast Fourier Transform to display vibration frequency components.

F_{MAX} - Maximum Frequency Limit of the spectrum being evaluated.

F_{min} - Minimum Frequency Limit of the spectrum being evaluated.

Frequency - The repetition rate of a periodic event, usually expressed in cycles per second (Hertz -abr. HZ), cycles per minute (CPM), or multiples of rotational speed (Orders). Orders are commonly referred to as 1X for rotational speed, 2X for twice rotational speed, etc. Frequency is the reciprocal of the Period.

NOTE: Vibration frequencies are expressed in Hertz (cycle per sec) or CPM (cycle per minute). Rotational speed (Running Speed) is expressed in RPM (Revolutions per minute).

Frequency Domain - Presentation of a signal whose amplitude is measured on the Y axis, and the frequency is measured on the X-axis.

Frequency Resolution (ΔF) - $\Delta f = (F_{MAX} - F_{MIN})/\#$ Lines of resolution. Δf represents the minimum spacing between data points in the spectrum.

Frequency Response - Portion of the frequency spectrum that can be covered within specified frequency limits.

Function - A defined performance standard. Usually quantitative in nature (flow rate, cooling capacity, etc.).

Gear Mesh Frequency - A potential vibration frequency on any machine that contains gears: equal to the number of teeth multiplied by the rotational frequency of the gear.

Hanning Window - A Digital Signal Analysis (DSA) window function that provides better frequency resolution than the flat top window, but with reduced amplitude

Harmonic - Frequency component at a frequency that is an integer (whole number e.g. 2X. 3X. 4X, etc.) multiple of the fundamental (reference) frequency.

Hertz (Hz) - The unit of frequency represented by cycles per second.

Hi Bandpass Filter - A device that separates the components of a signal and allows only those components above a selected frequency to be amplified.

Horizontal - Parallel to the mounting surface.

Imbalance - Unequal radial weight distribution of a rotor system; a shaft condition such that the mass and shaft geometric centerlines do not coincide.

Inspection - A time- or cycle-based action performed to identify hidden failure or potential failure.

Infrared Thermography - A predictive technique that uses infrared imaging to identify defects in electrical and electro-mechanical devices such as fuse boxes, circuit breakers, and switchgear. It also can be used effectively in a non-predictive manner to detect thermal cavities and leaks in walls, ceilings, and rooftops, the correction of which can result in sizeable reductions in heating and air conditioning expenses. Thermal imaging is extremely sensitive, and since it evaluates the heat an object emits, emittance and reflective factors of the object and environment must be considered.

Jackbolts, Jackscrews - Positioning bolts on the machine base that are located at each foot of the machine and are used to adjust the position of the machines.

Large Apparatus AC/DC Motors - Reference NEMA Publication No. MG 1, Motors and Generators, Section III

Level - Parallel to a reference plane or a reference line established by a laser.

Line Amplitude Limit - The maximum amplitude of any line of resolution contained within a band shall not exceed the Line Amplitude Acceptance Limit for the Band.

Linear Non-Overlapping Average - An averaging process where each Time block sample used in the averaging process contains data not contained in other Time blocks (i.e. Non-overlapping) used in the averaging. Linear averaging is performed in the Frequency Domain, and each sample is weighted equally.

Line Of Resolution - A single data point from a spectrum which contains vibration amplitude information. The Line of Resolution amplitude is the Band Overall Amplitude of the frequencies contained in the Δf Frequency Resolution.

Machine - The total entity made up of individual machine components such as motors, pumps, spindles, fixtures, etc. Also see Machine Component.

Machine Base - The structure that supports the machine or machine components under consideration.

Machine Component - An individual unit such as a motor, pump, spindle, fixture, etc. often referred to as a machine in its own context.

Maintainability - The ability to retain or restore function within a specified period of time, when provided with an identified level of tools, training, and procedures. Maintainability factors include machine and systems access, visibility, simplicity, ease of monitoring or testing, special training requirements, special tools, and capability of local work force

Maintenance - Action taken to retain function (i.e., prevent failure). Actions include Preventive Maintenance, Predictive Testing & Inspection, lubrication and minor repair (such as replacing belts and filters), and inspection for failure. Also see Preventive Maintenance and Predictive Testing & Inspection.

Measurement Point - A location on a machine or component at which vibration measurements are made.

Micrometer (Micron) - One millionth (0.000001) of a meter. (1 micron = 1×10^{-6} meters = 0.04 mils.)

MIL - One thousandth (0.001) of an inch. (1 mil = 25.4 microns.)

Motor Circuit Analysis (MCA) - A predictive technique whereby the static characteristics (i.e.; impedance, capacitance to ground, inductance) of a motor or generator are measured as indicators of equipment condition.

Motor Current Spectrum Analysis (MCSA) - A predictive technique whereby motor current signatures provide information on the electro-mechanical condition of AC induction motors. It detects faults such as broken rotor bars, high resistance joints, and cracked rotor end rings by collecting motor current spectrums with clamp-on sensors and analyzing the data.

Natural Frequency - The frequency of free vibration of a system when excited with an impact force. (Bump Test).

Offset - The distance (in thousands of an inch or in millimeters) between the rotational centerlines of two parallel shafts.

Order - A unit of frequency unique to rotating machinery where the first order is equal to rotational speed. See FREQUENCY.

Pass Frequency - A potential vibration frequency on any bladed machine (turbine, axial compressor, fan, pump, etc.). It is represented by the number of fan blades or pump vanes times shaft rotating frequency. Also Pumping Frequency.

Peak - Refers to the maximum of the units being measured, i.e., peak velocity, peak acceleration, peak displacement.

Peak-To-Peak - Refers to the displacement from one travel extreme to the other travel extreme. In English units, this is measured in mils (.001 inch) and in metric units it is expressed in micro-meter μM (.000001 meters).

Period - The amount of time, usually expressed in seconds or minutes, required to complete one cycle of motion of a vibrating machine or machine part. The reciprocal of the period is the frequency of vibration.

Phase (Phase Angle) - The relative position, measured in degrees, of a vibrating part at any instant in time to a fixed point or another vibrating part. The Phase Angle (usually in degrees) is the angle between the instantaneous position of a vibrating part and the reference position. It represents the portion of the vibration cycle through which the part has moved relative to the reference position .

Pitch - An angular misalignment in the vertical plane. (ANSI/ASME b5.54-1991)

Position Error (Centerline/Offset Misalignment) - A misalignment condition that exist when the shaft centerline is parallel but not in line with (not coincidental) with the desired alignment centerline.

Potential Failure - An identifiable condition that indicates a failure is imminent.

Predictive Testing & Inspection (PT&I) - The use of advanced technology to assess machinery condition. The PT&I data obtained allows for planning and scheduling preventive maintenance or repairs in advance of failure. Also known as Condition Monitoring, Predictive Maintenance and Condition-Based Maintenance.

Preventive Maintenance - Time- or cycle-based actions performed to prevent failure, monitor condition, or inspect for failure.

Predictive Maintenance - See Predictive Testing and Inspection (PT&I).

Proactive Maintenance - The collection of efforts to identify, monitor and control future failure with an emphasis on the understanding and elimination of the cause of failure. Proactive maintenance activities include the development of design specifications to incorporated maintenance lessons learned and to ensure future maintainability and supportability, the development of repair specifications to eliminate underlining causes of failure, and performing root cause failure analysis to understand why in-service systems failed.

Radial Measurement - Measurements taken perpendicular to the axis of rotation.

Radial Vibration - Shaft dynamic motion or casing vibration which is in a direction perpendicular to the shaft centerline.

Reliability - The dependability constituent or dependability characteristic of design. From MIL-STC-721C: Reliability - (1) The duration or probability of failure-free performance under stated conditions. (2) The probability that an item can perform its intended function for a specified interval under stated conditions.

Reliability-Centered Maintenance (RCM) - The process that is used to determine the most effective approach to maintenance. It involves identifying actions that, when taken, will reduce the probability of failure and which are the most cost effective. It seeks the optimal mix of Condition-Based Actions, other Time- or Cycle-Based actions, or Run-to-Failure approach.

Repair - That facility work required to restore a facility or component thereof, including collateral equipment, to a condition substantially equivalent to its originally intended and designed capacity, efficiency, or capability. It includes the substantially equivalent replacements of utility systems and collateral equipment necessitated by incipient or actual breakdown. Also, the restoration of function, usually after failure.

Repeatability - The consistency of readings and results between consecutive sets of measurements.

Resonance - The condition of vibration amplitude and phase change response caused by a corresponding system sensitivity to a particular forcing frequency. A resonance is typically identified by a substantial amplitude increase and related phase shift.

Rolling Element Bearing - Bearing whose low friction qualities derive from rolling elements (balls or rollers), with little lubrication.

Root Cause Failure Analysis (RCFA) - The process of exploring, in increasing detail, all possible causes related to a machine failure. Failure causes are grouped into general categories for further analysis. For example, causes can be related to machinery, people, methods, materials, policies, environment, and measurement error.

Rotational Speed - The number of times an object completes one complete revolution per unit of time, e.g., 1800 RPM.

Shaft Alignment - Positioning two or more machines (e.g. a motor driving a hydraulic pump(s), etc.) so that the rotational centerlines of their shafts are collinear at the coupling center under operating conditions.

Side Band - Equals the frequency of interest plus or minus one times the frequency of the exciting force.

Signature (Spectrum) - Term usually applied to the vibration frequency spectrum which is distinctive and special to a machine or component, system or subsystem at a specific point in time, under specific machine operating conditions, etc.

Usually presented as a plot of vibration amplitude (displacement, velocity or acceleration) versus time or versus frequency. When the amplitude is plotted against time it is usually referred to as the TIME WAVE FORM.

Small (Fractional) And Medium (Integral) Horsepower AC/DC Motors - Reference NEMA Publication No. MG 1, Section II SMALL (FRACTIONAL) AND MEDIUM (INTEGRAL) MACHINES. Part 12. Tests and Performance - AC and DC Motors.

Soft Foot - A condition that exists when the bottom of all of the feet of the machinery components are not on the same plane (can be compared to a chair with one short leg). Soft foot is present if the machine frame distorts when a foot bolt is loosened or tightened. It must be corrected before the machine is actually aligned.

SpecsIntact - SpecsIntact is an acronym for "Specification Kept Intact." It is a system that uses standard master specifications (Master Text), issued by the three government agencies it supports (NASA, Army and Navy), for the preparation of facility construction projects

Stress Free Condition - The condition that exists when there are no forces acting on the structure of a machine, machine component, or machine base that would cause distortion in the structure such as bending, twist, etc.

Thermal Effects (Growth Or Shrinkage) - This term is used to describe displacement of shaft axes due to machinery temperature changes (or dynamic loading effects) during start-up.

Time- or Cycle-Based Actions - Maintenance activities performed from time-to-time that have proven to be effective in preventing failure. Items such as lubrication and restoration of wear fit this description. Other items that are Time- or Cycle-Based are inspection and condition monitoring. Also see Predictive Testing and Inspection.

Time Domain - Presentation of a signal whose amplitude is measured on the Y axis and the time period is measured on the X axis.

Tolerance - An area where all misalignment forces sum to a negligible amount and no further improvement in alignment will reduce significantly the vibration of the machine or improve efficiency. Also Deadband, Window or Envelope.

Tolerance Values - Maximum allowable deviation from the desired values, whether such values are zero or non-zero.

Transducer (Pickup) -Vibration - A device that converts shock or vibratory motion into an electrical signal that is proportional to a parameter of the vibration measured. Transducer selection is related to the frequencies of vibration which are important to the analysis of the specific machine(s) being evaluated/analyzed.

Unbalance - See IMBALANCE

Velocity - The time rate of change of displacement with respect to some reference position. For purposes of this document, velocity is measured in the units Inch per second-Peak.

Vertical - Perpendicular to the horizontal plane.

Vibration Analysis— The dominant technique used in predictive maintenance. Uses noise or vibration created by mechanical equipment to determine the equipment's actual condition. Uses transducers to translate a vibration amplitude and frequency into electronic signals. When measurements of both amplitude and frequency are available, diagnostic methods can be used to determine both the magnitude of a problem and its probable cause. Vibration techniques most often used include broadband trending (looks at the overall machine condition), narrowband trending (looks at the condition of a specific component), and signature analysis (visual comparison of current versus normal condition). Vibration analysis most often reveals problems in machines involving mechanical imbalance, electrical imbalance, misalignment, looseness, and degenerative problems.

Yaw Misalignment - An angular misalignment in the horizontal plane.

Page Intentionally Left Blank

Appendix H – Reference Data Requirements

Data Set 1

- **Airborne Ultrasonic Tests**

The contractor shall use ultrasonic testing to verify that electrical arcing and other high frequency events do not exist.

Minimum acceptance criteria:

- No electric arcing or other problems detectable with ultrasonic test equipment exist.

Data Set 2

- **Contact Resistance Test**

The contractor shall perform a contact resistance test to determine the contact condition on a switch where visual observation is not possible.

Minimum acceptance criteria:

- Better than or equal to manufacturer's specifications

Data Set 3

- **High Voltage Test**

The contractor shall perform the high voltage test to verify the insulation in a new breaker and to ensure that there is no excessive leakage current. This is a potentially destructive test and requires authorization from the NASA Construction Manager.

Minimum acceptance criteria:

- Better than or equal to manufacturer's specifications, or in the absence of manufacturer's specifications, use the information contained in section B.10.2, Insulation Resistance Testing for Switchgear and Motor Control Centers.
- Limits in accordance with ANSI/IEEE Standard 400

Data Set 4

- **Infrared Thermography (IRT)**

The contractor shall perform a thermographic survey to detect uneven heating indicative of loose or dirty connections.

Minimum acceptance criteria:

- Qualitative inspection using predefined relative difference limits, hot and cold spots, and deviations from normal or expected temperature ranges consistent with manufacturer's design data. At no time should any wiring, wiring connections, or components, display a temperature in excess of 11.3°C greater than ambient unless specified otherwise.

Data Set 5

- **Insulation Resistance Test**

The contractor shall perform the insulation resistance test to determine insulation resistance to ground. Use both the Dielectric Absorption and the Polarization Index. The insulation resistance test set shall have all of the following minimum requirements:

- Test Voltage increments of 500V, 1000V, 2500V, and 5000V DC
- Resistance range of 0.0 to 500,000 megohms at 500,000V DC
- A short-circuit terminal current of at least 2.5 milliamps
- Test voltage stability of $\pm 0.1\%$
- Resistance accuracy of $\pm 5\%$ at 1 megohm

Minimum acceptance criteria:

- Better than or equal to manufacturer's specifications, or in the absence of manufacturer's specifications, use the information contained in section B.10 for Insulation Resistance Testing.

Data Set 6

• Laser Alignment or Other Alignment Methods

The contractor shall use laser alignment to verify that shafts are properly aligned.

Document the following parameters

RPM

Soft Foot Actual (in)

Soft Foot Tolerance

Vertical angularity at coupling – actual

Vertical angularity tolerance

Vertical offset at coupling – actual

Vertical offset tolerance

Horizontal angularity at coupling – actual

Horizontal angularity tolerance

Horizontal offset at coupling – actual

Horizontal offset tolerance

Document actual shaft play

Document Shim information (type, condition, number, thickness)

Document Sheave information (true to shaft, runout (in.))

Minimum Acceptance Criteria: refer to Table B-2

Data Set 7

• Lubricating Oil Tests

The contractor shall use the following tests to verify an acceptable quality of the lubricating oil:

- Total Acid number testing for pH balance
- Visual testing for cloudiness
- IR Spectral Analysis testing for metal particles
- Particle Count testing for number and size of particles
- Water Content testing for the presence of water
- Viscosity testing for lubricating quality

Minimum Acceptance Criteria: refer to Table B-11

- Total Acid Number < 0.05 gm KOH/ml
- Visual – Non cloudy
- IR Spectral Analysis – No presence of metals
- Particle count < 100 for particles > 10 um
- Water content < 25 ppm @ 20 °C
- Viscosity as per manufacturer's specification

Data Set 8

- **Power Factor Test**

The contractor shall use the power factor test to verify acceptable dissipation and power loss from the insulation to ground. Measure with Grounded Specimen Test (GST), Ungrounded Specimen Test (UST), and GST with Ground. Breakers rated 15KV and higher should also have their bushings power factored. The power factor test set shall have all of the following minimum requirements:

- Test voltage range of 500V to 12kV
- Ability to perform UST, GST, and GST with guard tests
- Readings for power factor, dissipation factor, capacitance, and watts-loss
- Power factor/Dissipation factor range of 0 to 200%
- Capacitance measuring range of 0 to 0.20 picofarads

Minimum acceptance criteria:

- All phases should be within $\pm 10\%$ of each other, open and closed
- Power factor must not exceed manufacturer's data. Verify manufacturer's maximum power factor with Table B-5

Data Set 9

- **Thermodynamic Performance Tests**

The contractor shall perform thermodynamic performance tests to verify that design specifications are met. The required tests and calculations will be specified by the Design Engineer.

Minimum acceptable limits for thermodynamic performance tests:

$\pm 5\%$ of manufacturer's specifications or as specified by the Design Engineer.

Graph outputs of blower at various speeds and compare to manufacture specifications

Data Set 10

- **Vibration Analysis Test**

The contractor shall use vibration analysis to verify alignment, balance, smooth operation and minimal noise and vibration in all rotating elements, including motors, gearboxes, blowers and drives.

Document test instrumentation information for the following:

- FFT Analyzer, Type, Model, Serial number
- Last calibration date, Line Resolution Bandwidth
- Dynamic Range, Hanning window, Amplitude Accuracy
- Linear Non-overlap Averaging, Anti-aliasing Filters

Document Sound disk thickness

Document Adhesive (hard/soft)

Document vibration readings at each test location

Document the following:

- Velocity Amplitude (in/sec-peak)
- Running speed order
- Frequency (CPM)
- Balanced condition?

Balance Wt. Type

Minimum Acceptance Criteria: refer to Section 2.2.2.2

- Better than or equal to manufacturer's specifications