

REVISIONS			
SYMBOL	DESCRIPTION	DATE	APPROVAL
—	RELEASED	3/16/92	<i>[Signature]</i>

SHEET REVISION STATUS

SH	1	2	3	4	5	6	7	8	9	10	11	12	13	14	15	16	17	18	19	20
REV	--	--	--	--	--	--	--	--	--	--	--	--	--	--	--	--	--	--	--	--
SH	21	22	23	24	25	26	27	28	29	30	31	32	33	34	35	36	37	38	39	40
REV	--	--																		

ORIGINATOR <i>T.J. Perry</i> T.J. Perry/Paramax	DATE 3/6/92	FSC: 5935
APPROVED <i>[Signature]</i> S.E. Archer-Davies/Paramax	3/6/92	Connectors, Electrical, Rectangular, Polarized Shell, For Space Flight Use, Detail Specification For
CODE 311 APPROVAL S.A. Naus/GSFC <i>[Signature]</i>	3/9/92	
CODE 311 SUPERVISORY APPL G.P. Kramer, Jr./GSFC <i>[Signature]</i>	3/16/92	
ADDITIONAL APPROVAL		S-311-P-718/1

NATIONAL AERONAUTICS AND SPACE ADMINISTRATION
 GODDARD SPACE FLIGHT CENTER
 GREENBELT, MARYLAND 20771

CAGE CODE: 25306 PAGE 1 OF 22

1. SCOPE

- 1.1 Specification for connectors. This specification covers the detail provisions for rectangular, polarized shell, electrical connectors. Connectors use rear-insertion and rear-release crimp-type contacts, supplied separately. Detail specification GSFC S-311-P-718/2 covers the contacts for the electrical connectors.
- 1.2 GSFC general specification. Unless otherwise noted, all connector provisions and requirements of GSFC general specification S-311-P-718 apply of this specification (2.4).
- 1.3 Connector-type designations. Connectors shall be of the following type designations, and shall be ordered by their type designations only.

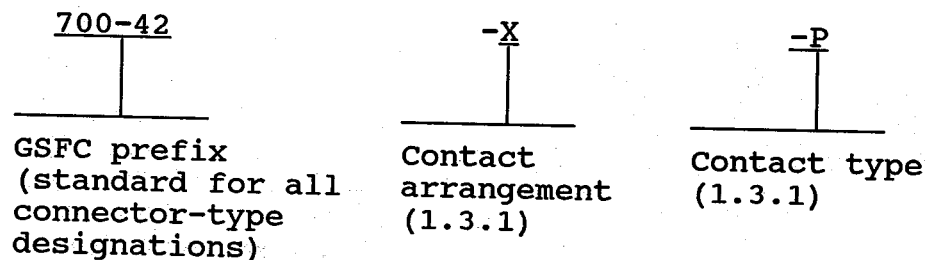

- 1.3.1 Contact arrangement. Select the contact arrangement from Figure 1.
- 1.3.2 Contact type. Select the contact type: P for pin; S for socket (Note: Plug-type connectors are available with socket-type contacts only while receptacles are equipped with pin-type contacts only). (See Figure 2)

2. APPLICABLE DOCUMENTS

- 2.1 Documents. The following documents, of the issue in effect on date of invitation for bids or request for proposal, form a part of this specification to the extent specified herein.

SPECIFICATIONS

FEDERAL

- | | | |
|-------------|---|---|
| QQ-A-200/8 | - | Aluminum Alloy Bar, Rod, Shapes and Tube, Extruded, 6061 and 6062 |
| QQ-A-250/11 | - | Aluminum Alloy 6061, Plate and Sheet |
| ZZ-R-765 | - | Rubber, Silicone, Low and High Temperature and Tear Resistant |

MILITARY

- MIL-A-8625 - Anodic Coatings, for Aluminum and Aluminum Alloys
- MIL-C-17 - Cables, Radio Frequency; Coaxial, Dual Coaxial, Twin Conductor, and Twin Lead
- MIL-M-14 - Molding Plastics and Molded Plastic Parts, Thermosetting
- MIL-W-16878 - Wire, Electrical, Insulated, High Temperature
- MIL-P-19833 - Molding Plastics and Molded Plastic Parts, Glass Fiber Filled Diallyl Phthalate Resin
- MIL-C-5541 - Chemical Conversion Coating on Aluminum Alloys
- MIL-C-22520 - Crimping Tools, Contact, Electric, Hand, General Specifications for
- MIL-T-22910 - Tool, Crimping, Hand, for Crimp Style Electric Terminal and Shield Ferrule

NASA/GSFC

- GSFC-S-311-P-718 - Connectors, Electrical, Rectangular (Power and Coaxial Contacts) for Space Flight Use, General Specification for
- GSFC-S-311-P-718/2 - Contacts, Power and Coaxial, Removable, for Electrical Connectors

STANDARDS

MILITARY

- MS3197 - Gage Pin, for Socket Engagement Test
- MS9353 - Clamp, Loop Aluminum
- MS35275 - Screw, Machine-Drilled Fillister Head, Slotted, Corrosion Resisting Steel, Passivated
- MS35338 - Washer, Lock, Spring, Helical

2.2 Other publications.

- NAS1668 - Plug, Grommet Sealing, Electrical Connector

2.3 Order of precedence. The order of precedence delineated in the general specification shall apply.

3. REQUIREMENTS

- 3.1 Materials, design, and construction. Connectors shall be of the materials, design, construction, and physical dimensions as specified herein (Figures 1 and 2). They shall be

constructed to accommodate removable crimp-type power and coaxial contacts conforming to specification GSFC S-311-P-718/2. (Reference: Finishes not specified, which are known to sublimate in a hard vacuum, such as cadmium, shall not be used.)

- 3.1.1 Material weight loss (vacuum). Connector materials used shall be such that in no case will outgassing limits of 3.2.3 be exceeded when tested in accordance with GSFC S-311-P-718.
- 3.1.2 Insert material. Inserts shall be made of glass fiber filled diallyl phthalate resin or Epiall in accordance with either:
- MIL-M-14, type SDG or SDGF
 - MIL-P-19833, type GDI-30 or GDI-30F
 - Epiall 1908 or Epiall 1914

The inserts shall meet the material weight loss requirement of 3.1.1.

- 3.1.3 Contact designation. Contact locations (numerals) shall appear on the front and rear faces of inserts to identify the contacts (Figure 1). The socket contact identification shall correspond to the mating-pin contact identification.
- 3.1.4 Shell design. The shell shall be designed to positively retain the insert and be so constructed that the insert cannot be removed without the use of tools. Shells shall be scoop-proof or semi scoop-proof and shall be chamfered at the mating surfaces. The connector shall be so designed that a single shell configuration pair will accommodate either contact arrangement (Figure 1). Flange location shall be as indicated in Figure 2.
- 3.1.4.1 Shell polarization. Polarization shall be accomplished by a shaped-shell design. Polarization shall be accomplished before engagement of the contacts.
- 3.1.4.2 Shell material and finish. The shells shall be made of aluminum alloy in accordance with QQ-A-200/8, 6061-T6511, or QQ-A-250/11, 6061-T651. The shell's mounting surfaces, through, tapped and mounting holes, shall be iridited per MIL-C-5541, Class 3. The balance (mating surfaces) of the connector's shell surface shall be hard anodized per MIL-A-8625, Type III, Class 1 or 2.

- 3.1.5 Connector mating. Plugs and receptacles shall be capable of being mated and unmated without the use of tools, except during ground system checkout. The supplier shall design and/or recommend the required tooling necessary for connector mating/demating during ground system checkout.
- 3.1.6 Contact retention clips. Contact retention clips shall be heat treated to a hardness of 65,000 psi and suitably protected to prevent corrosion with a hard gold flash. The clip material shall be beryllium copper.
- 3.1.7 Interfacial seal. All pin contact inserts shall have a resilient interface seal bonded to the front face, with individual pin barriers. The pin barrier projections shall seal in their respective lead-in chamfers of the hard face socket insert. The resilient interfacial seal shall provide individual contact seals in the mated condition to ensure circuit isolation between each contact and contact to shell. The interfacial seal shall meet the material weight loss requirement of 3.1.1.
- 3.1.8 Wire sealing member (rear grommet). A wire sealing member shall be provided on the rear of both the plug and receptacle and it shall not be removable from the connector. It shall be designed to provide sealing to meet the environmental requirements of this specification when using wire of outer diameters within the range shown below. When wires of smaller diameter are specified, (e.g., for qualification) the use of shrink-fit tubing is permitted, as required. The grommet shall meet the material weight loss requirement of 3.1.1. The grommet shall be of a triple-gland design.

<u>Contact Cavity</u>	<u>Wire Size</u>	<u>Finished Wire Outside Dimensions (in.)</u>	
		<u>Min.</u>	<u>Max.</u>
8	8(1)	0.197	- 0.217
16	16-18-20(1)	0.064	- 0.095
RG-393/U	RG-393/U(2)	0.380	- 0.400
RG-142B/U	RG-142B/U(3)	0.190	- 0.200

- (1) MIL-W-16878, type EE
 (2) MIL-C-17/127
 (3) MIL-C-17/60

3.1.9 Sealing plugs. The same sealing plugs shall be capable of being used in both connector plugs and receptacles. The sealing plug identification shall be as follows:

SP-8	For size 8 grommet cavity
NAS1668-2	For size 16 grommet cavity
SP-393	For RG 393/U grommet cavity
SP-142	For RG 142B/U grommet cavity

3.1.10 Angular connect and disconnect capability. The connector pairs, when suitably mounted with one connector half on a floating, spring supported plate, must be capable of engagement or separation without binding, degradation or jamming and without exceeding acceptable force limits when the two connector mounting surfaces are engaged or separated at angles of up to $\pm 10^\circ$ combined with a ± 0.12 in. misalignment.

3.1.11 Connector weight. The maximum weight of each connector half (including a full complement of contacts) shall be in accordance with Figure 1.

3.1.12 Coaxial contact installation. Coaxial plug contacts shall only be installed in plug connector halves. Coaxial receptacle (jack) contacts shall only be installed in receptacle connector halves.

3.1.13 Cable clamp and bushing. A cable clamp, with a compatible resilient cable bushing, shall be of the materials, construction and physical dimensions as specified herein (Figure 2). A cable clamp and cable busing shall be supplied with each connector half.

3.2 Performance.

3.2.1 Dielectric withstanding voltage. The applicable dielectric withstanding voltage shall be in accordance with Table I.

Table I. Dielectric withstanding voltage.

	ac V (rms) 60 Hz	
	Sea Level	70,000 ft
Size 8 or 16 contact-to-contact and contact-to-shell.	1000	350
Coaxial outer contact-to-shell; coaxial outer contact-to-nearest Size 8 or 16 contact.	1000	350
Coaxial outer contact-to-coaxial center contact.	1000	350

- 3.2.2 Contact retention (in insert). The applicable axial load shall be in accordance with Table II.

Table II. Contact retention.

Contact Type	Force in lb (min.)
Size 8	25
Size 16	15
Coaxial (RG-393/U)	20
Coaxial (RG-142B/U)	15

- 3.2.3 Vacuum effects (material outgassing). The material outgassing limits of the insert, interfacial seal and grommet individually shall not exceed 1.0 percent in total weight loss and 0.1 percent in volatile-condensable material.
- 3.2.4 Contact resistance. The contact resistance shall not exceed the limits of Table III.

Table III. Voltage drop.

AWG Wire Size	Test Current (Amperes)	Voltage Drop (mV) max.	Voltage Drop (mV max.) After Salt Spray
Size 8-8	46	12	25
Size 16-16	13	21	35

3.2.5 Insert retention (in shell). The applicable load shall be 60 lb. per square in. (psf).

3.2.6 Connector mating and unmating forces. The connectors shall not exceed the forces listed in Table IV.

Table IV. Connector mating and unmating forces.

Contact Arrangement	Force in lb. (max)	
	Mating	Unmating
No. 1	141	141
No. 2	225	225

3.2.7 Contact engagement and separation. Contacts shall conform to the forces in Table V. Test pins shall be in accordance with MS3197, except as noted.

Table V. Contact engaging and separating forces.

	Force in Ounces				
	Engaging	Separating		Test Pin or Socket Diameter in in.	
		Max.	Min.	Max.	Min.*
Size 8	75	5	TBD	0.1410	0.1430
Size 16	17	2	TBD	0.0615	0.0635
Coax. (RG-393/U) (center contact)	11	1.0	TBD	0.0630	0.0660
Coax. (RG-142B/U) (center contact)	11	1.0	TBD	0.0480	0.0490
Coax. (RG-393/U) (outer contact)	48	3	TBD	0.4333	0.4356
Coax. (RG-142/U) (outer contact)	48	3	TBD	0.3122	0.3146

*Min. = +0.0001
-0.0000

Max. = +0.0000
Min. -0.0001

3.2.8 Moisture resistance. Connectors shall meet the dielectric withstanding voltage, when tested as specified in 4.1.2, and the applicable insulation resistance as follows:

- a. After step 6(c), the insulation resistance shall be 1 megohm, min.
- b. After 24 hours, (g), the insulation resistance shall be 1,000 megohms.

4. QUALITY ASSURANCE PROVISIONS

4.1 Quantity of samples for qualification. The quantity of connector samples for each connector type designation desired for qualification shall be two, minimum, together with their counterpart connectors. The connectors shall have their full complement of contacts. The connector type designation shall be specified.

4.1.1 Connector wiring. The connectors shall be wired using wire per specification MIL-W-16878, (Type E) or (Type EE) as follows: Note: The percentages listed are only a approximate; however, all contact cavities shall be filled.

- | | |
|---------------------------------|--------------|
| a. Size 8-1 | AWG 8 - 25% |
| Size 8-3 | AWG 10 - 25% |
| Size 8-2 | AWG 12 - 25% |
| Size 8-2 | AWG 14 - 25% |
| b. Size 16-1 | AWG 16 - 30% |
| Size 16-1 | AWG 20 - 30% |
| Size 16-2 | AWG 22 - 20% |
| Size 16-2 | AWG 26 - 20% |
| c. Coax (RG-393/U) - RG-393/U* | - 100% |
| d. Coax (RG-142B/U) - RG-142/U* | - 100% |

*MIL-C-17

4.1.2 Moisture resistance. Unmated connectors shall be subjected to the moisture-resistance test as specified in the general specification (1.2), except when modified as follows:

- a. After completion of the sixth step of the final cycle and after removal of surface moisture from the insulator, the insulation resistance shall be measured while observing the limit of 3.2.8(a).
- b. The sea-level dielectric-withstanding-voltage test shall be sustained with 600 V ac (rms) 60 Hz applied.
- c. After the 24-hour conditioning period, the insulation

4.2 Final inspection. As a minimum, each connector shall be 100 percent inspected per the workmanship provisions of the general specification.

5. PREPARATION FOR DELIVERY

6. NOTES

Custodian:
Goddard Space Flight Center
Greenbelt, Maryland 20771

ATTN: QPL Administrator
Code 311.2

CONTACT TYPE	QUANTITY	CONNECTOR WEIGHT POUNDS (MAX) (3.1.11)	
		PLUG	RECEPTACLE
SIZE 8	8		
SIZE 16	60		
COAX (RG-393/U)	6	2.75	2.85
COAX (RG-142B/U)	6		

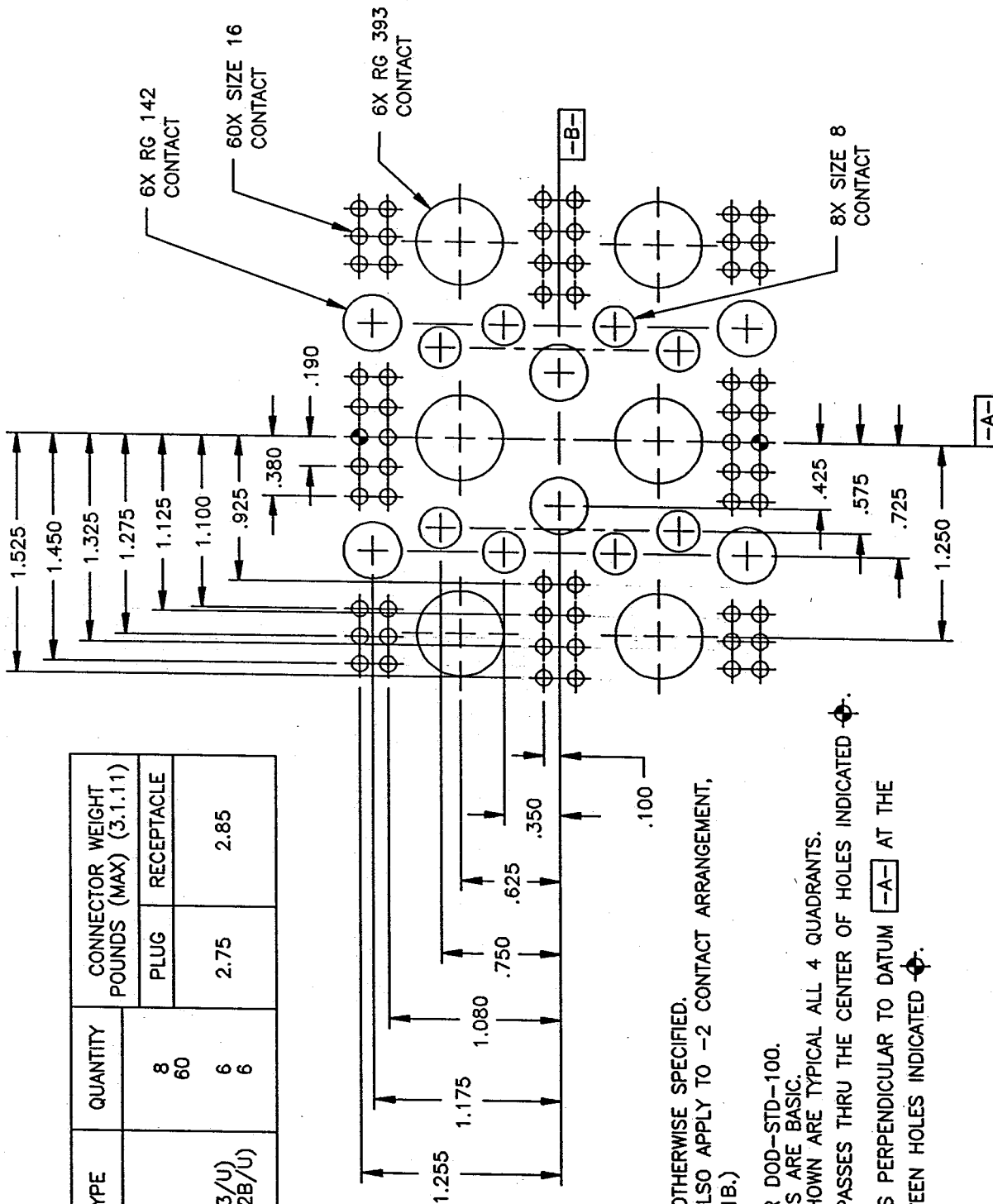

NOTES: UNLESS OTHERWISE SPECIFIED.
 (NOTES ALSO APPLY TO -2 CONTACT ARRANGEMENT, FIGURE 1B.)

1. INTERPRET PER DOD-STD-100.
2. ALL DIMENSIONS ARE BASIC.
3. DIMENSIONS SHOWN ARE TYPICAL ALL 4 QUADRANTS.
4. DATUM **-A-** PASSES THRU THE CENTER OF HOLES INDICATED \odot .
5. DATUM **-B-** IS PERPENDICULAR TO DATUM **-A-** AT THE MIDPOINT BETWEEN HOLES INDICATED \odot .

FIGURE 1A - CONTACT ARRANGEMENT-1

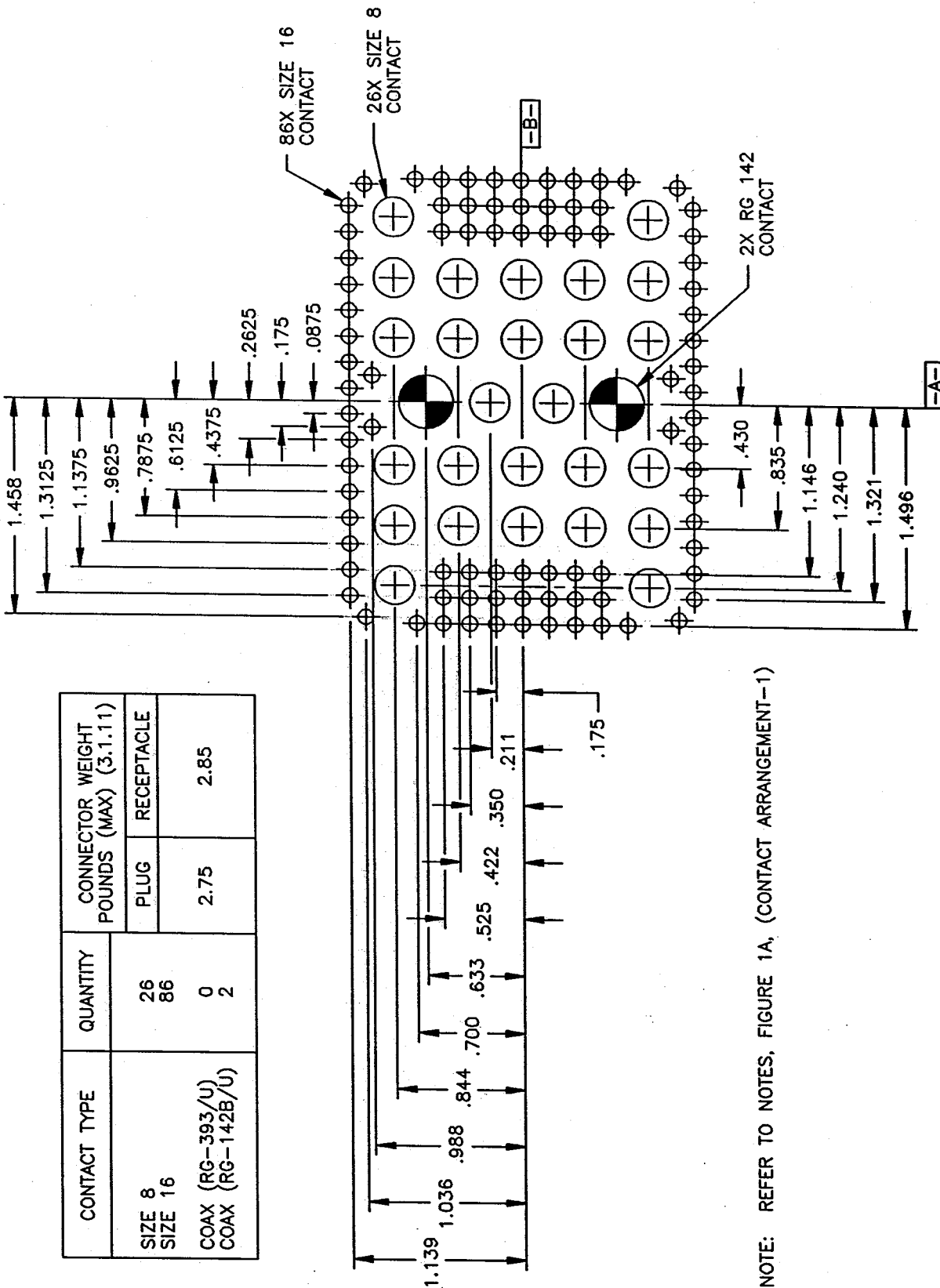

NOTE: REFER TO NOTES, FIGURE 1A, (CONTACT ARRANGEMENT-1)

FIGURE 1B - CONTACT ARRANGEMENT-2

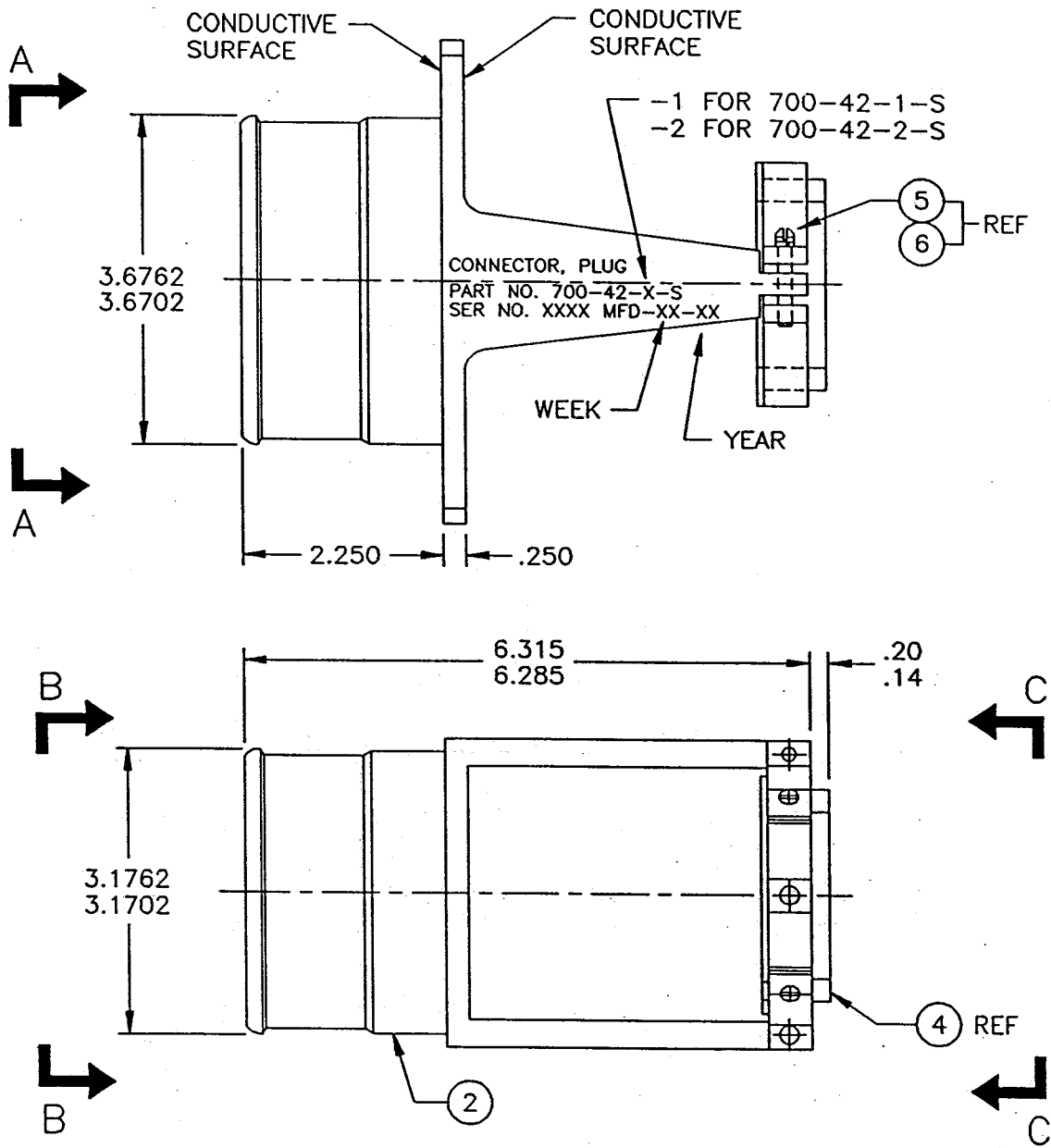

NOTES: UNLESS OTHERWISE SPECIFIED
(NOTES ALSO APPLY TO FIGURE 2B.)

1 INTERPRET PER DOD-STD-100

2 PICO CRIMPING TOOL CO, (CAGE CODE 29268)

3 BUCHANAN CRIMP TOOL PRODUCTS, (CAGE CODE 89020)

4 MIL-C-17

FIGURE 2A - CONNECTOR CONFIGURATION, CONNECTOR,
PLUG, ELECTRICAL, RECTANGULAR
(PAGE 1 OF 6)

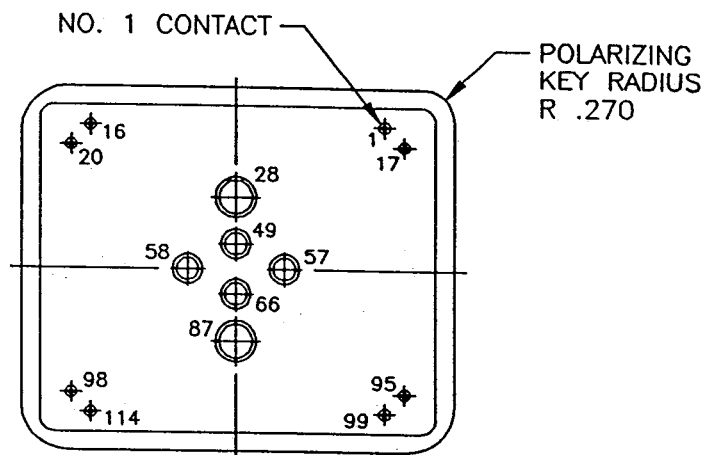

700-42-2-S

CONTACT CONFIGURATION ONLY $\triangle 12$

VIEW A-A

- $\triangle 5$ THE PROTECTIVE COVER IS SUPPLIED WITH THE CONNECTOR, BUT IS NOT SHOWN IN THE FIELD OF DRAWING. LISTING IS FOR REFERENCE ONLY.
- $\triangle 6$ THIS ITEM IS SUPPLIED WITH THE CONNECTOR, BUT PACKAGED SEPARATELY, AND IS SHOWN ASSEMBLED FOR REFERENCE ONLY.
- $\triangle 7$ MAKE FROM 6061-T6511 PER QQ-A-200/8 OR 6061-T651 PER QQ-A-250/11.
- $\triangle 8$ MAKE FROM CLASS 3B, GRADE 50 SILICONE RUBBER PER ZZ-R-765.
- $\triangle 9$ MAKE FROM WHITE LOW-DENSITY POLYETHYLENE.
- 10 DIMENSIONS ARE IN INCHES. DECIMAL TOLERANCE .XX \pm .03; .XXX \pm .010; ANGULAR TOLERANCE \pm 0° 30'. CORNER AND FILLET RADII .010 \pm .005
- $\triangle 11$ SEE PARAGRAPH 3.1.9
- $\triangle 12$ VIEW SHOWN IS ENGAGING FACE.
- $\triangle 13$ WITH M22520/7-04, USE SELECTOR NUMBERS 1, 2 AND 3 FOR WIRE SIZES 26, 24 AND 22 RESPECTIVELY. (NOT SHOWN ON DECAL)
- $\triangle 14$ FINISH: CHEM FILM PER MIL-C-5541, CLASS 3.
- $\triangle 15$ FLASHING ALLOWABLE .010 MAX.
- $\triangle 16$ ALL DIAMETERS $\textcircled{\text{O}} \text{ } \varnothing .010 \text{ } \boxed{\text{A}}$

FIGURE 2A - CONNECTOR CONFIGURATION, CONNECTOR, PLUG, ELECTRICAL, RECTANGULAR (CONTD)
(PAGE 2 OF 6)

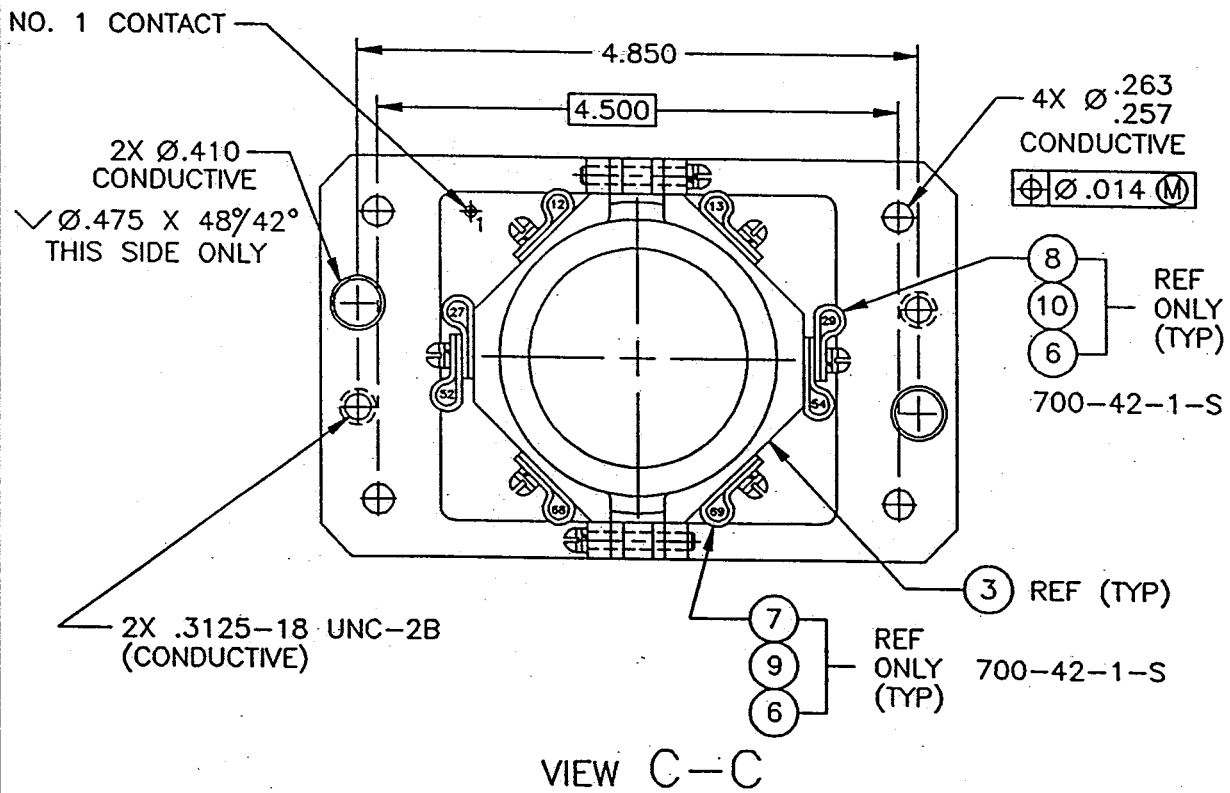
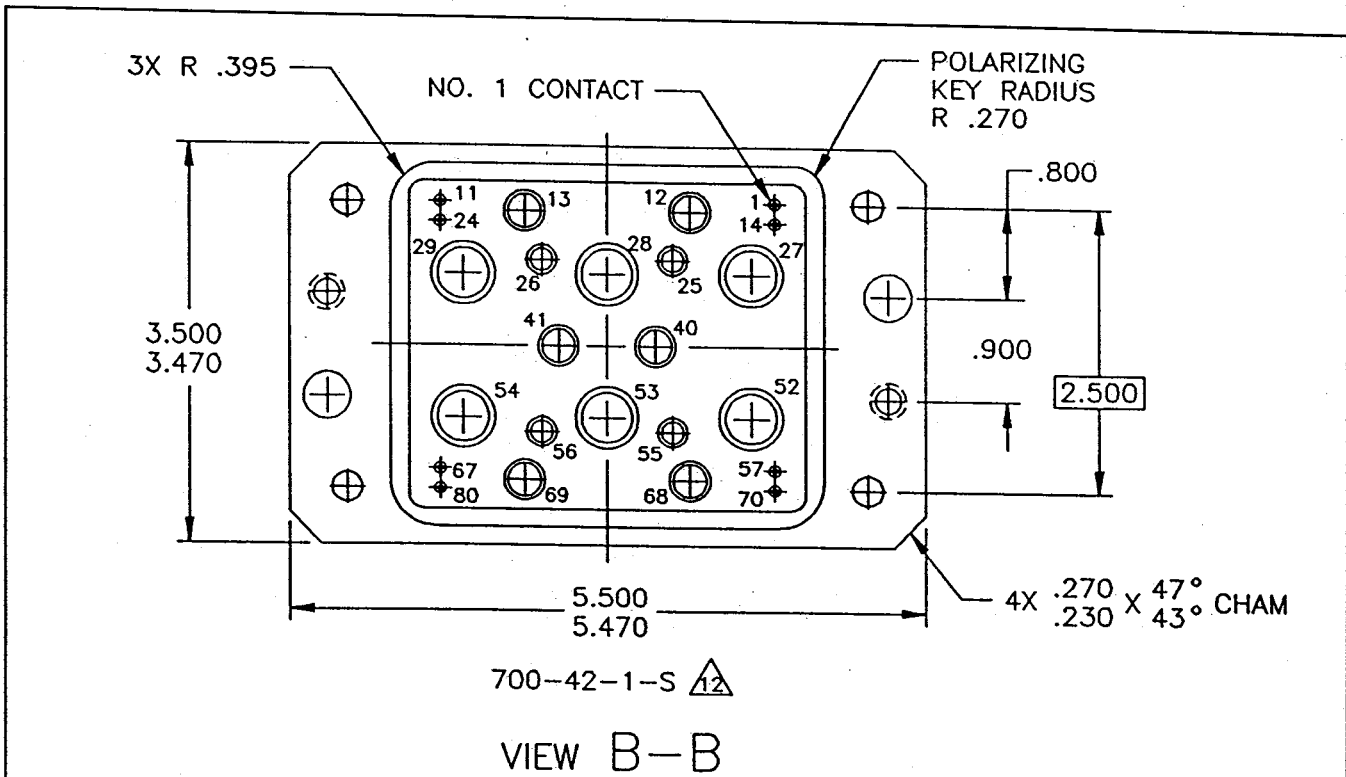
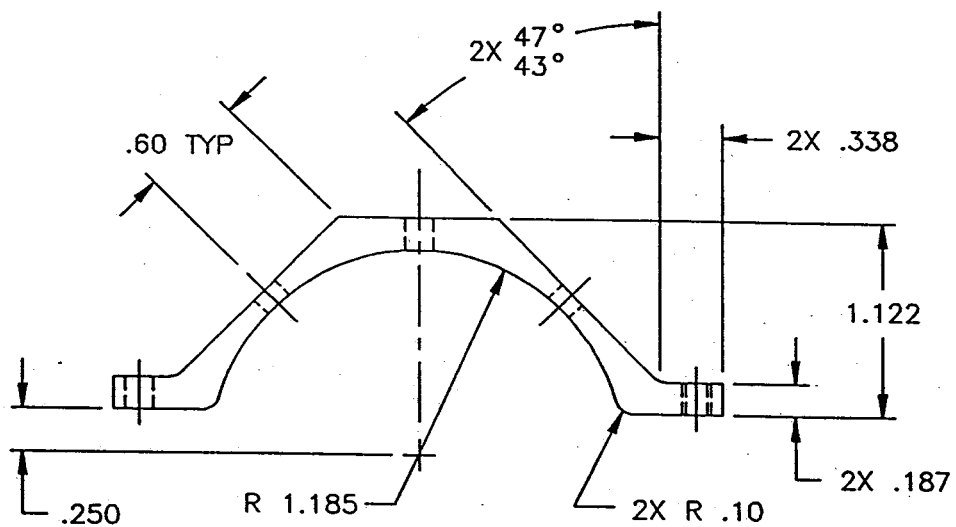
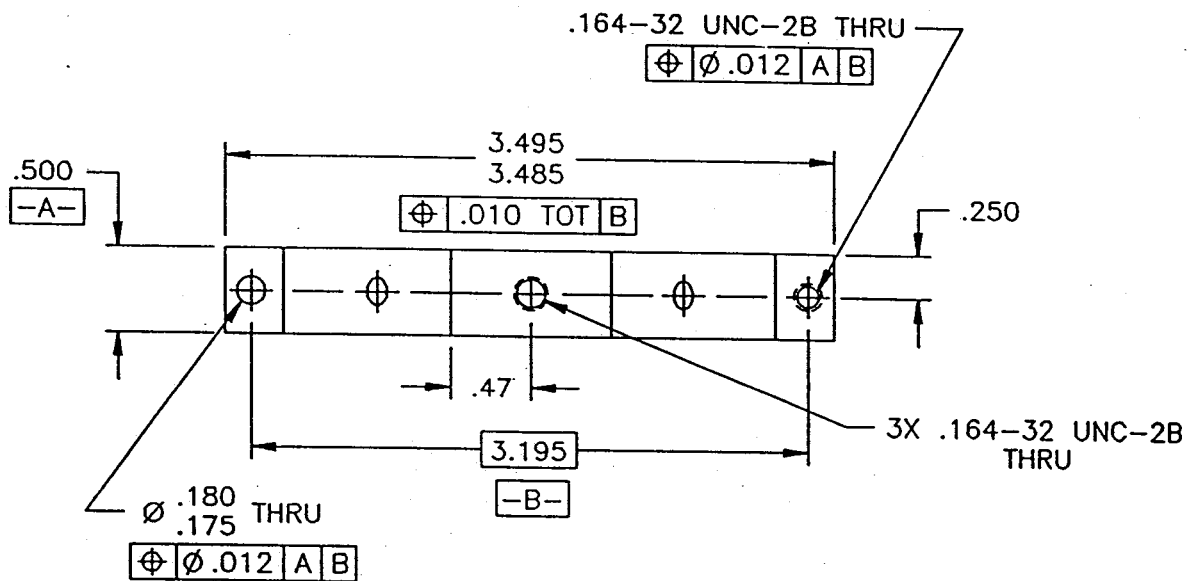
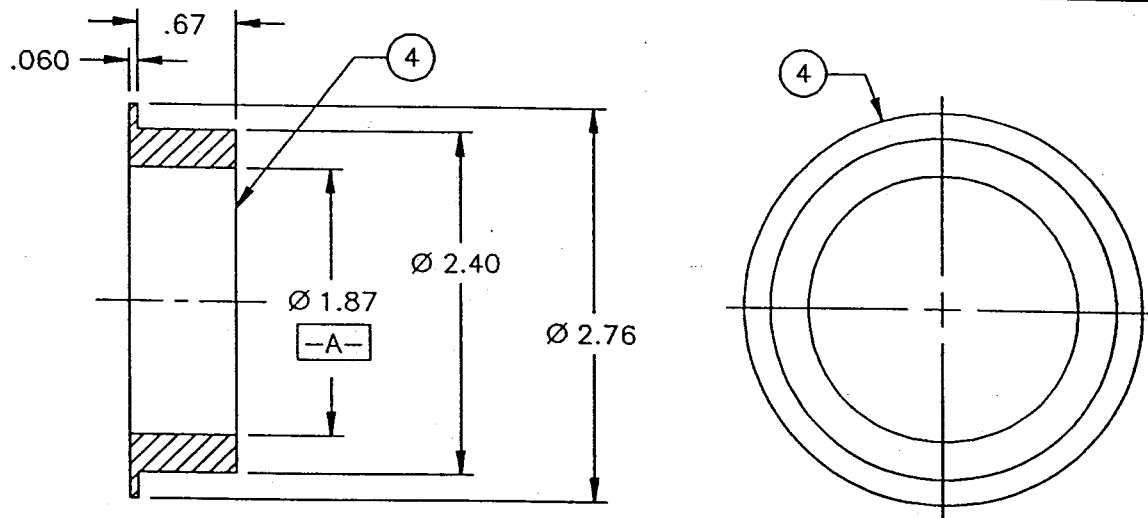

FIGURE 2A - CONNECTOR CONFIGURATION, CONNECTOR, PLUG, ELECTRICAL, RECTANGULAR (CONTD)
(PAGE 3 OF 6)



CABLE CLAMP (3)





FIGURE 2A - CONNECTOR CONFIGURATION, CONNECTOR, PLUG, ELECTRICAL, RECTANGULAR (CONTD) (PAGE 4 OF 6)



③	⑤	1 REF	1 REF			12	S-700-42/1-4	COVER, PROTECTIVE (FOR -1P AND -2P ONLY)		
③	⑤			1 REF	1 REF	11	S-700-42/1-3	COVER, PROTECTIVE (FOR -1S AND -2S ONLY)		
⑥		2 REF		2 REF		10	MS35275-243	SCREW, FIL HD		
⑥		4 REF		4 REF		9	MS35275-241	SCREW, FIL HD		
⑥		4 REF		4 REF		8	MS9353-06	CLAMP		
⑥		4 REF		4 REF		7	MS9353-03	CLAMP		
⑥		2 REF	8 REF	2 REF	8 REF	6	MS35338-137	WASHER, LOCK		
⑥		2 REF	2 REF	2 REF	2 REF	5	MS35275-249	SCREW, FIL HD, DRILLED		
⑩	⑤	⑧	⑥	1 REF	1 REF	1 REF	1 REF	4	S-700-42/1-2	BUSHING, CABLE
④	⑦	⑥		2 REF	2 REF	2 REF	2 REF	3	S-700-42/1-1	CLAMP, CABLE
				1				2B	700-42-2P	CONNECTOR, RECEPTACLE
					1			2A	700-42-1P	CONNECTOR, RECEPTACLE
						1		1B	700-42-2-S	CONNECTOR, PLUG
							1	1A	700-42-1-S	CONNECTOR, PLUG
				700-42-2P	700-42-2S	700-42-1P	700-42-1S	ITEM NO.	PART NO. IDENTIFYING NO.	NOMENCLATURE OR DESCRIPTION
				QTY REQD						

NOTE: LIST OF MATERIALS APPLIES TO BOTH FIGURES 2A AND 2B

FIGURE 2A - CONNECTOR CONFIGURATION, CONNECTOR, PLUG, ELECTRICAL, RECTANGULAR (CONTD)
(PAGE 5 OF 6)

CONTACT NO.		CONTACT SIZE	WIRE SIZE AWG
GSFC-700-42-1-S	GSFC-700-42-2-S		
1 THRU 11, 14 THRU 24, 32 THRU 39, 42 THRU 49, 57 THRU 67, 70 THRU 80	1 THRU 20, 27, 29 THRU 38, 43 THRU 48, 50 THRU 55, 60 THRU 65, 67 THRU 72, 77 THRU 86, 88, 95 THRU 114	16	16-18-20
			22-24-26
25, 26, 30, 31, 50, 51, 55, 56	21 THRU 26, 39 THRU 42, 49, 56 THRU 59, 66, 73 THRU 76, 89 THRU 94	8	8
			12-14
			10
12, 13, 40, 41, 68, 69	28, 87	RG-142 B/U 	RG-142 B/U 
27, 28, 29, 52, 53, 54		RG-393/U 	RG-393/U 









CONTACT PART NO.	COLOR CODE	SEALING PLUG NO. 	CRIMP TOOL NO.	POSITIONER LOCATOR, DIE NO.
GPS-12	BLUE	NAS1668-2	M22520/1-01	M22520/1-02
GPS-13	GREEN		M22520/7-01	M22520/7-04 
GPS-10	RED	SP 8	PICO CRIMP TOOL #400 B WITH #4354 LOCATOR 	PICO #414 DA-8N 
GPS-11	YELLOW			PICO #414 DA-12N 
GPS-16	WHITE			PICO #414 DA-8N 
GPS-15	NONE	SP 142	M22910/7-1	BUCHANAN 612700 
GPS-14	NONE	SP 393		BUCHANAN 613802 

FIGURE 2A - CONNECTOR CONFIGURATION, CONNECTOR, PLUG, ELECTRICAL, RECTANGULAR (CONTD)
(PAGE 6 OF 6)

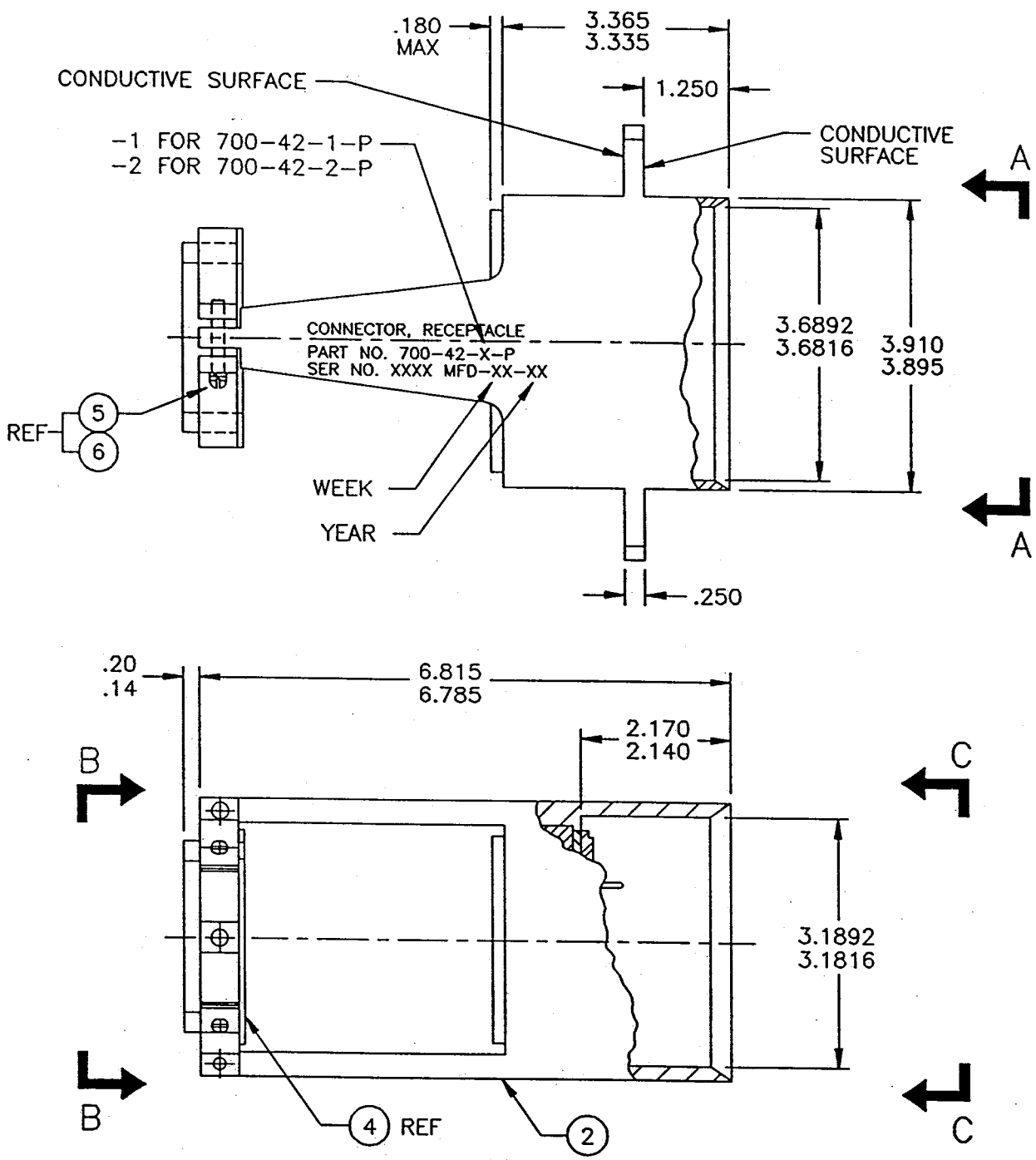
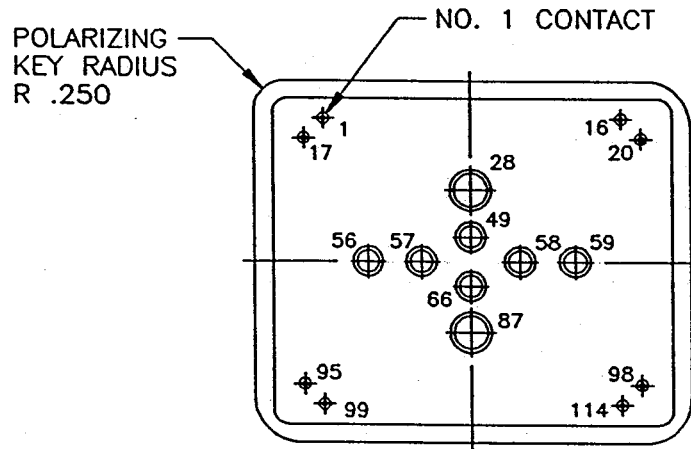

FIGURE 2B - CONNECTOR CONFIGURATION, CONNECTOR, RECEPTACLE, ELECTRICAL, RECTANGULAR (PAGE 1 OF 4)



700-42-2-P

CONTACT CONFIGURATION ONLY $\triangle 12$

VIEW A-A

FIGURE 2B - CONNECTOR CONFIGURATION, CONNECTOR, RECEPTACLE; ELECTRICAL, RECTANGULAR (CONTD) (PAGE 2 OF 4)

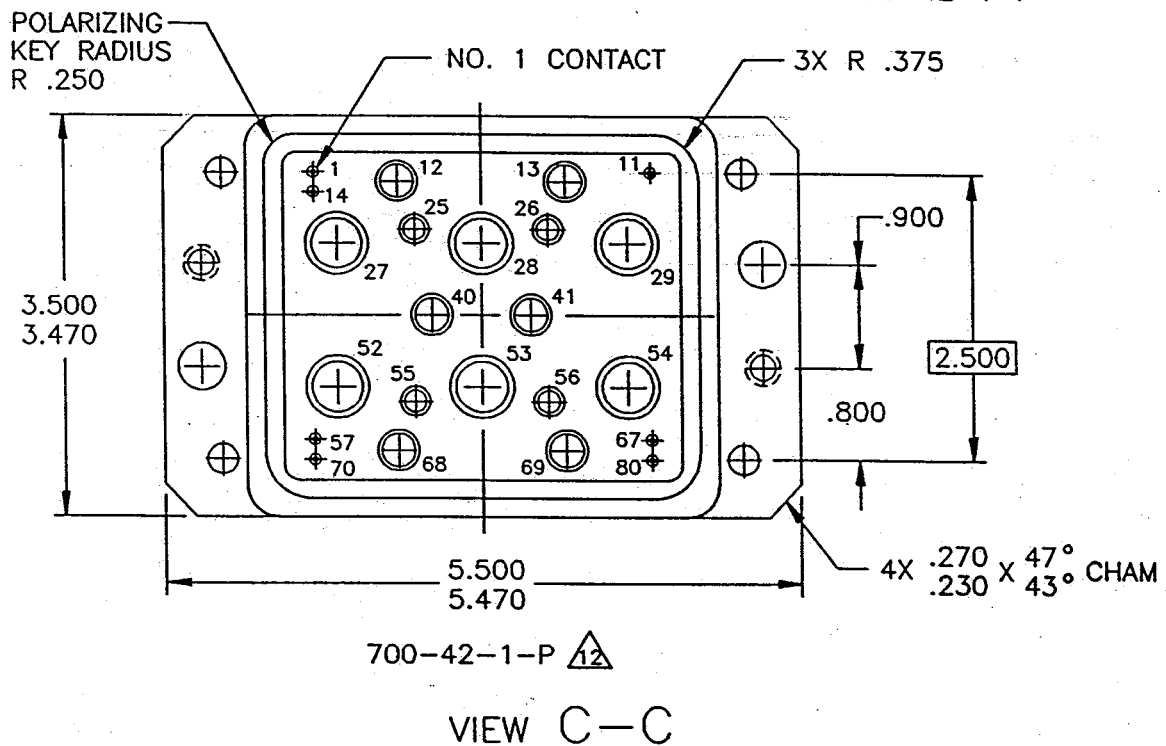
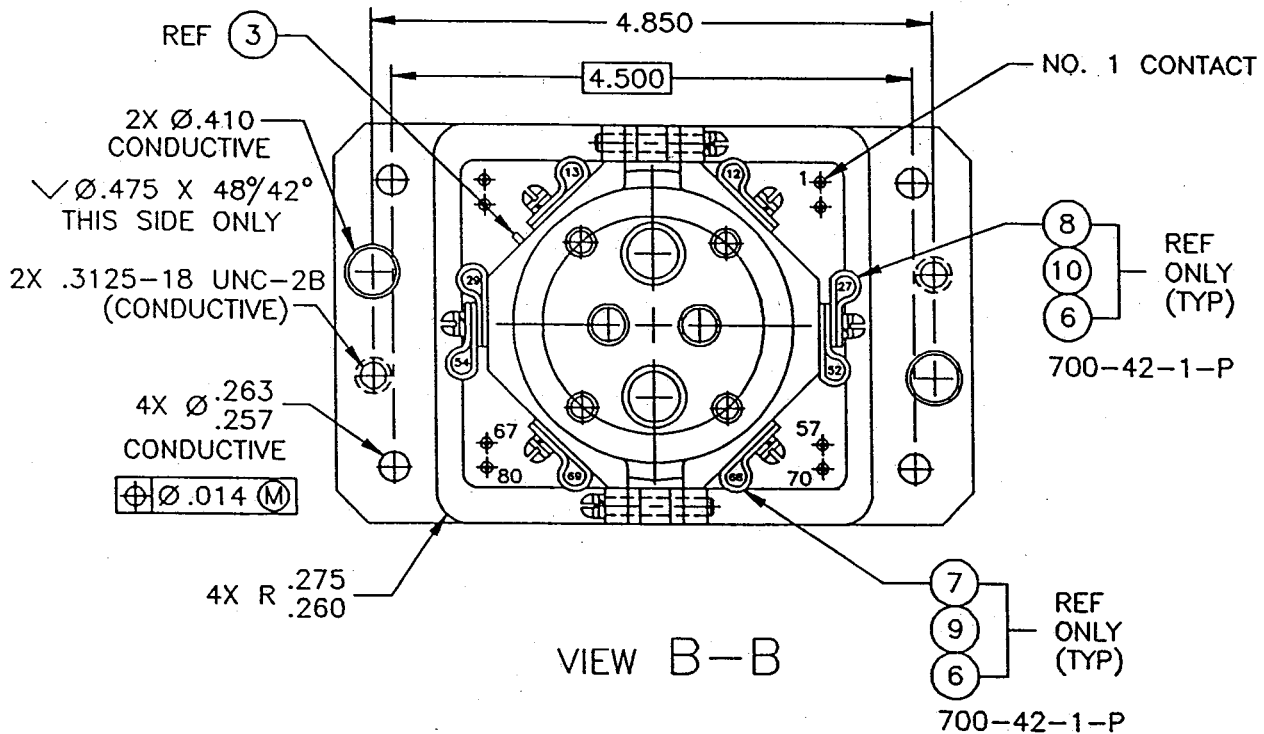

NOTE: REFER TO NOTES, FIGURE 2A
REFER TO LIST OF MATERIALS, FIGURE 2A

FIGURE 2B - CONNECTOR CONFIGURATION, CONNECTOR, RECEPTACLE, ELECTRICAL, RECTANGULAR (CONTD)
(PAGE 3 OF 4)













CONTACT NO.		CONTACT SIZE	WIRE SIZE AWG	
GSFC-700-42-1-P	GSFC-700-42-2-P	16	16-18-20	
1 THRU 11, 14 THRU 24, 32 THRU 39, 42 THRU 49, 57 THRU 67, 70 THRU 80	1 THRU 20, 27, 29 THRU 38, 43 THRU 48, 50 THRU 55, 60 THRU 65, 67 THRU 72, 77 THRU 86, 88, 95 THRU 114		22-24-26	
25, 26, 30, 31, 50, 51, 55, 56	21 THRU 26, 39 THRU 42, 49, 56 THRU 59, 66, 73 THRU 76, 89 THRU 94	8	8	
			12-14	
			10	
12, 13, 40, 41, 68, 69	28, 87	RG-142 B/U 	RG-142 B/U 	
27, 28, 29, 52, 53, 54		RG-393/U 	RG-393/U 	
CONTACT PART NO.	COLOR CODE	SEALING PLUG 	CRIMP TOOL NO.	POSITIONER LOCATOR, DIE NO.
GPP-12	BLUE	NAS1668-2	M22520/1-01	M22520/1-02
GPP-13	GREEN		M22520/7-01	M22520/7-04 
GPP-10	RED	SP 8	PICO CRIMP TOOL #400 B WITH #4354 LOCATOR 	PICO #414 DA-8N 
GPP-11	YELLOW			PICO #414 DA-12N 
GPP-16	WHITE			PICO #414 DA-8N 
GCS-15	NONE	SP 142	M22910/7-1	BUCHANAN 612700 
GCS-14	NONE	SP 393		BUCHANAN 613802 

FIGURE 2B - CONNECTOR CONFIGURATION, CONNECTOR, RECEPTACLE, ELECTRICAL, RECTANGULAR (CONTD)
(PAGE 4 OF 4)