

GSFC X-673-64-1F

ENGINEERING DRAWING STANDARDS MANUAL

August 1994

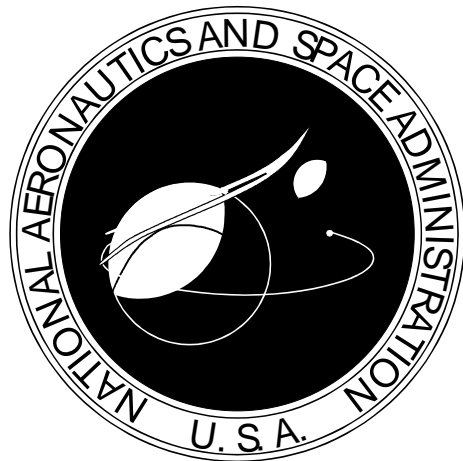

X-673-64-1F

Supersedes GSFC X-673-64-1E/July 1991

ENGINEERING DRAWING STANDARDS MANUAL

Mechanical Engineering Branch
Goddard Space Flight Center
Greenbelt, Maryland

August 1994

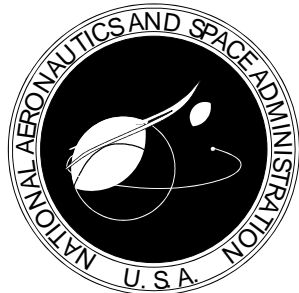

National Aeronautics and
Space Administration

Goddard Space Flight Center
Greenbelt, Maryland 20771
1994

DESCRIPTION OF REVISION

This revision, which supersedes the Goddard Space Flight Center (GSFC) Standard X-673-64-1E, *Engineering Drawing Standards Manual*, is intended to update and reflect the latest formats and standards adopted by GSFC.

The following is a summary of the principal changes and improvements incorporated in this issue:

- a. Addition of Composite Material Drawing definition.
- b. Changing of the signature to a printed name in Title blocks.
- c. New example of the Metric Drawings format and tolerance presentation.
- d. Improved placement of views on Types of Drawings samples to prevent unnecessary rework of drawings at a later date.
- e. New Engineering Order (EO) forms added; old EO forms will be phased out.
- f. Additional notes on various topics added to Note Examples section.
- g. Deletion of microfilming requirements for drawing format.
- h. Flow chart for flight projects redefined.

PREFACE

The GSFC *Engineering Drawing Standards Manual* is the official source for the requirements and interpretations to be used in the development and presentation of engineering drawings and related documentation for the GSFC.

The Mechanical Engineering Branch, Mechanical Systems Division, has been delegated the responsibility for interpretation, periodic updates, and distribution of the GSFC *Engineering Drawing Standards Manual*.

All Engineering Directorate design organizations and their contractors shall adhere to the requirements of this manual when preparing GSFC engineering documentation for flight hardware and ground support systems.

Comments or inquiries concerning this manual should be directed to the Mechanical Engineering Branch, Code 722.

Dr. Allan Sherman
Director of Engineering

TABLE OF CONTENTS

INTRODUCTION	1
1. DRAWING ELEMENTS	3
1.1. Drawing Sizes	3
1.2. Multisheet Drawings	3
1.3. Zoning	4
1.4. Title Block and Revision Block	4
1.5. Drawing Format	10
2. NOMENCLATURE	11
2.1. Drawing Title	11
2.2. Abbreviations	12
2.3. List of Material	14
2.3.1. Requirements on the Body of the Drawing	14
2.3.2. Requirements in the List of Material	14
2.4. Notes on Drawings	15
2.4.1. Security Classification	15
2.4.2. Note Location	15
2.4.3. Numbering of Notes	16
2.4.4. Note Examples	16
2.4.4.1. Dimension Notes	16
2.4.4.2. Heat Treating Notes	17
2.4.4.3. Joining Method Notes (welding, brazing, etc.)	18
2.4.4.4. Plating and Coating Notes	18
2.4.4.5. Surface Preparation Notes	19
2.4.4.6. Testing and Inspection Notes	20
2.4.4.7. Threaded Inserts — Cleaning and Installation Notes	20
2.4.4.8. Miscellaneous Notes	21
2.4.4.9. Informational Notes	23
2.4.5. Local Character Notes	23
2.4.6. General Dimensional Tolerance Notes	23
2.5. Specification Callouts	23
3. DRAFTING PRACTICES	25
3.1. General	25
3.2. Lines	25
3.2.1. Ink Lines and Plotted Lines	25
3.2.2. Pencil Lines	27
3.2.3. Types of Lines	27
3.2.3.1. Center Lines	27
3.2.3.2. Dimension Lines	28
3.2.3.3. Leaders	28
3.2.3.4. Break Lines	28
3.2.3.5. Phantom Lines	29
3.2.3.6. Sectioning Lines	29
3.2.3.7. Extension Lines	30
3.2.3.8. Hidden Lines	30
3.2.3.9. Stitch Lines	30
3.2.3.10. Outlines or Visible Lines	30
3.2.3.11. Datum Lines	30
3.2.3.12. Cutting-Plane/Viewing-Plane Lines	30
3.3. Lettering and Numerals	31
3.3.1. Style	31
3.3.2. Heights	32
3.4. Scale	32
3.5. Positioning the Part on the Drawing	33

3.5.1. Picturization	33
3.5.2. Sections	34
3.5.3. Views	36
3.5.4. Details	37
3.5.5. Identification of Sections, Views, and Details	37
3.5.6. Locating Sections, Views, and Details	38
4. TYPES OF DRAWINGS	39
4.1. Altered or Selected Vendor Part Drawing	39
4.2. Assembly Drawing	40
4.3. Detail Drawing	41
4.4. Drawing Tree	42
4.5. Electrical/Electronic Drawings	43
4.5.1. Electrical and Electronic Symbols	43
4.5.2. Electrical and Electronic Diagrams	43
4.6. Inseparable Assembly Drawing	44
4.7. Installation Assembly Drawing	45
4.8. Interface Control Drawing	46
4.9. Matched-Set Drawing	48
4.10. Mechanical Schematic	49
4.11. Modification Drawing	51
4.12. Outline Drawing	51
4.13. Source Control Drawing	53
4.14. Specification Control Drawing	54
4.15. Standard Part Drawing	56
4.16. Tabulated Drawing	56
4.17. Tooling Drawing	57
4.18. Composite Material Drawing	58
5. NUMBERING SYSTEM FOR DRAWINGS AND SUPPORTING DOCUMENTATION .60	
5.1. Part Numbering	61
5.2. Find or Item Numbering	62
5.3. Order of Precedence of Specifications and Standards	62
5.3.1. Group I	62
5.3.2. Group II	62
5.3.3. Group III	63
5.3.4. Group IV	63
5.3.5. Group V	63
6. ENGINEERING ORDER	64
6.1. General Requirements	64
6.2. Format Sample	64
7. DRAWING REVISIONS	68
7.1. Revision Methods	68
7.2. Revision Identification	68
7.3. Revision of Multisheet Drawings	68
7.4. Revision Recording	68
7.5. Redrawn or Replaced Drawings	70
8. PARTS LIST AND INDEX LIST	71
8.1. Definitions	71
8.2. Requirements	71
8.2.1. List Preparation	71
8.2.2. List Formats	72
8.2.3. Revision Identification	72
8.2.4. Deleting Items	72
8.2.5. Adding Items	72
8.3. Cover Sheet	72
8.3.1. Format	72

8.3.2. Entries.....	72
8.4. Parts List Continuation Sheet.....	75
8.4.1. Format.....	75
8.4.2. Entries.....	75
8.5. Index List Continuation Sheet.....	77
8.5.1. Format.....	77
8.5.2. Entries.....	77
8.6. Find or Item Number System of Identification.....	79
8.6.1. Definition.....	79
8.6.2. Application and Limitation.....	79
8.6.3. Drawing Requirements.....	80
8.7. List of Material.....	81
8.7.1. Format.....	81
8.7.2. Entries.....	81
9. DOCUMENTATION MANAGEMENT.....	82
9.1. Typical Drawing Flow for Flight Projects.....	82
9.2. Archiving.....	83
9.3. Computer-Aided Design Drawings.....	83
9.3.1. Presentation of Computer-Generated Data.....	83
9.3.2. Developing and Using Computer-Generated Drawings.....	84
9.3.3. Specification Data.....	84
10. DESIGN REFERENCES, STANDARDS, AND SPECIFICATIONS.....	85
10.1. Dimensioning and Tolerancing.....	85
10.1.1. Dimensioning and Tolerancing Practices.....	85
10.1.2. Statements on Dimensioning.....	85
10.2. Metric Dimensioning.....	86
10.2.1. SI Units and Symbols.....	86
10.2.2. Unit Conversions.....	89
10.2.2.1. Conversion of Dimensions.....	89
10.2.2.2. Unit Rounding.....	89
10.3. Design References.....	92
10.4. Control of Surface Roughness.....	93
10.4.1. Surface Texture.....	93
10.4.2. Surface Texture Symbols.....	93
10.4.3. Surface Texture Standards.....	93
10.5. Thread Specifications.....	93
10.6. Welding—Fusion and Resistance.....	95
10.6.1. General.....	95
10.6.2. Basic Weld Symbols and Their Location Significance.....	95
10.7. Outgassing of Spacecraft Materials.....	95
10.8. Standards and Specifications Index.....	96
10.8.1. National Bureau of Standards.....	96
10.8.2. Federal.....	96
10.8.3. Industrial.....	97
10.8.4. Military.....	98
10.8.5. NASA.....	100
10.9. Standards and Specifications Numerical Index.....	101
APPENDIX A. DESIGN REVIEW DOs AND DON'Ts.....	107
INDEX.....	110

INTRODUCTION

This drawing standards manual establishes the conventions to be adhered to by engineering and drafting personnel in the preparation, revision, and completion of engineering drawings. This manual sets forth the minimum requirements acceptable at GSFC for the preparation of engineering drawings for flight hardware and ground support systems. The requirements specified herein are essential to the standardization of practices and to a uniform interpretation of drawings.

A system, payload, or component assembly shall be completely defined by means of drawings, including lists, schematics, wiring diagrams, and specifications, to ensure that components fabricated are in accordance with the design. The documentation information shall serve as a permanent record.

Flight hardware shall be fabricated in accordance with the approved design documents. These documents shall reflect the characteristics and acceptance criteria for all materials, component/parts, subsystems, and the complete system. The acceptance criteria for parts and materials shall be specified by standard specifications when applicable.

Engineering drawings are defined as those drawings that communicate the requirements for the manufacture of the end-product items, their assembly, and their installation in the end product.

The engineering drawings prepared by GSFC design personnel or contractors on GSFC drawing format using GSFC drawing numbers shall be known as "Government Design Activity Drawings." Parts made to these drawings typically would be manufactured through the Fabrication Engineering Branch, Engineering Services Division, GSFC. "Contractor Design Activity Drawings" (which are a company's drawings bearing the company name, address, federal code identification, and drawing number) should be used when the company is designing and delivering the finished product in accordance with the terms of a NASA contract.

The Design Activity shall be defined as an activity having responsibility for the design of an item or system. The activity may be a government entity, a contractor, a vendor, or another organization such as a university.

Although generally in accordance with the Department of Defense and industry practices and procedures, this drawing standards manual does contain specific differences and exceptions to *Engineering Drawing Practices*, MIL-STD-100E. This manual, while not intended as a manual of instruction in the basic principles of drafting, does set forth the minimum requirements acceptable at the GSFC. One of those requirements is that persons engaged in the preparation of drawings shall have a thorough understanding of the fundamentals of drafting and geometrical dimensioning and tolerancing (in accordance with ANSI Y14.5M-1982, *Dimensioning and Tolerancing*) in order to produce interpretable drawings.

1. DRAWING ELEMENTS

1.1. Drawing Sizes

The following table defines the standard drawing sizes, and their letter designations to be used at GSFC:

Letter Designation	Sheet Width (inches)	Sheet Length (inches)	Margin (inches)
B	11	17	3/8
C	17	22	1/2
D	22	34	1/2
E	34	44	1/2
F	28	40	1/2
J	34	48 to 144(a)	1/2(b)

Notes:

- (a) Lengths for "J" roll size to be in 11-inch increments.
- (b) Not inclusive of added protective margins of at least 2 inches on both ends of roll size drawings.

1.2. Multisheet Drawings

Multisheet drawings are permitted in all sizes.

- a. The first sheet of a multisheet drawing shall always contain the complete Title block, List of Material, Revision Block, and general notes.
- b. All sheets of multisheet drawings shall be of the same letter size. Use of multisheet drawings shall be found to be advantageous for certain types of schematics and diagrams.
- c. The sheets of "J" size drawings may be any of the above-noted lengths and may be intermixed in different lengths.
- d. Sheet numbering for all first sheets shall include the total number of sheets, as "SHEET 1 OF 1," "SHEET 1 OF 2," etc. Numbering of continuation sheets shall be limited to stating the specific sheet number (e.g., "SHEET 2," "SHEET 3") without specifying the total number of sheets.

1.3. Zoning

Vertical and horizontal zoning may be used if necessary to provide orientation to the field of drawings. Zoning is mandatory for multisheet drawings "D" size and larger and single-sheet drawings "E" size and larger. Zones shall be identified by alphabetical (uppercase) and numerical entries in the margin spaces as indicated in Figure 1. Zone sizes shall be 8½ inches (width) by 11 inches (length) for "E" and "J" size, 7 inches (width) by 10 inches (length) for "F" size, and 5½ inches (width) by 8½ inches (length) for "D" size.

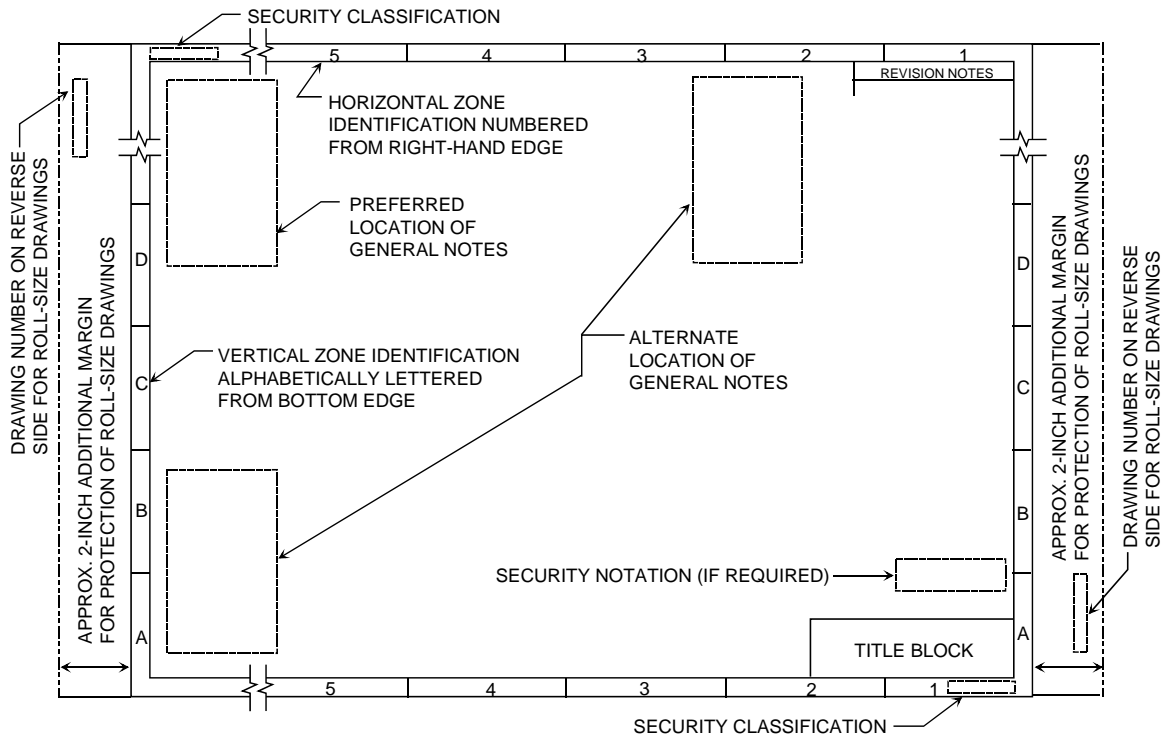

Figure 1: Format for B, C, D, E, F, and J Size Drawings

1.4. Title Block and Revision Block

Title blocks and revision blocks shall be prepared and completed as follows:

The Title block of single-sheet drawings, first sheets of multisheet drawings, and revision blocks shall appear as shown in either Figure 2a on page 5 (dimensional system/inches) or Figure 2b on page 6 (dimensional system/millimeters). The information required in the Title block shall be as specified or referenced by items 1 through 28, below. The Title block of continuation sheets for multisheet drawings shall contain information listed in items 1, 2, and 4 through 11.

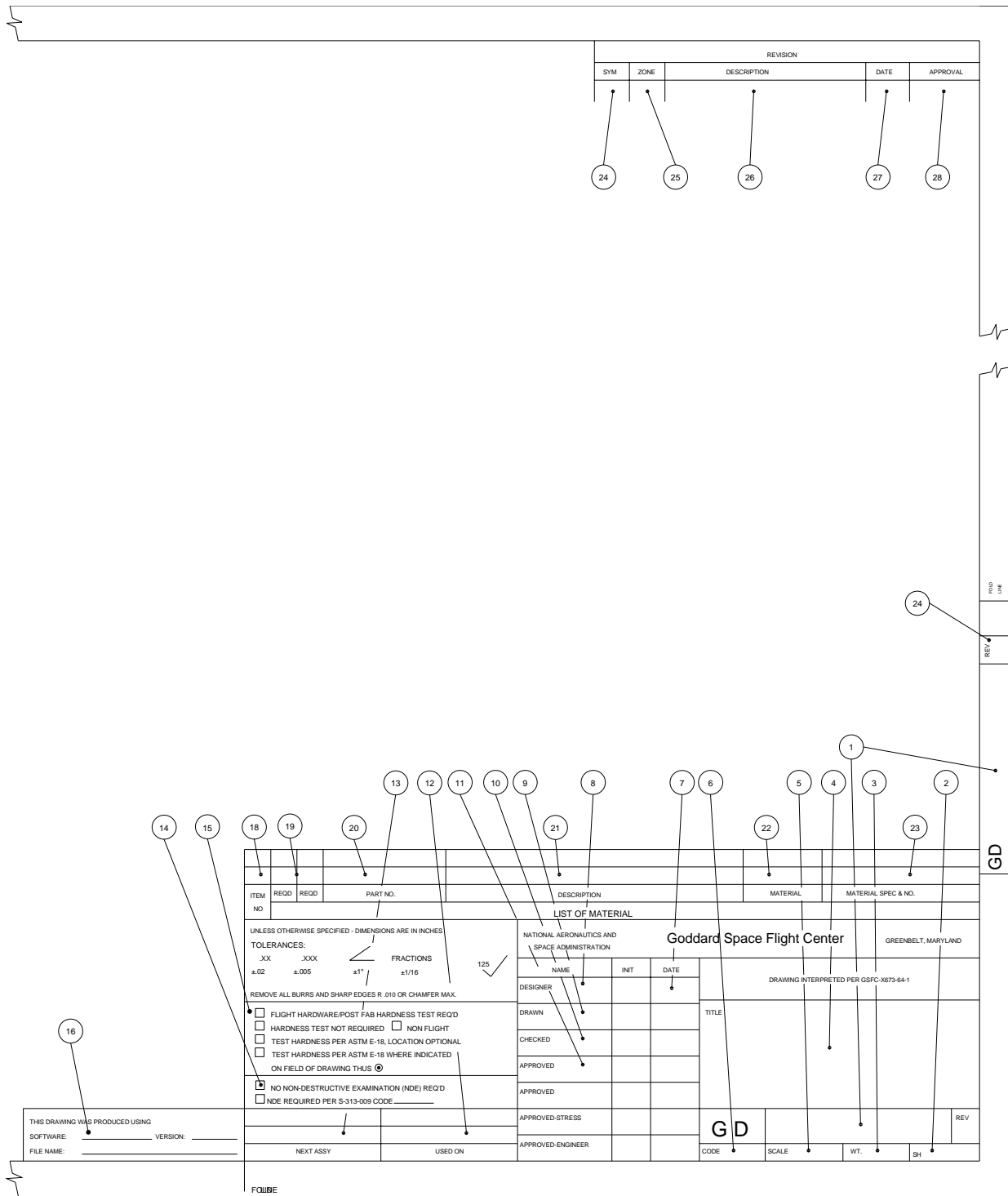

Figure 2a: Sample "Title and Revision Block" (Enlarged View) for Dimensional System/Inches

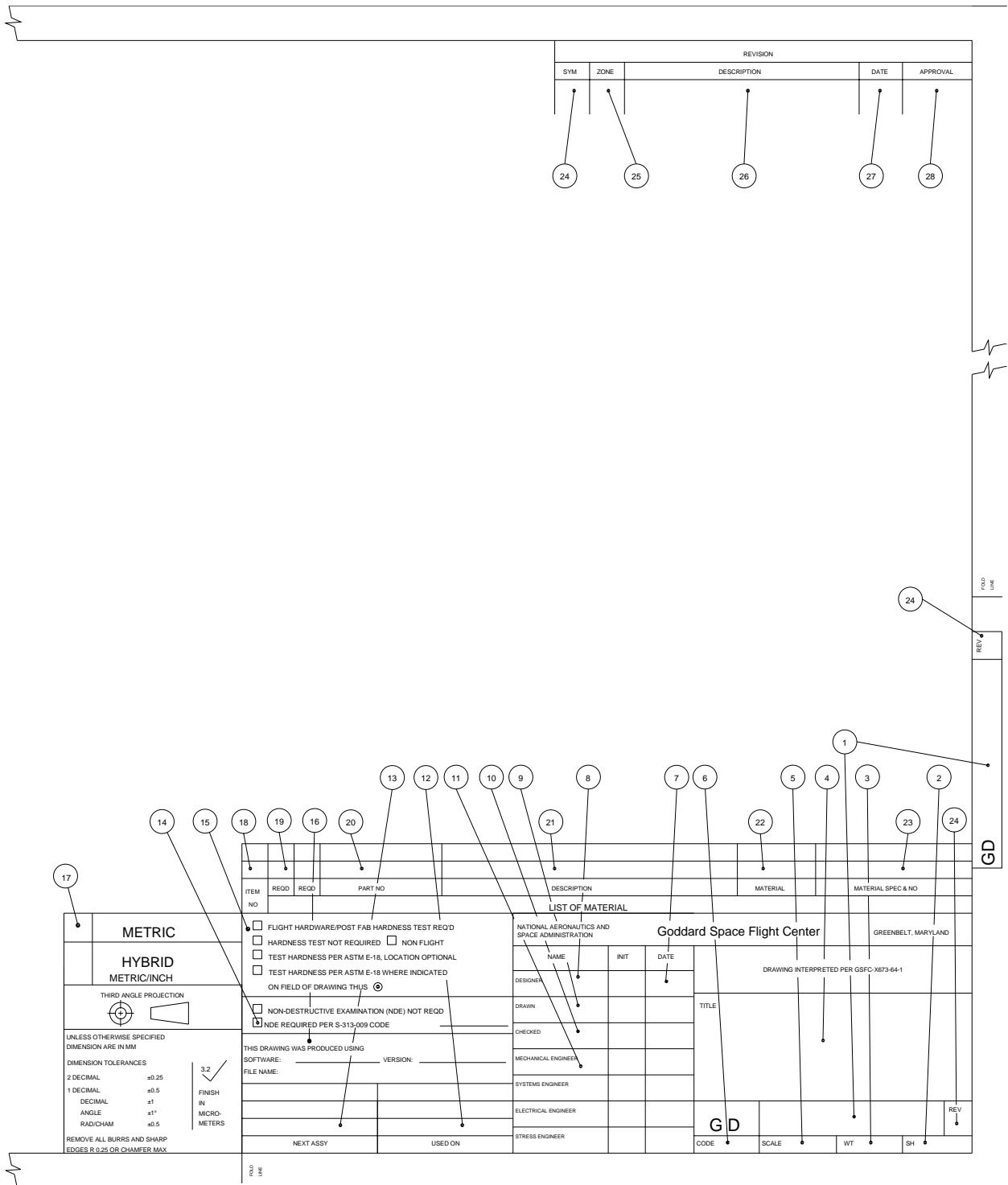

Figure 2b: Sample "Title and Revision Block" (Enlarged View) for Dimensional System/Millimeters

- 1 DRAWING NO.: See page 60.
- 2 “SH ___ OF ___ ”: Enter sheet number as applicable. Indicate total sheets only on sheet 1.
- 3 WT: Enter unit weight calculated at time of design if required.
- 4 TITLE: See paragraph 2.1 on page 11 for selection and arrangement of drawing title. See paragraph 3.3.2 on page 32 for drawing title size.
- 5 SCALE: Enter scale. See paragraph 3.4 on page 32 for selection of scale.
- 6 CODE: For drawings prepared by the Goddard Space Flight Center (GSFC) with an official GSFC drawing number, enter the three-digit GSFC code identifying the group responsible for the drawing.

For drawings prepared by a contractor with a contractor drawing number and format, the contractor's code number from the Commercial and Government Entity (CAGE) Publication H4/H8 (formerly *Federal Supply Code for Manufacturers* (FSCM) H4 and *Federal Supply Codes for Non-Manufacturers* (FSCNM) H8) shall appear.

- 7 DATE: Enter date of initials.
- 8 DESIGNER: Enter designer's printed name and initials.
- 9 DRAWN: Enter draftsman's printed name or if drawn by the designer, the designer's printed name may be repeated.
- 10 CHECKED: Enter design analyst's printed name. This name shall be an independent name from all other names on the drawing. It represents that the drawing has been checked against the parameters of this drawing manual and, where possible, to form, fit, function, and feasibility. The checker must have a thorough understanding of the methods and practices of geometric tolerancing and be able to specify such practices in accordance with ANSI Standard Y14.5M-1982, *Dimensioning and Tolerancing*.
- 11 APPROVED: Enter the printed names of GSFC personnel assigned to approve the drawing. Project requirements for drawing names shall vary from program to program, but each name shall be identified. For example, after each approval name, note the following: “ENG” for engineer, “STRESS” for stress engineer, “QA” for quality assurance engineer, “MATL” for materials engineer, “ELEC” for electrical engineer, etc. All names in line items 8 through 11 must be legible. The hand-written initials on the paper original are the official approval of that document.
- 12 USED ON: Enter acronym name of program and acronym name of subsystem or experiment where applicable.

- 13** NEXT ASSY: Enter drawing number on which the part is next utilized, modified, or assembled. In the case of tooling drawings, in the Next Assembly block refer to a general note that states “This drawing is used to fabricate (drawing number).” Installation drawings should reflect a top configuration drawing number as the next assembly. When a configuration drawing is not being produced, the installation drawing shall indicate by note “The installation forms a part of the configuration for program (project name).”
- 14** EXAMINATION: The appropriate “Non-Destructive Examination (NDE) Required” block shall be checked off, and the addition of the applicable code or “see note XX” shall be added where required. Refer to Testing and Inspection Notes of the general notes section paragraph 2.4.4.6 on page 20.
- 15** FLIGHT HARDWARE and HARDNESS TESTING: The Flight Hardware block must be checked off when the part is used in actual flight configurations. The appropriate Hardness Testing block shall be checked off regardless of whether the part is flight hardware or not.
- 16** On CAD-produced drawings, add a 3.5-inch-long by 0.88-inch-high block as follows:

<p>THIS DRAWING WAS PRODUCED USING:</p> <p>SOFTWARE: (a) _____ VERSION: (b) _____</p> <p>FILENAME: (c) _____</p>

Notes:

- (a) Software used (example: “AUTOCAD”)
 (b) Version of software (example: “10c7”)
 (c) Filename (example: “GSFC1234”)

- 17** METRIC/HYBRID METRIC-INCH: Add “X” to type of drawing block.AAAA
- 18** ITEM NO.: Enter item numbers when more than one type of material or part is required, and coordinate drawing callouts on the drawing field. Parts made of the same material, condition, and specification shall be assigned only one item number, even though the part may be required in various sizes and thicknesses. The quantity for such items in the List of Material (L/M) shall be stated as “A/R” with the specific sizes spelled out in the field of the drawing. Refer to Figure 3 on page 10, Figure 34 on page 80, and Section 8.6, Find or Item Number System of Identification, on page 79. Do not skip item numbers on new drawings.
- 19** REQD: Enter quantity of parts required only for the parts of an inseparable assembly or assembly drawing.
- 20** PART NO.: Enter identifying part numbers when required (Government, contractor, vendor, or other). On new drawings, group like items together.

- 21 DESCRIPTION: Enter material description (plate, etc.) or a part name title if it is another drawing. Enclose reference information such as fastener sizes in brackets.
- 22 MATERIAL: Enter the material from which the part is fabricated. Examples: "AL ALY"; "CRES"; "BE CU."
- 23 MATERIAL SPEC.: Enter the applicable material specifications, number, and final condition. Examples: "QQ-A-250/11 6061-T6" for AL ALY plate; "ASTM A582 303 COND A" for CRES bar.
- The information required in the revision block shall be as specified or referenced by items 24 through 28, below, and in accordance with "Drawing Revisions," paragraph 7, page 68.
- 24 REVISIONS - SYM: Enter revision symbol.
- 25 REVISIONS - ZONE: Enter zone (where used).
- 26 REVISIONS - DESCRIPTION: Enter description of the revision (refer to Section 7, "Drawing Revisions").
- 27 REVISIONS - DATE: Enter date approved by authorized signer(s) in block.
- 28 REVISIONS - APPROVAL: Enter signature of GSFC person assigned to approve. If change was by approved EO, drawing only needs approval of the draftsman or person incorporating the change, and the checker. If changes made are not covered by an EO, then approval must include the engineer.

DETAIL DRAWING

ITEM NO.	REQD	PART NO.	DESCRIPTION	MATERIAL	MATERIAL SPEC & NO.
—	—	—	WIRE	BE CU	QQ-C-530, COND 1/2 HT

DETAIL SHOWN & OPPOSITE DRAWING

ITEM NO.	REQD	PART NO.	DESCRIPTION	MATERIAL	MATERIAL SPEC & NO.
—	—	-2	BAR OPPOSITE	AL ALY	QQ-A-225/8 6061-T6
—	—	-1	BAR SHOWN	AL ALY	QQ-A-225/8 6061-T6

INSEPARABLE ASSEMBLY DRAWING

ITEM NO.	REQD	PART NO.	DESCRIPTION	MATERIAL	MATERIAL SPEC & NO.
2	2	MS21209C0415	INSERT (4-40 UNC x .168 LG)		SEE NOTE 1
1	1	—	PLATE	AL ALY	QQ-A-250/11 6061-T6

INSEPARABLE ASSEMBLY DRAWING

ITEM NO.	REQD	PART NO.	DESCRIPTION	MATERIAL	MATERIAL SPEC & NO.
2	3	MS21209C0415	INSERT (4-40 UNC x .168 LG)		SEE NOTE 1
1	A/R	—	PLATE	AL ALY	QQ-A-250/11 6061-T6
—	—	GD1000001	PLATE ASSY		

ASSEMBLY DRAWING

ITEM NO.	REQD	REQD	PART NO.	DESCRIPTION	MATERIAL	MATERIAL SPEC & NO.
4	3	3	MS51957-12	SCREW (4-40 UNC 2A x .187 LENGTH)	CRES	
3	2	2	GD1003451	BLOCK		
2	1		GC1003467-2	PLATE		
1		1	GC1003467-1	PLATE		
—	—	—	GE1002500-2	PADDLE ASSEMBLY OPPOSITE		
—	—	—	GE1002500-1	PADDLE ASSEMBLY SHOWN		

Notes:

- Paint, adhesives, and protective coatings shall appear in note form.
- Hardware shall appear in List of Material with required quantity.
- "A/R" shall be used in REQD column when same material (same material specification and condition) appears more than once in different sizes in the field of the drawing.
- "A/R" may be used to indicate large quantities of rivets.
- A material specification shall only appear once in the List of Material unless material conditions vary or a Shown and Opposite part is required. Sheet and plate shall not be listed as separate items.

Figure 3: Examples of "List of Material"

1.5. Drawing Format

The drawing format for the drawing sizes listed on page 3, including zoning, drawing numbers, security classification, etc., is shown in Figure 1, page 4.

2. NOMENCLATURE

2.1. Drawing Title

General information for the selection or development of a drawing title is as follows:

- a. The title should be as brief as possible but should contain sufficient information to categorize the part properly and to distinguish it from other similar parts.
- b. The drawing title shall consist of the following:
 1. Identifying noun or noun phrase.
 2. The most significant modifier or modifying phrase.
 3. The next most significant modifier or modifying phrase.

The noun or noun phrase establishes a basic concept of an item. The modifiers serve to narrow the area of concept established by the basic name. A modifier is separated from the noun or noun phrase by a comma and from any preceding modifier by a comma. The type designator and/or any additional modifiers required to further identify an item are separated from the first part of the title by a dash. Where applicable, the word "ASSEMBLY" shall be used as the last word of the noun phrase.

EXAMPLES:

"Beam, Hoisting, Guided Missile"

"Cover, Protective, Rocket Motor—Forward Section"

"Cabinet, Electrical Equipment—CY-147"

"Transportation—Dolly Assembly, Earth Satellite"

- c. The noun, or noun phrase, is never abbreviated. Abbreviations are used in the modifiers only when space is limited. When used, abbreviations shall conform to Abbreviations, paragraph 2.2 on page 12.
- d. When one drawing supersedes another, the new drawing, when practical, has the same title.
- e. Parentheses are not used to enclose any portion of the drawing title.
- f. Program names (or abbreviations) should be added to the "Used On" block and **not** the Title block; exceptions are on the final or top assembly drawing.

2.2. Abbreviations

The purpose of this section is to provide a list of authorized abbreviations for use on drawings and associated documents. When used, abbreviations and acronyms shall be in accordance with GSFC STD-256-WE-1 and MIL-STD-12 (in that order of precedence).

- a. Uppercase Gothic letters shall be used.
- b. Abbreviations for word combinations (e.g., MMC—Maximum Material Condition) shall be used as such and shall not be separated for use singly. Single abbreviations may be combined when necessary.
- c. The same abbreviation shall be used for all tenses, the possessive case and the singular and plural forms of a given word.
- d. Abbreviations should be used only to save space or time, but never at the expense of clarity.
- e. Periods shall be used with abbreviations that spell entire words to provide clarity and to avoid misinterpretation.

The following abbreviations are acceptable to use and are “industry-related” associations not found in GSFC STD-256-WE-1 or MIL-STD-12.

AFBMA Anti-Friction Bearing Manufacturers Association, Inc.
 1101 Connecticut Avenue, NW
 Suite 700
 Washington, DC 20036

AGMA American Gear Manufacturers Association, Inc.
 1500 King Street
 Suite 201
 Arlington, VA 22314

ANSI American National Standard Institute
 1430 Broadway
 New York, NY 10018

ASME American Society of Mechanical Engineers
 345 E. 47th Street
 New York, NY 10017

ASTM American Society for Testing and Materials
 1916 Race Street
 Philadelphia, PA 19103

AWS	American Welding Society, Inc. 550 N.W. Ledeune Road P.O. Box 351040 Miami, FL 33135
IEEE	Institute of Electrical and Electronic Engineers, Inc. 445 Hose Lane P.O. Box 1331 Piscataway, NJ 08855-1331
ISO	International Organization for Standardization/ (Organisation Internationale de Normalisation) 1, rue de Varembé 1211 Geneve 20 Switzerland/Suisse
NEMA	National Electrical Manufacturers Association 2101 L Street, NW Washington, DC 20037
NSA	National Standards Association, Inc. 1200 Quince Orchard Blvd Gaithersburg, MD 20878
NAS	Aerospace Industries Association of America, Inc. 1250 I Street, NW Washington, DC 20005
SAE	Society of Automotive Engineers, Inc. 400 Commonwealth Drive Warrendale, PA 15096

2.3. List of Material

2.3.1. Requirements on the Body of the Drawing

Each part listed in the List of Material (Parts List) must be identified at least once by an Item (Find) Number on the body of the drawing (except single item drawings and shown and opposite item drawings).

Note:

Parts shall be bracketed, indicating reference, when they are identified by number and are not noted in the List of Material. Such parts are shown in phantom. Repeated item numbers shall be indicated as reference either within brackets or by the word "REF."

2.3.2. Requirements in the List of Material

- a. The List of Material is a list of all parts and materials called out on the drawing. See Figure 3 on page 10.
- b. The quantity of parts noted in the List of Material is the number required to complete the noted assembly.
- c. When a new drawing is made, all parts in the List of Material should be grouped as to type, such as dash number (for shown and opposite assemblies), GSFC drawings (for detailed parts), MS parts, NAS parts, etc., and listed in this sequence.
- d. Quantities of Bulk Items and placement: refer to notes (a) through (e) on Figure 3 on page 10.
- e. Preferred parts lists for parts, materials, and processes can be found in an unofficial publication available for viewing in the Mechanical Engineering Branch. The "Design Selection Guide" contains a wide range of hardware, materials, design standards, and processes. It shall be noted that not all of the items in this reference guide are rated for space flight use.

Note:

All fasteners used in flight hardware and critical nuts and bolts used on ground support equipment, including all flight/GSE interfaces, must meet the specification *GSFC Fastener Integrity Requirements*, GSFC S-313-100, Materials Branch, Office of Flight Assurance.

2.4. Notes on Drawings

Information other than pictorial views and dimensions necessary for completing a drawing is classified as “notes.” The two types of note forms are General Notes and Local Character Notes. Notes on a drawing take precedence over specification requirements; hence, notes conflicting with referenced specifications shall not be placed on a drawing unless they are necessary for deviations from certain provisions of the specification.

2.4.1. Security Classification

The security classification “Top Secret,” “Secret,” or “Confidential” shall be located on the drawing as noted in Figure 1 on page 4.

Each sheet of a multisheet drawing shall be individually classified as to its contents. The security stamp on each sheet shall be that of the highest classification for any item shown on that individual sheet, not the general overall classification of the entire set of drawings or the end item. On roll-size drawings, the security classification shall be shown on the reverse side at both ends of the drawings next to the drawing number to enable the classification to be seen without unrolling the drawing.

A warning note shall be included adjacent to the security classification located above the Title block and shall read as follows:

THIS MATERIAL CONTAINS INFORMATION
AFFECTING THE NATIONAL DEFENSE OF THE
UNITED STATES WITHIN THE MEANING OF THE
ESPIONAGE LAWS, TITLE 18 U.S.C., SECTIONS 793
AND 794. THE TRANSMISSION OR REVELATION OF
WHICH IN ANY MANNER TO AN UNAUTHORIZED
PERSON IS PROHIBITED BY LAW.

2.4.2. Note Location

Notes of general character that do not require leaders to indicate where they apply, and for which provision has not been made in the supplementary blocks of the drawing format, shall be located in the following order of preference:

- a. Adjacent to the upper left border and to the left of all views.
- b. Immediately to the left of the revision block.
- c. Adjacent to the lower left border or below the revision block, space being left for extending the revision block downward. This location should be avoided whenever practical because the space required for revisions cannot be anticipated.

2.4.3. Numbering of Notes

General notes are numbered consecutively downward. Note numbers may be identified on the field of the drawing by placing the note number in a pennant-shaped flag at the general note location and in the field of the drawing, or in the List of Material (Material Specification column), whichever location is more appropriate.

2.4.4. Note Examples

The following notes are listed as representative examples and should be used on Engineering Drawings when applicable.

Significant information is to be inserted where blank(s) are indicated and, for most cases, the notations in parentheses are for information only. (When not applicable, do not use in note).

Before using the referenced specifications, check the Department of Defense *Index of Specifications and Standards Publications* to ensure that the specification has not been cancelled or superseded.

Use either of the following statements as main heading for notes: "Except as noted" or "Unless otherwise specified."

2.4.4.1. Dimension Notes

ALL DIMENSIONS APPLY AFTER SURFACE TREATMENT.

DIMENSIONAL LIMITS AND SURFACE ROUGHNESS DESIGNATIONS APPLY (state "BEFORE" or "AFTER") PLATING.

(For other coatings, substitute the appropriate expression for "plating.")

DIMENSIONS TO APPLY AFTER STRESS RELIEF.

DIMENSIONING AND TOLERANCING TO BE INTERPRETED IN ACCORDANCE WITH ANSI Y14.5M-1982.

(Note need be added only when drawings are not in compliance with GSFC X-673-64-1F.)

GEAR TOLERANCES TO BE IN ACCORDANCE WITH AGMA STANDARD QUALITY (insert number).

DIMENSIONS ARE IN MILLIMETERS.

TOOLING-CONTROLLED DIMENSION PER TEMPLATE (or "TOOL") NUMBER GX XXXXXXX. THE ACTUAL TOLERANCES ON THE FEATURE'S LOCATIONS ARE CONTROLLED BY THE TEMPLATE. (Note to be flagged to tooling-affected dimensions and tolerances, which are then enclosed in parentheses to indicate a reference; template drawings shall carry a note stating the drawing number of the part they are used to fabricate.)

TORQUE LIMITS FOR THREADED FASTENERS SHALL BE IN ACCORDANCE WITH PROJECT APPROVED SPECIFICATION NUMBER (OR ENGINEERING ANALYSIS).

2.4.4.2. Heat Treating Notes

Note for beryllium copper:

HEAT TREAT IN ACCORDANCE WITH MIL-H-7199 TO _____ (Brinell) _____.

Note for steel:

HEAT TREAT IN ACCORDANCE WITH MIL-H-6875 TO _____ XXX.

(XXX = "Rockwell," "Brinell," or "Vickers").

Notes for aluminum:

HEAT TREAT IN ACCORDANCE WITH MIL-H-6088 TO _____ (Brinell) _____.

HEAT TREAT TO _____ CONDITION AFTER (insert "BRAZING" or "WELDING") IN ACCORDANCE WITH MIL-H-6088.

AFTER WELDING, SOLUTION HEAT TREAT AND ARTIFICIALLY AGE TO T-6 CONDITION PER MIL-H-6088.

2.4.4.3. Joining Method Notes (welding, brazing, etc.)

The following specification supersedes MIL-W-8604 for Alum.; MIL-W-8611A for Steel, CRES, and HT RES ALY; and MIL-W-18326 for Magnesium:

FUSION WELD IN ACCORDANCE WITH MIL-STD-2219, PROCESS _____ CLASS _____ USING FILLER METAL _____ AND APPROPRIATE FLUX.

(Joint dimension and design should be specified on the drawing.)

ELECTRON BEAM WELDING IN ACCORDANCE WITH MIL-W-46132.

SOLDER IN ACCORDANCE WITH NHB 5300.4(3A-1), USING SOLDER MATERIAL, QQ-S-571, TYPE _____.

SOLDER IN ACCORDANCE WITH DOD-STD-1866 (GENERAL SOLDERING PROCESS FOR ALL TYPES AND MATERIALS FOR NONELECTRICAL APPLICATIONS).

Note for aluminum:

DIP BRAZE IN ACCORDANCE WITH MIL-STD-645; HEAT TREAT TO _____ CONDITION PER MIL-H-6088.

SILVER SOLDER IN ACCORDANCE WITH MIL-B-7883, TYPE _____ GRADE _____ USING SOLDER MATERIAL QQ-B-654, CLASS _____.

RIVET IN ACCORDANCE WITH MIL-STD-403.

2.4.4.4. Plating and Coating Notes

Plating notes are generally not for space flight hardware use in restricted areas such as optics, electronics, etc., due to flaking.

CADMIUM PLATE IN ACCORDANCE WITH QQ-P-416, TYPE _____ CLASS _____.

HARD CHROME PLATE (size)-(size) THICK PER QQ-C-320, TYPE _____, CLASS _____; DIMENSIONS SHOWN APPLY AFTER PLATING.

NICKEL PLATE IN ACCORDANCE WITH MIL-STD-171, FINISH (para. number), TYPE _____.

SILVER PLATE IN ACCORDANCE WITH QQ-S-365,
TYPE _____, GRADE _____.

PAINT IN ACCORDANCE WITH MIL-STD-171, TABLE
_____; FINISH NO. _____ COLOR _____ IN
ACCORDANCE WITH FED-STD-595 (color
number).

Notes for aluminum:

ANODIZE IN ACCORDANCE WITH MIL-A-8625, TYPE
_____, CLASS _____ COLOR _____
(name of color only).

IRIDITE IN ACCORDANCE WITH MIL-C-5541,
CLASS _____.

Note for CRES:

PASSIVATE PER QQ-P-35, TYPE _____.

FINISH _____ OF MIL-STD-171.
Use paragraph that applies to material
being used.

Note for iron and steel:

APPLY PROTECTIVE PHOSPHATE COATING IN
ACCORDANCE WITH MIL-C-12968, TYPE _____.
(Add "CLASS _____" if applicable.)

Note for titanium:

SURFACE FINISH TO BE IN ACCORDANCE WITH
AMS 2488, TYPE _____.

2.4.4.5. Surface Preparation Notes

SURFACE TO BE CLEANED AND POLISHED FOR
VACUUM USE. DO NOT USE ROUGE COMPOUNDS
OR CHEMICALS DURING BUFFING OR POLISHING
ON ITEMS REQUIRING TANK-TYPE LEAK TESTS.

EXTERNAL SURFACE TO BE BUFFED TO .

BEFORE ELECTROPOLISHING, MASK ALL
SURFACES MARKED .

VAPOR DEGREASING PER ASTM D4126, GENERAL SOLVENT GRADE 1,1,1 TRICHLOROETHANE.

2.4.4.6. Testing and Inspection Notes

THIS PART SHALL HAVE A LEAK RATE OF NOT MORE THAN (1×10^{-7} CC/SEC OF HELIUM) WHEN MEASURED BY A CALIBRATED MASS SPECTROMETER HAVING A SENSITIVITY OF (1×10^{-9} CC/SEC WITH GREATER THAN 90% HELIUM) AT A DIFFERENTIAL OF (ONE) ATMOSPHERE OR EQUIVALENT TEST.

RADIOGRAPHIC INSPECTION OF ALL WELDS IN ACCORDANCE WITH MIL-STD-00453.

ULTRASONIC INSPECTION PER MIL-STD-2154, TYPE __ (Insert "I" or "II"), CLASS __. (I = Immersion Method, II = Contact Method.)

For *General Fracture Control Plan for Payloads Using the Space Transportation System (STS)*, refer to GSFC 731-0005-83. One of the following notes should be used for parts requiring etching and/or liquid penetrant inspection:

FRACTURE CRITICAL PART - ETCH AND PENETRANT INSPECT PER GSFC S-313-009, CODE XXXXX.
(Usually used for machined parts.)

FRACTURE CRITICAL PART - DO NOT ETCH PART. PENETRANT INSPECT PER GSFC S-313-009, CODE XXXXX.
(Usually used for rolled parts.)

If areas of a part are to be etched and inspected prior to finish machining, a separate drawing note should call out this requirement to avoid costly mistakes.

2.4.4.7. Threaded Inserts — Cleaning and Installation Notes

Note for aluminum and magnetic surfaces:

CLEAN THREADED INSERTS WITH TRICHLOROETHANE AND BAKE OUT AT 100 DEGREES CELSIUS FOR 3 TO 4 HOURS PRIOR TO INSTALLATION. APPLY DRY FILM LUBRICANT GOVT. DESIGNATION M-6003, TYPE ____ (insert "I" or "II") PER MIL-L-46010 QPL (LIST).
(Type I cure temp. = 150 degrees C.)
(Type II cure temp. = 240 degrees C.)

INSTALL THREADED INSERTS PER XXX.
 (XXX = "MS33537" for coil type,
 "MS51835" for Keen type, or
 "MIL-I-45932/1" for thin wall type.)

INSTALL CLINCH NUTS PER MIL-N-45938/1.

AFTER THE BONDING EPOXY IS CURED PER NOTE _____, ALL ITEM _____ (insert number) THREADED INSERTS SHALL BE CAPABLE OF WITHSTANDING A CORRESPONDING TORQUE LOAD, AS LISTED IN TORQUE TABLE, WITHOUT BECOMING LOOSE. ALL THREADS ON THREADED FASTENERS SHALL BE FREE OF ADHESIVE AND FOREIGN MATERIAL.

TORQUE TABLE	
THREAD SIZE	TORQUE, IN-LBS
6-32 UNC	x.x
...	...
...	...

TAP ALL HOLES PRIOR TO COATING; INSTALL THREADED INSERT AFTER COATING.

2.4.4.8. Miscellaneous Notes

PLACE IN BAG AFTER FINAL ELECTROPOLISHING. BAG SHALL CONFORM TO MIL-P-116, METHOD (see spec.).

ALTERED PART SOURCE INFORMATION:

PART NO.: _____

VENDOR: _____

ADDRESS: _____

MAINTAIN AS MATCHED SET AFTER MACHINING.

Note for NON-flight parts ONLY:

STEEL STAMP, ETCH, OR ENGRAVE (size) HIGH CHARACTER AS SHOWN, X .010 ^{+.005} _{-.000} DEEP.

THIS DRAWING TO BE INTERPRETED IN ACCORDANCE WITH GSFC X-673-64-1F.

RUBBER STAMP (size) HIGH CHARACTER AS SHOWN, USING _____ (insert "INK" or "PAINT") IN ACCORDANCE WITH (specification *).

(* Include manufacturer's part number and address.)

BAG PART PER MIL-P-116, METHOD _____, AND TAG WITH PART NUMBER."

ALTERED SURFACES TO HAVE .

(Refer to paragraph 10.4.1, page 93, for symbol notation.)

FINISH ALL OVER.

(Refer to paragraph 10.4.1, page 93, for symbol notation.)

SURFACE ROUGHNESS AS XXX:

MACHINED SURFACES .

(where XXX is "ROLLED," "EXTRUDED," or "DRAWN").

(Refer to paragraph 10.4.1, page 93, for symbol notation.)

INSIDE CORNERS R _____ MAXIMUM.

UNIT TO BE STRAIGHTENED AND STRESS-RELIEVED AFTER WELDING.

WELDED OR BRAZED FILLETS TO BE CONFINED TO INSIDE SURFACE.

TWINE SHALL CONFORM TO THE REQUIREMENTS OF MIL-T-713, TYPE _____, CLASS _____.

A MANUFACTURER'S CERTIFICATION OF MATERIAL SPECIFICATION COMPLIANCE MUST BE SUPPLIED WITH PART _____ (insert number).

MAGNETIC SPECIFICATION--PERMEABILITY OF LESS THAN _____ (specify units) _____.

COMPONENTS MUST BE PACKAGED AND MARKED IN ACCORDANCE WITH APPLICABLE INTERSTATE COMMERCE COMMISSION (ICC) REGULATION 49-CFR71-78; SHIPMENT SHALL BE MADE DIRECTLY TO THE USING AGENCY. EXPLOSIVE (or other applicable wording) COMPONENTS ARE HAZARDOUS AND MUST BE HANDLED IN ACCORDANCE WITH APPLICABLE SAFETY REGULATION 49-CFR71-78.

2.4.4.9. Informational Notes

Informational notes, such as the following government rights to manufacture note, shall appear adjacent to the right border and Title block of the drawing:

THE XXXX COMPANY, CHICAGO, IL., PART NUMBER XXXX CORRESPONDS TO THE ITEM DEPICTED ON THIS DRAWING, WHICH IS FURNISHED FOR UNRESTRICTED USE IN CONNECTION WITH ANY U.S. GOVERNMENT MANUFACTURE OR PROCUREMENT. SUCH USE IS AUTHORIZED BY THE XXX COMPANY LETTER NO. XXX SIGNED _____ AND DATED _____. NO OTHER USE IS AUTHORIZED.

2.4.5. Local Character Notes

Notes of local character, such as drill notes, thread notes, etc., that require leaders to indicate the features to which they apply, shall be located in the field of the drawing in positions adjacent to such features. Each note shall state the number of features to which it applies unless a leader is drawn to each feature.

2.4.6. General Dimensional Tolerance Notes

The general tolerances entered in the supplementary portion of the Title block shall control all dimensions applied to the drawing, except those specifically labeled "Max," "Min," "Ref," "Datum," or "Basic," or dimensions having tolerances applied directly thereto, or dimensions controlled by notes or documents invoked on the drawing. General tolerances may be changed to the prevalent tolerances that are required by the drawing type. This is done by striking through the tolerance and inserting the new tolerance beneath the old. In the case where metric tolerancing is required, see Section 10.2, subparagraph i, for general tolerances.

2.5. Specification Callouts

Normally, only the basic document number of a specification should be shown on the drawing, in which case, the latest issue in effect at the time of invitation to bid shall be imposed in all procurement actions. Changes to the specification occurring subsequent to the time of invitation to bid shall not be imposed in current procurement actions unless the drawing is revised to show the new issue by basic document number, revisions, amendment, and/or date and current procurement actions amended to specify the new drawing revision or Engineering Order (EO).

If the basic document number, revision, amendment, and/or date of a specification are shown on a drawing, only that particular issue shall be imposed in all procurement actions. Changes to the specification occurring subsequent to the time of invitation to bid shall not be imposed in either current or future procurement actions unless the drawing is revised to show the new issue by basic document number, revision, amendment, and/or date and current procurement actions amended to specify the new drawing revision or EO.

Regardless of whether a specification is shown on the drawing by basic document number only or by a particular issue, superseding specifications (new number) shall not be imposed in either current or future procurement actions unless the drawing is revised to show the new basic document number and, if applicable, issue and current procurement actions amended to specify the new drawing revision or EO.

3. DRAFTING PRACTICES

3.1. General

These drafting practices are to be employed in the preparation of drawings by GSFC personnel to achieve commonality throughout and result in legible reproductions at the least cost from original drawings.

Drawings must be complete and unambiguous in interpretation. Complete drawings contain or make reference to all data necessary for fabricating and installing the part and, when applicable, the necessary test requirements, procurement requirements, and source.

Third-angle orthographic projection shall be used for mechanical engineering drawings. (Certain diagrams, schematics, etc., are excepted.) Although other types of projection, such as isometric, perspective, etc., are not prohibited, their use must be confined to an auxiliary view on a drawing of a complex part when such a view shall aid in visualizing the part.

Drawings need not have three views, (i.e., one or two views are permissible for objects that can be completely defined). Complementary notes or dimensions are acceptable in place of the additional views. The rule shall be that only those views shall be drawn that are necessary to convey the required characteristics of the part. Views, dimensions, etc., shall not extend into the margins of the drawing.

3.2. Lines

Acceptable quality of reproductions is dependent on the density and uniformity of line work (and lettering). Types of lines described herein are merely line conventions, but in every case, each type of line shall be opaque and of uniform width and shall be used on all drawings other than diagrams, such as schematics, etc.

3.2.1. Ink Lines and Plotted Lines

Lines, whether hand-drawn or plotted, shall be opaque and of uniform width for each type of line. Two widths of lines, i.e., thin and thick, with their widths in the proportions of 1:2, shall be used. The actual width of each type of line shall be governed by the size and style of the drawing; the relative widths of the lines shall approximate those shown in Figure 4 on page 26.











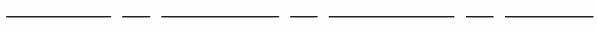

CENTER LINE		THIN
DIMENSION		THIN
LEADER		THIN
BREAK (LONG)		THIN
SECTION AND EXTENSION LINE		THIN
PHANTOM		THIN
HIDDEN		THIN
STITCH LINE		THIN
DATUM LINE		THICK
OUTLINE OR VISIBLE LINE		THICK
BREAK (SHORT)		THICK
CUTTING PLANE OR VIEWING PLANE		THICK
CUTTING PLANE FOR COMPLEX OR OFFSET VIEWS		THICK

Figure 4: Line Types and Conventions

3.2.2. Pencil Lines

Pencil lines shall be opaque and of uniform width throughout their length.

The line widths which are specified for ink lines do not apply to pencil lines. Cutting and viewing plane lines are the thickest lines on the drawing. However, the thick lines used for outlines and other visible lines shall be sufficiently prominent to immediately differentiate them from lines used for other purposes. Hidden, sectioning, center, phantom, extension, dimension, and leader lines shall be thinner than outlines. In selecting the widths of pencil lines, consideration shall be given to the medium of reproduction involved to ensure proper reproduction and reduction of the thinner lines.

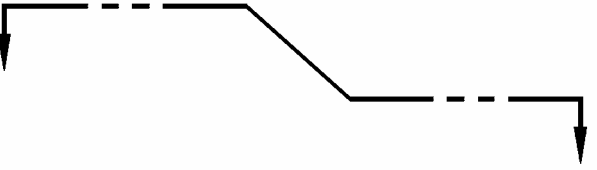
3.2.3. Types of Lines

3.2.3.1. Center Lines

Center lines shall be composed of long and short dashes, alternately and evenly spaced, with a long dash at each end. Center lines shall cross without voids. See Figure 5, below, and Figure 6, page 28.

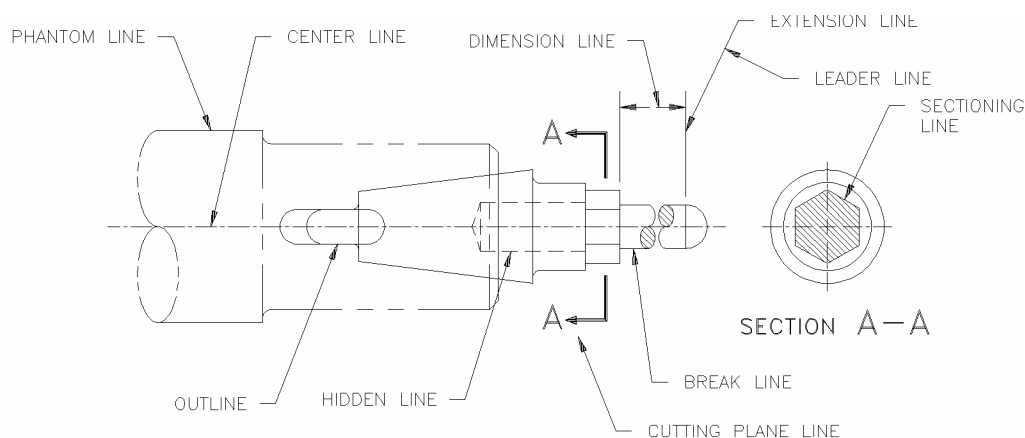

Figure 5: Line Conventions

Very short center lines may be unbroken if there is no confusion with other lines. Center lines shall also be used to indicate the travel of a center. See Figure 6 on page 28.

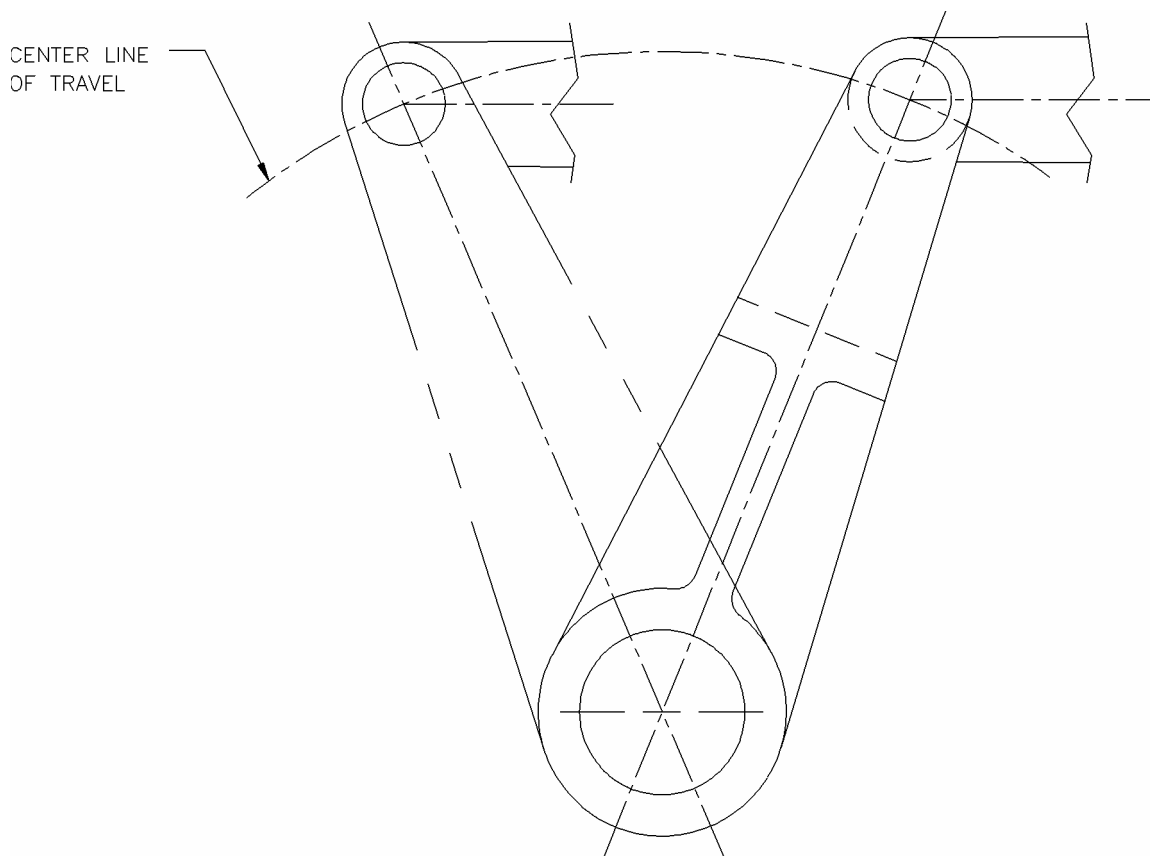

Figure 6: Alternate Position

3.2.3.2. Dimension Lines

Dimension lines shall terminate in arrowheads at each end. They shall be unbroken except where space is required for the dimension. The proper method of showing dimensions and tolerances is explained in Section 1.7 of ANSI Y14.5M-1982.

3.2.3.3. Leaders

Leaders shall be used to indicate a part or portion to which a number, note, or other reference applies and shall be an unbroken line terminating in an arrowhead, dot, or wavy line. Arrowheads should always terminate at a line; dots should be within the outline of an object.

3.2.3.4. Break Lines

Short breaks shall be indicated by solid freehand lines. For long breaks, full ruled lines with freehand zigzags shall be used. Shafts, rods, tubes, etc., which have a portion of their length broken out, shall have the ends of the break drawn as indicated in Figure 7 on page 29.

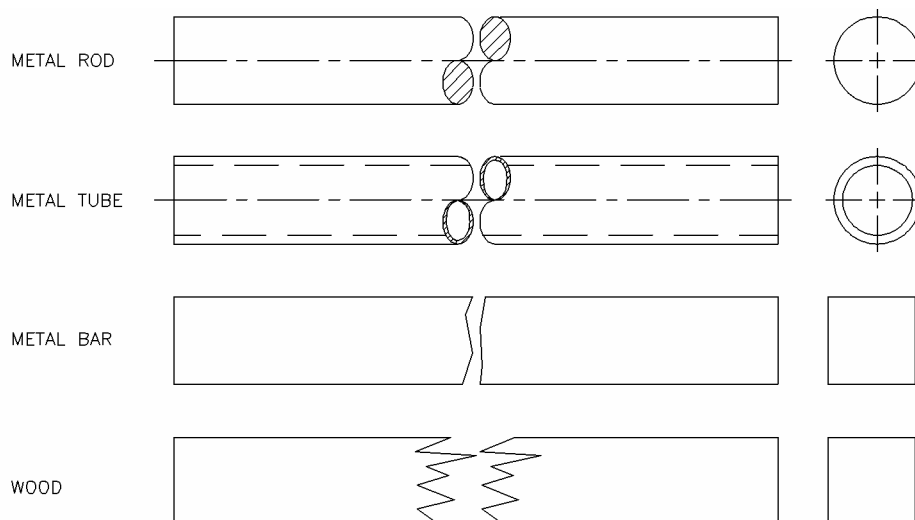

Figure 7: Break Lines

3.2.3.5. Phantom Lines

Phantom lines shall be used to indicate the alternate position of parts of the item delineated, repeated detail, or the relative position of an absent part and shall be composed of alternating one long and two short dashes, evenly spaced, with a long dash at each end. See Figure 5 on page 27, Figure 6 on page 28, and Figure 8, below.

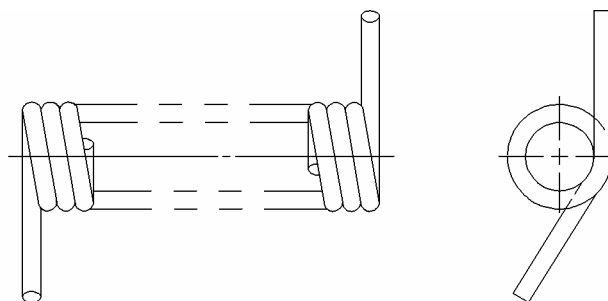

Figure 8: Repeated Detail

3.2.3.6. Sectioning Lines

Sectioning lines shall be used to indicate the exposed surfaces of an object in a sectional view. They are generally thin full lines, but may vary with the kind of material shown in section.

3.2.3.7. Extension Lines

Extension lines are used to indicate the extension of a surface or to point to a location outside the part outline. They start with a short, visible gap from the outline of the part and are usually perpendicular to their associated dimension lines.

3.2.3.8. Hidden Lines

Hidden lines shall consist of short dashes, evenly spaced. These lines are used to show the hidden features of a part. They shall always begin with a dash in contact with the line from which they begin, except when such a dash would form a continuation of a full line. Dashes shall touch at corners, and arcs shall begin with dashes on the tangent points. See Figure 5 on page 27 and Figure 8 on page 29.

3.2.3.9. Stitch Lines

Stitch lines shall be used to indicate the stitching or sewing lines on an article and shall consist of a series of very short dashes, approximately half the length of dash or hidden lines, evenly spaced. Long lines of stitching may be indicated by a series of stitch lines connected by phantom lines.

3.2.3.10. Outlines or Visible Lines

The outline or visible line shall be used for all lines on the drawing representing visible lines on the object; see Figure 5 on page 27.

3.2.3.11. Datum Lines

Datum lines shall be used to indicate the position of a datum plane and shall consist of one long dash and two short dashes, evenly spaced.

3.2.3.12. Cutting-Plane/Viewing-Plane Lines

The cutting-plane lines shall be used to indicate a plane or planes in which a section is taken. The viewing-plane lines shall be used to indicate the plane or planes from which a surface or surfaces are viewed. On simple views, the cutting planes shall be indicated as shown in Figure 9 on page 31. View shall be shown in back of the cutting plane (3rd angle).

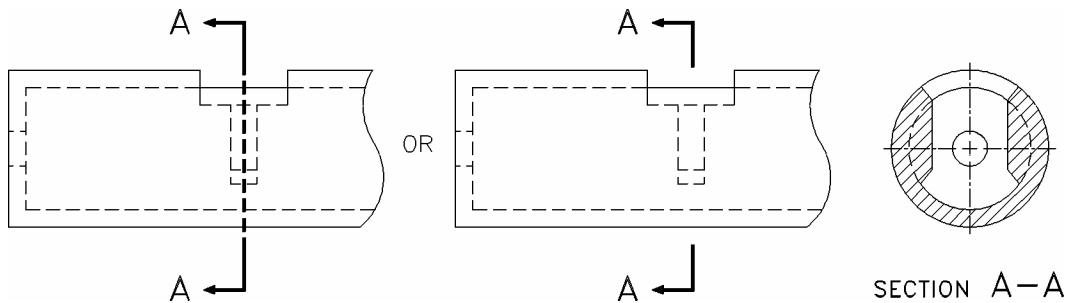

Figure 9: Full Sectional View

On complex views, or when the cutting planes are bent or offset, the cutting planes shall be indicated as shown in Figure 10.

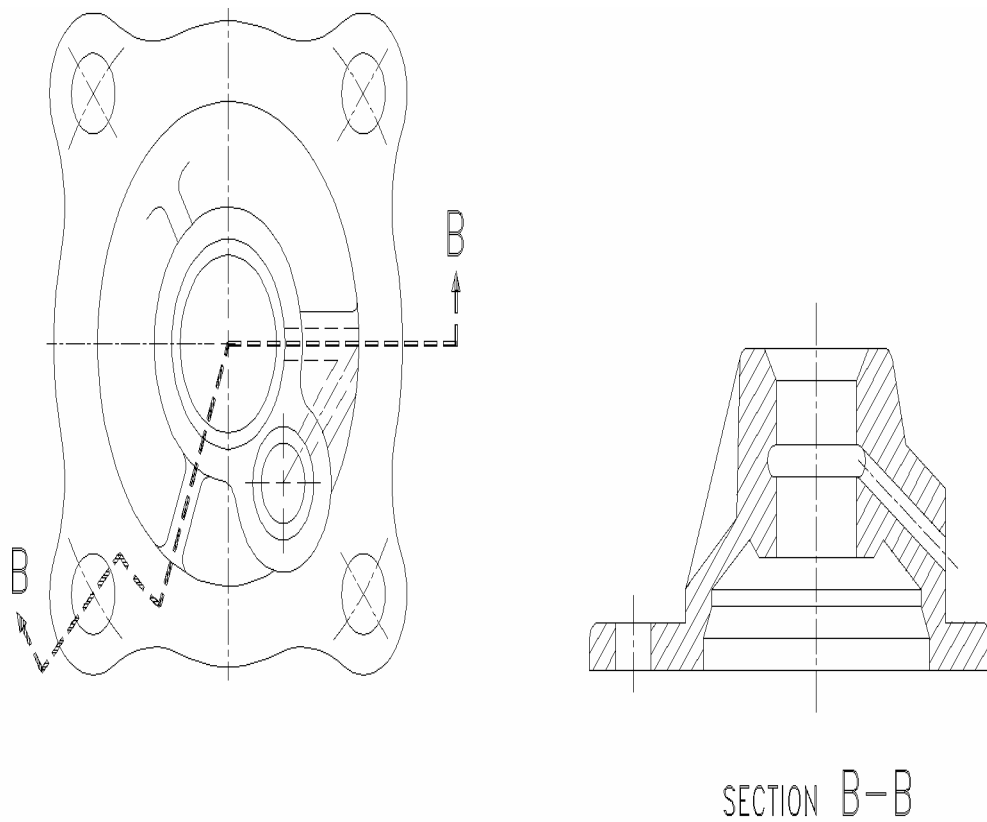

Figure 10: Offset Sections

3.3. Lettering and Numerals

All lettering shall be uppercase (capital letters). Numbers shall be Arabic numerals. The lettering and numerals shall always be placed in a horizontal reading position as far as practicable. Other than this, lettering shall be in a horizontal reading position when the drawing is rotated 90° clockwise. Legible lettering is essential for reproductions. Letters and/or numerals shall not run together.

When typewritten letters or digits are used on drawings or related data, nothing smaller than pica type is permitted.

3.3.1. Style

Other than being uppercase Roman and placed in a horizontal reading position, the lettering is that of the individual's style.

3.3.2. Heights

Lettering heights shall be as follows:

Drawing Feature:	Lettering height in inches
Drawing number in identification blocks	.25
Drawing title and description of drawing type above L/M	.25
Drawing subtitle, border, letters, and numerals	.19
Section, detail, view, and tabulation letters	.25
Description titles of section, detail, view, notes, and tabulations	.19
Dimensions, tolerances, limits, notes, subtitles, tables, revision, and zone letters on the field of the drawing	.16
List of materials information, name blocks, used on, and next assy	.14

Note: Use of fit text is not allowed.

3.4. Scale

Drawings shall be made to full scale unless the parts (or assembly) are too large to permit it or so small and complex that drawing to an enlarged scale is essential for clarity. When the main views of large parts are drawn to a reduced scale, the detail views "taken" to clarify detail should be made to full scale whenever possible. When the part has been drawn to an enlarged scale for clarity, it is not necessary to make an actual-size view.

- a. The scales preferred for engineering drawings are full size 1/1, reduced 1/2, 1/4, 1/10, 1/20, and enlarged 2/1, 4/1, 10/1, 20/1. The computer data base for the format size shall be 1/1 at all times.

EXCEPTION:

Certain drawings or figures, by their very nature, cannot be drawn to a specific scale (for example, wiring and schematic diagram drawings.) The scale designation for these cases is "NONE." See "b," below.

- b. The scale, as noted above, or the word "NONE" must be entered in the Title block. Do not use the word "SIZE" following the ratio. The notations "1/4 & NOTED" or "1/2 & NOTED," etc., apply to those drawings on which the main views are to a reduced scale and auxiliary views are to some other scale.
- c. To maintain consistency with title block callout for scale, detail views shall be noted thus:

DETAIL - A
SCALE 1/1

Note:

The scale of the view shall be stated only when it differs from that noted in the Title block, which represents the majority of views and sections.

- d. Original pencil drawings should be to scale within 0.03 inch. When changes to an existing drawing take place, it is required to indicate that a particular feature is not to scale by underlining the dimensions with a straight line.
- e. The geometry of CAD-produced drawings shall be entered into the electronic database at one-to-one (full) scale.

3.5. Positioning the Part on the Drawing

Installations shall usually be positioned on the drawing as they would be seen when viewed from the left side or top side of the equipment with its forward end pointing to the left.

If clarity can be greatly improved by a position that results in fewer hidden lines and foreshortened projections, then that position should be used, and the above rule should be disregarded. Such instances would be a door or door jamb which installs on the right side being drawn with the forward portion to the right, or a number of items installed on the forward side of a panel being drawn looking at the forward side.

Parts and minor assemblies are not necessarily drawn in the position they assume in the equipment. They may be drawn with some surface, side, or reference line parallel or perpendicular to the lower border of the drawing. Lathe-turned parts are usually drawn with the larger diameters to the left.

3.5.1. Picturization

Unnecessary detail shall be omitted from all views and sections if clarity is not sacrificed and if drafting time is reduced. See Figure 11 on page 34.

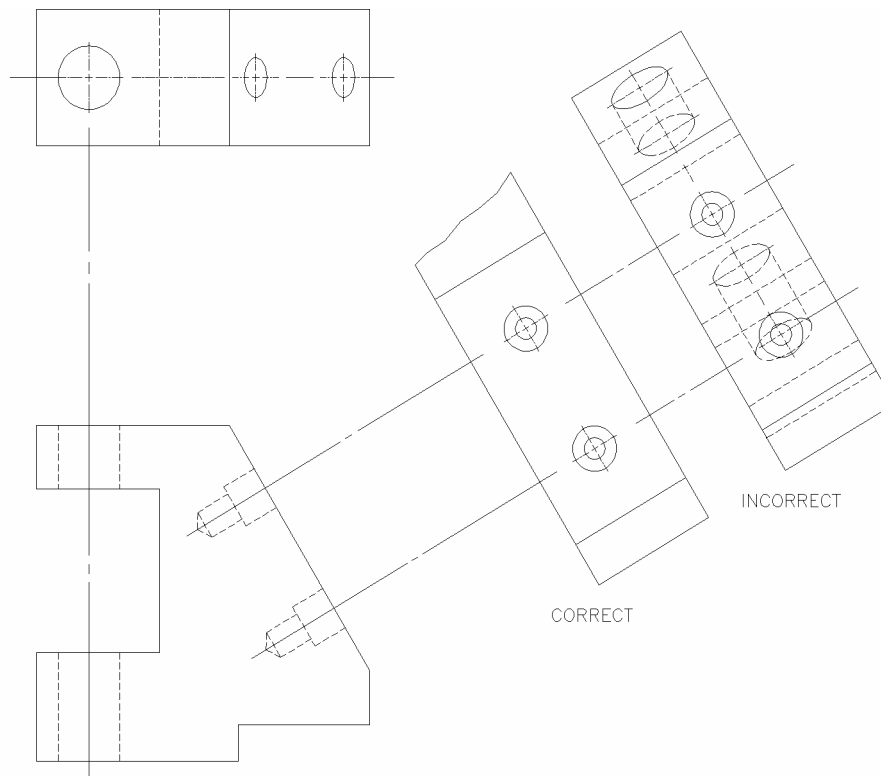

Figure 11: Details of Auxiliary

3.5.2. Sections

- a. A sectional view shall be made through an outside view and not through another sectional view. See Figure 12 on page 35.
- b. The location of a section is indicated by a cutting plane with reference letters and arrowheads showing the direction in which the section is viewed.
- c. Sectional views shall not project directly ahead of the cutting-plane arrowheads and should be as near as practicable to the portions of the drawing that they clarify.
- d. The axes of sectional views should not be rotated; however, the cutting plane may vary in direction (see Figure 12). If views have to be rotated, the angle and direction of rotation must be given.
- e. Visible and invisible outlines beyond the cutting plane should not be shown unless necessary for clarification.
- f. Shafts, bolts, nuts, etc., which are in a cutting plane should not be cross-hatched.

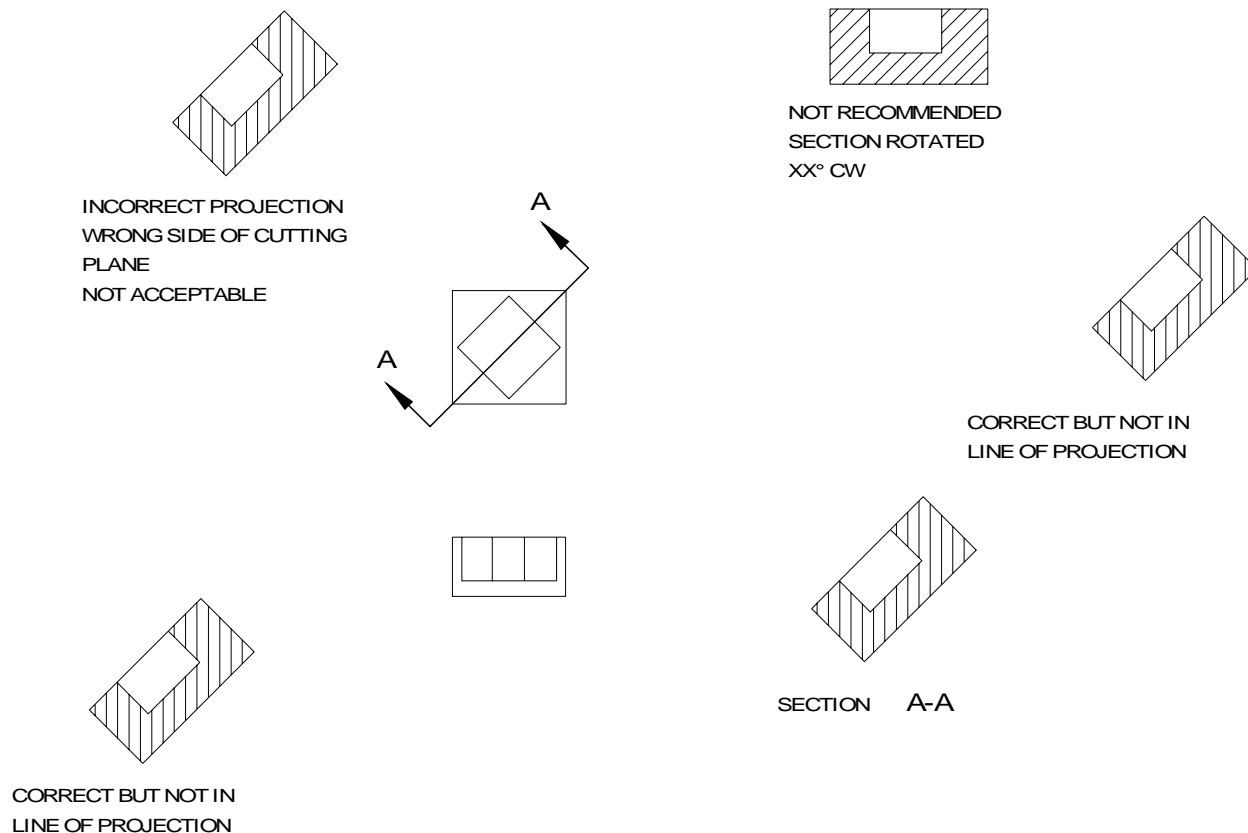
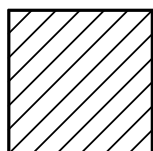

Figure 12: Designation and Positioning of Sectional Views

- g. The cross-hatching symbol for cast iron should be used regardless of material as shown in Figure 13. If essential for clarity, material from which the parts are made should be indicated by the conventions given in ANSI Y14.2M-1979.



CAST OR MALLEABLE
IRON AND GENERAL USE
FOR ALL MATERIALS

Figure 13: Conventions for Material

- h. When sections are remotely located, zone information shall be added to both locations (i.e., from where the section is taken and to the location where the section is shown).

3.5.3. Views

A view is used to enlarge or clarify a portion of the drawing. See Figure 14.

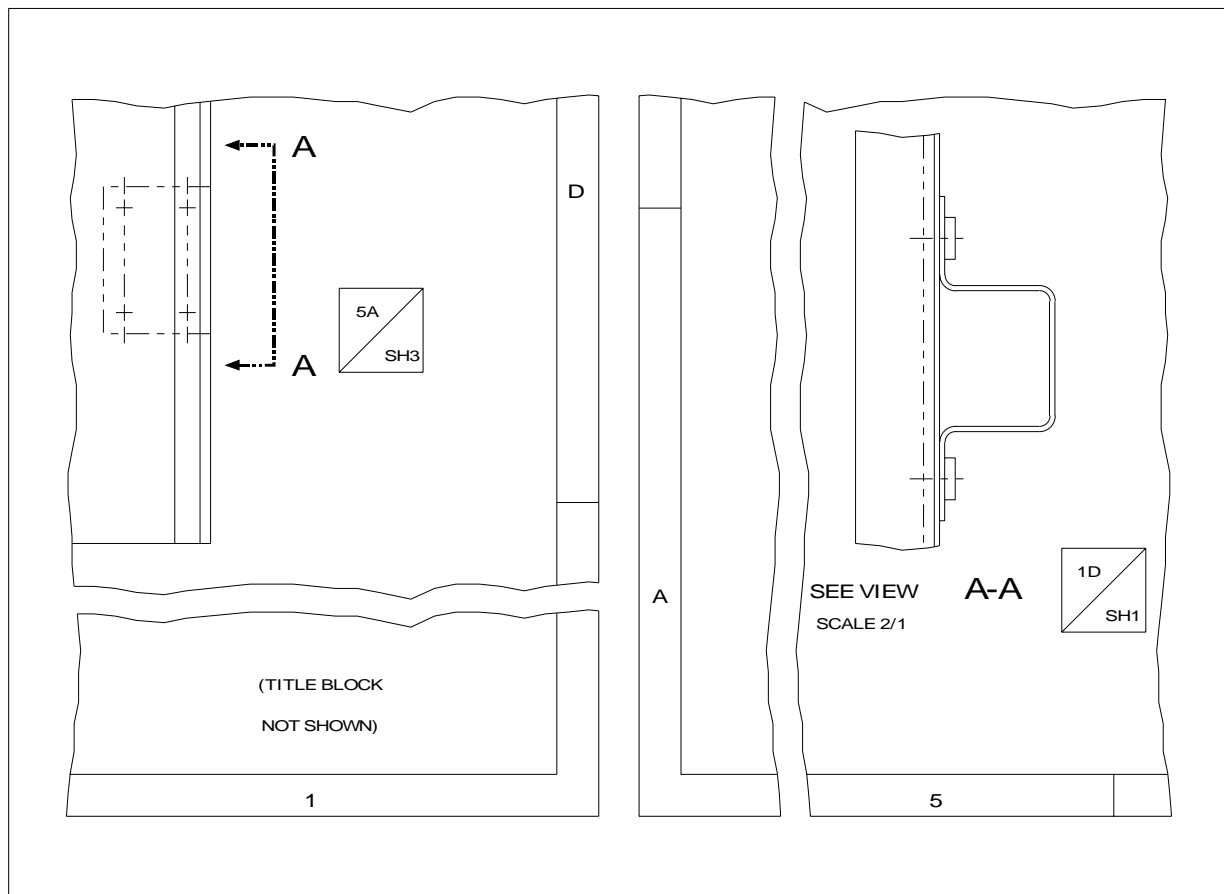

Figure 14: Clarification of a Portion of a Drawing

- a. Projected views which are shown along common center lines to their origin need not be identified. Views located directly ahead of viewing plane arrowheads are absolutely prohibited.
- b. “Transported” views or sections are those which are not direct projections. They must be identified where shown, by letters, and at their origin by the cutting plane lines and letters.
- c. Views should not be rotated; however, if views have to be rotated for a legitimate reason, the angle and direction of rotation must be given.

3.5.4. Details

A detail is a partial view which shows a portion of another view in the same plane and will usually depict greater detail. Details should not be rotated. See Figure 15.

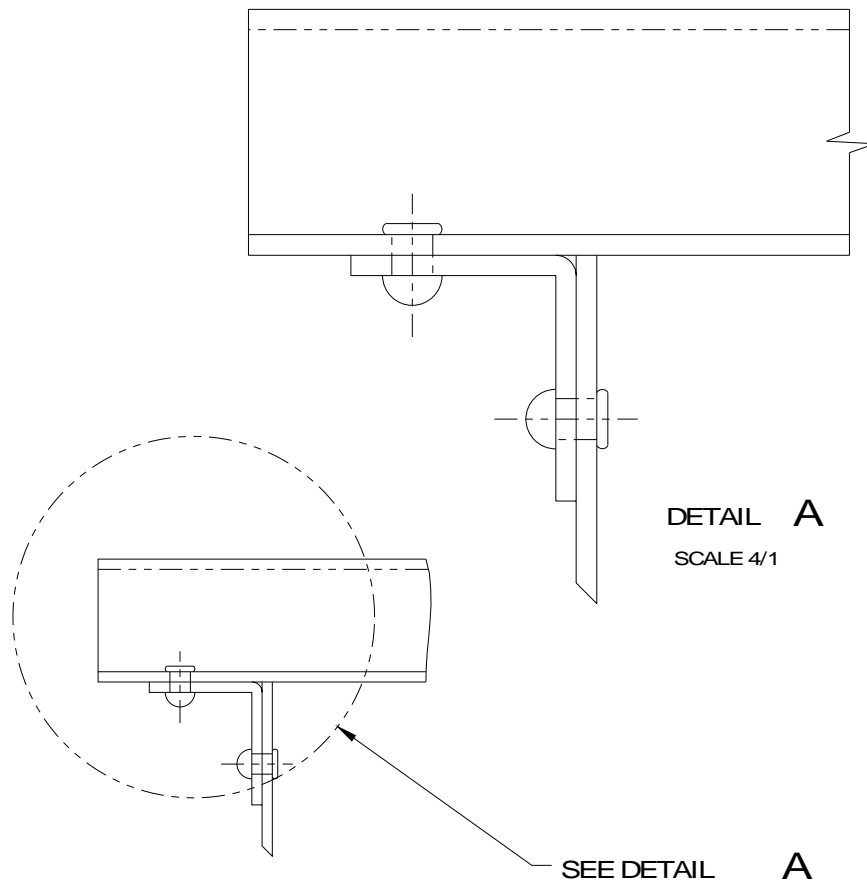

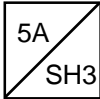

Figure 15: Identification of Details

3.5.5. Identification of Sections, Views, and Details

- Identifying letters for sections, views, and details are assigned in alphabetical sequence as follows: For sections and such views as "A-A" in Figure 14 on page 36, use hyphenated letters. After "Z-Z," begin: "AA-AA," "AB-AB," etc.
- For encircled details such as detail "A" in Figure 15, use single letters. After "Z," begin: "AA," "AB," etc.
- The letters "I," "O," "Q," and "X," either as a single letter or as double-letter entries, shall not be used. A designated letter or combination of letters on a released drawing shall not be used for another section, view, or detail on the same drawing.

3.5.6. Locating Sections, Views, and Details

On zoned and/or multisheet drawings, a view, section, or detail and the portion of the drawing it clarifies shall be cross-referenced as follows:

Reference on Original Drawing to View on Clarifying Sheet	Reference at View on Clarifying Sheet to Original Drawing
SEE VIEW A-A 	VIEW A-A  SCALE 4/1

Note: Zone block size is 1/2-inch square.

4. TYPES OF DRAWINGS

4.1. Altered or Selected Vendor Part Drawing

Altered vendor part or selected vendor part drawings shall be prepared on GSFC format when an existing vendor part cannot be used as is and it is desired to document and control the alteration or selection of the part. Preparation shall not be initiated until the vendor has been requested to make the alteration or selection, supply his number, and supply documentation. When the drawing is prepared by GSFC, it shall specify the part to be altered or selected by vendor number, name, and address and shall completely delineate the alteration or selection. In addition, the drawing shall specify reidentification of the part by the GSFC part number. An altered or selected vendor part drawing shall be identified by the words "Altered Vendor Part Drawing" immediately above the Title block. See Figure 16.

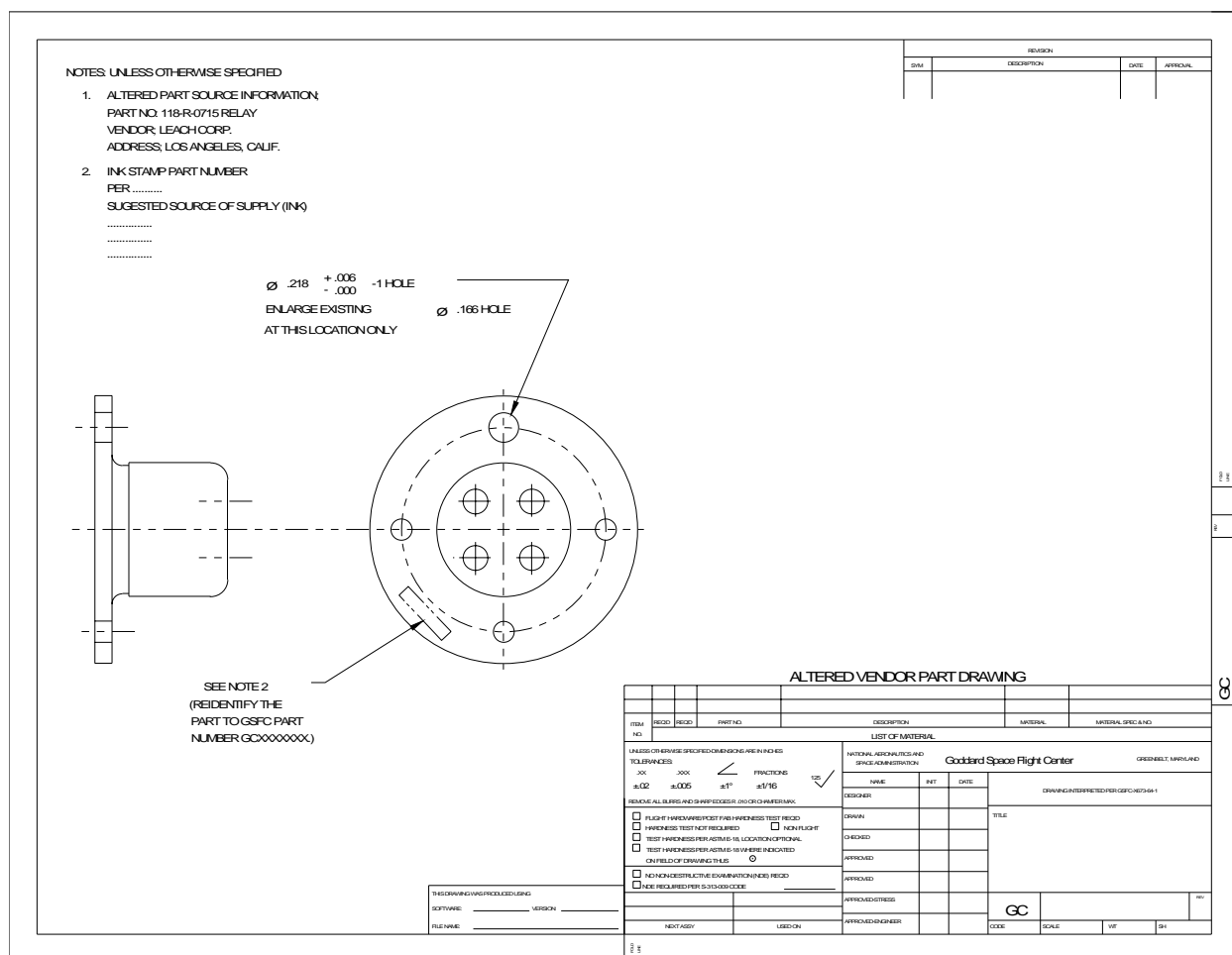

Figure 16: Sample Altered or Selected Vendor Part Drawing

4.2. Assembly Drawing

An assembly drawing shows two or more separable parts joined to form a stockable item, or a group of assemblies required to form an assembly of higher order. Figure 17 shows an example of an assembly drawing when a separate parts list is required. Figure 34, "Assembly Drawing With List of Material," on page 80, shows an assembly drawing with the List of Material on the drawing. Refer also to Section 5.1, "Part Numbering," on page 61.

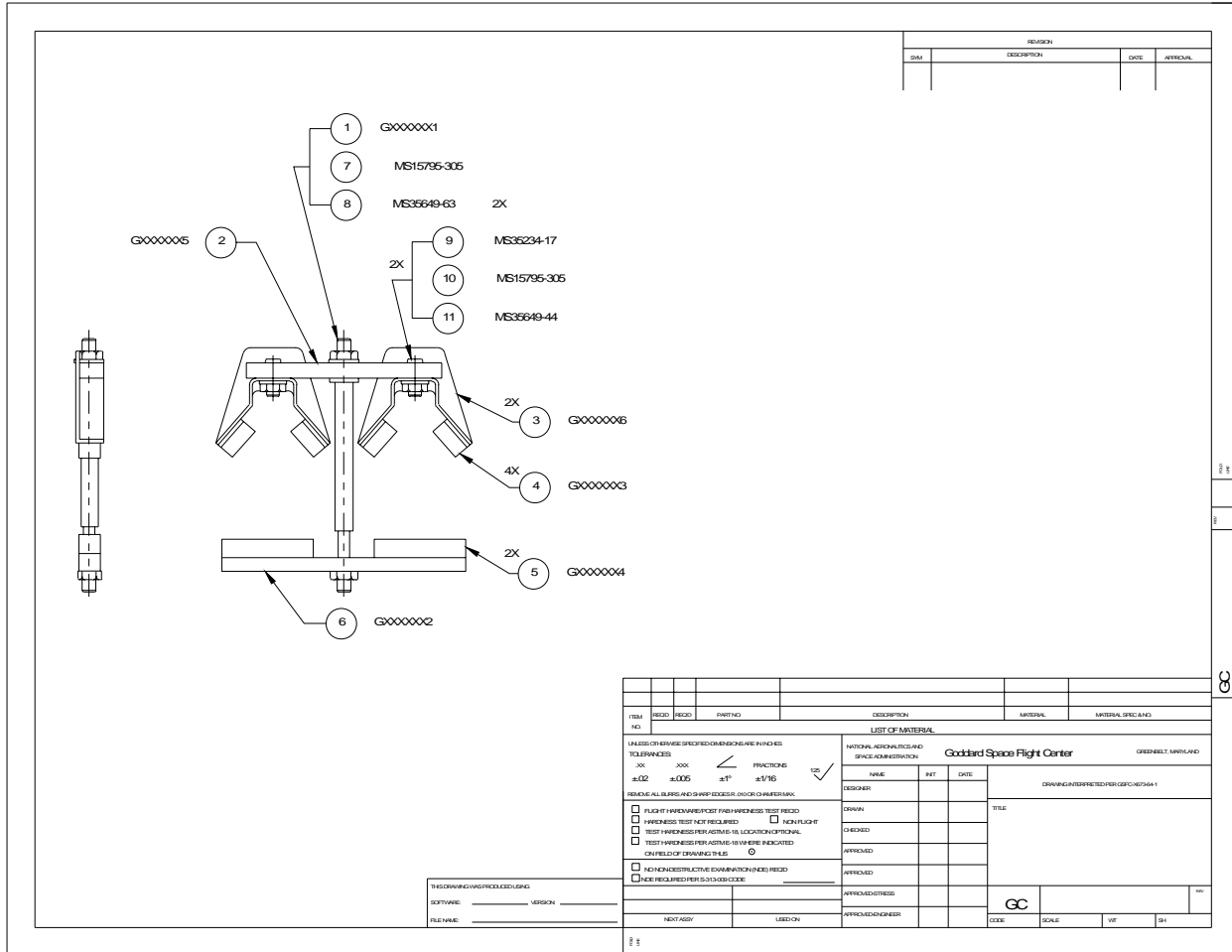

Figure 17: Sample Assembly Drawing

4.3. Detail Drawing

A detail drawing shows all the information necessary for fabricating an item, including the material from which it is made and those finishes, protective coatings, and processes required to fabricate the end product. Only one item (detail part) shall be presented per drawing. See Figure 18.

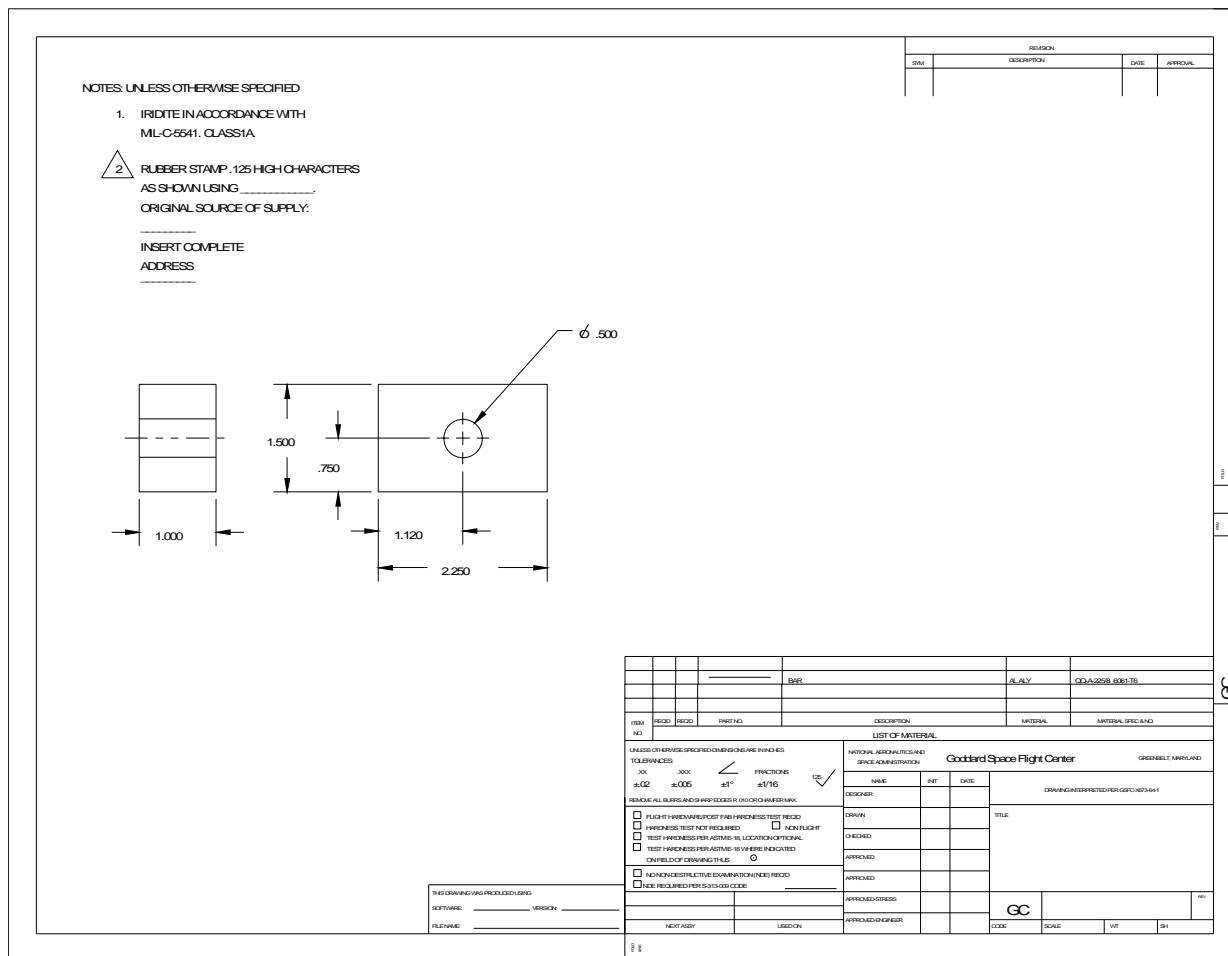

Figure 18: Sample Detail Drawing

In the case of inseparable parts (such as those that are welded, riveted, bonded, or brazed, etc.) which form an integral unit (part) not capable of being disassembled for replacement, refer to paragraph 4.6 entitled “Inseparable Assembly Drawing” on page 44.

Multidetail drawings are not allowed. The GSFC requires a unique drawing number per part so that each part can be individually estimated by fabricators and identified for inspection and configuration tracking.

4.4. Drawing Tree

A drawing tree is used to control the development of drawings and their place in the overall scheme of the project. Although this type drawing is not a requirement for each project, when used properly and kept up to date, it can be a valuable management aid and can be contained in a configuration management database. See Figure 19.

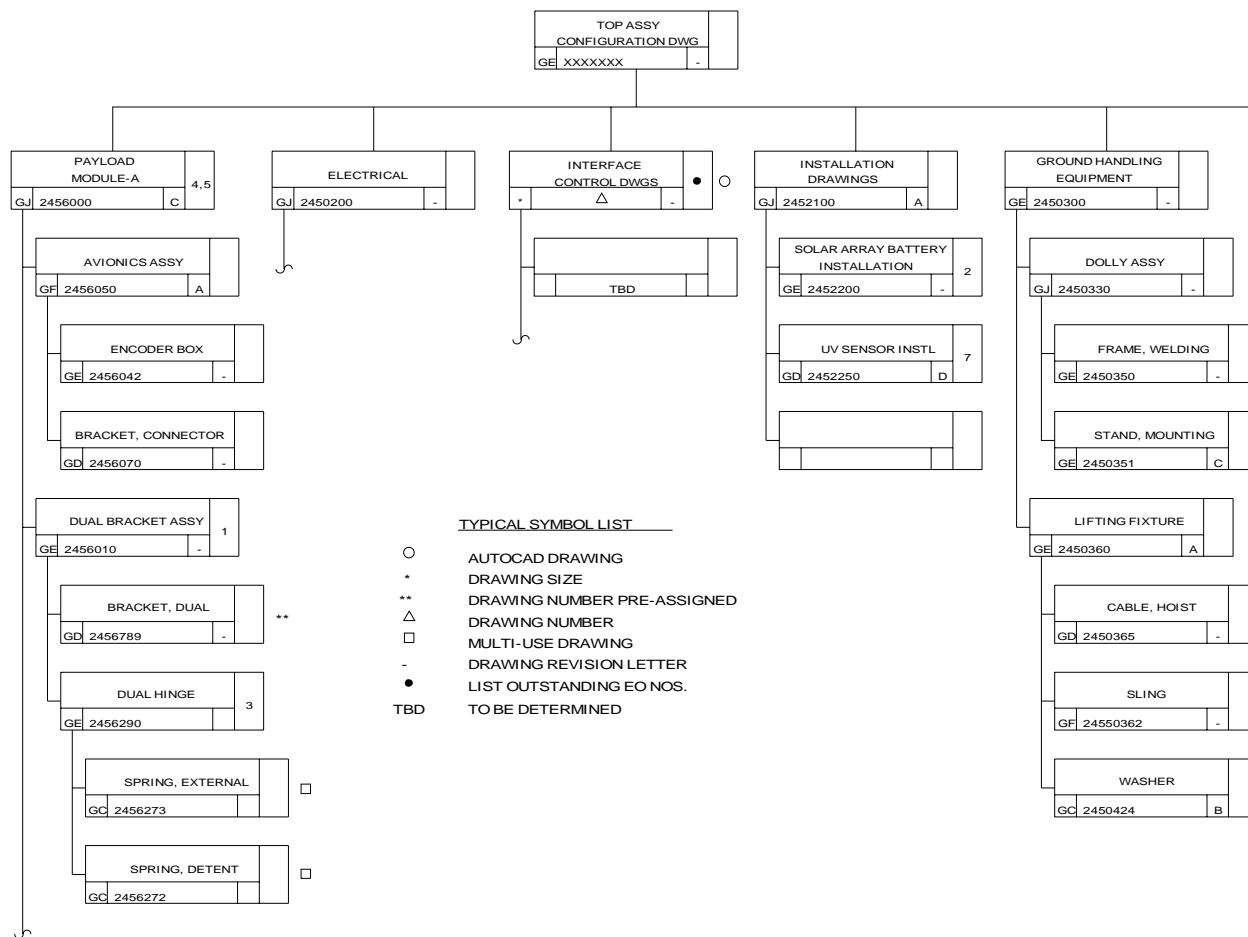

Figure 19: Sample Drawing Tree

4.5. Electrical/Electronic Drawings

Electrical/electronic drawings are prepared to depict schematics, wiring diagrams, cable interconnections, and detailed cable assembly drawings.

4.5.1. Electrical and Electronic Symbols

Application: Symbols shall be in accordance with ANSI Y32.2-1975, *Graphic Symbols for Electrical and Electronic Diagrams* (or later revisions), unless otherwise noted.

Graphic electrical wiring symbols for architectural and electrical layout drawings shall conform to ANSI Y32.9-1972, *Graphic Symbols for Electrical Wiring and Layout Diagrams Used in Architecture and Building Construction* (or later revisions).

4.5.2. Electrical and Electronic Diagrams

Application: Diagrams shall be in accordance with ANSI Y14.15-1966 (R-73) *Electrical and Electronic Diagrams* (or later revisions); ANSI Y14.15a-1971, *Interconnection Diagrams*, subsection 15-11; ANSI Y14.15b-1973, *Electrical and Electronics Diagrams*, subsections 15-1 through 15-10, and 15-12.

4.6. Inseparable Assembly Drawing

An inseparable assembly drawing delineates items (pieces) which are separately fabricated and are permanently joined together (e.g., welded, brazed, riveted, nailed, bonded, etc.) to form an integral unit (part) not capable of being readily disassembled. An inseparable assembly drawing may be prepared in lieu of individual monodetail drawings for inseparable assemblies intended to be procured and replaced as a unit, where (except for standard hardware) the separate parts are of similar or compatible materials. See Figure 20 (all data, such as notes and list of material, are not shown).

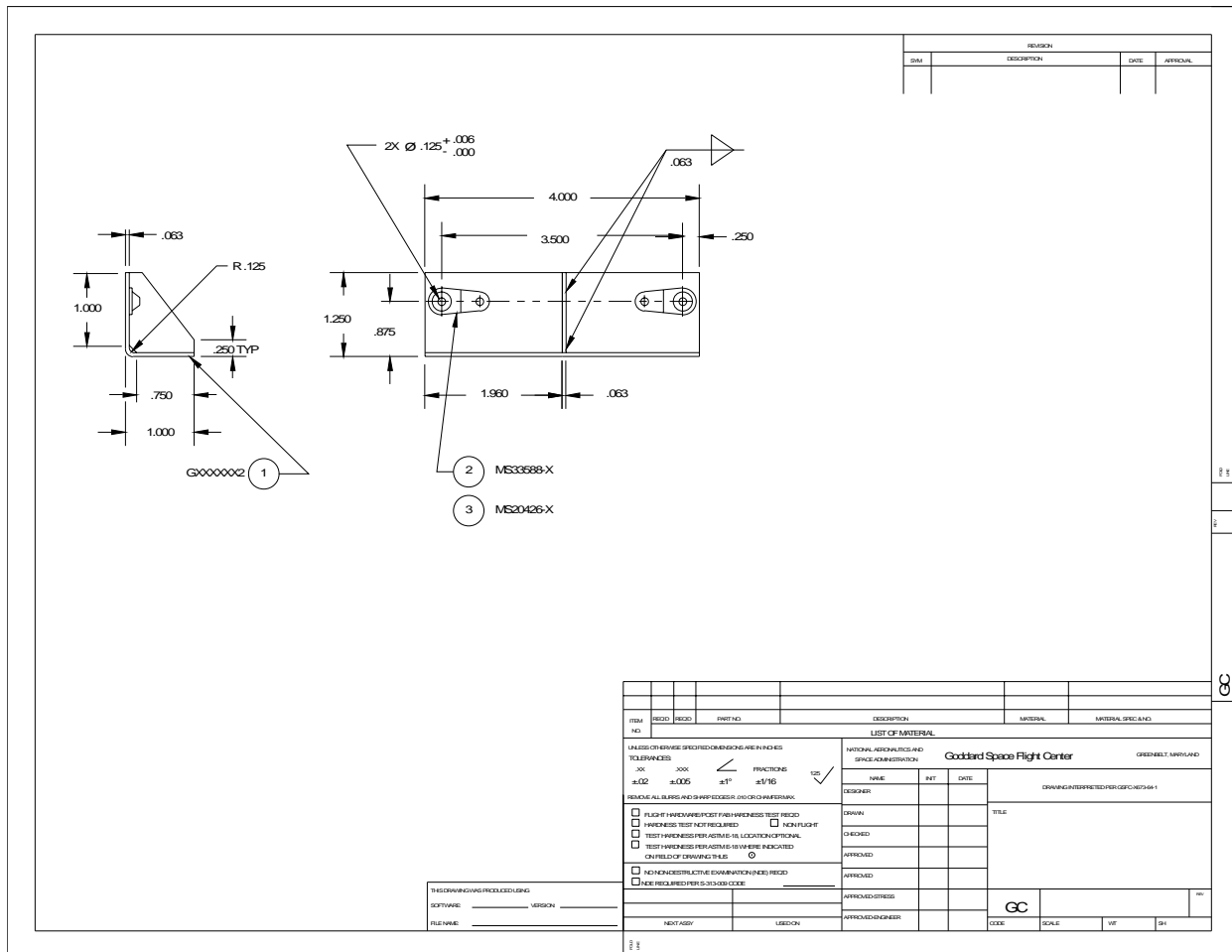

Figure 20: Sample Inseparable Assembly Drawing

An inseparable assembly drawing shall fully define the end product or detail assembly as assembled. Pieces of the inseparable assembly may be detailed either on separate detail drawings or on the inseparable assembly drawing itself. In the case of weldments, the parts shall not be individually detailed on separate drawings (due to the consumable material allowances that would have to be shown on detail drawings), except in cases where extensive machining might be necessary.

4.7. Installation Assembly Drawing

An installation assembly drawing shows where and how parts and/or assemblies are installed relative to supporting structure or associated items. It shows locating dimensions, tolerancing, specifies attaching parts (such as rivets, bolts, or screws) and specific adjustments, assembly instructions, and processes required for completing and inspecting the installation. Figure 21 shows an example when a separate parts list is required.

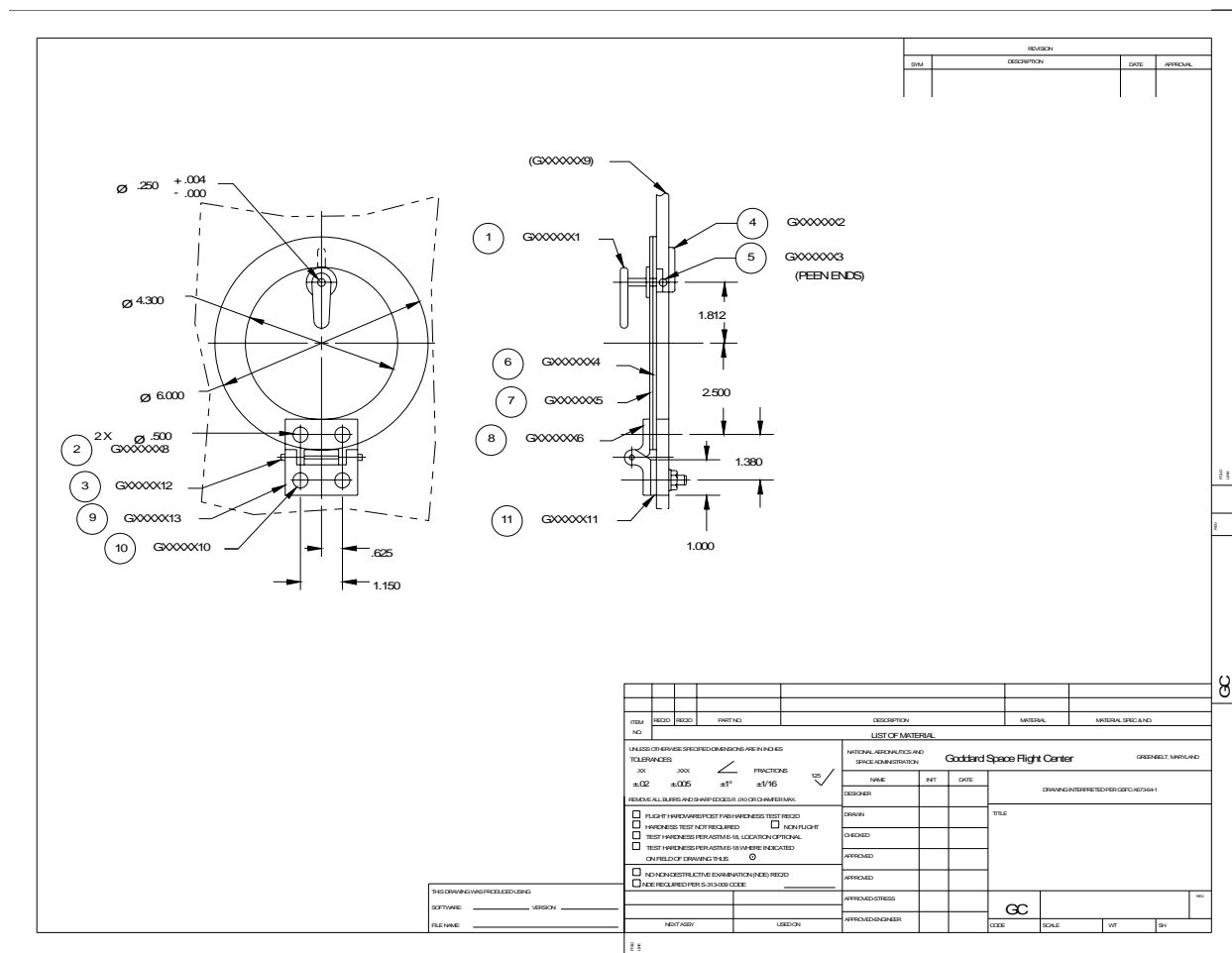

Figure 21: Sample Installation Assembly Drawing

- That portion of the structure into which the installation is being installed shall be shown in phantom and identified by its part number. Such identifications shall be indicated as reference information by enclosure of the part number in parentheses or by use of the symbol "REF."
- Applicable datum points or planes, such as center lines of structure, plane of symmetry, station planes, etc., shall be shown and identified.
- Parts may be detailed in place on installation drawings when convenient.

4.8. Interface Control Drawing

An interface control drawing shall be used to maintain compatibility of all physical and functional designs between different engineering design activities. The drawing shall communicate design criteria such as dimensions, hole and/or bolt sizes, hardware, and ultimate changes relative to cofunctioning systems. "Interface Control Drawing" shall be added directly above the Title block. No list of materials is permitted on this type of drawing; it is not to be used to manufacture parts. See Figures 22a, below, and 22b on page 48.

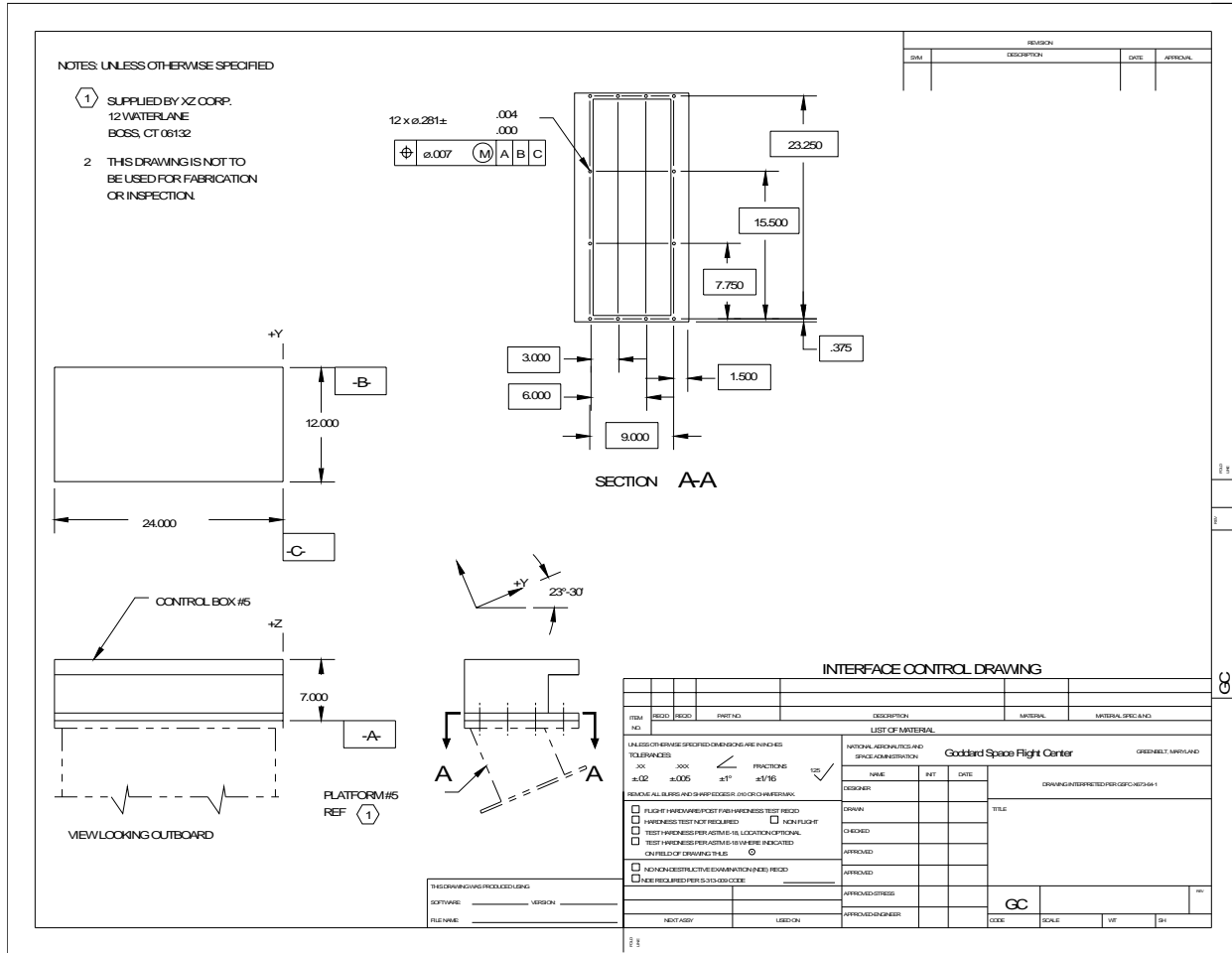

Figure 22a: Sample Interface Control Drawing

Figure 22b: Sample Interface Control Drawing
 Note: Format is too small. No information should appear beneath revision block or above list of material. Choose a larger format in this case.

4.9. Matched-Set Drawing

A matched-set drawing depicts parts that are machine-matched or otherwise mated and for which replacement as a matched set or pair is essential. The operating or mating characteristics of the matched parts (set) shall be indicated. The parts shall be uniquely marked with a serial number identification to indicate a matched set. See Figure 23 (all data required for the finished drawing are not shown).

The drawing title becomes an assembly, although the parts are not actually attached. “Maintain and Furnish Only As A Matched Set” shall be added directly above the Title block or List of Material.

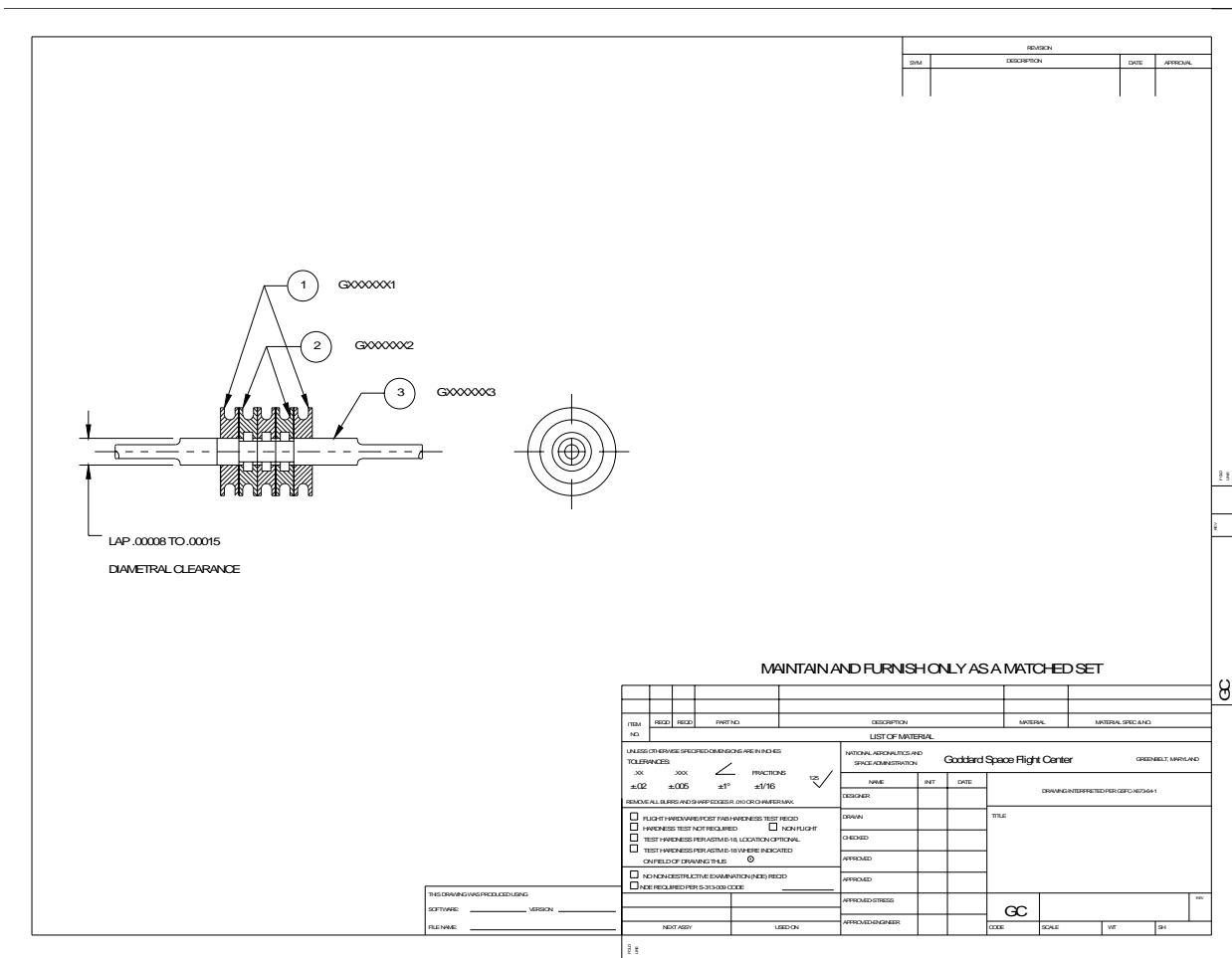

Figure 23: Sample Matched-Set Drawing

4.10. Mechanical Schematic

A mechanical schematic diagram drawing illustrates the operational sequence or arrangement of a mechanical device. Dimensions and relative sizes of items may be shown to indicate mechanical relationship. See Figure 24.

4.11. Modification Drawing

Modification drawings delineate changes to delivered items, stockable items (e.g., Standard Part Drawing of honeycomb panel blanks), assemblies, installations, or systems. Drawings are prepared to add, remove, or rework items, equipment installations, or systems to satisfy the using activity's requirements. They also incorporate mandatory changes (e.g., safety, reliability, or application extension) in delivered equipment. A modification drawing shall be identified by the words "Modification Drawing" immediately above the Title block. This type of drawing has also been known or referred to as a "Make From Drawing."

4.12. Outline Drawing

An outline drawing is a drawing that defines the external contour of an item, usually by showing the projected views in two or three perpendicular planes. Two types of outline drawings are depicted in Figures 25a, below, and 25b on page 52.

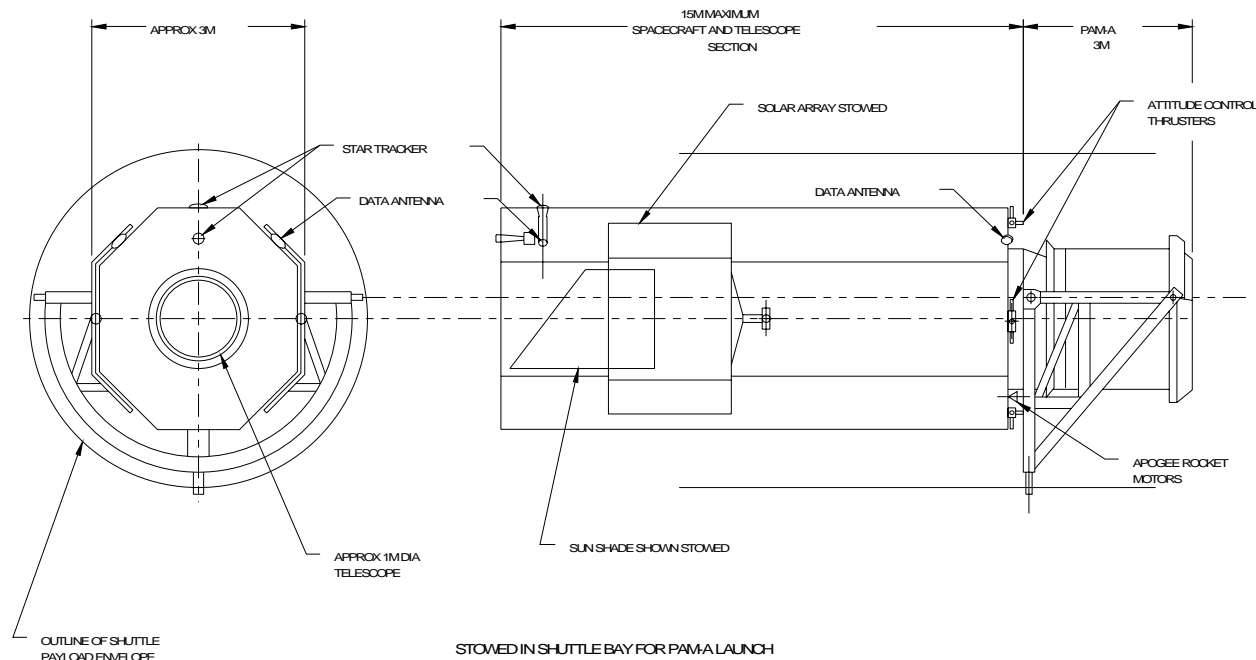

Figure 25a: First Sample Outline Drawing

SHUTTLE TRANSPORTATION SYSTEM

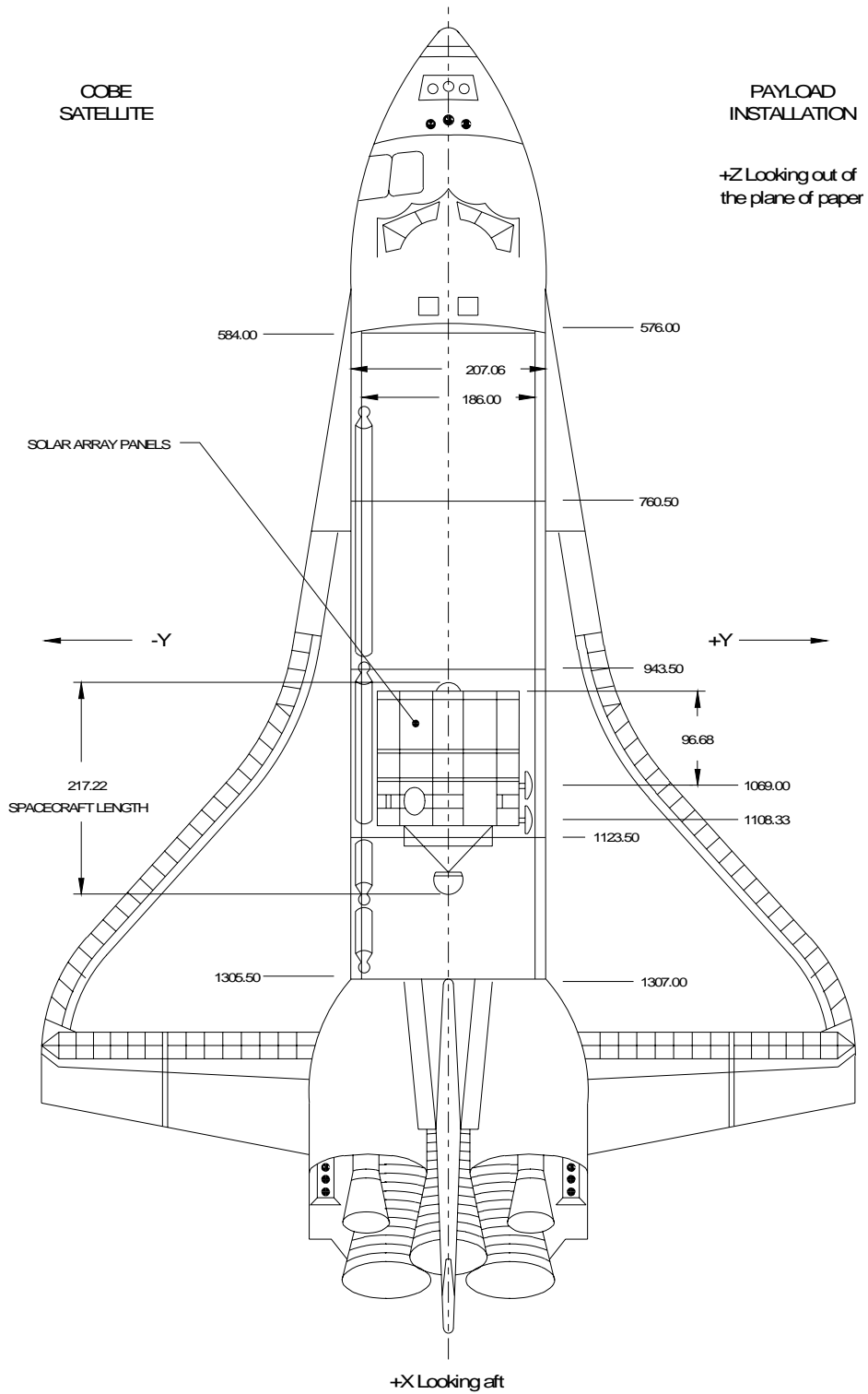

Figure 25b: Second Sample Outline Drawing

4.13. Source Control Drawing

A source control drawing shall be used to limit procurement of a vendor-designed and manufactured part (or assembly) to that source or sources that exclusively provide the performance, installation, and interchangeable characteristics of the part selected and tested for a specific application. In the event the vendor shall not provide drawings as described in paragraph 4.14.d on page 56, the source control drawing shall include the same description of the part as required on specification control drawings. If vendor drawings are made available, the content of the source control drawing shall be limited to vendor's part number, name, and address. In either case, the following note shall appear on the source control drawing: "Only the part(s) specified on this drawing and identified by vendor's name(s), address(es), and part number(s) has (have) been tested and approved by GSFC for use in name of item. A substitute part shall not be used without prior testing and approval by GSFC." See Figure 26.

				REVISION			
REV	DATE	DESCRIPTION	DATE	APPROVAL			

NOTES: UNLESS OTHERWISE SPECIFIED

- ONLY THE PART SPECIFIED ON THIS DRAWING AND IDENTIFIED BY VENDOR'S NAME, ADDRESS AND PART NUMBER HAS BEEN TESTED AND APPROVED BY GSFC FOR USE IN MODEL XYZ. A SUBSTITUTE PART SHALL NOT BE USED WITHOUT PRIOR TESTING AND APPROVAL BY GSFC.
- APPROVED SOURCE

JONES MFG. CO.
STREET ADDRESS, CHICAGO, IL
PART NUMBER XX3-X4XX

SOURCE CONTROL DRAWING

ITEM NO.	REQD	REQD	QTY/NO	DESCRIPTION	UNITS	MATERIAL SPEC/AND
LIST OF MATERIAL						
UNLESS OTHERWISE SPECIFIED DIMENSIONS ARE IN INCHES				Goddard Space Flight Center		
TOLERANCES	3X	30X	FRACTIONS	SPACE ADMINISTRATION		
±.002	±.005	±.010	±.015	GREENBELT, MARYLAND		
REMOVE ALL DIMENSIONS AND DIMENSIONS FROM THIS DRAWING				DRAWING NUMBER TESTED FOR GSFC USE 64-1		
<input type="checkbox"/> FLIGHT HARDWARE/POST FLIGHT WAREHOUSE TEST PROC			DESIGNER	DATE	TITLE	
<input type="checkbox"/> WAREHOUSE TEST NOT REQUIRED			CHECKED			
<input type="checkbox"/> TEST HARDNESS PER ASTM B 94, LOCATION OPTIONAL			APPROVED			
<input type="checkbox"/> TEST HARDNESS PER ASTM B 94, WAREHOUSE LOCATED			APPROVED			
<input type="checkbox"/> NON-CONSTRUCTIVE EXAMINATION (NDE) PROC			APPROVED/TESTED			
<input type="checkbox"/> NDE REQUIRED PER DISC 3030 CODE			APPROVED/ENGINEER			
DRAWING NUMBER TESTED FOR GSFC USE 64-1				GC	SCALE	1/8" = 1"
DRAWING NUMBER TESTED FOR GSFC USE 64-1				DATE		
DRAWING NUMBER TESTED FOR GSFC USE 64-1						

THE DRAWING NUMBER TESTED FOR GSFC USE 64-1

SOFTWARE: _____ VERSION: _____

FILE NAME: _____

NEXT ASSY: _____ LIB/ON: _____

Figure 26: Sample Source Control Drawing

- The source control drawing number is not a part number. The vendor part itself shall be identified by the vendor's identifying number.

- b. The assembly (or installation) drawing shall call out the part by source control drawing number. In the List of Material (parts list) of the drawing, the source control drawing number shall be accompanied by the following note: “Vendor Part—see source control drawing.” A source control drawing shall be identified by the words “Source Control Drawing” immediately above the Title block.
- c. A source control drawing shall not upgrade a vendor's part beyond the vendor's stipulations.

4.14. Specification Control Drawing

Specification control drawings are prepared to record the characteristics of a vendor-designed and manufactured part (or assembly). This type of drawing may also be used to document GSFC parts that are sent to a unique vendor to perform a specific operation because of special equipment and/or hardware only available there. Such characteristics are size, shape, mounting dimensions, and other design requirements, including tests, when applicable, that could be obtained from the vendor's manufacturing drawings if they were made available. The vendor's part number, name, and address shall be included, either in note or table form. See Figure 27.

VENDOR NAME & ADDRESS SMITH ENGINEERING COMPANY BUFFALO, N.Y.		VENDOR PART NO. XX3-X23XX		REVISION	
				DATE	APPROVAL

PRODUCTION TEST PROCEDURE				COMMENTS
WITH PORT 3 PLUGGED APPLY PRESSURE AS FOLLOWS	PERMISSIBLE LEAKAGE AT RATE OF		PORT 1 SHOULD BE HELD DOWN DURING THESE TESTS	
	INTERNAL	EXTERNAL		PORT 2 SHOULD BE HELD DOWN DURING THESE TESTS
5 PSI AT PORT 2	1 DROP PER HR AT PORT 1	NONE	PORT 1 SHOULD BE HELD DOWN DURING THESE TESTS	BE SURE THAT SEALING POPPET IS LOOSE IN VALVE WHEN EACH TEST PRESSURE IS APPLIED
2250 PSI AT PORT 2	NONE AT PORT 1	NONE		
5 PSI AT PORT 1	1 DROP PER HR AT PORT 1	NONE	PORT 2 SHOULD BE HELD DOWN DURING THESE TESTS	
2250 PSI AT PORT 1	NONE AT PORT 2	NONE		

SPECIFICATION CONTROL DRAWING					
ITEM NO.	REQD.	PROV'D.	DESCRIPTION	INTERNAL	INTERNAL SPEC. AND
LIST OF MATERIAL					
UNLESS OTHERWISE SPECIFIED DIMENSIONS ARE IN INCHES					
TOLERANCES: .3X .004 .5X .005 .7X .006 1.0X .008 1.5X .010 2.0X .012 3.0X .015 4.0X .020 5.0X .025 6.0X .030 8.0X .040 10.0X .050 12.0X .060 15.0X .075 20.0X .100 25.0X .125 30.0X .150 40.0X .200 50.0X .250 60.0X .300 80.0X .400 100.0X .500 120.0X .600 150.0X .750 200.0X 1.000					
FINISHES: .125 .250 .500 .750 1.000 1.500 2.000 3.000 4.000 5.000 6.000 8.000 10.000 12.000 15.000 20.000 25.000 30.000 40.000 50.000 60.000 80.000 100.000 120.000 150.000 200.000 250.000 300.000 400.000 500.000 600.000 800.000 1000.000					
REMOVE ALL DIMENSIONS AND DIMENSIONS FROM THIS DRAWING					
<input type="checkbox"/> FLIGHT HARDWARE PORT FINISHNESS TEST REQD. <input type="checkbox"/> NON FLIGHT <input type="checkbox"/> FINISHNESS TEST NOT REQUIRED <input type="checkbox"/> NON FLIGHT <input type="checkbox"/> TEST FINISHNESS PER ASTM 16, LOCATION OPTIONAL <input type="checkbox"/> TEST FINISHNESS PER ASTM 16 WHERE REQUIRED <input type="checkbox"/> ON FIELD OF DRAWING TITLE <input type="checkbox"/>					
<input type="checkbox"/> NON DESTRUCTIVE EXAMINATION (NDE) REQD. <input type="checkbox"/> <input type="checkbox"/> NDE REQUIRED PER 5-20-03 CODE <input type="checkbox"/>					
THIS DRAWING IS PRELIMINARY SOFTWARE: _____ VERSION: _____ FILE NAME: _____					
		NEXT ASSY		USED ON	
		APPROVED ENGINEER		APPROVED STRESS	
		CODE		SCALE	
		VP		SH	

Figure 27: Sample Specification Control Drawing

- The specification control drawing number is not a part number. The vendor part itself shall be identified by the vendor's identifying number.
- The assembly (or installation) drawing shall call out the part by the specification control drawing number. In the List of Material (parts list) of the drawing, the specification control drawing number shall be accompanied by the note "Vendor Part—see specification control drawing." A specification control drawing shall be identified by the words "Specification Control Drawing" immediately above the Title block.
- A specification control drawing does not prevent procurement from multiple sources when the vendor part has been determined to be equivalent to other vendor parts by the Federal Cataloging Program, resulting in Federal Item Identification Number (FIIN) number assignment or when the part is manufactured by a licensee of the vendor.

- d. The preparation of specification control drawings can be avoided by procuring the vendor's manufacturing drawings. In the event the vendor claims proprietary rights and refuses to provide his manufacturing drawings, he shall be requested to furnish an outline drawing of his part sufficient to include the requirements stated above. When the vendor provides either type of drawings (i.e., manufacturing drawings or an outline drawing), the part number callout on the drawing shall be by the vendor's number.
- e. A specification control drawing shall not upgrade a vendor's part beyond the vendor's stipulations.

4.15. Standard Part Drawing

Standard parts shall be selected from government and industry standards in that order of precedence. If neither of these contain a part satisfactory for the design needs, a drawing shall be prepared. Before preparation, it must be determined that the part shall be a GSFC standard part, in which case it shall be drafted on GSFC standard manual format.

4.16. Tabulated Drawing

A tabulated drawing depicts similar items with differences in characteristics such as dimensions, material, finish, and other requirements. These differences are tabulated on the drawing, the fixed characteristics depicted once.

Pictorial differences that are not clear should be shown in views or details and should be properly labeled. A tabulated drawing precludes the preparation of an individual drawing for each item. See Figure 28.

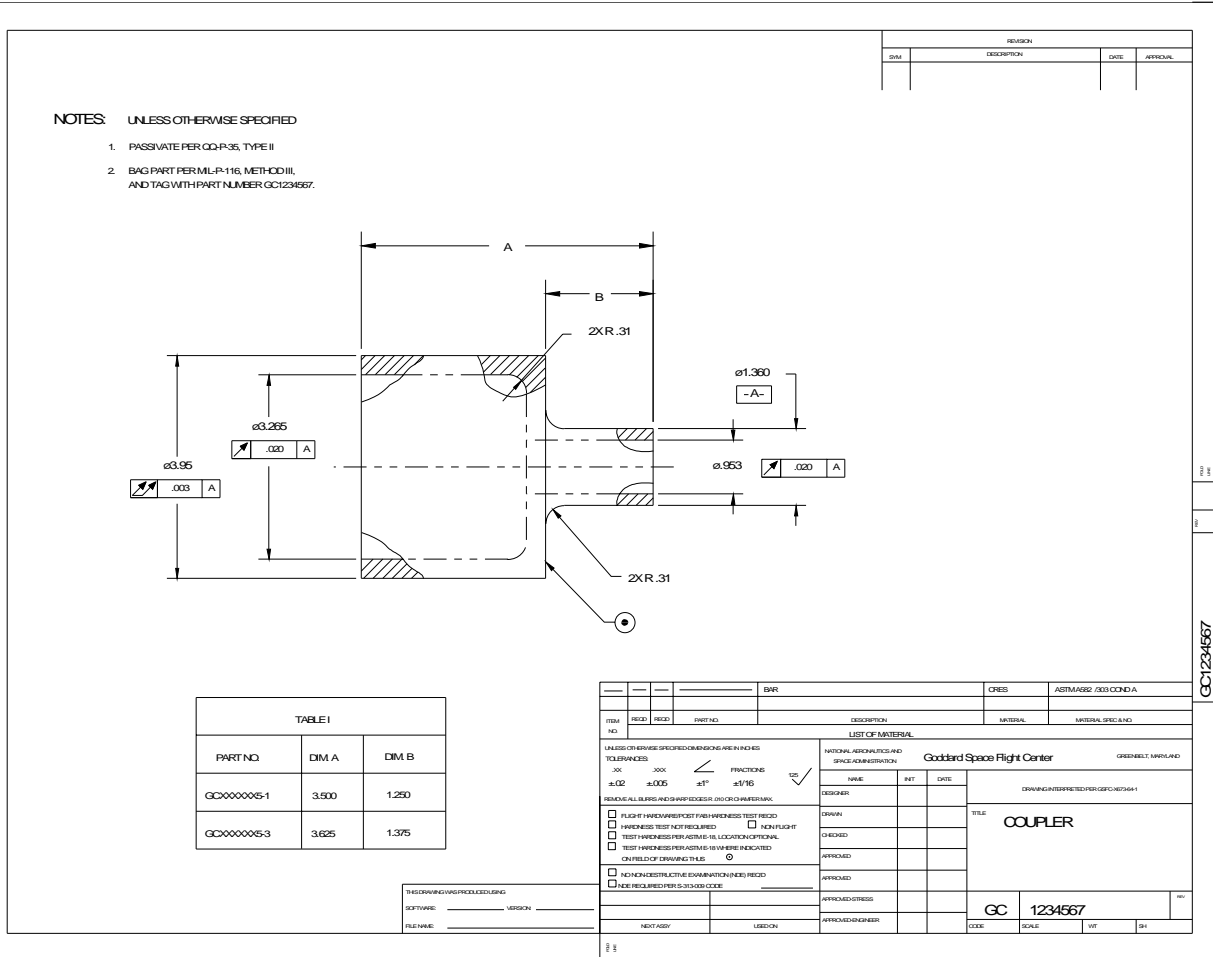

Figure 28: Sample Tabulated Drawing

4.17. Tooling Drawing

Tooling fixtures and templates are production aids. The templates are not intended as engineering documentation of the final end item configuration.

The engineering drawing for which a Tooling drawing is being produced shall carry the following note:

THESE FEATURES ARE TO BE INSTALLED USING TOOLING TEMPLATE GX-XXXXXXX ONLY. THE ACTUAL TOLERANCES ON THE FEATURES LOCATIONS ARE CONTROLLED BY THE TEMPLATE.

When affected by tooling, dimensions and their tolerances shall be flagged on the engineering drawing to the above note and enclosed in parentheses to indicate reference information only.

The following note shall be added to the tooling drawing:

THIS TOOLING IS USED TO FABRICATE PIECE PART
GX-XXXXXXX.

The tooling drawing shall be dimensioned the same way as the engineering drawing.

4.18. Composite Material Drawing

A composite material drawing is an engineering representation of two or more materials in combination (reinforcing fibers and resin binder). The fiber and resin differ in form or composition, and are tailored to meet specific engineering properties. The drawing shall specify the multi-ply laminate configuration that defines the number of plies, the stacking sequence, the ply angle orientation, the prepreg fiber-resin materials, and the physical dimensions.

For the following requirements, refer to Figure 29 as an example of a composite material drawing.

- a. A coordinate reference and angle direction shall be shown for both the part and the stacked detail.
- b. Each ply shall be identified by Item No., angle, and thickness, as shown in Table 1 of Figure 29.
- c. Dash numbers may be used to show variations, such as length and material, as shown in Table 2 of Figure 29.
- d. Stacking sequence code $(+30/0/-30/90)_2S$, as shown in Table 1 in Figure 29 defines the following features:

Ply 1	+30-degree orientation
Ply 2	0-degree orientation
Ply 3	-30-degree orientation
Ply 4	+90-degree orientation
Subscript “ ₂ ”	indicates repeat sequence (plies 1–4) two times, for build up of plies 5–8.
Subscript “ _S ”	indicates symmetry, i.e., plies 1–8 repeated in reverse order for buildup of plies 9–16.

The code is read $(+30/0/-30/90/+30/0/-30/90/90/-30/0/+30/90/-30/0/+30)$.

Examples of other variations to the code are $(0_3/90_2/45/-45_3)_S$. This code is read $(0/0/0/90/90/+45/-45/-45/-45/-45/-45/-45/+45/90/90/0/0/0)$.

In the same example, the subscript “_T” can be used in lieu of “_S” to designate the total laminate. For example, $(0_3/90_2/45/-45_6/45/90_2/0_3)_T$. However, in this example, using the “_S” to denote symmetry is the preferred method. “_T” is generally reserved for laminates where symmetry is not specified, as in $(0/30/60/90)_T$.

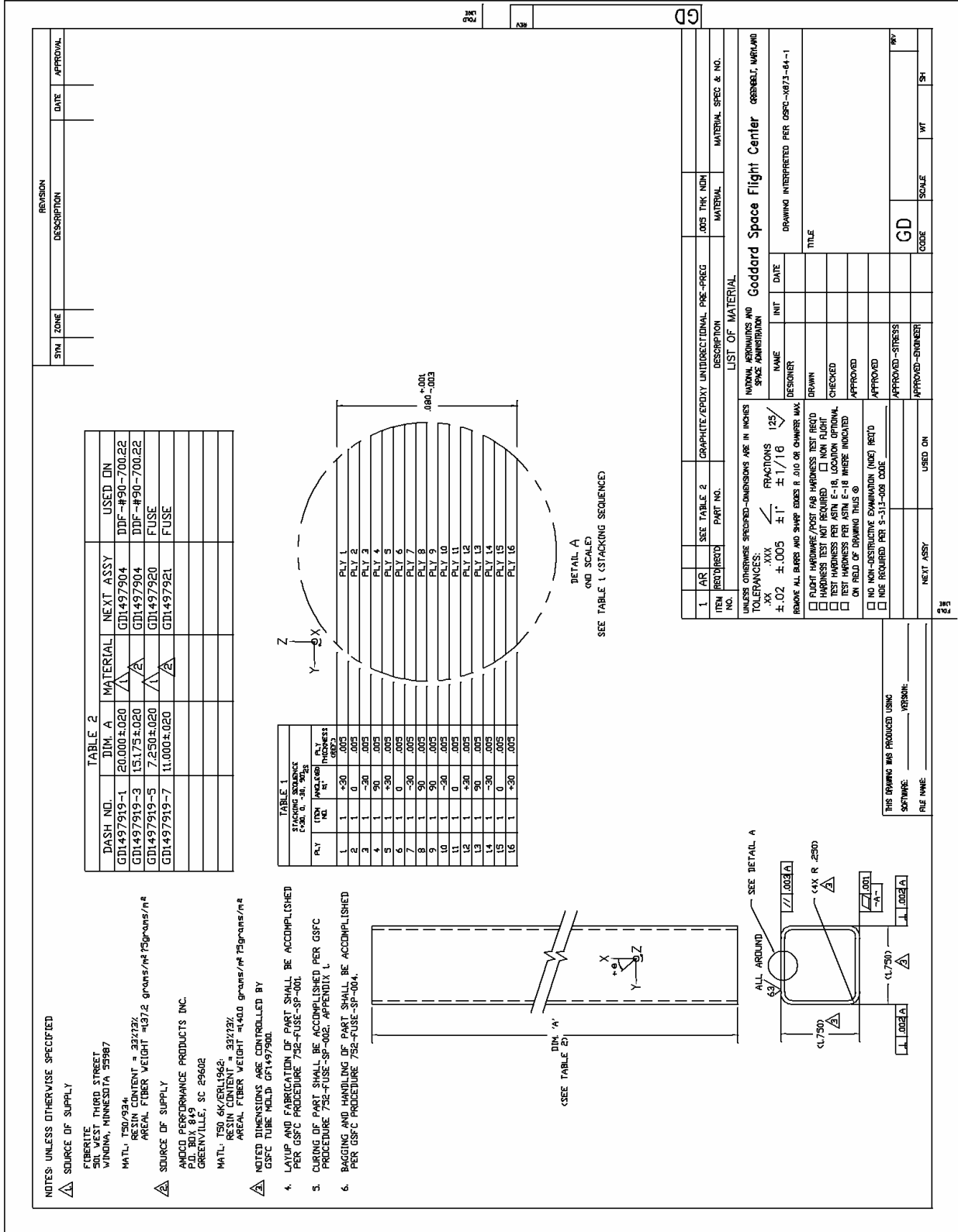

Figure 29: Composite Material Drawing Example

5. NUMBERING SYSTEM FOR DRAWINGS AND SUPPORTING DOCUMENTATION

The GSFC numbering system for identifying engineering drawings and associated lists is based on the “unit number” principle, whereby the same basic number assigned to an assembly drawing is also applied to index, usage, data, and parts lists.

- a. Drawing numbers shall consist of assigned basic seven-digit numbers, prefixed by the letter “G” (signifying GSFC) and a second letter signifying the drawing size (B, C, D, E, F, or J).
- b. Associated list numbers shall be the basic seven-digit drawing number prefix with PL or IL as applicable. Refer to Definitions paragraph 8.1 on page 71.
- c. All GSFC organizations using drawing numbers shall make their request to the Mechanical Systems Division, Mechanical Engineering Branch (designated custodian) for blocks of numbers for their flight hardware and ground support equipment.
- d. The management of drawing numbers becomes the responsibility of the engineering design group to whom they are assigned. Reassignment of the numbers to group subsections or individuals, other contractors or subcontractors, or other programs or projects must be controlled, recorded, and maintained by the Configuration Management Officer.
- e. Engineering documentation (drawings, engineering change orders, and configuration change requests) shall be retained by the Configuration Manager in the responsible engineering organization until otherwise directed by the Project.
- f. When it is necessary to identify a drawing as a sketch, the number shall be assigned by the originator. The sketch shall be maintained by the originator to prevent the necessity of a central control. Sketches shall not be prepared in place of engineering drawings for procurement of mockups, models, preproduction hardware or flight hardware, and associated equipment.
- g. GSFC numbers for specifications, processes, and standards shall be issued by the specific organization for which such documents are being developed. Procedures governing the preparation of GSFC specifications, processes, and standards shall be in accordance with GSFC-S-250-3, *Guide for the Preparation of Specifications*. The Library Services Branch of the GSFC Information Management Division shall receive two copies of final, approved documents that are of general interest and use. A list of existing specifications is maintained by the Library Services Branch.

- h. In the absence of a project-directed document numbering plan, the following system shall be used:

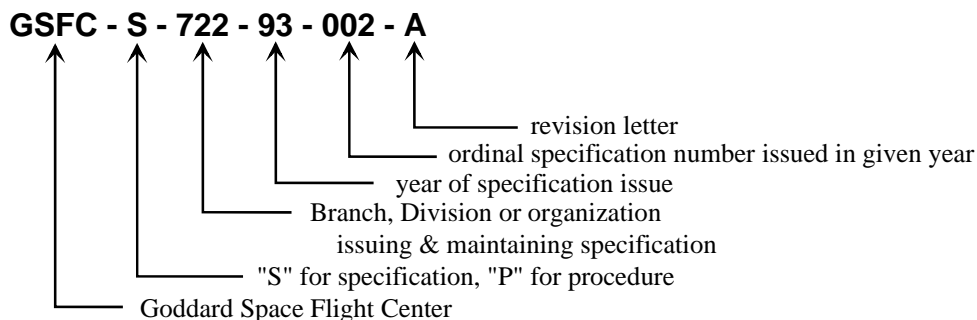

5.1. Part Numbering

Each detail part, subassembly, etc., shall be identified by a part number as follows:

- An item covered by an approved standard and used without alteration or selection shall be identified by the proper standard number (such as MS number for military standard), which shall include any dash number or code necessary for complete identity.
- Each nonstandard item shall be identified by a part number that shall be, or shall include, the drawing number.
- Vendor-designed and manufactured parts or assemblies shall be identified by the vendor's part number. See "Specification Control Drawing," paragraph 4.14 on page 54, and "Source Control Drawing," paragraph 4.13 on page 53.
- Altered or selected parts shall be identified as required. See "Altered or Selected Vendor Part Drawing," paragraph 4.1 on page 39.
- Symmetrically opposite parts shall be designated by -1 (shown) and -2 (opposite) carrying the odd/even relationship to higher numbers as necessary. The part shown shall always be an odd number, and its opposite, the next higher number.

Parts shall be identified on the field of drawing by showing both the identifying part number and find number where cross-referenced on a separate Engineering Parts List. See "Sample Assembly Drawing," Figure 17 on page 40. When the parts appear in the List of Material on the drawing, only the item number is called out on the field of the drawing. See Figure 34, "Sample Assembly Drawing With List of Material," on page 80.

A detail drawing depicts a single detail part, and the part shall be designated by the drawing number. See "Detail Drawing," paragraph 4.3 on page 41.

An inseparable assembly drawing depicts parts permanently fastened together, and the assembly shall be designated by the drawing number. The individual parts shall be designated by part number as described per "Inseparable Assembly Drawing," paragraph 4.6 on page 44.

Each of the parts shown on a tabulated drawing shall be identified by the drawing number suffixed with a dash number. The basic drawing number alone shall not be used to identify a part. See "Tabulated Drawing," paragraph 4.16 on page 56.

Parts that must be mated, and for which replacement as a matched set or pair is required, shall be assigned a single number to designate each matched set or pair. Component parts shown in matched-set drawings instead of separate detail drawings shall be identified by the identifying part number and find number. See "Matched-Set Drawing," paragraph 4.9 on page 48.

5.2. Find or Item Numbering

Under the find or item numbering system, a number is assigned to a part or detail assembly for the purpose of locating it in the field of the assembly drawing. The find or item number is also shown in the Engineering Parts List for an assembly drawing, cross-referenced to the part number used for procurement purposes.

5.3. Order of Precedence of Specifications and Standards

When identical parts or assemblies of equal quality are identified by more than one document, the item shall be referenced on drawings in the following order:

5.3.1. Group I

Group I covers government specifications and standards listed for use by GSFC and industry documents coordinated to the extent indicated as follows in (c) and (e).

- a. Coordinated federal specifications and standards.
- b. Coordinated military specifications and standards (including JANs, ANs, and ANDs).
- c. Industry specifications and standards (e.g., those promulgated by nationally recognized associations, committees, and technical societies) having coordinated status established under policies and procedures of other government agencies and approved for GSFC use.
- d. Limited coordination military and interim federal specifications and standards issued by other government agencies and approved for GSFC use.
- e. Industry specifications and standards having limited coordination status established under policies and procedures of other government agencies and approved for GSFC use.

5.3.2. Group II

Group II covers industry specifications and standards (e.g., those promulgated by nationally recognized associations, committees, and technical societies) approved for use by GSFC, for which status equivalent to military documents has not been established.

5.3.3. Group III

Group III covers Government specifications and standards not previously listed by GSFC.

5.3.4. Group IV

Group IV covers industry specifications and standards not previously listed for use by GSFC. Company specifications and standards are not to be considered as a part of this group. Copies of industry specifications and standards should be obtained from the association concerned.

5.3.5. Group V

Group V covers company specifications and standards. Reference to a company specification or standard for new applications or designs shall be discontinued upon the issuance of a specification or standard in Group I, II, III, or IV covering an interchangeable item of equivalent quality.

Note (applicable to Groups I, II, IV, and V above):

When industry specifications and standards are specified on GSFC drawings and documents, such specifications and standards shall be available to GSFC personnel.

6. ENGINEERING ORDER

6.1. General Requirements

The use of Engineering Order (EO) for the purpose of revising released drawings is the preferred method of changing drawings, although the method of direct change to the drawing may be chosen by the project engineer.

After an EO system is elected, it is the responsibility of that project design activity to assign numbering and maintain the documentation system. The approved EO is considered an official part of the original drawing and shall always be available to others, even after incorporation. With this system, reference to EOs in the revision block of drawings is permitted in place of the usual detailed listing of changes.

6.2. Format Sample

The following minimum information should be included on an EO form. See Figure 30a on page 66.

1. DRAWING & REV. LEVEL: The number of the drawing to be changed and the revision level affected. Where the change is exactly the same on more than one drawing, add an asterisk to the drawing and revision level block; then add the drawing numbers along with the next applicable EO number to the asterisk table on the field of change on EO page 1. If more than one EO page is required, the additional EO pages will only note that those pages affect the list of drawings the EO is written against.
2. INC. REV.: The revision letter to be provided by the Configuration Manager (CM) at the time of drawing change incorporation. Outstanding EO numbers may be incorporated under one revision letter.
3. TITLE: Title of the drawing to be revised.
4. NEXT ASSEMBLY: Next assembly number of the drawings affected by the change.
5. USED ON: The type of equipment such as Ground-Support Equipment (GSE) or Flight (FLT).
6. PROGRAM: Name of program.
7. REASON: Reason why the change is necessary rather than description of the change. A Configuration Change Request (CCR) number and class to be provided by the project engineer where applicable or when required by the CM.
8. TYPE OF EO:

Advance Notice of Change: A change to the drawing that shall take place at some future date. Several EOs may be incorporated under the same revision letter.

Deviation: A record of a change to a manufactured part. The change is to accept a discrepancy correction in a part. The EO would be assigned a back slash (\) instead of an EO revision letter and identified as a “Deviation for serial number _____” in the revision block. No physical change to the field of the drawing will occur.

Other: A record of special tests or circumstances that might not be required of all parts.

9. **DESCRIPTION:** Description of the change to be made shall be shown using the words “Was” and “Now” or “Remove” and “Add.” The words “Delete,” “Cancelled” or “Superseded” may also be used. In the situation of superseding a previous EO, a “Was” and “Now” current condition must also be shown, just as if the previous EO had been incorporated.

If the current EO format is insufficient in size, a sheet 2 or more may be added (see Figure 30b). If a larger page is required a supplemental sheet shall be prepared on a regular drawing-size sheet reproducible vellum and shall state “This supplemental sheet is page ___ of EO number _____ of drawing number _____.” Enter in the description area of page 1 of the EO to “see supplemental sheet page ___ of this EO.”

The EO must be on an approved EO form. No paste ons or line strikeouts are permitted. All lettering must be .12 inch or larger and uniform in size.

10. **“SHEET ___ OF ___”:** Indicate number 1 and the total number of EO sheets. On remaining sheets, enter the number of that particular sheet of the EO only.
11. **Disposition:** Actions to be taken as a result of the change.
12. **EFFECTIVE:** If the change affects only a limited number of a series of like parts, fill in the serial number(s) and date. **IF THE CHANGE**
13. **DRAWN BY:** Signature, date, and GSFC CODE.
14. **ISSUED BY:** Signature, date, and GSFC code of CM official.
15. **CHECKED:** Signatures, date, and GSFC codes. When practicable, signatures should be those of persons who approved the original drawing.
16. **APPROVED:** SIGNATURE, DATE, AND Signature, date, and GSFC CODE.
17. **ENGINEER:** Signature, date, and GSFC CODE of project responsible engineer.
18. **CCB APPROVAL:** Configuration control board signature.
19. **JOB ORDER NO:** Fabrication number to be assigned by the cognizant engineer.code
20. **EO NO:** To be assigned by the configuration management office or the designated representative for the program for which the EO is being written. EO numbers are issued in numerical sequence against a particular drawing number when the EO is sent for checking.

ENGINEERING ORDER
GODDARD SPACE FLIGHT CENTER
GREENBELT, MARYLAND

EO DRAWING & REV. LEVEL SHEET OF E.O. NO. INC. REV.

1. DRAWING TITLE 2. REASON 3a. CCS APPROVAL 3b. JOBS ORDER NO. 4. ISSUED BY GMD GSFC CODE LOCATION DATE

5. TYPE OF E.O.
 ADVANCED NOTICE OF CHANGE (Drawing will be revised)
 DEVIATION (Drawing will not be revised)
 OTHER (Explain) _____

6. PROGRAM USED ON NEXT ASSY 7. EFFECTIVE SERIAL DATE

8. DESCRIPTION

10. DISPOSITION	USE AS IS	RANK	SCRAP NO.	NO. PARTS MADE	DRAWN BY	CHECKED	APPROVED	APPROVED	ENGINEERING
RAW MATERIAL					DATE CODE	DATE CODE	DATE CODE	DATE CODE	DATE CODE
PART IN PROCESS									

Figure 30a: Engineering Order (sheet 1)

ENGINEERING ORDER
GODDARD SPACE FLIGHT CENTER
GREENBELT, MARYLAND

EO DRAWING & REV. LEVEL SHEET OF E.O. NO. INC. REV.

Figure 30b: Engineering Order (sheet 2)

7. DRAWING REVISIONS

7.1. Revision Methods

Revisions in the field of drawings are made by deletion, either by erasure or crossing out (a series of parallel lines placed on the face of drawing over the deleted portions of drawing), by addition, or by redrawing (all delineations shall be made to scale).

7.2. Revision Identification

Revisions shall be identified by symbols in the field of the drawing (see paragraph 7.4) cross-referenced to the revision description. Revision symbols shall be entered in the revision block (see Figures 31a, 31b, and 31c, page 69). Revisions shall be by alphabetical letter and order, except that letters I, O, Q, S, X, and Z shall not be used as revision symbols. Following letter Y, use AA, AB, etc.; after AY, use BA, BB, etc.

7.3. Revision of Multisheet Drawings

There is only one acceptable method of recording changes to multisheet drawings.

Revisions to any sheet(s) shall be recorded in the revision description block on sheet 1, and reference shall be made to sheet(s) affected. Level of revision shall be changed on each drawing sheet whether or not that particular sheet is affected. The revision description block on all sheets other than sheet 1 shall state "See sheet 1 for revisions."

7.4. Revision Recording

A symbol (e.g., "A3") enclosed in a circle shall appear in the field of drawing at the point of revision. The letter "A" refers to any revisions completed at a given time. The number following refers to the number of the revision made. Figure 31a shows examples of this. The same symbol may appear more than once if, in the revision description column, more than one action took place per line (see Figure 31a under symbol "A3," line 2).

When changes are made to a drawing through a direct incorporation, revision symbols are required on the field of the drawing, and abbreviated descriptions of the changes must be recorded in the revision block.

When changes are made to a drawing through an EO or Revision Notice system, revision symbols are not required on the field of the drawing, but the Revision Block must state "See EO number _____ for changes" or "See Revision Notice number _____" in the revision description column.

For either method of incorporation, the person incorporating the revision, the person assigned to check the incorporation, and the cognizant engineer responsible for the revision all shall date and initial the revision block in the approved column.

REVISION			
SYM	DESCRIPTION	DATE	APPROVAL
A3	(1) R.188 WAS R.250 (2) ADDED .500, 1.500 AND 2.000 DIMS (3) REM'D .750 AND 7.000 DIMS	1-2-84	(SIGNATURE)
B4	(1) WAS 1.500; (2) WAS .635; (3) WAS 1.000+.005; (4) WAS "NOTE 4" -.000	2-3-84	(SIGNATURE)

Note:

Zone column not required on C-size drawings and smaller.

Figure 31a: Sample Revision Block

REVISION			
SYM	DESCRIPTION	DATE	APPROVAL
C	(1) REPLACES REV-B WITH CHANGE, SEE EO NUMBER XXX	1-9-84	(SIGNATURE)

Note:

If no "EO" system is used, the changes would be spelled out, similar to Figure 31a.

Figure 31b: Sample Revision Block

REVISION			
SYM	DESCRIPTION	DATE	APPROVAL
B	REPLACES REVISION-B WITHOUT CHANGE	1-9-84	(SIGNATURE)

Note:

The old drawing shall have the statement "REDRAWN WITHOUT CHANGE" added to its revision block, requiring no change letter, and "SUPERSEDED" added above its Title block.

Figure 31c: Sample Revision Block

7.5. Redrawn or Replaced Drawings

The next revision letter in sequence shall be entered in the revision block of the new drawing. To the revision block shall be added "Replaces Revision (old revision letter) With Change" and a description of the change or reference to an Engineering Order (EO) document number shall be recorded in the description column. All previous revisions shall be omitted from the superseding drawing. The statement "Replaced With Change By Revision (new revision letter)" shall be added to the superseded drawing's revision block and "Superseded" shall be placed in 1/4-inch-high lettering directly above the Title block. When a drawing is redrawn without changes, the phrase "Replaces Revision (old revision letter) Without Change" shall be added to revision block and revision letter shall remain unchanged. See Figure 31c. Original names and dates from the old title block shall be typed in on the replacement drawing.

8. PARTS LIST AND INDEX LIST

This section establishes minimum requirements for the preparation and submission of Parts Lists (PL) and Index Lists (IL) used with engineering drawings.

Parts Lists may be prepared for each assembly drawing in accordance with this section. For parts lists on drawings, see Figure 34 on page 80 or Figure 3 on page 10.

Index Lists may be prepared for each Payload, Engineering Model, Major Assembly, Complex Assembly of assemblies, as directed by Project Manager.

8.1. Definitions

Cover Sheet: This refers to the first sheet of each Parts List or Index List and is a record of the revisions.

Parts List (PL): This is a tabulation of the items necessary for fabricating or assembling the end item(s) to which the list applies.

Index List (IL): This is a list of the one principal and all subordinate PLs applicable to a major assembly.

Bulk Materials: These are items that are necessary constituents of an assembly or subassembly, for which the quantity required is not readily predeterminable. Examples are oil, wax, solder, cement, ink, damping fluid, grease, powdered graphite, flux, welding rod, thread, twine, and chain. If the quantity is known, but the physical nature of the material is such that it is not adaptable to depiction on a drawing, or the material can be cut to finished size by the use of such hand or bench tools as shears, pliers, knives, etc. without further machining operations, then the material's configuration shall be fully described in writing without the necessity of pictorial presentation.

Special Handling Equipment and Packaging: This term applies to items such as boxes, shipping containers, cradles, crane attachments, and other special items needed for storing and transporting.

Special Test Equipment: This term applies to items of special test equipment that are required for government inspection or service maintenance, such as test stands, indicators, etc.

Applicable Standards, Specifications, and Publications: This term applies to documents referenced on or invoked by the drawings.

8.2. Requirements

8.2.1. List Preparation

The PL and IL may be prepared manually or by typewriter or computer word processor.

8.2.2. List Formats

Lists shall use preprinted 8 1/2- by 11-inch size format. The preparation requirements are provided herein.

When more than a single sheet is required to prepare or revise a list, the list title is required on the first sheet only.

The design activity shall use a cover sheet as illustrated in Figure 32a on page 74. Entries on the cover sheet shall be completed as explained in "Cover Sheet," section 8.3, below.

8.2.3. Revision Identification

A revision letter and the date of revision shall be applied to each list when any change is made. The letters I, O, Q, and X shall not be used as revision letters. List shall be revised independently of the associated drawings.

8.2.4. Deleting Items

Items to be deleted may be either lined out, erased, or omitted.

8.2.5. Adding Items

New or superseding items may be added at the end of a list or inserted in the list in proper sequence.

8.3. Cover Sheet

The Cover Sheet shall be the first sheet for each PL or IL and shall be prepared as indicated herein.

8.3.1. Format

The Cover Sheet shall be prepared on Form 670-36 (1/65). Refer to Figure 32a on page 74.

8.3.2. Entries

Entries shall be made in the blocks and columns of the Cover Sheet as directed on the following page:

1. CODE IDENT: Enter Code Identification number as assigned by Federal Supply CAGE Publication H4/H8 for using activity. Number is located in title block of design activity.
2. LIST NO.: Enter the number of the PL or IL for which the cover sheet is being prepared.
3. SHEET __ OF __: Enter the total number of sheets used.

4. REV: Enter revision letter of the latest revision to the PL. Changes to this block shall be made by erasure.
5. ITEM NOMENCLATURE: Enter the same nomenclature that appears in the Title block of the assembly for which the list is being prepared. The item nomenclature shall always be a noun.
6. VENDOR: If prepared by contractor for GSFC, enter contractor name and Federal Supply CAGE Code Numbers.
7. PREPARED: Enter name of person preparing list.
8. APPROVED: Enter signature of person approving for accuracy and completeness.
9. ENG APPROVAL: Enter signature of Assistant Project Engineer (optional).
10. ENG APPROVAL: Enter signature of Project Engineer (mandatory for all procurement).
11. AUTHENTICATION: Enter name of person designated to sign for design activity or division.
12. CONTRACT NO: When prepared by contractor for GSFC, enter the contract number.
13. LTR: Enter revision letter of current revision.
14. DESCRIPTION: Enter a complete and concise description of the revision that applies to the PL.
15. DATE: Enter date of revision.
16. APP (Approval): Enter initials of person completing revision review.
17. RECORD OF REVISION: Enter revision status of individual PL sheets.

 GODDARD SPACE FLIGHT CENTER GREENBELT, MARYLAND				LIST NO. PL GF1055545 (2)					REV (4)																		
				SHEET <u>1</u> OF <u>2</u> (3)																							
CODE IDENT 88006 (1)				ITEM NOMENCLATURE MECHANISM ASSEMBLY EXPERIMENT (5)																							
VENDOR (6)				PREPARED (7)			ENG APPROVAL (10)																				
				APPROVED (8)			AUTHENTICATION (11)																				
CONTRACT NO. (12)				ENG APPROVAL (9)																							
LTR	DESCRIPTION								DATE	APP	LTR	DESCRIPTION								DATE	APP						
(13)	(14)								(15)	(16)																	
(17) RECORD OF REVISION OF ALL SHEETS																											
1	2	3	4	5	6	7	8	9	10	11	12	13	14	15	16	17	18	19	20	21	22	23	24	25	26	27	28

670-36 (1/65)

Figure 32a: Parts List (and Index List) Cover Sheet

8.4. Parts List Continuation Sheet

The PL continuation sheet shall be prepared as indicated herein. Circled numbers have been assigned to each column or block for identification only. The PL shall contain a cover sheet and as many PL continuation sheets as necessary to completely list all the information.

8.4.1. Format

The PL continuation sheet shall be prepared on Form 670-37 (1/65). Refer to Figure 32b on page 76

8.4.2. Entries

Entries shall be made in the blocks and columns as directed below:

1. PARTS LIST NO.: On each sheet of the PL, enter the number of the corresponding drawing.
2. SHEET NO.: On each sheet, enter the appropriate sheet number.
3. ITEM FIND NOS.: Enter number taken from assembly drawing.
4. DWG. DOCUMENT PART OR STOCK NO.: Enter the part number or other identifying number of each item in the list.
5. QTY REQD PER ASSY.: Enter the quantity required for each assembly.
6. CODE IDENT NO. (Code identification number): Enter appropriate number assigned to the design activity per CAGE Publication H4/H8. When a government or industry standard part or specification number appears in Column 4, no entry shall be made in Column 6. When the Code Identification Number for an item is identical to that entered in Block 1 of the Cover Sheet, do not repeat the number in Column 6 of the PL continuation sheet.
7. DRAWING TITLE OR ITEM DESCRIPTION (Item description or nomenclature): Enter the noun or noun phrase describing the item whose part or identifying number appears on assembly drawing.
8. REMARKS: Enter information that could be useful for reference [i.e., specification, control drawings, designations (e.g., R10, J14, etc.), vendor's items, etc.].

NASA PARTS LIST GODDARD SPACE FLIGHT CENTER GREENBELT, MARYLAND				PL GF1055545	1
				SHEET NO.	2
ITEM FIND NOS.	DWG. DOCUMENT PART OR STOCK NO.	QTY REQ'D PER ASSY	CODE IDENT NO.	DRAWING TITLE OR ITEM DESCRIPTION	REMARKS
	GF1055545	1		Mechanism Assembly	
1	GF1055506	1		Base Plate and Side Rail	
2	GC1055535	1		Gasket	
3	5279726	1		Electrical Disconnect McDonnell	
3	4	5	6	7	8
APPLICABLE STANDARDS, SPECIFICATIONS AND PUBLICATIONS					
MIL-S-22473					
GSFC X673-64-1					

670-37 (1/65)

Figure 32b: Parts List Continuation Sheet

Supplementary Heading List. In addition to the headings that are used for the items of the PL, a supplementary heading list as stated below shall be used if applicable:

- Bulk Material.
- Special Handling Equipment and Packaging.
- Special Test Equipment.

- Applicable Standards, Specifications, and Publications.

8.5. Index List Continuation Sheet

The IL continuation sheet shall be prepared as indicated herein. Circled numbers have been assigned to each column or block for identification only. The IL shall contain a cover sheet and as many IL continuation sheets as necessary to completely list all the information.

8.5.1. Format

The IL continuation sheet shall be prepared on Form 670-39 (1/65). Refer to Figure 33 on page 78.

8.5.2. Entries

Entries shall be made in the blocks and columns as directed below:

1. INDEX LIST NUMBER: On each sheet, enter the number of first assembly level (top or main assembly).
2. SHEET NO.: On each sheet, enter the appropriate sheet number.
3. CODE IDENT.: Enter code identification taken from PL.
4. LIST NO.: Enter number of the PL.
5. LIST NOMENCLATURE: Enter nomenclature as it appears on the PL.
6. ASSY LEVEL: Enter the next assembly level number of the list number.

NASA		INDEX LIST GODDARD SPACE FLIGHT CENTER GREENBELT, MARYLAND		IL GD1055547 (1)
				SHEET NO. 2 (2)
CODE IDENT	LIST NO.	LIST NOMENCLATURE	ASSY LEVEL	
88006	PLGD1055547	Experiment X Assembly		
88006	PLGF1055545	Mechanism Assembly		
88006	PLGF1055546	Mechanism Cassette Assembly		
(3)	(4)	(5)	(6)	

670-39 (1/65)

Figure 33: Index List Continuation Sheet

8.6. Find or Item Number System of Identification

8.6.1. Definition

A find number or item number is a number assigned to a part or subassembly for the purpose of locating the part or subassembly in the field of the assembly drawing. The find or item number is also shown in the Parts List for an assembly drawing, whether the list is separate or an integral part of the drawing. The “find number” is usually associated with a separate Parts List, and the “item number” is usually associated with the List of Material on drawings, but both are used for locating parts. Parts and subassemblies are identified by other numbers for purposes of procurement and marking. These identifying numbers are cross-referenced to the find or item numbers in the PL or in a tabulation on the assembly drawing.

8.6.2. Application and Limitation

The find or item number system provides a quick means of locating parts on a relatively small area of a drawing having a high density of parts. It is preferred that the conventional method of identification (item numbers) be used on drawings of simple assemblies, even though find and part numbers are used for complex assemblies that are components of the same equipment. See Figure 34 on page 80. For a sample drawing of an assembly using the find and part number system, see Figure 17 on page 40. The item number system of identification shall also be used to locate pieces on drawings of inseparable assemblies when material specifications or material tempers differ from one another.

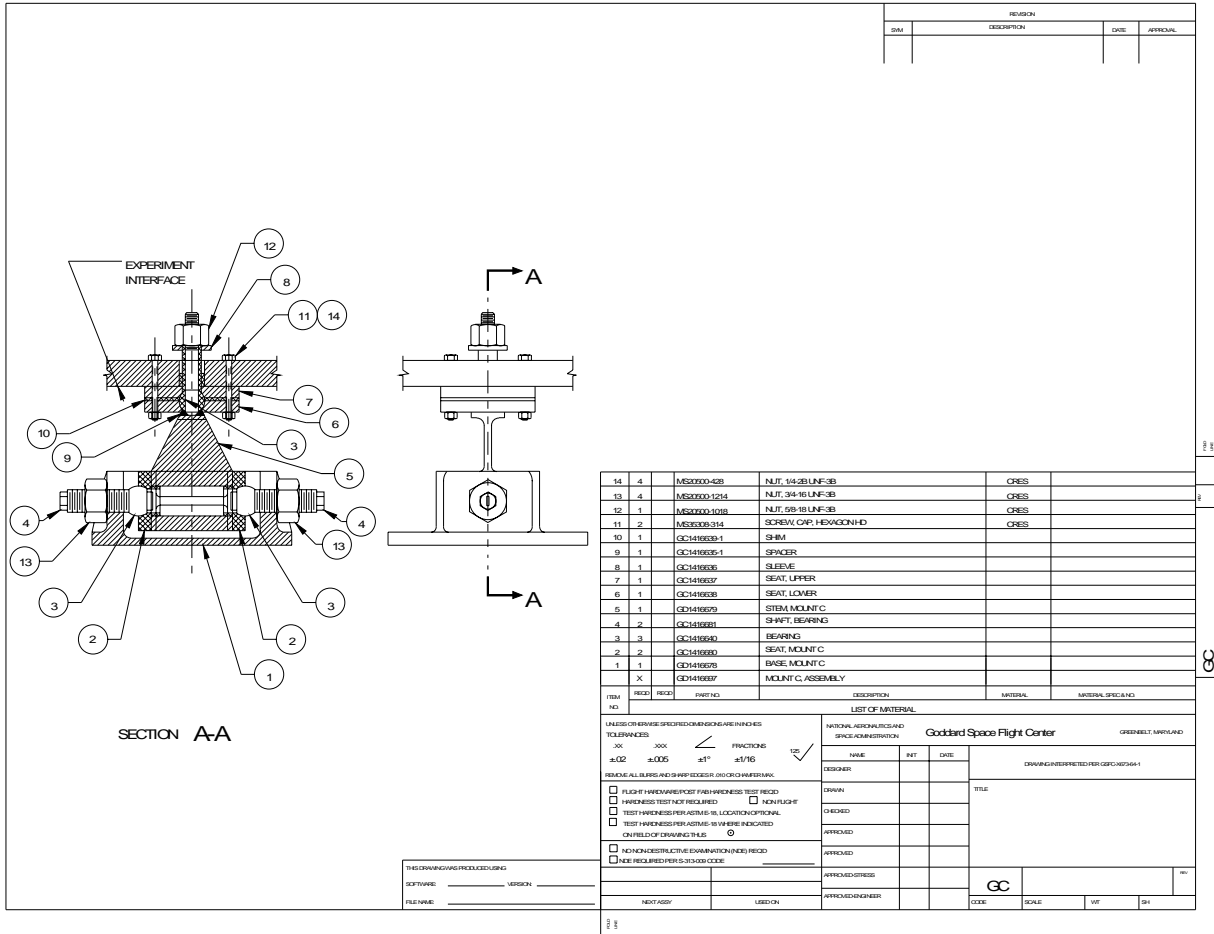

Figure 34: Sample Assembly Drawing With List of Material

8.6.3. Drawing Requirements

When used in the field of the drawing, item numbers shall be enclosed in circular-shaped 1/2-inch-diameter balloons. For drawings of electronic chassis assemblies, if the outlines of resistors or capacitors are shown, the reference designations shall be placed within those outlines when practical. The corresponding find numbers shall be omitted from the views. In such cases, a table shall be provided on the drawing to show the find number assigned to each item that is identified by a reference designation on the views. The same find number shall be used for any group of reference designations assigned to items of identical characteristics. The item or find numbers on any drawing shall be assigned independently of those on any other drawing. Find numbers assigned to subassemblies shown on an assembly drawing shall be distinguished from those assigned to parts by adding a letter suffix to the subassembly find number.

8.7. List of Material

A List of Material (LM) shall be prepared and included on each assembly drawing to provide the individual part or subassembly item number, quantity required, part number, description, material, and material specification. See Figure 34 on page 80.

8.7.1. Format

The List of Material shall be placed above the drawing Title block as shown in Figure 34 on page 80.

8.7.2. Entries

Entries shall be made in the blocks and columns as indicated in Figure 3 on page 10.

9. DOCUMENTATION MANAGEMENT

9.1. Typical Drawing Flow for Flight Projects

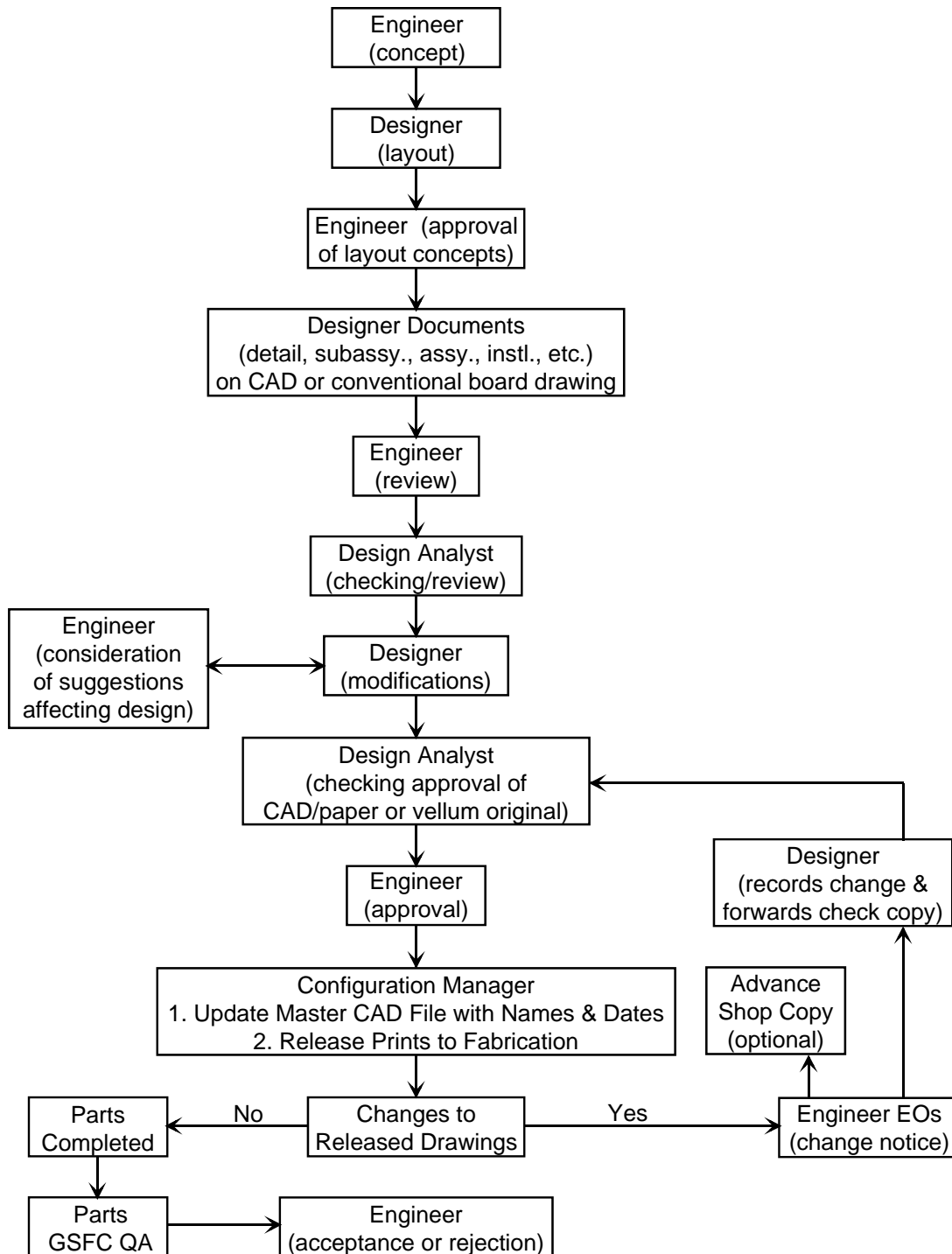

Figure 35: Typical Drawing Flow for Flight Projects

9.2. Archiving

Drawings, Engineering Orders (EOs), Certification Logs, Associated Lists, and Engineering Parts Lists (EPLs) shall be archived after signoff. Following are some sample archiving methods:

- a. Filing of all paper originals.
- b. Scanning of the paper originals to a standard digital raster image format such as CCITT Group 4 (CALs, MIL-R-28002) and then using a digital storage system to archive the resulting database of raster images.
- c. Microfilming and storing on aperture cards when requested by a GSFC division that still has equipment to retrieve the information.

Note:

Before deciding to archive using aperture cards, the availability of retrieval equipment and the quality of reproduction should be considered. The quality of drawings, lists, and documents shall meet the legibility and contrast requirements of MIL-D-5480 and MIL-M-9868. The microfilm supplied shall be Type I, Class 1.

9.3. Computer-Aided Design Drawings

The purpose of this section is to set policy on how Computer-Aided Design (CAD) drawings are to be handled while active, supplied, documented, and archived.

9.3.1. Presentation of Computer-Generated Data

A computer graphics or CAD program is used to create electronic data file drawings. A paper original is produced on which drawing signature requirements are placed. The electronic data file must be updated to include names, initials, and dates. The paper original is now the active original and is filed with the configuration manager (CM), along with the electronic data file which must be used for future changes.

When a revision is needed, an Engineering Order (EO) paper original is written and submitted to the CM for distribution and filing. After no more than five outstanding EOs are written, a new electronic CAD drawing should be produced by the originating GSFC group or contractor. The changes shall be recorded in the revision block, dated, and initialed. A new paper original with the changes incorporated, dated, and initialed, shall replace the previous original in the CM file. The new original shall be so stamped, dated, and signed by the CM representative.

CAD data files are to be stored on media that are compatible with currently used GSFC systems. These media include multitrack reels of computer tape or flexible disks (3-1/2" or 5-1/4" double side, high density). Each storage medium may contain one or more files. The following shall accompany each storage request:

- a. A computer-generated list of information contained on each piece of storage medium (for example: number, drawing size, etc.).
- b. The brand name of the computer and software used to create the files, and the software version number if practical.

GSFC requires that CAD data be converted to a standard format, such as the Drawing Interchange File (DXF) or Initial Graphics Exchange Specification (IGES). Refer to the National Institute for Standards and Technology for the latest version of IGES. This type of format allows the CAD data to be read by different types of CAD systems. For a technical overview of IGES, refer to the National Bureau of Standards publication, NBS IR81-229, *A Technical Briefing on the Initial Graphics Exchange*.

9.3.2. Developing and Using Computer-Generated Drawings

All questions regarding the latest information systems and applications should be directed to the Computer-Aided Design Section of the Mechanical Engineering Branch. Drawings generated by computer must be to scale per section 3.4 on page 32 of this manual.

9.3.3. Specification Data

The American National Standards Institute publication, *Digital Representation for Communication of Product Definition Data* (ANSI Y14.26M-1987 and updates), should be consulted to establish a standard data communications format.

10. DESIGN REFERENCES, STANDARDS, AND SPECIFICATIONS

10.1. Dimensioning and Tolerancing

10.1.1. Dimensioning and Tolerancing Practices

The dimensioning and tolerancing for all types of drawings shall be in accordance with ANSI Y14.5M-1982 (or later revisions). Copies are available from

American National Standards Institute
1430 Broadway
New York, NY 10018

American Society of Mechanical Engineers
345 E. 47th Street
New York, NY 10017

10.1.2. Statements on Dimensioning

- a. Dimensions shall be chosen and placed on drawings based on the parts interrelationships with mating parts, not to insignificant theoretical center lines.
- b. Primary, secondary, and tertiary datum features shall be labeled in alphabetical order when creating a new drawing.
- c. Drawings of parts requiring templates in the fabrication process and their template drawings must be dimensioned alike. Refer to tooling required notes in "Dimension Notes," paragraph 2.4.4.1 on page 16.
- d. Use a minimum of reference dimensions on drawings.
- e. When using true position dimensioning*, the dimension from the feature to other edges and its perpendicularity relationship to a surface must be identified with datum letters. Implied datums (when no datum letter(s) are specified) are no longer acceptable.

*basic, or theoretically exact dimensions; example:

X.XXX

10.2. Metric Dimensioning

NMI 8010.2A, *Use of the Metric System of Measurement in NASA Programs*, establishes policy and requirements for use of the metric measurement system (also known as the International System of Units, or SI) in NASA programs and the conditions under which both English and metric measurements may be used. When metric dimensioning is to be used, the documents ASTM E380-91a, *Standard Practice for Use of the International System of Units (SI)*, and NAS10000, *NA Documents Preparation and Maintenance in SI (Metric) Units*, give specific information and conversion factors.

10.2.1. SI Units and Symbols

- a. SI base units are seven well-defined units that are regarded as dimensionally independent. They are as follows:

SI Base Units			
Quantity	Name	Symbol	
length	meter	m	
mass	kilogram	kg	
time	second	s	
electric current	ampere	A	
thermodynamic temperature*	kelvin	K	
luminous intensity	candela	cd	
amount of substance	mole	mol	
Selected List of Derived Units			
Quantity	Name or Unit	Symbol	Formula
acceleration	meter per second squared	m/s^2	-
angular acceleration	radian per second squared	rad/s^2	-
angular velocity	radian per second	rad/s	-
area	square meter	m^2	-
density, mass	kilogram per cubic meter	kg/m^3	-
electric charge	coulomb	C	$A \times s$
electric potential	volt	V	W/A
electrical resistance	ohm	(Omega)	V/A
energy	joule	J	$N \times m$
force	newton	N	$kg \times m/s^2$
frequency	hertz	Hz	$1/s$
magnetic flux	weber	Wb	$V \times s$
moment of force	newton meter	$N \times m$	-
power	watt	W	J/s
pressure or stress	pascal	Pa	N/m^2
velocity	meter per second	m/s	-
volume	cubic meter	m^3	-

*The SI temperature scale is the International Thermodynamic Kelvin Scale, symbol K. Degree Celsius, symbol C, is for general use. The span of one degree Celsius is exactly one Kelvin.

- b. Dimensioning and tolerancing shall be in SI units and decimal fractions of the unit. All linear dimensions shall be in millimeters and decimal fractions of millimeters. Although the SI unit for the plane angle is the radian, angles stated in degrees, minutes, and seconds, or in degrees and decimal of a degree (preferred), shall be used when dimensioning parts. The number of decimal places in the dimension shall be the same as the number of places in the required tolerance. The rounding of dimensions and tolerancing shall be in accordance with section 10.2.2.2 on page 89. Drawings shall be dimensioned and toleranced in accordance with ANSI Y14.5M-1982.
- c. Surface texture values shall be noted in micrometers (μm). See the following table:

Surface Texture Conversion Values		
Micrometers	Microinches	Roughness Grade Numbers
50	2000	N12
25	1000	N11
12.5	500	N10
6.3	250	N9
3.2	125	N8
1.6	63	N7
0.8	32	N6
0.4	16	N5
0.2	8	N4
0.1	4	N3
0.05	2	N2
0.025	1	N1

- d. Forces, such as tensile and shear loads, shall be shown in newtons (N).
- e. Stresses shall be shown in megapascals ($\text{MPa} = \text{Pa} \times 10^6$). The following table gives examples:

Ultimate Strength			
English (PSI)		SI (MPa)	
Tensile	Shear	Tensile	Shear
85,000	50,000	600	340
125,000	75,000	900	540
160,000	95,000	1,100	660
180,000	110,000	1,250	750
220,000	132,000	1,550	930
260,000	156,000	1,800	1,080

- f. Pressure values for liquid and gas shall be shown in kilopascals ($\text{kPa} = \text{Pa} \times 10^3$).

- g. Mass values shall be shown in kilograms (kg).
- h. Preferred diameter/pitch combinations for threaded fasteners are shown in the following table, in accordance with ISO/TC20/SC4 Resolutions 169 and 220.

Thread Size	Dash Numbers		
	Nominal Size	First Oversize (0.5 mm)	Second Oversize (1 mm)
1.0 x 0.25	-010	-	-
1.2 x 0.25	-012	-	-
1.6 x 0.35	-016	-	-
2.0 x 0.40	-020	-	-
2.5 x 0.45	-025	-	-
3.0 x 0.50	-030	-	-
3.5 x 0.60	-035	-	-
4.0 x 0.70	-040	-	-
5.0 x 0.80	-050	-055	-
6.0 x 1.0	-060	-065	-
7.0 x 1.0	-070	-075	-
8.0 x 1.0	-080	-085	-090
10.0 x 1.25	-100	-105	-110
12.0 x 1.25	-120	-125	-130
14.0 x 1.50	-140	-145	-150
16.0 x 1.50	-160	-165	-170
18.0 x 1.50	-180	-185	-190
20.0 x 1.50	-200	-205	-210
22.0 x 1.5	-220	-225	-230
24.0 x 2.0	-240	-245	-250
27.0 x 2.0	-270	-275	-280
30.0 x 2.0	-300	-305	-310
33.0 x 2.0	-330	-335	-340
36.0 x 2.0	-360	-365	-370
39.0 x 2.0	-390	-395	-400

- i. The tolerance block on the GSFC drawing format shall be in accordance with the format example in Figure 2b on page 6. Tolerances given in the format may be adjusted to reflect the requirements of the design.
- j. *Preferred Metric Limits & Fits* (ANSI B4.2-1978) encompasses tolerance required designations, preferred limits, basic sizes, and symbols.
- k. *General Tolerances for Metric Dimensioned Products* (ANSI B4.3-1978) is used for metric dimensions without tolerance designations.

10.2.2. Unit Conversions

10.2.2.1. Conversion of Dimensions

Following is a table of selected conversion factors. If further conversion factors are needed, the references outlined in paragraph 10.2 on page 86 are very useful.

To Convert From:	To:	Multiply By:
inch	meter	2.540000 E-2*
in ²	m ²	6.451600 E-4*
foot	meter	3.048000 E-1*
ft ²	m ²	9.290304 E-2*
lb	kg	4.5359237 E-1*
lbf/in ² (psi)	Pa	6.894757 E3
degrees Fahrenheit	degrees Celsius	$t_C = (t_F - 32)/1.8^*$
degrees Fahrenheit	kelvin	$t_K = (t_F + 459.67)/1.8^*$

*Exact conversion

10.2.2.2. Unit Rounding

- a. General Rounding Rules

When a figure is to be rounded to fewer digits than the total number available and the first digit discarded is less than 5, the last digit retained should not be changed. For example, 3.46325, if rounded to three decimal places (i.e., 4 significant digits or simply 4 digits), would be 3.463; if rounded to three significant digits, 3.46.

When the first digit discarded is greater than 5, or if it is a 5 followed by at least one digit other than 0, the last digit retained should be increased by one unit. For example 8.37652, if rounded to four digits, would be 8.377; if rounded to three digits, 8.38.

When the first digit discarded is exactly 5, followed only by zeros, the last digit retained (i.e., the digit preceding the 5, underlined in the examples below) should be rounded upward if it is an odd number, but no adjustment made if it is an even number. For example, 4.365, when rounded to three significant digits, becomes 4.36. The number 4.355 would also round to the same value, 4.36, if rounded to three significant digits. This procedure is known as “odd-even rounding.”

Example: Round 46.02500 to two decimal places.

Answer: 46.02

Example: Round 41.27500 to two decimal places.

Answer: 41.28

Generally, the accuracy of the number of significant digits to which a value is to be rounded must be known before a conversion factor is used. If this is not known, then the best rule of thumb is to round the final value to the number of significant digits corresponding to the least number of significant digits of the original, unconverted numbers. For example, to convert 11.4 feet (ft) to meters (m): $11.4 \times 0.3048 = 3.47472$, which rounds to 3.47 meters. Neither the conversion factor nor the quantity shall be rounded before performing the multiplication, because accuracy would be reduced. For converting inches (in) to millimeters (mm), which would generally be the case in drawings, the rule of thumb is to round to one less decimal place than the original inch dimension. When converting from millimeters to inches, the rule is to round to two more decimal places than the original value.

Example: Convert 3.5748 inches to millimeters.

$3.5748 \times 25.4 = 90.79992$ Answer: 90.800 mm

Example: Convert 1.625 inches to millimeters.

$1.625 \times 25.4 = 41.275$ Answer: 41.28 mm

Example: Convert 101.83 millimeters to inches.

$101.83/25.4 = 4.009055118$ Answer: 4.0091 inches

b. Rounding Basic Dimensions

To convert basic dimensions of drawings from inches to millimeters, the converted value shall be rounded to three decimal places since this shall provide a maximum conversion error of 0.00002 inch. In converting basic dimensions from millimeters to inches, the value shall be rounded to five decimal places, giving a maximum conversion error of 0.000005 inch.

c. Rounding Toleranced Dimensions

The use of the exact relation 1 inch = 25.4 millimeters generally produces more than the required number of significant digits. To round both the dimension and the tolerances, first convert the values to the necessary units. When converting from inches to millimeters, multiply by 25.4 for a product; when converting from millimeters to inches, divide by 25.4 for a quotient. Next, take the total tolerance (i.e., the total value between the maximum and minimum limits) and from the respective table below find the correct number of decimal places. Then round both the dimension and the tolerances to the number of decimal places indicated. However, care must be taken so that the rounded tolerances fall inside the original tolerance values as explained in paragraph 10.2.2.2.d., "Precision Rounding," on page 92.

Original Total Tolerance in Inches		
At Least:	But Less Than:	Round Product To:
0.4 & over		Whole mm
0.04	0.4	0.X mm
0.004	0.04	0.XX mm
0.0004	0.004	0.XXX mm
0.00004	0.0004	0.XXXX mm

Original Total Tolerance in Millimeters		
At Least:	But Less Than:	Round Quotient To:
2.0 & over		0.XX in
0.2	2.0	0.XXX in
0.02	0.2	0.XXXX in
0.002	0.02	0.XXXXX in

Example: Convert 1.387 ± 0.003 inches to millimeters.

$$1.387 \times 25.4 = 35.2298; \quad 0.003 \times 25.4 = 0.0762$$

$$35.2298 \pm 0.0762$$

The total original tolerance is 0.006, which lies between 0.004 and 0.04, and according to the first table, should be rounded to 0.XX millimeter.

$$\text{Answer: } 35.23 \pm 0.08 \text{ mm}$$

d. Precision Rounding (Inside)

When converted, tolerances must never exceed the originally specified limits (as in the case where the “converted” parts are to be inspected by gages made for the original parts). The round-off must be such that the new dimensions shall lie inside the original tolerance limits. This may be accomplished by converting the maximum and minimum limits exactly, and then rounding the upper limit to the next lower value and rounding the lower limit to the next higher value.

Example: Convert 0.877 from inches to millimeters without
0.874
violation of the original limits:

$$0.877 \times 25.4 = 22.2758; \quad 0.874 \times 25.4 = 22.1996$$

The total original tolerance is 0.003, which lies between 0.0004 and 0.004 and, according to the preceding table, should be rounded to 0.XXX millimeters.

$$\begin{array}{ll} \text{Answer:} & 22.275 \text{ mm} \\ & 22.200 \text{ mm} \end{array}$$

Note that 22.2758 is not rounded to 22.276 mm because it would violate the “inside” rule.

10.3. Design References

- a. Finishes of Metal and Wood Surfaces: MIL-STD-171. Reference document (for a working knowledge): MIL-HDBK-132A.
- b. Gears/Gear Classification and Inspection Handbook Tolerances and Measuring Methods for Unassembled Spur and Helical Gears (including metric equivalents): AGMA 2000-A-88.
- c. Gear Classification, Materials, and Measuring Methods for Bevel, Hypoid, Fine Pitch Wormgearing, and Racks Only as Unassembled Gears: AGMA 390.03A-88.
- d. Optics/General Specification Governing the Manufacture, Assembly, and Inspection of Optical Components for Fire Control Instruments: MIL-O-13830.
- e. Soldering/General Specification for Soldering Process (for nonelectrical applications): MIL-S-6872.
- f. Springs/Drawing Requirements for Mechanical Springs: MIL-STD-29.

10.4. Control of Surface Roughness

10.4.1. Surface Texture

Surface texture, surface roughness, waviness, and lay shall be in accordance with ANSI B46.1-1985 (or later revisions). The symbols below are examples of microinch finish symbols and their micrometer equivalents that are most commonly used. Refer to the ANSI B46.1-1985 for further data such as waviness and lay. Metric equivalents with roughness grade numbers to the following are found in paragraph 10.2.1c on page 87.

Microinch

Micrometer

Rough Machining.

Mating Surfaces.

Moving Parts.

Precision Parts.

Polished Parts.

Lapped Parts.

10.4.2. Surface Texture Symbols

Symbols depicting acceptable surface conditions shall be in accordance with ANSI Y14.36-1978 (R 1987) (or later revisions).

10.4.3. Surface Texture Standards

Copies of both ANSI B46.1-1985 and ANSI Y14.36-1978 are available from

American National Standards Institute
1430 Broadway
New York, NY 10018

10.5. Thread Specifications

Screw-thread conventions, methods of specifying, and design shall be in accordance with the following specifications:

- a. Screw-Thread Standards for Federal Services, Federal Standard FED-STD-H28, detailed standards as follows:

- FED-STD-H28/1 Nomenclature, Definitions, and Letter Symbols for Screw Threads.
- FED-STD-H28/2 Unified Thread Form and Thread Series for Bolts, Screws, Nuts, Tapped Holes, and General Applications.
- FED-STD-H28/3 Unified Threads of Special Diameter, Pitches, and Lengths of Engagement.
- FED-STD-H28/4 Controlled Radius Root Screw Threads, UNJ Symbol.
- FED-STD-H28/5 Unified Miniature Screw Threads.
- FED-STD-H28/6 Gages and Gaging for Unified Screw Threads.
- FED-STD-H28/7 American Standard Pipe Threads (except Dryseal and Hose Coupling Types).
- FED-STD-H28/8 Dryseal American Standard Pipe Threads.
- FED-STD-H28/9 Gas Cylinder Valve Outlet and Inlet Threads.
- FED-STD-H28/10 American National Hose Coupling and Fire-Hose Coupling Threads.
- FED-STD-H28/11 Hose Connections for Welding and Cutting Equipment.
- FED-STD-H28/12 Acme Threads.
- FED-STD-H28/13 Stub Acme Threads.
- FED-STD-H28/14 National Buttress Threads.
- FED-STD-H28/15 American Standard Rolled Threads for Screw Shells of Electric Lamp Holders and for Screw Shells of Unassembled Lamp Bases.
- FED-STD-H28/16 Microscope Objective and Nosepiece Threads, 0.800—36AMO.
- FED-STD-H28/17 Surveying Instrument Mounting Threads.
- FED-STD-H28/18 Photographic Equipment Threads.
- FED-STD-H28/19 Miscellaneous Threads.
- FED-STD-H28/20 Inspection Methods for Acceptability of UN, UNR, UNJ, M, and MJ Screw-Threads.
- FED-STD-H28/21A Metric Screw-Thread Standards.
- FED-STD-H28/22 Metric Screw-Thread Gages.
- b. General Specification for Screw Threads, Standard, Optimum Selected Series, Military Specification MIL-S-7742.

- c. General Requirements for Pipe Threads, Taper, Aeronautical National Form, Symbol-ANPT, Military Specification MIL-P-7105.
- d. General Specification for Screw Threads, Controlled Radius Root With Increased Minor Diameter, Military Specification MIL-S-8879.
- e. Metric Screw Threads M Profile ANSI/ASME B1.13M-1983.
- f. Metric Screw Threads MJ Profile ANSI B1.21M-1978.
- g. Screw Thread Representations (Conventions and Methods of Specifying), American National Standard ANSI Y14.6-1978, and ANSI Y14.6aM-1981 (Metric Supplement).

10.6. Welding—Fusion and Resistance

10.6.1. General

The standard definition for the term “weld” is a localized coalescence of metals where coalescence is produced by heating to suitable temperatures, with or without the application of pressure, and with or without the use of filler metal. The filler metal either has a melting point approximately the same as the base metal or has a melting point below that of the base metal but above 800 degrees F. For standard welding specification callouts, refer to “Joining Method Notes,” paragraph 2.4.4.3 on page 18.

10.6.2. Basic Weld Symbols and Their Location Significance

Basic weld symbols and their location significance shall be in accordance with ANSI AWS A 2.4-86 (or later revisions).

Copies are available from

American Welding Society
2501 NW 7th Street
Miami, FL 33125

10.7. Outgassing of Spacecraft Materials

NASA Reference Publication, RP-1124, November 1990, *Outgassing Data for Selecting Spacecraft Materials*, covers a wide range of materials, including adhesives, compounds, coatings, insulation, and various other materials. As presented, the data represent the “total mass loss” (TML) and the “Collected Volatile Condensable Materials” (CVCM), as derived from tests at 398 K (125 C) for 24 hours in vacuum per ASTM E595-84.

The publication can be purchased as document number N-88-10117 from

National Technical Information Service (NTIS)
5285 Port Royal Road
Springfield, VA 22151

10.8. Standards and Specifications Index

10.8.1. National Bureau of Standards

NBS IR81-229, A Technical Briefing on the Initial Graphics Exchange Specification (IGES).

10.8.2. Federal

Commerce Commission Regulation 49-CFR71-78 Commerce Commission Safety Regulations

Commercial and Government Entity (CAGE) Publication H4/H8 Section A: Name to CAGE Code; Section B: CAGE Code to Name (formerly FSCM H4 and FSCNM H8).

FED-STD-H28/1, Nomenclature, Definitions, and Letter Symbols for Screw Threads.

FED-STD-H28/2, Unified Thread Form and Thread Series for Bolts.

FED-STD-H28/3, Unified Threads of Special Diameter, Pitches, and Lengths of Engagement.

FED-STD-H28/4, Controlled Radius Root Screw Threads, UNJ Symbol.

FED-STD-H28/5, Unified Miniature Screw Threads.

FED-STD-H28/6, Gages and Gaging for Unified Screw Threads.

FED-STD-H28/7, American Standard Pipe Threads (except Dryseal and Hose Coupling Types).

FED-STD-H28/8, Dryseal American Standard Pipe Threads.

FED-STD-H28/9, Gas Cylinder Valve Outlet and Inlet Threads.

FED-STD-H28/10, American National Hose Coupling and Fire-Hose.

FED-STD-H28/11, Hose Connections for Welding and Cutting Equipment.

FED-STD-H28/12, Acme Threads.

FED-STD-H28/13, Stub Acme Threads.

FED-STD-H28/14, National Buttress Threads.

FED-STD-H28/15, American Standard Rolled Threads for Screw Shells for Electric Lamp Holders & Unassembled Lamp Bases.

FED-STD-H28/16, Microscope Objective and Nosepiece Threads.

FED-STD-H28/17, Surveying Instrument Mounting Threads.

FED-STD-H28/18, Photographic Equipment Threads.

FED-STD-H28/19, Miscellaneous Threads.

FED-STD-H28/20, Inspection Methods for Acceptability of UN, UNR, UNJ, M, and MJ Screw-Threads.

FED-STD-H28/21, Metric Screw-Thread Standards.

FED-STD-H28/22, Metric Screw-Thread Gages.

FED-STD-595, Colors.

QQ-B-654, Brazing Alloys, Silver.

QQ-C-320, Chromium Plating (Electrodeposited).

QQ-P-35, Passivation Treatments for Corrosion-Resistant Steel.

QQ-P-416, Plating, Cadmium (Electrodeposited).

QQ-S-365, Silver Plating (Electrodeposited), General Requirements for.

QQ-S-571, Solder, Tin Alloy, Tin-Lead Alloy, and Lead Alloy.

Safety Regulations 49-CFR71-78, Commerce Commission Safety Regulations.

10.8.3. Industrial

AGMA 390.03A-88, Gear Classification and Inspection Handbook Tolerances and Measuring Methods for Bevel, Hypoid, Fine Pitch Wormgearing, and Racks.

AGMA 2000-A-88, Gear Classification and Inspection Handbook Tolerances and Measuring Methods for Unassembled Spur and Helical Gears (Including Metric Equivalents).

AMS 2488, Anodic Treatment of Titanium and Titanium Alloys.

ANSI AWS A2.4-1986, Symbols for Welding and Nondestructive Testing.

ANSI/ASME B1.13M-1983, Metric Screw Threads M Profile.

ANSI B1.21M-1978, Metric Screw Threads MJ Profile.

- ANSI B4.2-1978, Preferred Metric Limits and Fits.
- ANSI B4.3-1978 General Tolerances for Metric Dimensioned Products.
- ANSI B46.1-1985, Surface Texture (Surface Roughness, Waviness, and Lay).
- ANSI Y14.15-1966 (R-73), Electrical and Electronics Diagrams.
- ANSI Y14.15a-1971, Interconnection Diagrams.
- ANSI Y14.15b-1973, Electrical and Electronics Diagrams.
- ANSI Y14.2M-1979, Line Conventions and Lettering.
- ANSI Y14.26M-1987, Digital Representation for Communication of Product Definition Data.
- ANSI Y14.36-1978 (R1987), Surface Texture Symbols.
- ANSI Y14.5M-1982, Dimensioning and Tolerancing.
- ANSI Y14.6-1978, Screw Thread Representation.
- ANSI Y14.6AM-1981, Screw Thread Representation (Metric Supplement).
- ANSI Y32.2-1975, IEEE STD 315-1975, CSA Z99-1975, Graphic Symbols for Electrical and Electronics Diagrams.
- ANSI Y32.9-1972, Graphic Symbols for Electrical Wiring and Layout Diagrams Used in Architecture and Building Construction.
- ASTM D4126, Vapor Degreasing.
- ASTM E380-91a, Standard Practice for Use of the International System of Units (The Modernized Metric System).
- ASTM E595-84, Standard Test Method for Total Mass Loss and Collected Volatile Condensable Materials From Outgassing in a Vacuum Environment.
- N-88-10117, National Technical Information Service—Outgassing Data for Selecting Spacecraft Materials.
- NAS10000, NA Documents Preparation and Maintenance in SI (Metric) Units.

10.8.4. Military

- DOD-STD-1866, Soldering Specification.

MIL-A-8625, Anodic Coatings, for Aluminum and Aluminum Alloys.

MIL-B-7883, Brazing of Steels, Copper, Copper Alloys, Nickel Alloys, Aluminum, and Aluminum Alloys.

MIL-C-5541, Chemical Conversion Coatings on Aluminum and Aluminum Alloys.

MIL-C-12968, Coatings, Phosphate, Protective.

MIL-C-13924, Coating, Oxide, Black, for Ferrous Metals.

MIL-D-5480, Data, Engineering and Technical, Reproduction Requirements for.

MIL-H-6088, Heat Treatment of Aluminum Alloys.

MIL-H-6875, Heat Treatment of Steel, Processes for.

MIL-H-7199, Heat Treatment of Wrought Copper-Beryllium Alloys, Process for.

MIL-HDBK-132A, Protective Finishes for Metal and Wood Surfaces.

MIL-I-45932/1, Insert, Screw Thread - Thin Wall, Locked in.

MIL-L-46010, Lubricant, Solid Film, Heat Cured, Corrosion.

MIL-M-9868, Microfilming of Engineering Documents, 35MM, Requirements for.

MIL-N-45938/1, Nut, Plain, Clinch (Self-Clinching, Round).

MIL-O-13830, Optical Components for Fire Control Instruments; General Specification Governing the Manufacturing, Assembly, and Inspection of.

MIL-P-116, Preservation, Methods of.

MIL-P-7105, Pipe Threads, Taper, Aeronautical National Form, Symbol ANPT, General Requirement for.

MIL-R-28002, Raster Graphics Representation in Binary Format, Requirements for.

MIL-S-6872, General Specification for Soldering Process (non-electrical).

MIL-S-7742, Screw Threads, STD, Optimum Selected Series, General Specification for.

MIL-S-8879, Screw Threads, Controlled Radius Root With Increased Minor Diameter; General Specification for.

MIL-STD-12, Abbreviations.

MIL-STD-29, Drawing Requirements for Mechanical Springs.

MIL-STD-100, Engineering Drawing Practices.

MIL-STD-171, Finishes of Metal and Wood Surfaces.

MIL-STD-403, Preparation for and Installation of Rivets and Screws, Rocket and Missile Structures.

MIL-STD-00453, Radiographic Inspection.

MIL-STD-645, Dip Brazing of Aluminum Alloys.

MIL-STD-2154, Ultrasonic Inspection.

MIL-STD-2219, Fusion Welding for Aerospace Applications.

MIL-T-713, Twine, Fibrous; Impregnated, Lacing and Tying.

MIL-W-46132, Electronic Beam Welding.

MS33537, Insert, Screw Thread, Helical Coil, Coarse and Fine Thread, Standard Dimensions for.

MS51835, Inserts and Studs, Locked In-Key Locked, Hole Dimensions for and Assembly of.

10.8.5. NASA

GSFC 731-0005-83, General Fracture Control Plan for Payloads Using the Space Transportation System (STS).

GSFC-GHB-2200.2, Scientific and Technical Information Handbook.

GSFC S-250-3, Guide for the Preparation of Specifications.

GSFC S-313-009, Fluorescent Penetrant Test Method Requirements and Guidelines.

GSFC S-313-100, GSFC Fastener Integrity Requirements.

GSFC-STD-256-WE-1, For Your Information, A Compendium of General Reference Data for Technical Writing and Editing.

GSFC X-673-64-1F, GSFC Engineering Standards Design Manual.

NASA Reference Publication RP-1124, November 1990, Outgassing Data for Selecting Spacecraft Materials.

NHB 5300.4 (3A-1) 1976, Requirements for Soldered Electrical Connections.

NMI 80102A, Use of the Metric System of Measurement in NASA Programs.

NSTS 07700, System Description and Design Data, Intervehicular Activities.

10.9. Standards and Specifications Numerical Index

<u>Specification</u>	<u>Page</u>
AGMA 2000-A-88, Gear Classification and Inspection Handbook Tolerances and Measuring Methods for Unassembled Spur and Helical Gears (Including Metric Equivalents).	92
AGMA 390.03A-88, Gear Classification Materials and Measuring Methods for Bevel, Hypoid, Fine Pitch Wormgearing, and Racks.	92
AMS 2488, Anodic Treatment of Titanium and Titanium Alloys.	19
ANSI AWS A 2.4-86, Symbols for Welding and Nondestructive Testing.	95
ANSI B1.21M-1978, Metric Screw Threads MJ Profile	95
<u>Specification</u>	<u>Page</u>
ANSI B4.2-1978, Preferred Metric Limits and Fits.	89
ANSI B46.1-1985, Surface Texture (Surface Roughness, Waviness, and Lay).	93
ANSI Y14.15-1966 (R-73), Electrical and Electronics Diagrams.	43
ANSI Y14.15a-1971, Interconnection Diagrams.	43
ANSI Y14.15b-1973, Electrical and Electronics Diagrams.	43
ANSI Y14.2M-1979, Line Conventions and Lettering.	35
ANSI Y14.26M-1987, Digital Representation for Communication of Product.	84
ANSI Y14.36-1978 (R 1987), Surface Texture Symbols.	93
ANSI Y14.5M-1982, Dimensioning and Tolerancing.	1, 7, 16, 28, 85, 87, 107, 108

ANSI Y14.6-1978, Screw Thread Representation.	95
ANSI Y14.6aM-1981, Screw Thread Representation (Metric Supplement).	95
ANSI Y32.2-1975, IEEE STD 315-1975, CSA Z99-1975, Graphic Symbols for Electrical and Electronic Diagrams.	43
ANSI Y32.9-1972, Graphic Symbols for Electrical Wiring and Layout Diagrams Used in Architecture and Building Construction.	43
ANSI/ASME B1.13M-1983, Metric Screw Threads M Profile	95
ASTM D4126, Vapor Degreasing.	20
ASTM E380-91a, Standard Practice for Use of the International System of Units (The Modernized Metric System).	86
ASTM E595-84, Standard Test Method for Total Mass Loss and Collected Volatile Condensable Materials From Outgassing in a Vacuum Environment.	95
Commerce Commission Regulation 49-CFR71-78, Commerce Commission Safety Regulations.	22
Commercial and Government Entity (CAGE) Publication H4/H8.	7, 72, 75
<u>Specification</u>	<u>Page</u>
DOD-STD-1866, Soldering Specification.	18
FED-STD-595, Colors	19
FED-STD-H28/1, Nomenclature, Definitions, and Letter Symbols for Screw Threads.	93
FED-STD-H28/2, Unified Thread Form and Thread Series for Bolts, Screws, Nuts, Tapped Holes, and General Applications.	93
FED-STD-H28/3, Unified Threads of Special Diameter, Pitches, and Lengths of Engagements.	93
FED-STD-H28/4, Controlled Radius Root Screw Threads, UNJ Symbol.	93
FED-STD-H28/5, Unified Miniature Screw Threads.	93
FED-STD-H28/6, Gages and Gaging for Unified Screw Threads.	93

FED-STD-H28/7, American Standard Pipe Threads (except Dryseal and Hose Coupling Types).	93
FED-STD-H28/8, Dryseal American Standard Pipe Threads.	93
FED-STD-H28/9, Gas Cylinder Valve Outlet and Inlet Threads.	93
FED-STD-H28/10, American National Hose Coupling and Fire-Hose Coupling Threads.	93
FED-STD-H28/11, Hose Connections for Welding and Cutting Equipment.	93
FED-STD-H28/12, Acme Threads.	93
FED-STD-H28/13, Stub Acme Threads.	93
FED-STD-H28/14, National Buttress Threads.	93
FED-STD-H28/15, American Standard Rolled Threads for Screw Shells of Electric Lamp Holders and for Screw Shells of Unassembled Lamp Bases.	93
FED-STD-H28/16, Microscope Objective and Nosepiece Threads, 0.800-36AMO.	93
FED-STD-H28/17, Surveying Instrument Mounting Threads.	93
FED-STD-H28/18, Photographic Equipment Threads.	93
<u>Specification</u>	<u>Page</u>
FED-STD-H28/19, Miscellaneous Threads.	93
FED-STD-H28/20, Inspection Methods for Acceptability of UN, UNR, UNJ, M, and MJ Screw-Threads.	94
FED-STD-H28/21A, Metric Screw-Thread Standards.	94
FED-STD-H28/22, Metric Screw-Thread Gages.	94
GSFC 731-0005-83, General Fracture Control Plan for Payloads Using the Space Transportation System (STS).	20
GSFC S-250-3, Guide for the Preparation of Specifications.	60
GSFC S-313-009, Fluorescent Penetrant Test Method Requirements and Guidelines.	20
GSFC S-313-100, GSFC Fastener Integrity Requirements.	14
GSFC STD-256-WE-1, For Your Information—A Compendium Of General Reference Data.	12

GSFC X-673-64-1F, GSFC Engineering Drawing Standards Manual.	iii, 16, 21
MIL-A-8625, Anodic Coatings, for Aluminum and Aluminum Alloys.	19
MIL-B-7883, Brazing of Steels, Copper, Copper Alloys, Nickel Alloys, Aluminum, and Aluminum Alloys.	18
MIL-C-5541, Chemical Conversion Coatings on Aluminum and Aluminum Alloys.	19
MIL-C-12968, Coatings, Phosphate, Protective.	19
MIL-C-13924, Coating, Oxide, Black, for Ferrous Metals.	109
MIL-D-5480, Data, Engineering and Technical, Reproduction Requirements for.	83
MIL-H-6088, Heat Treatment of Aluminum Alloys.	17, 18
MIL-H-6875, Heat Treatment of Steel, Processes for.	17
MIL-H-7199, Heat Treatment of Wrought Copper-Beryllium Alloys, Process for.	17
MIL-HDBK-132A, Protective Finishes for Metal and Wood Surfaces.	92
<u>Specification</u>	<u>Page</u>
MIL-I-45932/1, Insert, Screw Thread - Thin Wall, Locked In.	21
MIL-L-46010, Lubricant, Solid Film, Heat Cured, Corrosion.	20, 109
MIL-M-9868, Microfilming of Engineering Documents, 35mm, Requirements for.	83
MIL-N-45938/1, Nut, Plain, Clinch (Self-Clinching, Round).	21
MIL-O-13830, Optical Components for Fire Control Instruments; General Specification Governing the Manufacturing, Assembly, and Inspection of.	92
MIL-P-116, Preservation, Methods of.	21, 22
MIL-P-7105, Pipe Threads, Taper, Aeronautical National Form, Symbol ANPT, General Requirements for.	95
MIL-R-28002, Raster Graphics Representation in Binary Format, Requirements for.	83

MIL-S-6872, General Specification for Soldering Process (non-electrical).	92
MIL-S-7742, Screw Threads, STD, Optimum Selected Series, General Specification for.	94
MIL-S-8879, Screw Threads, Controlled Radius Root with Increased Minor.	95
MIL-STD-00453, Radiographic Inspection.	20
MIL-STD-12, Abbreviations.	12
MIL-STD-100E, Engineering Drawing Practices.	1
MIL-STD-171, Finishes of Metal and Wood Surfaces.	18, 92
MIL-STD-2154, Ultrasonic Inspection.	20
MIL-STD-2219, Fusion Welding for Aerospace Applications.	18
MIL-STD-29, Drawing Requirements for Mechanical Springs.	92
MIL-STD-403, Preparation for and Installation of Rivets and Screws, Rocket and Missile Structures.	18
MIL-STD-645, Dip Brazing of Aluminum Alloys	18
<u>Specification</u>	<u>Page</u>
MIL-T-713, Twine, Fibrous; Impregnated, Lacing and Tying.	22
MIL-W-46132, Electronic Beam Welding.	18
MS33537, Insert, Screw Thread, Helical Coil, Coarse and Fine Thread, Standard Dimensions for.	21
MS51835, Inserts and Studs, Locked In-Key Locked, Hole Dimensions for and Assembly of.	21
N-88-10117, National Technical Information Service—Outgassing Data Compilation of Spacecraft Materials.	95
NAS10000, NA Documents Preparation and Maintenance in SI (Metric) Units.	86
NASA Reference Publication, RP-1124, November 1990, Outgassing Data for Selecting Spacecraft Materials.	95, 108
NBS IR81-229, A Technical Briefing on the Initial Graphics Exchange.	84

NHB 5300.4(3A-1) 1976, Requirements for Soldered Electrical Connections.	18
NMI 8010.2A, Use of the Metric System of Measurement in NASA Programs.	86
NSTS 07700, System Description and Design Data, Intervehicular Activities.	108
QQ-B-654, Brazing Alloys, Silver.	18
QQ-C-320, Chromium Plating (Electrodeposited).	18
QQ-P-35, Passivation Treatments for Corrosion-Resistant Steel.	19
QQ-P-416, Plating, Cadmium (Electrodeposited).	18
QQ-S-365, Silver Plating (Electrodeposited), General Requirements for.	19
QQ-S-571, Solder, Tin Alloy, Tin-Lead Alloy, and Lead Alloy.	18
Safety Regulations 49-CFR71-78, Commerce Commission Safety Regulations.	22

APPENDIX A. DESIGN REVIEW DOs AND DON'Ts

All drawings should adhere to the following guidelines:

- a. **Dimension parts correctly.** Dimensioning shall be to primary or mating surfaces. Unwanted buildup of tolerances between mating surfaces should be avoided. Dimensions to insignificant theoretical center lines can result in mistakes by the machinist, as well as the inspectors, because of the multiple additions and subtractions required to locate the feature in relation to other features. Whenever possible, dimensions should be left to right and bottom to top (Quadrant I, all positive numbers) or from datums established by design requirements.
- b. **Do not detail weldment parts separately.** Since each part may be fabricated by a different manufacturer, the required tolerancing typically cannot be met, resulting in delays and additional cost. Different parts of a weldment should be drawn on an Inseparable Assembly Drawing (Figure 20 on page 44) so that the overall assembly tolerancing is the responsibility of a single manufacturer.
- c. **Implied datums are no longer allowed.** Whenever possible, select datums that are functional to the part. A datum should always be assigned to a physical surface or a feature of size. When using true position dimensioning (basic dimensions), the dimensions from the feature to other edges and its perpendicularity relationship to a surface must be identified with datum letters. The combined usage of positional tolerancing with plus and minus methods as related to basic dimensioned patterns is discontinued and replaced with the composite tolerancing method. Refer to ANSI Y14.5M-1982, "Dimensioning and Tolerancing."

Note:

Although there is no requirement that all holes be true positioned, it is preferred that hole patterns be true positioned, regardless of use, since tolerancing specified in the true position block is the controlling factor.

- d. **Drawings for parts produced using templates must be properly dimensioned and toleranced.** Lack of dimensioning may result in inadequate stress analysis, fit checking, and/or inspection. Engineering and tooling drawings should be dimensioned alike and related to one another. Refer to tooling required notes in "Dimension Notes," paragraph 2.4.4.1 on page 16.
- e. **Use the list of material format correctly.** The assembly number does not get an item number. While the material is properly an item on the List of Material, on end product drawings, there is no need to specify either the drawing number or an item number in the List of Material if there is only one part or material. An item with the same material and specification requires only one item number and "A/R" (as required) as a quantity. The various material sizes required are indicated on the field of the drawing, as is the case of inseparable assemblies (weldments, riveted parts, etc.). Dash numbers are required only when there is a "shown" (odd number) and "opposite" (even number), when there is more than one assembly version, or when the drawing is of a tabulated type (refer to types of drawings). Multidetail drawings are not allowed (refer to "Detail Drawing," paragraph 4.3 on page 41 for explanation).

- f. **Do not use “SK” (short for sketch) on any drawing that is used to manufacture a part.** Use only GSFC drawing numbers when using the GSFC drawing format; contractor drawing numbers are used on the contractor's drawing format. The Mechanical Engineering Branch does not check or give approval for drawings produced on contractor format. Contracts should specify that the contractor shall supply copies of company specifications when using contractor formats.
- g. **Specify low-outgassing materials.** Use low-outgassing film lubricants for space flight hardware where disassembly is likely and/or galling of like materials is possible. Refer to NASA RP-1124, November 1990 (or later), *Outgassing Data for Selecting Spacecraft Materials*, or to Section 10, paragraph 10.6.1, page 95 of this manual, “Outgassing of Spacecraft Materials.”
- h. **Specify the identification of parts.** To maintain traceability, all parts should be identified by ink stamping with the GSFC drawing number, rather than by bagging and tagging. Use only low-outgassing ink (specify original source) and do not overcoat. Do not steel stamp engrave, or etch on flight hardware to prevent material stress concentrations. Identical parts with different uses should be serialized.
- i. **Specify the original manufacturer source of supply and complete address.** List the original source and complete address in the General Notes, and flag them to the List of Material or Parts List.
- j. **Specify regardless of feature size when applying to fixed locations.** Positional tolerance should be specified as “Regardless of Feature Size” when applying to thread inserts, tapped hole locations, and slip fit designs.
- k. **Specify loose tolerances where possible.** The use of the true position method of dimensioning should not be mistaken for a tighter tolerancing control system. True position tolerancing can be as loose as the application shall allow. Loose tolerances make inspection easier and allow fewer rejected parts.
- l. **Specify radii and chamfers.** Edge radii, in-plane corner radii, and protrusion chamfers must be specified to space flight standard size requirements. Refer to Johnson Space Center document NSTS 07700, Volume XIV, Appendix 9, “System Description and Design Data Intervehicular Activities,” Section 5.5, “Crew Equipment Safety,” for size requirements. Specify radii at the bottom of counterbores to prevent sharp corners, which could develop into stress cracks, particularly on flight parts.
- m. **Specify interference range only for press fits.** Only the amount “.000X to .000X interference” should be stated next to the item call out.
- n. **Specify as few reference dimensions as possible.** Too many reference dimensions make checking, inspection, and cost estimating more difficult.
- o. **Specify projected tolerance zone dimensions where applicable.** Add a projected tolerance zone dimension to the true position tolerance when specifying threaded inserts, tapped holes, or dowel pins. Refer to ANSI Y14.5M-1982.

- p. **Specify fastener torque requirements.** These requirements may refer to a project-developed specification number, or fastener size and torque requirements can be tabulated in the General Notes and flagged to item call-outs in the field of the drawing.
- q. **Avoid double fixations.** A pattern of countersunk holes in one part and tapped holes in the mating part leaves no tolerancing for either part, resulting in bending stresses in the screw. If the situation shall allow, counterbore one of the parts and use a pan head screw. If not, drill out the second part and use a nut in place of tapped holes. Matched drilling should be avoided because of loss of interchangeability.
- r. **Avoid severe galling between like materials.** To avoid severe galling in CRES-to-CRES fastener applications, consider the following possibilities:
- Use of phosphor bronze inserts.
- Use of dry film lubricant per MIL-G-46010, Lubricant, Solid Film, Heat Cured, Corrosion Inhibiting (for CRES inserts and nuts).
- Use of black oxide coating per MIL-C-13924 (for bolts and screws).
- s. **Avoid the use of internal, external, or split-ring lock washers.** These types of washers are not used on aerospace flight projects for several reasons; the worst is possible particulate contamination.
- t. **Avoid using silver-plated hardware around electronic applications.** This can cause contamination particles. However, it is acceptable for all other applications.
- u. **Design a part so it can be made with the least amount of machine setups possible.**

INDEX

For an alphabetical (numerical) listing of the Standards and Specifications listed in this manual, see Section 10.9, page 101.

A

Abbreviations 11, 12
 AFBMA 12
 AGMA 12
 AGMA standard quality 16
 Altered parts *see* Parts—Vendor
 Altered vendor part drawings
 *see* Drawings
 ANSI 12
 Archiving 80
 ASME 12
 Assembly drawings *see* Drawings
 Associated lists 80
 ASTM 13
 AWS 13, 92

B

Basic dimensions
 *see* Dimensioning—True position
 Brazing 18

C

CAD *see* Computer-aided design
 CAD-produced drawings *see* Drawings
 Certification logs 80
 Chamfers 105
 Coating Notes *see* Notes
 Composite material drawing 56
 Computer-aided design 33, 80
 *see also* Drawings—Computer-aided design
 Data files
 Media 81
 Presentation of data 80
 Specification data 81
 Computer-generated data
 Presentation of 80
 Configuration management officer 58
 Configuration manager 58, 80
 Contractor design activity drawings
 *see* Drawings
 Conversion of dimensions 86
 Cross-hatching symbol 35

D

Datum 30, 45, 82
 Implied 104
 Design references 82
 Design review Dos and Don'ts 104
 Design Selection Guide 14
 Detail drawings *see* Drawings
 Details 37
 Identification 37
 Locating 38
 Diagrams
 Electrical and electronic 43
 Dimension notes *see* Notes
 Dimensional tolerance notes *see* Notes
 Dimensioning
 Metric *see* Metric dimensioning
 Statements on 82
 True position 82, 104, 105
 Dimensioning and tolerancing .. 82, 84, 104
 Metric 83
 Practices 82
 Dimensions
 ... 15, 16, 24, 25, 28, 55, 82, 84, 88, 104
 Conversion of 86
 Projected tolerance zone 106
 Reference 105
 Documentation management 79
 Double fixations 106
 Drafting practices 25
 Drawing elements 3
 Drawing flow chart *see* Flow chart
 Drawing format 10
 Drawing Interchange File 81
 Drawing notes *see* Notes
 Drawing number 1, 7, 10, 41, 58, 60
 Source control 53
 Specification control 54
 Drawing revisions *see* Revisions
 Drawing sizes 3
 Drawing title 11
 Drawing tree 42
 Drawings
 Archiving 80
 Assembly 40, 53, 54
 CAD-produced 8
 Computer-aided design 80

Developing and using	81
Revisions	80
Contractor design activity	1
Detail	41
Electrical/Electronic	43
Engineering	1, 16, 58, 104
Format	10
Government Design Activity	1
Inseparable assembly	44
Installation assembly	45, 53, 54
Interface control	46, 47
Manufacturing	54
Matched-set	48
Mechanical schematic	49
Modification	50
Monodetail	44
Multidetail	41
Multisheet	3, 4, 15, 38, 65
Notes	<i>see</i> Notes
Numbering system	58
One view	25
Outline	50, 51, 54
Pencil	33
Positioning	33
Redrawn or replaced	67
Scale	32
Source control	52, 53
Specification control	52, 53, 54
Standard part	54
Tabulated	54
Three view	25
Tooling	8, 55, 104
Two view	25
Types of	39
Vendor part	
Altered	39
Selected	39
Zoned	4, 38
DXF	<i>see</i> Drawing Interchange File

E

Electrical and electronic diagrams	
.....	<i>see</i> Diagrams
Electrical and electronic symbols	
.....	<i>see</i> Symbols
Electrical/electronic drawings	
.....	<i>see</i> Drawings
Engineering drawings	<i>see</i> Drawings
Engineering order	62, 64
APPROVED	63
Archiving	80
DESCRIPTION	63
Disposition	63
DRAWING	62

EFFECTIVE SERIAL	63
EO NO.	63
Format sample	62
General requirements	62
INITIATED	63
ISSUED BY	63
NEXT ASSEMBLY	62
Number	64
PARTS IN PROCESS	
.....	<i>see</i> Engineering order—Disposition
PROGRAM	62
REASON	62
REV	62
REVIEWED	63
SHEET __ OF __	63
TITLE	62
TYPE OF EO	63
USED ON	62
Engineering parts list	<i>see</i> Parts list
EO	<i>see</i> Engineering order
EPL	<i>see</i> Parts list—Engineering

F

Fastener torque	106
Federal Cataloging Program	54
Federal Item Identification Number	54
Federal standards and specifications	93
FIIN	
.....	<i>see</i> Federal Item Identification Number
Find number	14
Application and limitation	76
Definition	76
Drawing requirements	77
System of identification	76
Find or Item number	
.....	<i>see either</i> Find number <i>or</i> Item number
Find or item numbering	<i>see</i> Numbering
Flow chart	
For drawings	79

G

Galling	106
Government Design Activity Drawings	
.....	<i>see</i> Drawings

H

Heat treating notes	<i>see</i> Notes
---------------------------	------------------

I

IEEE	13
IGES	

.....	<i>see</i> Initial Graphics
.....	Exchange Specification
IL	<i>see</i> Index list
Index list	68
Continuation sheet	75
Entries	74
Format	74
Cover sheet	69
Entries	69, 70
Format	69
Definitions	68
Requirements	
Adding items	69
Deleting items	69
List formats	69
List preparation	68
Revision identification	69
Industrial standards and specifications	95
Information Management Division	58
Informational notes	<i>see</i> Notes
Initial Graphics Exchange Specification	81
Ink lines	<i>see</i> Lines
Inseparable assembly drawings	<i>see</i> Drawings
Inseparable parts	<i>see</i> Parts
Inside rounding	<i>see</i> Metric dimensioning— Rounding—Precision
Inspection notes	<i>see</i> Notes
Installation assembly drawings	<i>see</i> Drawings
Interface control drawings	<i>see</i> Drawings
Interference range	105
International System of Units	83
.....	<i>see also</i> 'SI' and 'Metric'
Introduction	1
ISO	13
Item number	14
Application and limitation	76
Definition	76
Drawing requirements	77
System of identification	76
Item numbering	<i>see</i> Numbering

J

J roll size	3
Joining method notes	<i>see</i> Notes

L

Lay (of a surface)	90
Lettering and Numerals	31
Heights	32

Style	31
Library Services Branch	58
Lines	25
Conventions	26, 27
Ink	25
Pencil	27
Plotted	25
Types	26, 27
Break	28
Center	27
Cutting-plane	30
Datum	30
Dimension	28
Extension	30
Hidden	30
Leaders	28
Outlines	30
Phantom	29
Sectioning	29
Stitch	30
Viewing-plane	30
Visible	30
List of Material	8, 10, 14
Entries	78
Format	78, 104
Requirements in	14
LM	<i>see</i> List of Material
Local character notes	<i>see</i> Notes
Lock washers	106
Low-outgassing materials	105

M

Matched-set drawings	<i>see</i> Drawings
Material	
Conventions	35
Low-outgassing	105
Outgassing	93
Mechanical Engineering Branch	58
Mechanical schematic diagram drawings	<i>see</i> Drawings
Metric	<i>see also</i> SI
Metric dimensioning	
Rounding	
Basic dimensions	87
General rules	86
Precision	88, 89
Toleranced dimensions	88
Unit conversions	86
Metric system	83
Military standards and specifications	96
Modification drawings	<i>see</i> Drawings
Multisheet drawings	<i>see</i> Drawings

N

NAS	13
NASA standards and specifications	98
National Bureau of Standards index	93
NEMA	13
Nomenclature	11
Notes	25
Coating	18
Dimension	16
Dimensional tolerance	24
Examples	16
General	15
Heat treating	17
Informational	23
Inspection	20
Joining method	18
Local character	15, 23
Location	15
Miscellaneous	21
Numbering of	16
Plating	18
Surface preparation	19
Testing	20
Threaded inserts	
Cleaning and installation	21
Warning note	15
NSA	13
NTIS	93
Numbering	58
Find	60
Item	60
Parts	59
Numbering of notes	see Notes

O

Order of precedence	see Specifications
Orthographic projection	25
Outgassing	
Low-outgassing materials	105
Of spacecraft materials	93
Outline drawings	see Drawings
Outlines	
Invisible	34
Visible	34

P

Part number	52, 59
Part Positioning	see Positioning
Parts	
Dimensions	104
Identification of	105
Inseparable	41

Numbering	59
Separable	40
Vendor	52, 53, 59
Altered	39, 59
Selected	39, 59
Weldment	104
Parts list	14, 68
Continuation sheet	73
Entries	72
Format	72
Supplementary heading list	73
Cover sheet	
Entries	69, 70
Format	69
Definitions	68
Engineering	59, 60, 80
Preferred	14
Requirements	
Adding items	69
Deleting items	69
List formats	69
List preparation	68
Revision identification	69
Pencil drawings	see Drawings
Pencil lines	see Lines
Picturization	33
PL	see Parts list
Plating notes	see Notes
Plotted lines	see Lines
Positioning	33, 35
Precision rounding	
..... see Metric dimensioning—Rounding	
Press fits	105
Projected tolerance zone	106
Projected views	see Views

R

Radii	105
Regardless of Feature Size	105
Revision block	4, 9, 65
APPROVAL	9
DATE	9
DESCRIPTION	9
Samples	5, 66
SYM	9
ZONE	9
Revisions	65
Identification	65
Methods	65
Multisheet drawings	65
Recording	65
Redrawn or replaced drawings	67
Rotated views	see Views
Rounding	86

Rounding:.... *see also* Metric dimensioning

S

SAE	13
Scale.....	32
Sections	34
Identification	37
Locating	38
Security classification	10, 15
Selected parts	<i>see</i> Parts—Vendor
Selected vendor part drawings	<i>see</i> Drawings
Separable parts	<i>see</i> Parts
Sheet numbering.....	3
SI... <i>see also</i> International System of Units	
Units and symbols	83
Silver-plated hardware	106
Soldering.....	18, 89
Source control drawings.....	<i>see</i> Drawings
Space Transportation System	20
Specification callouts	24
Specification control drawings.....	<i>see</i> Drawings
Specifications	82
Order of precedence.....	60
Subsequent changes	24
Thread.....	91, 92
Specifications index	<i>see</i> Standards and specifications index
Standard part drawing.....	<i>see</i> Drawings
Standards	82
Order of precedence.....	60
Standards and specifications index	93
Federal.....	93
Industrial.....	95
Military.....	96
NASA	98
National Bureau of Standards.....	93
Standards and specifications numerical index.....	98
STS	<i>see</i> Space Transportation System
Supporting documentation	
Numbering	58
Surface preparation notes	<i>see</i> Notes
Surface roughness	
Control of.....	90
Surface texture.....	90
Standards.....	90
Symbols	90
Symbols	
Cross-hatching	35
Electrical/Electronic	43
Welding.....	92
Wiring.....	43

T

Tabulated drawings	<i>see</i> Drawings
Templates.....	55, 82, 104
Testing notes	<i>see</i> Notes
Third-angle orthographic projection	25
Thread specifications.....	91, 92
Threaded inserts—Cleaning and installation notes.....	<i>see</i> Notes
Title block	4, 9, 32, 33
APPROVED	7
CHECKED.....	7
CODE	7
DATE	7
DESCRIPTION.....	9
DESIGNER.....	7
Drawing No.	7
DRAWN.....	7
EXAMINATION.....	8
FLIGHT HARDWARE.....	8
HARDNESS TESTING	8
ITEM NO.	8
MATERIAL	9
MATERIAL SPEC.	9
METRIC.....	8
NEXT ASSY	8
PART NO.	8
REQD	8
Sample	5
SCALE.....	7
SH__OF__	7
Software used	8
TITLE	7
USED ON.....	7
WT	7
Tolerance Block	
Metric	86
Tolerances.....	24, 82, 84, 88, 104
Loose.....	105
Metric	86
Tolerancing	
True position	105
Tooling drawings	<i>see</i> Drawings
Tooling fixtures	55
Transported views	<i>see</i> Views
True position dimensioning	<i>see</i> Dimensioning

U

Unit number principle.....	58
Unit rounding	<i>see</i> Rounding

V

Vapor degreasing	20
Vendor part	<i>see</i> Parts
Vendor part drawings.....	<i>see</i> Drawings
Views	25, 36
Identification	37
Locating	38
Projected	36
Rotated.....	36
Sectional	34
Designation.....	35
Positioning	35
Transported	36

W

Waviness (of a surface).....	90
Welding	18
General	92
Notes	18
Specification callouts.....	92
Symbols	<i>see also</i> Symbols
Location significance	92
Weldments.....	44, 104
Wiring symbols	<i>see</i> Symbols

Z

Zoning	4, 10
--------------	-------

