

NOT MEASUREMENT
SENSITIVE

MIL-STD-1353C
18 February 2014
SUPERSEDING
MIL-STD-1353B
2 July 1980

**DEPARTMENT OF DEFENSE
STANDARD PRACTICE**

**ELECTRICAL CONNECTORS,
PLUG-IN SOCKETS AND ASSOCIATED HARDWARE,
SELECTION AND USE OF**



MIL-STD-1353C

FOREWARD

1. This standard is approved for use by all Departments and Agencies of the Department of Defense.
2. This standard provides selected electrical connector and plug-in socket types and associated hardware which are approved for use in the design of military equipment.
3. The selection guidance in this standard is to assist in guiding the project engineer to the proper connector series.
4. The criteria for inclusion of electrical connector types and associated hardware in this standard are as follows:
 - a. The electrical connector and associated hardware are suitable for use in military equipment.
 - b. Electrical connectors and associated hardware are covered by government standards or government specifications.
 - c. Electrical connectors and associated hardware are available for procurement.
 - d. Electrical connectors and associated hardware are suitable for multiple applications.
 - e. Electrical connectors and associated hardware are approved for listing or listed on applicable qualified products list or approved via first article testing.
5. Comments, suggestions, or questions on this document should be addressed to: DLA Land and Maritime, Columbus, Attn: VAI, P.O. Box 3990, Columbus, OH 43218-3990, or emailed to CircularConnector@dla.mil, RFConnector@dla.mil, or RectangularConnector@dla.mil. Since contact information can change you may want to verify the currency of this address information using the ASSIST Online database at <https://assist.dla.mil>.

MIL-STD-1353C

CONTENTS

<u>PARAGRAPH</u>		<u>PAGE</u>
	FOREWARD	ii
1	SCOPE	1
1.1	Scope	1
1.2	Detailed requirements	1
1.3	Purpose of standard	1
2.	APPLICABLE DOCUMENTS	1
2.1	General	1
2.2	Government documents	1
2.2.1	Specifications, standards, and handbooks	1
2.2.2	Other Government documents, drawings, and publications	2
2.3	Non-government publications	3
2.4	Order of precedence	4
3.	DEFINITIONS	4
3.1	Definitions	4
3.2	Recovered material	4
3.3	Recycled material	4
3.4	Biobased material	4
3.5	General specification	4
3.6	Interchangeable item	5
4.	GENERAL REQUIREMENTS	5
4.1	General	5
4.1.1	Electrical connectors	5
4.2	Dissimilar metals and compatible couples	5
4.3	Service life of electrical interconnections	6
4.4	Mechanical affects	6
4.5	Test Methods	6
4.5.1	Supplemental testing	6
4.5.2	Radio frequency (RF) connectors test methods	6
4.5.3	Test documents	6
4.6	Wiring	7
4.6.1	Wiring for aerospace applications	7
4.6.2	SAE-AS-22759/9 wire	7
4.6.3	SAE-AS-22759/33 wire	7
4.6.4	Polyvinyl chloride (PVC) wiring	7
4.6.5	Pre-wired nanominiature connectors	7
4.7	Oxygen restricted materials	7
4.8	Cleanliness	7
4.9	Special considerations	8
4.9.1	Fireproof connectors	8
4.10	Cross reference listing (SAE-ARP1308)	8
4.11	Recycled, recovered, environmentally preferable, or biobased materials	8
4.12	Toxic chemicals, hazardous substances, and ozone-depleting chemicals	8

MIL-STD-1353C

5.	<u>DETAILED REQUIREMENTS</u>	8
5.1	<u>General</u>	8
5.2	<u>Contacts</u>	8
5.2.1	<u>Beryllium copper</u>	8
5.2.2	<u>Beryllium copper strip and wire</u>	9
5.2.3	<u>Localized finish (selective plating)</u>	9
5.2.4	<u>Tin/lead plating</u>	9
5.2.5	<u>Pure tin plating is prohibited</u>	9
5.2.5.1	<u>Replating pure tin finished parts (lead free)</u>	9
5.2.5.2	<u>Tin whisker growth</u>	9
5.2.6	<u>Nickel underplating</u>	9
5.2.6.1	<u>Low stress sulfamate nickel</u>	10
5.2.6.2	<u>Silver underplating problems</u>	10
5.2.7	<u>Gold plating</u>	10
5.2.7.1	<u>Contact mating surfaces</u>	10
5.2.7.2	<u>20μ inches of gold</u>	10
5.2.7.3	<u>30μ inches of gold</u>	10
5.2.7.4	<u>50μ inches of gold</u>	10
5.2.7.5	<u>100μ inches of gold</u>	10
5.2.7.6	<u>150μ inches of gold</u>	10
5.2.7.7	<u>Gold Embrittlement of solder joints</u>	11
5.2.7.8	<u>Stamped and formed contacts</u>	11
5.2.7.9	<u>Gold flash palladium nickel</u>	11
5.2.8	<u>Rhodium</u>	11
5.2.9	<u>Nickel-iron</u>	11
5.2.10	<u>Solderless wrap termination platings</u>	11
5.2.11	<u>Silver plating</u>	11
5.2.12	<u>Replating of contacts</u>	11
5.2.13	<u>Crimp type wire barrels (SAE-AS5261)</u>	11
5.2.13.1	<u>Crimp barrel plating</u>	11
5.2.14	<u>Thermal couples</u>	11
5.2.15	<u>Shielded contacts</u>	12
5.2.16	<u>Radio frequency (RF)</u>	12
5.2.17	<u>Silver plated contacts</u>	12
5.2.18	<u>Sockets</u>	12
5.2.18.1	<u>Printed wiring board contact design</u>	12
5.2.18.2	<u>Printed circuit, eyelet, solder wire turrent, and solder cup tin-lead plating</u>	12
5.2.18.3	<u>Solderless wrap, printed circuit, solder wire turrent, and solder cup gold plating</u>	12
5.2.18.4	<u>Tinning solder cups</u>	13
5.2.19	<u>Flat ribbon connectors overall finish</u>	13
5.2.20	<u>Nonfunctional areas (crimp and solder contacts)</u>	13
5.2.21	<u>Nonfunctional area gold plating absence</u>	13
5.3	<u>Solderless wrapp (wire wrap)</u>	13
5.4	<u>Contacts, crimp tools, positioned, installing and removal tools</u>	13
5.5	<u>Shells</u>	13
5.5.1	<u>Platings</u>	13
5.5.2	<u>Cadmium plated shells</u>	13
5.5.3	<u>Composite connectors</u>	13
5.5.4	<u>Connector materials exposed directly to salt water</u>	13

MIL-STD-1353C

5.5.5	Plating's and electromagnetic interference (EMI)	14
5.5.6	RF connector bodies (MIL-PRF-39012)	16
5.5.7	NASA preferred metal shell finish	17
5.5.8	NASA prohibited materials for electrical connectors	17
6.	NOTES	17
6.1	Intended use	17
6.2	Changes from previous issue	17
6.3	Subject term (key word) listing	17
APPENDIXES		
Appendix A	Printed wiring board connectors and test points	18
A	Scope	18
A.1	Scope	18
A2	Applicable documents	18
A.2.1	General	18
A2.2	Government Documents	18
A.2.2.1	Specifications, standards, and handbooks	18
A.2.2.2	Other Government documents, drawings and publications	35
A.2.2.3	Non-Government publications	38
A3	MIL-DTL-83505	39
A.3.1	Socket applications	39
A.4	MIL-DTL-39024	40
A.4.1	Test point applications	40
A.5	MIL-DTL-83502	42
A.5.1	Intended use	42
A.5.2	Terminal types	42
A.6	MIL-DTL-83734	43
A.6.1	Intended use	43
A.7	MIL-DTL-12883	44
A.8	Unshrouded headers	46
A.8.1	Use and restrictions	46
A.9	MIL-DTL-83503	49
A.9.1	Intended use	49
A.10	MIL-DTL-55302	51
A.10.1	Intended use	51
A.10.2	Spacing between contacts	51
A.10.3	Soldering	51
A.10.4	Hardware options	51
A.11	MIL-C-28754	67
A.11.1	Naval Avionics Facility Indianapolis (NAFI)	67
A.11.2	Intended use	67
A.11.3	Press fit	67
A.11.4	Connection	67
A.11.5	Interface	67
A.11.6	Compliant pin system	67
A.12	MIL-C-28859	78
A12.2	Intended use	78
A12.3	Connector component parts	78
A.13	MIL-DTL-32234 and DLA Land and Maritime drawings UHD connectors	79
A.13.1	Intended applications	79

MIL-STD-1353C

A.13.2	DLA Land and Maritime drawings and specifications	79
A.14	MIL-DTL-21097	81
A.14.1	Intended use	81
A.15	MIL-DTL-24308	83
A.15.1	Intended use	83
A.15.2	Class N connectors	83
A.15.3	Class H receptacles	83
A.15.4	Crimp contact connectors	83
A.15.5	Classes D, K, and M	83
A.15.6	Installation design	83
A.15.7	Accessories	87
A.15.8	Design documentation	87
A.15.9	Material plating	87
A.15.10	Type-D Subminiature	87
A.16	MIL-DTL-32139	89
A.16.1	Intended use	89
A.16.2	Use and restrictions	94
A.16.3	Mating connectors	94
A.16.4	Use restrictions aluminum with cadmium	94
A.16.5	Use restrictions aluminum with electroless nickel	94
A.16.6	Prewired connector restrictions	94
Appendix B	Rectangular connectors	95
B.1	Scope	95
B1.1	Scope	95
B.2	Applicable documents	95
B2.3	Non-Government publications	95
B.3	MIL-DTL-28748	102
B3.1	Intended use	102
B3.2	Contact characteristics	102
B.3.3	Coupling types	102
B.3.4	Plating	102
B.4	MIL-DTL-26518	108
B.4.1	Intended use	108
B.4.2	New design restriction	108
B.5	MIL-DTL-28731	110
B.5.1	Intended use	110
B.5.2	Contact wire sizes	110
B.5.3	Coupling	110
B.5.4	Shell plating	110
B.6	MIL-DTL-21617	112
B.6.1	Type P, plug	112
B.6.2	Type J, receptacle	112
B.6.3	Type JS, pressurized receptacle	112
B.7	MIL-DTL-28804	115
B.7.1	Intended use	115
B.8	MIL-DTL-83513	116
B.8.1	Intended use	116
B.8.2	Characteristics	116
B.9	MIL-DTL-83733	119
B.9.1	Intended use	119
B.9.2	Coupling mounting	119

MIL-STD-1353C

Appendix C	Radio frequency connectors	122
C.1	Scope	122
C.1.1	Scope	122
C.2	Applicable documents	122
C.2.1	General	122
C.2.2	Government documents	122
C.2.2.1	Specifications, standards, and handbooks	122
C.2.2.2	Other Government documents, drawings and publications	130
C.2.2.3	Non-Government publications	132
C.3	Radio Frequency (RF) connectors general information	133
C.3.1	Connector series definitions	133
C.3.2	MIL-PRF-39012 connector series	135
C.3.3	Connector categories and definitions	135
C.3.4	Platings	135
C.3.5	Radio frequency connector restrictions	136
C.3.6	Applicable characteristics	136
C.4	DLA Land and Maritime RF connectors dimensions and configurations	136
C.5	MIL-STD-348	140
C.6	MIL-DTL-3607	140
C.7	MIL-DTL-3643	141
C.7.1	Nominal impedance	141
C.8	MIL-C-3655	143
C.8.1	MIL-DTL-3655 connector classes	143
C.8.2	RF connector rms ratings	143
C.8.3	MIL-DTL-3655 connectors to RF cables	145
C.9	MIL-DTL-3650	147
C.9.1	Intended use	147
C.10	MIL-PRF-39012	148
C.10.1	O-Ring seals	148
C.10.2	Temperature range	148
C.10.3	Safety wire	148
C.10.4	Class of MIL-PRF-39012 connectors consists of the following	148
C.10.5	Categories	148
C.10.6	Satellite connectors	148
C.10.7	MIL-PRF-39012 connectors to RF cable	158
C.11	MIL-PRF-49142	174
C.11.1	Class of MIL-PRF-49142 connectors consists of the following	174
C.11.2	MIL-PRF-49142 RF connectors to cable	176
C.12	MIL-DTL-55235	180
C.12.1	MIL-DTL-55235 RF connectors	180
C.13	MIL-PRF-55339	182
C.13.1	Classification	182
C.14	MIL-DTL-83517	187
C.14.1	Nominal impedance	187

MIL-STD-1353C

Appendix D	Circular connectors	190
D.1	Scope	190
D.1.1	Scope	190
D.2	Applicable documents	190
D.2.1	General	190
D.2.2	Government documents	190
D.2.2.1	Specifications, standards, and handbooks	190
D.2.2.2	Other Government documents, drawings and publications	204
D.2.2.3	Non-Government publications	206
D.3	Circular connectors AN and DLA Land and Maritime drawing	207
D.4	MIL-DTL-22992	212
D.4.1	Heavy-duty gaskets	212
D.5	MIL-C-24217	216
D.5.1	Intended use	216
D.6	MIL-C-24231	218
D.6.1	Primary uses	218
D.6.2	Pressure proof fittings	218
D.7	MIL-DTL-25955	223
D.7.1	Classes	223
D.7.2	Styles of engagement	223
D.8	MIL-DTL-26482	224
D.8.1	Each series contains hermetic receptacles	224
D.8.2	MIL-DTL-26482 termination types	225
D.8.3	Intended use (Series 1)	225
D.8.4	Intended use (Series 2)	225
D.8.5	Insert arrangements	225
D.9	MIL-DTL-26500	232
D.9.1	Intended use	232
D.9.2	Capabilities	232
D.9.3	Non-magnetic	232
D.9.4	Contacts	232
D.10	MIL-DTL-27599	234
D.10.1	MIL-DTL-27599 series I and II	234
D.10.1.1	Series I	234
D.10.1.2	Series II	234
D.10.3	Crimp type connectors	234
D.10.4	Insert arrangements	234
D.11	MIL-DTL-28840	236
D.11.1	RFI/EMI suppression	236
D.11.2	Scoop proof protection	236
D.11.3	Shell sizes	236
D.11.4	Intended usage	236
D.12	MIL-DTL-38999	243
D.12.1	Series I	243
D.12.2	Series I Temperature ranges	243
D.12.3	Series III Crimp contacts, rear release	243
D.12.4	Series III temperature ranges	243
D.12.5	Series IV contacts	243
D.12.6	Series IV temperature ranges	243
D.12.7	Insert arrangements	243
D.12.8	MIL-DTL-38999 circular, miniature, high density	244
D.13	MIL-C-81511	256

MIL-STD-1353C

D.13.1	MIL-C-81511 series	256
D.13.2	Intermatibility	256
D.14	MIL-DTL-83538	261
D14.1	Electrical umbilical assembly	261
D.14.2	Characteristics	261
D.14.3	Intended use	261
D14.4	MIL-DTL-8358 dimensions and configurations	261
D.15	MIL-DTL-83723	264
D.15.1	Series III	264
D15.2	Intended use (all classes)	264
D.15.3	MIL-DTL-83723 temperature ranges	264
D.15.4	Insert arrangements	265
D.15.5	MIL-DTL-83723 dimensions and configurations	265
Appendix E	Audio connectors	275
E.1	Scope	275
E.1.1	Scope	275
E.2	Applicable documents	275
E.2.1	General	275
E.2.2	Government documents	275
E.2.2.1	Specifications, standards, and handbooks	275
E.2.2.2	Other Government documents, drawings, and publications	276
E.2.2.3	Non-Government publications	277
E.3	MIL-DTL-641	278
E.3.1	Intended use	278
E.3.2	Jacks to mating plug	281
E.4	MIL-DTL-9177	283
E.4.1	Features	283
E.4.2	Intended use	283
E.5	MIL-DTL-55116	284
E.5.1	Intended use	284
E.5.2	Plug connectors	284
E.5.3	Receptacle connector	284
E.6	MIL-C-10544	286
E.6.1	Intended use	286
E.7	MIL-DTL-55074	288
E.7.1	Intended use	288
Appendix F	Power connectors	289
F.1	Scope	289
F.1.1	Scope	289
F.2	Applicable documents	289
F.2.1	General	289
F.2.2	Government documents	289
F.2.2.1	Specifications, standards, and handbooks	289
F.3	MIL-DTL-2726	300
F.3.1	Intended use	300
F.4	MIL-DTL-12520	313
F.4.1	Intended use	313
F.4.2	Environmental conditions	313
F.5	MIL-C-55181	315
F.5.1	Intended use	315

MIL-STD-1353C

F.6	W-C-596	316
F.6.1	Connector design	316
F.6.2	Grades	316
F.7	Vehicular and trailer connectors	336
F.7.1	Intended use	336

TABLES

TABLE I	Thermocouple types	12
TABLE II	Properties of various plating's	16
TABLE A-I	MIL-DTL-83505 descriptions and configurations	39
TABLE A-II	MIL-DTL-39024 descriptions and configurations	40
TABLE A-III	MIL-DTL-83502 descriptions and configurations	42
TABLE A-IV	MIL-DTL-83734 descriptions and configurations	43
TABLE A-V	MIL-DTL-12883 descriptions and configurations	44
TABLE A-VI	DLA Land and Maritime drawings PWB descriptions and configurations	46
TABLE A-VII	MIL-DTL-83503 descriptions and configurations	49
TABLE A-VIII	DLA Land and Maritime drawings and MIL-DTL-55302 descriptions and configurations	51
TABLE A-IX	MIL-C-28754 descriptions and configurations	68
TABLE A-X	MIL-C-28859 descriptions and configurations	78
TABLE A-XI	DLA Land and Maritime drawings and MIL-DTL-32234 descriptions and configurations	79
TABLE A-XII	MIL-DTL-21097 descriptions and configurations	81
TABLE A-XIII	MIL-DTL-24308 descriptions and configurations	84
TABLE A-XIV	MIL-DTL-24308 termination types and positions available	86
TABLE A-XV	DLA Land and maritime MIL-DTL-24308 types, descriptions and configurations	87
TABLE A-XVI	DLA Land and Maritime drawings accessories for MIL-DTL-24308	88
TABLE A-XVII	MIL-DTL-32139 and DLA Land and Maritime drawings nano connectors descriptions and configurations	89
TABLE B-I	MIL-DTL-28748 descriptions and configurations	103
TABLE B-II	MIL-DTL-26518 descriptions and configurations	108
TABLE B-III	MIL-DTL-28731 descriptions and configurations	110
TABLE B-IV	MIL-DTL-21617 descriptions and configurations	112
TABLE B-V	MIL-DTL-28804 descriptions and configurations	115
TABLE B-VI	MIL-DTL-83513 descriptions and configurations	116
TABLE B-VII	MIL-DTL-83733 descriptions and configurations	119
TABLE C-I	RF applicable characteristics	136
TABLE C-II	DLA Land and Maritime drawing RF connectors descriptions and configurations	137
TABLE C-III	MIL-C-3607 RF descriptions and configurations	140
TABLE C-IV	MIL-DTL-3643 descriptions and configurations	141
TABLE C-V	MIL-DTL-3655 descriptions and configurations	143
TABLE C-VI	MIL-DTL-3655 RF connectors to RF cable	145
TABLE C-VII	MIL-DTL-3650 descriptions and configurations	147
TABLE C-VIII	MIL-PRF-39012 descriptions and configurations	149
TABLE C-IX	MIL-PRF-39012 RF connectors to cable	159
TABLE C-X	MIL-PRF-49142 descriptions and configurations	174
TABLE C-XI	MIL-PRF-49142 RF connectors to cable	176
TABLE C-XII	MIL-DTL-55235 descriptions and configurations	180

MIL-STD-1353C

TABLE C-XIII	MIL-PRF-55339 descriptions and configurations	182
TABLE C-XIV	MIL-C-83517 descriptions and configurations	188
TABLE D-I	AN and DLA Land and Maritime drawings connectors	207
TABLE D-II	MIL-DTL-22992 descriptions and configurations	213
TABLE D-III	MIL-C-24217 descriptions and configurations	216
TABLE D-IV	MIL-C-24231 descriptions and configurations	218
TABLE D-V	MIL-DTL-25995 descriptions and configurations	223
TABLE D-VI	MIL-DTL-26482 connector class and series	224
TABLE D-VII	MIL-DTL-26482 descriptions and configurations	226
TABLE D-VIII	MIL-DTL-26500 descriptions and configurations	232
TABLE D-IX	MIL-DTL-27599 descriptions and configurations	234
TABLE D-X	MIL-DTL-28840 descriptions and configurations	237
TABLE D-XI	MIL-DTL-38999 series I finishes and temperature ranges	243
TABLE D-XII	MIL-DTL-38999 series III finishes and temperature ranges	243
TABLE D-XIII	MIL-DTL-38999 series III finishes and temperature ranges series XIII	243
TABLE D-XIV	MIL-DTL-38999 descriptions and configurations	244
TABLE D-XV	MIL-C-81511 descriptions and configurations	256
TABLE D-XVI	MIL-C-83538 descriptions and configurations	262
TABLE D-XVII	MIL-DTL-83723 class, finish and temperature range	264
TABLE D-XVIII	MIL-DTL-83723 descriptions and configurations	265
TABLE E-I	MIL-DTL-641 descriptions and configurations	278
TABLE E-II	Jacks and mating plugs	281
TABLE E-III	MIL-DTL-9177 descriptions and configurations	283
TABLE E-IV	MIL-DTL-55116 descriptions and configurations	284
TABLE E-V	MIL-C-10544 descriptions and configurations	286
TABLE E-VI	MIL-C-55074 descriptions and configurations	288
TABLE F-I	MIL-DTL-2726 descriptions and configurations	300
TABLE F-II	MIL-DTL-12520 descriptions and configurations	313
TABLE F-III	MIL-DTL-55181 descriptions and configurations	315
TABLE F-IV	W-C-596 descriptions and configurations	316
TABLE F-V	Vehicular and trailer connectors	336
 FIGURES		
A-1	PWB and flat cable connectors	49
A-2	Insulation displacement contact (IDC)	49
A-3	Connectors, electrical, modular and component parts	67
A-4	Section view of daughterboard and backplane connectors	79
A-6	General configuration	83
A-7	Mating limits	83
A-8	General configuration nano connector dual row	89
B-1	MIL-DTL-83733, mounting configurations	119
C-1	UG-1366/U or UG-1412/U	180
C-2	UG-1365/U	180
D-1	Electrical umbilical assembly	261
E-1	Telephone jack	278
 CONCLUDING MATERIAL		337

MIL-STD-1353C

1. SCOPE

1.1 Scope. This standard establishes requirements for selection of electrical connectors, plug-in sockets and their associated hardware, shown in detail in appendix's A, B, C, D, E, and F, for use in military equipment. Included are the following:

- a. Selected electrical connector types and associated hardware chosen jointly by the Departments of the Army, the Navy, and the Air Force for use in the design of military equipment.
- b. Guides for the choice and application of electrical connectors and associated hardware for use in military equipment.

1.2 Detailed requirements. Complete detailed requirements for electrical connectors, plug-in sockets, and associated hardware listed in this standard are covered in the applicable specification sheets of MS sheets (see 4.2). When it has been determined that equipment requirements cannot be met by using the connector styles of characteristics listed in this standard, the design engineer with the approval of the cognizant military activity, should select from the applicable connector specification, styles or characteristics not listed herein, see 4.5.

1.3 Purpose of standard. The purpose of this standard is to promote the use of standard parts for new equipment design. The standard parts cover the majority of uses and are arranged in a form for quick references and selection. The standard also directs the engineer to use standardized contact platings, shell platings and other characterizes for design consideration for similar type connectors. The applicable connector specification should be used for specific design details.

2. APPLICABLE DOCUMENTS

2.1 General. The documents listed in this section are specified in sections 3, 4, and 5 of this standard. This section does not include documents cited in other sections of this standard or recommended for additional information or as examples. While every effort has been made to ensure the completeness of this list, document users are cautioned that they must meet all specified requirements of documents cited in sections 3, 4, and 5 of this standard, whether or not they are listed.

2.2 Government documents.

2.2.1 Specifications, standards, and handbooks. The following specifications, standards, and handbooks form a part of this document to the extent specified herein.

FEDERAL SPECIFICATION

- | | | |
|----------|---|---|
| QQ-N-281 | - | Nickel-Copper Alloy Bar, Rod, Plate, Sheet, Strip, Wire, Forgings, and Structural and Special Shaped Sections |
|----------|---|---|

DEPARTMENT OF DEFENSE SPECIFICATIONS

- | | | |
|---------------|---|--|
| MIL-A-8625 | - | Anodic Coatings for Aluminum and Aluminum Alloys |
| MIL-DTL-38999 | - | Connectors, Electrical, Circular, Miniature, High Density, Quick Disconnect (Bayonet, Threaded, and Breech Coupling), Environment Resistant, Removable Crimp and Hermetic Solder Contacts, General Specification For |
| MIL-DTL-45204 | - | Gold Plating, Electrodeposited |
| MIL-DTL-83488 | - | Coating, Aluminum, High Purity |

MIL-STD-1353C

- MIL-DTL-83723 - Connectors, Electrical, (Circular, Environment Resisting), Receptacles And Plugs, General Specification For
- MIL-PRF-39012 - Connectors, Coaxial, Radio Frequency, General Specification For

DEPARTMENT OF DEFENSE STANDARDS

- MIL-STD-202 - Test Method Standard Electronic and Electrical Component Parts
- MIL-STD-889 - Dissimilar Metals
- MIL-STD-1130 - Connections, Electrical, Solderless Wrapped

DEPARTMENT OF DEFENSE HANDBOOK

- MIL-HDBK-454 - General Guidelines for Electronic Equipment.

(Copies of these documents are available online at <http://quicksearch.dla.mil> or from the Standardization Document Order Desk, 700 Robbins Avenue, Building 4D, Philadelphia, PA 19111-5094.)

2.2.2 Other Government documents, drawings and publications. The following other Government documents, drawings and publications form a part of this document to the extent specified herein. Unless otherwise specified, the issues of these documents are those cited in the solicitation or contract.

DLA LAND AND MARITIME DRAWINGS

- 04034 - Wire, Electrical, Composite, Polytetrafluoroethylene/Polyimide Insulated, Light Weight, Copper Conductor, Tin Coated, 150°C, 600 Volt
- 04035 - Wire, Electrical, Composite, Polytetrafluoroethylene/Polyimide Insulated, Light Weight, Silver Coated, High Strength or Ultra High Strength Copper Alloy, 200°C, 600 Volt
- 04036 - Wire, Electrical, Composite, Polytetrafluoroethylene/Polyimide Insulated, Light Weight, Nickel Coated, High Strength or Ultra High Strength Copper Alloy, 260°C, 600 Volt
- 04037 - Wire, Electrical, Composite, Polytetrafluoroethylene/Polyimide Insulated, Normal Weight, Silver Coated, Copper Conductor, 200°C, 600 Volt
- 04038 - Wire, Electrical, Composite, Polytetrafluoroethylene/Polyimide Insulated, Normal Weight, Nickel Coated, Copper Conductor, 260°C, 600 Volt
- 04039 - Wire, Electrical, Composite, Polytetrafluoroethylene/Polyimide Insulated, Normal Weight, Tin Coated, Copper Conductor, 150°C, 600 Volt
- 04040 - Wire, Electrical, Composite, Polytetrafluoroethylene/Polyimide Insulated, Normal Weight, Silver Coated, Copper Conductor, 200°C, 600 Volt
- 04041 - Wire, Electrical, Composite, Polytetrafluoroethylene/Polyimide Insulated, Normal Weight, Nickel Coated, Copper Conductor, 260°C, 600 Volt
- 04042 - Wire, Electrical, Composite, Polytetrafluoroethylene/Polyimide Insulated, Normal Weight, Tin Coated, Copper Conductor, 150°C, 600 Volt
- 04043 - Wire, Electrical, Composite, Polytetrafluoroethylene/Polyimide Insulated, Normal Weight, Silver Coated, High Strength or Ultra High Strength Copper Alloy, 200°C, 600 Volt
- 04044 - Wire, Electrical, Composite, Polytetrafluoroethylene/Polyimide Insulated, Normal Weight, Nickel Coated, High Strength or Ultra High Strength Copper Alloy, 260°C, 600 Volt
- 04045 - Wire, Electrical, Composite, Polytetrafluoroethylene/Polyimide Insulated,

MIL-STD-1353C

- | | | |
|-------|---|---|
| 04046 | - | Light Weight, Silver Coated, Copper Conductor, 200°C, 600 Volt Wire, Electrical, Composite, Polytetrafluoroethylene/Polyimide Insulated, |
| 04047 | - | Light Weight, Nickel Coated, Copper Conductor, 260°C, 600 Volt Wire, Electrical, Composite, Polytetrafluoroethylene/Polyimide Insulated, 30, 28, 26 AWG, 600 Volt |
| 04048 | - | Wire, Electrical, Composite, Polytetrafluoroethylene/Polyimide Insulated, 26, 20, 18, 16 AWG, 600 Volt |
| 04049 | - | Cable, Power, Electrical and Special Purpose, Shielded and Unshielded, Electrical, Composite Wire, Polytetrafluoroethylene/Polyimide Insulated |

(Copies of DLA Land and Maritime drawings are available for download at internet web address <http://www.dscc.dla.mil/programs/milspec/>.)

2.3 Non-Government publications. The following documents form a part of this document to the extent specified herein. Unless otherwise specified, the issues of these documents are those cited in the solicitation or contract.

ASTM INTERNATIONAL

- | | | |
|-----------|---|---|
| ASTM A276 | - | Standard Specification for Stainless Steel Bars and Shapes |
| ASTM B164 | - | Standard Specification for Nickel-Copper Alloy Rod, Bar, and Wire |
| ASTM B166 | - | Standard Specification for Nickel-Chromium-Iron Alloys (UNS N06600, N06601, N06603, N06690, N06693, N06025, N06045, and N06696) and Nickel-Chromium-Cobalt-Molybdenum Alloy (UNS N06617) Rod, Bar, and Wire |
| ASTM B339 | - | Standard Specification for Pig Tin |
| ASTM B488 | - | Standard Specification for Electrodeposited Coatings of Gold for Engineering Uses |
| ASTM-B545 | - | Standard Specification for Electrodeposited Coatings of Tin |
| ASTM B564 | - | Standard Specification for Nickel Alloy Forgings |
| ASTM B700 | - | Standard Specification for Electrodeposited Coatings of Silver for Engineering Use |
| ASTM B733 | - | Standard Specification for Autocatalytic (Electroless) Nickel-Phosphorus Coatings on Metal |
| ASTM B841 | - | Standard Specification for Electrodeposited Coatings of Zinc Nickel Alloy Deposits |

(Copies of these documents are available online at <http://www.astm.org> or from the ASTM International, P.O. Box C700, 100 Barr Harbor Drive, West Conshohocken, PA 19428-2959.)

ELECTRONIC COMPONENTS INDUSTRY ASSOCIATION (ECIA)

- | | | |
|-------------|---|---|
| EIA/ECA-622 | - | Glossary of Electrical Connector Related Terms |
| EIA-364 | - | Electrical Connector/Socket Test Procedures Including Environmental Classifications |
| EIA-364-26 | - | TP-26B Salt Spray Test Procedure for Electrical Connectors, Contacts and Sockets |

(Copies of these documents are available online at <http://www.eciaonline.org> or from the Electronic Component Industry Association, 1111 Alderman Drive, Suite 400, Alpharetta, GA 30005-4175.)

MIL-STD-1353C

IPC - ASSOCIATION CONNECTING ELECTRONICS INDUSTRIES

- IPC-J-STD-004 - Requirements for Soldering Fluxes.
- IPC-J-STD-006 - Requirements for Electronic Grade Solder Alloys and Fluxed and Non-Fluxed Solid Solders for Electronic Soldering Applications.

(Copies of these documents are available online at <http://www.ipc.org> or from the IPC - Association Connecting Electronics Industries, 3000 Lakeside Drive, Suite 309 S, Bannockburn, IL 60015-1249.)

SAE INTERNATIONAL

- SAE-ARP1308 - Preferred Electrical Connectors for Aerospace Vehicles and Associated Equipment
- SAE-AS5261 - Contact, Wire Barrel, Crimp Type
- SAE-AS22759/9 - Wire, Electrical, Fluoropolymer-Insulated, Extruded TFE, Silver-Coated Copper Conductor, 1000 Volt
- SAE-AS22759/33 - Wire, Electrical, Fluoropolymer-Insulated, Crosslinked Modified ETFE, Lightweight, Silver-Coated, High-Strength Copper Alloy, 200°C, 600 Volt
- SAE-AS39029 - Contacts, Electrical Connector, General Specification for
- SAE-AS50881 - Wiring Aerospace Vehicle
- SAE-AMS-P-81728 - Plating, Tin-Lead (Electrodeposited)
- SAE-AMS2700 - Passivation of Corrosion Resistant Steels
- SAE-AMS-QQ-N-290 - Nickel Plating (Electrodeposited)
- SAE-AMS-QQ-P-416 - Plating, Cadmium (Electrodeposited)

(Copies of these documents are available on line at www.sae.org from SAE International, 400 Commonwealth Drive, Warrendale, PA 15096-0001, and Tel: 877-606-7323 [inside USA and Canada] or 724-776-4970 [outside USA], email at CustomerService@sae.org.)

2.4 Order of precedence. Unless otherwise noted herein or in the contract, in the event of a conflict between the text of this document and the references cited herein, the text of this document takes precedence. Nothing in this document, however, supersedes applicable laws and regulations unless a specific exemption has been obtained.

3. DEFINITIONS

3.1 Definitions. The terms used in this standard are generally accepted by the Electronic Components Association and commonly used in electrical connector engineering practice reference EIA/ECA-622.

3.2 Recovered material. Waste material and by-products that have been recovered or diverted from solid waste. It does not include those materials and by-products generated from and commonly reused within, an original manufacturing process.

3.3 Recycled material. Product or other material recovered from the solid waste stream for use in the form of raw materials in the manufacture of new products other than fuel for producing heat or power by combustion.

3.4 Biobased material. A material made from substances derived from living (or once living) organisms.

3.5 General specification. A specification prepared in the six-section format, which covers requirements and test procedures that are common to a group of parts, materials, or equipment's and is used with specification sheets.

MIL-STD-1353C

3.6 Interchangeable item. An item which poses such functional and physical characteristics as to be equivalent in performance, reliability, and maintainability, to another item of similar or identical purposes. An interchangeable item is cable of being exchanged for the other item without selection for fit or performance, and alteration of the items themselves or of adjoining items, except for adjustment.

4. GENERAL REQUIRMENTS.

4.1 General. This section covers general aspects of factors that can influence the service life of electrical connectors.

4.1.1 Electrical connectors. Electrical connectors are often the critical interface points between printed circuit boards and electrical subsystem. Electrical connectors may be used internally in a "black box" and pass through to external applications where they are used between multiple parts of a system, subsystem or component. Connectors not only perform signal and power distribution they must also function mechanically. Be it holding two separate circuit boards apart while exchanging data between them or exchanging signals between a printed circuit board and subcomponent using bulkhead or firewall connectors. Connectors are often used between separate pieces of equipment so they can interface with each other. Connectors in this configuration are often times exposed to the environment (salt water, dust, temperature extremes). Connectors must be capable of enduring electrical, mechanical and environmental punishments. This is why, in the electrical connector field, that the electrical, mechanical, and environmental characteristics have to be well defined and controlled by some authority.

Even the most reliable and well designed connector, by its nature, introduces variability and increased resistance into an electronic circuit. Manufacturers continue to try to put more signals, higher frequencies with more noise into increasingly smaller connectors. Smaller connectors do not mean they are more fragile. Because of their tiny size they get closer to the harsh environments and mechanical stresses imposed upon them. These tiny connectors generally require more stressful testing to prove they have greater durability.

Most components are installed directly into/onto the printed wiring board (PWB) and left alone. Other connectors, however, are usually installed in areas where they are exposed to the environment and at a mechanical point in the system. Military connectors are expected to be repeatedly interfaced with connectors manufactured by multiple suppliers. In many cases, having a military specification is the best way to define the connectors that customers need to use and to ensure intermateability and interchangeability from supplier to supplier. This ensures connectors are manufactured to the same performance standards from one qualified manufacturer to the next.

4.2 Dissimilar metals and compatible couples. Dissimilar metals and compatible couples are defined in MIL-STD-889. Dissimilar metals shall not be used in intimate contact unless suitably protected against electrolytic corrosion. Because of the seriousness of galvanic corrosion, every effort shall be made to avoid the use of dissimilar metals, to exclude moisture or other electrolyte from the system and to protect metal surfaces in the contact area. When mixing materials and platings, like the result of receptacle + plug + backshell =?, the engineer needs to consider what kind of galvanic activity is occurring. The use of dissimilar metals in contact with each other which tend toward active galvanic corrosion (particularly brass, copper, or steel used in contact with aluminium or aluminium alloy), is not acceptable. However, metal plating of dissimilar base metals to provide similar or suitable abutting surfaces is permitted. The use of dissimilar metals separated by a suitable insulating material is also permitted. It must be recognized that humidity and moisture controlled environments can be assured only by hermetically sealed compartments or containers in which moisture vapour content has been adequately reduced so no galvanic corrosion can occur. Due to the fact that hermetically sealed compartments can be compromised, the usage of one should take into account the cost of latent defects.

MIL-STD-1353C

4.3 Service life of electrical interconnections. The service life of electrical interconnections is affected by factors like residual contact force, vibrations, and corrosion. The time-to-failure depends on the connection technology and on the connector service environment, and varies widely from hours to tens of years. Please note that the primary cause of connector/contact failure is always preceded by a significant increase in contact resistance at the electrical interfaces. Contact resistance originates from the fundamental property of electrical junctions and that area of metallic contact, which is generally very small. Degradation stems from a large decrease in this small area of contact due to the synergistic action of failure-inducing mechanisms as mentioned above.

4.4 Mechanical affects. Achieving good electrical contact in a connector is a function of contact surface films (oxides and sulfides), surface roughness, contact area, plastic deformation of the contacting materials and load applied. Since even the best machined, polished, and coated surfaces look rough and uneven when viewed microscopically, the common concept of a flat, smooth contact is grossly oversimplified. In reality the connector interface is basically an insulating barrier with a few widely scattered points of microscopic contact. The performance is dependent upon the chemicals, thermal, and mechanical behavior at these contact points.

4.5 Test methods. For general power and signal contacts test methods reference EIA-364 (Electrical Connector/Socket Test Procedures Including Environmental Classifications). This document has various test methods to test electrical contacts and connectors to mechanical, environmental, and stresses that have been identified through the years that would eventually succeed in compromising the integrity of connectors and contact interfaces. Also listed in EIA-364 are definitions of classes that cover a broad range of environmental conditions and equipment operating environmental conditions such as temperature and humidity levels to reflect what the end item maximum operating conditions are.

4.5.1 Supplemental testing. Exceptions to the standard tests specified in EIA-364 would be described in the applicable or closest military specification for a particular connector type. These tests would be for special applications not ordinarily encountered in regular use. Examples of some exceptions are shown below for MIL-DTL-38999.

Backshell shield braid-to-shell conductivity	Ice resistance
Contact retention after fluid immersion	Installing and removal tool abuse
Contact walkout	Indirect lightning test
Electrolytic erosion	Pin contact stability
EMI shielding, low frequencies	Resistance to probe damage
Fluid immersion	Removal tool rotation
High impact shock	Shell spring finger forces
High temperature exposure	Thermal vacuum outgassing
High temperature exposure with contact loading	

4.5.2 Radio frequency (RF) connectors test methods. RF connectors such as MIL-PRF-39012 have its own test methods referenced in the body of the specification. This document also references environmental testing in accordance with MIL-STD-202 such as hermetic seal, and insulation resistance.

4.5.3 Test documents. When including testing in a particular connector drawing, specification, or standard reference the closest specification for the connector type being used and include testing that has already been industry/military accepted.

MIL-STD-1353C

4.6 Wiring. Reference MIL-HDBK-454.

4.6.1 Wiring for aerospace applications. See SAE-AS50881 for wire installation practices and approved wire for aerospace applications. Other approved wires for aerospace equipment are DLA Land and Maritime drawings 04034 through 04049.

4.6.2 SAE-AS22759/9 wire. SAE-AS22759/9 wire should be used for internal wiring (black box) use only.

4.6.3 SAE-AS22759/33 wire. SAE-AS22759/33 does not define nor restrict the volatiles that can outgas from the wire insulation. Use of this wire has exhibited corrosive effects to connectors, hardware or end item equipment that is hermitically sealed or devices prewired and subject to long-term sealed storage, should consider the risk of corrosion degradation. Programs using XL-ETFE insulated wire and XL-ETFE jacketed cable should perform a risk assessment for their hardware and end item equipment.

4.6.4 Polyvinyl chloride (PVC) wiring. PVC wiring shall not be used in manned spacecraft, manned aircraft, or shipboard applications. PVC, when burned, gives off thick black smoke that can hinder a pilot from seeing and hides the fire from shipboard crew members trying to fight the fire. PVC on burning generally produces hydrochloric acid in the form of gas and can cause latent defects in equipment exposed to the smoke.

4.6.5 Pre-wired nanominiature connectors. Nanominiature connectors prewired with insulated 30 AWG wire. Due to small conductor size these connectors should be limited to board to board connections within units, and are not recommended for use as black box to black box cable assemblies.

4.7 Oxygen restricted materials.

- a. Cadmium: The toxicity and vapor pressure of cadmium restrict its use.
- b. Titanium: Titanium metal is not be used with liquid oxygen at any pressure or with gaseous oxygen or air at oxygen partial pressures above 30 psig (2 bar). Titanium and its alloys are impact sensitive in oxygen.
- c. Magnesium: Magnesium metal is not be used in oxygen systems. In addition, its alloys are not to be used except in areas with minimal exposure to corrosive environments. Reactivity with halogenated compounds constrains its use with lubricants containing chlorine and fluorine.
- d. Mercury: Mercury is not be used in oxygen systems in any form because it is toxic; in addition, it and its compounds can cause accelerated stress cracking of aluminum and titanium alloys.
- e. Beryllium: Beryllium and its oxides and salts are highly toxic and are not be used in oxygen systems or near oxygen systems where they could be consumed in a fire.

4.8 Cleanliness. Care should be taken that cleaning materials are compatible with all materials in the connector assembly. Grease, oil, dust, dirt, flux, solder splatter and fingerprints shall be removed.

MIL-STD-1353C

4.9 Special considerations . Special considerations need to be taken when selecting electrical connectors for applications involving space, missiles, aerospace, shipboard, vehicular, and ground benign. A few examples for digital and low amperage connectors are listed below:

- a. Space- Shock, vibration , thermal vacuum outgassing, and atomic oxygen. Recommend 50μ inches (1.27 μm) of gold on the contact mating surface.
- b. Missile - Shock and vibration. Recommend 50μ inches (1.27 μm) of gold on the contact mating surface.
- c. Aerospace - Shock, vibration, salt spray, fungus growth. Recommend 50μ inches (1.27 μm) of gold on the contact mating surface.
- d. Shipboard - Salt spray, sea air even in controlled environments, hulls can be breached. Recommend 30μ inches (0.76μm) of gold on the contact mating surface.
- e. Vehicular - Shock, vibration, sand and dust. Recommend 50μ inches (1.27 μm) of gold on the contact mating surface.
- f. Ground benign - Industrial gas. Recommend 30μ inches (0.76 μm) of gold on the contact mating surface. If 20μ inches (0.51 μm) of gold is used it is recommended for applications requiring less than 20 mate and unmate cycles. If tin/lead is used it is recommended for applications requiring less than 10 mate and unmate cycles.

4.9.1 Fireproof connectors. Fireproof and fire wall connectors shall be class K and shall conform to MIL-DTL-83723 and MIL-DTL-38999. These connectors only maintain electrical continuity for a limited time under continuous flame.

4.10 Cross reference listing (SAE-ARP1308). For a cross reference listing of cancelled Government standards, specifications, and military specification sheets to SAE electrical connectors, reference SAE-ARP1308.

4.11 Recycled, recovered, environmentally preferable, or biobased materials. Recycled, recovered, environmentally preferable, or biobased materials should be used to the maximum extent possible, provided that the material meets or exceeds the operational and maintenance requirements, and promotes economically advantageous life cycle costs.

4.12 Toxic chemicals, hazardous substances, and ozone-depleting chemicals. The use of toxic chemicals, hazardous substances, or ozone-depleting chemicals shall be avoided, if feasible. The desired performance requirements should be specified rather than the specific chemical or substance. The Environmental Protection Agency maintains an online list of toxic chemicals and hazardous substances at <http://www.epa.gov/emergencies/tools.htm#lol> that should be consulted.

5. DETAILED REQUIREMENTS.

5.1 General. This section covers detailed electrical connector requirements including contact materials, contact plating requirements, and shell plating options.

5.2 Contacts:

5.2.1 Beryllium copper. Beryllium is used as an alloying agent in producing beryllium copper; it is used on electrical contacts and springs in electrical contacts. Beryllium and its salts are toxic and should be handled with the greatest of care. Handling copper beryllium in solid form poses no special health risk. Like many industrial materials, beryllium-containing materials may pose a health risk if recommended safe handling practices are not followed. Inhalation of airborne beryllium may cause serious lung disorder in susceptible individuals.

MIL-STD-1353C

5.2.2 Beryllium copper strip and wire. Beryllium copper strip and wire have a long history of success in the cyclic stress environment of electrical and electronic contact springs. Fatigue strength is defined as the maximum stress that can be endured for a specified number of cycles without failure.

5.2.3 Localized finish (selective plating). The non functional areas shall have a 20 μ inch (0.51 μ m) minimum of gold. Selectively plated contacts must have a transition area between the Au and Sn-Pb of nickel to avoid overlap and resultant embrittlement. A non-functioning part of a contact shall be defined as a part of the contact that is not used for a contact mating surface (engagement area) or a crimp, soldering, or other termination point. The mating gold plating requirements are specified in 5.2.7.1.

5.2.4 Tin/lead plating. Tin-lead (solder) coating in accordance with SAE-AMS-P-81728, shall be applied by hot dip or electrodeposited, 50 to 97 percent tin, 100 μ inches (2.54 μ m) minimum. Solderability in accordance with MIL-STD-202, method 208. Tin/lead plating is recommended for soldered applications. It is not recommended for contact mating surfaces. However if it is used for contact mating surfaces it shall be for applications where the mate and unmate cycles are less than 30 units. Recommended for ground benign applications.

5.2.5 Pure tin plating is prohibited. Use of pure tin coating such as specified in ASTM B545 is prohibited. The use of pure tin, as an underplate or final finish, is prohibited both internally and externally. Tin content of connector components and solder shall not exceed 97 percent, by mass. Tin shall be alloyed with a minimum of 3 percent lead, by mass. Though there are many alternative solder alloys available to replace traditional tin-lead, none of them has passed the reliability testing required of aerospace-quality hardware.

5.2.5.1 Replating pure tin finished parts (lead free). Pure tin finished parts shall not be replated/reflowed. It cannot be assured that the replating process has effectively covered the entire tin plated surface to inhibit tin whisker growth.

5.2.5.2 Tin whisker growth. The use of alloys with tin content greater than 97 percent, by mass, may exhibit tin whisker growth problems after manufacture. "Tin whiskers" or very fine filaments" are a phenomenon associated with the use of pure tin coating as a final finish on cases and leads of small electronic components. These whiskers can break off and cause shorts and intermittent in components, especially low voltage applications. Tin whiskers may occur anytime from a day to years after manufacture and can develop under typical operating conditions, on products that use such materials. Conformal coatings applied over top of a whisker-prone surface will not prevent the formation of tin whiskers. Alloys of 3 percent lead, by mass, have shown to inhibit the growth of tin whiskers. For additional information on this matter, refer to ASTM-B545 (Standard Specification for Electrodeposited Coatings of Tin). Pure tin plated parts that are dipped into tin/lead (solder) are not acceptable, as pure tin may still be present on areas that are not coated with the tin/lead dip.

5.2.6 Nickel underplating. One of the basic reasons for nickel underplate is that it increase hardness and wear resistance. When gold is applied to a copper rich surface such as brass, bronze, or beryllium copper, metal ions from these base metals will diffuse into the gold layer and degrade its hardness and non-oxidizing properties. Nickel underplating provides a protective coating and serves as a pore corrosion inhibitor, corrosion creep inhibitor, a diffusion barrier, and a mechanically supporting underlayer, when applied over the entire contact. When used as underplating in conjunction with gold it creates a surface which allows gold to easily adhere to. Thickness of the nickel underplating is critical. Thickness less than 50 μ inches the nickel and gold will have a tendency to peel off, greater than 150 μ inches (3.81 μ m) the nickel and gold plating will tend to crack. When nickel underplating is to be specified the entire contact shall have an underplate of nickel in accordance with SAE-AMS-QQ-N-290, class 2, 50 to 150 μ inches thick (1.27 - 3.81 μ m). A 30 μ inch (0.76 μ m) underplate has shown to have a wear rate 2 to 3 times greater than the 50 μ inch (1.27 μ m). This was demonstrated by work performed by Burndy and Bell Laboratories in the late 1960's early 1970's and reconfirmed by AMP Inc. (Tyco Amp) in the late 1970's. Increase in the thickness of the nickel and gold coatings will reduce porosity and help avoid problems due to pore corrosion. Silver shall not be used as an underplate.

MIL-STD-1353C

5.2.6.1 Low stress sulfamate nickel. A low stress sulfamate nickel in accordance with SAE-AMS-QQ-N-290, class 2 shall be used to prevent stress that may be either tensile or compressive and could react in a negative manner resulting in mechanical stress relaxation or due to thermal conditions which may exist. Uses of other nickels also impact the possibility of cracking contingent on the contact design.

5.2.6.2 Silver underplating problems. Imperfections ranging from porosity to deep scrapes penetrate the silver underplating and reveal the copper material of the contact. Moisture may penetrate through the silver underplating exposing the copper. The copper will tend to corrode and protect its more noble silver plating. As the water dries out cuprous-oxide crystals will form. These cuprous-oxide crystals have a characteristic red appearance (red-plague), precipitates out onto the silver plating. Excessive corrosion can impair the contacts electrical conductivity. Copper hydroxides are soluble in water, if the water does not dry out, and in the presence of oxygen the galvanic copper corrosion can go on indefinitely.

5.2.7 Gold plating. SAE-AS39029 at the time this was written has not been revised and still specifies gold plating in accordance with ASTM B488, this is not a suitable gold plating for electrical contacts. Gold plated parts shall be plated in accordance with MIL-DTL-45204 over an underplate of nickel. Increasing the thickness of a gold coating tends to decrease the porosity which reduces the contact vulnerability to pore corrosion.

5.2.7.1 Contact mating surfaces. Reference SAE-AS39029 for details about contact mating surfaces.

5.2.7.2 20 μ inches of gold. MIL-DTL-45204, any type, any grade, class 00 with an underplate of nickel in accordance with SAE-AMS-QQ-N-290, class 2, 50 to 150 μ inches (1.27 μ m to 3.81 μ m). The minimally accepted plating is 20 μ inches (5.1 μ m) of gold. Platings with less than 20 μ (0.51 μ m) of gold may have porosity problems that allow the underplate to bleed through. Plating thickness of 20 μ (0.51 μ m) of gold is used for lead finishes or contact bodies when localized contact plating is specified. Plating of leads with 20 μ (0.51 μ m) of gold or tin/lead are intended for soldered applications only. When used as plating for contacts it shall be for applications that have less than 30 mate and unmate cycles. This gold plating thickness is recommended for ground benign applications.

5.2.7.3 30 μ inches of gold. MIL-DTL-45204, type II, grade C, class 0 with an underplate of nickel in accordance with SAE-AMS-QQ-N-290, class 2, 50 to 150 μ inches (1.27 μ m to 3.81 μ m). The minimum recommended plating of gold for contact mating surfaces is 30 μ inches (0.76 μ m) of gold. This gold plating thickness is recommended for ground benign or shipboard electronics.

5.2.7.4 50 μ inches of gold. MIL-DTL-45204, type II, grade C, class 1 with an underplate of nickel in accordance with SAE-AMS-QQ-N-290, class 2, 50 to 150 μ inches (1.27 μ m to 3.81 μ m). Recommended for applications where shock and vibration are present, such as aerospace, missile, or combat vehicles.

5.2.7.5 100 μ inches of gold. MIL-STD-45204, type II, grade C, class 2 with an underplate of nickel in accordance with SAE-AMS-QQ-N-290, class 2, 50 to 150 μ inches (1.27 μ m to 3.81 μ m).

5.2.7.6 150 μ inches of gold. Generally referred to as "heavy gold" shall have a minimum plating thickness of 150 μ inch (3.81 μ m) gold plate in accordance with MIL-STD-45204, type II, grade C, class 6 over a minimum of 50 μ inch (1.27 μ m) nickel plate.

MIL-STD-1353C

5.2.7.7 Gold Embrittlement of solder joints. Under certain conditions, e.g. with respect to temperature and gold concentration; when solder containing tin is applied, gold and tin will form intermetallic structures within the solder joint. Some of the gold is mixed with the solder at the microscopic level. This eutectic tin-lead with gold embrittlement structures weakens the solder joint. This threshold is approximately 3 percent by weight of gold.

5.2.7.8 Stamped and formed crimp contacts. Stamped and formed crimp contacts use an open barrel concept and standard plating requirements of 5.2.7.2, 5.2.7.3, and 5.2.7.4 can be used.

5.2.7.9 Gold flash palladium nickel. Gold flash palladium nickel should only be used after careful and comprehensive evaluation. This plating system does not perform well in fretting conditions and harsh environments. Performance in large durability applications are highly questionable due to frictional polymer formation. Gold flash is used to offset this formation. However, durability problems with less than 30μ inches (0.76μm) will displace the gold flash exposing the PdNi to the formation indicated.

5.2.8 Rhodium. Rhodium contacts shall be a minimum of 50μ inch (1.27μm) rhodium plate over a minimum of 150μ inch (3.81μm) nickel plate.

5.2.9 Nickel-iron. Nickel-iron 52 alloy or equivalent.

5.2.10 Solderless wrap termination platings. Solderless wrap termination areas shall be either gold plated in accordance with MIL-DTL-45204 any type any grade any class or tin/lead in accordance with SAE-AMS-P-81728 100μ inches thick minimum. The entire solderless wrap termination post shall have an underplate of nickel in accordance with SAE-AMS-QQ-N-290, class 2, 50 to 150μ inches (1.27μm to 3.81μm).

5.2.11 Silver plating. Silver plating is used for RF and power type contacts generally 8 AWG and below. Silver plating shall be in accordance with ASTM B700 20μ inches (0.51μm) thick minimum. Silver is also necessary on high-temperature cables to prevent rapid oxidation of the copper during processing and use.

5.2.12 Replating of contacts. Contacts shall not be replated. Preplated material in its final form will have sheared edges exposing copper. This could easily result in corrosion products forming and creeping across the gold surface. If forming is performed the plating will be stretched particularly the nickel underplate. Depending on the thickness ratio of the gold/nickel system the gold may crack or separate in the form area which could expose copper leading to corrosion.

5.2.13 Crimp type wire barrels (SAE-AS5261). SAE-AS5261 is a design standard which describes 3 types of crimp type wire barrels, Type A, Type B, and Type C. This standard is used to describe the crimp ends of contacts in order to prevent manufacturers from making unique designs, on the crimp end, and using non-standard crimp tools.

5.2.13.1 Crimp barrel plating. Crimp terminations gold plating thickness inside the crimp barrel may be as low as 2 or 3μ inches (0.05 - 0.08μm). The plating on the OD of the barrel met the gold contact thickness requirement, however inside the barrel the plating tends to taper down to the minimum level indicated. To achieve a thick plating in the barrel, from an economical viewpoint, would be unfeasible and difficult to measure.

5.2.14 Thermal couples. Thermocouple contacts - crimp and PCB mount types and characteristics are listed in table I:

MIL-STD-1353C

TABLE I. Thermocouple types.

Type	Material	Color Code	Temperature range	Sensitivity
J	Iron	Black	-40°F to +1382°F (-40°C to +750°C)	55 $\mu\text{V}/^\circ\text{C}$
	Constantan			
K	Chromel (+)	Yellow	-328°F to +2462 F (-200°C to +1350 C)	41 $\mu\text{V}/^\circ\text{C}$
	Alumel (-)			
T	Copper (+)	Blue	-328°F to 662°F (-200 C to 350°C)	43 $\mu\text{V}/^\circ\text{C}$
	Constantan (-)			
E	Chromel (+)	Purple	Below -150 °C, -238 °F or 123 K	68 $\mu\text{V}/^\circ\text{C}$
	Constantan (-)			

Chromel® an alloy that is predominantly nickel with chromium that is used with Alumel® in thermocouples; a registered trademark of Hoskins Manufacturing Company.

5.2.15 Shielded contacts. Inner and outer contacts of shielded contacts shall be gold plated in accordance with MIL-DTL-45204, type II, grade C, class 1. The entire surface of the body of the contact shall have a nickel underplate in accordance with SAE-AMS-QQ-N-290, class 2, 50 μ to 150 μ inches (1.27 - 3.81 μm) thick.

5.2.16 Radio frequency (RF). RF connectors tin-and nickel-plated conductors should be limited to low-frequency applications where the thickness of the coating will not increase the conductor attenuation significantly.

5.2.17 Silver plated contacts. The external plated surface diameters of the bodies of contact sizes larger than 12 and size 12 contacts used in MIL-DTL-83723, series II connectors shall be silver plated 20 μ inches (0.51 μm) thick minimum in accordance with ASTM B700.

5.2.18 Sockets. Individual sockets (pin), transistor, and dual-in-line sockets (for such as integrated circuits, transistor or general purpose plastic type relays) are not recommended for aerospace applications. Sockets will not hold up to shock, vibration, or altitude. Spring finger contacts are preferred over the wipe type socket contacts.

5.2.18.1 Printed wiring board contact design. Contacts intended for soldering to a printed wiring board shall incorporate an anti-wicking feature as an integral part of the contact. The design shall not allow wicking into the contact that would interfere with mating and performance.

5.2.18.2 Printed circuit, solder wire turrent, and solder cup tin-lead plating. Tin-lead in accordance with SAE-AMS-P-81728, minimum thickness of 180 microinches (4.57 μm) over nickel, in accordance with SAE-AMS-QQ-N-290, thickness of 50 -150 μ inches (1.27 - 3.81 μm), or copper. For printed circuit termination's (through hole leads), the tin-lead finish shall be 50 to 70 percent tin; for all other termination's, the tin-lead finish shall be 5 percent minimum lead. For tin-lead finished copper sleeves, nickel or copper underplate is not required. Solder terminations shall not have a thickness in excess of 20 μ inches (0.51 μm) of gold to eliminate or minimize the possibility of gold/tin inter metallic formation.

5.2.18.3 Solderless wrap, printed circuit, eyelet, solder wire turrent, and solder cup gold plating. The minimum recommended gold plating for over the entire contact and solder terminations is 20 μ inches (0.51 μm) of gold. For aerospace and navy ships use, the recommended minimum gold plating for over the entire contact and solder terminations is 30 μ inches (0.76 μm). The minimum recommended gold plating for over the entire contact and solder terminations for missiles and NASA applications is 50 μ inches (1.27 μm) of gold.

MIL-STD-1353C

5.2.18.4 Tinning solder cups. Where pretinned solder cups are required, the interior surface of solder cups shall be completely tinned over 100 percent of the full circle portion and for at least 50 percent of the remainder of the solder well area with solder conforming to composition Sn60 of IPC-J-STD-004. Only fluxes meeting IPC-J-STD-006, shall be used, any excess of which shall be removed. Solder cup terminals shall be so constructed that liquid solder cannot leak through to the front of the socket and prevent insertion of the pin contact. No excess solder shall be on the exterior of the solder cup.

5.2.19 Flat ribbon connectors overall finish. All parts of the contact shall be gold in accordance with MIL-DTL-45204, type II, grade C, class 1, 50 μ inches (1.27 μ m) minimum thickness.

5.2.20 Nonfunctional areas (crimp and solder contacts). Any portion of the contact other than the contact mating area or termination area shall have nickel plating in accordance with SAE-AMS-QQ-N-290, 50 to 150 μ inches thick (1.27 μ m to 3.01 μ m).

5.2.20.1 Nonfunctional area gold plating absence. When contacts have been provided in strip form, the absence of gold plating where the gripping mechanism holds the contact during the plating process is acceptable provided it is in a non functional area that during corrosion testing (salt, concentrated sulfur atmosphere) the corrosion does not migrate into the contact mating area or the termination area. The area where the gold plating is absent shall have nickel plating in accordance with SAE-AMS-QQ-N-290, 50 to 150 μ inches (1.27 μ m to 3.01 μ m) thick.

5.3 Solderless wrap (wire wrap). For guidance on the proper procedure for wire wrap terminals reference MIL-STD-1130.

5.4 Contacts, crimp tools, positioning, installing and removal tools. For specific connectors reference the appropriate specifications for the correct contacts, crimp tools, positioner, installing and removal tools.

5.5 Shells.

5.5.1 Platings. Only plug-in component leads with similar finishes to the mating socket contacts should be mated. Avoid using different platings on the shells, backshells or any component assembled on the same connector and match the plating to the mating connector.

5.5.2 Cadmium plated shells. Cadmium plated shells are the most popular in use, however because cadmium is a hazardous material; alternate platings are encouraged. Cadmium plated shells shall not be used near reactors or oxygen enriched atmospheres. Advantages of cadmium plating include: low electrical resistance; outstanding conductivity; superior solderability; favorable galvanic coupling with aluminum; and excellent natural lubricity, which results in prevention of galling and a low coefficient of friction. This is especially useful in applications where components will be repeatedly disassembled and reassembled, such as in scheduled maintenance of aircraft. These consideration's need to be taken into account with selecting an alternate finish, especially in existing applications that have had shielding effectiveness (SE), electromagnetic compatibility (EMC), electromagnetic pulse (EMP), or lightning strike testing.

5.5.3 Composite connectors. Miniature composite environment resisting connectors reference MIL-DTL-38999.

5.5.4 Connector materials exposed directly to salt water. Recommended shell materials when connectors are to be exposed directly to salt water are titanium, nickel-aluminum-bronze, corrosion resistant steel alloy 316 in accordance with ASTM A276, thermoplastic, nickel-copper alloy UNS N04400 in accordance with ASTM B164 or QQ-N-281, or high-chromium nickel alloy UNS N06690 in accordance with ASTM B166 or ASTM B564.

MIL-STD-1353C

5.5.5 Plating's and electromagnetic interference (EMI). Regardless of the plating used consideration should be taken to the EMI shielding effectiveness, EMP, conductivity, relative permeability, or solderability requirements. Platings are listed below, see table II for properties:

- A. - Nickel plate a minimum of 200 μ inches (0.005 mm) followed by cadmium plate 100 μ inch (0.003 mm) minimum in accordance with SAE-AMS-QQ-P-416, type II. A preliminary plate of other metal is permissible. The final finish shall be electrically conductive and shall be silver to light iridescent yellow in color. Inactive for new design.
- B. - Olive drab cadmium plate in accordance with SAE-AMS-QQ-P-416 over a suitable underplate. Final finish shall be electrically conductive.
- C. - Composite (hard, anodic), nonconductive in accordance with MIL-A-8625, type III, 800 μ inches (0.020 mm) minimum thickness.
- D. - Fused tin plate in accordance with ASTM B545 or ASTM B339. The tin shall be reflowed to promote solderability. Tin application process shall inhibit tin whisker growth.
- E. - Electrically conductive, stainless steel shall be passivated in accordance with SAE-AMS2700, type 6 or 7.
- F. - Electrically conductive, electroless nickel plating conforming to ASTM B733. Use of a suitable under plate is permissible.
- G. - Electrodeposited nickel in accordance with MIL-DTL-38999 appendix A, class 2, to a minimum thickness of 100 μ inches to 200 μ inches (0.003 to 0.005 mm).
- H. - Corrosion resistant steel passivated (conductive).
- J. - Nickel plate followed by cadmium plate in accordance with SAE-AMS-QQ-P-416, type II. A preliminary plate of other metal is permissible. The final finish shall be electrically conductive and shall be silver to light iridescent yellow in color. The plating shall be such that connector finish shall withstand the salt spray (corrosion) test specified in test procedure EIA-364-26, test condition A.
- K. - Corrosion resistant steel passivated (conductive).
- M. - Electrically conductive, electroless nickel plating conforming to ASTM B733. The plating shall be such that connector finish shall withstand the salt spray (corrosion) test as specified in test procedure EIA-364-26, test condition A.
- N. - Electrodeposited nickel in accordance with MIL-DTL-38999, appendix A.
- P. - Pure dense electrodeposited aluminum (high purity) in accordance with MIL-DTL-83488, type II, to withstand 500 hours of dynamic salt spray testing.
- R. - Same as F, but higher corrosion requirements (conductive).
- S. - Same as N, but higher corrosion requirements.
- T. - Nickel fluorocarbon polymer. Nickel with fluorocarbon polymer additives over a suitable underplate to withstand 500 hours of dynamic salt spray testing.

MIL-STD-1353C

- U. - Light gold cadmium plate in accordance with SAE-AMS-QQ-P-416, type II over a suitable nickel underplate. Final finish shall be electrically conductive. The plating shall be such that connector finish shall withstand 96 hours of salt spray (corrosion) testing.
- W - Olive drab cadmium plate in accordance with SAE-AMS-QQ-P-416 over a suitable nickel underplate. Final finish shall be electrically conductive. The plating shall be such that connector finish shall withstand 500 hours of salt spray (corrosion) testing.
- X. - Olive drab cadmium plate in accordance with SAE-AMS-QQ-P-416 over a suitable nickel underplate. Final finish shall be electrically conductive. The plating shall be such that connector finish shall withstand 1000 hours of salt spray (corrosion) testing.
- Y. - Corrosion resistant steel passivated (conductive).
- Z. - Zinc nickel in accordance with ASTM B841, type D (black) over a suitable underplate (conductive).

MIL-STD-1353C

TABLE II. Properties of various plating's. 1/ 2/

Plating designator	Description	Shell material	Salt fog (hours)	Upper temp	Electrically conductive	Shell-to-shell conductivity (millivolts)
A	Cadmium over nickel, light gold	AL	48	175°C	Yes	2.5
B	Cadmium over nickel, olive-drab	AL	96/500	175°C	Yes	2.5
C	Anodic, black	AL	48/500	200°C	No	N/A
D	Tin	CRS	24	150°C	Yes	10.0
E	Passivate	SST	48/500	200°C	Yes	50.0
F	Electroless nickel	AL	48	200°C	Yes	1.0
G	Electroless nickel	AL	48	200°C	Yes	1.0
H	Passivate	SST	500	200°C	Yes	10.0
J	Cadmium over nickel, olive-drab	C	2000	175°C	Yes	3.0
K	Passivate	SST	500	200°C	Yes	10.0
L	Electrodeposited nickel	SST	500	200°C	Yes	1.0
M	Electroless nickel	C	2000	200°C	Yes	3.0
N	Electrodeposited nickel	SST	48	200°C	Yes	1.0
P	Electrodeposited aluminum	AL	500	175°C	Yes	2.5
R	Electroless nickel	AL	96	200°C	Yes	1.0
S	Electrodeposited nickel	SST	500	200°C	Yes	1.0
T	Nickel fluorocarbon polymer	AL	500	200°C	Yes	2.5
U	Cadmium over nickel, light gold	AL	96	175°C	Yes	2.5
W	Cadmium over nickel, olive-drab	AL	500	175°C	Yes	2.5
X	Cadmium over nickel, olive-drab	AL	1000	175°C	Yes	2.5
Y	Passivate	SST	500	200°C	Yes	10.0
Z	Zinc nickel	AL	500	175°C	Yes	2.5

1/ Shell material: AL = aluminum alloy, CRS = cold rolled steel, SST = stainless steel, C = composite

2/ Table taken from MIL-DTL-38999.

5.5.6 RF connector bodies (MIL-PRF-39012).

- a. Brass bodies' silver plated in accordance with ASTM B700 minimum thickness 200 μ inches (5000 μ m).
- b. Nickel plated. Nickel plated in accordance with SAE-QQ-N-290. Note nickel plated bodies may cause passive intermodulation (PIM) problems.
- c. Copper beryllium. All copper beryllium bodied connectors shall be gold plated to a minimum thickness of 50 μ inches (1.27 μ m) of gold over a copper flash.
- d. Corrosion resistant steel (CRES). CRES bodies shall be passivated in accordance with SAE-AMS2700.

MIL-STD-1353C

5.5.7 NASA preferred metal shell finish. Electroless nickel plating is the preferred plating for circular, D-subminiature, and microminature metal shell connectors.

5.5.8 NASA prohibited materials for electrical connectors. Pure tin finishes, cadmium, zinc, chemically coated cadmium or zinc, and silver shall not be used for a connector or contact finish.

6. NOTES

(This section contains information of a general or explanatory nature that may be helpful, but is not mandatory.)

6.1 Intended use. This standard is intended to be used as a guide to standard connector types. When an applicable standard does not exist for a particular connector this document can be used as an engineering guide to specify preferred contact finishes, shell materials and finishes, and testing by referencing a similar connector or connector's listed in this document.

6.2 Changes from previous issue. Marginal notations are not used in this revision to identify changes with respect to the previous issue due to the extent of the changes.

6.3 Subject term (key word) listing.

Beryllium
Cadmium
Lead
Nickel

MIL-STD-1353C
APPENDIX A

A.1 SCOPE

A.1.1 Scope. This appendix provides additional guidance to help the specification developer or engineer in selection of printed wiring board (PWB) connectors. This appendix is not a mandatory part of this standard. The information is intended for guidance only.

A.2 APPLICABLE DOCUMENTS

A.2.1 General. The documents listed in this appendix are specified herein. This section does not include documents cited in other sections of this document.

A.2.2 GOVERNMENT DOCUMENTS

A.2.2.1 Specifications, standards, and handbooks. The following specifications, standards, and handbooks form a part of this appendix to the extent specified herein.

DEPARTMENT OF DEFENSE SPECIFICATIONS

MIL-C-28731/3	- Connector, Electrical, Insert (Insulator), Male Rectangular, Polarized, Center Screw Lock, for 100 Removable Contacts
MIL-C-28731/4	- Connector, Electrical, Insert (Insulator), Female Rectangular, Polarized, Center Screw Lock, for 100 Removable Contacts
MIL-C-28731/9	- Connector, Electrical, Insert (Insulator), Male Rectangular, Polarized, Center Screw Lock, for 20 Removable Contacts
MIL-C-28731/10	- Connector, Electrical, Insert (Insulator), Female Rectangular, Polarized, Center Screw Lock, for 20 Removable Contacts
MIL-C-28731/11	- Connector, Electrical, Insert (Insulator), Male Rectangular, Polarized, Center Screw Lock, for 38 Removable Contacts
MIL-C-28731/12	- Connector, Electrical, Insert (Insulator), Female Rectangular, Polarized, Center Screw Lock, for 38 Removable Contacts
MIL-C-28731/13	- Connector, Electrical, Insert (Insulator), Male Rectangular, Polarized, Center Screw Lock, for 56 Removable Contacts
MIL-C-28731/14	- Connector, Electrical, Insert (Insulator), Female rectangular, Polarized, Center Screw Lock, for 56 Removable Contacts
MIL-C-28731/15	- Connector, Electrical, Insert (Insulator), Male Rectangular, Polarized, Center Screw Lock, for 90 Removable Contacts
MIL-C-28731/16	- Connector, Electrical, Insert (Insulator), Female Rectangular, Polarized, Center Screw Lock, for 90 Removable Contacts
MIL-C-28731/17	- Connector, Electrical, Insert (Insulator), Male Rectangular, Polarized, Center Screw Lock for 120 Removable Contacts
MIL-C-28731/18	- Connector, electrical, Insert (Insulator), Female Rectangular, Polarized, Center Screw Lock, for 120 Removable Contacts
MIL-C-28754	- Connectors, Electrical, Modular, and Component Parts General Specification For
MIL-C-28754/6	- Connectors, Electrical, Modular, Type IV, 40 Pin, Straight Through
MIL-C-28754/7	- Connectors, Electrical, Modular, Type IV, Single Span, Connector Assembly
MIL-C-28754/8	- Connectors, Electrical, Modular, Type IV, 40 Contact, Right Angle (For Die Cast Frame)
MIL-C-28754/9	- Connectors, Electrical, Modular, Type IV, Double Span, Connector Assembly, (Dip Frame)

MIL-STD-1353C
APPENDIX A

MIL-C-28754/10	- Connectors, Electrical, Modular, Connector, Type IV, 40 Pin, Contact Tails on 0.050 Centers
MIL-C-28754/11	- Connectors, Electrical, Modular, Type IV, 40 Contact, Right Angle (For Solid or Dip Frame)
MIL-C-28754/12	- Connectors, Electrical, Modular, Connector Assembly, Type IV, Single Span (For Solid State or Dip Frame)
MIL-C-28754/13	- Connectors, Electrical, Modular, Connector Assembly, Type IV, Single Span (Without Guide Ribs)
MIL-C-28754/14	- Connectors, Electrical, Modular, Connector, Type IV, 20 Contact, Right Angle (For Die Cast Frame)
MIL-C-28754/15	- Connectors, Electrical, Modular, Crimp, Contact, Type V
MIL-C-28754/16	- Connectors, Electrical, Modular, Block, 40 Pin, Type V, Straight Through
MIL-C-28754/18	- Connectors, Electrical, Modular, Spacer, Pin, Type IV, Single Span
MIL-C-28754/19	- Connectors, Electrical, Modular, Spacer, Pin, Type IV Single Span
MIL-C-28754/20	- Connectors, Electrical, Modular, Spacer, Pin, Type IV, Double Span
MIL-C-28754/21	- Connectors, Electrical, Modular, Frame, Casting, Type IV, Double Span
MIL-C-28754/22	- Frame, Casting, Type IV, Single Span
MIL-C-28754/23	- Connectors, Electrical, Modular, Connector Assembly, Type IV, Single Span
MIL-C-28754/24	- Connectors, Electrical, Modular, Pin, Keying
MIL-C-28754/25	- Connectors, Electrical, Modular, Guide, Retaining
MIL-C-28754/31	- Connectors, Electrical, Modular, Connector Assembly, Type V, 40-Pin, Two Piece Insert, and 20-Pin, One Half, One Piece Insert
MIL-C-28754/32	- Connectors, Electrical, Modular, Connector Assembly, Type V, Style I, Slip Lock Cover Plate
MIL-C-28754/33	- Connectors, Electrical, Modular, Connector Assembly, Type V, Style II, Slip Lock Cover Plate
MIL-C-28754/34	- Connectors, Electrical, Modular, Connector Type III, Female Contact and Insulator Bushing Set, Removable Wire Wrappost Terminal
MIL-C-28754/35	- Connectors, Electrical, Modular, Connector, Type III, Male Contact and Insulator Bushing Set, Removable Wire Wrappost Terminal
MIL-C-28754/36	- Connectors, Electrical, Modular, Connector, Type III, Female Contact and Grounding Bushing Set, Removable Wire Wrappost Terminal
MIL-C-28754/37	- Connectors, Electrical, Modular, Connector, Type III, Female Contact and Polarizing Bushing Set, Removable Wire Wrappost Terminal
MIL-C-28754/38	- Connectors, Electrical, Modular, Connector, Type III, Contact, Grounding, Wrappost
MIL-C-28754/39	- Connectors, Electrical, Modular, Connector, Type III, Keying Pegs
MIL-C-28754/40	- Connectors, Electrical, Modular, Type IV, Connector Assembly, Screw
MIL-C-28754/41	- Connectors, Electrical, Modular, Type IV, Connector Assembly, Screw, Insert
MIL-C-28754/42	- Connectors, Electrical, Modular, Type IV, Connector, 100 Pin, Offset Contact Tails on .050 Centers
MIL-C-28754/43	- Connectors, Electrical, Modular, Connector Assembly, Type IV, 100 Pin, Double Span, Contact Tails on .050 Centers
MIL-C-28754/44	- Connectors, Electrical, Modular, Type IV, 100 Pin, Straight Through, Contact Tails on, .100 Centers
MIL-C-28754/45	- Connectors, Electrical, Modular, Connector Frame, Type IV, Double Span
MIL-C-28754/46	- Connectors, Electrical, Modular, Connector Assembly, Type IV, 100 Pin, Double Span

MIL-STD-1353C
APPENDIX A

MIL-C-28754/47	- Connectors, Electrical, Modular, Type IV, Connector Assembly, Single Span
MIL-C-28754/48	- Connectors, Electrical, Modular, Housing
MIL-C-28754/49	- Connectors, Electrical, Modular, Housing
MIL-C-28754/50	- Connectors, Electrical, Modular, Insert, Top
MIL-C-28754/51	- Connectors, Electrical, Modular, Insert, Top
MIL-C-28754/52	- Connectors, Electrical, Modular, Housing, Connector Assembly, Style I
MIL-C-28754/53	- Connectors, Electrical, Modular, Housing, Connector Assembly, Style II
MIL-C-28754/54	- Connectors, Electrical, Modular, Extractor, Module, Single and Double Span, Styles I and II
MIL-C-28754/55	- Connectors, Electrical, Modular, Connector Assembly, Type V, Cable Connector, 100 Pin, Contacts on .100 Centers
MIL-C-28754/56	- Connectors, Electrical, Modular, Type IV, Connector, 100 Pin, Offset Contact Tails on .050 Centers (Ceramic Compatible)
MIL-C-28754/57	- Connectors, Electrical, Modular, Type IV, Connector, 100 Pin, Offset Contact Tails on .050 Centers (Modified Frame, Ceramic Compatible)
MIL-C-28754/58	- Connectors, Electrical, Modular, Type IV, Connector, 100 Pin, Offset Contact Tails on .050 Centers (Modified Frame)
MIL-C-28754/59	- Connectors, Electrical, Modular, Type IV, Connector, 100 Pin, Center Contact Tails on .100 Centers (Ceramic Compatible)
MIL-C-28754/60	- Connectors, Electrical, Modular, Type IV, Connector, 100 Pin, Center Contact Tails on .100 Centers
MIL-C-28754/61	- Connectors, Electrical, Modular, Type IV, Connector, 100 Pin, Center Crossover, Contact Tails on .050 Centers
MIL-C-28754/62	- Connectors, Electrical, Modular, Type IV, Connector, 100 Pin, Center Crossover, Contact Tails on .050 Centers
MIL-C-28754/63	- Connectors, Electrical, Modular, Type IV, Connector, 40 Pin, Offset, Contact Tails on .050 Centers (Ceramic Compatible)
MIL-C-28754/64	- Connectors, Electrical, Modular, Type IV, Connector, 40 Pin, Offset, Contact Tails on .050 Centers (Modified Frame, Ceramic Compatible)
MIL-C-28754/65	- Connectors, Electrical, Modular, Type IV, Connector, 40 Pin, Center Contact Tails on .100 Centers (Ceramic Compatible)
MIL-C-28754/66	- Connectors, Electrical, Modular, Type IV, Connector, 40 Pin, Crossover, Contact Tails on .050 Centers (Ceramic Compatible)
MIL-C-28754/67	- Connectors, Electrical, Modular, Connector Frame, Type IV, Double Span, Center
MIL-C-28754/68	- Connectors, Electrical, Modular, Connector Frame, Type IV, Double Span, T-Dip
MIL-C-28754/69	- Connectors, Electrical, Modular, Connector Frame, Type IV Double Span, Offset
MIL-C-28754/70	- Connectors, Electrical, Modular, Connector Frame, Type IV, Single Span, Center
MIL-C-28754/71	- Connectors, Electrical, Modular, Connector Frame, Type IV, Single Span, Offset
MIL-C-28754/72	- Connectors, Electrical, Modular, Connector Frame, Type IV, Single Span, T-Dip
MIL-C-28754/73	- Connectors, Electrical, Modular, Connector Assembly, Type IV, 100 Contact, Double Span, Dip
MIL-C-28754/74	- Connectors, Electrical, Modular, Connector Assembly, Type IV, 100 Contact, Double Span, Center

MIL-STD-1353C
APPENDIX A

MIL-C-28754/75	- Connectors, Electrical, Modular, Connector Assembly, Type IV, 100 Contact, Double Span, Offset
MIL-C-28754/76	- Connectors, Electrical, Modular, Connector Assembly, Type IV, 40 Contact, Single Span, Center
MIL-C-28754/77	- Connectors, Electrical, Modular, Connector Assembly, Type IV, 40 Contact, Single Span, Offset
MIL-C-28754/78	- Connectors, Electrical, Modular, Connector Assembly, Type IV, 40 Contact, Single Span, Dual Inline Package (Dip)
MIL-C-28754/79	- Connectors, Electrical, Modular, Type III, Female Contact and Insulator Bushing Set, Low Insertion Force (LIF), Removable Wire Wrappost Terminal
MIL-C-28754/80	- Connectors, Electrical, Modular, Type III, Female Contact and Polarizing Bushing Set, Low Insertion Force (LIF), Removable Wire Wrappost Terminal
MIL-C-28754/81	- Connectors, Electrical, Modular, Type III, Female Contact and Polarizing Bushing Set, Low Insertion Force (LIF), Removable Wire Wrappost Terminal
MIL-C-28754/82	- Connectors, Electrical, Modular, Type IV, Connector Assembly, Fastener
MIL-C-28754/83	- Connectors, Electrical, Modular, Type IV, Connector, 0.6 Pitch, 250 Contact, Center
MIL-C-28754/84	- Connectors, Electrical, Modular, Type IV, Connector, 0.3 Pitch, 100 Contact, Offset
MIL-C-28754/85	- Connectors, Electrical, Modular, Type IV, Connector, 0.3 Pitch, 100 Contact, Dual Inline Package (Dip)
MIL-C-28754/86	- Connectors, Electrical, Modular, Connector Frame, Type IV, Dual Inline Package (Dip)
MIL-C-28754/87	- Connectors, Electrical, Modular, Connector Frame, Type IV, Center
MIL-C-28754/88	- Frame, Type IV, Offset, (0.050 Thickness)
MIL-C-28754/89	- Connectors, Electrical, Modular, Connector Frame, Type IV, Offset, (0.071 Thickness)
MIL-C-28754/90	- Connectors, Electrical, Modular, Connector Frame, Type IV, Center Fin, 0.4 Pitch, Format C
MIL-C-28754/91	- Connectors, Electrical, Modular, Connector Frame, Type IV, Center Fin, 0.5 Pitch, Format C and E
MIL-C-28754/92	- Connectors, Electrical, Modular, Connector Frame, Type IV, Center Fin, 0.6 Pitch, Format C and E
MIL-C-28754/93	- Connectors, Electrical, Modular, Connector Frame, Type IV, Dip, 0.3 Pitch, Format C
MIL-C-28754/94	- Connectors, Electrical, Modular, Connector Frame, Type IV, Dip, 0.4 Pitch, Format C, D and E
MIL-C-28754/95	- Connectors, Electrical, Modular, Connector Frame, Type IV, Offset Fin, 0.3 Pitch, Format C
MIL-C-28754/96	- Connectors, Electrical, Modular, Connector Frame, Type IV, Offset Fin, 0.4 Pitch, Format C and E
MIL-C-28754/97	- Connectors, Electrical, Modular, Type IV, Connector, 150 Contact, Right Angle, Contact Tails on 0.100 Centers
MIL-C-28754/98	- Connectors, Electrical, Modular, Type IV, Connector, 150 Contact, Center, Contact Tails on 0.100 Centers
MIL-C-28754/99	- Connectors, Electrical, Modular, Type IV, Connector, 150 Contact, Offset
MIL-C-28754/100	- Connectors, Electrical, Modular, Type IV, Connector, 200 Contact, Center

MIL-STD-1353C
APPENDIX A

- MIL-C-28754/101 - Connectors, Electrical, Modular, Type IV, Connector, 0.6 Pitch, 250 Contact, Center
- MIL-C-28859 - Connector Component Parts, Electrical Backplane, Printed-Wiring, General Specification For
- MIL-C-28859/1 - Connector, Component Parts, Electrical Backplane, Printed Wiring, Standard Insertion Force, Compliant Contact
- MIL-C-28859/2 - Connector, Component Parts, Electrical Backplane, Printed Wiring, Housing
- MIL-C-28859/3 - Connector, Component Parts, Electrical Backplane, Printed Wiring, Compliant Contact, Feed-Through
- MIL-C-28859/4 - Connector, Component Parts, Electrical Backplane, Printed Wiring, Compliant Contact, Feed-To
- MIL-C-28859/5 - Connector, Component Parts, Electrical Backplane, Printed Wiring, Low Insertion Force (LIF), Compliant Contact
- MIL-C-39024/3 - Connectors, Electrical, Test Point Type, Printed Wiring; Single Test Point (Right Angle, 2-Leg Mounting), Low Voltage
- MIL-C-39024/5 - Connectors, Electrical, Test Point Type, Panel Type; Single Test Point (Hole Mounting, Push-Fit), Low Voltage
- MIL-C-55302/129 - Connectors, Printed Circuit Subassembly and Accessories: Plug, Right Angle, 90 through 240 Contact Positions, for Printed Wiring Boards (.100 Inch Spacing)
- MIL-C-55302/132 - Connectors, Printed Circuit Subassembly and Accessories: Receptacle Socket Contacts, Straight Thru, 64 or 96 Contact Positions, for Printed Wiring Boards (.100 Inch Spacing)
- MIL-DTL-12883 - Sockets and Accessories for Plug-In Electronic Components, General Specification For
- MIL-DTL-12883/1 - Electron Tube, Bottom Mounting, Saddle Type 8 Contact, Radial
- MIL-DTL-12883/2 - Electron Tube, Top Mounting, Saddle Type with Shield Base, 7 Contact, Radial
- MIL-DTL-12883/3 - Electron Tube, Top Mounting, Saddle Type with Shield Base, 9 Contact, Radial
- MIL-DTL-12883/8 - Electron Tube, Top Mounting, Saddle Type without Shield Base, 7 Contact, Radial
- MIL-DTL-12883/10 - Electron Tube, Bottom Mounting, Saddle Type without Shield Base, 7 Contact, Radial
- MIL-DTL-12883/11 - Electron Tube, Bottom Mounting, Saddle Type without Shield Base, 9 Contact, Radial
- MIL-DTL-12883/40 - For Relays, 4-Pole, 10 Amperes (Mil-PRF-6106, MIL-PRF-83536, MIL-PRF-83726, and MS27709)
- MIL-DTL-12883/41 - Sockets, Plug-In Electronic Components For Relays, 2-Pole, 10 Amperes (MIL-PRF-6106 AND MIL-PRF-83536)
- MIL-DTL-12883/42 - Sockets and Accessories For Plug-In Electronic Components (Power Transistor, 2 Contact, 10 Amperes, TO-3), Radial)
- MIL-DTL-12883/44 - Sockets, Plug-In Electronic Components, Socket For Relays, 4-Pole, 5 Amperes (MIL-PRF-6106 and MIL-PRF 83536)
- MIL-DTL-12883/45 - Sockets, Plug-In Electronic Components, For Relays, For 2-Pole, 5 Amperes (MIL-PRF-6106 and MIL-PRF-83536)
- MIL-DTL-12883/46 - Sockets, Plug-In Electronic Components, For Relays, 3-Pole, 10 Amperes (MIL-PRF-6106 and MIL-PRF- 83536)
- MIL-DTL-12883/47 - Socket, Plug-In Electronic Components, For Relays, 6-Pole, 10 Amperes (MIL-PRF-6106 and MIL-PRF-83536)

MIL-STD-1353C
APPENDIX A

- MIL-DTL-12883/48 - Socket, Plug-In Electronic Components, For Relays, 3-Pole, 25 Amperes (MIL-PRF-83536/32 and /33)
- MIL-DTL-12883/49 - Sockets and Accessories for Plug-In Electronic Components, Mounting Tracks For Relays, 10 Amperes (MIL-PRF-6106, MIL-PRF- 83536, and MIL-PRF-83726)
- MIL-DTL-12883/50 - Sockets and Accessories for Plug-In Electronic Components, Brackets and Socket Assembly For Relays, 2-Pole, 10 Amperes (MIL-PRF-6106 and MIL-PRF-83536)
- MIL-DTL-12883/51 - Sockets and Accessories for Plug-In Electronic Components, Bracket and Socket Assembly for Relays, 4-Pole, 10 Amperes (MIL-PRF-6106, MIL-PRF- 83536, and MIL-PRF-83726)
- MIL-DTL-12883/52 - Sockets And Accessories for Plug-In Electronic Components Socket Assembly for Relays, 2, 3, and 4-Pole, Track Mount (MIL-PRF-6106, MIL-PRF- 83536, and MIL-PRF-83726)
- MIL-DTL-12883/53 - Sockets and Accessories for Plug-In Electronic Components, Mounting Track, For Relay Sockets and Electromagnetic Relays
- MIL-DTL-12883/54 - Sockets, Plug-In Electronic Components Socket for MIL-PRF 6106 Relays and MS27742 Relays
- MIL-DTL-12883/55 - Sockets, Plug-In Electronic Components Socket for MIL-PRF-6106 Relays
- MIL-DTL-12883/56 - Socket, Plug-In Electronic Components, For Relays, 1-Pole, 10 Amperes (MIL-PRF-83536/34 and /35)
- MIL-DTL-21097 - Connectors, Electrical, Printed Wiring Board, General Purpose General Specification For
- MIL-DTL-21097/2 - Connectors, Electrical, Printed Wiring Board Composite, Receptacle, Contact Spacing (.200) Single Row, Type CR
- MIL-DTL-21097/3 - Connectors, Electrical, Printed Wiring Board Composite, Adapter, Contact Spacing (.200) Individual Contacts, Type CS
- MIL-DTL-21097/4 - Connectors, Electrical, Printed Wiring Board Composite, Receptacle, Contact Spacing (.200) Alternate Dual Row, Type CR
- MIL-DTL-21097/5 - Connectors, Electrical, Printed Wiring Board Male Adapter, Contact Spacing (.200) Alternate Dual Row, Type CS
- MIL-DTL-21097/11 - Connectors, Electrical, Printed Wiring Board Keys, Polarizing
- MIL-DTL-21097/13 - Connectors, Electrical, Printed Wiring Board Composite, Receptacle, Contact Spacing: 0.200, Alternate Dual Row, Type CR, Removable Contact
- MIL-DTL-21097/14 - Connectors, Electrical, Printed Wiring Board Male Adapter, Contact Spacing: 0.200, Alternate Dual Row, Type Cs, Blade Contact (Mounting Provision A)
- MIL-DTL-21097/15 - Connectors, Electrical, Printed Wiring Board Male Adapter, Contact Spacing: 0.200, Alternate Dual Row, Type Cs, Blade Contact (No Mounting Provision)
- MIL-DTL-21097/16 - Connectors, Electrical, Printed Wiring Board Contact, Crimp, Removable, Type CR
- MIL-DTL-21097/17 - Connectors, Electrical, Printed Wiring Board Contact, Solder, Removable, Type CR
- MIL-DTL-21097/18 - Connectors, Electrical, Printed Wiring Board Tool, Contact, Removal, For Type CR Connector Contacts
- MIL-DTL-21097/19 - Connectors, Electrical, Printed Wiring Board Blade Simulator For Measuring Engagement and Separation Forces For Type CR Contacts

MIL-STD-1353C
APPENDIX A

MIL-DTL-21097/21	- Connectors, Electrical, Printed Wiring Board Receptacle, Card Insertion, Contact Spacing (.156), Types A and AD
MIL-DTL-24308	- Connectors, Electric, Rectangular, Nonenvironmental, Miniature, Polarized Shell, Rack and Panel, General Specification For
MIL-DTL-24308/1	- Connectors, Electric, Rectangular, Miniature, Polarized Shell, Rack and Panel, Receptacle, Socket Contacts, General Purpose, Class D And G, Solder Type
MIL-DTL-24308/2	- Connectors, Electric, Rectangular, Miniature, Polarized Shell, Rack and Panel, Receptacle, Socket Contacts, General Purpose, Class D And G, Crimp Type
MIL-DTL-24308/3	- Connectors, Electric, Rectangular, Miniature, Polarized Shell, Rack and Panel, Pin Contacts, General Purpose, Class D and G, Solder Type
MIL-DTL-24308/4	- Connectors, Electric, Rectangular, Miniature, Polarized Shell, Rack and Panel, Pin Contacts, General Purpose, Class D and G, Crimp Type
MIL-DTL-24308/5	- Connectors, Electric, Rectangular, Miniature, Polarized Shell, Rack and Panel, Receptacle, Socket Contacts, Nonmagnetic, Class M and N, Solder Type
MIL-DTL-24308/6	- Connectors, Electric, Rectangular, Miniature, Polarized Shell, Rack and Panel, Receptacle Socket Contacts, Nonmagnetic, Classes M and N, Crimp Type
MIL-DTL-24308/7	- Connectors, Electric, Rectangular, Miniature, Polarized Shell, Rack and Panel, Pin Contacts, Nonmagnetic, Classes M and N, Solder Type
MIL-DTL-24308/8	- Connectors, Electric, Rectangular, Miniature, Polarized Shell, Rack and Panel, Pin Contacts, Nonmagnetic, Class M and N, Crimp Type
MIL-DTL-24308/9	- Connectors, Electric, Rectangular, Miniature, Polarized Shell, Rack and Panel, Plug, Pin Contacts, Hermetic, Classes H and K
MIL-DTL-24308/23	- Connectors, Electric, Rectangular, Nonenvironmental, Miniature, Polarized Shell, Rack and Panel, Socket Contacts Printed Wiring Board Termination Types
MIL-DTL-24308/24	- Connectors, Electric, Rectangular, Nonenvironmental, Miniature, Polarized Shell, Rack and Panel, Pin Contacts Printed Wiring Board Termination Types
MIL-DTL-24308/25	- Connectors, Electric, Rectangular, Miniature, Polarized Shell, Rack and Panel, Screw-Lock Assembly, Male
MIL-DTL-24308/26	- Connectors, Electric, Rectangular, Miniature, Polarized Shell, Rack and Panel, Screw-Lock Assembly, Female
MIL-DTL-24308/27	- Connectors, Electric, Rectangular, Miniature, Polarized Shell, Rack and Panel, Insulation Displacement, Socket Contacts, Nonenvironmental
MIL-DTL-24308/28	- Connectors, Electric, Rectangular, Miniature, Polarized Shell, Rack and Panel, Insulation Displacement, Pin Contacts, Nonenvironmental, Class G
MIL-DTL-28731/20	- Connector, Electrical, Contact, Fork Type, Crimp Removable (8.5 Amperes)
MIL-DTL-28731/23	- Connector, Electrical, Contact, Fork Type, Removable, Double Wire Crimp
MIL-DTL-28731/24	- Connector, Electrical, Rectangular Shield, for 120 Removable Contacts
MIL-DTL-28731/26	- Connectors, Electrical, Contact, Fork Type, Wrappost, Removable
MIL-DTL-28731/29	- Connectors, Electrical, Insert (Insulator), Male Rectangular, Polarized, Center Screw Lock, for 75 Removable Type Contacts
MIL-DTL-28731/30	- Connectors, Electrical, Insert (Insulator), Female Rectangular, Polarized, Center Screw Lock, for 75 Removable Type Contacts

MIL-STD-1353C
APPENDIX A

MIL-DTL-28731/31	- Connectors, Electrical, Insert (Insulator), Male Rectangular, Polarized, Center Screw Lock for 117 Removable Type Contacts
MIL-DTL-28731/32	- Connectors, Electrical, Insert (Insulator), Female Rectangular, Polarized, Center Screw Lock, for 117 Removable Type Contacts
MIL-DTL-28731/33	- Connectors, Electrical, Insert (Insulator), Male Rectangular, Polarized, Center Screw Lock, for 165 Removable Type Contacts
MIL-DTL-28731/34	- Connector, Electrical, Insert (Insulator), Female Rectangular, Polarized, Center Screw Lock, for 165 Removable Type Contacts
MIL-DTL-28731/35	- Connectors, Electrical, Contact Fork Type, Crimp Removable (5.0 Amperes)
MIL-DTL-28731/36	- Connector, Electrical, Contact, Fork Type, Wrappost Removable (3.0 Amperes)
MIL-DTL-28731/37	- Connector, Electrical, Rectangular Shield, for Female Rectangular 165 Removable Type Contacts
MIL-DTL-28731/38	- Connector, Electrical, Rectangular Shield, for use with MIL-C-28731/32
MIL-DTL-28754/17	- Connectors, Electrical, Modular, Connector Assembly, Type V, Style I, Contact Tails on .100 Centers
MIL-DTL-32139	- Connectors, Electrical, Rectangular, Nanominiature, Polarized Shell, General Specification For
MIL-DTL-32139/1	- Connectors, Electrical, Rectangular, Nanominiature, Single Row, Plug, Polarized Shell, Pin Contacts, Crimp Type
MIL-DTL-32139/2	- Connectors, Electrical, Rectangular, Nanominiature, Single Row, Receptacle, Polarized Shell, Socket Contacts, Crimp Type
MIL-DTL-32139/3	- Connectors, Electrical, Rectangular, Nanominiature, Dual Row, Plug, Polarized Shell, Pin Contacts, Crimp Type
MIL-DTL-32139/4	- Connectors, Electrical, Rectangular, Nanominiature, Dual Row, Receptacle, Polarized Shell, Socket Contacts, Crimp Type
MIL-DTL-32139/5	- Connectors, Electrical, Rectangular, Nanominiature, Single Row, Plug, Polarized Shell, Pin Contacts, Vertical PCB Through-Hole Type
MIL-DTL-32139/6	- Connectors, Electrical, Rectangular, Nanominiature, Single Row, Receptacle, Polarized Shell, Socket Contacts, Vertical PCB Through-Hole Type
MIL-DTL-32139/7	- Connectors, Electrical, Rectangular, Nanominiature, Single Row, Plug, Polarized Shell, Pin Contacts, Horizontal PCB Through-Hole Type
MIL-DTL-32139/8	- Connectors, Electrical, Rectangular, Nanominiature, Single Row, Receptacle, Polarized Shell, Socket Contacts, Horizontal PCB T
MIL-DTL-32234	- Connectors, Electrical, Ultra High Density, Modular, Blade and Fork, Eight Row, General Specification For
MIL-DTL-32234/1	- Connector, Electrical, Ultra High Density, Modular, Blade and Fork, Backpanel, Eight Row, 192 Pins
MIL-DTL-32234/2	- Connector, Electrical, Ultra High Density, Modular, Blade and Fork, Daughter Board, Eight Row, 192 Contact Positions
MIL-DTL-32234/3	- Connector, Electrical, Ultra High Density, Modular, Blade and Fork, Backpanel, EMI/RFI Shielding, Eight Row, 196 Pins
MIL-DTL-32234/4	- Connector, Electrical, Ultra High Density, Modular, Blade and Fork, Daughter Board, Eight Row, 196 Contact Positions
MIL-DTL-32234/5	- Connector, Electrical, Ultra High Density, Modular, Blade and Fork, Backpanel, Eight Row, 372 Pins
MIL-DTL-32234/6	- Connector, Electrical, Ultra High Density, Modular, Blade and Fork, Daughter Board, Eight Row, 372 Contact Positions

MIL-STD-1353C
APPENDIX A

- MIL-DTL-32234/7 - Connector, Electrical, Ultra High Density, Modular, Blade and Fork, Backpanel, Eight Row, 396 Pins
- MIL-DTL-32234/8 - Connector, Electrical, Ultra High Density, Modular, Blade and Fork, Daughter Board, Eight Row, 396 Contact Positions
- MIL-DTL-32234/9 - Connector, Electrical, Ultra High Density, Modular, Keying Pins and Bushings
- MIL-DTL-39024 - Connectors, Electrical: Jacks, Tip (Test Point, Panel or Printed Wiring Type), General Specification for
- MIL-DTL-39024/1 - Connectors, Electrical, Test Point Type, Panel Type; Single Test Point (Threaded), Low Voltage
- MIL-DTL-39024/2 - Connectors, Electrical, Test Point Type, Panel Type; Single Test Point (Threaded), High Voltage
- MIL-DTL-39024/4 - Connectors, Electrical, Test Point Type, Printed Wiring Type; Single Test Point (Right Angle, 3-Leg Mounting), Low Voltage
- MIL-DTL-39024/10 - Jack, Tip (Test Point Type, Panel Type; Single Test Point (Threaded), Low Voltage, .080)
- MIL-DTL-39024/11 - Jack, Tip, Test Point Type, Printed Wiring Type, Single Test Point, Right Angle, 2-Leg Mounting, Low Voltage, .080
- MIL-DTL-39024/12 - Connectors, Electrical, Test Point Type, Panel Type; Single Test Point, (Hole Mounting, Push-Fit), Low Voltage
- MIL-DTL-39024/13 - Connectors, Electrical, Test Point Type, Printed Wiring Type; Single Test Point, (Right Angle, 2-Leg Mounting), Low Voltage, .080
- MIL-DTL-39024/14 - Connectors, Electrical, Test Point Type, Panel Type; Single Test Point, Subminiature (Push-In), Low Voltage, .080
- MIL-DTL-39024/15 - Connectors, Electrical, Test Point Type, Printed Wiring Type; Single Test Point, Low Voltage, .080
- MIL-DTL-39024/18 - Connectors, Electrical, Test Point Type, Printed Wiring Type; Micro-Miniature, Single Test Point (2-Leg Mounting), Low Voltage, .080 Inch
- MIL-DTL-55302 - Connectors, Printed Circuit Subassembly and Accessories
- MIL-DTL-55302/1 - Connectors, Printed Circuit Subassembly and Accessories: Plug, Pin Contacts, Right-Angle, for Printed Wiring Boards (.150 Spacing)
- MIL-DTL-55302/2 - Connectors, Printed Circuit Subassembly and Accessories: Receptacle, Socket Contacts, Straight-Thru, for Printed Wiring Boards (.150 Spacing)
- MIL-DTL-55302/4 - Connectors, Printed Circuit Subassembly and Accessories: Plug, Pin Contacts, Right-Angle, for Multilayered Printed Wiring Boards (.100 Spacing)
- MIL-DTL-55302/5 - Connectors, Printed Circuit Subassembly and Accessories: Plug, Pin Contacts, Straight-Thru, for Multilayered Printed Wiring Boards (.100 Spacing)
- MIL-DTL-55302/6 - Connectors, Printed Circuit Subassembly and Accessories: Receptacle, Socket Contacts, Straight-Thru, for Multilayered Printed Wiring Boards (.100 Spacing)
- MIL-DTL-55302/7 - Connectors, Printed Circuit Subassembly and Accessories: Plug, Pin Contacts, Right-Angle, for Multilayered Printed Wiring Boards (.100 Spacing)
- MIL-DTL-55302/8 - Connectors, Printed Circuit Subassembly and Accessories: Receptacle, Socket Contacts, Straight-Thru, for Multilayered Printed Wiring Boards (.100 Spacing)
- MIL-DTL-55302/16 - Connectors, Printed Circuit Subassembly and Accessories: Pin, Right-Angle, for Printed Wiring Boards (.200 Spacing)

MIL-STD-1353C
APPENDIX A

- MIL-DTL-55302/17 - Connectors, Printed Circuit Subassembly and Accessories: Socket, Straight-Thru, for Printed Wiring Boards (.200 Spacing)
- MIL-DTL-55302/18 - Connectors, Printed Circuit Subassembly and Accessories: Pin, Straight-Thru, for Printed Wiring Boards (.200 Spacing)
- MIL-DTL-55302/19 - Connectors, Printed Circuit Subassembly and Accessories: Plug, Pin Contacts Right-Angle, 41 Composite Contact, for Printed Wiring Boards (.150 Spacing)
- MIL-DTL-55302/20 - Connectors, Printed Circuit Subassembly and Accessories: Receptacle, Socket Contact, Straight-Thru, for Printed Wiring Boards (.150 Spacing)
- MIL-DTL-55302/21 - Connectors, Printed Circuit Subassembly and Accessories: Plug, Pin Contacts, Right-Angle, 92 Composite Contact, for Multilayered Printed Wiring Boards (.100 Spacing)
- MIL-DTL-55302/22 - Connectors, Printed Circuit Subassembly and Accessories: Receptacle, Socket Contacts, Straight-Thru, for Multilayered Printed Wiring Boards (.100 Spacing)
- MIL-DTL-55302/23 - Connectors, Printed Circuit Subassembly and Accessories, Plug, Decade Increment 10 through 120, 150, 160, and 180 Contact Positions, for Printed Wiring Boards (.075 Inch Spacing)
- MIL-DTL-55302/24 - Connectors, Printed Circuit Subassembly and Accessories: Receptacle, Decade Increment 10 thru 110 Contact Positions, for Printed Wiring Boards (.075 Spacing)
- MIL-DTL-55302/25 - Connectors, Printed Circuit Subassembly and Accessories: Receptacle, 120, 150, 160, and 180 Contact Positions, for Printed Wiring Boards (.075 Spacing)
- MIL-DTL-55302/26 - Connectors, Printed Circuit Subassembly and Accessories: Plug, 30 Thru 140 Contact Positions, for Printed Wiring Boards (.100 Sq. Grid)
- MIL-DTL-55302/27 - Connectors, Printed Circuit Subassembly and Accessories: Receptacle, 30 thru 140 Contact Positions, for Printed Wiring Boards (.100 Sq. Grid)
- MIL-DTL-55302/29 - Connectors, Printed Circuit Subassembly and Accessories: Gage for Contact Separation Force Test Method
- MIL-DTL-55302/31 - Connectors, Printed Circuit, Subassembly and Accessories: Keying Accessories
- MIL-DTL-55302/32 - Connectors, Printed Circuit Subassembly and Accessories: Contacts, Solder Eyelet and Wrappost Removable Types
- MIL-DTL-55302/38 - Connectors, Printed Circuit Subassembly and Accessories: Plug, Electrical, Polarized Shell, Male, 0.100 Inch Contact Spacing, Pin Terminal
- MIL-DTL-55302/52 - Connectors, Printed Circuit Subassembly and Accessories: Receptacle, Straight-Thru, Hermaphroditic Contact, for Printed Wiring Boards (.100 Spacing)
- MIL-DTL-55302/53 - Connectors, Printed Circuit Subassembly and Accessories: Plug, Right-Angle, Hermaphroditic Contact, for Printed Wiring Boards (.100 Spacing)
- MIL-DTL-55302/54 - Connectors, Printed Circuit Subassembly and Accessories: Plug, Straight-Thru, Hermaphroditic Contact, for Printed Wiring Boards (.100 Spacing)
- MIL-DTL-55302/55 - Connectors, Printed Circuit Subassembly and Accessories, Plug, Socket Contacts, Decade Increments 10 through 70 Contact Positions and Intermediate Positions of 14, 24, 44, 54 and 26, 36, 56, 66 for Printed Wiring Boards (.100 Inch Spacing)
- MIL-DTL-55302/56 - Connectors, Printed Circuit Subassembly and Accessories: Receptacle, Pin Contacts, Decade Increments 10 Thru 70 Contact Positions and

MIL-STD-1353C
APPENDIX A

- Intermediate Positions of 14, 24, 44, 54 and 26, 36, 56, 66, for Printed Wiring Boards (.100 Inch Spacing)
- MIL-DTL-55302/57 - Connectors, Printed Circuit Subassembly and Accessories: Plug, Pin Contacts, Decade Increments 10 Thru 70 Contact Positions and Intermediate Positions of 14, 24, 44, 54 and 26, 36, 56, 66, for Printed Wiring Boards (.100 Inch Spacing)
- MIL-DTL-55302/58 - Connectors, Printed Circuit Subassembly and Accessories, Receptacle, Socket Contacts, Decade Increments 10 through 70 Contact Positions and Intermediate Positions of 14, 24, 44, 54 and 26, 36, 56, 66 for Printed Wiring Boards (.100 Inch Spacing)
- MIL-DTL-55302/59 - Connectors, Printed Circuit Subassembly and Accessories: Plug, Pin Contacts, Decade Increments 90, 100 and 120 Contact Positions, for Printed Wiring Boards (.100 Inch Spacing)
- MIL-DTL-55302/60 - Connectors, Printed Circuit Subassembly and Accessories, Plug, Pin Contacts, Decade Increments 10 through 70 Contact Positions and Intermediate Positions of 14, 24, 44, 54, and 26, 36, 56, and 66 for Printed Wiring Boards (.100 Inch Spacing)
- MIL-DTL-55302/61 - Connectors, Printed Circuit Subassembly and Accessories, Plug, Pin Contacts, Decade Increments 10 through 70 Contact Positions and Intermediate Positions of 14, 24, 44, 54, and 26, 36, 56, and 66 for Printed Wiring Boards (.100 Inch Spacing)
- MIL-DTL-55302/62 - Connectors, Printed Circuit Subassembly and Accessories, Receptacle, Socket Contacts, Decade Increments 10 through 70 Contact Positions and Intermediate Positions of 14, 24, 44, 54, and 26, 36, 56, and 66 for Printed Wiring Boards (.100 Inch Spacing)
- MIL-DTL-55302/63 - Connectors, Printed Circuit Subassembly and Accessories: Plug, Pin Contacts, Decade Increments 10 Thru 70 Contact Positions and Intermediate Positions of 14, 24, 44, 54, and 26, 36, 56, and 66, for Printed Wiring Boards (.100 Inch Spacing)
- MIL-DTL-55302/64 - Connectors, Printed Circuit Subassembly and Accessories, Receptacle, Socket Contacts, Decade Increments 10 through 70 Contact Positions and Intermediate Positions of 14, 24, 44, 54, and 26, 36, 56, and 66 for Printed Wiring Boards (.100 Inch Spacing)
- MIL-DTL-55302/65 - Connectors, Printed Circuit Subassembly and Accessories: Receptacle, Socket Contacts, Decade Increments 10 Thru 70 Contact Positions and Intermediate Positions of 14, 24, 44, 54, and 26, 36, 56, and 66, for Printed Wiring Boards (.100 Inch Spacing)
- MIL-DTL-55302/66 - Connectors, Printed Circuit Subassembly and Accessories: Receptacle, Socket Contacts, Decade Increments 10 Thru 70 Contact Positions and Intermediate Positions of 14, 24, 44, 54, and 26, 36, 56, and 66, for Printed Wiring Boards (.100 Inch Spacing)
- MIL-DTL-55302/67 - Connectors, Printed Circuit Subassembly and Accessories, Pin, Right Angle Plug, Electrical, Polarized for Printed Wiring Boards (.090 Inch Spacing)
- MIL-DTL-55302/68 - Connectors, Printed Circuit Subassembly and Accessories, Socket Receptacle, Electrical, Polarized (.090 Spacing), Removable Crimp Contacts
- MIL-DTL-55302/69 - Connectors, Printed Circuit Subassembly and Accessories, Pin Plug, Electrical, Polarized (.090 Spacing), Removable Crimp Contacts

MIL-STD-1353C
APPENDIX A

- MIL-DTL-55302/70 - Connectors, Printed Circuit Subassembly and Accessories, Pin, Right Angle Plug, Electrical, Polarized for Printed Wiring Boards (.100 Spacing)
- MIL-DTL-55302/71 - Connectors, Printed Circuit Subassembly and Accessories, Socket Receptacle, Electrical, Polarized Composite Contact (.100 Spacing)
- MIL-DTL-55302/72 - Connectors, Printed Circuit Subassembly and Accessories, Socket Environmental Resistant, Receptacle, Electrical, Polarized (.150 Spacing), Removable Crimp Contacts
- MIL-DTL-55302/73 - Connectors, Printed Circuit Subassembly and Accessories, Pin, Right Angle, Environmental Resistant, Plug, Electrical, Polarized for Printed Wiring Boards (.150 Spacing)
- MIL-DTL-55302/74 - Connectors, Printed Circuit Subassembly and Accessories, Pin, Right Angle, Plug, Electrical, Polarized for Printed Wiring Boards (.100 Spacing)
- MIL-DTL-55302/75 - Connectors, Printed Circuit Subassembly and Accessories, Socket, Receptacle, Electrical, Polarized (.100 Spacing), Removable Crimp Contacts
- MIL-DTL-55302/76 - Connectors, Printed Circuit Subassembly and Accessories, Socket, Straight-Thru, Polarized for Multilayered Printed Wiring Boards (.100 Spacing)
- MIL-DTL-55302/77 - Connectors, Printed Circuit Subassembly and Accessories, Pin Right-Angle for Multilayered Printed Wiring Boards (.100 Spacing)
- MIL-DTL-55302/78 - Connectors, Printed Circuit Subassembly and Accessories: Key, Polarizing, Connectors, Electrical Printed Wiring Boards
- MIL-DTL-55302/82 - Connectors, Printed Circuit Subassembly and Accessories: Receptacle, Socket Contacts, 41, 66, 114 Contact Positions: for Printed Wiring Boards (.100 x .050 Offset Grid)
- MIL-DTL-55302/83 - Connectors, Printed Circuit Subassembly and Accessories: Plug, Pin Contacts, 41, 66, 114 Contact Positions, for Printed Wiring Boards (.100 x .050 Offset Grid)
- MIL-DTL-55302/84 - Connectors, Printed Circuit Subassembly and Accessories: Contacts - Crimp, Dip Solder Tail, Solder Turret, and Wirewrap
- MIL-DTL-55302/89 - Connectors, Printed Circuit Subassembly and Accessories: Plug, Right-Angle, Hermaphroditic Contacts (.100 Inch Spacing)
- MIL-DTL-55302/90 - Connectors, Printed Circuit Subassembly and Accessories: Receptacle, Right-Angle, Hermaphroditic Contact (.100 Inch Spacing)
- MIL-DTL-55302/91 - Connectors, Printed Circuit Subassembly and Accessories: Plug, Straight-Thru, Hermaphroditic Contacts (.100 Inch Spacing)
- MIL-DTL-55302/92 - Connectors, Printed Circuit Subassembly and Accessories: Straight, Straight-Thru, Hermaphroditic Contacts (.100 Inch Spacing)
- MIL-DTL-55302/93 - Connectors, Printed Circuit Subassembly and Accessories: Plug, Insert (Insulator), Rectangular, Polarized, Removable Crimp Type, Hermaphroditic Contacts (.100 Inch Spacing)
- MIL-DTL-55302/94 - Connectors, Printed Circuit Subassembly and Accessories: Receptacle, Insert (Insulator), Rectangular, Polarized, Removable, Crimp Type, Hermaphroditic Contacts (.100 Inch Spacing)
- MIL-DTL-55302/95 - Connectors, Printed Circuit Subassembly and Accessories: Plug, Composite Wrappost, Hermaphroditic Contacts (.100 Inch Spacing)
- MIL-DTL-55302/96 - Connectors, Printed Circuit Subassembly and Accessories: Receptacle, Wrappost (Removable) Hermaphroditic Contacts (.100 Inch Spacing)

MIL-STD-1353C
APPENDIX A

- MIL-DTL-55302/97 - Connectors, Printed Circuit Subassembly and Accessories: Contacts, Hermaphroditic, Crimp Removable for Wire (Stranded)
- MIL-DTL-55302/98 - Connectors, Printed Circuit Subassembly and Accessories: Contact, Wrappost Removable Type
- MIL-DTL-55302/102 - Connectors, Printed Circuit Subassembly and Accessories: Receptacle, Straight-Thru, Hermaphroditic Contact, Crimp Removable, for Printed Wiring Boards (.100 Inch Spacing)
- MIL-DTL-55302/110 - Connectors, Printed Circuit Subassembly and Accessories: Plug, Right Angle, 30 Thru 140 Contact Positions, for Printed Wiring Boards (.100 Sq. Grid)
- MIL-DTL-55302/111 - Connectors, Printed Circuit Subassembly and Accessories: Receptacle, Socket Contacts, Straight- Thru, for Multilayered Printed Wiring Boards, (.100 Spacing)
- MIL-DTL-55302/113 - Connectors, Printed Circuit Subassembly and Accessories: Plug, Straight-Thru, 30 through 110 Contact Positions, Crimp Removable Contacts (.100 Square Grid)
- MIL-DTL-55302/117 - Connectors, Printed Circuit Subassembly and Accessories: Plug, Right Angle, Decade Increment 20 through 110 and 128 Contact Positions, for Printed Wiring Boards (.050 Spacing)
- MIL-DTL-55302/118 - Connectors, Printed Circuit Subassembly and Accessories: Plug, Decade Increment 20 Thru 110 and 128 Contact Positions, for Printed Wiring Boards (.050 Spacing)
- MIL-DTL-55302/119 - Connectors, Printed Circuit, Subassembly and Accessories: Receptacle, Decade Increment 20 through 110 and 128 Contact Positions, for Printed Wiring Boards (.050 Spacing)
- MIL-DTL-55302/120 - Connectors, Printed Circuit Subassembly and Accessories: Plug, Pin Contacts, 128 Contact Positions, for Printed Wiring Boards (.050 Inch Spacing)
- MIL-DTL-55302/121 - Connectors, Printed Circuit Subassembly and Accessories: Receptacle, Socket Contact, 128 Contact Positions, for Printed Wiring Boards (.050 Inch Spacing)
- MIL-DTL-55302/122 - Connectors, Printed Circuit Subassembly and Accessories: Plug, Pin Contacts, 184 Contact Positions, for Printed Wiring Boards (.050 Inch Spacing)
- MIL-DTL-55302/123 - Connectors, Printed Circuit Subassembly and Accessories: Receptacle, Socket Contact, 184 Contact Positions, for Printed Wiring Boards (.050 Inch Spacing)
- MIL-DTL-55302/124 - Connectors, Printed Circuit Subassembly and Accessories: Keying Accessories
- MIL-DTL-55302/125 - Connectors, Printed Circuit Subassembly and Accessories: Plug, 80 Contact Positions, for Printed Wiring Boards (.050 Inch Spacing)
- MIL-DTL-55302/126 - Connectors, Printed Circuit Subassembly and Accessories: Receptacle, 80 Contact Positions, for Printed Wiring Boards (.050 Inch Spacing)
- MIL-DTL-55302/127 - Connectors, Printed Circuit Subassembly and Accessories: Receptacle, Single Row, 2 through 65 Contact Positions, for Printed Wiring Boards (1/16", 3/32", and 1/8") (.100 Spacing)
- MIL-DTL-55302/128 - Connectors, Printed Circuit Subassembly and Accessories: Receptacle, Double Row, 4 through 130 Contact Positions, for Printed Wiring Boards (1/16", 3/32", and 1/8") (.100 Inch Spacing)

MIL-STD-1353C
APPENDIX A

- MIL-DTL-55302/130 - Connectors, Plug, Printed Circuit Subassembly and Accessories: Right Angle, Pin Contacts, 64 or 96 Contact Position for Printed Wiring Boards (.100 Inch Spacing)
- MIL-DTL-55302/131 - Connectors, Plug, Electrical, Printed Circuit Subassembly and Accessories: Right Angle, Pin Contacts, 64 or 96 Contact Position for Printed Wiring Boards (.100 Spacing)
- MIL-DTL-55302/133 - Connectors, Plug, Electrical, Printed Circuit Subassembly and Accessories: Right Angle, Pin Contacts, 32 or 64 Contact Positions, for Printed Wiring Boards (.100 Inch Spacing)
- MIL-DTL-55302/134 - Connectors, Printed Circuit Subassembly and Accessories: Receptacle Socket Contacts, Straight Thru, 32 or 64 Contact Positions, for Printed Wiring Boards (.100 Inch Spacing)
- MIL-DTL-55302/138 - Connectors, Printed Circuit Subassembly and Accessories, Plug, Pin Contacts, 160 Contact Positions for Printed Wiring Boards (.100 Inch Spacing)
- MIL-DTL-55302/139 - Connectors, Printed Circuit Subassembly and Accessories, Receptacle, Socket Contacts, 160 Contact Positions for Printed Wiring Boards (.100 Inch Spacing)
- MIL-DTL-55302/142 - Connectors, Printed Circuit Subassembly and Accessories: Receptacle with Socket Contacts, for Printed Wiring Boards (.100 Inch Spacing)
- MIL-DTL-55302/145 - Connectors, Printed Circuit Subassembly and Accessories: Receptacle with Pin Contacts, 2 Female Keying Guides, 2.114 Inches Length, for Printed Wiring Boards (.100 Inch Spacing)
- MIL-DTL-55302/150 - Connectors, Printed Circuit Subassembly and Accessories: Plug with Socket Contacts, 2.114 Inches Length, 2 Keying Pins, for Printed Wiring Boards (.100 Inch Spacing)
- MIL-DTL-55302/156 - Connectors, Printed Circuit Subassembly and Accessories: Plug, Right Angle, Decade Increments 10 Thru 120, 150, 160, and 180 Contact Positions for Printed Wiring Boards (.075 Spacing)
- MIL-DTL-55302/157 - Connectors, Printed Circuit Subassembly and Accessories: Plug, Straight Thru Contacts, 64 or 96 Contact Positions, for Printed Wiring Boards (.100 Inch Spacing)
- MIL-DTL-55302/158 - Connectors, Printed Circuit Subassembly and Accessories: Receptacle Socket Contacts, 64 or 96 Contact Positions, for Printed Wiring Boards (.100 Inch Spacing)
- MIL-DTL-55302/159 - Connectors, Printed Circuit Subassembly and Accessories: Receptacle, 17, 29, 33, 41, 53 and 65 Contact Positions, for Printed Wiring Boards 2.54 mm x 1.27 mm Offset Grid, Metric
- MIL-DTL-55302/160 - Connectors, Printed Circuit Subassembly and Accessories: Receptacle, 72, 84, 96 and 120 Contact Positions, for Printed Wiring Boards 2.54 mm x 1.27 mm Offset Grid, Metric
- MIL-DTL-55302/161 - Connectors, Printed Circuit Subassembly and Accessories, Receptacle, 160 Contact Positions, for Printed Wiring Boards, 2.54 mm x 1.27 mm Offset Grid, Metric
- MIL-DTL-55302/162 - Connectors, Printed Circuit Subassembly and Accessories, Plug, 17, 29, 33, 41, 53, and 65 Contact Positions, for Printed Wiring Boards, 2.54 mm x 1.27 mm Offset Grid, Metric
- MIL-DTL-55302/163 - Connectors, Printed Circuit Subassembly and Accessories, Plug, 72, 84, 96, and 120 Contact Positions, for Printed Wiring Boards, 2.54 mm x 1.27 mm Offset Grid, Metric

MIL-STD-1353C
APPENDIX A

- MIL-DTL-55302/164 - Connectors, Printed Circuit Subassembly and Accessories: Plug and/or Receptacle, 160 Contact Positions, for Printed Wiring Boards 2.54 mm x 1.27 mm Offset Grid, Metric
- MIL-DTL-55302/166 - Connectors, Printed Circuit Subassembly and Accessories, Low Mating Force, Male Brush, Straight-through, Polarized, for Multilayered Printed Wiring Boards (.100 Inch Spacing)
- MIL-DTL-55302/167 - Connectors, Printed Circuit Subassembly and Accessories: Low Mating Force, Male Brush, Straight- through, Polarized, with Wrappost Termination (.100 Spacing)
- MIL-DTL-55302/168 - Connectors, Printed Circuit Subassembly and Accessories: Low Mating Force, Male Brush, Right Angle, Polarized, for Multilayered Printed Wiring Boards (.100 Spacing)
- MIL-DTL-55302/169 - Connectors, Printed Circuit Subassembly and Accessories: Low Mating Force, Female Brush, Straight-Through, Polarized, (.100 Spacing)
- MIL-DTL-55302/170 - Connectors, Printed Circuit Subassembly and Accessories, Low Mating Force, Female Brush, Right Angle, Polarized, for Multilayered Printed Wiring Boards (.100 Inch Spacing)
- MIL-DTL-55302/171 - Connectors, Printed Circuit Subassembly and Accessories: Low Mating Force, Contact Brush
- MIL-DTL-55302/172 - Connectors, Printed Circuit Subassembly and Accessories: Hardware, Coupling and Locking
- MIL-DTL-55302/173 - Connectors, Printed Circuit Subassembly and Accessories: 2-Row Pin Assemblies, 20 through 150 Contact Positions, for Printed Wiring Boards (.100 Spacing)
- MIL-DTL-55302/174 - Connectors, Printed Circuit Subassembly and Accessories: 2 Row, Receptacle Assemblies, Right Angle, 20 through 150 Contact Positions, for Printed Wiring Boards (.100 Spacing)
- MIL-DTL-55302/175 - Connectors, Printed Circuit Subassembly and Accessories: 2 Row, Pin Assemblies, Right Angle, 20 through 150 Contact Positions, for Printed Wiring Boards (.100 Spacing)
- MIL-DTL-55302/176 - Connectors, Printed Circuit Subassembly and Accessories: 3-Row Pin Assemblies, 75 through 405 Contact Positions, for Printed Wiring Boards (.100 Spacing)
- MIL-DTL-55302/177 - Connectors, Printed Circuit Subassembly and Accessories: 3 Row, Receptacle Assemblies, Right Angle, 75 through 405 Contact Positions, for Printed Wiring Boards (.100 Spacing)
- MIL-DTL-55302/178 - Connectors, Printed Circuit Subassembly and Accessories: 3 Row, Pin Assemblies, Right Angle, 75 through 405 Contact Positions, for Printed Wiring Boards (.100 Spacing)
- MIL-DTL-55302/179 - Connectors, Printed Circuit Subassembly and Accessories: 4-Row Pin Assemblies, 100 through 684 Contact Positions, for Printed Wiring Boards (.100 Spacing)
- MIL-DTL-55302/180 - Connectors, Printed Circuit Subassembly and Accessories: 4 Row, Receptacle Assemblies, Right Angle, 100 through 684 Contact Positions, for Printed Wiring Boards (.100 Spacing)
- MIL-DTL-55302/181 - Connectors, Printed Circuit Subassembly and Accessories: 4 Row, Pin Assemblies, Right Angle, 100 through 684 Contact Positions, for Printed Wiring Boards (.100 Spacing)
- MIL-DTL-55302/182 - Connectors, Printed Circuit Subassembly and Accessories: Guide Pins, Jackcrews and Mounting Ears

MIL-STD-1353C
APPENDIX A

- MIL-DTL-55302/190 - Connectors, Printed Circuit Subassembly and Accessories: Receptacle, Socket Contacts, 100 Position, Printed Wiring Boards (.075 Inch Spacing)
- MIL-DTL-55302/191 - Connectors, Printed Circuit Subassembly and Accessories, Plug, Pin Contacts, 100 Position, Printed Wiring Boards (.075 Inch Spacing)
- MIL-DTL-55302/192 - Connectors, Printed Circuit Subassembly and Accessories, Receptacle, Socket Contacts, 122 and 152 Position, Printed Wiring Boards (.075 Inch Spacing)
- MIL-DTL-55302/193 - Connectors, Printed Circuit Subassembly and Accessories: Plug, Pin Contacts, 122 and 152 Position, Printed Wiring Board (.075 Spacing)
- MIL-DTL-83502 - Sockets, Plug-In Electronic Components, Round Style, General Specification For
- MIL-DTL-83502/1 - Sockets, Plug-In Electronic Components, Round Style (T07 Low Profile)
- MIL-DTL-83502/2 - Sockets, Plug-In Electronic Components, Round Style (T05 Press to Fit)
- MIL-DTL-83502/3 - Sockets, Plug-In Electronic Components, Round Style (T08)
- MIL-DTL-83502/5 - Sockets, Plug-In Electronic Components, Round Style (R052)
- MIL-DTL-83503 - Connectors, Electrical, Flat Cable, and/or Printed Wiring Board, Nonenvironmental, General Specification For
- MIL-DTL-83503/6 - Connectors, Electrical, Flat Cable, Nonenvironmental Dual-in-Line Plug for Terminating Round Conductors on .050 Centers for Mating with Standard Dip Sockets, .100 X .300 Contact Spacing .100 X .400 Contact Spacing and .100 X .600 Contact Spacing
- MIL-DTL-83503/20 - Connectors, Electrical, Flat Cable, Nonenvironmental Header, Right Angle (.100 Spacing) with Polarizing Feature Solderless Wrappost or PWB Termination
- MIL-DTL-83503/21 - Connectors, Electrical, Flat Cable, Nonenvironmental, Header, Straight Thru (.100 Inch Spacing) with Polarizing Feature Solderless Wrappost or PWB Termination
- MIL-DTL-83503/22 - Connectors, Electrical, Flat Cable, Nonenvironmental, Socket Insulation Displacement
- MIL-DTL-83503/23 - Connectors, Electrical, Flat Cable, Nonenvironmental Printed Wiring Board Solder Transition for Terminating Round Conductors on .050 Inch Centers
- MIL-DTL-83503/24 - Connectors, Electrical, Flat Cable, Nonenvironmental Four Wall Header, Right Angle (.100 Spacing) with Polarizing Feature Solderless Wrappost or PWB Termination
- MIL-DTL-83503/25 - Connectors, Electrical, Flat Cable, Nonenvironmental Four Wall Header, Straight Thru (.100 Spacing) with Polarizing Feature, Solderless Wrappost or PWB Termination
- MIL-DTL-83505 - Sockets, (Lead, Electronic Components), General Specification For
- MIL-DTL-83505/1 - Sockets (Lead, Electronic Components) (Type I, Solderless Wrap)
- MIL-DTL-83505/2 - Socket, (Lead, Electronic Components) (Type II, Printed Circuit)
- MIL-DTL-83505/6 - Sockets, (Lead, Electric Components) Type VI, Solderless Spring Contact)
- MIL-S-83505/7 - Sockets (Lead Electronic Components) (TYPE II, Printed Circuit) Low Insertion Force (LIF)
- MIL-DTL-83505/8 - Sockets (Lead Electronic Components) (Type II, Printed Circuit) Low Insertion Force (LIF)

MIL-STD-1353C
APPENDIX A

MIL-DTL-83734	-	Sockets, Plug-In Electronic Components, Dual-In-Line (Dips) and Single-In-Line Packages (SIPS), General Specification For
MIL-DTL-83734/1	-	Sockets, Plug-In Electronic Components, (For 6 Pin Dual-In-Line Packages)
MIL-DTL-83734/2	-	Sockets, Plug-In Electronic Components, (For 8 Pin Dual-In-Line Packages)
MIL-DTL-83734/3	-	Sockets, Plug-In Electronic Components, (For 14 Pin Dual-In-Line Packages)
MIL-DTL-83734/4	-	Sockets, Plug-In Electronic Components, (For 16 Pin Dual-In-Line Packages)
MIL-DTL-83734/5	-	Sockets, Plug-In Electronic Components, (For 18 Pin Dual-In-Line Packages)
MIL-DTL-83734/6	-	Sockets, Plug-In Electronic Components, (For 22 Pin Dual-In-Line Packages)
MIL-DTL-83734/7	-	Sockets, Plug-In Electronic Components, (For 28 Pin Dual-In-Line Packages)
MIL-DTL-83734/8	-	Sockets, Plug-In Electronic Components, (For 24 Pin Dual-In-Line Packages)
MIL-DTL-83734/9	-	Sockets, Plug-In Electronic Components, (For 36 Pin Dual-In-Line Packages)
MIL-DTL-83734/10	-	Sockets, Plug-In Electronic Components, (For 40 Pin Dual-In-Line Packages)
MIL-DTL-83734/13	-	Sockets, Plug-In Electronic Components, (For 20 Pin Dual-In-Line Packages)
MIL-DTL-83734/14	-	Sockets, Plug-In Electronic Components, (For 48 Pin Dual-In-Line Packages)
MIL-DTL-83734/15	-	Sockets, Plug-In Electronic Components, (For 64 Pin Dual-In-Line Packages)
MIL-DTL-83734/17	-	Sockets, Plug-In Electronic Components (For 32 Pin, Dual-In-Line Packages)
MIL-DTL-83734/18	-	Sockets, Plug-In Electronic Components, Low Profile, (For 6 Pin Dual-In-Line Packages)
MIL-DTL-83734/19	-	Sockets, Plug-In Electronic Components, Low Profile, (For 8 Pin Dual-In-Line Packages)
MIL-DTL-83734/20	-	Sockets, Plug-In Electronic Components, Low Profile, (For 14 Pin Dual-In-Line Packages)
MIL-DTL-83734/21	-	Sockets, Plug-In Electronic Components, Low Profile, (For 16 Pin Dual-In-Line Packages)
MIL-DTL-83734/22	-	Sockets, Plug-In Electronic Components, Low Profile, (For 18 Pin Dual-In-Line Packages)
MIL-DTL-83734/23	-	Sockets, Plug-In Electronic Components, Low Profile, (For 20 Pin Dual-In-Line Packages)
MIL-DTL-83734/24	-	Sockets, Plug-In Electronic Components, Low Profile, (For 22 Pin Dual-In-Line Packages)
MIL-DTL-83734/25	-	Sockets, Plug-In Electronic Components, Low Profile, (For 24 Pin Dual-In-Line Packages)
MIL-PRF-31032	-	Printed Circuit Board/Printed Wiring Board, General Specification for

(Copies of these documents are available online at <https://assist.dla.mil> or from the Standardization Document Order Desk, 700 Robbins Avenue, Building 4D, Philadelphia, PA 19111-5094.

MIL-STD-1353C
APPENDIX A

A.2.2.2 Other Government documents, drawings and publications. The following other Government documents, drawings and publications form a part of this document to the extent specified herein. Unless otherwise specified, the issues of these documents are those cited in the solicitation or contract.

DLA LAND AND MARITIME DRAWINGS

02007	-	Connector, High Density, Blade and Fork, Backpanel, Eight Row, 396 Contact Positions
03023	-	Connector, High Density, Blade and Fork, Daughter Board, Eight Row, 396 Contact Positions
04023	-	Connector, High Density, Keying Pin and Bushing
04027	-	Connector, High Density, Blade and Fork, Daughter Board, Eight Rows, 452 Contact Positions
04028	-	Connector, High Density, Blade and Fork, Backpanel, Eight Row, 452 Contact Positions
07013	-	Connectors, Printed Circuit Subassembly and Accessories: Receptacle, Socket Contacts, 41, 66, 114 Contact Positions: For Printed Wiring Boards (.100 X .050 Offset Grid)
07014	-	Connectors, Printed Circuit Subassembly and Accessories: Plug Pin Contacts, 41, 66, 114 Contact Positions: For Printed Wiring Boards (.100 X .050 Offset Grid)
07015	-	Connectors, Printed Circuit Subassembly and Accessories: Contacts – Crimp, Dip Solder Tail, Solder Turret, and Wirewrap
85039	-	Connectors, Electrical, Rack ad Panel, Miniature, General Specification For
85040	-	Connector, Electrical, Insert Arrangement, Miniature, Five Size 20 Signal Contacts, with Two Size 8 Contact Cavities
85041	-	Connector, Electrical, Insert Arrangement, Miniature, Ten Size 20 Signal Contacts, with One Size 8 Contact Cavity
85043	-	Connector, Electrical, Insert Arrangement, Miniature, Five Size 8 Contact Cavities
85044	-	Connector, Electrical, Insert Arrangement, Miniature, Fifteen Size 20 Signal Contacts, With Two Size 8 Contact Cavities
85045	-	Connector, Electrical, Insert Arrangement, Miniature, Ten Size 20 Signal Contacts, With Three Size 8 Contact Cavities
85047	-	Connector, Electrical, Insert Arrangement, Miniature, Eight Size 8 Contact Cavities
85048	-	Connector, Electrical, Insert Arrangement, Miniature, Seventeen Size 20 Signal Contacts, With Four Size 8 Contact Cavities
85054	-	Connector, Electrical, Insert Arrangement, Miniature, Seventeen Size 20 Signal Contacts, With Seven Size 8 Contact Cavities
86037	-	Connectors, Receptacle, Electrical, Latch Housings, Crimp To Wire Contacts, General Drawing For
86038	-	Connectors, Receptacle, Electrical, Latch Housings, Double Row, .025 Posts
86039	-	Connectors, Receptacle, Electrical, Latch Housings, Single Row, .045 Posts
86062	-	Connector, Electrical, Miniature, Retainer, Sliding Lock
86100	-	Connectors, Electrical, Unshrouded Headers, PWB Termination
86101	-	Connectors, Electrical, Unshrouded Headers, PWB Termination, .025, Single Row, Straight Thru
86102	-	Connectors, Electrical, Unshrouded Headers, PWB Termination, .025, Double Row, Right Angle
86103	-	Contact, Receptacle, Electrical, Crimp to Wire (for .025 Inch Post)

MIL-STD-1353C
APPENDIX A

86105	-	Jumper Pin, Insulated
86108	-	Connector, Receptacle, Electrical, Latch Housings, Double Row, Bulkhead Mount, .025 Posts
86112	-	Connector, Receptacle, Electrical, Latch Housings, Double Row, .040-.045 Posts
86113	-	Contact, Male Pin, Crimp To Wire
87109	-	Connectors, Receptacle, Electrical, Latch Housings, Polarized, Double Row, .025 Posts
87121	-	Polarizing Plug, .025 Posts, Fits Latch Housings
89042	-	Connectors, Electrical, Unshrouded Headers, PWB Termination, .025, Double Row, Straight Thru
89065	-	General Specification for High Performance, High Density, Two Piece Printed Circuit Board Connector
89107	-	Connector, Accessories, Electrical, Backshell, Environmental, 90 Degrees, End Entry, Category 2B, for MIL-C-24308 Connectors
89108	-	Connector, Accessories, Electrical, Backshell, Environmental, Straight Entry, 2B for MIL-DTL-24308 Connectors
89109	-	Connector, Accessories, Electrical, Backshell, Environmental, 90 Degrees, Side Entry, Category 2B, for MIL-C-24308 Connectors
91026	-	Connectors, Electrical, Rectangular, Polarized Shell, High Density, Nanominiature, General Requirements for
92003	-	Connectors, Electrical, Unshrouded Headers, PWB to PWB Termination, .025, Single Row, Tiered, Straight Thru
92004	-	Connectors, Electrical, Unshrouded Headers, PWB-PWB Termination, .025, Double Row, Tiered, Straight Thru
92022	-	Connectors, Electrical, Unshrouded Headers, PWB-Receptacle Termination, .025, Single Row, Tiered, Straight Thru
92023	-	Connectors, Electrical, Unshrouded Headers, PWB-Receptacle Termination, .025, Double Row, Tiered, Straight Thru
92024	-	Connector, Electrical, PWB Terminated, .025 Inch Square Post, Receptacle Housings, General Specification For
92025	-	Connectors, Receptacle, Electrical, PWB Termination (.062 to .093), Double Row, Top Entry, .100 Centers, .025 Posts
92026	-	Connectors, Receptacle, Electrical, PWB Termination (.062 TO .093), Double Row, Dual Entry, .100 Centers, .025 Posts
92027	-	Connectors, Receptacle, Flex-Circuit Termination (.032), Top Entry, Double Row, .100 Centers, .025 Posts
92028	-	Connectors, Receptacle, Electrical, Flex-Circuit Termination (.032), Double Row, Dual Entry, .100 Centers, .025 Posts
93002	-	Connector, High Density, Blade and Fork, Daughter Board, Eight Row, 372 Contact Positions
93003	-	Connector, High Density, Blade and Fork, Backpanel, Eight Row, 372 Contact Positions
93004	-	Connector, High Density, Blade and Fork, Daughter Board, Eight Row, 300 Contact, 8 Fiber Optic Positions
93005	-	Connector, High Density, Blade and Fork, Backpanel, Eight Row, 300 Contact, 8 Fiber Optic Positions
93006	-	Connector, High Density, Blade and Fork, Daughter Board, Eight Row, 296 Contact, 2 Power Positions
93007	-	Connector, High Density, Blade and Fork, Backpanel, Eight Row, 296 Contact Positions
93008	-	Connector, High Density, Blade and Fork, Daughter Board, Eight Row, 356 Contact, With Safety Ground

MIL-STD-1353C
APPENDIX A

- 93009 - Connector, High Density, Blade and Fork, Backpanel, Eight Row, 356 Contact, With Safety Ground
- 93010 - Connector, High Density, Blade and Fork, Daughter Board, Eight Row, 284 Contact, 8 Fiber Optic And Safety Ground
- 93011 - Connector, High Density, Blade and Fork, Backpanel, Eight Row, 284 Contact, 8 Fiber Optic And Safety Ground
- 93012 - Connector, High Density, Blade and Fork, Daughter Board, Eight Row, 280 Contact, 2 Power Positions
- 93013 - Connector, High Density, Blade and Fork, Backpanel, Eight Row, 280 Contact, 2 Power Positions, With Safety Ground
- 93014 - Socket, Plug-In Electronic Components, Single In-Line
- 93015 - Connectors, Receptacle, Electrical, PWB Termination (.062 to .093), Single Row, Top Entry, .100 Centers, .025 Posts
- 93029 - Connector, Plug, Electrical, Jumper Shunt
- 93044 - Jumper Shunt, .100 Inch Centerline, .025 Inch Square Pin, General Drawing
- 93045 - Low Profile Shunt, .100 Inch Centerline, .025 Inch Square Mating Pin
- 93046 - Mini Shunt, .100 Inch Centerline, .025 Inch Square Mating Pin
- 94031 - Connectors, Electrical, Rectangular, High Density Nanominiature, Lobe Keyed, General Requirements For
- 94032 - Connectors, Electrical, Rectangular, High Density Nanominiature, Lobe Keyed, Plug, Wire/Harness Terminated
- 94033 - Connectors, Electrical, Rectangular, High Density Nanominiature, Lobe Keyed, Receptacle, Wire/Harness Terminated
- 94034 - Connectors, Electrical, Rectangular, High Density Nanominiature, Lobe Keyed, Plug, Vertical, Through Hole Terminated
- 94035 - Connectors, Electrical, Rectangular, High Density Nanominiature, Lobe Keyed, Receptacle, Vertical, Through Hole Terminated
- 94036 - Connectors, Electrical, Rectangular, High Density Nanominiature, Lobe Keyed, Plug, Right Angle, Through Hole Terminated
- 94037 - Connectors, Electrical, Rectangular, High Density Nanominiature, Lobe Keyed, Receptacle, Right Angle, Through Hole Terminated
- 94038 - Connectors, Electrical, Rectangular, High Density Nanominiature, Lobe Keyed, Plug, Vertical, Surface Mount Terminated
- 94039 - Connectors, Electrical, Rectangular, High Density Nanominiature, Lobe Keyed, Receptacle, Vertical, Surface Mount Terminated
- 94040 - Connectors, Electrical, Rectangular, High Density Nanominiature, Lobe Keyed, Plug, Right Angle, Surface Mount Terminated
- 94041 - Connectors, Electrical, Rectangular, High Density Nanominiature, Lobe Keyed, Receptacle, Right Angle, Surface Mount Terminated
- 94042 - Connectors, Electrical, Rectangular, High Density Nanominiature, Lobe Keyed, Plug, Vertical, Through Hole Terminated (.025 Inch Termination Spacing)
- 94043 - Connectors, Electrical, Rectangular, High Density Nanominiature, Lobe Keyed, Receptacle, Right Angle, Through Hole Terminated (.050 and .100 Inch Termination Spacing)
- 94044 - Connectors, Electrical, Rectangular, High Density Nanominiature, Lobe Keyed, Receptacle, Vertical, Low Profile, Surface Mount Terminated
- 94045 - Connectors, Electrical, Rectangular, High Density Nanominiature, Lobe Keyed, Mounting Hardware

MIL-STD-1353C
APPENDIX A

- 94046 - Connectors, Electrical, Rectangular, High Density Nanominiature, Lobe Keyed, Backshell Hardware
- 98023 - Connectors, Electrical, Rectangular, Nonenviornmental, Miniature, One Piece Nonmagnetic, Polarized Shell, General Specification For
- 99012 - Connectors, Electrical, Rectangular, Nonenviornmental, Miniature, Polarized Shell, Size 22 Pin
- 99013 - Connectors, Electrical, Rectangular, Nonenviornmental, Miniature, Polarized Shell, Size 20 Pin
- 99014 - Connectors, Electrical, Rectangular, Nonenviornmental, Miniature, Polarized Shell, Size 22 Socket
- 99015 - Connectors, Electrical, Rectangular, Nonenviornmental, Miniature, Polarized Shell, Size 20 Socket

(Copies of this document required by contractors in connection with specific acquisition functions may be obtained from the procuring activity at <http://www.dscc.dla.mil/programs/milspec/>, or as directed by the contracting officer.)

NASA

- GSFC-S-311-P-4 - NASA Parts Selection List Connectors

(Copies of the NASA documents are available for download at the internet wet address <https://nepp.nasa.gov/index.cfm/13597>.)

A.2.2.3 Non-Government publications. The following documents form a part of this document to the extent specified herein. Unless otherwise specified, the issues of these documents are those cited in the solicitation or contract.

SAE INTERNATIONAL

- SAE-AS22759/33 - Wire, Electrical, Fluoropolymer-Insulated, Crosslinked Modified ETFE, Lightweight, Silver-Coated, High-Strength Copper Alloy, 200°C, 600 Volt

(Copies of these documents are available on line at www.sae.org from SAE International, 400 Commonwealth Drive, Warrendale, PA 15096-0001, and Tel: 877-606-7323 [inside USA and Canada] or 724-776-4970 [outside USA], email at CustomerService@sae.org.)

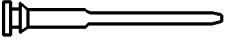
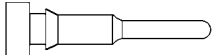
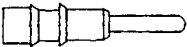
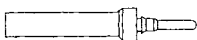
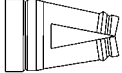
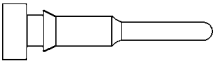
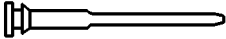
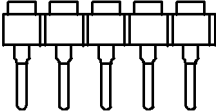
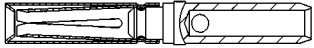
MIL-STD-1353C
APPENDIX A

A.3 MIL-DTL-83505. MIL-DTL-83505 this specification covers individual lead sockets for insertion through mounting boards or panels see table A-I.

Terminals: Type I - Solderless wrap
 Type II - Printed circuit
 Type III - Solder wire turrent
 Type IV - Solder cup
 Type V - Other

A.3.1 Socket applications. Sockets are recommended for use in ground benign applications only.

TABLE A-I. MIL-DTL-83505 descriptions and configurations.

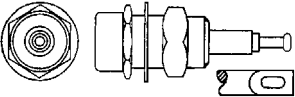
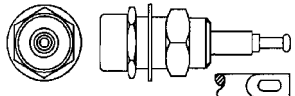
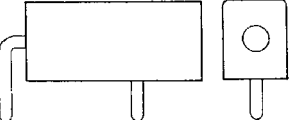
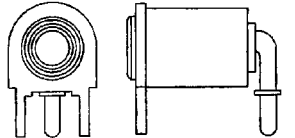
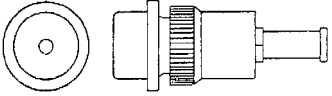
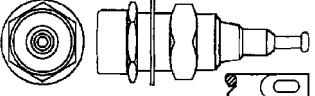
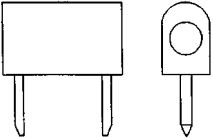
Specification	Description	Configuration
MIL-DTL-83505	Sockets, (Lead, Electronic Components), General Specification For	
MIL-DTL-83505/1	Sockets (Lead, Electronic Components) (Type I, Solderless Wrap)	
MIL-DTL-83505/2	Socket, (Lead, Electronic Components) (Type II, Printed Circuit)	
		
		
MIL-DTL-83505/6	Sockets, (Lead, Electric Components) Type VI, Solderless Spring Contact	
MIL-S-83505/7	Sockets (Lead Electronic Components) (TYPE II, Printed Circuit) Low Insertion Force (LIF)	
MIL-DTL-83505/8	Sockets (Lead Electronic Components) (Type II, Printed Circuit) Low Insertion Force (LIF)	
93015	Socket, Plug-In Electronic Components, Single In-Line	
07015	Connectors, Printed Circuit Subassembly and Accessories: Contacts - Crimp, Dip Solder Tail, Solder Turret, and Wirewrap	

MIL-STD-1353C
APPENDIX A

A.4 MIL-DTL-39024. MIL-DTL-39024 covers the general requirements for panel or printed wiring type.

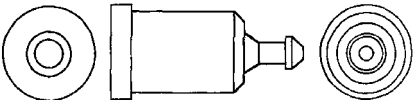
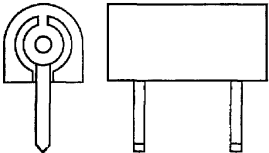
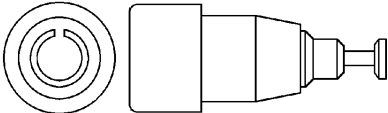
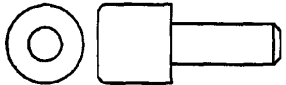
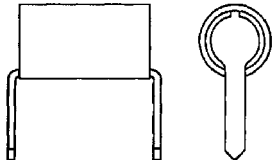
A.4.1 Test point applications. Test point connectors for use in in airborne, ground support, and shipboard electrical and electronic equipment see table A-II.

TABLE A-II. MIL-DTL-39024 descriptions and configurations.

Specification	Description	Configuration
MIL-DTL-39024	Connectors, Electrical: Jacks, Tip (Test Point, Panel or Printed Wiring Type), General Specification for	
MIL-DTL-39024/1	Connectors, Electrical, Test Point Type, Panel Type; Single Test Point (Threaded), Low Voltage	
MIL-DTL-39024/2	Connectors, Electrical, Test Point Type, Panel Type; Single Test Point (Threaded), High Voltage	
MIL-DTL-39024/3	Connectors, Electrical, Test Point Type, Printed Wiring; Single Test Point (Right Angle, 2-Leg Mounting), Low Voltage	
MIL-DTL-39024/4	Connectors, Electrical, Test Point Type, Printed Wiring Type; Single Test Point (Right Angle, 3-Leg Mounting), Low Voltage	
MIL-C-39024/5	Connectors, Electrical, Test Point Type, Panel Type; Single Test Point (Hole Mounting, Push-Fit), Low Voltage	
MIL-DTL-39024/10	Jack, Tip (Test Point Type, Panel Type; Single Test Point (Threaded), Low Voltage, .080)	
MIL-DTL-39024/11	Jack, Tip, Test Point Type, Printed Wiring Type, Single Test Point, Right Angle, 2-Leg Mounting, Low Voltage, .080	

MIL-STD-1353C
APPENDIX A

TABLE A-II. MIL-DTL-39024 descriptions and configurations - Continued.

Specification	Description	Configuration
MIL-DTL-39024/12	Connectors, Electrical, Test Point Type, Panel Type; Single Test Point, (Hole Mounting, Push-Fit), Low Voltage	
MIL-DTL-39024/13	Connectors, Electrical, Test Point Type, Printed Wiring Type; Single Test Point, (Right Angle, 2-Leg Mounting), Low Voltage, .080	
MIL-DTL-39024/14	Connectors, Electrical, Test Point Type, Panel Type; Single Test Point, Subminiature (Push-In), Low Voltage, .080	
MIL-DTL-39024/15	Connectors, Electrical, Test Point Type, Printed Wiring Type; Single Test Point, Low Voltage, .080	
MIL-DTL-39024/18	Connectors, Electrical, Test Point Type, Printed Wiring Type; Micro-Miniature, Single Test Point (2-Leg Mounting), Low Voltage, .080 Inch	

MIL-STD-1353C
APPENDIX A

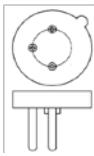
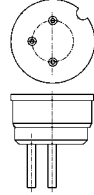
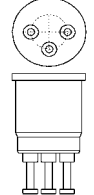
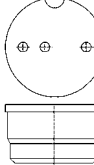
A.5 MIL-DTL-83502. MIL-DTL-83502 covers round, plug-in electronic component sockets for use on panel boards, printed circuit boards, and microelectronic components see table A-III.

A.5.1 Intended use. The sockets covered by this specification are intended for use on a printed circuit board or mounting into chassis. Terminals may be soldered to the printed circuit board unless otherwise noted. Only plug-in component leads with similar finishes to the mating socket contacts should be mated.

A.5.2 Terminal types. Terminals are of the following types:

- Type I - Solderless wrap
- Type II - Printed circuit
- Type III - Solder wire turrent
- Type IV - Solder cup
- Type V - Other

TABLE A-III. MIL-DTL-83502 descriptions and configurations.

Specification/drawing number	Description	Configuration
MIL-DTL-83502	Sockets, Plug-In Electronic Components, Round Style, General Specification For	
MIL-DTL-83502/1	Sockets, Plug-In Electronic Components, Round Style (T07 Low Profile)	
MIL-DTL-83502/2	Sockets, Plug-In Electronic Components, Round Style (T05 Press To Fit)	
MIL-DTL-83502/3	Sockets, Plug-In Electronic Components, Round Style (T08)	
MIL-DTL-83502/5	Sockets, Plug-In Electronic Components, Round Style (R052)	

MIL-STD-1353C
APPENDIX A

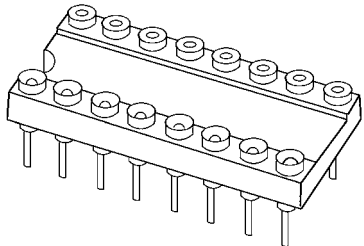
A.6 MIL-DTL-83734. MIL-DTL-83734 covers plug-in electronic component sockets for use on panel boards, printed circuit boards, and microelectronic components see table A-IV.

Terminals for Dual-in Line and Single-in-Line sockets are as follows:

- Type I - Solderless wrap
- Type II - Printed circuit
- Type III - Solder wire current

A.6.1 Intended use. IC sockets are recommended for use in ground benign applications only.

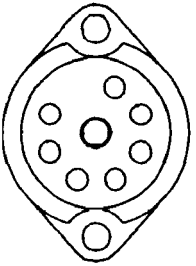
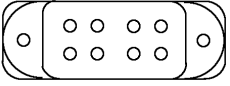
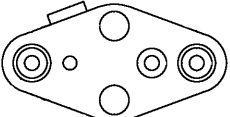

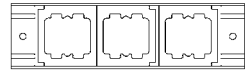
TABLE A-IV. MIL-DTL-83734 descriptions and configurations.

Specification	Description	Configuration
MIL-DTL-83734	Sockets, Plug-In Electronic Components, Dual-In-Line (Dips) and Single-In-Line Packages (SIPS), General Specification For	
MIL-DTL-83734/1	6 Pin Dual-In-Line Packages	
MIL-DTL-83734/2	8 Pin Dual-In-Line Packages	
MIL-DTL-83734/3	14 Pin Dual-In-Line Packages	
MIL-DTL-83734/4	16 Pin Dual-In-Line Packages	
MIL-DTL-83734/5	18 Pin Dual-In-Line Packages	
MIL-DTL-83734/6	22 Pin Dual-In-Line Packages	
MIL-DTL-83734/7	28 Pin Dual-In-Line Packages	
MIL-DTL-83734/8	24 Pin Dual-In-Line Packages	
MIL-DTL-83734/9	36 Pin Dual-In-Line Packages	
MIL-DTL-83734/10	40 Pin Dual-In-Line Packages	
MIL-DTL-83734/13	20 Pin Dual-In-Line Packages	
MIL-DTL-83734/14	48 Pin Dual-In-Line Packages	
MIL-DTL-83734/15	64 Pin Dual-In-Line Packages	
MIL-DTL-83734/17	32 Pin Dual-In-Line Packages	
MIL-DTL-83734/18	Low Profile 6 Pin Dual-in-Line Packages	
MIL-DTL-83734/19	Low Profile 8 Pin Dual-in-Line Packages	
MIL-DTL-83734/20	Low Profile 14 Pin Dual-in-Line Packages	
MIL-DTL-83734/21	Low Profile 16 Pin Dual-in-Line Packages	
MIL-DTL-83734/22	Low Profile 18 Pin Dual-in-Line Packages	
MIL-DTL-83734/23	Low Profile 20 Pin Dual-in-Line Packages	
MIL-DTL-83734/24	Low Profile 22 Pin Dual-in-Line Packages	
MIL-DTL-83734/25	Low Profile 24 Pin Dual-in-Line Packages	

MIL-STD-1353C
APPENDIX A

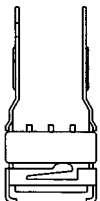
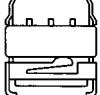
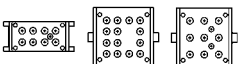
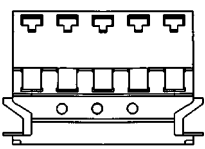

A.7 MIL-DTL-12883. MIL-DTL-12883 sockets and socket accessories for plug-in electronic components, such as electron tubes and related electronic devices, plug-in capacitors, crystal units, batteries, vibrators, relays, transistors, coils, etc., see table A-V.

TABLE A-V. MIL-DTL-12883 descriptions and configurations.

Specification	Description	Configuration	
MIL-DTL-12883	Sockets and Accessories For Plug-In Electronic Components, General Specification For		
MIL-DTL-12883/1	Electron Tube, Bottom Mounting, Saddle Type 8 Contact, Radial		
MIL-DTL-12883/2	Electron Tube, Top Mounting, Saddle Type With Shield Base, 7 Contact, Radial		
MIL-DTL-12883/3	Electron Tube, Top Mounting, Saddle Type With Shield Base, 9 Contact, Radial		
MIL-DTL-12883/8	Electron Tube, Top Mounting, Saddle Type Without Shield Base, 7 Contact, Radial		
MIL-DTL-12883/10	Electron Tube, Bottom Mounting, Saddle Type Without Shield Base, 7 Contact, Radial		
MIL-DTL-12883/11	Electron Tube, Bottom Mounting, Saddle Type Without Shield Base, 9 Contact, Radial		
MIL-DTL-12883/40	For Relays, 4-Pole, 10 Amperes (Mil-PRF-6106, MIL-PRF-83536, MIL-PRF-83726, and MS27709)		
MIL-DTL-12883/41	Sockets, Plug-In Electronic Components For Relays, 2-Pole, 10 Amperes (MIL-PRF-6106 AND MIL-PRF-83536)		
MIL-DTL-12883/42	Sockets And Accessories For Plug-In Electronic Components (Power Transistor, 2 Contact, 10 Amperes, TO-3), Radial		
MIL-DTL-12883/44	Sockets, Plug-In Electronic Components, Socket For Relays, 4-Pole, 5 Amperes (MIL-PRF-6106 and MIL-PRF 83536)		
MIL-DTL-12883/45	Sockets, Plug-In Electronic Components, For Relays, For 2-Pole, 5 Amperes (MIL-PRF-6106 and MIL-PRF-83536)		
MIL-DTL-12883/46	Sockets, Plug-In Electronic Components, For Relays, 3-Pole, 10 Amperes (MIL-PRF-6106 and MIL-PRF- 83536)		
MIL-DTL-12883/47	Socket, Plug-In Electronic Components, For Relays, 6-Pole, 10 Amperes (MIL-PRF-6106 and MIL-PRF-83536)		
MIL-DTL-12883/48	Socket, Plug-In Electronic Components, For Relays, 3-Pole, 25 Amperes (MIL-PRF-83536/32 and /33)		
MIL-DTL-12883/49	Sockets And Accessories For Plug-In Electronic Components, Mounting Tracks For Relays, 10 Amperes (MIL-PRF-6106, MIL-PRF- 83536, and MIL-PRF-83726)		

MIL-STD-1353C
APPENDIX A

TABLE A-V. MIL-DTL-12883 descriptions and configurations - Continued.

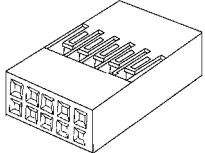
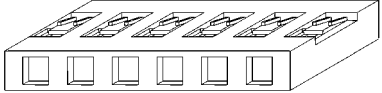
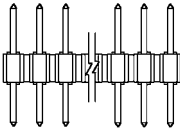
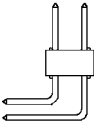
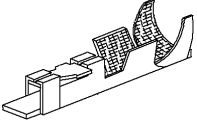
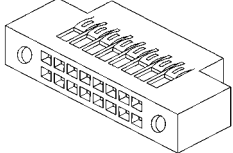
Specification	Description	Configuration
MIL-DTL-12883/50	Sockets And Accessories For Plug-In Electronic Components, Brackets And Socket Assembly For Relays, 2-Pole, 10 Amperes (MIL-PRF-6106 and MIL-PRF-83536)	
MIL-DTL-12883/51	Sockets And Accessories For Plug-In Electronic Components, Bracket And Socket Assembly For Relays, 4-Pole, 10 Amperes (MIL-PRF-6106, MIL-PRF-83536, and MIL-PRF-83726)	
MIL-DTL-12883/52	Sockets and Accessories For Plug-In Electronic Components Socket Assembly For Relays, 2, 3, and 4-Pole, Track Mount (MIL-PRF-6106, MIL-PRF- 83536, and MIL-PRF-83726)	
MIL-DTL-12883/53	Sockets And Accessories For Plug-In Electronic Components, Mounting Track, For Relay Sockets and Electromagnetic Relays	
MIL-DTL-12883/54	Sockets, Plug-In Electronic Components Socket For MIL-PRF 6106 Relays and MS27742 Relays	
MIL-DTL-12883/55	Sockets, Plug-In Electronic Components Socket For MIL-PRF-6106 Relays	
MIL-DTL-12883/56	Socket, Plug-In Electronic Components, For Relays, 1-Pole, 10 Amperes (MIL-PRF-83536/34 and /35)	

MIL-STD-1353C
APPENDIX A

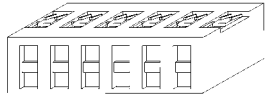
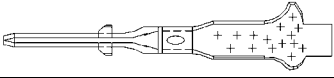
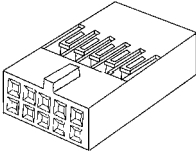
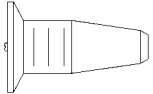
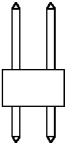

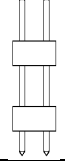

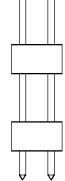
A.8 Unshrouded headers. DLA Land and Maritime drawings covering unshrouded .025 inch (0.64 mm) square pin headers, for use in low power applications requiring printed wiring board termination see table A-VI.

A.8.1 Use and restrictions.. Unshrouded headers gold plating is recommended for use with receptacles and latch housings. Tin/lead plated unshrouded headers are recommended for printed wiring board (PWB) to PWB, soldered use only.

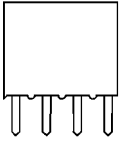
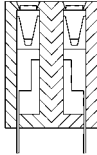
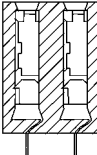

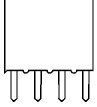
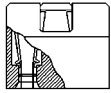

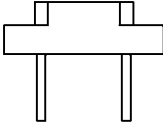
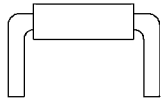
TABLE A-VI. DLA Land and Maritime drawings PWB descriptions and configurations.

DLA Land and Maritime drawing number	Description	Configuration
86037	Connectors, Receptacle, Electrical, Latch Housings, Crimp To Wire Contacts, General Drawing For	For DLA Land and Maritime drawings 86038, 86039, 86108, 86112, and 87109
86038	Connectors, Receptacle, Electrical, Latch Housings, Double Row, .025 Posts	
86039	Connectors, Receptacle, Electrical, Latch Housings, Single Row, .045 Posts	
86100	Connectors, Electrical, Unshrouded Headers, PWB Termination. Requirements for unshrouded square pin headers.	For use with DLA Land and Maritime drawings 86101, 86102, 89042, 92003, 92004, and 92023
86101	Connectors, Electrical, Unshrouded Headers, PWB Termination, .025, Single Row, Straight Thru	
86102	Connectors, Electrical, Unshrouded Headers, PWB Termination, .025, Double Row, Right Angle	
86103	Contact, Receptacle, Electrical, Crimp to Wire (for .025 Inch Post)	
86108	Connector, Receptacle, Electrical, Latch Housings, Double Row, Bulkhead Mount, .025 Posts	

MIL-STD-1353C
APPENDIX ATABLE A-VI. DLA Land and Maritime drawings PWB descriptions and configurations - Continued.

DLA Land and Maritime drawing number	Description	Configuration
86112	Connector, Receptacle, Electrical, Latch Housings, Double Row, .040-.045 Posts	
86113	Contact, Male Pin, Crimp To Wire	
87109	Connectors, Receptacle, Electrical, Latch Housings, Polarized, Double Row, .025 Posts	
87121	Polarizing Plug, .025 Posts, Fits Latch Housings	
89042	Connectors, Electrical, Unshrouded Headers, PWB Termination, .025, Double Row, Straight Thru	
92003	Connectors, Electrical, Unshrouded Headers, PWB to PWB Termination, .025, Single Row, Tiered, Straight Thru	
92004	Connectors, Electrical, Unshrouded Headers, PWB-PWB Termination, .025, Double Row, Tiered, Straight Thru	
92022	Connectors, Electrical, Unshrouded Headers, PWB-Receptacle Termination, .025, Single Row, Tiered, Straight Thru	
92023	Connectors, Electrical, Unshrouded Headers, PWB-Receptacle Termination, .025, Double Row, Tiered, Straight Thru	

MIL-STD-1353C
APPENDIX ATABLE A-VI. DLA Land and Maritime drawings PWB descriptions and configurations - Continued.

DLA Land and Maritime drawing number	Description	Configuration
92024	Connector, Electrical, PWB Terminated, .025 Inch Square Post, Receptacle Housings, General Specification For	For DLA Land and Maritime drawings 92025, 92026, 92027, 92028, 93015
92025	Connectors, Receptacle, Electrical, PWB Termination (.062 to .093), Double Row, Top Entry, .100 Centers, .025 Posts	
92026	Connectors, Receptacle, Electrical, PWB Termination (.062 to .093), Double Row, Dual Entry, .100 Centers, .025 Posts	
92027	Connectors, Receptacle, Flex-Circuit Termination (.032), Top Entry, Double Row, .100 Centers, .025 Posts	
92028	Connectors, Receptacle, Electrical, Flex-Circuit Termination (.032), Double Row, Dual Entry, .100 Centers, .025 Posts	
93015	Connectors, Receptacle, Electrical, PWB Termination (.062 To .093), Single Row, Top Entry, .100 Centers, .025 Posts	
93044	Jumper Shunt, .100 Inch Centerline, .025 Inch Square Pin, General Drawing	For drawings 93045 and 93046
93045	Low Profile Shunt, .100 Inch Centerline, .025 Inch Square Mating Pin	
93046	Mini Shunt, .100 Inch Centerline, .025 Inch Square Mating Pin	
86105	Jumper Pin, Insulated	
93029	Connector, Plug, Electrical, Jumper Shunt (Wire)	

MIL-STD-1353C
APPENDIX A

A.9 MIL-DTL-83503. MIL-DTL-83503 flat cable connectors see figures A-1, A-2, and table A-VII.

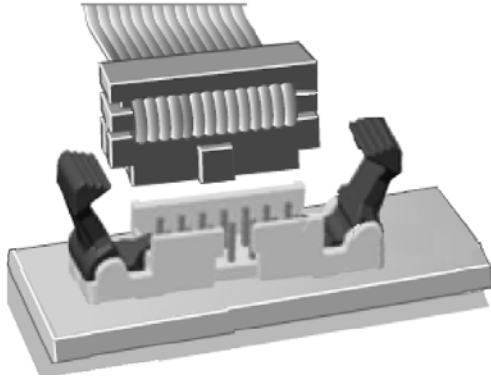


FIGURE A-1. PWB and flat cable connectors.

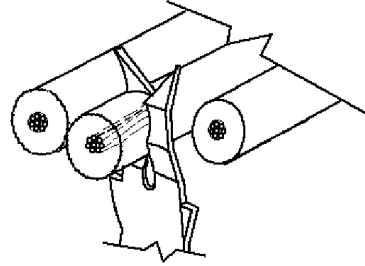


FIGURE A-2. Insulation displacement contact (IDC).

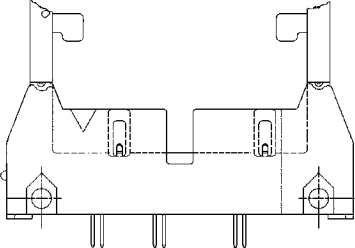

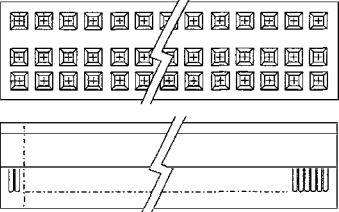

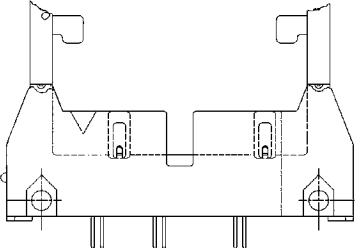
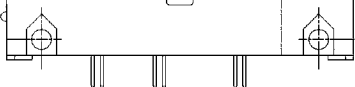
A.9.1 Intended use. For multi-contact electrical connectors terminating flexible flat cable, and for mounting on printed wiring boards. They include insulation displacement connectors (IDC), solder transition connectors, and header style connectors, and IDC dual-in-line plug style PWB mount.

TABLE A-VII. MIL-DTL-83503 descriptions and configurations.

Specification	Description	Configuration
MIL-DTL-83503	Connectors, Electrical, Flat Cable, and/or Printed Wiring Board, Nonenvironmental, General Specification For	
MIL-DTL-83503/6	Connectors, Electrical, Flat Cable, Nonenvironmental Dual-in-Line Plug for Terminating Round Conductors on .050 Centers for Mating with Standard Dip Sockets, .100 X .300 Contact Spacing .100 X .400 Contact Spacing and .100 X .600 Contact Spacing	
MIL-S-83503/7	Connector, Electrical, Flat Cable, Nonenvironmental Plug with Dual Polarization, Round Conductor, Insulation Displacing Non-Removable Socket Contacts (.100 X .100 Spacing)	

MIL-STD-1353C
APPENDIX A

TABLE A-VII. MIL-DTL-83503 descriptions and configurations - Continued.

Specification	Description	Configuration
MIL-DTL-83503/20	Connectors, Electrical, Flat Cable, Nonenvironmental Header, Right Angle (.100 Spacing) with Polarizing Feature, Solderless Wrappost or PWB Termination	
MIL-DTL-83503/21	Connectors, Electrical, Flat Cable, Nonenvironmental, Header, Straight Thru (.100 Inch Spacing) with Polarizing Feature, Solderless Wrappost or PWB Termination	
MIL-DTL-83503/22	Connectors, Electrical, Flat Cable, Nonenvironmental, Socket Insulation Displacement	
MIL-DTL-83503/23	Connectors, Electrical, Flat Cable, Nonenvironmental Printed Wiring Board Solder Transition For Terminating Round Conductors on .050 Inch Centers	
MIL-DTL-83503/24	Connectors, Electrical, Flat Cable, Nonenvironmental Four Wall Header, Right Angle (.100 Spacing) with Polarizing Feature Solderless Wrappost or PWB Termination	
MIL-DTL-83503/25	Connectors, Electrical, Flat Cable, Nonenvironmental Four Wall Header, Straight Thru (.100 Spacing) with Polarizing Feature, Solderless Wrappost or PWB Termination	

MIL-STD-1353C
APPENDIX A

A.10 MIL-DTL-55302. MIL-DTL-55302 plugs and receptacles for printed circuit subassembly and their accessories, for use with single-sided printed wiring, double-sided printed wiring, and multilayer printed wiring conforming to MIL-PRF-31032. Contact termination types available (see 3.1) are crimp, dip solder, flex, hand solder, and wire wrappost, see table A-VIII.

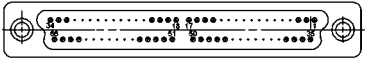
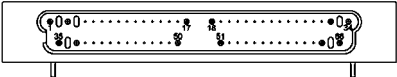
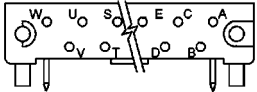
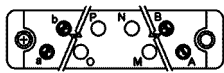

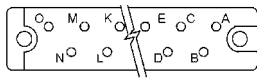
A.10.1 Intended use. Intended for use in airborne, ground support, shipboard electrical, and electronic equipment.

A.10.2 Spacing between contacts. MIL-DTL-55302/190 through /193 connectors have 0.075 inch spacing between contacts. All other connectors have 0.100 inch spacing between contacts.

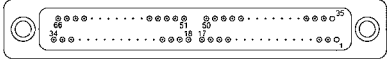
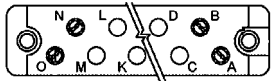
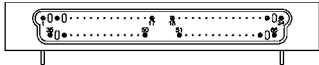

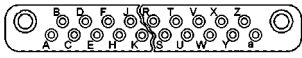

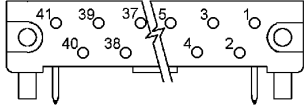
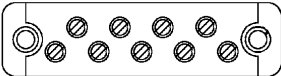
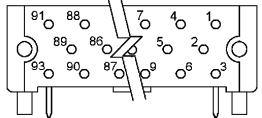
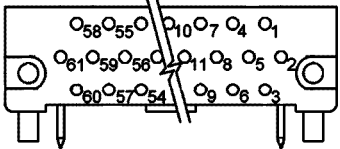
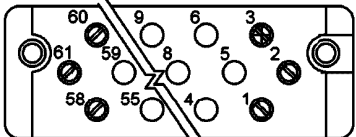
A.10.3 Soldering. Hand soldering of these connectors is recommended. The use of wave soldering or infrared reflow equipment may overheat connectors, resulting in warpage or shifting of contact positions, and may cause high mating force or insufficient contact engagements.

A.10.4 Hardware options. MIL-DTL-55302/57, /59 and /138 hardware options S and H, jackscrew length is .135 inches rather than .200 inches.

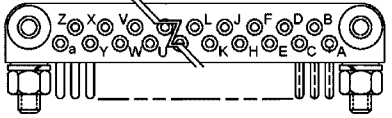


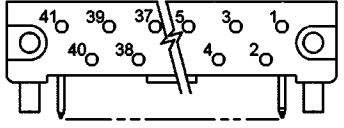
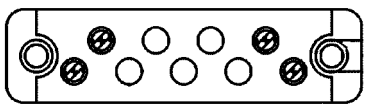
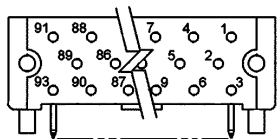
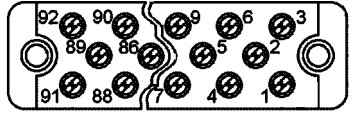
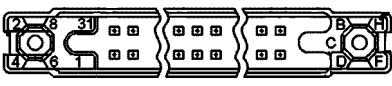
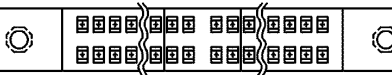
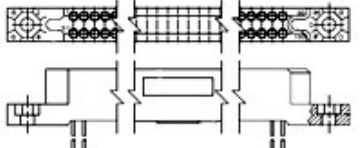
TABLE A-VIII. DLA Land and Maritime drawings and MIL-DTL-55302 descriptions and configurations.

Specification/ DLA Land and Maritime drawing number	Description	Configuration
07013	Connectors, Printed Circuit Subassembly and Accessories: Receptacle, Socket Contacts, 41, 66, 114 Contact Positions: For Printed Wiring Boards (.100 X .050 Offset Grid) 55302 type	
07014	Connectors, Printed Circuit Subassembly and Accessories: Plug Pin Contacts, 41, 66, 114 Contact Positions: For Printed Wiring Boards (.100 X .050 Offset Grid) 55302 type	
MIL-DTL-55302	Connectors, Printed Circuit Subassembly and Accessories	
MIL-DTL-55302/1	Connectors, Printed Circuit Subassembly and Accessories: Plug, Pin Contacts, Right-Angle, for Printed Wiring Boards (.150 Spacing)	
MIL-DTL-55302/2	Connectors, Printed Circuit Subassembly and Accessories: Receptacle, Socket Contacts, Straight-Thru, for Printed Wiring Boards (.150 Spacing)	
MIL-DTL-55302/4	Connectors, Printed Circuit Subassembly and Accessories: Plug, Pin Contacts, Right-Angle, for Multilayered Printed Wiring Boards (.100 Spacing)	
MIL-DTL-55302/5	Connectors, Printed Circuit Subassembly and Accessories: Plug, Pin Contacts, Straight-Thru, for Multilayered Printed Wiring Boards (.100 Spacing)	

MIL-STD-1353C
APPENDIX ATABLE A-VIII. DLA Land and Maritime drawings and MIL-DTL-55302 descriptions and configurations - Continued.

Specification/ drawing number	Description	Configuration
07013	Connectors, Printed Circuit Subassembly And Accessories: Receptacle, Socket Contacts, 41, 66, 114 Contact Positions: For Printed Wiring Boards (.100 X .050 Offset Grid)	
MIL-DTL-55302/6	Connectors, Printed Circuit Subassembly and Accessories: Receptacle, Socket Contacts, Straight-Thru, for Multilayered Printed Wiring Boards (.100 Spacing)	
07014	Connectors, Printed Circuit Subassembly And Accessories: Plug Pin Contacts, 41, 66, 114 Contact Positions: For Printed Wiring Boards (.100 X .050 Offset Grid)	
MIL-DTL-55302	Connectors, Printed Circuit Subassembly and Accessories: Pin, Right-Angle, for Printed Wiring Boards (.200 Spacing)	
MIL-DTL-55302/1	Connectors, Printed Circuit Subassembly and Accessories: Socket, Straight-Thru, for Printed Wiring Boards (.200 Spacing)	
MIL-DTL-55302/2	Connectors, Printed Circuit Subassembly and Accessories: Pin, Straight-Thru, for Printed Wiring Boards (.200 Spacing)	
MIL-DTL-55302/4	Connectors, Printed Circuit Subassembly and Accessories: Plug, Pin Contacts Right-Angle, 41 Composite Contact, for Printed Wiring Boards (.150 Spacing)	
MIL-DTL-55302/5	Connectors, Printed Circuit Subassembly and Accessories: Receptacle, Socket Contact, Straight-Thru, for Printed Wiring Boards (.150 Spacing)	
MIL-DTL-55302/6	Connectors, Printed Circuit Subassembly and Accessories: Plug, Pin Contacts, Right-Angle, 92 Composite Contact, for Multilayered Printed Wiring Boards (.100 Spacing)	
MIL-DTL-55302/7	Connectors, Printed Circuit Subassembly And Accessories: Plug, Pin Contacts, Right-Angle, For Multilayered Printed Wiring Boards (.100 Spacing)	
MIL-DTL-55302/8	Connectors, Printed Circuit Subassembly And Accessories: Receptacle, Socket Contacts, Straight-Thru, For Multilayered Printed Wiring Boards (.100 Spacing)	

MIL-STD-1353C
APPENDIX ATABLE A-VIII. DLA Land and Maritime drawings and MIL-DTL-55302
descriptions and configurations - Continued.

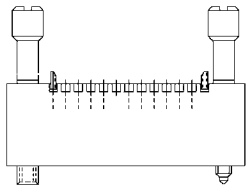
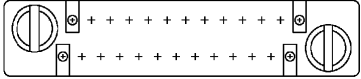
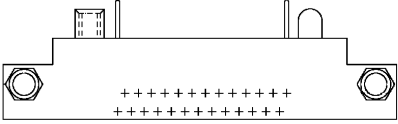
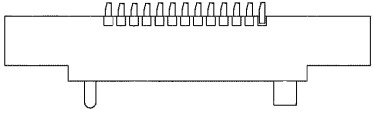
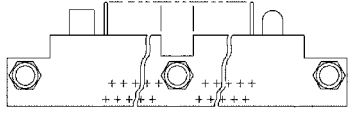
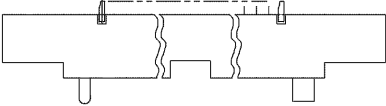

Specification/ drawing number	Description	Configuration
MIL-DTL-55302/16	Connectors, Printed Circuit Subassembly and Accessories: Pin, Right-Angle, For Printed Wiring Boards (.200 Spacing)	
MIL-DTL-55302/17	Connectors, Printed Circuit Subassembly and Accessories: Socket, Straight-Thru, For Printed Wiring Boards (.200 Spacing)	
MIL-DTL-55302/18	Connectors, Printed Circuit Subassembly and Accessories: Pin, Straight-Thru, For Printed Wiring Boards (.200 Spacing)	
MIL-DTL-55302/19	Connectors, Printed Circuit Subassembly and Accessories: Plug, Pin Contacts Right-Angle, 41 Composite Contact, For Printed Wiring Boards (.150 Spacing)	
MIL-DTL-55302/20	Connectors, Printed Circuit Subassembly and Accessories: Receptacle, Socket Contact, Straight-Thru, For Printed Wiring Boards (.150 Spacing)	
MIL-DTL-55302/21	Connectors, Printed Circuit Subassembly and Accessories: Plug, Pin Contact, Right-Angle, 92 Composite Contact, For Multilayered Printed Wiring Boards (.100 Spacing)	
MIL-DTL-55302/22	Connectors, Printed Circuit Subassembly and Accessories: Receptacle, Socket Contacts, Straight-Thru, For Multilayered Printed Wiring Boards (.100 Spacing)	
MIL-DTL-55302/23	Connectors, Printed Circuit Subassembly and Accessories: Plug, Decade Increment 10 Thru 120, 150, 160 And 180 Contact Positions, For Printed Wiring Boards (.075 Spacing)	
MIL-DTL-55302/24	Connectors, Printed Circuit Subassembly and Accessories: Receptacle, Decade Increment 10 Thru 110, Contact Positions, For Printed Wiring Boards (.075 Spacing)	
MIL-DTL-55302/25	Connectors, Printed Circuit Subassembly and Accessories: Receptacle, 120, 150, 160, and 180 Contact Positions, for Printed Wiring Boards (.075 Spacing)	

MIL-STD-1353C
APPENDIX ATABLE A-VIII. DLA Land and Maritime drawings and MIL-DTL-55302
descriptions and configurations - Continued.

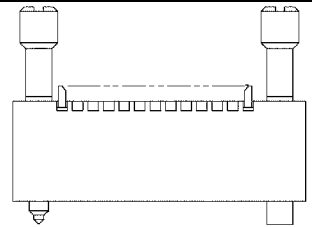
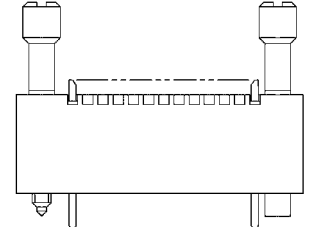
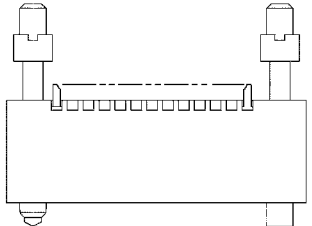
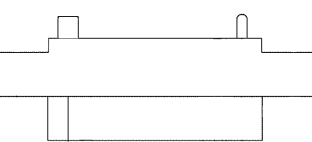
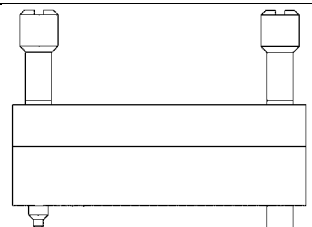
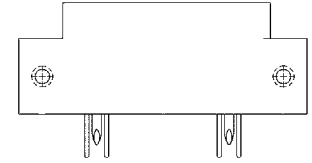
Specification/ drawing number	Description	Configuration
MIL-DTL-55302/26	Connectors, Printed Circuit Subassembly and Accessories: Plug, 30 Thru 140 Contact Positions, for Printed Wiring Boards (.100 Sq. Grid)	
MIL-DTL-55302/27	Connectors, Printed Circuit Subassembly and Accessories: Receptacle, 30 thru 140 Contact Positions, for Printed Wiring Boards (.100 Sq. Grid)	
MIL-DTL-55302/29	Connectors, Printed Circuit Subassembly and Accessories: Gage for Contact Separation Force Test Method	
MIL-DTL-55302/31	Connectors, Printed Circuit, Subassembly and Accessories: Keying Accessories	
MIL-DTL-55302/32	Connectors, Printed Circuit Subassembly and Accessories: Contacts, Solder Eyelet and Wrappost Removable Types	
MIL-DTL-55302/38	Connectors, Printed Circuit Subassembly and Accessories: Plug, Electrical, Polarized Shell, Male, 0.100 Inch Contact Spacing, Pin Terminal	
MIL-DTL-55302/52	Connectors, Printed Circuit Subassembly and Accessories: Receptacle, Straight-Thru, Hermaphroditic Contact, for Printed Wiring Boards (.100 Spacing)	
MIL-DTL-55302/53	Connectors, Printed Circuit Subassembly and Accessories: Plug, Right-Angle, Hermaphroditic Contact, for Printed Wiring Boards (.100 Spacing)	
MIL-DTL-55302/54	Connectors, Printed Circuit Subassembly and Accessories: Plug, Straight-Thru, Hermaphroditic Contact, for Printed Wiring Boards (.100 Spacing)	

MIL-STD-1353C
APPENDIX A

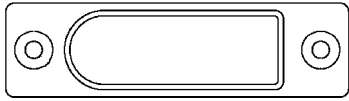


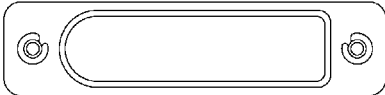
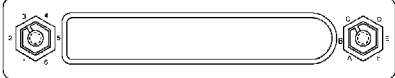
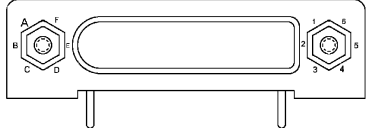
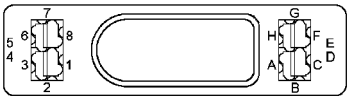
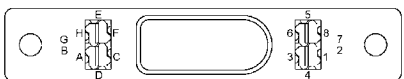
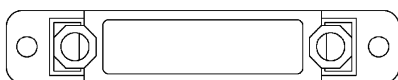
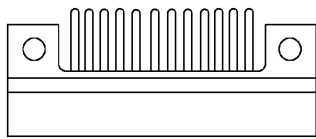
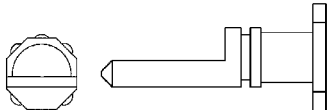
TABLE A-VIII. DLA Land and Maritime drawings and MIL-DTL-55302
descriptions and configurations - Continued.

Specification/ drawing number	Description	Configuration
MIL-DTL-55302/55	Connectors, Printed Circuit Subassembly and Accessories, Plug, Socket Contacts, Decade Increments 10 through 70 Contact Positions and Intermediate Positions of 14, 24, 44, 54 and 26, 36, 56, 66 for Printed Wiring Boards (.100 Inch Spacing)	
MIL-DTL-55302/56	Connectors, Printed Circuit Subassembly and Accessories: Receptacle, Pin Contacts, Decade Increments 10 Thru 70 Contact Positions and Intermediate Positions of 14, 24, 44, 54 and 26, 36, 56, 66, for Printed Wiring Boards (.100 Inch Spacing)	
MIL-DTL-55302/57	Connectors, Printed Circuit Subassembly and Accessories: Plug, Pin Contacts, Decade Increments 10 Thru 70 Contact Positions and Intermediate Positions of 14, 24, 44, 54 and 26, 36, 56, 66, for Printed Wiring Boards (.100 Inch Spacing)	
MIL-DTL-55302/58	Connectors, Printed Circuit Subassembly and Accessories, Receptacle, Socket Contacts, Decade Increments 10 through 70 Contact Positions and Intermediate Positions of 14, 24, 44, 54 and 26, 36, 56, 66 for Printed Wiring Boards (.100 Inch Spacing)	
MIL-DTL-55302/59	Connectors, Printed Circuit Subassembly and Accessories: Plug, Pin Contacts, Decade Increments 90, 100 and 120 Contact Positions, for Printed Wiring Boards (.100 Inch Spacing)	
MIL-DTL-55302/60	Connectors, Printed Circuit Subassembly and Accessories, Plug, Pin Contacts, Decade Increments 10 through 70 Contact Positions and Intermediate Positions of 14, 24, 44, 54, and 26, 36, 56, and 66 for Printed Wiring Boards (.100 Inch Spacing)	
MIL-DTL-55302/61	Connectors, Printed Circuit Subassembly and Accessories, Plug, Pin Contacts, Decade Increments 10 through 70 Contact Positions and Intermediate Positions of 14, 24, 44, 54, and 26, 36, 56, and 66 for Printed Wiring Boards (.100 Inch Spacing)	

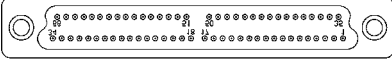
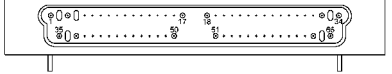
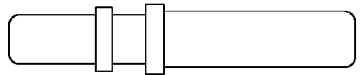
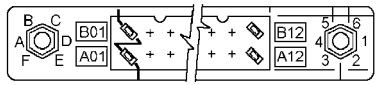
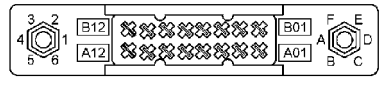
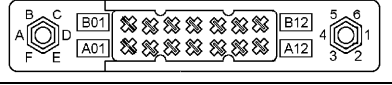
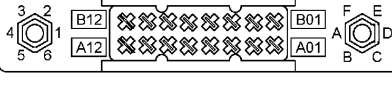
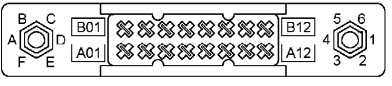
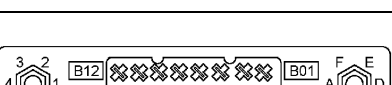

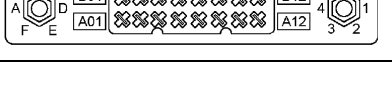
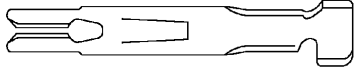
MIL-STD-1353C
APPENDIX ATABLE A-VIII. DLA Land and Maritime drawings and MIL-DTL-55302
descriptions and configurations - Continued.

Specification/ drawing number	Description	Configuration
MIL-DTL-55302/62	Connectors, Printed Circuit Subassembly and Accessories, Receptacle, Socket Contacts, Decade Increments 10 through 70 Contact Positions and Intermediate Positions of 14, 24, 44, 54, and 26, 36, 56, and 66 for Printed Wiring Boards (.100 Inch Spacing)	
MIL-DTL-55302/63	Connectors, Printed Circuit Subassembly and Accessories: Plug, Pin Contacts, Decade Increments 10 Thru 70 Contact Positions and Intermediate Positions of 14, 24, 44, 54, and 26, 36, 56, and 66, for Printed Wiring Boards (.100 Inch Spacing)	
MIL-DTL-55302/64	Connectors, Printed Circuit Subassembly and Accessories, Receptacle, Socket Contacts, Decade Increments 10 through 70 Contact Positions and Intermediate Positions of 14, 24, 44, 54, and 26, 36, 56, and 66 for Printed Wiring Boards (.100 Inch Spacing)	
MIL-DTL-55302/65	Connectors, Printed Circuit Subassembly and Accessories: Receptacle, Socket Contacts, Decade Increments 10 Thru 70 Contact Positions and Intermediate Positions of 14, 24, 44, 54, and 26, 36, 56, and 66, for Printed Wiring Boards (.100 Inch Spacing)	
MIL-DTL-55302/66	Connectors, Printed Circuit Subassembly and Accessories: Receptacle, Socket Contacts, Decade Increments 10 Thru 70 Contact Positions and Intermediate Positions of 14, 24, 44, 54, and 26, 36, 56, and 66, for Printed Wiring Boards (.100 Inch Spacing)	
MIL-DTL-55302/67	Connectors, Printed Circuit Subassembly and Accessories, Pin, Right Angle Plug, Electrical, Polarized for Printed Wiring Boards (.090 Inch Spacing)	

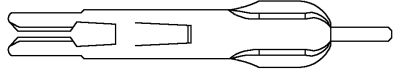
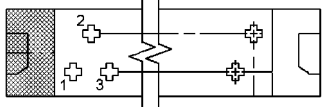
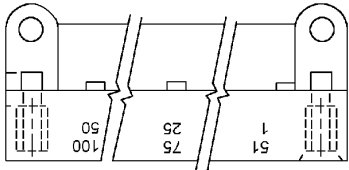
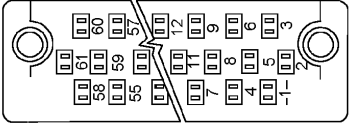

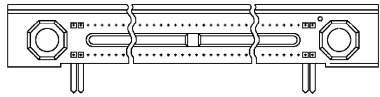
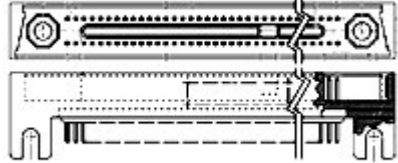
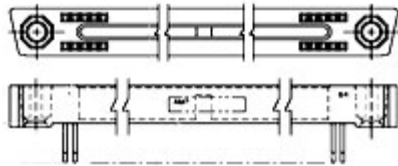
MIL-STD-1353C
APPENDIX ATABLE A-VIII. DLA Land and Maritime drawings and MIL-DTL-55302
descriptions and configurations - Continued.

Specification/ drawing number	Description	Configuration
MIL-DTL-55302/68	Connectors, Printed Circuit Subassembly and Accessories, Socket Receptacle, Electrical, Polarized (.090 Spacing), Removable Crimp Contacts	
MIL-DTL-55302/69	Connectors, Printed Circuit Subassembly and Accessories, Pin Plug, Electrical, Polarized (.090 Spacing), Removable Crimp Contacts	
MIL-DTL-55302/70	Connectors, Printed Circuit Subassembly and Accessories, Pin, Right Angle Plug, Electrical, Polarized for Printed Wiring Boards (.100 Spacing)	
MIL-DTL-55302/71	Connectors, Printed Circuit Subassembly and Accessories, Socket Receptacle, Electrical, Polarized Composite Contact (.100 Spacing)	
MIL-DTL-55302/72	Connectors, Printed Circuit Subassembly and Accessories, Socket Environmental Resistant, Receptacle, Electrical, Polarized (.150 Spacing), Removable Crimp Contacts	
MIL-DTL-55302/73	Connectors, Printed Circuit Subassembly and Accessories, Pin, Right Angle, Environmental Resistant, Plug, Electrical, Polarized for Printed Wiring Boards (.150 Spacing)	
MIL-DTL-55302/74	Connectors, Printed Circuit Subassembly and Accessories, Pin, Right Angle, Plug, Electrical, Polarized for Printed Wiring Boards (.100 Spacing)	
MIL-DTL-55302/75	Connectors, Printed Circuit Subassembly and Accessories, Socket, Receptacle, Electrical, Polarized (.100 Spacing), Removable Crimp Contacts	
MIL-DTL-55302/76	Connectors, Printed Circuit Subassembly and Accessories, Socket, Straight-Thru, Polarized for Multilayered Printed Wiring Boards (.100 Spacing)	
MIL-DTL-55302/77	Connectors, Printed Circuit Subassembly and Accessories, Pin Right-Angle for Multilayered Printed Wiring Boards (.100 Spacing)	
MIL-DTL-55302/78	Connectors, Printed Circuit Subassembly and Accessories: Key, Polarizing, Connectors, Electrical Printed Wiring Boards	

MIL-STD-1353C
APPENDIX ATABLE A-VIII. DLA Land and Maritime drawings and MIL-DTL-55302
descriptions and configurations - Continued.

Specification/ drawing number	Description	Configuration
MIL-DTL-55302/82	Connectors, Printed Circuit Subassembly and Accessories: Receptacle, Socket Contacts, 41, 66, 114 Contact Positions: for Printed Wiring Boards (.100 x .050 Offset Grid)	
MIL-DTL-55302/83	Connectors, Printed Circuit Subassembly and Accessories: Plug, Pin Contacts, 41, 66, 114 Contact Positions, for Printed Wiring Boards (.100 x .050 Offset Grid)	
MIL-DTL-55302/84	Connectors, Printed Circuit Subassembly and Accessories: Contacts - Crimp, Dip Solder Tail, Solder Turret, and Wirewrap	
MIL-DTL-55302/89	Connectors, Printed Circuit Subassembly and Accessories: Plug, Right-Angle, Hermaphroditic Contacts (.100 Inch Spacing)	
MIL-DTL-55302/90	Connectors, Printed Circuit Subassembly and Accessories: Receptacle, Right-Angle, Hermaphroditic Contact (.100 Inch Spacing)	
MIL-DTL-55302/91	Connectors, Printed Circuit Subassembly and Accessories: Plug, Straight-Thru, Hermaphroditic Contacts (.100 Inch Spacing)	
MIL-DTL-55302/92	Connectors, Printed Circuit Subassembly and Accessories: Straight, Straight-Thru, Hermaphroditic Contacts (.100 Inch Spacing)	
MIL-DTL-55302/93	Connectors, Printed Circuit Subassembly and Accessories: Plug, Insert (Insulator), Rectangular, Polarized, Removable Crimp Type, Hermaphroditic Contacts (.100 Inch Spacing)	
MIL-DTL-55302/94	Connectors, Printed Circuit Subassembly and Accessories: Receptacle, Insert (Insulator), Rectangular, Polarized, Removable, Crimp Type, Hermaphroditic Contacts (.100 Inch Spacing)	
MIL-DTL-55302/95	Connectors, Printed Circuit Subassembly and Accessories: Plug, Composite Wrappost, Hermaphroditic Contacts (.100 Inch Spacing)	
MIL-DTL-55302/96	Connectors, Printed Circuit Subassembly and Accessories: Receptacle, Wrappost (Removable) Hermaphroditic Contacts (.100 Inch Spacing)	
MIL-DTL-55302/97	Connectors, Printed Circuit Subassembly and Accessories: Contacts, Hermaphroditic, Crimp Removable for Wire (Stranded)	

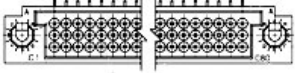
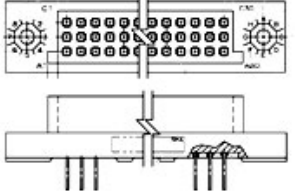
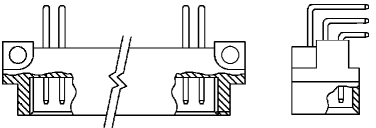
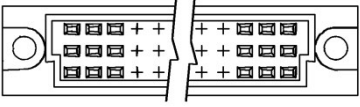
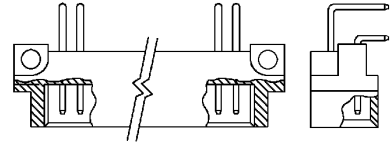
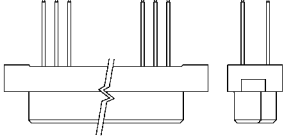
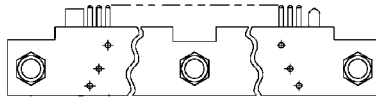
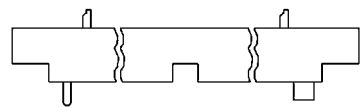

MIL-STD-1353C
APPENDIX ATABLE A-VIII. DLA Land and Maritime drawings and MIL-DTL-55302
descriptions and configurations - Continued.

Specification/ drawing number	Description	Configuration
MIL-DTL-55302/98	Connectors, Printed Circuit Subassembly and Accessories: Contact, Wrappost Removable Type	
MIL-DTL-55302/102	Connectors, Printed Circuit Subassembly and Accessories: Receptacle, Straight-Thru, Hermaphroditic Contact, Crimp Removable, for Printed Wiring Boards (.100 Inch Spacing)	
MIL-DTL-55302/110	Connectors, Printed Circuit Subassembly and Accessories: Plug, Right Angle, 30 Thru 140 Contact Positions, for Printed Wiring Boards (.100 Sq. Grid)	
MIL-DTL-55302/111	Connectors, Printed Circuit Subassembly and Accessories: Receptacle, Socket Contacts, Straight- Thru, for Multilayered Printed Wiring Boards, (.100 Spacing)	
MIL-DTL-55302/113	Connectors, Printed Circuit Subassembly and Accessories: Plug, Straight-Thru, 30 through 110 Contact Positions, Crimp Removable Contacts (.100 Square Grid)	
MIL-DTL-55302/117	Connectors, Printed Circuit Subassembly and Accessories: Plug, Right Angle, Decade Increment 20 through 110 and 128 Contact Positions, for Printed Wiring Boards (.050 Spacing)	
MIL-DTL-55302/118	Connectors, Printed Circuit Subassembly and Accessories: Plug, Decade Increment 20 Thru 110 and 128 Contact Positions, for Printed Wiring Boards (.050 Spacing)	
MIL-DTL-55302/119	Connectors, Printed Circuit, Subassembly and Accessories: Receptacle, Decade Increment 20 through 110 and 128 Contact Positions, for Printed Wiring Boards (.050 Spacing)	

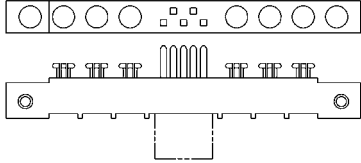
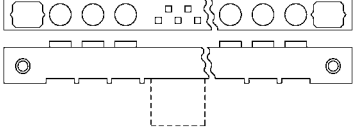
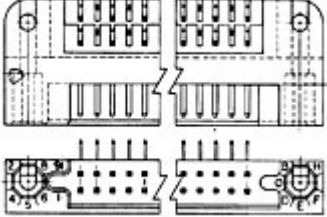
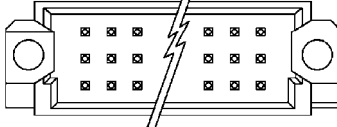
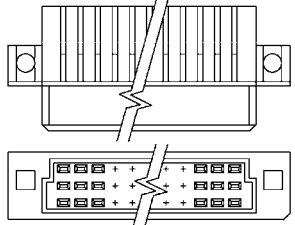
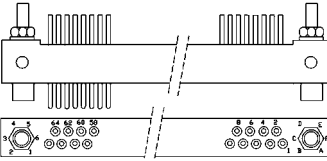
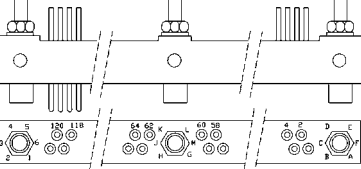
MIL-STD-1353C
APPENDIX ATABLE A-VIII. DLA Land and Maritime drawings and MIL-DTL-55302
descriptions and configurations - Continued.

Specification/ drawing number	Description	Configuration
MIL-DTL-55302/120	Connectors, Printed Circuit Subassembly and Accessories: Plug, Pin Contacts, 128 Contact Positions, for Printed Wiring Boards (.050 Inch Spacing)	
MIL-DTL-55302/121	Connectors, Printed Circuit Subassembly and Accessories: Receptacle, Socket Contact, 128 Contact Positions, for Printed Wiring Boards (.050 Inch Spacing)	
MIL-DTL-55302/122	Connectors, Printed Circuit Subassembly and Accessories: Plug, Pin Contacts, 184 Contact Positions, for Printed Wiring Boards (.050 Inch Spacing)	
MIL-DTL-55302/123	Connectors, Printed Circuit Subassembly and Accessories: Receptacle, Socket Contact, 184 Contact Positions, for Printed Wiring Boards (.050 Inch Spacing)	
MIL-DTL-55302/124	Connectors, Printed Circuit Subassembly and Accessories: Keying Accessories	
MIL-DTL-55302/125	Connectors, Printed Circuit Subassembly and Accessories: Plug, 80 Contact Positions, for Printed Wiring Boards (.050 Inch Spacing)	
MIL-DTL-55302/126	Connectors, Printed Circuit Subassembly and Accessories: Receptacle, 80 Contact Positions, for Printed Wiring Boards (.050 Inch Spacing)	
MIL-DTL-55302/127	Connectors, Printed Circuit Subassembly and Accessories: Receptacle, Single Row, 2 through 65 Contact Positions, for Printed Wiring Boards (1/16", 3/32", and 1/8") (.100 Spacing)	
MIL-DTL-55302/128	Connectors, Printed Circuit Subassembly and Accessories: Receptacle, Double Row, 4 through 130 Contact Positions, for Printed Wiring Boards (1/16", 3/32", and 1/8") (.100 Inch Spacing)	

MIL-STD-1353C
APPENDIX ATABLE A-VIII. DLA Land and Maritime drawings and MIL-DTL-55302
descriptions and configurations - Continued.

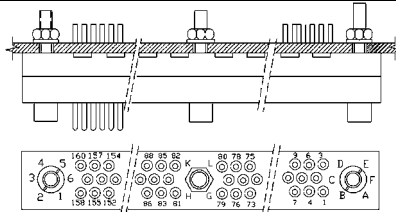
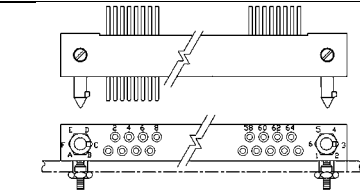
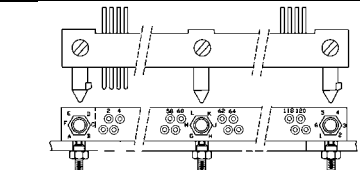
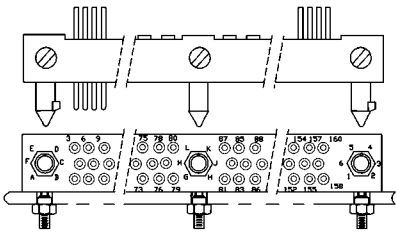

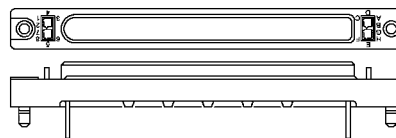

Specification/ drawing number	Description	Configuration
MIL-C-55302/129	Connectors, Printed Circuit Subassembly and Accessories: Plug, Right Angle, 90 through 240 Contact Positions, for Printed Wiring Boards (.100 Inch Spacing)	
MIL-DTL-55302/130	Connectors, Plug, Printed Circuit Subassembly and Accessories: Right Angle, Pin Contacts, 64 or 96 Contact Position for Printed Wiring Boards (.100 Inch Spacing)	
MIL-DTL-55302/131	Connectors, Plug, Electrical, Printed Circuit Subassembly and Accessories: Right Angle, Pin Contacts, 64 or 96 Contact Position for Printed Wiring Boards (.100 Inch Spacing)	
MIL-C-55302/132	Connectors, Printed Circuit Subassembly and Accessories: Receptacle Socket Contacts, Straight Thru, 64 or 96 Contact Positions, for Printed Wiring Boards (.100 Inch Spacing)	
MIL-DTL-55302/133	Connectors, Plug, Electrical, Printed Circuit Subassembly and Accessories: Right Angle, Pin Contacts, 32 or 64 Contact Positions, for Printed Wiring Boards (.100 Inch Spacing)	
MIL-DTL-55302/134	Connectors, Printed Circuit Subassembly and Accessories: Receptacle Socket Contacts, Straight Thru, 32 or 64 Contact Positions, for Printed Wiring Boards (.100 Inch Spacing)	
MIL-DTL-55302/138	Connectors, Printed Circuit Subassembly and Accessories, Plug, Pin Contacts, 160 Contact Positions for Printed Wiring Boards (.100 Inch Spacing)	
MIL-DTL-55302/139	Connectors, Printed Circuit Subassembly and Accessories, Receptacle, Socket Contacts, 160 Contact Positions for Printed Wiring Boards (.100 Inch Spacing)	
MIL-DTL-55302/142	Connectors, Printed Circuit Subassembly and Accessories: Receptacle with Socket Contacts, for Printed Wiring Boards (.100 Inch Spacing)	

MIL-STD-1353C
APPENDIX ATABLE A-VIII. DLA Land and Maritime drawings and MIL-DTL-55302
descriptions and configurations - Continued.

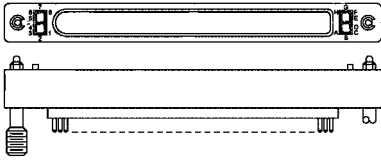
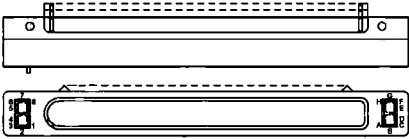

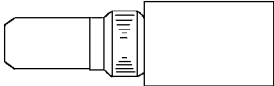
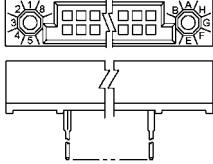
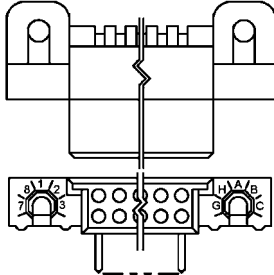
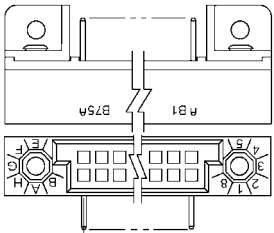
Specification/ drawing number	Description	Configuration
MIL-DTL-55302/145	Connectors, Printed Circuit Subassembly and Accessories: Receptacle with Pin Contacts, 2 Female Keying Guides, 2.114 Inches Length, for Printed Wiring Boards (.100 Inch Spacing)	
MIL-DTL-55302/150	Connectors, Printed Circuit Subassembly and Accessories: Plug with Socket Contacts, 2.114 Inches Length, 2 Keying Pins, for Printed Wiring Boards (.100 Inch Spacing)	
MIL-DTL-55302/156	Connectors, Printed Circuit Subassembly and Accessories: Plug, Right Angle, Decade Increments 10 Thru 120, 150, 160, and 180 Contact Positions for Printed Wiring Boards (.075 Spacing)	
MIL-DTL-55302/157	Connectors, Printed Circuit Subassembly and Accessories: Plug, Straight Thru Contacts, 64 or 96 Contact Positions, for Printed Wiring Boards (.100 Inch Spacing)	
MIL-DTL-55302/158	Connectors, Printed Circuit Subassembly and Accessories: Receptacle Socket Contacts, 64 or 96 Contact Positions, for Printed Wiring Boards (.100 Inch Spacing)	
MIL-DTL-55302/159	Connectors, Printed Circuit Subassembly and Accessories: Receptacle, 17, 29, 33, 41, 53 and 65 Contact Positions, for Printed Wiring Boards 2.54 mm x 1.27 mm Offset Grid, Metric	
MIL-DTL-55302/160	Connectors, Printed Circuit Subassembly and Accessories: Receptacle, 72, 84, 96 and 120 Contact Positions, for Printed Wiring Boards 2.54 mm x 1.27 mm Offset Grid, Metric	

MIL-STD-1353C
APPENDIX A

TABLE A-VIII. DLA Land and Maritime drawings and MIL-DTL-55302
descriptions and configurations - Continued.

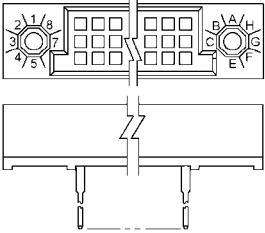
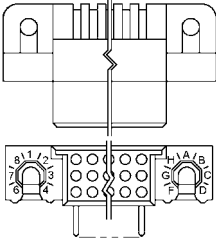
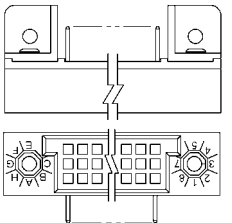
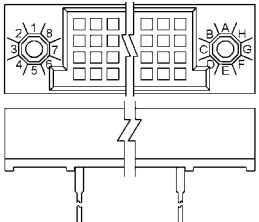
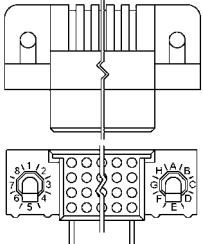
Specification/ drawing number	Description	Configuration
MIL-DTL-55302/161	Connectors, Printed Circuit Subassembly and Accessories, Receptacle, 160 Contact Positions, for Printed Wiring Boards, 2.54 mm x 1.27 mm Offset Grid, Metric	
MIL-DTL-55302/162	Connectors, Printed Circuit Subassembly and Accessories, Plug, 17, 29, 33, 41, 53, and 65 Contact Positions, for Printed Wiring Boards, 2.54 mm x 1.27 mm Offset Grid, Metric	
MIL-DTL-55302/163	Connectors, Printed Circuit Subassembly and Accessories, Plug, 72, 84, 96, and 120 Contact Positions, for Printed Wiring Boards, 2.54 mm x 1.27 mm Offset Grid, Metric	
MIL-DTL-55302/164	Connectors, Printed Circuit Subassembly and Accessories: Plug and/or Receptacle, 160 Contact Positions, for Printed Wiring Boards 2.54 mm x 1.27 mm Offset Grid, Metric	
MIL-DTL-55302/166	Connectors, Printed Circuit Subassembly and Accessories, Low Mating Force, Male Brush, Straight-through, Polarized, for Multilayered Printed Wiring Boards (.100 Inch Spacing)	
MIL-DTL-55302/167	Connectors, Printed Circuit Subassembly and Accessories: Low Mating Force, Male Brush, Straight- through, Polarized, with Wrappost Termination (.100 Spacing)	
MIL-DTL-55302/168	Connectors, Printed Circuit Subassembly and Accessories: Low Mating Force, Male Brush, Right Angle, Polarized, for Multilayered Printed Wiring Boards (.100 Spacing)	

MIL-STD-1353C
APPENDIX ATABLE A-VIII. DLA Land and Maritime drawings and MIL-DTL-55302 descriptions and configurations - Continued.

Specification/ drawing number	Description	Configuration
MIL-DTL-55302/169	Connectors, Printed Circuit Subassembly and Accessories: Low Mating Force, Female Brush, Straight-Through, Polarized, (.100 Spacing)	
MIL-DTL-55302/170	Connectors, Printed Circuit Subassembly and Accessories, Low Mating Force, Female Brush, Right Angle, Polarized, for Multilayered Printed Wiring Boards (.100 Inch Spacing)	
MIL-DTL-55302/171	Connectors, Printed Circuit Subassembly and Accessories: Low Mating Force, Contact Brush	
MIL-DTL-55302/172	Connectors, Printed Circuit Subassembly and Accessories: Hardware, Coupling and Locking	
MIL-DTL-55302/173	Connectors, Printed Circuit Subassembly and Accessories: 2-Row Pin Assemblies, 20 through 150 Contact Positions, for Printed Wiring Boards (.100 Spacing)	
MIL-DTL-55302/174	Connectors, Printed Circuit Subassembly and Accessories: 2 Row, Receptacle Assemblies, Right Angle, 20 through 150 Contact Positions, for Printed Wiring Boards (.100 Spacing)	
MIL-DTL-55302/175	Connectors, Printed Circuit Subassembly and Accessories: 2 Row, Pin Assemblies, Right Angle, 20 through 150 Contact Positions, for Printed Wiring Boards (.100 Spacing)	

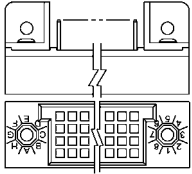
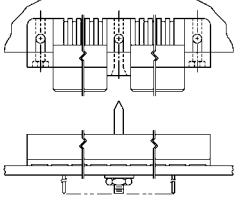
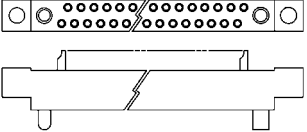
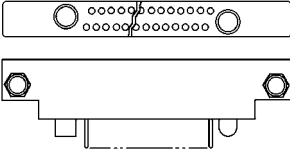
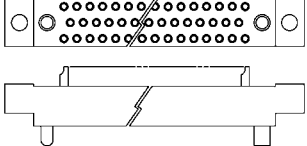
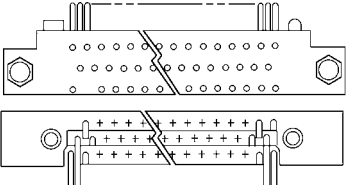
MIL-STD-1353C
APPENDIX A

TABLE A-VIII. DLA Land and Maritime drawings and MIL-DTL-55302
descriptions and configurations - Continued.

Specification/ drawing number	Description	Configuration
MIL-DTL-55302/176	Connectors, Printed Circuit Subassembly and Accessories: 3-Row Pin Assemblies, 75 through 405 Contact Positions, for Printed Wiring Boards (.100 Spacing)	
MIL-DTL-55302/177	Connectors, Printed Circuit Subassembly and Accessories: 3 Row, Receptacle Assemblies, Right Angle, 75 through 405 Contact Positions, for Printed Wiring Boards (.100 Spacing)	
MIL-DTL-55302/178	Connectors, Printed Circuit Subassembly and Accessories: 3 Row, Pin Assemblies, Right Angle, 75 through 405 Contact Positions, for Printed Wiring Boards (.100 Spacing)	
MIL-DTL-55302/179	Connectors, Printed Circuit Subassembly and Accessories: 4-Row Pin Assemblies, 100 through 684 Contact Positions, for Printed Wiring Boards (.100 Spacing)	
MIL-DTL-55302/180	Connectors, Printed Circuit Subassembly and Accessories: 4 Row, Receptacle Assemblies, Right Angle, 100 through 684 Contact Positions, for Printed Wiring Boards (.100 Spacing)	

MIL-STD-1353C
APPENDIX A

TABLE A-VIII. DLA Land and Maritime drawings and MIL-DTL-55302
descriptions and configurations - Continued.

Specification/ drawing number	Description	Configuration
MIL-DTL-55302/181	Connectors, Printed Circuit Subassembly and Accessories: 4 Row, Pin Assemblies, Right Angle, 100 through 684 Contact Positions, for Printed Wiring Boards (.100 Spacing)	
MIL-DTL-55302/182	Connectors, Printed Circuit Subassembly and Accessories: Guide Pins, Jackcrews and Mounting Ears	
MIL-DTL-55302/190	Connectors, Printed Circuit Subassembly and Accessories: Receptacle, Socket Contacts, 100 Position, Printed Wiring Boards (.075 Inch Spacing)	
MIL-DTL-55302/191	Connectors, Printed Circuit Subassembly and Accessories, Plug, Pin Contacts, 100 Position, Printed Wiring Boards (.075 Inch Spacing)	
MIL-DTL-55302/192	Connectors, Printed Circuit Subassembly and Accessories, Receptacle, Socket Contacts, 122 and 152 Position, Printed Wiring Boards (.075 Inch Spacing)	
MIL-DTL-55302/193	Connectors, Printed Circuit Subassembly and Accessories, Plug, Pin Contacts, 122 and 152 Position, Printed Wiring Boards (.075 Inch Spacing)	

MIL-STD-1353C
APPENDIX A

A.11 MIL-C-28754. MIL-C-28754 covers the general requirements for backplane connectors, module connectors, cable connectors, and their component parts. The compliant interface section of the contact consists of two bow-shaped springs. Upon insertion of the contact into the plated-through-hole in the PWB, these springs interface with the sides of the hole and resiliently flex inwards see figure A-3 and table A-IX.

A.11.1 Naval Avionics Facility Indianapolis (NAFI). NAFI was developed in the late 1960s for the US Navy for defense and aerospace applications, based on blade and tuning fork interconnection system on a .100 inch x .100 inch grid.



FIGURE A-3. Connectors, electrical, modular and component parts.

A.11.2 Intended use. These connectors and component parts are intended for use in ground support, airborne, and shipboard electrical and electronic equipment.

A.11.3 Press fit. Solderless gas tight, press-fit tuning fork contact, wire wrap termination.


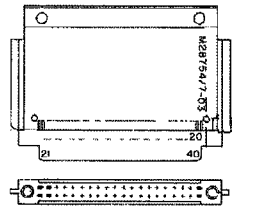

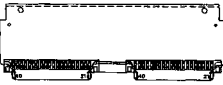
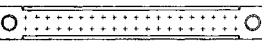

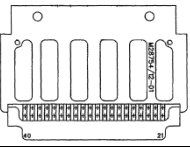
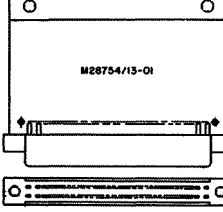


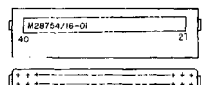
A.11.4 Connection. High reliability gas-tight connection.

A.11.5 Interface. The press-fit contact depends upon interface with the sides of the hole for retention, some abrasion and scoring of the plating is normal.

A.11.6 Compliant pin system. The compliant pin system the retention force is low (typically 100N) resulting in its consistent insertion and removal forces create minimum changes in hole characteristics, thus permitting contact removal and replacement up to three times with no sacrifice of reliability.

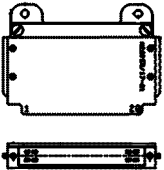

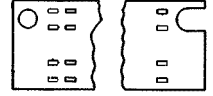

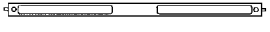


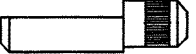

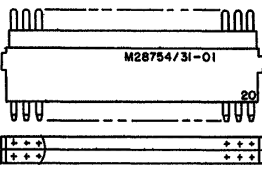
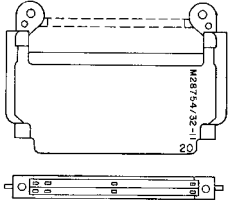
MIL-STD-1353C
APPENDIX A

TABLE A-IX. MIL-C-28754 descriptions and configurations.

Specification number	Description	Configuration
MIL-C-28754	Connectors, Electrical, Modular, and Component Parts General Specification For	
MIL-C-28754/6	Connectors, Electrical, Modular, Type IV, 40 Pin, Straight Through	
MIL-C-28754/7	Connectors, Electrical, Modular, Type IV, Single Span, Connector Assembly	
MIL-C-28754/8	Connectors, Electrical, Modular, Type IV, 40 Contact, Right Angle (For Die Cast Frame)	
MIL-C-28754/9	Connectors, Electrical, Modular, Type IV, Double Span, Connector Assembly, (Dip Frame)	
MIL-C-28754/10	Connectors, Electrical, Modular, Connector, Type IV, 40 Pin, Contact Tails On 0.050 Centers	
MIL-C-28754/11	Connectors, Electrical, Modular, Type IV, 40 Contact, Right Angle (For Solid Or Dip Frame)	
MIL-C-28754/12	Connectors, Electrical, Modular, Connector Assembly, Type IV, Single Span (For Solid State Or Dip Frame)	
MIL-C-28754/13	Connectors, Electrical, Modular, Connector Assembly, Type IV, Single Span (Without Guide Ribs)	
MIL-C-28754/14	Connectors, Electrical, Modular, Connector, Type IV, 20 Contact, Right Angle (For Die Cast Frame)	
MIL-C-28754/15	Connectors, Electrical, Modular, Crimp, Contact, Type V	
MIL-C-28754/16	Connectors, Electrical, Modular, Block, 40 Pin, Type V, Straight Through	

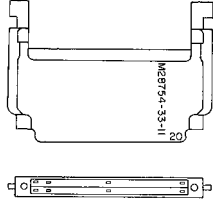
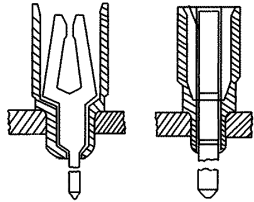
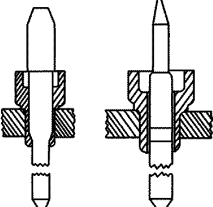
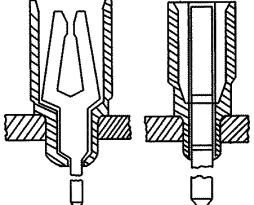
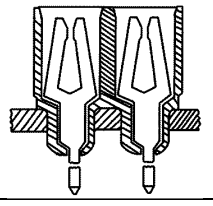
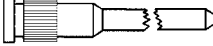
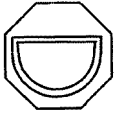
MIL-STD-1353C
APPENDIX A

TABLE A-IX. MIL-C-28754 descriptions and configurations - Continued.

Specification number	Description	Configuration
MIL-DTL-28754/17	Connectors, Electrical, Modular, Connector Assembly, Type V, Style I, Contact Tails On .100 Centers	
MIL-C-28754/18	Connectors, Electrical, Modular, Spacer, Pin, Type IV, Single Span	
MIL-C-28754/19	Connectors, Electrical, Modular, Spacer, Pin, Type IV Single Span	
MIL-C-28754/20	Connectors, Electrical, Modular, Spacer, Pin, Type IV, Double Span	
MIL-C-28754/21	Connectors, Electrical, Modular, Frame, Casting, Type IV, Double Span	
MIL-C-28754/22	Frame, Casting, Type Iv, Single Span	
MIL-C-28754/23	Connectors, Electrical, Modular, Connector Assembly, Type IV, Single Span	
MIL-C-28754/24	Connectors, Electrical, Modular, Pin, Keying	
MIL-C-28754/25	Connectors, Electrical, Modular, Guide, Retaining	
MIL-C-28754/31	Connectors, Electrical, Modular, Connector Assembly, Type V, 40-Pin, Two Piece Insert, And 20-Pin, One Half, One Piece Insert	
MIL-C-28754/32	Connectors, Electrical, Modular, Connector Assembly, Type V, Style I, Slip Lock Cover Plate	

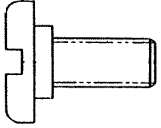
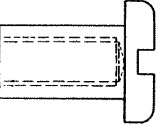
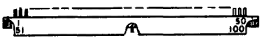

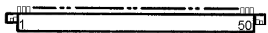

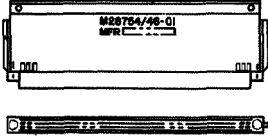

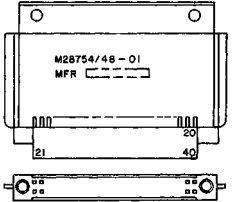
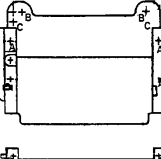
MIL-STD-1353C
APPENDIX A

TABLE A-IX. MIL-C-28754 descriptions and configurations - Continued.

Specification number	Description	Configuration
MIL-C-28754/33	Connectors, Electrical, Modular, Connector Assembly, Type V, Style II, Slip Lock Cover Plate	
MIL-C-28754/34	Connectors, Electrical, Modular, Connector Type III, Female Contact and Insulator Bushing Set, Removable Wire Wrappost Terminal	
MIL-C-28754/35	Connectors, Electrical, Modular, Connector, Type III, Male Contact and Insulator Bushing Set, Removable Wire Wrappost Terminal	
MIL-C-28754/36	Connectors, Electrical, Modular, Connector, Type III, Female Contact And Grounding Bushing Set, Removable Wire Wrappost Terminal	
MIL-C-28754/37	Connectors, Electrical, Modular, Connector, Type III, Female Contact And Polarizing Bushing Set, Removable Wire Wrappost Terminal	
MIL-C-28754/38	Connectors, Electrical, Modular, Connector, Type III, Contact, Grounding, Wrappost	
MIL-C-28754/39	Connectors, Electrical, Modular, Connector, Type III, Keying Pegs	

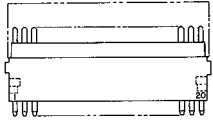
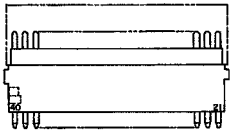
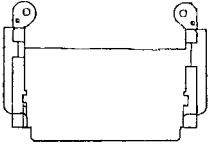
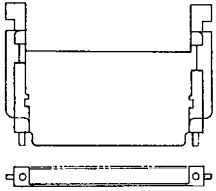
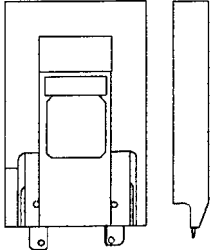
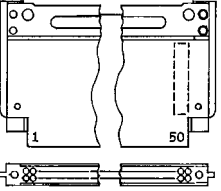
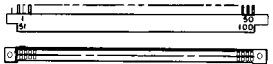
MIL-STD-1353C
APPENDIX A

TABLE A-IX. MIL-C-28754 descriptions and configurations - Continued.

Specification number	Description	Configuration
MIL-C-28754/40	Connectors, Electrical, Modular, Type IV, Connector Assembly, Screw	
MIL-C-28754/41	Connectors, Electrical, Modular, Type IV, Connector Assembly, Screw, Insert	
MIL-C-28754/42	Connectors, Electrical, Modular, Type IV, Connector, 100 Pin, Offset Contact Tails On .050 Centers	
MIL-C-28754/43	Connectors, Electrical, Modular, Connector Assembly, Type IV, 100 Pin, Double Span, Contact Tails On .050 Centers	
MIL-C-28754/44	Connectors, Electrical, Modular, Type IV, 100 Pin, Straight Through, Contact Tails On, .100 Centers	
MIL-C-28754/45	Connectors, Electrical, Modular, Connector Frame, Type IV, Double Span	
MIL-C-28754/46	Connectors, Electrical, Modular, Connector Assembly, Type IV, 100 Pin, Double Span	
MIL-C-28754/47	Connectors, Electrical, Modular, Type IV, Connector Assembly, Single Span	
MIL-C-28754/48	Connectors, Electrical, Modular, Housing	
MIL-C-28754/49	Connectors, Electrical, Modular, Housing	

MIL-STD-1353C
APPENDIX A

TABLE A-IX. MIL-C-28754 descriptions and configurations - Continued.

Specification number	Description	Configuration
MIL-C-28754/50	Connectors, Electrical, Modular, Insert, Top	
MIL-C-28754/51	Connectors, Electrical, Modular, Insert, Top	
MIL-C-28754/52	Connectors, Electrical, Modular, Housing, Connector Assembly, Style I	
MIL-C-28754/53	Connectors, Electrical, Modular, Housing, Connector Assembly, Style II	
MIL-C-28754/54	Connectors, Electrical, Modular, Extractor, Module, Single and Double Span, Styles I And II	
MIL-C-28754/55	Connectors, Electrical, Modular, Connector Assembly, Type V, Cable Connector, 100 Pin, Contacts On .100 Centers	
MIL-C-28754/56	Connectors, Electrical, Modular, Type IV, Connector, 100 Pin, Offset Contact Tails On .050 Centers (Ceramic Compatible)	

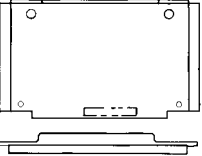
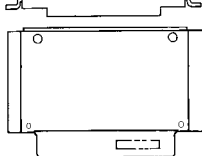


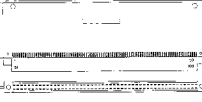
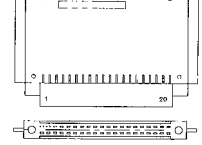
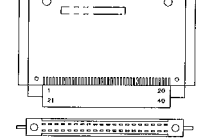
MIL-STD-1353C
APPENDIX A

TABLE A-IX. MIL-C-28754 descriptions and configurations - Continued.

Specification number	Description	Configuration
MIL-C-28754/57	Connectors, Electrical, Modular, Type IV, Connector, 100 Pin, Offset Contact Tails On .050 Centers (Modified Frame, Ceramic Compatible)	
MIL-C-28754/58	Connectors, Electrical, Modular, Type IV, Connector, 100 Pin, Offset Contact Tails On .050 Centers (Modified Frame)	
MIL-C-28754/59	Connectors, Electrical, Modular, Type IV, Connector, 100 Pin, Center Contact Tails On .100 Centers (Ceramic Compatible)	
MIL-C-28754/60	Connectors, Electrical, Modular, Type IV, Connector, 100 Pin, Center Contact Tails On .100 Centers	
MIL-C-28754/61	Connectors, Electrical, Modular, Type IV, Connector, 100 Pin, Center Crossover, Contact Tails On .050 Centers	
MIL-C-28754/62	Connectors, Electrical, Modular, Type IV, Connector, 100 Pin, Center Crossover, Contact Tails On .050 Centers	
MIL-C-28754/63	Connectors, Electrical, Modular, Type IV, Connector, 40 Pin, Offset, Contact Tails On .050 Centers (Ceramic Compatible)	
MIL-C-28754/64	Connectors, Electrical, Modular, Type IV, Connector, 40 Pin, Offset, Contact Tails On .050 Centers (Modified Frame, Ceramic Compatible)	
MIL-C-28754/65	Connectors, Electrical, Modular, Type IV, Connector, 40 Pin, Center Contact Tails On .100 Centers (Ceramic Compatible)	
MIL-C-28754/66	Connectors, Electrical, Modular, Type IV, Connector, 40 Pin, Crossover, Contact Tails On .050 Centers (Ceramic Compatible)	
MIL-C-28754/67	Connectors, Electrical, Modular, Connector Frame, Type IV, Double Span, Center	
MIL-C-28754/68	Connectors, Electrical, Modular, Connector Frame, Type IV, Double Span, T-Dip	

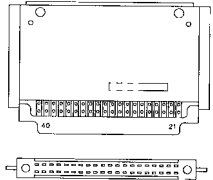
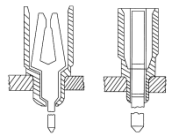
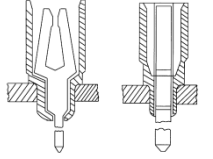
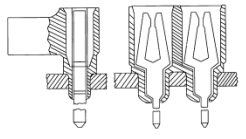
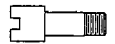

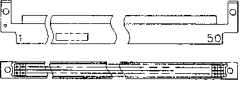



MIL-STD-1353C
APPENDIX A

TABLE A-IX. MIL-C-28754 descriptions and configurations - Continued.

Specification number	Description	Configuration
MIL-C-28754/69	Connectors, Electrical, Modular, Connector Frame, Type IV Double Span, Offset	
MIL-C-28754/70	Connectors, Electrical, Modular, Connector Frame, Type IV, Single Span, Center	
MIL-C-28754/71	Connectors, Electrical, Modular, Connector Frame, Type IV, Single Span, Offset	
MIL-C-28754/72	Connectors, Electrical, Modular, Connector Frame, Type IV, Single Span, T-Dip	
MIL-C-28754/73	Connectors, Electrical, Modular, Connector Assembly, Type IV, 100 Contact, Double Span, Dip	
MIL-C-28754/74	Connectors, Electrical, Modular, Connector Assembly, Type IV, 100 Contact, Double Span, Center	
MIL-C-28754/75	Connectors, Electrical, Modular, Connector Assembly, Type IV, 100 Contact, Double Span, Offset	
MIL-C-28754/76	Connectors, Electrical, Modular, Connector Assembly, Type IV, 40 Contact, Single Span, Center	
MIL-C-28754/77	Connectors, Electrical, Modular, Connector Assembly, Type IV, 40 Contact, Single Span, Offset	

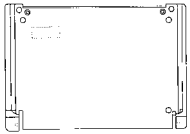



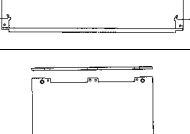
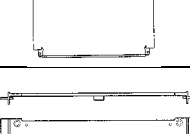
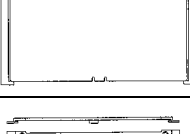
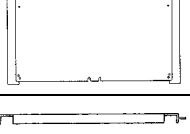
MIL-STD-1353C
APPENDIX A

TABLE A-IX. MIL-C-28754 descriptions and configurations - Continued.

Specification number	Description	Configuration
MIL-C-28754/78	Connectors, Electrical, Modular, Connector Assembly, Type IV, 40 Contact, Single Span, Dual Inline Package (Dip)	
MIL-C-28754/79	Connectors, Electrical, Modular, Type III, Female Contact And Insulator Bushing Set, Low Insertion Force (LIF), Removable Wire Wrappost Terminal	
MIL-C-28754/80	Connectors, Electrical, Modular, Type III, Female Contact and Polarizing Bushing Set, Low Insertion Force (LIF), Removable Wire Wrappost Terminal	
MIL-C-28754/81	Connectors, Electrical, Modular, Type III, Female Contact and Polarizing Bushing Set, Low Insertion Force (LIF), Removable Wire Wrappost Terminal	
MIL-C-28754/82	Connectors, Electrical, Modular, Type IV, Connector Assembly, Fastener	
MIL-C-28754/83	Connectors, Electrical, Modular, Type IV, Connector, 0.6 Pitch, 250 Contact, Center	
MIL-C-28754/84	Connectors, Electrical, Modular, Type IV, Connector, 0.3 Pitch, 100 Contact, Offset	
MIL-C-28754/85	Connectors, Electrical, Modular, Type IV, Connector, 0.3 Pitch, 100 Contact, Dual Inline Package (Dip)	
MIL-C-28754/86	Connectors, Electrical, Modular, Connector Frame, Type IV, Dual Inline Package (Dip)	
MIL-C-28754/87	Connectors, Electrical, Modular, Connector Frame, Type IV, Center	

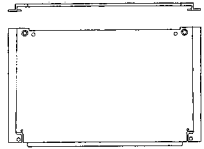

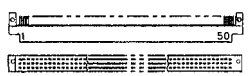
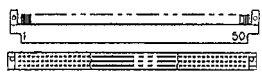
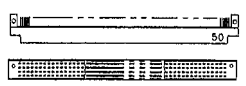
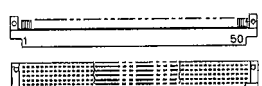
MIL-STD-1353C
APPENDIX A

TABLE A-IX. MIL-C-28754 descriptions and configurations - Continued.

Specification number	Description	Configuration
MIL-C-28754/88	Frame, Type IV, Offset, (0.050 Thickness)	
MIL-C-28754/89	Connectors, Electrical, Modular, Connector Frame, Type IV, Offset, (0.071 Thickness)	
MIL-C-28754/90	Connectors, Electrical, Modular, Connector Frame, Type IV, Center Fin, 0.4 Pitch, Format C	
MIL-C-28754/91	Connectors, Electrical, Modular, Connector Frame, Type IV, Center Fin, 0.5 Pitch, Format C And E	
MIL-C-28754/92	Connectors, Electrical, Modular, Connector Frame, Type IV, Center Fin, 0.6 Pitch, Format C And E	
MIL-C-28754/93	Connectors, Electrical, Modular, Connector Frame, Type IV, Dip, 0.3 Pitch, Format C	
MIL-C-28754/94	Connectors, Electrical, Modular, Connector Frame, Type IV, Dip, 0.4 Pitch, Format C, D And E	
MIL-C-28754/95	Connectors, Electrical, Modular, Connector Frame, Type IV, Offset Fin, 0.3 Pitch, Format C	

MIL-STD-1353C
APPENDIX A

TABLE A-IX. MIL-C-28754 descriptions and configurations - Continued.

Specification number	Description	Configuration
MIL-C-28754/96	Connectors, Electrical, Modular, Connector Frame, Type IV, Offset Fin, 0.4 Pitch, Format C And E	
MIL-C-28754/97	Connectors, Electrical, Modular, Type IV, Connector, 150 Contact, Right Angle, Contact Tails On 0.100 Centers	
MIL-C-28754/98	Connectors, Electrical, Modular, Type IV, Connector, 150 Contact, Center, Contact Tails On 0.100 Centers	
MIL-C-28754/99	Connectors, Electrical, Modular, Type IV, Connector, 150 Contact, Offset	
MIL-C-28754/100	Connectors, Electrical, Modular, Type IV, Connector, 200 Contact, Center	
MIL-C-28754/101	Connectors, Electrical, Modular, Type IV, Connector, 0.6 Pitch, 250 Contact, Center	

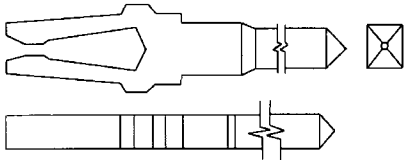
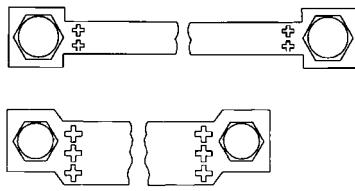
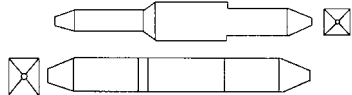
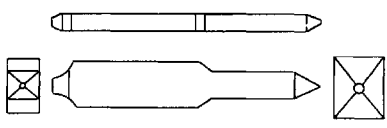
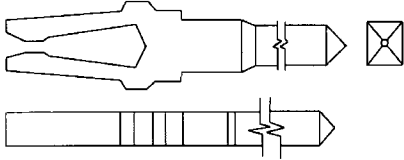
MIL-STD-1353C
APPENDIX A

A.12 MIL-C-28859. MIL-C-28859 connector Component Parts, Electrical Backplane, Printed Wiring. This specification covers the general requirements for printed-wiring electrical backplane connector component parts using a compliant feature, see table A-X.

A12.2 Intended use. These backplane connectors are intended for use to ground support, airborne and shipboard equipment.

A12.3 Connector component parts. Connector component parts consist of compliant female contacts, feed-thru pins, insulators, polarization pins, and bushings for press-fit printed wiring board applications.

TABLE A-X. MIL-C-28859 descriptions and configurations.

Specification number	Description	Configuration
MIL-C-28859	Connector Component Parts, Electrical Backplane, Printed-Wiring, General Specification For	
MIL-C-28859/1	Connector, Component Parts, Electrical Backplane, Printed Wiring, Standard Insertion Force, Compliant Contact	
MIL-C-28859/2	Connector, Component Parts, Electrical Backplane, Printed Wiring, Housing	
MIL-C-28859/3	Connector, Component Parts, Electrical Backplane, Printed Wiring, Compliant Contact, Feed-Through	
MIL-C-28859/4	Connector, Component Parts, Electrical Backplane, Printed Wiring, Compliant Contact, Feed-To	
MIL-C-28859/5	Connector, Component Parts, Electrical Backplane, Printed Wiring, Low Insertion Force (LIF), Compliant Contact	

MIL-STD-1353C
APPENDIX A

A.13 MIL-DTL-32234 and DLA Land and Maritime drawings UHD connectors. UHD connectors are backplane connectors that make use of compliant press-fit tuning fork contacts for a solderless, gas tight interface with the printed circuit panel. The UHD tuning fork is a downsized version of the standard MIL-C-28859 NAFI tuning fork, see figure A-4 and table A-XI.

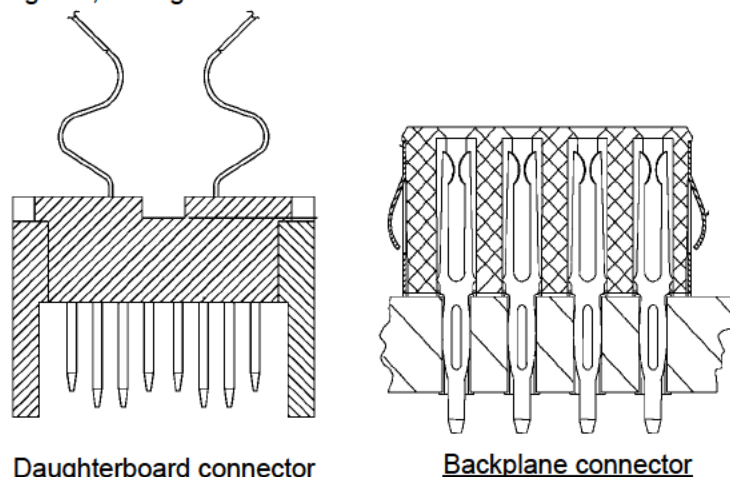


FIGURE A-4. Section view of daughterboard and backplane connectors.

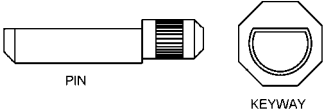
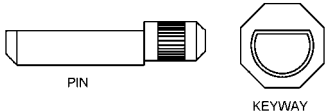
A.13.1 Intended applications. Recommended for applications such as avionics, satellite/space, shipboard, missile, and munitions. The system combines two elements: daughterboard connectors and mating backplane assemblies.

A.13.2 DLA Land and Maritime drawings and specifications. The DLA Land and Maritime drawings are for application specific applications they contain a mix of, signal, fiber optic, power contacts, and safety ground. The Defense specifications have signal contacts only.

TABLE A-XI. DLA Land and Maritime drawings and MIL-DTL-32234 descriptions and configurations.

Specification/drawing number	Description
89065	General Specification For High Performance, High Density, Two Piece Printed Circuit Board Connector
93002	Connector, High Density, Blade and Fork, Daughter Board, Eight Row, 372 Contact Positions
93003	Connector, High Density, Blade and Fork, Backpanel, Eight Row, 372 Contact Positions
93004	Connector, High Density, Blade and Fork, Daughter Board, Eight Row, 300 Contact, 8 Fiber Optic Positions
93005	Connector, High Density, Blade and Fork, Backpanel, Eight Row, 300 Contact, 8 Fiber Optic Positions
93006	Connector, High Density, Blade and Fork, Daughter Board, Eight Row, 296 Contact, 2 Power Positions
93007	Connector, High Density, Blade and Fork, Backpanel, Eight Row, 296 Contact Positions
93008	Connector, High Density, Blade and Fork, Daughter Board, Eight Row, 356 Contact, With Safety Ground

MIL-STD-1353C
APPENDIX ATABLE A-XI. DLA Land and Maritime drawings and MIL-DTL-32234 descriptions and configurations - Continued.

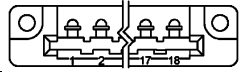
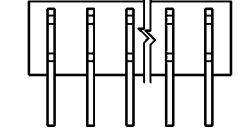


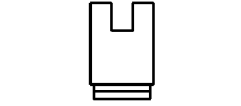
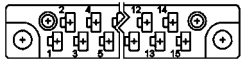

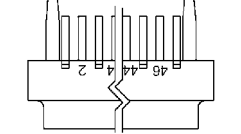
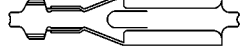

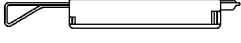
Specification/drawing number	Description	
93009	Connector, High Density, Blade and Fork, Backpanel, Eight Row, 356 Contact, With Safety Ground	
93010	Connector, High Density, Blade and Fork, Daughter Board, Eight Row, 284 Contact, 8 Fiber Optic And Safety Ground	
93011	Connector, High Density, Blade and Fork, Backpanel, Eight Row, 284 Contact, 8 Fiber Optic And Safety Ground	
93012	Connector, High Density, Blade and Fork, Daughter Board, Eight Row, 280 Contact, 2 Power Positions	
93013	Connector, High Density, Blade and Fork, Backpanel, Eight Row, 280 Contact, 2 Power Positions, With Safety Ground	
02007	Connector, High Density, Blade and Fork, Backpanel, Eight Row, 396 Contact Positions	
03023	Connector, High Density, Blade And Fork, Daughter Board, Eight Row, 396 Contact Positions	
04023	Connector, High Density, Keying Pin And Bushing	
04027	Connector, High Density, Blade and Fork, Daughter Board, Eight Rows, 452 Contact Positions	
04028	Connector, High Density, Blade and Fork, Backpanel, Eight Row, 452 Contact Positions	
MIL-DTL-32234	Connectors, Electrical, Ultra High Density, Modular, Blade and Fork, Eight Row, General Specification For	
MIL-DTL-32234/1	Connector, Electrical, Ultra High Density, Modular, Blade and Fork, Backpanel, Eight Row, 192 Pins	
MIL-DTL-32234/2	Connector, Electrical, Ultra High Density, Modular, Blade and Fork, Daughter Board, Eight Row, 192 Contact Positions	
MIL-DTL-32234/3	Connector, Electrical, Ultra High Density, Modular, Blade and Fork, Backpanel, EMI/RFI Shielding, Eight Row, 196 Pins	
MIL-DTL-32234/4	Connector, Electrical, Ultra High Density, Modular, Blade and Fork, Daughter Board, Eight Row, 196 Contact Positions	
MIL-DTL-32234/5	Connector, Electrical, Ultra High Density, Modular, Blade and Fork, Backpanel, Eight Row, 372 Pins	
MIL-DTL-32234/6	Connector, Electrical, Ultra High Density, Modular, Blade and Fork, Daughter Board, Eight Row, 372 Contact Positions	
MIL-DTL-32234/7	Connector, Electrical, Ultra High Density, Modular, Blade and Fork, Backpanel, Eight Row, 396 Pins	
MIL-DTL-32234/8	Connector, Electrical, Ultra High Density, Modular, Blade and Fork, Daughter Board, Eight Row, 396 Contact Positions	
MIL-DTL-32234/9	Connector, Electrical, Ultra High Density, Modular, Keying Pins and Bushings	

MIL-STD-1353C
APPENDIX A

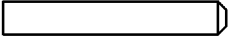

A.14 MIL-DTL-21097. MIL-DTL-21097 for 1/16, 3/32, and 1/8 inch printed wiring boards, and for interconnections between printed wiring boards. The connectors are intended to provide a reliable connection between printed wiring and conventional wiring, see table A-XII.

A.14.1 Intended use. The interconnector concept is intended to provide connection of printed wiring on one board to printed wiring on another board. For use in, ground support and shipboard electrical and electronic equipment.

TABLE A-XII. MIL-DTL-21097 descriptions and configurations.

Specification number	Description	Configuration
MIL-DTL-21097	Connectors, Electrical, Printed Wiring Board, General Purpose General Specification For	
MIL-DTL-21097/2	Connectors, Electrical, Printed Wiring Board Composite, Receptacle, Contact Spacing (.200) Single Row, Type CR	
MIL-DTL-21097/3	Connectors, Electrical, Printed Wiring Board Composite, Adapter, Contact Spacing (.200) Individual Contacts, Type CS	
MIL-DTL-21097/4	Connectors, Electrical, Printed Wiring Board Composite, Receptacle, Contact Spacing (.200) Alternate Dual Row, Type CR	
MIL-DTL-21097/5	Connectors, Electrical, Printed Wiring Board Male Adapter, Contact Spacing (.200) Alternate Dual Row, Type CS	
MIL-DTL-21097/11	Connectors, Electrical, Printed Wiring Board Keys, Polarizing	
MIL-DTL-21097/13	Connectors, Electrical, Printed Wiring Board Composite, Receptacle, Contact Spacing: 0.200, Alternate Dual Row, Type CR, Removable Contact	
MIL-DTL-21097/14	Connectors, Electrical, Printed Wiring Board Male Adapter, Contact Spacing: 0.200, Alternate Dual Row, Type Cs, Blade Contact (Mounting Provision A)	
MIL-DTL-21097/15	Connectors, Electrical, Printed Wiring Board Male Adapter, Contact Spacing: 0.200, Alternate Dual Row, Type Cs, Blade Contact (No Mounting Provision)	
MIL-DTL-21097/16	Connectors, Electrical, Printed Wiring Board Contact, Crimp, Removable, Type CR	
MIL-DTL-21097/17	Connectors, Electrical, Printed Wiring Board Contact, Solder, Removable, Type CR	
MIL-DTL-21097/18	Connectors, Electrical, Printed Wiring Board Tool, Contact, Removal, For Type CR Connector Contacts	

MIL-STD-1353C
APPENDIX ATABLE A-XII. MIL-DTL-21097 descriptions and configurations - Continued.

Specification number	Description	Configuration
MIL-DTL-21097/19	Connectors, Electrical, Printed Wiring Board Blade Simulator For Measuring Engagement and Separation Forces For Type CR Contacts	
MIL-DTL-21097/21	Connectors, Electrical, Printed Wiring Board Receptacle, Card Insertion, Contact Spacing (.156), Types A and AD	

MIL-STD-1353C
APPENDIX A

A.15 MIL-DTL-24308. These connectors are for nonenvironmental, polarized shell, miniature, rack and panel connectors having pin and socket, crimp (removable), solder (nonremovable), or insulation displacement (nonremovable) contacts with rigid or float mounting, see figure A-6, table A-XIII and table A-XIV for termination types and positions available.

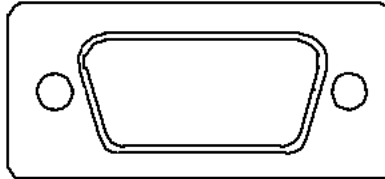


FIGURE A-6. General configuration.

A.15.1 Intended use. Classes G and N connectors are intended for use in applications where the operating temperature range -55°C to $+125^{\circ}\text{C}$ is experienced. Crimp contact connectors have the additional advantage of possessing removable crimp-type contacts. Contacts solder or crimp. Contact sizes 20 or 22D.

A.15.2 Class N connectors. Class N connectors are intended for use in applications where the presence of residual magnetism must be held to very low levels to avoid interference with nearby sensitive instrumentation. Contacts solder or crimp. Contact sizes 20 or 22D. Temperature range -55°C to $+125^{\circ}\text{C}$.

A.15.3 Class H receptacles. Class H receptacles are intended for use in applications where atmospheric pressures must be contained by the connectors across the wall or panels on which they are mounted. If air leakage requirements are critical, a class H connector should be used. Contact solder. Contact size 20. Temperature range -55°C to $+125^{\circ}\text{C}$.

A.15.4 Crimp contact connectors. Crimp contact connectors should have contacts present in all positions when the connector is installed.

A.15.5 Classes D, K, and M. Classes D, K, and M connectors are for high reliability space applications.

A.15.6 Installation design. Connector installations should be designed to assure that connectors are mated within the limits specified in figure A-7.

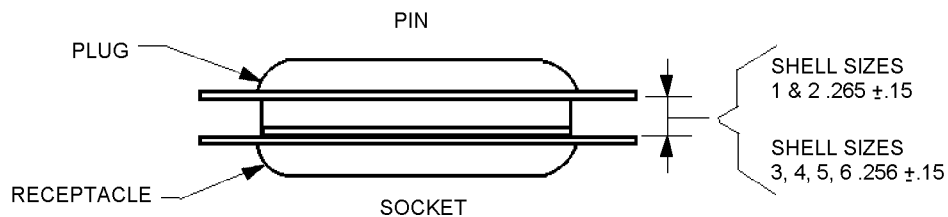
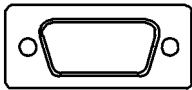
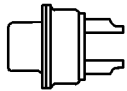

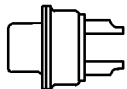

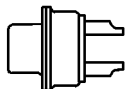

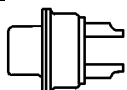

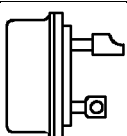
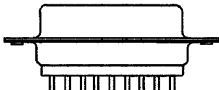
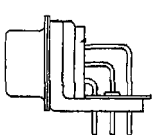


FIGURE A-7 Mating limits.

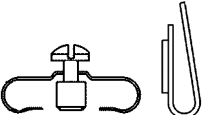
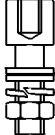


MIL-STD-1353C
APPENDIX A

TABLE A-XIII. MIL-DTL-24308 descriptions and configurations.

Specification/drawing number	Description	Configuration
MIL-DTL-24308	Connectors, Electric, Rectangular, Nonenvironmental, Miniature, Polarized Shell, Rack And Panel, General Specification For	
MIL-DTL-24308/1	Connectors, Electric, Rectangular, Miniature, Polarized Shell, Rack and Panel, Receptacle, Socket Contacts, General Purpose, Class D and G, Solder Type	
MIL-DTL-24308/2	Connectors, Electric, Rectangular, Miniature, Polarized Shell, Rack and Panel, Receptacle, Socket Contacts, General Purpose, Class D and G, Crimp Type	
MIL-DTL-24308/3	Connectors, Electric, Rectangular, Miniature, Polarized Shell, Rack and Panel, Pin Contacts, General Purpose, Class D and G, Solder Type	
MIL-DTL-24308/4	Connectors, Electric, Rectangular, Miniature, Polarized Shell, Rack and Panel, Pin Contacts, General Purpose, Class D and G, Crimp Type	
MIL-DTL-24308/5	Connectors, Electric, Rectangular, Miniature, Polarized Shell, Rack and Panel, Receptacle, Socket Contacts, Nonmagnetic, Class M and N, Solder Type	
MIL-DTL-24308/6	Connectors, Electric, Rectangular, Miniature, Polarized Shell, Rack and Panel, Receptacle Socket Contacts, Nonmagnetic, Classes M and N, Crimp Type	
MIL-DTL-24308/7	Connectors, Electric, Rectangular, Miniature, Polarized Shell, Rack and Panel, Pin Contacts, Nonmagnetic, Classes M and N, Solder Type	
MIL-DTL-24308/8	Connectors, Electric, Rectangular, Miniature, Polarized Shell, Rack and Panel, Pin Contacts, Nonmagnetic, Class M and N, Crimp Type	
MIL-DTL-24308/9	Connectors, Electric, Rectangular, Miniature, Polarized Shell, Rack and Panel, Plug, Pin Contacts, Hermetic, Classes H And K	
MIL-DTL-24308/23	Connectors, Electric, Rectangular, Nonenvironmental, Miniature, Polarized Shell, Rack and Panel, Socket Contacts Printed Wiring Board Termination Types	
MIL-DTL-24308/24	Connectors, Electric, Rectangular, Nonenvironmental, Miniature, Polarized Shell, Rack and Panel, Pin Contacts Printed Wiring Board Termination Types	

MIL-STD-1353C
APPENDIX A

TABLE A-XIII. MIL-DTL-24308 descriptions and configurations - Continued.

MIL-DTL-24308/25	Connectors, Electric, Rectangular, Miniature, Polarized Shell, Rack And Panel, Screw-Lock Assembly, Male	
MIL-DTL-24308/26	Connectors, Electric, Rectangular, Miniature, Polarized Shell, Rack and Panel, Screw-Lock Assembly, Female	
MIL-DTL-24308/27	Connectors, Electric, Rectangular, Miniature, Polarized Shell, Rack and Panel, Insulation Displacement, Socket Contacts, Nonenvironmental	
MIL-DTL-24308/28	Connectors, Electric, Rectangular, Miniature, Polarized Shell, Rack And Panel, Insulation Displacement, Pin Contacts, Nonenvironmental, Class G	

MIL-STD-1353C
APPENDIX A

TABLE A-XIV. MIL-DTL-24308 termination types and positions available.

Specification sheet	Class	Mounting method	Contact type	Termination type	Contact size	Positions available
MIL-DTL-24308/1	D, G	Panel	Socket	Solder cup <u>1/</u>	20 22D	9,15, 25, 37, 50 none
MIL-DTL-24308/2	D, G	Panel	Socket	Crimp	20 & 22D	9,15, 25, 37, 50 15, 26, 44, 62, 78, 104
MIL-DTL-24308/3	D, G	Panel	Pin	Solder cup <u>1/</u>	20 22D	9,15, 25, 37, 50 none
MIL-DTL-24308/4	D, G	Panel	Pin	Crimp	20 & 22D	9,15, 25, 37, 50 15, 26, 44, 62, 78, 104
MIL-DTL-24308/5	M, N	Panel	Socket	Solder cup <u>1/</u>	20 22D	9,15, 25, 37, 50 none
MIL-DTL-24308/6	M, N	Panel	Socket	Crimp	20 & 22D	9,15, 25, 37, 50 15, 26, 44, 62, 78, 104
MIL-DTL-24308/7	M, N	Panel	Pin	Solder cup <u>1/</u>	20 22D	9,15, 25, 37, 50 none
Specification sheet	Class	Mounting method	Contact type	Termination type	Contact size	Positions available
MIL-DTL-24308/8	M, N	Panel	Pin	Crimp	20 & 22D	9,15, 25, 37, 50 15, 26, 44, 62, 78, 104
MIL-DTL-24308/9	H, K	Panel	Pin	Solder cup, eyelet <u>1/</u>	20 22D	9,15, 25, 37, 50 none
MIL-DTL-24308/23	G	PCB	Socket	Straight, right angle	20 & 22D	9,15, 25, 37, 50 15, 26, 44, 62, 78
MIL-DTL-24308/24	G	PCB	Pin	Straight, right angle	20 & 22D	9,15, 25, 37, 50 15, 26, 44, 62, 78
MIL-DTL-24308/25	Male screw lock					
MIL-DTL-24308/26	Female screw lock					
MIL-DTL-24308/27	G	Panel	Socket	IDC	20 & 22D	9,15, 25, 37
MIL-DTL-24308/28	G	Panel	Pin	IDC	20 & 22D	9,15, 25, 37

1/ Reference appendix in MIL-DTL-24308.

MIL-STD-1353C
APPENDIX A

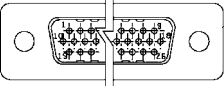
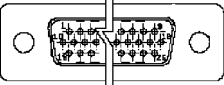
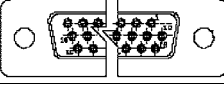
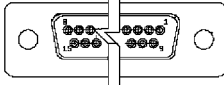
A.15.7 Accessories. DLA Land and Maritime drawings and MIL-DTL-24308 shells see table A-XV, insert arrangements and accessories are shown in [table A-XVI](#).

A.15.8 Design documentation. The design documentation in is accordance with MIL-DTL-24308 and GSFC-S-311-P-4 (Goddard Space Flight Center - GSFC).

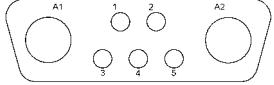
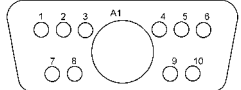
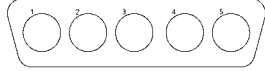
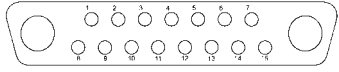
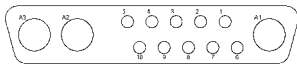
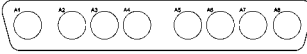
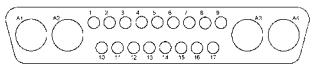
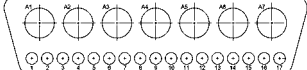
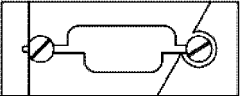
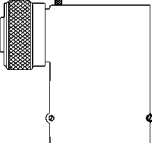
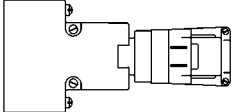
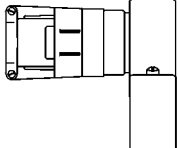
A.15.9 Material plating. All material and plating in accordance with MIL-DTL-24308 and GSFC-S-311-P-4.

A.15.10 Type-D Subminiature. Type-D Subminiature feed through based on MIL-DTL-24308 specifications for pin arrangements; identified by a "D" or keystone shape.

TABLE A-XV. DLA Land and maritime MIL-DTL-24308 types, descriptions, and configurations.

DLA Land and Maritime drawing number	Description	Configuration
98023	Connectors, Electrical, Rectangular, Nonenviornmental, Miniature, One Piece Nonmagnetic, Polarized Shell, General Specification For	
99012	Connectors, Electrical, Rectangular, Nonenviornmental, Miniature, Polarized Shell, Size 22 Pin	
99013	Connectors, Electrical, Rectangular, Nonenviornmental, Miniature, Polarized Shell, Size 20 Pin	
99014	Connectors, Electrical, Rectangular, Nonenviornmental, Miniature, Polarized Shell, Size 22 Socket	
99015	Connectors, Electrical, Rectangular, Nonenviornmental, Miniature, Polarized Shell, Size 20 Socket	

MIL-STD-1353C
APPENDIX ATABLE A-XVI. DLA Land and Maritime drawings accessories for MIL-DTL-24308.

DLA Land and Maritime drawing number	Description	Configuration
85039	Connectors, Electrical, Rack and Panel, Miniature, General Specification For	
85040	Connector, Electrical, Insert Arrangement, Miniature, Five Size 20 Signal Contacts, With Two Size 8 Contact Cavities	
85041	Connector, Electrical, Insert Arrangement, Miniature, Ten Size 20 Signal Contacts, with One Size 8 Contact Cavity	
85043	Connector, Electrical, Insert Arrangement, Miniature, Five Size 8 Contact Cavities	
85044	Connector, Electrical, Insert Arrangement, Miniature, Fifteen Size 20 Signal Contacts, With Two Size 8 Contact Cavities	
85045	Connector, Electrical, Insert Arrangement, Miniature, Ten Size 20 Signal Contacts, With Three Size 8 Contact Cavities	
85047	Connector, Electrical, Insert Arrangement, Miniature, Eight Size 8 Contact Cavities	
85048	Connector, Electrical, Insert Arrangement, Miniature, Seventeen Size 20 Signal Contacts, With Four Size 8 Contact Cavities	
85054	Connector, Electrical, Insert Arrangement, Miniature, Seventeen Size 20 Signal Contacts, With Seven Size 8 Contact Cavities	
86062	Connector, Electrical, Miniature, Retainer, Sliding Lock. Accessory for MIL-DTL-24308 subminiature rectangular connector.	
89107	Connector, Accessories, Electrical, Backshell, Environmental, EMI/RFI 90 Degrees End Entry, Category 2B, for MIL-DTL-24308 Connectors	
89108	Connector, Accessories, Electrical, Backshell, Environmental, Straight Entry, 2B for MIL-DTL-24308 Connectors	
89109	Connector, Accessories, Electrical, Backshell, Environmental, EMI/RFI 90 Degrees, Side Entry, Category 2B, for MIL-DTL-24308 Connectors	

MIL-STD-1353C
APPENDIX A

A.16 MIL-DTL-32139. MIL-DTL-32139 covers the detail requirements for nanominiature connectors terminated on printed circuit boards or attached to cable assemblies. The connector contacts are densely packed with .025 (.064 mm) inch spacing between contact centers in the same row. These connectors are intended for use in assemblies requiring very densely packaged electronic components, and are commonly used in digital applications, see figure A-8 and table A-XVII.

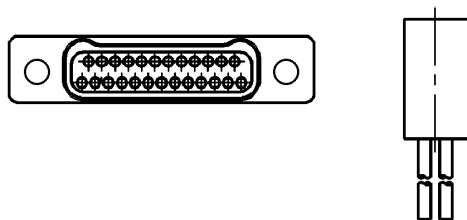


FIGURE A- 8. General configuration nano connector dual row.

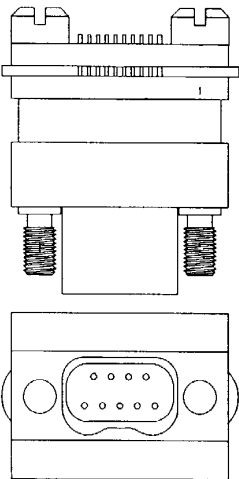
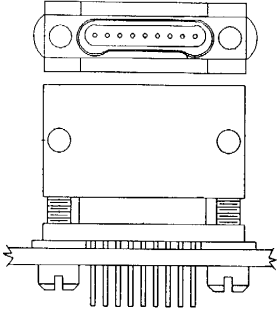
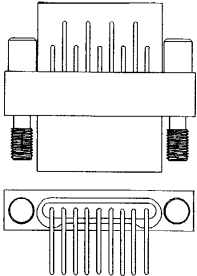
A.16.1 Intended use. These connectors are intended for use for interconnections on printed wiring board, printed wiring board to cable, cable to panel, or cable to cable on miniaturized equipment sub-assemblies with low power requirements.

TABLE A-XVII. MIL-DTL-32139 and DLA Land and Maritime drawings nano connectors descriptions and configurations.

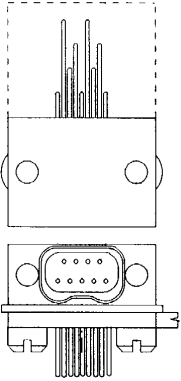
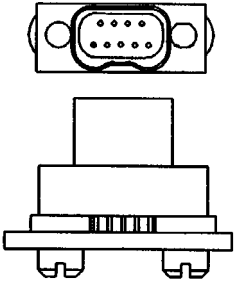
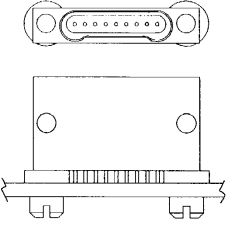
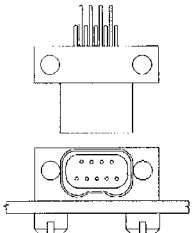
Specification/ DLA Land and Maritime drawing number	Description	Configuration
91026	Connectors, Electrical, Rectangular, Polarized Shell, High Density, Nanominiature, General Requirements for	
94031	Connectors, Electrical, Rectangular, High Density Nanominiature, Lobe Keyed, General Requirements For	
94032	Connectors, Electrical, Rectangular, High Density Nanominiature, Lobe Keyed, Plug, Wire/Harness Terminated	
94033	Connectors, Electrical, Rectangular, High Density Nanominiature, Lobe Keyed, Receptacle, Wire/Harness Terminated	

MIL-STD-1353C
APPENDIX A

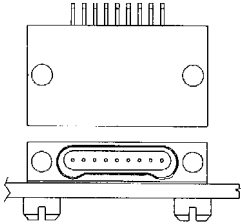
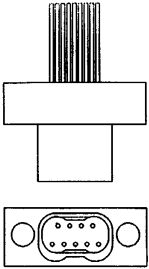
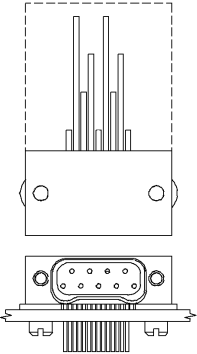
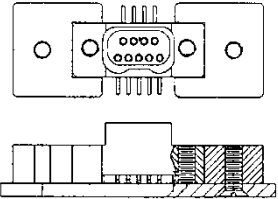
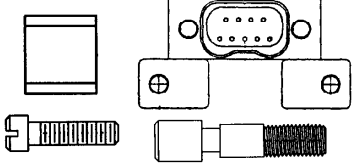
TABLE A-XVII. MIL-DTL-32139 and DLA Land and Maritime drawings
nano connectors descriptions and configurations - Continued.

Specification/ DLA Land and Maritime drawing number	Description	Configuration
94034	Connectors, Electrical, Rectangular, High Density Nanominiature, Lobe Keyed, Plug, Vertical, Through Hole Terminated	
94035	Connectors, Electrical, Rectangular, High Density Nanominiature, Lobe Keyed, Receptacle, Vertical, Through Hole Terminated	
94036	Connectors, Electrical, Rectangular, High Density Nanominiature, Lobe Keyed, Plug, Right Angle, Through Hole Terminated	

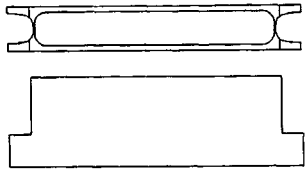
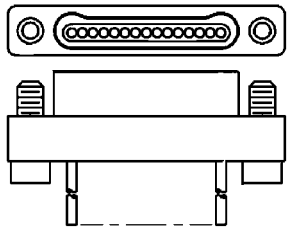
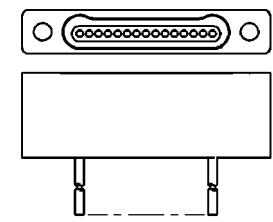
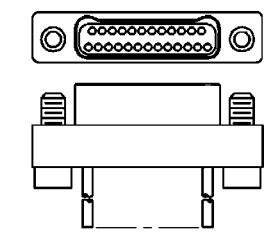
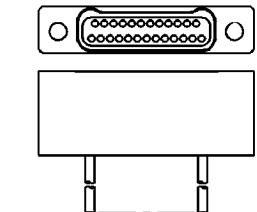
MIL-STD-1353C
APPENDIX ATABLE A-XVII. MIL-DTL-32139 and DLA Land and Maritime drawings
nano connectors descriptions and configurations - Continued.

Specification/ DLA Land and Maritime drawing number	Description	Configuration
94037	Connectors, Electrical, Rectangular, High Density Nanominiature, Lobe Keyed, Receptacle, Right Angle, Through Hole Terminated	
94038	Connectors, Electrical, Rectangular, High Density Nanominiature, Lobe Keyed, Plug, Vertical, Surface Mount Terminated	
94039	Connectors, Electrical, Rectangular, High Density Nanominiature, Lobe Keyed, Receptacle, Vertical, Surface Mount Terminated	
94040	Connectors, Electrical, Rectangular, High Density Nanominiature, Lobe Keyed, Plug, Right Angle, Surface Mount Terminated	

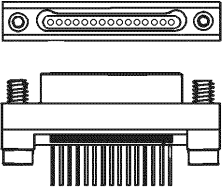
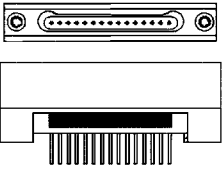
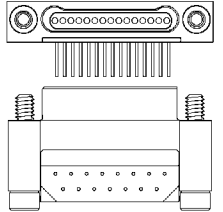
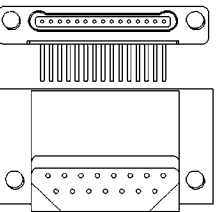
MIL-STD-1353C
APPENDIX ATABLE A-XVII. MIL-DTL-32139 and DLA Land and Maritime (DECC) drawings
nano connectors descriptions and configurations - Continued.

Specification/Drawing number	Description	Configuration
94041	Connectors, Electrical, Rectangular, High Density Nanominiature, Lobe Keyed, Receptacle, Right Angle, Surface Mount Terminated	
94042	Connectors, Electrical, Rectangular, High Density Nanominiature, Lobe Keyed, Plug, Vertical, Through Hole Terminated (.025 Inch Termination Spacing)	
94043	Connectors, Electrical, Rectangular, High Density Nanominiature, Lobe Keyed, Receptacle, Right Angle, Through Hole Terminated (.050 and .100 Inch Termination Spacing)	
94044	Connectors, Electrical, Rectangular, High Density Nanominiature, Lobe Keyed, Receptacle, Vertical, Low Profile, Surface Mount Terminated	
94045	Connectors, Electrical, Rectangular, High Density Nanominiature, Lobe Keyed, Mounting Hardware	

MIL-STD-1353C
APPENDIX ATABLE A-XVII. MIL-DTL-32139 and DLA Land and Maritime (DECC) drawings
nano connectors descriptions and configurations - Continued.

Specification/Drawing number	Description	Configuration
94046	Connectors, Electrical, Rectangular, High Density Nanominiature, Lobe Keyed, Backshell Hardware	
MIL-DTL-32139/1	Nanominiature, Single Row, Plug, Polarized Shell, Pin Contacts, Crimp Type	
MIL-DTL-32139/2	Nanominiature, Single Row, Receptacle, Polarized Shell, Socket Contacts, Crimp Type	
MIL-DTL-32139/3	Nanominiature, Dual Row, Plug, Polarized Shell, Pin Contacts, Crimp Type	
MIL-DTL-32139/4	Nanominiature, Dual Row, Receptacle, Polarized Shell, Socket Contacts, Crimp Type	

MIL-STD-1353C
APPENDIX ATABLE A-XVII. MIL-DTL-32139 and DLA Land and Maritime (DECC) drawings nano connectors description and configurations - Continued.

Specification/Drawing number	Description	Configuration
MIL-DTL-32139/5	Electrical, Rectangular, Nanominiature, Single Row, Plug, Polarized Shell, Pin Contacts, Vertical PCB Through-Hole Type	
MIL-DTL-32139/6	Connectors, Electrical, Rectangular, Nanominiature, Single Row, Receptacle, Polarized Shell, Socket Contacts, Vertical PCB Through-Hole Type	
MIL-DTL-32139/7	Connectors, Electrical, Rectangular, Nanominiature, Single Row, Plug, Polarized Shell, Pin Contacts, Horizontal PCB Through-Hole Type	
MIL-DTL-32139/8	Connectors, Electrical, Rectangular, Nanominiature, Single Row, Receptacle, Polarized Shell, Socket Contacts, Horizontal PCB T	

A.16.2 Use and restrictions.

A.16.3 Mating connectors. DLA Land and Maritime nanominiature connector drawings do not mate with MIL-DTL-32139 connectors.

A.16.4 Use restrictions aluminum with cadmium. Aluminum with cadmium is not suitable for use in reactor rooms or manned space applications.

A.16.5 Use restrictions aluminum with electroless nickel. Aluminum with electroless nickel finish is suitable for space applications only and is not intend for use in Army, Navy, Air Force, or Marine applications.

A.16.6 Prewired connector restrictions. Connectors are pre-wired with 30 AWG wire solid or stranded. SAE-AS22759/33 does not define nor restrict the volatiles that can outgas from the wire insulation. Use of this wire has exhibited corrosive effects to connectors. Programs using XL-ETFE insulated wire and XL-ETFE jacketed cable should perform a risk assessment for their hardware.

MIL-STD-1353C
APPENDIX B

B.1 SCOPE

B.1.1 Scope. This appendix provides additional guidance to help the specification developer or engineer in selection of rectangular connectors. This appendix is not a mandatory part of this standard. The information is intended for guidance only.

B.2. APPLICABLE DOCUMENTS

B.2.1 General. The documents listed in this appendix are specified herein. This section does not include documents cited in other sections of this document.

B.2.2 GOVERNMENT DOCUMENTS

B.2.2.1 Specifications, standards, and handbooks. The following specifications, standards, and handbooks form a part of this appendix to the extent specified herein.

DEPARTMENT OF DEFENSE SPECIFICATIONS

MIL-A-8625	-	Anodic Coatings for Aluminum and Aluminum Alloys
MIL-C-28731/3	-	Connector, Electrical, Insert (Insulator), Male Rectangular, Polarized, Center Screw Lock, For 100 Removable Contacts
MIL-C-28731/4	-	Connector, Electrical, Insert (Insulator), Female Rectangular, Polarized, Center Screw Lock, for 100 Removable Contacts
MIL-C-28731/9	-	Connector, Electrical, Insert (Insulator), Male Rectangular, Polarized, Center Screw Lock, for 20 Removable Contacts
MIL-C-28731/10	-	Connector, Electrical, Insert (Insulator), Female Rectangular, Polarized, Center Screw Lock, for 20 Removable Contacts
MIL-C-28731/11	-	Connector, Electrical, Insert (Insulator), Male Rectangular, Polarized, Center Screw Lock, for 38 Removable Contacts
MIL-C-28731/12	-	Connector, Electrical, Insert (Insulator), Female Rectangular, Polarized, Center Screw Lock, for 38 Removable Contacts
MIL-C-28731/13	-	Connector, Electrical, Insert (Insulator), Male Rectangular, Polarized, Center Screw Lock, for 56 Removable Contacts
MIL-C-28731/14	-	Connector, Electrical, Insert (Insulator), Female Rectangular, Polarized, Center Screw Lock, for 56 Removable Contacts
MIL-C-28731/15	-	Connector, Electrical, Insert (Insulator), Male Rectangular, Polarized, Center Screw Lock, for 90 Removable Contacts
MIL-C-28731/16	-	Connector, Electrical, Insert (Insulator), Female Rectangular, Polarized, Center Screwlock, for 90 Removable Contacts
MIL-C-28731/17	-	Connector, Electrical, Insert (Insulator), Male Rectangular, Polarized, Center Screw Lock, for 120 Removable Contacts
MIL-C-28731/18	-	Connector, Electrical, Insert (Insulator), Female Rectangular, Polarized, Center Screw Lock, for 120 Removable Contacts
MIL-C-28748/13	-	Connectors, Electrical, Rectangular, Rack and Panel, Crimp Type Removable Pin Contacts, Size 22
MIL-C-28748/14	-	Connectors, Electrical, Rectangular, Rack and Panel, Crimp Type Removable Socket Contacts, Size 22
MIL-C-28804/2	-	Connectors, Plug, Electric, Rectangular, High Density, Polarization Center Jackscrew, Crimp Removable Pin Contacts, Class G
MIL-C-28804/3	-	Connectors, Receptacle, Electric, Rectangular, High Density, Polarized Center Jackscrew, Crimp Removable Socket Contacts, Class E
MIL-C-28804/4	-	Connectors, Plug, Electric, Rectangular, High Density, Polarization

MIL-STD-1353C
APPENDIX B

MIL-C-28804/5	-	Center Jackscrew, Crimp Removable Pin Contacts, Class E Connectors, Receptacle, Electric, Rectangular, High Density, Polarized
MIL-C-28804/6	-	Center Jackscrew, Crimp Removable Socket Contacts, Class P Connectors, Plug, Electric, Rectangular, High Density, Polarization
MIL-C-28804/11	-	Center Jackscrew, Crimp Removable Pin Contacts, Class P Connectors, Plug, Electric, Rectangular, High Density, Polarization
MIL-DTL-21617	-	Center Jackscrew, Interfacial Seal, Solder Pin Contacts, Class SE Connectors, Plug and Receptacle, Electrical, Rectangular, Polarized Shell, Miniature Type General Specification For
MIL-DTL-21617/1	-	Connector, Female Plug Electrical, Rectangular, Polarized Shell, Miniature Type, Socket Contacts (Style 004A)
MIL-DTL-21617/2	-	Connector, Male Receptacle Electrical, Rectangular, Polarized Shell, Miniature Type, Pin Contacts (Style 004A)
MIL-DTL-21617/3	-	Connector, Male Receptacle Electrical, Rectangular, Polarized Shell, Miniature Type, Pin Contacts, Pressurized (Style 004A)
MIL-DTL-21617/4	-	Connector, Female Plug Electrical, Rectangular, Polarized Shell, Miniature Type, Socket Contacts (Style 008A)
MIL-DTL-21617/5	-	Connector, Male Receptacle Electrical, Rectangular, Polarized Shell, Miniature Type, Pin Contacts (Style 008A)
MIL-DTL-21617/6	-	Connector, Male Receptacle Electrical, Rectangular, Polarized Shell, Miniature Type, Pin Contacts, Pressurized (Style 008A)
MIL-DTL-21617/7	-	Connector, Female Plug Electrical, Rectangular, Polarized Shell, Miniature Type, Socket Contacts (Style 013A)
MIL-DTL-21617/8	-	Connector, Male Receptacle Electrical, Rectangular, Polarized Shell, Miniature Type, Pin Contacts (Style 013A)
MIL-DTL-21617/9	-	Connector, Male Receptacle Electrical, Rectangular, Polarized Shell, Miniature Type, Pin Contacts, Pressurized (Style 013A)
MIL-DTL-21617/10	-	Connector, Female Plug Electrical, Rectangular, Polarized Shell, Miniature Type, Socket Contacts (Style 017A)
MIL-DTL-21617/11	-	Connector, Male Receptacle Electrical, Rectangular, Polarized shell, Miniature Type, Pin Contacts (Style 017A)
MIL-DTL-21617/12	-	Connector, Male Receptacle Electrical, Rectangular, Polarized Shell, Miniature Type, Pin Contacts, Pressurized Type (Style 017A)
MIL-DTL-21617/13	-	Connector, Female Plug Electrical, Rectangular, Polarized Shell, Miniature Type, Socket Contacts (Style 023A)
MIL-DTL-21617/14	-	Connector, Male Receptacle Electrical, Rectangular, Polarized Shell, Miniature Type, Pin Contacts (Style 023A)
MIL-DTL-21617/15	-	Connector, Male Receptacle Electrical, Rectangular, Polarized Shell, Miniature Type, Pin Contacts, Pressurized (Style 023A)
MIL-DTL-21617/16	-	Connector, Female Plug Electrical, Rectangular, Polarized Shell, Miniature Type, Socket Contacts (Style 026A)
MIL-DTL-21617/17	-	Connector, Male Receptacle Electrical, Rectangular, Polarized Shell, Miniature Type, Pin Contacts (Style 026A)
MIL-DTL-21617/18	-	Connector, Male Receptacle Electrical, Rectangular, Polarized Shell, Miniature Type, Pin Contacts, Pressurized (Style 026A)
MIL-DTL-21617/19	-	Connector, Female Plug Electrical, Rectangular, Polarized Shell, Miniature Type, Socket Contacts (Style 032A)
MIL-DTL-21617/20	-	Connector, Male Receptacle Electrical, Rectangular, Polarized Shell, Miniature Type, Pin Contacts (Style 032A)
MIL-DTL-21617/21	-	Connector, Male Receptacle Electrical, Rectangular, Polarized Shell, Miniature Type, Pin Contacts, Pressurized (Style 032A)

MIL-STD-1353C
APPENDIX B

- MIL-DTL-21617/22 - Connector, Female Plug Electrical, Rectangular, Polarized Shell, Miniature Type, Socket Contacts (Style 040A)
- MIL-DTL-21617/23 - Connector, Male Receptacle Electrical, Rectangular, Polarized Shell, Miniature Type, Pin Contacts (Style 040A)
- MIL-DTL-21617/24 - Connector, Male Receptacle Electrical, Rectangular, Polarized Shell, Miniature Type, Pin Contacts, Pressurized (Style 040A)
- MIL-DTL-21617/25 - Connector, Female Plug Electrical, Rectangular, Polarized Shell, Miniature Type, Socket Coaxial Contacts (Style 007C)
- MIL-DTL-21617/26 - Connector, Male Receptacle Electrical, Rectangular, Polarized Shell, Miniature Type, Pin Coaxial Contacts (Style 007C)
- MIL-DTL-21617/27 - Connector, Female Plug Electrical, Rectangular, Polarized Shell, Miniature Type, Mixed Socket Contacts (Style 016C)
- MIL-DTL-21617/28 - Connector, Male Receptacle Electrical, Rectangular, Polarized Shell, Miniature Type, Mixed Pin Contacts (Style 016C)
- MIL-DTL-21617/29 - Connector, Receptacle Electrical, Rectangular, Polarized Shell, Miniature Type, Back Shells
- MIL-DTL-26518 - Connectors, Electrical, Miniature, Rack and Panel Environment Resistance, 200 Deg. C Ambient Temperature General Specification For
- MIL-DTL-28731 - Connectors, Electrical, Rectangular, Removable Contact, Formed Blade, Fork Type (for Rack and Panel and Other Applications)
- MIL-DTL-28731/19 - Connector, Electrical, Rectangular Shield, for 20, 38, 56, 90 or 120 Removable Contacts
- MIL-DTL-28731/20 - Connector, Electrical, Contact, Fork Type, Crimp Removable (8.5 Amperes)
- MIL-DTL-28731/23 - Connector Electrical, Contact, Fork Type, Removable, Double Wire Crimp
- MIL-DTL-28731/24 - Connector, Electrical, Rectangular Shield, for 120 Removable Contacts
- MIL-DTL-28731/26 - Connectors, Electrical, Contact, Fork Type, Wrappost, Removable
- MIL-DTL-28731/30 - Connectors, Electrical, Insert (Insulator), Female Rectangular, Polarized, Center Screw Lock, for 75 Removable Type Contacts
- MIL-DTL-28731/31 - Connectors, Electrical, Insert (Insulator), Male Rectangular, Polarized, Center Screw Lock, for 117 Removable Type Contacts
- MIL-DTL-28731/32 - Connectors, Electrical, Insert (Insulator), Female Rectangular, Polarized, Center Screw Lock, for 117 Removable Type Contacts
- MIL-DTL-28731/33 - Connectors, Electrical, Insert (Insulator), Male Rectangular, Polarized, Center Screw Lock, for 165 Removable Type Contacts
- MIL-DTL-28731/34 - Connector, Electrical, Insert (Insulator), Female Rectangular, Polarized, Center Screw Lock, for 165 Removable Type Contacts
- MIL-DTL-28731/35 - Connectors, Electrical, Contact Fork Type, Crimp Removable (5.0 Amperes)
- MIL-DTL-28731/36 - Connector, Electrical, Contact Fork Type, Wrappost Removable (3.0 Amperes)
- MIL-DTL-28731/37 - Connector, Electrical, Rectangular Shield, for Female Rectangular 165 Removable Type Contacts
- MIL-DTL-28731/38 - Connector, Electrical, Rectangular Shield, for Use with MIL-DTL-28731/32
- MIL-DTL-28748 - Connector, Plug and Receptacle, Rectangular, Rack and Panel Solder Type and Crimp Type Contacts General Specification For

MIL-STD-1353C
APPENDIX B

- MIL-DTL-28748/1 - Connectors, Electrical, Rectangular, Rack and Panel, Solder Type Pin Contacts, Size 16
- MIL-DTL-28748/2 - Connectors, Electrical, Rectangular, Rack and Panel, Solder Type Socket Contacts, Size 16
- MIL-DTL-28748/3 - Connectors, Electrical, Rectangular, Rack and Panel, Crimp Type Removable Pin Contacts, Sizes 16 and 20
- MIL-DTL-28748/4 - Connectors, Electrical, Rectangular, Rack and Panel, Crimp Type Removable Socket Contacts, Sizes 16 and 20
- MIL-DTL-28748/5 - Connectors, Electrical, Rectangular, Rack and Panel, Solder Type Pin Contacts, Size 20
- MIL-DTL-28748/6 - Connectors, Electrical, Rectangular, Rack and Panel, Solder Type Socket Contacts, Size 20
- MIL-DTL-28748/7 - Connectors, Electrical, Rectangular, Rack and Panel, Solder Type Pin Contacts, Size 22, insert sizes, Solder Type Socket Contacts, Size 22
- MIL-DTL-28748/8 - Connectors, Electrical, Rectangular, Rack and Panel, Solder Type Socket Contacts, Size 22
- MIL-DTL-28748/9 - Connectors, Electrical, Rectangular, Rack and Panel, Polarized Center Jackscrew or Guidepin Style Crimp Type Removable Pin Contacts, Size 16
- MIL-DTL-28748/10 - Connectors, Electrical, Rectangular, Rack and Panel, Polarized Center Jackscrew or Guidepin Style Crimp Type Removable Socket Contacts, Size 16
- MIL-DTL-28748/15 - Connectors, Electrical, Rectangular, Rack and Panel, Hexagonal, Rack and Panel, Miniature, Plug-Receptacle, Female Solder Cup or Printed Wiring Board Socket Contacts, Size 20
- MIL-DTL-28748/16 - Connectors, Electrical, Rectangular, Rack and Panel, Hexagonal, Rack and Panel, Miniature, Plug-Receptacle, Female Solder Cup Pin Contacts, Size 20
- MIL-DTL-28748/17 - Connectors, Electrical, Rectangular, Rack and Panel, Rack and panel, hardware for sizes 16 and 20
- MIL-DTL-28748/18 - Connectors, Electrical, Rectangular, Rack and Panel, Printed Wiring Board (PWB) Mount, Straight Through, Pin Contacts, Size 22
- MIL-DTL-28748/19 - Connectors, Electrical, Rectangular, Rack and Panel, Printed Wiring Board (PWB) Mount, Straight Through, Socket Contacts, Size 22
- MIL-DTL-28748/20 - Connectors, Electrical, Rectangular, Rack and Panel, Printed Wiring Board (PWB) Mount, Right Angle, Pin Contacts, Size 22
- MIL-DTL-28748/21 - Connectors, Electrical, Rectangular, Rack and Panel, Printed Wiring Board (PWB) Mount, Right Angle, Socket Contacts, Size 22
- MIL-DTL-28804 - Connectors, Plug and Receptacle, Electric, Rectangular, High Density, Polarization Center Jackscrew General Specification For
- MIL-DTL-28804/1 - Connectors, Receptacle, Electric, Rectangular, High Density, Polarized Center Jackscrew, Crimp Removable Socket Contacts, Class G. 14 to 244 contacts are available
- MIL-DTL-28804/7 - Connectors, Receptacle, Electric, Rectangular, High Density, Polarized Center Jackscrew, Solder Socket Contacts, Class S
- MIL-DTL-28804/9 - Connectors, Pin Contact, Electric, Rectangular, High Density, Polarized Center Jackscrew, Size 22, Crimp Removable
- MIL-DTL-28804/10 - Connectors, Socket Contact, Electric, Rectangular, High Density, Polarized Center Jackscrew, Size 22, Crimp Removable
- MIL-DTL-83513 - Connectors, Electrical, Rectangular, Microminiature, Polarized Shell, General Specification For

MIL-STD-1353C
APPENDIX B

MIL-DTL-83513/1	- Connectors, Electrical, Rectangular, Microminiature, Polarized Shell, Pin Contacts, Class M, Solder Type
MIL-DTL-83513/2	- Connectors, Electrical, Rectangular, Microminiature, Polarized Shell, Socket Contacts, Class M, Solder Type
MIL-DTL-83513/3	- Connectors, Electrical, Rectangular, Microminiature, Polarized Shell, Pin Contacts, Class M, Crimp Type
MIL-DTL-83513/4	- Connectors, Electrical, Rectangular, Microminiature, Polarized Shell, Socket Contacts, Class M, Crimp Type
MIL-DTL-83513/5	- Connectors, Electrical, Rectangular, Microminiature, Mounting Hardware
MIL-DTL-83513/6	- Connectors, Electrical, Rectangular, Microminiature, Polarized Shell, Pin Contacts, Class P, Solder Type
MIL-DTL-83513/7	- Connectors, Electrical, Rectangular, Microminiature, Polarized Shell, Socket Contacts, Class P, Solder Type
MIL-DTL-83513/8	- Connectors, Electrical, Rectangular, Microminiature, Polarized Shell, Pin Contacts, Class P, Crimp Type
MIL-DTL-83513/9	- Connectors, Electrical, Rectangular, Microminiature, Polarized Shell, Socket Contacts, Class P, Crimp Type
MIL-DTL-83513/10	- Connectors, Electrical, Rectangular, Plug, Microminiature, Polarized Shell, Right Angle, Pin Contacts, 2 Row, Solder Type, Narrow Profile, 9 Through 37 Contacts, Printed Circuit Boards
MIL-DTL-83513/11	- Connectors, Electrical, Rectangular, Plug, Microminiature, Polarized Shell, Right Angle, Pin Contacts, 3 Row, Solder Type, Narrow Profile, 51 Contacts, Printed Circuit Boards
MIL-DTL-83513/12	- Connectors, Electrical, Rectangular, Plug, Microminiature, Polarized Shell, Right Angle, Pin Contacts, 4 Row, Solder Type, Narrow Profile, 100 Contacts, Printed Circuit Boards
MIL-DTL-83513/13	- Connectors, Electrical, Rectangular, Receptacle, Microminiature, Polarized Shell, Right Angle, Socket Contacts, 2 Row, Solder Type, Narrow Profile, 9 Through 37 Contacts, Printed Circuit Boards
MIL-DTL-83513/14	- Connectors, Electrical, Rectangular, Receptacle, Microminiature, Polarized Shell, Right Angle, Socket Contacts, 3 Row, Solder Type, Narrow Profile, 51 Contacts, Printed Circuit Boards
MIL-DTL-83513/15	- Connectors, Electrical, Rectangular, Receptacle, Microminiature, Polarized Shell, Right Angle, Socket Contacts, 4 Row, Solder Type, Narrow Profile, 100 Contacts, Printed Circuit Boards
MIL-DTL-83513/16	- Connectors, Electrical, Rectangular, Plug, Microminiature, Polarized Shell, Right Angle, Socket Contacts, 2 Row, Solder Type, Standard Profile, 9 Through 37 Contacts, Printed Circuit Boards
MIL-DTL-83513/17	- Connectors, Electrical, Rectangular, Plug, Microminiature, Polarized Shell, Right Angle, Socket Contacts, 3 Row, Solder Type, Standard Profile, 51 Contacts, Printed Circuit Boards
MIL-DTL-83513/18	- Connectors, Electrical, Rectangular, Plug, Microminiature, Polarized Shell, Right Angle, Socket Contacts, 4 Row, Solder Type, Standard Profile, 100 Contacts, Printed Circuit Boards
MIL-DTL-83513/19	- Connectors, Electrical, Rectangular, Receptacle, Microminiature, Polarized Shell, Right Angle, Socket Contacts, 2 Row, Solder Type, Standard Profile, 9 Through 37 Contacts, Printed Circuit Boards
MIL-DTL-83513/20	- Connectors, Electrical, Rectangular, Receptacle, Microminiature, Polarized Shell, Right Angle, Socket Contacts, 3 Row, Solder Type, Standard Profile, 51 Contacts, Printed Circuit Boards

MIL-STD-1353C
APPENDIX B

- MIL-DTL-83513/21 - Connectors, Electrical, Rectangular, Receptacle, Microminiature, Polarized Shell, Right Angle, Socket Contacts, 4 Row, Solder Type, Standard Profile, 100 Contacts, Printed Circuit Boards
- MIL-DTL-83513/22 - Connectors, Electrical, Rectangular, Plug, Microminiature, Polarized Shell, Straight, Pin Contacts, 2 Row, Solder Type, 9 Through 37 Contacts, Printed Circuit Boards
- MIL-DTL-83513/23 - Connectors, Electrical, Rectangular, Plug, Microminiature, Polarized Shell, Straight, Pin Contacts, 3 Row, Solder Type, 51 Contacts, Printed Circuit Boards
- MIL-DTL-83513/24 - Connectors, Electrical, Rectangular, Plug, Microminiature, Polarized Shell, Straight, Pin Contacts, 4 Row, Solder Type, 100 Contacts, Printed Circuit Boards
- MIL-DTL-83513/25 - Connectors, Electrical, Rectangular, Receptacle, Microminiature, Polarized Shell, Straight, Socket Contacts, 2 Row, Solder Type, 9 Through 37 Contacts, Printed Circuit Boards
- MIL-DTL-83513/26 - Connectors, Electrical, Rectangular, Receptacle, Microminiature, Polarized Shell, Straight, Socket Contacts, 3 Row, Solder Type, 51 Contacts, Printed Circuit Boards
- MIL-DTL-83513/27 - Connectors, Electrical, Rectangular, Receptacle, Microminiature, Polarized Shell, Straight, Socket Contacts, 4 Row, Solder Type, 100 Contacts, Printed Circuit Boards
- MIL-DTL-83513/28 - Connectors, Electrical, Rectangular, Plug, Microminiature, Polarized Shell, Straight, Pin Contacts, 2 Row, Solder Type, Standard Profile, 9 Through 37 Contacts, Printed Circuit Boards
- MIL-DTL-83513/29 - Connectors, Electrical, Rectangular, Plug, Microminiature, Polarized Shell, Straight, Pin Contacts, 3 Row, Solder Type, Standard Profile, 51 Contacts, Printed Circuit Boards
- MIL-DTL-83513/30 - Connectors, Electrical, Rectangular, Plug, Microminiature, Polarized Shell, Straight, Pin Contacts, 4 Row, Solder Type, Standard Profile, 100 Contacts, Printed Circuit Boards
- MIL-DTL-83513/31 - Connectors, Electrical, Rectangular, Receptacle, Microminiature, Polarized Shell, Right Angle, Socket Contacts, 2 Row, Solder Type, Narrow Profile, 9 Through 37 Contacts, Printed Circuit Boards
- MIL-DTL-83513/32 - Connectors, Electrical, Rectangular, Receptacle, Microminiature, Polarized Shell, Straight, Socket Contacts, 3 Row, Solder Type, Standard Profile, 51 Contacts, Printed Circuit Boards
- MIL-DTL-83513/33 - Connectors, Electrical, Rectangular, Receptacle, Microminiature, Polarized Shell, Straight, Socket Contacts, 4 Row, Solder Type, Standard Profile, 100 Contacts, Printed Circuit Boards
- MIL-DTL-83733 - Connectors, Electrical Miniature, Rectangular Type, Rack to Panel, Environment Resisting, 200 Degrees C Total Continuous Operating Temperature, General Specification for
- MIL-DTL-83733/1 - Connectors, Electrical Miniature, Rectangular Type, Rack to Panel, Standard Hole Mounting, Environment Resisting, 200 Degrees C
- MIL-DTL-83733/2 - Connectors, Electrical Miniature, Rectangular Type, Rack to Panel, With Guide Pins and Spring Mounting, Environment Resisting, 200 Degrees C
- MIL-DTL-83733/3 - Connectors, Electrical Miniature, Rectangular Type, Rack to Panel, With Guide Sockets, Environment Resisting, 200 Degrees C
- MIL-DTL-83733/4 - Connectors, Electrical Miniature, Rectangular Type, Rack to Panel, With Captive Springs, Environment Resisting, 200 Degrees C

MIL-STD-1353C
APPENDIX B

MIL-DTL-83733/5	-	Connectors, Electrical Miniature, Rectangular Type, Rack to Panel, Bushing Mounting, Environment Resisting, 200 Degrees C
MIL-DTL-83733/6	-	Connectors, Electrical Miniature, Rectangular Type, Rack to Panel, Clinch Nut Mounting, Environment Resisting, 200 Degrees C
MIL-DTL-83733/7	-	Connectors, Electrical Miniature, Rectangular Type, Rack to Panel, With Guide Sockets and Spring Mounting, Environment Resisting, 200 Degrees C
MIL-DTL-83733/8	-	Connectors, Electrical Miniature, Rectangular Type, Rack to Panel, With Guide Pins, Environment Resisting, 200 Degrees C
MIL-DTL-83733/9	-	Connectors, Electrical Miniature, Rectangular Type, Rack to Panel, Staggered Standard Hole Mounting, Environment Resisting, 200 Degrees C
MIL-DTL-83733/10	-	Connectors, Electrical Miniature, Rectangular Type, Rack to Panel, Staggered Bushing Connectors, Electrical Miniature, Rectangular Type, Rack to Panel, Staggered Bushing Mounting, Environment Resisting, 200 Degrees C Mounting, Environment Resisting, 200 Degrees C
MIL-DTL-83733/11	-	Connectors, Electrical Miniature, Rectangular Type, Rack to Panel, Staggered Bushing Connectors, Electrical Miniature, Rectangular Type, Rack to Panel, Staggered Clinch Nut Mounting, Environment Resisting, 200 Degrees C Mounting, Environment Resisting, 200 Degrees C
MIL-DTL-83733/12	-	Connectors, Electrical Miniature, Rectangular Type, Rack to Panel, Staggered Bushing Connectors, Electrical Miniature, Rectangular Type, Rack to Panel, Staggered Spring Mounting, Environment Resisting, 200 Degrees C Mounting, Environment Resisting, 200 Degrees C
MIL-DTL-83733/17	-	Connector, Rack and Panel, Spring Loaded Mounting Assembly
MS18173	-	Washer, Flat
MS18192	-	Shield, Electrical Connector for 7, 9, 14, 20, 26, 34, 42, 50, and 75 Contact Connectors
MS18193	-	Shield, Electrical, Connectors for 66 and 104 Contact Connectors
MS18194	-	Jackscrew, Electrical Connector Male and Female, Long, Turnable
MS18195	-	Jackscrew, Electrical Connector Male and Female, Short, Turnable
MS18196	-	Jackscrew, Electrical Connector Male and Female, Fixed
MS18197	-	Guide Pin, Electrical Connector, Male and Female
MS18198	-	Plate, Retaining, Receptacle Electrical Connector, for 9, 14, 20, and 26 Contact Connectors
MS18199	-	Plate, Retaining, Receptacle Electrical Connector, for 34, 42, 50, and 75 Contact Connectors
MS18200	-	Plate, Retaining, Receptacle, Electrical Connector, for Size 66 and 104 Contact Connectors
MS18203	-	Shell, Electrical, Connector Plug, Rectangular, Polarizing
MS18204	-	Shell, Electrical Connector Receptacle, Rectangular Polarizing
MS18205	-	Pin, Straight Headed
MS24132	-	Shield, Electrical Connector for 7, 9, 14, 20, and 26 Rack and Panel Contact Connectors
MS24133	-	Shield, Electrical Connector for 34, 42, 50, and 75, Contact Rack and Panel Connectors
MS24285	-	Connector, Electrical, Style S, Rack and Panel, Miniature
MS24286	-	Connector, Electrical, Style P, Rack and Panel, Miniature
MS24287	-	Mated Assembly, Connector, Rack and Panel, Miniature
MS24288	-	Insert Arrangements, Electrical, Connector, Rack and Panel
MS24695	-	Spring Loaded Mounting Assembly, Connector, Rack and Panel, Miniature

MIL-STD-1353C
APPENDIX B

MS24696	- Retainer, Connector, Rack and Panel, Miniature
MS24697	- Spring, Connector, Rack and Panel, Miniature
MS24698	- Float Bushing, Connectors, Rack and Panel, Miniature
MS24699	- Shaft, Connector, Rack and Panel, Miniature
MS24700	- Bushing, Fixed, Connector, Rack and Panel, Miniature
MS27399	- Connectors, Electrical, Styles, Rack and Panel, Miniature, Closed Entry

(Copies of these documents are available online at <http://quicksearch.dla.mil> or from the Standardization Document Order Desk, 700 Robbins Avenue, Building 4D, Philadelphia, PA 19111-5094.)

B.2.3 Non-Government publications. The following documents form a part of this document to the extent specified herein.

AEROSPACE INDUSTRIES ASSOCIATION (AIA)

NASM21044	- Nut, Self-Locking, Hexagon, Regular Height, 250 DEG. F, 125 KSI FTU and 60 KSI FTU
-----------	--

(Copies of these documents are available online at <http://www.aia-aerospace.org> or from the Aerospace Industries Association, 1000 Wilson Boulevard, Suite 1700, Arlington, VA 22209-3928, Tel: 703-358-1000.)

ASTM INTERNATIONAL

ASTM B633	- Zinc on Iron and Steel, Electrodeposited Coatings of
-----------	--

(Copies of these documents are available online at <http://www.astm.org> or from the ASTM International, P.O. Box C700, 100 Barr Harbor Drive, West Conshohocken, PA 19428-2959.)

SAE INTERNATIONAL

SAE-AMS-QQ-P-416	- Plating, Cadmium (Electrodeposited)
------------------	---------------------------------------

(Copies of these documents are available on line at www.sae.org from SAE International, 400 Commonwealth Drive, Warrendale, PA 15096-0001, and Tel: 877-606-7323 [inside USA and Canada] or 724-776-4970 [outside USA], email at CustomerService@sae.org.)

B.3 MIL-DTL-28748. MIL-DTL-28748 rectangular connectors, see [table B-1](#).

B.3.1 Intended use. Connectors and contacts covered MIL-DTL-28748 are intended for use in airborne, ground support, and shipboard electrical and electronic equipment, nonenvironmental applications only.

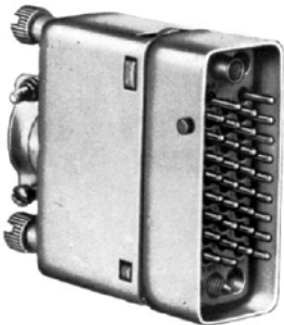
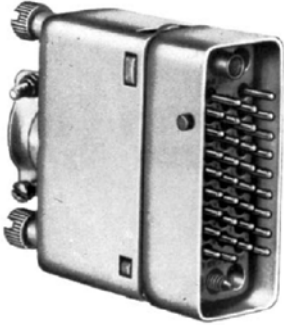
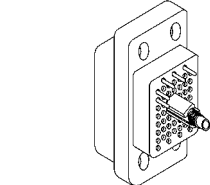
B.3.2 Contact characteristics. These connectors have contacts with nonremovable solder type contacts and removable front release crimp type contacts. Contact sizes: 16, 20, and 22.

B.3.3 Coupling types. Long jackscrews, guide pins, boss for jackscrews, boss for guide pins, fixed jackscrews.

B.3.4 Plating. Noncorrosion-resisting metal parts are cadmium plated in accordance with SAE-AMS-QQ-P-416, type II, class 1 or class 2, or zinc plated in accordance with ASTM B633, type II, SC 3 or SC 4, except that a preliminary plating of other metal is permissible. Aluminum alloy parts are anodized in accordance with MIL-A-8625, type I or II. "A" finishes shall be conductive, except anodized parts.


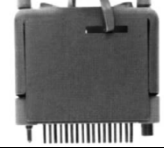
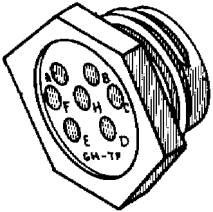
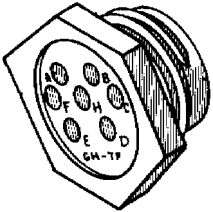
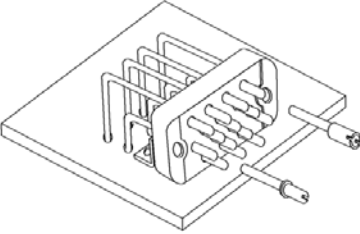
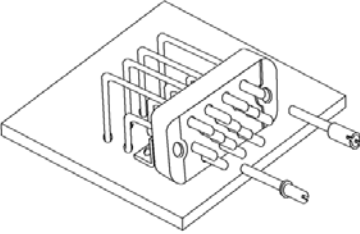
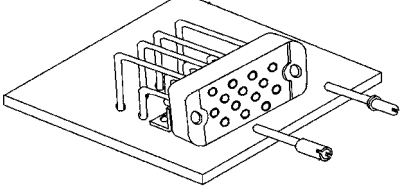
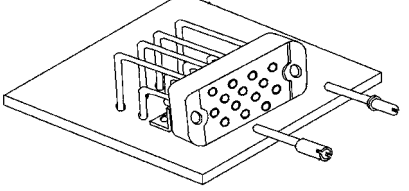
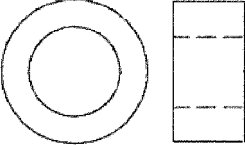
MIL-STD-1353C
APPENDIX B

TABLE B-I. MIL-DTL-28748 descriptions and configurations.

Specification	Description	Configuration
MIL-DTL-28748	Connector, Plug and Receptacle, Rectangular, Rack and Panel Solder Type and Crimp Type Contacts General Specification For	
MIL-DTL-28748/1	Solder Type Pin Contacts, Size 16, insert sizes 9, 14, 20, 34, 42, 50, 66, 75, and 104, up to 13 amps	
MIL-DTL-28748/2	Solder Type Socket Contacts, Size 16 insert sizes 9, 14, 20, 34, 42, 50, 66, 75, and 104, up to 13 amps	
MIL-DTL-28748/3	Crimp Type Removable Pin Contacts, Sizes 16 (up to 13 amps) and 20 (up to 7.5 amps), insert sizes 7, 9, 14, 20, 26, 34, 42, 50, 66, 75, and 104, , up to 13 amps	
MIL-DTL-28748/4	Crimp Type Removable Socket Contacts, Sizes 16 (up to 13 amps) and 20 (up to 7.5 amps) insert sizes 7, 9, 14, 20, 26, 34, 42, 50, 66, 75, and 104, ,	
MIL-DTL-28748/5	Solder Type Pin Contacts, Size 20, insert sizes 7, 9, 14, 18, 20, 26, 34, 42, 50, 75, and 104, up to 7 amps	
MIL-DTL-28748/6	Solder Type Socket Contacts, Size 20, insert sizes 7, 9, 14, 18, 20, 26, 34, 42, 50, 75, and 104, , up to 7 amps	
MIL-DTL-28748/7	Solder Type Pin Contacts, Size 22, insert sizes, Solder Type Socket Contacts, Size 22, insert sizes 4, 7, 14, 20, 26, 34, 44 and 50, up to 5 amps	
MIL-DTL-28748/8	Solder Type Socket Contacts, Size 22, insert sizes 4, 7, 14, 20, 26, 34, 44 and 50, up to 5 amps	
MIL-DTL-28748/9	Polarized Center Jackscrew or Guidepin Style Crimp Type Removable Pin Contacts, Size 16, insert sizes 10, 20, 36, 52, 80, 104, 158, and 212	
MIL-DTL-28748/10	Polarized Center Jackscrew or Guidepin Style Crimp Type Removable Socket Contacts, Size 16 insert sizes	

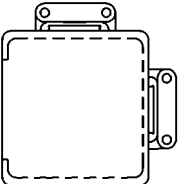
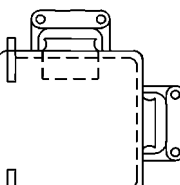
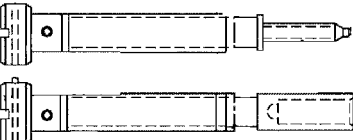
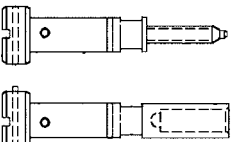
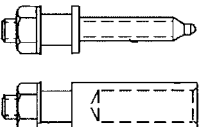
MIL-STD-1353C
APPENDIX B

TABLE B-I. MIL-DTL-28748 descriptions and configurations - Continued.

Specification	Description	Configuration
MIL-C-28748/13	Crimp Type Removable Pin Contacts, Size 22, insert sizes 7, 14, 20, 26, 34, 44, and 50	
MIL-C-28748/14	Crimp Type Removable Socket Contacts, Size 22, insert sizes 7, 14, 20, 26, 34, 44, and 50	
MIL-DTL-28748/15	Hexagonal, Rack and Panel, Miniature, Plug-Receptacle, Female Solder Cup or Printed Wiring Board Socket Contacts, Size 20, insert sizes 4, 5, 7, 9, 10, and 12, up to 7.5 amps	
MIL-DTL-28748/16	Hexagonal, Rack and Panel, Miniature, Plug-Receptacle, Female Solder Cup Pin Contacts, Size 20, insert sizes 4, 5, 7, 9, 10, and 12, up to 7.5 amps	
MIL-DTL-28748/17	Rack and panel, hardware for sizes 16 and 20 (Inactive for new design)	
MIL-DTL-28748/18	Printed Wiring Board (PWB) Mount, Straight Through, Pin Contacts, Size 22, insert sizes 4, 7, 14, 20, 26, 34, 44, and 50, up to 5 amps	
MIL-DTL-28748/19	Printed Wiring Board (PWB) Mount, Straight Through, Socket Contacts, Size 22, insert sizes 4, 7, 14, 20, 26, 34, 44, and 50, up to 5 amps	
MIL-DTL-28748/20	Printed Wiring Board (PWB) Mount, Right Angle, Pin Contacts, Size 22, insert sizes 4, 7, 14, 20, 26, 34, 44, and 50, up to 5 amps	
MIL-DTL-28748/21	Printed Wiring Board (PWB) Mount, Right Angle, Socket Contacts, Size 22, insert sizes 4, 7, 14, 20, 26, 34, 44, and 50, up to 5 amps	
MS18173	Washer, Flat	

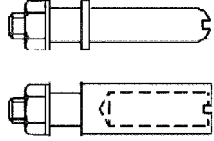
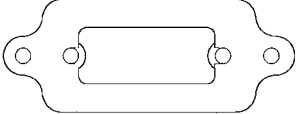
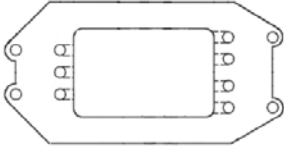

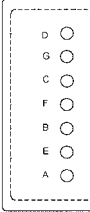
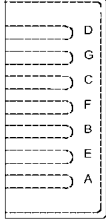
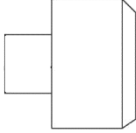
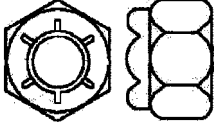
MIL-STD-1353C
APPENDIX B

TABLE B-I. MIL-DTL-28748 descriptions and configurations - Continued.

Specification	Description	Configuration
MS18192	Shield, Electrical Connector for 7, 9, 14, 20, 26, 34, 42, 50, and 75 Contact Connectors (used on slash sheets 1 through 6)	
MS18193	Shield, Electrical, Connectors for 66 and 104 Contact Connectors (used on slash sheets 1 through 6)	
MS18194	Jackscrew, Electrical Connector Male and Female, Long, Turnable Connectors (used on slash sheets 1 through 6)	
MS18195	Jackscrew, Electrical Connector Male and Female, Short, Turnable Connectors (used on slash sheets 1 through 6)	
MS18196	Jackscrew, Electrical Connector Male and Female, Fixed Connectors (used on slash sheets 1 through 6)	

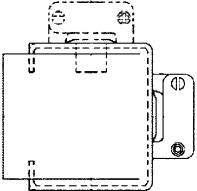
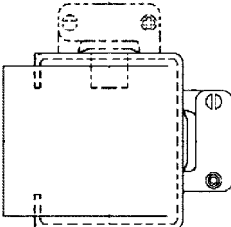
MIL-STD-1353C
APPENDIX B

TABLE B-I. MIL-DTL-28748 descriptions and configurations - Continued.

Specification	Description	Configuration
MS18197	Guide Pin, Electrical Connector, Male and Female (used on slash sheets 1 through 6)	
MS18198	Plate, Retaining, Receptacle Electrical Connector, for 9, 14, 20, and 26 Contact Connectors (used on slash sheets 1 through 6)	
MS18199	Plate, Retaining, Receptacle Electrical Connector, for 34, 42, 50, and 75 Contact Connectors (used on slash sheets 1 through 6)	
MS18200	Plate, Retaining, Receptacle, Electrical Connector, for Size 66 and 104 Contact Connectors (used on slash sheets 1 through 6)	
MS18203	Shell, Electrical, Connector Plug, Rectangular, Polarizing (used on slash sheets 1 through 6)	
MS18204	Shell, Electrical Connector Receptacle, Rectangular Polarizing (used on slash sheets 1 through 6)	
MS18205	Pin, Straight Headed (used on MS18203)	
NASM21044	Nut, Self-Locking, Hexagon, Regular Height, 250 Deg. F, 125 KSI FTU and 60 KSI FTU)	

MIL-STD-1353C
APPENDIX B

TABLE B-I. MIL-DTL-28748 descriptions and configurations - Continued.

Specification	Description	Configuration
MS24132	Shield, Electrical Connector for 7, 9, 14, 20, and 26 Rack and Panel Contact Connectors (used on slash sheets 1 through 6)	
MS24133	Shield, Electrical Connector for 34, 42, 50, and 75, Contact Rack and Panel Connectors (used on slash sheets 1 through 6)	

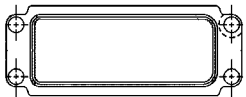
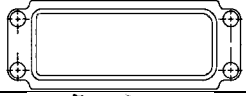
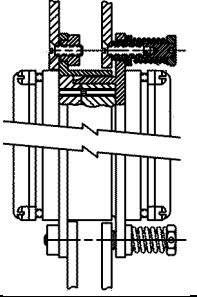
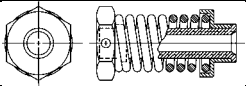
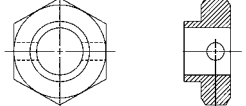
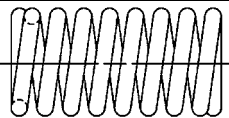
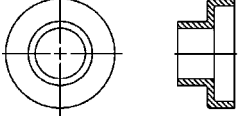
MIL-STD-1353C
APPENDIX B

B.4 MIL-DTL-26518. MIL-DTL-26518 covers the general requirements for rectangular environment-resisting miniature rack and panel type electrical connectors, see table B-II

B.4.1 Intended use. All connectors and contacts covered by this specification are intended for use in airborne, ground support, and shipboard electrical and electronic equipment where presence of residual magnetism must be held to very low levels to avoid interference with nearby sensitive instrumentation. The connectors and contacts covered by this specification are military unique because they must be able to operate at high altitude (70,000 feet (21.34 km) maximum), operate at a temperature range of -55°C to +200°C, withstand 48 hours of salt spray (without exposure of base metals, pitting and porosity of finishes), and 100 g's of shock with no electrical discontinuities.

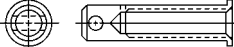
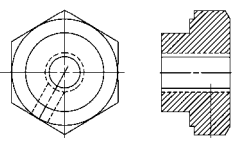
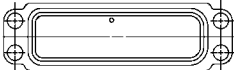
B.4.2 New design restriction. These connectors are inactive for new design after 22 April 1988. For new design use MIL-DTL-83733.

TABLE B-II. MIL-DTL-26518 descriptions and configurations.

Specification/drawing number	Description	Configuration
MS24285	Connector, Electrical, Style S, Rack and Panel, Miniature	
MS24286	Connector, Electrical, Style P, Rack and Panel, Miniature.	
MS24287	Mated Assembly, Connector, Rack and Panel, Miniature	
MS24288	Insert Arrangements, Electrical, Connector, Rack and Panel	
MS24695	Spring Loaded Mounting Assembly, Connector, Rack and Panel, Miniature	
MS24696	Retainer, Connector, Rack and Panel, Miniature	
MS24697	Spring, Connector, Rack and Panel, Miniature	
MS24698	Float Bushing, Connectors, Rack and Panel, Miniature	

MIL-STD-1353C
APPENDIX B

TABLE B-II. MIL-DTL-26518 descriptions and configurations - Continued.

Specification/drawing number	Description	Configuration
MS24699	Shaft, Connector, Rack and Panel, Miniature	
MS24700	Bushing, Fixed, Connector, Rack and Panel, Miniature	
MS27399	Connectors, Electrical, Styles, Rack and Panel, Miniature, Closed Entry	

MIL-STD-1353C
APPENDIX B

B.5 MIL-DTL-28731. Contacts removable, formed blade, crimp fork type, solder fork type, wrappost fork type, see table B-III.

B.5.1 Intended use. Intended for use in airborne, ground support, and shipboard electrical and electronic equipment.

B.5.2 Contact wire sizes. 18 - 26 AWG.

B.5.3 Coupling. Jackscrews, jack sockets, fixed screws, and fixed sockets.

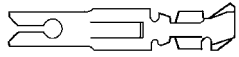



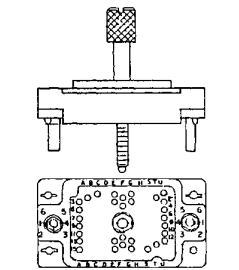
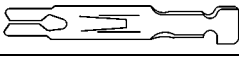

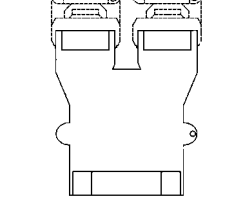
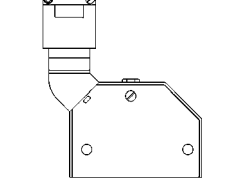
B.5.4 Shell plating. Shells are cadmium plated.

TABLE B-III. MIL-DTL-28731 descriptions and configurations.

Specification number	Description	Configuration	
MIL-DTL-28731	Connectors, Electrical, Rectangular, Removable Contact, Formed Blade, Fork Type (for Rack and Panel and Other Applications)		
MIL-C-28731/3	Connector, Electrical, Insert (Insulator), Male Rectangular, Polarized, Center Screw Lock, For 100 Removable Contacts		
MIL-C-28731/4	Connector, Electrical, Insert (Insulator), Female Rectangular, Polarized, Center Screw Lock, for 100 Removable Contacts		
MIL-C-28731/9	Connector, Electrical, Insert (Insulator), Male Rectangular, Polarized, Center Screw Lock, for 20 Removable Contacts		
MIL-C-28731/10	Connector, Electrical, Insert (Insulator), Female Rectangular, Polarized, Center Screw Lock, for 20 Removable Contacts		
MIL-C-28731/11	Connector, Electrical, Insert (Insulator), Male Rectangular, Polarized, Center Screw Lock, for 38 Removable Contacts		
MIL-C-28731/12	Connector, Electrical, Insert (Insulator), Female Rectangular, Polarized, Center Screw Lock, for 38 Removable Contacts		
MIL-C-28731/13	Connector, Electrical, Insert (Insulator), Male Rectangular, Polarized, Center Screw Lock, for 56 Removable Contacts		
MIL-C-28731/14	Connector, Electrical, Insert (Insulator), Female Rectangular, Polarized, Center Screw Lock, for 56 Removable Contacts		
MIL-C-28731/15	Connector, Electrical, Insert (Insulator), Male Rectangular, Polarized, Center Screw Lock, for 90 Removable Contacts		
MIL-C-28731/16	Connector, Electrical, Insert (Insulator), Female Rectangular, Polarized, Center Screwlock, for 90 Removable Contacts		
MIL-C-28731/17	Connector, Electrical, Insert (Insulator), Male Rectangular, Polarized, Center Screw Lock, for 120 Removable Contacts		
MIL-C-28731/18	Connector, Electrical, Insert (Insulator), Female Rectangular, Polarized, Center Screw Lock, for 120 Removable Contacts		
MIL-DTL-28731/19	Connector, Electrical, Rectangular Shield, for 20, 38, 56, 90 or 120 Removable Contacts		

MIL-STD-1353C
APPENDIX B

TABLE B-III. MIL-DTL-28731 descriptions and configurations - Continued.

Specification number	Description	Configuration
MIL-DTL-28731/20	Connector, Electrical, Contact, Fork Type, Crimp Removable (8.5 Amperes)	
MIL-DTL-28731/23	Connector Electrical, Contact, Fork Type, Removable, Double Wire Crimp	
MIL-DTL-28731/24	Connector, Electrical, Rectangular Shield, for 120 Removable Contacts	
MIL-DTL-28731/26	Connectors, Electrical, Contact, Fork Type, Wrappost, Removable	
MIL-DTL-28731/29	Connectors, Electrical, Insert (Insulator), Male Rectangular, Polarized, Center Screw Lock, for 75 Removable Type Contacts	
MIL-DTL-28731/30	Connectors, Electrical, Insert (Insulator), Female Rectangular, Polarized, Center Screw Lock, for 75 Removable Type Contacts	
MIL-DTL-28731/31	Connectors, Electrical, Insert (Insulator), Male Rectangular, Polarized, Center Screw Lock, for 117 Removable Type Contacts	
MIL-DTL-28731/32	Connectors, Electrical, Insert (Insulator), Female Rectangular, Polarized, Center Screw Lock, for 117 Removable Type Contacts	
MIL-DTL-28731/33	Connectors, Electrical, Insert (Insulator), Male Rectangular, Polarized, Center Screw Lock, for 165 Removable Type Contacts	
MIL-DTL-28731/34	Connector, Electrical, Insert (Insulator), Female Rectangular, Polarized, Center Screw Lock, for 165 Removable Type Contacts	
MIL-DTL-28731/35	Connectors, Electrical, Contact Fork Type, Crimp Removable (5.0 Amperes)	
MIL-DTL-28731/36	Connector, Electrical, Contact Fork Type, Wrappost Removable (3.0 Amperes)	
MIL-DTL-28731/37	Connector, Electrical, Rectangular Shield, for Female Rectangular 165 Removable Type Contacts	
MIL-DTL-28731/38	Connector, Electrical, Rectangular Shield, for Use with MIL-DTL-28731/32	

MIL-STD-1353C
APPENDIX B

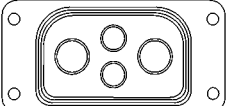
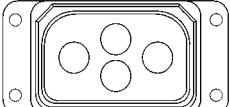
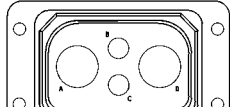
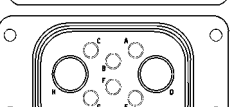
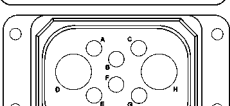
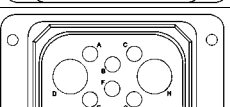
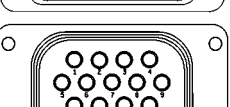
B.6 MIL-DTL-21617. MIL-DTL-21617 multi-contact, rectangular, polarized shell, miniature type, electrical and electronic rack and panel connectors (plugs and receptacles), see table B-IV.

B.6.1 Type P, plug. Plugs are intended for use at the end of a cable mounted on panel of a unit plug-in to be mated with a panel mounted receptacle.

B.6.2 Type J, receptacle. Receptacles are intended for fixed panel mounting of unit and for use with conduit to eliminate the necessity of a conduit box.

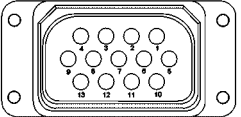
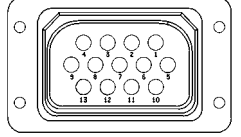
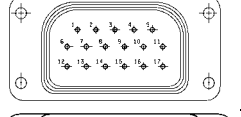

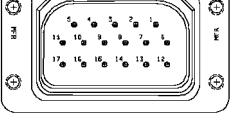
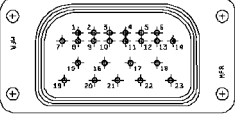
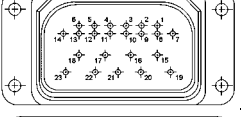
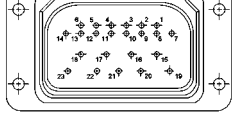
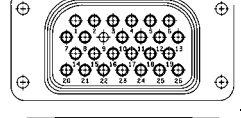
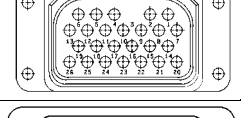
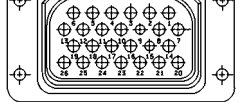
B.6.3 Type JS, pressurized receptacle. Pressurized receptacles are intended for use on pressurized devices, and their performance requirements are determined by the particular application. They should maintain the degree of pressurization required by the equipment specification and be suitable for mating with plugs conforming to the requirements of this specification.

TABLE B-IV. MIL-DTL-21617 descriptions and configurations.

Specification number	Description	Configuration
MIL-DTL-21617	Connectors, Plug And Receptacle, Electrical, Rectangular, Polarized Shell, Miniature Type General Specification For	
MIL-DTL-21617/1	Connector, Female Plug Electrical, Rectangular, Polarized Shell, Miniature Type, Socket Contacts (Style 004A)	
MIL-DTL-21617/2	Connector, Male Receptacle Electrical, Rectangular, Polarized Shell, Miniature Type, Pin Contacts (Style 004A)	
MIL-DTL-21617/3	Connector, Male Receptacle Electrical, Rectangular, Polarized Shell, Miniature Type, Pin Contacts, Pressurized (Style 004A)	
MIL-DTL-21617/4	Connector, Female Plug Electrical, Rectangular, Polarized Shell, Miniature Type, Socket Contacts (Style 008A)	
MIL-DTL-21617/5	Connector, Male Receptacle Electrical, Rectangular, Polarized Shell, Miniature Type, Pin Contacts (Style 008A)	
MIL-DTL-21617/6	Connector, Male Receptacle Electrical, Rectangular, Polarized Shell, Miniature Type, Pin Contacts, Pressurized (Style 008A)	
MIL-DTL-21617/7	Connector, Female Plug Electrical, Rectangular, Polarized Shell, Miniature Type, Socket Contacts (Style 013A)	

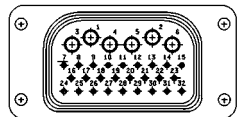
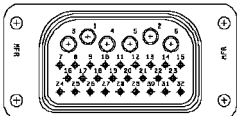
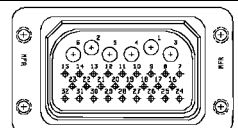
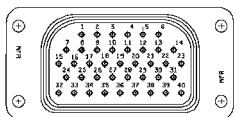
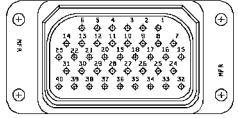
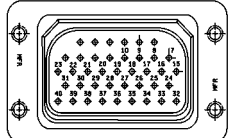
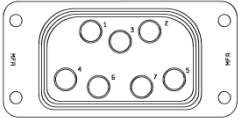
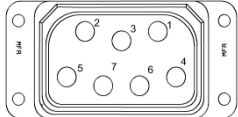
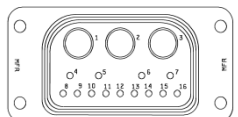
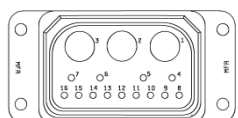
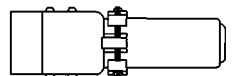
MIL-STD-1353C
APPENDIX B

TABLE B-IV. MIL-DTL-21617 descriptions and configurations - Continued.

Specification number	Description	Configuration
MIL-DTL-21617/8	Connector, Male Receptacle Electrical, Rectangular, Polarized Shell, Miniature Type, Pin Contacts (Style 013A)	
MIL-DTL-21617/9	Connector, Male Receptacle Electrical, Rectangular, Polarized Shell, Miniature Type, Pin Contacts, Pressurized (Style 013A)	
MIL-DTL-21617/10	Connector, Female Plug Electrical, Rectangular, Polarized Shell, Miniature Type, Socket Contacts (Style 017A)	
MIL-DTL-21617/11	Connector, Male Receptacle Electrical, Rectangular, Polarized shell, Miniature Type, Pin Contacts (Style 017A)	
MIL-DTL-21617/12	Connector, Male Receptacle Electrical, Rectangular, Polarized Shell, Miniature Type, Pin Contacts, Pressurized Type (Style 017A)	
MIL-DTL-21617/13	Connector, Female Plug Electrical, Rectangular, Polarized Shell, Miniature Type, Socket Contacts (Style 023A)	
MIL-DTL-21617/14	Connector, Male Receptacle Electrical, Rectangular, Polarized Shell, Miniature Type, Pin Contacts (Style 023A)	
MIL-DTL-21617/15	Connector, Male Receptacle Electrical, Rectangular, Polarized Shell, Miniature Type, Pin Contacts, Pressurized (Style 023A)	
MIL-DTL-21617/16	Connector, Female Plug Electrical, Rectangular, Polarized Shell, Miniature Type, Socket Contacts (Style 026A)	
MIL-DTL-21617/17	Connector, Male Receptacle Electrical, Rectangular, Polarized Shell, Miniature Type, Pin Contacts (Style 026A)	
MIL-DTL-21617/18	Connector, Male Receptacle Electrical, Rectangular, Polarized Shell, Miniature Type, Pin Contacts, Pressurized (Style 026A)	

MIL-STD-1353C
APPENDIX B

TABLE B-IV. MIL-DTL-21617 descriptions and configurations - Continued.

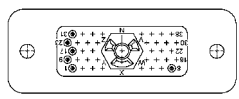
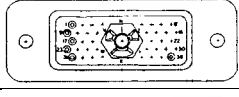
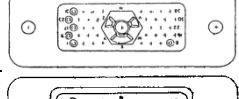
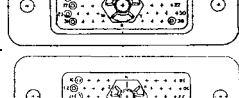
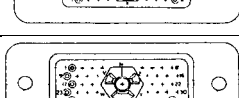
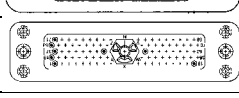
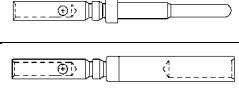
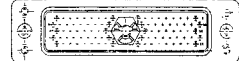


Specification number	Description	Configuration
MIL-DTL-21617/19	Connector, Female Plug Electrical, Rectangular, Polarized Shell, Miniature Type, Socket Contacts (Style 032A)	
MIL-DTL-21617/20	Connector, Male Receptacle Electrical, Rectangular, Polarized Shell, Miniature Type, Pin Contacts (Style 032A)	
MIL-DTL-21617/21	Connector, Male Receptacle Electrical, Rectangular, Polarized Shell, Miniature Type, Pin Contacts, Pressurized (Style 032A)	
MIL-DTL-21617/22	Connector, Female Plug Electrical, Rectangular, Polarized Shell, Miniature Type, Socket Contacts (Style 040A)	
MIL-DTL-21617/23	Connector, Male Receptacle Electrical, Rectangular, Polarized Shell, Miniature Type, Pin Contacts (Style 040A)	
MIL-DTL-21617/24	Connector, Male Receptacle Electrical, Rectangular, Polarized Shell, Miniature Type, Pin Contacts, Pressurized (Style 040A)	
MIL-DTL-21617/25	Connector, Female Plug Electrical, Rectangular, Polarized Shell, Miniature Type, Socket Coaxial Contacts (Style 007C)	
MIL-DTL-21617/26	Connector, Male Receptacle Electrical, Rectangular, Polarized Shell, Miniature Type, Pin Coaxial Contacts (Style 007C)	
MIL-DTL-21617/27	Connector, Female Plug Electrical, Rectangular, Polarized Shell, Miniature Type, Mixed Socket Contacts (Style 016C)	
MIL-DTL-21617/28	Connector, Male Receptacle Electrical, Rectangular, Polarized Shell, Miniature Type, Mixed Pin Contacts (Style 016C)	
MIL-DTL-21617/29	Connector, Receptacle Electrical, Rectangular, Polarized Shell, Miniature Type, Back Shells	

MIL-STD-1353C
APPENDIX B

B.7 MIL-DTL-28804 characteristics. MIL-DTL-28804 rectangular electrical connectors, with size 22, non-removable, solder type contacts, and rear removable crimp type contacts, environment resistant and non-environment, see table B-V.

B.7.1 Intended use. All connectors and contacts covered by this specification are intended for use in airborne, ground support, and shipboard electrical and electronic equipment where presence of residual magnetism must be held to very low levels to avoid interference with nearby sensitive instrumentation.

TABLE B-V. MIL-DTL-28804 descriptions and configurations.

Specification number	Description	Configuration
MIL-DTL-28804	Connectors, Plug and Receptacle, Electric, Rectangular, High Density, Polarization Center Jackscrew General Specification For	
MIL-DTL-28804/1	Connectors, Receptacle, Electric, Rectangular, High Density, Polarized Center Jackscrew, Crimp Removable Socket Contacts, Class G. 14 to 244 contacts are available	
MIL-C-28804/2	Connectors, Plug, Electric, Rectangular, High Density, Polarization Center Jackscrew, Crimp Removable Pin Contacts, Class G	
MIL-C-28804/3	Connectors, Receptacle, Electric, Rectangular, High Density, Polarized Center Jackscrew, Crimp Removable Socket Contacts, Class E	
MIL-C-28804/4	Connectors, Plug, Electric, Rectangular, High Density, Polarization Center Jackscrew, Crimp Removable Pin Contacts, Class E	
MIL-C-28804/5	Connectors, Receptacle, Electric, Rectangular, High Density, Polarized Center Jackscrew, Crimp Removable Socket Contacts, Class P	
MIL-C-28804/6	Connectors, Plug, Electric, Rectangular, High Density, Polarization Center Jackscrew, Crimp Removable Pin Contacts, Class P	
MIL-DTL-28804/7	Connectors, Receptacle, Electric, Rectangular, High Density, Polarized Center Jackscrew, Solder Socket Contacts, Class S	
MIL-DTL-28804/9	Connectors, Pin Contact, Electric, Rectangular, High Density, Polarized Center Jackscrew, Size 22, Crimp Removable	
MIL-DTL-28804/10	Connectors, Socket Contact, Electric, Rectangular, High Density, Polarized Center Jackscrew, Size 22, Crimp Removable	
MIL-C-28804/11	Connectors, Plug, Electric, Rectangular, High Density, Polarization Center Jackscrew, Interfacial Seal, Solder Pin Contacts, Class SE	

MIL-STD-1353C
APPENDIX B



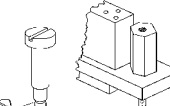
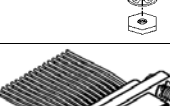
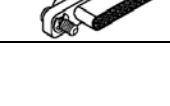


B.8 MIL-DTL-83513 characteristics. MIL-DTL-83513 polarized shell, microminiature D type, rectangular connectors, plastic and metal shell, crimp, solder and printed circuit board contacts, see table B-VI.

B.8.1 Intended use. These connectors are intended for use in airborne, ground support and shipboard electrical and electronic equipment in nonenvironmental resisting applications where the operating temperature ranges from -55°C to +125°C. These connectors are not intended for use in blind mating rack and panel applications.

B.8.2 Characteristics. Characteristics are shown below:

- a. Solder cup metal shell - M83513/01, M83513/02
- b. Solder cup plastic shell - M83513/06, M83513/07
- c. Pre-Wired pigtailed, metal shell - M83513/03, M83513/04
- d. Jackscrews and jackposts - M83513/05
- e. Pre-wired pigtailed, plastic shell - M83513/08, M83513/09
- f. 100" pitch right angle PCB connectors (CBR) - M83513/10 thru M83513/15
- g. 100" pitch right angle PCB connectors (BR) - M83513/16 thru M83513/21
- h. .100" pitch straight PCB connectors (BS) - M83513/22 thru M83513/27
- i. compact vertical mount printed circuit board (CBS) - M83513/28 thru M83513/33

TABLE B-VI. MIL-DTL-83513 descriptions and configurations.

Specification number	Description	Configuration
MIL-DTL-83513	Connectors, Electrical, Rectangular, Microminiature, Polarized Shell, General Specification For	
MIL-DTL-83513/1	Connectors, Electrical, Rectangular, Microminiature, Polarized Shell, Pin Contacts, Class M, Solder Type	
MIL-DTL-83513/2	Connectors, Electrical, Rectangular, Microminiature, Polarized Shell, Socket Contacts, Class M, Solder Type	
MIL-DTL-83513/3	Connectors, Electrical, Rectangular, Microminiature, Polarized Shell, Pin Contacts, Class M, Crimp Type	
MIL-DTL-83513/4	Connectors, Electrical, Rectangular, Microminiature, Polarized Shell, Socket Contacts, Class M, Crimp Type	
MIL-DTL-83513/5	Connectors, Electrical, Rectangular, Microminiature, Mounting Hardware	
MIL-DTL-83513/6	Connectors, Electrical, Rectangular, Microminiature, Polarized Shell, Pin Contacts, Class P, Solder Type	
MIL-DTL-83513/7	Connectors, Electrical, Rectangular, Microminiature, Polarized Shell, Socket Contacts, Class P, Solder Type	

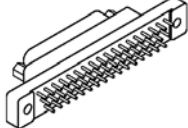
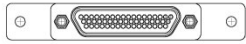
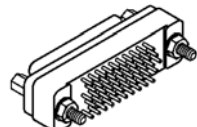
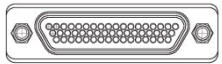
MIL-STD-1353C
APPENDIX B

TABLE B-VI. MIL-DTL-83513 descriptions and configurations - Continued.

Specification number	Description	Configuration
MIL-DTL-83513/8	Connectors, Electrical, Rectangular, Microminiature, Polarized Shell, Pin Contacts, Class P, Crimp Type	
MIL-DTL-83513/9	Connectors, Electrical, Rectangular, Microminiature, Polarized Shell, Socket Contacts, Class P, Crimp Type	
MIL-DTL-83513/10	Connectors, Electrical, Rectangular, Plug, Microminiature, Polarized Shell, Right Angle, Pin Contacts, 2 Row, Solder Type, Narrow Profile, 9 Through 37 Contacts, Printed Circuit Boards	
MIL-DTL-83513/11	Connectors, Electrical, Rectangular, Plug, Microminiature, Polarized Shell, Right Angle, Pin Contacts, 3 Row, Solder Type, Narrow Profile, 51 Contacts, Printed Circuit Boards	
MIL-DTL-83513/12	Connectors, Electrical, Rectangular, Plug, Microminiature, Polarized Shell, Right Angle, Pin Contacts, 4 Row, Solder Type, Narrow Profile, 100 Contacts, Printed Circuit Boards	
MIL-DTL-83513/13	Connectors, Electrical, Rectangular, Receptacle, Microminiature, Polarized Shell, Right Angle, Socket Contacts, 2 Row, Solder Type, Narrow Profile, 9 Through 37 Contacts, Printed Circuit Boards	
MIL-DTL-83513/14	Connectors, Electrical, Rectangular, Receptacle, Microminiature, Polarized Shell, Right Angle, Socket Contacts, 3 Row, Solder Type, Narrow Profile, 51 Contacts, Printed Circuit Boards	
MIL-DTL-83513/15	Connectors, Electrical, Rectangular, Receptacle, Microminiature, Polarized Shell, Right Angle, Socket Contacts, 4 Row, Solder Type, Narrow Profile, 100 Contacts, Printed Circuit Boards	
MIL-DTL-83513/16	Connectors, Electrical, Rectangular, Plug, Microminiature, Polarized Shell, Right Angle, Socket Contacts, 2 Row, Solder Type, Standard Profile, 9 Through 37 Contacts, Printed Circuit Boards	
MIL-DTL-83513/17	Connectors, Electrical, Rectangular, Plug, Microminiature, Polarized Shell, Right Angle, Socket Contacts, 3 Row, Solder Type, Standard Profile, 51 Contacts, Printed Circuit Boards	
MIL-DTL-83513/18	Connectors, Electrical, Rectangular, Plug, Microminiature, Polarized Shell, Right Angle, Socket Contacts, 4 Row, Solder Type, Standard Profile, 100 Contacts, Printed Circuit Boards	
MIL-DTL-83513/19	Connectors, Electrical, Rectangular, Receptacle, Microminiature, Polarized Shell, Right Angle, Socket Contacts, 2 Row, Solder Type, Standard Profile, 9 Through 37 Contacts, Printed Circuit Boards	
MIL-DTL-83513/20	Connectors, Electrical, Rectangular, Receptacle, Microminiature, Polarized Shell, Right Angle, Socket Contacts, 3 Row, Solder Type, Standard Profile, 51 Contacts, Printed Circuit Boards	
MIL-DTL-83513/21	Connectors, Electrical, Rectangular, Receptacle, Microminiature, Polarized Shell, Right Angle, Socket Contacts, 4 Row, Solder Type, Standard Profile, 100 Contacts, Printed Circuit Boards	
MIL-DTL-83513/22	Connectors, Electrical, Rectangular, Plug, Microminiature, Polarized Shell, Straight, Pin Contacts, 2 Row, Solder Type, 9 Through 37 Contacts, Printed Circuit Boards	
MIL-DTL-83513/23	Connectors, Electrical, Rectangular, Plug, Microminiature, Polarized Shell, Straight, Pin Contacts, 3 Row, Solder Type, 51 Contacts, Printed Circuit Boards	

MIL-STD-1353C
APPENDIX B

TABLE B-VI. MIL-DTL-83513 descriptions and configurations - Continued.

Specification number	Description	Configuration
MIL-DTL-83513/24	Connectors, Electrical, Rectangular, Plug, Microminiature, Polarized Shell, Straight, Pin Contacts, 4 Row, Solder Type, 100 Contacts, Printed Circuit Boards	
MIL-DTL-83513/25	Connectors, Electrical, Rectangular, Receptacle, Microminiature, Polarized Shell, Straight, Socket Contacts, 2 Row, Solder Type, 9 Through 37 Contacts, Printed Circuit Boards	
MIL-DTL-83513/26	Connectors, Electrical, Rectangular, Receptacle, Microminiature, Polarized Shell, Straight, Socket Contacts, 3 Row, Solder Type, 51 Contacts, Printed Circuit Boards	
MIL-DTL-83513/27	Connectors, Electrical, Rectangular, Receptacle, Microminiature, Polarized Shell, Straight, Socket Contacts, 4 Row, Solder Type, 100 Contacts, Printed Circuit Boards	
MIL-DTL-83513/28	Connectors, Electrical, Rectangular, Plug, Microminiature, Polarized Shell, Straight, Pin Contacts, 2 Row, Solder Type, Standard Profile, 9 Through 37 Contacts, Printed Circuit Boards	
MIL-DTL-83513/29	Connectors, Electrical, Rectangular, Plug, Microminiature, Polarized Shell, Straight, Pin Contacts, 3 Row, Solder Type, Standard Profile, 51 Contacts, Printed Circuit Boards	
MIL-DTL-83513/30	Connectors, Electrical, Rectangular, Plug, Microminiature, Polarized Shell, Straight, Pin Contacts, 4 Row, Solder Type, Standard Profile, 100 Contacts, Printed Circuit Boards	
MIL-DTL-83513/31	Connectors, Electrical, Rectangular, Receptacle, Microminiature, Polarized Shell, Right Angle, Socket Contacts, 2 Row, Solder Type, Narrow Profile, 9 Through 37 Contacts, Printed Circuit Boards	
MIL-DTL-83513/32	Connectors, Electrical, Rectangular, Receptacle, Microminiature, Polarized Shell, Straight, Socket Contacts, 3 Row, Solder Type, Standard Profile, 51 Contacts, Printed Circuit Boards	
MIL-DTL-83513/33	Connectors, Electrical, Rectangular, Receptacle, Microminiature, Polarized Shell, Straight, Socket Contacts, 4 Row, Solder Type, Standard Profile, 100 Contacts, Printed Circuit Boards	

MIL-STD-1353C
APPENDIX B

B.9 MIL-DTL-83733. MIL-DTL-83733 connectors are environment and fluid resisting, miniature, rectangular type, rack to panel electrical connectors (plugs and receptacles). These connectors utilize rear release, removable crimp type contacts and are capable of continuous operation from -65°C to $+200^{\circ}\text{C}$. Contact sizes 12, 16, 20, 22D, and 12 shielded, see figure B-1 and table B-VII.

B.9.1 Intended use. These connectors are intended for use in applications wherein extremes of temperature (-60°C to $+200^{\circ}\text{C}$), humidity (90 to 95 percent for 96 hours), and barometric pressure 110,000 feet (33.53 km) are experienced. They are not intended for use at operating temperatures higher than $+200^{\circ}\text{C}$ for extended periods.

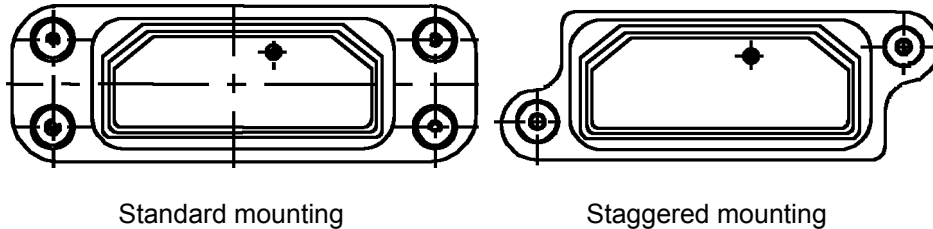


FIGURE B-1. MIL-DTL-83733, mounting configurations.

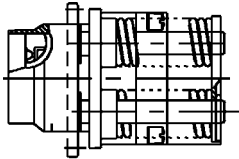
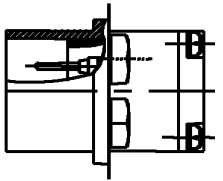
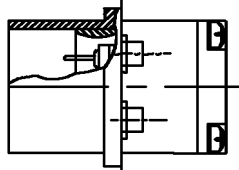
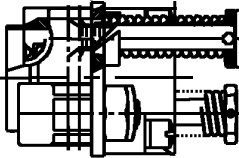
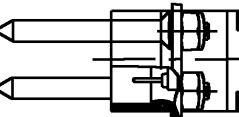
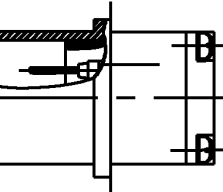
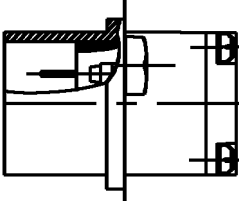
B.9.2 Coupling mounting. Standard hole, guide pins and spring, guide pins, guide sockets, guide sockets and spring, captive springs, clinch nut, bushing.

TABLE B-VII. MIL-DTL-83733 descriptions and configurations.

Specification number	Description	Configuration
MIL-DTL-83733	Connectors, Electrical Miniature, Rectangular Type, Rack to Panel, Environment Resisting, 200 Degrees C Total Continuous Operating Temperature, General Specification for	
MIL-DTL-83733/1	Connectors, Electrical Miniature, Rectangular Type, Rack to Panel, Standard Hole Mounting, Environment Resisting, 200 Degrees C	
MIL-DTL-83733/2	Connectors, Electrical Miniature, Rectangular Type, Rack to Panel, With Guide Pins and Spring Mounting, Environment Resisting, 200 Degrees C	
MIL-DTL-83733/3	Connectors, Electrical Miniature, Rectangular Type, Rack to Panel, With Guide Sockets, Environment Resisting, 200 Degrees C	

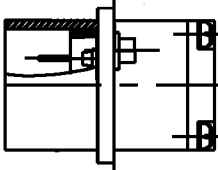
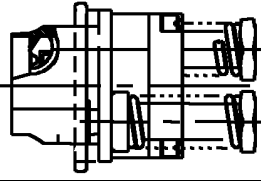
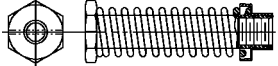
MIL-STD-1353C
APPENDIX B

TABLE B-VII. MIL-DTL-83733 descriptions and configurations - Continued.

Specification number	Description	Configuration
MIL-DTL-83733/4	Connectors, Electrical Miniature, Rectangular Type, Rack to Panel, With Captive Springs, Environment Resisting, 200 Degrees C	
MIL-DTL-83733/5	Connectors, Electrical Miniature, Rectangular Type, Rack to Panel, Bushing Mounting, Environment Resisting, 200 Degrees C	
MIL-DTL-83733/6	Connectors, Electrical Miniature, Rectangular Type, Rack to Panel, Clinch Nut Mounting, Environment Resisting, 200 Degrees C	
MIL-DTL-83733/7	Connectors, Electrical Miniature, Rectangular Type, Rack to Panel, With Guide Sockets and Spring Mounting, Environment Resisting, 200 Degrees C	
MIL-DTL-83733/8	Connectors, Electrical Miniature, Rectangular Type, Rack to Panel, With Guide Pins, Environment Resisting, 200 Degrees C	
MIL-DTL-83733/9	Connectors, Electrical Miniature, Rectangular Type, Rack to Panel, Staggered Standard Hole Mounting, Environment Resisting, 200 Degrees C	
MIL-DTL-83733/10	Connectors, Electrical Miniature, Rectangular Type, Rack to Panel, Staggered Bushing Connectors, Electrical Miniature, Rectangular Type, Rack to Panel, Staggered Bushing Mounting, Environment Resisting, 200 Degrees C	

MIL-STD-1353C
APPENDIX B

TABLE B-VII. MIL-DTL-83733 descriptions and configurations - Continued.

Specification number	Description	Configuration
MIL-DTL-83733/11	Connectors, Electrical Miniature, Rectangular Type, Rack to Panel, Staggered Bushing Connectors, Electrical Miniature, Rectangular Type, Rack to Panel, Staggered Clinch Nut Mounting, Environment Resisting, 200 Degrees C Mounting, Environment Resisting, 200 Degrees C	
MIL-DTL-83733/12	Connectors, Electrical Miniature, Rectangular Type, Rack to Panel, Staggered Bushing Connectors, Electrical Miniature, Rectangular Type, Rack to Panel, Staggered Spring Mounting, Environment Resisting, 200 Degrees C Mounting, Environment Resisting, 200 Degrees C	
MIL-DTL-83733/17	Connector, Rack and Panel, Spring Loaded Mounting Assembly	

MIL-STD-1353C
APPENDIX C

C.1 SCOPE

C.1.1 Scope. This appendix provides additional guidance to help the specification developer or engineer in selection of radio frequency connectors. This appendix is not a mandatory part of this standard. The information is intended for guidance only.

C.2 APPLICABLE DOCUMENTS

C.2.1 General. The documents listed in this appendix are specified herein. This section does not include documents cited in other sections of this document.

C.2.2 GOVERNMENT DOCUMENTS

C.2.2.1 Specifications, standards, and handbooks. The following specifications, standards, and handbooks form a part of this appendix to the extent specified herein.

DEPARTMENT OF DEFENSE STANDARDS

- MIL-STD-348 - Radio Frequency Connector Interfaces for MIL-C-3643, MIL-C-3650, MIL-C-3655, MIL-C-25516, MIL-C-26637, MIL-PRF-39012, MIL-PRF-49142, MIL-PRF-49142, MIL-PRF-55339, MIL-C-83517

DEPARTMENT OF DEFENSE SPECIFICATIONS

- MIL-A-55339/42 - Adapter, Connector, Coaxial, Radio Frequency, (Between Series SMA (Female) to Series TNC (Male)), Class 2, Straight Plug
- MIL-C-3643/1 - Connector, Plug, Electrical, Series HN, Type UG-59E/U
- MIL-C-3643/2 - Connector, Plug, Electrical, Series HN, Type UG-60E/U
- MIL-C-3643/3 - Connector, Receptacle, Electrical, Series HN, Type UG- 61E/U
- MIL-C-3643/5 - Connector, Plug, Electrical, Series HN, Type UG-333C/U
- MIL-C-3643/6 - Connector, Adapter, Series HN, Type UG-413/U
- MIL-C-3643/7 - Connector, Plug, Electrical, Series HN, Type UG-494B/U
- MIL-C-3643/8 - Connector, Plug, Electrical, Series HN, Type UG-495D/U
- MIL-C-3643/9 - Connector, Receptacle, Electrical, Series HN, Type UG- 496/U
- MIL-C-3643/11 - Connector, Receptacle, Electrical, Series HN, Type UG- 427C/U
- MIL-C-3643/12 - Connector, Plug, Electrical, Series HN, Type UG-926B/U
- MIL-C-3643/14 - Clamp, Armor, Series HN, Type MX-1462/U
- MIL-C-39012/9 - Connector, Coaxial, Radio Frequency Series C (Cabled Receptacle, Female, Jam Nut, Front Mounted, Class 2)
- MIL-C-39012/15 - Connectors, Plug, Electrical, Coaxial, Radio Frequency, (Series C, (Cabled) Male, Class 2)
- MIL-DTL-3607 - Connectors, Coaxial, Radiofrequency, Series Pulse, General Specification for
- MIL-DTL-3607/1 - Connector, Plug, Electrical, Series Pulse, Type UG-36/U
- MIL-DTL-3607/2 - Connector, Receptacle, Electrical, Series Pulse, Type UG-37A/U
- MIL-DTL-3607/3 - Connector, Receptacle, Electrical, Series Pulse, Type UG-37/U
- MIL-DTL-3607/7 - Connector, Plug, Electrical, Series Pulse, Type UG-180A/U
- MIL-DTL-3607/9 - Connector, Receptacle, Electrical, Series Pulse, Type UG-182A/U
- MIL-DTL-3643 - Connectors, Coaxial, Radio Frequency, Series HN, and Associated Fittings, General Specification For
- MIL-DTL-3650 - Connectors, Coaxial, Radio Frequency, Series LC
- MIL-DTL-3643/4 - Connector, Adapter, Series HN, Type UG-212C/U

MIL-STD-1353C
APPENDIX C

- MIL-DTL-3655 - Connectors, Plug and Receptacle, Electrical (Coaxial, Series Twin), and Associated Fittings, General Specification for
- MIL-DTL-3655/1 - Connector, Plug, Electrical, Class I (Coaxial, Series Twin), Type UG-421B/U
- MIL-DTL-3655/2 - Connector, Receptacle, Electrical, Class I (Coaxial, Series Twin) Type UG-422/U
- MIL-DTL-3655/3 - Connector, Receptacle, Electrical, Class I (Coaxial, Series Twin) Type UG-423B/U
- MIL-DTL-3655/4 - Connector Adapter, Class I (Coaxial, Series Twin) Type UG-493A/U
- MIL-DTL-3655/5 - Connector Adapter, Class I (Coaxial, Series Twin) Type UG-981/U
- MIL-DTL-3655/6 - Connector, Receptacle, Electrical, Class II (Coaxial, Series Twin) Type UG-1057/U (Inactive for new design)
- MIL-DTL-3655/8 - Connector Adapter, Class II (Coaxial, Series Twin), Type UG-1059/U
- MIL-DTL-3655/9 - Connector, Plug, Electrical, Class I (Coaxial, Series Twin), Type UG-1060A/U (Inactive for new design)
- MIL-DTL-3655/10 - Connector Shield, Electrical, (Coaxial, Series Twin), Type MX-1556/U
- MIL-DTL-3655/11 - Connector Shield, Electrical (Coaxial, Series Twin), Type UG-106/U
- MIL-DTL-3655/13 - Connector, Receptacle, Electrical, Class I (Coaxial, Series Twin, TWTNC, Jam Nut Mounted)
- MIL-DTL-3655/14 - Connector, Plug, Electrical, Class I (Coaxial, Series Twin, TWTNC)
- MIL-DTL-3655/15 - Connector, Plug, Electrical, Class I (Coaxial, Series Twin, TWBNC)
- MIL-DTL-3655/16 - Connector, Receptacle, Electrical, Class I (Coaxial, Series Twin, TWBNC)
- MIL-DTL-3655/17 - Connector, Plug, Electrical, Class I (Coaxial, Series Twin, TWTNC, Right Angle)
- MIL-DTL-3655/22 - Connector, Receptacle, Electrical, Class I (Coaxial, Series Twin, TWTNC, Bulkhead)
- MIL-DTL-3655/23 - Connector, Receptacle, Electrical, Class I (Coaxial, Series Twin, TWBNC, Bulkhead)
- MIL-DTL-55235 - Connectors, Coaxial, Radio Frequency, Series TPS, General Specification
- MIL-DTL-83517 - Connector, Coaxial, Radio Frequency for Coaxial, Strip or Microstrip Transmission Line General Specification For
- MIL-DTL-83517/1 - Connector, Receptacle, Electrical, Coaxial, Radio Frequency, Strip or Microstrip Transmission Line, Series SMA (Socket Contact, Flange Mounted Tab Terminal)
- MIL-DTL-83517/2 - Connector, Receptacle, Electrical, Coaxial, Radio Frequency, Strip or Microstrip Transmission Line, Series SMA (Pin Contact, Flange Mounted Tab Terminal)
- MIL-DTL-83517/3 - Connector, Receptacle, Electrical, Coaxial, Radio Frequency, Strip or Microstrip Transmission Line, Series SMA (Socket Contact, Flange Mounted Slotted Tab Terminal)
- MIL-DTL-83517/4 - Connector, Receptacle, Electrical, Coaxial, Radio Frequency, Strip or Microstrip Transmission Line, Series SMA (Socket Contact, Flange Mounted Extended Dielectric)
- MIL-DTL-83517/5 - Connector, Receptacles, Electrical, Coaxial, Radio Frequency, Strip or Microstrip Transmission Line, Series SMA (Pin Contact, Flange Mounted Extended Dielectric)
- MIL-DTL-83517/6 - Connector, Receptacles, Electrical, Coaxial, Radio Frequency, Strip or Microstrip Transmission Line, Series SMA (Socket Contact, 8 Hole Surface Launch)

MIL-STD-1353C
APPENDIX C

- MIL-DTL-835177 - Connector, Receptacles, Electrical, Coaxial, Radio Frequency, Strip or Microstrip Transmission Line, Series SMA (Pin Contact, 8 Hole Surface Launch)
- MIL-DTL-835178 - Connector, Receptacles, Electrical, Coaxial, Radio Frequency, Strip or Microstrip Transmission Line, Series SMA (Socket Contact, 8 Hole Surface Launch Right Angle)
- MIL-DTL-835179 - Connector, Receptacles, Electrical, Coaxial, Radio Frequency, Strip or Microstrip Transmission Line, Series SMA (Socket Contact, End Launch)
- MIL-DTL-8351710 - Connector, Receptacles, Electrical, Coaxial, Radio Frequency, Strip or Microstrip Transmission Line, Series SMA (Socket Contact, Flange Mounted)
- MIL-DTL-8351711 - Connector, Receptacles, Electrical, Coaxial, Radio Frequency, Strip or Microstrip Transmission Line, Series SMA (Pin Contract, Flange Mounted)
- MIL- DTL-8351712 - Connector, Receptacle, Electrical, Coaxial, Radio Frequency, Stripline, Series BMA (Pin Contact), Flange Mounted, Extended Dielectric
- MIL- DTL-8351713 - Connector, Receptacle, Electrical, Coaxial, Radio Frequency, Series SMA, (Socket Contact) Feed through, Hermetic
- MIL-PRF-31031 - Connectors, Electrical, Plugs and Receptacles, Coaxial, Radio Frequency, High Reliability, For Flexible and Semirigid Cables, General Specification For
- MIL-PRF-31031/1 - Connector, Receptacle, Electrical, Radio Frequency, Series BMA, Flange Mount, For Flexible Cable, Socket Contact, High Reliability
- MIL-PRF-31031/2 - Connector, Receptacle, Electrical, Radio Frequency, Series BMA, Jamnut Mount, For Flexible Cable, Pin Contact, High Reliability
- MIL-PRF-31031/11 - Connector, Receptacle, Electrical, Radio Frequency, Series BMA, Flange Mount, For Semirigid Cable, Socket Contact, High Reliability
- MIL-PRF-31031/12 - Connector, Receptacle, Electrical, Radio Frequency, Series BMA, Jamnut Mount, For Semirigid Cable, Pin Contact, High Reliability
- MIL-PRF-31031/30 - Connector, Electrical, Coaxial, Radio Frequency, Socket Contact, Series SMP to SMP, Shroud, 2 Hole Flange
- MIL-PRF-31031/31 - Connector, Electrical, Coaxial, Radio Frequency, Socket Contact, Series SMP, For .047 And .086 Semirigid Cable
- MIL-PRF-31031/32 - Connector, Electrical, Receptacle, Radio Frequency, High Reliability, Coaxial, Series BMZ, Socket Contact, For Flexible Cable
- MIL-PRF-31031/40 - Connector, Electrical, Receptacle, Radio Frequency, High Reliability, Coaxial, Series BMZ, Socket Contact, For Flexible Cable
- MIL-PRF-31031/41 - Connector, Electrical, Receptacle, Radio Frequency, High Reliability, Coaxial, Series BMZ, Pin Contact, For Flexible Cable
- MIL-PRF-31031/42 - Connector, Electrical, Receptacle, Radio Frequency, High Reliability, Coaxial, Series BMZ, Socket Contact, For Semirigid Cable
- MIL-PRF-31031/43 - Frequency, High Reliability, Coaxial, Series BMZ, Right Angle, Pin Contact, For Semirigid Cable
- MIL-PRF-31031/44 - Connector, Electrical, Receptacle, Radio Frequency, High Reliability, Coaxial, Series BMZ, Pin Contact, For Semirigid Cable
- MIL-PRF-39012 - Connectors, Coaxial, Radio Frequency, General Specification For
- MIL-PRF-39012/1 - Connectors, Plug, Electrical, Coaxial, Radio Frequency, (Series N (Cabled), Pin Contact, Class 2)
- MIL-PRF-39012/2 - Connectors, Plugs and Receptacles, Electrical, Coaxial, Radio Frequency, (Series TNC (Cabled), Flange Mounted, Socket Contact, Class 2)

MIL-STD-1353C
APPENDIX C

MIL-PRF-39012/3	- Connectors, Receptacles, Electrical, Coaxial, Radio Frequency (Series N (Cabled), Jam Nut Mounted, Socket Contact, Class 2)
MIL-PRF-39012/4	- Connectors, Coaxial, Radio Frequency (Series N (Uncabled) - Receptacles-Jam Nut and Flange Mounted, Socket Contact, Class 2)
MIL-PRF-39012/5	- Connectors, Plug, Electrical, Coaxial, Radio Frequency (Series N (Cabled), Right Angle, Pin Contact, Class 2)
MIL-PRF-39012/6	- Connectors, Plug, Electrical, Coaxial, Radio Frequency, (Series C, (Cabled), Male, Class 2)
MIL-PRF-39012/7	- Connectors, Plug, Electrical, Coaxial, Radio Frequency, (Series C (Cabled), Female, Class 2)
MIL-PRF-39012/8	- Connectors, Receptacle, Electrical, Coaxial, Radio Frequency, (Series C, (Cabled), Female, Flange Mounted, Rear Mounted, Class 2)
MIL-PRF-39012/10	- Connectors, Plug, Electrical, Coaxial, Radio Frequency, (Series C, (Cabled), Male, Right Angle, Class 2)
MIL-PRF-39012/11	- Connectors, Receptacle, Electrical, Coaxial, Radio Frequency, (Series C, (Cable) Female, Jam Nut, Rear Mounted, Pressurized, Class 2)
MIL-PRF-39012/12	- Connectors, Coaxial, Radio Frequency, Series C (Uncabled-Receptacle, Female, Flange Mounted, Rear Mounted, Class 2)
MIL-PRF-39012/13	- Connectors, Coaxial, Radio Frequency, Series C (Uncabled-Receptacle, Female, Jam Nut Mounted, Front Mounted, Pressurized, Class 2)
MIL-PRF-39012/14	- Connectors, Coaxial, Radio Frequency, Series C (Uncabled-Receptacle, Female, Jam Nut Mounted, Hermetic Seal, Class 2)
MIL-PRF-39012/16	- Connectors, Plugs, Electrical, Coaxial Radio Frequency, (Series BNC (Cabled), Pin Contact, Class 2)
MIL-PRF-39012/17	- Connectors, Plugs, Electrical, Coaxial, Radio Frequency, (Series BNC, (Cabled), Socket Contact, CLASS 2)
MIL-PRF-39012/18	- Connectors, Receptacle, Electrical, Coaxial, Radio Frequency, (Series BNC, (Cabled), Socket Contact, Flange Mounted, Class 2)
MIL-PRF-39012/19	- Connectors, Receptacle, Electrical, Coaxial, Radio Frequency, (Series BNC (Cabled), Socket Contact, Jam Nut Mounted, Class 2)
MIL-PRF-39012/20	- Connectors, Plug, Electrical, Coaxial, Radio Frequency, (Series BNC (Cabled), Pin Contact, Right Angle, Class 2)
MIL-PRF-39012/21	- Connectors, Receptacles, Electrical, Coaxial, Radio Frequency, (Series BNC (Uncabled), Socket Contact, Flange Mounted, Class 2)
MIL-PRF-39012/22	- Connectors, Receptacles, Electrical, Coaxial, Radio Frequency, (Series BNC (Uncabled), Socket Contact, Flange Mounted, Class 2)
MIL-PRF-39012/23	- Connectors, Receptacles, Electrical, Coaxial, Radio Frequency, (Series BNC (Uncabled), Socket Contact, Right Angle, Class 2)
MIL-PRF-39012/24	- Connectors, Receptacle, Electrical, Coaxial, Radio Frequency, (Series BNC (Uncabled), Socket Contact, Hermetic Sealed, Jam Nut Mounted, Class 2)
MIL-PRF-39012/25	- Connectors, Coaxial, Radio Frequency, (Hardware for Radio Frequency Coaxial Connectors)
MIL-PRF-39012/26	- Connectors, Plugs, Electrical, Coaxial Radio Frequency, (Series TNC (Cabled), Pin Contact, Class 2)
MIL-PRF-39012/27	- Connectors, Plugs, Electrical, Coaxial, Radio Frequency, (Series TNC, (Cabled), Socket Contact, Class 2)
MIL-PRF-39012/28	- Connectors, Receptacles, Electrical, Coaxial, Radio Frequency, (Series TNC, (Cabled), Socket Contact, Jam Nut Mounted, Class 2)
MIL-PRF-39012/29	- Connectors, Receptacle, Electrical, Coaxial, Radio Frequency, (Series TNC, (Cabled), Socket Contact, Flange Mounted, Class 2)

MIL-STD-1353C
APPENDIX C

- MIL-PRF-39012/30 - Connectors, Plugs, Electrical, Coaxial Radio Frequency, (Series TNC (Cabled), Pin Contact, Right Angle, Class 2)
- MIL-PRF-39012/31 - Connectors, Coaxial, Radio Frequency, Series TNC (Uncabled- Receptacle, Socket, Jam Nut Mounted, Class 2)
- MIL-PRF-39012/32 - Connectors, Coaxial, Radio Frequency, Series TNC (Uncabled - Receptacle, Socket, Flange Mounted, Class 2)
- MIL-PRF-39012/33 - Connectors, Coaxial, Radio Frequency, Series TNC (Uncabled- Receptacle, Socket, Right Angle, Class 2)
- MIL-PRF-39012/34 - Connectors, Coaxial, Radio Frequency Series INC (Uncabled - Receptacle, Socket, Hermetic Sealed, Jam Nut Mounted, Class 2)
- MIL-PRF-39012/35 - Connectors, Plug, Electrical, Coaxial, Radio Frequency (Series SC (Cabled), Pin Contact, Class 2)
- MIL-PRF-39012/38 - Electrical, Coaxial, Radio Frequency (Series SC (Cabled), Socket Contact, Flange Mounted, Rear Mounted, Class 2)
- MIL-PRF-39012/39 - Connectors, Receptacle, Electrical, Coaxial, Radio Frequency (Series SC (CABLED), Pin Contact, Right Angle, Class 2)
- MIL-PRF-39012/40 - Connectors, Receptacle, Electrical, Coaxial, Radio Frequency (Series SC (Cabled), Socket Contact, Jam Nut, Rear Mounted, Class 2)
- MIL-PRF-39012/55 - Connectors, Plugs, Electrical, Coaxial, Radio Frequency (Series SMA (Cabled) - Plug, Pin Contact, Class 2)
- MIL-PRF-39012/56 - Connectors, Plugs, Electrical, Coaxial, Radio Frequency (Series SMA (Cabled) - Plug, Pin Contact, Right Angle, Class 2)
- MIL-PRF-39012/57 - Coaxial, Radio Frequency, (Series SMA (Cabled)-Socket Contact, Class 2)
- MIL-PRF-39012/58 - Connectors, Receptacles, Electrical, Coaxial, Radio Frequency, (Series SMA (Cabled) - Socket Contact, Flange Mounted Class 2)
- MIL-PRF-39012/59 - Connectors, Receptacles, Electrical, Coaxial, Radio Frequency, (Series SMA (Cabled) - Socket Contact, Jam Nut Mounted Class 2)
- MIL-PRF-39012/60 - Connectors, Receptacles, Electrical, Coaxial, Radio Frequency Series SMA (Uncabled, Socket Contact, Flange Mounted, Class 2)
- MIL-PRF-39012/61 - Connectors, Receptacles, Electrical, Coaxial, Radio Frequency, Series SMA (Uncabled, Socket Contact, Jam Nut Mounted, Class 2)
- MIL-PRF-39012/62 - Connectors, Receptacles, Electrical, Coaxial, Radio Frequency, Series SMA (Uncabled, Socket Contact, Jam Nut Mounted, Hermetic Seal, Class 2)
- MIL-PRF-39012/67 - Connectors, Plugs, Electrical, Coaxial, Radio Frequency, Series SMB (Cabled, Socket Contact, Class 2)
- MIL-PRF-39012/68 - Connectors, Plugs, Electrical, Coaxial, Radio Frequency, Series SMB (Cabled, Pin Contact, Class 2)
- MIL-PRF-39012/69 - Connectors, Plugs, Electrical, Coaxial, Radio Frequency, Series SMB (Cabled, Socket Contact, Right Angle Class 2)
- MIL-PRF-39012/70 - Connectors, Receptacle, Electrical, Coaxial, Radio Frequency, Series SMB (Cabled, Pin Contact, Jamnut Mounted, Rear Mounted, Class 2)
- MIL-PRF-39012/71 - Connectors, Receptacles, Electrical, Coaxial, Radio Frequency, Series SMB (Uncabled, Male, Jamnut Mounted, Class 2)
- MIL-PRF-39012/73 - Connectors, Plugs, Electrical, Coaxial, Radio Frequency, Series SMC (Cabled, Socket Contact, Class 2)
- MIL-PRF-39012/74 - Connectors, Plugs, Electrical, Coaxial, Radio Frequency, Series SMC (Cabled, Pin Contact, Class 2)
- MIL-PRF-39012/75 - Connectors, Plugs, Electrical, Coaxial, Radio Frequency, Series SMC (Cabled, Socket Contact, Right Angle, Class 2)

MIL-STD-1353C
APPENDIX C

- MIL-PRF-39012/76 - Connectors, Receptacles, Electrical, Coaxial, Radio Frequency, Series SMC (Cabled, Pin Contact, Jamnut Mounted, Rear Mounted, Class 2)
- MIL-PRF-39012/77 - Connectors, Receptacle, Electrical, Coaxial, Radio Frequency, Series SMC (Uncabled, Male, Jamnut Mounted, Class 2)
- MIL-PRF-39012/79 - Connectors, Plug, Electrical, Coaxial, Radio Frequency, Series SMA (Cabled) Pin Contact, Class 2, Semirigid Cable
- MIL-PRF-39012/80 - Connectors, Plug, Electrical, Coaxial, Radio Frequency, Series SMA (Cabled) Pin Contact, Right Angle, Class 2, Semirigid Cable
- MIL-PRF-39012/81 - Connectors, Plug, Electrical, Coaxial, Radio Frequency, Series SMA (Cabled, Semirigid) – Socket Contact, Class 2
- MIL-PRF-39012/82 - Connectors, Receptacle, Electrical, Coaxial, Radio Frequency, Series SMA (Cabled, Semirigid), Flange Mounted - Socket Contact, Class 2
- MIL-PRF-39012/83 - Connectors, Plug, Electrical, Coaxial, Radio Frequency, Series SMA (Cabled, Semirigid) - Jam Nut Mounted, Socket Contact, Class 2
- MIL-PRF-39012/92 - Connectors, Plug, Electrical, Coaxial, Radio Frequency, Series SMA (Cabled, Class 2, Without Contact, .141 Semirigid Cable)
- MIL-PRF-39012/93 - Connectors, Receptacles, Electrical, Coaxial, Radio Frequency, Series SMA (Uncabled, Female, Printed Circuit, Class 2)
- MIL-PRF-39012/94 - Connectors, Receptacles, Electrical, Coaxial, Radio Frequency, and Series SMA (Uncabled, Female, Printed Circuit, Right Angle, Class 2)
- MIL-PRF-39012/95 - Connectors, Receptacle, Electrical, Coaxial, Radio Frequency, Series SMB (Uncabled, Male, Printed Circuit, Class 2)
- MIL-PRF-39012/96 - Connectors, Receptacle, Electrical, Coaxial, Radio Frequency, Series SMB (Uncabled, Male, Printed Circuit, Class 2)
- MIL-PRF-39012/100 - Connectors, Plug, Electrical, Coaxial, Radio Frequency, High Voltage (Series MHV (Cabled), Pin Contact, Class 2)
- MIL-PRF-39012/128 - Connectors, Receptacle, Electrical Coaxial, Radio Frequency (Series BNC, Solder Pocket, Socket Contact Jam Nut Mounted, Isolated, Class 2)
- MIL-PRF-39012/133 - Electrical, Coaxial, Radio Frequency, Series SMC, Printed Circuit Board Mount
- MIL-PRF-39012/134 - Connectors, Receptacle, Electrical, Coaxial, Radio Frequency, Series SMC, Printed Circuit Board Mount, Right Angle
- MIL-PRF-39012/135 - Connectors, Receptacle, Electrical, Coaxial, Radio Frequency, Series SSMB, Printed Circuit Board Mount, Right Angle
- MIL-PRF-39012/136 - Connectors, Plug, Electrical, Series SSMA, Pin Contact, For Semirigid Cable, Class 2
- MIL-PRF-39012/137 - Connectors, Plug, Electrical, Series SSMA, Right Angle, Pin Contact, For Semirigid Cable, Class 2
- MIL-PRF-39012/138 - Connector, Receptacle, Electrical, Series SSMA, Socket Contact, For Semirigid Cable
- MIL-PRF-39012/139 - Connector, Plug, Electrical, Series SSMA, Pin Contact, For Flexible Cable, Class 2
- MIL-PRF-39012/140 - Connector, Plug, Electrical, Series SSMA, Pin Contact, Right Angle, For Flexible Cable, Class 2
- MIL-PRF-39012/141 - Connector, Receptacle, Electrical, Coaxial, Radio Frequency, Series SSMB, Printed Circuit Board Mount, Straight
- MIL-PRF-49142 - Connector, Triaxial, Radio Frequency, General Specification For
- MIL-PRF-49142/3 - Connector, Plug, Electrical, Triaxial, Radio Frequency (Series TRB, Pin Contact, Class 2)

MIL-STD-1353C
APPENDIX C

- MIL-PRF-49142/4 - Connectors, Receptacle, Electrical, Triaxial, Radio Frequency, Uncabled, (Series TRB, Socket Contact, Jamnut Mounted, Class 2) Hermetic and Nonhermetic
- MIL-PRF-49142/5 - Connector, Receptacle, Electrical, Triaxial, Radio Frequency (Series TRB (Cabled), Socket Contact, Jam Nut Mounted, Class 2)
- MIL-PRF-49142/6 - Connector, Plug, Electrical, Triaxial, Radio Frequency (Series TRB (Cabled), Socket Contact, Class 2)
- MIL-PRF-49142/7 - Connector, Plug, Electrical, Triaxial, Radio Frequency (Series TRB (Cabled), Pin Contact, Right Angle, Class 2)
- MIL-PRF-49142/8 - Connectors, Triaxial, Radio Frequency (Series TRT (Cabled), Plug, Pin Contact, Class 2)
- MIL-PRF-49142/9 - Connector, Triaxial, Radio Frequency, (Series TRT (Cabled) Receptacle, Socket Contact, Jamnut Mounted, Class 2)
- MIL-PRF-49142/10 - Connectors, Receptacle, Electrical, Triaxial, Radio Frequency, Uncabled (Series TRT, Socket Contact, Jamnut Mounted, Class 2) Hermetic and Nonhermetic
- MIL-PRF-49142/11 - Connectors, Triaxial, Radio Frequency, (Series TRT (Cabled) Receptacle, Socket Contact, Class 2)
- MIL-PRF-49142/12 - Connectors, Plug, Electrical, Triaxial, Radio Frequency, (Series TRT (Cabled), Pin Contact, Right Angle, Class 2)
- MIL-PRF-55339 - Adapters, Connectors, Coaxial, Radio Frequency, (Between Series and Within Series), General Specification For
- MIL-PRF-55339/1 - Adapter, Connector, Coaxial, Radio Frequency, In-Line, (Between Series BNC Jack to Series N JACK), Class 2
- MIL-PRF-55339/2 - Adapters, Connector, Coaxial, Radio Frequency, (Series SMA), Class 2, Right Angle, Male to Female
- MIL-PRF-55339/3 - Adapter, Connector, Coaxial, Radio Frequency, Right Angle, (Within Series N Plug to Series N Jack), Class 2
- MIL-PRF-55339/4 - In-Line, Jamnut Mounted, (Within Series N Jack to Series N Jack, (Hermetic and Non-Hermetic)), Class 2
- MIL-PRF-55339/5 - Adapter, Connector, Coaxial, Radio Frequency, In-Line, (Within Series N Plug to Series N Plug), Class 2
- MIL-PRF-55339/6 - Adapter, Connector, Coaxial, Radio Frequency, (Within Series N), Class 2, "T" Plug
- MIL-PRF-55339/7 - Adapter, Connector, Coaxial, Radio Frequency, (Within Series N), Class 2, Straight Plug
- MIL-PRF-55339/8 - Adapter, Connector, Coaxial, Radio Frequency, In-Line, (Within Series C Jack to Series C Jack), Class 2
- MIL-PRF-55339/9 - Adapter, Connector, Coaxial, Radio Frequency, (Within Series C), Class 2, Straight Plug
- MIL-PRF-55339/10 - Adapter, Connector, Coaxial, Radio Frequency, (Within Series C), Class 2, Right Angle Plug
- MIL-PRF-55339/11 - Adapter, Connector, Coaxial, Radio Frequency (Within Series C), Class 2, "T" Plug
- MIL-PRF-55339/12 - Adapter, Connector, Coaxial, Radio Frequency, In-Line, Jamnut Mounted, (Within Series C Jack to Series C Jack (Hermetic)), Class 2
- MIL-PRF-55339/13 - Adapters, Connector, Coaxial, Radio Frequency, In-Line, Jamnut Mounted, (Within Series BNC Jack to Series BNC Jack, (Hermetic and Non-Hermetic)), Class 2
- MIL-PRF-55339/14 - Adapter, Connector, Coaxial, Radio Frequency, Right Angle (Within Series BNC Jack to Series BNC Plug), Class 2

MIL-STD-1353C
APPENDIX C

- MIL-PRF-55339/15 - Adapter, Connector, Coaxial, Radio Frequency (Within Series BNC), Class 2, Straight Plug
- MIL-PRF-55339/16 - Adapter, Connector, Coaxial, Radio Frequency. In-Line, (Within Series BNC Jack to Series BNC Jack), Class 2
- MIL-PRF-55339/17 - Adapter, Connector, Coaxial, Radio Frequency, "T", (Within Series BNC Jack to Jack and Series BNC Plug to Jack) Class 2
- MIL-PRF-55339/18 - Adapter, Connector, Coaxial, Radio Frequency, In-Line, (Between Series BNC Plug to Series N Plug), Class 2
- MIL-PRF-55339/19 - Adapter, Connector, Coaxial, Radio Frequency, In-Line, (Between Series N Jack to Series C Plug), Class 2
- MIL-PRF-55339/20 - Adapter, Connector, Coaxial, Radio Frequency, In-Line, (Between Series BNC Jack to Series N Plug), Class 2
- MIL-PRF-55339/21 - Adapter, Connector, Coaxial, Radio Frequency, In-Line, (Between Series C Jack to Series N Plug), Class 2
- MIL-PRF-55339/22 - Adapter, Connector, Coaxial, Radio Frequency, In-Line, (Between Series BNC Jack to Series C Plug), Class 2
- MIL-PRF-55339/23 - Adapter, Connector, Coaxial, Radio Frequency, In-Line, (Between Series C Jack to Series BNC Plug), Class 2
- MIL-PRF-55339/24 - Adapter, Connector, Coaxial, Radio Frequency, Flange Mounted, (Within Series BNC Plug to Series N Jack), Class 2
- MIL-PRF-55339/25 - Adapter, Connector, Coaxial, Radio Frequency, In-Line, Jamnut Mounted, (Between Series BNC Jack to Series N Jack), Class 2
- MIL-PRF-55339/28 - Adapter, Connector, Coaxial, Radio Frequency, In Line, Jamnut Mounted, (Within Series SMA Plug to Series SMA Plug (Hermetic)), Class 2
- MIL-PRF-55339/29 - Adapter, Connector, Coaxial, Radio Frequency, In-Line, (Within Series SMA Plug to SMA Plug), Class 2
- MIL-PRF-55339/30 - Adapter, Connector, Coaxial, Radio Frequency, "T", (Within Series SMA Plug to Two Series SMA Jacks), Class 2
- MIL-PRF-55339/31 - Adapter, Connector, Coaxial, Radio Frequency, In-Line (Within Series SMA Jack to SMA Series Jack), Class 2
- MIL-PRF-55339/32 - Adapter, Connector, Coaxial, Radio Frequency, (Within Series TNC) Right Angle, Male to Female
- MIL-PRF-55339/33 - Adapter, Connector, Coaxial, Radio Frequency, (Within Series TNC) Class 2, Straight Plug
- MIL-PRF-55339/34 - Adapter, Connector, Coaxial, Radio Frequency, (Within Series TNC, (Hermetic)), Class 2, Receptacle
- MIL-PRF-55339/35 - Adapter, Connector, Coaxial, Radio Frequency (Within Series TNC), Class 2, "T" Plug
- MIL-PRF-55339/36 - Adapter, Connector, Coaxial, Radio Frequency (Within Series TNC), Class 2, Straight Plug
- MIL-PRF-55339/37 - Adapter, Connector, Coaxial, Radio Frequency (Between Series BNC To Series TNC), Class 2, Straight Plug
- MIL-PRF-55339/38 - Adapter, Connector, Coaxial, Radio Frequency, (Between Series BNC to Series TNC), Class 2, Straight Plug
- MIL-PRF-55339/39 - Adapters, Connector, Coaxial, Radio Frequency, (Between Series SMA (Male) to Series TNC (Female)), Class 2, Straight Plug
- MIL-PRF-55339/40 - Adapters, Connector, Coaxial, Radio Frequency, (Between Series SMA (Male) to Series TNC (Female)), Class 2, Straight Plug
- MIL-PRF-55339/41 - Adapter, Connector, Coaxial, Radio Frequency, (Between Series SMA (Female) To Series TNC (Female)), Class 2, Straight Plug

MIL-STD-1353C
APPENDIX C

MIL-PRF-55339/43	-	Adapters, Connector, Coaxial, Radio Frequency, (Between Series SMA (Male) to Series TNC (Male)), Class 2, Straight Plug
MIL-PRF-55339/44	-	Adapter, Connector, Coaxial, Radio Frequency, In-Line (Between Series SMA Jack to Series BNC), Class 2
MIL-PRF-55339/45	-	Adapter, Connector, Coaxial, Radio Frequency, In-Line, (Between Series SMA Plug to Series BNC Plug), Class 2
MIL-PRF-55339/46	-	Adapter, Connector, Coaxial, Radio Frequency, In-Line, (Between Series SMA Jack to Series BNC Jack), Class 2
MIL-PRF-55339/47	-	Adapter, Connector, Coaxial, Radio Frequency, In Line, (Between Series SMA Plug to Series BNC Jack), Class 2
MIL-PRF-55339/48	-	Adapter, Connector, Coaxial, Radio Frequency, (Between Series SMA to Series TNC), Class 2, Straight Plug
MIL-PRF-55339/49	-	Adapter, Connector, Coaxial, Radio Frequency (Between Series N Jack to Series BNC Plug)
MIL-PRF-55339/50	-	Adapter, Connector, Coaxial, Radio Frequency (Within Series TNC Jack to Two Series TNC Jacks), Class 2 "T" Jamnut Mount
MIL-PRF-55339/51	-	Adapter, Connector, Coaxial, Radio Frequency, (Between Series TNC to Series N), Class 2, Straight Plug
MIL-PRF-55339/52	-	Adapter, Connector, Electrical, Coaxial, Radio Frequency, (Between Series SMA to N)
MIL-PRF-55339/53	-	Adapter, Connector, Electrical, Coaxial, Radio Frequency, Pin Contact (Within Series SMA), Right Angle
MIL-PRF-55339/54	-	Adapter, Connector, Electrical, Coaxial, Radio Frequency, (Between Series SMA to N)
MIL-PRF-55339/55	-	Adapter, Connectors, Electrical, Coaxial, Radio Frequency, Series SMA, Connector Saver
MS33695	-	Contacts, Video Coaxial Connector
MS91604	-	Connector, Plug, Electrical, Series LC, UG-154A/U
MS91610	-	Connector, Receptacle, Electrical, Series LC, UG-352B/U
MS91618	-	Adapter, Connector, Series LC, UG-287B/U

(Copies of these documents are available online at <https://assist.dla.mil> or from the Standardization Document Order Desk, 700 Robbins Avenue, Building 4D, Philadelphia, PA 19111-5094.

C.2.2.2 Other Government documents, drawings and publications. The following other Government documents, drawings and publications form a part of this document to the extent specified herein. Unless otherwise specified, the issues of these documents are those cited in the solicitation or contract.

DLA LAND AND MARITIME DRAWINGS

01004	-	Connector, Plug, Electrical, RF, Series N, For Low Smoke Cables
04013	-	Connector, Receptacle, Electrical, Series BMZ, Socket Contact, For Semirigid Cable
04014	-	Connector, Receptacle, Electrical, Series BMZ, Pin Contact, for Semirigid Cable
04015	-	Connector, Receptacle, Electrical, Series BMZ, Pin Contact, Right Angle, for Semirigid Cable
04016	-	Connector, Receptacle, Electrical, Coaxial, Radio Frequency, Stripline, Series BMA (Pin Contact), Flange Mounted, Extended Dielectric
04017	-	Connector, Plug, Electrical, Radio Frequency 2.4mm, Pin Contact, for Semirigid Cable

MIL-STD-1353C
APPENDIX C

04018	-	Connector, Plug, Electrical, Radio Frequency 2.4mm, Socket Contact, for Semirigid Cable
04019	-	Connector, Concentric Twinaxial, Radio Frequency, (Threaded Receptacle, Socket Contact) Jamnut Mounted, Series DBA
04020	-	Connector, Concentric Twinaxial, Radio Frequency, (Threaded Plug, Pin Contact), Series DBA
04024	-	Connector, Plug, Electrical, Series TWTNC
04026	-	Connector, Concentric Twinaxial, Radio Frequency, (Threaded Receptacle, Socket Contact) Jamnut Mounted, Solder Pocket, Series DBA
05004	-	Connector, Electrical, Plug, Radio Frequency, Series ZMA, Pin Contact, For .141 and .086 Semirigid Cable
05005	-	Connector, Electrical, Plug, Radio Frequency, Series ZMA, Socket Contact, For .141 and .086, Semirigid Cable
05011	-	Connector, Plug, Electrical, Radio Frequency 2.4mm, For Semirigid Cable (Without Contact)
06026	-	Connector, Interface Test Gages, Series SMP
84148	-	Connectors, Plugs and Receptacles, Electrical, Coaxial, Twinaxial and Triaxial, Radio Frequency
84149	-	Connector, Plug, Electrical, Coaxial, Radio Frequency, Series SMA for Semirigid Cables
85017	-	Adapters, Electrical, Coaxial, Radio Frequency
85018	-	Adapter, Electrical, Coaxial, Radio Frequency, (Between Series SMA to Series TNC)
85022	-	Connector, Receptacle, Electrical, Coaxial, Radio Frequency, Series SMA for Semirigid Cables, Flange Mount
85027	-	Adapter, Connector, BNC to Dual Banana Jack
85037	-	Connector, Plug, Electrical Coaxial, Radio Frequency, Right Angle, Series SMA For Semirigid Cable
85038	-	Adapter, Electrical, Coaxial, Radio Frequency, (Between Series SMA to N)
85139	-	Connector, Receptacle, Electrical, Coaxial, Radio Frequency, Series SMC, Printed Circuit Board Mount, Straight
85140	-	Connector, Receptacle, Electrical, Coaxial, Radio Frequency, Series SMC, Printed Circuit Board Mount, Right Angle
86006	-	Connector, Receptacle, Electrical, Coaxial, Radio Frequency, Series S-SMB, Printed Circuit Board Mount
86106	-	Connector, Receptacle, Electrical, Coaxial, Radio Frequency, Series N For Semirigid Cable
86116	-	Connector, Plug, Electrical, Series SSMA, Pin Contact, For Semirigid Cable
86117	-	Connector, Receptacle, Electrical, Series SSMA, Socket Contact, For Semirigid Cable
86118	-	Connector, Plug, Electrical, Series SSMA, Right Angle, Pin Contact, For Semirigid Cable
86119	-	Connector, Plug, Electrical, Series SSMA, Pin Contact, For Flexible Cable
86120	-	Connector, Plug, Electrical, Series SSMA, Pin Contact, Right Angle, For Flexible Cable
87036	-	Connector, Receptacle, Electrical, Series SMA, Feed Through, Hermetic
87093	-	Connector, Radio Frequency, Dummy Stowage, Various Series
88046	-	Connector, Receptacle, Electrical, Coaxial, RF, Series SMA for Semirigid Cable
88047	-	Connector, Receptacle, Electrical, Coaxial, RF, Series SMA for Semirigid Cable, Jam Nut Mounted
88065	-	Connector, Electrical, Hardware, Series TRB
89008	-	Connector Plug, Electrical, Radio Frequency, Series N, Socket Contact, For Semirigid Cable

MIL-STD-1353C
APPENDIX C

89030	-	Connector, Electrical, Plug, Coaxial, Radio Frequency, Series TNC, Pin Contact, Hex Nut, Corrosion Resistant Steel
89031	-	Connector, Electrical, Plug, Coaxial, Radio Frequency, Series TNC, PIN Contact, for M17/152-00001
89032	-	Connector, Electrical, Receptacle, Radio Frequency, Series TNC, Socket Contact, for M17/152-00001 Cable
89033	-	Connector, Electrical, Receptacle, Radio Frequency, Series TNC, Socket Contact, CRES Bodies, Standard Screws
89034	-	Connector, Electrical, Receptacle, Radio Frequency, Series TNC, Flange Mounted, CRES Body, Solder Pocket, Standard Screws
89035	-	Connector, Electrical, Receptacle, Radio Frequency, Series BNC, Socket Contact, for M17/152-00001 Cable
89036	-	Connector, Electrical, Plug, Radio Frequency, Series BNC, Pin Contact, Straight and Right Angle, for M17/152-00001 Cable
89037	-	Connector, Electrical, Plug, Radio Frequency, Series, SMA, Pin Contact, Straight and Right Angle, for M17/152-00001 Cable
89038	-	Connector, Electrical, Receptacle, Radio Frequency, Series, SMA, Socket Contact, for M17/152-00001 Cable
89043	-	Connector, Hardware, Cap, Series SMA
94007	-	Connector, Electrical, Coaxial, Radio Frequency, Shroud 2 Hole Pin And Adapter, Electrical, Coaxial, RF, Socket Contact, Series SMP To SMP
94008	-	Connector, Electrical, Coaxial, Radio Frequency, Socket Contact Series SMP for .047 and .086 Semirigid Cables
99010	-	Connector, Electrical, Plug, Radio Frequency, Series TNC, Special Application

(Copies of this document required by contractors in connection with specific acquisition functions may be obtained from the procuring activity at <http://www.dscc.dla.mil/programs/milspec/> or as directed by the contracting officer.)

C.2.2.3 Non-Government publications. The following documents form a part of this document to the extent specified herein. Unless otherwise specified, the issues of these documents are those cited in the solicitation or contract

SAE INTERNATIONAL

SAE-AS39029 - Contacts, Electrical Connector, General Specification for

(Copies of these documents are available on line at www.sae.org from SAE International, 400 Commonwealth Drive, Warrendale, PA 15096-0001, and Tel: 877-606-7323 [inside USA and Canada] or 724-776-4970 [outside USA], email at CustomerService@sae.org.)

MIL-STD-1353C
APPENDIX CC.3 Radio Frequency (RF) connectors general information.C.3.1 Connector series definitions.

- a. Series N - Named after Paul Neill of Bell Labs after being developed in the 1940's the series N offered the first true microwave performance. The series N was developed to satisfy the need for durability, weatherproof, medium-size RF connector with consistent performance to 11 to 18 GHz depending on the outer contact design. See MIL-PRF-39012 for performance ratings.
- b. Series BNC - Developed in the late 1940's as a miniature version of the Series C, BNC stands for Bayonet Neill Concelman and is named after Amphenol engineer Carl Concelman. The series BNC is a miniature quick connect/disconnect RF connector. It features 2 bayonet lugs on the socket contact connector mating is achieved with only a quarter turn of the coupling nut. See MIL-PRF-39012 for performance ratings.
- c. Series C - Series C connectors are medium size and weather proof. Coupling is a two stud bayonet lock. Series C connectors provide constant 50 ohm impedance. They may be used with 75 ohm cable, at lower frequencies (below 300 MHz) where no serious mismatch is introduced. See MIL-PRF-39012 for performance requirements.
- d. Series TNC - Developed in the late 1950's, the TNC stands for Threaded Neill Concelman and is named after Amphenol engineer Carl Concelman. Designed as a threaded version of the BNC, the TNC series features screw threads for mating. See MIL-PRF-39012 for performance requirements.
- e. Series SC - A 50 ohm screw coupling connector. See MIL-PRF-39012 for performance requirements.
- f. Series SMA- SMA is an acronym for Sub-miniature version A and was developed in the 1960,s. It uses a threaded interface. 50 ohm SMA connectors are semi-precision, subminiature units that provide excellent electrical performance from DC to 18 GHz. These high performance connectors are compact in size and mechanically have outstanding durability. See MIL-PRF-39012 for performance requirements and MIL-DTL-83517 for stripline applications.
- g. Series SMB - The SMB name derives from Sub-miniature B (the second subminiature design). Developed in the 1960;s, the SMB is a smaller version of the SMA with snap-on coupling. The SMB provides broadband capability through 4 GHz. See MIL-PRF-39012 for performance requirements.
- h. Series SMC - Series SMC name derives from Sub-miniature C (the third subminiature design). The SMC was developed in the 1960's. Refer to MIL-PRF-39012 for performance requirements.
- i. Series SSMA - Series SSMA is a micro-miniature version of the SMA the operational frequencies up to 26 GHz. See MIL-PRF-39012 for additional performance requirements.
- j. Series SSMB - Series SSMB is a micro-miniature version of the SMB. See MIL-PRF-39012 for performance requirements.

MIL-STD-1353C
APPENDIX C

- k. Series SSMC - Series SSMB is a micro-miniature version of the SMC. Please refer to the DLA Land and Maritime web page, <http://www.dscc.dla.mil/programs/milspec/> for all performance requirements.
- l. Series HN - Connectors are medium size weatherproof units designed for high voltage applications. HN connectors feature a captivated contact design which prevents contact recession under temperature extremes and mechanical stresses. Threaded coupling utilized for mating. For performance requirements refer to MIL-DTL-3643.
- m. Series LC- Connector is a weatherproof, radio frequency, coaxial connector. Nominal impedance of 50 ohms. Threaded coupling mechanism. For performance requirements refer to MIL-DTL-3650.
- n. Series TWBNC - TWBNC stands for twinaxial BNC. TWBNC connectors are used with 78 and 95 ohm cables and operate from 0-200 MHz. Due to the improved shielding characteristics (>30 dB), these connectors are used in balanced low level and high sensitivity circuits. TWBNC features the same two-stud bayonet locking mechanism as standard BNC connectors and polarized contacts (one socket, one pin) to prevent signals from being mixed. They are ideal for computer networks and process control devices. For performance requirements refer to MIL-DTL-3655.
- o. Series TWTNC - TWTNC stands for twinaxial TNC. TWTNC connectors are used with 78 and 95 ohm cables and operate from 0-200 MHz. Due to the improved shielding characteristics (>30 dB), these connectors are used in balanced low level and high sensitivity circuits. TWTNC features a threaded coupling mechanism as standard TNC connectors and polarized contacts (one socket, one pin) to prevent signals from being mixed. They are ideal for computer network and process control devices.
- p. Series TWSMB - Same as above, but utilizing the snap-on SMB coupling.
- q. Series TWSMC - Same as above, but utilizing the snap-on SMC coupling.
- r. Series TRB and TRT - TRB stands for triaxial bayonet coupling and TRT stands for triaxial threaded coupling. These connectors are used in applications where maximum RF shielding and minimum noise radiation is required. These connectors have been used in MIL-STD-1553 digital data bus applications. For performance requirements refer to MIL-PRF-49142.
- s. Series SMP- Stands for subminiature push on connector. It was developed in the early 1980's. After review and testing of all designs in the connector industry this design was accepted and named by Ron Gary of the DLA Land and Maritime, Columbus, Ohio, Department of engineering. Frequency range is from 0-18 GHz. It has a radial misalignment requirement and is covered under the first high-rel specification in the RF connector area, MIL-PRF-31031. There are several designs for use depending on the application. A full detent, limited detent, smooth bore and catcher's mitt. Refer to MIL-PRF-31031 for performance requirements.
- t. Series SMPM - Stands for subminiature push on microminiature connector. It is a coaxial connector. It was developed in the 1980's. Interface is specified in MIL-STD 348, as all RF connector interfaces are, for military use. Frequency range is from 0-40 GHz. It offers float mounting. Named by the late and well respected John Dunbabin, President of Connecting Device, Inc., and accepted by DLA Land and Maritime.

MIL-STD-1353C
APPENDIX C

- u. Series DBA - Stands for Data Base A. Named by Ron Gary of DLA Land and Maritime, Columbus, Ohio after technical reviews and modifications on military standardization issues, with the approved sources. This triaxial connector is being used in the MIL-STD 1553 data base instrumentation. Please refer to DLA Land and Maritime drawings at web site: <http://www.dsccl.dla.mil/programs/milspec/> for all performance requirements.

C.3.2 MIL-PRF-39012 connector series. MIL-PRF-39012 connector series are: N, BNC, C, TNC, SC, SMA, SMB, SMC, SSMB and SSMA.

C.3.3 Connector categories and definitions.

- a. Category A - Connectors, which do not require special tools to assemble are designated as category A connectors. Standard wrenches, soldering equipment, pliers, etc., are not defined as special tools.
- b. Category B - Connectors, which require special tools to be assembled are designated as category B connectors. These connectors may be used for original installations only. Field replacement is intended to be made by categories A, C, D, E, or F connectors, which will provide the same form, fit and function. Category B connectors will not be stocked or procured by the Government.
- c. Category C - Connectors, which require only standard military crimping tools and standard cable stripping dimensions to assemble, are designated as category C connectors. The standard military crimping tool is as specified.
- d. Category D - Connectors, which require only standard military crimp tools for the center contact and outer ferrule, and standard cable stripping dimensions to assemble are designated as category D connectors. The standard military crimp tool is as specified.
- e. Category E - Connectors using semi-rigid cables with standard stripping dimensions and using standard military tools. The method of assembly of the connector to the cable outer conductor will be by solder.
- f. Category F - Connectors using semirigid cables with standard stripping dimensions and using standard military assembly tools. The method of assembly of the connector to the cable will be solderless.

C.3.4 Platings.

- a. Shell bodies usually consist of silver plated brass, passivated corrosion-resistant steel, gold plated copper beryllium, or nickel plated brass.
- b. Center contacts are 50 microinches of gold over 50 microinches of nickel. Base material for socket center contacts shall be beryllium copper for resilience.

MIL-STD-1353C
APPENDIX C

C.3.5 Radio frequency connector restrictions.

- a. Use of nickel plated connector bodies- The only plating options allowable are silver or nickel overbrass in accordance with MIL-PRF-39012. Only connectors of the same materials shall be mated to avoid dissimilar metal problems.

CAUTION: A NICKEL PLATED BODY IS NOT FOR USE IN APPLICATIONS WHERE PASSIVE INTERMODULATION GENERATION (PIM) MAY BE A CONCERN.

- b. Silver has been restricted as an underplate for gold due to excessive porosity problems that occur over time and temperature.
- c. Category B connectors are for Original Equipment Manufacturers use only.
- d. Category D connectors are not for use in Army equipment.
- e. BNC connectors are not for use in high vibration applications. Refer to MIL-PRF-39012 for environmental limitations.

C.3.6 Applicable characteristics. Applicable characteristics, see table C-1.

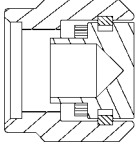
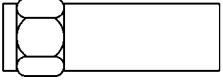
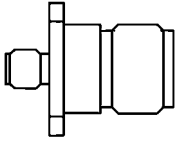
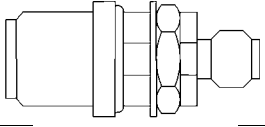
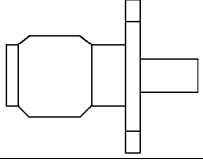
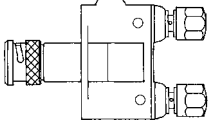
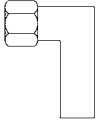
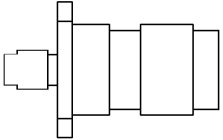
TABLE C-I. RF applicable characteristics.

Series	Applicable characteristics	Maximum operating volts (at sea level)
N	Threaded coupling for RF cable in the .195 to .870 inch OD range.	1,000 rms
C	Bayonet coupling for RF cable in the .280 to .870 inch OD range.	1,000 rms
BNC	Bayonet coupling for RF cable in the .160 to .250 inch OD range.	500 rms
TNC	Threaded coupling for RF cable in the .100 to .250 inch OD range.	500 rms
SC	Threaded coupling for RF cable in the .195 to .250 inch OD range.	1,000 rms
SMA	Threaded coupling for RF cable in the .071 to .100 inch OD range.	170 rms
SMB	Bayonet coupling for RF cable in the .071 to .100 inch OD range.	250 rms
SMC	Threaded coupling for RF cable in the .071 to .100 inch OD range.	250 rms

C.4 DLA Land and Maritime RF connectors dimensions and configurations . DLA Land and Maritime RF connectors dimensions and configurations, see [table C-II](#).

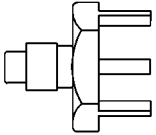
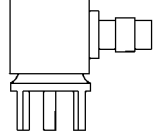
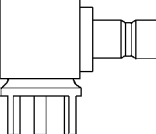
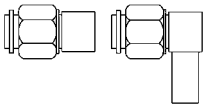
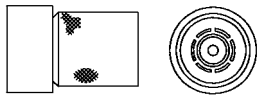

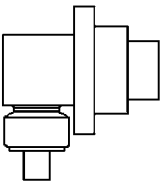
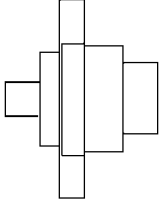
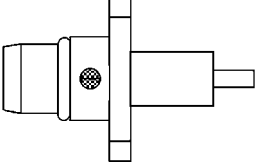
MIL-STD-1353C
APPENDIX C

TABLE C-II. DLA Land and Maritime drawing RF connectors descriptions and configurations.

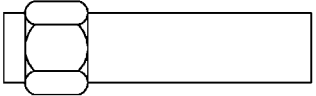
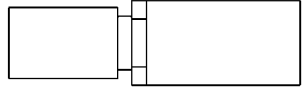
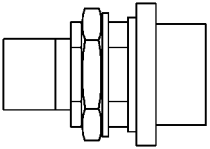
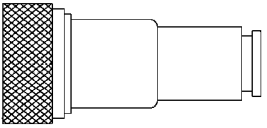
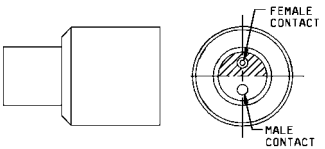
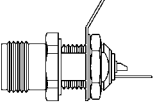
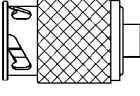
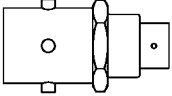
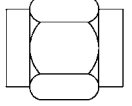
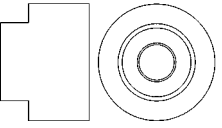
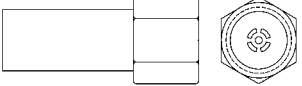
Drawing number	Description	Configuration
84148	Connectors, Plugs And Receptacles, Electrical, Coaxial, Twinaxial and Triaxial, Radio Frequency. General Specification for connectors used with flexible RF cables and certain other types of coaxial transmission lines.	N, C, BNC, TNC, SMB, SMC, and SMA
89043	Connector, Hardware, Cap, Series SMA	
84149	Connector, Plug, Electrical, Coaxial, Radio Frequency, Series SMA for Semirigid Cables	
85017	Adapters, Electrical, Coaxial, Radio Frequency	C, N, BNC, TNC, SMA, HN, UHF. Bulkhead mount, flange mount, right angle, straight, and TEE
85018	Adapter, Electrical, Coaxial, Radio Frequency, (Between Series SMA to Series TNC)	
		
85022	Connector, Receptacle, Electrical, Coaxial, Radio Frequency, Series SMA for Semirigid Cables, Flange Mount	
85027	Adapter, Connector, BNC to Dual Banana Jack	
85037	Connector, Plug, Electrical Coaxial, Radio Frequency, Right Angle, Series SMA For Semirigid Cable	
85038	Adapter, Electrical, Coaxial, Radio Frequency, (Between Series SMA To N)	

MIL-STD-1353C
APPENDIX C

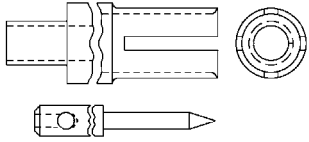
TABLE C-II. DLA Land and Maritime drawing RF connectors descriptions and configurations - Continued.

Drawing number	Description	Configuration
85139	Connector, Receptacle, Electrical, Coaxial, Radio Frequency, Series SMC, Printed Circuit Board Mount, Straight	
85140	Connector, Receptacle, Electrical, Coaxial, Radio Frequency, Series SMC, Printed Circuit Board Mount, Right Angle	
86006	Connector, Receptacle, Electrical, Coaxial, Radio Frequency, Series S-SMB, Printed Circuit Board Mount	
89030	Connector, Electrical, Plug, Coaxial, Radio Frequency, Series TNC, Pin Contact, Hex Nut, Corrosion Resistant Steel	
99010	Connector, Electrical, Plug, Radio Frequency, Series TNC, Special Application	
04013	Connector, Receptacle, Electrical, Series BMZ, Socket Contact, For Semirigid Cable	
04014	Connector, Receptacle, Electrical, Series BMZ, Pin Contact, for Semirigid Cable	
04015	Connector, Receptacle, Electrical, Series BMZ, Pin Contact, Right Angle, for Semirigid Cable	
04016	Connector, Receptacle, Electrical, Coaxial, Radio Frequency, Stripline, Series BMA (Pin Contact), Flange Mounted, Extended Dielectric	

MIL-STD-1353C
APPENDIX CTABLE C-II. DLA Land and Maritime drawing RF connectors descriptions and configurations - Continued.

Drawing number	Description	Configuration
04017	Connector, Plug, Electrical, Radio Frequency 2.4mm, Pin Contact, for Semirigid Cable	
04018	Connector, Plug, Electrical, Radio Frequency 2.4mm, Socket Contact, for Semirigid Cable	
04019	Connector, Concentric Twinaxial, Radio Frequency, (Threaded Receptacle, Socket Contact) Jamnut Mounted, Series DBA	
04020	Connector, Concentric Twinaxial, Radio Frequency, (Threaded Plug, Pin Contact), Series DBA	
04024	Connector, Plug, Electrical, Series TWTNC	
04026	Connector, Concentric Twinaxial, Radio Frequency, (Threaded Receptacle, Socket Contact) Jamnut Mounted, Solder Pocket, Series DBA	
05004	Connector, Electrical, Plug, Radio Frequency, Series ZMA, Pin Contact, For .141 and .086 Semirigid Cable	
05005	Connector, Electrical, Plug, Radio Frequency, Series ZMA, Socket Contact, For .141 and .086, Semirigid Cable	
05011	Connector, Plug, Electrical, Radio Frequency 2.4mm, For Semirigid Cable (Without Contact)	
06026	Connector, Interface Test Gages, Series SMP	
01004	Connector, Plug, Electrical, RF, Series N, For Low Smoke Cables	

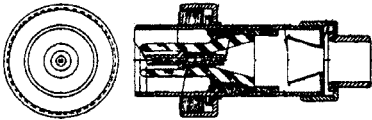
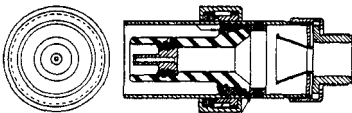
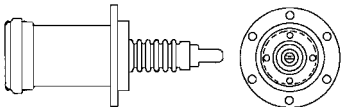


MIL-STD-1353C
APPENDIX CTABLE C-II. DLA Land and Maritime drawing RF connectors descriptions and configurations - Continued.

Drawing number	Description	Configuration
MS33695	Contacts, Video Coaxial Connector	

C.5 MIL-STD-348. MIL-STD-348 is a standard that covers RF connector interfaces for MIL-C-3643, MIL-C-3650, MIL-DTL-3655, MIL-DTL-25516, MIL-C-26637, MIL-PRF-39012, MIL-PRF-49142, MIL-PRF-49142, MIL-PRF-55339, and MIL-C-83517.

C.6 MIL-DTL-3607. MIL-DTL-3607 for use in radio frequency applications up to 100 megahertz. They are designed for use with radiofrequency pulse cables. Their use is governed by temperature limitation of materials, and they are not recommended for use in applications where temperatures exceed +125°C, see table C-III.

TABLE C-III. MIL-C-3607 RF descriptions and configurations.

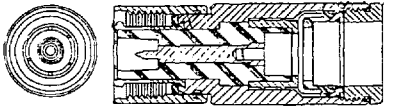
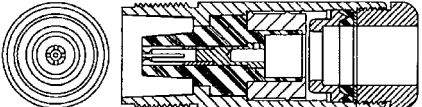
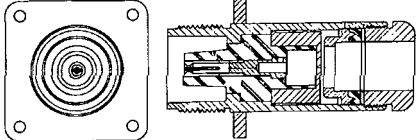
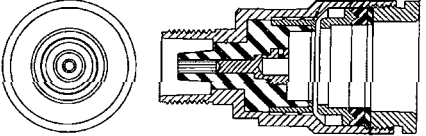
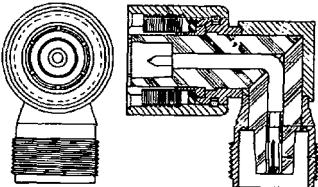
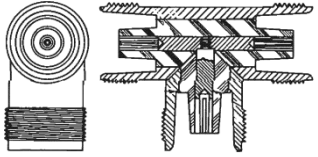
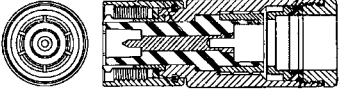
Specification number	Description	Configuration
MIL-DTL-3607	Connectors, Coaxial, Radiofrequency, Series Pulse, General Specification for	
MIL-DTL-3607/1	Connector, Plug, Electrical, Series Pulse, Type UG-36/U	
MIL-DTL-3607/2	Connector, Receptacle, Electrical, Series Pulse, Type UG-37A/U	
MIL-DTL-3607/3	Connector, Receptacle, Electrical, Series Pulse, Type UG-37/U	
MIL-DTL-3607/7	Connector, Plug, Electrical, Series Pulse, Type UG-180A/U	
MIL-DTL-3607/9	Connector, Receptacle, Electrical, Series Pulse, Type UG-182A/U	

MIL-STD-1353C
APPENDIX C

C.7 MIL-DTL-3643. MIL-DTL-3643 Slightly larger than type N connectors, but uses basically the same cables. They have a 3/4-20 mating thread and have a teflon interface. They have increased voltage capabilities without realizing the loss of its RF parameters, see table C-IV.

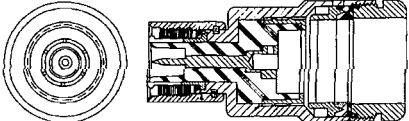
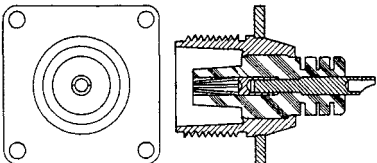
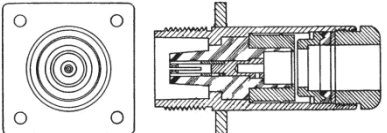
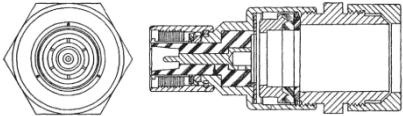
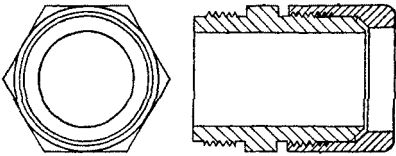
C.7.1 Nominal impedance. Nominal impedance is 50 ohms, frequency range DC - 4 GHz.

TABLE C-IV. MIL-DTL-3643 descriptions and configurations.

Specification number	Description	Configuration
MIL-DTL-3643	Connectors, Coaxial, Radio Frequency, Series HN, and Associated Fittings, General Specification for	
MIL-C-3643/1	Connector, Plug, Electrical, Series HN, Type UG-59E/U (Inactive for new design)	
MIL-C-3643/2	Connector, Plug, Electrical, Series HN, Type UG-60E/U (Inactive for new design)	
MIL-C-3643/3	Connector, Receptacle, Electrical, Series HN, Type UG-61E/U (Inactive for new design)	
MIL-DTL-3643/4	Connector, Adapter, Series HN, Type UG-212C/U (Inactive for new design)	
MIL-C-3643/5	Connector, Plug, Electrical, Series HN, Type UG-333C/U (Inactive for new design)	
MIL-C-3643/6	Connector, Adapter, Series HN, Type UG-413/U (Inactive for new design)	
MIL-C-3643/7	Connector, Plug, Electrical, Series HN, Type UG-494B/U (Inactive for new design)	

MIL-STD-1353C
APPENDIX C

TABLE C-IV. MIL-DTL-3643 descriptions and configurations - Continued.

Specification number	Description	Configuration
MIL-C-3643/8	Connector, Plug, Electrical, Series HN, Type UG-495D/U (Inactive for new design)	
MIL-C-3643/9	Connector, Receptacle, Electrical, Series HN, Type UG- 496/U (Inactive for new design)	
MIL-C-3643/11	Connector, Receptacle, Electrical, Series HN, Type UG- 427C/U (Inactive for new design)	
MIL-C-3643/12	Connector, Plug, Electrical, Series HN, Type UG-926B/U (Inactive for new design)	
MIL-C-3643/14	Clamp, Armor, Series HN, Type MX-1462/U (Inactive for new design)	

MIL-STD-1353C
APPENDIX C

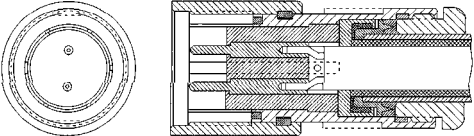
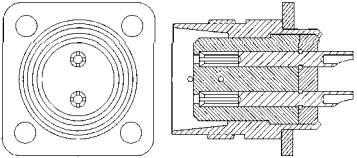
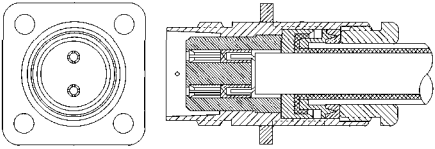
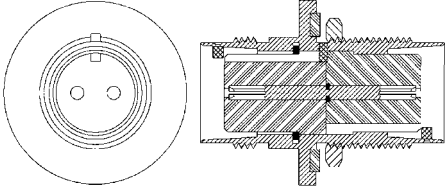
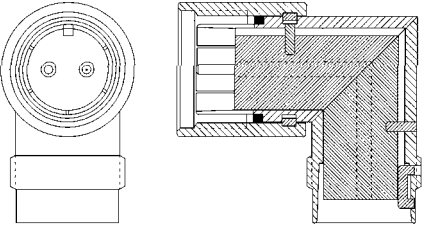
C.8 MIL-DTL-3655. MIL-C-3655 covers a series twin, coaxial connectors and associated fittings, see table C-V.

C.8.1 MIL-DTL-3655 connector classes. MIL-DTL-3655 connectors in the following classes:

- Class I - Weatherproof
- Class II - Non-weatherproof

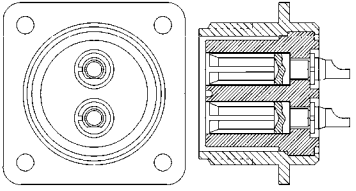
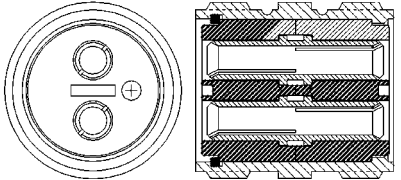
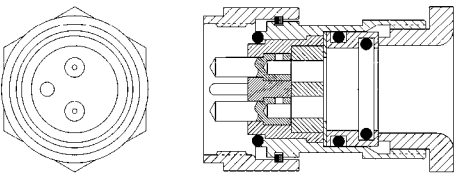
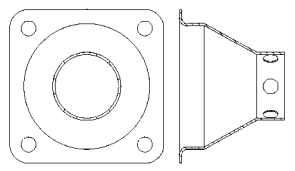
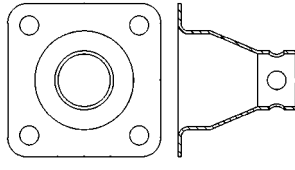
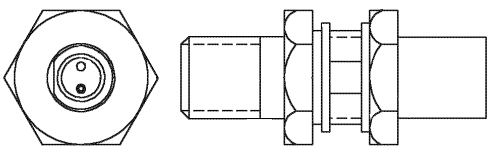
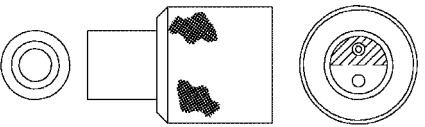
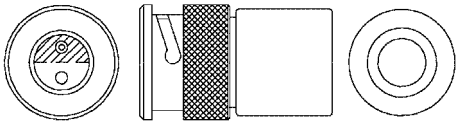
C.8.2 RF connector rms ratings. RF connector is rated at 500 Volts rms maximum at sea level, 125 V rms maximum at 70,000 feet.

TABLE C-V. MIL-DTL-3655 descriptions and configurations.

Specification number	Description	Configuration
MIL-DTL-3655	Connectors, Plug and Receptacle, Electrical (Coaxial, Series Twin), and Associated Fittings, General Specification for	
MIL-DTL-3655/1	Connector, Plug, Electrical, Class I (Coaxial, Series Twin), Type UG-421B/U (Inactive for new design)	
MIL-DTL-3655/2	Connector, Receptacle, Electrical, Class I (Coaxial, Series Twin) Type UG-422/U (Inactive for new design)	
MIL-DTL-3655/3	Connector, Receptacle, Electrical, Class I (Coaxial, Series Twin) Type UG-423B/U (Inactive for new design)	
MIL-DTL-3655/4	Connector Adapter, Class I (Coaxial, Series Twin) Type UG-493A/U (Inactive for new design)	
MIL-DTL-3655/5	Connector Adapter, Class I (Coaxial, Series Twin) Type UG-981/U (Inactive for new design)	

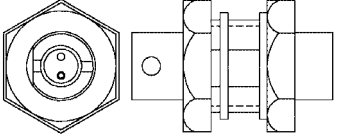
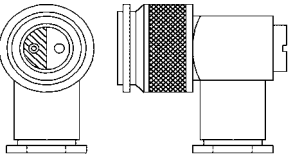
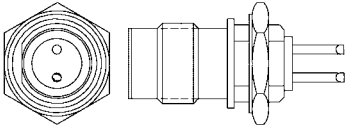
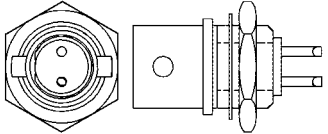
MIL-STD-1353C
APPENDIX C

TABLE C-V. MIL-DTL-3655 descriptions and configurations - Continued.

Specification number	Description	Configuration
MIL-DTL-3655/6	Connector, Receptacle, Electrical, Class II (Coaxial, Series Twin) Type UG-1057/U (Inactive for new design)	
MIL-DTL-3655/8	Connector Adapter, Class II (Coaxial, Series Twin), Type UG-1059/U (Inactive for new design)	
MIL-DTL-3655/9	Connector, Plug, Electrical, Class I (Coaxial, Series Twin), Type UG-1060A/U (Inactive for new design)	
MIL-DTL-3655/10	Connector Shield, Electrical, (Coaxial, Series Twin), Type MX-1556/U (Inactive for new design)	
MIL-DTL-3655/11	Connector Shield, Electrical (Coaxial, Series Twin), Type UG-106/U (Inactive for new design)	
MIL-DTL-3655/13	Connector, Receptacle, Electrical, Class I (Coaxial, Series Twin, TWTNC, Jam Nut Mounted)	
MIL-DTL-3655/14	Connector, Plug, Electrical, Class I (Coaxial, Series Twin, TWTNC)	
MIL-DTL-3655/15	Connector, Plug, Electrical, Class I (Coaxial, Series Twin, TWBNC)	

MIL-STD-1353C
APPENDIX C

TABLE C-V. MIL-DTL-3655 descriptions and configurations - Continued.

Specification number	Description	Configuration
MIL-DTL-3655/16	Connector, Receptacle, Electrical, Class I (Coaxial, Series Twin, TWBNC)	
MIL-DTL-3655/17	Connector, Plug, Electrical, Class I (Coaxial, Series Twin, TWTNC, Right Angle)	
MIL-DTL-3655/22	Connector, Receptacle, Electrical, Class I (Coaxial, Series Twin, TWTNC, Bulkhead)	
MIL-DTL-3655/23	Connector, Receptacle, Electrical, Class I (Coaxial, Series Twin, TWBNC, Bulkhead)	

C.8.3 MIL-DTL-3655 RF connectors to RF cables. MIL-DTL-3655 RF connectors to RF cables, see table C-VI.

TABLE C-VI. MIL-DTL-3655 RF connectors to RF cable.

Specification number	Description	Frequency	RF cable
MIL-DTL-3655/1	Plug, Class I, Series Twin, Type UG-421B/U, 95 Ohms (balanced line not matched) Mating connector M3655/2-0422	DC to 500MHZ	M17/15-RG22
MIL-DTL-3655/2	Receptacle, Class I, Series Twin Type UG-422/U, 95 Ohms (balanced line not matched) Mating connector M3655/1-0421	DC to 500MHZ	Use with electrical shield M3655/11-106
MIL-DTL-3655/3	Receptacle, Class I Series Twin Type UG-423B/U, 95 Ohms (balanced line not matched) Mating connector M3655/1-0421	DC to 500MHZ	M17/15-RG22
MIL-DTL-3655/4	Adapter, Class I, Series Twin Type UG-493A/U, 95 Ohms (balanced line not matched) Mating connector M3655/1-0421	DC to 500MHZ	N/A

MIL-STD-1353C
APPENDIX C

TABLE C-VI. MIL-DTL-3655 RF connectors to RF cable - Continued.

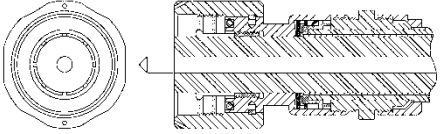
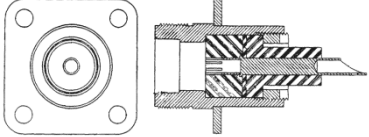
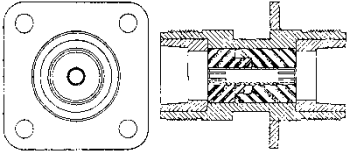
Specification number	Description	Frequency	RF cable
MIL-DTL-3655/5	Adapter, Class I Series Twin Type UG-981/U, 95 Ohms (balanced line not matched) Mating connector M3655/1-0421 and M3655/2-0422	DC to 500MHZ	Use with electrical shield M3655/11-106
MIL-DTL-3655/6	Receptacle, Class II Series Twin Type UG-1057/U, 95 Ohms, Mating connector M3655/7-1058	DC to 500MHZ	M17/56-RG130 and shield M3655/10-1556
MIL-DTL-3655/8	Adapter, Class II Series Twin, Type UG-1059/U, 95 Ohms, Mating connector M3655/9-1060	DC to 500MHZ	N/A
MIL-DTL-3655/9	Plug, Class I, Series Twin, Type UG-1060A/U, 95 Ohms, Mating connector M3655/8-1059	DC to 500MHZ	M17/56-RG130
MIL-DTL-3655/10	Shield, Electrical, Series Twin, Type MX-1556/U, Mating Connector M3655/6-1057	N/A	N/A
MIL-DTL-3655/11	Shield, Series Twin, Type UG-106/U, Mating Connector M3655/11-106	N/A	N/A
MIL-DTL-3655/13	Receptacle, Class I, Series Twin, TWTNC, Jam Nut Mounted, 78 Ohms Mating connector M3655/14	DC to 500MHZ	M17/45-RG108 M17/182-00001 M17/182-00002 M17/186-00001
MIL-DTL-3655/14	Plug, Class I Coaxial, Series Twin, TWTNC, 78 Ohms Mating connector M3655/13	DC to 500MHZ	M17/45-RG108 M17/182-00001 M17/182-00002 M17/186-00001
MIL-DTL-3655/15	Plug, Electrical, Class I, Coaxial, Series Twin, TWBNC, 78 Ohms Mating connector M3655/16	DC to 500MHZ	M17/45-RG108 M17/182-00001 M17/182-00002 M17/186-00001
MIL-DTL-3655/16	Receptacle, Class I, Coaxial, Series Twin, TWBNC, 78 Ohms Mating connector M3655/15	DC to 500MHZ	Various types of twin axial RF cables
MIL-DTL-3655/17	Plug, Class I, Series Twin, TWTNC, Right Angle, 78 Ohms Mating connector M3655/16	DC to 500MHZ	M17/45-RG108 M17/182-00001 M17/182-00002 M17/186-00001
MIL-DTL-3655/22	Receptacle, Electrical, Class I, Series Twin, TWTNC, Bulkhead, 78 Ohms Mating connector M3655/14	DC to 500MHZ	Solder pocket
MIL-DTL-3655/23	Receptacle, , Class I, Series Twin, TWBNC, Bulkhead, 78 Ohms Mating connector M3655/15	DC to 500MHZ	Solder pocket

MIL-STD-1353C
APPENDIX C

C.9 MIL-DTL-3650. MIL-DTL-3650 coaxial, radio frequency, series LC, see table C-VII.

C.9.1 Intended use. For use in radio frequency applications up to 1,000 megahertz. They are designed for use with large-size, radio frequency, coaxial cables. Their use is governed by temperature limitation of materials, and they are not recommended for use in applications where temperatures exceed 125°C.

TABLE C-VII. MIL-DTL-3650 descriptions and configurations.

Specification number	Description	Configuration
MIL-DTL-3650	Connectors, Coaxial, Radiofrequency, Series LC	
MS91604	Connector, Plug, Electrical, Series LC, UG-154A/U, 50 Ohms, Frequency range 1 GHz RG-17/U and RG/18/u cable	
MS91610	Connector, Receptacle, Electrical, Series LC, UG-352B/U, Weatherproof, 50 Ohms, Frequency range 1 GHz, solder cup	
MS91618	Adapter, Connector, Series LC, UG-287B/U, Weatherproof, 50 Ohms, Frequency range 1 GHz, Connectors plug UG/154A/U or equal to adapter UG/218/U or equal.	

MIL-STD-1353C
APPENDIX C

C.10 MIL-PRF-39012. MIL-PRF-39012 connectors used with flexible RF cables and certain other types of coaxial transmission lines; see [tables C-VIII](#) and [C-IX](#).

C.10.1 O-Ring seals . Plug coupling nuts and cable nut mounted connectors may have silicone rubber O-Ring seals which are an outgassing concern. Connectors may require additional processing for outgassing control. This should include a bake of the connector and removal or replacement of the silicone rubber O-Rings with fluorosilicone O-rings which meet outgassing requirements.

C.10.2 Temperature range . Temperature range for flexible and semirigid connectors is -65°C to +165°C . Temperature range for PC mounted connectors is -65°C to +105°C.

C.10.3 Safety wire. The use of safety wire is recommended to secure mated connectors together.

C.10.4 Class of MIL-PRF-39012 connectors consists of the following:

Class 1 - A class 1 connector is a connector which is intended to provide superior RF performance at specified frequencies, and for which all RF characteristics are completely defined.

Class 2 - A class 2 connector is intended to provide mechanical connection within an RF circuit providing specified performance.

C.10.5 Categories. Categories of MIL-PRF-39012 connectors are designated by:

Category A - Field replaceable

Category B- Connectors require special tooling for assembly are considered non-field replaceable. These connectors may be used for original equipment manufacturers installations only.

Category C - Field replaceable solder center contact.

Category D - Field replaceable crimp center contact.

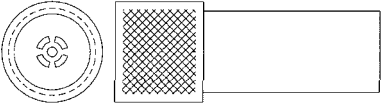
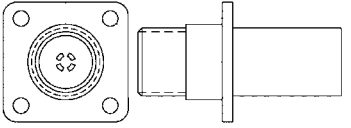
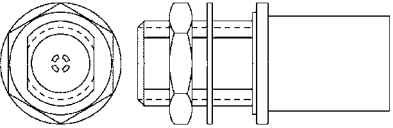
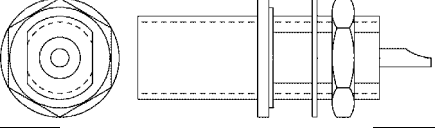
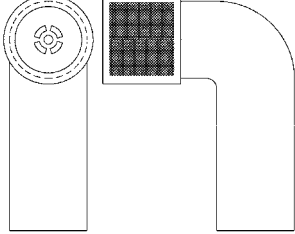
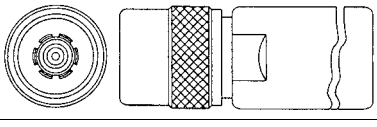
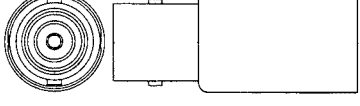
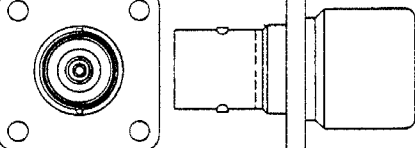
Category E - Field replaceable

Category F - (Feld replaceable crimp, for semirigid cable.

C.10.6 Satellite connectors. Only series SMA connectors are recommended for satellite use in lower earth orbits. Series N and TNC connectors are not recommended for use in lower earth orbits due to atomic oxygen corrosion concerns of their silver plating.

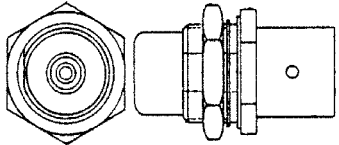
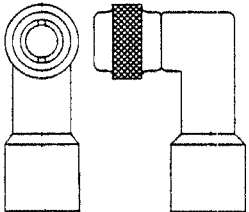
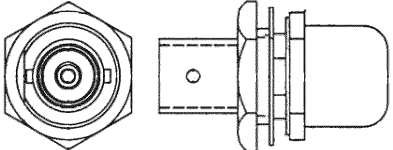
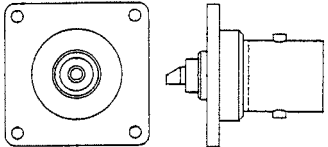
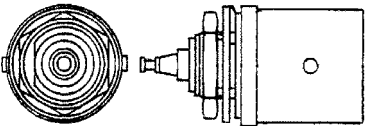
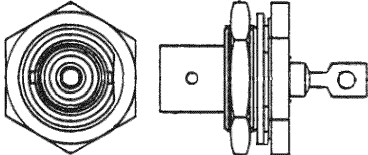
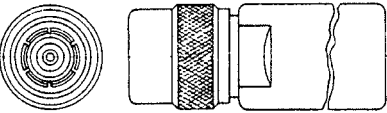
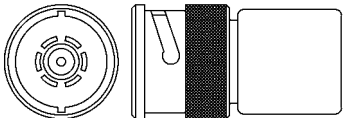
MIL-STD-1353C
APPENDIX C

TABLE C-VIII. MIL-PRF-39012 descriptions and configurations.

Performance specification sheet	Description	Configuration
MIL-PRF-39012	Connectors, Coaxial, Radio Frequency, General Specification for	
MIL-PRF-39012/1	Connectors, Plug, Electrical, Coaxial, Radio Frequency, (Series N (Cabled), Pin Contact, Class 2)	
MIL-PRF-39012/2	Connectors, Plugs and Receptacles, Electrical, Coaxial, Radio Frequency, (Series N (Cabled), Flange Mounted, Socket Contact, Class 2)	
MIL-PRF-39012/3	Connectors, Receptacles, Electrical, Coaxial, Radio Frequency, (Series N (Cabled), Jam Nut Mounted, Socket Contact, Class 2)	
MIL-PRF-39012/4	Connectors, Coaxial, Radio Frequency, (Series N (Uncabled) - Receptacles - Jam Nut and Flange Mounted, Socket Contact, Class 2)	
MIL-PRF-39012/5	Connectors, Plug, Electrical, Coaxial, Radio Frequency, (Series N (Cabled), Right Angle, Pin Contact, Class 2)	
MIL-PRF-39012/6	Connectors, Plug, Electrical, Coaxial, Radio Frequency, Series C (Cabled), Male, Class 2	
MIL-PRF-39012/7	Connectors, Plug, Electrical, Coaxial, Radio Frequency, (Series C (Cabled), Female, Class 2)	
MIL-PRF-39012/8	Connectors, Receptacle, Electrical, Coaxial, Radio Frequency, (Series C (Cabled), Female, Flange Mounted, Rear Mounted Class 2)	

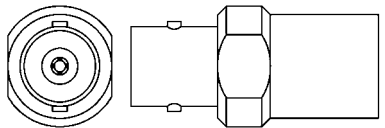
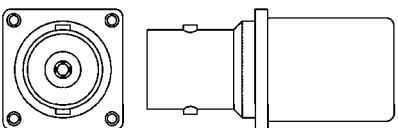
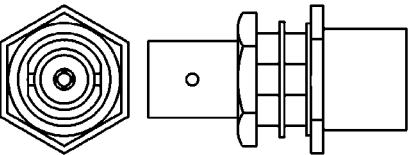
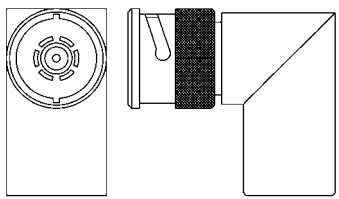
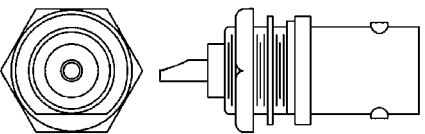
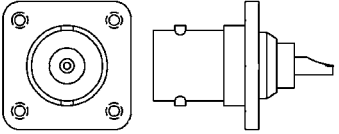
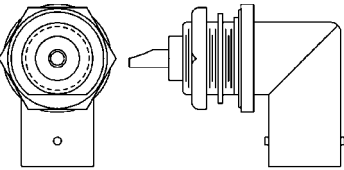
MIL-STD-1353C
APPENDIX C

TABLE C-VIII. MIL-PRF-39012 descriptions and configurations - Continued.

Performance specification sheet	Description	Configuration
MIL-C-39012/9	Connectors, Receptacle, Electrical, Coaxial, Radio Frequency, (Series C (Cabled-Receptacle), Female, Jam Nut, Front Mounted, Class 2)	
MIL-PRF-39012/10	Connectors, Plug, Electrical, Coaxial, Radio Frequency, (Series C (Cabled), Male, Right Angle, Class 2)	
MIL-PRF-39012/11	Connectors, Receptacle, Electrical, Coaxial, Radio Frequency, (Series C (Cabled), Female, Jam Nut, Rear Mounted, Pressurized, Class 2)	
MIL-PRF-39012/12	Connectors, Coaxial, Radio Frequency, Series C (Uncabled-Receptacle, Female, Flange Mounted, Rear Mounted, Class 2)	
MIL-PRF-39012/13	Connectors, Coaxial, Radio Frequency, Series C (Uncabled-Receptacle, Female, Jam Nut Mounted, Front Mounted, Pressurized, Class 2)	
MIL-PRF-39012/14	Connectors, Coaxial, Radio Frequency, Series C (Uncabled-Receptacle, Female, Jam Nut Mounted, Hermetic Seal, Class 2)	
MIL-C-39012/15	Connectors, Plug, Electrical, Coaxial, Radio Frequency, (Series C (Cabled), Male, Class 2) Inactive for new design	
MIL-PRF-39012/16	Connectors, Plug, Electrical, Coaxial, Radio Frequency, (Series BNC (Cabled), Pin Contact, Class 2)	

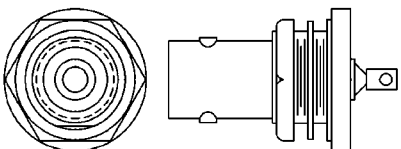
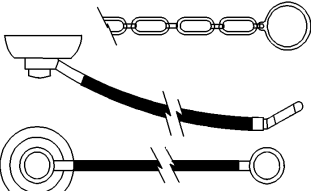
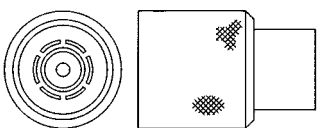
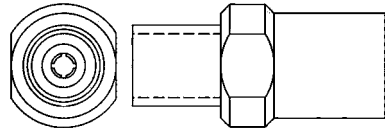
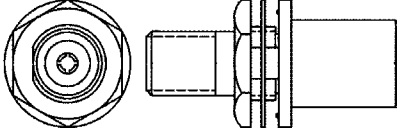
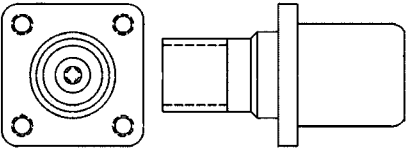
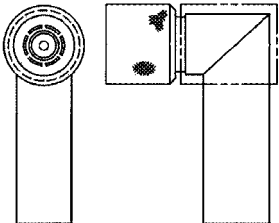
MIL-STD-1353C
APPENDIX C

TABLE C-VIII. MIL-PRF-39012 descriptions and configurations - Continued.

Performance specification sheet	Description	Configuration
MIL-PRF-39012/17	Connectors, Plug, Electrical, Coaxial, Radio Frequency, (Series BNC, (Cabled), Socket Contact, Class 2)	
MIL-PRF-39012/18	Connectors, Receptacle, Electrical, Coaxial, Radio Frequency (Series BNC (Cabled), Socket Contact, Flange Mounted, Class 2)	
MIL-PRF-39012/19	Connectors, Receptacle, Electrical, Coaxial, Radio Frequency (Series BNC (Cabled), Socket Contact, Jam Nut Mounted, Class 2)	
MIL-PRF-39012/20	Connectors, Plug, Electrical, Coaxial, Radio Frequency, (Series BNC (Cabled), Pin Contact, Right Angle, Class 2)	
MIL-PRF-39012/21	Connectors, Coaxial, Radio Frequency, (Series BNC (Uncabled) - Receptacles, Female, Jam Nut Mounted, Class II)	
MIL-PRF-39012/22	Connectors, Coaxial, Radio Frequency, Series BNC (Uncabled), Receptacles, Female, Flange Mounted, Class II	
MIL-PRF-39012/23	Connectors, Coaxial, Radio Frequency, (Series BNC (Uncabled) - Receptacles, Female, Right Angle, Class II)	

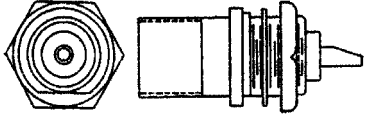
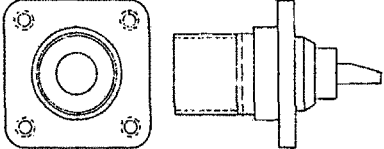
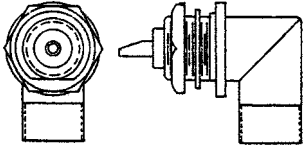
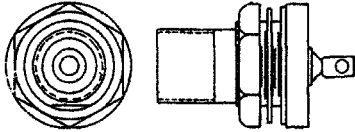
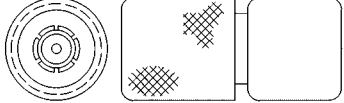
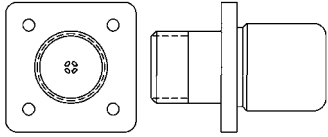
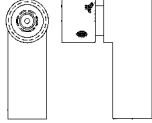
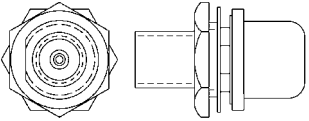
MIL-STD-1353C
APPENDIX C

TABLE C-VIII. MIL-PRF-39012 descriptions and configurations - Continued.

Performance specification sheet	Description	Configuration
MIL-PRF-39012/24	Connectors, Receptacles, Electrical, Coaxial, Radiofrequency, Series BNC (Uncabled) - Female, Hermetically Sealed, Jam Nut Mounted, Class 2	
MIL-PRF-39012/25	Connectors, Coaxial, Radio Frequency, (Hardware for Radio Frequency Coaxial Connectors)	
MIL-PRF-39012/26	Connectors, Plug, Electrical, Coaxial, Radio Frequency, Series TNC (Cabled), Pin Contact, Class 2	
MIL-PRF-39012/27	Connectors, Plugs, Electrical, Coaxial, Radio Frequency, Series TNC (Cabled) Socket Contact, Class 2	
MIL-PRF-39012/28	Connectors, Receptacle, Electrical, Coaxial, Radio Frequency, Series TNC (Cabled) Socket Contact, Jam Nut Mounted, Class 2	
MIL-PRF-39012/29	Connectors, Receptacle, Electrical, Coaxial, Radio Frequency (Series TNC (Cabled), Socket Contact, Flange Mounted, Class 2)	
MIL-PRF-39012/30	Connectors, Receptacle, Electrical, Coaxial, Radio Frequency, Series TNC (Cabled) Pin Contact, Right Angle Class 2	

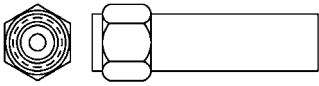
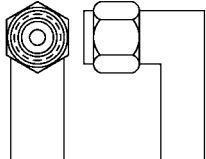
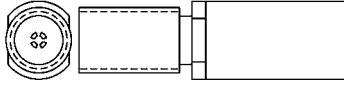
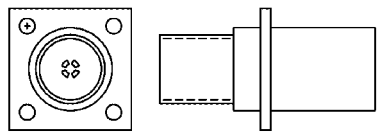
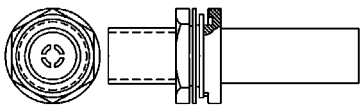
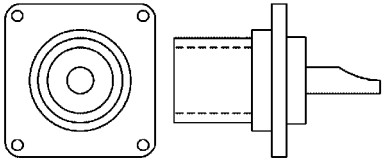
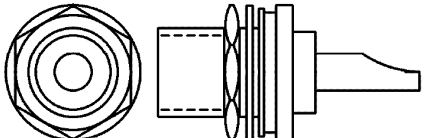
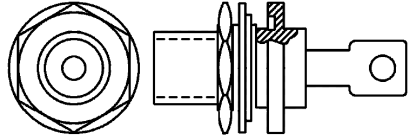
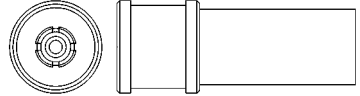
MIL-STD-1353C
APPENDIX C

TABLE C-VIII. MIL-PRF-39012 descriptions and configurations - Continued.

Performance specification sheet	Description	Configuration
MIL-PRF-39012/31	Connectors, Coaxial, Radio Frequency, Series TNC (Uncabled), Receptacles, Socket, Jam Nut Mounted, Class 2	
MIL-PRF-39012/32	Connectors, Coaxial, Radio Frequency, Series TNC (Uncabled), Receptacle, Socket, Flange Mounted, Class 2	
MIL-PRF-39012/33	Connectors, Coaxial, Radio Frequency, Series TNC (Uncabled), Receptacle, Socket, Right Angle, Class 2	
MIL-PRF-39012/34	Connectors, Coaxial, Radio Frequency, Series TNC (Uncabled), Receptacle, Socket, Hermetically Sealed, Jam Nut Mounted, Class 2	
MIL-PRF-39012/35	Connectors, Plug, Electrical, Coaxial, Radio Frequency, Series SC (Cabled), Pin Contact, Class 2	
MIL-PRF-39012/38	Connectors, Receptacle, Electrical, Coaxial, Radio Frequency, Series SC (Cabled), Socket Contact, Flange Mounted, Rear Mounted, Class 2	
MIL-PRF-39012/39	Connectors, Receptacle, Electrical, Coaxial, Radio Frequency, Series SC (Cabled), Pin Contact, Right Angle, Class 2	
MIL-PRF-39012/40	Connectors, Receptacle, Electrical, Coaxial, Radio Frequency, Series SC (Cabled), Socket Contact, Jam Nut, Rear Mounted, Class 2	

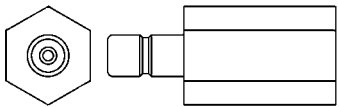
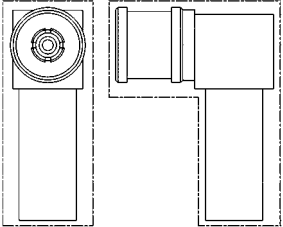
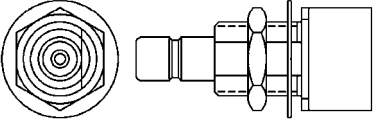
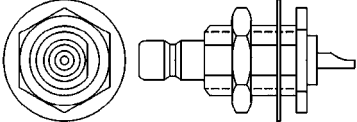
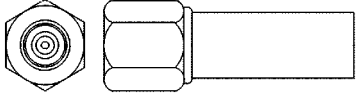
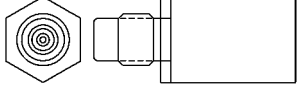
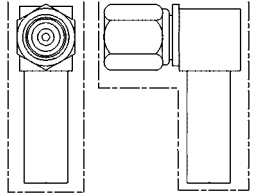
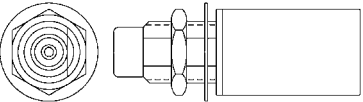
MIL-STD-1353C
APPENDIX C

TABLE C-VIII. MIL-PRF-39012 descriptions and configurations - Continued.

Performance specification sheet	Description	Configuration
MIL-PRF-39012/55	Connectors, Plugs, Electrical, Coaxial, Radio Frequency, (Series SMA (Cabled), Pin Contact, Class 2)	
MIL-PRF-39012/56	Connectors, Plugs, Electrical, Coaxial, Radio Frequency, (Series SMA (Cabled), Pin Contact, Right Angle, Class 2)	
MIL-PRF-39012/57	Connectors, Plugs, Electrical, Coaxial, Radio Frequency, (Series SMA (Cabled) - Socket Contact, Class 2)	
MIL-PRF-39012/58	Connectors, Receptacles, Electrical, Coaxial, Radio Frequency, Series SMA (Cabled), Socket Contact, Flange Mounted, Class 2	
MIL-PRF-39012/59	Connectors, Receptacle, Electrical, Coaxial, Radio Frequency, Series SMA (Cabled), Socket Contact, Jam Nut Mounted, Class 2	
MIL-PRF-39012/60	Connectors, Receptacles, Electrical, Coaxial, Radio Frequency, Series SMA (Uncabled), Socket Contact, Flange Mounted, Class 2)	
MIL-PRF-39012/61	Connectors, Receptacles, Electrical, Coaxial, Radio Frequency, Series SMA (Uncabled), Socket Contact, Jam Nut Mounted, Class 2)	
MIL-PRF-39012/62	Connectors, Receptacles, Electrical, Coaxial, Radio Frequency, Series SMA (Uncabled), Socket Contact, Jam Nut Mounted, Hermetic Seal, Class 2)	
MIL-PRF-39012/67	Connectors, Plugs, Electrical, Coaxial, Radio Frequency, Series SMB (Cabled, Socket Contact, Class 2)	

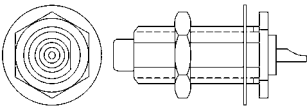

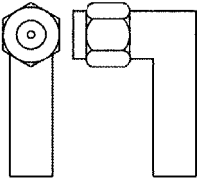
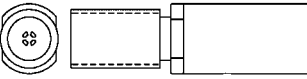
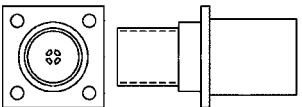
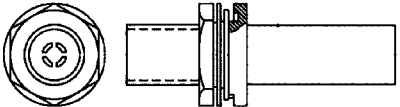
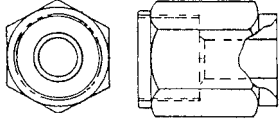
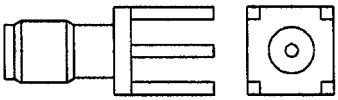
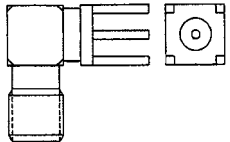
MIL-STD-1353C
APPENDIX C

TABLE C-VIII. MIL-PRF-39012 descriptions and configurations - Continued.

Performance specification sheet	Description	Configuration
MIL-PRF-39012/68	Connectors, Plugs, Electrical, Coaxial, Radio Frequency, Series SMB (Cabled), Pin Contact, Class 2	
MIL-PRF-39012/69	Connectors, Plugs, Electrical, Coaxial, Radio Frequency, Series SMB (Cabled, Socket Contact, Right Angle, Class 2)	
MIL-PRF-39012/70	Connectors, Receptacle, Electrical, Coaxial, Radio Frequency, Series SMB (Cabled), Pin Contact, Jam Nut Mounted, Rear Mounted, Class 2	
MIL-PRF-39012/71	Connectors, Receptacle, Electrical, Coaxial, Radio Frequency, Series SMB (Uncabled, Male, Jam Nut Mounted, Class 2)	
MIL-PRF-39012/73	Connectors, Plugs, Electrical, Coaxial, Radio Frequency, Series SMC (Cabled, Socket Contact, Class 2)	
MIL-PRF-39012/74	Connectors, Plugs, Electrical, Coaxial, Radio Frequency, Series SMC (Cabled), Pin Contact, Class 2	
MIL-PRF-39012/75	Connectors, Plugs, Electrical, Coaxial, Radio Frequency, Series SMC (Cabled, Socket Contact, Right Angle, Class 2)	
MIL-PRF-39012/76	Connectors, Receptacle, Electrical, Coaxial, Radio Frequency, Series SMC (Cabled), Pin Contact, Jam Nut Mounted, Rear Mounted, Class 2	

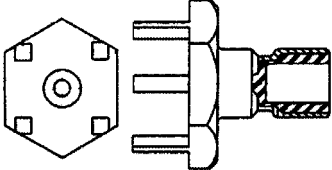
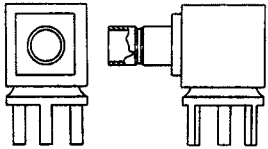
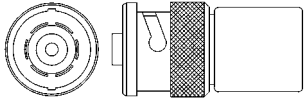
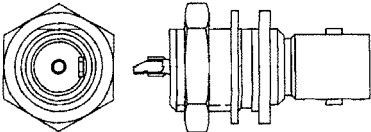
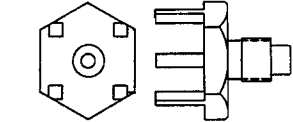
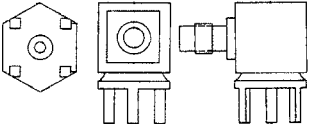
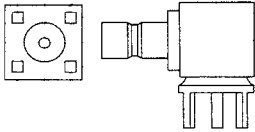
MIL-STD-1353C
APPENDIX C

TABLE C-VIII. MIL-PRF-39012 descriptions and configurations - Continued.

Performance specification sheet	Description	Configuration
MIL-PRF-39012/77	Connectors, Receptacle, Electrical, Coaxial, Radio Frequency, Series SMC (Uncabled, Male, Jam Nut Mounted, Class 2)	
MIL-PRF-39012/79	Connectors, Plug, Electrical, Coaxial, Radio Frequency, Series SMA (Cabled), Pin, Class 2, Semirigid Cable	
MIL-PRF-39012/80	Connectors, Plug, Electrical, Coaxial, Radio Frequency, Series SMA (Cabled), Pin, Right Angle, Class 2, Semirigid Cable	
MIL-PRF-39012/81	Connectors, Plug, Electrical, Coaxial, Radio Frequency, Series SMA (Cabled, Socket, Class 2, Semirigid Cable)	
MIL-PRF-39012/82	Connectors, Receptacle, Electrical, Coaxial, Radio Frequency, Series SMA (Cabled), Socket, Flange Mounted, Class 2, Semirigid Cable	
MIL-PRF-39012/83	Connectors, Receptacle, Electrical, Coaxial, Radio Frequency, Series SMA (Cabled), Socket, Jam Nut Mounted, Class 2, Semirigid Cable	
MIL-PRF-39012/92	Connectors, Plug, Electrical, Coaxial, Radio Frequency, Series SMA (Cabled), Class 2, Without Contact, .141 Semirigid Cable	
MIL-PRF-39012/93	Connectors, Receptacles, Electrical, Coaxial, Radio Frequency, Series SMA (Uncabled), Female, Printed Circuit, Class 2	
MIL-PRF-39012/94	Connectors, Receptacle, Electrical, Coaxial, Radio Frequency, Series SMA (Uncabled), Female, Printed Circuit, Right Angle, Class 2	

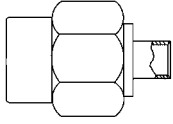
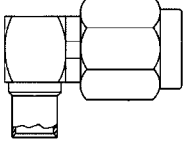
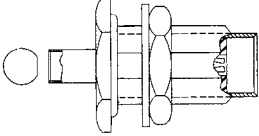
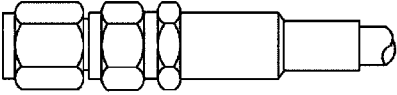
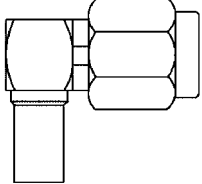
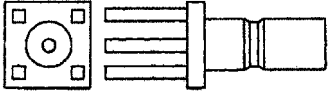
MIL-STD-1353C
APPENDIX C

TABLE C-VIII. MIL-PRF-39012 descriptions and configurations - Continued.

Performance specification sheet	Description	Configuration
MIL-PRF-39012/95	Connectors, Receptacle, Electrical, Coaxial, Radio Frequency, Series SMB (Uncabled, Male, Printed Circuit, Class 2)	
MIL-PRF-39012/96	Connectors, Receptacle, Electrical, Coaxial, Radio Frequency, Series SMB (Uncabled, Male, Printed Circuit, Right Angle, Class 2)	
MIL-PRF-39012/100	Connectors, Plug, Electrical, Coaxial, Radio Frequency, High Voltage (Series MHV (Cabled), Pin Contact, Class 2)	
MIL-PRF-39012/128	Connectors, Receptacle, Electrical Coaxial, Radio Frequency (Series BNC, Solder Pocket, Socket Contact Jam Nut Mounted, Isolated, Class 2)	
MIL-PRF-39012/133	Connectors, Receptacle, Electrical, Coaxial, Radio Frequency, Series SMC, Printed Circuit Board Mount	
MIL-PRF-39012/134	Connectors, Receptacle, Electrical, Coaxial, Radio Frequency, Series SMC, Printed Circuit Board Mount, Right Angle (Inactive)	
MIL-PRF-39012/135	Connectors, Receptacle, Electrical, Coaxial, Radio Frequency, Series SSMB, Printed Circuit Board Mount, Right Angle (Inactive)	

MIL-STD-1353C
APPENDIX C

TABLE C-VIII. MIL-PRF-39012 descriptions and configurations - Continued.

Performance specification sheet	Description	Configuration
MIL-PRF-39012/136	Connector, Plug, Electrical, Series SSMA, Pin Contact, for Semirigid Cable, Class 2	
MIL-PRF-39012/137	Connector, Plug, Electrical, Series SSMA, Right Angle, Pin Contact, for Semirigid Cable	
MIL-PRF-39012/138	Connector, Receptacle, Electrical, Series SSMA, Socket Contact, for Semirigid Cable	
MIL-PRF-39012/139	Connector, Plug, Electrical, Series SSMA, Pin Contact, for Flexible Cable	
MIL-PRF-39012/140	Connector, Plug, Electrical, Series SSMA, Pin Contact, Right Angle, for Flexible Cable	
MIL-PRF-39012/141	Connector, Receptacle, Electrical, Coaxial, Radio Frequency, Series SSMB, Printed Circuit Board Mount, Straight	

C10.7 MIL-PRF-39012 connectors to RF cable. MIL-PRF-39012 connectors to RF cable see [table C-IX](#).

MIL-STD-1353C
APPENDIX C

TABLE C-IX. MIL-PRF-39012 RF connectors to cable.

Document ID	Description	Frequency	RF cable
MIL-PRF-39012/1	Plug, Pin Contact (Series N) 50 Ohms	0 - 11 GHz	M17/60-RG142 M17/60-RG400 M17/62-RG144 M17/65-RG165 M17/65-RG304 M17/74-RG215 M17/75RG214 M17/78-RG217 M17/77RG216 M17/79-RG218 M17/86-00001 M17/111-RG303 M17/112-RG304 M17/127-RG393 M17/189-00002 M17/220-00001 M17/220-00002
MIL-PRF-39012/2	Plugs And Receptacles Flange Mounted (Series N) 50 Ohms	0 - 11 GHz	M17/60-RG142 M17/62-RG144 M17/65RG165 M17/74-RG215 M17/77-RG216 M17/78-RG217 M17/86-00001 M17/11-RG303 M17/112-RG304 M17/127-RG393 M17/128-RG400 M17/220-00001 M17/220-00002 M17/222-00001 M17/222-00002 M17/221-00001 M17/221-00002 M17/223-00001 M17/223-00002 M17/224-00001 M17/224-00002 M17/225-00001 M17/226-00001 M17/226-00002 M17/227-00001 M17/227-00002 M17/228-00002

MIL-STD-1353C
APPENDIX C

TABLE C-IX. MIL-PRF-39012 RF connectors to cable - Continued.

Document ID	Description	Frequency	RF cable
MIL-PRF-39012/3	Receptacle, Socket Contact (Series N) 50 Ohms	0 - 11 GHz	M17/60-RG142 M17/62-RG144 M17/65-RG165 M17/74-RG215 M17/78-RG217 M17/77-RG216 M17/79-RG218 M17/86-00001 M17/111-RG303 M17/112-RG303 M17/112-RG304 M17/127-RG393 M17/128-RG400 M17/189-00002 M17/220-00001 M17/220-00002 M17/221-00001 M17/221-00002 M17/223-00001 M17/223-00002 M17/224-00001 M17/224-00002 M17/225-00001 M17/226-00001 M17/226-00002 M17/227-00001 M17/227-00002 M17/228-00001 M17/228-00002
MIL-PRF-39012/4	Receptacle Socket, Flange Mounted (Series N) 50 Ohms	0 - 11 GHz	Solder cup All flexible cable types
MIL-PRF-39012/5	Right Angle Pin Contact (Series N) 50 Ohms	0 - 11 GHz	M17/2-RG006 M17/60-RG142 M17/62-RG144 M17/65-RG165 M17/74-RG215 M17/77-RG216 M17/78-RG217 M17/79-RG218 M17/86-00001 M17/112-RG303 M17/112-RG304 M17/111-RG303 M17/127-RG393 M17/128-RG400 M17/189-00002 M17/220-00001 M17/220-00002

MIL-STD-1353C
APPENDIX C

TABLE C-IX. MIL-PRF-39012 RF connectors to cable - Continued.

Document ID	Description	Frequency	RF cable
MIL-PRF-39012/5 Continued	Right Angle Pin Contact (Series N) 50 Ohms	0 - 11 GHz	M17/221-00001 M17/221-00002 M17/222-00001 M17/222-00002 M17/223-00001 M17/223-00002 M17/224-00001 M17/224-00002 M17/225-00001 M17/225-00002 M17/226-00001 M17/226-00002 M17/227-00001 M17/227-00002 M17/228-00001 M17/228-00002
MIL-PRF-39012/6	Plug (Series C) 50 Ohms	0 - 11 GHz	M17/6-RG11 M17/65-RG165 M17/72-RG211 M17/73-RG212 M17/74-RG213 M17/74-RG215 M17/75-RG214 M17/78-RG217 M17/79-RG218 M17/86-00001 M17/92-RG115 M17/112-RG304
MIL-PRF-39012/7	Plug (Series C) 50 Ohms	0 - 11 GHz	M17/6-RG11 M17/065-RG165 M17/073-RG212 M17/074-RG213 M17/75-RG214 M17/075-RG215 M17/92-RG115 M17/112-RG304 M17/RG-225/U
MIL-PRF-39012/8	Receptacle, Female, Flange Mounted (Series C) 50 Ohms	0 - 11 GHz	M17/6-RG11 M17/065-RG165 M17/073-RG212 M17/074-RG215 M17/074-RG213 M17/75-RG214 M17/92-RG115 M17/112-RG304 M17/RG-225/U

MIL-STD-1353C
APPENDIX C

TABLE C-IX. MIL-PRF-39012 RF connectors to cable - Continued.

Document ID	Description	Frequency	RF cable
MIL-PRF-39012/9	Receptacle, Female, Jam Nut (Series C) 50 Ohms	0 - 4 GHz	M17/29-RG59 M17/30-RG062 M17/90-RG71 M17/28-RG058 M17/84-RG223
MIL-PRF-39012/10	Plug, Male, Right Angle (Series C) 50 Ohms	0 - 11 GHz	M17/6-RG11 M17/65-RG165 M17/73-RG212 M17/74-RG213 M17/75-RG214 M17/74-RG215 M17/92-RG115 M17/112-RG304 M17/86-00001
MIL-PRF-39012/11	Receptacle, Female, Jam Nut (Series C) 50 Ohms	0 - 11 GHz	M17/6-RG11 M17/65-RG165 M17/73-RG212 M17/74-RG213 M17/74-RG215 M17/75-RG214 M17/92-RG115 M17/112-RG304 M17/86-00001
MIL-PRF-39012/12	Receptacle, Female, Flange Mounted (Series C) 50 Ohms	0 - 11 GHz	Solder pocket All Flexible Cable Types
MIL-PRF-39012/13	Receptacle, Female, Jam Nut, Pressurized (Series C) 50 Ohms	0 - 11 GHz	Solder wire turrent All Flexible Cable Types
MIL-PRF-39012/14	Receptacle, Female, Jam Nut Mounted, Hermetic Seal (Series C) 50 Ohms	0 - 11 GHz	Solder pocket or solder lug All Flexible Cable Types
MIL-PRF-39012/15	Plug, Male (Series C) 50 Ohms	0 - 4 GHz	M17/29-RG59 M17/030-RG062 M17/90-RG71 M17/028-RG058 M17/084-RG223
MIL-PRF-39012/16	Plug, Pin Contact (Series BNC) 50 Ohms	0 - 4 GHz	M17/54-RG122 M17/60-RG142 M17/90-RG71 M17/95-RG180 M17/113-RG316 M17/128-RG400 M17/110-RG302 M17/111-RG303 M17/111-RG305 M17/113-RG316 M17/127-RG393

MIL-STD-1353C
APPENDIX C

TABLE C-IX. MIL-PRF-39012 RF connectors to cable - Continued.

Document ID	Description	Frequency	RF cable
MIL-PRF-39012/17	Plug, Pin Contact (Series BNC) 50 Ohms	0 - 4 GHZ	M17/54-RG122 M17/60-RG142 M17/90-RG71 M17/95-RG180 M17/110-RG302 M17/111-RG303 M17/113-RG316 M17/127-RG393 M17/128-RG400 M17/128-00001
MIL-PRF-39012/18	Receptacle, Socket, Flange Mounted (Series BNC) 50 Ohms	0 - 4 GHZ	M17/54-RG122 M17/60-RG142 M17/90-RG71 M17/95-RG180 M17/110-RG302 M17/111-RG303 M17/113-RG316 M17/127-RG393 M17/128-RG400 M17/128-00001
MIL-PRF-39012/19	Receptacle, Socket, Jam Nut Mounted (Series BNC) 50 Ohms	0 - 4 GHZ	M17/54-RG122 M17/60-RG142 M17/90-RG71 M17/95-RG180 M17/110-RG302 M17/111-RG303 M17/113-RG316 M17/113-RG393 M17/128-RG400
MIL-PRF-39012/20	Plug, Pin Contact, Right Angle (Series BNC) 50 Ohms	0 - 4 GHZ	M17/11-RG302 M17/54-RG122 M17/60-RG142 M17/90-RG71 M17/95-RG180 M17/110-RG302 M17/111-RG303 M17/113-RG316 M17/127-RG393 M17/128-RG400
MIL-PRF-39012/21	Receptacle, Female Jam Nut Mounted (Series BNC) 50 Ohms	0 - 4 GHz	Solder pocket
MIL-PRF-39012/22	Receptacles, Female, Flange Mounted Angle (Series BNC) 50 Ohms	0 - 4 GHz	Solder pocket
MIL-PRF-39012/23	Receptacles, Female, Right Angle (Series BNC) 50 Ohms	0 - 4 GHz	Solder pocket

MIL-STD-1353C
APPENDIX C

TABLE C-IX. MIL-PRF-39012 RF connectors to cable - Continued.

Document ID	Description	Frequency	RF cable
MIL-PRF-39012/24	Female, Hermetically Sealed, Jam Nut Mounted Angle (Series BNC) 50 Ohms	0 - 4 GHz	Solder lug
MIL-PRF-39012/26	Plugs, Socket Contact (Series TNC) 50 Ohms	0 - 11 GHZ	M17/54-RG122 M17/60-RG142 M17/90-RG71 M17/95-RG180 M17/110-RG302 M17/111-RG303 M17/111-RG305 M17/113-RG316 M17/127-RG393 M17/128-RG400 M17/220-00001 M17/220-00002 M17/221-00001 M17/221-00002 M17/222-00001 M17/222-00002 M17/223-00001 M17/223-00002 M17/224-00001 M17/224-00002 M17/225-00001 M17/225-00002
MIL-PRF-39012/27	Plugs, Socket Contact (Series TNC) 50 Ohms	0 - 11 GHZ	M17/54-RG122 M17/60-RG142 M17/90-RG71 M17/95-RG180 M17/110-RG302 M17/111-RG303 M17/113-RG316 M17/128-RG400 M17/128-00001 M17/220-00001 M17/220-00002 M17/221-00001 M17/221-00002 M17/222-00001 M17/222-00002 M17/223-00001 M17/223-00002 M17/224-00001 M17/224-00002 M17/225-00001 M17/225-00002

MIL-STD-1353C
APPENDIX C

TABLE C-IX. MIL-PRF-39012 RF connectors to cable - Continued.

Document ID	Description	Frequency	RF cable
MIL-PRF-39012/28	Receptacle, Socket Contact, Jam Nut Mounted (Series TNC) 50 Ohms	0 - 11 GHZ	M17/54-RG122 M17/60-RG142 M17/90-RG71 M17/95-RG180 M17/110-RG302 M17/111-RG303 M17/113-RG316 M17/128-RG400 M17/128-00001 M17/220-00001 M17/220-00002 M17/221-00001 M17/221-00002 M17/222-00001 M17/222-00002 M17/223-00001 M17/223-00002 M17/224-00001 M17/224-00002 M17/225-00001 M17/225-00002
M MIL-PRF-39012/29	Receptacle, Socket Contact, Flange Mounted (series TNC) 50 Ohms	0 - 11 GHz	M17/54-RG122 M17/60-RG142 M17/90-RG71 M17/95-RG180 M17/110-RG302 M17/111-RG303 M17/113-RG316 M17/127-RG393 M17/128-RG400 M17/128-00001 M17/220-00001 M17/220-00002 M17/221-00001 M17/221-00002 M17/222-00001 M17/222-00002 M17/223-00001 M17/223-00002 M17/224-00001 M17/224-00002 M17/225-00001 M17/225-00002

MIL-STD-1353C
APPENDIX C

TABLE C-IX. MIL-PRF-39012 RF connectors to cable - Continued.

Document ID	Description	Frequency	RF cable
MIL-PRF-39012/30	Receptacle, Pin Contact, Right Angle (series TNC) 50 Ohms	0 - 11 GHz	M17/54-RG122 M17/60-RG142 M17/90-RG71 M17/95-RG180 M17/110-RG302 M17/111-RG303 M17/111-RG305 M17/113-RG316 M17/127-RG393 M17/128-RG400 M17/220-00001 M17/220-00002 M17/221-00001 M17/221-00002 M17/222-00001 M17/222-00002 M17/223-00001 M17/223-00002 M17/224-00001 M17/224-00002 M17/225-00001 M17/225-00002
MIL-PRF-39012/31	Socket, Jam Nut Mounted (Series TNC) 50 Ohms	0 - 11 GHz	Solder pocket All Flexible Cable Types
MIL-PRF-39012/32	Receptacle, Socket, Flange Mounted (Series TNC) 50 Ohms	0 - 11 GHz	Solder pocket All Flexible Cable Types
MIL-PRF-39012/33	Receptacle, Socket, Right Angle (Series TNC) 50 Ohms	0 - 11 GHz	Solder pocket All Flexible Cable Types
MIL-PRF-39012/34	Receptacle, Socket, Hermetically Sealed, Jam Nut Mounted (Series TNC) 50 Ohms	0 - 11 GHz	Solder lug All Flexible Cable Types

MIL-STD-1353C
APPENDIX C

TABLE C-IX. MIL-PRF-39012 RF connectors to cable - Continued.

Document ID	Description	Frequency	RF cable
MIL-PRF-39012/35	Plug, Pin Contact (Series SC) 50 Ohms	0 - 11 GHz	M17/2-RG6 M17/6-RG11 M17/60-RG142 M17/62-RG144 M17/65-RG165 M17/72-RG211 M17/74-RG215 M17/78-RG217 M17/79-RG218 M17/92-RG115 M17/112-RG304 127-RG393 M17/128-RG400 M17/86-00001 M17/161-00001 M17/165-00001 M17/180-00001 M17/181-00001 M17/188-00001
MIL-PRF-39012/38	Receptacle, Socket Contact, Flange Mounted, (Series SC) 50 Ohms	0 - 11 GHz	M17/2-RG6 M17/6-RG11 M17/60-RG142 M17/62-RG144 M17/65-RG165 M17/72-RG211 M17/79-RG218 M17/92-RG115 M17/112-RG304 M17/127-RG393 M17/128-RG400 M17/86-00001 M17/161-00001 M17/180-00001 M17/181-00001

MIL-STD-1353C
APPENDIX C

TABLE C-IX. MIL-PRF-39012 RF connectors to cable - Continued.

Document ID	Description	Frequency	RF cable
MIL-PRF-39012/39	Receptacle, Electrical, Coaxial, Radio Frequency, Pin Contact, Right Angle(Series SC) 50 Ohms	0 - 11 GHz	M17/2-RG6 M17/6-RG11 M17/60-RG142 M17/62-RG144 M17/65-RG165 M17/72-RG211 M17/73-RG212 M17/74-RG215 M17/74-RG213 M17/75-RG214 M17/77-RG216 M17/78-RG217 M17/79-RG218 M17/84-RG223 M17/92-RG115 M17/112-RG304 M17/127-RG393 M17/125-RG400 M17/86-00001 M17/200-00001 M17/158-00001 M17/159-00001 M17/162-00001 M17/161-00001 M17/163-00001 M17/164-00001 M17/165-00001 M17/166-00001 M17/167-00001 M17/168-00001 M17/171-00001 M17/174-00001 M17/175-00001 M17/180-00001 M17/181-00001 M17/188-00001 M17/189-00001 M17/189-00002 M17/190-00001 M17/191-00001 M17/193-00001 M17/194-00001 M17/199-00001

MIL-STD-1353C
APPENDIX C

TABLE C-IX. MIL-PRF-39012 RF connectors to cable - Continued.

Document ID	Description	Frequency	RF cable
MIL-PRF-39012/40	Receptacle, Socket Contact, Jam Nut (Series SC) 50 Ohms	0 - 11 GHz	M17/2-RG6 M17/6-RG11 M17/60-RG142 M17/62-RG144 M17/65-RG165 M17/72-RG211 M17/72-RG217 M17/74-RG215 M17/77-RG216 M17/78-RG217 M17/79-RG218 M17/92-RG115 M17/112-RG304 M17/127-RG393 M17/128-RG400 M17/86-00001 M17/161-00001 M17/180-00001 M17/181-00001 M17/191-00001
MIL-PRF-39012/55	Plugs, Pin Contact Cable Mount, Straight Plug For Flexible Cable (Series SMA) 50 Ohms	0 - 12.4 GHz	M17/28-RG058 M17/54-RG122 M17/60-RG142 M17/84-RG223 M17/93-RG178 M17/111-RG303 M17/113-RG316 M17/128-RG400 M17/152-00001
MIL-PRF-39012/56	Plug, Pin Contact Right Angle (Series SMA) 50 Ohms	0 - 12.4 GHz	M17/28-RG058 M17/54-RG122 M17/60-RG142 M17/84-RG223 M17/93-RG178 M17/111-RG303 M17/113-RG316 M17/128-RG400 M17/152-00001
MIL-PRF-39012/57	Receptacle, Socket Contact, (Series SMA) 50 Ohms	0 - 12.4 GHz	M17/54-RG122 M17/60-RG142 M17/84-RG223 M17/93-RG178 M17/111-RG303 M17/113-RG316 M17/128-RG400 M17/152-00001

MIL-STD-1353C
APPENDIX C

TABLE C-IX. MIL-PRF-39012 RF connectors to cable - Continued.

Document ID	Description	Frequency	RF cable
MIL-PRF-39012/58	Receptacle, Socket Contact 4-Hole Flange Mount (Series SMA) 50 Ohms	0 - 12.4 GHz	M17/28-RG058 M17/54-RG122 M17/60-RG142 M17/84-RG223 M17/93-RG178 M17/111-RG303 M17/113-RG316 M17/128-RG400 M17/152-00001
MIL-PRF-39012/59	Receptacle, Socket Contact, Jam Nut Mount (SMA) 50 Ohms	0 - 12.4 GHz	M17/28-RG058 M17/54-RG122 M17/60-RG142 M17/84-RG223 M17/93-RG178 M17/111-RG303 M17/113-RG316 M17/128-RG400 M17/152-00001
MIL-PRF-39012/60	Receptacle, Socket Contact Solder Cup, Rear Flange Mount (2 or 4 holes) (SMA) 50 Ohms	Not rated	Solder cup All Flexible Cable Types
MIL-PRF-39012/61	Receptacle, Socket Contact Jam Nut Mount (Series SMA) 50 Ohms	Not rated	Solder cup
MIL-PRF-39012/62	Receptacle, Socket Contact, Hermetic Seal, Jam Nut Mount (Series SMA) 50 Ohms	Not rated	Solder lug All Flexible Cable Types
MIL-PRF-39012/67	Cabled, Socket Contact, class 2 (Series SMB) 50 Ohms	0 to 4GHz	M17/93-RG178 M17/94-RG179 M17/113-RG316 M17/169-00001 M17/172-00001
MIL-PRF-39012/68	Plug, Pin Contact, (Series SMB) 50 Ohms	0 to 4 GHz	M17/93-RG178 M17/94-RG179 M17/113-RG316 M17/169-00001 M17/172-00001

MIL-STD-1353C
APPENDIX C

TABLE C-IX. MIL-PRF-39012 RF connectors to cable - Continued.

Document ID	Description	Frequency	RF cable
MIL-PRF-39012/69	Plug, Socket Contact, Right Angle (Series SMB) 50 Ohms	0 to 4 GHz	M17/93-RG178 M17/94-RG179 M17/113-RG316 M17/169-00001 M17/172-00001
MIL-PRF-39012/70	Receptacle, Pin Contact, Jamnut Mounted, (Series SMB) 50 Ohms	0 to 4 GHz	M17/93-RG178 M17/94-RG179 M17/113-RG316 M17/169-00001 M17/172-00001
MIL-PRF-39012/71	Bulkhead Jack Receptacle, Solder Pot Contact, Rear Mount (Series SMB) 50 Ohms	0 to 4GHz	Solder cup All Flexible Cable Types
MIL-PRF-39012/73	Plugs, Socket Contact (Series SMC) 50 Ohms	0 to 10 GHz	M17/93-RG178 M17/94-RG179 M17/113-RG316 M17/169-00001 M17/172-00001
MIL-PRF-39012/74	Plugs, Pin Contact(Series SMC) 50 Ohms	0 to 10 GHz	M17/93-RG178 M17/94-RG179 M17/95-RG180 M17/113-RG316 M17/169-00001 M17/172-00001
MIL-PRF-39012/75	Plugs, Socket Contact, Right Angle (Series SMC) 50 Ohms	0 to 10 GHz	M17/93-RG178 M17/94-RG179 M17/95-RG180 M17/113-RG316 M17/169-00001 M17/172-00001
MIL-PRF-39012/76	Receptacle, Pin Contact, Jam Nut Mounted (Series SMC) 50 Ohms	0 to 10 GHz	M17/93-RG178 M17/94-RG179 M17/95-RG180 M17/113-RG316 M17/169-00001 M17/172-00001
MIL-PRF-39012/77	Receptacle, Male, Jam Nut Mounted (Series SMC) 50 Ohms	0 to 4 GHz	Solder Cup Any flexible cable
MIL-PRF-39012/79	Plug, Pin Contact Cable Mount (Series SMA) 50 Ohms	0 to 18 GHz	M17/130-RG402 M17/133-RG405
MIL-PRF-39012/80	Plug, Pin Contact Right Angle (Series SMA) 50 Ohms	0 to 18 GHz	M17/130-RG402 M17/133-RG405

MIL-STD-1353C
APPENDIX C

TABLE C-IX. MIL-PRF-39012 RF connectors to cable - Continued.

Document ID	Description	Frequency	RF cable
MIL-PRF-39012/81	Plug, Socket Contact (Series SMA) 50 Ohms	0 to 18 GHz	M17/130-RG402 M17/133-RG405
MIL-PRF-39012/82	Receptacle, Socket Contact Flange Mounted (Series SMA) 50 Ohms	0 to 18 GHz	M17/130-RG402 M17/133-RG405
MIL-PRF-39012/83	Receptacle, Socket Contact Jam Nut Mount (Series SMA)	0 to 18 GHz	M17/130-RG402 M17/133-RG405
MIL-PRF-39012/92	Plug, With Out Contact, .141 Semirigid Cable (Series SMA)	Not applicable	M17/130-RG402 M17/130-00001 through M17/130-00011
MIL-PRF-39012/93	Receptacle, Female, Printed Circuit (Series SMA) 50 Ohms	0 to 18 GHz	Printed Wiring Board (PWB) Mounted
MIL-PRF-39012/94	Receptacle, Female, Printed Circuit, Right Angle (Series SMA) 50 Ohms	0 to 18 GHz	PWB Mounted
MIL-PRF-39012/95	Receptacle, Male, Printed Circuit (Series SMB) 50 Ohms	0 to 4 GHz	PWB Mounted
MIL-PRF-39012/96	Receptacle, Male, Printed Circuit, Right Angle (Series SMB) 50 Ohms	0 to 4 GHz	PWB Mounted
MIL-PRF-39012/100	Plug, High Voltage, Pin Contact (Series SHV) Impedance Non-constant	Not applicable	M17/29-RG59 M17/30-RG62 M17/90-RG71 M17/97-RG210 M17/184-00001 M17/185-00001
MIL-PRF-39012/128	Receptacle, Socket Contact, Solder Pocket, Jam Nut Mounted (Series BNC) 50 Ohm	0 to 4 GHz	Solder cup All flexible cable types
DLA Land and Maritime 89008	Plug, Socket Contact (Series N) 50 Ohms	DC to 18 GHz	M17/129-RG401 M17/130-RG402
DLA Land and Maritime 86106	Receptacle, Socket Contact, Panel Mount (Series N) 50 Ohms	0 to 18 GHz	M17/129-RG401 M17/130-RG402 M17/130-00001 M17/130-00002 M17/130-00003

MIL-STD-1353C
APPENDIX C

TABLE C-IX. MIL-PRF-39012 RF connectors to cable - Continued.

Document ID	Description	Frequency	RF cable
MIL-PRF-39012/133	Receptacle, Printed Circuit Board Mount (Series SMC) 50 Ohms	0 to 4 GHz	PWB Mounted
MIL-PRF-39012/134	Receptacle, Printed Circuit Board Mount, Right Angle (Series SMC) 50 Ohms	0 to 4 GHz	PWB Mounted
MIL-PRF-39012/135	Receptacle, Printed Circuit Board Mount, Right Angle (Series SSMB) 50 Ohms	0 to 12.4 GHz	PWB Mounted
MIL-PRF-39012/136	Plug, Electrical, , Pin Contact, for Semirigid Cable (Series SSMA) 50 Ohms	0 to 35 GHz	M17/133-RG405
MIL-PRF-39012/137	Plug, Right Angle, Pin Contact, for Semirigid Cable (Series SSMA) 50 Ohms	0 to 26 GHz	M17/133-RG405
MIL-PRF-39012/138	Receptacle, Socket Contact, for Semirigid Cable (Series SSMA) 50 Ohms	0 to 35 GHz	M17/133-RG405 M17/133-00001 through M17/133-00011
MIL-PRF-39012/139	Plug, Pin Contact, for Flexible Cable (Series SSMA) 50 Ohms	0 to 35 GHz	M17/113-RG316
MIL-PRF-39012/140	Plug, Pin Contact, Right Angle, for Flexible Cable (Series SSMA) 50 ohms	0 to 26 GHz	M17/113-RG316
MIL-PRF-39012/141	Receptacle, Electrical, , Printed Circuit Board Mount, Straight (Series SSMB) 50 ohms	0 to 12.4 GHz	PWB Mounted

MIL-STD-1353C
APPENDIX C

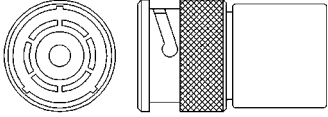
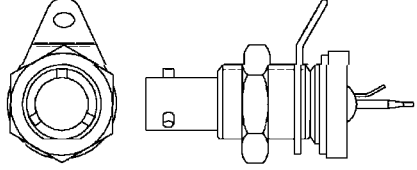
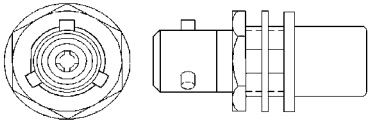
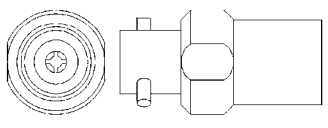
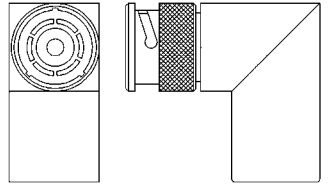
C.11 MIL-PRF-49142. MIL-PRF-49142 triaxial RF connector, see table C-X.

C.11.1 Class of MIL-PRF-49142 connectors consists of the following:

Class 1 - A class 1 connector is a connector which is intended to provide superior RF performance at specified frequencies, and for which all RF characteristics are completely defined.

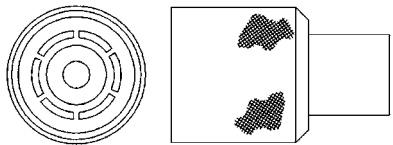
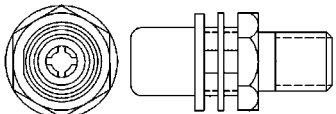
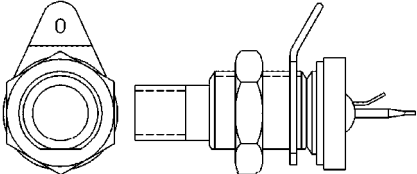
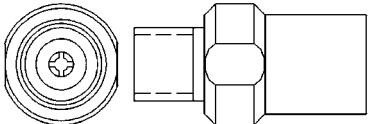
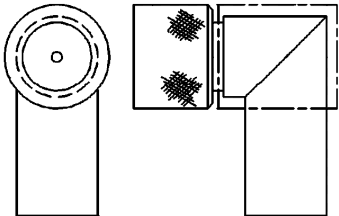
Class 2 - A class 2 connector is intended to provide mechanical connection within an RF circuit providing specified performance.

TABLE C-X. MIL-PRF-49142 descriptions and configurations.

Specification number	Description	Configuration
MIL-PRF-49142	Connectors, Plugs and Receptacles, Electrical, Triaxial, Radio Frequency, General Specification for	
MIL-PRF-49142/3	Connector, Plug, Electrical, Triaxial, Radio Frequency (Series TRB, Pin Contact, Class 2)	
MIL-PRF-49142/4	Connectors, Receptacle, Electrical, Triaxial, Radio Frequency, Uncabled, (Series TRB, Socket Contact, Jamnut Mounted, Class 2) Hermetic and Nonhermetic	
MIL-PRF-49142/5	Connector, Receptacle, Electrical, Triaxial, Radio Frequency (Series TRB (Cabled), Socket Contact, Jam Nut Mounted, Class 2)	
MIL-PRF-49142/6	Connector, Plug, Electrical, Triaxial, Radio Frequency (Series TRB (Cabled), Socket Contact, Class 2)	
MIL-PRF-49142/7	Connector, Plug, Electrical, Triaxial, Radio Frequency (Series TRB (Cabled), Pin Contact, Right Angle, Class 2)	

MIL-STD-1353C
APPENDIX C

TABLE C-X. MIL-PRF-49142 descriptions and configurations - Continued..

Specification number	Description	Configuration
MIL-PRF-49142/8	Connectors, Triaxial, Radio Frequency (Series TRT (Cabled), Plug, Pin Contact, Class 2)	
MIL-PRF-49142/9	Connector, Triaxial, Radio Frequency, (Series TRT (Cabled) Receptacle, Socket Contact, Jamnut Mounted, Class 2)	
MIL-PRF-49142/10	Connectors, Receptacle, Electrical, Triaxial, Radio Frequency, Uncabled (Series TRT, Socket Contact, Jamnut Mounted, Class 2) Hermetic and Nonhermetic	
MIL-PRF-49142/11	Connectors, Triaxial, Radio Frequency, (Series TRT (Cabled) Receptacle, Socket Contact, Class 2)	
MIL-PRF-49142/12	Connectors, Plug, Electrical, Triaxial, Radio Frequency, (Series TRT (Cabled) Pin Contact, Right Angle, Class 2)	

MIL-STD-1353C
APPENDIX C

C.11.2. MIL-PRF-49142 RF connectors to cable. MIL-PRF-49142 RF connectors to cable, see table C-XI.

TABLE C-XI. MIL-PRF-49142 RF connectors to cable.

Document ID	Description	Frequency	RF cable
MIL-PRF-49142/1/3	Plug, Pin Contact, Triaxial (Series TRB) Impedance Non-constant	0 to 500 MHz min	D3-7619-5/336 D3-7619-5/338 M17/45-RG108 M17/116-RG307 M17/134-00001 M17/134-00002 M17/134-00003 M17/134-00004 M17/135-00003 M17/135-00004 M17/135-00005 M17/135-00006 M17/176-00002 M17/177-00001 M17/178-00001 M17/179-00001 M17/186-00001 M17/186-00008 380-10045-1
MIL-PRF-49142/1/4	Receptacle, Triaxial, Uncabled, Socket Contact, Jamnut Mounted, Hermetic and Nonhermetic (Series TRB) Impedance Non-constant	0 to 500 MHz min	Solder lugs Any flexible cable types
MIL-PRF-49142/1/5	Connector, Receptacle, Electrical, Triaxial, Cabled, Socket Contact, Jam Nut Mounted (Series TRB) Impedance Non-constant	0 to 500 MHz min	D3-7619-5/336 D3-7619-5/338 M17/45-RG108 M17/116-RG307 M17/134-00001 M17/134-00002 M17/134-00003 M17/134-00004 M17/135-00003 M17/135-00004 M17/135-00005 M17/135-00006 M17/176-00002 M17/177-00001 M17/178-00001 M17/179-00001 M17/186-00001 380-10045-1

MIL-STD-1353C
APPENDIX C

TABLE C-XI. MIL-PRF-49142 RF connectors to cable - Continued.

Document ID	Description	Frequency	RF cable
MIL-PRF-49142/1/6	Connector, Plug, Electrical, Triaxial, Cabled, Socket Contact (Series TRB) Impedance Non-constant	0 to 500 MHz min	D3-7619-5/336 D3-7619-5/338 M17/45-RG108 M17/116-RG307 M17/134-00001 M17/134-00002 M17/134-00003 M17/134-00004 M17/135-00003 M17/135-00004 M17/135-00005 M17/135-00006 M17/176-00002 M17/177-00001 M17/178-00001 M17/178-00001 M17/179-00001 M17/186-00001 380-10045-1
MIL-PRF-49142/1/7	Connector, Plug, Electrical, Triaxial, Cabled, Pin Contact, Right Angle, (Series TRB) Impedance Non-constant	0 to 500 MHz min	D3-7619-5/336 D3-7619-5/338 M17/45-RG108 M17/116-RG307 M17/134-00001 M17/134-00002 M17/134-00003 M17/134-00004 M17/135-00003 M17/135-00004 M17/135-00005 M17/135-00006 M17/176-00002 M17/177-00001 M17/178-00001 M17/179-00001 M17/186-00001 380-10045-1

MIL-STD-1353C
APPENDIX C

TABLE C-XI. MIL-PRF-49142 RF connectors to cable - Continued.

Document ID	Description	Frequency	RF cable
MIL-PRF-49142/1/8	Connectors, Triaxial, Cabled), Plug, Pin Contact, (Series TRT) Impedance Non-constant	0 to 500 MHz min	D3-7619-5/336 D3-7619-5/338 M17/45-RG108 M17/116-RG307 M17/134-00001 M17/134-00002 M17/134-00003 M17/134-00004 M17/135-00003 M17/135-00004 M17/135-00005 M17/135-00006 M17/176-00002 M17/177-00001 M17/178-00001 M17/179-00001 M17/176-00002 M17/186-00001 M24643/33-01UN
MIL-PRF-49142/1/9	Triaxial, Receptacle, Socket Contact, Cabled, Jamnut Mounted (Series TRT)) Impedance Non-constant	0 to 500 MHz min	D3-7619-5/336 D3-7619-5/338 M17/45-RG108 M17/116-RG307 M17/134-00001 M17/134-00002 M17/134-00003 M17/134-00004 M17/135-00003 M17/135-00004 M17/135-00005 M17/135-00006 M17/176-00002 M17/177-00001 M17/178-00001 M17/179-00001 M17/186-00001 M24643/33-01UN
MIL-PRF-49142/1/10	Receptacle, Triaxial, , Uncabled, Socket Contact, Jamnut Mounted, Class 2) Hermetic and Nonhermetic (Series TRT) Impedance Non-constant	0 to 500 MHz min	Solder lug Any flexible cable type

MIL-STD-1353C
APPENDIX C

TABLE C-XI. MIL-PRF-49142 RF connectors to cable - Continued.

Document ID	Description	Frequency	RF cable
MIL-PRF-49142/1/11	Triaxial, Radio Receptacle, Cabled, Socket Contact, (Series TRT)	0 to 500 MHz min	D3-7619-5/336 D3-7619-5/338 M17/45-RG108 M17/116-RG307 M17/134-00001 M17/134-00002 M17/134-00003 M17/134-00004 M17/135-00003 M17/135-00004 M17/135-00005 M17/135-00006 M17/176-00002 M17/177-00001 M17/178-00001 M17/179-00001 M17/186-00001 M24643/33-01UN
MIL-PRF-49142/1/12	Plug, Triaxial, (Cabled) Pin Contact, Right Angle (Series TRT) Impedance Non-constant	0 to 500 MHz min	D3-7619-5/336 D3-7619-5/338 M17/45-RG108 M17/116-RG307 M17/134-00001 M17/134-00002 M17/134-00003 M17/134-00004 M17/135-00003 M17/135-00004 M17/135-00005 M17/135-00006 M17/176-00002 M17/177-00001 M17/178-00001 M17/179-00001 M17/186-00001 M24643/33-01UN

MIL-STD-1353C
APPENDIX C

C.12 MIL-DTL-55235. MIL-DTL-55235 weatherproof connectors of the “TPS” series, designed to produce minimum discontinuities in a solid dielectric coaxial cable of a characteristic impedance of 50 ohms, up to a frequency of 10 Gigahertz and rated at 1,500 volts rms at sea level, see figures C-1, C-2 and table C-XII.

C.12.1 MIL-DTL-55235 RF connectors . MIL-DTL-55235 RF connectors are designed for use with small size 50 ohm cables. Their use is governed by temperature limitations of their associated cables.

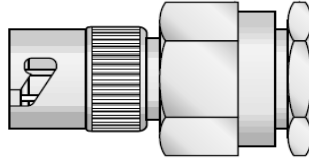


FIGURE C-1. UG-1366/U or UG-1412/U.

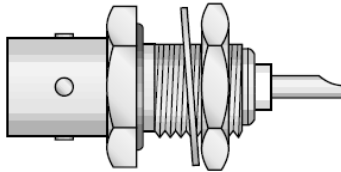


FIGURE C-2. UG-1365/U.

TABLE C-XII. MIL-DTL-55235 descriptions and configurations.

Specification/drawing number	Description	Configuration
		As specified on Electronics Command drawings
MIL-DTL-55235	Connectors, Coaxial, Radio Frequency, Series TPS, General Specification	SC-D-358720 Dimensional Interchangeability Requirements for Male Connectors.
		SC-D-358721 Dimensional Interchangeability Requirements for Female Connectors.
		SC-D-358722 Outline and Mounting Dimensions for Receptacles, Jacks and Adapters.
Impedance 50 ohms, up to a frequency of 10 GHz, rated 1,500 volts rms at sea level		
UG number		Army drawing
Connector, Receptacle, Electrical; UG-1364()/U		SC-DL-358723 Connector, Receptacle, Electrical UG-1364()/U (Bulkhead Jack for RG-58 Cable).
Connector, Receptacle, Electrical; UG-1365()/U		SC-DL-358724 Connector, Receptacle, Electrical UG-1365()/U.
Connector, Plug, Electrical; UG-1366()/U		SC-DL-358725 Connector, Plug, Electrical UG-1366()/U (For RG-58 Cable).
Adapter, Connector; UG-1367()/U		SC-DL-358726 Adapter, Connector UG-1367()/U (Bulkhead, Female-Female, TPS to TPS).
Adapter, Connector; UG-1368()/U		SC-DL-358727 Adapter, Connector UG-1368()/U (Bulkhead, Female-Female, TPS to BNC).

MIL-STD-1353C
APPENDIX C

TABLE C-XII. MIL-DTL-55235 descriptions and configurations - Continued.

UG type	Army drawing
Connector, Receptacle, Electrical; UG-1443()/U	
Connector, Receptacle, Electrical; UG-1471()/U	SC-DL-358736 Connector, Receptacle, Electrical UG-1471()/U.
Connector, Plug, Electrical; UG-1412()/U	SC-DL-358728 Connector, Plug, Electrical UG-1412()/U (For RG-223 Cable).
Connector, Receptacle, Electrical; UG-1413()/U	SC-DL-358729 Connector, Receptacle, Electrical UG-1413()/U (Bulkhead Jack for RG-223 Cable).
Connector, Plug, Electrical; UG-1415()/U	SC-DL-358730 Connector, Plug, Electrical UG-1415()/U (Jack for RG-58 Cable).
Connector, Plug, Electrical; UG-1416()/U	SC-DL-358731 Connector, Plug, Electrical UG-1416()/U (Jack for RG-223 Cable).
Adapter, Connector; UG-1426()/U	SC-DL-358732- Adapter, Connector UG-1426()/U (TPS-Female to N-Female).
Adapter, Connector; UG-1427()/U	SC-DL-358733 Adapter, Connector UG-1427()/U (TPS-Male to N-Male).
Adapter, Connector; UG-1428()/U	SC-DL-358734 Adapter, Connector UG-1428()/U (TPS-Male to N-Female).
Adapter, Connector; UG-1429()/U	SC-DL-835735 Adapter, Connector UG-1429()/U (TPS-Male to N-Male).

MIL-STD-1353C
APPENDIX C

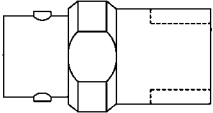
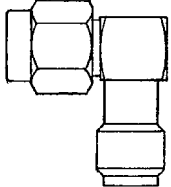
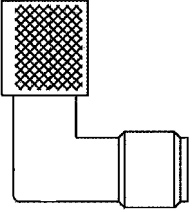
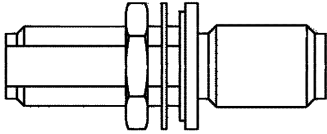
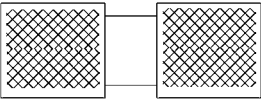
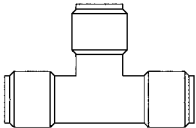
C.13 MIL-PRF-55339. covers the performance requirements and tests for between series and within series, radio frequency, coaxial connector adapters, see table C-XIII.

C.13.1 Classification. Adapters consist of the following classes:

a. Class 1. - A class 1 adapter is an adapter which is intended to provide superior RF performance at specified frequencies, and for which all RF characteristics are completely defined.

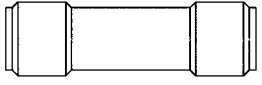
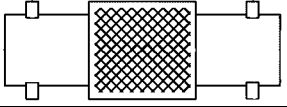
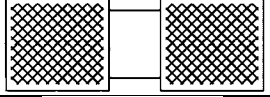
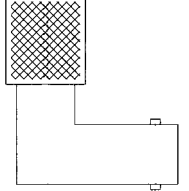
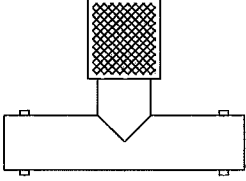
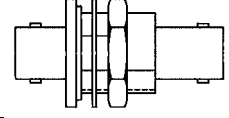
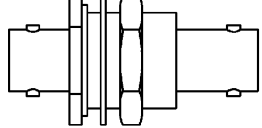
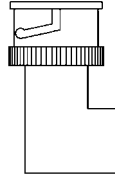
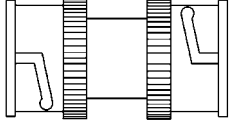
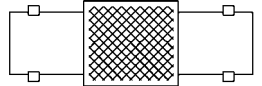
b. Class 2. - A class 2 adapter is intended to provide mechanical connection within an RF circuit providing specified RF performance

TABLE C-XIII. MIL-PRF-55339 descriptions and configurations.

Specification	Description	Configuration
MIL-PRF-55339	Adapters, Connectors, Coaxial, Radio Frequency, (Between Series and Within Series), General Specification For	
MIL-PRF-55339/1	Adapter, Connector, Coaxial, Radio Frequency, In-Line, (Between Series BNC Jack to Series N JACK), Class 2	
MIL-PRF-55339/2	Adapters, Connector, Coaxial, Radio Frequency, (Series SMA), Class 2, Right Angle, Male To Female	
MIL-PRF-55339/3	Adapter, Connector, Coaxial, Radio Frequency, Right Angle, (Within Series N Plug to Series N Jack), Class 2	
MIL-PRF-55339/4	In-Line, Jamnut Mounted, (Within Series N Jack to Series N Jack, (Hermetic and Non-Hermetic)), Class 2	
MIL-PRF-55339/5	Adapter, Connector, Coaxial, Radio Frequency, In-Line, (Within Series N Plug to Series N Plug), Class 2	
MIL-PRF-55339/6	Adapter, Connector, Coaxial, Radio Frequency, (Within Series N), Class 2, "T" Plug	

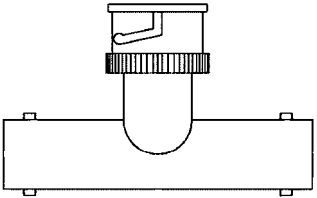
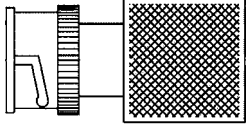
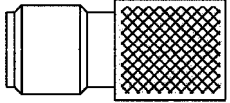
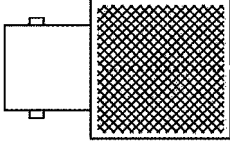
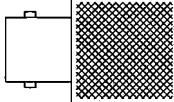
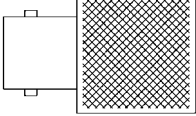
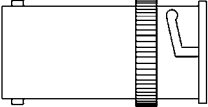
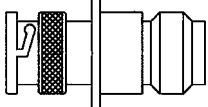
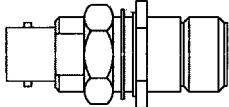
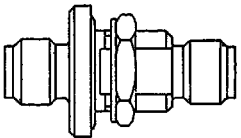
MIL-STD-1353C
APPENDIX C

TABLE C-XIII. MIL-PRF-55339 descriptions and configurations - Continued.

MIL-PRF-55339/7	Adapter, Connector, Coaxial, Radio Frequency, (Within Series N), Class 2, Straight Plug	
MIL-PRF-55339/8	Adapter, Connector, Coaxial, Radio Frequency, In-Line, (Within Series C Jack to Series C Jack), Class 2	
MIL-PRF-55339/9	Adapter, Connector, Coaxial, Radio Frequency, (Within Series C), Class 2, Straight Plug	
MIL-PRF-55339/10	Adapter, Connector, Coaxial, Radio Frequency, (Within Series C), Class 2, Right Angle Plug	
MIL-PRF-55339/11	Adapter, Connector, Coaxial, Radio Frequency (Within Series C), Class 2, "T" Plug	
MIL-PRF-55339/12	Adapter, Connector, Coaxial, Radio Frequency, In-Line, Jamnut Mounted, (Within Series C Jack to Series C Jack (Hermetic)), Class 2	
MIL-PRF-55339/13	Adapters, Connector, Coaxial, Radio Frequency, In-Line, Jamnut Mounted, (Within Series BNC Jack to Series BNC Jack, (Hermetic and Non-Hermetic)), Class 2	
MIL-PRF-55339/14	Adapter, Connector, Coaxial, Radio Frequency, Right Angle (Within Series BNC Jack to Series BNC Plug), Class 2	
MIL-PRF-55339/15	Adapter, Connector, Coaxial, Radio Frequency (Within Series BNC), Class 2, Straight Plug	
MIL-PRF-55339/16	Adapter, Connector, Coaxial, Radio Frequency. In-Line, (Within Series BNC Jack to Series BNC Jack), Class 2	

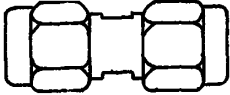
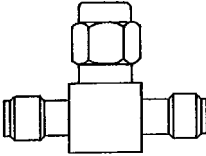
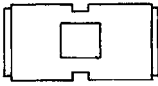
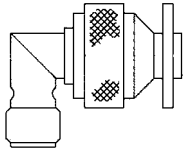
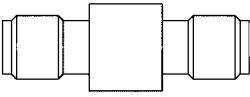
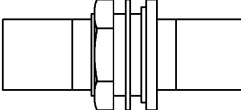
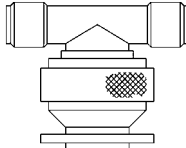
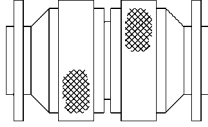
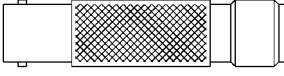
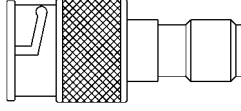
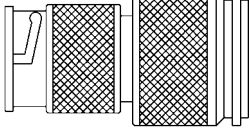
MIL-STD-1353C
APPENDIX C

TABLE C-XIII. MIL-PRF-55339 descriptions and configurations - Continued.

MIL-PRF-55339/17	Adapter, Connector, Coaxial, Radio Frequency, "T", (Within Series BNC Jack to Jack and Series BNC Plug to Jack) Class 2	
MIL-PRF-55339/18	Adapter, Connector, Coaxial, Radio Frequency, In-Line, (Between Series BNC Plug to Series N Plug), Class 2	
MIL-PRF-55339/19	Adapter, Connector, Coaxial, Radio Frequency, In-Line, (Between Series N Jack to Series C Plug), Class 2	
MIL-PRF-55339/20	Adapter, Connector, Coaxial, Radio Frequency, In-Line, (Between Series BNC Jack to Series N Plug), Class 2	
MIL-PRF-55339/21	Adapter, Connector, Coaxial, Radio Frequency, In-Line, (Between Series C Jack to Series N Plug), Class 2	
MIL-PRF-55339/22	Adapter, Connector, Coaxial, Radio Frequency, In-Line, (Between Series BNC Jack to Series C Plug), Class 2	
MIL-PRF-55339/23	Adapter, Connector, Coaxial, Radio Frequency, In-Line, (Between Series C Jack to Series BNC Plug), Class 2	
MIL-PRF-55339/24	Adapter, Connector, Coaxial, Radio Frequency, Flange Mounted, (Within Series BNC Plug to Series N Jack), Class 2	
MIL-PRF-55339/25	Adapter, Connector, Coaxial, Radio Frequency, In-Line, Jamnut Mounted, (Between Series BNC Jack to Series N Jack), Class 2	
MIL-PRF-55339/28	Adapter, Connector, Coaxial, Radio Frequency, In Line, Jamnut Mounted, (Within Series SMA Plug to Series SMA Plug (Hermetic)), Class 2	

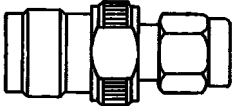
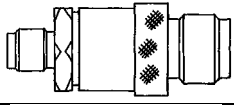
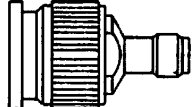
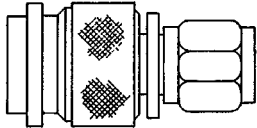
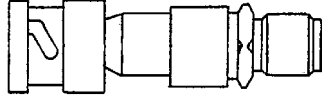
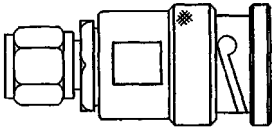
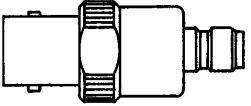
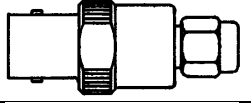
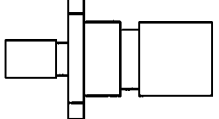
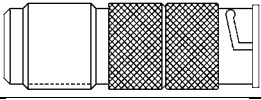
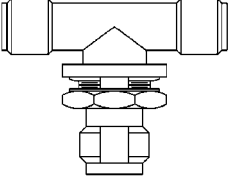
MIL-STD-1353C
APPENDIX C

TABLE C-XIII. MIL-PRF-55339 descriptions and configurations - Continued.

MIL-PRF-55339/29	Adapter, Connector, Coaxial, Radio Frequency, In-Line, (Within Series SMA Plug To SMA Plug), Class 2	
MIL-PRF-55339/30	Adapter, Connector, Coaxial, Radio Frequency, "T", (WITHIN SERIES SMA Plug To Two Series SMA Jacks), Class 2	
MIL-PRF-55339/31	Adapter, Connector, Coaxial, Radio Frequency, In-Line (Within Series SMA Jack to SMA Series Jack), Class 2	
MIL-PRF-55339/32	Adapter, Connector, Coaxial, Radio Frequency, (Within Series TNC) Right Angle, Male to Female	
MIL-PRF-55339/33	Adapter, Connector, Coaxial, Radio Frequency, (Within Series TNC) Class 2, Straight Plug	
MIL-PRF-55339/34	Adapter, Connector, Coaxial, Radio Frequency, (Within Series TNC, (Hermetic)), Class 2, Receptacle	
MIL-PRF-55339/35	Adapter, Connector, Coaxial, Radio Frequency (Within Series TNC), Class 2, "T" Plug	
MIL-PRF-55339/36	Adapter, Connector, Coaxial, Radio Frequency (Within Series TNC), Class 2, Straight Plug	
MIL-PRF-55339/37	Adapter, Connector, Coaxial, Radio Frequency (Between Series BNC To Series TNC), Class 2, Straight Plug	
MIL-PRF-55339/38	Adapter, Connector, Coaxial, Radio Frequency, (Between Series BNC to Series TNC), Class 2, Straight Plug	
MIL-PRF-55339/39	Adapters, Connector, Coaxial, Radio Frequency, (Between Series SMA (Male) to Series TNC (Female)), Class 2, Straight Plug	

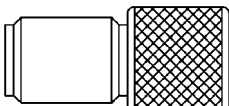
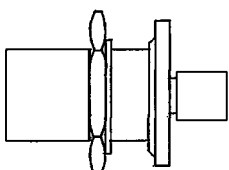
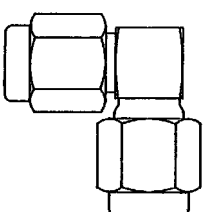
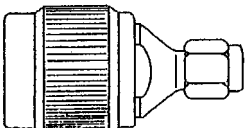
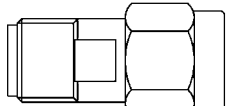
MIL-STD-1353C
APPENDIX C

TABLE C-XIII. MIL-PRF-55339 descriptions and configurations - Continued.

MIL-PRF-55339/40	Adapters, Connector, Coaxial, Radio Frequency, (Between Series SMA (Male) To Series TNC (Female)), Class 2, Straight Plug	
MIL-PRF-55339/41	Adapter, Connector, Coaxial, Radio Frequency, (Between Series SMA (Female) To Series TNC (Female)), Class 2, Straight Plug	
MIL-A-55339/42	Adapter, Connector, Coaxial, Radio Frequency, (Between Series SMA (Female) YO Series TNC (Male)), Class 2, Straight Plug (Inactive)	
MIL-PRF-55339/43	Adapters, Connector, Coaxial, Radio Frequency, (Between Series SMA (Male) To Series TNC (Male)), Class 2, Straight Plug (Inactive for new design)	
MIL-PRF-55339/44	Adapter, Connector, Coaxial, Radio Frequency, In-Line (Between Series SMA Jack to Series BNC), Class 2	
MIL-PRF-55339/45	Adapter, Connector, Coaxial, Radio Frequency, In-Line, (Between Series SMA Plug to Series BNC Plug), Class 2	
MIL-PRF-55339/46	Adapter, Connector, Coaxial, Radio Frequency, In-Line, (Between Series SMA Jack to Series BNC Jack), Class 2	
MIL-PRF-55339/47	Adapter, Connector, Coaxial, Radio Frequency, In Line, (Between Series SMA Plug to Series BNC Jack), Class 2	
MIL-PRF-55339/48	Adapter, Connector, Coaxial, Radio Frequency, (Between Series SMA to Series TNC), Class 2, Straight Plug	
MIL-PRF-55339/49	Adapter, Connector, Coaxial, Radio Frequency (Between Series N Jack to Series BNC Plug)	
MIL-PRF-55339/50	Adapter, Connector, Coaxial, Radio Frequency (Within Series TNC Jack to Two Series TNC Jacks), Class 2 "T" Jamnut Mount	

MIL-STD-1353C
APPENDIX C

TABLE C-XIII. MIL-PRF-55339 descriptions and configurations - Continued.

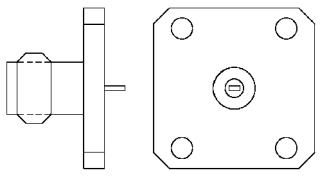
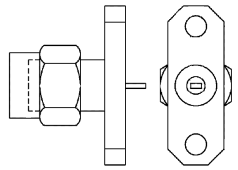
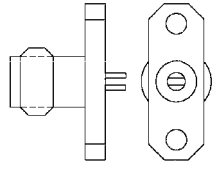
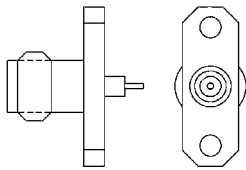
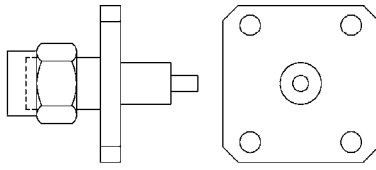
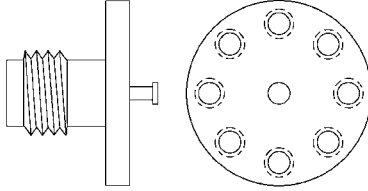
MIL-PRF-55339/51	Adapter, Connector, Coaxial, Radio Frequency, (Between Series TNC to Series N), Class 2, Straight Plug	
MIL-PRF-55339/52	Adapter, Connector, Electrical, Coaxial, Radio Frequency, (Between Series SMA to N)	
MIL-PRF-55339/53	Adapter, Connector, Electrical, Coaxial, Radio Frequency, Pin Contact (Within Series SMA), Right Angle	
MIL-PRF-55339/54	Adapter, Connector, Electrical, Coaxial, Radio Frequency, (Between Series SMA to N)	
MIL-PRF-55339/55	Adapter, Connectors, Electrical, Coaxial, Radio Frequency, Series SMA, Connector Saver	

C.14 MIL-DTL-83517. MIL-DTL-83517 transmission line, radio frequency, series (Subminiature version A) SMA. Used with coaxial, strip, or microstrip transmission line devices. These connectors are not recommended for field replacement unless the final end product is retested, see [table C-XIV](#).

C.14.1 Nominal impedance. Nominal impedance is 50 Ohms.

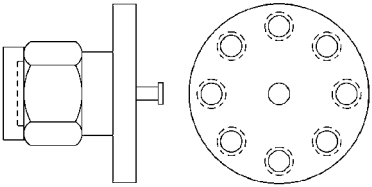
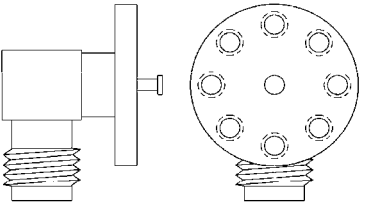
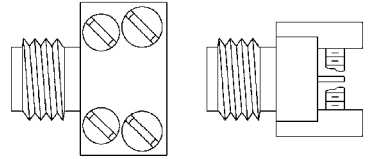
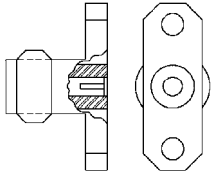
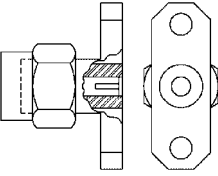
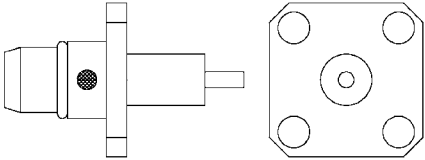
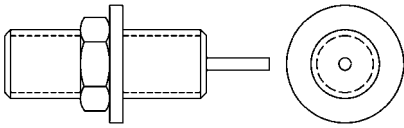
MIL-STD-1353C
APPENDIX C

TABLE C-XIV. MIL-C-83517 descriptions and configurations.

Specification number	Description	Configuration
MIL-DTL-83517	Connector, Coaxial, Radio Frequency For Coaxial, Strip Or Microstrip Transmission Line General Specification For	
MIL- DTL-83517/1	Connector, Receptacle, Electrical, Coaxial, Radio Frequency, Strip Or Microstrip Transmission Line, Series SMA (Socket Contact, Flange Mounted Tab Terminal) Frequency range: 0 to 18 GHz	
MIL- DTL-83517/2	Connector, Receptacle, Electrical, Coaxial, Radio Frequency, Strip Or Microstrip Transmission Line, Series SMA (Pin Contact, Flange Mounted Tab Terminal) Frequency range: 0 to 18 GHz	
MIL- DTL-83517/3	Connector, Receptacle, Electrical, Coaxial, Radio Frequency, Strip Or Microstrip Transmission Line, Series SMA (Socket Contact, Flange Mounted Slotted Tab Terminal) Frequency range: 0 to 18 GHz	
MIL- DTL-83517/4	Connector, Receptacle, Electrical, Coaxial, Radio Frequency, Strip Or Microstrip Transmission Line, Series SMA (Socket Contact, Flange Mounted Extended Dielectric) Frequency range: 0 to 18 GHz	
MIL-DTL-83517/5	Connector, Receptacles, Electrical, Coaxial, Radio Frequency, Strip Or Microstrip Transmission Line, Series SMA (Pin Contact, Flange Mounted Extended Dielectric) Frequency range: 0 to 18 GHz	
MIL-DTL-83517/6	Connector, Receptacles, Electrical, Coaxial, Radio Frequency, Strip Or Microstrip Transmission Line, Series SMA (Socket Contact, 8 Hole Surface Launch) Frequency range: 0 to 12.4 GHz	

MIL-STD-1353C
APPENDIX C

TABLE C-XIV. MIL-C-83517 descriptions and configurations - Continued.

Specification number	Description	Configuration
MIL-DTL-83517/7	Connector, Receptacles, Electrical, Coaxial, Radio Frequency, Strip Or Microstrip Transmission Line, Series SMA (Pin Contact, 8 Hole Surface Launch)) Frequency range: 0 to 12.4 GHz	
MIL-DTL-83517/8	Connector, Receptacles, Electrical, Coaxial, Radio Frequency, Strip Or Microstrip Transmission Line, Series SMA (Socket Contact, 8 Hole Surface Launch Right Angle)) Frequency range: 0 to 12.4 GHz	
MIL-DTL-83517/9	Connector, Receptacles, Electrical, Coaxial, Radio Frequency, Strip Or Microstrip Transmission Line, Series SMA (Socket Contact, End Launch) Frequency range: 0 to 18 GHz	
MIL-DTL-83517/10	Connector, Receptacles, Electrical, Coaxial, Radio Frequency, Strip Or Microstrip Transmission Line, Series SMA (Socket Contact, Flange Mounted) Frequency range: 0 to 18 GHz	
MIL-DTL-83517/11	Connector, Receptacles, Electrical, Coaxial, Radio Frequency, Strip Or Microstrip Transmission Line, Series SMA (Socket Contact, Flange Mounted) Frequency range: 0 to 18 GHz	
MIL-DTL-83517/12	Connector, Receptacle, Electrical, Coaxial, Radio Frequency, Series SMA, (Socket Contact) Feedthrough, Hermetic Frequency Range DC to 22 GHz	
MIL-DTL-83517/13	Connector, Receptacle, Electrical, Coaxial, Radio Frequency, Series SMA, (Socket Contact) Feedthrough, Hermetic Frequency range: 0 to 18 GHz	

MIL-STD-1353C
APPENDIX D

D.1 SCOPE

D.1.1 Scope. This appendix provides additional guidance to help the specification developer or engineer in selection of circular connectors. This appendix is not a mandatory part of this standard. The information is intended for guidance only.

D.2 APPLICABLE DOCUMENTS

D.2.1 General. The documents listed in this appendix are specified herein. This section does not include documents cited in other sections of this document.

D.2.2 GOVERNMENT DOCUMENTS

D.2.2.1 Specifications, standards, and handbooks. The following specifications, standards, and handbooks form a part of this appendix to the extent specified herein.

DEPARTMENT OF DEFENSE STANDARDS

MIL-STD-1554	-	Insert Arrangements for MIL-C-83723 Series III and MIL-C-26500
MIL-STD-1560	-	Insert Arrangements for MIL-DTL-38999, MIL-DTL-27599 and MIL-C-29600 Series A Electrical Circular Connectors
MIL-STD-1651	-	Insert Arrangements for MIL-C-5015, MIL-C-22992 (Classes C, J, and R), and MIL-C-83723 (Series II) Electrical Connectors
MIL-STD-1669	-	Insert Arrangements for MIL-DTL-26482 Environment Resisting, Circular, Electrical Connectors
MIL-STD-1760	-	Aircraft/Store Electrical Interconnection System

DEPARTMENT OF DEFENSE SPECIFICATIONS

AN3115	-	Receptacle - Airspeed Tube Electrical
MIL-C-24217	-	Connectors, Electrical, Deep Submergence, Submarine
MIL-C-24231	-	Connectors, Plugs, Receptacles, Adapters, Hull Inserts, and Hull Insert Plugs, Pressure-Proof, General Specification For
MIL-C-24231/1	-	Connector, Plug, Type I, Molded, Three-, Four-, and Five-Conductor
MIL-C-24231/2	-	Connector, Plug, Type I, 90-Degree, Molded, Three-, Four-, and Five-Conductor
MIL-C-24231/3	-	Connector, Plug, Type I, Molded, Seven- and Nine-Conductor (Straight and 90 Degrees)
MIL-C-24231/4	-	Connectors, Plug, Type I, Molded, 14-, 24-, 30-, or 40-Conductor (Straight and 90 Degrees)
MIL-C-24231/5	-	Connectors, Single Cable, Type III, Three-, Four- or Five-Conductor
MIL-C-24231/6	-	Connector, Single Cable, Type III, for DSS-3 Cable
MIL-C-24231/7	-	Connector, Single Cable, Type III, Seven-Conductor
MIL-C-24231/8	-	Connector, Single Cable, Type III, Seven-Conductor
MIL-C-24231/9	-	Connector, Single Cable, Type III, Seven- and Nine-Conductor
MIL-C-24231/10	-	Connectors, Single Cable, Type III, 14-, 24-, 30-, or 40-Conductor
MIL-C-24231/11	-	Connector, Multiple Cable, Type IV
MIL-C-24231/12	-	Connector, Receptacle, Multi-Pin, Type V, Three-, Four-, and Five-Conductor
MIL-C-24231/13	-	Connectors, Receptacle, Multi-Pin, Type V, Seven- and Nine-Conductor
MIL-C-24231/14	-	Connectors, Receptacle, Multi-Pin, Type V, 14-, 24-, 30-, and 40-Conductor

MIL-STD-1353C
APPENDIX D

- MIL-C-24231/15 - Connector, Adapter, For Molded Plug, Type II Three- and Four-Conductor
- MIL-C-24231/16 - Connector, Adapter, For Molded Plug, Type II, Seven-Conductor
- MIL-C-24231/17 - Connector, Adapter For Molded Plug, Type II, Nine-Conductor
- MIL-C-24231/18 - Connector, Plug, Type I, Molded, 65-Conductor
- MIL-C-24231/19 - Connector, Single Cable, Type III, 65-Conductor
- MIL-C-24231/20 - Connector, Receptacle, Multi-Pin, Type V, 65-Conductor
- MIL-C-24231/21 - Connector, Plug, Type I, Molded, 80-Conductor
- MIL-C-24231/22 - Connector, Receptacle, Type IV, 80-Conductor
- MIL-C-24231/24 - Connector, Single Cable, Type III, Three-Conductor, For THOF-9 Cable
- MIL-C-24231/25 - Connector, Hull Inserts, Type VII
- MIL-C-24231/26 - Connector, Single Cable, Type III, For Type 2SWF Cables
- MIL-C-24231/27 - Connector, Receptacle, Multi-Pin, Type V, For Type 2SWF Cables
- MIL-C-24231/28 - Connector, Plug, For Hull Inserts, Type VI
- MIL-C-24231/29 - Connector, Preform Molded Inserts, for Molded Plugs, Type I
- MIL-C-24231/30 - Connector, Plug, Glass Reinforced Polymer, Type I Molded, Three- and Four-Conductor
- MIL-C-81511 - Connectors, Electrical, Circular, High Density, Quick Disconnect, Environment Resisting; and Accessories, General Specification For
- MIL-C-81511/1 - Connectors, Electrical, Circular, High Density, Quick Disconnect, Environment Resisting; And Accessories: Receptacle, Flange Mount, Crimp-Type Contacts, Class A, F and E (Series 2)
- MIL-C-81511/3 - Connectors, Electrical, Circular, High Density, Quick Disconnect, Environment Resisting; and Accessories: Receptacle, Jam Nut Mount, Crimp-Type Contacts, Class A, F and E (Series 2)
- MIL-C-81511/5 - Connectors, Electrical, Circular, High Density, Quick Disconnect, Environment Resisting; and Accessories: Receptacle, Cable Connecting, Crimp-Type Contacts, Class A, F and E (Series 2)
- MIL-C-81511/6 - Connectors, Electrical, Circular, High Density, Quick Disconnect, Environment Resisting; and Accessories: Plug, Crimp-Type Contacts, Class A, F and E (Series 2)
- MIL-C-81511/13 - Connectors, Electrical, Circular, High Density, Quick Disconnect, Environment Resisting; and Accessories: F Adapter, Rotatable, Type I (Series 1 Or 2)
- MIL-C-81511/14 - Connectors, Electrical, Circular, High Density, Quick Disconnect, Environment Resisting; and Accessories: Adapter, Straight
- MIL-C-81511/15 - Connectors, Electrical, Circular, High Density, Quick Disconnect, Environment Resisting; and Accessories: Plug, Sealing Contact (Series 1 or 2)
- MIL-C-81511/16 - Connectors, Electrical, Circular, High Density, Quick Disconnect, Environment Resisting and Accessories: Cap, Protective Locking
- MIL-C-81511/17 - Connectors, Electrical, Circular, High Density, Quick Disconnect, Environment Resisting; and Accessories: Cover, Protective, Plug (Series 2)
- MIL-C-81511/18 - Connectors, Electrical, Circular, High Density, Quick Disconnect, Environment Resisting; and Accessories: Cover, Protective, Receptacle (Series 1 or 2)
- MIL-C-81511/19 - Connectors, Electrical, Circular, High Density, Quick Disconnect, Environment Resisting; and Accessories: Receptacle, Dummy Stowage, For Series 2 Connectors

MIL-STD-1353C
APPENDIX D

- MIL-C-81511/20 - Connectors, Electrical, Circular, High Density, Quick Disconnect, Environment Resisting; and Accessories: Nut, Slotted Hexagon, Connector Mounting, For Series 1 and 2 Connectors
- MIL-C-81511/21 - Connectors, Electrical, Circular, High Density, Quick Disconnect, Environment Resisting; and Accessories: Receptacle, Flange Mount, Crimp-Type Contacts Class A, F and E (Series 1)
- MIL-C-81511/23 - Connectors, Electrical, Circular, High Density, Quick Disconnect, Environment Resisting; and Accessories: Receptacle, Jam Nut Mount, Crimp-Type Contacts Class A, F and E (Series 1)
- MIL-C-81511/25 - Connectors, Electrical, Circular, High Density, Quick Disconnect, Environment Resisting; and Accessories: Receptacle, Cable Connecting, Crimp-Type Contacts Class A, F and E (Series 1)
- MIL-C-81511/26 - Connectors, Electrical, Circular, High Density, Quick Disconnect, Environment Resisting; and Accessories: Plug, Crimp-Type Contacts, Class A, F and E (Series 1)
- MIL-C-81511/41 - Connectors, Electrical, Circular, High Density, Quick Disconnect, Environment Resisting: Receptacle, Flange Mount, Individual Release, Crimp-Type Contacts, Class A, F and W (Series 3)
- MIL-C-81511/45 - Connectors, Electrical, Circular, High Density, Quick Disconnect, Environment Resisting: Receptacle, Cable Connecting, Individual Release, Crimp-Type Contacts, Class A, F and W (Series 3)
- MIL-C-81511/46 - Connectors, Electrical, Circular, High Density, Quick Disconnect, Environment Resisting: Plug, Individual, Release, Crimp-Type Contacts, Class A, F and W (Series 3)
- MIL-C-81511/49 - Connectors, Electrical, Circular, High Density, Quick Disconnect, Environment Resisting: Receptacle, Jam Nut Mount, Individual Release, Crimp Type Contacts, Class A, F and W (Series 3)
- MIL-C-81511/51 - Connectors, Electrical, Circular, High Density, Quick Disconnect, Environment Resisting: Receptacle, Flange Mount, Individual Release, Crimp-Type Contacts Class A, F and W (Series 4)
- MIL-C-81511/53 - Connectors, Electrical, Circular, High Density, Quick Disconnect, Environment Resisting: Receptacle, Jam Nut Mount, Individual Release, Crimp-Type Contacts, Class A, F and W (Series 4)
- MIL-C-81511/55 - Connectors, Electrical, Circular, High Density, Quick Disconnect, Environment Resisting: Receptacle, Cable Connecting, Individual Release, Crimp-Type Contacts, Class A, F and W (Series 4)
- MIL-C-81511/56 - Connectors, Electrical, Circular, High Density, Quick Disconnect, Environment Resisting: Plug, Individual Release, Crimp-Type Contacts, Class A, F and W (Series 4)
- MIL-DTL-22992 - Connectors, Plugs and Receptacles, Electrical, Waterproof, Quick Disconnect, Heavy Duty Type, General Specification For
- MIL-DTL-25955 - Connectors, Electrical, Environment Resisting, Miniature, With Snap-In Contacts
- MIL-DTL-26482 - Connectors, Electrical, (Circular, Miniature, Quick Disconnect, Environment Resisting), Receptacles and Plugs, General Specification for
- MIL-DTL-26500 - Connectors, General Purpose, Electrical, Miniature, Circular, Environment Resisting, General Specification for
- MIL-DTL-27599 - Connectors, Electrical, Circular, Miniature, High Density, Quick Disconnect, Environmental Resistant, Solder Contacts, General Specification for

MIL-STD-1353C
APPENDIX D

- MIL-DTL-28840 - Connectors, Electrical, Circular, Threaded, High Shock, High Density, Shipboard, Class D, General Specification for
- MIL-DTL-28840/1 - Connector Accessories, Electrical, Circular, Threaded, High Shock, High Density, Shipboard, Clamps, Strain Relief, Straight, Open, for Electrical Connectors
- MIL-DTL-28840/2 - Connector Accessories, Electrical, Circular, Threaded, High Shock, High Density, Shipboard, Clamps, Strain Relief, 90 Degrees, Open, for Electrical Connectors
- MIL-DTL-28840/3 - Connector Accessories, Electrical, Circular, Threaded, High Shock, High Density, Shipboard, Clamps, Strain Relief, 45 Degrees, Open, for Electrical Connectors
- MIL-DTL-28840/4 - Connectors, Electrical, Circular, Threaded, High Shock, High Density, Shipboard, Metal Conduit, for EMI Shielding
- MIL-DTL-28840/5 - Connectors, Electrical, Circular, Threaded, High Shock, High Density, Shipboard, Backshell, Straight, Metal Conduit for EMI Shielding
- MIL-DTL-28840/6 - Connectors, Electrical, Circular, Threaded, High Shock, High Density, Shipboard, Backshell, Straight, Cable Sealing and Shield Termination
- MIL-DTL-28840/7 - Connectors, Electrical, Circular, Threaded, High Shock, High Density, Shipboard, Crimp Contacts, Dummy Receptacle, Wall Mounting
- MIL-DTL-28840/8 - Connectors, Electrical, Circular, Threaded, High Shock, High Density, Shipboard, Backshell, 90 Degrees, Cable Sealing and Shield Termination
- MIL-DTL-28840/9 - Connectors, Electrical, Circular, Threaded, High Shock, High Density, Shipboard, Backshell, 45 Degrees, Cable Sealing and Shield Termination
- MIL-DTL-28840/10 - Connectors, Electrical, Circular, Threaded, High Shock, High Density, Shipboard, Crimp Contacts, Receptacle, Wall Mounting, Classes D, DS, P, T, TS, Z, and ZS
- MIL-DTL-28840/11 - Connectors, Electrical, Circular, Threaded, High Shock, High Density, Shipboard, Crimp Contacts, Receptacle, Cable Connecting, Classes D, DS, P, T, TS, Z, and ZS
- MIL-DTL-28840/12 - Connectors, Electrical, Circular, Threaded, High Shock, High Density, Shipboard, Crimp Contacts, Receptacle, Box Mounting, Classes D, DS, P, T, TS, Z and ZS
- MIL-DTL-28840/13 - Connectors, Electrical, Circular, Threaded, High Shock, High Density, Shipboard, Dust Cover, Receptacle
- MIL-DTL-28840/14 - Connectors, Electrical, Circular, Threaded, High Shock, High Density, Shipboard, Crimp Contacts, Receptacle, Jam Nut Mounting, Classes D, DS, P, T, TS, Z and ZS
- MIL-DTL-28840/15 - Connectors, Electrical, Circular, Threaded, High Shock, High Density, Shipboard, Dust Cover, Plug
- MIL-DTL-28840/16 - Connectors, Electrical, Circular, Threaded, High Shock, High Density, Shipboard, Crimp Contacts, Plug, Classes D, DS, P, T, TS, Z, and ZS
- MIL-DTL-28840/17 - Connectors, Electrical, Circular, Threaded, High Shock, High Density, Shipboard, Crimp Contacts, Plug Assembly, Open Wire, Classes D, DS, P, T, TS, Z, and ZS
- MIL-DTL-28840/18 - Connectors, Electrical, Circular, Threaded, High Shock, High Density, Shipboard, Crimp Contacts, Plug Assembly, Open Wire, 90 Degrees, Classes D, DS, P, T, TS, Z, and ZS

MIL-STD-1353C
APPENDIX D

- MIL-DTL-28840/19 - Connectors, Electrical, Circular, Threaded, High Shock, High Density, Shipboard, Crimp Contacts, Plug Assembly, Open Wire, 45 Degrees, Classes D, DS, P, T, TS, Z, and ZS
- MIL-DTL-28840/20 - Connectors, Electrical, Circular, Threaded, High Shock, High Density, Shipboard, Crimp Contacts, Receptacle, Wall Mounting Assembly, Straight, Classes DJ, DJS, PJ, TJ, TJS, ZJ, and ZJS
- MIL-DTL-28840/21 - Connectors, Electrical, Circular, Threaded, High Shock, High Density, Shipboard, Crimp Contacts, Receptacle, Cable Connecting Assembly, Straight, Classes DJ, DJS, PJ, TJ, TJS, ZJ, and ZJS
- MIL-DTL-28840/22 - Connectors, Electrical, Circular, Threaded, High Shock, High Density, Shipboard, Metal Conduit, Bushing
- MIL-DTL-28840/23 - Connectors, Electrical, Circular, Threaded, High Shock, High Density, Shipboard, Backshell, Gland Nut, Wiring
- MIL-DTL-28840/24 - Connectors, Electrical, Circular, Gasket, Flange Mounting, Florosilicone and EMI Shielding (for MIL-DTL-28840)
- MIL-DTL-28840/25 - Connectors, Electrical, Circular, Threaded, High Shock, High Density, Shipboard, Backshell, 90°, Metal Conduit for EMI Shielding.
- MIL-DTL-28840/26 - Connectors, Electrical, Circular, Threaded, High Density, High Shock, Shipboard, Crimp Contacts, Plug Assembly, Straight, Classes DJ, DJS, PJ, TJ, TJS, ZJ, and ZJS
- MIL-DTL-28840/27 - Connectors, Electrical, Circular, Threaded, High Shock, High Density, Shipboard, Backshell, 45°, Metal Conduit for EMI Shielding
- MIL-DTL-28840/28 - Connectors, Electrical, Circular, Threaded, High Density, High Shock, Shipboard, Crimp Contacts, Plug Assembly, 90 Degrees, Classes DJ, DJS, PJ, TJ, TJS, ZJ, and ZJS
- MIL-DTL-28840/29 - Connectors, Electrical, Circular, Threaded, High Shock, High Density, Shipboard, Crimp Contacts, Plug Assembly, 45 Degrees, Classes DJ, DJS, PJ, TJ, TJS, ZJ and ZJS
- MIL-DTL-28840/30 - Connectors, Electrical, Circular, Threaded, High Shock, High Density, Shipboard, Metal Conduit Coupling
- MIL-DTL-38999 - Connectors, Electrical, Circular, Miniature, High Density, Quick Disconnect (Bayonet, Threaded, and Breech Coupling), Environment Resistant, Removable Crimp and Hermetic Solder Contacts, General Specification For
- MIL-DTL-38999/9 - Connectors, Electrical, Circular, Receptacle, Dummy Stowage, Bayonet Coupling, (MIL-C-27599 Series I and MIL-DTL-38999 Series I)
- MIL-DTL-38999/10 - Connectors, Electrical, Circular, Receptacle, Dummy Stowage, Bayonet Coupling, (MIL-C-27599, Series II and MIL-DTL-38999, Series II)
- MIL-DTL-38999/20 - Connectors, Electrical, Circular, Receptacle, Threaded, Wall Mounting Flange, Removable Crimp Contacts, Series III, Metric
- MIL-DTL-38999/21 - Connectors, Electrical, Circular, Threaded, Receptacle, Box Mounting Flange, Hermetic, Hermetic Solder Contacts, Series III, Metric
- MIL-DTL-38999/22 - Connectors, Electrical, Circular, Receptacle, Threaded, Dummy Stowage, Series III, Metric
- MIL-DTL-38999/23 - Connectors, Electrical, Circular, Threaded, Receptacle, Jam-Nut Mounting, Hermetic, Hermetic Solder Contacts, Series III, Metric
- MIL-DTL-38999/24 - Connectors, Electrical, Circular, Receptacle, Threaded, Jam-Nut Mounting, Removable Crimp Contacts, Series III, Metric
- MIL-DTL-38999/25 - Connector, Electrical, Circular, Threaded, Receptacle, Solder Mounting, Hermetic, Hermetic Solder Contacts, Series III, Metric

MIL-STD-1353C
APPENDIX D

- MIL-DTL-38999/26 - Connectors, Electrical, Plug, Circular, Threaded, Straight, Removable Crimp Contacts, Series III, Metric
- MIL-DTL-38999/27 - Connectors, Electrical, Circular, Threaded, Receptacle, Weld Mounting, Hermetic, Hermetic Solder Contacts, Series III, Metric
- MIL-DTL-38999/28 - Connectors, Electrical, Circular, Nut, Hexagon, Connector Mounting, Series III and IV, Metric
- MIL-DTL-38999/29 - Connectors, Electrical, Circular, Threaded, Plug, Lanyard Release, Fail-Safe, Removable Crimp Contacts, Pins, Series Iii, Metric
- MIL-DTL-38999/30 - Connectors, Electrical, Circular, Threaded, Plug, Lanyard Release, Fail-Safe, Removable Crimp Contacts, Sockets, Series Iii, Metric
- MIL-DTL-38999/31 - Connectors, Electrical, Circular, Threaded Plug, Lanyard Release, Fail-Safe Removable Crimp Contacts, Pins, Shell Size 25, Series Iii, Metric
- MIL-DTL-38999/32 - Connector, Electrical Circular, Cover, Protective, Plug, Series III, Metric
- MIL-DTL-38999/33 - Connector, Electrical Circular, Cover, Protective, Receptacle, Series III, Metric
- MIL-DTL-38999/34 - Connectors, Receptacle, Electrical, Circular, Breakaway, Jamnut Mounting, Removable Crimp Contacts, Sockets, Series III, Shell Size 25, Metric
- MIL-DTL-38999/35 - Connectors, Receptacle, Electrical, Circular, Breakaway, Wall Mounting Flange, Removable Crimp Contacts, Sockets, Series III, Shell Size 25, Metric
- MIL-DTL-38999/36 - Connectors, Electrical, Circular, Threaded, Plug, Lanyard Release, Fail-Safe, Removable Crimp Contacts, Pins, Shell Size 25, Series III, Metric
- MIL-DTL-38999/40 - Connectors, Electrical, Circular, Receptacle, Wall Mounting Flange, Breech Coupling, Removable Crimp Contacts, Series IV, Metric
- MIL-DTL-38999/41 - Connectors, Electrical, Circular, Receptacle, Box Mounting Flange, Hermetic, Breech Coupling, Hermetic Solder Contacts, Series IV, Metric
- MIL-DTL-38999/42 - Connectors, Electrical, Circular, Receptacle, Box Mounting Flange, Breech Coupling, Removable Crimp Contacts, Series IV, Metric
- MIL-DTL-38999/43 - Connectors, Electrical, Circular, Receptacle, Jam Nut Mounting, Hermetic, Breech Coupling, Hermetic Solder Contacts, Series IV, Metric
- MIL-DTL-38999/44 - Connectors, Electrical, Circular, Receptacle, Jam-Nut Mounting, Breech Coupling, Removable Crimp Contacts, Series IV, Metric
- MIL-DTL-38999/45 - Connectors, Electrical, Circular, Receptacle, Solder Mounting, Hermetic, Breech Coupling, Hermetic Solder Contacts, Series IV, Metric
- MIL-DTL-38999/46 - Connectors, Electrical, Circular, Plug, Breech Coupling, EMI Grounding, Removable Crimp Contacts, Series IV, Metric
- MIL-DTL-38999/47 - Connectors, Electrical, Circular, Plug, Breech Coupling, Removable Crimp Contacts, Series IV, Metric
- MIL-DTL-38999/48 - Connectors, Electrical, Circular, Receptacle, Weld Mounting, Hermetic, Breech Coupling, Hermetic Solder Contacts, Series IV, Metric
- MIL-DTL-38999/49 - Connectors, Electrical, Circular, Receptacle, In Line Cable, Breech Coupling, Removable Crimp Contacts, Series IV, Metric
- MIL-DTL-38999/50 - Connectors, Electrical, Circular, Receptacle, Dummy Stowage, Breech Coupling, Series IV, Metric
- MIL-DTL-38999/51 - Connector, Electrical Circular, Cover, Protective, Plug, MIL-DTL-38999 Series IV
- MIL-DTL-38999/52 - Connectors, Electrical, Circular, Cover, Protective, Receptacle, MIL-DTL-38999 Series IV

MIL-STD-1353C
APPENDIX D

- MIL-DTL-38999/60 - Connectors, Electrical, Plug, Circular, Threaded, Straight, Removable Crimp Contacts, Fiber Optic Termini, Tight Tolerance, Series III, Shell Size 25, Metric
- MIL-DTL-38999/61 - Connectors, Electrical, Circular, Receptacle, Threaded, Wall Mounting Flange, Removable Crimp Contacts, Fiber Optic Termini, Tight Tolerance, Series III, Shell Size 25, Metric
- MIL-DTL-83538 - Connectors and Accessories, Electrical, Circular, Umbilical, Environment Resistant, Removable Crimp Contacts For MIL-STD-1760 Applications (Metric), General Specification For
- MIL-DTL-83538/1 - Connectors and Accessories, Electrical, Circular, Umbilical, Receptacle, Store Assembly, Removable Crimp Contacts, Sockets, For MIL-STD-1760 Applications (Metric)
- MIL-DTL-83538/3 - Connectors and Accessories, Electrical, Circular, Umbilical, Adapter, Buffer Plug, Nonremovable Pin Contacts, For MIL-STD-1760 Applications (Metric)
- MIL-DTL-83538/4 - Connectors and Accessories, Electrical, Circular, Umbilical, Receptacle, Launcher Assembly, Removable Crimp Contacts, Sockets For MIL-STD-1760 Applications (Metric)
- MIL-DTL-83538/5 - Connectors and Accessories, Electrical, Circular, Umbilical, Bracket, Store Receptacle Adapter For MIL-STD-1760 Applications (Metric)
- MIL-DTL-83538/6 - Connectors and Accessories, Electrical, Circular, Umbilical, Nut, Hexagon, Store Receptacle Connector Mounting, For MIL-STD-1760 Applications (Metric)
- MIL-DTL-83538/7 - Connectors and Accessories, Electrical, Circular, Umbilical, Cover, Protective, Store Receptacle For MIL-STD-1760 Applications (Metric)
- MIL-DTL-83538/8 - Connectors and Accessories, Electrical, Circular, Umbilical, Cover, Protective, Launcher Receptacle, For MIL-STD-1760 Applications (Metric)
- MIL-DTL-83538/9 - Connectors and Accessories, Electrical, Circular, Umbilical, Adapter, Accessory, Launcher Receptacle For MIL-STD-1760 Applications (Metric)
- MIL-DTL-83538/10 - Connectors and Accessories, Electrical, Circular, Umbilical, Bushing, Cable, Launcher Receptacle For MIL-STD-1760 Applications (Metric)
- MIL-DTL-83538/11 - Connectors and Accessories, Electrical, Circular, Umbilical, Adapter, Buffer Plug, Non-Removable Pin Contacts, For MIL-STD-1760 Applications (Metric)
- MIL-DTL-83538/12 - Connectors and Accessories, Electrical, Circular, Umbilical, Protective Cap, Installation And Removal Tool, For MIL-STD-1760 Applications (Metric)
- MIL-DTL-83538/13 - Connectors and Accessories, Electrical, Circular, Umbilical, Test Plug, Removable Crimp Contacts, Pins, For MIL-STD-1760 Applications (Metric)
- MIL-DTL-83723 - Connectors, Electrical, (Circular, Environment Resisting), Receptacles and Plugs, General Specification For
- MIL-DTL-83723/16 - Connector, Electrical, Backshell, With Heat-Shrinkable Strain-Relief, Boot (Straight or Right Angle), Bayonet-Coupling, Series I and III
- MIL-DTL-83723/17 - Connectors Electrical, (Circular, Environment Resisting), Receptacle, (Cable Connecting, Threaded Coupling, Crimp Socket Contacts), (Series II, Classes A, G, and R)

MIL-STD-1353C
APPENDIX D

- MIL-DTL-83723/18 - Connectors, Electrical, (Circular, Environment Resisting), Receptacle, (Cable connecting, Threaded Coupling, Crimp Pin Contacts), (Series II, Classes A, G, and R)
- MIL-DTL-83723/19 - Connectors, Electrical, (Circular, Environment Resisting), Receptacle, (Wall Mount, Threaded Coupling, Crimp Socket Contacts), (Series II, Classes A, G, K, and R)
- MIL-DTL-83723/20 - Connectors, Electrical, (Circular, Environment Resisting), Receptacle, (Wall Mount, Threaded Coupling, Crimp Pin Contacts), (Series II, Classes A, G, K, and R)
- MIL-DTL-83723/21 - Connectors, Electrical, (Circular, Environment Resisting), Receptacle, (Box Mount, Threaded Coupling, Crimp Socket Contacts), (Series II, Classes A, G, and R)
- MIL-DTL-83723/22 - Connectors, Electrical, (Circular, Environment Resisting), Receptacle, (Box Mount, Threaded Coupling, Crimp Pin Contacts), (Series II, Classes A, G, and R)
- MIL-DTL-83723/23 - Connectors, Electrical, (Circular, Environment Resisting), Plug, (Threaded Coupling, Crimp Socket Contacts), (Series II, Classes A, G, K, and R)
- MIL-DTL-83723/24 - Connectors, Electrical, (Circular, Environment Resisting), Plug, (Threaded Coupling, Crimp Pin Contacts), Series II, Classes A, G, K, and R
- MIL-DTL-83723/27 - Connectors, Electrical, Backshell, With Heat-Shrinkable Strain-Relief Boot (Straight and Right Angle), Threaded Coupling
- MIL-DTL-83723/35 - Connector, Electric, Backshell, Straight W/O Strain Relief, and With Mechanical Strain Relief, Straight or Right Angle Threaded Coupling Series II
- MIL-DTL-83723/37 - Connector, Electrical, (Circular, Environment Resisting), Plug, (Bayonet Coupling, Prewired, Socket Contact), (Series I, Classes A, G, and R), (Shell Size 8 for Inserts 8-2, 8-3, and 8-4 Only)
- MIL-DTL-83723/50 - Connector, Electrical, Circular, Environment Resisting, Backshell, Straight, 90 Deg., and 45 Deg. With Dielectric Strain Relief, For Series 2 Connectors
- MIL-DTL-83723/59 - Connectors, Electrical, (Circular, Environment Resisting), Protective Covers, Plugs, (For MIL-DTL-26500 and MIL-DTL-83723, Series III, Classes A, M, R, T, W and Z)
- MIL-DTL-83723/60 - Connectors, Electrical, (Circular, Environment Resisting), Protective Covers, Receptacles, (For MIL-DTL-26500 and MIL-DTL-83723, Series III, Classes A, M, R, T, W and Z)
- MIL-DTL-83723/61 - Connectors, Electrical, (Circular, Environment Resisting), Dummy Connectors, Receptacles, (For MIL-DTL-26500 and MIL-DTL-83723, Series III, Classes A, M, R, T, W and Z)
- MIL-DTL-83723/65 - Connector, Electric, (Circular, Environment Resisting), Receptacle, (Single Hole Mount, Bayonet Coupling, Pin Contact), (Series III, Class H)
- MIL-DTL-83723/66 - Connectors, Electrical, (Circular, Environment Resisting), Plug, Threaded Coupling, (Push-Pull, Quick-Disconnect Without Lanyard), Crimp Pin Contact, Series III, Classes A, G, M, R, T, W and Z
- MIL-DTL-83723/67 - Connectors, Electrical, (Circular, Environment Resisting), Plug, Threaded Coupling, (Push-Pull, Quick-Disconnect Without Lanyard), Crimp Socket Contact, Series III, Classes A, G, M, R, T, W and Z

MIL-STD-1353C
APPENDIX D

- MIL-DTL-83723/68 - Connectors, Electrical, (Circular, Environment Resisting), Plug, Threaded Coupling, (Push-Pull, Quick-Disconnect With Lanyard), Crimp Pin Contact, Series III, Classes A, G, M, R, T, W and Z
- MIL-DTL-83723/69 - Connectors, Electrical, (Circular, Environment Resisting), Plug, Threaded Coupling, (Push-Pull, Quick-Disconnect With Lanyard), Crimp Socket Contact, Series III, Classes A, G, M, R, T, W and Z
- MIL-DTL-83723/70 - Connectors, Electrical, (Circular, Environment Resisting), Receptacle Adapter (Push-Pull), Quick-Disconnect, Series III, Classes A, G, M, R, T, W and Z
- MIL-DTL-83723/71 - Connectors, Electrical, (Circular, Environment Resisting), Receptacle, (Flange Mount, Bayonet Coupling, Crimp Socket Contact), Series III, Classes A, G, M, R, T, W and Z
- MIL-DTL-83723/72 - Connector, Electric, (Circular, Environment Resisting), Receptacle, (Flange Mount, Bayonet Coupling, Crimp Pin Contact) (Series III, Classes A, G, M, R, T, W and Z)
- MIL-DTL-83723/73 - Connector, Electric, (Circular, Environment Resisting), Receptacle, (Single Hole Mount, Bayonet Coupling, Crimp Socket Contact) (Series III, Classes A, G, M, R, T, W and Z)
- MIL-DTL-83723/74 - Connectors, Electric, (Circular, Environment Resisting), Receptacle, (Single Hole Mount, Bayonet Coupling, Crimp Pin Contact), (Series III, Classes A, G, M, R, T, W and Z)
- MIL-DTL-83723/75 - Connectors, Electrical, (Circular, Environment Resisting), Plug, (Bayonet Coupling, Crimp Socket Contact), (Series III, Classes A, G, K, M, R, T, W and Z)
- MIL-DTL-83723/76 - Connectors, Electrical, (Circular, Environment Resisting), Plug, (Bayonet Coupling, Crimp Pin Contact), (Series III, Classes A, G, M, R, T, W and Z)
- MIL-DTL-83723/77 - Connectors, Electrical, (Circular, Environment Resisting), Plug, (RFI, Bayonet Coupling, Crimp Socket Contact), (Series III, Classes G, M, R, T, W and Z)
- MIL-DTL-83723/78 - Connectors, Electrical, (Circular, Environment Resisting), Plug, (RFI, Bayonet Coupling, Crimp Pin Contact), (Series III, Classes G, M, R, T, W, and Z)
- MIL-DTL-83723/79 - Connectors, Electrical, (Circular, Environment Resisting), Receptacle, (Flange Mount, Bayonet Coupling, Solder Pin Contact), (Series III, Classes H, J, L, P and Y)
- MIL-DTL-83723/80 - Connectors, Electrical, (Circular, Environment Resisting), Receptacle, (Solder Or Weld Flange Mount, Bayonet Coupling, Solder Pin Contact), (Series III, Classes H, J, L, P and Y)
- MIL-DTL-83723/81 - Connectors, Electrical, (Circular, Environment Resisting), Receptacle, (Single Hole Mount, Bayonet Coupling, Solder Pin Contact), (Series III, Classes H, J, L, P and Y)
- MIL-DTL-83723/82 - Connectors, Electrical, (Circular, Environment Resisting), Receptacle, (Flange Mount, Threaded Coupling, Crimp Socket Contact), (Series III, Classes A, G, K, M, N, R, S, T, W and Z)
- MIL-DTL-83723/83 - Connectors, Electrical, (Circular, Environment Resisting), Receptacle, (Flange Mount, Threaded Coupling, Crimp Pin Contact), (Series III, Classes A, G, K, M, N, R, S, T, W AND Z)
- MIL-DTL-83723/84 - Connectors, Electrical, (Circular, Environment Resisting), Receptacle, (Single Hole Mount, Threaded Coupling, Crimp Socket Contact), (Series III, Classes A, G, K, M, N, R, S, T, W and Z)

MIL-STD-1353C
APPENDIX D

- MIL-DTL-83723/85 - Connectors, Electrical, (Circular, Environment Resisting), Receptacle, (Single Hole Mount, Threaded Coupling, Crimp Pin Contact), (Series III, Classes A, G, K, M, N, R, S, T, W and Z)
- MIL-DTL-83723/86 - Connectors, Electrical, (Circular, Environment Resisting), Plug, (Threaded Coupling, Crimp Pin Contact), (Series III, Classes A, G, K, M, R, T, W and Z)
- MIL-DTL-83723/87 - Connectors, Electrical, (Circular, Environment Resisting), Plug, (Threaded Coupling, Crimp Pin Contact), (Series III, Classes A, G, K, M, R, T, W and Z)
- MIL-DTL-83723/88 - Connectors, Electrical, (Circular, Environment Resisting), Receptacle, (Flange Mount, Threaded Coupling, Solder Pin Contact), (Series III, Classes H, J, L, N, P and Y)
- MIL-DTL-83723/89 - Connectors, Electrical, (Circular, Environment Resisting), Receptacle, (Single Hole Mount, Threaded Coupling, Solder Pin Contact), (Series III, Classes H, J, L, N, P and Y)
- MIL-DTL-83723/90 - Connectors, Electrical, (Circular, Environment Resisting), Receptacle, (Solder or Weld Flange Mount, Threaded Coupling, Solder Pin Contact), (Series III, Classes H, J, L, N, P and Y)
- MIL-DTL-83723/91 - Connectors, Electrical, (Circular, Environment Resisting), Plug, (RFI, Threaded Coupling, Crimp Socket Contact), (Series III, Classes G, M, R, T, W and Z)
- MIL-DTL-83723/92 - Connectors, Electrical, (Circular, Environment Resisting), Plug, (RFI, Threaded Coupling, Crimp Pin Contact), (Series III, Classes G, M, R, T, W and Z)
- MIL-DTL-83723/93 - Connectors, Electrical, (Circular, Environment Resisting), Receptacle, (Solder or Weld Flange Mount, Bayonet Coupling, Straight Pin Contact), (Series III, Classes H and Y)
- MIL-DTL-83723/94 - Connectors, Electrical, (Circular, Environment Resisting), Receptacle, (Single Hole Mount, Bayonet Coupling, Straight Pin Contact), (Series III, Classes H, and Y)
- MIL-DTL-83723/95 - Connectors, Electrical, (Circular, Environment Resisting), Plug, (Threaded Coupling, Self-Locking, Crimp Socket Contact), (Series III, Classes A, G, K, M, R, T, W and Z)
- MIL-DTL-83723/96 - Connectors, Electrical, (Circular, Environment Resisting), Plug, (Threaded Coupling, Self-Locking, Crimp Pin Contact), (Series III, Classes A, G, K, M, R, T, W and Z)
- MIL-DTL-83723/97 - Connectors, Electrical, (Circular, Environment Resisting), Plug, (Threaded Coupling, Self-Locking, R.F.I. Grounding, Crimp Socket Contacts), (Series III, Classes N and S Firewall)
- MIL-DTL-83723/98 - Connectors, Electrical, (Circular, Environment Resisting), Plug, (Threaded Coupling, Self-Locking, R.F.I. Grounding, Crimp Pin Contact), (Series III, Classes N and S Firewall)
- MIL-R-24217/1 - Receptacle Assembly (Welded Type)
- MIL-R-24217/2 - Receptacle Assembly (Flanged - Welded Type)
- MIL-R-24217/3 - Receptacle Assembly (In Line Type)
- MIL-R-24217/4 - Receptacle Assembly (Mid-Flanged Bolted Type)
- MIL-R-24217/5 - Receptacle Assembly (Mid-Flanged Bolted Type)
- MIL-R-24217/6 - Receptacle Assembly (Locknut Flange Type)
- MIL-R-24217/11 - Receptacle Assembly (Union Type)
- MIL-R-24217/12 - Receptacle Assembly (Mid-Flange, Bolted, Union Type)
- MIL-R-24217/13 - Receptacle Assembly (Mid-Flange, Locknut, Union Type)

MIL-STD-1353C
APPENDIX D

MIL-U-24217/14	- Union Plug Assemblies, Straight
MIL-U-24217/15	- Union Plug Assemblies, Right Angle
MS3110	- Connectors, Receptacle, Electrical, Solder Type, Wall Mounting, Bayonet Coupling, Series 1, Classes E, F, J and P
MS3111	- Connectors, Plug, Electrical, Solder Type, Cable Connecting, Bayonet Coupling, Classes E, F, J, and P
MS3112	- Connectors, Electrical, (Circular, Miniature, Quick Disconnect, Environment Resisting), Receptacle, (Box Mounting Flange, Bayonet Coupling, Solder Contact), (Series 1)
MS3113	- Connectors, Receptacle, Electrical, Series I, Solder Type, Solder Mounting, Bayonet Coupling, Class H
MS3114	- Connectors, Receptacle, Electrical, Series 1, Solder Type, Jam Nut Mounting, Bayonet Coupling, Classes E, F, H and P
MS3115	- Connectors, Receptacle, Electrical, Dummy Stowage, Bayonet Coupling, for MIL-DTL-26482 Connectors, Series 1 and 2
MS3116	- Connectors, Plug, Electric, Series 1, Solder Type, Straight, Bayonet Coupling
MS3119	- Adapter, Connectors, Receptacle, Electric, Thru-Bulkhead Mounting, Flange, Bayonet Coupling, Series 1
MS3120	- Connectors, Receptacle, Electrical, Crimp type, Wall Mounting, Flange, No. 4 Holes, Bayonet Coupling, Classes E, F, and P
MS3121	- Connectors, Plug, Electrical, Crimp type, Cable-Connecting, Bayonet Coupling, Classes E, F, and P
MS3122	- Connectors, Receptacle, Electric, Crimp-Type, Box Mounting, Flange, No. 4 Holes, Bayonet Coupling
MS3124	- Connectors, Plug, Electrical, Crimp type, Rear Mounting, Jam Nut, Bayonet Coupling, Classes E, F, and P
MS3126	- Connectors, Plug, Electrical, Crimp-Type, Straight, Bayonet Coupling
MS3127	- Connectors, Receptacle, Electric, Crimp-Type, Box Mounting, Flange, No. 4/6 Holes, Bayonet Coupling
MS3128	- Connectors, Plug, Electrical, Crimp Type, Wall Mounting, No 4/6 Holes, Bayonet Coupling, Classes E, F, and P
MS3180	- Cover, Protective, Electrical Connector Plug, Bayonet Coupling for, MIL-C-26482 Connectors
MS3181	- Cover, Protective, Electrical Connector Receptacle, Bayonet Coupling for, MIL-C-26482 Connectors
MS3186	- Connector, Mounting to Connectors, Mounting Nuts, Plain Hexagon
MS3187	- Plug, Sealing, For MIL-C-26482 and MIL-C-81703 (Navy) Electrical Connectors
MS3440	- Connectors, Receptacle, Electric, Series 2, Narrow Flange Mount, Bayonet Coupling, Solder Pin Contact Class H, Series 2
MS3442	- Connectors, Receptacle, Electric, Series 2, Wide Flange Mounting, Bayonet Coupling, Solder Pin Contact, Class H, Series 2
MS3443	- Connectors, Receptacle, Electric, Series 2, Solder Flange Mount, Bayonet Coupling, Solder Pin Contact, Class H
MS3449	- Connectors, Receptacle, Electric, Series 2, Single Hole Mount, Bayonet Coupling, Solder Pin Contact, Class H
MS3460	- Test Gage, MIL-C-0026482 Series 1 or MIL-C-81703 Series 2 Contact Retention Feature
MS3461	- Test Gage, MIL-C-0026482 Series 2 or MIL-C-81703 Series 3 Contact Retention Feature

MIL-STD-1353C
APPENDIX D

- MS3462 - Test Gage, MIL-C-26482 Series 2 (Class N), MIL-C-81703 Series 3 (CLASS N) and MIL-C-0081511 Series 3 and 4 (Class L) Contact Retention Feature
- MS3470 - Connectors, Receptacle, Electric, Series 2, Crimp Type, Narrow Flange Mount, Bayonet Coupling, Classes A, L, S, and W
- MS3471 - Connectors, Receptacle, Electric, Series 2, Crimp Type, Cable Connecting, Bayonet Coupling, Classes A, L, S, and W
- MS3472 - Connectors, Receptacle, Electric, Series 2, Crimp Type, Wide Flange Mounting, Bayonet Coupling, Classes A, L, S, and W
- MS3473 - Connectors, Receptacle, Electric, Series 2, Hermetic, Solderless, Solder Mounting, Bayonet Coupling, Class N
- MS3474 - Connectors, Receptacle, Electrical, Series 2, Crimp Type, Rear Mounting Jam Nut, Bayonet Coupling, Classes A, D, L, T, W and Z
- MS3475 - Connectors, Plug, Electrical, RFI Shielded, Series 2, Crimp Type, Bayonet Coupling, Classes D, L, T, W and Z
- MS3476 - Connectors, Plug, Electrical, Series 2, Crimp Type, Bayonet Coupling, Classes A, D, L, T, W and Z
- MS3477 - Connectors, Receptacle, Electrical, Series II, Hermetic, Solderless, Box Mounting, Bayonet Coupling, Class N
- MS3479 - Connectors, Receptacle, Electrical, Series II, Hermetic, Solderless, Rear Mounting, Jam Nut, Bayonet Coupling, Class N
- MS3481 - Tool, Connector Assembly, for MIL-DTL-26482 Connectors
- MS14054 - Insert Arrangements, Electrical Connector, Size 28, Class L, 40 Amps.
- MS14055 - Insert Arrangements, Electrical Connector, Size 44, Class L, 100 Amps.
- MS14056 - Contacts, Electrical Connector, Shielded Cable Applications, Size 8.
- MS14057 - Insert Arrangements, Electrical Connector, Size 52, Class L, 200 Amps.
- MS17343 - Connector, Receptacle, Electrical, Wall Mounting.
- MS17344 - Connector, Plug, Electrical, Straight.
- MS17345 - Connector, Plug, Electrical, Cable Connecting (Female).
- MS17346 - Connector, Receptacle, Electrical, Box Mounting.
- MS17347 - Connector, Receptacle, Electrical, Jam Nut.
- MS17348 - Connector, Receptacle, Electrical, Jam Nut (Box).
- MS17349 - Cover, Protective, Electrical Connector, Receptacle.
- MS17350 - Cover, Protective, Connector, Plug.
- MS18062 - Connector, Receptacle, Dummy Stowage.
- MS20026 - Connectors, Receptacle, Electrical, Wall Mount, Solder Type, Bayonet Coupling, Class T, Series 1
- MS20027 - Connectors, Line Plug, Electrical, Solder Type, Bayonet Coupling, Class T, Series I
- MS20028 - Connectors, Plug, Electrical, Straight, Solder Type, Bayonet Coupling, Class T, Series I
- MS20029 - Connectors, Receptacle, Electrical, Jam Nut Mounting, Solder Type, Bayonet Coupling, Class P, Series I
- MS23747 - Gland, Cable Sealing, Class L
- MS24240 - Connector, Receptacle, Electrical, Hermetic, Jam Nut, Rear Mounting
- MS24241 - Connector, Receptacle, Electrical, Hermetic, Jam Nut, Front Mounting.
- MS24242 - Connectors, Receptacle, Electrical, "D" Hole Mount, Firewall Series
- MS24264 - Connector, Receptacle, Electrical, Flange Mount, Miniature, Classes E, F, G and R
- MS24265 - Connector, Receptacle, Electrical, Single Hole Mount, Miniature, Classes E, F, G and R

MIL-STD-1353C
APPENDIX D

MS24266	- Connector, Plug, Electrical, Straight, Miniature, Classes E, F, G and R
MS27034	- Connector, Receptacle, Electrical, Pin Insert, Cylindrical, Miniature, Hermetic, Solder Mount
MS27291	- Support, Cable, Electrical Connector
MS27334	- Connectors, Receptacle, Electrical, Wall Mounting Flange, Solder Type, Bayonet Coupling, Classes P & T, Series II
MS27335	- Connectors, Receptacle, Electrical, Box, Flange Mount, Solder Type, Bayonet Coupling, Class T, Series II
MS27336	- Connectors, Plug, Electrical, Straight, Solder Type, Bayonet Coupling, Classes P & T, Series II
MS27337	- Connectors, Receptacle, Electrical, Jam Nut Mounting, Solder Type, Bayonet Coupling, Classes P & T, Series II
MS27466	- Connectors, Receptacle, Electrical, Wall Mounting Flange, Crimp Type, Bayonet Coupling, Series I
MS27467	- Connectors, Plug, Electrical, Straight, Crimp Type, Bayonet Coupling, Series I
MS27468	- Connector, Receptacle, Electrical Jam Nut Mounting, Crimp Type, Bayonet Coupling, Series I
MS27469	- Connectors, Receptacle, Electrical, Wall Mounting Flange, Solder Type, Hermetic Seal, Series I
MS27470	- Connectors, Receptacle, Electrical, Jam Nut Mounting, Solder Type, Hermetic Seal, Series I
MS27471	- Connectors, Receptacle, Electrical, Solder Mounting, Solder Type, Hermetic Seal, Series I
MS27472	- Connectors, Receptacle, Electrical, Wall Mounting Flange, Crimp Type, Bayonet Coupling, Series II
MS27473	- Connectors, Plug, Electrical, Straight, Crimp Type, Bayonet Coupling, Series II
MS27474	- Connectors, Receptacle, Electrical, Jam Nut Mounting, Crimp Type, Bayonet Coupling, Series II
MS27475	- Connectors, Receptacle, Electrical, Wall Mounting, Flange Solder Type, Hermetic Seal, Series II
MS27476	- Connector, Receptacle, Electrical, Box Mounting, Solder Type, Hermetic Seal, Series II
MS27477	- Connectors, Receptacle, Electrical, Jam Nut Mounting, Solder Type, Hermetic Seal, Series II
MS27478	- Connectors, Receptacle, Electrical, Solder Mounting, Solder Type, Hermetic Seal, Series II
MS27479	- Connector, Receptacle, Electrical, Wall Mounting Flange, Crimp Type, Bayonet Coupling, Series II
MS27488	- Plug, End Seal, Electric Connector
MS27496	- Connectors, Receptacle, Electrical, Box Mounting, Crimp Type, Bayonet Coupling, Series I
MS27499	- Connectors, Receptacle, Electrical, Box Mounting Flange, Crimp Type, Bayonet Coupling, Series II
MS27500	- Connectors, Plug, Electrical, 90° Elbow, Crimp Type, Bayonet Coupling, Series II
MS27501	- Connectors, Electrical, Circular, Cover, Protective, Plug, Bayonet Coupling, Series I
MS27502	- Connectors, Electrical, Circular, Cover, Protective, Receptacle, Bayonet Coupling, Series I

MIL-STD-1353C
APPENDIX D

MS27505	- Connectors, Receptacle, Electrical, Back Panel, Box Mounting Flange, Crimp Type, Bayonet Coupling, Series I
MS27508	- Connectors, Receptacle, Electrical, Back Panel, Box Mounting Flange, Crimp Type, Bayonet Coupling, Series II
MS27510	- Covers, Protective, Electrical, Connector Plug, Bayonet Coupling, Series II
MS27511	- Covers, Protective, Electrical, Connector Receptacle plug, Bayonet Coupling, Series II
MS27512	- Connectors, Electrical, Circular, Nut, Hexagon, Connector Mounting, Series II (Inactive for new design, use MS3186)
MS27513	- Connectors, Receptacle, Electrical, Box Mounting, Flange, Crimp Type, Bayonet Coupling, Series II
MS27515	- Connectors, Receptacle, Electrical, Crimp Type, Back Panel, Wall Mounting Flange, Series I
MS27480	- Connectors, Plug, Electrical, Straight, Crimp Type, Bayonet Coupling, Series II
MS27558	- Support, Cable, Right Angle, Closed
MS27559	- Support, Cable, Right Angle
MS27613	- Connectors, Receptacle, Electrical, Panel Mount, Firewall Series
MS27614	- Connectors, Receptacle, Electrical, "D" Hole Mount, Firewall Series
MS27615	- Connectors, Plug, Electrical, Ratchet Lock Coupling, Firewall Series
MS27652	- Connectors, Receptacle, Electrical, Wall Mounting Flange, Crimp Type, Bayonet Coupling, Series I (Inactive for New Design use MS27466)
MS27653	- Connectors, Plug, Electrical, Straight, Crimp Type, Bayonet Coupling, Series I (In active for New Design Use MS27467)
MS27654	- Connectors, Receptacle, Electrical, Back Panel, Wall Mounting Flange, Crimp Type, Bayonet Coupling, Series I (For New Design Use MS27656)
MS27656	- Connectors, Receptacle, Electrical, Back Panel, Wall Mounting Flange, Crimp Type, Bayonet Coupling, Series I
MS27657	- Short Support, Cable, electrical Connector (For Classes E and K Connectors)
MS27661	- Connectors, Plug, Electrical, Crimp Type, Lanyard Release, Fail-Safe, Series I
MS27662	- Connectors, Receptacle, Electrical, Thru-Bulkhead Mounting, Bayonet Coupling, Series I
MS27741	- Connector, Electrical, Individual Shield Termination
MS33678	- Connector, Receptacle, Electrical, Integral Mounting
MS90555	- Connector, Receptacle, Electrical, Wall Mounting, Class L (Power Source Receptacle)
MS90556	- Connector, Plug, Electrical, Straight, Class L
MS90557	- Connector, Plug, Electrical, Cable Connecting (Without Coupling Ring), Class L
MS90558	- Connector, Receptacle, Electrical, Wall Mounting (With Coupling Ring), Class L, (Equipment Receptacle)
MS90561	- Grip, Cable, Woven, Strain Relief, Axial.
MS90563	- Cover, Electrical Connector, Receptacle, Class L
MS90564	- Cover, Electrical Connector, Plug, Class L

MIL-STD-1353C
APPENDIX D

MS90565 - Insert Arrangements, Electrical Connector, Size 32, Class L, 60 Amps

(Copies of these documents are available online at <http://quicksearch.dla.mil> or from the Standardization Document Order Desk, 700 Robbins Avenue, Building 4D, Philadelphia, PA 19111-5094.)

D.2.2.2 Other Government documents, drawings and publications. The following other Government documents, drawings and publications form a part of this document to the extent specified herein. Unless otherwise specified, the issues of these documents are those cited in the solicitation or contract.

DLA LAND AND MARITIME DRAWINGS

01003	- Connectors, Plug, Electrical, Rear Release, Crimp Contact, AN Type
01040	- Connectors, Plug, Electrical, Straight, Crimp Type, Bayonet Coupling, Series II
02003	- Contact Electrical Connector Concentric Twinax, Socket, Shielded, Size 12 (for MIL-DTL-38999 Series I, III, and IV Connectors)
02004	- Contact Electrical Connector Concentric Twinax, Pin, Shielded, Size 12 (For MIL-DTL-38999 Series I, III, and IV Connectors)
06025	- Receptacle - Airspeed, Tube, Electrical
89015	- Connector Accessories, Electrical, Adapter, Shrink Boot, RFI/EMI, 45° Category 3C (for MIL-DTL-38999 Series I and II)
89016	- Connector Accessories, Electrical, Adapter, Shrink Boot, RFI/EMI, 90°, Category 3C, for MIL-DTL-38999 Series I and II)
89017	- Connector Accessories, Electrical, Adapter, Shrink Boot, RFI / EMI, 45°, Category 3C, for MIL-DTL-83723 series III, MIL-DTL-5015 (SAE-AS3400 and MS3450), SAE-AS81703 Series III, and MIL-C-26482 Series II
89018	- Connector Accessories, Electrical, Adapter, Shrink Boot, RFI/EMI, 90°, Category 3C, for MIL-DTL-83723 Series III, MIL-DTL-5015 (SAE-AS3400 and MS3450), SAE-AS81703 Series III, and MIL-C-26482 Series II
89019	- Connector Accessories, Electrical, Adapter, Shrink Boot, RFI/EMI, 45°, Category 3C for, (MIL-DTL-38999 Series III and IV Connectors)
89020	- Connector Accessories, Electrical, Adapter, Shrink Boot, RFI/EMI, 90°, Category 3C (MIL-DTL-38999 series III and IV)
89090	- Connector, Electrical, Circular, Plug, Straight, Removal Crimp Contacts, Series III, Hybrid Construction
89093	- Connector, Electrical, Circular, Receptacle Wall Mounting Flange, Removable Crimp Contacts, Series III, Hybrid Construction
89094	- Connector, Electrical, Circular, Receptacle, Jam Nut Mounting, Removable Crimp Contacts, Series III, Hybrid Construction
89107	- Connector, Accessories, Electrical, Backshell, Environmental, EMI/RFI 90 Degrees End Entry, Category 2B, for MIL-C-24308 Connectors
89108	- Connector, Accessories, Electrical, Backshell, Environmental, Straight Entry, 2B for MIL-DTL-24308 Connectors
89109	- Connector, Accessories, Electrical, Backshell, Environmental, EMI/RFI 90 Degrees, Side Entry, Category 2B, for MIL-DTL-24308 Connectors
89110	- Connector, Accessories, Electrical, Backshell, Environmental, Straight EMI/RFI Hybrid Construction, Category 3C
89111	- Connector, Accessories, Electrical, Backshell, Environmental, 90° EMI/RFI Hybrid Construction, Category 3C
92014	- Adaptor, Flange Mounting, RFI/EMI Environmental, Strain Relief

MIL-STD-1353C
APPENDIX D

- 92015 - Adaptor, Thru Bulkhead Mounting, RFI/EMI Environmental, Strain Relief
- 92016 - Adaptor, Jam Nut "D" Hole Mounting, RFI/EMI Environmental, Strain Relief
- 93031 - Connector Accessories, Electrical, Shorting Cap Backshell, Environmental, Category 4C of MIL-C-85049, for use with MIL-C-5015 Crimp, MIL-C-26482 Series 2, SAE-AS81703, and MIL-DTL-83723 Series III Connector
- 93032 - Connector Accessories, Electrical, Shorting Cap Backshell, Environmental, Category 4C of MIL-C-85049, for use with MIL-DTL-38999 Series I and II Connectors
- 93033 - Connector Accessories, Electrical, Shorting Cap Backshell, Environmental, Category 4C of MIL-C-85049, for use with MIL-DTL-38999 Series III and IV Connectors
- 93035 - Connector Accessories, Electrical, Backshell, Environmental, 90° Individual and/or Overall Shield Termination, Category 2A (for MIL-DTL-38999 Series III and IV Connectors)
- 93036 - Connector Accessories, Electrical, Backshell, Environmental, Straight, Individual and /or Overall Shield Termination, Category 1A (for MIL-DTL-83723 Series III, MIL-C-5015 Crimp, SAE-AS81703 Series III, and MIL-C-26482 Series II)
- 93037 - Connector Accessories, Electrical, Backshell, Environmental, 45°, Individual and /or Overall Shield Termination, Category 2A (For MIL-DTL-38999 Series III and IV Connectors)
- 93038 - Connector Accessories, Electrical, Backshell, Environmental, 90° Individual and /or Overall Shield Termination, Category 2A (For MIL-DTL-38999 Series I and II Connectors)
- 93039 - Connector Accessories, Electrical, Backshell, Environmental, Straight, Individual and /or Overall Shield Termination, Category 2A (for MIL-DTL-38999 Series III and IV Connectors)
- 93040 - Connector Accessories, Electrical, Backshell, Environmental, 45° Individual and /or Overall Shield Termination, Category 2A (for MIL-DTL-38999 Series I and II Connectors)
- 93041 - Connector Accessories, Electrical, Backshell, Environmental, 90° Individual and /or Overall Shield Termination, Category 1A (for MIL-DTL-83723 series III, MIL-C-5015 crimp, SAE-AS81703 Series III, and MIL-C-26482 Series II)
- 93042 - Connector Accessories, Electrical, Backshell, Environmental, Straight, Individual and /or Overall Shield Termination, Category 2A (for MIL-DTL-38999 Series I and II Connectors)
- 93043 - Connector Accessories, Electrical, Backshell, Environmental, 45°, Individual and /or Overall Shield Termination, Category 1A (for MIL-DTL-83723 Series III, MIL-C-5015 Crimp, SAE-AS81703 Series III, and MIL-C-26482 II)

(Copies of this document required by contractors in connection with specific acquisition functions may be obtained from the procuring activity at <http://www.dscc.dla.mil/programs/milspec/>, or as directed by the contracting officer.)

MIL-STD-1353C
APPENDIX D

D.2.2.3 Non-Government publications. The following documents form a part of this document to the extent specified herein. Unless otherwise specified, the issues of these documents are those cited in the solicitation or contract.

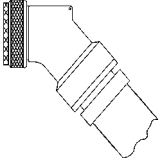
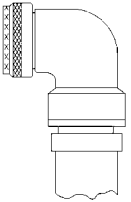
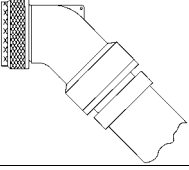
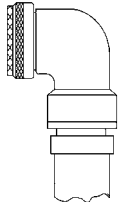
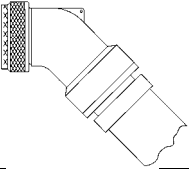
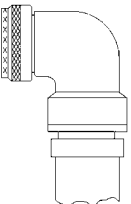
- | | | |
|-------------|---|--|
| SAE-AS3400 | - | Connectors, Receptacle, Electric, Wall Mounting, Front Release, Crimp Contact, AN Type |
| SAE-AS81703 | - | Connectors, Electric, Circular, Miniature, Rack and Panel or Push-Pull Coupling, Environment Resisting |

(Copies of these documents are available on line at www.sae.org from SAE International, 400 Commonwealth Drive, Warrendale, PA 15096-0001, and Tel: 877-606-7323 [inside USA and Canada] or 724-776-4970 [outside USA], email at CustomerService@sae.org.)

MIL-STD-1353C
APPENDIX D

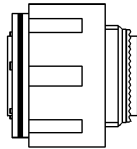
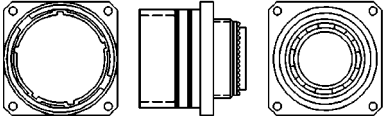
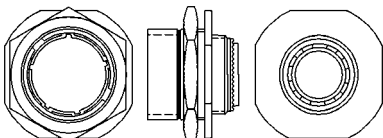
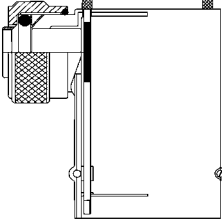
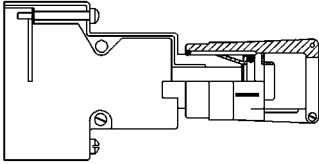
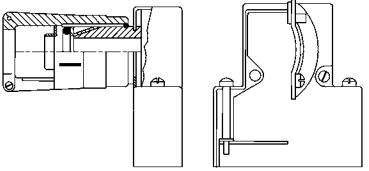
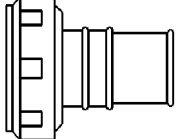
D.3 Circular connectors AN and DLA Land and Maritime drawings. Circular connectors AN and DLA Land and Maritime drawings, see table D-I.

TABLE D-I. AN and DLA Land and Maritime drawings connectors.

Drawing number	Description	Configuration
AN3115	Receptacle - Airspeed Tube Electrical	(Inactive for new design, use DLA Land and Maritime drawing 06025)
06025	Receptacle - Airspeed, Tube, Electrical	
89015	Connector Accessories, Electrical, Adapter, Shrink Boot, RFI/EMI, 45° Category 3C (for MIL-DTL-38999 Series I and II)	
89016	Connector Accessories, Electrical, Adapter, Shrink Boot, RFI/EMI, 90°, Category 3C, for MIL-DTL-38999 Series I and II)	
89017	Connector Accessories, Electrical, Adapter, Shrink Boot, RFI / EMI, 45°, Category 3C, for MIL-DTL-83723 series III, MIL-DTL-5015 (SAE-AS3400 and MS3450), SAE-AS81703 Series III, and MIL-DTL-26482 Series II	
89018	Connector Accessories, Electrical, Adapter, Shrink Boot, RFI/EMI, 90°, Category 3C, for MIL-DTL-83723 SERIES III, MIL-DTL-5015 (SAE-AS3400 and MS3450), SAE-AS81703 Series III, and MIL-DTL-26482 Series II	
89019	Connector Accessories, Electrical, Adapter, Shrink Boot, RFI/EMI, 45°, Category 3C for, (MIL-DTL-38999 Series III and IV Connectors)	
89020	Connector Accessories, Electrical, Adapter, Shrink Boot, RFI/EMI, 90°, Category 3C (MIL-DTL-38999 series III and IV)	

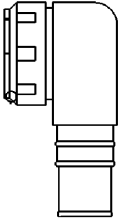
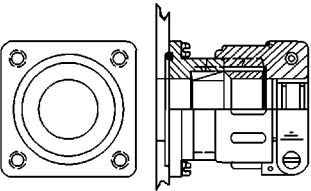
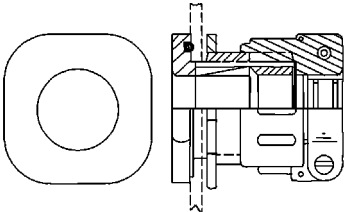
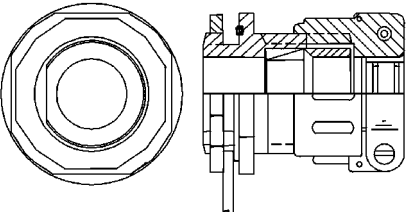
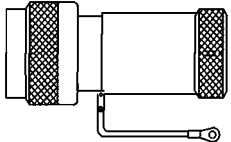
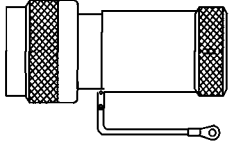
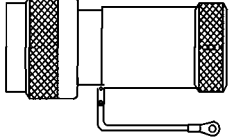
MIL-STD-1353C
APPENDIX D

TABLE D-I. AN and DLA Land and Maritime drawings connectors - Continued.

89090	Connector, Electrical, Circular, Plug, Straight, Removal Crimp Contacts, Series III, Hybrid Construction	
89093	Connector, Electrical, Circular, Receptacle Wall Mounting Flange, Removable Crimp Contacts, Series III, Hybrid Construction	
89094	Connector, Electrical, Circular, Receptacle, Jam Nut Mounting, Removable Crimp Contacts, Series III, Hybrid Construction	
89107	Connector, Accessories, Electrical, Backshell, Environmental, EMI/RFI 90 Degrees End Entry, Category 2B, for MIL-C-24308 Connectors	
89108	Connector, Accessories, Electrical, Backshell, Environmental, Straight Entry, 2B for MIL-DTL-24308 Connectors	
89109	Connector, Accessories, Electrical, Backshell, Environmental, EMI/RFI 90 Degrees, Side Entry, Category 2B, for MIL-DTL-24308 Connectors	
89110	Connector, Accessories, Electrical, Backshell, Environmental, Straight EMI/RFI Hybrid Construction, Category 3C	

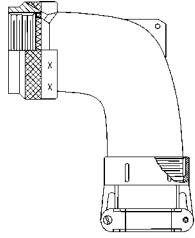
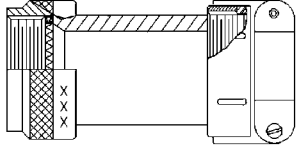
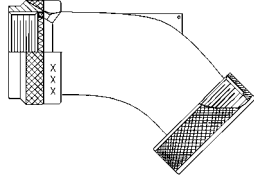
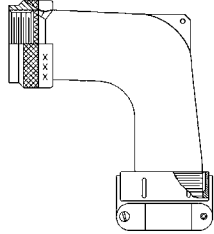
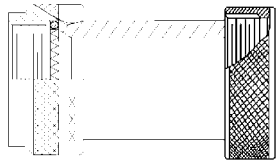
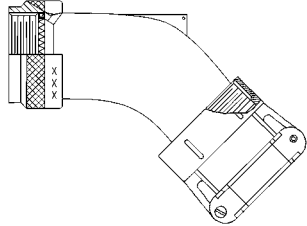
MIL-STD-1353C
APPENDIX D

TABLE D-I. AN and DLA Land and Maritime drawings connectors - Continued.

89111	Connector, Accessories, Electrical, Backshell, Environmental, 90° EMI/RFI Hybrid Construction, Category 3C	
92014	Adaptor, Flange Mounting, RFI/EMI Environmental, Strain Relief	
92015	Adaptor, Thru Bulkhead Mounting, RFI/EMI Environmental, Strain Relief	
92016	Adaptor, Jam Nut "D" Hole Mounting, RFI/EMI Environmental, Strain Relief	
93031	Connector Accessories, Electrical, Shorting Cap Backshell, Environmental, Category 4C of MIL-C-85049, for use with MIL-DTL-26482 Series 2, SAE-AS81703, and MIL-DTL-83723 Series III Connector	
93032	Connector Accessories, Electrical, Shorting Cap Backshell, Environmental, Category 4C of MIL-C-85049, for use with MIL-DTL-38999 Series I and II Connectors	
93033	Connector Accessories, Electrical, Shorting Cap Backshell, Environmental, Category 4C of MIL-C-85049, for use with MIL-DTL-38999 Series III and IV Connectors	

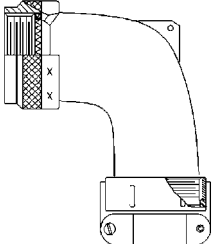
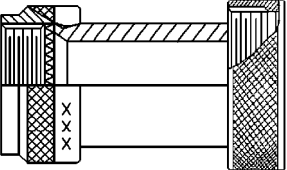
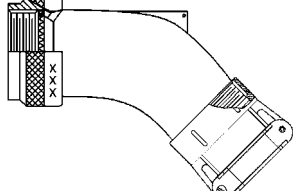
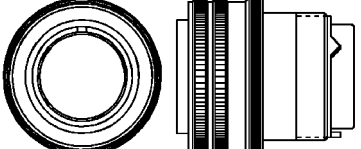
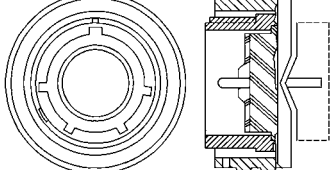
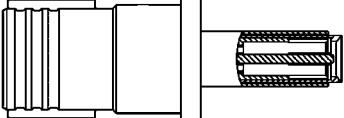
MIL-STD-1353C
APPENDIX D

TABLE D-I. AN and DLA Land and Maritime drawings connectors - Continued.

Drawing number	Description	Configuration
93035	Connector Accessories, Electrical, Backshell, Environmental, 90° Individual and/or Overall Shield Termination, Category 2A (for MIL-DTL-38999 Series III and IV Connectors)	
93036	Connector Accessories, Electrical, Backshell, Environmental, Straight, Individual and /or Overall Shield Termination, Category 1A (for MIL-DTL-83723 Series III, SAE-AS81703 Series III, and MIL-DTL-26482 Series II)	
93037	Connector Accessories, Electrical, Backshell, Environmental, 45°, Individual and /or Overall Shield Termination, Category 2A (for MIL-DTL-38999 Series III and IV Connectors)	
93038	Connector Accessories, Electrical, Backshell, Environmental, 90° Individual And /Or Overall Shield Termination, Category 2A (for MIL-DTL-38999 Series I and II Connectors)	
93039	Connector Accessories, Electrical, Backshell, Environmental, Straight Individual and/or Overall Shield Termination, (for MIL-DTL-38999 Series III and IV Connectors).	
93040	Connector Accessories, Electrical, Backshell, Environmental, 45° Individual and /or overall shield termination, category 2A (for MIL-DTL-38999 Series I and II Connectors)	

MIL-STD-1353C
APPENDIX D

TABLE D-I. AN and DLA Land and Maritime drawings connectors - Continued.

Drawing number	Description	Configuration
93041	Connector Accessories, Electrical, Backshell, Environmental, 90° Individual and /or Overall Shield Termination, Category 1A (for MIL-DTL-83723 Series III, SAE-AS81703 Series III, and MIL-DTL-26482 Series II)	
93042	Connector Accessories, Electrical, Backshell, Environmental, Straight, Individual and /or Overall Shield Termination, Category 2A (for MIL-DTL-38999 SERIES I and II Connectors)	
93043	Connector Accessories, Electrical, Backshell, Environmental, 45°, Individual and /or Overall Shield Termination, Category 1A (for MIL-DTL-83723 SERIES III, SAE-AS81703 Series III, and MIL-DTL-26482 II)	
01003	Connectors, Plug, Electrical, Rear Release, Crimp Contact, An Type	
01040	Connectors, Plug, Electrical, Straight, Crimp Type, Bayonet Coupling, Series II	
02004	Contact Electrical Connector Concentric Twinax, Pin, Shielded, Size 12 (For MIL-DTL-38999 Series I, III, and IV Connectors)	

MIL-STD-1353C
APPENDIX D

D.4 MIL-DTL-22992. MIL-DTL-22992 specification are for power circular connectors, multi-contact, heavy duty, quick disconnect, environment resisting, non-magnetic, electrical plug and receptacle connectors and associated accessories for electronic and electrical power and control circuits, see [table D-II](#).

D.4.1 Heavy-duty gaskets . Heavy-duty gaskets for weatherproof connections classes are defined below:

Class C - Connectors are intended for heavy duty (rough service) applications for external interconnection use on vans, shelters, trailers, buildings, missile and launch sites. They are not for primary power distribution. Contacts are non-removable solder cup. Contact sizes #1/0, 4, 8, 12, and 16. Temperature range -55°C to +125°C.

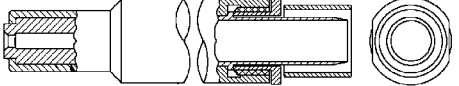
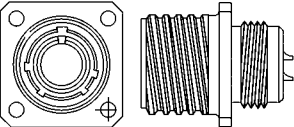
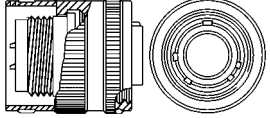
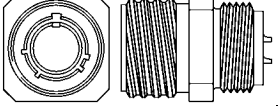
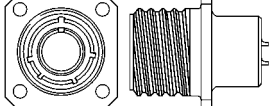
Class J - Connectors are intended for use only where class C connectors can be used, but where a wire support grommet is necessary.

Class L - Connectors are intended for power connections in the current range from 40 to 200 amperes where heavy duty, waterproof and arc quenching ability are required and are to be used only with heavy-duty jacketed cables specified on the applicable insert standard. This type of connector is designed as a circuit breaking connector with special provisions to minimize damage to cable or connector and reduce the hazard to personnel during circuit rupture under the worst field conditions of high humidity and standing in mud or water. Specifically, any arc drawn while mating or unmating connectors under maximum electrical load will be extinguished before the pin contact leaves the socket contact insert chamber. Contacts are front release - rear removable crimp or solder cup. Contact sizes #4/0, 2/0, 1/0, 4, and 6. Temperature range -55°C to +125°C.

Class R - Connectors are intended for use as general purpose heavy-duty (rough service) connectors where pressurization and arc quenching ability are not required. The connectors can be made weatherproof when the accessory sealing adapter is attached. They are not for primary power distribution. Contacts are non-removable solder cup. Contact size #1/0, 4, 8, 12, and 16. Temperature range -55°C to +125°C.

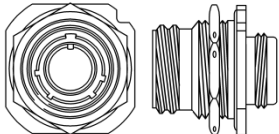
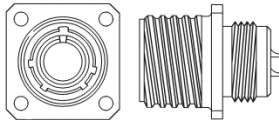

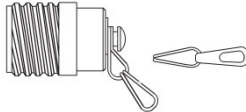
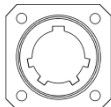

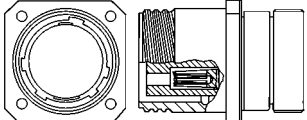
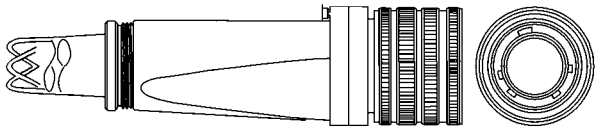
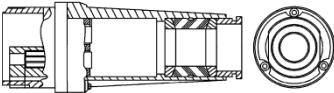
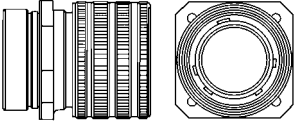
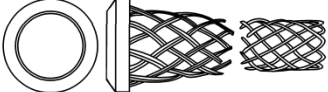
MIL-STD-1353C
APPENDIX D

TABLE D-II. MIL-DTL-22992 descriptions and configurations.

Specification number	Description	Configuration
MIL-DTL-22992	Connectors, Plugs and Receptacles, Electrical, Waterproof, Quick Disconnect, Heavy Duty Type, General Specification For	
MS14054	Insert Arrangements, Electrical Connector, Size 28, Class L, 40 Amps.	28 volt DC two wire AC single phase two wire grounding AC single phase three wire grounding AC three phase four wire grounding
MS14055	Insert Arrangements, Electrical Connector, Size 44, Class L, 100 Amps.	28 volt DC two wire Single phase two wire grounding AC single phase three wire grounding AC three phase four wire grounding AC three phase three wire grounding
MS14056	Contacts, Electrical Connector, Shielded Cable Applications, Size 8.	
MS14057	Insert Arrangements, Electrical Connector, Size 52, Class L, 200 Amps.	28 volt DC two wire single phase three wire grounding AC three phase four wire grounding
MS17343	Connector, Receptacle, Electrical, Wall Mounting.	
MS17344	Connector, Plug, Electrical, Straight.	
MS17345	Connector, Plug, Electrical, Cable Connecting (Female).	
MS17346	Connector, Receptacle, Electrical, Box Mounting.	

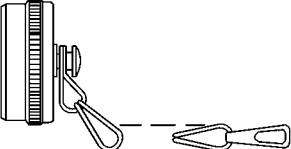
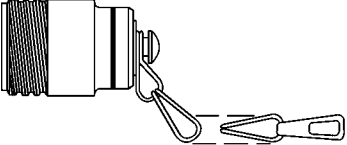
MIL-STD-1353C
APPENDIX D

TABLE D-II. MIL-DTL-22992 descriptions and configurations - Continued.

Specification number	Description	Configuration
MS17347	Connector, Receptacle, Electrical, Jam Nut.	
MS17348	Connector, Receptacle, Electrical, Jam Nut (Box).	
MS17349	Cover, Protective, Electrical Connector, Receptacle.	
MS17350	Cover, Protective, Connector, Plug.	
MS18062	Connector, Receptacle, Dummy Stowage.	
MS23747	Gland, Cable Sealing, Class L.	
MS90555	Connector, Receptacle, Electrical, Wall Mounting, Class L (Power Source Receptacle).	
MS90556	Connector, Plug, Electrical, Straight, Class L.	
MS90557	Connector, Plug, Electrical, Cable Connecting (Without Coupling Ring), Class L.	
MS90558	Connector, Receptacle, Electrical, Wall Mounting (With Coupling Ring), Class L, (Equipment Receptacle).	
MS90561	Grip, Cable, Woven, Strain Relief, Axial.	

MIL-STD-1353C
APPENDIX D

TABLE D-II. MIL-DTL-22992 descriptions and configurations - Continued.

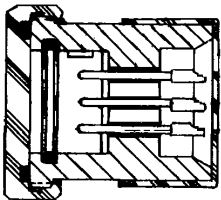
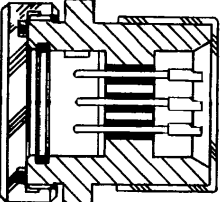
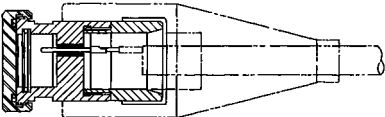
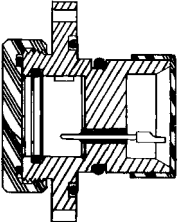
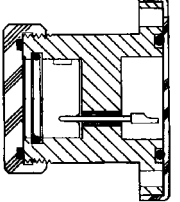
Specification number	Description	Configuration
MS90563	Cover, Electrical Connector, Receptacle, Class L.	
MS90564	Cover, Electrical Connector, Plug, Class L.	
MS90565	Insert Arrangements, Electrical Connector, Size 32, Class L, 60 Amps.	28 volt DC two wire 28 volt AC single phase two wire grounding 28 volt AC single phase three wire grounding 28 volt AC three phase four wire grounding

MIL-STD-1353C
APPENDIX D

D.5 MIL-C-24217. MIL-C-24217 this specification covers deep submergence electrical connectors for submarine applications outboard of the pressure hull, see table D-III.

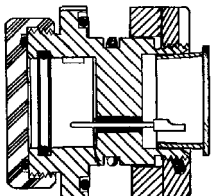
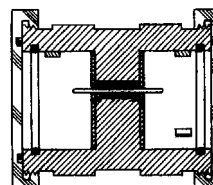
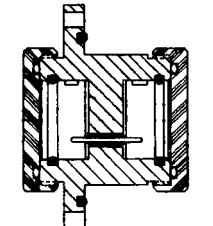
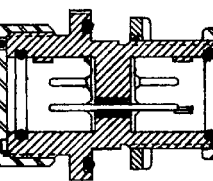
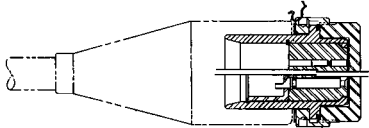
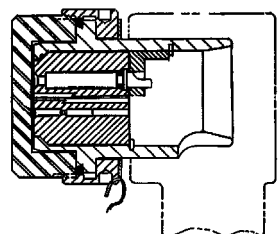
D.5.1 Intended use. Connectors built to this specification are capable of handling a hydrostatic pressure range from zero psi/in² to 10,000 psi/in², with a maximum recommended operating pressure of 6,500 psi/in². These are not hull penetrating or harness assemblies.

TABLE D-III. MIL-C-24217 descriptions and configurations.

Specification number	Description	Configuration
MIL-C-24217	Connectors, Electrical, Deep Submergence, Submarine	
MIL-R-24217/1	Receptacle Assembly (Welded Type)	
MIL-R-24217/2	Receptacle Assembly (Flanged - Welded Type)	
MIL-R-24217/3	Receptacle Assembly (In Line Type)	
MIL-R-24217/4	Receptacle Assembly (Mid-Flanged Bolted Type)	
MIL-R-24217/5	Receptacle Assembly (Mid-Flanged Bolted Type)	

MIL-STD-1353C
APPENDIX D

TABLE D-III. MIL-C-24217 descriptions and configurations - Continued.

Specification number	Description	Configuration
MIL-R-24217/6	Receptacle Assembly (Locknut Flange Type)	
MIL-R-24217/11	Receptacle Assembly (Union Type)	
MIL-R-24217/12	Receptacle Assembly (Mid-Flange, Bolted, Union Type)	
MIL-U-24217/13	Receptacle Assembly (Mid-Flange, Locknut, Union Type)	
MIL-R-24217/14	Union Plug Assemblies, Straight	
MIL-U-24217/15	Union Plug Assemblies, Right Angle	

MIL-STD-1353C
APPENDIX D

D.6 MIL-C-24231. MIL-C-24231 pressure-proof connectors, plugs, receptacles, adapters, hull inserts, and hull insert plugs.

D.6.1 Primary uses. Submarine sonar, submarine antennas, undersea switches, underwater lights, weapons systems, deep submergence vehicles, junction boxes, fluid flow sensors, underwater communications, and satellite systems, see table D-IV.

D.6.2 Pressure proof fittings . Pressure proof fittings are of the following types:

Type I - Molded plugs (straight and 90°).

Type II - Adapters for molded plugs.

Type III - Single cable connectors.

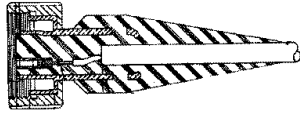
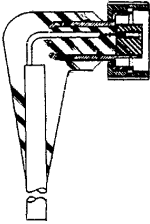
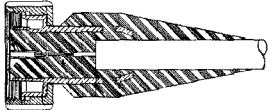
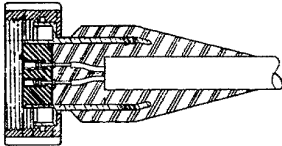
Type IV - Multiple cable connectors.

Type V - Multi-pin receptacles

Type VI - Plugs for hull inserts.

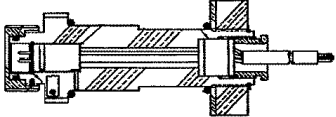
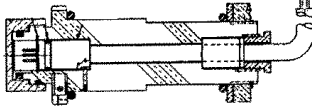
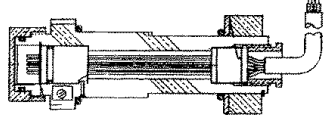
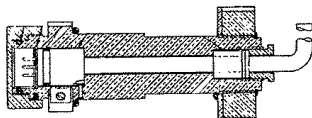
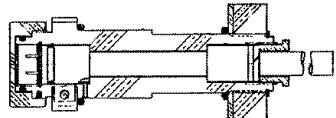
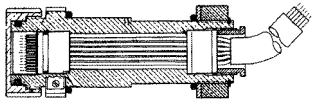
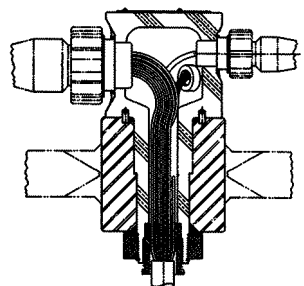
Type VII - Hull inserts,

TABLE D-IV. MIL-C-24231 descriptions and configurations.

Specification number	Description	Configuration
MIL-C-24231	Connectors, Plugs, Receptacles, Adapters, Hull Inserts, and Hull Insert Plugs, Pressure-Proof, General Specification For	
MIL-C-24231/1	Connector, Plug, Type I, Molded, Three-, Four-, and Five-Conductor	
MIL-C-24231/2	Connector, Plug, Type I, 90-Degree, Molded, Three-, Four-, and Five-Conductor	
MIL-C-24231/3	Connector, Plug, Type I, Molded, Seven- and Nine-Conductor (Straight and 90 Degrees)	
MIL-C-24231/4	Connectors, Plug, Type I, Molded, 14-, 24-, 30-, or 40-Conductor (Straight and 90 Degrees)	

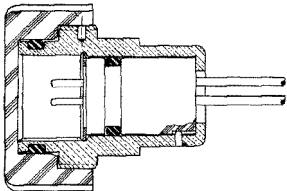
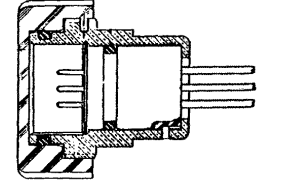
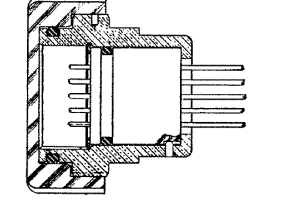
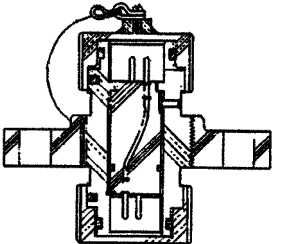
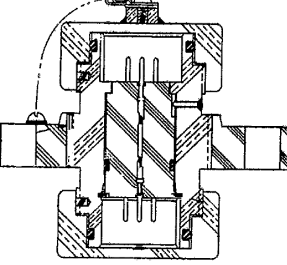
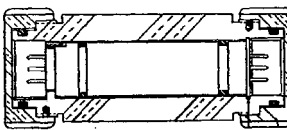
MIL-STD-1353C
APPENDIX D

TABLE D-IV. MIL-C-24231 descriptions and configurations - Continued.

Specification number	Description	Configuration
MIL-C-24231/5	Connectors, Single Cable, Type III, Three-, Four- or Five-Conductor	
MIL-C-24231/6	Connector, Single Cable, Type III, for DSS-3 Cable	
MIL-C-24231/7	Connector, Single Cable, Type III, Seven-Conductor	
MIL-C-24231/8	Connector, Single Cable, Type III, Seven-Conductor	
MIL-C-24231/9	Connector, Single Cable, Type III, Seven- and Nine-Conductor	
MIL-C-24231/10	Connectors, Single Cable, Type III, 14-, 24-, 30-, or 40-Conductor	
MIL-C-24231/11	Connector, Multiple Cable, Type IV	

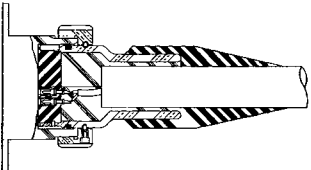
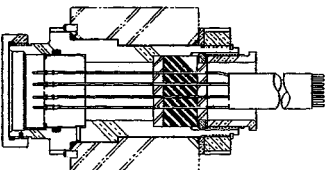
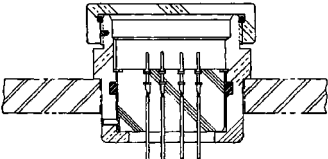
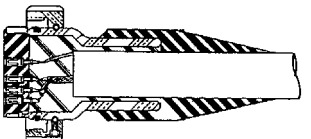
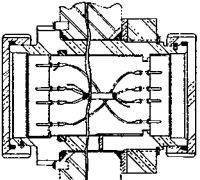
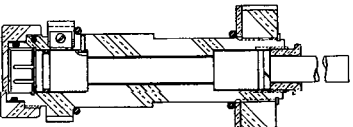
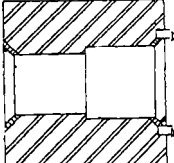
MIL-STD-1353C
APPENDIX D

TABLE D-IV. MIL-C-24231 descriptions and configurations - Continued.

Specification number	Description	Configuration
MIL-C-24231/12	Connector, Receptacle, Multi-Pin, Type V, Three-, Four-, and Five-Conductor	
MIL-C-24231/13	Connectors, Receptacle, Multi-Pin, Type V, Seven- and Nine-Conductor	
MIL-C-24231/14	Connectors, Receptacle, Multi-Pin, Type V, 14-, 24-, 30-, and 40-Conductor	
MIL-C-24231/15	Connector, Adapter, for Molded Plug, Type II Three- and Four-Conductor	
MIL-C-24231/16	Connector, Adapter, For Molded Plug, Type II, Seven-Conductor	
MIL-C-24231/17	Connector, Adapter For Molded Plug, Type II, Nine-Conductor	

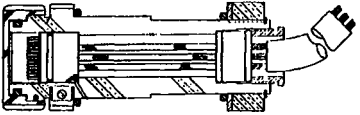
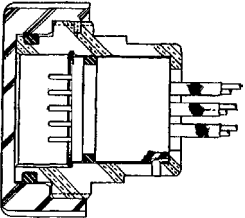
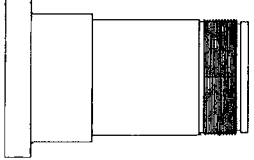
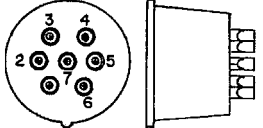
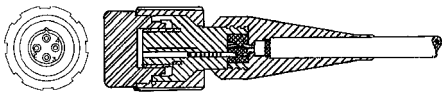
MIL-STD-1353C
APPENDIX D

TABLE D-IV. MIL-C-24231 descriptions and configurations - Continued.

Specification number	Description	Configuration
MIL-C-24231/18	Connector, Plug, Type I, Molded, 65-Conductor	
MIL-C-24231/19	Connector, Single Cable, Type III, 65-Conductor	
MIL-C-24231/20	Connector, Receptacle, Multi-Pin, Type V, 65-Conductor	
MIL-C-24231/21	Connector, Plug, Type I, Molded, 80-Conductor	
MIL-C-24231/22	Connector, Receptacle, Type IV, 80-Conductor	
MIL-C-24231/24	Connector, Single Cable, Type III, Three-Conductor, For THOF-9 Cable	
MIL-C-24231/25	Connector, Hull Inserts, Type VII	

MIL-STD-1353C
APPENDIX D

TABLE D-IV. MIL-C-24231 descriptions and configurations - Continued.

Specification number	Description	Configuration
MIL-C-24231/26	Connector, Single Cable, Type III, For Type 2SWF Cables	
MIL-C-24231/27	Connector, Receptacle, Multi-Pin, Type V, For Type 2SWF Cables	
MIL-C-24231/28	Connector, Plug, For Hull Inserts, Type VI	
MIL-C-24231/29	Connector, Preform Molded Inserts, for Molded Plugs, Type I	
MIL-C-24231/30	Connector, Plug, Glass Reinforced Polymer, Type I Molded, Three- and Four-Conductor	

MIL-STD-1353C
APPENDIX D

D.7 MIL-DTL-25955. MIL-DTL-25955 miniature electrical connectors, plugs and receptacles, are an environment resisting class with snap-in contacts and receptacles of identical mating dimensions of a hermetically sealed class with non-removable contacts see table D-V.

D.7.1 Classes. Classes are defined as follows:

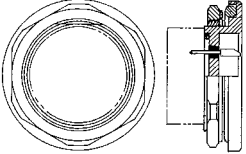
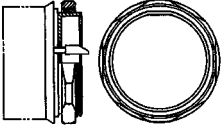
Class E- Environment resisting connectors are intended for use in applications wherein extremes of temperature, humidity, and barometric pressure are experienced. Moisture sealing is provided in engaged pairs, but receptacles are not intended to contain pressure across the connector.

Class H - Hermetic connectors are intended for use in applications wherein pressures must be contained by the connectors across the walls or panels on which they are mounted. The air leakage is to be low enough to be termed hermetically sealed. Moisture and environmental protection similar to the class E is provided on the engaging end only when class H receptacles are engaged with counterpart class E connectors. Class H connectors are supplied only in receptacles with pin contacts.

D.7.2 Styles of engagement:

- P - Coupling ring engagement with pin contacts.
- F - Coupling ring engagement with socket contacts.
- M - Male thread engagement with pin contacts.
- S - Male thread engagement with socket contacts.

TABLE D-V. MIL-DTL-25995 descriptions and configurations.

Specification number	Description	Configuration
MIL-DTL-25955	Connectors, Electrical, Environment Resisting, Miniature, With Snap-In Contacts	Inactive for new design
MS24240	Connector, Receptacle, Electrical, Hermetic, Jam Nut, Rear Mounting	
MS24241	Connector, Receptacle, Electrical, Hermetic, Jam Nut, Front Mounting.	
MS24242	Insert Arrangement - Electrical Connector Receptacle	3 number 20 contacts 20 number 20 contacts

MIL-STD-1353C
APPENDIX D

D.8 MIL-DTL-26482. MIL-DTL-26482 two series of environment resisting, quick disconnect, miniature, circular electrical connectors (and accessories), see tables D-VI and [D-VII](#).

NOTE: MIL-DTL-26482 series I connectors are still active however DoD does not want them in new designs or new projects.

D.8.1 Each series contains hermetic receptacles. The two series of connectors are intermateable when using power contacts and are not intermateable when using shielded contacts, series are defined as follows:

Series 1 - Connector, bayonet coupling, solder or front release crimp removable contacts (125°C). Series 1, hermetic are also available.

Series 2 - Connector, bayonet coupling, rear release crimp removable contacts (200°C), (classes H, N, and W, 175°C). Series 2, hermetic connectors are available with nonremovable solder type contacts or crimp removable terminations

TABLE D-VI. MIL-DTL-26482 connector class and series.

Class	Series 1 (125°C)		Series 2 (200°C)		Series 2 (175°C)
	Solder	Front release crimp removable contacts	Rear release crimp removable contacts	Solder	Rear release crimp removable contacts
A-Grommet seal, nonconductive			X		
E-Grommet seal, conductive	X	X	<u>1/</u>		
P-Potted seal, conductive	X	X			
H-Hermetic seal, conductive	X			X	
J-Insert seal with gland seal for jacketed cable, conductive	X				
L-Fluid resistant, conductive electroless nickel <u>1/ 2/</u>			X		
N-Hermetic seal, crimp termination conductive					X
F-Grommet seal with strain relief clamp conductive	X	X			
W-Cadmium plate, corrosive and fluid resistant, conductive					X

1/ Class L is upgraded to 200°C and replaces class E, series 2, rear release, crimp removable contacts.

2/ Class L is for space applications only.

MIL-STD-1353C
APPENDIX D

D.8.2. MIL-DTL-26482 termination types. MIL-DTL-26482 termination types:

- Type A - Solder cup termination (may be hermetic) - stainless steel shell (series 1 and 2).
- Type B - Eyelet termination - stainless steel shell (series 1 and 2).
- Type C - Solder cup termination (may be hermetic) - ferrous alloy shell (series 1 and 2).
- Type D - Crimp termination (may be hermetic) - ferrous alloy shell (series 2).
- Type Y - Eyelet termination - ferrous alloy shell (series 1).

D.8.3 Intended use (Series 1). Series 1 connectors intended use:

- a. Classes E, F, J, and P connectors are intended for use in environment-resisting applications where the operating temperature range of -55° to 125°C (-67° to 257°F) is experienced. Crimp contact connectors have the additional advantage of possessing removable crimp-type contacts. Class J connectors are intended for use with light-weight, single-jacketed cable.
- b. Class H receptacles are intended for use in applications wherein pressures must be contained by the connectors across the walls or panels on which they are mounted.
- c. Crimp contact connectors should have contacts installed in all positions when the connector is wired. Sealing plugs should be installed in the grommet holes when no wire is attached to the contact in grommet sealed connectors.
- d. The potting form should remain with the connector after potting.
- e. Counterpart solder and crimp contact connectors are intended to be intermateable. Moisture resistance capability is then reduced to that of the solder contact connector.
- f. If air leakage requirements are critical, a resilient insert, solder contact receptacle, a through bulkhead receptacle, or class H receptacle should be used, or the connector should be potted.
- g. For finished wire diameters less than specified in MIL-DTL-26482 shrink-fit sleeving should be used over the wire.
- h. Where two or more wires are used in a solder cup or wire barrel, grommet sealing is not obtainable. Wires should be potted if sealing is required.

D.8.4 Intended use (Series 2). Series 2 connectors intended use:

- a. Connector backshells must be installed to meet the specified moisture sealing requirements.
- b. Class A connectors are intended for use in application where 200°C temperature, grommet seal, and nonconductive finish are required.
- c. Class L connectors are intended for use in environment resisting applications at 200°C temperature and are fluid resistant. These connectors have wire sealing grommets.
- d. Class H and N receptacles are intended for use in applications wherein pressure must be contained by the connectors across walls or panels on which they are mounted. They have fluid resistant insert face seals. In addition, class N receptacles have crimp type terminations.
- e. Mechanical strain reliefs are intended for use where a saddle type clamp is desired.
- f. Shielded contacts are intended for use with shielded and jacketed single conductor cables, and may be used with certain coaxial cables when impedance matching is not required. Shielded contacts are not furnished with connectors, and must be ordered separately when required. Shielded contacts will not intermate with standard size 12 contacts or with series 1 shielded contacts. It is the user's responsibility to assure mating contact compatibility at time of contact installation.
- g. RFI backshell and grounding fingers on plug are available in class L and provide RFI shielding.
- h. Class W connectors are intended for use in salt spray environments providing a corrosive resistant shell, conductive finish, and fluid resistance at 175°C (347°F) service temperature.

D.8.5 Insert arrangements. Insert arrangements for MIL-DTL-26482 refer to MIL-STD-1669.

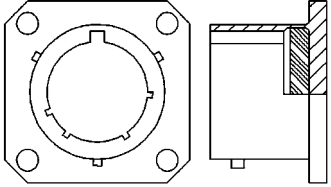
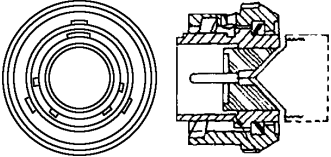
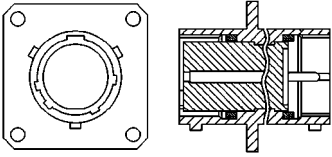
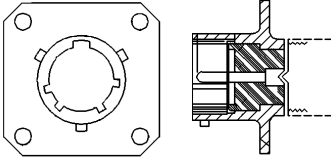
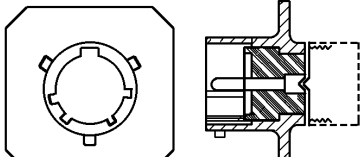
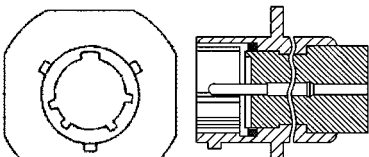
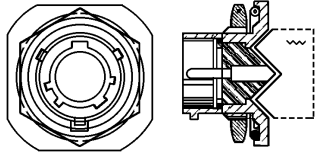
MIL-STD-1353C
APPENDIX D

TABLE D-VII. MIL-DTL-26482 descriptions and configurations.

Specification number	Description	Configuration
MIL-DTL-26482	Connectors, Electrical, (Circular, Miniature, Quick Disconnect, Environment Resisting), Receptacles and Plugs, General Specification for	
	Coupling method: Bayonet Keying position: Blank (normal), W, X, Y, Z Alternate keying method: Rotation of insert keys remain stationary EMI/RFI grounding: EMI/RFI grounding fingers may not be available on all models	
Connectors, Solder Contact, Bayonet coupling (Series 1)		
MS3110	Connectors, Receptacle, Electrical, Solder Type, Wall Mounting, Bayonet Coupling, Series 1, Classes E, F, J and P (Inactive for new design use MS3470)	
MS3111	Connectors, Plug, Electrical, Solder Type, Cable Connecting, Bayonet Coupling, Classes E, F, J, and P (Inactive for new design use MS3476)	
MS3112	Connectors, Electrical, (Circular, Miniature, Quick Disconnect, Environment Resisting), Receptacle, (Box Mounting Flange, Bayonet Coupling, Solder Contact), (Series 1) (Inactive for new design use MS3470)	
MS3113	Connectors, Receptacle, Electrical, Series I, Solder Type, Solder Mounting, Bayonet Coupling, Class H (Inactive for new design use MS3443)	
MS3114	Connectors, Receptacle, Electrical, Series 1, Solder Type, Jam Nut Mounting, Bayonet Coupling, Classes E, F, H and P (Inactive for new design use MS3474 for classes E, F, and P)	

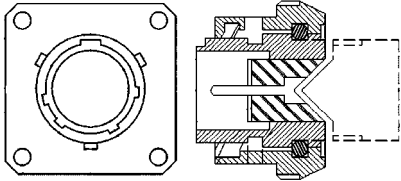
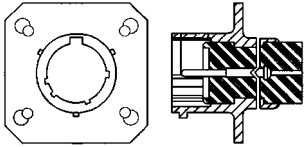
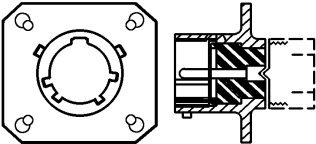
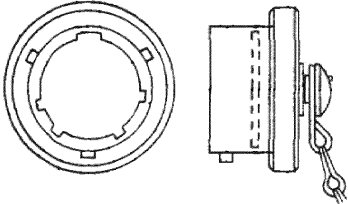
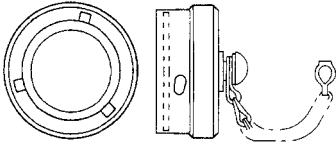
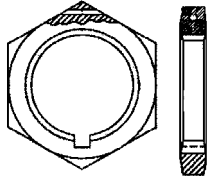
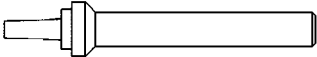
MIL-STD-1353C
APPENDIX D

TABLE D-VII. MIL-DTL-26482 descriptions and configurations - Continued.

Specification number	Description	Configuration
Connectors, Solder Contact, Bayonet coupling (Series 1)		
MS3115	Connectors, Receptacle, Electrical, Dummy Stowage, Bayonet Coupling, for MIL-DTL-26482 Connectors, Series 1 and 2	
MS3116	Connectors, Plug, Electric, Series 1, Solder Type, Straight, Bayonet Coupling (Inactive for new design)	
MS3119	Connectors, Electrical, (Circular, Miniature, Quick Disconnect, Environment Resisting), Receptacle, (Thru-Bulkhead Mounting Flange, Bayonet Coupling), (Series 1) (Inactive for new design)	
MS3120	Connectors, Receptacle, Electrical, Crimp type, Wall Mounting, Flange, No. 4 Holes, Bayonet Coupling, Classes E, F, and P	
MS3121	Connectors, Plug, Electrical, Crimp type, Cable-Connecting, Bayonet Coupling, Classes E, F, and P	
MS3122	Connectors, Receptacle, Electrical, Crimp Type, Box Mounting, Flange, No. 4 Holes, Bayonet Coupling, Series 1 (Inactive for new design)	
MS3124	Connectors, Plug, Electrical, Crimp type, Rear Mounting, Jam Nut, Bayonet Coupling, Classes E, F, and P	

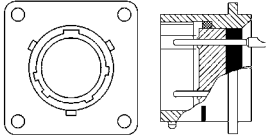
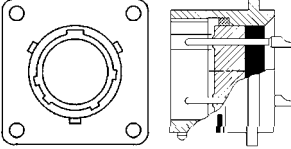
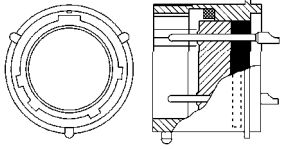
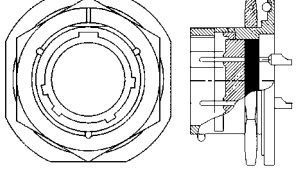
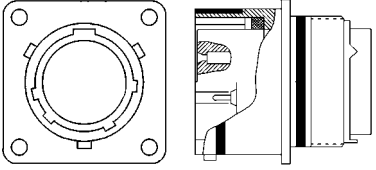
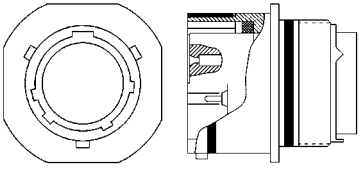
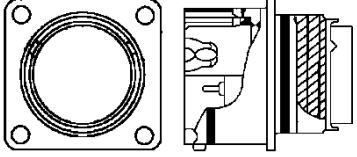
MIL-STD-1353C
APPENDIX D

TABLE D-VII. MIL-DTL-26482 descriptions and configurations - Continued.

Specification number	Description	Configuration
Connectors, Solder Contact, Bayonet coupling (Series 1)		
MS3126	Connectors, Plug, Electrical, Crimp-Type, Straight, Bayonet Coupling	
MS3127	Connectors, Receptacle, Electrical, Series 1, Crimp Type, Box Mounting, Flange, No. 4/6 Holes, Bayonet Coupling, Class E	
MS3128	Connectors, Plug, Electrical, Crimp Type, Wall Mounting, No 4/6 Holes, Bayonet Coupling, Classes E, F, and P	
MS3180	Cover, Protective, Electrical Connector Plug, Bayonet Coupling for MIL-DTL-26482 Connectors	
MS3181	Cover, Protective, Electrical Connector Receptacle, Bayonet Coupling for MIL-DTL-26482 Connectors	
MS3186	Connector Mounting to Connectors, Mounting Nuts, Plain Hexagon	
MS3187	Plug, End Seal, for MIL-DTL-26482, SAE-AS81703 and MIL-DTL-83723 Electrical Connectors	

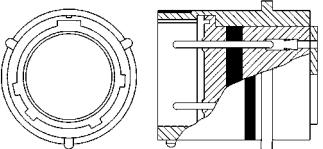
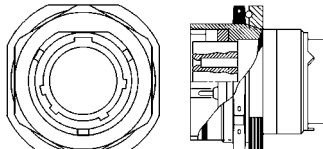
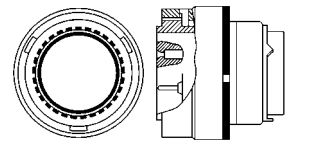
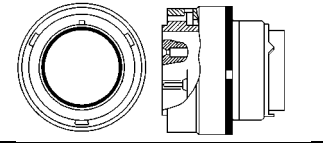
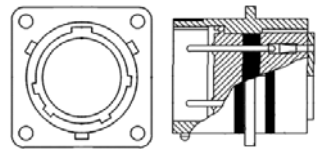
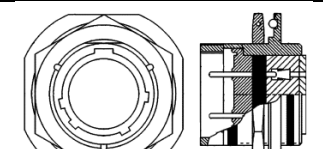

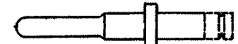
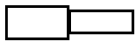
MIL-STD-1353C
APPENDIX D

TABLE D-VII. MIL-DTL-26482 descriptions and configurations - Continued.

Specification number	Description	Configuration
Connectors, Solder Contact, Bayonet Coupling (Series 2)		
MS3440	Connectors, Receptacle, Electric, Series 2, Narrow Flange Mount, Bayonet Coupling, Solder Pin Contact Class H	
MS3442	Connectors, Receptacle, Electric, Series 2, Wide Flange Mounting, Bayonet Coupling, Solder Pin Contact, Class H	
MS3443	Connectors, Receptacle, Electric, Series 2, Solder Flange Mount, Bayonet Coupling, Solder Pin Contact, Class H	
MS3449	Connectors, Receptacle, Electric, Series 2, Single Hole Mount, Bayonet Coupling, Solder Pin Contact, Class H	
MS3470	Connectors, Receptacle, Electric, Series 2, Crimp Type, Narrow Flange Mount, Bayonet Coupling, Classes A, L, S, and W	
MS3471	Connectors, Receptacle, Electric, Series 2, Crimp Type, Cable Connecting, Bayonet Coupling, Classes A, L, S, and W	
MS3472	Connectors, Receptacle, Electric, Series 2, Crimp Type, Wide Flange Mounting, Bayonet Coupling, Classes A, L, S, and W	

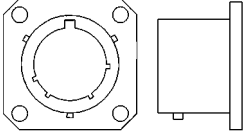
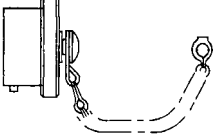
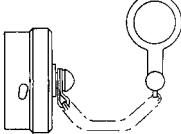

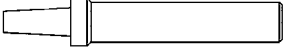

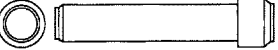
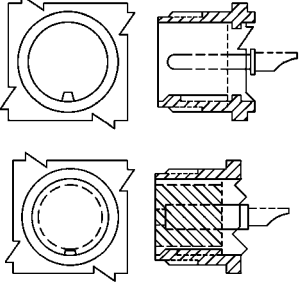
MIL-STD-1353C
APPENDIX D

TABLE D-VII. MIL-DTL-26482 descriptions and configurations - Continued.

Specification number	Description	Configuration
Connectors, Crimp contact, Bayonet Coupling (Series 2)		
MS3473	Connectors, Receptacle, Electric, Series 2, Hermetic, Solderless, Solder Mounting, Bayonet Coupling, Class N	
MS3474	Connectors, Receptacle, Electrical, Series 2, Crimp Type, Rear Mounting Jam Nut, Bayonet Coupling, Classes A, D, L, T, W and Z	
MS3475	Connectors, Plug, Electrical, RFI Shielded, Series 2, Crimp Type, Bayonet Coupling, Classes D, L, T, W and Z	
MS3476	Connectors, Plug, Electrical, Series 2, Crimp Type, Bayonet Coupling, Classes A, D, L, T, W and Z	
MS3477	Connectors, Receptacle, Electrical, Series II, Hermetic, Solderless, Box Mounting, Bayonet Coupling, Class N	
MS3479	Connectors, Receptacle, Electrical, Series II, Hermetic, Solderless, Rear Mounting, Jam Nut, Bayonet Coupling, Class N	
Test Gages		
MS3460	Test Gage, MIL-DTL-26482 Series 1 or SAE-AS81703 Series 2 Contact Retention Feature (Inactive for new design)	
MS3461	Test Gage, MIL-DTL-26482 Series 2 or SAE-AS81703 Series 3 Contact Retention Feature (Inactive for new design)	
MS3462	Test Gage, MIL-DTL-26482, Series 2 (Class N) or SAE-AS81703 Series 3 (Class N) Contact Retention Feature (Inactive for new design)	

MIL-STD-1353C
APPENDIX D

TABLE D-VII. MIL-DTL-26482 descriptions and configurations - Continued.

Connector Accessories		
MS3115	Connectors, Receptacle, Electrical, Dummy Stowage, Bayonet Coupling, for MIL-DTL-26482 Connectors, Series 1 and 2	
MS3180	Cover, Protective, Electrical Connector Plug, Bayonet Coupling for, MIL-DTL-26482 Connectors (Inactive for new design)	
MS3181	Cover, Protective, Electrical Connector Receptacle, Bayonet Coupling for, MIL-DTL-26482 Connectors	
MS3186	Connector, Mounting to Connectors, Mounting Nuts, Plain Hexagon	
MS3187	Plug, End Seal, for MIL-DTL-26482, SAE-AS81703 and MIL-DTL-83723 Electrical Connectors	
MS3481	Tool, Connector Assembly, for MIL-DTL-26482 Connectors	
MS27488	Plug, End Seal, Electric Connector	
MS33678	Connector, Receptacle, Electrical, Integral Mounting (This is a design standard not to be used as an MS part number)	
MIL-STD-1669	Insert Arrangements for MIL-DTL-26482 Environment Resisting, Circular, Electrical Connectors	

MIL-STD-1353C
APPENDIX D

D.9 MIL-DTL-26500. MIL-DTL-26500 miniature, environment resisting, see table D-VIII. MIL-C-26500 is inactive for new design for new design use MIL-DTL-83723, series III.

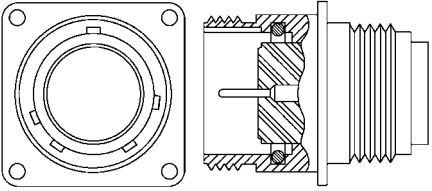
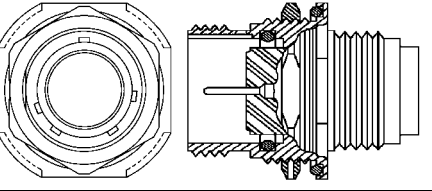
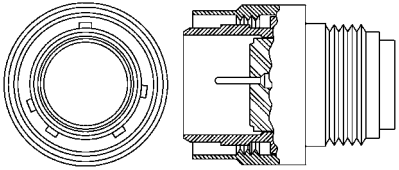
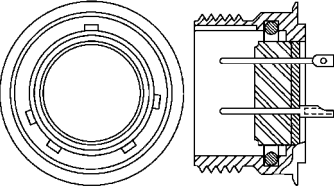
D.9.1 Intended use. Used on avionics, missile systems, space environments, aircraft general-purpose applications, aircraft engines and firewalls.

D.9.2 Capabilities. Firewall capability connectors meet the fireproof requirements of Class K.

D.9.3 Non-magnetic. Non-magnetic stainless steel shells designed for superior strength and elevated temperatures up to 460°F for extended periods.

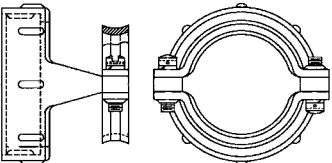
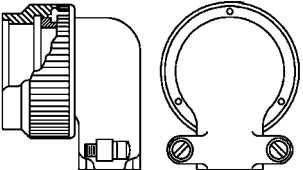
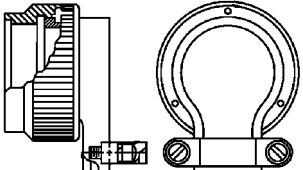
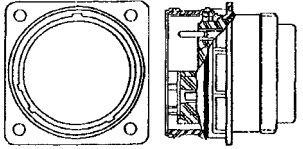
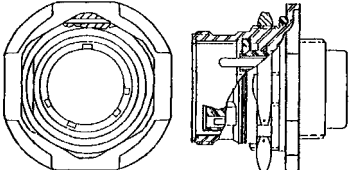
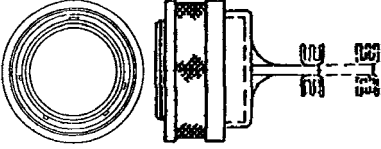
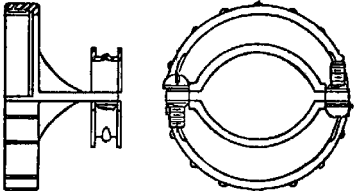
D.9.4 Contacts. SAE-AS39029 qualified contacts and special application contacts including thermocouple, printed circuit board and shielded/coaxial types.

TABLE D-VIII. MIL-DTL-26500 descriptions and configurations.

Specification number	Description	Configuration
MIL-DTL-26500	Connectors, General Purpose, Electrical, Miniature, Circular, Environment Resisting, General Specification for	
MS24264	Connector, Receptacle, Electrical, Flange Mount, Miniature, Classes E, F, G and R	
MS24265	Connector, Receptacle, Electrical, Single Hole Mount, Miniature, Classes E, F, G and R	
MS24266	Connector, Plug, Electrical, Straight, Miniature, Classes E, F, G and R	
MS27034	Connector, Receptacle, Electrical, Pin Insert, Cylindrical, Miniature, Hermetic, Solder Mount	

MIL-STD-1353C
APPENDIX D

TABLE D-VIII. MIL-DTL-26500 descriptions and configurations - Continued.

Specification number	Description	Configuration
MS27291	Support, Cable, Electrical Connector	
MS27558	Support, Cable, Right Angle, Closed	
MS27559	Support, Cable, Right Angle	
MS27613	Connectors, Receptacle, Electrical, Panel Mount, Firewall Series	
MS27614	Connectors, Receptacle, Electrical, 'D' Hole Mount, Firewall Series	
MS27615	Connectors, Plug, Electrical, Ratchet Lock Coupling, Firewall Series	
MS27657	Short Support, Cable, electrical Connector (For Classes E and K Connectors) For new design use MIL-DTL-83723, series III, which is interchangeable.	

MIL-STD-1353C
APPENDIX D

D.10 MIL-DTL-27599. MIL-DTL-27599 solder type connectors use a rigid, hard dielectric insert which is molded around the pin and socket contacts. This permits pressurization of 1 atmosphere across an interface with a leak rate up to 1×10^{-3} cc/sec, see table IX.

D.10.1 MIL-DTL-27599 series I and II. Series I & II is the solder contact version of the popular MIL-DTL-38999 series I and II series of military qualified connectors.


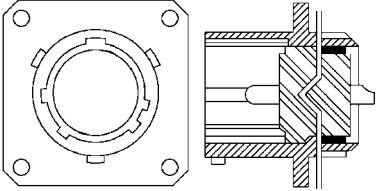
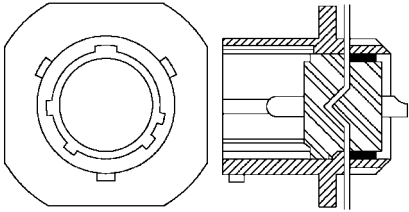
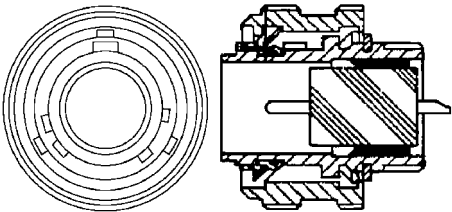
D.10.1.1 Series I. Series I has a scoop-proof design in shell sizes 9 thru 25 (.844" to 1.875" diameter) and 8 shell styles with contact sizes 22 thru 8.

D.10.1.2 Series II. Series II of these connectors comes in shell sizes 8 thru 24 (.734" to 1.750" diameter) and 8 shell styles with contact sizes 22 thru 8.

D.10.3 Crimp type connectors. Fully intermateable and intermountable with MIL-DTL-38999 series I and II, as applicable, crimp type connectors.

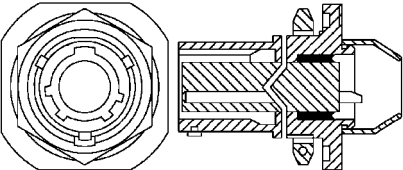
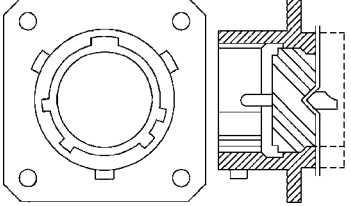
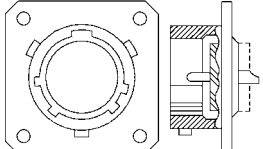
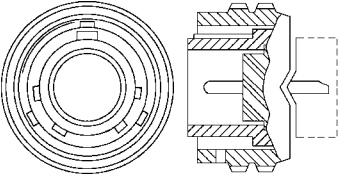
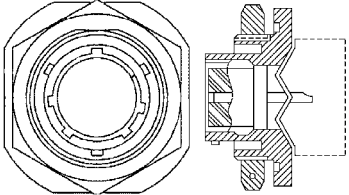
D.10.4 Insert arrangements. Insert arrangements for MIL-DTL-27599 are in MIL-STD-1560.

TABLE D-IX. MIL-DTL-27599 descriptions and configurations.

Specification number	Description	Configuration
MIL-DTL-27599	Connectors, Electrical, Circular, Miniature, High Density, Quick Disconnect, Environmental Resistant, Solder Contacts, General Specification for	
MS20026	Connectors, Receptacle, Electrical, Wall Mount, Solder Type, Bayonet Coupling, Class T, Series I	
MS20027	Connectors, Line Plug, Electrical, Solder Type, Bayonet Coupling, Class T, Series I	
MS20028	Connectors, Plug, Electrical, Straight, Solder Type, Bayonet Coupling, Class T, Series I	

MIL-STD-1353C
APPENDIX D

TABLE D-IX. MIL-DTL-27599 descriptions and configurations - Continued.

Specification number	Description	Configuration
MS20029	Connectors, Receptacle, Electrical, Jam Nut Mounting, Solder Type, Bayonet Coupling, Class P, Series I	
MS27334	Connectors, Receptacle, Electrical, Wall Mounting Flange, Solder Type, Bayonet Coupling, Classes P & T, Series II (Inactive for new design)	
MS27335	Connectors, Receptacle, Electrical, Box, Flange Mount, Solder Type, Bayonet Coupling, Class T, Series II	
MS27336c	Connectors, Plug, Electrical, Straight, Solder Type, Bayonet Coupling, Classes P & T, Series II	
MS27337	Connectors, Receptacle, Electrical, Jam Nut Mounting, Solder Type, Bayonet Coupling, Classes P & T, Series II	

MIL-STD-1353C
APPENDIX D

D.11 MIL-DTL-28840. MIL-DTL-28840 was developed to meet the Navy's requirement for crimp front release contact connectors for use with jacketed cable in shipboard signal applications. Temperature range -55°C to 200°C, the upper temperature is the maximum internal hot-spot temperature resulting from any combination of electrical load and ambient conditions, see [table D-X](#).

D.11.1 RFI/EMI suppression. RFI/EMI suppression is obtained by means of the spring fingers located in the plug. Additionally, a metal to metal bonding occurs when accessories are attached to the rear of the connector through a unique spline and ramp design system.

D.11.2 Scoop proof protection. 100% scoop proof protection on all connectors prevents bent pins and inadvertent electrical contact whether the pins are mounted in the plug or the receptacle.

D.11.3 Shell sizes. 9 shell sizes and 9 insert configurations with a maximum number of 155 size 20 contacts.

D.11.4 Intended usage. MIL-DTL-28840 connectors are intended for use where the connector will be subject to heavy condensation and rapid changes in temperature or pressure, and where the connector is subject to high vibratory conditions. A type MIL-C-28840/12 receptacle does not provide moisture or vibration protection at its back end, and a type MIL-C-28840/10 or MIL-C-28840/11 should be used if such protection is desired, other characteristics are as follows:

MIL-DTL-28840/10 - Receptacles intended for wall or bulkhead flange mounting and for use with conduit backshells, or cable clamps.

MIL-DTL-28840/11 - Receptacles intended for use at the end of a cable where mounting provisions are not required.

MIL-DTL-28840/12 - Receptacles intended for mounting on shielding boxes and equipment eases. They have no fittings and are for use with open wiring. Individual wires should not exceed 12 inches in length. Box mount connectors will be used only in controlled atmosphere applications where environmental sealing is not required.


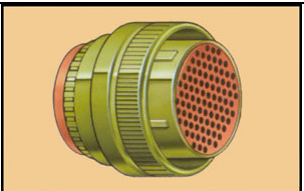
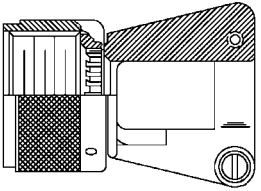
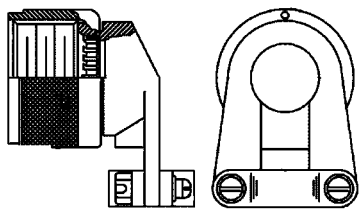
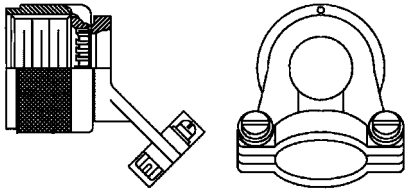

MIL-DTL-28840/14 - Receptacles intended for wall or bulkhead jam nut mounting and for use with conduit or a cable clamp.

MIL-DTL-28840/16 - Plugs intended for use at the end of a cable to be mated with a receptacle.

MIL-DTL-28840/18 - 90° plugs intended for use at the end of a cable where space does not permit the use of a straight plug.

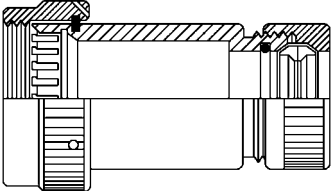
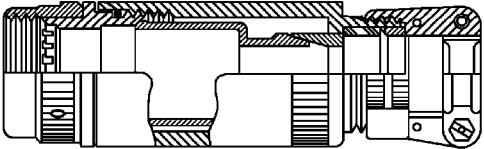
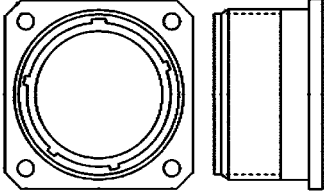
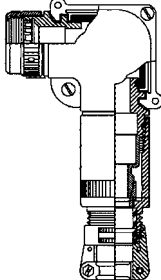
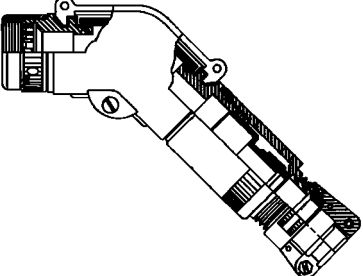
MIL-STD-1353C
APPENDIX D

TABLE D-X. MIL-DTL-28840 descriptions and configurations.

Specification number	Description	Configuration
MIL-DTL-28840	COUPLING METHOD: THREADED KEYING POSITION: 1, 2, 3, 4, 5, 6 ALTERNATE KEYING METHOD: MASTER KEY REMAINS STATIONARY - MINOR KEYS ROTATE INDEPENDENTLY	
	EMI/RFI GROUNDING: YES (EMI/RFI GROUNDING FINGERS MAY NOT BE AVAILABLE ON ALL MODELS)	
MIL-DTL-28840/1	Connector Accessories, Electrical, Circular, Threaded, High Density, High Shock, Shipboard, Clamps, Strain Relief, Straight, Open for Electrical Connectors	
MIL-DTL-28840/2	Connector Accessories, Electrical, Circular, Threaded, High Density, High Shock, Shipboard, Clamps, Strain Relief, 90°, Open for Electrical Connectors	
MIL-DTL-28840/3	Connector Accessories, Electrical, Circular, Threaded, High Density, High Shock, Shipboard, Clamps, Strain Relief, 45°, Open for Electrical Connectors	
MIL-DTL-28840/4	Connectors, Electrical, Circular, Threaded, High Shock, High Density, Shipboard, Metal Conduit for EMI Shielding	

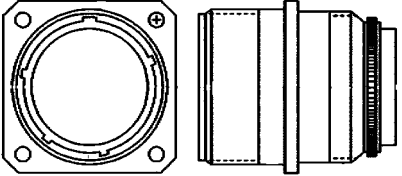
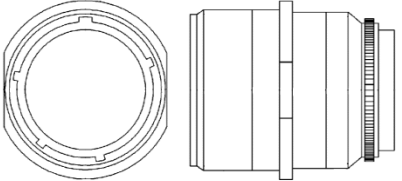
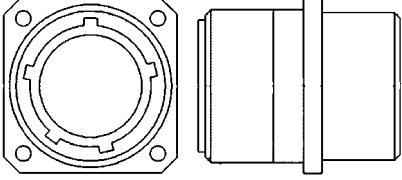
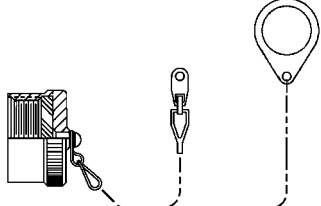
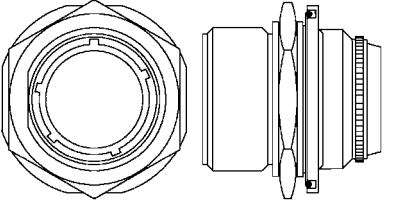
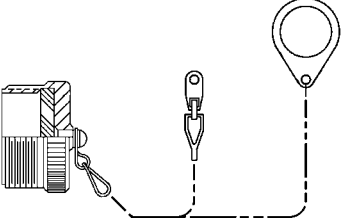
MIL-STD-1353C
APPENDIX D

TABLE D-X. MIL-DTL-28840 descriptions and configurations - Continued

Specification number	Description	Configuration
MIL-DTL-28840/5	Connectors, Electrical, Circular Threaded, High Shock, High Density, Shipboard, Backshell, Straight, Metal Conduit for EMI Shielding	
MIL-DTL-28840/6	Connectors, Electrical, Circular Threaded, High Shock, High Density, Shipboard, Backshell, Straight, Cable Sealing and Shield Termination, Connector, Electric	
MIL-DTL-28840/7	Connectors, Electrical, Circular, Screw Threads, High Shock, High Density, Shipboard, Crimp Contacts Dummy Receptacle, Wall Mounting	
MIL-DTL-28840/8	Connectors, Electrical, Circular, Threaded, High Shock, High Density, Shipboard, Backshell, 90°, Cable Sealing and Shield Termination, Connector, Electric	
MIL-DTL-28840/9	Connectors, Electrical, Circular, Threaded, High Shock, High Density, Shipboard, Backshell, 45°, Cable Sealing and Shield Termination, Connector, Electric	

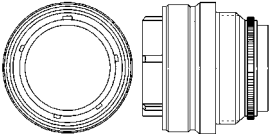
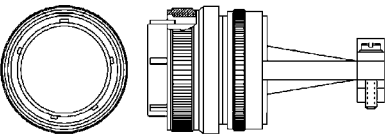
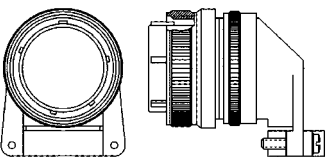
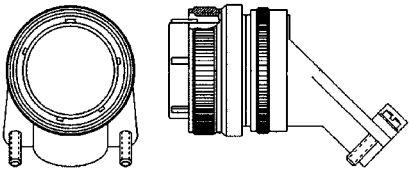
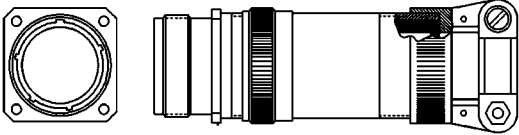
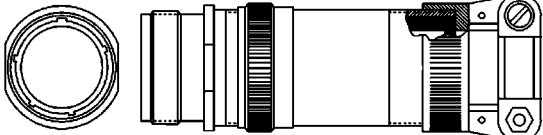
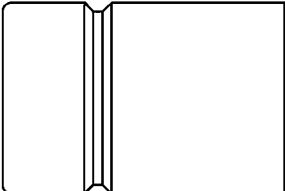
MIL-STD-1353C
APPENDIX D

TABLE D-X. MIL-DTL-28840 descriptions and configurations - Continued.

Specification number	Description	Configuration
MIL-DTL-28840/10	Connectors, Electrical, Circular, Screw Threads, High Shock, High Density, Shipboard, Crimp Contacts Receptacle, Wall Mounting, Classes D and DS	
MIL-DTL-28840/11	Connectors, Electrical, Circular, Screw Threads, High Density, High Shock, Shipboard, Crimp Contacts Receptacle, Box Mounting, Classes D and DS	
MIL-DTL-28840/12	Connectors, Electrical, Screw Threads, High Density, High Shock, Shipboard, Crimp Contacts Receptacle, Box Mounting, Classes D and DS	
MIL-DTL-28840/13	Connectors, Electrical, Circular Threaded, High Shock, High Density, Shipboard, Cover, Receptacle	
MIL-DTL-28840/14	Connectors, Electrical, Circular, Screw Threads, High Density, High Shock, Shipboard, Crimp Contacts Receptacle, Jam Nut Mounting, Classes D and DS	
MIL-DTL-28840/15	Connectors, Electrical, Circular Threaded, High Shock, High Density, Shipboard, Dust Cover, Plug	

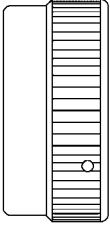
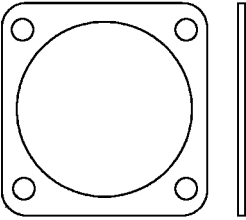
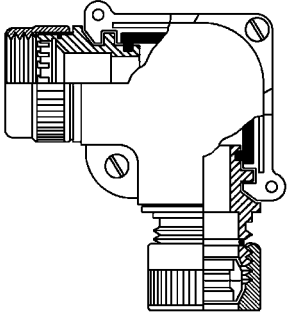
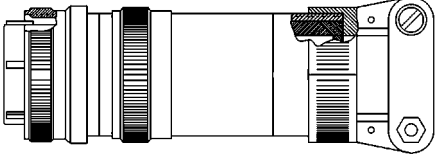
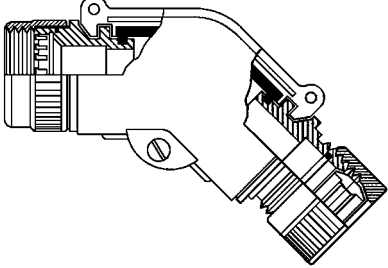
MIL-STD-1353C
APPENDIX D

TABLE D-X. MIL-DTL-28840 descriptions and configurations - Continued.

Specification number	Description	Configuration
MIL-DTL-28840/16	Connectors, Electrical, Circular, Screw Threads, High Density, High Shock, Shipboard, Crimp Contacts Plug, Classes D and DS	
MIL-DTL-28840/17	Connectors, Electrical, Circular, Screw Threads, High Density, High Shock, Shipboard, Crimp Contacts, Plug, Assembly, Open Wire, Classes D and DS	
MIL-DTL-28840/18	Connectors, Electrical, Circular, Screw Threads, High Density, High Shock, Shipboard, Crimp Contacts, Plug, Assembly, Open Wire, 90 Degrees, Classes D and DS	
MIL-DTL-28840/19	Connectors, Electrical, Circular, Screw Threads, High Density, High Shock, Shipboard, Crimp Contacts, Plug, Assembly, Open Wire, 45 Degrees, Classes D and DS	
MIL-DTL-28840/20	Connectors, Electrical, Circular, Screw Threads, High Density, High Shock, Shipboard, Crimp Contacts Receptacle, Wall Mounting, Assembly, Straight Classes DJ and DJS	
MIL-DTL-28840/21	Connectors, Electrical, Circular, Screw Threads, High Density, High Shock, Shipboard, Crimp Contacts Receptacle, Cable Connecting Assembly, Straight Classes DJ and DJS	
MIL-DTL-28840/22	Connectors, Electrical, Circular Threaded, High Shock, High Density, Shipboard, Metal Conduit Bushing	

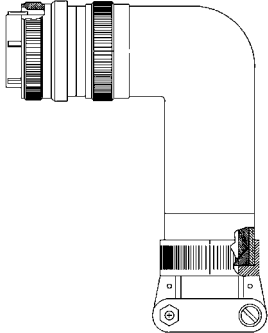
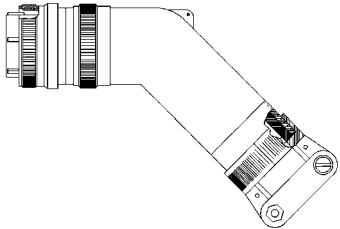
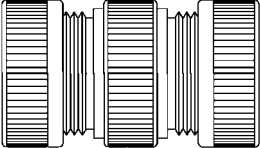
MIL-STD-1353C
APPENDIX D

TABLE D-X. MIL-DTL-28840 descriptions and configurations - Continued.

Specification number	Description	Configuration
MIL-DTL-28840/23	Connectors, Electrical, Circular Threaded, High Shock, High Density, Shipboard, Backshell, Gland Nut, Wiring, Electric Connector	
MIL-DTL-28840/24	Connectors, Electrical, Circular, Screw Threads, High Density, High Shock, Shipboard, Crimp Contacts Gasket, Flange Mounting	
MIL-DTL-28840/25	Connectors, Electrical, Circular Threaded, High Shock, High Density, Shipboard, Backshell, 90°, Metal Conduit for EMI Shielding	
MIL-DTL-28840/26	Connectors, Electrical, Circular, Screw Threads, High Density, High Shock, Shipboard, Crimp Contacts, Plug Assembly, Straight Classes DJ and DJS	
MIL-DTL-28840/27	Connectors, Electrical, Circular Threaded, High Shock, High Density, Shipboard, Backshell, 45°, Metal Conduit for EMI Shielding	

MIL-STD-1353C
APPENDIX D

TABLE D-X. MIL-DTL-28840 descriptions and configurations - Continued.

Specification number	Description	Configuration
MIL-DTL-28840/28	Connectors, Electrical, Circular, Screw Threads, High Density, High Shock, Shipboard, Crimp Contacts, Plug Assembly, 90°, Classes DJ and DJS	
MIL-DTL-28840/29	Connectors, Electrical, Circular, Screw Threads, High Density, High Shock, Shipboard, Crimp Contacts, Plug Assembly, 45°, Classes DJ and DJS	
MIL-DTL-28840/30	Connectors, Electrical, Circular, Threaded, High Density, High Shock, Shipboard, Metal Conduit Coupling	

MIL-STD-1353C
APPENDIX D

D.12 MIL-DTL-38999. MIL-DTL-38999 specification covers miniature, high density, quick disconnects, bayonet, threaded or breech coupling, circular, environment resistant, electrical connectors. These connects have removable crimp or fixed hermetic solder contacts, and are capable of continuous operation within a temperature range of -65°C to +200°C for electroless nickel finish and (-65°C to +175°C for cadmium finish. EMI shielding capabilities are included.

D.12.1 Series I. Crimp contacts, rear release. Solder contacts, hermetics only. Scoop proof. Contact sizes 12, 16, 20, and 22D. Coupling - bayonet coupling.

D.12.2 Series I Temperature ranges. Series I temperature ranges see table D-XI.

TABLE D-XI. MIL-DTL-38999 series I finishes and temperature ranges.

Finish	Temperature
Cadmium plate over a suitable underplate (conductive)	-65°C to +175°C
Carbon steel (conductive)	-65°C to +150°C
Nickel coating (conductive) Space applications only.	-65°C to +200°C

D.12.3 Series III Crimp contacts, rear release. Solder contacts, hermetics only, scoop proof. Contact sizes 12, 16, 20, and 22D. Coupling - threaded triple start, self locking.

D.12.4 Series III temperature ranges. Series III temperature ranges see table D-XII.

TABLE D-XII. MIL-DTL-38999 series III finishes and temperature ranges.

Finish	Temperature
Cadmium plate over a suitable underplate (conductive)	-65°C to +175°C
Corrosion resistant steel passivated (conductive)	-65°C to +200°C
Carbon steel (conductive)	-65°C to +150°C
Electroless nickel coating (conductive) Space applications only.	-65°C to +200°C

D.12.5 Series IV contacts. Crimp contacts, rear released, solder contacts, hermetics only. Scoop proof. Contact sizes 12, 16, 20, and 22D. Coupling - Self-locking breech coupling.

D.12.6 Series IV temperature ranges. Series IV temperature ranges see table D-XIII.

TABLE D-XIII. MIL-DTL-38999 series III finishes and temperature ranges series XIII.

Finish	Temperature
Cadmium plate over a suitable underplate (conductive)	-65°C to +175°C
Corrosion resistant steel passivated (conductive)	-65°C to +200°C
Electroless nickel coating (conductive) Space applications only.	-65°C to +200°C

D.12.7 Insert arrangements. Insert arrangements for MIL-DTL-38999 reference MIL-STD-1560.

MIL-STD-1353C
APPENDIX D

D.12.8 MIL-DTL-38999 circular, miniature, high density. MIL-DTL-38999 circular, miniature, high density, quick disconnect (bayonet, threaded, and breech coupling), environment resistant, removable crimp and hermetic solder contacts, see table D-XIV.

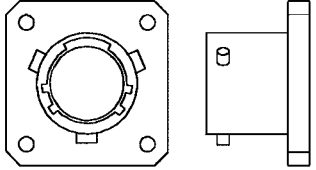
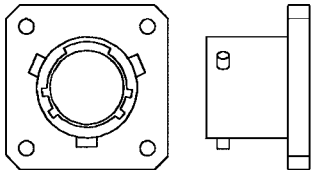
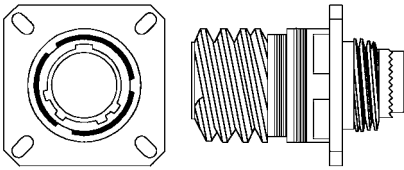
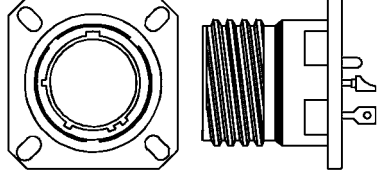
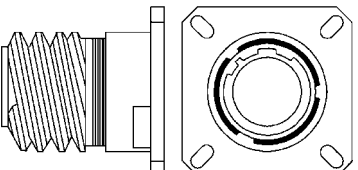
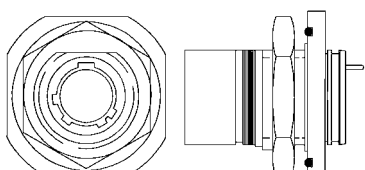
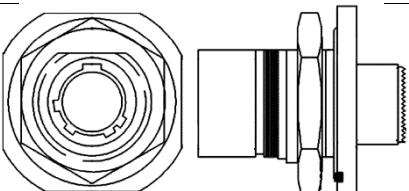
NOTE: MIL-DTL-38999, Series II, while still active DoD does not want them in new designs or new projects.

TABLE D-XIV. MIL-DTL-38999 descriptions and configurations.

Specification number	Description
MIL-DTL-38999	Connectors, Electrical, Circular, Miniature, High Density, Quick Disconnect (Bayonet, Threaded, and Breech Coupling), Environment Resistant, Removable Crimp and Hermetic Solder Contacts, General Specification for
Series I	Coupling method: Bayonet Keying position: Blank (normal), A, B, C, D Alternate keying method: Rotation of master key - Minor keys remain stationary EMI/RFI grounding: EMI/RFI Grounding fingers may not be available on all models
Series II	Coupling method: Bayonet Keying position: Blank (normal), A, B, C, D Alternate keying method: Master key rotates - Minor keys remain stationary EMI/RFI grounding: EMI/RFI grounding fingers may not be available on all models
Series III	Coupling method: Threaded, triple start self-locking Keying position: N (normal), A, B, C, D Alternate keying method: Master key remains stationary - Minor keys rotate independently EMI/RFI GROUNDING: EMI/RFI grounding fingers may not be available on all models

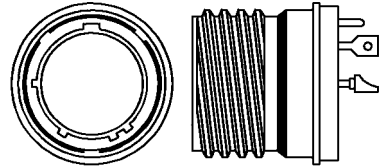
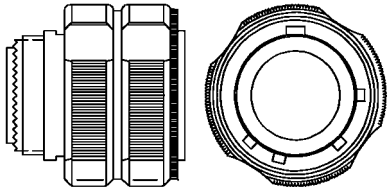
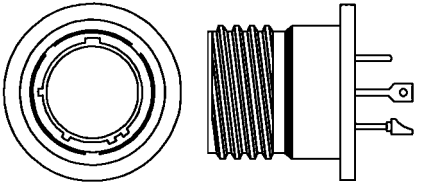
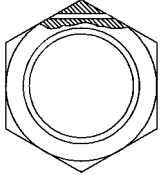
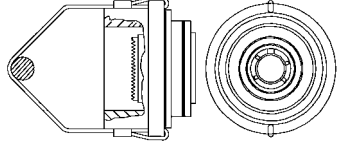
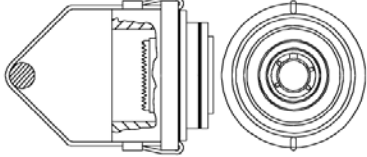
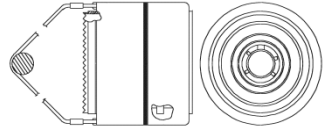
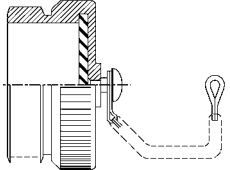
MIL-STD-1353C
APPENDIX D

TABLE D-XIV. MIL-DTL-38999 descriptions and configurations - Continued.

Specification number	Description	Configuration
MIL-DTL-38999/9	Connectors, Electrical, Circular, Receptacle, Dummy Stowage, Bayonet Coupling, (MIL-DTL-27599 Series I and MIL-DTL-38999 Series I)	
MIL-DTL-38999/10	Connectors, Electrical, Circular, Receptacle, Dummy Stowage, Bayonet Coupling, (MIL-DTL-27599, Series II and MIL-DTL-38999, Series II)	
MIL-DTL-38999/20	Connectors, Electrical, Circular, Receptacle, Threaded, Wall Mounting Flange, Removable Crimp Contacts, Series III, Metric	
MIL-DTL-38999/21	Connectors, Electrical, Circular, Threaded, Receptacle, Box Mounting Flange, Hermetic, Hermetic Solder Contacts, Series III, Metric	
MIL-DTL-38999/22	Connectors, Electrical, Circular, Receptacle, Threaded, Dummy Stowage, Series III, Metric	
MIL-DTL-38999/23	Connectors, Electrical, Circular, Threaded, Receptacle, Jam-Nut Mounting, Hermetic, Hermetic Solder Contacts, Series III, Metric	
MIL-DTL-38999/24	Connectors, Electrical, Circular, Receptacle, Threaded, Jam-Nut Mounting, Removable Crimp Contacts, Series III, Metric	

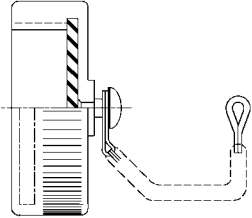
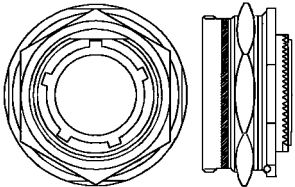
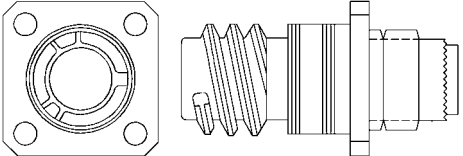
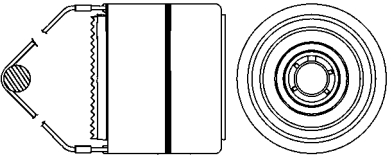
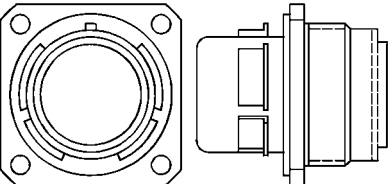
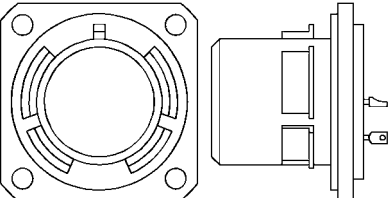
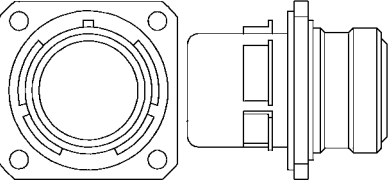
MIL-STD-1353C
APPENDIX D

TABLE D-XIV. MIL-DTL-38999 descriptions and configurations - Continued.

Specification number	Description	Configuration
MIL-DTL-38999/25	Connector, Electrical, Circular, Threaded, Receptacle, Solder Mounting, Hermetic, Hermetic Solder Contacts, Series III, Metric	
MIL-DTL-38999/26	Connectors, Electrical, Plug, Circular, Threaded, Straight, Removable Crimp Contacts, Series III, Metric	
MIL-DTL-38999/27	Connectors, Electrical, Circular, Threaded, Receptacle, Weld Mounting, Hermetic, Hermetic Solder Contacts, Series III, Metric	
MIL-DTL-38999/28	Connectors, Electrical, Circular, Nut, Hexagon, Connector Mounting, Series III and IV, Metric	
MIL-DTL-38999/29	Connectors, Electrical, Circular, Threaded, Plug, Lanyard Release, Fail-Safe, Removable Crimp Contacts, Pins, Series III, Metric	
MIL-DTL-38999/30	Connectors, Electrical, Circular, Threaded, Plug, Lanyard Release, Fail-Safe, Removable Crimp Contacts, Sockets, Series Iii, Metric	
MIL-DTL-38999/31	Connectors, Electrical, Circular, Threaded Plug, Lanyard Release, Fail-Safe Removable Crimp Contacts, Pins, Shell Size 25, Series Iii, Metric	
MIL-DTL-38999/32	Connector, Electrical Circular, Cover, Protective, Plug, Series III, Metric	

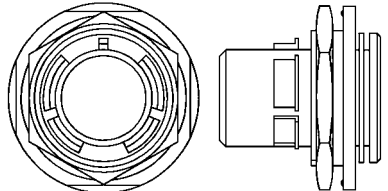
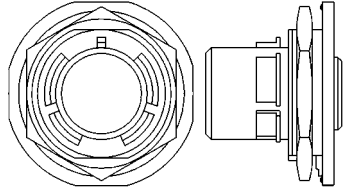
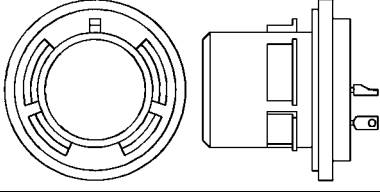
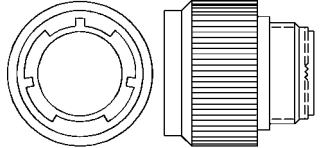
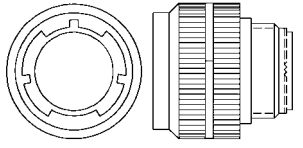
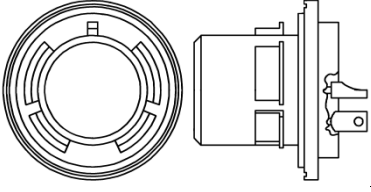
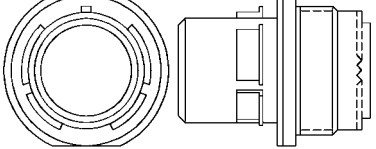
MIL-STD-1353C
APPENDIX D

TABLE D-XIV. MIL-DTL-38999 descriptions and configurations - Continued.

Specification number	Description	Configuration
MIL-DTL-38999/33	Connector, Electrical Circular, Cover, Protective, Receptacle, Series III, Metric	
MIL-DTL-38999/34	Connectors, Receptacle, Electrical, Circular, Breakaway, Jamnut Mounting, Removable Crimp Contacts, Sockets, Series III, Shell Size 25, Metric	
MIL-DTL-38999/35	Connectors, Receptacle, Electrical, Circular, Breakaway, Wall Mounting Flange, Removable Crimp Contacts, Sockets, Series III, Shell Size 25, Metric	
MIL-DTL-38999/36	Connectors, Electrical, Circular, Threaded, Plug, Lanyard Release, Fail-Safe, Removable Crimp Contacts, Pins, Shell Size 25, Series III, Metric	
MIL-DTL-38999/40	Connectors, Electrical, Circular, Receptacle, Wall Mounting Flange, Breech Coupling, Removable Crimp Contacts, Series IV, Metric	
MIL-DTL-38999/41	Connectors, Electrical, Circular, Receptacle, Box Mounting Flange, Hermetic, Breech Coupling, Hermetic Solder Contacts, Series IV, Metric	
MIL-DTL-38999/42	Connectors, Electrical, Circular, Receptacle, Box Mounting Flange, Breech Coupling, Removable Crimp Contacts, Series IV, Metric	

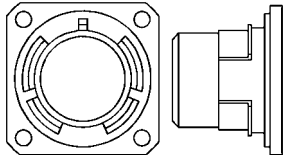
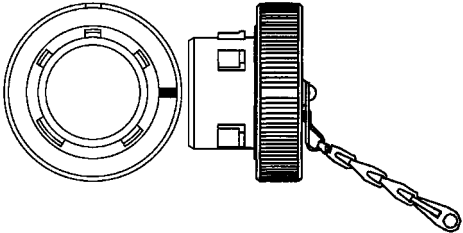
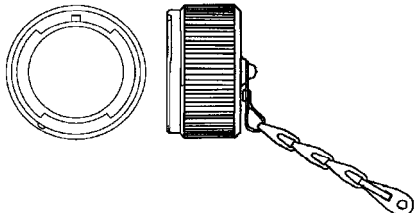
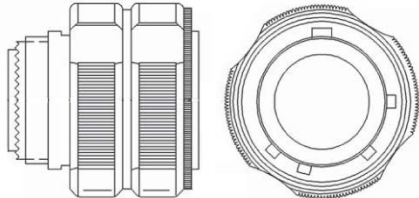
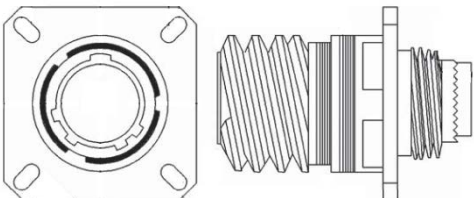
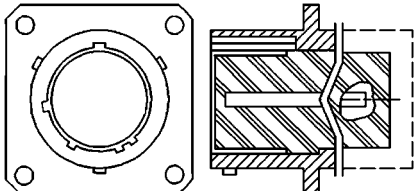
MIL-STD-1353C
APPENDIX D

TABLE D-XIV. MIL-DTL-38999 descriptions and configurations - Continued.

Specification number	Description	Configuration
MIL-DTL-38999/43	Connectors, Electrical, Circular, Receptacle, Jam Nut Mounting, Hermetic, Breech Coupling, Hermetic Solder Contacts, Series IV, Metric	
MIL-DTL-38999/44	Connectors, Electrical, Circular, Receptacle, Jam-Nut Mounting, Breech Coupling, Removable Crimp Contacts, Series IV, Metric	
MIL-DTL-38999/45	Connectors, Electrical, Circular, Receptacle, Solder Mounting, Hermetic, Breech Coupling, Hermetic Solder Contacts, Series IV, Metric	
MIL-DTL-38999/46	Connectors, Electrical, Circular, Plug, Breech Coupling, EMI Grounding, Removable Crimp Contacts, Series IV, Metric	
MIL-DTL-38999/47	Connectors, Electrical, Circular, Plug, Breech Coupling, Removable Crimp Contacts, Series IV, Metric	
MIL-DTL-38999/48	Connectors, Electrical, Circular, Receptacle, Weld Mounting, Hermetic, Breech Coupling, Hermetic Solder Contacts, Series IV, Metric	
MIL-DTL-38999/49	Connectors, Electrical, Circular, Receptacle, In Line Cable, Breech Coupling, Removable Crimp Contacts, Series IV, Metric	

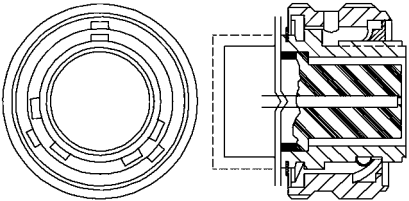
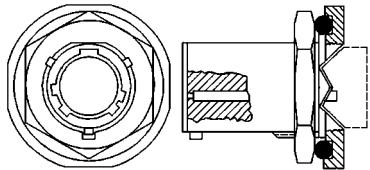
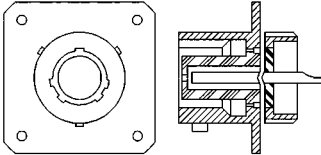
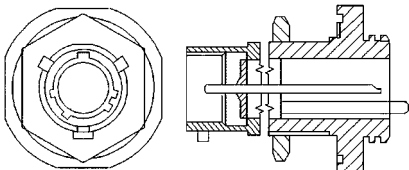
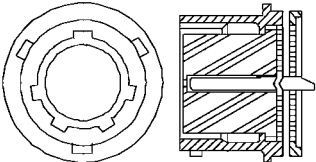
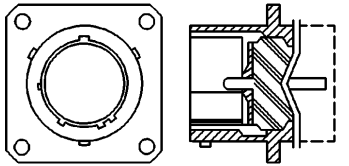
MIL-STD-1353C
APPENDIX D

ABLE D-XIV. MIL-DTL-38999 descriptions and configurations - Continued.

Specification number	Description	Configuration
MIL-DTL-38999/50	Connectors, Electrical, Circular, Receptacle, Dummy Stowage, Breech Coupling, Series IV, Metric	
MIL-DTL-38999/51	Connector, Electrical Circular, Cover, Protective, Plug, MIL-DTL-38999 Series IV	
MIL-DTL-38999/52	Connectors, Electrical, Circular, Cover, Protective, Receptacle, MIL-DTL-38999 Series IV	
MIL-DTL-38999/60	Connectors, Electrical, Plug, Circular, Threaded, Straight, Removable Crimp Contacts, Fiber Optic Termini, Tight Tolerance, Series III, Shell Size 25, Metric	
MIL-DTL-38999/61	Connectors, Electrical, Circular, Receptacle, Threaded, Wall Mounting Flange, Removable Crimp Contacts, Fiber Optic Termini, Tight Tolerance, Series III, Shell Size 25, Metric	
MS27466	Connectors, Receptacle, Electrical, Wall Mounting Flange, Crimp Type, Bayonet Coupling, Series I	

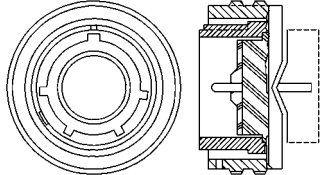
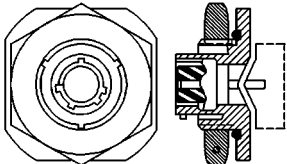
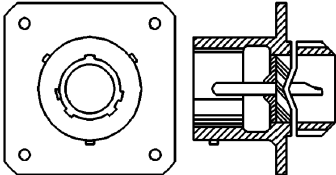
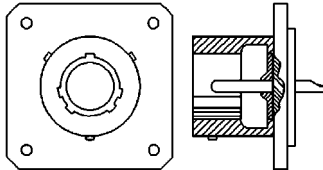
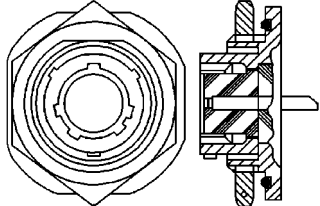
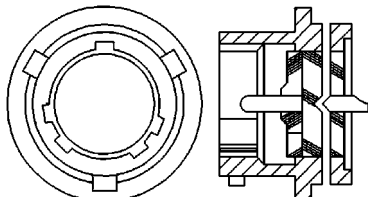
MIL-STD-1353C
APPENDIX D

TABLE D-XIV. MIL-DTL-38999 descriptions and configurations - Continued.

Specification number	Description	Configuration
MS27467	Connectors, Plug, Electrical, Straight, Crimp Type, Bayonet Coupling, Series I	
MS27468	Connector, Receptacle, Electrical Jam Nut Mounting, Crimp Type, Bayonet Coupling, Series I	
MS27469	Connectors, Receptacle, Electrical, Wall Mounting Flange, Solder Type, Hermetic Seal, Series I	
MS27470	Connectors, Receptacle, Electrical, Jam Nut Mounting, Solder Type, Hermetic Seal, Series I	
MS27471	Connectors, Receptacle, Electrical, Solder Mounting, Solder Type, Hermetic Seal, Series I	
MS27472	Connectors, Receptacle, Electrical, Wall Mounting Flange, Crimp Type, Bayonet Coupling, Series II	

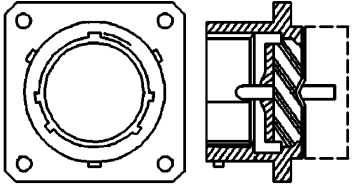
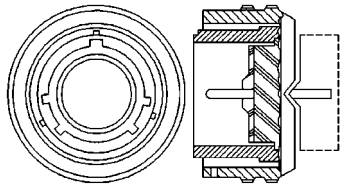
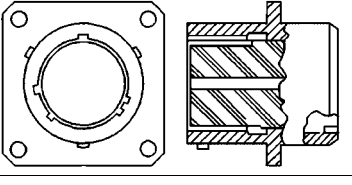
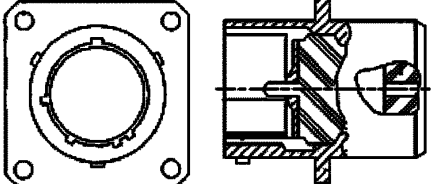
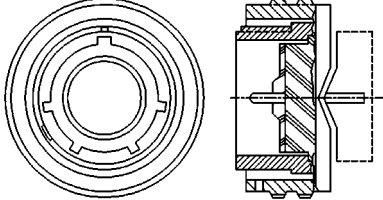
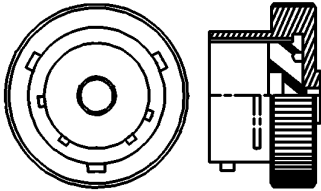
MIL-STD-1353C
APPENDIX D

TABLE D-XIV. MIL-DTL-38999 descriptions and configurations - Continued.

Specification number	Description	Configuration
MS27473	Connectors, Plug, Electrical, Straight, Crimp Type, Bayonet Coupling, Series II	
MS27474	Connectors, Receptacle, Electrical, Jam Nut Mounting, Crimp Type, Bayonet Coupling, Series II	
MS27475	Connectors, Receptacle, Electrical, Wall Mounting, Flange Solder Type, Hermetic Seal, Series II	
MS27476	Connector, Receptacle, Electrical, Box Mounting, Solder Type, Hermetic Seal, Series II	
MS27477	Connectors, Receptacle, Electrical, Jam Nut Mounting, Solder Type, Hermetic Seal, Series II	
MS27478	Connectors, Receptacle, Electrical, Solder Mounting, Solder Type, Hermetic Seal, Series II	

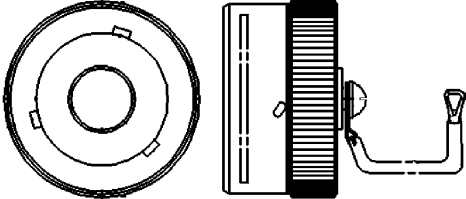
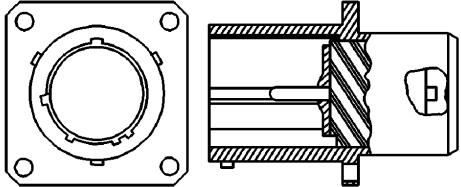
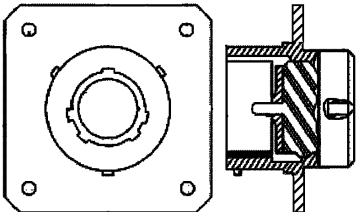
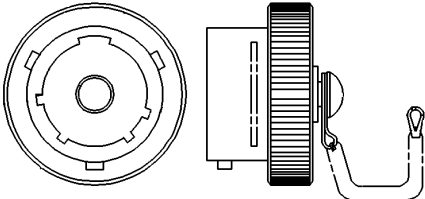
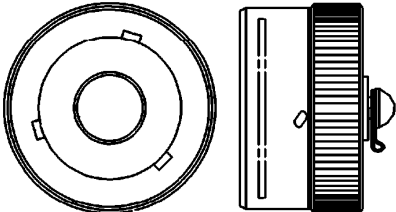
MIL-STD-1353C
APPENDIX D

TABLE D-XIV. MIL-DTL-38999 descriptions and configurations - Continued.

Specification number	Description	Configuration
MS27479	Connector, Receptacle, Electrical, Wall Mounting Flange, Crimp Type, Bayonet Coupling, Series II	
MS27480	Connectors, Plug, Electrical, Straight, Crimp Type, Bayonet Coupling, Series II	
MS27496	Connectors, Receptacle, Electrical, Box Mounting, Crimp Type, Bayonet Coupling, Series I	
MS27499	Connectors, Receptacle, Electrical, Box Mounting Flange, Crimp Type, Bayonet Coupling, Series II	
MS27500	Connectors, Plug, Electrical, 90° Elbow, Crimp Type, Bayonet Coupling, Series II	
MS27501	Connectors, Electrical, Circular, Cover, Protective, Plug, Bayonet Coupling, Series I	

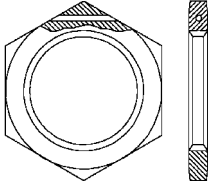
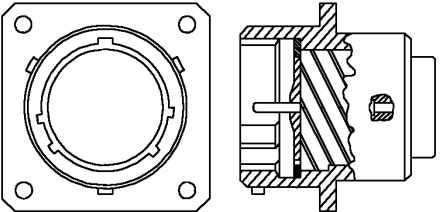
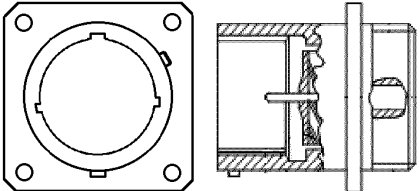
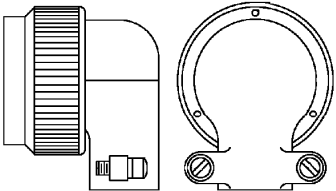
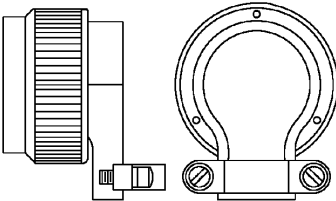
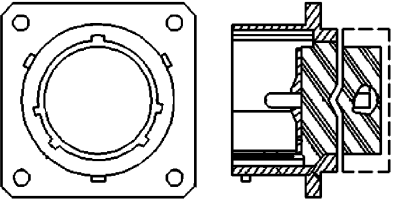
MIL-STD-1353C
APPENDIX D

TABLE D-XIV. MIL-DTL-38999 descriptions and configurations - Continued.

Specification number	Description	Configuration
MS27502	Connectors, Electrical, Circular, Cover, Protective, Receptacle, Bayonet Coupling, Series I	
MS27505	Connectors, Receptacle, Electrical, Back Panel, Box Mounting Flange, Crimp Type, Bayonet Coupling, Series I	
MS27508	Connectors, Receptacle, Electrical, Back Panel, Box Mounting Flange, Crimp Type, Bayonet Coupling, Series II	
MS27510	Covers, Protective, Electrical, Connector Plug, Bayonet Coupling, Series II	
MS27511	Covers, Protective, Electrical, Connector Receptacle, Plug, Bayonet Coupling, Series II	

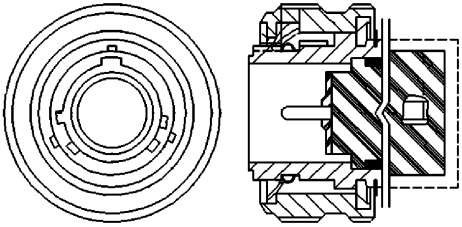
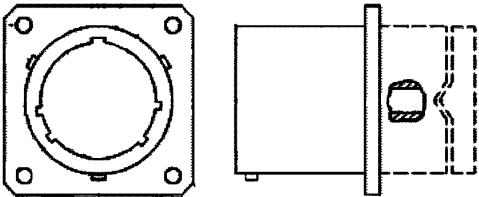
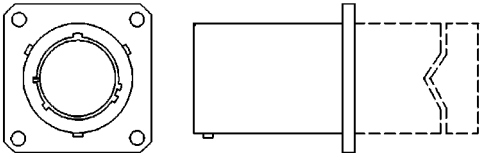
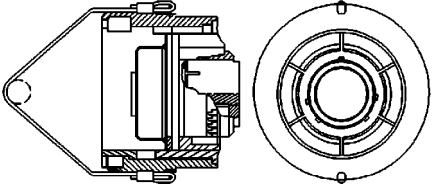
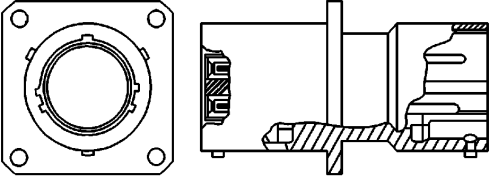
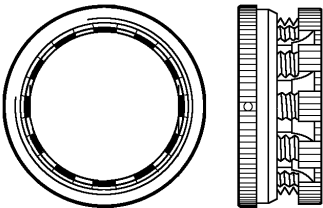
MIL-STD-1353C
APPENDIX D

TABLE D-XIV. MIL-DTL-38999 descriptions and configurations - Continued.

Specification number	Description	Configuration
MS27512	Connectors, Electrical, Circular, Nut, Hexagon, Connector Mounting, Series II (Inactive for new design, use MS3186)	
MS27513	Connectors, Receptacle, Electrical, Box Mounting, Flange, Crimp Type, Bayonet Coupling, Series II	
MS27515	Connectors, Receptacle, Electrical, Crimp Type, Back Panel, Wall Mounting Flange, Series I (Inactive for new design after 7 July 1971. For new design, use MS27656)	
MS27558	Support, Cable, Right Angle, Closed	
MS27559	Support, Cable, Right Angle	
MS27652	Connectors, Receptacle, Electrical, Wall Mounting Flange, Crimp Type, Bayonet Coupling, Series I (Inactive for New Design use MS27466)	

MIL-STD-1353C
APPENDIX D

TABLE D-XIV. MIL-DTL-38999 descriptions and configurations - Continued..

Specification number	Description	Configuration
MS27653	Connectors, Plug, Electrical, Straight, Crimp Type, Bayonet Coupling, Series I (In active for New Design Use MS27467)	
MS27654	Connectors, Receptacle, Electrical, Back Panel, Wall Mounting Flange, Crimp Type, Bayonet Coupling, Series I (For New Design Use MS27656)	
MS27656	Connectors, Receptacle, Electrical, Back Panel, Wall Mounting Flange, Crimp Type, Bayonet Coupling, Series I	
MS27661	Connectors, Plug, Electrical, Crimp Type, Lanyard Release, Fail-Safe, Series I	
MS27662	Connectors, Receptacle, Electrical, Thru-Bulkhead Mounting, Bayonet Coupling, Series I	
MS27741	Connector, Electrical, Individual Shield Termination	

MIL-STD-1353C
APPENDIX D

D.13 MIL-C-81511. MIL-DTL-81511 Connectors are circular, high density, quick disconnect, environment resisting, see table D-XV.

NOTE: The entire series is inactive for new design.

D.13.1 MIL-C-81511 series. MIL-C-81511 series are specified as follows:


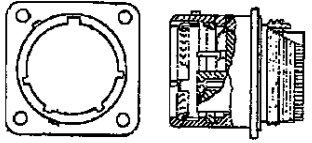
- Series 1: Long shell (shell size 8 through 24). Scoop-proof when pins are installed in either plug or receptacle. Plugs contain grounding spring members. Gang contact release system.
- Series 2: Lightweight short shell (shell size 8 through 18). Scoop-proof when pins are installed in the receptacle, not scoop-proof when pins are installed in the plug. Receptacles contain grounding spring members. Gang contact release system.
- Series 3: Long shell (shell size 8 through 24). Scoop-proof when pins are installed in either plug or receptacle. Plug contains the grounding spring members. Individual contact release system.
- Series 4: Lightweight, short shell (shell size 8 through 18). Scoop-proof when pins are installed in the receptacle, not scoop-proof when pins are installed in the plug. Receptacles contain grounding spring members. Individual contact release system.

D.13.2 Intermatability. MIL-C-81511 intermatability is as follows:

Series 1 is intermateable with series 3

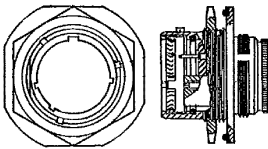
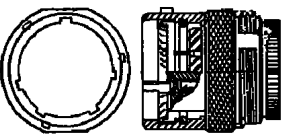
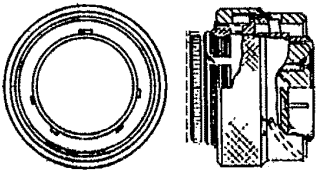
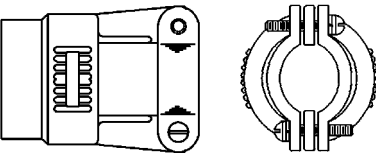
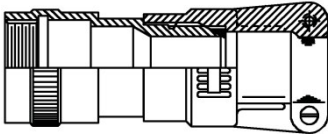

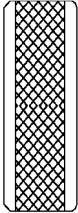
Series 2 is intermateable with series 4.

TABLE D-XV. MIL-C-81511 descriptions and configurations.

Specification number	Description	Configuration
MIL-C-81511	Connectors, Electrical, Circular, High Density, Quick Disconnect, Environment Resisting; and Accessories, General Specification For	
MIL-C-81511/1	Connectors, Electrical, Circular, High Density, Quick Disconnect, Environment Resisting; and Accessories: Receptacle, Flange Mount, Crimp-Type Contacts, Class A, F and E (Series 2)	

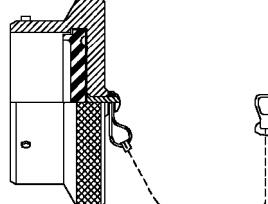
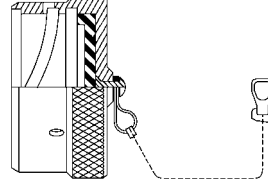
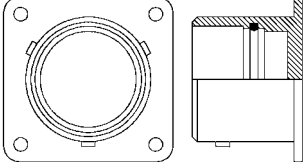
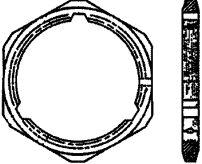
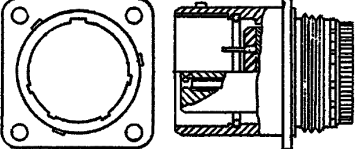
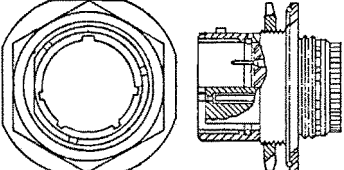
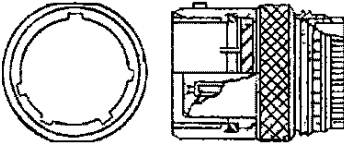
MIL-STD-1353C
APPENDIX D

TABLE D-XV. MIL-C-81511 descriptions and configurations - Continued.

Specification number	Description	Configuration
MIL-C-81511/3	Connectors, Electrical, Circular, High Density, Quick Disconnect, Environment Resisting; And Accessories: Receptacle, Jam Nut Mount, Crimp-Type Contacts, Class A, F and E (Series 2)	
MIL-C-81511/5	Connectors, Electrical, Circular, High Density, Quick Disconnect, Environment Resisting; And Accessories: Receptacle, Cable Connecting, Crimp-Type Contacts, Class A, F and E (Series 2)	
MIL-C-81511/6	Connectors, Electrical, Circular, High Density, Quick Disconnect, Environment Resisting; And Accessories: Plug, Crimp-Type Contacts, Class A, F and E (Series 2)	
MIL-C-81511/13	Connectors, Electrical, Circular, High Density, Quick Disconnect, Environment Resisting; And Accessories: F Adapter, Rotatable, Type I (Series 1 Or 2)	
MIL-C-81511/14	Connectors, Electrical, Circular, High Density, Quick Disconnect, Environment Resisting; and Accessories: Adapter, Straight	
MIL-C-81511/15	Connectors, Electrical, Circular, High Density, Quick Disconnect, Environment Resisting; and Accessories: Plug, Sealing Contact (Series 1 Or 2)	
MIL-C-81511/16	Connectors, Electrical, Circular, High Density, Quick Disconnect, Environment Resisting and Accessories: Cap, Protective Locking	

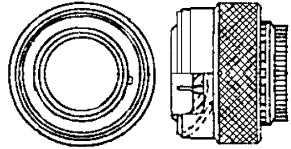
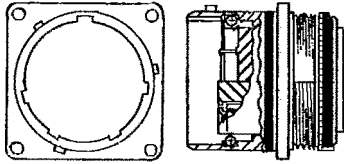
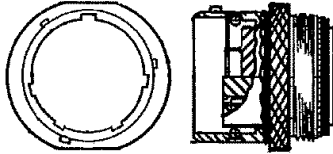
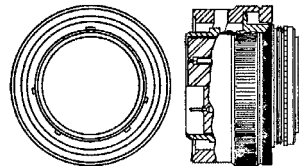
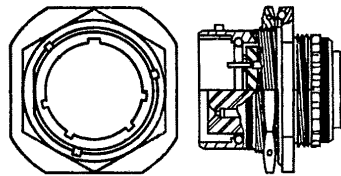
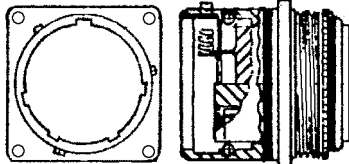
MIL-STD-1353C
APPENDIX D

TABLE D-XV. MIL-C-81511 descriptions and configurations - Continued.

Specification number	Description	Configuration
MIL-C-81511/17	Connectors, Electrical, Circular, High Density, Quick Disconnect, Environment Resisting; and Accessories: Cover, Protective, Plug (Series 2)	
MIL-C-81511/18	Connectors, Electrical, Circular, High Density, Quick Disconnect, Environment Resisting; and Accessories: Cover, Protective, Receptacle (Series 1 or 2)	
MIL-C-81511/19	Connectors, Electrical, Circular, High Density, Quick Disconnect, Environment Resisting; and Accessories: Receptacle, Dummy Stowage, For Series 2 Connectors	
MIL-C-81511/20	Connectors, Electrical, Circular, High Density, Quick Disconnect, Environment Resisting; and Accessories: Nut, Slotted Hexagon, Connector Mounting, For Series 1 And 2 Connectors	
MIL-C-81511/21	Connectors, Electrical, Circular, High Density, Quick Disconnect, Environment Resisting; and Accessories: Receptacle, Flange Mount, Crimp-Type Contacts Class A, F and E (Series 1)	
MIL-C-81511/23	Connectors, Electrical, Circular, High Density, Quick Disconnect, Environment Resisting; and Accessories: Receptacle, Jam Nut Mount, Crimp-Type Contacts Class A, F and E (Series 1)	
MIL-C-81511/25	Connectors, Electrical, Circular, High Density, Quick Disconnect, Environment Resisting; and Accessories: Receptacle, Cable Connecting, Crimp-Type Contacts Class A, F and E (Series 1)	

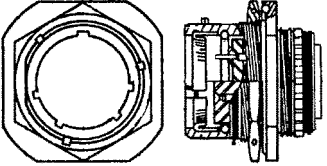
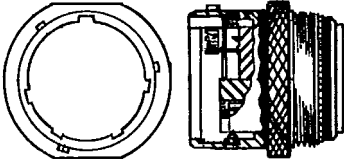
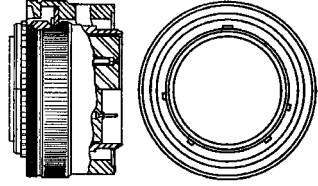
MIL-STD-1353C
APPENDIX D

TABLE D-XV. MIL-C-81511 descriptions and configurations - Continued.

Specification number	Description	Configuration
MIL-C-81511/26	Connectors, Electrical, Circular, High Density, Quick Disconnect, Environment Resisting; and Accessories: Plug, Crimp-Type Contacts, Class A, F and E (Series 1)	
MIL-C-81511/41	Connectors, Electrical, Circular, High Density, Quick Disconnect, Environment Resisting: Receptacle, Flange Mount, Individual Release, Crimp-Type Contacts, Class A, F and W (Series 3)	
MIL-C-81511/45	Connectors, Electrical, Circular, High Density, Quick Disconnect, Environment Resisting: Receptacle, Cable Connecting, Individual Release, Crimp-Type Contacts, Class A, F and W (Series 3)	
MIL-C-81511/46	Connectors, Electrical, Circular, High Density, Quick Disconnect, Environment Resisting: Plug, Individual, Release, Crimp-Type Contacts, Class A, F and W (Series 3)	
MIL-C-81511/49	Connectors, Electrical, Circular, High Density, Quick Disconnect, Environment Resisting: Receptacle, Jam Nut Mount, Individual Release, Crimp Type Contacts, Class A, F and W (Series 3)	
MIL-C-81511/51	Connectors, Electrical, Circular, High Density, Quick Disconnect, Environment Resisting: Receptacle, Flange Mount, Individual Release, Crimp-Type Contacts Class A, F and W (Series 4)	

MIL-STD-1353C
APPENDIX D

TABLE D-XV. MIL-C-81511 descriptions and configurations - Continued.

Specification number	Description	Configuration
MIL-C-81511/53	Connectors, Electrical, Circular, High Density, Quick Disconnect, Environment Resisting: Receptacle, Jam Nut Mount, Individual Release, Crimp-Type Contacts, Class A, F and W (Series 4)	
MIL-C-81511/55	Connectors, Electrical, Circular, High Density, Quick Disconnect, Environment Resisting: Receptacle, Cable Connecting, Individual Release, Crimp-Type Contacts, Class A, F and W (Series 4)	
MIL-C-81511/56	Connectors, Electrical, Circular, High Density, Quick Disconnect, Environment Resisting: Plug, Individual Release, Crimp-Type Contacts, Class A, F and W (Series 4)	

MIL-STD-1353C
APPENDIX D

D.14 MIL-DTL-83538. MIL-DTL-83538 connectors are intended for use with launcher mechanisms using a "blind mating" mechanism.

D14.1 Electrical umbilical assembly. Electrical umbilical assembly consists of three parts, see figure D1.

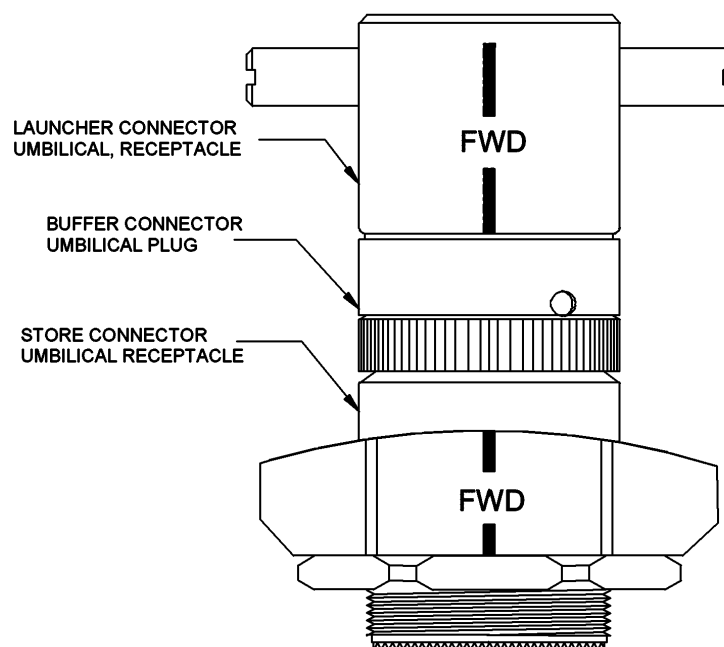


FIGURE D-1. Electrical umbilical assembly.

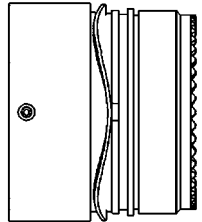
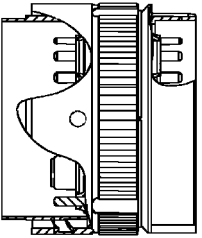
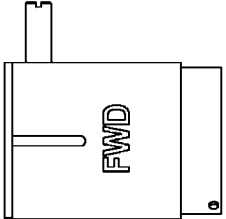
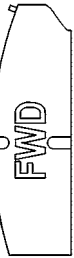
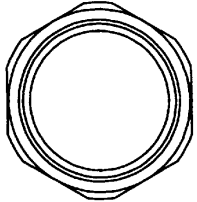
D.14.2 Characteristics. The connector assembly provides the necessary connections required to meet MIL-STD-1760, class I electrical interface between stores and their associated launchers using a "blind mating" mechanism. The connector assembly consists of a receptacle installed on the launcher, a receptacle installed on the store, and a buffer plug installed between the two receptacles. This specification also includes the required mounting adapters and nut, accessory adapter, cable bushing, and protective covers. The connectors covered by this specification are intended for use with launcher mechanisms with an applied holding force in the range 271 Newtons (61 lbs) to 427 Newton (96 lbs).

D.14.3 Intended use. This connector is designated the MIL-STD-1760, type II connector. This connector assembly will be used to provide the transfer of MIL-STD-1760 interface class I electrical signals and power between an aircraft (or ground vehicle) mounted launcher and an associated store. This connector is intended to be used on rail and eject launchers where engagement/disengagement of the launcher receptacle (with attached buffer plug) to the store receptacle will be via a blindmate mechanical mechanism. The signal and power transfer may occur at various phases of all store operations from store upload through store launch.

D14.4 MIL-DTL-83538 dimensions and configurations. MIL-DTL-83538 dimensions and configurations see [table D-XVI](#).

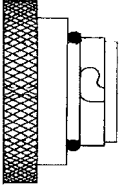
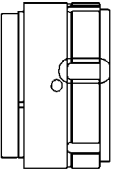
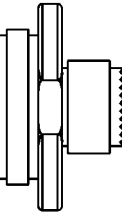
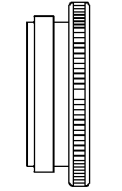
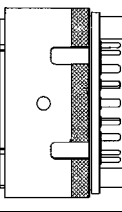
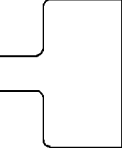

MIL-STD-1353C
APPENDIX D

TABLE D-XVI. MIL-C-83538 descriptions and configurations.

Specification number	Description	Configuration
MIL-DTL-83538	Connectors and Accessories, Electrical, Circular, Umbilical, Environment Resistant, Removable Crimp Contacts For MIL-STD-1760 Applications (Metric), General Specification For	
MIL-DTL-83538/1	Connectors and Accessories, Electrical, Circular, Umbilical, Receptacle, Store Assembly, Removable Crimp Contacts, Sockets, For MIL-STD-1760 Applications (Metric)	
MIL-DTL-83538/3	Connectors and Accessories, Electrical, Circular, Umbilical, Adapter, Buffer Plug, Nonremovable Pin Contacts, For MIL-STD-1760 Applications (Metric)	
MIL-DTL-83538/4	Connectors and Accessories, Electrical, Circular, Umbilical, Receptacle, Launcher Assembly, Removable Crimp Contacts, Sockets For MIL-STD-1760 Applications (Metric)	
MIL-DTL-83538/5	Connectors and Accessories, Electrical, Circular, Umbilical, Bracket, Store Receptacle Adapter For MIL-STD-1760 Applications (Metric)	
MIL-DTL-83538/6	Connectors and Accessories, Electrical, Circular, Umbilical, Nut, Hexagon, Store Receptacle Connector Mounting, For MIL-STD-1760 Applications (Metric)	

MIL-STD-1353C
APPENDIX D

TABLE D-XVI. MIL-C-83538 descriptions and configurations - Continued.

Specification number	Description	Configuration
MIL-DTL-83538/7	Connectors and Accessories, Electrical, Circular, Umbilical, Cover, Protective, Store Receptacle For MIL-STD-1760 Applications (Metric)	
MIL-DTL-83538/8	Connectors and Accessories, Electrical, Circular, Umbilical, Cover, Protective, Launcher Receptacle, For MIL-STD-1760 Applications (Metric)	
MIL-DTL-83538/9	Connectors and Accessories, Electrical, Circular, Umbilical, Adapter, Accessory, Launcher Receptacle For MIL-STD-1760 Applications (Metric)	
MIL-DTL-83538/10	Connectors and Accessories, Electrical, Circular, Umbilical, Bushing, Cable, Launcher Receptacle For MIL-STD-1760 Applications (Metric)	
MIL-DTL-83538/11	Connectors and Accessories, Electrical, Circular, Umbilical, Adapter, Buffer Plug, Non-Removable Pin Contacts, For MIL-STD-1760 Applications (Metric)	
MIL-DTL-83538/12	Connectors and Accessories, Electrical, Circular, Umbilical, Protective Cap, Installation And Removal Tool, For MIL-STD-1760 Applications (Metric)	
MIL-DTL-83538/13	Connectors and Accessories, Electrical, Circular, Umbilical, Test Plug, Removable Crimp Contacts, Pins, For MIL-STD-1760 Applications (Metric)	

MIL-STD-1353C
APPENDIX D

D.15 MIL-DTL-83723. MIL-DTL-83723 connectors are environment resisting, circular, electrical connectors and their associated contacts (crimp or solder (class H only)) and accessories.

D.15.1 Series III. Crimp contacts, rear release solder contacts - hermetics only. Contact sizes 12, 16, and 20. Coupling - Threaded bayonet.

D15.2 Intended use (all classes). These connectors utilize crimp or solder contacts.

- a. Connector backshells shall be installed to meet the specified moisture sealing requirements.
- b. Class G connectors are stainless steel connectors intended for use in environment resisting applications that require a peripheral shield, 200°C service temperature, and fluid resistance.
- c. Class R connectors are intended for use in environment resisting applications at 200°C service temperature. They have conductive finish with fluid resistance requirements.
- d. Class H receptacles are intended for use in applications where pressures must be contained by the connectors across walls or panels on which they are mounted. They must have fluid resistance insert face seal. Class H receptacles are limited to 150°C service temperature.
- e. Class S connectors are intended for use in firewall applications where RFI protection is required. These connectors have self-locking coupling nuts, which eliminates the need for safety wiring and are rated at 200°C service temperature.
- f. Class A connectors are intended for use in applications where a conductive shell is not required. Class A connectors also provide excellent durability and resistance to salt spray.
- g. Class K connectors are intended for use in firewall applications where RFI protection is not required. Class K connectors are available with self-locking coupling nuts.
- h. Series II receptacles are to be used for maintenance replacement purposes only.
- i. Series II plugs are to be used for maintenance replacement purposes only.
- j. Mechanical strain reliefs are intended for use where a saddle type clamp is desired.
- k. Shrink strain reliefs are intended to provide wire support and vibration dampening when used.
- l. To remove unwired contacts, contact contractors for specific tools and instructions.
- m. Class Y receptacles are intended for use in applications where pressures must be contained by the connectors across walls or panels on which they are mounted. They must have fluid resistance insert face seal. Class Y receptacles are rated at 200°C service temperature.
- n. Type T threaded are intermateable but not completely interchangeable with applicable MIL-C-26500 threaded connectors except for shell size 8. Type B bayonets are completely interchangeable with applicable MIL-C-26500 bayonet connectors.
- o. Class N connectors are for the same use as class S or Y except they have electrodeposited nickel finish.
- p. Class W connectors are intended for use in environment resisting applications at 175°C service temperature where extreme corrosion resistance requirements exist.

D.15.3 MIL-DTL-83723 temperature ranges. Temperature ranges see table D-XVII:

TABLE D-XVII. MIL-DTL-83723 class, finish and temperature range.

Class	Finish	Temperature
H	Tin/cold rolled steel *Hermetic)	-65°C to +150°C
K	Corrosion resistant steel passivated (Firewall)	-65°C to +200°C
R	Electroless nickel/aluminum (Space applications only)	-65°C to +200°C
S	Corrosion resistant steel passivated (Firewall plug and receptacle, RFI grounding self locking plug)	-65°C to +200°C
W	Cadmium over suitable underplate aluminum	-65°C to +175°C

MIL-STD-1353C
APPENDIX D

D.15.4 Insert arrangements. Insert arrangements shall conform to:

Series II - MIL-STD-1651.

Series III - MIL-STD-1554.

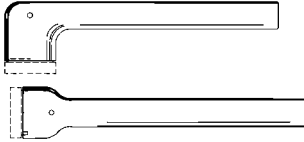
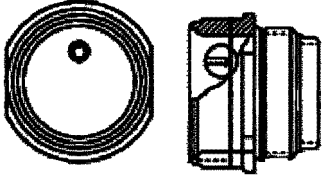
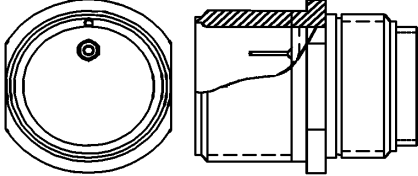
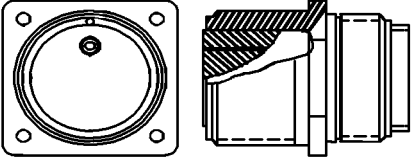
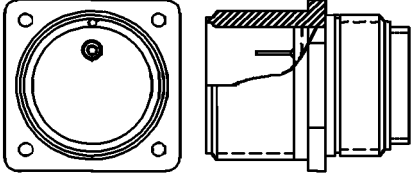
D.15.5 MIL-DTL-83723 dimensions and configurations. MIL-DTL-83723 dimensions and configurations see table D-XVIII.

TABLE D-XVIII. MIL-DTL-83723 descriptions and configurations.

Specification number	Description
Series I	Type B bayonet coupling. Transferred to MIL-C-26482 series II, as applicable, see MIL-DTL-83723 supersession data.
Series II - (Inactive for new design, use: MS3450, MS3451, MS3452, MS3456, and MS3459 of MIL-DTL-5015, as applicable.)	<p>Coupling method: Threaded: Type T threaded coupling, intermateable with MIL-DTL-5015.</p> <p>Keying position: N (normal), W, X, Y, Z</p> <p>Alternate keying method: Rotation of insert - Keys remain stationary</p> <p>EMI/RFI grounding: No</p>
Series III	<p>Coupling method: Bayonet or threaded: Type T threaded and type B bayonet coupling connectors, intermateable with applicable MIL-C-26500 connectors (see MIL-DTL-83723)</p> <p>Keying position: N (normal), 1, 2, 3, 4, 5, 6, 7, 8, 9, 10</p> <p>Alternate keying method: Insert Rotation In Postions1 Thru 5, Minor Key Rotation In Positions 6 Thru 10</p> <p>EMI/RFI grounding: EMI/RFI fingers may not available on all models</p> <p>Requirements for hermetic receptacles with nonremovable contacts are included.</p> <p>Hermetic receptacle must mate with the appropriate bayonet or threaded type connector and must meet the same temperature requirements.</p>

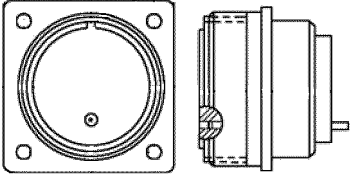
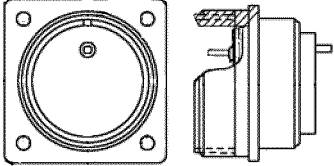
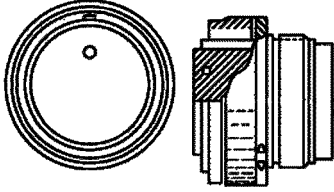
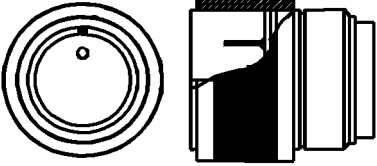
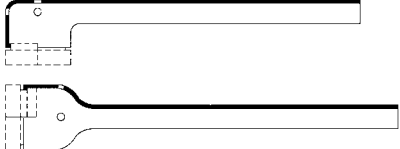
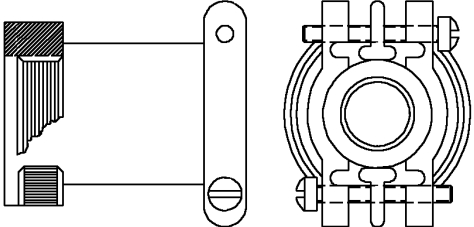
MIL-STD-1353C
APPENDIX D

TABLE D-XVIII. MIL-DTL-83723 descriptions and configurations - Continued.

Specification number	Description	Configuration
MIL-DTL-83723/16	Connector, Electrical, Backshell, with Heat Shrinkable Strain-Relief, Boot (Straight or Right Angle), Bayonet- Coupling Series I and III (Inactive for new design)	
MIL-DTL-83723/17	Connectors, Electrical, (Circular, Environment Resisting), Receptacle, (Cable Connecting, Threaded Coupling, Crimp Socket Contacts), (Series II, Classes A, G, and R) (Inactive for new design)	
MIL-DTL-83723/18	Connectors, Electrical, (Circular, Environment Resisting), Receptacle, (Cable Connecting, Threaded Coupling, Crimp Pin Contacts), (Series II, Classes A, G, and R) (Inactive for new design)	
MIL-DTL-83723/19	Connectors, Electrical, (Circular, Environment Resisting), Receptacle, (Wall Mount, Threaded Coupling, Crimp Socket Contacts), (Series II, Classes A, G, K, and R) (Inactive for new design)	
MIL-DTL-83723/20	Connectors, Electrical, (Circular, Environment Resisting), Receptacle, (Wall Mount, Threaded Coupling, Crimp Pin Contacts), (Series II, Classes A, G, K, and R) (Inactive for new design)	

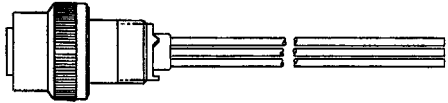
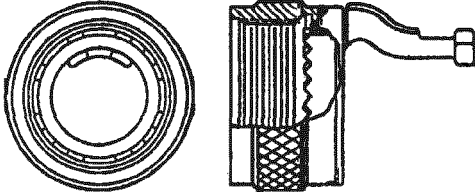
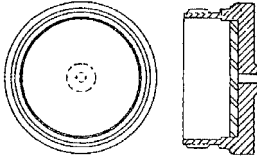
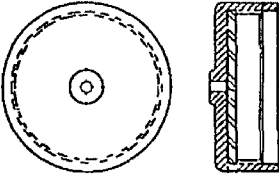
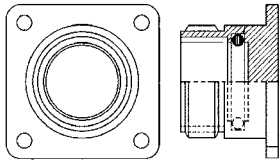
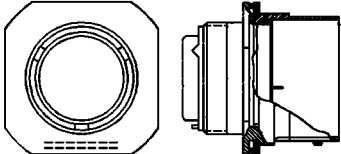
MIL-STD-1353C
APPENDIX D

TABLE D-XVIII. MIL-DTL-83723 descriptions and configurations - Continued.

Specification number	Description	Configuration
MIL-DTL-83723/21	Connectors, Electrical, (Circular, Environment Resisting), Receptacle, (Box Mount, Threaded Coupling, Crimp Socket Contacts), (Series II, Classes A, G, and R) (Inactive for new design)	
MIL-DTL-83723/22	Connectors, Electrical, (Circular, Environment Resisting), Receptacle, (Box Mount, Threaded Coupling, Crimp Pin Contacts), (Series II, Classes A, G, and R) (Inactive for new design)	
MIL-DTL-83723/23	Connectors, Electrical, (Circular, Environment Resisting), Plug, (Threaded Coupling, Crimp Socket, Contacts), (Series II, Classes A, G, K, and R) (Inactive for new design)	
MIL-DTL-83723/24	Connectors, Electrical, (Circular, Environment Resisting), Plug, (Threaded Coupling, Crimp Pin Contacts), (Series II, Classes A, G, K, and R) (Inactive for new design)	
MIL-DTL-83723/27	Connector, Electric, Backshell, with Heat-Shrinkable Strain-Relief Boot (Straight or Right Angle), Threaded-Coupling Series (Inactive for new design)	
MIL-DTL-83723/35	Connector, Electric, Backshell, Straight W/O Strain Relief, and with Mechanical Strain Relief, Straight or Right Angle Threaded Coupling Series II (Inactive for new design)	

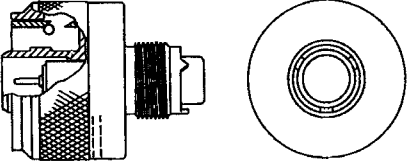
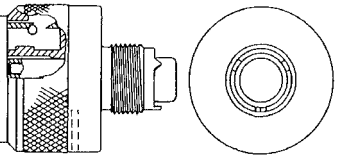
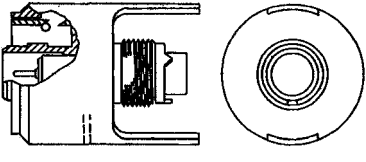
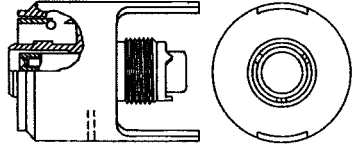
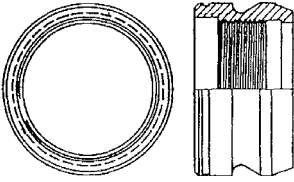
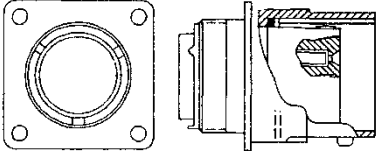
MIL-STD-1353C
APPENDIX D

TABLE D-XVIII. MIL-DTL-83723 descriptions and configurations - Continued.

Specification number	Description	Configuration
MIL-DTL-83723/37	Connectors, Electrical, (Circular, Environment Resisting), Plug, (Bayonet Coupling, Prewired, Socket Contact), (Series I, Classes A, G, and R(Shell Size 8 for Inserts 8-2, 8-3, and 8-4 Only) (Inactive for new design)	
MIL-DTL-83723/50	Connector, Electrical, Circular, Environment Resisting, Backshell, Straight, 90°, and 45° with Dielectric Strain Relief, for Series 2 Connectors (Inactive for new design)	
MIL-DTL-83723/59	Connectors, Electrical, (Circular, Environment Resisting), Protective Covers, Plug (for MIL-DTL-26500 and MIL-DTL-83723, Series III, Classes A, R, and W)	
MIL-DTL-83723/60	Connectors, Electrical, (Circular, Environment Resisting), Protective Covers, Receptacles, (for MIL-DTL-26500 and MIL-DTL-83723, Series III, Classes A, R, and W)	
MIL-DTL-83723/61	Connectors, Electrical, (Circular, Environment Resisting), Dummy Connector, Receptacles (for MIL-DTL-26500 and MIL-DTL-83723, Series III, Classes A, R, & W)	
MIL-DTL-83723/65	Connector, Electric, (Circular, Environment Resisting), Receptacle, (Single Hole Mount, Bayonet Coupling, Pin Contact), (Series III, Class H)	

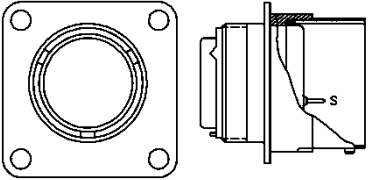
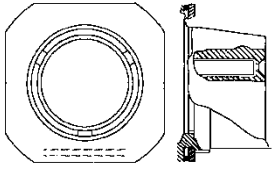
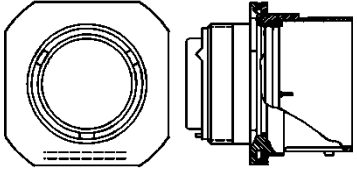
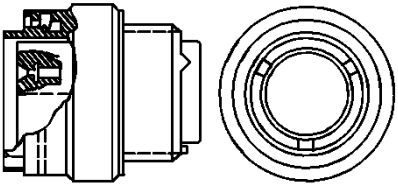
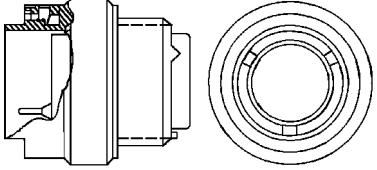
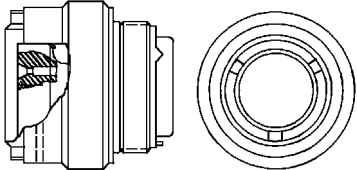
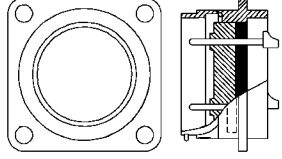
MIL-STD-1353C
APPENDIX D

TABLE D-XVIII. MIL-DTL-83723 descriptions and configurations - Continued.

Specification number	Description	Configuration
MIL-DTL-83723/66	Connectors, Electrical, (Circular, Environment Resisting), Plug, Threaded Coupling, (Push-Pull, Quick-Disconnect Without Lanyard), Crimp Pin Contact, Series III, Class A, G, R, and W	
MIL-DTL-83723/67	Connectors, Electrical, (Circular, Environment Resisting), Plug, Threaded Coupling, (Push-Pull, Quick-Disconnect Without Lanyard), Crimp Socket Contact, Series III, Class A, G, R, and W	
MIL-DTL-83723/68	Connectors, Electrical, (Circular, Environment Resisting), Plug, Threaded Coupling, (Push-Pull, Quick-Disconnect with Lanyard), Crimp Pin Contact, Series III, Classes A, G, M, R, T, W and Z	
MIL-DTL-83723/69	Connectors, Electrical, (Circular, Environment Resisting), Plug, Threaded Coupling, (Push-Pull, Quick-Disconnect with Lanyard), Crimp Socket Contact, Series III, Class A, G, R, and W	
MIL-DTL-83723/70	Connectors, Electrical, (Circular, Environment Resisting), Receptacle Adapter (Push-Pull), Quick-Disconnect Series III, Classes A, G, R, and W	
MIL-DTL-83723/71	Connectors, Electrical, (Circular, Environment Resisting), Receptacle, (Flange Mount, Bayonet Coupling, Crimp Socket Contact) Series III, Classes A, G, R, and W	

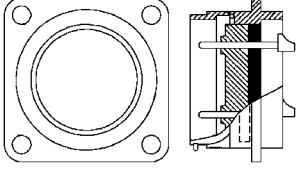
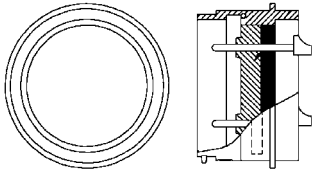
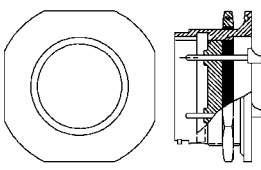
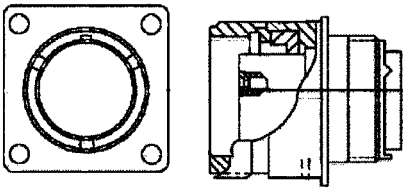
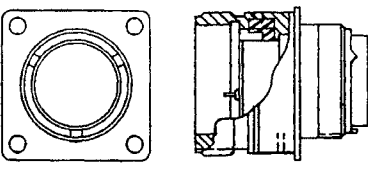
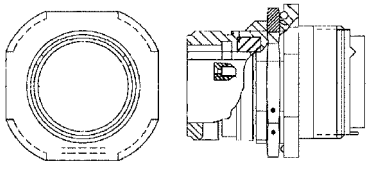
MIL-STD-1353C
APPENDIX D

TABLE D-XVIII. MIL-DTL-83723 descriptions and configurations - Continued.

Specification number	Description	Configuration
MIL-DTL-83723/72	Connector, Electric, (Circular, Environment Resisting), Receptacle, (Flange Mount, Bayonet Coupling, Crimp Pin Contact) (Series III, Class A, G, R, and W)	
MIL-DTL-83723/73	Connector, Electric, (Circular, Environment Resisting), Receptacle, (Single Hole Mount, Bayonet Coupling, Crimp Socket Contact) (Series III, Classes A, G, R, and W)	
MIL-DTL-83723/74	Connectors, Electric, (Circular, Environment Resisting), Receptacle, (Single Hole Mount, Bayonet Coupling, Crimp Pin Contact), (Series III, Classes A, G, R, and W)	
MIL-DTL-83723/75	Connectors, Electrical, (Circular, Environment Resisting), Plug, (Bayonet Coupling, Crimp Socket Contact), (Series III, Classes A, G, K, R, and W)	
MIL-DTL-83723/76	Connectors, Electrical, (Circular, Environment Resisting), Plug, (Bayonet Coupling, Crimp Pin Contact), (Series III, Classes A, G, R, and W)	
MIL-DTL-83723/77	Connectors, Electrical, (Circular, Environment Resisting), Plug, (RFI, Bayonet Coupling, Crimp Socket Contact), (Series III, Classes G, R, and W)	
MIL-DTL-83723/78	Connectors, Electrical, (Circular, Environment Resisting), Plug, (RFI, Bayonet Coupling, Crimp Pin Contact), (Series III, Classes G, R, and W)	

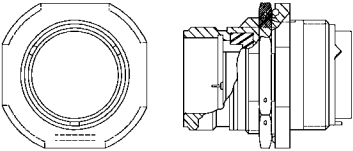
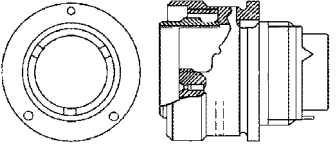
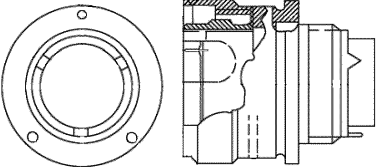
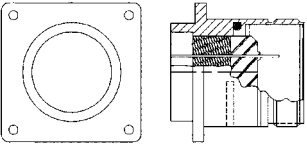
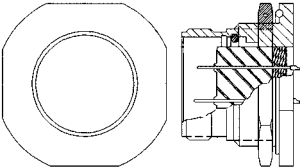
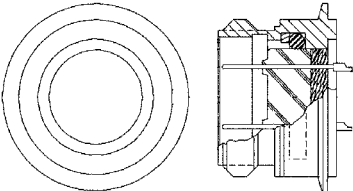
MIL-STD-1353C
APPENDIX D

TABLE D-XVIII. MIL-DTL-83723 descriptions and configurations - Continued.

Specification number	Description	Configuration
MIL-DTL-83723/79	Connectors, Electrical, (Circular, Environment Resisting), Receptacle, (Flange Mount, Bayonet Coupling, Solder Pin Contact), (Series III, Classes H and Y)	
MIL-DTL-83723/80	Connectors, Electrical, (Circular, Environment Resisting), Receptacle, (Solder Flange Mount, Bayonet Coupling, Solder Pin Contact), (Series III, Classes H and Y)	
MIL-DTL-83723/81	Connectors, Electrical, (Circular, Environment Resisting), Receptacle, (Single Hole Mount, Bayonet Coupling, Solder Pin Contact), (Series III, Classes H and Y)	
MIL-DTL-83723/82	Connectors, Electrical, (Circular, Environment Resisting), Receptacle, (Flange Mount, Threaded Coupling, Crimp Socket Contact), (Series III, Classes A, G, K, M, N, R, S, T, W and Z)	
MIL-DTL-83723/83	Connectors, Electrical, (Circular, Environment Resisting), Receptacle, (Flange Mount, Threaded Coupling, Crimp Pin Contact), (Series III, Classes A, G, K, N, R, S, and W)	
MIL-DTL-83723/84	Connectors, Electrical, (Circular, Environment Resisting), Receptacle, (Single Hole Mount, Threaded Coupling, Crimp Socket Contact), (Series III, Classes A, G, K, N, R, S, and W)	

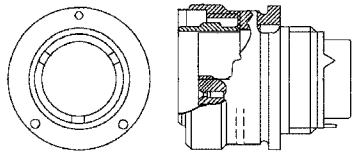
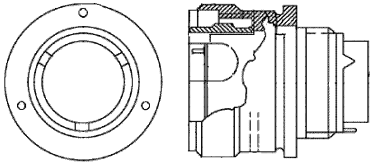
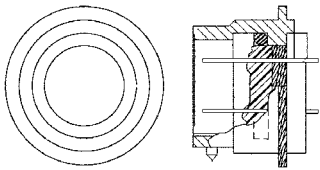
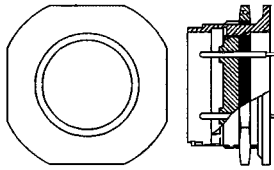
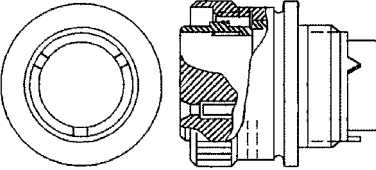
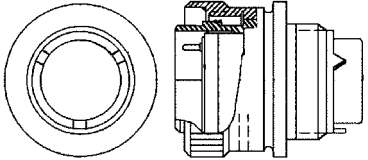
MIL-STD-1353C
APPENDIX D

TABLE D-XVIII. MIL-DTL-83723 descriptions and configurations - Continued.

Specification number	Description	Configuration
MIL-DTL-83723/85	Connectors, Electrical, (Circular, Environment Resisting), Receptacle, (Single Hole Mount, Threaded Coupling, Crimp Pin Contact), (Series III, Classes A, G, K, N, R, s, and W)	
MIL-DTL-83723/86	Connectors, Electrical, (Circular, Environment Resisting), Plug, (Threaded Coupling, Crimp Socket Contact), (Series III, Classes A, G, K, R, and W)	
MIL-DTL-83723/87	Connectors, Electrical, (Circular, Environment Resisting), Plug, (Threaded Coupling, Crimp Pin Contact), (Series III, Classes A, G, K, R, and W)	
MIL-DTL-83723/88	Connectors, Electrical, (Circular, Environment Resisting), Receptacle, (Flange Mount, Threaded Coupling, Solder Pin Contact), (Series III, Classes H, N, and Y)	
MIL-DTL-83723/89	Connectors, Electrical, (Circular, Environment Resisting), Receptacle, (Single Hole Mount, Threaded Coupling, Solder Pin Contact), (Series III, Classes H, N, and Y)	
MIL-DTL-83723/90	Connectors, Electrical, (Circular, Environment Resisting), Receptacle, (Solder Flange Mount, Threaded Coupling, Solder Pin Contact), (Series III, Classes H, N, and Y)	

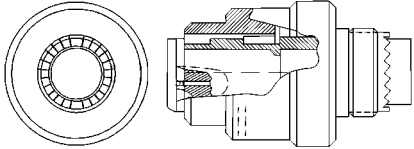
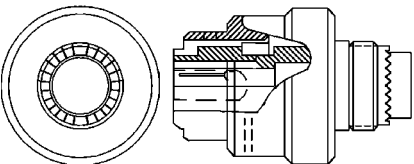
MIL-STD-1353C
APPENDIX D

TABLE D-XVIII. MIL-DTL-83723 descriptions and configurations - Continued.

Specification number	Description	Configuration
MIL-DTL-83723/91	Connectors, Electrical, (Circular, Environment Resisting), Plug, (RFI, Threaded Coupling, Crimp Socket Contact), (Series III, Classes G, R, and W)	
MIL-DTL-83723/92	Connectors, Electrical, (Circular, Environment Resisting), Plug, (RFI, Threaded Coupling, Crimp Pin Contact), (Series III, Classes G, R, and W)	
MIL-DTL-83723/93	Connectors, Electrical, (Circular, Environment Resisting), Receptacle (Solder Flange Mount, Bayonet Coupling, Straight Pin Contact), (Series III, Classes H and Y)	
MIL-DTL-83723/94	Connectors, Electrical, (Circular, Environment Resisting), Receptacle, (Single Hole Mount, Bayonet Coupling, Straight Pin Contact), (Series III, Classes H and Y)	
MIL-DTL-83723/95	Connectors, Electrical, (Circular, Environment Resisting), Plug, (Threaded Coupling, Self-Locking, Crimp Socket Contact), (Series III, Classes A, G, K, R, and W)	
MIL-DTL-83723/96	Connectors, Electrical, (Circular, Environment Resisting), Plug, (Threaded Coupling, Self-Locking, Crimp Pin Contact), (Series III, Classes A, G, K, R, and W)	

MIL-STD-1353C
APPENDIX D

TABLE D-XVIII. MIL-DTL-83723 descriptions and configurations - Continued.

Specification number	Description	Configuration
MIL-DTL-83723/97	Connectors, Electrical, (Circular, Environment Resisting), Plug, (Threaded Coupling, Self-Locking, R.F.I. Grounding, Crimp Socket Contacts), (Series III, Classes N and S Firewall)	
MIL-DTL-83723/98	Connectors, Electrical, (Circular, Environment Resisting), Plug, (Threaded Coupling, Self-Locking, R.F.I. Grounding, Crimp Pin Contacts), (Series III, Classes N and S Firewall)	

MIL-STD-1353C
APPENDIX E

E.1 SCOPE

E.1.1 Scope. This appendix provides additional guidance to help the specification developer or engineer in selection of electrical receptacles, plugs, and telephone jacks. This appendix is not a mandatory part of this standard. The information is intended for guidance only.

E.2 APPLICABLE DOCUMENTS

E.2.1 General. The documents listed in this appendix are specified herein. This section does not include documents cited in other sections of this document.

E.2.2 GOVERNMENT DOCUMENTS

E.2.2.1 Specifications, standards, and handbooks. The following specifications, standards, and handbooks form a part of this appendix to the extent specified herein.

DEPARTMENT OF DEFENSE SPECIFICATIONS

MIL-DTL-641	-	Jacks, Telephone, General Specification for
MIL-DTL-641/1	-	Jacks, Telephone, Types JJ-015 and JJ-019
MIL-DTL-641/2	-	Jacks, Telephone Types JJ-016, JJ-017, JJ-024, JJ-035, JJ-072
MIL-DTL-641/3	-	Jacks, Telephone, Types JJ-022, JJ-042, JJ-073, JJ-074, JJ-075, JJ-077, and JJ-078
MIL-DTL-641/4	-	Jacks, Telephone Type JJ-026
MIL-DTL-641/5	-	Jacks, Telephone, Type JJ-033
MIL-DTL-641/6	-	Jacks, Telephone, Type JJ-034
MIL-DTL-641/7	-	Jacks, Telephone, Type JJ-048
MIL-DTL-641/8	-	Jack, Telephone, Type JJ-055
MIL-DTL-641/9	-	Jacks, Telephone, Types JJ-079, JJ-081, JJ-082, and JJ-106
MIL-DTL-641/10	-	Jacks, Telephone, Type JJ-083
MIL-DTL-641/11	-	Jacks, Telephone, Type JJ-088
MIL-DTL-641/12	-	Jacks, Telephone, Type JJ-089
MIL-DTL-641/13	-	Jacks, Telephone, Types JJ-092, JJ-093, JJ-096, and JJ-097
MIL-DTL-641/14	-	Jacks, Telephone, Types JJ-095, JJ-101, and JJ-103
MIL-DTL-641/15	-	Jacks, Telephone, Types JJ-098, JJ-099, and JJ-102
MIL-DTL-641/16	-	Jacks, Telephone, Types JJ-104, JJ-105, and JJ-107
MIL-DTL-641/19	-	Jacks, (Bantam) Telephone, 3 Conductor, Single
MIL-DTL-641/20	-	Jacks, (Bantam) Telephone, 3 Conductor, Triple
MIL-DTL-641/21	-	Jacks, (Bantam) Telephone, 3 Conductor, Double
MIL-DTL-641/22	-	Jack, Telephone, U-385/U
MIL-DTL-9177	-	Connector, Audio, Airborne
MIL-DTL-9177/1	-	Connector, Audio, Airborne, Plug, 4 Contact
MIL-DTL-9177/2	-	Connector, Audio, Airborne, Plug, Miniature, 4 Contact
MIL-DTL-9177/3	-	Connector, Audio, Airborne, Jack, Cable, 4 Contact
MIL-DTL-9177/4	-	Connector, Audio, Airborne, Jack, Panel Mount, 4 Contact
MIL-DTL-9177/5	-	Connector, Audio, Airborne, Jack, Switch, 4 Contact
MIL-C-10544	-	Connectors, Plug, and Receptacle (Electrical, Audio, Weatherproof, Ten Contact, Polarized)
MIL-DTL-55116	-	Connectors: Miniature Audio, Five-Pin and Six-Pin General Specification for
MIL-DTL-55116/1	-	Connector, Plug, Five Pin Audio, Crimp Sleeve Terminals, Wire Strain Relief, U-229 Type

MIL-STD-1353C
APPENDIX E

- MIL-DTL-55116/2 - Connector, Plug, Six Pin Audio, Crimp Sleeve Terminals, Wire Strain Relief, U-229 Type
- MIL-DTL-55116/3 - Connector, Plug, Five Pin Audio, Solder Cup Terminals, Wire Strain Relief, U-229 Type
- MIL-DTL-55116/4 - Connector, Plug, Six Pin Audio, Solder Cup Terminals, Wire Strain Relief, U-229 Type
- MIL-DTL-55116/5 - Connector, Plug, Five Pin Audio, Crimp Sleeve Terminals, Molded Strain Relief, U-182 Type
- MIL-DTL-55116/6 - Connector, Plug, Six Pin Audio, Crimp Sleeve Terminals, Molded Strain Relief, U-182 Type
- MIL-DTL-55116/7 - Connector, Plug, Five Pin Audio, Solder Cup Terminals, Molded Strain Relief, U-182 Type
- MIL-DTL-55116/8 - Connector, Plug, Six Pin Audio, Solder Cup Terminals, Molded Strain Relief, U-182 Type
- MIL-DTL-55116/9 - Connector, Receptacle, Five-Pin Audio, Solder Cup Spring Terminals, Panel Mount, U-183 Type
- MIL-DTL-55116/10 - Connector, Receptacle, Six-Pin Audio, Solder Cup Spring Terminals, Panel Mount, U-183 Type
- MIL-DTL-55116/11 - Connector, Receptacle, Five Pin Audio, Crimp Sleeve Spring Terminals, Wire Strain Relief, U-228 Type
- MIL-DTL-55116/12 - Connector, Receptacle, Six Pin Audio, Crimp Sleeve Spring Terminals, Wire Strain Relief, U-228 Type
- MIL-DTL-55116/13 - Connector, Receptacle, Five Pin Audio, Solder Cup Spring Terminals, Wire Strain Relief, U-228 Type
- MIL-DTL-55116/14 - Connector, Receptacle, Six Pin Audio, Solder Cup Spring Terminals, Wire Strain Relief, U-228 Type
- MIL-DTL -55074 - Connectors, Plug and Receptacle, Telephone, Electrical, Subassembly and Accessories and Contact Assembly, Electrical, General Specification for
- MIL-DTL -55074/1 - Connector, Plug, Telephone, Electrical
- MIL-DTL -55074/2 - Connector, Receptacle, Telephone, Electrical
- MIL-DTL-55074/3 - Connector, Receptacle, Telephone, Electrical
- MIL-DTL-55074/4 - Contact, Assembly, Electrical

(Copies of these documents are available online at <http://quicksearch.dla.mil> or from the Standardization Document Order Desk, 700 Robbins Avenue, Building 4D, Philadelphia, PA 19111-5094.)

E.2.2.2 Other Government documents, drawings, and publications. The following other Government documents, drawings, and publications form a part of this document to the extent specified herein. Unless otherwise specified, the issues of these documents are those cited in the solicitation or contract.

US ARMY SIGNAL CORPS

- SC-A-46439 - List of Accessories for Package Tester
- SC-DL-22728 - Connector, Receptacle, Electrical, U-165()/U
- SC-DL-34036 - Connector, Receptacle, Electrical, U-161()/U
- SC-DL-34037 - Connector, Receptacle, Electrical, U-162()/U
- SC-DL-34038 - Connector, Receptacle, Electrical, U-163()/U
- SC-DL-34039 - Connector, Receptacle, Electrical, U-164()/U

MIL-STD-1353C
APPENDIX E

SC-DL-68417	-	Connector, Plug, U-77()/U
SC-DL-83049	-	Receptacle Connector, U-79()/U
SC-DL-99587	-	Connector, Plug, U-78()/U
SC-DL-99590	-	Connector, Plug, U-126()/U
SC-DL-105995	-	Connector, Plug, U-127()/U
SC-DL-106000	-	Connector, Plug, U-128()/U

(Copies of these documents are available at DLA Land and Maritime, Columbus, ATTN:VAI, Post Office Box 3990, Columbus, OH 43216-5000 or emailed to RFConnector@DLA.Land.and.Maritime.dla.mil.)

E.2.2.3 Non-Government publications. The following documents form a part of this document to the extent specified herein. Unless otherwise specified, the documents are the issues of the documents cited in the solicitation or contract.

UNDERWRITERS LABORATORIES INC. (UL)

UL498 - UL Standard for Safety Attachment Plugs and Receptacles

(Copies of these documents are available online at <http://www.ul.com> or from the Underwriters Laboratories Inc., Publication Stock, 333 Pflugsten Road, Northbrook, IL 60062-2096.)

MIL-STD-1353C
APPENDIX E

E.3 MIL-DTL-641. MIL-DTL-641 this series of connectors covers telephone jacks, see table E-I.

E.3.1 Intended use. This specification covers jacks used in telephone (including telephone switchboards consoles), telegraph, and teletype circuits, and for headsets, handsets, and microphones into communications circuits. Primarily used in ground support and shipboard communications equipment. May be used in aerospace applications that do not encounter high vibration environments.




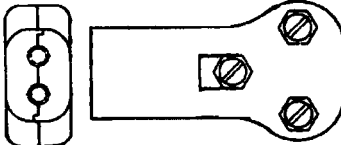
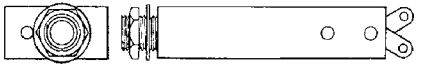
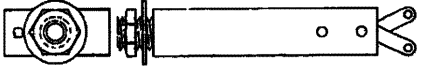
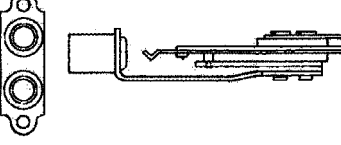

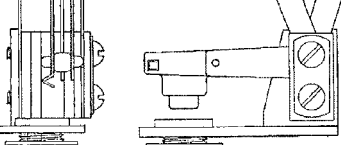
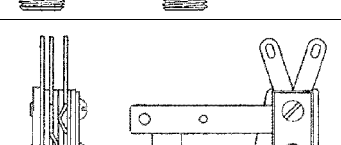
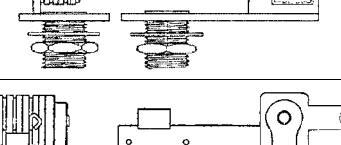
FIGURE E-1. Telephone jack.

TABLE E-I. MIL-DTL-641 descriptions and configurations.

Specification number	Description	Configuration
MIL-DTL-641	Jacks, Telephone, General Specification For	
MIL-DTL-641/1	Jacks, Telephone, Types JJ-015 and JJ-019	
MIL-DTL-641/2	Jacks, Telephone Types JJ-016, JJ-017, JJ-024, JJ-035, JJ-072	
MIL-DTL-641/3	Jacks, Telephone, Types JJ-022, JJ-042, JJ-073, JJ-074, JJ-075, JJ-077, and JJ-078	
MIL-DTL-641/4	Jacks, Telephone Type JJ-026	
MIL-DTL-641/5	Jacks, Telephone, Type JJ-033	
MIL-DTL-641/6	Jacks, Telephone, Type JJ-034	

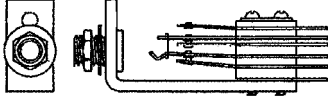

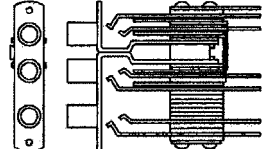
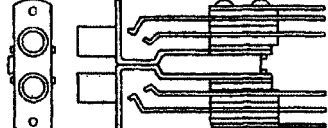

MIL-STD-1353C
APPENDIX E

TABLE E-I. MIL-DTL-641 descriptions and configurations - Continued.

Specification number	Description	Configuration
MIL-DTL-641/7	Jacks, Telephone, Type JJ-048	
MIL-DTL-641/8	Jack, Telephone, Type JJ-055	
MIL-DTL-641/9	Jacks, Telephone, Types JJ-079, JJ-081, JJ-082, and JJ-106	
MIL-DTL-641/10	Jacks, Telephone, Type JJ-083	
MIL-DTL-641/11	Jacks, Telephone, Type JJ-088	
MIL-DTL-641/12	Jacks, Telephone, Type JJ-089	
MIL-DTL-641/13	Jacks, Telephone, Types JJ-092, JJ-093, JJ-096, and JJ-097	
MIL-DTL-641/14	Jacks, Telephone, Types JJ-095, JJ-101, and JJ-103	
MIL-DTL-641/15	Jacks, Telephone, Types JJ-098, JJ-099, and JJ-102	

MIL-STD-1353C
APPENDIX E

TABLE E-I. MIL-DTL-641 descriptions and configurations - Continued.

Specification number	Description	Configuration
MIL-DTL-641/16	Jacks, Telephone, Types JJ-104, JJ-105, and JJ-107	
MIL-DTL-641/19	Jacks, (Bantam) Telephone, 3 Conductor, Single	
MIL-DTL-641/20	Jacks, (Bantam) Telephone, 3 Conductor, Triple	
MIL-DTL-641/21	Jacks, (Bantam) Telephone, 3 Conductor, Double	
MIL-DTL-641/22	Jack, Telephone, U-385/U	

MIL-STD-1353C
APPENDIX EE.3.2 Jacks to mating plug. Applicable receptacles (jacks) to mating plug, see table E-II.TABLE E-II. Jacks and mating plugs.

Jacks		Plugs	
Part number	Type designation	Part number	Type designation
M641/1-1	JJ-015	M642/1-1	PJ-047B
M641/1-2	JJ-019	M642/1-2	PJ-047R
M641/2-1	JJ-016	M642/4-1	PJ-055B
M641/2-2	JJ-017	M642/4-2	PJ-055R
M641/2-3	JJ-024	M642/4-3	PJ-055M
M641/2-4	JJ-035	M642/11-1	PJ-636
M641/2-5	JJ-072		
M641/2-6	JJ-064		
M641/2-7	JJ-065		
M641/2-8	JJ-066		
M641/2-9	JJ-067		
M641/6-1	JJ-034		
M641/12-1	JJ-069		
M641/13-1	JJ-082		
M641/13-2	JJ-083		
M641/13-3	JJ-096		
M641/13-4	JJ-097		
M641/15-1	JJ-098		
M641/15-2	JJ-099		
M651/15-3	JJ-102		
M641/16-1	JJ-104		
M641/16-2	JJ-105		
M641/16-3	JJ-107		
M641/18-1	JJ-134		
M641/3-1	JJ-022	M642/2-1	PJ-051B
M641/3-2	JJ-042	M642/3-2	PJ-051R
M641/3-3	JJ-073		
M641/3-4	JJ-074		
M641/3-5	JJ-075		
M641/3-6	JJ-077		
M641/3-7	JJ-078		
M641/9-1	JJ-079		
M641/9-2	JJ-081		
M641/9-3	JJ-082		
M641/9-4	JJ-106		
M641/14-1	JJ-095		
M641/14-2	JJ-101		
M641/14-3	JJ-103		
M641/4-1	JJ-026	M642/3-1	<u>1/</u> PJ-054B
M641/4-2	JJ-026	M642/3-2	<u>1/</u> PJ-054R
		M642/10-1	PJ-540B
		M642/10-2	PJ-540R

See notes at end of table.

MIL-STD-1353C
APPENDIX ETABLE E-II. Jacks and mating plugs - Continued.

Jacks		Plugs	
Part number	Type designation	Part number	Type designation
M641/5-1	JJ-033	M642/5-1	PJ-058
M641/10-1	JJ-063	M642/3-1	PJ-309
M641/17-1	JJ-133		
M641/7-1	JJ-048	M642/6-1	PJ-291
M641/7-2	JJ-048		
M641/8-1	JJ-065	M642/7-1	PJ-292
M641/8-2	JJ-065		
M641/2-8	<u>2/</u> JJ-066	M642/9-1	PJ-327
M641/11-1	JJ-068		
M641/19-9	JJ-805		
M641/20-1	N/A		
thru			
M641/20-8	N/A	M641/13-1	PJ-711
thru		thru	PJ-778
M641/21-12		M642/13-4	
M641/22-1	U-385/U	M642/14-1	U-384/U

1/ Types PJ-054B and PJ-054R can be replaced by types PJ-540B and PJ-540R, respectively.
The cord-entrance dimension for PJ-054B and PJ-054R is 0.250 inch, for PJ-540B and PJ-540R, the cord-entrance dimension is 0.281 inch.

2/ Two JJ-086 are needed for use with PJ-327

MIL-STD-1353C
APPENDIX E


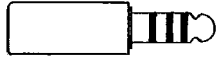
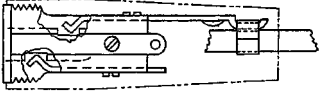
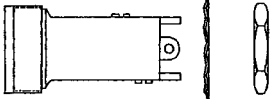
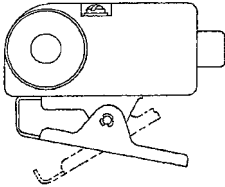
E.4 MIL-DTL-9177. MIL-DTL-9177 this specification covers the general requirements for airborne audio connectors for use in electrical and electronic equipment. Electrical, mechanical, and environmental, see table E-III.

E.4.1 Features. Features of these connectors include:

- a. Environment resisting.
- b. RFI/EMI protection.
- c. Low-level circuit capabilities.
- d. High-cross talk resistance.

E.4.2 Intended use. The connectors covered by this specification are primarily for use in airborne audio systems.

TABLE E-III. MIL-DTL-9177 descriptions and configurations.

Specification/drawing number	Description	Configuration
MIL-DTL-9177	Connector, Audio, Airborne	
MIL-DTL-9177/1	Connector, Audio, Airborne, Plug, 4 Contact	
MIL-DTL-9177/2	Connector, Audio, Airborne, Plug, Miniature, 4 Contact	
MIL-DTL-9177/3	Connector, Audio, Airborne, Jack, Cable, 4 Contact	
MIL-DTL-9177/4	Connector, Audio, Airborne, Jack, Panel Mount, 4 Contact	
MIL-DTL-9177/5	Connector, Audio, Airborne, Jack, Switch, 4 Contact	

MIL-STD-1353C
APPENDIX E

E.5 MIL-DTL-55116. MIL-DTL-55116 this specification covers waterproof, polarized, five and six contact electrical connectors for use in audio frequency circuits at 60 volts maximum potential and 0.5 amperes maximum current, SEE TABLE E-V.

E.5.1 Intended use. The connectors are used in connection with audio frequency equipment's, such as headsets, chest sets, handsets, etc.

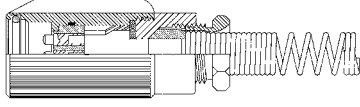
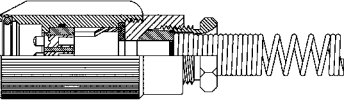
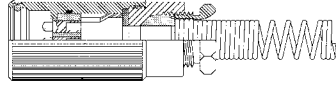
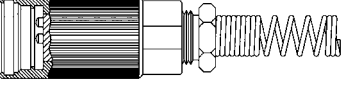
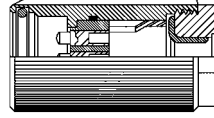
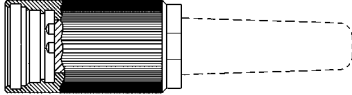
E.5.2 Plug connectors. Connector plugs U-228()/U and U-229()/U are field serviceable and replace the unserviceable molded boot type connector plugs U-181()/U and U-182()/U.

U-182()/U	Rigid contacts;	mates with U-228()/U, U-183()/U
U-228 ()/U	Non-rigid contacts;	mates with U-229()/U, U-182()/U
U-229()/U	Rigid contact;	mates with U-228()/U and U-183()/U

E.5.3 Receptacle connector. Receptacle connector U-183.

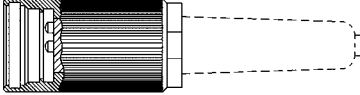
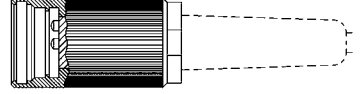
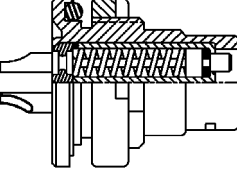
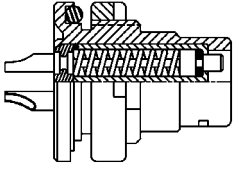
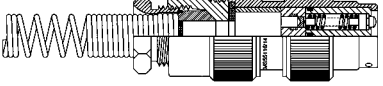

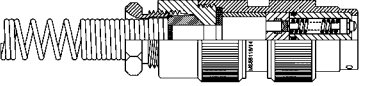
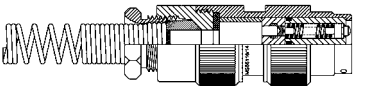
U-183()/U Non-rigid contacts; mates with U-229()/U

TABLE E-V MIL-DTL-55116 descriptions and configurations.

Specification number	Description	Configuration
MIL-DTL-55116	Connectors: Miniature Audio, Five-Pin and Six-Pin General Specification for	
MIL-DTL-55116/1	Connector, Plug, Five Pin Audio, Crimp Sleeve Terminals, Wire Strain Relief, U-229 Type	
MIL-DTL-55116/2	Connector, Plug, Six Pin Audio, Crimp Sleeve Terminals, Wire Strain Relief, U-229 Type	
MIL-DTL-55116/3	Connector, Plug, Five Pin Audio, Solder Cup Terminals, Wire Strain Relief, U-229 Type	
MIL-DTL-55116/4	Connector, Plug, Six Pin Audio, Solder Cup Terminals, Wire Strain Relief, U-229 Type	
MIL-DTL-55116/5	Connector, Plug, Five Pin Audio, Crimp Sleeve Terminals, Molded Strain Relief, U-182 Type	
MIL-DTL-55116/6	Connector, Plug, Six Pin Audio, Crimp Sleeve Terminals, Molded Strain Relief, U-182 Type	

MIL-STD-1353C
APPENDIX E

TABLE E-V. MIL-DTL-55116 descriptions and configurations - Continued.

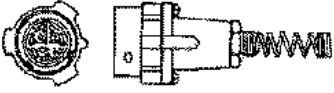

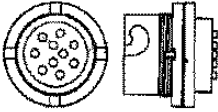
Specification number	Description	Configuration
MIL-DTL-55116/7	Connector, Plug, Five Pin Audio, Solder Cup Terminals, Molded Strain Relief, U-182 Type	
MIL-DTL-55116/8	Connector, Plug, Six Pin Audio, Solder Cup Terminals, Molded Strain Relief, U-182 Type	
MIL-DTL-55116/9	Connector, Receptacle, Five-Pin Audio, Solder Cup Spring Terminals, Panel Mount, U-183 Type	
MIL-DTL-55116/10	Connector, Receptacle, Six-Pin Audio, Solder Cup Spring Terminals, Panel Mount, U-183 Type	
MIL-DTL-55116/11	Connector, Receptacle, Five Pin Audio, Crimp Sleeve Spring Terminals, Wire Strain Relief, U-228 Type	
MIL-DTL-55116/12	Connector, Receptacle, Six Pin Audio, Crimp Sleeve Spring Terminals, Wire Strain Relief, U-228 Type	
MIL-DTL-55116/13	Connector, Receptacle, Five Pin Audio, Solder Cup Spring Terminals, Wire Strain Relief, U-228 Type	
MIL-DTL-55116/14	Connector, Receptacle, Six Pin Audio, Solder Cup Spring Terminals, Wire Strain Relief, U-228 Type	

MIL-STD-1353C
APPENDIX E

E.6 MIL-C-10544. MIL-C-10544 audio connectors for handset, and microphone operation, see table E-VI.

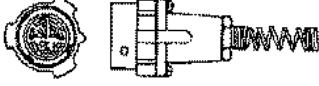
E.6.1 Intended use. Intended use in audio frequency circuits at 60 millivolts minimum to 60 volts maximum potential and .5 amps maximum current.

TABLE E-VI. MIL-C-10544 descriptions and configurations.

Specification/drawing number	Description	Configuration reference ECOM drawing (Signal Corps)
MIL-C-10544	Connectors, Plug, and Receptacle (Electrical, Audio, Weatherproof, Ten Contact, Polarized)	
U-77()/U	Connector, Plug, (Rigid Contacts, mates with all non-rigid contact plugs and receptacles)	 Connector, Plug, U-77()/U ECOM DWG SC-DL-68417
U-78()/U	Connector, Plug, (Non-rigid contacts, mates with all rigid contact plugs and receptacles)	 Connector, Plug, U-78()/U ECOM DWG SC-DL-99587
U-79()/U	Receptacle Connector, (Non-rigid contacts, mates with all rigid contact plugs)	 Connector, Plug, U-127()/U ECOM DWG SC-DL-105995
U-126()/U	Connector, Receptacle, (Rigid contacts, mates with all non-rigid contact plugs)	Connector, Plug, U-128()/U ECOM DWG SC-DL-106000
U-127()/U	Connector, Plug, (Rigid contacts, right angle, mates with U-79()/U and U-165()/U connectors)	Connector, Plug, U-161()/U ECOM DWG SC-DL-34036
U-128()/U	Connector, Plug, (Non-rigid contacts, right angle, mates with U-126()/U connector and all receptacles)	Connector, Plug, U-162()/U ECOM DWG SC-DL-34037

MIL-STD-1353C
APPENDIX E

TABLE E-IV. MIL-C-10544 descriptions and configurations - Continued.

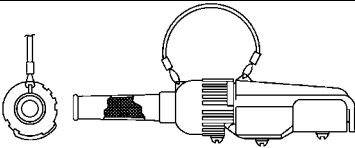
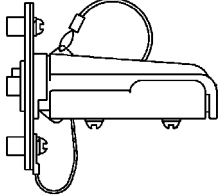
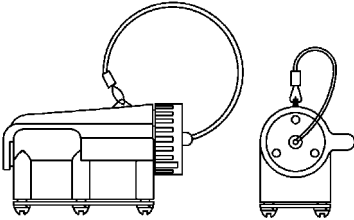
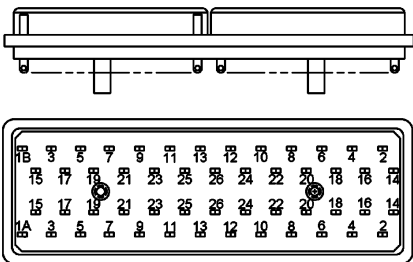
Specification/drawing number	Description	Configuration
U-161()/U	Connector, Plug, Electrical, (Rigid contacts, mates with all non-rigid contact plugs and receptacles)	 Connector, Plug, U-163()/U ECOM DWG SC-DL-34038
U-162()/U	Connector, Plug, Electrical, (Non-rigid contacts, mates with all rigid contact plugs and receptacles)	Connector, Plug, U-164()/U ECOM DWG SC-DL-34039
U-163()/U	Connector, Plug, Electrical, (Rigid contacts, right angle, mates with U-79()/U and U-165()/U connectors)	Connector, Receptacle, U-79()/U ECOM DWG SC- DL-83049
U-164()/U	Connector, Plug, Electrical, (Non-rigid contacts, right angle, mates with U-126()/U- connector)	Connector, Receptacle, U-126()/U ECOM DWG SC-DL-99590
U-165()/U	Connector, Receptacle, Electrical, (Non-rigid contacts, mates with all rigid contact plugs)	Connector, Receptacle, U-164()/U ECOM DWG SC-DL-22728

MIL-STD-1353C
APPENDIX E

E.7 MIL-DTL-55074. This specification covers the following types of 26 pair connectors, contacts hermaphroditic for use with 26 pair telephone cable WM-130()/G.

E.7.1 Intended use. These connectors are used in mobile, transportable, and semi-permanent military communications facilities (telephones, telegraph, teletype, radio, etc.). Plugs mate interchangeably with both receptacles, and plugs, permitting connection of either cable end to any other cable end of distribution box.

TABLE E-V. MIL-DTL-55074 descriptions and configurations.

Specification	Description	Configuration
MIL-DTL-55074	Connectors, Plug and Receptacle, Telephone, Electrical, Subassembly and Accessories and Contact Assembly, Electrical, General Specification for	
MIL-DTL-55074/1	Connector, Plug, Telephone, Electrical (U-185 ()/G)	
MIL-DTL-55074/2	Connector, Receptacle, Telephone, Electrical (U-186 ()/G)	
MIL-DTL-55074/3	Connector, Receptacle, Telephone, Electrical U-187 ()/G	
MIL-DTL-55074/4	Contact, Assembly, Electrical MX-3227/G	

MIL-STD-1353C
APPENDIX F

F.1 SCOPE

F.1.1 Scope. This appendix provides additional guidance to help the specification developer or engineer in selection of power connectors. This appendix is not a mandatory part of this standard. The information is intended for guidance only.

F.2 APPLICABLE DOCUMENTS

F.2.1 General. The documents listed in this appendix are specified herein. This section does not include documents cited in other sections of this document.

F.2.2 GOVERNMENT DOCUMENTS

F.2.2.1 Specifications, standards, and handbooks. The following specifications, standards, and handbooks form a part of this appendix to the extent specified herein.

FEDERAL SPECIFICATIONS

W-C-596	-	Connector, Electrical, Power, General Specification For
W-C-596/3	-	Connector, Plug, Electrical, General Purpose, General Grade, 2 Pole, 2 Wire, 15 Amperes, 125 Volts, 50/60 Hertz
W-C-596/4	-	Connector, Plug, Electrical, General Purpose, General Grade, Cable Outlet, 2 Pole, 2 Wire, 15 Amperes, 125 Volts, 50/60 Hertz
W-C-596/7	-	Connector, Plug, Electrical, Specific Purpose, General Grade, Locking, 2 Pole, 2 Wire, 15 Amperes, 125 Volts, 50/60 Hertz
W-C-596/8	-	Connector, Plug, Electrical, Specific Purpose, Cable Outlet, General Grade, Locking, 2 Pole, 2 Wire, 15 Amperes, 125 Volts, 50/60 Hertz
W-C-596/11	-	Connector, Receptacle, Electrical, General Purpose, Single, General Grade, Grounding, 2 Pole, 3 Wire, 15 Amperes, 125 Volts, 50/60 Hertz
W-C-596/12	-	Connector, Receptacle, Electrical, General Purpose, Duplex, General Grade and Hospital Grade, Grounding, 2 Pole, 3 Wire, 15 Amperes, 125 Volts, 50/60 Hertz
W-C-596/13	-	Connector, plug, Electrical, general Purpose, Hospital Grade, Grounding, 2 Pole, 3 Wire, 15 Amperes, 125 Volts, 50/60 Hertz
W-C-596/14	-	Connector, Cable Outlet, Electrical, General Purpose, Hospital Grade, Cable Connecting, Grounding, 2 Pole, 3 Wire, 15 Amperes, 125 Volts, 50/60 Hertz
W-C-596/15	-	Connector, Receptacle, Electrical, General Purpose, Single, General Grade, Grounding, 2 Pole, 3 Wire, 15 Amperes, 250 Volts, 50/60 Hertz
W-C-596/16	-	Connector, Receptacle, Electrical, General Purpose, Duplex, General Grade, Grounding, 2 Pole, 3 Wire, 15 Amperes, 250 Volts, 50/60 Hertz
W-C-596/17	-	Connector, Plug, Electrical, General Purpose, General Grade, Grounding, 2 Pole, 3 Wire, 15 Amperes, 250 Volts, 50/60 Hertz
W-C-596/18	-	Connector, Cable Outlet, Electrical, General Purpose, General Grade, Cable Connecting, Grounding, 2 Pole, 3 Wire, 15 Amperes, 250 Volts, 50/60 Hertz
W-C-596/20	-	Connectors, Plug, Electrical, Specific Purpose, Locking, General Grade, 2 Pole, 2 Wire, 20 Amperes, 250 Volts, 50/60 Hertz
W-C-596/21	-	Connector, Plug, Electrical, Specific Purpose, Cable Outlet, Locking, General Grade, 2 Pole, 2 Wire, 20 Amperes, 250 Volts, 50/60 Hertz
W-C-596/23	-	Connector, Plug, Electrical, General Purpose, General Grade, 2 Pole, 2 Wire, 20 Amperes, 250 Volts, 50/60 Hertz

MIL-STD-1353C
APPENDIX F

W-C-596/26	- Connector, Plug, Electrical, General Purpose, General Grade, 3 Pole, 3 Wire, 20 Amperes, 125/250 Volts, 50/60 Hertz
W-C-596/27	- Connector, Plug, Electrical, General Purpose, Cable Outlet, General Grade, 3 Pole, 3 Wire, 20 Amperes, 125/250 Volts, 50/60 Hertz
W-C-596/29	- Connector, Plug, Electrical, General Purpose, General Grade, 4 Pole, 4 Wire, 20 Amperes, 3 Phase WYE, 120/208 Volts, 50/60 Hertz
W-C-596/30	- Connector, Plug, Electrical, General Purpose, Cable Outlet, General Grade, 4 Pole, 4 Wire, 20 Amperes, 3 phase WYE, 120/208 Volts, 50/60 Hertz
W-C-596/33	- Connector, Receptacle, Electrical, General Purpose, Single, General Grade, 3 Pole, 3 Wire, 30 Amperes, 125/250 Volts, 50/60 Hertz
W-C-596/34	- Connector, Plug, Electrical, General Purpose, General Grade, 3 Pole, 3 Wire, 30 Amperes, 125/250 Volts, 50/60 Hertz
W-C-596/35	- Connector, Plug, Electrical, General Purpose, Cable Outlet, 3 Pole, 3 Wire, 20 Amperes, 125/250 Volts, 50/60 Hertz
W-C-596/36	- Connector, Receptacle, Electrical, General Purpose, Single, 3 Pole, 3 Wire, 50 Amperes, 125/250 Volts, 50/60 Hertz
W-C-596/37	- Connector, Plug, Electrical, General Purpose, 3 Pole, 3 Wire, 50 Amperes, 125/250 Volts, 50/60 Hertz
W-C-596/38	- Connector, Receptacle, Electrical, General Purpose, Single, General Grade, 4 Pole, 4 Wire, 60 Amperes, 3 Phase Wye, 120/208 Volts, 50/60 Hertz
W-C-596/39	- Connector, Plug, Electrical, General Purpose, General Grade, 4 Pole, 4 Wire, 60 Amperes, 3 Phase WYE, 120/208 Volts, 50/60 Hertz
W-C-596/40	- Connector, Receptacle, Electrical, General Purpose, Duplex, General Grade and Hospital Grade, Grounding, 2 Pole, 3 Wire, 20 Amperes, 125 Volts, 50/60 Hertz
W-C-596/41	- Connector, Receptacle, Electrical, General Purpose, Single, Hospital Grade, Grounding, 2 Pole, 3 Wire, 20 Amperes, 125 Volts, 50/60 Hertz
W-C-596/42	- Connector, Plug, Electrical, General Purpose, Hospital Grade, Grounding, 2 Pole, 3 Wire, 20 Amperes, 125 Volts, 50/60 Hertz
W-C-596/43	- Connector, Receptacle, Electrical, Specific Purpose, Single Locking, 3 Pole, 3 Wire, 20 Amperes, 125/250 Volts, 50/60 Hertz
W-C-596/44	- Connector, Plug, Electrical, Specific Purpose, Locking, 3 Pole, 3 Wire, 20 Amperes, 125/250 Volts, 50/60 Hertz
W-C-596/45	- Connector, Plug, Electrical, Specific Purpose, Cable Outlet, Locking, 3 Pole, 3 Wire, 20 Amperes, 125/250 Volts, 50/60 Hertz
W-C-596/46	- Connector, Receptacle, Electrical, Specific Purpose, Single, General Grade, Locking, 3 Pole, 3 Wire, 20 Amperes, 125/250 Volts, 50/60 Hertz
W-C-596/59	- Connector, Receptacle, Electrical, Specific Purpose, Single Locking, 4 Pole, 4 Wire, 20 Amperes, 3 Phase WYE, 120/208 Volts, 50/60 Hertz
W-C-596/60	- Connector, Plug, Electrical, Specific Purpose, General Grade, Locking, 4 Pole, 4 Wire, 20 Amperes, 3 Phase WYE, 120/208 Volts, 50/60 Hertz
W-C-596/61	- Connector, Cable Outlet, Electrical, Specific Purpose, Cable Connecting, General Grade, Locking, 4 Pole, 4 Wire, 20 Amperes, 3 Phase WYE, 120/208 Volts, 50/60 Hertz
W-C-596/64	- Connector, Receptacle, Electrical, General Purpose, Single, General Grade, Grounding, 2 Pole, 3 Wire, 20 Amperes, 250 Volts, 50/60 Hertz
W-C-596/65	- Connector, Receptacle, Electrical, General Purpose, Duplex, General Grade, Grounding, 2 Pole, 3 Wire, 20 Amperes, 250 Volts, 50/60 Hertz

MIL-STD-1353C
APPENDIX F

W-C-596/66	- Connector, Plug, Electrical, General Purpose, General Grade, Grounding, 2 Pole, 3 Wire, 20 Amperes, 250 Volts, 50/60 Hertz
W-C-596/67	- Connector, Cable Outlet, Electrical, General Purpose, General Grade, Grounding, 2 Pole, 3 Wire, 20 Amperes, 250 Volts, 50/60 Hertz
W-C-596/68	- Connector, Receptacle, Electrical, General Purpose, Single, General Grade, Grounding, 2 Pole, 3 Wire, 30 Amperes, 125 Volts, 50/60 Hertz
W-C-596/69	- Connector, Plug, Electrical, general Purpose, general grade, Grounding, 2 Pole, 3 Wire, 30 Amperes, 125 Volts, 50/60 Hertz
W-C-596/70	- Connector, Cable Outlet, Electrical, General Purpose, General Grade, Grounding, 2 Pole, 3 Wire, 30 Amperes, 125 Volts, 50/60 Hertz
W-C-596/73	- Connector, Plug, Electrical, General Purpose, General Grade, Grounding, 2 Pole, 3 Wire, 15 Amperes, 277 Volts AC, 50/60 Hertz
W-C-596/74	- Connector, Cable Outlet, Electrical, General Purpose, General Grade, Grounding, 2 Pole, 3 Wire, 15 Amperes, 277 Volts AC, 50/60 Hertz
W-C-596/77	- Connector, Receptacle, Electrical, Specific Purpose, General Grade, Single, Grounding, Locking, 2 Pole, 3 Wire, 30 Amperes, 250 Volts, 50/60 Hertz
W-C-596/78	- Connector, Plug, Electrical, Specific Purpose, General Grade, Grounding, Locking, 2 Pole, 3 Wire, 30 Amperes, 250 Volts, 50/60 Hertz
W-C-596/79	- Connector, Cable Outlet, Electrical, Specific Purpose, General Grade, Single, Grounding, Locking, 2 Pole, 3 Wire, 30 Amperes, 250 Volts, 50/60 Hertz
W-C-596/80	- Connector, Receptacle, Electrical, Male Inlet, Special Purpose, Grounding, Locking, 2 Pole, 3 Wire, 30 Amperes, 250 Volts, 50/60 Hertz
W-C-596/81	- Connector, Receptacle, Electrical, General Purpose, Single, Grounding, 2 Pole, 3 Wire, 20 Amperes, 250 Volts, 50/60 Hertz
W-C-596/82	- Connector, Plug, Electrical, Special Purpose, Grounding, Locking, 2 Pole, 3 Wire, 20 Amperes, 250 Volts, 50/60 Hertz
W-C-596/83	- Connector, Plug, Electrical, Special Purpose, Cable Outlet, Grounding, Locking, 2 Pole, 3 Wire, 20 Amperes, 250 Volts, 50/60 Hertz
W-C-596/84	- Connector, Receptacle, Electrical, Male Inlet, Special Purpose, Grounding, Locking, 2 Pole, 3 Wire, 20 Amperes, 250 Volts, 50/60 Hertz
W-C-596/85	- Connector, Receptacle, Electrical, Special Purpose, Single, Grounding, 2 Pole, 3 Wire, 15 Amperes, 250 Volts, 50/60 Hertz
W-C-596/86	- Connector, Receptacle, Electrical, Special Purpose, Duplex, Grounding, 2 Pole, 3 Wire, 15 Amperes, 250 Volts, 50/60 Hertz
W-C-596/87	- Connector, Plug, Electrical, Special Purpose, Grounding, Locking, 2 Pole, 3 Wire, 15 Amperes, 250 Volts, 50/60 Hertz
W-C-596/88	- Connector, Plug, Electrical, Special Purpose, Cable Outlet, Grounding, Locking, 2 Pole, 3 Wire, 15 Amperes, 250 Volts, 50/60 Hertz
W-C-596/89	- Connector, Receptacle, Electrical, Male Inlet, Special Purpose, Locking, Grounding, 2 Pole, 3 Wire, 15 Amperes, 250 Volts, 50/60 Hertz
W-C-596/90	- Connector, Receptacle, Electrical, Special Purpose, Single, Grounding, 2 Pole, 3 Wire, 30 Amperes, 125 Volts, 50/60 Hertz
W-C-596/91	- Connector, Plug, Electrical, Special Purpose, Grounding, Locking, 2 Pole, 3 Wire, 30 Amperes, 125 Volts, 50/60 Hertz
W-C-596/92	- Connector, Plug, Electrical, Special Purpose, Cable Outlet, Grounding, Locking, 2 Pole, 3 Wire, 30 Amperes, 125 Volts, 50/60 Hertz
W-C-596/93	- Connector, Receptacle, Electrical, Male Inlet, Special Purpose, Grounding, Locking, 2 Pole, 3 Wire, 30 Amperes, 125 Volts, 50/60 Hertz

MIL-STD-1353C
APPENDIX F

- W-C-596/94 - Connector, Receptacle, Electrical, Special Purpose, Single, Grounding, 2 Pole, 3 Wire, 20 Amperes, 125 Volts, 50/60 Hertz
- W-C-596/95 - Connector, Plug, Electrical, Special Purpose, Grounding, Locking, 2 Pole, 3 Wire, 20 Amperes, 125 Volts, 50/60 Hertz
- W-C-596/96 - Connector, Plug, Electrical, Special Purpose, Cable Outlet, Grounding, Locking, 2 Pole, 3 Wire, 20 Amperes, 125 Volts, 50/60 Hertz
- W-C-596/97 - Connector, Receptacle, Electrical, Male Inlet, Special Purpose, Grounding, Locking, 2 Pole, 3 Wire, 20 Amperes, 125 Volts, 50/60 Hertz
- W-C-596/98 - Connector, Receptacle, Electrical, Special Purpose, Single, Grounding, 2 Pole, 3 Wire, 15 Amperes, 125 Volts, 50/60 Hertz
- W-C-596/99 - Connector, Receptacle, Electrical, Special Purpose, Duplex, Grounding, 2 Pole, 3 Wire, 15 Amperes, 125 Volts, 50/60 Hertz
- W-C-596/100 - Connector, Plug, Electrical, Special Purpose, Grounding, Locking, 2 Pole, 3 Wire, 15 Amperes, 125 Volts, 50/60 Hertz
- W-C-596/101 - Connector, Plug, Electrical, Special Purpose, Cable Outlet, Grounding, Locking, 2 Pole, 3 Wire, 15 Amperes, 125 Volts, 50/60 Hertz
- W-C-596/102 - Connector, Receptacle, Electrical, Male Inlet, Special Purpose, Grounding, Locking, 2 Pole, 3 Wire, 15 Amperes, 125 Volts, 50/60 Hertz
- W-C-596/103 - Connector, Receptacle, Electrical, Special Purpose, Single, Grounding, 2 Pole, 3 Wire, 30 Amperes, 277 Volts, 50/60 Hertz
- W-C-596/104 - Connector, Plug, Electrical, Special Purpose, Grounding, Locking, 2 Pole, 3 Wire, 30 Amperes, 277 Volts, 50/60 Hertz
- W-C-596/105 - Connector, Plug, Electrical, Special Purpose, Cable Outlet, Grounding, Locking, 2 Pole, 3 Wire, 30 Amperes, 277 Volts, 50/60 Hertz
- W-C-596/106 - Connector, Receptacle, Electrical, Male Inlet, Special Purpose, Locking, Grounding, 2 Pole, 3 Wire, 30 Amperes, 277 Volts, 50/60 Hertz
- W-C-596/107 - Connector, Receptacle, Electrical, Special Purpose, Single, Grounding, 2 Pole, 3 Wire, 20 Amperes, 277 Volts, 50/60 Hertz
- W-C-596/108 - Connector, Plug, Electrical, Special Purpose, Locking, Grounding, 2 Pole, 3 Wire, 20 Amperes, 277 Volts, 50/60 Hertz
- W-C-596/109 - Connector, Plug, Electrical, Special Purpose, Cable Outlet, Locking, Grounding, 2 Pole, 3 Wire, 20 Amperes, 277 Volts, 50/60 Hertz
- W-C-596/110 - Connector, Receptacle, Electrical, Male Inlet, Special Purpose, Locking, Grounding, 2 Pole, 3 Wire, 20 Amperes, 277 Volts, 50/60 Hertz
- W-C-596/111 - Connector, Receptacle, Electrical, Special Purpose, Single, Grounding, 2 Pole, 3 Wire, 15 Amperes, 277 Volts, 50/60 Hertz
- W-C-596/112 - Connector, Receptacle, Electrical, Special Purpose, Duplex, Grounding, 2 Pole, 3 Wire, 15 Amperes, 277 Volts, 50/60 Hertz
- W-C-596/113 - Connector, Plug, Electrical, Special Purpose, Locking, Grounding, 2 Pole, 3 Wire, 15 Amperes, 277 Volts, 50/60 Hertz
- W-C-596/114 - Connector, Plug, Electrical, Special Purpose, Cable Outlet, Locking, Grounding, 2 Pole, 3 Wire, 15 Amperes, 277 Volts, 50/60 Hertz
- W-C-596/115 - Connector, Receptacle, Electrical, Male Inlet, Special Purpose, Locking, Grounding, 2 Pole, 3 Wire, 15 Amperes, 277 Volts, 50/60 Hertz
- W-C-596/116 - Connector, Receptacle, Electrical, Special Purpose, Single, Grounding, 3 Pole, 4 Wire, 30 Amperes, 125/250 Volts, 50/60 Hertz
- W-C-596/117 - Connector, Plug, Electrical, Special Purpose, Locking, Grounding, 3 Pole, 4 Wire, 30 Amperes, 125/250 Volts, 50/60 Hertz
- W-C-596/118 - Connector, Plug, Electrical, Special Purpose, Cable Outlet, Locking, Grounding, 3 Pole, 4 Wire, 30 Amperes, 125/250 Volts, 50/60 Hertz

MIL-STD-1353C
APPENDIX F

- W-C-596/119 - Connector, Receptacle, Electrical, Male Inlet, Special Purpose, Locking, Grounding, 3 Pole, 4 Wire, 30 Amperes, 125/250 Volts, 50/60 Hertz
- W-C-596/120 - Connector, Receptacle, Electrical, Special Purpose, Single, Grounding, 3 Pole, 4 Wire, 20 Amperes, 125/250 Volts, 50/60 Hertz
- W-C-596/121 - Connector, Plug, Electrical, Special Purpose, Grounding, 3 Pole, 4 Wire, 20 Amperes, 125/250 Volts, 50/60 Hertz
- W-C-596/122 - Connector, Plug, Electrical, Special Purpose, Cable Outlet, Locking, Grounding, 3 Pole, 4 Wire, 20 Amperes, 125/250 Volts, 50/60 Hertz
- W-C-596/123 - Connector, Receptacle, Electrical, Male Inlet, General Purpose, Locking, Grounding, 3 Pole, 4 Wire, 20 Amperes, 125/250 Volts, 50/60 Hertz
- W-C-596/124 - Connector, Receptacle, Electrical, Special Purpose, Single, Grounding, 3 Pole, 4 Wire, 20 Amperes, 250 Volts, 50/60 Hertz, 3 Phase
- W-C-596/125 - Connector, Plug, Electrical, Special Purpose, Grounding, 3 Pole, 4 Wire, 20 Amperes, 250 Volts, 50/60 Hertz, 3 Phase
- W-C-596/126 - Connector, Plug, Electrical, Special Purpose, Cable Outlet, Locking, Grounding, 3 Pole, 4 Wire, 20 Amperes, 125/250 Volts, 50/60 Hertz, 3 Phase
- W-C-596/127 - Connector, Receptacle, Electrical, Male Inlet, General Purpose, Locking, Grounding, 3 Pole, 4 Wire, 20 Amperes, 250 Volts, 50/60 Hertz, 3 Phase
- W-C-596/128 - Connector, Receptacle, Electrical, Special Purpose, Single, Grounding, 3 Pole, 4 Wire, 30 Amperes, 250 Volts, 50/60 Hertz, 3 Phase
- W-C-596/129 - Connector, Plug, Electrical, Special Purpose, Locking, Grounding, 3 Pole, 4 Wire, 30 Amperes, 250 Volts, 50/60 Hertz, 3 Phase
- W-C-596/130 - Connector, Receptacle, Electrical, Male Inlet, General Purpose, Locking, Grounding, 3 Pole, 4 Wire, 30 Amperes, 250 Volts, 50/60 Hertz, 3 Phase
- W-C-596/131 - Connector, Receptacle, Electrical, Male Inlet, General Purpose, Locking, Grounding, 3 Pole, 4 Wire, 30 Amperes, 250 Volts, 50/60 Hertz, 3 Phase
- W-C-596/132 - Connector, Receptacle, Electrical, Special Purpose, Single, Grounding, 4 Pole, 5 Wire, 30 Amperes, 120/208 Volts, 50/60 Hertz, 3 Phase, Y
- W-C-596/133 - Connector, Plug, Electrical, Special Purpose, Locking, Grounding, 4 Pole, 5 Wire, 30 Amperes, 120/208 Volts, 50/60 Hertz, 3 Phase, Y
- W-C-596/134 - Connector, Plug, Electrical, Special Purpose, Cable Outlet, Locking, Grounding, 4 Pole, 5 Wire, 30 Amperes, 120/208 Volts, 50/60 Hertz, 3 Phase, Y
- W-C-596/135 - Connector, Receptacle, Electrical, Male Inlet, General Purpose, Locking, Grounding, 4 Pole, 5 Wire, 30 Amperes, 120/208 Volts, 50/60 Hertz, 3 Phase, Y
- W-C-596/136 - Connector, Receptacle, Electrical, Special Purpose, Single, Grounding, 4 Pole, 5 Wire, 20 Amperes, 120/208 Volts, 50/60 Hertz, 3 Phase, Y
- W-C-596/137 - Connector, Plug, Electrical, Special Purpose, Grounding, 4 Pole, 5 Wire, 20 Amperes, 120/208 Volts, 50/60 Hertz, 3 Phase, Y
- W-C-596/138 - Connector, Plug, Electrical, Special Purpose, Cable Outlet, Locking, Grounding, 4 Pole, 5 Wire, 20 Amperes, 120/208 Volts, 50/60 Hertz, 3 Phase, Y
- W-C-596/139 - Connector, Receptacle, Electrical, Male Inlet, General Purpose, Locking, Grounding, 4 Pole, 5 Wire, 20 Amperes, 120/208 Volts, 50/60 Hertz, 3 Phase, Y
- W-C-596/140 - Connector, Receptacle, Electrical, Male Inlet, General Purpose, Grounding, 2 Pole, 3 Wire, 15 Amperes, 125 Volts, 50/60 Hertz
- W-C-596/141 - Connector, Receptacle, Electrical, Male Inlet, General Purpose, Grounding, 2 Pole, 3 Wire, 15 Amperes, 250 Volts, 50/60 Hertz

MIL-STD-1353C
APPENDIX F

- W-C-596/142 - Connector, Receptacle, Electrical, Male Inlet, General Purpose, Grounding, 2 Pole, 3 Wire, 20 Amperes, 125 Volts, 50/60 Hertz
- W-C-596/143 - Connector, Plug, Electrical, General Purpose, Cable Outlet, Grounding, 2 Pole, 3 Wire, 20 Amperes, 125 Volts, 50/60 Hertz
- W-C-596/144 - Connector, Receptacle, Electrical, Male Inlet, General Purpose, Grounding, 2 Pole, 3 Wire, 20 Amperes, 250 Volts, 50/60 Hertz
- W-C-596/145 - Connector, Receptacle, Electrical, Special Purpose, Duplex, Hospital Grade, Isolated Grounding, 2 Pole, 3 Wire, 15 Amperes, 125 Volts, 50/60 Hertz
- W-C-596/148 - Connector, Receptacle, Electrical, Specific Purpose, Single, Locking, Grounding, 2 Pole, 3 Wire, 30 Amperes, 28 Volts, Direct Current
- W-C-596/149 - Connector, Plug, Electrical, Specific Purpose, Locking, Grounding, 2 Pole, 3 Wire, 30 Amperes, 28 Volts, Direct Current
- W-C-596/150 - Connector, Cable Outlet, Electrical, Specific Purpose, Single, Locking, Grounding, 2 Pole, 3 Wire, 30 Amperes, 28 Volts, Direct Current
- W-C-596/151 - Connector, Receptacle, Electrical, Specific Purpose, Single, Grounding, Locking, 2 Pole, 3 Wire, 30 Amperes, 120 Volts, 400 Hertz, 1 Phase
- W-C-596/152 - Connector, Plug, Electrical, Specific Purpose, Locking, Grounding, 2 Pole, 3 Wire, 30 Amperes, 120 Volts, 400 Hertz, 1 Phase
- W-C-596/153 - Connector, Cable Outlet, Electrical, Specific Purpose, Single, Grounding, Locking, 2 Pole, 3 Wire, 30 Amperes, 120 Volts, 400 Hertz, 1 Phase
- W-C-596/154 - Connector, Receptacle, Electrical, Specific Purpose, Single, Locking, Grounding, 3 Pole, 4 Wire, 30 Amperes, 120 Volts, 400 Hertz, 3 Phase
- W-C-596/155 - Connector, Plug, Electrical, Specific Purpose, Locking, Grounding, 3 Pole, 4 Wire, 30 Amperes, 120 Volts, 400 Hertz, 3 Phase
- W-C-596/156 - Connector, Cable Outlet, Electrical, Specific Purpose, Cable Connecting, Locking, Grounding, 3 Pole, 4 Wire, 30 Amperes, 120 Volts, 400 Hertz, 3 Phase
- W-C-596/157 - Connector, Receptacle, Electrical, Specific Purpose, Single, Locking, Grounding, 4 Pole, 5 Wire, 30 Amperes, 120/208 Volts, 3 Phase Y, 400 Hertz
- W-C-596/158 - Connector, Plug, Electrical, Specific Purpose, Locking, Grounding, 4 Pole, 5 Wire, 30 Amperes, 120/208 Volts, 3 Phase Y, 400 Hertz
- W-C-596/159 - Connector, Cable Outlet, Electrical, Specific Purpose, Cable Connecting, Locking, Grounding, 4 Pole, 5 Wire, 30 Amperes, 120/208 Volts, 3 Phase Y, 400 Hertz
- W-C-596/161 - Connector, Plug, Electrical, General Purpose, Grounding, 2 Pole, 3 Wire, 50 Amperes, 125 Volts, 50/60 Hertz
- W-C-596/163 - Connector, Receptacle, Electrical, Male Inlet, General Purpose, Grounding, 2 Pole, 3 Wire, 50 Amperes, 125 Volts, 50/60 Hertz
- W-C-596/164 - Connectors, Receptacle, Electrical, General Purpose, Single, Grounding, 2 Pole, 3 Wire, 50 Amperes, 250 Volts, 50/60 Hertz
- W-C-596/165 - Connector, Plug, Electrical, General Purpose, Grounding, 2 Pole, 3 Wire, 50 Amperes, 250 Volts, 50/60 Hertz
- W-C-596/167 - Connector, Receptacle, Electrical, Male Inlet, General Purpose, Grounding, 2 Pole, 3 Wire, 50 Amperes, 250 Volts, 50/60 Hertz
- W-C-596/168 - Connectors, Receptacle, Electrical, General Purpose, Single, Grounding, 2 Pole, 3 Wire, 30 Amperes, 250 Volts, 50/60 Hertz
- W-C-596/169 - Connector, Plug, Electrical, General Purpose, Grounding, 2 Pole, 3 Wire, 30 Amperes, 250 Volts, 50/60 Hertz

MIL-STD-1353C
APPENDIX F

- W-C-596/171 - Connector, Receptacle, Electrical, Male Inlet, General Purpose, Grounding, 2 Pole, 3 Wire, 30 Amperes, 250 Volts, 50/60 Hertz
- W-C-596/173 - Connector, Plug, Electrical, General Purpose, Grounding, 2 Pole, 3 Wire, 50 Amperes, 277 Volts, 50/60 Hertz
- W-C-596/175 - Connector, Receptacle, Electrical, Male Inlet, General Purpose, Grounding, 2 Pole, 3 Wire, 50 Amperes, 277 Volts, 50/60 Hertz
- W-C-596/177 - Connector, Plug, Electrical, General Purpose, Grounding, 2 Pole, 3 Wire, 30 Amperes, 277 Volts, 50/60 Hertz
- W-C-596/179 - Connector, Receptacle, Electrical, Male Inlet, General Purpose, Grounding, 2 Pole, 3 Wire, 30 Amperes, 277 Volts, 50/60 Hertz
- W-C-596/181 - Connector, Plug, Electrical, General Purpose, Grounding, 2 Pole, 3 Wire, 20 Amperes, 277 Volts, 50/60 Hertz
- W-C-596/184 - Connectors, Receptacle, Electrical, General Purpose, Single, Grounding, 3 Pole, 4 Wire, 50 Amperes, 125/250 Volts, 50/60 Hertz
- W-C-596/185 - Connector, Plug, Electrical, General Purpose, Grounding, 3 Pole, 4 Wire, 50 Amperes, 125/250 Volts, 50/60 Hertz
- W-C-596/189 - Connector, Plug, Electrical, General Purpose, Grounding, 3 Pole, 4 Wire, 30 Amperes, 125/250 Volts, 50/60 Hertz
- W-C-596/196 - Connectors, Receptacle, Electrical, General Purpose, Single, Grounding, 3 Pole, 4 Wire, 60 Amperes, 250 Volts, 50/60 Hertz, 3-Phase
- W-C-596/200 - Connectors, Receptacle, Electrical, General Purpose, Single, Grounding, 3 Pole, 4 Wire, 50 Amperes, 250 Volts, 50/60 Hertz, 3-Phase
- W-C-596/205 - Connector, Plug, Electrical, General Purpose, Grounding, 3 Pole, 4 Wire, 30 Amperes, 250 Volts, 50/60 Hertz, 3-Phase
- W-C-596/212 - Connector, Receptacle, Electrical, General Purpose, Duplex, Grounding,

DEFENSE SPECIFICATIONS

- MIL-DTL-2726 - Receptacles, Receptacle Plugs, Switch and Receptacles, and Outlets (Electrical), General Specification For
- MIL-DTL-2726/1 - Receptacle, Plug, Electrical, 2-Pin, 40-Ampere, 125-Volt, Direct Current (Symbol No. 715.1) (Inactive)
- MIL-DTL-2726/2 - Receptacle, Plug, Electrical, 3-Pin Grounded, 50-Ampere, 250-Volt, Direct Current (Symbol No. 716.1)
- MIL-DTL-2726/3 - Receptacle, Plug, Electrical, 3-Pin Grounded, 50-Ampere, 250-Volt, Direct Current (Symbol No. 716.1)
- MIL-DTL-2726/5 - Receptacle, Plug, Electrical, 12-Pin, 5-Ampere 125-Volt, Direct Current (Symbol No. 718.1)
- MIL-DTL-2726/6 - Receptacle, Plug, Electrical, 3-Pin Grounded, 40-Ampere, 125-Volt, Alternating Current (Symbol No. 1143.1)
- MIL-DTL-2726/7 - Receptacle, Electrical, 2-Pin, 40-Ampere, 125-Volt, Direct Current (Symbol Nos. 756.1 and 756.2)
- MIL-DTL-2726/8 - Receptacle, Electrical, 3-Pin Grounded, 50-Ampere, 250-Volt, Direct Current (Symbol Nos. 757.1 And 757.2)
- MIL-DTL-2726/9 - Receptacle, Electrical, 4-Pin Grounded, 40-Ampere, 450-Volt, Alternating Current (Symbol Nos. 758.1 And 758.2)
- MIL-DTL-2726/11 - Receptacle, Electrical, 3-Pin Grounded, 50-Ampere, 250-Volt, Direct Current (Symbol Nos. 757.1 And 757.2)
- MIL-DTL-2726/12 - Receptacle, Electrical, 3-Pin Grounded, 40-Ampere, 450-Volt, Alternating Current (Symbol Nos. 1141.1 And 1141.2)

MIL-STD-1353C
APPENDIX F

MIL-DTL-2726/13	- Receptacle, Cap Assembly, Electrical (Symbol No. 1142.1)
MIL-DTL-2726/14	- Receptacle, Electrical, Enclosed, 3 - Pin Grounded, 40 - Ampere, 450-Volt, Alternating Current (Symbol Nos. 1145.1, 1145.2 and 1145.3)
MIL-DTL-2726/15	- Receptacle, Electrical, Enclosed, 3 - Pin Grounded, 40 - Ampere, 450-Volt, Alternating Current (Symbol Nos. 1145.1, 1145.2 and 1145.3)
MIL-DTL-2726/16	- Receptacle, Electrical, Enclosed, 4-Pin Grounded, 40-Ampere, 450-Volt, Alternating Current (Symbol Nos. 1147.1, 1147.2 and 1147.3)
MIL-DTL-2726/17	- Receptacle, Electrical, Enclosed, 3-Pin Grounded, 40-Ampere, 125-Volt, Alternating Current (Symbol Nos. 1148.1, 1148.2 and 1148.3)
MIL-DTL-2726/18	- Receptacle, Electrical, Triple, 50-Ampere, 250-Volt, Direct Current, 3-Pole Grounded (Symbol No. 1105.1)
MIL-DTL-2726/19	- Receptacle With Switch, Electrical, 30 - Ampere, 450 - Volt, Alternating Current, 60-Hertz, 3-Phase, Interlocking, Ground (Symbol No. 915.1)
MIL-DTL-2726/20	- Receptacle with Switch, Electrical, 30 - Ampere, 450 - Volt, 1 - Phase, Interlocking, Grounded (Symbol No. 916.1)
MIL-DTL-2726/21	- Receptacle with Switch, Electrical, 30-Ampere, 250-Volt, Direct Current, Interlocking, Grounded (Symbol No. 917.1)
MIL-DTL-2726/22	- Receptacle, Outlet, Electrical, Welding, 200-Ampere, Direct Current, Constant Potential (Symbol No. 770.2)
MIL-DTL-2726/23	- Receptacle, Electrical, Enclosed, 100-Ampere, 250-Volt, Direct Current, Bulkhead Mounted (Symbol No. 726.1)
MIL-DTL-2726/24	- Receptacle, Plug, Electrical, Connector, 25-Ampere, 500-Volt, 3-Phase Grounded (Symbol No. 707.1)
MIL-DTL-2726/25	- Receptacle, Plug, Electrical 4-Pin, 60-Ampere, 208/117-Volt, 3-Phase Grounded (Symbol No. 728.1)
MIL-DTL-2726/26	- Receptacle, Plug, Electrical 4-Pin, 60-Ampere, 208/117-Volt, 3-Phase Grounded (Symbol No. 728.1))
MIL-DTL-2726/27	- Receptacle with Switch, Electrical, 60-Ampere, 208/117-Volt, 3-Phase, Interlocking, Grounded (Symbol No. 776.1)
MIL-DTL-2726/28	- Receptacle, Plug, Electrical, 4 Pole Grounded, 100 - Ampere, 450 Volt, 3 - Phase (Symbol No. I222)
MIL-DTL-2726/29	- Receptacle, Plug, Electrical, 4 Pole Grounded, 100 - Ampere, 450 Volt, 3 - Phase (Symbol No. I222)
MIL-DTL-2726/30	- Receptacle, Plug, Electrical, 10 - Ampere, 125 Volt, Single Pole, Male (Symbol No. 727.1 - Red; Symbol No. 727.2 - Black)
MIL-DTL-2726/31	- Receptacle, Electrical, 10 - Ampere, 125 - Volt, Single Pole, Panel Mounted (Symbol No. 775.1 - Black; Symbol No. 775.2 - Red)
MIL-DTL-2726/32	- Receptacle, Plug, Electrical, 40-Ampere, 125-Volt, Single Pole, Male (Symbol No. 1214.2-Red; Symbol No. 1214.5-Black)
MIL-DTL-2726/33	- Receptacle, Plug, Electrical, 40-Ampere, 125-Volt, Single Pole, Male (Symbol No. 1214.2-Red; Symbol No. 1214.5-Black)
MIL-DTL-2726/34	- Receptacle, Plug, Electrical, 40 - Ampere, 125 Volt, Single Pole, Female Type (Symbol No. 1214.3 - Red; Symbol No. 1214.4 - Black)
MIL-DTL-2726/35	- Receptacle, Electrical, 40 - Ampere, 125 - Volt Single Pole, Panel Mounted, Female (Symbol No. 1213.2 - Red; Symbol No. 1213.4 - Black)
MIL-DTL-2726/36	- Receptacle, Electrical, 40-Ampere, 125-Volt, Single Pole, Panel Mounted, Male Type (Symbol No. 1213.3 - Red; Symbol No. 1213.5 - Black)
MIL-DTL-2726/37	- Receptacle, Electrical, 15 - Ampere, 125 - Volt, 60 Hertz, Bladed Type, Grounded (Symbol No. 1099.1)
MIL-DTL-2726/38	- Receptacle, Plug, Electrical, 15-Ampere, 125-Volt, Bladed Type,

MIL-STD-1353C
APPENDIX F

- MIL-DTL-2726/39 - Grounded (Symbol No. 1218.3)
- Receptacle and Switch, Electrical, 15-Ampere, 125-Volt, Bladed Type, Grounded (Symbol No. 919) (Inactive)
- MIL-DTL-2726/40 - Receptacle, Electrical, Enclosed, 15-Ampere, 125-Volt, (Symbol No. 1098.1)
- MIL-DTL-2726/41 - Receptacle, Electrical, Enclosed, 15-Ampere, 125-Volt, (Symbol No. 1098.1)
- MIL-DTL-2726/42 - Receptacle, Electrical, Enclosed, 60-Ampere, 500-Volt, 3-Phase, Grounded (Symbol No. 746.2) (Inactive)
- MIL-DTL-2726/43 - Receptacle, Electrical, (Bladed) 15-Ampere with 3-Ampere Switch, Type DPST, 125-Volt, Grounded, Totally Enclosed (Symbol 918.1)
- MIL-DTL-2726/44 - Receptacle, Portable Triple Outlet, Electrical, 60-Ampere, 500-Volt, 3-Phase Grounded (Symbol No. 765.3)
- MIL-DTL-2726/45 - Receptacle, Outlet Switch, Electrical, 100-Ampere, 125-Volt, 60-Ampere, 250-Volt, Interlocking, Grounded (Symbol No. 772.1)
- MIL-DTL-2726/46 - Receptacle, Outlet Switch, Electrical, 100-Ampere, 125-Volt, 60-Ampere, 250-Volt, Interlocking, Grounded (Symbol No. 772.1)
- MIL-DTL-2726/47 - Receptacle, Electrical, Enclosed, 15-Ampere, 125-Volt, 2-Pole, Grounded (Symbol No. 735.3)
- MIL-DTL-2726/48 - Receptacle, Electrical, Enclosed, 15-Ampere, 125-Volt, 2-Pole, Grounded (Symbol No. 735.3)
- MIL-DTL-2726/49 - Receptacle, Outlet, Triple, Electrical, 40-Ampere, 450-Volt, 60 Hertz, Alternating Current, 4-Pole, Portable, Plastic Grounded (Symbol Nos. 765.6, 765.7 And 765.8)
- MIL-DTL-2726/50 - Receptacle, Plug, Electrical, 15-Ampere, 125/250-Volts, 2-Pole, Grounded (Symbol No. 720.3)
- MIL-DTL-2726/51 - Receptacle, Adapter, Electrical, 15-Ampere, 125-Volt, Alternating Current, Grounded (Symbol No. 2440.2)
- MIL-DTL-2726/52 - Receptacle, Plug, Electrical, 3-Pin Grounded, 10-Ampere, 450-Volt, 60-Hertz, Single Phase (Symbol No. 1257)
- MIL-DTL-2726/53 - Receptacle, Plug, Electrical, 4-Pin Grounded, 10-Ampere, 450-Volt, 400-Hertz, Single-Phase (Symbol No. 1258)
- MIL-DTL-2726/54 - Receptacle, Plug, Electrical, 3-Pin Grounded, 10-Ampere, 450-Volt, 400-Hertz, Single-Phase (Symbol No. 1259)
- MIL-DTL-2726/55 - Receptacle, Plug, Electrical, 4-Pin Grounded, 10-Ampere, 450-Volt, 400 Hertz, 3-Phase (Symbol No. 1260)
- MIL-DTL-2726/56 - Receptacle, Plug, Electrical, 4-Pin Grounded, 10-Ampere, 450-Volt, 400 Hertz, 3-Phase (Symbol No. 1260)
- MIL-DTL-2726/57 - Receptacle, Plug, Electrical, 3-Pole Grounded, 10-Ampere, 450-Volt, Single Phase (Symbol No. 1262)
- MIL-DTL-2726/58 - Receptacle, Electrical, 4-Pin Grounded, 10-Ampere, 450-Volt, 60-Hertz, Alternating Current (Symbol No. 1263)
- MIL-DTL-2726/59 - Receptacle, Electrical, 3-Pin Grounded, 10-Ampere, 450-Volt, 400 Hertz, Single Phase (Symbol No. 1264))
- MIL-DTL-2726/60 - Receptacle, Electrical, 4-Pin Grounded, 10-Ampere, 450-Volt, 400 Hertz, 3-Phase (Symbol No. 1265)
- MIL-DTL-2726/61 - Receptacle, Electrical, 4-Pole Grounded, 60-Ampere, 450-Volt, 3-Phase (Symbol No. 1266)
- MIL-DTL-2726/62 - Receptacle, Electrical, Enclosed 3-Pin Grounded, 10-Ampere, 450-Volt, 60-Hertz Single-Phase (Symbol No. 1267)
- MIL-DTL-2726/63 - Receptacle, Electrical, Enclosed 4-Pin Grounded, 10-Ampere, 450-Volt,

MIL-STD-1353C
APPENDIX F

	60-Hertz Alternating Current (Symbol No. 1268)
MIL-DTL-2726/64	- Receptacle, Electrical, Enclosed 4-Pin Grounded, 10-Ampere, 450-Volt, 60-Hertz Alternating Current (Symbol No. 1268)
MIL-DTL-2726/65	- Receptacle, Electrical, Enclosed, 4-Pin Grounded, 10-Ampere, 450-Volt, 400-Hertz, 3-Phase (Symbol No. 1272)
MIL-DTL-2726/67	- Receptacle, Electrical, Enclosed, 10-Ampere, 125-Volt, 3-Phase, Grounded (Symbol No. 741.2)
MIL-DTL-2726/68	- Receptacle, Plug, Connector, Electrical, 10-Ampere, 125-Volt, 3-Phase, Grounded (Symbol No. 706.1)
MIL-DTL-2726/69	- Receptacle, Outlet, Triple, Electrical, Portable, 15-Ampere, 125-Volt Alternating Current, Double Pole, Grounded, 25-Foot Cable Extension (Symbol No. 779)
MIL-DTL-2726/70	- Receptacle, Electrical, Totally Enclosed, 15-Ampere, 125-Volt, 400-Hertz, Bladed Type, Single Phase, Grounded (Symbol No. 1100)
MIL-DTL-2726/72	- Receptacle, Adapter, Electrical, 15-Ampere, 125-Volt, Alternating Current, 60 To 400-Hertz Grounded (Symbol No. 2439)
MIL-DTL-2726/73	- Receptacle, Electrical, 15-Ampere, 125-Volt, Bladed Type, Grounded (Portable) (Symbol No. 1215)
MIL-DTL-12520	- Connectors, Plug and Receptacle (Electrical, Waterproof), and Accessories; General Specification For
MIL-DTL-12520/8	- Connectors, Receptacle, Electrical, Waterproof (Shell Size 20, Male Inserts)
MIL-DTL-12520/9	- Connectors, Receptacle, Electrical, Waterproof (Shell Size 20, Female Inserts)
MIL-DTL-12520/10	- Connectors, Receptacle, Electrical, Waterproof (Shell Size 26, Male Inserts)
MIL-DTL-12520/11	- Connectors, Receptacle, Electrical, Waterproof (Shell Size 26, Female Inserts)
MIL-C-12520/3	- Connectors, Plug, Electrical, Waterproof (Cathedral Shape, Shell Size 26, Female Inserts)
MIL-C-12520/5	- Connectors, Plug, Electrical, Waterproof (Round Sharp, Shell Size 20, Female Inserts)
MIL-C-12520/6	- Connectors, Plug, Electrical, Waterproof (Round Shape, Shell Size 20, Male Inserts)
MIL-C-12520/7	- Connectors, Plug, Electrical, Waterproof (Round Shape, Shell Size 26, Male Inserts)
MIL-C-12520/12	- Cover and Chain Assemblies (External Threads, for Use on Waterproof Connectors)
MIL-C-12520/13	- Cover and Chain Assemblies (Internal Threads, for Use on Waterproof Connectors)
MIL-C-12520/14	- Connectors, Plug, Electrical, Waterproof (Round Shape, Shell Size 20, Male Inserts, Bellows Clamp)
MIL-C-12520/15	- Connectors, Plug, Electrical, Waterproof (Round Shape, Shell Size 26, Male Inserts, Bellows Camp)
MIL-C-12520/16	- Connectors, Plug, Electrical, Waterproof (Cathedral Shape, Shell Size 20, Female Inserts)
MIL-C-12520/17	- Connectors, Plug, Electrical, Waterproof (Cathedral Shape, Shell Size 20, Male Inserts)
MIL-C-12520/18	- Connectors, Plug, Electrical, Waterproof (Cathedral Shape, Shell Size 26, Male Inserts)

MIL-STD-1353C
APPENDIX F

- MIL-DTL-55181 - Connectors, Plug and Receptacle, Intermediate Power (Electrical, Waterproof), Type Mw, General Specification For
- MIL-DTL-55181/1 - Connector, Plug, Electrical, Waterproof, 4 Socket Contacts, Solder Turret, 35 AMP
- MIL-DTL-55181/2 - Connector, Receptacle, Electrical, Panel Mount, Waterproof, 4 Pin Contacts, Solder Turret, 35 Amp
- MIL-DTL-55181/3 - Connector, Plug, Electrical, Waterproof, 4 Pin Contacts, Solder Turret, 35 Amp
- MIL-DTL-55181/4 - Connector, Receptacle, Electrical, Panel Mount, Waterproof, 4 Socket Contacts, 35 Amp
- MIL-DTL-55181/5 - Connector, Plug, Electrical, Panel Mount, Waterproof, 9 Pin Contacts, Solder Cup, 7.5 Amp
- MIL-DTL-55181/6 - Connector, Receptacle, Electrical, Waterproof, 9 Socket Contacts, Solder Cup, 7.5 Amp
- MIL-DTL-55181/7 - Connector, Electrical, Plug, Intermediate Power, Waterproof, 18 Pin Contacts, Solder Cup, 7.5 Amps
- MIL-DTL-55181/8 - Connector, Receptacle, Electrical, Waterproof, Panel Mount, 18 Contacts, 7.5 Amp
- MS75020 - Connector, Plug electrical - 12 Contact Intervehicular, 28 Volt, Waterproof
- MS75021 - Connector, Receptacle, Electrical-12 Contact, Intervehicular, 28 Volt Waterproof

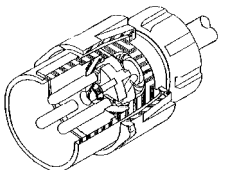
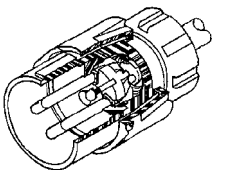
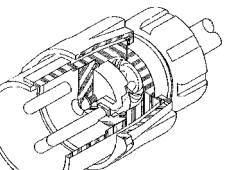
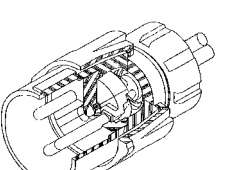
(Copies of these documents are available online at <http://quicksearch.dla.mil> or from the Standardization Document Order Desk, 700 Robbins Avenue, Building 4D, Philadelphia, PA 19111-5094.)

MIL-STD-1353C
APPENDIX F

F.3 MIL-DTL-2726. MIL-DTL-2726 covers the general requirements for power type electrical plugs, receptacles, switch and receptacle combinations, and outlets for use in direct current (dc) circuits up to 250 volts alternating current (ac) and direct current (dc) circuits up to 600 volts at frequencies up to and including 400 hertz (Hz), see table F-I.

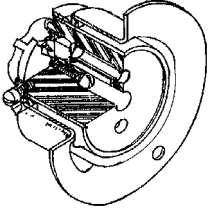
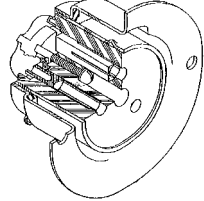
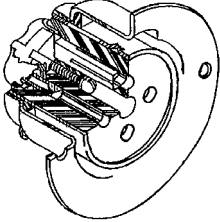
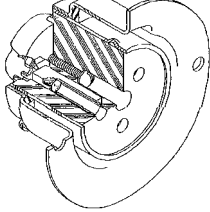
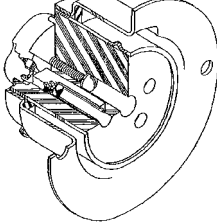
F.3.1 Intended use. The plugs, receptacles, switch and outlets provide connections for the distribution of ac and dc power throughout naval ships.

TABLE F-I. MIL-DTL-2726 descriptions and configurations.

Specification	Description	Configuration
MIL-DTL-2726	Receptacles, Receptacle Plugs, Switch and Receptacles, and Outlets (Electrical), General Specification For	
MIL-DTL-2726/1	Receptacle, Plug, Electrical, 2-Pin, 40-Ampere, 125-Volt, Direct Current (Symbol No. 715.1) (Inactive for new design)	
MIL-DTL-2726/2	Receptacle, Plug, Electrical, 3-Pin Grounded, 50-Ampere, 250-Volt, Direct Current (Symbol No. 716.1) (Inactive for new design)	
MIL-DTL-2726/3	Receptacle, Plug, Electrical, 3-Pin Grounded, 50-Ampere, 250-Volt, Direct Current (Symbol No. 716.1)	
MIL-DTL-2726/5	Receptacle, Plug, Electrical, 12-Pin, 5-Ampere 125-Volt, Direct Current (Symbol No. 718.1)	
MIL-DTL-2726/6	Receptacle, Plug, Electrical, 3-Pin Grounded, 40-Ampere, 125-Volt, Alternating Current (Symbol No. 1143.1) (Inactive for new design)	

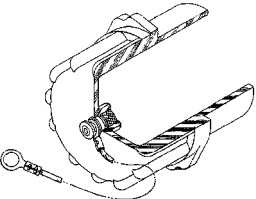
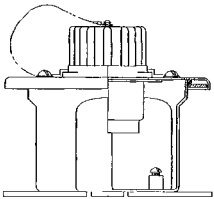
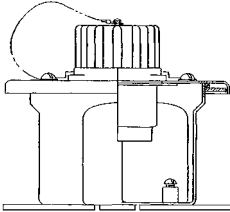
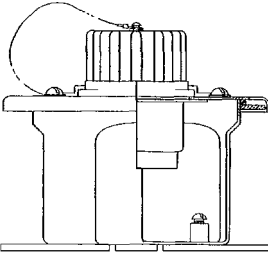
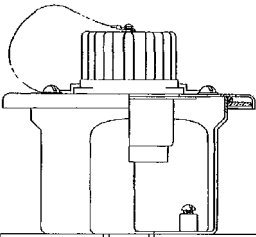
MIL-STD-1353C
APPENDIX F

TABLE F-I. MIL-DTL-2726 descriptions and configurations - Continued.

Specification	Description	Configuration
MIL-DTL-2726/7	Receptacle, Electrical, 2-Pin, 40-Ampere, 125-Volt, Direct Current (Symbol Nos. 756.1 and 756.2) (Inactive for new design)	
MIL-DTL-2726/8	Receptacle, Electrical, 3-Pin Grounded, 50-Ampere, 250-Volt, Direct Current (Symbol Nos. 757.1 and 757.2) (Inactive for new design)	
MIL-DTL-2726/9	Receptacle, Electrical, 4-Pin Grounded, 40-Ampere, 450-Volt, Alternating Current (Symbol Nos. 758.1 And 758.2) (Inactive for new design)	
MIL-DTL-2726/11	Receptacle, Electrical, 3-Pin Grounded, 50-Ampere, 250-Volt, Direct Current (Symbol Nos. 757.1 and 757.2) (Inactive for new design)	
MIL-DTL-2726/12	Receptacle, Electrical, 3-Pin Grounded, 40-Ampere, 450-Volt, Alternating Current (Symbol Nos. 1141.1 and 1141.2) (Inactive for new design)	

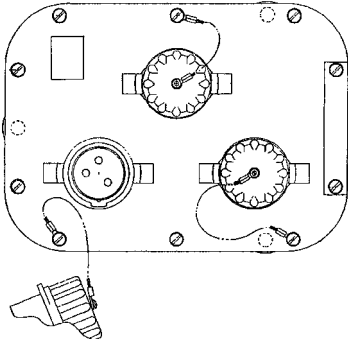
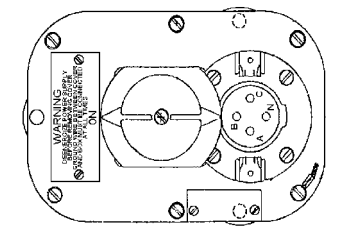
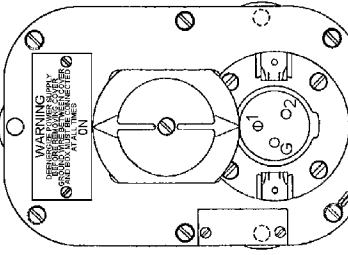
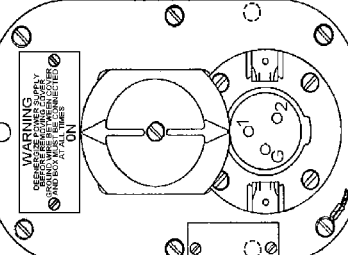
MIL-STD-1353C
APPENDIX F

TABLE F-I. MIL-DTL-2726 descriptions and configurations - Continued.

Specification	Description	Configuration
MIL-DTL-2726/13	Receptacle, Cap Assembly, Electrical (Symbol No. 1142.1) (Inactive for new design)	
MIL-DTL-2726/14	Receptacle, Electrical, Enclosed, 3 - Pin Grounded, 40 - Ampere, 450-Volt, Alternating Current (Symbol Nos. 1145.1, 1145.2 and 1145.3)	
MIL-DTL-2726/15	Receptacle, Electrical, Enclosed, 3 - Pin Grounded, 40 - Ampere, 450-Volt, Alternating Current (Symbol Nos. 1145.1, 1145.2 and 1145.3) (Inactive for new design)	
MIL-DTL-2726/16	Receptacle, Electrical, Enclosed, 4-Pin Grounded, 40-Ampere, 450-Volt, Alternating Current (Symbol Nos. 1147.1, 1147.2 and 1147.3)	
MIL-DTL-2726/17	Receptacle, Electrical, Enclosed, 3-Pin Grounded, 40-Ampere, 125-Volt, Alternating Current (Symbol Nos. 1148.1, 1148.2 and 1148.3) (Inactive for new design)	

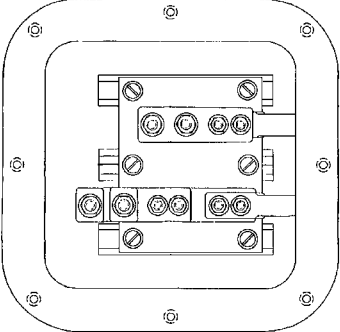
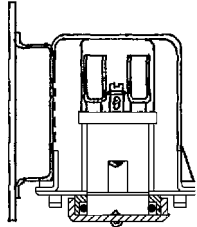
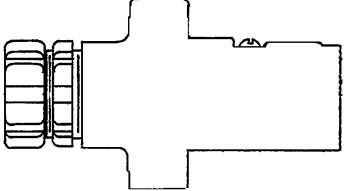
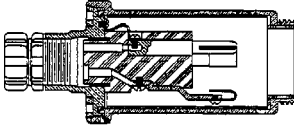
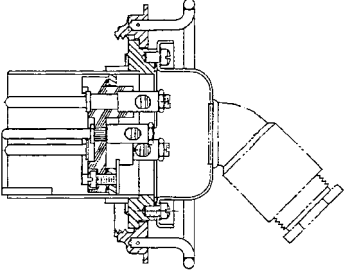
MIL-STD-1353C
APPENDIX F

TABLE F-I. MIL-DTL-2726 descriptions and configurations - Continued.

Specification	Description	Configuration
MIL-DTL-2726/18	Receptacle, Electrical, Triple, 50-Ampere, 250-Volt, Direct Current, 3-Pole Grounded (Symbol No. 1105.1) (Inactive for new design)	
MIL-DTL-2726/19	Receptacle With Switch, Electrical, 30 - Ampere, 450 - Volt, Alternating Current, 60-Hertz, 3-Phase, Interlocking, Ground (Symbol No. 915.1)	
MIL-DTL-2726/20	Receptacle With Switch, Electrical, 30 - Ampere, 450 - Volt, 1 - Phase, Interlocking, Grounded (Symbol No. 916.1)	
MIL-DTL-2726/21	Receptacle With Switch, Electrical, 30-Ampere, 250-Volt, Direct Current, Interlocking, Grounded (Symbol No. 917.1) (Inactive for new design)	

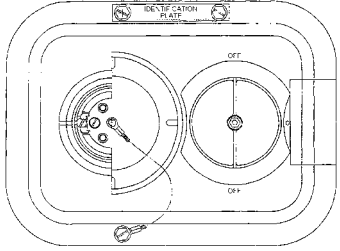
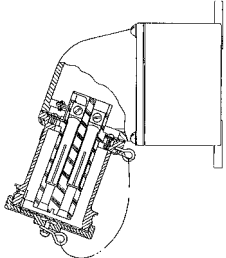
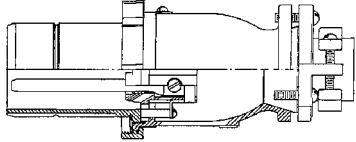
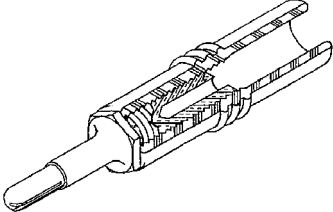
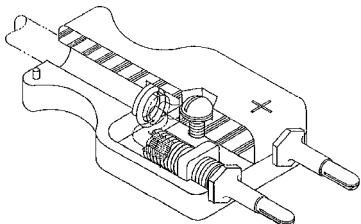
MIL-STD-1353C
APPENDIX F

TABLE F-I. MIL-DTL-2726 descriptions and configurations - Continued.

Specification	Description	Configuration
MIL-DTL-2726/22	Receptacle, Outlet, Electrical, Welding, 200-Ampere, Direct Current, Constant Potential (Symbol No. 770.2) (Inactive for new design)	
MIL-DTL-2726/23	Receptacle, Electrical, Enclosed, 100-Ampere, 250-Volt, Direct Current, Bulkhead Mounted (Symbol No. 726.1) (Inactive for new design)	
MIL-DTL-2726/24	Receptacle, Plug, Electrical, Connector, 25-Ampere, 500-Volt, 3-Phase Grounded (Symbol No. 707.1) (Inactive for new design)	
MIL-DTL-2726/25	Receptacle, Plug, Electrical 4-Pin, 60-Ampere, 208/117-Volt, 3-Phase Grounded (Symbol No. 728.1) (Inactive for new design)	
MIL-DTL-2726/26	Receptacle, Plug, Electrical 4-Pin, 60-Ampere, 208/117-Volt, 3-Phase Grounded (Symbol No. 728.1) (Inactive for new design)	

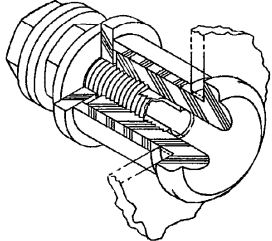
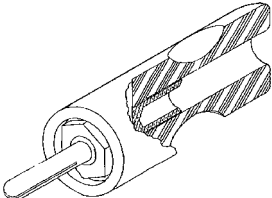
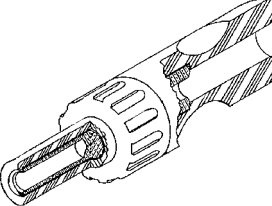
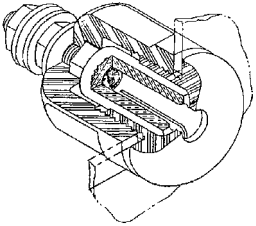
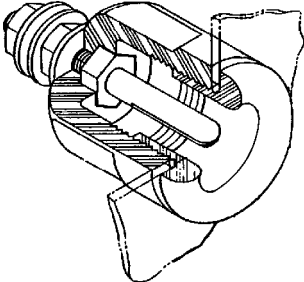
MIL-STD-1353C
APPENDIX F

TABLE F-I. MIL-DTL-2726 descriptions and configurations - Continued.

Specification	Description	Configuration
MIL-DTL-2726/27	Receptacle With Switch, Electrical, 60-Ampere, 208/117-Volt, 3-Phase, Interlocking, Grounded (Symbol No. 776.1) (Inactive for new design)	
MIL-DTL-2726/28	Receptacle, Plug, Electrical, 4 Pole Grounded, 100 - Ampere, 450 Volt, 3 - Phase (Symbol No. I222) (Inactive for new design)	
MIL-DTL-2726/29	Receptacle, Plug, Electrical, 4 Pole Grounded, 100 - Ampere, 450 Volt, 3 - Phase (Symbol No. I222) (Inactive for new design)	
MIL-DTL-2726/30	Receptacle, Plug, Electrical, 10 - Ampere, 125 Volt, Single Pole, Male (Symbol No. 727.1 - Red; Symbol No. 727.2 - Black)	
MIL-DTL-2726/31	Receptacle, Electrical, 10 - Ampere, 125 - Volt, Single Pole, Panel Mounted (Symbol No. 775.1 - Black; Symbol No. 775.2 - Red) (Inactive for new design)	

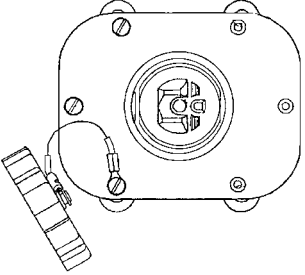
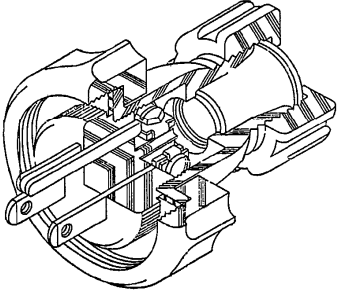
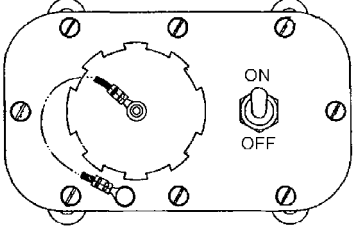
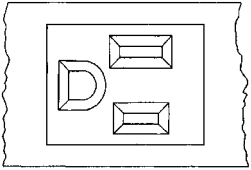
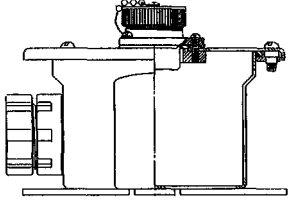
MIL-STD-1353C
APPENDIX F

TABLE F-I. MIL-DTL-2726 descriptions and configurations - Continued.

Specification	Description	Configuration
MIL-DTL-2726/32	Receptacle, Plug, Electrical, 40-Ampere, 125-Volt, Single Pole, Male (Symbol No. 1214.2-Red; Symbol No. 1214.5-Black)	
MIL-DTL-2726/33	Receptacle, Plug, Electrical, 40-Ampere, 125-Volt, Single Pole, Male (Symbol No. 1214.2-Red; Symbol No. 1214.5-Black) (Inactive for new design)	
MIL-DTL-2726/34	Receptacle, Plug, Electrical, 40 - Ampere, 125 Volt, Single Pole, Female Type (Symbol No. 1214.3 - Red; Symbol No. 1214.4 - Black) (Inactive for new design)	
MIL-DTL-2726/35	Receptacle, Electrical, 40 - Ampere, 125 - Volt Single Pole, Panel Mounted, Female (Symbol No. 1213.2 - Red; Symbol No. 1213.4 - Black) (Inactive for new design)	
MIL-DTL-2726/36	Receptacle, Electrical, 40-Ampere, 125-Volt, Single Pole, Panel Mounted, Male Type (Symbol No. 1213.3 - Red; Symbol No. 1213.5 - Black) (Inactive for new design)	

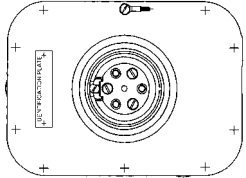
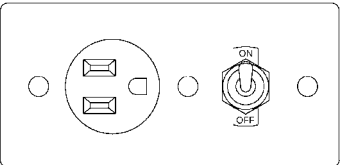
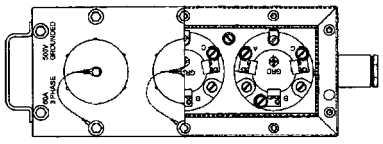
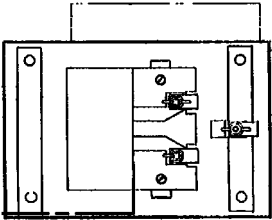
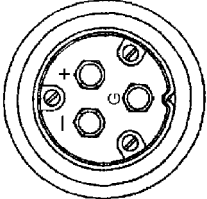
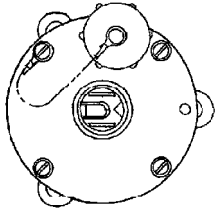
MIL-STD-1353C
APPENDIX F

TABLE F-I. MIL-DTL-2726 descriptions and configurations - Continued.

Specification	Description	Configuration
MIL-DTL-2726/37	Receptacle, Electrical, 15 - Ampere, 125 - Volt, 60 Hertz, Bladed Type, Grounded (Symbol No. 1099.1)	 <p>A top-down view of a square electrical receptacle with four screws around the perimeter. A circular opening in the center contains a three-pronged blade assembly. A separate diagram shows a single blade with a ground pin.</p>
MIL-DTL-2726/38	Receptacle, Plug, Electrical, 15-Ampere, 125-Volt, Bladed Type, Grounded (Symbol No. 1218.3)	 <p>An isometric view of a three-pronged electrical plug with a ground pin, designed to fit into a receptacle.</p>
MIL-DTL-2726/39	Receptacle And Switch, Electrical, 15-Ampere, 125-Volt, Bladed Type, Grounded (Symbol No. 919) (Inactive for new design)	 <p>A top-down view of a square electrical component. On the left is a circular opening with a three-pronged blade assembly. On the right is a toggle switch with 'ON' and 'OFF' markings. The component is secured with four screws.</p>
MIL-DTL-2726/40	Receptacle, Electrical, Enclosed, 15-Ampere, 125-Volt, (Symbol No. 1098.1) (Inactive for new design)	 <p>A top-down view of a square electrical component with a central rectangular opening. Inside the opening, a three-pronged blade assembly is visible. The component is secured with four screws.</p>
MIL-DTL-2726/41	Receptacle, Electrical, Enclosed, 15-Ampere, 125-Volt, (Symbol No. 1098.1)	 <p>A side view of an electrical component mounted on a base. It features a three-pronged blade assembly on the left and a toggle switch on the right. The component is secured with screws.</p>

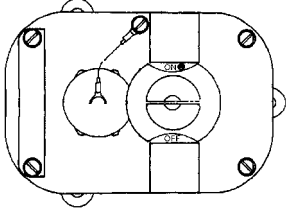
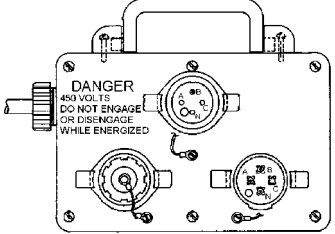
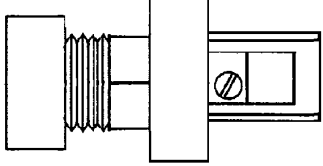
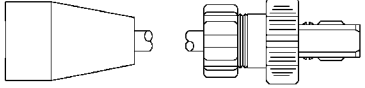
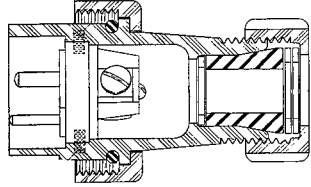
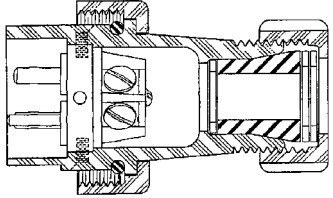
MIL-STD-1353C
APPENDIX F

TABLE F-I. MIL-DTL-2726 descriptions and configurations - Continued.

Specification	Description	Configuration
MIL-DTL-2726/42	Receptacle, Electrical, Enclosed, 60-Ampere, 500-Volt, 3-Phase, Grounded (Symbol No. 746.2) (Inactive for new design)	
MIL-DTL-2726/43	Receptacle, Electrical, (Bladed) 15-Ampere With 3-Ampere Switch, Type DPST, 125-Volt, Grounded, Totally Enclosed (Symbol 918.1)	
MIL-DTL-2726/44	Receptacle, Portable Triple Outlet, Electrical, 60-Ampere, 500-Volt, 3-Phase Grounded (Symbol No. 765.3) (Inactive for new design)	
MIL-DTL-2726/45	Receptacle, Outlet Switch, Electrical, 100-Ampere, 125-Volt, 60-Ampere, 250-Volt, Interlocking, Grounded (Symbol No. 772.1) (Inactive for new design)	
MIL-DTL-2726/46	Receptacle, Outlet Switch, Electrical, 100-Ampere, 125-Volt, 60-Ampere, 250-Volt, Interlocking, Grounded (Symbol No. 772.1) (Inactive for new design)	
MIL-DTL-2726/47	Receptacle, Electrical, Enclosed, 15-Ampere, 125-Volt, 2-Pole, Grounded (Symbol No. 735.3)	

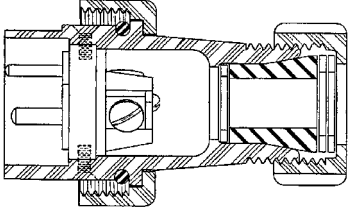
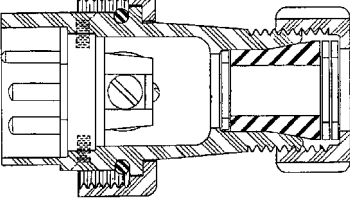
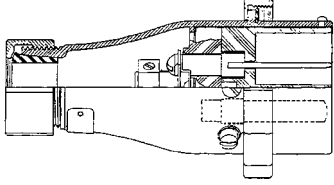
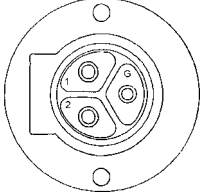
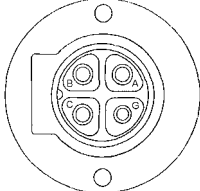
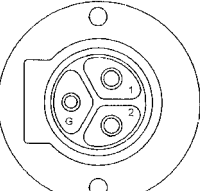
MIL-STD-1353C
APPENDIX F

TABLE F-I. MIL-DTL-2726 descriptions and configurations - Continued.

MIL-DTL-2726/48	Receptacle, Electrical, Enclosed, 15-Ampere, 125-Volt, 2-Pole, Grounded (Symbol No. 735.3)	
MIL-DTL-2726/49	Receptacle, Outlet, Triple, Electrical, 40-Ampere, 450-Volt, 60 Hertz, Alternating Current, 4-Pole, Portable, Plastic Grounded (Symbol Nos. 765.6, 765.7 and 765.8)	
MIL-DTL-2726/50	Receptacle, Plug, Electrical, 15-Ampere, 125/250-Volts, 2-Pole, Grounded (Symbol No. 720.3)	
MIL-DTL-2726/51	Receptacle, Adapter, Electrical, 15-Ampere, 125-Volt, Alternating Current, Grounded (Symbol No. 2440.2) (Inactive for new design)	
MIL-DTL-2726/52	Receptacle, Plug, Electrical, 3-Pin Grounded, 10-Ampere, 450-Volt, 60-Hertz, Single Phase (Symbol No. 1257) (Inactive for new design)	
MIL-DTL-2726/53	Receptacle, Plug, Electrical, 4-Pin Grounded, 10-Ampere, 450-Volt, 400-Hertz, Single-Phase (Symbol No. 1258) (Inactive for new design)	

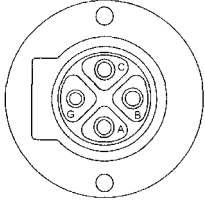
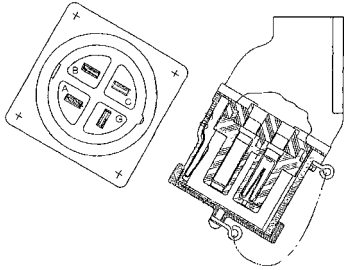
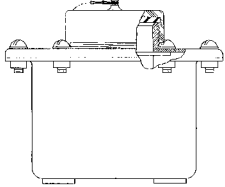
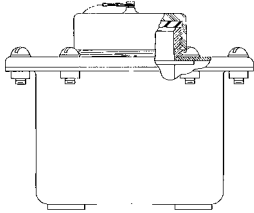
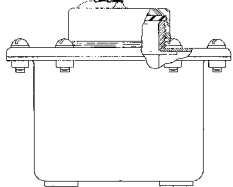
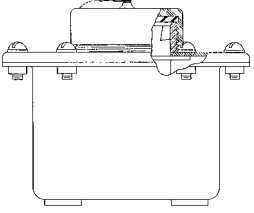
MIL-STD-1353C
APPENDIX F

TABLE F-I. MIL-DTL-2726 descriptions and configurations - Continued.

Specification	Description	Configuration
MIL-DTL-2726/54	Receptacle, Plug, Electrical, 3-Pin Grounded, 10-Ampere, 450-Volt, 400-Hertz, Single-Phase (Symbol No. 1259) (Inactive for new design)	
MIL-DTL-2726/55	Receptacle, Plug, Electrical, 4-Pin Grounded, 10-Ampere, 450-Volt, 400 Hertz, 3-Phase (Symbol No. 1260) (Inactive for new design)	
MIL-DTL-2726/56	Receptacle, Plug, Electrical, 4-Pin Grounded, 10-Ampere, 450-Volt, 400 Hertz, 3-Phase (Symbol No. 1260) (Inactive for new design)	
MIL-DTL-2726/57	Receptacle, Plug, Electrical, 3-Pole Grounded, 10-Ampere, 450-Volt, Single Phase (Symbol No. 1262) (Inactive for new design)	
MIL-DTL-2726/58	Receptacle, Electrical, 4-Pin Grounded, 10-Ampere, 450-Volt, 60-Hertz, Alternating Current (Symbol No. 1263) (Inactive for new design)	
MIL-DTL-2726/59	Receptacle, Electrical, 3-Pin Grounded, 10-Ampere, 450-Volt, 400 Hertz, Single Phase (Symbol No. 1264) (Inactive for new design)	

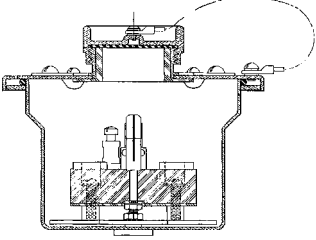
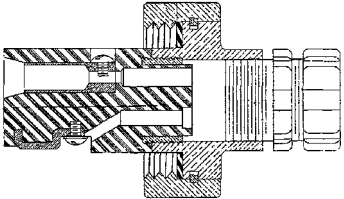
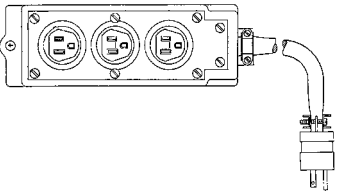
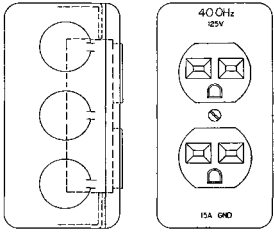
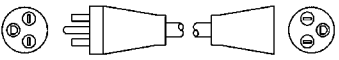
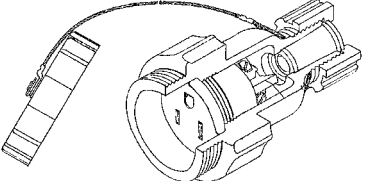
MIL-STD-1353C
APPENDIX F

TABLE F-I. MIL-DTL-2726 descriptions and configurations - Continued.

Specification	Description	Configuration
MIL-DTL-2726/60	Receptacle, Electrical, 4-Pin Grounded, 10-Ampere, 450-Volt, 400 Hertz, 3-Phase (Symbol No. 1265) (Inactive for new design)	
MIL-DTL-2726/61	Receptacle, Electrical, 4-Pole Grounded, 60-Ampere, 450-Volt, 3-Phase (Symbol No. 1266) (Inactive for new design)	
MIL-DTL-2726/62	Receptacle, Electrical, Enclosed 3-Pin Grounded, 10-Ampere, 450-Volt, 60-Hertz Single-Phase (Symbol No. 1267) (Inactive for new design)	
MIL-DTL-2726/63	Receptacle, Electrical, Enclosed 4-Pin Grounded, 10-Ampere, 450-Volt, 60-Hertz Alternating Current (Symbol No. 1268) (Inactive for new design)	
MIL-DTL-2726/64	Receptacle, Electrical, Enclosed 4-Pin Grounded, 10-Ampere, 450-Volt, 60-Hertz Alternating Current (Symbol No. 1268) (Inactive for new design)	
MIL-DTL-2726/65	Receptacle, Electrical, Enclosed, 4-Pin Grounded, 10-Ampere, 450-Volt, 400-Hertz, 3-Phase (Symbol No. 1272) (Inactive for new design)	

MIL-STD-1353C
APPENDIX F

TABLE F-I. MIL-DTL-2726 descriptions and configurations - Continued.

Specification	Description	Configuration
MIL-DTL-2726/67	Receptacle, Electrical, Enclosed, 10-Ampere, 125-Volt, 3-Phase, Grounded (Symbol No. 741.2) (Inactive for new design)	
MIL-DTL-2726/68	Receptacle, Plug, Connector, Electrical, 10-Ampere, 125-Volt, 3-Phase, Grounded (Symbol No. 706.1) (Inactive for new design)	
MIL-DTL-2726/69	Receptacle, Outlet, Triple, Electrical, Portable, 15-Ampere, 125-Volt Alternating Current, Double Pole, Grounded, 25-Foot Cable Extension (Symbol No. 779) (Inactive for new design)	
MIL-DTL-2726/70	Receptacle, Electrical, Totally Enclosed, 15-Ampere, 125-Volt, 400-Hertz, Bladed Type, Single Phase, Grounded (Symbol No. 1100) (Inactive for new design)	
MIL-DTL-2726/72	Receptacle, Adapter, Electrical, 15-Ampere, 125-Volt, Alternating Current, 60 to 400-Hertz Grounded (Symbol No. 2439)	
MIL-DTL-2726/73	Receptacle, Electrical, 15-Ampere, 125-Volt, Bladed Type, Grounded (Portable) (Symbol No. 1215) (Inactive for new design)	

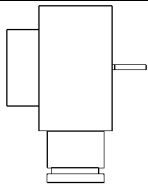
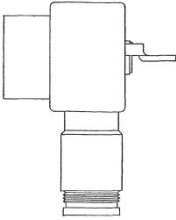
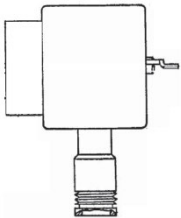
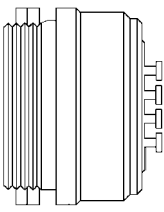

MIL-STD-1353C
APPENDIX F

F.4 MIL-DTL-12520. MIL-DTL-12520 series of centerlock screw coupling, waterproof, polarized, multicontact connectors and accessories for inter-connection of power and control circuits, see table F-II.

F.4.1 Intended use. The electrical connectors covered by this specification are intended primarily for ground or shore use.

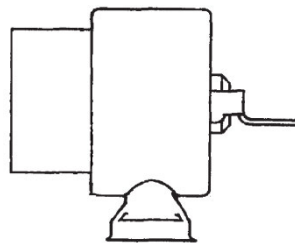
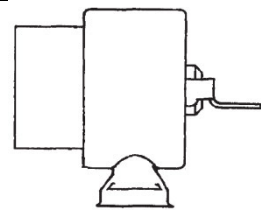
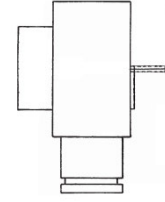
F.4.2 Environmental conditions. These connectors are waterproof and can withstand the extreme range of environmental conditions encountered by ground support equipment.

TABLE F-II. MIL-DTL-12520 descriptions and configurations.

Specification	Description	Configuration
MIL-DTL-12520	Connectors, Plug and Receptacle (Electrical, Waterproof), and Accessories; General Specification For	
MIL-C-12520/3	Connectors, Plug, Electrical, Waterproof (Cathedral Shape, Shell Size 26, Female Inserts)	
MIL-C-12520/5	Connectors, Plug, Electrical, Waterproof (Round Sharp, Shell Size 20, Female Inserts)	
MIL-C-12520/6	Connectors, Plug, Electrical, Waterproof (Round Shape, Shell Size 20, Male Inserts)	
MIL-C-12520/7	Connectors, Plug, Electrical, Waterproof (Round Shape, Shell Size 26, Male Inserts)	
MIL-DTL-12520/8	Connectors, Receptacle, Electrical, Waterproof (Shell Size 20, Male Inserts)	
MIL-DTL-12520/9	Connectors, Receptacle, Electrical, Waterproof (Shell Size 20, Female Inserts)	
MIL-DTL-12520/10	Connectors, Receptacle, Electrical, Waterproof (Shell Size 26, Male Inserts)	
MIL-DTL-12520/11	Connectors, Receptacle, Electrical, Waterproof (Shell Size 26, Female Inserts)	
MIL-C-12520/12	Cover and Chain Assemblies (External Threads, for Use on Waterproof Connectors)	
MIL-C-12520/13	Cover and Chain Assemblies (Internal Threads, for Use on Waterproof Connectors)	

MIL-STD-1353C
APPENDIX F

TABLE F-II. MIL-DTL-12520 descriptions and configurations - Continued.

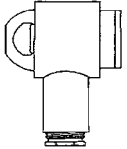
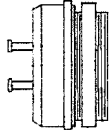
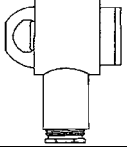
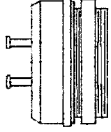
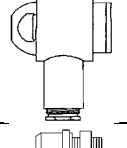
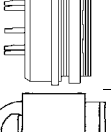
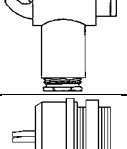

Specification	Description	Configuration
MIL-C-12520/14	Connectors, Plug, Electrical, Waterproof (Round Shape, Shell Size 20, Male Inserts, Bellows Clamp)	
MIL-C-12520/15	Connectors, Plug, Electrical, Waterproof (Round Shape, Shell Size 26, Male Inserts, Bellows Camp)	
MIL-C-12520/16	Connectors, Plug, Electrical, Waterproof (Cathedral Shape, Shell Size 20, Female Inserts)	
MIL-C-12520/17	Connectors, Plug, Electrical, Waterproof (Cathedral Shape, Shell Size 20, Male Inserts)	
MIL-C-12520/18	Connectors, Plug, Electrical, Waterproof (Cathedral Shape, Shell Size 26, Male Inserts)	

MIL-STD-1353C
APPENDIX F

F.5 MIL-C-55181. MIL-C-55181 center-lock coupling screw, waterproof, polarized, multi-contact see table F-III.

F5.1 Intended use. Intermediate power connectors for interconnection of power and control circuits on electronic equipment, used primarily for portable and vehicular mounted equipment.

TABLE F-III. MIL-DTL-55181 descriptions and configurations.

Specification number	Description	Configuration
MIL-DTL-55181	Connectors, Plug And Receptacle, Intermediate Power (Electrical, Waterproof), Type MW, General Specification For	
MIL-DTL-55181/1	Connector, Plug, Electrical, Waterproof, 4 Socket Contacts, Solder Turret, 35 AMP	
MIL-DTL-55181/2	Connector, Receptacle, Electrical, Panel Mount, Waterproof, 4 Pin Contacts, Solder Turret, 35 Amp	
MIL-DTL-55181/3	Connector, Plug, Electrical, Waterproof, 4 Pin Contacts, Solder Turret, 35 Amp	
MIL-DTL-55181/4	Connector, Receptacle, Electrical, Panel Mount, Waterproof, 4 Socket Contacts, 35 Amp	
MIL-DTL-55181/5	Connector, Plug, Electrical, Panel Mount, Waterproof, 9 Pin Contacts, Solder Cup, 7.5 Amp	
MIL-DTL-55181/6	Connector, Receptacle, Electrical, Waterproof, 9 Socket Contacts, Solder Cup, 7.5 Amp	
MIL-DTL-55181/7	Connector, Electrical, Plug, Intermediate Power, Waterproof, 18 Pin Contacts, Solder Cup, 7.5 Amps	
MIL-DTL-55181/8	Connector, Receptacle, Electrical, Waterproof, Panel Mount, 18 Contacts, 7.5 Amp	

MIL-STD-1353C
APPENDIX F

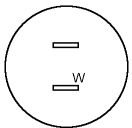
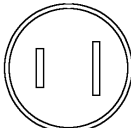
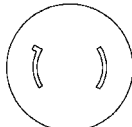

F.6 W-C-596. W-C-596 electrical covers general grade, hospital grade, specific, and special purpose electrical receptacles and plugs, see table F-IV.

F.6.1 Connector design. These connectors are designed with mating polarization for specific current rating, voltage, frequency (Hz), phase, and grounding requirements. This prevents mating with a connector of incompatible power characteristics.

F.6.2 Grades:

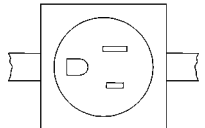
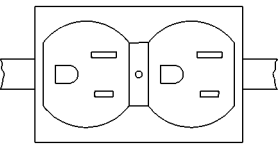

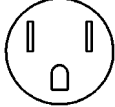

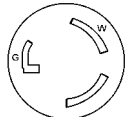
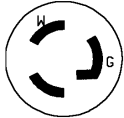
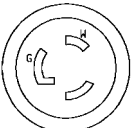

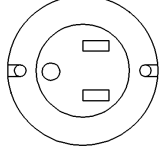
- a. General grade. A class of connectors that meets the requirements of Underwriters Laboratories, Inc. (UL) standard 498 and the additional requirements of W-C-596.
- B. Hospital grade. A class of connectors that A class of connectors that meets the requirements of UL standard 498 and the additional requirements of W-C-596. These connectors are designed to meet the added performance requirements of high abuse areas.

TABLE F-IV. W-C-596 descriptions and configurations.

Rating Amps - Volts	Type of connector	WC596 PIN	Features	Configuration
2 Pole, 2 Wire 50/60 Hz				
15 - 125	Plug, General Purpose, General Grade	WC596/3-1 WC596/3-2	Polarized Unpolarized	
15 - 125	Plug, General Purpose, General Grade, Cable Outlet	WC596/4-1		
15 - 125	Plug, Specific Purpose, General Grade, Locking	WC596/7-1 WC596/7-2	Straight Angle	
15 - 125	Plug, Specific Purpose, Cable Outlet, general Grade, Locking	WC596/8-1		

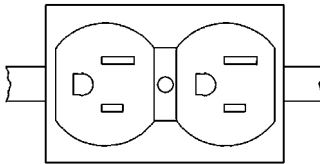
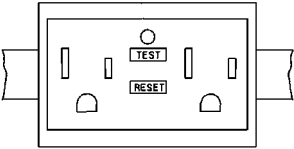
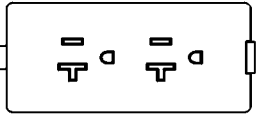
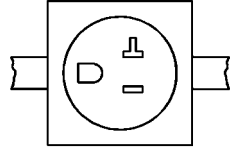
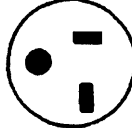
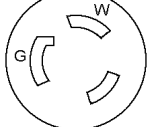
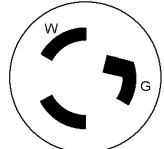
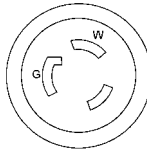
MIL-STD-1353C
APPENDIX F

Table F-IV. Standard connectors, W-C-596 type - Continued.

Rating Amps - Volts	Type of connector	WC596 PIN	Features	Configuration
2 Pole, 3 Wire				
15 - 125	Receptacle, General Purpose, Single, General Grade, Grounding	WC596/11-1 WC596/11-2	Ivory Brown	
15 - 125	Receptacle, General Purpose, Duplex, General Grade and Hospital Grade, Grounding	WC596/12-1 WC596/12-2 WC596/12-3 WC596/12-4	General Grade General Grade Hospital Grade Hospital Grade	
15 - 125	Plug, General Purpose, Hospital Grade, Grounding	WC596/13-3 WC596/13-4 WC596/13-5	Straight Angled Straight	
15 - 125	Cable Outlet, General Purpose, Hospital Grade, Cable Connecting	WC596/14-2		
15 - 125	Receptacle, Special Purpose, Single, Grounding	WC596/98-1		
15 - 125	Receptacle, Special Purpose, Duplex, Grounding	WC596/99-1		
15 - 125	Plug, Special Purpose, Grounding, Locking	WC596/100-1 WC596/100-2	Straight Angle	
15 - 125	Plug, Special Purpose, Cable Outlet, Grounding, Locking	WC596/101-1		
15 - 125	Receptacle, Male Inlet, Special Purpose, Grounding, Locking	WC596/102-1		
15 - 125	Receptacle, Male Inlet, General Purpose, Grounding	WC596/140-1		

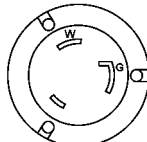
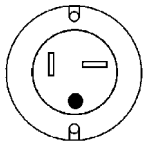
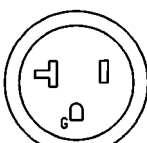
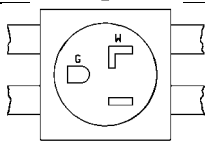
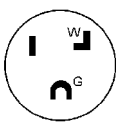
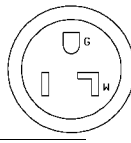
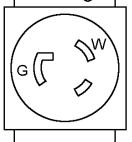

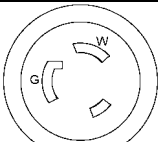
MIL-STD-1353C
APPENDIX F

Table F-IV. Standard connectors, W-C-596 type - Continued.

Rating Amps - Volts	Type of connector	WC596 PIN	Features	Configuration
2 Pole, 3 Wire				
15 - 125	Receptacle, Special Purpose, Duplex, Hospital Grade, Isolated Grounding	WC596/145-1	Orange	
15 - 125	Receptacle, General Purpose, Duplex, Grounding, Hospital Grade, Ground Fault Circuit Interrupting	WC596/212-1 WC596/212-2	Ivory Brown	
20 - 125	Receptacle, General Purpose, Duplex, General Grade and Hospital Grade, Grounding	WC596/40-1 WC596/40-2 WC596/40-3 WC596/40-4 WC596/40-5 WC596/40-6 WC596/40-7	General Grade General Grade Hospital Grade Hospital Grade General Grade General Grade General Grade	
20 - 125	Receptacle General Purpose, Single, Hospital Grade, Grounding	WC596/41-1 WC596/41-2 WC596/41-3 WC596/41-4	General Grade General Grade Hospital Grade Hospital Grade	
20 - 125	Plug, General Purpose, Hospital Grade, Grounding	WC596/42-1 WC596/42-2 WC596/42-3 WC596/42-4	Straight Angle Straight Angle Straight Angle	
20 - 125	Receptacle, Special Purpose, Single, Grounding	WC596/94-1 WC596/94-2	Flush mount Surface mount	
20 - 125	Plug, Special Purpose, Grounding, Locking	WC596/95-1 WC596/95-2	Straight Angle	
20 - 125	Plug, Special Purpose, Cable Outlet, Grounding, Locking	WC596/96-1		

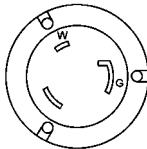
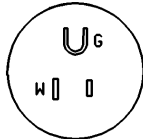
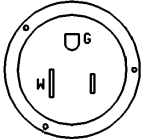
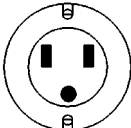
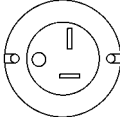

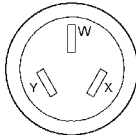
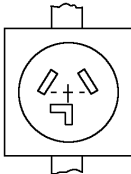
MIL-STD-1353C
APPENDIX F

Table F-IV. Standard connectors, W-C-596 type - Continued.

Rating Amps - Volts	Type of connector	WC596 PIN	Features	Configuration
2 Pole, 3 Wire				
20 - 125	Receptacle, Male Inlet, Special Purpose, Grounding, Locking	WC596/97-1		
20 - 125	Receptacle, Male Inlet, General Purpose, Grounding	WC596/142-1		
20 - 125	Plug, General Purpose, Cable Outlet, Grounding	WC596/143-1		
30 - 125	Receptacle, General Purpose, Single, General Grade, Grounding	WC596/68-1		
30 - 125	Plug, General Purpose, General Grade, Grounding	WC596/69-1 WC596/69-2	Straight Angle	
30 - 125	Cable Outlet, , General Purpose, General Grade, Grounding	WC596/70-1		
30 - 125	Receptacle, Special Purpose, Single, Grounding	WC596/90-1 WC596/90-2	Flush mount Surface mount	
30 - 125	Plug, Special Purpose, Grounding, Locking	WC596/91-1 WC596/91-2	Straight Angle	
30 - 125	Plug, Special Purpose, Cable Outlet, Grounding, Locking	WC596/92-1		


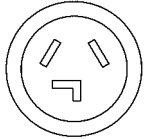
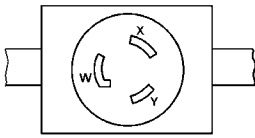
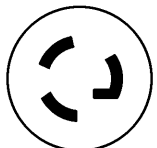
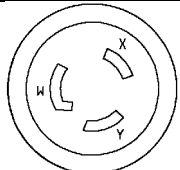
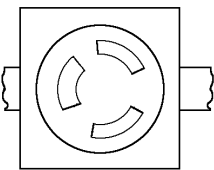
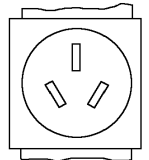
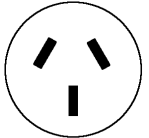
MIL-STD-1353C
APPENDIX F

Table F-IV. Standard connectors, W-C-596 type - Continued.

Rating Amps - Volts	Type of connector	WC596 PIN	Features	Configuration
2 Pole, 3 Wire				
30 - 125	Receptacle, Male Inlet, Special Purpose, Grounding, Locking	WC596/93-1		
50 - 125	Plug, General Purpose, Grounding (Inactive for new design)	WC596/161-1 WC596/161-2	Straight Angle	
50 - 125	Receptacle, Male Inlet, General Purpose, Grounding (Inactive for new design)	WC596/163-1		
2 Pole, 2 Wire 50/60 Hz				
15 - 250	Receptacle, Male Inlet, General Purpose, Grounding	WC596/141-1		
15 - 250	Receptacle, Male Inlet, General Purpose, Grounding	WC596/144-1		
3 Pole, 3 Wire 50/60 Hz				
20 - 125/250	Plug, General Purpose, General Grade	WC596/26-1		
20 - 125/250	Plug, General Purpose, Cable Outlet, General Grade	WC596/27-1		
30 - 125/250	Receptacle, General Purpose, Single, General Grade	WC596/33-1		

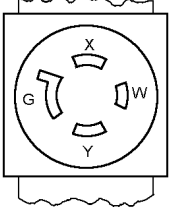
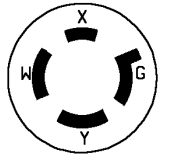
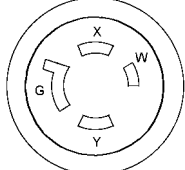
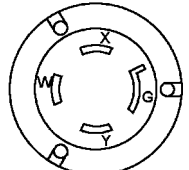
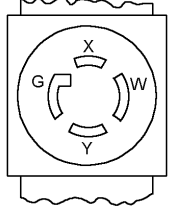
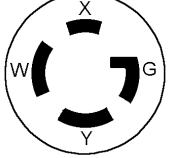
MIL-STD-1353C
APPENDIX F

Table F-IV. Standard connectors, W-C-596 type - Continued.

Rating Amps - Volts	Type of connector	WC596 PIN	Features	Configuration
30 - 125/250	Plug, General Purpose, General Grade	WC596/34-1 WC596/34-2	Straight Angle	
20 - 125/250	Plug, General Purpose, Cable Outlet	WC596/35-1		
20 - 125/250	Receptacle, Specific Purpose, Single Locking	WC596/43-1		
20 - 125/250	Plug, Specific Purpose, Locking	WC596/44-1 WC596/44-2	Straight Angle	
20 - 125/250	Plug, Specific Purpose, Cable Outlet, Locking	WC596/45-1		
20 - 125/250	Receptacle, Specific Purpose, Single, General Grade, Locking	WC596/46-1		
50 - 125/250	Receptacle, General Purpose, Single	WC596/36-1 WC596/36-2	Flush mount Surface mount	
50 - 125/250	Plug, General Purpose	WC596/37-1 WC596/37-2	Flush mount Surface mount	

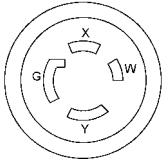
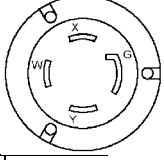
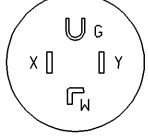
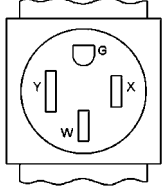
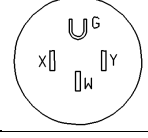
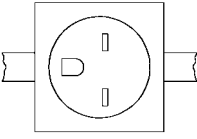
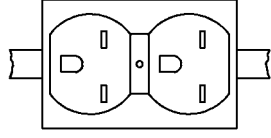

MIL-STD-1353C
APPENDIX F

Table F-IV. Standard connectors, W-C-596 type - Continued.

Rating Amps - Volts	Type of connector	WC596 PIN	Features	Configuration
3 Pole, 4 Wire 50/60 Hz				
20 - 125/250	Receptacle, Special Purpose, Single, Grounding	WC596/120-1 WC596/120-2	Flush mount Surface mount	
20 - 125/250	Plug, Special Purpose, Grounding	WC596/121-1 WC596/121-2	Straight Angle	
20 - 125/250	Plug, Special Purpose, Cable Outlet, Locking, Grounding	WC596/122-1		
20 - 125/250	Receptacle, Male Inlet, General Purpose, Locking, Grounding	WC596/123-1		
30 - 125/250	Receptacle, Special Purpose, Single, Grounding	WC596/116-1 WC596/116-2	Flush mount Surface mount	
30 - 125/250	Plug, Special Purpose, Locking, Grounding	WC596/117-1 WC596/117-2	Straight Angle	

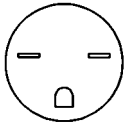

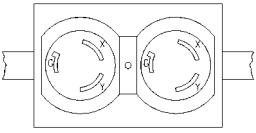
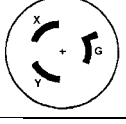
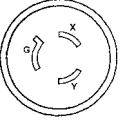

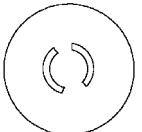
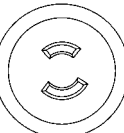
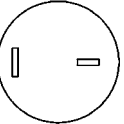
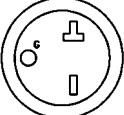
MIL-STD-1353C
APPENDIX F

Table F-IV. Standard connectors, W-C-596 type - Continued.

Rating Amps - Volts	Type of connector	WC596 PIN	Features	Configuration
3 Pole, 4 Wire 50/60 Hz				
30 - 125/250	Plug, Special Purpose, Cable Outlet, Locking, Grounding	WC596/118-1		
30 - 125/250	Receptacle, Male Inlet, Special Purpose, Locking, Grounding	WC596/119-1		
30 - 125/250	Plug, General Purpose, Grounding (Inactive for new design)	WC596/189-1 WC596/189-2	Straight Angle	
50 - 125/250	Receptacle, General Purpose, Single, Grounding (Inactive for new design)	WC596/184-1		
50 - 125/250	Plug, General Purpose, Grounding (Inactive for new design)	WC596/185-1 WC596/185-2	Straight Angle	
2 Pole, 3 Wire 50/60 Hz				
15 - 250	Connector, Receptacle, Electrical, General Purpose, Single, General Grade, Grounding	WC596/15-1		
15 - 250	Connector, Receptacle, Electrical, General Purpose, Duplex, General Grade, Grounding	WC596/16-1		
15 - 250	Connector, Plug, Electrical, General Purpose, General Grade, Grounding	WC596/17-1 WC596/17-2	Straight Angle	

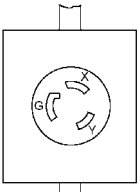
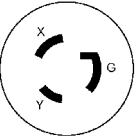
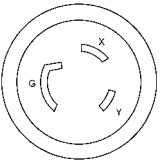
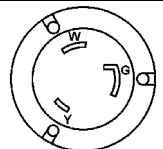
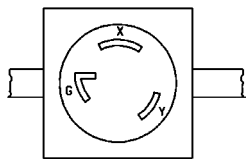
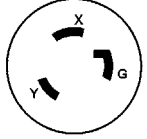
MIL-STD-1353C
APPENDIX F

Table F-IV. Standard connectors, W-C-596 type - Continued.

Rating Amps - Volts	Type of connector	WC596 PIN	Features	Configuration
2 Pole, 3 Wire 50/60 Hz				
15 - 250	Connector, Cable Outlet, Electrical, General Purpose, General Grade, Cable Connecting, Grounding	WC596/18-1		
15 - 250	Connector, Receptacle, Electrical, Special Purpose, Single, Grounding	WC596/85-1		
15 - 250	Connector, Receptacle, Electrical, Special Purpose, Duplex, Grounding	WC596/86-1		
15 - 250	Connector, Plug, Electrical, Special Purpose, Grounding, Locking	WC596/87-1 WC596/87-2	Straight Angle	
15 - 250	Connector, Plug, Electrical, Special Purpose, Cable Outlet, Grounding, Locking	WC596/88-1		
15 - 250	Connector, Receptacle, Electrical, Male Inlet, Special Purpose, Locking, Grounding	WC596/89-1		
20 - 250	Connectors, Plug, Electrical, Specific Purpose, Locking, General Grade	WC596/20-1 WC596/20-2	Nonpolarized Polarized	
20 - 250	Connector, Plug, Electrical, Specific Purpose, Cable Outlet, Locking, General Grade	WC596/21-1		
20 - 250	Connector, Plug, Electrical, General Purpose, General Grade	WC596/23-1		
20 - 250	Connector, Cable Outlet, Electrical, General Purpose, General Grade, Grounding	WC596/67-1		

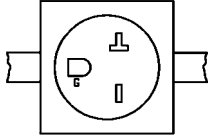
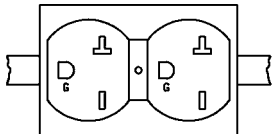

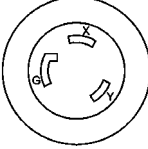
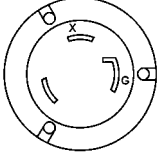
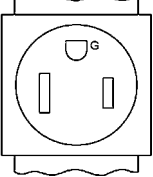
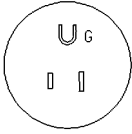
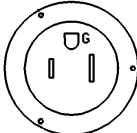
MIL-STD-1353C
APPENDIX F

Table F-IV. Standard connectors, W-C-596 type - Continued.

Rating Amps - Volts	Type of connector	WC596 PIN	Features	Configuration
2 Pole, 3 Wire 50/60 Hz				
20 - 250	Connector, Receptacle, Electrical, General Purpose, Single, Grounding	WC596/81-1 WC596/81-2	Flush mount Surface mount	
20 - 250	Connector, Plug, Electrical, Special Purpose, Grounding, Locking	WC596/82-1 WC596/82-2	Straight Angle	
20 - 250	Connector, Plug, Electrical, Special Purpose, Cable Outlet, Grounding, Locking	WC596/83-1		
20 - 250	Connector, Receptacle, Electrical, Male Inlet, Special Purpose, Grounding, Locking	WC596/84-1		
30 - 250	Connector, Receptacle, Electrical, Specific Purpose, General Grade, Single, Grounding, Locking	WC596/77-1		
30 - 250	Connector, Plug, Electrical, Specific Purpose, General Grade, Grounding, Locking	WC596/78-1		

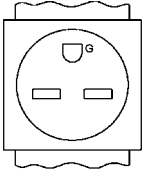
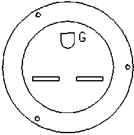
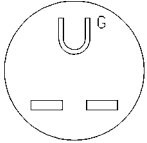

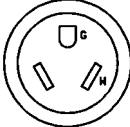
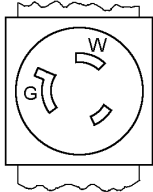
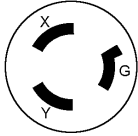
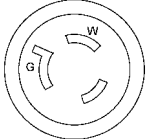
MIL-STD-1353C
APPENDIX F

Table F-IV. Standard connectors, W-C-596 type - Continued.

Rating Amps - Volts	Type of connector	WC596 PIN	Features	Configuration
2 Pole, 3 Wire 50/60Hz				
20 - 250	Receptacle, General Purpose, Single, General Grade, Grounding	WC596/64-1		
20 - 250	Receptacle, General Purpose, Duplex, General Grade, Grounding	WC596/65-1		
20 - 250	Plug, General Purpose, General Grade, Grounding	WC596/66-1 WC596/66-2	Straight Angle	
20 - 250	Cable Outlet, Specific Purpose, General Grade, Single, Grounding, Locking	WC596/79-1		
20 - 250	Receptacle, Male Inlet, Special Purpose, Grounding, Locking	WC596/80-1		
20 - 250	Receptacle, General Purpose, Single (Inactive for new design)	WC596/164-1		
20 - 250	Plug, General Purpose, Grounding (Inactive for new design)	WC596/165-1 WC596/165-2	Straight Angle	
20 - 250	Receptacle, Male Inlet, General Purpose, Single, Grounding (Inactive for new design)	WC596/167-1		

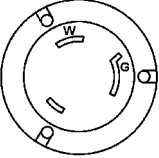
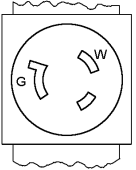
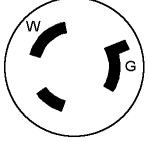
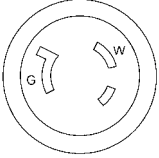
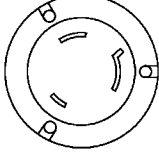
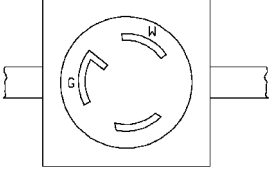
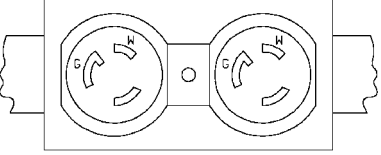

MIL-STD-1353C
APPENDIX F

Table F-IV. Standard connectors, W-C-596 type - Continued.

Rating Amps - Volts	Type of connector	WC596 PIN	Features	Configuration
2 Pole, 3 Wire 50/60Hz				
20 - 250	Plug, General Purpose, Grounding (Inactive for new design)	WC596/168-1 WC596/168-2	Flush mount Surface mount	
20 - 250	Receptacle, Male Inlet, General Purpose, Grounding (inactive use /80)	WC596/171-1		
30 - 250	Plug, General Purpose, Grounding (Inactive use /78)	WC596/169		
2 Pole, 3 Wire 50/60 Hz				
15 - 277	Plug, General Purpose, General Grade, Grounding	WC596/73-1 WC596/73-2	Straight Angle	
15 - 277	Cable Outlet, General Purpose, General Grade, Grounding	WC596/74-1		
30 - 277	Receptacle, Special Purpose, Single, Grounding	WC596/103-1 WC596/103-2	Flush mount Surface mount	
30 - 277	Plug, Special Purpose, Grounding, Locking	WC596/104-1 WC596/104-2	Straight Angle	
30 - 277	Plug, Special Purpose, Cable Outlet, Grounding, Locking	WC596/105-1		

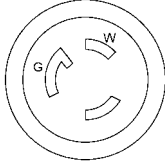
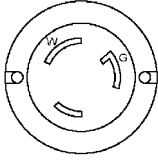
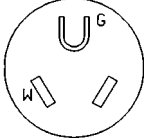

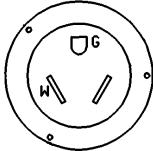
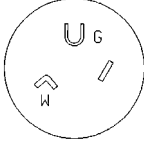
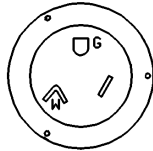
MIL-STD-1353C
APPENDIX F

Table F-IV. Standard connectors, W-C-596 type - Continued.

Rating Amps - Volts	Type of connector	WC596 PIN	Features	Configuration
2 Pole, 3 Wire 50/60Hz				
30 - 277	Receptacle, Male Inlet, Special Purpose, Locking, Grounding	WC596/106-1		
20 - 277	Receptacle, Special Purpose, Single, Grounding	WC596/107-1 WC596/107-2	Flush mount Surface mount	
20 - 277	Plug, Special Purpose, Locking, Grounding	WC596/108-1 WC596/108-2	Straight Angle	
20 - 277	Plug, Special Purpose, Cable Outlet, Locking, Grounding	WC596/109-1		
20 - 277	Receptacle, Male Inlet, Special Purpose, Locking, Grounding	WC596/110-1		
15 - 277	Receptacle, Special Purpose, Single, Grounding	WC596/111-1		
15 - 277	Receptacle, Special Purpose, Duplex, Grounding	WC596/112-1		
15 - 277	Plug, Special Purpose, Locking, Grounding	WC596/113-1 WC596/113-2	Straight Angle	

MIL-STD-1353C
APPENDIX F

Table F-IV. Standard connectors, W-C-596 type - Continued.

Rating Amps - Volts	Type of connector	WC596 PIN	Features	Configuration
2 Pole, 3 Wire 50/60Hz				
15 - 277	Plug, Special Purpose, Cable Outlet, Locking, Grounding	WC596/114-1		
15 - 277	Receptacle, Male Inlet, Special Purpose, Locking, Grounding	WC596/115-1		
20 - 277	Plug, General Purpose, Grounding (Inactive use /108)	WC596/181-1		
50 - 277	Plug, General Purpose, Grounding	WC596/173-1 WC596/173-2	Straight Angle	
50 - 277	Receptacle, Male Inlet, General Purpose, Grounding	WC596/175-1		
30 - 277	Plug, General Purpose, Grounding	WC596/177-1		
30 - 277	Receptacle, Male Inlet, General Purpose, Grounding	WC596/179-1		

MIL-STD-1353C
APPENDIX F

Table F-IV. Standard connectors, W-C-596 type - Continued.

Rating Amps - Volts	Type of connector	WC596 PIN	Features	Configuration
4 Pole, 4 Wire, 3 Phase 50/60 Hz				
20 - 120/208	Plug, General Purpose, General Grade	WC596/29-1		
20 - 120/208	Plug, General Purpose, Cable Outlet, General Grade	WC596/30-1		
20 - 120/208	Receptacle, Specific Purpose, Single Locking	WC596/59-1		
20 - 120/208	Plug, Specific Purpose, General Grade, Locking	WC596/60-1		
20 - 120/208	Cable Outlet, Specific Purpose, Cable Connecting, General Grade, Locking	WC596/61-1		
60 - 120/208	Receptacle, General Purpose, Single, General Grade	WC596/38-1		
60 - 120/208	Plug, General Purpose, General Grade	WC596/39-1 WC596/39-2	Straight Angle	

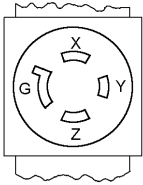
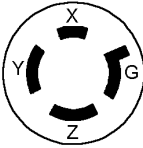
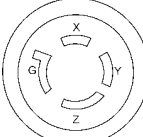
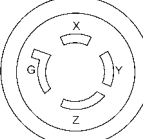
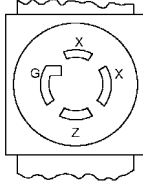
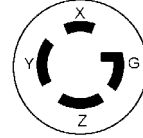
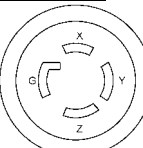
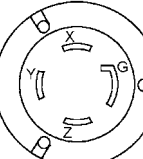
MIL-STD-1353C
APPENDIX F

Table F-IV. Standard connectors, W-C-596 type - Continued.

Rating Amps - Volts	Type of connector	WC596 PIN	Features	Configuration
4 Pole, 3 Phase, 5 Wire 50/60 Hz				
20 - 120/208	Receptacle, Special Purpose, Single, Grounding	WC596/136-1 WC596/136-2	Flush mount Surface mount	
20 - 120/208	Plug, Special Purpose, Grounding	WC596/137-1 WC596/137-2	Straight Angle	
20 - 120/208	Plug, Special Purpose, Cable Outlet, Locking, Grounding	WC596/138-1		
20 - 120/208	Receptacle, Male Inlet, General Purpose, Locking, Grounding	WC596/139-1		
30 - 120/208	Receptacle, Special Purpose, Single, Grounding	WC596/132-1 WC596/132-2	Flush mount Surface mount	
30 - 120/208	Plug, Special Purpose, Locking, Grounding	WC596/133-1 WC596/133-2	Straight Angle	
30 - 120/208	Plug, Special Purpose, Cable Outlet, Locking, Grounding	WC596/134-1		
30 - 120/208	Receptacle, Male Inlet, General Purpose, Locking, Grounding	WC596/135-1		

MIL-STD-1353C
APPENDIX F

Table F-IV. Standard connectors, W-C-596 type - Continued.

Rating Amps - Volts	Type of connector	WC596 PIN	Features	Configuration
3 Pole, 3 Phase, 4 Wire 50/60 Hz				
20 - 250	Receptacle, Special Purpose, Single, Grounding	WC596/124-1 WC596/124-2	Flush mount Surface mount	
20 - 250	Plug, Special Purpose, Grounding	WC596/125-1 WC596/125-2	Straight Angle	
20 - 125/250	Plug, Special Purpose, Cable Outlet, Locking, Grounding	WC596/126-1		
20 - 250	Receptacle, Male Inlet, General Purpose, Locking, Grounding	WC596/127-1		
30 - 250	Receptacle, Special Purpose, Single, Grounding	WC596/128-1 WC596/128-2	Flush mount Surface mount	
30 - 250	Plug, Special Purpose, Locking, Grounding	WC596/129-1 WC596/129-2	Straight Angle	
30 - 250	Plug, Special Purpose, Cable Outlet, Locking, Grounding	WC596/130-1		
30 - 250	Receptacle, Male Inlet, General Purpose, Locking, Grounding,	WC596/131-1		

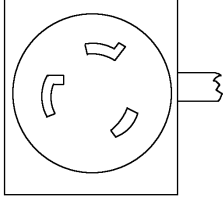
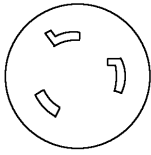
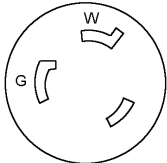
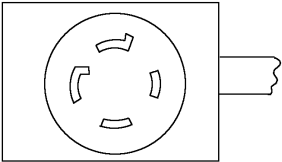
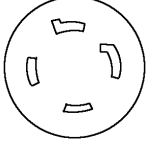
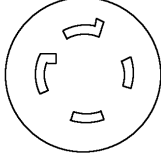
MIL-STD-1353C
APPENDIX F

Table F-IV. Standard connectors, W-C-596 type - Continued.

Rating Amps - Volts	Type of connector	WC596 PIN	Features	Configuration
3 Pole, 3 Phase, 4 Wire 50/60 Hz				
30 - 250	Plug, General Purpose, Grounding	WC596/205-1 WC596/205-2	Straight Angle	
50 - 250	Receptacle, General Purpose, Single, Grounding	WC596/200-1 WC596/200-2	Flush mount Surface Mount	
60 - 250	Receptacle, General Purpose, Single, Grounding	WC596/196-1 WC596/196-2	Flush mount Surface Mount	
2 Pole, 3 Wire DC				
30 - 28 DC	Receptacle, Specific Purpose, Single, Locking, Grounding	WC596/148-1 WC596/148-2	Ruggedized	
30 - 28 DC	Plug, Specific Purpose, Locking, Grounding	WC596/149-1 WC596/149-2	Ruggedized	
30 - 28 DC	Cable Outlet, Specific Purpose, Single, Locking, Grounding	WC596/150-1 WC596/150-2	Ruggedized	

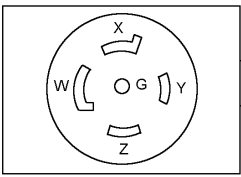
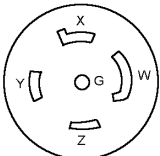

MIL-STD-1353C
APPENDIX F

Table F-IV. Standard connectors, W-C-596 type - Continued.

Rating Amps - Volts	Type of connector	WC596 PIN	Features	Configuration
2 Pole, 3 Wire 1 Phase, 400 Hz				
30 - 120	Receptacle, Specific Purpose, Single, Grounding, Locking	WC596/151-1 WC596/151-2	Ruggedized	
30 - 120	Plug, Specific Purpose, Locking, Grounding	WC596/152-1 WC596/152-2	Ruggedized	
30 - 120	Cable Outlet, Specific Purpose, Single, Grounding, Locking	WC596/153-1 WC596/153-2	Ruggedized	
3 Pole 3 Wire 3 Phase, 400 Hz				
30 - 120	Receptacle, Male Inlet, General Purpose, Locking, Grounding	WC596/154-1 WC596/154-2	Ruggedized	
30 - 120	Plug, Specific Purpose, Locking, Grounding	WC596/155-1 WC596/155-2	Ruggedized	
30 - 120	Cable Outlet, Specific Purpose, Cable Connecting, Locking, Grounding	WC596/156-1 WC596/156-2	Ruggedized	

MIL-STD-1353C
APPENDIX F

Table F-IV. Standard connectors, W-C-596 type - Continued.

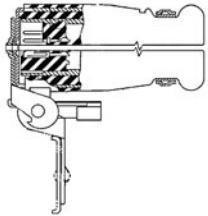
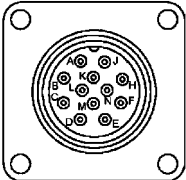
Rating Amps - Volts	Type of connector	WC596 PIN	Features	Configuration
4 Pole, 5 Wire 3 Phase, 400 Hz				
30 - 120/208	Receptacle, Specific Purpose, Single, Locking, Grounding	WC596/157-1 WC596/157-2	Ruggedized	
30 - 120/208	Plug, Specific Purpose, Locking, Grounding	WC596/158-1 WC596/158-2	Ruggedized	
30 - 120/208	Cable Outlet, Specific Purpose, Cable Connecting, Locking, Grounding	WC596/159-1 WC596/159-2	Ruggedized	

MIL-STD-1353C
APPENDIX F

F.7 Vehicular and trailer connectors. MS75020 and MS75021 electrical covers trailer cable plug and receptacle, see table F-V.

F.7.1 Intended use. Plug used on trailer cables and fits to Military vehicle's trailer receptacle. Solder contacts on pins and sockets.

TABLE F-V. Vehicular and trailer connectors.

Specification number	Description	Configuration
MS75020	Connector, Plug, Electrical-12 contact, Intervehicular, 28 Volt, Waterproof	
PIN	Gender	
MS75020-1	Pin	
MS75020-2	Socket	
MS75021	Connector, Receptacle, Electrical-12 Contact, Intervehicular, 28 Volt Waterproof	
PIN	Gender	
MS75021-1	Pin	
MS75021-2	Socket	

MIL-STD-1353C
APPENDIX F

CONCLUDING MATERIAL

Custodians:

Army - CR
Navy - EC
Air Force - 99
DLA - CC

Preparing activity:
DLA - CC

Review activities:

Army - AV, CR4, MI
Navy - AS, MC, OS, SH
Air Force - 19

(Project 5935-2012-207)

NOTE: The activities listed above were interested in this document as of the date of this document. Since organizations and responsibilities can change, you should verify the currency of the information above using the ASSIST Online database at <https://assist.dla.mil>