

NOT  
MEASUREMENT  
SENSITIVE

MIL-STD-188-110C

w/CHANGE 1

3 JANUARY 2012

---

SUPERSEDING

MIL-STD-188-110C

23 SEPTEMBER 2011

# DEPARTMENT OF DEFENSE INTERFACE STANDARD

## INTEROPERABILITY AND PERFORMANCE STANDARDS FOR DATA MODEMS



AMSC N/A

AREA TCSS

DISTRIBUTION STATEMENT A: Approved for public release; distribution unlimited.

MIL-STD-188-110C  
w/CHANGE 1

FOREWORD

1. This Military Standard is approved and mandatory for use by all Departments and Agencies of the Department of Defense (DoD) in accordance with Joint Technical Architecture (JTA) Version 6, dated 3 October 2003.
2. This document contains technical standards and design objectives for minimum interface and performance standards pertinent to voice frequency band modulators-demodulators (modems) which operate in both long-haul and tactical communications systems. The terms "system standard" and "design objective (DO)" are defined in FED-STD-1037. In this document, the word "shall" identifies mandatory system standards. The word "should" identifies DOs that are desirable but not mandatory.
3. Comments, suggestions, or questions on this document should be addressed to Oklahoma City Air Logistics Center (OC-ALC)/ENSDDAA, 3001 Staff Drive, Tinker AFB, OK 73145 or e-mailed to [af71@tinker.af.mil](mailto:af71@tinker.af.mil). Since contact information can change, you may want to verify the currency of this address information using the ASSIST Online database at <https://assist.daps.dla.mil>.

MIL-STD-188-110C  
w/CHANGE 1

SUMMARY OF CHANGE 1 MODIFICATIONS

1. Paragraph D.5.4. Removed sentence "The reinserted preamble facilitates acquisition (or re-acquisition) of an ongoing broadcast transmission." That refers to a feature that is obsolete.
2. Changed title of TABLE D-LII from "Data performance requirements, All Bandwidths" to "Data performance requirements, 3, 6, 9, 12, and 24 kHz Bandwidths" for clarification purposes.

MIL-STD-188-110C  
w/CHANGE 1

### 3. TABLE OF CONTENTS

<b><u>TITLE</u></b>	<b><u>PAGE</u></b>
1 SCOPE.....	1
1.1 Scope.....	1
1.2 Applicability.....	1
1.3 Application guidance.....	1
2 APPLICABLE DOCUMENTS .....	2
2.1 Government documents.....	2
2.1.1 Specifications and standards.....	2
2.1.2 Other Government documents and publications.....	3
2.2 Non-government publications.....	3
2.3 Order of precedence.....	3
3 DEFINITIONS.....	4
3.1 Terms.....	4
3.2 Abbreviations and acronyms.....	5
4 GENERAL REQUIREMENTS.....	10
4.1 Functional employment.....	10
4.2 Common parameters.....	10
4.2.1 Modulation and data signaling rates and tolerance.....	10
4.2.2 Logic and signaling sense for binary signals.....	11
4.2.3 Digital interface characteristics.....	12
4.2.4 Terminal impedance for quasi-analog signals.....	12
4.2.4.1 Modems used in single-channel radio subsystems.....	12
4.2.4.2 Quasi-analog signal levels.....	13
4.2.5 Clock equipment, control, and timing.....	13
4.2.5.1 Transmission modes.....	13
4.2.5.2 Clock characteristics.....	13
4.2.5.2.1 Modulation rates.....	13
4.2.5.2.2 Modulation rate stability.....	13
4.2.5.2.3 Modulation rate phase adjustment.....	13
4.2.5.2.4 Output signal.....	14
4.2.5.2.5 Clock period.....	14
4.2.5.3 Clock/data phase relationship.....	14
4.3 General design requirements.....	15
4.3.1 Federal maritime interoperability requirements.....	15
4.3.2 International interoperability requirements.....	15
4.3.2.1 Shore-to-ship broadcast systems.....	15
4.3.2.2 Maritime air communications systems.....	15
4.3.2.3 Radio teletypewriter systems.....	15
4.4 Data link protocol (optional).....	15

MIL-STD-188-110C  
w/CHANGE 1

5	DETAILED REQUIREMENTS.....	16
5.1	Frequency shift keying (FSK) modems for single-channel radio equipment.....	16
5.1.1	Narrow-shift FSK modem.....	16
5.1.2	Wide-shift FSK modem.....	16
5.2	FSK data modems for voice frequency (VF) channel operation (withdrawn).....	16
5.3	HF data modems.....	16
5.3.1	General requirements.....	16
5.3.1.1	Capability.....	17
5.3.1.2	Voice digitization.....	17
5.3.1.3	Optional modes.....	17
5.3.1.4	Interface requirements.....	18
5.3.1.4.1	Line-side data characteristics.....	18
5.3.1.4.2	LAN interface (DO).....	18
5.3.1.4.3	Equipment side characteristics (informative).....	18
5.3.1.4.4	Transmit override.....	18
5.3.1.4.5	Buffering in synchronous serial mode.....	18
5.3.1.5	Remote control interface.....	18
5.3.1.5.1	Electrical interface.....	18
5.3.1.5.2	Optional modem control driver.....	18
5.3.2	Serial (single-tone) mode.....	18
5.3.2.1	General.....	18
5.3.2.2	Sequencing of time phases.....	19
5.3.2.2.1	Synchronization (sync) preamble phase.....	21
5.3.2.2.2	Data phase.....	24
5.3.2.2.3	EOM phase.....	25
5.3.2.2.4	FEC coder and interleaver flush phase.....	25
5.3.2.3	Functional descriptions.....	25
5.3.2.3.1	EOM sequence.....	25
5.3.2.3.2	Interleaver flush.....	25
5.3.2.3.3	FEC encoder.....	25
5.3.2.3.4	Interleave load.....	28
5.3.2.3.5	Interleave fetch.....	29
5.3.2.3.6	Modified-Gray decoder.....	30
5.3.2.3.7	Symbol formation.....	31
5.3.2.3.8	Scrambler.....	36
5.3.2.3.9	PSK modulation.....	37
5.3.2.4	Waveform summary.....	38
5.3.2.5	Performance requirements.....	38
5.3.3	Frequency hopping mode (optional).....	39
5.3.4	Robust serial tone mode for severely degraded HF links (optional).....	39
6	NOTES.....	39
6.1	Intended use.....	39
6.2	Issue of Department of Defense Index of Specifications and Standards (DODISS).....	40
6.3	Subject term (key word) listing.....	40

MIL-STD-188-110C  
w/CHANGE 1

LIST OF FIGURES

FIGURE 1. STANDARD INTERFACE BETWEEN DATA TERMINAL EQUIPMENT AND DATA CIRCUIT-TERMINATING EQUIPMENT.....	12
FIGURE 2. SERIAL (SINGLE-TONE) WAVEFORM FUNCTIONAL BLOCK DIAGRAM .....	20
FIGURE 3. AN EXAMPLE OF EQUIPMENT INTERFACE BLOCK DIAGRAM.....	22
FIGURE 4. FEC ENCODER BLOCK DIAGRAM .....	27
FIGURE 5. STATE CONSTELLATION DIAGRAM .....	35
FIGURE 6. RANDOMIZING SHIFT REGISTER FUNCTIONAL DIAGRAM .....	37

LIST OF TABLES

TABLE I. REFERENCE LIST FOR MODEM APPLICATIONS. ....	10
TABLE II. LOGIC AND SIGNAL SENSE FOR BINARY SIGNALS.....	11
TABLE III. CHARACTERISTIC FREQUENCIES OF FSK DATA MODEMS FOR SINGLE-CHANNEL RADIO EQUIPMENT. ....	16
TABLE IV. ERROR CORRECTING CODING, FREQUENCY HOPPING OPERATION.....	26
TABLE V. ERROR-CORRECTING CODING, FIXED FREQUENCY OPERATION.....	28
TABLE VI. INTERLEAVER MATRIX DIMENSIONS.....	29
TABLE VII. BITS-PER-CHANNEL SYMBOL.....	30
TABLE VIII. MODIFIED-GRAY DECODING AT 2400 BPS AND 4800 BPS.....	31
TABLE IX. MODIFIED-GRAY DECODING AT 75 BPS (FIXED FREQUENCY) AND 1200 BPS. ....	31
TABLE X. CHANNEL SYMBOL MAPPING FOR 75 BPS. ....	33
TABLE XI. ASSIGNMENT OF DESIGNATION SYMBOLS D1 AND D2.....	34
TABLE XII. CONVERSION OF TWO BIT COUNT VALUE TO THREE BIT SYMBOL.....	34
TABLE XIII. CHANNEL SYMBOL MAPPING FOR SYNC PREAMBLE.....	36
TABLE XIV. FREQUENCY-HOPPING OPERATION WAVEFORM CHARACTERISTICS.....	38
TABLE XV. FIXED-FREQUENCY OPERATION WAVEFORM CHARACTERISTICS.....	38
TABLE XVI. SERIAL (SINGLE-TONE) MODE MINIMUM PERFORMANCE.....	39

MIL-STD-188-110C  
w/CHANGE 1

## 1. SCOPE

### 1.1 Scope.

This document establishes mandatory technical standards and design objectives (DO) that are necessary to ensure interoperability and to promote performance among data modulators-demodulators (modems) used in the voice frequency (VF) band of long-haul and tactical communications systems. This document also provides guidance to the designers of new data modems that incorporate characteristics not yet standardized by specifying the technical characteristics of data modems currently in the inventory. The purpose of this guidance is to ensure attainment of minimum acceptable performance and maximum interoperability between existing and future data modems with specified transmission channel conditions.

### 1.2 Applicability.

These standards are mandatory within the Department of Defense (DoD) in the design, development and engineering of new communications facilities for both narrowband and wideband long-haul and tactical systems. In some cases, reference is made to other documents that provide standards for specific applications. It is not intended that existing systems be immediately converted to comply with the requirements of these standards. New systems, and those undergoing major modification or rehabilitation, conformance to these standards is subject to current procurement regulations. This document is applicable to the design and development of new data modems with standard data signaling rates up to and including 120,000 bits per second (bps) used in long-haul and tactical communications systems. This document is not applicable to high frequency (HF) data modems used in the Tactical Digital Information Link (TADIL) A. The HF data modem standards for TADIL A are published in MIL-STD-188-203-1.

### 1.3 Application guidance.

Requirements in this document, if applied as intended, ensure the interoperability and performance of data modems having the same or similar functions. The variety of data modems is limited to that which are essential to effectively support the missions of the military forces. It is not intended that the standards contained in this document inhibit advances in communications technology. Such advances are encouraged by including DOs that should be used if economically feasible. Additionally, standardizing parameter values but not the technology that may be used to meet these parameter values facilitates such advances. Minimum performance requirements for the high frequency (HF) serial (single-tone) modem waveforms are specified in Table XVI and Appendices B, C, D, and F. The specified values shown represent HF modem performance under ideal test conditions. To identify the minimum acceptable performance available to users, many factors, including operational test and evaluation must be considered.

MIL-STD-188-110C  
w/CHANGE 1

## 2. APPLICABLE DOCUMENTS

2.1 General. The documents listed in this section are specified in sections 3, 4, or 5 of this standard. This section does not include documents cited in other sections of this standard or recommended for additional information or as examples. While every effort has been made to ensure the completeness of this list, document users are cautioned that they must meet all specified requirements of documents cited in sections 3, 4, or 5 of this standard, whether or not they are listed.

### 2.2 Government documents.

2.2.1 Specifications and standards, and handbooks. The following specifications and standards form a part of this document to the extent specified herein. Unless otherwise specified, the issues of these documents are those listed in the solicitation or contract.

## INTERNATIONAL STANDARDIZATION AGREEMENTS

STANAG 4197	Modulation and Coding Characteristics That Must Be Common to Assure Interoperability of 2400 BPS Linear Predictive Encoded Digital Speech Transmitted over HF Radio Facilities
STANAG 4198	Parameters and Coding Characteristics That Must Be Common to Assure Interoperability of 2400 BPS Linear Predictive Encoded Digital Speech
STANAG 4203	Technical Standard for Single Channel HF Radio Equipment
STANAG 4285	Characteristics of 1200/2400/3600 bps Single Tone Modulators/Demodulators for HF Radio Links
STANAG 4291	Modulation and Coding Characteristics That Must Be Common to Assure Interoperability of 2400 BPS Wireline Modems for Use in Narrow-Band Secure Voice Systems
STANAG 4415	Characteristics of a Robust, Non-hopping Serial Tone Modulator/Demodulator for Severely Degraded HF Radio Links
STANAG 4529	Characteristics of Single-Tone Modulators/Demodulators for Maritime HF Radio Links with 1240 Hz bandwidth
STANAG 4481	Minimum Technical Standards for Naval HF Shore-To-Ship Broadcast Systems
STANAG 4591	The 600 Bit/s, 1200 Bit/s, and 2400 Bit/s NATO Interoperable Narrow Band Voice Coder



MIL-STD-188-110C  
w/CHANGE 1

STANAG 5066                      Profile For HF Radio Data Communications

FEDERAL STANDARDS

FED-STD-1035                      Coding, Modulation and Transmission Requirements for Single Channel Medium and High Frequency Radiotelegraph Systems Used in Government Maritime Mobile Telecommunications

FED-STD-1037                      Glossary of Telecommunication Terms

DEPARTMENT OF DEFENSE STANDARDS

MIL-STD-188-141                      Interoperability and Performance Standards for Medium and High Frequency Radio Equipment

MIL-STD-188-148                      (S) Interoperability Standard for Anti-Jam (AJ) Communications in the High Frequency Band (2-30 MHz) (U)

(Copies of these documents are available online at <https://assist.daps.dla.mil/quicksearch/> or from the Standardization Document Order Desk, 700 Robbins Avenue, Building 4D, Philadelphia, PA 19111-5094.)

2.2.2 Other Government documents and publications.

The following other Government documents and publications form a part of this document to the extent specified herein. Unless otherwise specified, the issues are those cited in the solicitation.

DEPARTMENT OF DEFENSE (DoD)

DoD 4120.24M                      Defense Standardization Program

(Copies of this document is available online at <http://www.dsp.dla.mil> or from the Standardization Document Desk, 700 Robbins Avenue, Building 4D, Philadelphia, PA 19111-5094)

DoD JTA                              Joint Technical Architecture

(Copies of this document is available online at <http://www.acq.osd.mil/osjtf/pdf/jta-vol-I.pdf> )

2.3 Order of precedence.

In the event of a conflict between the text of this document and the references cited herein, the text of this document takes precedence. Nothing in this document, however, supersedes applicable laws and regulations unless specific exemption has been obtained.

MIL-STD-188-110C  
w/CHANGE 1

## 3. DEFINITIONS

3.1 Terms.

Definitions of terms used in this document are specified in FED-STD-1037. For the purposes of this standard, definitions are provided for the following terms, some of which have been repeated, from FED-STD-1037 for the convenience of the reader.

Automatic link establishment (ALE). The capability of an HF radio station to make contact, or initiate a circuit, between itself and another specified radio station, without operator assistance and usually under processor control.

NOTE: ALE techniques include automatic signaling, selective calling, and automatic handshaking. Other automatic techniques that are related to ALE are channel scanning and selection, link quality analysis (LQA), polling, sounding, message store and forward, address protection, and anti-spoofing.

Balanced to ground. Pertaining to electrical symmetry with respect to a common ground.

Clear-to-send (CTS) signal. The control signal generated by the transmitting modem on the CTS connection to denote a state of readiness for transmission. The CTS signal is a response to the request-to-send (RTS) signal from the transmitting device

Code rate. The ratio of the number of information symbols (k) to the total number of encoded symbols (n) in a code (i.e., the ratio of k/n).

Dead time. In hopping, the portion of a hop dwell period in which no transmission occurs.

Dwell period. The maximum amount of time a transmission occurs on a particular frequency.

Galois field. An arithmetic system, containing a set of symbol elements with two operations (and their inverses) for combining pairs of elements.

In-band diversity combining. A combining of two or more signals which uses frequencies within the bandwidth of the information channel and carries the same information received with the objective of providing a single resultant signal that is superior in quality to any of the contributing signals.

Mode. An available format in a data modem supporting multi-waveform capability.

Narrowband. At HF radio frequencies (1.5 - 30 MHz) the nominal voice frequency (VF) bandwidth allocated for single channel radio (i.e., 3 kHz).

Nominal bandwidth. The widest band of frequencies, inclusive of guard bands, assigned to a channel.

MIL-STD-188-110C  
w/CHANGE 1

Occupied bandwidth. The width of a band of frequencies that contains 99% of the total mean power of a given emission.

Preamble code. A short sequence of symbols at the beginning of a coded sequence used to achieve synchronization.

Request-to-send (RTS) signal. The control signal generated by the transmitting terminal on the RTS connection to denote a request for transmission.

Secure voice. A voice communication that is protected against compromise through the use of an encryption system.

Transmission level point (TLP). A point in a transmission system at which the ratio, in decibels, of the power of the test signal at that point to the power of the test signal at a reference point, is specified.

Unbalanced to ground. Pertaining to electrical asymmetry with respect to a common ground.

NOTE: Frequently, the term "unbalanced" describes a circuit, one side of which is grounded.

Wideband. At HF radio frequencies (1.5 - 30 MHz) a bandwidth larger than 3 kHz.

### 3.2 Abbreviations and acronyms.

Abbreviations and acronyms used in this document are defined below. Those that are also found in FED-STD-1037 have been included for the convenience of the reader.

ABCA	American, British, Canadian, Australian (armies)
AJ	anti-jamming
ALE	automatic link establishment
ANC	automatic node controller
ANDVT	Advanced Narrowband Digital Voice Terminal
ANSI	American National Standard Institute
ARQ	Automatic repeat request
Bd	Baud
BER	Bit error ratio

MIL-STD-188-110C  
w/CHANGE 1

bps	Bits per second
BW	Bandwidth
CTS	Clear to send
CTX	Clear to transmit
CVSD	Continuously variable slope delta (modulation)
dB	Decibel(s)
dBm	dB referred to one milliwatt
dBm0	Noise power in dBm referred to or measured at 0 TLP
DCD	Data carrier detect
DCE	Data circuit-terminating equipment
DCS	Defense Communications System
DISA	Defense Information Systems Agency
DISAC	Defense Information Systems Agency Circular
DO	Design objective
DoD	Department of Defense
DODISS	Department of Defense Index of Specifications and Standards
DPSK	Differential phase shift keying
DSN	Digital Switched Network
DTE	Data terminal equipment
EIA	Electronic Industries Association
EMI	Electromagnetic interference
EOM	End of message
FCC	Federal Communications Commission

MIL-STD-188-110C  
w/CHANGE 1

FDM	Frequency-division multiplexing
FEC	Forward error correction
FED-STD	Federal Standard
FSK	Frequency-shift keying
GF	Galois field
HF	high frequency
Hz	Hertz
ISB	independent sideband
ITU	International Telecommunication Union
JCS	Joint Chiefs of Staff
kHz	kilohertz (1,000 hertz)
km	kilometer (1,000 meters)
LF	low frequency
log	Logarithm
LQA	link quality analysis
LSB	least significant bit
MF	medium frequency
MGD	modified-Gray decoder
MHz	megahertz (1,000,000 hertz)
MIL-STD	military standard
MM	maritime mobile
modem	modulator-demodulator

MIL-STD-188-110C  
w/CHANGE 1

ms	millisecond(s)
MSB	most significant bit
NATO	North Atlantic Treaty Organization
NMCS	National Military Command System
PCM	pulse-code modulation
PSK	phase-shift keying
PSN	public switched network
PTT	push-to-talk
QAM	quadrature amplitude modulation
QDPSK	quadrature differential phase-shift keying
QSTAG	Quadripartite Standardization Agreement
RA	receive audio
RATT	radio teletypewriter system
RC	receive clock
RCE	radio communications equipment
RD	receive data
rms	root-mean-square
RS	receive (HF radio) signal
RTE	radio terminal equipment
RTS	request to send
RTX	request to transmit
s	second(s)
(S)	SECRET

MIL-STD-188-110C  
w/CHANGE 1

SNR	signal-to-noise ratio
STANAG	Standardization Agreement (NATO)
sync	Synchronization
TA	transmit audio
TT	tactical terminal
TC	transmit clock
TADIL	tactical digital information link
TD	transmit data
TDM	time-division multiplexing
TIA	Telecommunications Industries Association
TLP	transmission level point
TS	transmit (HF radio) signal
TX	Transmit
(U)	UNCLASSIFIED
UHF	ultra high frequency
VP	voice frequency
VHF	very high frequency
VLF	very low frequency
0 TLP	zero transmission level point(s)

MIL-STD-188-110C  
w/CHANGE 1

#### 4. GENERAL REQUIREMENTS

##### 4.1 Functional employment.

Data modulators-demodulators (modems) are employed in long-haul and tactical communications systems and subsystems. Delineation between long-haul and tactical communications systems can be found in Federal Standard (FED-STD)-1037. Data modems employ a variety of techniques for converting digital signals into quasi-analog signals for transmission over analog channels. Various modulation techniques have been standardized and no single optimum technique has been found for all applications. This section covers general requirements for both long-haul and tactical data modems operating over voice frequency (VF) and radio channels. A representative list is given in Table I with the modulation types and data rates noted for each channel category listed. This Table also provides a cross-reference to section 5 requirements. (Additional modulation types and data rates for HF modems are specified in the Appendices.)

NOTE: Very low frequency (VLF) radio modems are not standardized.

**TABLE I. Reference list for modem applications.**

CHANNEL	MODULATION TYPE	DATA RATE (BPS)	REFERENCE PARAGRAPH
MM RADIO (3 KHZ)	FSK	$\leq 150$	5.1.1
HF RADIO (3 KHZ)	FSK	$\leq 150$	5.1.2
HF RADIO (3 KHZ)	PSK	75-4800	5.3.2

##### 4.2 Common parameters.

All data modems shall comply with the applicable requirements of 4.2.1 through 4.2.5.

##### 4.2.1 Modulation and data signaling rates and tolerance.

The modulation rates expressed in baud (Bd) and the data signaling rates expressed in bits per second (bps) at the standard interfaces shown on Figure 1 shall be as listed below (as appropriate for each application listed in Table I).

- a. 50 Bd or bps (optional, for legacy use only)
- b.  $75 \times 2^m$  Bd or bps, up to and including 9600 Bd or bps, where m is a positive integer 0, 1, 2, ... 7.

NOTE: The data signaling rate is expressed in bps; the modulation rate is expressed in Bd. Data signaling rates in bps and modulation rates in Bd are the same only for binary signaling. Data signaling rates in bps relate to modulation rates in Bd through the following equation:



MIL-STD-188-110C  
w/CHANGE 1

Data signaling rates (bps) =  $k \times$  modulation rates (Bd)

where  $k = \log_2 M$  is the number of binary digits per modulation symbol, and  $M$  is the number of modulation symbols.

Except where specified otherwise, signaling rates shall not deviate from the nominal values by more than 10 parts per million ( $\pm 0.001\%$ ).

#### 4.2.2 Logic and signaling sense for binary signals.

For data and timing circuits, the signal voltage with respect to signal ground shall be negative to represent the MARK condition and positive to represent the SPACE condition. The significant conditions and other logic and signal states shown in Table II shall apply to telegraph and data transmission. An alternative capability shall be provided to interface with equipment that accepts positive mark and negative space signals.

**TABLE II. Logic and signal sense for binary signals.**

Application	Condition	Condition
Voltage to signal ground	Negative (-)	Positive (+)
Conventional term	Mark	Space
Binary digit value	One (1)	Zero (0)
Timing signal state	Off	On
FSK signal state	Lower frequency	Higher frequency

MIL-STD-188-110C  
w/CHANGE 1

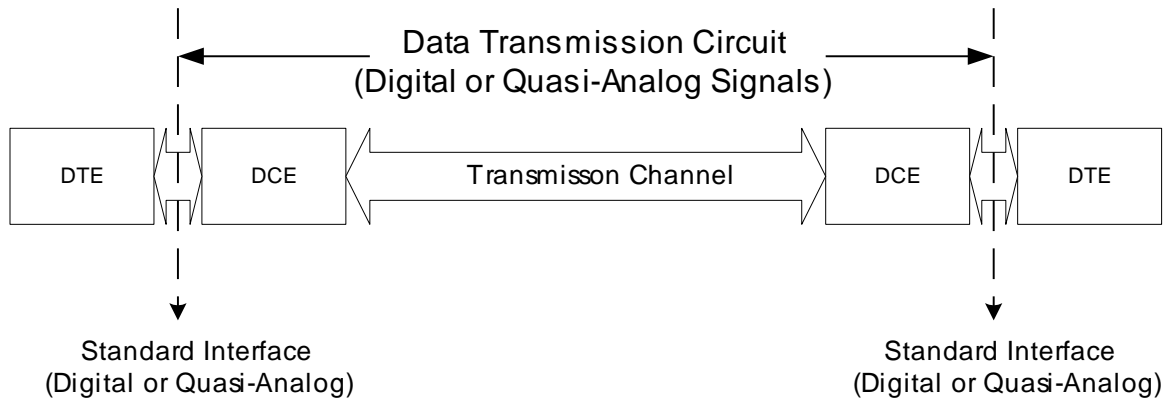

Notes:

1. DTE= Data Terminal Equipment  
DCE = Data Circuit - Terminating Equipment.
2. DTE and DCE may include data adapters, modems, error control algorithm, encryption devices, control units and other equipment, as required.
3. DTE and DCE can be combined in a single unit device.
4. The transmission channel may include nodes and single or multichannel transmission equipments.
5. Modulation rates and data signaling rates at the standard interface are specified in 4.2.1.

**FIGURE 1. Standard interface between data terminal equipment and data circuit terminating equipment.**

4.2.3 Digital interface characteristics.

A synchronous serial interface shall be provided. The electrical characteristics of the digital interface at the modulator input and the demodulator output shall be in accordance with the applicable requirements of EIA-422 for balanced signals and EIA-423 for unbalanced signals.

4.2.4 Terminal impedance for quasi-analog signals.

4.2.4.1 Modems used in single-channel radio subsystems.

For modems used with radio equipment of single-channel radio subsystems, the modulator shall meet all other requirements of this standard when operating into a load of 150 ohms, unbalanced to ground, or 600 ohms balanced to ground. The terminal impedance at the demodulator input shall be balanced to ground (nominally 600 ohms, but a range of 300 to 1200 ohms is permitted).

MIL-STD-188-110C  
w/CHANGE 1

NOTE: A terminal impedance balanced to ground is recommended for equipment (radios, data modems, etc.) operating in an environment that has a high electromagnetic interference (EMI) level, such as in aircraft, ships, and tanks. Measurements have shown that an electrical noise-rejection improvement of up to 20 dB can be achieved for balanced terminations, compared with unbalanced terminations.

4.2.4.2 Quasi-analog signal levels.

Standards for the quasi-analog signal levels of modulators and demodulators are documented in MIL-STD-188-141. The quasi-analog signal level at the modulator output shall be adjustable from at least -18 dB referred to one milliwatt (dBm) to +3 dBm. The demodulator shall be capable of operating, without degradation of performance, with a received quasi-analog signal level ranging from at least -35 dBm to +3 dBm. The difference in FSK output levels between the MARK and SPACE binary signals shall be less than 1 dB.

4.2.5 Clock equipment, control, and timing.

All data modems shall have the capability to accept external timing signals. The clock is the device which provides the time base for controlling operation of digital equipment. An equipment clock provides the peculiar needs of its equipment and in some cases may control the flow of data at its equipment interface. A master or station clock, regardless of its physical location, controls two or more equipments which are linked together as a system. The following subparagraphs, 4.2.5.1 through 4.2.5.3 are primarily concerned with master or Station clocks.

4.2.5.1 Transmission modes.

All future communications equipment requiring a stable clock or precise character interval control shall make provisions for operating from station clocks. During periods when the sending equipment has no traffic to send, an idle pattern or all "ones" may be transmitted

4.2.5.2 Clock characteristics.

4.2.5.2.1 Modulation rates.

The standard clock modulation rates for compatibility with modulation or data signaling rates shall be two times the standard rates specified in subparagraph 4.2.1.

4.2.5.2.2 Modulation rate stability.

The stability of synchronized or clock timing supplied in all synchronous digital transmission, switching, terminal, and security equipment shall be sufficient to ensure that synchronization is maintained within  $\pm 25$  percent of the unit interval between transmitted and received signals for periods of not less than 100,000 consecutive seconds.

4.2.5.2.3 Modulation rate phase adjustment.

Means shall be provided in all digital transmission, switching, terminal, and security equipment so that, at the applicable modulation rates, a shift in phase of the incoming data stream with

MIL-STD-188-110C  
w/CHANGE 1

relation to the clocking pulse shall be possible over a period of three unit intervals (i.e., a shift of 1.5 unit intervals early or late from theoretical center of the unit interval at the applicable modulation rate).

4.2.5.2.4 Output signal.

The output of the clock shall be an alternating symmetrically-shaped wave at the required clock modulation rate. In the case of an unbalanced digital interface, the clock output signal shall comply with the voltage and wave-shaping requirement of subparagraphs 4.3.1.3.3.4 and 4.3.1.3.3.5, respectively. In the case of a balanced digital interface, the clock output signal shall comply with the voltage requirements of subparagraph 4.3.1.3.4.4 and shall contain no points of inflection prior to reaching the maximum amplitudes. When the clock is quiescent, the clock signal state shall be negative.

4.2.5.2.5 Clock period.

A clock period or cycle is defined as having one half-cycle of positive polarity (sense) and one half-cycle of negative polarity (sense). The duty cycle shall be 50 percent  $\pm 1.0$  percent. Thus, in the binary sense, each clock period or cycle is composed of two clock unit intervals, and it follows that a clock rate of 50 Hz is a clock modulation rate of 100 Bd.

4.2.5.3 Clock/data phase relationship.

Arrangements which may be used to supply clock pulses to sources and sinks are shown in subparagraph 4 3.1.6.3.1. Typical standard arrangements are shown from which one may be selected to meet a specific application. For those digital devices operated at dc baseband which are interconnected by metallic wire (or other equipment which provides in effect the same function as a metallic wire), the following clock/data phase relationships apply if, and only if, interface circuit lengths permit. It is noted that, due to signal propagation delay time differences over different dc wire circuits or dc equivalent circuits at data modulation rates higher than 2400 Bd, there may be a significant relative clock/data phase shift which must be adjusted in accordance with subparagraph 4.3.1.6.2.3. Practical operating experience indicates that typical multiple pair paper cable or polyvinyl chloride (PVC) insulated exchange grade telephone cable may be expected to function at modulation rates of 4800 Bd data/ 9600 Bd clock at distances up to 3000 cable feet without any need for concern over relative pulse shift or noise if the standard low level digital interface is applied to both clock and data signals in accordance with subparagraph 4 3.1.3.

All data transition emitted by a source under direct control of an external clock shall occur on (be caused by) negative to positive transitions of that clock. The design objective is a minimum delay between the clock transition and the resulting data transition, but in no case shall this delay exceed 12.5 percent of the duration of the data unit interval. For each equipment, once this delay is fixed in hardware, it shall be consistent within  $\pm 1$  percent of itself for each clock transition. These delay limits shall apply directly at the driver interface.

Sampling of the data signal by the external clock at a sink interface shall occur on (be caused by) positive to negative clock transitions.

MIL-STD-188-110C  
w/CHANGE 1

When the clock is used for controlling intermittent data transmission, data may not change state except when requested by a negative to positive clock transition. The quiescent state of the clock shall be at negative voltage. The quiescent state of the data shall be that state resulting from the last negative to positive clock transition.

The phase relationship between external clock and data *is* not specified for devices in which the external clock is related only indirectly to the source data; for example, to maintain synchronism between a data source and data sink for a signal with a constant modulation rate. However, whatever the phase delay, it shall be consistent to within +/- 1 percent at the data unit interval at the applicable modulation rate. If the clock at twice the modulation rate at the same data is also supplied as an output, then data transitions shall coincide within +/- 1 percent of the data unit interval with the negative to positive transitions of the output clock (see Figure 4. 3-9). Direct control means control of the data by a clock signal at twice the modulation rate of the data. Indirect control means use of a clock at some higher standard modulation rate; e.g., 4, 8, 128 times the modulation rate.

4.3 Federal maritime interoperability requirements.

Ship-to-ship and shore-to-ship medium frequency (MF) and high frequency (HF) radio teletypewriter system (RATT) operation shall be in accordance with the requirements of FED-STD-1035. Extreme care must be used to ensure that this document is tailored to select only the provisions applicable to a given design task.

4.4 Data link protocol (optional).

When an ARQ protocol is used it shall be in accordance with STANAG 5066.

MIL-STD-188-110C  
w/CHANGE 1

## 5. DETAILED REQUIREMENTS

### 5.1 Frequency shift keying (FSK) modems for single-channel radio equipment.

Non-diversity FSK modems used primarily with single-channel (3 kHz) radio equipment shall comply with the applicable requirements of 4.2, 4.3, 5.1.1, and 5.1.2.

NOTE: The waveform requirements in this paragraph apply when backward compatibility and interoperability are necessary.

Table III shows characteristic frequencies of the various FSK modems for different radio channels.

**TABLE III. Characteristic frequencies of FSK data modems for single-channel radio equipment.**

Channel	Mark frequency (Hz)	Center frequency (Hz)	Space frequency (Hz)
MM radio	1615	1700	1785
HF radio	1575	2000	2425

#### 5.1.1 Narrow-shift FSK modem.

For single-radio operation with binary narrow-shift FSK modulation, a shift of 170 hertz (Hz) shall be used with the characteristic frequencies given in Table III. The tolerance of each characteristic frequency shall be  $\pm 4$  Hz.

#### 5.1.2 Wide-shift FSK modem.

For single-channel telegraph operation over high frequency (HF) radio links operating under 150 baud (Bd), the use of FSK with an 850-Hz shift is not consistent with the requirement that the U.S. operate its HF communication services in accordance with International Telecommunication Union (ITU) recommendations. However, where 850-Hz wide-shift FSK is used, the characteristic frequencies given in Table III shall apply. The tolerance of each characteristic frequency shall be  $\pm 4$  Hz.

### 5.2 FSK data modems for voice frequency (VF) channel operation (withdrawn).

### 5.3 HF data modems.

The serial (single tone) transmit waveform described in this paragraph establishes the minimum essential interoperability and performance requirements for new HF modems.

#### 5.3.1 General requirements.

MIL-STD-188-110C  
w/CHANGE 1

5.3.1.1 Capability.

The HF modems shall be capable of modulating and demodulating serial binary data into/from a serial (single-tone) waveform. This waveform is transmitted received over HF radio operating in either fixed-frequency or frequency-hopping modes of operation. The minimum acceptable performance and joint service interoperability shall be at 75, 150, 300, 600, 1200, and 2400 bps using the fixed-frequency phase shift keying (PSK) serial waveform specified herein. Uncoded serial tone modem operation at 4800 bps is a design objective (DO). Note that this is a less robust mode of operation at 4800 than that capability specified in Appendix C.

5.3.1.2 Voice digitization.

When integrated within the data modem, voice digitization functions shall be in accordance with North Atlantic Treaty Organization (NATO) Standardization Agreement (STANAG) 4198 or STANAG 4591.

5.3.1.3 Optional modes.

As a DO, the modem should be expandable to include one or more of the following optional modes:

- a. NATO mode. If included, this mode shall be in accordance with STANAG 4285 and 4481.
- b. Binary FSK mode. If included, this mode shall be in accordance with 5.1. This mode is not recommended for new systems.
- c. Medium data rate mode (3200 – 9600 bps). If included, this mode shall be in accordance with Appendix C. Note that in NATO documents (AC/322-D/17) data rates from 1200 through 9600 bps are termed “Medium Data Rate.”
- d. Wideband HF mode (up to 24 kHz channels). If included, this mode shall be in accordance with Appendix D.
- e. Multiple channel mode (including two independent sideband, or 2-ISB mode). If included, this mode shall be in accordance with Appendix F.
- f. Robust 75 bps mode. If included, this mode shall be in accordance with STANAG 4415.
- g. Frequency-hopping mode. If included, this mode shall be in accordance with the PSK serial (single-tone) waveform contained herein and the data training and timing format provided in MIL-STD-188-148.
- h. NATO narrowband mode. When narrowband operation (1240 Hz channels) is required, it shall be in accordance with STANAG 4529.

MIL-STD-188-110C  
w/CHANGE 1

5.3.1.4 Interface requirements.

5.3.1.4.1 Line-side data characteristics.

Line-side data interfaces shall be in accordance with 4.2.3.

5.3.1.4.2 LAN interface (DO).

If an additional Ethernet LAN interface is provided (see Joint Technical Architecture, 2.3.2.2.2.1: Local Area Network (LAN) Access), the modem should be capable of performing both line side and Remote Control (see 5.3.1.5) interface functions over the LAN including transport of user data, in accordance with Appendix A.

5.3.1.4.3 Equipment side characteristics (informative).

Modems shall be designed to provide the required performance (see 5.3.2.5) using the single-channel bandwidth and characteristics as given in MIL-STD-188-141.

5.3.1.4.4 Transmit override.

When operating in other than full duplex mode, data presented for transmission at the line-side or LAN interface shall cause the modem to commence transmit operation, overriding any reception of data on the equipment side. An option may be provided to disable transmit override, so that CTS is delayed after the assertion of RTS until a reception in progress is complete.

5.3.1.4.5 Buffering in synchronous serial mode.

When transferring line-side data in the synchronous mode, the modem shall transmit all user data that occur after the assertion of CTS by the modem and before the de-assertion of RTS by the DTE. At the receive end of the link, all of the bits that occur in this interval shall be delivered by the modem to the DTE. Transmission and reception of user bits that fall outside this interval is not precluded.

5.3.1.5 Remote control interface.

A remote control interface is mandatory for all new procurements of HF data modems.

5.3.1.5.1 Electrical interface.

The electrical interface for remote control of the modem shall comply with the specified industrial or military interface standard.

5.3.1.5.2 Optional modem control driver.

As an option a software remote control driver shall be supplied for installation in a remote control unit that provides an open, documented Application Programming Interface (API) to communications software.

5.3.2 Serial (single-tone) mode.

5.3.2.1 General.

This mode shall employ M-ary phase-shift keying (PSK) on a single carrier frequency as the modulation technique for data transmission. Serial binary information accepted at the line-side



MIL-STD-188-110C  
w/CHANGE 1

input is converted into a single 8-ary PSK-modulated output carrier. The modulation of this output carrier shall be a constant 2400-symbols-per-second waveform regardless of the actual throughput rate. The rate-selection capability shall be as given in 5.3.1.1. Selectable interleaver settings shall be provided. This waveform (signal structure) has four functionally distinct, sequential transmission phases. These time phases are:

- a. Synchronization preamble phase.
- b. Data phase.
- c. End-of-message (EOM) phase.
- d. Coder and interleaver flush phase.

NOTE: Unless otherwise specified, the included serial (single-tone) waveform requirements apply to both the fixed-frequency and frequency-hopping modes of operation.

5.3.2.2 Sequencing of time phases.

Figure 2 illustrates the functional block diagram for fixed-frequency and frequency-hopping operation.

MIL-STD-188-110C  
w/CHANGE 1

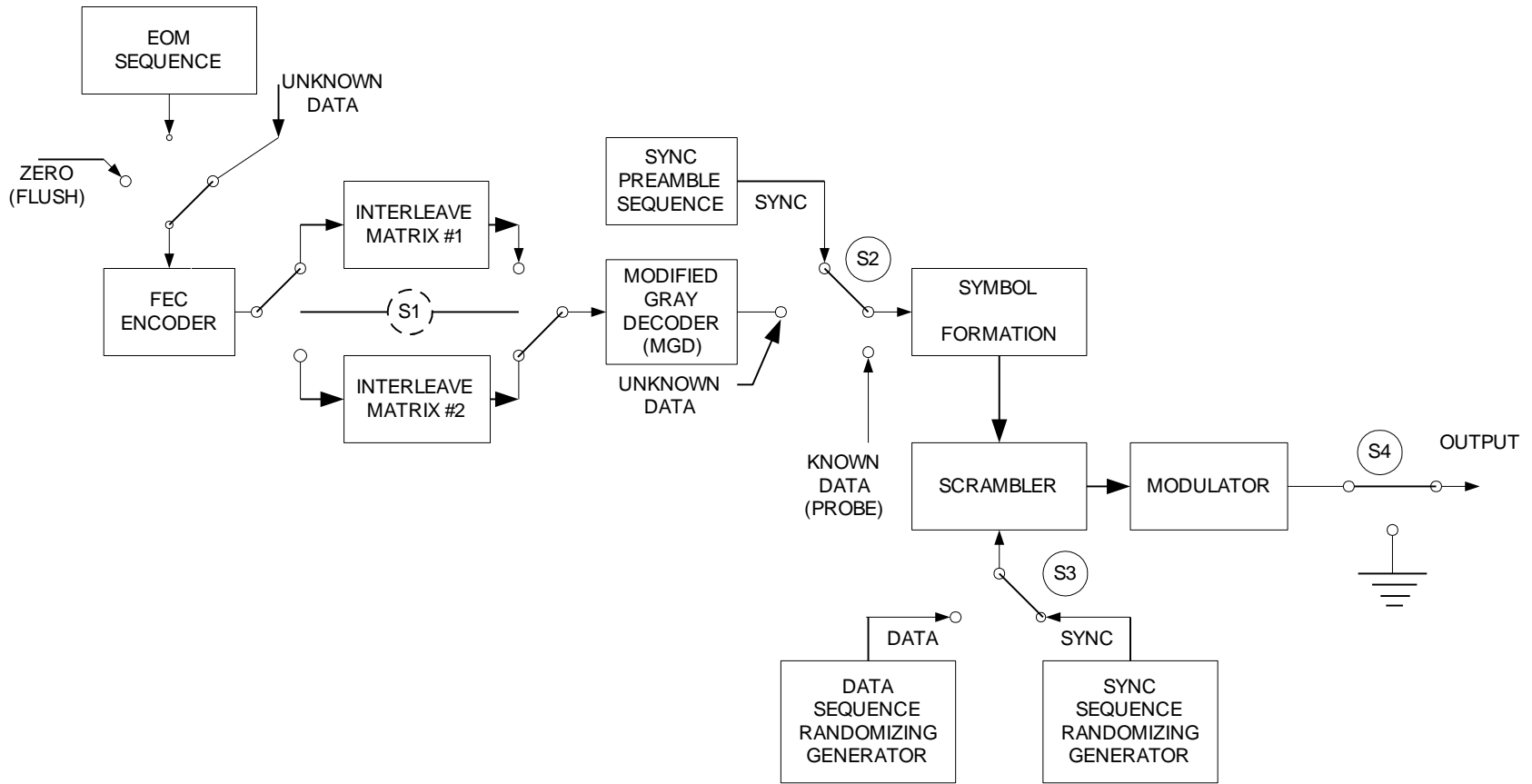

**FIGURE 2. Serial (single-tone) waveform functional block diagram**

MIL-STD-188-110C  
w/CHANGE 1

5.3.2.2.1 Synchronization (sync) preamble phase.

The duration of the sync preamble phase shall correspond to the exact time required to load the selected interleaver matrix when an interleaver is present, with one block of data. During this phase, switch S1 (see figure 2) shall be in the UNKNOWN DATA position and the encode and load interleave functions shall be active as the modem begins accepting data from the data terminal equipment (DTE). Switches S2 and S3 shall be in the SYNC position. The transmitting modem shall send the required sync preamble sequence (see 5.3.2.3.7.2) to achieve time and frequency sync with the receiving modem. The length of the sync preamble sequence pattern shall be 0.6 s for the zero interleaver setting (this requires that a 0.6 s buffer be used to delay data traffic during the sync preamble transmission), 0.6 s for the short interleaver setting, and 4.8 s for the long interleaver setting. For radio frequency hopping operation, S4 and the data fetch controller shall provide the required traffic dead time at the beginning of each hop by disabling the modem output. The dead time shall be equal to the duration of 96 symbols. Switch S4 shall be placed in the through position during fixed-frequency operation. Referring to figure 3, the sequence of events for synchronous and asynchronous operation is as follows:

a. For fixed-frequency, full-duplex data operation, upon receipt of the message request-to-send (RTS) signal from the DTE, the modem shall simultaneously perform the following;

(1) Return to the DTE a clear-to-send (CTS) signal,

(2) Begin loading the interleaver with data traffic, and

(3) Commence sending the special sync preamble pattern described in 5.3.2.3.7.2 and 5.3.2.3.8.2.

b. For fixed-frequency half-duplex (one-way reversible) data operation using radio equipment without automatic link establishment (ALE) capability, the radio set transmitter shall be keyed first, then the sequence of events shall be identical to that given for fixed-frequency full-duplex operation.

c. Fixed-frequency half duplex data operation using ALE radio equipment shall incorporate a method of delaying the data CTS signal until radio link confirmation. In an example of this operation, upon receipt of the RTS signal from the user data terminal, the controller first initiates and confirms linking with the called station. During this link confirmation period, the RTS signal is controlled and delayed in the controller until the link is confirmed. After link confirmation, the controller sends the RTS signal to the modem. (In effect, the delaying of the RTS signal provides the needed delay of the data CTS signal.) Upon receipt of the RTS signal from the controller, the modem shall simultaneously perform the following:

(1) Key the radio,

(2) Return to the DTE a CTS signal,

(3) Begin loading the interleaver with data traffic, and

(4) Commence sending the special sync pattern described in 5.3.2.3.7.2 and 5.3.2.3.8.2.

MIL-STD-188-110C  
w/CHANGE 1

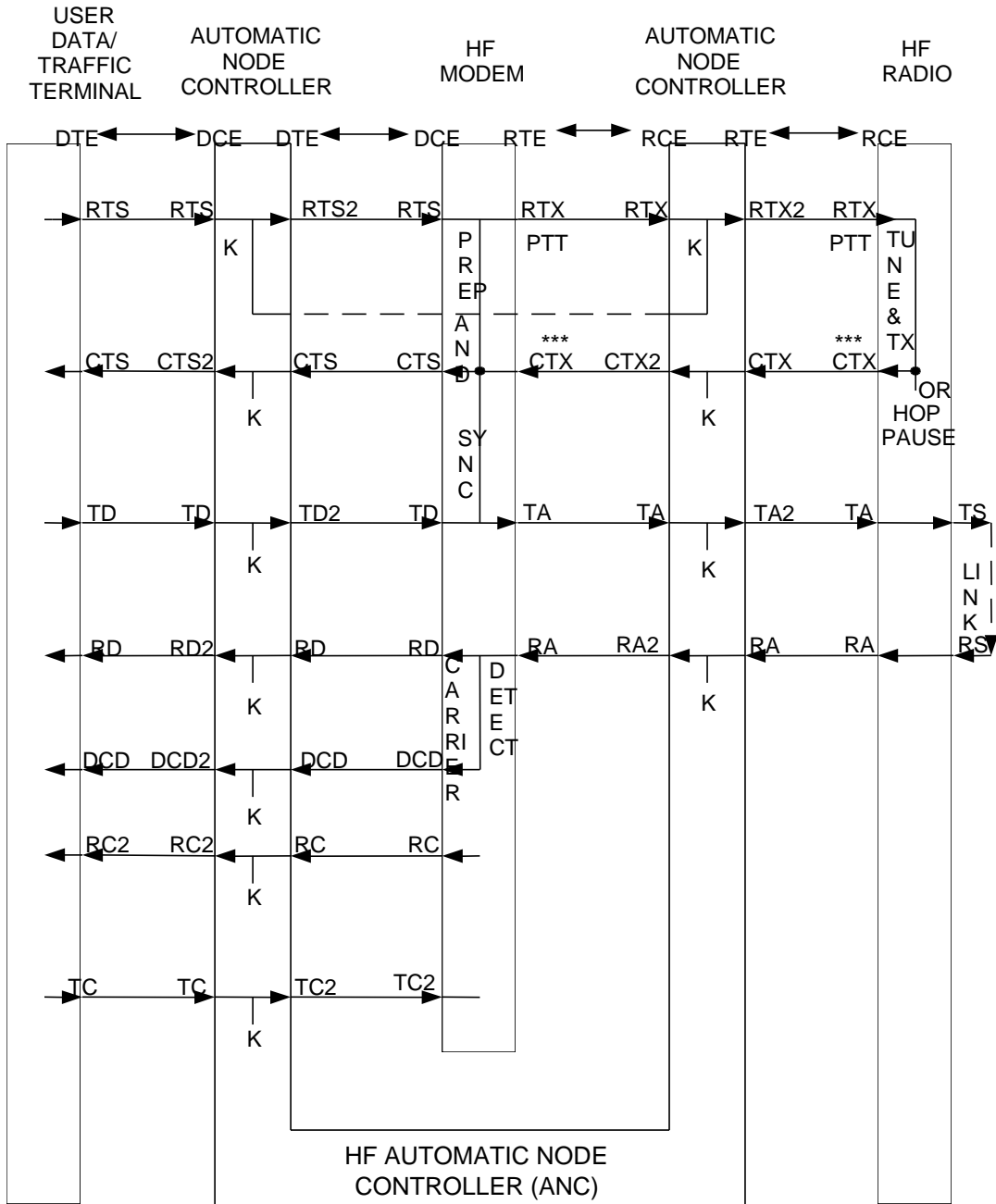

FIGURE 3. An example of equipment interface block diagram.

MIL-STD-188-110C  
w/CHANGE 1

LEGEND:

\*\*\* INDICATES A NECESSARY INTERFACE WHICH IS NOT PRESENTLY DEFINED AND REQUIRED IN PRESENT EQUIPMENTS AND STANDARDS, AND MUST BE INCORPORATED.

ANC	AUTOMATIC NODE CONTROLLER
AND	LOGICAL AND, ALL (AVAILABLE) INPUTS MUST BE TRUE TO OBTAIN A TRUE OUTPUT
CTS	CLEAR TO SEND
CTS2	CTS CONTROLLED THROUGH ANC
CTX	CLEAR TO TRANSMIT (TRANSMITTER TUNED AND ON)
CTX2	CTX CONTROLLED THROUGH ANC
DCD	DATA CARRIER DETECT (RECEIVED DATA CARRIER DETECTION)
DCD2	DCD CONTROLLED THROUGH ANC
DCE	DATA CIRCUIT-TERMINATING EQUIPMENT
DTE	DATA TERMINAL EQUIPMENT
HOP PAUSE	COMMAND TO PAUSE (TRANSMIT DATA) WHILE RADIO CHANGES FREQUENCY
K	INDICATES HF AUTOMATIC NODE CONTROLLER (ANC) CONTROL, WHICH MAY ALSO INCLUDE MONITORING AND/OR INJECTION.
LINK	HF RADIO LINK, INCLUDING DISTANT STATION AND PROPAGATION
OR	LOGICAL OR, SOME (AVAILABLE) INPUTS MUST BE TRUE TO OBTAIN A TRUE OUTPUT
PREP	PREPARATION TO ACCEPT AND SEND DATA, AND KEY TRANSMITTER
PTT	PUSH TO TALK (KEY TRANSMITTER ON)
RA	RECEIVE AUDIO
RA2	RA CONTROLLED THROUGH ANC
RC	RECEIVE CLOCK
RC2	RC CONTROLLED THROUGH ANC
RCE	RADIO COMMUNICATIONS EQUIPMENT
RD	RECEIVE DATA
RD2	RD CONTROLLED THROUGH ANC
RS	RECEIVE (HF RADIO) SIGNAL
RTE	RADIO TERMINAL EQUIPMENT
RTS	REQUEST TO SEND
RTS2	RTS CONTROLLED THROUGH ANC
RTX	REQUEST TO TRANSMIT
RTX2	RTX CONTROLLED THROUGH ANC
SYNC	SYNCHRONIZATION FOR DATA TRANSMISSION
TA	TRANSMIT AUDIO
TA2	TA CONTROLLED THROUGH ANC
TC	TRANSMIT CLOCK
TC2	TC CONTROLLED THROUGH ANC

MIL-STD-188-110C  
w/CHANGE 1

TD	TRANSMIT DATA
TD2	TD CONTROLLED THROUGH ANC
TS	TRANSMIT (HF RADIO) SIGNAL
TUNE	TUNING OF THE TRANSMITTER AND ANTENNA SYSTEM BEFORE TRANSMIT
TX	TRANSMIT (HF RADIO ON AND READY TO SEND DATA)

**FIGURE 3. An example of equipment interface block diagram - Continued.**

d. For frequency-hopping data operation, the modem shall, upon receipt of the RTS signal from the DTE input device, simultaneously perform the following:

- (1) key the radio,
- (2) return a data CTS signal to the DTE,
- (3) commence loading the interleaver, and
- (4) wait for the radio clear-to-transmit (CTX) signal. In no case shall the radio CTX signal occur later than 2.4 seconds after receipt of the data CTS signal. This requires, in addition to an interleaver buffer, a buffer of at least 2.45 times the highest data rate used.

NOTE: This additional buffer shall be bypassed during fixed-frequency operation.

Upon receipt of the radio CTX, the transmitting modem shall then commence sending the sync pattern as given in 5.3.2.3.7.2 and 5.3.2.3.8.2, and will use the data framing and timing format in MIL-STD-188-148.

NOTE: The interleaver fetch and modified Gray decoding functions are not active during this phase. All received data prior to entry into the data phase must be buffered by the modem. The radio CTX signal can originate from either the radio set itself or, if using ALE radio equipment, an ALE controller.

#### 5.3.2.2.2 Data phase.

During the data phase, the transmit waveform shall contain both message information (UNKNOWN DATA) and channel probes (KNOWN DATA), that is, training bits reserved for channel equalization by the distant receive modem. Function switches S1 and S3 (figure 2) are in the UNKNOWN DATA and DATA position, respectively, and switch S2 toggles between the UNKNOWN DATA (modified Gray decoder (MGD) output) and the KNOWN DATA (probe) positions. The probe shall consist of zeros, D1, and D2 (D1 and D2 are defined in 5.3.2.3.7.1.2). The period of dwell in each switch position shall be as follows:

MIL-STD-188-110C  
w/CHANGE 1

a. For frequency-hopping operation, the dwell is a function of bit rate and time duration of the hop. MIL-STD-188-148 gives the required timing of switches S2 and S4 during each hop time as a function of data rate and dead time.

b. For fixed-frequency operation, the period of dwell shall be a function of bit rate only. At 2400 and 4800 bps, there shall be a 32-symbol duration in the UNKNOWN DATA position followed by a 16-symbol duration in the KNOWN DATA position. At 150, 300, 600, and 1200 bps, the two durations shall be 20 symbols in each position. At 75 bps, switch S2 shall remain in the UNKNOWN DATA position. Data transfer operation shall be terminated by removal of the RTS signal by the input DTE.

NOTE: In all cases, switch S2 is placed in the UNKNOWN DATA position first, following the end of the sync preamble phase.

5.3.2.2.3 EOM phase.

When the last UNKNOWN DATA bit prior to the absence of the RTS signal has entered the forward error correction (FEC) encoder, S1 (figure 2) shall be switched to the EOM position. This shall cause a fixed 32-bit pattern (see 5.3.2.3.1) to be sent to the FEC encoder. Function switches S2 and S3 (and also S4 in frequency-hopping operation) shall continue to operate as established for the data phase.

5.3.2.2.4 FEC coder and interleaver flush phase.

Immediately upon completion of the EOM phase, S1 (figure 2) shall be switched to the FLUSH position causing input of flush bits (see 5.3.2.3.2) to the FEC encoder.

5.3.2.3 Functional descriptions.

The following subparagraphs provide figure 2 block descriptions.

5.3.2.3.1 EOM sequence.

The eight-digit hexadecimal number, 4B65A5B2 shall represent the EOM sequence. The bits shall be transmitted with the most significant digit first. Thus the first eight bits are, left to right, 0100 1011.

5.3.2.3.2 Interleaver flush

If an interleaver is used, the duration of the flush phase shall be 144 bits (for coder flush) plus enough bits to complete transmission of the remainder of the interleaved matrix data block (see 5.3.2.3.4 for data block size) containing the last coder flush bit. Flush bits shall be set to "0". If the interleaver is in a bypass (0.0 s) state, only the coder flush bits are transmitted.

NOTE: This causes the transmission of enough flush bits to allow effective flushing of the FEC decoder and the deinterleaver at the receiving modem.

5.3.2.3.3 FEC encoder.

The FEC encoder shall be used for data rates up to and including 2400 bps. The FEC encoder block diagram for frequency-hopping and fixed-frequency operation is shown on figure 4.

MIL-STD-188-110C  
w/CHANGE 1

a. For frequency-hopping operation, the FEC encoder function shall be accomplished by a constraint length 7 convolutional coder with repeat coding used at the 75, 150, and 300 bps rates. The two summing nodes on the figure represent modulo 2 addition. For each bit input to the encoder, two bits shall be taken as output from the encoder, the upper output bit  $T_1(x)$  being taken first. For the 2400 bps rate, every fourth bit (the second value of  $T_2(x)$ ) shall be omitted at the interleaver output to form a punctured rate  $2/3$  convolutional rate. At all other rates, the convolutional coder shall be rate  $1/2$ . Coded bit streams of 3600, 2400, and 1200 bps shall be generated for the input data rates of 2400, 1200, and 600 bps, respectively. For the 300, 150, and 75 bps input data rates, a 1200 bps coded bit stream shall be generated by repeating the pairs of output bits the appropriate number of times. The bits shall be repeated in pairs rather than repetitions for the first,  $T_1(x)$ , followed by repetitions of the second  $T_2(x)$ . Error correction coding for frequency-hopping operation shall be in accordance with Table IV.

**TABLE IV. Error correcting coding, frequency hopping operation.**

Data rate (bps)	Effective Code rate	Method for achieving the code rate
2400	$2/3$	Rate $2/3$ punctured convolutional code
1200	$1/2$	Rate $1/2$ code
600	$1/2$	Rate $1/2$ code
300	$1/4$	Rate $1/2$ code repeated 2 times
150	$1/8$	Rate $1/2$ code repeated 4 times
75	$1/16$	Rate $1/2$ code repeated 8 times



MIL-STD-188-110C  
w/CHANGE 1

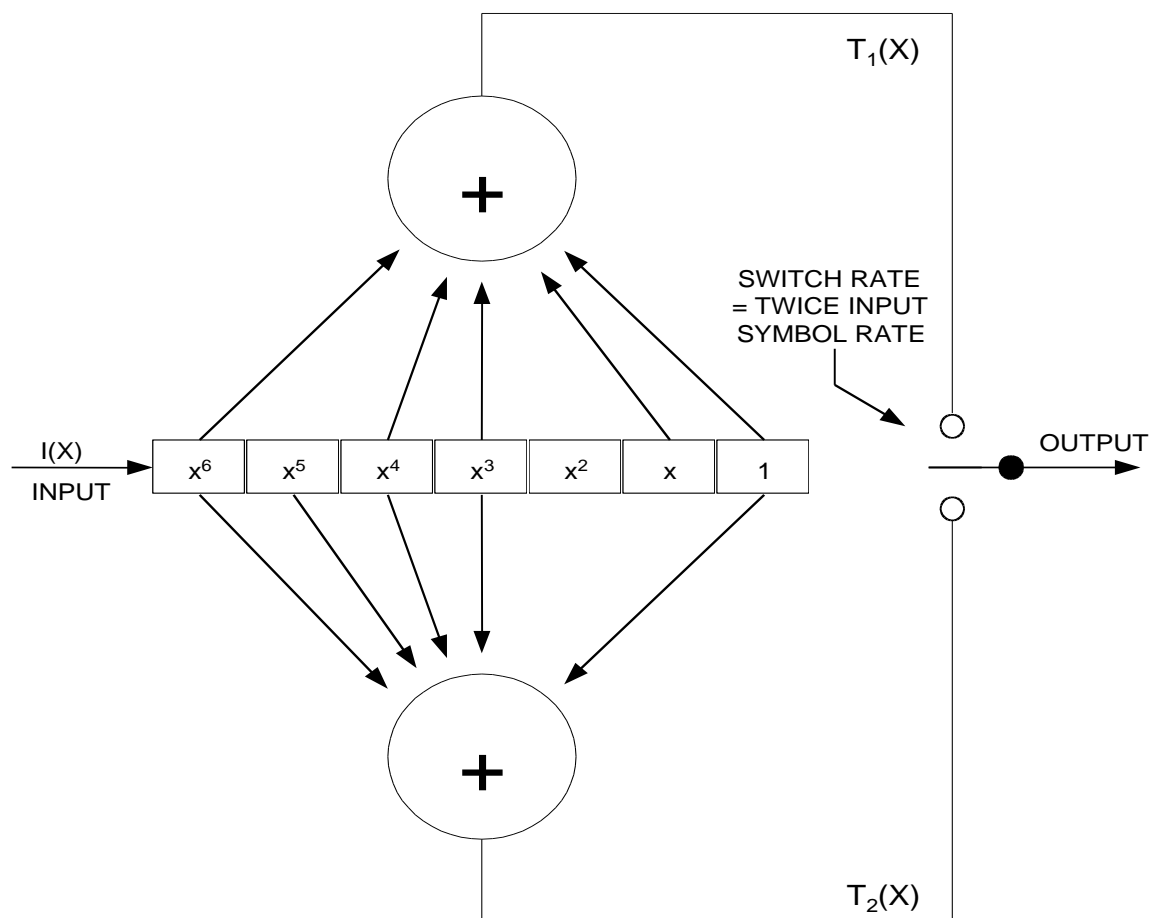

CONSTRAINT LENGTH =  
GENERATOR  
POLYNOMIALS:

FOR  $T_1$   $X^6+X^4+X^3+X+1$   
FOR  $T_2$   $X^6+X^5+X^4+X^3+1$

**FIGURE 4. FEC encoder block diagram.**

MIL-STD-188-110C  
w/CHANGE 1

b. For fixed-frequency operation, the FEC encoder function shall be accomplished by a single rate 1/2 constraint length 7 convolutional coder with repeat coding used at 150 and 300 bps. The two summing nodes shall operate as given for frequency-hopping operation; that is, for each bit input to the encoder, two bits shall be taken as output from the encoder. Coded bit streams of 4800, 2400, and 1200 bps shall be generated for input data rates of 2400, 1200, and 600 bps, respectively. For 300-bps and 150-bps input data rates, repeating the pairs of output bits the appropriate number of times shall generate a 1200-bps coded bit stream. The bits shall be repeated in pairs rather than repetitions for the first,  $T_1(X)$ , followed by repetitions of the second  $T_2(X)$ . At 75 bps, a different transmit format (see 5.3.2.3.7.1.1) is used and the effective code rate of 1/2 shall be employed to produce a 150-bps coded stream. Error correction coding for fixed-frequency operation shall be in accordance with Table V.

**TABLE V. Error-correcting coding, fixed frequency operation.**

Data rate (bps)	Effective code rate	Method for achieving the code rate
4800	(no coding)	(no coding)
2400	1/2	Rate 1/2
1200	1/2	Rate 1/2 code
600	1/2	Rate 1/2 code
300	1/4	Rate 1/2 code repeated 2 times
150	1/8	Rate 1/2 code repeated 4 times
75	1/2	Rate 1/2

c. For 4800-bps fixed-frequency operation, the FEC encoder shall be bypassed.

#### 5.3.2.3.4 Interleave load.

The interleaver, when used, shall be a matrix block type that operates upon input bits. The matrix size shall accommodate block storage of 0.0, 0.6, or 4.8 s of receiving bits (depending on whether the zero, short, or long interleave setting is chosen) at all required data rates. Because the bits are loaded and fetched in different orders, two distinct interleave matrices shall be required.

NOTE: This allows one block of data to be loaded while the other is being fetched. The selection between the long and short interleaves is contained in the transmitted sync pattern (5.3.2.3.7.2). The short interleaves shall be switch selectable to be either 0.0 s or 0.6 s (see 5.3.2.3.7.2.1).

To maintain the interleave delay at a constant value, the block size shall be scaled by bit rate. Table VI lists the interleaver matrix dimensions (rows and columns) that shall be allocated for each required bit rate and interleave delay.

NOTE: For frequency-hopping operation at rates of 300, 150, and 75 bps, the number of bits required for a constant time delay is the same as that for 600 bps due

MIL-STD-188-110C  
w/CHANGE 1

to repeat coding. For fixed-frequency operation, repeat coding is used with only the 300-bps and 150-bps rates.

Unknown data bits shall be loaded into the interleaver matrix starting at column zero as follows: the first bit is loaded into row 0, the next bit is loaded into row 9, the third bit is loaded into row 18, and the fourth bit into row 27. Thus, the row location for the bits increases by 9 modulo 40. This process continues until all 40 rows are loaded. The load then advances to column 1 and the process is repeated until the matrix block is filled. This procedure shall be followed for both long and short interleave settings.

NOTE: The interleaver shall be bypassed for 4800-bps fixed-frequency operation.

For fixed-frequency operation at 75 bps only, the following changes to the above description shall apply:

a. When the interleaver setting is on long, the procedure is the same, but the row number shall be advanced by 7 modulo 20.

b. When the interleaver setting is on short, the row number shall be advanced by 7 modulo 10. If the short interleaver is selected and the short interleaver setting is 0.0 s, the interleaver shall be bypassed.

**TABLE VI. Interleaver matrix dimensions.**

Bit rate (bps)	Long interleaver		Short interleaver	
	Number of rows	Number of columns	Number of rows	Number of columns
2400	40	576	40	72
1200	40	288	40	36
600	40	144	40	18
300	40	144	40	18
150	40	144	40	18
75H	40	144	40	18
75N	20	36	10	9

NOTE: H = frequency-hopping operation, N = fixed-frequency operation.

#### 5.3.2.3.5 Interleave fetch.

The fetching sequence for all rates shall start with the first bit being taken from row zero, column zero. The location of each successive fetched bit shall be determined by incrementing the row by one and decrementing the column number by 17 (modulo number of columns in the interleaver matrix). Thus, for 2400 bps with a long interleave setting, the second bit comes from row 1, column 559, and the third bit from row 2, column 542. This interleaver fetch shall continue until the row number reaches the maximum value. At this point, the row number shall

MIL-STD-188-110C  
w/CHANGE 1

be reset to zero, the column number is reset to be one larger than the value it had when the row number was last zero and the process continued until the entire matrix data block is unloaded. The interleaver fetch process shall be the same for frequency-hopping and fixed-frequency operation except as follows:

a. For frequency-hopping operation (as stated in 5.3.2.3.3), the puncture process at 2400 bps shall occur during the fetch routine by omitting every fourth bit from the interleaver output.

b. For fixed-frequency operation at the 75-bps rate, the interleaver fetch is similar except the decrement value of the column number shall be 7 rather than 17.

The bits obtained from the interleaver matrix shall be grouped together as one, two, or three bit entities that will be referred to as channel symbols. The number of bits that must be fetched per channel symbol shall be a function of bit rate as given in Table VII.

**TABLE VII. Bits-per-channel symbol.**

Data rate (bps)	Number of bits fetched per channel symbol
2400	3
1200	2
600	1
300	1
150	1
75H	1
75N	2

NOTE: H = frequency-hopping operation, N = fixed-frequency operation.

**5.3.2.3.6 Modified-Gray decoder.**

At 4800 and 2400 bps, the channel bits are effectively transmitted with 8-ary channel symbols. At 1200 bps and 75 bps (fixed frequency), the channel bits are effectively transmitted with 4-ary channel symbols.

NOTE: The purpose of decoding the bits from the interleaver matrix (through the MGD) is to guarantee that only one bit is in error when symbol errors involving adjacent phases are made at the receiving demodulator.

Modified Gray decoding of the 2400 bps, 4800 bps (tribit), and 75 bps (fixed frequency) 1200 bps (dibit) channel symbols shall be in accordance with Tables VIII and IX respectively. When one-bit channel symbols are used (600-150 bps, and 75 bps (frequency-hopping operation)) the MGD does not modify the unknown data bit stream.

MIL-STD-188-110C  
w/CHANGE 1

**TABLE VIII. Modified Gray decoding at 2400 bps and 4800 bps.**

Input bits			Modified Gray decoded value
First bit	Middle bit	Last bit	
0	0	0	000
0	0	1	001
0	1	0	011
0	1	1	010
1	0	0	111
1	0	1	110
1	1	0	100
1	1	1	101

**TABLE IX. Modified-Gray decoding at 75 bps (fixed frequency) and 1200 bps.**

Input bits		Modified-Gray decoded value
First bit	Last bit	
0	0	00
0	1	01
1	0	11
1	1	10

#### 5.3.2.3.7 Symbol formation.

The function of symbol formation is one of mapping the one, two, or three bit channel symbols from the MGD or from the sync preamble sequence into tribit numbers compatible with transmission using an 8-ary modulation scheme. The mapping process is discussed separately for data and preamble transmissions.

##### 5.3.2.3.7.1 Symbol formation for data transmission.

Channel symbols shall be fetched from the interleaver only during the portion of time that unknown symbols are to be transmitted. For all frequency-hopping and fixed-frequency operation data rates, the output of the symbol formation shall be scrambled with pseudo-random three bit numbers. This scrambled waveform shall appear to be 8-ary tribit numbers regardless of operational throughput bit rates. The relationship of tribit numbers (0-7) to the transmitted phase of the waveform is further defined in 5 3.2.3.9.

##### 5.3.2.3.7.1.1 Unknown data.

At all frequency-hopping operation rates and rates above 75 bps for fixed-frequency operation, each one, two, or three bit channel symbol shall map directly into one of the 8-ary tribit numbers as shown on the state constellation diagram, figure 5. When one bit channel symbols are used (600-150 bps, and 75 bps (frequency-hopping)), the symbol formation output shall be tribit numbers 0 and 4 At the 1200-bps rate, the dibit channel symbol formation shall use tribit

MIL-STD-188-110C  
w/CHANGE 1

numbers 0, 2, 4, and 6. At the 4800-bps and 2400-bps rates, all the tritbit numbers (0-7) shall be used for symbol formation. At 75 bps fixed-frequency operation, the channel symbols shall consist of two bits for 4-ary channel symbol mapping. Unlike the higher rates, no known symbols (channel probes) shall be transmitted and no repeat coding shall be used. Instead, the use of 32 tritbit numbers shall be used to represent each of the 4-ary channel symbols. The mapping that shall be used is given in Table X. The mapping in Table Xa shall be used for all sets of 32 tritbit numbers with the exception of every 45th set (following the end of the sync pattern) if short interleave is selected, and every 360th set (following the end of sync pattern) if long interleave is selected. These exceptional sets, every 45th set for short interleave and every 360th set for long interleave, shall use the mappings of Table Xb. In any case, the resultant output is one of four orthogonal waveforms produced for each of the possible dibits of information. As before, these values will be scrambled later to take on all 8-phase states.

NOTE: Each set consists of 32 tritbit numbers. The receive modem shall use the modification of the known data at interleaver boundaries to synchronize without a preamble and determine *the* correct data rate and mode of operation.

#### 5.3.2.3.7.1.2 Known data.

During the periods where known (channel probe) symbols are to be transmitted, the channel symbol formation output shall be set to 0 (000) except for the two known symbol patterns preceding the transmission of each new interleaved block.. The block length shall be 1440 tritbit channel symbols for short interleave setting and 11520 tritbit channels symbols for the long interleave setting. When the two known symbol patterns preceding the transmission of each new interleaver block are transmitted, the 16 tritbit symbols of these two known symbol patterns shall be set to D1 and D2, respectively, as defined in Table XI of 5.3.2.3.7.2.1 and Table XIII of 5.3.2.3.7.2.2. The two known symbol patterns are repeated twice rather than four times as they are in Table XIII to produce a pattern of 16 tritbit numbers. In cases where the duration of the known symbol pattern is 20 tritbit symbols, the unused last four tritbit symbols shall be set to 0 (000).

NOTE: When zero interleaver setting is selected, the pattern associated with the 0.6 s block is used. When 4800 bps operation is selected, the pattern associated with the short interleaver setting is selected.

MIL-STD-188-110C  
w/CHANGE 1

**TABLE X. Channel symbol mapping for 75 bps.**

Channel symbol	Tribit numbers
<u>a. Mapping for normal sets</u>	
00	(0000) repeated 8 times
01	(0404) repeated 8 times
10	(0044) repeated 8 times
11	(0440) repeated 8 times
<u>b. Mapping for exceptional sets.</u>	
00	(0000 4444) repeated 4 times
01	(0404 4040) repeated 4 times
10	(0044 4400) repeated 4 times
11	(0440 4004) repeated 4 times

5.3.2.3.7.2 Sync preamble sequence.

5.3.2.3.7.2.1 General.

The waveform for synchronization is essentially the same for all data rates. The synchronization pattern shall consist of either three or twenty four 200 millisecond (ms) segments (depending on whether either zero, short, or long interleave periods are used). Each 200-ms segment shall consist of a transmission of 15 three bit channel symbols as described in 5.3.2.3.7.2.2. The sequence of channel symbols shall be 0, 1, 3, 0, 1, 3, 1, 2, 0, D1, D2, C1, C2, C3, 0.

The three bit values of D1 and D2 shall designate the bit rate and interleave setting of the transmitting modem. Table XI gives the assignment of these values.

NOTE: The D1, D2 combinations 5,6 and 5,7 are reserved for application-specific use.

If a demodulator receives any D1, D2 combination that it does not implement, it shall not synchronize but shall continue to search for synchronization.

NOTE: The short interleave can be selected to either 0.0 (bypassed) or 0.6 s. The short interleave generally should be set to 0.6 s. If the 0.0s interleave is selected, coordination with the distant terminal must be made before transmitting data. An automatic feature of selection between the 0.0 s and 0.6 s interleaver for both transmitter and receiver is a DO.

The three count symbols C1, C2, and C3 shall represent a count of the 200 ms segments starting at 2 for the zero and short sync (interleave) setting cases and 23 for the long sync (interleave) case. The count in either case shall start at the value established by the sync case

MIL-STD-188-110C  
w/CHANGE 1

setting and count down each segment to zero. The values shall be read as a six-bit word (C1, C2, C3), where C1 contains the most significant two bits. The two bit values of each C (C1, C2, C3) shall be converted to three bit values. Adding a "1" before the two-bit value does this so that this "1" becomes the most significant bit. This conversion shall be as shown in Table XII.

NOTE: The converted count of 23 (010111) would have values of 5, 5, and 7 for C1, C2, and C3, respectively.

**TABLE XI. Assignment of designation symbols D1 and D2.**

Bit rate	Short interleave		Long interleave	
	D1	D2	D1	D2
4800	7	6	reserved	reserved
2400 (Digital voice).	7	7	reserved	reserved
2400 (Data)	6	4	4	4
1200	6	5	4	5
600	6	6	4	6
300	6	7	4	7
150	7	4	5	4
75	7	5	5	5

**TABLE XII. Conversion of two bit count value to three bit symbol.**

Two-bit count value	Three-bit sync symbol
00	4 (100)
10	5 (101)
01	6 (110)
11	7 (111)

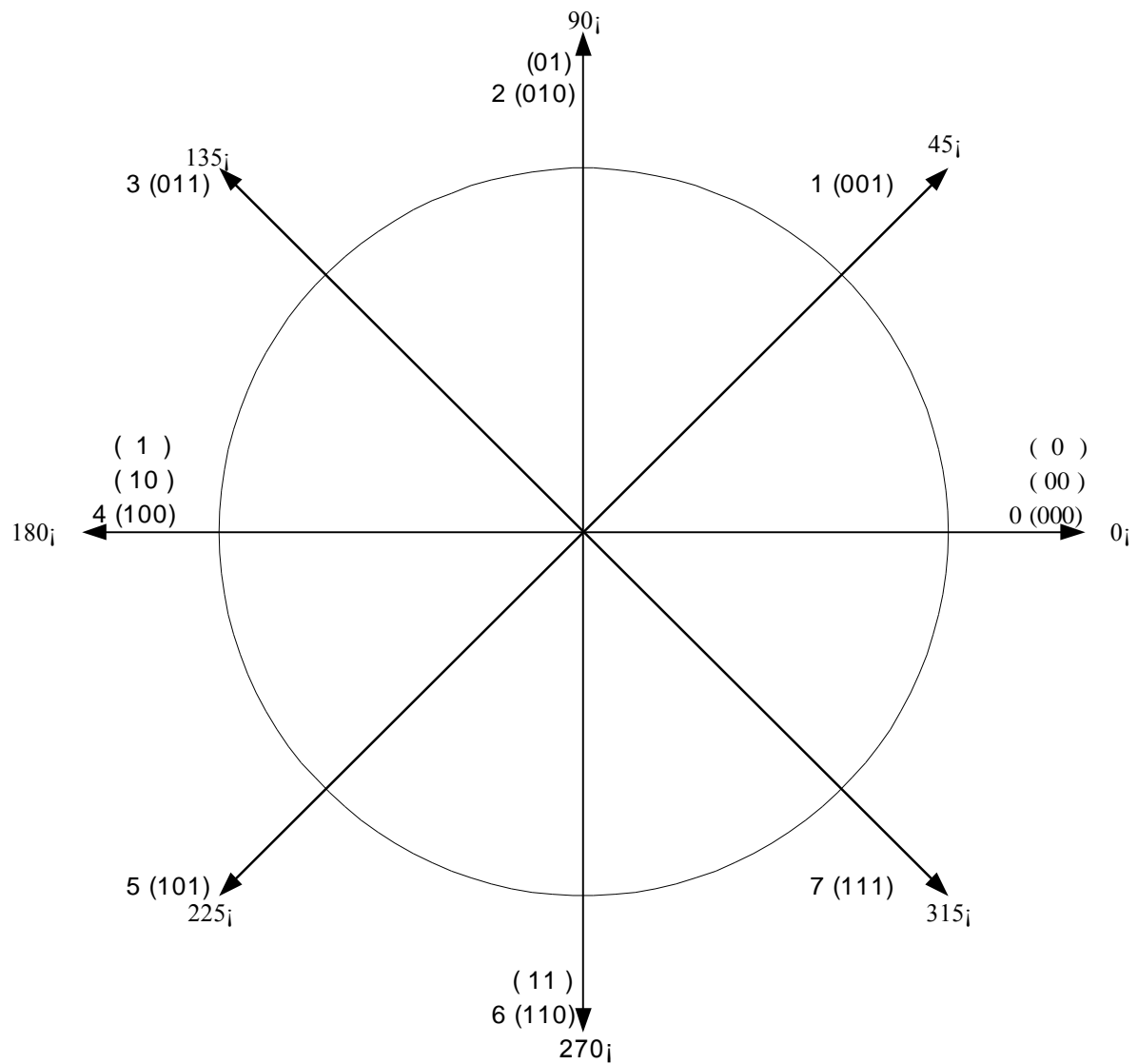

MIL-STD-188-110C  
w/CHANGE 1

## LEGEND:

0<sub>i</sub>...315<sub>i</sub> = PHASE (DEGREES)

0 ...7 = TRIBIT NUMBERS

(000) ... (111) = THREE BIT CHANNEL SYMBOLS

(00) ... (11) = TWO BIT CHANNEL SYMBOLS

(0) ... (1) = ONE BIT CHANNEL SYMBOLS

FIGURE 5. State constellation diagram

MIL-STD-188-110C  
w/CHANGE 1

5.3.2.3.7.2.2 Preamble pattern generation.

The sync preamble pattern shall be a sequence of channel symbols containing three bits each (see 5.3.2.3.7.2.1). These channel symbols shall be mapped into thirty two tritbit numbers as given in Table XIII.

NOTE: When the two known symbol patterns preceding the transmission of each new interleaves block are transmitted, the patterns in Table XIII are repeated twice rather than four times to produce 8 pattern of 16 tritbit numbers.

**TABLE XIII. Channel symbol mapping for sync preamble.**

Channel Symbol	Tritbit Numbers
000	(0000 0000)repeated 4 times
001	(0404 0404) repeated 4 times
010	(0044 0044) repeated 4 times
011	(0440 0440) repeated 4 times
100	(0000 4444) repeated 4 times
101	(0404 4040) repeated 4 times
110	(0044 4400) repeated 4 times
111	(0440 4004) repeated 4 times

5.3.2.3.8 Scrambler.

The tritbit number supplied from the symbol formation function for each 8-ary transmitted symbol shall be modulo 8 added to a three bit value supplied by either the data sequence randomizing generator or the sync sequence randomizing generator.

5.3.2.3.8.1 Data sequence randomizing generator.

The data sequence randomizing generator shall be a 12 bit shift register with the functional configuration shown on figure 6. At the start of the data phase, the shift register shall be loaded with the initial pattern shown in figure 6 (101110101101 (binary) or BAD (hexadecimal)) and advanced eight times. The resulting three bits, as shown, shall be used to supply the scrambler with a number from 0 to 7. The shift register shall be shifted eight times each time a new three bit number is required (every transmit symbol period). After 160 transmit symbols, the shift register shall be reset to BAD (hexadecimal) prior to the eight shifts.

NOTE: This sequence produces a periodic pattern 160 transmit symbols in length.

MIL-STD-188-110C  
w/CHANGE 1

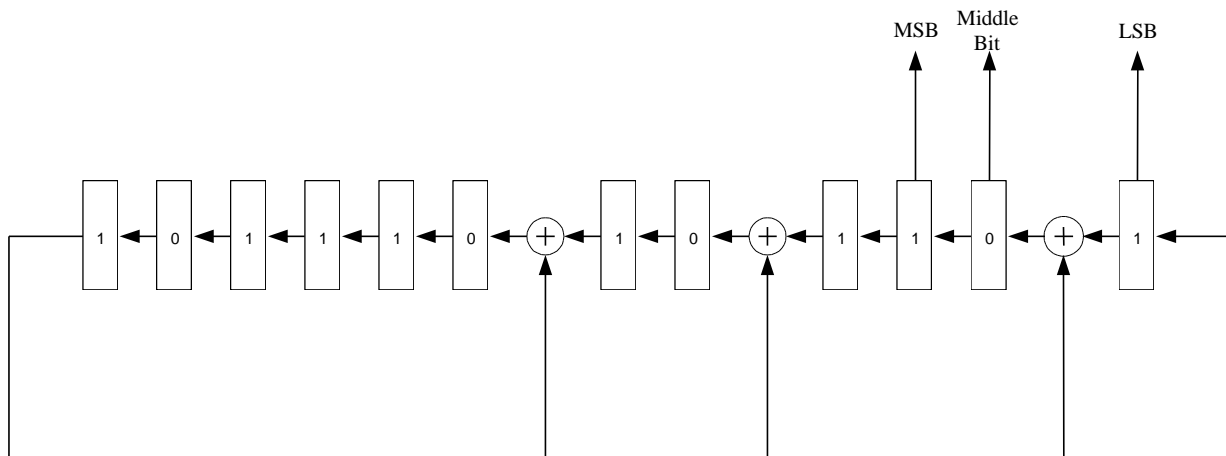

NOTES:

1. Initial settings shown
2. Shifted 8 times between outputs

**FIGURE 6. Randomizing shift register functional diagram**

5.3.2.3.8.2 Sync sequence randomizing Generator.

The following scrambling sequence for the sync preamble shall repeat every 32 transmitted symbols:

7 4 3 0 5 1 5 0 2 2 1 1 5 7 4 3 5 0 2 6 2 1 6 2 0 0 5 0 5 2 6 6

where 7 shall always be used first and 6 shall be used last. The sequences in 5.3.2.3.8.1 and this paragraph shall be modulo 8 added to the output of the symbol formation function.

5.3.2.3.9 PSK modulation.

a. The eight-phase modulation process shall be achieved by assigning the tribit numbers from the scrambler to 45-degree increments of an 1800-Hz sinewave. Thus, 0 (000) corresponds to 0 degrees, 1 (001) corresponds to 45 degrees, 2 (010) corresponds to 90 degrees, etc. Figure 5 shows the assignment and pattern of output waveform generation.

NOTE: Since the transmit channel symbol duration is less than one cycle of the 1800-Hz carrier, the waveforms controlling the sine and cosine components must be filtered to prevent severe aliasing.

b. Clock accuracy for generation of the 1800-Hz carrier shall be within  $\pm 1$  Hz.

MIL-STD-188-110C  
w/CHANGE 1

5.3.2.4 Waveform summary.

For frequency-hopping and fixed-frequency operation, tables XIV and XV summarize the data phase characteristics of the transmitted formats that shall be used for each bit rate.

NOTE: 4800 bps is not applicable to the frequency-hopping operation.

**TABLE XIV. Frequency-hopping operation waveform characteristics.**

Information rate	Coding rate	Channel rate	Bits/channel symbol	8-Phase channel symbol	Hop format
2400	2/3	3600	3	1	*
1200	1/2	2400	2	1	*
600	1/2	1200	1	1	*
300	1/4	1200	1	1	*
150	1/8	1200	1	1	*
75	1/16	1200	1	1	*

\*See MIL-STD-188-148 (S).

**TABLE XV. Fixed-frequency operation waveform characteristics.**

Information rate	Coding rate	Channel rate	Bits/channel symbol	8-Phase symbols/channel symbol	No. of unknown 8-phase symbols	No. of known 8-phase symbols
4800	No coding	4800	3	1	32	16
2400	1/2	4800	3	1	32	16
1200	1/2	2400	2	1	20	20
600	1/2	1200	1	1	20	20
300	1/4	1200	1	1	20	20
150	1/8	1200	1	1	20	20
75	1/2	150	2	32	All	0

5.3.2.5 Performance requirements.

The measured performance of the serial (single-tone) mode, using fixed-frequency operation and employing the maximum interleaving period, shall be equal to or better than the coded BER performance in Table XVI. Performance verification shall be tested using a baseband HF simulator patterned after the Watterson Model in accordance with Appendix E. The modeled multipath spread values and fading (two sigma) bandwidth (BW) values in Table XVI shall consist of two independent but equal average power Rayleigh paths. For frequency-hopping operation, an additional 2 dB in signal-to-noise ratio (SNR) shall be allowed.

MIL-STD-188-110C  
w/CHANGE 1

**TABLE XVI. Serial (single-tone) mode minimum performance.**

User bit rate	Channel Paths	Multipath (ms)	Fading (Note 1) BW (Hz)	SNR (Note 2) (dB)	Coded BER
4800	1 Fixed	-	-	17	1.0 E-3
4800	2 Fading	2	0.5	27	1.0 E-3
2400	1 Fixed	-	-	10	1.0 E-5
2400	2 Fading	2	1	18	1.0 E-5
2400	2 Fading	2	5	30	1.0 E-3
2400	2 Fading	5	1	30	1.0 E-5
1200	2 Fading	2	1	11	1.0 E-5
600	2 Fading	2	1	7	1.0 E-5
300	2 Fading	5	5	7	1.0 E-5
150	2 Fading	5	5	5	1.0 E-5
75	2 Fading	5	5	2	1.0 E-5

NOTE: Both signal and noise powers are measured in a 3-kHz bandwidth.

When testing a modem embedded with a radio, so that only radio frequency (RF) signals are available for testing, the RF signals must be downconverted to baseband for processing by the channel simulator, and the result upconverted to RF for the receiver. In this case, the built-in radio filters will affect the performance of the modems. Therefore, when testing embedded modems, the SNR values specified in Table XVI shall be increased by 1 dB.

### 5.3.3 Frequency hopping mode (optional).

See MIL-STD-188-148 (S).

### 5.3.4 Robust serial tone mode for severely degraded HF links (optional).

The optional robust serial tone mode shall employ the waveform specified above for 75 bps operation, and shall meet the performance requirements of STANAG 4415.

## 6. NOTES

(This section contains information of a general or explanatory nature that may be helpful, but is not mandatory.)

### 6.1 Intended use.

This standard contains requirements to ensure interoperability and minimum performance of new long-haul and tactical data modulators-demodulators (modems). These modems are

MIL-STD-188-110C  
w/CHANGE 1

intended for use in dedicated point-to-point circuits, public switched network (PSN) circuits, and in single purpose systems such as medium frequency (MF) and high frequency (HF) radio; however, other radio systems employ this standard.

6.2 Acquisition requirements.

Acquisition documents should specify the title, number, and date of this standard.

6.3 Subject term (key word) listing.

Asynchronous  
DPSK  
Error-correcting code  
Fallback Operation  
Fixed-frequency  
Frequency hopping  
FSK  
Full-duplex  
Modified gray decoder  
Half-duplex  
HF data modems  
In-band signaling  
Interleaving  
Modulator/demodulator  
PSK  
QAM  
Quasi-analog signals  
Randomizing generator  
Scrambler  
Serial (single tone)  
Synchronous  
16-tone DPSK mode  
39-tone parallel mode

6.4 Changes notations.

The margins of this standard are marked with vertical lines to indicate the modifications generated by this change. This was done as a convenience only and the Government assumes no liability whatsoever for any inaccuracies in these notations. Bidders and contractors are cautioned to evaluate the requirements of this document based on the entire content irrespective of the marginal notations.

MIL-STD-188-110C  
w/CHANGE 1  
APPENDIX A

**LAN INTERFACE**

TABLE OF CONTENTS

<b><u>PARAGRAPH</u></b>	<b><u>PAGE</u></b>
A.1 SCOPE.....	42
A.1.1 Scope.....	42
A.1.2 Applicability.....	42
A.2 APPLICABLE DOCUMENTS.....	42
A.3 DEFINITIONS.....	42
A.4 GENERAL REQUIREMENTS.....	42
A.4.1 Protocol overview.....	42
A.4.2 TCP port number.....	42
A.4.3 Full duplex threads.....	42
A.4.4 Byte order.....	42
A.5 DETAILED REQUIREMENTS.....	43
A.5.1 TCP socket interface.....	43
A.5.1.1 Packet format.....	43
A.5.1.2 TCP socket interface protocol.....	51
A.5.2 UDP socket interface (UDSI).....	59
A.5.2.1 Control connection.....	59
A.5.2.2 UDP socket interface packet format.....	59
A.5.2.3 UDP socket interface packet header format.....	59
A.5.2.4 Packet types.....	61
A.5.2.5 Data FEC and interleaving.....	68
A.5.2.6 Protocol operation.....	72
A.5.3 CRC computation.....	78

MIL-STD-188-110C  
w/CHANGE 1  
APPENDIX A

A.1 SCOPE.

A.1.1 Scope.

This appendix describes the requirements for an optional local area network (LAN) interface for radio data modems.

A.1.2 Applicability.

This appendix is a non-mandatory part of MIL-STD-188-110C.

A.2 APPLICABLE DOCUMENTS.

None.

A.3 DEFINITIONS.

See section 3.

A.4 GENERAL REQUIREMENTS.

A.4.1 Protocol overview.

This interface is designed to enable a Data Terminal Equipment (DTE) to interact with a modem via a data network. Only one DTE at a time can control the modem using this interface. Attempts by a second DTE to establish a connection shall be rejected by the modem.

Two protocols are specified here: a TCP-based protocol for higher-performance networks, and a UDP-based protocol for data networks that experience long delays or non-negligible packet loss rates. Both protocols shall be supported in all implementations of this appendix.

A.4.2 TCP port number.

Both the TCP-based and UDP-based protocols require the DTE to establish a TCP connection through the Ethernet interface of the modem. The TCP port number on the modem shall be configurable (port 3000 is suggested). After the connection is established the DTE and modem shall exchange control and data packets in accordance with the requirements of section 5 of this appendix.

A.4.3 Full duplex threads.

Both the modem and the DTE device may send packets asynchronously on this interface, i.e., without prompting from the other device. Therefore, a separate thread blocked only on socket input port must be employed in each device to prevent system failure.

A.4.4 Byte order.

Unless otherwise specified, all multi-byte fields shall be sent in network byte order i.e., most-significant byte first.



MIL-STD-188-110C  
w/CHANGE 1  
APPENDIX A

## A.5 DETAILED REQUIREMENTS.

### A.5.1 TCP socket interface.

#### A.5.1.1 Packet format.

Each packet exchanged between the DTE and the modem shall consist of an 8-byte header, optionally followed by a variable-length payload and a 16-bit CRC computed on the payload data (see Figure A-1). The total packet length shall be less than or equal to 4096 bytes.

Therefore at most 4086 payload bytes may be sent in a single packet.

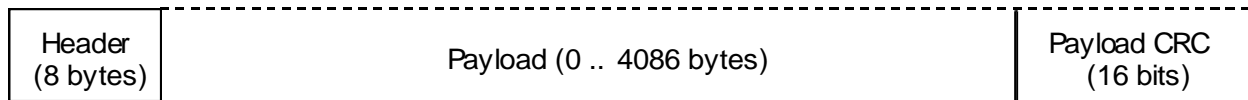

**Figure A-1. Packet Format**

#### A.5.1.1.1 Packet header format.

Each packet shall begin with a header consisting of the following fields (see Figure A-2):

Preamble 0x49	Preamble 0x50	Preamble 0x55	Type	Payload Size (16 bits) 0 .. 4086	Header CRC (16 bits)
------------------	------------------	------------------	------	-------------------------------------	----------------------

**Figure A-2. Packet Header Format**

The header shall begin with a three-byte Preamble containing the fixed values 0x49, 0x50, 0x55.

A 1-byte Type field shall follow the Preamble. The following meanings are assigned to the Type field values specified. Unused values shall not be sent, and shall result in an Error (0xFF) response if received.

**Table A-I: Packet Type Byte Values**

Byte Value	Packet Type Name	Description
0x00	DATA	Data type packet (see 0)
0x01	CONNECT	Initial Socket Connection packet (see 0)
0x02	CONNECT ACK	Initial Socket Connection Acknowledgement packet (see 0)
0xFF	ERROR	Packet format or protocol error (see Section 0)

MIL-STD-188-110C  
w/CHANGE 1  
APPENDIX A

The Type field shall be followed by a 2 byte Payload Size field, which indicates the number of bytes in the packet payload (exclusive of Payload CRC). Valid values for this field range from 0 to 4086 bytes.

The header shall be concluded with a 2 byte Header CRC, following the Payload Size field. The Header CRC shall be computed (see 0) for the preceding 6 header bytes only.

A.5.1.1.2 CONNECT and CONNECT ACK payload format.

Both CONNECT and CONNECT ACK packets shall have a one (1) byte version number payload. The version number may be used by the DTE and modem to differentiate among protocol format variations. The version number shall be set to 12 for devices that implement the protocol described in this appendix.

A.5.1.1.3 DATA Mode packet payload format.

If the payload size is zero in a DATA mode packet, no payload bytes are sent following the header. If the payload size is non-zero, the 8 byte header shall be followed by the number of payload bytes specified in the header Payload Size field, which are in turn followed by a 16-bit Payload CRC. The Payload CRC shall be computed (see 0) for the payload bytes only.

The first byte of the payload shall be a Payload Command (see 0). The format of the remainder of the payload field varies, depending on the Payload Command (see Table A-II).

A.5.1.1.4 Payload command Field.

The valid Payload Commands for use within DATA packets are specified in Table A-II. Unused values shall not be sent, and shall result in an Error response if received.

MIL-STD-188-110C  
w/CHANGE 1  
APPENDIX A

**Table A-II: Payload Commands**

Command	Command Byte	Arguments (in the remaining payload bytes)	Details	Sent by
Data Transfer	0x00	Packet order byte Packet ID Data to be sent over the air	0	both
Transmit Arm	0x01	none		DTE
Transmit Start	0x02	none		DTE
Request Tx Status	0x03	none		DTE
Tx_Data_NAK	0x04	Cause Packet ID	0	modem
Tx_Status	0x05	modem TX state and buffer status	0	modem
Abort_reception	0x06	none		DTE
Carrier Detect	0x08	Carrier State Receive Data Rate Info	0	Modem
Transmit Setup	0x09	Transmit Data Rate Info	0	Modem
Initial Setup	0x0A	Data Socket Setup Parameters Sync/Async Setup Version	0	Modem
Connection Probe	0x0B	None		Both

**A.5.1.1.5 Data transfer payloads: (sent to/from modem from/to DTE) .**

Between 0 and 4072 bytes of over-the-air data may be sent to/from the modem using a data transfer payload. If N is the number of data bytes to be sent, the 14 + N information bytes of a data transfer payload shall be formatted as shown in Figure A-3.

Payload Command (0x00)	Packet Order (1 byte)	Packet ID (12 bytes)	Data (0 to 4072 bytes)

**Figure A-3. Data Transfer Payload Format**

MIL-STD-188-110C  
w/CHANGE 1  
APPENDIX A

A.5.1.1.5.1 Packet order byte.

The packet order byte shall take one of the following 4 values:

**Table A-III: Packet Order Byte Values**

Byte Value	Order Type Name	Description
1	FIRST ONLY	The first packet of a multi-packet transmission
2	FIRST AND LAST	The only packet of a transmission
3	CONTINUATION	A continuation packet of a multi-packet transmission
4	LAST	The last packet of a multi-packet transmission

The packet order byte of first packet of complete over-the-air transmission/reception must be either FIRST\_ONLY or FIRST\_AND\_LAST. If only entire transmission/reception fits within a single packet, that packet may be sent with the packet order byte set to FIRST\_AND\_LAST. Otherwise, the packet order byte must be FIRST\_ONLY for the first packet.

Each additional packet sent/received must have packet packet order set to either CONTINUATION if more data is to follow or LAST if this is the last data packet.

Packets with no data bytes are accepted, e.g. to notify transmitter of data termination with LAST set.

A.5.1.1.5.2 Packet ID field.

The Packet ID field shall contain a unique 12-byte identifier for each Data Transfer packet sent. This value is used only in acknowledgements (see 0).

A.5.1.1.6 Transmitted data packet NACK payload.

Sent from modem to DTE only.

This message shall be sent by the modem in response to an unaccepted data packet from the DTE. Note that packets that fail CRC checks shall be silently dropped by the DTE or Modem (no NACK packet shall be generated).

MIL-STD-188-110C  
w/CHANGE 1  
APPENDIX A

Payload Command (0x04)	Cause  (1 byte)	NACKed Packet ID  (12 bytes)
------------------------------	-----------------------	------------------------------------

**Figure A-4. NACK Payload Format**

The Cause byte shall take one of the following values:

**Table A-IV: NACK Cause Byte Values**

Byte Value	Cause for NACK	Description
0	TRANSMIT QUEUES NOT ARMED	Modem transmit queues are not in armed or started state
1	TRANSMIT UNDERRUN	Modem transmitter underrun, transmitter is currently in a forced drain state
2	MISSING FIRST PACKET	Modem transmitter has not received a previous data packet marked as a "FIRST"-type data packet for the current transmission.
3	MULTIPLE FIRST PACKET	More than one packets received for current transmission marked as a "FIRST"-type data packet

The NACKed packet ID shall contain the Packet ID of the data packet that caused the NACK command to be sent by the modem.

**A.5.1.1.7 Transmitter status payload.**

Sent from modem to DTE only.

Sent by modem in response to a Request Tx Status packet from the DTE or unsolicited when the modem transmitter's queues and/or status changes.

Payload Command (0x05)	Transmitter State (1 byte)	Serial FIFO Space (32 bits)	Serial FIFO Fill (32 bits)	FIFO Critical Milliseconds (32 bits)	FIFO Critical Bytes (32 bits)
------------------------------	----------------------------------	-----------------------------------	----------------------------------	--	-------------------------------------

**Figure A-5: Transmitter Status Payload Format**

MIL-STD-188-110C  
w/CHANGE 1  
APPENDIX A

The Transmitter State byte shall take one of the values shown in Table A-V according to the current state of the Modem transmitter.

**Table A-V: Transmitter State Byte Values**

Byte Value	Command Name	Description
1	FLUSHED	Modem Transmitter flushed (Idle)
2	QUEUES ARMED AND PORT NOT READY	Modem Transmitter is ready to queue data bytes from DTE but is not ready to accept request to start transmission
3	QUEUES ARMED AND PORT READY	Modem Transmitter is ready to queue data bytes and is ready to accept request to start transmission
4	STARTED	Modem Transmitter has started processing the serial data
5	DRAINING OK	Modem transmitter is in a drain phase in response to a "LAST"-type data packet
6	DRAINING FORCED	Modem transmitter is in a forced drain phase in response to a data underrun condition.

The Serial FIFO Space field shall indicate the space in bytes available in the transmitter serial FIFO.

The Serial FIFO Fill field shall indicate the space in bytes used in the transmitter serial FIFO.

The FIFO Critical Milliseconds field shall indicate the time in milliseconds before the modem goes into a forced drain state if no more data is sent to the modem by the DTE.

The FIFO Critical Bytes field shall indicate the number of bytes that the DTE must send to the modem to prevent the modem from going into a forced drain state.

MIL-STD-188-110C  
w/CHANGE 1  
APPENDIX A

A.5.1.1.8 Carrier detect payload.

Sent from modem to DTE only.

This packet shall be sent by the modem in response to any change in the state of the receiver. This packet shall also be sent by the modem to the DTE after the initial connection handshake and after a non-destructive configuration change.

Payload Command (0x08)	Carrier State (1 byte)	Rx Data Rate in bits/s (32 bits)	Rx Blocking Factor in bits (32 bits)
------------------------------	---------------------------	--	--

**Figure A-6: Carrier Detect Payload Format**

**Table A-VI: Carrier State Byte Values**

Byte Value	State Name	Description
0	NO CARRIER	Modem receiver is Idle
1	CARRIER DETECTED	Modem has synchronized on a preamble or is processing data from the air. This state indicates CARRIER_DETECTED or RECEIVING state from Figure A-10.

The Rx Data Rate field shall indicate the data rate in bits per second of the received signal.

The Rx Blocking Factor field shall indicate the chunk size in bits of the received signal. This value is tied to the interleaver length of the receive signal of most waveforms. Data shall be transferred to the DTE in data chunks equal to this value.

A.5.1.1.9 Transmit setup payload.

Sent from modem to DTE only.

Sent by modem in response to a change in the state of the transmitter. This packet shall be sent by the modem to the DTE after the initial connection handshake and after a non-destructive configuration change.

MIL-STD-188-110C  
w/CHANGE 1  
APPENDIX A

Payload Command (0x09)	Tx Data Rate in bits/s (32 bits)	Tx Blocking Factor in bits (32 bits)
------------------------------	--	--

**Figure A-7: Transmit Setup Payload Format**

The Tx Data Rate field shall indicate the data rate in bits per second of the transmitted signal.

The Tx Blocking Factor field shall indicate the chunk size in bits of the transmitter signal. This value is tied to the interleaver length of the transmitter of most waveforms. Data shall be read from the transmit buffers in data chunks equal to this value.

A.5.1.1.10 Initial setup payload.

Sent from modem to DTE only, as part of the initial connection exchange (see 0). This packet contains information about the configuration of the data socket, and shall be formatted as shown in Figure A-8.

Payload Command (0x0A)	Round-Trip Time in milliseconds (32 bits)	Minimum Socket Latency in milliseconds (32 bits)			
Maximum Socket Latency in milliseconds (32 bits)	Sync Flag (1 byte)	Async Data Bits (1 byte)	Async Stop Bits (1 byte)	Async Parity (1 byte)	Async Data Mode (1 byte)

**Figure A-8: Initial Setup Payload Format**

The Round-Trip Time field shall indicate the Ethernet link round-trip time in milliseconds as calculated by the Modem during the initial connection probe exchange (see 0)

The Minimum Socket Latency field shall indicate the minimum allowed socket latency value in milliseconds as configured on the modem. This value may be used by the modem for pre-buffer calculations instead of the Round-Trip Time value if it is greater than the Round-Trip Time.

The Maximum Socket Latency field shall indicate the maximum allowed socket latency value in milliseconds as configured on the modem. The connection may be dropped by the modem if the Round-Trip Time is greater than the Maximum Socket Latency.



MIL-STD-188-110C  
w/CHANGE 1  
APPENDIX A

**Table A-VII: Synchronous Flag Byte Values**

Byte Value	State Name	Description
0	ASYNCHRONOUS	Operate socket in asynchronous mode. When in this mode, the modem shall convert the data stream into an asynchronous bit stream (see 0)
1	SYNCHRONOUS	Standard synchronous socket mode of operation. When this mode is enabled, the four following bytes shall be set to 0

**Table A-VIII: Async Setup Fields Byte Values**

Byte Value	Data Bits Field	Stop Bits Field	Parity Field
0	5 DATA BITS	1 STOP BIT	NO PARITY BIT
1	6 DATA BITS	2 STOP BITS	EVEN PARITY BIT
2	7 DATA BITS	(reserved)	ODD PARITY BIT
3	8 DATA BITS	(reserved)	(reserved)

**Table A-IX: Async Data Mode Field**

Byte Value	State Name	Description
0	STANDARD MODE	Sends all start, stop and parity bits over the air
1	DATA ONLY MODE	Sends only the data bits over the air

A.5.1.2 TCP socket interface protocol.

A.5.1.2.1 Initial Connection Operation

Immediately after the Data terminal (DTE) device establishes a TCP-streaming connection to the modem, both the modem and DTE shall each send a CONNECT packet with version number set to 12 (see 0). If the CONNECT packet is not received within 3 seconds of the socket

MIL-STD-188-110C  
w/CHANGE 1  
APPENDIX A

establishment, the entity that timed out (DTE or modem) shall terminate the TCP connection by closing the TCP socket.

After receiving a correct CONNECT packet, the modem or DTE shall validate the version numbers by immediately sending a CONNECT\_ACK packet with version number set to 12 (see 0). If the CONNECT\_ACK packet is not received within 3 seconds of the CONNECT packet transmission, the entity that timed out (DTE or modem) shall terminate the TCP connection.

If the version is not 12 for any of the above packets, the TCP connection shall be terminated by the DTE or modem. The modem shall terminate the TCP connection if any timeout (as stated above) or packet failures occur during the initial connection phase.

Once the connection is established, the modem shall send a CONNECTION\_PROBE packet to the DTE. The DTE shall immediately respond to the packet with another CONNECTION\_PROBE packet. If the modem does not receive a CONNECTION\_PROBE from the DTE within 6 seconds of the CONNECTION\_PROBE transmission, it shall terminate the TCP connection.

The modem shall then send the following packets to the DTE:

1. Initial Setup Packet: The modem takes the time taken between the transmission of the CONNECTION\_PROBE and the reception of the CONNECTION\_PROBE from the DTE and saves it in the Round-Trip Time field. The rest of the settings are obtained from the Modem Data Socket configuration (user configured using a mechanism beyond the scope of this Appendix.)
2. Transmit Setup Packet: The data rate and blocking factor fields are obtained from the waveform configuration (user configured).
3. Transmit Status Packet: The state shall be set to FLUSHED and all other fields except for "Serial FIFO space" shall be set to 0
4. Carrier Detect Packet: If the modem is not currently receiving, the payload shall indicate NO CARRIER with all other fields set to 0. If the modem was receiving when the socket was established, the payload shall indicate CARRIER DETECTED and the Receive Rate and Receive Blocking Factor fields shall indicate the detected received waveform parameters.

#### A.5.1.2.2 Connection Keep-Alive

After successful completion of the Initial Connection protocol (see 0), when no packet (status, control or data) has been sent for a period of 2 seconds (by the DTE or modem), a keep-alive packet shall be sent. The keep-alive packet shall be a DATA type packet (see 0) with no payload (0 bytes).

When any DATA type packet (including the 0 byte keep-alive packet) is received by the DTE or Modem, a timeout timer is reset. If this timeout timer reaches 30 seconds, the TCP connection is terminated by the entity (DTE or modem) whose timeout has reached 30 seconds.

MIL-STD-188-110C  
w/CHANGE 1  
APPENDIX A

A.5.1.2.3 Error Handling

Any packet received by the DTE or Modem that fails the header or payload CRC check shall be silently dropped as if the packet was never received.

In the event of a protocol error for which a response is not specified elsewhere in this appendix (e.g., receipt of a reserved or unimplemented command, or receipt of a payload-bearing packet before the initial connection has been established), an ERROR type packet (see 0) shall be returned by the receiving device, and that device shall terminate the TCP connection by closing the TCP socket.

A.5.1.2.4 Modem Configuration Changes

Modifying the modem configuration while the data socket connection is established may cause the modem to terminate the TCP connection. When this happens, the DTE should detect the TCP socket closure, re-establish the TCP connection and perform a new initial connection handshake.

MIL-STD-188-110C  
w/CHANGE 1  
APPENDIX A

A.5.1.2.5 Full Duplex Modem Transmitter operation

The Initial Connection handshake must be successfully completed before data can be sent from the DTE to the modem.

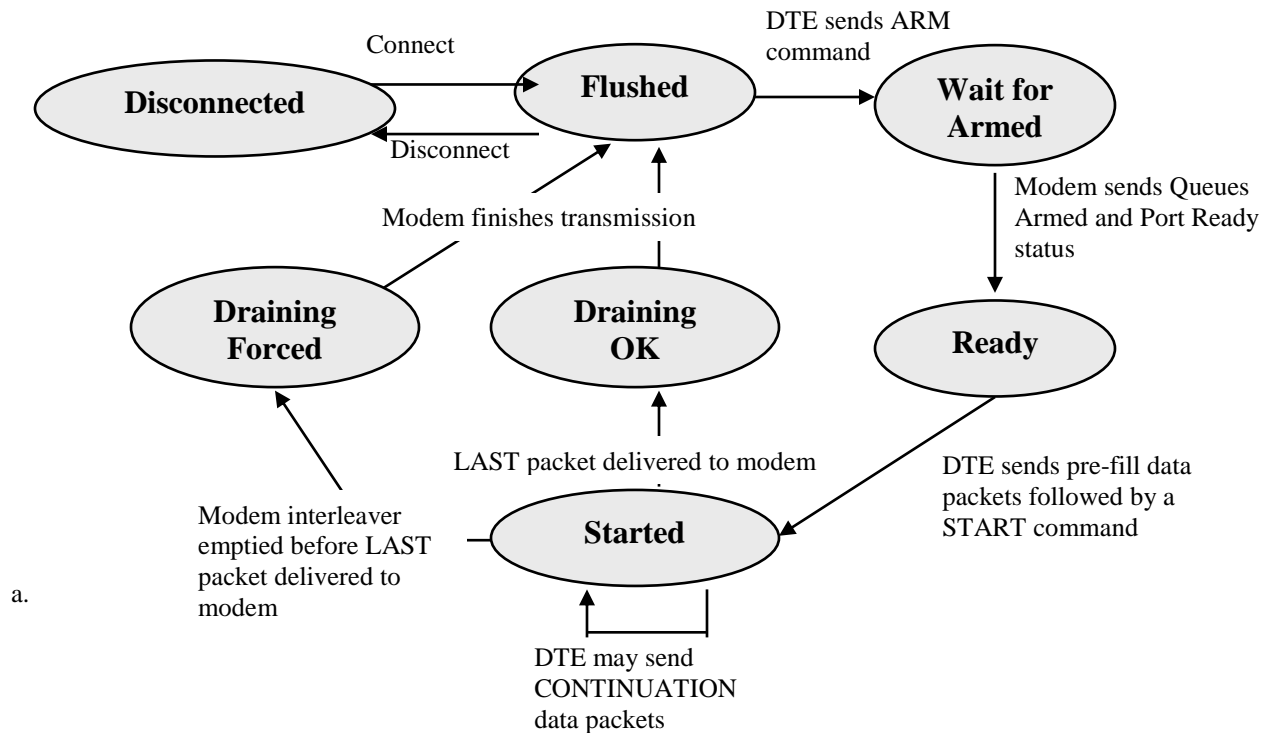

**Figure A-9: Sending Modem States**

The sending process from the DTE to the modem shall proceed as follows:

1. Before sending a TRANSMIT\_ARM command packet to the modem, the DTE should wait until it receives a transmit status packet from the modem indicating a FLUSHED state. If a TRANSMIT\_ARM command packet is sent when the modem is not in the FLUSHED state, the modem shall send a Transmit Status Packet to the DTE indicating the modem's current state.
2. The DTE sends a TRANSMIT\_ARM packet to the modem to arm the modem's transmit queues.
3. The modem shall respond with a transmit status packet of either (see 0) QUEUES\_ARMED\_AND\_PORT\_NOT\_READY or QUEUES\_ARMED\_AND\_PORT\_READY if the packet is accepted. Otherwise, repeat from step 1.
4. The DTE sends at least three blocking factors of data packets to pre-fill the modem's interleaver queue (waveform and Ethernet link jitter dependent). Data packets shall be sent

MIL-STD-188-110C  
w/CHANGE 1  
APPENDIX A

using proper packet order as described in 0. The DTE may send fewer than three blocking factors of data packets if a FIRST\_AND\_LAST or a LAST packet is sent.

5. The DTE sends a TRANSMIT\_START packet after receiving a transmit status packet with QUEUES\_ARMED\_AND\_PORT\_READY state to start the transmission.
6. If the transmission has started, the modem shall respond with a transmit status packet with state STARTED.
7. The DTE should wait for a TRANSMIT\_STATUS packet to arrive from the modem. If the state of the packet is not STARTED, the DTE should wait at least 10 milliseconds and repeat step 5. This may happen when the modem is in receive-master half-duplex mode (see 0).
8. When the modem is in the STARTED or DRAINING state, it shall send transmit status packets to the DTE indicating the number of queued bytes and number of spaces for bytes in the modem's transmitter's queue at least every 2 seconds.
9. At any time, the client may request a transmit status packet by sending a Request Tx Status packet.
10. Data packets that are in transit to the modem are not included in the calculation of the queue size. Packets shall not be inserted into the queue if the number of free bytes in the queue is less than the maximum packet data size. This shall cause the TCP socket on the DTE to block until the modem's queue frees up.
11. If the critical bytes parameter of the transmit setup packet is non-zero, the modem shall receive from the DTE at least that number of bytes before the critical milliseconds parameter expires, or the modem shall transition into a DRAINING\_FORCED state. This shall cause the modem to send a TRANSMIT\_UNDERRUN Tx Data NACK packet to the DTE.
12. When the modem is in the STARTED state, if a packet is processed with the packet order set to ORDER\_FIRST\_AND\_LAST or ORDER\_LAST, and if the modem transmitter has not transitioned into a DRAINING\_FORCED state, transmit status packets shall be issued with the DRAINING\_OK state.
13. After the modem transmitter has finished sending all the user data to the DTE, the modem transmitter shall transition into the FLUSHED state.

While in any states shown in Figure A-9, if the TCP connection is terminated by either the DTE or the modem (from an error or a timeout), the modem transmitter shall immediately transition into the DISCONNECTED state.

MIL-STD-188-110C  
w/CHANGE 1  
APPENDIX A

A.5.1.2.6 Full Duplex Modem Receiver Operation

The Initial Connection handshake must be successfully completed before data can be sent from the modem to the DTE.

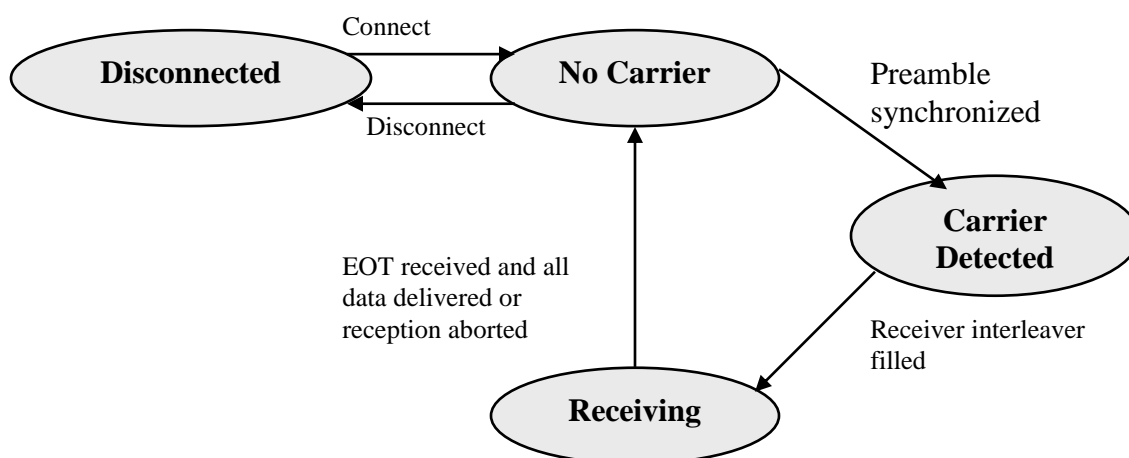

**Figure A-10: Receiving Modem States**

The receiving process at the DTE shall proceed as follows:

1. When the modem receiver is in a sync-acquire phase, at least one Carrier Detect packet shall be sent to the DTE with the carrier state set to NO\_CARRIER. The data rate and blocking factor shall be set to 0.
2. When the modem receiver has fully detected a preamble, the modem shall issue a Carrier Detect packet with the carrier state set to CARRIER\_DETECTED. The data rate and blocking factor shall be set to the detected values of the received waveform.
3. Once data is available, the modem shall begin sending data packets (first packet's order is either FIRST\_AND\_LAST for single packet or FIRST\_ONLY).
4. If available, any additional data packets shall be sent with the CONTINUATION order flag set.
5. In a multi-packet transfer, the last packet (potentially zero data bytes) shall be marked as LAST packet.
6. When the modem is in the RECEIVING state, to cancel a reception and force the modem to return to the sync-acquire phase, the DTE may send an ABORT\_RECEPTION packet to the modem. This shall force the modem to send a LAST packet and transition into the NO\_CARRIER state until it can resynchronize on the stream.
7. Once an end of message condition has been detected on the modem receiver a Carrier Detect packet shall be sent to the DTE with state set to NO\_CARRIER. The data rate and blocking factor shall be set to 0. This may happen before or after the last data packet is delivered to the DTE.

MIL-STD-188-110C  
w/CHANGE 1  
APPENDIX A

While in any states shown in Figure A-10, if the TCP connection is terminated by either the DTE or the modem (from an error or a timeout), the modem receiver shall immediately transition into the DISCONNECTED state.

A.5.1.2.7 Half Duplex Operation.

In addition to the Full-Duplex receiver and transmitter operation described in 0 and 0, half-duplex operation shall also be supported. In half-duplex mode, the modem shall only be able to receive or transmit at any one time (not both at the same time). In addition, the modem shall also support the following two modes of operation when operating in half-duplex mode:

1. Transmitter Master
2. Receiver Master

A.5.1.2.7.1 Half Duplex Transmitter Master

When in half-duplex transmitter master mode, the modem shall prioritize the transmitter operation.

If a reception is currently in progress (CARRIER\_DETECTED or RECEIVING states from Figure A-10), and the transmitter is in the FLUSHED state (see Figure A-9), the DTE may send a TRANSMIT\_ARM command and initiate a transfer as shown in 0. Once the modem is transitioned into the STARTED state, the modem receiver shall immediately return to the NO\_CARRIER state (see Figure A-10), which shall abort the reception. The modem shall then send a LAST data packet to the DTE and send a Carrier Detect packet with state set to NO\_CARRIER to the DTE.

While the modem transmitter is in the STARTED, DRAINING\_OK or DRAINING\_FORCED states (Figure A-9), the modem receiver shall remain in the NO\_CARRIER state (Figure A-10).

A.5.1.2.7.2 Half Duplex Receiver Master

When in half-duplex receiver master mode, the modem shall prioritize the receiver operation if a transmission is not currently in progress.

If a reception is currently in progress (CARRIER\_DETECTED or RECEIVING states from Figure A-10), and the transmitter is in the FLUSHED state (see Figure A-9), the DTE may send a TRANSMIT\_ARM command to the modem. While the modem reception is in progress, the modem shall transition into the QUEUES\_ARMED\_AND\_PORT\_NOT\_READY state and remain in that state until the modem receiver transitions into the NO\_CARRIER state.

While the modem is in the QUEUES\_ARMED\_AND\_PORT\_NOT\_READY state, the DTE may send data packets to be queued onto the modem but may not send a TRANSMIT\_START command to the modem. If the DTE sends a TRANSMIT\_START command to the modem, the

MIL-STD-188-110C  
w/CHANGE 1  
APPENDIX A

modem shall send another Transmit Status packet with state set to QUEUES\_ARMED\_AND\_PORT\_NOT\_READY to the DTE. In this case, once the modem receiver transitions into the NO\_CARRIER state, the modem shall send a Transmit Status packet with state set to QUEUES\_ARMED\_AND\_PORT\_READY to the DTE. The DTE may then send a TRANSFER\_STARTED command to the modem and perform a data transfer as shown in 0.

The receiver master mode shall only prevent the modem from transitioning into the STARTED state while the receiver is in the CARRIER\_DETECTED or RECEIVING state. Once the modem transmitter is in the STARTED, DRAINING\_OK or DRAINING\_FORCED states (see Figure A-9), the modem receiver shall remain in the NO\_CARRIER state (see Figure A-10).

#### A.5.1.2.8 Data Socket Modes

The TCP data socket interface (TDSI) supports both synchronous and asynchronous operation. The differences between the two data modes are explained in this section. The mode of operation is specified by the modem and is sent to the DTE during the connection handshake.

##### A.5.1.2.8.1 Synchronous

While the TDSI is in the synchronous mode of operation the data shall be transferred from the DTE to the modem at the specified data rate to prevent the modem from going into a TRANSMIT\_UNDERRUN state. The data is also not byte-synchronized in this mode of operation, which means that the DTE shall perform bit-synchronization to byte-align the received data stream.

##### A.5.1.2.8.2 Asynchronous

The asynchronous mode of operation supports two sub-modes of operation:

1. Standard Mode: All asynchronous data bits are transmitted over the air
2. Data Only Mode: Only the data bits are transmitted over the air

##### A.5.1.2.8.2.1 Asynchronous Standard Mode (Send-All)

When the Async Data Mode is set to STANDARD MODE, the sending modem shall convert the data stream into an asynchronous bit stream (adding start bits, stop bits and parity bits) with the specified settings before sending the data over the air. The receiving modem shall decode the received asynchronous stream from the air and convert it to a standard data stream before sending it to the DTE.

In this mode, the DTE does not have to keep a steady data stream to the modem. If the modem's transmit queues are emptied, it shall transmit stop bits over the air until more data is available for transmission up to a user specified keep-alive time. If no data is received by the modem for a period longer than the keep-alive time, the modem shall transition into a TRANSMIT\_UNDERRUN state.

Data is always exchanged in the data packets using 8-bit byte alignment. If the ASYNC DATA BITS parameter is set to N DATA BITS, where N is less than 8, the least significant N bits of each 8-bit data bytes of the Data Payload shall be used for the OTA stream.



MIL-STD-188-110C  
w/CHANGE 1  
APPENDIX A

A.5.1.2.8.2.2 Asynchronous Data-Only Mode

When the Async Data Mode is set to DATA ONLY MODE, only the data bits are transmitted over the air. In this mode, the ASYNC DATA BITS shall be 8 DATA BITS and the ASYNC

PARITY shall be NO PARITY. Since no control bits are sent over the air, the data shall be transferred from the DTE to the modem at the specified data rate to prevent the modem from going into a TRANSMIT\_UNDERRUN state.

The difference between asynchronous DATA ONLY MODE and synchronous is that for async mode, the modem receiver does not need to buffer data at the start of a reception before sending it to the DTE. The data is sent directly to the DTE as it is decoded from the waveform. For the synchronous mode, the modem shall buffer the data to keep the constant data rate specified by the receiving waveform before starting the data stream to the DTE.

A.5.2 UDP socket interface (UDSI).

A.5.2.1 Control connection.

UDP packets shall not be exchanged between the DTE and modem until a TCP Remote Control Interface (RCI) connection is established from the DTE to the modem. The RCI connection shall be used by the modem to obtain the DTE source address and port number that will be used for the UDP data stream. The protocol used for the RCI is beyond the scope of this appendix.

A.5.2.2 UDP socket interface packet format.

Each UDP packet exchanged between the DTE and the modem shall consist of a 4-byte header, optionally followed by a variable-length payload. A 16 bit CRC shall be appended to the end of each packet. The total packet length, including the 2 byte CRC, shall be less than or equal to 1226 bytes; at most 1220 payload bytes may be sent in a single packet.

Packet Header (4 bytes)	Payload (0 to 1220 bytes)	Packet CRC (16 bits)
-------------------------------	------------------------------	----------------------------

**Figure A-11: UDSI packet format**

The payload length may be inferred from the packet type (see Table A-X). The Packet CRC shall be computed (see 0) for the Packet Header bytes and Payload Bytes (if present).

A.5.2.3 UDP socket interface packet header format.

Each packet shall begin with a header consisting of the following fields:

MIL-STD-188-110C  
w/CHANGE 1  
APPENDIX A

Version (4 bits)	Packet Type (4 bits)	Session Identification (24 bits)
---------------------	----------------------------	-------------------------------------

**Figure A-12: Packet Header Format**

The header shall begin with a 4-bit version number set to 1. Only packets with the version number field set to 1 shall be processed.

A 4-bit Packet Type field shall follow the Preamble. Valid values for the Packet Type field values are listed in Table A-X. Values not specified in Table A-X shall not be sent, and shall result in an Error response if received.

**Table A-X: Packet Type Byte Values**

Packet Type	Packet Type Name	Description	Details	Payload Size	Sent By
1	PING REQUEST	Connection Keep-Alive		0 bytes	Both
2	PING REPLY	Connection Keep-Alive Reply		0 bytes	Both
3	STATUS REQUEST	Force the transmission of a modem status packet		0 bytes	DTE
4	STATUS REPLY	Transfer, error, state, link quality, modem buffer and tx and rx waveform data rate info	0	32 bytes	Modem
5	ENCODED DATA	FEC Encoded Data Packet	0	16 bytes + data	Both
6	ENHANCED ENCODED DATA	FEC Encoded Data Packet with data rate information	0	20 bytes + data	Modem
7	MODEM COMMAND REQUEST	Reliable Modem Command Request	0	4 bytes	DTE
8	MODEM COMMAND ACK	Modem Command Request Acknowledgement	0	4 bytes	Modem

The Packet Type field shall be followed by a pseudo-random 24-bit Session Identification number, which shall be selected by the initiating device before the initial connection exchange. When the modem configuration changes the modem may increment this number, thus notifying the DTE that a new session has started. The DTE may also change this number to force a resynchronization on the modem side.

MIL-STD-188-110C  
w/CHANGE 1  
APPENDIX A

A.5.2.4 Packet types.

A.5.2.4.1 Status reply payload.

(Sent from modem to DTE only.) This message shall be sent by the modem when the state of any field changes or if a Status Reply packet has not been sent for 500 milliseconds. The DTE may also request a transmission of this packet from the modem by sending a STATUS\_REQUEST packet.

Packet Sequence Number (16 bits)	Current Transfer Identification (16 bit)	Reserved (16 bits)	Error Vector (8 bits)	Status Vector (8 bits)
Packets Dropped (16 bits)	Jitter (16 bits)	Transmit Queue Fill (32 bits)		
Transmit Queue Space (32 bits)		OTA Receive Bit Rate (24 bits)	MSB of next field	
OTA Receive Blocking Factor (24 bits)	OTA Transmit Bit Rate (24 bits)		OTA Transmit Blocking Factor (24 bits)	

**Figure A-13: Status Reply Payload Format**

Packet Sequence Number (16-bit number sent in network byte order): The modem shall increment the sequence number of the status packet for every successive packet. The Packet sequence number shall be computed modulo 65536 so that 0xFFFF, when incremented by 1 shall become 0. This shall be used by the DTE to detect out-of-order and duplicate status packets. The DTE shall calculate the modulo 65536 difference between the packet sequence number and the last received status sequence number. If this difference is less than zero when treated as a signed 16 bit value, the DTE shall ignore the status packet. This results in packets being ignored if the sequence number falls within the 0xFFFF/2 values previous to the last received sequence number. The DTE shall always accept the first status packet.

Current Transfer Identification (16-bit number sent in network byte order): The transfer ID shall be used by the DTE to identify which transfer the status packet pertains to, when sending many short transfers over a long latency network.

The modem shall set the current transfer identification number of the status packet to the transfer ID of the current transmission.

Reserved: This field shall be set to 0

MIL-STD-188-110C  
w/CHANGE 1  
APPENDIX A

The Error Vector shall be a bit field formatted as follows:

Reserved (bits 7-5)	Not in Control (bit 4)	Rx Underrun (bit 3)	Rx Overrun (bit 2)	Tx Underrun (bit 1)	Tx Overrun (bit 0)
------------------------	------------------------------	---------------------------	--------------------------	---------------------------	--------------------------

**Figure A-14: Error Vector Format**

When the modem is not in an error state all bits in this vector shall be 0. The reserved bits shall always be 0. The following table provides a description of the error bits:

**Table A-XI: Error Vector Bit Values**

Bit	Bit Name	Description
0	TX OVERRUN	When set to 1, The modem's transmit buffers have overflowed. This happens when the DTE sends data to the modem too fast. The transfer will be terminated and the modem's transmitter will return to the FLUSHED state
1	TX UNDERRUN	When set to 1, The modem's transmitter buffers have emptied unexpectedly. This happens when the DTE does not send data fast enough to the modem. The transfer will be terminated and the modem's transmitter will return to the FLUSHED state
2	RX OVERRUN	When set to 1, The modem's receive buffers have overflowed. This should not happen during normal operation
3	RX UNDERRUN	When set to 1, The modem's receive buffers have emptied unexpectedly. This should not happen during normal operation
4	NOT IN CONTROL	When set to 1, The modem has received data from the DTE but the DTE does not have "Control Mode" enabled on the RCI connection. No data will be accepted by the modem

The Status Vector shall be a bit field formatted as follows:

Reserved (bit 7)	Receiver State (bits 6-5)	Carrier Detect (bit 4)	Transmitter State (bits 3-1)	In Control (bit 0)
---------------------	------------------------------	------------------------------	---------------------------------	--------------------------

**Figure A-15: Status Vector Format**

The reserved bits shall always be 0.

The following table provides a description of the status bits:

MIL-STD-188-110C  
w/CHANGE 1  
APPENDIX A

**Table A-XII: Status Vector Bit Values**

Bit(s)	Bit Name	Description
6-5	RECEIVER STATE	2-bit value (MSB is bit 6): Reflects the current state of the modem receiver (see <b>Table</b> )
4	CARRIER DETECT	When set to 1, the modem's receiver has synchronized on a preamble or is processing data from the air
3-1	TRANSMITTER STATE	3-bit value (MSB is bit 3): Reflects the current state of the modem transmitter (see <b>Table</b> )
0	In Control	When set to 1, the modem has received the "Control Mode" request from the DTE on its RCI connection. The client may now send data to the modem

**Table A-XIII: Status Vector Receiver State Values**

Bit Value	Status Name	Description
00	FLUSHED	Modem Receiver is flushed (Idle)
01	STARTED	Modem Receiver has started processing user data

**Table A-XIV: Status Vector Transmitter State Values**

Bit Value	Status Name	Description
000	FLUSHED	Modem Transmitter flushed (Idle)
001	QUEUEING	Modem Transmitter has started receiving data from the DTE but has not started OTA transmission yet
010	STARTED	Modem Transmitter has started OTA transmission
011	DRAINING	Modem Transmitter is in a drain phase in response to a "Last" type data packet, an underrun condition or an unrecoverable data error (too many missed packets)

**Packets Dropped** (16-bit number sent in network byte order): The number of packets that have been missed (dropped) by the modem for the current transmission. Packets are dropped either because of a network error (packet error) or because the packet arrives late. The dropped packets are recovered by the modem (using FEC) unless the modem transmitter has unexpectedly changed to a DRAINING state. This value may be used by the DTE as an Ethernet link quality value.

MIL-STD-188-110C  
w/CHANGE 1  
APPENDIX A

Jitter: The Ethernet packet jitter in milliseconds as seen by the modem for the current transmission. This value shall be the standard deviation of: the inter-packet arrival time minus the expected arrival time (uses the packet timestamp for calculations). This value is calculated over a window of 100 packets and is based on the standard deviation of the difference between the time of reception of a packet and the timestamp in the packet.

Transmit Queue Fill: Space in bytes used in the transmitter serial queue.

Transmit Queue Space: Space in bytes available in the transmitter serial queue.

OTA Receive Bit Rate: Over-the-air data rate in bits per second of the received signal.

OTA Receive Blocking Factor: Chunk size in bits of the received signal. This value is tied to the interleaver length of the receive signal of most waveforms. Data shall be written to the DTE in data chunks equal to this value.

OTA Transmit Bit Rate: Over-the-air data rate in bits per second of the transmitter waveform.

OTA Transmit Blocking Factor: Chunk size in bits of the transmitter waveform. This value is tied to the interleaver length of the transmit signal of most waveforms. Data shall be written to the DTE in data chunks equal to this value.

Encoded data payload.

Between 0 and 1200 bytes of FEC/interleaved data may be sent to/from the modem using an encoded data payload (see 0 for more information on the FEC/Interleaver scheme). If N is the number of data bytes to be sent, the 16 + N information bytes of a data packet shall consist of:

Transfer Identification (16 bits)			Packet Sequence Number (16 bits)	
Control Vector (8 bits)	FEC Type (4 bits)	Inter- leaver Type (4 bits)	FEC N Value (8 bits)	FEC K Value (8 bits)
Data Length (16 bits)			Reserved (16 bits)	
Timestamp (32 bits)				
Data (0 to 1200 bytes)				

**Figure A-16: Encoded Data Payload Format**

MIL-STD-188-110C  
w/CHANGE 1  
APPENDIX A

Transfer Identification (16-bit number sent in network byte order): A pseudo-random number shall be selected and maintained for the duration of a transfer. This number shall be incremented every time a new transfer is started. The transfer identification number shall be computed modulo 65536 so that 0xFFFF, when incremented by 1 shall become 0.

Packet Sequence Number (16-bit number sent in network byte order): Each successive encoded data packet has an incremented sequence number associated to it. The packet sequence number shall be computed modulo 65536 so that 0xFFFF, when incremented by 1 shall become 0. This number is initialized to 0 for each new transfer. This is used by the DTE and modem to detect duplicate data packets and reorder out-of-order packets.

The Control Vector is a bit field as follows:

Reserved (bits 7-3)	Holdoff Flag (bit 2)	Last Inter- leaver Set (bit 1)	First Inter- leaver Set (bit 0)
------------------------	-------------------------	--------------------------------------	---------------------------------------

**Figure A-17: Control Vector Format**

The reserved bits shall always be 0. The following table provides an explanation of the control bits:

**Table A-XV: Control Vector Bit Values**

Bit	Bit Name	Description
2	HOLDOFF FLAG	May be used by the DTE to affect the modem's auto-prebuffer handling (default 0 for auto-prebuffer handling). See 0.
1	LAST INTERLEAVER SET	When set to 1, this packet belongs to the last interleaver set of a transfer. An interleaver set is defined as N packets, where N is the FEC N value.
0	FIRST INTERLEAVER SET	When set to 1, this packet belongs to the first interleaver set of a transfer

FEC Type (4-bits): The UDP data socket currently only supports the "Reed Solomon with Erasures" (see 0) FEC Type, which is type 1. Only packets with FEC Type set to 1 shall be accepted.

Interleaver Type (4-bits): The UDP data socket currently only supports the "Standard FEC-matched byte-wise Interleaver" Interleaver Type, which is type 1. Only packets with Interleaver Type set to 1 shall be accepted.

MIL-STD-188-110C  
w/CHANGE 1  
APPENDIX A

FEC N Value (8-bits): The total number of bytes per FEC codeword.

FEC K Value (8-bits): The number of user bytes per FEC codeword.

Data Length (16-bit number sent in network byte order): The number of data bytes stored in the Encoded Data Payload packet (immediately following the Timestamp bytes).

Reserved: This field shall be set to 0

Timestamp field shall indicate the A timestamp in milliseconds taken at the source just before the packet is sent to the UDP socket. The timestamp may be calculated from the system time as follows:

```
struct timeval tv;
unsigned int nTimestamp;

gettimeofday(&tv, NULL);
nTimestamp = ((tv.tv_sec % 3600) * 1000000) + tv.tv_usec;
```

A.5.2.4.3 Enhanced encoded data payload.

(Sent from modem to DTE only) Between 0 and 1200 bytes of FEC/interleaved data may be sent to/from the modem using an enhanced encoded data payload (see 0 for more information on the FEC/Interleaver scheme). If  $N$  is the number of data bytes to be sent, the  $20 + N$  information bytes of a data packet consist of:

Transfer Identification (16 bits)			Packet Sequence Number (16 bits)	
Control Vector (8 bits)	FEC Type (4 bits)	Inter- leaver Type (4 bits)	FEC $N$ Value (8 bits)	FEC $K$ Value (8 bits)
Data Length (16 bits)			<b>Data Bit Rate</b> (24 bits)	
<b>LSB of Data Bit Rate</b>	Data Blocking Factor (24 bits)			
Timestamp (32 bits)				
Data (0 to 1200 bytes)				

**FigureA-18: Encoded Data Payload Format**



MIL-STD-188-110C  
w/CHANGE 1  
APPENDIX A

The Enhanced Encoded Data Payload has all the same fields as the Encoded Data Payload. Extra fields are provided to supply data rate information. The modem shall send an interleaver set of Extended Encoded Data packets at the start of each transfer and continue with Encoded Data packets if required.

See 0 for descriptions of the following fields:

- Transfer Identification
- Packet Sequence Number
- Control Vector
- FEC Type
- Interleaver Type
- FEC *N* Value
- FEC *K* Value
- Data Length
- Timestamp

Data Bit Rate (24-bit number sent in network byte order): Data rate in bits per second of the received data stream. This value shall not change for the remainder of the transfer.

Data Blocking Factor (24-bit number sent in network byte order): Chunk size in bits of the received signal. This value is tied to the interleaver length of the receive signal of most waveforms. Data shall be written to the DTE in data chunks equal to this value. This value shall not change for the remainder of the transfer.

Modem command request payload.

(Sent from DTE to Modem only) This packet may be sent by the DTE to instruct the modem to execute a particular command. Since this command is reliable, if the DTE does not get a Modem Command ACK packet in response to a Modem Command Request, it shall re-send the command. See 0.

Packet Sequence Number (16 bits)	Command (8 bits)	Reserved (8 bits)
-------------------------------------	---------------------	----------------------

**FigureA-19: Modem Command Request Payload Format**

Packet Sequence Number (16-bit number sent in network byte order): Each successive encoded Modem Command Request packet shall have an incremented sequence number associated to it. This number shall be initialized to 0 for the first command sent. If a packet is retransmitted, it shall keep the same sequence number as when it was initially transmitted.

MIL-STD-188-110C  
w/CHANGE 1  
APPENDIX A

The following table shows the list of commands that shall be supported by the protocol:

**Table A-XVI: Command Byte Values**

Byte Value	Command Name	Description
1	ABORT RECEPTION	Force the modem to return to the Sync-Acquire phase. This will cause the modem to issue a LAST packet and switch to a FLUSHED state until it can resynchronize to the stream

The modem shall ignore command request packets with unsupported command values.

Reserved: This field shall be set to 0

**A.5.2.4.5 Modem command acknowledgement payload.**

(Sent from Modem to DTE only) This packet shall be sent by the modem in response to a Modem Command Request packet.

Packet Sequence Number  (16 bits)	Reserved  (16 bits)
---	---------------------------

**Figure A-20: Modem Command Acknowledgement Payload Format**

Packet Sequence Number (16-bit number sent in network byte order): The sequence number of the Modem Command Request that is being acknowledged

Reserved: This field shall be set to 0

**A.5.2.5 Data FEC and interleaving.**

A Reed Solomon code is used to encode data so that data from late or missing data packets can be reconstructed by the receiver, whether it is Modem or DTE. Data to be sent are used to fill the data portion of an interleaver block and RS parity symbols are used to fill the remainder of the interleaver block.

The interleaver block is shown pictorially below, where the  $M * N$  symbols of the interleaver block are composed of rows consisting of RS encoded data with  $N-K$  parity symbols for each  $K$  data symbols. Note that the RS symbol size used, 4 bits, is one nibble or one half of a byte, so that in the diagram below, the cells with diagonal stripes represent the lower nibble of each byte. Data is written into the interleaver in rows. That is, the first row of the interleaver shown below, which contains the first Reed Solomon codeword is formed from the upper nibble of the first  $K$  data bytes. The second row of the interleaver, containing the second Reed Solomon codeword is formed using the lower nibbles of the first  $K$  data bytes. Data is transmitted, one interleaver at a time, with data being read out in columns. The precise details are described in this section.

MIL-STD-188-110C  
w/CHANGE 1  
APPENDIX A

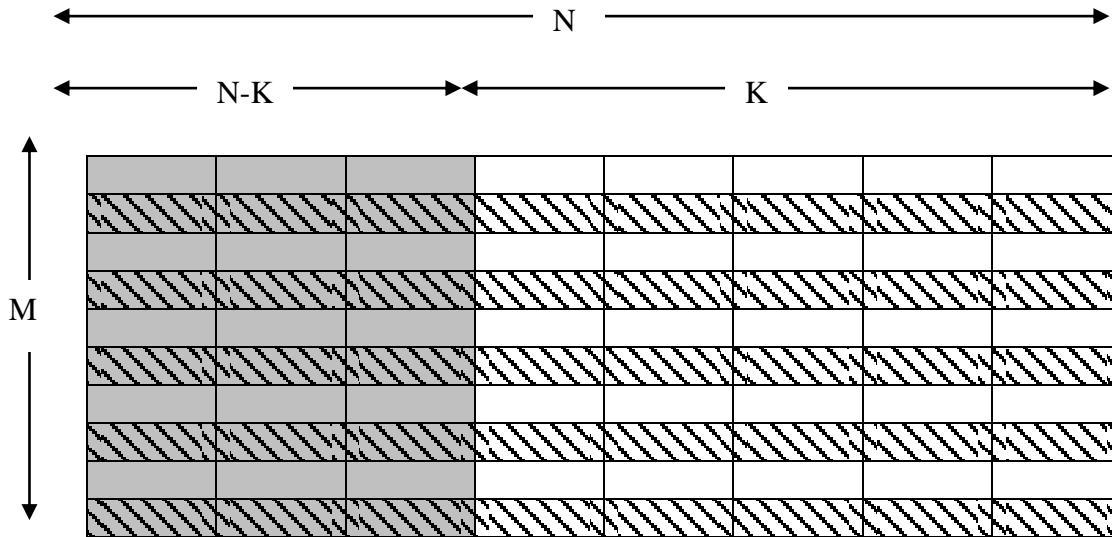

**Figure A-21: FEC Interleaver**

To allow the Modem or DTE to recover from late data packets or data packet losses, the UDSI shall provide forward error correction coding using Shortened Reed-Solomon (RS) error correction coding with erasures using 4-bit symbols, whose generator polynomial is:

$$g(x) = x^4 + a^{13} x^3 + a^6 x^2 + a^3 x + a^{10};$$

where  $a$  is a non zero element of the Galois field  $(GF)(2^4)$  formed as the field of polynomials over  $GF(2)$  modulo  $x^4 + x + 1$ .

For each data stream, an appropriate set of shortened N, shortened K and L parameters is chosen to maximize error recovery while minimizing the amount of pre-buffering, delay and overhead that is added by using the FEC and Interleaving scheme. The parameters are dependent on the Data Rate and Blocking Factor (tied to the waveform interleaver) of the waveform using the following formula:

**Table A-XVII: FEC Coding Length Table**

Data Rate (bps)	N	K	Shortened N	Shortened K
50 to 2400	15	11	6	2
3200 to 28800	15	12	7	4
32000 to 76800	15	12	8	5

MIL-STD-188-110C  
w/CHANGE 1  
APPENDIX A

$$L = \min \left( \text{ceil} \left( \frac{B}{K * 8} \right), 1200 \right) * N$$

Where L = Interleaver Length in bytes  
B = Blocking Factor in bits  
N = FEC N (total bytes per code)

**Figure A-22: Interleaver Length Calculation**

The shortened N value (stored in the data packets as FEC N) is the length in RS Symbols (or nibbles as the symbol size used is 4 bits or one nibble) of each RS codeword (This also translates to the number of data packets in an interleaver set).

The shortened K value (stored in the data packets as FEC K) is the number of user nibbles stored in each RS codeword.

L is the total number of bytes (data and parity) stored in an interleaver set of packets. (L / N) translates to the number of bytes stored in each packet.

The resulting Reed-Solomon codes are spread across N packets. Data packets that are late or lost are flagged as erasures. Using erasures, N-K packet losses may be recovered per interleaver. The user data length of each packet shall be equal to the interleaver length L / N.

**A.5.2.5.1 FEC and interleaving example.**

Assuming the data stream consists of the bytes { ABCDEFGHIJKLMNOP } the N, K is (7, 4) and L is 14 bytes, the FEC shall be applied to the data stream to as follows:

**Table A-XVIII: Reed-Solomon Table**

	Byte	1	2	3	4	5	6	7
<b>1<sup>st</sup> Interleaver</b>	<b>1<sup>st</sup> RS codeword</b>	X	X	X	A	B	C	D
	<b>2<sup>nd</sup> RS codeword</b>	x	x	x	a	b	c	d
	<b>3<sup>rd</sup> RS codeword</b>	X	X	X	E	F	G	H
	<b>4<sup>th</sup> RS codeword</b>	x	x	x	e	f	g	h
<b>2<sup>nd</sup> Interleaver</b>	<b>5<sup>th</sup> RS codeword</b>	X	X	X	I	J	K	L
	<b>6<sup>th</sup> RS codeword</b>	x	x	x	i	j	k	l
	<b>7<sup>th</sup> RS codeword</b>	X	X	X	M	N	O	P
	<b>8<sup>th</sup> RS codeword</b>	x	x	x	m	n	o	p

where capital letters have been used to denote the upper (most significant) nibble of each byte, lower case letters have been used to denote the lower (least significant) nibble of each byte, and upper and lower case X have been used to denote the RS parity symbols constructed from the data symbols in that row. In the example above the byte stream ABCD is shown as the following set of 4-bit nibbles: AaBbCcDd

MIL-STD-188-110C  
w/CHANGE 1  
APPENDIX A

The first RS codeword, stored in the most significant 4 bits of each byte, is created from the most significant 4 bits of each user byte (denoted by uppercase letters) resulting in {XXXABCD}

The second RS codeword, stored in the least significant 4 bits of each byte, is created from the least significant 4 bits of each user byte (denoted by lowercase letters) resulting in {xxxabcd}

L bytes of RS encoded data are then segmented into an “interleaver set” of N packets. As such, each data packet shall contain L / N bytes of data (14 / 7 = 2). The first four rows of Table A-XVIII are shaded to outline the 14 bytes that will be inserted in the first interleaver set of packets. The first black box containing Xx and Xx shows the set of 2 bytes that will be inserted in the first data packet. See Table A-XIX for an example showing how the first 7 enhanced encoded data packets shall be created, including the pertinent header information:

**Table A-XIX: FEC and Interleaving Example 1**

Data Packet Number	1	2	3	4	5	6	7
Transfer ID	0	0	0	0	0	0	0
Packet Sequence	0	1	2	3	4	5	6
First Interleaver Set	1	1	1	1	1	1	1
Last Interleaver Set	0	0	0	0	0	0	0
Data Length	2	2	2	2	2	2	2
Data	XxXx	XxXx	XxXx	AaEe	BbFf	CcGg	DdHh

The above packets shall be transmitted to the DTE or modem and the remaining data is encoded in the same manner:

**Table A-XX: FEC and Interleaving Example 2**

Data Packet Number	8	9	10	11	12	13	14
Transfer ID	0	0	0	0	0	0	0
Packet Sequence	7	8	9	10	11	12	13
First Interleaver Set	0	0	0	0	0	0	0
Last Interleaver Set	1	1	1	1	1	1	1
Data Length	2	2	2	2	2	2	2
Data	XxXx	XxXx	XxXx	IiMm	JjNn	KkOo	LlPp

Assuming packets 2, and 5 and 6 are late or lost at the receiver, the receiver shall replace the missed code bytes with erasures. In this case since the code length is (7,4), up to 7 – 4 = 3 packets may be lost per interleaver set.

The data received from the First Interleaver Set would look as follows:

Codeword pair 1 = {Xx??XxAa????Dd}

Codeword pair 2 = {Xx??XxEe????Hh}

Where the “?” nibbles from the lost packets and are marked as erasures before running each codeword through the RS decoder.

MIL-STD-188-110C  
w/CHANGE 1  
APPENDIX A

Codeword pair 1 shall be decoded as {AaBbCcDd} and Codeword pair 2 as {EeFfGgHh}.

A.5.2.5.2 End of message detection.

The following EOM string shall be used to delineate the end of the user data portion of a data stream:

{0x4B, 0x65, 0xA5, 0xB2, 0x26, 0xD2, 0xD3, 0x69}

The above string of bytes shall be appended to the end of the user data stream. The bytes shall be added before running the FEC encoder and Interleaver (i.e. the EOM bytes are also FECed). Any remaining bytes (to fill the rest of the last interleaver) shall be padded with 0x00. Note that the EOM string may span multiple interleaver sets. Upon reception, the EOM string and following padding bytes shall be detected and removed from the data stream.

A.5.2.6 Protocol operation.

A.5.2.6.1 Initial connection operation.

Since UDP is a connectionless protocol, no connection is required before the data terminal (DTE) can send UDP data to the modem. However, the DTE shall establish a control connection, and obtain write lockout of the modem before sending data. The modem shall use the source address of the control connection to ensure that UDP data is only sent to, and received from a single DTE.

A.5.2.6.2 Connection keep-alive.

As a means to detect network failures, keep-alive ping packets shall be regularly sent from the DTE or the modem. Ping packets shall be sent to the modem at a rate of once every five seconds. The keep-alive packet shall be a PING REQUEST type packet (see 0) with no payload (0 bytes).

When any PING REPLY type packet is received by the DTE or Modem, a timeout timer shall be reset. If the timeout timer reaches 30 seconds, the modem shall ignore any further data sent by the DTE and shall abort the current transmission. The modem shall only accept further data sent by the DTE once a PING REPLY is received, or the DTE sends data with a new session ID.

A.5.2.6.3 Error handling.

Packets received containing error(s) in the header or payload CRC shall be ignored. Packets of unrecognized type or incorrect format shall be ignored. Duplicate packets shall also be ignored.

Both the modem and DTE are responsible for re-ordering the packets they receive, and discarding packets that arrive late (after the interleaver set has been decoded).

MIL-STD-188-110C  
w/CHANGE 1  
APPENDIX A

The modem shall decode interleaver sets as they come, replacing any missing packets with erasures. If an interleaver set is unable to be decoded by the modem, an end of message will be sent over the air and the modem will transition to a DRAINING state.

Likewise, the DTE shall determine a maximum time to wait for a packet before considering it lost. This timeout shall be calculated as the amount of time to transmit the user data of the interleaver over the air ( $(\text{FEC } K * L * 8 \text{ bits/byte}) / \text{over air data rate (bps)}$ ), plus the expected latency of the UDP socket, plus the maximum expected jitter of the UDP socket. If the packet is considered lost, the DTE shall replace it with an erasure before performing the FEC decoding.

**A.5.2.6.4 Modem configuration changes.**

Modifying the modem configuration while the data socket is in use may cause the current transmission to be terminated. When this happens, the modem shall update its session ID, and return to a flushed transmitter state.

**A.5.2.6.5 Modem transmitter operation.**

The DTE must gain control of the modem before it can successfully send data.

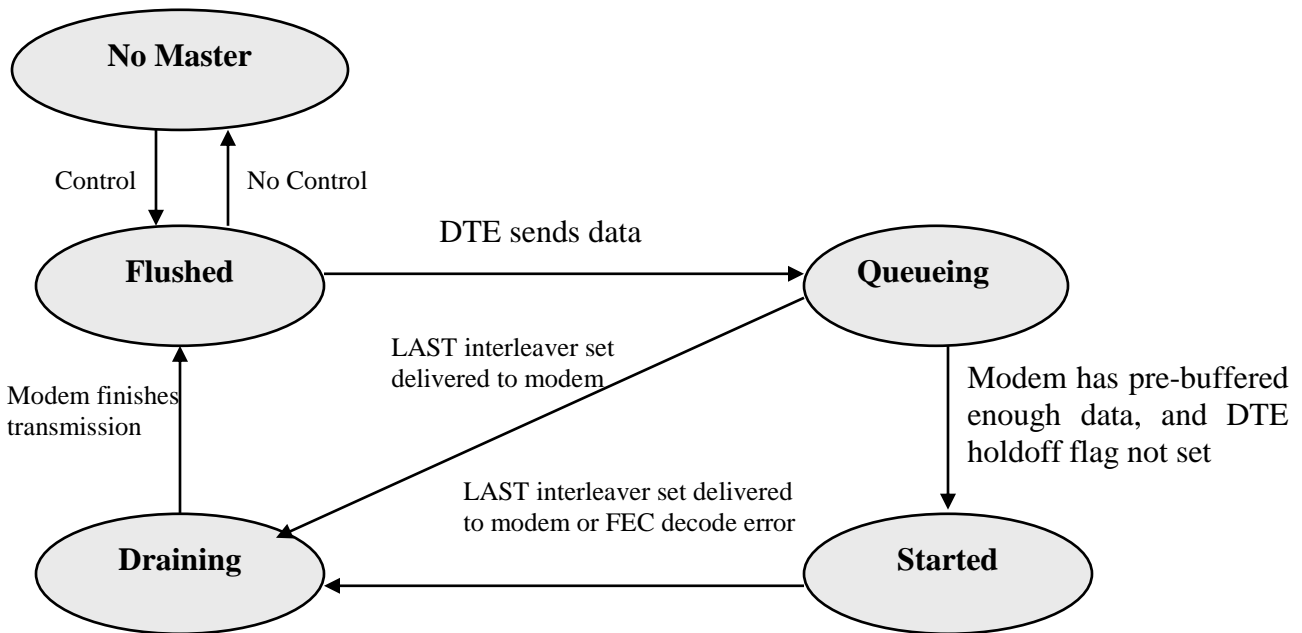

**Figure A-23: Sending Modem States**

The sending process from the DTE to the modem shall proceed as follows:

1. Before sending commands, the DTE must wait until it receives a modem transmit status packet from the modem indicating a FLUSHED state.

MIL-STD-188-110C  
w/CHANGE 1  
APPENDIX A

2. The Modem will transition to a **QUEUEING** state when it begins to receive data from the DTE.
3. The modem will automatically detect when it has enough data queued, and will begin to transmit. At this point, the modem will transition to a **STARTED** state. The DTE may prevent the modem from automatically starting by setting the hold off flag in the control vector of the encoded data packets. The modem will remain in a queueing state until this flag is cleared (in which case automatic pre-buffer detection resumes) or the last interleaver set is received by the modem (in which case the modem will transition to a draining state).
4. When the last interleaver set is received by the modem, it will transition into a **DRAINING** state.
5. When the modem is in the **STARTED** or **DRAINING** state, it shall periodically send status packets to the DTE indicating the number of queued bytes and number of spaces for bytes in the udp receive buffer. The udp receive buffer is a packet based buffer, so all packets are considered to be of max length (1200) for the purposes of the queued/space bytes calculation. The DTE shall use longer interleavers and lower N/K ratios at higher data rates. See Table A-XXI for a list of recommended FEC settings.
6. At anytime, the client may request a status packet by sending a Status Request packet.
7. Data packets that are in transit to the modem are not included in the calculation of the queue size. Packets will not be inserted into the queue if there is no remaining space in the queue. In this case the packet will be dropped.
8. The data sent from the DTE to the modem shall be paced such that the amount of user data sent to the modem over a given period of time is equal to the amount of data the modem is capable of sending over air in the same period of time.
9. If the modem is unable to decode data due to insufficient packets, or too much packet loss, it will force an end of transmission and transition to a **DRAINING** state.
10. After the transmitter has finished sending all the radio data, the modem transmitter will transition into the **FLUSHED** state.



MIL-STD-188-110C  
w/CHANGE 1  
APPENDIX A

**Table A-XXI: Recommended FEC Settings**

Data Rate (bps)	FEC N	FEC K	Interleaver
50	6	2	1
75	6	2	1
150	6	2	1
300	6	2	2
600	6	2	4
1200	6	2	8
1800	6	2	12
2400	6	2	15
3200	7	4	10
3600	7	4	12
4800	7	4	15
6400	7	4	20
7680	7	4	24
8000	7	4	25
9600	7	4	30
12800	7	4	40
14400	7	4	45
16000	7	4	50
19200	7	4	60
24000	7	4	75
25600	7	4	80
28800	7	4	90
32000	8	5	32
38400	8	5	39
48000	8	5	48
51200	8	5	52
64000	8	5	64
76800	8	5	77
80000	8	5	80
96000	8	5	96
128000	8	5	128
192000	8	5	192
256000	8	5	256
384000	8	5	384

MIL-STD-188-110C  
w/CHANGE 1  
APPENDIX A

A.5.2.6.6 Modem receiver operation.

The DTE must gain control of the modem before the modem can send data to the DTE.

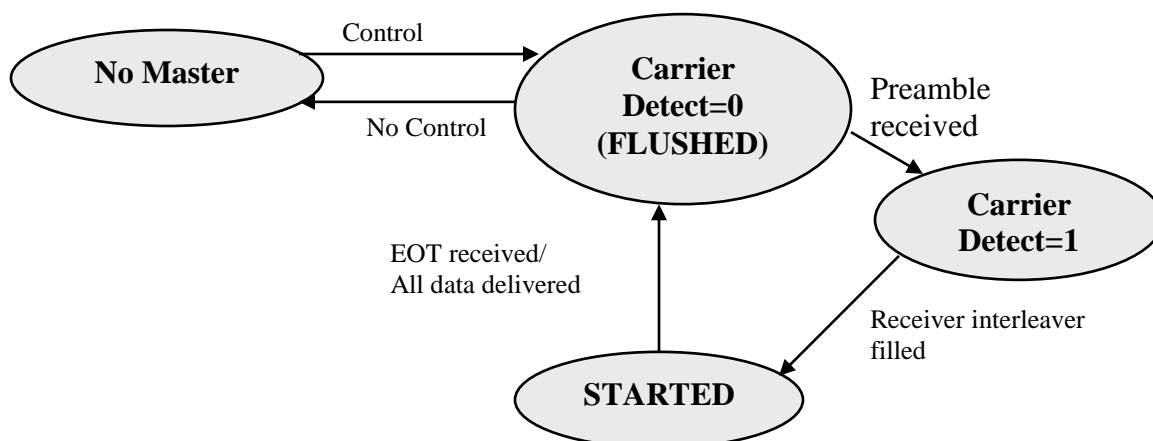

**Figure A-24: Receiving Modem States**

The receiving process at the DTE shall proceed as follows:

1. When the modem receiver is in a sync-acquire phase, status reply packets shall be sent to the DTE with the carrier detect flag set to 0.
2. When the modem receiver has fully detected a preamble, the modem shall issue a status reply packet with the carrier detect flag set to 1.
3. Once data is available, the modem shall begin sending data packets. The first interleaver shall be sent using ENHANCED ENCODED DATA packets indicating the rate and blocking factor for the reception. This interleaver set shall have the first interleaver flag set to 1. Any subsequent interleaver sets shall be sent using ENCODED DATA packets. The last interleaver set will have the last interleaver flag set to 1.
4. Once an end of message condition has been detected on the modem receiver a status reply packet shall be sent to the DTE with the carrier detect packet set to 0. This may happen before or after the last data packet is delivered to the DTE.
5. When the modem completes processing the received data, it shall send a status reply packet to the DTE indicating that the receiver is in a FLUSHED state. This may happen before or after the last data packet is delivered to the DTE.

A.5.2.6.7 Modem commands.

The DTE may send commands to the modem using a modem command request packet at any time to affect its operation. Currently the only supported command is the receiver abort command. When the modem receives a command, it shall send a modem command ack indicating that it has processed the command. Because the UDP protocol is unreliable, the DTE

MIL-STD-188-110C  
w/CHANGE 1  
APPENDIX A

may be required to retransmit commands using a pre-determined timeout with an exponential back off.

A.5.2.6.8 Data socket modes.

The UDP data socket supports a synchronous and asynchronous operation. The differences between the two data modes are explained in this section. The modem and DTE must be configured to use the same mode.

A.5.2.6.8.1 Synchronous.

The synchronous mode of operation is the standard mode of operation. The data must be transferred from the DTE to the modem at the specified data rate to prevent the modem from dropping packets or terminating the transmission due to a FEC decode error. The data is also not byte-synchronized in this mode of operation, which means that the DTE must perform bit-synchronization to byte-align the received data stream.

A.5.2.6.8.2 Asynchronous.

The asynchronous mode of operation with the Async Data Mode set to STANDARD MODE will cause the modem to convert the data stream into an asynchronous bit stream (adding start bits, stop bits and parity bits) with the specified settings before sending the data over the air. The modem will also decode the received asynchronous stream from the air, stripping the start, stop and parity bits from the data stream before sending it to the DTE.

In this case, the DTE does not have to keep a steady data stream to the modem. If the modem's transmit queues are emptied, it will transmit stop bits over the air until more data is available for transmission.

Data is always exchanged in the data packets using 8-bit byte alignment. If the ASYNC DATA BITS parameter is set to 5 DATA BITS, the least significant 5-bits of each 8-bit data bytes of the Data Payload will be used for the OTA stream.

When the Async Data Mode is set to DATA ONLY MODE, only the data bits are transmitted over the air. In this mode, the ASYNC DATA BITS must be 8 DATA BITS and the ASYNC PARITY must be NO PARITY. Since no control bits are sent over the air, the data must be transferred from the DTE to the modem at the specified data rate to prevent the modem from going into a TX\_UNDERRUN state.

The difference between asynchronous DATA ONLY MODE and synchronous is that for async mode, the modem receiver does not need to buffer data at the start of a reception before sending it to the DTE. The data is sent directly to the DTE as it is decoded from the waveform. For the synchronous mode, the modem must buffer the data to keep the constant data rate specified by the receiving waveform before starting the data stream to the DTE.

MIL-STD-188-110C  
w/CHANGE 1  
APPENDIX A

### A.5.3 CRC computation.

The 2 byte CRCs for the header and the optional payload portions shall be computed as follows, using the polynomial  $(x^{16} + x^{15} + x^{12} + x^{11} + x^8 + x^6 + x^3 + x^0)$ .

The 16 bit CRC word is initially set to 0. Bits are consecutively shifted and combined into the CRC, starting with the least significant bit of the first byte, until all the bits are shifted in. After shifting all the data into the shift register, the 16 bit CRC to be transmitted consists of the contents of the 16 bit shift register. This CRC shall be sent most-significant byte first.

The following C code can be used to calculate the CRC value using the above polynomial:

```

unsigned short CalculateCRC16(unsigned char* pData, unsigned short nBytes)
{
    unsigned short nCrc, i;
    unsigned char bit, j;

    nCrc = 0x0000;

    for ( i = 0; i < nBytes; i++ ) {
        for ( j = 0x01; j; j <<= 1 ) {
            bit = (((nCrc & 0x0001) ? 1 : 0) ^ ((pData[i] & j) ? 1 : 0));
            nCrc >>= 1;
            if ( bit ) nCrc ^= 0x9299; /* polynomial representation */
        }
    }
}

```

Any packet received by the DTE or Modem that fail the header or payload CRC check shall be silently dropped as if the packet was never received.

MIL-STD-188-110C  
w/CHANGE 1  
APPENDIX B

39-TONE PARALLEL MODE

**TABLE OF CONTENTS**

<b><u>PARAGRAPH</u></b>	<b><u>PAGE</u></b>
B.1 SCOPE.....	80
B.1.1 Scope.....	80
B.1.2 Applicability.....	80
B.2 APPLICABLE DOCUMENTS.....	80
B.3 DEFINITIONS.....	81
B.4 GENERAL REQUIREMENTS.....	81
B.5 DETAILED REQUIREMENTS.....	81
B.5.1 Characteristics.....	81
B.5.2 Error-correcting coding.....	81
B.5.3 Interleaving.....	82
B.5.4 Synchronization.....	82
B.5.4.1 Preamble.....	82
B.5.4.2 Extended preamble.....	82
B.5.4.3 Data block synchronization.....	83
B.5.5 Modulator output signal.....	83
B.5.6 In-band diversity.....	84
B.5.6.1 Time/frequency diversity.....	84
B.5.6.2 Frequency diversity.....	84
B.5.7 Asynchronous data operation.....	84
B.5.7.1 Character length.....	84
B.5.7.2 Data signaling rate constraint.....	84
B.5.7.3 Data-rate adjustment.....	84
B.5.7.3.1 Input data source rate greater than modem rate.....	85
B.5.7.3.2 Input data source rate less than modem rate.....	85
B.5.7.4 End-of-message (EOM) indication.....	85
B.5.7.5 Asynchronous mode interleaving and block framing.....	85
B.5.7.6 Bit packing.....	85
B.6 PERFORMANCE REQUIREMENTS.....	85

MIL-STD-188-110C  
w/CHANGE 1  
APPENDIX B

**LIST OF TABLES**

TABLE B- I. SELECTABLE INTERLEAVING DEGREES.....	86
TABLE B- II. NORMALIZED TONE AMPLITUDES AND INITIAL PHASES.....	86
TABLE B- III. FRAMING SEQUENCE INSERTION INTERVALS AND LENGTHS.....	88
TABLE B- IV. DATA-TONE FREQUENCIES AND BIT LOCATIONS.....	89
TABLE B- V. MODULATION CHARACTERISTICS OF THE 39-TONE HF MODEM.....	90
TABLE B- VI. IN-BAND TIME/FREQUENCY DIVERSITY.....	91
TABLE B- VII. IN-BAND FREQUENCY DIVERSITY.....	92
TABLE B- VIII. ASYNCHRONOUS CHARACTER SET.....	93
TABLE B- IX. 75 BPS AND 150 BPS ASYNCHRONOUS OPERATIONAL PARAMETERS...	94
TABLE B- X. 300 BPS AND 600 BPS ASYNCHRONOUS OPERATIONAL PARAMETERS..	96
TABLE B- XI. 1200 BPS AND 2400 BPS ASYNCHRONOUS OPERATIONAL PARAMETERS.....	98
TABLE B- XII. PROBABILITY OF BIT ERROR VS SIGNAL-TO-NOISE RATIO.....	100

**LIST OF FIGURES**

FIGURE B- 1. TRANSMIT DIRECTION FUNCTIONAL DIAGRAM.....	105
FIGURE B- 2. DATA FLOW THROUGH ENCODER AND INTERLEAVER FOR AN INTERLEAVER CONTAINING AN EVEN NUMBER OF CODE WORDS.....	102
FIGURE B- 3. DATA FLOW THROUGH ENCODER AND INTERLEAVER FOR AN INTERLEAVER CONTAINING AN ODD NUMBER OF CODE WORDS.....	104
FIGURE B- 4. TRANSMIT SEQUENCE OF EVENTS.....	104
FIGURE B- 5. FRAMING SEQUENCE FEEDBACK SHIFT REGISTER GENERATOR .....	105

MIL-STD-188-110C  
w/CHANGE 1  
APPENDIX B

## B.1 SCOPE

### B.1.1 Scope.

This appendix describes the 39-tone parallel mode.

### B.1.2 Applicability.

This appendix is optional, and not recommended for new systems; however, when the 39-tone parallel mode is used, it shall be implemented in accordance with this appendix.

## B.2 APPLICABLE DOCUMENTS

This section is not applicable to this appendix.

## B.3 DEFINITIONS

See section 3.

## B.4 GENERAL REQUIREMENTS

The mode specified herein uses 39 orthogonal subcarrier tones in the audio frequency band with quadrature differential phase shift keying (QDPSK) modulation for bit synchronous data transmission. In the transmit direction, this mode (see figure B-1) (1) accepts UNKNOWN serial binary data at its line side data input port, (2) performs forward error correction (FEC) encoding and interleaving, and (3) converts the resulting bit stream into QDPSK data tones at the modulator output port. The modulation rate of the modulator output is constant for all data rates. In-band diversity of varying degrees is used at data rates below 1200 bits per second (bps). A means is provided for synchronization of the signal element and interleaved data block timing. A 40th unmodulated tone is used for correcting frequency offsets introduced by Doppler shift or radio equipment instability. In a like manner, the receive direction (1) accepts QDPSK data tones at its input, (2) converts them into the transmitted serial bit stream, (3) performs deinterleaving and FEC decoding, and (4) makes the resulting data stream available at its line-side output port.

## B.5 DETAILED REQUIREMENTS

### B.5.1 Characteristics.

In this section, detailed requirements are given for the waveform characteristics for which knowledge is needed to achieve over-the-air interoperability. These characteristics are error correction coding, interleaving, synchronization, modulator output signal, in-band time/frequency diversity, and asynchronous data operation.

### B.5.2 Error-correcting coding.

All UNKNOWN input data shall have redundant bits added to it, prior to modulation, for the purpose of correcting errors introduced by the transmission medium. The added bits shall be computed by a shortened Reed-Solomon (15,11) block code, whose generator polynomial is:

MIL-STD-188-110C  
w/CHANGE 1  
APPENDIX B

$$g(x) = x^4 + a^{13} x^3 + a^6 x^2 + a^3 x + a^{10};$$

where  $a$  is a non zero element of the Galois field  $(GF)(2^4)$  formed as the field of polynomials over  $GF(2)$  module  $x^4 + x + 1$ .

For input signaling rates of 2400 bps, the code shall be shortened to (14,10). Otherwise, the code shall be shortened to (7,3).

### B.5.3 Interleaving.

The mode shall perform block interleaving for the purpose of providing time separation between contiguous symbols of a code word. Selectable interleaving degrees for the data rates is shown in Table B-I shall be provided. For a data signaling rate of 2400 bps, the selection shall consist of eight degrees. At data signaling rates below 2400 bps, four degrees for each bit rate shall be provided as shown in Table B-I. The input data stream shall be loaded into the interleaver buffer as described by figures B-2 and B-3.

### B.5.4 Synchronization.

A means shall be provided whereby the receive demodulator process achieves time alignment with both signal element and code word timing. Frame synchronization shall be acquired within 680 milliseconds (ms). The transmit sequence of events is shown on figure B-4.

#### B.5.4.1 Preamble.

Prior to the transmission of data, a three part preamble shall be transmitted. Part one shall last for 14 signal element periods and consist of four equal amplitude unmodulated data tones of 787.5, 1462.5, 2137.5, and 2812.5 hertz (Hz). Part two shall last for 8 signal element periods and consist of three modulated data tones of 1125.0, 1800.0, and 2475.0 Hz. The three data tones of part two shall be advanced 180 degrees at the boundary of each data signal element. Part three shall last for one signal element period and consist of all 39 data tones plus the Doppler correction tone. This last part establishes the starting phase reference for subsequent signal element periods. During all parts of the preamble, the transmitted level of the composite signals shall have a root-mean-square (rms) value within  $\pm 1$  decibel (dB) of the rms value of the modulator output (39-tone) levels occurring during subsequent data transmission. The tone phases at the onset of each part of the preamble, along with their normalized amplitudes, shall be in accordance with Table B-II.

#### B.5.4.2 Extended preamble.

To improve the probability of synchronization and signal presence detection in low signal-to-noise ratio situations, the ability to select an extended preamble shall be provided. Part one of the extended preamble shall last for 58 signal element periods, part two shall last for 27 signal element periods, and part three shall last for 12 signal element periods. In parts one and two, the data tones shall be as described in the nonextended preamble given above. In part three, the phase of each data tone shall be set at the onset of each signal element to the phase that it had at the onset of the first signal element in this part.



MIL-STD-188-110C  
w/CHANGE 1  
APPENDIX B

NOTE: When operating with the extended preamble, the minimum doppler correction shall be  $\pm 20$  Hz and frame synchronization shall be acquired within 2.5 seconds (s).

**B.5.4.3 Data block synchronization.**

A set of interleaved code words is known as a super block. Block synchronization (framing) is the process whereby a receiving demodulator locates super block boundaries. This synchronization process must occur before proper deinterleaving and decoding can commence. Framing shall be established and maintained by periodically inserting into the encoded unknown data bit stream a known pseudo-random sequence. The required sequence is defined by the primitive polynomial  $f(x) = x^9 + x^7 + x^6 + x^4 + 1$ , when used in the feedback shift register configuration shown in figure B-5.

The first insertion of the block framing sequence shall start on the first signal element following the synchronization preamble. Upon transmission of the last bit of the sequence, the first bit of the first super block shall be transmitted without interruption. Thereafter, the framing sequence shall be inserted each time the number of super blocks specified in Table B-III has been transmitted. Upon transmission of the last bit of the framing sequence, transmission of data bits shall resume without interruption.

The number of framing bits to be transmitted per insertion varies with data rate and interleaving degree, and is specified in Table B-III. However, the final bit of the framing sequence shall always be the first space bit that follows a contiguous block of nine MARK bits. Equivalently, the final sequence bit shall be the bit generated by the shift register when its present state is 11111111 (binary) or 511 (decimal).

**B.5.5 Modulator output signal.**

The modulator output shall contain 39 QDPSK data tones (see Table B-IV). The 39 data tones shall be simultaneously keyed to produce a signal element interval of 22.5 milliseconds (ms) for each data tone. The composite modulator output shall have a constant modulation rate of 44.44 baud (Bd) for all standard input data signaling rates from 75 to 2400 bps. At input signaling rates less than 2400 bps, information carried on data tones 1 through 7 shall also be carried on data tones 33 through 39. The modulator shall also provide the required special preamble tone combinations used to initiate synchronization and Doppler correction.

During data transmission, the unmodulated Doppler correction tone shall be 6 dB  $\pm 1$  dB higher than the normal level of any data tone. All tone frequencies shall maintain an accuracy of  $\pm 0.05$  Hz. At the onset of each signal element, every data tone shall experience a phase change relative to its phase at the onset of the previous signal element. The modulator shall partition the bit stream to be transmitted into 2 bit symbols (dibits) and map them into a phase change of the appropriate data tone according to Table B-V.

MIL-STD-188-110C  
w/CHANGE 1  
APPENDIX B

**B.5.6 In-band diversity.**

Two selectable methods of in-band diversity for data rates of 75 - 600 bps shall be incorporated in each modem as follows: a modern method containing both time and frequency diversity, and a frequency-only diversity method for backward compatibility with older modems. The requirements given for these methods in the following subparagraphs apply to diversities of order  $d$ , where  $d = 1200/(\text{data signaling rate})$ .

**B.5.6.1 Time/frequency diversity.**

Disregarding the redundant data carried on data tones 33 through 39, 64 bits, equally partitioned into  $d$  data words, shall be transmitted during each 22.5 ms signal element. Each data word and its  $d-1$  copies shall be transmitted on  $32/d$  unique data tones in  $d$  different signal elements. If data word  $i$  is being transmitted in a given signal element, the other data words that are to be transmitted in the same signal element are given by  $i - k(16/d)$ , where  $k$  ranges from 1 through  $d-1$  (see Table B-VI).

**B.5.6.2 Frequency diversity.**

In-band diversity shall be characterized by transmitting a data word and its  $(d-1)$  copies in one signal element (e.g., 22.5 ms time interval). This characterization is according to the tone/bit assignments shown in Table B-VII.

**B.5.7 Asynchronous data operation.**

In addition to bit synchronous data transmission, an asynchronous mode shall also be supported. When operating in the asynchronous mode, the modulator shall accept source data in asynchronous start/stop character format, and convert it to bit synchronous data prior to FEC encoding. Conversely, after FEC decoding, the demodulator shall convert bit synchronous data back into asynchronous format. Also, before FEC encoding, SPACE bits shall replace the start, stop, and parity bits. After FEC decoding, the start, stop, and parity bits shall be re-generated before placing the characters in the output data stream.

Otherwise, the mode operates as specified in B.5.1 through B.5.6.2 above.

**B.5.7.1 Character length.**

A means shall be provided whereby the modulator will accept, and the demodulator will generate, any of the data characters shown in Table B-VIII.

**B.5.7.2 Data signaling rate constraint.**

A means shall be provided whereby the selected data signaling rate of the modem is constrained to not exceed the nominal bit rate of the data input source.

**B.5.7.3 Data-rate adjustment.**

A means shall be provided whereby differences between data signaling rates of the data input source and the modem are accommodated with no loss of data or introduction of extraneous data in the demodulated output.

MIL-STD-188-110C  
w/CHANGE 1  
APPENDIX B

**B.5.7.3.1 Input data source rate greater than modem rate.**

The modem shall maintain a control path to the data source for the purpose of stopping the flow of data into the modulator. When the modem senses that continued flow of input data will result in data loss, it shall cause the data source to suspend the transfer of data. Upon sensing that the threat of data loss has passed, the modem shall allow the transfer of data to resume.

**B.5.7.3.2 Input data source rate less than modem rate.**

When the modem senses that it is about to exhaust its supply of source data, it shall insert a special "null" character into the source data bit stream prior to encoding. The null character shall be formed by making each of its bits a SPACE, and the start, stop, and parity bits a MARK. The demodulator shall recognize this bit pattern as a null character, and discard it from its data output.

**B.5.7.4 End-of-message (EOM) indication.**

Upon reception of the source's final data character, the modulator shall insert a series of EOM characters into the source data bit stream prior to encoding. The EOM character shall be formed by making each of its bits a MARK. The number of EOM characters inserted shall range from a minimum of ten to the number greater than ten required to fill a super block. The demodulator shall use the arrival of the EOM characters to terminate its data output.

**B.5.7.5 Asynchronous mode interleaving and block framing.**

The degree of interleaving, and the framing sequence length used in the asynchronous mode, vary with data signaling rate and character length. With each data rate and character length, four selectable interleaving degrees shall be provided as shown in tables B-IX, B-X, and B-XI, along with the corresponding framing sequence length.

**B.5.7.6 Bit packing.**

An integral number of data characters shall be transmitted between framing sequence transmissions. Therefore, the number of bits encoded will not always equal the number of bits received from the data source. In such cases, the modulator shall insert into the source data a number of fill bits equal to the difference between the number of bits encoded and the number of bits received (see tables B-IX, B-X, and B-XI). The fill bits shall be located in the bit stream so that they are the first bits encoded, thereby permitting the remainder of the data transmission to carry an integral number of data characters.

## B.6 PERFORMANCE REQUIREMENTS

The minimum performance of the 39-tone mode employing soft decision decoding and maximum interleaving, as measured using a baseband HF simulator patterned after the Watterson Model for channel simulation in accordance with Appendix E, shall be as shown in Table B-XII.

When testing a modem embedded with a radio, so that only radio frequency (RF) signals are available for testing, the RF signals must be down-converted to baseband for processing by the

MIL-STD-188-110C  
w/CHANGE 1  
APPENDIX B

channel simulator, and the result up-converted to RF for the receiver. In this case, the built-in radio filters will affect the performance of the modems. Therefore, when testing embedded modems, the SNR values specified in Table B-XII shall be increased by 2 dB.

**TABLE B- I. Selectable interleaving degrees.**

Data rate (bps)	75	150	300	600	1200	2400	
Interleaving degree	1	1	1	1	1	1	36
	4	9	17	33	63	9	72
	12	25	47	99	189	18	144
	36	81	153	297	567	27	288

**TABLE B- II. Normalized tone amplitudes and initial phases.**

Preamble part number	Tone freq (Hz)	Function	Normalized amplitude	Initial phase (degrees)
1	787.50	Data tone 3	3	0.0
1	1462.50	Data tone 15	3	103.7
1	2137.50	Data tone 27	3	103.7
1	2812.50	Data tone 39	3	0.0
2	1125.00	Data tone 9	4	0.0
2	1800.00	Data tone 21	4	90.0
2	2475.00	Data tone 33	4	0.0
3	393.75	Doppler	2	0.0
3	675.00	Data tone 1	1	0.0
3	731.25	Data tone 2	1	5.6
3	787.50	Data tone 3	1	19.7
3	843.75	Data tone 4	1	42.2
3	900.00	Data tone 5	1	73.1
3	956.25	Data tone 6	1	115.3
3	1012.50	Data tone 7	1	165.9
3	1068.75	Data tone 8	1	225.0
3	1125.00	Data tone 9	1	295.3
3	1181.25	Data tone 10	1	14.1
3	1237.50	Data tone 11	1	101.3
3	1293.75	Data tone 12	1	199.7
3	1350.00	Data tone 13	1	303.8
3	1406.25	Data tone 14	1	59.1
3	1462.50	Data tone 15	1	185.6
3	1518.75	Data tone 16	1	317.8
3	1575.00	Data tone 17	1	101.3
3	1631.25	Data tone 18	1	253.1
3	1687.50	Data tone 19	1	56.3

MIL-STD-188-110C  
w/CHANGE 1  
APPENDIX B

Preamble part number	Tone freq (Hz)	Function	Normalized amplitude	Initial phase (degrees)
3	1743.75	Data tone 20	1	225.0
3	1800.00	Data tone 21	1	45.0
3	1856.25	Data tone 22	1	236.3
3	1912.50	Data tone 23	1	73.1
3	1968.75	Data tone 24	1	281.3
3	2025.00	Data tone 25	1	137.8
3	2081.25	Data tone 26	1	5.6
3	2137.50	Data tone 27	1	239.1
3	2193.75	Data tone 28	1	123.8
3	2250.00	Data tone 29	1	19.7
3	2306.25	Data tone 30	1	281.3
3	2362.50	Data tone 31	1	194.1
3	2418.75	Data tone 32	1	115.3
3	2475.00	Data tone 33	1	45.0
3	2531.25	Data tone 34	1	345.9
3	2587.50	Data tone 35	1	295.3
3	2643.75	Data tone 36	1	253.1
3	2700.00	Data tone 37	1	222.2
3	2756.25	Data tone 38	1	199.7
3	2812.50	Data tone 39	1	185.6

MIL-STD-188-110C  
w/CHANGE 1  
APPENDIX B

**TABLE B- III. Framing sequence insertion intervals and lengths.**

Data rate (bps)	Interleaving degree	Insertion interval		Sequence length (bits)
		(super blocks)	(bits)	
75	1	567	15876	252
75	4	234	26208	416
75	12	75	25200	400
75	36	16	16128	256
150	1	576	16128	256
150	9	100	25200	400
150	25	36	25200	400
150	81	8	18144	288
300	1	567	15876	252
300	17	54	25704	408
300	47	18	23688	376
300	153	4	17136	272
600	1	567	15876	252
600	33	30	27720	440
600	99	10	27720	440
600	297	2	16632	264
1200	1	567	15876	252
1200	63	14	24696	392
1200	189	6	31752	504
1200	567	1	15876	252
2400	1	144	8064	256
2400	9	16	8064	256
2400	18	12	12096	384
2400	27	9	13608	432
2400	36	7	14112	448
2400	72	3	12096	384
2400	144	1	8064	256
2400	288	1	16128	512

NOTE: Insertion interval does not include framing sequence bits.

MIL-STD-188-110C  
w/CHANGE 1  
APPENDIX B

**TABLE B- IV. Data-tone frequencies and bit locations.**

Tone freq(Hz)	Function	Bit locations			
		2400 bps		1200 bps	
393.75	Continuous Doppler				
675.00	Data tone 1	1	2	1	2
731.25	Data tone 2	3	4	3	4
787.50	Data tone 3	5	6	5	6
843.75	Data tone 4	7	8	7	8
900.00	Data tone 5	9	10	9	10
956.25	Data tone 6	11	12	11	12
1012.50	Data tone 7	13	14	13	14
1068.75	Data tone 8	15	16	15	16
1125.00	Data tone 9	17	18	17	18
1181.25	Data tone 10	19	20	19	20
1237.50	Data tone 11	21	22	21	22
1293.75	Data tone 12	23	24	23	24
1350.00	Data tone 13	25	26	25	26
1406.25	Data tone 14	27	28	27	28
1462.50	Data tone 15	29	30	29	30
1518.75	Data tone 16	31	32	31	32
1575.00	Data tone 17	33	34	33	34
1631.25	Data tone 18	35	36	35	36
1687.50	Data tone 19	37	38	37	38
1743.75	Data tone 20	39	40	39	40
1800.00	Data tone 21	41	42	41	42
1856.25	Data tone 22	43	44	43	44
1912.50	Data tone 23	45	46	45	46
1968.75	Data tone 24	47	48	47	48
2025.00	Data tone 25	49	50	49	50
2081.25	Data tone 26	51	52	51	52
2137.50	Data tone 27	53	54	53	54
2193.75	Data tone 28	55	56	55	56
2250.00	Data tone 29	57	58	57	58
2306.25	Data tone 30	59	60	59	60
2362.50	Data tone 31	61	62	61	62
2418.75	Data tone 32	63	64	63	64
2475.00	Data tone 33	65	66	1	2
2531.25	Data tone 34	67	68	3	4
2587.50	Data tone 35	69	70	5	6
2643.75	Data tone 36	71	72	7	8
2700.00	Data tone 37	73	74	9	10
2756.25	Data tone 38	75	76	11	12
2812.50	Data tone 39	77	78	13	14

MIL-STD-188-110C  
w/CHANGE 1  
APPENDIX B

**TABLE B- V. Modulation characteristics of the 39-tone HF modem.**

Logic sense of dibits		
Later bit	Earlier bit	Phase change (degrees)
MARK (1)	SPACE (0)	+45
SPACE (0)	SPACE (0)	+135
SPACE (0)	MARK (1)	+225
MARK (1)	MARK (1)	+315



MIL-STD-188-110C  
w/CHANGE 1  
APPENDIX B

**TABLE B- VI. In-band time/frequency diversity.**

Tone number	600 bps		Data word	300 bps		Data word	150 bps		Data word	75 bps		Data word		
1	1	2	i	1	2	i	1	2	i	1	2	i		
2	3	4		3	4		3	4		3	4		3	4
3	5	6		5	6		5	6		5	6	1	2	i-1
4	7	8		7	8		7	8		7	8	3	4	
5	9	10		9	10		9	10	1	2	i-2	1	2	i-2
6	11	12		11	12		11	12	3	4		3	4	
7	13	14		13	14		13	14	5	6		1	2	i-3
8	15	16		15	16		15	16	7	8		3	4	
9	17	18		1	2	i-4	1	2	i-4	1	2	i-4		
10	19	20		3	4		3	4		3	4		3	4
11	21	22		5	6		5	6		5	6	1	2	i-5
12	23	24		7	8		7	8		7	8	3	4	
13	25	26		9	10		9	10	1	2	i-6	1	2	i-6
14	27	28		11	12		11	12	3	4		3	4	
15	29	30		13	14		13	14	5	6		1	2	i-7
16	31	32		15	16		15	16	7	8		3	4	
17	1	2	i-8	1	2	i-8	1	2	i-8	1	2	i-8		
18	3	4		3	4		3	4		3	4		3	4
19	5	6		5	6		5	6		5	6	1	2	i-9
20	7	8		7	8		7	8		7	8	3	4	
21	9	10		9	10		9	10	1	2	i-10	1	2	i-10
22	11	12		11	12		11	12	3	4		3	4	
23	13	14		13	14		13	14	5	6		1	2	i-11
24	15	16		15	16		15	16	7	8		3	4	
25	17	18		1	2	i-12	1	2	i-12	1	2	i-12		
26	19	20		3	4		3	4		3	4		3	4
27	21	22		5	6		5	6		5	6	1	2	i-13
28	23	24		7	8		7	8		7	8	3	4	
29	25	26		9	10		9	10	1	2	i-14	1	2	i-14
30	27	28		11	12		11	12	3	4		3	4	
31	29	30		13	14		13	14	5	6		1	2	i-15
32	31	32		15	16		15	16	7	8		3	4	
33	1	2	i	1	2	i	1	2	i	1	2	i		
34	3	4		3	4		3	4		3	4		3	4
35	5	6		5	6		5	6		5	6	1	2	i-1
36	7	8		7	8		7	8		7	8	3	4	
37	9	10		9	10		9	10	1	2	i-2	1	2	i-2
38	11	12		11	12		11	12	3	4		3	4	
39	13	14		13	14		13	14	5	6		1	2	i-3

MIL-STD-188-110C  
w/CHANGE 1  
APPENDIX B

**TABLE B- VII. In-band frequency diversity.**

Tone freq (Hz)	Function	600 bps		300 bps		150 bps		75 bps	
393.75	Continuous Doppler								
675.00	Data tone 1	1	2	1	2	1	2	1	2
731.25	Data tone 2	3	4	3	4	3	4	3	4
787.50	Data tone 3	5	6	5	6	5	6	1	2
843.75	Data tone 4	7	8	7	8	7	8	3	4
900.00	Data tone 5	9	10	9	10	1	2	1	2
956.25	Data tone 6	11	12	11	12	3	4	3	4
1012.50	Data tone 7	13	14	13	14	5	6	1	2
1068.75	Data tone 8	15	16	15	16	7	8	3	4
1125.00	Data tone 9	17	18	1	2	1	2	1	2
1181.25	Data tone 10	19	20	3	4	3	4	3	4
1237.50	Data tone 11	21	22	5	6	5	6	1	2
1293.75	Data tone 12	23	24	7	8	7	8	3	4
1350.00	Data tone 13	25	26	9	10	1	2	1	2
1406.25	Data tone 14	27	28	11	12	3	4	3	4
1462.50	Data tone 15	29	30	13	14	5	6	1	2
1518.75	Data tone 16	31	32	15	16	7	8	3	4
1575.00	Data tone 17	1	2	1	2	1	2	1	2
1631.25	Data tone 18	3	4	3	4	3	4	3	4
1687.50	Data tone 19	5	6	5	6	5	6	1	2
1743.75	Data tone 20	7	8	7	8	7	8	3	4
1800.00	Data tone 21	9	10	9	10	1	2	1	2
1856.25	Data tone 22	11	12	11	12	3	4	3	4
1912.50	Data tone 23	13	14	13	14	5	6	1	2
1968.75	Data tone 24	15	16	15	16	7	8	3	4
2025.00	Data tone 25	17	18	1	2	1	2	1	2
2081.25	Data tone 26	19	20	3	4	3	4	3	4
2137.50	Data tone 27	21	22	5	6	5	6	1	2
2193.75	Data tone 28	23	24	7	8	7	8	3	4
2250.00	Data tone 29	25	26	9	10	1	2	1	2
2306.25	Data tone 30	27	28	11	12	3	4	3	4
2362.50	Data tone 31	29	30	13	14	5	6	1	2
2418.75	Data tone 32	31	32	15	16	7	8	3	4
2475.00	Data tone 33	1	2	1	2	1	2	1	2
2531.25	Data tone 34	3	4	3	4	3	4	3	4
2587.50	Data tone 35	5	6	5	6	5	6	1	2
2643.75	Data tone 36	7	8	7	8	7	8	3	4
2700.00	Data tone 37	9	10	9	10	1	2	1	2
2756.25	Data tone 38	11	12	11	12	3	4	3	4
2812.50	Data tone 39	13	14	13	14	5	6	1	2

MIL-STD-188-110C  
w/CHANGE 1  
APPENDIX B

**TABLE B- VIII. Asynchronous character set.**

Number of bits	Character bit designation and location												
	1	2	3	4	5	6	7	8	9	10	11	12	
7	St	Da	Da	Da	Da	Da	Sp						
8	St	Da	Da	Da	Da	Da	P+	Sp					
8	St	Da	Da	Da	Da	Da	P-	Sp					
8	St	Da	Da	Da	Da	Da	Sp	Sp					
8	St	Da	Da	Da	Da	Da	Da	Sp					
9	St	Da	Da	Da	Da	Da	P+	Sp	Sp				
9	St	Da	Da	Da	Da	Da	P-	Sp	Sp				
9	St	Da	Da	Da	Da	Da	Da	P+	Sp				
9	St	Da	Da	Da	Da	Da	Da	P-	Sp				
9	St	Da	Da	Da	Da	Da	Da	Sp	Sp				
9	St	Da	Da	Da	DA	Da	Da	Da	Sp				
10	St	Da	Da	Da	Da	Da	Da	P+	Sp	Sp			
10	St	Da	Da	Da	Da	Da	Da	P-	Sp	Sp			
10	St	Da	Da	Da	Da	Da	Da	Da	P+	Sp			
10	St	Da	Da	Da	Da	Da	Da	Da	P-	Sp			
10	St	Da	Da	Da	Da	Da	Da	Da	Sp	Sp			
10	St	Da	Da	Da	Da	Da	Da	Da	Da	Sp			
11	St	Da	Da	Da	Da	Da	Da	Da	P+	Sp	Sp		
11	St	Da	Da	Da	Da	Da	Da	Da	P-	Sp	Sp		
11	St	Da	Da	Da	Da	Da	Da	Da	Da	P+	Sp		
11	St	Da	Da	Da	Da	Da	Da	Da	Da	P-	Sp		
11	St	Da	Da	Da	Da	Da	Da	Da	Da	Sp	Sp		
12	St	Da	Da	Da	Da	Da	Da	Da	Da	P+	Sp	Sp	
12	St	Da	Da	Da	Da	Da	Da	Da	Da	P-	Sp	Sp	

Bit labeling key: Da = Data

St = Start  
Sp = Stop

P+ = Positive parity  
P- = Negative parity

MIL-STD-188-110C  
w/CHANGE 1  
APPENDIX B

**TABLE B- IX. 75 bps and 150 bps asynchronous operational parameters.**

Data rate (bps)	Char length (bits)	Intlv degree	Super blocks	Number of bits encoded	Number of source bits	fill bits	Seq Number length (bits)
75	7	1	567	6804	6804	0	252
75	7	5	189	11340	11340	0	420
75	7	12	84	12096	12096	0	448
75	7	35	18	7560	7560	0	280
75	8	1	576	6912	6912	0	256
75	8	4	234	11232	11232	0	416
75	8	12	75	10800	10800	0	400
75	8	36	16	6912	6912	0	256
75	9	1	567	6804	6804	0	252
75	9	4	252	12096	12096	0	448
75	9	12	84	12096	12096	0	448
75	9	36	16	6912	6912	0	256
75	10	1	585	7020	7020	0	260
75	10	4	242	11616	11610	6	416
75	10	12	75	10800	10800	0	400
75	10	35	18	7560	7560	0	280
75	11	1	594	7128	7128	0	264
75	11	4	260	12480	12474	6	448
75	11	11	99	13068	13068	0	484
75	11	33	18	7128	7128	0	264
75	12	1	567	6804	6804	0	252
75	12	4	261	12528	12528	0	464
75	12	12	84	12096	12096	0	448
75	12	36	16	6912	6912	0	256
150	7	1	567	6804	6804	0	252
150	7	9	112	12096	12096	0	448
150	7	27	35	11340	11340	0	420
150	7	81	7	6804	6804	0	252
150	8	1	576	6912	6912	0	256

MIL-STD-188-110C  
w/CHANGE 1  
APPENDIX B

Data rate (bps)	Char length (bits)	Intlv degree	Super blocks	Number of bits encoded	Number of source bits	fill bits	Seq Number length (bits)
150	8	9	100	10800	10800	0	400
150	8	25	36	10800	10800	0	400
150	8	81	8	7776	7776	0	288
150	9	1	567	6804	6804	0	252
150	9	9	112	12096	12096	0	448
150	9	25	38	11400	11394	6	408
150	9	81	7	6804	6804	0	252
150	10	1	585	7020	7020	0	260
150	10	9	110	11880	11880	0	440
150	10	25	36	10800	10800	0	400
150	10	75	9	8100	8100	0	300
150	11	1	594	7128	7128	0	264
150	11	9	110	11880	11880	0	440
150	11	27	33	10692	10692	0	396
150	11	77	9	8316	8316	0	308
150	12	1	567	6804	6804	0	252
150	12	9	110	11880	11880	0	440
150	12	27	33	10692	10692	0	396
150	12	81	7	6804	6804	0	252

MIL-STD-188-110C  
w/CHANGE 1  
APPENDIX B

**TABLE B- X. 300 bps and 600 bps asynchronous operational parameters.**

Data rate (bps)	Char length (bits)	Intlv degree	Super blocks	Number of bits encoded	Number of source bits	fill bits	Seq Number length (bits)
300	7	1	567	6804	6804	0	252
300	7	15	63	11340	11340	0	420
300	7	49	18	10584	10584	0	392
300	7	145	5	8700	8694	6	308
300	8	1	576	6912	6912	0	256
300	8	17	54	11016	11016	0	408
300	8	47	18	10152	10152	0	376
300	8	153	4	7344	7344	0	272
300	9	1	567	6804	6804	0	252
300	9	17	54	11016	11016	0	408
300	9	47	18	10152	10152	0	376
300	9	153	4	7344	7344	0	272
300	10	1	585	7020	7020	0	260
300	10	17	49	9996	9990	6	356
300	10	45	22	11880	11880	0	440
300	10	153	5	9180	9180	0	340
300	11	1	594	7128	7128	0	264
300	11	19	43	9804	9801	3	356
300	11	45	22	11880	11880	0	440
300	11	161	4	7728	7722	6	272
300	12	1	567	6804	6804	0	252
300	12	17	54	11016	11016	0	408
300	12	49	18	10584	10584	0	392
300	12	153	4	7344	7344	0	272
600	7	1	567	6804	6804	0	252
600	7	35	27	11340	11340	0	420
600	7	105	9	11340	11340	0	420
600	7	315	2	7560	7560	0	280
600	8	1	576	6912	6912	0	256

MIL-STD-188-110C  
w/CHANGE 1  
APPENDIX B

600	8	33	30	11880	11880	0	440
600	8	99	10	11880	11880	0	440
600	8	297	2	7128	7128	0	264
600	9	1	567	6804	6804	0	252
600	9	33	30	11880	11880	0	440
600	9	99	10	11880	11880	0	440
600	9	297	2	7128	7128	0	264
600	10	1	585	7020	7020	0	260
600	10	33	30	11880	11880	0	440
600	10	99	10	11880	11880	0	440
600	10	315	2	7560	7560	0	280
600	11	1	594	7128	7128	0	264
600	11	33	30	11880	11880	0	440
600	11	99	10	11880	11880	0	440
600	11	297	2	7128	7128	0	264
600	12	1	567	6804	6804	0	252
600	12	33	30	11880	11880	0	440
600	12	99	10	11880	11880	0	440
600	12	297	2	7128	7128	0	264

MIL-STD-188-110C  
w/CHANGE 1  
APPENDIX B

**TABLE B- XI. 1200 bps and 2400 bps asynchronous operational parameters.**

Data rate (bps)	Char length (bits)	Intlv degree	Super blocks	Number of bits encoded	Number of source bits	fill bits	Seq Number length (bits)
1200	7	1	567	6804	6804	0	252
1200	7	63	15	11340	11340	0	420
1200	7	189	6	13608	13608	0	504
1200	7	567	1	6804	6804	0	252
1200	8	1	576	6912	6912	0	256
1200	8	63	14	10584	10584	0	392
1200	8	189	6	13608	13608	0	504
1200	8	576	1	6912	6912	0	256
1200	9	1	567	6804	6804	0	252
1200	9	63	15	11340	11340	0	420
1200	9	189	6	13608	13608	0	504
1200	9	567	1	6804	6804	0	252
1200	10	1	585	7020	7020	0	260
1200	10	63	15	11340	11340	0	420
1200	10	195	6	14040	14040	0	520
1200	10	585	1	7020	7020	0	260
1200	11	1	594	7128	7128	0	264
1200	11	65	16	12480	12474	6	448
1200	11	203	5	12180	12177	3	444
1200	11	619	1	7428	7425	3	268
1200	12	1	567	6804	6804	0	252
1200	12	63	15	11340	11340	0	420
1200	12	189	6	13608	13608	0	504
1200	12	567	1	6804	6804	0	252
2400	7	1	145	5800	5796	4	252
2400	7	36	7	10080	10080	0	448
2400	7	73	3	8760	8757	3	385
2400	7	282	1	11280	11277	3	497
2400	8	1	144	5760	5760	0	256



MIL-STD-188-110C  
w/CHANGE 1  
APPENDIX B

Data rate (bps)	Char length (bits)	Intlv degree	Super blocks	Number of bits encoded	Number of source bits	fill bits	Seq Number length (bits)
2400	8	36	7	10080	10080	0	448
2400	8	72	3	8640	8640	0	384
2400	8	288	1	11520	11520	0	512
2400	9	1	144	5760	5760	0	256
2400	9	36	7	10080	10080	0	448
2400	9	72	3	8640	8640	0	384
2400	9	288	1	11520	11520	0	512
2400	10	1	144	5760	5760	0	256
2400	10	36	7	10080	10080	0	448
2400	10	72	3	8640	8640	0	384
2400	10	288	1	11520	11520	0	512
2400	11	1	151	6040	6039	1	267
2400	11	33	9	11880	11880	0	528
2400	11	71	3	8520	8514	6	370
2400	11	297	1	11880	11880	0	528
2400	12	1	144	5760	5760	0	256
2400	12	36	7	10080	10080	0	448
2400	12	72	3	8640	8640	0	384
2400	12	288	1	11520	11520	0	512

MIL-STD-188-110C  
w/CHANGE 1  
APPENDIX B

**TABLE B- XII. Probability of bit error vs signal-to-noise ratio.**

Signal-to-noise ratio (dB in 3-kHz bandwidth)	Probability of bit error	
	2400 bps	1200 bps
5	-	6.4 E-2
11	3.5 E-2	4.4 E-3
16	1.0 E-2	3.4E-4
21	1.0 E-3	9.0 E-6
31	1.8 E-4	2.7 E-6
	Probability of bit error	
	300 bps	75 bps
1	1.8 E-2	4.4 E-4
3	6.4 E-3	5.0 E-5
5	1.0 E-3	1.0 E-6
7	5.0 E-5	1.0 E-6
9	1.5 E-6	1.0 E-6

NOTE: Two independent equal average power Rayleigh fading paths, with 2 Hz fading bandwidth and 2 ms multipath spread, using a simulator in accordance with Appendix E.

MIL-STD-188-110C  
w/CHANGE 1  
APPENDIX B

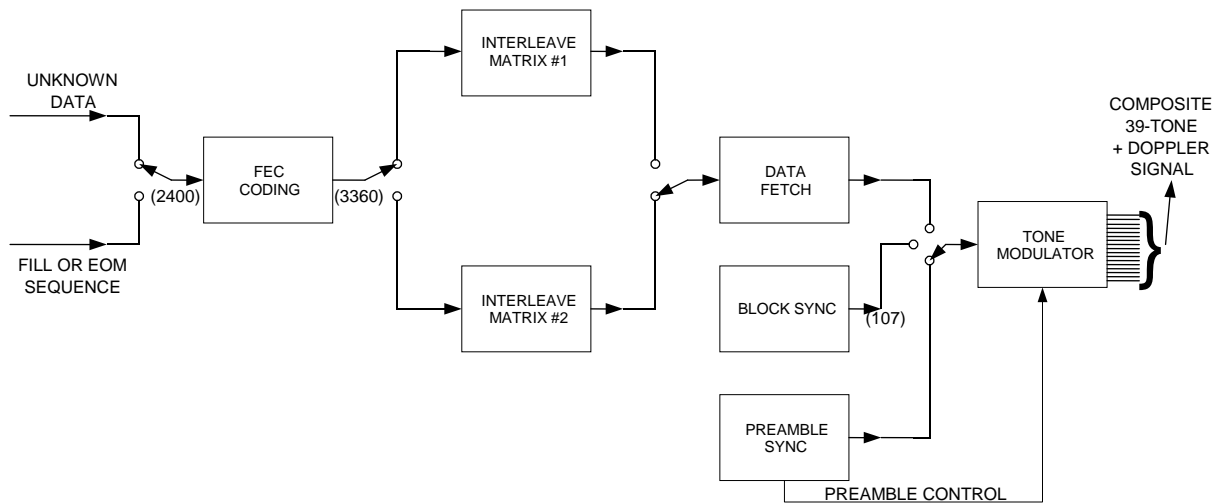

**FIGURE B- 2. Transmit direction functional diagram.**

MIL-STD-188-110C  
w/CHANGE 1  
APPENDIX B

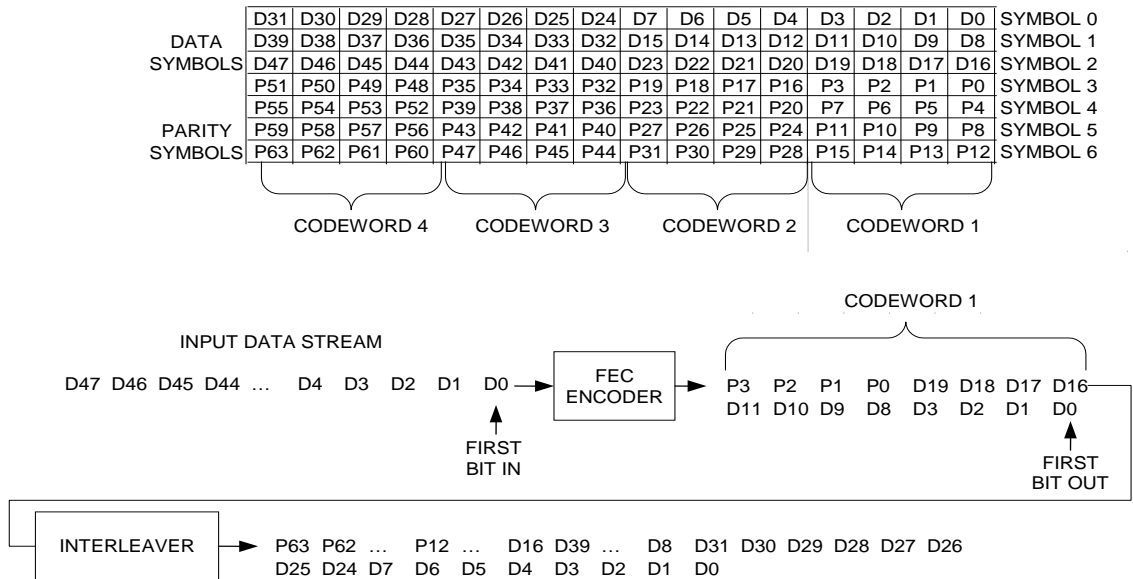
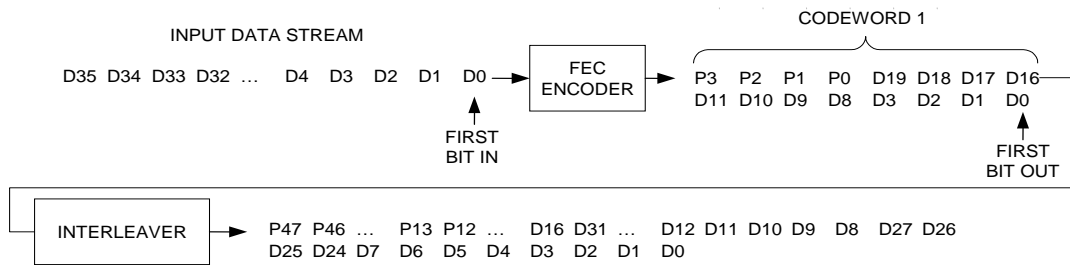

**FIGURE B-3. Data flow through encoder and interleaver for an interleaver containing an even number of code words.**

MIL-STD-188-110C  
w/CHANGE 1  
APPENDIX B

DATA	D27	D26	D25	D24	D7	D6	D5	D4	D3	D2	D1	D0	SYMBOL 0
SYMBOLS	D31	D30	D29	D28	D15	D14	D13	D12	D11	D10	D9	D8	SYMBOL 1
	D35	D34	D33	D32	D23	D22	D21	D20	D19	D18	D17	D16	SYMBOL 2
	P35	P34	P33	P32	P19	P18	P17	P16	P3	P2	P1	P0	SYMBOL 3
PARITY	P39	P38	P37	P36	P23	P22	P21	P20	P7	P6	P5	P4	SYMBOL 4
SYMBOLS	P43	P42	P41	P40	P27	P26	P25	P24	P11	P10	P9	P8	SYMBOL 5
	P47	P46	P45	P44	P31	P30	P29	P28	P15	P14	P13	P12	SYMBOL 6

CODEWORD 3
CODEWORD 2
CODEWORD 1



**FIGURE B- 4. Data flow through encoder and interleaver for an interleaver containing an odd number of code words.**

MIL-STD-188-110C  
w/CHANGE 1  
APPENDIX B

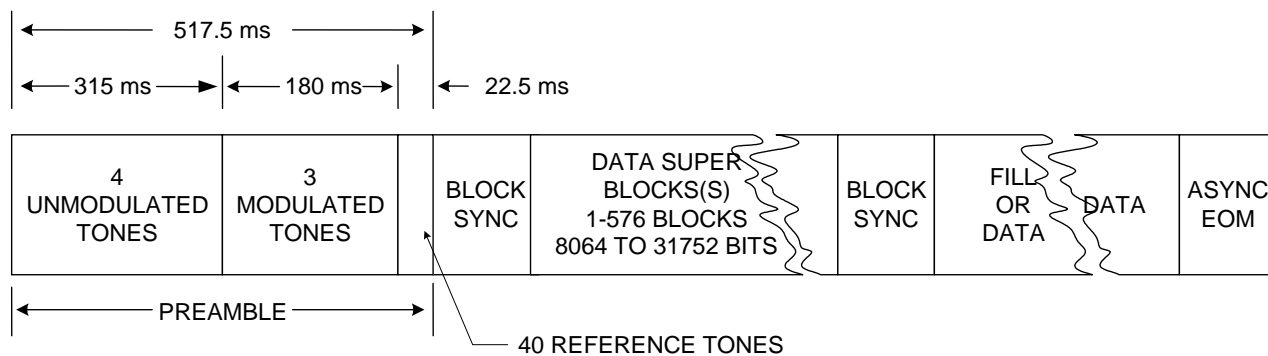

**FIGURE B- 5. Transmit sequence of events.**

MIL-STD-188-110C  
w/CHANGE 1  
APPENDIX B

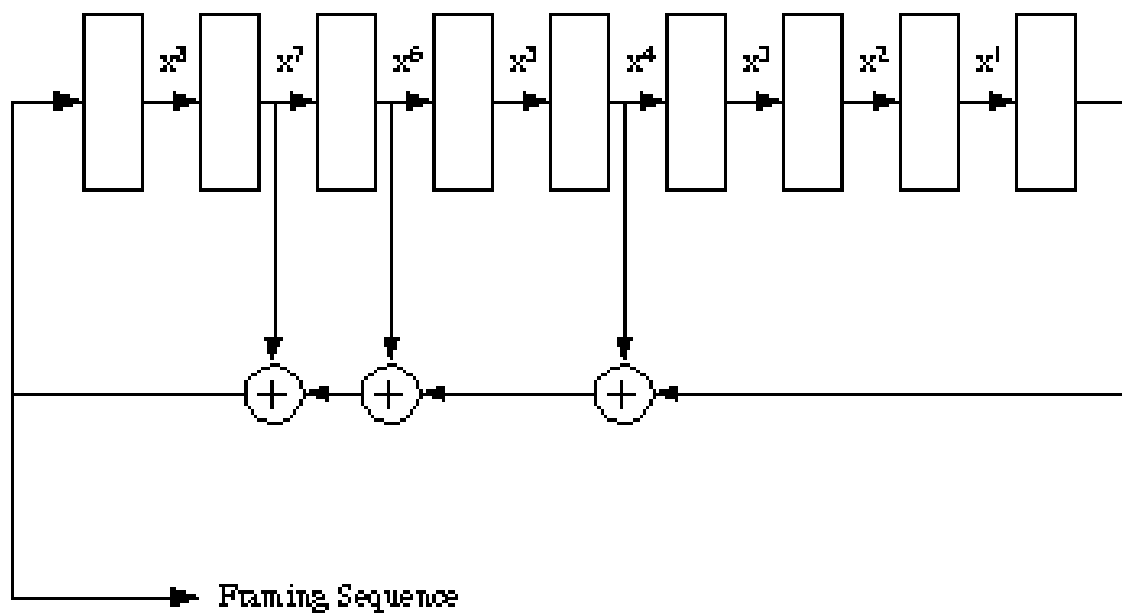

**FIGURE B- 6. Framing sequence feedback shift register generator**

MIL-STD-188-110C  
w/CHANGE 1  
APPENDIX C

HF DATA MODEM WAVEFORMS FOR DATA RATES ABOVE 2400 BPS  
IN 3 KHZ BANDWIDTH

TABLE OF CONTENTS

<u>PARAGRAPH</u> .....	<u>PAGE</u>
C.1 GENERAL.....	109
C.1.1 <u>Scope</u> .....	109
C.1.2 <u>Applicability</u> .....	109
C.2 APPLICABLE DOCUMENTS.....	109
C.3 DEFINITIONS .....	109
C.4 GENERAL REQUIREMENTS .....	109
C.5 DETAILED REQUIREMENTS .....	110
C.5.1 <u>Modulation</u> .....	110
C.5.1.1 <u>Known symbols</u> .....	110
C.5.1.2 <u>Data symbols</u> .....	111
C.5.1.2.1 <u>PSK data symbols</u> .....	112
C.5.1.2.2 <u>QAM data symbols</u> .....	112
C.5.1.3 <u>Data scrambling</u> .....	117
C.5.1.4 <u>Modulation filter</u> .....	119
C.5.2 <u>Frame structure</u> .....	119
C.5.2.1 <u>Synchronization and reinserted preambles</u> .....	120
C.5.2.1.1 <u>Synchronization preamble</u> .....	120
C.5.2.1.2 <u>Reinserted preamble</u> .....	122
C.5.2.2 <u>Mini-probes</u> .....	123
C.5.3 <u>Coding and interleaving</u> .....	125
C.5.3.1 <u>Block boundary alignment</u> .....	125
C.5.3.2 <u>Block encoding</u> .....	126
C.5.3.2.1 <u>Rate 1/2 convolutional code</u> .....	126
C.5.3.2.2 <u>Full-tail-biting encoding</u> .....	127
C.5.3.2.3 <u>Puncturing to rate 3/4</u> .....	128
C.5.3.3 <u>Block interleaver structure</u> .....	128
C.5.3.3.1 <u>Interleaver size in bits</u> .....	129
C.5.3.3.2 <u>Interleaver load</u> .....	129
C.5.3.3.3 <u>Interleaver fetch</u> .....	130
C.5.4 <u>Operational features and message protocols</u> .....	130
C.5.4.1 <u>User interfaces</u> .....	130
C.5.4.1.1 <u>Conventional asynchronous interface</u> .....	130
C.5.4.1.2 <u>High speed asynchronous user interface with flow control</u> .....	130
C.5.4.1.3 <u>Ethernet interface</u> .....	131
C.5.4.2 <u>Onset of transmission</u> .....	131
C.5.4.3 <u>End of message</u> .....	131
C.5.4.4 <u>Termination of a transmission</u> .....	131



## MIL-STD-188-110C

## w/CHANGE 1

## APPENDIX C

## TABLE OF CONTENTS (continued)

C.5.4.5	<u>Termination of receive data processing</u> .....	132
C.5.4.5.1	<u>Detection of EOM</u> .....	132
C.5.4.5.2	<u>Command to return to acquisition</u> .....	132
C.5.4.5.3	<u>Receipt of a specified number of data blocks</u> .....	132
C.5.4.5.4	<u>Initiation of a transmission</u> .....	132
C.5.4.6	<u>Remote control</u> .....	132
C.6	PERFORMANCE.....	134
C.6.1	<u>BER performance</u> .....	134
C.6.2	<u>Acquisition performance</u> .....	134
C.6.3	<u>Doppler shift test</u> .....	135
C.6.4	<u>Doppler sweep performance</u> .....	135
C.7	ASSOCIATED COMMUNICATIONS EQUIPMENT.....	135

**LIST OF TABLES**

•	TABLE C- I. 8PSK SYMBOL MAPPING.....	110
•	TABLE C- II. MODULATION USED TO OBTAIN EACH DATA RATE.....	111
•	TABLE C- III. TRANSCODING FOR 3200 BPS.....	112
•	TABLE C- IV. TRANSCODING FOR 4800 BPS.....	112
•	TABLE C- V. IN-PHASE AND QUADRATURE COMPONENTS OF EACH 16QAM SYMBOL.....	114
•	TABLE C- VI. IN-PHASE AND QUADRATURE COMPONENTS OF EACH 32QAM SYMBOL.....	115
•	TABLE C- VII. IN-PHASE AND QUADRATURE COMPONENTS OF EACH 64QAM SYMBOL.....	117
•	TABLE C- VIII. SYNCHRONIZATION PREAMBLE.....	121
•	TABLE C- IX. D0, D1, D2 8 PSK SYMBOL VALUES AS A FUNCTION OF DATA RATE AND INTERLEAVER LENGTH.....	122
•	TABLE C- X. BIT PATTERNS FOR SPECIFYING DATA RATE AND INTERLEAVER LENGTH.....	122
•	TABLE C- XI. REINSERTED PREAMBLE.....	123
•	TABLE C- XII. S0, S1, S2, S3, S4, S5 (SIGN) VALUES AS A FUNCTION OF DATA RATE AND INTERLEAVER SETTING.....	124
•	TABLE C- XIII. S6, S7, S8 (SIGN) VALUES AS A FUNCTION OF MINI-PROBE SET....	124
•	TABLE C- XIV. INPUT DATA BLOCK SIZE IN BITS AS A FUNCTION OF DATA RATE AND INTERLEAVER LENGTH.....	125
•	TABLE C- XV. INTERLEAVER SIZE IN BITS AS A FUNCTION OF DATA RATE AND INTERLEAVER LENGTH.....	129
•	TABLE C- XVI. INTERLEAVER INCREMENT VALUE AS A FUNCTION OF DATA RATE AND INTERLEAVER LENGTH.....	129
•	TABLE C- XVII. MDR WAVEFORM PERFORMANCE REQUIREMENTS.....	134

MIL-STD-188-110C  
w/CHANGE 1  
APPENDIX C

**LIST OF FIGURES**

- FIGURE C- 1. 8PSK SIGNAL CONSTELLATION AND SYMBOL MAPPING. .... 111
- FIGURE C- 2. 16QAM SIGNALING CONSTELLATION. .... 113
- FIGURE C- 3. 32QAM SIGNALING CONSTELLATION. .... 114
- FIGURE C- 4. 64QAM SIGNALING CONSTELLATION. .... 116
- FIGURE C- 5. SCRAMBLING SEQUENCE GENERATOR ILLUSTRATING  
SCRAMBLING GENERATOR FOR 8PSK SYMBOLS. .... 118
- FIGURE C- 6. FRAME STRUCTURE FOR ALL WAVEFORMS. .... 120
- FIGURE C- 7. CONSTRAINT LENGTH 7, RATE 1/2 CONVOLUTIONAL ENCODER..... 127

MIL-STD-188-110C  
w/CHANGE 1  
APPENDIX C

## C.1 SCOPE

### C.1.1 Scope.

This appendix describes HF data modem waveforms for data rates above 2400 bps in 3 kHz channels. These may be termed narrowband, medium data rate (MDR) waveforms.

### C.1.2 Applicability.

This appendix is a non-mandatory part of MIL-STD-188-110B; however, when using HF data modem waveforms for data rates above 2400 bps in 3 kHz channels, they shall be implemented in accordance with this appendix.

## C.2 APPLICABLE DOCUMENTS

This section is not applicable to this appendix.

## C.3 DEFINITIONS

See section 3.

## C.4 GENERAL REQUIREMENTS

This appendix presents a modem waveform and coding specification for data rates of 3200, 4800, 6400, 8000 and 9600 bps. Uncoded operation at 12800 bps is a DO. The single-tone waveforms specified in this appendix use modulation techniques of greater complexity and data blocks larger than those found in section 5.3.2 of this standard in order to achieve the efficiencies necessary to obtain the required data rates. A block interleaver is used to obtain 6 interleaving lengths ranging from 0.12 s to 8.64 s. A single coding option, a constraint length 7, rate 1/2 convolutional code, punctured to rate 3/4, is used for all data rates. The full-tail-biting approach is used to produce block codes from this convolutional code that are the same length as the interleaver. Since the minimum interleaver length spans a single data frame, there is no option of zero interleaving, since the time delays would not be reduced.

Both the data rate and interleaver settings are explicitly transmitted as a part of the waveform, both as part of the initial preamble and then periodically as both a reinserted preamble and in the periodic known symbol blocks. This “autobaud” feature is critical in developing an efficient (ARQ) protocol for high frequency (HF) channels. The receive modem is required to be able to deduce the data rate and interleaver setting both from the preamble or from the subsequent data portion of the waveform.

MIL-STD-188-110C  
w/CHANGE 1  
APPENDIX C

## C.5 DETAILED REQUIREMENTS

### C.5.1 Modulation.

The symbol rate for all symbols shall be 2400 symbols-per-second, which shall be accurate to a minimum of  $\pm 0.024$  (10 ppm) symbols-per-second when the transmit data clock is generated by the modem and not provided by the data terminal equipment (DTE). Phase-shift keying (PSK) and quadrature amplitude modulation (QAM) modulation techniques shall be used. The sub-carrier (or pair of quadrature sub-carriers in the case of QAM) shall be centered at 1800 Hz accurate to a minimum of 0.018 Hz (10 ppm). The phase of the Quadrature sub-carrier relative to the In-phase carrier shall be 90 degrees. The correct relationship can be achieved by making the In-phase sub-carrier  $\cos(1800 \text{ Hz})$  and the Quadrature sub-carrier  $-\sin(1800 \text{ Hz})$ .

The output of the modulator shall have an occupied bandwidth (see section 3) no greater than 3 kHz. This measurement can be performed at RF, IF or audio baseband.

#### C.5.1.1 Known symbols.

For all known symbols, the modulation used shall be PSK, with the symbol mapping shown in Table C-I and figure C-1. No scrambling shall be applied to the known symbols.

**TABLE C- I. 8PSK symbol mapping.**

Symbol Number	Phase	In-Phase	Quadrature
0	0	1.000000	0.000000
1	$\pi/4$	0.707107	0.707107
2	$\pi/2$	0.000000	1.000000
3	$3\pi/4$	-0.707107	0.707107
4	$\pi$	-1.000000	0.000000
5	$5\pi/4$	-0.707107	-0.707107
6	$3\pi/2$	0.000000	-1.000000
7	$7\pi/4$	0.707107	-0.707107

Note that the complex symbol values =  $\exp[jn\pi/4]$  where n is the symbol number.

MIL-STD-188-110C  
w/CHANGE 1  
APPENDIX C

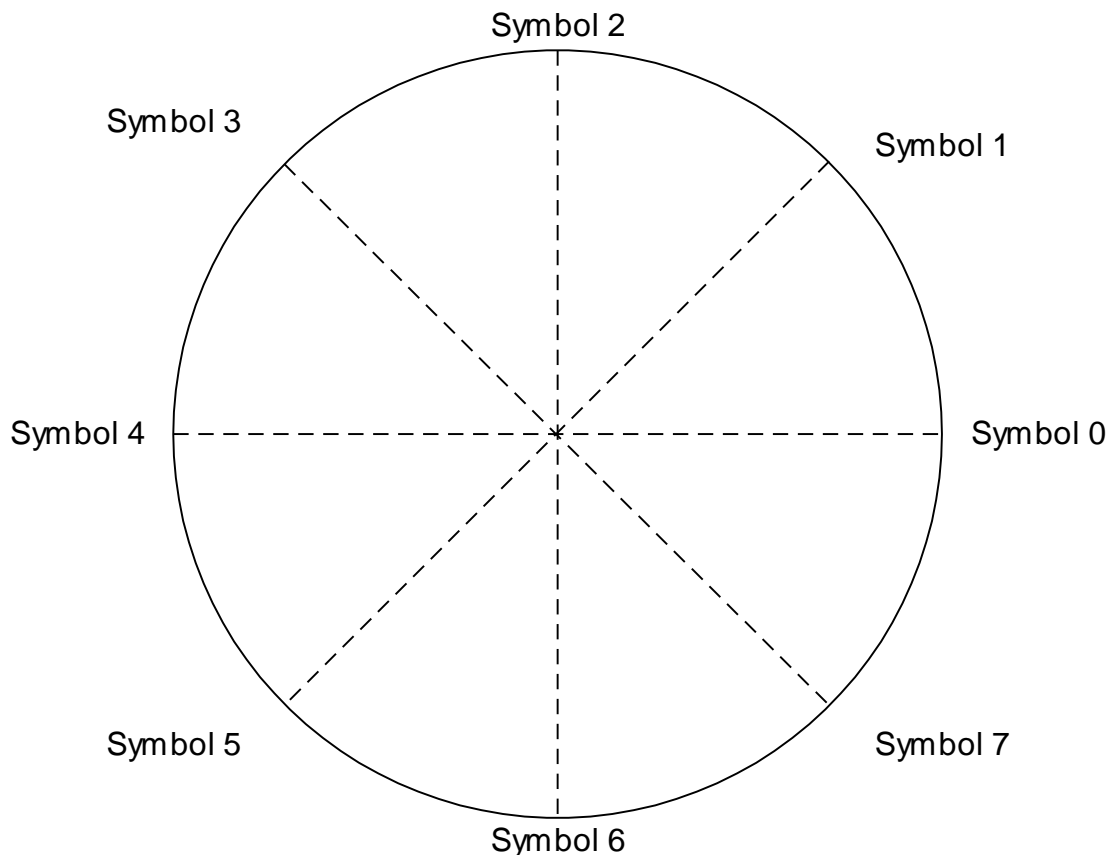

**FIGURE C- 1. 8PSK signal constellation and symbol mapping.**

C.5.1.2 Data symbols.

For data symbols, the modulation used shall depend upon the data rate. Table C-II specifies the modulation that shall be used with each data rate.

**TABLE C- II. Modulation used to obtain each data rate.**

Data Rate (bps)	Modulation
3200	QPSK
4800	8PSK
6400	16QAM
8000	32QAM
9600	64QAM
12800	64QAM

The 3200 bps quadrature phase-shift keying (QPSK) constellation is scrambled to appear, on-air, as an 8PSK constellation. Both the 16QAM and 32QAM constellations use multiple PSK rings to maintain good peak-to-average ratios, and the 64QAM constellation is a variation of the standard square QAM constellation, which has been modified to improve the peak-to-average ratio.

MIL-STD-188-110C  
w/CHANGE 1  
APPENDIX C

C.5.1.2.1 PSK data symbols.

For the PSK constellations, a distinction is made between the data bits and the symbol number for the purposes of scrambling the QPSK modulation to appear as 8PSK, on-air. Scrambling is applied as a modulo 8 addition of a scrambling sequence to the 8PSK symbol number. Transcoding is an operation which links a symbol to be transmitted to a group of data bits.

C.5.1.2.1.1 QPSK symbol mapping.

For the 3200 bps user data rate, transcoding shall be achieved by linking one of the symbols specified in Table C-I to a set of two consecutive data bits (dibit) as shown in Table C-III. In this Table, the leftmost bit of the dibit shall be the older bit; i.e., fetched from the interleaver before the rightmost bit.

**TABLE C- III. Transcoding for 3200 bps.**

Dibit	Symbol
00	0
01	2
11	4
10	6

C.5.1.2.1.2 8PSK symbol mapping.

For the 4800 bps user data rate, transcoding shall be achieved by linking one symbol to a set of three consecutive data bits (tribit) as shown in Table C-IV. In this Table, the leftmost bit of the tribit shall be the oldest bit; i.e., fetched from the interleaver before the other two, and the rightmost bit is the most recent bit.

**TABLE C- IV. Transcoding for 4800 bps.**

Tribit	Symbol
000	1
001	0
010	2
011	3
100	6
101	7
110	5
111	4

C.5.1.2.2 QAM data symbols.

For the QAM constellations, no distinction is made between the number formed directly from the data bits and the symbol number. Each set of 4 bits (16QAM), 5 bits (32QAM) or 6 bits (64QAM) is mapped directly to a QAM symbol. For example, the four bit grouping 0111 would map to symbol 7 in the 16QAM constellation while the 6 bits 100011 would map to symbol 35 in the 64QAM constellation. Again, in each case the leftmost bit shall be the oldest bit, i.e. fetched from the interleaver before the other bits, and the rightmost bit is the most recent bit. The

MIL-STD-188-110C  
w/CHANGE 1  
APPENDIX C

mapping of bits to symbols for the QAM constellations has been selected to minimize the number of bit errors incurred when errors involve adjacent signaling points in the constellation.

C.5.1.2.2.1 The 16 QAM constellation.

The constellation points which shall be used for 16QAM are shown in figure C-2 and specified in terms of their In-phase and Quadrature components in Table C-V. As can be seen in the figure, the 16 QAM constellation is comprised of two PSK rings: 4 PSK inner and 12 PSK outer

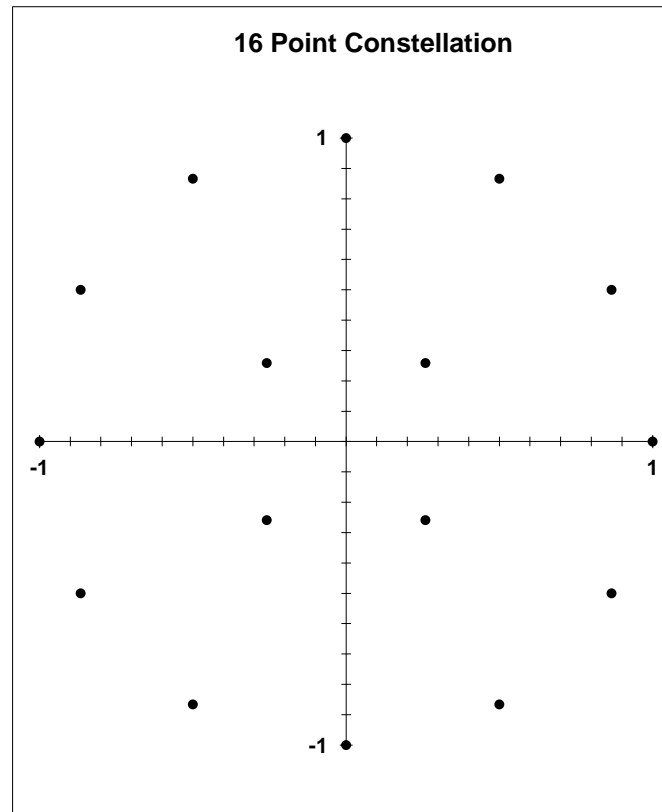

**FIGURE C- 2. 16QAM Signaling Constellation.**

MIL-STD-188-110C  
w/CHANGE 1  
APPENDIX C

**TABLE C- V. In-phase and Quadrature components of each 16QAM symbol.**

Symbol Number	In-Phase	Quadrature
0	0.866025	0.500000
1	0.500000	0.866025
2	1.000000	0.000000
3	0.258819	0.258819
4	-0.500000	0.866025
5	0.000000	1.000000
6	-0.866025	0.500000
7	-0.258819	0.258819
8	0.500000	-0.866025
9	0.000000	-1.000000
10	0.866025	-0.500000
11	0.258819	-0.258819
12	-0.866025	-0.500000
13	-0.500000	-0.866025
14	-1.000000	0.000000
15	-0.258819	-0.258819

C.5.1.2.2.2 The 32 QAM constellation.

The constellation points which shall be used for 32QAM are shown in figure C-3 and specified in terms of their In-phase and Quadrature components in Table C-VI. This constellation contains an outer ring of 16 symbols and an inner square of 16 symbols.

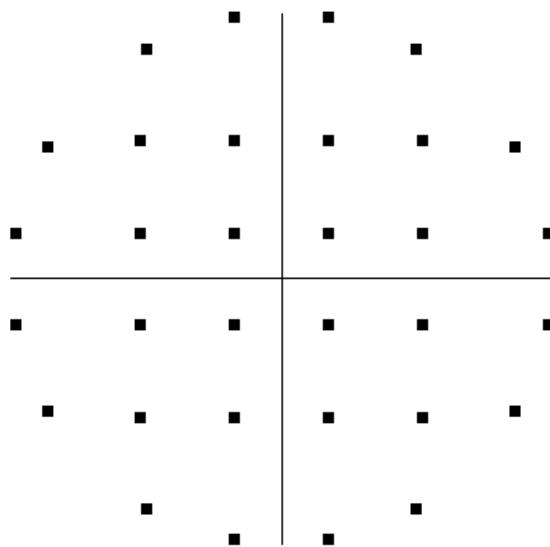

**FIGURE C- 3. 32QAM signaling constellation.**



MIL-STD-188-110C  
w/CHANGE 1  
APPENDIX C

**TABLE C- VI. In-phase and Quadrature components of each 32QAM symbol.**

Symbol Number	In-Phase	Quadrature	Symbol Number	In-Phase	Quadrature
0	0.866380	0.499386	16	0.866380	-0.499386
1	0.984849	0.173415	17	0.984849	-0.173415
2	0.499386	0.866380	18	0.499386	-0.866380
3	0.173415	0.984849	19	0.173415	-0.984849
4	0.520246	0.520246	20	0.520246	-0.520246
5	0.520246	0.173415	21	0.520246	-0.173415
6	0.173415	0.520246	22	0.173415	-0.520246
7	0.173415	0.173415	23	0.173415	-0.173415
8	-0.866380	0.499386	24	-0.866380	-0.499386
9	-0.984849	0.173415	25	-0.984849	-0.173415
10	-0.499386	0.866380	26	-0.499386	-0.866380
11	-0.173415	0.984849	27	-0.173415	-0.984849
12	-0.520246	0.520246	28	-0.520246	-0.520246
13	-0.520246	0.173415	29	-0.520246	-0.173415
14	-0.173415	0.520246	30	-0.173415	-0.520246
15	-0.173415	0.173415	31	-0.173415	-0.173415

**C.5.1.2.2.3 The 64QAM constellation.**

The constellation points which shall be used for the 64QAM modulation are shown in figure C-4 and specified in terms of their In-phase and Quadrature components in Table C-VII. This constellation is a variation on the standard 8 x 8 square constellation, which achieves better peak-to-average without sacrificing the very good pseudo-Gray code properties of the square constellation.

MIL-STD-188-110C  
w/CHANGE 1  
APPENDIX C

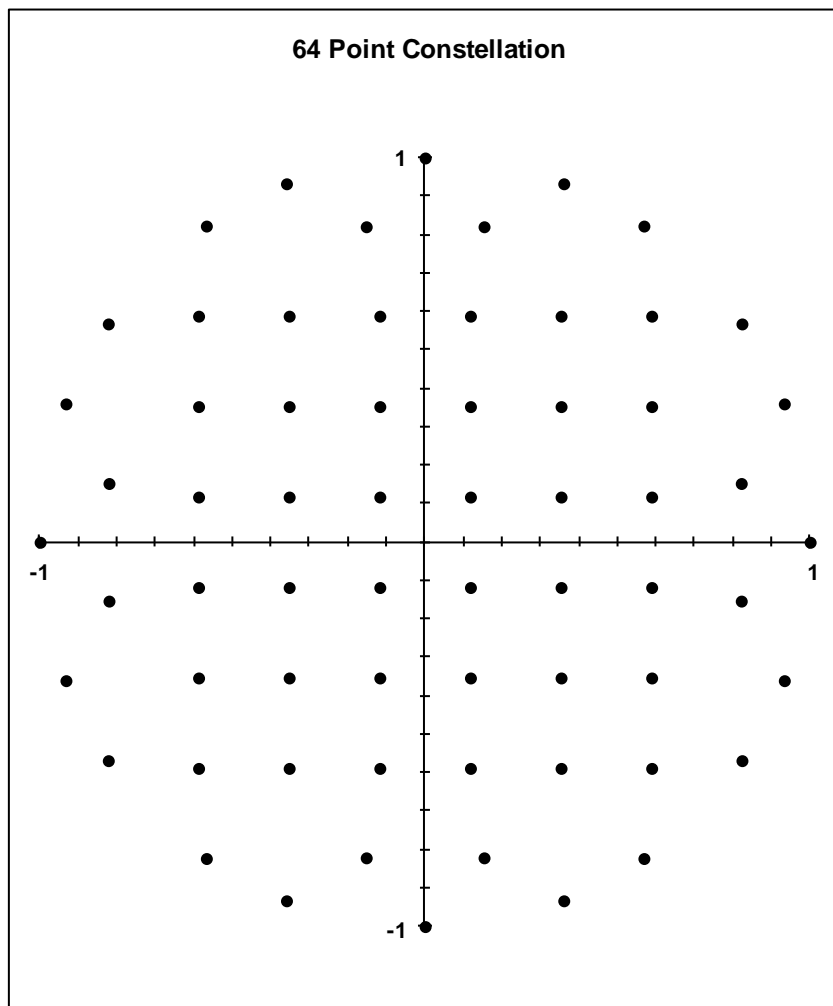

**FIGURE C- 4. 64QAM signaling constellation.**

MIL-STD-188-110C  
w/CHANGE 1  
APPENDIX C

**TABLE C- VII. In-phase and Quadrature components of each 64QAM symbol.**

Symbol Number	In-Phase	Quadrature	Symbol Number	In-Phase	Quadrature
0	1.000000	0.000000	32	0.000000	1.000000
1	0.822878	0.568218	33	-0.822878	0.568218
2	0.821137	0.152996	34	-0.821137	0.152996
3	0.932897	0.360142	35	-0.932897	0.360142
4	0.000000	-1.000000	36	-1.000000	0.000000
5	0.822878	-0.568218	37	-0.822878	-0.568218
6	0.821137	-0.152996	38	-0.821137	-0.152996
7	0.932897	-0.360142	39	-0.932897	-0.360142
8	0.568218	0.822878	40	-0.568218	0.822878
9	0.588429	0.588429	41	-0.588429	0.588429
10	0.588429	0.117686	42	-0.588429	0.117686
11	0.588429	0.353057	43	-0.588429	0.353057
12	0.568218	-0.822878	44	-0.568218	-0.822878
13	0.588429	-0.588429	45	-0.588429	-0.588429
14	0.588429	-0.117686	46	-0.588429	-0.117686
15	0.588429	-0.353057	47	-0.588429	-0.353057
16	0.152996	0.821137	48	-0.152996	0.821137
17	0.117686	0.588429	49	-0.117686	0.588429
18	0.117686	0.117686	50	-0.117686	0.117686
19	0.117686	0.353057	51	-0.117686	0.353057
20	0.152996	-0.821137	52	-0.152996	-0.821137
21	0.117686	-0.588429	53	-0.117686	-0.588429
22	0.117686	-0.117686	54	-0.117686	-0.117686
23	0.117686	-0.353057	55	-0.117686	-0.353057
24	0.360142	0.932897	56	-0.360142	0.932897
25	0.353057	0.588429	57	-0.353057	0.588429
26	0.353057	0.117686	58	-0.353057	0.117686
27	0.353057	0.353057	59	-0.353057	0.353057
28	0.360142	-0.932897	60	-0.360142	-0.932897
29	0.353057	-0.588429	61	-0.353057	-0.588429
30	0.353057	-0.117686	62	-0.353057	-0.117686
31	0.353057	-0.353057	63	-0.353057	-0.353057

#### C.5.1.3 Data scrambling.

Data symbols for the 8PSK symbol constellation (3200 bps, 4800 bps) shall be scrambled by modulo 8 addition with a scrambling sequence. The data symbols for the 16QAM, 32QAM, and 64QAM constellations shall be scrambled by using an exclusive or (XOR) operation. Sequentially, the data bits forming each symbol (4 for 16QAM, 5 for 32QAM, and 6 for 64QAM) shall be XOR'd with an equal number of bits from the scrambling sequence. In all cases, the scrambling sequence generator polynomial shall be  $x^9 + x^4 + 1$  and the generator shall be

## MIL-STD-188-110C

w/CHANGE 1

## APPENDIX C

initialized to 1 at the start of each data frame. A block diagram of the scrambling sequence generator is shown in figure C-5.

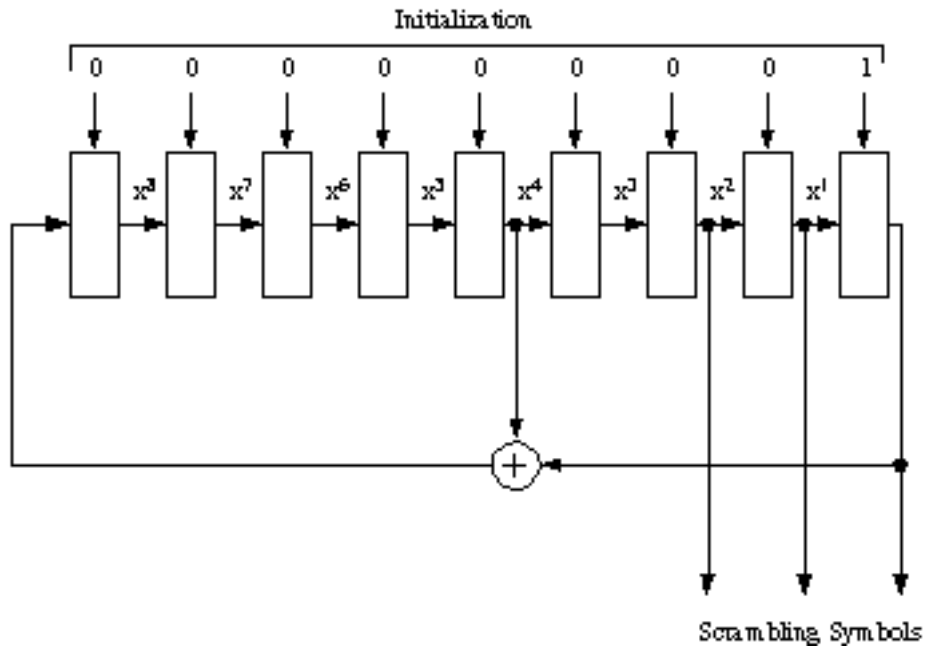

**FIGURE C- 5. Scrambling sequence generator illustrating scrambling generator for 8PSK symbols.**

For 8PSK symbols (3200 bps and 4800 bps), the scrambling shall be carried out taking the modulo 8 sum of the numerical value of the binary triplet consisting of the last (rightmost) three bits in the shift register, and the symbol number (transcoded value). For example, if the last three bits in the scrambling sequence shift register were 010 which has a numerical value equal 2, and the symbol number before scrambling was 6, symbol 0 would be transmitted since:  $(6+2) \text{ Modulo } 8 = 0$ . For 16QAM symbols, scrambling shall be carried out by XORing the 4 bit number consisting of the last (rightmost) four bits in the shift register with the symbol number. For example, if the last 4 bits in the scrambling sequence shift register were 0101 and the 16QAM symbol number before scrambling was 3 (i.e. 0011), symbol 6 (0110) would be transmitted. For 32QAM symbols, scrambling shall be carried out by XORing the 5 bit number formed by the last (rightmost) five bits in the shift register with the symbol number. For 64QAM symbols, scrambling shall be carried out by XORing the 6 bit number formed by the last (rightmost) six bits in the shift register with the symbol number.

After each data symbol is scrambled, the generator shall be iterated (shifted) the required number of times to produce all new bits for use in scrambling the next symbol (i.e., 3 iterations for 8PSK, 4 iterations for 16QAM, 5 iterations for 32QAM and 6 iterations for 64QAM). Since the generator is iterated after the bits are use, the first data symbol of every data frame shall, therefore, be scrambled by the appropriate number of bits from the initialization value of 00000001.

MIL-STD-188-110C  
w/CHANGE 1  
APPENDIX C

The length of the scrambling sequence is 511 bits. For a 256 symbol data block with 6 bits per symbol, this means that the scrambling sequence will be repeated just slightly more than 3 times, although in terms of symbols, there will be no repetition.

#### C.5.1.4 Modulation filter.

The role of the modulation filter is to spectrally constrain the transmit waveform to within the specified bandwidth. A square root of raised cosine filter is recommended with a roll off factor (excess bandwidth) of 35%. Utilizing this filter as both the modem modulation filter and demodulation filter will maximize the signal to noise ratio and minimize inter-symbol interference. The combined modulation and demodulation filters will have the following frequency response:

$$H(f) = 1 \quad \text{for } f \leq f_n - pf_n$$

$$H(f) = 0.5(1 - \sin((f-f_n) * \pi / 2pf_n)) \quad \text{for } f_n - pf_n \leq f \leq f_n + pf_n$$

$$H(f) = 0 \quad \text{elsewhere}$$

Where:

$f_n$  is the Nyquist frequency ( $f_n = 1 / (2T) = 1200$  Hz)

$p$  is the roll off factor or excess bandwidth.

The individual modulation and demodulation filters are realized by taking the square root of the above frequency response.

#### C.5.2 Frame structure.

The frame structure that shall be used for the waveforms specified in this appendix is shown in figure C-6. An initial 287 symbol preamble is followed by 72 frames of alternating data and known symbols. Each data frame shall consist of a data block consisting of 256 data symbols, followed by a mini-probe consisting of 31 symbols of known data. After 72 data frames, a 72 symbol subset of the initial preamble is reinserted to facilitate late acquisition, Doppler shift removal, and sync adjustment. It should be noted that the total length of known data in this segment is actually 103 symbols: the 72 reinserted preamble symbols plus the preceding 31 symbol mini-probe segment which follows the last 256 symbol data block.

MIL-STD-188-110C  
w/CHANGE 1  
APPENDIX C

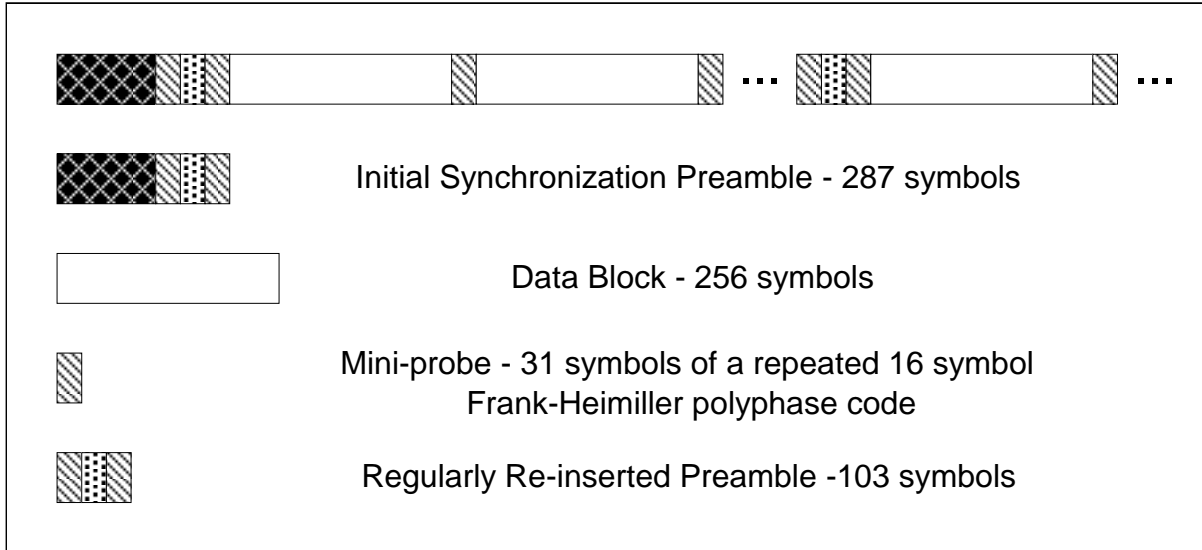

**FIGURE C- 6. Frame structure for all waveforms.**

C.5.2.1 Synchronization and reinserted preambles.

The synchronization preamble is used for rapid initial synchronization. The reinserted preamble is used to facilitate acquisition of an ongoing transmission (acquisition on data).

C.5.2.1.1 Synchronization preamble.

The synchronization preamble shall consist of two parts. The first part shall consist of at least N blocks of 184 8-PSK symbols to be used exclusively for radio and modem AGC. The value of N shall be configurable to range from values of 0 to 7 (for N=0 this first section is not sent at all). These 184 symbols shall be formed by taking the complex conjugate of the first 184 symbols of the sequence specified below for the second section.

The second section shall consist of 287 symbols. The first 184 symbols are intended exclusively for synchronization and Doppler offset removal purposes while the final 103 symbols, which are common with the reinserted preamble, also carry information regarding the data rate and interleaver settings.

MIL-STD-188-110C  
w/CHANGE 1  
APPENDIX C

Expressed as a sequence of 8PSK symbols, using the symbol numbers given in Table C-I the synchronization preamble shall be as shown in Table C-VIII:

**TABLE C- VIII. Synchronization preamble.**

<p>1, 5, 1, 3, 6, 1, 3, 1, 1, 6, 3, 7, 7, 3, 5, 4, 3, 6, 6, 4, 5, 4, 0,  2, 2, 2, 6, 0, 7, 5, 7, 4, 0, 7, 5, 7, 1, 6, 1, 0, 5, 2, 2, 6, 2, 3,  6, 0, 0, 5, 1, 4, 2, 2, 2, 3, 4, 0, 6, 2, 7, 4, 3, 3, 7, 2, 0, 2, 6,  4, 4, 1, 7, 6, 2, 0, 6, 2, 3, 6, 7, 4, 3, 6, 1, 3, 7, 4, 6, 5, 7, 2,  0, 1, 1, 1, 4, 4, 0, 0, 5, 7, 7, 4, 7, 3, 5, 4, 1, 6, 5, 6, 6, 4, 6,  3, 4, 3, 0, 7, 1, 3, 4, 7, 0, 1, 4, 3, 3, 3, 5, 1, 1, 1, 4, 6, 1, 0,  6, 0, 1, 3, 1, 4, 1, 7, 7, 6, 3, 0, 0, 7, 2, 7, 2, 0, 2, 6, 1, 1, 1,  2, 7, 7, 5, 3, 3, 6, 0, 5, 3, 3, 1, 0, 7, 1, 1, 0, 3, 0, 4, 0, 7, 3,  0, 0, 0, 0, 0, 2, 4, 6, 0, 4, 0, 4, 0, 6, 4, 2, 0, 0, 0, 0, 0, 2, 4, 6, 0, 4, 0, 4, 0, 6, 4,  2,  ( D<sub>0</sub>, D<sub>0</sub>, D<sub>0</sub>, D<sub>0</sub>, D<sub>0</sub>, D<sub>0</sub>, D<sub>0</sub>, D<sub>0</sub>, D<sub>0</sub>, D<sub>0</sub>, D<sub>0</sub>, D<sub>0</sub>, D<sub>0</sub> + 0, 4, 0, 4, 0, 0, 4, 4, 0, 0, 0, 0, 0) Modulo 8  ( D<sub>1</sub>, D<sub>1</sub>, D<sub>1</sub>, D<sub>1</sub>, D<sub>1</sub>, D<sub>1</sub>, D<sub>1</sub>, D<sub>1</sub>, D<sub>1</sub>, D<sub>1</sub>, D<sub>1</sub>, D<sub>1</sub>, D<sub>1</sub> + 0, 4, 0, 4, 0, 0, 4, 4, 0, 0, 0, 0, 0) Modulo 8  ( D<sub>2</sub>, D<sub>2</sub>, D<sub>2</sub>, D<sub>2</sub>, D<sub>2</sub>, D<sub>2</sub>, D<sub>2</sub>, D<sub>2</sub>, D<sub>2</sub>, D<sub>2</sub>, D<sub>2</sub>, D<sub>2</sub>, D<sub>2</sub> + 0, 4, 0, 4, 0, 0, 4, 4, 0, 0, 0, 0, 0) Modulo 8  6,  4, 4, 4, 4, 4, 6, 0, 2, 4, 0, 4, 0, 4, 2, 0, 6, 4, 4, 4, 4, 4, 6, 0, 2, 4, 0, 4, 0, 4, 2, 0</p>
---

where the data symbols D<sub>0</sub>, D<sub>1</sub>, and D<sub>2</sub> take one of 30 sets of values chosen from Table C-IX to indicate the data rate and interleaver settings. The Modulo operations are meant to signify that each of the D values are used to shift the phase of a length 13 bit Barker code (0101001100000) by performing modulo 8 addition of the D value with each of the Barker code 13 phase values (0 or 4). This operation can encode 6 bits of information using QPSK modulation of the 13 bit (chip) Barker codes. Since the three Barker code sequences only occupy 39 symbols, the 31 symbol mini-probes are lengthened to 32 symbols each to provide the additional 2 symbols required to pad the three 13 symbol Barker codes up to a total of 41 symbols.

MIL-STD-188-110C  
w/CHANGE 1  
APPENDIX C

**TABLE C- IX. D0, D1, D2 8 PSK symbol values as a function of data rate and interleaver length.**

Data Rate (bps)	Interleaver Length in Frames (256 Symbol Data Blocks)					
	1	3	9	18	36	72
3200	0,0,4	0,2,6	0,2,4	2,0,6	2,0,4	2,2,6
4800	0,6,2	0,4,0	0,4,2	2,6,0	2,6,2	2,4,0
6400	0,6,4	0,4,6	0,4,4	2,6,6	2,6,4	2,4,6
8000	6,0,2	6,2,0	6,2,2	4,0,0	4,0,2	4,2,0
9600	6,0,4	6,2,6	6,2,4	4,0,6	4,0,4	4,2,6
12800	6,6,2*	reserved	reserved	reserved	reserved	reserved

\* For 12800 bps 1 frame interleaver shall be interpreted as no interleaving

The mapping chosen to create Table C-IX uses 3 bits each to specify the data rate and interleaver length. The 3 data rate bits are the 3 most significant bits (MSB) of 3 dibit symbols and the interleaver length bits are the least significant bits (LSB). The phase of the Barker code is determined from the 3 resulting dibit words using TABLE C- III, the dibit transcoding Table. The 3 bit data rate and interleaver length mappings are shown in Table C-X. Note that the transcoding has the effect of placing the 3 interleaver length bits in quadrature with the 3 data rate bits.

**TABLE C- X. Bit patterns for specifying data rate and interleaver length.**

Data Rate	3 Bit Mapping	Interleaver Length	3 Bit Mapping	Name
reserved	000	illegal: see C.5.2.1.2	000	
3200	001	1 Frame	001	Ultra Short (US)
4800	010	3 Frames	010	Very Short (VS)
6400	011	9 Frames	011	Short (S)
8000	100	18 Frames	100	Medium (M)
9600	101	36 Frames	101	Long (L)
12800	110	72 Frames	110	Very Long (VL)
reserved	111	illegal: see C.5.2.1.2	111	

Because the Barker code is unbalanced in terms of the number of 0s and 1s, the 000 or 111 patterns exhibit a net imbalance in each quadrature component of the 39 symbols that is 12 to 27. These two patterns are reserved for future standardization of higher data rate modes that employ constellations more dense than those specified in C.5.1. The other 3-bit patterns are more balanced (17 to 22) and are used for the more robust constellations.

#### C.5.2.1.2 Reinserted preamble.

The reinserted preamble shall be identical to the final 72 symbols of the synchronization preamble. In fact, the final 103 symbols are common between the synchronization preamble and



MIL-STD-188-110C  
w/CHANGE 1  
APPENDIX C

the contiguous block consisting of the reinserted preamble and the mini-probe which immediately precedes it. The 103 symbols of known data (including the 31 mini-probe symbols of the preceding data frame) are thus:

**TABLE C- XI. Reinserted preamble.**

0, 0, 0, 0, 0, 2, 4, 6, 0, 4, 0, 4, 0, 6, 4, 2, 0, 0, 0, 0, 0, 2, 4, 6, 0, 4, 0, 4, 0, 6, 4,  
2,  
  
( D<sub>0</sub>, D<sub>0</sub>, D<sub>0</sub>, D<sub>0</sub>, D<sub>0</sub>, D<sub>0</sub>, D<sub>0</sub>, D<sub>0</sub>, D<sub>0</sub>, D<sub>0</sub>, D<sub>0</sub>, D<sub>0</sub>, D<sub>0</sub> + 0, 4, 0, 4, 0, 0, 4, 4, 0, 0, 0, 0, 0) Modulo 8  
( D<sub>1</sub>, D<sub>1</sub>, D<sub>1</sub>, D<sub>1</sub>, D<sub>1</sub>, D<sub>1</sub>, D<sub>1</sub>, D<sub>1</sub>, D<sub>1</sub>, D<sub>1</sub>, D<sub>1</sub>, D<sub>1</sub>, D<sub>1</sub> + 0, 4, 0, 4, 0, 0, 4, 4, 0, 0, 0, 0, 0) Modulo 8  
( D<sub>2</sub>, D<sub>2</sub>, D<sub>2</sub>, D<sub>2</sub>, D<sub>2</sub>, D<sub>2</sub>, D<sub>2</sub>, D<sub>2</sub>, D<sub>2</sub>, D<sub>2</sub>, D<sub>2</sub>, D<sub>2</sub>, D<sub>2</sub> + 0, 4, 0, 4, 0, 0, 4, 4, 0, 0, 0, 0, 0) Modulo 8  
  
6,  
4, 4, 4, 4, 4, 6, 0, 2, 4, 0, 4, 0, 4, 2, 0, 6, 4, 4, 4, 4, 4, 6, 0, 2, 4, 0, 4, 0, 4, 2, 0;

where the data symbols D<sub>0</sub>, D<sub>1</sub>, and D<sub>2</sub> again take one of 30 sets of values chosen from Table C-IX to indicate the data rate and interleaver settings as described in the Synchronization Preamble section above. The first 31 of these symbols are the immediately preceding mini-probe, which follows the last of the 72 data blocks.

Note that the 3 Bit Mappings for Interleaver Length of 000 or 111 may result in an S<sub>0</sub> to S<sub>8</sub> pattern that could be confused with the fixed (- - - - - +) mini probe pattern. For this reason, these mappings are referred to as “illegal” in Table C-X.

#### C.5.2.2 Mini-probes.

Mini-probes 31 symbols in length shall be inserted following every 256 symbol data block and at the end of each preamble (where they are considered to be part of the preamble). Using the 8PSK symbol mapping, each mini-probe shall be based on the repeated Frank-Heimiller sequence. The sequence that shall be used, specified in terms of the 8PSK symbol numbers, is given by:

0, 0, 0, 0, 0, 2, 4, 6, 0, 4, 0, 4, 0, 6, 4, 2, 0, 0, 0, 0, 0, 2, 4, 6, 0, 4, 0, 4, 0, 6, 4.

This mini-probe will be designated ‘+’.

The phase inverted version of this is:

4, 4, 4, 4, 4, 6, 0, 2, 4, 0, 4, 0, 4, 2, 0, 6, 4, 4, 4, 4, 4, 6, 0, 2, 4, 0, 4, 0, 4, 2, 0

and mini-probes using this sequence will be designated ‘-’, as the phase of each symbol has been rotated 180 degrees from the ‘+’.

There are a total of 73 mini-probes for each set of 72 data blocks. For convenience, each mini-probe will be sequentially numbered, with mini-probe 0 being defined as the last 31 symbols of

MIL-STD-188-110C  
w/CHANGE 1  
APPENDIX C

the preceding (reinserted) preamble, mini-probe number 1 following the first data block after a (reinserted) preamble. Mini-probe 72 follows the 72nd data block, and is also the first 31 symbols of the next 103 symbol reinserted preamble. Mini-probes 0 and 72 have been defined as part of the reinsertion preamble to have the signs - and + respectively. The data rate and interleaver length information encoded into the synchronization and reinserted preambles shall also be encoded into mini-probes 1 through 72. These 72 mini-probes are grouped into four sets of 18 consecutive mini-probes (1 to 18, 19 to 36, 37 to 54, and 55 to 72). Note that the 256 symbol data block that immediately follows the 18<sup>th</sup> mini-probe, in each of the first three sets, is also the 1<sup>st</sup> data block of an interleaver block with frame lengths of 1, 3, 9, and 18. The length 36 interleaver block begins after the second set, and a reinserted preamble begins after the fourth set. This structure permits data to begin to be demodulated as soon as the interleaver boundary becomes known.

Each 18 mini-probe sequence shall consists of seven - signs, a + sign, followed by six sign values that are dependent on the data rate and interleaver length, three sign values that specify which of the four sets of 18 mini-probes it is, and then finally a + sign. For the fourth set, this final + sign (mini-probe 72) is also the initial mini-probe of the next reinserted preamble (which uses the + phase).

Pictorially, this length 18 sequence is: - - - - - - + S<sub>0</sub>S<sub>1</sub>S<sub>2</sub>S<sub>3</sub>S<sub>4</sub>S<sub>5</sub>S<sub>6</sub>S<sub>7</sub>S<sub>8</sub> +, where the first six S<sub>i</sub> sign values are defined in Table C-XII. Note that these 6 bit patterns (+ is a 0) correspond to the concatenation of the 3 bit mappings from Table C-X for the data rate (S<sub>0</sub> S<sub>1</sub> S<sub>2</sub>) and the interleaver length (S<sub>3</sub> S<sub>4</sub> S<sub>5</sub>). The final three S<sub>i</sub> sign values which specify the mini-probe set (count) are defined in Table C-XIII.

**TABLE C- XII. S<sub>0</sub>, S<sub>1</sub>, S<sub>2</sub>, S<sub>3</sub>, S<sub>4</sub>, S<sub>5</sub> (sign) values as a function of data rate and interleaver setting.**

Data Rate (bps)	Interleaver Length in Frames (256 Symbol Data Blocks)					
	1	3	9	18	36	72
3200	+++++	+++--	++++-	+++++	++++-	+++++
4800	+-----	+++--	+-----	+-----	+-----	+-----
6400	+++++	+++--	++++-	+++++	++++-	+++++
8000	+++++	+++--	++++-	+++++	+++--	+++--
9600	+-----	+++--	++++-	+++++	+++--	+++--
12800	+++++	N/A	N/A	N/A	N/A	N/A

**TABLE C- XIII. S<sub>6</sub>, S<sub>7</sub>, S<sub>8</sub> (sign) values as a function of mini-probe set.**

Mini-probe set			
1 to 18	19 to 36	37 to 54	55 to 72
+++	+++	+++	+++



MIL-STD-188-110C  
w/CHANGE 1  
APPENDIX C

contain all of the encoded bits for a single input data block. The first data symbol from the first data frame in each interleaver set shall have as its MSB the first bit fetched from the interleaver. This is no different from what would normally be expected, but is a requirement.

C.5.3.2 Block encoding.

The full-tail-biting and puncturing techniques shall be used with a rate 1/2 convolutional code to produce a rate 3/4 block code that is the same length as the interleaver.

C.5.3.2.1 Rate 1/2 convolutional code.

A constraint length 7, rate 1/2 convolutional code shall be used prior to puncturing. This shall be the same code as is used in the single-tone waveform described in section 5.3.2 of this standard. figure C-7 is a pictorial representation of the encoder.

MIL-STD-188-110C  
w/CHANGE 1  
APPENDIX C

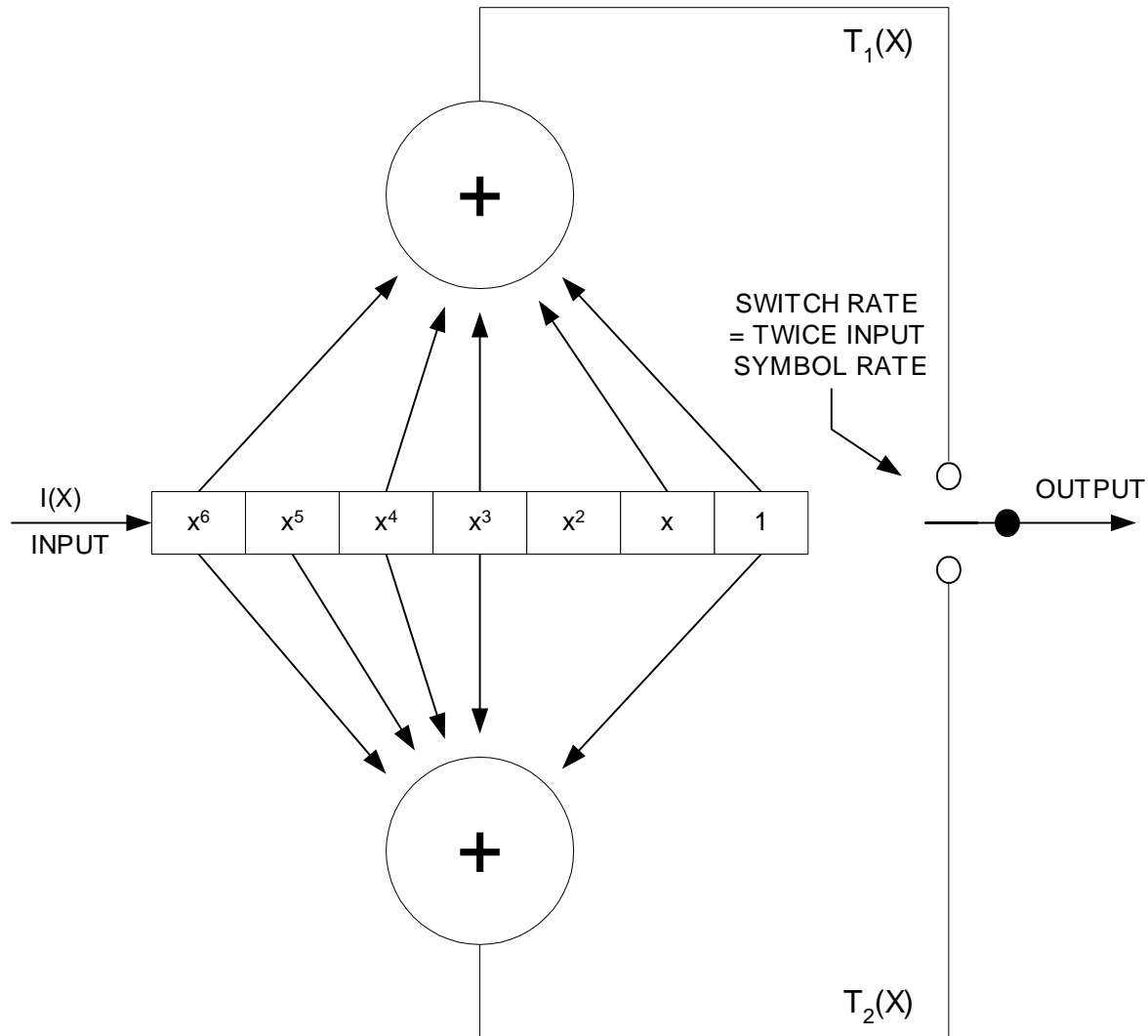

CONSTRAINT LENGTH = 7  
GENERATOR POLYNOMIALS:  
FOR  $T_1$   $X^6+X^4+X^3+X+1$   
FOR  $T_2$   $X^6+X^5+X^4+X^3+1$

**FIGURE C-7. Constraint length 7, rate 1/2 convolutional encoder.**

The two summing nodes in the figure represent modulo 2 addition. For each bit input to the encoder, two bits are taken from the encoder, with the upper output bit,  $T_1(x)$ , taken first.

**C.5.3.2.2 Full-tail-biting encoding.**

To begin encoding each block of input data, the encoder shall be preloaded by shifting in the first six input data bits without taking any output bits. These six input bits shall be temporarily saved so that they can be used to “flush” the encoder. The first two coded output bits shall be taken after the seventh bit has been shifted in, and shall be defined to be the first two bits of the resulting block code. After the last input data bit has been encoded, the first six “saved” data bits

MIL-STD-188-110C  
w/CHANGE 1  
APPENDIX C

shall be encoded. Note that the encoder shift register should not be changed before encoding these saved bits; i.e., it should be filled with the last seven input data bits. The six “saved” data bits are encoded by shifting them into the encoder one at a time, beginning with the earliest of the six. The encoding thus continues by taking the two resulting coded output bits as each of the saved six bits is shifted in. These encoded bits shall be the final bits of the resulting (unpunctured) block code. Prior to puncturing, the resulting block code will have exactly twice as many bits as the input information bits. Puncturing of the rate 1/2 code to the required rate 3/4 shall be done prior to sending bits to the interleaver.

C.5.3.2.3 Puncturing to rate 3/4.

In order to obtain a rate 3/4 code from the rate 1/2 code used, the output of the encoder must be punctured by not transmitting 1 bit out of every 3. Puncturing shall be performed by using a puncturing mask of 1 1 1 0 0 1, applied to the bits output from the encoder. In this notation a 1 indicates that the bit is retained and a 0 indicates that the bit is not transmitted. For an encoder generated sequence of

$$T_1(k), T_2(k), T_1(k+1), T_2(k+1), T_1(k+2), T_2(k+2) \dots$$

the transmitted sequence shall be

$$T_1(k), T_2(k), T_1(k+1), T_2(k+2) \dots$$

Defining  $T_1(0)$ ,  $T_2(0)$  to be the first two bits of the block code generated as defined in paragraph C.5.3.2, then the value of  $k$  in the above sequences shall be an integral multiple of 3. The block code shall be punctured in this manner before being input to the interleaver.

C.5.3.3 Block interleaver structure.

The block interleaver used is designed to separate neighboring bits in the punctured block code as far as possible over the span of the interleaver with the largest separations resulting for the bits that were originally closest to each other. Because of the 30 different combinations of data rates and interleaver lengths, a more flexible interleaver structure than used for the single-tone waveform described in section 5.3.2 of this standard is needed. The structure to be used is actually simpler than that used previously.

MIL-STD-188-110C  
w/CHANGE 1  
APPENDIX C

C.5.3.3.1 Interleaver size in bits.

The interleaver shall consist of a single dimension array, numbered from 0 to its size in bits –1. The array size shall depend on both the data rate and interleaver length selected as shown in Table C-XV.

**TABLE C- XV. Interleaver size in bits as a function of data rate and interleaver length.**

Data Rate (bps)	Interleaver Length in Frames					
	1	3	9	18	36	72
	Interleaver Size in Bits					
3200	512	1536	4608	9216	18,432	36,864
4800	768	2304	6912	13,824	27,648	55,296
6400	1024	3072	9216	18,432	36,864	73,728
8000	1280	3840	11,520	23,040	46,080	92,160
9600	1536	4608	13,824	27,648	55,296	110,592

C.5.3.3.2 Interleaver load.

The punctured block code bits shall be loaded into the interleaver array beginning with location 0. The location for loading each successive bit shall be obtained from the previous location by incrementing by the “Interleaver Increment Value” specified in Table C-XVI, modulo the “Interleaver Size in Bits.”

Defining the first punctured block code bit to be B(0), then the load location for B(n) is given by:

$$\text{Load Location} = (n * \text{Interleaver Increment Value}) \text{ Modulo } (\text{Interleaver Size in Bits})$$

Thus for 3200 bps, with a one frame interleaver (512 bit size with an increment of 97), the first 8 interleaver load locations are: 0, 97, 194, 291, 388, 485, 582, and 679.

**TABLE C- XVI. Interleaver increment value as a function of data rate and interleaver length.**

Data Rate (bps)	Interleaver Length in Frames					
	1	3	9	18	36	72
	Interleaver Increment Value					
3200	97	229	805	1393	3281	6,985
4800	145	361	1045	2089	5137	10,273
6400	189	481	1393	3281	6985	11,141
8000	201	601	1741	3481	8561	14,441
9600	229	805	2089	5137	10,273	17,329

These increment values have been chosen to ensure that the combined cycles of puncturing and assignment of bit positions in each symbol for the specific constellation being used is the same as

MIL-STD-188-110C  
w/CHANGE 1  
APPENDIX C

if there had been no interleaving. This is important, because each symbol of a constellation contains “strong” and “weak” bit positions, except for the lowest data rate. Bit position refers to the location of the bit, ranging from MSB to LSB, in the symbol mapping. A strong bit position is one that has a large average distance between all the constellation points where the bit is a 0 and the closest point where it is a 1. Typically, the MSB is a strong bit and the LSB a weak bit. An interleaving strategy that did not evenly distribute these bits in the way they occur without interleaving could degrade performance.

C.5.3.3.3 Interleaver fetch.

The fetching sequence for all data rates and interleaver lengths shall start with location 0 of the interleaver array and increment the fetch location by 1. This is a simple linear fetch from beginning to end of the interleaver array.

C.5.4 Operational features and message protocols.

The format of this narrowband MDR waveform has been designed to permit it to work well with most of the protocols used and planned for use with HF. The reinserted preamble facilitates acquisition (or re-acquisition) of an ongoing broadcast transmission. The short length of the synchronization preamble, wide range of interleaving lengths, and the use of full-tail-biting coding is intended to provide efficient operation with ARQ protocols. To further enhance the operation with these protocols, the following operational features shall be included in the HF modem.

C.5.4.1 User interfaces.

C.5.4.1.1 Conventional asynchronous interface.

In addition to the standard synchronous serial interface (see 4.2.3), the modem shall also be capable of interfacing with an asynchronous DTE. In this case the DTE provides (accepts) asynchronous Words consisting of a Start Bit, an N bit Character, and some minimum number of Stop Bits. Additional Stop Bits are provided (accepted) by the DTE between Words as necessary to accommodate gaps between their occurrence. Interoperability shall be provided for those cases where the value of N, the number of Bits in the Character, is 5,6,7, or 8 (including any parity bits), and the minimum number of Stop Bits is 1 or 2. Hence interoperability is defined for those cases where the number of Bits in the Word is N+2 and N+3. In these cases the entire N+2 or N+3 bits of the Word shall be conveyed contiguously in the modulated signal. Additional Stop Bits shall be conveyed as necessary to accommodate gaps in data from the DTE; there shall be no modem-defined null character incorporated into the modulated signal.

C.5.4.1.2 High speed asynchronous user interface with flow control.

Certain high speed user interfaces provide data to (and accept data from) the modem in units of 8 bit bytes. Furthermore, the Input Data Blocks shown in Table C-XIV are all multiples of 8 bit bytes. An optional mode shall be provided to accommodate the special case of an 8 bit character (which includes any parity check bits) and a 1.0 unit interval Stop Bit. In this optional mode, the 8 bit Character shall be aligned with the 256 symbol modem frame boundary, and no Start or Stop Bits shall be transmitted. In this mode of operation it is assumed that the DTE data rate is greater than that which can be accommodated by the modem. Consequently flow control shall be



MIL-STD-188-110C  
w/CHANGE 1  
APPENDIX C

used to temporarily stop data flow from the DTE to the modem when the modem's input buffer becomes full. Conversely, when the modem's input buffer becomes empty, the modem shall assume that the DTE has finished its message, and the modem shall initiate its normal message-termination procedure. This method of operation obviates the need for the transmission of Null characters for the purpose of "rate padding." Consequently, no Null characters shall be transmitted for this purpose.

C.5.4.1.3 Ethernet interface.

The modem shall provide an Ethernet interface (see Appendix A) for byte oriented user data transfers (see C.5.4.1.2), and these bytes shall be aligned with the Input Data Block boundaries.

C.5.4.2 Onset of transmission.

The modem shall begin a transmission no later than 100 ms after it has received an entire input data block (enough bits to fill a coded and interleaved block), or upon receipt of the last input data bit, whichever occurs first. The latter would only occur when the message is shorter than one interleaver block. A transmission shall be defined as beginning with the keying of the radio, followed by the output of the preamble waveform after the configured pre-key delay, if any.

The delay between when the modem receives the first input data bit and the onset of transmission will be highly dependent on the means for delivery of the input data bits to the modem. A synchronous serial interface at the user data rate will have the greatest delay. For this reason it is recommended that a high speed asynchronous interface (serial or Ethernet port) with flow-control be used if this delay is of concern for the deployed application.

C.5.4.3 End of message.

The use of an end-of-message (EOM) in the transmit waveform shall be a configurable option. When the use of an EOM has been selected, a 32-bit EOM pattern shall be appended after the last input data bit of the message. The EOM, expressed in hexadecimal notation is 4B65A5B2, where the left most bit is sent first. If the last bit of the EOM does not fill out an input data block, the remaining bits in the input data block shall be set to zero before encoding and interleaving the block.

If the use of an EOM has been inhibited, and the last input data bit does not fill out an input data block, the remaining bits in the input data block shall be set to zero before encoding and interleaving the block. It is anticipated that the use of an EOM will only be inhibited when an ARQ data protocol uses ARQ blocks which completely fill (or nearly so) the selected input data block size (interleaver block). Without this feature, the use of an EOM would require the transmission of an additional interleaver block under these circumstances.

C.5.4.4 Termination of a transmission.

Upon receipt of a radio silence (or equivalent) command, the modem shall immediately un-key the radio and terminate its transmit waveform.

In normal operation, the modem shall terminate a transmission only after the transmission of the final data frame, including a mini-probe, associated with the final interleaver block. Note that a data frame consists of a 256 symbol data block followed by a mini-probe. Note that any signal

MIL-STD-188-110C  
w/CHANGE 1  
APPENDIX C

processing and/or filter delays in the modem and the HF transmitter must be accounted for (as part of the key line control timing) to ensure that the entire final mini-probe is transmitted before the transmitter power is turned off.

C.5.4.5 Termination of receive data processing.

There are a number of events which shall cause the HF modem to cease processing the received signal to recover data, and return to the acquisition mode. These are necessary because a modem is not able to acquire a new transmission while it is attempting to demodulate and decode data.

C.5.4.5.1 Detection of EOM.

The HF modem shall always scan all of the decoded bits for the 32-bit EOM pattern defined in paragraph C.5.4.3. Upon detection of the EOM the modem shall return to the acquisition mode. The modem shall continue to deliver decoded bits to the user (DTE) until the final bit immediately preceding the EOM has been delivered.

C.5.4.5.2 Command to return to acquisition.

Upon receipt of a command to terminate reception, the HF modem shall return to the acquisition mode and terminate the delivery of decoded bits to the user (DTE).

C.5.4.5.3 Receipt of a specified number of data blocks.

The maximum message duration measured in number of Input Data Blocks (interleaver blocks) shall be a configurable parameter. One value of this parameter shall specify that an unlimited number may be received. Once the modem has decoded and delivered to the user (DTE), the number of bits corresponding to the configured maximum message duration, the HF modem shall return to the acquisition mode and terminate the delivery of decoded bits to the user (DTE). Note that for a given interleaver length, this parameter also specifies the maximum message duration in time, independent of the bit rate. Note that this parameter is the maximum duration and that the transmit end always has the option of using an EOM for shorter transmissions.

Operation with a specified number of input data blocks may be used by an ARQ protocol where the size of the ARQ packet is fixed, or occasionally changed to accommodate changing propagation conditions. In this case we anticipate that this parameter (maximum message duration) will be sent to the receiving end of the link as part of the ARQ protocol. It would then be sent to the receiving modem through the remote control interface (see C.5.4.6 below), since it is not embedded in the waveform itself as the data rate and interleaver length parameters are.

C.5.4.5.4 Initiation of a transmission.

If, and only if, the HF Modem is configured to operate in half-duplex mode with transmit override, the initiation of a transmission by the user (DTE) shall cause the HF modem to terminate the receive processing and the delivery of decoded bits to the user (DTE).

C.5.4.6 Remote control.

The remote control interface (see section 5.3.1.5) shall provide the capability to specify the following parameters and commands:

- a. MDR waveform parameters:
  - 1) The 5 data rates for the MDR waveform

MIL-STD-188-110C

w/CHANGE 1

APPENDIX C

- 2) The 6 interleaver lengths for the MDR waveform
  - b. A command to select the usage of the optional EOM in the transmit waveform. Note that the receiving modem must always scan for the EOM regardless of this setting.
  - c. A command to specify the maximum message duration measured in number of Input Data Blocks (interleaver blocks). The value of 0 (zero) for this parameter shall specify that an unlimited number may be received.
  - d. A command to cause the modem to terminate receive data processing and return to acquisition mode.

MIL-STD-188-110C  
w/CHANGE 1  
APPENDIX C

## C.6 PERFORMANCE

### C.6.1 BER performance.

The measured performance of the narrowband MDR waveform, using fixed-frequency operation and employing the maximum interleaving period (the 72-frame “Very Long” interleaver), shall achieve coded BER of no more than 1.0E-5 under each of the conditions listed in Table C-XVII.

**TABLE C- XVII. MDR waveform performance requirements.**

User data rate (bps)	Average SNR (dB) for BER $\leq$ 1.0E-5	
	AWGN Channel	ITU-R Poor Channel
12800	27	-
9600	21	31
8000	19	27
6400	16	23
4800	13	19
3200	9	14

Performance shall be tested using a baseband HF simulator patterned after the Watterson Model in accordance with Appendix E.

- The AWGN channel shall consist of a single, non-fading path. Each condition shall be measured for at least 60 minutes.
- The ITU-R Poor channel shall consist of two independent but equal average power Rayleigh fading paths, with a fixed 2 ms delay between paths, and with a fading (two sigma) bandwidth (BW) of 1 Hz. Each condition shall be measured for at least 5 hours.
- Both signal and noise power shall be measured in a 3 kHz bandwidth. Note that the average power of QAM symbols is different from that of the 8PSK mini-probes and reinserted preambles; the measured signal power shall be the long-term average of user data, mini-probe, and reinserted preamble symbols.

When testing a modem embedded with a radio, so that only radio frequency (RF) signals are available for testing, the RF signals must be downconverted to baseband for processing by the channel simulator, and the result upconverted to RF for the receiver. In this case, the built-in radio filters will affect the performance of the modems. Therefore, when testing embedded modems, the SNR values specified in Table C-XVII shall be increased by 2 dB (3 dB at 9600 bps and above).

When the sending and receiving modems used in this test are not identical make and model, an extra dB of SNR shall be allowed due to potential degradation in mismatched filters.

### C.6.2 Acquisition performance.

Not yet standardized.

MIL-STD-188-110C  
w/CHANGE 1  
APPENDIX C

C.6.3 Doppler shift test.

The modem shall acquire and maintain synchronization for at least 5 minutes with a test signal having the following characteristics: 9600 bps/Very Long interleaver, 75 Hz frequency offset, 2 ms delay spread, a fading BW of 1 Hz, and an average SNR of 30 dB. The test shall be repeated with a -75 Hz frequency offset. No BER test is required.

C.6.4 Doppler sweep performance.

The AWGN BER test at 9600 bps from Table C-XVII shall be repeated with a test signal having a frequency offset that continuously varies at a rate of 3.5 Hz/s between the limits of -75 and +75 Hz, such that a plot of frequency offset vs. time describes a periodic “triangle” waveform having a period of (300/3.5) seconds. Over a test duration of 1 hour, the modem shall achieve a BER of 1.0E-5 or less at an SNR of 24 dB.

C.7 ASSOCIATED COMMUNICATIONS EQUIPMENT

The QAM constellations specified in this appendix are more sensitive to equipment variations than the PSK constellations specified in section 5.3.2 of this standard. Because of this sensitivity, radio filters will have a significant impact on the performance of modems implementing the waveforms in this appendix. In addition, because of the level sensitive nature of the QAM constellations, turn-on transients, AGC, and ALC can cause significant performance degradation.

It is recommended that modems implementing the waveforms in this appendix should include a variable pre-key feature, by which the user can specify a delay between the time when the transmitter is keyed and the modem signal begins. This allows for turn-on transient settling, which is particularly important for legacy radio equipment.

It is recommended that a slow AGC setting (e.g., the “nondata” mode in MIL-STD-188-141) be used when receiving the waveforms in this appendix.

MIL-STD-188-110C  
w/CHANGE 1  
APPENDIX D

HF DATA MODEM WAVEFORMS FOR SINGLE CONTIGUOUS BANDWIDTHS  
UP TO 24 KHZ

TABLE OF CONTENTS

<u>PARAGRAPH</u> .....	<u>PAGE</u>
D.1 GENERAL.....	140
D.1.1 Scope.....	140
D.1.2 Applicability.....	140
D.2 APPLICABLE DOCUMENTS.....	140
D.3 DEFINITIONS.....	140
D.3.1 Abbreviations and acronyms.....	140
D.4 GENERAL REQUIREMENTS.....	141
D.4.1 WBHF Block 1 Requirements.....	141
D.4.2 WBHF Block 2 Requirements.....	141
D.4.3 WBHF Block 3 Requirements.....	141
D.5 DETAILED REQUIREMENTS.....	142
D.5.1 Modulation.....	142
D.5.1.1 Known symbols.....	142
D.5.1.2 Data symbols.....	142
D.5.1.2.1 PSK data symbols.....	144
D.5.1.2.2 QAM data symbols.....	147
D.5.1.2.3 Walsh Orthogonal Modulation.....	157
D.5.1.3 Data scrambling.....	157
D.5.1.4 Waveform ID 0 Walsh Orthogonal Modulation Data scrambling.....	159
D.5.1.5 Modulation filter.....	160
D.5.2 Frame structure.....	161
D.5.2.1 Synchronization preamble.....	163
D.5.2.1.1 4-ary Orthogonal Walsh Modulation in the preamble.....	163
D.5.2.1.2 TLC Section.....	164
D.5.2.1.3 Synchronization Section.....	164
D.5.2.2 Mini-probes.....	168
D.5.3 Coding and interleaving.....	187
D.5.3.1 Block boundary alignment.....	196
D.5.3.2 Block encoding.....	196

MIL-STD-188-110C  
w/CHANGE 1  
APPENDIX D

D.5.3.2.1	Constraint length 7, rate 1/2 convolutional code.....	198
D.5.3.2.2	Constraint length 9, rate 1/2 convolutional code.....	199
D.5.3.2.3	Full-tail-biting encoding.....	199
D.5.3.2.4	Puncturing and Repetition.....	200
D.5.3.3	Block interleaver structure.....	201
D.5.3.3.1	Interleaver size in bits.....	201
D.5.3.3.2	Interleaver load.....	201
D.5.3.3.3	Interleaver fetch.....	209
D.5.4	Operational features and message protocols.....	210
D.5.4.1	User interfaces.....	210
D.5.4.1.1	Conventional synchronous interface.....	210
D.5.4.1.2	Conventional asynchronous interface.....	210
D.5.4.1.3	High speed asynchronous user interface with flow control.....	210
D.5.4.1.4	Ethernet interface.....	210
D.5.4.2	Onset of transmission.....	211
D.5.4.3	End of message.....	211
D.5.4.4	Termination of a transmission.....	211
D.5.4.5	Termination of receive data processing.....	213
D.5.4.5.1	Detection of EOM.....	214
D.5.4.5.2	Command to return to acquisition.....	214
D.5.4.5.3	Receipt of a specified number of data blocks.....	214
D.5.4.5.4	Initiation of a transmission.....	214
D.5.4.6	Remote control.....	214
D.6	PERFORMANCE.....	215
D.6.1	BER performance on AWGN and Multipath Fading Channels.....	215
D.6.2	BER performance on static multipath channels.....	216
D.6.3	Acquisition performance.....	217
D.6.4	Doppler shift test.....	217
D.6.5	Doppler sweep performance.....	218
D.7	ASSOCIATED COMMUNICATIONS EQUIPMENT.....	218

MIL-STD-188-110C  
w/CHANGE 1  
APPENDIX D

**LIST OF FIGURES**

• FIGURE D-1. 8PSK SIGNAL CONSTELLATION AND SYMBOL MAPPING. ....	146
• FIGURE D-2. 16QAM SIGNALING CONSTELLATION. ....	147
• FIGURE D-3. 32QAM SIGNALING CONSTELLATION. ....	149
• FIGURE D-4. 64QAM SIGNALING CONSTELLATION. ....	150
• FIGURE D-5. 256QAM SIGNALING CONSTELLATION. ....	152
• FIGURE D-6. SCRAMBLING SEQUENCE GENERATOR ILLUSTRATING SCRAMBLING GENERATOR FOR PSK SYMBOLS. ....	158
• FIGURE D-7. FRAME STRUCTURE FOR WAVEFORMS 1-13. ....	161
• FIGURE D-8. SYNCHRONIZATION PREAMBLE STRUCTURE. ....	163
• FIGURE D-9. CONSTRAINT LENGTH 7, RATE 1/2 CONVOLUTIONAL ENCODER. ....	198
• FIGURE D-10. CONSTRAINT LENGTH 9, RATE 1/2 CONVOLUTIONAL ENCODER. ....	199

**LIST OF TABLES**

• TABLE D-I. SYMBOL RATES AND SUB CARRIER. ....	142
• TABLE D-II. MODULATION USED TO OBTAIN EACH DATA RATE. ....	143
• TABLE D-III. TRANSCODING FOR BPSK. ....	144
• TABLE D-IV. TRANSCODING FOR QPSK. ....	145
• TABLE D-V. TRANSCODING FOR 8PSK. ....	145
• TABLE D-VI. 8PSK SYMBOL MAPPING. ....	146
• TABLE D-VII. IN-PHASE AND QUADRATURE COMPONENTS OF EACH 16QAM SYMBOL. ....	148
• TABLE D-VIII. IN-PHASE AND QUADRATURE COMPONENTS OF EACH 32QAM SYMBOL. ....	149
• TABLE D-IX. IN-PHASE AND QUADRATURE COMPONENTS OF EACH 64QAM SYMBOL. ....	151
• TABLE D-X. IN-PHASE AND QUADRATURE COMPONENTS OF EACH 256QAM SYMBOL. ....	153
• TABLE D- XI. NUMBER OF UNKNOWN (DATA) SYMBOLS IN FRAME. ....	162
• TABLE D- XII. NUMBER OF KNOWN SYMBOLS (MINI-PROBE) IN FRAME. ....	162
• TABLE D-XIII. LENGTH OF PREAMBLE SYNCHRONIZATION SECTION CHANNEL SYMBOLS. ....	163
• TABLE D-XIV. WALSH SEQUENCES FOR SYNCHRONIZATION SECTION OF THE PREAMBLE. ....	164
• TABLE D-XV. TLC / FIXED SYNCHRONIZATION PREAMBLE. ....	167
• TABLE D-XVI. COUNT SYNCHRONIZATION PREAMBLE. ....	167
• TABLE D-XVII. WAVEFORM NUMBER SYNCHRONIZATION PREAMBLE. ....	168
• TABLE D-XVIII. WAVEFORM NUMBER MAPPING. ....	166
• TABLE D-XIX. INTERLEAVER SELECTION MAPPING. ....	166
• TABLE D-XX. CONSTRAINT LENGTH AND VOICE MODE MAPPING. ....	167



MIL-STD-188-110C  
w/CHANGE 1  
APPENDIX D

**LIST OF TABLES (continued)**

- TABLE D-XXI. MINI-PROBE LENGTHS AND BASE SEQUENCES.....169
- TABLE D-XXII (A). IN-PHASE AND QUADRATURE COMPONENTS OF BASE SEQUENCE OF LENGTH 13 USED TO FORM 24 SYMBOL MINI-PROBE(TBD). .....170
- TABLE D-XXII (B). IN-PHASE AND QUADRATURE COMPONENTS OF LENGTH 24 MINI-PROBE .....171
- TABLE D-XXII(C). IN-PHASE AND QUADRATURE COMPONENTS OF LENGTH 24 MINI-PROBE CYCLICALLY SHIFTED BY 6 SYMBOLS.....172
- TABLE D-XXIII. IN-PHASE AND QUADRATURE COMPONENTS OF 16 SYMBOL BASE SEQUENCE USED TO FORM THE 32 SYMBOL MINI-PROBE. ....173
- TABLE D-XXIV. IN-PHASE AND QUADRATURE COMPONENTS OF 19 SYMBOL BASE SEQUENCE USED TO FORM THE 36 SYMBOL MINI-PROBE .....174
- TABLE D-XXV. IN-PHASE AND QUADRATURE COMPONENTS OF 25 SYMBOL BASE SEQUENCE USED TO FORM THE 48 SYMBOL MINI-PROBE. ....175
- TABLE D-XXVI. IN-PHASE AND QUADRATURE COMPONENTS OF 36 SYMBOL BASE SEQUENCE USED TO FORM THE 64 AND 72 SYMBOL MINI-PROBES.....176
- TABLE D-XXVII. IN-PHASE AND QUADRATURE COMPONENTS OF LENGTH 49 BASE SEQUENCE USED TO FORM THE 96 SYMBOL MINI-PROBE. ....177
- TABLE D-XXVIII. IN-PHASE AND QUADRATURE COMPONENTS OF LENGTH 64 BASE SEQUENCE USED TO FORM 128 SYMBOL MINI-PROBE. ....178
- TABLE D-XXIX. IN-PHASE AND QUADRATURE COMPONENTS OF 81 SYMBOL BASE SEQUENCE USED TO FORM THE 144 AND 160 SYMBOL MINI-PROBES.....179
- TABLE D-XXX. IN-PHASE AND QUADRATURE COMPONENTS OF 100 SYMBOL BASE SEQUENCE USED TO FORM THE 192 SYMBOL MINI-PROBE. ....181
- TABLE D-XXXI. IN-PHASE AND QUADRATURE COMPONENTS OF 121 SYMBOL BASE SEQUENCE USED TO FORM THE 224 AND 240 SYMBOL MINI-PROBES.....183
- TABLE D-XXXII. IN-PHASE AND QUADRATURE COMPONENTS OF 144 SYMBOL BASE SEQUENCE USED TO FORM THE 272 SYMBOL MINI-PROBE. ....185
- TABLE D-XXXIII. INTERLEAVER PARAMETERS FOR 3KHZ BANDWIDTH .....188
- TABLE D-XXXIV. INTERLEAVER PARAMETERS FOR 6KHZ BANDWIDTH .....189
- TABLE D-XXXV. INTERLEAVER PARAMETERS FOR 9KHZ BANDWIDTH .....190
- TABLE D-XXXVI. INTERLEAVER PARAMETERS FOR 12KHZ BANDWIDTH .....191
- TABLE D-XXXVII. INTERLEAVER PARAMETERS FOR 15KHZ BANDWIDTH.....192
- TABLE D-XXXVIII. INTERLEAVER PARAMETERS FOR 18KHZ BANDWIDTH .....193
- TABLE D-XXXIX. INTERLEAVER PARAMETERS FOR 21KHZ BANDWIDTH .....194
- TABLE D-XL. INTERLEAVER PARAMETERS FOR 24KHZ BANDWIDTH.....195
- TABLE D-XLI. CODE RATE AND MODULATION. ....197

MIL-STD-188-110C  
w/CHANGE 1  
APPENDIX D

**LIST OF TABLES (continued)**

- TABLE D-XLII. PUNCTURE PATTERNS.....201
- TABLE D-XLIII. INTERLEAVER INCREMENT VALUE FOR 3 KHZ WAVEFORM .....202
- TABLE D-XLIV. INTERLEAVER INCREMENT VALUE FOR 6 KHZ WAVEFORM.....203
- TABLE D-XLV. INTERLEAVER INCREMENT VALUE FOR 9 KHZ WAVEFORM .....204
- TABLE D-XLVI. INTERLEAVER INCREMENT VALUE FOR 12 KHZ WAVEFORM.....205
- TABLE D-XLVII. INTERLEAVER INCREMENT VALUE FOR 15 KHZ WAVEFORM...206
- TABLE D-XLVIII. INTERLEAVER INCREMENT VALUE FOR 18 KHZ WAVEFORM ..207
- TABLE D-XLIX. INTERLEAVER INCREMENT VALUE FOR 21 KHZ WAVEFORM.....208
- TABLE D-L. INTERLEAVER INCREMENT VALUE FOR 24 KHZ WAVEFORM .....209
- TABLE D-LI. IN-PHASE AND QUADRATURE COMPONENTS OF 13 SYMBOL BASE  
SEQUENCE USED TO FORM 24 SYMBOL MINI-PROBE AND  
CYCLICALLY EXTENDED BY 32 SYMBOLS TO MARK THE EOT. ....213
- TABLE D-LII. DATA PERFORMANCE REQUIREMENTS, ALL BANDWIDTHS. ....216
- TABLE D-LIII. STATIC CHANNEL TESTS.....217

MIL-STD-188-110C  
w/CHANGE 1  
APPENDIX D

D.1 SCOPE

D.1.1 Scope.

This appendix describes the HF data modem waveforms for use with single contiguous bandwidths from 3 KHz to 24 KHz.

D.1.2 Applicability.

This appendix is a non-mandatory part of MIL-STD-188-110C; however, when data is to be communicated in single contiguous HF radio bandwidths greater than 3 kHz, up to 24 kHz, the waveforms employed shall be in accordance with this appendix.

D.2 APPLICABLE DOCUMENTS

This section is not applicable to this appendix.

D.3 DEFINITIONS

D.3.1 Abbreviations and acronyms.

Abbreviations and acronyms used in this appendix are defined below. Also see section 3 of this document.

WBHF

Wide Band High Frequency (radio)

MIL-STD-188-110C  
w/CHANGE 1  
APPENDIX D

#### D.4 GENERAL REQUIREMENTS

This appendix presents a family of wideband high-frequency radio (WBHF) modem waveforms and coding specifications for bandwidths of 3, 6, 9, 12, 15, 18, 21, and 24 kHz. Data rates of 75 through 120,000 bps are supported. The single-tone waveforms specified in this appendix use modulation techniques similar to those found in Appendix C of this standard in order to achieve the required data rates. A block interleaver is used to obtain 4 interleaving lengths ranging from approximately 0.12 s to 10.24 s. Various code rates are implemented based on a constraint length 7 or a constraint length 9 convolutional code. Various puncturing and repeat coding schemes are utilized to achieve a family of code rates from 1/16 up to 9/10. The full-tail-biting approach is used to produce block codes from this convolutional code that are the same length as the interleaver. Since the minimum interleaver length spans approximately 120ms, there is no option of zero interleaving, since the time delays would not be reduced.

The waveform data rate, encoder constraint length and interleaver settings are explicitly transmitted as a part of the initial preamble of the waveform. This “autobaud” feature is critical in developing an efficient (ARQ) protocol for high frequency (HF) channels. The receive modem is required to be able to determine the data rate, encoder constraint length and interleaver setting during the reception of the preamble.

For broadcast applications, the receive modem is required to know the bandwidth, data rate, encoder constraint length and interleaver setting in order to acquire the waveform without the initial preamble.

##### D.4.1 WBHF Block 1 Requirements

A subset of the requirements of this appendix when implemented only for 3 kHz is termed the WBHF Block 1 capability. A Block 1 WBHF modem shall implement all of the following:

- Waveforms 0 through 13 for bandwidth of 3 kHz (see Table D-II).
- Constraint length 7 convolutional coding

and shall meet the Performance Requirements in D.6 for those waveforms.

##### D.4.2 WBHF Block 2 Requirements

The same subset of the requirements, but offered at 3, 6, 9, and 12 kHz, is termed the WBHF Block 2 capability. A Block 2 WBHF modem shall implement all of the following:

- Waveforms 0 through 12 for bandwidth of 3, 6, 9, and 12 kHz, and waveform 13 for 3 kHz only (see Table D-II).
- Constraint length 7 convolutional coding

and shall meet the Performance Requirements in D.6 for those waveforms.

##### D.4.3 WBHF Block 3 Requirements

A Block 3 WBHF modem shall implement all of the Detailed Requirements in D.5 and all of the Performance Requirements in D.6 in this appendix.

MIL-STD-188-110C  
w/CHANGE 1  
APPENDIX D

## D.5 DETAILED REQUIREMENTS

### D.5.1 Modulation.

The symbol rate for all symbols is dependent on the bandwidth (BW). The symbol rate shall be accurate to within 10ppm. For example, at 2400 symbols per second, the symbol rate shall be accurate to a minimum of  $\pm 0.024$  symbols per second when the transmit data clock is generated by the modem and not provided by the data terminal equipment (DTE). Phase-shift keying (PSK) and quadrature amplitude modulation (QAM) modulation techniques shall be used. The sub-carrier (or pair of quadrature sub-carriers in the case of QAM) shall be centered at  $(300+(BW/2))$  Hz accurate to a minimum of 10 ppm. The phase of the quadrature sub-carrier relative to the In-phase carrier shall be 90 degrees. The correct relationship can be achieved by making the In-phase sub-carrier  $\cos(\text{Sub-Carrier})$  and the quadrature sub-carrier  $-\sin(\text{Sub-Carrier})$ . Table D-I specifies the symbol rates and sub-carrier frequencies for all Bandwidths.

**TABLE D-I. Symbol Rates and Sub Carrier**

Bandwidth (kHz)	Symbol Rate (Sym/sec)	Sub-Carrier (Hz)
3	2400	1800
6	4800	3300
9	7200	4800
12	9600	6300
15	12000	7800
18	14400	9300
21	16800	10800
24	19200	12300

The output of the modulator shall have an occupied bandwidth (see section 3) no greater than the bandwidth of the waveform in Table D-I. This measurement can be performed at RF, IF or audio baseband.

#### D.5.1.1 Known symbols.

For all known symbols, the modulation used shall be PSK. No scrambling shall be applied to the known symbols.

#### D.5.1.2 Data symbols.

For data symbols, the modulation used shall depend upon the data rate. Table D-II specifies the modulation that shall be used with each data rate.

MIL-STD-188-110C  
w/CHANGE 1  
APPENDIX D

**TABLE D-II. Modulation used to obtain each data rate.**

<i>Waveform Number</i>	<i>0 Walsh</i>	<i>1 BPSK</i>	<i>2 BPSK</i>	<i>3 BPSK</i>	<i>4 BPSK</i>	<i>5 BPSK</i>	<i>6 QPSK</i>	<i>7 8PSK</i>	<i>8 16QAM</i>	<i>9 32QAM</i>	<i>10 64QAM</i>	<i>11 64QAM</i>	<i>12 256QAM</i>	<i>13 QPSK</i>
<b><i>Bandwidth (kHz)</i></b>														
<i>3</i>	<i>75</i>	<i>150</i>	<i>300</i>	<i>600</i>	<i>1200</i>	<i>1600</i>	<i>3200</i>	<i>4800</i>	<i>6400</i>	<i>8000</i>	<i>9600</i>	<i>12000</i>	<i>16000</i>	<i>2400</i>
<i>6</i>	<i>150</i>	<i>300</i>	<i>600</i>	<i>1200</i>	<i>2400</i>	<i>3200</i>	<i>6400</i>	<i>9600</i>	<i>12800</i>	<i>16000</i>	<i>19200</i>	<i>24000</i>	<i>32000</i>	
<i>9</i>	<i>300</i>	<i>600</i>	<i>1200</i>	<i>2400</i>	<i>-</i>	<i>4800</i>	<i>9600</i>	<i>14400</i>	<i>19200</i>	<i>24000</i>	<i>28800</i>	<i>36000</i>	<i>48000</i>	
<i>12</i>	<i>300</i>	<i>600</i>	<i>1200</i>	<i>2400</i>	<i>4800</i>	<i>6400</i>	<i>12800</i>	<i>19200</i>	<i>25600</i>	<i>32000</i>	<i>38400</i>	<i>48000</i>	<i>64000</i>	
<i>15</i>	<i>300</i>	<i>600</i>	<i>1200</i>	<i>2400</i>	<i>4800</i>	<i>8000</i>	<i>16000</i>	<i>24000</i>	<i>32000</i>	<i>40000</i>	<i>48000</i>	<i>57600</i>	<i>76800</i>	
<i>18</i>	<i>600</i>	<i>1200</i>	<i>2400</i>	<i>4800</i>	<i>-</i>	<i>9600</i>	<i>19200</i>	<i>28800</i>	<i>38400</i>	<i>48000</i>	<i>57600</i>	<i>72000</i>	<i>90000</i>	
<i>21</i>	<i>300</i>	<i>600</i>	<i>1200</i>	<i>2400</i>	<i>4800</i>	<i>9600</i>	<i>19200</i>	<i>28800</i>	<i>38400</i>	<i>48000</i>	<i>57600</i>	<i>76800</i>	<i>115200</i>	
<i>24</i>	<i>600</i>	<i>1200</i>	<i>2400</i>	<i>4800</i>	<i>9600</i>	<i>12800</i>	<i>25600</i>	<i>38400</i>	<i>51200</i>	<i>64000</i>	<i>76800</i>	<i>96000</i>	<i>120000</i>	

MIL-STD-188-110C  
w/CHANGE 1  
APPENDIX D

The waveforms utilizing binary phase-shift keying BPSK, quadrature phase-shift keying (QPSK), and eight-ary phase-shift keying (8PSK) constellations are scrambled to appear, on-air, as an 8PSK constellation. The scrambling serves a secondary purpose of randomizing the on air waveform in the presence of a fixed user data stream. The 16QAM and 32QAM constellations use multiple PSK rings to maintain good peak-to-average ratios, and the 64QAM constellation is a variation of the standard square QAM constellation, which has been modified to improve the peak-to-average ratio. The 256 QAM constellation is better than the standard 16 x 16 square constellation and achieves superior peak-to-average without sacrificing the very good pseudo-Gray code properties of the square constellation. An interesting feature of the constellation is the slight displacement of the 2 center-top and center-bottom constellation points to protect constellation points with larger Hamming distances by increasing the signal-space distance.

**D.5.1.2.1 PSK data symbols.**

For the PSK constellations, a distinction is made between the data bits and the symbol number for the purposes of scrambling the BPSK and QPSK modulations to appear as 8PSK, on-air. Scrambling is applied as a modulo 8 addition of a scrambling sequence to the 8PSK symbol number. Transcoding is an operation that links a symbol to be transmitted to a group of data bits.

**D.5.1.2.1.1 BPSK symbol mapping.**

For the waveforms utilizing binary phase-shift keying BPSK, transcoding shall be achieved by linking one of the symbols specified in Table D-VI to a single data bits (bit) as shown in Table D-III.

**TABLE D-III. Transcoding for BPSK.**

bit	Symbol
0	0
1	4

**D.5.1.2.1.2 QPSK symbol mapping.**

For the waveforms utilizing quadrature phase-shift keying QPSK, transcoding shall be achieved by linking one of the symbols specified in Table D-VI to a set of two consecutive data bits (dibit) as shown in Table D-IV. In this Table, the leftmost bit of the dibit shall be the older bit; i.e., fetched from the interleaver before the rightmost bit.

MIL-STD-188-110C  
w/CHANGE 1  
APPENDIX D

**TABLE D-IV. Transcoding for QPSK.**

Dibit	Symbol
00	0
01	2
11	4
10	6

**D.5.1.2.1.3 8PSK symbol mapping.**

For the waveforms utilizing quadrature 8-ary phase-shift keying 8PSK, transcoding shall be achieved by linking one symbol to a set of three consecutive data bits (tribit) as shown in Table D-V. In this Table, the leftmost bit of the tribit shall be the oldest bit; i.e., fetched from the interleaver before the other two, and the rightmost bit is the most recent bit.

**TABLE D-V. Transcoding for 8PSK.**

Tribit	Symbol
000	1
001	0
010	2
011	3
100	6
101	7
110	5
111	4

**D.5.1.2.1.4 The 8PSK constellation.**

The constellation points which shall be used for 8PSK are shown in figure D-1 and specified in terms of their In-phase and Quadrature components in Table D-VI.



MIL-STD-188-110C  
w/CHANGE 1  
APPENDIX D

**TABLE D-VI. 8PSK symbol mapping.**

Symbol Number	Phase	In-Phase	Quadrature
0	0	1.000000	0.000000
1	$\pi/4$	0.707107	0.707107
2	$\pi/2$	0.000000	1.000000
3	$3\pi/4$	-0.707107	0.707107
4	$\pi$	-1.000000	0.000000
5	$5\pi/4$	-0.707107	-0.707107
6	$3\pi/2$	0.000000	-1.000000
7	$7\pi/4$	0.707107	-0.707107

Note that the complex symbol values =  $\exp[jn\pi/4]$  where n is the symbol number.

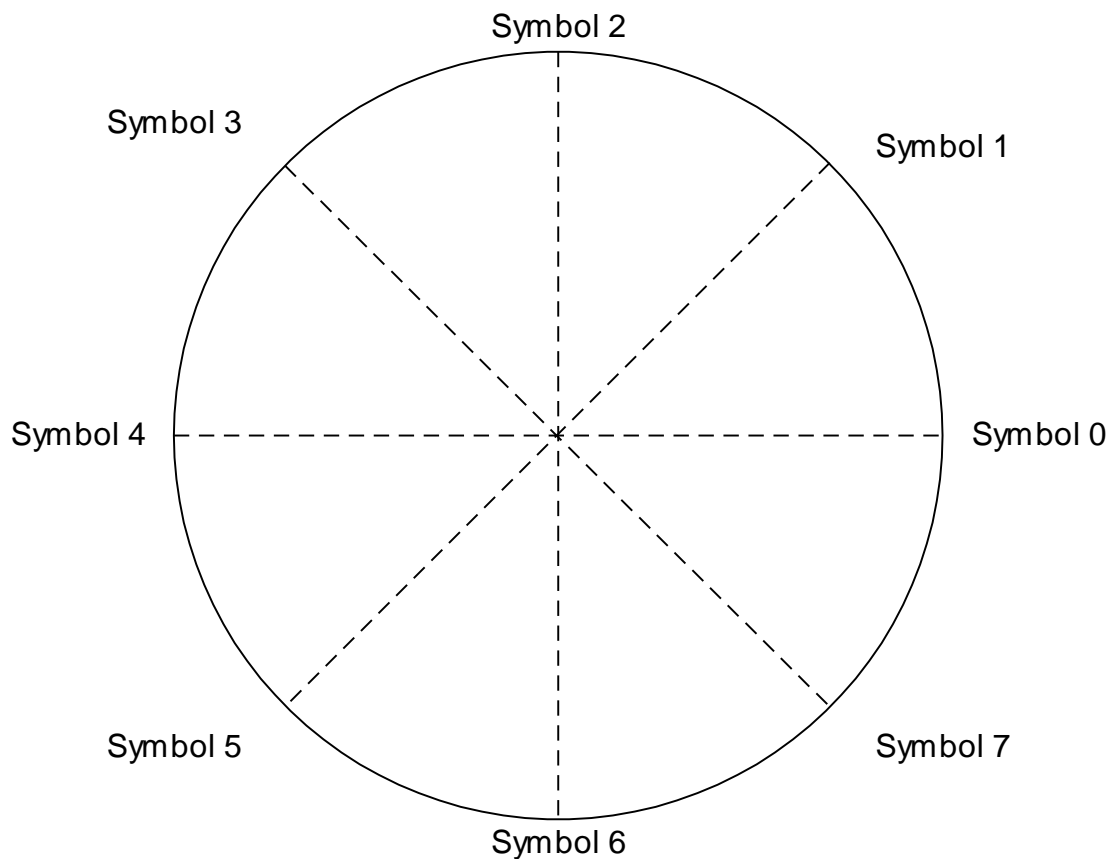

**FIGURE D-1. 8PSK signal constellation and symbol mapping.**

MIL-STD-188-110C  
w/CHANGE 1  
APPENDIX D

D.5.1.2.2 QAM data symbols.

For the QAM constellations, no distinction is made between the number formed directly from the data bits and the symbol number. Each set of 4 bits (16QAM), 5 bits (32QAM), 6 bits (64QAM), or 8 bits (256QAM) is mapped directly to a QAM symbol. For example, the four bit grouping 0111 would map to symbol 7 in the 16QAM constellation while the 6 bits 100011 would map to symbol 35 in the 64QAM constellation. Again, in each case the leftmost bit shall be the oldest bit, i.e. fetched from the interleaver before the other bits, and the rightmost bit is the most recent bit. The mapping of bits to symbols for the QAM constellations has been selected to minimize the number of bit errors incurred when errors involve adjacent signaling points in the constellation.

D.5.1.2.2.1 The 16 QAM constellation.

The constellation points which shall be used for 16QAM are shown in figure D-2 and specified in terms of their In-phase and Quadrature components in Table D-VII. As can be seen in the figure, the 16 QAM constellation is comprised of two PSK rings: a 4 PSK inner ring and a 12 PSK outer ring.

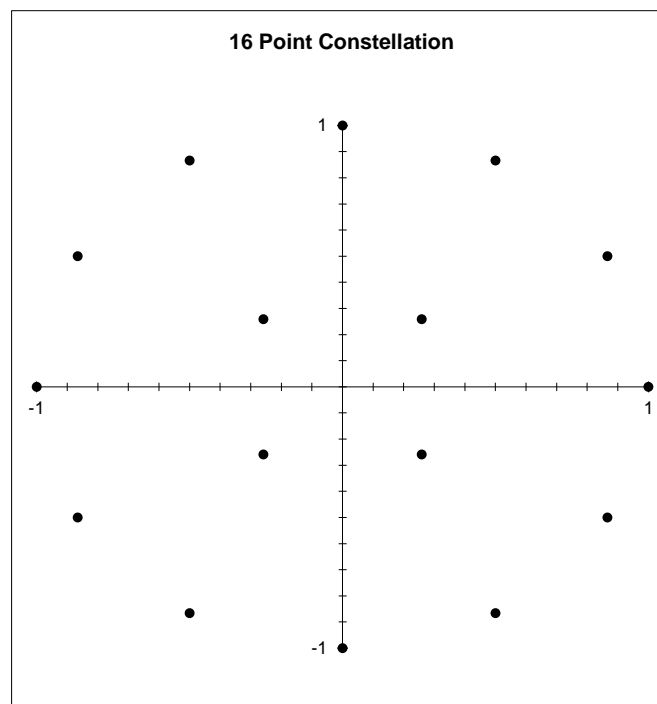

**FIGURE D-2. 16QAM Signaling Constellation.**

MIL-STD-188-110C  
w/CHANGE 1  
APPENDIX D

**TABLE D-VII. In-phase and Quadrature components of each 16QAM symbol.**

Symbol Number	In-Phase	Quadrature
0	0.866025	0.500000
1	0.500000	0.866025
2	1.000000	0.000000
3	0.258819	0.258819
4	-0.500000	0.866025
5	0.000000	1.000000
6	-0.866025	0.500000
7	-0.258819	0.258819
8	0.500000	-0.866025
9	0.000000	-1.000000
10	0.866025	-0.500000
11	0.258819	-0.258819
12	-0.866025	-0.500000
13	-0.500000	-0.866025
14	-1.000000	0.000000
15	-0.258819	-0.258819

MIL-STD-188-110C  
w/CHANGE 1  
APPENDIX D

D.5.1.2.2.2 The 32 QAM constellation.

The constellation points which shall be used for 32QAM are shown in figure D-3 and specified in terms of their In-phase and Quadrature components in Table D-VIII. This constellation contains an outer ring of 16 symbols and an inner square of 16 symbols.

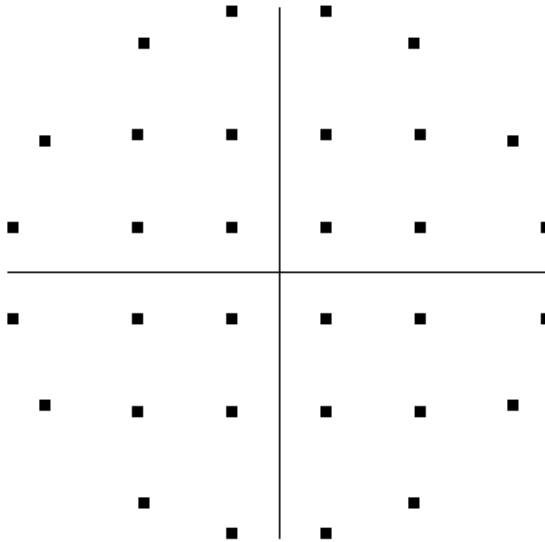

**FIGURE D-3. 32QAM signaling constellation.**

**TABLE D-VIII. In-phase and Quadrature components of each 32QAM symbol.**

Symbol Number	In-Phase	Quadrature	Symbol Number	In-Phase	Quadrature
0	0.866380	0.499386	16	0.866380	-0.499386
1	0.984849	0.173415	17	0.984849	-0.173415
2	0.499386	0.866380	18	0.499386	-0.866380
3	0.173415	0.984849	19	0.173415	-0.984849
4	0.520246	0.520246	20	0.520246	-0.520246
5	0.520246	0.173415	21	0.520246	-0.173415
6	0.173415	0.520246	22	0.173415	-0.520246
7	0.173415	0.173415	23	0.173415	-0.173415
8	-0.866380	0.499386	24	-0.866380	-0.499386
9	-0.984849	0.173415	25	-0.984849	-0.173415
10	-0.499386	0.866380	26	-0.499386	-0.866380
11	-0.173415	0.984849	27	-0.173415	-0.984849
12	-0.520246	0.520246	28	-0.520246	-0.520246
13	-0.520246	0.173415	29	-0.520246	-0.173415
14	-0.173415	0.520246	30	-0.173415	-0.520246
15	-0.173415	0.173415	31	-0.173415	-0.173415

MIL-STD-188-110C  
w/CHANGE 1  
APPENDIX D

D.5.1.2.2.3 The 64QAM constellation.

The constellation points which shall be used for the 64QAM modulation are shown in figure D-4 and specified in terms of their In-phase and Quadrature components in Table D-IX. This constellation is a variation on the standard 8 x 8 square constellation, which achieves better peak-to-average without sacrificing the very good pseudo-Gray code properties of the square constellation.

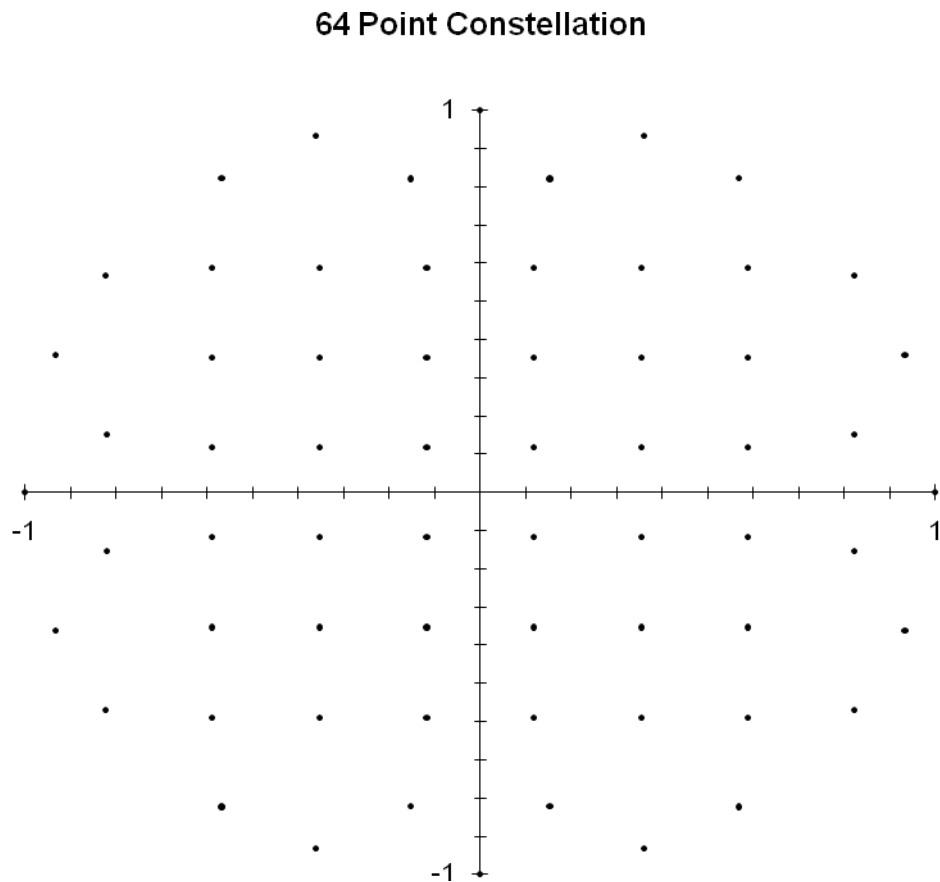

**FIGURE D-4. 64QAM signaling constellation.**

MIL-STD-188-110C  
w/CHANGE 1  
APPENDIX D

**TABLE D-IX. In-phase and Quadrature components of each 64QAM symbol.**

Symbol Number	In-Phase	Quadrature	Symbol Number	In-Phase	Quadrature
0	1.000000	0.000000	32	0.000000	1.000000
1	0.822878	0.568218	33	-0.822878	0.568218
2	0.821137	0.152996	34	-0.821137	0.152996
3	0.932897	0.360142	35	-0.932897	0.360142
4	0.000000	-1.000000	36	-1.000000	0.000000
5	0.822878	-0.568218	37	-0.822878	-0.568218
6	0.821137	-0.152996	38	-0.821137	-0.152996
7	0.932897	-0.360142	39	-0.932897	-0.360142
8	0.568218	0.822878	40	-0.568218	0.822878
9	0.588429	0.588429	41	-0.588429	0.588429
10	0.588429	0.117686	42	-0.588429	0.117686
11	0.588429	0.353057	43	-0.588429	0.353057
12	0.568218	-0.822878	44	-0.568218	-0.822878
13	0.588429	-0.588429	45	-0.588429	-0.588429
14	0.588429	-0.117686	46	-0.588429	-0.117686
15	0.588429	-0.353057	47	-0.588429	-0.353057
16	0.152996	0.821137	48	-0.152996	0.821137
17	0.117686	0.588429	49	-0.117686	0.588429
18	0.117686	0.117686	50	-0.117686	0.117686
19	0.117686	0.353057	51	-0.117686	0.353057
20	0.152996	-0.821137	52	-0.152996	-0.821137
21	0.117686	-0.588429	53	-0.117686	-0.588429
22	0.117686	-0.117686	54	-0.117686	-0.117686
23	0.117686	-0.353057	55	-0.117686	-0.353057
24	0.360142	0.932897	56	-0.360142	0.932897
25	0.353057	0.588429	57	-0.353057	0.588429
26	0.353057	0.117686	58	-0.353057	0.117686
27	0.353057	0.353057	59	-0.353057	0.353057
28	0.360142	-0.932897	60	-0.360142	-0.932897
29	0.353057	-0.588429	61	-0.353057	-0.588429
30	0.353057	-0.117686	62	-0.353057	-0.117686
31	0.353057	-0.353057	63	-0.353057	-0.353057

MIL-STD-188-110C  
w/CHANGE 1  
APPENDIX D

D.5.1.2.2.4 The 256QAM constellation.

The constellation points that shall be used for the 256QAM modulation are shown in Figure D-5 and specified in terms of their In-phase and Quadrature components in Table D-X. This constellation is better than the standard 16 x 16 square constellation and achieves superior peak-to-average without sacrificing the very good pseudo-Gray code properties of the square constellation. An interesting feature of the constellation is the slight displacement of the 2 center-top and center-bottom constellation points to protect constellation points with larger Hamming distances by increasing the signal-space distance.

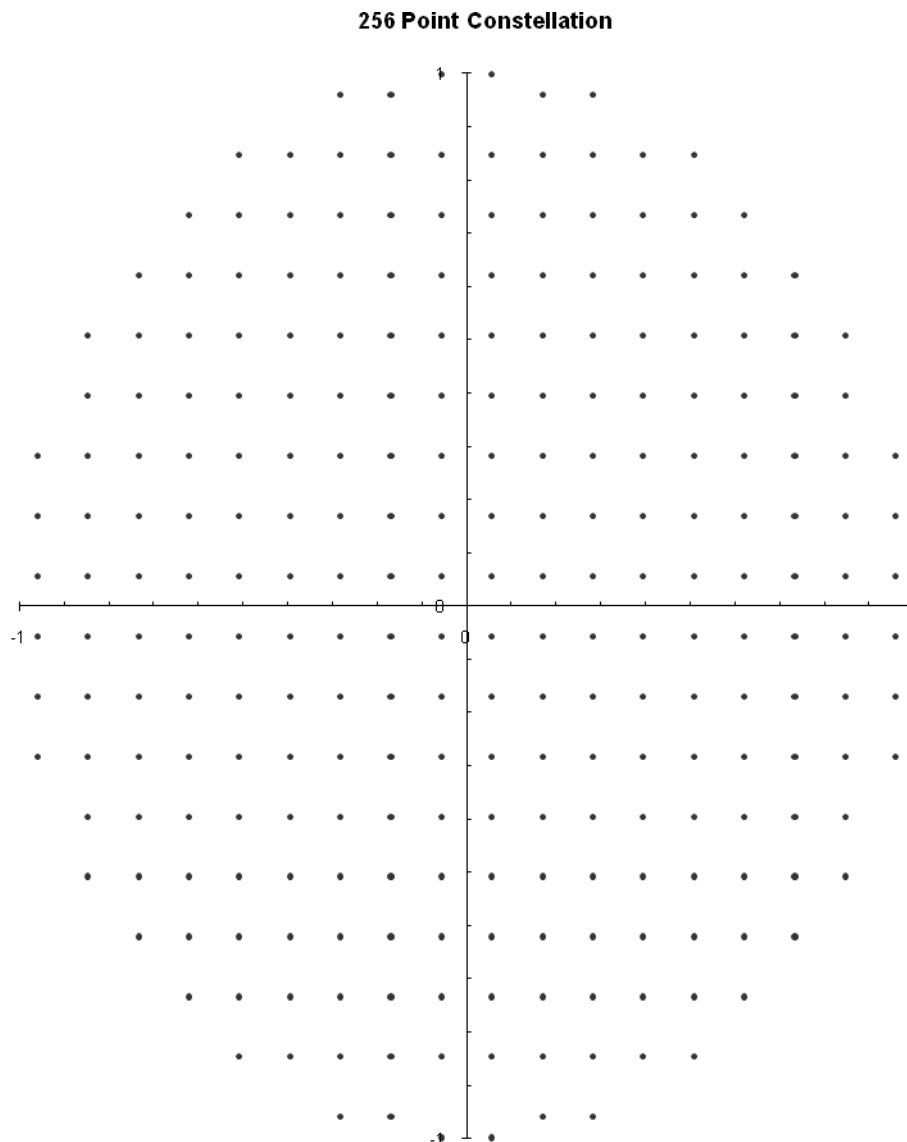

**FIGURE D-5. 256QAM signaling constellation.**

MIL-STD-188-110C  
w/CHANGE 1  
APPENDIX D

**TABLE D-X. In-phase and Quadrature components of each 256QAM symbol.**

Symbol Number	In-Phase	Quadrature	Symbol Number	In-Phase	Quadrature
0	0.959366	0.056433	32	0.507899	0.846499
1	0.959366	0.169300	33	0.507899	0.733632
2	0.846499	0.507899	34	0.507899	0.507899
3	0.959366	0.282166	35	0.507899	0.620766
4	0.846499	0.056433	36	0.507899	0.056433
5	0.846499	0.169300	37	0.507899	0.169300
6	0.846499	0.395033	38	0.507899	0.395033
7	0.846499	0.282166	39	0.507899	0.282166
8	0.959366	-0.056433	40	0.507899	-0.846499
9	0.959366	-0.169300	41	0.507899	-0.733632
10	0.846499	-0.507899	42	0.507899	-0.507899
11	0.959366	-0.282166	43	0.507899	-0.620766
12	0.846499	-0.056433	44	0.507899	-0.056433
13	0.846499	-0.169300	45	0.507899	-0.169300
14	0.846499	-0.395033	46	0.507899	-0.395033
15	0.846499	-0.282166	47	0.507899	-0.282166
16	0.169300	0.959366	48	0.282166	0.959366
17	0.056433	0.998304	49	0.620766	0.733632
18	0.733632	0.507899	50	0.620766	0.507899
19	0.733632	0.620766	51	0.620766	0.620766
20	0.733632	0.056433	52	0.620766	0.056433
21	0.733632	0.169300	53	0.620766	0.169300
22	0.733632	0.395033	54	0.620766	0.395033
23	0.733632	0.282166	55	0.620766	0.282166
24	0.169300	-0.959366	56	0.282166	-0.959366
25	0.056433	-0.998304	57	0.620766	-0.733632
26	0.733632	-0.507899	58	0.620766	-0.507899
27	0.733632	-0.620766	59	0.620766	-0.620766
28	0.733632	-0.056433	60	0.620766	-0.056433
29	0.733632	-0.169300	61	0.620766	-0.169300
30	0.733632	-0.395033	62	0.620766	-0.395033
31	0.733632	-0.282166	63	0.620766	-0.282166



MIL-STD-188-110C  
w/CHANGE 1  
APPENDIX D

**TABLE D-X continued**

Symbol Number	In-Phase	Quadrature	Symbol Number	In-Phase	Quadrature
64	0.056433	0.846499	96	0.395033	0.846499
65	0.056433	0.733632	97	0.395033	0.733632
66	0.056433	0.507899	98	0.395033	0.507899
67	0.056433	0.620766	99	0.395033	0.620766
68	0.056433	0.056433	100	0.395033	0.056433
69	0.056433	0.169300	101	0.395033	0.169300
70	0.056433	0.395033	102	0.395033	0.395033
71	0.056433	0.282166	103	0.395033	0.282166
72	0.056433	-0.846499	104	0.395033	-0.846499
73	0.056433	-0.733632	105	0.395033	-0.733632
74	0.056433	-0.507899	106	0.395033	-0.507899
75	0.056433	-0.620766	107	0.395033	-0.620766
76	0.056433	-0.056433	108	0.395033	-0.056433
77	0.056433	-0.169300	109	0.395033	-0.169300
78	0.056433	-0.395033	110	0.395033	-0.395033
79	0.056433	-0.282166	111	0.395033	-0.282166
80	0.169300	0.846499	112	0.282166	0.846499
81	0.169300	0.733632	113	0.282166	0.733632
82	0.169300	0.507899	114	0.282166	0.507899
83	0.169300	0.620766	115	0.282166	0.620766
84	0.169300	0.056433	116	0.282166	0.056433
85	0.169300	0.169300	117	0.282166	0.169300
86	0.169300	0.395033	118	0.282166	0.395033
87	0.169300	0.282166	119	0.282166	0.282166
88	0.169300	-0.846499	120	0.282166	-0.846499
89	0.169300	-0.733632	121	0.282166	-0.733632
90	0.169300	-0.507899	122	0.282166	-0.507899
91	0.169300	-0.620766	123	0.282166	-0.620766
92	0.169300	-0.056433	124	0.282166	-0.056433
93	0.169300	-0.169300	125	0.282166	-0.169300
94	0.169300	-0.395033	126	0.282166	-0.395033
95	0.169300	-0.282166	127	0.282166	-0.282166

MIL-STD-188-110C  
w/CHANGE 1  
APPENDIX D

**TABLE D-X continued**

Symbol Number	In-Phase	Quadrature	Symbol Number	In-Phase	Quadrature
128	-0.959366	0.056433	160	-0.507899	0.846499
129	-0.959366	0.169300	161	-0.507899	0.733632
130	-0.846499	0.507899	162	-0.507899	0.507899
131	-0.959366	0.282166	163	-0.507899	0.620766
132	-0.846499	0.056433	164	-0.507899	0.056433
133	-0.846499	0.169300	165	-0.507899	0.169300
134	-0.846499	0.395033	166	-0.507899	0.395033
135	-0.846499	0.282166	167	-0.507899	0.282166
136	-0.959366	-0.056433	168	-0.507899	-0.846499
137	-0.959366	-0.169300	169	-0.507899	-0.733632
138	-0.846499	-0.507899	170	-0.507899	-0.507899
139	-0.959366	-0.282166	171	-0.507899	-0.620766
140	-0.846499	-0.056433	172	-0.507899	-0.056433
141	-0.846499	-0.169300	173	-0.507899	-0.169300
142	-0.846499	-0.395033	174	-0.507899	-0.395033
143	-0.846499	-0.282166	175	-0.507899	-0.282166
144	-0.169300	0.959366	176	-0.282166	0.959366
145	-0.056433	0.998304	177	-0.620766	0.733632
146	-0.733632	0.507899	178	-0.620766	0.507899
147	-0.733632	0.620766	179	-0.620766	0.620766
148	-0.733632	0.056433	180	-0.620766	0.056433
149	-0.733632	0.169300	181	-0.620766	0.169300
150	-0.733632	0.395033	182	-0.620766	0.395033
151	-0.733632	0.282166	183	-0.620766	0.282166
152	-0.169300	-0.959366	184	-0.282166	-0.959366
153	-0.056433	-0.998304	185	-0.620766	-0.733632
154	-0.733632	-0.507899	186	-0.620766	-0.507899
155	-0.733632	-0.620766	187	-0.620766	-0.620766
156	-0.733632	-0.056433	188	-0.620766	-0.056433
157	-0.733632	-0.169300	189	-0.620766	-0.169300
158	-0.733632	-0.395033	190	-0.620766	-0.395033
159	-0.733632	-0.282166	191	-0.620766	-0.282166

MIL-STD-188-110C  
w/CHANGE 1  
APPENDIX D

**TABLE D-X continued**

Symbol Number	In-Phase	Quadrature	Symbol Number	In-Phase	Quadrature
192	-0.056433	0.846499	224	-0.395033	0.846499
193	-0.056433	0.733632	225	-0.395033	0.733632
194	-0.056433	0.507899	226	-0.395033	0.507899
195	-0.056433	0.620766	227	-0.395033	0.620766
196	-0.056433	0.056433	228	-0.395033	0.056433
197	-0.056433	0.169300	229	-0.395033	0.169300
198	-0.056433	0.395033	230	-0.395033	0.395033
199	-0.056433	0.282166	231	-0.395033	0.282166
200	-0.056433	-0.846499	232	-0.395033	-0.846499
201	-0.056433	-0.733632	233	-0.395033	-0.733632
202	-0.056433	-0.507899	234	-0.395033	-0.507899
203	-0.056433	-0.620766	235	-0.395033	-0.620766
204	-0.056433	-0.056433	236	-0.395033	-0.056433
205	-0.056433	-0.169300	237	-0.395033	-0.169300
206	-0.056433	-0.395033	238	-0.395033	-0.395033
207	-0.056433	-0.282166	239	-0.395033	-0.282166
208	-0.169300	0.846499	240	-0.282166	0.846499
209	-0.169300	0.733632	241	-0.282166	0.733632
210	-0.169300	0.507899	242	-0.282166	0.507899
211	-0.169300	0.620766	243	-0.282166	0.620766
212	-0.169300	0.056433	244	-0.282166	0.056433
213	-0.169300	0.169300	245	-0.282166	0.169300
214	-0.169300	0.395033	246	-0.282166	0.395033
215	-0.169300	0.282166	247	-0.282166	0.282166
216	-0.169300	-0.846499	248	-0.282166	-0.846499
217	-0.169300	-0.733632	249	-0.282166	-0.733632
218	-0.169300	-0.507899	250	-0.282166	-0.507899
219	-0.169300	-0.620766	251	-0.282166	-0.620766
220	-0.169300	-0.056433	252	-0.282166	-0.056433
221	-0.169300	-0.169300	253	-0.282166	-0.169300
222	-0.169300	-0.395033	254	-0.282166	-0.395033
223	-0.169300	-0.282166	255	-0.282166	-0.282166

MIL-STD-188-110C  
w/CHANGE 1  
APPENDIX D

**D.5.1.2.3 Walsh Orthogonal Modulation.**

Waveform ID 0 utilizes a different modulation technique, Walsh Orthogonal Modulation. For each pair of coded and interleaved data bits, the method produces a 32 symbol repeated Walsh sequence. The Walsh Orthogonal Modulation is accomplished by taking each pair of bits, or di-bit, and selecting a corresponding Walsh Sequence.

Di-bit	Walsh Sequence
00	0000
01	0404
10	0044
11	0440

The selected four element Walsh sequence is repeated 8 times to yield a 32 element Walsh sequence.

For example, if the di-bit is 01, the sequence 0404 is repeated to generate

0, 4, 0, 4, 0, 4, 0, 4, 0, 4, 0, 4, 0, 4, 0, 4, 0, 4, 0, 4, 0, 4, 0, 4, 0, 4, 0, 4, 0, 4

The last di-bit in any interleaver block shall be identified by use of an alternate set of Walsh sequences, which are repeated 4 times to achieve 32 symbols:

Di-bit	Alternate Walsh Sequence
00	00004444
01	04044040
10	00444400
11	04404004

The 32-symbol channel symbol shall be produced by an element by element modulo 8 addition of the repeated Walsh Sequence and the scrambling sequence (see 0).

**D.5.1.3 Data scrambling.**

Data symbols for Waveforms 1 through 7 and 13 (using BPSK, QPSK, or 8PSK modulation) shall be scrambled by modulo 8 addition with a scrambling sequence.

The data symbols for Waveforms 8 through 12(16QAM, 32QAM, 64QAM and 256QAM modulation) shall be scrambled by using an exclusive or (XOR) operation. Sequentially, the data bits forming each symbol (4 for 16QAM, 5 for 32QAM, 6 for 64QAM and 8 for 256 QAM) shall be XOR'd with an equal number of bits from the scrambling sequence.

For Waveforms 1 through 13, the scrambling sequence generator polynomial shall be  $x^9 + x^4 + 1$  and the generator shall be initialized to 1 at the start of each data frame. A block diagram of the scrambling sequence generator is shown in Figure D-6. In this illustration, three output bits are

MIL-STD-188-110C  
w/CHANGE 1  
APPENDIX D

shown; this is the case for all PSK waveforms. For  $2^N$  QAM waveforms, the rightmost N bits are used.

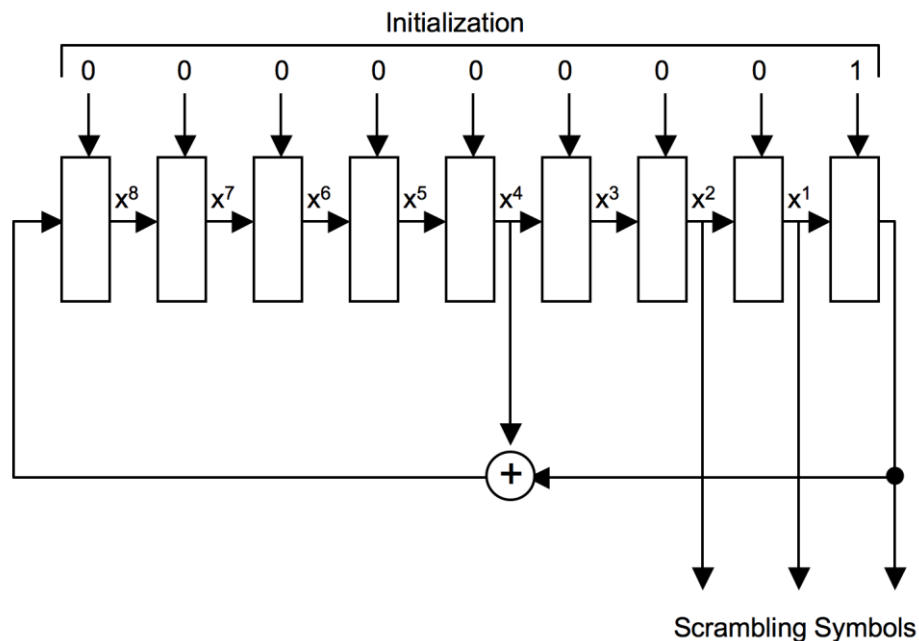

**FIGURE D-6. Scrambling sequence generator illustrating scrambling generator for PSK symbols.**

For PSK symbols (BPSK, QPSK, and 8PSK), the scrambling shall be carried out taking the modulo 8 sum of the numerical value of the binary triplet consisting of the last (rightmost) three bits in the shift register, and the symbol number (transcoded value). For example, if the last three bits in the scrambling sequence shift register were 010 which has a numerical value equal 2, and the symbol number before scrambling was 6, symbol 0 would be transmitted since  $(6+2) \text{ Modulo } 8 = 0$ .

For 16QAM symbols, scrambling shall be carried out by XORing the 4 bit number consisting of the last (rightmost) four bits in the shift register with the symbol number. For example, if the last 4 bits in the scrambling sequence shift register were 0101 and the 16QAM symbol number before scrambling was 3 (i.e. 0011), symbol 6 (0110) would be transmitted. For 32QAM symbols, scrambling shall be carried out by XORing the 5 bit number formed by the last (rightmost) five bits in the shift register with the symbol number. For 64QAM symbols, scrambling shall be carried out by XORing the 6 bit number formed by the last (rightmost) six bits in the shift register with the symbol number. For 256QAM symbols, scrambling shall be carried out by XORing the 8 bit number formed by the last (rightmost) eight bits in the shift register with the symbol number.

After each data symbol is scrambled, the generator shall be iterated (shifted) the required number of times to produce all new bits for use in scrambling the next symbol (i.e., 3 iterations for 8PSK, 4 iterations for 16QAM, 5 iterations for 32QAM and 6 iterations for 64QAM, and 8

MIL-STD-188-110C  
w/CHANGE 1  
APPENDIX D

iterations for 256QAM). Since the generator is iterated after the bits are used, the first data symbol of every data frame shall, therefore, be scrambled by the appropriate number of bits from the initialization value of 00000001.

The length of the scrambling sequence is 511 bits. For a 256 symbol data block with 6 bits per symbol, this means that the scrambling sequence will be repeated just slightly more than 3 times, although in terms of symbols, there will be no repetition.

D.5.1.4 Waveform ID 0 Walsh Orthogonal Modulation Data scrambling.

For the case of Waveform ID 0, an 8-PSK data scrambling sequence is utilized. This sequence is generated in a fashion similar to that described above but is based on a longer shift register of 159 bits with a single tap after bit 31. This is an implementation of a Trinomial (159, 31). The shift register is initialized to the following state:

```
int bitshift[159] =
{0, 0, 0, 1, 0, 0, 1, 1, 0, 1, 1, 0, 0, 1, 0, 1,
 1, 1, 1, 1, 0, 1, 0, 0, 1, 0, 0, 0, 0, 0, 0, 0,
 1, 0, 1, 1, 0, 0, 1, 1, 0, 0, 1, 0, 1, 1, 1, 0,
 1, 1, 1, 0, 0, 0, 1, 1, 0, 0, 0, 1, 0, 0, 0, 0,
 1, 0, 0, 0, 0, 0, 1, 0, 0, 0, 0, 0, 0, 1, 1, 0, 1,
 0, 1, 1, 1, 1, 0, 1, 0, 1, 0, 0, 0, 0, 1, 1, 1, 1,
 1, 1, 0, 0, 1, 1, 0, 1, 0, 1, 1, 1, 1, 1, 0, 1,
 1, 1, 1, 0, 0, 0, 1, 1, 0, 0, 0, 1, 1, 0, 1, 0,
 1, 1, 1, 0, 0, 1, 1, 1, 0, 0, 0, 1, 1, 0, 0, 0,
 1, 0, 0, 1, 0, 0, 0, 1, 1, 0, 1, 0, 0, 1, 1};
```

For Waveform ID 0 this implementation is used to generate 256\*8 or 2048 values. The shift register is iterated 16 times between the generation of each 8-PSK symbol.

```
int tri( void)
{
  int bitout, bittap, bitin;
  int i,j;

  for(j=0;j<16;j++)
  {
    bitout = bitshift[158];
    bittap = bitshift[31];
    for(i=158;i>=1;i--) bitshift[i]=bitshift[i-1];
    bitin = bitout^bittap;
    bitshift[0]=bitin;
  }
  return (bitshift[2]<<2)+(bitshift[1]<<1)+bitshift[0];
}
```

Each channel symbol of the WID 0 waveforms is scrambled using 32 chips or symbols of the scramble sequence, generated as defined above.

MIL-STD-188-110C  
w/CHANGE 1  
APPENDIX D

For example, the first 32 symbols of the scramble sequence are

5, 6, 2, 1, 7, 3, 1, 1, 6, 0, 5, 4, 0, 7, 7, 0, 5, 3, 1, 3, 3, 2, 2, 5, 5, 4, 7, 3, 5, 4, 3, 0,

For this example, assume the coded and interleaved data di-bit to be sent is 01; then the corresponding Walsh sequence 0 4 0 4 is repeated and combined with this scrambling sequence as shown below:

0, 4, 0, 4, 0, 4, 0, 4, 0, 4, 0, 4, 0, 4, 0, 4, 0, 4, 0, 4, 0, 4, 0, 4, 0, 4, 0, 4, 0, 4, 0, 4  
5, 6, 2, 1, 7, 3, 1, 1, 6, 0, 5, 4, 0, 7, 7, 0, 5, 3, 1, 3, 3, 2, 2, 5, 5, 4, 7, 3, 5, 4, 3, 0,  
=====

5, 2, 2, 5, 7, 7, 1, 5, 6, 4, 5, 0, 0, 3, 7, 4, 5, 7, 1, 7, 3, 6, 2, 1, 5, 0, 7, 7, 5, 0, 3, 4

For the Walsh Orthogonal Modes the sequences are continuously wrapped around the 2048 symbol boundary. The sequence is reset to the initialization value at the interleaver boundary.

#### D.5.1.5 Modulation filter.

The role of the modulation filter is to spectrally constrain the transmit waveform to within the specified bandwidth. A square root of raised cosine filter is recommended with a roll off factor (excess bandwidth) of 35%. Utilizing this filter as both the modem modulation filter and demodulation filter will maximize the signal to noise ratio and minimize inter-symbol interference. The combined modulation and demodulation filters will have the following frequency response (symmetric around 0 Hz):

$$H(f) = 1 \quad \text{for } |f| \leq f_n - pf_n$$

$$H(f) = 0.5(1 - \sin(f - f_n * \text{PI} / 2pf_n)) \quad \text{for } f_n - pf_n < |f| \leq f_n + pf_n$$

$$H(f) = 0 \quad \text{elsewhere}$$

Where:

$f_n$  is the Nyquist frequency ( $f_n = 1 / (2T) = (1 / 2) * \text{SYMBOL RATE} = 1200 \text{ Hz}$  for 3kHz BW, 9600Hz for 24kHz BW)

$p$  is the roll off factor or excess bandwidth.

The individual modulation and demodulation filters are realized by taking the square root of the above frequency response.

MIL-STD-188-110C  
w/CHANGE 1  
APPENDIX D

D.5.2 Frame structure.

The frame structure that shall be used for the waveforms specified in this appendix is shown in Figure D-7. An initial synchronization preamble is followed by frames of alternating data (Unknown) and probe (Known) symbols. Each data frame shall consist of a data block consisting of U data symbols, followed by a mini-probe consisting of K known symbols.

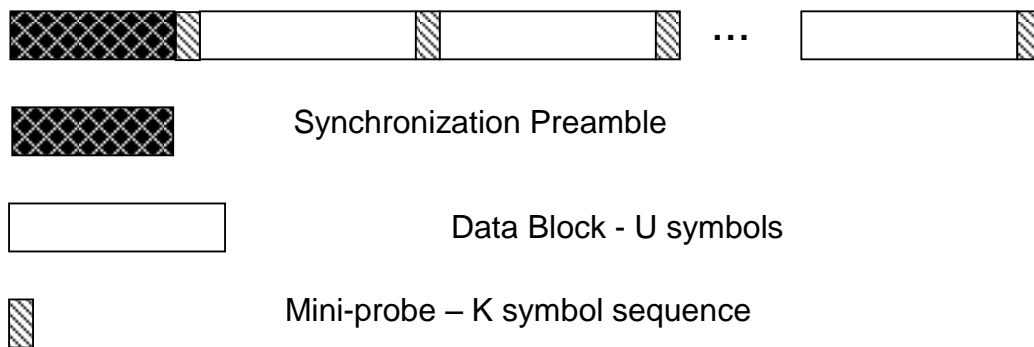

**FIGURE D-7. Frame structure for waveforms 1-13.**

Tables D-XI and D-XII provide the Unknown and Known frame structure for waveforms 1 through 12.

Waveform 0 uses a different structure after the Synchronization Preamble, in which data “frames” are 32-symbol Walsh sequences (channel symbols), each corresponding to a single unknown (data) bit (a di-bit after coding). Mini-probes are not sent in waveform 0, so Walsh-coded data symbols are sent continuously after the initial Synchronization Preamble.



MIL-STD-188-110C  
w/CHANGE 1  
APPENDIX D

**TABLE D- XI. Number of Unknown (Data) Symbols in Frame**

Waveform Number	0 Walsh	1 BPSK	2 BPSK	3 BPSK	4 BPSK	5 BPSK	6 QPSK	7 8PSK	8 16QAM	9 32QAM	10 64QAM	11 64QAM	12 256QAM	13 QPSK
<b>Bandwidth (kHz)</b>														
3	N/A	48	48	96	96	256	256	256	256	256	256	360	360	256
6	N/A	96	96	204	204	544	544	544	544	544	544	540	540	
9	N/A	288	288	288	-	768	768	768	768	768	768	1080	1080	
12	N/A	192	192	384	384	1024	1024	1024	1024	1024	1024	1080	1080	
15	N/A	288	288	288	288	1280	1280	1280	1280	1280	1280	1152	1152	
18	N/A	448	448	448	-	1536	1536	1536	1536	1536	1536	1920	1920	
21	N/A	320	320	320	320	1344	1344	1344	1344	1344	1344	2560	2560	
24	N/A	272	272	816	816	2176	2176	2176	2176	2176	2176	1920	1920	

**TABLE D- XII. Number of Known Symbols (Mini-Probe) in Frame**

Waveform Number	0 Walsh	1 BPSK	2 BPSK	3 BPSK	4 BPSK	5 BPSK	6 QPSK	7 8PSK	8 16QAM	9 32QAM	10 64QAM	11 64QAM	12 256QAM	13 QPSK
<b>Bandwidth (kHz)</b>														
3	N/A	48	48	32	32	32	32	32	32	32	32	24	24	32
6	N/A	96	96	68	68	68	68	68	68	68	68	36	36	
9	N/A	144	144	144	-	96	96	96	96	96	96	72	72	
12	N/A	192	192	128	128	128	128	128	128	128	128	72	72	
15	N/A	192	192	192	192	160	160	160	160	160	160	128	128	
18	N/A	224	224	224	-	192	192	192	192	192	192	128	128	
21	N/A	240	240	240	240	224	224	224	224	224	224	128	128	
24	N/A	272	272	272	272	272	272	272	272	272	272	128	128	

MIL-STD-188-110C  
w/CHANGE 1  
APPENDIX D

D.5.2.1 Synchronization preamble.

The synchronization preamble is used for rapid initial synchronization and provides time and frequency alignment. The synchronization preamble shall consist of two main sections, a transmitter level control (TLC) settling time section, and a synchronization section containing a repeated preamble super-frame. The preamble super-frame consists of three distinct subsections, one with a fixed (known) modulation, one to convey a downcount, and one to convey waveform identification. The superframe shall be repeated M times. The Synchronization section shall be immediately followed by the modulated data (Figure D-8).

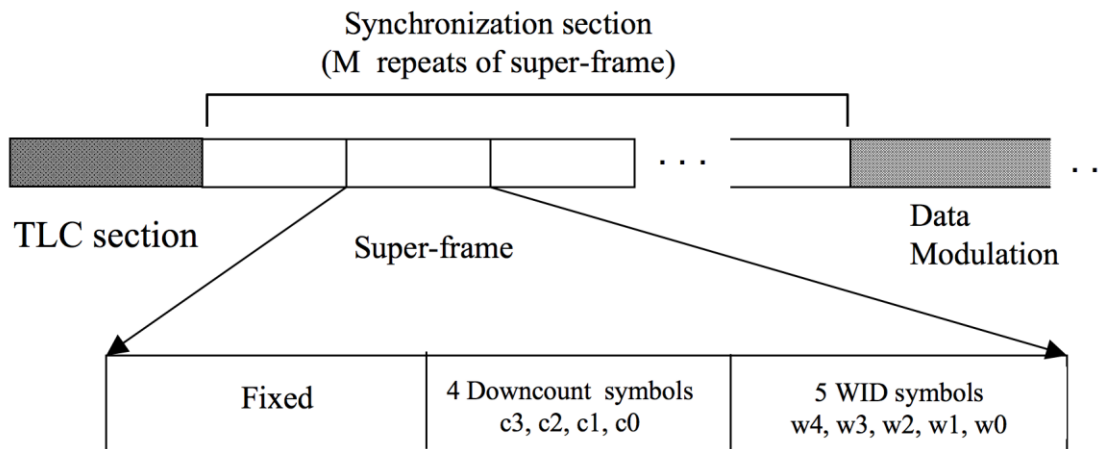

**FIGURE D-8. Synchronization preamble structure.**

D.5.2.1.1 4-ary Orthogonal Walsh Modulation in the preamble.

4-ary orthogonal Walsh modulation shall be used in the synchronization section of the preamble. The length of each channel symbol, in chips or symbols, is dependent on the bandwidth of the modem waveform selected and shall be as given by Table D-XIII.

**TABLE D-XIII. Length of Preamble Channel Symbols**

Bandwidth (kHz)	Walsh Sequence Length in Preamble
3	32
6	64
9	96
12	128
15	160
18	192
21	224
24	256

MIL-STD-188-110C  
w/CHANGE 1  
APPENDIX D

The 4-ary orthogonal Walsh modulation shall use the Walsh sequences in Table D-XIV. The di-bit representing the 2 bits of information to convey is mapped into a 4 element Walsh sequence of 0 and 4 as defined in Table D-XIV. This 4-element sequence shall be repeated to satisfy the Walsh sequence length requirement in Table D-XIII for the bandwidth in use.

**TABLE D-XIV. Walsh Sequences for Synchronization Section of the Preamble**

Di-bit	Walsh Sequence
00	0000
01	0404
10	0044
11	0440

Scrambling shall be performed by aligning the expanded Walsh sequence with the Fixed, Count, or the Waveform ID synchronization preambles defined in Tables D-XVIII, D-XIX, D-XX, respectively, and performing a modulo 8 addition between the specified 8-PSK symbol from the table and the corresponding Walsh element.

**D.5.2.1.2 TLC Section.**

The first section of the preamble, denoted TLC, is provided exclusively for radio and modem TGC and AGC. It shall consist of N blocks of 8-PSK. The length of each block in PSK symbols, based on the bandwidth used in the transmission to follow, shall be as shown in Table D-XIII. The value of N shall be configurable to range from 0 to 255 (for N=0 this first section is not transmitted). These symbols shall be formed by taking the complex conjugate of the symbols of the sequence specified below for the Fixed section in Table D-XVIII.

**D.5.2.1.3 Synchronization Section.**

The Fixed subsection of the super-frame shall consist of either 1 or 9 orthogonal Walsh modulated channel symbols. The length of each channel symbol, dependent on bandwidth, is given in Table D-XIII. For the case of the single Walsh symbol the di-bit shall be 3 (binary 11), and the super frame shall be transmitted only once (M=1). For the case of 9 Walsh symbols the di-bits shall be {0, 0, 2, 1, 2, 1, 0, 2, 3}, 3 being the last di-bit transmitted. The Fixed subsection is intended exclusively for synchronization and Doppler offset removal purposes.

The next subsection shall consist of four, orthogonal Walsh modulated di-bits, labeled as c3, c2, c1 and c0, each conveying two bits of information. This subsection represents a 5 bit downcount plus 3 parity bits. This count shall be initialized to a value of (M-1) and shall be decremented with each of the M preamble repetitions until it reaches zero in the final super-frame before data begins.

The final subsection of the preamble super-frame shall consist of five, orthogonal Walsh modulated channel symbols, each conveying two bits of information. These di-bits are labeled

MIL-STD-188-110C  
w/CHANGE 1  
APPENDIX D

as w4, w3, w2, w1, and w0. These 10 bits represent a Waveform ID consisting of waveform number, interleaver option, convolutional code length and parity check.

D.5.2.1.3.1 Mapping of the downcount di-bits c3, c2, c1, and c0.

The 5 bit super-frame down count is initialized to M-1 where M is the number of repeats of the super-frame and can be viewed as a binary number b4b3b2b1b0 where b4 is the MSB and b0 is the LSB. Bits b7, b6, and b5 shall contain a parity check computed over b4b3b2b1b0 as follows, where the ^ symbol indicates exclusive-or:

$$b7 = b1 \wedge b2 \wedge b3$$

$$b6 = b2 \wedge b3 \wedge b4$$

$$b5 = b0 \wedge b1 \wedge b2$$

C3 shall contain the two MSBs b7 and b6, b7 being the MSB. C2 shall contain the next two bits of the count b5 and b4, b5 being the MSB. C1 shall contain the next two bits of the count b3 and b2, b3 being the MSB. C0 shall contain the last two bits of the count b1 and b0, b1 being the MSB.

D.5.2.1.3.2 Mapping of the Waveform ID di-bits w4, w3, w2, w1, and w0.

The 10 bit waveform ID field consists of 5 di-bits w4, w3, w2, w1, and w0. The 10 bits are labeled d9 down to d0. W4 contains d9 and d8, where d9 is the MSB, w3 contains d7 and d6, and so on down to w0 which contains d1 and d0.

The 3 LSBs, d2, d1, and d0, shall contain a 3 bit checksum calculated over d9d8d7d6d5d4d3 as follows, where the ^ symbol indicates exclusive-or:

$$d2 = d9 \wedge d8 \wedge d7$$

$$d1 = d7 \wedge d6 \wedge d5$$

$$d0 = d5 \wedge d4 \wedge d3$$

MIL-STD-188-110C  
w/CHANGE 1  
APPENDIX D

The four bit waveform number, defined in Table D-II for all possible waveform options for a given bandwidth, shall be mapped into the w4 and w3 di-bits as defined in Table D-XV. The reserved encodings shall not be sent.

**TABLE D-XV. Waveform number mapping.**

Waveform Number	w4 d9 d8	w3 d7 d6
0	0 0	0 0
1	0 0	0 1
2	0 0	1 0
3	0 0	1 1
4	0 1	0 0
5	0 1	0 1
6	0 1	1 0
7	0 1	1 1
8	1 0	0 0
9	1 0	0 1
10	1 0	1 0
11	1 0	1 1
12	1 1	0 0
13	1 1	0 1
(reserved)	1 1	1 0
(reserved)	1 1	1 1

The Interleaver selection shall be mapped to w2 as defined in Table D-XVI.

**TABLE D-XVI. Interleaver selection mapping.**

Interleaver	w2 d5 d4
Ultra Short	0 0
Short	0 1
Medium	1 0
Long	1 1

The convolutional code constraint length shall be mapped into w1 as defined in Table D-XVII. The lsb of w1 shall be 0.

MIL-STD-188-110C  
w/CHANGE 1  
APPENDIX D

**TABLE D-XVII. Constraint length and voice mode mapping.**

Constraint Length	MSB of w1 d3
7	0
9	1

**D.5.2.1.4 Preamble scrambling sequences.**

Expressed as a sequence of 8PSK symbols, using the symbol numbers given in Table D-VI the sections of the preamble shall be scrambled as described in D.5.2.1.1 using the respective sequences shown in Table D-XVIII through D-XX:

**TABLE D-XVIII. TLC / Fixed Synchronization preamble**

```
int fixedPN[256] =
{2,4,0,0,6,2,1,4,6,1,0,5,7,3,4,1,2,6,1,7,0,7,3,2,2,2,3,2,4,6,3,6,
6,3,7,5,4,7,5,6,7,4,0,2,6,1,5,3,0,4,2,4,6,4,5,2,5,4,5,3,1,5,4,5,
6,5,1,0,7,1,0,1,0,5,3,5,2,2,4,5,4,0,6,4,1,4,0,3,3,0,0,3,3,7,3,4,
2,7,4,4,4,0,3,4,7,6,4,2,6,2,0,3,5,3,2,2,4,5,2,0,0,3,5,0,3,2,6,6,
1,4,2,3,6,1,3,0,3,3,2,4,2,2,6,5,5,3,6,7,6,5,6,6,5,2,5,4,2,3,3,3,
5,7,5,5,3,7,0,4,7,0,4,1,6,2,3,5,5,6,2,6,4,6,3,4,0,7,0,0,5,2,1,5,
4,3,4,5,7,0,5,3,7,6,6,6,4,5,6,0,2,0,4,2,3,4,4,0,7,6,6,2,0,0,3,3,
0,5,2,4,2,2,4,5,4,6,6,6,3,2,1,0,3,2,6,0,6,2,4,0,6,4,1,3,3,5,3,6};
```

**TABLE D-XIX. Count Synchronization preamble.**

```
int cntPN[256] =
{5,5,2,2,0,2,5,6,7,1,3,5,1,5,6,5,3,7,0,4,0,3,3,2,1,3,0,3,1,6,2,6,
0,6,4,1,2,5,6,3,5,3,7,4,2,6,7,3,0,2,0,1,7,5,0,6,1,5,0,3,2,2,5,2,
5,2,3,4,2,7,6,1,1,5,2,1,5,4,0,3,5,5,0,3,1,4,0,5,0,3,0,6,0,0,3,1,
6,1,4,4,7,7,0,5,7,0,1,5,1,0,1,3,1,5,0,7,1,2,2,2,7,1,2,5,0,3,3,2,
2,0,4,5,1,3,1,3,5,3,1,7,5,2,7,1,3,1,5,6,2,4,6,0,6,1,0,0,3,6,2,7,
3,2,4,7,6,4,1,3,6,6,0,3,0,0,7,5,4,5,1,2,1,5,0,3,1,0,4,6,6,1,0,5,
2,6,3,2,7,4,2,4,0,1,7,0,7,0,5,1,4,5,7,2,0,4,4,3,5,2,7,7,4,5,1,4,
4,6,3,3,0,5,1,5,5,4,3,2,0,3,0,4,7,4,5,1,5,5,7,7,6,2,4,3,5,2,2,4};
```

MIL-STD-188-110C  
w/CHANGE 1  
APPENDIX D

**TABLE D-XX. Waveform Number Synchronization preamble.**

```
int widPN[256] =
{2,3,0,3,7,3,3,0,1,4,4,6,5,5,4,5,6,2,0,5,6,6,5,3,5,5,2,2,1,2,3,6,
1,1,4,3,1,0,5,1,0,3,3,0,3,0,4,4,6,2,5,6,1,7,2,6,2,0,0,4,7,2,3,5,
2,7,1,6,5,0,4,1,6,2,1,5,4,3,5,0,3,4,1,3,2,1,6,1,5,7,0,4,7,6,6,0,
4,7,6,6,6,6,2,3,5,0,7,0,3,1,5,1,2,0,5,3,2,4,5,6,6,7,7,3,5,1,6,0,
1,4,4,5,6,0,6,7,2,4,4,0,3,7,2,0,0,1,4,0,7,1,7,4,5,4,5,5,5,3,3,2,
0,5,1,3,1,5,3,4,1,5,4,1,4,4,2,2,4,3,0,7,4,1,5,7,1,4,7,2,5,5,6,6,
1,6,5,6,3,0,2,5,7,7,4,4,3,4,4,6,0,7,2,2,0,0,2,1,0,0,3,6,6,4,0,2,
4,3,4,5,2,6,3,7,7,5,7,3,0,7,0,0,7,2,6,2,2,6,1,4,3,7,6,5,0,6,5,4};
```

#### D.5.2.2 Mini-probes.

Mini-probes shall be inserted, following every data block and at the end of each preamble, for non-Walsh based modulations (i.e., all except Waveform ID 0). To support the wide range of bit rate and bandwidth options of this standard, 14 different mini-probe sequences are utilized. Each of the mini-probes consists of the base sequence cyclically extended to the required length.

The mini-probes are also utilized to identify the long interleaver block boundary. This is accomplished by transmitting a cyclically rotated version of the mini-probe following the second to last data block of the long interleaver frame. The position of this cyclically shifted mini-probe remains constant regardless of which interleaver has actually been selected. As all interleavers line up on the long interleaver block boundary, this feature can be used to synchronize to a broadcast transmission and provide a late entry feature when the Waveform ID fields are known in advance by the receiver. The cyclically rotated version of the mini-probe is obtained by first cyclically extending the base sequence, and then shifting by a predetermined number of symbols.

Table D-XXI defines the mini-probe lengths and the base sequence used to generate the full mini-probe and also the cyclic shift utilized to signal the interleaver block boundary.

MIL-STD-188-110C  
w/CHANGE 1  
APPENDIX D

**TABLE D-XXI. Mini-probe lengths and base sequences.**

Mini-Probe Length	Base Sequence	Cyclic Shift for Interleaver Boundary
24	13	6
32	16	8
36	19	9
48	25	12
64	36	18
68	36	18
72	36	18
96	49	24
128	64	32
144	81	40
160	81	40
192	100	50
224	121	60
240	121	60
272	144	72

In the case of the cyclic shift applied to the mini-probe for use in marking the long interleaver block boundary, the first element of the sequence transmitted is the one corresponding to the specified cyclic shift.

The method of forming the mini-probe from the specified base sequence will be illustrated using the 24 symbol mini-probe and the cyclically shifted version of the 24 symbol mini-probe formed from the 13 symbol base sequence. The base sequence of length 13 is listed in Table D-XXII(a). This sequence is cyclically extended by repeating the first 11 symbols of the sequence as shown in Table D-XXII (b) to obtain the required mini-probe of length 24.



MIL-STD-188-110C  
w/CHANGE 1  
APPENDIX D

**TABLE D-XXII (a). In-phase and Quadrature components of base sequence of length 13 used to form 24 symbol mini-probe.**

Symbol Number	In-Phase	Quadrature
0	1.00000	0.0
1	1.00000	0.0
2	1.00000	0.0
3	1.00000	0.0
4	1.00000	0.0
5	-1.00000	0.0
6	-1.00000	0.0
7	1.00000	0.0
8	1.00000	0.0
9	-1.00000	0.0
10	1.00000	0.0
11	-1.00000	0.0
12	1.00000	0.0

MIL-STD-188-110C  
w/CHANGE 1  
APPENDIX D

**TABLE D-XXII (b). In-phase and Quadrature components of Length 24 mini-probe**

Symbol Number	In-Phase	Quadrature
0	1.00000	0.0
1	1.00000	0.0
2	1.00000	0.0
3	1.00000	0.0
4	1.00000	0.0
5	-1.00000	0.0
6	-1.00000	0.0
7	1.00000	0.0
8	1.00000	0.0
9	-1.00000	0.0
10	1.00000	0.0
11	-1.00000	0.0
12	1.00000	0.0
13	1.00000	0.0
14	1.00000	0.0
15	1.00000	0.0
16	1.00000	0.0
17	1.00000	0.0
18	-1.00000	0.0
19	-1.00000	0.0
20	1.00000	0.0
21	1.00000	0.0
22	-1.00000	0.0
23	1.00000	0.0

MIL-STD-188-110C  
w/CHANGE 1  
APPENDIX D

Table D-XXII(c) provides an example of the cyclic shift of the 24 symbol mini-probe. As specified in Table D-XXI, the shifted mini-probe sequence begins 6 symbols into the original 13 symbol base sequence. Thus, the shifted mini-probe contains the last 7 symbols of the length 13 base sequence, followed by a complete length 13 base sequence, followed by the first 4 symbols of the length 13 base sequence to complete the 24 symbol mini-probe.

**TABLE D-XXII(c). In-phase and Quadrature components of Length 24 mini-probe cyclically shifted by 6 symbols**

Symbol Number	In-Phase	Quadrature
0	-1.00000	0.0
1	1.00000	0.0
2	1.00000	0.0
3	-1.00000	0.0
4	1.00000	0.0
5	-1.00000	0.0
6	1.00000	0.0
7	1.00000	0.0
8	1.00000	0.0
9	1.00000	0.0
10	1.00000	0.0
11	1.00000	0.0
12	-1.00000	0.0
13	-1.00000	0.0
14	1.00000	0.0
15	1.00000	0.0
16	-1.00000	0.0
17	1.00000	0.0
18	-1.00000	0.0
19	1.00000	0.0
20	1.00000	0.0
21	1.00000	0.0
22	1.00000	0.0
23	1.00000	0.0

MIL-STD-188-110C  
w/CHANGE 1  
APPENDIX D

The tables which follow provide the In-phase and Quadrature components of each of the base sequences used to form the mini-probes identified in Table D-XXI. The method of construction of each of the mini-probe sequences and the cyclic shifted variant of the mini-probe sequence follows the methodology just illustrated for the length 13 base sequence.

**TABLE D-XXIII. In-phase and Quadrature components of 16 symbol Base Sequence used to form the 32 symbol mini-probe.**

Symbol Number	In-Phase	Quadrature
0	1.000000	0.000000
1	1.000000	0.000000
2	1.000000	0.000000
3	1.000000	0.000000
4	1.000000	0.000000
5	0.000000	-1.000000
6	-1.000000	0.000000
7	0.000000	1.000000
8	1.000000	0.000000
9	-1.000000	0.000000
10	1.000000	0.000000
11	-1.000000	0.000000
12	1.000000	0.000000
13	0.000000	1.000000
14	-1.000000	0.000000
15	0.000000	-1.000000

MIL-STD-188-110C  
w/CHANGE 1  
APPENDIX D

**TABLE D-XXIV. In-phase and Quadrature components of 19 symbol Base Sequence used to form the 36 symbol mini-probe**

Symbol Number	In-Phase	Quadrature
0	1.000000	0.000000
1	-1.000000	0.000000
2	1.000000	0.000000
3	1.000000	0.000000
4	-1.000000	0.000000
5	-1.000000	0.000000
6	-1.000000	0.000000
7	-1.000000	0.000000
8	1.000000	0.000000
9	-1.000000	0.000000
10	1.000000	0.000000
11	-1.000000	0.000000
12	1.000000	0.000000
13	1.000000	0.000000
14	1.000000	0.000000
15	1.000000	0.000000
16	-1.000000	0.000000
17	-1.000000	0.000000
18	1.000000	0.000000

MIL-STD-188-110C  
w/CHANGE 1  
APPENDIX D

**TABLE D-XXV. In-phase and Quadrature components of 25 symbol Base Sequence used to form the 48 symbol mini-probe.**

Symbol Number	In-Phase	Quadrature
0	1.000000	0.000000
1	1.000000	0.000000
2	1.000000	0.000000
3	1.000000	0.000000
4	1.000000	0.000000
5	1.000000	0.000000
6	0.309017	-0.951057
7	-0.809017	-0.587785
8	-0.809017	0.587785
9	0.309017	0.951056
10	1.000000	0.000000
11	-0.809017	-0.587785
12	0.309017	0.951056
13	0.309017	-0.951057
14	-0.809017	0.587785
15	1.000000	0.000000
16	-0.809017	0.587785
17	0.309017	-0.951057
18	0.309017	0.951057
19	-0.809017	-0.587785
20	1.000000	0.000000
21	0.309017	0.951056
22	-0.809017	0.587785
23	-0.809017	-0.587785
24	0.309016	-0.951057

MIL-STD-188-110C  
w/CHANGE 1  
APPENDIX D

**TABLE D-XXVI. In-phase and Quadrature components of 36 symbol Base Sequence used to form the 64 and 72 symbol mini-probes.**

Symbol Number	In-Phase	Quadrature
0	1.000000	0.000000
1	1.000000	0.000000
2	1.000000	0.000000
3	1.000000	0.000000
4	1.000000	0.000000
5	1.000000	0.000000
6	1.000000	0.000000
7	0.500000	-0.866025
8	-0.500000	-0.866025
9	-1.000000	0.000000
10	-0.500000	0.866025
11	0.500000	0.866025
12	1.000000	0.000000
13	-0.500000	-0.866025
14	-0.500000	0.866025
15	1.000000	0.000000
16	-0.500000	-0.866025
17	-0.500000	0.866025
18	1.000000	0.000000
19	-1.000000	0.000000
20	1.000000	0.000000
21	-1.000000	0.000000
22	1.000000	0.000000
23	-1.000000	0.000000
24	1.000000	0.000000
25	-0.500000	0.866025
26	-0.500000	-0.866025
27	1.000000	0.000000
28	-0.500000	0.866026
29	-0.500000	-0.866026
30	1.000000	0.000000
31	0.500000	0.866025
32	-0.500000	0.866025
33	-1.000000	0.000000
34	-0.500000	-0.866026
35	0.500000	-0.866026

MIL-STD-188-110C  
w/CHANGE 1  
APPENDIX D

**TABLE D-XXVII. In-phase and Quadrature components of length 49 Base Sequence used to form the 96 symbol mini-probe.**

Symbol Number	In-Phase	Quadrature	Symbol Number	In-Phase	Quadrature
0	1.000000	0.000000	25	-0.222521	0.974928
1	1.000000	0.000000	26	0.623490	-0.781831
2	1.000000	0.000000	27	-0.900968	0.433885
3	1.000000	0.000000	28	1.000000	0.000000
4	1.000000	0.000000	29	-0.900969	0.433884
5	1.000000	0.000000	30	0.623490	-0.781832
6	1.000000	0.000000	31	-0.222521	0.974928
7	1.000000	0.000000	32	-0.222521	-0.974928
8	0.623490	-0.781832	33	0.623490	0.781832
9	-0.222521	-0.974928	34	-0.900969	-0.433884
10	-0.900969	-0.433884	35	1.000000	0.000000
11	-0.900969	0.433884	36	-0.222521	0.974928
12	-0.222521	0.974928	37	-0.900969	-0.433884
13	0.623490	0.781832	38	0.623490	-0.781831
14	1.000000	0.000000	39	0.623490	0.781832
15	-0.222521	-0.974928	40	-0.900969	0.433883
16	-0.900969	0.433884	41	-0.222520	-0.974928
17	0.623490	0.781832	42	1.000000	0.000000
18	0.623490	-0.781832	43	0.623490	0.781832
19	-0.900969	-0.433884	44	-0.222521	0.974928
20	-0.222521	0.974928	45	-0.900968	0.433885
21	1.000000	0.000000	46	-0.900969	-0.433884
22	-0.900969	-0.433884	47	-0.222520	-0.974928
23	0.623490	0.781832	48	0.623488	-0.781833
24	-0.222521	-0.974928			



MIL-STD-188-110C  
w/CHANGE 1  
APPENDIX D

**TABLE D-XXVIII. In-phase and Quadrature components of length 64 Base Sequence used to form 128 symbol mini-probe.**

Symbol Number	In-Phase	Quadrature	Symbol Number	In-Phase	Quadrature
0	1.000000	0.000000	32	1.000000	0.000000
1	1.000000	0.000000	33	-1.000000	0.000000
2	1.000000	0.000000	34	1.000000	0.000000
3	1.000000	0.000000	35	-1.000000	0.000000
4	1.000000	0.000000	36	1.000000	0.000000
5	1.000000	0.000000	37	-1.000000	0.000000
6	1.000000	0.000000	38	1.000000	0.000000
7	1.000000	0.000000	39	-1.000000	-0.000000
8	1.000000	0.000000	40	1.000000	0.000000
9	0.707107	-0.707107	41	-0.707107	0.707107
10	0.000000	-1.000000	42	0.000000	-1.000000
11	-0.707107	-0.707107	43	0.707107	0.707107
12	-1.000000	0.000000	44	-1.000000	0.000000
13	-0.707107	0.707107	45	0.707107	-0.707107
14	0.000000	1.000000	46	0.000000	1.000000
15	0.707107	0.707107	47	-0.707107	-0.707107
16	1.000000	0.000000	48	1.000000	0.000000
17	0.000000	-1.000000	49	0.000000	1.000000
18	-1.000000	0.000000	50	-1.000000	0.000000
19	0.000000	1.000000	51	0.000000	-1.000000
20	1.000000	0.000000	52	1.000000	0.000000
21	0.000000	-1.000000	53	0.000000	1.000000
22	-1.000000	0.000000	54	-1.000000	0.000000
23	0.000000	1.000000	55	0.000000	-1.000000
24	1.000000	0.000000	56	1.000000	0.000000
25	-0.707107	-0.707107	57	0.707107	0.707107
26	0.000000	1.000000	58	0.000000	1.000000
27	0.707107	-0.707107	59	-0.707107	0.707106
28	-1.000000	0.000000	60	-1.000000	-0.000001
29	0.707107	0.707107	61	-0.707107	-0.707107
30	0.000000	-1.000000	62	0.000000	-1.000000
31	-0.707107	0.707106	63	0.707108	-0.707106

MIL-STD-188-110C  
w/CHANGE 1  
APPENDIX D

**TABLE D-XXIX. In-phase and Quadrature components of 81 symbol Base Sequence used to form the 144 and 160 symbol mini-probes.**

Symbol Number	In-Phase	Quadrature	Symbol Number	In-Phase	Quadrature
0	1.000000	0.000000	32	-0.500000	0.866025
1	1.000000	0.000000	33	1.000000	0.000000
2	1.000000	0.000000	34	-0.500000	-0.866025
3	1.000000	0.000000	35	-0.500000	0.866026
4	1.000000	0.000000	36	1.000000	0.000000
5	1.000000	0.000000	37	-0.939693	-0.342020
6	1.000000	0.000000	38	0.766044	0.642788
7	1.000000	0.000000	39	-0.500000	-0.866025
8	1.000000	0.000000	40	0.173648	0.984808
9	1.000000	0.000000	41	0.173648	-0.984808
10	0.766044	-0.642788	42	-0.500000	0.866026
11	0.173648	-0.984808	43	0.766044	-0.642788
12	-0.500000	-0.866025	44	-0.939693	0.342020
13	-0.939693	-0.342020	45	1.000000	0.000000
14	-0.939693	0.342020	46	-0.939693	0.342020
15	-0.500000	0.866025	47	0.766044	-0.642788
16	0.173648	0.984808	48	-0.500000	0.866025
17	0.766044	0.642788	49	0.173648	-0.984808
18	1.000000	0.000000	50	0.173649	0.984808
19	0.173648	-0.984808	51	-0.500000	-0.866026
20	-0.939693	-0.342020	52	0.766045	0.642787
21	-0.500000	0.866025	53	-0.939693	-0.342020
22	0.766044	0.642788	54	1.000000	0.000000
23	0.766044	-0.642788	55	-0.500000	0.866025
24	-0.500000	-0.866025	56	-0.500000	-0.866025
25	-0.939693	0.342020	57	1.000000	0.000000
26	0.173648	0.984808	58	-0.500000	0.866026
27	1.000000	0.000000	59	-0.500000	-0.866026
28	-0.500000	-0.866025	60	1.000000	-0.000000
29	-0.500000	0.866025	61	-0.500000	0.866025
30	1.000000	0.000000	62	-0.500000	-0.866025
31	-0.500000	-0.866025	63	1.000000	0.000000

MIL-STD-188-110C  
w/CHANGE 1  
APPENDIX D

**TABLE D-XXIX. In-phase and Quadrature components of 81 symbol Base Sequence  
used to form the 144 and 160 symbol mini-probes-Continued**

Symbol Number	In-Phase	Quadrature	Symbol Number	In-Phase	Quadrature
64	0.173648	0.984808	73	0.766044	0.642788
65	-0.939693	0.342020	74	0.173648	0.984808
66	-0.500000	-0.866025	75	-0.500000	0.866026
67	0.766044	-0.642788	76	-0.939693	0.342020
68	0.766045	0.642787	77	-0.939693	-0.342020
69	-0.500000	0.866025	78	-0.500001	-0.866025
70	-0.939693	-0.342019	79	0.173648	-0.984808
71	0.173648	-0.984808	80	0.766045	-0.642787
72	1.000000	0.000000			

MIL-STD-188-110C  
w/CHANGE 1  
APPENDIX D

**TABLE D-XXX. In-phase and Quadrature components of 100 symbol Base Sequence used to form the 192 symbol mini-probe.**

Symbol Number	In-Phase	Quadrature	Symbol Number	In-Phase	Quadrature
0	1.000000	0.000000	32	-0.809017	0.587785
1	1.000000	0.000000	33	0.809017	0.587785
2	1.000000	0.000000	34	0.309017	-0.951057
3	1.000000	0.000000	35	-1.000000	0.000000
4	1.000000	0.000000	36	0.309017	0.951057
5	1.000000	0.000000	37	0.809017	-0.587785
6	1.000000	0.000000	38	-0.809017	-0.587785
7	1.000000	0.000000	39	-0.309018	0.951056
8	1.000000	0.000000	40	1.000000	0.000000
9	1.000000	0.000000	41	-0.809017	-0.587785
10	1.000000	0.000000	42	0.309017	0.951056
11	0.809017	-0.587785	43	0.309017	-0.951057
12	0.309017	-0.951057	44	-0.809017	0.587785
13	-0.309017	-0.951056	45	1.000000	0.000000
14	-0.809017	-0.587785	46	-0.809017	-0.587785
15	-1.000000	0.000000	47	0.309017	0.951057
16	-0.809017	0.587785	48	0.309016	-0.951057
17	-0.309017	0.951056	49	-0.809017	0.587785
18	0.309017	0.951056	50	1.000000	0.000000
19	0.809017	0.587785	51	-1.000000	0.000000
20	1.000000	0.000000	52	1.000000	0.000000
21	0.309017	-0.951057	53	-1.000000	0.000000
22	-0.809017	-0.587785	54	1.000000	0.000000
23	-0.809017	0.587785	55	-1.000000	0.000000
24	0.309017	0.951056	56	1.000000	0.000000
25	1.000000	0.000000	57	-1.000000	-0.000000
26	0.309017	-0.951057	58	1.000000	-0.000000
27	-0.809017	-0.587785	59	-1.000000	0.000000
28	-0.809017	0.587785	60	1.000000	0.000000
29	0.309017	0.951057	61	-0.809017	0.587785
30	1.000000	0.000000	62	0.309017	-0.951057
31	-0.309017	-0.951056	63	0.309017	0.951057

MIL-STD-188-110C  
w/CHANGE 1  
APPENDIX D

**TABLE D-XXX. In-phase and Quadrature components of 100 symbol Base Sequence used to form the 192 symbol mini-probe.-Continued**

Symbol Number	In-Phase	Quadrature	Symbol Number	In-Phase	Quadrature
64	-0.809017	-0.587785	82	-0.809017	0.587785
65	1.000000	0.000000	83	-0.809017	-0.587785
66	-0.809017	0.587785	84	0.309016	-0.951057
67	0.309018	-0.951056	85	1.000000	-0.000000
68	0.309018	0.951056	86	0.309018	0.951056
69	-0.809016	-0.587786	87	-0.809018	0.587785
70	1.000000	0.000000	88	-0.809018	-0.587784
71	-0.309017	0.951056	89	0.309018	-0.951056
72	-0.809017	-0.587785	90	1.000000	0.000000
73	0.809017	-0.587785	91	0.809017	0.587785
74	0.309017	0.951057	92	0.309017	0.951057
75	-1.000000	-0.000000	93	-0.309018	0.951056
76	0.309018	-0.951056	94	-0.809017	0.587785
77	0.809017	0.587786	95	-1.000000	0.000000
78	-0.809018	0.587785	96	-0.809016	-0.587786
79	-0.309018	-0.951056	97	-0.309018	-0.951056
80	1.000000	0.000000	98	0.309018	-0.951056
81	0.309017	0.951056	99	0.809016	-0.587787

MIL-STD-188-110C  
w/CHANGE 1  
APPENDIX D

**TABLE D-XXXI. In-phase and Quadrature components of 121 symbol Base Sequence used to form the 224 and 240 symbol mini-probes.**

Symbol Number	In-Phase	Quadrature	Symbol Number	In-Phase	Quadrature
0	1.000000	0.000000	32	0.415415	0.909632
1	1.000000	0.000000	33	1.000000	0.000000
2	1.000000	0.000000	34	-0.142315	-0.989821
3	1.000000	0.000000	35	-0.959493	0.281733
4	1.000000	0.000000	36	0.415415	0.909632
5	1.000000	0.000000	37	0.841254	-0.540641
6	1.000000	0.000000	38	-0.654861	-0.755750
7	1.000000	0.000000	39	-0.654861	0.755750
8	1.000000	0.000000	40	0.841253	0.540641
9	1.000000	0.000000	41	0.415415	-0.909632
10	1.000000	0.000000	42	-0.959493	-0.281732
11	1.000000	0.000000	43	-0.142315	0.989821
12	0.841254	-0.540641	44	1.000000	0.000000
13	0.415415	-0.909632	45	-0.654861	-0.755750
14	-0.142315	-0.989821	46	-0.142315	0.989821
15	-0.654861	-0.755750	47	0.841254	-0.540641
16	-0.959493	-0.281733	48	-0.959493	-0.281733
17	-0.959493	0.281733	49	0.415415	0.909632
18	-0.654861	0.755750	50	0.415415	-0.909632
19	-0.142315	0.989821	51	-0.959493	0.281733
20	0.415415	0.909632	52	0.841253	0.540641
21	0.841253	0.540641	53	-0.142315	-0.989821
22	1.000000	0.000000	54	-0.654861	0.755749
23	0.415415	-0.909632	55	1.000000	0.000000
24	-0.654861	-0.755750	56	-0.959493	-0.281733
25	-0.959493	0.281733	57	0.841253	0.540641
26	-0.142315	0.989821	58	-0.654861	-0.755750
27	0.841253	0.540641	59	0.415415	0.909632
28	0.841254	-0.540641	60	-0.142315	-0.989821
29	-0.142315	-0.989821	61	-0.142315	0.989821
30	-0.959493	-0.281733	62	0.415415	-0.909632
31	-0.654861	0.755750	63	-0.654861	0.755749

MIL-STD-188-110C  
w/CHANGE 1  
APPENDIX D

**TABLE D-XXXI. In-phase and Quadrature components of 121 symbol Base Sequence  
used to form the 224 and 240 symbol mini-probes.-Continued**

Symbol Number	In-Phase	Quadrature	Symbol Number	In-Phase	Quadrature
64	0.841254	-0.540640	93	-0.654861	0.755749
65	-0.959493	0.281732	94	-0.654861	-0.755750
66	1.000000	0.000000	95	0.841253	-0.540641
67	-0.959493	0.281733	96	0.415414	0.909633
68	0.841254	-0.540641	97	-0.959493	0.281733
69	-0.654861	0.755750	98	-0.142314	-0.989822
70	0.415415	-0.909632	99	1.000000	0.000000
71	-0.142315	0.989821	100	0.415415	0.909632
72	-0.142315	-0.989821	101	-0.654861	0.755750
73	0.415414	0.909632	102	-0.959493	-0.281732
74	-0.654861	-0.755750	103	-0.142315	-0.989821
75	0.841254	0.540640	104	0.841254	-0.540640
76	-0.959493	-0.281733	105	0.841254	0.540640
77	1.000000	0.000000	106	-0.142315	0.989821
78	-0.654861	0.755750	107	-0.959493	0.281733
79	-0.142315	-0.989821	108	-0.654862	-0.755748
80	0.841253	0.540641	109	0.415416	-0.909632
81	-0.959493	0.281733	110	1.000000	0.000000
82	0.415415	-0.909632	111	0.841253	0.540641
83	0.415414	0.909632	112	0.415415	0.909632
84	-0.959493	-0.281732	113	-0.142315	0.989821
85	0.841253	-0.540641	114	-0.654861	0.755749
86	-0.142315	0.989821	115	-0.959493	0.281732
87	-0.654860	-0.755750	116	-0.959493	-0.281733
88	1.000000	0.000000	117	-0.654860	-0.755750
89	-0.142315	0.989821	118	-0.142314	-0.989822
90	-0.959493	-0.281733	119	0.415416	-0.909632
91	0.415415	-0.909632	120	0.841254	-0.540640
92	0.841253	0.540641			

MIL-STD-188-110C  
w/CHANGE 1  
APPENDIX D

**TABLE D-XXXII. In-phase and Quadrature components of 144 symbol Base Sequence used to form the 272 symbol mini-probe.**

Symbol Number	In-Phase	Quadrature	Symbol Number	In-Phase	Quadrature
0	1.000000	0.000000	32	-0.500000	-0.866025
1	1.000000	0.000000	33	-1.000000	0.000000
2	1.000000	0.000000	34	-0.500000	0.866025
3	1.000000	0.000000	35	0.500000	0.866026
4	1.000000	0.000000	36	1.000000	0.000000
5	1.000000	0.000000	37	0.000000	-1.000000
6	1.000000	0.000000	38	-1.000000	0.000000
7	1.000000	0.000000	39	0.000000	1.000000
8	1.000000	0.000000	40	1.000000	0.000000
9	1.000000	0.000000	41	0.000000	-1.000000
10	1.000000	0.000000	42	-1.000000	0.000000
11	1.000000	0.000000	43	0.000000	1.000000
12	1.000000	0.000000	44	1.000000	0.000000
13	0.866025	-0.500000	45	0.000000	-1.000000
14	0.500000	-0.866025	46	-1.000000	0.000000
15	0.000000	-1.000000	47	-0.000001	1.000000
16	-0.500000	-0.866025	48	1.000000	0.000000
17	-0.866025	-0.500000	49	-0.500000	-0.866025
18	-1.000000	0.000000	50	-0.500000	0.866025
19	-0.866025	0.500000	51	1.000000	0.000000
20	-0.500000	0.866025	52	-0.500000	-0.866025
21	0.000000	1.000000	53	-0.500000	0.866025
22	0.500000	0.866025	54	1.000000	0.000000
23	0.866025	0.500000	55	-0.500000	-0.866025
24	1.000000	0.000000	56	-0.500000	0.866026
25	0.500000	-0.866025	57	1.000000	0.000000
26	-0.500000	-0.866025	58	-0.500000	-0.866026
27	-1.000000	0.000000	59	-0.500001	0.866025
28	-0.500000	0.866025	60	1.000000	0.000000
29	0.500000	0.866025	61	-0.866025	-0.500000
30	1.000000	0.000000	62	0.500000	0.866025
31	0.500000	-0.866025	63	0.000000	-1.000000



MIL-STD-188-110C  
w/CHANGE 1  
APPENDIX D

**TABLE D-XXXII. In-phase and Quadrature components of 144 symbol Base Sequence  
used to form the 272 symbol mini-probe.-Continued**

Symbol Number	In-Phase	Quadrature	Symbol Number	In-Phase	Quadrature
64	-0.500000	0.866025	96	1.000000	0.000000
65	0.866025	-0.500000	97	-0.500000	0.866025
66	-1.000000	0.000000	98	-0.500000	-0.866025
67	0.866025	0.500001	99	1.000000	0.000000
68	-0.500000	-0.866026	100	-0.500000	0.866026
69	0.000000	1.000000	101	-0.500000	-0.866026
70	0.500000	-0.866026	102	1.000000	-0.000001
71	-0.866025	0.500001	103	-0.500000	0.866025
72	1.000000	0.000000	104	-0.500001	-0.866025
73	-1.000000	0.000000	105	1.000000	0.000000
74	1.000000	0.000000	106	-0.500001	0.866025
75	-1.000000	0.000000	107	-0.499999	-0.866026
76	1.000000	0.000000	108	1.000000	0.000000
77	-1.000000	0.000000	109	0.000000	1.000000
78	1.000000	0.000000	110	-1.000000	0.000000
79	-1.000000	-0.000001	111	0.000000	-1.000000
80	1.000000	-0.000001	112	1.000000	0.000000
81	-1.000000	0.000000	113	0.000000	1.000000
82	1.000000	0.000001	114	-1.000000	0.000000
83	-1.000000	-0.000001	115	0.000002	-1.000000
84	1.000000	0.000000	116	1.000000	0.000000
85	-0.866025	0.500000	117	-0.000002	1.000000
86	0.500000	-0.866025	118	-1.000000	0.000000
87	0.000000	1.000000	119	0.000002	-1.000000
88	-0.500000	-0.866025	120	1.000000	0.000000
89	0.866025	0.500001	121	0.500000	0.866025
90	-1.000000	-0.000001	122	-0.500000	0.866025
91	0.866026	-0.500000	123	-1.000000	0.000000
92	-0.500000	0.866025	124	-0.500000	-0.866026
93	0.000002	-1.000000	125	0.500000	-0.866026
94	0.499999	0.866026	126	1.000000	0.000001
95	-0.866025	-0.500001	127	0.499999	0.866026

MIL-STD-188-110C  
w/CHANGE 1  
APPENDIX D

**TABLE D-XXXII. In-phase and Quadrature components of 144 symbol Base Sequence used to form the 272 symbol mini-probe.-Continued**

Symbol Number	In-Phase	Quadrature	Symbol Number	In-Phase	Quadrature
128	-0.500001	0.866025	136	-0.500000	0.866025
129	-1.000000	0.000000	137	-0.866025	0.500000
130	-0.500001	-0.866025	138	-1.000000	-0.000000
131	0.499998	-0.866026	139	-0.866025	-0.500000
132	1.000000	0.000000	140	-0.499999	-0.866026
133	0.866025	0.500000	141	0.000000	-1.000000
134	0.500000	0.866026	142	0.500000	-0.866026
135	-0.000001	1.000000	143	0.866025	-0.500000

**D.5.3 Coding and interleaving.**

The interleaver used shall be a block interleaver. Each block of input data shall also be encoded using a block encoding technique with a code block size equal to the size of the block interleaver. Thus, the input data bits will be sent as successive blocks of bits that span the duration of the interleaver length selected. Tables D-XXXIII through D-XL show the number of input data bits per block as function of both data rate and interleaver length, one table for each bandwidth. Note that the “Number of Input Bits” should not be confused with the “Number of Bits,” which is the interleaver size. The bits from an input data block will be mapped through the coding and interleaving into a number of data frames and it is the number of bits per frame times the number of data frames that defines the interleaver length.

MIL-STD-188-110C  
w/CHANGE 1  
APPENDIX D

**TABLE D-XXXIII. Interleaver Parameters for 3kHz Bandwidth**

Waveform Number	UltraShort			Short			Medium			Long		
	Number of Frames	Number of bits	Number of Input Bits	Number of Frames	Number of bits	Number of Input Bits	Number of Frames	Number of bits	Number of Input Bits	Number of Frames	Number of bits	Number of Input Bits
0	-	-	-	40	80	40	144	288	144	576	1152	576
1	4	192	24	16	768	96	64	3072	384	256	12288	1536
2	4	192	48	16	768	192	64	3072	768	256	12288	3072
3	2	192	64	8	768	256	32	3072	1024	128	12288	4096
4	2	192	128	8	768	512	32	3072	2048	128	12288	8192
5	1	256	192	4	1024	768	16	4096	3072	64	16384	12288
6	1	512	384	4	2048	1536	16	8192	6144	64	32768	24576
7	1	768	576	4	3072	2304	16	12288	9216	64	49152	36864
8	1	1024	768	4	4096	3072	16	16384	12288	64	65536	49152
9	1	1280	960	4	5120	3840	16	20480	15360	64	81920	61440
10	1	1536	1152	4	6144	4608	16	24576	18432	64	98304	73728
11	1	2160	1920	4	8640	7680	16	34560	30720	64	138240	122880
12	1	2880	2560	4	11520	10240	16	46080	40960	64	184320	163840
13	1	512	288	4	2048	1152	16	8192	4608	64	32768	18432

MIL-STD-188-110C  
w/CHANGE 1  
APPENDIX D

**TABLE D-XXXIV. Interleaver Parameters for 6kHz Bandwidth**

Waveform Number	UltraShort			Short			Medium			Long		
	Number of Frames	Number of bits	Number of Input Bits	Number of Frames	Number of bits	Number of Input Bits	Number of Frames	Number of bits	Number of Input Bits	Number of Frames	Number of bits	Number of Input Bits
0	-	-	-	80	160	80	288	576	288	1152	2304	1152
1	4	384	48	16	1536	192	64	6144	768	256	24576	3072
2	4	384	96	16	1536	384	64	6144	1536	256	24576	6144
3	2	408	136	8	1632	544	32	6528	2176	128	26112	8704
4	2	408	272	8	1632	1088	32	6528	4352	128	26112	17408
5	1	544	408	4	2176	1632	16	8704	6528	64	34816	26112
6	1	1088	816	4	4352	3264	16	17408	13056	64	69632	52224
7	1	1632	1224	4	6528	4896	16	26112	19584	64	104448	78336
8	1	2176	1632	4	8704	6528	16	34816	26112	64	139264	104448
9	1	2720	2040	4	10880	8160	16	43520	32640	64	174080	130560
10	1	3264	2448	4	13056	9792	16	52224	39168	64	208896	156672
11	1	3240	2880	4	12960	11520	16	51840	46080	64	207360	184320
12	1	4320	3840	4	17280	15360	16	69120	61440	64	276480	245760

MIL-STD-188-110C  
w/CHANGE 1  
APPENDIX D

**TABLE D-XXXV. Interleaver Parameters for 9kHz Bandwidth**

Waveform Number	UltraShort			Short			Medium			Long		
	Number of Frames	Number of bits	Number of Input Bits	Number of Frames	Number of bits	Number of Input Bits	Number of Frames	Number of bits	Number of Input Bits	Number of Frames	Number of bits	Number of Input Bits
0	-	-	-	120	240	160	432	864	576	1728	3456	2304
1	2	576	72	8	2304	288	32	9216	1152	128	36864	4608
2	2	576	144	8	2304	576	32	9216	2304	128	36864	9216
3	2	576	288	8	2304	1152	32	9216	4608	128	36864	18432
4	-	-	-	-	-	-	-	-	-	-	-	-
5	1	768	576	4	3072	2304	16	12288	9216	64	49152	36864
6	1	1536	1152	4	6144	4608	16	24576	18432	64	98304	73728
7	1	2304	1728	4	9216	6912	16	36864	27648	64	147456	110592
8	1	3072	2304	4	12288	9216	16	49152	36864	64	196608	147456
9	1	3840	2880	4	15360	11520	16	61440	46080	64	245760	184320
10	1	4608	3456	4	18432	13824	16	73728	55296	64	294912	221184
11	1	6480	5760	4	25920	23040	16	103680	92160	64	414720	368640
12	1	8640	7680	4	34560	30720	16	138240	122880	64	552960	491520

MIL-STD-188-110C  
w/CHANGE 1  
APPENDIX D

**TABLE D-XXXVI. Interleaver Parameters for 12kHz Bandwidth**

Waveform Number	UltraShort			Short			Medium			Long		
	Number of Frames	Number of bits	Number of Input Bits	Number of Frames	Number of bits	Number of Input Bits	Number of Frames	Number of bits	Number of Input Bits	Number of Frames	Number of bits	Number of Input Bits
0	-	-	-	160	320	160	576	1152	576	2304	4608	2304
1	3	576	72	12	2304	288	48	9216	1152	192	36864	4608
2	3	576	144	12	2304	576	48	9216	2304	192	36864	9216
3	2	768	256	8	3072	1024	32	12288	4096	128	49152	16384
4	2	768	512	8	3072	2048	32	12288	8192	128	49152	32768
5	1	1024	768	4	4096	3072	16	16384	12288	64	65536	49152
6	1	2048	1536	4	8192	6144	16	32768	24576	64	131072	98304
7	1	3072	2304	4	12288	9216	16	49152	36864	64	196608	147456
8	1	4096	3072	4	16384	12288	16	65536	49152	64	262144	196608
9	1	5120	3840	4	20480	15360	16	81920	61440	64	327680	245760
10	1	6144	4608	4	24576	18432	16	98304	73728	64	393216	294912
11	1	6480	5760	4	25920	23040	16	103680	92160	64	414720	368640
12	1	8640	7680	4	34560	30720	16	138240	122880	64	552960	491520

MIL-STD-188-110C  
w/CHANGE 1  
APPENDIX D

**TABLE D-XXXVII. Interleaver Parameters for 15kHz Bandwidth**

Waveform Number	UltraShort			Short			Medium			Long		
	Number of Frames	Number of bits	Number of Input Bits	Number of Frames	Number of bits	Number of Input Bits	Number of Frames	Number of bits	Number of Input Bits	Number of Frames	Number of bits	Number of Input Bits
0	-	-	-	200	400	160	720	1440	576	2880	5760	2304
1	3	864	72	12	3456	288	48	13824	1152	192	55296	4608
2	3	864	144	12	3456	576	48	13824	2304	192	55296	9216
3	3	864	288	12	3456	1152	48	13824	4608	192	55296	18432
4	3	864	576	12	3456	2304	48	13824	9216	192	55296	36864
5	1	1280	960	4	5120	3840	16	20480	15360	64	81920	61440
6	1	2560	1920	4	10240	7680	16	40960	30720	64	163840	122880
7	1	3840	2880	4	15360	11520	16	61440	46080	64	245760	184320
8	1	5120	3840	4	20480	15360	16	81920	61440	64	327680	245760
9	1	6400	4800	4	25600	19200	16	102400	76800	64	409600	307200
10	1	7680	5760	4	30720	23040	16	122880	92160	64	491520	368640
11	1	6912	6144	4	27648	24576	16	110592	98304	64	442368	393216
12	1	9216	8192	4	36864	32768	16	147456	131072	64	589824	524288

MIL-STD-188-110C  
w/CHANGE 1  
APPENDIX D

**TABLE D-XXXVIII. Interleaver Parameters for 18kHz Bandwidth**

Waveform Number	UltraShort			Short			Medium			Long		
	Number of Frames	Number of bits	Number of Input Bits	Number of Frames	Number of bits	Number of Input Bits	Number of Frames	Number of bits	Number of Input Bits	Number of Frames	Number of bits	Number of Input Bits
0	-	-	-	240	480	320	864	1728	1152	3456	6912	4608
1	3	1344	168	12	5376	672	48	21504	2688	192	86016	10752
2	3	1344	336	12	5376	1344	48	21504	5376	192	86016	21504
3	3	1344	672	12	5376	2688	48	21504	10752	192	86016	43008
4	-	-	-	-	-	-	-	-	-	-	-	-
5	1	1536	1152	4	6144	4608	16	24576	18432	64	98304	73728
6	1	3072	2304	4	12288	9216	16	49152	36864	64	196608	147456
7	1	4608	3456	4	18432	13824	16	73728	55296	64	294912	221184
8	1	6144	4608	4	24576	18432	16	98304	73728	64	393216	294912
9	1	7680	5760	4	30720	23040	16	122880	92160	64	491520	368640
10	1	9216	6912	4	36864	27648	16	147456	110592	64	589824	442368
11	1	11520	10240	4	46080	40960	16	184320	163840	64	737280	655360
12	1	15360	12800	4	61440	51200	16	245760	204800	64	983040	819200



MIL-STD-188-110C  
w/CHANGE 1  
APPENDIX D

**TABLE D-XXXIX. Interleaver Parameters for 21kHz Bandwidth**

Waveform Number	UltraShort			Short			Medium			Long		
	Number of Frames	Number of bits	Number of Input Bits	Number of Frames	Number of bits	Number of Input Bits	Number of Frames	Number of bits	Number of Input Bits	Number of Frames	Number of bits	Number of Input Bits
0	-	-	-	280	560	160	1008	2016	576	4032	8064	2304
1	4	1280	80	16	5120	320	64	20480	1280	256	81920	5120
2	4	1280	160	16	5120	640	64	20480	2560	256	81920	10240
3	4	1280	320	16	5120	1280	64	20480	5120	256	81920	20480
4	4	1280	640	16	5120	2560	64	20480	10240	256	81920	40960
5	1	1344	896	4	5376	3584	16	21504	14336	64	86016	57344
6	1	2688	1792	4	10752	7168	16	43008	28672	64	172032	114688
7	1	4032	2688	4	16128	10752	16	64512	43008	64	258048	172032
8	1	5376	3584	4	21504	14336	16	86016	57344	64	344064	229376
9	1	6720	4480	4	26880	17920	16	107520	71680	64	430080	286720
10	1	8064	5376	4	32256	21504	16	129024	86016	64	516096	344064
11	1	15360	12288	4	61440	49152	16	245760	196608	64	983040	786432
12	1	20480	18432	4	81920	73728	16	327680	294912	64	1310720	1179648

MIL-STD-188-110C  
w/CHANGE 1  
APPENDIX D

**TABLE D-XL. Interleaver Parameters for 24kHz Bandwidth**

Waveform Number	UltraShort			Short			Medium			Long		
	Number of Frames	Number of bits	Number of Input Bits	Number of Frames	Number of bits	Number of Input Bits	Number of Frames	Number of bits	Number of Input Bits	Number of Frames	Number of bits	Number of Input Bits
0	-	-	-	320	640	320	1152	2304	1152	4608	9216	4608
1	4	1088	136	16	4352	544	64	17408	2176	256	69632	8704
2	4	1088	272	16	4352	1088	64	17408	4352	256	69632	17408
3	2	1632	544	8	6528	2176	32	26112	8704	128	104448	34816
4	2	1632	1088	8	6528	4352	32	26112	17408	128	104448	69632
5	1	2176	1632	4	8704	6528	16	34816	26112	64	139264	104448
6	1	4352	3264	4	17408	13056	16	69632	52224	64	278528	208896
7	1	6528	4896	4	26112	19584	16	104448	78336	64	417792	313344
8	1	8704	6528	4	34816	26112	16	139264	104448	64	557056	417792
9	1	10880	8160	4	43520	32640	16	174080	130560	64	696320	522240
10	1	13056	9792	4	52224	39168	16	208896	156672	64	835584	626688
11	1	11520	10240	4	46080	40960	16	184320	163840	64	737280	655360
12	1	15360	12800	4	61440	51200	16	245760	204800	64	983040	819200

MIL-STD-188-110C  
w/CHANGE 1  
APPENDIX D

D.5.3.1 Block boundary alignment.

Each code block shall be interleaved within a single interleaver block of the same size. The boundaries of these blocks shall be aligned such that the beginning of the first data frame shall coincide with an interleaver boundary. The first data symbol from the first data frame in each interleaver set shall have as its MSB the first bit fetched from the interleaver. This is no different from what would normally be expected, but is a requirement.

D.5.3.2 Block encoding.

The full-tail-biting and puncturing techniques shall be used with either a rate  $1/2$   $k=7$  convolutional code or a rate  $1/2$   $k=9$  convolutional code to produce a block code that is the same length as the interleaver. For those data rates where the code is punctured to rate  $9/10$ ,  $8/9$ ,  $5/6$ ,  $4/5$ ,  $3/4$ ,  $2/3$ ,  $9/16$ ,  $1/2$ ,  $2/5$ ,  $1/3$ ,  $2/7$ ,  $1/4$ ,  $1/6$ ,  $1/8$ ,  $1/12$  and  $1/16$  the punctured block shall still fit exactly within the interleaver. Table D-XLI indicates which code rates and modulations are used by the different waveform and bandwidths supported by this standard.

MIL-STD-188-110C  
w/CHANGE 1  
APPENDIX D

**TABLE D-XLI. Code Rate and Modulation.**

Waveform Number	0 Walsh	1 BPSK	2 BPSK	3 BPSK	4 BPSK	5 BPSK	6 QPSK	7 8PSK	8 16QAM	9 32QAM	10 64QAM	11 64QAM	12 256QAM	13 QPSK	
<b>Bandwidth</b> (kHz)															
3	1/2	1/8	1/4	1/3	2/3	3/4	3/4	3/4	3/4	3/4	3/4	3/4	8/9	8/9	9/16
6	1/2	1/8	1/4	1/3	2/3	3/4	3/4	3/4	3/4	3/4	3/4	3/4	8/9	8/9	
9	2/3	1/8	1/4	1/2	-	3/4	3/4	3/4	3/4	3/4	3/4	3/4	8/9	8/9	
12	1/2	1/8	1/4	1/3	2/3	3/4	3/4	3/4	3/4	3/4	3/4	3/4	8/9	8/9	
15	2/5	1/12	1/6	1/3	2/3	3/4	3/4	3/4	3/4	3/4	3/4	3/4	8/9	8/9	
18	2/3	1/8	1/4	1/2	-	3/4	3/4	3/4	3/4	3/4	3/4	3/4	8/9	5/6	
21	2/7	1/16	1/8	1/4	1/2	2/3	2/3	2/3	2/3	2/3	2/3	2/3	4/5	9/10	
24	1/2	1/8	1/4	1/3	2/3	3/4	3/4	3/4	3/4	3/4	3/4	3/4	8/9	5/6	

MIL-STD-188-110C  
w/CHANGE 1  
APPENDIX D

D.5.3.2.1 Constraint length 7, rate 1/2 convolutional code.

A constraint length 7, rate 1/2 convolutional code shall be used prior to puncturing. This shall be the same code as is used in the single-tone waveform described in section 5.3.2 of this standard. Figure D-9 is a pictorial representation of the encoder.

**Polynomials:**

**(b0)**  $T_1 = x^6 + x^4 + x^3 + x^1 + 1$

**(b1)**  $T_2 = x^6 + x^5 + x^4 + x^3 + 1$

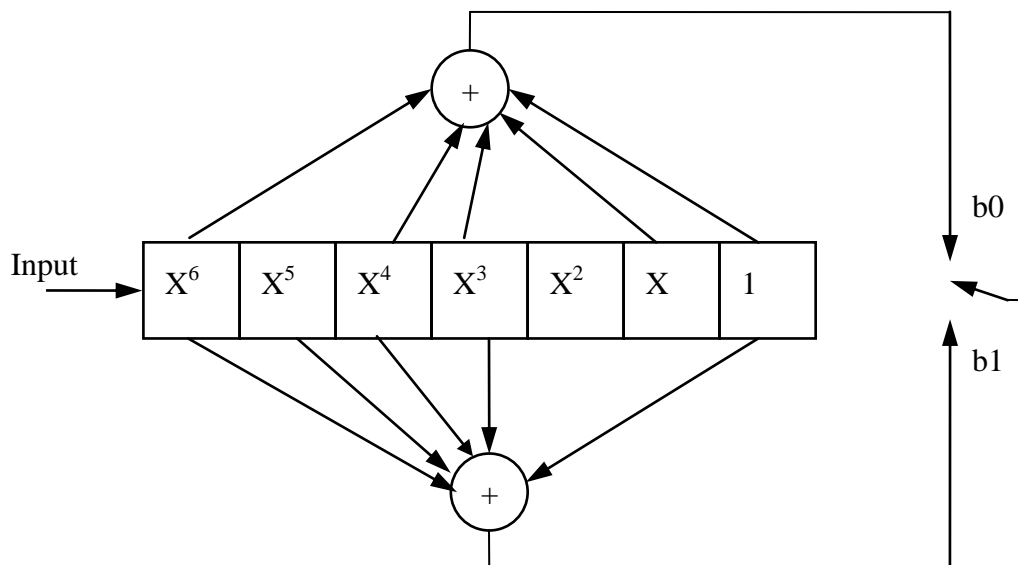

**FIGURE D-9. Constraint length 7, rate 1/2 convolutional encoder.**

The two summing nodes in the figure represent modulo 2 additions. For each bit input to the encoder, two bits are taken from the encoder, with the upper output bit b0, generated by polynomial  $T_1(x)$ , taken first.

MIL-STD-188-110C  
w/CHANGE 1  
APPENDIX D

D.5.3.2.2 Constraint length 9, rate 1/2 convolutional code.

A constraint length 9, rate 1/2 convolutional code shall be used prior to puncturing. Figure D-10 is a pictorial representation of the encoder.

**Polynomials:**

**(b0)**  $T1 = x^8 + x^6 + x^5 + x^4 + 1$

**(b1)**  $T2 = x^8 + x^7 + x^6 + x^5 + x^3 + x^1 + 1$

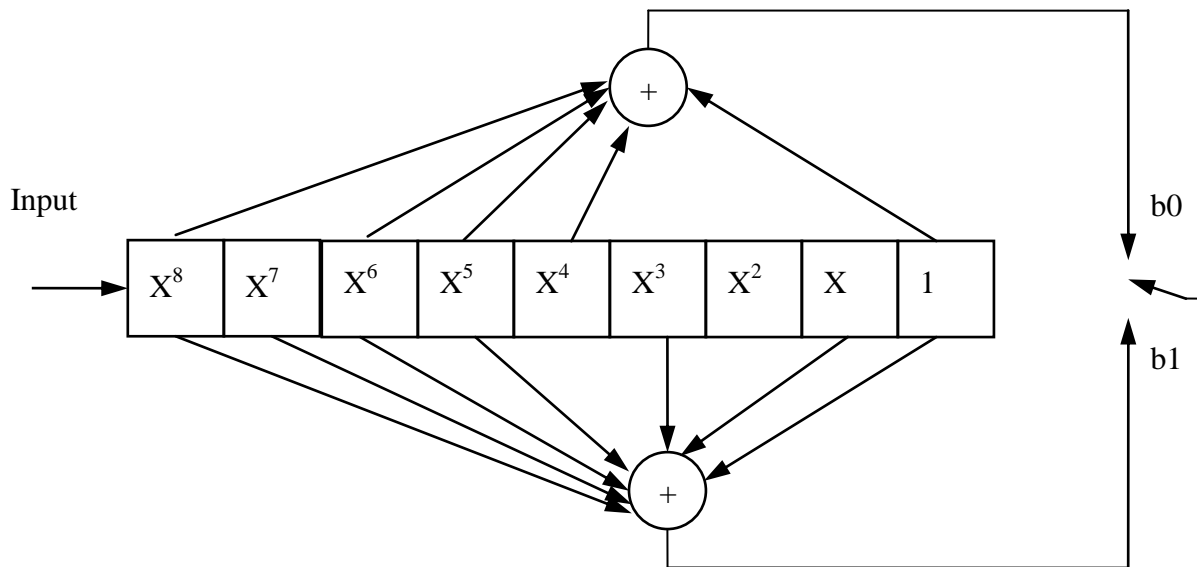

**FIGURE D-10. Constraint length 9, rate 1/2 convolutional encoder.**

The two summing nodes in the figure represent modulo 2 additions. For each bit input to the encoder, two bits are taken from the encoder, with the upper output bit  $b_0$ , generated by polynomial  $T_1(x)$ , taken first.

D.5.3.2.3 Full-tail-biting encoding.

To begin encoding each block of input data, the encoder shall be preloaded by shifting in the first  $(k-1)$  input data bits without taking any output bits. These  $(k-1)$  input bits shall be temporarily saved so that they can be used to “flush” the encoder. The first two coded output bits shall be taken after the  $(k)$ th bit has been shifted in, and shall be defined to be the first two bits of the resulting block code. After the last input data bit has been encoded, the first  $(k-1)$  “saved” data bits shall be encoded. Note that the encoder shift register should not be changed before encoding these saved bits; i.e., it should be filled with the last seven input data bits. The  $(k-1)$  “saved” data bits are encoded by shifting them into the encoder one at a time, beginning with the earliest of the  $(k-1)$ . The encoding thus continues by taking the two resulting coded output bits as each of the saved  $(k-1)$  bits is shifted in. These encoded bits shall be the final bits of the resulting (unpunctured) block code. Prior to puncturing, the resulting block code will have exactly twice as many bits as the input information bits. Puncturing of the rate 1/2 code to the other required rates shall be done prior to sending bits to the interleaver.

MIL-STD-188-110C  
w/CHANGE 1  
APPENDIX D

D.5.3.2.4 Puncturing and Repetition.

In order to obtain a higher rate code from a lower rate code, the output of the encoder must be punctured by not transmitting all of the encoder's output bits. Which bits are transmitted are defined by a puncturing mask. For example, when puncturing a rate  $\frac{1}{2}$  code to rate  $\frac{3}{4}$  code one out of every 3 bits must not be transmitted. In this case puncturing shall be performed by using a puncturing mask of

110  
101

In this notation the first row indicates the bits retained by the T1 branch, the second row indicates the bits retained by the T2 branch. A 1 indicates that the bit is transmitted and a 0 indicates that the bit is not transmitted. For an encoder generated sequence of

$T_1(k), T_2(k), T_1(k+1), T_2(k+1), T_1(k+2), T_2(k+2) \dots$

the transmitted sequence shall be

$T_1(k), T_2(k), T_1(k+1), P, P, T_2(k+2) \dots$

Defining  $T_1(0), T_2(0)$  to be the first two bits of the block code generated as defined in paragraph 0, then the value of  $k$  in the above sequences shall be an integral multiple of 3. The block code shall be punctured in this manner before being input to the interleaver.

In order to obtain a lower code rate from a higher code rate repetition can be used. For example to generate a rate  $\frac{1}{4}$  code from a rate  $\frac{1}{2}$  code the two output bits

$T_1(k), T_2(k), T_1(k+1), T_2(k+1),$

Are repeated to yield four output bits for each input bit, giving

$T_1(k), T_2(k), T_1(k), T_2(k), T_1(k+1), T_2(k+1), T_1(k+1), T_2(k+1)$

For the cases that require a combination of repetition and puncturing the code words are first repeated and then the puncturing is applied. For example to generate a rate  $\frac{1}{3}$  code from a rate  $\frac{1}{2}$  code the two output,  $T_1(k), T_2(k)$  bits are repeated twice

$T_1(k), T_2(k), T_1(k), T_2(k), T_1(k+1), T_2(k+1), T_1(k+1), T_2(k+1),$

The Puncturing pattern from the Rate  $\frac{2}{3}$  code is now applied twice resulting in

$T_1(k), T_2(k), T_1(k), P, T_1(k+1), T_2(k+1), T_1(k+1), P$

## MIL-STD-188-110C

w/CHANGE 1

## APPENDIX D

**TABLE D-XLII. Puncture patterns.**

Code Rate	K=7 Puncture Pattern	K=9 Puncture Pattern	Number of Repeats
9 / 10	111101110 100010001	111000101 100111010	n/a
8 / 9	11110100 10001011	11100000 10011111	n/a
5 / 6	11010 10101	10110 11001	n/a
4 / 5	1111 1000	1101 1010	n/a
3 / 4	110 101	111 100	n/a
2 / 3	11 10	11 10	n/a
9/16	111101111 111111011	111101111 111111011	n/a
1 / 2	n/a	n/a	n/a
2 / 5	1110 1010	1110 1010	1/2 Repeated 2x
1 / 3	n/a	n/a	2/3 Repeated 2x
2 / 7	1111 0111	1111 0111	1/2 Repeated 2x
1 / 4	n/a	n/a	1/2 repeated 2x
1 / 6	n/a	n/a	1/2 repeated 3x
1 / 8	n/a	n/a	1/2 repeated 4x
1 / 12	n/a	n/a	1/2 repeated 6x
1 / 16	n/a	n/a	1/2 repeated 8x

**D.5.3.3 Block interleaver structure.**

The block interleaver used is designed to separate neighboring bits in the punctured block code as far as possible over the span of the interleaver with the largest separations resulting for the bits that were originally closest to each other.

**D.5.3.3.1 Interleaver size in bits.**

The interleaver shall consist of a single dimension array, numbered from 0 to its size in bits -1. The array size shall depend on both the data rate and interleaver length selected as shown in the Tables D-XXXIII through D-XL, one for each bandwidth.

**D.5.3.3.2 Interleaver load.**

The punctured block code bits shall be loaded into the interleaver array beginning with location 0. The location for loading each successive bit shall be obtained from the previous location by



MIL-STD-188-110C  
w/CHANGE 1  
APPENDIX D

incrementing by the “Interleaver Increment Value” specified in Tables D-XLIII through D-L, modulo the “Interleaver Size in Bits.”

Defining the first punctured block code bit to be B(0), then the load location for B(n) is given by:

$$\text{Load Location} = (n * \text{Interleaver Increment Value}) \text{ Modulo } (\text{Interleaver Size in Bits})$$

Thus for Waveform 1 in Table D-XXXIII, using ultrashort interleaver (192 bit size with an increment of 25), the first 9 interleaver load locations are: 0, 25, 50, 75, 100, 125, 150, 175 and 8.

**TABLE D-XLIII. Interleaver increment value for 3 kHz waveform**

WID	Interleaver Size			
	Ultrashort	Short	Medium	Long
0	-	11	37	145
1	25	97	385	1543
2	25	97	385	1543
3	25	97	385	1549
4	25	97	385	1549
5	33	129	513	2081
6	65	257	1025	4161
7	97	385	1537	6241
8	129	513	2049	8321
9	161	641	2561	10403
10	193	769	3073	12481
11	271	1081	4321	17551
12	361	1441	5761	23401
13	65	257	1025	4161

MIL-STD-188-110C  
w/CHANGE 1  
APPENDIX D

**TABLE D-XLIV. Interleaver increment value for 6 kHz waveform**

WID	Interleaver Size			
	Ultrashort	Short	Medium	Long
0	-	21	73	289
1	49	193	769	3085
2	49	193	769	3085
3	53	205	817	3293
4	53	205	817	3293
5	69	273	1089	4421
6	137	545	2177	8841
7	205	817	3265	13261
8	273	1089	4353	17681
9	341	1361	5441	22103
10	409	1633	6529	26521
11	409	1621	6481	26329
12	553	2161	8641	35113

MIL-STD-188-110C  
w/CHANGE 1  
APPENDIX D

**TABLE D-XLV. Interleaver increment value for 9 kHz waveform**

WID	Interleaver Size			
	Ultrashort	Short	Medium	Long
0	-	31	109	433
1	73	289	1153	4645
2	73	289	1153	4645
3	73	289	1153	4645
4	-	-	-	-
5	97	385	1537	6241
6	193	769	3073	12481
7	289	1153	4609	18721
8	385	1537	6145	24961
9	481	1921	7681	31207
10	577	2305	9217	37441
11	811	3241	13771	52651
12	1081	4321	18361	70201

MIL-STD-188-110C  
w/CHANGE 1  
APPENDIX D

**TABLE D-XLVI. Interleaver increment value for 12 kHz waveform**

WID	Interleaver Size			
	Ultrashort	Short	Medium	Long
0	-	41	145	577
1	73	289	1153	4633
2	73	289	1153	4633
3	97	385	1537	6193
4	97	385	1537	6193
5	129	513	2049	8321
6	257	1025	4097	16641
7	385	1537	6145	24961
8	513	2049	8193	33281
9	641	2561	10241	41603
10	769	3073	13057	49921
11	811	3241	13771	52651
12	1081	4321	18361	70201

MIL-STD-188-110C  
w/CHANGE 1  
APPENDIX D

**TABLE D-XLVII. Interleaver increment value for 15 kHz waveform**

WID	Interleaver Size			
	Ultrashort	Short	Medium	Long
0	–	51	181	721
1	109	433	1729	6949
2	109	433	1729	6949
3	109	433	1729	6949
4	109	433	1729	6949
5	161	641	2561	10401
6	321	1281	5121	20801
7	481	1921	7681	31201
8	641	2561	10241	41601
9	801	3201	13603	52003
10	961	3841	16321	62401
11	865	3457	14689	56161
12	1153	4609	19585	74881

MIL-STD-188-110C  
w/CHANGE 1  
APPENDIX D

**TABLE D-XLVIII. Interleaver increment value for 18 kHz waveform**

WID	Interleaver Size			
	Ultrashort	Short	Medium	Long
0	-	61	217	865
1	169	673	2689	10811
2	169	673	2689	10811
3	169	673	2689	10811
4	-	-	-	-
5	193	769	3073	12481
6	385	1537	6145	24961
7	577	2305	9217	37441
8	769	3073	13057	49921
9	961	3841	16327	62407
10	1153	4609	19585	74881
11	1441	5761	24481	93601
12	1921	7681	32641	124801

MIL-STD-188-110C  
w/CHANGE 1  
APPENDIX D

**TABLE D-XLIX. Interleaver increment value for 21 kHz waveform**

WID	Interleaver Size			
	Ultrashort	Short	Medium	Long
0	-	71	253	1009
1	161	641	2561	10281
2	161	641	2561	10281
3	161	641	2561	10281
4	161	641	2561	10281
5	169	673	2689	10921
6	337	1345	5377	21841
7	505	2017	8065	32761
8	673	2689	11425	43681
9	841	3361	14293	54613
10	1009	4033	17137	65521
11	1921	7681	32641	124801
12	2561	10241	43521	166401

MIL-STD-188-110C  
w/CHANGE 1  
APPENDIX D

**TABLE D-L. Interleaver increment value for 24 kHz waveform**

WID	Interleaver Size			
	Ultrashort	Short	Medium	Long
0	-	81	289	1153
1	137	545	2177	8739
2	137	545	2177	8739
3	205	817	3265	13159
4	205	817	3265	13159
5	273	1089	4353	17681
6	545	2177	8705	35361
7	817	3265	13873	53041
8	1089	4353	18497	70721
9	1361	5441	23123	88403
10	1633	6529	27745	106081
11	1441	5761	24481	93601
12	1921	7681	32641	124801

These increment values have been chosen to ensure that the combined cycles of puncturing and assignment of bit positions in each symbol for the specific constellation being used is the same as if there had been no interleaving. For waveforms 7-12, this is important, because each symbol of a constellation contains “strong” and “weak” bit positions. Bit position refers to the location of the bit, ranging from MSB to LSB, in the symbol mapping. A strong bit position is one that has a large average distance between all the constellation points where the bit is a 0 and the closest point where it is a 1. Typically, the MSB is a strong bit and the LSB a weak bit. An interleaving strategy that does not evenly distribute these bits in the way they occur without interleaving could degrade performance.

#### D.5.3.3.3 Interleaver fetch.

The fetching sequence for all data rates and interleaver lengths shall start with location 0 of the interleaver array and increment the fetch location by 1. This is a simple linear fetch from beginning to end of the interleaver array.



MIL-STD-188-110C  
w/CHANGE 1  
APPENDIX D

D.5.4 Operational features and message protocols.

The format of this high-rate waveform has been designed to permit it to work well with most of the protocols used and planned for use with HF. The short length of the synchronization preamble, wide range of interleaving lengths, and the use of full-tail-biting coding is intended to provide efficient operation with ARQ protocols. To further enhance the operation with these protocols, the following operational features shall be included in the HF modem.

D.5.4.1 User interfaces.

D.5.4.1.1 Conventional synchronous interface.

A synchronous serial interface shall be provided IAW 4.2.3.

D.5.4.1.2 Conventional asynchronous interface.

In addition to the standard synchronous serial interface (see 4.2.3), the modem shall also be capable of interfacing with an asynchronous DTE. In this case the DTE provides (accepts) asynchronous Words consisting of a Start Bit, an N bit Character, and some minimum number of Stop Bits. Additional Stop Bits are provided (accepted) by the DTE between Words as necessary to accommodate gaps between their occurrence. Interoperability shall be provided for those cases where the value of N, the number of Bits in the Character, is 5,6,7, or 8 (including any parity bits), and the minimum number of Stop Bits is 1 or 2. Hence interoperability is defined for those cases where the number of Bits in the Word is N+2 and N+3. In these cases the entire N+2 or N+3 bits of the Word shall be conveyed in the modulated signal. Additional Stop Bits shall be conveyed as necessary to accommodate gaps in data from the DTE; there shall be no modem-defined null character incorporated into the modulated signal.

D.5.4.1.3 High speed asynchronous user interface with flow control.

Certain high speed user interfaces provide data to (and accept data from) the modem in units of 8 bit bytes. Furthermore, the Input Data Blocks shown in Tables D-XXXIII through D-XL are all multiples of 8 bit bytes. An optional mode shall be provided to accommodate the special case of an 8 bit character (which includes any parity check bits) and a 1.0 unit interval Stop Bit. In this optional mode, the 8 bit Character shall be aligned with the 256 symbol modem frame boundary, and no Start or Stop Bits shall be transmitted. In this mode of operation it is assumed that the DTE data rate is greater than that which can be accommodated by the modem. Consequently flow control shall be used to temporarily stop data flow from the DTE to the modem when the modem's input buffer becomes full. Conversely, when the modem's input buffer becomes empty, the modem shall assume that the DTE has finished its message, and the modem shall initiate its normal message-termination procedure. This method of operation obviates the need for the transmission of Null characters for the purpose of "rate padding." Consequently, no Null characters shall be transmitted for this purpose.

D.5.4.1.4 Ethernet interface.

The modem shall provide an Ethernet interface (see Appendix A) for byte oriented user data transfers (see D.5.4.1.2), and these bytes shall be aligned with the Input Data Block boundaries.

MIL-STD-188-110C  
w/CHANGE 1  
APPENDIX D

D.5.4.2 Onset of transmission.

The modem shall begin a transmission no later than 100 ms after it has received an entire input data block (enough bits to fill a coded and interleaved block), or upon receipt of the last input data bit, whichever occurs first. The latter would only occur when the message is shorter than one interleaver block. A transmission shall be defined as beginning with the keying of the radio, followed by the output of the preamble waveform after the configured pre-key delay, if any.

The delay between when the modem receives the first input data bit and the onset of transmission will be highly dependent on the means for delivery of the input data bits to the modem. A synchronous serial interface at the user data rate will have the greatest delay. For this reason it is recommended that a high speed asynchronous interface (serial or Ethernet port) with flow-control be used if this delay is of concern for the deployed application.

D.5.4.3 End of message.

The use of an end-of-message (EOM) in the transmit waveform shall be a configurable option. When the use of an EOM has been selected, a 32-bit EOM pattern shall be appended after the last input data bit of the message. The EOM, expressed in hexadecimal notation is 4B65A5B2, where the left most bit is sent first. If the last bit of the EOM does not fill out an input data block, the remaining bits in the input data block shall be set to zero before encoding and interleaving the block.

If the use of an EOM has been inhibited, and the last input data bit does not fill out an input data block, the remaining bits in the input data block shall be set to zero before encoding and interleaving the block. It is anticipated that the use of an EOM will only be inhibited when an ARQ data protocol uses ARQ blocks which completely fill (or nearly so) the selected input data block size (interleaver block). Without this feature, the use of an EOM would require the transmission of an additional interleaver block under these circumstances.

D.5.4.4 Termination of a transmission.

Upon receipt of a radio silence (or equivalent) command, the modem shall immediately un-key the radio and terminate its transmit waveform.

In normal operation, the modem shall terminate a transmission only after the transmission of the final data frame, including a mini-probe, associated with the final interleaver block. Note that a data frame consists of a 256 symbol data block followed by a mini-probe. Note that any signal processing and/or filter delays in the modem and the HF transmitter must be accounted for (as part of the key line control timing) to ensure that the entire final mini-probe is transmitted before the transmitter power is turned off.

An optional feature can be added to the end of each transmission. The transmitter can insert an end-of-transmission (EOT) marker following the last mini-probe sequence. The purpose of this EOT marker is to allow receiver implementations to detect the end of a transmission immediately, without having to wait for the EOM marker embedded within the data. The EOT will not be as robust an indicator of the end of a transmission as the embedded EOM. However,

MIL-STD-188-110C  
w/CHANGE 1  
APPENDIX D

in relatively benign channels, this feature will reduce the time before the receiver is able to return to acquisition mode, with the result that in a TDMA system, back-to-back receptions can be scheduled with a significantly smaller guard time between them. The EOT shall consist of a cyclic extension of the last mini-probe, where the mini-probe sequence has been defined in Table D-XXI. The length of the cyclic extension shall be 13.333 ms (an integer multiple of 32 symbols for each symbol rate). Furthermore, it will be optional for the receiver to search for this EOT marker, so that operation on challenging multipath fading channels is not affected by the need to search for EOT marker.

For example, for the length 13 base sequence used with the 3 kHz bandwidth, the last mini-probe shall consist of the 24 symbols of the last mini-probe, plus 32 additional symbols formed by the cyclic extension of the 13 symbol Base Sequence. Thus, the final mini-probe will be 56 symbols in length and consist of 4 complete 13 symbol Base sequences plus the first 4 symbols of a fifth base sequence. This specific example is illustrated in Table D-LI.

MIL-STD-188-110C  
w/CHANGE 1  
APPENDIX D

**TABLE D-LI. In-phase and Quadrature components of 13 symbol Base Sequence used to form 24 symbol mini-probe and cyclically extended by 32 symbols to mark the EOT.**

Symbol Number	In-Phase	Quadrature	Symbol Number	In-Phase	Quadrature
0	1.00000	0.0	28	1.00000	0.0
1	1.00000	0.0	29	1.00000	0.0
2	1.00000	0.0	30	1.00000	0.0
3	1.00000	0.0	31	-1.00000	0.0
4	1.00000	0.0	32	-1.00000	0.0
5	-1.00000	0.0	33	1.00000	0.0
6	-1.00000	0.0	34	1.00000	0.0
7	1.00000	0.0	35	-1.00000	0.0
8	1.00000	0.0	36	1.00000	0.0
9	-1.00000	0.0	37	-1.00000	0.0
10	1.00000	0.0	38	1.00000	0.0
11	-1.00000	0.0	39	1.00000	0.0
12	1.00000	0.0	40	1.00000	0.0
13	1.00000	0.0	41	1.00000	0.0
14	1.00000	0.0	42	1.00000	0.0
15	1.00000	0.0	43	1.00000	0.0
16	1.00000	0.0	44	-1.00000	0.0
17	1.00000	0.0	45	-1.00000	0.0
18	-1.00000	0.0	46	1.00000	0.0
19	-1.00000	0.0	47	1.00000	0.0
20	1.00000	0.0	48	-1.00000	0.0
21	1.00000	0.0	49	1.00000	0.0
22	-1.00000	0.0	50	-1.00000	0.0
23	1.00000	0.0	51	1.00000	0.0
24	-1.00000	0.0	52	1.00000	0.0
25	1.00000	0.0	53	1.00000	0.0
26	1.00000	0.0	54	1.00000	0.0
27	1.00000	0.0	55	1.00000	0.0

**D.5.4.5 Termination of receive data processing.**

There are a number of events which shall cause the HF modem to cease processing the received signal to recover data, and return to the acquisition mode. These are necessary because a modem is not able to acquire a new transmission while it is attempting to demodulate and decode data.

MIL-STD-188-110C  
w/CHANGE 1  
APPENDIX D

D.5.4.5.1 Detection of EOM.

The HF modem shall always scan all of the decoded bits for the 32-bit EOM pattern defined in paragraph 0. Upon detection of the EOM the modem shall return to the acquisition mode. The modem shall continue to deliver decoded bits to the user (DTE) until the final bit immediately preceding the EOM has been delivered.

D.5.4.5.2 Command to return to acquisition.

Upon receipt of a command to terminate reception, the HF modem shall return to the acquisition mode and terminate the delivery of decoded bits to the user (DTE).

D.5.4.5.3 Receipt of a specified number of data blocks.

The maximum message duration measured in number of Input Data Blocks (interleaver blocks) shall be a configurable parameter. One value of this parameter shall specify that an unlimited number may be received. Once the modem has decoded and delivered to the user (DTE), the number of bits corresponding to the configured maximum message duration, the HF modem shall return to the acquisition mode and terminate the delivery of decoded bits to the user (DTE). Note that for a given interleaver length, this parameter also specifies the maximum message duration in time, independent of the bit rate. Note that this parameter is the maximum duration and that the transmit end always has the option of using an EOM for shorter transmissions.

Operation with a specified number of input data blocks may be used by an ARQ protocol where the size of the ARQ packet is fixed, or occasionally changed to accommodate changing propagation conditions. In this case we anticipate that this parameter (maximum message duration) will be sent to the receiving end of the link as part of the ARQ protocol. It would then be sent to the receiving modem through the remote control interface (see 0 below), since it is not embedded in the waveform itself as the data rate and interleaver length parameters are.

D.5.4.5.4 Initiation of a transmission.

If, and only if, the HF Modem is configured to operate in half-duplex mode with transmit override, the initiation of a transmission by the user (DTE) shall cause the HF modem to terminate the receive processing and the delivery of decoded bits to the user (DTE).

D.5.4.6 Remote control.

The remote control interface (see section 5.3.1.5) shall provide the capability to specify the following parameters and commands:

- a. waveform parameters:
  - 1) The bandwidth (from 3kHz through 24 kHz, in multiples of 3 kHz )
  - 2) The waveform ID (0 through 13)
  - 3) The Interleaver length (UltraShort, Short, Medium, or Long)
  - 4) The convolutional code constraint length (7 or 9)
- b. A command to select the usage of the optional EOM in the transmit waveform. Note that the receiving modem must always scan for the EOM regardless of this setting.

MIL-STD-188-110C  
w/CHANGE 1  
APPENDIX D

- c. A command to specify the maximum message duration measured in number of Input Data Blocks (interleaver blocks). The value of 0 (zero) for this parameter shall specify that an unlimited number may be received.
- d. A command to cause the modem to terminate receive data processing and return to acquisition mode.

## D.6 PERFORMANCE

All MIL-STD-188-110C modem functionality testing should be performed at baseband. In the case of testing a modem embedded in an HF Radio, a baseband interface should be utilized if available. If no baseband interface is provided, care must be taken in the test set up to ensure that two radios, back to back, deliver a signal to Noise ratio (SNR) significantly higher than the condition under test so as to not compromise the measurement.

When testing a modem embedded in a radio with no baseband audio interface, the RF signals must be downconverted to baseband for processing by the channel simulator, and the result upconverted to RF for the receiver. In this case, transmit gain control (TGC), built-in analog and digital radio filters and automatic gain control (AGC) will affect the performance of the modems. Therefore, when testing embedded modems, the SNR values specified in Table D-LII shall be increased by 3 dB after verifying that the SNR condition mentioned in previous paragraph is met. Note that the SNR requirement mentioned in previous paragraph must also be met by the up/down conversion chain with the channel simulator set to non-fading path with 99 dB SNR.

### D.6.1 BER performance on AWGN and Multipath Fading Channels

The measured performance of the wideband waveform modes, using fixed-frequency operation and employing the maximum interleaving period (“Long” interleaver) and a 20-superframe preamble, shall achieve coded BER of no more than  $1.0E-5$  under each of the conditions listed in Table D-LII. Refer to Appendix E for channel simulator requirements. The channel conditions denoted “Poor Channel” in the tables shall comply with the ITU-R F.1487 Mid-Latitude-Disturbed Channel.

MIL-STD-188-110C  
w/CHANGE 1  
APPENDIX D

**TABLE D-LII. Data performance requirements, 3, 6, 9, 12, and 24 kHz Bandwidths.**

Waveform Number	Average SNR (dB) for BER $\leq 1.0E-5$		Exceptions (for specific bandwidths)
	AWGN Channel	“Poor” Channel	
0	-6	-1	9 kHz Poor channel only: allow +1 dB
1	-3	3	
2	0	5	
3	3	7	9 kHz: allow extra 1 dB (both channels)
4	5	10	this waveform not available in 9 or 18 kHz
5	6	11	
6	9	14	
7	13	19	
8	16	23	
9	19	27	
10	21	31	24 kHz Poor channel only: test for BER $\leq 1.0E-4$ and allow 33 dB
11	24	-	
12	30	-	
13	6	11	this waveform available in 3 kHz only

Performance shall be tested using a baseband HF simulator patterned after the Watterson Model in accordance with Appendix E.

- The AWGN channel shall consist of a single, non-fading path. Each condition shall be measured for at least 60 minutes.
- The “Poor” channel shall consist of two independent but equal average power Rayleigh fading paths, with a fixed 2 ms delay between paths, and with a fading (two sigma) bandwidth (BW) of 1 Hz. Each condition shall be measured for at least 5 hours.
- To compute SNR, both signal and noise power shall be measured *in the specified bandwidth*.

When testing a modem embedded with a radio, so that only radio frequency (RF) signals are available for testing, the RF signals must be downconverted to baseband for processing by the channel simulator, and the result upconverted to RF for the receiver. In this case, the built-in radio filters will affect the performance of the modems. Therefore, when testing embedded modems, the SNR values specified in Table D-LII shall be increased by 2 dB (3 dB at 9600 bps and above).

When the sending and receiving modems used in this test are not identical make and model, an extra dB of SNR shall be allowed due to potential degradation in mismatched filters.

#### D.6.2 BER performance on static multipath channels

The measured performance of the wideband waveform modes, using fixed-frequency operation and employing the maximum interleaving period (“Long” interleaver), shall achieve coded

MIL-STD-188-110C  
w/CHANGE 1  
APPENDIX D

BER of no more than 1.0E-5 for an SNR of 50 dB under the static multipath channel conditions shown in Table D-LIII. For all the static channels defined in table, all paths have equal power. The test period for each test should be 10 minutes. Due to possible alignment issues when acquiring channels with large delay spread, up to 3 opportunities are allowed per test to achieve a BER < 1e-5. Table shows the delay in milliseconds (ms) between the equal-power paths. For example, for WID 2 in 3 kHz, the second path is delayed 3.0 ms from the first path, and the third is delayed 9.0 ms from the first path.

**TABLE D-LIII. Static Channel Tests**

Bandwidth	WID	Multipath Channel Delays (ms)
3 KHz	2	3-Path (0.0, 3.0, 9.0)
	10	3-Path (0.0, 2.0, 4.5)
	12	2-Path (0.0, 1.5)
6 KHz	2	3-Path (0.0, 2.0, 9.0)
	10	4-Path (0.0, 1.5, 3.0, 5.0)
	12	2-Path (0.0, 1.5)
9 KHz	3	3-Path (0.0, 3.0, 8.0)
	10	3-Path (0.0, 2.0, 4.5)
	12	2-Path (0.0, 1.5)
12 KHz	2	3-Path (0.0, 2.5, 8.5)
	10	4-Path (0.0, 1.5, 3.0, 5.0)
	12	2-Path (0.0, 1.5)
24 KHz	5	3-Path (0.0, 2.5, 5.5)
	10	4-Path (0.0, 1.5, 3.0, 5.0)
	12	2-Path (0.0, 1.5)

**D.6.3 Acquisition performance.**

Not yet standardized.

**D.6.4 Doppler shift test.**

The modem shall acquire and maintain synchronization in 3, 6, 9, 12, and 24 kHz channels for at least 5 minutes with a test signal having the following characteristics: WID 10/Long interleaver, 75 Hz frequency offset, 2 ms delay spread, a fading BW of 1 Hz, and an average



MIL-STD-188-110C  
w/CHANGE 1  
APPENDIX D

SNR of 30 dB. The test shall be repeated with a  $-75$  Hz frequency offset. No BER test is required.

D.6.5 Doppler sweep performance.

The AWGN BER test for WID 10 shall be repeated in 3, 6, 9, 12, and 24 kHz channels with a test signal having a frequency offset that continuously varies at a rate of 3.5 Hz/s between the limits of  $-75$  and  $+75$  Hz, such that a plot of frequency offset vs. time describes a periodic “triangle” waveform having a period of  $(300/3.5)$  seconds. Over a test duration of 1 hour, the modem shall achieve a BER of  $1.0E-5$  or less at an SNR of 24 dB.

## D.7 ASSOCIATED COMMUNICATIONS EQUIPMENT

The QAM constellations specified in this appendix are more sensitive to equipment variations than the PSK constellations specified in section 5.3.2 of this standard. Because of this sensitivity, radio filters will have a significant impact on the performance of modems implementing the waveforms in this appendix. In addition, because of the level sensitive nature of the QAM constellations, turn-on transients, AGC, and ALC can cause significant performance degradation.

It is recommended that external modems (i.e., modems not integrated with the radio) implementing the waveforms in this appendix should include a variable pre-key feature, by which the user can specify a delay between the time when the transmitter is keyed and the modem signal begins. This allows for turn-on transient settling, which is particularly important for legacy radio equipment.

It is recommended that a slow AGC setting (e.g., the “nondata” mode in MIL-STD-188-141) be used when receiving the waveforms in this appendix.

MIL-STD-188-110C  
w/CHANGE 1  
APPENDIX E

CHARACTERISTICS OF HF CHANNEL SIMULATORS

TABLE OF CONTENTS

<b><u>PARAGRAPH</u></b>	<b><u>PAGE</u></b>
E.1 GENERAL.....	220
E.1.1 Scope.....	220
E.1.2 Applicability.....	220
E.2 APPLICABLE DOCUMENTS.....	220
E.2.1 Non-government documents.....	220
E.2.2 Order of precedence.....	220
E.3 DEFINITIONS .....	220
E.4 GENERAL REQUIREMENTS .....	221
E.4.1 Watterson Channel Model.....	221
E.4.2 Implementation of the Watterson HF Channel Model .....	221
E.4.3 Radio Filters .....	222
E.4.4 Latency .....	222
E.5 DETAILED REQUIREMENTS .....	222
E.5.1 Sample rate.....	222
E.5.2 Delay spread simulation .....	222
E.5.3 White gaussian noise generation.....	222
E.5.4 Fading tap gain generation.....	222
E.5.5 Signal-to-noise ratio .....	223
E.6 IMPLEMENTATION DETAILS FOR WIDEBAND HF CHANNEL SIMULATORS.....	224
E.6.1 Analog interface .....	224
E.6.2 Hilbert Transform Alternative .....	224
E.6.3 Output LPF .....	224
E.7 CHANNEL SIMULATOR VALIDATION .....	225
E.7.1 Bandwidth.....	225
E.7.2 Signal-to-noise ratio – Single Non-fading path.....	225
E.7.3 Signal-to-noise ratio – Single fading path .....	225
E.7.4 Doppler Spectrum.....	225

MIL-STD-188-110C  
w/CHANGE 1  
APPENDIX E

**FIGURES**

<u>FIGURE</u>	<u>PAGE</u>
FIGURE E-1. IMPLEMENTATION OF THE WATTERSON HF CHANNEL MODEL .....	221
FIGURE E-2. FADING TAP GAIN GENERATION .....	223
FIGURE E-3. DOPPLER SPECTRUM.....	<b>ERROR! BOOKMARK NOT DEFINED.</b>

MIL-STD-188-110C  
w/CHANGE 1  
APPENDIX E

## E.1 SCOPE

### E.1.1 Scope.

This appendix describes the characteristics of baseband HF channel simulators to be used in performance testing of modems that are intended for use in HF channels up to 24 kHz (nominally  $N \times 3$  kHz, where  $N$  is 1, 2, 3, 4, 5, 6, 7, or 8).

### E.1.2 Applicability.

This appendix is a nonmandatory part of MIL-STD-188-110B; however, channel simulators used to evaluate the compliance of modems with the performance requirements of this standard shall comply with this appendix.

## E.2 APPLICABLE DOCUMENTS

### E.2.1 Non-government documents.

The following documents form a part of this document to the extent specified herein..

1. C. C. Watterson, J. R. Juroshek, W. D. Bensema, "Experimental Confirmation of an HF Channel Model", *IEEE Transactions On Communications Technology*, Vol. **COM-18**, No. 6, Dec. 1970
2. Michel C. Jeruchim, Philip Balaban, and K. Sam Shanmugan, "Simulation of Communication Systems", ISBN 0-306-43989-1, Plenum Publishing
3. W. N. Furman, J. W. Nieto, "Understanding HF Channel Simulator Requirements in Order to Reduce HF Modem Performance measurement Variability," *Proceedings of HF01, Nordic HF Conference*, Faro, Sweden, August 2001.

### E.2.2 Order of precedence.

In the event of a conflict between the text of this document and the references cited herein, the text of this document takes precedence. Nothing in this document, however, supersedes applicable laws and regulations unless specific exemption has been obtained.

## DEFINITIONS

See section 3.

MIL-STD-188-110C  
w/CHANGE 1  
APPENDIX E

E.4 GENERAL REQUIREMENTS

E.4.1 Watterson Channel Model

The model of the HF channel to be implemented in simulators specified in this Appendix is the two-path model originally described by Watterson, et al, in “*Experimental Confirmation of an HF Channel Model*”, *IEEE Transactions On Communications Technology*, Vol. COM-18, No. 6, Dec. 1970. In this model, the output of the channel consists of white Gaussian noise (WGN) added to two copies of the input signal which are delayed relative to each other by a fixed amount (the “delay spread”). The amplitudes of the two delayed copies of the input signal vary according to independent fading gains which have Gaussian power spectral densities with a specified “fading bandwidth.” The two paths have equal power, averaged over a long period.

The Watterson model of a channel is completely specified by three parameters: the delay spread, the fading bandwidth per path, and the average signal-to-noise ratio (SNR) of the received signal.

E.4.2 Implementation of the Watterson HF Channel Model

The Watterson model shall be implemented using a tap-delay line as shown in Figure E-1.

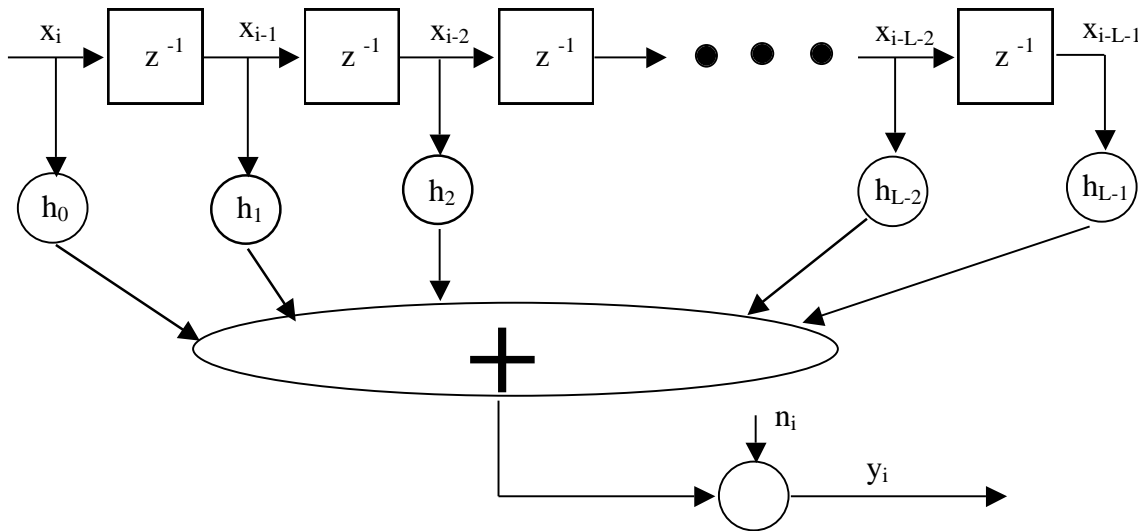

**Figure E-1. Implementation of the Watterson HF Channel Model**

The input  $x_i$ , output  $y_i$ , noise  $n_i$ , and filter tap gains  $h_j$  are complex, time-varying quantities;  $i$  is the time index. For a two-path model with fixed delay spread, only two of the tap gains shall be non-zero:  $h_0$  and  $h_{L-1}$ , where  $L$  is the specified delay spread of the channel divided by the sampling period. Mathematically, the relationship among these quantities is as follows:

$$f_j(t) = k\sqrt{2}e^{-\pi^2 t^2 d^2}, \quad -\tau < t < \tau$$

MIL-STD-188-110C  
w/CHANGE 1  
APPENDIX E

NOTE: when the external input to the channel simulator is a real audio signal, a Hilbert transform may be used to create the complex signal  $x_i$ .

NOTE: since the external output from the channel simulator is a real audio signal, only the real part of the resulting output signal  $y_i$  is output.

#### E.4.3 Radio Filters

If radio filters are implemented within the channel simulator, they shall be disabled when the simulator is used for testing compliance with the performance requirements in this standard.

#### E.4.4 Latency

Delay through the channel simulator ( $x_i$  to  $y_i$ ) shall not exceed 25 ms (DO: 10 ms) when the simulator is used to test two-way (interactive) systems.

### E.5 DETAILED REQUIREMENTS

NOTE: “Simulation of Communication Systems,” by Jeruchim, et al, and “Understanding HF Channel Simulator Requirements in Order to Reduce HF Modem Performance measurement Variability,” by Furman and Nieto are useful references for implementers of channel simulators.

#### E.5.1 Sample rate.

The sample rate of the simulator shall be at least four times the symbol rate of the anticipated modem waveform to test. For example 9600 samples per second for the 3kHz bandwidth waveforms specified in Appendix C and 76800 samples per second for the 24kHz bandwidth waveforms specified in Appendix D.

The crystal used to generate the sample rate should be specified to drift no more than 500 parts per million (PPM) over its operating temperature range.

#### E.5.2 Delay spread simulation

The length of the simulated channel,  $L$ , shall be computed as the specified delay spread divided by the sample rate, and rounded to the nearest integer.

#### E.5.3 White gaussian noise generation.

The white noise generated for use in producing the channel noise ( $n_i$  in Figure E-1) and the fading gains ( $h_0$  and  $h_{L-1}$  in Figure E-1) shall be independent random processes with power spectra that are uniform within  $\pm 1$  dB up to the sampling rate  $/2$ .

#### E.5.4 Fading tap gain generation.

Fading tap gains (see Figure E-1) shall be obtained by filtering complex white Gaussian noise samples as shown in Figure E-2.

MIL-STD-188-110C  
w/CHANGE 1  
APPENDIX E

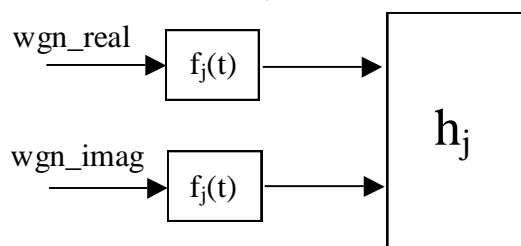

**Figure E-2. Fading Tap Gain Generation**

- Filters  $f_j(t)$  used for fading process in the Watterson model have a Gaussian shaped power spectrum in the frequency domain whose standard deviation  $\sigma_j$  is equal to half the fading bandwidth  $d_j$  (also called the “Doppler spread”) of each path:

$$|H_j(f)|^2 = \frac{e^{-2f^2/d_j^2}}{\sqrt{\frac{\pi d_j^2}{2}}} \quad -\infty < f < \infty$$

In the time domain, the equation for the  $f_j(t)$  shall be as follows,

$$f_j(t) = k\sqrt{2}e^{-\pi^2 t^2 d^2}, \quad -\tau < t < \tau$$

where  $\tau$  (the truncation width) is selected so that the magnitude of the tap gain function at  $\pm \tau$  is no greater than 1% of the peak value,

$d$  is the desired fading bandwidth in Hz, and

$k$  is set so that the total power gain of all paths is equal to 1.0 (i.e., so that the total average power output from the filters equals the average input power).

- Fading tap gains shall be computed at a rate of at least 32 times the specified fading bandwidth.
- Fading tap gains shall be interpolated to at least the symbol rate of the waveform to avoid introducing large discontinuities in the output of the simulator. (DO: the fading taps should be interpolated to the sample rate of the channel simulator.)

#### E.5.5 Signal-to-noise ratio

The power of  $n_i$  shall be set to achieve the specified SNR in the bandwidth of the waveform under test with reference to the average power of the input signal  $x_i$ .

NOTE: Accurate measurement of the average power of the input signal may require several minutes in the case of higher data rate waveforms.

MIL-STD-188-110C  
w/CHANGE 1  
APPENDIX E

## E.6. IMPLEMENTATION DETAILS FOR WIDEBAND HF CHANNEL SIMULATORS

### E.6.1 Analog interface

The analog interface is of primary concern, especially for wideband HF waveform testing and evaluation. It should be noted that many PC soundcards have an analog filter on the audio input between 20 kHz and 24 kHz. Care should be taken to make sure that the pass band of the channel simulator is consistent with the waveform bandwidths to be tested.

An additional factor for consideration for wideband testing is the center or subcarrier frequency of the waveform under test. It may be beneficial to have the interface implemented at a common subcarrier frequency, for example 19.2 kHz, where all modem waveforms, independent of their bandwidth, would be centered at 19.2 kHz.

The sample rate of the simulator shall be at least four times the symbol rate of the anticipated modem waveform to test. For example 9600 samples per second for the 3kHz bandwidth waveforms specified in Appendix C and 76800 samples per second for the 24kHz bandwidth waveforms specified in Appendix D.

### E.6.2 Hilbert Transform Alternative

Baseband channel simulators generally employ a Hilbert transform to generate a complex baseband equivalent signal, from the real input signal in order to easily implement the amplitude and phase variations of the fading multipath channel. Hilbert transforms are often implemented as an FIR filter. As the sample rate is increased to support wider bandwidth signals the lower limit of the Hilbert pass band also increased, possibly to a point that would impact the lower frequencies of the modem waveform.

An alternate Hilbert architecture can be implemented by an overlapped FFT approach, where the phase and gain properties of the Hilbert transform are implemented in the frequency domain and an inverse FFT is utilized to return the signal to the time domain.

### E.6.3 Output LPF

Depending on the analog interface of the output of the channel simulator it may be beneficial to have a low-pass or band-pass filter that is slightly wider than the waveform signal under test. This will prevent the wider bandwidth noise signal, which may be present because of the higher sampling rate, from causing any aliasing issues with the waveform receive hardware.

A low-pass or band-pass filter can easily be implemented by an overlapped FFT approach similar in nature to the Hilbert transform described above.



MIL-STD-188-110C  
w/CHANGE 1  
APPENDIX E

## E.7 CHANNEL SIMULATOR VALIDATION

### E.7.1 Bandwidth

The frequency response of a channel simulator implementation should be within +/- 0.5 dB. This test should be performed at the band-center and repeated at the band-center +/- 25% of the waveform bandwidth.

### E.7.2 Signal-to-noise ratio – Single Non-fading path

The signal to noise ratio should be within 0.25 dB of the specified SNR. This is validated by measuring the channel simulator output power, consisting of signal and noise output power for an input tone in the center of the waveform bandwidth. The tone is then removed a noise power is measured. These two measurements can be combined to yield an estimate of SNR.

This test should be performed at the band-center and repeated at the band-center +/- 25% of the waveform bandwidth.

Each measurement should be an average taken over at least 20 minutes.

### E.7.3 Signal-to-noise ratio – Single fading path, Dual fading path

The signal to noise ratio should be within 0.5 dB of the specified SNR. The tests described in H 7.2 above should be repeated for a single fading path as well as a dual fading path channel with the paths separated by 2ms. Doppler spreads of 1.0 and 10.0 Hz should be tested. Each measurement should be an average taken over at least 2 hours.

### E.7.4 Doppler Spectrum

The Doppler spectrum can be evaluated by inputting a tone into the channel simulator and logging the output samples to a file. The long term windowed average of FFT bins can be used to approximate the output spectrum. A total number of samples representing at least 3 hours of operation is recommended. It is further recommended that a Kaiser window be utilized in the spectrum averaging process.

Figure E-3 displays the ideal Gaussian spectrum compared to an example measured fading spectrum obtained as recommended above. Table E-I recommends the maximum allowable deviation in dB, from the ideal spectrum at -20dB and -30dB from the center (0 Hz) gain.

MIL-STD-188-110C  
w/CHANGE 1  
APPENDIX E

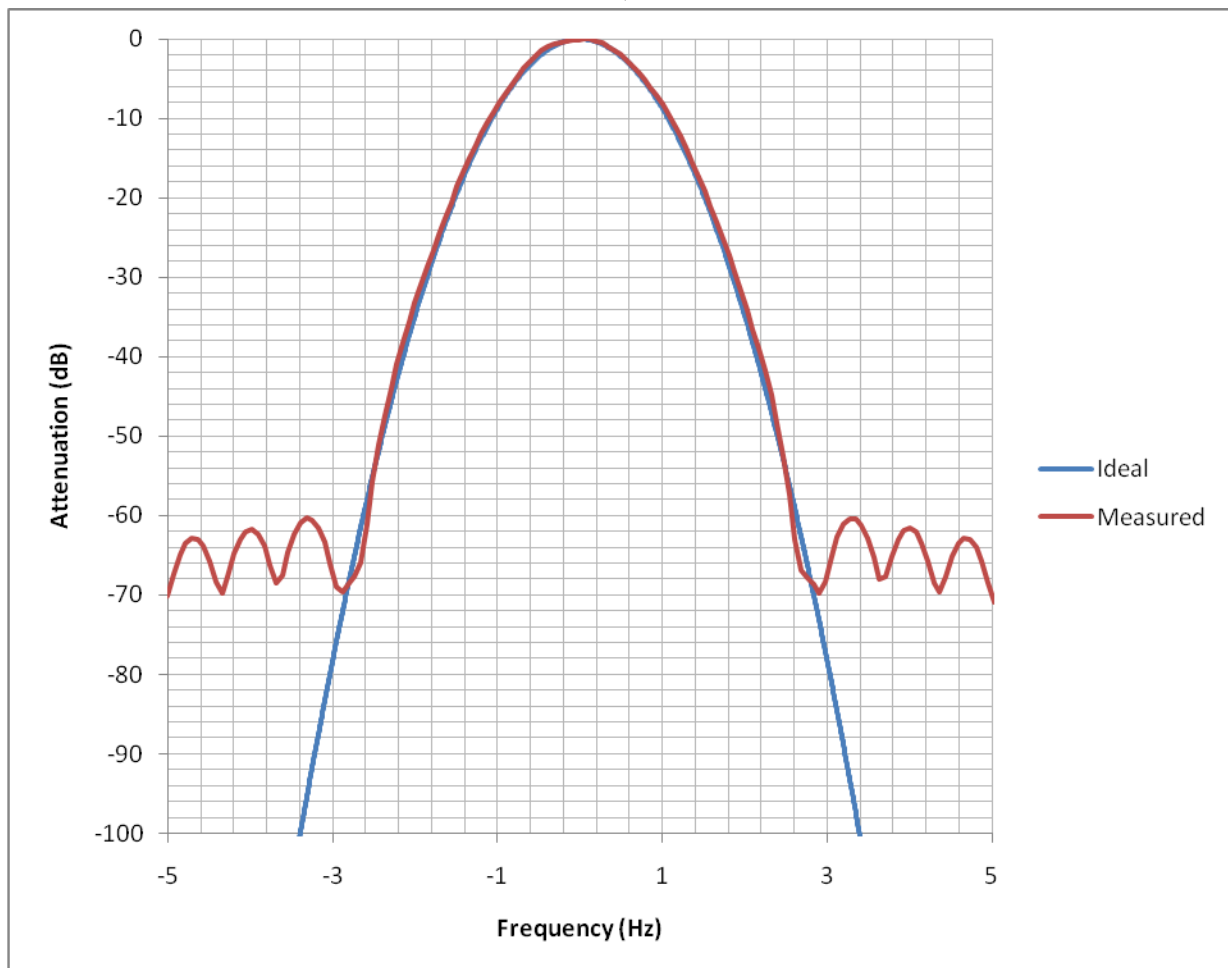

**Figure E-3. Doppler Spectrum**

**TABLE E-I – Allowed Deviation from Ideal Gaussian Fading Spectrum,  
Single path 1.0 Hz Doppler Spread**

Attenuation	Deviation
-20	+/-1.5dB
-30	+/- 2.0dB

MIL-STD-188-110C  
W/CHANGE 1  
APPENDIX F

HF DATA MODEMS FOR MULTIPLE CHANNEL SYSTEMS

TABLE OF CONTENTS

<b><u>PARAGRAPH</u></b> .....	<b><u>PAGE</u></b>
F.1 GENERAL .....	229
F.1.1 Scope.....	229
F.1.2 Applicability.....	229
F.2 APPLICABLE DOCUMENTS .....	229
F.3 DEFINITIONS .....	229
F.4 GENERAL REQUIREMENTS .....	229
F.4.1 Architectures for multiple channel operation.....	229
F.4.1.1 Multiple channel operation with independent-sideband modem.....	229
F.4.1.2 Multiple channel operation with multiple modems. (Optional).....	230
F.4.1.3 Multiple channel operation with parallel ARQ channels. (Optional).....	231
F.4.2 HF data modem waveform for two-independent-sideband applications.....	231
F.5 DETAILED REQUIREMENTS.....	232
F.5.1 Modulation.....	232
F.5.1.1 Known symbols.....	232
F.5.1.2 Data symbols.....	233
F.5.1.3 PSK data symbols.....	233
F.5.1.6 QAM data symbols.....	233
F.5.1.7 The 16 QAM constellation.....	233
F.5.1.8 The 32 QAM constellation.....	233
F.5.1.9 The 64QAM constellation.....	234
F.5.1.10 Data scrambling.....	234
F.5.2 Frame structure.....	234
F.5.3 Coding and interleaving.....	235
F.5.3.1 Block boundary alignment.....	236
F.5.3.2 Block encoding.....	236
F.5.3.3 Block interleaver structure.....	236
F.5.3.4 Interleaver size in bits.....	236
F.5.3.5 Interleaver load.....	236
F.5.3.6 Interleaver fetch.....	237
F.5.4 Operational features and message protocols.....	237
F.6 PERFORMANCE.....	237
F.7 ASSOCIATED COMMUNICATIONS EQUIPMENT.....	238

MIL-STD-188-110C  
W/CHANGE 1  
APPENDIX F

**LIST OF FIGURES**

FIGURE F-1. MULTIPLE CHANNEL OPERATION WITH INDEPENDENT-SIDEBAND MODEM. ....	230
FIGURE F-2. MULTIPLE CHANNEL OPERATION WITH SINGLE-SIDEBAND MODEMS. .....	230
FIGURE F-3. MULTIPLE CHANNEL OPERATION WITH PARALLEL ARQ CHANNELS.	231
FIGURE F-4. 2-ISB MODEM. ....	232

**LIST OF TABLES**

TABLE F-I. MODULATION USED TO OBTAIN EACH DATA RATE FOR 2-ISB OPERATION. ....	233
TABLE F-II. DATA SYMBOL PATTERNS FOR SPECIFYING DATA RATE AND INTERLEAVER LENGTH FOR THE 2-ISB MODEM. ....	235
TABLE F-III. INPUT DATA BLOCK SIZE IN BITS AS A FUNCTION OF DATA RATE AND INTERLEAVER LENGTH. ....	235
TABLE F- IV. INTERLEAVER SIZE AND INCREMENT IN BITS AS A FUNCTION OF DATA RATE AND INTERLEAVER LENGTH. ....	236
TABLE F-V. APPENDIX F HIGH DATA RATE MODE PERFORMANCE REQUIREMENTS. .....	237

MIL-STD-188-110C  
W/CHANGE 1  
APPENDIX F

## F.1 SCOPE

### F.1.1 Scope.

This appendix describes HF data modem operation over multiple discrete channels (including independent sidebands of a single carrier), and specifies a waveform that supports data rates of 9600 to 19,200 bps over two-independent-sideband (2-ISB) radios using the waveforms from Appendix C.

### F.1.2 Applicability.

This appendix is a nonmandatory part of MIL-STD-188-110B; however, systems using HF data modem waveforms on multiple discrete channels shall operate in accordance with this appendix.

## F.2 APPLICABLE DOCUMENTS

This section is not applicable to this appendix.

## F.3 DEFINITIONS

See section 3.

## F.4 GENERAL REQUIREMENTS

The use of multiple HF channels in parallel can provide data throughput greater than the use of a single sideband channel. Section F.4.1 describes a range of architectures for multiple channel operation that may be useful in specific applications. Section 0 describes an independent sideband (ISB) modem waveform that may be used in any of these architectures.

### F.4.1 Architectures for multiple channel operation.

#### F.4.1.1 Multiple channel operation with independent-sideband modem.

When ISB radios and channel allocations are available, the channels provided by the radio inherently have similar channel characteristics, and can support similar data rates. A modem that spreads coded symbols over the available channels takes full advantage of this capability. Such a modem is shown in Figure F-1 (with optional link-level encryption). The two-channel ISB (2-ISB) modem specified in sections 0 and 0 is the mandatory portion of this appendix. The ISB capability is currently limited to two channels per modem. Four-channel radios support two such 2-ISB modems using either of the techniques described in the following sections.

MIL-STD-188-110C  
W/CHANGE 1  
APPENDIX F

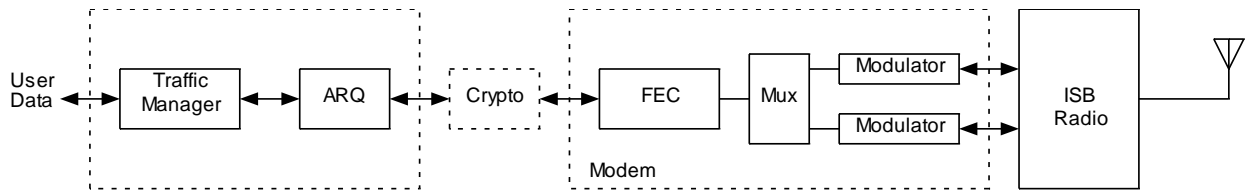

**FIGURE F-1. Multiple channel operation with independent-sideband modem.**

**F.4.1.2 Multiple channel operation with multiple modems. (Optional)**

When ISB radios and channel allocations are available, but ISB modems with a matching number of audio channels are not available, multiple modems may be employed as shown in Figure F-2. The upper diagram illustrates the case of unencrypted user data and link-level encryption (as in the previous section). The lower diagram depicts application-layer (end-to-end) encryption.

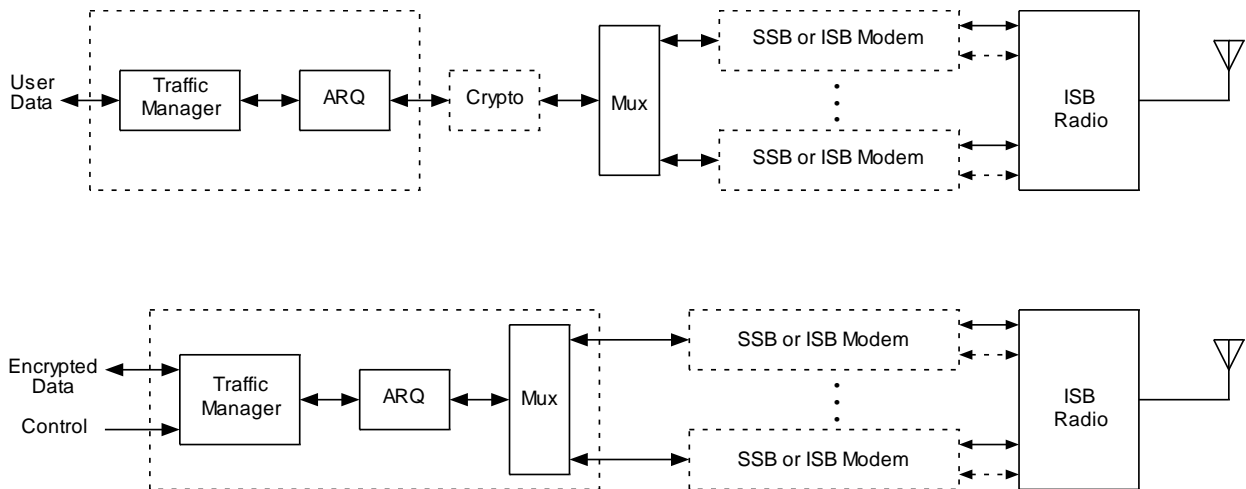

**FIGURE F-2. Multiple channel operation with single-sideband modems.**

The first bit of data to be sent shall be delivered to the modem associated with the highest over-the-air frequency, with succeeding bits delivered to modems with decreasing frequencies. When  $M$  modems are attached to a single ISB radio ( $M = 2$  shown), all modems shall operate at a single data rate, and modem  $i$  ( $i = 0 .. M - 1$ ) shall carry bits numbered  $i + nM$  ( $n = 0, 1, \dots$ ).

This architecture also may be applied to multiple radios operating on unrelated frequencies. However, performance may not be satisfactory if the characteristics of the various channels are not sufficiently similar to support a common maximum data rate. Bit ordering shall be as specified above, with the identity of the modem associated with the highest over-the-air frequency determined when the link is initially established, regardless of subsequent frequency changes while linked.

MIL-STD-188-110C  
W/CHANGE 1  
APPENDIX F

In the bit-synchronous approach described above, it is understood that the multiplexer and modems share a common clock. In addition, the multiplexer provides a short synchronization header in the bit stream to each modem prior to the payload data. Note that this header is transparent to the ARQ or other modem-user process. The header is used by the multiplexer at the receive end to establish bit-order integrity. This header is required since a bit-synchronous Tx modem interface does not generally guarantee that the first bit out of the receiving modem is the first bit out of the transmitting DTE following assertion of CTS.

Alternatively, the High Speed Asynchronous Interface with Flow Control that is described in section C.5.4.1 may be used. In this case, data to successive modems from the multiplexer will be successive bytes rather than successive bits.

#### F.4.1.3 Multiple channel operation with parallel ARQ channels. (Optional)

The architecture shown in Figure F-3 accommodates any combination of radios and modems for multiple-channel operation. As above, the upper diagram illustrates link-level encryption while the lower diagram depicts application-layer (end-to-end) encryption.

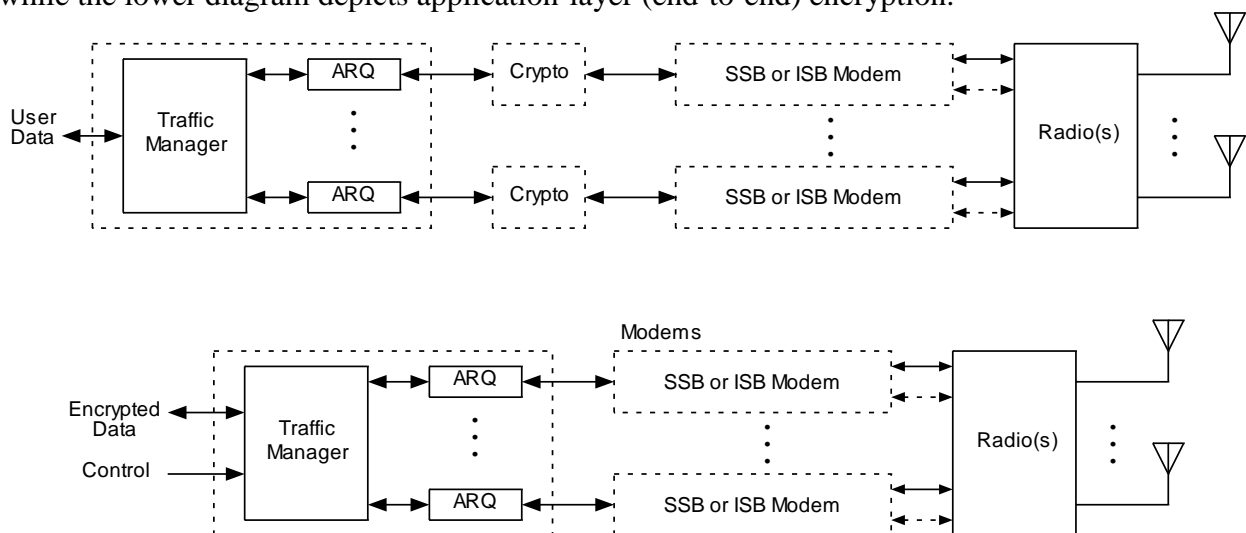

**FIGURE F-3. Multiple channel operation with parallel ARQ channels.**

A traffic manager process dynamically assigns packets to a separate ARQ protocol process associated with each modem. Each ARQ process adapts its modem's data rate to the channel conditions it encounters; the traffic manager likewise adapts the rate that it assigns packets to the ARQ processes based on their completion rates. Message reassembly relies on packet offset fields in the packet headers.

#### F.4.2 HF data modem waveform for two-independent-sideband applications.

This appendix presents a modem waveform and coding specification for data transmission over two HF sidebands for data rates from 9.6 up to 19.2 kbps. As in Appendix C, a block interleaver is used to obtain 6 interleaving lengths ranging from 0.12 s to 8.64 s. The

MIL-STD-188-110C  
W/CHANGE 1  
APPENDIX F

waveforms in this appendix have been designed to be compatible with the Appendix C waveforms, and use identical preamble processing with the exception that these waveforms employ settings for specifying data rate and interleaver that are reserved in Appendix C.

Data rate and interleaver settings are explicitly transmitted as a part of the waveform, both as part of the initial preamble and then periodically as a reinserted preamble and in the periodic known symbol blocks (“mini-probes”). This “autobaud” feature is critical in developing an efficient (ARQ) protocol for high frequency (HF) channels. The receive modem is required to be able to deduce the data rate and interleaver setting from either the preamble or the subsequent data portion of the waveform.

A block diagram of the 2-ISB modem with 2-ISB radios is shown in Figure F-4. In all applications of this modem, the quasi-analog signal designated Channel 0 shall be connected to the radio equipment so that the sideband that it produces is higher in frequency than the sideband produced by the quasi-analog signal designated Channel 1. In particular, with 2-ISB radios Channel 0 shall use the upper sideband and Channel 1 shall use the lower sideband.

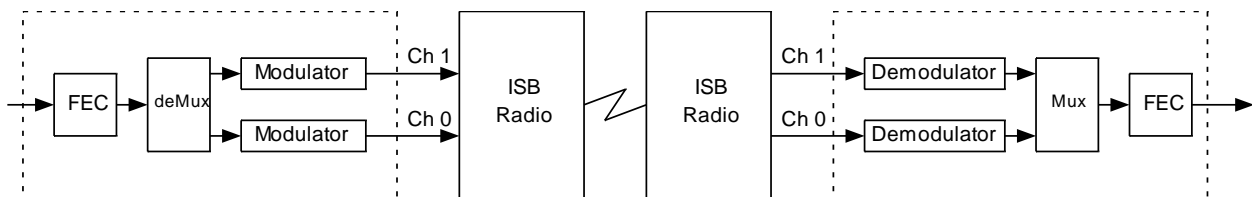

**FIGURE F-4. 2-ISB Modem.**

## F.5 DETAILED REQUIREMENTS

### F.5.1 Modulation.

Each of the channels shall be modulated independently. The modulation of each of the channels is identical, with a few specified exceptions, to that specified in appendix C for the high data rate single sideband option. The transmit data clock for both of the channels shall be synchronized so that there is no drift in the relative clocks for each of the channels.

The power spectral density of each modulator output signal should be constrained to be at least 20 dB below the signal level measured at 1800 Hz, when tested outside of the band from 200 Hz to 3400 Hz. The filter employed shall result in a ripple of no more than  $\pm 2$  dB in the range from 800 Hz to 2800 Hz.

#### F.5.1.1 Known symbols.

For all known symbols, the modulation used shall be PSK, with the symbol mapping shown in Table C-I and figure C-1. No scrambling shall be applied to the known symbols.



MIL-STD-188-110C  
W/CHANGE 1  
APPENDIX F

F.5.1.2 Data symbols.

For data symbols, the modulation used depends upon the data rate as shown in Table F-I.

**TABLE F-I. Modulation used to obtain each data rate for 2-ISB operation.**

Modulation	Code Rate	Data Rate (kbps)
8PSK	3/4	9.6
16QAM	3/4	12.8
32QAM	3/4	16.0
64QAM	3/4	19.2

F.5.1.3 PSK data symbols.

For the PSK constellations, a distinction is made between the data bits and the symbol number. Transcoding is an operation which links a symbol to be transmitted to a group of data bits.

F.5.1.4 QPSK symbol mapping.

For QPSK symbols, used in the preamble and reinserted preamble to specify data rate and interleaving, transcoding shall be achieved by linking one of the symbols specified in Table C-I to a set of two consecutive data bits (dibit) as shown in Table C-III. In this Table, the leftmost bit of the dibit shall be the older bit; i.e., fetched from the interleaver before the rightmost bit.

F.5.1.5 8PSK symbol mapping.

For the 9600 bps user data rate, transcoding shall be achieved by linking one symbol to a set of three consecutive data bits (tribit) as shown in Table C-IV. In this Table, the leftmost bit of the tribit shall be the oldest bit; i.e., fetched from the interleaver before the other two, and the rightmost bit is the most recent bit.

F.5.1.6 QAM data symbols.

For the QAM constellations, no distinction is made between the number formed directly from the data bits and the symbol number. Each set of 4 bits (16QAM), 5 bits (32QAM) or 6 bits (64QAM) is mapped directly to a QAM symbol. For example, the four bit grouping 0111 would map to symbol 7 in the 16QAM constellation while the 6 bit grouping 100011 would map to symbol 35 in the 64QAM constellation. Again, in each case the leftmost bit shall be the oldest bit, i.e. fetched from the interleaver before the other bits, and the rightmost bit is the most recent bit.

F.5.1.7 The 16 QAM constellation.

See figure C-2 and Table C-V.

F.5.1.8 The 32 QAM constellation.

See figure C-3 and Table C-VI.

MIL-STD-188-110C  
W/CHANGE 1  
APPENDIX F

F.5.1.9 The 64QAM constellation.

See figure C-4 and Table C-VII.

F.5.1.10 Data scrambling.

Data symbols for the 8PSK symbol constellation shall be scrambled by modulo 8 addition with a scrambling sequence. The data symbols for the 16QAM, 32QAM, and 64QAM constellations shall be scrambled by using an exclusive or (XOR) operation. Sequentially, the data bits forming each symbol (4 for 16QAM, 5 for 32QAM, and 6 for 64QAM) shall be XOR'd with an equal number of bits from the scrambling sequence. In all cases, the scrambling sequence generator polynomial shall be  $x^9 + x^4 + 1$  and the generator shall be initialized to 1 at the start of each data frame. A block diagram of the scrambling sequence generator is shown in figure C-5. Further details of the operation of the data scrambler may be found in C.5.1.3.

F.5.2 Frame structure.

The frame structure shall be as described in C.5.2 except that the data symbols  $D_0$ ,  $D_1$ , and  $D_2$  (used in the preambles and encoded in the mini-probes) take on values distinct from those used for the Appendix C SSB modes.

For the two sideband option, the 3 bits used for data rate in SSB are fixed at 000. The bits normally used for interleaver setting in SSB are employed as specified in Table F-II, using both channels, to select data rate and interleaver settings. Channel 0 carries the code for the combined data rate and Channel 1 carries the code for the common interleaver. Recall that channel 0 is always the higher frequency of the two sidebands. Unused codings are reserved and shall not be used until standardized.

MIL-STD-188-110C  
W/CHANGE 1  
APPENDIX F

**TABLE F-II. Data symbol patterns for specifying data rate and interleaver length for the 2-ISB modem.**

Channel 0

Data Rate (kbps)	D0,D1,D2	3 Bit Mapping
9.6	0,0,2	001
12.8	0,2,0	010
16.0	0,2,2	011
19.2	2,0,0	100

Channel 1

Interleaver	D0,D1,D2	3 Bit Mapping
Ultra Short	0,0,2	001
Very Short	0,2,0	010
Short	0,2,2	011
Medium	2,0,0	100
Long	2,0,2	101
Very Long	2,2,0	110

### F.5.3 Coding and interleaving.

The interleaver used shall be a block interleaver. Each block of input data shall be encoded using a block encoding technique with a code block size equal to the size of the block interleaver. Thus, the input data bits will be sent as successive blocks of bits on both channels that together span the duration of the interleaver length selected.

Table F-III shows the number of input data bits per block as function of both data rate and interleaver length. Note that an “input data block” should not be confused with the 256 symbol data block that is part of a data frame in the waveform format. The bits from an input data block will be mapped through the coding and interleaving to the number of data frames, and thus 256 symbol data blocks, that define the interleaver length.

**TABLE F-III. Input data block size in bits as a function of data rate and interleaver length**

Data Rate (kbps)	Interleaver Length in Frames					
	1	3	9	18	36	72
	Number of Input Data Bits per Block					
9.6	1,152	3,456	10,368	20,736	41,472	82,944
12.8	1,536	4,608	13,824	27,648	55,296	110,592
16.0	1,920	5,760	17,280	34,560	69,120	138,240
19.2	2,304	6,912	20,736	41,472	82,944	165,888

MIL-STD-188-110C  
W/CHANGE 1  
APPENDIX F

**F.5.3.1 Block boundary alignment.**

Each code block shall be interleaved within a single interleaver block of the same size. The boundaries of these blocks shall be aligned such that the beginning of the first data frame following each reinserted preamble shall coincide with an interleaver boundary. Thus for an interleaver length of 3 frames, the first three data frames following a reinserted preamble will contain all of the encoded bits for a single input data block. The first data symbol from the first data frame in each interleaver set shall have as its MSB the first bit fetched from the interleaver. This is no different from what would normally be expected, but is a requirement.

**F.5.3.2 Block encoding.**

See C.5.3.2.

**F.5.3.3 Block interleaver structure.**

The block interleaver used is designed to separate neighboring bits in the punctured block code as far as possible over the span of the interleaver with the largest separations resulting for the bits that were originally closest to each other.

**F.5.3.4 Interleaver size in bits.**

The interleaver shall consist of a single dimension array, numbered from 0 to its size in bits –1. The array size shall depend on both the data rate and interleaver length selected as shown in Table F-IV.

**TABLE F- IV. Interleaver size and increment in bits as a function of data rate and interleaver length.**

Modulation	Data Rate (kbps)	Ultra Short 1 Frame		Very Short 3 Frames		Short 9 Frames		Medium 18 Frames		Long 36 Frames		Very Long 72 Frames	
		Size	Inc	Size	Inc	Size	Inc	Size	Inc	Size	Inc	Size	Inc
8 PSK	9.6	1536	229	4608	805	13,824	2089	27,648	5,137	55,296	10,273	110,592	17,329
16QAM	12.8	2048	363	6144	1303	18,432	3281	36,864	6,985	73,728	11,141	147,456	28,007
32QAM	16.0	2560	453	7680	1343	23,040	3481	46,080	8,561	92,160	14,441	184,320	34,907
64QAM	19.2	3072	481	9216	1393	27,648	5137	55,296	10,273	110,592	17,329	221,184	47,069

**F.5.3.5 Interleaver load.**

The punctured block code bits shall be loaded into the interleaver array beginning with location 0. The location for loading each successive bit shall be obtained from the previous location by incrementing by the interleaver increment value “Inc” specified in Table F-IV, modulo the interleaver size in bits, “Size.”

Defining the first punctured block code bit to be B(0), then the load location for B(n) is given by:

$$\text{Load Location} = (n * \text{Inc}) \text{ modulo } (\text{Size})$$

MIL-STD-188-110C  
W/CHANGE 1  
APPENDIX F

F.5.3.6 Interleaver fetch.

The fetching sequence for all data rates and interleaver lengths shall start with location 0 of the interleaver array and increment the fetch location by 1. The first bit fetched from the interleaver (bit 0) shall be sent to the symbol formation module for channel 0, the second bit fetched (bit 1) shall be sent to the symbol formation module for channel 1, and this pattern shall continue until all bits have been fetched from the interleaver. This is a linear fetch from beginning to end of the interleaver array with even numbered bits delivered to channel 0 and odd numbered bits to channel 1.

F.5.4 Operational features and message protocols.

See C.5.4.

F.6 PERFORMANCE

The measured performance of the 2-ISB high data rate mode, using fixed-frequency operation and employing the maximum interleaving period (the 72-frame “Very Long” interleaver), shall achieve coded BER of no more than 1.0E-5 under each of the conditions listed in Table F-V.

**TABLE F-V. Appendix F High data rate mode performance requirements.**

User data rate (bps)	Average SNR (dB) for BER $\leq$ 1.0E-5	
	AWGN Channel	ITU-R Poor Channel
19200	21	34
16000	19	29
12800	16	25
9600	13	21

Performance shall be tested using a baseband HF simulator for each sideband patterned after the Watterson Model in accordance with Appendix H. SNR values specified in Table F-V are per sideband.

- Each AWGN channel shall consist of a single, non-fading path. Each condition shall be measured for at least 60 minutes.
- Each ITU-R Poor channel shall consist of two independent but equal average power Rayleigh fading paths per sideband, with a fixed 2 ms delay between paths, and with a fading (two sigma) bandwidth (BW) of 1 Hz. A separate simulator shall be used for each sideband (to avoid correlation among their fading processes). Each condition shall be measured for at least 5 hours.
- Both signal and noise power shall be measured in a 3 kHz bandwidth. Note that the average power of QAM symbols is different from that of the 8PSK mini-probes and

MIL-STD-188-110C  
W/CHANGE 1  
APPENDIX F

reinserted preambles; the measured signal power shall be the long-term average of user data, mini-probe, and reinserted preamble symbols.

When testing a modem embedded with a radio, so that only radio frequency (RF) signals are available for testing, the RF signals must be down-converted to baseband for processing by the channel simulator, and the result up-converted to RF for the receiver. In this case, the built-in radio filters will affect the performance of the modems. Therefore, when testing embedded modems, the SNR values specified in Table F-xyz shall be increased by 3 dB for all data rates.

#### F.7 ASSOCIATED COMMUNICATIONS EQUIPMENT

See C.7 “ASSOCIATED COMMUNICATIONS EQUIPMENT”

MIL-STD-188-110C  
W/CHANGE 1

CONCLUDING MATERIAL

Custodians:

Air Force – 71

Army – CR

Navy – EC

Preparing Activity:

Air Force – 71

(Project Number TCSS-2012-001)

Review Activities:

Air Force – 02, 07

Navy – MC

DoD – DC1, NS

NOTE: The activities listed above were interested in this document as of the date of this document. Since organizations and responsibilities can change, you should verify the currency of the information above using the ASSIST Online database at <https://assist.daps.dla.mil>.