

MIL-STD-187-310
14 OCTOBER 1976

MILITARY STANDARD

STANDARDS FOR LONG HAUL COMMUNICATIONS

SWITCHING PLANNING STANDARDS

FOR THE DEFENSE COMMUNICATIONS SYSTEM



SLHC

MIL-STD-187-310

DEPARTMENT OF DEFENSE
WASHINGTON, D. C. 20306

Switching Planning Standards for
the Defense Communications System

MIL-STD-187-310

1. This Military Standard is approved for use by all Departments and Agencies of the Department of Defense.

2. Beneficial comments (recommendations, additions, deletions) and any pertinent data which may be of use in improving this document, should be addressed to Director, Defense Communications Engineering Center, ATTN: Code RL10, 1860 Wiehle Avenue, Reston, Virginia 22090, by using the self-addressed Standardization Document Improvement Proposal (DD Form 1426) appearing at the end of this document or by letter.

FOREWORD

1. Electrical performance standards for the Defense Communications System (DCS) are contained in the MIL-STD-188-100 and 300 series of documents. These standards, which apply primarily to today's analog system, contain performance values which must be within the state-of-the-art and based on measured performance of actual equipment and circuits. Since standards are the basis for specifying equipment to be procured or reprocured for use in the DCS, they provide assurance that new equipment will perform satisfactorily and interface properly with other equipment in the DCS.
2. At present, the standardization coverage of the DCS is fairly comprehensive. This is due to the relatively stable configuration of the DCS since completion of the major switched subsystems, which has permitted standards development to "catchup." Currently, however, the DoD is entering a period, of perhaps ten years or more, during which many major changes are planned in the DCS. Unless some modification is made to the DoD standards program, standards will continue to be developed essentially after-the-fact, and will be of little help in planning and designing these forthcoming changes. Accordingly, the standardization effort is being expanded to include the development of "future" or planning standards for the DCS. These standards are being developed at an earlier date than, and are to be forerunners of, conventional standards.
3. DCS Planning Standards contain characteristics which apply to the evolving and future DCS. Performance values assigned to these characteristics may meet the same criteria as conventional standards, i.e., proven by measured performance, etc., or they may be based on best technical judgment of what is needed for the future. In some cases, performance values have not been determined as yet and their definition may depend upon the completion of related studies or RDT&E programs. This category of unknown performance values serves to identify and, in a sense, reserve these areas until agreed-upon values can be established. This tends to preclude unilateral decisions by designers that might preempt the opportunity of making a better choice later on.
4. Planning standards provide uniform guidance for the design of the evolving and future DCS. Providing this guidance at the concept engineering stage will help to minimize ineffective designs and costly interoperability problems at later stages of implementation, as well as assuring utilization of appropriate advances in technology. Also, establishing a reference source of design guidance will: minimize unilateral design decisions by one project engineering group; pinpoint areas where design decisions are needed; facilitate the comparison and

MIL-STD-187-310

evaluation of design criteria in regard to tradeoffs and impact on other subsystems and overall system performance; and provide wider exposure of design decisions to all interested DoD activities.

5. The need for interoperability with other DoD and non-DoD systems has been a major consideration in the development of planning standards. Specifications for the characteristics and parameters in the planning standards were developed considering present specifications and future plans for the TRI-TAC system, commercial systems (both national and international), and NATO/NICS. Also considered was the Final Report of the DoD Committee on Interoperability and DoD, national and international communication system standards.

6. It is planned to develop planning standards in the following areas:

- a. Network and System Design
- b. Switching
- c. Secure Communications
- d. Transmission
- e. Satellites
- f. Terminals
- g. System Management and Control
- h. Survivability.

This planning standard, for switching, is the first to be developed. An analysis has been made of the evolving and future DCS, as planned, to determine what switching planning standards are needed. Services and features which will differ from those in the present DCS, thereby requiring new design effort or design decisions, have been identified and broken down into specific subject areas, characteristics, and parameters. Technical descriptions of these characteristics and parameters have been prepared which represent a technical snapshot of where DCA/DoD stands in defining/specifying them for the evolving and future DCS.

7. In order to provide a reference for the switching planning standard, a description of the evolving and future DCS, together with the aforementioned analysis, is provided and is divided into time periods. The first time period applies to the Nominal Future DCS, which is a configuration based on logical extensions of ongoing programs; i.e. Phase II Secure Voice, AUTODIN II, and a DCS-suitable AN/TTC-39. This period is considered herein as the 1976-1986 time

MIL-STD-187-310

period, although full implementation of these programs may extend beyond 1986. The second period applies to the Future DCS - Advanced Concepts, the definition of which depends on the ability to take advantage of evolving technologies. This period is considered the post-1986 time period, although advanced concepts could be implemented earlier. Switching planning standards applicable to the post-1986 time period will be based on the results of advanced R&D pertaining to a unified switch. This will provide a frame of reference for judging performance requirements or acceptability of intermediate switching applications; e.g. AN/TTC-39.

MIL-STD-187-310

CONTENTS

	<u>Page</u>
FOREWORD	
CONTENTS	
<u>CHAPTER</u>	
1. SCOPE	1-1
2. REFERENCED DOCUMENTS	2-1
3. TERMS, DEFINITIONS AND ACRONYMS	3-1
4. THE PRESENT DCS	4-1
5. THE FUTURE DCS	5-1
6. CIRCUIT SWITCHING	6-0-1
SECTION 1 - NUMBERING PLAN	6-1-1
SECTION 2 - SERVICE FEATURES	6-2-1
SECTION 3 - INFORMATION TONES AND RECORDED ANNOUNCEMENTS	6-3-1
SECTION 4 - SIGNALING AND SUPERVISION	6-4-1
SECTION 5 - ROUTING	6-5-1
SECTION 6 - INTERFACES	6-6-1
SECTION 7 - CIRCUIT SWITCH CHARACTERISTICS - OVERSEAS	6-7-1
SECTION 8 - CIRCUIT SWITCH CHARACTERISTICS - CONUS	6-8-1

CONTENTS - Continued

<u>CHAPTER</u>	<u>Page</u>
7. DATA SWITCHING	7-0-1
SECTION 1 - SYSTEM PERFORMANCE REQUIREMENTS	7-1-1
SECTION 2 - FUNCTIONAL REQUIREMENTS	7-2-1
SECTION 3 - PROTOCOLS	7-3-1
SECTION 4 - PACKET SWITCH CHARACTERISTICS	7-4-1
SECTION 5 - AUTODIN II SYSTEM CONTROL	7-5-1
SECTION 6 - AUTODIN II SOFTWARE	7-6-1
8. ACCESS AREA	8-0-1
SECTION 1 - DIGITAL ACCESS EXCHANGE (DAX)	8-1-1
SECTION 2 - LOCAL DIGITAL MESSAGE EXCHANGE (LDMX)	8-2-1
SECTION 3 - COMMUNICATIONS ACCESS PROCESSOR (CAP)	8-3-1
SECTION 4 - PRIVATE AUTOMATIC BRANCH EXCHANGE (PABX)	8-4-1
SECTION 5 - COMMUNICATIONS SELECTOR SWITCH (CSS)	8-5-1
SECTION 6 - INTERFACES	8-6-1
9. SYSTEM CONTROL ELEMENTS APPLICABLE TO SWITCHING	9-0
10. FUTURE DCS - ADVANCED CONCEPTS	10-0-1
SECTION 1 - UNIFIED DIGITAL SWITCH (UDS)	10-1-1
SECTION 2 - SOFTWARE	10-2-1

FIGURES

		<u>Page</u>
Figure 5.1	Future DCS Generic Configuration	5-7
6.1.1	Message Format for Call Initiate To Be Used by Switches with CCS	6-1-11
6.1.2	Message Format for Call Initiate to be Used by Switches with Digital In-Band Signaling	6-1-12
6.4.1	Trunk Signaling Buffer	6-4-3
6.4.2	MUX/DEMUX Subchannel Allocations	6-4-4
6.4.3	Format of Call Initiate Message	6-4-6
6.4.4	Format of Call Complete Message	6-4-7
6.4.5	Format of Call Answer, Release, Call Incomplete (Except Invalid Route), Trunk Test, and Special Messages	6-4-7
6.4.6	Format of Acknowledgment and Test Sync Messages	6-4-8
6.4.7	Format of Invalid Route Message	6-4-8
6.4.8	Format of Sync A and Sync B Messages	6-4-8
6.4.9	Typical Message Sequence	6-4-12
6.5.1	Basic Pattern of Polygrid Network Structure	6-5-2
6.5.2	Home Grid Array	6-5-3
6.5.3	Order of Trunk Group Cluster Selection	6-5-13
7.2.1	Standard Interface Between Data Terminal Equipment and Data Communication Equipment	7-2-10
7.3.1	Protocol Structure	7-3-2
7.3.2	Binary Segment Leader	7-3-6
7.3.3	Effect of Line Modes	7-3-7
7.3.4	Type A Binary Segment Leader Mode VI	7-3-8
7.3.5	Process-To-Process Transfer of Information	7-3-12
7.3.6	Type B - Packed Binary Segment Leader/Mode I	7-3-15
7.5.1	System Control General Message Format	7-5-4
8.1.1	DAX System Concept	8-1-2
10.1.1	Frequency-Time Representations	10-1-12
10.1.2	Multiplex Structure for Typical Frame Period	10-1-13
10.1.3	Functional Structure for Future Switch Architecture	10-1-16

LIST OF TABLES

		<u>Page</u>
Table 6.1.1	Subscriber Dialed Information	6-1-3
6.1.2	Allowable Subscriber Dialed Sequences	6-1-7
6.1.3	Allowable Trunk Dialing Sequences	6-1-14
6.3.1	Information Tones Provided to the Subscriber	6-3-3
6.4.1	Trunk Signaling Messages	6-4-9
6.5.1	Route Control Digit Meanings Exterior to Home Grid	6-5-5
6.5.2	Route Control Digit Meanings in Home Grid	6-5-6
6.5.3	Trunk Selection Rules at an Originating or Gateway Switch	6-5-10
6.5.4	Trunk Selection Rules at an Intermediate Node Which is Not a Gateway	6-5-11
7.1.1	Traffic Acceptance Categories	7-1-8
7.1.2	Precedence Category	7-1-10
7.2.1	Subscriber/Constraint Matrix	7-2-6
7.2.2	Subscriber/Subscriber Cross-Connection Matrix	7-2-8
7.2.3	Subscriber Interchange Capabilities and Leader Formats	7-2-9
7.3.1	Binary and Character Oriented Subscriber Characteristics	7-3-4
8.1.1	Special Service Features	8-1-8

1A61438

CHAPTER 1

SCOPE

1.1 Purpose. This planning standard establishes a reference source of unified system design guidance applicable to the evolving and future Defense Communications System (DCS). This guidance is intended to help assure the compatibility of future DCS subsystems, as well as the interoperability of the DCS with other DoD and non-DoD communications systems. Specifically, this planning standard is intended to:

- a. Avoid unilateral design decisions by one engineering group
- b. Pinpoint areas where design decisions are needed
- c. Facilitate the comparison and evaluation of design criteria in regard to tradeoffs, impact on other subsystems, and overall system performance
- d. Assure utilization of appropriate advances in technology
- e. Provide wider exposure of design decisions to all interested DoD activities.

1.2 Application. This planning standard is to be used in the planning and design of future DCS subsystems, as well as programs for communications facilities to be used in, or that interface with, the DCS. This planning standard is to be used as a basis for preparing system and equipment development specifications (Types A and B respectively, as described in MIL-STD-490), but should not be used for preparing procurement specifications, since it is subject to change as the design of the future DCS evolves and is refined.

CHAPTER 2

REFERENCED DOCUMENTS

2.1 This document is arranged in chapters and sections with page numbers keyed to the chapters and sections. For example, page 5 of section 4 of chapter 6 is numbered 6-4-5. This format is being used initially so that changes can be made and new material inserted without extensive retyping, page renumbering, etc. For the same reasons, referenced documents have been decentralized. References pertaining to a particular section are listed under the last paragraph of that section. Reference keys in the text consist of small letters in brackets, e.g. [a]. Requests for information on how references may be obtained should be addressed to Director, Defense Communications Engineering Center, ATTN: Code R110, 1860 Wiehle Avenue, Reston, Virginia 22090.

CHAPTER 3

TERMS, DEFINITIONS AND ACRONYMS

3.1 Terms and Definitions. Standard definitions for telecommunications terms used in this document may be found in MIL-STD-188-120, "Common Long Haul/Tactical Telecommunications Terms and Definitions," presently in the final stages of development.

3.2 Acronyms

<u>ACRONYM</u>	<u>MEANING</u>
ACOC	Area Communications Operations Center
A/D	Analog (to) Digital
ADCCP	Advanced Data Communication Control Procedures
ADI	Analog/Digital Interface
ADP	Automatic Data Processing
AMME	Automated Multi-Media Exchange
ARM	Asynchronous Response Mode
ARPA	Advanced Research Projects Agency
ARQ	Automatic Repeat Request
ASC	Automatic Switching Center
ASCII	American Standard Code for Information Interchange
ATB	All Trunks Busy
ATEC	Automatic Technical Control
ATP	Automated Telecommunications Program
AUTODIN	Automatic Digital Network
AUTOSEVOCOM	Automatic Secure Voice Communications

MIL-STD-187-310

<u>ACRONYM</u>	<u>MEANING</u>
AUTOVON	Automatic Voice Network
BCS	Backbone Circuit Switch
BEC	Buffer and Executive Control
BPS	Backbone Packet Switch
b/s	Bits Per Second
BSC	Binary Segment Leader
CAP	Communications Access Processor
CCIR	Consultative Committee International Radio
CCIS	Common Channel Interoffice Signaling
CCITT	Consultative Committee International Telegraph and Telephone
CCS	Common Channel (Interoffice) Signaling
CCSL	Character Canned Segment Leader
CID	Channel Identifier
CNCE	Communications Network Control Element
COL	Communications Oriented Language
COMSEC	Communications Security
CRC	Cyclic Redundancy Check
CRT	Cathode Ray Tube
CSL	Character Segment Leader
CSN	Channel Sequence Number
CSS	Communications Selector Switch
CUSL	Character Unclassified Segment Leader

<u>ACRONYM</u>	<u>MEANING</u>
CVSD	Continuously Variable Slope Delta Modulation
DA-TDMA	Demand Assigned-Time Division Multiple Access
DAX	Digital Access Exchange
DCA	Defense Communications Agency
DCACC	DCA Operations Center
DCS	Defense Communications System
DDD	Direct Distance Dialing
DMA	Direct Memory Access
DOCC	DCA Operations Complex
DSCS	Defense Satellite Communications System
DSVT	Digital Subscriber Voice Terminal
DTG	Date-Time-Group
DTMF	Dual Tone Multifrequency
ECP	Engineering Change Proposal
EMP	Electromagnetic Pulse
EOM	End of Message
ETS	European Telephone System
FCS	Flag Check Sequence
FDM	Frequency Division Multiplexer
FOC	Full Operational Capability
GOS	Grade of Service
GTS	Go to Sync
HEMP	High Altitude Electromagnetic Pulse

MIL-STD-187-310

<u>ACRONYM</u>	<u>MEANING</u>
HLP	Host Level Program
HOL	Higher Order Language
I/A	Interactive
IASA	Integrated AUTODIN System Architecture
ICAT	Intermediate Capacity Automated Telecommunications System
ICU	Interface Control Unit
IOC	Initial Operational Capability
K	Key Generator
Kb/s	Kilobits Per Second
KDC	Key Distribution Center
LC	Line Control
LDMX	Local Digital Message Exchange
LMF	Language Media Format
Mb/s	Megabits Per Second
MCATS	Medium Capacity Automated Telecommunication System
MCCU	Multiple Channel Control Unit
MLPP	Multilevel Precedence and Preemption
MP	Microprograms
MTBF	Mean Time Between Failures
MTTR	Mean Time to Repair
NATO	North Atlantic Treaty Organization
NAVCOMPARS	Naval Communications Processing and Routing System

<u>ACRONYM</u>	<u>MEANING</u>
NCS	National Communications System
NCC	Network Control Center
NICS	NATO Integrated Communications System
NID	Network Inward Dialing
NOD	Network Outward Dialing
NSWT	Nonsecure Warning Tone
NVT	Network Virtual Terminal
OCR	Optical Character Reader
O&M	Operating and Maintenance
OSRI	Originating Station Routing Indicator
OSSN	Originating Station Serial Number
PABX	Private Automatic Branch Exchange
PAN	Programmed Assigned Number
PBSL	Packed Binary Segment Leader
PBX	Private Branch Exchange
PCM	Pulse Code Modulation
PH	Packet Header
PLA	Plain Language Addressing
PSN	Packet Switching Node
PTF	Patch and Test Facility
PWIN	Prototype WWMCCS Integrated Network
QOS	Quality of Service
Q/R	Query/Response

MIL-STD-187-310

<u>ACRONYM</u>	<u>MEANING</u>
RBS	Ringback Secure
RBN	Ringback Nonsecure
RDT&E	Research, Development, Test and Evaluation
RI	Routing Indicator
RNR	Receive Not Ready
RR	Receive Ready
RSC	Record Service Center
RV	Ring Voice
SATIN IV	SAC Automated Total Information Network
SC	Switch Control
SCCU	Single Channel Control Unit
SDMX	Space Division Matrix
S/F	Store and Forward
SIP	Segment Interface Protocol
SL	Segment Leader
SOM	Start of Message
S/S	Signaling and Supervision
SYSCON	System Control
TAC	Terminal Access Control
TCC	Transmission Control Code
TCF	Technical Control Facility
TCCF	Tactical Communications Control Facilities
TCP	Transmission Control Program

<u>ACRONYM</u>	<u>MEANING</u>
TDM	Time Division Multiplexer
TDMX	Time Division Matrix
TED	Trunk Encryption Device
TF	Test Facility
TGC	Trunk Group Cluster
TH	Terminal Handler
TSB	Trunk Signaling Buffer
TTY	Teletypewriter
ULS	Unit Level Switchboard
UDS	Unified Digital Switch
WAWCS	Washington Area Wideband Communications System
WWMCCS	Worldwide Military Command and Control System
WWOLS	Worldwide On-line System

CHAPTER 4

THE PRESENT DCS

4.1 The DCS is the single, worldwide complex comprising all long-haul point-to-point communications facilities, associated personnel, and material within the DoD. It is primarily a long-haul, general purpose system of government-owned and leased transmission media, relay stations, and switching centers. The composite DCS is a very extensive and complex system located in 70 countries throughout the world. Engineering, operating, and maintenance functions for the DCS require over 16,000 DoD personnel, both military and civilian, including about 2,700 DCA personnel. Employees of operating telephone companies, record carriers, and other suppliers of leased voice and data switches are not included in these figures. The annual O&M costs are about \$500 million. The DCS comprises three major networks; AUTOVON, AUTODIN, and AUTOSEVOCOM.

4.2 Automatic Voice Network (AUTOVON). AUTOVON is the principal long-haul, nonsecure voice communications network in the DCS, and has over 500,000 users connected by 15,000 access lines. It handles approximately 750,000 originating calls a day. The 65 automatic switches located in the United States and Canada are connected in a target-avoidance routed polygrid scheme and are leased from independent and Bell Telephone operating companies. There are 16 AUTOVON switches located overseas: 5 in the Pacific, 1 in Panama and 10 in Europe. With the exception of the switch in Hawaii, which is leased, all are military operated. Overseas AUTOVON survivability is limited by available interswitch transmission media.

4.3 Automatic Digital Network (AUTODIN). AUTODIN is the principal record communications system of the DCS. It is a secure, computer-controlled store-and-forward system which handles approximately 350,000 messages a day. Nine AUTODIN switches are located on military installations in CONUS and Hawaii, with equipment and services leased from Western Union Company. Eight additional switches are located overseas, and are operated by the military departments. AUTODIN interswitch trunking is not as survivable as CONUS AUTOVON. However, alternate routing for AUTODIN via AUTOVON is available by dial-up. The 17 AUTODIN switches are interconnected by 52 interswitch circuits and serve approximately 1400 terminals, 600 of which are teleprinters. AUTODIN accepts and delivers traffic in a variety of modes: teletypewriter punched cards, magnetic and paper tape, and some classes of computer-to-computer traffic. Transmission rates vary, according to subscriber needs, from 45 to 4800 baud.

MIL-STD-187-310

4.4 Automatic Secure Voice Communications (AUTOSEVOCOM). AUTOSEVOCOM is a secure voice subsystem serving approximately 1400 subscribers throughout the world and consists of two types of service. First, there are enclaves of subscribers equipped with 50 kb/s KY-3 terminals homed on wideband switches. These subscribers can make high quality intraswitch calls. In addition, certain of these wideband switches are interconnected by wideband circuits and thus offer high quality, long-haul, secure voice service where available. The second type of service utilizes the HY-2, operating over the nominal 4 kHz analog media of AUTOVON at 2400 baud. The HY-2 voice processor is a vocoder, and sounds artificial. User acceptance is usually directly relatable to experience in using the system. It is difficult to use for the infrequent subscriber and under conditions of stress, when procedures for proper use may not be carefully observed, the service tends to degrade rapidly. Inadequate transmission media, the complications of remote locations, and sometimes improperly maintained subscriber terminal equipment, have resulted in occasional failure to provide urgently required secure voice service. As an augmented service at selected locations, the HY-11, using continuously variable slope delta (CVSD) modulation technique, has been operating at 9.6 kb/s on the same nominal 4-kHz analog media. In addition to providing some improvement over the HY-2 in both voice intelligibility and quality, the HY-11 is more tolerant of transmission media and imperfect maintenance than is the HY-2. Narrowband subscribers have access to the wideband enclaves through narrowband-to-wideband conversion equipment, although the interface is presently a manual operation. The various types of equipment utilized in the secure voice network requires an inordinate call setup procedure and quite complex calling instructions. Key distribution for a large number of subscribers on these dissimilar crypto devices is a logistics task of large proportions.

4.5 The European Telephone System (ETS). The ETS, which provides non-tactical, general purpose, common user, voice telephone service for U.S. Forces in Central Europe, was recently placed under DCA management. The ETS switching network consists of five tandem switching centers and 24 intermediate switching centers, interconnected via 4-wire interswitch trunks. This system will interconnect via 2-wire access trunks, 130 PBX's which service 68,000 main telephone lines, all of which are managed, operated, and maintained by the owning military departments. When operational, this system will replace the USAREUR, USARERU DSA, and USAF VF Dial Systems.

4.6 In addition to the three common-user switched networks and the ETS, the DCS contains numerous special-purpose or dedicated networks. The future integrated digital DCS should be able to absorb most of these dedicated networks into the integrated switched system while still providing the needed services [a].

MIL-STD-187-310

4.7 References

- [a] DCEC TR 20-75, "Engineering Concept for DCS Transition (U)," December 1975 (SECRET).

CHAPTER 5
THE FUTURE DCS
CONTENTS

	<u>Page</u>
Paragraph 5.1	Program Developments (1976-1990) 5-3
5.1.1	Phase II Secure Voice (P2SV) 5-3
5.1.1.1	Introduction 5-3
5.1.1.2	System Description 5-3
5.1.1.2.1	Switching 5-3
5.1.1.2.1.1	AN/TTC-39 5-3
5.1.1.2.1.2	ESS No. 1 Modification 5-4
5.1.1.2.1.3	Digital Access Exchange 5-4
5.1.1.2.2	Other System Features 5-5
5.1.1.3	Transitional Aspects 5-6
5.1.2	AUTODIN II 5-6
5.2	The Nominal Future DCS 5-8
5.2.1	Generic Configuration 5-8
5.2.2	Switching Subsystem Elaboration 5-11
5.2.2.1	Backbone Switching 5-11
5.2.2.1.1	Backbone Circuit Switch 5-12
5.2.2.1.2	Backbone Packet Switch 5-12
5.2.2.1.3	Record Service Center 5-12
5.2.2.2	Access Area Switching 5-12
5.2.2.2.1	PBX 5-12
5.2.2.2.2	DAX 5-13
5.2.2.2.3	LDMX 5-13
5.2.2.2.4	Communications Access Processor (CAP) 5-14
5.2.2.2.5	Communications Selector Switch (CSS) 5-14
5.2.3	Planning Standards Requirements 5-14
5.2.3.1	Overseas DCS 5-15
5.2.3.1.1	Voice 5-15
5.2.3.1.2	Data 5-16
5.2.3.1.3	Special Services 5-17
5.2.3.1.4	Access Area 5-18
5.2.3.2	CONUS DCS 5-18
5.2.3.2.1	Clear Voice 5-18
5.2.3.2.2	Secure Voice 5-19
5.2.3.2.3	Data 5-19
5.2.3.2.4	Special Services 5-19
5.2.3.2.5	Access Area 5-19
5.3	The Future DCS - Advanced Concepts 5-20
5.3.1	Overview 5-20
5.3.2	Switching Subsystem Elaboration and Planning Standards Requirements 5-21

MIL-STD-187-310

CONTENTS - Continued

		<u>Page</u>
Paragraph 5.4	Areas Deserving Special Emphasis	5-21
5.4.1	Signaling and Supervision	5-21
5.4.2	System Control	5-22
5.4.3	Secure Communications	5-22
5.4.4	Interoperability	5-22
5.5	Summary of Planning Standards	5-22
	Requirements	
5.6	References	5-23

CHAPTER 5

THE FUTURE DCS

5.1 Program Developments (1976-1990). Major changes in DCS switching are required during the 1976-1986 time period to support the AUTOSEVOCOM II and AUTODIN II programs. AUTOSEVOCOM II will require modification of the CONUS AUTOVON No. 1 ESS switches and replacement of Overseas AUTOVON switches with the AN/TTC-39 to provide a digital switching capability. Also Digital Access Exchanges (DAX) will be provided to concentrate digital secure voice traffic in the access areas. Under the AUTODIN II program, packet switches will be installed to provide a general purpose, data communications switched network to meet computer communications requirements. These switches and related program features and estimated implementation time periods are discussed in the paragraphs following.

5.1.1 AUTOSEVOCOM II

5.1.1.1 Introduction. The proposed AUTOSEVOCOM II system is defined as the DCS single integrated worldwide secure voice communications system. It is designed to provide a high quality, fully automatic system which will also interoperate with the TRI-TAC secure voice system.

The system will replace the existing AUTOSEVOCOM I system commencing in 1980. It will be configured to serve 2500 secure voice subscribers initially, 10,000 subscribers by 1985 and will have the capability to expand further to meet future secure voice needs.

5.1.1.2 System Description. AUTOSEVOCOM II will provide an integrated worldwide backbone 16 kbps digital system for secure voice communications.

5.1.1.2.1 Switching. In CONUS, AUTOVON ESS No. 1 switches will be modified for wideband digital service and will emulate the TRI-TAC AN/TTC-39 switch. Initially, approximately 20 of the CONUS switches will be modified for digital service. In the overseas areas, AN/TTC-39 switches will replace the existing AUTOVON switches. This switching configuration permits direct interconnectivity, without modification, of the TRI-TAC equipment in the DCS and thereby preserves the commonality of equipment within the DCS and between the DCS and TRI-TAC. In the access area, Digital Access Exchanges (DAX) will be used to concentrate digital secure voice traffic.

5.1.1.2.1.1 AN/TTC-39. The AN/TTC-39 family of circuit switches will provide the DCS with transportable (fixed installation) automatic

MIL-STD-187-310

switching systems with voice switching capability, communication security capability and circuit switched data communications capability. The circuit switches will serve both analog, (4 kHz and wideband) and digital traffic, and will make use of a flexible stored-program control system. This stored program will give the capability for insertion, or removal of functions or services prior to, and during switch deployment by altering the subscriber classmarks and the data base resident in the switch memory. These switches will interface with the existing AUTOVON circuit switches on an interswitch trunk basis as well as a PBX access line basis. In addition, they will interface with their tactical counterpart AN/TTC-39 circuit and message switches, as well as with other tactical switches such as the AN/TTC-38, AN/TTC-30 and AN/TTC-25. Interfaces with other systems include NATO and commercial carriers.

The AN/TTC-39 will incorporate an Automatic Key Distribution Center and associated key generators for loops and trunks. The interswitch trunks will be provided link encryption protection whereas the loops terminated with DSVT's will be provided end-to-end protection by the terminal security device. Inventory COMSEC equipments such as KY-3's and Narrowband Secure Terminals (HY-2 and HY-11) will be able to place calls through the analog matrix and through the loop-around trunks which provide both key conversion and mode conversion.

The AN/TTC-39 is of modular design so that a basic switch can provide growth capability from 120 to 600 external terminations per switch, and this modularity also permits the exchange of one analog module for one digital module in the same physical space. The analog module size is 156 terminations of which 120 are external terminations; and the digital module size is 256 terminations of which 150 are external terminations.

5.1.1.2.1.2 ESS No. 1 Modification. In CONUS, the AN/TTC-39 switching center would be emulated by the modification of selected AT&T ESS No. 1 switches. The present ESS No. 1 is an analog switch. A portion of the switch would be modified for digital service while the remainder of the switch will continue to provide analog service. Digital line units and trunk units will be added to the switch to provide an interface with the new 16 kbps digital subscriber voice terminals (DSVT) and digital interswitch trunks. The call processing software program of the ESS No. 1 will be modified to perform the necessary interface communications with the TENLEY COMSEC unit. The switch software program will also be modified to provide a Common Channel Signaling (CCS) capability to permit a trunk interface with the TRI-TAC AN/TTC-39.

5.1.1.2.1.3 Digital Access Exchange (DAX). Small circuit switches (DAXs) are to be located in the access area to concentrate digital secure voice traffic. It is envisioned that the DAX will be a family

MIL-STD-187-310

of access switches developed to meet the needs of immediate short term programs and also the need to transition to a longer range more digitized DCS. The DAX will service secure voice users and selected bulk data users, the latter operating primarily during non-busy hours in order to maintain the GOS designed for Secure Voice users and to provide greater transmission plant efficiency. The basic DAX will be a four-wire, fully automatic, common control switch operating at 16 kbps. It will provide digital access line terminations and interfaces for digital AUTOVON switches in the CONUS, AN/TTC-39 type switches Overseas, and DAX-DAX tie lines for tandem operation. It is intended that the DAX will not contain any crypto elements, and therefore can be treated as a BLACK switch for COMSEC purposes. It will be compatible with TENLEY COMSEC procedures. Digital signaling and supervision will be provided. The basic DAX will be capable of having 90 subscribers, and fabricated in depopulated models to meet the 60 and 30 subscriber requirements.

5.1.1.2.2 Other System Features

a. AUTOSEVOCOM II will provide a 16 kbps terminal for DCS secure voice users. The terminal will be the TRI-TAC digital subscriber voice terminal (DSVT). Those users who cannot be provided 16 kbps transmission facilities economically will use a narrowband terminal and 4 kHz or low-rate digital facilities with a narrowband/wideband converter.

b. An alternate clear voice/secure voice capability will be provided to all subscribers. Also, the network will permit calls between digital subscribers and analog subscribers. The switch will insert an analog-to-digital converter between the analog and digital portion of the matrix when this type of connection is required.

c. Inband digital signaling and supervision will be used by the terminals on access lines. Digital common channel signaling (CCS) will be used on interswitch trunks.

d. Automatic remote electronic cryptographic key distribution will be provided on a call-by-call basis by use of the TRI-TAC TENLEY Key Distribution Center (KDC) in both CONUS and Overseas. Therefore, the TENLEY COMSEC will be identical on a worldwide basis for the DCS and TRI-TAC networks.

e. The Phase II Secure Voice Network will be digital and will operate synchronously. A stable clock source will be provided at each modified ESS No. 1 switch. Clock timing, contained in the data stream, will be transmitted to each subscriber terminal. The terminal will extract the timing for internal use. The clock will also furnish timing on the interswitch trunks between switches.

MIL-STD-187-310

f. A full duplex conferencing capability will be made available in both CONUS and Overseas.

g. End-to-end encryption will be provided for all secure calls within the DCS network except for conferencing, which may require a RED breakout.

h. TRI-TAC interoperability can be provided on a direct end-to-end encrypted basis with both the CONUS and Overseas DCS switches, when TRI-TAC operates at 16 kbps. If TRI-TAC operates at 32 kbps, a 16/32 kbps dual mode interface will be required to provide end-to-end encryption.

5.1.1.3 Transitional Aspects. Present plans call for an AUTOSEVOCOM II CONUS Initial Operational Capability (IOC) of 1980 and an Overseas IOC of 1982 (per AN/TTC-39 availability). These IOCs also pertain to the DAX. An important transitional aspect of AUTOSEVOCOM II development is the interim period between the CONUS and Overseas IOC's. During this interim period the AUTOSEVOCOM II program will retain a residual AUTOSEVOCOM I system in CONUS to provide AUTOSEVOCOM I connectivity with overseas HY-2 subscribers, and KY-3 subscribers with narrowband HY-2 and HY-11 trunk connectivity. Where possible, some CONUS and overseas 50 kbps connectivity will be expanded by satellite and terrestrial PCM systems. Consequently, it is expected that a substantial portion of the CONUS AUTOSEVOCOM I system will be retained until 1982 or beyond.

5.1.2 AUTODIN II. The AUTODIN II system will provide a worldwide, general purpose, data communications switched network to support interactive data transmission capabilities through the use of packet switching technology. Phase I will be a backbone system consisting of eight switching nodes which may be collocated with CONUS AUTODIN I switching centers. Phase II will provide additional CONUS switches and overseas switches as demands for service increase.

Packet switching is a store-and-forward switching technique allowing interleaving of message parts (packets) within the network. Packet switches are inherently designed to handle short message entities. Packet accountability is maintained between packet switches and message accountability is maintained on an end-to-end basis. Keeping the message short minimizes buffer space requirements in the switches, which allows the exclusion of slow access intransit and intermediate storage (disc, drum, and magnetic tape). Because the buffering can reside wholly in main memory, the end-to-end response time is greatly

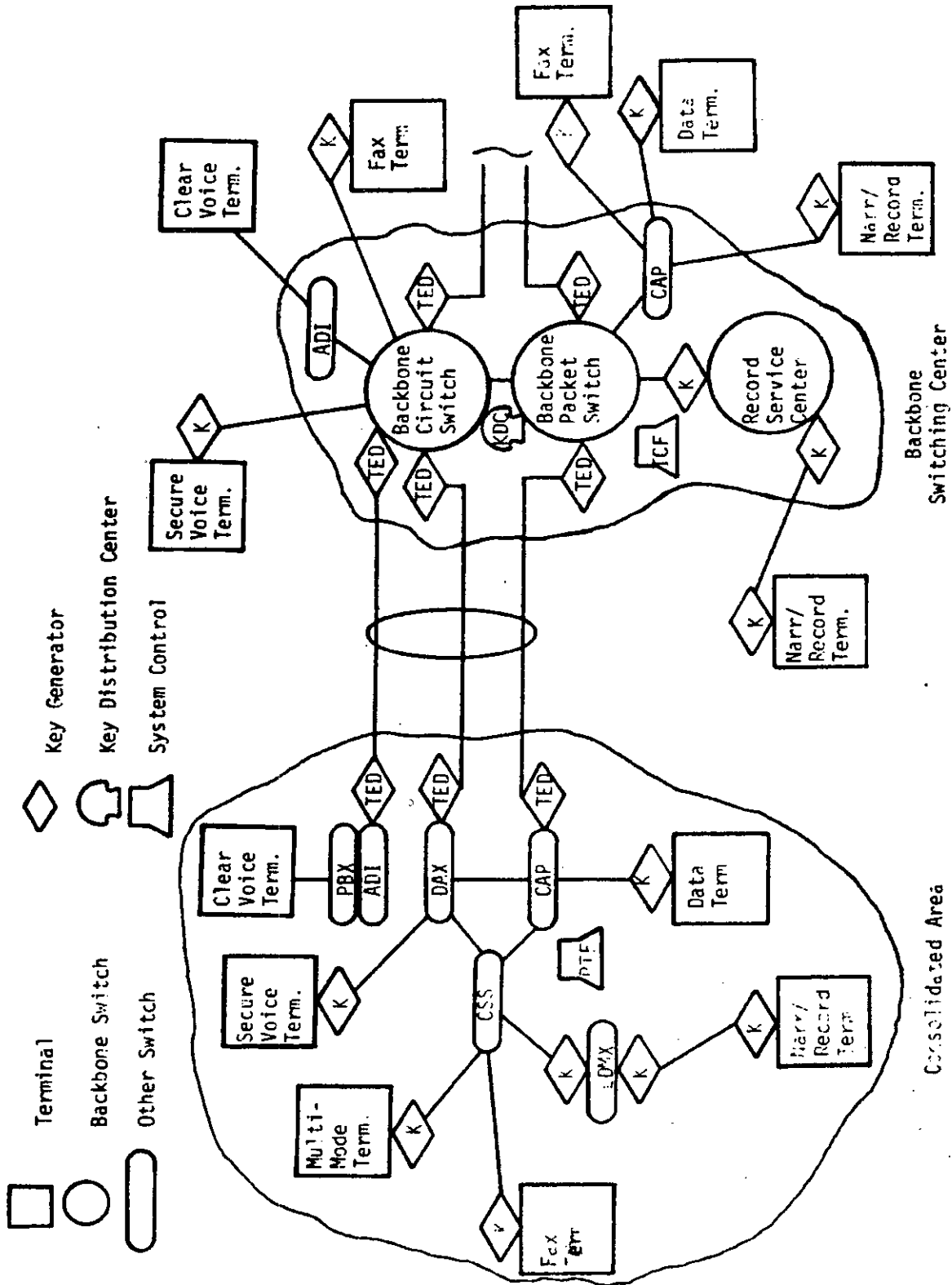

FIGURE 5.1 Future DCS Generic Configuration

MIL-STD-187-310

improved (less than a second coast to coast in the ARPA system). This service is attractive for interactive and query-response users. The disadvantages are that the lack of intransit storage prevents exchange multiaddress messages and reduces the availability of statistical traffic analysis information at each node.

Each AUTODIN I ASC will be connected to an AUTODIN II switch as a Host subscriber. The AUTODIN II subsystem will provide the backbone trunking for the ASC's. The Data Switches, in addition to packet switching will provide packetizing of the data, line scanning for switch channels, interim storage during error checks and routing, call signaling to the backbone switch, routing tables, traffic monitoring and control, distribution of multipackets to multichannels, and error control. The COMSEC system will be basically an extension of the current AUTODIN I COMSEC technology i.e. a link encrypted configuration providing full period traffic flow security. Future planning calls for automatic key distribution and end-to-end security in addition to link security.

Various users in the DoD have identified 24 ADP systems that will be operational during 1976 with 1,174 subscriber terminals (includes 101 host computers and 1,073 terminals) which are candidates for AUTODIN II service. Twenty-two have an interactive requirement, 23 require query-response, 24 require bulk data transfer, and 7 require narrative/record capability or interoperability with AUTODIN I. All near-term WWMCCS ADP systems requirements are included. By 1986 growth will increase this total to 2,980 subscriber terminals. This approximates a 10 percent per year increase in requirements which is considered the minimal expected growth rate. A 25 percent per year increase in subscriber requirements is considered the upper bounds of the expected growth rate during the 1976-1986 time frame.

It is planned that AUTODIN II will be provided as a leased or tariffed service in the CONUS (PHASE I). Experience from this subsystem as well as results of related RDT&E will be used to refine the design prior to expansion of the CONUS system and implementation of a government-owned system overseas (Phase II). Present plans call for a Phase I Initial Operational Capability (IOC) of 1978, a Full Operational Capability (FOC) of 1980 and a Phase II IOC of 1985.

5.2 The Nominal Future DCS (1990's)

5.2.1 Generic Configuration. In order to serve as a guide in DCS transition and long-term planning, a generic configuration has been defined as shown in Figure 5.1. The details of the configuration are subject to change, but the general arrangement of elements illustrates present DCA concepts for the DCS of the 1990's, assuming

logical extensions of ongoing DCA programs described in paragraph 5.1. Figure 5.1 is a functional diagram, and certain of the separate functions shown could be combined for implementation. The topology of the future DCS could change significantly over the next 10 to 20 years, taking advantage of evolving technologies. In particular, those ideas discussed in paragraph 5.3 are being evaluated at DCA for possible recommendation at a later time.

Figure 5.1 illustrates the interrelationship of subsystem elements within consolidated areas and backbone switching centers. A consolidated area is a geographically small access area that has a sufficiently dense subscriber population to justify the use of concentrators (e.g., PBX's, LDMX's, CAP's). Isolated terminals served by switching centers are also shown. The configuration of Figure 5.1 is only an example; not all of the elements will be located in every consolidated area or in every backbone switching center.

Clear voice terminals within consolidated areas will be connected to PBX's, normally in an all-analog format. PBX's will be connected to the DCS via A/D interfaces (ADI's), which will provide the interface between the analog clear voice in the loops and the nominal 16 kb/s clear voice in the DCS backbone. Digital PBX's called DAX's will provide concentration and local circuit switching for digital subscribers when a sufficient number of subscribers exist within a consolidated area. Digital access circuits between concentrated areas and backbone switching centers will normally be encrypted by trunk encryption devices. Some consolidated areas will be connected to more than one backbone switching center to satisfy survivability/reliability requirements. Isolated clear voice terminals will be connected over analog access lines to ADI's at backbone circuit switches, or they will perform their own A/D conversions and be connected directly to backbone circuit switches.

Secure voice terminals will contain their own A/D devices and key generators, and will be connected over digital loops to DAX's in consolidated areas, or over digital access circuits to backbone circuit switches. When more economical, secure voice may be handled via protected transmission within a local area until concentrated via pooled A/D equipment. Key variables for secure voice calls to allow end-to-end encryption on a call-by-call basis will be provided by the key distribution centers (KDC's) located in the backbone switching centers. Secure voice traffic will utilize the same backbone switching and transmission facilities as the clear voice traffic.

MIL-STD-187-310

Data terminals may or may not utilize terminal key generators, depending on their applications. Figure 5.1 shows data terminals connected to communications access processors (CAP's), which convert serial bit streams into packets for switching by one or more backbone packet switches. Some types of data, such as bulk data, may be more suited to circuit switching than packet switching. Bulk data will be entered through ports on secure voice terminals, through CAP's, or through multimode terminals. In the case of a multimode terminal, either circuit- or packet-switching can be selected at the terminal, or automatically by the communications selector switch (CSS). Studies are currently under way to determine whether KDC's should be utilized by data terminal key generators to allow the desired end-to-end encryption of data traffic.

Facsimile terminals in consolidated areas will be connected to CSS's, to DAX's, or to CAP's depending on their applications. Isolated terminals will be connected either to backbone circuit switches or to CAP's.

The record service center (RSC) will provide the same service features to narrative/record users of the future as provided by the AUTODIN switches of today. Narrative/record terminals will be connected either directly to the RSC's or to LDMX's (local digital message exchanges) which are in turn connected to the RSC's; in either case, the connecting circuits will normally be derived by packet switching. In locations served by a CSS, connecting circuits may be provided by circuit switching. Low-speed narrative/record terminals will in many cases utilize low-bit-rate circuits derived by submultiplexing the 16 kb/s basic telecommunications channel. Submultiplexed circuits will normally be nonswitched access circuits; where remote CAP exists in a consolidated area, the CAP performs a buffering and concentration function as an inherent part of its normal packetizing function. Narrative/record terminals might utilize KDC's to provide end-to-end encryption, or they might use only "link" encryption between terminals and LDMX's, terminals and RSC's, or LDMX's and RSC's.

Other types of traffic, such as imagery and television, will normally be carried by special purpose circuits.

The concept of system control for the future DCS is one of localized control, centralized management, and operational direction by exception. Primary responsibility for real-time control decisions resides locally at a set of control centers called major control centers. A major control center (not shown in Figure 5.1) will typically be required for each 16 tech control or patch and test facilities (TCF/PTF), for every 300 circuits, or for a combination of the two. Higher control levels will be notified of any major control actions taken, will be

able to monitor the consequences of these actions, and, if required, will be able to override these actions. Figure 5.1 shows a PTF in the concentrated area and a TCF at the backbone switching center; however, that allocation is not rigid.

The backbone switching centers will contain all of the backbone switches in a given locality. Some switching centers will contain only one or more backbone circuit switches (including the ADI function). Some will contain both backbone circuit switches and one or more packet switches, and others will contain, in addition, a record service center. Individual switches within backbone switching centers will be separated sufficiently to achieve satisfactory system survivability. Many consolidated areas will contain only a PBX, an ADI, and a DAX, in which case multimode terminals would not exist, and data, narrative/record, and facsimile terminals would either utilize dedicated or circuit-switched access circuits. Dedicated circuits would be submultiplexed as appropriate to maintain circuit utilization efficiency.

The transmission subsystem for the future DCS will be primarily digital in nature, except possibly for clear voice or protected secure voice local loops. Modems or analog-to-digital (A/D) converters will be used on any residual analog transmission segments. Most of the future DCS transmission needs will continue to be provided by common carriers, under tariff, and by government-owned or leased transmission facilities. Transmission in CONUS and worldwide will use the secure voice bit rate as the basic digital channel; however, some access circuits and interswitch trunks for packet switching may operate at higher or lower bit rates within the multiplex hierarchy [a].

5.2.2 Switching Subsystem Elaboration. Switching subsystems in the future DCS will consist of the various functional switching elements described in paragraph 5.2.1, with the topological arrangement illustrated by Figure 5.1. This paragraph is divided into backbone and access area switching and presents functional, hardware/software, and O&M considerations for each.

5.2.2.1 Backbone Switching. Backbone switches will normally be grouped into backbone switching centers, with one or more BCS's (backbone circuit switches), possibly a BPS (Backbone Packet Switch), and possibly an RSC (Record Service Center). Switches within a backbone switching center will be physically separated for survivability enhancement. DCA studies have estimated that in CONUS the future DCS switch quantities will be 43 BCS's, 24 BPS's, and 4 RSC's, with 43 switching centers. In Europe, the tentative quantities are 16 BCS's, 3 BPS's, and 2 RSC's, with 16 switching centers. In the Pacific, the tentative quantities are 9 BCS's, 4 BPS's, and 2 RSC's, with 4 switching centers

MIL-STD-187-310

(some with more than one BCS). A discussion of each of the backbone switch types follows.

5.2.2.1.1 BCS. The Backbone Circuit Switch will switch clear voice, secure voice, and circuit-switched data. Service features will include multi-level precedence and preemption (MLPP), conferencing, call forwarding, compressed keying, off-hook service, and others. Some features may not be implemented at all BCS's. Within CONUS, BCS's are expected to be modified ESS #1 switches. Overseas, AN/TTC-39 switches are to be used to assure interoperability with tactical telecommunications, and to facilitate implementation of the JMTSS concept as required. ESS #1's or TTC-39's may be replaced with other switches by the mid-1990 period of the future DCS, but a decision on that need not be made for several years.

5.2.2.1.2 BPS. The Backbone Packet Switch will normally switch interactive, query response, narrative record, and some bulk data traffic. The BPS will receive packets from CAP's or other BPS's, perform format and error checks, possibly perform additional service functions, and forward packets to other BPS's or destination CAP's, as appropriate. In addition to the CAP's located in high density subscriber areas, other CAP's will generally be collocated with a BPS; in fact, the likelihood is that CAP functions (see paragraph 5.2.2.2 on access switches) will be built into the BPS, resulting in an integrated and unseparable BPS/CAP.

5.2.2.1.3 RSC. The Record Service Center will provide the same service features to narrative/record users of the future as is provided by AUTODIN switches today. RSC's will utilize hardware with lower O&M requirements than today's AUTODIN switches, and they will be located in the vicinity of BPS's and BCS's in order to further minimize O&M and manning requirements. Within CONUS, where RSC's, BPS's, and BCS's might be operated by two or three different contractors, these O&M savings may not be realized. An effort needs to begin now to determine how the three types of switches can realize the same sort of O&M savings that are anticipated for government-owned backbone switching centers overseas.

5.2.2.2 Access Switching. The access area switching elements shown in Figure 5.1 for the future DCS are the PBX (Private Branch exchange) and associated analog/digital interface unit (ADI), the DAX (Digital Access Exchange), the CAP (Communications Access Processor), the CSS (Communications Selector Switch), and the LDMX (Local Digital Message Exchange).

5.2.2.2.1 PBX. The primary function of the PBX will be to interconnect local clear voice subscribers, to connect them to the DCS

backbone, and, in most cases, to other telephone systems such as local common carriers. The PBX function will usually be automated, making it a PABX (Private Automatic Branch exchange). Operator assistance will often be available at PABX's; however, an attempt should be made to automate as many operator functions as possible to minimize O&M costs. PBX service options may include such features as inward and outward MLPP (Multi-Level Precedence and Preemption), call forwarding, conferencing, abbreviated dialing, etc. The TRI-TAC version of the PBX will be called the ULS (Unit Level Switchboard). It is expected that PBX operation will continue in the analog mode, with possible exceptions in tactical areas. Conversion of clear voice from analog to digital will normally take place at the ADI (Analog Digital Interface) in consolidated areas, or at the ADI in backbone switching centers. Secure voice and circuit-switched data will be concentrated at the DAX rather than at the PBX. At some locations, the functions of the ADI and the DAX (or even the PBX) may be combined into a single switching element, and in most cases the O&M for the PBX, ADI, and the DAX should be combined in order to minimize manning and O&M costs.

5.2.2.2.2 DAX. The DAX provides the digital-subscriber interface with the DCS. It provides local switching for digital traffic (secure voice, and circuit switched data), it maintains a local time source, and it serves to interconnect local secure voice, circuit-switched data, facsimile, and possibly clear voice traffic to the DCS backbone. It also serves as a restoral path for packet-switched data traffic. As stated above, the DAX could be a separate switching element or integrated with the ADI and possibly the PBX; in any case, all three should normally be located in close proximity so that O&M can be handled on an integrated basis. DAX O&M should also be unified with that for the CAP, the CSS, and possibly the LDMX. This integrated O&M is the only way to justify some of these switching elements (i.e., the CAP and the CSS) from a cost consideration.

5.2.2.2.3 LDMX. The LDMX does for record traffic what the PBX does for clear voice traffic. The LDMX receives and distributes messages from and to local narrative/record terminals. It also provides recordkeeping, automated routing, and facilities to simplify the message release/approval function. The LDMX provides the interconnection between consolidated-area narrative/record terminals and the RSC (Record Service Center). The RSC provides the same function as the AUTODIN switch of today. LDMX's will not be located in all consolidated areas, and service features will vary from one LDMX to another. Where used, however, the LDMX should greatly reduce the writer-to-reader time of record traffic from that of the current AUTODIN system. This interconnection can either be by direct access line, through the packet-switched subnetwork (the CAP and BPS (Backbone Packet Switch)), or through the circuit-switched subnetwork (the DAX and the BCS (Backbone

MIL-STD-187-310

Circuit Switch)). At some facilities, the CSS will make the decision whether to use the CAP/BPS or the DAX/BCS route. The LDMX O&M should be integrated with that of other consolidated-area switching facilities to the maximum extent practical in order to reduce manning/O&M costs.

5.2.2.2.4 CAP. The CAP provides interconnection of consolidated area data traffic to the BPS (Backbone Packet Switch); the CAP serves as the interface with the packet-switched subnetwork. Interactive, query/response, and narrative/record traffic can normally be served more efficiently by the packet-switched subnetwork than the circuit-switched network as conceived for the future DCS. This is true because the CAP serves as an efficient concentrator, interspersing traffic from various low-speed subscribers into the same bit stream, thereby serving as a virtual "submultiplexer." The CAP has an advantage over the submultiplexer, however, in that it is not restricted to any specific multiplex hierarchy other than nominal multiples of 2 kilobits, and the 2-kilobit segments (packets) are only used for any given subscriber when they are actually needed to transmit data. The access circuit between the CAP and the BPS can operate at fixed bit-rate within the 8000N multiplex hierarchy of the future DCS. The CAP/DAX/BCS/BPS path can be used for augmentation or restoral in increments of 16 kb/s. Bulk data traffic can utilize either the circuit-switched or the packet-switched subnetwork, depending on the need for error correction, the relative loads in the circuit and packet subnetworks, and the characteristics of the bulk data (e.g., quantity, precedence, data structure, desired transfer rate). The O&M for the CAP will normally be combined with that for other consolidated area switching elements.

5.2.2.2.5 CSS. The CSS function is to facilitate the selection of circuit switching or packet switching for bulk data and narrative/record traffic. Facsimile, graphics, and multipurpose terminals may also be connected to the CSS. The CSS could also serve as an automatic restoral device, routing CAP traffic into the DAX or DAX traffic into the CAP. Packet switching could potentially be used to provide voice restoral, with only modest degradation; e.g., a 1 or 2 second time lag in each direction. The decision on using circuit switching or packet switching for a given type of traffic will be made at the terminal or at the CSS. Selection at the CSS will normally be based on network status. The CSS will probably not be located at all consolidated areas, but it can be installed when and where needed to improve the efficiency of circuit utilization. O&M for the CSS should be combined with that for other switching elements in the access area [a].

5.2.3 Planning Standards Requirements. In order to determine the areas in which switching planning standards are needed, it is necessary to trace the changes planned for the DCS in the switching area and the major design decisions required to implement these changes.

5.2.3.1 Overseas DCS

5.2.3.1.1 Voice. Implementation of a DCS-suitable version of the AN/TTC-39 is planned for the early to mid-1980's, to replace the overseas AUTOVON switches. A review of the switch design was made and a number of design changes have been identified which must be made before the AN/TTC-39 can be effectively used in the DCS [b]. Required changes have been submitted to the TRI-TAC Office in a series of DCA Engineering Change Proposals (ECP's). These ECP's, the most recent of which is reference [c], have been technically approved by the TRI-TAC Configuration Control Board (CCB). Reference [b] also identifies aspects of the AN/TTC-39 performance requiring further analysis. These are:

- a. Forecasting DCS traffic flow under a TTC-39 switched DCS to evaluate switch and network sizing and connectivity.
- b. Investigating interface arrangements between the TTC-39 time division matrix (TDMX), and DCS terrestrial and DSCS transmission facilities. Also, investigating synchronization of the TTC-39 with digital channels or trunk groups.
- c. Specifying DCS system control elements to interface with the AN/TTC-39.
- d. Developing common format standards for Common Channel Signaling (CCS).
- e. Investigating performance of repeated A/D conversions with tandemed conference bridges.
- f. Investigating provisions required for zone restrictions.
- g. Investigating the capability for replacing Space Division Matrix (SDMX) modules with Time Division Matrix (TDMX) modules to accommodate transition to an all-digital DCS.
- h. Evaluating the problem of interoperability between a 16 kb/s DCS TTC-39 and a 32 kb/s tactical TTC-39. Included is the problem of transitioning from a 16 kb/s DCS TTC-39 to a lower rate DCS switch.
- i. Investigate the desirability of the TTC-39 having single channel interface rather than interface interswitch trunk groups on a group basis.

MIL-STD-187-310

- j. Investigate interface arrangements with lower level digital exchanges.
- k. Identification of unique equipment that the DCS must provide.
- l. Identification of procedures to handle secure voice enclaves.

5.2.3.1.2 Data. The DCS AUTODIN, currently operational, will be retained to provide classic store and forward (S/F) narrative and DATA-PATTERN message traffic capability as may be required subsequent to the implementation and cutover to operation of the AUTODIN II packet switching centers. Implementation of AUTODIN II will provide additional data services in the DCS to meet record communications and teleprocessing needs. This subsystem will be the first step in achieving a unified data switching subsystem. Each AUTODIN I ASC will be connected to an AUTODIN II switch as a host subscriber. The AUTODIN II subsystem will provide the backbone trunking for the ASC's. The data switches, in addition to packet switching, will provide packetizing of the data, line scanning for switch channels, interim storage during error checks and routing, call signaling to the backbone switch, routing tables, traffic monitoring and control, distribution of multipackets to multichannels, and error control. AUTODIN II switches will require only minimal hardware development; existing computers or minicomputers can be used, with the design consisting mainly of system engineering and software development. The primary problems during the transition from AUTODIN I to AUTODIN II will be the maintenance of satisfactory software interface (i.e., protocol) between AUTODIN I subscribers and the AUTODIN II packet switch, and the satisfaction of the transmission and switching requirements of the Worldwide Military Command and Control System (WWMCCS) and of dedicated users being absorbed into the system. It is planned that AUTODIN II will be provided as a leased or tariffed service in the CONUS (PHASE I). Experience from this subsystem as well as results of related RDT&E will be used to refine the design prior to expansion of the CONUS system and implementation of a government-owned system overseas (Phase II). A system specification for AUTODIN II, Phase I has been developed [d]. The specification defines the network topology, routing, addressing and numbering, codes, protocols, error control, traffic flow control, system and network control, security provisions, electrical interfaces, switch architecture, processing requirements, and software requirements. It also covers traffic statistics, the subscriber types and their modes of information transfer, the speed and quality of service, and the operational relationships of AUTODIN II with other DoD networks and systems. AUTODIN I subscribers will not be impacted in any way under AUTODIN II (Phase I) arrangements. Therefore, initially, AUTODIN I functional, operational, and performance aspects will remain as presently defined. Although the specification for AUTODIN II has been developed, all aspects (i.e., system, network,

subsystem, equipment, and interface designs) must be confirmed by development, test, and evaluation. Key items in the switching area are:

- a. Addressing/numbering plan
- b. Internal network and network-to-user protocols
- c. Segment and packet design
- d. Line control procedures
- e. Error control
- f. Switch internal architecture
- g. Software subsystems
- h. System control aspects
- i. Interface arrangements including procedural and electrical interface with various modes of AUTODIN I and other DoD data networks
- j. Switch size tradeoff. Development of a small, modular, expendable AUTODIN II switch may be the most cost-effective solution to satisfy requirements.
- k. Development and fielding of KDC equipment for the data network.

5.2.3.1.3 Special Services. Special services will include wideband facsimile, television and imagery. The primary users of wideband services will be WWMCCS and intelligence systems. These services will be carried over the switched networks, or over dedicated networks if necessary, and require an average of 1 Mb/s capacity per circuit. The DSCS has the capacity and long-haul capability to provide these special services as dedicated links under DCS management. Present plans are to provide WWMCCS with a global satellite capability via the DSCS Phase II and Phase III satellite systems. Aspects of the DCS special services program that require further analysis are:

- a. Role of varying wideband user demands in an integrated switched environment
- b. Control and signal structure compatibility between DSCS demand assignment modems and the switching networks
- c. Implications of packet switching when applied to varying satellite multiple access alternatives

MIL-STD-187-310

- d. In band/out of band control between switching networks and satellite earth terminals that maintain the bit integrity, traffic flow, security and synchronism of user-to-user encrypted data
- e. Effects of error control and switching/power transients on user compressed data.

5.2.3.1.4 Access Area. A design goal for more efficient use of transmission capacity and backbone switching is to provide traffic concentration and switching in the access area. The favorable cost of switching compared to transmission, and the operational advantages of dynamic control and allocation of transmission capacity, foster increased use of local area switching and concentration of traffic for the DCS. Access area concepts are discussed in paragraph 5.1.2.2; however, system level design of the access area as an integrated sub-network remains to be accomplished. Design requirements include specification of the following:

- a. Subnetwork features such as topology, routing, traffic flow, etc.
- b. Allocation of functions/features among the backbone switches, access area switches and facilities, and terminals
- c. Access area switch and facility designs
- d. Interfaces between backbone switches, access area switches/facilities and terminals in regard to signaling and supervision, circuit and signal characteristics, etc.

5.2.3.2 CONUS DCS

5.2.3.2.1 Clear Voice. Since the policy of leasing backbone facilities from commercial carriers in CONUS is not expected to change, the principal options for achieving digital clear voice switching are to modify the present CONUS switches to a digital configuration, or fund for carrier development of a new digital switch which in turn would be leased. Implementation of digital clear voice will be governed by commercial network transition to digital service and the economic competitiveness of digital service to analog service. Although digital transmission capability may be expanded, it is unlikely that clear voice will be digitally switched prior to 1990. Local area concentration and A/D conversion would be accomplished as discussed in paragraph 5.2.2.2.

5.2.3.2.2 Secure Voice. Implementation plans for secure voice in the CONUS require modification of selected AUTOVON switches for 16 kb/s digital operation (including digital signaling). In order to provide this additional capability, it is necessary to:

- a. Establish digital trunk and loop signaling plans.
- b. Consider any modifications needed to the numbering plan for secure voice calls.
- c. Determine service features to be provided secure voice subscribers.
- d. Modify switches to handle 8/16 kb/s bandwidth and processing speed; detect, interpret, and processing digital signaling; and process clear-to-secure connections involving A/D voice and signaling conversion.
- e. COMSEC features applicable to the switch, to be included in a Secure Communications Planning Standard, will cover characteristics/techniques applicable to:
 - (1) Electronic key distribution
 - (2) Secure call placement procedures
 - (3) Crypto synchronization modes.

5.2.3.2.3 Data. S/F service will continue to be provided by AUTODIN. Interactive data service will be provided on a dedicated basis through a lease or tariff service. The packet-switched subnetwork will be integrated with the eight tariffed CONUS AUTODIN I switches. This subsystem will be a vehicle for confirming/revising design decisions prior to implementation of the AUTODIN II, Phase II. (See paragraph 5.2.3.1.2.)

5.2.3.2.4 Special Services. The discussion in paragraph 5.2.3.1.3 pertaining to special services in the overseas DCS also applies essentially to CONUS DCS. Also the Washington Area Wideband Communications System (WAWCS) will interface Washington, D. C. metropolitan users requiring special services with the appropriate switching networks.

5.1.3.2.5 Access Area. The discussion in paragraphs 5.2.2.2 and 5.2.3.1.4 pertaining to the access area in the overseas DCS also applies, essentially, to the CONUS DCS.

MIL-STD-187-310

5.3 The Future DCS - Advanced Concepts

5.3.1 Overview. In paragraph 5.2 the nominal future DCS was defined in a number of key areas; however, several aspects of the future system remain either very broad in their definition, or not fully delineated. This paragraph addresses these aspects and some specific choices that need to be examined. Most basic of these is the general architecture which the future system will follow. The nominal future DCS described in paragraph 5.2 still retains an overall structure very similar in form to the present system. As discussed in paragraph 5.2 a number of significant improvements in the DCS now being planned (e.g., Phase II Secure Voice, AUTODIN II, digital transmission upgrades) will have been implemented by the mid-1980's. These modifications are being planned as evolutionary changes to subsystem elements, and do not represent significant departures from the present DCS structure. Although more fundamental changes may occur their exact nature cannot be predicted, precluding a plan or program for implementation. Both technical details and time phasing are highly conjectural at this time.

The concepts discussed in this overview, or any variations ultimately proved to be cost-effective, could lead to a system structure with the following features:

- a. Increased installation of satellite terminals associated directly with individual access areas - emphasizing direct interconnectivity between access areas via satellite, and deemphasizing connectivity via the terrestrial backbone transmission and switching structure, with its physical rigidity and O&M overhead burden.
- b. Use of a single, integrated structure for switching and multiplexing of voice, data, and other traffic - either by packetizing all traffic, or by using computer technology to achieve a real-time dynamic allocation of wideband transmission among varying traffic rates and service requirements.
- c. Movement of DCS switching nodes closer to the main frames - a logical extension of greater use of satellite communications and integrated switching.
- d. Diminishing visibility of tactical/strategic and user/system interfaces in a highly flexible, satellite-oriented environment trending toward a more unified DoD network.

Some will judge that these changes are at least 20-30 years in the future, if desirable at all, while others may think that such changes can and should be substantially begun within the next 5 to 10 years. They are included in this planning standard to identify them as potential changes, so that sufficient R&D efforts are initiated [a].

5.3.2 Switching Subsystem Elaboration and Planning Standards Requirements. A design goal for the future digital DCS is to have common switching and transmission facilities to service all modes of traffic, including video and facsimile. A common or unified switch, as described in Chapter 10, mixes the multiplexing and switching functions and permits "dynamic" allocation of transmission capacity, instead of providing an end-to-end connection for a call and providing this connection over a standard (i.e. 4 kHz/8 kb/s) channel. Until an efficient unified switch is developed, however, the DCS will continue to employ different switching techniques to meet various subscriber requirements. Planning standards (which also include undefined characteristics) are required in the following areas:

- a. Anticipated traffic handling requirements; i.e., types of traffic, arrival rates, holding times, traffic flow, etc.
- b. Functional description
- c. Performance characteristics
- d. Switch internal architecture
 - (1) Processing and control elements
 - (2) Storage
 - (3) Input/Output
- e. Interface design.

5.4 Areas Deserving Special Emphasis. In previous paragraphs, various optional arrangements were identified which require specification for the evolving and future DCS. Several of these deserve special consideration and are highlighted or noted in the following paragraphs.

5.4.1 Signaling and Supervision. During the 1976-1986 time period new signaling schemes will be introduced into the DCS. When the AN/TTC-39 is introduced overseas, in addition to the present AUTOVON signaling, there will be common channel signaling (CCS) on trunks and either in-band or out-band digital signaling on access lines depending on access line cross section. CCS and digital access line signaling are also under consideration for the CONUS DCS. It is important that signaling schemes for the access area and the access area to backbone switch are compatible, and that CONUS and overseas versions of inter-switch trunk signaling are interoperable. A similar case can be made for line control and signaling formats for data. In addition, the possibility of a future unified switch (wherein all modes of traffic

MIL-STD-187-310

could have common call setup procedures, common methods of line control, signaling, addressing, etc., and common codewords and formats) needs to be considered in the design of signaling plans to permit evolution to a future unified signaling system.

5.4.2 System Control. A separate system control planning standard is to be developed. However, those aspects of system control which affect switch design need to be addressed in the switching planning standard. This includes specification of the parameters to be monitored, control actions to be taken, and methods of implementation (hardware/software).

5.4.3 Secure Communications. A separate planning standard on secure communications is to be developed. However, those aspects of secure communications which affect switch design need to be addressed in the switching planning standard. This includes characteristics discussed under paragraphs 5.2.3.1.1 and 5.2.3.2.2 for secure voice, and security level access protection and other security safeguards required for the AUTODIN II switch.

5.4.4 Interoperability. The need for the DCS to interoperate with other DoD and non-DoD systems must be considered in planning standards development. Therefore, the specification of characteristics and parameters to be included in the planning standards must be done in full consideration of present specifications and future plans for the TRI-TAC system, commercial systems (both national and international), and NATO/NICS. Also, consideration must be given to the Final Report of the Committee on Interoperability, and DoD, national, and international communications system standards.

5.5 Summary of Planning Standards Requirements. In view of the foregoing, switching planning standards are needed as follows:

- a. Specification of DCS requirements, including both clear and secure voice, for the AN/TTC-39. In addition, numbering plan, service features, and signaling and supervision must be specified to ensure compatibility with the tactical AN/TTC-39 and the U. S. commercial system.
- b. Specification of CONUS Phase II Secure Voice requirements to include modification of AUTOVON switches, numbering plan, signaling plans, and service features.
- c. Specification of all elements in the access area and the interface with the backbone switches.
- d. Specification of AUTODIN II switching. Addressing, protocols, segment and packet design, and line control procedures must

be specified considering the need to satisfy WWMCCS requirements and assure compatibility with SATIN IV and other dedicated users to be absorbed into the system.

- e. Specification of System Management and Control procedures, operation and maintenance aspects.
- f. The switching planning standard should be structured to accommodate technical data, as it becomes available, on:
 - (1) A future unified switch capable of switching all modes of traffic
 - (2) Software, including a communications-oriented Higher Order Language (HOL).

5.6 References

- [a] DCEC TR 14-75, "Engineering Concepts for the Future DCS" (U), July 1975 (SECRET).
- [b] DCEC TR 20-74, "Technical Review of the AN/TTC-39 for Use in the DCS" (U), August 1974 (CONFIDENTIAL).
- [c] DCA (Code 410) letter to Director, Joint Tactical Communications Office, subject: Modification of Engineering Change Proposal (ECP) DCA 003R3, 20 November 1974, 19 March 1975.
- [d] DCA System Performance Specification (Type "A") for AUTODIN II, Phase I, November 1975.

CHAPTER 6
CIRCUIT SWITCHING
CONTENTS

		<u>Page</u>
<u>SECTION 1 - NUMBERING PLAN</u>		6-1-1
Paragraph 6.1.1	Introduction	6-1-1
6.1.1.1	Purpose	6-1-1
6.1.1.2	Scope	6-1-1
6.1.2	Numbering Plan Format	6-1-2
6.1.2.1	Precedence Codes	6-1-2
6.1.2.2	Special Feature Codes	6-1-2
6.1.2.3	Escape Codes	6-1-4
6.1.2.4	Address Digits	6-1-4
6.1.2.4.1	Area Codes	6-1-5
6.1.2.4.2	Switch Codes	6-1-5
6.1.2.4.3	Line or Station Numbers	6-1-6
6.1.3	Subscriber Dialed Instructions	6-1-6
6.1.4	Interswitch Numbering System	6-1-10
6.1.4.1	Interswitch Numbering Between Digital Switches	6-1-10
6.1.4.2	Interswitch Numbering Between Analog and Digital Switches	6-1-13
6.1.5	Interfaces	6-1-13
6.1.5.1	Tactical	6-1-13
6.1.5.2	NATO	6-1-13
6.1.5.3	Store and Forward	6-1-13
6.1.5.4	Commercial	6-1-13
6.1.6	References	6-1-16
<u>SECTION 2 - SERVICE FEATURES</u>		6-2-1
Paragraph 6.2.1	Introduction	6-2-1
6.2.2	Service Features Selected by the Subscriber	6-2-1
6.2.2.1	Precedence	6-2-2
6.2.2.2	Conferencing	6-2-2
6.2.2.2.1	Progressive Conferencing	6-2-2
6.2.2.2.2	Preprogrammed Conference	6-2-4
6.2.2.2.3	Meet-Me Conference	6-2-5
6.2.2.2.4	Application of Conferencing	6-2-5
6.2.2.3	Call Transfer	6-2-6
6.2.2.4	Operator Access and Operator Recall	6-2-6

MIL-STD-187-310

CONTENTS - Continued

		<u>Page</u>
Paragraph 6.2.2.5	Call Hold	6-2-7
6.2.2.6	Abbreviated Dialing	6-2-7
6.2.2.7	Compressed Dialing	6-2-8
6.2.2.8	Trunk Access	6-2-9
6.2.2.9	Data Service	6-2-9
6.2.2.10	Direct Access	6-2-10
6.2.3	Predetermined or Network Service Features	6-2-10
6.2.3.1	Preemption	6-2-10
6.2.3.2	Line Grouping	6-2-11
6.2.3.3	Multiline Terminals	6-2-12
6.2.3.4	Zone Restriction	6-2-12
6.2.3.5	Community of Interest	6-2-12
6.2.3.6	Traffic Load Control	6-2-13
6.2.3.7	Bridging	6-2-13
6.2.3.8	Trouble Response	6-2-14
6.2.3.9	Intercept	6-2-14
6.2.3.10	Secure Call Mode/Key Conversion	6-2-14

SECTION 3 - DIGITIZED INFORMATION TONES AND RECORDED ANNOUNCEMENTS 6-3-1

Paragraph 6.3.1	Introduction	6-3-1
6.3.2	Information Tones	6-3-2
6.3.2.1	Dial Tone	6-3-2
6.3.2.2	Busy Tone	6-3-2
6.3.2.3	Error Tone	6-3-4
6.3.2.4	Ringback Tone	6-3-4
6.3.2.5	Nonsecure Warning Tone (NSWT)	6-3-4
6.3.2.6	Conference Disconnect Tone	6-3-4
6.3.2.7	Ring Signal	6-3-5
6.3.3	Recorded Announcements	6-3-5
6.3.3.1	Authorized Precedence Exceeded	6-3-5
6.3.3.2	Restricted Area Call	6-3-5
6.3.3.3	Unassigned Number	6-3-5
6.3.3.4	Temporarily Out of Service	6-3-5
6.3.3.5	Conference Notification	6-3-6
6.3.4	References	6-3-6

CONTENTS - Continued

	<u>Page</u>
<u>SECTION 4 - SIGNALING AND SUPERVISION</u>	6-4-1
Paragraph 6.4.1 Introduction	6-4-1
6.4.2 Interswitch Trunk Signaling and Supervision	6-4-1
6.4.2.1 DCS Overseas S/S	6-4-2
6.4.2.1.1 Common Channel Signaling Equipment	6-4-2
6.4.2.1.2 Trunk Message Formats	6-4-5
6.4.2.1.3 Message Sequences	6-4-11
6.4.2.1.4 Message Routing	6-4-13
6.4.2.1.5 Message Acknowledgment	6-4-14
6.4.2.1.6 Trunk Numering and Selection	6-4-15
6.4.2.1.7 Message Processing	6-4-16
6.4.2.2 CONUS DCS S/S	6-4-21
6.4.3 Access Line Signaling and Supervision	6-4-22
6.4.3.1 Interfaces	6-4-22
6.4.3.2 DAX To/From Digital Backbone Switch	6-4-22
6.4.3.2.1 Out-of-Band S/S	6-4-22
6.4.3.2.2 In-Band S/S	6-4-23
6.4.3.3 S/S Between DAX's	6-4-23
6.4.3.4 DAX To/From Analog PBX	6-4-23
6.4.3.5 Directly Connected Digital Subscriber To/From Digital Backbone Switch	6-4-23
6.4.3.5.1 DSVT Signaling in Overseas	6-4-23
6.4.3.5.2 DSVT Signaling in CONUS	6-4-24
6.4.4 Loop Signaling	6-4-24
6.4.4.1 Digital Loop S/S	6-4-25
6.4.4.2 Analog User on the DAX	6-4-25
6.4.4.3 Analog Loop S/S	6-4-25
6.4.5 References	6-4-25
<u>SECTION 5 - ROUTING</u>	6-5-1
Paragraph 6.5.1 Introduction	6-5-1
6.5.2 CONUS AUTOVON Routing	6-5-1
6.5.2.1 General Description	6-5-1
6.5.2.2 Routing Procedures	6-5-1
6.5.2.3 Route Control Principles	6-5-4
6.5.2.4 Precedence Routing	6-5-4
6.5.3 Overseas AUTOVON Routing	6-5-7
6.5.3.1 General Description	6-5-7
6.5.3.2 Routing Procedures	6-5-7

MIL-STD-187-310

CONTENTS - Continued

		<u>Page</u>
Paragraph 6.5.3.3	Route Control Principles	6-5-7
6.5.3.3.1	Originating Office Control	6-5-7
6.5.3.3.1.1	Early Cut-Through	6-5-7
6.5.3.3.1.2	No-Early Cut-Through	6-5-7
6.5.3.3.2	Spill-Forward Feature	6-5-8
6.5.3.3.2.1	Spill-Forward Service Treatment Indication	6-5-8
6.5.3.3.2.2	Spill-Forward from CONUS Gateway to Overseas Gateway Offices	6-5-8
6.5.3.4	Precedence Routing	6-5-8
6.5.4	AN/TTC-39 Routing	6-5-8
6.5.4.1	Routing Procedures	6-5-9
6.5.4.2	Route Control Principles	6-5-9
6.5.4.2.1	Originating Office Control	6-5-9
6.5.4.2.2	Spill Forward	6-5-9
6.5.4.2.3	Traveling Classmarks	6-5-12
6.5.4.3	Precedence Routing	6-5-12
6.5.5	DAX Routing	6-5-12
6.5.5.1	Normal Routing	6-5-12
6.5.5.2	DAX-DAX Routing	6-5-12
6.5.6	Routing Methods for Future CONUS Network	6-5-12
6.5.7	References	6-5-12
 <u>SECTION 6 - INTERFACES</u>		 6-6-1
Paragraph 6.6.1	Introduction	6-6-1
6.6.2	Terminals	6-6-1
6.6.2.1	Clear Telephone Terminals	6-6-1
6.6.2.2	Secure Telephone Terminals	6-6-2
6.6.2.2.1	KY-3	6-6-2
6.6.2.2.2	NBST (Narrowband Subscriber Terminal)	6-6-2
6.6.2.2.3	Digital Subscriber Voice Terminal (DSVT)	6-6-2
6.6.2.3	Data Terminals	6-6-2
6.6.3	PBX	6-6-2
6.6.3.1	Backbone Switch to PBX	6-6-2
6.6.3.2	PBX to ADI to Backbone Switch	6-6-2
6.6.4	Trunks	6-6-2
6.6.4.1	Interswitch Trunks	6-6-2
6.6.4.2	Extraswitch Trunks	6-6-3
6.6.4.2.1	Digital Access Exchange (DAX)	6-6-3
6.6.5	Backbone Packet Switch to Circuit Switch	6-6-3
6.6.6	References	6-6-3

CONTENTS - Continued

	<u>Page</u>
<u>SECTION 7 - CIRCUIT SWITCH CHARACTERISTICS - OVERSEAS</u>	
Paragraph 6.7.1	Introduction 6-7-1
6.7.2	Design Requirements 6-7-1
6.7.3	References 6-7-3
<u>SECTION 8 - CIRCUIT SWITCH CHARACTERISTICS - CONUS</u>	
	6-8-1

CHAPTER 6
CIRCUIT SWITCHING
SECTION 1
NUMBERING PLAN

6.1.1 Introduction. An essential element of local and long distance dialing is a numbering system wherein each subscriber has a unique number which is convenient to use, readily understandable, and identical in its format to that of all other telephones connected to the network. With such a numbering system any subscriber, wherever located, may use this system to reach the desired telephone anywhere in the world.

The current DCS numbering system has been derived from the commercial numbering system used by the U.S. common carriers and adopted throughout most of the nations of the world. Therefore, the overall numbering system which the DCS uses is an accepted standard throughout the world, and future DCS plans should reflect our adherence to this standard.

6.1.1.1 Purpose. The purpose of this document is to describe briefly the numbering system that will exist in the DCS in the time frame of 1979-1981 when the Phase II secure voice program will begin to be implemented. In this time period, modification for digital operation will have begun on several existing CONUS AUTOVON (No. 1 ESS) switches and TENLEY COMSEC equipment will be in the process of being introduced into the modified switches. The introduction of the AN/TTC-39 circuit switches is also planned for approximately the 1980-82 time frame, so that eventually they will replace all the existing overseas AUTOVON switches. In this time frame a new Digital Access Exchange (DAX) will be introduced into the DCS to perform the local (low level) switching and concentrating function in both CONUS and overseas.

6.1.1.2 Scope. The numbering system described herein is applicable to circuit switched service originated by clear voice, secure voice, or data subscribers.

Note that data subscribers may have a numbering system peculiar to their own needs; however, when these subscribers need to place circuit switch data calls, they will use the numbering system and dialing instructions described herein to reach the distant end. Any additional switching and routing necessitated by the data numbering system is not of a circuit switch nature, and is not covered by this paper.

MIL-STD-187-310

6.1.2 Numbering Plan Format. The numbering plan format to be used in the DCS for circuit switched service will be made up of the following parts which will appear in the order indicated:

P F E A,

where P is the precedence code, F is the special features code, E is the escape code, and A is the address information.

6.1.2.1 Precedence Codes. The precedence indicator is the first element in the sequence and it will be the first element dialed by the subscriber or user 1/ if he exercises his option for precedence routing. A subscriber will be able to assign any precedence up to and including the highest precedence authorized to him for any call which he attempts to establish. The precedence indicators in order of decreasing precedence are:

FO - Flash Override
 F - Flash
 I - Immediate
 P - Priority.

The Routine (R) precedence is indicated by the absence of any other precedence indicator at the start of the subscriber dialing sequence. As noted above, the dialing of the precedence code is optional; if the precedence code is not dialed, Routing precedence will be assumed by the switch.

6.1.2.2 Special Feature Codes. Subscribers using the new types of switches will have available to them a variety of special features based on their classmarks. These special features will be accommodated in the numbering plan via special feature codes which the subscriber will dial. The special feature code is optional and its absence will cause the call to be treated as an ordinary voice call, contingent on the subscriber's classmarks. For example, a call from a secure voice subscriber will be treated as a secure voice call, even though a special feature code for secure voice service was not designated and not dialed by the originator. Table 6.1.1 indicates the codes used to request the

1/ In general, a subscriber is a terminal connected to a No. 1 ESS or AN/TTC-39 switch, and a user is a terminal connected to a DAX. As used in this document, the term subscriber will include capabilities of both subscribers and users, whereas the term user will include capabilities that are peculiar to those terminals.

MIL-STD-187-310

TABLE 6.1.1 SUBSCRIBER DIALED INFORMATION 1/

Feature	Backbone Subscribers		DAX User
	(Analog) 15-key <u>2/</u>	(DVST) 16-key <u>3/</u>	
Precedence			
Flash Override	FO	FO	FO
Flash	F	F	F
Immediate	I	I	I
Priority	P	P	P
Reserved Prefix <u>4/</u>	LXX		
Conferences			
Progressive			
Initiate <u>5/</u>	A + Address	C + Address	9C + Address
Release Unanswered	A	C	C
Preprogrammed			
Initiate	6A NX	6C NX	6C NX
Release Unanswered	A	C	C
Meet-me	<u>6/</u>	<u>6/</u>	<u>6/</u>
Call Transer	2A + Address	2C + Address	<u>7/</u>
Data Service	3A + Address	3C + Address	<u>7/</u>
Compressed Dialing	NXA	NXC	<u>7/</u>
Attendant Access, Recall	0	0	0
Call Forwarding	0	0	0
Abbreviated Dialing <u>8/</u>	GGXX	GGXX	KXX
Trunk Access	-	-	9
DAX Tieline Access	-	-	7,8

1/ Digit assignments are X = 0 to 9, N = 2 to 9, C = 1 to 8, K = 1 to 6.

2/ This subset contains 0 to 9 numerics plus FO, F, I, P and A keys.

3/ This subset contains 0 to 9 numerics plus FO, F, I, P, C and R keys.

4/ Prefix LX is currently in use and LXX is reserve for future use and unassigned.

5/ A and C represent the same electrical signal.

6/ Meet-me conference not currently incorporated into AN/TTC-39 and undefined for the DAX.

7/ These features are undefined pending cost dependent tradeoffs on the DAX.

8/ Abbreviated dialing is optional in the AN/TTC-39 but it is not planned for use in the DCS's AN/TTC-39's. However, it will be used in the DAX.

MIL-STD-187-310

various special features by the subscribers who will interface the AN/TTC-39 circuit switch, modified ESS, and DAX. Note that the features of the current systems are indicated by the subscriber via a 1X prefix, and those features will continue to be indicated in the same way to the current analog switches. Also note that a 1XX prefix is planned for future use in the AN/TTC-39 (to replace the 1X prefix) to increase the number of features available.

6.1.2.3 Escape Codes. Escape codes will be used only when abbreviated dialing is provided at either the backbone switch or the DAX. Abbreviated dialing was defined by the Committee on Interoperability of DoD Telecommunications as the ability of a subscriber to call another subscriber at the same switch by means of a shortened directory number, ranging from three to five digits. Thus, this definition will be used in this planning standard although it conflicts with the abbreviated keying definition currently used in AUTOVON.

The AN/TTC-39 circuit switch will have the capability to provide abbreviated dialing on an optional basis; however, current DCS plans indicate that this option will not be implemented in the DCS backbone switches.

The DAX will have abbreviated dialing of the form indicated in Table 6.1.1, namely KXX, where K is any number from 1 to 6 and X is any number from 0 to 9. This capability will require the DAX users to dial access codes for network calls and for inter-DAX calls. The user will dial a 9 for accessing the backbone switch, and on receipt of dial tone from the switch, the user will dial the desired address digits. Access codes of 7 and 8 will be used for accessing other DAX's connected via tielines, and on receipt of second dial tone, the user will dial the last three of the four digits of the desired address.

6.1.2.4 Address Digits. The address digits are the main body of the numbering system and uniquely identify every subscriber in the network. The address digits to be utilized in the DCS for circuit switched service will be composed of a basic ten digit format

NYX NNX XXXX

where each of the digits may take on the values

N = 2, 3, 4, 5, 6, 7, 8, or 9

Y = 0 or 1

X = 0, 1, 2, 3, 4, 5, 6, 7, 8, or 9.

The first three digits of this format indicate an area code, the next three digits indicate a switch code, and the last four digits indicate a line or station number. This format is compatible with the format recommended by the Final Report of the Committee on Interoperability; the digit assignments are a subset of the digit assignments recommended by the Final Report.

6.1.2.4.1 Area Codes. The area code is primarily used by the originating switch to determine a general geographical area of the world to which the call is destined. Currently there are only five world geographical areas in the DCS; however, the area codes are also used as a traveling classmark to indicate the need to insert regenerators and crypto key changing devices in the call path. At present, there are 18 area codes in use out of a possible 160 combinations.

As planned for the future DCS, the subscriber will not have to indicate the need to insert the regenerators and key changing devices; instead the switch will make this determination based on the classmarks associated with each subscriber and on the feature code dialed by the subscriber. All traveling classmarks will be contained in the signaling messages exchanged between switching centers. Therefore, it is anticipated that the NYX code will be used primarily for designation of world geographical locations within the DCS. The one exception to this is the plan to effect the interface to the U. S. tactical network on an area code basis. Under this arrangement, separate sets of area codes for DCS, U. S. tactical, and possibly other interfaces need to be jointly determined and agreed upon.

The digits assigned to the NYX codes are a subset of the BYX codes (where B is any digit from 1 to 9) recommended by the Committee on Interoperability. However, the DCS cannot use the B as the first area code digit because the assignment of digit 1 would cause conflict and ambiguity with the subscriber dialed 1 of the reserved feature code 1XX.

6.1.2.4.2 Switch Codes. The switch codes (NNX) are primarily used by the originating switch to determine a specific switch within a geographical area to which the call is destined. Currently the NNX codes are used to route calls to backbone switches and to PBX's connected to the backbone switches, and in addition they are used to establish worldwide preprogrammed (preset) conferences. In the latter case, the subscriber does not dial an area code even when the conference involves conferees located in distant area codes. In addition, several NNX codes are utilized to segregate a command and control network from the common user network. Other, lesser uses for NNX codes include a worldwide NNX code (550) reserved for Directory Assistance and a few NNX codes reserved for restoral purposes.

MIL-STD-187-310

For the future DCS it is planned to use the NNX codes to identify backbone switches, PBX's, and DAX's.

The digit assignments for NNX codes are a subset of the BNK codes recommended by the Committee on Interoperability. The DCS cannot use the B assignment for the same rationale provided above for area codes.

6.1.2.4.3 Line or Station Numbers. The last 4 digits of a 7 or 10 digit address indicate a specific line number at the switch to which the subscriber terminal is connected. Current utilization of line numbers also includes numbers reserved for test purposes as well as for operator access. It is planned to continue using the same functions in the future DCS. The digit assignments of the line numbers (XXXX) are identical with those recommended by the Committee on Interoperability; however, the spectrum of the numbers will differ between those switches equipped with abbreviated dialing and those without it. The switches, e.g., DAX's, that provide abbreviated dialing will use the KXX codes (where K is any number from 1 to 6), whereas the switches without it will use the full XXXX codes. It is recommended that all test and operator numbers be grouped under the 10XX code for all switches (including DAX's) in both CONUS and overseas.

6.1.3 Subscriber Dialed Instructions. The future DCS backbone switches will provide services to both analog and digital subscribers, where the analog subscriber may utilize the same subset he currently uses, and the digital subscriber may use a new digital subset such as the Digital Subscriber Voice Terminal (DSVT). Since the DSVT will be able to place clear voice calls through the network, his dialing sequences must be identical to the sequences used by the analog subscribers. Table 6.1.2 indicates the allowable sequences which the subscriber may dial. The switch (backbone or DAX) will be capable of accepting all such sequences indicated and will reject and return an error indication to a subscriber dialing any sequence not indicated. Table 6.1.2 is divided into eight categories, A through H, each of which provides a set of compatible sequences. As an example, consider category D, Special Features with Precedence. A subscriber may dial any precedence code indicated, followed by a special feature code, followed by one of the six combinations of escape code and address digits. As indicated before, the escape code is not optional and is therefore combined with the address digits. Two specific examples of allowable dial sequences in category D are:

I3C9 NNX XXXX - Data call at Immediate precedence to subscriber at distant switch. Local switch has abbreviated dialing.

MIL-STD-187-310

TABLE 6.1.2 ALLOWABLE SUBSCRIBER DIALED SEQUENCES

Basic Format: P F E Address Digits

A. Address Digits Only, Routine Precedence

<u>E</u>	<u>Address Digits</u>	<u>Notes</u>
9	NYX NNXXXXXX	10 digit number at switch with abbreviated dialing
9	NNXXXXXX	7 digit number at switch with abbreviated dialing
	NYX NNXXXXXX	10 digit number at switch without abbreviated dialing
	NNXXXXXX	7 digit number at switch without abbreviated dialing
7,8	KXX	3 digit call DAX to DAX tieline
	KXX	3 digit abbreviated dial
	NXC	Compressed dial code
	0	Operator

B. Address Digits with Precedence Above Routine

<u>P</u>	<u>E</u>	<u>Address Digits</u>
FO	9	NYX NNXXXXXX
F	9	NNXXXXXX
I		NYX NNXXXXXX
P		NNXXXXXX
	7,8	KXX
		KXX
		NXC
		0

MIL-STD-187-310

TABLE 6.1.2 ALLOWABLE SUBSCRIBER DIALED SEQUENCES - Continued

C. Special Features, Routine Precedence

	<u>F</u>	<u>E</u>	<u>Address Digits</u>	<u>Notes</u>
(call transfer)	2C	9	NYX NNXXXXXX	
(data)	3C	9	NNXXXXXX	
(reserved)	1XX		NYX NNXXXXXX	
			NNXXXXXX	
		7,8	KXX	
			KXX	

D. Special Features with Precedence Above Routine

<u>P</u>	<u>F</u>	<u>E</u>	<u>Address Digits</u>
FO	2C	9	NYX NNXXXXXX
F	3C	9	NNXXXXXX
I	1XX		NYX NNXXXXXX
P			NNXXXXXX
		7,8	KXX
			KXX

E. Preprogrammed Conference, Precedence Above Routine

<u>P</u>	<u>F</u>	<u>E</u>	<u>Address Digits</u>
FO	6C		NX
F			
I			
P			

TABLE 6.1.2 ALLOWABLE SUBSCRIBER DIALED SEQUENCES - Continued

F. Preprogrammed Conference, Routine Precedence

<u>P</u>	<u>F</u>	<u>E</u>	<u>Address Digits</u>
	6C		NX

G. Progressive Conference, Routine Precedence

<u>F</u>	<u>E</u>	<u>Address Digits</u>
C	9	NYX NNXXXXXX
	9	NNXXXXXX
		NYX NNXXXXXX
		NNXXXXXX
	7,8	KXX
		KXX
		0

H. Progressive Conference with Precedence Above Routine

<u>P</u>	<u>F</u>	<u>E</u>	<u>Address Digits</u>
FO	C	9	NYX NNXXXXXX
F		9	NNXXXXXX
I			NYX NNXXXXXX
P			NNXXXXXX
		7,8	KXX
			KXX
			0

MIL-STD-187-310

- P KXX - Call Priority priority precedence to local subscriber. Local switch has abbreviated dialing.

6.1.4 Interswitch Numbering System. The numbering plan information sent from one switch to another switch provides the receiving switch information about the routing of the call or the identity of a local subscriber. As a minimum, this information must contain the distant subscriber's address, but it can also contain several characteristics of the calling subscriber as well as several network characteristics applicable to the type of call being placed. The amount of additional information and numbering plan information is a function of the signaling system between the two switches in question. Thus, when the system consists of common channel signaling (CCS) messages, more information can be exchanged than if the system consists of in-band tones. Therefore, the interswitch numbering is presented in two parts: the numbering information exchanged between digital switches (i.e., DAX's and AN/TTC-39's), and the numbering information exchanged between analog and digital switches (i.e., AUTOVON and AN/TTC-39's). The numbering information exchanged only between analog switches is well documented in DCA circulars and will not be repeated here.

6.1.4.1 Interswitch Numbering Between Digital Switches. Future DCS switches will exchange information via digital transmission media. The information is formatted into messages that carry the called subscriber's address, as well as several traveling classmarks designed to give the receiving switch all the information needed to complete the call according to the instructions dialed by the subscriber. When the switches are equipped with CCS, the information transferred will be as shown in Figure 6.1.1; when the switches are equipped with in-band digital messages, the information transferred will be as shown in Figure 6.1.2. It should be noted that Figures 6.1.1 and 6.1.2 are subject to change as further definition of the application of AN/TTC-39 and DAX in the DCS is developed. Also note that there are several differences between the information dialed by the subscriber and that transmitted by the switch on interswitch calls. Some of these differences are:

- a. All messages carry a precedence indicator; even routing messages.
- b. The compressed dial code is translated into the full 7 or 10 digit number.
- c. The preprogrammed conference code 6C and the conference number NX are translated into the conference indicator, and the full 7 or 10 digit number for each conferee of the conference is transmitted.

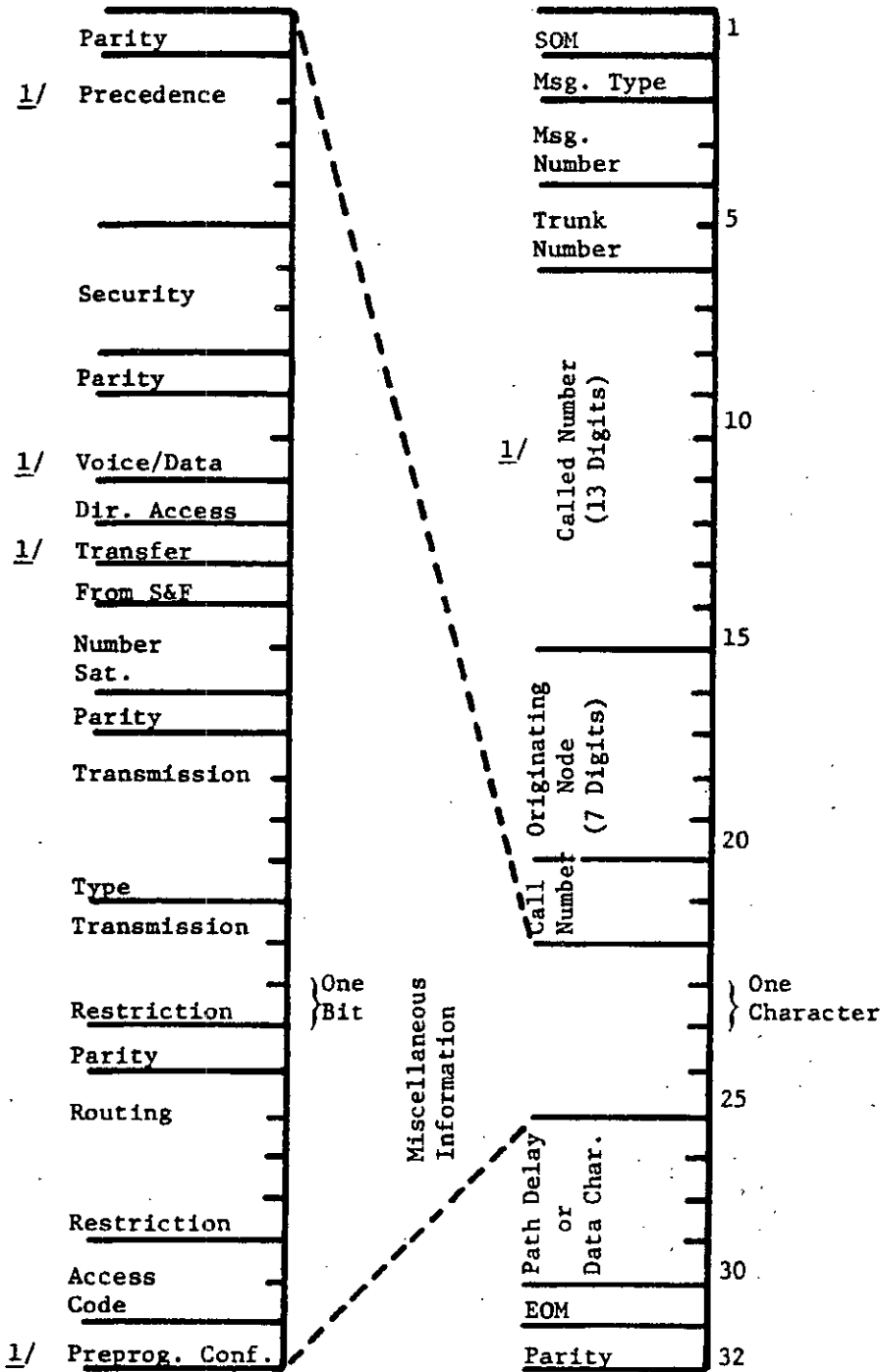

1/ Information dialed by subscriber.
2/ For a definition of each field, see reference [a]

FIGURE 6.1.1 Message Format for CALL INITIATE To Be Used By Switches With Common Channel Signaling

32 Char.

(1)

1	2	3	4	5	6	7	8	9	1	11	12	13	14	15	16	17	18	19	20	21	22	23	24	25	
SOM	MSG Type	Originating N	DAX	x	x	MSG Number	Key Net	Cat	PREC	Classmarks															
31	23	23	(D)	23	(D)	23	(D)	23	(D)	23	(D)	23	(D)	23	(D)	23	(D)	23	(F)	23	(B)	23	(G)	23	(H)

(1)

26	27	28	29	30	31	32	33	34	35	36	37-49*	50	51	52
7	Routing Constraints	Call Term	PRIV	EOM										
23	(I)	23	(J)	23	(K)	23	(C)	23	(E)	23	23	36	23	23

Destination Constraints

CALLED ADDRESS

N	N	x	x	x	x	x	x	x	x	x	x	x	x	x
(D)	23	(D)	23	(D)	23	(D)	23	(D)	23	(D)	23	(D)	23	(D)

LEGEND

PREC → DATA ITEM

17 → CODEWORD

Notes: (1) Information dialed by subscriber.
 (2) For the definition of each field see reference [b].

FIGURE 6.1.2 Message Format for CALL INITIATE Used By Switches With Digital In-band Signaling

- d. Escape codes are not transferred on interswitch calls.
- e. Abbreviated dial codes are used only for local calls and are not transmitted over interswitch trunks.

6.1.4.2 Interswitch Numbering Between Analog and Digital Switches. The allowable sequences on interswitch trunks between the AN/TTC-39 switch and an AUTOVON switch or PBX are shown in Table 6.1.3. If direct connectivity is planned between the DAX and the current AUTOVON or PBX SWITCHES; no numbering sequences will have to be developed.

6.1.5 Interfaces. The circuit switches of the future DCS are expected to interface with a variety of existing and some proposed systems. In general, these systems can be grouped as described in the following paragraphs.

6.1.5.1 Tactical. The DCS can interface the tactical networks on a trunk basis as well as a PBX access line basis. The interface on a trunk basis will require that the DCS switch send the area code of the called number across the interface, and, in addition, the tactical and DCS networks must have disjointed sets of area codes in their numbering systems. The PBX interface will be implemented as described in 6.1.4.1.b, above.

6.1.5.2 NATO. The DCS interface to the NATO Integrated Communications System (NICS) has not been determined yet because NICS has not settled on its desired numbering system, although several proposals are under study. The AN/TTC-39 presently has the capability to transfer up to 13 address digits across this interface and is equipped with a NATO baseband interface box capable of terminating eight analog NATO circuits.

6.1.5.3 Store and Forward. The AN/TTC-39 circuit switches will be capable of interfacing with a store-and-forward switch on a trunk basis. This interface will be similar to the interface to another circuit switch and will be implemented with CCIS formatted messages described in paragraph 6.1.4.1. The current DCS circuit switches do not have the capability of interfacing with a store-and-forward switch and it is planned to retain this characteristic.

6.1.5.4 Commercial. The AN/TTC-39 circuit switch will have the capability to interface with the commercial carriers on a PBX basis. This interface can take several forms and the particular interface must be programmed into the switch. (For further information see AN/TTC-39 Specification TT-B1-1101-0001A). The current DCS interface to the commercial carriers is also on a PBX (second dial tone) basis. It is planned that the DAX will not provide an interface to the commercial networks.

MIL-STD-187-310

TABLE 6.1.3 ALLOWABLE TRUNK DIALING SEQUENCES

A. AUTOVON Trunks to and from AN/TTC-39. Note 1.

<u>Basic Format</u>	<u>P</u>	<u>PX(X)</u>	<u>Address Digits</u>
(Flash Override)	0	0 (voice)	NYX NNXXXXX
(Flash)	1	1 (data)	NNXXXXX
(Immediate)	2	5 (direct access voice)	
(Priority)	3	6 (direct access data)	

Note 1: The AN/TTC-39 switch will be capable of operating with X or XX as a special feature code. Only one will be in use in the network at any one time; when the XX code is implemented, the use of the X code will be discontinued.

B. AUTOVON PBX's to the AN/TTC-39. Note 1.

<u>Basic Format</u>	<u>P</u>	<u>IX</u>	<u>PIX(X)</u>	<u>Address Digits</u>	<u>Notes</u>
(1) FO	10	(voice)	NYX NNXXXXX		
F	11	(data)	NNXXXXX		
I					
P					
(2)	10		NYX NNXXXXX		routine voice call
	11		NNXXXXX		routine data call
(3) FO			NYX NNXXXXX		
F			NNXXXXX		
I					
P					
(4)			NYX NNXXXXX		routine voice call
			NNXXXXX		

C. AUTOVON PBX's from the AN/TTC-39.

<u>Basic Format</u>	<u>P</u>	<u>Address Digits</u>	<u>Notes</u>
(1) (Flash Override)		XX ... X	last 3 to 7 digits of NNXXXX based on trunk classmarked editing, this sequence only for PNID capable PBX
(Flash)	1		
(Immediate)	2		
(Priority)	3		
(Routine)	4		
(2)		XX ... X	last 3 to 7 digits of NNXXXX based on trunk classmarked editing, this sequence only for routine call to INID PBX
(3)			no address information forwarded to manual PBX's; precedence alerting signal used on precedence calls to manual and INID PBX's

TABLE 6.1.3 ALLOWABLE TRUNK DIALING SEQUENCES - Continued

D. From AUTOVON switch to AN/TTC-39 acting as a PBX.

<u>Basic Format</u>		<u>P</u>	<u>Address Digits</u>	<u>Address Digits</u>	<u>Notes</u>
	<u>P</u>		<u>Address Digits</u>		
(1) (Flash Over-ride)	0		NNX XXXX		PNID PBX access lines
(Flash)	1				
(Immediate)	2				
(Priority)	3				
(Routine)	4				
(2)			NNX XXXX		INID PBX access line, routine level call
(3)					no address info forwarded to INID PBX access line on precedence call above routine; precedence alerting signal used

E. To AUTOVON switch from AN/TTC-39 acting as a PBX.

<u>Basic Format</u>		<u>P</u>	<u>IX</u>	<u>PLX(X)</u>	<u>Address Digits</u>	<u>Notes</u>
	<u>P</u>	<u>IX</u>		<u>Address Digits</u>		
(1) FO		10 (voice)			NYX NNXXXXX	
F		11 (data)			NNXXXXX	
I						
P						
(2)		10			NYX NNXXXXX	routine voice call
		11			NNXXXXX	routine data call
(3) FO					NYX NNXXXXX	
F					NNXXXXX	
I						
P						
(4)					NYX NNXXXXX	routine voice call
					NNXXXXX	

MIL-STD-187-310

6.1.5.5 Satellites. The AN/TTC-39 switch will have the capability to interface with DSCS earth terminals. Analyses are to be performed for the control and routing function that will exist between DCS/TRI-TAC switches and the planned demand assigned-time division multiple access (DA-TDMA) super high frequency (SHF) modems in the earth terminals utilizing the DSCS [c].

6.1.6 References

- [a] Sylvania Electronic Systems, System Requirement 118, Operational Specification for AN/TTC-39 Interswitch Trunking.
- [b] Appendix III to Specification No. TT-B1-1201-0030, Digital Common Channel Trunk Signaling/Supervision, Central Office, Telephone, Automatic, AN/TTC-42(v) 1-2.
- [c] Study of Functional Requirements for Demand Assigned SHF TDMA Modems, Final Report, December 1975, U. S. Army Satellite Communications Agency.

CHAPTER 6

SECTION 2

SERVICE FEATURES

6.2.1 Introduction. One requirement for interoperability among the various networks of the DoD is the provision of standard service features. This is especially true for those features, such as "off-hook" service, which may cross network boundaries. Another requirement for interoperability is the provision of standard service features to all persons having access to the network, regardless of whether they are directly connected to a backbone switch (i.e., subscribers) 2/ or to a DAX (i.e., users) 2/. Local PABX service features will be described in chapter 8, section 4.

The service features described in this Planning Standard will be provided by the switches of the network; however, the service features do not necessarily have to be offered by all switches. The subscriber actions required to utilize the service feature or the information given to the subscriber as a result of a service feature being executed by the network, is described herein.

Commonality of operational procedures is required in order to minimize the amount of information that must be given to a subscriber in order for him to use the network facilities, and to eliminate a possible source of human error by avoiding different procedures at different switches. The service features are discussed in two groups: those that require an action by the subscriber at the time he places the call, i.e., on a call-by-call basis; and those that are controlled by the network and apply to all calls involving a particular subscriber, or all calls within the network.

6.2.2 Service Features Selected by the Subscriber. When placing a call, any subscriber should be able to select, subject to the restrictions given, any of the features described in this section.

2/ As used herein the term "subscriber" describes terminals connected to a backbone switch and terminals connected to the DAX; and the term "user" describes terminals connected only to the DAX.

MIL-STD-187-310

6.2.2.1 Precedence. A subscriber should be able to indicate to the originating switch one of five precedence levels for the connection he is attempting to establish. The five precedence levels in decreasing order of precedence are Flash Override, Flash, Immediate, Priority, and Routine.

6.2.2.1.1 Procedure. A subscriber will depress the appropriate button on the terminal at the start of the sequence to indicate one of the top four precedences. All requests for service not prefixed by one of the top four precedence indicators will be processed as Routine. A subscriber will be permitted to indicate any precedence up to and including his highest authorized precedence. If a subscriber enters a precedence indicator higher than that authorized for the terminal, then, after completion of the initiating sequence, the subscriber will receive a recorded announcement that the highest authorized precedence has been exceeded and that the initiated request will be processed at the terminal's highest authorized precedence.

6.2.2.1.2 Dialing Sequence. In order to establish a call at a Routine precedence, a subscriber will omit the precedence indicator and go to the next step in the signaling sequence; i.e., the initial digit of an address or the start of a service request.

6.2.2.1.3 Application. This feature will be available to all DCS subscribers equipped with a DSVT or a four-wire DTMF subset. The users equipped with a rotary dial subset may obtain this feature by requesting the operator to place their calls.

6.2.2.2 Conferencing. Conferencing is the capability of simultaneously connecting three or more subscribers in a single call. Three distinct types of conferences are identified: progressive, preprogrammed, and meet-me. A possible fourth type, broadcast conferencing, is defined as a special case of the preprogrammed conference and is treated thus.

6.2.2.2.1 Progressive Conference. A progressive conference is a conference in which the originating subscriber or attendant calls each conferee in sequence, waiting and verifying the success or failure of connecting the called conferee into the conference before calling the next one.

6.2.2.2.1.1 Procedures. A progressive conference may be established on a random call-up basis, directly by a subscriber without attendant intervention, or alternately by an attendant at the request of a subscriber.

The conference originator will have complete control of the conference at all times. The originator will be able to cancel a call to a potential conferee before the called line is answered or where

the called line is busy. The originator will be capable of adding new conferees up to the maximum number of conferees per conference, while the conference is in progress.

A conferee, other than the originator, will not affect the remaining conference connections by going "on-hook." A short tone burst denoting a "conference disconnect" will be used to alert remaining conferees and the originator that a conferee has disconnected from the conference. When the originator goes "on-hook" the conference connection will be broken down.

The conference originator will be able to establish the conference at any precedence up to and including his highest authorized precedence. The attendant will be able to designate a conference originator and establish conference calls for subscribers who are not authorized conference capability, or to establish a conference at a precedence higher than that authorized to the originator.

Progressive conferences will normally be limited to 20 or less conferees including the originator, and will be established only with conference bridges at the originating switch.

A call to any conferee will not preempt the connection to that conferee unless it is of a precedence higher than that of the conference. All calls of a precedence equal to or lower than that of the conference will be diverted to intercept.

Upon answering a conference call, the called conferee will receive a burst of "conference tone" for a 1-second duration. The need for the conference tone burst is being reconsidered.

6.2.2.2.1.2 Dialing Sequence. In order to originate a progressive conference, the originator goes off-hook, enters the precedence digit, if any, the conference indicator "C," followed by the address designator of the first conferee. The address designator may be the trunk access code (for a DAX user), followed by a 7 or 10 digit subscriber address (see Section 1, Chapter 6), an abbreviated dial address, or a compressed dial address. After the first called conferee answers, the originator calls the second conferee by entering the conference indicator "C" and the address designator of the second conferee. If the first conferee does not answer, is busy, or is to be deleted from the conference for some other reason, the originator will enter "C" to release the first conferee. The remaining conferees are added or, as necessary, deleted in a similar manner.

To add a subscriber during a conference, the originator will enter the conference designator "C," followed by the address designator of the called conferee. The called conferee may be deleted in the same

MIL-STD-187-310

manner as described above. A called conferee may leave the conference voluntarily by going on-hook. The originator will terminate the conference by going on-hook.

6.2.2.2.2 Preprogrammed Conference. A preprogrammed conference is one in which a list of the identity and addresses of the conferees is predetermined and stored in the switch on which the originator is homed. Normally, a conference involves two-way communications among the conferees. In a broadcast conference, however, only the originator has the capability to transmit and receive, whereas the rest of the conferees have receive only capability.

6.2.2.2.2.1 Procedures. A preprogrammed conference may include subscribers of both the originating and remote switch. If more than one subscriber in the conference is served by the same remote switch, combining those subscribers should be accomplished using a conference bridge in that remote switch. The list is assigned a two-digit identifier unique to the originator. This two-digit identifier will be of the form NX, where N and X are as defined in Section 1, Chapter 6. The NX set must be disjoint from the set of two-digit identifiers unique to that subscriber used for compressed dialing, and disjoint from the set of "meet-me" conference codes at the same switch.

The originator will be the conference controller and the conference will not be affected by any conferee, other than the originator, going on-hook. A short tone burst, denoted "conference disconnect," will be used to alert the remaining conferees that a conferee has been disconnected from the conference. The originator shall be capable of recalling any conferee who has gone on-hook. Use of a conference notification tone or announcement is under consideration.

6.2.2.2.2.2 Dialing Sequence. A subscriber will originate a preprogrammed conference by going off-hook, entering the precedence indicator, if any; the escape code, if applicable; the conference indicator 6C; and the two digit NX identification of the preprogrammed conference. The switch, upon receipt of the complete signaling sequence, will automatically ring and connect all predetermined conferees in the stored list.

Any level of precedence up to and including the highest level authorized the originator may be assigned to a preprogrammed conference. When the conference is established, all conferees will be connected at the assigned level of precedence of the conference, even though their individually highest authorized precedence may be less than the conference. Conference bridges shall be preemptable by a conference request of higher precedence.

In the event that an unanswered (1 minute) or busy condition (of equal or higher precedence) is encountered with any of the predesignated conferees, the call to these conferees will be automatically released and the calls to the remaining conferees processed. The originator will be capable of reinitiating calls to previously unanswered or busy subscribers while the conference is in progress. Any conferee who is unavailable for either of the reasons given above will be automatically released. Calls to the other previously unavailable conferees will be processed.

6.2.2.2.3 Meet-Me Conference. A meet-me conference is one in which a switch attendant selects and assigns points of access to the conference bridge, and the conference is established by having each participant dial a special number which automatically connects the conferee with the conference originator and the rest of the conferees.

6.2.2.2.3.1 Procedures. When a subscriber desires to establish a meet-me conference, he must call and give the operator the called number of each conferee. The operator will in turn call each conferee and give each one the special number to be dialed and the approximate time to place the call. At that particular time each conferee, including the originator, must call that special number to be connected to the conference. The operator will select and interconnect local conference bridges when more than one is required to handle a large conference. The operator also completes necessary interconnections when one or more bridges in another switch is involved.

6.2.2.2.3.2 Dialing Sequence. A meet-me conference is a variation of progressive conference in which each conferee adds himself to the conference by entering the conference indicator followed by the code for the specific meet-me conference. The conference indicator is C and the codes for meet-me conferences are tentatively chosen to be of the form NXC, where N and X are as defined in Section 1, Chapter 6. No precedence indicator is required since all parties to the conference are preidentified, and each specific conference is used for only one purpose. The use of the conference indicator C to initiate the conference utilizes the same procedure as the other types of conference, thereby making the procedure simpler for the user.

6.2.2.2.4 Application of Conferencing. Conferencing is a service feature that is provided only to certain selected subscribers. Each subscriber that is authorized to be a conference originator will be classmarked as being privileged to select this service feature. A subscriber not authorized this feature will be returned error tone upon dialing the conference codes.

Only the backbone switches (and not the DAX) will provide conferencing capabilities. Therefore, authorized DAX users must dial an access code (9) prior to dialing the conference code.

MIL-STD-187-310

6.2.2.3 Call Transfer. A capability will be provided for certain selected subscribers to have incoming calls temporarily directed to another selected subscriber line. This capability will be provided when both (initiator and recipient) terminals are connected to the same switch. It will not be used to transfer calls to terminals connected to different switches.

6.2.2.3.1 Procedures. A selected subscriber may have all of his incoming calls transferred to another subscriber terminal by indicating to his home switch the call transfer code followed by the address of the subscriber terminal to which the calls are to be transferred.

The call transfer service feature will be disabled when the transferring subscriber calling from his own terminal enters the call transfer code followed by his own telephone address. The transferring subscriber terminal will still be capable of initiating outgoing calls while the call transfer service feature is in effect. When the transferring subscriber terminal has the call transfer service feature in effect, it will receive a unique dial tone upon going off-hook.

6.2.2.3.2 Dialing Sequence. The subscriber or an attendant will be capable of initiating this service feature by entering the call transfer code, 2 C, followed by the address of the subscriber terminal to which his incoming calls are to be transferred. The address may be a 7 digit address, an abbreviated dial code or a compressed dial code.

6.2.2.3.3 Application. This feature is provided to certain selected subscribers who will be appropriately classmarked at their originating switch. Subscribers not authorized this service feature will be given error tone when they attempt to exercise it.

This capability will be provided with the AN/TTC-39 circuit switch, but it has not been determined if it will be utilized in the DCS. This capability is also being considered as a cost dependent trade-off for utilization in the DAX.

6.2.2.4 Operator Access and Operator Recall. Operator access and recall are the capabilities provided to any subscriber to gain access to the operator/attendant for purposes of assistance in call placement. Operator access is normally considered to be an initial call between a subscriber and the operator, whereas operator recall is considered to occur after a connection between two subscribers has occurred and both subscribers are able to communicate with the operator without terminating the call in progress.

6.2.2.4.1 Procedures. A subscriber wishing to establish a call to an operator will go off-hook, enter a precedence code, if any, followed by the operator code. When two subscribers are engaged in a connection,

either one of them may recall the operator merely by dialing the operator code. (Subscribers with DSVT subsets will dial the operator code. Analog nonsecure subscribers will be able to recall the operator by depressing the switchhook, provided that the original call was established by an operator.) If the existing connection is a secure voice call, the backbone switch will be responsible for obtaining the correct call variables to permit the three-way conversation.

6.2.2.4.2 Dialing Sequence. To initiate an attendant access call, the subscriber would go off-hook and dial 0. If precedence is desired the subscriber would dial the precedence digit prior to dialing 0. The dialing sequence for a DAX user is tentatively identified as P 90.

6.2.2.4.3 Application. This service feature will be available to every subscriber. Users of the DAX, which will be an unmanned switch, will be serviced from an attendant at one of the nearest backbone switches. Normally an attendant access call does not traverse interswitch trunks; however, since all the backbone switches may not provide attendant service it may be necessary to send the attendant access signal on interswitch trunks.

6.2.2.5 Call Hold. Call hold is the capability of a subscriber to retain an existing connection while at the same time initiate or complete a connection on a different line of a multiline terminal. Call hold is normally considered as a terminal feature, but its implementation will affect system operation.

6.2.2.5.1 Procedures. A subscriber must be engaged in a telephone conversation prior to exercising this capability.

6.2.2.5.2 Dialing Sequence. To exercise this service feature, a subscriber will depress the call hold button on the multiline instrument.

6.2.2.5.3 Application. This feature will be available only to those subscribers with multiline instruments.

6.2.2.6 Abbreviated Dialing. Abbreviated dialing is the capability whereby subscribers of the same switch can call each other by means of a shortened directory code. This definition agrees with the definition provided by the DoD Committee on Interoperability; however, it does not describe the same service feature termed "abbreviated keying" in the DCA circulars.

6.2.2.6.1 Procedures. Abbreviated dialing will be provided to the DAX users and it may be provided to subscribers of the AN/TTC-39.

6.2.2.6.1.1 DAX. A user wishing to call another user of the same DAX need only dial the last three digits of the called number to reach the

MIL-STD-187-310

desired party. To make network calls, the DAX user will have to dial an access code plus a 7 or 10 digit number, according to the appropriate format of the numbering plan standard.

6.2.2.6.1.2 AN/TTC-39. Should the DCS AN/TTC-39 switches provide abbreviated dialing, it will be implemented using the last four digits of the normal subscriber address. To make network calls, subscribers would also have to dial an access code plus the regular called number according to the format of the numbering plan standards.

6.2.2.6.2 Dialing Sequences. In order to exercise this service feature, a DAX user will dial the precedence digit, if any, plus the last three digits (KXX) of the user's address. An AN/TTC-39 subscriber with abbreviated dialing capability will dial the precedence digit, if any, plus the last four (GGXX) digits of the subscriber address. In these addresses K can take on values of 1 through 6, G can be 1 through 8, and X can be 0 through 9.

6.2.2.6.3 Application. Abbreviated dialing, when implemented at a switch, is provided to all subscribers of that switch; i.e., it is not a classmarked service. Normally, abbreviated dialing signaling does not traverse interswitch trunks; however, in the DCS, it may be permitted to traverse DAX-to-DAX tielines which will allow one DAX user to call a user of a different DAX via a shortened dial code.

6.2.2.7 Compressed Dialing. Compressed dialing is the capability provided to certain subscribers which allows them to access frequently called subscribers on remote switches by means of a shortened dial code. This definition coincides with the definition developed by the DoD Committee on Interoperability and is more akin to the service feature termed "abbreviated keying" in the DCA circulars.

6.2.2.7.1 Procedures. Compressed dialing is used to call subscribers directly served by switches remote from the calling subscriber's originating switch. A subscriber wishing to call a distant subscriber by means of compressed dialing will dial a two-digit code plus the end-of-dial key. The switch will translate this information into the appropriate 7 or 10 digit number necessary to route the call. Compressed dialing will be provided by the switches on the basis of pools, where each switch may have several pools. Each pool will consist of several two-digit codes (80 for AN/TTC-39 and AUTOVON switches), and a subscriber will be classmarked for accessing the codes within only one pool.

6.2.2.7.2 Dialing Sequence. To exercise this feature, a subscriber would go off-hook, enter the precedence if any, and the compressed dial code of the form NXC where N is any digit 2 to 9, X is any digit 0 to 9, and C is the end-of-dial key.

6.2.2.7.3 Application. This service feature is provided only to certain designated subscribers. Each of these subscribers is class-marked to permit him access to only one of the several pools within that switch. The codes and the pools are independent sets from one switch to another. A compressed dial code of the form NXC is not transferred over interswitch trunks; the originating switch will translate that number into the appropriate network address necessary to route the call.

6.2.2.8 Trunk Access. The trunk access feature must be used whenever the abbreviated dialing service feature is provided. This feature allows subscribers to gain access to the trunking network.

6.2.2.8.1 Procedures. A subscriber wishing to make a long distance call (as opposed to a local call) will dial the precedence, if any, the trunk access code and the called subscriber's address.

6.2.2.8.2 Dialing Sequences. DAX users will have three access codes; access codes 7 and 8 will allow them access to the DAX-to-DAX tieline, whereas access code 9 will allow them access to the connecting AN/TTC-39 switch. In the event that abbreviated dialing is provided with the DCS AN/TTC-39 switches, its subscribers will dial access code 9 prior to dialing the regular network address.

6.2.2.8.3 Application. The trunk access feature is used only at switches that provide abbreviated dialing. When the trunk access code is used, it notifies the switch that the address following it must be routed outside of the local exchange. The access code is stripped off by the originating switch and is not included in the interswitch signaling messages.

6.2.2.9 Data Service. Certain designated subscribers will be provided the capability to utilize the circuit switch for real time exchange of data.

6.2.2.9.1 Procedure. The AN/TTC-39 will provide real-time circuit switching service for subscribers equipped with dual mode (voice and data) terminals for connection to data only terminals. This capability will be provided when a subscriber enters the correct data service prefix, after the precedence digit, and follows it with the address of the called party.

6.2.2.9.2 Dialing Sequence. A subscriber will dial the precedence digit, if any, followed by 3C plus the address of the called party.

6.2.2.9.3 Application. Data service will be provided only to those subscribers equipped with data terminals and classmarked for that service at the switch. These subscribers must be operating with AUTOVON

MIL-STD-187-310

compatible signaling and supervision, or with AN/TTC-39 compatible digital loop signaling and supervision.

6.2.2.10 Direct Access. Direct access is the capability allowed to certain predesignated subscribers to connect to any one preselected subscriber by merely indicating an off-hook condition to the switch which causes the called subscriber to be rung. This capability is termed "off-hook service" in the DCA circulars.

6.2.2.10.1 Procedure. The direct access call will be processed by the switched communications network. The originating switch, upon detecting an off-hook indication, will immediately process a request for connection to the predetermined distant subscriber. The called address, precedence, and all other required information for establishing the call will be stored at the originating switch. With this capability, subscriber A has direct access service to subscriber B, can originate calls only to subscriber B, and can accept calls only from subscriber B. These conditions also hold in reverse for subscriber B.

6.2.2.10.2 Dialing Sequence. A subscriber having this service need only to go off-hook to establish a connection and need not dial any digits.

6.2.2.10.3 Application. This capability is provided only to certain designated subscribers. The AN/TTC-39 has the capability of providing direct access service to a maximum of 60 subscribers for a 600 line switch. The originating switch will translate the off-hook indication into the appropriate signaling information necessary to route the call through the network.

6.2.3 Predetermined or Network Service Features. This is a class of required call service features which are predetermined on a subscriber-by-subscriber basis or by design constraints on the activities of the network. This set of service features is controlled by the network and is imposed by the network on every call originated or received (as appropriate) by the subscriber in question.

6.2.3.1 Preemption. Preemption facilities will be provided, offering four levels of switching preemption for voice and nonvoice calls. This capability will permit calls having higher precedence indicators to preempt lower precedence traffic for the use of interswitch trunks, access lines, local loops, and common equipment facilities.

6.2.3.1.1 Procedure. Subscribers will be capable of establishing local and interswitch calls using a five level precedence and preemption service. When any type of call is established, the connections will be maintained at the precedence level assigned by the originator of the call regardless of the precedence level authorized to other

participants in the connection. A call will not be allowed to preempt a line, trunk, or switching center function handling another call of equal or higher precedence. The precedence indicator will precede all other dialed digits. For a call of a higher precedence to an existing connection, such as subscriber-to-subscriber, conference, trunk, or a subscriber participating in a conference, the existing connection will be released and the called party will be connected to the higher precedence originator.

6.2.3.1.2 Application. Every subscriber will be authorized to place calls up to and including his highest authorized precedence. If a subscriber places a call at a precedence higher than his authorized level, the switch will return a recorded announcement to the subscriber. Each switch will record the classmark of the highest authorized precedence for each of its directly connected subscribers. Preemption of subscriber lines and interswitch trunks will be as described below.

6.2.3.1.2.1 Subscriber Preemption. Both subscribers involved in a lower precedence preempted call will be informed of the preemption by a "preemption tone" of 1 second duration for a voice call, or a pre-empt indicator to the subscribers in a data call, after the connection is broken. The called subscriber will then be immediately connected to the higher precedence call, while the third party will be returned a busy tone. The third party must return to an on-hook condition.

6.2.3.1.2.2 Trunk Preemption. The preemption of a trunk that is being used as an intermediate link in an existing connection will be accomplished following procedures similar to those described above. The switch receiving the request for preempt will generate the appropriate signaling in both directions on the existing connection and will provide for the use of the preempted trunk in the new, preempting connection. In all cases, the equipment to be preempted will be of the lowest precedence level in use.

6.2.3.2 Line Grouping. Line grouping is the capability of a terminating switch to access any one line of a group (two or more) in a preferred sequence by using a principal number.

6.2.3.2.1 Procedure. A terminating switch will provide automatic line grouping service (also called automatic idle hunting service) for selected subscribers. When a terminating switch receives a call destined for a terminal that is busy, but whose number is a member of a line group, the switch will hunt for an idle number in that group according to a predetermined order of hunting. The line numbers in a line group need not be in an ordered numerical sequence. In the event that all lines in a group are busy, the calling party will be returned a line busy tone. In the event a call with a precedence higher than Routine experiences an "all lines busy" condition and the precedence of the

MIL-STD-187-310

call is higher than at least one of the busy lines, the lowest precedence busy line will be preempted and the higher precedence caller will be connected to it.

6.2.3.2.2 Application. Automatic line hunting is provided only for certain selected subscribers which are appropriately classmarked at the switch. The AN/TTC-39 provides for up to 32 line hunting groups where each group may have up to five lines. This service feature has not been identified for implementation in the DAX. This feature is related to the multiline terminal service feature.

6.2.3.3 Multiline Terminals. Multiline terminals are not explicitly a service feature provided by a switch or the network, but they are related to other features such as line grouping and call hold. Multiline terminals are subscriber instruments that can terminate more than one line from a switch. Each line may be independent of all others or they may be a part of a line hunting group. The characteristics of each line may also be independent of the characteristics of other lines. Any subscriber may be provided a multiline instrument to terminate his multiline service, and there is no switch classmark associated with it.

6.2.3.4 Zone Restriction. This capability (also called restricted area calling and trunk barring) will be provided in the switching center to prevent selected subscribers from originating calls over interswitch trunks and from completing calls to certain designated destinations.

6.2.4.1 Procedures. The switching center, upon receiving the called address from the originator, will determine with the aid of tables and classmarks, if the called number is permitted or restricted to the originator. If the number is permitted the switch will proceed with the processing of the call, and if the number is restricted the switch will provide a recorded announcement to the originator so indicating.

6.2.3.4.2 Application. Zone restriction can be applied to any switch termination (trunk, access line, or loop) and will be implemented at the switch originating the call. The AN/TTC-39 will provide eight zone restriction tables that will contain the destination codes which are allowed or restricted to the callers. The destination codes may be area codes (NYX), switch codes (NNX), combinations of area/switch codes (NYXNNX), or the first six digits of a station number (NNXXXX). Each switch termination will be classmarked for only one zone restriction table, or for no restriction at all. The zone restriction capability has not been identified for the DAX.

6.2.3.5 Community of Interest. This capability allows call originators to place calls within a given "community" at a precedence level which is higher than their maximum authorized precedence level.

6.2.3.5.1 Procedures. When an originator places a call within his community, the precedence of the call is compared by the switch to the classmark termed "maximum level of precedence in the community of interest" to determine if a violation has occurred. On calls out of the "community," the switch compares the dialed precedence against another classmark termed "maximum calling area precedence." If a violation occurs, the switch will inform the originator via a recorded announcement.

6.2.3.5.2 Application. This capability is provided in the AUTOVON switches where three communities are implemented at each switch. A community at one switch is independent of the communities at other switches. This capability is not being implemented into the AN/TTC-39 circuit switch and it has not been identified for the DAX.

6.2.3.6 Traffic Load Control. The circuit switch will provide the capability whereby the traffic offered to trunks and the traffic offered to the switch can be controlled during periods of critical activity and peak busy loads. This will be accomplished by restricting less essential subscribers from accessing the trunks and also restricting the least essential subscribers from accessing the switch.

6.2.3.6.1 Procedures. The circuit switch will provide five levels of traffic load control and each subscriber will be classmarked as being assigned to one level. Level 1 provides no restriction, levels 2 and 3 apply trunk restriction, and levels 4 and 5 apply switch access restriction. The circuit switch will implement trunk restriction independently from switch access restriction.

6.2.3.6.2 Application. The switch will apply trunk restriction when the number of outgoing calls offered to trunks exceeds a preset threshold, and it will apply switch access restriction when the number of calls originated by subscribers exceeds a preset threshold. The circuit switch will apply trunk restriction to level 3 first, and to level 2 secondly if additional trunk restriction needs to be applied. The circuit switch will apply switch access restriction to level 5 first, and to level 4 secondly if additional switch access restriction needs to be applied.

6.2.3.7 Bridging. This capability (also called extensions) will permit switch loops (subscriber access lines) to terminate in more than one subscriber instrument.

6.2.3.7.1 Procedure. The extension telephone must provide the same characteristics as the basic telephone; however, any side tone equipment used in the extension telephones must be disabled.

6.2.3.7.2 Application. This capability may be provided to any subscriber. An AUTOVON telephone subscriber may have up to six extensions

MIL-STD-187-310

from the basic unit. This capability has been defined for the AN/TTC-39's Digital Subscriber Voice Terminal, but it has not been identified for DAX users.

6.2.3.8 Trouble Response. This is a capability provided by the switch whereby a subscriber is informed that his terminal instrument is not in proper operating condition within the limits of the fault encountered.

6.2.3.8.1 Procedures. A switch will periodically perform certain tests on each subscriber line and apply diagnostic procedures when the tests do not provide the expected results. The switch will provide a wavering error tone (similar to the error tone indication provided by the commercial system) interspersed with a recorded announcement.

6.2.3.8.2 Application. This capability will be available to all subscribers of the switch. This capability is not implemented in the AN/TTC-39 circuit switch and is not identified for the DAX.

6.2.3.9 Intercept. The circuit switch will provide the capability to return recorded announcements to a calling voice subscriber when the called number does not exist, is unassigned, or is marked disabled.

6.2.3.9.1 Procedure. Intercept can be provided by any switch in the path of the call that determines the error condition. If a switch other than the originating switch detects the need to intercept, it shall inform the originating switch which in turn will provide the necessary announcement to the call originator.

6.2.3.9.2 Application. Intercept will be applied by the switch for a time duration determined by local operating practices, or as long as the trouble persists. This capability is provided by AUTOVON switches, and will be implemented in the AN/TTC-39 circuit switch; however, it has not been identified for the DAX.

6.2.3.10 Secure Call Mode/Key Conversion. The circuit switch will provide the capability to properly classmarked subscribers whereby terminals with dissimilar secure voice equipment may communicate in the secure voice mode.

6.2.3.10.1 Procedure. The circuit switch will provide security mode and security key conversion equipment which will be automatically inserted in the voice path when the calling and called parties are secure subscribers whose equipments require that the conversions be made.

MIL-STD-187-310

6.2.3.10.2 Application. The circuit switch shall apply this equipment after the initial loop signaling and trunk signaling have been completed. The circuit switch will determine from the classmarks the appropriate equipment to institute in the voice path. The AN/TTC-39 provides mode key conversion equipment for KY-3 and HY-2 equipment. This capability has not been identified for the DAX.

CHAPTER 6

SECTION 3

DIGITIZED INFORMATION TONES AND RECORDED ANNOUNCEMENTS

6.3.1 Introduction. The objective of this section is to identify the information tones and recorded announcements that can be used with the DCS switches of the transitional period and the future DCS. During this time the DCS is likely to introduce AN/TTC-39 circuit switches for the overseas areas to serve in a backbone role, and will probably modify existing CONUS No. 1 ESS facilities to accommodate digital operation. In addition, the Digital Access Exchange (DAX) will probably be introduced to the access area to handle certain local switching functions and concentrate the access to the network.

The information tones and recorded announcements proposed by this planning standard are intended to be utilized between these switches and the digital terminal subsets that these switches will serve. The set of information tones and recorded announcements used by analog terminals is described in reference [a] and will not be repeated here.

The fundamental purpose of the information tones and recorded announcements is to inform the backbone switch subscriber or the DAX user ^{3/} of the status of his call currently being processed by the network. The information tones may be provided by the connecting switch or they may be provided by the terminal subset upon command from the connecting switch. The recorded announcements will be provided by the connecting switch. Information tones and recorded announcements are normally divided into three groups: those used to inform a calling subscriber of the status of his call being established; those used to inform subscribers of the status of an active connection; and those used to inform a subscriber of a call placed to him. These information tones and recorded announcements should be implemented using the human engineering principles which apply to any man-machine (subscriber/network) interface; that is, the minimum number of such tones and recorded announcements should be used to avoid ambiguity in the mind of the subscriber regarding the actions the subscriber should take.

3/ In general a subscriber is a terminal connected to a No. 1 ESS or AN/TTC-39 switch, and a user is a terminal connected to a DAX. As used in this document, the term subscriber will include capabilities of both subscribers and users, whereas the term user will include capabilities that are peculiar to those terminals.

MIL-STD-187-310

6.3.2 Information Tones. A set of the minimum number of information tones required is proposed for future planning. This minimum number is consistent with the report of the Call Set-Up Subgroup of the Committee on Interoperability for DoD Telecommunications reference [b]. This set contains dial tone, busy tone, error tone, ringback tone, non-secure warning tone, and ring signal. A summary of the characteristics of these tones is presented in Table 6.3.1.

6.3.2.1 Dial Tone. Dial tone is delivered by the network after recognition of a request for service (off-hook after being idle) from a subscriber and when the network is prepared to receive the call initiation sequence. Upon receipt of dial tone the subscriber is expected to enter the call initiation sequence consisting of the precedence, service feature, access code, and address information, as applicable to the particular call. Dial tone will be delivered by the network regardless of whether the call is originating from a normal terminal or from a terminal which is on a call transfer mode. (A different dial tone has been proposed for the AN/TTC-39 as a reminder to the originator of a call transfer that he may not receive calls while his terminal is in the call transfer condition.)

6.3.2.2 Busy Tone. Busy tone is delivered by the network when the network is unable to complete a call requested by a subscriber, or to signify that the network can no longer provide an existing call connection. The subscriber, upon receipt of busy tone, is expected to go on-hook and attempt to establish (or reestablish) the call after a subscriber selectable interval.

Currently there are four types of busy tones: line busy and trunk busy which differ in the rate of interruption, which are returned by the network during call initiation when the network cannot establish the call; and preempt notification and released party preempt, which are returned by the network when an established connection has been preempted. Preempt notification is the tone given to a preempted subscriber before he is automatically connected to the preempting subscriber. It requires no specific subscriber action and is potentially ambiguous. With the exception of preempt notification, the action to be taken by a subscriber upon receipt of any of the types of busy signal is the same; i.e., go on-hook and attempt to reinitiate the call at a later time. For this reason, it is proposed that only one busy tone be used for all cases, and that the procedures for preempt notification be modified to require the subscriber to go on-hook when preempted and have the switch ring the subscriber for the new call. Although the AN/TTC-39 circuit switch will provide line busy, trunk busy and preempt notification tones, it is recommended that line busy tone be used to represent all three tones for future DCS applications.

TABLE 6.3.1. INFORMATION TONES PROVIDED TO THE SUBSCRIBER

<u>Tone</u>	<u>Source</u>	<u>Frequency</u> Hz	<u>Level</u> dBm 1/	<u>Duration</u> Sec	<u>Rate</u> 2/	<u>Tone On</u> Sec	<u>Time Off</u> Sec
Dial	Switch	425	-14 ± 1	≥10 ± 3	Cont 3/	-----	-----
Busy	Switch	425	-14 ± 1	≥10 ± 3	60	0.5	0.5
Error	Switch	425/1050 4/	-14 ± 1	≥10 ± 3	Cont	0.125 @ 425 0.125 @ 1050	-----
Ringback	Terminal Switch	500/10 5/ 570	6/ -14 ± 1	6/ 180 ± 30	10 10	2 2	4 4
Non-Secure Warning	Terminal Switch	1000 1050	6/ -24 ± 1	Call duration Call duration	10 20	0.05 0.05	5.95 2.5
Conference Disc.	Switch	480/620 7/	-14 ± 1	1.0	Cont	-----	-----
Ring	Terminal	1000/10 5/	6/	6/	10	2	4

1/ Level in dBm at -4 dBm TLP per frequency.

2/ Rate in interruptions per minute.

3/ Cont = Continuous

4/ FSK

5/ Modulated

6/ Information not yet available.

7/ Mixed

MIL-STD-187-310

6.3.2.3 Error Tone. Error tone is delivered by the network when a calling subscriber makes an error in the call initiation sequence, when a subscriber does something inconsistent with the allowable sequence, or when a subscriber terminal is inoperative. Upon receipt of error tone, a subscriber is expected to go on-hook and correct the error which he made prior to reinitiating a call or, if the terminal is inoperative, to attempt calls from a different terminal. Error tone can occur at any time during a calling sequence, instead of dial tone, or after the completion of the call initiation sequence.

Error tone is proposed as the single tone to replace other tones such as the lockout tone and trouble response which elicit the same response from the subscriber; i.e., go on-hook.

6.3.2.4 Ringback Tone. Ringback tone indicates to the calling subscriber that all connections through the network necessary to complete the call have been made and any further delay in completion of the call is the result of the called party's failure to respond to the ring signal.

Ringback tone will be provided to the subscriber by either the terminal subset or the switch. The terminal subset will provide ringback for all normal call situations except for conference calls, in which case the switch will provide the ringback tone.

When the terminal provides ringback, it will do so upon receipt of one of the codewords, Ringback Secure (RBS), Ringback Nonsecure (RBN), or Go To Sync (GTS). Ringback will be stopped by the terminal upon receipt of the codeword Lockin.

6.3.2.5 Nonsecure Warning Tone (NSWT). NSWT will be provided to a secure subscriber to indicate when any portion of his connection is not secure. The terminal subset will provide this tone for all calls except conference calls, in which case the switch will provide the tone. When the locally generated tone occurs during ringback, it is inserted in the middle of the 4 second tone-off period to enable its detection.

NSWT will be provided as soon as the secure subscriber goes off-hook and will be turned off only when the call is end-to-end secure as indicated by the code word GTS being sent by the switch to the terminal.

6.3.2.6 ConferenceDisconnect Tone. Conference disconnect tone is a short tone burst delivered by the switch to all the parties of a conference when a conferee other than the originator leaves the conference. Although this indication does not identify the subscriber leaving the

conference, it is considered that it is valuable to let the other conferees know when a subscriber leaves the conference. The tone is necessarily made short so as not to interfere with the ongoing conversation.

6.2.3.7 Ring Signal. A ring signal is delivered by the network through a subscriber terminal to inform a subscriber that he is being called. Upon receipt of a ring signal, the subscriber is expected to go off-hook. The terminal subset provides the ring signal upon receipt of the codeword Ring Voice (RV) from the switch.

6.3.3 Recorded Announcements. The following types of recorded announcements have been identified: authorized precedence exceeded, restricted area call, unassigned number, temporarily out-of-service, and conference notification.

6.3.3.1 Authorized Precedence Exceeded. Each subscriber is assigned a maximum authorized precedence. If, during the call initiation sequence, he assigns a precedence indicator which exceeds his highest authorized precedence, he should be informed of this fact and that his call is to be processed at his highest authorized precedence. The recommended wording for this recorded announcement is as follows: "You have exceeded your highest authorized precedence for your call. Your call is being processed at your highest authorized precedence."

6.3.3.2 Restricted Area Call. Each subscriber is given a particular set of area codes and switch code combinations which he is authorized to call. If he attempts to call an area code or a switch code combination which he is not authorized to call, he should be so informed. The suggested wording of this recorded announcement is as follows: "You have attempted to call a subscriber who is restricted to you."

6.3.3.3 Unassigned Number. When a subscriber attempts to call a number which is not assigned to any subscriber at the terminating switch, he should be informed of the fact in order to preclude a further attempt to call the unassigned number. The recommended wording for the recorded announcement which would thus inform the subscriber is as follows: "You have attempted to call an unassigned number. Please consult your directory or directory assistance."

6.3.3.4 Temporarily Out-of-Service. At times, calls can be made to active subscriber numbers which are temporarily out-of-service, either individually or collectively, at a switch or subnetwork. The recommended recorded announcement for this purpose is given below. The second sentence of the recorded announcement is optional and could be included for those cases where all subscribers of the switch are out-of-service and a scheduled activation time is available. "The number you have called is temporarily out-of-service. (Service is expected to be restored at _____ hours.)"

MIL-STD-187-310

6.3.3.5 Conference Notification. When a called subscriber is to be a party to a conference, either preprogrammed or broadcast, there will be a delay in fully connecting all the conferees to the conference. This delay is required to allow establishment of the connections to all parties to the conference and to give them time to answer the call. At the end of the delay, all busy or unanswered parties are released and the active conferees are interconnected. During the delay period, a short recorded announcement will be sent in order to properly inform a subscriber that he is to take part in a conference and to remind him that further instructions for proceeding with the call will be forthcoming from the originator of the conference. The recommended wording for this recorded announcement is as follows: "Stand by for a conference."

The AN/TTC-39 circuit switch will provide a conference notification tone; however, for future DCS applications it is recommended that a recorded announcement be used.

6.3.4 References

- [a] MIL-STD-188-346, Equipment Technical Design Standards for Analog End Instruments and Central Office Ancillary Devices, 30 November 1973.
- [b] Final Report, Call Set-Up Subgroup, Committee on Interoperability of DoD Telecommunications, 15 August 1973.

CHAPTER 6

SECTION 4

SIGNALING AND SUPERVISION

6.4.1 Introduction. This section covers trunk, access line, and loop signaling and supervision schemes for circuit switching in the Nominal Future DCS. As described in Chapter 5, the Nominal Future DCS will consist of AN/TTC-39 backbone circuit switches overseas and modified AUTOVON backbone circuit switches in the CONUS. Digital Access Exchanges (DAX's) will be used in both the overseas and CONUS access areas. This section also covers signaling and supervision plans for the transitional period when, for example, the overseas DCS will be configured with a mix of AN/TTC-39's and presently installed AUTOVON (490L) switches. Signaling and supervision plans for data switching are covered in Chapter 7, Data Switching.

6.4.2 Interswitch Trunk Signaling and Supervision. The signaling and supervision (S/S) scheme to be utilized on DCS overseas interswitch trunks is the common channel signaling (CCS) scheme to be used by the AN/TTC-39 circuit switches. During the period when AN/TTC-39 switches are being installed overseas and the DCS consists of a mix of AN/TTC-39 and AUTOVON switches, trunk signaling between the AN/TTC-39 and AUTOVON will be as described in reference [a]. For CONUS interswitch trunks the digital S/S will be based on a recommendation from an ongoing study of three alternatives: (1) AN/TTC-39 digital S/S; (2) AT&T's version of CCITT #6, commonly known as common channel interoffice signaling (CCIS) #6; or (3) a proposed signaling standard, also based on CCITT #6, known as Federal (F) #6, developed by DCEC for the National Communications System (NCS). The signaling scheme to be used between CONUS and overseas switches is the AN/TTC-39 CCS. Other trunk signaling schemes not presently covered in this section but which should be developed pertain to:

- a. DCS/tactical interface
- b. DCS/NICS interface
- c. DCS CONUS/overseas interface
- d. DCS/non-DCS interface

MIL-STD-187-310

- (1) Conus commercial
- (2) Overseas commercial
- (3) CONUS federal networks.

The requirements for these interfaces and the specifications, to some extent, are provided in the specification for the AN/TTC-39 switch [a]. However, their specification for DCS application is still to be determined.

6.4.2.1 DCS Overseas S/S. The signaling and supervision scheme to be used on DCS overseas interswitch trunks is the common channel signaling for the AN/TTC-39 switch specified in reference [b]. Interswitch trunk signaling will utilize formatted messages transmitted over a common signaling channel. In this technique, the signaling channel controls the disposition of one or more trunks. In contrast, all extraswitch trunks (trunks to other switch types which do not use common channel signaling) utilize signaling on a trunk-by-trunk basis; each individual trunk carries its own signaling information rather than formatted signaling messages. Extraswitch trunks use analog tones and voltage levels to carry information. Specifications for extraswitch signaling are included in reference [a].

At each end of the interswitch trunk signaling channel there is a device which effects the transmission and reception of trunk signaling messages, the Trunk Signaling Buffer (TSB). The TSB serves as the primary interface between the processor and the transmission medium. It performs the functions of forward error correction encoding and decoding, certain parity checks, and handshaking with the processor.

6.4.2.1.1 Common Channel Signaling Equipment. The common channel signaling equipment consists of several Trunk Signaling Buffers (some of which may be analog), a single system control (SYSCON) Signaling Buffer (SSB), and the redundant Signaling Buffer Controller, which serves all of the preceding devices.

6.4.2.1.1.1 Trunk Signaling Buffer. The Trunk Signaling Buffer (TSB) will have the capability of operating with either a digital or an analog signaling channel, and is shown in Figure 6.4.1.

When operating in the digital mode, the TSB will interface with the signaling channel via the TDMX. The input to and output from the TSB will be a 16 kb/s data stream. This data stream will carry trunk and SYSCON signaling, and framing information as shown in Figure 6.4.2. On transmission, the TSB will insert a 11001100... pattern on the framing subchannel. The use, if any, of the framing subchannel on reception is to be determined.

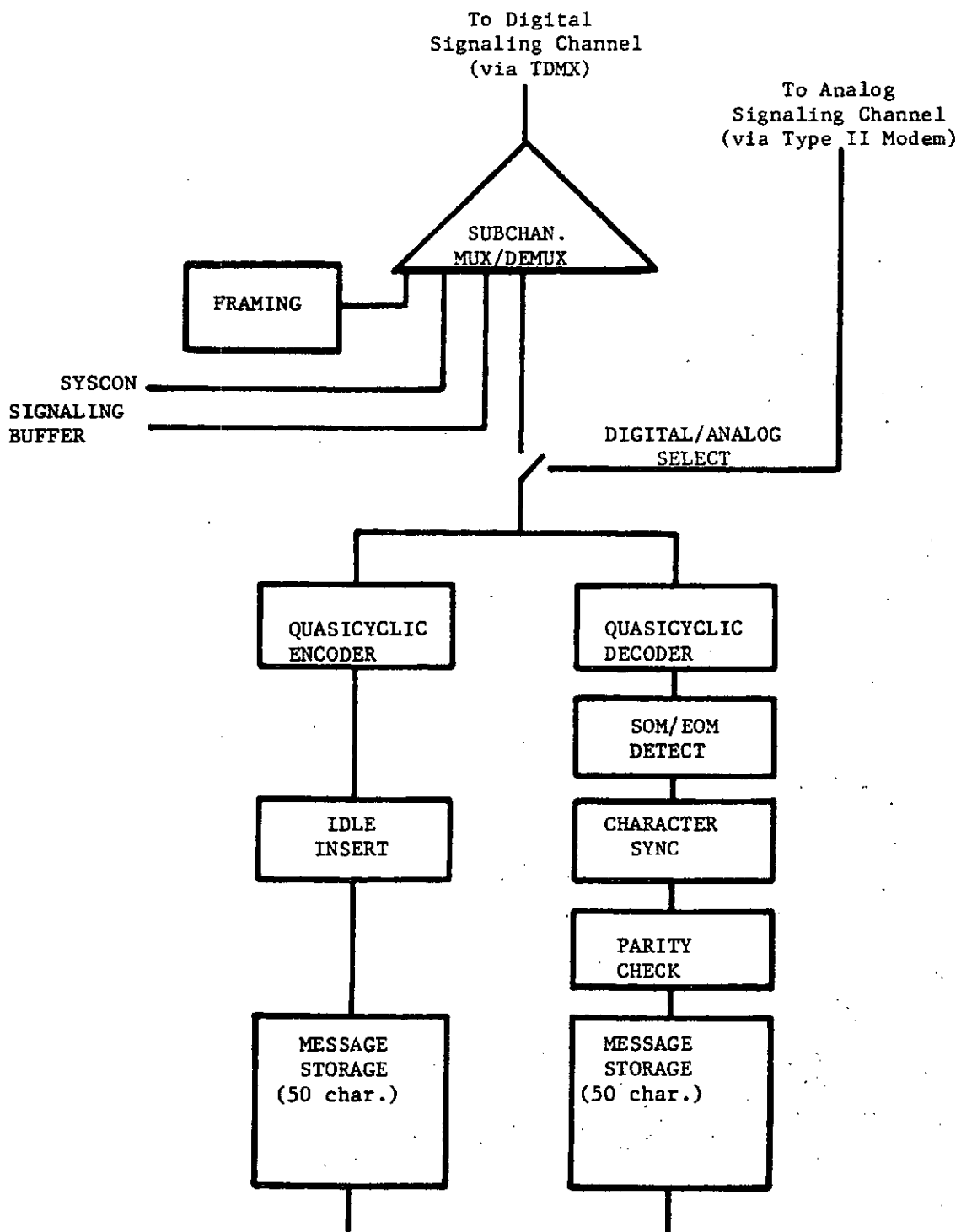

FIGURE 6.4.1 Trunk Signaling Buffer

MIL-STD-187-310

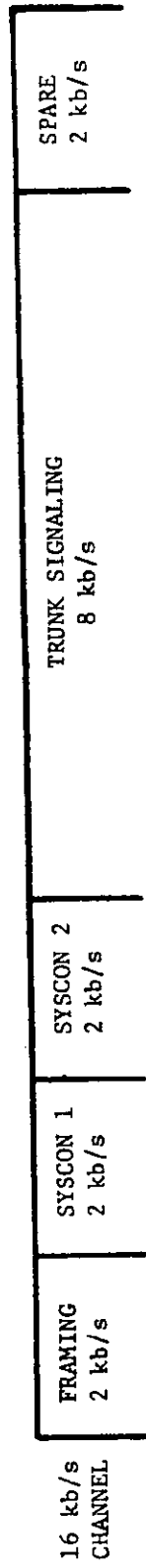

FIGURE 6.4.2 MUX/DEMUX SUBCHANNEL ALLOCATIONS

A digital signaling channel may carry two SYSCON signaling sub-channels. These will be separated by the subchannel mux/demux and sent to the SYSCON Signaling Buffer.

Eight kilobits of the original 16 kilobit signaling channel will be used for trunk signaling. This data stream will be processed by the TSB for eventual transfer to the processor.

In the analog mode the TSB will interface with the signaling channel via a 1200 b/s modem. The analog signaling channel will have no subchannel framing or SYSCON signaling functions. The full 1200 b/s data content of the channel will be processed by the TSB.

The TSB will perform the functions of quasicyclic (16, 8) encoding/decoding. This is a half-rate code, so while the data rate (speed over the signaling channel) is either 8 or 1.2 kb/s, the information rate (speed between the processor and the encoder/decoder) is either 4 or 0.6 kb/s.

The TSB must attain character synchronization in order to receive trunk signaling messages. On command from the Signaling Buffer Controller, the TSB will attempt to attain character synchronization by searching for the idle character which is always present on the signaling channel whenever messages are not being sent. When it receives three consecutive idle characters, the TSB will assume that character synchronization has been achieved. The TSB will monitor for maintenance of character synchronization by checking for the presence of idle characters or SOM (start of message) characters in the received data stream. If the TSB detects neither an idle character nor an SOM character in a string of 100 (+10) consecutive received characters, it will begin searching for synchronization. As transmitted over the signaling channel, trunk signaling messages are composed of eight bit characters, where the most significant bit (in the first transmitted bit position) is set to give odd parity for the eight bits. On the receiving side the TSB will check each character received from the signaling channel for odd parity. If a character is received with even parity, the TSB will delete it and insert in its place the parity error character which does have odd parity.

6.4.2.1.2 Trunk Message Formats. The formats of the messages to be used on interswitch trunks are depicted in Figures 6.4.3, 6.4.4, 6.4.5, 6.4.6, 6.4.7 and 6.4.8. Table 6.4.1 defines the message types. In these figures, each field in the messages is identified. A field is simply a subset of the message chosen for convenience in description. Each field consists of one or more characters. Each character consists of 8 bits, of which only 6 are usable to carry trunk signaling information, the other 2 being reserved for parity and control. Certain fields are further divided into subfields, which consist of one or more bits.

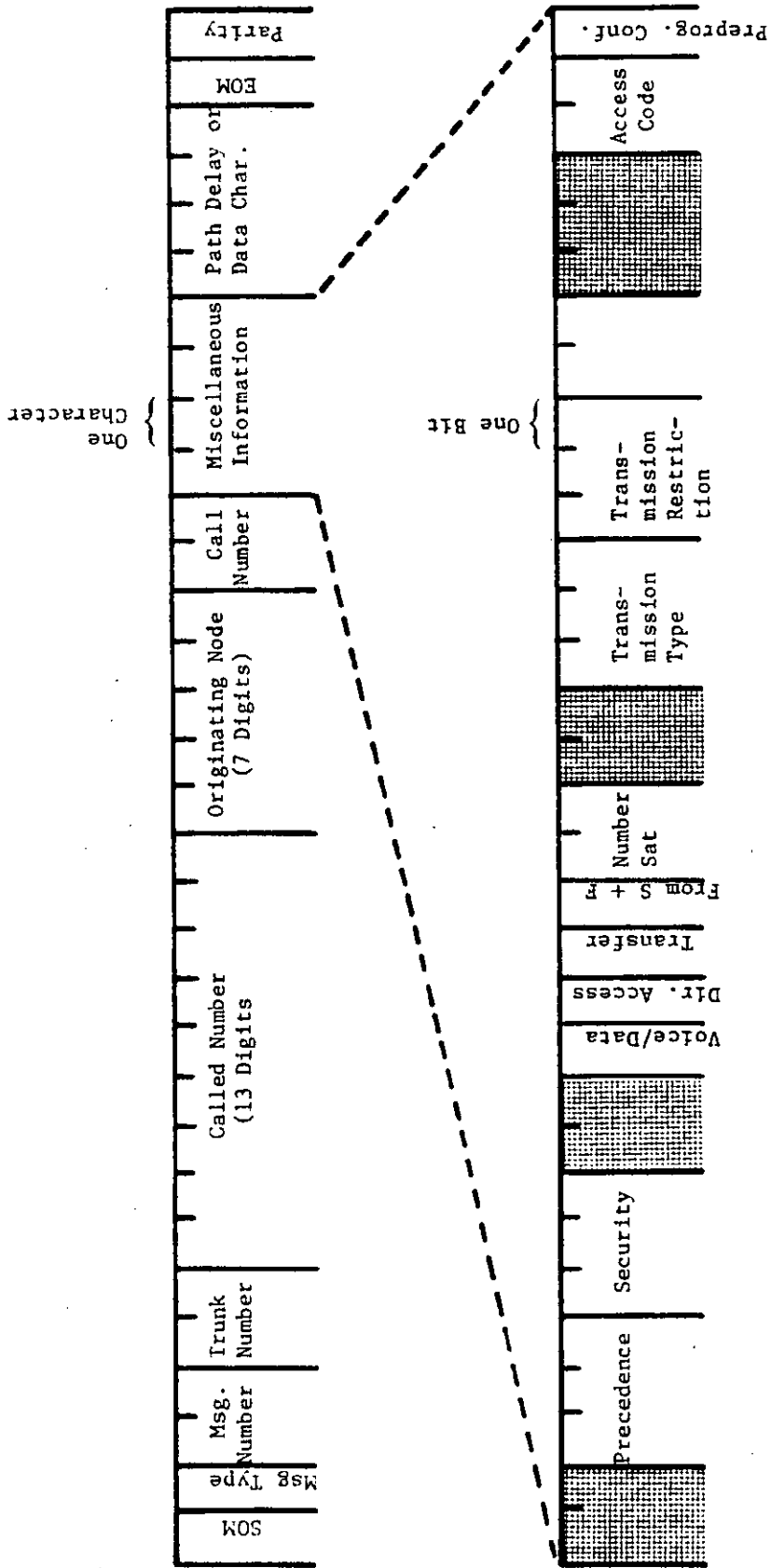

6-4-6

FIGURE 6.4.3 Format of Call Initiate Message

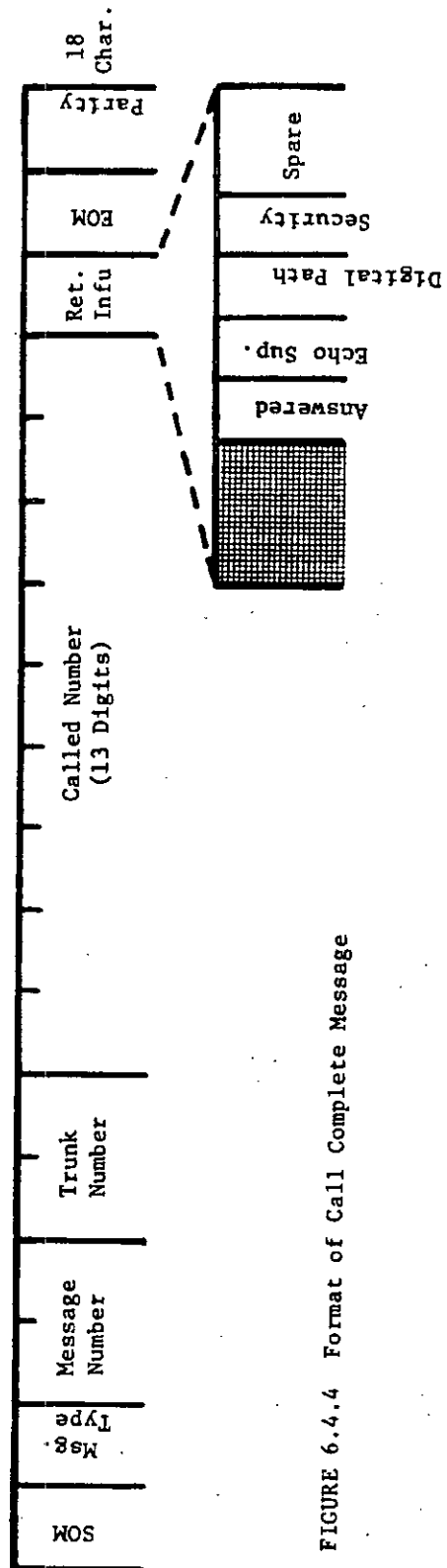

FIGURE 6.4.4 Format of Call Complete Message

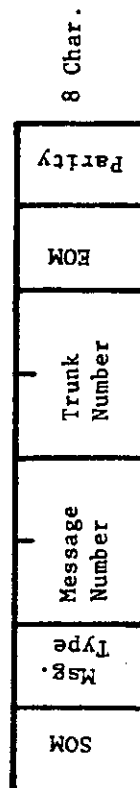

FIGURE 6.4.5 Format of Call Answer, Release, Call Incomplete (Except Invalid Route), Trunk Test, and Special Messages

MIL-STD-187-310

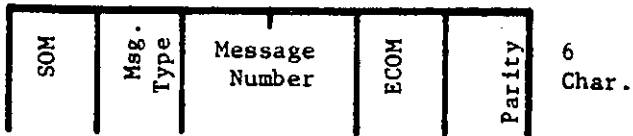

FIGURE 6.4.6 Format of Acknowledgment and Test Sync Messages

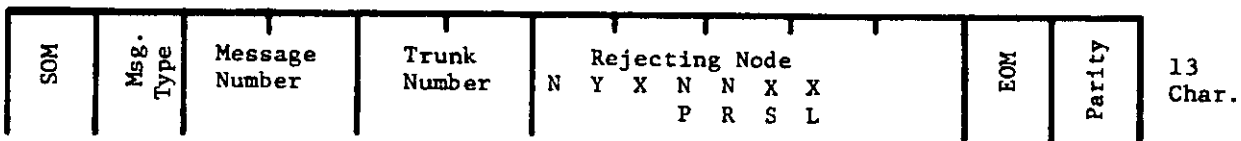

FIGURE 6.4.7 Format of Invalid Route Message

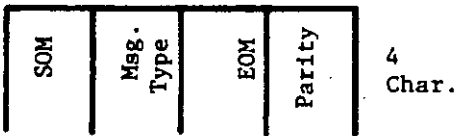

FIGURE 6.4.8 Format of Sync A and Sync B Messages

TABLE 6.4.1 TRUNK SIGNALING MESSAGES

1. CALL INITIATE	Sent to establish all calls and set up trunk paths between TTC-39 nodes.
2. CALL COMPLETE	Sent by called TTC-39 to cause all switches in call to cut through a path.
3. CALL ANSWER	Sent by called TTC-39 when called party answers.
4. Release Messages	
a. CALL RELEASE	Sent to release trunks when calling or called party goes on hook.
b. PREEMPT RELEASE	Sent to release trunks due to a preemption.
c. BUSY RELEASE	Sent by a TTC-39 to which control has been spilled forward when it encounters an all-trunks-busy condition.
5. Acknowledgment Messages	
a. ACKNOWLEDGE	Sent to indicate a message has been received without errors.
b. NON-ACKNOWLEDGE	Sent to indicate a message has been received, but with errors.
c. GLARE	Sent to indicate a simultaneous seizure has occurred.
d. OUT OF SERVICE	Sent to indicate that the referenced trunk is marked out of service at the receiving switch.
6. Call Incomplete Messages	
a. CALLED PARTY UNAVAILABLE	Sent to indicate the called party is busy on a call of equal or higher precedence.
b. ALL TRUNKS BUSY	Sent by a TTC-39 to which control has <u>not</u> been spilled forward when it encounters an all-trunks-busy condition.

MIL-STD-187-310

TABLE 6.4.1 TRUNK SIGNALING MESSAGES - Continued

c. EQUIPMENT BUSY	Sent when the call cannot be completed due to necessary equipment being busy at the called switch.
d. UNASSIGNED LOOP	Sent by the called TTC-39 when the called loop number is unassigned.
e. INCOMPATIBLE CONNECTION	Sent by a called TTC-39 when an incompatibility exists between the incoming call and the called party.
f. INVALID ROUTE	Sent by a TTC-39 when its translation table does not contain the area or switch code specified by a CALL INITIATE.
7. Synchronization Messages	
a. SYNC A	Sent to indicate that synchronization has been lost and resynchronization method A will be attempted.
b. SYNC B	Sent to indicate that synchronization has been lost and resynchronization method B will be attempted.
c. TEST SYNC	Sent to check for the reestablishment or maintenance of synchronization.
8. Trunk Test Messages	
a. LOOP-BACK TRUNK	Sent to have a trunk looped back on itself for testing purposes.
b. LOOP-BACK COMPLETE	Sent to indicate that the requested loop-back has been achieved.
9. Special Messages	
a. OPERATOR RECALL	Sent to facilitate operator recall in a TENLEY Stage II call.

Each message, as an absolute minimum, contains an SOM character field, a message type field, an EOM character field, and a message parity field. The SOM, for start of message, identifies the beginning of a trunk signaling message. The message type field specifies the type of message being sent. The EOM, for end of message, identifies the completion of the message. The message parity field, immediately following the EOM, is the exclusive or of all preceding characters in the message. This field provides the column parity of the message, for use in error detection.

In addition, most messages contain message number and trunk number fields. The message number field identifies the message for the purposes of acknowledgment and retransmission. The trunk number field specifies that trunk to which the message refers.

6.4.2.1.3 Message Sequences. The events which occur in the course of a typical call over interswitch trunks are described below. Figure 6.4.9 represents the sequence of messages transmitted.

The calling party goes off-hook and, upon receiving dial tone, dials the called party. The originating switch (switch A) translates the dialed digits and determines that it must route to switch B. After selecting a trunk, it formats a CALL INITIATE message containing the number of the trunk selected, the called number, certain characteristics of the calling party (obtained from classmarks), and various characteristics of the call (e.g., precedence). This message is transmitted by the Trunk Signaling Buffer which serves the trunk selected to carry the call.

Switch B receives the CALL INITIATE through its TSB. After performing certain error checking operations on the received message and determining its syntactical correctness, switch B returns an ACKNOWLEDGE message to switch A. The ACKNOWLEDGE carries the message number of the CALL INITIATE which is being acknowledged.

Switch B translates the digits contained in the called party field and determines that it must route the call to switch C. Switch B then selects a trunk to C, reserves the matrix path between the selected trunk and the trunk from switch A, and creates a CALL INITIATE message to be sent to C. The Trunk Signaling Buffer then transmits the CALL INITIATE to C.

Upon receipt of the CALL INITIATE from B, switch C performs certain error checking and then returns an ACKNOWLEDGE message to B. Switch C then translates the called number and determines that the called party is a local subscriber. Switch C reserves the matrix path from the called party to the trunk from B, begins ringing the called party, sends ringback to the trunk from B, and formats a CALL COMPLETE message to be returned to B. The CALL COMPLETE contains the called number (copied

MIL-STD-187-310

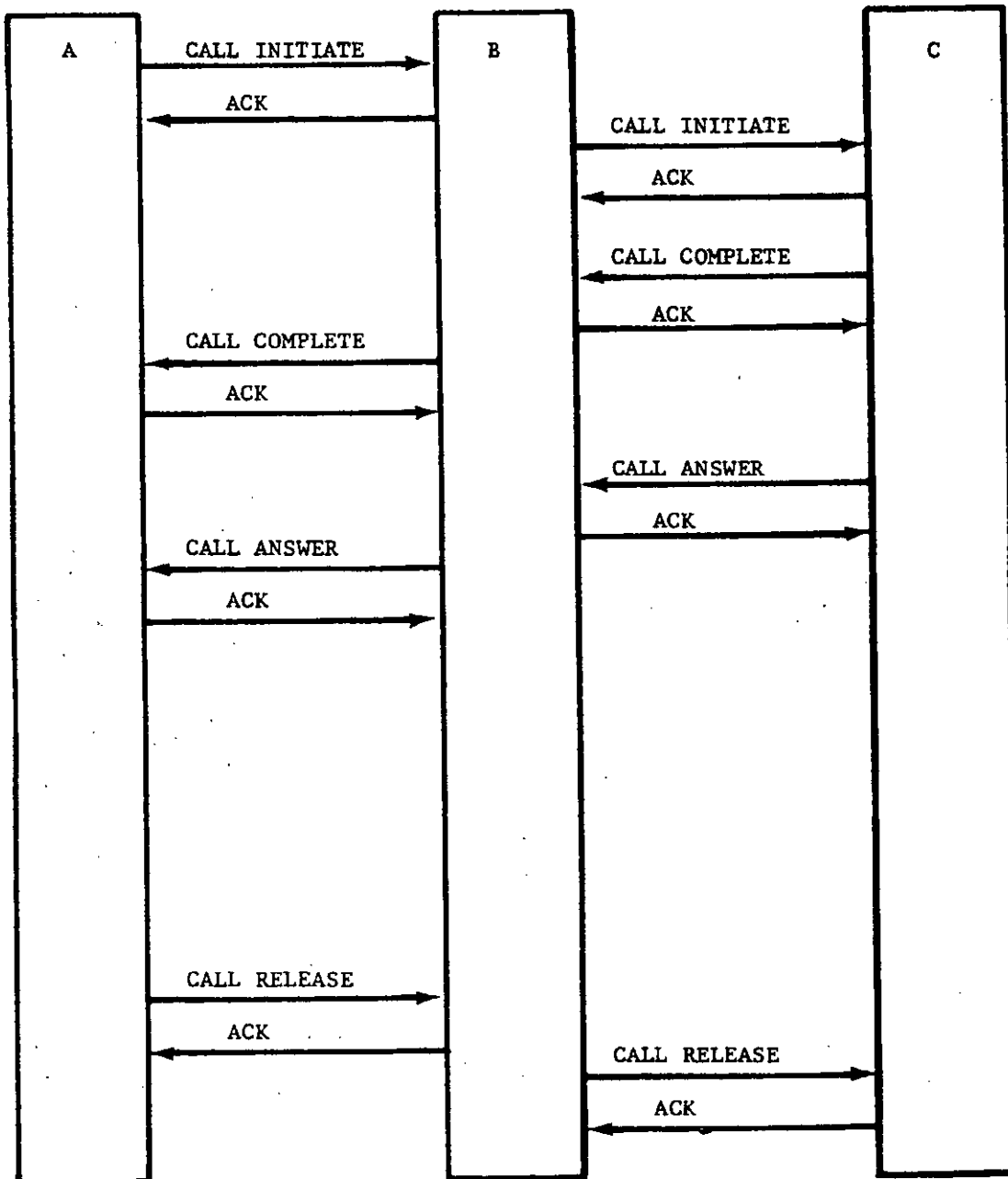

FIGURE 6.4.9 Typical Message Sequence

6-4-12

MIL-STD-187-310

from the CALL INITIATE) and the number of the trunk between B and C which had been selected by B to establish the call.

When B receives the CALL COMPLETE from C, it first performs error checking, and then returns an ACKNOWLEDGE message to C. The reserved matrix path is then established and switch B sends a CALL COMPLETE to switch A. This CALL COMPLETE contains the number of the trunk between A and B.

When switch A, the originating switch, receives the CALL COMPLETE, it performs standard error checking, returns an ACKNOWLEDGE to B, and verifies the correctness of the called number. It then establishes the previously reserved matrix path from the calling party to the trunk to switch B. The calling party is thus connected through switches A and B to the terminating switch for the call (switch C) from which he receives a ringback.

When the called party goes off-hook, switch C stops ring and ringback and connects him to the trunk from B, completing the connection between calling and called parties. Switch C then sends a CALL ANSWER message to switch B.

Switch B, after performing error checking on the CALL ANSWER, returns an ACKNOWLEDGE to switch C, and sends a CALL ANSWER to switch A. Switch A responds to the CALL ANSWER by returning an ACKNOWLEDGE to switch B. No further action is taken.

After the completion of the call, the calling party goes on-hook (if the called party goes on-hook first, the roles of switches A and C described in the following are reversed). Switch A breaks down the matrix path from the calling party to the trunk and formats a CALL RELEASE message, containing the number of the trunk to be released, for transmission to switch B.

After error checking and returning an ACKNOWLEDGE TO SWITCH A, switch B responds to the CALL RELEASE by breaking down the matrix path which had been used by the call being released, and sending a CALL RELEASE message on to switch C.

Switch C check the CALL RELEASE message for errors and returns an ACKNOWLEDGE to switch B. Switch C then breaks down the matrix path and performs an outgoing release to the called party.

6.4.2.1.4 Message Routing. Certain trunk signaling messages are transmitted on a single link basis; they are transmitted only to the next switch in the call. These messages include all types of acknowledge, trunk test, and synchronization messages.

MIL-STD-187-310

The CALL INITIATE message is routed by each successive switch. Each switch selects the outgoing trunk to be used in the completion of the call by translating the number contained in the called party field.

All other messages (except acknowledge, trunk test, synchronization, and CALL INITIATE) retrace the route initially selected for the CALL INITIATE. When a switch receives one of these messages referring to a particular trunk, it determines if a connection is either reserved or established to another interswitch trunk. If there is, the received message will be transmitted through the TSB serving that other trunk. The only exception to this rule, in addition to those noted above, is the ALL TRUNKS BUSY message, which causes the receiving switch to attempt alternate routing before propagating the message back towards the calling party.

6.4.2.1.5 Message Acknowledgement. In order to ensure reliable communications in a noisy environment, it must be possible to repeat trunk signaling messages which are received with errors. The switch will utilize a message acknowledgment scheme to facilitate retransmission.

Most trunk signaling messages transmitted by the switch (exceptions being acknowledgment and SYNC A and B messages) will be acknowledged. When switch A sends a message to switch B, it will expect to receive some sort of acknowledgment from B. This acknowledgment will indicate whether or not the message had been received without errors.

Four types of acknowledgement messages will be used: ACKNOWLEDGE, indicating that the message has been received without errors; NON-ACKNOWLEDGE, the message has been received with errors; GLARE, a simultaneous seizure has been detected; and OUT-OF-SERVICE, the requested trunk has been marked out of service.

The message being acknowledged will be identified by the message number contained in the acknowledgment messages. Each message (with the exception of the acknowledgment messages and certain synchronization messages) transmitted by the switch over a given signaling channel is assigned a message number in chronological sequence. If a given message is formatted with message number N, the next new (as opposed to repeated) message created by the switch for transmission over that signaling channel will be assigned the message number N + 1. If N happens to be the largest number which can be carried in the message number field, the next message will be assigned the number 0, the next, 1, then 2, etc. Every switch assigns message numbers independently of every other switch in the network. There will be no particular relationship between the numbers assigned at the two ends of the same signaling channel. Similarly, there will be no relationship between numbers being assigned for different signaling channels on the same switch.

The message number carried in the acknowledgment messages will be copied from the message number field of the message being acknowledged.

When a trunk signaling message (other than acknowledgment) is transmitted, the sending switch will expect to receive some acknowledgment. If an ACKNOWLEDGE is received, the message has been correctly received by the other switch and will not have to be retransmitted. If a NON-ACKNOWLEDGE is received, the message has also been received, but with at least one detectable error. Upon receipt of the NON-ACKNOWLEDGE, the switch will retransmit the indicated message. The retransmitted message will be identical to the original transmission, including message number. A message number is assigned to a message when it is formatted for its first transmission, and it keeps that same number for any retransmissions.

If the transmission medium causes errors in a message to the extent that even a NON-ACKNOWLEDGE cannot be returned, no acknowledgment to the message will be received. To handle this event, an acknowledgment time-out must be defined. When a switch transmits a message which requires an acknowledgment, it will start a timer. If that message is not acknowledged (by any of the acknowledgment messages) by the end of the time-out, that message will be retransmitted. The time-out must be short enough that a missed message does not cause excessive call completion delay, but long enough that messages are not retransmitted needlessly. A time-out of 3 seconds (+10%) appears to meet both criteria adequately.

In a very noisy environment, it may be necessary to transmit a message several times before it is correctly received. A maximum number of retransmission must be specified, however, because after so many tries, the most reasonable assumption is that there is a failure in the common signaling channel, rather than in the transmission medium. If a message is still not acknowledged after five retransmissions, the call will be released.

6.4.2.1.6 Trunk Numbering and Selection. Because for common channel signaling one signaling channel controls a number of trunks, it is essential that most types of trunk signaling messages specify uniquely which trunk is being acted upon. The CALL INITIATE message must tell the receiving switch which trunk has been selected for the call being attempted; the RELEASE message must indicate which trunk is no longer needed.

Each trunk in an interswitch trunk group must be assigned a trunk number, which must be the same at both ends.

MIL-STD-187-310

Each type of call selects types of trunks in a particular order. For example, a nonsecure analog call would select voice nonsecure trunks before voice secure trunks. Also, the order of trunk selection within a type must be defined. The simplest technique would be a top-down search: start with the lowest trunk number and proceed to the larger numbers. If both switches connected to an interswitch trunk group cluster use the same selection order, excessive glare (simultaneous seizure of a trunk from both ends) will result. If both switches need a trunk at the same time, they would invariably select the same trunk and a glare condition would result.

In order to minimize the incidence of glare, the switch class-marked for a given interswitch trunk group cluster to accept GLARE will select trunks in that group using a bottom-up search.

6.4.2.1.7 Message Processing. This section concentrates on the functions performed by the various trunk signaling messages. It defines the manner in which the various message fields and subfields are set for transmission and how they are interpreted on reception.

6.4.2.1.7.1 Call Initiate. When the switch determines that it must route a call via an interswitch trunk, it will format a CALL INITIATE message (Figure 5.4.3) for transmission over the common signaling channel which serves that trunk. This message is the longest message, containing 32 bytes of 8 bits each. In addition to the message number and trunk number fields, the CALL INITIATE message contains five important fields. The called number field carries the most critical information of the CALL INITIATE message, the address of the called party. The originating node field identifies the switch of the calling party or extraswitch trunk. The call number field carries the message number selected by the switch identified in the originating node field. The miscellaneous information field contains a wide variety of information necessary for the proper initiation of a call, such as precedence, security, special restrictions, and whether the call is voice or data. The path delay or data characteristics field carries either the path delay of a voice call or the data characteristics of a data call.

6.4.2.1.7.2 Call Complete. A CALL COMPLETE message (Figure 6.4.4) will be returned by a terminating message or intermediate switch in response to a received CALL INITIATE when it has determined that the called party can be rung, or when it has completed outgoing signaling to an extraswitch trunk.

If the switch receiving the CALL INITIATE is the terminating switch of the call (the called party is a local subscriber), the called party will be rung and the terminating switch will return ringback to the calling party (except in the case of an alldigital path between calling and called parties, in which case ringback will be generated at the

MIL-STD-187-310

calling terminal, as per the Digital Loop Signaling Plan described in paragraph 6.4.4.1). If the called party is a ringdown subscriber, it will be rung and a 2-second burst of ringback will be sent over the trunk from a sender; the called party will then be connected to the trunk.

If the switch receiving the CALL INITIATE message is an intermediate switch (i.e., the called termination is an extraswitch trunk), the processing is determined by the particular external interface involved. In general, if the extraswitch trunk is to an automatic switch (TTC-38, AUTOVON, etc.), ringback will be returned by the automatic switch, and so the incoming trunk will be connected to the extraswitch trunk as soon as outgoing signaling is completed. If the extraswitch trunk is to a manual switchboard (SB-22, common battery trunk, etc.), ringback will be provided by the automatic switch, in a manner analogous to the terminating switch case.

The message number and trunk number fields will be set as discussed previously. Since the CALL COMPLETE must retrace the route selected for the CALL INITIATE, the trunk number field will be copied from the CALL INITIATE.

6.4.2.1.7.3 Call Answer. A CALL ANSWER message (Figure 6.4.5) will be sent in the calling direction from a terminating or intermediate switch in a call when it receives an indication that the called party has answered. This indication may be an off-hook from a local subscriber, or answer tone or its equivalent from an extraswitch trunk.

When CALL ANSWER is received at an intermediate switch, a CALL ANSWER shall be transmitted toward the calling party. No other processing is required.

When a CALL ANSWER is received at the originating switch, the processor will consider that call to be in the answered phase. This information is necessary to achieve correct processing of certain types of calls; e.g., preprogrammed conferences.

6.4.2.1.7.4 Release Messages. The function of each release message is to terminate a call and to return reserved and busy trunks, matrix paths, and common equipment to the idle pool. Three types of release messages will be used by the switch: CALL RELEASE, PREEMPT RELEASE, and BUSY RELEASE (Figure 6.4.5).

The CALL RELEASE message will be sent when either the calling or called party releases the call. Thus, when an originating or a terminating switch receives an on-hook indication from the calling or the called party, or when an intermediate switch receives a release from an extraswitch trunk, that switch will release the matrix paths and common equipment used for the call and will transmit the CALL RELEASE message.

MIL-STD-187-310

When a CALL RELEASE is received at an intermediate switch, it shall release the matrix path and perform the appropriate release procedure for the extraswitch trunk.

PREEMPT RELEASE will be sent when a TTC-39 determines that it must release an interswitch trunk call in order to free equipment needed to complete a call of higher precedence. PREEMPT RELEASE may be initiated by any switch in a call. If initiated by an intermediate, it shall propagate in both directions through the DCS network.

Like CALL RELEASE, the PREEMPT RELEASE causes the release of matrix paths as it is received. An extraswitch trunk will be sent the appropriate preempt indication (which varies with the type of trunk). When this indication is received at an originating or terminating switch, the calling or called party shall receive a burst of preempt tone followed by release.

BUSY RELEASE will be sent to indicate that the call must be terminated because of a busy condition. This message differs from ALL TRUNKS BUSY in that the latter indicates that the call must be rerouted because of a busy condition; whereas BUSY RELEASE obviates the possibility of rerouting; it summarily terminates the call.

6.4.2.1.7.5 Acknowledgment Messages. The acknowledgment messages (Figure 6.4.6) are used to facilitate the retransmission of trunk signaling messages received in error. Four types of acknowledgment messages shall be used: ACKNOWLEDGE, NON-ACKNOWLEDGE, GLARE, and OUT-OF-SERVICE.

- a. To be "syntactically correct," a received message must satisfy the following conditions:
 - (1) It must have a SOM character and EOM character.
 - (2) It must be free of any "parity error" characters.
 - (3) It must have correct message parity.
 - (4) The message type field must indicate a defined message type.
 - (5) The message must contain the number of characters appropriate for its type.
- b. In order for a message with syntax errors to be returned a NON-ACKNOWLEDGE message, another set of conditions must be satisfied.

- (1) The message must possess a SOM character.
- (2) There must be at least six characters received (otherwise, the received message is probably an acknowledgment).
- (3) The message number field (assumed to be the third and fourth characters of the message) must not contain "parity error" characters.

- c. A glare situation may occur when two switches connected by an interswitch trunk group seize the same trunk simultaneously. In order to accommodate this situation, one of the two switches at the ends of every signaling trunk should be classmarked to "accept glare."

6.4.2.1.7.6 Call Incomplete Messages. A call incomplete message shall be returned in response to a received CALL INITIATE when any of a number of conditions is encountered which makes the completion of the call impossible. In these cases, the appropriate call incomplete message shall be returned in place of the CALL COMPLETE message. Six call incomplete messages (Figure 6.4.5) shall be used: CALLED PARTY UNAVAILABLE, ALL TRUNKS BUSY, EQUIPMENT BUSY, UNASSIGNED LOOP, INCOMPATIBLE CONNECTION, and INVALID ROUTE.

A terminating switch will return CALLED PARTY UNAVAILABLE when it determines that the called party is busy on a call of equal or higher precedence. When CALLED PARTY UNAVAILABLE is received at any switch in the call, all reserved matrix paths and common equipment will be released and the copy of the CALL INITIATE awaiting completion shall be destroyed. When received at the originating switch, the calling party will be sent line busy tone.

An ALL TRUNKS BUSY message will be returned by a circuit switch to which routing control has not been spilled forward when that switch determines that it cannot route the call because all trunks are busy on calls of equal or higher precedence. When a switch receives ALL TRUNKS BUSY, it will attempt to perform alternate routing using the copy of the relevant CALL INITIATE message.

EQUIPMENT BUSY will be returned by the terminating switch when the called party is idle or preemptible but the equipment necessary to effect a connection (matrix path, A/D conversion equipment, etc.) is not. EQUIPMENT BUSY is sent only when the necessary equipment does exist at the switch, but is simply unavailable. EQUIPMENT BUSY will be processed at other switches exactly as CALLED PARTY UNAVAILABLE, except that trunk busy will be sent rather than line busy.

MIL-STD-187-310

UNASSIGNED LOOP will be returned by the terminating switch when the loop number contained in the called number field is not assigned at that switch. This message will be processed at other switches exactly as CALLED PARTY UNAVAILABLE, except that the "out-of-service" recorded announcement will be sent rather than line busy.

INCOMPATIBLE CONNECTION will be returned by the terminating switch when the called party's classmarks indicate that it is incompatible with the call characteristics as represented in the CALL INITIATE message. The INCOMPATIBLE CONNECTION message will be processed at other switches exactly as CALLED PARTY UNAVAILABLE, except that error tone will be sent rather than line busy.

INVALID ROUTE (Figure 6.4.7) will be returned by the switch in response to a CALL INITIATE message which contains an area or switch code which is not contained in its translation tables. That switch will print the CALL INITIATE message at the Switch Supervisor Position. The rejecting node field of the INVALID ROUTE message will be sent to the area and switch code of the switch which could not route the call. The INVALID ROUTE message will be processed at other switches exactly as INCOMPATIBLE CONNECTION, except that the INVALID ROUTE message and the referenced CALL INITIATE will be printed at the Switch Supervisor's position.

6.4.2.1.7.7 Synchronization Messages. Synchronization messages (Figures 6.4.7 and 6.4.8) will be used in the initial synchronization, monitoring for maintained synchronization, and resynchronization. Three synchronization messages will be used: SYNC A, SYNC B, and TEST SYNC. SYNC A or SYNC B will be sent by a switch when it believes that it has lost synchronization over a signaling channel. SYNC A will differ from SYNC B in the comprehensiveness of the sync procedure.

TEST SYNC will be transmitted to verify the establishment or maintenance of synchronization. If an ACKNOWLEDGE message is returned in response to a TEST SYNC message, the switch will assume that the signaling channel is synchronized.

6.4.2.1.7.8 Trunk Test Messages. The trunk test messages will be used by the switch to verify the operability of interswitch trunk groups on a trunk-by-trunk basis. These tests will be performed under the direction of diagnostic, rather than call processing, software. Two test messages will be used: LOOP BACK TRUNK and LOOP BACK COMPLETE.

The LOOP BACK TRUNK message will be sent by the switch initiating the test. Upon receipt, the adjacent switch will connect the referenced trunk back upon itself (connect inlet to outlet). Upon completing this connection, the switch will return a LOOP BACK COMPLETE message. The switch initiating the test will then send a tone over the trunk, detect it, and will then send CALL RELEASE, ending the test.

6.4.2.1.7.9 Special Messages. Special messages (Figure 6.4.5) are simply those messages which are used to perform certain functions under special call conditions which do not fit into other message categories. At present, only a single message, OPERATOR RECALL, is defined. The OPERATOR RECALL message will be sent by either the originating or terminating switch in a secure call when the calling or called party, respectively, initiates a recall to the operator. This message will propagate to the other party in the call. The function of the message is to break down the end-to-end encryption of the call to link-by-link, so that both parties may talk to the switch attendant while maintaining security. When a terminating or originating switch receives this message, it will take the required actions to effect link-by-link encryption.

6.4.2.2 CONUS DCS S/S. The interswitch signaling for CONUS DCS has not been fully defined. As mentioned earlier, a study contract will investigate and recommend cost-effective signaling techniques for implementation in certain existing AUTOVON switches which are to be modified to permit digital operation and digital signaling. The three alternatives under study include: the AN/TTC-39 interswitch digital S/S; the AT&T version of CCITT #6; and a proposed Federal Standard on common channel signaling known as F6, developed by DCEC.

Should DCA decide (after completion of the study) to adopt the AN/TTC-39 signaling plan for CONUS, then this section of the planning standard would be exactly like the previous section. If DCA adopts either of the other signaling plans, a new section will be developed for CONUS signaling, and in addition, there should be other sections addressing the CONUS/overseas interface.

Until that decision is made, the interswitch CONUS S/S can be described with the following characteristics:

- a. It will be digital, which can be transmitted over digital or analog transmission facilities.
- b. It will be out-of-band signaling, requiring a channel between every pair of modified switches to be dedicated for signaling purposes.
- c. It will consist of formatted signaling units or messages which require bit, character, and block synchronism.
- d. It will incorporate error control techniques.
- e. It will incorporate all the necessary signals to set up all the different types of calls which are currently possible for

MIL-STD-187-310

secure and clear voice service, with all the attributes of each call; e.g., precedence, preemption, conferencing, security, etc.

6.4.3 Access Line Signaling and Supervision

6.4.3.1 Interfaces. The simple definition of an access line is that it is a circuit other than an interswitch trunk which terminates at a backbone switch. As such, there are several interfaces whose signaling and supervision characteristics must be considered for a standard:

- a. Digital Access Exchange (DAX) to/from digital backbone switch (assuming that CONUS will be identical to overseas)
- b. DAX to/from other DAX
- c. DAX to/from analog PBX
- d. Directly connected digital subscriber to/from digital backbone switch (There will be differences between the CONUS and overseas S/S.)
- e. Analog PBX to/from digital backbone switch
- f. Directly connected analog subscriber to/from digital backbone switch.

6.4.3.2 DAX To/From Digital Backbone Switch. The S/S for this interface has not been fully defined; however, it is anticipated that the CONUS and overseas portions of DCS will be exactly alike. Furthermore, it is anticipated that the signaling and supervision plan currently being developed by TRI-TAC for the Unit Level Switch (ULS) program [c] will play a decisive role in the S/S chosen for the DAX. The S/S is expected to be of two types:

- a. Out-of-band signaling in which eight or more access lines are in the group to the switch.
- b. In-band signaling in which seven or less access lines are in the group to the switch.

6.4.3.2.1 Out-of-Band S/S. For access line signaling to a backbone switch using a dedicated channel, the DAX is expected to utilize the identical scheme as will be used on interswitch trunks at overseas switches, and described in paragraph 6.4.2.1. Security protection for the S/S information may be provided on a link basis.

6.4.3.2.2 In-Band S/S. This method of access line signaling is specified in reference [c] and is an extension of the loop signaling plan described later in paragraph 6.4.3.5.1, with certain modifications which have not been fully defined. In essence, the S/S will utilize formatted messages transmitted in-band over the access line which will be used as the voice path. The messages will comprise codewords; these codewords will represent message types, control signals, supervisory signals, information signals, terminal characteristics, and call features.

The signaling messages are sent (a codeword at a time followed by a delimiter) from the originating DAX processor using a codeword generator which will encode the stream for error protection. A codeword when received at the destination DAX will be decoded by a receiver register which performs error detection and forwards the codeword to the processor. The codewords will be chosen to be 8-bit permutable with even parity. It is anticipated that the in-band S/S will be performed in the clear.

6.4.3.3 S/S Between DAX's. It is not certain that connectivity between DAX's will be established, because the DAX may not be capable of alternate routing. However, if connectivity is provided, the S/S will be implemented on a tieline basis, requiring the use of an exit code and a second dial tone. A signaling scheme for inter-DAX signaling has not been specified; however, applicable portions of the AN/TCC-39 Loop Signaling Plan [d] could be used.

6.4.3.4 DAX To/From Analog PBX. The capability to terminate analog lines at a DAX is considered to be a second level requirement, to be implemented if proven to be cost-effective. If it is decided to implement that capability, the S/S to accommodate such service must be developed at that time.

6.4.3.5 Directly Connected Digital Subscriber To/From Digital Backbone Switch. It is anticipated that all digital subscribers will be equipped with a Digital Subscriber Voice Terminal (DSVT) which will be unmodified for overseas use, but will have certain changes incorporated for use in CONUS. Some of these modifications between the DSVT and the digital backbone switch will result in differences in the S/S schemes of the overseas and CONUS.

6.4.3.5.1 DSVT Signaling in Overseas. The S/S to be employed overseas between a DSVT and a backbone switch will be similar to the signaling currently specified in the Loop Signaling Plan for the AN/TTC-39 circuit switch and its directly connected subscribers. This plan is described in reference [d] and will not be repeated here. Some of the characteristics of this plan are:

MIL-STD-187-310

- a. It will provide secure address signals.
- b. It consists of digital codewords and digitized tones which indicate all necessary signals to set up and release all necessary types of calls.
- c. It provides a nonsecure warning tone when any part of the connection is not secure.
- d. It incorporates capabilities for two-party, conference (progressive, broadcast, and preprogrammed), direct access, sole user and circuit switch data terminal access.
- e. Its codewords are chosen from a set of cyclical permutable words which require only bit synchronization, but no word or character synchronization.
- f. It does not incorporate error control procedures.
- g. It provides a digital-to-analog signaling capability as long as the digital/analog conversion is provided at the switch.
- h. It provides for S/S for a dual voice/data terminal.

6.4.3.5.2 DSVT Signaling in CONUS. The DSVT will be provided to secure voice subscribers who will be terminated at the AUTOVON switches, which will be modified for digital operation. Basically, the S/S for these subscribers will be the same as for overseas, with the following exception.

The DSVT will be modified so that clear and secure calls can alternately be placed from the same instrument. As a consequence, a signal to indicate when the call is to be in the clear or secure must be incorporated into the S/S plan.

6.4.3.6 Analog S/S. Analog PBX's and analog directly connected subscribers terminated on a digital backbone switch will interface with the analog portion of that backbone switch and will employ analog signaling and supervision techniques. Those techniques are well documented in DCA circulars and need not be repeated here.

6.4.4 Loop Signaling. A loop is herein defined as a circuit between a lower level switch, i.e., DAX or PBX, and an individual user. It is anticipated that all loop signaling and supervision will be performed in-band regardless of the characteristics of the end instrument. Three possible interfaces have been identified over which loop S/S can occur:

- a. Digital user to/from DAX
- b. Analog user to/from DAX
- c. Analog user to/from analog PBX.

6.4.4.1 Digital Loop S/S. The digital loop signaling plan for the DCS has not been fully defined, but it is expected that this plan will resemble very closely the S/S plan used between a DSVT and a backbone switch [d]. It is expected that the CONUS and overseas portions will be identical and the plan will incorporate provisions for clear signaling by the user when placing a clear or a secure voice call.

6.4.4.2 Analog User on the DAX. The capability to terminate analog users at a DAX was stated as a second level requirement which would be implemented if proven to be cost effective. The S/S to effect such an interface will be developed when such a decision is made.

6.4.4.3 Analog Loop S/S. Analog users terminated on analog PBX's employ analog loop signaling techniques which are well documented in DCA circulars, and will not be repeated here.

6.4.5 References

- [a] Performance Specification, Central Office, Communications, Automatic, AN/TTC-39 () (v), Specification Number TT-B1-1101-0001A, 7 June 1974, as amended.
- [b] Sylvania Electronic Systems, System Requirement 118, Operational Specification for AN/TTC-39 Interswitch Trunking.
- [c] Appendix III, Digital Common Channel Trunk Signaling/Supervision, to Specification No. TT-B1-1201-0030, Central Office, Telephone, Automatic, AN/TTC-42(V)1-2.
- [d] Appendix II, AN/TTC-39, Digital Loop Signaling and Supervision Specification (U), to Specification No. TT-A3-9002-0017, AN/TTC-39 Circuit Switch/TENLY COMSEC Module Interface Specification, 14 March 1974 (CONFIDENTIAL).

CHAPTER 6

SECTION 5

ROUTING

6.5.1 Introduction. The current routing methods employed in the DCS CONUS and overseas AUTOVON networks are briefly described in paragraphs 6.5.2 and 6.5.3 below for reference purposes. Additional details are contained in reference [a] for CONUS and reference [b] for overseas. Future overseas circuit-switched DCS networks will employ the AN/TTC-39 switch. The AN/TTC-39 routing methods described in paragraph 4 are based on data from the switch contractor [c]. The routing methods of the future CONUS network will be based on the recommendations from an ongoing study and will most likely represent some degree of combining both the AN/TTC-39 and the current CONUS AUTOVON polygrid routing features.

6.5.2 CONUS AUTOVON Routing

6.5.2.1 General Description. The CONUS AUTOVON Network uses a polygrid routing plan based on the general network structure illustrated in Figure 6.5.1. Most switching centers in the network will have direct trunk groups available from six adjacent centers. Additional trunk groups available to the next closest surrounding centers provide a basic grid configuration called the "Home Grid," as shown in Figure 6.5.2.

The basic polygrid structure is overlaid with a system of long-haul trunk groups to minimize the number of links required on long-haul calls. The distribution of long-haul trunk groups is based on load sensitivity.

6.5.2.2 Routing Procedures. Each switching center can be programmed for up to 10 possible trunk routes to each center, exterior to the originating center home grid. The first route is a single trunk group direct to the destination center, where available. Following the direct trunk group are three alternate trunk group "triples." The first is called the most direct triple and normally represents a set of three forward routes. The second group is called the best alternate triple, and the third is designated the second best alternate triple. Both the first and the second best alternate triples normally represent lateral routes.

Switching centers on the home grid of the destination center can be programmed for seven possible trunk routes; the first is a direct trunk group, which is followed by two alternate trunk group "triples."

MIL-STD-187-310

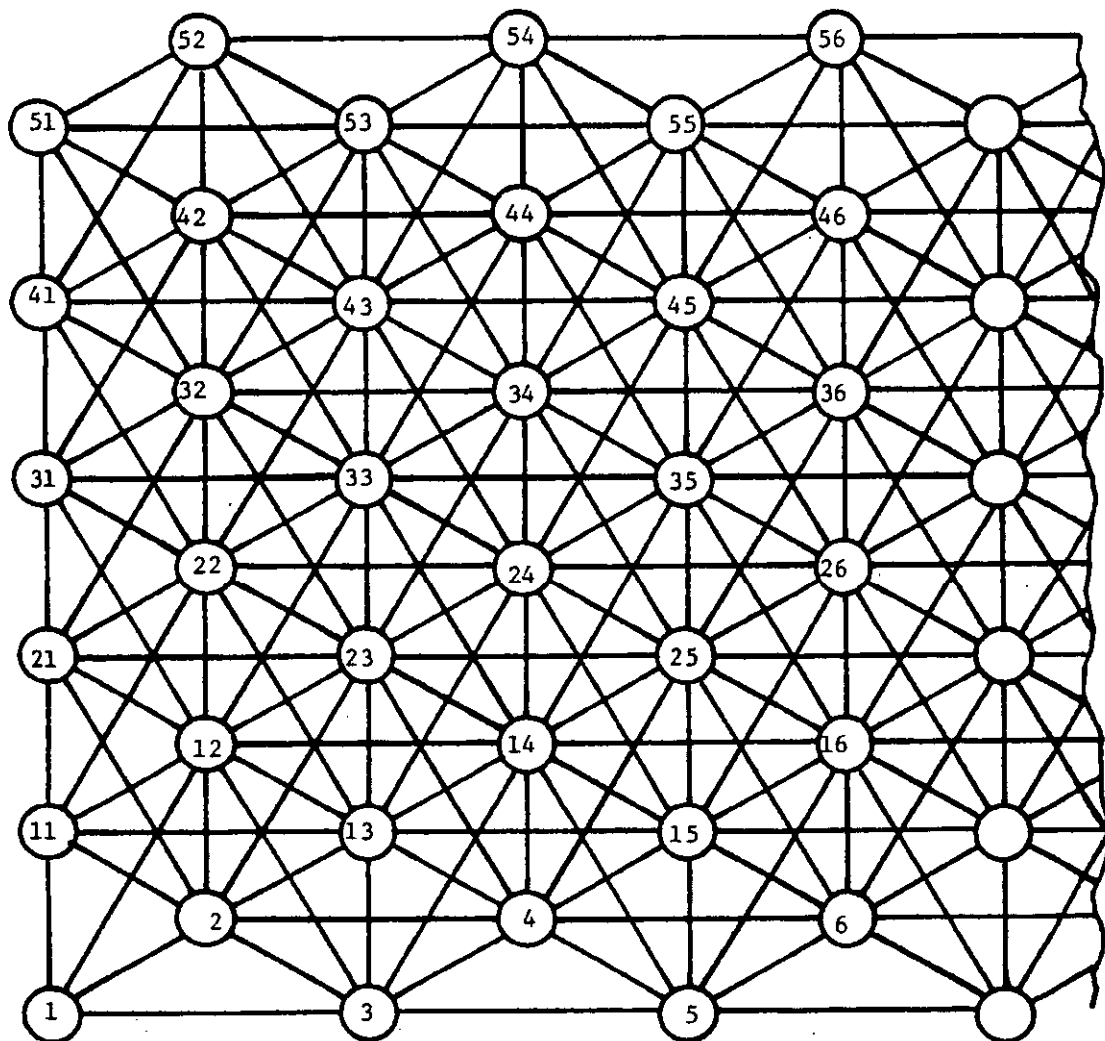

FIGURE 6.5.1 Basic Pattern of Polygrid Network Structure

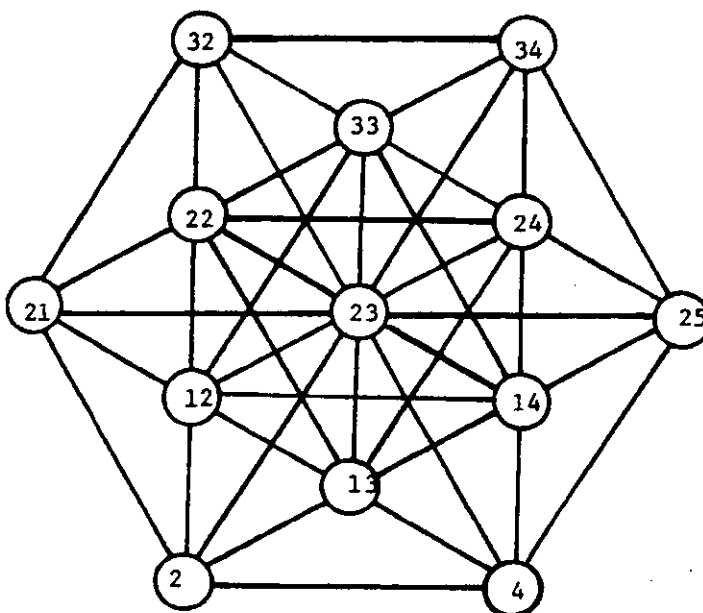

FIGURE 6.5.2 Home Grid Array

MIL-STD-187-310

Centers on the periphery of the home grid are limited to five programmed trunk routes, as all other routes would be away from the destination.

6.5.2.3 Route Control Principles. The polygrid route control principles require that all programmed trunk routes be either forward or lateral. Forward routing is defined as advancing a call to a switching center which is geographically nearer the destination, in a greater degree than an established minimum. Further, to meet the definition for forward routing, there must be no traffic programmed for that destination in the reverse direction over the trunk group in question. Lateral routing is defined as routing a call to a switching center that does not advance the call geographically by the factor required for forward routing.

Route control in the polygrid network depends on the use of a route control digit. The route control digit is a decimal digit (0 to 3) transmitted over the interswitch trunks to impose restrictions on the next switch's trunk selection. The meanings of the route control digits are listed in Table 6.5.1 for switches exterior to the home grid, and in Table 6.5.2 for the home grid. The route control digits are in general assigned by the following rules:

- (1) Calls routed over a forward trunk will be accompanied by a 0 route control digit and will impose no routing restrictions at the next switch.
- (2) Calls routed over a lateral trunk from an originating switch or a switch having received the call with a 0 route control digit, will assign either a 1 or 2 route control digit to the call. The 1 or 2 is selected so as to eliminate any programmed triple in the next switch that could result in "shuttle."
- (3) Calls routed over a lateral trunk from a switch having received the call with a 1 or 2 will assign a 3 route control digit to ensure forward routing at the next switch.

6.5.2.4 Precedence Routing. Calls of a Routine precedence are restricted to only forward routes, with the exception of one allowable lateral in the home grid (see Tables 6.5.1 and 6.5.2). This restriction is imposed to ensure that the most efficient routing is employed for the very large share of calls placed at Routine precedence. Calls placed at Priority, Immediate, Flash, or Flash-Override precedence will be routed based on an initial idle search of the forward routes only. If all forward routes are busy, a precedence search will be employed using the full polygrid routing capabilities as described above.

TABLE 6.5.1 ROUTE CONTROL DIGIT MEANINGS EXTERIOR TO HOME GRID

ROUTINE CALLS (P4)

- 0 USE DIRECT ROUTE PLUS MOST DIRECT TRIPLE
- 1 USE DIRECT ROUTE PLUS MOST DIRECT TRIPLE
- 2 USE DIRECT ROUTE PLUS MOST DIRECT TRIPLE
- 3 USE DIRECT ROUTE PLUS MOST DIRECT TRIPLE

NON-ROUTINE CALLS (PO-P3)

- 0 USE ALL PROGRAMMED ROUTES
- 1 USE DIRECT ROUTE PLUS MOST DIRECT TRIPLE
PLUS BEST ALTERNATE TRIPLE
- 2 USE DIRECT ROUTE PLUS MOST DIRECT ROUTE
PLUS SECOND BEST ALTERNATE TRIPLE
- 3 USE DIRECT ROUTE PLUS MOST DIRECT TRIPLE

MIL-STD-187-310

TABLE 6.5.2 ROUTE CONTROL DIGIT MEANINGS IN HOME GRID

ROUTINE CALLS (P4)

- 0 USE DIRECT ROUTE PLUS BEST ALTERNATE TRIPLE
- 1 USE DIRECT ROUTE ONLY
- 2 USE DIRECT ROUTE ONLY
- 3 USE DIRECT ROUTE ONLY

NON-ROUTINE CALLS (PO-P3)

- 0 USE ALL PROGRAMMED ROUTES
- 1 USE DIRECT ROUTE PLUS BEST ALTERNATE TRIPLE
- 2 USE DIRECT ROUTE PLUS SECOND BEST ALTERNATE TRIPLE
- 3 USE DIRECT ROUTE ONLY

6.5.3 Overseas AUTOVON Routing

6.5.3.1 General Description. The overseas AUTOVON network structure is largely determined by geographic and transmission availability limitations. The resulting network does not have the geometric properties required to employ a formulated routing philosophy such as that used in the CONUS AUTOVON. The overseas AUTOVON routing program is based on an evaluation of the relative merits of the available routes toward each destination switch.

6.5.3.2 Routing Procedures. Each switch may be programmed for one to three routes to each other switch in the network. Where more than one route is programmed, calls that cannot be completed on the first or most efficient route overflow automatically to the second, and from the second to the third. Each programmed route may comprise channels with more than one physical route to enhance survivability.

6.5.3.3 Route Control Principles

6.5.3.3.1 Originating Office Control. The originating office (AUTOVON switching center serving an originating subscriber) controls the routing of the call. It recognizes a service treatment indication and then offers the call to the first engineered route, determined by translation of the terminating office code, on a friendly basis. If no circuit is available to the called point on that route, the originating office directs the call to the second engineered route, on a friendly basis, if there is one, and then to the third if unable to complete the call on the second engineered route. After all routes are exhausted on the friendly search, the switch then returns to the first engineered route to search all routes on a preemptive basis.

6.5.3.3.1.1 Early Cut-Through. A call may be extended from AUTOVON Switching Center to AUTOVON Switching Center by forwarding to each succeeding switch only as many confirmed digits (three or six digits) as are necessary to select a route. Each time a succeeding switch is entered, the necessary portion of the address is retransmitted from the originating switch. The succeeding switch attempts to forward the call on a friendly - then a preemptive - search, only on the first engineered route. If the call cannot be forwarded on the first engineered route the switch returns a trunk-busy (TB) signal to the originating office, and the originating office then attempts to forward the call on the next programmed route. If no trunks are available in any programmed route, either a trunk-busy tone or an announcement will be returned to the originating line or trunk by the originating switch.

6.5.3.3.1.2 No-Early Cut-Through. When extending a call to an intermediate AUTOVON switching center where the mode of signaling will change from confirmation to nonconfirmation, or where it is necessary to search

MIL-STD-187-310

all routes for an available trunk while retaining control from the originating switch during search, a service treatment indication on the trunk group at the intermediate center will permit receipt of all address digits and search of all routes for an available trunk. If an available trunk is found, the intermediate switch will return an ST signal, releasing the register in the originating office, and the intermediate office will assume control, i.e., control of the call is spilled forward from the originating to the intermediate office (see paragraph 6.5.3.3.2). If no trunk is available in any route searched at the intermediate switch, a trunk busy signal is returned to the originating switch, which will release the intermediate office trunk and attempt to complete the call on the next programmed route.

6.5.3.3.2 Spill-Forward Feature. Certain switching centers will have fewer trunk groups than most, thus limiting their relative ability to complete calls. To minimize this limitation, such offices will spill-forward control of their calls to an intermediate office with a larger number of groups. This intermediate office (the spill office) will treat such calls as if they had been originated by its own subscribers; that is, it will try to complete a call via all its programmed routes, if necessary, rather than via its first engineered route only.

6.5.3.3.2.1 Spill-Forward Service Treatment Indication. A service treatment indication to the spill office on a particular trunk group will instruct the spill office to accept the complete telephone address digits from the originating office. The spill office will then search all of its programmed routes for an idle trunk.

6.5.3.3.2.2 Spill-Forward from CONUS Gateway to Overseas Gateway Offices. Calls coming from CONUS via any of the overseas gateway offices will spill forward to that gateway office. The latter will then search all its programmed routes to the terminating office.

6.5.3.4 Precedence Routing. An office finding all trunks busy on all engineered routes toward the called point that it is programmed to search will:

- a. On precedence calls, again search the engineered routes and preempt the first trunk tested on which a lower precedence call is in progress. If no trunk can be preempted, the precedence call is routed to a recorded announcement.
- b. On ROUTINE calls, return all trunks busy indication.

6.5.4. AN/TTC-39 Routing. The AN/TTC-39 will provide considerable routing flexibility, allowing it to handle a mixture of various types of subscriber terminals and transmission media, and to interface with various other systems (AUTOVON, AN/TTC-38, AN/TTC-25, etc.). The

MIL-STD-187-310

general routing procedures with an AN/TTC-39 based network are provided in the following subparagraphs.

6.5.4.1 Routing Procedures. Each AN/TTC-39 may be programmed for one primary and up to five alternate trunk group clusters (TGC) for each destination switch or area code. Each TGC comprises a set of trunks interconnecting two switching nodes. A TGC may contain up to five different types of trunks: VN - 4 kHz nonsecured voice; VS - 4 kHz secured voice; WN - nonsecured wideband; WS - secured wideband; and D - digital at digital matrix loop rate (16 or 32 kb/s).

On calls originated by a local subscriber or locally connected PBX, the AN/TTC-39 shall search the primary and all alternate TGC's in turn for an idle trunk. Within each TGC, the order of search through the various types of trunk groups is determined by the originator class-marking (see Table 6.5.3). The first idle trunk will be selected and a CALL INITIATE message will be forwarded via the TGC CCIS channel. If the call is subsequently blocked within the network, an ALL TRUNKS BUSY message will be returned and the originating switch search will be resumed with the next TGC. An ALL TRUNKS BUSY signal will be provided to the originator upon exhausting all alternate routes.

On calls not destined for a local subscriber and received over a trunk from a distant node, the AN/TTC-39 shall operate as an intermediate node. The AN/TTC-39 may be classmarked to utilize either its alternate route capability or only its primary TGC, when acting as an intermediate node. The order of search within a TGC is specified in Table 6.5.4, with the call type being determined from traveling classmarks provided via the CCIS channel.

6.5.4.2 Route Control Principles

6.5.4.2.1 Originating Office Control. Route control within an AN/TTC-39 network will normally be exercised by the originating switch. Intermediate nodes in a connection will not accomplish alternate routing on receipt on an ALL TRUNKS BUSY message. The message will be retransmitted back through all intermediate nodes to the originating switch. On receipt, the originating switch shall attempt to use its allowable alternate routes, if any, to complete the call. Trunk selection shall pick up from where it left off.

6.5.4.2.2 Spill Forward. Each TGC may be classmarked to allow routing control to be spilled forward to an intermediate node. If a TGC over which an incoming call is being received is marked for spill-forward operation, the receiving switch shall assume routing control and process the call as though it were the originating node. Once control is spilled forward, alternate routing shall no longer be available to switches

MIL-STD-187-310

TABLE 6.5.3 TRUNK SELECTION RULES AT AN ORIGINATING OR GATEWAY SWITCH

<u>Originator Classmark/ Call Type</u>	<u>1st Choice</u>	<u>2nd Choice</u>	<u>3rd Choice</u>	<u>4th Choice</u>	<u>5th Choice</u>
Unencrypted Analog Voice Call, nonsecure	VN	VS	WN	WS	D (CVSD)
Unencrypted Analog Voice Call, security referred	VS	WS	D (CVSD)	VN <u>1/</u>	WN <u>1/</u>
Unencrypted Analog Voice Call, security required	VS	WS	D (CVSD)		
Wideband Analog Data Call	WN	WS			
NBST Encrypted Call	VN	VS	WN	WS	D (NBST, CVSD)
KY-3 Encrypted Call	WN	WS	VS (KY-3)	D (KY-3, CVSD)	
Digital Call, nonsecure	D	VN (CVSD)	VS (CVSD)	WN (CVSD)	WS (CVSD)
Digital Call, security preferred	D	VS (CVSD)	WS (CVSD)	VN <u>1/</u> (CVSD)	WN <u>1/</u> (CVSD)
Digital Call, security required	D	VS (CVSD)	WS (CVSD)		

NOTE: Mode conversion equipment required shown in parentheses.

1/ Security of the call is lost.

MIL-STD-187-310

TABLE 6.5.4 TRUNK SELECTION RULES AT AN
INTERMEDIATE NODE WHICH IS NOT A GATEWAY

<u>Call Type</u>	<u>1st Choice</u>	<u>2nd Choice</u>	<u>3rd Choice</u>	<u>4th Choice</u>	<u>5th Choice</u>
Unencrypted Analog Voice Call, nonsecure	VN	VS	WN	WS	
Unencrypted Analog Voice Call, security preferred	VS	WS	VN <u>1/</u>	WN <u>1/</u>	
Unencrypted Analog Voice Call, security required	VS	WS			
Wideband Analog Data Call	WN	WS			
NBST Encrypted Call	VN	VS	WN	WS	
KY-3 Encrypted Call	WN	WS			
Digital Call, nonsecure	D				
Digital Call, security preferred	D				
Digital Call, security required	D				

1/ Security of the call is lost.

MIL-STD-187-310

through which the call has passed. The spill-forward feature will be used when crossing area code boundaries.

6.5.4.2.3 Traveling Classmarks. Route control at intermediate nodes shall be accomplished in accordance with the above routing procedures, in consonance with the restrictions imposed by traveling classmarks. Traveling classmarks are contained in the Common Channel Signaling (CCS) channel Call Initiate message and may require (a) the use of special grade transmission facilities, (b) the use of approved or encrypted facilities, (c) restriction on the use of satellite links, or (d) prevention of "ring-around-the-rosey" and/or shuttle.

6.5.4.3 Precedence Routing. Regardless of the precedence of a call, the AN/TTC-39 first attempts to find an idle trunk in the primary or any of the alternate TGC's. If no acceptable idle trunk is found and the call has ROUTINE precedence, the calling party shall be returned an all trunks busy (ATB) indication. If the call is above ROUTINE, a preemptive search shall be started (see Figure 6.5.3).

6.5.5 DAX Routing

6.5.5.1 Normal Routing. The DAX shall search all DAX to backbone switch trunks for precedence calls, and shall preempt a trunk that has a lesser precedence only if all trunks are busy.

6.5.5.2 DAX-DAX Routing. Where a configuration exists with a DAX to DAX tieline, provisions shall be made within the DAX's so that a DAX will first search its backbone switch trunks for lines with lesser precedence, and if none exists transfer the call to the other DAX which shall search its trunks for lesser precedence calls. If a trunk with lesser precedence exists, the second DAX shall preempt the line and provide access for the other DAX's subscriber. If all DAX trunks and tielines are busy with equal or higher precedence calls, the subscriber's DAX shall return an ALL TRUNKS BUSY (ATB) signal to its subscribers and release the subscribers' access line.

6.5.6 Routing Methods For Future CONUS Network

6.5.6.1 This paragraph will be developed after completion of the study mentioned in paragraph 6.5.1.

6.5.7 References

- [a] DCAC 370-V120-1, "CONUS AUTOVON Routing Philosophy," December 1966.
- [b] DCAC 370-V185-7, "Overseas AUTOVON Network Switching Plan," October 1967.

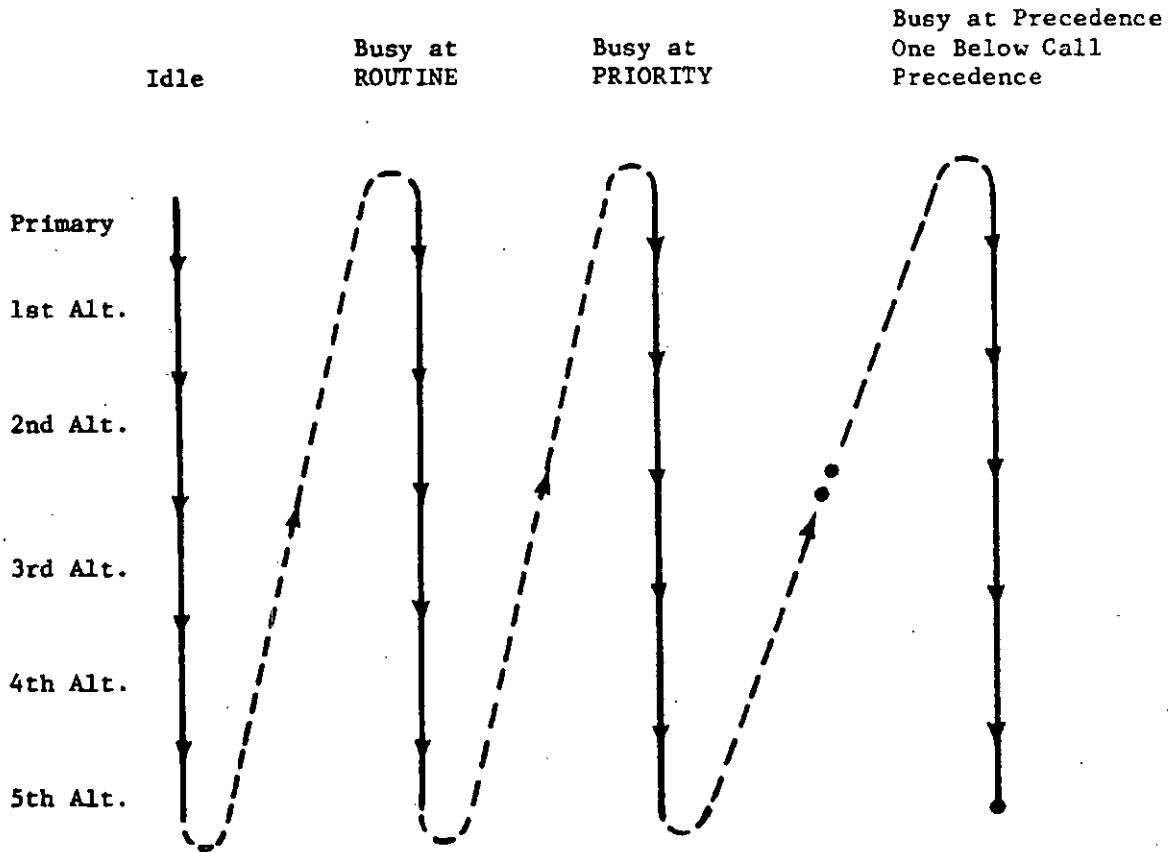

FIGURE 6.5.3 Order of Trunk Group Cluster Selection

MIL-STD-187-310

[c] Sylvania Electronic Systems, System Requirement 116, Revision B, "AN/TTC-39 Circuit Switch Routing Plan," 27 March 1975.

CHAPTER 6

SECTION 6

INTERFACES

6.6.1 Introduction. The purpose of this section is to summarize requirements for direct interface with the backbone circuit switch. Interface criteria is interpreted to include:

- a. Features. For example, features for a trunk circuit between an AUTOVON switch and an unattended PBX include E and M lead signaling, network inward dialing (NID), and network outward dialing (NOD).
- b. Functions. Using the illustration above, functions for a NOD call include call setup, disconnect, and associated signaling.
- c. Electrical Characteristics of Circuits. This includes such circuit characteristics as insertion loss versus frequency, envelope delay distortion, error rates, and error distribution. It also includes signal and circuit characteristics of a binary interface; e.g. low-level interface.
- d. Physical Arrangements. In some cases, particularly when developing specifications for new equipment which must interface with existing equipment, it is necessary to describe the interface in schematic form to show connections and arrangements of circuit components such as resistors, capacitors, and relays, and ancillary devices such as line adapters, echo suppressors, and equalizers.

6.6.2 Terminals

6.6.2.1 Clear Telephone Terminals. This is the AUTOVON basic and special purpose telephone subscriber equipment as described in reference [a]. This class of telephone instrument is a four-wire unit, requiring local battery (48 volts, 60 milliamperes nominal) power and utilizing dual tone multifrequency (DTMF) signaling, and SF supervision. This will be the normal mode of operation when this instrument is used with the AN/TTC-39. Interface criteria is specified in reference [b]. Interface criteria for this equipment when used with an analog to digital interface unit (ADI), described in paragraph 5.1.1, is yet to be specified.

MIL-STD-187-310

6.6.2.2 Secure Telephone Terminals. Several types of secure telephone terminals exist within this category.

6.6.2.2.1 KY-3. This is a 50 kb/s, pulse code modulation (PCM) encoded, full-duplex, four-wire encrypted terminal that will be terminated on the SDMX. Signaling and supervision are performed in the clear using in-band 2600-Hz SF signals, similar to standard commercial practices. On-hook conditions are represented by the presence of the 2600-Hz signal, whereas off hook as burst of 2600-Hz signal at nominal rotary dial rates. The ring signal used to signal the KY-3 of an incoming call is 1000 Hz. Further information may be found in NSA CSEEB-3A (CONFIDENTIAL).

6.2.2.2.2 NBST (Narrowband Subscriber Terminal). This is a 2400 b/s VOCODER terminal terminated on the SDMX. It operates as a full-duplex, four-wire unit with a separate encryption device and associated terminal control unit. Signaling and supervision are sent in the clear using AUTOVON compatible supervision and DTMF addressing. A telephone instrument is used to establish the call and verbally coordinate switchover to the secure mode.

6.6.2.2.3 Digital Subscriber Voice Terminal (DSVT KY-68). This class of telephone set is a four-wire unit, capable of either common or local battery operation. The design goal in the common battery configuration is to be capable of operating at distances of up to 4 km (8 km desired) from its parent switch. The DSVT, developed as part of the TENLEY program, uses CVSD analog to digital conversion. DSVT interface criteria are specified in Appendix I of reference [c]. Signaling and supervision techniques are specified in Appendix II of reference [c].

6.6.2.3 Data Terminals. These terminals include teletype, paper tape and card readers and punches, facsimile, low speed video scanner, printers, magnetic tape terminals, and imagery terminals. Data terminal performance and interface characteristics are specified in reference [d]. Circuit Switch - Data Terminal interface characteristics are specified in reference [e].

6.6.3 PBX

6.6.3.1 Backbone Switch to PBX. Backbone switch to PBX (manual and attended/unattended dial PBX's, both 4-wire and 2-wire) interface criteria is specified in reference [f].

6.6.3.2 PBX-ADI-Backbone Switch. Interface criteria remains to be specified.

6.6.4 Trunks

6.6.4.1 Interswitch Trunks. The interswitch trunks will provide the primary trunk routes among AN/TTC-39 switches. In general, these trunks

can be engineered as multipurpose voice/data grade trunks. Specifically, it shall be possible to interconnect AN/TTC-39 switches by any of the following types of trunks:

- a. Digital time-division-multiplexed (TDM) trunks
- b. Nominal 4-kHz analog trunks
- c. Special wideband (50 kb/s) analog trunks.

All interswitch trunks shall be four-wire, full-duplex circuits, and shall operate on a two-way automatic basis. These trunks may employ either digital time-division-multiplexed (TDM) trunk groups or individual analog channels combined externally via existing frequency division multiplexed (FDM) or PCM multiplexing facilities. In the case of TDM trunk groups, the group modularities shall be 8 through 72 channels per group when contained within a transmission group. In the case of analog trunk groups, the group modularity will be as required by the existing equipment. Trunk signaling and supervision is covered in Section 4, Chapter 6. The signaling and control channel is described in reference [e].

6.6.4.2 Extraswitch Trunks

6.6.4.2.1 Digital Access Exchange (DAX). Backbone switch to DAX trunk signaling and supervision is covered in Section 4, Chapter 6. Signal and circuit characteristics remain to be specified.

6.6.5 Backbone Packet Switch to Circuit Switch. Interface criteria is described in reference [g].

6.6.6 References

- [a] DCAC 370-V165-1, "AUTOVON Basic and Special Purpose Telephone Subscriber Equipment," December 1965.
- [b] DCAC 370-V175-6, "System Interface Criteria," February 1965.
- [c] Specification No. TT-A3-9002-0017, "AN/TTC-39 Circuit Switch/TENLEY COMSEC Module Interface Specification (U)," 14 March 1974, CONFIDENTIAL.
- [d] MIL-STD-188-347, "Equipment Technical Design Standards for Digital End Instruments and Ancillary Devices," 29 March 1973.

MIL-STD-187-310

- [e] Specification No. TT-B1-1101-0001A, "Performance Specification, Central Office, Communications, Automatic, AN/TTC-39 () (V)," 7 June 1974, as amended.
- [f] "System Performance Specification (Type A) for AUTODIN II, Phase I," September 1975.

CHAPTER 6

SECTION 7

CIRCUIT SWITCH CHARACTERISTICS - OVERSEAS

6.7.1 Introduction. This section is presently under development. Pending its completion, the following information is provided to indicate areas where engineering design effort is required.

6.7.2 Design Requirements. As discussed in Chapter 5, implementation of a DCS-suitable version of the AN/TTC-39 is planned for the early to mid-1980's to replace the overseas AUTOVON switches. A review of the AN/TTC-39 switch design was made and a number of design changes have been identified which must be made before the AN/TTC-39 can be effectively used in the DCS [a]. Required changes have been submitted to the TRI-TAC Office in a series of DCA Engineering Change Proposals (ECP's). These ECP's, the most recent of which is reference [b], have been technically approved by the TRI-TAC Configuration Control Board (CCB). Reference [a] also identifies aspects of the AN/TTC-39 performance requiring further analysis. These are:

- a. Capability of the switch to perform adequately required functions under a variety of switch configurations and traffic conditions. This assessment will permit determination of the common pooled equipment required per switch and the final switch configuration. Also, it will permit determination of input parameters for design of a network simulator (DCS simulator, for this purpose, being procured under PR R510-75-1/DCA/DCEC Project/Task No. 13103, P. E. 33127K).
- b. Capability of the switch to meet DCS network requirements; i.e., sizing and connectivity.
- c. Capability of the switch to interface with the DCS DAX and with digital voice terminals terminated on a DAX, and operating interchangeably in a clear voice or secure voice mode.
- d. Capability of the AN/TTC-39 common-channel signaling system to meet DCS requirements.
- e. Capability of the switch common-channel signaling scheme to accommodate all necessary analog routing features in the AUTOVON backbone role.

MIL-STD-187-310

- f. Use of an E&M interface between the switch and the supervision unit on AUTOVON interswitch trunks, AUTOVON PBX access lines, and subscriber access lines versus the SF supervision technique.
- g. Capability for employing a loop extension method to meet DCS loop length distributions.
- h. Ability to perform A/D conversions with satisfactory performance must be evaluated and related to the operational deployment concepts, to include the impact of A/D conversion for conferencing and for bit rate or A/D method compatibility.
- i. Capability of the switch to meet required COMSEC doctrine for long haul/tactical applications.
- j. Capability of the switch to meet HEMP protection requirements.
- k. Capability of the switch to accommodate transition to an all-digital DCS by permitting replacement of Space Division Matrix (SDMX) modules with Time Division Matrix (TDMX) modules without taking the switch out of service, for with a minimum of downtime.
- l. Capability of interoperation between a 16 kb/s DCS TTC-39 and a 32 kb/s tactical TTC-39. Included is the problem of transitioning to a lower rate DCS switch.
- m. Development of AN/TTC-39-compatible DCS system control elements.
- n. Capability of the AN/TTC-39 TDMX to interface with DCS terrestrial and DSCS transmission facilities; also, the capability of the switch to synchronize with digital channels or trunk groups derived via DSCS.
- o. Capability of the switch to provide for additional DCS requirements for zone restrictions.
- p. Identification of additional changes required for Phase II, Secure Voice applications.
- q. Design of the interface between CONUS and overseas in the areas of bit rates, signaling, A/D techniques, electronic key distribution, and conferencing.

6.7.3 References

- [a] DCEC TR 20-74, "Technical Review of the AN/TTC-39 For Use in the DCS (U)," August 1974 (CONFIDENTIAL).
- [b] DCA (Code 410) letter to Director, Joint Tactical Communications Office, subject: Modification of Engineering Change Proposal (ECP) DCA 003R3," 20 November 1974, 19 March 1975.

CHAPTER 6

SECTION 8

CIRCUIT SWITCH CHARACTERISTICS - CONUS

This section is under development.

CHAPTER 7
DATA SWITCHING
CONTENTS

		<u>Page</u>
<u>SECTION 1 - SYSTEM PERFORMANCE REQUIREMENTS</u>		7-1-1
Paragraph 7.1.1	Introduction	7-1-1
7.1.2	AUTODIN Packet Switched Network Description	7-1-1
7.1.2.1	Packet Switch Node (PSN) Functional and Operational Description	7-1-2
7.1.2.1.1	General	7-1-2
7.1.2.1.2	Packet Switch Node Function	7-1-3
7.1.3	Performance Requirements	7-1-4
7.1.3.1	Traffic	7-1-4
7.1.3.1.1	Traffic Statistics	7-1-4
7.1.3.1.2	Transaction Statistics	7-1-4
7.1.3.1.3	Subscriber Statistics	7-1-7
7.1.3.1.4	Traffic Acceptance Categories	7-1-7
7.1.3.2	Quality of Service	7-1-9
7.1.3.3	Availability	7-1-11
7.1.3.4	Bit Error Rate	7-1-11
7.1.3.5	End-to-End Delivery Delay	7-1-12
7.1.3.6	Probability of Misdelivery	7-1-13
7.1.3.7	Data Signaling Rates	7-1-13
7.1.3.8	Data Signaling Codes	7-1-14
7.1.3.9	Interoperation With Other Networks and Systems	7-1-14
7.1.3.9.1	General	7-1-14
7.1.3.9.2	AUTODIN I	7-1-14
7.1.3.9.3	AUTOVON and Common Carrier Switched Networks	7-1-14
7.1.3.10	References	7-1-15
<u>SECTION 2 - FUNCTIONAL REQUIREMENTS</u>		7-2-1
Paragraph 7.2.1	Network Design Requirements	7-2-1
7.2.1.1	Network Design	7-2-1
7.2.2	Routing	7-2-1
7.2.3	AUTODIN II Communications Security	7-2-2
7.2.4	Subscriber Requirements	7-2-2

MIL-STD-187-310

CONTENTS - Continued

		<u>Page</u>
Paragraph 7.2.4.1	General	7-2-2
7.2.4.2	Access Circuit Types	7-2-2
7.2.4.3	Multiplexing	7-2-2
7.2.4.4	Host Systems	7-2-2
7.2.4.5	Terminals	7-2-2
7.2.4.6	Terminal Interfaces	7-2-4
7.2.4.7	Subscriber Constraint Matrix	7-2-5
7.2.4.7.1	Subscriber/Subscriber Cross Connection Matrix	7-2-5
7.2.4.7.2	Subscriber Interchange Capabilities and Leader Formats	7-2-5
7.2.5	Intrasystem Interfaces	7-2-5
7.2.5.1	Backbone	7-2-5
7.2.5.2	Access Transmission Circuit Interface	7-2-5
7.2.6	Data Handling	7-2-11
7.2.6.1	Access Line Modes	7-2-11
7.2.6.1.1	Character Synchronous - Mode I	7-2-11
7.2.6.1.1.1	Link Control Structure	7-2-11
7.2.6.1.1.2	Link Control Discipline	7-2-11
7.2.6.1.1.3	Timing and Synchronization	7-2-11
7.2.6.1.1.4	Standard Code	7-2-11
7.2.6.1.2	Character Synchronous - Mode IB	7-2-12
7.2.6.1.2.1	Link Control Structure and Discipline	7-2-12
7.2.6.1.2.2	Standard Code	7-2-12
7.2.6.1.3	Character Asynchronous - Mode IIA	7-2-12
7.2.6.1.3.1	Link Control Structure and Discipline	7-2-12
7.2.6.1.3.2	Timing and Synchronization	7-2-12
7.2.6.1.3.3	Standard Code	7-2-13
7.2.6.1.3.4	Mode IIA Interface Control Unit (ICU)	7-2-13
7.2.6.1.4	Binary Synchronous (Mode VI)	7-2-13
7.2.6.1.4.1	Frame Format	7-2-13
7.2.6.1.4.2	Commands and Responses	7-2-13
7.2.6.1.4.3	Acceptance and Acknowledgment	7-2-13
7.2.6.1.4.4	Recovery from Exception Conditions	7-2-14
7.2.6.1.4.5	Idle Link Periods	7-2-14
7.2.6.1.4.6	Control Messages	7-2-14
7.2.6.1.4.7	Response Timer	7-2-15
7.2.6.2	Subscriber Access Alternatives	7-2-15
7.2.6.2.1	Terminals	7-2-15
7.2.6.2.2	User Host Access	7-2-15
7.2.7	References	7-2-16

CONTENTS - Continued

	<u>Page</u>
<u>SECTION 3 - PROTOCOLS</u>	7-3-1
Paragraph 7.3.1 Protocol Structure	7-3-1
7.3.1.1 Physical Communications Channels	7-3-1
7.3.1.2 Virtual Communications Channels	7-3-1
7.3.2 Modularization Approach	7-3-3
7.3.3 Binary Oriented Subscribers	7-3-3
7.3.3.1 Binary Oriented Formats and Protocols	7-3-3
7.3.3.1.1 Leader Formats	7-3-5
7.3.3.1.2 Subscriber Formats and Modes for PSN Access	7-3-5
7.3.3.1.3 Type A - Binary Segment Leader/Mode VI	7-3-5
7.3.3.1.3.1 Precedence Field	7-3-5
7.3.3.1.3.2 Security Field	7-3-5
7.3.3.1.3.3 Command Control Field	7-3-5
7.3.3.1.3.4 Logical Addressing	7-3-9
7.3.3.1.3.5 TCP Version Number	7-3-10
7.3.3.1.3.6 Segment Number Field	7-3-10
7.3.3.1.3.7 Spare Fields	7-3-10
7.3.3.2 Host Level Protocol (Host-to-Host)	7-3-10
7.3.3.2.1 Host Level Protocol Functions	7-3-11
7.3.3.2.2 Connection Management	7-3-11
7.3.3.2.3 Information Transfer Management	7-3-13
7.3.3.2.4 Security and Precedence	7-3-13
7.3.3.3 Host-Switch Protocols	7-3-13
7.3.3.3.1 Host-Switch Access	7-3-13
7.3.3.4 Type B - Packet Binary Segment Leader with Mode I	7-3-14
7.3.3.5 AUTODIN I - Packet Switch Network Interchange	7-3-14
7.3.3.5.1 AUTODIN II Access by AUTODIN I Message Switches	7-3-14
7.3.3.5.2 AUTODIN I Access Mode and Format	7-3-14
7.3.3.5.3 AUTODIN I Message Acknowledgment and Accountability	7-3-14
7.3.3.5.3.1 AUTODIN I Line Block Framing for Type B Operation	7-3-14
7.3.3.5.4 Packet Switch Subscriber Access to AUTODIN I	7-3-16
7.3.4 Character Oriented Subscriber Characteristics	7-3-16
7.3.4.1 Transmit Commands - Terminal to TAC	7-3-17
7.3.4.1.1 Command Options	7-3-17

MIL-STD-187-310

CONTENTS - Continued

		<u>Page</u>
Paragraph 7.3.4.1.1.1	Packet Release	7-3-17
7.3.4.1.1.2	Echo	7-3-17
7.3.4.1.2	Initialization Commands	7-3-17
7.3.4.1.3	Break Command	7-3-18
7.3.4.1.4	Terminal-to-Host Protocol	7-3-18
7.3.4.2	Formats	7-3-18
7.3.4.2.1	Type C - Character Segment Leader with Mode VI	7-3-18
7.3.4.2.2	Type D - Character Canned Segment Leader with Mode VI	7-3-19
7.3.4.2.3	Type E - Character UNCLASS Segment Leader with Mode VI	7-3-19
7.3.4.2.4	Type F - Character Segment Leader with Mode I or IB	7-3-19
7.3.4.2.5	Type G - Character Canned Segment Leader with Mode I or IB	7-3-19
7.3.4.2.6	Type H - Character UNCLASS Segment with Mode I or IB	7-3-19
7.3.4.2.7	Type I - Character Segment Leader with Mode IIA	7-3-19
7.3.4.2.8	Type J - Character Canned Segment Leader with Mode IIA	7-3-19
7.3.4.2.9	Type K - Character UNCLASS Segment Leader with Mode IIA	7-3-19
7.3.5	Backbone Protocols	7-3-20
7.3.6	References	7-3-20

SECTION 4 - PACKET SWITCH CHARACTERISTICS

		7-4-1
Paragraph 7.4.1	Introduction	7-4-1
7.4.2	Packet Switch Architecture	7-4-1
7.4.2.1	Terminating Subsystem	7-4-1
7.4.2.2	Processing Subsystem	7-4-1
7.4.2.2.1	Software Loading	7-4-1
7.4.2.2.2	Switch Software Alteration	7-4-1
7.4.2.2.3	Fault Isolation	7-4-2
7.4.2.3	Memory Subsystem	7-4-2
7.4.2.4	Switch Control Position	7-4-2
7.4.3	Switch Node Sizing and Modularity	7-4-2
7.4.3.1	Switches	7-4-2
7.4.3.2	Multiplexers	7-4-3
7.4.4	PSN Availability, Reliability and Maintainability	7-4-3
7.4.5	References	7-4-3

CONTENTS - Continued

	<u>Page</u>
<u>SECTION 5 - AUTODIN II SYSTEM CONTROL</u>	7-5-1
Paragraph 7.5.1 Introduction	7-5-1
7.5.2 Definition of System Management and Control	7-5-1
7.5.2.1 System Control	7-5-1
7.5.2.1.1 Functions	7-5-2
7.5.2.2 Packet Switch Network/NCC Dependency	7-5-2
7.5.2.3 Levels of System Management and Control and Functional Responsibilities	7-5-2
7.5.3 Network Disturbances	7-5-3
7.5.4 Network Management Requirements	7-5-3
7.5.4.1 Sampling for Performance Measurements	7-5-8
7.5.4.2 Packet Trace Capability	7-5-8
7.5.5 Network Control Design Requirements	7-5-8
7.5.5.1 Detailed Design Requirements	7-5-8
7.5.6 Network Control Center (NCC) Requirements	7-5-10
7.5.6.1 Location of NCC Equipment	7-5-11
7.5.6.2 NCC Availability	7-5-11
7.5.6.3 NCC Reliability	7-5-11
7.5.6.4 NCC Maintainability	7-5-11
7.5.6.5 NCC Minimum Configuration	7-5-11
7.5.6.6 IBM S360/370 Compatible Disk	7-5-11
7.5.6.7 NCC Operational Environment	7-5-11
7.5.7 Network Control Center Relationship to the DCA World-Wide On-Line System	7-5-12
7.5.7.1 WWOLS Computer Support for AUTODIN II	7-5-12
7.5.7.2 WWOLS Interface with the NCC and PSN	7-5-12
7.5.7.3 NCC Controller Access to WWOLS	7-5-12
7.5.7.4 Management Data Transfer to WWOLS	7-5-12
7.5.8 References	7-5-13
<u>SECTION 6 - AUTODIN II SOFTWARE</u>	7-6-1
Paragraph 7.6 AUTODIN II Software	7-6-1
7.6.1 General	7-6-1
7.6.2 Development Alternatives	7-6-1
7.6.2.1 Assembler/Compiler	7-6-1
Implementation Alternatives	
7.6.2.1.1 Alternative I - Switch Hardware	7-6-1
7.6.2.1.2 Alternative II - IBM 370 and Switch Hardware	7-6-1
7.6.2.2 Proposed Alternative	7-6-1

MIL-STD-187-310

CONTENTS - Continued

		<u>Page</u>
Paragraph 7.6.3	Design Considerations	7-6-1
7.6.3.1	Security Modules	7-6-2
7.6.4	Storage Allocation and Expansion	7-6-2
7.6.5	Software Programming Techniques	7-6-2
7.6.5.1	On-Line Software Component Features	7-6-2
7.6.5.2	System Initialization Reload and Reprogramming	7-6-3
7.6.5.3	Capability for Reloading and Reprogramming of Packet Switch Software	7-6-4
7.6.5.3.1	Local Packet Switch Capability	7-6-4
7.6.5.3.2	Remote Test Facility Capability	7-6-4
7.6.5.3.3	Network Control Center (NCC) Software Capability	7-6-5
7.6.5.4	Security Processing for Support of Remote Programming	7-6-5
7.6.5.5	Binary Loader	7-6-6
7.6.6	Off-Line Software	7-6-6
7.6.6.1	Component Feature	7-6-6
7.6.6.1.1	Debugging Aids	7-6-6
7.6.6.1.2	Off-Line Utility Subsystem	7-6-7
7.6.6.1.3	Programming Languages	7-6-8
7.6.7	Test and Diagnostic	7-6-9
7.6.8	Documentation	7-6-9
7.6.8.1	Design Documentation	7-6-9
7.6.8.1.1	System Software Specification	7-6-9
7.6.8.1.2	Internal Topic Documentation	7-6-9
7.6.8.2	Computer Program Documentation	7-6-10
7.6.8.2.1	General Program Description	7-6-10
7.6.8.2.2	Detailed Program Description	7-6-11
7.6.8.2.3	Program Flowcharts	7-6-11
7.6.8.3	Computer Programmers Manuals	7-6-11
7.6.8.3.1	Programmer's Reference Manual	7-6-11
7.6.8.3.2	On-Line/Off-Line System User Manual	7-6-11
7.6.8.3.3	Program Listing with Comments	7-6-11
7.6.8.3.4	Major List and Tables	7-6-11
7.6.8.4	Source Programs on File	7-6-11
7.6.9	Software Testing	7-6-11
7.6.10	References	7-6-12

CHAPTER 7

DATA SWITCHING

SECTION 1

SYSTEM PERFORMANCE REQUIREMENTS

7.1.1 Introduction. Over the last 5 years requirements for handling computer-related communications traffic have increased in DoD applications, such as command and control and logistics, as well as commercial applications. This traffic is typified by interactive, query/response, and one-way message transactions, which are significantly different than present-day AUTODIN traffic.

This computer related traffic can be handled satisfactorily under a form of store-and-forward switching called packet switching. Under packet switching, messages are divided into small, addressed segments (e.g., 2000 bits in length). Transmission of these small message segments reduces message storage time and permits very efficient sharing of communication lines by many diverse users, thus reducing end-to-end delivery delay to a point where it is acceptable for computer traffic. A packet-switched network has a routing algorithm which also contributes to reducing the end-to-end delay by directing each packet to its destination along the path with the smallest total estimated transit time.

The best-documented example of a packet-switched network is the ARPANET, an advanced experimental network sponsored by the Advanced Research Projects Agency. This network, operational since 1969, is composed of more than 50 host computers distributed among more than 40 different locations in the United States. In addition, numerous experimental and commercial packet-switched networks have been established in the U. S. and foreign countries, and the technical and economic feasibility of the technique has been well proven.

A packet switching capability is to be added to the DCS, as a subnetwork (AUTODIN II), to meet DoD computer-related traffic requirements. Performance, operational, and functional requirements for AUTODIN II are described in the paragraphs following.

7.1.2 AUTODIN II Packet-Switched Network Description. The AUTODIN II will provide the DoD a general purpose data communications network within CONUS which will: (a) meet the majority of ADP teleprocessing needs during the 1978 - post-1980 time frame, (b) provide a means for computer-to-computer interactive communications, and (c) provide an

MIL-STD-187-310

integrated backbone system for DoD digital communications as a cost efficiency measure. This network will facilitate information transfer between and within ADP systems.

The AUTODIN II will be designed to meet the man/man, man/computer, computer/computer, and computer/machine data transmission requirements. The system shall:

- a. Consist of packet switching nodes (PSN) (the first of which shall preferably be collocated with the existing CONUS AUTODIN I switching centers.)
- b. Have a distributed network topology, employing distributed adaptive routing and wideband backbone transmission circuits within CONUS.
- c. Provide for all levels of security, using link encryption and physically secure red switches.
- d. Provide a direct interface and interoperability between the PSN's and AUTODIN I.
- e. Have less than 1 second, one-way, subscriber-to-subscriber delivery delay for interactive transactions, and shall also accommodate ADP bulk transaction traffic.
- f. Provide interface protocols and formats specifically designed for ADP teleprocessing.
- g. Permit subscribers to access the switching nodes via full-time or dial-up circuits.
- h. Provide, where economically advantageous, hardware for multiplexing access circuits.

Selected groups of subscribers will be homed to multiplexer sites which will in turn be connected to a packet switch via a high speed circuit. Each AUTODIN I switch will also be a host computer subscriber and will be connected initially to the collocated AUTODIN II switch by a number of 4.8 kb/s full-duplex lines.

7.1.2.1 Packet Switch Node (PSN) Functional and Operational Description

7.1.2.1.1 General. The packet-switched network will employ fast links and a short data handling unit (approximately 2000 data bits) to provide communications support for both ADP and record data (message) systems.

The source node shall accept traffic from subscribers a segment or character at a time, perform incoming validation checks on the traffic, form incoming subscriber traffic into packets, and forward the packets toward their destination. Intervening nodes shall relay the packets and acknowledge receipt. Destination nodes shall reform the packets into subscriber traffic, perform outgoing validation checks on the traffic, and deliver the segments or characters one at a time to subscribers. In addition to performing destination, intervening, and source node functions, the PSN shall accomplish other specified processing; e.g., statistics gathering, and speed conversion.

7.1.2.1.2 Packet Switch Node Functions. Each PSN shall have two primary functions: tandem and regional. The tandem function shall handle all traffic in the form of packets to and from other PSN's. The primary tandem function shall be to route each packet onto the proper backbone trunk. The primary regional function shall be to terminate the access lines between the PSN and its subscribers, including multiplexers. This function shall provide for a number of procedural interfaces and protocols, necessary to accommodate the full range of subscriber needs. The regional function shall control the data transfers between subscribers and the PSN. In addition to the primary tandem and regional functions, the PSN shall perform the following functions:

- a. Security level and TCC checking
- b. Traffic acceptance and flow control (precedence processing)
- c. Traffic and management statistics gathering and reporting
- d. Error control
- e. Synchronization
- f. Traffic delivery acknowledgment
- g. Data transfer protocols
- h. Routing
- i. Hardware fault detection and correction
- j. Interfacing and exchange procedures for use of satellite channels.

PSN functions are further described in reference [a], which covers the modularization approach, Line Control (LC) function, Switch Control (SC) module, and Terminal Access Control (TAC) module.

MIL-STD-187-310

7.1.3 Performance Requirements

7.1.3.1 Traffic

7.1.3.1.1. Traffic Statistics

7.1.3.1.1.1 Traffic Volume. The composite projected traffic volume, applicable for initial planning only, is based on a FY 1978 subscriber scenario contained in Appendix B of reference [a] and is specified in paragraph 3.2.1 of reference [a].

7.1.3.1.2 Transaction Statistics

7.1.3.1.2.1 Types of Transaction Applications. Transactions are categorized into the following defined types:

- a. Interactive (I/A). The rapid exchange of information in a conversational mode whereby the continuity of the information transfer process is maintained during the "session." Each exchange constitutes a transaction.
- b. Query/Response (Q/R). The exchange of a question and answer with no attempt to sustain the continuity of the process. Each exchange constitutes a transaction.
- c. Narrative. The transmission of narrative messages in a character-oriented format.
- d. Bulk 1 Transfer (B1). The transmission of entire files, programs or processing results with maximum transaction lengths in the range of 10^6 bits.
- e. Bulk 2 Transfer (B2). The transfer of extremely lengthy information, such as an entire data base or sensor data, with maximum transaction length in the range of 10^8 bits.

7.1.3.1.2.2 Transaction Length. Transaction lengths are assumed to be exponentially distributed with the following average lengths.

MIL-STD-187-310

<u>Type of Transaction</u>		<u>Average</u>
<u>Main Category</u>	<u>Subcategory</u>	<u>Length (Bits)</u>
Interactive	Computer-to-Computer	600/6000 ¹
	Human Interaction	
	Alarms/Status Indicators	2
	Monitoring/Telemetry	600
Query/Response	----	600/6000 ¹
Narrative	----	1.2 x 10 ⁴
Bulk 1	----	5 x 10 ⁵
Bulk 2	----	3 x 10 ⁷
AUTODIN I Messages	----	2.7 x 10 ⁴

¹Figures denote "query/response" lengths and are found in the network in the ratio of 2 responses for every 3 queries. The delivery delays specified in paragraph 7.1.3.5 pertain to Interactive and Query/Response transactions having an average length of 600 bits.

MIL-STD-187-310

7.1.3.1.2.3 Transaction Frequency. Transaction frequency for each type of transaction is given as a percentage of the busy hour transactions as follows:

<u>Type of Transaction</u>		<u>% Total Transactions</u>
<u>Main Category</u>	<u>Subcategory</u>	<u>Busy Hour</u>
Interactive	Human Interaction	23
	Alarms/Status	4
	Indicators	
	Monitoring/Telemetry	10
Query/Response	----	12
Narrative	----	22
Bulk 1	----	10
Bulk 2	----	*
AUTODIN I Messages	----	19

*The PS network shall not be sized to handle Bulk 2 transactions during the busy hour. During the non-busy hour period approximately 0.04% of the transactions are expected to be Bulk 2.

Traffic Acceptance Categories by type and percentage of total transactions.

Busy Hour Transactions

<u>Precedence/ Type</u>	<u>Category I</u>	<u>Category II</u>	<u>Category III</u>	<u>Category IV</u>
Interactive	0.4	5.5	14.1	17.0
Query/Response	0.1	1.8	4.6	5.5
Bulk 1 or Narrative	0.3	4.8	12.2	14.7
AUTODIN I	0.2	2.0	7.2	8.7

7.1.3.1.3 Subscriber Statistics

7.1.3.1.3.1 Computers and Terminals. Computers are generally large information or computational sources (referred to also as Host Systems or Host Computers). Terminal computers (included in the terminals category above) are generally mini to small size computers which serve as communications handlers or terminal concentrators and may also provide some limited local computational capability. Terminals are input-output devices such as TTY's, CRT's, printers, remote batch terminals, card and magnetic tape terminals.

7.1.3.1.4 Traffic Acceptance Categories. Originating computers and terminals will define traffic in accordance with designated categorization levels (precedences). All traffic must contain a Criticality and Application Type designation which is specified by the originating subscriber. Application (transaction) Type is as defined in paragraph 7.1.3.1.2.1. Criticality and Application Type designations in combination form the traffic acceptance categories (precedences) shown in Table 7.1.1. The precedence of traffic shall be used by the source and destination switches as a means to allocate resources, thereby permitting use of a priority scheme for entry of data into and the flow of data through the network. Although four application type categories are specified, as a minimum only two basic application type categories (Interactive and Bulk) may be implemented, depending on the flow control design. The elements of the Criticality and Application Type designations are listed below.

a. Application Type. (See paragraph 7.1.3.1.2.1)

- Class A - Interactive
- Class B - Query/Response
- Class C1 - Bulk 1 or Narrative
- Class C2 - Bulk 2

b. Criticality. AUTODIN II criticality nomenclature has not as yet been officially defined but will be essentially equivalent to the following:

- Flash Override (Y & W)
- Flash (Z)
- Immediate (O)

MIL-STD-187-310

TABLE 7.1.1 TRAFFIC ACCEPTANCE CATEGORIES

<u>Traffic Acceptance Category</u>	<u>Criticality Class</u>	<u>PRECEDENCE LEVELS</u> Application Types Ordered as Indicated	
		<u>First</u>	<u>Last</u>
	NONBLOCKING		
I <u>1/</u>	Y, W & Z	I1, I2	I3, I4
	BLOCKING		
II	O	A, B, C1, C2	<u>2/</u>
III	P	A, B, C1, C2	<u>2/</u>
IV	R	A, B, C1, C2	<u>2/</u>

1/ Category 1 subclasses are specially defined as follows:

- I1 - AUTODIN II control messages
- I2 - Subscribing network control messages
- I3 - Critic/ECP messages
- I4 - Application types A, B, C1, or C2, in any order

2/ The system shall not be sized to handle C2 Category II, III, IV traffic during the busy hour; however, this traffic shall be accepted during the busy hour if the system has sufficient capacity to do so.

MIL-STD-187-310

Priority (P)

Routine (R)

The precedence levels for the initial system shall be designed to the following general structure. Traffic will be assigned to one of four categories according to the normal military precedence structure. Category I shall be nonblocking and includes both Flash Override and Flash (W, Y, Z) traffic. Since Category I is nonblocking, the minimum capacity of the network, both in terms of channel capacity and switch buffer capacity, shall be sized as if all (Y and W) and (Z) subscribers were inputting data at their maximum connected access circuit rates. Categories II, III, and IV shall include the military designations of Immediate (O), Priority (P), and Routine (R) respectively. Categories II, III, and IV shall be blocking and sized to the blocking probabilities specified in paragraph 7.1.3.2. Within each category, there are four different classes of traffic. Class A is interactive (I/A) traffic. Class B is query-response (Q/R) traffic. Class C1 is narrative or bulk 1 traffic, and Class C2 is bulk 2 traffic. Since traffic can only effectively enter the network one segment at a time, there is no protocol difference between long bulk (C2) and short bulk (C1) transactions. Subclasses of Category I are defined in terms of traffic criticality. Subclass I-1 shall be assigned to packet switch network control messages. Subclass I-2 shall be assigned to subscribing network control messages. Subclass I-3 shall be assigned to the Critic/ECP, and Subclass I-4 shall be assigned to I/A, Q/R, and bulk transactions. The categories, classes, and subclasses discussed above effectively define a 16-level precedence system. The precedence field is a combination of category and class, as defined above. The priority flag bit (used for Category I only) of the precedence field instructs the packet switch how to queue on trunks. The priority queue is always delivered before the nonpriority queue during packet relay. The precedence field allows up to 16 category designators for acceptance and flow control. The precedence field is shown in Table 7.1.2.

7.1.3.2 Quality of Service. Quality of Service (QOS) is defined as the percentage of source address-to-destination address connection requests for each traffic acceptance category that must wait more than a specified time before being accepted for connection/transmission by the communications system. Service denials due to busy destination users are excluded from consideration in the QOS. For the purpose of sizing the QOS, blocked requests shall be assumed to be ERLANG C distributed (i.e., queued at the host rather than lost). The PS network shall be nonblocking to all Category I traffic (i.e., the system shall be sized and designed to accept all expected Category I busy-hour connection requests immediately). The PS network shall be sized and designed such that on the average not more than 1 out of 100

MIL-STD-187-310

TABLE 7.1.2 PRECEDENCE CATEGORY

USER CATEGORY	Bit Positions	Priority Flag Bit					DESCRIPTION
		1	2	3	4	5	
CAT I	I-1	1	1	1	1	1	Control
	I-2	1	1	1	1	0	Subnet Control
	I-3	1	1	1	0	1	Critic/ECP
	I-4	1	1	1	0	0	Flash, I/A, Q/R, N/R & Bulk
CAT II	IIA	0	1	0	1	1	I/A
	IIB	0	1	0	1	0	Q/R
	IIC1	0	1	0	0	1	Bulk 1/Narrative
	IIC2	0	1	0	0	0	Bulk 2
CAT III	IIIA	0	0	1	1	1	I/A
	IIIB	0	0	1	1	0	Q/R
	IIIC1	0	0	1	0	1	Bulk 1/Narrative
	IIIC2	0	0	1	0	0	Bulk 2
CAT IV	IVA	0	0	0	1	1	I/A
	IVB	0	0	0	1	0	Q/R
	IVC1	0	0	0	0	1	Bulk 1/Narrative
	IVC2	0	0	0	0	0	Bulk 2

Note that the combination of bits in positions 2 and 3 uniquely define the user precedence category. The combination of bits in positions 4 and 5 uniquely define the subcategory within each category.

Category II, III, and IV connections encounter any acceptance delay ^{4/} and when such delay is necessary it shall not exceed 5, 10, and 30 seconds (respectively) in more than 1 out of 100 occurrences. Once the first segment of a connection request is accepted for transmission by the PS network, all the subsequent segments of the connection shall be serviced without further traffic acceptance revalidation unless the connection is preempted. These blocking probabilities and associated acceptance delays must be evaluated in terms of their technical and cost impact before firm values are established.

7.1.3.3 Availability. The PS network availability, to include all network components between the source terminal interface and the destination terminal interface (excluding single channel control units (SCCU's) and multiple channel control units (MCCU's) described in paragraph 7.2.6.2.2), is defined as the percentage of time that any pair of users are able to communicate with each other through the undamaged PS network with at least the following capability:

- a. The End-to-End Undetected Bit Error Rate shall not exceed that specified in paragraph 7.1.3.4.
- b. The Mean Delivery Delays shall not exceed twice those specified in paragraph 7.1.3.5.
- c. On the average (averaging interval to be defined), not more than 5 out of 100 Category II, III, and IV transactions shall encounter any acceptance delay, and when such delay is necessary it shall not exceed 5, 10, and 30 seconds (respectively) in more than 5 out of 100 occurrences. (This requirement is an intentional relaxation of the requirement as specified in paragraph 7.1.3.2.)

The PS network availability for those users who connect to a single PSN with a single access circuit shall be at least 99%. The PS network availability for those users who connect to two PSN's with one access circuit to each PSN shall be at least 99.95%.

7.1.3.4 Bit Error Rate. The user-to-user undetected bit error rate through the PS network, for subscribers having cyclic redundancy check (CRC) error controlled access circuits, shall be 10^{-12} or less. It is necessary to ensure that the PSN error rates combined with the link error control requirements specified in paragraph 7.2.6.1.4 meet this required overall user-to-user undetected bit error rate.

^{4/} Acceptance delay is defined as the lapsed time from source request-to-connect/transmit until the connection is established through AUTODIN II.

MIL-STD-187-310

7.1.3.5 End-to-End Delivery Delay. Delivery Delay is defined as the lapsed time from the START of source transaction until the last transaction bit is received at the destination. However, the backbone network shall have no specific knowledge of transactions, and in the backbone transactions lose their identity and simply become a sequence of unrelated segments. For character oriented operation as specified in paragraph 7.3.4, delivery delay shall be measured from PSN receipt of the transmit controls as specified in paragraph 7.3.4.1.1.1. The nominal delivery delay encountered in the one-way passage of Category I, II, III, and IV transactions through the data communications network (under normal busy-hour traffic load conditions) from the originating terminal to the destination terminal shall be approximately as follows, assuming subscribers will use the lowest possible access line speed consistent with these delivery delays. Shorter transaction delivery delays shall be available during periods of lower network utilization.

<u>Type of Transaction</u>		<u>Delivery Delay</u>	
<u>Main Category</u>	<u>Subcategory</u>	<u>Mean</u>	<u>Max (CAT IV)</u>
Interactive	Human Interaction	1 Sec	2 Sec
	Alarms/Status Indicators	1 Sec	3 Sec
	Monitoring/Telemetry	0.3 Sec	1 Sec
Query/Response	----	36 Sec	2 Min
Bulk 1 or Narrative	----	1.6 Min	6.4 Min
Bulk 2	----	4 Hrs	12 Hrs

These delivery delays pertain for transactions of average length. Within each transaction type category, transactions that are longer or shorter than the average shall have proportionally longer or shorter delivery delays. Within each transaction type category, the delivery delay distribution for a transaction of average length is assumed to be a gamma distribution (the actual distribution may differ) where the maximum delay corresponds to the 99%, or 3 sigma point. Category I transactions shall not be subject to flow (throughput) control restrictions except to speed-match the source to the destination, and they also shall be queued ahead of Category II, III, and IV segments. Consequently, Category I transactions shall have delivery delays somewhat less than those specified above, such that when a source and destination host are communicating exclusively with each other, the subscriber source-to-destination throughput shall be primarily limited by the lower source or destination access circuit speed. The maximum delivery delays specified above are for Category IV transactions only.

7.1.3.5.1 Backbone Delivery Delays. Backbone delivery delay is defined as the time from receipt, from the source host, of a complete segment at the source PSN until the segment is queued at the destination PSN for transmission to the destination host. This time does not include any access circuit transmission time or Terminal Access Controller (TAC) (reference paragraph 7.2.4.5) processing, or buffering time. The backbone delivery delay shall be on the order of 75 to 100 milliseconds for a 600 bit segment, assuming the segment does not traverse a backbone satellite circuit. Interactive, query/response, and all Category I segments shall not normally, except for transoceanic circuits, traverse satellite circuits. During conditions of system degradation or congestion, satellite circuits may be used for this traffic; however, when satellite circuits are used, the one-way delivery delay shall not exceed 350 milliseconds.

7.1.3.6 Probability of Misdelivery. The packet-switched network shall be designed to deliver segments in accordance with addressing (i.e., destination address, security level, and TCC) specified to the originating switch by the originating subscriber. Misdelivery is defined as the delivery of a segment in violation of the originally specified addressing information. The AUTODIN II packet-switched network probability of misdelivery shall be less than one in 10^{11} delivered segments.

7.1.3.7 Data Signaling Rates

7.1.3.7.1 Access Circuit Speeds. The allowable transmission speeds of subscriber access circuits are:

- a. Terminals 75×2^n , $n = 1, 2, 3, 4, 5, 6, 7$; and 110 b/s
- b. Computers)
- Multiplexers) 75×2^n b/s, $n = 2, 3, 4, 6, 7$ and $8000n$ b/s,
-) $n = 1, 2, 7$ and 19.2 kb/s, 50 kb/s 5/

7.1.3.7.2 Backbone Circuit Speeds. The allowable transmission speeds of backbone circuits are: 9.6, 16, 19.2, 50, 56, 230 kb/s, and 1.544 Mb/s.

7.1.3.7.3 Speed Conversion. The PSN shall be a buffered system, with the capability to input and output at access speeds of 110 b/s up to and including 56 kb/s, depending on supplied timing. The switch shall be

5/ Rates for $n = 1$ and 2 are not currently available, but the switch shall be capable of accommodating these speeds if and when they become available.

MIL-STD-187-310

capable of connecting subscribers regardless of their individual line speeds, providing the subscribers adhere to one of the line interface protocols. If the input and output subscribers are utilizing devices with different line speeds, the PS network shall automatically provide for the required speed conversion.

7.1.3.8 Data Signaling Codes. The PS network shall be designed to be a text transparent medium to the maximum possible extent. As such, it shall be insensitive to the transmission codes contained in the text of subscriber segments. Message text code conversion, syntax checking, or format conversion shall not be performed by the PSN.

7.1.3.9 Interoperation With Other Networks and Systems

7.1.3.9.1 General. The packet-switched network will be capable of interfacing with DCS networks, such as AUTODIN I and AUTOVON, as well as various other military and nonmilitary communications systems. This interfacing will include user communities which will interconnect and interoperate with the DCS packet-switched network, but whose prime operational mode is via other networks (such as the overseas portion of AUTODIN I and SATIN IV), as well as those communities of subscribers who will use the PS network as their prime communications mode. The interoperability relationships of AUTODIN II with other major networks is summarized in the following paragraphs.

7.1.3.9.2 AUTODIN I. The PS network will provide backbone trunking for the 8 CONUS tariffed AUTODIN I Automatic Switching Centers (ASCs). Each ASC will be connected to the PS network as a host subscriber via Mode I packed binary interface (for details see paragraph 7.3.3.4). AUTODIN I subscribers will not be impacted in any way by deriving the AUTODIN I trunking through the PS backbone network. Interoperability will be established between the PS community of subscribers and the AUTODIN I community of narrative/record subscribers, where required. Message traffic between PS and AUTODIN I subscribers will be in accordance with the PS network-AUTODIN I message preparation procedures specified herein. AUTODIN I and PS network management and operational functions will be integrated where feasible.

7.1.3.9.3 AUTOVON and Common Carrier Switched Network. Low usage data subscribers shall be permitted to access the PS network via dial-up access. Dial-up access shall be via AUTOVON or common-carrier circuit switched networks. In either case, the dial access shall be provided by a specific port at the PSN. The service features and line identification of all dial-up subscribers to a particular port shall be identical, and any user higher-level terminal identification, verification, and authentication beyond port identification and initial connection authentication shall be the function of the terminal-to-host protocol (i.e., not a PSN function). The PSN shall authenticate each

connection attempt to each dial-up port to only authorized users of that port. The authentication technique is to be developed. Blocking in the circuit-switched network or competition for port availability shall not be considered in the overall service quality specifications for the PS network. Since circuit-switched networks are likely to be predominantly analog for many years to come, standard modem interfaces shall be provided for all dial-up ports. Upon completion of dial-up connection and modem synchronization, dial-up subscribers shall be protocol transparent to the PSN. After connection is established, dial-up subscribers are required to emulate the functions of dedicated full-period subscribers during their active periods. There shall be no provision for dial-out service. Transactions addressed to dial-up ports shall be handled in a manner consistent with the security control procedures specified in Appendix A of reference [a].

The parameters for the AUTOVON interface are defined in reference [b]. Available AUTOVON station arrangements shall be used to provide the terminal modems, PSN modems, and data auxiliary equipment.

7.1.3.10 References

- [a] DCA System Performance Specification (Type "A") for AUTODIN II, Phase I, November 1975.
- [b] DCAC 370-V175-6, AUTOVON System Interface Criteria, Chapter XI, "Interface With Other Systems," February 1965, as amended.

CHAPTER 7

SECTION 2

SYSTEM FUNCTIONAL REQUIREMENTS

7.2.1 Network Design Requirements. The AUTODIN II network shall be designed as a packet-switched network. The backbone network architecture shall be distributed (as opposed to hierarchical) in all respects, e.g., topology, routing, and essential control. The access area network design shall employ multiplexers, and single and dual homing as required to satisfy individual subscriber requirements, and the subscriber community as a whole, in the most cost-effective manner. Considerable effort and attention must be devoted to the access area design because of the diversity of user requirements, and, also, because the access area costs are anticipated to dominate the backbone network costs.

7.2.1.1 Network Design. A tentative network design is provided in Appendix B to reference [a]. Design options, including the possible use of satellite transmission, both in point-to-point and broadcast modes, for both the backbone and access portions of the network, are still under consideration.

7.2.2 Routing. The general routing methodology to be implemented in the design of the PS network shall be a single-path distributed, adaptive routing strategy. The routing plan shall be adaptive in the sense that the routing table shall be updated at certain time and/or event related intervals. The primary path shall be selected to minimize system delay and maximize throughput. Availability requirements dictate that the capability for adaptive update to the routing tables shall be distributed throughout the network, with each node having the ability to update its own routing table on the basis of information exchanged with its neighbors. The input to the distributed adaptive calculations at each switching node are the minimum expected delay tables from the neighboring nodes and the expected delays on the outgoing routes from the switch. The routing scheme must have provisions to preclude routing failures such as shuttling and looping, and to provide the means to prevent and/or detect looping along with appropriate recovery procedures. Also, there must be provisions to ensure that no PSN hardware failures or degraded modes of operation, which affect the correct operation of the adaptive routing operation, go undetected, and that upon detection the PSN shall automatically inform the PSN operator and the NCC of a routing failure and cease the transmission of routing update packets. Under no circumstances shall a PSN transmit an incorrect routing update packet.

MIL-STD-187-310

The ARPANET routing algorithm shall be implemented to the maximum extent possible consistent with the above requirements. The ARPANET routing algorithm documentation is provided in Appendix C to reference [a].

7.2.3 AUTODIN II Communications Security. All information relating to communications security is specified in Appendix A of reference [a].

7.2.4 Subscriber Requirements

7.2.4.1 General. AUTODIN II shall be capable of interconnecting those computers and terminals presently in the DoD inventory, as well as current equipment and equipment developments planned for implementation through post-1980 time period. Dedicated access shall be class marked according to the permissible categories of input traffic, input and output security classification, input and output community of interest (TCC designator), and service features (e.g., connection limitation). Input traffic to the network shall be delivered with positive identification as to source input access circuit.

7.2.4.2 Access Circuit Types. Subscriber access circuits shall be full-duplex or half-duplex circuits with a secondary control channel, as required by the subscriber. Because of acknowledgment and control requirements, the use of simplex or half-duplex only circuits is prohibited.

7.2.4.3 Multiplexing. Data multiplexers shall be used to reduce the total cost of access line transmission from subscribers to the AUTODIN II switch locations.

7.2.4.4 Host Systems. The hosts in the PS network are computers capable of simultaneously conducting multiple conversations with multiple destinations. These hosts will use binary segment leaders in conjunction with Mode I or Mode VI line control procedures (see paragraph 7.2.6). Hosts using Mode I (e.g., AUTODIN I ASC's) will be required to pack the leader bits into a character-oriented structure (called packed binary) as specified in paragraph 7.3.3.4. Host systems in general are centers of major ADP work capability and are major sources of network traffic. However, some of the smaller computers function more as peripheral controllers in terms of network traffic generating capacity. In terms of the access protocols, these may either interface as a small host or as a terminal (see below).

7.2.4.5 Terminals. Terminals are defined as character-oriented devices capable of conducting a conversation with only one destination at a time. Terminals access the network using character-oriented terminal protocols and can input to the PS network, at any one time, either bulk, I/A, N, or Q/R type applications. Terminal devices may be computer

peripheral controllers and intelligent or unintelligent input-output devices. An example of a computer terminal is a Remote Job Entry Station. Examples of unintelligent terminals are keyboard/printers (TTY-33, 35, 37) and nonprogrammable buffered CRT terminals. Examples of intelligent terminals are programmable buffered CRT's, magnetic tape cards, and terminals. Terminals require different access circuit control procedures, depending on the individual terminal characteristics. The PSN shall interface with terminals so as to minimize the hardware and software impacts on those users.

Character oriented terminals shall interact with the switch through a module of the PSN called the Terminal Access Controller (TAC), which provides to the terminals those features and services normally provided to terminals by their hosts.

The TAC module shall consist of four major functions:

1. Buffer and Executive Control (BEC)
2. Terminal Handler (TH)
3. Transmission Control Program (TCP)
4. Segment Interface Protocol (SIP).

These TAC functions shall provide five basic capabilities:

1. Format data from terminals into segments for output to the PS network and reformatting segments received from the PS network into characters for output to the terminals.
2. Initiate and terminate connections.
3. Provide flow control.
4. Provide error control.
5. Provide interrupt capability.

The Terminal Handler, Transmission Control Program and Segment Interface Protocol functions are further described in the following paragraphs.

7.2.4.5.1 Terminal Handler (TH) Function. The terminals being serviced by the TAC module select a desired mode of operation by transmitting command codes which are interpreted by the Terminal Handler (TH) function. The TH function shall also include the TELNET type function specified in paragraph 7.3.4.1.4. The TH also performs flow

MIL-STD-187-310

control between the TAC and the terminals, and generates service messages using a brief format to provide information to the subscribers.

7.2.4.5.2 Transmission Control Program (TCP) Function. The function of the TCP in the TAC is to allow a collection of character-oriented subscribers to appear as a host subscriber. The subscribers requiring the services of the TAC are identified in Table 7.3.2. The TCP performs three basic functions when service between a terminal and a host is required:

1. Make the initial connection between the subscriber and the desired host. As part of this function the TCP performs connection control and allocate control.
2. Transmits data over the connection. As part of this function the TCP performs acknowledgment control, interrupt control, and host level protocol error control.
3. Clears the connection using connection clearing control.

These functions are described in detail in Appendix D of reference [a]. The initialization of the connection is accomplished by the terminal, using command codes.

7.2.4.5.3 Segment Interface Protocol (SIP) Function. The SIP functions may be best illustrated using the Segment Format shown in Figure 7.3.4. The TCP function output, when processing access area input traffic, consists of Segment Leader information (precedence, security, destination address, and TCP version number), the Message Header, and data/text portions of the Segment Format. The SIP functions, when processing the access area input traffic, includes: (1) building the circuit identification leader, (2) building the Segment Leader (by adding to the segment leader information obtained from the TCP, the TCC, Command Control, and segment number fields), and (3) assembling the circuit identification leaders and segments in the Buffer and Executive Control Function. The assembled segments are now in a suitable format for transmission over the DMA channel to the Binary function in the Line Control Module. The SIP functions when processing traffic to be output to the access area includes: stripping off all the extraneous Segment Leader information (i.e., TCC, security, segment number, etc.) from all segments in a transaction except the first, and transferring the processed segments and their output information to the Buffer and Executive Control for processing by the TCP function.

7.2.4.6 Terminal Interfaces. Two subscriber terminal equipment-to-access circuit interfaces shall be provided. Electrically, both shall be in accordance with reference [b] which is presently in draft status undergoing final DoD coordination. Reference [b] is the DoD equivalent

of references [d] and [e] and is expected to be finally approved in Calendar Year 1976. However, functionally and mechanically one interface shall be in accordance with reference [f], which is also in draft pending approval, while the other shall be in accordance with reference [c] in order to be compatible with existing terminals. A packet switching subscriber or subscribing network desiring to interface with the PS portion of AUTODIN II will be required to meet the new electrical, functional, mechanical, and procedural requirements of the PS interface specification to be prepared. The implementation of these interface requirements, both hardware and software (with the exception of Mode IIA interface control unit specified in paragraph 7.2.6.1.3.4), will be the responsibility of the user. Subscriber terminals which meet the interface requirements of this paragraph and operate Mode IIA, as specified in paragraph 7.2.6.1.3, will be able to interface the PS network directly (without modification) via a PSN provided interface control unit.

7.2.4.7 Subscriber Constraint Matrix. The matrix in Table 7.2.1 establishes the range of subscribers to be served by the PSN and describes each type in terms of its constraining characteristics. For example, the nonbuffered, character-oriented terminal (line 5) cannot support the ADCCP line control procedures.

7.2.4.7.1 Subscriber/Subscriber Cross-connection Matrix. The matrix in Table 7.2.2 is intended to define source/destination pairs. In some cases cross-connection shall be a requirement and in other cases the connection shall not be allowed. The matrix shows certain other cases where the source/destination connection is desirable but not a mandatory requirement, and shall be provided only if no cost or additional hardware is involved.

7.2.4.7.2 Subscriber Interchange Capabilities and Leader Formats. The matrices in Table 7.2.3 provide a general overview of the subscriber mode types, leaders, and interchange capabilities which must be accommodated. Details of the mode criteria and formats are provided in paragraphs 7.2.6.1, 7.3.3, and 7.3.4.

7.2.5 Intrasystem Interfaces. The PSN intrasystem interfaces shown in Figure 7.2.1 shall be low-level digital interface.

7.2.5.1 Backbone. The PSN port-to-backbone circuit electrical interface shall be in accordance with reference [b]. The functional and mechanical interface shall be in accordance with reference [f]. (See paragraph 7.2.4.6.)

7.2.5.2 Access Transmission Circuit Interface. The PSN port-to-access circuit interface shall be as specified in paragraph 7.2.5.1.

MIL-STD-187-310

TABLE 7.2.1. SUBSCRIBER/CONSTRAINT MATRIX

NUMBER	LINE TYPE		LINE CONTROL				LEADER		TEXT CODE CAPABILITY		SERVICE FEATURES			
	SYNC	ASNC	INTERFACE CONTROL UNIT	MODE 1	ADCCP P/P	BIN	ASCII	BIN	ASCII		CANNED LEADER	DIAL-IN	DIN I XCHANGE	
1	X				X	X		X	X				X	
2	X				X	X		X	X		X	X	X	
3	X			X		X		X	X				X	
4	X			X		X		X	X		X	X	X	
5		X	X				X		X		X	X	X	
6	X or	X	X or	X			X		X		X	X	X	
7	X			X			X		X		X	X	X	
8	X				X		X	X	X		X	X	X	
9	X				X		X	X	X		X	X	X	
10	X			X			X		X		X	X	X	
11	X				X	X		X			X	X		
12	X				X	X		X			X	X		
13	X				X	X		X			X	X		

NOTE: The definition of the number column is given in Table 7.2.2.

TABLE 7.2.1 SUBSCRIBER/CONSTRAINT MATRIX - Continued

NUMBER	ERROR CONTROL			LEADER INPUT		DUPLLEX		APPLICATIONS					LINE SPEEDS										
	CRC	BLOCK PARITY	CHAR PARITY	SEL ECHO	PER CONECT	PER SEGM	FDX	HDX	I/A	Q/R	H	BULK	110	150	300	600	1200	2400	4800	9600	50k	56k	19.2k
1	X					X	X		X	X	X	X						X	X	X	X	X	
2	X				X		X		X	X	X	X						X	X	X	X	X	
3		X				X	X		X	X	X	X						X	X	X	X	X	
4		X			X		X		X	X	X	X						X	X	X	X	X	
5				X	X		X or X 1/	X	X	X	X	X						X	X	X	X	X	
6		X 2/	X		X		X or X 1/	X	X	X	X	X						X	X	X	X	X	
7		X			X		X or X 1/	X	X	X	X	X						X	X	X	X	X	
8	X				X		X or X 1/	X	X	X	X	X						X	X	X	X	X	
9	X				X		X or X 1/	X	X	X	X	X						X	X	X	X	X	
10		X	X		X		X		X	X	X	X						X	X	X	X	X	
11	X				X		X		X	X	X	X						X	X	X	X	X	
12	X				X		X		X	X	X	X						X	X	X	X	X	
13	X				X		X		X	X	X	X						X	X	X	X	X	

1/ For HDX terminal operation, a secondary control channel is required.
 2/ Used with Mode 1 only.

MIL-STD-187-310

TABLE 7.2.2 SUBSCRIBER/SUBSCRIBER CROSS-CONNECTION MATRIX

		RECEIVE												
		1	2	3	4	5	6	7	8	9	10	11	12	13
S E N D	1	X	X	X	X	X	X	X	X	X	X	-	X	X
	2	X	X	X	X	X	X	X	X	X	X	-	X	X
	3	X	X	X	X	X	X	X	X	-	-	-	X	R
	4	X	X	X	X	X	X	X	X	-	-	-	X	R
	5	X	X	X	X	X	X	-	-	-	-	-	X	R
	6	X	X	X	X	X	X	-	-	-	-	-	X	R
	7	X	X	X	X	X	X	-	-	-	-	-	X	R
	8	X	X	X	X	X	X	-	-	-	-	-	X	-
	9	X	X	-	-	-	-	X	X	-	-	-	X	R
	10	X	X	-	-	-	-	X	X	-	-	-	X	R
	11	X	X	R	R	R	R	-	R	X	-	X	-	R
	12	X	X	R	R	R	R	-	R	-	-	-	-	R
	13	X	X	R	R	R	R	R	R	R	R	R	R	-

1. Multiple Logical Channel Host Computer (Mode VI)
2. Single Logical Channel Computer (Mode VI)
3. Multiple Logical Channel Host Computer (Mode I)
4. Single Logical Channel Computer (Mode I)
5. CRT/TTY (e.g., Model 33, 35, 37) Terminal
6. Non-Programmable Buffered CRT Terminal
7. Programmable (Mode I) Buffered CRT Terminal
8. Programmable (ADCCP) Buffered CRT Terminal
9. Mag Tape/Card (ADCCP) Terminal
10. Mag Tape/Card (Mode I) Terminal
11. Facsimile Terminal
12. Graphic/Light Pen RAND Tablet Terminal
13. Sensor Terminal

X = Cross Connection is a requirement.

- = Connection is desirable but not mandatory
(to be provided only if no additional cost
or hardware is involved).

R = Restricted (connection is not allowed).

TABLE 7.2.3 SUBSCRIBER INTERCHANGE CAPABILITIES AND LEADER FORMATS

A. Authorized Formats - Mode/Leader Combinations

Type	Mode	Segment Leader	Sym
A	VI	Binary	BSL
B	I	Packed Binary	PBSL
C	VI	Character	CSL
D	VI	Character Canned ⁵	CCSL
E	VI	Character Unclass ⁵	CUSL
F	I or IB	Character	CSL
G	I or IB	Character Canned ⁵	CCSL
H	I	Character Unclass ⁵	CUSL
I	IIA	Character ⁶	CSL
J	IIA	Character Canned ⁵	CCSL
K	IIA	Character Unclass ⁵	CUSL

B. Subscriber Interchange Matrix of Mode/Leader Combinations

Subscriber Type	Mode	SUBSCRIBER TYPE					
		1	2	3	4	5	6
1 AUTODIN I Switch	I ¹	B-B ²	B-A	B-B	B-C	B-F	
2 COMPUTER ³	VI	A-B	A-A	A-B	A-C	A-F	A-I
3 COMPUTER ³	I ¹	B-B	B-A	B-B	B-C	B-F	B-I
4 TERMINAL ⁴	VI	C-B	CDE- A	CDE- B	CDE- C	CDE- F	CDE- I
5 TERMINAL ⁴	I ¹	F-B	FGH- A	FGH- B	FGH- C	FGH- F	FGH- I
6 TERMINAL ⁴	IIA	I-B ⁵	IJK- A	IJK- B	IJK- C	IJK- F	IJK- I

Notes:

1. Mode I data exchanges are ASCII.
2. First letter(s) in each block is input format(s) and second letter is output format.
3. Computers have multi-connection capability.
4. Terminal subscribers have only single connection capability
5. Abbreviated formats are not authorized for transmission of message traffic to AUTODIN I.
6. The Type Column is defined in paragraphs 7.3.3 and 7.3.4.

MIL-STD-187-310

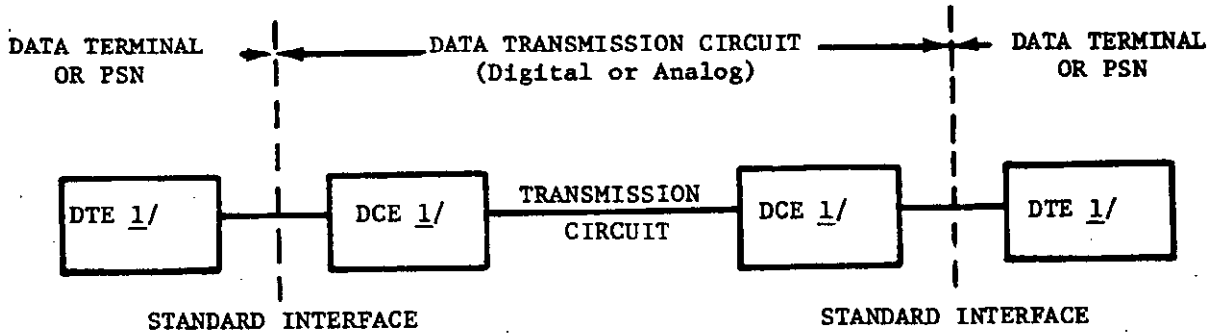
Legend

DTE - Data Terminal Equipment
 DCE - Data Communication Equipment

1/ May include Modems, Error Control Devices, Control Units and Other Equipment as required

FIGURE 7.2.1 Standard Interface Between Data Terminal Equipment and Data Communication Equipment

7.2.6 Data Handling

7.2.6.1 Access Line Modes and Subscriber Access Alternatives. The PSN shall accommodate four modes of line control operation. Three modes, Character Synchronous (Modes I and IB) and Bit Synchronous (Mode VI), provide automatic error detection and error correction capability (ARQ), while the fourth mode, Character Asynchronous (Mode IIA), has no error detection or correction capability. These line control modes, or protocols, are transparent to the higher level protocols such as host-to-switch.

7.2.6.1.1 Character Synchronous - Mode I. Mode I is a full-duplex character-oriented synchronous type of link control. It uses character parity and block parity checking along with retransmission of errored blocks to achieve an automatic error detection and correction capability. Mode I allows for independent and simultaneous operation between both ends of the link.

7.2.6.1.1.1 Link Control Structure. The PSN shall be designed to interoperate with subscribers and other networks conforming to the link control structure defined in chapters 1 and 2 of reference [g].

7.2.6.1.1.2 Link Control Discipline. The PSN shall be designed to interoperate with subscribers and other networks conforming to the Mode I, continuous mode requirements defined in chapter 5, paragraph 6 of reference [g]. The PSN shall generate and recognize those control characters defined in chapter 3 of reference [g]. In addition to generation and recognition of control characters, the PSN shall respond to and act upon control characters as individually defined in chapter 3 of reference [g]. Acceptance and acknowledgment requirements, error control techniques and procedures, and recovery from exception conditions shall conform to the requirements of chapters 1, 3, and 5 of reference [g].

7.2.6.1.1.3 Timing and Synchronization. For Mode I operation, the PS network shall conform to the synchronization requirements defined in chapter 4 of reference [g]. Timing requirements are defined in chapter 3, paragraph 4.a of reference [g].

7.2.6.1.1.4 Standard Code. The standard code for use by the PS network when exchanging text characters on a link using Mode I control techniques is the American Standard Code for Information Interchange (ASCII) as specified in reference [h], with an eighth (parity) bit added which will always maintain odd character parity. The standard control code for use on Mode I controlled links for generation and recognition of control characters shall conform to Table 2, columns 0 and 1 of supplement 1 to reference [g]. The sense of the eighth or parity bit added in this case shall always maintain even character parity.

MIL-STD-187-310

7.2.6.1.1.4.1 Code Conversion. Code conversion is not a requirement for the PSN when operating over Mode I controlled character-synchronous links. Bit oriented subscribers addressing Mode I character-synchronous subscribers are required to present 7-bits plus parity ASCII characters to the PSN. Chapter 10, paragraph 7.b(2) of reference [g] defines a method of converting binary data to pseudo 8-bit ASCII characters.

7.2.6.1.2 Character Synchronous - Mode IB. Mode IB is a character-oriented synchronous type of link control which uses character parity and block parity checking along with retransmission of errored "messages" to achieve an error detection and correction capability.

7.2.6.1.2.1 Link Control Structure and Discipline. The PSN shall be designed to interoperate with subscribers conforming to the two-way alternate point-to-point link control procedures of either reference [i] or [j].

7.2.6.1.2.2 Standard Code. The standard code for use by the PS network on Mode IB access circuits shall be ASCII as specified in reference [h], with an added eighth odd parity bit.

7.2.6.1.3 Character Asynchronous - Mode IIA. Mode IIA is a character-asynchronous half- or full-duplex operation with no automatic error detection or error correction capabilities. Simple synchronization of the end devices is achieved through the start and stop elements inherent in the code used. Mode IIA operation is defined for use on subscriber access lines using the 10 or 11 unit asynchronous ASCII. A character in asynchronous ASCII is composed of one start bit, seven information bits, one parity bit (ANSI even parity), and, depending on system requirements, one or two stop bits. Mode IIA is not designed to support computer interfaces, but is established for economical and efficient operation with unintelligent terminals. Current anticipated usage of Mode IIA is for unsophisticated CRT terminals and Model 33, 35, and 37 teletype devices.

7.2.6.1.3.1 Link Control Structure and Discipline. There is no automatic link control structure or discipline defined for use on access lines between the PSN and Mode IIA subscribers. The PS network is not required to provide any automatic error recovery techniques, automatic acceptance and acknowledgment capability, or automatic intranetwork capability for recovery from exception conditions. Protection of character and message integrity and recovery from exception conditions are the responsibility of the end Mode IIA subscribers.

7.2.6.1.3.2 Timing and Synchronization. Timing on Mode IIA access lines is derived from the modem. Character synchronization in the PS network is not required. End-to-end control and synchronization is achieved through the start and stop bits inherent in the code used.

7.2.6.1.3.3 Standard Code. The PS network shall intercommunicate with Mode IIA subscribers in asynchronous ASCII only. Code conversion is required for parity on input to match the ASCII standard for synchronous and asynchronous lines.

7.2.6.1.3.4 Mode IIA Interface Control Unit (ICU). A control unit must be designed and provided, between the data terminal equipment and the data communications equipment, to implement the full Mode IIA operational capability. This control unit is necessary to implement required protocol functions such as traffic flow control, half-duplex terminal operation with "break" capability, and other functions such as "loop back" for testing. The data terminal equipment-to-control unit interface and the control unit-to-data communications equipment interface shall be as specified in paragraph 7.2.4.6.

7.2.6.1.4 Binary Synchronous (Mode VI). The PS network shall use the procedures specified in the fourth draft of reference [k], Advanced Data Communications Control Procedures (ADCCP), for line control on Mode VI access circuits and all backbone circuits. Specifically, the operational class defined as primary-to-primary shall be implemented to satisfy the full-duplex requirements of the PS network. The method of implementation used must be flexible because it will be revised as required to be fully compliant with the finally adopted version of reference [k].

7.2.6.1.4.1 Frame Format. The frame format specified in reference [k] shall be implemented for the PS network with the exception of the Frame Check Sequence (FCS). The FCS implemented in the PS network shall be 32 bits. The 32nd degree generator polynomial specified for the PS network is

$$g(x) = x^{32} + x^{26} + x^{23} + x^{22} + x^{16} + x^{12} + x^{11} \\ + x^{10} + x^6 + x^7 + x^5 + x^4 + x^2 + x + 1$$

which is 40460216667 (OCTAL).

7.2.6.1.4.2 Commands and Responses. The PS network shall accept and act upon that set of commands and responses defined in the ADCCP draft for use with the Asynchronous Response Mode (ARM) operational mode and the Primary-to-Primary Operational Class.

7.2.6.1.4.3 Acceptance and Acknowledgment. In the PS network ADCCP implementation, a response shall be returned for error-free information frames accepted without waiting for an instruction frame with P bit set from the transmitting station. The response action is accomplished by generation of a response frame or by updating the N(R) (i.e., Numbered

MIL-STD-187-310

Received) count in the next transmitted information frame. The N(R) count in information frames and in RR (Receive Ready) or RNR (Receive Not Ready) response frames acknowledges all received frames up to and including N(R) - 1.

7.2.6.1.4.4 Recovery From Exception Conditions. The PS network shall implement the recovery from exception conditions defined in ADCCP for use with the ARM and the Primary-to-Primary class of operation, modified as follows: Any frame received with an FCS error shall be discarded and no action shall be taken as a result of that frame. Recovery actions at the receiving station shall depend upon the contents of the control field of the next error-free frame received. The transmitting station shall, upon expiration of the response timer, initiate recovery action by retransmitting the unacknowledged frame or by use of a supervisory frame.

7.2.6.1.4.5 Idle Link Periods. During idle link periods, continuous flags are exchanged to maintain synchronization on the circuit. Although this exchange of flags maintains synchronization between both ends of the link, it does not provide any definite indication to the transmitter at either end when synchronization is lost or the receiver is not ready to accept information frames. This lack of indication could result in the transmitter sending up to 7 frames (Modulo 8), or even more if using the extended format (Modulo 128), before it becomes aware that the frames are not being accepted and will require eventual retransmission. To preclude this, the interface shall be designed such that during idle link periods the transmitter shall periodically interject Supervisory Format Commands RR (if ready to receive) or RNR (if not ready to receive) with P bit set to 1 to solicit a response from the receiver. This response may be an information frame, or frames, or Supervisory Responses RR or RNR (depending on the receiver's capability to accept frames) with the F bit set to 1. The frequency for initiating this procedure during idle link periods must be determined.

7.2.6.1.4.6 Control Messages. The PSN exchanges short supervisory control messages (e.g., routing update packets) which do not require the level of accountability provided by implied acknowledgments keyed to sequentially numbered frames. The ADCCP Unnumbered (U) format shall be used to accomplish this requirement. The U format does not increment the N(S) (i.e., Number Sent) count at either the transmitting or receiving station. There are currently 32 undefined additional supervisory functions available in the U format. Since implied acknowledgments are not required for these types of frames, the P bit shall not be set to 1. The method for using the U format to allow the exchange of short supervisory frames without requiring implied acknowledgments must be determined.

7.2.6.1.4.7 Response Timer. A response timer shall be maintained at the packet switch to aid in recovery from an exception condition caused by a failure to receive a response. If a response to any information frame transmitted on an unencrypted circuit is not received within a determined time interval, the transmitter shall solicit a response from the receiver by setting the P bit in a subsequent information frame or in a RR or RNR frame to solicit the required response. After a frame with the P bit set is sent, a response frame with the F bit set must be received within the interval of the response timer. If it is not, the action shall be repeated up to a maximum of three times. The third repetition of the action without receiving a satisfactory response shall cause the PSN to alarm, thereby informing the operator of the need for maintenance intervention. If a response to any information frame transmitted on an encrypted circuit is not received within a determined time, the PSN shall take the same recovery action as defined above for an unencrypted circuit, except it will not alarm after three unsuccessful attempts to deliver the frame. On encrypted circuits the switch shall, after three unsuccessful attempts to accept a frame, assume an out-of-synchronization condition and initiate the resynchronization process by applying the appropriate control signal to the COMSEC equipment. Unsuccessful attempts to synchronize the COMSEC equipment shall result in additional attempts. Three unsuccessful COMSEC synchronization attempts shall result in an alarm and notification that maintenance intervention is required. If COMSEC synchronization is successful and the transmitter is still unable after three attempts to deliver the frame, it shall then alarm, thereby informing the operator that maintenance intervention is required.

7.2.6.2 Subscriber Access Alternatives. Subscribers shall be able to access the AUTODIN II network in one of eight ways; five for terminal access and three for host computer access. (AUTODIN I access is discussed in paragraph 7.3.3.4).

7.2.6.2.1 Terminals. Terminals may access the PS network using Mode 1B, Mode IIA or Mode VI procedures. In cases where multiplexing is used to interface several terminals located in a common geographic area, all three line disciplines will be supported. In addition, reference [a] specifies a user-provided terminal interface.

7.2.6.2.2 User Host Access. Two different types of host control units are to be designed; the Single Channel Control Unit (SCCU) and the Multiple Channel Control Unit (MCCU). The purpose of these two devices is to allow certain host subscribers to interface the AUTODIN II network with little or no modification to their hardware and software configurations. Basically, the SCCU and MCCU shall perform those functions associated with host and network level protocols and line control procedures. The SCCU shall be designed to allow a host computer to

MIL-STD-187-310

maintain a single connection to any other host or terminal on the network at any one time without modification of the host software or hardware. The MCCU shall be designed to allow a host computer to maintain up to 32 connections to other hosts and/or terminals on the network simultaneously; also without modification of the host software or hardware. All SCCU/MCCU functions shall be performed by three functional modules, the Host Specific Interface (HSI) (paragraph 3.3.4.11.2.1, reference [a]), the Transmission Control Program (TCP) (paragraph 7.2.4.5.2) and the Segment Interface Protocol (SIP) (paragraph 7.2.4.5.3). The SCCU/MCCU concept was developed as a less expensive and more flexible alternative to host software modifications. Therefore, cost should be a very important consideration in the design of these devices. Additional design requirements for the SCCU and MCCU are contained in paragraph 3.3.4.11.1 of reference [a]. In addition to the SCCU/MCCU interfaces, paragraph 3.3.3.2.3.2.3 of reference [a] specifies a user-provided host interface.

7.2.7 References

- [a] DCA System Performance Specification (Type "A") for AUTODIN II, Phase I, November 1975.
- [b] MIL-STD-188-114, Electrical Characteristics of Digital Interface Circuits (DRAFT), 24 February 1975.
- [c] Electronic Industries Association (EIA) RS-232C, Interface Between Data Terminal Equipment and Data Communication Equipment Employing Serial Binary Data Interchange, August 1969.
- [d] Electronic Industries Association (EIA) RS-422, Electrical Characteristics of Balanced Voltage Digital Interface Circuits, April 1975.
- [e] Electronic Industries Association (EIA) RS-423, Electrical Characteristics of Unbalanced Voltage Digital Interface Circuits, April 1975.
- [f] Electronic Industries Association (EIA) RS-XYZ, Functional and Mechanical Interface Between Data Terminal Equipment and Data Communications Equipment Employing Serial Binary Data Interchange, Tenth Draft, 8 September 1975.
- [g] DCAC 370-D175-1, DCS AUTODIN Interface and Control Criteria, October 1970.
- [h] Federal Information Processing Standard (FIPS) PUB 1, Code for Information Interchange, November 1968.

MIL-STD-187-310

- [i] IBM GA 27-3004-2, Binary Synchronous Communications, 3rd Edition, October 1970.
- [j] American National Standard X3.28-1971, Procedures for the Use of the Communication Control Characters of the American National Standard Code for Information Interchange in Specified Data Communication Links, 10 March 1971.
- [k] American National Standard X3S34/589, Advanced Data Communication Control Procedures (ADCCP), Independent Numbering, 15 August 1975 (Proposed).

CHAPTER 7

SECTION 3

PROTOCOLS

7.3.1 Protocol Structure. The protocols of the AUTODIN II network are the set of rules, procedures, formats, and standards which enable communication of data messages and transactions to take place. Protocols exist in a hierarchy, or in layers, as conceptually represented in Figure 7.3.1. These protocols are an adaptation of the ARPANET protocols to meet the unique requirements of military data communications. Much of the terminology has also been taken from ARPANET practices. Because Figure 7.3.1 shows the functional interrelationships between major elements of the network, it serves as a logical "road map" or index to the data handling paragraphs of section 2.

7.3.1.1 Physical Communication Channels. The solid lines in Figure 7.3.1 are the actual physical communications links over which data communication takes place between the component elements shown in the figure. These components labeled with ARPANET terminology are more general in context than as described in subsequent sections and therefore are defined briefly here. A "host" is a computer capable of supporting multiple host-to-host connections. A "user" is a terminal accessing the host directly and the network via the host. Terminals (T) may access the switch directly through a module called Terminal Access Controller (TAC).

Each of the physical channels shown has associated with it a set of protocols. Each protocol at a lower level must be transparent to all those at a higher level. On any particular channel more than one level of protocol may be used. For instance, a host-to-switch protocol must include as a transparent subprotocol the line control protocol which provides framing and error control.

7.3.1.2 Virtual Communications Channels. The channels represented by the dotted lines are "virtual" channels. For example, one host will communicate with another via the physical host-to-switch, switch-to-switch, and switch-to-host channels. However, these physical channels are transparent to the communicating hosts and each host sees only the agreed upon protocols between the two hosts; a host-to-host protocol. Because of the transparency of lower level protocols to higher, other virtual channels than those illustrated are possible. An important example is that of a terminal using a process in a remote host. The virtual channel is from the terminal to the process within the remote host. The physical channel is terminal-to-TAC, switch-to-switch, switch-to-host, and host-to-process.

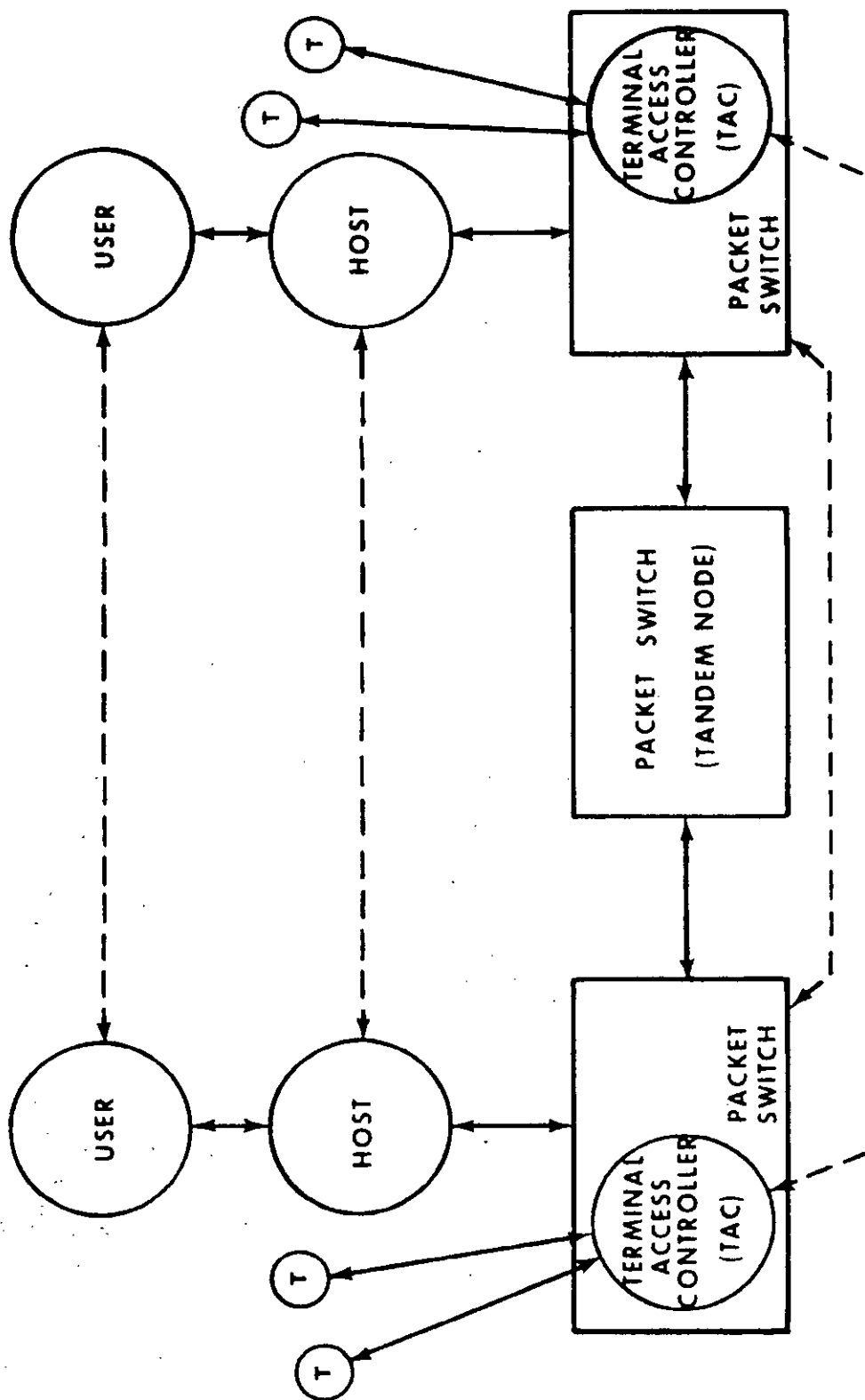

FIGURE 7.3.1 Protocol Structure

7.3.2 Modularization Approach. The packet switch functional modularity approach described in reference [a] is keyed to the layered/hierarchical structure of the AUTODIN II communications protocols and the two basic subscriber classes the PS network will be called upon to service. This approach offers a logical matching of the layered structure of the protocols, the subscriber classes, and the functions that the PS must perform.

Two formats are used in the AUTODIN II. The Segment Format is used in the access area between a host and its source PS and the Packet Format is used in the backbone between PS's. The Segment and Packet Formats may be subdivided into two major classes of network subscribers: Binary oriented and Character oriented. Based on the structure of the protocols, three functions are required: a line control function; a switch control function to handle binary oriented subscribers; and a Terminal Access Control function to provide the services required by character-oriented terminals (the host protocol level is transparent to the PS, thus does not require a function in the PS).

7.3.3 Binary Oriented Subscribers. The Binary oriented terminals transmit and receive traffic on a segment-by-segment basis where a leader is contained in every segment. Typical examples of Binary oriented subscribers are given in Table 7.3.1. The Binary oriented subscribers shall use Modes I and VI line control while the Character oriented subscribers shall use Modes I, IB, IIA and IV. All Mode I, IB and Mode VI access circuits shall be full duplex. Mode IIA terminals may operate with either full or half-duplex circuits. The half-duplex (HDX) access circuits shall have a secondary control channel.

Multilogical channel Binary oriented subscribers are capable of conducting multiple transactions concurrently while character oriented subscribers are not.

7.3.3.1 Binary Oriented Formats and Protocols. The host computer shall interface with the PSN by use of formatted segments of data and a rigid sequence of protocol exchange. All host systems developed by subscribing agencies not using the SCCU's or MCCU's will conform to the following formats and protocols. These formats and protocols will be supported at the packet switch interface. The basic element for communications exchange between a host and the PSN shall be the segment. It is the unit of data that the PSN receives from its Type A and B subscribers (Figure 7.2.3). For unintelligent subscribers, the segment is constructed by the TAC. A segment shall contain an 80 bit leader field, a text field variable from 0 to 1952 bits, 32 error control (CRC) bits, and up to 40 bits of ADCCP line control for a total transmitted segment length of up to 2104 bits.

7.3.3.1.1 Leader Formats. Figure 7.3.2 shows the binary segment leader format which hosts and TAC's shall use. Source node TAC's or host computers shall convert the user leader data to a binary formatted leader, consistent with the binary codes used for segment transmission, and assemble the binary leader in front of the data portion of each segment to be processed by the source node. Descriptions of the Binary Segment Leader fields are contained in paragraph 3.3.3.4.1 of reference [a].

7.3.3.1.2 Subscriber Formats and Modes for PSN Access. PSN subscriber formats and modes have been designed for a wide range of operations. Figure 7.3.3 shows the general relationship of line control designators to the total format for each mode. The formats will permit efficient and reliable operation for complex computer interfaces with wideband communications. There are two basic formats or Segment Leaders (i.e., Type A and Type B) designed for use by host subscribers. The formats are designed to meet subscriber equipment and functional requirements while also supporting the subscriber line modes and meeting AUTODIN I interchange requirements.

7.3.3.1.3 Type A - Binary Segment Leader With Mode VI. Figure 7.3.4 depicts the Binary Segment Leader (BSL) format. Mode VI line controls are defined by paragraph 7.2.6.1.4. The BSL format is only permitted on Mode channels where full binary coding is possible. Note that the BSL format and the Packed Binary Segment Leader (PBSL) (Type B) are the only formats which enable multiplexed host-to-host connections on the same access circuit.

7.3.3.1.3.1 Precedence Field. Bit 1 is a priority flag. Bits 2-5 are 16 levels of precedence.

7.3.3.1.3.2 Security Fields. Refer to Appendix A of reference [a] for this information.

7.3.3.1.3.3 Command Control Field. This field contains the host-to-PSN protocol commands which control the operation and state of the Segment Interface Protocol (SIP) - PSN interface. Host-to-Host commands shall be included in the Transmission Control Program (TCP) interface (see paragraph 7.2.4.5.2). Certain commands shall require subcommands which provide the argument or reason for a given command/condition. The structure to permit this command-subcommand capability is to be determined. Also, which commands (if any) can be piggybacked on data segments and the mechanism for accomplishing this are to be determined. The comments shall be provided for in the SIP to PSN interface. However, these commands shall be expanded or modified as necessary to accommodate each condition that is encountered over this interface. Appropriate reactions to these commands when received must also be provided. Commands are defined in paragraph 7.3.3.1.3.3 of reference [a] and are listed below:

MIL-STD-187-310

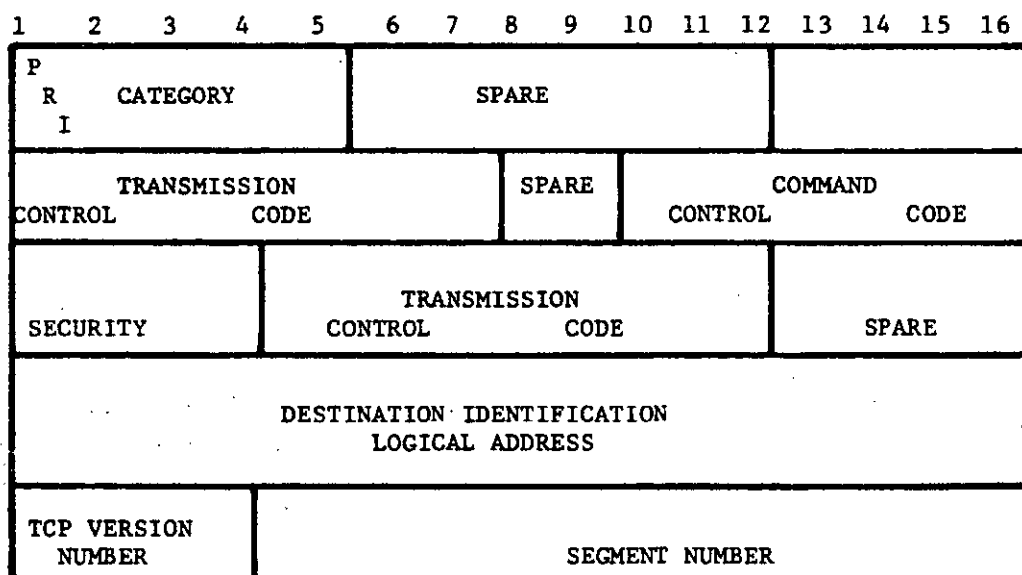

FIGURE 7.3.2 Binary Segment Leader

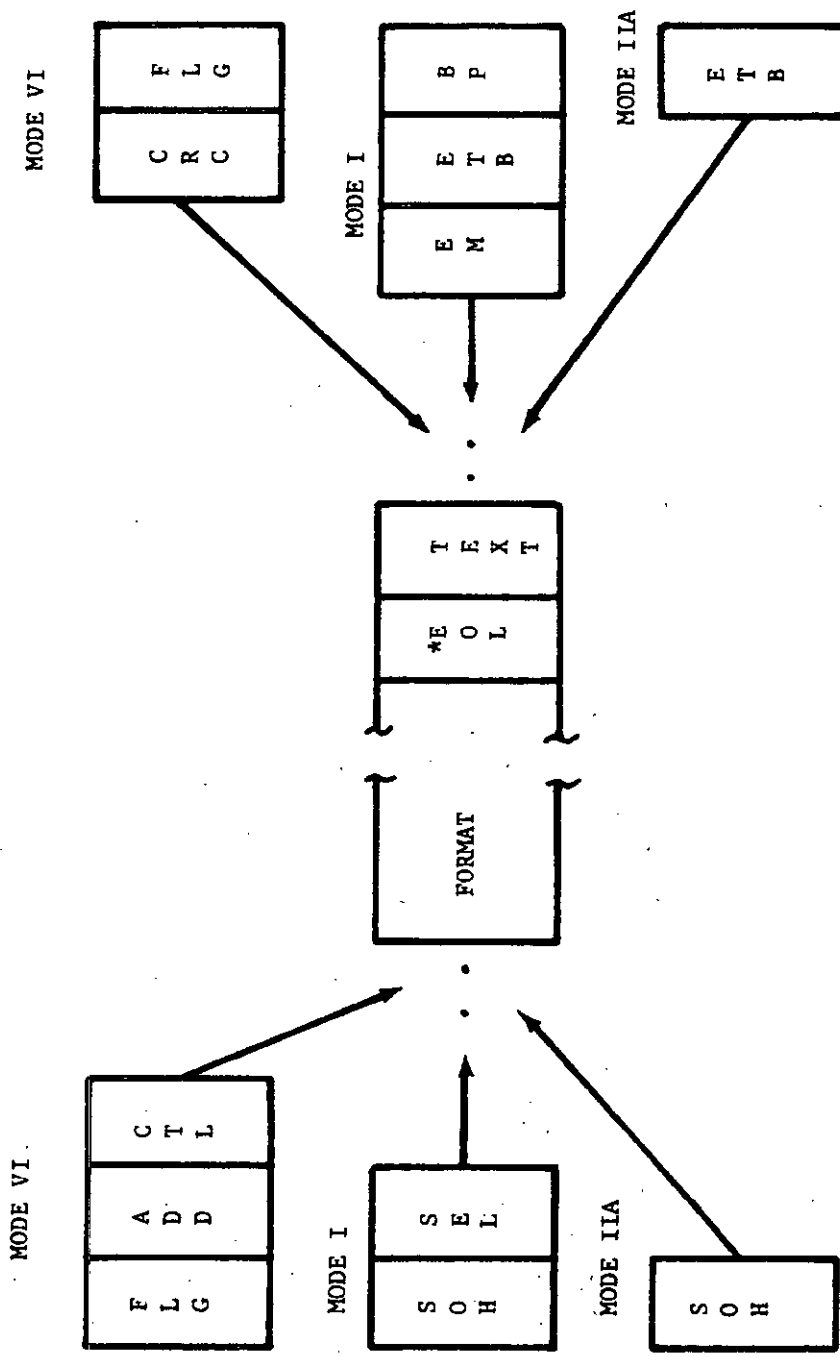

FIGURE 7.3.3 Effect of Line Modes

MIL-STD-187-310

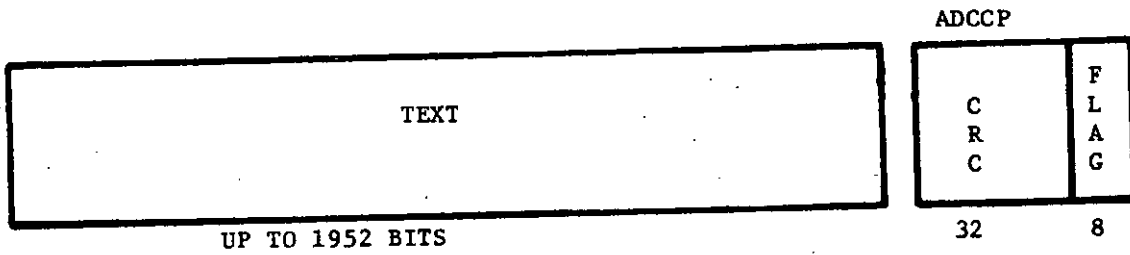
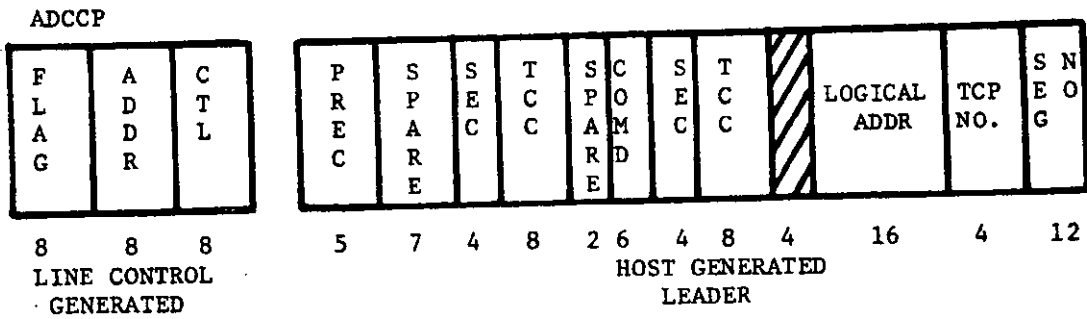

FIGURE 7.3.4 Type A Binary Segment Leader Mode VI

- a. Data
- b. PSN Reject
- c. Nonoperable (NOP)
- d. Access Circuit Operable
- e. Access Circuit Going Inoperable
- f. Echo
- g. Undelivered
- h. PSN Going Down
- i. Error Without Segment Identification
- j. Error With Segment Identification
- k. Host Inoperable
- l. Ready for Next Segment
- m. Segments Acknowledged
- n. Incomplete Transmission
- o. Stop Transmission.

7.3.3.1.3.4 Logical Addressing. The network shall provide unique identification of network subscribers to allow for positive differentiation between any given subscriber and all other network subscribers. Each subscriber identification (address) shall consist of a fixed numerical logical address. The subscriber logical address shall be translated via table lookup to a serving switch, and/or a port or line identification shall always be used for interchange of information between the switching node and that given subscriber.

7.3.3.1.3.4.1 Origination and Destination Addressing. Transactions shall enter the PSN in the segment format or character format, such that text is preceded by a leader. The leader shall contain the destination address as well as other identification, control, and verification information. The originating switch uses the leader and the origination address to build a packet header for transmission to the destination switch. At the destination switch a leader is generated from the information contained in the packet header. This leader, as delivered to the destination subscriber, differs from the

MIL-STD-187-310

original leader only in that it contains the origination address inserted in the packet header by the originating switch.

7.3.3.1.3.4.2 Directory Control. A directory of all subscribers to a switch shall reside in each PSN. Switch directories shall be maintained at the Network Control Center described in section 5.

7.3.3.1.3.4.3 Directory Content and Implementation Concept. For each subscriber of a PSN, the directory shall consist of, but not be limited to, user identification (address), maximum authorized precedence, maximum security level limit, and transmission control codes (TCC) authorized. In addition, as an integral part of the overall switch directory, an address translation table shall contain the switch(es) or local access circuit (port) identification for each logical address to be served in the network. For the subscribers connected to a PSN, the table entry shall identify the local access circuit (port) identification. For all other subscribers of the network, the table entry shall identify the appropriate destination switch. The table look-up process for address translation shall be required only for the initial segment of a source address-to-destination address connection.

7.3.3.1.3.4.4 Dual-Homed Subscribers. Certain critical subscribers require access to the PS network via two PSN's. However, the subscriber logical address shall be invariant. Traffic shall normally be transmitted and received via the primary PSN and only upon failure of the primary PSN or access circuit shall the traffic be automatically switched to the alternate PSN.

7.3.3.1.3.5 Transmission Control Program (TCP) Version Number. This four-bit field provides for the designation of 16 different versions of TCP's used either in AUTODIN II or in interfacing networks, such as SATIN IV.

7.3.3.1.3.6 Segment Number Field. Each segment transmitted to the PSN shall be sequentially numbered. This field shall contain the number assigned to the segment by the SIP.

7.3.3.1.3.7 Spare Fields. The segment leader contains a 7 bit, a 2 bit, and a 4 bit spare field. Use of these bit fields has not been designated.

7.3.3.2 Host Level Protocol (Host-to-Host). A host level protocol must be developed for TAC/SCCU/MCCU to TAC/SCCU/MCCU communication. It may also be used by user host systems, at their option (user host system to TAC/SCCU/MCCU communication will be required to use the host level protocol). As a result, the host level protocol developed must be capable of user implementation and, at the same time, network level

operations must not be affected by its absence; i.e., network level operations must not depend upon the existence of any particular version of the host level protocol. A Draft Specification of Transmission Control Program (TCP), Appendix D, reference [a], is a basis for the host level protocol development.

The host level protocol will be implemented in the TAC, SCCU, and MCCU. The implementation shall permit the user to communicate with any other compatible host level protocol implementation in the network, including the TAC's, SCCU's, and MCCU's, subject to appropriate security and other interconnection restrictions.

7.3.3.2.1 Host Level Protocol Functions. As outlined in the draft TCP Specification of Appendix D, reference [a], the primary host level protocol function is the orderly and efficient host level transfer of information. The general mechanics for this process-to-process transfer of information are illustrated by Figure 7.3.5. At this level it is useful to speak of process-to-process communication, without regard to the actual host level entity within which the process resides. A process, as used here, is that active element in the host level entity which actually controls the transfer of information. Except for some network performance characteristics such as throughput, response time, and reliability, the process-to-process communication is in general not dependent on the medium over which the information is transferred. In fact, one of the functions of the host level protocol is to make the network as transparent as possible. It does this in several ways, such as relying on lower level protocols for such things as network routing, circuit level communication and error detection, and network flow control. The host level protocol itself addresses two major functions: connection management and information transfer management.

7.3.3.2.2 Connection Management. To achieve communications between a pair of processes through a switched network, a major function of the host level protocol is to provide the means by which a connection may be established between the processes, controlled during the transfer of the information, and disestablished at the completion of the connection. The disestablishment may not be complete, but may be a transfer of one end of the connection from one process to another process in the same host entity. This connection management function is discussed in greater detail in the draft TCP Specification of Appendix D, reference [a]. The important point is that the connection management function shall be implemented in a network transparent manner; i.e., process level connection management shall not be dependent on network level connection management, and, more importantly from the network standpoint, the network level operations shall not depend upon the host level protocol connection management.

MIL-STD-187-310

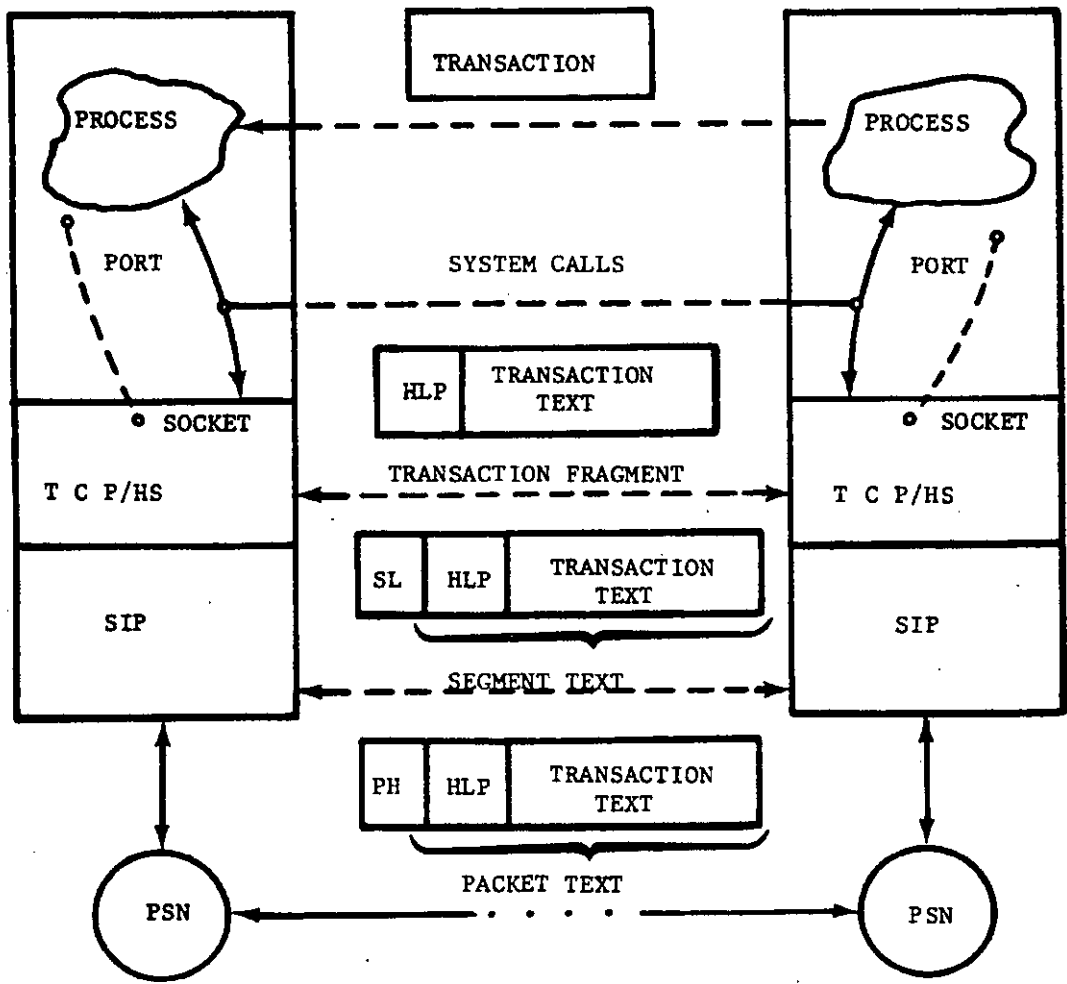

LEGEND:

- TCP/HS - Transmission Control Protocol/Host Specific
- SIP - Segment Interface Protocol
- PSN - Packet Switch Node
- HLP - Host Level Protocol
- SL - Segment Leader
- PH - Packet Header

FIGURE 7.3.5 Process-To-Process Transfer of Information

7.3.3.2.3 Information Transfer Management. A second major function of the host level protocol, possible after the establishment of a connection, is the management of the actual transfer of information. This involves such functions as synchronization, sequencing, delivery acknowledgment, error detection, identification and elimination of duplicates, addressing, nondelivery identification and recovery, and process level flow control. This function shall also be implemented in a network transparent manner, and shall be independent of such network constraints as packet size, network routing, network configuration changes, and link control procedures, to the maximum extent possible. Information Transfer Management is covered in greater detail in the draft TCP Specification of Appendix D, reference [a].

7.3.3.2.4 Security and Precedence. Two other areas that the host level protocol shall address are the unique DoD common user requirements of security and precedence. These requirements are discussed in greater detail in paragraphs 7.2.3 and 7.1.3.1.4. They apply to both the connection management and the information transfer management functions of the host level protocol which shall provide the capability to handle multiple connections of varying security requirements, varying precedence levels, or a combination of both, in the same host entity. In general, a connection may be assumed to have only one security state and one precedence state at any one time, and these can be changed only by disestablishing the connection and reestablishing a new connection. Some users may choose not to implement the host level protocol, using instead their own version for their own unique operations. However, user-unique host level protocols must still provide the security and precedence information required by the SIP.

7.3.3.3 Host-Switch Protocols. A host computer is a sophisticated, multiprogrammed processor capable of transmitting, receiving, and accounting for multiple connections in what appears to be a simultaneous manner. It has the capability of carrying on a dialog with another Host and will give or accept instructions to or from the source node. The command control field (reference 7.3.3.1.3.3) of the segment leader contains these instructions and also identifies the segment as being data, a service message, commands, etc.

7.3.3.3.1 Host-Switch Access. The host will gain access to the network by creating a leader, appending the leader to the data portion of the segment, and transmitting the segment to the source node. Line control procedures will only indicate that the source node has correctly received the segment. The host will then wait for instructions from the source node as described in paragraph 7.3.3.1.3.3. The host will initially receive data on a new connection from the network when a leader is received with a new source address, and an appropriate command code.

MIL-STD-187-310

7.3.3.4 Type B - Packed Binary Segment Leader With Mode I. Figure 7.3.6 defines the Packed Binary Segment Leader (PBSL) coupled with Mode I I line control. The format defines a character oriented structure with the eighth bit position reserved for parity in order to comply with current Mode I requirements. This format will be used over the interface lines between the PSN and the AUTODIN I switch. The line control procedures for Mode I are defined in paragraph 7.2.6.1.1. The Type B Leader or PBSL provides for all capabilities defined for the BSL except that all data (i.e., leader and text) must be coded in odd parity ASCII characters.

7.3.3.5 AUTODIN I - Packet Switched Network Interchange. Interchange between AUTODIN I and PSN will be consistent with the mode defined in paragraph 7.2.4.7. Paragraph 7.2.4.7 also defines the subscriber types with detailed definitions of AUTODIN I access. As a minimum, the interchange capability will provide a means for AUTODIN I to derive backbone trunking via PSN.

7.3.3.5.1 AUTODIN II Access by Autodin I Message Switches. The following sections and paragraphs provide detailed requirements for exchange of AUTODIN I traffic via the PS network. These requirements apply to all AUTODIN I message formats, control traffic, and service message traffic. AUTODIN I access to PSN will be accomplished through computer software programming of the AUTODIN I message processors.

7.3.3.5.2 AUTODIN I Access Mode and Format. The AUTODIN I message switch will be reprogrammed as a host able to generate and receive the Type B - Packed Binary Segment Leader Mode I format defined by paragraph 7.3.3.4.

7.3.3.5.3 AUTODIN I Message Acknowledgment and Accountability. The AUTODIN I message switch use of the Mode I Type B operation negates AUTODIN I's current end-of-message (EOM)/acknowledgment design. Utilizing the PS network, AUTODIN I will be required to suspend output processing for end-of-message until acknowledgment is received from the destination PSN subscriber which may or may not be an AUTODIN I switch. To accomplish EOM processing, AUTODIN I will be interfaced with the PSN accountability acknowledgment and ready-for-next segment processing defined in reference [a].

7.3.3.5.3.1 AUTODIN I Line Block Framing For Type B Operation. To operate with Type B (PBSL/Mode I) channels, AUTODIN I shall not be required to provide new line controls and associated processing. The PSN shall be designed to receive, and regenerate, Mode I line block framing on output as received from AUTODIN I or other Mode I subscribers.

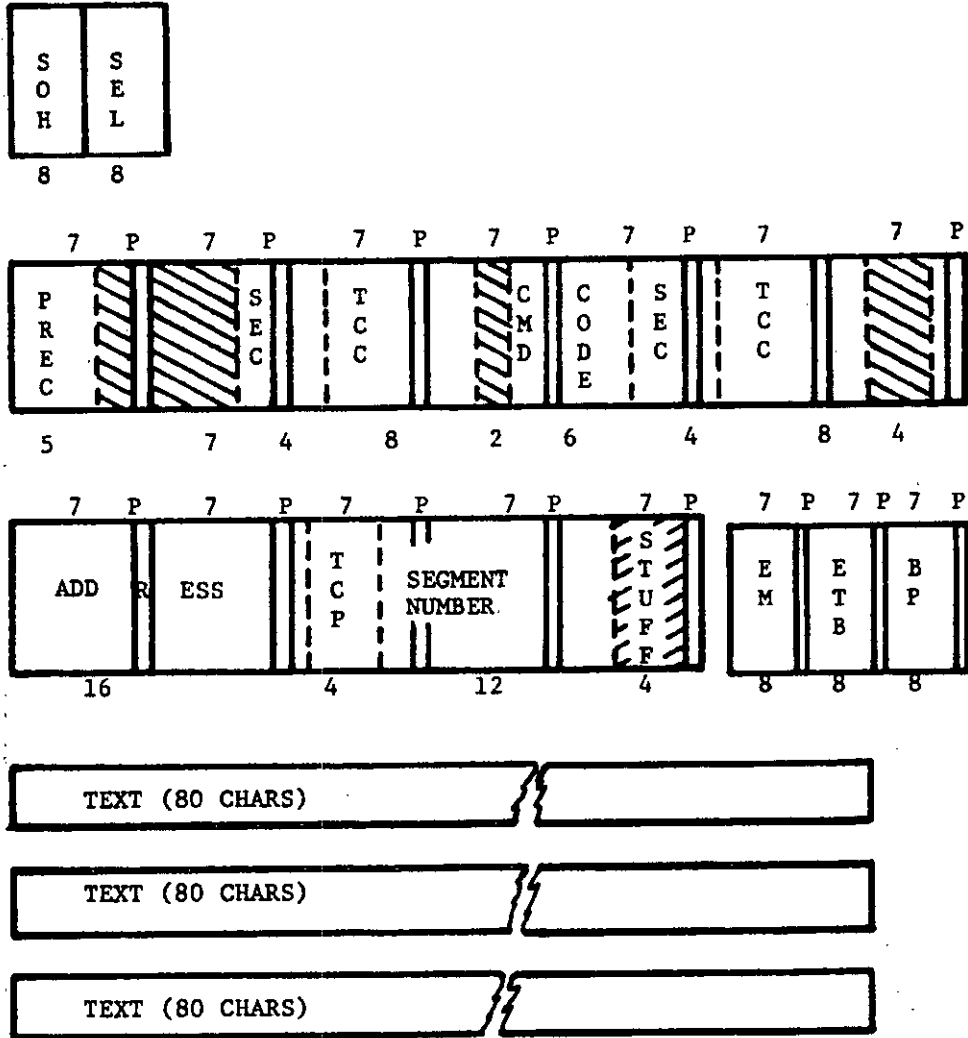

- Note: (1) Mode I data characters require 8th bit coded as odd parity, control characters coded as even parity
- (2) Dashed vertical line defines boundary for binary coded field.

FIGURE 7.3.6 Type B - Packed Binary Segment Leader/Mode I

MIL-STD-187-310

7.3.3.5.4 Packet Switch Subscriber Access to AUTODIN I. AUTODIN I message traffic received from a packet switch shall always be transmitted to a predetermined or "home" AUTODIN I message switching center. Each AUTODIN II subscriber authorized traffic origination to AUTODIN I will be designated an AUTODIN I home switch and each AUTODIN I switch may serve as a home switch. The "home switch" will have prestored table information (e.g., class marking, RI tables, etc.) which will enable proper message switch processing and servicing for the terminal.

7.3.4 Character Oriented Subscribers Characteristics. Character oriented subscribers may be viewed as being "transaction" based; that is, Character oriented terminals transmit and receive traffic on a character-by-character basis, where the leader is sent only once at the beginning of each transaction. Typical examples of Character oriented subscribers are also shown in Table 7.3.1.

Character oriented terminals, as defined in paragraph 7.2.4.5, will access the switch either directly or through a multiplexer using one of the four access circuit modes given in paragraph 7.2.6.1.

The Character oriented terminals shall interact with the switch through a module of the PSN called the Terminal Access Controller (TAC) which was described under paragraph 7.2.4.5.

Connections between Character oriented terminals are established by the source TAC TCP coordinating the connection with the TCP in the TAC serving the destination terminal. Connections between terminals and hosts are established by the source TAC TCP coordinating the connection with the destination host's TCP. The specification of TCP operation is given in Appendix D, reference [a]. The normal mode of operation of Character oriented terminals is to transmit and receive data from one subscriber at a time. A second subscriber attempting to connect to the terminal, while it is receiving data from the first subscriber, shall be blocked and given an indication that the destination is busy. The terminal shall receive the leader information only once at the start of the transaction. The connection shall stay in effect until broken by any of the following: the transmitting subscriber, the receiving subscriber, time-out by the TAC (time to be determined), or switch preemption (Category I shall preempt Categories II, III or IV).

This paragraph specifies the formats, protocols, and functions of the Character oriented subscribers and the functions to be provided within the TAC for terminal-to-TAC communications. These form a minimum set. In addition, higher level protocols necessary to accomplish all of the TAC functions specified herein need to be designed.

7.3.4.1 Transmit Commands - Terminal To TAC. The TAC shall have the capability to differentiate between command information and data. A command prefix character shall be provided to indicate that command information follows. Command information shall only apply to the source terminal and source TAC except that an escape capability shall also be provided which directs the TAC to transfer the command character as a valid data character.

7.3.4.1.1 Command Options. Unique command codes shall be provided to enable the terminals to select from the TAC Terminal Handler one of each of the options listed below.

7.3.4.1.1.1 Packet Release. The source terminal may select any one of the following Terminal Handler (TH) segment release options:

- a. Release segment when full segment is accumulated.
- b. Release segment upon receipt of carriage return character.
- c. Release segment upon receipt of N characters, 1 N L, where L is the number of characters in a full line.
- d. Release segment upon receipt of a special "transmit" character.

7.3.4.1.1.2 Echo. A unique command code shall be provided which enables Mode IIA, full-duplex subscribers to select echoing. This shall result in transmitting the ASCII characters as received from the sending terminal back to the sending terminal. When in the echo mode, the terminal shall not transmit while receiving from the destination.

7.3.4.1.2 Initialization Commands. The TAC TH shall support the following commands which are defined in paragraph 3.3.3.5.1.2 of reference [a]:

- a. OPEN CONNECTION
- b. CLOSE CONNECTION
- c. CANCEL OPEN
- d. DEVICE CHARACTERISTICS
- e. INTERRUPT AND FLUSH
- f. CHANGE PREFIX CHARACTER
- g. RESET TO DEFAULT STATE.

MIL-STD-187-310

7.3.4.1.3 Break Command. Additionally, the TAC shall accommodate a terminal originated "break" which activates the modem long space "break" timer. Upon detection of a "break" on input, the TAC shall send a unique "break character" to the destination. Upon receipt of a break character at the destination, the destination TAC shall cause the output modem to place an extended "space" interval on the access circuit. Destination hosts receiving the unique break character shall enter the appropriate "wait" condition. Detailed implementation of these functions need to be specified.

7.3.4.1.4 Terminal-To-Host Protocol. In order for terminals connected to the TAC to be able to communicate with subscriber hosts, the TAC will use a standard protocol. This protocol is like the ARPA network TELNET higher-level protocol which, when used in conjunction with the TCP, will provide a mechanism for terminals to access host computer systems via the communications network.

To enable hosts to communicate with various types of terminals, a Network Virtual Terminal (NVT) has been defined in the ARPA network. The TELNET protocol requires that all terminal-like devices be made to look like an NVT. The definition of the NVT specifies a standard character set (ASCII) and a set of codes for control functions such as break, interrupt process, and abort output.

Specifications need to be developed for a TELNET type protocol to be used for TAC/SCCU/MCCU-to-TAC/SCCU/MCCU communication. It may also be used by user host systems, at their option (user host system to TAC/SCCU/MCCU communication will be required to use the TELNET type protocol). As a result, the TELNET type protocol developed must be capable of user implementation and, at the same time, network level operations must not be affected by its absence; i.e., network level operations must not depend upon the existence of the TELNET type protocol.

7.3.4.2 Formats. There are three basic character-oriented protocols: character, character canned, and character unclassified. These will only be used by the terminals defined in paragraph 7.2.4.5. These protocols as used with various line controls are described below. Formats are depicted in paragraph 3.3.3.5.2 of reference [a].

7.3.4.2.1 Type C - Character Segment Leader with Mode VI. The Character Segment Leader (CSL), coupled with Mode VI line control previously defined, provides for operator entry of precedence, command code, security, transmission control code, and addressing information. Terminals send the switch precedence, security, and addressing information in ASCII alphanumeric form which the TAC TH function interprets. Coding requirements are specified in paragraph 3.3.3.5.2 of reference [a].

7.3.4.2.2 Type D - Character Canned Segment Leader With Mode VI.

The Character Canned Segment Leader (CCSL), coupled with Mode VI line control, previously defined, only requires that the operator enter a command which causes the TAC TH to generate all segment leader data from a preestablished canned leader table. Each access circuit authorized the canned leader capability shall be limited to one canned leader.

7.3.4.2.3 Type E - Character Unclass Segment Leader With Mode VI.

The Character UNCLASS Segment Leader (CUSL), coupled with Mode VI line control, previously defined, is the same as the CSL format defined in paragraph 7.3.4.2.1, except that the TAC TH will insert a prestored security field in all leaders received from the subscriber. This format type is provided to lessen the formatting requirement for an unclassified user.

7.3.4.2.4 Type F - Character Segment Leader With Mode I or IB. The CSL, coupled with Mode I line control, previously defined, is the same as defined for the CSL (Type C) with the exception of line control. CSL is coupled with Mode IB line control in a similar fashion.

7.3.4.2.5 Type G - Character Canned Segment Leader With Mode I or IB. The CCSL, coupled with Mode I line control, previously defined, is the same as defined for the CCSL format (Type D). CCSL is coupled with Mode IB line control in a similar fashion.

7.3.4.2.6 Type H - Character Unclass Segment Leader With Mode I or IB. The CUSL, coupled with Mode I line control, previously defined, is the same as defined for CUSL format (Type E). CUSL is coupled with Mode IB line control in a similar fashion.

7.3.4.2.7 Type I - Character Segment Leader With Mode IIA. The CSL format, coupled with Mode IIA line operation, is not authorized for transmission of "message" JANAP 128 type traffic unless the echo option is used. The CSL format is the same as defined for Type C.

7.3.4.2.8 Type J - Character Canned Segment Leader With Mode IIA. The CCSL format coupled with Mode IIA line operation is basically the same as defined for Type D except for the AUTODIN I transmission restriction.

7.3.4.2.9 Type K - Character Unclass Segment Leader With Mode IIA. The CUSL format coupled with Mode IIA line operation is basically the same as defined for Type E except for the AUTODIN I transmission restriction.

MIL-STD-187-310

7.3.5 Backbone Protocols. The individual packet switches carry on a protocol exchange which is transparent to host computers or terminals. This exchange when used with the priority structure and the flow control concept provides the framework for a highly controlled PS network. Backbone functional requirements and protocols including switch-to-switch commands, source switch to destination switch commands, overall packet structure, header field structure, and associated header field coding are specified in reference [a].

7.3.6 References

- [a] DCA System Performance Specification (Type "A") for AUTODIN II, Phase II, November 1975.

CHAPTER 7

SECTION 4

PACKET SWITCH CHARACTERISTICS

7.4.1 Introduction. This section contains general information pertaining to packet switch characteristics pending development of more detailed data.

7.4.2 Packet Switch Architecture. The packet switch shall provide terminating, processing, memory and control position(s), the requirements for which are described in the paragraphs following.

7.4.2.1 Terminating Subsystem. The terminating subsystem of the PSN shall provide the necessary duplex transmission from the patch and test facility to the processing subsystem. This transmission shall include any serial to parallel and parallel to serial conversion necessary, and any transmission voltage levels to logic levels and logic levels to transmission voltage level conversion necessary. The terminating subsystem shall have sufficient flexibility to interface all of the protocols specified herein.

7.4.2.2 Processing Subsystem. The processing subsystem shall be programmable, as specified in section 7.6, meet the processing requirements specified in paragraph 7.1.2.1, and provide the processing capabilities described below.

7.4.2.2.1 Software Loading. The processing subsystem shall have the capability of being loaded locally and remotely in accordance with paragraph 7.6.5.2. Remote loading shall be activated as an option. The initial loading and reloading capability subsequent to node failure shall be done locally and loading or reloading shall not take more than five minutes. Provisions shall be made for entering revisions, updates, patches, table changes, etc., locally or remotely from the Network Control Center (NCC) in accordance with the provisions of section 7.5 and paragraph 7.6.5.3.3.

7.4.2.2.2 Switch Software Alteration. The AUTODIN II shall employ sufficient safeguards, to be developed, against inadvertent (overt) or unauthorized (covert) switch software alteration. The safeguards shall include software protection under abnormal as well as normal operating conditions, definition of operator authority, and physical security.

MIL-STD-187-310

7.4.2.2.3 Fault Isolation. Hardware failures in the PSN shall be detected, localized, isolated, and identified. Notification of a hardware failure shall be provided the local operator and the NCC. For failures external to the switching hardware (e.g., a modem, a crypto), the processing subsystem shall provide fault isolation through loop-back techniques.

7.4.2.3 Memory Subsystem. The configuration and size of the memory subsystem is to be determined. Static high-speed random access storage shall be used; mass memory in the form of tape, disk, or drum shall be discouraged unless other techniques will impose a substantial technical or cost penalty.

7.4.2.4 Switch Control Position. Provisions shall be made for the local supervisory personnel to effect control of the packet switch from a single switch control position, called the switch console. The switch console shall be composed of a display, keyboard, an auxiliary input/output device (such as magnetic tape cassette or floppy disk), and a printer. In addition to the console position(s), a single line and equipment status display panel shall be furnished for routine display status conditions. Changes in status, in addition to being reflected on the display panel, shall be displayed on the switch console and printed out. All lamp indicators whether on the console or the display panel shall have a lamp test feature. The console display shall be capable of displaying 24 lines of 80 characters each. The keyboard shall be a Type 1, Class 1, MIL-STD-1280 keyboard. In addition to the alphanumeric keys, the keyboard shall permit the operator to perform keyboard and machine, cursor, editing and processor control functions described in paragraph 3.3.4.4.1.4 of reference [a].

7.4.3 Switching Node Sizing and Modularity

7.4.3.1 Switches. The minimum number of full duplex terminations at any switching node shall be approximately 50, and the maximum number of full duplex terminations at any node shall be approximately 150. The switching node shall be designed modularly to allow for any number and mix of trunks, subscribers, and multiplexers (see paragraph 7.1.3.7 and 7.2.4) to be terminated at the node. Also, all areas within the switching node shall be capable of modular growth or alteration to meet both increasing or decreasing subscribers' requirements. The modular design shall be such that the throughput of each switch (including traffic control) can be incrementally expanded from a minimum of approximately 0.5 Mbs to a maximum of approximately 2.5 Mbs. Each switching node shall have sufficient capacity to withstand a peak traffic surge of approximately twice the busy hour throughput for a period of one second.

7.4.3.2 Multiplexers. The multiplexer shall be designed modularly to allow terminating any number and mix of terminal speeds given in paragraph 7.1.3.7, subject to a maximum aggregate input speed of 56 kbps and a total of 64 subscribers full-duplex terminations. The multiplexer design shall permit expansion in the most economic increments.

7.4.4 PSN Availability, Reliability and Maintainability. The packet switch node shall have an availability consistent with the end-to-end availability specified in paragraph 7.1.3.3 and shall be designed to provide essentially continuous service, including periods when failures have occurred causing degradation. Degradation can be caused by failure of a single component or subsystem or a multiple failure involving two or more components or subsystems. The result of a single isolated failure shall be the loss of no more than a single termination. The result of multiple failures shall be graceful degradation of termination capability, throughput capability, or both. Graceful degradation is defined to be the loss of several communication circuits (e.g., 4, 8, 16, etc.), a reduction in throughput capability (e.g., from 100% to 90%), or both a loss of several circuits and a throughput reduction. The packet switch node reliability and maintainability shall be consistent with the determined switch node availability. Guidance for the AUTODIN II, Phase I maintainability program is described in paragraph 3.5.2 of reference [a].

7.4.5 References

- [a] DCA System Performance Specification (Type "A") for AUTODIN II, Phase I, November 1975.

CHAPTER 7

SECTION 5

AUTODIN II SYSTEM CONTROL

7.5.1 Introduction. The following paragraphs specify the system control and management requirements for AUTODIN II and the concept for a Network Control Center. Network disturbances listed in paragraph 7.5.3, the management requirements listed in paragraph 7.5.4 and the design requirements listed in paragraph 7.5.5 must be addressed to provide a complete structure of reports, actions, hardware, and software at each level of the network to accomplish DCA's management and control mission.

The DCS has been subdivided into geographical areas, each of which is supported by a DCA field activity. The operations elements of the DCA field activities make up the DCA Operations Complex (DOCC), through which the Director, DCA, exercises day-to-day operational direction over the DCS technical control facilities and DCS operating elements. Within this context, the authority in the DOCC in descending order is the National Communications System/DCA Operations Center (NCS/DCAOC) and the DCA Area Communications Operations Centers (ACOC's). The AUTODIN II Network Control Center (NCC) will be established as an integral part of the DCAOC.

7.5.2 Definition of System Management and Control. System management and control includes the equipment procedures, policies, and reports required to provide system control, operational direction, and management over the DCS. Operational direction is the authoritative direction necessary to ensure effective operation of the network. It includes: authority to direct the operating elements of the network, assignment of tasks to those elements, supervision of the execution of those tasks, and short term reallocation of operational facilities to accomplish DCA's daily mission. Management Control refers to longer term actions required to control and improve the network. It includes establishment of a single set of standards, practices, methods, and procedures for the performance and operation of the network, and analysis of the system performance and operation to ensure proper operation and derive improvements.

7.5.2.1 System Control. System control is the application of real-time and near-real-time measures to control the operation of the network. It does not include the system planning and engineering processes, which are considered network management tasks, although it does provide tools and data to assist in those processes. (Network management requirements are addressed in paragraph 7.5.4.)

MIL-STD-187-310

7.5.2.1.1 Functions. System control embodies four major functions: (1) network control, (2) traffic and routing control, (3) performance assessment and status monitoring, and (4) Patch and Test Facility (PTF). Network control includes transmission and switch restoral, network configuration control, reconstitution, and the addition or deletion of subscribers and coordination to detect and resolve network related subscriber problems. Traffic and routing control includes the control of traffic congestion and routing modifications. Performance assessment and status monitoring provide switch, subscriber, transmission, and network data to determine the status and performance of the system as it is currently operating and over an extended period of time. The patch and test facility performs the quality assurance monitoring, patching, testing, coordinating, restoring, and reporting functions necessary for effective technical supervision and control over backbone and access circuits traversing or terminating in a facility.

7.5.2.2 Packet Switch Network/NCC Dependency. The AUTODIN II network shall be designed such that the packet switch network shall be able to continue operations in the absence of the NCC. The PSN shall possess, as a minimum, those system controls considered essential for continued network operation in the event the NCC is out of operation. Within this criteria, the NCC must be designed to additionally possess those network and traffic controls which can be more efficiently accomplished from a centralized control facility for a higher performance network in a normal peacetime environment.

7.5.2.3 Levels of System Management and Control and Functional Responsibilities

7.5.2.3.1 Headquarters, DCA. The Headquarters, DCA staff develops policies and reporting criteria for long term management analyses and traffic engineering and may direct network changes as a result of these analyses.

7.5.2.3.2 NCC. The NCC as an integral part of the DCAOC, has two primary responsibilities: the day-to-day system control and operational direction of the PS network and the collection and dissemination of statistical information.

7.5.2.3.3 Packet Switch. The packet switch is responsible for (1) the operation of the switch functions; (2) status reporting to the NCC, the PTF, other switches, and its own subscribers; (3) fault detection and isolation; (4) implementing control actions directed from the NCC and PTF and locally determined control; and (5) identifying subscriber problems.

To ensure interoperability with planned future system control, the PSN shall be capable of transmitting status information and

receiving control directives in Tactical Communications Control Facility compatible format (refer to Figure 7.5.1) over the PS network to the NCC. PSN status shall be reported to the NCC on a periodic, demand, or occurrence basis. The reporting interval is to be determined. Control actions will be initiated from the System Control Center to the AUTODIN II switches for action. Table 7.5.1 is a minimum set of status reports and controls which should be available for implementing the reporting functions. NCC and PSN remote control capabilities shall be developed in accordance with the requirements of paragraphs 7.6.5.2 through 7.6.5.4. The requirements of paragraphs 7.5.3, 7.5.4, and 7.5.5 shall not be considered altered by this requirement.

7.5.2.3.4 Patch and Test. The Patch and Test Facilities are responsible for maintaining the required transmission path quality and for coordinating path restoral in the event of failures. Their functions include status reporting, fault detection and isolation, dial-up restoral, and quality assurance testing. Reports generated to the NCC shall be in accordance with reference [a] and prepared by the PSN operational personnel.

7.5.2.3.5 AUTODIN II Subscriber. The subscriber is responsible for the operation and maintenance of the terminal and provides status reports related to terminal problems and associated downtime to the PSN and NCC.

7.5.3 Network Disturbances. The AUTODIN II consists of a network and its individual components each of whose improper operation may cause disturbances. These disturbances are listed in Table 7.5.2 and are described in paragraph 3.3.5.3 of reference [a]. This list must be evaluated to determine parameters to be monitored, possible trending algorithms, thresholds, reports, reporting intervals, and control actions to be implemented at each level of the network. Each report and action shall be provided according to the design requirements specified in paragraph 7.5.5. For each disturbance, it is necessary to establish initial threshold settings, duration of condition before each report or control is activated and the frequency of subsequent reports and/or controls along with the range over which the threshold settings, durations and frequencies may be varied.

7.5.4 Network Management Requirements. Network management reporting shall include status of the network configuration as well as network performance. Reports and actions to be implemented at each level of the network need to be determined. Each report and action shall be evaluated in accordance with the design requirements provided in paragraph 7.5.5. Network management reports are listed in Table 7.5.3 and are described in paragraph 3.3.5.4 of reference [a].

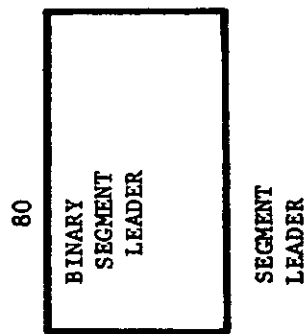
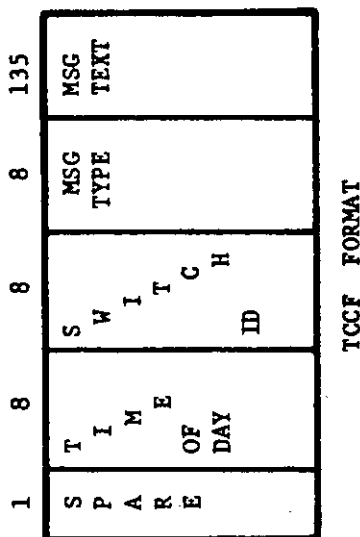
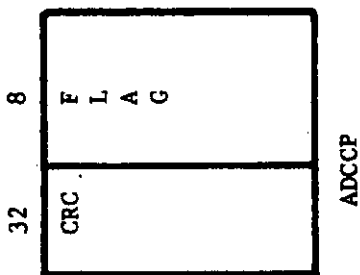

FIGURE 7.5.1 System Control General Message Format

TABLE 7.5.1

STATUS ELEMENTS AND CONTROL ACTIONS

PSN-to-NCC Status Elements

1. Packet throughput by precedence (including format errors and header extracts).
2. Number of retransmissions (on a link and end-to-end basis).
3. Input, relay, and output buffer utilization by priority.
4. Security mismatch (on occurrence).
5. Acknowledgment that an NCC control directive was implemented (on occurrence).
6. Switch/line outage and reason (on occurrence).
7. Switch Hazardous Condition HAZCON (on occurrence).
8. Program reload/restart (on occurrence).
9. Packet Preemption/Discard.
10. Traces (on demand).

NCC-to-PSN Controls

1. Order status reports on an exception basis.
2. Request diagnostic tests.
3. Change reporting thresholds and sampling intervals.
4. Select different program modules for utilization count measurements.
5. Change of approved parameters, tables, and program modules.

MIL-STD-187-310

TABLE 7.5.2 NETWORK DISTURBANCES

Transmission Media

- Access Circuit Impairment or Total Outage
- Interswitch Trunk Impairment or Total Outage
- Improper Line Patching

Switch Disturbances

- Isolated Switch - Handles Only Intraswitch Traffic
- Switch Outage/Impairment - Switch Unable to Handle Any Traffic
- Hazardous Condition - Switch Equipment Outage
- Reporting Problem
- PSN/Table Reload
- Software Fault

Traffic Disturbances

- Traffic Congestion
- Looping

Terminal Equipment Outages

Critical Switch Functions

- Duplicate or Lost Packet Protection
- Switch Buffering Allocation
- Source Switch Connection Control)
- Etc. (see paragraph 3.3.5.3.5, reference [a])

TABLE 7.5.3 NETWORK MANAGEMENT REPORTS

Network Configuration Reporting

Circuit/Link Installation/Deactivation

Rerouting

Restoral

Network Performance Data Measurements

Data Volumes

Transaction Length

Segment/Character Occurrence Frequency

Blocking

Segment Rejects/Preemption Count

Segment/Character End-to-End Throughput Rate

MIL-STD-187-310

7.5.4.1 Sampling for Performance Measurements. Full period or continuous collection of statistics shall be accomplished for each subscriber access line to enable monitoring of precedence and also to enable a volume-by-precedence billing or cost recovery method. Peak periods will be sampled for measurements of traffic volume and speed and quality of service. Sampling for Network Efficiency/Throughput and Community of Interest in regard to segment/character occurrence frequency, throughput and dial-in subscriber data is desirable during peak periods; however, if this has a prohibitively adverse cost impact, sampling may be done during nonpeak periods. Sampling start date/time and duration shall be adjustable switch parameters; however, it will be necessary to provide a capability of at least a 4-hour duration of peak period sampling.

7.5.4.2 Packet Trace Capability. It is necessary to provide an NCC-controlled packet tracing capability for NCC investigation of network activity such as routing, queueing, and switch processing. An example of data that might be required, in addition to header data, includes:

- a. Node
- b. Time the packet was received
- c. Time the packet was transmitted
- d. Time acknowledgment was received.

A trace message shall be built by the switch whenever the packet arrives with its trace bit set. The trace bit in the packet header will be set by the source switch upon NCC direction.

7.5.5 Network Control Design Requirements. Paragraph 7.5.3 defines disturbances which require real-time monitoring and reporting. Paragraph 7.5.4 defines management reporting requirements. The design for PSN and NCC operations and reporting shall address all of the design requirements (given in paragraph 7.5.5.1) for each disturbance or critical function defined in paragraphs 7.5.3 and 7.5.4. The PSN design must provide the capability to meet the requirements of this section with the NCC supporting network operations. However, the network must also be able to maintain its operational availability requirements specified in 7.1.3.3 in the absence of the NCC.

7.5.5.1 Detailed Design Requirements. The following subparagraphs indicate areas which must be defined in the detailed design of AUTODIN II System Control:

- a. Switch, PTF, subscriber, and/or NCC involvement in each control and/or reporting action.
- b. The switches in the network required for each control and/or reporting action and define the role of each.
- c. The timing criteria for generating a report or implementing a control action and the timing criteria for repeating a report and/or alarm.
- d. The format, content, and use of all reports required by the design.
- e. The need, duration, and method for retaining control or report data for NCC historical journaling requirements.
- f. Operator workload in terms of actions to be performed, control responses required, number and skill level required, and percentage of time required for various operator functions.
- g. Provisions in the NCC design for consolidation of information generated by control actions and reports, and the transmittal of same to the WWOLS for long-term management statistical purposes. As a minimum, the following categories of data concerning network disturbances are required for incorporation with worldwide DCS management statistics:
 - (1) Transmission media (access circuits and interswitch trunks)
 - (2) Switch outage
 - (3) Critical switch equipment
 - (4) Program/table reloads
 - (5) Looping
 - (6) Terminal equipment outages
 - (7) Critical switch functions.
- h. Which control actions and responses (e.g., for different disturbances) are interrelated and how the NCC, PTF, or PSN control design deals with interrelated control actions.
- i. The impact of control actions on security, precedence, or flow control if any.

MIL-STD-187-310

- j. How control actions are related to critical switch thresholds (e.g., buffering allocated to switch relay operation).
- k. The estimated data volume of control actions expressed in bits and segments expressed in summary form for a single hour and 24 hour period.
- l. Identification of all control actions designed to support Category I subscribers.
- m. Control actions and reports designed to detect switch, transmission, and network faults.
- n. Control actions and reports designed to support the switch failure/recovery procedures.
- o. Distribution of all control action reports.
- p. Control actions and reports designed to support the PSN interface with multiplexers.
- q. How controls and reports are used for degraded network operations (e.g., failure of a group of circuits).
- r. The primary and backup output devices for the display of the proposed control reports and measurements.
- s. The primary and backup input devices for each control action.
- t. The recommended timing criteria for generating the control report and recommended supervisor response time for inputting the control action and the associated required response time for effecting the control action.
- u. The network impact of delayed or lost control actions.
- v. Initial threshold settings for all timed or event-monitored functions and the range of increments for all settings.
- w. The applicability of audible and/or visual alarms for system control.
- x. The disposition of both critical and noncritical reports and control data when the NCC is inoperable due to failure or scheduled maintenance. Critical switch functions are listed Table 7.5.2.

7.5.6 Network Control Center (NCC) Requirements. Requirements for the NCC site are given in the following subparagraphs.

7.5.6.1 Location of NCC Equipment. All computer equipment and terminals defined by paragraph 7.5.6.5.1 shall be installed at the Defense Communications Agency Operations Center (DCAOC), DCA Headquarters, Arlington, Virginia. The proposed computer has not yet been selected.

7.5.6.2 NCC Availability. The NCC shall be designed to have an availability of no less than 99.6%.

7.5.6.3 NCC Reliability. The NCC reliability shall be consistent with the determined NCC availability, but shall not be less than a MTBF of 160 hours.

7.5.6.4 NCC Maintainability. The NCC maintainability shall be consistent with the determined NCC availability.

7.5.6.5 NCC Minimum Configuration. The following subparagraphs define minimum capabilities for the NCC. These NCC hardware and/or software capabilities are minimum capabilities and may be expanded or improved.

7.5.6.5.1 NCC Hardware Configuration. A processor with mass storage, display devices, console with alarm capability, tape cassette or mini-disk input/output, and printing capability is recommended. Based on anticipated usage of the NCC, it is estimated that a minimum of three CRT display devices and two line printers will be necessary. It is anticipated that the tape cassette operation or a minidisk will be an integral part of the display subsystem. The NCC equipment shall meet the security and TEMPEST requirements specified in Appendix A of reference [c].

7.5.6.5.2 Software Features. A generalized reporting and retrieval system, an interactive English-like display language, and a modular general-purpose operating system is preferred for the NCC. The applications software preferably should be written in a higher order language (see paragraph 7.6.2) using structured programming and modular programming techniques.

7.5.6.5.3 Storage Capacity. A 25 percent reserve of main memory and 50 percent reserve of mass memory must be available for use after implementation of the NCC.

7.5.6.6 IBM S360/370 Compatible Disk. The mass storage system of the NCC shall provide for a removable disk pack in the NCC for use on an IBM S370.

7.5.6.7 NCC Operational Environment. The NCC, which shall be located in the DCAOC, shall operate with on-line control 24 hours per day. The NCC shall be dual homed to the PSN.

MIL-STD-187-310

7.5.7 Network Control Center Relationship to the DCA World-Wide On-Line System (WWOLS). The information in this paragraph provides guidance regarding planned WWOLS support of AUTODIN II.

7.5.7.1 WWOLS Computer Support for AUTODIN II. The DCA WWOLS computer has a capability which could support the NCC. Specifically, the DCAOC S360 and S370 are linked with an IBM Channel-to-Channel adapter and both could support NCC operations.

7.5.7.2 WWOLS Interface with the NCC and PSN. Provisions will be made for the transfer of control and management data as defined in paragraph 7.5.5.1.g between the NCC and DCA WWOLS, and for NCC controller support of AUTODIN I as defined by paragraph 7.5.7.3. The WWOLS will be provided with a Mode VI (Type A) interface into the PSN for transfer of data between WWOLS sites. This interface will be designated as the PSN addressee for transmission of management data required by paragraph 7.5.4. In addition to this interface, cost data and technical information must be developed for the following two WWOLS/NCC interface methods.

7.5.7.2.1 WWOLS to NCC Mode VI. A direct Mode VI (Type A) interface between the NCC and WWOLS is a local communications interface designed for operation without the use of modems. The NCC and WWOLS will be interfaced to separate PSN nodes via Mode VI (Type A). Dual homing to the NCC could be provided through the WWOLS interface.

7.5.7.2.2 WWOLS to NCC via PSN. The NCC would be dual homed via Mode VI (Type A) while the WWOLS would be interfaced to a single PSN via Mode VI (Type A). The interface between the NCC and WWOLS would be through the PSN.

7.5.7.3 NCC Controller Access to WWOLS. In addition to supporting PSN control and management actions, the NCC controllers will be tasked with control and management support for AUTODIN I. Depending upon the interface proposed, it is desirable that these functions and operations be originated at the NCC display devices and access the WWOLS computers via the WWOLS/NCC interface. It is anticipated that the NCC controllers will be able to call up a preformatted leader which can be addressed to the WWOLS, and that WWOLS would respond with a properly formatted segment(s) containing the AUTODIN I control data for NCC controller release to the PSN for subsequent delivery to AUTODIN I (i.e., the segment from WWOLS would contain an AUTODIN I address in the leader).

7.5.7.4 Management Data Transfer to WWOLS. Paragraph 7.5.5.1.5 defines requirements for retention of management data to be transferred from the NCC to WWOLS.

7.5.8 References

- [a] DCA Circular 310-55-1, Operational Direction and Status Reporting for the Defense Communications System (FOUO), Volumes I and II, 13 July 1972.
- [b] DCA Circular 310-D70-13, DCA AUTODIN Software Management Procedures (FOUO), Draft Version, July 1975.
- [c] DCA System Performance Specification (Type "A") for AUTODIN II, Phase I, November 1975.

CHAPTER 7

SECTION 6

AUTODIN II SOFTWARE

7.6 AUTODIN II Software

7.6.1 General. The operational PSN software and associated support program must be developed in order to provide the necessary tools to properly maintain, alter, debug, and test the PSN software and the Network Control Center (reference paragraph 7.5.6).

7.6.2 Development Alternatives. It is necessary to develop a comparative analysis of Higher Order Language (HOL) alone, Assembly Language alone, and a combination of the two in terms of costs (which include any necessary language development), timing considerations, node core requirements, program development, debugging considerations, program maintenance, and compiler versus assembler security certification.

7.6.2.1 Assembler/Compiler Implementation Alternatives

7.6.2.1.1 Alternative I - Switch Hardware. Technical and cost breakouts shall be defined for: (1) implementing a switch and NCC computer source language assembly capability on switch hardware located at the PSN test facility, and (2) employing an HOL compiler on the test facility hardware.

7.6.2.1.2 Alternative II - IBM 370 and Switch Hardware. Technical and cost breakouts shall be defined for: (1) implementing a switch and NCC computer source language assembly capability using a cross assembler on IBM 370/145 or 370/155, or (2) implementing a switch and NCC computer HOL cross-compiler capability on an IBM 370/145 or 370/155. Alternative II shall also include the source language assembly capability on the test facility hardware defined in Alternative I.

7.6.2.2 Proposed Alternative. Based on the above analyses, a recommended approach for the language to be used and the implementation method can be proposed.

7.6.3 Design Considerations. System and module design shall consider the hardware and processing features necessary to allow the designer to choose control structures. The hardware internal architecture will dictate certain phases of the software organization, while a precise understanding of the processing requirements and the nature of data

MIL-STD-187-310

being processed will influence other software organizations. An overall system architecture narrative description and the rationale used to develop the processing and data control mechanisms must be developed (reference paragraph 7.6.8).

7.6.3.1 Security Modules. The security related tasks shall be clearly identified during the design stage. These tasks shall be collected and confined to a minimum number of modules. The dependency that each module has upon the correct behavior of any other module shall be minimized.

7.6.4 Storage Expansion. Overall table size and field size used for initial program operation shall be sufficient to accommodate a minimum of 25% growth. Tables and fields will be parametrically defined for system initialization. A 25% growth or spare capability in main memory used for the switch and NCC program, not including buffer storage, shall also be provided.

7.6.5 Software Programming Techniques. The design must implement structured programming to the maximum possible extent. A number of techniques are presented in paragraph 3.3.6.6 of reference [a] as a recommended approach for a structured programming design. The structured programming technique will facilitate modular program development and top-down program design.

7.6.5.1 On-Line Software Component Features. The operational PSN software shall contain a minimum of five major subfunctions. These are an I/O-COMM function, an Executive function, a packet processing function, a recovery function, and a utility function.

- a. I/O-COMM Functions. These functions comprise the line interfaces, realtime clock, and special hardware interrupts (memory parity, out-of-bounds write, power failure, etc.). In general, each function shall be made up of three subfunctions: initialization, interrupt, and program call entry. The failure detection routines shall have links to the recovery function.
- b. Executive Function. The processing of a packet will generally be queue driven. The executive is composed of functions which organize, control, and dispatch the processing of packets on queue, and ensure that the proper sequence of events occurs in terms of data and processing priorities.
- c. Packet Processing Function. There are two major subfunctions in the packet processing function. The first is a group of subfunctions that process packets which transit the node (relay packets). They are generally defined as input and output processing. The second major subfunction is one that

MIL-STD-187-310

processes packets which originate or terminate in the node. This is a group of functions called queuing, host-node, and pseudo-node capabilities. Packet processing is described under paragraph 7.3.3.

- d. Recovery Functions. This element consists of three major functions, as follows.
- (1) Fault Isolation. Rapid methods to detect failures and system malfunctions to ensure against incorrect processing of bits, characters, packets, and segments shall be provided. Displays and alarms shall be provided to indicate trouble conditions. These alarms shall continue to operate until released. The failure analysis shall provide, but not be limited to, detection for instructions not completed, particular error detected, conditions under which errors were detected, logic elements causing the errors, error alarms for malfunctions in the CPU, and error alarms for malfunction in the peripheral devices.
 - (2) Data Recovery. Traffic lost because of access circuit or backbone circuit failures may be recovered by retransmission at the circuit level, but if an access or backbone circuit is deemed out of service, the traffic on that circuit shall be analyzed for an alternate path. Backbone circuit traffic can be routed on a different backbone circuit, and if a failed circuit is part of a multichannel link, the traffic can be requeued to an operating circuit.
 - (3) Configuration Switching. This is the process by which the system resumes/continues operations after a failure in the system. The associated tables are marked appropriately and the necessary control messages are sent to the NCC and switch supervisor. In the event that the system cannot remain on-line, this function shall make the necessary notifications and bring the system to an orderly shutdown. The requirements of paragraph 7.6.5.2 also apply.
- e. On-Line Utility Subsystem. The utility function shall be made up of modules which operate as background processes in the system. These include capabilities such as a patch/dump procedures, a line status report, and a queue status report.

7.6.5.2 System Initialization, Reload and Reprogramming.

- a. Initialization. The initialization (startup) program unit shall establish all access and backbone circuit tables, routing tables, buffer allocations, etc., each time a load of the software program is required. Initialization capability shall be provided

MIL-STD-187-310

which will establish all necessary control measures for the correct operation of the equipment. Each initialization phase shall be developed as a unique function so that restart following a configuration change is a subset of the total startup.

- b. Reload. The packet switch shall provide for reload of the House Operating Program (HOP) (reference paragraph 7.6.5.5) to enable a restart of failed equipment, or as a part of initial startup.
- c. Reprogramming. Reprogramming capability for the PS shall be provided to include a readout, change (program patching), load, and memory dump capability for any particular core location or instruction, all or part of the packet switch unique line parameters, a program module, or the complete program. This capability shall be fully supported by the utility software requirements defined by paragraphs 7.6.5.1.e and 7.6.7. Control of software modification shall be in accordance with reference [a].

7.6.5.3 Capability for Reloading and Reprogramming of Packet Switch Software

7.6.5.3.1 Local Packet Switch Capability. The local switch supervisor or operator shall be provided the capability for performing the functions defined in paragraph 7.6.5.2, and for obtaining all required outputs. The packet-switch software local load device (e.g., a stand-alone direct input from a magnetic tape, tape cassette, floppy disk, or other suitable medium) remains to be determined. For initial operation, all parameters and controls shall be entered by the local switch operator.

7.6.5.3.2 Remote Test Facility Capability. A remote PSN programming capability will be provided for use by computer programmers at the Test Facility which provides the capability for requesting and receiving readouts, and necessary dumps for any core location, or instruction, all or part of the packet switch unique line parameters, a program module, or the complete program. All outputs necessary for performing remote programming shall be provided to the programmers at the Test Facility (TF). The switch design shall ensure that all remote programming functions adhere to the security requirements defined in paragraph 7.6.5.4 below. The initial PSN operating system as specified in paragraph 7.6.5.2 shall not be designed to support remote programming operations. However, necessary operating system software modifications shall be developed for use at the PSN to implement this function.

7.6.5.3.3 Network Control Center (NCC) Software Capability. The NCC shall be provided the capability to load the switch software as defined by paragraphs 7.6.5.2.a and 7.6.5.2.b above. In addition, the NCC shall be provided with the capability for updating or changing of the switch line parameters and loading program changes (patches) in the PSN. The initial PSN operating system as specified in paragraph 7.6.5.2 shall not be designed to support remote programming operation. However, the operating system software modifications that are necessary for use at the PSN to implement this function will be developed.

7.6.5.4 Security Processing for Support of Remote Programming. To enable secure implementation of the remote programming functions described above, it must be designed to prevent unauthorized programming actions. As a minimum, the design shall utilize the following capabilities:

- a. All circuits carrying switch programming data shall be link encrypted.
- b. All segments and packets from the TF and NCC shall have a unique and exclusive:
 - (1) Security Level Designation (8 bits)
 - (2) Transmission Control Code (16 bits)
 - (3) Command Control Code (8 bits)
 - (4) Destination Address (16 bits)
 - (5) Source Address (16 bits) (packets only)
 - (6) Precedence Level Designation (5 bits).
- c. Before a PSN shall accept and act on a switch programming message, it shall check and validate that each packet of the message contains all of the above six information fields correctly.
- d. Packet switches shall check and validate all subscriber access circuit traffic to insure that only valid and authorized traffic is accepted into the switch.
- e. Only the encrypted NCC and TF access circuits and backbone circuits shall be allowed by the PSN to transmit and receive segments whose leader contains the unique and exclusive PS program message codes.

MIL-STD-187-310

- f. A PSN shall accept and act on a routing control packet if and only if all of the following conditions are satisfied:
- (1) The packet header command control field contains the correct routing update code.
 - (2) The packet header single routing update bit is set.
 - (3) The packet header destination address field contains the correct unique address of the PS that will accept and act on the routing control packet.
 - (4) The packet header source address field contains the correct unique address of the neighboring switch.

7.6.5.5 Binary Loader. The output of the relocatable link/loader shall be an executable binary module. This is written to the load device (reference paragraph 7.6.5.3.1) to be loaded in the on-line system.

7.6.6 Off-Line Software

7.6.6.1 Component Feature. The off-line system shall comprise five major functions; by broad category these are debugging aids, utility support, assembler, compiler, and test and diagnostics.

7.6.6.1.1 Debugging Aids

7.6.6.1.1.1 Internal Storage Dumps. A routine shall be provided for dumping areas of internal storage onto magnetic tape or directly onto a printer, and for transmitting the data to the Test Facility. The areas to be dumped should be specified by operator-inserted parameters. Printouts shall provide machine language representation of the instructions and their alphanumeric equivalents.

7.6.6.1.1.2 Cross-Reference Dictionary. Routines must be developed to generate the cross-reference dictionaries indicated in the following subparagraphs.

7.6.6.1.1.2.1 Command Cross-Reference Dictionary. A capability shall be provided to generate a cross reference dictionary of all command activity contained on a designated source, (e.g., assembly language) medium. The dictionary, or analyzer, shall contain all commands, on both the processor and I/O level, that reference a symbolic address, index register, absolute address, or standard memory location within the system. The dictionary shall also indicate, if determinable, the actual machine (e.g., octal) address of the symbolic address, the command mnemonic, a sequence number that is unique throughout the

system, and any indirect address capability, index register modification, or other special features of the command. The cross-reference dictionary shall be sorted and segregated in an order appropriate for logical retrieval.

7.6.6.1.1.2.2 Bit Command Cross-Reference Dictionary. A capability shall be provided to generate the cross reference dictionary of all bit command activity contained on a designated source medium. The dictionary or analyzer shall contain all bit instructions, on both the processor and I/O level, that access or interrogate a given symbolic address. The address isolation shall contain the complete address including any index register indirect reference or arithmetic modifications, the bit command mnemonic, and a sequence number which is unique throughout the system.

7.6.6.1.1.2.3 Program Patching. A capability shall be provided which will permit the insertion of corrections and patches into the object program without necessitating a complete assembly or compilation. This capability shall also permit the building and updating of all required tables, and shall be capable of being used both on-line and off-line using either machine code or symbolic language code.

7.6.6.1.1.2.4 Compare Routine. A capability shall be provided to compare the original object program with the corrected one, whether on load device storage medium (reference paragraph 7.6.8.4) or core image, and to permit the differences to be dumped directly onto a printer. In addition, it is a requirement that more sophisticated debugging aids be available at the test bed or development site to include, as a minimum, traces, routine timing, and trap routines.

7.6.6.1.2 Off-Line Utility Subsystem. This subsystem is the Executive for the off-line system and performs all I/O and resource management for user programs.

7.6.6.1.2.1 Text Editor. A text editing facility shall be provided so that a programmer can request specific programs and/or files and either enter, delete, or modify the programs or files, and write them into files. The text editor facility shall be designed as a maintenance/debugging tool with its own command language that is composed of an easy-to-understand language syntax.

7.6.6.1.2.2 Relocatable Loader. The loader is the module which accepts object programs and prepares them for execution. In particular, the loader shall perform the following functions:

- a. Allocate space in memory for the object program.
- b. Adjust all address-dependent locations (e.g., address constants) to correspond to the allocated space.

MIL-STD-187-310

c. Place the object programs and data into memory.

7.6.6.1.2.3 Relocatable Link Editor. The link editor shall operate in conjunction with the loader and perform the additional function of linking. It shall resolve symbolic references between the independently compiled or assembled modules.

7.6.6.1.2.4 Magnetic Tape to Printer or Punch. A capability shall be provided to permit printout of a magnetic tape on a line printer, or punching the tape data onto cards or paper tape for permanent file purposes.

7.6.6.1.2.5 Card or Paper Tape to Magnetic Tape Capability. A capability shall be provided to permit the prestoring of data from cards or paper tape onto magnetic tape for delayed or repetitive processing by the computer.

7.6.6.1.3 Programming Languages. The capabilities defined by the following subparagraphs shall be tailored to the development options stated under paragraph 7.6.2.

7.6.6.1.3.1 Characteristics. Elements of data shall be expressible symbolically and converted to machine language by the assembly/compiling system. The program preparation functions shall allow assembly/compiling from cards and from prestored magnetic tape, including tape cassettes, disks, or a combination thereof. Output should include an assembled/compiled program on the suitable loading device and a side-by-side program listing, giving both the symbolic and absolute representation of the machine instructions. If assembly/compilation is unsuccessful, the assembly or compiler program should output a symbolic listing depicting errors encountered in the input. The output from the assembly or compiler program should be either absolute or relocatable, as appropriate.

7.6.6.1.3.2 Assembler. The assembler shall provide for diagnostic/maintenance tools such as cross-reference tables, label and variable dictionaries, and the use of relative addressing, as well as full listing capability for both mnemonic and numeric representation of instructions. The assembler shall be designed for an extensible language and therefore must be capable of easily accepting additions to the language and macro definitions.

7.6.6.1.3.3 Compiler. The IBM 370 cross-compiler if used, (reference paragraph 7.6.2) shall be designed to be an optimizing compiler. Care must be taken to design a compiler that produces efficient running code. The HOL compiler shall provide diagnostic/maintenance tools in the form of diagnostic/error messages, and full assembly listing capability, as well as cross-reference maps and variable label dictionaries. The

cross-compiler shall be designed to compile HOL subprograms (modules) independently. This necessitates the existence of a suitable linking loader or linking editor.

7.6.7 Test and Diagnostics. Off-line maintenance routines shall be used to assist maintenance personnel in localization of malfunctions within subsystems, in testing of equipment after repair, and in certifying hardware operability before placing on-line. These routines shall be designed to detect malfunctioning equipment and weak components, and to force malfunctions for testing "worst case" conditions.

7.6.8 Documentation

7.6.8.1 Design Documentation. Descriptive literature defining the design structure and operating procedures of the software package must be developed in the form of a top-down design.

7.6.8.1.1 System Software Specification. As defined below, a software design specification must be developed prior to progressing on final coding and debugging.

7.6.8.1.2 Internal Topic Documentation. Documentation shall begin during the design phase and continue throughout the production of the system. System requirements and design specifications shall comprise the documentation during the early stages of the project. These documents shall communicate interface and data base information to be used during system production. At all times the working documentation should reflect the current status of the project.

7.6.8.1.2.1 Initial Design Phase Documentation. At the completion of the initial design phase, the following information shall comprise the documentation.

7.6.8.1.2.1.1 Module Description. For each module, information defining how the module interfaces with the rest of the system shall be required to include:

- a. Module purpose
- b. Description of required input parameters including physical units, structure and type, and value ranges.
- c. Description of return results including physical units, structure and type, and value ranges.

7.6.8.1.2.1.2 Data Base Description. General abstract description of the data base shall include:

7.6.8.2.2 Detailed Program Description. The detailed program description shall cover each program unit in detail without dependency on any flowcharts provided.

7.6.8.2.3 Program Flowcharts. Program flowcharts shall be provided through use of an "AUTO FLOWCHARTER." The flowcharts are required for detailed analysis; therefore the facility shall be provided to keep them current as software changes are developed and applied to the operating system.

7.6.8.3 Computer Programmers Manuals

7.6.8.3.1 Programmer's Reference Manual. A programmer's reference manual shall clearly describe the interrelationships between the various registers and logic of the computer provided. The manual shall provide detailed descriptions of each instruction in the delivered repertoire to include its machine language identifier, its use, its effect on each register in the system, the mnemonic identifiers recognized by the machine, and its operating time. If HOL is employed, a HOL language manual shall be provided which clearly describes the language organization, instructions, and use. It shall contain a description of all options accepted by the compiler and describe in detail all options relating to filing structures, I/O operations, data communications, and interface with the Executive.

7.6.8.3.2 On-Line/Off-Line System User Manual. Separate on-line and off-line user manuals shall include a narrative description of operating instructions, and a discussion of any human intervention required.

7.6.8.3.3 Program Listing With Comments. Program listings must contain detailed comments for each program unit in the complete software package. The comments shall be developed in a way that complement output of the "AUTO FLOWCHARTER."

7.6.8.3.4 Major List and Tables. A manual must be developed which includes a narrative description of each table used in the program and the use of each designator within the table.

7.6.8.4 Source Programs on File. The source program shall be kept on magnetic storage media.

7.6.9 Software Testing. Comprehensive and integrative testing of software is necessary in the development of the system software. Requirements for software test plans and procedures are contained in reference [b].

MIL-STD-187-310

7.6.10 References

- [a] DCA Circular 310-D70-13, DCA AUTODIN Software Management Procedures (FOUO), Draft Version, July 1975.
- [b] DCA System Performance Specification (Type "A") for AUTODIN II, Phase I, November 1975.

CHAPTER 8
ACCESS AREA
CONTENTS

		<u>Page</u>
	<u>SECTION 1 - DIGITAL ACCESS EXCHANGE (DAX)</u>	8-1-1
Paragraph 8.1.1	Introduction	8-1-1
8.1.2	General	8-1-1
8.1.2.1	DAX System Concept	8-1-1
8.1.2.1.1	DAX Tandem Operation	8-1-1
8.1.2.2	DAX Design Considerations	8-1-1
8.1.2.2.1	DAX Size	8-1-1
8.1.2.2.2	DAX COMSEC	8-1-3
8.1.3	DAX Design Requirements	8-1-3
8.1.3.1	Physical	8-1-3
8.1.3.2	Functional	8-1-3
8.1.3.2.1	DAX Functional Subsystems	8-1-3
8.1.3.2.1.1	Line Terminating Subsystem	8-1-3
8.1.3.2.1.2	Matrix Subsystem	8-1-3
8.1.3.2.1.3	Memory/Processor Control Subsystem	8-1-3
8.1.3.2.1.4	Subscriber/Switch Status Subsystem	8-1-4
8.1.3.2.1.5	Timing Subsystem	8-1-4
8.1.3.2.1.6	Maintenance/Diagnostic Subsystem	8-1-4
8.1.3.2.1.7	Main and Standby Power Subsystems	8-1-4
8.1.3.2.2	Traffic Data Analysis, Switch Status Control, and Reporting	8-1-4
8.1.3.2.2.1	Traffic Data Analysis	8-1-4
8.1.3.2.2.1.1	Line and Trunk Group Utilization	8-1-4
8.1.3.2.2.1.2	Peg Count and Overflow Count	8-1-4
8.1.3.2.2.1.3	Pooled Equipment	8-1-5
8.1.3.2.2.1.4	Total DAX Cumulative Count	8-1-5
8.1.3.2.2.2	Switch Status Control	8-1-5
8.1.3.2.2.3	Reporting	8-1-5
8.1.3.2.2.4	Memory Updating	8-1-6
8.1.3.2.3	Precedence/Preemption	8-1-6
8.1.3.2.3.1	Precedence Handling	8-1-6
8.1.3.2.3.2	DAX-DAX Operation	8-1-6
8.1.3.2.4	Conferencing	8-1-7
8.1.3.2.5	Bulk Data Users	8-1-7
8.1.3.2.6	Classmarking	8-1-7
8.1.3.2.7	Call-Mode Service	8-1-7
8.1.3.2.8	DAX-DAX Tielines	8-1-7
8.1.3.2.9	Dual Home	8-1-7

CONTENTS - Continued

		<u>Page</u>
Paragraph 8.1.3.2.10	Modes of DSVT Operation	8-1-7
8.1.3.3	Traffic Handling	8-1-7
8.1.3.4	Numbering Plan	8-1-7
8.1.3.5	Call Service Features	8-1-7
8.1.3.6	Information Tones and Recorded Announcements	8-1-7
8.1.3.7	Signaling and Supervision	8-1-9
8.1.3.8	Routing	8-1-9
8.1.3.9	Electrical Characteristics	8-1-9
8.1.3.9.1	Digital Transmission Requirements	8-1-9
8.1.3.9.2	Timing	8-1-10
8.1.3.9.3	Speed-of-Service	8-1-10
8.1.3.9.4	Crosstalk	8-1-10
8.1.3.9.5	MTBF	8-1-10
8.1.3.9.6	MTTR	8-1-10
8.1.3.9.7	Operational Availability	8-1-10
8.1.3.9.8	Power	8-1-10
8.1.3.10	Other DAX Design Factors Needing Considerations	8-1-11
8.1.3.10.1	Access Lines and Switch Trunk(s) Terminations	8-1-11
8.1.3.10.2	Sizing	8-1-11
8.1.3.10.3	Service Features	8-1-11
8.1.3.10.4	External Interfaces	8-1-11
8.1.3.10.5	Connectivity	8-1-11
8.1.3.10.6	Overseas vs CONUS Applications	8-1-11
8.1.3.10.7	System Control	8-1-11
8.1.3.10.8	COMSEC Operation	8-1-12
8.1.3.10.10	Patch and Test	8-1-12
8.1.3.11	References	8-1-12
 <u>SECTION 2 - LOCAL DIGITAL MESSAGE EXCHANGE</u>		 8-2-1
Paragraph 8.2.1	Introduction	8-2-1
8.2.2	Requirements	8-2-2
8.2.3	Functions	8-2-4
8.2.4	References	8-2-6

MIL-STD-187-310

CONTENTS - Continued

	<u>Page</u>
<u>SECTION 3 - COMMUNICATIONS ACCESS PROCESSOR</u>	8-3-1
<u>SECTION 4 - PRIVATE AUTOMATIC BRANCH EXCHANGE (PABX)</u>	8-4-1
<u>SECTION 5 - COMMUNICATIONS SELECTOR SWITCH (CSS)</u>	8-5-1
<u>SECTION 6 - INTERFACES</u>	8-6-1
Paragraph 8.6.1 Introduction	8-6-1
8.6.2 Digital Access Exchange (DAX)	8-6-1
8.6.3 Communications Access Processor (CAP)	8-6-1
8.6.4 Local Digital Message Exchange (LDMX)	8-6-1
8.6.5 Communications Selector Switch (CSS)	8-6-1
8.6.6 PBX	8-6-1

CHAPTER 8

ACCESS AREA SWITCHING

SECTION 1

DIGITAL ACCESS EXCHANGE (DAX)

8.1.1 Introduction. The access area switching elements for the Nominal Future DCS are the Digital Access Exchange (DAX), Local Digital Message Exchange (LDMX), Communications Access Processor (CAP), Private Automatic Branch Exchange (PABX) and Communications Selector Switch (CSS). The arrangement of these elements in the access area and their functions are described in Chapter 5.

8.1.2 General. The DAX is to function as a digital concentrator for collocated subscribers requiring access to a Phase II Secure Voice (P2SV) backbone switch. The DAX will be used in locations where an economic gain can be realized by a reduction in the number of Digital Subscribers Voice Terminal (DSVT) access lines to a Phase II Secure Voice backbone switch. The DAX is also to provide communications for selected bulk data users during non-busy hours for greater transmission efficiency. The DAX will be used overseas as well as in CONUS.

8.1.2.1 DAX System Concept. The DAX will provide access to the P2SV network for concentrations of secure voice subscribers. Where large concentrations of subscribers exist, a DAX to DAX tie-line may interconnect two DAX's. The DAX will provide trunk access to the AN/TTC-39 overseas and the ESS #1's (modified to emulate the AN/TTC-39) in CONUS. Figure 8.1.1 is a simplified block diagram of the DAX system concept.

8.1.2.1.1 DAX Tandem Operation. The DAX shall be capable of tandem operation. DAX tandem operation is defined as operation of one DAX and its DSVT subscribers working through another DAX to reach a distant backbone switch. The tandem operation also works from the distant backbone switch in the opposite direction through the tandem DAX's to the subscriber. Tandem DAX operation is required in the P2SV network prior to availability of the AN/TTC-39 switches overseas.

8.1.2.2 DAX Design Considerations. The DAX will be a fully automatic, unattended, common control, 4-wire digital switch operating at 16 kilobits per second (kb/s) for voice and data.

8.1.2.2.1 DAX Size. Study of preliminary P2SV subscribers lists has indicated several DAX sizes are required to fulfill this requirement. For preliminary design purposes, a DAX size list is included in paragraph 8.1.3.10.2.

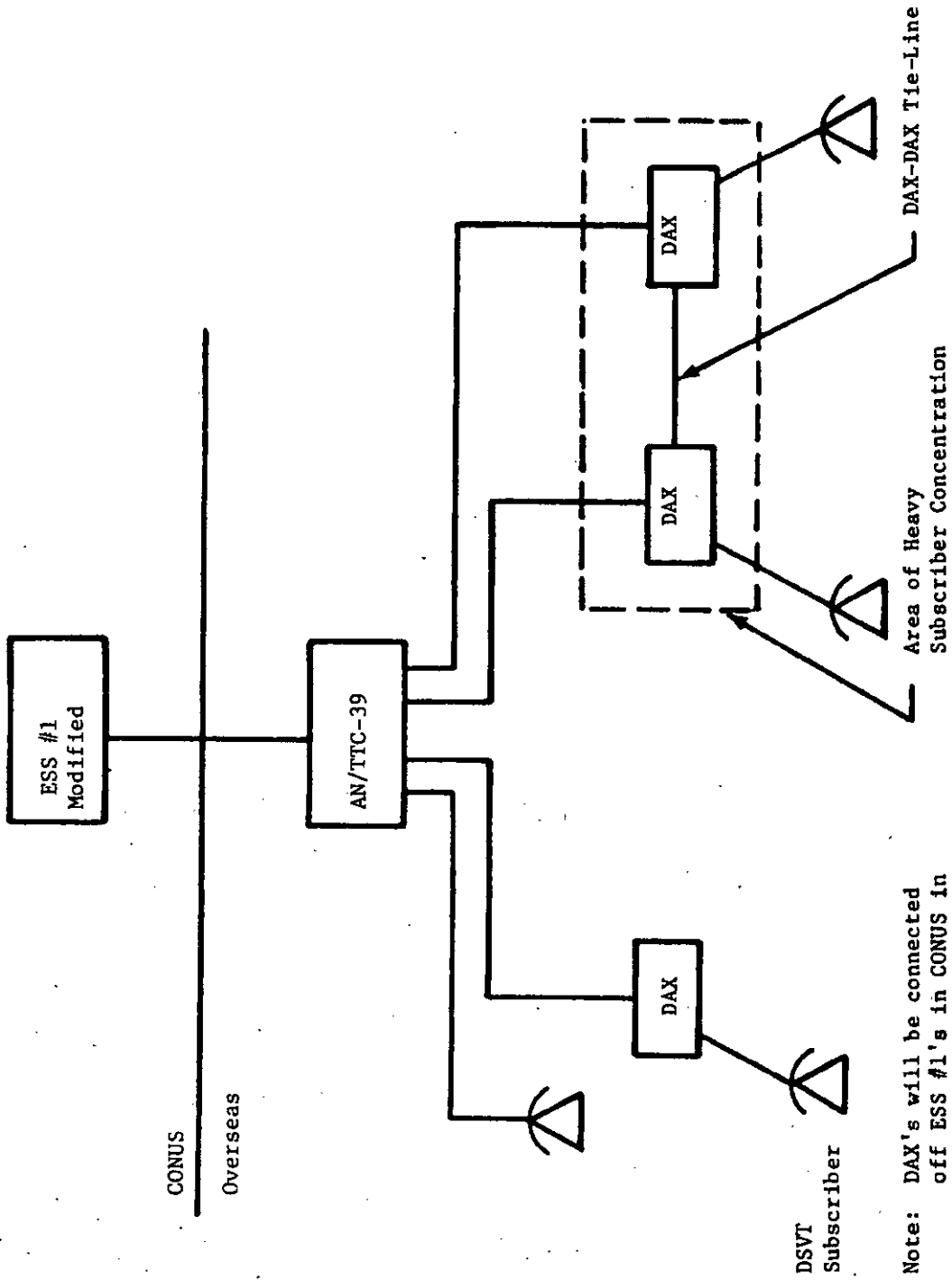

Note: DAX's will be connected off ESS #1's in CONUS in a similar manner as shown for Overseas

FIGURE 8.1.1.1 DAX System Concept

8.1.2.2.2 DAX COMSEC. No COMSEC equipment is to be included in the DAX. The design is based on a COMSEC Category IV ULS operation, as defined in reference [a]. Reference [b] describes the COMSEC.

8.1.3 DAX Design Requirements. DAX design requirements have been extracted from reference [b].

8.1.3.1 Physical. The DAX shall be designed for recoverable installation in an unattended area, normally a nonsecure "BLACK" area. No operator position is required. The DAX shall be designed for minimum size consistent with the state-of-the-art, and in a minimum number of enclosures for ease in installation, maintenance, and recovery.

8.1.3.2 Functional. The DAX shall operate with Digital Subscriber Voice Terminals (DSVT) on the loop access lines. On the trunk side, the DAX shall be designed to interoperate with the AN/TTC-39 and the CONUS ESS #1, modified to emulate the AN/TTC-39, in the CONUS. The DAX will be dual-homed to two backbone switches. A dual-homed DAX is defined as a single DAX that is connected to two different switches by separate trunks.

8.1.3.2.1 DAX Functional Subsystems. The DAX provides a 4-wire path for incoming and outgoing calls through the DAX. The DAX interconnects subscribers to the backbone switch on outgoing calls, and the switch to subscriber on incoming calls. Also, it can interconnect DSVT subscribers connected to the same DAX. The DSVT is strapped for COMSEC Category IV operation to provide initial clear signaling through the DAX. The precedence and access digit will be signaled in the clear in both CONUS and overseas. Upon receipt of second dial tone, the subscriber's number is dialed secure overseas and in the clear in CONUS. Timing for operation of the DAX is obtained from the prime backbone switch that serves the DAX, and will be obtained from the secondary backbone switch when dual-homed and communications with the primary switch is lost. The change of the timing source will be automatic. The return from secondary timing to primary timing, when primary timing is restored, shall also be automatic. The following are representative subsystems integral to the DAX.

8.1.3.2.1.1 Line Terminating Subsystem. Provides terminations for subscriber loops and switch trunk lines.

8.1.3.2.1.2 Matrix Subsystem. Includes switching for subscriber lines and switch trunk lines.

8.1.3.2.1.3 Memory/Processor Control Subsystem. Includes subscribers tables with classmarkings, precedence, and preemption subroutines; and generates subscriber status, routing, checking, reporting, etc. The subsystem controls the matrix connections.

MIL-STD-187-310

8.1.3.2.1.4 Subscriber/Switch Status Subsystem. As an unattended switch, the DAX is required to maintain the status of its subscribers for reporting purposes and to determine if maintenance is required. The purpose of this subsystem is to periodically poll its subscribers and report any needed maintenance to the technical control associated with the switch it serves. The subsystem includes the line scanning required in the DAX.

8.1.3.2.1.5 Timing Subsystem. This subsystem includes circuits required for deriving timing from the backbone switch and for distribution of timing within the DAX and to the connected subscribers. The DAX shall provide internal timing as backup should primary and secondary source timing fail. The timing shall provide the accuracy necessary to permit DSVT's to interoperate behind the DAX.

8.1.3.2.1.6 Maintenance/Diagnostic Subsystem. This subsystem determines the need for maintenance and reports the condition. Additionally, the subsystem provides diagnostic capability for maintenance purposes.

8.1.3.2.1.7 Main and Standby Power Subsystem. This subsystem provides power for operation of the DAX and provides the required standby power to keep the DAX operational during short main power interruptions. Switching from main to standby power and back to main power when it is restored shall be automatic. It provides for powering up or down and automatic startup after extended power interruptions.

8.1.3.2.2 Traffic Data Analysis, Switch Status Control, and Reporting. The following features are being considered for inclusion in the DAX design.

8.1.3.2.2.1 Traffic Data Analysis. Long-term traffic data analysis requires traffic data be made available at the DAX. These need not be specially formatted or stored in the DAX, but may be outputted to some suitable storage or processing device. Traffic data requirements are as follows.

8.1.3.2.2.1.1 Line and Trunk Group Utilization. Ten-second sampling of all lines and trunks will be done with data accumulated for a period of up to 4 hours.

8.1.3.2.2.1.2 Line and Trunk Group Peg Count and Overflow Count. Outgoing call-attempts and overflow (optionally by precedence) count will be made by line and trunk groups. Incoming calls-peg count (optionally by precedence) will be made by line and trunk groups. All counts are to be accumulated for a period of up to 4 hours.

8.1.3.2.2.1.3 Pooled Equipment. If any pooled (common) equipment should be utilized, pool utilization (1-second sampling) and peg and overflow counts will be required as traffic data.

8.1.3.2.2.1.4 Total DAX Cumulative Count. There will be a total DAX cumulative count (for up to 4 hours) of:

Originated calls (DAX to backbone switch)

Terminating calls (backbone switch to DAX)

Intra-DAX calls

DAX-DAX tieline calls

Total originated calls by precedence

Total blocked calls by precedence

TANDEM calls.

8.1.3.2.2.2 Switch Status Control. Local and remote tests, diagnostics, and measurements will be performed to:

- a. Assure all switch elements are functioning properly. These elements include:

DAX software

DAX matrix

DAX interfaces

Special alarms

DAX hardware.

- b. Fault isolation for all elements of the switch in the event of malfunctions or degradation.

8.1.3.2.2.3 Reporting. A capability will be provided for system control channels to receive, act on incoming control messages, and to transmit monitoring and control messages. Error control using ARQ techniques or equivalent should be provided for the control messages. Formats should be compatible with specifications for the TCCF (Tactical Communications Control Facility), CNCE (Communication Network Control Element), and AN/TTC-39. Listed below are three possible techniques

MIL-STD-187-310

for providing a system control channel. The technique(s) most cost-effective and compatible with the DAX design should be chosen.

- a. Use of dedicated control channel.
- b. Use of CCS subchannel (2 kb/s) for system control messages.
- c. Use of normal subscriber capability where DAX should have the ability to recognize system control messages.

8.1.3.2.2.4 Memory Updating. The capability will be provided in the DAX to permit update of the DAX memory. The update may be initiated either locally at the DAX or from a location remote from DAX where installation conditions permit. Remote updating is to be utilized for connectivity, subscriber lists, etc.

8.1.3.2.3 Precedence/Preemption. The DAX shall handle five levels of precedence and preemption: FLASH OVERRIDE, FLASH, IMMEDIATE, PRIORITY and ROUTING PRECEDENCE. To initiate a call with a precedence level higher than ROUTINE, the subscriber will depress the appropriate precedence key (FO, F, I, or P) on the DSVT at the beginning of the signaling sequence. The absence of a precedence signal will indicate that the call is ROUTINE in precedence. Each loop shall be classmarked, indicating the precedence authorization of each subscriber. This classmark shall be entered into the line number table. If a precedence level higher than authorized is dialed, the DAX shall assign the authorized level for that call and return a recorded announcement.

8.1.3.2.3.1 Precedence Handling. A preemptive search of the trunk group from the DAX to the backbone switch shall be initiated if a call is of a precedence higher than ROUTINE and the initial search of the trunk group fails to find an idle trunk. When in the preemptive search mode, all trunk groups shall be scanned to determine the lowest preemptable call being handled. The lowest preemptable trunk shall be used to forward the call. If no preemptable trunk is found in the primary or alternate trunk group, an all trunks busy (ATB) indication shall be returned to the calling party.

8.1.3.2.3.2 DAX-DAX Operation. Where a DAX to DAX tie trunk is available, the second tandem DAX shall search available trunk groups to the backbone switch and follow the single DAX method of preemption. The call shall then be cut through the second DAX if a trunk group is available. The call shall be monitored for call completion by both DAX's and shall disconnect when the call is completed. Calls from DSVT to DSVT through the DAX-DAX tieline shall be provided but shall be limited to calls in the same COMSEC net. Paragraph 8.1.3.2.8 describes the requirement for DAX-DAX tieline operation.

8.1.3.2.4 Conferencing. Origination and participation in conferencing from a DSVT shall be provided for subscribers through the DAX's that are classmarked for this service. DSVT subscribers not classmarked for conferencing shall be blocked at the backbone switch. Local conferencing (i.e., not accessing the backbone switch) is not a requirement.

8.1.3.2.5 Bulk Data Users. The capability shall be available in the DAX to provide digital bulk data user service during times of low usage of the P2SV Network. Bulk data users service is supplied through a data port in the DSVT.

8.1.3.2.6 Classmarking. The capability for classmarking shall be included in the DAX to allow or restrict special service features for DAX subscribers, as shown in Table 8.1.1.

8.1.3.2.7 Call-Mode Service. The DAX will provide or pass distinctive signals to subscriber's terminals to indicate that an incoming call is voice or data, as described in reference [c].

8.1.3.2.8 DAX-DAX Tielines. The DAX shall be designed to include the capability to be interconnected with another DAX through use of tielines in areas with heavy concentrations of subscribers. Operation between DSVT's is limited to subscribers in the same COMSEC net.

8.1.3.2.9 Dual Home. The DAX shall be designed to be homed on two backbone switches. A single address shall be used to access a subscriber through either backbone switch.

8.1.3.2.10 Modes of DSVT Operation. The following modes of operation shall be available from DSVT subscribers through the DAX:

- a. Clear
- b. Stored Net Variable
- c. Utilizing a call variable from a backbone switch.

8.1.3.3 Traffic Handling. Traffic handling requirements have not been established, however, Traffic Load Assumptions, Call Rates and Traffic Distribution and Blocking specified in reference [d] apply to the DAX for planning purposes.

8.1.3.4 Numbering Plan. (See Section 1, Chapter 6.)

8.1.3.5 Call Service Features. (See Table 8.1.1, this Section and Section 2, Chapter 6.)

8.1.3.6 Information Tones and Recorded Announcements. (See Section 3, Chapter 6.)

MIL-STD-187-310

TABLE 8.1.1 SPECIAL SERVICE FEATURES

1. Maximum level of precedence.
2. Conference privilege.
3. Subscriber instrument classification.
4. Trunk signaling classification.
5. Dialing access restrictions
6. Direct access service.
7. Compressed dialing privilege.
8. Security level.

NOTE: The features listed are representative of special service features; the final list shall be based on detailed study of the P25V Network requirements.

8.1.3.7 Signaling and Supervision. (See Section 4, Chapter 6.)

8.1.3.8 Routing. (See Section 5, Chapter 6.)

8.1.3.9 Electrical Characteristics

8.1.3.9.1 Digital Transmission Requirements. A bit shall be defined as an error if the sense of the bit forwarded to the DAX is changed by the DAX in the process of reception, regeneration, processing, and retransmission. A bit shall be defined as correctly transmitted if an error does not occur. Transmission from digital termination to digital termination shall meet the following requirements, when valid bit transmissions and invalid transmissions (bit errors) are defined as above.

8.1.3.9.1.1 Digital Error Rate Environment. The DAX shall regenerate and retransmit digital signals arriving at the switch with a worst case bit error rate of 10^{-3} , randomly distributed, with interspersed bursts of 20 percent errors at a duty cycle of 5 percent and a rate of 1 to 20 Hz. The DAX shall retransmit bits with an error rate no worse than the sum of the actual rate encountered (up to the limits above) and the error rate specified in 8.1.3.9.3 and 8.1.3.9.4. In addition, all signaling and supervisory information shall be coded and/or repeated as required, as specified in 8.1.3.9.5.

8.1.3.9.1.2 Transmission Bit Rates. The DAX shall accommodate a 16 kb/s channel transmission rate on all channels.

8.1.3.9.1.3 Bit Error Rate. The probability of a DAX generated error shall not exceed 1×10^{-10} for all traffic through the switch.

8.1.3.9.1.4 Bit Stream Integrity. The probability of a bit insertion or deletion attributable to the DAX shall not be greater than 1×10^{-10} .

8.1.3.9.1.5 Error Detection and Correction. Error detection and correction for signaling and supervisory information shall be provided by synchronization, repetition, and encoding as specified in reference [a]. Error control is not specified for any other traffic, except as necessary to meet the requirements of 8.1.3.9.3.

8.1.3.9.1.6 Impedance

8.1.3.9.1.6.1 Single Channel Loop Terminations. Single channel loop terminations shall be Balanced Low Level Digital Interface in accordance with reference [d].

8.1.3.9.1.6.2 Group Terminations. Group terminations shall be Balanced Low Level Digital Interface in accordance with reference [d].

MIL-STD-187-310

8.1.3.9.1.6.3 Single Channel Trunk Terminations. Single channel trunk terminations shall be Balanced Low Level Digital Interface in accordance with reference [d].

8.1.3.9.1.7 Induced Noise. Induced noise levels between any two paths in the DAX shall not exceed -60 dBm.

8.1.3.9.1.8 Misrouting. Each call shall be connected only to the termination to which the call is addressed. The probability that a given call is misrouted or missent shall be no greater than 1×10^{-6} .

8.1.3.9.1.9 Inadvertent Third Party Connection. Numerous simultaneous transmissions are normal, and there is a risk that a third party will be inadvertently connected into a transmission and obtain information for which he has no clearance or need-to-know. The probability of an inadvertent third party connection shall be no greater than 1×10^{-6} .

8.1.3.9.1.10 Protection. Circuit protection shall be provided for each termination in accordance with MIL-STD-188-100, subparagraph titled "Protection" under "Balanced Low Level Digital Interface."

8.1.3.9.2 Timing. Timing for the DAX shall be derived from the serving backbone switch. Paragraph 8.1.3.2.1 describes operation in the event of loss of timing from the primary backbone switch.

8.1.3.9.3 Speed-of-Service. The maximum DAX connective time shall be 200 ms for completing connections after dialing.

8.1.3.9.4 Crosstalk. Crosstalk levels between any two paths in the DAX shall not exceed -60 dBm.

8.1.3.9.5 MTBF. The DAX shall have a Mean Time Between Failures (MTBF) of 5000 hours.

8.1.3.9.6 MTTR. The DAX shall have a Mean Time to Repair (MTTR) of 30 minutes with on-site availability of parts. Since the switch is unattended, availability criteria allows up to 9 hours for the repairman to arrive on site.

8.1.3.9.7 Operational Availability. The DAX shall have an operational availability of at least 99.9%.

8.1.3.9.8 Power. The small DAX (30, 60 line unit) shall be designed to operate on 50/60 Hz, 115/230 volts, single phase ac. The large DAX (120, 240 line unit) shall be designed to operate on both 50/60 Hz, 115/230 volts, single phase ac, and 50/60 Hz 120/208 volts, three phase ac (but not simultaneously). The power switchover required herein

shall be field alterable. Provisions shall be included to provide continued DAX operation (both sizes of DAX) for 1 hour in the event of a primary power source failure.

8.1.3.10 Other DAX Design Factors Needing Considerations

8.1.3.10.1 Access Lines and Switch Trunk(s) Terminations. To provide for maximum flexibility in varied installation configurations, universal line and trunk terminations should be considered in the design of the DAX. The intention is to allow the use of any termination with either a line or trunk.

8.1.3.10.2 Sizing. An analysis of cost versus size is necessary to establish modularity breakpoints for DCS applications. Based on preliminary analysis of requirements, the basic DAX shall be for 90 subscribers, and configured in depopulated models to meet the 60 and 30 subscriber requirements. Only the addition of circuit cards and associated software upgrade shall be required to expand from 30 subscribers to either 60 or 90 subscriber configurations.

8.1.3.10.3 Service Features. The service features specified for the DAX (Sections 1 and 2, Chapter 6) must be evaluated in terms of "off-the-shelf" or "state-of-the-art" equipment in order to avoid cost and availability problems.

8.1.3.10.4 External Interfaces. The current access area concepts identify DAX interfaces with DVST's, other DAX's, and the backbone switches (also with CAP's and CSS's). Transitional P2SV configurations may require interfaces with current AUTOSEVOCOM components, as well as with future narrowband subscribers. Provisions for these interfaces need to be considered.

8.1.3.10.5 Connectivity. If it is decided to establish connectivity between DAX's, present plans are to implement it on a tie line basis requiring the use of an exit code and a second dial tone. This is based on the network configuration described in Chapter 5 and illustrated in Figure 5-1 which includes AN/TTC-39 backbone switches. Use of DAX's prior to implementation of the AN/TTC-39 would require establishing a DAX based subnetwork. The possible application of DAX switches in such a subnetwork needsto be considered in the DAX design.

8.1.3.10.6 Overseas vs CONUS Applications. Special considerations unique to overseas or CONUS applications need to be considered in the DAX design.

8.1.3.10.7 System Control. System control aspects of DAX switching need to be defined for consideration in the DAX design. Also, system control aspects applicable to a pre-AN/TTC-39 DAX subnetwork need to be considered.

MIL-STD-187-310

8.1.3.10.8 COMSEC Operation. A trade off study involving a number of subscribers on a common unique variable, key change frequency, AN/TTC-39 and TENLEY KDC modifications, and transmission sizing must all be made to arrive at a cost-effective solution to COMSEC operation through the BLACK DAX. The implications of features such as subscriber self-identification and subscriber population partitioning will strongly influence system and DAX design.

8.1.3.10.9 Patch and Test. A patch and test capability shall be included in the DAX to permit loop and trunk test, restoration, and equipment substitution.

8.1.3.11 References

- [a] Specification No. TT-B1-1201-0030, TT-B1-1203-0033, TT-B1-1204-0034, "Performance Specifications for Tactical Unit Level Circuit Switches, Volume IV (U)" (CONFIDENTIAL).
- [b] Digital Access Exchange (DAX) Specification Criteria, November 1975 (CONFIDENTIAL).
- [c] "AN/TTC-39 Digital Loop Signaling and Supervision Specification," Appendix II to Specification No. TT-A3-9002-0017A, "AN/TTC-39 Circuit Switch/TENLEY COMSEC Module Interface Specification (U)," 14 March 1975 (CONFIDENTIAL).
- [d] MIL-STD-188-100, Common Long Haul and Tactical Communication System Technical Standards, 15 November 1972.
- [e] Specification No. TT-B1-1203-0033, "Performance Specification for Tactical Unit Level Circuit Switches, Volume II, AN/UTC - () (V) 1, 2 & 3," 30 June 1975 (DRAFT).

CHAPTER 8

SECTION 2

LOCAL DIGITAL MESSAGE EXCHANGE (LDMX)

8.2.1 Introduction. The LDMX is basically a store-and-forward message switch capable of: message entry from OCRE, paper tape, punched card and magnetic tape; automatic code conversion; automatic conversion from Plain Language Address (PLA) to AUTODIN Routing Indicator (RI); automatic segregation and routing of messages received from remote terminal devices and from AUTODIN; message retrieval; local distribution; mass storage (including paper tape storage) for history; and journaling.

The hardware configuration could typically be composed of the following: a central processor with one or more AUTODIN interfaces, mass storage for message storage and routing (in addition to that required for automatic PLA/RI conversion); mass storage for history and journaling; line control modules for communicating with the remote terminal devices; connecting stations consisting of display devices with keyboards; OCR subsystem; printers; and all or any combination of paper tape, punched card, magnetic tape, display and facsimile.

The military services have been implementing LDMX type equipment in their access areas for some time. The Navy has installed NAVCOMPARS (Navy Communications Processing and Routing System) at all NAVCOMSTA's. The Army AMME (Automated Multi Media Exchange) has been implemented and has been approved by DTACCS for all services to utilize where possible. The Air Force has begun development of their own version of LDMX - the ICAT and MCATS (Intermediate and Medium Capacity Automated Telecommunication System) - as part of their ATP (Automated Telecommunications Program). GSA has recently awarded a contract for the development of Standard Remote Terminals, the larger versions of which will perform like an LDMX.

Although the Director, Telecommunications and Command and Control Systems (DTACCS) authorized the MILDEPS to proceed with automation programs using separate Service approaches, the programs are subject to interservice consolidation program efforts and progress made toward achieving an integrated AUTODIN system architecture. In regard to the integrated architecture, DTACCS tasked DCA, in coordination with the JCS, the Services, and Defense Agencies to:

- a. Develop a total communications terminal-to-terminal integrated AUTODIN system architecture (IASA) considering all elements of the AUTODIN: i.e., backbone switches, access area concentrators, and terminals.

MIL-STD-187-310

- b. Define a common family of AUTODIN system and terminal hardware and software.
- c. Develop appropriate standards and operating procedures for subsystem interfaces, common software, message forms, addressing and routing, message distribution methods, privacy systems, etc.

To carry out this tasking, the AUTODIN system architecture will essentially be redefined to treat the backbone (AUTODIN switches and interswitch trunks), concentrators, and terminals as a single, integrated system. A common family of AUTODIN terminals will be defined for post-1977 implementation, based on the resulting integrated AUTODIN system architecture (IASA) and existing terminal configurations.

DCA will head this effort and will make maximum use of in-house resources and MILDEP/DoD Agency AUTODIN related expertise and facilities to perform the necessary system development and the simulation and testing of concepts and terminal designs which will result in the IASA and the common family of terminals.

The IASA will be designed to be compatible with existing AUTODIN terminals and provide for orderly transition to the bit orientation of AUTODIN II. The IASA will be responsive to user needs under varying conditions of subscriber access and loading and will accommodate the common family of terminals. To the extent practical, the IASA will have real-time, adaptive controls based on network status, load, and user demand; design will provide for fault isolation and system performance monitoring.

A design base line for the common family of terminals will be established by DCA from a comprehensive survey of needs, available capabilities, and off-the-shelf hardware, and consideration of related efforts such as IDN, ARPANET, and PWIN [a].

Pending completion of the above task, anticipated requirements and functions for an LDMX are provided in the following paragraphs.

8.2.2 Requirements. An LDMX developed for use in the DCS must be capable of:

- a. Automatically interfacing the Defense Communications Common User Systems (AUTODIN, AUTOVON, etc.) and non-DoD communications circuits/systems.
- b. Automatically performing those administrative procedures/functions inherent in the processing of incoming record communications traffic that are now performed manually in communication/message centers.

MIL-STD-187-310

- c. Automating certain procedures/functions involved in outgoing message preparation.
- d. Automatically routing traffic according to precedence on a first-in/first-out basis with visual/aural alarms for high precedence traffic.
- e. Storing and forwarding (to include intermediate storage, overflow storage, and intercept storage) with the ability to access all storage sources for in-transit traffic, for delivery without interfering with normal operation while maintaining first-in/first-out technique.
- f. Circuit switching operation through DCS and/or non-DCS facilities and switching between in-station terminals, including computer-to-computer Bulk II type operation.
- g. Incorporating "state-of-the-art" principles of modularity to allow flexibility for implementation and expansion of processing and/or distribution capability. The system must have virtually uninterrupted availability. No single equipment malfunction, nor most combinations of multiple malfunctions, will totally disable the system. Dual purpose equipment is to be used wherever possible. Software systems must be capable of detecting, diagnosing, and circumventing hardware malfunctions without coming to a complete halt and with a minimum of degradation of service.
- h. Automatic error detection in terms of line control and as pertains to message format required for the system circuit to be assessed. (Must further provide a limited capability of applying automatic corrective action for errored messages; messages not correctable by automatic means must be visually displayed and/or printed out to be corrected by operator intervention.)
- i. Distributing single and multiple-addressed record communications to and from both classified and unclassified circuits/terminals, and automatically protecting classified traffic from accessing unauthorized terminals.
- j. Transmitting and receiving in full duplex or half duplex to/from high, intermediate, or low speed terminals with format/code conversion and routing line segregation.
- k. Terminating the following types of terminal equipment at high and/or low speeds:

MIL-STD-187-310

Cathode ray tube (video screen)

Computer

Electric typewriter

Facsimile (digital)

Keyboard

Line printer

Magnetic tape

Optical character recognition equipment

Paper tape

Punch card

Teletypewriter.

- l. On-line application of supervisory initiated commands for appropriate control of the system and updating of its parameters.
- m. Controlling designated in-station record communications networks.
- n. Automatically preparing logs and journals, performing statistical analysis of traffic, and preparing management reports.
- o. Automatically or manually selecting predesignated subscriber alternates for the routing of record traffic by precedence and/or security classification in or out of station.
- p. Dual homing and alternate routing with DCS automatic switching centers for system flexibility and survivability.

8.2.3 Functions. The major functions envisioned for the LDMX are summarized as follows:

- a. Error detection, including circuit and transmission errors, hardware and peripheral equipment malfunctions, read/write errors, missent messages, suspected duplicates, stragglers, overdue messages, security violations, loss of message integrity, invalid formats, erroneous header fields, and all

other detectable errors encountered during the message processing operation.

- b. Format conversion as required to receive and transmit JANAP 128, DD173, and Preamble messages in accordance with originating and receiving terminal LMF requirements.
- c. First-In-First-Out (FIFO) message handling by precedence, including priority interrupts for Flash and Flash Override messages and the handling of sectionalized messages.
- d. Circuit switching capability provided between compatible terminals upon request.
- e. Distribution and routing, including appropriate handling procedures for messages to or from AUTODIN, AIG's, official titles, office symbols, local distribution parameters, and operator-initiated alternate routing based on predetermined or operator-provided destinations.
- f. Protection of message integrity, accountability, and security, including the maintenance of active and historical journal files; coordination of message recording, backup, and acknowledgment procedures; complete audit trail generation procedures; disk space monitoring and intercept procedures; automated traffic analysis and journal balancing procedures; accountable rebuild and restart operations; integrated input and output processing control and error checking; and extensive security checks applied throughout the system, within the message itself, and in relation to all incoming and outgoing lines and terminals.
- g. Management statistics, logging, and compilation of operating and management statistics and records including traffic statistics and message processing time statistics, accumulated by daily and month-to-date periods reportable upon demand. Hardware failures are also logged for subsequent analysis.
- h. Formatting of messages, including header generation from operator supplied parameters, special pilot headers, and automatic service message generation.
- i. File storage. Implementation, maintenance, and control of file storage to accommodate on- and off-line data and program files, including dynamic allocation of core and disk areas and automatic notification of threshold levels.

MIL-STD-187-310

- j. Message retrieval. Originating Station Routing Indicator/ Originating Station Serial Number and disposition from disk and history files by PAN (Programmed Assigned Number) and date, OSRI/OSSN and date, CID (Channel Identifier) and CSN (Channel Sequence Number), DTG (Date-Time-Group) and originator, and by a variety of subparameters within any specified period of time. Disposition options include message display and edit capabilities, readdressal, redistribution, and output to any system peripheral.
- k. Rebuild and recovery capabilities for resuming on-line operations after a CPU system failure, including restoration of disk files, restarting incomplete messages, and reprocessing traffic passed during degraded mode operations for system retention, retrieval, and statistical purposes.

8.2.4 References

- [a] DCA Plan for Development of an Integrated AUTODIN System Architecture and Design of a Common Family of Terminals, June 1975, Rev. 8 September 1975.

CHAPTER 8

SECTION 3

COMMUNICATIONS ACCESS PROCESSOR (CAP)

The concept of a CAP arose as a result of planning for the Future DCS and preliminary engineering of the AUTODIN II Program. As described in Chapter 5, and DCS Subsystem Project Plan 2-74, AUTODIN II (Integrated Data Network) 1976-1982, October 1973, the CAP was to be the lowest level packet switch in a hierarchical packet switching network which was composed of tandem, regional, and small access area packet switches (CAP's). This concept has since given way to a single-level switching concept and, as a result, engineering of the CAP is not being actively pursued for AUTODIN II. Future planning for the CAP will draw heavily from the AUTODIN II Switch Design (see Chapter 7), as the CAP in all probability will be a scaled-down version of the basic AUTODIN II switch.

MIL-STD-187-310

CHAPTER 8

SECTION 4

PRIVATE AUTOMATIC BRANCH EXCHANGE (PABX)

The function of a future PABX is described in Chapter 5. Design requirements and criteria remain to be developed.

MIL-STD-187-310

CHAPTER 8

SECTION 5

COMMUNICATIONS SELECTOR SWITCH (CCS)

The function of a future CCS is described in Chapter 5. Design requirements and criteria remain to be developed.

CHAPTER 8

SECTION 6

INTERFACES

8.6.1 Introduction. Interface criteria for the access area will be developed in conjunction with the access area subnetwork design. Interface criteria is interpreted to include the areas itemized in paragraph 6.6.1. Following is a summary of access area interface requirements.

8.6.2 DAX

- a. DAX to Secure Voice Subscriber
- b. DAX to CAP
- c. DAX to AUTOSEVOCOM Components
- d. DAX to DAX Tieline.

8.6.3 CAP

- a. CAP to Subscriber Terminals
- b. CAP to Communications Selector Switch (CSS).

8.6.4 LDMX

- a. LDMX to Narrative/Record Terminal.

8.6.5 Communications Selector Switch (CSS)

- a. CSS to Facsimile Terminal
- b. CSS to Multimode Terminal
- c. CSS to LDMX.

8.6.6 PBX

- a. PBX Tie Trunks
- b. Main to Tributary PBX's
- c. User Loops to PBX's.

MIL-STD-187-310

In regard to the present AUTOVON system, the interface of various combinations of 4- and 2-wire PBX's to 4- and 2-wire tributary PBX's is described in DCAC 370-V175-6, "System Interface Criteria," February 1965. This reference also describes the interface between various combinations of 4- and 2-wire loops to 4- and 2-wire PBX's.

CHAPTER 9

SYSTEM CONTROL ELEMENTS APPLICABLE TO SWITCHING

CONTENTS

		<u>Page</u>
Paragraph 9.1	Definition of System Control	9-1
9.2	Current Status of System Control	9-2
9.2.1	Determination of System Control Requirements	9-2
9.2.2	Development of System Control Concept	9-2
9.2.3	Specification of System Control Structure and Hierarchy	9-3
9.2.4	System Control Transition Strategy	9-3
9.2.5	Specification of Control Hardware and Software	9-4
9.3	Fundamental Considerations for Design of all System Control Elements	9-4
9.4	Switched Network System Control Conceptual Approach	9-5
9.5	General Switch Requirements	9-5
9.5.1	Switch Performance Parameters	9-5
9.5.2	Data Processing	9-6
9.5.3	Communications Interfaces	9-6
9.5.4	Execution of Control Actions	9-6
9.6	Switch Processor Requirements	9-6
9.7	Characteristics of Specific System Control Elements	9-6
9.8	References	9-7

CHAPTER 9

SYSTEM CONTROL ELEMENTS APPLICABLE TO SWITCHING

9.1 Definition of System Control. Communications system control is the process of controlled rapid adaptation of the available communications assets so as to achieve and restore maximum end-to-end performance under changing traffic conditions, natural or man-made stresses, disturbances, and equipment disruptions as measured against established prioritized performance criteria. There are three basic aspects to the control process: the timely acquisition (sensing and telemetry) of system performance, status, and quality indications; the rapid analysis, processing, and display of this data; and the subsequent decision and execution of control actions.

Major categories of control actions are: reconfigurations of the communications plant and the transmission subsystems; dynamic routing and traffic control of switches and satellite facilities; corrections of incipient system malfunctions by performance predictions and trend analysis; and guidance for equipment replacement or corrective maintenance (via fault prediction, detection, and isolation), system restoral, and reconstitution.

There are two natural interlocking levels to the system control process: each functional subsystem needs a closed loop control and these various subsystems jointly need an overall closed loop control at the total systems level. At the subsystems level, each communications subsystem must have built into its design the necessary sensing and control provisions to ensure, to the maximum extent possible, the uninterrupted operation of its subsystem in the face of stress, disturbances, and disruptions, and the containment of the degrading effects of errors and failures. Each subsystem must be designed for the higher overall system level of control.

Technical control is a well-established activity which deals with the DCS transmission subsystem. The primary technical control functions can be briefly summarized as consisting of performance assessment, fault isolation, service restoration, and reporting on the transmission subsystems; or in other words, patch, test, monitor, and reporting. These activities are located at the major DCS transmission nodes and today represent the lowest level of the DCS that is primarily "system" rather than "box" oriented. The tech controller therefore represents the lowest level of personnel that is oriented toward the DCS system control functions outlined above. The Automated Technical Control (ATEC) program has been directed at providing automated assistance to the tech controller in performing his basic tech control activities. The ATEC therefore addresses

MIL-STD-187-310

the first two essential aspects in the system control process; namely, data acquisition and performance monitoring and analysis. It, therefore, forms a basis upon which the DCS system control can be built. The technical control activity including ATEC is, however, strictly transmission subsystems oriented. For the above reasons, the Technical Control Activity in general, and the ATEC program in particular, can be seen as representing a subset of, but not the entire set of, system control functions.

Additional functions may be performed by DCS system control which, although not primary mission objectives, are natural byproducts and offer significant potential benefit to DCA. For example, changes to the DCS come in the form of reconfiguration/reorientation management decisions, and disturbances. The disturbances may include equipment failures, circuit outages, circuit degradation, or traffic demands which the network must accommodate. DCS system control in response to these changes and disturbances must acquire, analyze, and display data necessary to support the decision-making and the subsequent control execution process. This data collection and analysis capability could be adapted to support DCA management control, planning, and engineering requirements. This usage should have the effect of improving management visibility and of streamlining the effectiveness and efficiency of the present operational feedback reporting systems. This capability could also be adapted to serve as an input and as guidance to the direction and execution of maintenance actions.

9.2 Current Status of System Control. System control is presently in the early stages of development, with a number of fundamental conceptual and practical issues yet to be resolved. As a result, much of the detail expected in a planning standard is unavailable. Most of the identified issues fall in the following areas, which are currently the subject of considerable in-house and contractual effort.

9.2.1 Determination of System Control Requirements. This area requires study and understanding of present and future transmission systems, switched networks, and user requirements. The basic goals of system control design are:

- a. Assured connectivity
- b. Increased system performance
- c. Reduced O&M cost
- d. Increased survivability and reliability.

9.2.2 Development of System Control Concept. The system control concept for the DCS is presently in an advanced stage of development but has not

yet been approved. Until a concept is approved and published, system control structure and deployment strategy cannot be stated with a high degree of certainty. From a system engineering viewpoint, the fundamental design issues can be summarized as the:

- a. Number of levels of control
- b. Distribution of functions among control levels
- c. Strategy for achieving system control goals.

9.2.3 Specification of System Control Structure and Hierarchy. This can only be accomplished if the foregoing issues are successfully resolved. In order to resolve the fundamental design issues, DCEC has conducted an analysis of the following seven alternative system control designs:

- a. The present system
- b. The present system upgraded according to current and proposed plans
- c. A deployment of the TRI-TAC TCCF as currently defined
- d. Decentralized control
- e. Centralized control
- f. Distributed control on an area basis
- g. Distributed control on a regional basis.

The analysis compared the seven alternatives in terms of performance, survivability/reliability, manpower requirements, life cycle cost, and risk. As a result of the analysis, the recommended alternative is the decentralized control system. The decentralized control system postulates that ATEC minicomputer-equipped reporting stations will exercise near-real-time control of the DCS, while a modestly upgraded and centralized World-Wide-On-Line System (WWOLS) supports long-term planning and engineering activities. The number of minicomputer-equipped reporting stations will vary according to an as yet to be determined deployment strategy.

9.2.4 System Control Transition Strategy. It has been recommended that the preferred decentralized system control concept be implemented in the following three phases:

MIL-STD-187-310

- a. Phase 0. Changes in procedural, protocol, reporting, and functional relationships, and a modest hardware investment consisting primarily of a DCAOC upgrade.
- b. Phase 1. An extremely limited deployment of ATEC and a few small front-end and interface units.
- c. Phase 2. Full-scale deployment of system control equipment.

9.2.5 Specification of Control Hardware and Software. This area has, with the exception of ATEC, received the least attention and is the least firm because of its obvious dependence on the preceding five areas of study. Control hardware and software can be conveniently divided into two major categories:

- a. Those equipments to be incorporated in the DCS System Control Subsystem itself.
- b. Those equipments to be incorporated in the individual DCS mission subsystems, such as switches.

9.3 Fundamental Considerations for Design of All System Control Elements. The fundamental considerations for the design of all system control elements are:

- a. System control must demonstrate the capability to measurably increase system performance in terms of availability, reliability, and quality.
- b. System control elements must be distributed throughout the system.
- c. System control elements, individually or together, must not degrade the capability of the DCS to accomplish its assigned mission.
- d. System control must not increase system vulnerability to enemy attempts to degrade or disrupt service.
- e. System control design should maximize use of system control capabilities inherent in the structural design of the DCS.
- f. System control design should drive the DCS in the direction of reduced O&M costs.
- g. The system control design must ensure both a manual fallback mode and a manual override capability.

- h. Each level of the system control hierarchy must be capable of totally autonomous operation in the event of failure of the next higher level.
- i. System control element design should promote unmanned or minimum manned facilities through remote performance assessment, automatic control action, etc.
- j. Performance monitoring and information processing should be automated.
- k. System control will always be exercised at the lowest possible level.

9.4 Switched Network System Control Conceptual Approach. The approach to switched network system control is based on the following concepts:

- a. The basic concept is the use of adaptive controls. Control logic is adaptive if current information regarding the network status and user demands is utilized to examine continuously the effectiveness of existing controls, such as the switch routing tables, and to readjust those controls to maintain a near optimum system performance at nearly every instant of time. Analysis to date indicates that significant performance advantages can be achieved at reasonable cost by means of adaptive traffic flow and adaptive facility assignment.
- b. Control should be exercised at the lowest practical level in order to minimize system control overhead requirements, and to ensure that an adequate level of system control will remain during stressed conditions.
- c. Near real-time status monitoring and exception reporting is required.
- d. The large number of potential parameters to be measured demands that the actual transfer of data be minimized through establishment of thresholds, preprocessing of data, etc.
- e. Both an automatic and a manual mode must be provided to allow for crisis conditions.

9.5 General Switch Requirements. The following are minimum requirements to be considered in switch design.

9.5.1 Switch Performance Parameters. The switch must provide a means of monitoring specified performance parameters. Various studies are now under way to determine those parameters and their relative usefulness and importance for system control. The results of such studies

MIL-STD-187-310

will be available in 1976. In the interim period, the appropriate switch related parameters from Table 16.2.2.2.1 of reference [a] should be used for planning. Information for specific applications to AUTODIN II and the European Telephone System is contained in references [b] and [c].

9.5.2 Data Preprocessing. To reduce data transfer, the switch should be capable of limited preprocessing. This will allow control action at the lowest possible level and promote reporting by exception.

9.5.3 Communications Interfaces. In addition to providing an interface with other switches, the switch communications subsystem should provide an interface with the DCS System Control Subsystem to ensure functions such as send and receive messages, format messages, transmit alarm, transfer data, and acknowledge receipt or nonreceipt of queries and directives. Provision should be made for error detection/correction. The details of this interface will be provided when a system control structure and hierarchy are finalized. TRI-TAC specifications [d] should be used as a reference for formats.

9.5.4 Execution of Control Actions. The switch will be capable of executing control actions within specified response times. Table 16.4.1.2-1 of reference [a] should be used as an interim source for specifications. Future development and modification of control actions and response times will be determined by contract studies, performance requirements, and the finalized hierarchy and structure of DCS system control. Those specifications named in paragraph 9.5.1 above contain detailed information for use at present.

9.6 Switch Processor Requirements. The processor must accommodate the switch to the specified DCS system control structure and hierarchy. The identification and distribution of functions between switching processor and system control subsystem have yet to be defined. The processor must be sized for performance monitoring and data gathering, certain preprocessing, communications functions and control action execution. However, it should not be sized for functions assigned to the DCS System Control Subsystem, such as trending and fault isolation, on an area basis. Those specifications named in paragraph 9.5.1 above contain detailed information for use at present.

9.7 Characteristics of Specific System Control Elements. This section of the planning standard will be provided after completion of the in-progress work described in paragraph 9.1 above. It will address AUTOVON, AUTODIN, secure voice, and the European Telephone System. The specification for AUTODIN II and system control for the European Telephone System now contains sections on system control. The following areas will be covered as applicable:

MIL-STD-187-310

- a. Control concept
 - (1) Performance parameters to be measured
 - (2) Procedures and protocols
 - (3) Data base requirements
 - (4) Response time requirements
 - (5) Interface requirements.
- b. Description of control elements
 - (1) Functional description
 - (2) Interface
 - (3) Tasks
 - (4) Sizing and modularity.

9.8 References

- [a] Final Report, Committee on Interoperability of DoD Telecommunications, September 1973 (SECRET).
- [b] System Performance Specification (Type A) for AUTODIN II, Phase I, November 1975.
- [c] European Telephone System Control Specification (under development).
- [d] TRI-TAC Specification No. TT-A3-9004-0019A, Appendix II, Data Message Formats - AN/TTC-39: CNCE, CSCE, 21 August 1975.

CHAPTER 10
FUTURE DCS - ADVANCED CONCEPTS
CONTENTS

		<u>Page</u>
<u>SECTION 1 UNIFIED DIGITAL SWITCH (UDS)</u>		10-1-1
Paragraph 10.1.1	Introduction	10-1-1
10.1.2	Objectives for New Structure	10-1-2
10.1.3	General Performance Requirements	10-1-3
10.1.3.1	Integrated Concept	10-1-3
10.1.3.2	Improved System Availability	10-1-3
10.1.3.3	Improved System Versatility	10-1-3
10.1.3.4	Mixed Mode Transactions	10-1-3
10.1.3.5	Rapid Message System	10-1-3
10.1.3.6	End-to-End Security	10-1-3
10.1.3.7	Switch Compartment Security	10-1-4
10.1.4	Functional and Operational Description	10-1-4
10.1.4.1	Available Services	10-1-4
10.1.4.1.1	On Demand "Fixed" (Small Variance) Delay (Class I)	10-1-4
10.1.4.1.2	On Demand Variable Delay (Class II)	10-1-4
10.1.4.1.3	As Available Variable Delay (Class III)	10-1-5
10.1.4.2	Service Characteristics	10-1-5
10.1.4.2.1	Address of Virtual Resources and Terminals	10-1-5
10.1.4.2.2	Interconnection of Incompatible Services	10-1-5
10.1.4.2.3	Precedence Levels	10-1-5
10.1.4.2.4	Information Processing	10-1-5
10.1.4.3	Call Types	10-1-5
10.1.4.3.1	Circuit Connection Type	10-1-5
10.1.4.3.2	Message Type	10-1-6
10.1.4.4	Dynamic Reallocation of Bandwidth	10-1-6
10.1.5	Switch Internal Architecture Features	10-1-6
10.1.5.1	Modularity	10-1-6
10.1.5.2	Multiprocessor Functional Arrangement	10-1-6
10.1.5.2.1	Multiprocessor	10-1-7
10.1.5.2.2	Associative Processor	10-1-7
10.1.5.2.3	Microprocessors	10-1-8
10.1.5.3	Protocol Aspects	10-1-8
10.1.5.3.1	Hierarchical Sets of Protocols	10-1-8
10.1.5.3.2	Desirable Features of Protocols	10-1-8
10.1.5.4	Security Aspects	10-1-9

MIL-STD-187-310

CONTENTS - Continued

		<u>Page</u>
Paragraph 10.1.5.5	UDS Operating System	10-1-9
10.1.5.5.1	Interprocess Communications	10-1-9
10.1.5.5.2	Dynamic Migration of Tasks	10-1-9
10.1.5.5.3	Security	10-1-9
10.1.5.5.4	Switch Language	10-1-10
10.1.5.5.5	Network Language	10-1-10
10.1.5.5.6	Remote Load	10-1-10
10.1.6	Proposed Unified Digital Switch	10-1-10
10.1.6.1	Description of New Structure	10-1-11
10.1.6.1.1	Operating Rules for Voice	10-1-11
10.1.6.1.2	Operating Rules for Packets	10-1-14
10.1.6.2	System Implementation	10-1-15
10.1.6.2.1	Switching	10-1-15
10.1.6.2.2	Nodal Control Information	10-1-15
10.1.7	References	10-1-17
 <u>SECTION 2 - SOFTWARE</u>		 10-2-1
Paragraph 10.2.1	Objectives of the Modern Approach to Software	10-2-1
10.2.1.1	Software Cost Spiral	10-2-1
10.2.1.2	The Emergence of Software as a Science	10-2-1
10.2.2	Elements of the Software System	10-2-1
10.2.2.1	Communications of Oriented Language (COL)	10-2-1
10.2.2.1.1	Typed Languages	10-2-1
10.2.2.1.2	The Concept of Structured Programming	10-2-1
10.2.2.1.3	Transportability	10-2-2
10.2.2.1.4	The Relationship of COL to Non-COL Programs and the Operating Environment	10-2-2
10.2.2.1.5	Syntax and Semantics	10-2-2
10.2.2.1.6	Dialects	10-2-2
10.2.2.1.7	Relationship of COL to Other Programming Languages	10-2-2
10.2.2.2	Compiler	10-2-3
10.2.2.2.1	Source Language for the Compiler	10-2-3
10.2.2.2.2	The Cross Compiler Implementation	10-2-3
10.2.2.2.3	Interpretive Execution	10-2-3
10.2.2.2.4	Compiler Modifications and Extensions	10-2-3
10.2.2.3	Program Documentation	10-2-3
10.2.2.3.1	Automatic Flow Charts	10-2-3
10.2.2.3.2	Manual Documentation	10-2-3
10.2.2.3.3	Responsibility for Maintaining Documentation	10-2-3

CONTENTS - Continued

		<u>Page</u>
Paragraph 10.2.2.4	Program Verification	10-2-4
10.2.2.4.1	Emergency of Program Proving as a Science	10-2-4
10.2.2.4.2	Effect of Program Verification on Standards for Program Writing	10-2-4
10.2.2.5	The Operating Environment	10-2-4
10.2.2.5.1	Target Computer Executive Programming	10-2-4
10.2.2.5.2	Target Computer Firmware	10-2-4
10.2.2.5.3	Effect of Firmware Changes on the Software	10-2-4
10.2.2.6	Programming Techniques	10-2-4
10.2.2.6.1	Programming Team Concept	10-2-4
10.2.2.6.2	Responsibility for Programming Discipline	10-2-4
10.2.2.6.3	Structured Programming	10-2-5
10.2.2.7	Software Engineering System	10-2-5
10.2.2.7.1	Scope	10-2-5
10.2.2.7.2	Elements of the System	10-2-5

CHAPTER 10

FUTURE DCS - ADVANCED CONCEPTS

SECTION 1

UNIFIED DIGITAL SWITCH (UDS)

10.1.1 Introduction. A characteristic of present switched communications systems is their inherent inability to achieve maximal use of the integral transmission capacity while simultaneously maintaining high performance objectives. One reason is that conventional circuit-switched voice systems provide end-to-end connection for the full duration of a call, resulting in the four-wire portion of the circuit being used a maximum of 50% of the call time, since conversation is generally in one direction at a time. Additionally, pauses and silent periods further reduce the transmission utilization to even lower levels. In any system, a significant number of lines are inactive a large portion of the time, providing the excess capacity that must be available during short peak periods to achieve a specified grade-of-service.

Modern packet networks require high transmission rates in order to satisfy the fast response times necessary for interactive computer communications. As a consequence, these high rates provide a transmission capacity which is very lightly utilized. Additionally, the use of ordinary telephone connections to connect interactive terminals to the network through acoustic coupling devices makes very inefficient use of the access circuit.

Trends of future requirements for switched digital communications systems indicate an increasing diversity of traffic characteristics such as:

- Wide disparities between traffic rates, ranging from low-rate TTY terminals requiring hundreds of bits/sec up to wideband video and graphics requiring hundreds of kilobits/sec.
- Wide disparities in transaction sizes, ranging from interactive messages of several hundred bits to bulk data transfers of millions of bits.
- Varying delivery time characteristics, ranging from the continuous, near-real-time requirements of voice and video to the intermittent operation of interactive data terminals which can be queued for varying delivery time requirements.

MIL-STD-187-310

10.1.2 Objectives for New Structure. Two fundamental objectives form the basis for a newintegrated switching/transmission structure:

- a. Transmission capacity originating at each node shall be allocated on a dynamic demand assignment basis.
- b. All information sources will encounter some form of segmentation once they enter the communications system, to allow flexible nodal handling.

One rationale for such objectives rests upon the quantum nature of most information sources. Experimental evidence indicates that both man and machine originated messages tend to contain small, discrete segments rich in information, while the remaining portions are either highly redundant or contain no information at all. A certain amount of information processing is required to extract the substance of information content. As advancing technology makes this processing cost effective, the location of information bandwidth compression equipment will move closer and closer to the actual user, and as a result only messages rich in information will be communicated over long distances. The paragraphs that follow describe the functional attributes and projected requirements for a unified switching system. The exact definition of the term "unified" will evolve as architectures, designs, and programs progress. The generic term "unified" is intended to emphasize the desirability of processing and handling all traffic modes in the DCS with common transmission and switching plants. An additional modification for a unified network is to provide maximum communicability between all terminals in the system. Without this factor it may be extremely difficult and costly to provide a capability for a terminal in one subnetwork to communicate with a terminal in the other subnetwork. It could be argued that there is little need for such a capability, and within today's traffic pattern this argument is valid. However, there are potential future requirements which would alter such patterns. For example, consider voice-answerback systems in which stored answers or data in a computer is communicated to a human listener. These systems are interactive in nature and hence would appear suited to a packet-type of network. However, the type of customer generally served is one that has a telephone instrument only, and in today's world is connected to a circuit-switched network. Further examples of services which might equally be desirable by users of both networks are facsimile and graphics. These and other examples indicate that more efficient and effective communications could be achieved in the future if all such terminals could operate through a common network.

10.1.3 General Performance Requirements

10.1.3.1 Integrated Concept. The Unified Digital Switch (UDS) will integrate a variety of modes such as voice, graphics, and interactive data traffic. Three different approaches to communications systems are currently in general use: circuit switching for voice traffic, message switching for record traffic, and packet switching for data traffic. Each approach is generally responsive to its user's requirements when properly implemented. However, use of transmission facilities and interaction between different terminal types can be greatly increased if these approaches are combined into a single integrated communications system.

10.1.3.2 Improved System Availability. The brute force way of dealing with system availability is to provide sufficient capacity to handle worst-case loading on each subnetwork (e.g., AUTOVON, AUTODIN, AUTOSEVOCOM). An alternative is to provide a distributed capacity switched network which encompasses all such networks and which can readily adapt to changing traffic patterns within and across each network. Such an approach provides more graceful degradation with more efficient use of costly resources and transmission capability.

10.1.3.3 Improved System Versatility. The UDS must have the capability to handle a variety of data frames, line speeds, and formats. Line formats include binary, packed binary, and character. The types of users will vary from very slow terminals to wideband video, and the UDS must have the capability to provide services to these types of users in an efficient way, in both the backbone and access areas. Future digital voice terminals may also require different transmission rates as capabilities in this area evolve with time. These rate variations can be most readily accommodated on a nonchannelized, switched network structure.

10.1.3.4 Mixed Mode Transactions. A Unified Digital Switch will also provide greater flexibility for services in that it can readily provide interconnection between completely different terminal modes; e.g., use of voice in an interactive mode with computers, and possible use of both CRT terminals and voice in a working group conference. Man-machine interactions may also require the UDS to handle voice in one direction and digital data in the other.

10.1.3.5 Rapid Message System. The capability should exist for very short important interactive messages to be transmitted quickly (in a few seconds) to ensure an equally responsive reply.

10.1.3.6 End-to-End Security. The UDS shall provide an integrated solution in facilitating end-to-end security. This includes the areas of subscriber (terminal device) protocols, key variable distribution

MIL-STD-187-310

(KVD) interfaces and terminal authentication. The security protocols shall minimize overhead traffic and call setup times. Distributed key distribution centers have been shown to be desirable from an overhead/response point of view. An efficient host-to-host interface between the UDS and the KDC is required if rapid and frequent transactions are to be carried out. The use of a terminal-unique variable will provide a facility to authenticate the subscriber identity from the switching center.

10.1.3.7 Switch Compartment Security. Two operational features dictate a multilevel security facility be provided the UDS. One feature is the capability of the switched network to perform remote program load. Remote load is very desirable from a DCS System Control point of view; however, it provides an on-line capability to alter node programs and files. As such, stringent security measures must be undertaken to guarantee no unauthorized nodal changes. The second operational feature is the necessity to store both classified and unclassified text in a single node. This comes about by the unavailability of compatible encryption devices between two terminal devices, therefore, making a red interface necessary.

10.1.4 Functional and Operational Description

10.1.4.1 Available Services. Network services fall into the general categories of voice (clear and secure); video/graphics, narrative/record messages, interactive data, and bulk data. Other specific uses include dial-up ports for terminal access to packet-like network services, and interconnection of various data terminals and computer services. Three distinct classes of users are defined in the following subparagraphs.

10.1.4.1.1 On Demand "Fixed" (Small Variance) Delay (Class I). This class of traffic is characterized by calls comprising continuous synchronous transmission (perhaps one long transmission) which the network accepts without delay and forwards with a fixed delay (voice, facsimile, video).

10.1.4.1.2 On Demand Variable Delay (Class II). This class of traffic is characterized by calls comprising discontinuous bursts of short transactions which can tolerate variable delays so long as the average delay is near real-time and does not exceed an acceptable threshold. Two subclasses are further defined. One class includes interactive data and has a relatively short (seconds) delay, and another class is for narrative/record message traffic with a longer (minutes) delay.

10.1.4.1.3 As Available Variable Delay (Class III). This class of traffic is characterized by calls comprising long non-real-time transactions which may be throttled by the network and delivered with significant variable delays (bulk data).

10.1.4.2 Service Characteristics

10.1.4.2.1 Addressing of Virtual Resources and Terminals. All network resources should be allocatable as individual virtual entities whose particular location at any point in time may vary. Thus, users will address virtual resources and the network will provide the necessary translation in obtaining the required resource. At the very highest level, a user of a resource should be able to execute programs without needing to know the internal protocols or the physical location of the resource service.

10.1.4.2.2 Interconnection of Incompatible Services. Various subscribers and services with incompatible data rates and protocols will be afforded interconnection wherever feasible through buffering and translation services provided by the network.

10.1.4.2.3 Precedence Levels. A precedence procedure is required which guarantees both a given grade-of-service to voice subscribers and maximum allowable delay to message subscribers without sacrificing the other. Preemption must be reexamined in the context of short interactive communications. Conventional preemption procedures may no longer be an effective means to guarantee these services.

10.1.4.2.4 Information Processing. The functional characteristics of the UDS shall include the inherent capability to accommodate and perform information processing. An example of this type of requirement is for the UDS to access, from the network, and distribute security keys to subscribers. It can be anticipated that there will be some common data files generated and maintained by the subnetwork for common user access. Therefore, the hardware/firmware/software structure must be such that this type of subnetwork information processing can be provided subscribers in a manner consistent with normal process to process communications.

10.1.4.3 Call Types

10.1.4.3.1 Circuit Connection Type. In a circuit connection type call, a calling and a called subscriber are uniquely and exclusively provided access to each other. An example is a terminal-to-terminal call. For a connection-oriented call, the sender attaches a leader to the message in only the initial transaction segment, which is used to set up the call. A receiver operating in this mode will accept the first segment only with a leader, after which it will indicate

MIL-STD-187-310

that it can receive no segments other than those from the subscriber whose call it just accepted. This segment or message receipt is restricted to only one subscriber at a time. The call will remain up until either calling or called subscriber initiates a call termination.

10.1.4.3.2 Message Type. For message-oriented calls, a leader must accompany every segment. Although a subscriber may be operating in a connection mode for sending, it can also be receiving in a message mode, as with a time-sharing terminal user who is able to accept messages from other users although his dialogue may be with a single computer.

10.1.4.4 Dynamic Reallocation of Bandwidth. It shall be possible to dynamically reallocate bandwidth based on terminal needs to integrate, on a flexible transmission basis, a large variety of terminal data rate requirements. The UDS shall have the capability to handle increased transmission speeds such as provided by satellite. If a hierarchy of switches, concentrators, etc. is required, use of basic building modules is highly desirable.

10.1.5 Switch Internal Architecture Features. The switch internal architecture is concerned with the hardware, software, and firmware structural configurations used for switching.

10.1.5.1 Modularity. The UDS shall be only as large as the traffic density dictates, but it shall be capable of being upgraded by adding new modules. Internal mode redundancy and distributed control techniques shall be used within the nodal architecture to assure graceful degradation of processing functions and capabilities in the event of failure. Insofar as possible, the network switches will use common, multifunction equipment for data path connections and signaling, supervision, and control, as well as for switch control, to minimize critical unique-function equipments.

10.1.5.2 Multiprocessor Functional Arrangement. Characteristics possessed by multiprocessors (which is meant to include multiprocessors, associative processors, and microprocessors) make them useful as the basic architecture of an integrated switch. Such characteristics are:

- a. Modular expansion capability
- b. Variable capacity (Same basic architecture can serve different capacity switches.)
- c. Graceful degradation, due to inherent redundancy
- d. Distributed control
- e. Concurrent processing.

MIL-STD-187-310

In the discussions that follow, each of these architectures is discussed in some detail. However, note that a UDS may contain portions of each of these architectures.

10.1.5.2.1 Multiprocessor. A multiprocessor structure is defined as a set of processors, a set of memory modules, and a set of I/O modules that are interconnected in such a way that each processor can directly access (almost) all of memory, and can communicate with any I/O module. The number of processors, memory, and I/O devices are modularly expandable up to some limit. The multiprocessor contains at least a minimal operating system which allows processes to be mapped onto a set of processors. The scheduling can be very specific (static), without priority or preemption, in which case the operating system would be very simple (i.e., would consist of placing the proper process in the proper processor). On the other hand, the operating system could be quite general, in which case it must take care of priority, allocation of tasks and buffers, etc.

The operating system envisioned for the switch should be of the more general case. This offers several advantages. First of all, no particular processor failure is catastrophic, since any other processor can perform its function. In addition, control can be distributed among the processors, and each processor can operate asynchronously and concurrently. Since call processing, by nature, contains many operations that could go on in parallel, it is possible to decompose it into parallel elements and promote much faster throughput when executed on a multiprocessor. However, it should be pointed out that the most optimum decomposition is an open problem. Also note that a synchronization problem can exist in a multiprocessing system. That is, since processes are executing asynchronously, there needs to be a way that processes can signal each other their appropriate states. Alternately, the software can be designed so that all processes execute within a certain time frame (synchronously). However, this decreases flexibility and could result in inefficient design and implementation. Throughput and overall efficiency can be further optimized by the use of a microprogrammable control store. Utilizing this technique, processes that are used often are coded in microcode for more efficient execution.

10.1.5.2.2 Associative Processor. An associative processor is a device with a single control unit that controls many processing elements which perform the basic automatic and logic functions. Thus, a single instruction (e.g., ADD) can be executed simultaneously by all processing elements. An example of how an associative process can be used in the UDS is that data from separate channels can be input to individual processing elements (assuming adequate storage), such that each channel can be processed simultaneously. Channel data can be gated to any

MIL-STD-187-310

processing element, so that a failure of a processing element does not cause a complete system failure (fault tolerant). The processing elements are modularly expandable up to some maximum number.

10.1.5.2.3 Microprocessors. Microprocessors are small, inexpensive processing units that can be connected together through a bus, in which each microprocessor performs a portion of the switching functions. This modular type structure allows the number of processors to vary, and promotes concurrent processing and high reliability. In addition, the relatively low cost of microprocessors allow them to be used as line terminators to provide speed and format compatibility between computing elements. One drawback of a pure microprocessing system is its slow cycle time and primitive I/O. The slow cycle time can be overcome if the switch processing can be decomposed at a level which allows a high degree of concurrency. The primitive I/O suggests that microprocessors be supplemented with other computing elements such as associative or multiprocessors so that performance is not unduly degraded.

10.1.5.3 Protocol Aspects. In all communications situations, rules of protocols (procedures) are needed to enable communications to be accomplished without errors or hangups (deadlocks). Protocols are used for establishing and clearing links or calls between processes, ensuring adequate buffering, and for an interruption scheme.

10.1.5.3.1 Hierarchical Sets of Protocols. Protocols exist at various levels. There is a low level protocol concerned with establishing and maintaining connections. There is a medium level concerned with the transfer of messages once connections have been made, and there is a high level protocol concerned with the transfer of programs, files, etc.

10.1.5.3.2 Desirable Features of Protocols. Protocols should have the following features:

- a. Each level of protocol should be transparent to the levels above it so that actions initiated by a given level cannot be affected by a lower level.
- b. Protocols should be self-limiting to prevent deadlocks (or at a minimum detect and correct deadlock situations).
- c. The protocols should be suitable for use by unintelligent as well as intelligent terminals.
- d. A way should be provided for users to dynamically establish variations in the parameters specified in protocols (e.g., the amount of buffer space allocated to a connection).

- e. It should be possible to make changes to one level of protocols without requiring extensive changes at other levels.
- f. Capability to interface with other (foreign) networks should be provided.

10.1.5.4 Security Aspects. A strategy must be developed for the integrated network to provide a compatible system solution to multilevel security and the secure communications problem. Cost effective and performance acceptable solutions may require a degree of software integration of "key generation" mechanisms with the switch line control interface. In addition, red/black hardware modularity and classification/category security verification software modularity are required. These requirements shall be an integral part of the UDS and subnetwork system design from the initial planning stages and not as an add-on component.

10.1.5.5 UDS Operating System. To provide the capabilities described in paragraph 10.1.4, as well as effective utilization of switch resources, an operating system structure is required. It should be pointed out that these operation system functions may be embedded in the UDS operational software, or may be distinct from them. A tradeoff must be made between speed and flexibility in choosing between them. Discussed herein are the minimal functions that such an operating system should perform.

10.1.5.5.1 Interprocess Communications. Interprocess communications include event signaling and interlock mechanisms among independent processes. Because the execution of processes on a multiprocessor occurs asynchronously, suitable methods must be devised for passing information among the processes in the proper time sequence. A possible way of doing this is having parameters set in a process such that these parameter settings determine whether the process is in the "execute" or "wait" state. A suitable switch language (see paragraph 10.1.5.5.4) is required to support interprocess communications.

10.1.5.5.2 Dynamic Migration of Tasks. Dynamic migration of tasks can permit load leveling, dynamic reliability, and execution of a task by a processor best matched to task requirement. In a multiprocess system, the function of a processor that is overloaded or fails, should be transferable to another processor with minimal lost time.

10.1.5.5.3 Security. Present multiprocessor computer systems cannot provide sufficient program or data resource protection from unauthorized use while at the same time providing authorized access for multilevel security clearance users. Current security functions are complex and have a low probability of certifiability. Development of hardware and software techniques is required that ensure the integrity and security of computer systems, with emphasis on security control and isolation mechanisms.

MIL-STD-187-310

10.1.5.5.4 Switch Language. A switch language built upon basic primitives is required to support the optimal execution of switch processing tasks. Required is a set of primitives for synchronizing tasks, sharing resources, and creating and destroying processes. Examples of some possible primitives are:

- a. WAIT (event) - Prevents the executing process from proceeding until the event has transpired.
- b. OBTAIN (resource) - Requests exclusive rights to the resource.

10.1.5.5.5 Network Language. The basic requirement of a network language is to support network activities such as terminal/switch and switch/switch protocols (see paragraph 10.1.5.3), error control, etc. by providing the ability to easily implement, modify, and utilize such functions.

10.1.5.5.6 Remote Load. It should be possible to reload the switch software from a remote control center or from a neighbor node when conditions warrant, such as an irrecoverable failure, an update in software release, etc. Note that security precautions should be undertaken to prevent an arbitrary unauthorized reload to take place.

10.1.6 Proposed Unified Digital Switch. A number of approaches to fulfilling the above objectives, requirements, and characteristics are under active investigation. One approach is to use packet switching techniques for all classes of traffic. The effects of packet switching on voice traffic in particular are being investigated. Another approach, being developed for military tactical use, is the use of buffered low-rate terminals from which signals are transmitted at the "standard" digital channel rate. However, a significantly different approach is proposed here for satisfying these diverse characteristics. This approach uses a single, unified, transmission, switching, and multiplexing structure that efficiently utilizes the total transmission capacity. The "dynamic allocation" of transmission capacity described herein can be implemented with current computer technology by the substitution of computer memory manipulation for the traditional space or time division matrices currently used in communications system switches. This approach exhibits a level of transmission utilization efficiency not obtainable by separate systems. This structure, therefore, has many salient features to offer mixed traffic communications systems where transmission cost is a significant portion of the total.

Further, this flexible approach precludes the need for having one particular channel bit rate as a system standard. Also, this approach will accommodate future concepts involving the use of voice and data together in a more complete man/machine interactive dialogue, a concept whose implementation would not be desirable in separate voice

MIL-STD-187-310

and data networks. The description which follows was extracted from reference [a], which contains more complete details and related analyses.

10.1.6.1 Description of New Structure. The fundamental difference between the proposed system and the more conventional systems is illustrated by Figure 10.1.1. Part (a) of Figure 10.1.1 illustrates the conventional method of partitioning the F-T plane into a frequency slice (e.g., the standard 4 khz voice channel). Each channel is occupied for the duration of a voice call, shown as shaded areas. The proposed approach, however, partitions the F-T plane into time slices (or master frames) as shown in Part (b) of Figure 10.1.1. The full bandwidth is always used while there is traffic, and the width of the shaded portions represents the traffic being transmitted. This format is similar to time-division demand assignment.

The detailed structure of a typical frame period is portrayed in Figure 10.1.2, which illustrates a 10 millisecond frame taken from a T1 carrier, resulting in a frame length of 15,440 bits. Starting from the frame marker at 12 o'clock, a certain number of bits is reserved for CCS (common channel signaling), followed by Class I traffic which is loaded into the frame in the order of arrival. Because this class comprises real-time traffic, the time slot to which each call is assigned is reserved during succeeding frame periods until the termination of the connection. Such master frame slots are assigned and delivered through CCS, a method nearly identical to that used for standard synchronized TDM. There is one major exception, however; slot sizes allocated to different channels can be made variable to accommodate different bit rates. In the structure of Figure 10.1.2, an 8 kb/s A/D rate was assumed for voice, resulting in 80-bit slots being assigned to voice channels. Wider bandwidth video and FAX channels are shown occupying 1000- and 500-bit slots respectively. In Figure 10.1.2, the first marker, indicated at 4 o'clock, marks the end of Class I traffic. As new connections are requested, they are added to the frame and the marker is indexed ahead (clockwise) until some predetermined limit is reached, after which blocking is experienced. As connections are terminated, the remaining assignments are collapsed to fill the resulting empty slot(s) and the first marker is appropriately indexed downward (counterclockwise). In general, the assigned slots remain relatively fixed from frame to frame, and each channel retains a continuous uninterrupted path between switching nodes, even though the actual slot position within the frame may change as other channels are added or deleted.

10.1.6.1.1 Operating Rules for Voice. The operating rules of the switching node for reservation of master frame voice slots are as follows:

MIL-STD-187-310

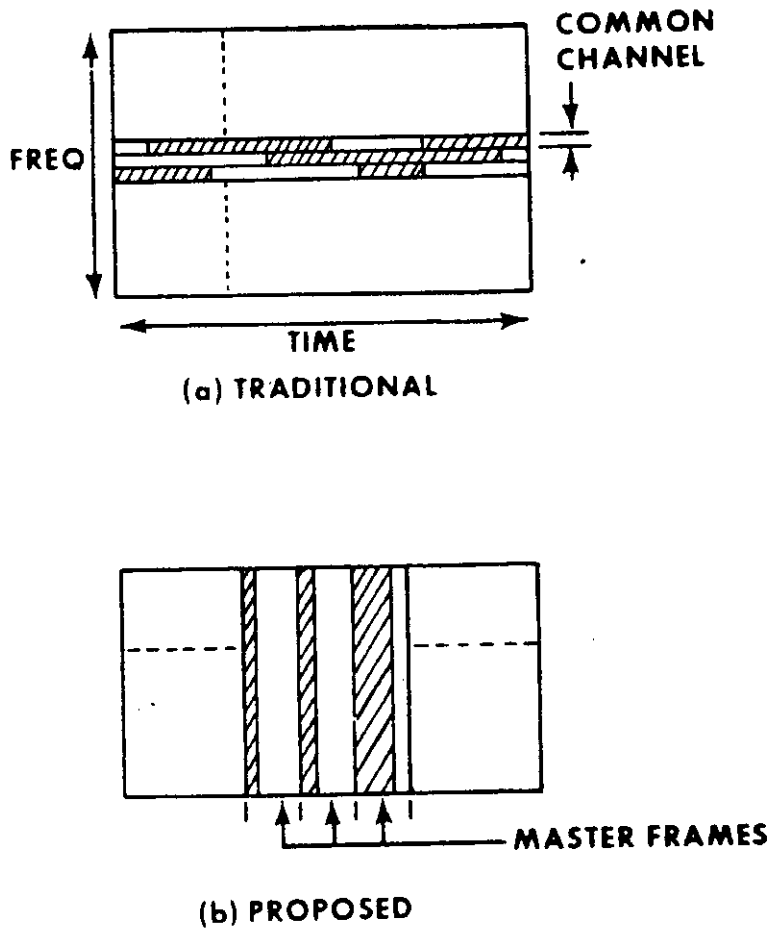

FIGURE 10.1.1 Frequency-Time Representations

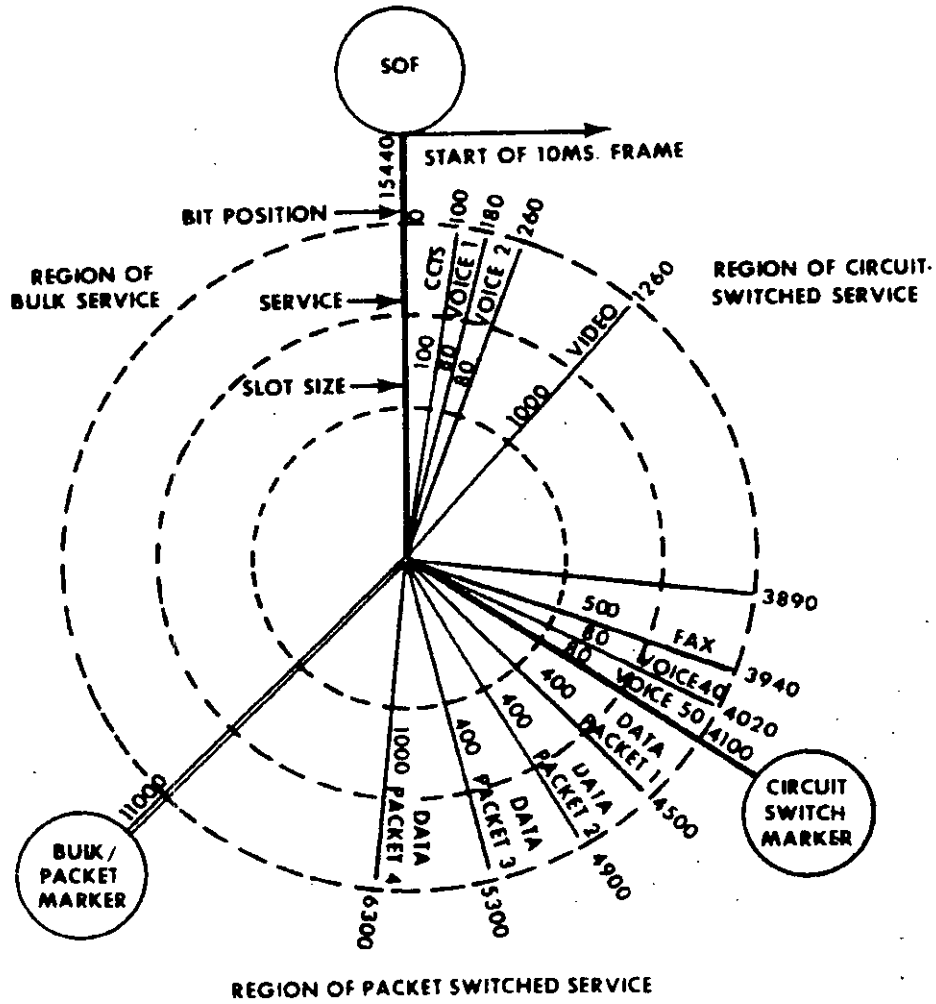

FIGURE 10.1.2 Multiplex Structure for Typical Frame Period

MIL-STD-187-310

- a. Each node memorizes time slot exchange information between trunks after initial routing has been accomplished to facilitate frame-by-frame switching.
- b. Once a Class I call has been set up, voice slots are reserved across the network for the duration of the call. The definition of reservation is that each node guarantees a tandem voice call a specific outgoing frame slot on each succeeding master frame. The implication here is, that on a frame-by-frame basis, Class II traffic may exploit unused but reserved voice slots.
- c. No error control is exercised over voice slot information.
- d. Exact changes in format of the Class I master frame region are identified each frame cycle by the CCS slot.

The second region of the master frame is dedicated to Class II traffic. This region contains a variable number of self-contained information packets of variable but limited size. The number depends on the arrivals, queue level, and available capacity of the Class II region. Source, destination, sequence, error control, size, etc. are included in overhead information that accompanies each packet.

10.1.6.1.2 Operating Rules for Packets. The operating rules of the switching node for handling packets are as follows:

- a. All packets are queued on first-in, first-out (FIFO) basis.
- b. In each master frame, the Class II region is filled to capacity (if required) from packets contained in queues.
- c. Error control is exercised on a packet basis at each node and retransmission is requested if an error is indicated.

The third region of the master frame is dedicated to Class III traffic. This region will be filled with blocks of bulk data appropriately sized for efficient error control. These blocks will have a minimum of overhead and occupy a transitory buffer at each node. Therefore, the bulk data (Class III) user sees a high-capacity end-to-end connection (circuit type) with error control. If this bulk data capacity is needed to augment the Class II region, the system temporarily inhibits the bulk data source and reestablishes communications when capacity becomes available.

10.1.6.2 System Implementation

10.1.6.2.1 Switching. This proposed structure handles both multiplexing and switching with a common mechanism. The deviation from a channelized transmission structure and the reliance of the system on dynamic bandwidth assignment inherently mixes the multiplexing and switching functions. These functions can be efficiently accomplished at each node by buffer management. The economic advantages of associative processors and microprocessors allow buffer management to be performed efficiently.

Figure 10.1.3 illustrates a functional structure for the switch architecture. Basically, it consists of one common memory into which all incoming "master frame" contents are directly loaded, and within which each outgoing "master frame" is formatted before transmission. Flow into and out of memory, as well as the manipulation of data within memory, as well as the manipulation of data within memory, is controlled by a number of microprograms (MP's), as shown. The line MP's are used to interface each connecting trunk. The CCS MP provides the communications link to the control processor, and the packet MP manipulates packet headers (e.g., for multiple addressing), error detection on each packet, etc. The control processor provides a similar function to that of present-day, program-controlled switches. It provides all necessary signaling, supervision, and schedule and control over the "matrix function," represented by the memory and its associated MP's. For convenience, imagine incoming data as being manipulated and moved around in memory to prepare the format of each outgoing frame. Actually, however, more sophisticated software techniques are available, such as list processing, to provide management and control without unnecessary manipulation of data.

10.1.6.2.2 Nodal Control Information. Two types of controlling information are required for this type of system structure:

- a. Initial call setup information for the Class I traffic
- b. Master frame fine structure information for all traffic regions.

The call setup information and procedures are integral to the routing method. The Class II traffic facilities could very well be used to propagate this type of information through the network. Clearly, frame information must accompany every frame which differs from the immediately preceding frame. The periodicity and amount by which master frames may change is an area large enough for a tradeoff study in itself.

MIL-STD-187-310

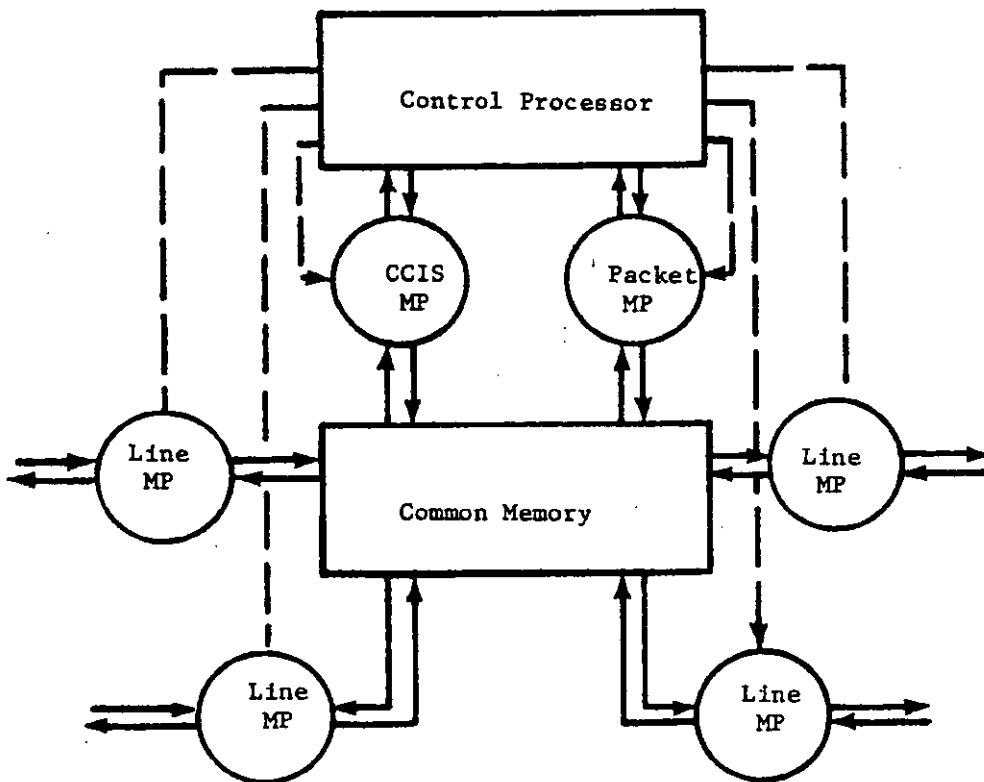



-  = Microprograms
-  = Data Flow
-  = Control Actions

FIGURE 10.1.3 Functional Structure for Future Switch Architecture
10-1-16

10.1.7 References

- [a] DCEC TC 8-75, "Concept for an Integrated Circuit/Packet Telecommunication System," G. J. Coviello, P. A. Vena, January 1975.

CHAPTER 10

SECTION 2

SOFTWARE

10.2.1 Objectives of the Modern Approach to Software

10.2.1.1 Software Cost Spiral. During the past several years, hardware costs have decreased continually, but this has been offset by steeper increases in software costs. It has been estimated that in the 1980's software will account for 85 to 90% of system costs. This trend has caused designers to become more concerned with techniques for reducing the costs of such software.

10.2.1.2 The Emergence of Software as a Science. With first and second generation computers, software development advanced from a low key mechanical process performed by technicians to a skilled craft performed by artisans. Now this craft is growing into a science which is ready to be structured into an engineering discipline. Such a discipline is indicated by the elements of this standard.

10.2.2 Elements of the Software System

10.2.2.1 Communications Oriented Language (COL). Programming of switch software shall be in a high order language. A specification for the syntax of such a language is currently under development; the language will be referred to as COL, Communications Oriented Language, and will have the characteristics described in this section.

10.2.2.1.1 Typed Languages. COL shall be a typed rather than a typeless language. As a minimum the language shall contain the following data types:

Integers

Character strings

Bit strings

Labels and pointers.

10.2.2.1.2 The Concept of Structured Programming. The language shall support the ideas of structured programming. Thus, it shall include constructs which support a block organization for programs. These constructs shall include the following capabilities:

MIL-STD-187-310

- a. IF-THEN-ELSE
- b. DO and DO WHILE
- c. BEGIN
- d. GOTO
- e. Branch to the bottom of a block without using a GOTO or defining a label.

10.2.2.1.3 Transportability. One of the main objectives of COL is to develop software which is generic to the application and can be transported to new target computers as they enter the system. Thus, the language shall not contain target machine-dependent features.

10.2.2.1.4 The Relationship of COL to Non-COL Programs and the Operating Environment. It is realized that programs for switches may be written in a number of languages, for example, COL, FORTRAN, COBOL, and assembly language. Although these languages are quite diverse, a uniform protocol (linkage method) shall be devised so that programs can communicate (interface) regardless of source language. To implement this interface, it is within the COL system concept to require the object modules from any approved language to be compatible and the "argument linkages" to obey a standard protocol. In addition, the calls to the system executive shall be independent of the source used to create the executive. Such sources include COL, assembler language, firmware, or a combination of the preceding.

10.2.2.1.5 Syntax and Semantics. The syntax of the COL will be as natural as practicable to the computer specialists and engineers who will have to work with the language. The programs will be intelligible to persons who have general experience with common high order languages, but not necessarily extensive familiarity with COL.

10.2.2.1.6 Dialects. The language shall be free of dialects. However, it is recognized that machine-dependent programming is sometimes unavoidable. When such programming is incorporated within a COL written program, the generic form shall be well documented.

10.2.2.1.7 Relationship of COL to Other Programming Languages. COL shall be developed in conjunction with DoD elements engaged in developing languages and standards for other system applications. It is recognized that the acceptability of a new language is enhanced if it resembles an existing, widely used language. Thus, an effort is to be made to use as a basis of COL, a language with a broader application base. This will not be accomplished at the expense of decreasing the utility of COL.

10.2.2.2 Compiler

10.2.2.2.1 Source Language for the Compiler. Since COL is a specialized language for communications processing, there is no requirement for the COL compiler to be written in its own language. However, the COL compiler should be written in an appropriate high order language, so that the same benefits which accrue to communications programs through the use of COL will accrue to the compiler program through the use of an appropriate high order language.

10.2.2.2.2 The Cross-Compiler Implementation. Since the communications computer family will include machines which are too small to be self-targeting, the compiler will be a cross-implementation on a large, general-purpose computer system. This implementation will be organized to keep the essentially target computer independent features of the compiler separate from the target machine dependent features. This will permit retargeting of the compiler with minimal effort.

10.2.2.2.3 Interpretive Execution. The compiler output shall be used as input to a communications computer simulator/emulator which will be used for preliminary program checkout on the source computer.

10.2.2.2.4 Compiler Modifications and Extensions. It is recognized that the initial version of COL and the COL compiler will need modifications and extensions. Thus, the compiler shall be organized to permit syntax extensions. Such extensions will not be permitted at the user level.

10.2.2.3 Program Documentation

10.2.2.3.1 Automatic Flow Charts. There will be the capability to produce, on the source computer, a flow chart from the COL source programs. This will not necessarily be a conventional flow chart. Ideas from the software engineering literature concerning automatic documentation and self-documentation will be considered before the form of such documentation is finalized.

10.2.2.3.2 Manual Documentation. Since programs cannot be fully documented from the source program, additional manual documentation will be required. Specifications for such documentation will be developed, as will techniques for having the source computer assist in the documentation.

10.2.2.3.3 Responsibility for Maintaining Documentation. A definite line of responsibility will be specified for maintaining program documentation. Ultimate responsibility will be with the program manager. The program librarian function will be considered an important part of the overall COL program development effort.

MIL-STD-187-310

10.2.2.4 Program Verification

10.2.2.4.1 Emergence of Program Proving as a Science. Program proving and verification is currently undergoing research and development within the computer science community. It is not practical to define standards at this time.

10.2.2.4.2 Effect of Program Verification on Standards for Program Writing. Although program verification techniques are currently embryonic, evidence indicates that a set of good programming practice rules can be defined now. These rules will make programs adaptable to program verification as techniques for such operations become available. Thus, a set of programming practice rules will be part of the COL environment.

10.2.2.5 The Operating Environment

10.2.2.5.1 Target Computer Executive Programming. The COL concept will permit implementation of a level of executive control which is closer to the hardware than the level normally implemented with the COL. If possible, this programming will also be in COL; however, other programming languages are permissible, as described in 10.2.1.4.

10.2.2.5.2 Target Computer Firmware. If the architecture of the target computer contains microprogramming, then the executive program may be partially or completely implemented in this firmware. COL is not intended to program firmware; however, COL features may possibly influence such firmware.

10.2.2.5.3 Effect of Firmware Changes on the Software. Changes in the firmware must not require changes in existing COL programs. However, the extensibility features of the compiler should allow a "better" compilation of existing COL programs to reflect such improvements in the firmware.

10.2.2.6 Programming Techniques

10.2.2.6.1 Programming Team Concept. Various forms of a programming team concept have recently been promulgated in the literature. A team programming concept will be used for the development and maintenance of communications software. Procedures will be developed from a study of the experience of others in this area and of the Defense Communications System.

10.2.2.6.2 Responsibility for Programming Discipline. The lead professional in a programming team is responsible for maintaining programming discipline and ensuring that the use of COL and the associated

compilers and tools follows good software engineering and system engineering discipline. Such an individual is commonly called the chief programmer.

10.2.2.6.3 Structured Programming. The COL will support the concepts of structured programming. Structured programming is considered in its broad sense and influences the structure of the software, the order of implementation, and coding conventions. The results of studies in this area are not complete, but certain findings are apparent. The COL will permit software to be modular. Within a module the COL will support the constructs mentioned in 10.2.2.1.2. The use of these constructs enhances the understanding of the code and helps in its verification. The GOTO structure extends the capability of the language, but its use is discouraged. Also some modules or parts of modules must contain target machine-dependent code. When this occurs, additional documentation will be required.

10.2.2.7 Software Engineering System

10.2.2.7.1 Scope. An overall long term goal is the development of a Software Engineering System for managing software through its life cycle. Although such a system is several years in the future, the emphasis in the near term is on developing software and software aid elements that will become parts of such a system.

10.2.2.7.2 Elements of the System. Elements of the Software Engineering System which are to be considered as part of our long-term development program include the following:

- a. Languages
 - (1) COL
 - (2) Existing HOL's
 - (3) Assembly
 - (4) Specification
- b. Compiler
 - (1) COL
- c. Systems
 - (1) Operating
 - (2) Program Documentation

MIL-STD-187-310

d. Concepts

- (1) Structured Programming
- (2) Program Verification
- (3) Programming Team.

MIL-STD-187-310

CUSTODIANS:

ARMY - SC
NAVY - EC
AIR FORCE - 17

PREPARING ACTIVITY:

DCA - DC

PROJECT NO.:

SLHC-7310

SPECIFICATION ANALYSIS SHEET		Form Approved Budget Bureau No. 22-R255
<p>INSTRUCTIONS: This sheet is to be filled out by personnel, either Government or contractor, involved in the use of the specification in procurement of products for ultimate use by the Department of Defense. This sheet is provided for obtaining information on the use of this specification which will insure that suitable products can be procured with a minimum amount of delay and at the least cost. Comments and the return of this form will be appreciated. Fold on lines on reverse side, staple in corner, and send to preparing activity. Comments and suggestions submitted on this form do not constitute or imply authorization to waive any portion of the referenced document(s) or serve to amend contractual requirements.</p>		
SPECIFICATION		
ORGANIZATION		
CITY AND STATE		CONTRACT NUMBER
MATERIAL PROCURED UNDER A <input type="checkbox"/> DIRECT GOVERNMENT CONTRACT <input type="checkbox"/> SUBCONTRACT		
<p>1. HAS ANY PART OF THE SPECIFICATION CREATED PROBLEMS OR REQUIRED INTERPRETATION IN PROCUREMENT USE?</p> <p>A. GIVE PARAGRAPH NUMBER AND WORDING.</p>		
<p>B. RECOMMENDATIONS FOR CORRECTING THE DEFICIENCIES</p>		
2. COMMENTS ON ANY SPECIFICATION REQUIREMENT CONSIDERED TOO RIGID		
<p>3. IS THE SPECIFICATION RESTRICTIVE?</p> <p><input type="checkbox"/> YES <input type="checkbox"/> NO (If "yes", in what way?)</p>		
<p>4. REMARKS (Attach any pertinent data which may be of use in improving this specification. If there are additional papers, attach to form and place both in an envelope addressed to preparing activity)</p>		
SUBMITTED BY (Printed or typed name and activity - Optional)		DATE

DD FORM 1426
1 JAN 66

REPLACES EDITION OF 1 OCT 64 WHICH MAY BE USED.

S/N-0102-014-1801 C-25294

FOLD

POSTAGE AND FEES PAID

OFFICIAL BUSINESS

Defense Communications Engineering Center
ATTN: Code R110
1860 Wiehle Avenue
Reston, Virginia 22090

FOLD