

MIL-R-47196A(MI)  
 6 September 1977  
 SUPERSEDING  
 MIL-R-46196(MI)  
 12 July 1974

## MILITARY SPECIFICATION

### RIVETS, BUCK TYPE, PREPARATION FOR AND INSTALLATION OF

This specification is approved for use by US Army Missile Command, Department of the Army, and is available for use by all Departments and Agencies of the Department of Defense.

#### 1. SCOPE

1.1 Scope. This specification covers the preparation for and installation of buck rivets.

#### 2. APPLICABLE DOCUMENTS

2.1 Government documents. The following document, of the issue in effect on date of invitation for bid or request for proposals forms a part of the specification to the extent specified herein:

#### SPECIFICATIONS

\* Federal

\* TT-P-1757 Primer Coating, Zinc Chromate,  
 \* Low Moisture Sensitivity

\* STANDARDS

Military

MIL-STD-171 Finishing of Metal and Wood Surfaces.

(Copies of specifications, standards, drawings, and publications required by suppliers in connection with specific procurement functions should be obtained from the procuring activity or as directed by the contracting officer.)

#### 3. REQUIREMENTS

3.1 Rivets. The rivet type, size, and material shall be as specified on the engineering drawing, parts list or specification.

FSC 5320

MIL-R-47196A(MI)

3.1.1 Rivet handling. The rivets, as furnished, shall be free from dust or dirt.

3.2 Preparation for installation.

3.2.1 Rivet holes.

3.2.1.1 Drilling. Oversize, oblong and irregular-shaped holes shall be cause for rejection. Rivet holes shall be drilled in accordance with the following requirements:

a. All holes shall be drilled normal (at 90 degrees) to the working surface.

b. Extreme pressure shall not be applied and holes shall not be punched through with the drill.

c. When drilling through more than one sheet, hold the sheets securely together so there is no misalignment of holes due to shifting or separation of the sheets.

3.2.1.2 Piercing. Only piercing tools which produce true and clean holes, equivalent to acceptable drilled holes may be used. Piercing tools shall not be used without written approval from the procuring activity. If piercing is used, all holes shall be inspected for radial cracking.

\* 3.2.1.3 Hole size. Hole size for rivets shall conform to Table I unless otherwise specified on the engineering drawing or specification.

\* 3.2.1.4 Countersinking. Countersinking shall be used in the installation of all flush type rivets. Countersinks shall be produced with a tool that incorporates an automatic stop countersinking feature. The countersinking tool shall be held at 90 degrees to the work surface during the entire cutting cycle. Countersinks shall be free of chatter marks and concentric with the rivet holes. The countersink diameter shall be in accordance with Table VI unless otherwise specified on the applicable engineering drawings or specifications.

3.3 Installation.

3.3.1 Cleaning mating surfaces. Before parts are riveted together, all chips, burrs and foreign material shall be removed from the mating surfaces. Burrs may be removed from rivet holes by chamfering to a depth not to exceed 10 percent of the stock thickness, or 0.032 inch, whichever is less. Disassembly after drilling and before riveting, in order to deburr faying surfaces, shall not be required.

3.3.2 Installation grip. The rivet grip lengths shown on drawings shall be verified prior to installation. Grip length shall be changed as material thickness dictates as required to achieve minimum head dimensions as shown in Table III without buckling or bending or other driving difficulties.

3.3.3 Driving procedure.

3.3.3.1 Head direction. Unless specified on the engineering drawing or specification, the manufactured head of the rivet shall be located on exterior surfaces.

3.3.3.2 Rivet set. Flat dies may be used on the manufactured head of universal head rivets provided the head is not flattened beyond the dimensions specified on Table II.

3.3.3.3 Peening. The driven rivet shall completely fill the hole. Peening of the driven head by rolling the buckling bar shall not be permitted since the rivet hole will not be filled.

3.3.3.4 Head diameter. Unless otherwise specified on the engineering drawing or specification, all rivets shall be driven to minimum head diameter specified in Table III. Driven head thickness larger than the maximum specified in Table III must be approved by the procuring activity.

3.3.3.4.1 Driven universal heads. Driven universal heads may be formed on the shank side of the rivet using the next smaller size universal type head riveting die (example, 1/8 inch die for 5/32 inch shop head rivet). Driven universal type head sizes shall conform to the respective rivet diameter shown on Table III, unless otherwise specified on the engineering drawing or specification.

3.3.4 Multiple (gang) riveting.

3.3.4.1 Head height. The height of manufactured heads after riveting shall not be less than as specified in Table II.

3.3.4.2 Head flushness. To prevent gapping of heads, when drive with a gang riveter, the rivet heads shall not be flush prior to driving.

3.3.5 Riveting contoured surfaces. Tack rivets or other suitable devices at increments of every fifth or sixth hole must be used before final riveting when riveting contoured surfaces.

## MIL-R-47196A(MI)

3.3.6 Countersunk rivet head flushness. Unless otherwise specified on the engineering drawing or specification, flushness limits shall be 0.010 inch above to 0.005 inch below the material surface. Countersink diameters are provided in Table IV for reference.

3.3.7 Shaving countersunk rivets. Rivets failing to meet flushness requirements may be shaved to new close tolerances. The material surface shall not be damaged by the shaving tools. The stop device on the shaver shall be adjusted so that it extends 0.001 inch to 0.002 inch beyond the cutter and the setting shall be tested prior to shaving the rivet head. The cutter used in the shaver shall be larger in diameter than the rivet head. Table V contains recommended cutter diameters. Shaved rivets may not protrude prior to shaving in excess of the dimensions shown in Table IV. The minimum head diameter after shaving shall be specified in Table IV.

3.3.7.1 Shaving countersunk aluminum alloy rivets. If shaving is required for aluminum alloy rivets to meet surface flushness requirements, one of the following checks shall be made to prevent loss of rivet tensile strength:

- a. Head protrusion shall not exceed "H" in Table IV, after driving and prior to shaving.
- b. Head diameter shall not be less than "D" in Table IV after driving and shaving.

3.3.7.2 Refinishing shaved rivet heads. Refinishing of shaved rivet heads shall be required in areas where the parent material is painted, chemically treated, or primed. Refinishing shall be to the same requirements as the parent material.

3.4 Repair procedure. Any repairs exceeding the limitations listed in the sub-paragraphs hereunder are prohibited without prior written approval from the procuring activity.

3.4.1 Oversize rivet holes. When rivet holes are enlarged beyond specified tolerances, the next larger rivet size (diameter) may be used provided the row spacing, pitch and edge margin minimum are maintained and the requirements of para 3.5.3 are not exceeded. The pitch is defined as the distance between the holes centers of adjacent rivets in a row. For pitch minimums, see Table VII. Row spacing minimum shall be .866 times the rivet spacing nominal dimension as given on the drawing. Edge margin is defined as the distance between hole centers and the edge of the material. There are two types of edge margins, visible and invisible. When viewed from the outside, or side from which the rivet is inserted, the

MIL-R-47196A(MI)

material edge in view is the visible edge and the edge hidden is the invisible edge. In case of conflict between the side rivet is inserted or outside, outside shall take precedence. See Table VIII for edge margin minimums.

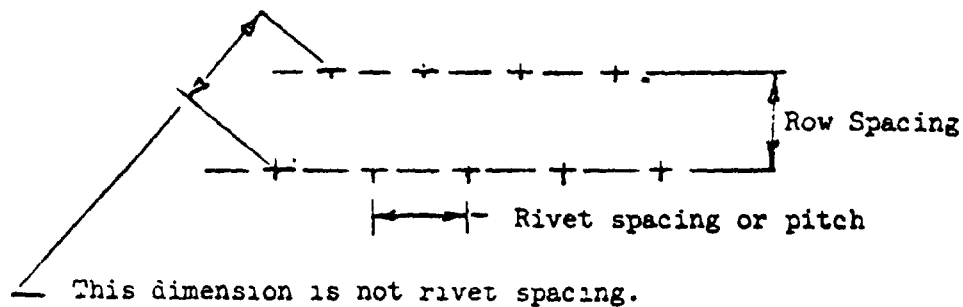

3.4.2 Oversize countersinks. When countersinks are enlarged beyond specified tolerances, the next larger size rivet may be used, provided pitch and edge margins requirements are maintained, the material thickness to be riveted will permit the use of a larger rivet and the limitations of 3.4.3 are not exceeded. The term "next larger size" shall be defined as the next larger diameter listed under the MS or NAS standard drawing, specification or other document specified on the engineering drawing for that application, but not to exceed 1/32 inch increments for sizes up to 1/4 inch diameter and 1/16 inch increments for sizes above 1/4 inch.

3.4.3 Repair limitations. The combined oversize rivet hole repairs and oversize countersink repairs shall be limited to a maximum of 20 percent of the rivets, or 10 rivets in a single rivet pattern, whichever is less. Repairs to more than two adjacent oversize rivets, or replacing more than half the rivets with oversize rivets in any 10 inch length of pattern is prohibited.

3.5 Corrosion prevention. When the rivet material is dissimilar to the material being riveted (reference MIL-STD-171), the rivet hole, countersink, and rivet shall be coated with zinc chromate primer in accordance with TT-P-1757 prior to installation. The rivet shall be installed while the primer is in the wet condition.

## MIL-R-47196A(MI)

3.6 Finishing of riveted surfaces. Unless other finishing requirements are specified on the engineering drawing, surfaces which are painted, primed or chemically treated prior to riveting shall have the surfaces, including rivets finished in the same manner after riveting, per specifications applicable to the parent material. Any exterior damage to the finish of the parent material shall be touched up to the same requirements.

3.7 Workmanship. Installation of buck type rivets shall be accomplished in a workmanlike manner. Rivet assemblies shall be of uniform quality and free from cracks, gaps, sharp edges, burrs, loose parts, or other defects which might render the assemblies unsuitable for its intended purpose.

## 4. QUALITY ASSURANCE PROVISIONS

4.1 Responsibility for inspection. Unless otherwise specified in the contract or purchase order, the supplier is responsible for the performance of all inspection requirements as specified herein. Except as otherwise specified in the contract or order, the supplier may use his own or any other facilities suitable for the performance of the inspection requirements specified herein, unless disapproved by the Government. The Government reserves the right to perform any of the inspections set forth in the specification where such inspections are deemed necessary to assure suppliers and services conform to prescribed requirements.

4.2 Inspection requirements. To determine conformance to Section 3, installation of buck type rivets shall be performed in accordance with and inspected to all the requirements of Section 3 of this specification. Rivets, rivet holes, countersinks and material surface around rivets shall be visually and dimensionally inspected to determine compliance with the requirements of applicable drawings and specifications and this standard.

4.2.1 Defect standard. Rivet installations showing evidence of the following defect shall be classed defective (Typical examples of unacceptability are shown on Figure 1).

a. On a beveled driven head where the minimum or maximum head height is outside Table III (see Figure 1A).

b. On an offset, clinched, bent over, or clubbed driven head (1) where a portion of the hole or the deburred surface is visible, (2) rivets on which the entire periphery of the bucked head does not show evidence of

## MIL-R-47196A(MI)

upset, or (3) clubbed or bent over portion exceeds the heights of Table III over any part of the surface area (see Figure 1B).

c. In a stepped driven head where the minimum or maximum head height is outside Table III (The high part may be removed to be within acceptable limits.) (See Figure 1C).

d. Rivet does not completely fill hole (see Figure 1D).

e. Punch rings in driven head where lowest or highest surface is outside Table III head heights (see Figure 1E).

f. Loose rivets (see Figure 1F).

g. Sheet separation after riveting which allows a 0.002 inch feeler gage to be inserted between sheets from any direction far enough to touch rivet shank (see Figures 1G and 1H).

h. Any crack in 24S type rivet.

i. Cracked, cut or ringed heads on flush type rivets (see Figure 1J).

j. Misshaped driven heads (1) whose head heights exceed that shown in Table III, (2) where the shortest dimension is less than the minimum diameter of Table III, or (3) where the longest dimension of the head exceeds one and one-half (1.5) times the shortest dimension (see Figure 1K).

k. Cracks in driven heads (1) which fall within a circle which is concentric with and 1.10 times the nominal shank diameter, or (2) intersecting cracks, or (3) five or more cracks (see Figure 1L).

l. Cracks in non-flush type manufactured rivet heads which fall within a circle which is concentric with and 1.40 times the nominal shank diameter (see Figure 1M).

m. The occurrence of any gap around a continuous 60 percent of the circumference of the driven head. In the other 40 percent, gaps which allow a feeler gauge larger than 0.002 inch to be inserted. Any gap under the manufactured head.

n. Deformed skin or open seams caused by pressure on rivets.

o. Bulging skin caused by expanded skin or trapped chips.

MIL-R-47196A(MI)

p. Cut or marred skin caused by careless use of a bucking bar or rivet set.

q. Rivets not meeting requirements of Section 3 of this document.

5. PREPARATION FOR DELIVERY

This section not applicable to this specification.

6. NOTES

6.1 Intended use. The material covered by this specification is intended for the preparation and installation of buck rivets.

6.2 Ordering data. Procurement documents should specify the following:

Title, number, and date of this specification.

6.3 Supersession data. This specification includes the requirements of Missile Interim Specification MIS-10096, dated 27 April 1965.

6.4 Changes from previous issue. The margins of this specification are marked with an asterisk to indicate where changes (additions, modifications, corrections, deletions) from the previous issue were made. This was done as a convenience only and the Government assumes no liability whatsoever for any inaccuracies in these notations. Bidders and contractors are cautioned to evaluate the requirements of this document based on the entire content irrespective of the marginal notations and relationship to the last previous issue.

Custodian:  
Army-MI

Preparing activity:  
Army-MI

Project No. 5320-A005



TABLE I

## Hole size, standard rivets

Rivet Diameter (Inches)	Recommended Drill Sizes	Hole Diameter Limits	
		Minimum	Maximum
1/16	#51 (0.067)	0.062	0.072
3/32	#40 (0.098)	0.093	0.103
1/8	#30 (0.128)	0.125	0.135
5/32	#21 (0.159) #20 (0.161)	0.156	0.171
3/16	#11 (0.191) #10 (0.194)	0.187	0.202
7/32	#1 (0.228)	0.218	0.233
1/4	F (0.257)	0.250	0.265
9/32	L (0.290)	0.281	0.296
5/16	O (0.316)	0.312	0.327
11/32	S (0.348)	0.343	0.358
3/8	V (0.377)	0.375	0.390
13/32	Z (0.413)	0.406	0.421

MIL-R-47196A(MI)

Table II

Minimum Flattened Dimension of Manufactured Rivet Heads  
(Universal Type)

Rivet Shank Unbucked Nominal Diameter	Minimum Manufactured Head Height (inches)
1/16	0.022
3/32	0.032
1/8	0.042
5/32	0.052
3/16	0.062
7/32 **	0.072
1/4	0.083
9/32 **	0.093
5/16	0.104
11/32 **	0.114
3/8	0.125
13/32 **	0.135

\*\* Indicates oversize replacements.

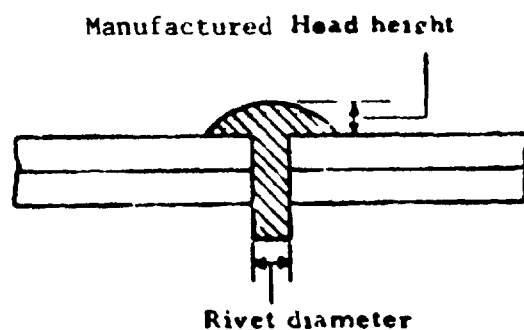

MIL-R-47196A(MI)

**Table III**  
Standard flat driven head dimensions

Rivet Shank Unbucked Nominal Dia	MINIMUM DRIVEN HEAD Diameter (Inches)	Driven Head Thickness (Inches)	
		Minimum	Maximum
1/16	0.081	0.025	0.040
3/32	0.122	0.038	0.050
1/8	0.163	0.050	0.070
5/32	0.203	0.062	0.092
3/16	0.244	0.075	0.105
7/32*	0.285	0.087	0.110
1/4	0.325	0.100	0.130
9/32*	0.365	0.113	0.140
5/16	0.406	0.125	0.158
11/32*	0.450	0.137	0.170
3/8	0.488	0.150	0.190
13/32*	0.530	0.165	0.200

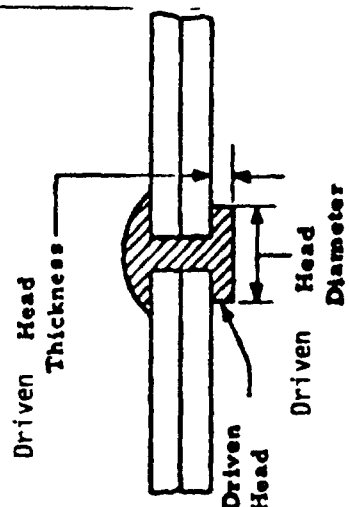

\* Indicates oversize replacements.

MIL-R-47196A(MI)

Table IV  
Required Dimensions for Rivet Shaving

Nominal Rivet Diameter	1/16	3/32	1/8	5/32	3/16	7/32	1/4	9/32	5/16	11/32	3/8	13/32
"H" Maximum Head Protrusion Prior to Shaving	0.005	0.006	0.007	0.009	0.010	0.011	0.012	0.013	0.014	0.015	0.016	0.017
"D" Minimum Head Diameter After Shaving	0.095	0.161	0.204	0.262	0.326	0.383	0.443	0.490	0.526	0.588	0.650	0.712

Table V

Rivet Shaver Cutter Diameters

Rivet Diameter	1/16	3/32	1/8	5/32	3/16	7/32	1/4	9/32	5/16	11/32	3/8	13/32
Cutter Diameter	3/8	3/8	3/8	3/8	7/16	1/2	9/16	9/16	5/8	5/8	3/4	3/4

Table VI

Countersink Diameters

Rivet Diameter	1/16	3/32	1/8	5/32	3/16	7/32	1/4	9/32	5/16	11/32	3/8	13/32
Countersink Diameter	0.110	0.176	0.222	0.284	0.351	0.411	0.474	0.522	0.560	0.625	0.690	0.756

TABLE VII

## Minimum Pitch (Inches)

1/ (For repair using oversize rivets only, see 3.4.1)

Rivet Dia (Inches)	Dimpled Csk Rivets	Machine Csk Flush Rivets	Universal Head Rivets
1/16	.375	.313	.250
3/32	.563	.438	.375
1/8	.625	.531	.500
5/32	.688	.625	.563
3/16	.750	.750	.688
7/32 *	.875	.875	.781
1/4	.938	1.375	.875
9/32 *	1.125	1.125	1.000
5/16	1.250	1.250	1.125
11/32	1.375	1.375	1.250
3/8	1.500	1.500	1.344
13/32 *	1.625	1.625	1.469

\* Indicates sizes normally used for oversize replacement only.

1/ Lesser minimum spacings require government design activity approval unless otherwise indicated on the drawing.

MIL-R-47196A(MI)

TABLE VIII

## Minimum Edge Margins (Inches)

1/ (For repair using oversize rivets only (see 3.4.1))

Rivet Dia	Min A and B	Min C and D
1/16	.094	.156
3/32	.156	.219
1/8	.219	.281
5/32	.281	.344
3/16	.344	.375
7/32 *	.406	.438
1/4	.438	.500
9/32 *	.500	.563
5/16	.563	.625
11/32 *	.625	.688
3/8	.688	.750
13/32 *	.750	.812

\* Indicates sizes normally used for oversize replacement only.

\* 1/ Lesser minimum spacings require government design activity approval unless otherwise indicated on the drawing (see Figure 2).

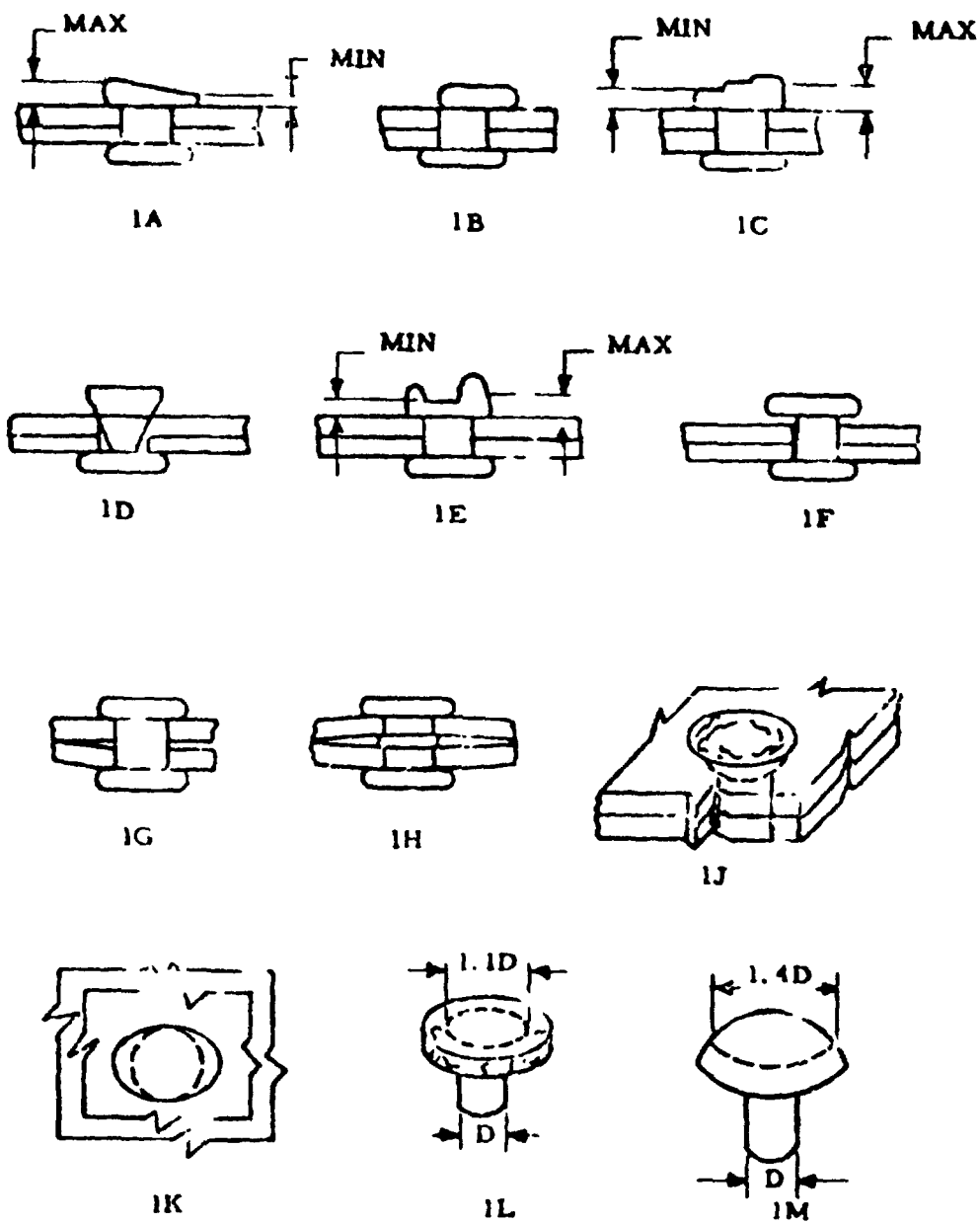
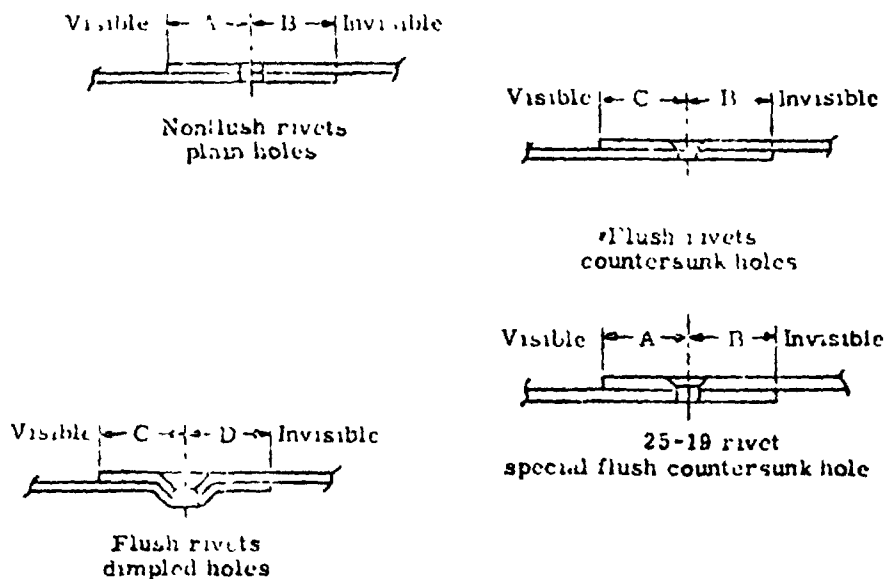

Figure 1. Typical Examples of Unacceptable Rivets

MIL-R-47196A(MI)

Edge Margins



Special Considerations

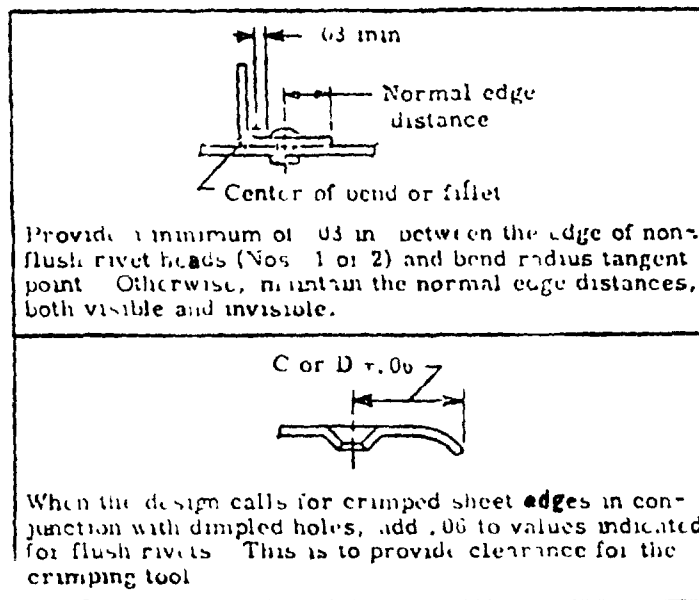

Figure 2 - Minimum Edge Margins



**INSTRUCTIONS** In a continuing effort to make our standardization documents better, the DoD provides this form for use in submitting comments and suggestions for improvements. All users of military standardization documents are invited to provide suggestions. This form may be detached, folded along the lines indicated, taped along the loose edge (*DO NOT STAPLE*), and mailed. In block 5, be as specific as possible about particular problem areas such as wording which required interpretation, was too rigid, restrictive, loose, ambiguous, or was incompatible, and give proposed wording changes which would alleviate the problems. Enter in block 6 any remarks not related to a specific paragraph of the document. If block 7 is filled out, an acknowledgement will be mailed to you within 30 days to let you know that your comments were received and are being considered.

**NOTE** This form may not be used to request copies of documents, nor to request waivers, deviations, or clarification of specification requirements on current contracts. Comments submitted on this form do not constitute or imply authorization to waive any portion of the referenced document(s) or to amend contractual requirements.

(Fold along this line)

(Fold along this line)

DEPARTMENT OF THE ARMY



NO POSTAGE  
NECESSARY  
IF MAILED  
IN THE  
UNITED STATES

**OFFICIAL BUSINESS**  
PENALTY FOR PRIVATE USE \$300

**BUSINESS REPLY MAIL**  
FIRST CLASS PERMIT NO 12062 WASHINGTON D C  
POSTAGE WILL BE PAID BY THE DEPARTMENT OF THE ARMY

Commander  
US Army Missile Command  
ATTN: DRSMI-RSDS  
Redstone Arsenal, AL 35898

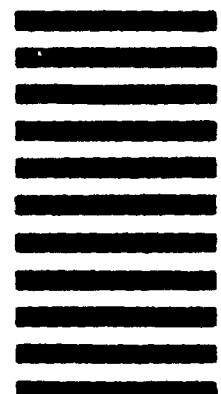

## STANDARDIZATION DOCUMENT IMPROVEMENT PROPOSAL

*(See Instructions - Reverse Side)*

1 DOCUMENT NUMBER	2 DOCUMENT TITLE
3a. NAME OF SUBMITTING ORGANIZATION	4 TYPE OF ORGANIZATION <i>(Mark one)</i> <input type="checkbox"/> VENDOR  <input type="checkbox"/> USER  <input type="checkbox"/> MANUFACTURER  <input type="checkbox"/> OTHER <i>(Specify)</i> _____
b ADDRESS <i>(Street, City, State, ZIP Code)</i>	
5 PROBLEM AREAS	
a. Paragraph Number and Wording	
b. Recommended Wording	
c. Reason/Rationale for Recommendation	
6. REMARKS	
7a. NAME OF SUBMITTER <i>(Last, First, MI)</i> - Optional	b WORK TELEPHONE NUMBER <i>(Include / Code)</i> - Optional
c MAILING ADDRESS <i>(Street, City, State, ZIP Code)</i> - Optional	8 DATE OF SUBMISSION (YYMMDD)

(TO DETACH THIS FORM, CUT ALONG THIS LINE)

MIL-R-47196A(MI)  
AMENDMENT 1  
13 September 1977

MILITARY SPECIFICATION

RIVETS, BUCK TYPE, PREPARATION FOR AND INSTALLATION OF

This Amendment forms a part of MIL-R-47196A(MI) dated 1 September 1977, and is approved for use by all Departments and Agencies of the Department of Defense.

Page 1

At the upper right side of this page the superseding specification should be changed from MIL-R-46196(MI) to MIL-R-47196(MI).

Custodian  
Army-MI

Preparing activity  
Army-MI

Project No. 5320A007

INCH-POUND

NOTICE  
OF VALIDATION

MIL-R-47196A(MI)  
NOTICE 1  
5 November 1990

MILITARY SPECIFICATION

RIVETS, BUCK TYPE, PREPARATION FOR AND INSTALLATION OF

MIL-R-47196A(MI), dated 1 September 1977, has been reviewed and determined to be valid for use in acquisition.

Custodians:  
Army - MI

Preparing Activity:  
Army - MI

AMSC N/A

FSC 5325

DISTRIBUTION STATEMENT A. Approved for public release; distribution is unlimited.