

INCH-POUND

MIL-DTL-85670C  
16 May 2007  
SUPERSEDING  
MIL-DTL-85670B  
30 October 2001

## DETAIL SPECIFICATION

## ANTENNA, BROADBAND

## AS-3191/A, AS-3792/A, AND AS-3793/A

This specification is approved for use within the Naval Air Systems Command, Department of the Navy, and is available for use by all Departments and Agencies of the Department of Defense.

## 1. SCOPE

1.1 Scope. This specification establishes the design, performance, and acceptance requirements for AS-3191/A, AS-3792/A, and AS-3793/A broadband antennas, hereinafter referred to as the antenna. The separately nomenclatured antennas differ only in surface finish and color. The antenna is a universal blade type to be used in aircraft equipped with the AN/ARC-182(V) radio set. The antenna is an aircraft fuselage mounted blade enclosed element. The antenna is a broadband, fix tuned, exhibits omnidirectional radiation pattern, and is vertically polarized for radiating and receiving radio waves in the 30-88 MHz, 108-174 MHz, and 225-400 MHz communication bands.

## 2. APPLICABLE DOCUMENTS

2.1 General. The documents listed in this section are specified in sections 3 and 4 of this specification. This section does not include documents cited in other sections of this specification or recommended for additional information or as examples. While every effort has been made to ensure the completeness of this list, document users are cautioned that they must meet all specified requirements documents cited in sections 3 and 4 of this specification, whether or not they are listed.

2.2 Government documents.

2.2.1 Specifications, standards, and handbooks. The following specifications, standards, and handbooks form a part of this document to the extent specified herein. Unless otherwise specified, the issues of these documents are those cited in the solicitation or contract ([see 6.2](#)).

## FEDERAL STANDARDS

- |                   |   |  |
|-------------------|---|--|
| FED-STD-595/17875 | - | Miscellaneous, Gloss (Colors Used in Government Procurement).      |
| FED-STD-595/37039 | - | Miscellaneous, Lusterless (Colors Used in Government Procurement). |

## DEPARTMENT OF DEFENSE SPECIFICATIONS

- |              |   |   |
|--------------|---|---|
| MIL-PRF-8516 | - | Sealing Compound, Synthetic Rubber, Electric Connectors and Electric Systems, Chemically Cured.       |
| MIL-E-17555  | - | Electronic and Electrical Equipment, Accessories, and Provisioned Items (Repair Parts); Packaging of. |

Comments, suggestions, or questions on this document should be addressed to Defense Supply Center Columbus, ATTN: DSCC-VAT, P.O. Box 3990 Columbus, OH 43218-3990, or e-mailed to [TubesAmps@dsccl.dla.mil](mailto:TubesAmps@dsccl.dla.mil). Since contract information can change, you may want to verify the currency of this address information using the ASSIST Online database at <http://assist.daps.dla.mil>.

## MIL-DTL-85670C

MIL-T-18303	-	Test Procedures; Preproduction, Acceptance and Life for Aircraft Electronic Equipment, Format for.
MIL-DTL-18307	-	Nomenclature and Identification for Aeronautical Systems Including Joint Electronics Type Designated Systems and Associated Support Systems.
MIL-PRF-22750	-	Coating, Epoxy, High-Solids.
MIL-PRF-23586	-	Sealing Compound (with Accelerator) Silicone Rubber, Electrical.
MIL-PRF-39012	-	Connectors, Coaxial, Radio Frequency, General Specification for.
MIL-A-46146	-	Adhesives-Sealants, Silicone, RTV Noncorrosive (for use with Sensitive Metals and Equipment).
MIL-DTL-53039	-	Coating, Aliphatic Polyurethane, Single Component, Chemical Agent Resistant.
MIL-DTL-64159	-	Coating, Water Dispersible, Aliphatic Polyurethane, Chemical Agent Resistant.

## DEPARTMENT OF DEFENSE STANDARDS

MIL-STD-129	-	Military Marking for Shipment and Storage.
MIL-STD-130	-	Identification Marking of U. S. Military Property.
MIL-STD-810	-	Environmental Engineering Considerations and Laboratory Tests.
MIL-STD-2073-1	-	Standard Practice for Military Packaging.

## DEPARTMENT OF DEFENSE HANDBOOKS

MIL-HDBK-454	-	General Guidelines for Electronic Equipment.
MIL-HDBK-5400	-	Electronic Equipment, Airborne, General Guidelines for.

(Copies of these documents are available online at <http://assist.daps.dla.mil/quicksearch/> or <http://assist.daps.dla.mil/> or from the Standardization Document Order Desk, 700 Robbins Avenue, Building 4D, Philadelphia, PA 19111-5094.)

2.4 Order of precedence. In the event of a conflict between the text of this document and the references cited herein, the text of this document takes precedence. Nothing in this document, however, supersedes applicable laws and regulations unless a specific exemption has been obtained.

## 3. REQUIREMENTS

3.1 Qualification. Antennas furnished under this specification shall be products which have passed the qualification tests and are approved for listing on the qualified products list (QPL) at the time set for opening of bids.

3.2 Qualification inspection/testing. In order to be listed on the qualified products list, three samples shall have complied with the qualification inspection/testing (see 4.4 and 6.3). Testing must be authorized by and conducted under the review of the qualifying activity (DSCC-VQE, Defense Supply Center Columbus, P. O. Box 3990, Columbus OH 43218-3990 or online at [vqe.chief@dlamil](mailto:vqe.chief@dlamil)).

3.3 Parts and materials. Parts and materials shall be in accordance with best manufacturing practices for class 1 equipment designed for 15.20 km (50,000 feet) altitude and continuous sea level operation over the temperature range of -54°C to +55°C (+71°C intermittent operation) and as specified herein.

3.3.1 Nonstandard part approvals. Approval for the use of nonstandard parts shall be obtained from the qualifying activity. Approval of all nonstandard parts shall be completed before qualification approval can be granted.

3.3.2 Parts reliability assurance. When available, all electrical and electronic parts shall be military approved, established reliability parts. All non-established reliability parts shall be subjected to a 100 percent screening test in accordance with the procedures of 4.8, prepared in accordance with MIL-T-18303.

## MIL-DTL-85670C

3.3.3 Parts derating and applications. All parts used shall be applied well within the ratings. The derating shall encompass the appropriate and meaningful application conditions such as voltage, current, power, temperature, mechanical, and duty cycle. Electronic parts shall conform to table I electronic parts derating for worst case electrical and environmental stress unless formal written approval is received from the acquiring activity prior to incorporating into the design. Part level stress analysis shall be used to verify that all parameter stresses are within the derated values at worst case circuit and environmental conditions. The limitations on parts usage shall be in accordance with table I.

TABLE I. Part derating requirements.

Part type	Parameter maximum	Maximum allowable stress
Capacitors	Voltage	50 percent of rating
Resistors	Power	50 percent of rating
	Voltage	70 percent of rating
Transformer/inductive devices <u>1/</u>	Winding temperature	30 percent below rated temperature
	Current	70 percent of rating

1/ Coils wound by the antenna manufacturers shall be considered assemblies, not parts.

3.3.4 Sealing materials (electrical). The antenna shall be encapsulated. The use of encapsulated materials for the purpose of sealing, supporting, attaching, or protecting electronic components shall conform to the following requirements, and shall be in strict conformance to sealant manufacturer's instructions.

- a. Encapsulating and potting materials shall be hydrolytically stable. (MIL-HDBK-454, guideline 47 may be used for guidance).
- b. Adhesive sealants used to seal and protect terminations shall conform to MIL-A-46146.
- c. If potting compounds are used to seal and protect connector terminations, MIL-PRF-8516 and MIL-PRF-23586, grade B compounds are required.
- d. Compatible primers and barrier coating shall be used where necessary to promote adhesion. Polytetrafluoroethylene (TFE) and fluorinated ethylene propylene surfaces shall be etched to promote adhesion.
- e. Conformal coatings shall conform to best manufacturing practice.
- f. All organic materials having ester linkages shall have been tested for hydrolytic stability. The use of natural leather, magnesium, and magnesium alloys is prohibited.
- g. Protection of dissimilar metal combinations shall be assured. Unless suitably protected against electrolytic corrosion, dissimilar metals shall not be used in intimate contact with each other. (MIL-HDBK-454, guideline 16 may be used for guidance).

3.3.5 Interchangeability. Physical and functional interchangeability shall exist for the antenna. (MIL-HDBK-5400 guidelines may be used for guidance). The antenna shall be constructed to preclude the requirement for any adjustment when replacing an item by another item of the same type designation.

3.3.6 Pure tin. The use of pure tin, as an underplate or final finish, is prohibited both internally and externally. Tin content of antenna components and solder shall not exceed 97 percent, by mass. Tin shall be alloyed with a minimum of 3 percent lead, by mass (see 6.8).

## MIL-DTL-85670C

3.4 Design and construction. The antenna shall conform with best manufacturing practices and with this specification for construction and for workmanship. In any case, it is a condition of final acceptance that the antenna shall meet all the performance requirements of this specification. (MIL-HDBK-5400 guidelines may be used for guidance.)

3.4.1 RF connector. The RF connector shall be as specified in MIL-PRF-39012 (Series TNC, uncabled receptacle, socket, jam nut mounted, class 2).

3.4.2 Maintainability. The antenna shall require no scheduled maintenance.

3.4.2.1 Repairability. The antenna shall be classified as a non-repairable, throw-away type item.

3.4.3 Transportability. The antenna shall be transportable by air, rail, truck, and ship when packaged as specified in contract or order.

3.4.4 Standard conditions. The following conditions shall be used to establish normal performance characteristics under standard conditions and for making laboratory bench tests, except that required field tests may be conducted under outside ambient conditions:

- a. Temperature: Room ambient ( $25^{\circ}\text{C} \pm 10^{\circ}\text{C}$ ).
- b. Altitude: Normal ground.
- c. Vibration: None.
- d. Humidity: Room ambient up to 90 percent relative humidity.

3.4.4.1 Service conditions. The antenna shall operate as required under any of the environmental service conditions or combination of these conditions as indicated herein. The antenna shall meet class 1 temperature and altitude requirements of 50,000 feet altitude and continuous sea level operation over the temperature range of  $-54^{\circ}\text{C}$  to  $+55^{\circ}\text{C}$  ( $+71^{\circ}\text{C}$  intermittent operation). The environmental test methods in 4.5.3 shall apply.

3.4.4.1.1 Thermal conditions. The antenna shall operate as required under class 1 thermal conditions as defined in 3.4.4.1, without the requirements for auxiliary cooling.

3.4.5 Dimensions. The dimensions of the antenna shall be as specified on [figure 1](#).

3.4.6 Weight. The weight of the antenna shall be not greater than 3.5 pounds.

3.4.7 Finish. The exterior finish of the antenna shall be as follows:

- a. AS-3191/A color shall be lusterless black epoxy paint in accordance with MIL-PRF-22750, color number 37038 in accordance with FED-STD-595/37038.
- b. AS-3792/A finish shall be gloss white epoxy paint in accordance with MIL-PRF-22750, color number 17875 in accordance with FED-STD-595/17875.
- c. AS-3793/A finish shall be aircraft green in accordance with MIL-DTL-53039 or MIL-DTL-64159.

MIL-DTL-85670C

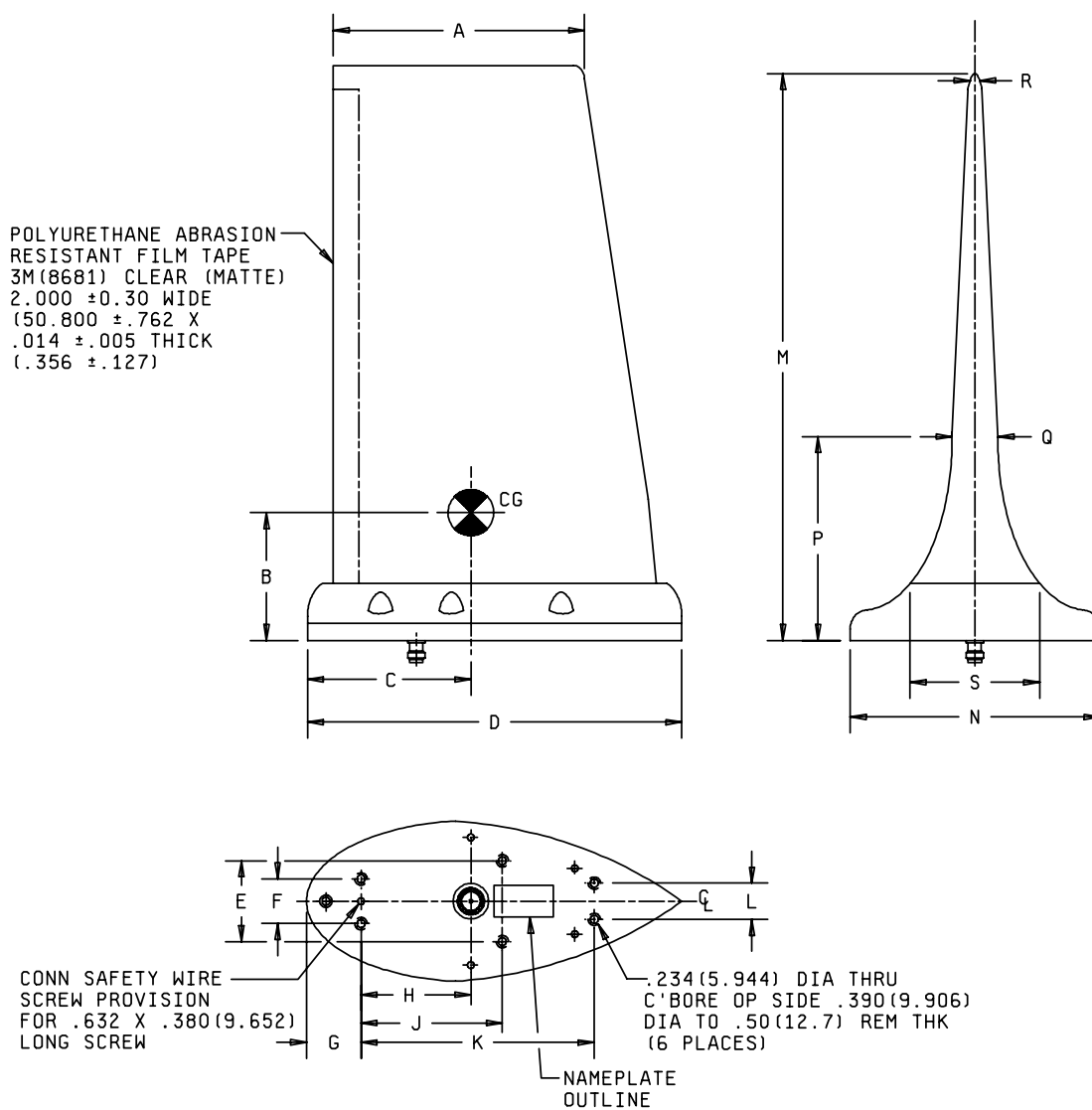

FIGURE 1. Outline dimensions.

## MIL-DTL-85670C

Dimensions									
Ltr	Inches		Millimeters		Ltr	Inches		Millimeters	
	Min	Max	Min	Max		Min	Max	Min	Max
A	6.500	7.100	165.10	180.34	K	6.396	6.416	162.46	162.97
B	3.300	3.500	83.82	88.90	L	1.365	1.385	34.67	35.18
C	4.900	5.100	124.46	129.54	M	14.350	14.650	364.50	372.11
D	10.450	10.750	265.43	273.05	N	3.650	3.950	92.71	100.33
E	2.470	2.530	62.74	64.26		Reference values			
F	1.740	1.760	44.20	44.70	P	7.00		177.8	
G	1.54	1.70	39.1	43.2	Q	.800		20.32	
H	2.110	2.140	53.59	54.36	R	.180		4.57	
J	2.771	2.791	70.38	70.89	S	1.52		38.6	

## NOTES:

1. Dimensions are in inches.
2. Metric equivalents (to the nearest 0.01 mm) are given for general information, using 1.00 inch = 25.4 mm.

FIGURE 1. Outline dimensions - Continued.

## MIL-DTL-85670C

3.4.8 Nameplates and identification marking. Serial number assignment and nameplate approval shall be in accordance with MIL-DTL-18307. Identification marking shall be in accordance with MIL-STD-130. Nameplates and identification markings shall include the following information:

- a. Unit name (Broadband Antenna).
- b. Unit nomenclature (AS-3191/A, AS-3792/A, or AS-3793/A).
- c. Contract number.
- d. Manufacturer's CAGE code number.
- e. Equipment drawing number.
- f. Acquiring activity.

3.4.8.1 Serial number. Serial numbers will be assigned for the antenna under contract or purchase order. The contractor shall serialize sequentially all antennas which are delivered under the contract.

3.4.9 Radome/casting. The radome shall be type 1, grade A, class 1. Any alloy castings used must be in accordance with best manufacturing practices. Castings shall be class 4.

3.5 Performance. Unless otherwise specified herein, values set forth to establish specified performance apply to performance under both standard and extreme service. When reduced performance under the extreme conditions is acceptable, tolerances or values setting forth acceptable variations from the performance under the standard conditions will be specified herein.

3.5.1 Operation. The antenna shall be a universal blade type capable of being used in aircraft equipped with the AN/ARC-182(V) Radio Set. The antenna shall be an aircraft fuselage mounted blade enclosed element. The antenna shall be broadband fix tuned, which shall exhibit omnidirectional radiation pattern, and shall be vertically polarized for radiating and receiving radio waves in the 30 - 88 MHz, 108 - 174 MHz, and 225 - 400 MHz communication bands. Additionally, the antenna shall be compatible with associated equipment listed in 6.5 to meet requirements of 3.6.

### 3.6 Detail requirements.

3.6.1 Function. The AS-3191/A, AS-3792/A, and AS-3793/A broadband antennas shall be aircraft fuselage mounted blades with enclosed elements, for universal installation. The blades shall meet the functional requirements of 3.6.2 through 3.6.9.

3.6.2 Side loading. The antenna shall be designed to withstand a functional side-loading stress of 5.3 PSI and an ultimate side-loading stress of 8.0 PSI.

3.6.3 Bandwidth. The electrical performance specified herein shall be met over the entire frequency bands (30 to 88 MHz, 108 to 174 MHz, and 225 to 400 MHz).

3.6.4 Voltage standing wave ratio (VSWR). The antenna VSWR shall be not greater than 2.5:1 in the 30 - 88 MHz band and the 108 - 118 MHz portion of the 108 - 174 MHz band; and shall be not greater than 2.0:1 in the 118 - 174 MHz portion of the 108 - 174 MHz band and in the 225 - 400 MHz band when measured at the antenna connector and referenced to a 50 ohm impedance. VSWR measurements shall be performed with the antenna mounted on a 10 foot square (min) ground plane.

3.6.5 Impedance. The impedance shall be nominally 50 ohms in all bands to operate with a 50 ohm transmitter-receiver output using 50 ohm aircraft cabling.

3.6.6 Radiation pattern gain. The radiation patterns shall be essentially omnidirectional. The antenna gain pattern shall be as specified in table II when measured on a 32-foot octagonal ground plane with reference to a vertically polarized antenna.

## MIL-DTL-85670C

The gain shall be determined by comparing the amplitude of the signal received by the blade antenna at its beam maximum with that of a one quarter wavelength monopole (tuned to the frequency of interest) at its beam maximum. The test shall be conducted on a 32-foot octagonal ground plane. Measured values shall be in accordance with table II. The established reference gain values of the resonant quarter wave length monopole antenna when mounted on the 32-foot octagonal ground plane are:

- a. +3.5 dBi at 30 MHz.
- b. +4.5 dBi at 50 MHz.
- c. +5.0 dBi at 88, 108, 116, 130, 174, 225, 300, and 400 MHz.

TABLE II. Antenna gain pattern.

Frequency (MHz)	Minimum gain at Beam Max. (dBi)
30	-23.0
40	-21.0
50	-20.0
70	-16.0
88	-11.0
108	-8.0
130	-2.5
174	0.0
225	+2.5
300	+4.0
400	+3.0

3.6.7 Power handling capability. The antenna system shall be capable of handling 100 watts average power in the 225 - 400 MHz band, 40 watts average power in the 108 - 174 MHz band, and 40 watts average power in the 30 - 88 MHz band. Duty cycle shall be continuous.

3.6.8 Polarization. The antenna shall be essentially vertically polarized when mounted on a horizontal ground plane.

3.6.9 Lightning protection. The antenna shall comply with lightning protection requirements of 4.5.3.7 when the unit is subjected to the current wave form specified in the following test method for direct effects on antennas in zone 1B.

3.6.9.1 Lightning protection test method. The lightning effects which aerospace vehicles experience and the effects which are reproduced through laboratory testing with simulated lightning waveforms are divided into direct effects and indirect effects. The direct effects of lightning are the burning, eroding, blasting, and structural deformation caused by lightning arc attachment, as well as the high pressure shock waves and magnetic forces produced by the associated high currents. The physical damage to the antenna will be discussed as a direct effect.

3.6.9.1.1 Lightning attachment zones.

- a. Zone 1. Surfaces of the vehicles for which there is a high probability of initial lightning flash attachment (entry or exit).

A "B" type region is one in which there is a high probability that the arc will remain attached.

- b. Zone 1B: Initial attachment point with high probability of flash hang-on, such as a trailing edge.



## MIL-DTL-85670C

3.6.9.1.2 Test method for lightning protection. See the appendix for test method procedures.

3.7 Workmanship. Workmanship for the antenna must conform with best manufacturing practices.

#### 4. VERIFICATION

4.1 Zero defect sampling. This specification uses accept on zero defect sampling. Sampling in conformance does not authorize submission of known defective material, either indicated or actual, nor does it commit the Government to acceptance of defective material.

4.1.1 Test equipment and inspection facilities. The contractor shall insure that test and inspection facilities of sufficient accuracy, quality, and quantity are established and maintained to permit performance of required inspections.

4.2 Classification of inspections. The inspection requirements specified herein are classified as follows:

- a. Qualification inspection ([see 4.4](#)).
- b. Qualification testing ([see 4.5](#)).
- c. Conformance inspection ([see 4.6](#)).

4.3 Inspection conditions. Unless otherwise specified herein, all inspections shall be performed with conditions specified as follows:

- a. Temperature: Room ambient (25°C ± 10°C).
- b. Altitude: Normal ground.
- c. Vibration: None.
- d. Humidity: Room ambient up to 90 percent relative humidity.

4.4 Qualification inspection. Qualification inspection shall be performed at a laboratory acceptable to the Government ([see 6.3](#)) on sample antennas produced with equipment and procedures normally used in production.

4.4.1 Qualification inspection sample. Three antennas, one of each finish as described by [3.4.7](#), shall be subjected to the qualification inspection ([see table III](#)). The three samples shall be subjected to the electrical and operational test in [table III](#). Qualification inspection samples shall first have successfully completed individual tests before being submitted for qualification testing.

4.4.2 Inspection routine. Sample antennas shall be subjected to qualification inspection consisting of the qualification tests in [4.5.2.1](#) through [4.5.3.8](#). All three sample antennas shall be subjected to the tests of [4.5.2.1](#) through [4.5.3.8](#) in the order listed ([see table III](#)).

4.4.3 Failures. Any failure incurred shall be reported as soon as possible to the qualifying activity. All failures shall be analyzed to the extent necessary to determine the root cause of the failure and reported to the qualifying activity. The adequacy of corrective actions shall be proven by test. Qualification shall not be granted unless corrective actions are proven by test and implemented in production hardware. Any antenna failure shall be cause for refusal to grant qualification.

## MIL-DTL-85670C

TABLE III. Inspection requirements.

Requirements	I. Qualification inspection	II. Conformance inspections		
		Individual	Sampling	Test frequency
Visual examination (workmanship 3.7)	4.6.1	4.6.1a	---	Each sample
VSWR (3.6.4)	4.5.2.2	4.6.1b	---	Each sample
Bandwidth (3.6.3)	4.5.2.2	4.6.1c	---	Each sample
Impedance (3.6.5)	4.5.2.2	4.6.1d	---	Each sample
Pattern, polarization, and gain (3.6.6 and 3.6.8)	4.5.2.1	---	4.5.2.1	One every 2 years <u>1/</u>
Power handling (3.6.7)	4.5.2.3	---	4.5.2.3	One every 5 years <u>1/</u>
Temperature-altitude (3.4.4.1)	4.5.3.1	---	4.5.3.1	One every 5 years <u>1/</u>
Shock (3.4.4.1)	4.5.3.2	---	---	
Humidity (3.4.4.1)	4.5.3.3	---	---	
Salt fog (3.4.4.1)	4.5.3.4	---	4.5.3.4	One every 2 years <u>1/</u>
Vibration (3.4.4.1)	4.5.3.5	---	4.5.3.5	One every 2 years <u>1/</u>
Side loading (3.6.2)	4.5.3.6	---	---	
Lightning (3.6.9)	4.5.3.7	---	---	
<u>Certification/analysis (3.5)</u>				
Fungus (3.5)	4.5.3.8a	---	---	
Rain (3.5)	4.5.3.8b	---	---	
Hail impact (3.5)	4.5.3.8c	---	---	
Static electricity (3.5)	4.5.3.8d	---	---	
Sunshine (3.5)	4.5.3.8e	---	---	
Fluids (3.5)	4.5.3.8f	---	---	

## NOTES:

1/ If a major design change is incorporated into the antenna, the first unit with the change shall be tested.

## MIL-DTL-85670C

4.4.4 Retention of qualification. To retain qualification, the contractor shall forward a report at 24-month intervals to the qualifying activity. The qualifying activity shall establish the initial reporting data, based upon conformance inspection requirements in 4.6 and in table III. Requirements for qualification retention shall be specified by the qualifying activity (Code DSCC-VQE, Defense Supply Center Columbus, P. O. Box 3990, Columbus OH 43218-3990 or online at [vqe.chief@dla.mil](mailto:vqe.chief@dla.mil)) (see 6.3), consistent with conformance inspection requirements in 4.6 and in table III.

4.5 Qualification testing. Qualification testing shall be conducted on three antennas (one of each finish in accordance with 3.4.7 and table III). All samples shall be representative of normal production antennas to be supplied under the contract. Before authorization to conduct qualification testing may be granted, the contractor's test procedures must be reviewed and accepted by the qualifying activity (see 4.8).

4.5.1 Scope of qualification tests. Qualification tests shall include electrical tests in accordance with 4.5.2 and environmental tests to determine that the antennas meet all the requirements of this specification, and the contract (see table III).

4.5.2 Electrical testing. The electrical tests shall include radiation pattern, polarization, gain, VSWR, and power handling.

4.5.2.1 Pattern, polarization, and gain tests. The pattern, polarization, and gain test shall be conducted on a 32-foot octagonal ground plane. The ground plane shall be capable of shielding the operator and all equipment from the antenna assembly. The complete ground plane shall be so placed that maximum clearance shall be maintained between the radiating elements of the antenna and all foreign objects. The minimum acceptable clearance shall be that of a hemisphere having a radius of 16 feet. The test installation shall be so located that the antenna under test will not be affected by intermittent traffic of personnel.

4.5.2.2 VSWR test. The VSWR, measured at the RF connector and referenced to an impedance of 50 ohms, shall be swept across the frequency bandwidth of 30 to 88 MHz, 108-174 MHz, and 225-400 MHz. The data can be taken by any of the current measurement techniques and presented in the form of an X-Y plot (graph) or oscilloscope picture calibrated in return loss (dB) or VSWR.

4.5.2.3 Power handling test. The antenna shall be tested for power handling capability in accordance with 3.6.7.

4.5.3 Environmental tests. Unless otherwise specified herein, antenna performance test during environmental test, may be limited to a VSWR test in accordance with 4.5.2.2, except that power handling and duty cycle shall also be required during temperature-altitude testing.

4.5.3.1 Temperature-altitude. The antenna shall be tested in accordance with MIL-STD-810 to verify conformance with class I equipment requirements [50,000 feet altitude and continuous sea level operation over temperature range of -54°C to +55°C (+71°C intermittent operation)]. Details, methods, and criteria specified in 4.5.3.1.1 and 4.5.3.1.2 shall apply.

4.5.3.1.1 Applied environments. The antenna shall be subjected to the following worst case cold day, hot day, and flight environments as depicted by the test sequence of table IV. Each step must be completed in its entirety with no interruptions. Power shall be applied in accordance with 4.5.3.1.2.

4.5.3.1.2 Applied power. Pre and post test measurements of applied power shall be taken in the test chamber at standard conditions. A physical examination of the antenna shall be conducted after the environmental exposure. When equipment operation is required during the temperature-altitude test, operating time shall be divided equally between two operational frequency bands (lower and middle frequency bands) of the antenna. The method of applying power shall be as follows:

- a. DC power equivalent to the maximum RF power specified shall be applied for the lower and middle frequency bands.
- b. The test shall be considered failed if the power handling capability of the antenna degrades below the reference level established above. Any discrepancy noted during the post environmental visual examination shall be considered a failure.

## MIL-DTL-85670C

TABLE IV. Temperature-altitude test sequence.

Step	Temperature	Duration	Altitude	Operation
1-a	+25°C to -54°C	Max rate	Ground	No
-b	-54°C	20 hours	Ground	No
-c	-54°C	3 hours	40,000 feet	No
-d	-54°C	1 hour	40,000 feet	Yes
-e	-54°C to +25°C	Max rate	Ground	No
2-a	+25°C to +71°C	16 hours	Ground	No
-b	+71°C	1 hour	Ground	No
-c	+71°C	3 hours	Ground	Yes
-d	+71°C to -10°C	Max rate	Ground	No
-e	-10°C	3 hours	40,000 feet	Yes
-f	-10°C to +25°C	Max rate	Ground	No
3	Repeat step one			
4	Repeat step two			

4.5.3.2 Shock. The antenna shall be tested in accordance with MIL-STD-810, method 516.3, procedure 1. The test item shall be mounted in a manner reflecting normal installation on the aircraft. The shock pulse shall be half sine, 15g and 11 milliseconds duration. Pre and post-test VSWR measurements shall be conducted and passed.

4.5.3.3 Humidity. The antenna shall be tested in accordance with MIL-STD-810, method 507.2, procedure 1, cycle 1. Pre and post test VSWR measurements shall be conducted and passed.

4.5.3.4 Salt fog. The antenna shall be tested in accordance with MIL-STD-810, method 509.2. Pre and post-performance measurements shall be conducted and passed.

4.5.3.5 Random vibration test. A random vibration test shall be conducted as specified in 4.5.3.5.1 through 4.5.3.5.5.

4.5.3.5.1 Test item operation. VSWR shall be monitored during application of random vibration so that the functional effects may be evaluated. The test item shall meet VSWR requirements, as specified, while the functional vibration levels are being applied and immediately preceding and following the application of the endurance levels.

4.5.3.5.2 Mounting techniques. The test item shall be attached by its normal mounting means, either directly to the vibration exciter or transition table, or by means of a rigid fixture capable of transmitting the vibration conditions specified herein. The input control sensing device(s) shall be rigidly attached to the vibration table, or fixture if used, as near as possible to the attachment point(s) of the test item.

4.5.3.5.3 Performance of test. The antenna shall be subjected to the durations and vibration levels of 4.5.3.5.4 and 4.5.3.5.5.

4.5.3.5.4 Test duration. The random vibration test requires two levels, function level and an endurance level. For each axis, one half of the functional test shall be conducted first, then the endurance test, followed by the second half of the functional test. The antenna shall perform according to the specified operating requirements of 4.5.2.2. The acceleration power spectral density ( $g^2/Hz$ ) of applied vibration, as measured on the test fixture at mounting point of the test item, shall be as specified in 4.5.3.5.5. Test times shall, for each axis, be one hour each for functional and endurance levels. The instantaneous random vibration acceleration peaks may be limited to three times the rms acceleration level. The power spectral density of the best control signal shall not deviate from the specified requirements by more than +100, -50 percent (+3, -3 dB) between 500 Hz and 2,000 Hz except that deviations as large as +300, -75 percent (+6, -6 dB) shall be allowed over a cumulative bandwidth of 100 Hz maximum, between 500 and 2,000 Hz.

MIL-DTL-85670C

4.5.3.5.5 Vibration levels. The following minimum test levels shall be used:

- a. Functional level: 6.79g rms minimum in accordance with the vibration envelope of [figure 2](#).
- b. Endurance level: 12.1g rms minimum in accordance with the vibration envelope of [figure 3](#).

4.5.3.6 Sideloading. The antenna shall be subjected to a design limit side loading test followed by an ultimate side loading test.

4.5.3.6.1 Design limit test. The antenna shall be normally mounted and subjected to a pressure of 5.3 PSI for a minimum of 4 applications. The pressure shall be applied over the entire surface area of either side of the antenna. The deflection of the tip of the antenna shall be measured as the pressure is applied. Full pressure shall be attained within approximately one minute and maintained for one minute. The antenna tip deflection versus time shall be plotted. The pressure shall be applied in a similar manner to the remaining side. This cycle shall be repeated. All four plots shall be similar and display no sharp breaks or angularity. There shall be no physical damage, distortion, or permanent set. Any damage indicated, either internal or external, shall be considered a failure. Following the test, the antenna shall comply with electrical performance requirements of [3.6.4](#).

4.5.3.6.2 Ultimate limit test. Following the design limit test, the antenna shall be subjected to the ultimate limit test. All conditions shall be the same as for the design limit test with the following exceptions:

- a. The applied pressure shall be 8 PSI.
- b. The pressure shall be applied once to each side.
- c. Damage is acceptable as long as no pieces separate from the test specimen.

4.5.3.7 Lightning protection. The antenna shall be tested to demonstrate compliance with the requirements of [3.6.9](#) as follows:

- a. The antenna shall be connected to a section of RG-58 coaxial cable that is terminated in 50 ohms.
- b. The output of the antenna shall be monitored during the test.

## MIL-DTL-85670C

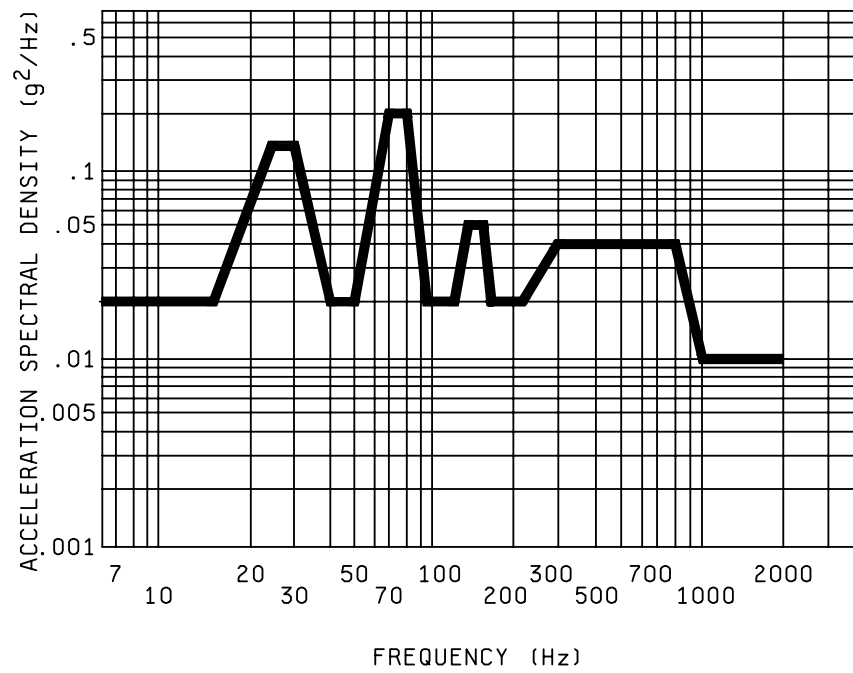

Freq. (Hz)	ASD Level (g <sup>2</sup> /Hz)
---------------	--------------------------------------

10	.02
15	.02
25	.13
30	.13
40	.02
50	.02
65	.2
70	.2
95	.02
110	.02
130	.05
140	.05
155	.02
210	.02
300	.04
800	.04
990	.01
2,000	.01

FIGURE 2. Functional random vibration envelope (6.97g rms).

## MIL-DTL-85670C

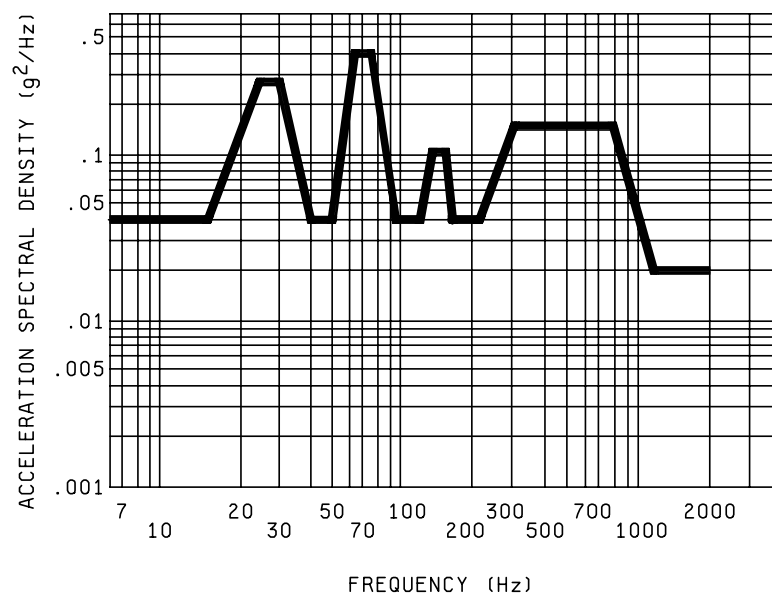

Freq. (Hz)	ASD Level (g <sup>2</sup> /Hz)
10	.04
15	.04
25	.26
30	.26
40	.04
50	.04
65	.4
70	.4
90	.048
110	.048
130	.1
140	.1
150	.048
170	.048
300	.16
800	.16
1,100	.02
2,000	.02

FIGURE 3. Endurance random vibration envelope (12.1 g rms).

## MIL-DTL-85670C

- c. The electrical and mechanical integrity of the RG-58 cable must not be degraded by the test, and the antenna must remain securely attached to the mounting plate that is used for the test purposes. The plate may be deformed but shall not be torn.
- d. The mounting plate shall be Type 6061-T6, 16 gauge aluminum, octagonal, 3 feet in width, held rigidly at the perimeter.

4.5.3.8 Verification of compliance by similarity. The following requirements may be verified without testing. Analysis of the materials and processes, relative to the particular test requirements, shall be compared to units of a similar type that have been previously subjected to the test. Certification by the contractor of the similarity of existing materials and processes to those proven by previous tests is subject to approval by the qualifying activity. Any information regarding changes in materials and processes since the original qualification must be supplied to the qualifying activity for approval prior to implementing the change. Such changes are subject to requalification to the extent deemed necessary by the qualifying activity ([see 4.4.4](#)).

- a. Fungus. The requirements of MIL-STD-810, method 508.2 shall be fulfilled on acquiring activity acceptance of the contractor's detailed materials list, and the certification thereof.
- b. Rain. The antenna shall be analyzed with consideration to the test in accordance with MIL-STD-810, method 506.2
- c. Hail impact. The radome surfaces which are subject to airstream impingement angles greater than 30° shall be analyzed to demonstrate compliance with hail impact requirements for class 1 (flight vehicle) radomes designed to withstand impact of .75 inch-diameter hail stones at the aircraft cruise velocity at the rate of six impacts per square inch per minute without catastrophic failure.
- d. Static electricity. The antenna shall be analyzed to demonstrate compliance with the precipitation static electricity requirements as specified for radomes. If charging of external surfaces in the airframe air flow is detrimental to equipment performance or personnel safety, then equipment shall be finished with anti-static coating. The measured resistance of the coating shall not be greater than 25 megohms or less than 0.5 megohm per unit area.
- e. Sunshine. The plastic radome shall be analyzed to demonstrate compliance with sunshine requirements as specified for radomes; shall withstand 100 hours of exposure described in MIL-STD-810, method 505 with no degradation of physical or electrical properties.
- f. Fluids. The antenna shall be analyzed to demonstrate compliance with resistance to fluids requirements: the antenna shall not be softened or permanently damaged by contact with petroleum products or other fluids common to aircraft operation or maintenance.

4.5.4 Production antennas. Antennas supplied under the production contract shall in all respects, including design, construction, workmanship, performance, and quality, be equal to the approved qualification sample(s). Each equipment shall be capable of successfully passing the same tests as imposed on the preproduction sample. Evidence of non-compliance with the above shall constitute cause for rejection of equipment already accepted by the Government.

4.6 Conformance inspection. The contractor shall furnish all samples and shall be responsible for accomplishing the conformance tests. All inspection and testing may be under the supervision of the acquiring activity. The contractor shall retain test data showing quantitative results for all conformance tests. Such tests shall be signed/stamped by an authorized representative of the contractor or laboratory, as applicable. Acceptance or approval of material during the course of manufacture shall not be construed as a guarantee of the acceptance of the finished product. Conformance tests shall consist of the following ([see table III](#), part II Conformance inspections).

- a. Individual tests ([see 4.6.1](#)).
- b. Sampling tests ([see 4.6.2](#)).
- c. Special tests ([see 4.6.3](#)).



## MIL-DTL-85670C

4.6.1 Individual tests. Each antenna submitted for acceptance shall be subjected to the individual tests. The tests shall be adequate to determine compliance with the requirements of materials, workmanship, and operational adequacy. All inspections and testing shall be delineated in the acceptance test procedures submitted to the acquiring activity. As a minimum, each antenna accepted shall have met the following tests:

- a. Examination of product (see 4.6.1.1).
- b. VSWR (see 3.6.4 and 4.5.2.2).
- c. Bandwidth (see 3.6.3 and 4.5.2.2).
- d. Impedance (see 3.6.5 and 4.5.2.2).

4.6.1.1 Examination of product. Each antenna shall be examined for compliance with design and construction (see 3.4) and for workmanship (see 3.7).

4.6.2 Sampling tests. The sampling tests from table III shall be conducted on samples randomly selected by the Government inspector according to table III. The selection shall be made from antennas having passed all the requirements for inspection prior to packaging. Sample selection shall be irrespective of color. Any sample shall undergo all required sample tests. Environmental sample tests shall be conducted prior to electrical and performance sample tests. Corrective action following failure shall be verified effectively by test on a sample from the next ten produced.

4.6.2.1 Scope of sampling tests. As a minimum, each antenna selected for sampling tests shall be subjected to the following:

- a. VSWR test in accordance with 4.5.2.2.
- b. Pattern, polarization, and gain tests in accordance with 4.5.2.1.
- c. Random vibration test in accordance with 4.5.3.5.
- d. Temperature-altitude test in accordance with 4.5.3.1.
- e. Salt fog test in accordance with 4.5.3.4.
- f. Power handling test in accordance with 4.5.2.3.
- g. Similarity certification in accordance with 4.5.3.8.

4.6.3 Special tests. When specified in the contract, special tests shall be conducted for the purpose of checking the effect of any design or material change in the performance of the antenna and to assure quality control. The antenna selected for special tests may be selected from antennas previously subjected to sampling tests.

4.6.3.1 Special test schedule. Selection of antennas for special tests shall be made as follows:

- a. On an early equipment after an engineering or material change.
- b. Whenever failure reports or other information indicate that additional test(s) are required. (This will be determined by the acquiring activity.)

4.6.3.2 Scope of special tests. Special tests shall consist of such tests as authorized by the acquiring activity. Test procedures previously approved for the qualification tests shall be used where applicable.

## MIL-DTL-85670C

4.6.4 Equipment failure. Should a failure occur during the sampling or special tests, the following actions shall be taken:

- a. As directed, inform the qualifying activity ([see 4.4.4](#)) as soon as possible.
- b. Analyze the failure to determine the root cause.
- c. Propose corrective action, as appropriate.
- d. Implement corrective action, as appropriate.
- e. Test, as appropriate, to verify the effectiveness of the corrective action.
- f. Include the results of a. through e. in the report submitted to the qualifying activity ([see 4.4.4](#)).

4.7 Inspection of packaging. The sampling and inspection of the preservation, packing, and container marking shall be in accordance with the requirements of MIL-E-17555, MIL-STD-2073-1 and MIL-STD-129.

4.8 Test procedures. The right is reserved by the acquiring activity or the Government representative to modify the tests or to require any additional tests deemed necessary to determine compliance with the requirements of the specification or of the contract. MIL-T-18303 shall be used as a guide for preparation of test procedures. When approved test procedures are available from a previous contract, such procedures will be provided and may be used when their use is authorized by the acquiring activity.

4.9 Presubmission testing. No item, part, or complete equipment shall be submitted by the contractor until it has been previously tested by the contractor and found to comply with all applicable requirements of this specification and the contract.

## 5. PACKAGING

5.1 Packaging. For acquisition purposes, the packaging requirements shall be as specified in the contract or order ([see 6.2](#)). When packaging of materiel is to be performed by DoD or in-house contractor personnel, these personnel need to contact the responsible packaging activity to ascertain packaging requirements. Packaging requirements are maintained by the Inventory Control Point's packaging activities within the Military Service or Defense Agency, or within the military service's system commands. Packaging data retrieval is available from the managing Military Department's or Defense Agency's automated packaging files, CD-ROM products, or by contacting the responsible packaging activity.

## 6. NOTES

(This section contains information of a general or explanatory nature that may be helpful, but is not mandatory.)

6.1 Intended use. The antenna covered by this specification is intended for use with the AN/ARC-182(V) radio set described by MIL-R-85664 and NAC Drawing Number 1533AS102. The antenna is also intended to operate with equipment listed in [6.5](#). The antenna is intended to be newly installed or provide replacement for existing antenna on the fuselage of an aircraft. They are intended for production incorporation in all new aircraft plus retrofit in selected existing aircraft.

6.2 Acquisition requirements. Acquisition documents must specify the following:

- a. Title, number, and date of the specification.
- b. If required, the specific issue of individual documents referenced ([see 2.2](#)).
- c. Packaging requirements ([see 5.1](#)). All major units and parts of the antenna must be preserved, packaged, packed, and marked in accordance with MIL-E-17555 and MIL-STD-2073-1 requirements.
- d. Marking: Shipments must be marked in accordance with MIL-STD-129.

## MIL-DTL-85670C

6.3 Qualification. With respect to products requiring qualification, awards will be made only for products which are, at the time of award of contract, qualified for inclusion in Qualified Products List whether or not such products have actually been so listed by that date. The attention of the contractors is called to these requirements, and manufacturers are urged to arrange to have the products that they propose to offer to the Federal Government tested for qualification in order that they may be eligible to be awarded contracts or orders for the products covered by this specification. Information pertaining to qualification of products may be obtained from Code DSCC-VQE, Defense Supply Center Columbus, P.O. Box 3990, Columbus, OH 43218-3990 or online at [vqe.chief@dla.mil](mailto:vqe.chief@dla.mil).

6.4 Part or Identifying Number (PIN). This specification requires a PIN that is as described in the appropriate reference to associated documents ([see 3.1](#)).

6.5 Associated equipment. This equipment should operate with the associated equipment listed in table V which should not be supplied as part of this equipment:

TABLE V. Associated equipment.

Item	Equipment designation	Military specification or drawing number
Receiver-transmitter Receiver-transmitter } Receiver-transmitter } Receiver-transmitter }	RT-1250A/ARC RT-1324A/ARC RT-1327A/ARC RT-1407/ARC	MIL-R-85664 MIL-R-85665 } MIL-R-85665 } MIL-R-85655 } Inactive
Switch	SA-521A/A with selector, antenna C-2193B/A	MIL-DTL-25879
Radio set } Radio set } Digital data communication set }	AN/ARC-143 AN/ARC-159(V) AN/ASW-27	MIL-R-81628 } MIL-R-81877 } Inactive

6.6 Subject term (key word) listing.

AN/ARC-182 (V) Radio set  
Communication bands  
Enclosed element  
Fix tuned  
Fuselage mounted blade  
Hydrolytic stability  
Omnidirectional radiation pattern  
Polarization  
Radome  
Universal blade type  
Universal installation  
Vertical polarization  
Voltage standing wave ratio

6.7 Environmentally preferable material. Environmentally preferable materials should be used to the maximum extent possible to meet the requirements of this specification. [Table VI](#) lists the Environmental Protection Agency (EPA) top seventeen hazardous materials targeted for major usage reduction. Use of these materials should be minimized or eliminated unless needed to meet the requirements specified herein.

## MIL-DTL-85670C

TABLE VI. EPA top seventeen hazardous materials.

Benzene	Dichloromethane	Tetrachloromethylene
Cadmium and Compounds	Lead and Compounds	Toluene
Carbon Tetrachloride	Mercury and Compounds	1, 1, 1 - Trichloroethane
Chloroform	Methyl Ethyl Ketone	Trichloroethylene
Chromium and Compounds	Methyl Isobutyl Ketone	Xylenes
Cyanide and Compounds	Nickel and Compounds	

6.8 Tin whisker growth. The use of alloys with tin content greater than 97 percent, by mass, may exhibit tin whisker growth problems after manufacture. Tin whiskers may occur anytime from a day to years after manufacture and can develop under typical operating conditions, on products that use such materials. Conformance coatings applied over top of a whisker-prone surface will not prevent the formation of tin whiskers. Alloys of 3 percent lead, by mass, have shown to inhibit the growth of tin whiskers ([see 3.3.6](#)). For additional information on this matter, refer to ASTM-B545 (Standard Specification for Electrodeposited Coatings of Tin).

6.9 Changes from previous issue. Marginal notations are not used in this revision to identify changes with respect to the previous issue due to the extent of the changes.

MIL-DTL-85670C

APPENDIX A

TEST METHOD

DIRECT EFFECTS - STRUCTURAL

A.1. SCOPE.

A.1.1 Scope. This appendix is a mandatory part of the specification. The information contained herein is intended for compliance.

A.2. PURPOSE.

A.2.1 Purpose. This method is used to determine the direct affects which result from the interaction of lightning currents with aerospace vehicles and hardware.

A.3. APPLICABILITY.

A.3.1 Applicability. This test method is applicable to aerospace vehicle structures and components which are susceptible to lightning current attachment or transfer, which includes antennas.

A.4. APPARATUS.

A.4.1 Test apparatus. The test apparatus shall include:

- a. A high current generator(s) capable of producing the specified waveforms.
- b. High current measuring and recording instruments.
- c. Photographic equipment for recording strike points/damage areas.

A.4.2 Test setup. The test object should be a production hardware, a full-scale prototype, or an electrically representative mockup of the production configuration. All conducting objects (within or on nonmetallic hardware) that are normally connected to the vehicle when installed in the aircraft should be electrically connected to ground (the return side of the lightning generator). Surrounding external metallic vehicle structure should be simulated and attached to the test object. The test setup shall be such that the simulated lightning currents are delivered to and conducted away from the test object in a manner representative of the aircraft being struck by lightning. Care must be taken to assure that magnetic forces, and other interactions which are unrepresentative of the natural situation, are minimized.

CAUTION

There may be interactions between the arc and the test conductors. Care must be taken to assure that these interactions do not influence the test results.

A.4.2.1 Arc-entry tests.

- a. Test electrodes: The electrode material shall be a good electrical conductor capable of resisting the erosion produced by the test currents involved.
- b. Test gap. The gap spacing shall be sufficient so that arc jet and blast pressure effects do not influence the test results. This will require that the gap be at least 50 mm for component A or D and at least 10 mm for multiple component tests. Alternatively, suitable jet-diverting techniques shall be incorporated in the design of the electrode assembly. A fine wire such as No. 30 copper wire can be used as required in the gap to assist in the current discharge of low-voltage-driven current generator(s).
- c. Electrode polarity. The electrode polarity of the waveform components A and D shall be either positive or negative. The electrode polarity of the waveform components B and C shall be negative.

## MIL-DTL-85670C

## APPENDIX A

## A.5. CRITERIA TO BE SPECIFIED

- a. Zone 1B: Apply waveform components A, B, C, and D in that order, but not necessarily as one continuous discharge.
- b. Number of discharges to be fired.
- c. Lightning damage may be in the form of pit marks or burn-through holes on skin panels, weakened or distorted structural joints, structural deformation from blast pressures, puncture or delamination of composite structures. Structural tests and non-destructive inspections may be required both before and after tests for damage evaluation.

## A.6. TEST PROCEDURE

- a. Set up the high current generator, discharge circuit, and diagnostic equipment.
- b. Inspect the equipment and area for safe operation.
- c. Insert a dummy test object beneath the electrode, or place a conductive bar over the actual test object such that waveform-checkout discharges cannot damage the test object.
- d. Fire a discharge to the dummy test object to check the current waveforms and establish that the specified waveform(s) are in fact being applied and check the operation of the diagnostic equipment.
- e. Place the test object in the discharge circuit.
- f. Fire the specified number of discharges and inspect the test object after each discharge and record the results.
- g. Correlate photographs with arc entry points/damage areas observed on the test object.

## A.7. DATA TO BE COLLECTED

- a. Environmental data which may affect the test results.
- b. Description and photographs of the test setup.
- c. Date, personnel performing the tests, and location of tests.
- d. Test object photographs both before and after lightning tests.
- e. Test current waveforms.

## A.8. CURRENT WAVEFORMS AND COMPONENTS.

A.8.1 Qualification testing. For qualification testing, there are four current components: A, B, C, and D, that are used to determine direct effects. Components A, B, C, and D each simulate a different characteristic of the current in a natural lightning flash and are shown on [FIGURE A-1](#). They are applied individually or as a composite of two or more components together in one test.

- a. Component A: Initial high peak current. Component A has a peak amplitude of 200 kA ( $\pm 10$  percent) and an action integral ([see A.9.a](#)) of  $2 \times 10^6 \text{ A}^2 \cdot \text{s}$  ( $\pm 20$  percent) with a total time duration not exceeding 500 microseconds. This component may be unidirectional or oscillatory.

## MIL-DTL-85670C

## APPENDIX A

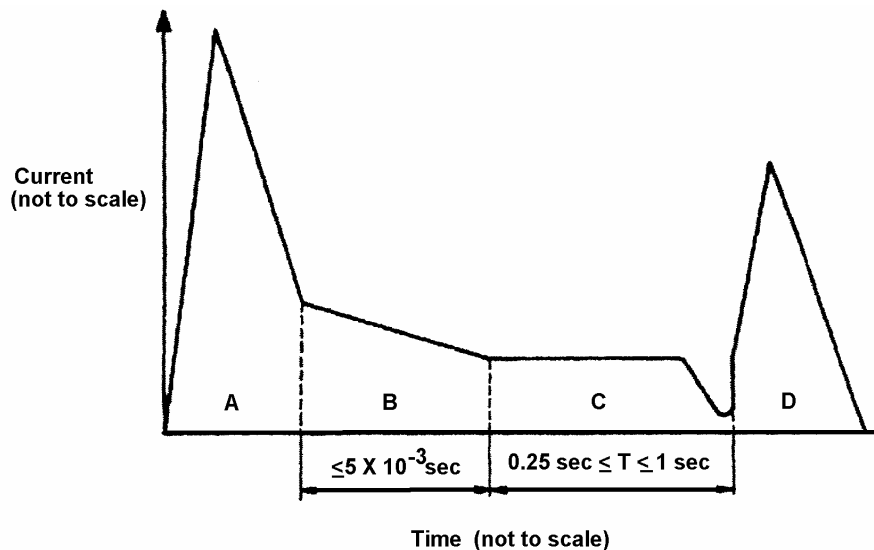

## Component A (Initial stroke)

Peak amplitude = 200 kA  $\pm$  10 percentAction integral =  $2 \times 10^6 \text{ A}^2 \cdot \text{s} \pm 20$  percentTime duration  $\leq 500 \mu\text{s}$ 

## Component C (continuing current)

Charge transfer = 200 Coulombs  $\pm 20$  percent

Amplitude = 200-800A

## Component B (Intermediate current)

Maximum charge transfer = 10 Coulombs

Average amplitude = 2 kA  $\pm 10$  percent

## Component D (Restrike)

Peak amplitude = 100 kA  $\pm 10$  percentAction integral =  $0.25 \times 10^6 \text{ A}^2 \cdot \text{s} \pm 20$  percentTime duration  $\leq 500 \mu\text{s}$ 

FIGURE A-1. Current waveforms.

## MIL-DTL-85670C

## APPENDIX A

- b. Component B: Intermediate current. Component B has an average amplitude of 2 kA ( $\pm 10$  percent) flowing for a maximum duration of 5 milliseconds and a maximum charge transfer (see A.9.b) of 10 coulombs. The waveform shall be unidirectional, for example, rectangular, exponential or linearly decaying.
- c. Component C: Continuing current. Component C transfers a charge of 200 coulombs ( $\pm 20$  percent) in a time of between 0.25 and 1 second. The waveform shall be unidirectional, for example, rectangular, exponential, or linearly decaying.
- d. Component D: Restrike current. Component D has a peak amplitude of 100 kA ( $\pm 10$  percent) and an action integral of  $0.25 \times 10^6 \text{ A}^2 \cdot \text{s}$  ( $\pm 20$  percent). This component may be either unidirectional or oscillatory with a total time duration not exceeding 500 microseconds.

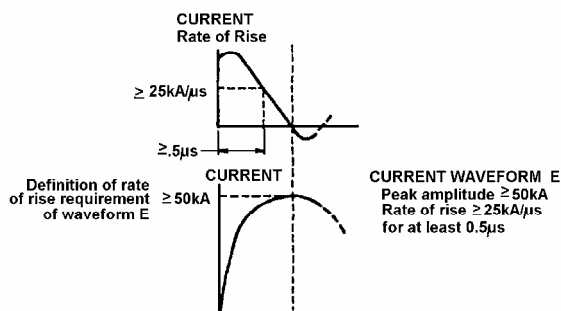
## A.9. DEFINITION OF INTEGRALS

- a. Action integral. The action integral of a current waveform is a measure of the ability of the current to deliver energy and is defined as the integral of the square of the time-varying current over its time duration, that is,  $\int_0^T i(t)^2 dt (\text{A}^2 \cdot \text{s})$ .
- b. Charge transfer. The charge transfer,  $Q$ , is defined as the integral of the time-varying current over its time duration, or  $Q = \int_0^T i(t) dt (\text{A} \cdot \text{s or coulombs})$  and is equivalent to the area beneath the current waveform as shown on [FIGURE A-2](#).

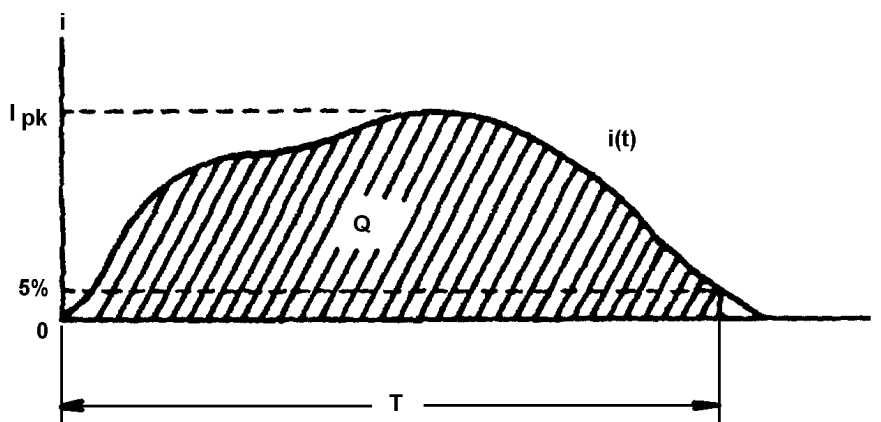
FIGURE A-2. Charge transfer of a current waveform.



## MIL-DTL-85670C

## APPENDIX A

- c. Time duration. The time duration,  $T$ , of a current waveform is defined as the time from initiation of current flow until the current amplitude (peak amplitude in the case of a damped sinusoid) has reduced to five percent of its initial peak value as shown on [FIGURE A-3](#).

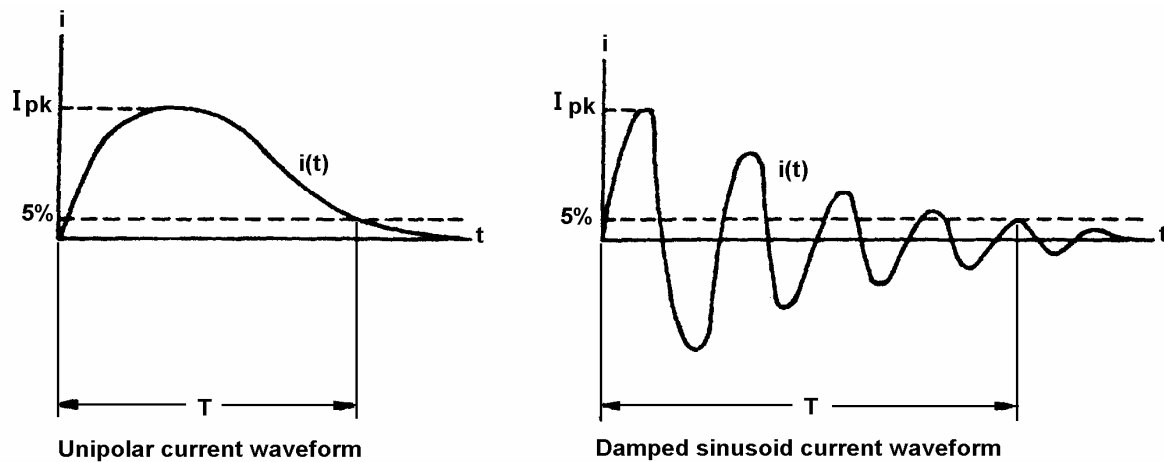
FIGURE A-3. Time duration of current waveform.

## A.10. NOTES

- a. This lightning test shall be conducted by personnel experienced in high voltage testing and it shall be performed at a controlled access test area. A laboratory with adequate safety measures and controlled test procedures is required.
- b. The discharge circuit of the current generator shall be designed and maintained to avoid unnecessary arcing and other phenomena which may affect personnel and equipment safety and test accuracy.
- c. All personnel should be provided with appropriate eye and ear protection.
- d. The test instrumentation shall be adequately shielded from electromagnetic fields associated with the lightning test currents and other sources.
- e. In cases where inductive sparking may be a problem, a test with current waveform E may be advisable.

Custodians:  
Navy - AS  
Air Force - 11  
DLA - CC

Preparing activity:  
DLA - CC  
(Project 5821-2007-001)

NOTE: The activities listed above were interested in this document as of the date of this document. Since organizations and responsibilities can change, you should verify the currency of the information above using the ASSIST Online database at <http://assist.daps.dla.mil>.