

INCH-POUND

MIL-PRF-83446C
8 November 2004
 SUPERSEDING
 MIL-PRF-83446B
 16 December 1980

PERFORMANCE SPECIFICATION

COILS, RADIO-FREQUENCY, CHIP, FIXED OR VARIABLE,

GENERAL SPECIFICATION FOR

This specification is approved for use by all Departments and Agencies of the Department of Defense.

1. SCOPE

1.1 Scope. This specification covers the general requirements for fixed or variable, chip coil primarily intended for incorporation into hybrid microelectronic circuits. Acquisition of chip coil of a specific design will require additional data in the form of specification sheets, giving detailed electrical and mechanical requirements, tolerances, and applicable additions and exceptions to the general requirements and tests specified herein (see 3.1 and 6.1).

1.2 PIN construction.

1.2.1 Part or Identifying Number (PIN). The PIN shall be in the following form, and as specified (see 3.1 and 6.2).

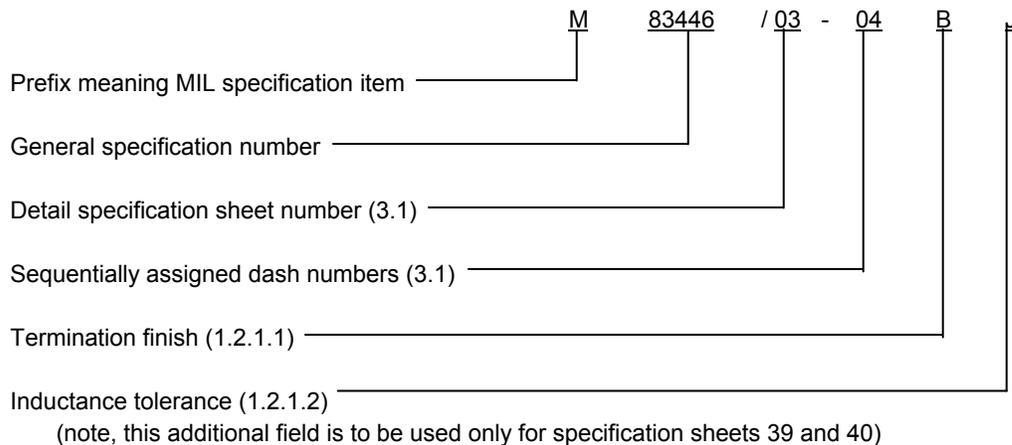

Comments, suggestions or questions on this document should be addressed to Defense Supply Center Columbus, ATTN: VAT, Post Office Box 3990, Columbus, OH 43216-5000), or emailed to Transformers@dla.mil. Since contact information can change, you may want to verify the currency of this address information using the ASSIST Online database at <http://assist.daps.dla.mil/>.

MIL-PRF-83446C

1.2.1.1 Termination finish. The termination finish is identified by a single letter as shown in table I.

TABLE I. Termination finish.

Code	Final finish	Methods of assembly
A	Gold over nickel	Solderable/weldable
B	Tin-lead over nickel	Solderable
C	Tin plated	Solderable
D	Platinum-gold	Solderable/weldable
E	Palladium-silver	Solderable/weldable
F	Tin-lead	Solderable

1.2.1.2 Inductance tolerance. A single letter in accordance with table II identifies the inductance tolerance.

TABLE II. Inductance tolerance.

Symbol	Tolerance (percent)
M	± 20
K	± 10
J	± 5
H	± 3
G	± 2
F	± 1

2. APPLICABLE DOCUMENTS

2.1 General. The documents listed in this section are specified in sections 3 and 4 of this specification. This section does not include documents cited in other sections of this specification or recommended for additional information or as examples. While every effort has been made to ensure the completeness of this list, document users are cautioned that they must meet all specified requirements of documents in sections 3 and 4 of this specification, whether or not they are listed.

2.2 Government documents.

2.2.1 Specifications, standards, and handbooks. The following specifications, standards, and handbooks form a part of this document to the extent specified herein. Unless otherwise specified, the issues of these documents are those cited in the solicitation or contract.

FEDERAL STANDARDS

[FED-STD-H28](#) - Screw-Thread Standards for Federal Services.

DEPARTMENT OF DEFENSE STANDARDS

[MIL-STD-202](#) - Test Methods for Electronic and Electrical Component Parts.
[MIL-STD-810](#) - Environmental Test Methods.
[MIL-STD-883](#) - Test Method Standard, Microcircuits.
[MIL-STD-1285](#) - Marking of Electrical and Electronic Parts.

MIL-PRF-83446C

(Copies of these documents are available online at <http://assist.daps.dla.mil/quicksearch/> or from the Standardization Document Order Desk, 700 Robbins Avenue, Building 4D, Philadelphia, PA 19111-5094.)

2.3 Non-Government publications. The following documents form a part of this document to the extent specified herein. Unless otherwise specified, the issues of these documents are those cited in the solicitation or contract.

AMERICAN NATIONAL STANDARDS INSTITUTE (ANSI)

[ANSI/NCSL Z540-1](#) - Calibration Laboratories and Measuring Equipment-General Requirements.

(Application for copies should be addressed to American National Standards Institute, 1819 L Street NW, Suite 600, Washington, DC 20036, <http://www.ansi.org>).

INTERNATIONAL ORGANIZATION FOR STANDARDS (ISO)

[ISO 10012-1](#) - Quality Assurance Requirements for Measuring Equipment-Part 1: Metrological Confirmation System for Measuring Equipment.

(Application for copies should be addressed to American National Standards Institute, 1819 L Street NW, Suite 600, Washington, DC 20036, <http://www.ansi.org>).

2.4 Order of precedence. In the event of a conflict between the text of this document and the references cited herein (except for related specification sheets), the text of this specification takes precedence. Nothing in this document, however, supersedes applicable laws and regulations unless a specific exemption has been obtained.

3. REQUIREMENTS

3.1 Specification sheets. The individual item requirements shall be as specified herein and in accordance with the applicable specification sheets. In the event of any conflict between requirements of this specification and the specification sheets, the latter shall govern.

3.2 Qualification. Chip coils furnished under this specification shall be products that are authorized by the qualifying activity for listing on the applicable qualified products list before contract award (see 4.4 and 6.3).

3.3 Materials (see 4.6.1). Materials shall be as specified herein. However, when a definite material is not specified, a material shall be used which will enable the coils to meet the performance requirements of this specification. Acceptance or approval of any constituent material shall not be construed as a guaranty of the acceptance of the finished product.

3.3.1 Recycled, recovered, or environmentally preferable materials. Recycled, recovered, or environmentally preferable materials should be used to the maximum extent possible, provided that the material meets or exceeds the operational and maintenance requirements, and promotes economically advantageous life cycle costs.

3.3.2 Solder and soldering flux. Solder and soldering flux, when used, shall be selected to enable the part to meet the requirements of this specification. Additional information and guidance on solder and soldering flux is provided in 6.8.

3.3.3 Threaded parts. Threaded part shall be of corrosion-resistant material or shall be protected against corrosion.

MIL-PRF-83446C

3.3.4 Magnet wire. Magnet wire, when used, shall be selected to enable the part to meet the requirements of this specification. Additional information and guidance on magnet wire is provided in 6.9.

3.4 Design and construction (see 4.6.1). Coils shall be of the design, construction, and physical dimensions specified (see 3.1).

3.4.1 Body structure. The body structure shall be in a monolithic form that shall protect the inductive element from the effects of prolonged exposure to high humidity and shall meet the requirements specified herein. The terminations shall be metallized with solderable or weldable metals or alloys. When specified (see 3.1), the terminations shall be pretinned with a suitable solder that shall meet the solderability requirements specified herein. See 6.4 for guidance in metallized terminations.

3.4.2 Termination area. Connection to the inductive element shall be made via metallized termination areas. Unless otherwise specified, all terminations (areas) shall be available on one surface of the body of the chip coil. Termination finishes shall be as specified in table I. Termination finish codes A, D, and E shall be used for weldable terminations and codes A through F inclusive shall be used for solderable terminations. (See 6.4).

3.4.3 Substrate bonding. The underside of the chip coil (the surface opposite the side containing the inductive element) may be metallized, when specified, to provide for eutectic bonding of the chip to a substrate.

3.4.4 Threaded parts. Unless otherwise specified (see 3.1), all threaded parts shall be in accordance with FED-STD-H28.

3.4.4.1 Engagement of threaded parts. Unless otherwise specified (see 3.1), all threaded parts shall engage by at least three full threads.

3.4.5 Weight. The weight shall be as specified (see 3.1).

3.4.6 Tin-plated finishes. Use of tin plating is prohibited as a final finish and as an undercoat (see 6.7). Use of tin-lead (Sn-Pb) finishes are acceptable provided that the minimum lead content is 3 percent.

3.5 Thermal shock. When coils are tested as specified in 4.6.2, all windings shall be electrically continuous (see 3.6 and 4.6.3) and there shall be no impairment of protective coatings.

3.6 Winding continuity. When coils are tested as specified in 4.6.3, the windings shall be electrically continuous.

3.7 Dielectric withstanding voltage. When coils are tested as specified in 4.6.4, there shall be no arcing, flashover, breakdown, nor other damage.

3.8 Barometric pressure (when applicable). When coils are tested as specified in 4.6.5, there shall be no arcing, breakdown, flashover, or other damage.

3.9 Insulation resistance. When measured as specified in 4.6.6, the insulation resistance shall be not less than 1,000 megohms.

3.10 Electrical characteristics. The electrical characteristics shall be as specified (see 3.1).

3.10.1 Inductance. When coils are tested as specified in 4.6.7.1, the inductance shall be as specified (see 3.1).

3.10.2 Q of coils. When coils are tested as specified in 4.6.7.2, the Q shall be as specified (see 3.1).

MIL-PRF-83446C

3.10.3 Self-resonant frequency. When coils are tested as specified in 4.6.7.3, the self-resonant frequency shall be not less than 90 percent of the self-resonant frequency specified (see 3.1). However, when a minimum value of self-resonant frequency is specified (see 3.1), the minimum value shall govern.

3.10.4 DC resistance. When coils are tested as specified in 4.6.7.4, the dc resistance shall be as specified (see 3.1).

3.10.5 Percent coupling. When coils are tested as specified in 4.6.7.5, the percent coupling shall be as specified (see 3.1).

3.10.6 Incremental current inductance change (applicable to ferrite core materials only). When coils are tested as specified in 4.6.7.6, the inductance value shall not change more than 5 percent from its value measured with zero direct current.

3.10.7 Effective parallel resistance. When coils are tested as specified in 4.6.7.7, the effective parallel resistance shall be as specified (see 3.1).

3.11 Turning torque. When variable coils are tested as specified in 4.6.8, the torque required to rotate the turning core shall be .05 ounce-inch minimum, .5 ounce-inch maximum, unless otherwise specified (see 3.1). The turning screw threads of the variable coils shall not shed conductive or magnetic particles.

3.12 Life. When coils are tested as specified in 4.6.9, there shall be no evidence of mechanical damage. The changes in electrical characteristics between the initial measurements and 250 +48, -0 hours shall not exceed the initial limits specified. The electrical characteristics from 250 +48, -0 hours up to and including 2,000 hours shall not exceed the degradation limits specified (see 3.1).

3.13 Solderability. When coils are tested as specified in 4.6.10, the immersed metallized surface shall be at least 95 percent covered with a new clean smooth coating and shall exhibit no demetallization or leaching of the terminal areas. The remaining 5 percent may contain only small pinholes or rough spots; these shall not be concentrated in one area. In case of dispute, the percentage of coverage with pinholes or rough spots shall be determined by actual measurement of these areas, as compared to the total area.

3.14 Low-temperature operation. When coils are tested as specified in 4.6.11, there shall be no evidence of mechanical damage.

3.15 Temperature rise. When coils are tested as specified in 4.6.12, the temperature rise of any winding above the specified maximum ambient temperature (see 3.1) shall not exceed the value specified (see 3.1) and there shall be no evidence of physical damage.

3.16 Overload. When coils are tested as specified in 4.6.13, there shall be no evidence of arcing, burning, or charring.

3.17 High-temperature exposure. When coils are tested as specified in 4.6.14, there shall be no evidence of mechanical damage.

3.18 Moisture resistance. When coils are tested as specified in 4.6.15, there shall be no evidence of mechanical damage.

3.19 Bond strength. When coils are tested as specified in 4.6.16, there shall be no evidence of mechanical damage.

MIL-PRF-83446C

3.20 Fungus. All external materials shall be nonnutrient to fungus growth or shall be suitably treated to retard fungus growth. The manufacturer shall verify by certification that all external materials are fungus resistant or shall test the coils as specified in 4.6.17. There shall be no evidence of fungus growth on the external surfaces.

3.21 Marking (see 4.6.1). Unless otherwise specified (see 3.1 and 6.2), a noncorrosive label containing the military PIN, CAGE code, date code, and lot symbol shall be inserted in each package, as shown in the following example:

Example:

M83446/1-12BK ----PIN
12345-----CAGE code
0219B -----Date code and lot symbol

The manufacturer's source code, date code, and lot symbol shall be in accordance with MIL-STD-1285.

3.22 Workmanship (see 4.6.1). Coils shall be processed in such a manner as to be uniform in quality and shall meet the requirements of 3.1, 3.3, 3.4, 3.4.1 through 3.4.4.1, and 3.20, as applicable, and be free from other defects that will affect life, serviceability, or appearance, and shall pass the visual inspection as specified on figure 1.

4. VERIFICATION

4.1 Test equipment and inspection facilities. Test and measuring equipment and inspection facilities of sufficient accuracy, quality, and quantity to permit performance of the required inspection shall be established and maintained by the contractor. The establishment and maintenance of a calibration system to control the accuracy of the measuring and test equipment shall be accordance with ANSI/NCSL Z540-1, ISO 10012-1, or equivalent as approved by the qualifying activity.

4.2 Classification of inspections. The inspection requirements specified herein are classified as follows:

- a. Qualification inspection (see 4.4).
- b. Conformance inspection (see 4.5).

4.3 Inspection conditions. Unless otherwise specified herein, all inspections shall be performed in accordance with the test conditions specified in the "General Requirements" of MIL-STD-202.

4.3.1 Precautions. Adequate precautions shall be taken during inspection to prevent condensation of moisture on coils except during the moisture-resistance and thermal shock tests.

4.3.2 Test voltage. The test voltage shall contain no more than 5 percent harmonic distortion.

4.3.3 Test frequency. When a test frequency is specified without a tolerance, the frequency used shall be within ± 1.0 percent of the specified value.

4.3.4 Demagnetization. When necessary to overcome remanence effects, demagnetization is permitted.

MIL-PRF-83446C

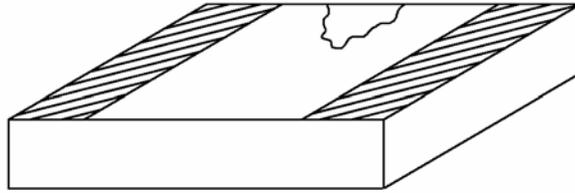

REJECT: Void, nick, bubble, or cut in coil area greater than 25 percent of the width.

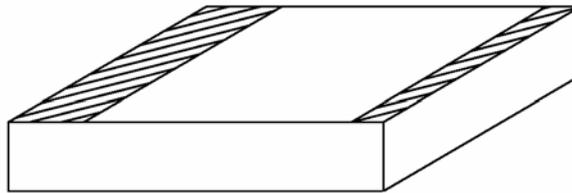

REJECT: Termination width less than specified (see 3.1).

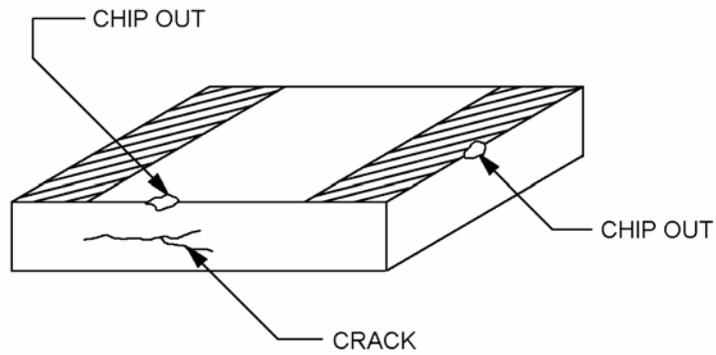

REJECT: Any crack, chip out, or void in the substrate greater than .003 inch (0.08 mm) in any one direction.

FIGURE 1. Chip coil visual inspection.

MIL-PRF-83446C



REJECT: Excessive build up of termination on any surface material greater than .003 inch (0.08 mm) for solderable and solderable/weldable leads.

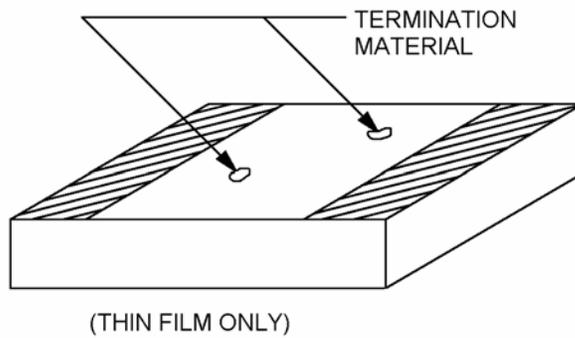

REJECT: Visible termination material splattered through coil area.

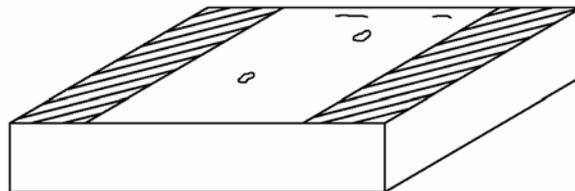

REJECT:

1. Visible imbedded foreign particles in either the film or termination areas.
2. Foreign particles are those that are not normal to coil design or process.

FIGURE 1. Chip coil visual inspection - Continued.

MIL-PRF-83446C

4.4 Qualification inspection. Qualification inspection shall be as specified in [table III](#).

4.4.1 Sample. The number of sample units comprising a sample of coils to be submitted for qualification inspection, shall be as specified in the appendix to this specification.

4.4.2 Inspection routine. The sample shall be subjected to the inspections specified in [table III](#), in the order shown. All sample units except group III, shall be subjected to the inspections of group I. The sample shall then be divided as specified in [table III](#) for groups II to VII inclusive, and the sample units subjected to the inspection for their particular group.

4.4.3 Failures. Two or more failures shall be cause for refusal to grant qualification approval.

4.4.4 Retention of qualification. To retain qualification, the contractor shall forward a report at 6-month intervals to the qualifying activity. The qualifying activity shall establish the initial reporting date. The report shall consist of:

- a. A summary of the results of the tests performed for inspection of product for delivery, group A, indicating as a minimum the number of lots that have passed and the number that have failed. The results of tests of all reworked lots shall be identified and accounted for.
- b. The results of tests performed for periodic inspection, group C, including the number and mode of failures. The test report shall include results of all periodic inspection tests performed and completed during the 6-month period. If the test results indicate nonconformance with specification requirements, and corrective action acceptable to the qualifying activity has not been taken, action may be taken to remove the failing product from the qualified products list.

Failure to submit the report within 30 days after the end of each 6-month period may result in loss of qualification for the product. In addition to the periodic submission of inspection data, the contractor shall immediately notify the qualifying activity at any time during the 6-month period that the inspection data indicates failure of the qualified product to meet the requirements of this specification.

In the event that no production occurred during the reporting period, a report shall be submitted certifying that the company still has the capabilities and facilities necessary to produce the item. If during six consecutive reporting periods, there has been no production, the manufacturer may be required, at the discretion of the qualifying activity, to submit the products, a representative product of each specification sheet, to testing in accordance with the qualification inspection requirements.

MIL-PRF-83446C

TABLE III. Qualification inspection.

Inspection	Requirement paragraph	Method paragraph	Number of sample units to be inspected	Number of failures permitted	
<u>Group I (all samples) 1/</u>					
Thermal shock -----	3.5	4.6.2	All sample units except group III	0	
Winding continuity -----	3.6	4.6.3			
Dielectric withstanding voltage	3.7	4.6.4			
Barometric pressure (when applicable) -----	3.8	4.6.5			
Insulation resistance -----	3.9	4.6.6			
Electrical characteristics (initial) -----	3.10	4.6.7			
Turning torque (when applicable)	3.11	4.6.8			
Visual and mechanical inspection -----	3.1, 3.3 through 3.4.5, 3.21, 3.22	4.6.1			
<u>Group II 1/</u>					
Life -----	3.12	4.6.9	6	1	
Electrical characteristics (final) -----	3.10	4.6.7			
<u>Group III 2/</u>					
Solderability -----	3.13	4.6.10	3		
<u>Group IV 1/</u>					
Low-temperature operation ----	3.14	4.6.11	6		
Temperature rise -----	3.15	4.6.12			
Overload -----	3.16	4.6.13			
High-temperature exposure ---	3.17	4.6.14			
Electrical characteristics (final) -	3.10	4.6.7			
<u>Group V 1/</u>					
Moisture resistance -----	3.18	4.6.15	6		
Electrical characteristics (final) -					
Inductance -----	3.10.1	4.6.7.1			
Q -----	3.10.2	4.6.7.2			
<u>Group VI 1/</u>					
Bond strength -----	3.19	4.6.16	3		
<u>Group VII 3/</u>					
Fungus -----	3.20	4.6.17	6		

1/ The number of sample units indicated is for single-type submission qualification inspection. This quantity is doubled for combined-type submission where the lowest and highest inductance values of each style are to be tested.

2/ The units shall not have been previously subjected to any other tests.

3/ The fungus requirement is either by certification or performance.

MIL-PRF-83446C

4.5 Conformance inspection.

4.5.1 Inspection of product for delivery. Inspection of product for delivery shall consist of group A inspections.

4.5.1.1 Inspection lot. An inspection lot shall consist of all the coils produced under essentially the same conditions, and offered for inspection at one time. The manufacturer may combine coils of different inductance values and inductance tolerances. The inductance value shall be equally representative of the production lot (see 6.5) for that period.

4.5.1.2 Group A inspection. Group A inspection shall consist of the inspections specified in table IV, in the order shown.

TABLE IV. Group A inspection.

Inspection	Requirement paragraph	Method paragraph
<u>Subgroup I</u>		
Thermal shock -----	3.5	4.6.2
Electrical characteristics-----		
Inductance -----	3.10.1	4.6.7.1
Q -----	3.10.2	4.6.7.2
<u>Subgroup II</u>		
Turning torque (when applicable)	3.11	4.6.8
Visual and mechanical inspection -----	3.1, 3.3 through 3.4.5, 3.21 and 3.22	4.6.1
Electrical characteristics		
Self-resonant frequency -----	3.10.3	4.6.7.3
DC resistance -----	3.10.4	4.6.7.4
Percent coupling -----	3.10.5	4.6.7.5
Incremental current inductance charge -----	3.10.6	4.6.7.6
Effective parallel resistance --	3.10.7	4.6.7.7

4.5.1.2.1 Sampling plan. If, during the 100 percent inspection of subgroup I, screening requires that over 10 percent of the coils be discarded, the lot shall be rejected. For subgroup II a sample of parts shall be randomly selected from each inspection lot in accordance with table V, if one or more defects are found, the lot shall be rescreened and defects removed. After screening and removal of defects, a new sample of parts shall be randomly selected in accordance with table V, if one or more defects are found in the second sample, the lot shall be rejected and shall not be supplied to this specification. If the manufacturer can demonstrate that the group A inspections have been performed five (5) consecutive times with zero failures, the subgroup II sampling plan with the approval of the qualifying activity can be reduced to the requirements of table VI. If the design, material, construction or process of the part is changed or, if there are any quality problems or failures, the qualifying activity may require the resumption of the original sample size.

4.5.1.2.2 Rejected lots (subgroup I). A rejected lot can be screened and resubmitted one time, a resubmitted lot will also have a PDA requirement of 10 percent, however if a lot is rejected after the second submission it shall be rejected and not supplied to this specification.

MIL-PRF-83446C

TABLE V. Sampling plan.

Lot size	Group A	
	Subgroup I	Subgroup II
1 to 13	100 percent	100 percent
14 to 150	100 percent	13
151 to 280	100 percent	20
281 to 500	100 percent	29
501 to 1,200	100 percent	34
1,201 to 3,200	100 percent	42
3,201 to 10,000	100 percent	50
10,001 to 35,000	100 percent	60
35,001 to 150,000	100 percent	74
150,001 to 500,000	100 percent	90
500,001 and over	100 percent	102

TABLE VI. Reduced group A, subgroup II sampling plan.

Lot size	Subgroup II
14 to 150	5
151 to 1200	13
1,201 to 3,200	20

4.5.2 Periodic inspection. Periodic inspection shall consist of group C inspection except as specified in 4.5.2.1.3. Delivery of products that have passed group A inspection shall not be delayed pending the results of group C inspection.

4.5.2.1 Group C inspection. Group C inspection shall consist of the inspections in table VII, in the order shown. Group C inspection shall be made on sample units selected from inspection lots that have passed the group A inspection.

4.5.2.1.1 Sampling plan.

4.5.2.1.1.1 Quarterly (subgroup I). Every 3 months, three sample units of any inductance value shall be subjected to subgroup I inspection.

4.5.2.1.1.2 Semiannually (subgroup II). Every 6 months, 12 sample units, 6 of the highest and 6 of the lowest inductance values produced during that period (6 months) shall be inspected.

4.5.2.1.1.3 Quarterly (subgroup III). Every 3 months, three sample units of any inductance value shall be subjected to subgroup III inspection.

4.5.2.1.1.4 Semiannually (subgroup IV). Every 6 months, six sample units, three of the highest and three of the lowest inductance values produced during that period (6 months) shall be subjected to the subgroup IV inspection.

4.5.2.1.2 Disposition of sample units. Sample units which have been subjected to group C inspection shall not be delivered on the contract or purchase order.

MIL-PRF-83446C

TABLE VII. Group C inspection.

Inspection	Requirement paragraph	Method paragraph	Number of sample units to be inspected	Number of failures permitted
<u>Subgroup I (quarterly)</u>				
Bond strength -----	3.19	4.6.16	3	0
<u>Subgroup II (semiannually)</u>				
Thermal shock -----	3.5	4.6.2	}	1
Dielectric withstanding voltage -	3.7	4.6.4		
Barometric pressure (when applicable) -----	3.8	4.6.5		
Insulation resistance-----	3.9	4.6.6		
Electrical characteristics (initial) -----	3.10	4.6.7		
Low-temperature operation ----	3.14	4.6.11		
Temperature rise -----	3.15	4.6.12		
Overload -----	3.16	4.6.13		
Moisture resistance -----	3.18	4.6.15		
Electrical characteristics (final) -				
Inductance -----	3.10.1	4.6.7.1		
Q -----	3.10.2	4.6.7.2		
High-temperature exposure ---	3.17	4.6.14		
Electrical characteristics (final)	3.10	4.6.7		
Turning torque (when applicable)	3.11	4.6.8		
<u>Subgroup III (quarterly)</u>				
Solderability -----	3.13	4.6.10	3	0
<u>Subgroup IV(semiannually)</u>				
Electrical characteristics (initial)-----	3.10	4.6.7	}	1
Life -----	3.12	4.6.9		
Electrical characteristics (final) -	3.10	4.6.7		

4.5.2.1.3 Noncompliance. If a sample fails to pass group C inspection, the manufacturer shall notify the qualifying activity and the cognizant inspection activity of such failure and take corrective action on the materials or processes, or both, as warranted, and on all units of product which can be corrected and which were manufactured under essentially the same materials and processes, and which are considered subject to the same failure. Acceptance and shipment of the product shall be discontinued until corrective action, acceptable to the qualifying activity has been taken. After the corrective action has been taken, group C inspection shall be repeated on additional sample units (all inspection, or the inspection which the original sample failed, at the option of the qualifying activity). Group A inspection may be reinstated; however, final acceptance and shipment shall be withheld until the group C inspection has shown that the corrective action was successful. In the event of failure after reinspection, information concerning the failure shall be furnished to the cognizant inspection activity and the qualifying activity.

MIL-PRF-83446C

4.6 Methods of inspection.

4.6.1 Visual and mechanical inspection. Coils shall be inspected under magnification power (when necessary) to verify that the materials, design, construction, physical dimensions, markings, and workmanship are in accordance with the applicable requirements (see [3.1](#), [3.3](#) through [3.4.5](#), [3.21](#), and [3.22](#)).

4.6.1.1 Chip test handling procedures. When specified herein, the chip coil shall be tested while mounted on a test substrate as described in 4.6.1.2. For those test procedures where mounting requirements are unspecified, the chip coils may be tested unmounted using pressure type contacts.

4.6.1.2 Specified mounting. When specified in the test procedure, the chip coil shall be mounted on a suitable test substrate, which shall be a minimum of 95 percent alumina. The test substrate material shall be such that it shall not be the cause of, nor contribute to any failure of a chip coil in any of the tests for which it may be used. The test substrate shall be prepared with metallized surface land areas of proper spacing so that a minimum of 1.0 inch (2.54 mm) separates the chips when mounted. The metallized surface land areas shall be designed in a pattern to accommodate a number of coil chips. The metallization material shall be compatible with the bonding technique to be employed and the material used on the chip termination. The method of chip mounting for the different termination materials shall be as follows:

- a. All solderable and solderable/weldable terminations. Chip coils shall be mounted on the test substrate by soldering the chip terminations directly to the test substrate metallized land areas in the following manner:
 - (1) Solder and soldering flux, when used shall be selected to enable the parts to meet the requirements of this specification. Additional information and guidance on solder and flux is provided in paragraph [6.8](#).
 - (2) All chips shall then be placed across the metallized land areas of the test substrate with contact between the chip terminations and substrate land areas only.
 - (3) The test substrate with all chips in position shall then be placed in or on a suitable heat transfer unit (molten solder, hot plate, tunnel oven, etc.) with the temperature maintained at 260°C +/- 5°C until the solder melts and reflows forming a homogenous solder connection.
- b. Weldable termination material. Chip coils with weldable terminations shall be mechanically attached to the test substrate and electrically connected by thermo-compression bonding flying lead interconnections between the chip termination and the test substrate metallized land areas. The interconnecting lead shall be 0.001 inch (0.03 mm) diameter gold wire. The chip shall be mechanically mounted by any procedure, which will not be the cause of or contribute to any failures of the chip coil in any test.

4.6.2 Thermal shock (see [3.5](#)). Coils shall be tested in accordance with [method 107 of MIL-STD-202](#). The following details and exception shall apply:

- a. Mounting: Coils shall not be mounted. They shall be placed in containers, which allow circulation of air to each coil.
- b. Test condition: A-2 (50 cycles) for qualification and group C inspection; A (5 cycles) for group A inspection, step 3 shall be the maximum operating temperature.
- c. Measurements after cycling: Measurements after cycling shall take place after stabilization at room temperature and within 24 hours.

MIL-PRF-83446C

4.6.3 Winding continuity (see 3.6). All windings of coils shall be tested for electrical continuity by any suitable means that will not introduce currents in excess of the rated value.

4.6.4 Dielectric withstanding voltage (see 3.7). Chip coils shall be tested in accordance with [method 301](#) of [MIL-STD-202](#). The following details shall apply:

- a. Method of mounting: Chip coils shall be mounted on a test substrate by being soldered, welded, or held in place by pressure applied through the contact arm, so the terminals are shorted and accessible to the power source through the metallized land areas of the substrate. The contact arm or assembly shall be made of a resilient conducting material connected to ground and shall cover at least the entire surface opposite the terminals. Test fixtures shall be as specified on the applicable specification sheet (see [3.1](#)).
- b. Magnitude and nature of test voltage: The ac test voltage shall be a minimum of 500 volts rms for encapsulated units and 200 volts for conformal coated units unless otherwise specified (see [3.1](#)). The time duration for quality conformance inspection shall be not less than 2 seconds nor more than 60 seconds.
- c. Points of application of test voltage: Unless otherwise specified (see [3.1](#)), the test voltage shall be applied between the terminals of the coil connected together and the contact arm.
- d. Inspection after test: Coils shall be inspected for evidence of damage resulting from arcing, flashover, breakdown of insulation, or other damage.

4.6.5 Barometric pressure (when applicable) (see 3.8). Coils designed for operation above 10,000 feet shall be tested in accordance with [method 105](#) of [MIL-STD-202](#). The following details and exception shall apply:

- a. Method of mounting: Same as 4.6.4a.
- b. Test condition letter: As specified (see [3.1](#)).
- c. Magnitude and nature of test voltage: Unless otherwise specified (see [3.1](#)), coils shall be subjected to 60 Hz, ac test voltage at a minimum of 200 volts rms for encapsulated units and 80 volts rms for conformal coated units at 70,000 feet. For qualification inspection, the test voltage shall be applied for a period of 60 seconds and for quality conformance inspection, the time duration shall be not less than 2 seconds nor more than 60 seconds.
- d. Points of application of test voltage: Unless otherwise specified (see [3.1](#)), the test voltage shall be applied between the terminals of the coil connected together and the contact arm.
- e. Inspection after test: Coils shall be inspected for evidence of damage resulting from arcing, flashover, breakdown of insulation, or other damage.

MIL-PRF-83446C

4.6.6 Insulation resistance (see 3.9). Coils shall be tested in accordance with method 302 of MIL-STD-202. The following details and exception shall apply:

- a. Method of mounting: Same as 4.6.4a.
- b. Test condition letter: B, except that for coils with a dielectric withstanding voltage less than 500 volts (see 3.1 and 4.6.4b.), test condition letter A shall be used.
- c. Points of measurement: Unless otherwise specified (see 3.1), measurements shall be made between insulated points. For chip coils the measurements shall be made between the coil winding and the contact arm in the coil-connecting assembly as specified in 4.6.4a.

4.6.7 Electrical characteristics (see 3.1 and 3.10). The coils shall be mounted by their normal mounting means on their applicable test fixture. The electrical characteristics to be determined shall include inductance, Q, self-resonant frequency, and dc resistance. Additional electrical characteristics shall be measured when specified (see 3.1).

4.6.7.1 Inductance. Unless otherwise specified (see 3.1), effective inductance of coils shall be measured using the procedure detailed in 4.6.7.1.1.

4.6.7.1.1 Inductance measurement. The test shall be performed using a Q meter such as the Hewlett Packard (HP) model 260A, HP4342A, HP250B RX meter, or equivalent at appropriate test frequencies as listed in the instructions for the test equipment. Suitable means shall be used to calibrate the frequency of the Q-meter within ± 0.1 percent for the applicable test frequency. Frequencies to be used for testing the various ranges of inductance shall be as follows:

<u>Inductance range, μH</u>	<u>Reference test frequency, (MHz) for 260A</u>
Less than 0.1 -----	See 3.1
0.1 to 1.0 inclusive -----	25.0
Above 1.0 to 10.0 inclusive -----	7.9

Effective inductance shall be determined as follows when using the applicable test fixture. The appropriate test fixture shall be inserted in the Q-meter coil terminals. The Q-meter capacitance dial shall be set at 400 picofarads and the vernier capacitance dial at zero. The applicable shorting bar shall be inserted in the clips of the test fixture in such a manner that the terminals rest firmly against the stops, and so that the bar is centered between the test-fixture terminals. The Q-meter shall then be resonated using the frequency dial until a peak reading is obtained. This frequency shall be monitored in order to obtain an accuracy of 0.1 percent. This resonant frequency value in megahertz shall be recorded. The main capacitance dial shall be calibrated periodically in accordance with a routine calibration program for test equipment. The sum of the residual inductance of the Q-meter and the inductance of the test circuit shall be calculated from:

$$L_{cf} = \frac{1}{4\pi^2 F^2 C} - L_{bar}$$

Where: L_{cf} = Inductance in microhenries of the test fixture and residual inductance of the Q-meter.
 F = Frequency in megahertz.
 c = Capacitance in microfarads.
 L_{bar} = Calculated inductance in microhenries of the shorting bar as determined from the following formula:

MIL-PRF-83446C

$$L_{bar} = 0.002 \ell \left(2.303 \log_{10} \left(\frac{4\ell}{d} \right) - 1 + \mu\sigma + \frac{d}{2\ell} \right)$$

Where: σ = a quantity as a function of X and if σ is between 0.000 and 0.007, σ can be considered negligible.

$$X = 0.1405d \sqrt{\frac{\mu f}{p}}$$

Where: ℓ = Length of wire (cm).
 d = Diameter of cross section (cm).
 μ = Permeability of the material of the wire: $\mu = 1$ for brass or copper.
 p = Volume resistivity of wire in microhm-centimeters.
 f = Frequency in hertz.

The shorting bar shall then be removed and the Q-meter frequency shall be set to the frequencies specified in 4.6.7.1.1. The L-C dial of the Q-meter shall then be turned until the resonance meter indicates a peak reading. The inductance (L_d) shall be read directly on the L-C dial, using the inductance scale and the effective inductance (see 3.1) of the coil calculated from the formula:

$$L = L_d - L_{cf}$$

Where: L = Effective inductance in microhenries of coils.
 L_d = Inductance dial reading in microhenries.
 L_{cf} = Correction factor for inductance of test fixture and residual inductance of the Q-meter in microhenries.

4.6.7.1.2 Inductance (inductance greater than 10 microhenries). Test as specified in 4.6.7.1, except no allowance is made for residual inductance of Q-meter and inductance of test fixture. Frequencies to be used for testing various ranges of inductance shall be as follows:

<u>Inductance range, μH</u>	<u>Reference test frequency, (MHz)</u>
Above 10.0 to 100.0, inclusive	2.5
Above 100.0 to 1,000.0, inclusive	0.790
Above 1,000.0 to 10,000.0, inclusive	0.250
Above 10,000.0 to 100,000.0, inclusive	0.079

4.6.7.2 Q of coils. The test shall be performed using instruments such as the HP260A, HP4342A, HP250B RX meter, or equivalent. Note; HP250B Rx Meter measures R_p , the Q should be calculated using: $Q = R_p (2\pi F) C$, where R_p is in ohms, F is in megahertz, and C is in microfarads. Suitable means shall be used to calibrate the frequency of the instrument within ± 0.1 percent of the applicable test frequency. Frequencies to be used for testing the various ranges of inductance shall be as specified in 4.6.7.1.1 and 4.6.7.1.2.

MIL-PRF-83446C

4.6.7.3 Self-resonant frequency. Unshielded coils shall be placed in the field of a variable-frequency oscillator, such as McGraw-Edison Model 159 LF megacycle meter, or equivalent. The oscillator shall include a device for indicating the relative amount of power absorbed from the field (e.g., a grid-dip meter). Units shall be suspended or supported a minimum of 1.0 inch (2.54 mm) from any surface other than the test-fixture supports or oscillator coil. The frequency of the oscillator shall be varied through the frequency range near the self-resonant frequency specified (see 3.1). At any frequency in the frequency range where an abrupt increase in power absorption is indicated, the coupling between the oscillator coil and the unit under test shall be decreased, by increasing the separation between the coils, until a moderate dip in grid current results when tuning to this resonance. This frequency shall be considered the self-resonant frequency of the unit, and shall be accurately determined by suitable means to within ± 5 percent. A check shall be made for spurious indications due to a resonance not associated with the unit under test, by removing the unit from the field (at frequencies below 2.5 MHz, any suitable method may be used).

4.6.7.3.1 Alternate test method. When coils under test cannot be resonated by the method specified in 4.6.7.3, the test shall be performed using the instruments specified in 4.6.7.3.1, or equivalent. The coil shall be mounted in the appropriate test fixture (see 3.1). The tuning capacitor of the Q-meter shall then be set to approximately 400 pF, and the Q-circuit shall be resonated by adjusting the oscillator frequency of the Q-meter. The unit under test shall then be replaced with a shielded comparison inductor having an inductance about 4 percent of the unit under test, or a coil that will resonate in the Q-circuit at a frequency about 10 times the initial resonant frequency. The Q-meter shall then be set to a frequency approximately 10 times the initial resonant frequency, and the Q-circuit shall then be resonated at this new frequency. (This factor of 10 is based on the distributed capacitance of the unit under test being in the region of 4 pF, which is common for small coils. Higher distributed capacitances will lower the resonant frequency of the unit under test, and a factor smaller than 10 will prevail.) The unit under test shall then be connected across the capacitance terminals of the Q-meter, taking care to avoid coupling between the unit under test and the comparison coils. The Q-circuit shall then be re-resonated by means of the Q-tuning capacitor or the vernier-tuning capacitor, observing whether the capacitance has to be increased or decreased from its previous value, in order to restore resonance. If the capacitance has to be increased, the oscillator frequency shall be increased by 10 to 20 percent. If the capacitance has to be decreased, the oscillator frequency shall be decreased by the same amount. The unit under test shall then be disconnected from the Q-meter, and the Q-circuit shall be resonated to the new frequency by means of the Q-tuning capacitor. The previous procedure shall then be repeated, while at the same time changing the oscillator frequency by smaller increments as it approaches the resonant frequency of the unit under test, until the frequency reaches a value at which the Q-circuit capacitance is unchanged when the unit under test is connected or disconnected. The self-resonant frequency of the unit under test will then be the frequency of the oscillator and shall be accurately determined to within ± 0.2 percent (see 3.10.3).

4.6.7.4 DC resistance (see 3.10.4). Direct current (dc) resistance of coils shall be measured in accordance with method 303 of MIL-STD-202.

MIL-PRF-83446C

4.6.7.5 Percent coupling. The percent coupling of radiofrequency coils is determined by the formula below. Two coils with the same dash number shall be positioned under mounting means as specified (see 3.1). The inductance values are taken of the two coils, connected first series aiding (L_{T1}) and then series bucking (L_{T2}) at the frequency specified in table VIII. The ac test voltage shall be the lowest voltage across the coils that will permit the bridge to operate satisfactorily. The percent coupling is then calculated using the following formula:

$$\text{Percent coupling} = \frac{M}{\sqrt{L_1 L_2}} \times 100$$

Where: $M = (L_{T1} - L_{T2})/4$ = Coefficient of mutual inductance in microhenries.

L_{T1} = Total inductance series aiding (μH)

L_{T2} = Total inductance series bucking (μH)

The inductance values L_1 and L_2 in microhenries are the measured values of the two coils under measurement at the specified frequency in table VII.

TABLE VIII. Test equipment for percent coupling.

Inductance μH	Test frequency kHz	Instrument
≤ 1.0	100	Boonton Electronics 63H inductance bridge, or equal.
> 1.0 to 100 incl.	10	General Radio 1632-A inductance bridge, or equal
> 100	1.0	General Radio 1632-A inductance bridge, or equal

4.6.7.6 Incremental current inductance change (applicable to ferrite core materials only). Incremental current inductance change is the change in inductance between a measurement made with zero direct current superimposed and a measurement made with the specified incremental current superimposed (see 3.1). This test is performed using a General Radio Type 1633-A incremental inductance bridge, or equivalent at 10 kilohertz for inductance values between 10 and 100 microhenries, and 1 kHz for inductance values greater than 100 microhenries, and the General Radio Type 1632-A inductance bridge, or equivalent at 10 kHz for inductance values less than 10 microhenries. The ac test voltage to be used across the coil for bridge operation shall be determined by the following formula:

$$E = f \times 10^{-3} \sqrt{L}$$

Where: E = Voltage (rms) in millivolts.

f = Frequency in hertz.

L = Nominal value of inductance in microhenries.

This voltage is to be measured with one megohm impedance voltmeter connected directly across the coil. This voltmeter is disconnected prior to making the inductance measurement. The inductance of the coil under test shall be determined and recorded with zero dc current in the chip. The specified value of incremental current shall be applied through the chip and this inductance measurement recorded.

MIL-PRF-83446C

4.6.7.7 Effective parallel resistance. The test shall be performed using instruments such as the HP260A, HP4342A, HP250B RX meter, or equivalent test method. The oscillator controls shall be set at the specified measurement frequency followed by the insertion of a suitable work coil attached to the Q-meter coil terminals and the capacitor adjusted for resonance. The capacitance dial reading (C_1) and Q dial (Q_1) shall be recorded, also the "multiply Q by" meter dial, when it is other than XI, which is preferable. Connect the coil under test to the capacitance terminals and restore resonance by adjusting the capacitor. Record the Q dial reading (Q_2). The effective parallel resistance of the coil is calculated by the following formula:

$$R_p = \frac{159 Q_1 Q_2}{F C_1 (Q_1 - Q_2)}$$

Where: Q_1 = Q of the Q-circuit alone,

Q_2 = Q of the Q-circuit with the test coil connected to the Q-circuit.

R_p = Effective resistance in kilohms.

F = Frequency in megahertz.

C_1 = Capacitance in picofarads.

4.6.8 Turning torque (see 3.11) (applicable only to variable coils). Coils shall be exposed to a temperature of 25°C +10°C, -5°C. The coil under test shall be rigidly clamped by the body or firmly mounted on the test substrate. The tuning screw shall be rotated for eight cycles (16 excursions) from maximum core extension to minimum and return to maximum in one complete cycle while not exceeding the maximum or minimum torque specified (see 3.1). Each cycle shall take a minimum of 40 seconds to perform.

4.6.9 Life (see 3.12). Coils shall be tested in accordance with [method 108 of MIL-STD-202](#). The following details and exceptions shall apply.

- a. Test condition letter: F.
- b. Method of mounting: Chip coil sample units shall be mounted on a test substrate as specified in [4.6.1.2](#).
- c. Unless otherwise specified (see [3.1](#)), ambient test temperature and tolerance shall be 90°C ±2°C.
- d. Operating conditions: 100 percent rated cyclic loaded conditions (see [3.1](#)), 1.5 hours on and .5 hour off, for the applicable number of hours specified and at the ambient test temperatures. "On time" shall be three-fourths of the total lapsed time.
- e. Initial measurements: Initial measurements shall be performed at room temperature prior to subjecting the coil to the specified test temperature. These initial measurements shall be used as reference in determining degradation limits after exposure to the test temperature for each of the specified test intervals.
- f. Measurements after exposure to the test temperature: Final measurements shall be made after each of the following intervals: 250 +48, -0; 500 +48, -0; 1,000 +48, -0; and 2,000 +72, -0 hours. The coil shall be stabilized at room temperature for a minimum of 30 minutes after removal from the test chamber prior to taking measurements. Coils shall remain at room temperature for no greater period of time than necessary to perform the required measurements before return to that temperature.
- g. Degradation limits: Unless otherwise specified, coils shall not exceed the degradation limits specified (see [3.1](#)) for the 250-hour test interval and for succeeding test intervals up to and including the 2,000-hour test interval.

MIL-PRF-83446C

h. Inspection after test: Coils shall be inspected for evidence of mechanical damage.

j. Unless otherwise specified (see 3.1), room temperature and tolerance shall be +25°C +/- 5°C.

4.6.10 Solderability (see 3.13). Coils shall be tested according to MIL-STD-202, method 208. Both end terminations shall be immersed completely at a time.

4.6.11 Low-temperature operation (see 3.14). The coil shall be mounted on a substrate as specified in 4.6.1.2. The units shall then be placed in a cold chamber maintained at -55°C +0°C, -5°C. After 1 hour of stabilization at this temperature, full rated continuous dc current shall be applied for 45 minutes +5, -0 minutes. 15 +5, -0 minutes after the removal of the current, the coils shall be removed from the chamber and maintained at a temperature of 25°C ±5°C for approximately 24 hours. Coils shall then be inspected for evidence of mechanical damage.

4.6.12 Temperature rise (see 3.15). The temperature rise of chip coils shall be determined as specified in 4.6.12.1. This test shall be performed at the specified ambient temperature and with rated dc current applied (see 3.1). When the resistance of the winding, measured at 5-minute intervals, remains constant, the temperature of the winding shall be considered stabilized. If the method used for determining the resistance of the winding requires the removal of power, the measurement shall be made within 30 seconds after the removal of power.

4.6.12.1 Temperature rise determination. The coil under test shall be mounted on the test substrate. The test substrate with the attached coil shall then be placed in a test chamber that allows forced-air circulation to be shut off during testing. The test chamber shall be free of test-area drafts and direct thermal radiation. A temperature-indicating device with an accuracy of ±0.5°C shall be located in the area surrounding the coil under test, but not where it will be influenced by the temperature rise of the coil. The test chamber temperature shall then be stabilized at the specified ambient temperature (see 3.1). The dc resistance (r) shall be measured with one-tenth rated direct current applied at the specified ambient temperature (t). When the resistance of the coil is stabilized, the resistance value shall be recorded. The ammeter-voltmeter method may be used for determining this resistance provided the accuracy of these meters is ±0.5 percent or better and the resistance of the voltmeter is at least 1,000 ohms per volt. The rated direct current (see 3.1) shall then be applied to the coil under test, using a stable current source such as a storage battery. Forced-air circulation shall be shut off when rated current is applied. When the resistance of the coil under test is stabilized with rated current applied, the resistance (R) and the test chamber temperature (T) shall be recorded. The temperature rise (ΔT) shall be calculated by the following formula:

$$\Delta T = \frac{R - r}{r} (t + 234.5) - (T - t)$$

Where:

- ΔT = Temperature rise in °C above the specified ambient temperature of the coils under test.
- R = Resistance of coils in ohms with rated direct current applied at temperature (T + ΔT).
- r = Resistance of coils in ohms at temperature (t), the specified ambient temperature.
- t = Stabilized specified ambient temperature in °C of the coil under test without dc current applied.
- T = Ambient temperature in °C (at time forced-air circulation is shut off) with rated dc current applied. T shall not differ from t by more than 5°C.

4.6.13 Overload (see 3.16). Coils shall be mounted on test substrate as specified in 4.6.1.2. DC current equivalent to 1.5 times the specified rated current (see 3.1) shall be applied to the windings for 5 minutes minimum. After the test, chip coils shall be inspected for evidence of arcing, burning, and charring.

MIL-PRF-83446C

4.6.14 High-temperature exposure (see 3.17). The chip coils mounted on the test substrate as specified in 4.6.1.2, shall be subjected to the maximum operating temperature (temperature rise (see 4.6.12) plus maximum ambient temperature) +3°C, -2°C continuously for 100 ±4 hours, in a test chamber with forced-air circulation. The units shall then be stabilized at room ambient temperature for 4 to 12 hours.

4.6.15 Moisture resistance (see 3.18). Coils shall be tested in accordance with method 106 of MIL-STD-202. The following details shall apply:

- a. Mounting: As specified in 4.6.1.2.
- b. Polarization and loading voltage: No voltage shall be applied.
- c. Subcycle: Step 7b shall not be applicable. Step 7a shall be performed during any five of the first eight cycles only.
- d. Measurements at high humidity: None.
- e. Final measurements: Upon completion of step 6 of the final cycle, the coil shall be removed from the chamber and air-dried for 30 ±15 minutes, then the final measurements shall be made.
- f. Inspection after test: Coils shall be inspected for evidence of electrical and mechanical damage.

4.6.16 Bond strength (see 3.19). Coils shall be tested in accordance with method 2011 of MIL-STD-883. The following details apply:

- a. Test condition letter: F.
- b. Mounting: For components with terminal area on the mounting surface, and finishes A through F, mounting shall be as specified in 4.6.1.2a. For components where terminal areas are on the top or side, and finishes are A, D or E, mounting shall be as specified in 4.6.1.2b.
- c. Force: For solderable units use a force of 2 pounds for encapsulated units or 0.5 pound for conformal coated units.
- d. Inspection after test: Coils shall be inspected for evidence of mechanical damage.

4.6.17 Fungus (see 3.20). Unless certification is provided, coils shall be tested in accordance with method 508 of MIL-STD-810.

5. PACKAGING

5.1 Packaging requirements. For acquisition purposes, the packaging requirements shall be as specified in the contract or order (see 6.2). When actual packaging of materiel is to be performed by DoD personnel, these personnel need to contact the responsible packaging activity to ascertain requisite packaging requirements. Packaging requirements are maintained by the Inventory Control Point's packaging activity within the Military Department or Defense Agency, or within the Military Department's System Command. Packaging data retrieval is available from the managing Military Department's or Defense Agency's automated packaging files, CD-ROM products, or by contacting the responsible packaging activity.

MIL-PRF-83446C

6. NOTES

6.1 Intended use. Chip coils are intended to be used in hybrid circuits.

6.2 Ordering data. Procurement documents should specify the following:

- a. Title, number, and date of this specification.
- b. Title, number, and date of the applicable specification sheet, and the complete PIN (see 3.1).
- c. Special marking, if required (see 3.1).
- d. Packaging requirements (see 5.1).

6.3 Qualification. With respect to products requiring qualification, awards will be made only for products, which are, at the time of award of contract, qualified for inclusion in Qualified Products List QPL No. 83446 whether or not such products have actually been so listed by that date. The attention of the contractors is called to these requirements, and manufacturers are urged to arrange to have the products that they propose to offer to the Federal Government tested for qualification in order that they may be eligible to be awarded contracts or orders for the products covered by this specification. Information pertaining to qualification of products may be obtained from Defense Supply Center, Columbus, Post Office Box 3990, Columbus OH 43216-5000, Transformers@dla.mil.

6.4 Metallized termination. It should be noted that when pure silver is used for the terminations, silver migration between the terminations may occur under conditions of simultaneous application of high humidity and dc voltage. This produces a troublesome electrical leakage path across the coil chip. Addition of about 20 percent of palladium to the silver to form an alloy will retard the tendency toward silver migration. Complete over coating of the silver termination by the lead-tin bonding solder also will retard the tendency toward silver migration. Addition of about 3 percent of silver to the lead-tin bonding solder will tend to reduce the leaching of the silver from a silver termination during the solder bonding operation.

6.5 Production lot. A production lot consists of parts manufactured from the same basic raw materials, processed under the same specifications and procedures and produced with the same equipment. Each production lot of parts should be a group identified by a common manufacturing record through all significant manufacturing operations, including the final assembly operation. The final assembly operation should be considered the last major assembly operation, such as casing, rather than painting or marking, for example.

6.6 Additional data for preparation of specification sheets. Data submitted for preparation of specification sheets to MIL-PRF-83446 should specify the following in addition to the requirements of section 3.

6.6.1 Positioning of the coil for determination of the percent coupling (see 4.6.7.5), when applicable. The orientation of the coil with respect to one another should be specified with regard to an x, y, z coordinate system, where the x-axis is the length, the y-axis is the height, and the z-axis is the width of the coil (see figure 2).

6.6.2 Chip coil test fixture. Detailed drawings of the test fixtures should be submitted for inclusion on the specification sheets.

MIL-PRF-83446C

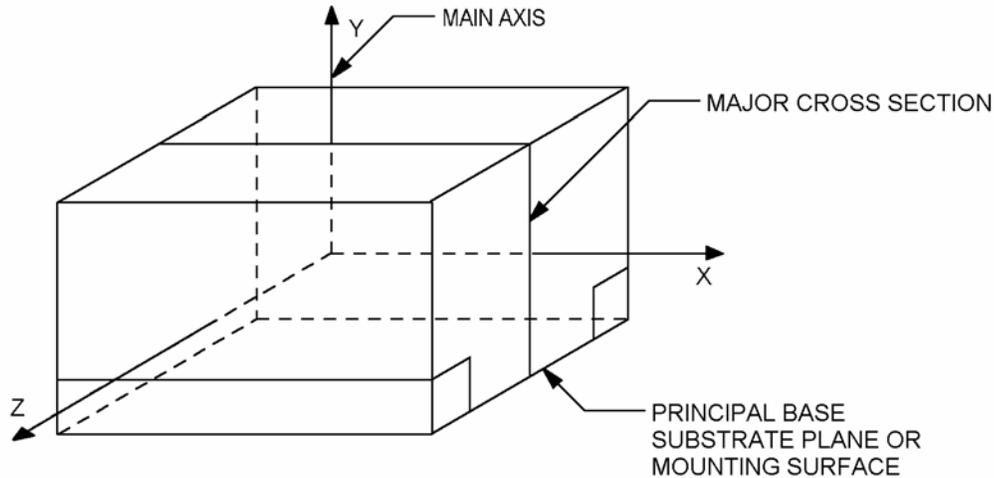
FIGURE 2. Orientation of chip coils.

6.7 Tin plated finishes. Tin plating is prohibited (see 3.4.6) since it may result in tin whisker growth. Tin whisker growth could adversely affect the operation of electronic equipment systems. For additional information on this matter, refer to ASTM B545 (Standard Specification for Electrodeposited Coatings of Tin).

6.8 Solder and soldering flux (see 3.3.2). It is recommended that solder and soldering flux to be in accordance with ANSI/J-STD-004, ANSI/J-STD-005 and ANSI/J-STD-006.

6.9 Magnet wire (see 3.3.4). It is recommended that NEMA Standards Publication MW-1000 be considered for magnet wire.

6.10 Environmentally preferred material. Environmentally preferable materials should be used to the extent possible to meet the requirements of this specification. Table IX lists the Environmental Protection Agency (EPA) top seventeen hazardous materials targeted for major usage reduction. Use of these materials should be minimized or eliminated unless needed to meet the requirements specified herein (see section 3).

Table IX. EPA top seventeen hazardous materials.

Benzene	Dichloromethane	Tetrachloroethylene
Cadmium and Compounds	Lead and Compounds	Toluene
Carbon Tetrachloride	Mercury and Compounds	1,1,1 - Trichloroethane
Chloroform	Methyl Ethyl Ketone	Trichloroethylene
Chromium and Compounds	Methyl Isobutyl Ketone	Xylenes
Cyanide and Compounds	Nickel and Compounds	

6.11 Changes from previous issue. Marginal notations are not used in this revision to identify changes with respect to the previous issue due to the extent of the changes.

MIL-PRF-83446C

APPENDIX

PROCEDURE FOR QUALIFICATION INSPECTION

A.1. SCOPE

A.1.1 Scope. This appendix details the procedure for submission of samples, with related data, for qualification inspection of coils covered by this specification. The procedure for extending qualification of the required sample to other coils covered by this specification is also outlined herein. This Appendix is a mandatory part of the specification. The information contained herein is intended for compliance.

A.2. SUBMISSION

A.2.1 Sample size.

A.2.1.1 Single-type submission. A sample consisting of 24-sample units of each inductance value and termination material for which qualification is sought shall be submitted. Six additional sample units shall be submitted for the fungus test if certification is not provided.

A.2.1.2 Combined-type submission. A sample consisting of 24-sample units of the lowest inductance value and 24-sample units of the highest inductance value, for a given termination material covered by a single specification sheet for which qualification is sought, shall be submitted. Six additional sample units shall be submitted for the fungus test if certification is not provided.

A.2.2 Description of items. The manufacturer shall submit a detailed description of the coil being submitted for inspection, including materials used for the construction of the coil. After qualification has been granted, no change shall be made in materials, design, or construction without prior notification to the qualifying activity.

A.2.1.3 Alternate termination finish. When qualification has been granted in accordance with A.2.1.1 or A.2.1.2 and qualification is sought for an alternate termination finish, the following procedures shall be used.

A.2.1.3.1 Single-type submission. A sample of six sample units of the alternate termination finish is required. Submit three sample units to the tests of groups I and VI of table III. Submit the remaining three samples to the tests of group III of table III.

A.2.1.3.2 Combined-type submission. A sample of nine sample units of the alternate termination finish is required. Submit six sample units (three of the highest and three of the lowest inductance value) to the tests of groups I and VI of table III. Submit the remaining three sample units to the tests of group III of table III.

A.3. EXTENT OF QUALIFICATION

The extent of qualification between termination materials shall be as follows:

Termination	Will qualify termination
A	A
B	B, C, F
C	C, B, F
D	D, E
E	D
F	B, C

MIL-PRF-83446C

Custodians:

Army - CR
Navy - EC
Air Force - 11

Preparing activity:
DLA - CC

(Project 5950-1178)

Review activities:

Army - AR, CR4, MI
Navy - AS, GC, MC, OS, SH
Air Force - 19, 99

NOTE: The activities listed above were interested in this document as of the date of this document. Since organizations and responsibilities can change, you should verify the currency of the information above using ASSIST Online database at <http://assist.daps.dla.mil>.