

MIL-HDBK-1040
28 FEBRUARY 1989

MILITARY HANDBOOK

BASIC GUIDELINES FOR CHEMICAL WARFARE

HARDENING OF NEW MILITARY FACILITIES



AMSC N/A

DISTRIBUTION STATEMENT A. APPROVED FOR PUBLIC RELEASE: DISTRIBUTION IS UNLIMITED

AREA FACR

MIL-HBK-1040

MIL-HBK-1040

ABSTRACT

The military requires that operations in mission-critical shore facilities are protected in the event of an attack with chemical weapons. This collective protection will afford a shirt-sleeve environment within the critical spaces in order that personnel may work unhampered by individual protective equipment.

A chemically warfare-hardened building consists of a toxic free area which provides a safe shelter for personnel, a contamination control area for personnel decontamination at the entry/exit, and protective facility support equipment. This handbook provides basic design criteria for the design of the chemically hardened facility. Criteria included are chemical, architectural, structural, mechanical, and electrical. The criteria are presented to permit design of facilities for any given number of personnel. Recommended architectural plans and illustrative examples are included to aid the designer.

MIL-HBK-1040

MIL-HBK-1040

FOREWORD

This military handbook has been developed from an evaluation of facilities in the shore establishment, from surveys of the availability of new materials and construction methods, and from selection of the best design practices of the Naval Facilities Engineering Command (NAVFACENGCOM), other Government agencies, and the private sector. This handbook was prepared using, to the maximum extent feasible, national professional society, association, and institute standards. Deviations from these criteria, in the planning, engineering, design, and construction of Naval shore facilities, cannot be made without prior approval of NAVFACENGCOMHQ Code 04.

Design cannot remain static any more than can the function it serves or the technologies it uses. Accordingly, recommendations for improvement are encouraged and should be furnished to Commanding Officer, Naval Civil Engineering Laboratory, Code L30, Port Hueneme, CA 93043; telephone (805) 982-5743.

THIS HANDBOOK SHALL NOT BE USED AS A REFERENCE DOCUMENT FOR PROCUREMENT OF FACILITIES CONSTRUCTION. IT IS TO BE USED IN THE PURCHASE OF FACILITIES ENGINEERING STUDIES AND DESIGN (FINAL PLANS, SPECIFICATIONS, AND COST ESTIMATES). DO NOT REFERENCE IT IN MILITARY OR FEDERAL SPECIFICATIONS OR OTHER PROCUREMENT DOCUMENTS.

MIL-HBK-1040

MIL-HBK-1040

BASIC GUIDELINES FOR CHEMICAL WARFARE HARDENING
OF NEW MILITARY FACILITIES

CONTENTS

	<u>Page</u>
Section 1	INTRODUCTION
1.1	Scope.....1
1.2	Application.....1
1.3	Special Considerations.....2
1.4	Definition of Acronyms.....2
1.5	Related Technical Documents.....3
Section 2	CHEMICAL THREAT
2.1	Introduction.....6
2.2	Definition of Terms.....6
2.3	Chemical Agent Characteristics.....7
2.3.1	Nonpersistent Agents.....7
2.3.2	Persistent Agents.....7
2.4	Effects of Chemical Agents.....7
2.4.1	Nerve Agents.....7
2.4.2	Blood Agents.....8
2.4.3	Vesicants.....8
2.5	Objective of a CW Attack.....8
2.6	Delivery Means.....8
2.6.1	Liquid Chemical Contamination Concentration.....9
2.7	Chemical Hardening.....9
2.7.1	Persistent and Nonpersistent Chemical Agents.....9
2.7.2	Toxic Free Environment.....9
2.7.3	Decontamination Procedures.....10
Section 3	ARCHITECTURAL DESIGN CRITERIA
3.1	Introduction.....17
3.2	Design.....17
3.2.1	Site Selection and Site Preparation.....17
3.2.2	Planning and Layout of Chemically-Hardened Facilities.....17
3.2.2.1	Specific Layout Considerations.....18
3.2.2.2	Operational and Noncritical Functions.....18
3.3	Construction and Materials.....18
3.3.1	Exterior Construction.....18
3.3.1.1	Windows.....18
3.3.1.2	External Doors.....20
3.3.1.3	External Utility Openings.....20
3.3.2	Interior Construction.....20

MIL-HBK-1040

	<u>Page</u>
3.3.2.1	CCA.....20
3.3.2.2	TFA.....26
3.3.2.3	Dirty and Clean Mechanical Rooms.....26
3.3.2.4	Coatings.....26
3.3.2.5	Gasket Material.....26
Section 4	STRUCTURAL DESIGN CRITERIA
4.1	Introduction.....27
4.2	Performance Requirements.....27
4.2.1	Operational Requirements.....27
4.2.2.1	CW External Envelope.....27
4.2.2.2	TFA.....28
4.2.2.3	CCA.....28
4.2.2.4	Dirty Mechanical Room (DMR).....28
4.2.2.5	CMR.....28
4.2.3	Protection Levels.....28
4.3	Design Explosive Threat.....28
4.4	Design Loads.....31
4.4.1	External Blast Overpressures.....31
4.4.1.1	Vertical Wall Loads.....31
4.4.1.2	Earth-Bermed Wall Loads.....32
4.4.1.3	Roof Loads.....32
4.4.2	Internal Leakage Pressure.....34
4.4.3	Primary and Secondary Fragments.....34
4.4.4	Ground Shock.....34
4.4.5	Combined Loads.....36
4.5	Reinforced Concrete.....36
4.5.1	Design Stresses.....36
4.5.1.1	Reinforcing Steel.....36
4.5.1.2	Concrete.....37
4.5.2	Allowable Deflections.....37
4.5.3	Design for Bending and Shear.....38
4.5.4	Reinforcement Details.....39
4.5.4.1	Concrete Cover.....39
4.5.4.2	Flexural Reinforcement.....39
4.5.4.3	Diagonal Bars.....39
4.5.4.4	Stirrups.....39
4.5.5	Spalling and Breaching.....39
4.5.5.1	Design Criteria for Breaching.....42
4.5.5.2	Design Criteria for Direct Spalling.....42
4.5.6	Fragment Penetration.....42
4.6	Blast Doors.....44
4.6.1	Design Concepts.....44
4.6.2	Design Stresses.....47
4.6.3	Allowable Deflections.....47
4.6.4	Design Procedures.....48
4.6.5	Fragment Penetration.....51

MIL-HBK-1040

	<u>Page</u>
4.7	Windows.....51
4.7.1	Materials.....51
4.7.1.1	Acceptable Materials.....51
4.7.1.2	Unacceptable Materials.....52
4.7.2	Window Design.....52
4.8	Blast Valves.....53
4.9	Barriers.....53
Section 5	MECHANICAL - HVAC DESIGN CRITERIA
5.1	Background.....55
5.1.1	Design Philosophy.....55
5.1.2	Shelter Room Arrangement.....55
5.1.2.1	Liquid Hazard Area.....55
5.1.2.2	Change Booth.....55
5.1.2.3	Vapor Hazard Area.....58
5.1.2.4	Airlock.....58
5.1.2.5	Toxic Free Area.....58
5.1.2.6	Mechanical Equipment Room.....58
5.1.2.7	Clean Mechanical Room.....58
5.1.3	Overview of Typical System Configuration.....58
5.1.4	Design Considerations.....59
5.1.5	Example CW HVAC Configuration.....59
5.1.5.1	Normal Operation Mode.....60
5.1.5.2	CW Operation Mode.....60
5.2	Design Calculations.....60
5.2.1	Calculation of Heating Load.....63
5.2.2	Calculation of Cooling Load.....63
5.2.3	Calculation of Moisture Load.....63
5.2.4	Calculation of Ventilation Air Requirements.....63
5.2.4.1	Normal Operation Mode Ventilation Requirement.....64
5.2.4.2	CW Operation Mode Ventilation Requirement.....64
5.2.4.3	Recommended Airflow Configuration.....64
5.2.5	Filter-Adsorber Sizing.....65
5.2.6	Airlock Design.....66
5.2.6.1	Air Velocity.....67
5.2.6.2	Air Shower.....67
5.2.7	Pressurization Requirements.....67
5.3	Mechanical Equipment Design and Selection
	Guidelines.....67
5.3.1	Cooling Equipment Selection.....69
5.3.1.1	Cooling Coils.....69
5.3.1.2	Condensing Unit.....69
5.3.2	Heating Equipment Selection.....69
5.3.2.1	Electric Resistance Heaters.....69
5.3.2.2	Hot-Water Coils.....69
5.3.3	Humidification Equipment Selection.....69
5.3.4	Ventilation Equipment Selection.....69

MIL-HBK-1040

	<u>Page</u>
5.3.4.1	Basic Design Criteria.....69
5.3.4.2	Elements of the CW Ventilation System.....70
5.3.4.3	Filter Housing.....70
5.3.4.4	Internal Components.....71
5.3.4.5	Prefilters.....71
5.3.4.6	HEPA Filters.....75
5.3.4.7	Adsorber Cells.....76
5.3.4.8	After-Filters.....77
5.3.4.9	Extreme Environmental Conditions.....77
5.3.4.10	Spacing.....78
5.3.4.11	Sizing and Unit Selection.....78
5.3.4.12	Blower Assembly.....80
5.3.4.13	Fresh Air Intakes/Exhaust.....81
5.3.4.14	Air Distribution.....81
5.4	HVAC System Controls.....83
5.4.1	General.....83
5.4.2	Local Loop Controls.....83
5.4.2.1	Supply Air Fan.....83
5.4.2.2	Cooling Coil.....84
5.4.2.3	Reheat Coil.....84
5.4.2.4	Humidifier.....84
5.4.2.5	Air Mixing Dampers.....85
5.4.2.6	System Control Valves.....85
5.4.2.7	Monitoring and Instrumentation.....85
5.5	Survivability and Reliability.....86
5.5.1	General.....86
5.5.2	Redundancy of Equipment.....86
5.5.2.1	Series Redundant System.....86
5.5.2.2	Parallel Redundant System.....86
5.5.2.3	Other Factors.....88
5.5.3	Survivability of Equipment.....88
5.5.3.1	Shock and Overpressure.....88
5.6	System Testing.....89
5.6.1	Normal Mode Operation.....89
5.6.2	CW Mode of Operation.....89
5.6.2.1	Air Distribution Test.....89
5.6.2.2	Filter-Adsorber System Test.....90
Section 6	MECHANICAL - PLUMBING SYSTEMS DESIGN CRITERIA
6.1	Criteria.....91
6.2	Domestic Water System.....91
6.2.1	Water Service.....91
6.2.1.1	Water Supply CW Mode.....92
6.2.2	Piping.....93
6.2.3	Hot Water Supply.....93
6.2.4	Fixtures.....94
6.3	Valves.....94

MIL-HBK-1040

	<u>Page</u>
6.3.1	Water Hammer Arresters.....94
6.4	Sanitary Drainage System.....94
6.4.1	Drainage System and Drainage Storage Tanks.....94
6.4.1.1	Uncontaminated Sewage Tank.....94
6.4.1.2	CCA Contaminated Sewage Tank.....95
6.4.1.3	Sewage Tank Details.....95
6.4.1.4	Contaminated Floor Drains.....95
6.4.1.5	Uncontaminated Floor Drains.....95
6.4.2	Traps.....95
6.4.3	Venting System.....95
6.5	Fuel Tank.....96
Section 7	MECHANICAL - FIRE PROTECTION DESIGN CRITERIA
7.1	Special Note.....98
7.2	Criteria.....98
Section 8	ELECTRICAL SYSTEMS DESIGN CRITERIA
8.1	Introduction.....99
8.2	General Requirements for CCAs and Airlocks.....99
8.2.1	Electrical Equipment Enclosures.....99
8.2.2	Cable Penetrations in Walls of CCA and AL.....99
8.3	Intercommunication System.....99
8.4	Closed Circuit TV (Optional for Some Facilities).....99
8.5	Pressurization and Airflow.....100
8.6	Water Supply.....100
8.7	Solid Waste and Wastewater Tanks.....100
8.8	Fuel Tank.....101
8.9	Electric Door Interlocks.....101
8.10	Airlock Doors.....101
8.10.1	Access Status Indicators.....101
8.10.2	Door Lock Time Sequences.....102
8.11	Remote Motors.....102
8.11.1	Status Indicators.....102
8.11.2	Remote Control.....103
8.12	Emergency Lighting.....103
8.13	Unique Generator Requirements.....103
8.14	Power Transfer Switch.....104
8.15	Connections for Portable Generators.....104
Section 9	STORAGE REQUIREMENTS
9.1	Storage Requirements.....105
9.1.1	General.....105
9.1.1.1	VHA.....105
9.1.1.2	TFA.....105
9.1.1.3	LHA (Supplies).....105

MIL-HBK-1040

	<u>Page</u>
9.1.2 Example.....	105
9.1.2.1 VHA.....	106
9.1.2.2 Decon Supplies.....	107
9.1.2.3 TFA.....	107
9.1.2.4 LHA.....	107
9.1.3 Summary.....	107
9.1.3.1 VHA.....	107
9.1.3.2 TFA.....	108
9.1.3.3 LHA.....	108
9.1.3.4 Total.....	108
 Section 10	
PHYSICAL SECURITY DESIGN CRITERIA	
10.1 Physical Security Criteria.....	109
 APPENDIX A - ESTIMATING CW MODE VENTILATION AIR REQUIREMENTS.....	110

FIGURES

1	Conceptual layout configurations.....	19
2	Entrance arrangements.....	21
3a	Plan contamination control area (CCA).....	22
3b	Section A.....	23
3c	Section B.....	23
3d	Section C.....	24
3e	Section D.....	24
3f	Section E.....	25
4a	Front wall loading: Idealized Normal Reflection Controls ($t_f < t_c$).....	33
4b	Front wall loading: Normal reflection, incident, and dynamic pressure controls (short clearing time, t_c).....	33
5a	Roof loading: Span parallel to traveling shock wave.....	35
5b	Roof loading: Span perpendicular to traveling to shock wave....	35
6	Typical section through conventionally reinforced concrete wall.....	40
7	Design criteria for single-leg stirrups.....	41
8	Design criteria to prevent breaching and direct spalling of reinforced concrete slabs.....	43
9a	Blast resistant door concepts - build-up and solid plate flexural doors.....	45
9b	Blast resistant door concepts compressive membrane doors.....	45
9c	Blast resistant door concepts - tensile membrane doors.....	46
9d	Blast resistant door - cushion support doors.....	46
10	System schematic.....	56
11	Typical CCA configuration.....	57
12	Example of HVAC system for CBR shelter.....	61
13	Wind pressure chart.....	68

MIL-HBK-1040

	<u>Page</u>
14	Typical particle size.....72
15	Comparison of HEPA filter life with and without prefilter.....73
16	Room airflow pattern.....82
17	Schematic of series redundant system.....87
18	Schematic of parallel redundant system.....87
19a	Single vent extension system.....97
19b	Multiventing system arrangements.....97
A-1	Model of CW shelter.....117
A-2	Central data monitoring panel.....118
A-3	Detail A.....119
A-4	Detail B.....120
A-5	Detail C.....121
A-6	Detail D.....122

TABLES

1	Chemical agent characteristics.....11
2	Protection level descriptions.....29
3	Protection level requirements at area interfaces.....30
4	Glazing thickness (inches) for interior area dividing doors.....52
5	Comparison of prefilters by percent removal efficiency for various particle sizes.....74
6	Airflow capacity, resistance, and dust-holding capacity of filters.....74
7	Typical characteristics of open-face HEPA filters.....76
8	Characteristics of standard military CW filtration units.....79
A-1	CW shelter design example.....111
BIBLIOGRAPHY.....125	
REFERENCES.....131	
INDEX.....136	

MIL-HBK-1040

MIL-HBK-1040

SECTION 1: INTRODUCTION

1.1 Scope. This handbook shall be used for the engineering design of new chemically-hardened military facilities. It provides information for the designer of the facility in the area of chemical/biological and mixed-munitions attack hardening of buildings. At the present this handbook is based upon design criteria developed and/or used by the U.S. military services and the private sector. The design criteria in this handbook will be revised or expanded as new information becomes available through experience and research or products and procedures. The contents include chemical threat considerations, and architectural, structural, mechanical, and electrical design criteria unique to chemical warfare protection.

THIS HANDBOOK SHALL NOT BE USED AS A REFERENCE DOCUMENT FOR PROCUREMENT OF FACILITIES CONSTRUCTION. IT IS TO BE USED IN THE PURCHASE OF FACILITIES ENGINEERING STUDIES AND DESIGN (FINAL PLANS, SPECIFICATIONS, AND COST ESTIMATES). DO NOT REFERENCE IT IN MILITARY OR FEDERAL SPECIFICATIONS OR OTHER PROCUREMENT DOCUMENTS.

1.2 Application. The military requires that operations in mission-critical shore facilities are protected in the event of an attack with chemical/biological agents and conventional weapons. This collective protection will afford a shirt-sleeve environment within the critical spaces in order that personnel may work unhampered by individual protective equipment.

Typical shore facilities requiring collective protection in operations spaces are:

- a) Communications Centers
- b) Command-Control-Communication (C3) Posts
- c) Squadron Operations/Briefing Spaces
- d) Intelligence Centers
- e) Photography laboratories intelligence material
- f) Explosive Ordnance Disposal (EOD) Research spaces
- g) Micro-miniature electronic repair facilities (avionics) and calibration laboratories
- h) Flight line clinics and branch hospitals
- i) Buildings housing special operations, on a case-by-case basis

MIL-HBK-1040

This handbook addresses only the design features unique to chemical/biological and mixed-munitions warfare protection. To arrive at a complete and integrated design, the conventional military design guidelines and applicable building codes must be followed conjunctively.

1.3 Special Considerations. This handbook differentiates between chemical/biological hardening and conventional weapons hardening (blast protection) of shore facilities. If design requirements stipulate chemical/biological hardening only, most of the structural criteria guidelines in this handbook may be ignored. However, it must be emphasized that any threat is likely to be mixed-munitions, i.e., the chemical attack will include conventional explosive weapons. The design threat referred to in the Structural Section will have to be stipulated by the appropriate command.

1.4 Definition of Acronyms. The following are definitions of acronyms listed in this Handbook:

AC	Hydrogen cyanide
acm	Air changes per minute
ADP	Automated data processing
AL	Airlock
AP	Armor piercing
ASHRAE	American Society of Heating, Refrigerating, and Air Conditioning Engineers
ASTM	American Society for Testing and Materials
C3	Command - Control - Communication
CB	Change booth
CBR	Chemical, biological, and radiological
CCA	Contamination control area
CCTV	Closed circuit television
CDMP	Central data monitoring panel
cfm	cubic feet per minute
CFR	Code of Federal Regulations
CG	Phosgene
CK	Cyanogen chloride
CMR	Clean mechanical room
CT	Concentration time
CW	Chemical warfare
DIF	Dynamic increase factor
DMR	Dirty mechanical room
DWDI	Double-width, double inlet
DX	Direct expansion
EOD	Explosive ordnance disposal
fpm	feet per minute
GB	Sarin
GD	Soman
HD/L	Mustard/lewisite
HEPA	High efficiency particulate air
HOB	Height of burst
HVAC	Heating, ventilating, and air conditioning

MIL-HBK-1040

IPE	Individual protection equipment
LC	Limited-combustible
LHA	Liquid hazard area
LSS	Life support system
mph	miles per hour
NATO	North Atlantic Treaty Organization
NAVFAC	Naval Facilities Engineering Command
NC	Normally closed
NFPA	National Fire Protection Association
NO	Normally open
psi	pounds per square inch
psig	pounds per square inch gauge
R	Range
r _u	Ultimate unit resistance in psi, for slabs and lb/in. for beams
R/C	Reinforced concrete
SWSI	Single-width, single inlet
TFA	Toxic free area
TGD	Thickened Soman (GD)
THD	Thickened mustard
TIR	Total indicator reading
TNT	Trinitrotoluene
UPS	Uninterruptible power supply
USAF	United States Air Force
VHA	Vapor hazard area
W	Weight
wc	Water column
wg	Water gauge

1.5 Related Technical Documents. The following documents will have to be obtained to effectively use this Military Handbook.

American Concrete Institute (ACI), P.O. Box 19150, Detroit, MI 48219

ACI 318-86	Building Code Requirements for Reinforced Concrete
------------	--

American Society of Heating, Refrigerating, and Air Conditioning Engineers (ASHRAE), 1791 Tullie Circle, N.E., Atlanta, GA 30329

ASHRAE	1988 Handbook - Fundamentals
ASHRAE	1988 Handbook - Equipment
ASHRAE GRP-158	Cooling and Heating Load Calculations Manual
ASHRAE STD-55-1981	Thermal Environmental Conditions for Human Occupancy

Army Armament Research and Development Center, Large Caliber Weapon Systems Laboratory, Dover, NJ 07801

ARLCD-SP-84001	Structures to Resist the Effects of Accidental Explosion, Volume III
----------------	--

MIL-HBK-1040

National Association of Plumbing Heating - Cooling Contractors (NAHPCC),
180 S. Washington Street, P.O.Box 6808, Falls Church, VA 22046

National Standard Plumbing Code

American Society of Plumbing Engineers (ASPE), 3617 Thousand Oaks Boulevard,
No. 210, Westlake, CA 91362

Fundamentals of Plumbing Design

Special Systems Volume

Building Official and Code Administrators International, 4051 W. Flossman
Road, Country Club Hills, IL 60477

Basic Plumbing Code

International Association of Plumbing and Mechanical Officials, 5032 Alhambra
Avenue, Los Angeles, CA 90032

Uniform Plumbing Code

National Fire Protection Association (NFPA), Batterymarch Park, Quincy,
MA 02269

NFPA No. 70

National Electric Code

NFPA No. 90A

Standard for the Installation of Air
Conditioning and Ventilating Systems

NFPA No. 90B

Standard for the Installation of Warm Air
Heating and Air Conditioning Systems

Naval Facilities Engineering Command reports available from Naval Publications
and Forms Center, 5801 Tabor Avenue, Philadelphia, PA 19120

DM-3 Series

Mechanical Engineering

DM-3.01

Plumbing Systems

DM-3.03

Heating, Ventilating, Air Conditioning, and
Dehumidifying Systems

MIL-HDBK-1004/1

Preliminary Design Considerations

MIL-HDBK-1004/4

Electrical Utilization Systems

DM-4.07

Wire Communication and Signal Systems

MIL-HDBK-144

Engineering Design Handbook for Air Cleaning
for Chemical Demilitarization

MIL-HDBK-1008A

Fire Protection for Facilities
Engineering, Design, and Construction

MIL-HBK-1040

MIL-HDBK-1013/1	Physical Security of Fixed Land-Based Facilities
MIL-HDBK-1190	Facility Planning and Design Guide
P-397	Structures to Resist the Effects of Accidental Explosions

Naval Facilities Engineering Command Guide Specifications are available from Naval Publications and Forms Center, 5801 Tabor Avenue, Philadelphia, PA 19120

NFGS-16202	Diesel Electric Generators (Design 1)
NFGS-16203	Diesel Electric Generators (Design 2)
NFGS-16204	Diesel Electric Generators (Design 3)
NFGS-16205	Diesel Electric Generators (Design 4)
NFGS-16208	Diesel Engine Generator Set
NFGS-16402	Interior Wiring Systems
NFGS-16760	Intercommunication System

Plumbing and Drainage Institute (PDI), 5342 Boulevard Place, Indianapolis, IN 46208

PDI-WH201	Water Hammer Arrestors
-----------	------------------------

Sheet Metal and Air Conditioning Contractors' National Association (SMACNA), P.O. Box 70, Merrifield, VA 22116

SMACNA	HVAC Duct Construction Standard - Metal and Flexible
--------	--

"Theory of Plates and Shells," by S. Timoshenko and S. Woinowsky-Krieger, 2nd edition, New York, McGraw-Hill, 1959.

Underwriters Laboratories (UL), 333 Pfingsten Road, Northbrook, IL 60062

UL-900	Test Performance of Air Filter Units
--------	--------------------------------------

MIL-HBK-1040

SECTION 2: CHEMICAL THREAT

2.1 Introduction. The Soviet Union's announced official policy with regard to the use of toxic chemicals in warfare coincides with the official United States position of "no first use." However, the reported use of chemical warfare agents by the Soviet forces in Afghanistan and Soviet allies in Yemen, Laos, and Kampuchea demonstrates Soviet policy and willingness to use chemicals in conventional (non-nuclear) wars.

The true intentions of the Soviet Union were exposed back in 1962 by key members of the Soviet intelligence service, and revealed the nature and extent of Soviet preparations for chemical and biological warfare. Among facts disclosed were:

a) The Soviets consider highly toxic agents to be "one of the most powerful means of destroying the enemy under modern combat conditions."

b) If hostilities should erupt, the Soviet Army would use chemical weapons against its opponents. The political decision had been made, and strategic military planners have developed a doctrine which permits the commander in the field to decide whether to use chemical weapons and when and where.

c) Chemical shells and missiles are considered just ordinary weapons available to the military commander to be used routinely by him when the situation calls for it.

d) The commander of the Army (front) makes the decision to use chemical weapons.

e) One of the most important uses for chemical missiles will be the destruction of the enemy's nuclear-strike capability.

f) Operational situations in which chemical weapons could be used to the greatest advantage, and the precautions required to prevent casualties to friendly troops, were pointed out to the military commanders.

2.2 Definition of Terms. The term chemical, biological, and radiological warfare, "CBR Warfare" is often used without realizing that these three agents are totally different kinds of agents, and have uniquely different effects on people. The three types of warfare are defined as follows:

a) Chemical Warfare (CW) agents are chemicals which are intended for use in military operations to kill, seriously injure or incapacitate man because of their physiological effects. Other chemicals such as riot control agents, herbicides and smoke and flame materials are also used in war.

b) Biological Warfare (BW) agents are microorganisms which cause disease in man, plants or animals or cause deterioration of material. This also includes toxins, naturally made by microorganisms or genetically engineered by man, which also produce disease in man.

MIL-HBK-1040

c) Radiological Warfare (RW) involves the employment of nuclear weapons which cause death and injury due to flash, blast, burns (thermal) or radiation.

The same procedures, equipment, and systems provide protection from all three types of airborne antipersonnel agents (CBR).

2.3 Chemical Agent Characteristics. The objective in employing chemical agents is to cause personnel casualties and deny the use of terrain by mass dissemination of agents over large areas. The inventory of chemical agents includes: nerve, blood, and vesicant (choking and blistering) agents in vapor, aerosol, and liquid forms. Most chemical agents, which may be classified as persistent or nonpersistent, are listed in Table 1.

2.3.1 Nonpersistent Agents. Nonpersistent agents include those with comparatively low boiling points and correspondingly high volatility; these agents turn into gases (vapors) rapidly. When a munition containing nonpersistent agents explodes, a vapor is formed, creating a surface-level poison cloud, which spreads in the direction of the wind and dissipates quickly. The dissipation speed depends on meteorological conditions and local terrain. Current chemical warfare nonpersistent agents include hydrogen cyanide (AC), Sarin (GB), cyanogen chloride (CK), and phosgene (CG). These nonpersistent agents injure personnel through the respiratory system. In cold weather these agents, such as GB, can be persistent.

2.3.2 Persistent Agents. Persistent agents have a high boiling point, are characteristically less volatile (they do not vaporize very readily). These agents present a threat of increased duration because they can remain slowly evaporating from contaminated surfaces. The persistence of agents can be enhanced by adding a few percent of plasticizer to the agent; this is called agent thickening. Persistent agents include: mustard/lewisite (HD/L), thickened mustard (THD), Soman (GD), thickened GD (TGD), and nerve agent VX. The persistence of the agent depends on several factors other than the agent itself. Such factors are winds, temperature, weather, and the nature of the contaminated surface. The rate of evaporation of a liquid agent from a surface is increased by higher wind velocities and temperatures. The agents persist much longer on cold Northern surfaces than the hot surfaces of the tropics. The persistent agents remain on site for several hours in the summer to several days or weeks in the winter.

2.4 Effects of Chemical Agents

2.4.1 Nerve Agents. Nerve agents do their damage by inhibiting the production of cholinesterase and, thus, interfering with neural transmission within the sympathetic nervous system. Cholinesterase deactivates acetylcholine, the enzyme that transmits neural impulses across synapses. In general, nerve agents are fast acting and deadly. Their action is similar to that of pesticides against insects. Death results from cessation of breathing due to excessive stimulation of the autonomic nervous system. Routes of toxicity for nerve agents include inhalation of vapor, dermal exposure to vapor and liquid, and

MIL-HBK-1040

ocular exposure. The latter results in miosis, an excessive contraction of the eye's pupil resulting in "pinpoint pupils," even if only small quantities of the agent are present. Other symptoms include dimness of vision, excessive salivation and perspiration, muscle twitching, and breathing difficulty. GB is a nonpersistent nerve agent that evaporates quickly once it is deployed. GD evaporates more slowly. Its greater persistence in liquid form creates a vapor hazard over a longer period of time, although the vapor concentrations are not likely to reach as high a level as those of GB. The Soviets are known to possess both GB and GD. It has been reported that an entire German chemical agent production facility was captured by the Russians during World War II, after which it was dismantled and moved in its entirety behind the Iron Curtain. The Soviets are also thought to have a thickened agent very much like thickened GD.

2.4.2 Blood Agents. Blood agents inhibit the cytochrome oxidase system, thereby interfering with the transfer of oxygen to the cells. It is the oxygen deprivation of the cells that causes death. Hydrogen cyanide is the most prominent of this class of agents, but it is difficult to weaponize efficiently. It is, however, a potent agent for nonpersistent applications by a spray tank or other bulk delivery means.

2.4.3 Vesicants. Vesicants cause their damage in liquid or vapor form by causing blistering and tissue destruction on the skin or in the eye on contact. Damage also occurs in the lungs when the agent vapors are inhaled. If a sufficient quantity of agent vapor is inhaled, death results from pulmonary edema. With severe exposure, death usually occurs from 7 to 14 days after exposure. The major problem is the length and intensity of medical care required for these casualties who must be treated primarily as burn patients. The insidious nature of this effect and the delayed death make this agent an especially feared threat and one against which precautions should be taken. Mustard is a particular threat in this category. It is low in volatility and, under certain conditions, can persist for long periods of time. Furthermore, it can be thickened so that it is even more difficult to remove than in an unthickened condition. Lewisite is less toxic than mustard and, although it decomposes in the presence of water, the intrinsic toxicity of the arsenic is retained.

2.5 Objective of a CW Attack. The objective of a CW attack determines the type of agent an enemy is likely to use. An attack with persistent chemical agents is likely if the intent of the enemy is to deny the use of critical equipment, facilities, or terrain for long periods of time. Such an attack might be directed against stationary centers of intense military activity, such as Naval bases and airfields. An attack with a nonpersistent agent could be used on an amphibious assault beachhead with the goal to produce casualties immediately. In order to continue to maintain a high level of casualty production with a nonpersistent agent, repeated attacks would be necessary.

2.6 Delivery Means. Chemical agents may be delivered to a base by any of the four following delivery means:

- a) Aircraft spray tanks

MIL-HBK-1040

- b) Artillery and mortar shells
- c) Tactical ballistic missiles
- d) Aerial bombs

Unlike conventional weapons, chemical weapons are used primarily to be effective against living targets. The advantage of their use occurs in the killing or degradation of efficiency of personnel. Only a slight amount of incidental damage may be expected from the small quantity of high explosive used in most chemical munitions. Through the use of these multiple delivery systems, Soviet or Soviet-equipped and trained forces could initiate and sustain large-scale CW operations in either a conventional or conventional-nuclear conflict. Their doctrine emphasizes using chemical weapons in close coordination with conventional and nuclear weapons to capitalize on the attributes of each. The threat of CW is as great to the rear area as it is to forces operating in the main battle areas.

2.6.1 Liquid Chemical Contamination Concentration. A Soviet chemical weapon is expected to disperse liquid agents at a chemical contamination concentration of 5 g/m² over a horizontal surface area.

2.7 Chemical Hardening. To be effective against man, all chemical agents must gain entry into the body by inhalation and/or absorption through the skin or eyes. Protection against all known battlefield agents is absorbed by proper filtering of one's air supply and by completely covering the body with a protective cover that prevents or at least slows the absorption rate until more adequate protection can be provided. Military personnel will be subject to such a contaminated environment and will be required to use and incorporate the individual protection equipment (IPE).

2.7.1 Persistent and Nonpersistent Chemical Agents. A chemically-hardened facility protects personnel from both persistent and nonpersistent chemical agents. Shelter operation need not be drastically affected by the presence of nonpersistent agents because once the vapor cloud has passed, shelter operations return to normal. The use of persistent agents, however, greatly hampers operations even after the original chemical cloud has passed because the surfaces contaminated with the persistent agent continue to release vapor (secondary vapor hazard). Persistent agents also can be picked up and transferred to other surfaces (contact hazard).

2.7.2 Toxic Free Environment. The primary objective of chemically hardening a military facility is to provide a toxic free environment in which military personnel can rest, eat, satisfy their physiological needs, replace their protective clothing, and/or for sheltering communications, command, and control personnel and equipment. The chemically hardened facility must provide a toxic free environment in which all required functions and procedures may be performed without the encumbrance of individual protective ensembles or masks.

MIL-HBK-1040

The maximum contamination level in the toxic free area shall not exceed 5 mg-min/m³ over a period of 12 hours. In the decontamination station (contamination control area), specifically in the vapor hazard area, the contamination level shall not exceed 100 mg-min/m³ (mustard) over a 6-minute period.

NOTE

To gain entrance into the chemically-hardened facility, personnel must follow strict decontamination procedures while passing through the decontamination station called "Contamination Control Area," which is an integral part of the chemically hardened facility.

2.7.3 Decontamination Procedures. The personnel decontamination procedures for entry/exit into the chemically hardened facility are not standard throughout the U.S. military services. U.S. Air Force (USAF) personnel doff and store their IPE while Navy personnel cut and discard the outer protective garment of the IPE. It is believed that in the near future the Navy will follow the USAF's procedures and will also store the outer protective garment. If this does occur, then the CW shelter designer must dedicate space in the CCA for outer garment storage (Section 3).

MIL-HBK-1040

Table 1
Chemical Agent Characteristics

Part A

Code Name		Chemical Name	Synonyms	Military Employment	FP/BP (°C)	Decomposition Temp (°C)	Average Lethal Dosage (mg-min/m ³)
US	USRR						
AC	R2	Hydrogen cyanide	Prussic acid hydrocyanic acid	Lethal	-14/26	65.5	V W/C ²
BZ		Diphenyl (hydroxy) acetic acid, 3-quinuclidinyl ester	3-Quinuclidinyl benzilate	Incapacitant			
CG		Phosgene	Carbonyl chloride	Lethal		800	3,200 (C) ³
CK		Cyanogen chloride		Lethal	-7/13	100	1,100
CN		a-chloroacetophenone	Phenacylchloride	Harassing	54/244	Stable to GP	11,000
CS		a-chlorobenzylidenemalonic acid, dinitrile	o-chlorobenzal-malononitrile	Harassing	93/310		25,000
CX		Phosgene oxime	Dichloroformoxime	Harassing	39/53		
DC		Diphenyl chloroarsine	Clark 1	Harassing	44/307	300	15,000
DC		Diphenyl cyanoarsine	Clark 2	Harassing	30/290	300	10,000

continued

MIL-HBK-1040

Table 1
Chemical Agent Characteristics (Continued)

Part A

Code Name		Chemical Name	Synonyms	Military Employment	FP/BP (°C)	Decomposition Temp (°C)	Average Lethal Dosage (mg-min/m ³)
US	USRR						
DM		10-chloro-5, 10-dihydrophenarsazine	Adamsite	Harassing		>410	15,000
DP		Chloroformic acid, Trichloromethyl ester	Diphosgene	Lethal	-57/127	300	3,200 ³ (C)
GA		Ethyl Dimethylphosphoramidocyanidate	Tabun	Lethal		130	40
GB	R35	Isopropyl methylphosphonofluoridate	Sarin, zarin	Lethal			100
GD		3-3-dimethyl-2-butyl methylphosphonofluoridate	Soman, zoman	Lethal			
G Type		Alkyl ester of alkylphosphonofluordic acid, or alkyl ester of dialkylphosphoramidocyanidic acid		Lethal			

continued

MIL-HBK-1040

Table 1
Chemical Agent Characteristics (Continued)

Part A

Code Name		Chemical Name	Synonyms	Military Employment	FP/BP (°C)	Decomposition Temp (°C)	Average Lethal Dosage (mg-min/m ³)
US	USRR						
H	R74	Bis (2-chloroethyl sulfide)	Sulfur mustard, yperite	Lethal	14/227	199-177	Inhalation-1,500 absorption-10,000
HL	RK7	See H, and L	Mustard-lewisite mixture	Lethal			
HN-3		Tris (2-chloroethyl) amine	Nitrogen mustard	Lethal	-4/144	<144	Inhalation-1,500 absorption-10,000
L	R43A	Dichloro(2-chloro-vinyl) arsine	Lewisite	Lethal	-18/190	100	Inhalation-1,200 absorption-100,000
PS		Trichloro-nitro-methane	Chloro-picrin	Harassing	64/112		
V-Type		O-alkyl S-2-dialkyl-aminoethyl ester of alkylphosphonothioic acid		Lethal			
VX		O-ethyl S-2-diisopropylaminoethyl methyl-phosphonothioate		Lethal			
	VR55			Lethal			

continued

MIL-HBK-1040

Table 1
Chemical Agent Characteristics (Continued)

Part B

Code Name		Average Incap. Dosage (mg-min/m ³)	Rate of Action ¹	Duration of Effectiveness	Agent Action On Materials	Decontaminants
US	USRR					
AC	R2	V W/C ²	A	Short (min)	None	None required under field conditions - aeration low rate of hydrolysis under field conditions
BZ						Personnel - soap/water wash Material - Hypochlorite or alcohol-caustic or detergent wash and scrub
CG		1,600	D 3 hr AH	Short (min)	None when dry. Acidic and corrosive when wet	None required under field conditions aeration. Hydrolysis by rain and vegetation
CK		7,000	A	Short (min)	None	None required under field conditions. Low rate of hydrolysis under field conditions
CN		80	A	Short - Disseminated as aerosol	Slightly corrosive to steel	Aeration, soda ash soln. or alcoholic caustic soda. Not readily hydrolyzed

continued

MIL-HBK-1040

Table 1
Chemical Agent Characteristics (Continued)

Part B

Code Name		Average Incap. Dosage ³ (mg-min/m ³)	Rate of Action ¹	Duration of Effectiveness	Agent Action On Materials	Decontaminants
US	USRR					
CS		10-20	A	Short (min)	Slightly corrosive to steel	Aeration, water
CX			A			Water
DC		12	A	Short - Disseminated as aerosol	None when dry	None required in field. Caustic soda or hypochlorite for gross contamination. Rapid hydrolysis when finely divided
DC		30	A	Short - Disseminated as aerosol	None	None required in field. Alkali solution or DS2. Slow hydrolysis
DM		22	A	Short - Disseminated as aerosol	None when dry	None required in field. Hypochlorite or DS2. Rapid hydrolysis when in aerosol form
DP		1,600	D 3 hr AH		Metals act as catalysts to convert to CG	None required in field. Line steam, ammonia, aeration
GA		300	A	1-2 days	None	Hypochlorite, dilute alkali solution, ammonia, hot soapy water

continued

MIL-HBK-1040

Table 1
Chemical Agent Characteristics (Continued)

Part B

Code Name		Average Incap. Dosage ³ (mg-min/m ³)	Rate of Action ¹	Duration of Effectiveness	Agent Action On Materials	Decontaminants
US	USRR					
GB		75	A	10 min - 12 hr	Slightly corrosive to steel	Hypochlorite, dilute alkali solution DS2. Steam and ammonia. Hot soapy water
GD			A	1-2 days	Slightly corrosive to steel	Hypochlorite, dilute alkali solution DS2. Steam and ammonia. Hot soapy water
H	R74	200 in eye 2,000 absorption 10,000	D 4 hr	1-2 days	Slightly corrosive to steel	Hypochlorite, DANC solution, M5 ointment, fire, DS2
HN-3		Eye inj. - 200-adsorption-2,500	D 4 hr	1-2 days	None when dry	Hypochlorite, DANC solution fire, DS2 M5 ointment
L	R43A	Eye inj. - 300 absorption-1,500	A	1-2 days	None when dry	Hypochlorite, DANC solution fire, DS2, M5 ointment, rapid hydrolysis
V-Type						Hypochlorite, DANC solution, DS2 solution

¹A - very rapid.

AH - very rapid only at high concentration.

D - delayed at low concentration.

²V W/C - varies with concentration.

³C - cumulative.

MIL-HBK-1040

SECTION 3: ARCHITECTURAL DESIGN CRITERIA

3.1 Introduction. This section defines the criteria for chemically-hardened facilities. If protection criteria also includes the threat from conventional weapons, the section on structural requirements will supplement and, in some instances, modify the information presented in this section.

The essential components of a chemically protected facility are:

- a) A structure with strictly controlled infiltration/exfiltration.
- b) A contamination control area (CCA) for decontamination of ingressing personnel and safe egress from the building.
- c) A filter-air blower system that provides uncontaminated breathing air, overpressurizes the operational areas, i.e., toxic free area (TFA) and creates a purging airflow through the CCA.
- d) The TFA is the pressurized, clean-air space accessed and exited via the airlock and CCA which permits personnel to work and rest without wearing individual protective equipment.
- e) Life sustaining facilities and amenities such as chemical toilets, emergency water supplies, and food stuffs sufficient to support personnel for 7 days.

For a description of the individual facility components, refer to Section 5.

3.2 Design.

3.2.1 Site Selection and Site Preparation. Where possible, chemically-hardened facilities should be sited at maximum distance from tactical targets (runways, aircraft aprons, pier facilities, or industrial areas). Sites should be upstream of the prevailing winds on the station. Depressions and stagnant air locations are to be avoided. The individual site should be well drained and the ground sloped away from all exterior building surfaces. Landscaping features like trees, shrubs, or bushes should be kept away from buildings a minimum of 10 feet (3.05 m) to facilitate natural ventilation around the structure, and to prevent nearby local accumulation of agents. It is preferred to install concrete pavement around the building to provide drainage away from the structure.

3.2.2 Planning and Layout of Chemically-Hardened Facilities. The planner should bear in mind that rooms with mission critical functions often require maintenance support for critical equipment. For instance, in the case of communication centers, terminal and cryptographic equipment maintenance functions are essential. These support activities should be housed in the chemically-hardened building. Functions of avionics maintenance requiring a toxic-free environment should be consolidated in one structure. Intelligence operations should be consolidated with their own photographic processing laboratories.

MIL-HBK-1040

3.2.2.1 Specific Layout Considerations. The layout of spaces in a chemically-hardened facility requires an unconventional approach. Since these structures must function in a normal or peacetime environment for most of their useful life, it is required that chemical protection features like CCAs, airlocks, and chemical filtration equipment not be subjected to the normal, day-to-day wear and abuse of foot traffic operation and maintenance. The CCA and airlock should be adjacent to the toxic-free operational spaces and kept in a standby status. The peacetime main entrance and lobby spaces are designed to be blocked and sealed prior to chemical attack, when the CCA becomes the main entry point. This arrangement will also facilitate compliance with existing life safety codes (see Paragraph 3.3.1).

The clean mechanical room (CMR) housing air conditioning equipment, emergency water heaters, and ancillary equipment should be located centrally to the toxic-free areas to avoid long, vulnerable duct and utility runs, and to provide immediate access. Interior spaces should be integrated and arranged to achieve a building with a rectangular floor plan. Interior corners in the building facade are to be avoided as they create unacceptable blast loads and allow chemical vapor accumulations.

3.2.2.2 Operational and Noncritical Functions. By necessity, some buildings will house both operational and noncritical functions such as administrative and supply support. Where these noncritical spaces exceed 50 percent of the total net floor space of the building, they should be consolidated and put into a part of the structure not to be chemically hardened, since it will not be cost-effective to protect the noncritical spaces. Provisions will be made in the design to effectively seal off the mission-critical spaces from the nonoperational area by choice of different construction materials for partitions, finishes, doors, hardware, gaskets, mechanical and electrical systems, and by variation of partition heights and ceiling continuity.

In geographical areas where basement construction is traditional, or when a building is sited on a slope, critical spaces should be located in the basement or lowest floor level possible. Various examples of conceptual layout configurations are shown in Figure 1.

3.3 Construction and Materials.

3.3.1 Exterior Construction. Exterior walls shall be substantial, either of reinforced concrete or reinforced concrete masonry construction with all cells grouted. Exterior surfaces shall be sealed with compatible coatings to produce a smooth finish that is both resistant to chemical agents, as well as decontamination agents. Roofs shall be of substantial construction, well-drained without parapets.

3.3.1.1 Windows. In chemically-hardened facilities, the installation of windows should be avoided. Where it is necessary to install windows for operational reasons, they should be provided with metal shutters. Windows should be in metal frames with vertical and horizontal mountings to keep the

MIL-HBK-1040

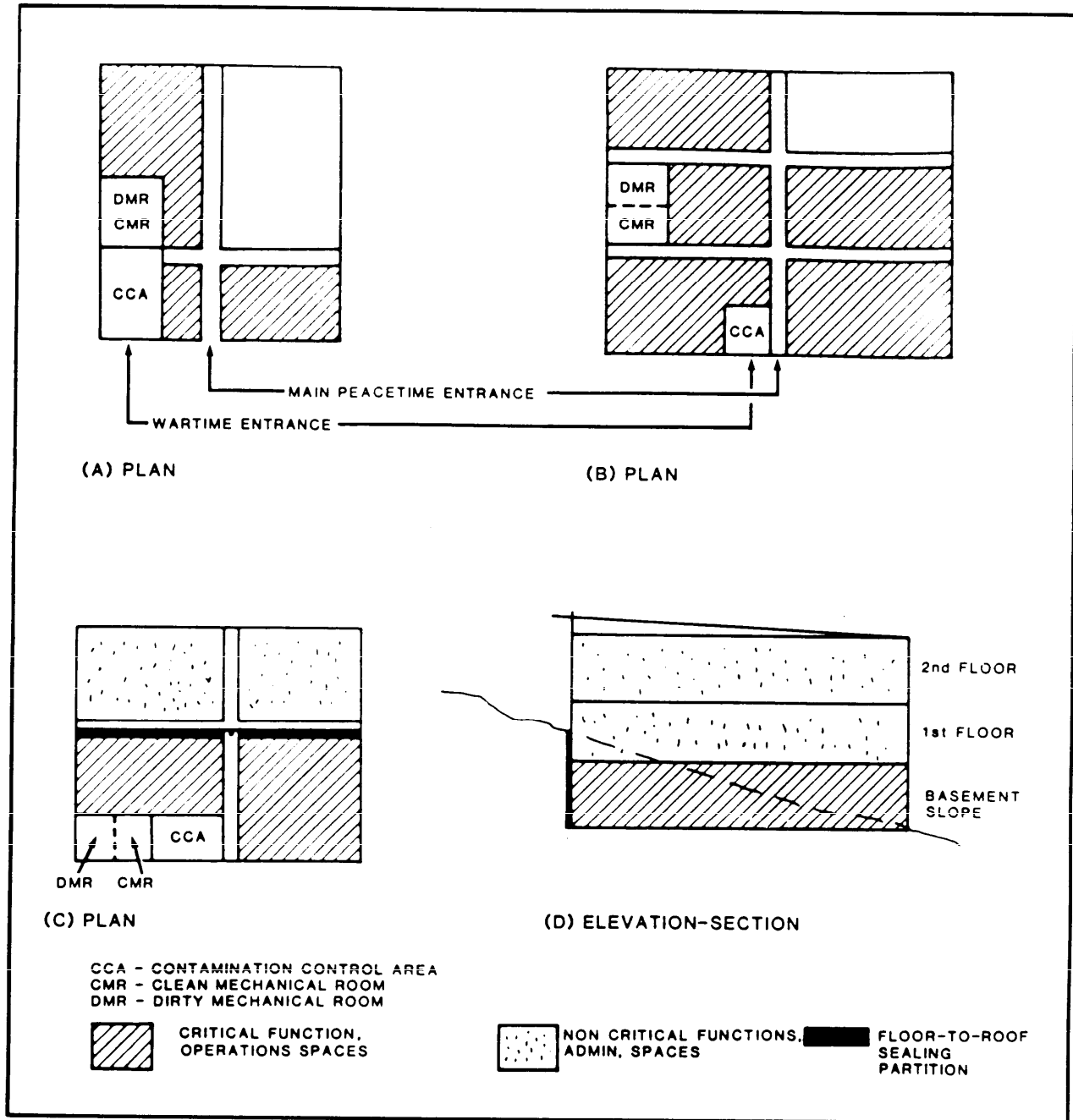

Figure 1
 Conceptual Layout Configurations

MIL-HBK-1040

size of any single glass area to a maximum 75 in² (0.048 m²). Glazing shall be thermally tempered. Operable windows shall be equipped with butyl rubber seals to provide air tightness when closed.

3.3.1.2 External Doors. The number of exterior doors shall be kept to a minimum. The main entrance, CCA exterior doors, and mechanical room doors should be single, metal type in metal frame, and solid core construction. Size shall be adequate to permit access for mechanical equipment. Weather stripping shall be butyl rubber to provide an effective seal when closed. For mixed-munitions hardened facilities, blast doors shall be installed to protect door openings.

One emergency exterior or interior door from the TFA is required. In the event that the TFA represents 100 percent of the building, then either install one exterior blast door at the back side of the building (3.28 feet (1 m) wide by 3.28 feet (1 m) high) located just below the ceiling, or use the dirty mechanical room's exit door as an emergency exit door.

3.3.1.3 External Utility Openings. Other necessary exterior openings into the protected area like makeup air grills to the chemical filter system shall be protected by blast attenuating shields. These barriers may be steel plate (7/8-inch (22.23-mm) thick) or equivalent reinforced concrete. Their installation shall permit access for maintenance. Typical entrance arrangements are shown in Figure 2.

3.3.2 Interior Construction.

3.3.2.1 CCA. The CCA has four main areas: the liquid hazard area (LHA), change booths (CB), vapor hazard area (VHA), and airlocks (AL). Figure 3 details a typical CCA. Walls and partitions, where shown, shall consist of epoxy-glazed concrete masonry units. Ceilings, floor, remaining partitions, and grout lines shall receive a finish coating of either epoxy or urethane paint. All interior corners shall be rounded.

NOTE

Liquid Storage Area: Dedicate a space adjacent to the CCA off the LHA for possible future addition of a room to serve as a place to store, repair, and decontaminate the items left by the people entering the building. This room will be needed in the event the Navy decides to doff and store the outer protective garments instead of cutting off and disposing of them.

For chemical-hardening criteria, the entrance door to the CCA shall be steel, solid core, in metal frame with 1-1/2 pair stainless steel, ball bearing hinges. Lock/latch set and strike plate shall be stainless steel, high-grade and of substantial construction. When using mixed-munitions hardening criteria, the entrance door and frame shall be blast resistant, with blast

MIL-HBK-1040

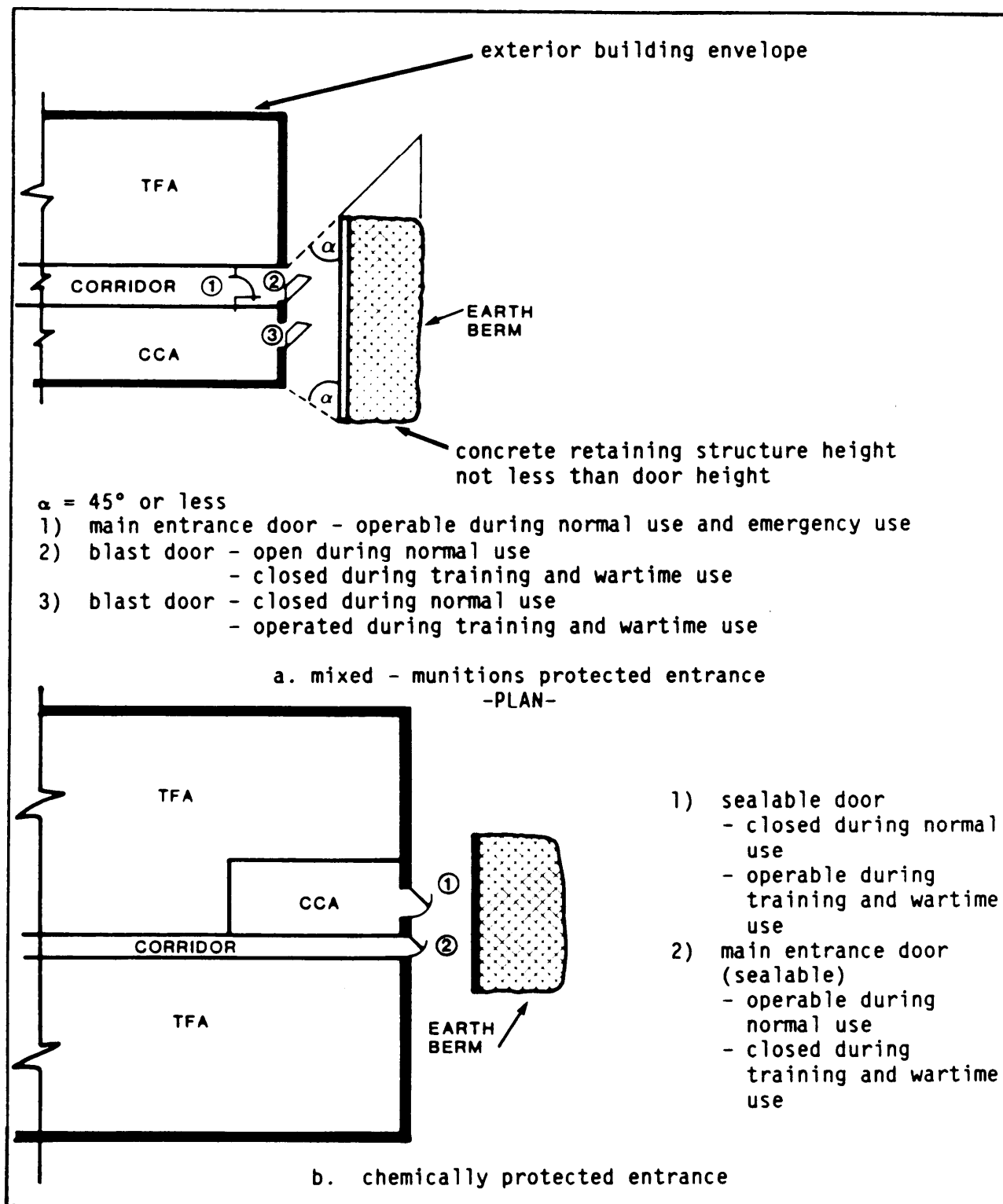

Figure 2
Entrance Arrangements

MIL-HBK-1040

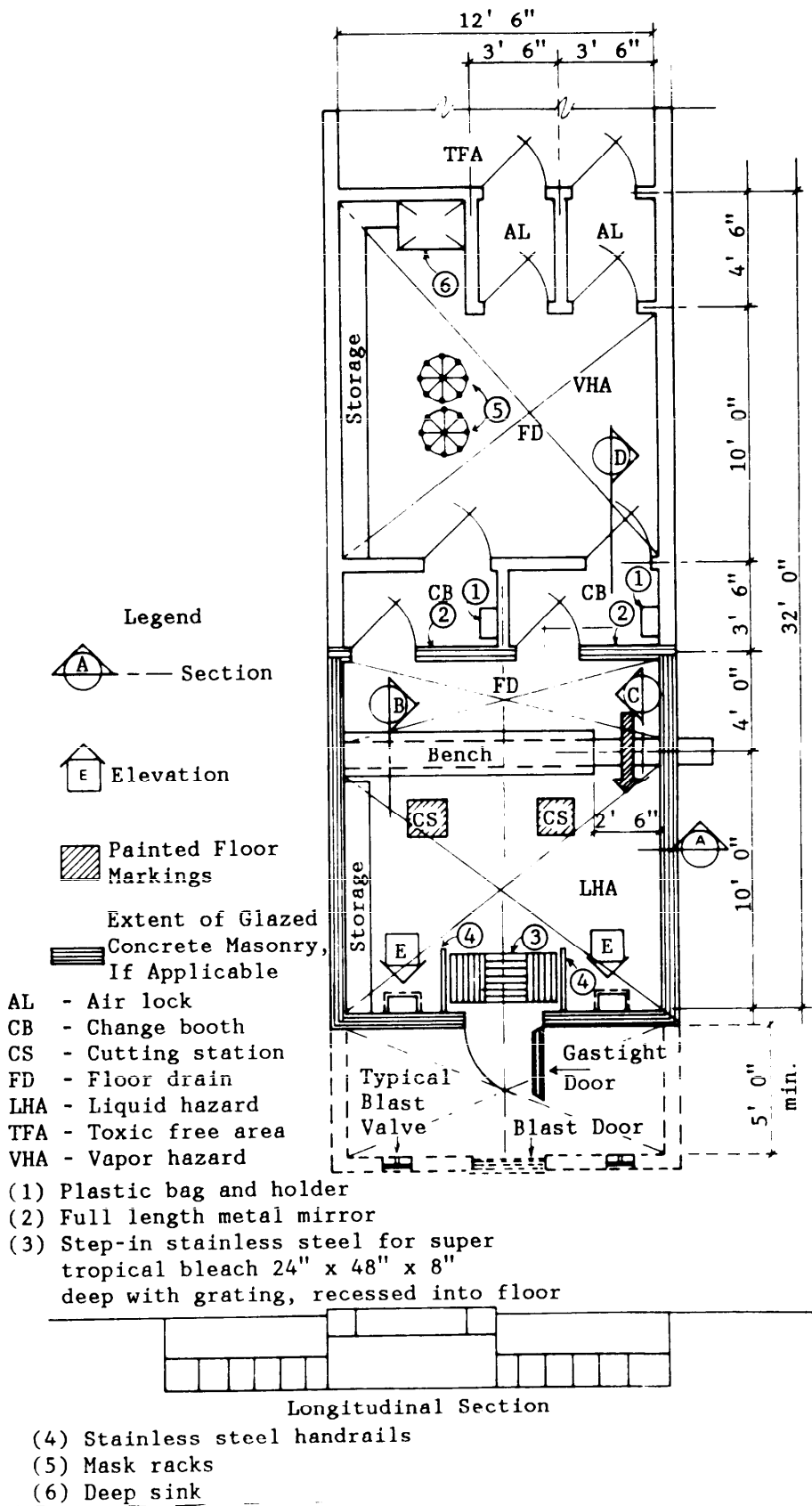

Figure 3a
 Plan Contamination Control Area (CCA)

MIL-HBK-1040

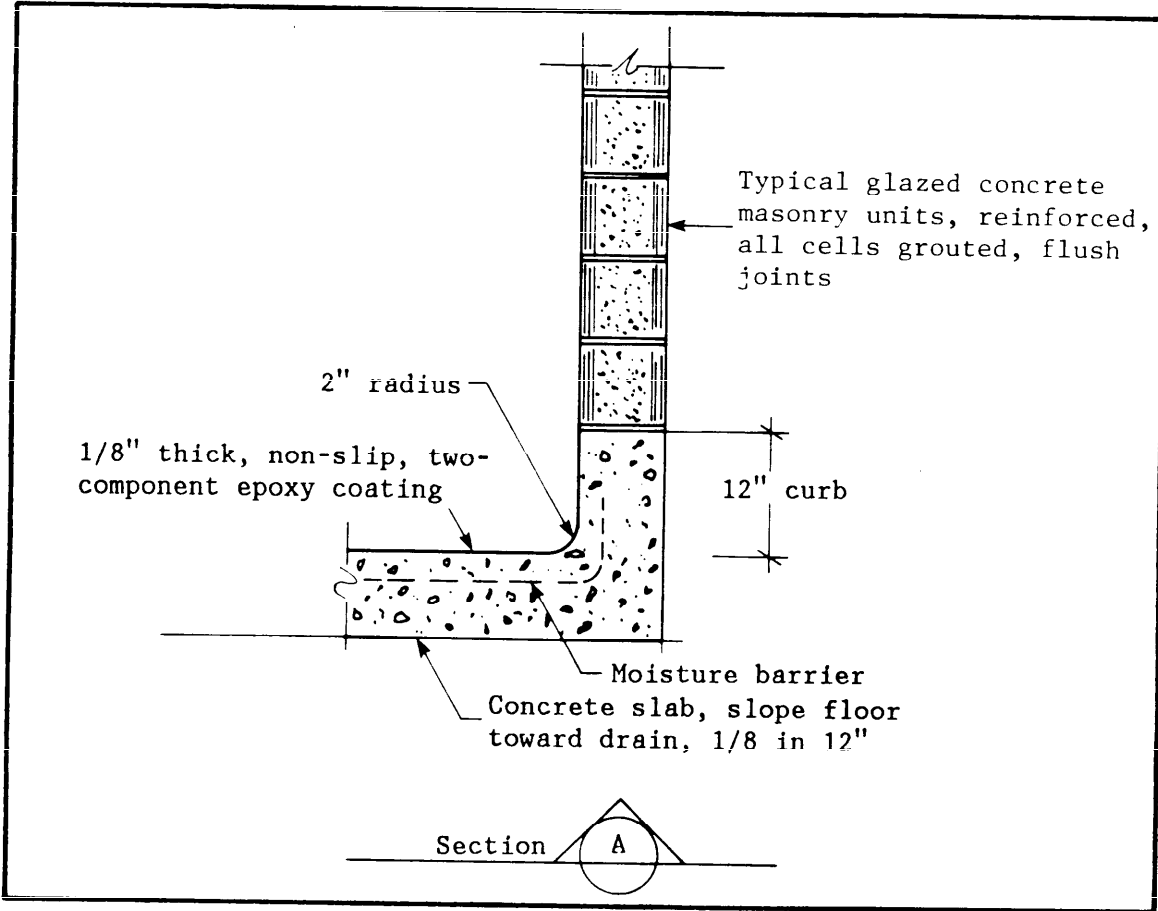

Figure 3b
Section A

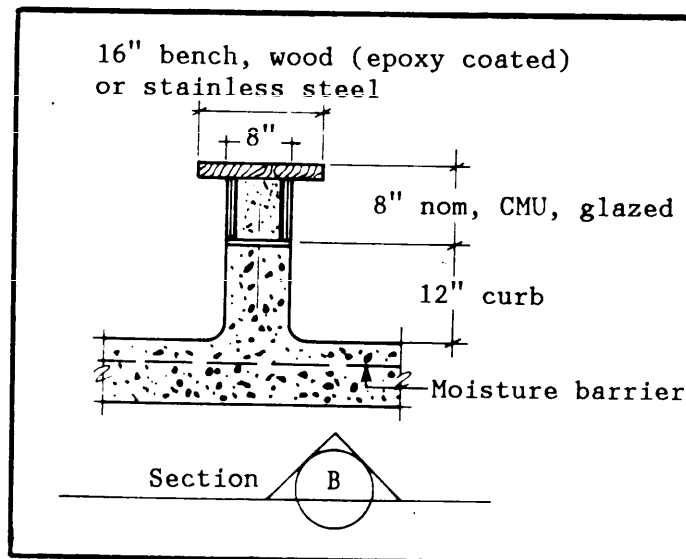

Figure 3c
Section B

MIL-HBK-1040

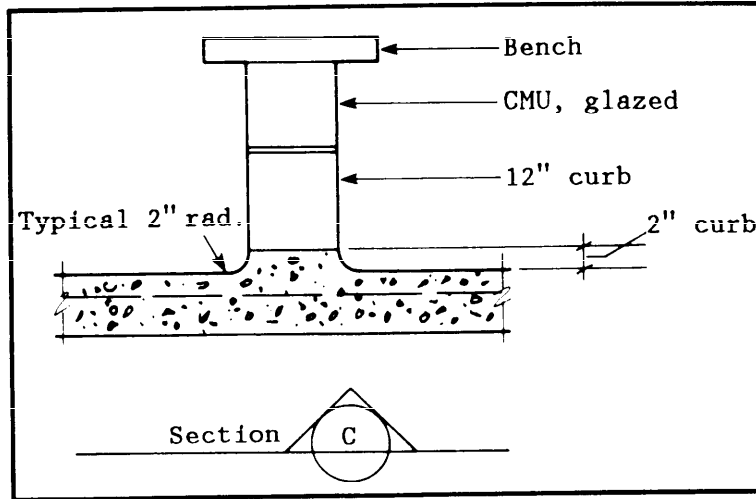
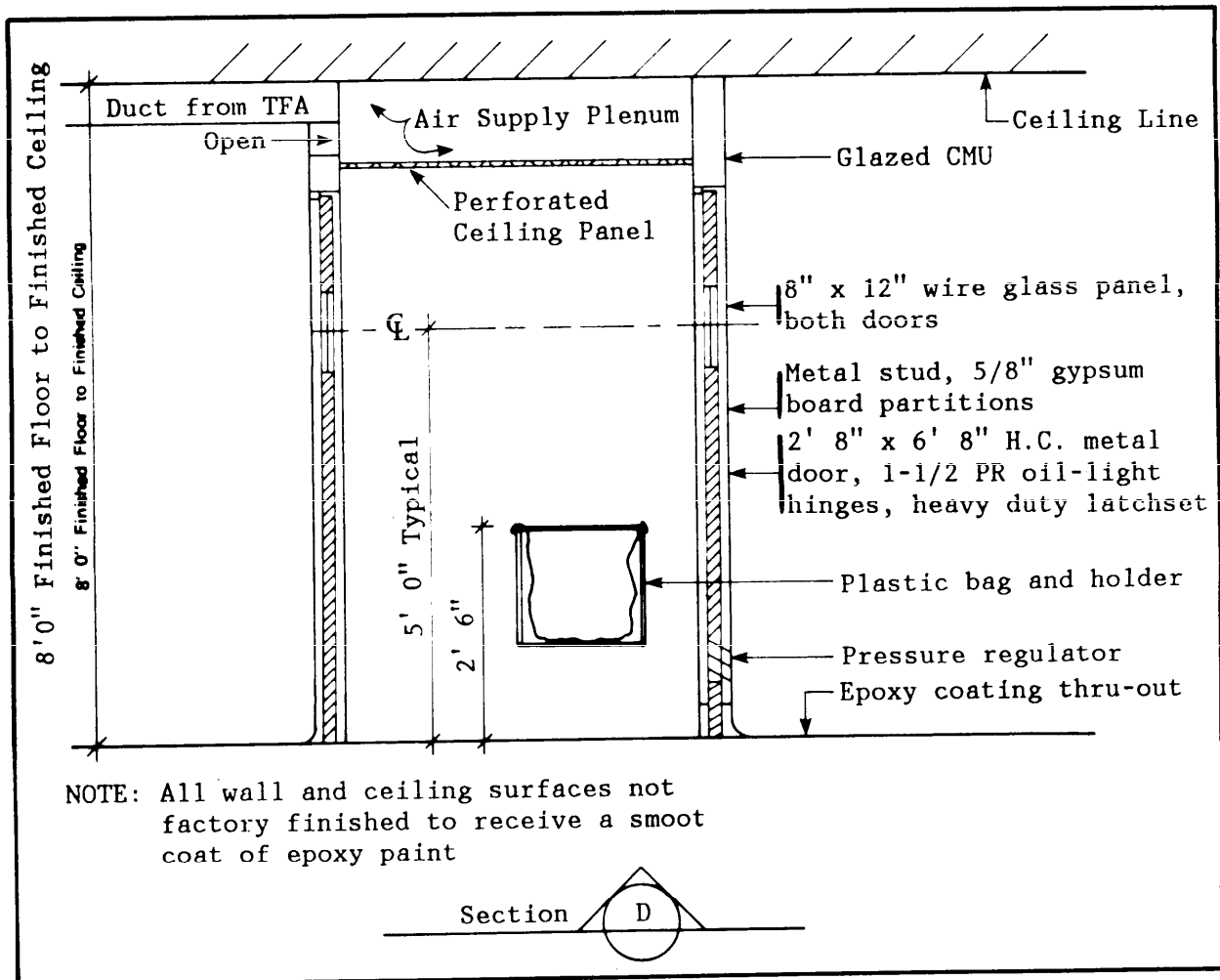

Figure 3d
Section C



NOTE: All wall and ceiling surfaces not factory finished to receive a smooth coat of epoxy paint

Figure 3e
Section D

MIL-HBK-1040

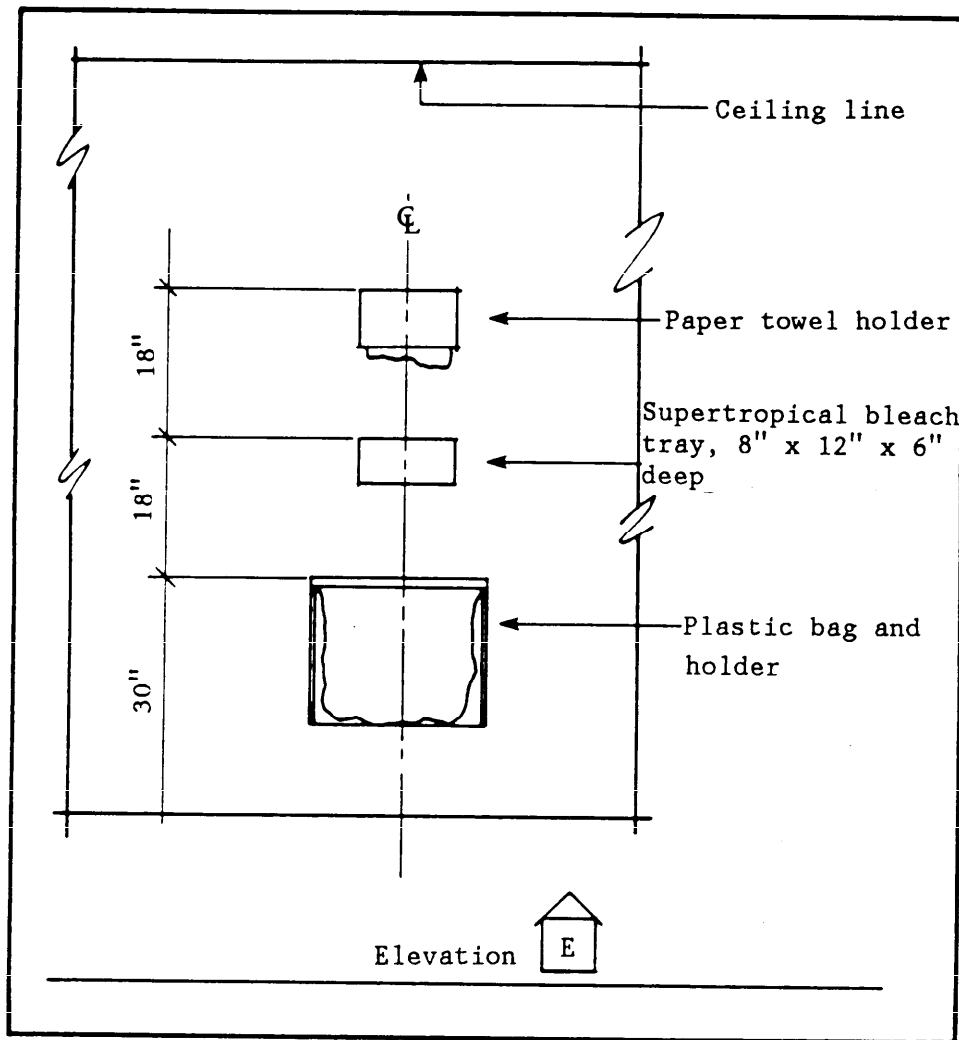

Figure 3f
Section E

MIL-HBK-1040

valves provided. Airlock doors and doors leading to the TFA shall be metal, hollow core, in metal frames with stainless steel hardware, partially glazed and fully gasketed. Primed metal surfaces shall receive a finish coat of either epoxy or urethane paint. Metal fixtures like trays, mirror frames, or storage racks shall be either stainless steel or primed steel with an epoxy or urethane paint finish.

3.3.2.2 TFA. The TFA may be of standard interior construction materials. However, special attention must be given to make the space airtight, i.e., control exfiltration in such a manner that the pressurizing air leaves the space through the CCA only. It is, therefore, necessary to detail the sealing and caulking of all surface joints, pipe and duct penetrations, electrical outlets, and vents. Acoustical ceiling systems using a T-bar grid and lay-in panels should be installed only if the space above can be effectively sealed to prevent leakage. Interior finishes shall be a primer coat and two finish coats of semi-gloss latex paint.

3.3.2.3 Dirty and Clean Mechanical Rooms. Interior finish shall be epoxy or urethane coating on all surfaces. All interior corners shall be rounded.

3.3.2.4 Coatings. Recommended coatings are:

a) MIL-C-22750, Epoxy, coating, epoxy-polyimide

b) MIL-C-46168, Urethane, coating, aliphatic polyurethane, chemical agent resistant

3.3.2.5 Gasket Material. Recommended gasket material is butyl rubber, chemical agent resistant.

MIL-HBK-1040

SECTION 4: STRUCTURAL DESIGN CRITERIA

4.1 Introduction. Survival in a chemical warfare (CW) environment will require proper response of the CW structural elements. The CW structure includes the external structural envelope, separating the CW shelter from the design threat, and the internal dividing walls between the mechanical equipment rooms, the CCA, and the TFA. The structural elements may include walls, roof, doors, windows (in special cases only), barriers, blast valves, and gas tight penetrations for plumbing, mechanical, and electrical lines. The external structural envelope and external barriers must withstand conventional weapon effects (including blast overpressures, ground shock, weapon fragments, and direct impact). Internal dividing walls must be designed for the internal air handling pressure differentials and blast leakage pressures through blast valves. The design loading will depend on the weapon threat (type of weapon and range at detonation). In most cases, the design should be based on the design threat loads rather than meeting prespecified cross-section requirements. Design for the threat will produce a balanced structural design (with all elements and the system having relatively equal hardness) for any structural geometry (e.g., roof span, story height) and type of structural element (e.g., slabs, beams, doors, etc.). The structural criteria and procedures that follow will provide a safe balanced design for a given threat.

NAVFAC P-397 Structures to Resist the Effects of Accidental Explosions, is referenced extensively and should be used in conjunction with the structural criteria. If the most recent six-volume revision of NAVFAC P-397 is not available, then U.S. Army Armament Research and Development Center Special Publication ARLCD-SP-84001 Volumes I-VI (the official review publication of the tri-service manual: NAVFAC P-397, ARMY TM 5-1300, and Air Force AFM 88-22) should be used. The criteria that follow are limited to above ground structures with or without earth-bermed sidewalls. If buried structures are required for direct-hit threats (such as the North Atlantic Treaty Organization (NATO)-Protected category threat), then other accepted design references should be used.

4.2 Performance Requirements

4.2.1 Operational Requirements. The CW shelter can be divided into three areas based on usage: The mechanical equipment rooms (contaminated and clean), the TFA, and the CCA. The structural envelope and dividing walls must meet the following performance objectives to provide safety against the design weapons threat and to maintain the proper internal environmental separation.

4.2.2 Performance Objectives

4.2.2.1 CW External Envelope. The external structural envelope of the CW shelter must provide protection against the direct design weapon threat. The walls and roof must be reinforced concrete (R/C, at least 12-inch (0.305-m) thick walls) and must be designed for limited deflection and spalling under the loads of the design weapon threat. Windows are not allowed in the external walls. Doors, blast valves, electrical, plumbing and mechanical penetrations are only allowed between the outside environment and contaminated areas (the

MIL-HBK-1040

LHA, VHA, or contaminated mechanical equipment room). All external penetrations (e.g., doors, blast valves, electrical conduits, etc.) must be protected against direct fragment or projectile hits by structural barriers.

4.2.2.2 TFA. The envelope around the TFA must not allow any leakage of contaminated air into the TFA. This is accomplished by maintaining the structural integrity while providing a positive internal pressure with the air distribution system. The design response of the structure must limit cracking and spalling of R/C elements and deformation around doors that would defeat seals. Entry from contaminated areas must be through airlocks with the doors designed to respond elastically to all design loads. No penetrations are allowed in the external walls and roof. Airlock doors may have small windows.

4.2.2.3 CCA. Contaminants will be introduced into the CCA during decontamination of incoming personnel. Therefore, some infiltration of contaminated air into the CCA can be accommodated. The external door must be designed to remain nearly elastic during the design blast load in order to remain operational and to maintain a relatively gastight seal. The external R/C elements should be designed for the same performance objectives as the TFA envelope. Dividing wall door, electrical, mechanical, and plumbing penetrations must be gastight. Air exhausts to the outside must be protected by blast valves to limit the design shock loads in the CCA.

4.2.2.4 Dirty Mechanical Room (DMR). The DMR may contain contaminated air. The external envelope must provide blast and fragment protection for the equipment but need not be airtight. Blast valves are needed to restrict the shock loads that can be introduced into the rooms. External walls, the roof, and entrances must be blast hardened against failure but can be allowed to respond into the plastic range of response. A gas-tight door (with small windows) leads to the CMR. Electrical, mechanical, and plumbing penetrations to clean areas must be gastight.

4.2.2.5 CMR. The CMR must meet the same performance objectives as the TFA. It will have no penetrations in its external R/C structural envelope. Only gas-tight electrical, mechanical, plumbing penetrations, and gas-tight doors are allowed into contaminated areas. Access to this room is from the TFA.

4.2.3 Protection Levels. The operational requirements, performance objectives, load intensity, and type of structural elements can be used to describe distinct protection levels. Four levels are required and are listed and described in Table 2.

A plan view showing the approximate physical relationship of the CW shelter functional areas is shown in Section 5, Figure 11. Table 3 provides the protection level required between each area. The structural response requirements for each category are quantified with the design criteria in Paragraphs 4.5 through 4.9.

4.3 Design Explosive Threat. The user should conduct a threat analysis and specify the design weapon threat. The minimum design explosive threat definition must include the trinitrotoluene (TNT) equivalent weight and its

MIL-HBK-1040

Table 2
Protection Level Descriptions

Protection Level	Structural Envelope	Contaminant Infiltration	Design Load	Allowed Structural Elements	Allowable Structural Response
A	External	No	Direct external blast and fragment	R/C walls and roof	Small (barely plastic)
B	External	Yes	Same as A	R/C walls and roof Blast doors Blast valves	Limited (plastic)
C	Internal	No	Internal blast leakage and air handling pressures	R/C internal walls and roof Elect/mech conduit	Minimal (elastic)
D	Internal	Yes	Same as C	R/C internal walls and roof Doors with windows Elect/Mech conduit	Minimal (elastic)

MIL-HBK-1040

Table 3
Protection Level Requirements at Area Interfaces

FROM	Mech Equip Rms		TFA	Contamination Control Area			
	Contam	Clean		Airlock	VHA	Chg Rm	LHA
DMR		C	C	C	C	C	C
CMR	C		D	C	C	C	C
TFA	C	D		D	C	C	C
CCA Airlock	C	C	D		D	C	C
CCA VHA	D	C	C	D		D	C
CCA Change Rm	C	C	C	C	D		D
CCA LHA	D	C	C	C	C	D	
Outside	B	A	A	A	A	A	B

MIL-HBK-1040

location at detonation (both range (R) from structure and height of burst (HOB)). The weapon and its critical design fragment weight and velocity should also be specified to guarantee proper design against fragment penetration.

The user should consider using one of three NATO threat categories: collateral, semi-hardened, or protected. Two NATO categories that need not be considered, because they do not provide appropriate protection, are the lowest threat category, splinter protected (basically fragment and small arms fire protection), and the highest threat category, hardened (below-ground nuclear weapon protection). The NATO threat levels to consider can be generally defined as:

a) Collateral: The threat for collateral protection is the near-miss of a general purpose bomb. This is the lowest level of protection that should be considered.

b) Semi-hardened: The threats for semihardened protection are specific weapons at specific miss distances from the structure. The list includes near misses of general purpose bombs and direct hits of artillery shells, rockets, and napalm.

c) Protected: The threats for protected structures are direct hits of specific weapons including general purpose bombs. Burster barriers and cushioning sand layers are required over this category shelter. Only above ground structures are addressed in the design procedures that follow. If this level of protection is required, then other accepted design references should be used.

4.4 Design Loads. The weapon threat must be converted to structural design loads in engineering terms. Blast overpressures versus time, fragment or projectile weight and velocity, and ground shock are the key load parameters for structural design. These engineering load parameters may also be used to define the design threat instead of specifying the weapon and location.

4.4.1 External Blast Overpressures. The overpressure loading from the detonation of the weapon threat can be determined from NAVFAC P-397 given the TNT equivalent weight (W), its distance from the structure (R), the height of burst (HOB), and the orientation of the structural surface to the shock wave. Although the HOB, charge shape, terrain effects, and other factors can affect the design loads, they are generally unknown or discounted. The hemispherical surface burst load parameters, given on a single graph in NAVFAC P-397, are used to calculate design loads. When calculating structural design loads, a 1.2 factor of safety on explosive weight is required (i.e., design explosive weight = 1.2 W).

4.4.1.1 Vertical Wall Loads. Walls, perpendicular to the ground, will usually be perpendicular to the direction of travel of the shock wave. When the shock wave hits the wall, much higher normal reflected waves develop on its surface. The actual load time history depends on W, R, HOB, and the clearing

MIL-HBK-1040

time of the reflected wave. Use NAVFAC P-397 to calculate the load time history. In most cases, the loading can be safely defined by the peak reflected pressure, P_r , and scaled impulse, $i_r/W^{1/3}$, from the hemispherical surface burst relationships. A triangular pressure-time relationship, with duration t'_r , is normally used in design, as shown in Figure 4a. If the design threat is very close to the structure, the height of the triple point may be below the height of the wall, or the clearing time of the reflected wave may be less than t'_r , and a bilinear load function (Figure 4b) can result. However, it is always conservative to replace the bilinear function with a triangular linear function, similar to that in Figure 4a, by equating the peak pressure and total impulse of the triangular and bilinear functions (i) and by choosing the triangular function duration as:

EQUATION:
$$t'_r = 2i/P_r \quad (1)$$

If the structure is oriented so that a wall will not be normal to the design threat, it may be treated as a wall at an oblique angle to the shock wave (with reduced reflected pressures) or a sidewall or backwall (with no reflected pressures). NAVFAC P-397 provides the procedures for calculating the loads on a wall at any orientation to the shock wave.

4.4.1.2 Earth-Bermed Wall Loads. When the structural surface is oblique to the shock wave, the reflected waves are lower in magnitude than a normal (90°) reflected wave. Use of an earth-bermed wall (minimum slope 1.5:1; maximum slope 2:1; mowing strip at top of at least 20 inches (0.51 m) will greatly reduce the blast pressure on the retaining wall because of (1) the reduced reflected pressure on the angled berm, (2) the distribution of loads to the ground, and (3) the energy dissipated in moving the soil mass. Reduction in the peak pressure will reduce or eliminate spalling. Unless an analysis is conducted to evaluate soil structure interaction, only the following assumptions should be used when designing an earth-bermed wall for a detonation outside the berm:

a) Spalling will be eliminated on the inside of the wall to the height of the earth berm.

b) For a partially bermed wall meeting the minimum requirements described above, it may be assumed that: (1) the impulse loads on the reinforced concrete retaining wall are reduced by 15 percent, and (2) the mass from one-half the minimum width of the berm, but not more than 2 feet (0.61 m), may be included in the mass of the wall when calculating wall response.

The berm described will also stop most fragment and debris hazards. The berm need only be as high as needed to stop spalling or fragment penetration.

4.4.1.3 Roof Loads. Surface explosions, and explosions with an HOB less than the height of the walls, will produce incident pressures (reduced somewhat by negative drag pressures) on a horizontal roof surface. If the HOB of the design threat is above the roof, it will see reflected pressures, as determined

MIL-HBK-1040

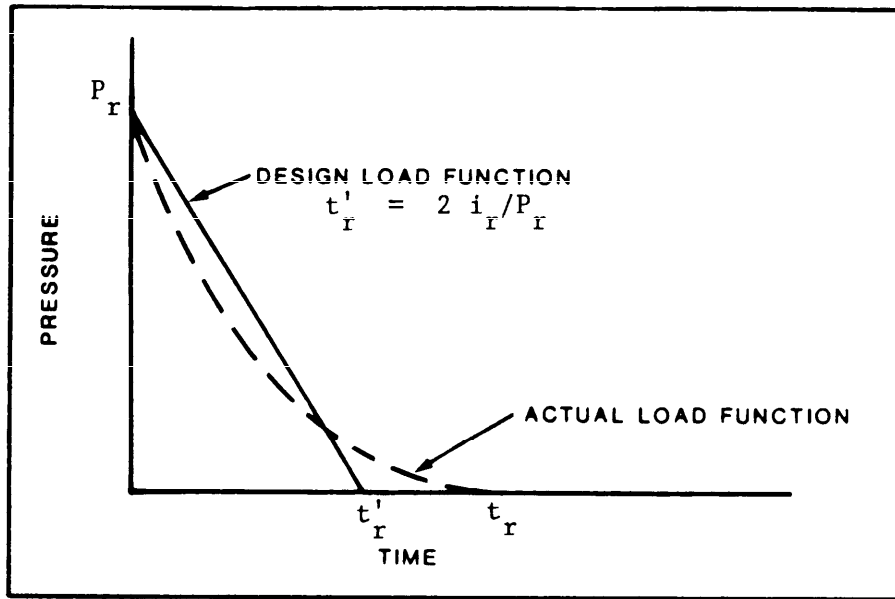

Figure 4a
Front Wall Loading: Idealized Normal Reflection
Controls ($t_r < t_c$)

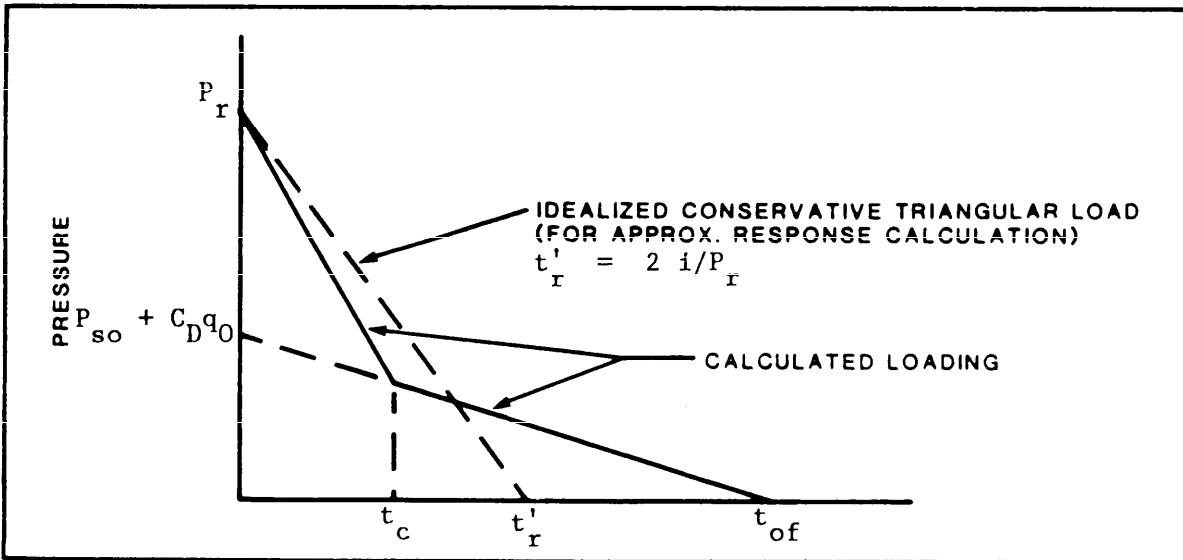

Figure 4b
Front Wall Loading: Normal Reflection, Incident,
and Dynamic Pressure Controls (Short Clearing Time, t_c)

MIL-HBK-1040

from free air load parameters. The loading is complicated by the time variation of loading along the length of the roof. NAVFAC P-397 procedures account for this effect. When the span is in the direction of travel of the shock front, a bilinear pressure time history results that begins with no load at time zero, linearly increases to the peak, and then linearly decays to zero. Figure 5a shows a typical pressure time design loading for a roof spanning parallel to the direction of the shock front. Figure 5b shows a typical loading for a span perpendicular to the direction of the shock front. To facilitate use of standard response charts, the parallel span bilinear load function in Figure 5a can be conservatively replaced by a linear load function with the same peak pressure, beginning at zero time, and the same duration (similar to that in Figure 5b).

4.4.2 Internal Leakage Pressure. When a structure with outside openings is enveloped in a blast wave, the interior of the structure will have an increase in its ambient pressure. The pressure time loading is a function of the area of openings, the inside volume, and the exterior pressure time load. A procedure is given in NAVFAC P-397 to estimate the internal pressure time loading. The effect of the blast valve on the leakage pressure can be conservatively obtained by using the maximum total blast valve opening for the full time it takes to close the valve (and zero area for time > closure time). This pressure should then be used in the design of internal dividing walls and doors. A sample solution is shown in NAVFAC P-397.

The pressures immediately adjacent to the blast valve will be higher than the calculated average. Therefore, a deflection plate, baffle, or a separate expansion room should be provided, immediately inside the blast valves, to contain these pressures.

4.4.3 Primary and Secondary Fragments. Primary fragments come from the explosive casing or container and are characterized by large numbers of high velocity (thousands of ft/sec) (where 1,000 ft/s = 304.8 m/s), small mass (0.032 ounce (0.907 g) is typical of bomb and shell casing fragments) chunky fragments. Secondary fragments can be produced by loose objects or pieces of failed structural components that are accelerated by the explosive shock wave. Secondary fragments should be controlled by restricting use of objects around the protected structure that could produce hazardous secondary fragments.

The mass and velocity of the design primary fragment can be calculated from the charge type and weight, casing shape, and casing weight, using methods given in NAVFAC P-397 Volume II, Section 2-16. Actual weapons test data may also be available. If the threat is not defined adequately to calculate design fragment weight and velocity, the NATO threat (collateral or semi-hardened), closest to the perceived threat, should be used.

4.4.4 Ground Shock. Explosions at or near the ground surface produce direct-induced and air-induced ground shock. Structures hardened for air blast and fragments should not be seriously damaged by ground shock. However a shock spectrum analysis should be made to assess the vulnerability of personnel and equipment to ground shock.

MIL-HBK-1040

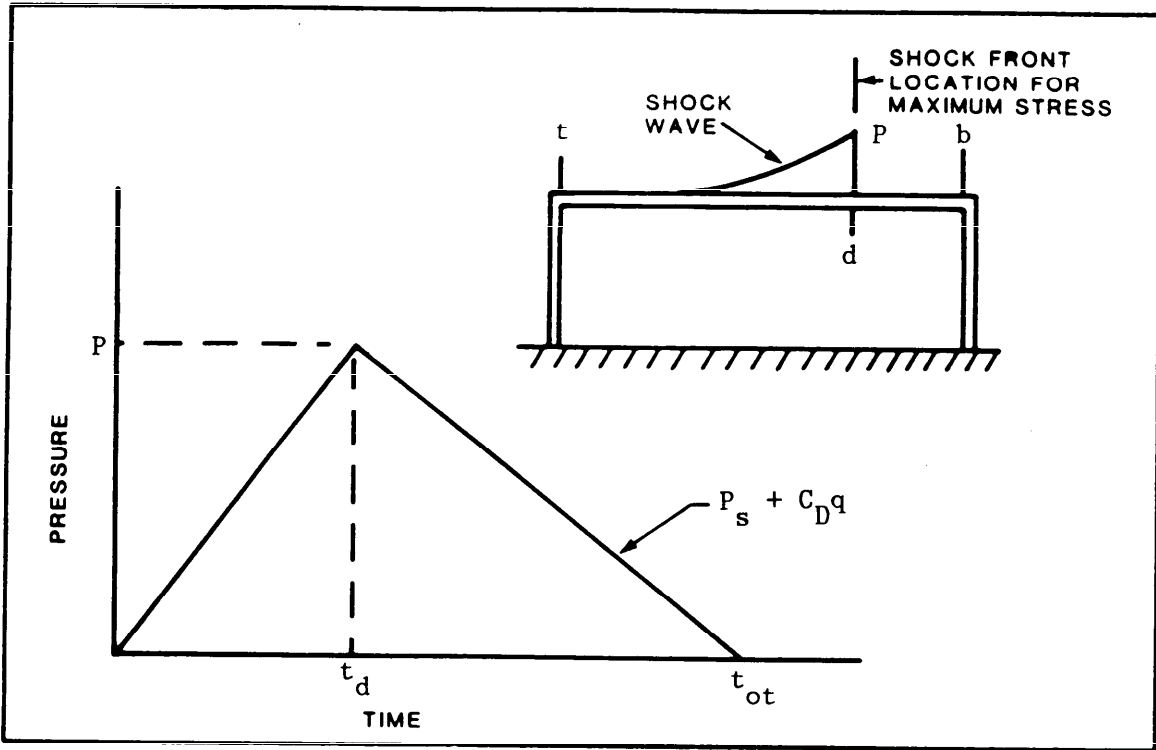

Figure 5a
Roof Loading: Span Parallel to Traveling Shock Wave

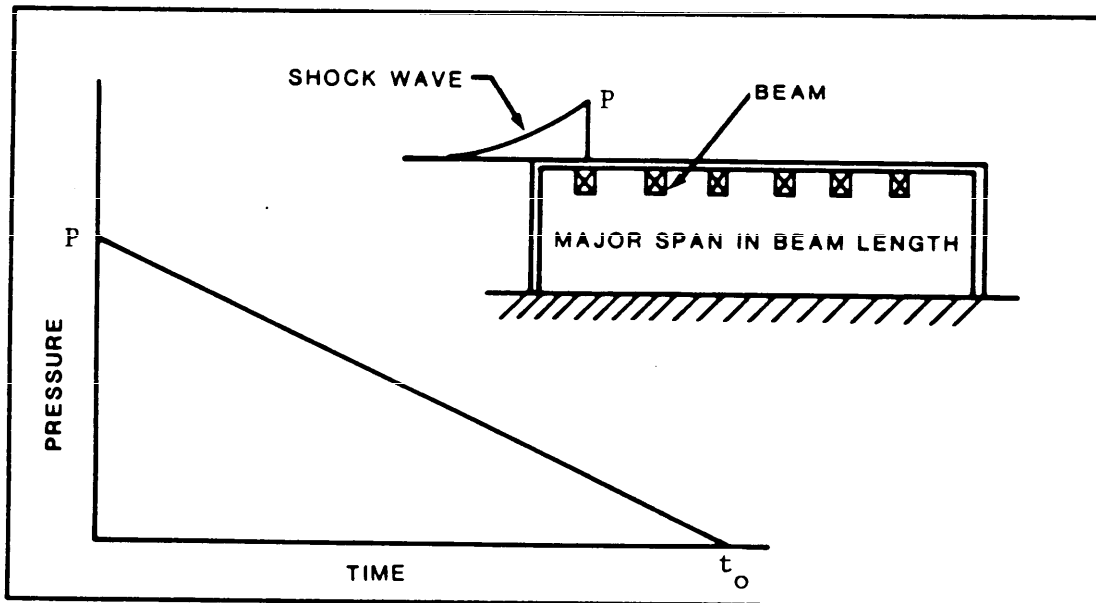

Figure 5b
Roof Loading: Span Perpendicular to Traveling Shock Wave

MIL-HBK-1040

4.4.5 Combined Loads. Gravity, soil pressure (including hydrostatic), and internal air handling pressure "dead" loads must be accounted for in the design for dynamic blast loads. Transitory "live" loads (e.g., wind, construction, and seismic) should not be considered in the blast load design.

The allowable resistance and deflection of the structural element should be reduced by the amount of the constant "dead" loads. The reduced resistance-deflection function is then used in the dynamic response calculation.

Hydrostatic and soil pressure loads will be site dependent.

4.5 Reinforced Concrete. The external walls (except doors and blast valve penetrations) shall be at least 12-inch (0.305-m) thick reinforced concrete. The roof shall also be reinforced concrete and must provide the same level of protection against the design threat as the reinforced concrete walls. The design guidelines in this section should be used in conjunction with NAVFAC P-397 to design for the external blast and fragment threat. Where differences exist, the criteria in this section will take precedence.

Two modes of behavior are considered in the design of R/C, ductile and brittle. The ductile bending mode can attain large inelastic deformations (and absorb large amounts of energy) without failing. The brittle modes (shear, fragment penetration, and spalling) may reach failure under relatively low energy input levels due to load concentrations or low ductility. Structural elements are designed to resist the overall blast loading in the ductile bending mode and then adequate shear reinforcement is provided to prevent low deflection brittle shear failure. Fragment penetration and spalling are prevented by providing adequate concrete thickness. Earth berms and steel plates (external armor plate or internal spall plates) may be used to reduce the required concrete thickness.

Protective structures are classified as shelters (enclosed - used to protect personnel and contents) and barriers (open - used to reduce fragment or pressure hazard). The CW structure enclosing the CCA, TFA, and mechanical rooms is a shelter. The criteria in this section applies to the CW R/C shelter components. Fragment and blast barriers, used to mitigate the blast and fragment loading on the external doors and blast valves, are covered in Paragraph 4.9.

4.5.1 Design Stresses.

4.5.1.1 Reinforcing Steel. All reinforcement in external and internal hardened walls will be A615 (Grade 60) reinforcing steel. If it is not readily available in foreign countries, a similar ductility steel may be used with a minimum yield stress between 50 and 75 pounds per square inch (psi) (344.7 kPa and 517.1 kPa).

A statistical analysis of the static yield strength of A615 (Grade 60) reinforcement shows the average yield strength is 10 percent greater than the minimum required. Consequently, the design static yield stress for A615 (and to be assumed for other similar steels) shall be,

$$\text{EQUATION:} \quad f_y = 1.10 \times f_y \text{ (nominal)} \quad (2)$$

MIL-HBK-1040

A dynamic increase factor (DIF) is used to account for the effect of strain rate on strength properties. The DIF depends on the loading intensity and type of stress.

$$\text{EQUATION:} \quad f_{dy} = \text{DIF} \times f_y \quad (3)$$

The following DIF values shall be used:

	<u>External Separation Wall</u>	<u>Internal Dividing Wall</u>
DIF (bending and bond)	1.23	1.17
DIF (diagonal tension and direct shear)	1.10	1.00
DIF (compression)	1.13	1.10

For example, the dynamic design stress, f_{dy} , for A615 (Grade 60) bending steel reinforcing bars in an exterior wall is,

$$\text{EQUATION:} \quad f_{dy} \text{ (ext wall, bending)} = 1.10 \times 1.23 \times 60,000 \quad (4)$$

$$= 81,200 \text{ psi}$$

4.5.1.2 Concrete. The static ultimate compressive strength of concrete, f'_c , shall be specified within the range,

$$\text{EQUATION:} \quad 3,000 \leq f'_c \leq 5,000 \text{ psi} \quad (5)$$

The DIF, to account for the effect of strain rate on concrete strength properties, also depends on the loading intensity and type of stress.

$$\text{EQUATION:} \quad f'_{dc} = f'_c \times \text{DIF} \quad (6)$$

The following DIF values can be used:

	<u>External Separation Wall</u>	<u>Internal Dividing Wall</u>
DIF (bending)	1.25	1.19
DIF (compression)	1.16	1.12
DIF (direct shear)	1.10	1.10
DIF (bond and diagonal tension)	1.00	1.00

4.5.2 Allowable Deflections. The maximum allowable deflection, X_u , is determined from the maximum allowable support rotation, r_u , following^u formation of the yield line mechanism.

MIL-HBK-1040

EQUATION:
$$X_u = \ell \tan \theta_u \quad (7)$$

where

ℓ = distance between support and point of maximum deflection.

The maximum allowable rotations for R/C elements, in terms of the protection level prescribed in Paragraph 4.2.3 are:

Protection Level	Support Rotation, θ_u (degrees)
A	2
B	4
C	1
D	1

4.5.3 Design for Bending and Shear. A trial cross-section (thickness of concrete and bending steel percentage) is chosen and the response to the design blast load is calculated. If the response rotation is less than the allowable given in Paragraph 4.5.2, the element is checked for shear and stirrups are added if necessary. The procedure is detailed in NAVFAC P-397 Volume IV, Section 4-24, Flexural Design for Limited Deflection (θ_u less than 4°). The following design steps are required.

a) Step 1: Determine the optimum distribution of reinforcement based on support conditions, aspect ratio, and a 45° yield line. The ratio of vertical and horizontal moment capacities are determined from the yield line location figures in NAVFAC P-397, Volume III.

b) Step 2: Select a trial cross-section thickness and reinforcement percentage ($p = 0.15$ percent minimum) that gives moment capacities near those determined in Step 1. The optimum total reinforcement ratio ($p_h + p_v$) ranged between 0.6 and 0.8 percent. A value of 0.7 percent can be used for design. Determine the moment capacity of the cross-section using the equations for a Type I ($\theta_u < 2^\circ$) or Type II ($2^\circ \leq \theta_u \leq 4^\circ$) cross-section as applicable and design stresses f_{dy} and f'_{dc} (see Paragraph 4.5.1).

c) Step 3: Calculate section properties and determine the resistance deflection function.

d) Step 4: Determine the deflection of the structure to the blast loads and compare it to the allowable response given in Paragraph 4.5.2.

e) Step 5: If the response is acceptable, check shear stresses and add stirrups if required. Note that stirrups are required for added ductility, at design rotations above 2° , even if they are not needed for shear (minimum $A_v = 0.15$ percent). If the deflection is not acceptable, repeat all steps.

MIL-HBK-1040

4.5.4 Reinforcement Details.

4.5.4.1 Concrete Cover. The clear concrete cover over bars shall not exceed 1 inch (0.025 m) for R/C surfaces facing the interior. This requirement is imposed to minimize the extent of concrete spalling and scabbing and the hazard this presents to personnel.

4.5.4.2 Flexural Reinforcement. The area of reinforcing bars to resist bending in R/C slabs shall comply with requirements of NAVFAC P-397 and ACI 318-86 Building Code Requirements for Reinforced Concrete.

All R/C surfaces designed for blast loads shall have equal areas of steel in each face of the slab (i.e., $A_s = A'_s$) in order to assure adequate ductility of R/C. The minimum area of flexural reinforcement (A_s or A'_s in main and secondary directions) shall be 0.15 percent.

4.5.4.3 Diagonal Bars. Even though a structural element is reinforced for diagonal tension, failure near the face of its supports is possible due to direct shear. Failure is characterized by the rapid propagation of a vertical crack through the depth of the element, which results in a premature, brittle-type failure long before its ultimate flexural resistance is mobilized.

Direct shear failures in R/C shall be avoided by reinforcing corners with diagonal truss bars, as shown in Figure 6. Diagonal truss bars shall be positioned at 45° relative to the main bars in adjoining slabs. Truss bars shall be designed to resist a force equal to $\sqrt{2} V_{sH}$ or $\sqrt{2} V_{sV}$, whichever is greater, where V_{sH} and V_{sV} are the shear at the supports of adjoining slabs corresponding to r_u of each slab. Further, the embedment length of diagonal bars shall develop the full strength of the bar.

4.5.4.4 Stirrups. Single- or double-leg stirrups shall be used to resist diagonal tension shear as specified in NAVFAC P-397, Volume IV. No bent-up bars or lacing bars shall be used to resist diagonal tension shear. All stirrups shall conform to the requirements specified in Figure 7. The stirrups shall be No. 3 bar minimum and No. 5 bar maximum. Double-leg stirrups shall be used if required to satisfy these limits. The hooks on double-leg stirrups shall be staggered as shown in Figure 7. All stirrups shall be located at the intersection of main bars.

When structural response exceeds 2° rotation, minimum stirrup requirements must be met ($A_s \geq 0.15$ percent), whether or not they are needed for shear (see NAVFAC P-397, Volume IV).

4.5.5 Spalling and Breaching. Direct spalling of concrete will occur on the back face of R/C when tensile stresses exceed the tensile strength of the concrete. Air shock waves induce high compression stress waves on the loaded outside face. These waves travel at high velocity through the R/C thickness and reflect off the back face to produce a tensile stress wave traveling in the opposite direction. The use of stirrups tends to reduce the extent of direct spalling. Breaching occurs when the local stresses are so high that the full concrete thickness is punched through. Figure 8a shows the various damage categories: cracking, spalling, and complete perforation (breaching). The best criteria for preventing spalling and breaching comes from empirical relationships derived from test data. Figure 8b shows damage from lightly

MIL-HBK-1040

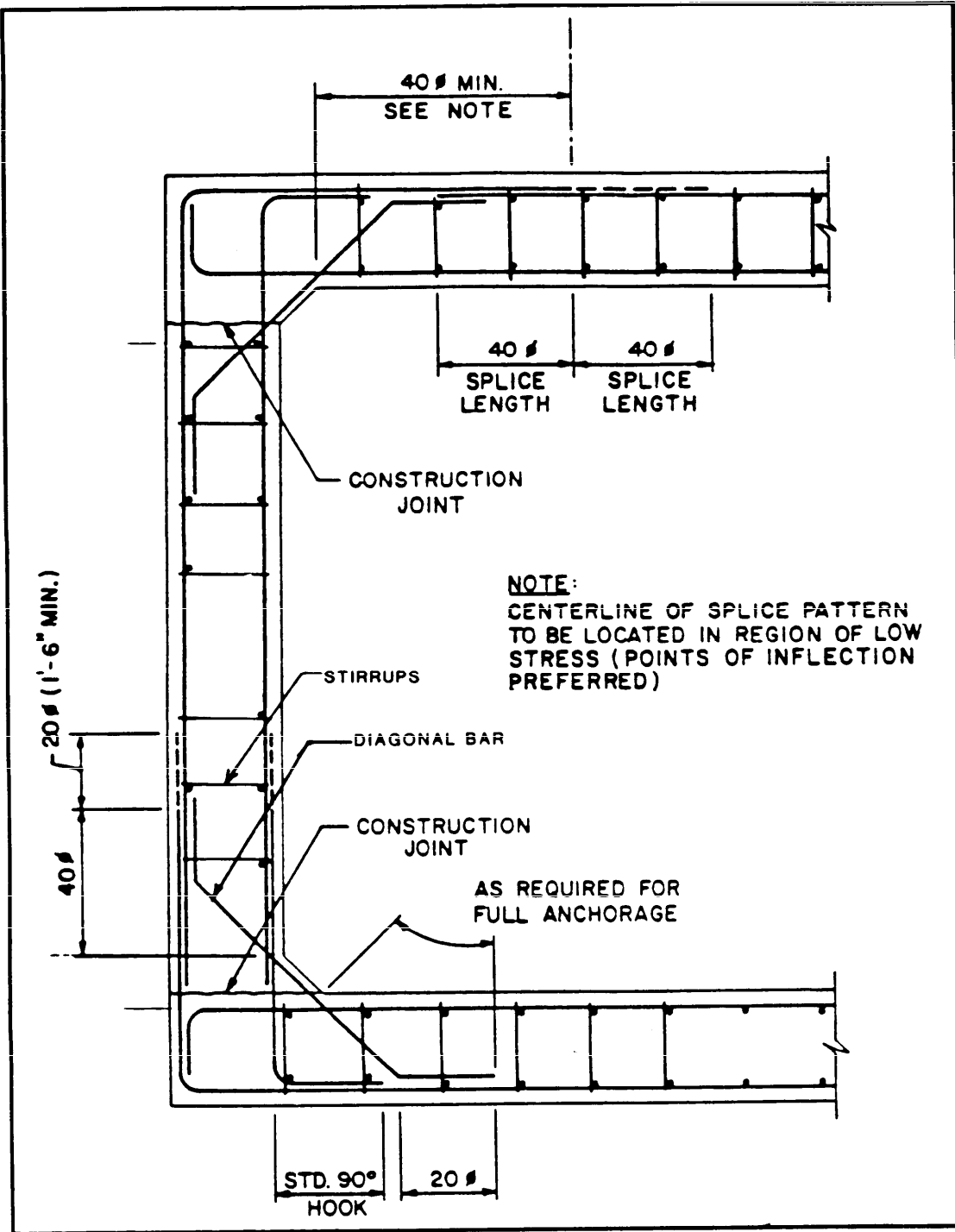

Figure 6
 Typical Section Through Conventionally
 Reinforced Concrete Wall

MIL-HBK-1040

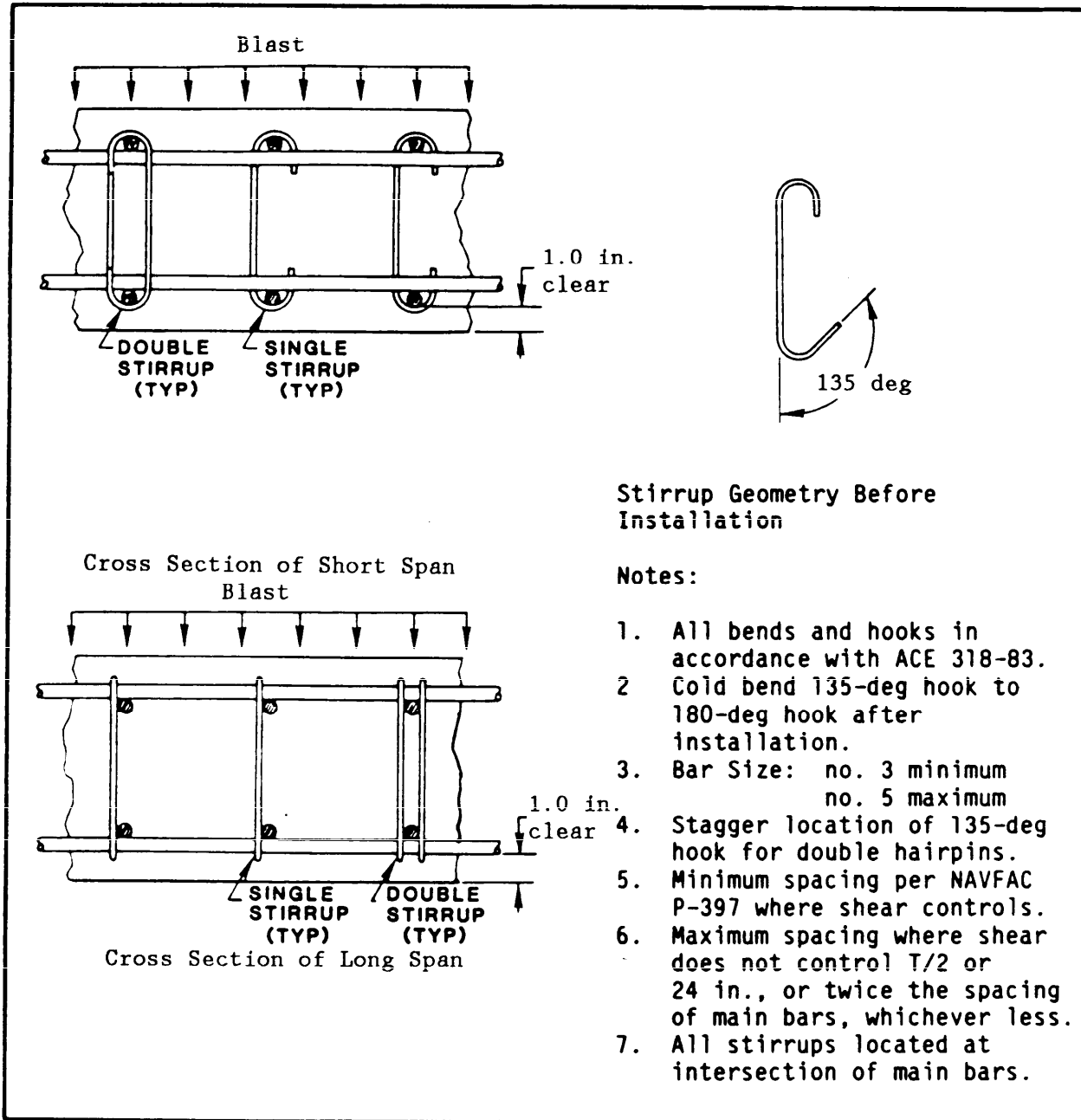

Figure 7
Design Criteria for Single-Leg Stirrups

MIL-HBK-1040

cased explosives (such as general purpose bombs). Straight lines, defining the threshold of each damage category, are the basis for the following design criteria.

4.5.5.1 Design Criteria for Breaching. All external R/C surfaces must be designed to prevent breaching by a close-in explosion. The R/C thickness, t_b , to prevent breaching (assuming a lightly cased charge), must not be less than the thickness given by:

$$\text{EQUATION:} \quad t_b = 4.120(R/W^{1/3})^{-0.40}W^{1/3} \quad (8)$$

where

t_b = minimum R/C thickness, in.

R = minimum distance from center of explosive to outside face of R/C slab, ft

W = design explosive weight, lb TNT equivalent

4.5.5.2 Design Criteria for Direct Spalling. Spalling should not be allowed in the TFA or the CCA. Some spalling might be allowable in the mechanical equipment rooms, where personnel are not normally present. The data in Figure 8b were also used to establish limiting design criteria to prevent spalling. To prevent spalling, the thickness of the R/C, t_s (inch) shall be at least equal to:

$$\text{EQUATION:} \quad t_s = 5.309(R/W^{1/3})^{-0.40}W^{1/3} \quad (9)$$

R and W are as defined above in the breaching criteria.

This spalling criteria includes the effect of fragment impact from a lightly cased explosive (such as a general purpose bomb). If design fragment information is given, the equation for spalling from fragment impact in Paragraph 4.5.6 should also be checked.

4.5.6 Fragment Penetration. Primary fragments must be kept from completely penetrating (perforating) external R/C surfaces. The minimum thickness t_{pf} , of R/C required to prevent perforation shall be determined from:

$$\text{EQUATION:} \quad t_{pf} = 1.13 Z d^{1.10} + 1.31 d \quad (10)$$













where

t_{pf} = required R/C thickness, in.

Z = x/d

d = diameter of fragment (in.)

MIL-HBK-1040

Distance of Explosion from Wall	Characteristic Damages	Desired Damage Category
	 No relevant damage, cracks, or small crater	O MINOR
	 Crater deflections and cracks	
	 Spalling on back	A SPALLING
	 Heavy spalling on back	
	 Perforation (BREACHING)	B BREACHING
	 Heavy perforation (BREACHING)	

(a) Definition of Damage Categories

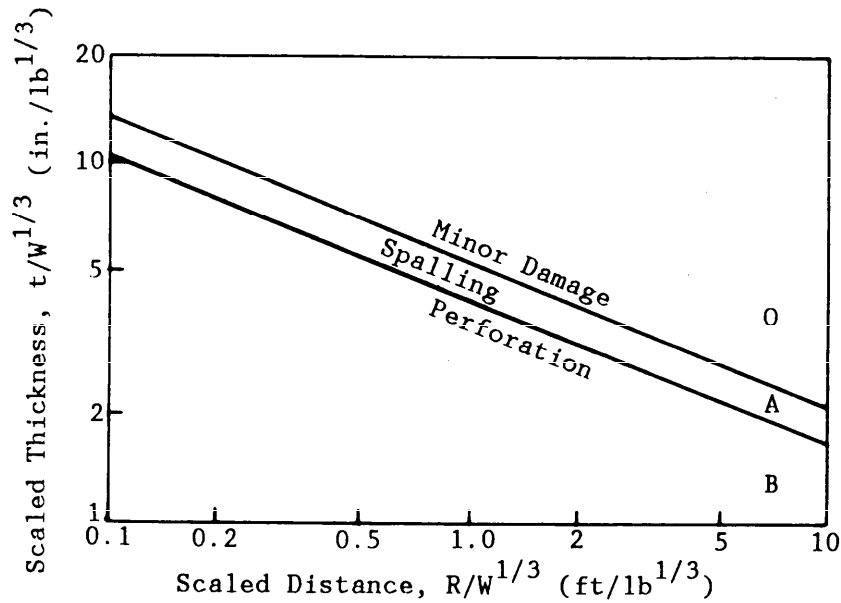

(b) Damage to Reinforced Concrete Slabs Caused by Detonation of Cased Explosives Charges

Figure 8
Design Criteria to Prevent Breaching and Direct Spalling of Reinforced Concrete Slabs

MIL-HBK-1040

for $x \leq 2d$:

$$x = 0.91 W_F^{0.37} V_F^{0.9} (5,000/f'_c)^{1/2}$$

for $x > 2d$:

$$x = [0.30 W_F^{0.40} V_F^{1.8} + 0.575 W_F^{0.33}] (5,000/f'_c)^{1/2}$$

W_F = fragment weight, oz

V_F = fragment velocity, kfps

f'_c = ultimate R/C compressive strength, psi

The impact from primary fragments also produces stress waves in R/C which can cause spalling on the inside face. The effect of general purpose bomb primary fragments are included in the breaching and spalling criteria in Paragraph 4.5.5. If other design fragments are included in the design threat, the minimum thickness, t_{sp} (inch) to prevent spalling from fragment impact is given by the following equation:

$$\text{EQUATION:} \quad t_{sp} = 1.22 Z d^{1.10} + 2.12 d \quad (11)$$

The variables are as defined in the perforation criteria.

4.6 Blast Doors. External doors into the CCA and contaminated mechanical equipment room must be designed for the external weapon threat. The entrance to the CCA must be reusable and must minimize contaminated air leakage. The design response must be limited (little permanent deformation) and seals are required. Fragment perforation cannot be allowed.

The large equipment door to the dirty mechanical equipment room must not fail or allow fragment perforation. The design response can be slightly greater than for the CCA door. Seals are required at this door to reduce air leakage. Internal doors must be designed to remain elastic. Because of the lower design loads, some internal doors, as indicated in Tables 2 and 3, may have thermally tempered glass windows. Airtight seals are required for internal doors between the functional areas listed in Table 3.

4.6.1 Design Concepts. Blast doors may be solid steel plate, built-up steel plate, or R/C (with or without steel facing plates). Figure 9 shows examples of blast door cross-sections. Usually, steel plate elements provide the most cost effective solution but built-up steel or arch-shaped may be needed for extreme loads. Design procedures are currently being developed for tensile membrane and cushion support doors to resist very high pressure loads.

MIL-HBK-1040

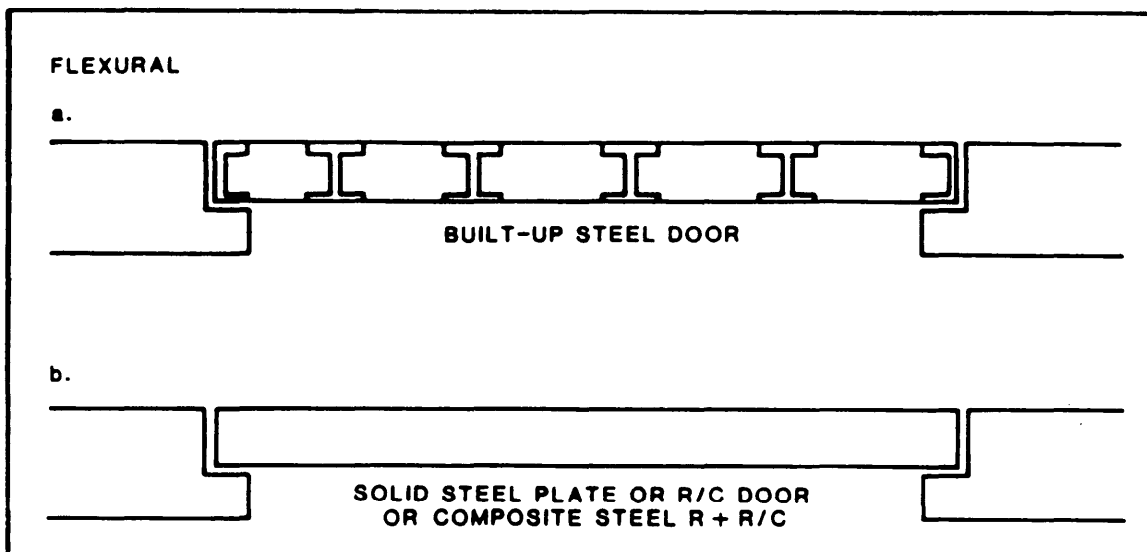

Figure 9a
Blast Resistant Door Concepts - Built-Up and
Solid Plate Flexural Doors

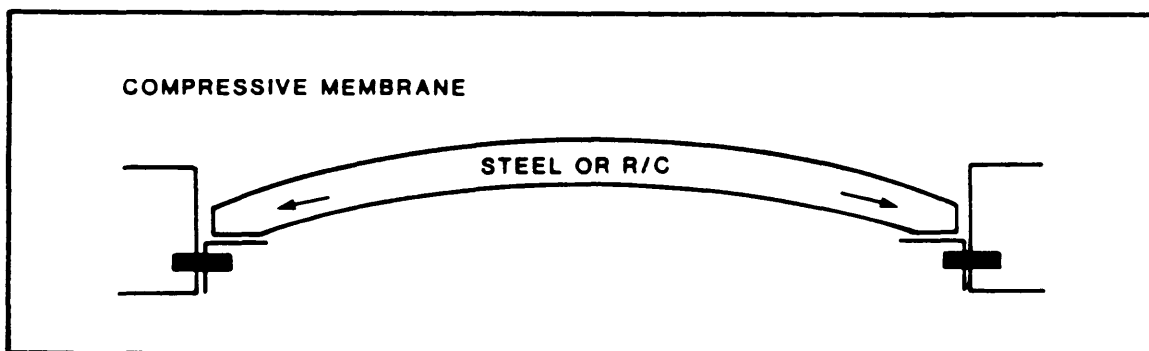

Figure 9b
Blast Resistant Door Concepts Compressive
Membrane Doors

MIL-HBK-1040

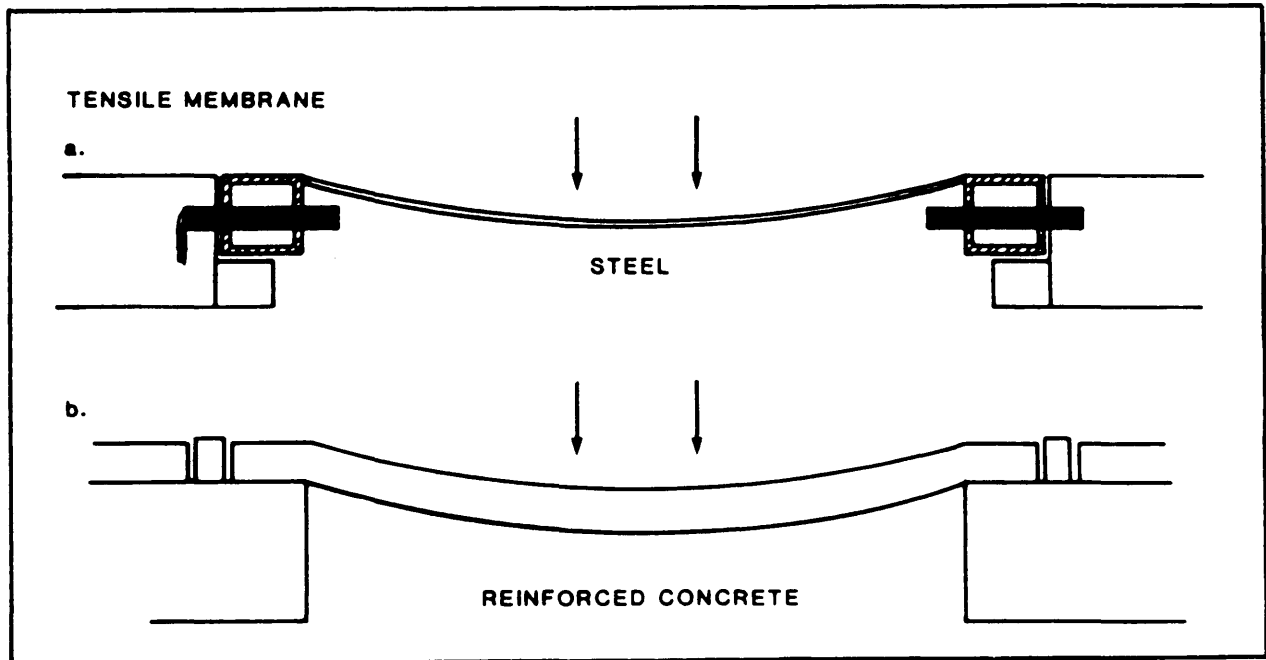

Figure 9c
Blast Resistant Door Concepts -
Tensile Membrane Doors

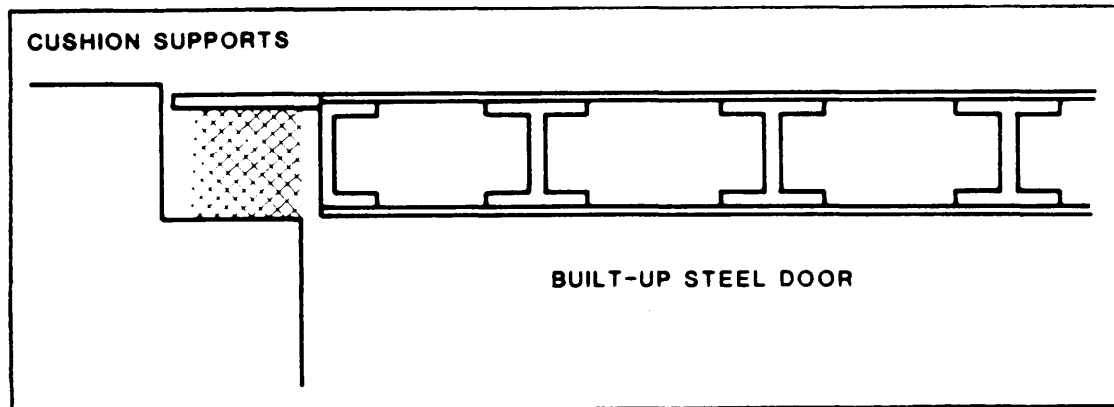

Figure 9d
Blast Resistant Door - Cushion Support Doors

MIL-HBK-1040

Loads on the critical external doors must be controlled by proper entrance design. Barriers with roofs, or below grade entrances, shall be used to eliminate fragment loads and decrease blast pressure loading. Proper architectural design of the entrances should allow the use of solid plate doors designed for incident overpressures (not high reflected pressures) and no fragment loads. Entrance design examples are shown in Section 3.

The design criteria in this section applies to solid plate steel doors. They are the most economical and should be feasible in the majority of applications. Design procedures for other door types are provided in NAVFAC P-397. Standard door designs, which are being tested for specific NATO protection categories, may also be available.

4.6.2 Design Stresses. Design stresses for steel doors shall be as follows:

ASTM Steel	f_y^a (psi)	Bending		Shear	
		DIF	f_{ds} (psi)	DIF	f_{ds} (psi)
High Design Overpressure Range (External Doors)					
A36	36,000	1.36	49,000	1.10	39,600
A514 ^b	100,000	1.12	112,000	1.00	100,000
A514 ^c	90,000	1.12	100,800	1.00	90,000
A588 ^d	50,000	1.10	55,000	1.00	50,000
Other	f_y	1.10	1.1 f_y	1.00	f_y
Low Design Overpressure Range (Internal Doors)					
A36	36,000	1.29	46,400	1.00	36,000
A514 ^b	100,000	1.09	109,000	1.00	100,000
A514 ^c	90,000	1.09	98,100	1.00	90,000
A588 ^d	50,000	1.10	55,000	1.00	50,000
Other	f_y	1.00	f_y	1.00	f_y

^aMay be increased to the static yield stress of the delivered steel, based on mill test report.

^bPlates and bars less than 2-1/2 inches.

^cPlates and bars greater than or equal to 2-1/2 inches.

^dPlates and bars less than 4 inches.

4.6.3 Allowable Deflections. The maximum allowable deflection, X_u , is defined in terms of the maximum allowable support rotation, θ_u , following formation of the yield line mechanism. An additional constraint is imposed on the maximum allowable deflection, X_u , by limiting the ductility factor X_u/X_E , where X_E is the equivalent elastic yield deflection.

MIL-HBK-1040

The maximum allowable deflections for solid steel plate doors are:

Door (Protection Level)	Area	Requirement	θ_u (deg)	X_u/X_E
Exterior (B)	Mechanical Room	Reusable	2.0	5
	CCA	Reusable	1.0	2
Interior (D)	Area Dividing Walls	Reusable	NA	1

A trial door design shall be considered adequate provided the maximum dynamic deflection, X_m , is such that $X_m \leq X_u$ based on the rotational constraint and $X_m/X_E \leq X_u/X_E$ based on the ductility constraint.

4.6.4 Design Procedure. The following design process is recommended for selecting the required thickness of steel plate for a blast door and the equivalent static design loads for door connections:

a) Step 1: Select a trial design for the door using solid steel plate. Determine f_{ds} for the steel and establish support conditions for the door.

b) Step 2: Calculate the dynamic ultimate moment capacity of the plate cross section,

EQUATION:
$$M_{VP} = M_{HP} = M_u = t^2 f_{ds} / 4.8 \quad (12)$$

where

M_{VP} = ultimate positive moment capacity in the vertical direction, in.-lb/in.

M_{HP} = ultimate positive moment capacity in the horizontal direction, in.-lb/in.

M_u = ultimate moment capacity of plate cross section, in.-lb/in.

In nearly all cases, the moment capacity of the plate at its supports is negligible (i.e., $M_{HN} = M_{VN} = 0$).

c) Step 3: Calculate the factor a,

EQUATION:
$$a = \frac{L}{H} \left(\frac{M_{VN} + M_{VP}}{M_{HN} + M_{HP}} \right)^{1/2} \quad (13)$$

MIL-HBK-1040

where

L = clear span of door in horizontal direction

H = clear span of door in vertical direction

d) Step 4: Use figures in NAVFAC P-397, Volume III, with a from Step 3, and find y/H . Calculate y .

e) Step 5: Select the proper equation from NAVFAC P-397, Volume III Tables 3-1 or 3-2, and calculate the dynamic ultimate resistance of the door, r_u (psi).

f) Step 6: Calculate the moment of inertia, I , and plate modulus, D , for the door. For a solid steel plate,

EQUATION:
$$D = E_s I / (1 - \nu^2) \quad (14)$$

where

$$I = t^3 / 12$$

t = plate thickness, in.

$$E_s = 29 \times 10^6 \text{ psi}$$

$$\nu = 0.3$$

g) Step 7: Calculate the equivalent plate stiffness, K_E (psi/in.).

EQUATION:
$$K_E = D / \gamma L^4 \quad (15)$$

where

γ = factor obtained from Table 42 of Timoshenko's Theory of Plates (second edition).

h) Step 8: Calculate the effective unit mass of the solid steel plate,

EQUATION:
$$M_e \text{ (psi-msec}^2\text{/in.)}, \quad (16)$$

$$M_e = 742 K_{LM} t$$

MIL-HBK-1040

where

K_{LM} = load-mass factor obtained from NAVFAC P-397, Volume III, Table 3-13 or Figure 3-44.

i) Step 9: Calculate the fundamental period of vibration, T_n , of the door,

EQUATION:
$$T_n = 2 \pi (m_e/K_E)^{1/2} \quad (17)$$

j) Step 10: Calculate the equivalent elastic yield deflection, X_E (in.),

EQUATION:
$$X_E = r_u/K_E \quad (18)$$

k) Step 11: Calculate the maximum allowable deflection, X_u , of the door for the constraints imposed in Paragraph 4.6.3 on the maximum allowable ductility factor, X_u/X_E , and maximum allowable rotation at supports, θ_u .

l) Step 12: Calculate the maximum positive deflection, X_m , of the door produced by the design blast load using response charts given in NAVFAC P-397, Volume III.

m) Step 13: Compare X_m with X_u . Go to Step 14 if $X_m \leq X_u$. Otherwise, increase the thickness of the trial design and repeat Steps 1 through 12.

n) Step 14: Calculate the "average" support reactions, V_v and V_h , using the appropriate equations given in NAVFAC P-397, Tables 3-9 and 3-10. Check the shear stress in the plate at its supports and repeat the above steps if the shear stress exceeds the design allowable. The reactions, V_v and V_h are the equivalent static design loads to be uniformly applied to the door casing for design of the supports.

o) Step 15: Structural connections joining the door (in closed position) to its casing must restrain the door and safely resist rebound forces introduced during the rebound phase of dynamic response. Otherwise, rebound will move the door away from its casing and thereby create air gaps and a path for blast overpressures around the door. Use NAVFAC P-397 to design these connections to resist rebound forces. The positive blast pressure may not be used to reduce the negative resistance, r_u^- , required to resist rebound.

p) Step 16: Design the casing and connections for the door to safely resist the forces at supports produced by the static uniform loads r_u obtained in Step 5 and r_u^- obtained in Step 15.

MIL-HBK-1040

q) Step 17: Given an acceptable door design, design the adjoining wall slab to safely support the door reactions, V_h and V_v .

4.6.5 Fragment Penetration. Although doors should be protected from fragments by barriers, if a door (or fragment barrier) must be designed to resist fragment perforation the following equations may be used.

For armor piercing (AP) fragments penetrating mild steel plates:

$$\text{EQUATION:} \quad x = 0.30 W_f^{0.33} V_s^{1.22} \quad (19)$$

For mild steel fragments penetrating mild steel plates:

$$\text{EQUATION:} \quad x = 0.21 W_f^{0.33} V_s^{1.22} \quad (20)$$

where

x = minimum steel thickness, in.

W_f = fragment weight, oz.

V_s = fragment velocity, kfps

These design equations consider only normal (90° angle of incidence) penetration which is critical for design of protective structures. They apply to penetration into mild steel plate (Brinell Hardness = 150) and are conservative for harder steel. Charts based on these equations are given in NAVFAC P-397, Volume V.

4.7 Windows. Because of the vulnerability of windows to fragments and blast loads from an explosive threat, they are not allowed in the external structural envelope. Small windows (no wider than 12 inches (0.305 m)) are allowed in area separation doors (Protection Level D). If a window is required at the outside entrance to the CCA, a double blast door entry must be provided with the window in the interior door.

4.7.1 Materials. Window materials for resistance to blast pressure loads vary in their acceptability:

4.7.1.1 Acceptable Materials.

- a) Monolithic thermally tempered glass
- b) Laminated thermally tempered glass
- c) Laminated Herculite II (chemically tempered glass)

MIL-HBK-1040

4.7.1.2 Unacceptable Materials.

- a) Chemically tempered glass, other than Herculite II
- b) Annealed glass (plate, float, or polished)
- c) Heat-treated, semi-tempered glass
- d) Wire-reinforced glass
- e) Soda-lime based chemically tempered glass
- f) Acrylic (Plexiglass or Lucite)

Polycarbonate materials have not been sufficiently tested as yet, to evaluate their suitability.

4.7.2 Window Design. Windows must not be larger than is necessary for operational requirements and the short dimension shall not exceed 12 inches (0.305 m). Allowable elastic resistances for standard glass thicknesses of the acceptable window materials are given in Table 4 for 12-inch (0.305-m) wide windows. The table is applicable for instantaneously applied long duration pressure loads (psi), as would be expected in interior areas. This table should also be used for windows with short dimensions less than 12 inches (0.305 m).

Window supports may be designed for the blast loading on the windows (pressure x tributary area for same duration). The supports must be designed to remain elastic.

Table 4
Glazing Thickness (Inches) for Interior Area Dividing Doors

[Short window dimension 12 inches or smaller]

Dimensions (in.)	Effective Elastic Static Resistance (psi) for Glass Thickness, t (in.) --					
	3/4	5/8	1/2	3/8	5/16	1/4
12 x 12	206	140	87	50	27	19
12 x 18	123	83	52	29	16	22
12 x 24	97	66	41	23	13	9
12 x 36	81	55	34	19	10	7
12 x 48	75	51	32	18	10	7

MIL-HBK-1040

4.8 Blast Valves. Blast valves are required in all air intake and exhaust lines penetrating the external envelope of the CW shelter. Fragment shields, or other architectural/structural design features, must eliminate exposure of the blast valves to line-of-sight fragments. Blast valves shall satisfy the following requirements:

a) The head loss at rated flow shall be less than 1 inch (25.4 mm) of water pressure (this may require valves to be installed in parallel).

b) The valve shall be blast-actuated by a minimum outside pressure (positive or negative) of 1 psi (6.895 kPa). The valve shall not allow more than 15 psi-ms (103.42 kPa-ms) incident impulse (positive or negative) at any point 3 feet (0.9144 m) from the valve under the design external blast load. If no explosive threat is specified, the design loads shall be based on:

- A triangular positive incident loading: peak pressure of $P_{SO} = 1,000$ psi (6,894.76 kPa) (at time = 0) and a duration of 0.4 ms.

- A triangular negative incident loading: -10 psi (-68.95 kPa) peak negative pressure of $P_{SO} = -10$ psi (-68.95 kPa) (at time = 0) and a duration of 100 ms.

- A triangular incident loading with $P_{SO} = 250$ psi (1,723.69 kPa) (at time = 0) and a duration of 20 ms.

- A long duration (500 ms) constant pressure of $P_{SO} = 150$ psi (1,034.2 kPa).

c) The valve shall remain closed as long as overpressure is present.

d) All valves shall be of the same design for ease of service.

e) The valve shall not flutter nor close from drag forces associated with the design airflow.

f) The valve must be capable of being proof-tested periodically.

g) The selected valve shall have been field- or shock-tube-tested under design blast pressures (maximum and minimum).

4.9 Barriers. Fragment barriers are required to protect doors, blast valves, and any other penetration (doors, blast valves, etc.) of the external envelope. They can also reduce the design blast pressures on the penetrations. Use of barriers is demonstrated in the door entrance design concepts shown in Figure 2.

R/C barriers should be designed using applicable large allowable deflection criteria ($4^\circ < \theta_u < 12^\circ$) in NAVFAC P-397. Fragment resistant and breaching criteria are given in Paragraphs 4.5.5, 4.5.6, and 4.6.5. Barriers

MIL-HBK-1040

need not be designed to prevent spalling (the design of the external CW envelope should be resistant to secondary debris from barrier spalling). Reinforced concrete or earth-bermed R/C should be used for large (wall-size) barriers. Steel plates may be used for local applications.

MIL-HBK-1040

SECTION 5: MECHANICAL - HVAC DESIGN CRITERIA

5.1 Background.

5.1.1 Design Philosophy. Space conditioning is the most important aspect of a CW protection system, for it is the flow of decontaminated air through the shelter that actually protects personnel inside the building and permits them to enter and leave the facility. Consequently, it is of utmost importance that the air cleaning and air distribution system be carefully designed, constructed and tested.

The CW shelter must be divided into two areas which are physically and environmentally separated from each other. These areas are the TFA and the CCA. The basic design philosophy is to provide clean, pressurized air to the TFA for habitat ventilation and use the exhaust air from the TFA (and additional clean air as required) to control the level of contamination in the CCA. Airflows caused by the pressure differences maintained between the different rooms of the shelter keep contaminant movement toward a region of higher contaminant concentration. Contaminants cannot flow into the TFA in a correctly designed air handling system. This design principle is illustrated in Figure 10. Factors such as room air pressures, airflow patterns, duct design, room size and construction, and other factors must be carefully analyzed if a CW protection system is to work effectively.

5.1.2 Shelter Room Arrangement. A CW shelter is usually designed to function as a conventional facility during normal times and as a protective facility that, in the event of a CW attack, can be inhabited for a specified number of days. The shelter building has six main areas: the TFA, the AL access to the TFA, the VHA, the CB, the LHA, and the mechanical equipment rooms. The LHA, CB, VHA and AL comprise the CCA. Water showers may also be part of the personnel cleansing system. The water showers must be located between the VHA and the airlocks. One CCA configuration is illustrated in Figure 11.

5.1.2.1 Liquid Hazard Area. To illustrate the functions of the various rooms, which comprise a CW shelter, the path personnel take as they enter the shelter from the outdoors can be followed. The first room a person enters is the LHA. The LHA will have both liquid and vapor contamination present. A mask is always worn in this area and great caution must be taken to prevent contaminants from contacting the skin. The LHA is the room where the outer layer of protective clothing is cut and removed from personnel entering the shelter. The outer protective suit is removed by attendants in the LHA. At the present time, contaminated clothing is placed in plastic bags, sealed, and discarded. The contaminated clothing is not cleaned or reused. If reusable outer garments are used by personnel using the shelter, then space must be provided in the LHA for outer garment storage.

5.1.2.2 Change Booth. From the LHA the person moves to the CB. The CB is a small room where personnel remove the remainder of their clothing, personal effects, and equipment (other than masks). The CB also serves as an airlock between the LHA and the VHA. Therefore, the entry and exit doors of a

MIL-HBK-1040

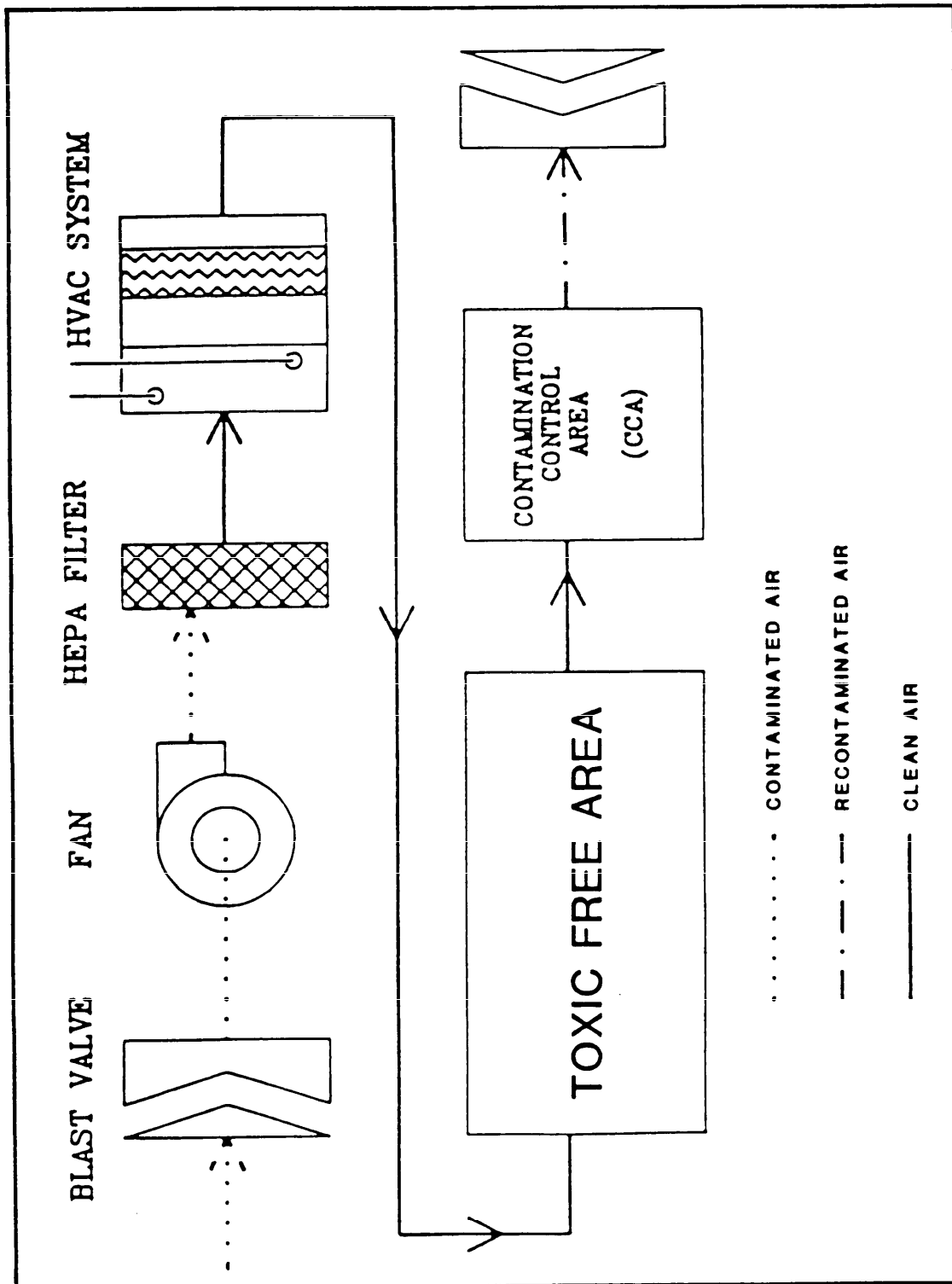

Figure 10
System Schematic

MIL-HBK-1040

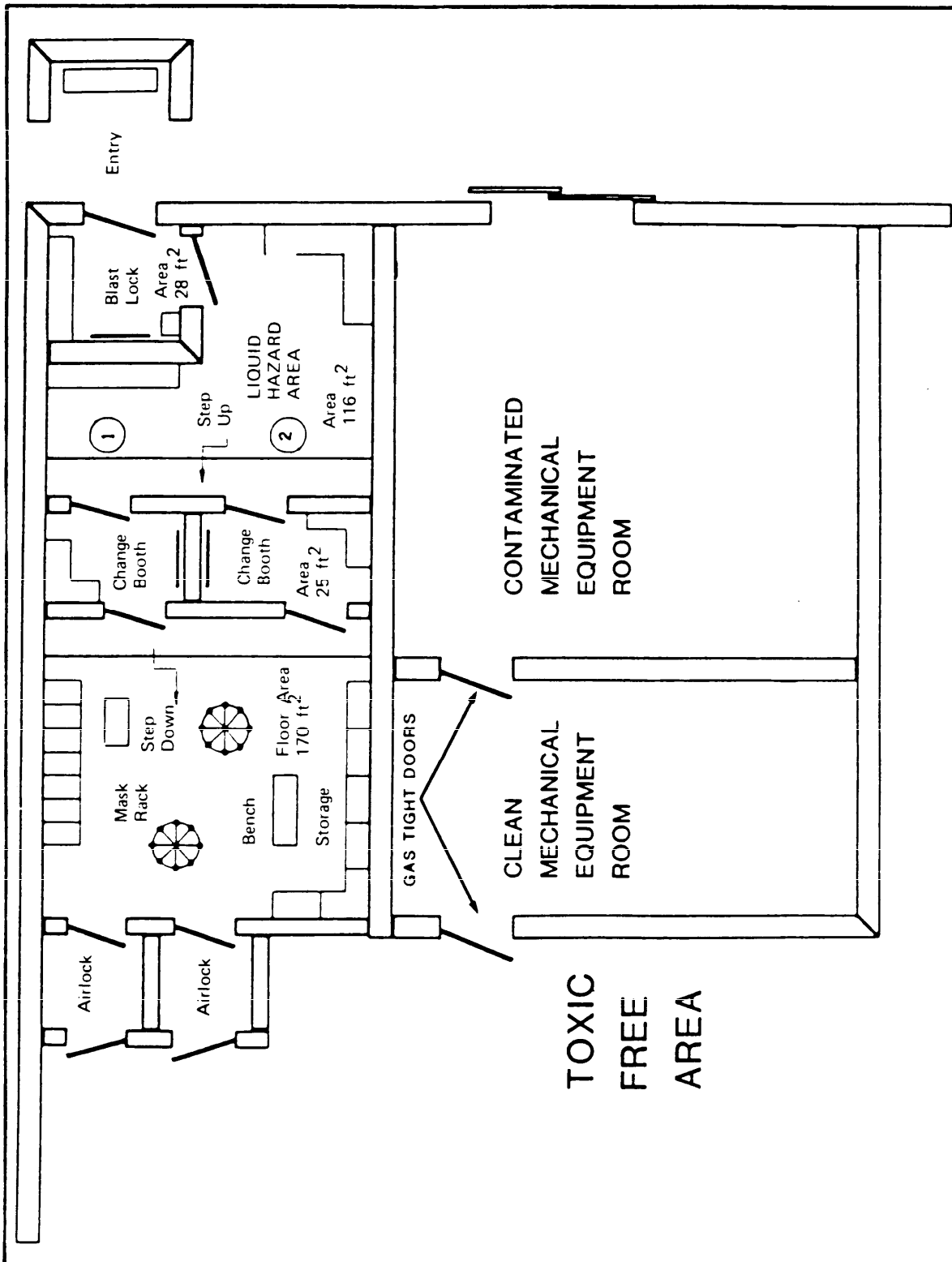

Figure 11
Typical CCA Configuration

MIL-HBK-1040

CB must be interlocked so that both cannot be opened at the same time. The items which are removed are placed in plastic bags. The bags are sealed and carried into the VHA.

5.1.2.3 Vapor Hazard Area. From the CB, the person enters the VHA. The VHA will have chemical vapors present, so personnel must wear protective masks while in the VHA. However, no liquid contaminant should be present so personnel may have exposed skin. The VHA serves as the place to store clothes and to exchange masks. Packages of clothes, personal effects, and equipment are placed in numbered storage bins. The mask is hung on a storage rack.

5.1.2.4 Airlock. To enter the TFA, the person must pass through an airlock (AL). The AL is a small room interposed between the TFA and the VHA which allows personnel to pass from the contaminated area into the clean area. A person must stay in the AL for an air wash of at least seven complete air exchanges. Designing for two air exchanges per minute will allow a person to leave the AL after three minutes. The time a person is in the AL is controlled by a countdown timer. When the door to the TFA is opened, clean filtered air (from the TFA) passes into the AL to prevent ingress of toxic vapors to the TFA. The AL must have interlocked doors or similar means of preventing the entry of contamination into the TFA.

5.1.2.5 Toxic Free Area. The last room the person enters is the TFA. The TFA is the part of the shelter supplied with pressurized filtered air to provide an environment in which personnel can safely work or rest without the need to wear individual protective equipment.

5.1.2.6 Mechanical Equipment Room. There are two mechanical equipment rooms, designated as the dirty mechanical room (DMR) and the clean mechanical room (CMR). The DMR contains the pressurization fans, filter-absorber system, generator sets, boilers, refrigeration condensers and other equipment that require large amounts of air. The air in this room may be contaminated by a CW attack. During normal operation, the DMR may be entered through a gas tight door between the CMR and the DMR. During CW defense operation, the DMR can be entered only from the outside. During a CW mode operation, the door between the CMR and the DMR must be closed and locked.

5.1.2.7 Clean Mechanical Room. The CMR is designed to remain uncontaminated by a CW attack. This area contains the main air handlers, drinking water pumps, motor control panels, hot water heater, and other items that must remain clean. The CMR must be accessible from the TFA.

5.1.3 Overview of Typical System Configuration. The shelter is capable of being operated in three modes:

- o The normal or peacetime mode of operation in which the regularly scheduled activities are performed.
- o The training mode of operation in which the performance of personnel and equipment is tested.

MIL-HBK-1040

- The CW shelter mode.

In the normal mode of operation, the shelter HVAC system is operated the same as if the shelter were a conventional building, that is to say, the HVAC system provides heated or cooled air to the TFA in the amount required to keep the occupants comfortable. The HVAC system also brings into the building sufficient outdoor air to meet the ventilation air requirements. During normal operations, the air pressurization and filtration system employed in the CW defense mode is bypassed.

In the training mode of operation, the building is pressurized and operated as it would be in a CW attack with the exception that the filter system is bypassed (to prevent unnecessary filter and adsorber loading and contamination). An insert is placed in the filter bypass piping to simulate the pressure drop across the filters.

In the CW mode of operation, the building is pressurized and all outdoor air is forced through the CW filter system. Clean conditioned air is supplied to the TFA to keep the shelter occupants comfortable. The air supply to the CCA is not, in general, specifically conditioned.

5.1.4 Design Consideration. Two sets of design conditions must be determined for the HVAC equipment: the normal mode and the CW shelter mode. Equipment must be selected that meets both of these sets of design conditions. The factors which differ between the normal and the CW modes of operation are: number of people in the shelter, activity level and equipment in the shelter, pressure levels and airflow patterns within the shelter, and the amount of outdoor air brought into the shelter.

Because most chemically-hardened facilities are either small, special purpose buildings (such as command and control centers) or a physically separated and protected portion of a larger building (such as a protected area built into an administration building), the CW shelter can often be treated as one or two zones for HVAC design purposes. Single zone and reheat systems are good choices for shelter applications because they provide precise control over temperature and humidity and because of their inherent simplicity. Heat pump systems are an attractive alternative heating and cooling system for smaller shelters where climatic conditions permit. Variable air volume systems must not be used for conditioning of shelters in the CW mode of operation because the air volume requirements in the CW mode are very stringent and must not be modulated.

In general, an existing building HVAC system cannot be used or adapted to CW shelter use. This is because of very different requirements placed on an HVAC system used in a CW defense environment. An HVAC system used for CW defense is designed to operate at higher pressures and often higher volume flow rates than a conventional system. Also, the air distribution patterns are likely to be different between a conventional HVAC system and a system designed to provide protection from CW agents.

5.1.5 Example CW HVAC Configuration. The features required in a shelter HVAC system are most easily illustrated by means of an example. The HVAC configuration used in this document as an example of CW shelter design is the

MIL-HBK-1040

reheat system. The reheat system was chosen because it can closely maintain temperature and humidity over a wide range of loads. A reheat system provides either heated or cooled air. Cool, dehumidified air is generated in the cooling coil section of the system and the supply air is then heated and humidified as required to meet the space conditions. Reheat systems are not very energy efficient, but energy conservation is of secondary importance in this application. The ability to provide close control of the environment in the shelter and the inherent simplicity of the reheat system were judged to be more important.

5.1.5.1 Normal Operation Mode. In the normal mode of operation, ventilation air is drawn into the building through a prefilter by the supply air fan, bypassing the high efficiency filter/adsorber system (see Figure 12). Outdoor air and return air from the TFA are mixed by modulating motorized dampers. Normally, the dampers are positioned so that the inlet air damper admits only the minimum required ventilation air. A cooling coil removes the sensible and latent heat of the ventilation and return air streams and the fan heat. Cool, nearly saturated air leaves the cooling coil. When the room sensible cooling load is lower than the design load (and during the heating season), a heating coil is used to reheat the air to the supply air temperature required to meet the TFA load. A closed loop controller on a humidifier controls the amount of moisture added to the air stream. Most of the ventilation air is exhausted from the TFA through the toilets with a powered exhaust system. The remainder of the ventilation air is exhausted from the TFA via the CCA. The amount of air leaving by this route is controlled by a damper. The actions of all dampers are controlled to provide a small positive pressure (0.02-0.05 inch wg) (0.51-1.27 mm wg) in the building under normal operating conditions.

5.1.5.2 CW Operation Mode. In the CW mode of operation, motorized valves are actuated so as to direct the flow of outdoor air through the high efficiency air cleaning system. A high pressure fan forces the ventilation air through a high efficiency particulate arrestance (HEPA) filter and trays of adsorbent compounds that remove chemical agent vapors. The motorized dampers are modulated to direct the flow of ventilation air through the TFA and CCA. Careful design is required to keep the outdoor airflow requirements in the CW mode as small as possible to minimize the size of the chemical filter system. In the CW mode of operation, the amount of ventilation air required may be set by the cleansing airflow requirement of the CCA rather than personnel ventilation requirements.

5.2 Design Calculations. The CW shelter can be treated as a single zone for design purposes: the TFA. The heating, cooling, and humidification loads are based on analysis of the requirements of the TFA. The CCA is used only for transient purposes and should not be conditioned for human comfort.

In the normal mode of operation, the air supplied to the TFA must be at a temperature and volume flow rate to meet the peak load condition. The peak load may be the largest of the sensible or latent internal cooling load, heating load, or ventilation air load.

MIL-HBK-1040

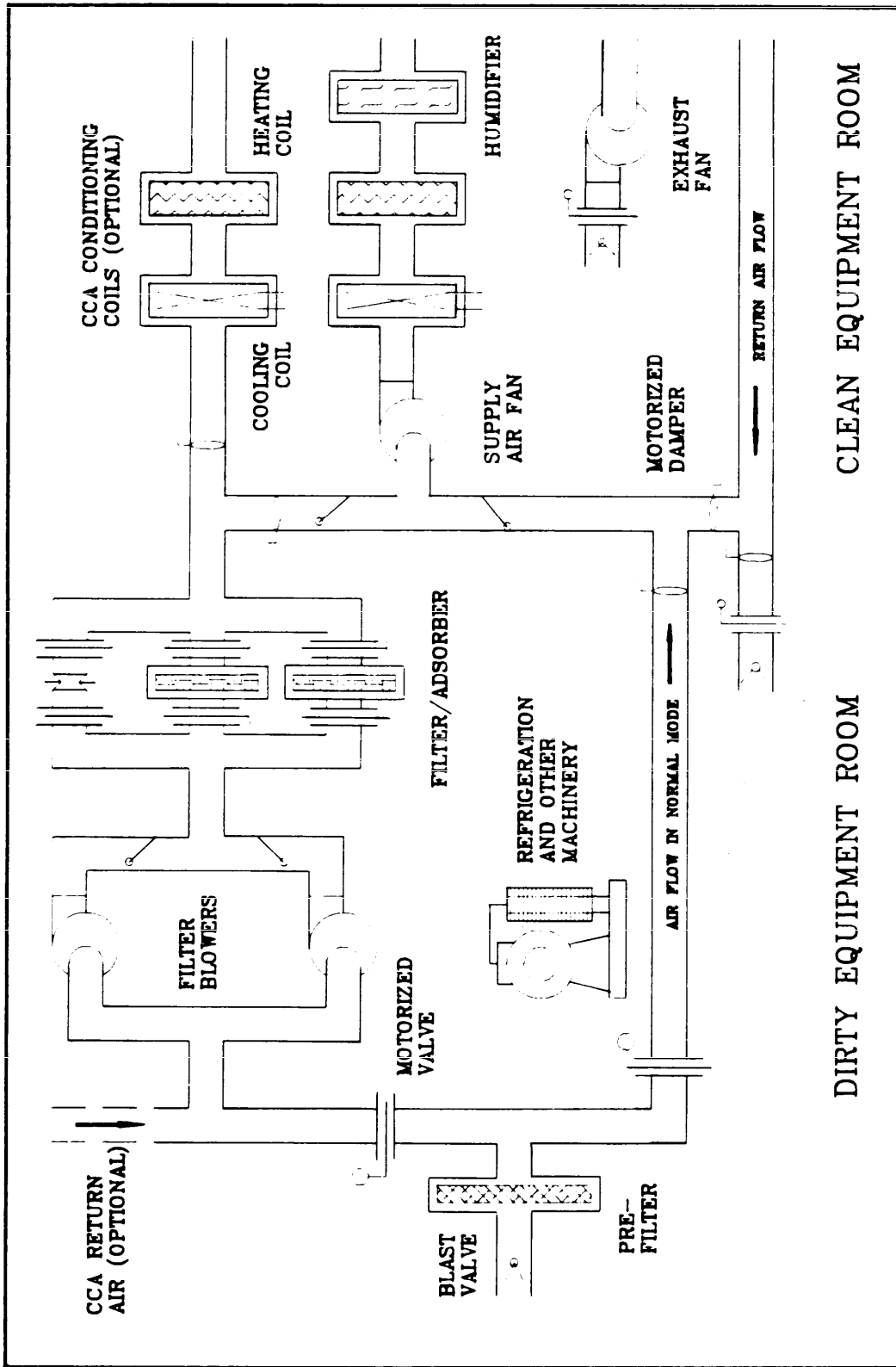

Figure 12
Example of HVAC System for CBR Shelter

MIL-HBK-1040

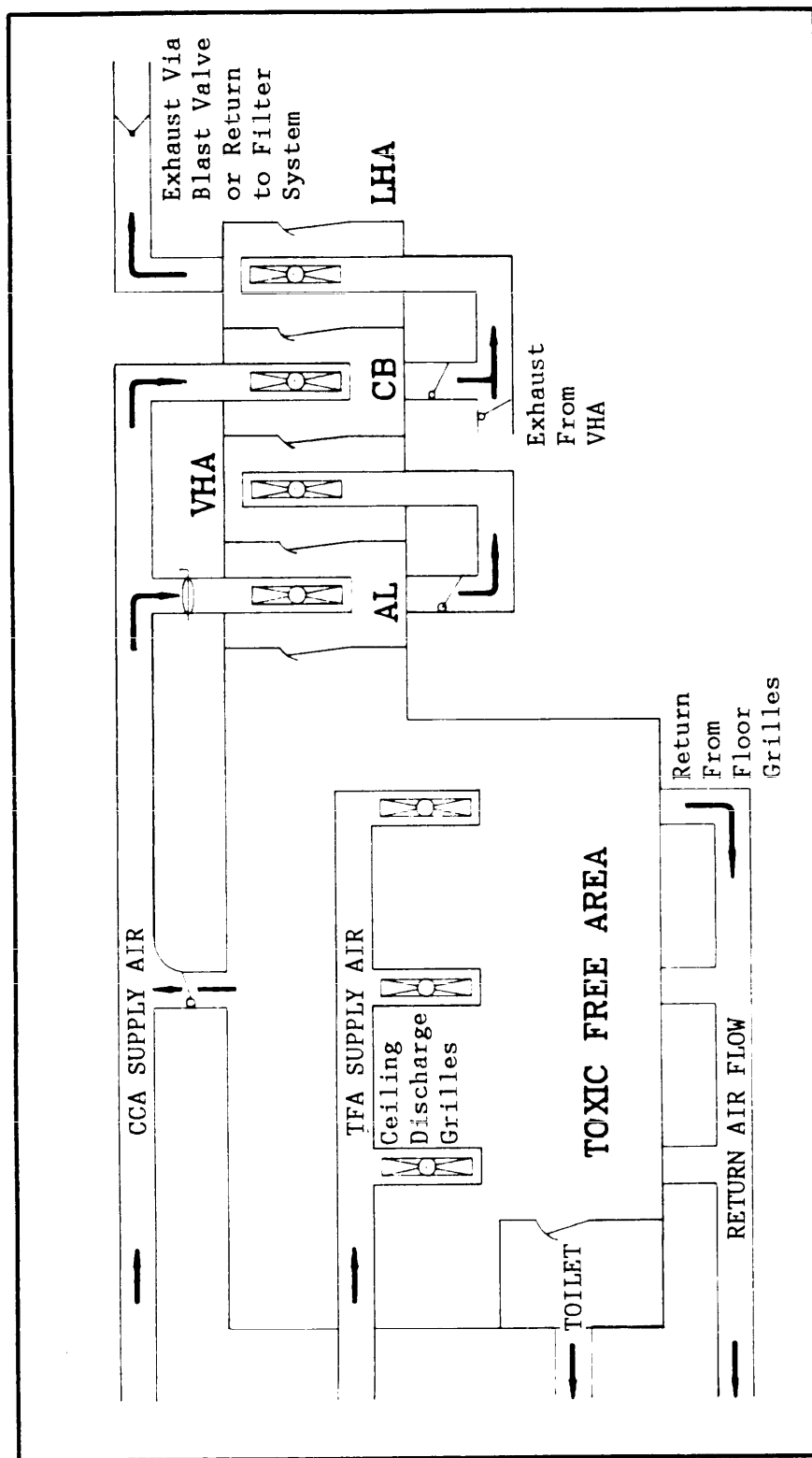

Figure 12
Continued

MIL-HBK-1040

In the CW mode of operation, the larger number of people and other heat and moisture sources in the TFA will result in larger internal sensible and latent loads. An increase in the ventilation load will also result from a larger number of people in the TFA during CW operation.

5.2.1 Calculation of Heating Load. Two calculations of heating requirements for the CW shelter are necessary: One calculation for the normal mode of operation and one calculation for the CW mode of operation. Use the appropriate climate data and the 97.5 percent winter design day for the heating load calculations for both modes of operation for the TFA. Shelter design information, such as building size, orientation, and construction are obtained from the architectural plans. The heating load is, in general, governed by transmission heat loss and heat load caused by ventilation air. As a minimum, use the American Society of Heating, Refrigerating, and Air Conditioning Engineers (ASHRAE) manual method of heating load estimation presented in ASHRAE 1988 Handbook - Fundamentals, or in ASHRAE 1987 Handbook - HVAC Systems and Applications. Use of a computer program to calculate the heating load is strongly recommended. Many load analysis programs are available for use on personal computers. These programs are accurate and easier to use than manual calculation methods. Indoor design conditions should be selected to comply with the winter comfort zone dry bulb temperature (see ASHRAE Standard 55-1981, Thermal Environmental Conditions for Human Occupancy).

5.2.2 Calculation of Cooling Load. Use the appropriate climatic data, shelter construction data, and internal load data to calculate the cooling load for the TFA in both normal and CW operation using the method presented in ASHRAE Handbook of Fundamentals, Chapter 26. Use the 2.5 percent summer design day dry bulb and wet bulb temperature data for the cooling load calculation. Repeat the cooling load calculation for the winter design conditions - cooling may be required year around. Use the data presented in the summer comfort region from ASHRAE STD 55-1981, as the interior design conditions. Use of a computer program is especially recommended for calculation of the cooling load.

5.2.3 Calculation of Moisture Load. The humidity in the TFA must be controlled for reasons of human comfort, process control and materials storage, control of static electricity, and control of airborne infections. The recommended humidity levels in the TFA during summer and winter are presented in ASHRAE STD 55-1981. The air supply to the TFA may need to be humidified during normal winter operation and dehumidified during normal summer operation or CW mode operation. The net humidity gain or loss is the difference between the desired humidity ratio in the TFA and the humidity ratio of the air entering the coil section of the air handling unit.

5.2.4 Calculation of Ventilation Air Requirements. A procedure for calculating the ventilation air requirements and the zone pressure relationships is provided in Paragraphs 5.2.4.1 through 5.2.4.3. Determining the airflow requirements in the CW mode of operation is the most critical part of the preliminary design process. The airflow in the CW mode must clean the CCA and provide ventilation air to the TFA, yet the airflow must be kept to a minimum to keep the size of the particulate and chemical filter systems as small as possible. The airflow requirements for the CW mode of operation will govern HEPA filter sizing and may influence fan and duct sizing.

MIL-HBK-1040

5.2.4.1 Normal Operation Mode Ventilation Requirement. For the normal mode of operation, the ventilation air requirement is 10 cfm/person (0.283 m³/min per person).

5.2.4.2 CW Operation Mode Ventilation Requirement. The ventilation air requirement in the CW mode of operation is determined by the amount of clean air necessary to provide clean air showers in the AL and CB and to keep the toxic concentration below a specified level in the VHA and the LHA. The required air volumes have a direct relation to the volumes of the rooms that comprise the CCA area. Therefore, it is very important to keep these rooms as small as practical. A configuration is presented in Figure 11.

There are two ways to keep the level of toxic agents in the air in the CCA below an acceptable limit value: use a high velocity (50-100 feet/minute) (15.24-30.48 m/min) uniform flow of clean air from ceiling diffusers to floor discharge grilles to capture the vapors as they are released into the air and sweep them out of the room, or dilute the contaminated air in the CCA with enough clean air to reduce the concentration of toxic vapors to an acceptable level. A quick calculation shows that the amount of clean air required to implement the "capture velocity" principle in the larger rooms of the CCA such as the VHA and LHA results in prohibitively large airflow rates. (For example, the small CCA illustrated in Figure 11 would require 20,000-40,000 cfm (566.34-1,132.68 m³/min) of clean air.)

Therefore, dilution ventilation principles must be applied to reduce the amount of toxic material in the CCA to an acceptable level. To do this, the designer needs to know: the rate at which toxic substances are released into the air of the CCA, and what are the acceptable levels of concentration for the different toxic materials. One procedure is presented in Appendix A for estimating the amount of ventilation air required by a shelter operating in the CW warfare mode.

5.2.4.3 Recommended Airflow Configuration. The recommended airflow configuration for the CCA ducts clean air from the TFA or a separate supply duct in an amount equal to the larger of either two air changes/minute in the AL or the design VHA airflow, first through the AL and then through the VHA. The air exhausted from the VHA is ducted to the LHA air inlet. The recommended airflow configuration also ducts clean air from the TFA or a separate clean air supply duct in an amount equal to the design VHA airflow through the CB. The exhaust from the CB is also ducted to the LHA air inlet. If no better data are available, design the air supply system to provide the AL with two air changes per minute of clean air and to provide each of the other rooms of the CCA (VHA, CB, and LHA) with one air change per minute of clean air.

The airflow configuration that results in the minimum clean air requirement cascades clean air from the AL through the VHA, through the CB, then out through the LHA. This design should be applied with caution, because the inlet air to the CB (the exhaust air from the VHA) might have unacceptably high contamination levels. The recommended configuration has a separate clean air supply for the CB. During the CW operation, the normal exhaust path for toilet exhaust is blocked by a closed valve. In the CW mode, toilet exhaust can be ducted into the TFA exhaust stream or a greater proportion of the clean

MIL-HBK-1040

air supply can be directed through the TFA to provide dilution ventilation. Note that if water showers or space for outer garment storage are added to the CCA, the required volume of decontaminated air must to be increased.

Usually, air cleaning systems are designed as "once through" or "100 percent outdoor air" systems. Thus, all of the air from the CCA would usually be exhausted outdoors. An alternative design exhausts only a portion of the air from the CCA to the outdoors (typically 10 cfm (0.283 m³/min) per person), adds an equal amount of outdoor air to the CCA exhaust, and returns the mixture to a point in the air cleaning system upstream of the filter pressurization fan. A recirculating air cleaning system reduces the amount of outdoor air brought into the shelter and, therefore, reduces the required capacity of the heating and cooling components. Also, the filters and adsorbers should last longer because the amount of contaminants taken into the air cleaning system is reduced. However, implementing this system design requires additional high pressure ductwork, dampers, and controls. The cost of these additional components may exceed the incremental cost of the larger heating/cooling capacity required by a 100 percent outdoor air design. Note that the flow through the filter-adsorber system is the same for both the once through and the recirculation air cleaning system designs.

5.2.5 Filter-Adsorber Sizing. In designing a filter system, the capacity and efficiency required are based upon the maximum challenge concentration anticipated and the length of time this challenge may exist. Once the worst-case challenge has been identified, the reduction ratio (and hence, capacity) required by the filter system may be computed from the formula,

EQUATION:
$$\frac{C_o}{C_i} = R_{\min} \quad (21)$$

where

C_o = concentration of chemical agent leaving the filter-adsorber system
= maximum allowable concentration entering the TFA, mg/m³

C_i = concentration of chemical agent entering filter-adsorber system
= worst-case challenge, mg/m³

R_{\min} = minimum agent reduction ratio required of filter-adsorber system

The minimum capacity required is obtained by multiplying the worst-case challenge by the time the shelter will be occupied and by the airflow rate. The designer shall use a reduction ratio of $R_{\min} = 10^{-4}$.

As an example of sizing the filter and adsorber system, suppose the filter system must be sized to provide protection for 4 days without changing the filter-adsorber units. The maximum allowed dosage in the TFA for any agent

MIL-HBK-1040

where

A_d = effective area of the airlock door opening

To effect inward flow to the AL, the airlock must be provided with a properly designed discharge damper. The AL discharge damper is controlled so that when the door to the TFA is closed, air passes through the damper at the rate:

$$\text{EQUATION:} \quad \text{cfm} = V_{\text{air lock}} \cdot 2 \text{ acm} \quad (27)$$

and the desired differential pressure is maintained. When the access door to the TFA is opened, the airlock supply air damper closes and the discharge damper is positioned so that all the AL supply air is drawn through the opened door. The discharge damper is positioned so that sufficient air flows from the TFA into the AL to maintain a velocity of approximately 100 fpm (30.48 m/min) through the door opening. Control of the supply and discharge dampers is most accurately done with electronic control devices. However, by careful design, balanced or spring loaded damper systems may be made to do the job.

5.2.6.1 Air Velocity. Care must be taken to ensure that the velocity of air out of the TFA through the AL doors is approximately 100 fpm (30.48 m/min). Although this value is less than the prescribed 150-fpm (45.72-m/min) velocity recommended for toxic vapor control, a lower value is allowable for AL doors because the likelihood of crossdrafts affecting the flow pattern is small. Also, the total area of a door opening is seldom experienced since personnel open the door only wide enough to enter, thereby, resulting in an inward velocity greater than 100 fpm (30.48 m/min).

5.2.6.2 Air Shower. Before entering an AL, personnel activate a timer that unlocks the door to the TFA after the preset time. This assures that entering personnel will receive an air shower of at least 3 minutes (but not exceeding 6 minutes) before entering the TFA. Personnel remove their protective mask immediately before entering the AL.

5.2.7 Pressurization Requirements. The internal pressure in the TFA is determined by the condition that the fan system be able to exhaust air from the building against the worst expected wind velocity pressure on the air handler discharge side of the building. A wind pressure chart is presented in Figure 13. Use a 30-mph (48.28 km/h) wind speed for design purposes. Therefore, the fan system should produce an overpressure at the discharge from the LHA of 0.45 inch (11.43 mm) of H₂O. The pressure in each of the rooms connecting the LHA to the TFA is higher than that in the LHA to produce airflow in the required direction. A typical pressure increment is 0.1 inch (2.54 mm) of H₂O. Therefore, the TFA might be pressurized to 1.0 inch (25.4 mm) H₂O relative to the outdoors.

5.3 Mechanical Equipment Design and Selection Guidelines. Much of the material presented in this section was adapted from information presented in DM-3.03, Heating, Ventilating, Air Conditioning, and Dehumidifying Systems,

MIL-HBK-1040

Table 7
Typical Characteristics of Open-Face HEPA Filters

Filter Size (in.)	Nominal Airflow Capacity* (cfm)	Approximate Overall Weight of Filter (lb) (Steel Case)
8 x 8 x 3-1/6	25	3
8 x 8 x 5-5/8	50	5.8
12 x 12 x 5-7/8	125	7.3
24 x 24 x 5-7/8	500	22
24 x 24 x 11-1/2	1,000	40

*These airflow capacities are recommended for design purposes only. Some newer filters constructed to these dimensions are rated at airflows 25 to 50 percent higher at a maximum drop of 1.0 inch wg (25.4 mm wg).

c) Selection. For logistical reasons, HEPA filters of standard design are generally preferred. However, the important advantage of simplified installation may be of overriding consideration even if it involves the disadvantage of a special filter design.

5.3.4.7 Adsorber Cells.

a) Agent Vapor Removal Methods. Most agent vapors can effectively be removed from the inlet airstream by one or more of the following methods:

- Physical adsorption on a spongelike surface of attracting material, such as activated carbon, alumina, or ion-exchange resin.
- Absorption by intimate scrubbing with a stable solvent.
- Chemical reaction, as with sodium hydroxide, in a packed gas scrubber.
- Combustion into harmless basic oxides by incineration.

This guide assumes that the necessary engineering evaluation and selection process has been completed and that the designer has justified the use of an adsorption air cleaning system.

Adsorber cells consist of beds containing an adsorbent, such as activated carbon, used for removing contaminant gases or vapors from the air. The types of adsorber cells considered for CW protection operations are intended for very high-efficiency air-cleaning service and not for common industrial applications.

MIL-HBK-1040

b) Adsorbent. The adsorbent is the material in the adsorber cells that removes gases or vapors from the airstream to prevent their escape into the shelter. Agent capture is accomplished by physically retaining the gaseous molecules or, if the adsorbent is impregnated, by chemical reaction, depending upon the type of chemical agent involved. The adsorbent is often a coal-base or coconut-base activated carbon meeting the following specifications:

<u>Test Used</u>	<u>Value</u>	<u>Specification</u>
Iodine Number, Minimum*	1,000	MIL-C-13724**
Carbon Tetrachloride Adsorption, Minimum, % Weight*	59	ASTM D3467***
Ash, Maximum, %	8.0	MIL-C-13724
Total Volatiles (150°C ± 50°C for 3 hours), %	4.0	MIL-C-13724
Hardness Number, Minimum	90	MIL-C-13724
Apparent Density (Bulk Density, Dense Packing, Minimum, g/cc)	0.48	MIL-C-13724
Packed Column Test (to determine maximum total capacity of GB agent retained on adsorbent), Minimum, grams agent/grams adsorbent	0.4	Unpublished test procedure

Particle Size (3-min shake test):

ASTM D2862 and
ASTM E323****

<u>Sieve Size</u>	<u>Percent Retained</u>
8 mesh	0.5
8 x 12 mesh	35-65
8 x 16 mesh	35-65
16 mesh (through)	1-5

- * Both of these tests are not required. The carbon tetrachloride adsorption test is preferred but the iodine number test may be run as an alternative.
- ** MIL-C-13724, Charcoal, Activated, Impregnated ASC.
- *** ASTM D3467, Test Method for Carbon Tetrachloride Activity of Activated Carbon.
- **** ASTM E323, Standard Specification for Perforated-Plate Sieves for Testing Purposes (DoD adopted).

5.3.4.8 After-Filters. An after-filter is an HEPA filter installed after the adsorber bank. The purpose of the after-filter is to catch any particles of contaminated adsorbent that break loose from the adsorber cells and find their way into the airstream.

5.3.4.9 Extreme Environmental Conditions. Special or unusual environmental conditions may present problems to the filter system. Several conditions that must be considered during the design phase to preclude costly changes after the equipment is installed are:

MIL-HBK-1040

a) The type of environment in which the filter system will operate. Specific design features and requirements may vary depending on the climate, such as cold/wet, hot/wet, cold/dry, or hot/dry, and altitude.

b) Aging and weathering of components. Construction materials should be selected or treated to resist corrosion and degradation that could result in loss of performance when exposed to specific environmental conditions.

(c) Temperature and humidity. Gauges and other instrumentation and equipment should be designed or selected to withstand the temperature extremes anticipated at the specific site. Temperature and humidity, unless extreme, do not normally appreciably degrade particulate filters. Prolonged exposure can degrade the adsorbent with respect to certain chemical agents primarily removed by chemisorption (i.e., by impregnated adsorbents). Physically-adsorbed agents (e.g., those removed by activated carbon) are affected to a lesser extent.

5.3.4.10 Spacing. The spacing between filter-adsorber units should be adequate to permit easy changeout of filter-adsorber units. Adequate spacing to perform basic maintenance on the blower assembly should be provided. The location of the blower relative to the initial filter bank should be such that uniform air distribution is obtained across the filter bank.

Space considerations determine the actual location of the filter-adsorber system in a CW shelter. An indoor location in a ventilated area is preferred. The filter-adsorber units should be securely fastened (e.g., by bolts) to a concrete pad or other solid foundation. The units must be installed level and at an elevation to allow for drainage and alignment of the ductwork.

Unless specific safety criteria demand otherwise, it is recommended that a path at least 5-feet (1.52-m) wide be provided to access the filter-adsorber units and the filter blower assembly. In addition, there should be access for a forklift truck to reach the housing to assist in the changeout operations.

5.3.4.11 Sizing and Unit Selection. It is strongly recommended that the shelter air cleaning system be designed around one of the standard military CW filtration units listed in Table 8 and described in detail in Appendix A. The units listed in Table 8 incorporate all of the features discussed above, meet all applicable military standards for such components, and are often military stock items.

By using interconnected, individual filter-adsorber units, such as those listed in Table 8, the air cleaning system can be any required size. However, there are certain limitations that apply to the individual modules. Generally, the filter-adsorber unit is limited in size because of: (1) ease of moving the filtration units, (2) the ability to test the filters and adsorbers, (3) the requirement to provide uniform airflow, (4) space availability, and (5) improved ability to manage system upsets. Any arrangement of individual filter-adsorber units must be designed to facilitate unit replacement.

MIL-HBK-1040

Table 8
 Characteristics of Standard Military CW Filtration Units

U.S. Army Fixed Installation Filter Systems				
Flow Capacity (ft ³ /min)	600	1,200	2,500	5,000
Designation of HEPA filter ¹	C18R1	C19R1	C30R1	C31R1
Designation of Adsorber Cell ²	C10	C31	C21	C21
Designation of HEPA + Adsorber	M14	M15	M16	M17
Designation of Filter Adsorber module ³	C22R1	C32R1	C29R1	C23R1
Length (in.)	34.5	62	62	62
Width (in.)	25.5	25.5	48	48
Height (in.)	25.5	25.5	25.5	48
Weight of Adsorbent (lb)	160	320	640	1,280
Initial Flow Resistance (in. WG)	2.75	2.75	2.75	2.75
U.S. Air Force Fixed Installation Filter Systems				
1. In the CONUS				
Flow Capacity (ft ³ /min)	600			
Designation of Filter Module	FFU-17			
2. In Europe				
Flow Capacity (ft ³ /min)	353			
U.S. Navy Fixed Installation Filter Systems				
Flow Capacity (ft ³ /min)	200			

¹ MIL-F-51215, filters, particulate, (600, 1,200, 2,500, and 5,000 cfm)

² MIL-F-51213, filters, gas, (60, 120, and 250 cfm)

³ MIL-F-51214, filters, gas, (600, 1,200, 2,500, and 5,000 cfm)

MIL-HBK-1040

If the required capacity of the filter-adsorber system cannot be achieved by using a combination of standard module sizes, it is recommended that the system be oversized and any unused filter-adsorber units blanked off. Oversizing does not significantly increase the price of the system since a standard unit is still being used (as opposed to the price of a custom sized unit of nonstandard capacity). Another advantage of an oversized unit is that by installing a larger blower and activating the closed-off filters/adsorbers sections, the filter-system capacity can be increased later at minimal cost should the need arise.

5.3.4.12 Blower Assembly. The fan in the blower unit must be capable of pushing the required airflow through the ventilated area. Since the total static pressure of the system is not constant but undergoes a continuous slow increase due to dust buildup on the particulate filters, the system must be capable of compensating for the increased static pressure and maintain constant airflow. Two types of flow control systems (centrifugal fan with flow-control damper in the duct and centrifugal fan with variable inlet vanes), have been successfully used to meet these requirements and are recommended. Fans should be centrifugal with backward-inclined airfoil blades. The HEPA filter/pressurization fan should be sized to provide the required airflow in the CW mode at a head equal to the maximum HEPA filter pressure loss plus the duct losses plus 1.5 inch (38.1 mm) wg. The supply fan should be sized to provide the required airflow in the CW mode at a head equal to the greater of: (a) the duct losses in the normal mode of operation plus 0.50 inch (12.7 mm) wg, or (b) the losses in the discharge air path in the CW mode of operation plus 0.50 inch (12.7 mm) wg. When in doubt, oversize the fans.

Since the supply air fan must supply two different volume flow rates at about the same increase in head, a method must be provided to vary output capacity of the fan. The output capacity of the supply air fan should be varied by changing the fan speed. Use of a two-speed motor or a variable speed drive mechanism is recommended. A centrifugal fan with an external damper must be sized to the maximum static pressure expected and always operated at this maximum condition. When the particulate filters are clean and the total static pressure in the ventilation system is minimum, the control damper is closed sufficiently to increase the static pressure to its maximum level. As the filters gradually clog and build up static pressure, the outlet damper is opened to maintain constant flow. A fan with inlet-vane control must also be sized for the maximum condition anticipated. At startup, with clean filters in the system, total static pressure in the ventilation system is minimum, and the inlet vanes close to compensate for the lower level of static pressure through the system. As the static pressure builds up, the position of the inlet vanes change to keep the total static pressure at a constant value.

A backup filter pressurization fan should be installed parallel to the main fan unit. Backup supply air and or return air fans may or may not be needed depending on the details of the system design, room sizes, duct lengths and so forth. A propeller fan should be used for toilet exhaust. Fans should be belt driven with multiple belts for improved reliability. See DM 3.03 for additional details on fan system design.

MIL-HBK-1040

5.3.4.13 Fresh Air Intakes/Exhaust. Fresh air intakes should be well above the ground, and should also be away from chimneys and exhaust systems. The preferred location for the fresh air intake grille is high on a wall on the windward (relative to the prevailing wind direction) side of the shelter building. The inlet shall be protected by a blast valve. Fresh air intakes should also avoid truck loading areas. Fresh air intake louvers should have eliminator baffles to prevent rainwater or snow from getting into the filters. In areas which receive snow, the minimum height of the air intake above the ground should be greater than the anticipated snow depth.

The shelter exhaust outlet should be located as far as possible from the fresh air inlet to preclude short circuiting of exhaust air into the fresh air intake. The preferred location for the exhaust grille is high on the leeward wall of the shelter. This location will usually be a low pressure area. The exhaust outlet should be protected by a blast valve.

Penthouse openings for the air inlet and exhaust can also be used if the openings are designed to minimize short circuiting of exhaust air into the air intake.

5.3.4.14 Air Distribution.

a) Duct Design. The air distribution system should be designed to provide a constant volume airflow and maintain the CW shelter at the design positive pressure. Constant air volume can be assured by use of fans with a steeply rising pressure volume curve and application of variable capacity fan systems.

The design of air duct systems shall be in accordance with the procedure and considerations outlined in the ASHRAE 1988 Handbook - Fundamentals, Chapter 33. Use of a computer program for duct sizing and terminal selection is recommended. The equal friction method is recommended to determine the appropriate ductwork size for most systems. Effort should be made to minimize duct fittings.

b) Construction Requirements. All ductwork in contamination free areas should be constructed in accordance with the Sheet Metal and Air Conditioning Contractors' National Association (SMACNA) HVAC Duct Construction Standard - Metal, and Flexible. No duct carrying contaminated air shall pass through a clean space.

Ductwork passing through contaminated areas must be airtight to prevent intake of contamination in case positive pressure is lost. Gauge, number, and size of reinforcements depend on pressure in the duct. All seams and transverse joints should be welded, with, insofar as possible, the minimum number of companion-flange gasketed joints necessary for erection and dismantling. Gasketing between all welded joints must be 1/4-inch (6.35-mm) minimum thickness to provide sealing. All ductwork should also conform with National Fire Protection Association's NFPA Standard 90A Standard for the Installation of Air Conditioning and Ventilating Systems, and 90B Standard for the Installation of Warm Air Heating and Air Conditioning Systems. Do not provide access doors in the duct work in the DMR or other contaminated area.

c) Room Air Distribution. The ceiling-to-wall airflow pattern (Figure 16) is recommended for all rooms of the CW shelter. Additional recommendations include:

MIL-HBK-1040

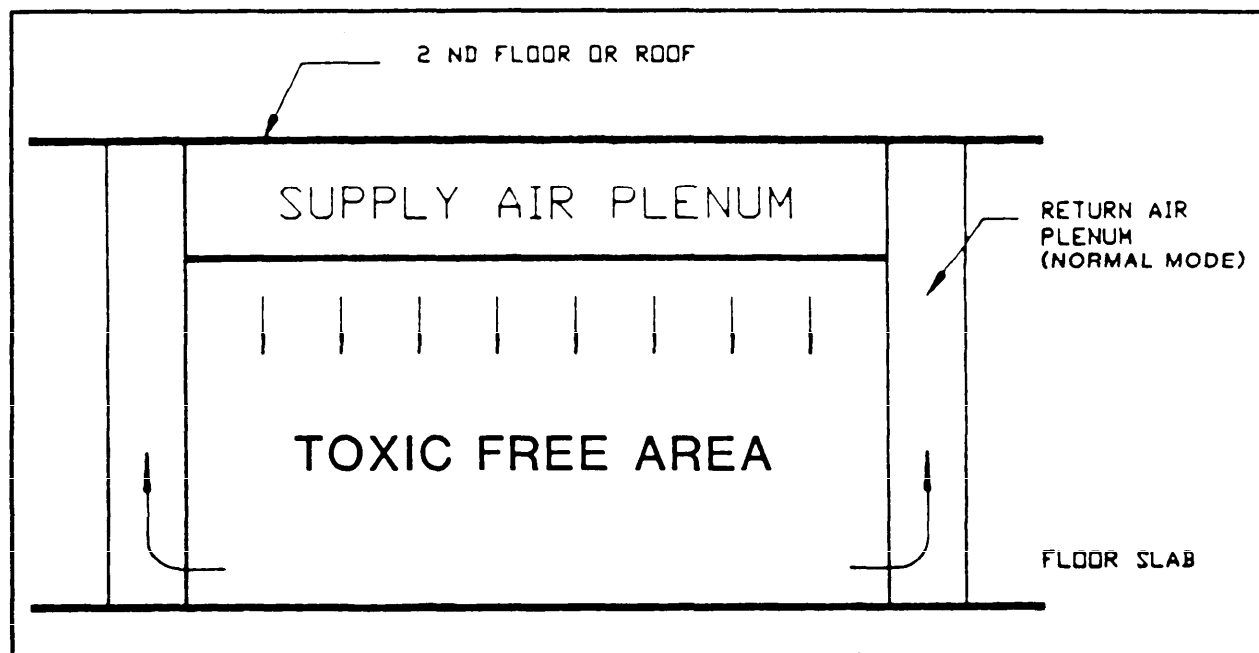

Figure 16
Room Airflow Pattern

MIL-HBK-1040

- Avoid direct connection of air outlets to the main ductwork system, especially if the air velocity in the duct is higher than the neck velocity. For proper installation, the neck length shall be four times the effective diameter of the duct.

- Provide each supply outlet with a set of deflectors so the approach velocity will be uniform and perpendicular to the outlet face.

- Each supply outlet shall have a volume control damper for balancing at the junction of the branch duct and the main duct. Provide volume dampers or splitter dampers in ductwork where it is necessary to obtain proper control, balancing, and distribution.

The AL and CB rooms shall be provided with laminar flow ceilings.

d) Flow Regulation. For the normal mode of operation, use automatic opposed blade dampers when modulating control is required. In the CW mode of operation, motorized dampers are used to regulate the amount of air flowing to the CCA and TFA. These dampers shall be of opposed or parallel blade design with a nominal leakage rating of 10 percent or less under rating conditions. When air backflow is to be stopped, use self-closing gravity operated back-draft dampers.

The motorized valves used to switch the HVAC system from normal operation to CW operation should be bubble tight butterfly valves of the same nominal diameter as the ductwork. The valves should be leak proof. Security from leaks can be achieved by using two valves in series, operated in unison, and separated by a short distance (two or three duct diameters). As an added safety feature, the space between the two butterfly valves can be pressurized with clean air from the discharge of the filter-adsorber assembly. The valve operators should be capable of closing or opening the valve in less than 10 seconds.

5.4 HVAC System Controls.

5.4.1 General. It is very important that the control systems for equipment that conditions the CW shelter work reliably. Reliability is obtained by using quality control components, redundant sensors and controllers, and a distributed control system design. Only industrial quality analog electronic or digital electronic controllers should be used. Proportional-integral controllers are recommended for all applications. No pneumatic controllers shall be used because of the requirement to provide and maintain an air compressor and air dryer. The exceptions to this guidance are situations where an explosive hazard exists or where electromagnetic interference might render electronic controls inoperative.

5.4.2 Local Loop Controls.

5.4.2.1 Supply Air Fan. The supply air fan should be on when the CW shelter HVAC system is in operation. If the required capacity of the supply air fan in the CW mode of operation is different from what is required in the normal

MIL-HBK-1040

mode of operation, the capacity of the supply should be adjusted to meet the airflow requirements. The pressure rise across the supply air fan need not be changed.

The shelter pressurization fan should be on when the shelter is operated in the CW protection mode. The shelter pressurization fan should be of sufficient flow capacity and pressure increase to force the required quantity of outdoor makeup air through the filter-adsorber system and into the TFA at the design TFA gauge pressure. Airflow and static pressure should be measured at a flow measuring station located at a point just before the air is discharged into the TFA. The pressurization fan shall be controlled so that it delivers sufficient flow to keep the static pressure at this point equal to the design value (for example, 1.0 inch (25.4 mm) wg). People entering or exiting the shelter will cause the pressure in the TFA to decrease. The pressurization fan control system should sense this pressure drop and act to increase fan output to keep the pressure in the TFA at the design value. In the CW mode of operation, the supply air fan is controlled so that its flow rates increase to match the increased flow required by CW mode operations. This is best done by changing fan speed. In most cases, the speed of the supply air fan will be increased to meet the additional ventilation airflow rates. Because the supply air fan is in series with the pressurization fan, the pressure rise caused by the supply fan will be added to the discharge pressure of the pressurization fan. The pressure rise due to the supply fan is, however, small compared with that of the pressurization fan.

5.4.2.2 Cooling Coil. The refrigerant flow control device should be modulated to keep the temperature of the air leaving the cooling coil equal to the controller setpoint temperature within about 1° F (0.56° C). A typical cooling coil discharge temperature is 55° F (12.78° C). The cooling coil discharge temperature may be set to a higher value as an energy conservation measure if conditions of cooling load and space humidity permit.

5.4.2.3 Reheat Coil. The electric reheat coil should be controlled to provide supply air at a temperature necessary to meet the space conditioning load. This means that at conditions other than the maximum cooling load, the supply air to the space will be reheated. Input to the reheat coil controller is from the space thermostat. As the space temperature increases, less reheat is called for and vice versa.

If space heating is required, the cooling coil should be shut off and the heating coil controlled to provide the desired space temperature. The heating coil control can be either modulating, stepped, or on-off.

5.4.2.4 Humidifier. The humidifier is controlled by a humidistat in the TFA. As the humidity in the space decreases, more moisture is added to the air. As the humidity increases, less moisture is added. The humidity sensor should be located where it measures the moisture in the air leaving the room. In this way, the moisture added to the air by people and activities in the shelter is accounted for.

MIL-HBK-1040

5.4.2.5 Air Mixing Dampers. The air mixing dampers control the proportion of outdoor air (ventilation air) to return air. In the normal mode of operation, the inlet damper shall be opened to provide the design quantity of ventilation air and the exhaust dampers shall open to provide for exhaust of the ventilation air (less the toilet exhaust). In the CW mode of operation, two inlet dampers in the CW mode flow path are modulated so as to provide the required ventilation airflow rates to the TFA and the CCA. In the CW mode of operation, it is usual to have all of the exhaust air from the TFA exit the shelter via the CCA. The flow of exhaust in the CW mode is governed by automatic flow control valves in the rooms which comprise the CCA. These valves are controlled to maintain the required flow rates and directions of the exhaust air as people enter and leave the shelter. When the CCA is not in use, there is no large demand for ventilated air. In this situation, dampers are modulated to reduce the amount of outdoor air drawn into the shelter to a minimum. The control signals for the damper controllers come from airflow measuring stations downstream of the supply fan and in the supply duct to the CCA. The inlet, exhaust, and mixing dampers should have spring motors that will automatically either fully open or fully close the dampers if power to the damper is lost. The type of valve (normally open or normally closed) used in each application should be selected so that the air distribution system fails to the CW mode if power is lost.

5.4.2.6 System Control Valves. When the shelter HVAC system is in the normal mode of operation, motorized valves are controlled to bypass the CW filter-adsorber system. In the normal mode, air exits the shelter through the exhaust duct, the toilet exhaust, and through the corridor (CCA). Valve actuators and controls should be designed so that the system fails to the CW mode of operation. In the CW mode of operation, the outdoor air passes through the filter-adsorber system before entering the shelter.

5.4.2.7 Monitoring and Instrumentation. Several quantities need to be monitored by the shelter management staff to assure optimum system reliability and performance. First, independent position indicators should confirm the position of all airflow control valves and dampers. Second, filter and supply fan discharge static pressure and flow rate should be measured and reported. The gauge pressure (relative to outdoor pressure) in all rooms should be measured and reported. The contaminant level upstream and downstream of the HEPA filter-adsorber system should be monitored. The total pressure losses across the prefilter system and the HEPA filter-adsorber system should also be monitored. Information on mechanical equipment such as refrigerant compressors, generators, pumps, etc., should also be monitored as deemed necessary.

All monitored quantities should be read from one central data monitoring panel (CDMP). This central panel should display a schematic diagram of the shelter mechanical system, which clearly indicates the equipment items for which data are being displayed. Also, the system should be capable of being changed over from normal to CW operation with one switch located on this central panel. Critical data values, such as contaminant level, filter pressure loss, airflow, or gauge pressure, should be compared against critical values and an alarm shall go off when these critical values are exceeded. The alarm should consist of both audible and visual signals.

MIL-HBK-1040

All control element actuators, e.g., valve and damper motors, motor starters, etc., should have manual overrides so that the device can be positioned or activated by hand if necessary. Backup instrumentation, such as manometers and dial thermometers, should be installed on critical system components.

5.5 Survivability and Reliability.

5.5.1 General. Heating and air-conditioning equipment installed in CW protection facilities should be rugged enough or protected to withstand the shock (ground motion) and overpressure effects of weapons. Experience has proven that standard air-conditioning equipment can be used in CW shelters if properly specified and protected.

5.5.2 Redundancy of Equipment. Systems requiring a high degree of reliability should include redundant units that automatically start and maintain the load should the operating unit fail. The required degree of reliability is based on the function of the facility, allowable downtime for critical systems, type of facility operation (continuous or standby), type of system operation (remote or local), and degree of maintenance.

The design of the total system must provide backup or redundant features to continue decontamination in the event of the loss of a primary system. The design techniques for incorporating redundancy into the basic filter design are series redundancy and parallel redundancy (see Figures 17 and 18).

5.5.2.1 Series Redundant System. With a series redundant system (Figure 17), no contamination should ever reach the air supply. When breakthrough of the first adsorber bank occurs and the agent monitor activates, the second adsorber bank still provides complete protection until operations can be shut down and a new first bank installed. In theory, each of the two adsorber banks should be sized to provide the full adsorptive capacity required for the worst case expected. Thus, if the first bank is penetrated, a second bank providing complete protection would be already on line. However, in view of cost, space, and/or power limitations, it may not always be practical to have each adsorber bank provide 100 percent protection.

Both adsorber banks of a series redundant system should be the same size and should, between them, provide the total adsorption capacity of the system. In case of a breakthrough by the first bank, as announced by the monitor, sufficient adsorption capacity remains in this bank to reduce the agent challenge concentration to the second bank until the problem can be repaired. As a consequence, the second bank suffers minimum agent intrusion and its life (and, hence, protection) is prolonged.

5.5.2.2 Parallel Redundant System. A parallel redundant system requires a completely separate (secondary) system through which airflow can be diverted if a malfunction or failure occurs in the primary filter system (see Figure 18). The two independent systems of a parallel redundant filtration system contain series-redundant filters and adsorbers together with a dampering mechanism capable of switching between the two systems. As an added safety feature, each system may be connected to a different power source.

MIL-HBK-1040

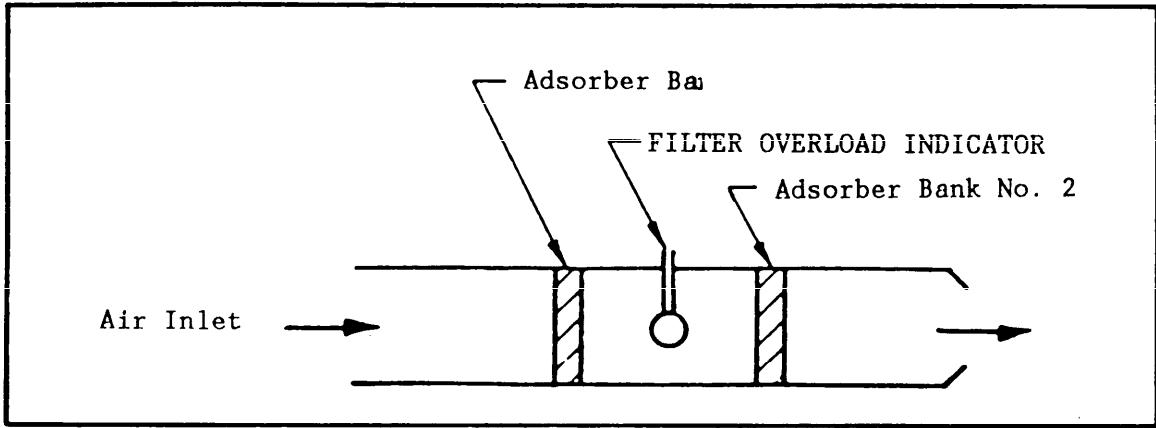

Figure 17
Schematic of Series Redundant System

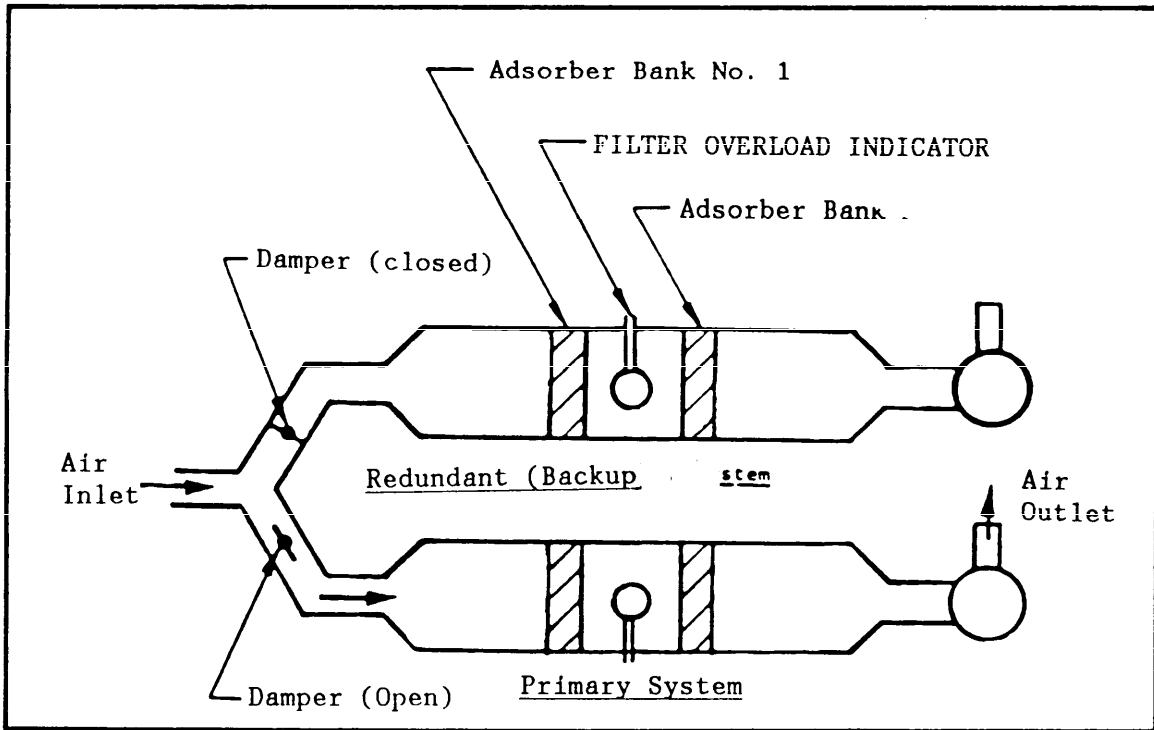

Figure 18
Schematic of Parallel Redundant System

MIL-HBK-1040

Parallel redundancy is required in many radiological protection applications. For CW shelter use, however, total parallel redundancy may not be practical or necessary in view of cost, space, and power considerations.

5.5.2.3 Other Factors. In addition to redundancy, there are other safety features that can be incorporated into the ventilation system design criteria. For instance, in the event of a complete loss of airflow, it is essential that the decontaminated areas be sealed airtight. This can be accomplished by the use of fail-safe (closed) dampers. The dampers may be programmed to close when a power loss occurs or when there is no airflow through the filter. Leak tight ducts are also necessary to prevent contamination from migrating into the ductwork in case of airflow loss or when differential static pressure between the contaminated area and the outside enclosure drops below a pre-determined value. Fans and pumps in critical HVAC systems should be installed in multiples of two or three. The degree of reliability required will determine whether units should be installed in multiples of two with each unit designed to carry 100 percent of the load or in multiples of three with each unit designed to carry 50 percent of the load. Controls should be arranged to keep one of the units in near new condition, operating it only as required for maintenance. Remotely operated valves in critical fluid systems should use two valves in a series to ensure reliability of facility isolation during the normal to CW changeover phase.

5.5.3 Survivability of Equipment. The overriding requirement of CW facility design is survival of equipment and personnel to complete the mission for which it was designed. A detailed dynamic analysis must be made of the supporting structure and the magnitude of motion and acceleration established at the mounting points for each piece of HVAC equipment.

Medium weight machinery, such as pumps, condensers, and air-conditioners, weighing from 1,000 to 4,000 pounds (453.9 to 1814.4 kg), can sustain accelerations (expressed in units of g), the acceleration due to gravity or 32.174 ft/sec^2 (9.81 m/s^2) of approximately 15 gs without damage. Airblast pressure on fans must be limited to 5 psi (34.47 kPa) to prevent damage due to the rapid acceleration of fans. Light machinery (1,000 pounds (453.6 kg) or less) such as fans, small motors, etc., can sustain accelerations of approximately 30 gs without damage. Where accelerations exceed the allowable limit of equipment available, the equipment must be mounted on shock isolation platforms.

The designer must specify, where feasible, certain features which will enhance the survivability of hard-mounted HVAC equipment. Double inlet fans and double suction pumps withstand shock and ground motion induced forces better than some designs because the fan wheel or impeller is supported on both sides with outboard bearings. Conversely, single inlet fans and pumps with overhung wheels or impellers should not be used on CW shelter installations unless they are mounted on shock isolated platforms.

5.5.3.1 Shock and Overpressure. Mechanical shock in an air cleaning system might be produced by explosion in an operating area of the building, by an earthquake, or by rapid compression or decompression of the air inside a system caused by sudden opening or closing of a damper, enclosure, or housing door.

MIL-HBK-1040

When pressure transients last for periods measurable in seconds, static pressure is primarily responsible for any destructive effect. For shocks that have a duration of only a few milliseconds with nearly instantaneous pressure rise, as occur in most chemical explosions, destructiveness is primarily a function of the momentum of the shock wave. Shocks produced by an earthquake or inadvertent opening or closing of a damper usually fall somewhere between these two extremes.

Protection of the filters and adsorbers against failure from shock can be accomplished by isolating them to prevent the transmission of forces to them and by increasing the shock resistance of ducts, housings, mounting frames, and equipment supports. The shock resistance of HEPA filters can be enhanced by face guards, and similar treatment may sometimes improve the shock resistance of prefilters. Most prefilters, however, probably have low shock and overpressure resistance, and a screen installed between them and the HEPA filter is recommended to prevent damage to the latter.

Protection of the primary filter components from explosive shock can be achieved by providing sharp turns, heavy perforated plates, or cushion chambers in the ductwork to "snub" shock forces, and by using fast-acting isolation dampers. Although turning vanes, dampers, moisture separators, and prefilters may be damaged by a shock wave, they may also serve to attenuate its force to some degree and thereby provide a measure of protection to the downstream filters and adsorbers. Damage to dampers, however, can result in an inability to control flows or isolate branch lines.

5.6 System Testing.

5.6.1 Normal Mode Operation. The system must be balanced before any tests are conducted. System performance in the normal (i.e., non-CW) mode of operation should be assessed using the current ASHRAE Standards for system testing and qualification. All deficiencies must be noted and corrected.

5.6.2 CW Mode of Operation. Tests of performance in the CW mode of operation are varied and complex and, to a large extent, depend upon the specifics of the shelter design. Thus, only general guidance can be given here. First, a comprehensive test plan must be developed to ensure all equipment performs as required and that the total system performs as required. The test plan must also contain an analysis of the most probable faults and failures and how the shelter protection system responds to these problems (and how the problems can be corrected).

5.6.2.1 Air Distribution Test. The air distribution can be tested without compromising the HEPA filter-adsorber system by use of the filter bypass. The filter bypass is a pair of orifices that offer the same resistance to airflow as either a clean filter system or a loaded HEPA filter-adsorber system. Both of these orifices are used to test fan control system performance under different load conditions. Manufacturers data shall be provided which shows actual filter pressure drop across the complete filter-adsorber system. The filter bypass orifices shall match the filter-adsorber system pressure drop to within 5 percent. Flow measurements must be taken in the rooms that comprise

MIL-HBK-1040

the CCA to ensure that the flow volumes and flow directions are as required. The gauge pressures in the TFA and the rooms of the CCA must also be recorded to ensure air discharge against the design winds. All valves, fittings, and ducts must be checked for leaks. Position and status indicators and alarms must also be checked.

5.6.2.2 Filter-Adsorber System Test. The critical test of the CW configuration is the test of the filter-adsorber system. Although this is an expensive test, actual chemical challenge tests of the air cleaning system are mandatory. If the filter-adsorber system fails, the CW shelter will fail also. Tests must be designed that generate particulates, aerosols, and traceable vapors in the appropriate concentration-duration quantities for ingestion by the shelter air intake system. The concentration of these test materials must be measured downstream of the filter-adsorber system. It must be confirmed that the concentration of contaminants entering the TFA is below the allowable concentration in the TFA.

MIL-HBK-1040

SECTION 6: MECHANICAL - PLUMBING SYSTEMS DESIGN CRITERIA

6.1 Criteria. This section provides suggested criteria and design guidelines for the plumbing systems for chemically hardened facilities. The plumbing system design for CW facilities will vary depending upon the usage of the facility. During the CW mode, the facility will be isolated from base water and sewage systems and the internal plumbing systems will have to provide adequate water and waste handling without outside support.

Other items which need to be considered in the plumbing design but require input from other sources are:

- a) Air conditioning water requirements.
- b) Fire protection supply and waste water storage system requirements.

Design of the plumbing systems in CW facilities should be done in accordance with the following documents:

- a) MIL-HDBK-1190, Facility Planning and Design Guide
- b) National Association of Plumbing Heating - Cooling Contractors, National Standard Plumbing Code
- c) American Society of Plumbing Engineers, Fundamentals of Plumbing Design
- d) American Society of Plumbing Engineers, Special Systems Volume
- e) International Association of Plumbing and Mechanical Officials, Uniform Plumbing Code
- f) Building Official and Code Administrators International, Basic Plumbing Code
- g) Plumbing and Drainage Institute, PDI-WH201, Water Hammer Arrestors
- h) Naval Facilities Engineering Command, DM-3.01, Plumbing Systems

6.2 Domestic Water System.

6.2.1 Water Service.

a) The water service to and in the building should be capable of supplying water at a pressure and rate to satisfy the peak loads requirements as determined by standard design procedures.

MIL-HBK-1040

b) An electric valve should be provided in the clean mechanical room to close off the base water supply when the building is in the CW mode.

c) A backup closed-type refill system should be provided that prevents contamination of the water. Backup water system will be provided by water tanker or trailer. Supply and venting line connections compatible with truck hose should be located in the dirty mechanical room near the exterior door. A purge capability should be incorporated. A gage should be installed in the clean mechanical room with a low water alarm.

d) A water softening system should be installed if required by the local water conditions.

e) Water filters should be installed on all drinking fountains if the water is supplied through a water storage tank.

6.2.1.1 Water Supply CW Mode. Water supply during the CW mode can be by storage tank, water well, or a combination.

a) Water Storage. Building water storage using a water storage tank shall be pressurized by a pressure tank with booster pumps (normal and standby). The main emergency water tank shall be located under the CMR but can extend under the toxic free area. The tank should be built of or lined with non-rusting, non-toxic materials. The domestic water system shall supply water through the tank to prevent stagnation. The tank should be provided with a means of adding a disinfection agent. Venting for the tank should be to the CMR and have a charcoal filter on the vent. Size of the vent will be determined by the withdrawal rate, but a minimum of 1-1/2 inch (38.1 mm) is recommended.

b) Water Well. The installation of water wells for the supply of domestic water during the CW mode should be considered. The well should be installed in the CMR or within the TFA.

c) Water Quantity. The amount of water required can be calculated by the following equation:

With showers:

$$\text{EQUATION:} \quad Q = P \times D \times [5 + (2.5 \times S)] \times 1.05 \quad (28)$$

Without showers:

$$\text{EQUATION:} \quad Q = (P \times D \times 5) \times 1.05 \quad (29)$$

MIL-HBK-1040

where

Q = Total gallons of water required

P = Maximum amount of people using the facility

D = Maximum number of design days in CW mode (normally 7)

5 = Gallons/person for drinking, food, washing, etc. per day

6 = Gallons/shower

S = Number of showers/person/day entering the CCA (normally 2)

1.05 = Allowance for decontamination and safety factor

The total amount of water should be contained in water storage tanks, or be supplied by a pump or a pump/storage tank system.

6.2.2 Piping.

a) The piping within the CMR and the TFA should be copper and soldered using 95/5 alloy or silver solder. Solder containing lead should not be used.

b) The piping entering and in the CCA should be stainless steel. It may be joined by compression or threaded fittings or by silver solder.

c) Plastic pipe should not be used within the CW facility for the water supply systems.

d) All piping should be supported with sway bracing that is provided in building in earthquake zones.

e) All water piping equipment used for domestic water should be totally in the CMR.

6.2.3 Hot Water Supply. The hot water should be heated by the same source as used for the building heating system and by electricity when the building heating system is off. The hot water system should be sized to supply normal building hot water needs for the protected area. The building water supply system should be a three-pipe system: two pipes for continuous hot water circulation and one pipe for the cold water.

If long runs of hot water piping exist in the facility, the use of instantaneous (point of use) heaters should be considered. In the event that a decontamination shower is installed in the CCA, the temperature of water supplied to the shower should be automatically mixed to 105° F (40.6° C), adjusted by ±10° F (±5.6° C). Processing individuals should not have control of water temperatures.

MIL-HBK-1040

6.2.4 Fixtures. The type and quantity of fixtures required should be based upon the number of people in the facility during the normal use of the facility. All fixtures should be industrial stainless steel including sinks, toilets, and faucets. Porcelain should not be used.

For each group of 49 people in the facility during the CW mode, one low flow (<1 gal/flush) (<3.79 L/flush) water closet will be installed in each of the restrooms. The low flow water closets will only be used during the CW mode.

Hose bibs will be provided in the LHA, VHA, CB, AL, CMR, DMR, toilet rooms, and exterior adjacent to front entrance. Temperature of water supplied to the hose bibs shall be automatically mixed to 110° F (43.33° C) (adjustable to ±10° F) (±5.6° C). Exterior hose bibs should be protected from freezing. All hose bibs in the CCA should have backflow prevention devices installed.

Overhead showers will be provided in the shower room of the CCA. A control valve for each shower shall be operated by a pull chain or push button to give a timed supply of water lasting 15 seconds each time the valve is operated. Temperatures of water supplied to the shower should be automatically mixed. Showers should supply a maximum of 2 gpm (7.57 L/min). A minimum of two showers should be installed in the CCA.

6.3 Valves. Two-position ball valves with electric actuators should be used for positive shutoff of water flow in the facility. Power should not be required to maintain the valve in either position, only movement to the position.

All valves used for positive shutoff of the venting system should be two-position ball or butterfly valves. Power will only be required to change the valve position.

6.3.1 Water Hammer Arresters. Water hammer arresters should be provided in conjunction with all automatically operated quick-closing valves. Arresters shall be the mechanical type and be sized in accordance with Water Hammer Arresters, Plumbing and Drainage Institute Standard PDI-WH201. The arresters should be installed upstream of the valves.

6.4 Sanitary Drainage System.

6.4.1 Drainage System and Drainage Storage Tanks. The building drainage consists of two separate systems: contaminated and uncontaminated drainage. In the normal mode, both systems are connected together and drain into the base system. In the CW mode, an electric valve should separate the two systems.

6.4.1.1 Uncontaminated Sewage Tank. The uncontaminated sewage shall drain into a tank under the CMR. The tank should vent to the exterior via a protected method, such as a penthouse, during normal operation and provided with a blast valve. During the CW mode, an electric valve will close off the exterior vent, and the tank should vent into the CMR or into the exhaust of the air conditioning system. An induced draft fan can be installed in the exhaust to provide a negative pressure in the tank. Tanks should be sized to handle all the wastewater and bio-waste generated within the facility, suggest 150 percent of the 7-day calculated storage water quantity.

MIL-HBK-1040

6.4.1.2 CCA Contaminated Sewage Tank. The CCA contaminated sewage shall drain into a tank under the DMR. Venting of the tank should be via a protected manner, such as a penthouse, and provided with a blast valve. An induced draft fan in the vent activated during the CW mode will help to provide negative pressures in the tank and prevent contamination from leaking back through the tank and into the CCA.

6.4.1.3 Sewage Tank Details. Each tank will have a gage in the CMR with a high level alarm. Each tank should be equipped with a pump and pipe to the DMR near the exterior door. During extended periods of operation in the CW mode, excess sewage will be removed truck or, in an emergency, the sewage will be pumped onto the ground. A hose will be provided to reach from the pipe end to 20 feet (6.1 m) from outside of the building wall.

6.4.1.4 Contaminated Floor Drains. Floor drains should be provided in all rooms of the AL and CCA areas except the blast lock. Additionally the metal grid recesses in liquid ingress and egress room shall have drains. Each floor drain will be equipped with a manual closing device to prevent airflow between rooms. Water traps shall also be at each floor drain but do not count as the manual closing device. These floor drains shall be connected to the contaminated drainage system. Sinks in the CCA (optional) and the floor drains in the DMR shall also have manual closing devices and be connected to the contaminated drainage system. Floor drainage grid network, strainers, piping, etc. should be made of stainless steel.

6.4.1.5 Uncontaminated Floor Drains. Floor drains in the CMR and TFA shall be connected to the uncontaminated system.

6.4.2 Traps. Fixture and drain traps should be a minimum of 6 inches (152.4 mm) deep to prevent the water seal from blowing out during the increased pressure of the CW mode air conditioning. It is recommended that all traps be installed with an automatic priming system to prevent the traps from losing the water seal. All priming systems will be connected to the domestic water system and have a backflow prevention device installed.

6.4.3 Venting System. Fixture arrangement and venting system should be selected to minimize roof penetrations. All stacks that vent through the roof will need a valve installed that closes the vent system to the outside during the CW mode. Blast valves should also be installed and/or a combination of blast valve/electric closure valve. A standby stack should be installed below the valves and terminate in the penthouse or exhaust of the air conditioning system. This stack will normally be closed by a valve but will be activated during the CW mode. If an induced draft fan is used in the standby stack, it should provide a negative pressure of 1/4 inch (6.35 mm) to 1/2 inch (12.7 mm) of water column (wc) above the pressure in the exhaust system or in the penthouse.

A venting system separate from the venting system for the TFA should be provided for the fixtures and drains in the CCA. For conceptual purposes Figure 19 shows one possible arrangement.

MIL-HBK-1040

6.5 Fuel Tank. A fuel storage tank should be installed below the DMR or CCA. It should be sized to provide 7 days supply of fuel for the electric generator (see Section 10, Electrical Systems Design Criteria).

MIL-HBK-1040

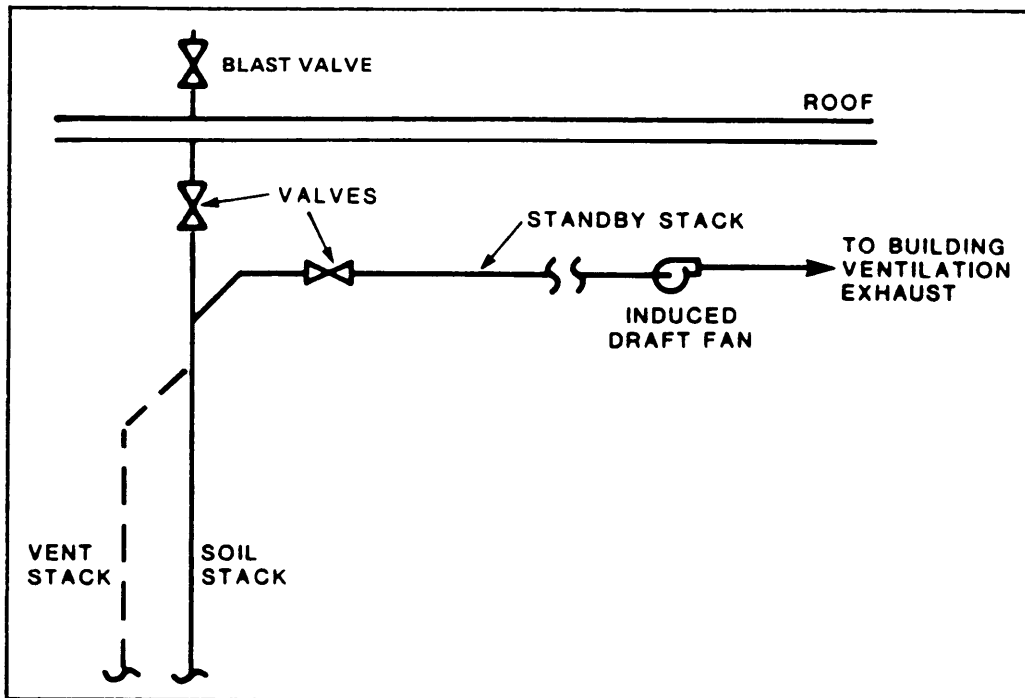

Figure 19a
Single Vent Extension System

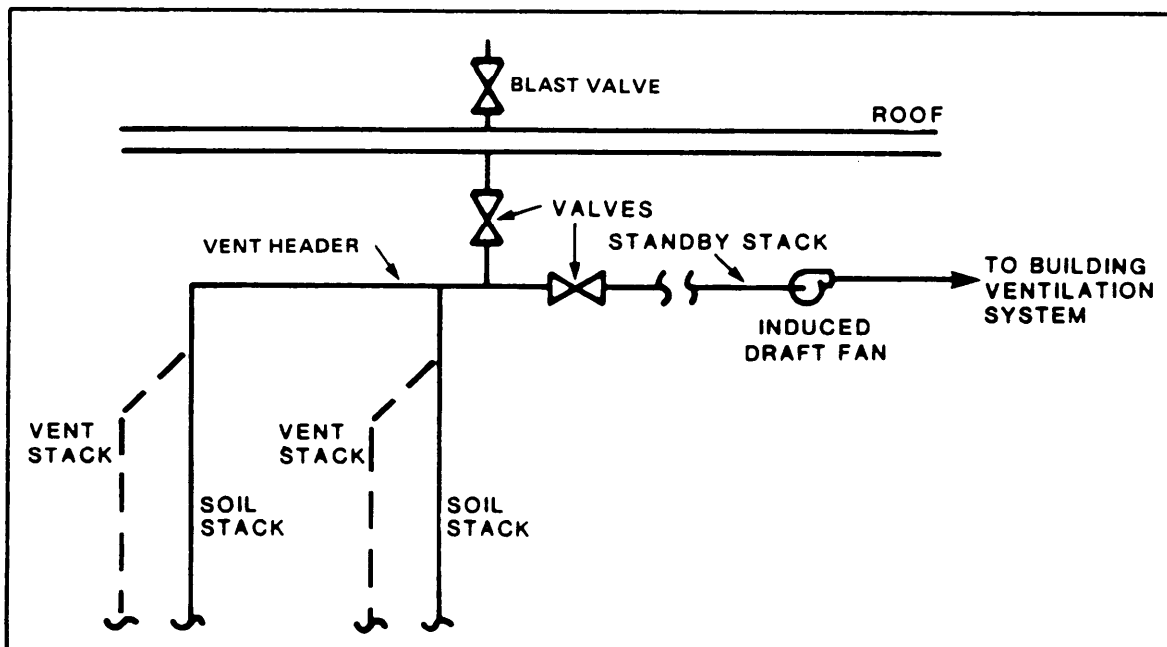

Figure 19b
Multiventing System Arrangements

MIL-HBK-1040

SECTION 7: MECHANICAL - FIRE PROTECTION DESIGN CRITERIA

7.1 Special Note. The designer of the fire protection system must evaluate all aspects of the facility requirement and design a system that provides the best protection for individuals, the facility, and will satisfy the mission's requirement.

7.2 Criteria. Fire protection design shall conform to the requirements of the applicable standards contained in MIL-HDBK-1008A, Fire Protection for Facilities Engineering, Design, and Construction, or any current national fire codes, published by the National Fire Protection Association (NFPA).

MIL-HBK-1040

SECTION 8: ELECTRICAL SYSTEMS DESIGN CRITERIA

8.1 Introduction. In addition to the routine requirements placed on the electrical systems for facility designs, chemically hardened facilities have additional requirements. Operation of equipment by personnel wearing IPE, preventing leaks of chemical agents into cleaner areas, and packaging controls in housings that can be decontaminated, are examples of the types of additional requirements for chemically hardened structures. This section deals with the additional requirements for chemically hardened facilities. All other guidance such as NFPA 70, National Electric Code, NFGS 16402, Interior Wiring Systems, and Electrical Design Manuals apply as they would in any nonhardened project.

Figures A-2, A-3, A-4, A-5, and A-6 of Appendix A are examples of a Central Data Monitoring Panel for a hypothetical CW protected facility. Reference to it will illustrate some of this chapter's concepts.

8.2 General Requirements for CCAs and Airlocks. Any exposed wiring, cable jacket, and gasket material must be nonporous, and must not absorb or react with CW agents or cleaning and decontamination materials. Equipment in CCAs and ALs should be designed to be operated by persons wearing CW IPE.

8.2.1 Electrical Equipment Enclosures. Electrical equipment installed in areas subject to contamination and decontamination requires analysis to determine if special protection is needed. Such equipment should be installed in enclosures that meet National Electrical Manufacturers Association (NEMA) Type 6 (submersible, watertight) requirements.

Electrical equipment may be installed in NEMA Type 4 or 4X if the completely installed assembly can be demonstrated to be gastight.

Electrical equipment may be installed in a manner that allows it to be bagged, safely disconnected, transported, decontaminated, or destroyed and replaced with available spares if that is more cost effective.

8.2.2 Cable Penetrations in Walls of CCA and AL. All cable penetrations into walls of CCA and AL shall be airtight and shall be sealed on the contaminated side of the wall. Walls that are contaminated on both sides shall be sealed on both sides.

8.3 Intercommunication System. Provide an intercom station in each room of the AL area, CCA, DMR, and TFA to communicate with the master intercom station located at the central data monitoring panel (CDMP), which is the shelter manager station in the TFA. Provide two-way communications between the CMR and DMR. Provide two-way communications between both sides of each AL door.

The intercom system shall be designed in accordance with NAVFAC DM 4.07, Section 6 Wire Communication and Signal Systems and NFGS-16760 Intercommunication System. Exceptions to those requirements are necessary to accommodate decontamination and cable penetration seal requirements.

8.4 Closed Circuit TV (Optional for Some Facilities). Provide a CCTV system to observe and identify personnel in the CCA, AL, and DMR.

MIL-HBK-1040

- a) Locate the monitor and camera controls at the CDMP. Only one monitor is required for general monitoring of the spaces, the specific application may require additional monitors.
- b) Select camera locations and remote control functions to permit sequential viewing of all occupiable spaces in the CCA, AL, and DMR.
- c) Provide a color monitor and cameras with two-to-one interlace. If additional monitors are needed, monochrome monitors may be adequate.
- d) Coordinate illumination levels, camera light sensitivity, and camera lens speed.
- e) Camera housings and mountings for the CCA and AL areas shall meet the electrical equipment housing requirements.
- f) The CCTV system shall be designed in accordance with NAVFAC DM 4.07, Section 11.

8.5 Pressurization and Airflow. The mode control switch on the CDMP will cause the air handling system to switch to the correct configuration for normal training or CW operating modes. Electrically actuated, positive closing valves shall control the airflow through all the appropriate intakes, exhausts, vents, and filters.

A visual alarm is needed at the CDMP to indentify all on/off air control valves that are not properly set as required by the mode control switch. The sensors should measure actual valve damper position as opposed to measuring the actuator's position. A time delay should be incorporated after the mode control switch is actuated to prevent extraneous alarm indications while the valves are changing positions. The same alarm conditions should also be displayed on annunciator panels in both the CMR and DMR.

8.6 Water Supply. The mode control switch on the CDMP will cause an electrically operated, positively closing valve to close off the base water supply to the main emergency water tank. The base supply shall be turned off during the training and CW modes. A visual alarm based on the actual position of the valve damper shall be displayed on the CDMP and CMR annunciator/control panel if the valve fails to operate as commanded after a reasonable time.

Provide a low water level alarm indication to the CMR annunciator/control panel. The alarm set point should be adjustable over a range of 0 to 25 percent of full tank capacity.

Provide water pump failure alarm indications to the CDMP and CMR annunciator/control panel for each water circulation pump. Alarms shall activate if pumps are commanded to operate but do not develop sufficient pressure.

8.7 Solid Waste and Wastewater Tanks. The mode control switch on the CDMP will cause electrically operated, positively closing valves to divert sewage to the storage tanks and to vent the uncontaminated sewage tank to the CMR. The base sewers will be used in normal and training modes. A visual

MIL-HBK-1040

alarm based on the actual position of the valve dampers shall be displayed on the CDMP and CMR annunciator/control panel if the valve fails to operate as commanded after a reasonable time.

Provide high level alarm indications on the CMR annunciator/control panel for both contaminated and uncontaminated waste storage tanks. The alarm set point should be adjustable over a range of 75 to 100 percent of full tank capacity. Provide a level indicating gauge on the CMR annunciator/control panel for each of the sewage storage tanks. Provide visual indication on the CMR annunciator/control panel when sewer drain pumps are on.

8.8 Fuel Tank. Provide a fuel storage tank below the mechanical room or CCA. The tank shall be sized to provide at least 7 days of continuous operation of the generator. The tank may be sized larger if required by other operational requirements. If the tank is in a room, the room shall have a raised door so that a fuel spill will be contained in the room. The door to the room shall be a fire-resistant, metal door. The tank shall vent to the exterior via a protected manner such as a penthouse. A refueling pipe shall run from the tank to a point inside the exterior blast door of DMR.

Provide a fuel level gauge and a low fuel level alarm indicator on the CMR annunciator/control panel and on the CDMP. The alarm set point should be adjustable over a range of 0 to 25 percent of full tank capacity.

8.9 Electric Door Interlocks. Emergency exit doors and other doors that allow passage between clean and contaminated areas must be equipped with electric locks and door-open sensors. The doors must automatically lock in a closed position when the mode control switch is placed in the training or CW mode. An emergency switch installed behind a glass-sealed enclosure is needed by each locked door to permit exit. The locks must automatically unlock in the event of power failure. Alarm indications identifying the specific door shall be displayed on the CDMP if the door is not fully closed while in the CW or training mode.

8.10 Airlock Doors. All airlock doors must be equipped with electric locks and door-open sensors. The doors must automatically lock in a closed position when the mode control switch is placed in the training or CW mode. An emergency switch installed behind a glass-sealed enclosure is needed by each locked door to permit exit. The locks must automatically unlock in the event of power failure.

8.10.1 Access Status Indicators. Access status indication should be provided on each side of each airlock door and on the CDMP. The indications needed are:

MIL-HBK-1040

At Each Side of Door

Wait
 Proceed
 Door Open
 Door Open Time Limit Exceeded

At CDMP (for Each Door)

Wait
 Proceed
 Door Open
 Door Open Time Limit Exceeded
 Both Doors of Airlock Open
 Emergency Open Switch at Door
 is Actuated

When the facility is in the training or CW mode, the airlock door locks should be controlled by automatic controls, "Unlock Door" switches at the doors, emergency override switches at the airlock doors, and override switches at the CDMP.

8.10.2 Door Lock Time Sequences. In training and CW operating modes, the airlock doors will normally be closed and locked. Actuating the unlock door switch will cause one door's electric lock to open for time sequence "B" and the next door to remain locked for fixed time sequence "A". During the time period "A", the door previously opened may be reopened from either side with the unlock door switch, but doing so will cause the time sequence "A" to reinitiate. Any airlock door that remains open longer than selected by time sequence "C" will cause a warning indication on the CDMP.

Time sequences "A", "B", and "C" should be knob (or switch) adjustable from the CMR. The adjustment knobs should be protected from accidental changes. Delay times should be indicated by the position of the knob setting. Nominal time setting for sequence "A" should be determined by the required number of airflow changes, and the airlock airflow rate. Time sequence "B" should be approximately 5 to 20 seconds. Time sequence "C" should be approximately 30 to 60 seconds.

A warning should be indicated at the CDMP and near the "A" adjustment knob if the measured airflow rate through the airlock and the time selected for "A" is inadequate to allow a sufficient number of air changes. An alarm shall be indicated at the CDMP if the second door is opened before the air change criteria is met. The CDMP shall have an emergency airlock door lock override switch that allows the door lock controls to be overridden.

8.11 Remote Motors.

8.11.1 Status Indicators. Monitor the operation of all motors that are necessary to maintain the integrity of the CW protection. This would include for example, pressurization fan motors and cooling water circulation pump motors. An actual measurement of the motor's performance as opposed to its commanded state should be used.

An alarm indication should occur at the CDMP, CMR annunciator/control panel, and in the DMR (if appropriate) for any CW necessary motor that is commanded on but does not indicate actual operation after an appropriate time delay.

MIL-HBK-1040

8.11.2 Remote Control. All the motors necessary for CW protection should be started automatically when the mode control switch is placed in the CW mode. Sequential starting to limit peak electrical demand is recommended. Appropriate motors should also be started in the training mode. This requirement should not preempt any safety requirements. If a motor is locked out for safety reasons and is commanded on by the system, an alarm should occur.

Start/stop control and status indication of all other motors that may need to be used in the CW mode should be located on the CMR annunciator/control panel (include equipment like sewage transfer pump motors).

8.12 Emergency Lighting. Emergency lighting levels should be determined by the designer.

The emergency lighting should be designed in accordance with NAVFAC MIL-HDBK-1004/4 Electrical Utilization Systems, and it should meet the added requirements as applicable for decontamination and electrical equipment enclosures. Locations for consideration of emergency lighting include:

- a) CCAs
- b) Airlocks
- c) CDMP
- d) CMR annunciator/control panel
- e) Generator

8.13 Unique Generator Requirements. Generator systems shall be designed in accordance with the following facility requirements and guidelines:

- o MIL-HDBK-1004/1 Preliminary Design Considerations
- o MIL-HDBK-1004/4 Electrical Utilization Systems
- o NFGS-16202 Diesel Electric Generators (Design 1)
500 to 2,500 kW Continuous-Duty Units
- o NFGS-16203 Diesel Electric Generators (Design 2)
2,501 kW and Larger Continuous Duty Units
- o NFGS-16204 Standby-Duty Diesel Electric Generators
(Design 3) 300 to 1,000 kW Standby-Duty Units
- o NFGS-16205 Standby-Duty Diesel Electric Generators
(Design 4) 300 to 1,000 kW
- o NFGS-16208 Diesel Engine-Generator Set (25-250 kW)

MIL-HBK-1040

Additional requirements for CW are:

a) The generator shall be provided and sized to accommodate the larger of the following two factors. First, the total electrical load under CW operation. Includes the power needed to operate the mission critical equipment and the power to meet the lighting, HVAC, pumping, and other utility types of loads. Second, the electrical power capacity as defined by requirements for emergency power under other than CW operations.

b) Remote start from CMR annunciator/control panel, under the condition of loss of normal power.

c) Appropriate gauges and alarms for the generator must be provided on the CMR annunciator/control panel and CDMP.

d) All operations on the generator during the C/W mode must be done by people in CW IPE.

8.14 Power Transfer Switch. In addition to the normal requirements, the power transfer switch(es) that select between normal power sources, external emergency sources, and the internal generator shall be operable from both the CMR annunciator/control panel and DMR. The switch and remote controls shall not depend upon normal facility power for operation. Ensure that transfer switches can be operated when the facility is temporarily without power.

8.15 Connections for Portable Generators. If the facilities mission warrants additional power backup capability, provide the necessary connection points and transfer switches. People, while wearing CW IPE, must be able to connect the external generators.

MIL-HBK-1040

SECTION 9: STORAGE REQUIREMENTS

9.1 Storage Requirements. Storage requirements depend on several factors:

- a) Ingress/egress procedures
- b) Number of personnel
- c) CCA and TSA configuration
- d) Operational schedule and equipment

9.1.1 General.

9.1.1.1 VHA.

Ingress

Store combat boots:	1.00 ft ³ (0.028 m ³)/location
Store uniform:	0.50 ft ³ (0.014 m ³)/location
Store mask:	0.50/location/person
Store bags:	2 bags/ingress

Egress

Ensembles:	0.21 ft ³ (0.006 m ³)/ensemble
Gloves:	0.21 ft ³ (0.006 m ³)/ensemble
Overboots:	0.13 ft ³ (0.004 m ³)/pair

9.1.1.2 TFA.

Meals ready to eat (MRE):	0.08 ft ³ (0.0023 m ³)/meal
Water (drinking, MRE, cleaning):	0.1625 ft ³ (0.005 m ³)/person
Store personal items in TFA:	1.00 ft ³ (0.028 m ³)/person
Water (personal hygiene):	Volume depends on system selected

9.1.1.3 LHA (Supplies).

Paper towels:	6 towels/ingress
Trash bags:	0.5 bag/ingress
Devon solution	

9.1.2 Example. An example of some of the items that must be considered for a relatively simple "rest and relief" is presented in the following paragraphs.

Assume two groups of personnel alternate in occupying the CW shelter for 7 days. Assume 168 hours of operations with four 12-hour duty/12-hour rest cycles. Assume ensemble is cut off and discarded during ingress.

MIL-HBK-1040

<u>Time (Hours)</u>	<u>Exiting Group</u>	<u>Entering Group</u>
0-12	--	A
12-24	A	B
24-36	B	A
36-48	A	B
48-60	B	A
60-72	A	B
72-84	B	A
84-96	A	B
96-108	B	A
108-120	A	B
120-132	B	A
132-144	A	B
144-156	B	A
156-168	A	A

9.1.2.1 VHA.Ingress

Store combat boots $1.00 \text{ ft}^3 (0.028 \text{ m}^3)/\text{location} (0.50 \text{ ft}^3 (0.014 \text{ m}^3)/\text{person} = 1.00 \text{ ft}^3 (0.028 \text{ m}^3)/\text{location} \times 1 \text{ location}/2 \text{ persons})^*$

Store uniform $0.50 \text{ ft}^3 (0.014 \text{ m}^3)/\text{location} (0.25 \text{ ft}^3 (0.007 \text{ m}^3)/\text{person} = 0.50 \text{ ft}^3 (0.014 \text{ m}^3)/\text{location} \times 1 \text{ location}/2 \text{ persons})^*$

Store mask $0.5 \text{ locations/person} (1 \text{ location}/2 \text{ persons})^*$

Storage bags $2 \text{ bags/ingress} (14 \text{ bags/person} = 2 \text{ bags/ingress} \times 7 \text{ ingress/person})$

Egress

Ensembles $0.21 \text{ ft}^3 (0.006 \text{ m}^3)/\text{ensemble} (1.47 \text{ ft}^3 (0.042 \text{ m}^3)/\text{person} = 0.21 \text{ ft}^3 (0.006 \text{ m}^3)/\text{ensemble} \times 7 \text{ ensembles/person})$

*One person leaves the shelter from Group A before one person enters the shelter from Group B. Two people share these storage locations.

MIL-HBK-1040

Gloves	$0.06 \text{ ft}^3 (0.0017 \text{ m}^3)/\text{pair}$ ($0.42 \text{ ft}^3 (0.012 \text{ m}^3)/\text{person} = 0.06 \text{ ft}^3 (0.0017 \text{ m}^3)/\text{pair} \times 7 \text{ pairs/person}$)
Overboots	$0.13 \text{ ft}^3 (0.004 \text{ m}^3)/\text{pair}$ ($0.91 \text{ ft}^3 (0.026 \text{ m}^3)/\text{person} = 0.13 \text{ ft}^3 (0.004 \text{ m}^3)/\text{pair} \times 7 \text{ pairs/person}$)
9.1.2.2 <u>Decon Supplies.</u>	
Decon solution	Volume depends on second stage mask decon procedures.
Paper towels, etc.	
9.1.2.3 <u>TFA.</u>	
MRE	$0.08 \text{ ft}^3 (0.0023 \text{ m}^3)/\text{meal}$ ($1.12 \text{ ft}^3 (0.0317 \text{ m}^3)/\text{person} = 0.08 \text{ ft}^3 (0.0023 \text{ m}^3)/\text{meal} \times 2 \text{ meals/day} \times 7 \text{ days/person}$)
Water (drinking, MRE, cleaning)	$0.1625 \text{ ft}^3 (0.005 \text{ m}^3)/\text{person}$ ($1.14 \text{ ft}^3 (0.0323 \text{ m}^3)/\text{person} = 1.25 \text{ gallons} (4.73 \text{ L})/\text{day} \times 7 \text{ days/person} \times 0.13 \text{ ft}^3/\text{gallon} (0.001 \text{ m}^3/\text{liter})$)
Store personal items in TFA	$1.00 \text{ ft}^3 (0.028 \text{ m}^3)/\text{person}$
Water (personal hygiene)	Volume depends on system selected.
9.1.2.4 <u>LHA.</u>	
Decon solution	
Paper towels	6 towels/ingress ($42 \text{ towels/person} = 6 \text{ towels/ingress} \times 42 \text{ ingress/person}$)
Trash bags	0.5 bag/ingress ($3.5 \text{ bags/person} = 0.5 \text{ bag/ingress} \times 7 \text{ ingress/person}$)
9.1.3 <u>Summary.</u>	
9.1.3.1 <u>VHA.</u>	
	$3.55 \text{ ft}^3 (0.1 \text{ m}^3)/\text{person}$
	0.5 mask location/person (1 location/2 persons)
	14 storage bags/person
	Decon supplies

MIL-HBK-1040

9.1.3.2 TFA.

3.26 ft³ (0.09 m³)/person
(Water volume for personal hygiene not included.)

9.1.3.3 LHA.

42 paper towels/person
3.5 trash bags/person
Decon solution

9.1.3.4 Total.

6.81 ft³ (0.193 m³)/person, plus:
14 storage bags/person
3.5 trash bags/person
42 paper towels/person
0.5 mask position/person
Water for personal hygiene in TFA
Decon supplies in VHA
Decon solution in LHA

MIL-HBK-1040

SECTION 10: PHYSICAL SECURITY DESIGN CRITERIA

10.1 Physical Security Criteria. The designer must consider all aspects of physical security of the facility in accordance with MIL-HDBK-1013/1, Design Guidelines for Physical Security of Fixed Land-Based Facilities, superseding NAVFAC DM 13.01, March 1983.

MIL-HBK-1040

APPENDIX A

ESTIMATING CW MODE VENTILATION AIR REQUIREMENTS

1.1 Introduction. A procedure is presented for estimating the amount of ventilation air required by a shelter operating in the CW warfare mode.

2.1 Assumptions. The following analysis is performed using the assumptions listed in Table A-1. The assumed threat is distilled mustard agent, a persistent blister agent first used in World War I. Mustard gas has a median lethal dosage (inhalation, 50% fatalities) of 1,500 mg-min/m³ or 225 ppm-min.

The design maximum dosage for CW agent exposure in the TFA is a value of five for the quantity: milligrams of agent per cubic meter of air times the duration of the exposure, e.g., 5 mg-min/m³ over a 12-hour period. This measure of agent dosage is called the concentration-time (CT) product, e.g., the allowable dosage in the TFA is 5 CT over 12 hours. The chemical filter system must be designed to reduce the concentration of the agent in the outdoor air to the level that results in a dosage no greater than 5 CT over a 12-hour period for the inhabitants of the TFA.

3.1 Experimental Personnel Exposure. Experiments have been conducted with "simulants" of CW weapons to determine the amount of toxic material that clings to the protective outer garments and equipment of personnel when they enter a CW shelter and how much of the toxic material enters the room environment at each stage of processing. Suppose that 2.5 gm (0.006 lb) of toxic material is brought into the LHA with each person who enters. The expected entry processing rate is 30 people per hour. The amount of time spent in entry processing is about 10 minutes. This time is divided as follows: 2.5 minutes in the LHA, 3 minutes in the CB, 2.5 minutes in the VHA, and 2 minutes in the AL.

3.2 LHA Process Activities. The LHA is the area of the CCA that has the lowest requirement for ventilation air purity, i.e., the LHA is the room having the highest allowable contamination level. This is because a mask is always worn while a person is in the LHA and the overgarment is worn for all but a very brief period. Conventional clothing items are worn beneath the overgarment so that dermal exposure is minimal.

3.3 CB Process Activities. The allowable contamination level in the CB is much lower than that of the LHA because the inner garments are removed in the CB. Therefore, protection against dermal agents is required in the CB. The mask is worn in the CB, however, so that protection from inhalation agents is minimal.

3.4 VHA Process Activities. The allowable level of dermal agents in the VHA is also low because personnel wear no clothing as they move through the VHA. Protection against inhalation agents is minimal because personnel wear a mask in the VHA up until the time they step in the AL. Before stepping into the AL, a person takes a deep breath, removes the mask, and hangs it on a storage rack.

MIL-HBK-1040

Table A-1
CW Shelter Design Example

The TFA shall be sized to accommodate all essential personnel on all shifts. Space permitting, persons not on duty will stay in the TFA to eat, rest and sleep. A maximum shelter stay of 7 days is anticipated. Space must be allocated for operational supplies, food, drinking water, beds, emergency equipment, repair materials and individual protective equipment in addition to that required by the normal work activities conducted in the TFA. Entry to the TFA is through the CCA. The CCA is used to decontaminate entering personnel and prevent toxic vapors from entering the TFA. Note that the CCA is composed of three parts, an LHA, a VHA, and airlocks between the different hazard areas.

Personnel	Normal Mode	CW Mode
Number	40	80
Processing time	N/A	30/hr
Oxygen consumption	0.85 ft ³ /hr/person	same
CO ₂ generation	0.70 ft ³ /hr/person	same
Sensible heat release	245 Btu/hr/person	295 Btu/hr/person
Latent heat release	205 Btu/hr/person	455 Btu/hr/person
Minimum O ₂ level	17%	same
Maximum CO ₂ level	0.015%	same
Dry bulb temperatures	70° F (W) 75° F (S)	same
Relative humidity	55-65%	45-70%
Ventilation rate	10 cfm/person	calculated
Allowable Contaminant Levels		
Agent	N/A	mustard (HD)
Short term exposure limit	N/A	100 mg/min/M ³
Threshold limit value-time	weighted average	0.005 mg/M ³
Personnel	Normal Mode	CW Mode
Floor Areas		
Blast valve	N/A	25 ft ² total
LHA	N/A	115 ft ² total
VHA	N/A	165 ft ² total
Change booth	N/A	25 ft ² /each
Airlock	N/A	16 ft ² /each
TFA	10-20 ft ² /person	same

MIL-HBK-1040

3.5 AL Process Activities. The purpose of the AL is twofold: to separate the clean and contaminated areas of the shelter, and to provide the final cleansing of agent from a person's skin and hair before they enter the TFA. The cleansing action is provided by a shower of clean air for a period of 2 to 3 minutes.

3.6 Airflow Determination Factor. Of the four areas of the CCA, it is the VHA that determines the clean airflow requirements because personnel must spend a substantial amount of time in this area with exposed skin and the release of agent vapor from masks on the storage racks can result in a build up of agent vapor concentration in the VHA. Because a protective mask is worn in the VHA, the worst threat is the most toxic dermal agent rather than an inhalation agent. This agent is distilled mustard (HD), Lewisite (L) or a mixture of the two.

3.6.1 Airflow Rate Calculation. The vapor pressure of many CW weapons is very high. This implies that in the worst case, the chemical agents will readily vaporize and diffuse to fill the volume available to the extent determined by their molar concentration. Cold temperatures and high humidity retard the vaporization of agents. Thickened agents evaporate at a slower rate than non-thickened agents.

The design maximum dosage for chemical warfare agent exposure in the VHA is specified as 100 CT over a 3-minute period, e.g.,

$$\text{EQUATION: } 100 \text{ mg-min/m}^3 (6.24 \times 10^{-6} \text{ lb-min/ft}^3) \text{ over 3 minutes} \quad (\text{A-1})$$

The corresponding values of allowable agent concentration are:

$$\text{EQUATION: } 33 \text{ mg/M}^3 = 2 \times 10^{-6} \text{ lb/ft}^3 \quad (\text{A-2})$$

For mustard, this is equivalent to:

$$\text{EQUATION: } 2 \times 10^{-6} \frac{\text{lb}_{\text{mustard}}}{\text{ft}^3 \text{ air}} \frac{1 \text{ ft}^3}{0.42 \text{ lb}_{\text{mustard}}} \times 10^6 = 4.9 \text{ ppm} \quad (\text{A-3})$$

The volume of clean air required per pound of chemical agent evaporated in the CCA (to dilute the agent to the specified concentration) is equal to:

$$\text{EQUATION: } \frac{\text{ft}^3 \text{ clean air}}{\text{lb agent vapor}} = \frac{387 \times 10^6}{\text{M} \times \text{ppm}} \quad (\text{A-4})$$

MIL-HBK-1040

where

M = molecular weight of the chemical agent
ppm = concentration of agent, parts per million by volume

Expressing clean air volume and weight of agent evaporated as rates and rearranging the above equation yields:

$$\text{EQUATION:} \quad \text{CFM} = \frac{387 \times 10^6 \times R}{M \times \text{ppm}} \quad (\text{A-5})$$

where

R = agent evaporation rate, lb/min.

4.1 Example Calculation.

4.1.1 VHA Airflow Rate. As an example, assume that experiments show that about 10 percent of the mustard agent entering a persons body is on the mask. Since approximately equal amounts of time are spent in the LHA, CB, and VHA, it is reasonable to assume that one third of the agent on the mask is released into the VHA. In the worst case, all of the contaminant that reaches the VHA is released into the air of the VHA. Since 0.0055 pounds of mustard agent enter the the LHA with each incoming person and people enter at at rate of 30 per hour, the expected rate of release of mustard agent into the VHA is:

$$\begin{aligned} \text{EQUATION:} \quad & \frac{0.0055 \text{ lb}}{\text{person}} \times \frac{30 \text{ people}}{\text{hr}} \times \frac{1 \text{ hr}}{60 \text{ min}} \times \frac{1}{3} \\ & = 9.17 \times 10^{-4} \text{ lb/min} \end{aligned} \quad (\text{A-6})$$

Therefore, the ventilation air flow rate required to keep the concentration of mustard agent below 5 ppm in the VHA is:

$$\text{EQUATION:} \quad \text{CFM}_{\text{VHA}} = \frac{387 \times 10^6 \times 9.17 \times 10^{-4}}{159.1 \times 4.9} = 455 \text{ cfm} \quad (\text{A-7})$$

The designer should apply a safety factor of 1 to 2 to the calculated values of clean airflow to account for variations from assumed conditions.

The CB also requires an air supply having a low dermal agent concentration because personnel may be in the CB for several minutes and have exposed skin for a significant fraction of that time. In theory, the design airflow requirement for the CB will be lower than that of the VHA since skin is exposed for a shorter time and there can be no increase in agent concentration in the CB due to off-gassing from stored equipment as is possible in the VHA. It is recommended, however, that the same airflow rate be used in the CB as is used in the VHA.

MIL-HBK-1040

4.2 Room Airflow Sequence Consideration. The air supply for the VHA should first pass through the AL to provide the air shower required before entry to the TFA. The airflow through the AL must not be less than two air changes per minute. If the calculated clean air requirement VHA and CB would result in fewer than two air changes per minute in the AL, increase the airflow until two air changes per minute are provided. The air supply for the LHA is the exhaust from the VHA and CB.

4.2.1 Recommended Airflow Configuration. The recommended airflow configuration for the CCA ducts clean air from the TFA or a separate supply duct in an amount equal to the larger of either: two air changes/minute in the AL, or the design VHA airflow, first through the AL and then through the VHA. The air exhausted from the VHA is ducted to the LHA air inlet. The recommended airflow configuration ducts also clean air from the TFA or a separate clean air supply duct in an amount equal to the design VHA airflow through the CB. The exhaust from the CB is also ducted to the LHA air inlet.

4.2.2 Minimum Clean Air Configuration. The airflow configuration that results in the minimum clean air requirement cascades the flow of clean air from the AL through the VHA, through the CW, then out through the LHA. This design should be applied with caution, because the inlet air to the CB (the exhaust air from the VHA) might have unacceptably high contamination levels. The recommended configuration has a separate clean air supply for the CB.

4.3 Example Airflow Rate.³ For this design example, the VHA air flow requirement is 455 cfm (12.88 m³/min). The number of air changes per minute in the AL is equal to the supply air cfm divided by the volume of the room. The volume of the AL rooms is 4 ft x 4 ft x 7 ft x 2 rooms = 224 ft³ (1.22 m x 1.22 m x 2.13 m x 2 rooms = 6.343 m³). The number of³ air changes per minute in an airlock is, therefore, 455 cfm/224₃ft³ (12.88 m³/min / 6.343 m³) = 2. Thus, for this example, 455 cfm (12.88 m³/min) of air flows through the AL (225 cfm (6.37 m³/min) for each AL) then through the VHA, then through the LHA. An additional 450 cfm (12.74 m³/min) of clean air flows through the CB and then out via the LHA. The air changes per minute for the rooms of the CCA are tabulated:

<u>Room</u>	<u>Air Changes/Min</u>	<u>cfm/ft² of Floor Area</u>
AL	2	14
VHA	0.4	3
CW	1.3	9
LHA	1.1	8

The total amount of clean air required for the CCA is about 900 cfm (25.49 m³/min).

If no better data are available, design the air supply system to provide the AL with two air changes per minute of clean air and to provide each of the other rooms of the CCA (VHA, CB and LHA) with one air change per

MIL-HBK-1040

minute of clean air. These calculations show that the amount of outdoor air that must be taken into the shelter can be governed by the air flow requirements of the CCA rather than the ventilation requirements of occupants of the TFA, since in this example, only 800 cfm (22.65 m³/min) (80 people x 10 cfm (0.283 m³/min)/person) is required for TFA habitability.

4.4 Heating and Cooling Loads. Once the ventilation air requirements are known, the shelter heating and cooling loads can be calculated. An example of shelter design requirements is presented in Figure A-1. The floor area of the TFA is 10,000 ft² (929.03 m²) and the floor area of the CCA is 420 ft² (39.02 m²). Only the TFA space is conditioned. The building is of heavyweight concrete construction, has a flat roof, and no windows. Infiltration is assumed to be equal to zero.

4.4.1 Normal Operation - Single Zone. For purposes of analysis, the CW shelter was modeled as a single zone. The exhaust from the TFA was used as the supply air to the CCA. An HVAC load analysis of the shelter operated in the normal mode yields a design cooling load of 17 tons (215.23 MJ/HR) and a design airflow of 7,200 cfm (203.88 m³/min). The design heating load in the normal mode of operation is 125,000 Btu/hr (131.88 MJ/HR). The design internal pressure in the normal mode is 0.05 inch wg (1.27 mm wg).

4.4.2 CW Operation - Single Zone. Computer modeling of the building was repeated for the building operated in the CW mode. A once-through air cleaning system design was used. The differences between the two modes of operation are the ventilation air requirement and the internal load. In the CW mode of operation, the cooling load increases to 23 tons (291.2 MJ/HR) (most of the increase in load is due to the increase in ventilation air from 400 cfm to 1000 cfm (11.33 m³/min to 28.32 m³/min) and larger internal loads). The zone airflow increases from 7,200 cfm to 7,500 cfm (203.9 to 212.38 m³/min). The CW mode design heating load is 150,000 Btu/hr (158.26 MJ/HR). The design internal pressure in the CW mode is 1.0 inch wg (25.4 mm wg). (If the capacity of the air filtration system is increased from 1,000 cfm to 2,000 cfm (28.32 m³/min to 56.63 m³/min) to provide an added margin of safety, the shelter heating load is increased to 200,000 Btu/hr (211 MJ/HR) and the cooling load to 29 tons (367.16 MJ/HR). The supply airflow remains equal to 7,500 cfm (212.38 m³/min).

4.4.3 Equipment Selection. These two sets of design conditions must be accommodated by the same HVAC system. This is done through system design and equipment selection. Refer to Figure 12. The filter pressurization fan must overcome the filter pressure loss and pressurize the building. The increased heating and cooling loads of the CW mode of operation could be met by modulating the flow of water through the coil, by using multiple refrigeration circuits, or by using dampers to control air volume or temperature. The choice of control method depends upon the required ranges of heating and cooling capacities. A hot water coil or a steam coil could be placed in the HVAC system to provide heat during normal operation, but electric heat is recommended for operation in the CW mode.

MIL-HBK-1040

That portion of the ventilation air which is directed to the CCA is generally not separately conditioned for several reasons: (1) people occupy the CCA for only a few minutes as they enter or leave the TFA and should be able to endure thermal discomfort for those brief periods, and (2) the large volume of outdoor air that may have to be conditioned in some CCA designs, would require a sizable investment in air conditioning machinery which would be used only under extreme circumstances. However, in some climatic regions it may be necessary to condition the CCA ventilation air. In these cases, heating and cooling coils for the CCA ventilation air should be located in the CCA air supply duct (see Figure 12).

5.1 Central Data Monitoring Panel. Figures A-2, A-3, A-4, and A-5 are examples of a Central Data Monitoring Panel for a CW protected facility.

MIL-HBK-1040

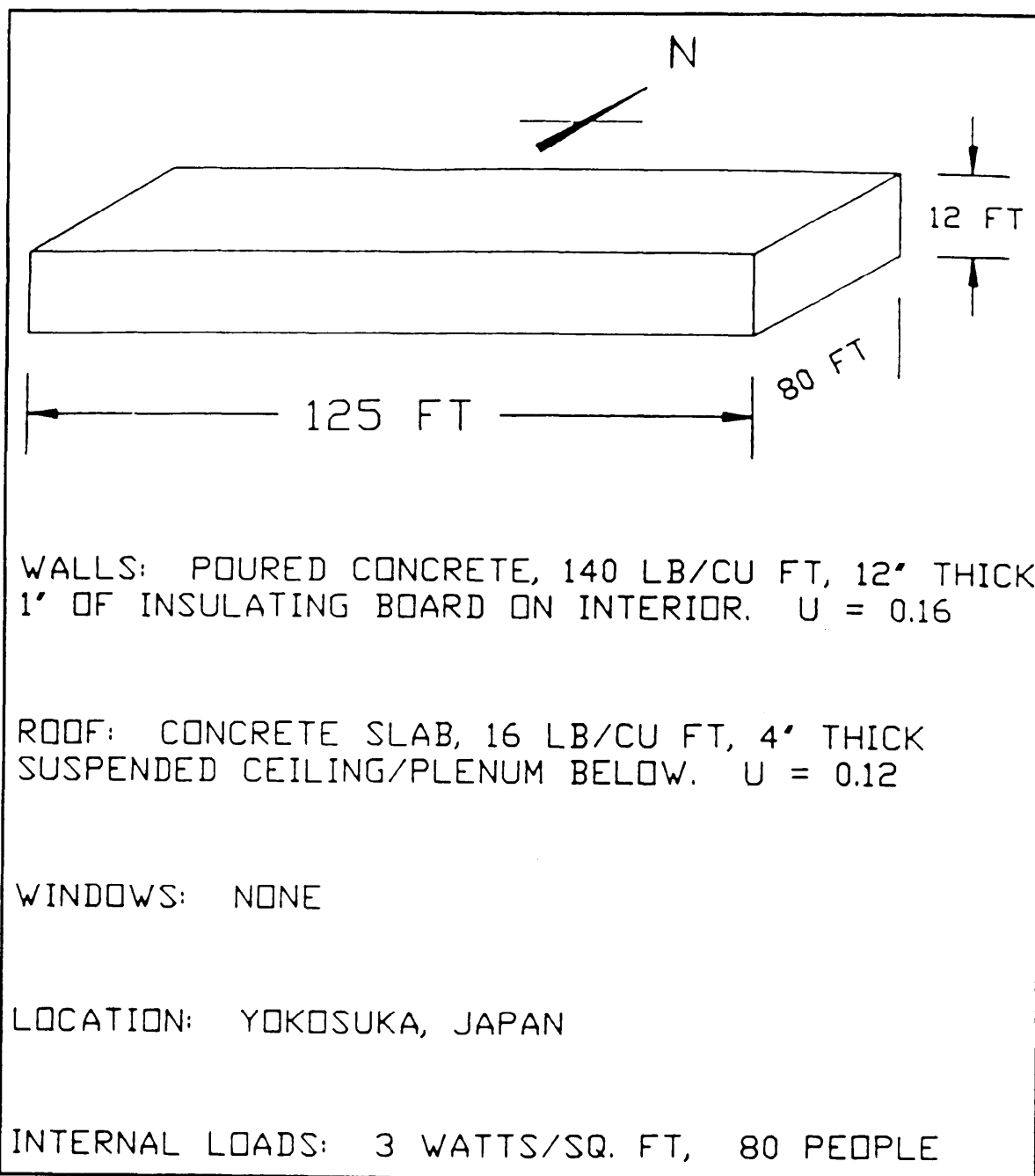

Figure A-1
Model of CW Shelter

MIL-HBK-1040

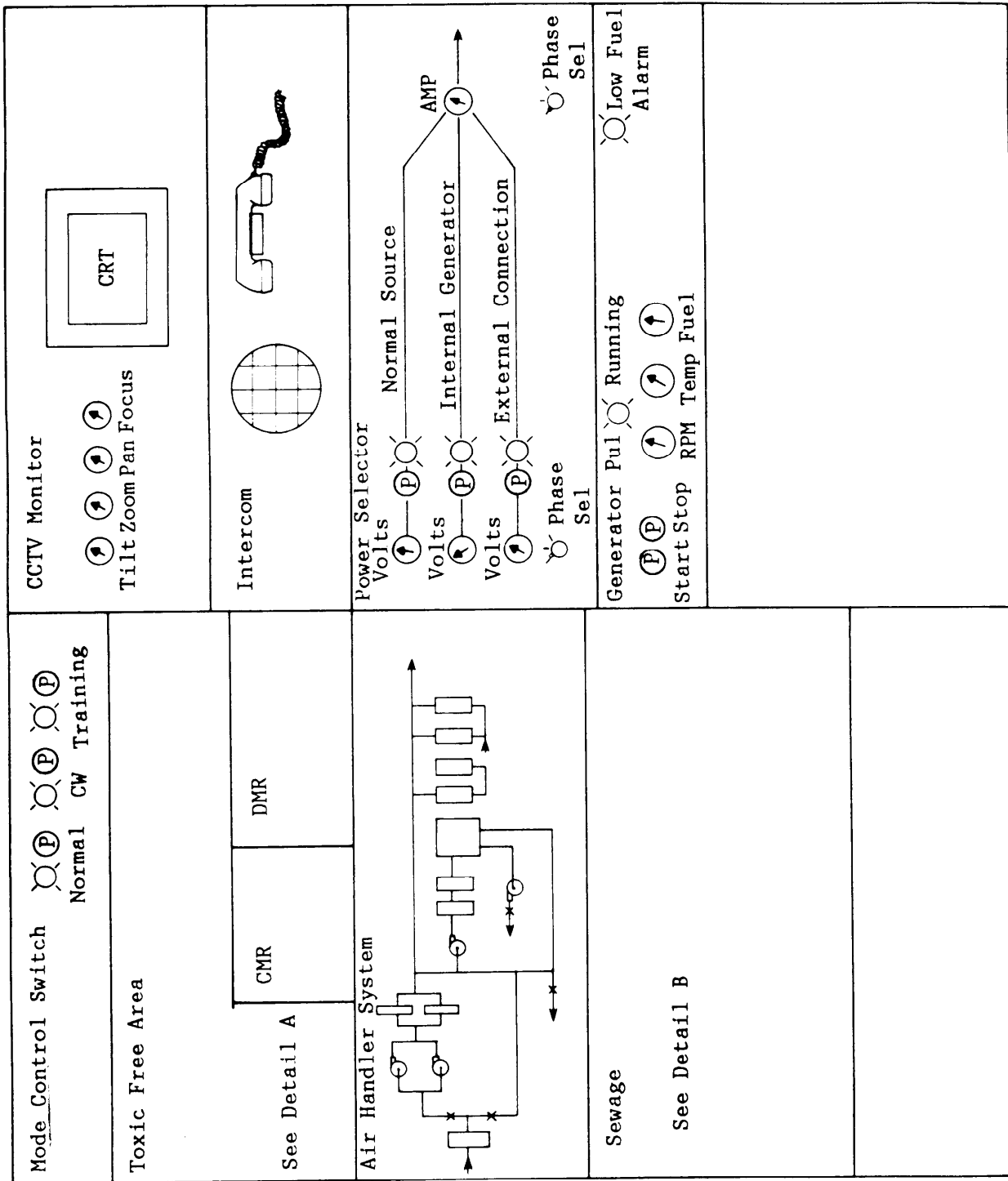

Figure A-2
Central Data Monitoring Panel

MIL-HBK-1040

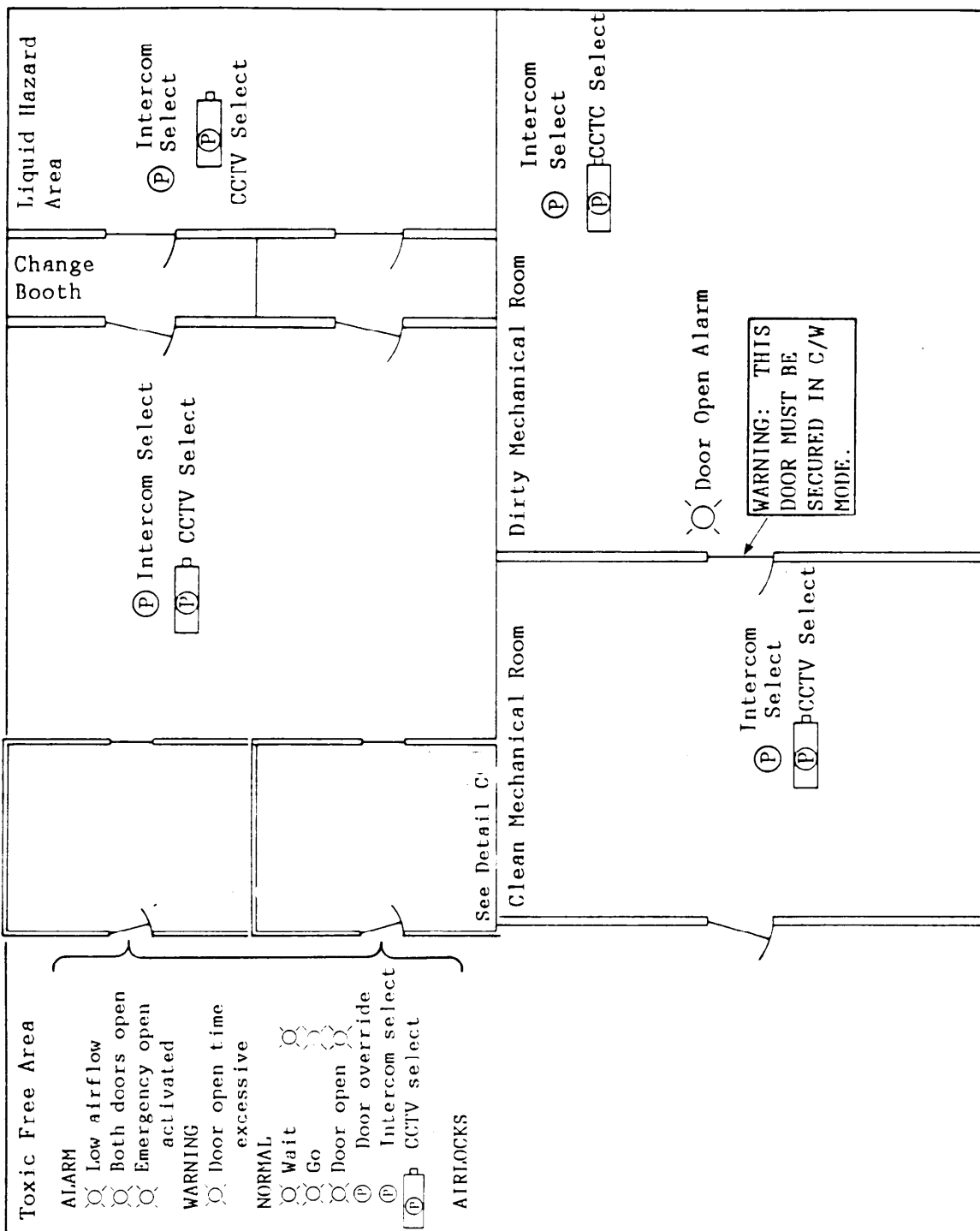

Figure A-3
Detail A

MIL-HBK-1040

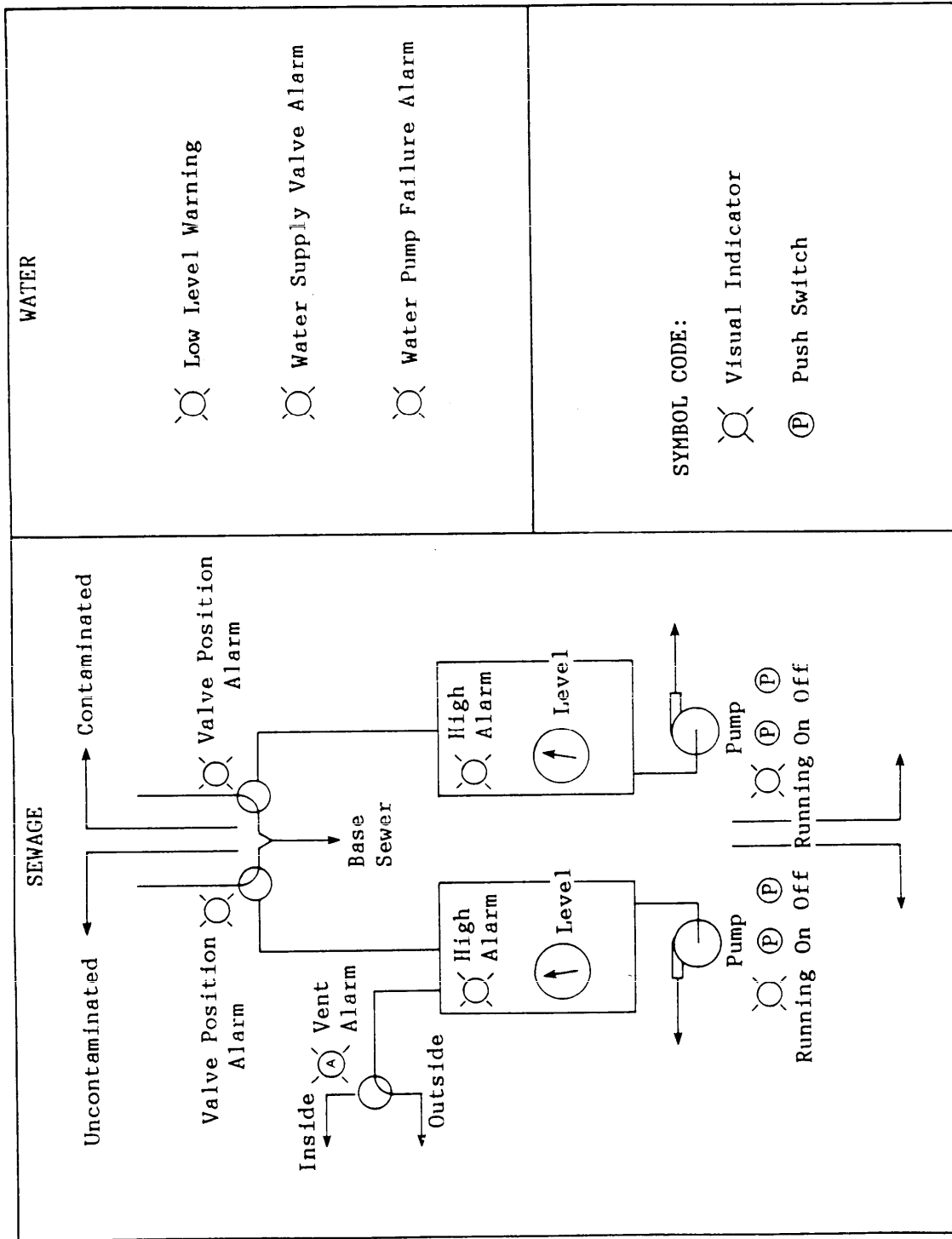
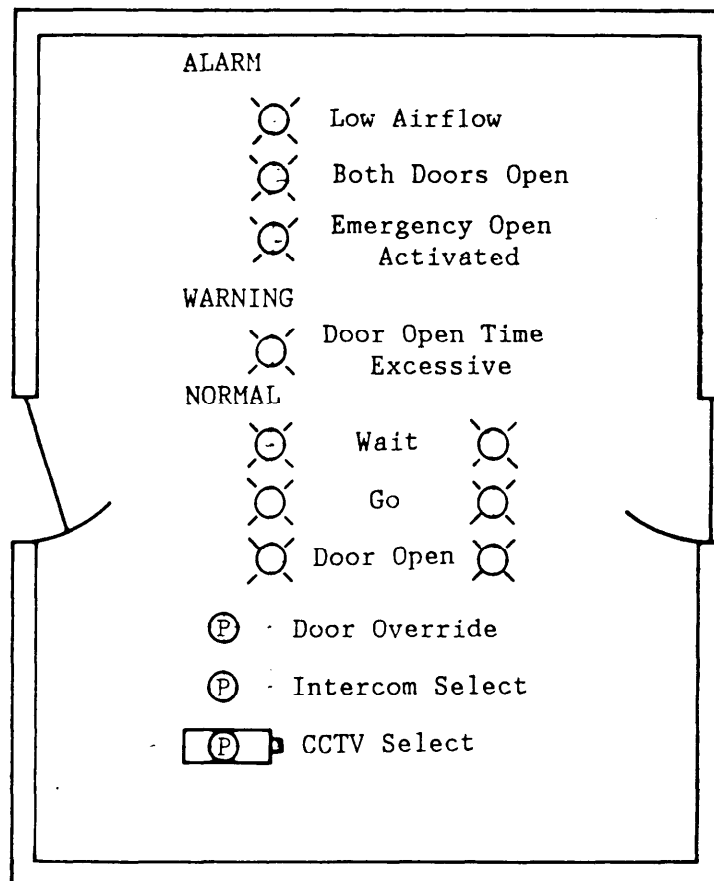

Figure A-4
Detail B

MIL-HBK-1040



AIRLOCK DETAIL

Figure A-5
Detail C

MIL-HBK-1040

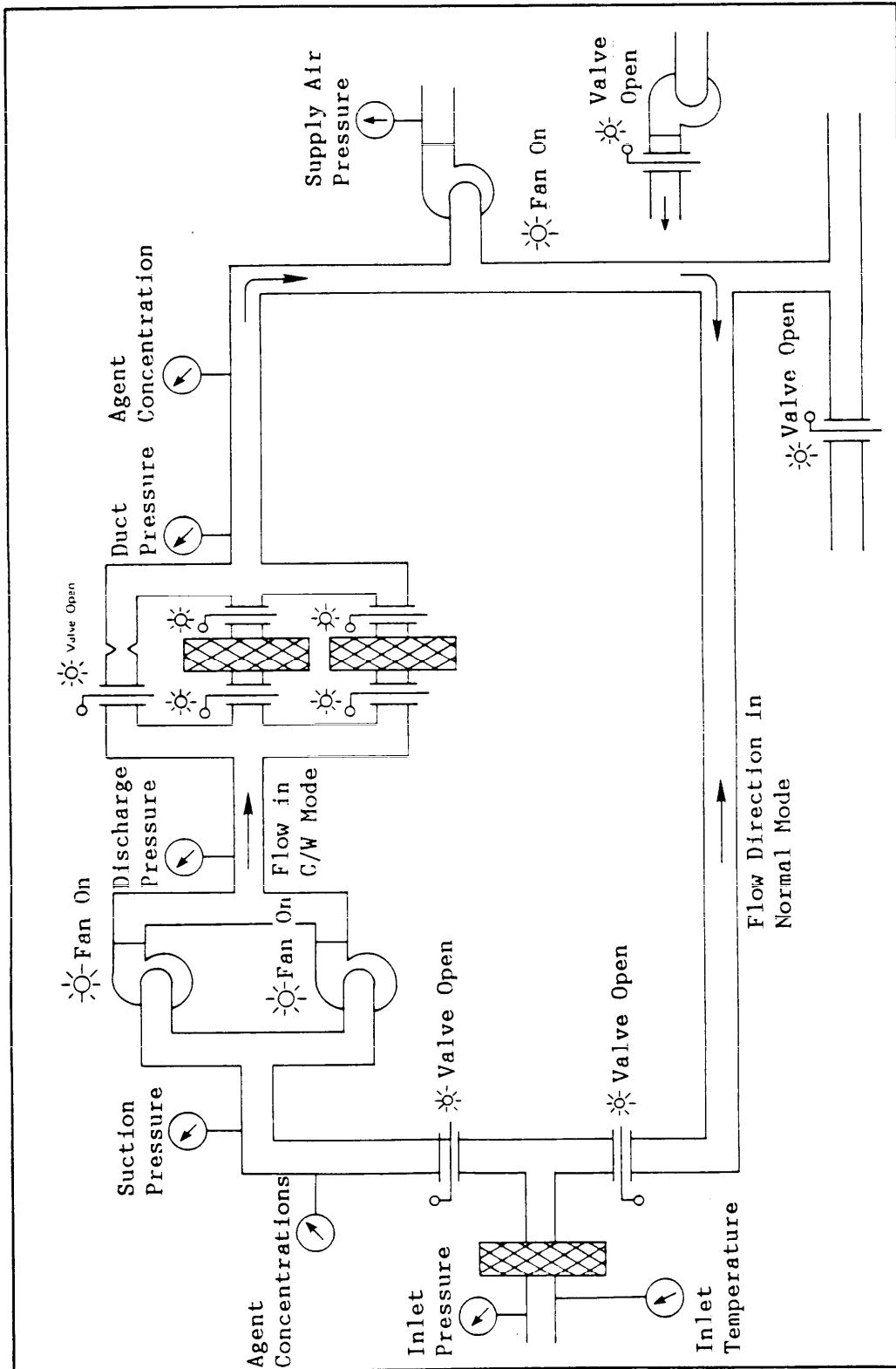

Figure A-6
Detail D

MIL-HBK-1040

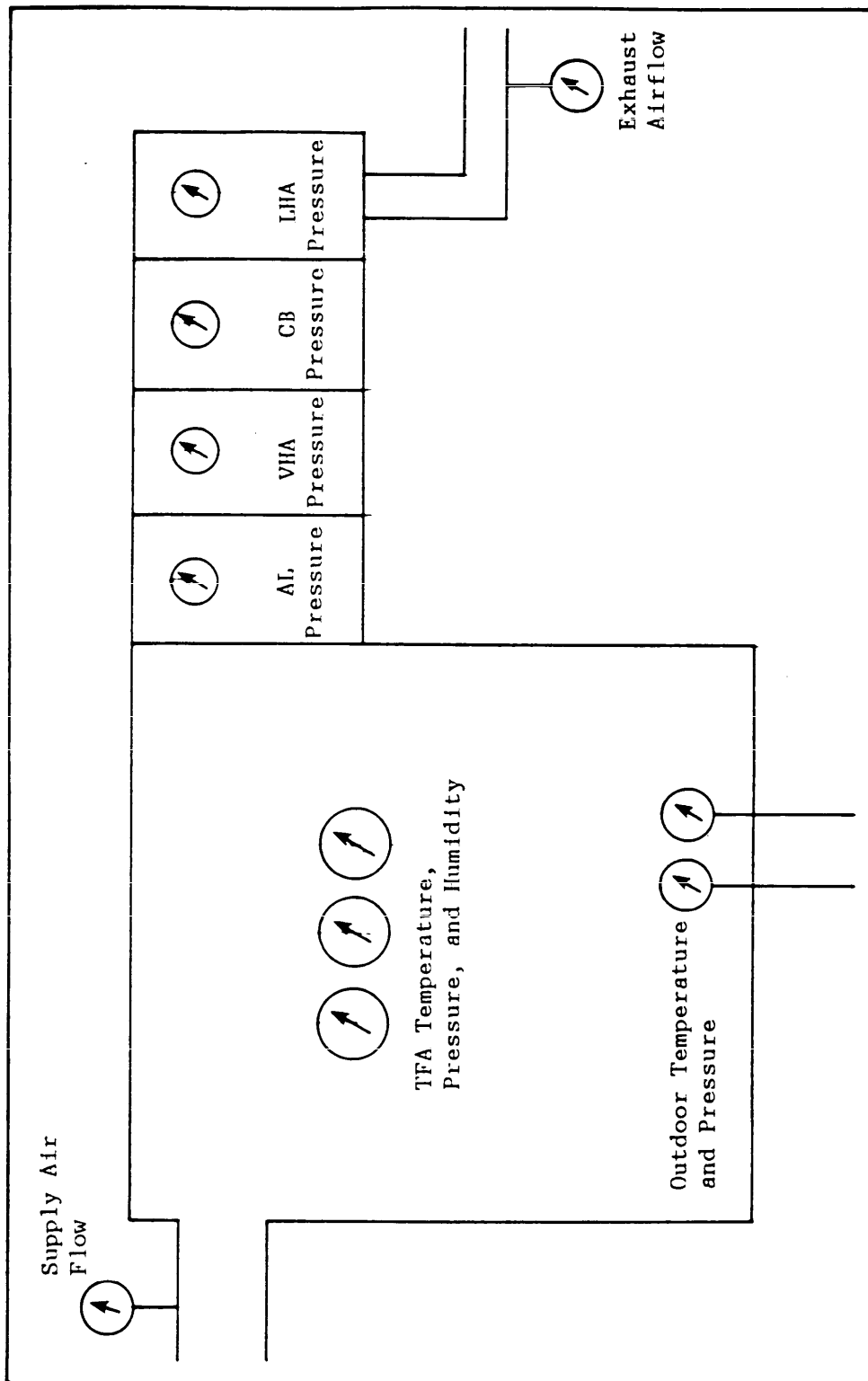

Figure A-6
Detail D (continued)

MIL-HBK-1040

MIL-HBK-1040

BIBLIOGRAPHY

Commercial Standards.

Air Movement and Control Association (AMCA), 30 W. University Drive, Arlington Heights, IL 60004

AMCA 99	Standards Handbook
AMCA 201	Fan Application Manual - Fans and Systems
AMCA-STD-300	Reverberant Room Method for Sound Testing of Fans
AMCA-STD-1401-66	Operating Limits for Central Station Units
AMCA-STD-2404-7	Drive Arrangements for Centrifugal Fans

American National Standards Institute, 1430 Broadway, New York, NY 10018

ANSI B46.1	Surface Texture (Surface Roughness, Waviness and Lay)
ANSI N509	Nuclear Power Plant Air Cleaning Units and Components
ANSI N510	Standards for Testing of Nuclear Air Cleaning Systems

American Society for Testing and Materials (ASTM), 1916 Race Street, Philadelphia, PA 19003

ASTM A167	Standard Specification for Stainless and Heat-Resisting Chromium-Nickel Steel Plate, Sheet, and Strip
ASTM A176	Standard Specification for Stainless and Heat-Resisting Chromium Steel Plate, Sheet, and Strip
ASTM A240	Standard Specification for Heat-Resisting Chromium and Chromium-Nickel Stainless Steel Plate, Sheet, and Strip
ASTM D1056	Specification for Flexible Cellular Materials - Sponge or Expanded Rubber
ASTM D1330	Specification for Rubber-Sheet Gaskets
ASTM D2652	Standard Definitions of Terms Relating to Activated Carbon

MIL-HBK-1040

NFPA No. 75	Protection of Electronic Computer/Data Processing Equipment
NFPA No. 91	Standard for the Installation, Blower and Exhaust Systems for Dust, Stock, and Vapor Removal or Conveying
NFPA No. 101	Code for Life Safety to Life from Fire in Buildings and Structures
NFPA No. 220	Types of Building Construction
NFPA No. 1221	Public Fire Service Communications

NEMA Standard 250-1985, Enclosures for Electrical Equipment (1,000 volts maximum). National Electrical Manufacturers Association, Washington, DC.

Underwriters Laboratories (UL), 333 Pfingsten Road, Northbrook, IL 60062

UL-181	Standard for Factory-Made Air Ducts and Connectors
UL-586	Safety Standard for High Efficiency Particulate, Air Filter Units

General Publications.

American Conference of Governmental Industrial Hygienists: Industrial Ventilation, A Manual of Recommended Practice. Cincinnati, OH.

American Engineering Council TID 7023, High Efficiency Particulate Air Filter Units, Guide to Inspection, Storage, Handling, and Installations. New York, NY.

American Society of Heating, Refrigerating, and Air Conditioning Engineers (ASHRAE), 1791 Tullie Circle, N.E., Atlanta, GA 30329

ASHRAE	Systems Handbook
ASHRAE STD 52-68	Method of Testing Air Cleaning Devices Used in General Ventilation for Removing Particulate Matter

ASME Boiler and Pressure Vessel Code. American Society of Mechanical Engineers, New York, NY.

DOE 76-21, Nuclear Air Cleaning Handbook. Department of Energy, Washington, DC.

Janas, L.A.; J.A. Rehrmann; and J.M. Eskow: Kinetics of Trace Gas Adsorption from Contaminated Air; reprint from American Chemical Society Symposium Series No. 17: Removal of Trace Contaminants from the Air. Washington, DC, 1975.

MIL-HBK-1040

"Theory of Plates and Shells," by S. Woinowsky-Krieger and S. Timoshenko
second edition, McGraw-Hill, New York, NY 10020

TLVs Threshold Limit Values for Chemical Substances and Physical Agents in the
Workroom Environment with Intended Changes for 1977. American Conference of
Governmental Industrial Hygienists, Cincinnati, OH, 1977.

Military and Federal Specifications and Standards. Naval Publications and
Forms Center, 5801 Tabor Avenue, Philadelphia, PA 19120.

Specifications:

MIL-F-51068	Filter, Particulate, (High-Efficiency, Fire Resistant)
MIL-F-51079	Filter, Medium, Fire Resistant, (High-Efficiency)
DOD-F-24669/7	Forgings, and Forging Stock, Steel Bars and Billets, Corrosion Resisting; Naval Steam Turbine Parts Use (METRIC)
MIL-W-12332	Welding, Resistance, Spot, Seam, and Projection; for Fabricating Assemblies of Low-Carbon Steel
MIL-W-46154	Welding, Resistance, Spot and Projection for Fabricating Assemblies of Carbon Steel Sheets

Standards:

MIL-STD-171	Finishing of Metal and Wood Surfaces
MIL-STD-282	Filter Units, Protective Clothing, Gas-Mask Components and Related Products, Performance Test Methods
MIL-STD-414	Sampling Procedures and Tables for Inspection by Variables for Percent Defective
MIL-STD-1261	Arc Welding Procedures for Construction Steel

Military Handbooks. Naval Publications and Forms Center, 5801 Tabor Avenue,
Philadelphia, PA 19120.

MIL-HDBK-753	CB Collective Protection of Mobile Vehicles, Vans, and Shelters
--------------	---

Miscellaneous DOD Publications.

ARLCD-SP-84001, Structures to Resist the Effects of Accidental Explosion,
Volume III. Army Armament Research and Development Center, Large Caliber
Weapon Systems Laboratory, Dover, NJ 07801.

MIL-HBK-1040

CSL 100-26, Medical Surveillance of Personnel Potentially Exposed to Cholin-esterase Inhibiting Substances (CIS). Letter AMCMM-0, Commanding General, Army Materiel Command, to Project Manager, Chemical Demilitarization and Installation Restoration, Aberdeen Proving Ground, MD, 11 Dec 1975.

DA Pamphlet 385-3, Protective Clothing Equipment. Department of the Army, 1968.

DARCOM Regulation 385-102, Safety Regulations for Chemical Agents GB and VX. Department of the Army, Development and Readiness Command Regulation, Feb 1977.

Design Criteria for Semihard and Protected Facilities with Nuclear, Biological and Chemical (NCB) Protection. Headquarters USAFE Europe Air Combat Operations Staff, Ramstein AB, Germany (HQUSAFEEUROPS/DEX).

FM 3-9, Military Chemistry. Department of the Army Field Manual, Oct 1975.

FM 3-21, Chemical-Biological Accident Contamination Control. Department of the Army Field Manual, Aug 1972.

Smith, G.; et al., Report No. ENCR 30: Protection of Structures from Chemical, Biological, and Radiological (CBR) Contamination. U.S. Army Chemical Corps Engineering Command, June 1959 (reprinted Mar 1962).

TM 3-4240-240-14: Mask, Chemical-Biological, Special Purpose, M9A1; Mask, Chemical-Biological, Special Purpose, M9; and Accessories. Department of the Army, Technical Manual, 26 Oct 1970.

TM 3-4240-258-14: Mask, CBR; Field, M17A1 and Accessories. Department of the Army, Technical Manual, Aug 1975.

TM 10-277: Protective Clothing Chemical Operations. Department of the Army, Technical Manual, July 1967.

TM 750-5-15: Chemical Weapons and Defense Equipment. Department of the Army, Technical Manual, Apr 1969.

Naval Facilities Engineering Command (NAVFAC) Publications. Naval Publications and Forms Center, 5801 Tabor Avenue, Philadelphia, PA 19120.

DM-3.10	Noise and Vibration Control for Mechanical Equipment
MO-114	Building Maintenance; Plumbing, Heating, and Ventilating
MO-117	Maintenance of Fire Protection Systems

NOTE: Commercial organizations may procure Design Manuals and Publications from:

Superintendent of Documents
U.S. Government Printing Office
Washington, DC 20420

MIL-HBK-1040

MIL-HBK-1040

REFERENCES

FEDERAL/MILITARY SPECIFICATIONS, STANDARDS, BULLETINS, HANDBOOKS, AND NAVFAC GUIDE SPECIFICATIONS:

The following specifications and handbooks form a part of this document to the extent specified herein. Unless otherwise indicated, copies are available from Commanding Officer, Naval Publications and Forms Center, ATTENTION: NPODS, 5801 Tabor Avenue, Philadelphia, PA 19120-5099.

SPECIFICATIONS

MILITARY

MIL-C-13724	Charcoal, Activated, Impregnated, ASC
MIL-C-22750	Coating, Epoxy-Polyamide
MIL-C-46168	Coating, Aliphatic Polyurethane, Chemical Agent Resistant
MIL-F-51213	Filters, Gas (60, 120, and 250 cfm modules) C10, C31, and C21
MIL-F-51214	Filters, Particulate, Gas, 600, 1200, 2500, and 5000 cfm; C18R1, C19R1, C30R1, and C20R1
MIL-F-51215	Filters, Particulate, 600, 1200, 2500, and 5000 cfm; C18R1, C19R1, C30R1, C20R1

HANDBOOKS

MIL-HDBK-144	Engineering Design Handbook for Air Cleaning for Chemical Demilitarization
MIL-HDBK-1004/1	Preliminary Design Considerations
MIL-HDBK-1004/4	Electrical Utilization Systems
MIL-HDBK-1008A	Fire Protection for Facilities Engineering, Design, and Construction
MIL-HDBK-1013/1	Design Guidelines for Physical Security of Fixed Land-Based Facilities
MIL-HDBK-1190	Facility Planning and Design Guide

NAVFAC GUIDE SPECIFICATIONS

NFGS-16202	Diesel Electric Generators (Design 1)
NFGS-16203	Diesel Electric Generators (Design 2)

MIL-HBK-1040

NFGS-16204	Standby-Duty Diesel Electric Generators (Design 3)
NFGS-16205	Standby-Duty Diesel Electric Generators (Design 4)
NFGS-16208	Diesel Engine-Generator Set (25-250 kW)
NFGS-16402	Interior Wiring Systems
NFGS-16760	Intercommunication System

NAVY MANUALS AND P-PUBLICATIONS:

Available from Commanding Officer, Naval Publications and Forms Center, (NPFC), 5801 Tabor Avenue, Philadelphia, PA 19120-5099. To order these documents: Government agencies must use the Military Standard Requisitioning and Issue Procedure (MILSTRIP); the private sector must write to NPFC, ATTENTION: Cash Sales, Code 1051, 5801 Tabor Avenue, Philadelphia, PA 19120-5099.

DESIGN MANUALS

DM-3 Series	Mechanical Engineering
DM-3.01	Plumbing Systems
DM-3.03	Heating, Ventilating, Air Conditioning, and Dehumidifying Systems
DM-4.07	Electrical Engineering Wire Communication and Signal Systems

P-PUBLICATIONS

P-397	Structures to Resist the Effects of Accidental Explosion
-------	---

NON-GOVERNMENT PUBLICATIONS:

The following publications form a part of this document to the extent specified herein. Unless otherwise specified, the issues of the documents which are DoD adopted are those listed in the Department of Defense Index of Specifications & Standards (DODISS):

AMERICAN CONCRETE INSTITUTE (ACI)

ACI 318-86	Building Code Requirements for Reinforced Concrete (DoD adopted)
------------	---

(Unless otherwise indicated, copies are available from American Concrete Institute (ACI), P.O. Box 19150, Detroit, MI 48219)

MIL-HBK-1040

AMERICAN SOCIETY OF HEATING, REFRIGERATING, AND AIR CONDITIONING ENGINEERS
(ASHRAE)

ASHRAE	1988 Handbook - Fundamentals
ASHRAE	1988 Handbook - Equipment
ASHRAE	1987 Handbook - HVAC Systems and Applications
ASHRAE STD-55-1981	Thermal Environmental Conditions for Human Occupancy

(Unless otherwise indicated, copies are available from American Society of Heating, Refrigerating, and Air Conditioning Engineers (ASHRAE), 1791 Tullie Circle, N.E., Atlanta, GA 30329)

AMERICAN SOCIETY FOR TESTING AND MATERIALS (ASTM)

ASTM D2862	Test Method for Particle Size Distribution of Granular Activated Carbon
ASTM D3467	Test Method for for Carbon Tetrachloride Activity of Activated Carbon
ASTM E323	Standard Specification for Perforated-Plate Sieves for Testing Purposes (DoD adopted)

(Unless otherwise indicated, copies are available from American Society for Testing and Materials, 1916 Race St., Philadelphia, PA 19103.)

AMERICAN SOCIETY OF PLUMBING ENGINEERS (ASPE)

Fundamentals of Plumbing Design

Special Systems Volume

(Unless otherwise indicated, copies are available from American Society of Plumbing Engineers (ASPE), 3617 Thousand Oaks Boulevard, No. 210, Westlake, CA 91362)

BUILDING OFFICIAL AND CODE ADMINISTRATORS INTERNATIONAL

Basic Plumbing Code

(Unless otherwise indicated, copies are available from Building Official and Code Administrators International, 4051 W. Flossman Road, Country Club Hills, IL 60477)

MIL-HBK-1040

INTERNATIONAL ASSOCIATION OF PLUMBING AND MECHANICAL OFFICIALS

Uniform Plumbing Code

(Unless otherwise indicated, copies are available from International Association of Plumbing and Mechanical Officials, 5032 Alhambra Avenue, Los Angeles, CA 90032)

NATIONAL ASSOCIATION OF PLUMBING HEATING - COOLING CONTRACTORS (NAHPCC)

National Standard Plumbing Code

(Unless otherwise indicated, copies are available from National Association of Plumbing Heating - Cooling Contractors, 180 S. Washington Street, P.O.Box 6808, Falls Church, VA 22046)

NATIONAL FIRE PROTECTION ASSOCIATION (NFPA)

NFPA No. 70 National Electric Code (DoD adopted)

NFPA No. 90A Standard for the Installation of Air
Conditioning and Ventilating Systems

NFPA No. 90B Standard for the Installation of Warm Air
Heating and Air Conditioning Systems

(Unless otherwise indicated, copies are available from National Fire Protection Association, Batterymarch Park, Quincy, MA. 02269)

PLUMBING AND DRAINAGE INSTITUTE (PDI)

PDI-WH201 Water Hammer Arrestors (DoD adopted)

(Unless otherwise indicated, copies are available from Plumbing and Drainage Institute (PDI), 5342 Boulevard Place, Indianapolis, IN 46208)

SHEET METAL AND AIR CONDITIONING CONTRACTORS' NATIONAL ASSOCIATION (SMACNA)

SMACNA HVAC Duct Construction Standard - Metal, and
Flexible

(Unless otherwise indicated, copies are available from Sheet Metal and Air Conditioning Contractors' National Association (SMACNA), P.O. Box 70, Merrifield, VA 22116)

UNDERWRITERS LABORATORIES (UL)

UL-900 Test Performance of Air Filter Units

(Unless otherwise indicated, copies are available from Underwriters Laboratories (UL), 333 Pfingsten Road, Northbrook, IL 60062)

MIL-HBK-1040

MIL-HBK-1040

INDEX

	<u>Page</u>
A	
Access status indicators	101
Adsorber cells	76
After-filters	77
Airflow configuration	64
Air distribution	81
Airflow rate calculation	112
Airflow rate example	114
Airlock doors	101
Air mixing dampers	85
Allowable deflections	37
Architectural design criteria	17
B	
Barriers	53
Base sewers	100
Base water supply	100
Blast doors	44
Allowable deflections	47
Design concepts	44
Design procedure	48
Design stresses	47
Blast valves	53
Blood agents	8
Blower assembly	80
C	
Cable penetrations	99
Calculating	
Cooling load	63
Heating load	63
Moisture load	63
Ventilation air requirements	63
CBR warfare	6
Biological	6
Chemical	6
Radiological	7
Central data monitoring panel (CDMP)	99
Chemically hardened military facilities	1
Chemical agents characteristics	7
Nonpersistent	7
Persistent	7

MIL-HBK-1040

	<u>Page</u>
Chemical hardening	9
Closed circuit TV (CTTV)	99
CMR annunciator/control panel	100
Combined loads	36
Concentration time (CT)	66
Concrete	37
Connections for portable generators	104
Construction and materials	18
Exterior	18
External doors	20
External utility openings	20
Windows	18
Interior	20
CCA	20
Coatings	26
Dirty and clean mechanical rooms	26
Gaskets	26
TFA	26
Contamination control area (CCA)	20
Contaminated sewage	95
Cooling equipment	69
CW external envelope	27
CW shelter	27
CW shelter design example	111
CW mode of ventilation air requirements	110

D

Design explosive threat	28
Design loads	31
Earth-bermed wall loads	32
External blast overpressures	31
Roof loads	32
Vertical wall loads	31
Domestic water system	91
Door-lock time sequences	102
Door-open sensors	101
Drain traps	95
Drainage systems	94
Drains	95
Tanks	94

E

Electric door interlocks	101
Electric locks	101
Electrical equipment enclosures	99
Electrical systems design criteria	99
Emergency exit doors	101
Emergency lighting	103

MIL-HBK-1040

	<u>Page</u>
F	
Filter-adsorber sizing	65
Fire protection design criteria	98
Fixtures	94
Flexural reinforcement	39
Fragment penetration	42
Fresh air intakes/exhaust	81
Fuel tank	96
G	
General requirements for CCAs and airlocks	99
Generator requirements	103
Ground shock	34
Group I, II, and III filters	74
H	
Heating equipment selection	79
HEPA filters	75
Hot water supply	93
Humidification equipment selection	69
HVAC configuration	59
HVAC design criteria	55
HVAC load analysis	115
HVAC system controls	83
General	83
Local loop	83
I	
Individual protection equipment	9
Intercommunication system	99
Interior construction	20
Internal leakage pressure	34
Internal components	71
L	
Local loop controls	83
Low fuel tank alarm	101
Low water level alarm	100

MIL-HBK-1040

	<u>Page</u>
M	
Mechanical design criteria	
Fire protection	98
HVAC design criteria	55
Plumbing systems	91
Master intercom station	99
Materials	51
Acceptable	51
Unacceptable	52
Mechanical equipment design and selection guidelines	67
Cooling equipment	69
Heating equipment	69
Humidification equipment	69
Ventilation equipment	69
Mode control switch	100
Mission-critical shore facilities	1
N	
Nerve agents	7
Nonpersistent agents	7
Cyanogen chloride (CK)	7
Hydrogen cyanide (AC)	7
Phosgene (CG)	7
Sarin (GB)	7
O	
Operation modes	60
Chemical warfare (CW)	60
Normal	60
Operational requirements	27
P	
Persistent agents	7
Mustard/Lewisite (HD/L)	7
Nerve agent VX	7
Soman (GD)	7
Thickened GD (TGD)	7
Thickened mustard (THD)	7
Physical security design criteria	109
Piping	93
Planning and layout of chemically-hardened facilities	17
Portable generators connections	104
Power transfer switch	104

MIL-HBK-1040

	<u>Page</u>
Prefilters	71
Function	71
Performance	74
Type	71
Pressurization and airflow	100
Pressurization requirements	67
Process activities	110
AL	112
CB	110
LHA	110
VHA	110
Protection levels	28

R

Redundancy of equipment	86
Reheat coil	84
Reinforced concrete	36
Allowable deflections	37
Design for bending and shear	38
Design stresses	36
Fragment penetration	42
Reinforcement details	39
Spalling and Breaching	39
Remote motors	102
Remote control	103
Status indicators	102
Room air distribution	81

S

Sanitary drainage system	94
Series redundant system	86
Shelter room arrangement	55
Airlock (AL)	58
Change booth (CB)	55
Clean mechanical room (CMR)	58
Dirty mechanical room (DMR)	58
Liquid hazard area (LHA)	55
Vapor hazard area (VHA)	58
Shock and overpressure	88
Site selection and site preparation	17
Sizing and unit selection	78
Solid waste and wastewater tanks	100
Start/stop control and status	103
Storage requirements	105
LHA	105
TFA	105
VHA	105

MIL-HBK-1040

	<u>Page</u>
Structural design criteria	27
System testing	89
Normal mode of operation	89
CW mode of operation	89
Survivability and reliability	86
T	
Temperature and humidity	78
Toxic free environment	9
Traps	95
Two-way communication	99
U	
Unique generator requirements	103
V	
Valves	94
Water hammer arresters	94
Ventilation equipment selection	69
Venting system	95
Vesicants	8
VHA airflow rate	113
Visual alarm	100
W	
Water handling	91
Water filters	92
Water pump failure alarm	100
Water softening system	92
Water supply	92
Quantity	92
Storage tanks	92
Wells	92
Weapon threat	27
Windows	51
Design	52
Materials	51

CUSTODIAN
 ARMY - CE
 NAVY - YD
 AF - 04

PREPARING ACTIVITY
 NAVY - YD
 PROJECT NO. FACR-0204

INSTRUCTIONS: In a continuing effort to make our standardization documents better, the DoD provides this form for use in submitting comments and suggestions for improvements. All users of military standardization documents are invited to provide suggestions. This form may be detached, folded along the lines indicated, taped along the loose edge (*DO NOT STAPLE*), and mailed. In block 5, be as specific as possible about particular problem areas such as wording which required interpretation, was too rigid, restrictive, loose, ambiguous, or was incompatible, and give proposed wording changes which would alleviate the problems. Enter in block 6 any remarks not related to a specific paragraph of the document. If block 7 is filled out, an acknowledgement will be mailed to you within 30 days to let you know that your comments were received and are being considered.

NOTE: This form may not be used to request copies of documents, nor to request waivers, deviations, or clarification of specification requirements on current contracts. Comments submitted on this form do not constitute or imply authorization to waive any portion of the referenced document(s) or to amend contractual requirements.

(Fold along this line)

(Fold along this line)

DEPARTMENT OF THE NAVY



NO POSTAGE
NECESSARY
IF MAILED
IN THE
UNITED STATES

OFFICIAL BUSINESS
PENALTY FOR PRIVATE USE \$300

BUSINESS REPLY MAIL
FIRST CLASS PERMIT NO. 12503 WASHINGTON D C

POSTAGE WILL BE PAID BY THE DEPARTMENT OF THE NAVY

COMMANDING OFFICER
NAVAL CIVIL ENGINEERING LABORATORY
L30
PORT HUENEME, CA 93043-5003



STANDARDIZATION DOCUMENT IMPROVEMENT PROPOSAL

(See Instructions - Reverse Side)

1. DOCUMENT NUMBER MIL-HDBK-1040		2. DOCUMENT TITLE BASIC GUIDELINES FOR CHEMICAL WARFARE HARDENING OF NEW MILITARY FACILITIES	
3a. NAME OF SUBMITTING ORGANIZATION		4. TYPE OF ORGANIZATION (Mark one)	
b. ADDRESS (Street, City, State, ZIP Code)		<input type="checkbox"/> VENDOR <input type="checkbox"/> EFD/PWO <input type="checkbox"/> USER <input type="checkbox"/> AE <input type="checkbox"/> MANUFACTURER <input type="checkbox"/> CONTRACTOR <input type="checkbox"/> OTHER (Specify): _____	
		5. PROBLEM AREAS	
a. Paragraph Number and Wording:			
b. Recommended Wording:			
c. Reason/Rationale for Recommendation:			
6. REMARKS			
7a. NAME OF SUBMITTER (Last, First, MI) - Optional		b. WORK TELEPHONE NUMBER (Include Area Code) - Optional	
c. MAILING ADDRESS (Street, City, State, ZIP Code) - Optional		8. DATE OF SUBMISSION (YYMMDD)	

(TO DETACH THIS FORM, CUT ALONG THIS LINE)