

INCH-POUND

MIL-HDBK-1036/4
15 AUGUST 1990
SUPERSEDING
DM 36.4
FEBRUARY 1978

MILITARY HANDBOOK

ENLISTED DINING FACILITIES



AMSC N/A

AREA FACR

DISTRIBUTION STATEMENT A. APPROVED FOR PUBLIC RELEASE: DISTRIBUTION IS UNLIMITED

MIL-HDBK-1036/4

ABSTRACT

Design criteria are presented on facilities covered by facility category code 722-10 for use by experienced architects and engineers. The contents include design and construction criteria for Enlisted Dining Facilities serving from 40 to 2,200 persons. Equipment requirements for food service facilities for brigs from 50 to 250 persons are also included.

MIL-HDBK-1036/4

FOREWORD

This handbook has been developed from an evaluation of facilities in the shore establishment, from surveys of the availability of new materials and construction methods, and from selection of the best design practices of the Naval Facilities Engineering Command (NAVFACENGCOM), other Government agencies, and the private sector. This handbook was prepared using, to the maximum extent feasible, national professional society, association, and institute standards. Deviations from these criteria in the planning, engineering, design, and construction of Naval shore facilities cannot be made without prior approval of NAVFACENGCOM HQ (Code 04).

Design cannot remain static any more than can the functions it serves or the technologies it uses. Accordingly, recommendations for improvement are encouraged and should be furnished to Commanding Officer, Chesapeake Division, Naval Facilities Command, Code 406C, Washington, D.C. 20374-2121; telephone (202) 433-3314.

THIS HANDBOOK SHALL NOT BE USED AS A REFERENCE DOCUMENT FOR PROCUREMENT OF FACILITIES CONSTRUCTION. IT IS TO BE USED IN THE PURCHASE OF FACILITIES ENGINEERING STUDIES AND DESIGN (FINAL PLANS, SPECIFICATIONS, AND COST ESTIMATES). DO NOT REFERENCE IT IN MILITARY OR FEDERAL SPECIFICATIONS OR OTHER PROCUREMENT DOCUMENTS.

MIL-HDBK-1036/4

HOUSING CRITERIA MANUALS

<u>Criteria Manual</u>	<u>Title</u>	<u>PA</u>
DM 36.1	Unaccompanied Personnel Housing	PACDIV
DM 36.2	Unaccompanied Enlisted Quarters	PACDIV
DM 36.3	Unaccompanied Officer Quarters	PACDIV
MH-1036/4	Enlisted Dining Facilities	CHESDIV

MIL-HDBK-1036/4

ENLISTED DINING FACILITIES

CONTENTS

	<u>Page</u>
Section 1	INTRODUCTION
1.1	Scope. 1
1.2	Cancellation. 1
1.3	Distribution of Responsibilities 1
1.4	Definitions 1
Section 2	PLANNING FACTORS
2.1	Navy Food Service Procedures. 2
2.1.1	Number of Personnel to be Served. 2
2.1.2	Time for Meals. 2
2.1.3	Seating Capacity and Turnover Rates. 2
2.1.4	Pricing. 2
2.1.5	Identification. 2
2.1.6	Payment. 2
2.1.7	Menu Selection. 2
2.1.8	Procurement and Restocking Procedures. 2
2.1.9	Bussing. 3
2.1.10	Staffing. 3
2.1.11	Trash and Garbage Removal. 3
2.2	Size of Facilities. 3
2.3	Space Program. 3
2.4	Preliminary Cost Estimating. 4
2.4.1	Cost Saving. 4
2.5	Adaptation of Existing Facilities. 4
Section 3	DESIGN OBJECTIVES
3.1	Introduction. 5
3.2	Building Site. 5
3.2.1	Separation of Circulation. 5
3.2.2	Patron Circulation. 5
3.2.3	Development of a Visual Image. 5
3.3	Public Spaces. 5
3.3.1	Separation of the Dining Area. 5
3.3.2	Development of Architectural Character. 5
3.3.3	Use of Natural Light. 6
3.3.4	Use of Durable Materials. 6
3.4	Food Service Spaces. 6
3.4.1	Functional Planning. 6
3.4.2	Quality Work Environment. 6
3.4.3	Design for Durability and Maintenance 6
3.4.4	Energy Efficiency. 6

MIL-HDBK-1036/4

	<u>Page</u>
Section 4	GENERAL DESIGN CRITERIA
4.1	General Information. 7
4.1.1	Civilian Codes. 7
4.1.2	Design for the Handicapped. 7
4.1.3	Seismic Design. 7
4.1.4	Design for Safety. 7
4.1.5	Design for Foreign Installations. 7
4.2	Civil Engineering and Site Planning. 7
4.3	Landscape Design. 7
4.3.1	Selection of Plant Material. 7
4.3.2	Screen Planting. 8
4.3.3	Definition of Circulation. 8
4.3.4	Solar Shading. 8
4.3.5	Wind Protection. 8
4.4	Architectural. 8
4.4.1	Building Envelope and Exterior Materials. 8
4.4.2	Interior Materials and Finishes. 8
4.4.3	Interior Details. 8
4.4.4	Doors and Hardware. 9
4.4.5	Acoustics. 9
4.4.5.1	Dining Areas. 9
4.4.5.2	Dishwashing. 9
4.4.5.3	Serving Line. 9
4.4.5.4	Kitchen. 9
4.4.5.5	Mechanical 9
4.4.6	Solar Design. 10
4.4.7	Protection. 10
4.5	Structural Engineering. 10
4.5.1	Roof Loads. 10
4.5.2	Column Locations. 10
4.5.3	Fly Fans. 10
4.6	Heating, Ventilation, and Air Conditioning Design. 10
4.6.1	Local Conditions. 11
4.6.2	Cooling and Heating. 11
4.6.2.1	Exhaust Hoods. 11
4.6.3	Ventilation. 12
4.6.4	HVAC Equipment. 12
4.6.4.1	Heat Recovery Equipment. 12
4.6.4.2	System Concept. 12
4.6.4.3	Redundancy and Equipment Replacement. 12
4.6.4.4	Special Considerations. 13
4.6.5	Controls. 13
4.6.6	Energy Monitoring and Control Systems (EMCS). 13
4.7	Plumbing Design. 13
4.7.1	Local Conditions. 13
4.7.2	Utility Access. 14

MIL-HDBK-1036/4

		<u>Page</u>
4.7.3	Waste Systems.	14
4.7.4	Water Supply Systems.	14
4.7.5	Fire Protection Systems.	15
4.7.6	Miscellaneous Piping Systems.	15
4.8	Electrical Design.	15
4.8.1	Local Conditions.	15
4.8.2	Lighting.	16
4.8.2.1	Gasketed Light	16
4.8.3	Wiring Distribution.	16
4.8.4	Lightning and Cathodic Protection.	16
4.8.5	Fire or Alarm Systems.	16
4.9	Food Service Equipment.	16
4.9.1	Codes.	17
4.9.2	Utilities.	17
4.9.3	Product Flow.	17
4.9.4	Coordination.	17
4.9.4.1	Architectural Coordination.	17
4.9.4.2	HVAC Coordination.	18
4.9.4.3	Plumbing Coordination.	18
4.9.4.4	Electrical Coordination.	19
4.9.5	Energy Conservation	19
4.10	Communications and Computer Systems.	19
4.10.1	Telephones.	19
4.10.2	Public Address System.	20
4.10.3	Electronic Cash Registers and Computers.	20
4.11	Interior Design and Furnishings.	20
4.11.1	Interior Design Finishes.	20
4.11.2	Furniture and Furnishings/Collateral Equipment.	20
4.11.3	Graphics and Signage.	20
Section 5	SPECIFIC DESIGN CRITERIA	
5.1	Introduction.	22
5.2	Entry.	22
5.2.1	Weather Protection.	22
5.2.2	Menu Boards.	22
5.3	Public Toilets.	22
5.4	Queue.	22
5.5	Sign-In/Cash Collection Station.	22
5.6	Dining Area.	23
5.6.1	Spatial Character.	23
5.6.2	Space Division.	23
5.6.3	Acoustic and Visual Separation.	23
5.6.4	Seating.	23
5.6.5	Bussing Provisions.	23
5.7	Regular Food Line.	23
5.8	Fast Food Line.	24

MIL-HDBK-1036/4

		<u>Page</u>
5.9	Combination Line.	24
5.10	Cashier Stations.	25
5.10.1	Marine Corps Requirements.	25
5.11	Beverage Stations.	25
5.12	Dishwashing Area.	25
5.13	Kitchen.	26
5.14	Vegetable Preparation Area.	26
5.15	Meat Preparation Area.	26
5.16	Bakery.	27
5.17	Utensil Wash	27
5.18	Dairy Chill	27
5.19	Cooks Chill	27
5.20	Meat and Vegetable Chill	28
5.21	Freezer	28
5.22	Dry Stores	28
5.23	Non-Food Storage	28
5.24	Carbonated Beverage Storage	28
5.25	Offices	28
5.26	Staff Toilets	29
5.27	Staff Lockers	29
5.28	Janitor's Closet	30
5.29	Can Wash Areas	30
5.30	Loading Docks	30
5.31	Flight Kitchen	31
Section 6	PROJECT SYNTHESIS	
6.1	Introduction	32
6.2	Public Areas	32
6.3	Serving Areas	34
6.4	Food Preparation Areas	34
6.5	Storage Areas	35
6.6	Support Areas	36
Section 7	U.S. MARINE CORPS	
7.1	Introduction	37
7.2	General	37
7.3	Fast Food Concept	37
7.3.1	Fast Food Delivery	38
7.3.1.1	Push Lines	38
7.3.2	Drive Through and Walk Up Service	39
7.3.2.1	Security	39
7.3.2.2.	Location and Use	39
7.3.3	Specialized Kitchen Equipment	39
7.3.4	Signage and Graphics	39
7.4	Waste Removal and Disposal	40
7.5	Interior Finishes	41

MIL-HDBK-1036/4

	<u>Page</u>
7.5.1	Flooring 41
7.5.1.1	Flooring Types 41
7.5.1.2	Stone 45
7.5.1.3	Burned Clay 45
7.5.1.4	Cementitious Floorings 46
7.5.1.5	Resilient Flooring 47
7.5.1.6	Seamless Flooring 48
7.5.2	Ceilings 49
7.5.2.1	Plaster and Gypsum Board 51
7.5.2.2	Acoustical Tile 51
7.5.3	Kitchen Doors 51
7.5.4	Walls 53

APPENDICES

APPENDIX A	SPECIALIZED KITCHEN EQUIPMENT	54
B	EQUIPMENT SCHEDULE FOR ENLISTED PERSONNEL FOOD SERVING AREAS	66
C	EQUIPMENT SCHEDULE FOR ENLISTED PERSONNEL FOOD PREPARATION AREAS	71

FACILITY PLATES

Facility Plate 1	Space Program	78
2	Architectural Finishes	81
3	Dining Facility Flow Schematic	82
4	Typical Small Dining - Fast Food	83
5	Typical Medium Dining Facility	84
6	Typical Large Dining Facility	85
7	Public Areas Flow Concept Diagram	86
8	Table Sizes and Clearances	87
9	Service Area Regular and Fast Food Serving Lines - Flow Concept Diagram	88
10	Serving Line for Small Dining Facility	89
11	Serving Line for Medium Dining Facility	90
12	Double Serving Line for Large Dining Facility	91
13	Fast Food Line	92
14	Service Area Beverage and Salad Self-Service Lines Flow Concept Diagram	93
15	Single Beverage Line	94
16	Double Beverage Line	95
17	Cashier Station	96

MIL-HDBK-1036/4

	<u>Page</u>
18 Support Area Dishwashing and Utensil Washing Flow Concept Diagram	97
19 Dishwashing for Small Dining Facility	98
20 Dishwashing for Medium Dining Facility	99
21 Dishwashing - Circular Type	100
22 Dishwashing - Flight Type	101
23 Utensil Washing	102
24 Mechanical Utensil Washing	103
25 Food Preparation Areas Flow Concept Diagram	104
26 Kitchen for Small Dining Facility (Pot Cookery)	105
27 Kitchen for Small Dining Facility (Ovens and Kettles)	106
28 Kitchen for Medium Dining Facility	107
29 Kitchen for Large Dining Facility	108
30 Management of Kettle Discharge	109
31 Vegetable Preparation Area Flow Concept Diagram	110
32 Typical Vegetable Preparation	111
33 Meat Preparation Area Flow Concept Diagram	112
34 Typical Meat Preparation	113
35 Bakery Area Flow Concept Diagram	114
36 Typical Bakery	115
37 Storage Areas Flow Concept Diagram	116
38 Typical Storage Areas	117
39 Loading Dock Criteria	118
40 Support Area Flow Concept Diagram	119
41 Doors in Kitchen Areas	120
42 Double Doors at Dishwashing Rooms	121
43 Guard Rail Locations	122
44 Typical Guard Rails	123
45 Corner Guards	124
46 Graphics and Signage	125
47 Menu Boards	126
48 Serving Line Tray Slide	127
49 Cold Storage Slab Insulation	128
50 Sump Drain - Pan Type	129
51 Sump Drain - Tile Type	130
52 Dishwasher Duct Vent	131
53 General Dining Facility Flow Diagram - Marine Corps	132
54 Large Fast Food Facility	133
55 Flow Concept Diagram - Fast Food	134
56 Equipment Plan - Fast Food Facility	135
57 Equipment Elevations - Fast Food	136
58 Equipment Elevations - Fast Food	137
59 Equipment Elevations - Fast Food	138
60 Equipment Elevations - Fast Food	139
61 Typical Graphics Typeface - Fast Food	140
62 Standard Entrance Graphics - Fast Food	141

MIL-HDBK-1036/4

	<u>Page</u>
63 Ordering and Pick Up Counter - Fast Food	142
64 Signage and Graphics - Fast Food	143
65 Waste Cabinets - Fast Food	144
66 Divider Panels - Fast Food	145
67 Floor Finishes	146
68 Floor Finishes	147

TABLES

Table 1	Gross Allowable Areas for Facilities	4
2	Locker Quantities for Staff Lockers	30
3	Loading Berths Per Facility Size	31
4	Finish Material Standards for Marine Corps	42
5	Floor Selection Criteria for Marine Corps	43
6	Ceiling Selection Criteria for Marine Corps	50
7	Ceiling Alternates in Wet Areas for Marine Corps	50
8	Service Doors for Marine Corps	52

REFERENCES	148
------------	-----------	-----

MIL-HDBK-1036/4

Section 1: INTRODUCTION

1.1 Scope. This handbook presents the design and construction criteria for all shore-based Navy and Marine Corps enlisted dining facilities for both outside and inside the continental United States. It applies to all facilities for 40 to 2200 persons. Larger size facilities shall be given special guidance. The purpose of this handbook is to provide general and specific design guidance. Special attention is focused on planning and budgeting, energy conservation, state-of-the-art food service equipment and design for durability. Emphasis is placed on the design of functional and pleasant food service facilities which attract and retain volunteer service personnel. Recent changes in Navy food service policies such as item pricing, computerized accounting and electronic identification are included.

1.2 Cancellation. This handbook, MIL-HDBK-1036/4, Enlisted Dining Facilities, cancels and supercedes DM-36.4, Enlisted Personnel Dining Facilities, February 1978.

1.3 Distribution of Responsibilities. Navy activities and A/E designers using this manual are advised that there are three cognizant participants in the development of facility design. First, there is the local Command which identifies the need for a new, modernized or enlarged dining facility and initiates the project developing process. Second, there is the Naval Facilities Engineering Command, who is responsible for management of design and construction of all Navy facilities. Third, there is the Navy Food Service Systems office who sets the standards for all Navy food service operations and determines the facilities and equipment required to perform these operations. At a minimum the above three cognizant entities will be required to review and approve all design submissions. The Marine Corps will have a contracting officer responsible for approval of design submission.

1.4 Definitions

Commuted Rations - A method of granting subsistence to service personnel in which the individual is given a cash allowance for the purpose of purchasing food.

Rations-in-kind - A method of granting subsistence to service personnel in which the individual is given eating privileges without a cash transaction.

Turnover Rate - The number of meals served per meal period divided by the seating capacity of the dining facilities, e.g. a facility with 500 seats which serves 2,000 meals per period has a turnover rate of four.

MIL-HDBK-1036/4

Section 2: PLANNING FACTORS

2.1 Navy Food Service Procedures. The specific design criteria presented later in this manual were developed based upon Navy food service policies and procedures. These policies are as follows:

2.1.1 Number of Personnel to be Served. Serving requirements shall be developed according to guidance in NAVFAC P-80, Facility Planning Criteria for Navy and Marine Corps Shore Facilities, category code 722, "Unaccompanied Personnel Housing-Mess Facilities." In all cases this determination shall be made before the commencement of the design process.

2.1.2 Time for Meals. Minimum and maximum meal periods and service periods are established in NAVFAC P-80. The local command determines duration of meal periods.

2.1.3 Seating Capacity and Turnover Rates. Seating capacities vary according to the size of facility. The larger the facility, the larger the turnover rate. The maximum turnover rate for larger facilities is held to four turnovers. Refer to para. 2.3 for further information.

2.1.4 Pricing. With minor exceptions, all Navy facilities shall use the item pricing method of pricing where food items are individually priced and sales are accounted for by electronic type cash registers. Current Navy exceptions to this policy are outside continental United States (OUTCONUS) activities, facilities designed to feed less than 100 persons, and facilities where an overwhelming patronage by rations-in-kind customers is anticipated.

2.1.5 Identification. All new Navy facilities employing the item pricing concept of pricing will eventually be equipped with magnetic card readers and magnetic ID cards. Pending introduction of the magnetic ID cards, however, these facilities will require a sign-in station located in advance of the serving line. All Navy facilities using the conventional fixed price method of pricing shall have a sign-in/cash collection station located in advance of the serving line.

2.1.6 Payment. Personnel pay for meals in two ways. Those on rations-in-kind only need to identify themselves for accounting purposes. Those on commuted rations pay for their meal in cash.

2.1.7 Menu Selection. All menus are selected by the local command. However, the general policy is that all personnel are offered the choice of a fast food/short order menu as well as full course menu.

2.1.8 Procurement and Restocking Procedures. As a general principle, all meats are purchased pre-butchered and frozen. With the exception of bread,

MIL-HDBK-1036/4

all bakery goods are to be made on site. Storage facilities have been sized according to the following replenishment schedule:

	<u>NAVY</u>	<u>MARINE CORPS</u>
Dry Provisions	45 days	10 days
Frozen Provisions	21 days	10 days
Meat Veg Chill Provisions	7 days	7 days
Dairy Provisions	3 days	3 days
Non-Provisions	30 days	30 days

2.1.9 Bussing. The choice of contract bussing or patron self-bussing is the option of the local command. All facilities are to be designed to accommodate either mode of bussing. If bussing carts are used, care should be taken to screen them from view of the dining area.

2.1.10 Staffing. All facilities are to be staffed by military mess management specialists and civilian contract messmen. Current exceptions to this policy are remote OUTCONUS and Recruit Training Commands. Staffing for these facilities will be subject to special guidance.

2.1.11 Trash and Garbage Removal. The local command chooses trash and garbage removal systems. Provisions for these facilities shall be architecturally screened.

2.2 Size of Facilities. MIL-HDBK-1190, Facility Planning and Design Guide, defines eleven categories of sizes for dining facilities. However, this handbook provides specific instruction for only the eight categories ranging in capacity from 40 to 2200 persons. The three largest sizes of facilities require special guidance.

The figures given in Table 1 are the allowable gross areas for each size category. These gross areas include: toilet facilities, receiving, storing, preparing, serving and dining area. It does not include area for mechanical space. The enclosed area required for mechanical usage varies widely depending on climatic zone. Other functions specifically not included are vestibules, covered walkways, and other weather related features as well as in-flight kitchens. All areas exceeding the allowable gross area must be fully justified. Aesthetic embellishments which add space to dining facilities are not justifiable. In all size categories the occupant load shall conform to NFPA 101, Life Safety Code, requirements. See Table 1 for allowable gross areas.

2.3 Space Program. Plate No. 1 identifies functional areas typical in most Navy dining facilities and provides a target space allotment for each functional area. These targets have been provided to serve as a budget to the

MIL-HDBK-1036/4

designer and are not intended to be restrictive. The critical area which must be adhered to rigorously is the allowable gross square footage of the facility and storage requirements, i.e., dry provisions, frozen, chill, dairy, and non-provisions.

Table 1
Gross Allowable Areas for Facilities

NUMBER OF ENLISTED PERSONNEL TO BE SERVED	GROSS ALLOWABLE AREA (ft ²)	(m ²)
40 to 80	3,500	325
81 to 150	5,000	465
151 to 250	6,400	595
251 to 400	8,900	830
401 to 650	12,900	1200
651 to 1,000	17,200	1600
1,001 to 1,500	20,800	1735
1,501 to 2,200	29,500	2745

Note: Actual gross allowable area for each project will be defined in facility planning document DD 1391.

2.4 Preliminary Cost Estimating. Cost estimating procedures shall follow the guidance given in MIL-HDBK-1010, Cost Engineering Policy and Procedures. Preliminary budget cost estimates should address all potential hidden costs that may occur.

2.4.1 Cost Saving. Designers are advised to find other solutions to the need for cost control than the downgrading of materials or systems. Durability of materials is essential to the success of a food service facility.

2.5 Adaptation of Existing Facilities. Although the design criteria included in this guide is primarily for use in the construction of new dining facilities, the general information and principles could also be used in the modernization of existing facilities.

MIL-HDBK-1036/4

Section 3: DESIGN OBJECTIVES

3.1 Introduction. In order to provide a facility which will attract volunteer service personnel, it is important that the design of the dining facility be given special attention. In contrast to the purely functional environments where enlisted personnel spend most of their day, or the repetitive nature of enlisted living quarters, the dining facility should be noticeably different in character.

3.2 Building Site. In addition to the guidance given in NAVFAC DM-1.01, Basic Architectural Requirements and Design Considerations, which essentially leaves exterior design to the discretion of the architect, the following factors should be given consideration.

3.2.1 Separation of Circulation. Service functions such as loading docks, maintenance yards, trash containers, on-grade mechanical equipment and staff parking shall be separated from the rest of the site by architectural screening, landscaping, or grading.

3.2.2 Patron Circulation. Dining facilities draw patrons from all parts of a base, and consequently they arrive from many directions. Attempt to identify the various access points, both pedestrian and vehicular, and channel circulation to the entrance of the building. Articulate smooth circulation by landscaping and paving complimentary to the building. Entry circulation should begin as the patron enters the site and continue through the interior circulation into the facility.

3.2.3 Development of a Visual Image. The dining experience represents a break in the service person's day, and as such, its environment should be a visual "break" as well. Therefore, the designer is encouraged to provide a change of visual imagery from the purely functional environments which characterize a service person's workplace.

3.3 Public Spaces. In addition to the guidelines given in DM-1.01 concerning the function and appearance of architectural spaces, the following issues are of special concern in the design of dining facilities.

3.3.1 Separation of the Dining Area. The seating area represents the conclusion of the process of arrival, queuing, identification, serving and payment. To the extent possible, separate dining patrons from the congestion and movement of arriving patrons.

3.3.2 Development of Architectural Character. Creation of interesting plan areas, spatial volumes, and other design elements under the architect's control should be considered as methods for the development of an interesting environment.

MIL-HDBK-1036/4

3.3.3 Use of Natural Light. The use of natural light is encouraged as it contributes significantly to the energy efficiency of the building and communicates a feeling of well-being and openness. Natural light can be used in conjunction with high efficiency artificial lighting with photosensitive controls that maintain lighting levels automatically.

3.3.4 Use of Durable Materials. Dining facilities are heavily used buildings. The continued success of initially achieved design objectives is dependent upon the longevity of the materials used.

3.4 Food Service Spaces. Beyond the normal requirements for architectural space, food service space requires special attention in the following areas:

3.4.1 Functional Planning. The relationship between the various storage, preparation, cooking, serving and cleaning functions must be carefully studied to provide the maximum flow and efficiency possible. Keep travel distances short and minimize cross-overs of circulation paths. Keep sight lines as open as possible, and utilize movable food service equipment for flexibility.

3.4.2 Quality Work Environment. Careful consideration should be given to all aspects of the work environment. This includes adequate lighting, both natural and artificial; proper exhaust ventilation with equal amount of conditioned air supply; adequate employee facilities; and inclusion of easily accessible safety devices.

3.4.3 Design for Durability and Maintenance. The materials which have proven to be the most durable will be carefully presented in Plate 2, "Architectural Finishes". However, to be successful, these materials must be detailed with an intimate understanding of where extremes of wear will be encountered. Dishwashing areas experience extreme wear and have the most difficult ventilation requirements. Corridors and aisles must be designed for cart traffic. All joints and intersections must be sealed free of pocketed/porous materials, and be accessible for cleaning.

3.4.4 Energy Efficiency. Consider all possible techniques for energy conservation, particularly in the selection of kitchen equipment. Among the other techniques to be considered are the use of natural daylighting, heat reclaim equipment, adjustable air movement, etc.

MIL-HDBK-1036/4

Section 4: GENERAL DESIGN CRITERIA

4.1 General Information. The following subjects affect a variety of design disciplines. To avoid redundancy, this information has been consolidated.

4.1.1 Civilian Codes. In many cases the references to Navy and DOD guidance will in turn refer the designer to civilian codes. The designer should be prepared to consult a full range of these codes including the International Conference of Building Officials (ICBO) Uniform Building Code, National Fire Protection Association Codes, Occupational Safety and Health Administration (OSHA) Safety Codes, and others. Frequently military guidance will direct that the design should be in "general compliance" with local codes. Direct questions regarding use of codes to the NAVFAC Architect-in-Charge/Engineer-in-Charge (AIC/EIC).

4.1.2 Design for the Handicapped. Federal Standard FED-STD 795, Uniform Federal Accessibility Standards, and MIL-HDBK-1190 contain guidance for design for the handicapped. NAVFAC will determine the application of this criteria for each project.

4.1.3 Seismic Design. Specific guidance for seismic design is given in NAVFAC Publication P-355, Seismic Design for Buildings. Although this guidance is directed primarily towards structural design, specific guidance is also provided for architectural, mechanical, and electrical elements.

4.1.4 Design for Safety. Design for safety shall be in accordance with MIL-HDBK-1190. Note that Chapters 5-7 of this reference states that whenever Construction Criteria and OSHA standards conflict, "the standard providing the greatest degree of safety shall govern."

4.1.5 Design for Foreign Installations. Specific guidance for construction in OUTCONUS locations will be the subject of special guidance.

4.2 Civil Engineering and Site Planning. NAVFAC Criteria Manual Series on civil engineering, provides general guidance for civil engineering, site work, and other related topics.

4.3 Landscape Design. General design guidance for landscape design is provided in NAVFAC Publication P-905, Planting and Establishment of Trees, Shrubs, Ground Covers and Vines. Guidance pertinent to enlisted dining facilities is as follows:

4.3.1 Selection of Plant Material. Plant materials shall be selected on the basis of hardiness and degree of maintenance required. Avoid plants requiring frequent attention to stay in a healthy condition or have an attractive appearance.

MIL-HDBK-1036/4

4.3.2 Screen Planting. Consider landscaping as a possible solution to the need for screening features adjacent to dining facilities, such as on-grade mechanical equipment, trash collection containers, parking, and service yards.

4.3.3 Definition of Circulation. Pedestrian circulation to the building entrance can be defined by use of plant materials.

4.3.4 Solar Shading. South facing glass in the building, particularly in dining facilities, may require summer shading with deciduous trees.

4.3.5 Wind Protection. Where winter prevailing winds are severe it is advantageous to provide wind breaks using coniferous trees. This is particularly helpful at entrances.

4.4 Architectural. General design guidance for architectural design is provided in DM-1.01 and MIL-HDBK-1190.

The codes applicable to the design of dining facilities shall be as cited in DM-1.01. In general, all life safety related issues shall be governed by the NFPA 101.

4.4.1 Building Envelope and Exterior Materials. The exterior of the building shall be constructed in accordance with DM-1.01. Particular attention should be given to the durability of materials used in heavy use areas such as:

- a) main entrances,
- b) loading docks,
- c) service entrances, and
- d) entrances to storage facilities.

4.4.2 Interior Materials and Finishes. All interior materials and finishes shall be selected on the basis of their durability and suitability for cleaning procedures. Approved finishes for functional areas are located in Plate No. 2. Deviation from these approved finishes shall be subject to approval by NAVFAC. Additionally, materials must also conform to flame spread characteristics as defined in MIL-HDBK-1008A, Fire Protection for Facilities Engineering, Design, and Construction.

4.4.3 Interior Details. Develop all interior detailing, both in dining facilities and in food service areas, to provide a high degree of durability and ease of maintenance. Avoid cracks, recesses and inaccessible voids. Carefully seal junctions in materials to prevent moisture or vermin penetration. All anchorage details shall be heavy duty. Detailing for public

MIL-HDBK-1036/4

areas, while being heavy duty, should not be overly heavy in appearance. Fasteners should be concealed.

4.4.4 Doors and Hardware. Provide hardware and accessories that are durable and can be easily cleaned throughout the dining facility. See Plates Nos. 42 and 43 for minimum door requirements. Also see section 5 for specific guidance and detailing for doors and hardware. Doors and hardware shall also conform to NFPA-101 and NFPA-80, Standard for Fire Doors and Windows. For specific Marine Corps kitchen door criteria, see para. 7.5.3.

4.4.5 Acoustics. Effective sound reduction techniques are needed to overcome the incompatibility between the dining areas and the noise producing areas, as well as overcoming the ambient noise produced within the various spaces. The maximum levels of ambient sound for each functional area shall be as recommended in DM-1.03, Architectural Acoustics. Procedures for attaining these levels are as referenced in the following paragraphs.

4.4.5.1 Dining Areas. Reduce noise in eating areas by using carpet in seating areas and by using one of the many suspended acoustical ceilings available. If additional acoustic treatment is necessary, floating or wall-hung sound absorbing panels can be used.

4.4.5.2 Dishwashing. Additional sound-absorbing materials may be required on walls due to the higher levels of noise experienced in the dishwashing area. Soundproof the doors leading to the dining area with sound gaskets and, if required, provide a sound-baffling partition to reduce sound from the dishwashing equipment. Ceilings should be metal pans with moisture-resistant acoustic material because of the moisture problem caused by condensing vapors from the dishwashing equipment.

4.4.5.3 Serving Line. The patron side of the serving line should be treated as the dining area. The serving side of the serving line shall be treated as the kitchen.

4.4.5.4 Kitchen. Metal pan ceilings of sound absorbing material should be used:

a) to counteract noise produced by the hard, sound-reflective surfaces of many durable finish materials found in kitchens;

b) for ease of cleaning. Mount vibration-producing equipment upon vibration isolators. Soundproof the doors leading from the kitchen to patron areas with sound gaskets.

4.4.5.5 Mechanical. The usual methods of sound reduction and vibration isolation should be employed in the design of air handling systems.

MIL-HDBK-1036/4

4.4.6 Solar Design. The use of solar energy design strategies is not a specific goal of this handbook. Active solar energy applications shall be employed only as specifically directed in the project scope of work. Passive solar energy design is encouraged to the extent that it can be incorporated into the design without significant additional cost and without compromising the stated goals of this handbook. Passive solar design features should not impose unsolicited operational or maintenance requirements upon the users.

4.4.7 Protection. Protective wall and corner guards shall be provided in all areas having cart traffic. Food service carts are a major cause of material wear and failure in kitchen areas. Designers shall give careful consideration to the placement of equipment with regard to potential abuse caused by carts. See Plate Nos. 44, 45 and 46.

4.5 Structural Engineering. General guidance for structural engineering is provided in MIL-HDBK-1002/1, Structural Engineering General Requirements. Additional general guidance is contained in MIL-HDBK-1190. Guidance pertinent to enlisted dining facilities is as follows:

4.5.1 Roof Loads. Coordinate structural requirements with design of mechanical systems to determine roof loads. Design screening for mechanical equipment in accordance with local wind loads and directional patterns. Anticipate other roof mounted accessories such as catwalks and ladders.

4.5.2 Column Locations. The patron seating areas should be planned to be as free of columns as possible. When columns are required, they should be carefully coordinated with the functional layout of seating and equipment. Food preparation, food service and refrigerated storage areas shall be free of free-standing columns. Where required, columns shall be located to form a section of a wall or partition.

4.5.3 Fly Fans. Fly fans shall be installed on all facility doors that open to the outside (except refrigerated storerooms).

4.6 Heating, Ventilation, and Air Conditioning Design. HVAC requirements for dining facilities are not standardized due to the multiplicity of functions performed. Food preparation and service areas have intense occupation and activity peaking at predictable times while the storage and administrative areas have static HVAC requirements. Food preparation and service equipment place special demands on HVAC systems similar to industrial operations, but environmental comfort is much more important than in an industrial context. Design criteria presented herein are to direct the design team towards creative, economical, serviceable and energy efficient designs. HVAC design shall comply with all applicable Navy criteria, including MIL-HDBK-1190, and DM-3.03, Heating, Ventilating, Air Conditioning, and Dehumidifying Systems.

MIL-HDBK-1036/4

4.6.1 Local Conditions. Climatic conditions shall be obtained from NAVFAC P-89, Engineering Weather Data. Design conditions and required calculations for heating and cooling shall be as required by DM-3.03. Relevant criteria contained in DM-11.1, Tropical Engineering may also be applicable.

The local seismic zone shall be identified and design coordinated with NAVFAC P-355. Specific standard details and systems support and restraint design guidance is available in NFGS 15200, Noise, Vibration (and Seismic) Control.

Determine available fuels at facility location. The use of centrally generated steam, hot or chilled water is encouraged. The use of centrally generated utilities or local generation should be determined based on life cycle cost. Project location and potential for fuel delivery and storage will determine the selection and design of alternate fuel systems. Identify characteristics of the available electrical service, coordinate with electrical equipment. Early identification of space requirements for HVAC equipment and systems will be necessary to determine compliance or variance from established space program criteria presented herein.

4.6.2 Cooling and Heating. Due to demands created by cooling for food preparation equipment and refrigeration for food storage areas, dining facilities will have cooling requirements at all times. This, in turn, creates a simultaneous demand for cooling and heating in temperate and cold climates. Therefore, the designer should investigate methods of heat reclaim as presented in DM 3.03. Guidance for building envelope energy conservation are contained in the design manuals and guidelines referenced. Systems shall be designed for zone temperature control based upon requirements of occupancy and usage for the following areas:

- a) Storage
- b) Food Preparation
- c) Support and Administration
- d) Loading Dock (when applicable)
- e) Dining Rooms

Investigation of these zone requirements, depending upon facility size, may indicate that separate types of systems should be designated for individual zones.

4.6.2.1 Exhaust Hoods. The designer shall provide an exhaust hood over all heat producing equipment to minimize heat gain to the space. Special consideration shall be given to dishwashing areas to control moisture and condensation. Hoods shall be designed in accordance with DM3.03. Spot

MIL-HDBK-1036/4

cooling shall be provided at food preparation and scullery areas in accordance with MIL-HDBK-1190.

4.6.3 Ventilation. General guidelines and specific criteria for required quantities of outside air ventilation are presented within the referenced publications. Pressurization of the building to eliminate infiltration of outside air is recommended. However, food preparation and food service areas should have a lower pressure relative to the dining and non-food related other building areas. Any variable air volume supply systems must be analyzed for coordination of ventilation balancing and building pressurization. Investigate air to air, and air to water, heat recovery potential from the exhaust system. Coordinate ventilation requirements of exhaust hoods, and automatic dishwashing equipment and ice makers, with their impact on the ventilation systems. Consider the use of separate equipment to ventilate individual appliances or entire food preparation areas. Specific design requirements for exhaust hoods for food preparation and dishwashing equipment is presented in American Conference of Industrial Hygienists, Committee on Industrial Ventilation, Industrial Ventilation: A Manual of Recommended Practice, and must be in compliance with NFPA 96, Standard for the Installation of Equipment for the Removal of Smoke and Grease-Laden Vapors from Commercial Cooking Equipment. The following spaces should be maintained at a negative pressure relative to adjacent spaces:

- a) Utensil and dishwashing areas
- b) Solid waste collection
- c) Locker rooms and showers

If cold storage deliveries have direct vehicle access, coordinate zone pressurization and loading dock equipment which connects to the opening of the delivery vehicle.

4.6.4 HVAC Equipment. The systems equipment selection process will be influenced by the following considerations in addition to normal requirements:

4.6.4.1 Heat Recovery Equipment. Economic analysis of heat recovery equipment, particularly from ventilation, cold storage and central HVAC refrigeration, shall be in accordance with "Life Cycle" guidelines in NAVFAC P-442, Economic Analysis Handbook.

4.6.4.2 System Concept. Divergent operating and occupancy requirements negate the desirability of central cooling equipment. Therefore equipment such as multicompressor cold generators and modular refrigerant circuiting and compressors are preferable.

4.6.4.3 Redundancy and Equipment Replacement. The continuous operation of the dining facility mechanical systems is essential, particularly in food

MIL-HDBK-1036/4

storage areas. Develop a well planned program for repair or replacement of equipment.

4.6.4.4 Special Considerations. HVAC designs for food preparation and service facilities require particular attention to detail on the following:

a) Coordinate as early as possible all related requirements for food service equipment to be provided, especially location and ventilation requirements.

b) Exhaust ductwork will transport grease and moisture-laden air which condenses on the inside surfaces of the ductwork. Provide construction materials and accessories such as fire dampers and sensors to facilitate fire prevention and suppression requirements. Ductwork runs shall be as direct as possible and fully accessible for cleaning. Ductwork from automatic dishwashing equipment and other areas with high moisture air must be pitched and sealed to facilitate drainage of condensed water.

c) Provide corrosion resistant drip pans below all food service piping electrical equipment areas.

d) Insulation coverings and jackets shall resist moisture.

4.6.5 Controls. Design control systems for simplicity of operation, maintenance and energy efficiency. The designer shall investigate thoroughly the potential of state-of-the-art systems including the local loop microprocessor controllers and single building microprocessor controllers.

4.6.6 Energy Monitoring and Control Systems (EMCS). Coordinate mechanical system controls to interface with existing or future energy monitoring and control systems (EMCS). Investigate and recommend appropriate portions of the mechanical system which can be successfully controlled by EMCS.

4.7 Plumbing Design. General guidance for plumbing design is provided in DM-3.01, Plumbing Systems, and MIL-HDBK-1190.

4.7.1 Local Conditions. Evaluate local conditions for their influence on design. Evaluate available fuels for the heating of potable water. Requirements for active solar system supplements to water heating will be as dictated by solar feasibility analysis.

Early analysis of available water supply sources, metering requirements pressures, temperatures, and chemical content shall be provided for the budgeting of extraordinary equipment such as bulk water storage, booster pumping, chemical water treatment and specialized fire protection piping systems. Any such equipment and preliminary space requirements presented to the planning team at the appropriate stage of project development will

MIL-HDBK-1036/4

Provide coordination of fire protection systems with the type of, and access for, mobile fire fighting apparatus.

4.7.2 Utility Access. Access to piping for maintenance and replacement shall be provided to the maximum extent possible. When economically feasible access to drain piping shall be provided by means of pipe tunnels or crawl spaces. Supply piping shall be done overhead and accessed through the ceiling system.

4.7.3 Waste Systems. Guidance for planning the systems is provided in DM-3.01. Additionally, special consideration shall be given to the following:

a) Grease traps and other interceptors must be applied to equipment as specified in DM-3.01. Grease traps shall be located remote from the building insofar as possible and shall be easily accessible for cleaning.

b) Food grinder connections shall be direct, and not routed through grease traps or interceptor systems.

c) An air gap of two pipe diameters shall be applied to all kitchen equipment drains not having other backflow protection.

d) Floor sinks of adequate size and nonsplash receptor design shall be coordinated with drained equipment requirements. Floor drains not used as indirect waste receptors shall be primed or provided with deep seal traps.

e) Provide drained drip pans constructed of corrosion resistant materials below piping installed above food preparation and electrical equipment areas.

f) Coordinate drain requirements for HVAC and cold storage refrigeration equipment.

g) Refer to para. 7.3 for Marine Corps requirements for waste removal.

4.7.4 Water Supply Systems. Criteria for plumbing the supply water for kitchen equipment and future needs is presented, with diversity factors applied, in DM-3.01. Special considerations shall be given to the following domestic water requirements:

a) Specialized food service equipment planned for the facility but not in this handbook.

b) Additional diversity factors for water heating based on food service equipment usage.

MIL-HDBK-1036/4

c) Hot water storage.

d) Hot water recirculation. Note: where limited flow fixtures are required, piping and recirculation system adjustments may be required to ensure hot water at fixture.

e) Local hot water reheating for food service equipment such as automatic dish and utensil washers.

4.7.5 Fire Protection Systems. Fire protection associated plumbing design shall comply with MIL-HDBK-1008A. Special consideration shall be given to the following:

a) By-passing of water meter for fire protection systems piping may be by local jurisdiction or command.

b) Pumping and storage of water to meet flow and pressure requirements.

c) Interface with fire protection equipment and systems electrical equipment.

4.7.6 Miscellaneous Piping Systems. Dining facilities plumbing design may include fuel gas systems. Criteria for these systems is presented in DM-3.01.

4.8 Electrical Design. Electrical design for dining facilities requires consideration of the power and lighting requirements for various functions and activities within the facility. Special consideration shall be given to coordination of food service equipment demand factors and available natural light to effect functional, economical and flexible electrical systems.

Electrical designs shall comply with all applicable related criteria in the Criteria Manual Series on electrical engineering, and MIL-HDBK-1008A.

4.8.1 Local Conditions. Local conditions shall be evaluated for their impact on facility design. Conditions which should be considered include:

a) Extended or shortened hours of daylight compared to those encountered in temperate zones will affect site and interior lighting consideration for hours of lighting power operation.

b) Available power and its source must be analyzed for adequacy, characteristics and potential for supplying future expansion.

MIL-HDBK-1036/4

c) Facilitate project flow by early coordination with electrical power communication systems supplier, interior equipment space requirements and site planning considerations.

4.8.2 Lighting. Lighting requirements shall comply with MIL-HDBK-1190. Criteria for lighting intensity levels is presented in MIL-HDBK-1004/4, Electrical Utilization Systems. Special considerations shall be given to lighting criteria for the following areas.

- a) Food Service Areas.
- b) Food Preparation Areas.
- c) Cold Storage Areas.
- d) Interior Accent Lighting.

4.8.2.1 Gasketed Light. Fixtures should be provided for food preparation and dishwashing areas to prevent grease and moisture damage. Food serving areas should be illuminated with fixtures provided with lamp guards or sleeves to prevent contamination of food in the event a lamp is broken or shattered.

4.8.3 Wiring Distribution. In addition to the criteria contained in the codes and related criteria special consideration for wire distribution design shall be given to the following:

- a) Requirements for increased demand flexibility.
- b) Future automation and equipment upgrade.
- c) Computerized communications systems including UHF, and food service management. Provide energy management control and security systems only when economic payback justifies it.
- d) Public address and intercom systems.
- e) Emergency power systems for safe exit from the building, and selected equipment.

4.8.4 Lightning and Cathodic Protection. Comply with applicable sections of MIL-HDBK-1004/6, Lightning Protection, and MIL-HDBK-1004/10, Cathodic Protection.

4.8.5 Fire or Alarm Systems. Comply with applicable sections and related criteria within MIL-HDBK-1008A.

4.9 Food Service Equipment. All design work relating to kitchen equipment shall be separately presented and shall include all information

MIL-HDBK-1036/4

required for fabrication and installation of all kitchen equipment. See Appendix B for equipment schedule for food serving areas, and Appendix C for equipment schedule for food preparation areas.

4.9.1 Codes. Facilities shall be designed in such a way and with such materials that applicable local and other applicable health codes are met. In general, food service equipment shall meet applicable National Sanitation Foundation (NSF) standards.

4.9.2 Utilities. Most food service equipment is available in electric, gas, and steam. Select equipment based on the type of utility available in the area. However, some items of equipment may operate more efficiently, or will produce a better product depending upon the utility which powers them. Confer with the appropriate operations representatives to make these types of equipment selection decisions (refer to NFGS-11400, Food Service Equipment).

4.9.3 Product Flow. The flow of food through a production facility should be streamlined and uninterrupted. In general, raw food products are received and stored at the rear of an ideal facility, are then issued for production and follow a straight path through the kitchen, where, in the final form, the products end up at the point of service, in the front of the facility. The various stations along this production path from rear to front usually include; receiving area, storage area, rough food preparation area, cold food preparation area, hot food preparation area, serving area, and dining area.

4.9.4 Coordination. Careful attention must be given to the coordination of Food Service Equipment design and the design work of other disciplines as indicated below.

4.9.4.1 Architectural Coordination. Items frequently requiring coordination with architectural design are as follows:

a) Requirements for floor drain depressions, recesses, stub walls, pads, piers, etc. needed for food service equipment but shown under architectural.

b) All bumpers, guards and protective devices required at specific locations.

c) The use of special materials such as non-slip quarry tile, non-corrosive ceiling grid, skim coat plaster on CMU walls, and smooth face lay-in tile, etc.

d) Structural elements built into architectural elements for the support of Food Service Equipment.

MIL-HDBK-1036/4

e) All roof, ceiling, floor and wall penetrations for ducts, control lines, refrigerant tubing, etc.

f) Floor elevation and pitch requirements to ensure proper drainage of water in wet areas.

4.9.4.2 HVAC Coordination. Items frequently requiring coordination with the HVAC design are as follows:

a) Location and size of all ventilated equipment such as exhaust hoods, dishwashing equipment, etc.

b) Special requirements for ductwork connecting to equipment such as drip pans and pitched or vented duct work. See Plate No. 53.

c) Ventilation of remote refrigeration compressors.

d) Balance of air supply systems so that cooking and waste areas are under negative pressure thereby ensuring that odors are not carried into public areas.

4.9.4.3 Plumbing Coordination. Items frequently requiring coordination with the plumbing design are as follows:

a) Location of spot connections for all equipment requiring plumbing except backflow preventers and air gaps, which will be located by the food service designer.

b) The location of all water, waste, steam and gas lines. These lines shall be concealed but readily accessible for maintenance.

c) Unavoidable exposed vents for island or freestanding equipment shall be coordinated with the architect for sleeving or chasing.

d) All special or custom made equipment provided by the Food Service Contractor but needing to be installed by the Plumbing Contractor shall be identified.

e) Design and location of the grease trap will require coordination among the mechanical, plumbing, architectural and possibly, the structural designers.

f) Special requirements for fuel gas lines such as strainers, or filters at equipment with thermostatic controls.

g) Empty conduit requirements for underfloor routing of beverage system.

MIL-HDBK-1036/4

h) Plumbing to the automatic washdown system for the grease interceptor exhaust ventilation hoods.

i) Special requirements for plumbing connections to utility distribution systems, when used.

4.9.4.4 Electrical Coordination. Items frequently requiring coordination with the electrical design are as follows:

a) Location of all spot connections for all equipment requiring electrical connection.

b) The food service designer shall inform the electrical engineer of all projected power requirements for food service equipment as early as possible. In addition to the power characteristics, the type of electrical connection required (plug-in, junction box) for each piece of equipment should also be determined.

c) Special requirements for equipment such as overload protection panels located at the equipment being protected.

d) Integration of food service equipment with fire suppression system controls.

e) Integrate electrical requirements with utility distribution system, used.

f) Location of conduit required for computer and electronic cash register stations.

g) Electrical service requirements for all equipment shall be specified as shown in NFGS-11400.

4.9.5 Energy Conservation. Due to the high energy-consuming nature of kitchen design, particularly with regard to heat producing equipment and make-up air requirements, the designers should give particular consideration to energy efficient equipment. Specifically, the use of direct supply, untempered make-up air and/or low air volume grease extraction hoods should be evaluated before equipment selections layouts are finalized.

4.10 Communications and Computer Systems. General guidance for the design of telephone systems is provided in DM-4.07, Wire Communication and Signal Systems. Guidance for the design of computer systems is not provided and is the subject of special guidance. Guidance pertinent to the design of dining facilities is as follows:

4.10.1 Telephones. Conditions affecting telecommunications will vary for each facility. Location of phones and phone equipment shall be coordinated

MIL-HDBK-1036/4

with the local command. NAVFAC provides empty conduit/raceway systems. Wiring for telephone systems shall be provided by major claimant.

4.10.2 Public Address System. A public address system shall be provided in each facility. The public address system shall be in conformance with MIL-HDBK-1190.

4.10.3 Electronic Cash Registers and Computers. Most facilities will be equipped with electronic type cash registers. Specific guidance for the installation of this equipment is contained in para. 5.9. In preparation for future computer systems, empty conduit shall be provided from the array of cash register terminals to a location in the food service officer's office. This will be for future linkage to a micro-computer in general use by the food service officer. Location shall be coordinated by the local command. Special requirements particular to Marine Corps installations shall be addressed as described in para 5.9.1.

4.11 Interior Design and Furnishings. When interior design package is included in the A/E design contract, the designers shall obtain their guidance from the NAVFAC Interior Design Division. All furnishings shall be selected from manufacturers on the GSA schedule of manufacturers. Issues pertinent to the design of dining facilities are as follows:

4.11.1 Interior Design Finishes. Select building finishes that are most appropriate for use in dining facilities. Finishes should be durable, easy to maintain, functional and aesthetic. Provide color boards showing actual samples and colors of materials selected for building finishes. DM-14.2, Carpet Selection Guide, provides information on carpet usage. Refer to para. 7.4 for Marine Corps interior finish requirements.

4.11.2 Furniture and Furnishings/Collateral Equipment. Select furniture and furnishings that are most appropriate for use in dining facilities. Items should be durable, easy to maintain, functional and coordinate with overall design. Use the Government's mandatory sources of supply when specifying furniture and furnishings. Mandatory sources include GSA Federal Supply Schedules and Stock catalogs, Federal Prison Industries, Blind-Made Products, and existing or warehouse stock. Selections made from sources other than those mandatory require a waiver with NAVFAC approval outlining the item's technical advantages and the inadequacies of GSA items in performing required functions. Lower cost is not acceptable as sufficient justification for a waiver.

4.11.3 Graphics and Signage. Signage and graphics for the entire project includes a logical room numbering and identification system, directional signs and menu boards. Plan, elevations, and specifications must indicate the design, location, and installation for implementation of the signage and graphics system. Use clear and readable typeface and coordinate signage systems with handicapped design criteria. Include in project specifications

MIL-HDBK-1036/4

the requirements that the general contractor provide information necessary for acquiring new or replacement signs. Refer to Plate No. 47 and 48 for an example of a coordinated signage system. Refer to para. 7.3.4 for Marine Corps signage and graphics criteria.

MIL-HDBK-1036/4

Section 5: SPECIFIC DESIGN CRITERIA

5.1 Introduction. The following material identifies the specific needs for each functional area as outlined in the space program. In addition to textual information, many of the spaces have graphic design guidance in the form of facility plates. These plates should not be considered absolute in their layout. These plates are schematic and are intended to inform the designer of principles and relationships necessary for proper functioning of the space. The designer is expected to interpret this guidance and configure the functional areas according to the needs of the project.

5.2 Entry. The entry may be an architectural focal point. All site circulation should clearly lead patrons to this point. Specific items which should be considered in the design of the entry are as follows:

5.2.1 Weather Protection. A canopy or enclosure should be provided for patrons who arrive in advance of the opening of the facility. In extreme weather areas this function can be accomplished in the form of a vestibule. Canopies are to be included in the gross area of the project at fifty percent of their actual area and vestibules at their full area. If unusually large amounts of weather protected space are required, an increase in the gross square footage may be justified.

5.2.2 Menu Boards. Part of the entry sequence should be the presentation of the menu boards. These may be located on the exterior or on the interior immediately inside the entrance. Separate menu boards shall be provided for the full service and fast food menus. If a split circulation type queue is used, the menu boards should be oriented in such a way that they define the entrance to the appropriate serving line. Specific guidance regarding menu boards can be found on Plate No. 48.

5.3 Public Toilets. The public toilets should be located near the Entry and should be positioned in such a way as not to interfere with circulation into or out of the building. Public toilets shall not be accessed directly from the dining areas. Capacity requirements for the public toilets are as shown in MIL-HDBK-1190.

5.4 Queue. The entry should lead directly to the queue. The queue shall meet the area requirements as specified in Plate 1. Single queues should be not less than 4 feet wide and double queues should be not less than 7 feet wide. When the queue abuts the dining area, it should be separated by a screen to prevent the infringement of entering patrons upon diners.

5.5 Sign-In/Cash Collection Station. At the end of the queue and in advance of the serving line, there should be space allotted for a sign-in/cash collection station. Facilities employing the head-count system for meal payment shall be equipped with a sign-in/cash collection station for the

MIL-HDBK-1036/4

purpose of identifying personnel and receiving payment for fixed price meals. All facilities must allot space for this function in the event that the head count system is reactivated and to accommodate identification in the item pricing system pending introduction of the magnetic ID card reader. Contact NAVFSSO to obtain definitive drawing of sign-in/cash collection stations.

5.6 Dining Area. The dining area is the principal functional focus in the facility. Issues of particular importance are as follows:

5.6.1 Spatial Character. The dining area should be coordinated and harmonious blending of all design elements into a space with a distinct and discernible character.

5.6.2 Space Division. For the larger facility it is an advantage to be able to close down portions of the dining area during off-peak serving periods. This suggests the spatial subdivision of the dining room. This approach also helps to reduce the ambient noise generated by patrons.

5.6.3 Acoustic and Visual Separation. A significant improvement to the quality of the dining experience is gained by separating and eating area from all other facility functions. Thus diners are not disturbed by entering patrons, the serving process, nor the dishwashing process. Therefore careful consideration should be given to acoustical treatment between these spaces as well as visual screening.

5.6.4 Seating. Seating should be composed of two-person and four-person tables and booths. Partitions or dividers may be desired by the local command to create subgroupings of tables. If this approach is taken, these subgroupings should be on the perimeter of the space and the central portion of the space should be composed of non-fixed furnishings to promote maximum flexibility. For specific design guidance on furnishings and spatial arrangement see Plate No.8.

5.6.5 Bussing Provisions. All facilities are to be designed to accommodate both self-bussing and staff-bussing procedures. Therefore, all facilities are required to provide a soiled dish window from the main exit area to the dishwashing area. This window may be used electively depending on the style of service to be provided. When a dish window is not used, an acoustically sealed and attractive appearing cover shall be used to close the window. The method of providing staff bussing may be in the form of remote tray carts located in the dining area or by bussing carts pushed throughout the facility by bussing personnel. Whatever the method of providing bussing, cart traffic in and out of the dishwashing area shall be shielded to prevent this activity from disturbing the patrons.

5.7 Regular Food Line. The regular food line must have the capability for serving various menu items including grilled foods, foods held and served from a hot food table, cold foods such as salads and desserts, sandwiches and

MIL-HDBK-1036/4

so forth. For examples of layouts and equipment selections refer to Plate Nos. 9 through 14. The regular food line should be immediately adjacent to the kitchen in all instances to permit rapid transfer of fresh products from the kitchen to the line. In many facilities, back-up refrigeration and food warming cabinets should be included in the wall behind the serving line. These units are best utilized when as roll-in/roll-through/pass-through units (between kitchen and serving line). Provide hand sinks behind the serving lines, especially if any actual food preparation is taking place (such as grilling or sandwich making). Sneeze shields over serving counters are required. The serving line should be designed to allow for maximum customer turnover utilizing minimum amounts of labor. This can be accomplished by good equipment placement, space planning and a combination of work and service stations. Because the serving area is part of a customer area, it should be designed to be as attractive as possible, using wear resistant materials. Serving line counterfront tray slides shall be separate from serving line equipment and shall serve as an electrical chase for mobile serving equipment. See Plate No. 49.

5.8 Fast Food Line. The fast food line will basically serve grilled and fried items. This line will generally be used in larger facilities. Separate fast food lines are used in facilities which serve 400 persons or more. Therefore both lines will offer a substantial array of menu items. For examples of fast food lines, refer to Plate Nos. 9 and 13. For examples of fast food services in U.S. Marine Corps Facilities, refer to Section 7.

The emphasis of this line is to provide rapid service and items such as hamburgers and french fries which will normally be pre-wrapped or pre-bagged for immediate pick-up. Therefore, proper spacing of equipment, sizing and selection of equipment is very important. This station does not have to be immediately adjacent to the kitchen. However, in cases where it is remote from the kitchen, the area must be relatively self sufficient to allow for storage of the amount of raw food required for one full meal period. This will lessen the necessity to make constant restocking trips to the kitchen. The finishes of this area are to be designed in accordance with those listed in the General Design Criteria section of the document. Like the full menu line, this station must receive the same attention to detail and attractive design.

5.9 Combination Line. The combination line is essentially a full menu line with the addition of a fry station. Therefore, the combination line has all the capabilities of a fast food line and full menu line. This type of serving line will be used in smaller facilities where space does not permit two separate serving lines for each type of menu.

In all cases, the combination line should be immediately adjacent to the kitchen for ease of service and freshness of product. Here, again, pass-through refrigeration and warming cabinets may be used. Hand sinks as

MIL-HDBK-1036/4

required by the Naval Medical Command. For examples of the combination line, refer to Plate Nos. 9 and 12.

The finishes for this area follow the same noted for full menu and fast food lines.

5.10 Cashier Stations. The cashier station is generally the last station a customer sees before entering the dining area. To make efficient use of the customer's time while waiting in the cashier's line, it is good design to allow space for portion control foods, napkins and flatware directly in front of the cashier. This will also control the amount of these items the customers take, since they will be in full view of the cashier.

Computerized cash registers do not always require special conduit unless specified by the manufacturer. Designer shall verify with manufacturer of cash register any special conditions or wiring requirements for the installation of the equipment.

The actual construction of the cashier station should allow for a courtesy panel on all sides and standard tray slides. Refer to Plate No. 18.

5.10.1 Marine Corps Requirements. A system of conduits shall be provided for installation of a computerized pricing and inventory control system. Control stations shall be tied back into a central point (preferably the food service officer's office). In addition, a dedicated electrical panel shall be provided to supply power to a central processor and printer at this location. Receptacles fed from this panel shall also be provided at the loading dock, food storage/refrigerators, and cash register locations.

5.11 Beverage Stations. All dining facilities will have beverage stations, usually located at the end of the serving line or as close to the cashier station as possible. By placing these stations last, the customer's drinks will stay their proper temperature by the time he reaches his seat in the dining area. Beverage stations consist of various hot and cold and ice dispensing machines. Dessert cold pans, ice cream, milkshakes, and frozen yogurt machines are included in many Navy beverage stations. Refer to Plate Nos. 16 and 17.

The plates depict several beverage station configurations, including a straight line type, island or back-to-back type, and scatter type. The appropriate line for a particular application will depend upon space available, length of meal period and preference of command.

5.12 Dishwashing Area. Dishwashing areas will vary greatly in layout and equipment type according to the size of the facility. Refer to Plate Nos. 19 through 23.

MIL-HDBK-1036/4

Soundproofing is a major concern when designing a dishwashing area, especially should the space be adjacent to a dining or serving area. Refer to General Design Criteria, Section 4.

All finish materials used in dishwashing areas must be highly durable and resistant to moisture. Floors which are well drained and are easily cleanable are of paramount importance. Floors must be able to endure cleaning by high pressure spray equipment. Ventilation systems designed to handle moisture-laden air must be provided. Refer to Plate No. 53 for dishwasher duct vent detail.

Three types of dishwashing equipment are shown in this handbook, including rack type, flight type, and circular or "merry-go-round" type machines. All dishwashing areas shall be designed so that soiled tableware is held in separate locations from clean tableware. Dishwashing areas shall be easily accessible to the serving areas for replacement of clean tableware. The dishwashing area should be located as close to the dining area exit as possible, so that it is on the customer's path out of the building. A conveyerized tray bussing system or a cart bussing system may be incorporated into the design.

5.13 Kitchen. The kitchen is where most food preparation and cooking tasks are done. Most hot food preparation involving grilling, frying, steaming and roasting occurs here. The type and size of equipment will vary greatly according to the type and size of facility. Refer to Plate Nos. 26 through 30.

The kitchen should be located as close as possible to the serving areas to allow easy transfer of products to the serving lines.

All finish materials must be highly durable and moisture resistant. To facilitate ease of cleaning at cooking equipment such as steam kettles and tilting frying pans provide individual or continuous floor grates to manage kettle discharge. Refer to Plate No. 31.

5.14 Vegetable Preparation Area. This area is used to wash and prepare all vegetables and fresh fruits for use in the facility. In smaller facilities, the vegetable preparation area may be no more than a two compartment sink, slicer, and work table that shares space with the kitchen. In larger facilities this area may be a separate, refrigerated room with its own dedicated walk-in refrigerator, sinks, slicers, choppers, mixers, work tables and so forth. Refer to Plate Nos. 32 and 33.

In all cases the prep area should be near the kitchen and have easy access to storage and trash removal.

5.15 Meat Preparation Area. This area is used for cleaning, cutting, slicing, and portioning of meats and will vary greatly according to the size

MIL-HDBK-1036/4

of the facility and extent of on-premise meat cutting the facility wishes to perform. Meat cutting and meat preparation rooms shall be air conditioned and maintained at 50 degrees F (10 degrees C) or below. Otherwise, all the spaces and equipment must be cleaned and sanitized every 4 hours.

Refer to Plate Nos. 34 and 35, and the information found under vegetable preparation.

5.16 Bakery. Bakery facilities will vary greatly according to size. The smaller bake shops will share space and equipment with the kitchen and cold food areas and will only prepare items such as rolls and cakes, and bake frozen products. Larger bake shops will be located in specific areas and will have the capability of producing cakes, pies, doughnuts, rolls, and danish pastries. Bread is bought locally.

Larger bake shops require very specialized equipment. Refer to Plate Nos. 36 and 37.

5.17 Utensil Wash. This area provides for the washing and sanitizing of pots and pans. Space should be allotted for proper trash removal, easy washdown of all surfaces, appropriate ventilation, and storage of clean utensils. Here again, as in the dishroom, the soiled pots should not come in contact with the clean, so separation of areas is required. A canopy-type exhaust hood shall be provided over the three compartmented sinks and utensil wash machings. See Plate No. 53 for dishwasher exhaust duct detail.

Utensil washing areas may be incorporated into dishwashing areas or may be separate entities. Refer to Plate Nos. 24 and 25.

5.18 Dairy Chill. This refrigerator is used to store dairy products such as milk, and cheeses. Typically, the floor under the box is depressed and insulated so that its finished height is level with the surrounding kitchen floor. Only in extreme cases should the use of a ramp up to the refrigerator be considered to avoid the necessity of transporting products up and down a ramp. See Plate No. 50 for guidance concerning cold storage slab insulation. Refer to Plate Nos. 38 and 39 for spatial relationships.

Most walk-in refrigerator manufacturers provide the necessary walls, ceilings, condensing and cooling units and lighting for their products. In most cases the condensing units will be removed and located in an easy to service area. The designer should allow for proper ventilation and protection from the elements in these areas.

5.19 Cooks Chill. This walk-in box is used to store daily supplies for the cook and to some extent, leftovers from previous meals. Refer to the information found under Dairy Chill (para. 5.18) and Plate Nos. 38 and 39.

MIL-HDBK-1036/4

5.20 Meat and Vegetable Chill. This box is used to hold meats and vegetables. Refer to the information under Dairy Chill and Plate Nos. 38 and 39.

5.21 Freezer. This box is used to hold frozen foods. Refer to the information found under Dairy Chill (para. 5.18) and Plate Nos. 38 and 39.

5.22 Dry Stores. All food products which do not require refrigeration will be held in the stores area. Generally these areas are the least expensive to construct and equip. Walls should be easily cleanable, and floors sealed and easily washable. Refer to Plate Nos. 38 and 39.

5.23 Non-Food Storage. Non-food storage areas are for holding paper and cleaning supplies. Cleaning supplies shall be stored in areas specifically designed for that purpose so that the cleaning products cannot be mixed with food products. Proper ventilation in the cleaning products storage area is important due to the various chemicals used in cleaning today's kitchen. Refer to Plate Nos. 38 and 39.

5.24 Carbonated Beverage Storage. This area is for storing carbonated beverage tanks, CO₂ tanks, and the beverage pumping system (remote). Due to the messy nature of soda syrups, it is recommended that the finishes be durable and cleanable and that a hose hook-up and floor drain be located in this room. The distance of the beverage pumping system from the beverage serving equipment shall be as recommended by the equipment manufacturer. This area shall be accessible from the delivery area.

5.25 Offices. Offices are to be provided for military and contract personnel in the following way. The number of workstations and the location for safes, computer stations, and public address equipment shall be as indicated in parentheses. Office requirements for Marine Corps facilities, if different than as shown below, shall be subject of special guidance as covered in para. 1.4

40 to 80	Food Service Officer (2 stations) (Safe) (PA) Civilian Contractor (1 station)
81 to 150	Food Service Officer (3 stations) (Safe) (Computer) (PA) Civilian Contractor (1 station)
151 to 250	Food Service Officer (3 stations) (Safe) (Computer) (PA) Civilian Contractor (1 station)
251 to 400	Food Service Officer (Safe) (1 station) Food Service Support Office (1 isolated station, 2 support stations) (Computer) (PA) Civilian Contractor (2 stations)

MIL-HDBK-1036/4

401 to 650	Food Service Officer (1 station) (Safe) Food Service Support Office (1 isolated station, 3 support stations) (Computer) (PA) Civilian Contractor (2 stations)
651 to 1000	Food Service Officer (1 station) (Safe) Food Service Support Office (1 isolated station, 3 support stations) (Computer) (PA) Civilian Contractor (2 stations)
1001 to 1500	Food Service Officer (1 station) (Safe) Food Service Support Office (1 isolated station, 3 support stations) (Computer) (PA) Civilian Contractor (2 stations)
1501 to 2200	Food Service Officer (1 station) (Safe) Food Service Support Office (1 isolated station, 4 support stations) (Computer) (PA) Civilian Contractor (2 stations)

All food service offices shall be adjacent to or readily accessible to each other. The food service support office (or the food service officer's office in smaller facilities) shall be adjacent to and have a view of the kitchen. It should also overlook the service entrance to the kitchen area. The civilian contractor's office should be adjacent to or readily accessible to the serving area and have a view of the service area. Office equipment requirements shall be coordinated with Navy Food Service System Office (NFSSO) and the local command for each project.

5.26 Staff Toilets. Toilet facilities provided for staff use shall be used by both military and contract personnel. Fixture counts shall be as indicated in MIL-HDBK-1190. Employees' toilet facilities for food establishments shall be provided with other than hand operated valves. Designer shall consult with the local command and/or Navy Food Service to determine staffing figures and shift population.

5.27 Staff Lockers. Separate facilities are to be provided for military and contract personnel. Locker facilities are to be adjacent to the toilets. Locker rooms are to be equipped with lockers, benches, and coat hooks to facilitate the changing of clothes. Locker quantities shall be as indicated in Table 2. All lockers shall be half height except for facilities for 1001 and over where third height lockers shall be used.

It should be noted that the number of lockers scheduled for each space exceeds the projected number of workers for each category. This has been done to accommodate the likely shifting balance of male to female workers. If equipment costs prohibit this number of lockers then space should be provided for the above number of lockers and lockers provided for the actual staffing levels. In this case, a portion of the lockers should be free-standing so that they can be shifted from space to space as the staffing balance changes.

MIL-HDBK-1036/4

Table 2
Locker Quantities for Staff Lockers

	MILITARY		CONTRACT	
	MALE	FEMALE	MALE	FEMALE
40 to 80	(Combined facilities, 10 male, 6 female)			
81 to 150	(Combined facilities, 16 male, 10 female)			
151 to 250	18	6	6	12
251 to 400	24	8	12	24
401 to 650	30	10	30	48
651 to 1000	48	12	44	70
1001 to 1500	64	16	64	96
1501 to 2200	96	24	88	132

5.28 Janitor's Closet. Janitor's closets shall be provided for the storage of janitorial supplies. Each janitor's closet shall be equipped with a mop receptor, mop rack, and shelf units. Facilities serving from 40 to 250 shall have one janitor's closet, only, adjacent to the public toilets. Other facilities shall also have janitors' closet, adjacent to the kitchen. Area requirements are as indicated in the space program.

5.29 Can Wash Areas. These areas are designated for washing trash containers. Some may be as simple as a curbed area off the loading dock containing hot water under pressure and a drain connecting to a sanitary sewer, or an enclosed area within the building which houses an automated can washing machine. Refer to Plate No. 41.

5.30 Loading Docks. Loading docks shall be provided for all facilities to accommodate deliveries made by trucks. Standard dimensions and layout for loading docks are shown on Plate No. 40. Loading platform heights shall be confirmed for each project to assure that the platform is set at the height closest to the majority of trucks servicing the facility. Dock levelers may be provided to accommodate varying truck platform heights. Facilities having multiple berths may use a dock leveler at one berth to service odd sized delivery vehicles. Loading dock area requirements shall be as indicated in the Space Program. In most cases the loading dock shall be open-air. In locations with extreme weather conditions, the loading dock may need to be enclosed. In this case each loading berth would be equipped with a rolling door and a weather seal. The number of loading berths for each facility size shall be as specified in Table 3. All loading docks shall have a ramp connecting the dock with the vehicular area to facilitate the use of hand carts.

MIL-HDBK-1036/4

Table 3
Loading Berths Per Facility Size

PERSONS	LOADING BERTH REQUIREMENTS
40 to 80	1
81 to 150	1
151 to 250	1
251 to 400	2
401 to 650	2
651 to 1000	2
1001 to 1500	3
1501 to 2200	3

5.31 Flight Kitchen. Not all locations will require a flight kitchen. Essentially, a flight kitchen is a staging area where food products are assembled and packaged for delivery to the aircraft. Specialized equipment may be required for food transport, packaging, food holding and food rethermalization. This can only be determined by operations representatives at specific locations.

The flight kitchens should have easy access to the galley and cold food preparation areas, and should also be adjacent to the loading dock area.

MIL-HDBK-1036/4

Section 6: PROJECT SYNTHESIS

6.1 Introduction. The organization of dining facilities breaks down into five functional groupings. These groupings have been used in the presentation of preceding material and by now should be quite familiar. They are:

- a) Public areas
- b) Serving areas
- c) Food preparation areas
- d) Storage areas
- e) Support areas

The basic relationships are shown in the diagram in Plate No. 3. These relationships are straightforward and should be clearly presented in the plan organization of any facility.

These basic relationships apply to all sizes of facilities. Whether a function is represented by a 10 square foot refrigerator or a 150 square foot walk-in cold storage room, its relationship to the overall flow of function remains the same. To demonstrate the overall synthesis of functions at different scales, three sample plans have been developed showing facilities designed for 81-150 persons, 101-650 persons, and 1,000-1,500 persons. These are presented on Plate Nos. 4, 5 and 6.

The purpose of these sample plans is to demonstrate differences of scale. They are not intended to be definitive plans. They do not reflect the architectural realities of a structure, mechanical systems, site circulation, orientation, form or architectural style; nor do they reflect a broad spectrum of organizational variations. These are issues which are left to the project designer, NAVFAC, NAVFSSO, and the local command to jointly arrive at appropriate resolutions.

The following material deals with the interrelationship of individual functions within the five basic groupings. Each of these functions is supported by material in the form of organizational flow diagrams and schematic layouts. The plates containing this information are referenced in the text for each of the functions.

6.2 Public Areas. The functions which are considered public include the following:

- a) the entry;

MIL-HDBK-1036/4

- b) the queue;
- c) the public toilets;
- d) the check-in station; and
- e) the dining area.

Ideally there should be one entrance. Larger facilities with more than two serving lines may require additional entry/exit points. The entry should offer the patron the choice of menu, as displayed on the menu board, and should lead the way to the selected queue. The public toilets should be inconspicuously associated with the entry.

The queue should be adequately sized so that waiting patrons do not feel overly crowded. There should always be adequate space for bypassing circulation. This would suggest a minimum of four feet in width for single line queues and seven feet for double. The queue should also be adequately screened from adjacent dining areas so that seated diners are not imposed upon by standing patrons.

The sign-in/cash collection station shall be provided at the end of the queue prior to entry into the serving area. The space allocated for this function should not project into the flow of the queue due to the optional nature of this function. Should the use of this space for check-in purposes not be required, alternate functions such as storage may be more useful. The cash register/stand for item pricing shall be located at the end of the service line and at the entry point to the dining areas. Dividers/partitions shall be provided to direct the traffic flow to the cash registers. One-way turnstiles shall be provided for patrons returning to the serving line for seconds.

The dining area should meet or surpass standards associated with first class restaurants. The success of the dining facility will be gauged by qualities which support the meal-taking experience, i.e., relative quietness, relative minimization of circulation, access to natural light, visual interest in form, texture, and color of materials and furnishings. The organization of spaces will affect many of these qualities.

Depending on local conditions, the dining area may function best as one large space or as smaller subdivisions. Sometimes it is helpful to be able to partially close down a dining area for certain meal periods or at times when the overall population is not as great as the design capacity. This subdivision can be accomplished by the introduction of other functions into the center of the dining area.

MIL-HDBK-1036/4

Depending on serving line arrangements, the queue may subdivide the space. The dishwashing function can also be used to subdivide the space. (This may also be done for other reasons as discussed below).

In all cases, the main eating area should be separated acoustically from all surrounding functions to the maximum extent possible. The dishwashing area presents the greatest challenge due to machine noise and clatter of dishware. This can be counteracted in part by how the spaces are arranged. The dish window and other openings should be baffled so that there is no line-of-sight exposure of the dishwashing equipment to the patron area.

6.3 Serving Areas. In general, the serving area begins where the queue ends. All of the functions falling into the grouping of serving areas, i.e., full menu lines, fast food lines, combination lines, beverage lines and cashiers stations should be contained in a single space and should not overlap into the dining area. In smaller facilities, the area allotments allow only the conventional linear arrangement of equipment. But in larger facilities, it is possible to develop other approaches to serving.

The dishwashing area has been included under the heading of serving areas; however, its function lies between serving and general dining. Soiled dishes must be delivered to the dishwashing area or they must be bussed by contract personnel. Navy/Marine Corps food service system policy is that all facilities shall be able to accommodate either self bussing, or contract bussing of patrons' dishware. Therefore it is Navy/Marine Corps policy that all dishwashing facilities have dish windows at the dishwashing area where exiting patrons can drop off their dishes.

For large facilities the dishwashing area may work best if centrally located near the main exit. This may place the dishwashing in the middle of the dining area. As suggested earlier, this can present problems in terms of noise control and flow of circulation.

An alternate approach is to have the dishwashing facilities located near a non-central exit and remote from dining. See Plate Nos. 4 and 6. Dishware collection for other exits may be accomplished by the use of tray carts.

6.4 Food Preparation Areas. The food preparation areas include:

- a) the kitchen;
- b) the vegetable preparation areas;
- c) meat preparation;
- d) the bakery; and
- e) utensil wash.

MIL-HDBK-1036/4

In most cases the kitchen, vegetable preparation, and meat preparation are all contained in a single large space which is as free of structural intrusions as possible. In larger facilities the bakery and vegetable areas become separate areas from the kitchen. The general flow should reflect the path of the food as it is being prepared. Preparation areas should be aligned with their respective cold storage areas and should lead to the hot/ cold holding boxes at the serving line. Arrangements for specific pieces of equipment within the functional areas have been indicated in earlier plates. In facilities for 650 and more the meat preparation area requires refrigeration and therefore should be included in the cold storage functional grouping rather than food preparation.

The bakery function is, except in the largest facilities, incorporated into the general kitchen and preparation areas. Because baking is done at a different time of day than the general meal preparation, this is not a problem. In large facilities which have extensive baking equipment this function is best placed out of the general flow of the kitchen.

The utensil wash area should be segregated from the rest of the kitchen. This area is the most heavily abused work area. It frequently has the largest concentration of heat and water vapor coming from the cleaning equipment. Therefore this function should be adjacent to but not in the general flow of the kitchen.

6.5 Storage Areas. The storage areas include:

- a) the cook's chill;
- b) the dairy chill;
- c) the vegetable chill;
- d) the meat chill;
- e) the freezer;
- f) the dry stores;
- g) the non-food storage; and
- h) the carbonated beverage storage.

In general, all of these functions should be located at the rear of the facility adjacent to the loading dock. When possible, flow-through circulation can be very efficient. The cook's chill should open only into the kitchen area. The meat chill area should function as an antechamber to the freezer. See Plate Nos. 38 and 39. The carbonated beverage storage area

MIL-HDBK-1036/4

shall be located as close as possible to the remote dispensers to eliminate long runs of high pressure syrup hoses.

6.6 Support Areas. The support areas include:

- a) the office area;
- b) staff toilets;
- c) staff lockers;
- d) janitor's closet;
- e) can wash; and
- f) loading dock.

These functions should be out of the general flow of the kitchen area but adjacent to it. Offices for Navy/Marine Corps staff should overlook the kitchen area. Offices for contract staff should overlook the serving area. The staff lockers and toilets should be near the rear entrance to the building. The location of the janitor's closet is not critical. The can wash should be located at the rear, near the loading dock and trash collection area.

MIL-HDBK-1036/4

Section 7: U.S. MARINE CORPS

7.1 Introduction. This section supplements the prior sections, and does not replace or supersede the general content of the handbook. Where legislative mandate, NAVFAC criteria, or command decisions either do not address items in this section or differ, prior approval must be obtained before finalizing design decisions. In no case should actual gross allowable areas as defined in NAVFAC P-80 be exceeded without prior justification and approval. Refer to Table 1 for actual areas.

As a general principle, USMC facilities should follow a replenishment schedule which emphasizes rapid turnover and fresh products where possible. General storage should be provided for on a 3-, 7-, or 10-day replenishment cycle, except for nonprovisions (30 days).

7.2 General. This section addresses various aspects of design and construction criteria which are unique to Marine Corps enlisted dining facilities. Emphasis is placed on the use of state-of-the-art systems, finishes, and construction detailing where appropriate, and where these best serve the functions in which they will be utilized. Due to the ever-changing nature of many of these systems, approval may be necessary from HQ USMC and/or NAVFAC prior to including items that have not yet stood the test of time in service. Reference is made to systems such as thin set ceramic and quarry tile which are in wide use in the private sector due to cost, ease of installation, and time considerations.

The inclusion of true fast food capabilities in USMC facilities is emphasized in this section in an effort to increase the enlisted dining facilities utilization by including facilities which are recognizable as producing and delivering a quality fast food product in a manner consistent with private sector operations. Fast food areas are required for facilities serving 401 patrons and greater. (See Plate No. 1). Minimum area required for fast food prep area is 500 ft² (47 m²). Plate No. 54 shows diagrammatically how a fast food facility is to be integrated into a major dining facility. An example of how this diagram has been interpreted is shown on Plate 55. This example is intended to be used as an aid for design only, rather than an actual floor plan.

7.3 Fast Food Concept. For the fast food facility to function as intended, it becomes necessary to create an impression that the facility is truly like those that patrons might visit in the private sector. Patrons have been exposed to and grown up with the bright colors and graphics of fast food restaurants on nearly every corner. These facilities are intended to simulate the establishment that the patron is familiar with to the greatest extent possible in a military facility.

MIL-HDBK-1036/4

7.3.1 Fast Food Delivery. (Refer to Plate No. 56). Operations and flows in standard dining areas are generally unchanged in USMC facilities. This section replaces the plates and copy related to fast food service elsewhere in this handbook. This area differs substantially in USMC enlisted dining facilities.

Conceptually, the fast food portion of the dining facility is based on push lines. Uncooked or partially cooked ingredients are "pushed" through linear preparation processes that flow from raw food to cooking to packaging to holding and are finally served. Prepared items are held for as short a time as is practical, dependent upon the expected patron volume. Food is packaged and served in containers identical to those used in private industry. (These are commonly available from numerous vendors).

In order to maximize the volume of meals prepared in a given time frame and minimize coordination and training of mess personnel, cooked entrees (sandwich items) are prepared without garnishes or condiments. Sandwich topping/salad bars and soft-serve topping bars are provided for patrons to garnish and dress their selections.

7.3.1.1 Push Lines. The "base" fast food facility includes:

a) Specialty Line: This line allows for the preparation of hot and cold items such as submarine sandwiches, tacos, chili dogs, etc. No facilities are typically provided for the preparation of pizza. The specialty line may be eliminated in renovate facilities where space is not available, at the direction of HQ US as it is not an absolute necessity for the function of the fast food operation. It should be noted that current trends toward breakfast biscuits and a more rounded fast food menu necessitate the inclusion of this line in all but the most limited facilities.

b) Frying Line: This line functions as the preparation and cooking area for all fried items in the fast food facility. Separate fryers using computerized timers, automatic lifts, and high volume filters are provided for french fries, fried chicken (both pieces and nuggets), fried fish, and any other fried items that are served. Additionally, the capability for marinating and breading (although these functions can be handled either in the main kitchen or through purchase of premarinated chicken) and for holding of biscuits for chicken dinners are included.

c) Burger Line: This line is the mainstay of the entire facility. Portion-packaged, frozen all-meat hamburgers (hamburgers must be relatively lean without soybean additives) are charbroiled in high volume conveyerized broilers after which the hamburgers are packaged and delivered for serving. Buns are toasted concurrently with the meat preparation operation. Facilities are provided to allow for garnishing and dressing entrees prior to delivery if required. Care must be used in selecting the charbroiler for this use. Broilers capable of producing 800 hamburgers per hour, which need minimal

MIL-HDBK-1036/4

cleaning operations, must be specified for this use. Exhaust hoods must be of very high efficiency type and should be capable of grease extraction. The broiler selected for this use should be capable of handling steaks, some fish entrees, sausages, chicken, and ribs, should it be required. Generally, the capability for running two concurrent burger preparation operations will be necessary in all facilities due to the volume of hamburgers which must be prepared at normal meal times.

As entrees and side dishes are completed on the various push lines, they are delivered to the servers via a group of through-wall chutes which incorporate both bottom and top warmers.

Servers enter orders via electronic registers which signal the appropriate push line operator as well as maintaining inventory control. In addition, servers prepare trays, fill and serve sodas, and shakes, and soft serve ice cream products. They are the front line of the fast food operation and are ultimately responsible for bringing entrees, side dishes, beverages, and desserts together and serving them to patrons.

7.3.2 Drive Through and Walk Up Service. Drive through pick up windows and walk up window service are optional features which may be considered as attachments to fast food functions in some large facilities with prior approval of Marine Corps, Headquarters (Code LFD-4).

7.3.2.1 Security. Problems associated with sign in/identification procedures should be addressed in detail prior to submitting plans for either option for approval.

7.3.2.2. Location and Use. Facilities with major training functions and other facilities which cater to patrons commonly in field gear on short mess periods are the preferred location for walk-up facilities. Typically, these facilities will be seasonal or cyclical in usage, provide little or no inside seating, and include outdoor covered seating areas adapted for patrons in field gear.

7.3.3 Specialized Kitchen Equipment. The nature of the fast food service incorporated in USMC enlisted dining facilities necessitates the use of a substantial amount of custom and specialized food service equipment. Although this section describes this equipment generically according to function and capacity, the contractor may choose to bid equipment with special mechanical and electrical requirements. Refer to Plate Nos. 57 through 61 for the items listed in Appendix A.

7.3.4 Signage and Graphics. In addition to the overall signage guidelines detailed in the body of the manual, fast food facilities will require a more comprehensive graphics and signage package. Refer to Plate Nos. 62 through 67. The graphics program for fast food areas can be broken into four separate phases.

MIL-HDBK-1036/4

a) Entry: Emphasis should be on identification. The patron should recognize, through the graphic elements used in this area, that he/she is entering the fast food area. The graphics in this area, although eye-catching, should not be so overpowering as to conflict with the appearance and character of surrounding buildings. (Plate No. 63).

b) Queue: Emphasis should be on orientation. Photographs, wall murals and silkscreened banners should be used in this area to display selections available and to prepare patrons for quickly negotiating the ordering/pickup area. (Plate 65).

c) Ordering/pickup: Emphasis should be to focus the patrons attention on the task at hand. Easy to read, colorful menu boards incorporating back lighted photographic materials and counters with lighted portions to emphasize location of waiting lines should be the major elements in this area. Graphics should all contribute to making the patron's decision as quick and painless as possible. (Plate No. 64).

d) Dining: Emphasis should be to provide color and spatial separation. Brightly colored banners, divider panels, and umbrellas should all be considered. Graphics should emphasize themes of local history or legend produce through silkscreened photographs, sepia tone prints, or similar techniques to create a character for the space. Divider panels and umbrellas should be used to enclose spaces and create an intimate feeling in seating areas. (Plate Nos. 65 and 67).

The standard typeface use by the Marine Corps fast food facilities is indicated on Plate No. 62. "POAGIES" is the name given to USMC fast food facilities. The colors red and yellow are used for the entrance graphics for these facilities.

7.4 Waste Removal and Disposal. Increase costs for solid waste disposal associated with larger dining facilities and the difficulties of locating and maintaining adequate environmentally acceptable disposal sites require that engineered waste disposal systems be studied by designers of all dining facilities.

In medium to large facilities, designers should consider incorporating a system of waste pulpers with the associated water press and containerized compactors.

Current practice in existing facilities is for all food and paper waste to be separate. Paper waste is transported to dumpsters, and food waste is stored and sold. Designers should consider a system with four waste pulpers and a water press. The waste system produces a pulp mixture of food, paper, and water. One pulper is located in each scullery area. Separation of waste is not generally required. Food and paper waste is scraped from dishes into a water trough that feeds directly into the waste pulper. The pulp is pumped to

MIL-HDBK-1036/4

the water press located in a remote location. A pulper in this remote location is used for miscellaneous waste items and cardboard boxes. Another pulper should be located in the cleaning gear area adjacent to the fast food dining area. All four pulpers are piped to one water press.

The engineered waste disposal system should generally be a closed-loop design. Nearly 95 percent of the water that carries the pulp to the water press is recovered and returned to the pulper, keeping the unit continually flushed and minimizing the introduction of fresh water. Bulk volume of waste should be reduced by 85 percent.

7.5 Interior Finishes. (Table 4). The designer is encouraged to explore state-of-the-art finish systems which have a proven record of use and testing. The following sections are intended as a generic guide for finish materials and to provide criteria by which the various available systems may be evaluated. Where possible, the specific pros and cons of various materials which are generally acceptable under similar conditions in private sector and institutional use have been included.

Through the use of common sense, selection criteria balancing all factors related to installation and usage (initial and life cycle costs, ease of maintenance, comfort, etc.), facilities can be developed which rival the cost efficiencies of private sector operations while providing for the long life, easy maintenance, and durability which are major requirements in USMC and other Government facilities. Refer to Table 4.

Where a Marine Corps fast food facility adjoins a Navy dining facility, a concerted effort should be made to coordinate the finishes of the two dining areas so that they are complimentary of one another.

7.5.1 Flooring. (Table 5). The designer should consider the following when selecting flooring materials:

- a) Durability and safety.
- b) Ease of maintenance,
- c) Traffic bearing requirements.
- d) Amounts and types of moisture that the flooring will be subjected to under normal and special conditions.
- e) Chemicals and compounds which will be used on flooring.
- f) Comfort of users and effects of impact noise due to traffic.

7.5.1.1 Flooring Types. Flooring types that are generally available include also (refer to Plates 68 and 69):

MIL-HDBK-1036/4

Table 4
Finish Material Standards for Marine Corps

FLOOR	BASE	WALL	PROTECT	CEILING	
Entry, Vestibule Queue, Check-In	Terrazo, QT, Seamless	QT, CT Vinyl	Note 1	N.R.	Note 3
Public Toilets Staff Toilets	CT, Seamless	CT, Vinyl	MR GYP BD, CT	N.R.	MR ACT, MR GYP BD
Serving Lines Patron Side	Terrazzo, QT, CT Seamless	QT, CT	CT, GSU	Note 5	MR, ACT, MR GYP BD
Serving Lines Kitchen Side	QT Seamless	QT, CT	CT, GSU	Note 5	MR ACT MR GYP BD
Dining Rooms	Carpet, Carpet Tile	Vinyl	Note 1	Note 2	Note 3
Food Preparation	QT, Seamless, Conc. Topping	QT, CT,	GSU, GWC, Panelized	Note 5	MTL Pan
Ref. Storage Frozen Storage	Note 4	N.R.	MIP	Note 2	MIP
Dishwashing Utensil Washing	QT, CT, Seamless Conc. Topping	QT, CT	GSU, GWC	Note 5	MTL Pan, Ceramic Tile
Dry and Non-Food Storage Areas	QT, Seamless, Resil Conc. Topping	QT, Vinyl	GWC on CMU	Note 2	ACT, GYP BD, Vinyl Coated
Offices	Resil, Cpt., Seamless	Vinyl	GYP BD Painted, CMU Painted	N.R.	ACT
Staff Lockers	Resil, Cpt., Seamless	Vinyl	GYP BD Painted CMU Painted	Note 2	MR ACT, MR GYP BD
Janitorial Mechanical	VCT, Conc. Topping	Vinyl	GYP BD Painted CMU Painted	Note 2	Exposed Const.
Can Wash	Conc. with Acid Resist Topping	QT	GYP BD Painted, GWC on CMU	Note 5	MTL Pan
Loading Areas	Conc. with Traffic Topping	N.R.	Exterior Finish	N.R.	Exposed Const.

- Notes: 1. Walls in public areas may be a variety of durable materials such as brick, concrete, plaster, vinyl wall covering on an approved substrate, or other materials as approved.
2. Wall and corner guard protection should be provided at locations where cart traffic is expected.
3. Ceilings in public areas may be a variety of suspended acoustical materials.
4. Quarry tile on an insulated slab.
5. Corner and wall guards required throughout.

ABBREVIATIONS:

Resil - Resilient Flooring	GSU - Glazed Structural Unit	QT - Quarry Tile
ACT - Acoustic Ceiling Tile	GWC - Glazed Wall Coating	VCT - Vinyl Composition Tile
CMU - Concrete Masonry Unit	INS - Insulated	MTL - Metal
Conc. - Concrete	MIP - Metal Insulated Panel	C.G. - Corner Guards
CT - Ceramic Tile	MR - Moisture Resistant	

MIL-HDBK-1036/4

Table 5
Floor Selection Criteria for Marine Corps

	MOISTURE				TRAFFIC			
	COMPARATIVE COST	COMFORT	DRY	OCCASIONALLY WET	FREQUENTLY WET	LIGHT	HEAVY UNIFORM	HEAVY LOCALIZED
	1.0 = Average Cost for Good Flooring							
Monolithic Concrete Slab	0 - 0.8	Poor	*	*	*	*	*	0
Concrete Topping	0.2 - 0.8	Poor	*	*	*	*	*	*
Terrazzo	4 - 5	Poor	*	*	*	*	*	*
Terrazzo Thin Set	2 - 3	Poor	*	*	*	*	*	*
Brick	4 - 9	Poor	*	*	*	*	*	*
Quarry Tile Thick Set	4 - 5.5	Poor	*	*	*	*	*	*
Ceramic Tile Thick Set	2 - 4	Poor	*	*	*	*	*	*
Quarry Tile Thin Set	2 - 4.5	Poor	*	*	*	*	*	*
Ceramic Tile Thin Set	1.5 - 3	Poor	*	*	*	*	*	*
Sheet Linoleum	1 - 1.3	Good	*	*	*	*	*	*
Sheet Rubber	1.5 - 1.6	VGood	*	*	*	*	*	*
Sheet Vinyl	1.3 - 1.4	VGood	*	*	*	*	*	*
Rubber Tile	1.4 1.5	VGood	*	*	*	*	*	*
Vinyl Tile	1.5 - 2.0	VGood	*	*	*	*	*	*
Vinyl Composition Tile	1 - 1.2	Good	*	*	*	*	*	*
Asphalt Tile	.6 - .75	Fair	*	*	*	*	*	*
Thermosetting Epoxy	3 - 5	Fair	*	*	*	*	*	*
Thermosetting Neoprene	4 - 6	Fair	*	*	*	*	*	*
Thermosetting Polyester	3 - 10	Fair	*	*	*	*	*	*
Thermoplastic Acrylic	2 - 3	Fair	*	*	*	*	*	*
Thermoplastic Mastic	3 - 3.5	Fair	*	*	*	*	*	*
Acrylic Carpet	1.5 - 2	VGood	0	*	*	*	*	0
Acrylic Nylon	1 - 1.5	VGood	*	*	*	*	*	*
Acrylic Polypropylene	2 - 3	Good	*	*	*	*	*	*
Polyester	2 - 2.5	VGood	*	*	*	*	*	*

* - Standard Usage
0 - Marginal Usage

MIL-HDBK-1036/4

Table 5 (continued)
Floor Selection Criteria for Marine Corps

		SUBJECTED TO						
	COMPARATIVE COST	COMFORT	IMPACT/INDENTATION	MOISTURE/DIRT SOLUTIONS	MILD CLEANING SOLUTIONS	STRONG CLEANING	STEAM	CHEMICALS/LUBRICANTS
	1.0 = Average Cost for Good Flooring							
Monolithic Concrete Slab	0 - 0.8	Poor	*	*	*	0	*	*
Concrete Topping	0.2 - 0.8	Poor	*	*	*	0	*	*
Terrazzo	4 - 5	Poor	*	*	*	0	*	*
Terrazzo Thin Set	2 - 3	Poor	*	*	*	0	*	*
Brick	4 - 9	Poor	*	*	*	*	*	*
Quarry Tile Thick Set	4 - 5.5	Poor	*	*	*	*	*	*
Ceramic Tile Thick Set	2 - 4	Poor	*	*	*	*	*	*
Quarry Tile Thin Set	2 - 4.5	Poor	*	*	*	*	*	*
Ceramic Tile Thin Set	1.5 - 3	Poor	*	*	*	*	*	*
Sheet Linoleum	1 - 1.3	Good	0	*	*	*	*	*
Sheet Rubber	1.5 - 1.6	VGood	*	*	*	*	*	*
Sheet Vinyl	1.3 - 1.4	VGood	*	*	*	*	*	*
Rubber Tile	1.4 - 1.5	VGood	*	*	*	*	*	*
Vinyl Tile	1.5 - 2.0	VGood	*	*	*	*	*	*
Vinyl Composition Tile	1 - 1.2	Good	0	0	*	0	*	*
Asphalt Tile	.6 - .75	Fair	0	0	*	*	*	*
Thermosetting Epoxy	3 - 5	Fair	*	*	*	*	*	*
Thermosetting Neoprene	4 - 6	Fair	*	*	*	*	*	*
Thermosetting Polyester	3 - 10	Fair	*	*	*	*	*	*
Thermoplastic Acrylic	2 - 3	Fair	*	*	*	*	*	*
Thermoplastic Mastic	3 - 3.5	Fair	0	*	0	*	0	0
Acrylic Carpet	1.5 - 2	VGood	*	*	*	*	*	*
Acrylic Nylon	1 - 1.5	VGood	*	*	*	*	*	*
Acrylic Polypropylene	2 - 3	Good	*	*	*	*	*	0
Polyester	2 - 2.5	VGood	*	*	*	*	*	*

* - Standard Usage
0 - Marginal Usage

MIL-HDBK-1036/4

- a) Cementitious types.
- b) Monolithic concrete with integral finish. (Least expensive but limited in appearance and performance characteristic).
- c) Concrete toppings over concrete substrate (used for floors where resistance to abrasion/wear is of primary importance).
- d) Terrazzo toppings of portland cement and selected aggregate (appearance and durability under heavy traffic). Terrazzo is also available as precast tile.
- e) Burned clay in either unglazed or glazed in various sizes, shapes, and colors. Available as brick pavers, ceramic, and quarry tile, which offer good resistance to grease, strong cleaning solutions, abrasion, and wear.
- f) Resilient flooring, available in sheet and tile form, of various compositions and are resistant to moderately heavy traffic.
- g) Seamless flooring available in formulations of a resinous matrix, fillers, or decorative additions, which, after installation and curing, form a seamless finished surface which is highly resistant to chemicals and generally good in concentrated traffic areas.
- h) Carpeting available in a variety of yarn materials, construction types, colors, patterns, and textures.

7.5.1.2 Stone. Stone is the most durable of all materials used for flooring and is generally suitable for indoor and outdoor locations where resistance to heavy foot traffic and appearance are important. Stone flooring is used mostly in enclosed public areas of institutional and commercial buildings.

7.5.1.3 Burned Clay. Burned clay flooring is suitable for indoor and outdoor locations where resistance to wear and moisture, appearance, and low maintenance costs are important. Types of burned clay flooring include brick, pavers, and ceramic tile. Bricks offer a choice of color and texture, may be laid in different patterns and have good resistance to wear, moisture, heat, and compression/indentation. Ceramic tile is available as porcelain tile, natural clay tile, and glazed or unglazed mosaic tiles. Quarry tile is made from natural clays or shales, unglazed. Pavers are formed of either porcelain or natural clay, unglazed.

Grouts are used to fill in the open joints between burned clay units and are generally the weakest part of the flooring. Various formulations are available in addition to conventional cement grout:

MIL-HDBK-1036/4

a) Dry-set grout is a mixture of portland cement and additives and is used for grouting floors subject to ordinary use.

b) Latex-portland cement grout is a mixture of either portland cement, or dry-set grout with special latex additive and is suitable for all installations subject to ordinary use and for most commercial installations.

c) Mastic grout is one part grouting composition which is more flexible and stain resistant than regular cement grout.

d) Furan resin grout system consists of furan resin and hardener portions and is used in industrial areas requiring chemical resistance, primarily for quarry tile and pavers.

e) Epoxy grout systems employ epoxy resin and hardeners especially formulated for industrial and commercial installations where chemical resistance is of primary importance.

f) Silicone rubber grout systems are resistant to staining, moisture, mildew, cracking, and shrinking and can withstand exposure to hot cooking oils, steam, and oxygen, as well as prolonged exposure to subfreezing temperatures and hot, humid conditions, but are for indoor use only.

Comply with the latest edition of Handbook for Ceramic Tile Installation (Tile Council of America).

Refer to standard NAVFAC procedures for flooring materials and installation methods not shown (i.e., mortar bedded ceramic tile and quarry tile).

7.5.1.4 Cementitious Floorings. Cementitious flooring consists of a mixture of aggregate and cementitious binder. The type of aggregate selected will largely determine the characteristics of the flooring; it may be selected for durability only, or for both durability and appearance.

Monolithic concrete slabs of selected hard, wear-resistant aggregate, hard sand and cement, placed on grade or suspended with the top surface of the slab steel-troweled to serve as the wearing surface. Alternately the surface of smooth finished slabs may be hardened by working selected aggregate into the top layer of the freshly poured concrete or by commercially available hardeners. Coloring pigments may also be added and various decorative surface finishes are available.

b) Toppings are thin concrete slabs poured over and bonded to concrete base slabs to produce a hard, dense, wear-resistant surface. Toppings, even though more expensive, will generally provide better service than monolithic, hardened surface slabs. Terrazzo is generally used in similar locations to stone flooring, when durability under heavy traffic and appearance are important.

MIL-HDBK-1036/4

c) Terrazzo is mixture of at least 70 percent of marble and/or granite chips, and 30 percent either white, gray, or pigmented portland cement. Thin set terrazzo is a topping, approximately 1/2 inch in thickness which is poured over a base slab first coated with an organic adhesive. Precast terrazzo is available in the form of ties, stair treads, risers, bases, and shower receptors and is generally available in the same types as cast-in-place terrazzo.

Both monolithic concrete slabs and concrete toppings are generally used when a durable, inexpensive flooring is require.

7.5.1.5 Resilient Flooring. Resilient flooring is produced in sheet or tile form suitable for indoor use only, and in dry locations subject to moderate wear of foot and rubber wheeled traffic. Underfoot comfort is greater than with stone, cementitious, and burned clay flooring. Types of resilient flooring include:

a) Linoleum: consists of a wearing layer over a backing of burlap or asphalt saturated felt which has very good resistance to grease and abrasion, but poor resistance to alkalies.

b) Rubber: offers excellent resilience and resistance to indentation and good resistance to grease, alkali, and abrasion.

c) Homogeneous vinyls: have excellent resilience and resistance to indentation, abrasion, grease, and alkalies.

Adhesives are of primary importance in the satisfactory performance of resilient flooring an include the following:

a) Pastes: water soluble, all purpose adhesive for above-grade installation of backed sheet materials such a linoleum and rubber tiles should not be used for asphalt and vinyl composition tile.

b) Synthetic rubber latex-base: a waterproof latex type of cement, used over concrete surfaces or below grade for securing backed sheet materials but should not be used for asphalt and vinyl composition tile.

c) Epoxy: a chemical-set, waterproof, two component adhesive with outstanding bonding characteristics, used for, on/or below grade concrete or wood substrate.

d) Asphalt and rubber-base brushing cement: used for all types of substrates.

e) Cut-back asphalt: an inexpensive, moisture resistant adhesive used over concrete surfaces, felt lining, and wood surfaces for asphalt and

MIL-HDBK-1036/4

vinyl composition tile but should not be used over latex or asphalt-type leveling coats.

7.5.1.6 Seamless Flooring. Seamless flooring consists of a resinous matrix and fillers for decorative additions, which after installation and curing form a seamless finished surface.

Thermosetting matrices include materials which cannot be melted down and reheated after initial curing without destroying their properties. These include the following:

- a) Epoxies: easily maintained and have good resistance to abrasion/wear, moisture, impact/indentation, and chemicals.
- b) Polyesters: nonslippery, nonporuous, nonabsorbent, greaseproof and should not be subjected to always wet conditions. They are inert and not affected by most commonly used chemicals such as hydraulic oils, ethyl alcohol, engine oil, kerosene, lactic oil, and lubricants and will generally withstand heavy wear without cracking, pitting, or scratching and will resist permanent staining, such as from tobacco, urine, coffee, carbonate, or alcoholic beverages.
- c) Polyurethanes: generally more resilient than epoxies and polyesters and may be expected to perform better in bridging and/or resisting cracks. They are nonslippery, grease and stain resistant, and unaffected by most commonly used chemicals, have excellent resistance to scuffing, scratching, and impact/indentation, but should not be subjected to always wet condition.
- d) Polysulfides: have outstanding resistance to oils, solvents, moisture and weathering, but are poor in resisting abrasion.
- e) Furan resins: have excellent resistance to most chemicals and are widely employed in laboratories and chemical plants. They are inherently brittle, which limits the choice to substrate suitable to receive them.

Thermoplastic matrices include materials which remain plastic after installation and curing. They will soften when heated, and will again harden when cooled. They include:

- a) Silicone: a protective coating for use over concrete floors where water, acid, or movement have caused damage.
- b) Mastics: low in cost and have inherent flexibility, self-repairing capabilities, will dampen impact noise and are badly affected by organic solvents and mineral acids. Heavy loads should not be allowed to stand on mastic, as they will permanently indent the mastic. Mastics are commonly used as a resurfacing material over concrete, wood, and metal

MIL-HDBK-1036/4

surfaces and can be made more durable by a surface coating of epoxy. They can be used to cover areas continuously exposed to water, such as entrance passages and loading docks.

c) Acrylics: resistant to heat, sunlight, oils, acids, alkalies and moisture, but not when continuously in contact with them.

d) Polyvinyl chloride (PVC): a water-resistant coating used as top coating for plasticized vinyl chloride acetate, to increase the chemical and abrasion resistance of the system.

e) Polystyrene film: has very good resistance to water, chemicals, oil, and grease and may be used outdoors, but is subject to erosion and embrittlement over a period of time and will require periodic protective resurfacing.

f) Polyethylene: has outstanding flexibility and high resistance to most commonly used chemicals.

7.5.2 Ceilings. (Tables 6 and 7). The ceiling is subject to a number of external factors which may affect its performance and the effects of which the ceiling may have to resist. These include:

- a) Pressure differentials
- b) Sound penetration
- c) Heat flow
- d) Air/water vapor penetration
- e) Chemical and biological attack
- f) Deflection
- g) Expansion/contraction
- h) Suspended loads
- i) Fire

Heat flow into a cold ceiling plenum space may also present a problem as air leaking into it will carry off heat. Installing thermal insulation over the ceiling to minimize the flow of heat may help this problem, but also create others including:

MIL-HDBK-1036/4

Table 6
Ceiling Selection Criteria for Marine Corps

	COMPARATIVE COST	SOUND ABSORPTION	SOUND TRANSMISSION	RESISTANCE TO		
				AIR/WATER VAPOR PENETRATION	HIGH HUMIDITY	STEAM
Metal Pan Concealed Grid	6 - 8	F	P	P	G	G
Metal Shapes Concealed Grid	10 - 14	F	P	P	G	G
Plastic Panels Exposed Grid	5 - 10	F	G	P	G	G
Plaster-Suspended	3 - 5	P	G	G	P	P to F
Gypsum Board Suspended	2.5 - 3	P	G	G	F to P	P to F
Plaster Attached	3 - 4	P	G	G	P	P
Gypsum Board Attached	2	P	G	G	F to P	F
Applied Coating	.5 - 1	P	G		F to P	F
Plaster Finishing Coat	1.5 - 2	P	G		F to P	F

P - Poor

F - Fair

G - Good

Consider the following systems in areas subject to high humidity in addition to metal pan systems:

Table 7
Ceiling Alternates in Wet Areas for Marine Corps

AREA	MATERIAL	SUSPENSION SYSTEM
Preparation Areas	Vinyl faced aluminum over water resistant mineral fiber substrate	Aluminum suspension system where fire resistance rating is not required
Dishwashing Utensil	High density ceramic lay-in panels (non-acoustical)	Heavy duty aluminum suspension system for high humidity environments according to ASTM C635

MIL-HDBK-1036/4

a) Condensation may occur within such insulation.

b) If recessed lighting fixtures are also covered by the insulation, heat buildup may result which will shorten the service life of the fixtures and/or lamps.

c) Adequate ventilation of the plenum should be provided to prevent high humidity conditions which may cause condensation on cold surfaces, for example, improperly insulated ducts or cold water piping during hot structural framing or other cold surfaces in winter.

7.5.2.1 Plaster and Gypsum Board. Openings in plaster generally require plaster frames or screens which add to the cost. Plaster has poor resistance to high humidity conditions unless completely sealed, and resistance to steam and chemical fumes depends largely on the protective coating used. Sound absorption of plaster and gypsum board membranes is poor as is that of all hard surfaces, up to 95 percent of the sound waves striking them may be reflected.

7.5.2.2 Acoustical Tile. The known advantages and general use of acoustic tile suggest careful consideration of some of its limitations.

Acoustical tile is difficult to clean. Where it is subject to soiling, dust accumulation or airborne moisture, the use of plastic film-faced tile is recommended.

Acoustical tile is not resistant to high humidity or steam, such as found in kitchens, although special types are available for use under high humidity conditions, including suspension systems of noncorroding metal.

Use of acoustic tile cemented directly to the underside of a concrete slab is generally not recommended. Moisture may collect and condense behind the tile, causing the tile to buckle.

When tile is secured to furring channels attached to the underside of a concrete slab, provide for air to circulate between furring strips. Seal all edges of lay-in panels in kitchen areas. All lay-in panels should incorporate a water-resistant back coating.

Provide positive ventilation in sufficient quantities to minimize condensation above dishwashing areas.

7.5.3 Kitchen Doors. (Table 8). The designer should incorporate door assemblies which will respond to the highly destructive nature of use experienced in kitchen locations. Consideration of the door itself as well as the wall in which the door is installed is required. Too often the door and hinges are serviceable and the wall adjacent disintegrates due to repeated impact from carts.

MIL-HDBK-1036/4

The following doors should be considered by the designer:

Table 8
Service Doors for Marine Corps

LOCATION	MATERIAL	CORE	HINGES	GLAZING	PROTECTION
Light duty (1-1/4 in. thick)	0.63 Anodized aluminum	Expanded polystyrene	Spring butt hinges or spring loaded gravity hinges or continuous hinges	Double glazed Lexan	Steel plate hinge and jamb guards
	1/8 in. one piece high impact cross linked polyethelene	Solid exterior grade plywood			Armor plate both sides
	1/8 in. Hypalon				Riveted const. and extruded edges
	1/8 in. textured ABS				
Heavy duty 1-5/8 in.	0.90 Anodized aluminum	Expanded polystyrene	Spring loaded gravity hinges	Double glazed Lexan	Steel plate hinge and jamb guards
	1/4 in. thick one piece high impact cross linked polyethelene	Solid exterior grade plywood	Continuous hinges		Armor plate both sides
	1/4 in. Hypalon				Riveted const. and extruded edges
	Textured ABS				

MIL-HDBK-1036/4

Include shock absorbing edges on all doors.

Set doors in fully braced steel channel frames in gypsum board walls or attach to grouted and reinforced CMU walls.

At exterior locations (loading docks) provide fully gasketed frames. Provide partially gasketed frames at connections between patron and kitchen areas and use ungasketed frames inside kitchen.

7.5.4 Walls. Although final approval is necessary from HQ USMC and NAVFAC, designers should consider the use of "state-of-the-art" surfacing systems in kitchens and areas subject to high humidity and frequent wetting in order to minimize problems often encountered in these areas. Systems in common use in industrial and commercial kitchens which inhibit bacteria and mold growth and which provide exceptional ease of maintenance should be considered.

Panelized systems incorporating plastic splines and stainless steel fasteners to mount methyl methacrylate panels or panels of alternating layers of phenolic and cellulose fibers impregnated with melamine resin or fiberglass reinforced plastic panels over water-resistant substrates are possible solutions to be considered.

Where plaster or "plaster-like" materials are utilized, the designer should specify plastic accessories. Installations and locations which require the use of ceramic tile over frame structures should include backer board of fiberglass reinforced portland cement panels rather than moisture-resistant gypsum board.

The designer should consider the use of trowelled-on, cementitious masonry coatings, vitreous cement coatings, high performance "tile-like" coatings, epoxy or polyester resin coatings or fiberglass reinforced polyester coatings over concrete masonry units in areas where appearance is of minimal importance.

MIL-HDBK-1036/4

APPENDIX A

SPECIALIZED KITCHEN EQUIPMENT

No. 1 - Service Counter: Plastic laminate front and top.

No. 2 - Cash Register: NES KR-80-1, Commercial. Voltage 115/60/1. Government furnished and Government installed.

No. 3 - Reach-in Freezer: Cabinet grille, front, door, NES KF-66-0 ends and complete inner liner of polished stainless steel. Foamed in place polyurethane insulation. Full-size hinged glass door with cylinder lock, magnetic gasket, safety grip handle. Capacity 21.5 cubic feet, one section, size 27 x 36 x 84. Self-contained refrigeration system mounted on top of cabinet, concealed behind grille. Fans and cooling coil contained in an insulated housing separate from product zone. Condensate evaporator. Electrical characteristics; 1/2 hp condensing unit, voltage 120/60/1, total amp 10.2. Provide three adjustable stainless steel wire shelves and 5-inch diameter heavy duty swivel casters with brakes, automatic interior lighting, and an indicator panel. Cabinet top, back and bottom heavy gauge aluminized steel.

No. 4 - Soda System: Fluidic controlled constant pressure, recirculating, mechanically refrigerated, single level carbonator cooler, complete with all lines, fittings, insulation, filter and regulators to supply 2 stations with 5 faucets at each station. Mechanical contractors' requirements provide a 120 volt 60 Hertz/1 phase, 20-amp circuit (CKT) at each dispensing station. A valved, 1/2-in. I.P.S. with female adapter and a minimum water pressure of 40 pounds for cold water supply, within 5 feet of the master unit. Furnish system complete and operational with syrup tank and CO₂ tank(s), insulated soda conduit and fitting, and accessory items necessary for a completely installed system.

No. 5 - Drink Tower With Ice Bin: Stainless steel interior and exterior construction. Ice chest has sealed in aluminum 6-circuit cold plate and insulated with one inch styrofoam insulation on sides and bottom, and sliding S/S lid, 80 lb ice capacity, drain. Tower has five valves, built-in drip tray with drain. Place in opening cut in counter top. Provide with 1 inch wide rim. Include installation kit of fittings, regulator, tubing. Size above counter 22-1/2 x 12 x 21. Electrical characteristics voltage 120/60/1. System may be remote installation.

No. 6 - Cold Cup Dispenser: Three tube dispensers in a rectangular cabinet for dispensing 6 oz. through 24 oz. paper or plastic cup. Dispensers adjustable to accommodate different cup sizes. Tempered aluminum cabinet with stainless steel face plate. Cabinet material 0.063 in. thick material with baked enamel finish. Cup dispensers bright annealed stainless steel. Cabinet size; 8 x 24 x 20. Collar cap color as selected.

MIL-HDBK-1036/4

APPENDIX A (continued)

No. 7 - Drawer Base Utility Cabinet: Top one piece 16-gauge stainless steel with front nosing and 6-inch high backsplash. Provide with one 22-gauge S/S shelf with turn up at rear. Exposed unit ends 22-gauge S/S, pan-type construction. Stainless steel back. Dry storage drawers placed below shelf. Drawer liner ABS plastic with drawer slides of 16-gauge galvanized steel with S/S bearings. Completely enclose drawer in housing of 20-gauge steel painted gray enamel. Drawer front: 22-gauge die-stamped S/S. Top shelf and bottom reinforced with channel-shaped members. Unit set on 8-in. high sanitary adjustable legs. Size: 60 x 32 x 42, 36 to top of counter.

No. 8 - Jet Spray: Two-flavor individual bowl display dispenser for noncarbonated drinks. Cabinet: stainless steel and plastic. Bowls: transparent resin, 5-gallon capacity each, size: 16 x 19 x 24. Refrigeration 1/5 hp hermetically sealed system. Electrical requirements: 120/60/1, 400 watts, 3.5 amps. Removable drip tray. Jet spray: JT20.

No. 9 - Ice Tea Dispenser: Counter model, continuous flow dispensing system using instant unsweetened tea. Built-in heating element to minimize caking of the tea. Tea strength adjustable. Stainless steel and plastic construction. Removable drip tray for cleaning. Capacity: 9 gallons with jar. Electrical requirements: 120/60/1, 0.3 amp, 25 watts. Size: 6 x 9 x 21. Cold water inlet: 1/4-inch.

No. 10 - Menu Boards - Illuminated. Acrylic plastic removable panels insert into 6-in. deep plastic laminate frames with radius corners, color or wood grain finish as selected. Fabricate panels with slide tracks for preprinted menu strips, individual price numerals, and photo prints, all changeable. Eleven strip panes. Height: 36 in. Provide fluorescent lamps compatible with fixture. Electrical characteristics, voltage 120/60/1.

Provide: As selected from standard items.

a) 12 fast food subjects processed into photographic prints for insertion into menuboard.

b) Set of 500 individual numbers in color to match menu strips.

c) Menu strips of heavy gauge acrylic plastic in colors, wording permanently imprinted in contrasting colors. Allow for 100 strips.

d) Caption strips same material as menu strips. Allow for 21 strips.

No. 11 - Counter Model Sandwich Rack Warmer: Stainless steel construction, single tier, inclined surface, 5 in. compartments. Thermostatically

MIL-HDBK-1036/4

APPENDIX A (continued)

controlled strip heaters mounted under each compartment to maintain 150 degrees F minimum. Adjustable legs. Electrical requirements: 120/60/1, 30 amps, supply with cord and plug. Size: 45 x 24 x 11.

No. 12 - Handsink.

No. 13 - Wall Shelf: Type 304 16-gauge stainless steel 12 inches wide, one inch channeled front edge with one inch turned up back and end flanges. Brackets of 16 gauge stainless steel. Length as indicated. Brackets of 16-gauge stainless steel. Length as indicate. Brackets welded to shelf member and drilled for attachment to wall surfaces.

No. 14 - Utility Stand: NES KS-76-0. Open shelf utility cabinet. Top one piece 16 gauge stainless steel with front nosing and 6 inch high backsplash. Provide with two 22-gauge S/S shelves with turn up at rear. Ends constructed of 22-gauge S/S, pan type construction, exterior ends S/S. Top shelves and bottom reinforced with channel shaped members. Unit set on 8-inch-high adjustable legs. Size; 48 x 32 x 42, 36 to top of counter.

No. 15 - Shake/Soft Serve Machine: NES KM-36-0, floor model with casters, air cooled, 27 x 36 x 69, three shake flavors with soft serve. Electrical requirements 208/60/1, 40 amp service. Provide with swivel type faucet over mix hopper with hot and cold water supplies for cleaning operations. Stainless steel housing on a welded steel framework. Solid state control system to automatically control viscosity of the frozen soft serve products. Provide with lights to indicate mix level and controls to automatically shut down freezer when mix has reached an unsafe level. Self-contained air compressor located in freezer.

a) Shake requirements:

- | | | |
|----|-------------------|------------------|
| 1. | Beater motor | 1 HP. |
| 2. | Freezing cylinder | 7 qts. |
| 3. | Mix reservoir | 40 qts. |
| 4. | Compressor | 11,500 Btu/hour. |

b) Soft serve requirements

- | | | |
|----|-------------------|-----------------|
| 1. | Beater motor | 1.5 hp. |
| 2. | Freezing cylinder | 3.4 qts. |
| 3. | Mix reservoir | 40 qts. |
| 4. | Compressor | 9,500 Btu/hour. |

No. 16 - Shake cup dispenser: Pull-type tube for 6 oz, to 12 oz. paper cup, adjustable to fit required cup size. Construct of bright stainless steel. Provide with mounting bracket. Height: 24 inches. Cup diameter: 2-3/4 inches to 3-3/8 inches.

MIL-HDBK-1036/4

APPENDIX A (continued)

- No. 17 - Syrup Tan Cabinet: Vertical type stainless steel cabinet to hold three individually regulated 2-gallon tanks. Dimensions: 10 x 10 x 63, Cabinet set on 4 legs. Hinged door.
- No. 18 - Three Door Reach-In Refrigerator NES KC-21-0. Cabinet grille, front, door, ends, and complete inner liner of polished stainless steel. Foamed in place polyurethane insulation. Three full-size doors with cylinder locks, magnetic gasket, safety grip handles. Capacity: 70.1 cubic feet, three sections; size: 78 x 36 x 84. Self-contained refrigeration system mounted on top of cabinet, concealed behind grille. Fans and cooling coil contained in an insulated housing separate from product zone. Non-electric condensate evaporator. Electrical characteristics 1/2 hp condensing unit, voltage 120/60/1, total amps: 11.7. Provide with nine adjustable stainless steel wire shelves, 5-in. diameter heavy duty swivel casters with brakes, automatic interior lighting, indicator panel. Cabinet top, back, and bottom heavy gauge aluminized steel.
- No. 19 - Work Sink: One compartment, overall size 22-1/2 x 24-3/4 inches, on legs, no drainboard.
- No. 20 - Soft Serve Topping Bar: Refrigerated base with condiment rail. Size 60 x 27 x 52, 36 to top of counter. Electrical requirements: 120/60/1, 1/5 hp, 5.0 amps. Top one piece 16 gauge stainless steel with nosing on front and raised syrup rail on rear. Exterior back, bottom and ends heavy gauge steel, reinforced and painted with gray enamel. Base reinforced with steel channels. Interior of compartment stainless steel. One stainless steel shelf. Automatic light. Door front laminated plastic bound all sides with S/S capping, vinyl magnetic gasket, S/S handle. Hermetically sealed refrigeration unit has blower type coils and condensate evaporator pan. Base insulated with 2 inches urethane foam insulation around compartments. Condiment rail has one chocolate pump equipped with lever action handle and 3-1/2 quart S/S jar. Provide with 11 crushed fruit 2-1/2 quart S/S jars with plexiglass hinged covers. Install compressor in housing with screened front removable panel. Place on sanitary adjustable legs. Furnish with cord and plug.
- No. 21 - Sneeze Guard: Frame of hardwood with tempered glass panels and concealed fluorescent lighting. Vertical supports adjustable in height. Rails, vertical supports, end panels, and lighting valance of selected hardwood. Glass: groove glaze. Light switch concealed behind louvered panel in salad bar.
- No. 22 - Chili Warmer: Recessed in counter top. Stainless steel well pans 20-gauge, type 304, 1-quart, with drain. Electrical requirements: 120/60/1, 500w, 4.25. amps. Provide 2-pole adjustable thermostat with indicator lamp. Mount control on front of cabinet. Provide with hinged cover.

MIL-HDBK-1036/4

APPENDIX A (continued)

No. 23 - Soup and Condiment Bar: Hinged door utility cabinet. Top plastic laminate with plastic laminate front nosing. Rear sloped elevated area 6 inches high by 16 inches deep of 16-gauge stainless steel provided with stamped raised rim openings to fit 2000 series pans divided 1/3 size by 4 inches deep. Provide base with two 22-gauge stainless steel shelves with turn-up at rear. Hinged doors constructed with plastic laminate panel trimmed with S/S cap, 22-gauge S/S pan type construction. Exterior ends steel painted gray enamel. Top shelf and bottom reinforced with channel shaped members. Stainless steel back. Unit set on sanitary adjustable legs. Cabinet size: 84 x 32 x 36. Provide cut out or chili warmer well, with fixed door panel at front of well. Mount thermostat in panel with close out protector plate under well. Top overhangs front at least 6 inches.

No. 24 - Salad Bar: Self-contained refrigeration unit. Electrical requirements: 208/60/1, 1/3 hp compressor motor, 15 amps. Top plastic laminate with cut out for one 15-inch diameter salad bowl and twenty 2.7-quart condiment crocks. Provide bowl and crocks. Plastic laminate front nosing. Cabinet interior: 22-gauge stainless steel back and bottom, interior ends and door frames ABS plastic, insulated with a minimum of 2 inches polyurethane foamed in place. Doors have ABS liner and plastic laminate fronts trimmed with S/S capping, magnetic vinyl gasket. One wire shelf each section. Compressor installed in a housing with louvered front. Unit to maintain 38 degrees to 42 degrees F. in base area. Furnish with automatic condensate evaporator. Provide cord and plug. Unit set on sanitary adjustable legs. Provide automatic interior lighting in refrigeration compartments. Cabinet size: 96 x 32 x 36 stainless steel back. Top overhangs front of base 6 inches. Provide lighting system voltage.

No. 25 - Wall Shelf: Refer to Item No. 13 for description.

No. 26 - Hot Food Table: NEX KT-56-0. Open shelf base. Four hot wells for pans with drains, wells individually thermostat controlled, size: 60 x 32 x 36. (20.9 amps). Top one-piece 16-gauge stainless steel, #3 finish, 1 with nosing on front and minimum 6-inch-high backsplash on rear. Top die stamped for 12 x 20 inch pans. Controls mounted on front edge of 18-gauge stainless steel pate shelf. Construct lower portion of unit with 22-gauge S/S shelf. Exterior end: S/S. Provide with full width cutting board. Bottom shelf approximately 12 inches above floor. Place on 5-inch diameter hard rubber casters (2 locking). Electrical characteristics voltage: 208/60/3.

No. 27 - Roll Warmer: Two-drawer cabinet. Size: 30 x 22 x 21 mounted on 5-inch casters. Drawers individually insulated and equipped with variable thermostat. Inside and outside construction stainless steel. Provide removable S/S pan for each drawer. Drawer capacity: 7 to 8 dozen average size dinner rolls. Electrical requirements: 208/60/1, 900 watts. Provide with 6-foot, 20 amp cord set and plug. Fasten handbar to one side of cabinet.

MIL-HDBK-1036/4

APPENDIX A (continued)

No. 28 - Finishing Oven: Countertop model on 2-1/2 inch legs. Welded stainless steel cabinet. Heating by two radiant quartz elements and forced convection. Control panel to include on/off switch, panel indicator light, and automatic timer for hold and cook modes. Cabinet size: 26 x 12 x 15. Supply with 4-foot cord and plug. Electrical requirements: 120/60/1, 14.5 amps.

No. 29 - Trash Receptacle: Commercial. Government furnished and Government installed.

No. 30 - Work Table: NES KT-30-0. Construct top of 14-gauge stainless steel with square channel edge and corners. Coat underside of top with sound-deadening material, and reinforce with 1-1/2 x 1-1/2 x 1/8 steel angle frame. Top to have integral 6-inch-high backsplash with 1-1/4 inch returns to wall at 45 degree angle with enclosed ends. Legs: 1-5/8 in. od x 16-gauge stainless steel with 5-inch swivel casters of hard rubber or polyurethane. Bolt legs to sanitary gussets welded to frame. Cross bracing welded to legs. Rear bracing bolted to legs using a bracket welded to legs. Top of bracing approximately 7-5/8 inches off floor. Front open. Width to match adjacent units. Size: 72 x 32 x 36 inches high.

No. 31 - Microwave Oven: NES KO-62-0. Mar resistant steel case, stainless steel interior and door, coved corners; 900-1100 watt, power output; 12-17-inch wide cavity, 1,200-1,500 cubic inch cooking capacity. Solid state microcomputer controls, six touch selectors and variable time control. Electrical requirements: 120/60/1, 2.4 kw. Case size: 22 x 23 x 19. Provide with power cord and plug. Oven to be approved by the FCC. Interlocking safety switches. Guarantee magnetron unit for a minimum of 3 years. Dedicated receptacle circuit for oven required.

No. 32 - Sandwich Make Table: Self-contained refrigeration table. Size: 84 x 32 x 52, 36 to top of counter. Electrical requirements: 120/60/1, 1/3 hp compressor motor, (12 amp). Top one-piece 16-gauge stainless steel, with nosing on front. Rear 6-inch - high by 16-inch-deep elevated area provided with die stamped raised rim openings to fit 2000 series pans with 18-gauge s/s removable covers. Rail area interior: 22-gauge S/S. Cabinet interior: 22-gauge S/S back and bottom. Interior ends and door frames ABS pastic. Base insulated with a minimum of 2 inches of polyurethane foamed in place. Doors to have ABS liner and 22-gauge S/S fronts. One wire shelf each section. Blower coil to refrigerate base and rail areas. Coil housing to enclose refrigeration lines, evaporator coil, expansion valve, and fans. Unit to maintain 38 degrees to 42 degrees F in base area. Compressor to be installed in a housing with louvered front. Exterior back and bottom of base constructed of 18 gauge aluminum. Exterior ends: S/S. Place on 5-inch diameter hard rubber casters (2 locking). Provide cord and plug. Furnish with automatic condensate evaporator.

MIL-HDBK-1036/4

APPENDIX A (continued)

No. 33 - Packaging Shelf: Single shelf, 14 inches deep, 4-gauge stainless steel, mounted on 1 inch square S/S tubular legs fastened to work table Shelf edge: 1-1/4 inch downturned channel shape. Size: 5-6 x 1-2 x 1-8 above counter top. On top of shelf, place paper holder compartments. Compartments made of 16-gauge S/S, measuring 9-1/4 in. wide by 12 in. deep and 6 in. deep.

No. 34 - Enclosed Dry Storage Cabinet: Size: 8 x 27 x 36. Top one piece 16-gauge stainless steel with nosing on front and raised nonrefrigerated syrup rail on rear. Exterior back, bottom and ends heavy gauge steel reinforced and painted with gray enamel. Door hinged, front laminated plastic bound all sides with S/S capping, S/S handle. Condiment rail has two 2-1/2 quart S/S jars with plexiglass hinged covers. Place on sanitary adjustable legs. Bottom pan and shelf backs turned up to enclose back of cabinet. Reinforce cabinet base with steel channels. This cabinet exterior must match soft serve topping bar refrigerated base. This item is optional if space allows its use.

No. 35 - Steamer: Front opening, stainless steel cabinet and drawer; handle for steam shots. Size: 12 x 16 x 12. Electrical requirements: 120/60/1, 1500 watts, 12.5 amps. Furnish 6-foot, 20 amp, 3-wire cord. Provide demineralizer kit in water supply line to steamer.

No. 36 - Bun Toaster: NES KT-800 Cabinet leg mounted, cabinet made of heavy gauge stainless steel. Cabinet size: 25 x 20 x 20. Electrical requirements: 208/60/1. Conveyor self-adjusting to accommodate Kaiser rolls, burger buns, Texas toast, bagels, bread. Capacity up to 1,600 pieces per hour. Provide with bun chute. Line cord, 3-prong plug, 20 amp rated.

No. 37 - Trash Receptacle: Commercial. Government furnished and Government installed.

No. 38 - Hood: Island types conform to NFPA 96 and UL 70. Provide over broilers located remote from wall.

No. 39 - Double module tube broiler, belt conveyors, electric, capacity per module 400 hamburgers per hour.

a) Assembly Structure: Base composed of 14 gauge hot rolled steel with baked on black enamel finish. Tubes composed of 18 gauge stainless steel wire mesh. Searing belt 7 gauge stainless steel wire mesh. Flame adjuster inserts are 1-1/2, 2, and 2-1/2 in. in diameter and composed of 16-gauge hot rolled steel. Grease pan 24 gauge stainless steel. Catch/drip pans 20-gauge stainless steel.

b) Dimensions: Outer dimensions are 34-1/2 in. high by 100-3/4 in. long by 16-1/4 in. wide. Belt dimensions are 5 in. wide for the infeed belt and 6 in. wide for the searing belt. The infeed belt 14-3/4 in. above the counter.

MIL-HDBK-1036/4

APPENDIX A (continued)

c) Conveying System: Includes 36 in. infeed conveyor and inner searing belt. Belts driven by permanently lubricated, sealed-gear motor. Cooktime speed adjustable from 30 seconds to 7 minutes.

d) Heating: Unit utilizes infrared emitters; placed one above and two below the searing belt to surround it for 24 in. in length. Flame adjuster insert sits directly under the belt for the length of broiling. Temperature sensed with thermocouple probes and adjustable from 600 degrees to 1,200 degrees Fahrenheit.

e) Control Panel: Panel is modular and sits under the tube in the base structure. Controls are located in front of the panel and include separate top and bottom temperature regulating controls, digital cooktime control, self-clean switch, on/off conveyor switch, and on/off circuit breaker.

f) Electrical requirements: 208V, 1 phase, 60 Hz, 23 amp, 4.7 kW for each unit. After the warm-up period, the units cycle the heat emitters on and off for temperature regulating, reducing kW draw to an average of 50 percent of rated input. Place electrical connections at rear of control panel, and include a 6-foot type SO, No. 10/3 AWG, power supply cord with 30-amp, 1-phase plug.

No. 40 - Chest Freezer: Mobile self-contained unit, 4.8 cubic feet, 36 x 24 x 31, compressor 1/5 HP, 120/60/1, temperature range sub-zero to 50 degrees F.

No. 41 - Broiler Stand: Custom design, tee shaped. Construct top of 14 gauge stainless steel with sanitary rolled edges and bullnose corners. Coat underside of top with sound deadening material and reinforce with 1-1/2 x 1-1/2 x 1/8 inch steel angle frame. Legs 1-5/8 inch od x 16-gauge stainless steel with 5-inch hard rubber casters. (Half with brakes). Bolt legs to sanitary gussets welded to frame. Construct under shelf of 16-gauge S/S with rolled channel edges with notched corners at legs. Secure under shelf to leg with plated gusset bolts. Shelf 10 inches above floor. Size 132 x 654 x 48 x 36 inches high.

No. 42 - Overshelf: Table mounted 14-gauge stainless steel single shelf unit mounted on 1-inch diameter S/S tubular legs. Shelf edges 1-1/4 inch downturned channel shape. Tubing legs have concealed flange for mounting. Size: 43 x 24 x 30 inches high.

No. 43 - Condiment Pans: Included in Item No. 44.

No. 44 - Refrigerated Work Table: Self-contained refrigeration table. Size: 66 x 32 x 42, 36 to top of counter. Electrical requirements 115/60/1, 1/3 hp compressor motor, (11 amps). Top one piece 16-gauge stainless steel, with nosing on front. Rear 6 inches high by 16 inches deep elevated area provided

MIL-HDBK-1036/4

APPENDIX A (continued)

with die stamped raise rim openings to fit 2000 series pans with 18-gauge S/S removable covers. Rail area interior 22-gauge S/S. Cabinet interior 22-gauge S/S back and bottom. Interior ends and door frames ABS plastic. Base insulated with a minimum of 2 inches of polyurethane foamed in place. Doors to have ABS liner and 22-gauge S/S fronts. One wire shelf each section. Blower coil to refrigerate base and rail areas. Coil housing to enclose refrigeration lines, evaporator coil, expansion valve, and fans. Unit to maintain 38 to 42 degrees F. in base area. Compressor to be installed in a housing with louvered front. Exterior back and bottom of base constructed of 18 gauge aluminum. Exterior ends S/S. Place on 5-inch diameter hard rubber casters (2 locking). Provide cord and plug. Furnish with automatic condensate evaporator.

No. 45 - Compressor: Included in Item No. 44.

No. 46 - Spreader Cabinet: Stainless steel door and cabinet. Cabinet size 16 x 30 x 45, 36 to top of counter, on casters. Backsplash arranged for food warmer accessory. Provide with French Fry Bag Holder, 12 in. x 24 in., welded S/S construction.

No. 47 - Food Warmer/Dump Station: Infrared heat tube placed in a stainless steel shell with indicator light and on/off switch. Tube to heat full width of 12 x 20 cafeteria pan. Electrical requirements: 120/60/1, 680 watts. Unit mounted on backsplash of cabinets. Dump station: 12 x 20 x 2-1/2 cafeteria pan with removable perforated screen. Pan to fit into countertop cut out where specified.

No. 48 - Fryers: NES KF-88-0. Shortening capacity 40-50 pounds. Stainless steel fry pot, door, and cabinet. Swing-up 22 KW electric self-cleaning elements with controlled burn off, two timer operated auto-basket lifts, and shortening melt cycle controls. Cabinet size: 16 x 31 x 45, 36 to top of counter, on casters. Electrical requirements: 208/60/3, 22 KW, solid state controls. Battered with a filter system placed in base of adjacent cabinet.

No. 49 - Filter Unit Cabinet: Stainless steel door and cabinet. Cabinet size: 16 x 31 x 45, 36 to top of counter. Top cut out for 12 x 20 x 2-1/2 inch cafeteria pan. Unit to have capacity to serve four fryers with built-in filtering system with automatic washdown and instant change filter. Provide with caster-mounted drain drawer for holding filters and filter media. Cabinet provided with casters. Backsplash arranged for food warmer accessory. Electrical requirements 120/60/1.

No. 50 - Roll Warmer: Refer to Item No. 27 for requirements.

No. 51 - Chicken Dump Station with Heat Lamp: Heating lamp housing made of stainless steel, furnished with infrared heating elements. Housing attached

MIL-HDBK-1036/4

APPENDIX A (continued)

to two vertical tubular legs with feet. Size 12-1/2 x 25 x 16 inches. Space between legs accommodate one 12 x 20 inch pan. Furnish with cord and plug. Electrical requirements: 120/60/1, 500 watts, 4.4 amps. Provide pan and infinite heat control.

No. 52 - Trash Receptacle: Commercial. Government furnished and Government installed.

No. 53 - Reach In Freezer: NES KF-66-0. Cabinet grille, front, door, ends and complete inner liner of polished stainless steel. Foamed in place polyurethane insulation. Full-sized door with cylinder lock, magnetic gasket, safety grip handle. Capacity 21.5 cubic feet, one section, size 27 x 36 x 84. Self-contained refrigeration system mounted on top of cabinet, concealed behind grille. Fans and cooling coil contained in an insulated housing separate from product zone. Nonelectric condensate evaporator. Electrical characteristics: 1/3 hp condensing unit, voltage 120/60/1, total amps 7.8. Provide with three adjustable stainless steel wire shelves, 5 in. diameter heavy duty swivel casters with brakes, automatic interior lighting, and indicator panel. Cabinet top, back and bottom heavy gauge aluminized steel.

No. 54 - Grease Drain for Hoods.

No. 55 - Fire Suppression Pull Station.

No. 56 - Wall Shelf: Refer to Item No. 13 for description.

No. 57 - Hood: Wall mounted, free standing type. Provide over fryers located along a wall.

No. 58 - Wall Shelf: Refer to Item No. 13 for description.

No. 59 - Coffee Maker: Five station automatic brewer, stainless steel construction. Pushbutton controls with indicator lights, quick boil element, thermostat for temperature control and high limit controls to turn off heater if machine runs dry or overheats. Electrical requirements: 120/60/1, 4500 watts, 20 amp. Size: 24 x 15 x 20. Provide 5 glass decanters. Extension cord for portable use. Hot water tap. Provide with 1/4 in. copper tubing compression fitting and water strainer.

No. 60 - Coffee Warmers: NES KW-80-0, stainless steel base, two warming elements, 120/60/1, 200 watts. Size approximately 8 x 7. Pushbutton controls with indicator lights. Extension cord for portable use. Government furnished and installed.

No. 61 - Hot Cup Dispenser: Cup, condiment, lid combination separated into two units for multiple uses. Three-tube dispenser units measure 18 x 24 x 8. Lid tray unit measures 16 x 16. Stainless steel cup dispensers adjustable to

MIL-HDBK-1036/4

APPENDIX A (continued)

accommodate 6 oz. through 24 oz. foam cups. Cabinets tempered aluminum with baked enamel finish. Dispenser unit to have a 6-compartment tray for condiments. Lid tray unit to have six compartments for lids and spoons.

No. 62 - Syrup Tank Stand: Heavy duty 12-gauge cold rolled stainless steel tube frame. Removable stainless steel shelf with stainless steel adjustable bullet feet. Storage capacity 12 tanks.

No. 63 - Drawer Base Beverage Stand: Top one piece 1-gauge stainless steel with front nosing and 6 inch high backsplash. Provide with one 22-gauge S/S shelf with turn up at rear. Dry storage drawer placed below shelf. Drawer liner of ABS plastic with drawer slides of 16-gauge galvanized steel with S/S bearings. Fronts of 22-gauge die stamped S/S. Completely enclose drawer in housing of 20-gauge steel painted gray enamel. Unit exterior ends S/S. Top, shelf, and bottom reinforced with channel shaped members. Unit set on 8 inch high sanitary adjustable legs. Provide 4-inch-wide drain in top across front of cabinet, stopping 3-1/2 inches from each end. Pitch top 1/4 inch to trough. Trough has 3/4-inch drain connection. Size: 36 x 32 x 42, 36 inches to top of counter.

No. 64 - Spreader Cabinet: Stainless steel door and cabinet. Cabinet size: 16 x 31 x 42, 36 inches to top of counter, on casters. Counter cut out for 12 x 20 x 2-1/2 inch cafeteria pan. Backsplash arranged for food warmer accessory.

No. 65 - Work Table: NFS KT-30-0. Construct top of 14-gauge stainless steel with square channel edge and corners. Coat underside of top with sound-deadening material and reinforce with 1-1/2 x 2 x 1-1/2 x 1/8 steel angle frame. Top to have integral 6-ch-high backsplash with 1-1/4 inch returns to wall at 45 degree angle with enclosed ends. Legs 1-5/8 in. od x 16-gauge stainless steel with 5-inch swivel casters of hard rubber or polyurethane. Bolt legs to sanitary gussets welded to frame. Cross bracing welded to legs. Rear bracing bolted to legs using a bracket welded to legs. Top of bracing approximately 7-5/8 inches off floor. Front open. Size approximately 60 x 30 x 36.

No. 66 - Hinged Door Utility Cabinet: Top, one-piece 16-gauge stainless steel with front nosing and 6-inch-high backsplash. Provide with stainless steel bottom shelf with rear turn up. Door constructed with 22-gauge S/S front panel and back panel. End panels 22-gauge S/S, pan type construction. Exterior ends steel painted gray enamel. Top and bottom reinforced with channel shaped members. Unit set on 8-inch-high sanitary adjustable legs. Top cut out for premix dispenser with ice chest. Size: 30 x 32 x 42, 36 inches to top of counter.

MIL-HDBK-1036/4

APPENDIX A (continued)

No. 67 - Open Shelf Utility Cabinet: Top, one-piece 16-gauge stainless steel with front nosing and 6-inch-high backsplash. Provide with 22-gauge S/S shelves with turn up at rear. Interior unit ends 22-gauge S/S, pan type construction. Size: 42 x 32 x 42, 36 inches to top of counter. Exterior unit ends steel painted gray enamel. Top, shelf, and bottom reinforced with channel shaped members. Unit set on 8-inch-high sanitary adjustable legs.

MIL-HDBK-1036/4

APPENDIX B
Equipment Schedule for Enlisted Personnel Food Serving Areas

Disclaimer: Manufacturer's names and/or catalogue numbers are used to provide an indication of equipment desired. Other manufacturer's equipment of equal quality and performance are acceptable.

ITEM AND DESCRIPTION	QUANTITY									
	40/ 80	81/ 150	151/ 250	251/ 400	401/ 650	651/ 1000	1001/ 1500	1501/ 2200		
REGULAR/FAST FOOD LINE										
1. Dispenser, tray, self-leveling, MIL-D-40631, type III, design B, size 3, model A, w/8-hole silver dispenser	2	2	3	4	0	0	0	0	0	0
2. Dispenser, tray, self-leveling, MIL-D-40631, type VI, design B, model A	0	0	0	0	6	10	14	21		
3. Dispenser, tableware, plates/bowls, MIL-D-40631, type III, style A, size to be determined, model A	2	3	4	5	8	10	14	20		
4. Counter front w/tray slide (plumbing/electrical raceway)	1/0	1/0	1/0	1/0	2/1	1/1	2/1	2/1		
*5. Table, food preparation, MIL-T-2256, type II, class 1, size 4, style 2	1/0	1/0	0	0	0	0	0	0		
*6. Table, food preparation, MIL-T-2256, type II, class 1, size 1, style 2	0	1/0	2/0	2/0	2/0	2/0	2/0	4/0		
*7. Table, food preparation, MIL-T-2256, type II, class 1, size 5, style 2	0	0	0	0	0/1	0/1	0/1	0/1		
*8. Table, bagging, MIL-T-2256, type III, w/overshelf w/heat lamp and cut-out for bagging well.	0	0	0	0	0/1	0/1	0/1	0/1		
*9. Table, wrapping, MIL-T-2256, type III, w/overshelf w/heat lamp. Size 1, class 1, grade A, style 1	0	0	0	0	0/1	0/1	0/1	0/1		
*10. Table w/single sink, size to fit arrangement	0	0	0	0	0/1	0/1	0/1	0/1		
11. Dispenser, butter, eutectic, MIL-D-43953	1	1	1	1	1	1	1	2		
12. Toaster, pop-up, W-T-550, 4-slice	1	2	0	0	0	0	0	0		
13. Toaster, rotary, S-T-540, 720 sl./hr.	0	0	1	1	2	2	2	4		
14. Griddle, MIL-G-2338, 3'-0" long	1	0	0	0	1/0	1/0	1/0	2/0		
15. Griddle, MIL-G-2338, 6'-0" long	0	1	1	1	1/1	1/1	1/1	2/1		
16. Hood, ventilation, filterless, pass-over type	3.5/LF	6.5/LF	6.5/LF	6.5/LF	9.5/LF	9.5/LF	9.5/LF	(2)9.5/LF		
17. Table, hot food, MIL-T-82049, type B, size 4	1	0	0	0	0/1	0/1	0/1	0/1		
18. Table, hot food, MIL-T-82049, type B, size 5	0	1	1	1	0	0	0	0		

MIL-HDBK-1036/4

APPENDIX B (continued)

ITEM AND DESCRIPTION	QUANTITY									
	40/ 80	81/ 150	151/ 250	251/ 400	401/ 650	651/ 1000	1001/ 1500	1501/ 2200		
REGULAR/FAST FOOD LINE (continued)										
19. Table, hot food, MIL-T-82049, type B, size 6	0	0	0	0	0	1/0	1/0	2/0		
20. Counter cold food, MIL-C-43300, type I, class 2, model A, size 5, style D, w/o tray rail, w/o display shelf over	1	1	1	1	1/1	1/1	1/1	2/1		
21. Counter cold food, MIL-C-43300, type I, class 2, model A, size 6, style D, w/o tray slide, w/o tray rail w/o display shelf	0	0	0	0	0/1	0/1	0/1	0/1		
22. Table, pastry/dessert MIL-T-2256, type I, size 4'-0" long model 1, form 1, style 2	1	1	1	1	0	0	0	0		
23. Table, pastry/dessert MIL-T-2256,, type I, size 1, model 1, form 1, style 2	0	0	0	1	1/0	1/0	1/0	2/0		
24. Table, toaster, MIL-T-2256, type II, size 4, class 1, style 2	1	1	0	0	0	0	0	0		
25. Table, toaster, MIL-T-2256, type II, size 2, class 1, style 2	0	0	1	1	1/0	1/0	1/0	2/0		
26. Dispenser, bread, Serv-a-Slice, size 3 size 1, model 1, form 1, style 2	1	1	0	0	0	0	0	0		
27. Dispenser, bread, Serv-a-Slice, size 5	0	0	1	1	1/0	1/0	1/0	2/0		
28. Char broiler w/mobile stand	1	2	2	2	2/0	2/0	2/0	4/0		
29. Sink, handwashing	1	1	1	1	1/1	1/1	1/1	2/1		
30. Cabinet, mobile, combination hot/cold	1	1	0	0	0	0	0	0		
31. Cabinet, hot food, MIL-C-43427, type II, class (to be determined), style D, model B	0	0	0	0	1/0	2/0	3/0	6/0		
32. Cabinet, cold food, roll-thru, built-in MIL-C-43427, type I, class (to be determined), inclosure I, duty B, style D, model B	0	0	1	1	1/0	2/0	3/0	6/0		
33. Fryer, deep fat, Fed. Spec. S-F-695, type II, size 5	0	0	0	0	0/2	0/2	0/2	0/2		
34. Hood, ventilation, filterless (fast food griddle/fryer)	0	0	0	0	/A/R	/A/R	/A/R	/A/R		
35. Oven, microwave, S-O-1425, 12" x 20" pan capacity	0	0	0	0	/1	/1	/1	/2		
36. Rack, mobile, MIL-R-43397, 18" x 26" pan capacity	0	0	0	0	0/1	0/1	0/1	0/1		
37. Refrigerator, AA-R-200, R/In, 70 cu. ft.	0	0	0	0	0	0/1	0/1	0/1		
38. Refrigerator, AA-R-200, R/In, 50 cu. ft.	0	0	0	0	0/1	0	0	0		
39. Freezer/dispenser, milk shake, MIL-I-43705	0	0	0	0	0/1	0/1	0/1	0/1		

MIL-HDBK-1036/4

APPENDIX B (continued)

ITEM AND DESCRIPTION	QUANTITY									
	40/ 80	81/ 150	151/ 250	251/ 400	401/ 650	651/ 1000	1001/ 1500	1501/ 2200		

REGULAR/FAST FOOD LINE (continued)

40. Freezer, storage, milk shake, 24 cu. ft.	0	0	0	0	0/1	0/1	0/1	0/1
41. Potato shaper, French fry, MIL-S-43589	0	0	0	0	0/1	0/1	0/1	0/2

Note: A/R - as required

*Table size and quantities listed meet optimum requirements, actual size and quantity combinations may vary from those listed, provided comparable functional characteristics are maintained.

DISHWASHING AREA

1. Dishwashing machine, Fed. Spec. 00-D-1390B, type II, size 50-20	1	0	0	0	0	0	0	0
2. Dishwashing machine, Fed. Spec. 00-D-1390B, type IV, size 60-20	0	1	0	0	0	0	0	0
3. Dishwashing machine, Fed. Spec. 00-D-1390B, type IV, size 115-20	0	0	1	0	0	0	0	0
5. Dishwashing machine, merry-go-round, 250 racks/hr.	0	0	0	0	1	0	0	0
6. Dishwashing machine, merry-go-round, 360 racks/hr.	0	0	0	0	0	1	0	0
7. Dishwashing machine, Fed. Spec. 00-D-1388, rackless conveyor, type III, size 13,000	0	0	0	0	0	0	1	0
8. Dishwashing machine, Fed. Spec. 00-D-1388, rackless conveyor, type III, size 18,000	0	0	0	0	0	0	0	1
9. Table, utensil wash w/three comp. sink	1	1	0	0	0	0	0	0
10. Table, soiled dish w/pre-rinse unit, two 24" x 24"	0	0	1	1	0	0	0	0
11. Table, clean dish, size and shape dictated by arrangement	1	1	1	1	0	0	0	0
12. Discharge conveyor, gravity	0	0	1	1	0	0	0	0
13. Heater, sink, MIL-H-43895	1	1	0	0	0	0	0	0
14. Disposal, garbage	0	0	0	0	1	1	1	1
15. Shelf, racking, inclined	1	1	1	1	0	0	0	0
16. Pre-rinse unit	0	0	0	0	2	2	3	3
17. Sink, service	1	1	1	1	1	1	1	1

MIL-HDBK-1036/4

APPENDIX B (continued)

ITEM AND DESCRIPTION	QUANTITY									
	40/ 80	81/ 150	151/ 250	251/ 400	401/ 650	651/ 1000	1001/ 1500	1501/ 2200		
DISHWASHING AREA (Continued)										
18. Cabinet, wall mounted	1	1	1	1	1	1	1	1	1	1
19. Dolly, MIL-D-43442, 20" x 20" rack	1	2	3	4	6	8	10	12		
20. Cleaner, jet spray	1	1	1	1	1	1	1	1	1	1
21. Soiled gear scrapping assembly	0	0	0	0	0	0	1	1	1	1
22. Soiled gear conveyor and scrapping trough, MIL-C-23565, type I, class 2, model B	0	0	0	0	1	1	0	0	0	0
23. Sink, handwashing	0	0	1	1	1	1	1	1	1	1
24. Sink, silver soak, mobile	0	0	0	0	1	1	2	2	2	2
25. Table, silver sort, mobile	0	0	0	0	1	1	0	0	0	0
26. Table, soiled dish w/pre-rinse sink (24" x 24" x 10"), pre-rinse unit, garbage disposal, and grate over	1	1	0	0	0	0	0	0	0	0
BEVERAGE/SALAD SELF SERVICE										
1. Dispensers, self-leveling cup/glass, MIL-D-40631, type II, design B, size 4, model A	2	3	0	0	0	0	0	0	0	0
2. Dispensers, self-leveling cup/glass, MIL-D-40631, type II, size 2, model A	0	0	5	6	10	12	20	28		
3. Ice maker/dispenser, MIL-D-43682, type I, grade A, size 1, style (to be determined), w/90 lb. storage capacity	0	1	1	1	2	3	3	4		
4. Ice Maker/dispenser w/bev. dispenser heads	1	0	0	0	0	0	0	0	0	0
5. Stand (s), beverage	A/R	A/R	A/R	A/R	A/R	A/R	A/R	A/R	A/R	A/R
6. Dispenser, non-carb, beverage, MIL-D-82035, type II, style A, size 4, single bowl	1	0	0	0	0	0	0	0	0	0
7. Dispenser, non-carb, beverage, MIL-D-82035, type II, style B, size 11, twin bowl	0	1	1	1	2	3	3	4		
8. Dispenser, carb. beverage, MIL-D-43738, type II, size 2, class 4, style A, service 1	0	1	1	1	2	3	3	4		
9. Dispenser, bulk milk, OO-D-4050, type I, style A, size, 2-5	1	1	0	0	0	0	0	0	0	0
10. Dispenser, bulk milk, OO-D-4050, type I, style A, size 3-5	0	0	1	1	2	3	3	4		

MIL-HDBK-1036/4

APPENDIX B (continued)

ITEM AND DESCRIPTION	QUANTITY									
	40/ 80	81/ 150	151/ 250	251/ 400	401/ 650	401/ 650	651/ 1000	1001/ 1500	1501/ 2200	
BEVERAGE/SALAD SELF SERVICE (Continued)										
11. Coffee maker, W-C-500, type I, class 1, style B, model S	1	1	1	0	0	0	0	0	0	0
12. Urn, coffee, MIL-V-43263, style 2, type I, size 1	0	0	0	1	1 or 2	1 or 2	1 or 2	1 or 2	2 or 3	(depends on arrangement)
13. Cabinet, ice cream, MIL-I-43385, size 1	1	1	0	0	0	0	0	0	0	0
14. Cabinet, ice cream, MIL-I-43385, size 2	0	0	1	1	2	3	3	3	4	4
15. Dispenser, MIL-I-43705, type I, style C, class 1, size 3, soft ice cream	0	0	1	1	2	3	3	3	4	4
16. Dispensers, MIL-D-43845, iced tea	0	1	1	1	2	3	3	3	4	4
17. Counter, cold food, MIL-C-43300, type (to be determined), class 1, model A, size 3, style D	1	0	0	0	0	0	0	0	0	0
18. Counter, cold food, MIL-C-43300, type (to be determined), class 1, model A, size 4, style D	0	1	1	0	0	0	0	0	0	0
19. Counter, cold food, MIL-C-43300, type (to be determined), class 1, model A, size 6, style d	0	0	0	1	1 or 2	1 or 2	1 or 2	1 or 2	2 or 3	(depends on arrangement)
20. Dispenser, self-leveling, MIL-D-40631, type VI, design B, size 7, style (to be determined, model A, salad plate)	1	1	2	2	4	4	4	4	6	6
21. Dispenser, silverware, MIL-D-23828, type II, size 16, cylinder console	0	0	0	0	4	4	4	4	6	8
22. Stand, cashier	1	1	2	2	3	3	3	4	5	5

MIL-HDBK-1036/4

APPENDIX C
Equipment Schedule for Enlisted Personnel Food Preparation Areas

ITEM AND DESCRIPTION	QUANTITY									
	40/ 80	81/ 150	151/ 250	251/ 400	401/ 650	651/ 1000	1001/ 1500	1501/ 2200		
KITCHEN										
1. Oven, convection, MIL-0-43633, type II, model B, size 1	0	1	2	2	3	4	6	8		
2. Hood, ventilation, filterless (oven)	0	A/R	A/R	A/R	A/R	A/R	A/R	A/R		
3. Pan, fry, tilting, MIL-P-23694, class B, style B,	0	0	1	1	2	2	3	4		
4. Range, combination griddle, hot plate MIL-R-43954, type II, grade B, style 1	1	0	0	0	0	0	0	0		
5. Range, hot plate MIL-R-43954, type III, grade B, style 1	1	0	0	0	0	0	0	0		
6. Hood, ventilation, filterless fry pan)	0	0	A/R	A/R	A/R	A/R	A/R	A/R		
7. Hood, ventilation, filterless range)	A/R	0	0	0	0	0	0	0		
8. Fryer, deep fat, Fed. Spec. S-F-695, type I, size 2	1	0	0	0	0	0	0	0		
9. Fryer, deep fat, Fed. Spec. S-F-695, type II, size 5	0	1	2	2	4	4	4	6		
10. Hood, ventilation, filterless fryer	A/R	A/R	A/R	A/R	A/R	A/R	A/R	A/R		
11. Cooker, steam, S-C-I 474	0	1	1	2	2	3	4	4		
12. Kettle, steam jacketed, RR-K-195, type I, style (to be determined), class B, size 5,	0	1	0	0	0	0	0	0		
13. Kettle, steam jacketed, RR-K-195, type I, style (to be determined), class B, size 10,	0	2	2	0	0	0	0	0		
14. Kettle, steam jacketed, RR-K-195, type I, style (to be determined), class B, size 20	0	0	1	1	0	0	0	0		
15. Kettle, steam jacketed, RR-K-195, type I, style (to be determined), class B, size 30	0	0	0	2	2	1	0	0		
16. Kettle, steam jacketed, RR-K-195, type I, style (to be determined), class B, size 40	0	0	0	1	1	1	2	3		
17. Kettle, steam jacketed, RR-K-195, type I, style (to be determined), class B, size 60	0	0	0	0	1	1	2	1		
18. Kettle, steam jacketed, RR-K-195, type I, style (to be determined), class B, size 80	0	0	0	0	0	1	1	2		
19. Hood, ventilation, filterless (steam equal)	0	A/R	A/R	A/R	A/R	A/R	A/R	A/R		
20. Table, steam jacketed kettle, RR-T-25	0	A/R	A/R	0	0	0	0	0		
21. Mixing machine, food, OO-M-38, model I, style 1, size 12 qt.	1	0	1	1	0	0	0	0		
22. Mixing machine, food, OO-M-38, model II, style 1, size 20 qt.	0	0	0	0	1	0	0	0		

MIL-HDBK-1036/4

APPENDIX C (Continued)

ITEM AND DESCRIPTION	QUANTITY									
	40/ 80	81/ 150	151/ 250	251/ 400	401/ 650	651/ 1000	1001/ 1500	1501/ 2200		
KITCHEN (Continued)										
23. Mixing machine, food, OO-M-38, model II, style 1, size 30 qt.	0	1	0	0	0	0	0	0	0	0
24. Mixing machine, food, OO-M-38, model II, style 1, size 60 qt.	0	0	1	1	1	1	1	0	0	0
25. Mixing machine, food, OO-M-38, model II, style 1, size 80 qt.	0	0	0	0	0	0	0	1	0	1
26. Sink, handwashing	1	1	1	1	1	2	2	2	2	2
27. Bin, ingredient, mobile, MIL-B-43386, size 2	0	2	2	3	3	3	3	4	4	4
28. Scale, dial & beam, bench	0	1	1	1	1	0	0	0	0	0
29. Scale, portion, over/under	1	1	1	1	1	1	1	1	1	1
30. Refrigerator, R/in, AA-R-200, 50 cu. ft.	1	1	1	1	0	0	0	0	0	0
31. Refrigerator, R/in, AA-R-200, 70 cu. ft.	1	1	0	0	0	0	0	0	0	0
32. Freezer, R/in, MIL-R-21098, 50 cu. ft.	1	0	0	0	0	0	0	0	0	0
33. Oven, microwave, S-O-1425, 12" x 20" pan capacity	1	1	1	1	1	1	1	2	2	2
34. Tenderizer, meat, MIL-T-17312	0	1	1	1	1	0	0	0	0	0
35. Cabinet, dough proofing, W-C-20, mobile	0	1	1	2	2	0	0	0	0	0
36. Slicer, meat, OO-M-280	1	1	1	1	2	2	3	3	3	3
37. Rack, knife, table mount, MIL-R-40607, style I, size 2	1	1	1	1	2	2	3	3	3	3
38. Peeler, vegetable, OO-V-185, style I, size A, 15 lb capacity	0	1	0	0	0	0	0	0	0	0
39. Processor, food, Valmont or equal	1	1	0	0	0	0	0	0	0	0
40. Filter, fat, MIL-F-2296, type II, size 1	0	1	1	1	2	2	2	2	2	2
41. Cabinet, wall mounted	1	2	0	0	0	0	0	0	0	0
42. Rack, utensil storage	2	3	0	0	0	0	0	0	0	0
43. Bubbler, water	1	1	1	1	1	2	2	2	2	2
*44. Table, food preparation w/single comp. sink, approx. 6'-0" long	1	1	1	1	2	2	2	2	2	2
*45. Table, food preparation w/single comp. sink, approx. 8'-0" long	1	0	0	0	0	0	0	0	0	0
*46. Table, food preparation w/two comp. sink, approx. 8'-0" long	0	1	0	0	0	0	0	0	0	0
*47. Table, food preparation, MIL-T-2256, type III, size 1, class 2, grade A, style 1, specify drawers as required	3	0	1	3	3	1	1	4	4	4

MIL-HDBK-1036/4

APPENDIX C (Continued)

ITEM AND DESCRIPTION	QUANTITY									
	40/ 80	81/ 150	151/ 250	251/ 400	401/ 650	651/ 1000	1001/ 1500	1501/ 2200		
KITCHEN (Continued)										
*48. Table, food preparation, MIL-T-2256, type III, size 2, class 1, grade A, style 1, specify drawers as required	0	2	2	1	2	3	3	4		
*49. Table, food preparation, MIL-T-2256, type III, size 4, class 2, grade A, style 1	0	1	2	2	0	2	0	0		
*50. Table, food preparation, MIL-T-2256, type III, size 3, class 1, grade A, style 1	0	0	0	0	2	1	1	1		
51. Donut fryer, OO-D-582, type I, size 40, 42 dz./hr. w/roto cooler	0	0	1	1	1	0	0	0		
52. Holder, roll paper	1	1	0	0	0	0	0	0		
53. Heater, sink, MIL-H-43895	0	1	0	0	0	0	0	0		
54. Disposal, garbage	0	1	0	0	0	0	0	0		
55. Cleaner, jet spray	0	1	0	0	0	0	0	0		
56. Holder, roll paper	1	1	0	0	0	0	0	0		

*Table size and quantities listed meet optimum requirements, actual sizes and quantities may vary from those listed, provided comparable functional characteristics are maintained.

VEGETABLE PREPARATION

1. Peeler, vegetable, OO-V-185, style 2, size B 30 lb capacity	0	0	1	1	1	1	1	1		
2. Cutter, food, MIL-F-43402, type I, size 2, style 2, grade A	0	0	0	0	0	1	1	1		
3. Processor, food, Valmont or equal	0	0	1	1	1	1	2	2		
4. Container, food, MIL-F-43392, item 1, size 1, grade A item 4	0	0	3	4	4	6	6	10		
5. Dolly, food container, MIL-F-43392, item 2, size 1	0	0	2	2	2	3	3	5		
*6. Table, food preparation w/two comp. sink. Peeler discharge into first sink. Length as req'd by equipment arrangement	0	0	1	1	1	1	1	1		
*7. Table, food preparation, MIL-T-2256, type IV, size 3, style 1, grade A, class 2	0	0	1	1	1	0	0	4		

MIL-HDBK-1036/4

APPENDIX C (Continued)

ITEM AND DESCRIPTION	QUANTITY									
	40/ 80	81/ 150	151/ 250	251/ 400	401/ 650	651/ 1000	1001/ 1500	1501/ 2200		
VEGETABLE PREPARATION (Continued)										
*8. Table, food preparation, MIL-T-2256, type IV, size 3, style 1, grade A, class 1	0	0	0	1	1	0	0	2		
*9. Table, food preparation, MIL-T-2256, type IV, size 8'-0" long, style 1, grade A, class 1	0	0	0	0	0	1	1	0		
*10. Table, food preparation, MIL-T-2256, type IV, size 8'-0" long, style 1, grade A, class 2	0	0	0	0	0	1	1	0		
*11. Table, food preparation, MIL-T-2256, type IV, size 5'-0" long, style 1, grade A, class 1	0	0	0	0	0	0	1	1		
12. Rack, knife, table mount, MIL-R-40607, type I, size 2	0	0	1	1	1	1	2	2		
13. Rack, dunnage	0	0	1	1	1	1	2	2		
14. Cabinet, wall-mounted	0	0	1	1	1	1	1	1		
15. Refrigerator, R/1, AA-R-200, 50 cu. ft.	0	0	1	1	1	0	0	0		
16. Refrigerator, R/1, AA-R-200, 70 cu. ft.	0	0	0	0	0	1	1	0		
17. Refrigerator, R/1, AA-R-200, 110 cu. ft.	0	0	0	0	0	0	0	1		
18. Sink, hand washing	0	0	1	1	1	1	1	1		
19. Board, cutting/chopping	0	0	1	1	2	2	3	3		
20. Holder, roll paper	0	0	1	1	1	1	1	1		

*Table size and quantities listed meet optimum requirements, actual size and quantity combinations may vary from those listed, provided comparable functional characteristics are maintained.

MEAT PREPARATION

1. Table, food preparation w/ two comp. sink. Length as required by equipment arrangement	0	0	0	0	0	1	1	1
2. Table, food preparation, MIL-T-2256, type IV, size 3, grade A, class 2	0	0	0	0	0	1	1	2
3. Table, food preparation, MIL-T-2256, type IV, size 8'-0" long, style 1, grade A, class 1	0	0	0	0	0	1	2	2
4. Molding machine, meat, MIL-M-40, type II, class 1	0	0	0	0	0	1	1	1
5. Tenderizer, meat, MIL-T-17312	0	0	0	0	0	1	2	2
6. Slicer, meat, OO-M-280	0	0	0	0	0	2	3	3
7. Saw, meat, MIL-S-40601, size 1	0	0	0	0	0	0	1	1

MIL-HDBK-1036/4

APPENDIX C (Continued)

ITEM AND DESCRIPTION	QUANTITY									
	40/ 80	81/ 150	151/ 250	251/ 400	401/ 650	651/ 1000	1001/ 1500	1501/ 2200		
MEAT PREPARATION (Continued)										
8. Container, food, MIL-F-43992, item I, size 1, grade A, item 4	0	0	0	0	0	4	4	6		
9. Dolly, food container, MIL-F-43992, item 2, size 1,	0	0	0	0	0	2	2	3		
10. Rack, knife, table mount, MIL-R-40607, type I, size 2	0	0	0	0	0	2	2	2		
11. Holder, roll paper	0	0	0	0	0	1	1	1		
12. Sink, hand washing	0	0	0	0	0	1	1	1		
13. Board, cutting/chopping	0	0	0	0	0	2	3	3		
BAKERY										
*1. Table, food preparation w/single comp. sink, length as required by equip. arrangement	0	0	0	0	0	1	1	1		
*2. Table, food preparation, MIL-T-2256, type III, size 4, class A/R, grade A, style 1	0	0	0	0	0	0	2	0		
*3. Table, food preparation, MIL-T-2256, type III, size 1, class A/R, grade A, style 1	0	0	0	0	0	2	1	0		
*4. Table, food preparation, MIL-T-2256, type III, size 2, class A/R, grade A, style 1	0	0	0	0	0	1	0	3		
*5. Table, food preparation, MIL-T-2256, baker's top, type II, grade C, style 1, size 6'-0" long	0	0	0	0	0	1	0	0		
*6. Table, food preparation, MIL-T-2256, bakers top, type II, grade C, style 1, size 8'-0" long	0	0	0	0	0	0	1	1		
*7. Table, food preparation, MIL-T-2256, type III, size 3, class 1, style 2	0	0	0	0	0	0	1	1		
8. Bin, ingredient, mobile, MIL-B-43386, size 2	0	0	0	0	0	3	3	3		
9. Mixing machine, food, OO-M-38, model II, style 1, size 60 qt.	0	0	0	0	0	1	0	0		
10. Mixing machine, food, OO-M-38, model II, style 1, size 80 qt.	0	0	0	0	0	1	0	0		
11. Mixing machine, food, OO-M-38, model II, style 1, size 140 qt.	0	0	0	0	0	0	0	1		
12. Donut machine, OO-D-582, type I, size 40, 42 doz./hr. w/roto cooler	0	0	0	0	0	1	0	0		

MIL-HDBK-1036/4

APPENDIX C (Continued)

ITEM AND DESCRIPTION	QUANTITY									
	40/ 80	81/ 150	151/ 250	251/ 400	401/ 650	651/ 1000	1001/ 1500	1501/ 2200		
BAKERY (Continued)										
13. Oven, convection, MIL-O-43633, type II, model B, size 3	0	0	0	0	0	3	4	6		
14. Proofing cabinet, dough, 36 pan capacity	0	0	0	0	0	1	0	0		
15. Proofing cabinet, dough, 48 pan capacity	0	0	0	0	0	0	1	0		
16. Proofing cabinet, dough, 72 pan capacity	0	0	0	0	0	0	0	1		
17. Refrigerator, AA-R-200, R/in, 70 cu. ft.	0	0	0	0	0	1	1	1		
18. Freezer, R/in, MIL-R-21098, 24 cu. ft.	0	0	0	0	0	1	1	1		
19. Cabinet, wall mounted	0	0	0	0	0	1	1	1		
20. Rack, mobile, MIL-R-43399, 18" x 26" pan	0	0	0	0	0	7	10	12		
21. Divider/rounder, dough, MIL-D-3886, type II, 36 pan w/mobile stand	0	0	0	0	0	1	1	1		
22. Sheeter, dough, MIL-D-2467, w/mobile stand	0	0	0	0	0	1	1	1		
23. Scale, 30 lb. capacity, ingredient	0	0	0	0	0	1	1	1		
24. Scale, portion, over/under	0	0	0	0	0	1	1	1		
25. Hood, ventilation, filterless (ovens)	0	0	0	0	0	A/R	A/R	A/R		
26. Hood, ventilation, filterless (Fryer)	0	0	0	0	0	A/R	A/R	A/R		
27. Hood, ventilation, filterless (kettle)	0	0	0	0	0	0	0	2		
28. Rack, dunnage	0	0	0	0	0	2	2	2		
29. Machine, food mixing, OO-M-38, model I, style 1, size 12 qt.	0	0	0	0	0	1	1	0		
30. Machine, food mixing, OO-M-38, model I, style 1, size 20 qt.	0	0	0	0	0	0	0	1		
31. Donut machine, OO-D-582, 200 dz./hr. w/dropper/cutter, transfer conveyor, glazer, accumulate conveyor and fat leveler	0	0	0	0	0	0	1	1		
32. Lowerator, sheet pan	0	0	0	0	0	0	1	1		
33. Filter fat, MIL-T-2296, type II, size 1	0	0	0	0	0	0	1	1		
34. Kettle, steam-jacketed, RR-K-195, type I style 8, 40 gal. capacity	0	0	0	0	0	0	0	1		
35. Board, cutting, chopping	0	0	0	0	0	2	3	3		
36. Holder, roll paper	0	0	0	0	0	1	1	1		

*Table size and quantities listed meet optimum requirements, actual size and quantity combinations may vary from those listed, provided comparable functional characteristics are maintained.

MIL-HDBK-1036/4

APPENDIX C (Continued)

ITEM AND DESCRIPTION	QUANTITY									
	40/ 80	81/ 150	151/ 250	251/ 400	401/ 650	651/ 1000	1001/ 1500	1501/ 2200		
UTENSIL WASH										
1. Rack, utensil storage, mobile	0	0	2	2	3	3	4	4		
2. Disposal, garbage	0	0	1	1	1	1	1	1		
3. Table, soiled utensil, w/3 comp. sink, size and shape to suit arrangement	0	0	1	1	1	1	1	1		
4. Heater, sink, MIL-H-43895	0	0	1	1	1	1	1	1		
5. Scrubber, utensil	0	0	1	1	1	1	1	1		
6. Table, clean utensil, size and shape to suit arrangement	0	0	1	1	1	1	1	1		
7. Washer/sanitizer, utensil	0	0	0	0	1	1	1	1		
8. Table, soiled utensil accumulation	0	0	0	1	1	1	1	1		

*See Dishwashing Area

Facility Size	Minimum Seals & Turnover Rate	Dining Area & Circulation	Public Toilets	Queue	Sign-in Station	Regular Food Line	Fast Food Line	Combina-tion Line	Beverage Line	Cashier Station	Dish-washing			
40 to 80	62 to 1.3	(87) 935 1285	(17) 180 1285	(12) 130 (119)	(4) 40	(23) 250		660	(19) 200 (61)	(3) 30	(17) 180			
81 to 150	1.08 to 1.4	(150) 1630 2120	(19) 200 2120	(23) 250 (197)	(4) 40	(30) 320		850	(21) 250 (79)	(3) 30	(23) 250			
151 to 250	1.16 to 2.2	(174) 1875 2460	(20) 220 2460	(30) 325 (229)	(4) 40			1140	(39) 420 (106)	(5) 50	(30) 320			
251 to 400	1.72 to 2.3	(279) 3000 3810	(23) 250 3810	(46) 500 (354)	(6) 60			1550	(58) 620 (144)	(5) 50	(35) 380			
401 to 650	2.88 to 2.3	(437) 4700 5830	(28) 300 5830	(70) 750 (542)	(8) 80	(56) 600 (48)		2400	(60) 650 (223)	(9) 100	(42) 450			
651 to 1000	3.45 to 2.9	(587) 6320 7750	(30) 320 7750	(93) 1000 (720)	(9) 100	(60) 650		2750	(65) 700 (255)	(14) 150	(56) 600			
1001 to 1500	4.60 to 3.3	(753) 7565 9125	(32) 340 9125	(102) 1100 (848)	(11) 120	(98) 1050		3440	(75) 810 (320)	(19) 200	(968) 730			
1501 to 2200	5.75 to 3.8	(1022) 11000 13140	(34) 370 13140	(153) 1650 (1221)	(11) 120	(121) 1300		5400	(98) 1056 (502)	(23) 250	(96) 1032			
PUBLIC AREAS														
SERVING AREAS														
<p>Note 1. For each heading in this chart the top number is the recommended area in square meters, the middle number is the same area in square feet. The lower number is the area of the functional sub-group in feet and meters.</p> <p>Note 2. Other: Includes all mechanical areas, all areas required for weather protection, such as vestibules and covered walkways, and any other justifiable functions.</p> <p>Note 3. The total area for any given project will vary with the number of special functional requirements added to the basic program.</p>														
Title			Page 1 of 3			Date			Category Code			Plate		
SPACE PROGRAM			3/30/90			722-10A			1					

Facility Size	Min. Seals & Turnover Rate	Kitchen	Vegetable Preparation	Meat Preparation	Bakery	Utensil Wash	Cooks Chill (Minimum)	Dairy Chill (Minimum)	Vegetable Chill (Minimum)	Meat Chill (Minimum)	Freezer (Minimum)	Dry Storage (Minimum)	Non-Food Storage	Carb. Beverage Storage	
40	62	(60)										(6)	(5)	(3)	
to		650										65	35	50	
80	1.3			650	(60)						150	(14)			
81	108	(74)							(6)	(6)	(7)	(11)	5	(3)	
to		800							60	60	70	120	50	35	
150	1.4			800	(74)						395	(37)			
151	116	(56)	(20)			(16)	(3)	(3)	(7)	(3)	(11)	(19)	(7)	(3)	
to		(600)	220			175	30	30	70	30	115	205	(76)	35	
250	2.2			995	(92)						555	(52)			
251	172	(79)	(24)			(20)	(5)	(5)	(10)	(5)	(17)	(30)	(8)	(5)	
to		845	255			220	50	50	110	50	180	325	(85)	50	
400	2.3			1320	(123)						900	(84)			
401	288	(93)	(28)			(31)	(6)	(6)	(16)	(6)	(27)	49	(9)	(5)	
to		1000	300			330	60	60	175	65	290	530	100	50	
650	2.3			1630	(151)						1330	(124)			
651	345	(102)	(33)	(22)	(64)	(37)	(8)	(8)	24	(11)	(42)	(75)	(12)	(5)	
to		1100	350	240	690	400	80	80	260	120	450	810	125	50	
1000	2.9			2780	(258)						1975	(183)			
1001	460	(119)	(33)	(28)	(77)	(46)	(10)	(10)	36	(14)	(62)	(113)	(16)	(7)	
to		1285	360	300	825	500	110	110	390	150	670	1220	175	75	
1500	3.3			3270	(304)						2900	(270)			
1501	575	(149)	(56)	(46)	(96)	(56)	(15)	(15)	54	(22)	(93)	(167)	(23)	(9)	
to		1600	600	500	1035	600	160	160	580	240	1000	1800	245	100	
2200	3.8			4335	(403)						4285	(398)			
PREPARATION AREAS															
STORAGE AREAS															
<p>Note 1. For each heading in this chart the top number is the recommended area in square meters, the middle number is the same area in square feet. The lower number is the area of the functional subgroup in feet and meters.</p> <p>Note 2. "Other" includes all mechanical areas, all areas required for weather protection, such as vestibules and covered walkways, and any other justifiable functions.</p> <p>Note 3. The total area for any given project will vary with the number of special functional requirements added to the basic program.</p>															
Title										Page 2 of 3		Date		Category Code	Plate
SPACE PROGRAM										3/30/90		722-10A		1	

Facility Size	Minimum Seals & Turnover Rate	Offices	Staff Toilets	Staff Lockers	Janitor's Closet	Can Wash	Loading Dock (Compute @ 50%)	Gross Allowable Area	Flight Kitchen	Other
40	62	(21)	(24)	(2)	(4)	(19)	(325)	(9)		
to		230	260	25	40	200	3,500	100	A/R	
80	1.3	755								
81	108	(29)	(24)	(2)	(4)	(19)	(465)	(9)		
to		310	260	25	40	200	5,000	100	A/R	
150	1.4	2120								
151	116	(37)	(24)	(11)	(2)	(19)	(595)	(9)		
to		400	260	120	25	200	6,400	100	A/R	
250	2.2	1250								
251	(54)	(24)	(15)	(5)	(4)	(21)	(827)	(9)		
to		580	260	160	50	40	230	8,900	100	A/R
400	2.3	1320								
401	288	(65)	(33)	(24)	(5)	(4)	(28)	(1199)	(12)	
to		700	360	260	50	40	300	12,900	125	A/R
650	2.3	1710								
651	345	(65)	(40)	(35)	(7)	(6)	(28)	(1599)	(12)	
to		700	430	380	75	60	300	17,200	125	A/R
1000	2.9	1945								
1001	460	(65)	(42)	(35)	(7)	(6)	(37)	(1933)	(14)	
to		700	450	380	75	60	400	20,800	150	A/R
1500	3.3	2065								
1501	575	(84)	(46)	(46)	(9)	(6)	(37)	(2742)	(14)	
to		900	500	480	100	60	400	29,500	150	A/R
2200	3.8	2340								
SUPPORT AREAS										
OTHER										
<p>Note 1. For each heading in this chart the top number is the recommended area in square meters, the middle number is the same area in square feet. The lower number is the area of the functional sub-group in feet and meters.</p> <p>Note 2. 'Other' includes all mechanical areas, all areas required for weather protection, such as vestibules and covered walkways, and any other justifiable functions.</p> <p>Note 3. The total area for any given project will vary with the number of special functional requirements added to the basic program.</p>										
Title		Page 3 of 3 SPACE PROGRAM			Date	3/30/90		Category Code	722-10A Plate 1	

SPACE	FLOOR	BASE	WALL	PROTECT	CEILING
Entry/vestibule	QT or VCT	QT or Vinyl	Note 1	-----	Note 3
Queue	QT or VCT	QT or Vinyl	Note 1	-----	Note 3
Public Toilets	CT	CT	CT	-----	MR ACT
Check-in	QT or VCT	QT or Vinyl	Note 1	-----	Note 3
Dining Area	Carpet	Vinyl	Note 1	Note 2	Note 3
Serving/patron side	QT	QT	CT or GSU	Wall,Corners	MR ACT
Serving/serve side	QT	QT	CT or GSU	Wall,Corners	MR ACT
Dishwashing	QT	QT	GSU	Wall,Corners	Metal Pan
Food Prep. Areas	QT	QT	GSU	Wall,Corners	Metal Pan
Utensil Wash	QT	QT	GSU	Wall,Corners	Metal Pan
Storage/Freezer	Note 4	---	MIP	-----	MIP
Storage/Chilled	Note 4	---	MIP	-----	MIP
Storage/Dry	VCT	QT or Vinyl	GWC on CMU	Corners	ACT
Storage/Non-food	Conc.	Vinyl	GWC on CMU	Corners	Exp.
Storage/Carb.Bev.	QT	QT or Vinyl	GWC on CMU	-----	ACT
Offices	VCT	Vinyl	PaintCMU	-----	ACT
Staff Toilets	CT	CT	GWC on CMU	-----	MR ACT
Staff Lockers	VCT	Vinyl	GWC on CMU	-----	MR ACT
Janitor Closet	VCT	Vinyl	GWC on CMU	Corners	Exposed
Can Wash	Acid Resist	QT	GWC on CMU	Wall,Corners	MR ACT
Loading Dock	Concrete	---	Exterior	-----	Exterior
Mechanical	Concrete	---	PaintCMU	-----	Exposed

- Note 1. Walls in public areas may be a variety of durable materials such as brick, split block, exposed concrete, plaster, vinyl wall covering on an approved substrate, or other materials as approved.
- Note 2. Wall guard protection should be provided at locations where cart traffic is expected. See plates 44, 45 and 46 for details.
- Note 3. Ceilings in public areas may be a variety of suspended acoustic ceiling materials.
- Note 4. Quarry tile on an insulated slab.

ABBREVIATIONS

ACT - Acoustic Ceiling Tile GSU - Glazed Structural Unit QT - Quarry Tile
 CMU - Concrete Masonry Unit GWC - Glazed Wall Coating VCT - Vinyl Composition Tile
 CT - Ceramic Tile MIP - Metal Insulated Panel
 MR - Moisture Resistant

Title	Date	Category Code	Plate
ARCHITECTURAL FINISHES	3/30/90	722-10	2

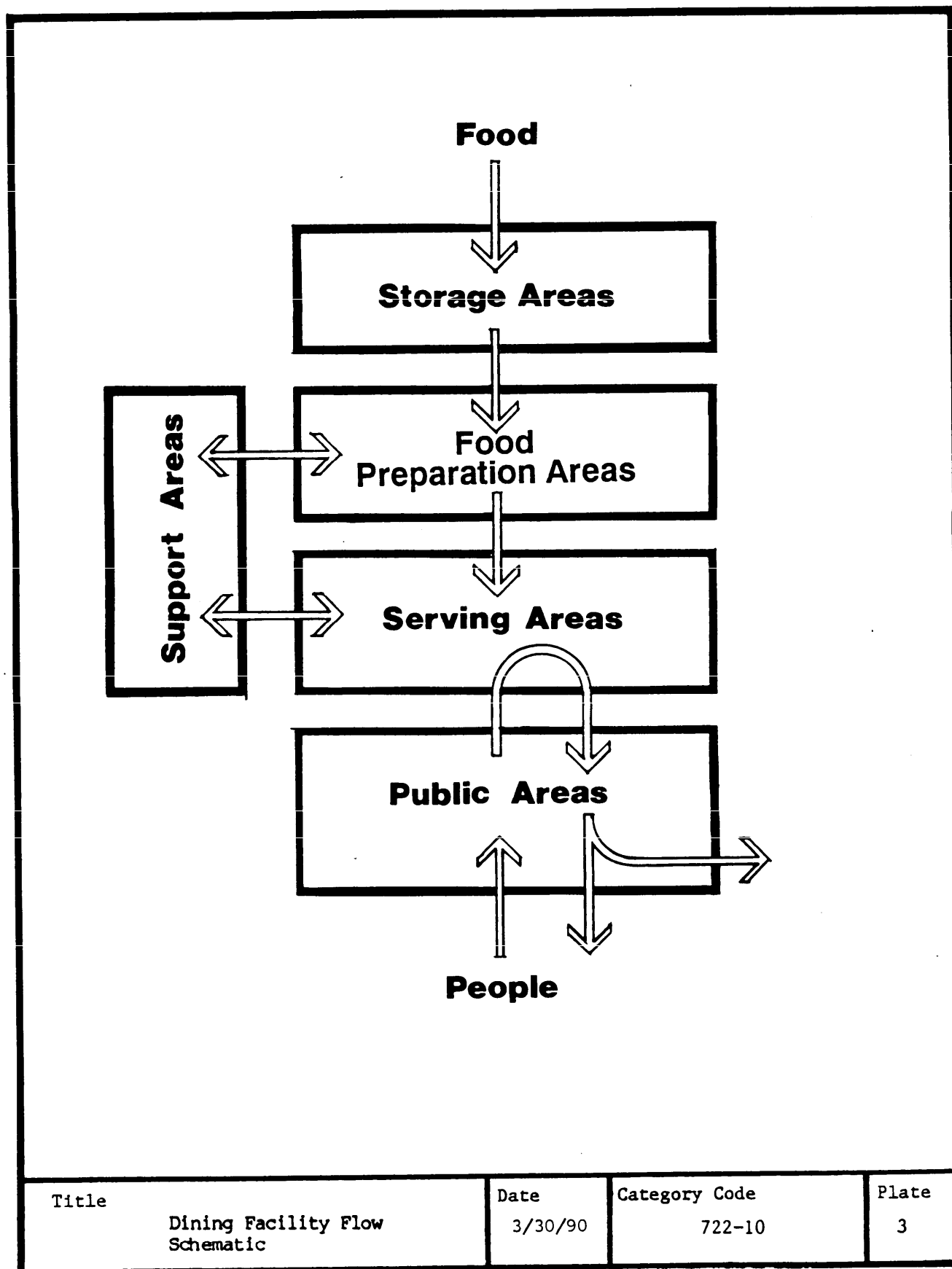

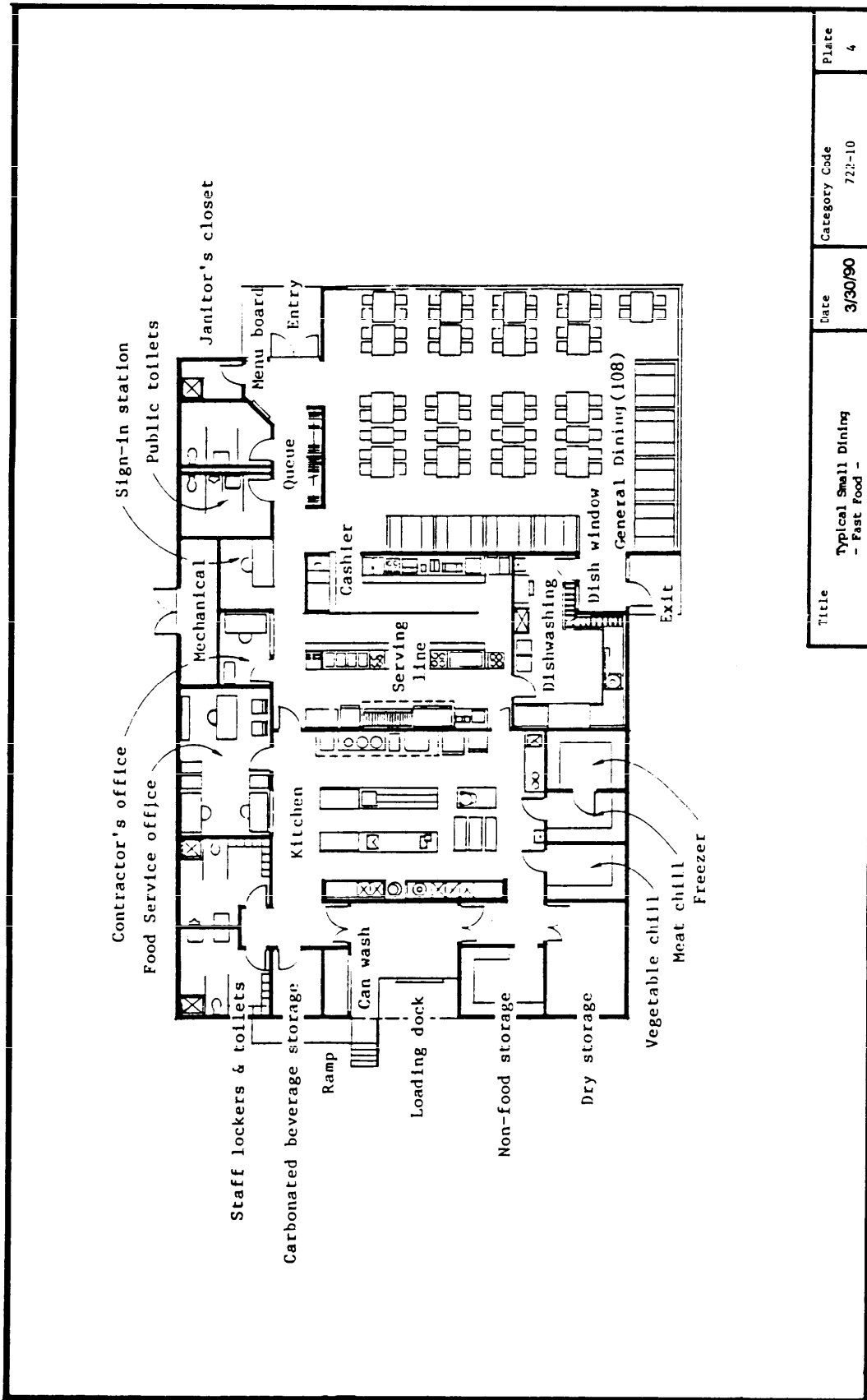

Title	Date	Category Code	Plate
Typical Small Dining - Past food -	3/30/90	722-10	4

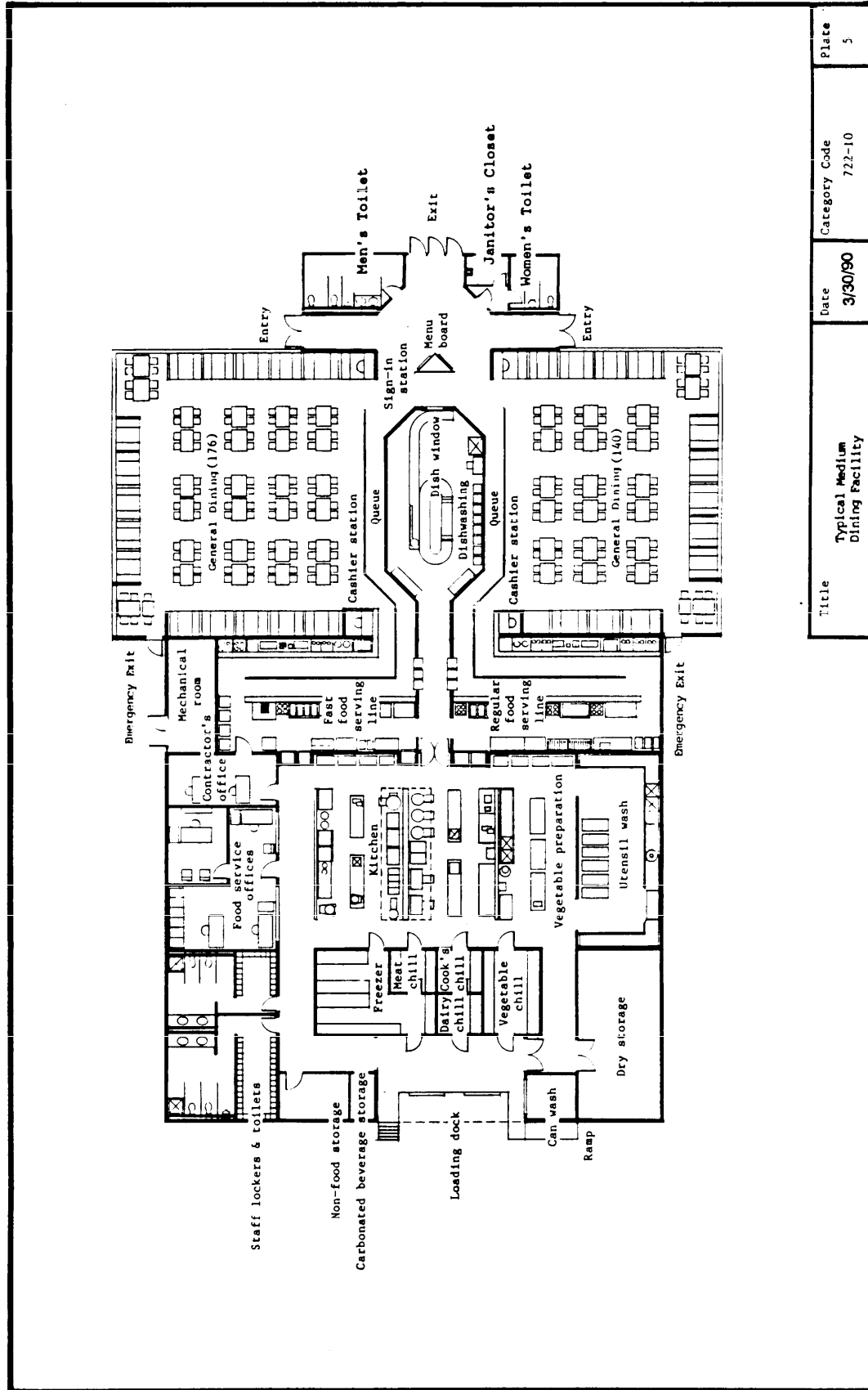

Title	Typical Medium Dining Facility
Date	3/30/90
Category Code	722-10
Plate	5

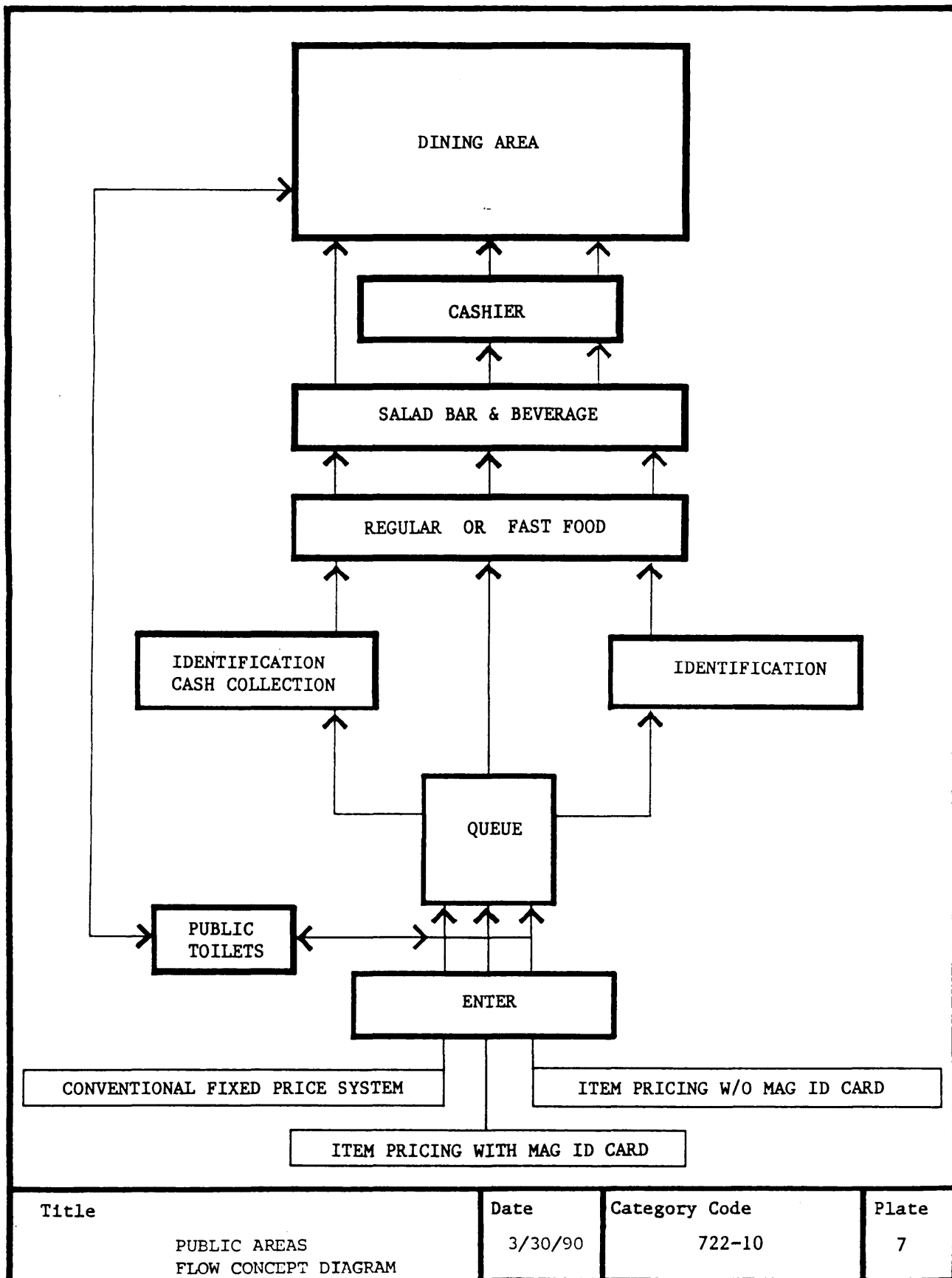

<p>Title PUBLIC AREAS FLOW CONCEPT DIAGRAM</p>	<p>Date 3/30/90</p>	<p>Category Code 722-10</p>	<p>Plate 7</p>
--	-------------------------	---------------------------------	--------------------

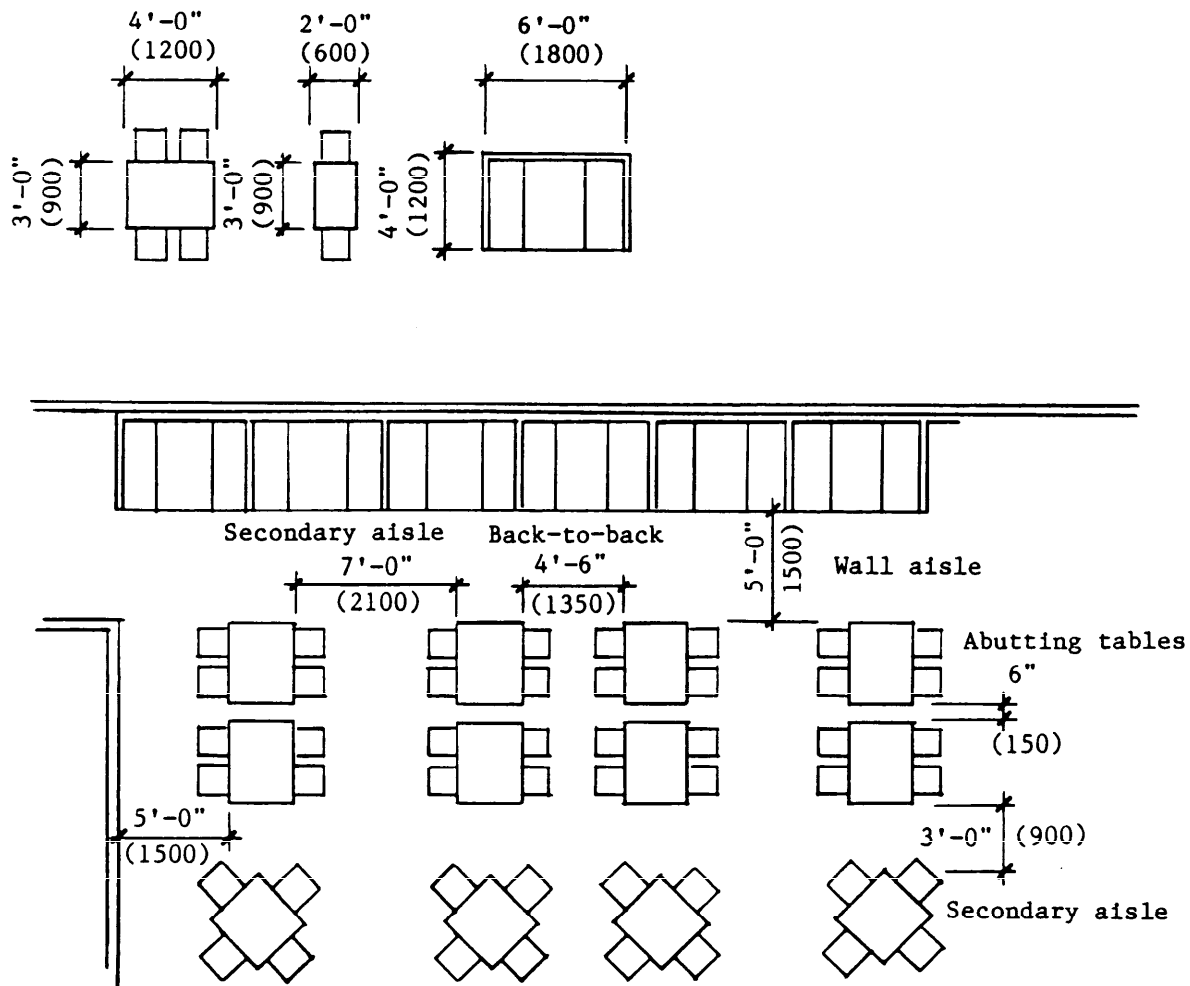

1. A variety of table sizes and configurations should be used to avoid a monotonous arrangement, however, the use of round or square tables is not as space efficient as rectangular tables. Consideration should be given to avoid or minimize seating arrangements which cause one patron to disturb another for access or egress.
2. Aisle widths shown are minimum and must be verified with NFPA 101 and Life Safety Code requirements. Sizes may need to be increased for very long aisles.
3. If partitions at tables are desired, partition height should be not greater than 4'-6" (1350mm) to maintain openness of space.
4. Booth seating should not exceed 30% of total seating.

Title

TABLE SIZES AND CLEARANCES

Date

3/30/90

Category Code

722-10

Plate

8

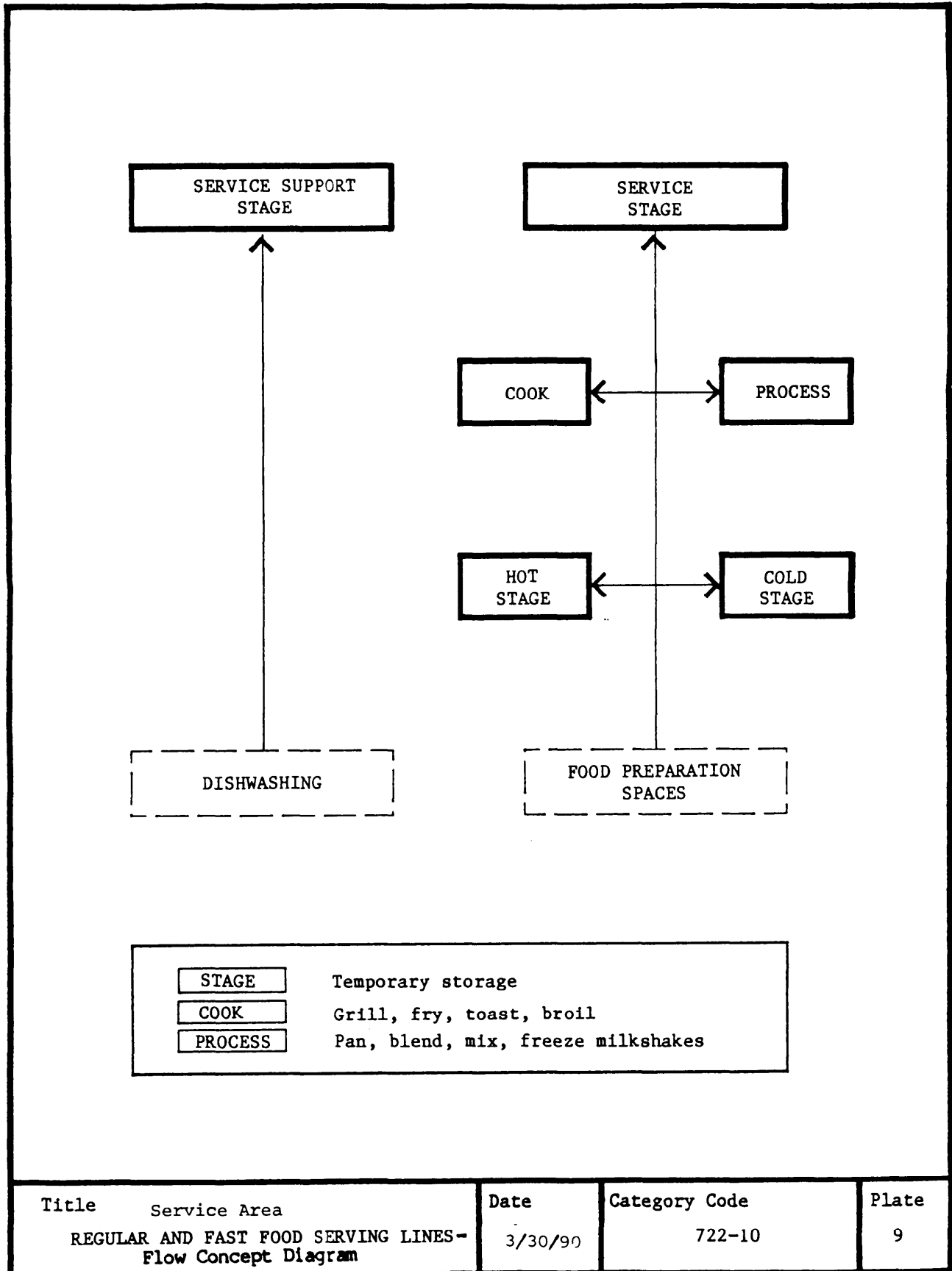

<p>Title Service Area</p> <p>REGULAR AND FAST FOOD SERVING LINES- Flow Concept Diagram</p>	<p>Date</p> <p>3/30/90</p>	<p>Category Code</p> <p>722-10</p>	<p>Plate</p> <p>9</p>
---	----------------------------	------------------------------------	-----------------------

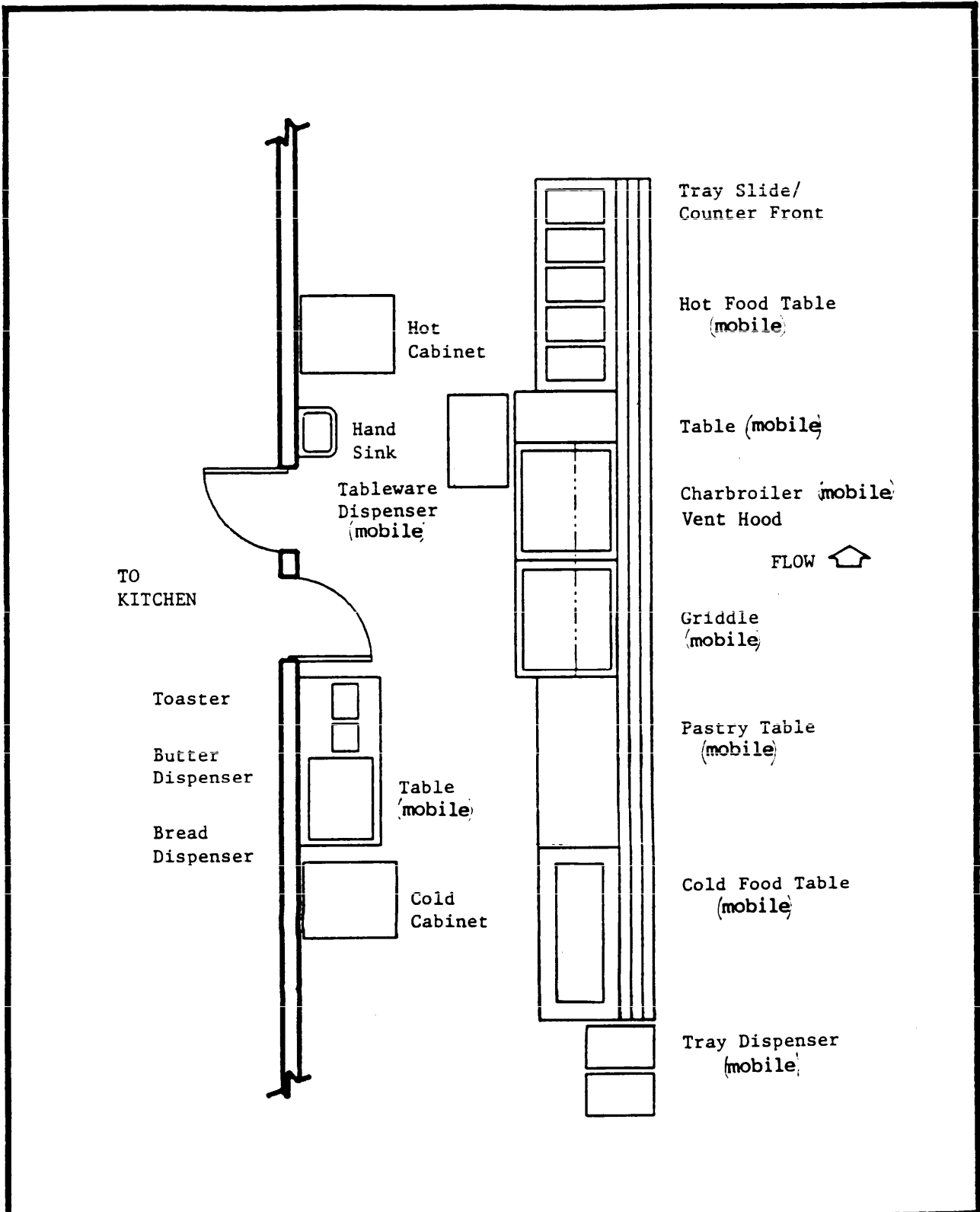

Title	Date	Category Code	Plate
Serving Line for Small Dining Facility	3/30/90	722-10	10

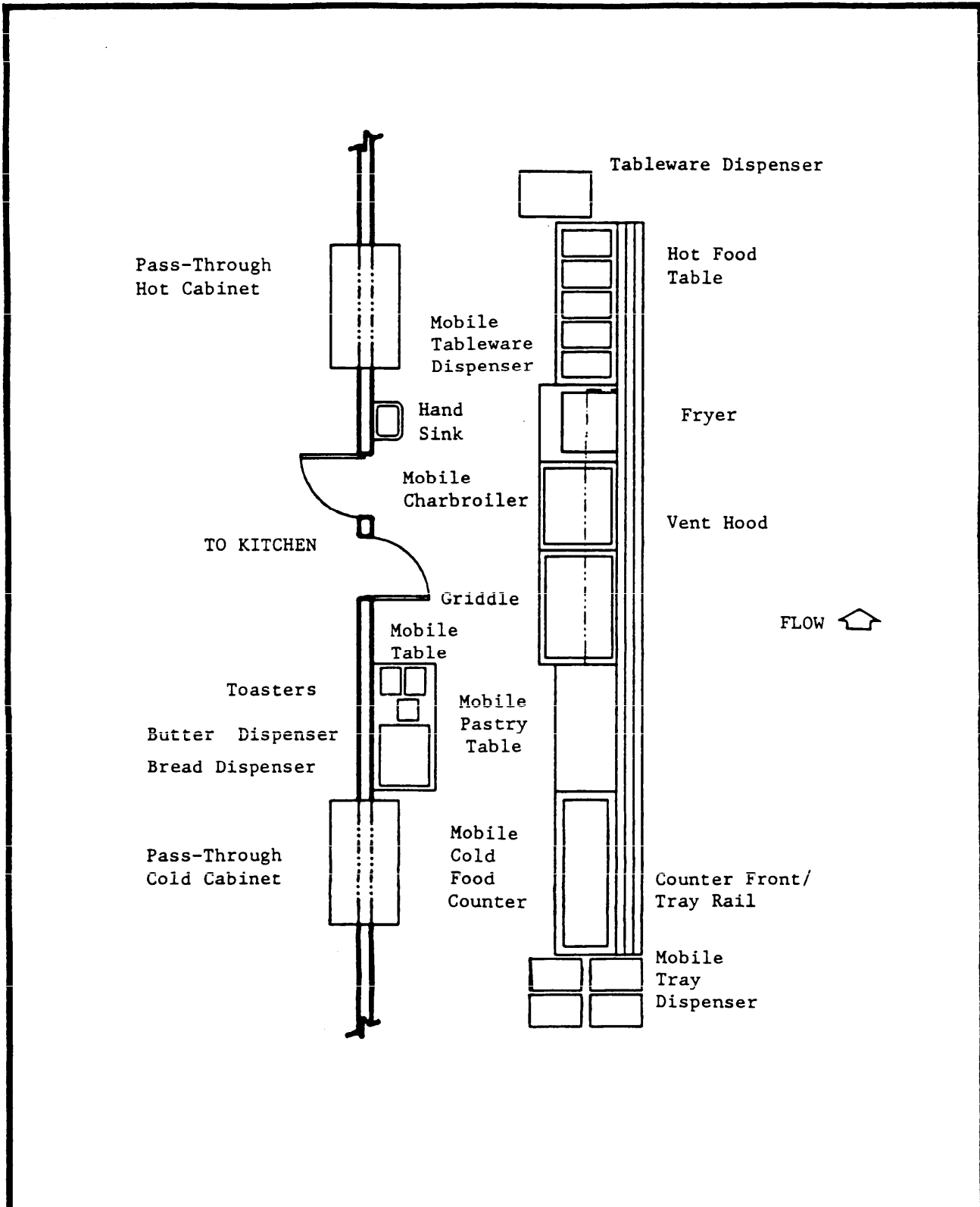

Title	Date	Category Code	Plate
Serving Line for Medium Dining Facility	3/30/90	722-10	11

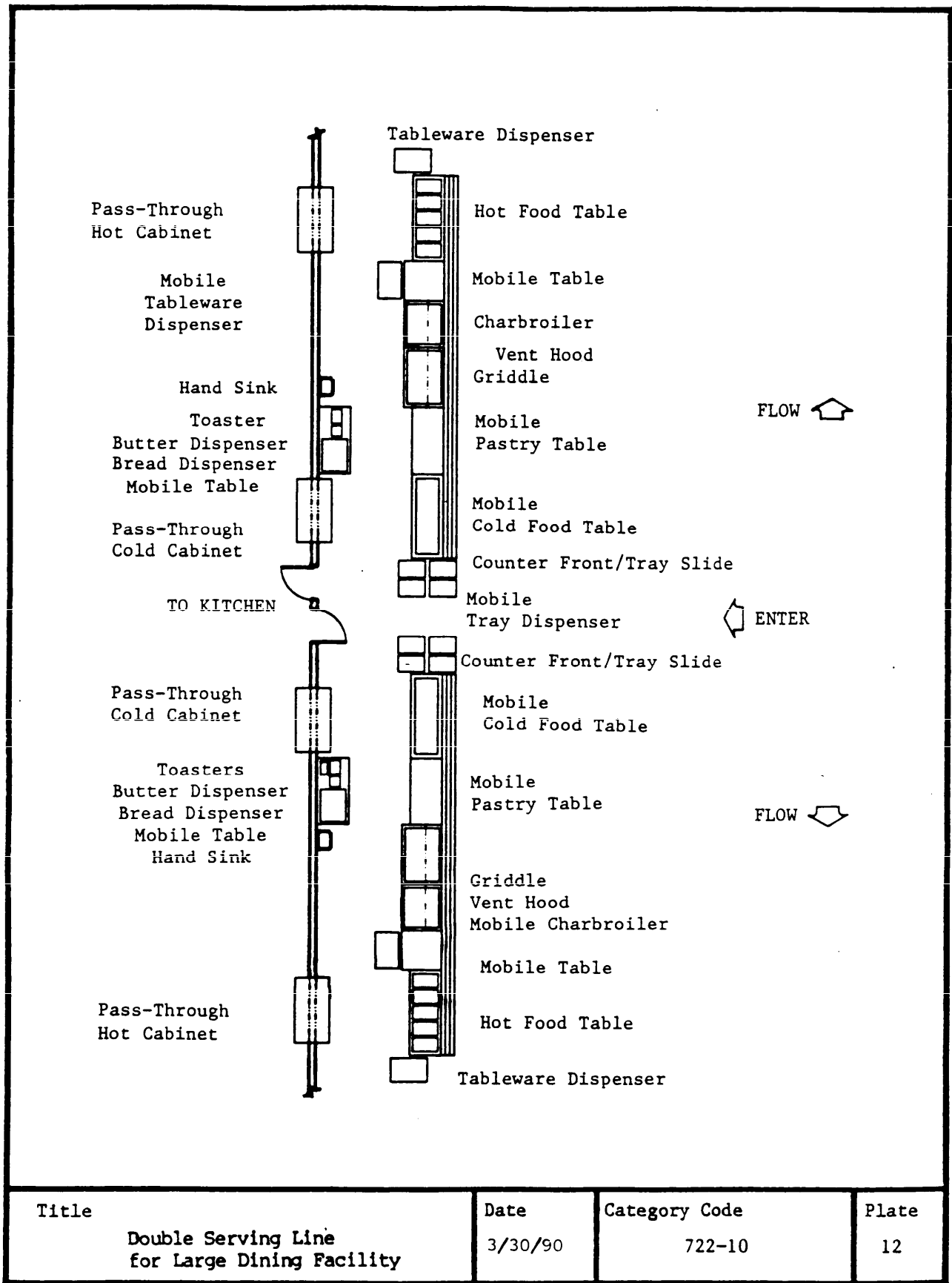

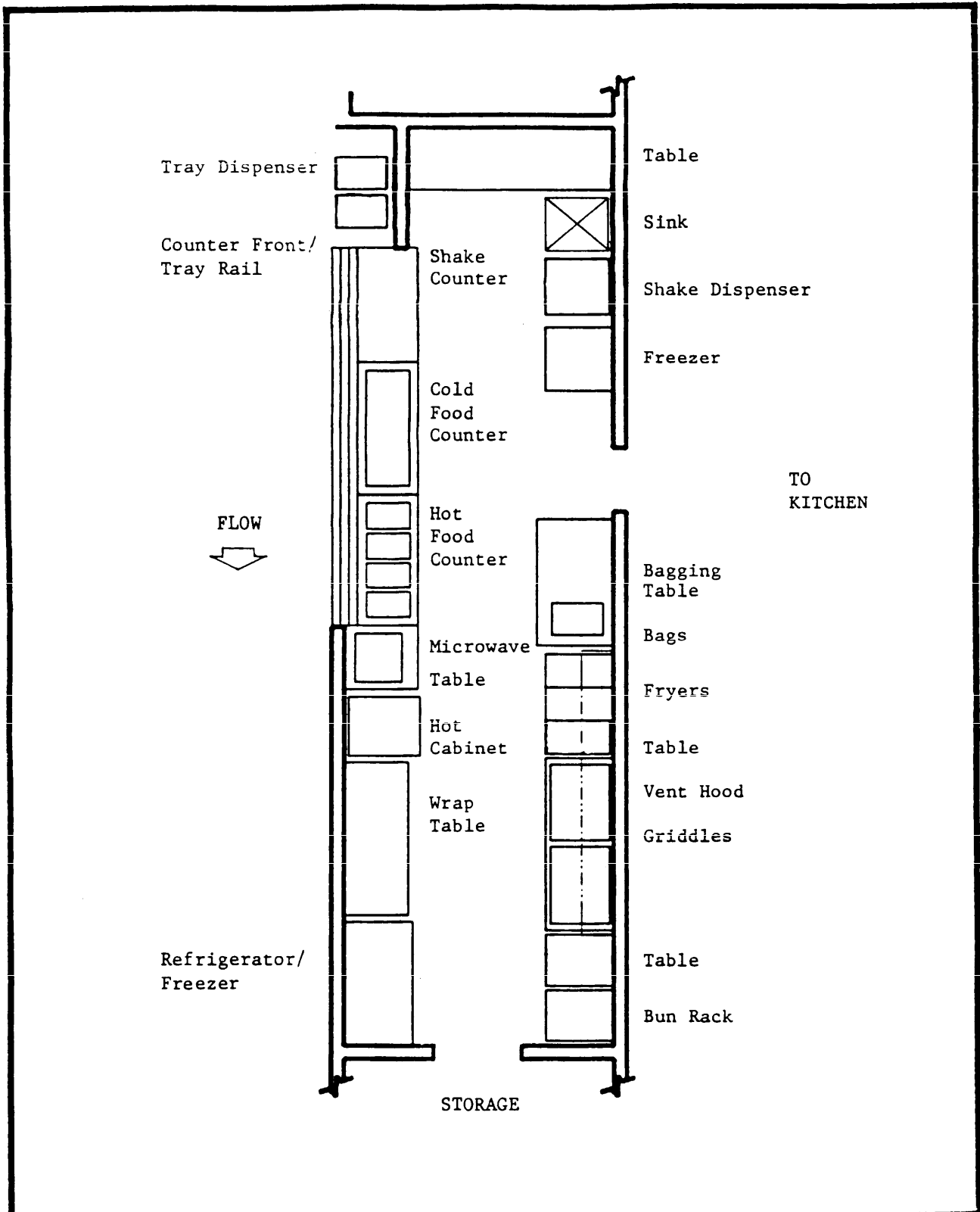

Title	Date	Category Code	Plate
FAST FOOD LINE	3/30/90	722-10	13

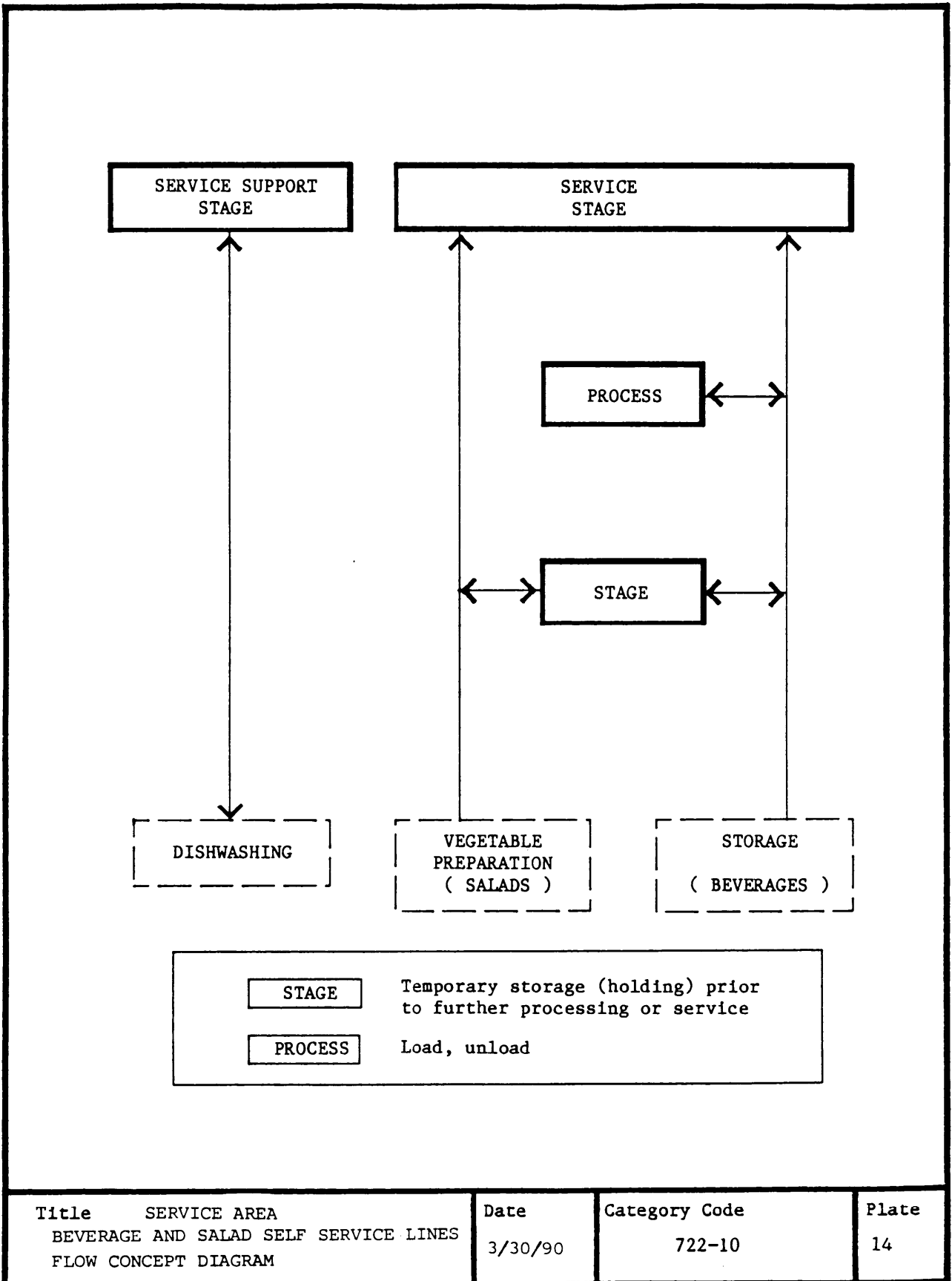

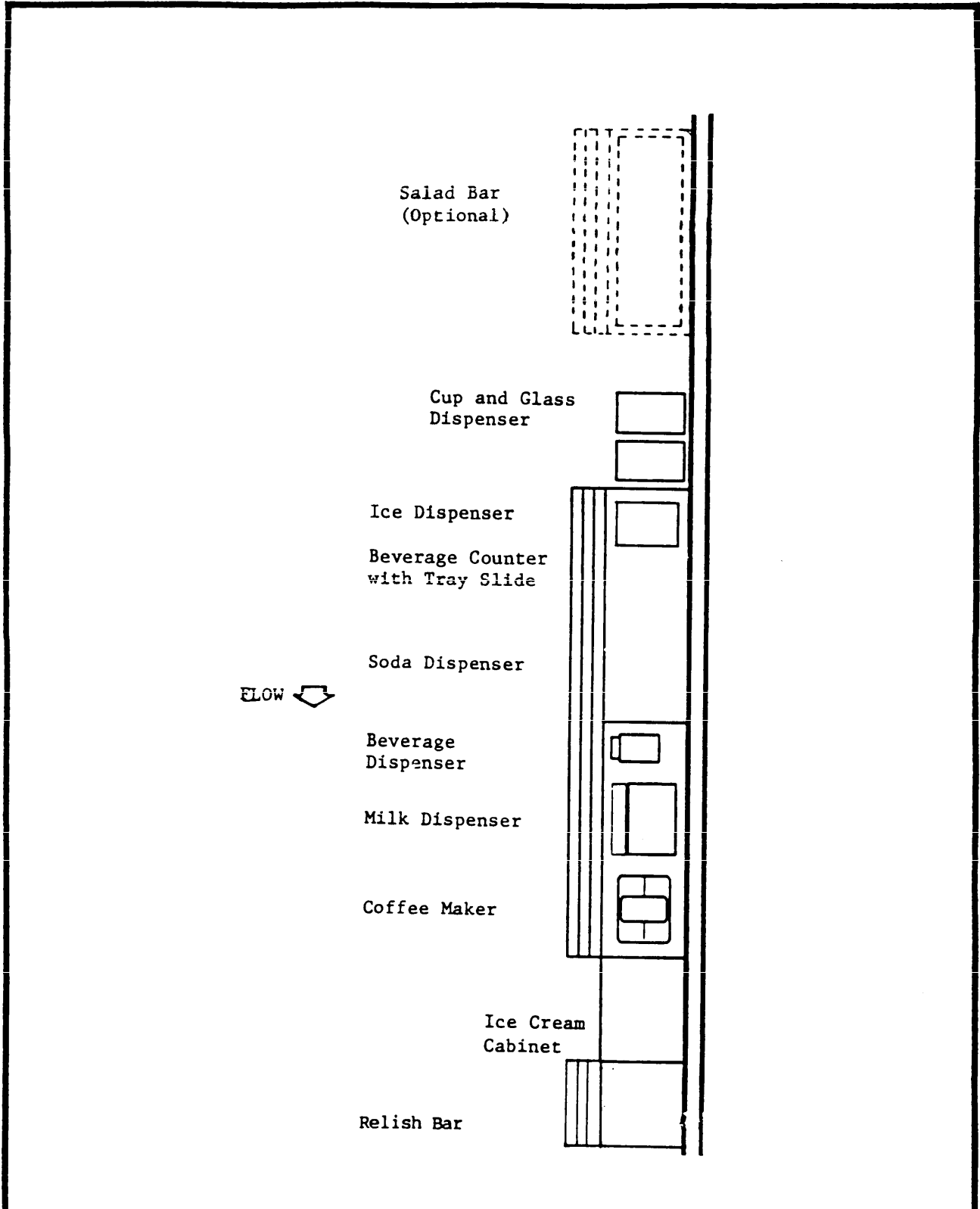

Title	Date	Category Code	Plate
SINGLE BEVERAGE LINE	3/30/90	722-10	15

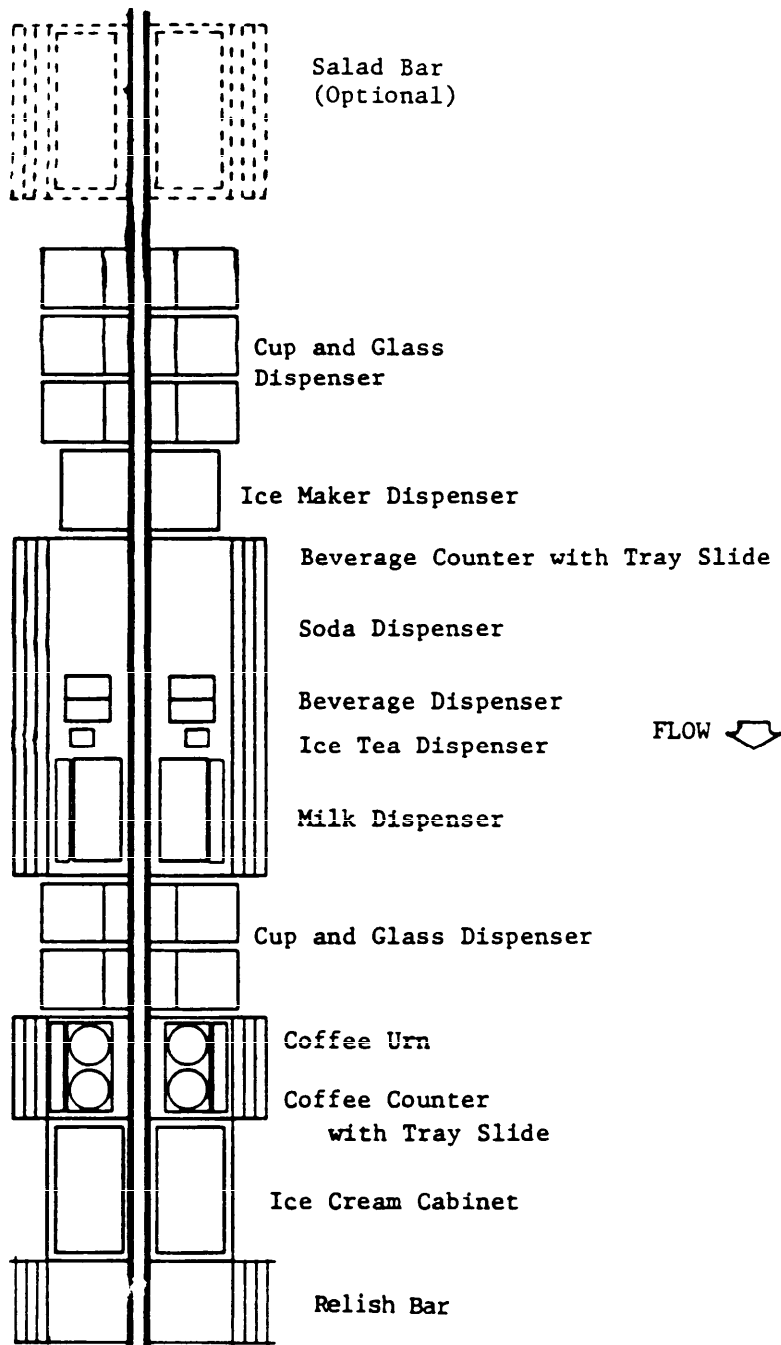

Note: Each line contains identical equipment

Title	Date	Category Code	Plate
DOUBLE BEVERAGE LINE	3/30/90	722-10	16

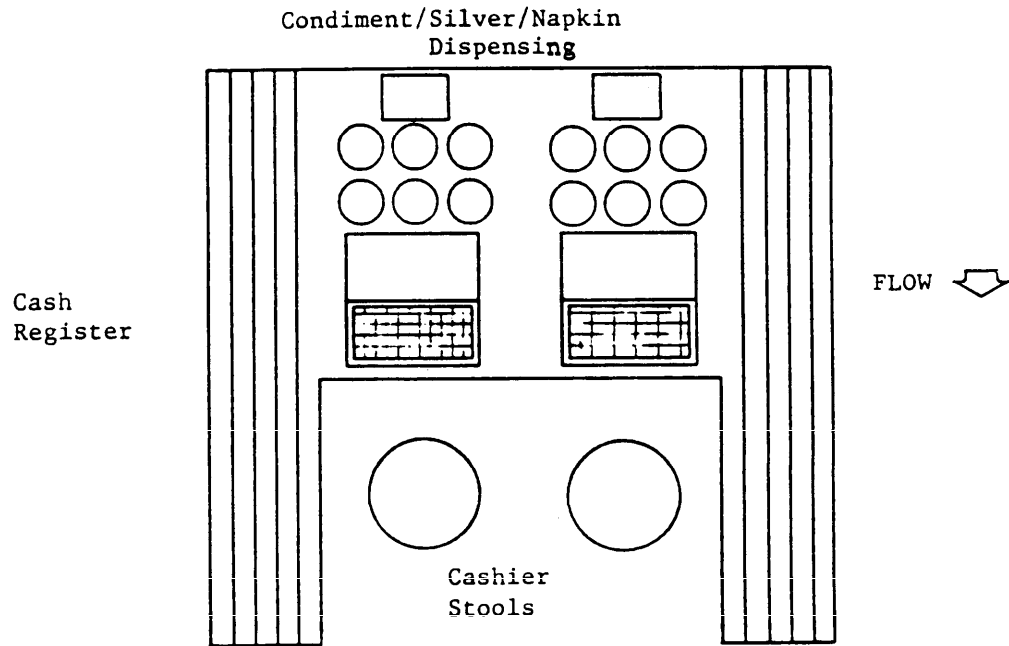

Note: Cashier stands are produced in several configurations as standard items by several food service equipment manufacturers.

Title	Date	Category Code	Plate
CASHIER STATION	3/30/90	722-10	17

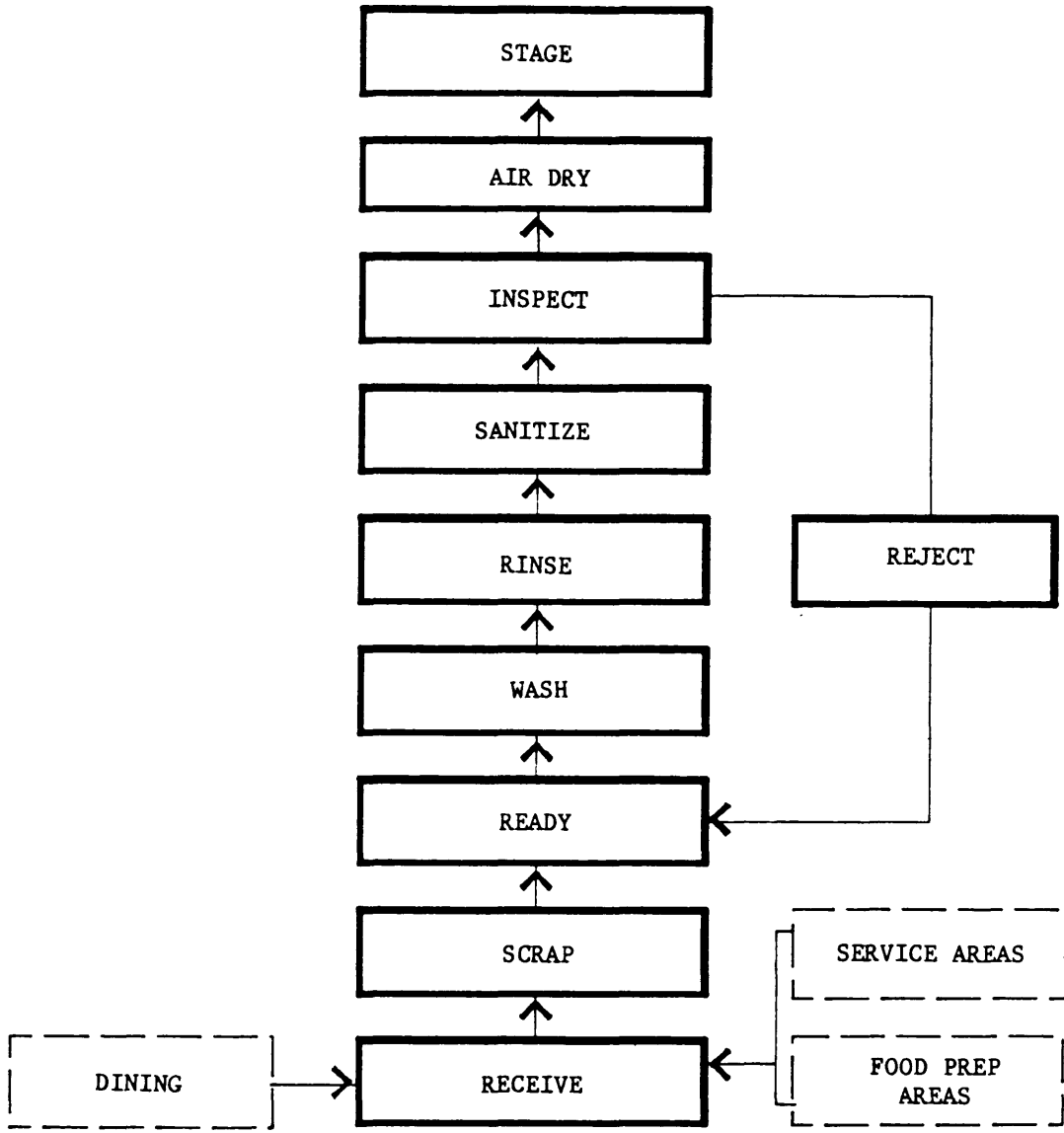

RECEIVE	Accumulate, sort, rack, soak
SCRAP	Drain, scrape, dispose
READY	Pre-rinse, scrub, rack, load
WASH	Rinse, sanitize, inspect, air dry
STAGE	Temporary stowage prior to service

Title	SUPPORT AREA DISHWASHING AND UTENSIL WASHING FLOW CONCEPT DIAGRAM	Date	3/30/90	Category Code	722-10	Plate	18
-------	---	------	---------	---------------	--------	-------	----

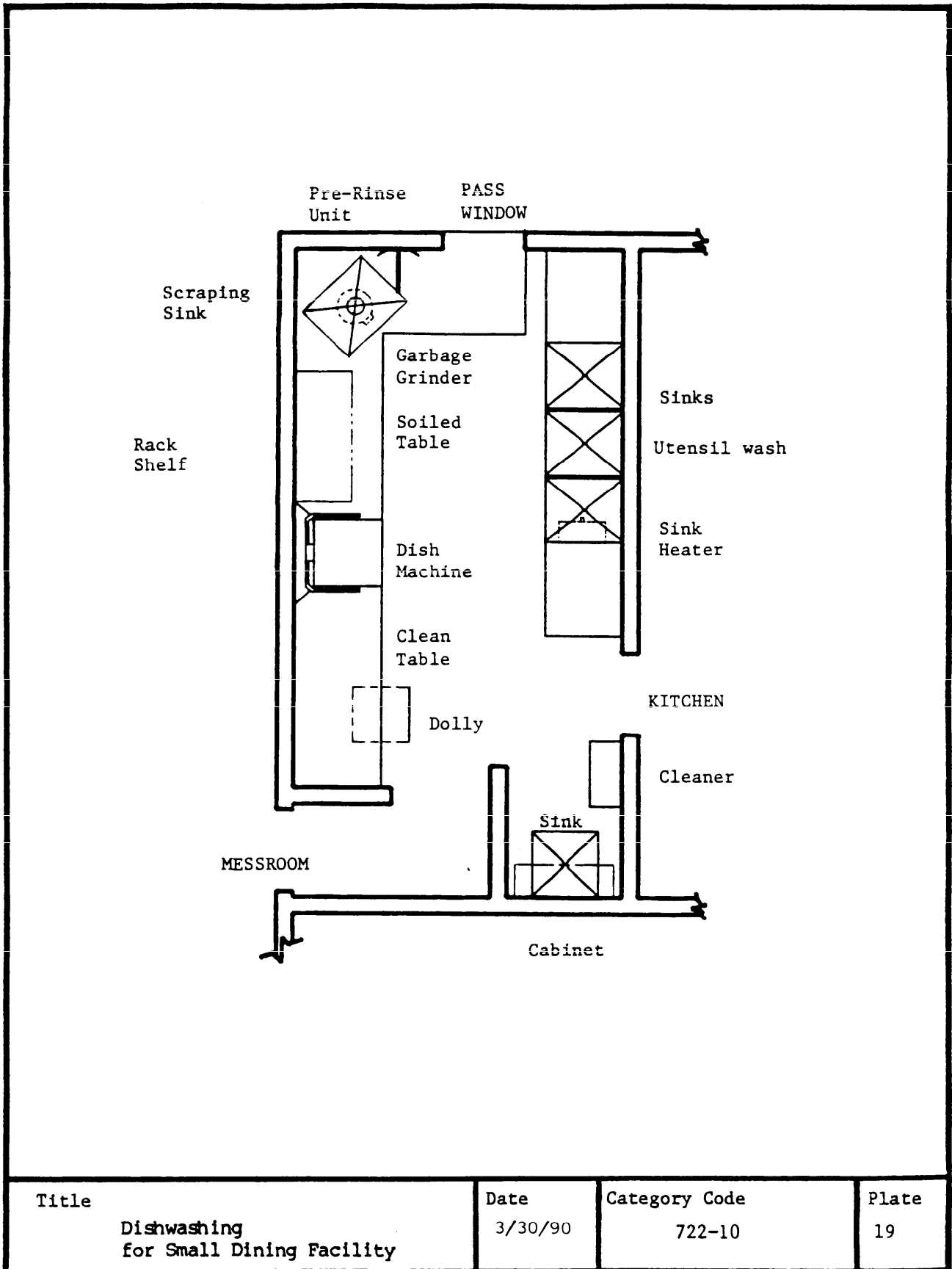

Title
Dishwashing
for Small Dining Facility

Date
3/30/90

Category Code
722-10

Plate
19

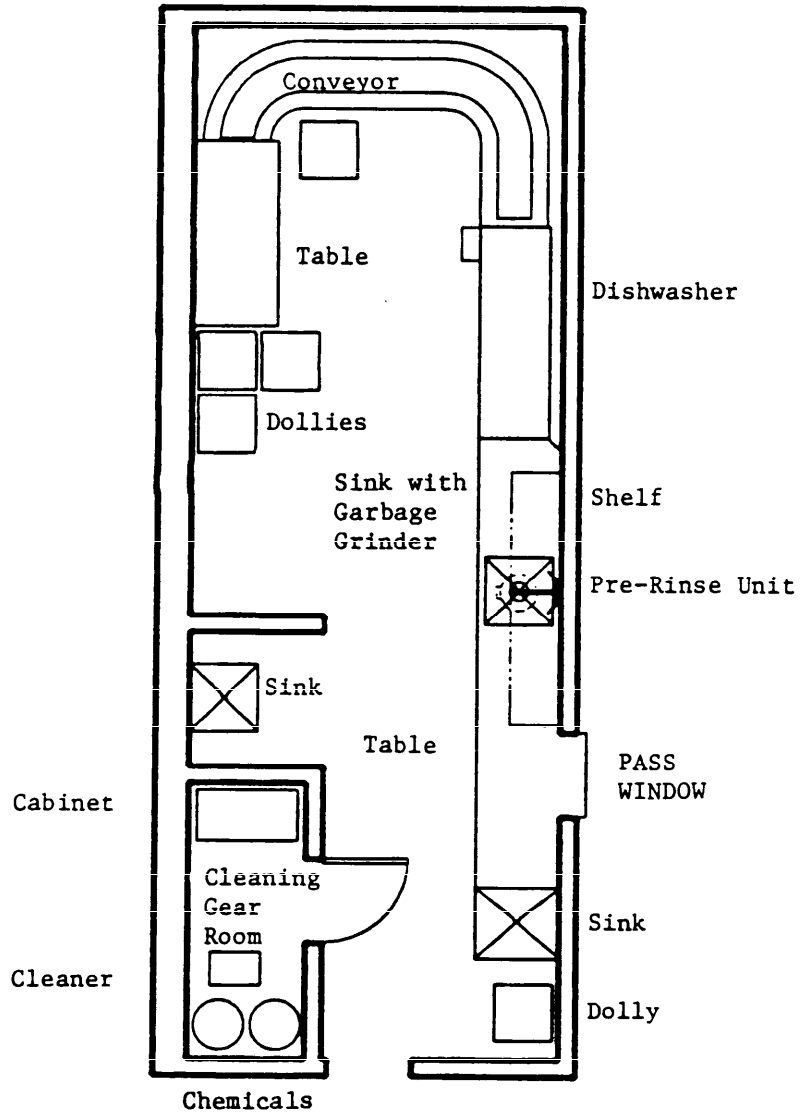

Title	Date	Category Code	Plate
Dishwashing for Medium Dining Facility	3/30/90	722-10	20

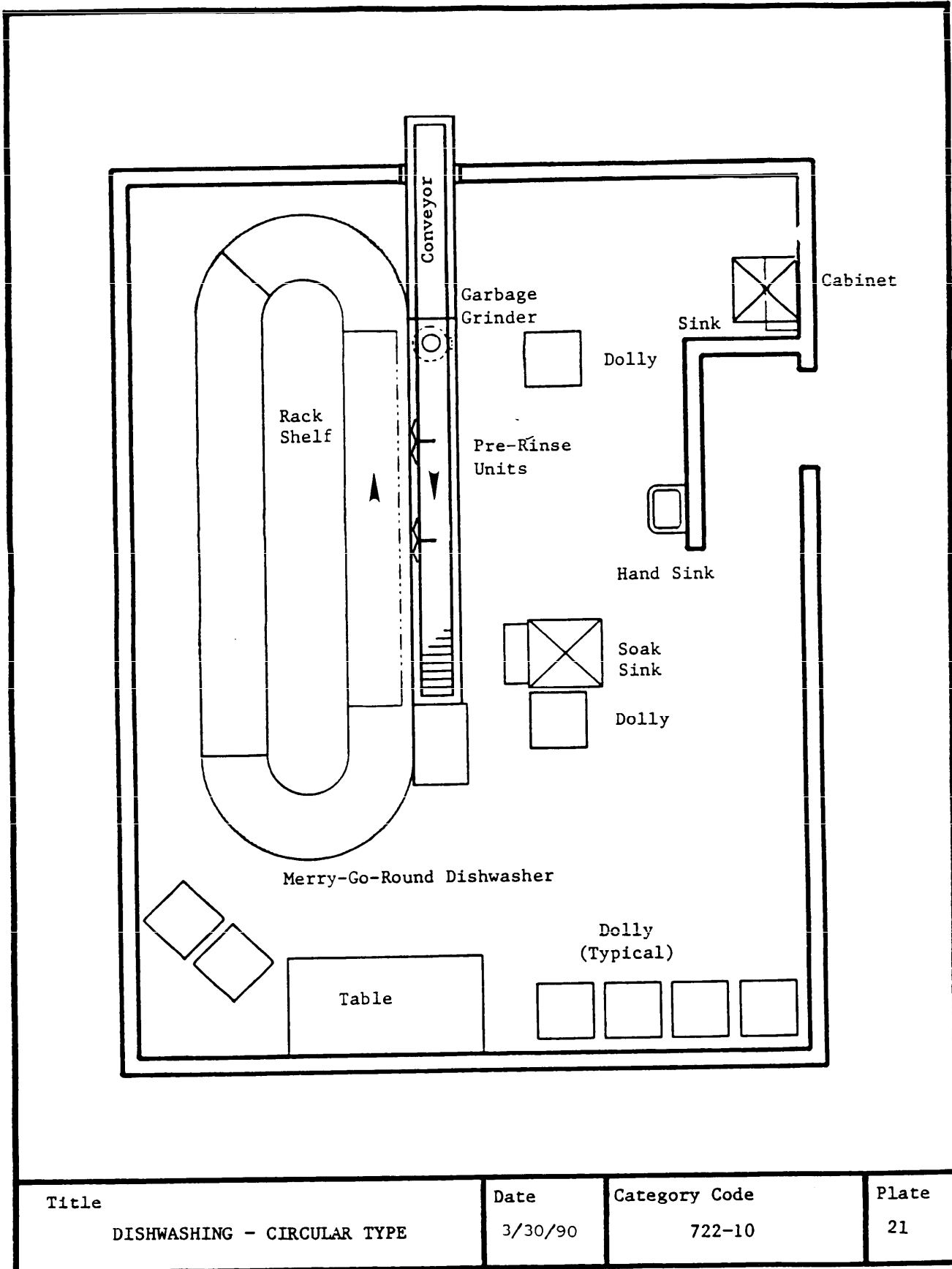

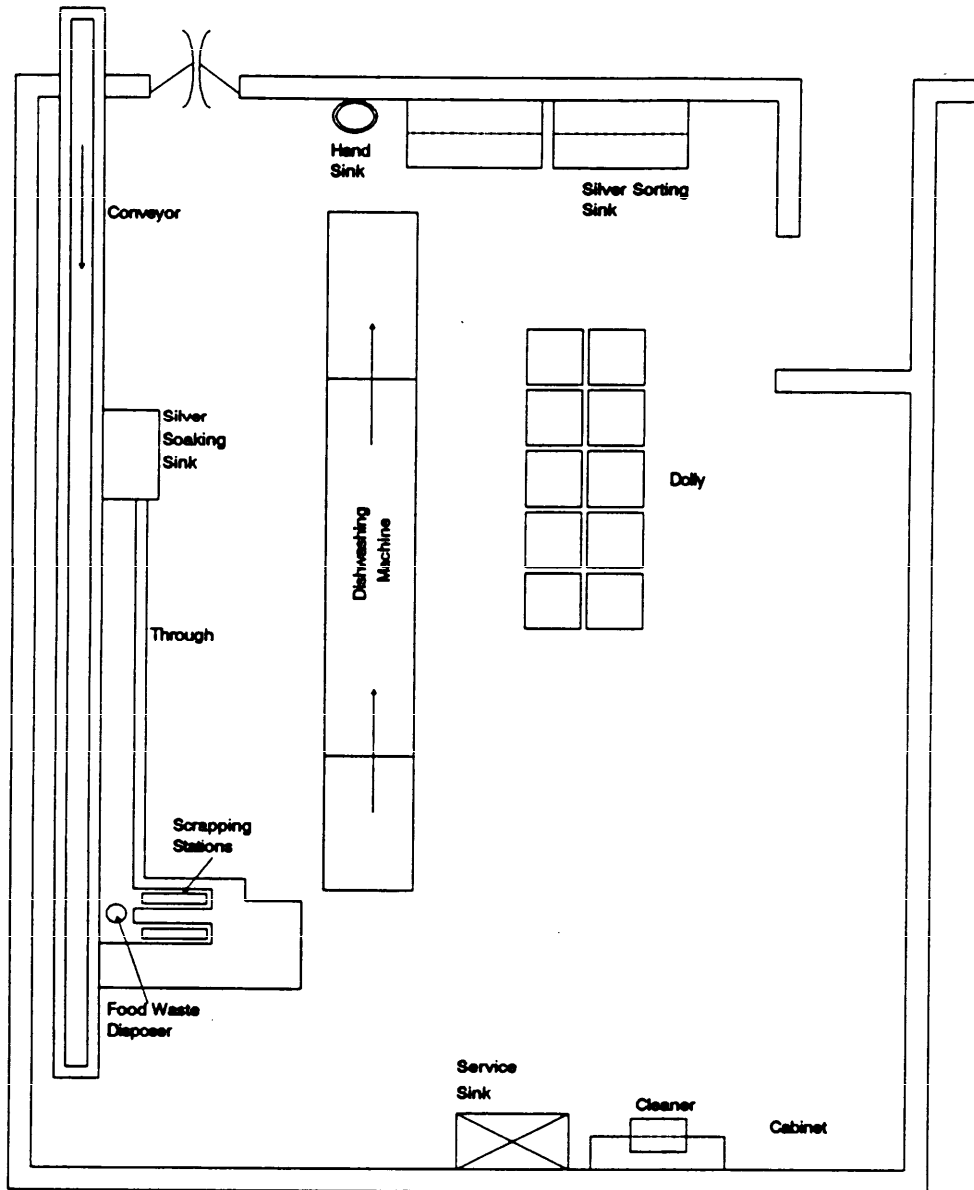

Title	Date	Category Code	Plate
DISHWASHING - FLIGHT TYPE	3/30/90	722-10	22

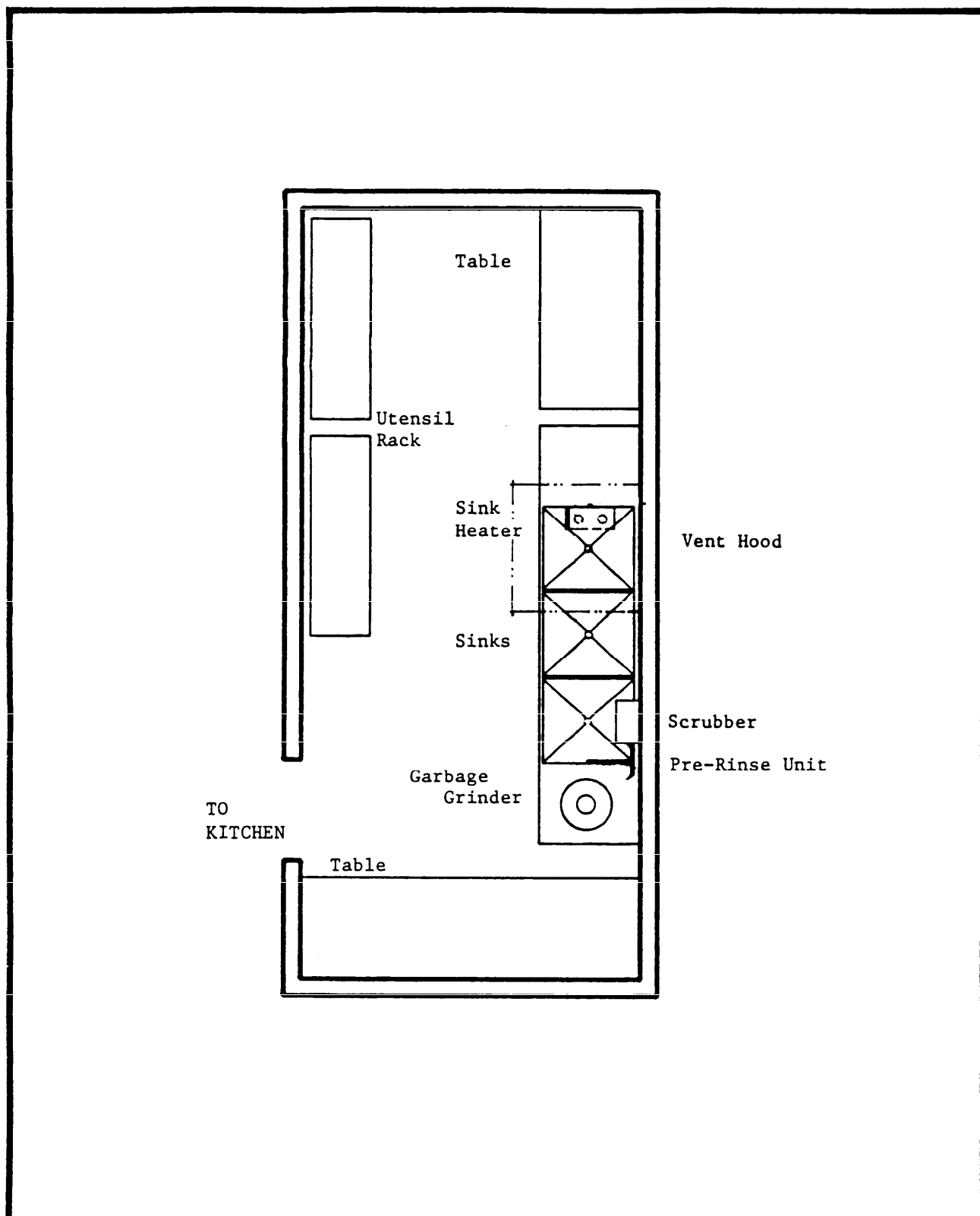

Title	Date	Category Code	Plate
UTENSIL WASHING	3/30/90	722-10	23

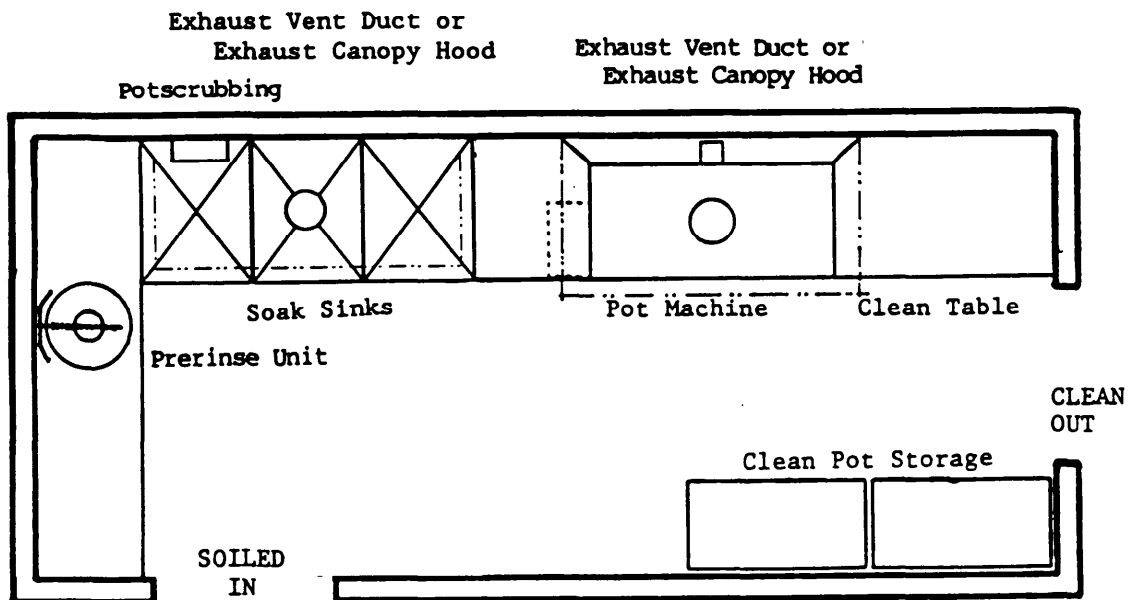

Title	Date	Category Code	Plate
MECHANICAL UTENSIL WASHING	3/30/90	722-10	24

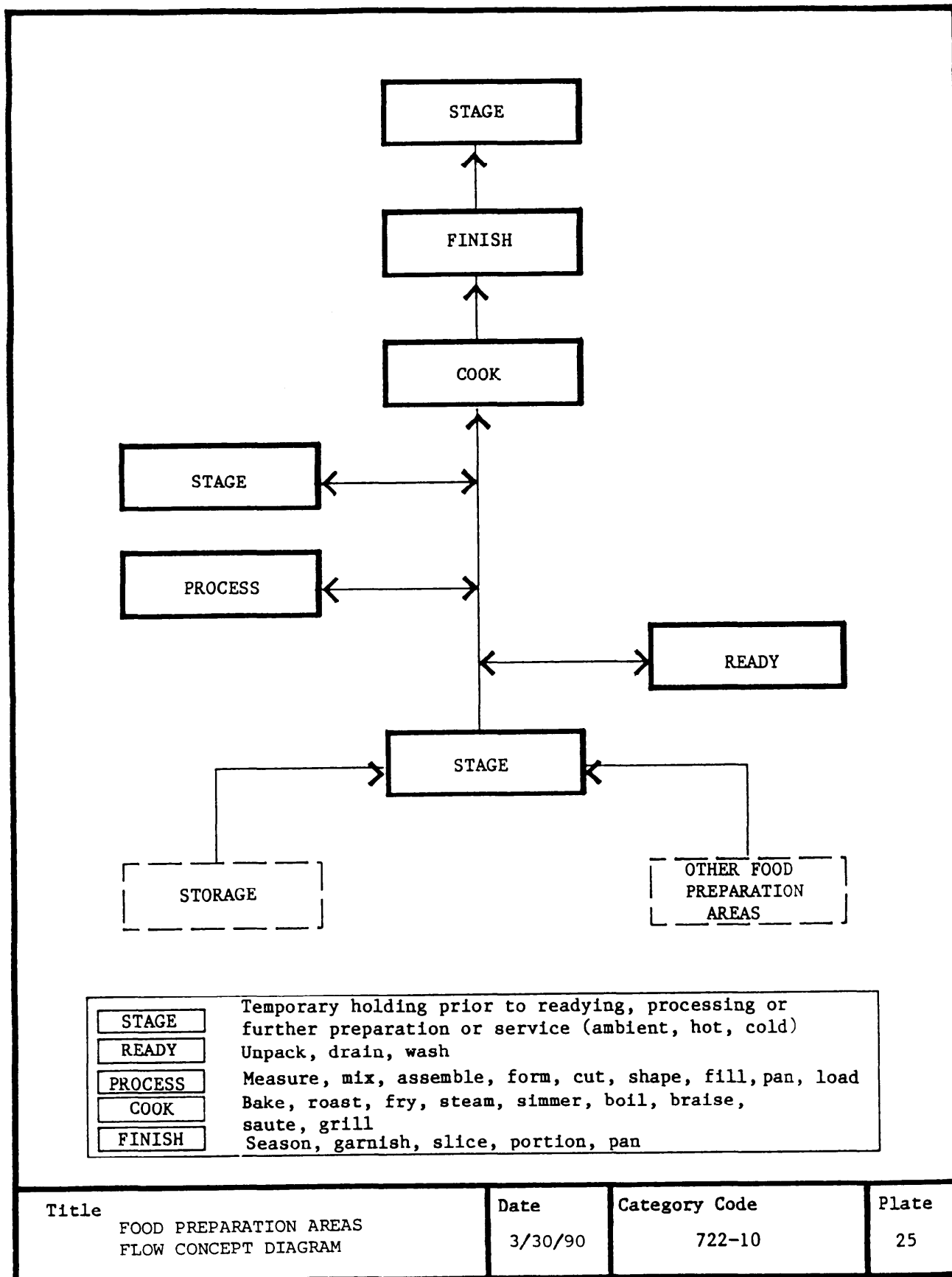

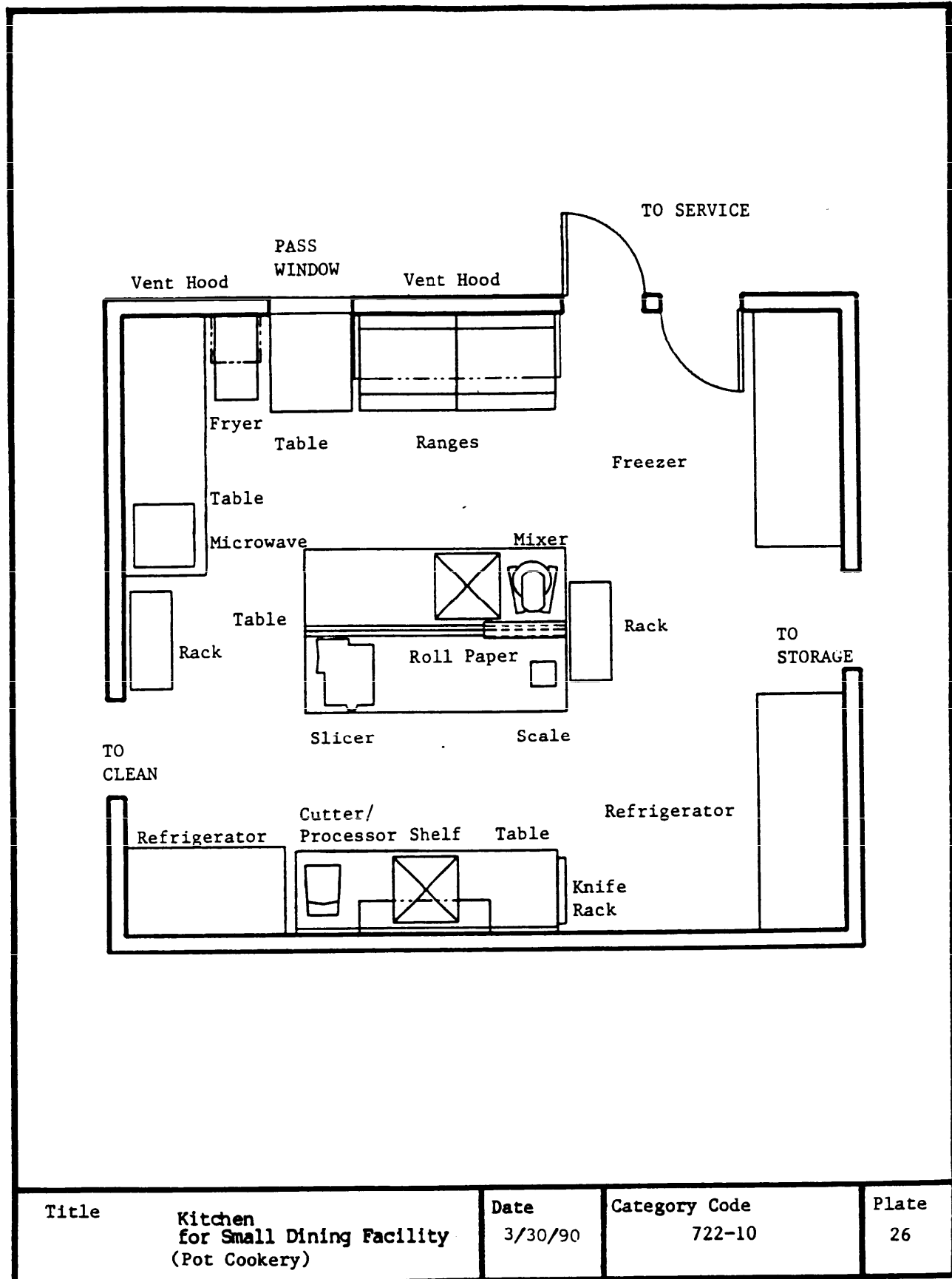

<p>Title Kitchen for Small Dining Facility (Pot Cookery)</p>	<p>Date 3/30/90</p>	<p>Category Code 722-10</p>	<p>Plate 26</p>
---	--	--	--------------------------------------

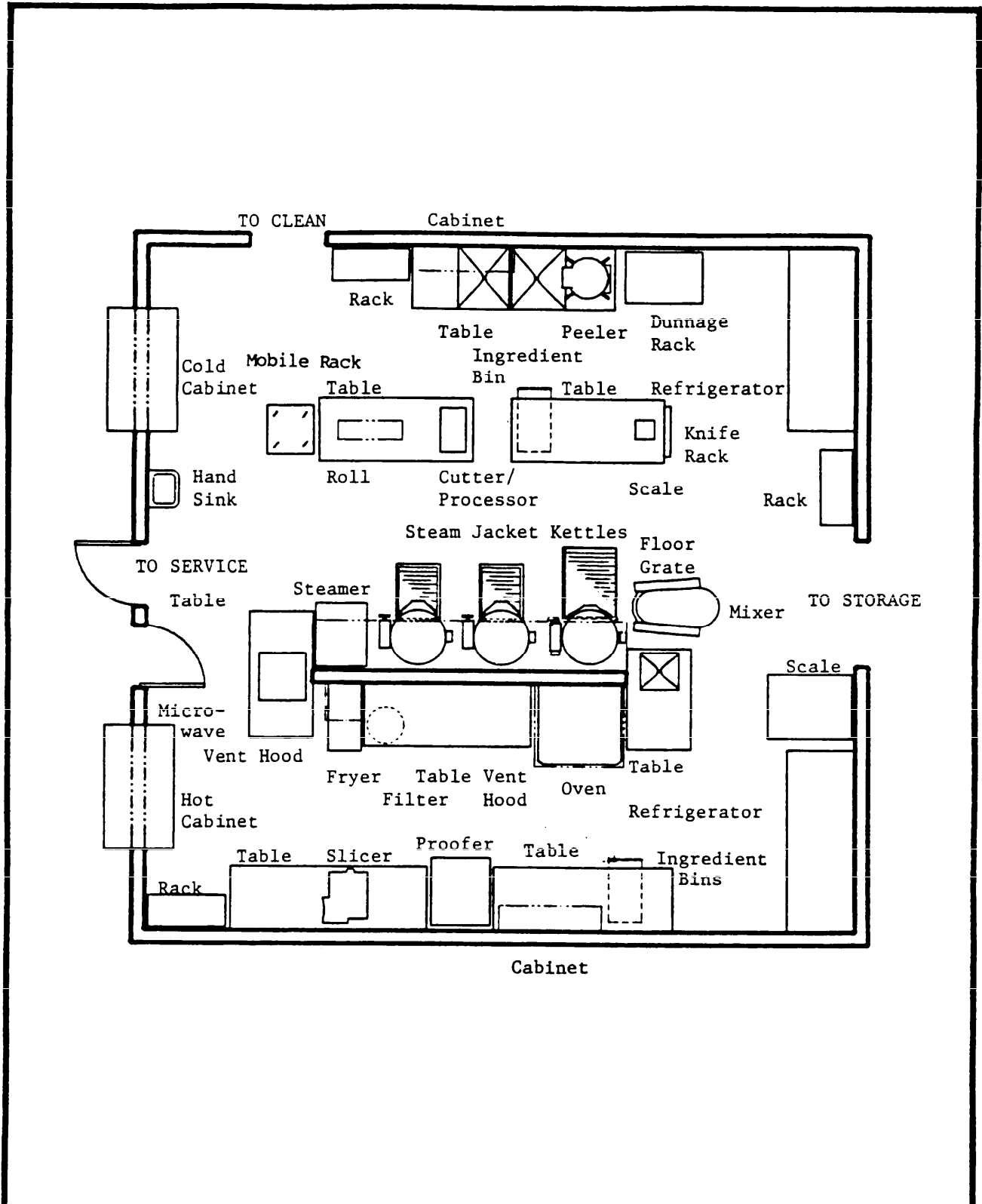

<p>Title Kitchen for Small Dining Facility (Ovens and Kettles)</p>	<p>Date 3/30/90</p>	<p>Category Code 722-10</p>	<p>Plate 27</p>
--	----------------------------	--------------------------------	------------------------

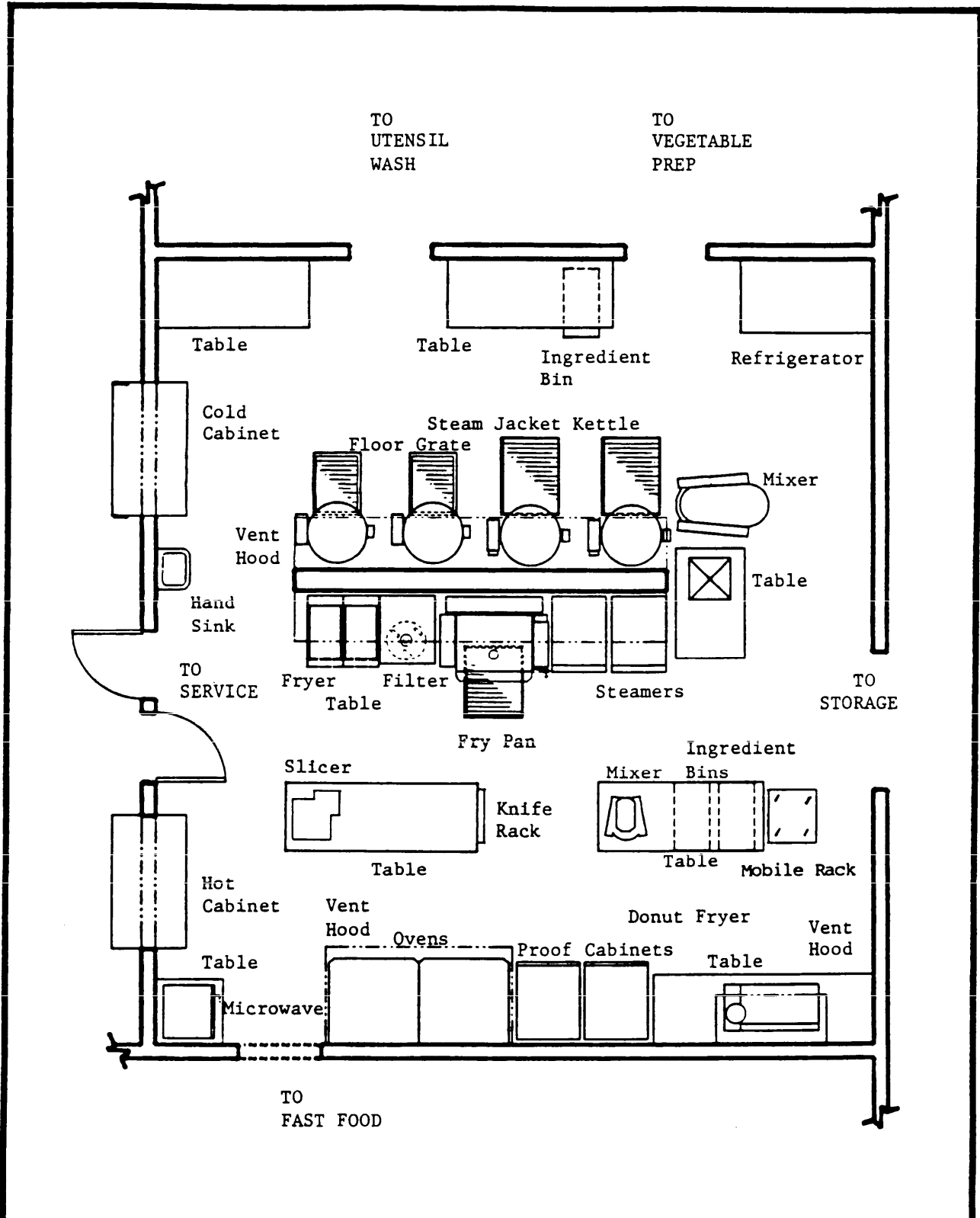

Title	Date	Category Code	Plate
Kitchen for Medium Dining Facility	3/30/90	722-10	28

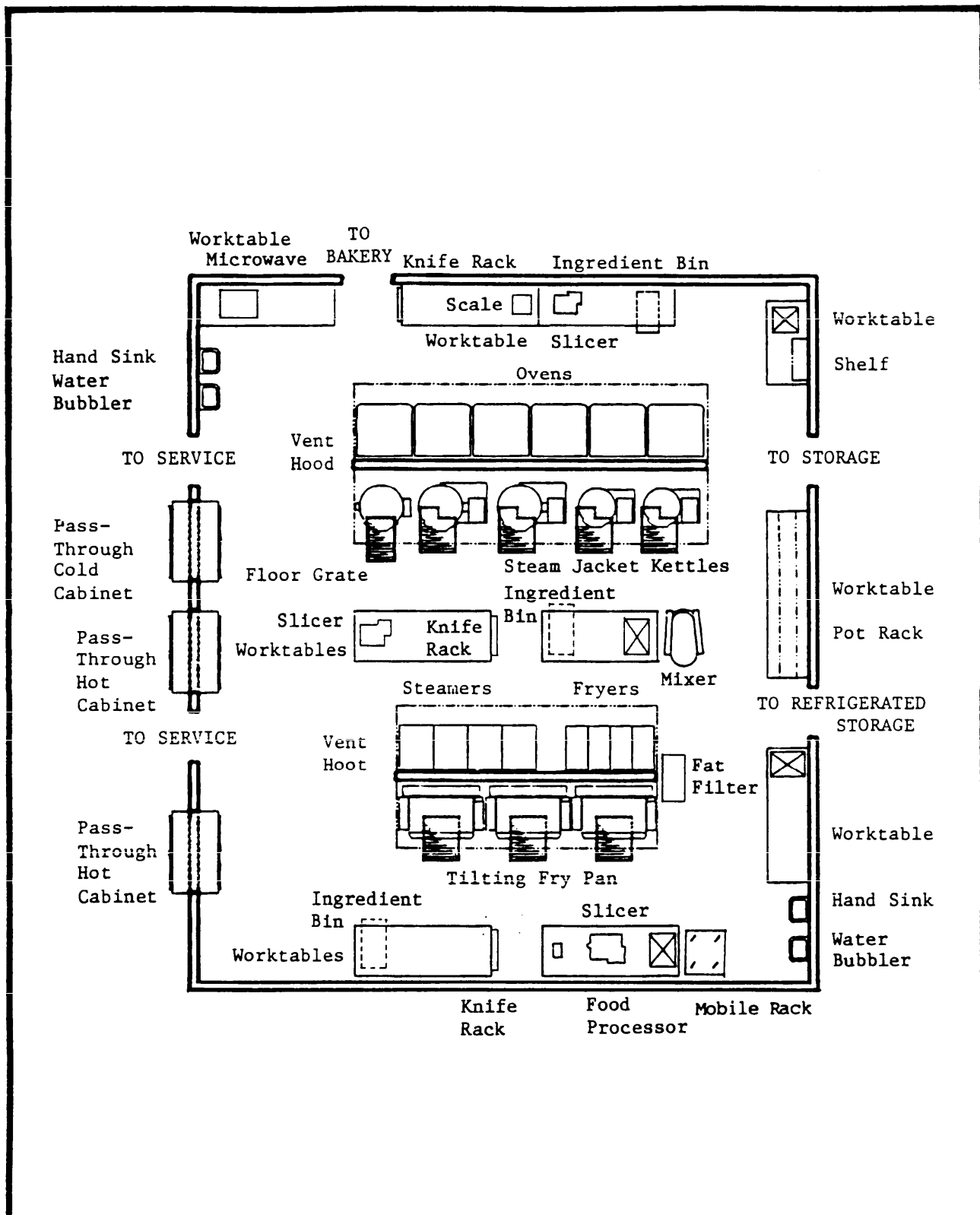

Title	Date	Category Code	Plate
Kitchen for Large Dining Facility	3/30/90	722-10	29

OPTION 1

Individual Sump Drain

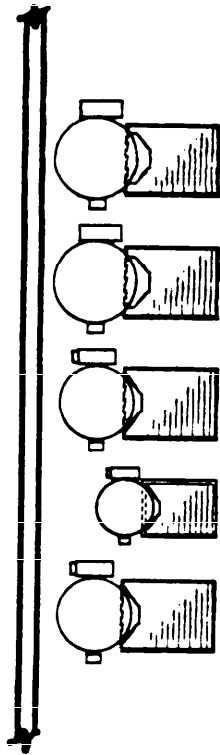

Each sump drain sized to accommodate each kettle

OPTION 2

Common Sump Drain

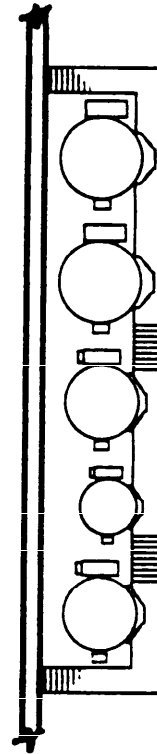

Use smallest "X" dimension and largest "Y" dimension
Kettles should be arranged so that all "X" dimensions coincide

Pour Pattern

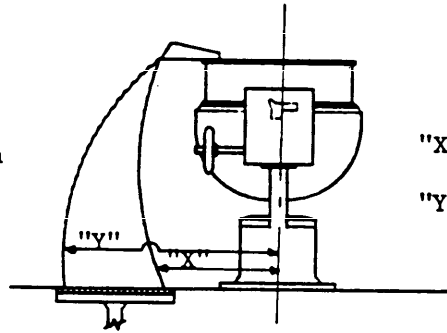

Sump Drain

"X" = Minimum Pour Distance

"Y" = Maximum Pour Distance

Title

MANAGEMENT OF KETTLE DISCHARGE

Date

3/30/90

Category Code

722-10

Plate

30

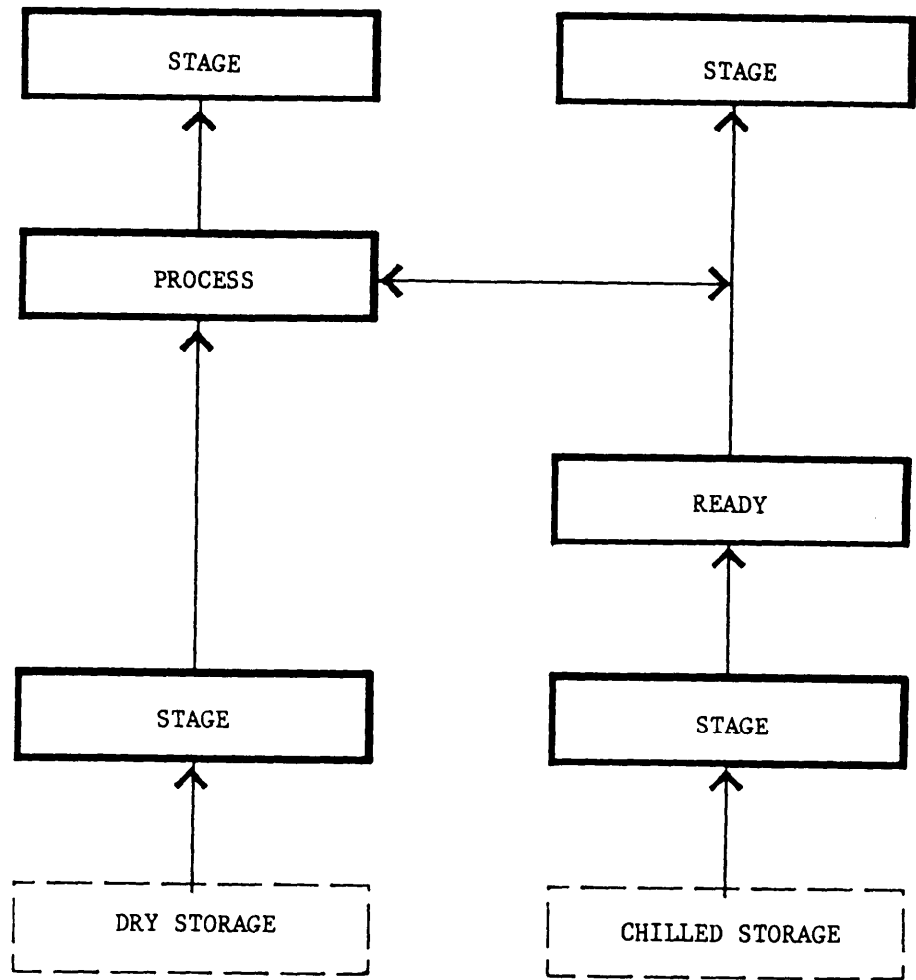

STAGE	Temporary storage prior to readying, processing further preparation or service (ambient, cold)
READY	Unpack, inspect, wash, trim, peel, drain
PROCESS	Measure, mix, assemble, cut, pan, load

Title VEGETABLE PREPARATION AREA FLOW CONCEPT DIAGRAM	Date 3/30/90	Category Code 722-10	Plate 31
--	------------------------	--------------------------------	--------------------

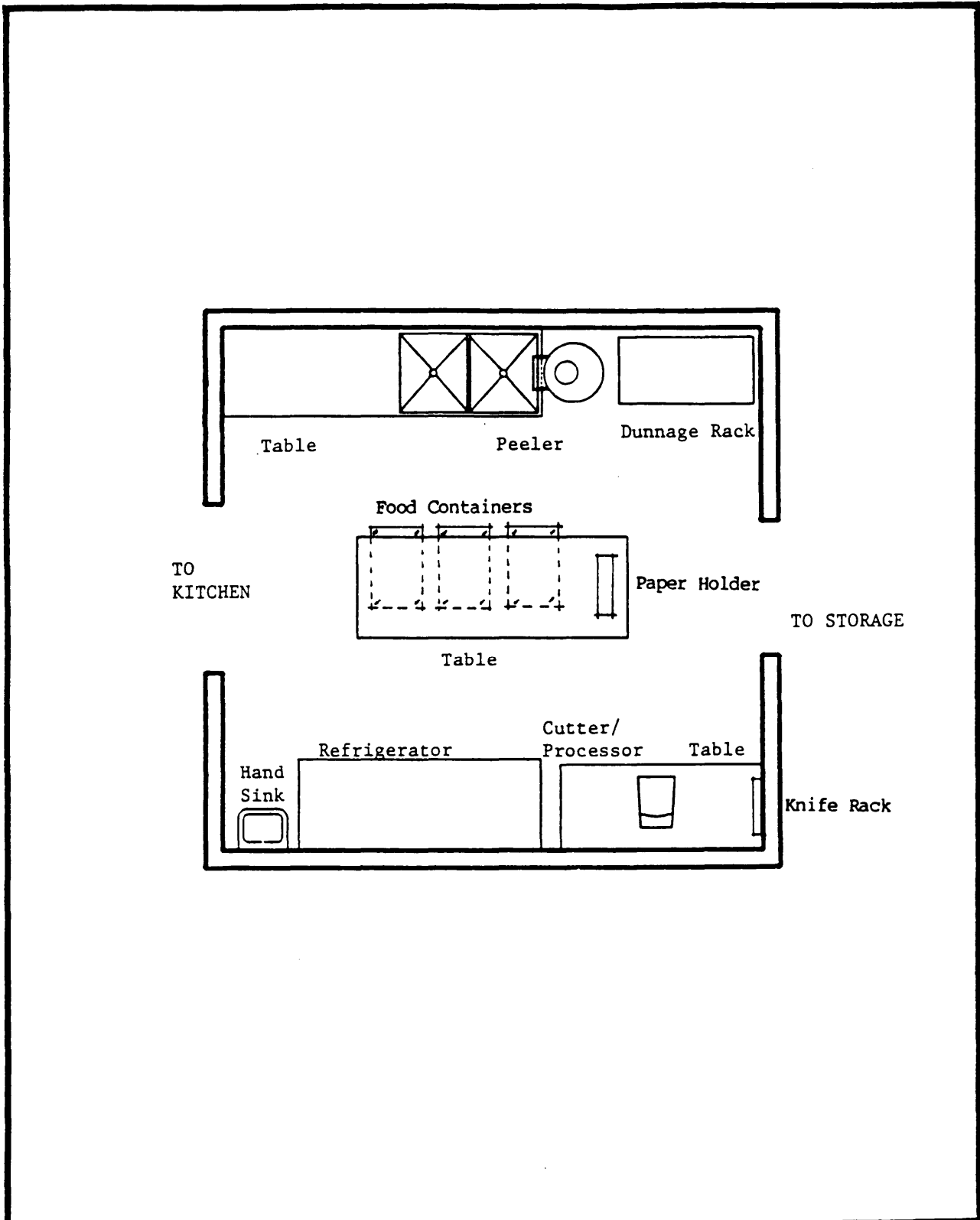

Title	Date	Category Code	Plate
TYPICAL VEGETABLE PREPARATION	3/30/90	722-10	32

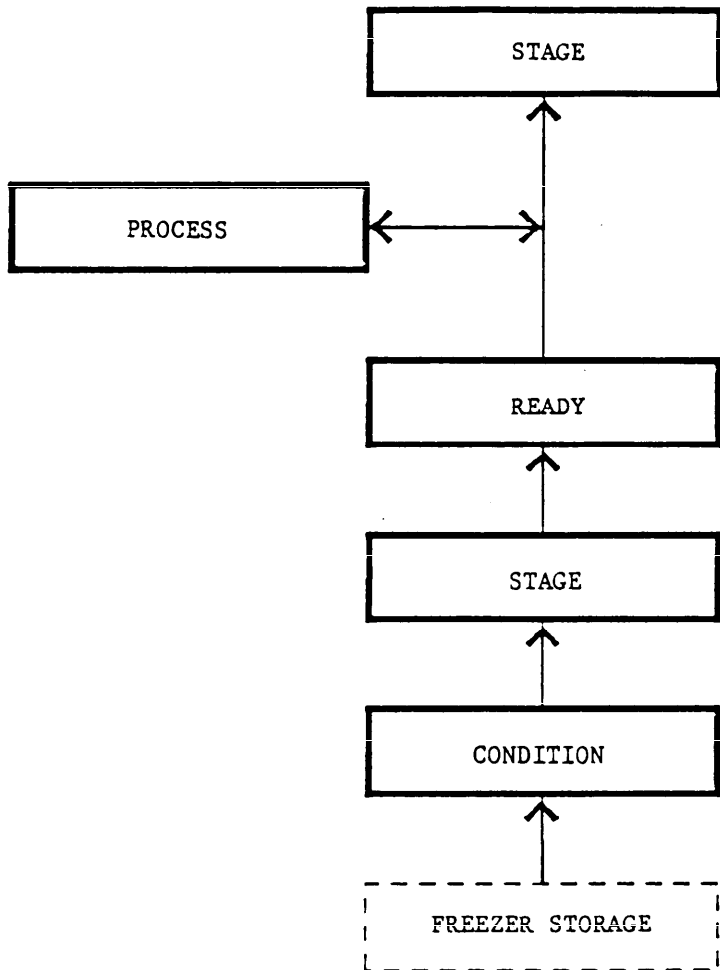

CONDITION	Thaw
STAGE	Temporary storage prior to readying, processing service or further preparation (ambient, cold)
READY	Unpack, inspect, trim, drain, wash
PROCESS	Cut, shape, mix, form, pan, load, measure

Title MEAT PREPARATION AREA FLOW CONCEPT DIAGRAM	Date 3/30/90	Category Code 722-10	Plate 33
--	-----------------	-------------------------	-------------

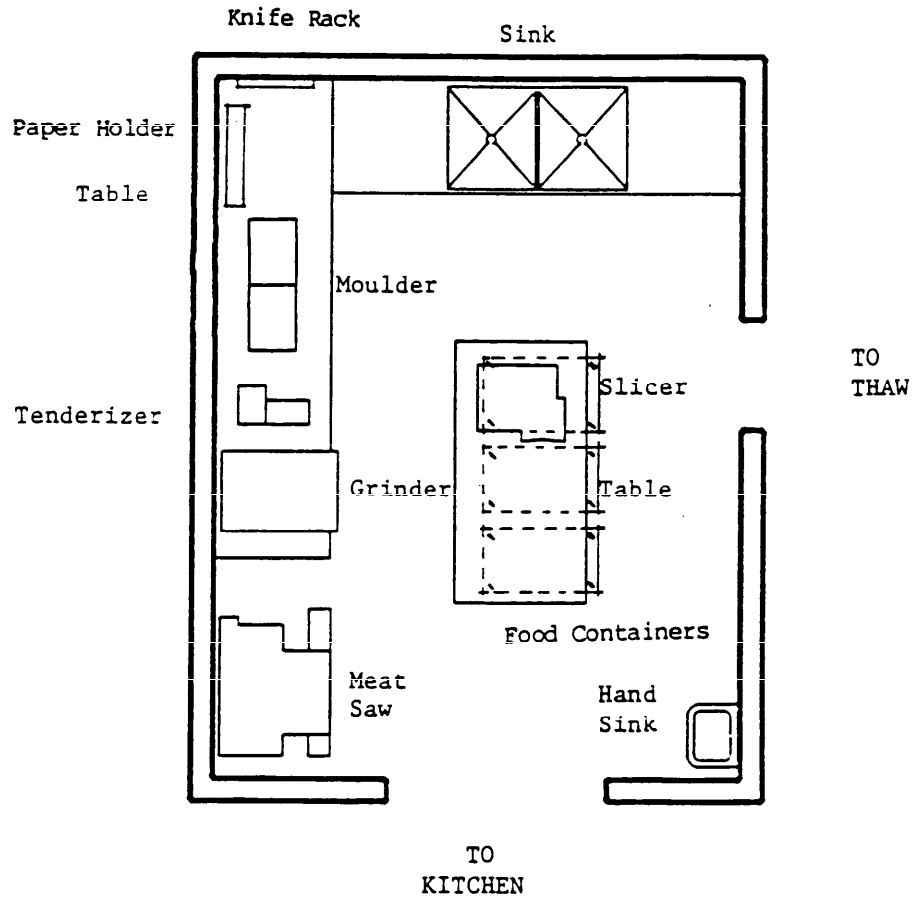

<p>Title TYPICAL MEAT PREPARATION</p>	<p>Date 3/30/90</p>	<p>Category Code 722-10</p>	<p>Plate 34</p>
---	-------------------------	---------------------------------	---------------------

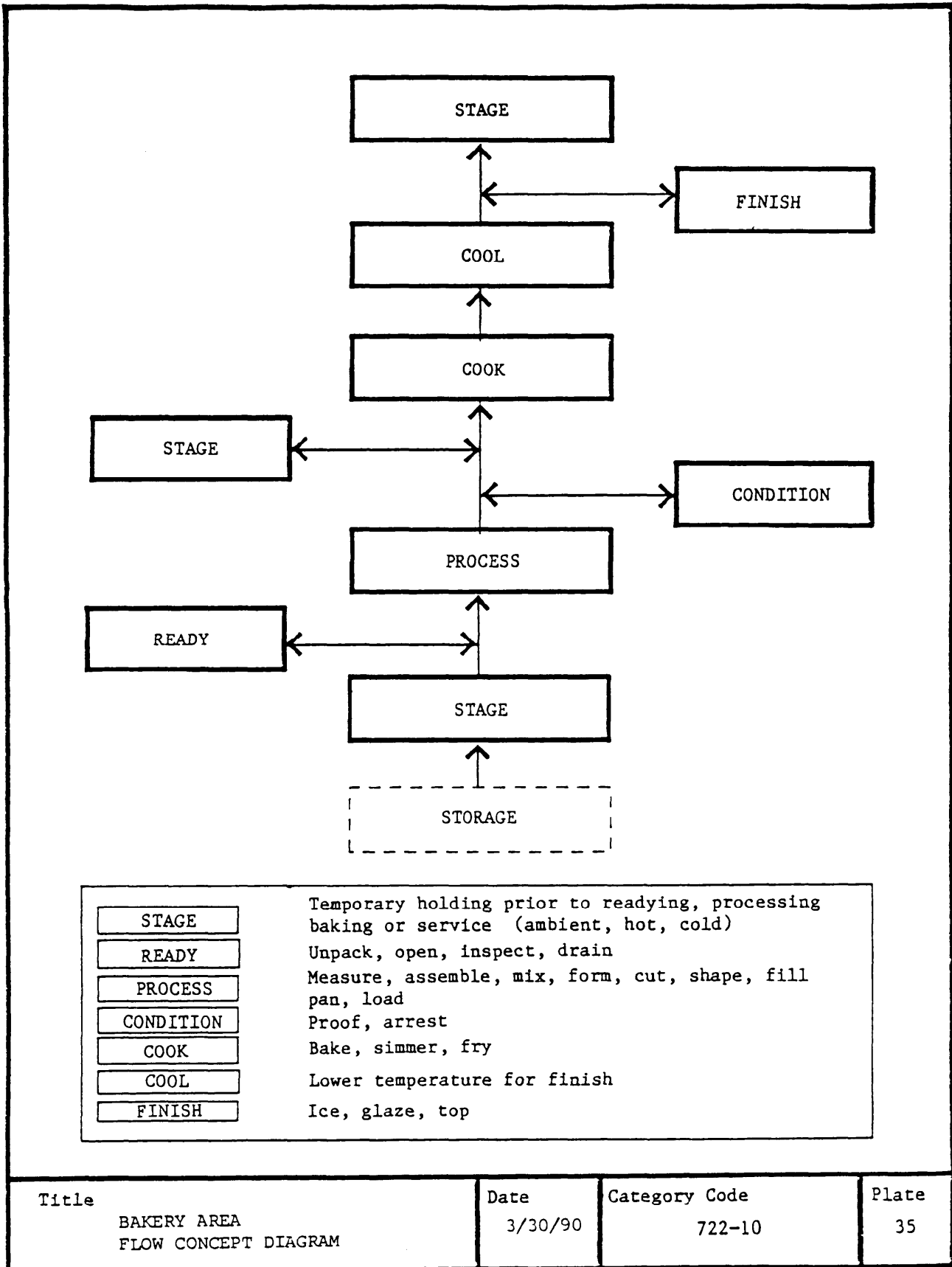

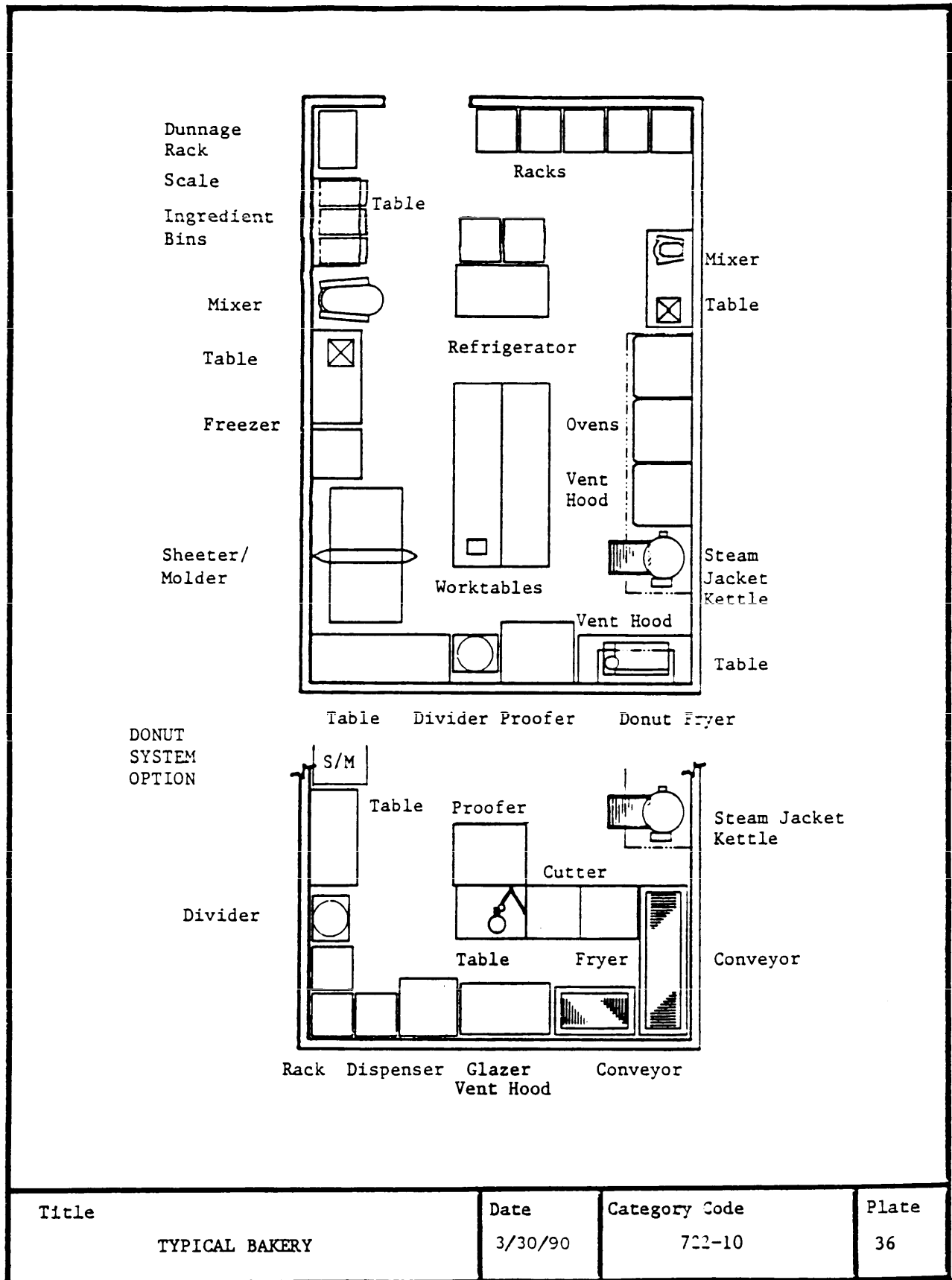

<p>Title</p> <p>TYPICAL BAKERY</p>	<p>Date</p> <p>3/30/90</p>	<p>Category Code</p> <p>722-10</p>	<p>Plate</p> <p>36</p>
------------------------------------	----------------------------	------------------------------------	------------------------

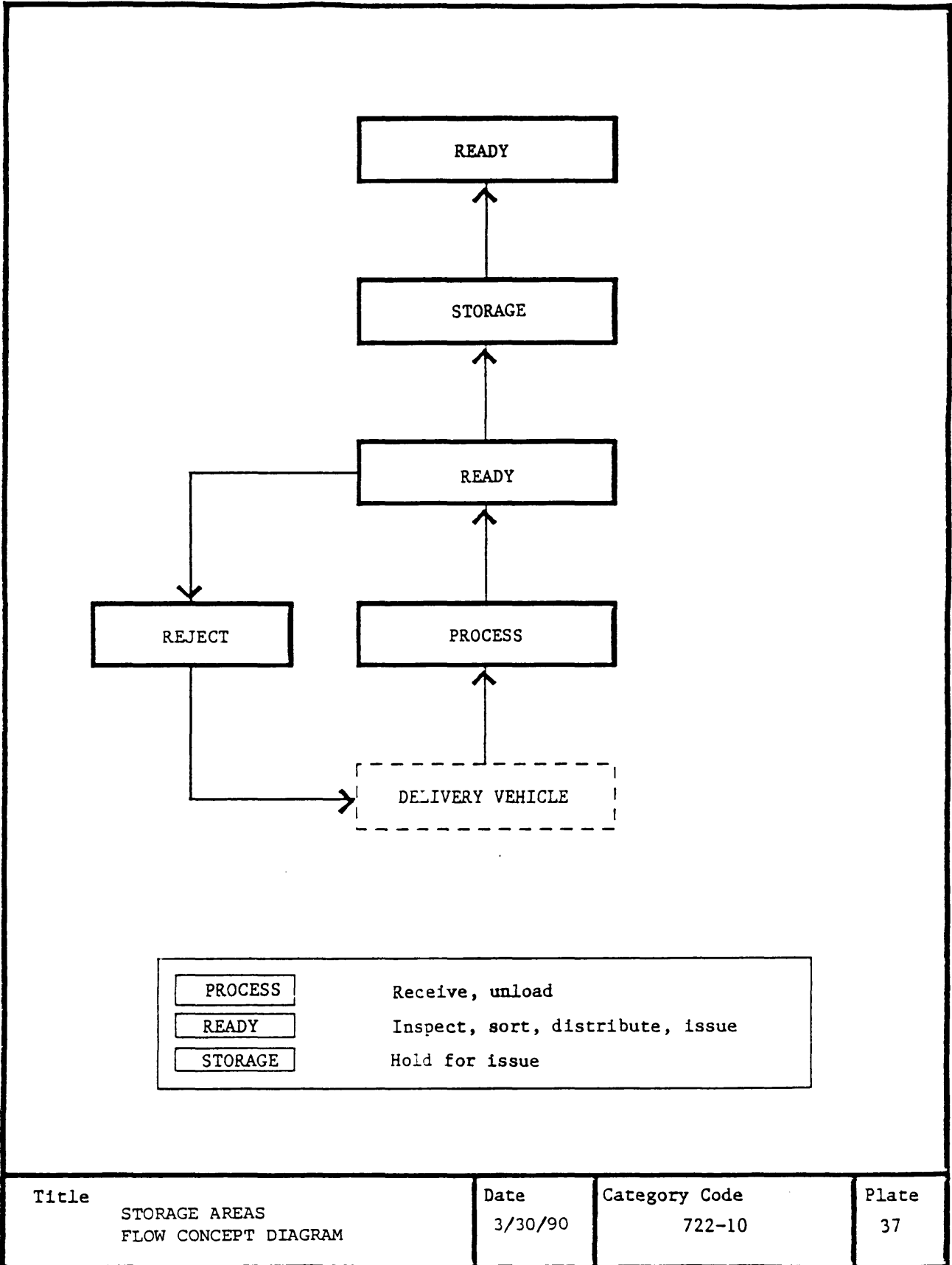

Title
STORAGE AREAS
FLOW CONCEPT DIAGRAM

Date
3/30/90

Category Code
722-10

Plate
37

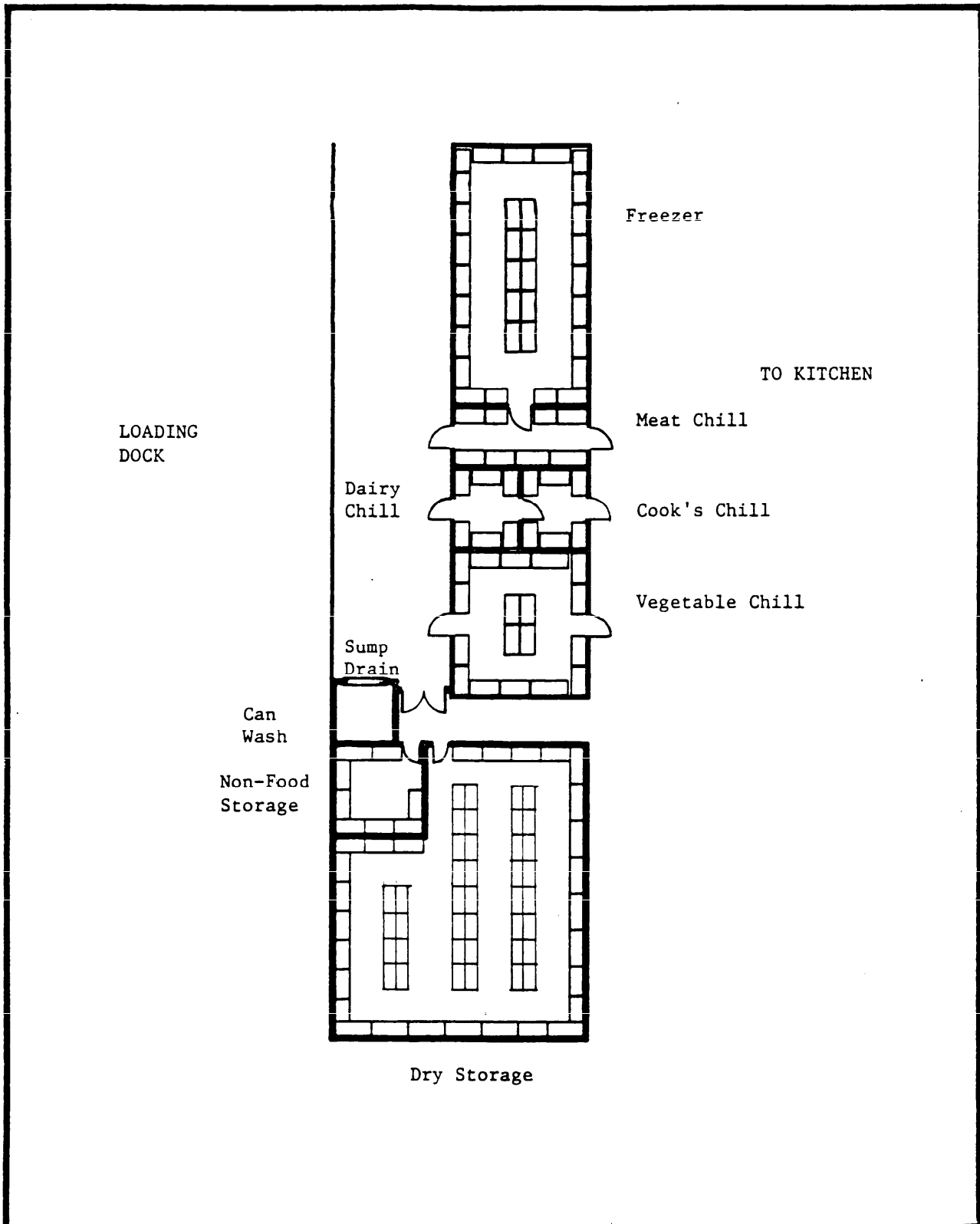

Title	Date	Category Code	Plate
TYPICAL STORAGE AREAS	3/30/90	722-10	38

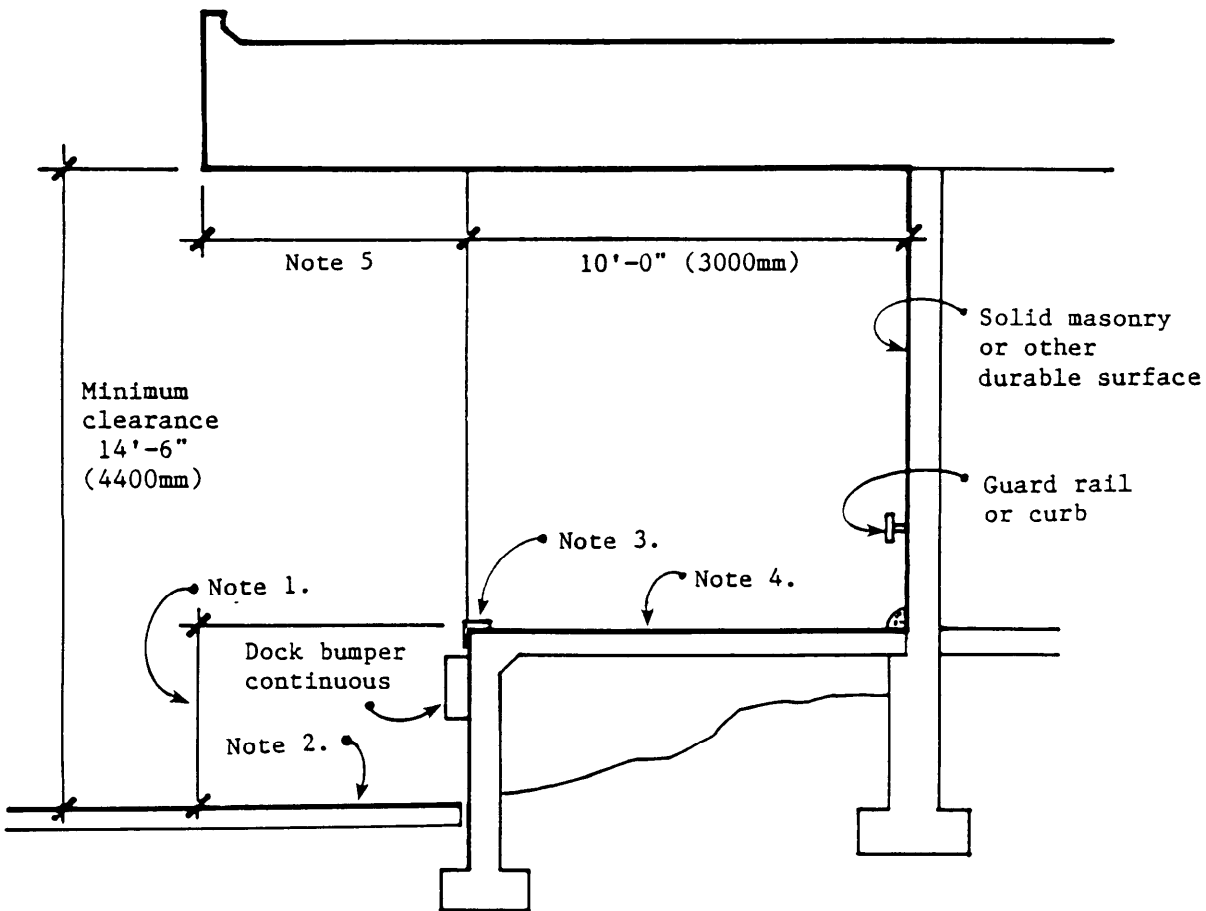

1. Coordinate height of loading dock with size of vehicles servicing facility. Standard height for larger facilities is 4'-0" (1200mm).
2. Pitch apron paving away from dock minimum 1/4" in 12".
3. 2" (50mm) metal lip to protect concrete edge of dock and to prevent carts from rolling off edge.
4. Slope dock away from building 1/8" in 12". Dock is to be broom finish concrete.
5. Overhang as required for weather protection. In cold weather areas requiring enclosed loading docks use insulated rolling doors and dock seals and omit overhang.
6. Provide concrete ramp from dock to vehicle area for hand cart access.

Title

LOADING DOCK CRITERIA

Date

3/30/90

Category Code

722-10

Plate

39

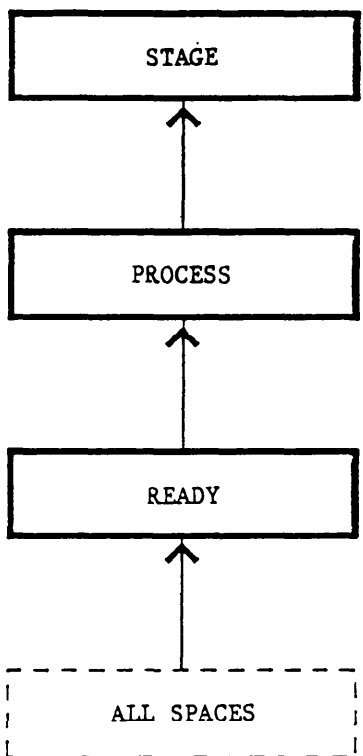

READY	Remove trash, garbage
PROCESS	Wash, rinse, sanitize
STAGE	Temporary storage

Title SUPPORT AREA FLOW CONCEPT DIAGRAM	Date 3/30/90	Category Code 722-10	Plate 40
---	-----------------	-------------------------	-------------

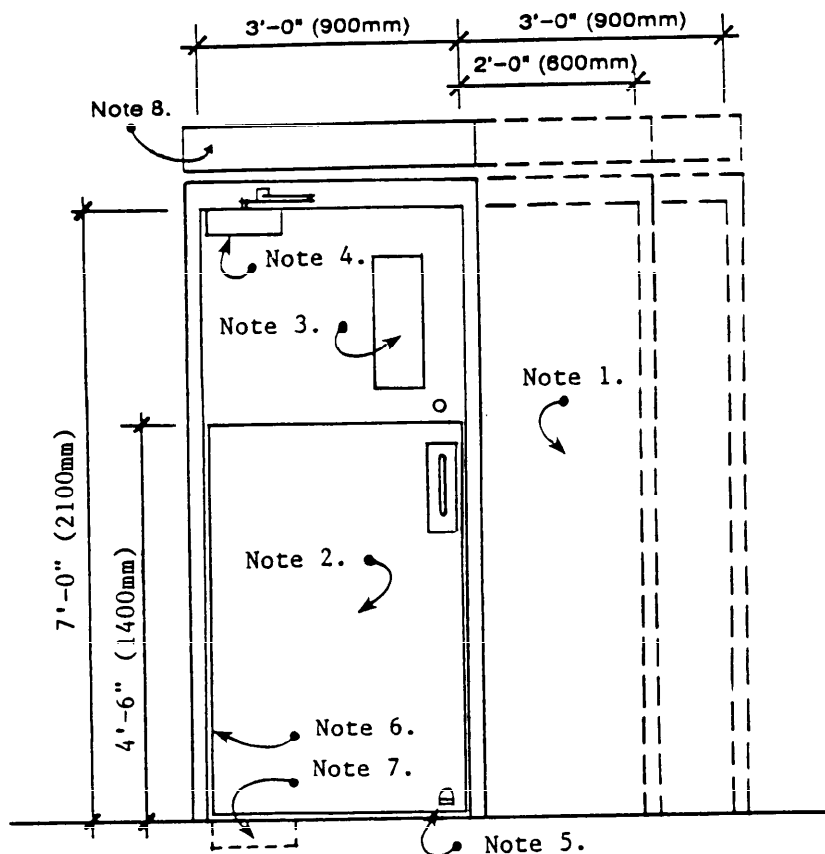

1. All doors in kitchen areas shall be a minimum of 3'-0"x7'-0" (900x2100mm). Doors to dry storage and loading dock areas shall be 6'-0" (1500mm) wide double doors. If space limitations require the use of a 5'-0" (1500mm) door, the inactive leaf should be 2'-0" (600mm)
2. Provide 16 Ga. (1.50mm) stainless steel protection to all doors in in areas having cart traffic.
3. Provide vision panel in all doors with two way traffic.
4. Provide heavy duty door closers with time delay closing feature at doors with heavy cart traffic.
5. Provide hold open device, either concealed in door head or wall mounted. Floor mounted hold open devices are not approved.
6. Provide heavy duty ball bearing hinges at all single swing doors.
7. Provide heavy duty recessed pivot hinges at all double swing doors.
8. Provide fly fans at frequently used doors leading to the kitchen area.
9. Provide plastic closure flaps at all exterior doors in cold storage spaces.

Title

DOORS IN KITCHEN AREAS

Date

3/30/90

Category Code

722-10

Plate

41

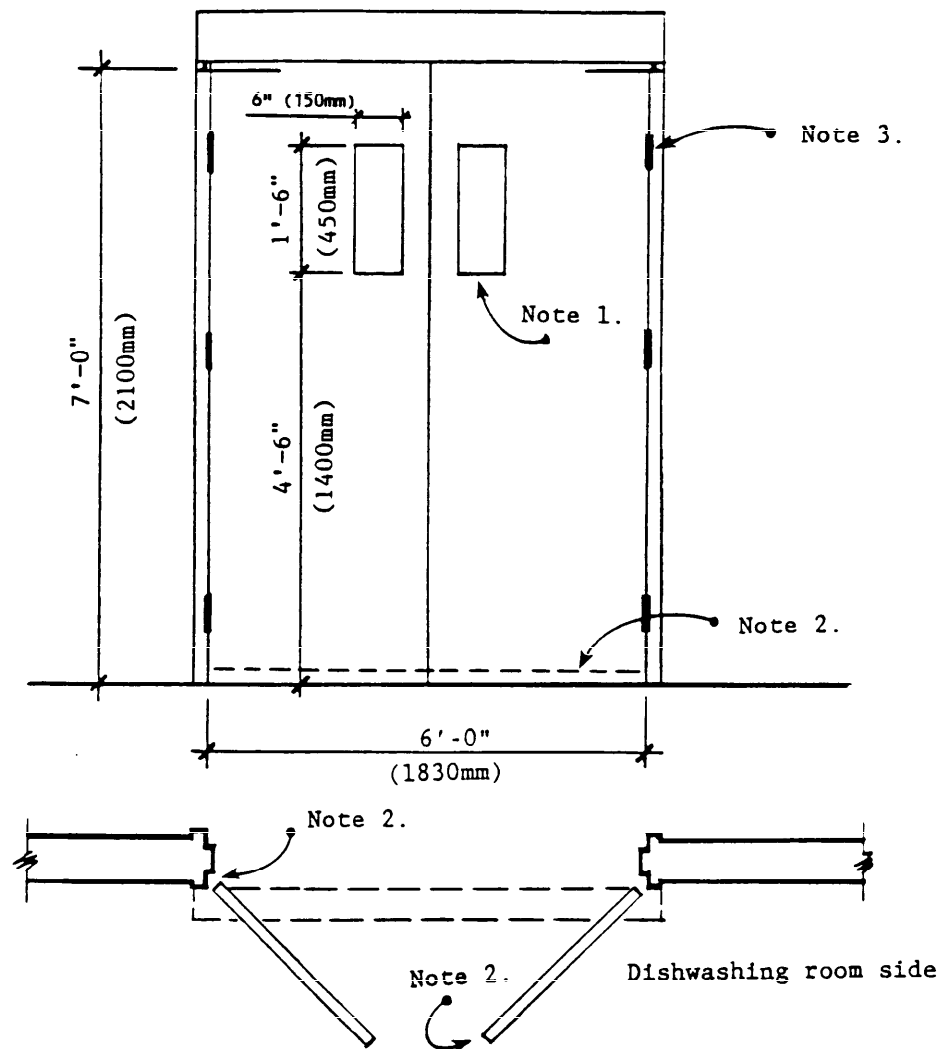

1. Provide vision panels as indicated.
2. Provide sound seal hardware at all door edges.
3. Heavy duty ball bearing type hinges.

Title	Date	Category Code	Plate
DOUBLE DOORS AT DISHWASHING ROOMS	3/30/90	722-10	42

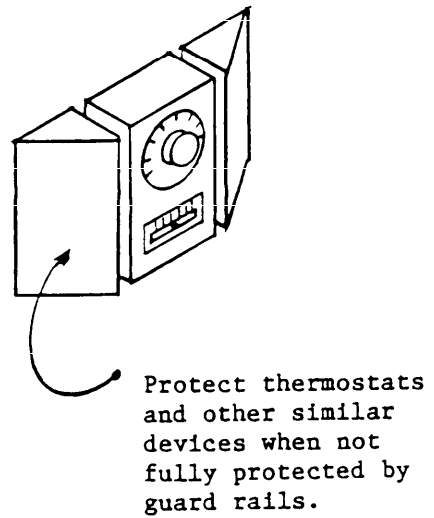
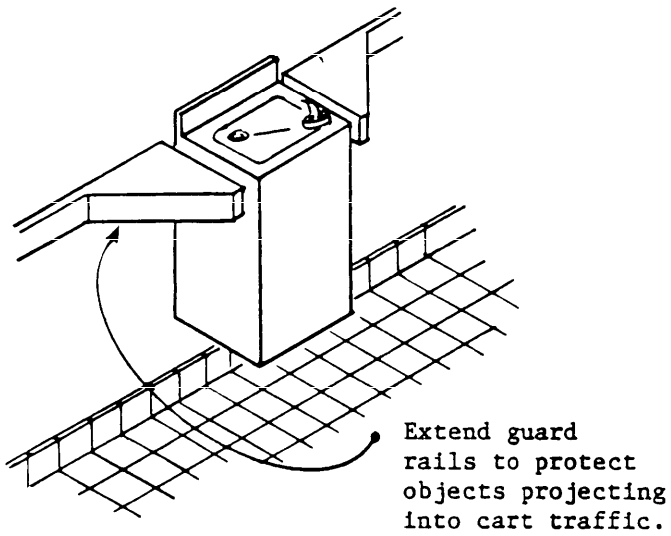
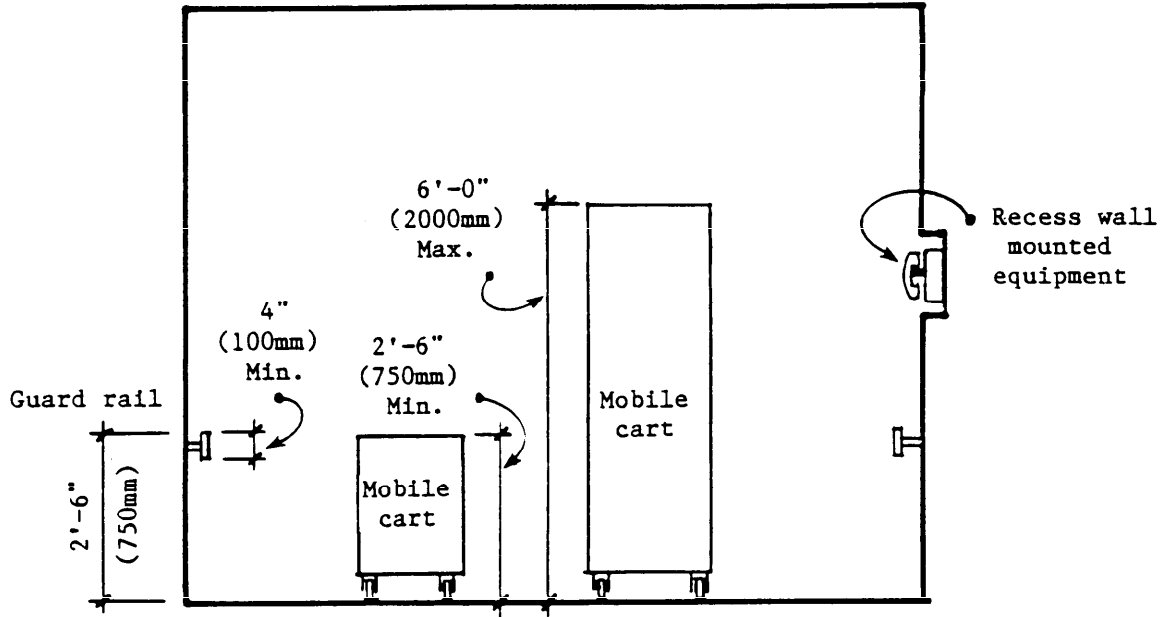

Title	Date	Category Code	Plate
GUARD RAIL LOCATIONS	3/30/90	722-10	43

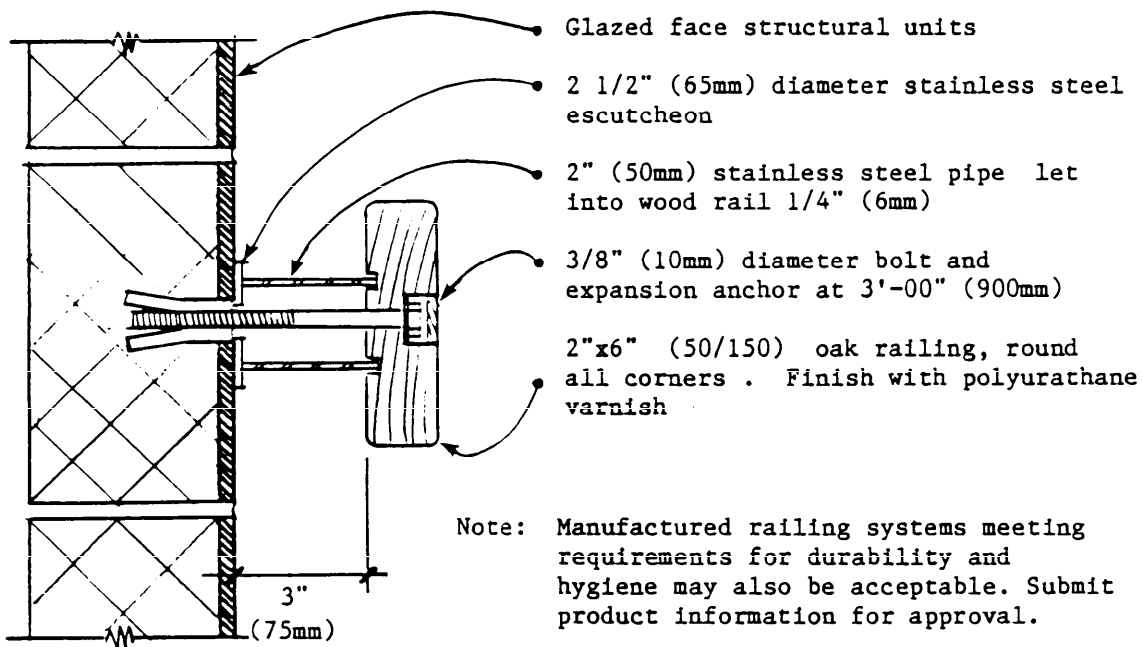
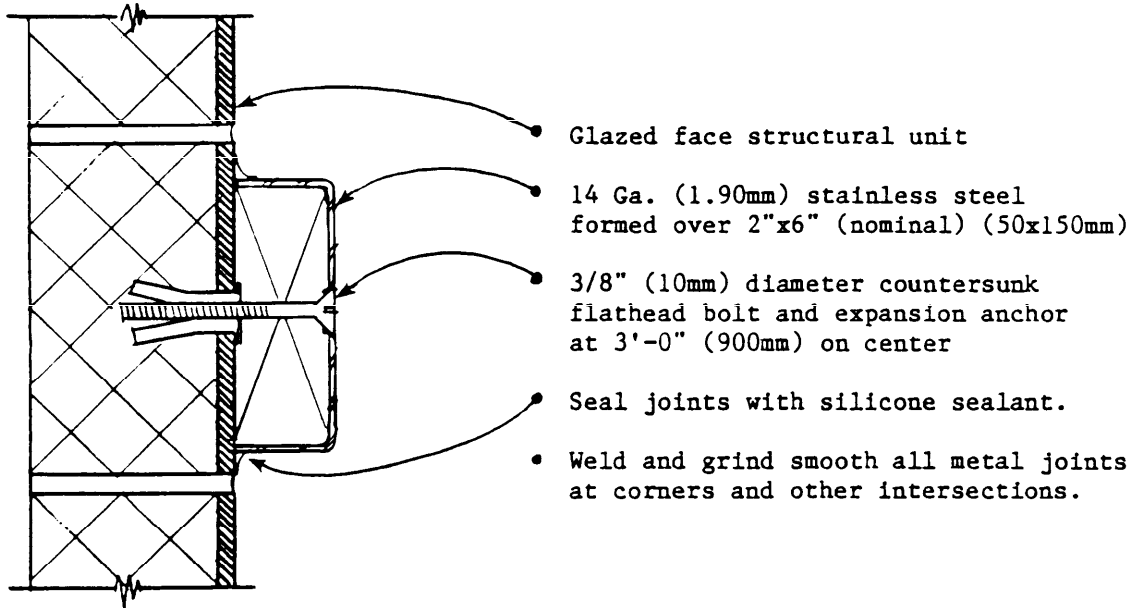

Coordinate railings with door opening requirements.

Title

TYPICAL GUARD RAILS

Date

3/30/90

Category Code

722-10

Plate

44

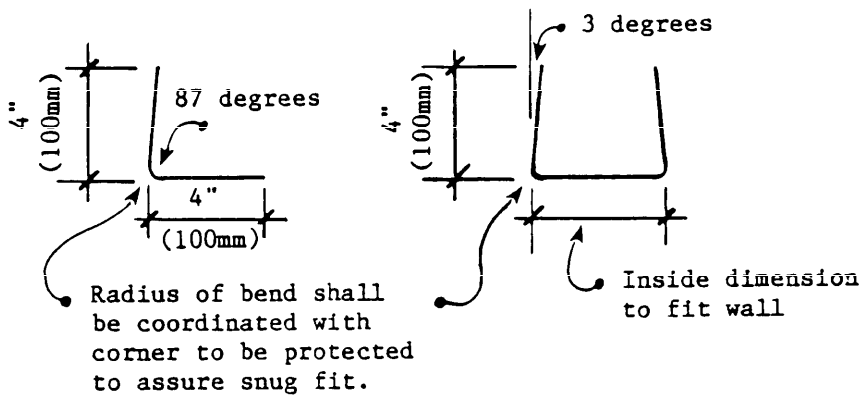
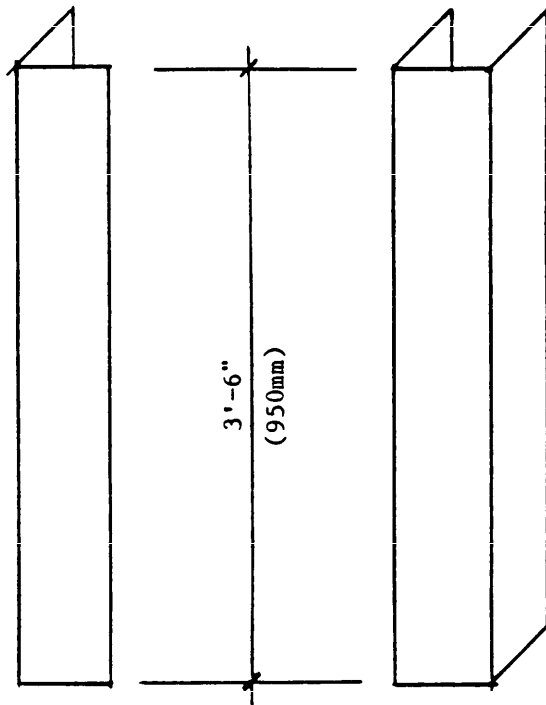

Mount 14 Ga. (1.90mm) stainless steel corner guards flush with base. Attach with stainless steel fasteners and caulk with silicone sealant.

Title	Date	Category Code	Plate
CORNER GUARDS	3/30/90	722-10	45

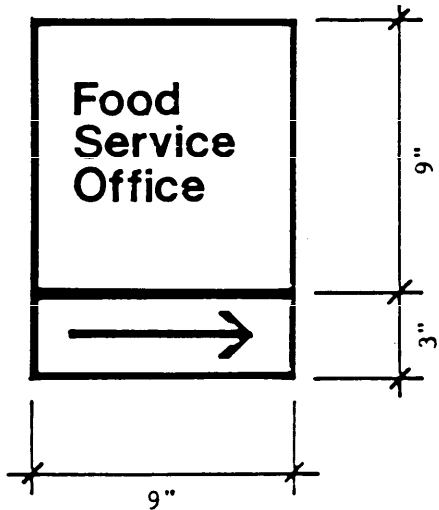
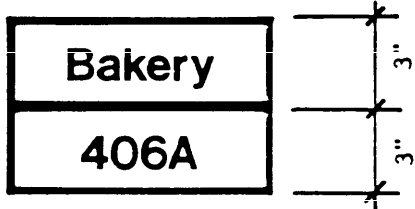
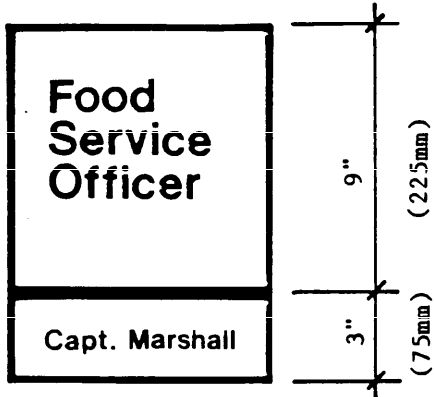

1. Graphics throughout the facility should be consistent in size, color and style.
2. 9"x9" signs are recommended for signs with more than one line of text, for room identification or informational signs.
3. 3"x9" signs are recommended for name i.d., room numbers, directional indicators, and other single line signs.

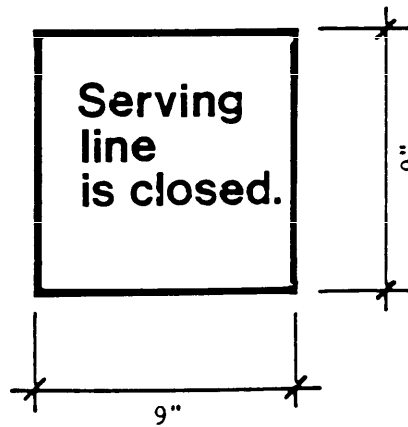

Title	Date	Category Code	Plate
GRAPHICS AND SIGNAGE	3/30/90	722-10	46

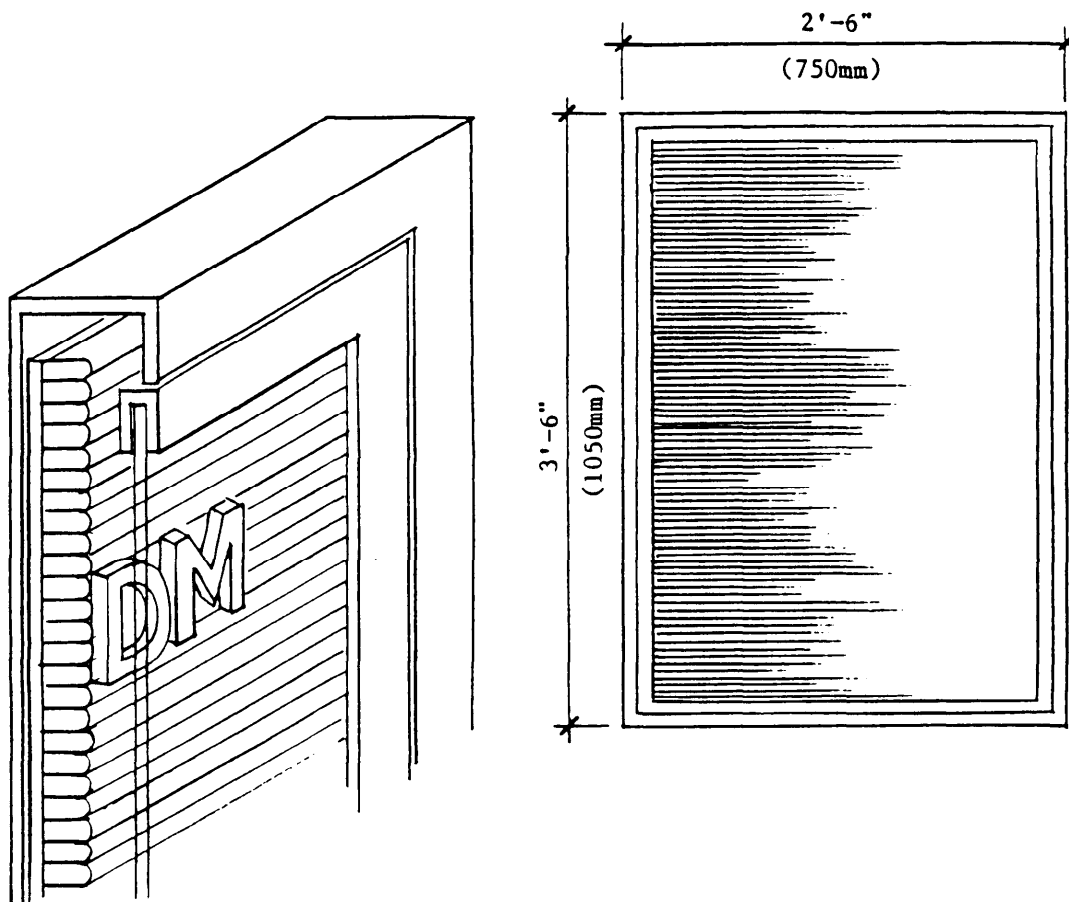

1. Provide one menu board for each serving line located in full view at the beginning of the line.
2. Menu boards shall be made of ribbed felt on rigid backing. Boards shall be contained in a metal and glass lockable case. Boards shall be removable to facilitate daily changing of the menu.
3. Type face of letters shall be coordinated with building graphics. Recommended color is white.
4. Color of felt shall be a dark color coordinated with building and graphics color schemes.

Title	Date	Category Code	Plate
MENU BOARDS	3/30/90	722-10	47

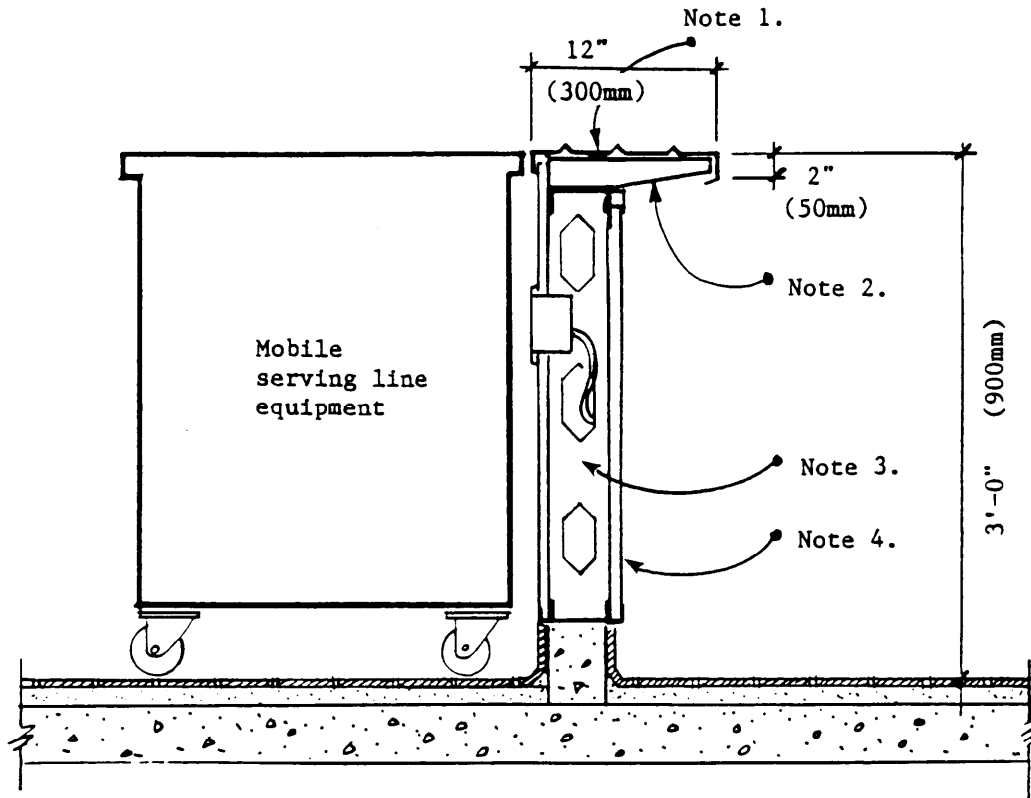

NOTE For more information on trayslide details contact Navy Food Service System office for current standard drawing.

1. 14 Ga. (1.90mm) stainless steel trayslide secured to bracket with welded studs.
2. Stainless steel trayslide bracket welded to continuous stainless steel channel at 4'-0" (1200mm) on center.
3. 16 Ga. (1.50mm) structural steel stud frame at 16" (400mm) on center, anchor bolted to concrete curb. Frame shall turn corner at ends and run 2'-6" (750mm) to stabilize free standing ends. Openings in stud work shall be used as raceway for electrical wiring and other utilities as required.
4. Face panels may be plastic laminate, ceramic tile or other approved wall surfaces.
5. Manufactured trayslide systems providing similar features to the above may be submitted for approval.

Title	Date	Category Code	Plate
SERVING LINE TRAY SLIDE	3/30/90	722-10	48

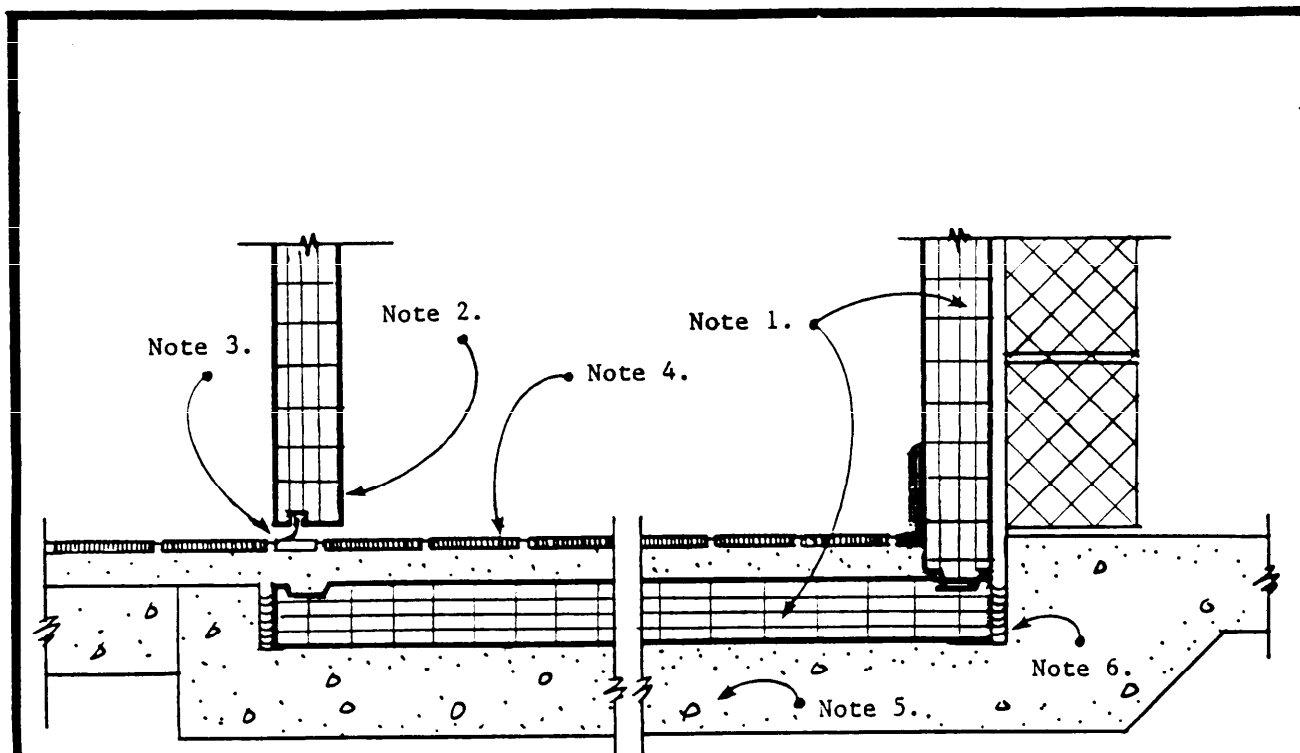

1. Metal covered insulated wall and floor panels.
2. Metal covered insulated walk-in door with adjustable floor wiper gasket.
3. Anti-sweat heater.
4. Quarry tile inseting bed. Set tile dead level.
5. Recessed concrete slab on polyethelene vapor barrier. Depth of recess shall be equal to thickness of insulated panel as specified and quarry tile and setting bed.
6. Provide sealant at edges of slab as indicated.
7. At freezer locations, if any portion of the slab is greater than 20'-0" (6000mm) from the perimeter, the slab must be heated to prevent freezing. Freezer requirements specified in this manual are not large enough to invoke this rule. However, larger facilities may require this measure.

Title	Date	Category Code	Plate
COLD STORAGE SLAB INSULATION	3/30/90	722-10	49

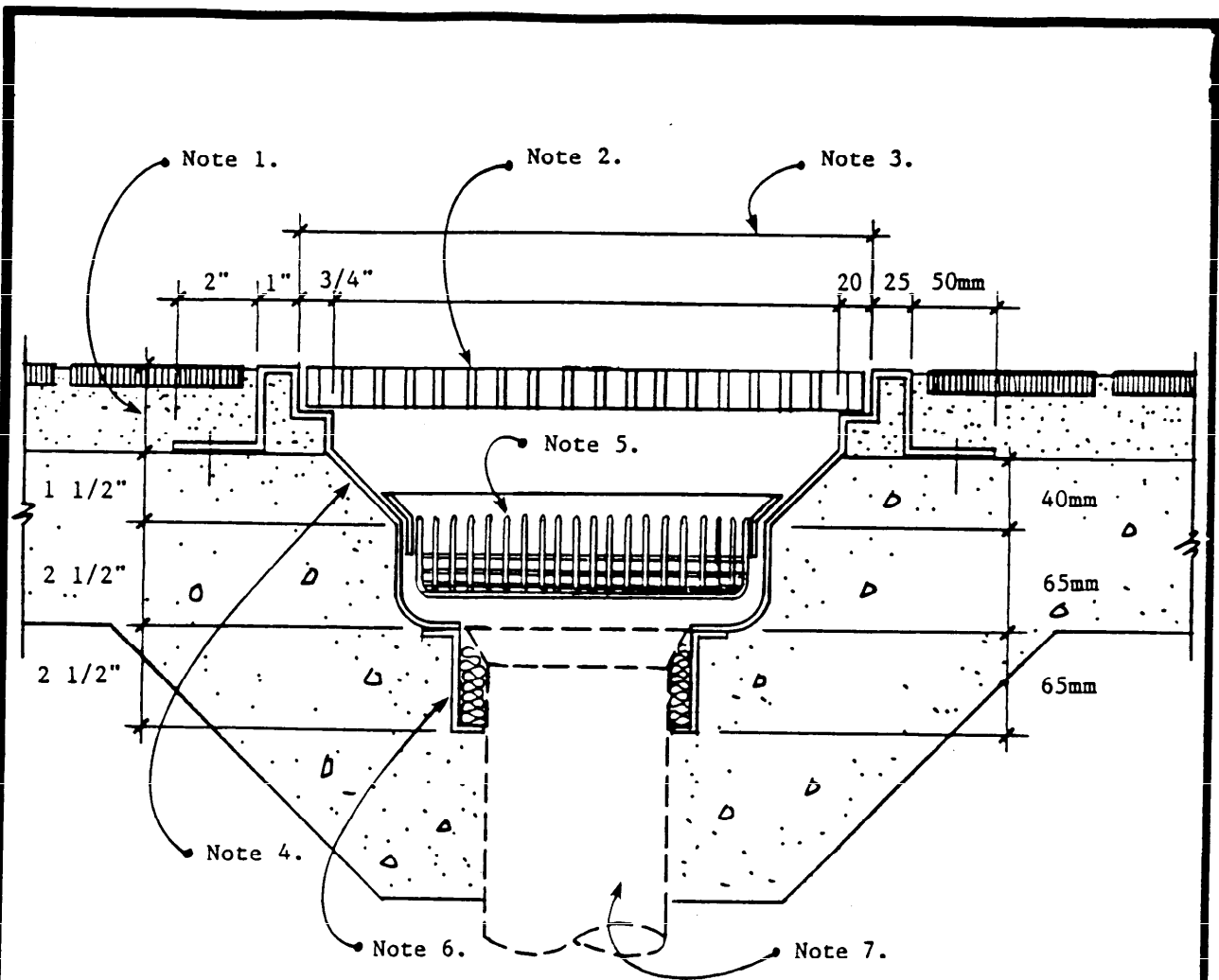

1. Coordinate depth of frame with depth of quarry tile setting bed.
2. Grating to be 1/4" x 1" (6x25mm) stainless steel bars fully welded at all connections. Allow 1/8" clearance on all sides.
3. Size of grating to be determined by designer.
4. 14 Ga. (1.90mm) stainless steel pan with all covered corners and fully welded seamless construction.
5. Removable mesh basket of #4 (5.75mm) stainless steel wire mesh reinforced at top with 16 Ga. (1.50mm) stainless steel perimeter frame.
6. 12 Ga. (2.65mm) stainless steel stuffing box.
7. 4" (100mm) waste plumbing with bell hub inside of stuffing box.

Title

SUMP DRAIN - PAN TYPE

Date

3/30/90

Category Code

722-10

Plate

50

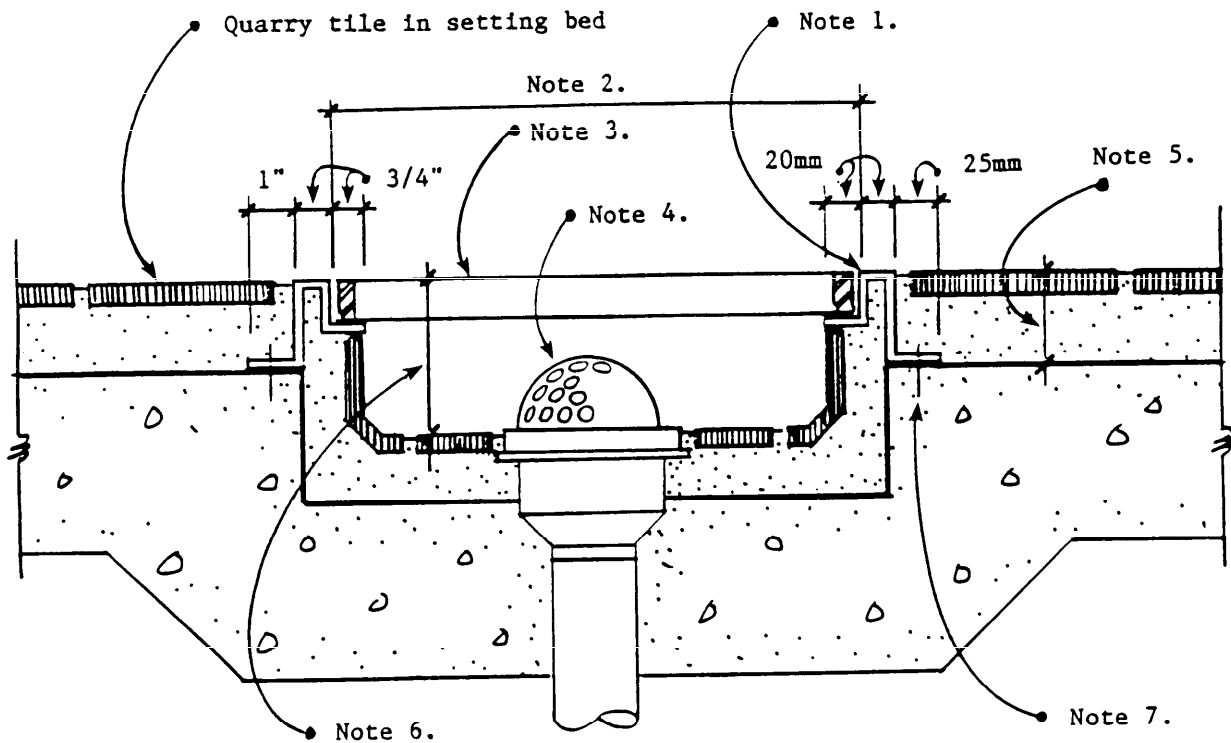

1. Grate frame is to be 12 Ga. (2.65mm) stainless steel.
2. Width and configuration of trench drain is to be determined by designer.
3. Floor grate is to be pressure locked stainless steel grating as required to fit trench configuration. Maximum size of individual grate to be the lesser of 3'-0" (900mm) or 30lbs. (14kg).
4. Adjustable beehive strainer.
5. Coordinate height of frame with specified depth of setting bed.
6. Finished depth of trench to be 4" (100mm).
7. Fasten to slab with ram set concrete anchors.
8. Pitch trench at 1/8" per foot to drain.

Title	Date	Category Code	Plate
SUMP DRAIN - TILE TYPE	3/30/90	722-10	51

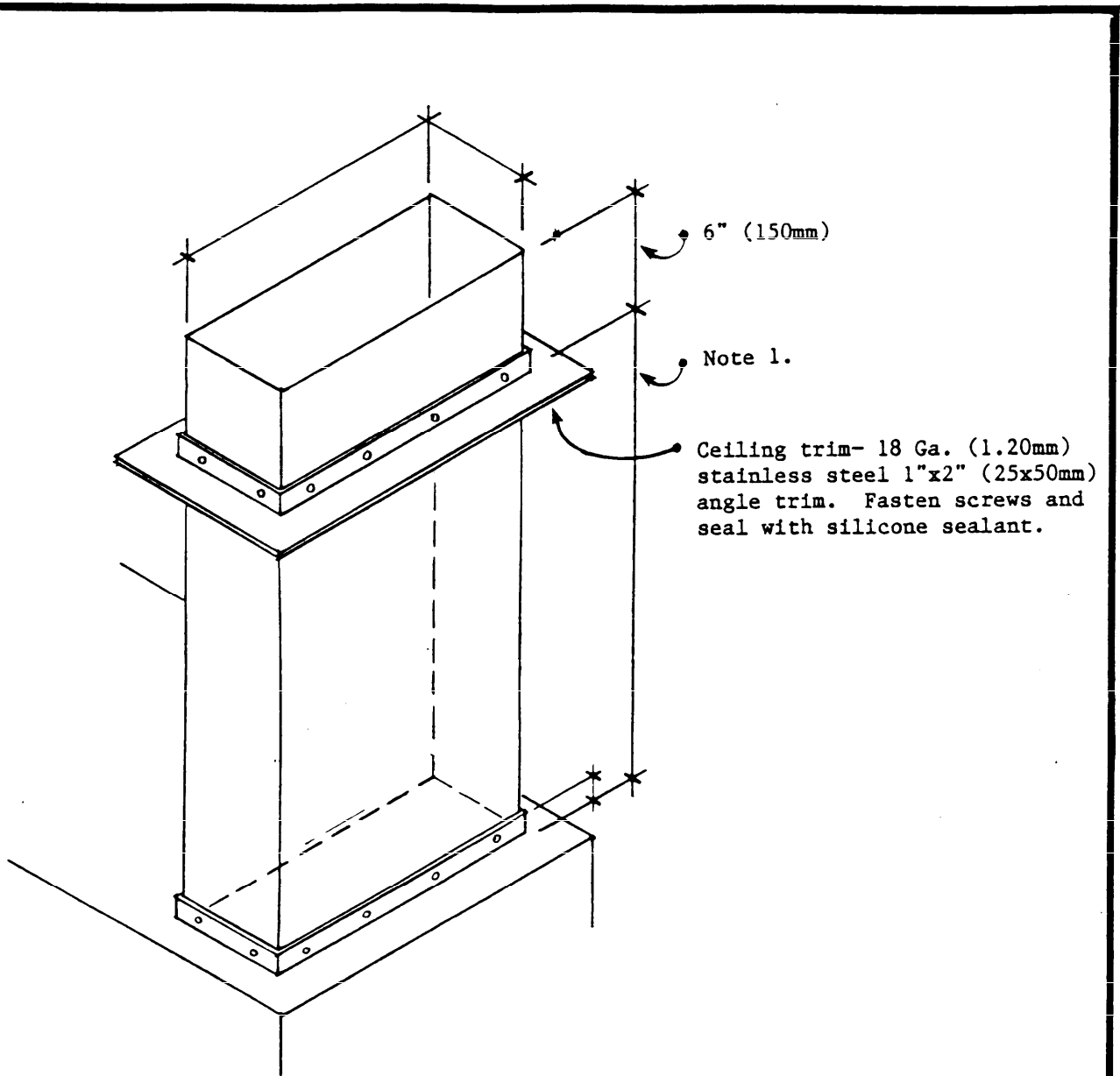

1. Ducts over 60" (1500mm) shall be cross creased for rigidity.
2. When dishwasher vents are not equipped with dampers, duct shall be provided with an 18 Ga. (1.20mm) stainless steel damper and locking quadrant located between the louvers and the dishwasher vent.

Title	Date	Category Code	Plate
DISHWASHER DUCT VENT	3/30/90	722-10	52

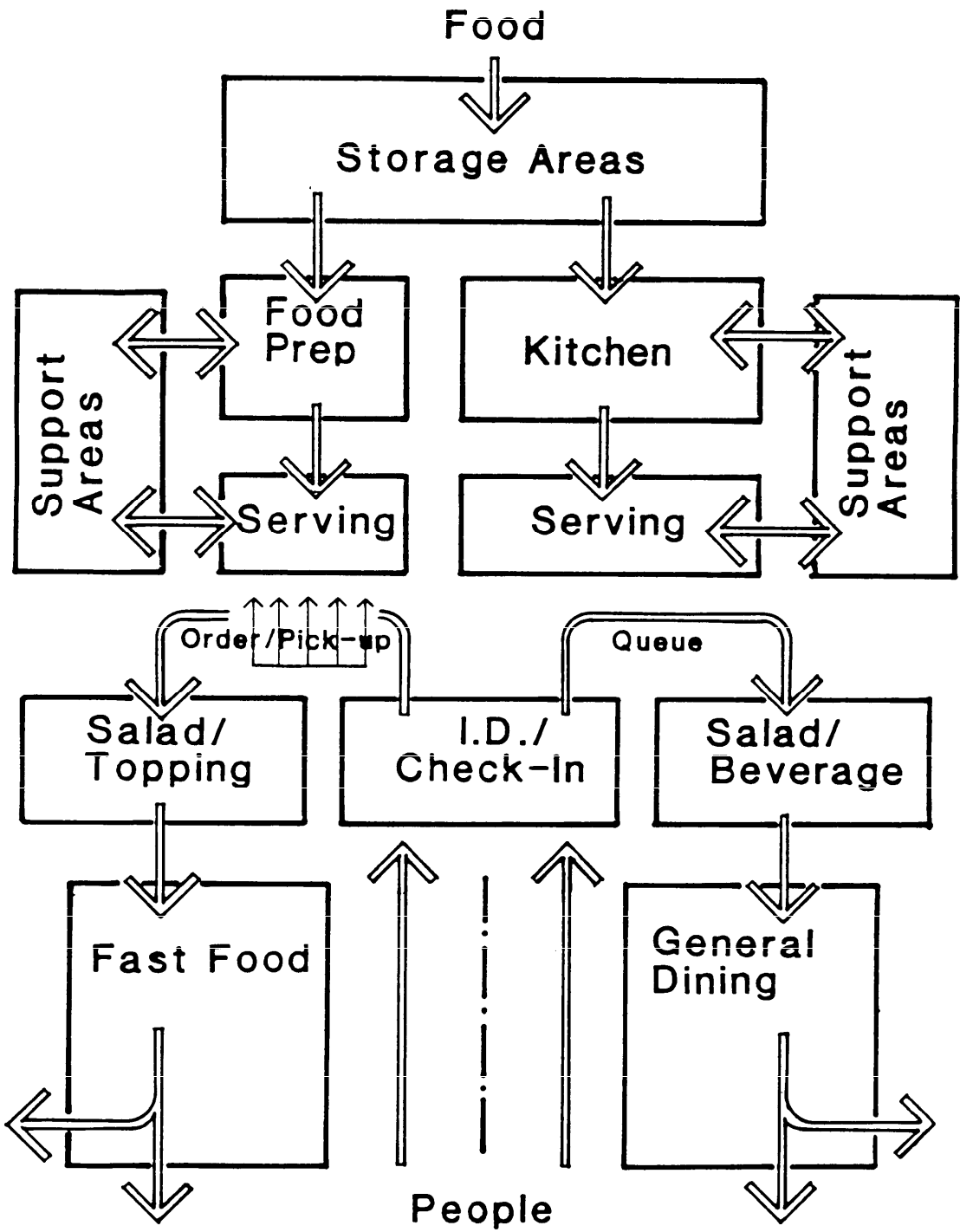

Note: For Dining Facilities with Total Seating above 400

<p>Title - General Dining Facility Flow Diagram - Marine Corps-</p>	<p>Date 3/30/90</p>	<p>Category Code 722-10</p>	<p>Plate 53</p>
---	-------------------------	---------------------------------	---------------------

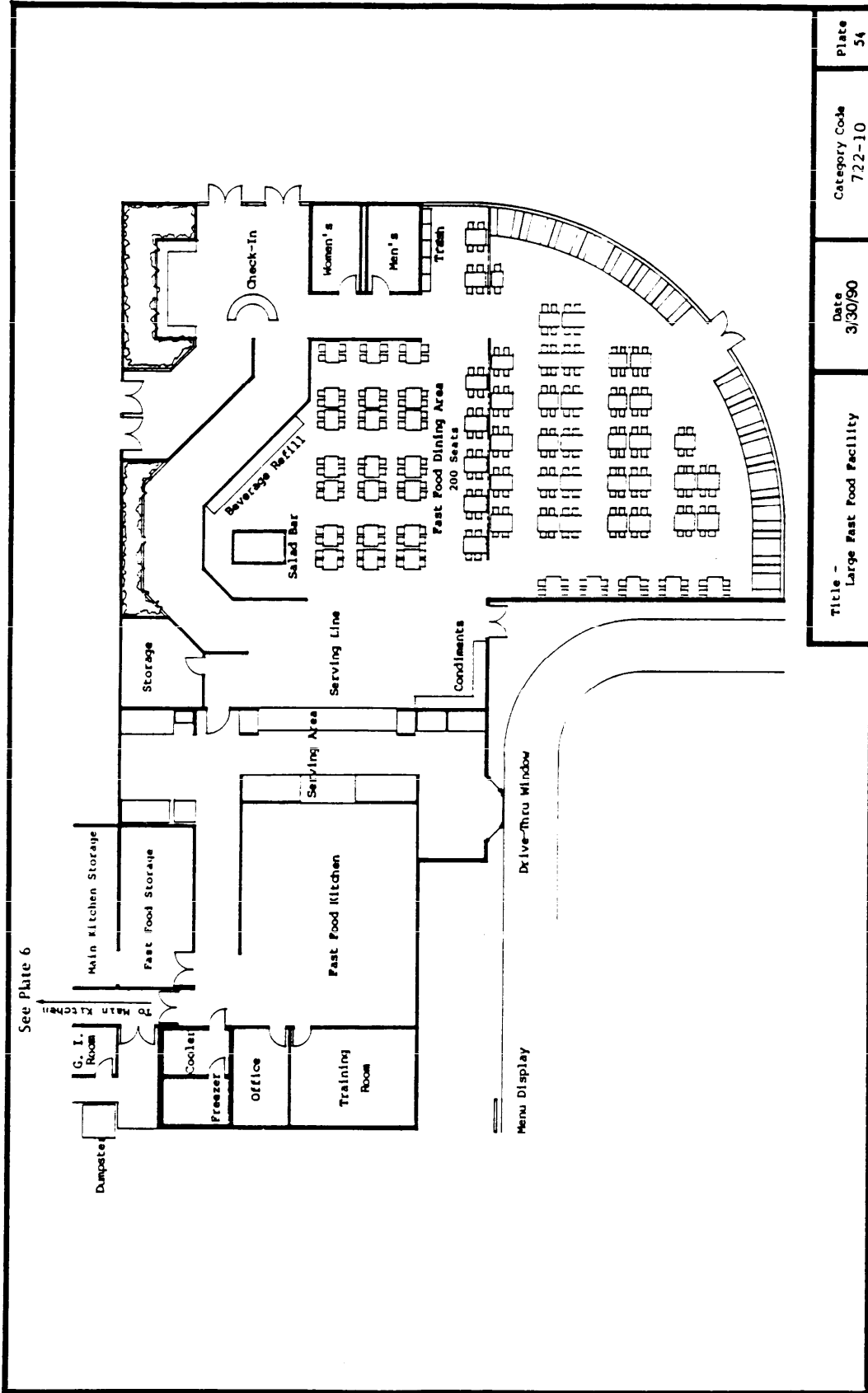

See Plate 6

Title -	Date	Category Code	Plate
Large Fast Food Facility	3/30/80	722-10	54

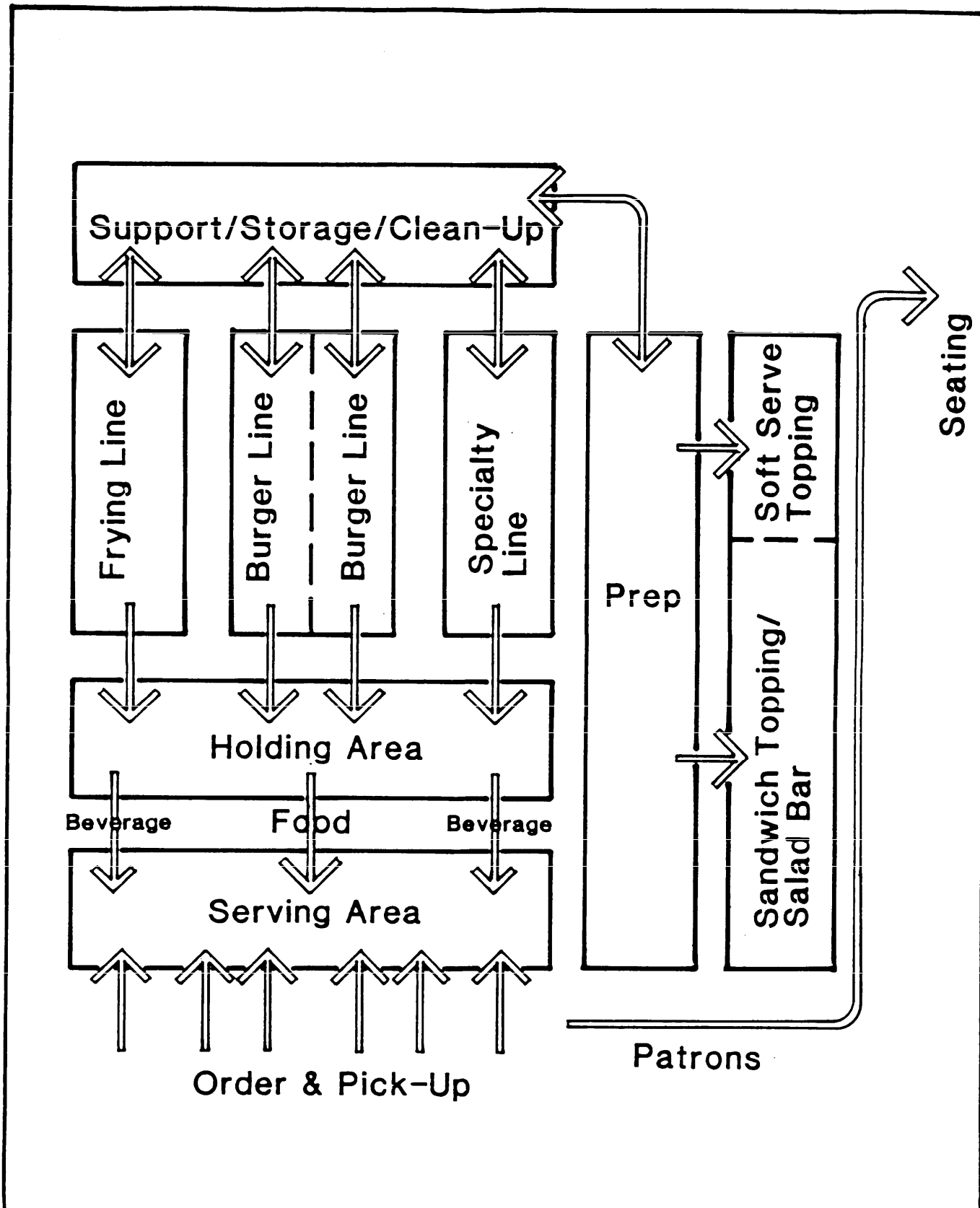

<p>Title - Flow Concept Diagram - Fast Food -</p>	<p>Date 3/30/90</p>	<p>Category Code 722-10</p>	<p>Plate 55</p>
---	-------------------------	---------------------------------	---------------------

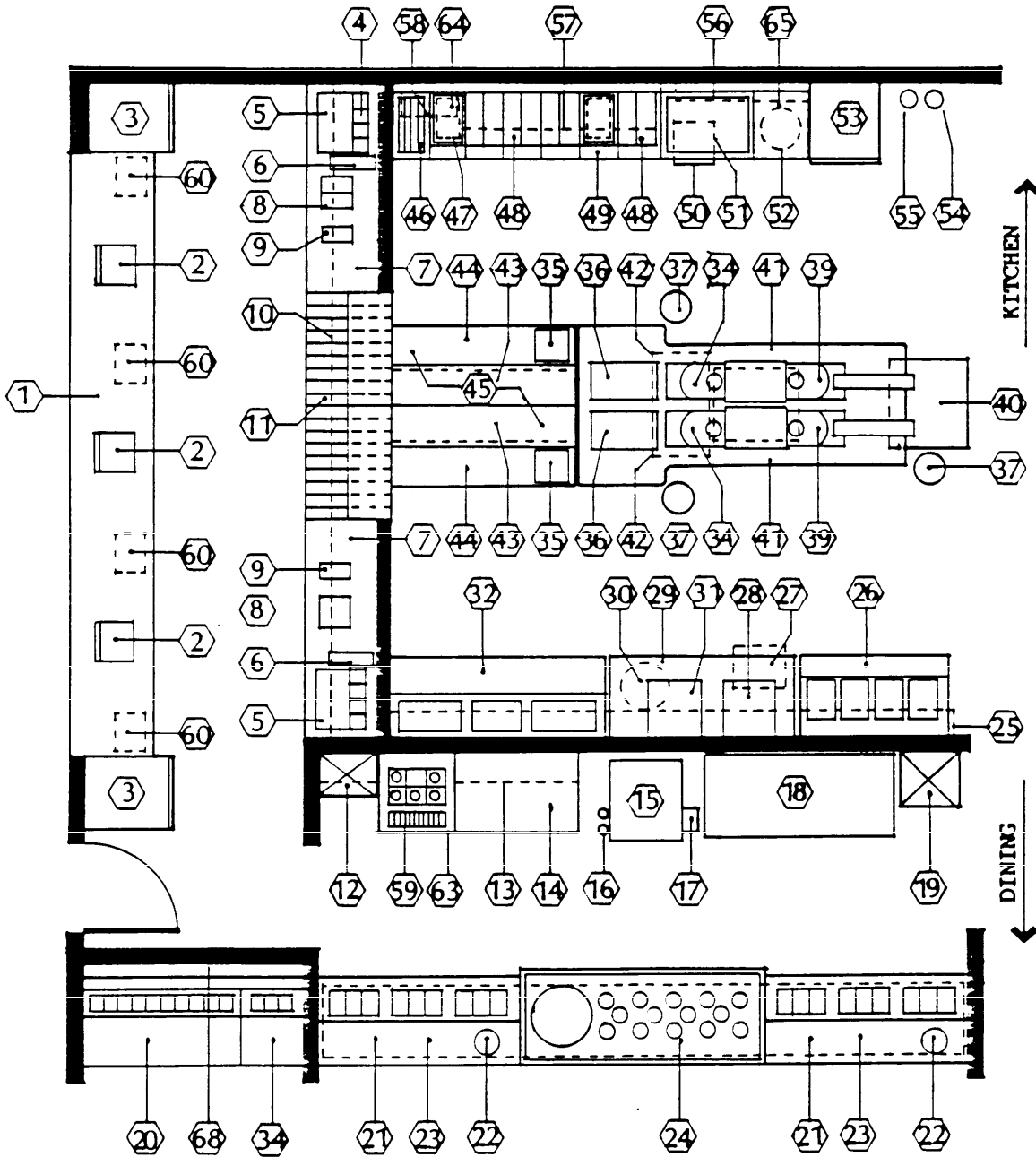

Title -
Equipment Plan
- Fast Food Facility -

Date
3/30/90

Category Code
722-10

Plate
56

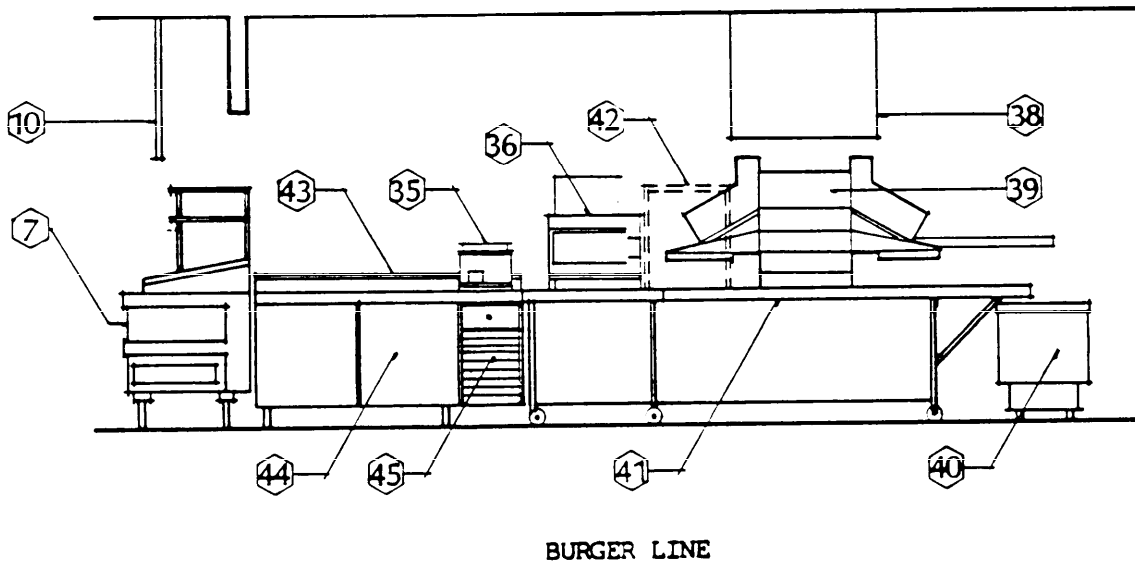
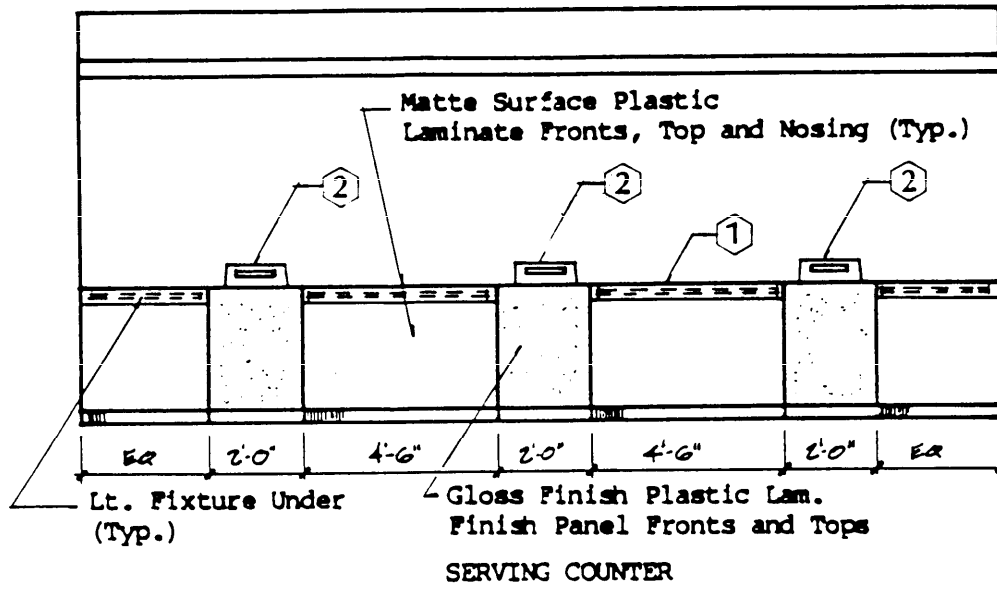

Title -
Equipment Elevations
- Fast Food -

Date
3/30/90

Category Code
722-10

Plate
57

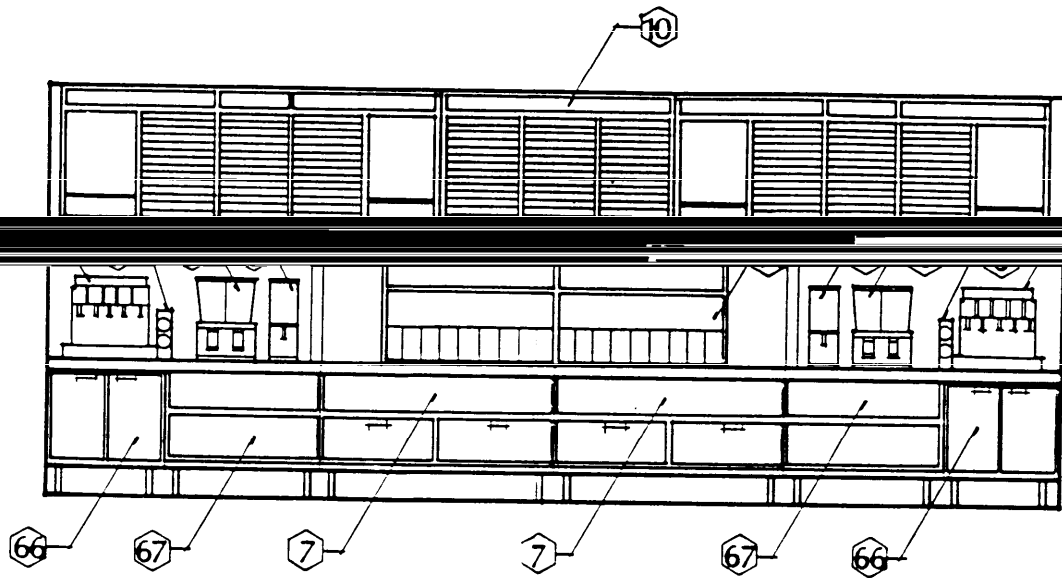

HOLDING AREA

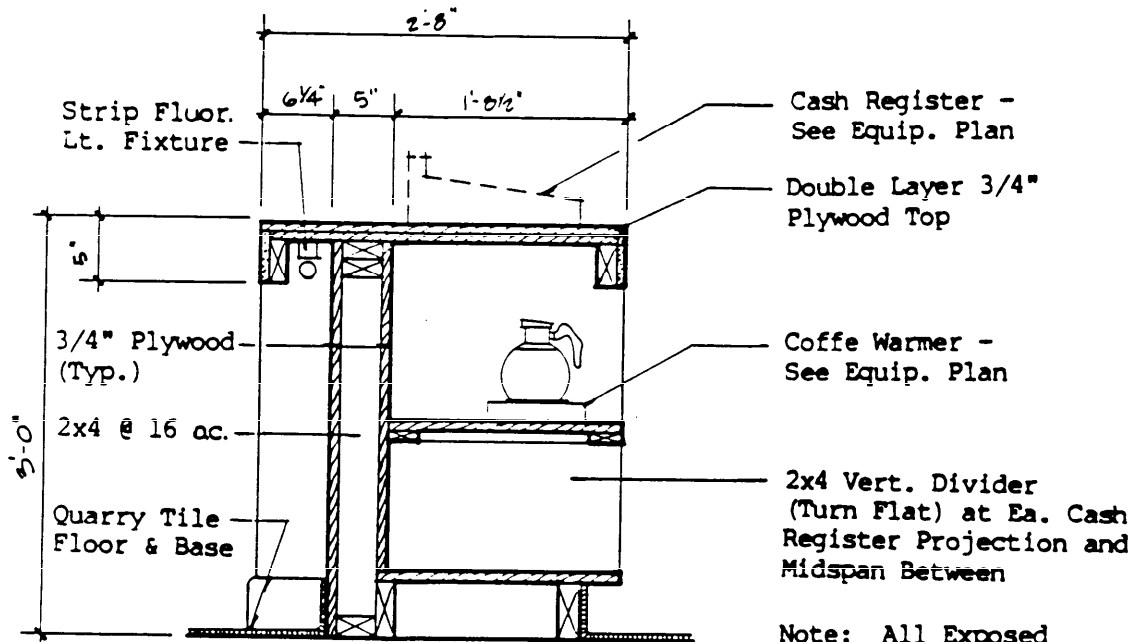

SECTION THRU SERVING COUNTER

<p>Title - Equipment Elevations - Fast Food -</p>	<p>Date 3/30/90</p>	<p>Category Code 722-10</p>	<p>Plate 58</p>
---	--------------------------	----------------------------------	----------------------

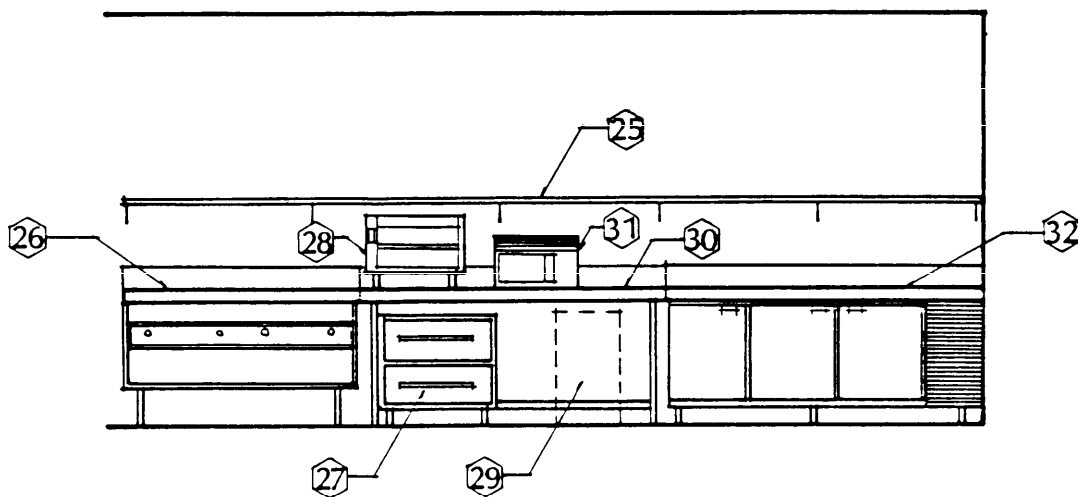

SPECIALTY LINE

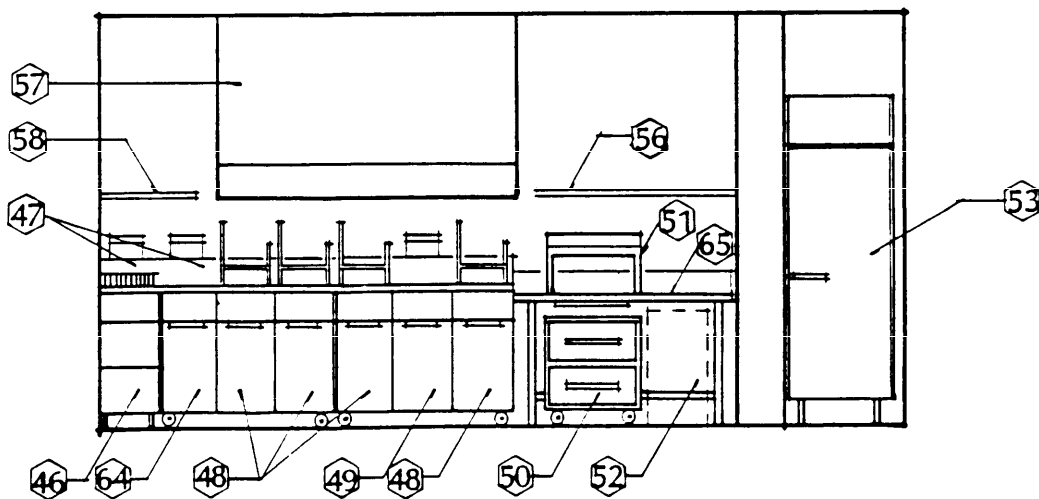

FRYING LINE

Title -
Equipment Elevations
- Fast Food -

Date
3/30/90

Category Code
722-10

Plate
59

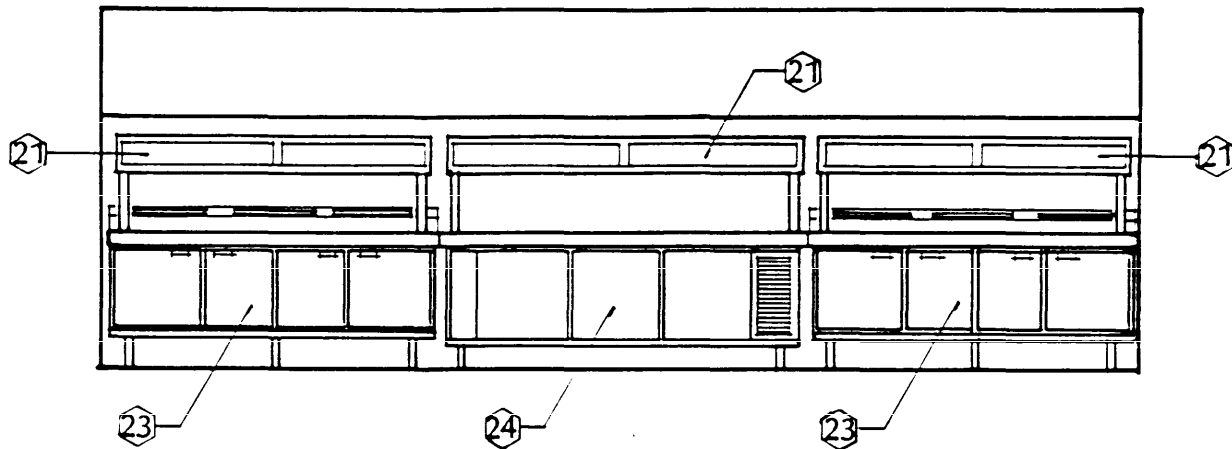

SANDWICH TOPPING/SALAD BAR

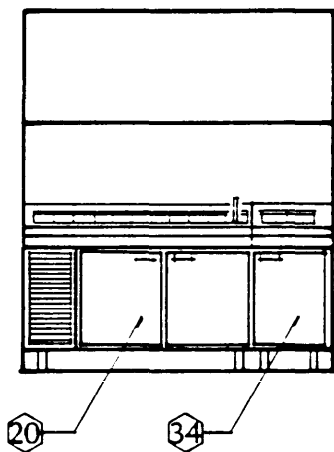

SOFT SERVE TOPPING BAR

Title - Equipment Elevations - Fast Food -	Date 3/30/90	Category Code 722-10	Plate 60
--	-----------------	-------------------------	-------------

ABCDEFGHIJ
KLMNOPQRS
TUVWXYZ ab
cdefghijklmno
pqrstuvwxyz1
234567890 &?!

Title -
Typical Graphics Typeface
- Fast Food -

Date
3/30/90

Category Code
722-10

Plate
61

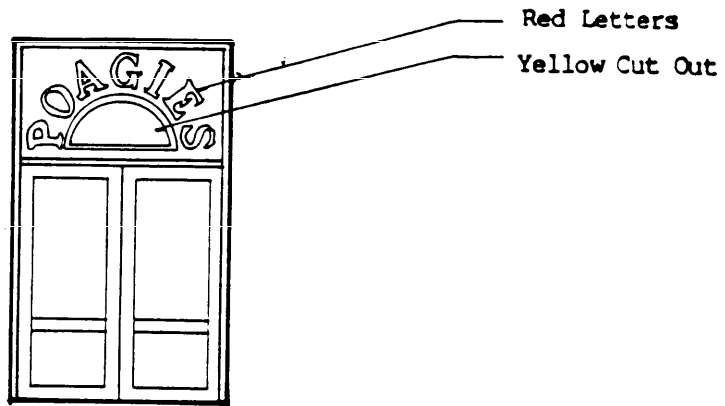

Note: Pressure Sensitive
Acetate Cut Outs
Applied Directly to
Glazing

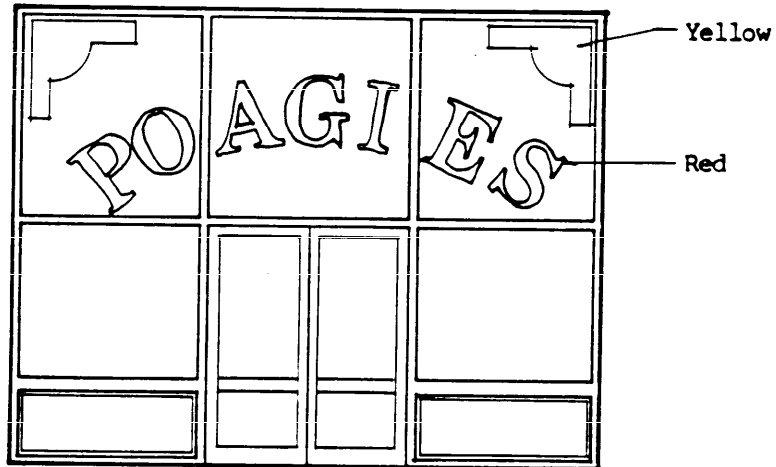

TYPICAL ENTRANCE GRAPHICS FOR FAST FOOD FACILITIES

Title -
Standard Entrance Graphics
- Fast Food -

Date
3/30/90

Category Code
722-10

Plate
62

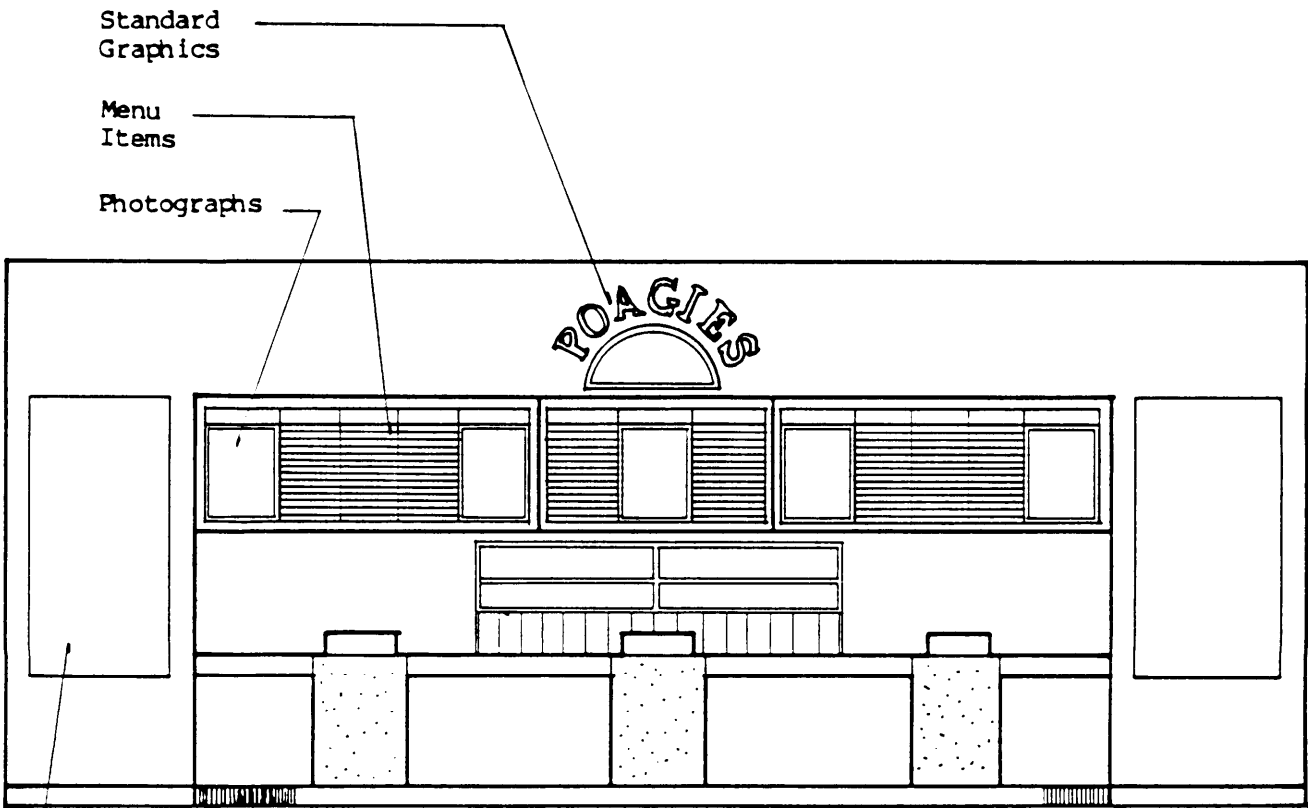

Flank Counter with Large Photographic Images

Strip Lighting Behind Fascia

ORDERING STATIONS AND PICK UP

<p>Title - Ordering and Pick Up Counter - Fast Food -</p>	<p>Date 3/30/90</p>	<p>Category Code 722-10</p>	<p>Plate 63</p>
---	-------------------------	---------------------------------	---------------------

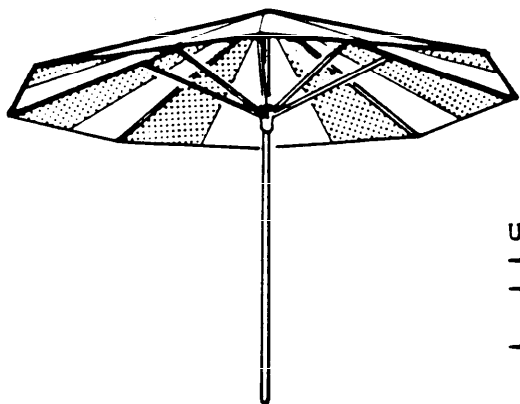

- Use To:
- Emphasize Color
 - Spatial Definition Within Seating Areas
 - Diminish Visual Height of Space

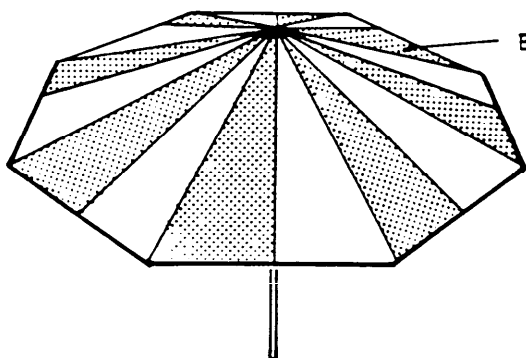

Bright Colored Fabric

UMBRELLAS

- General Usage
- Dining - Theme Graphics or Historical Text
- Queue - Words and Photographics

Solid or Multi-Color Graphics

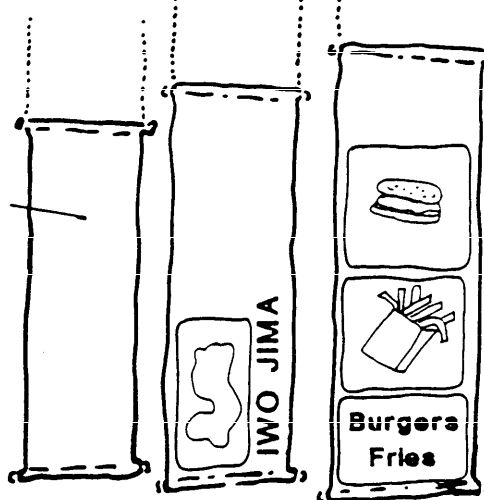

BANNERS

Note: Emphasis on color and graphic message. Silkscreen text and graphics on fabric.

TYPICAL ELEMENTS FOR COLOR, SPATIAL DEFINITION AND GRAPHIC MESSAGE

<p>Title - Signage and Graphics - Fast Food -</p>	<p>Date 3/30/90</p>	<p>Category Code 722-10</p>	<p>Plate 64</p>
---	-------------------------	---------------------------------	---------------------

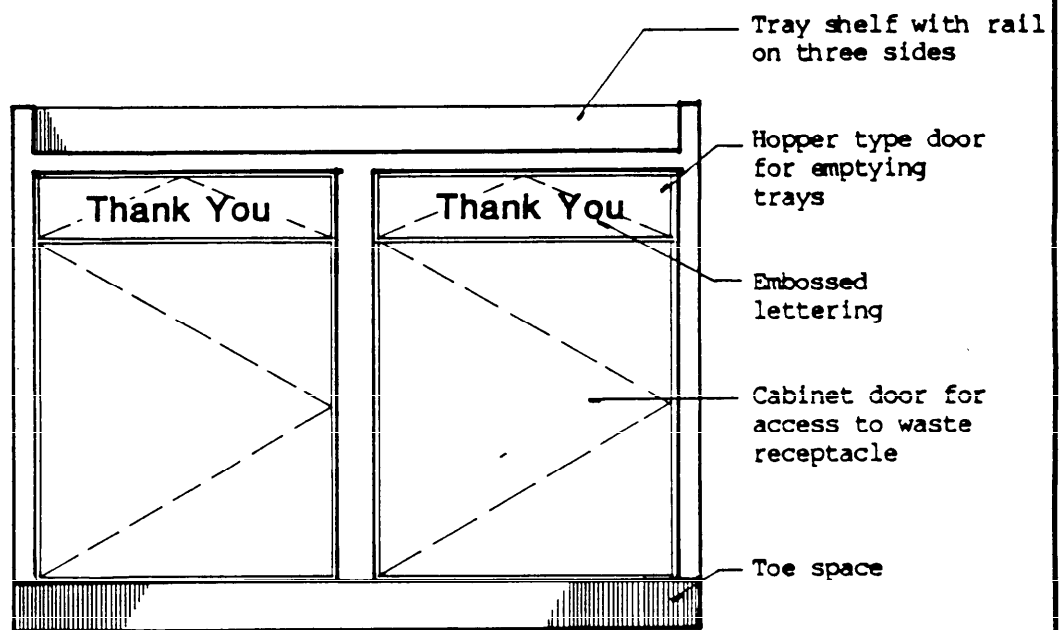

Note:

- All exposed surfaces plastic laminate finished with emphasis on color.
- Locate at exit to fast food dining area to help direct traffic flow.

Title -
Waste Cabinets
- Fast Food -

Date
3/30/90

Category Code
722-10

Plate
65

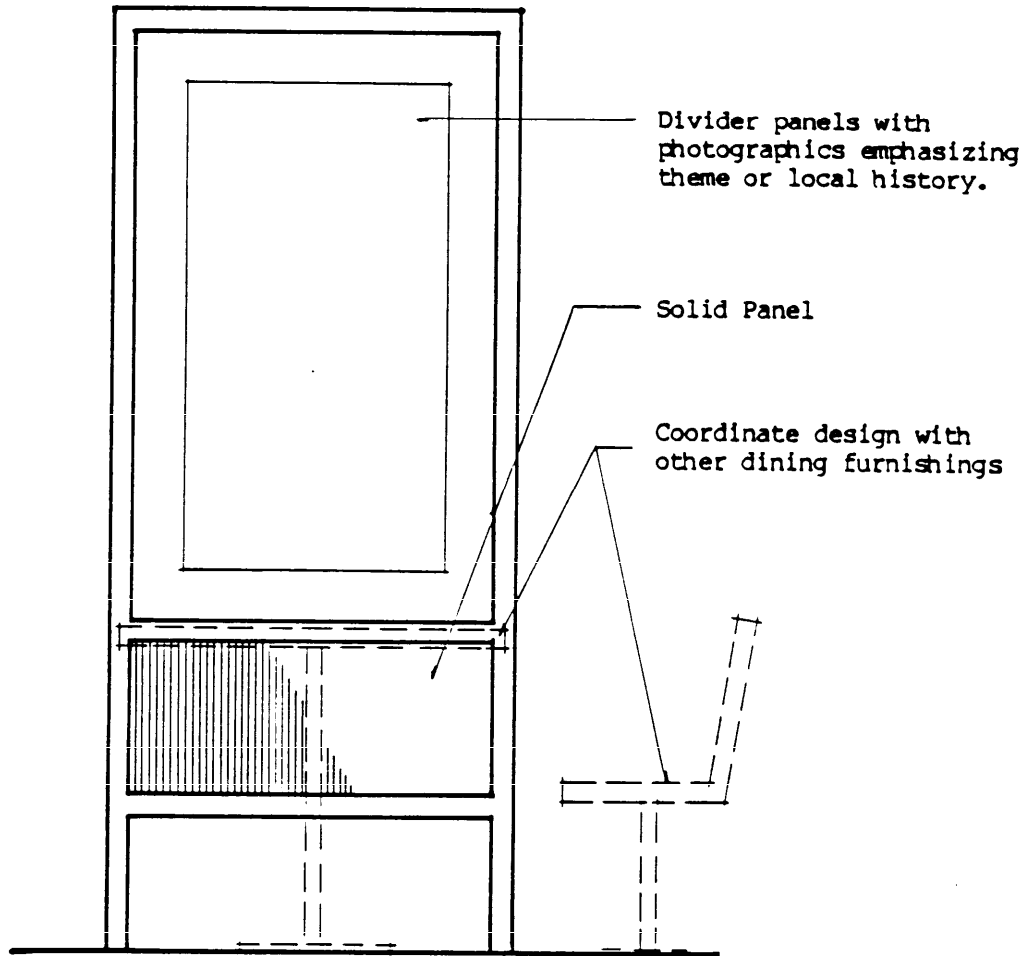

Use to:

- Emphasize color and/or graphic message.
- Define seating areas and provide privacy.

Title -
Divider Panels
- Fast Food -

Date
3/30/90

Category Code
722-10

Plate
66

COLORED CONCRETE

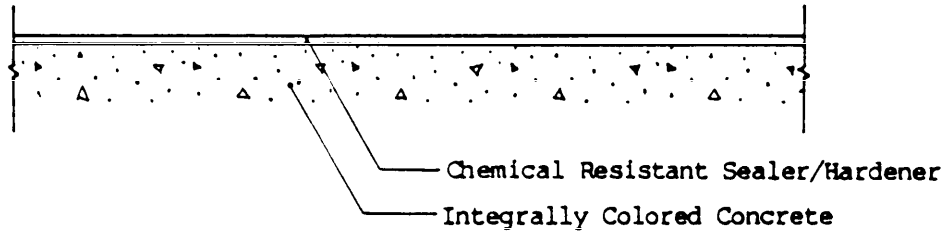

SEAMLESS

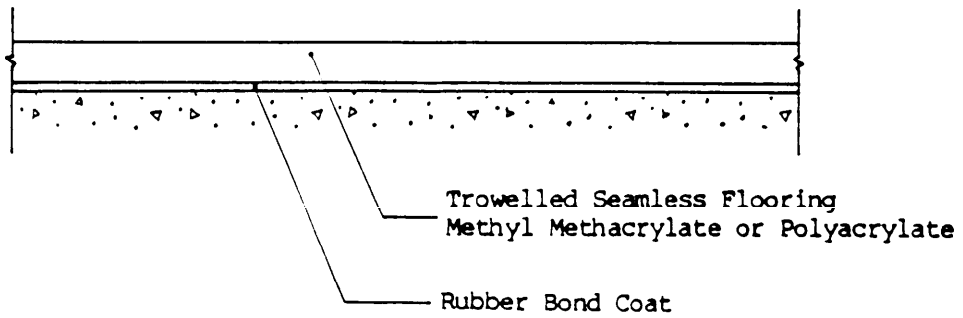

TERRAZZO

Sand Cushion Terrazzo (Isolation Membrane)

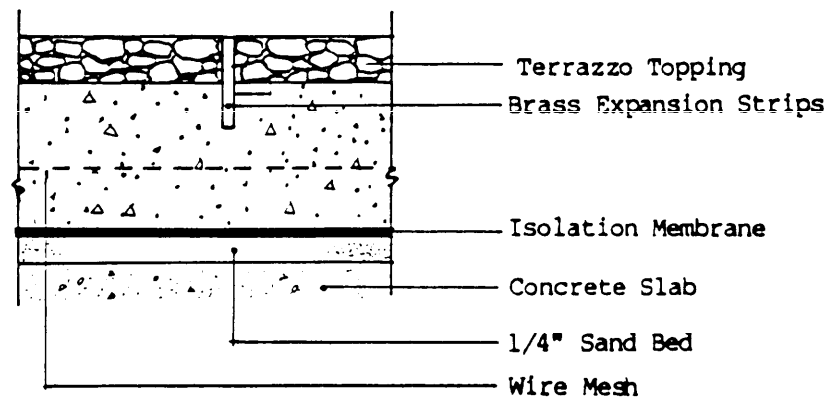

Title -
Floor Finishes

Date
3/30/90

Category Code

722-10

Plate

67

CAST STONE FLOOR TILES
 Marble or Granite Aggregate
 3/8" Thick, 12 x 12, 12 x 24,
 24 x 24 for Wall Installation

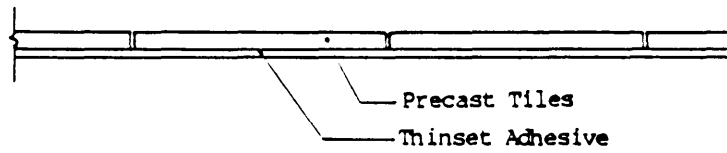

Precast Tiles
 Thinset Adhesive

TILE

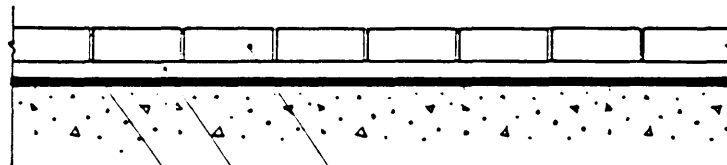

Ceramic, Quarry Tile, Brick Pavers
 Thin Set Adhesive
 Waterproof Membrane
 Trowelled into Mortar

WATERPROOF WALKWAY TOPPING

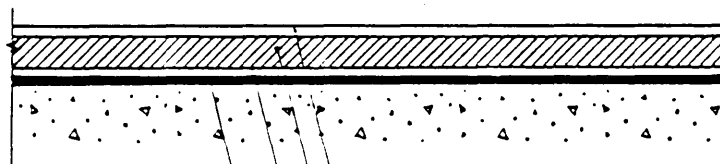

Topping Coat as Required
 Neoprene Cement Traffic Topping
 Fabric Reinf. Membrane
 Slip Sheet

Title - Floor Finishes	Date 3/30/90	Category Code 722-10	Plate 68
---------------------------	-----------------	-------------------------	-------------

MIL-HDBK-1036/4

REFERENCES

NOTE: Unless otherwise specified in the text, users of this handbook should utilize the latest revisions of the documents cited herein.

FEDERAL/MILITARY SPECIFICATIONS, STANDARDS, BULLETINS, HANDBOOKS, AND NAVFAC GUIDE SPECIFICATIONS:

The following specifications, standards, and handbooks form a part of this document to the extent specified herein. Unless otherwise indicated, copies are available from Naval Publishing and Printing Service Office (NPPSO), Standardization Documents Order Desk, Bldg. 4D, 700 Robbins Avenue, Philadelphia, PA 19111-5094.

STANDARDS

FEDERAL

FED-STD-795	Uniform Federal Accessibility Standards
-------------	---

HANDBOOKS

MILITARY

MIL-HDBK-1002/1	Structural Engineering General Requirements
MIL-HDBK-1004/4	Electrical Utilization Systems
MIL-HDBK-1004/6	Lightning Protection
MIL-HDBK-1004/10	Cathodic Protection
MIL-HDBK-1008A	Fire Protection for Facilities Engineering, Design, and Construction
MIL-HDBK-1010	Cost Engineering Policy and Procedures
MIL-HDBK-1190	Facility Planning and Design Guide

GUIDE SPECIFICATIONS

NFGS-11400	Food Service Equipment
NFGS-15200	Noise, Vibration (and Seismic) Control

MIL-HDBK-1036/4

NAVY MANUALS, DRAWINGS, P-PUBLICATIONS, AND MAINTENANCE OPERATING MANUALS:

Available from Commanding Officer, Naval Publications and Forms Center (NPFC), 5801 Tabor Avenue, Philadelphia, PA 19120-5099. To Order these documents: Government agencies must use the Military Standard Requisitioning and Issue Procedure (MILSTRIP); the private sector must write to NPFC, ATTENTION: Cash Sales, Code 1051, 5801 Tabor Avenue, Philadelphia, PA 19120-5099.

DESIGN MANUALS

DM-1.01	Basic Architectural Requirements and Design Considerations
DM-1.03	Architectural Acoustics
DM-3.01	Plumbing Systems
DM-3.03	Heating, Ventilating, Air Conditioning, and Dehumidifying Systems
DM-4.07	Wire Communication and Signal Systems
DM-11.1	Tropical Engineering
DM-14.2	Carpet Selection Guide

P-PUBLICATIONS

P-80	Facility Planning Criteria for Navy and Marine Corps
P-89	Engineering Weather Data
P-355	Seismic Design for Buildings
P-905	Planting and Establishment of Trees, Shrubs, Ground Covers and Vines

MIL-HDBK-1036/4

OTHER GOVERNMENT DOCUMENTS AND PUBLICATIONS:

The following Government documents and publications form a part of this document to the extent specified herein.

OCCUPATIONAL SAFETY AND HEALTH ADMINISTRATION (OSHA)

OSHA Safety Codes

(Unless otherwise indicated, copies are available from Superintendent of Documents, U.S. Government Printing Office, Washington, D.C. 20402.)

NON GOVERNMENT PUBLICATIONS:

The following publications form a part of this document to the extent specified herein. Unless otherwise specified, the issues of the documents which are DOD adopted are those listed in the Department of Defense Index of Specifications and Standards (DODISS).

AMERICAN INDUSTRIAL HYGIENE ASSOCIATION, AMERICAN CONFERENCE OF INDUSTRIAL HYGIENISTS, COMMITTEE ON INDUSTRIAL VENTILATION

Industrial Ventilation: A Manual of Recommended Practice

(Unless otherwise indicated, copies are available from American Industrial Hygiene Association, 475 Wolf Ledge Parkway, Akron, OH 44311.)

INTERNATIONAL CONFERENCE OF BUILDING OFFICIALS (ICBO)

Uniform Building Code

(Unless otherwise indicated, copies are available from International Conference of Building Officials, 5269 South Workman Mill Road, Whittier, CA 89691.)

NATIONAL FIRE PROTECTION ASSOCIATION (NFPA)

National Fire Protection Association Codes

NFPA 101	Life Safety Code
NFPA 80	Standard for Fire Doors and Windows
NFPA 96	Standard for the Installation of Equipment for the Removal of Smoke and Grease-Laden Vapors from Commercial Cooking Equipment

(Unless otherwise indicated, copies are available from National Fire Protection Association, Batterymarch Park, Quincy, MA 02269).

MIL-HDBK-1036/4

NATIONAL SANITATION FOUNDATION (NSF)

National Sanitation Foundation (NSF) Standards

(Unless otherwise indicated, copies are available from National Sanitation Foundation, 3475 Plymouth Road, P.O. Box 1468, Ann Arbor, MI 48106.)

TILE COUNCIL OF AMERICA

Handbook for Ceramic Tile Installation

(Unless otherwise indicated, copies are available from Tile Council of America, P.O. Box 326, Princeton, NJ 08540.)

CUSTODIAN
NAVY - YD

PREPARING ACTIVITY
NAVY - YD

PROJECT NO.
FACR 0263

STANDARDIZATION DOCUMENT IMPROVEMENT PROPOSAL

INSTRUCTIONS

1. The preparing activity must complete blocks 1, 2, 3, and 8. In block 1, both the document number and revision letter should be given.
2. The submitter of this form must complete blocks 4, 5, 6, and 7.
3. The preparing activity must provide a reply within 30 days from receipt of the form.

NOTE: This form may not be used to request copies of documents, nor to request waivers, or clarification of requirements on current contracts. Comments submitted on this form do not constitute or imply authorization to waive any portion of the referenced document(s) or to amend contractual requirements.

I RECOMMEND A CHANGE:

1. DOCUMENT NUMBER
MIL-HDBK-1036/4

2. DOCUMENT DATE (YYMMDD)
90/07/31

3. DOCUMENT TITLE

ENLISTED DINING FACILITIES

4. NATURE OF CHANGE (Identify paragraph number and include proposed rewrite, if possible. Attach extra sheets as needed.)

5. REASON FOR RECOMMENDATION

6. SUBMITTER

a. NAME (Last, First, Middle Initial)

b. ORGANIZATION

c. ADDRESS (Include Zip Code)

d. TELEPHONE (Include Area Code)

7. DATE SUBMITTED
(YYMMDD)

(1) Commercial
(2) AUTOVON
(if applicable)

8. PREPARING ACTIVITY

a. NAME
Commander
Chesapeake Division, Code 04

b. TELEPHONE (Include Area Code)
(1) Commercial
(2) AUTOVON
(202) 433-3314 288-3314

c. ADDRESS (Include Zip Code)
Naval Facilities Engineering Command
Washington, DC 20374-2121

IF YOU DO NOT RECEIVE A REPLY WITHIN 45 DAYS, CONTACT:
Defense Quality and Standardization Office
5203 Leesburg Pike, Suite 1403, Falls Church, VA 22041-3466
Telephone (703) 756-2340 AUTOVON 289-2340