

NOT MEASUREMENT
SENSITIVE

MIL-HDBK-57G (IS)
16 OCTOBER 2012
SUPERSEDING
MIL-HDBK-57F (IS)
21 JUNE 2011

DEPARTMENT OF DEFENSE HANDBOOK

LISTING OF FASTENER MANUFACTURER'S IDENTIFICATION SYMBOLS



**This handbook is for guidance only.
Do not cite this document as a requirement.**

MIL-HDBK-57G (IS)

DEPARTMENT OF DEFENSE
WASHINGTON, D.C. 20301

FORWARD

Listing of Fastener Manufacturer's Identification Symbols

MIL-HDBK-57D(IS)

1. This Military Handbook
2. Comments, suggestions, or questions on this document should be addressed to Defense Supply Center Philadelphia (DSCP), ATTN: DSCP-NASA, 700 Robbins Avenue, Philadelphia, PA 19111-5096 or e-mail to dscpg&inspeccomments@dla.mil. Since contact information can change, you may want to verify the currency of this address information using the ASSIST Online database at <https://assist.dla.mil>.
3. Copies of these documents are available online at <https://assist.dla.mil/quicksearch/> or from the Standardization Document Order Desk, 700 Robbins Avenue, Building 4D, Philadelphia, PA 19111-5094

MIL-HDBK-57G (IS)

FORWARD

This handbook is a compilation of the identifying symbols of fastener manufacturers as provided by the manufacturers themselves. This issue contains the names, addresses, and the symbols of all fastener manufacturers whose identifying symbols were received by 30 November, 2006. Each manufacturer who was listed in Revision B of this document was contacted to confirm the accuracy of the published information. We have annotated the listing to indicate those manufacturers that have responded to confirm or update appropriate information. The listing also annotates which manufacturers have not responded. Information about manufacturers who have not responded is still maintained in this latest revision. For the purpose of this handbook, a manufacturer is defined as the source which substantially makes the supplies, either by hand or machinery out of raw materials. Fasteners, as defined for the purpose of this handbook, refer to those threaded items included in Federal Supply Class (FSC) 5305 – Screws, 5306 – Bolts, 5307 – Studs, and 5310 – Nuts. As additional manufacturers submit their markings, the handbook will be updated.

All requests to be listed in the handbook should be addressed to:

Defense Supply Center Philadelphia (DSCP)
Attention: DSCP-NASA
700 Robbins Avenue.
Philadelphia, PA 19111-5096
or e-mail to dscpg&ispecomments@dla.mil.

In addition to the alphabetic index of manufacturers (Index A), this revision of the handbook incorporates a listing of manufacturers indexed by their identification symbol (index B).

At the back of this handbook is a registration form. Manufacturers wishing to be listed must complete this form and return it to DSCP. Submit the completed form, along with your fastener identification symbol artwork used on the fastener. All submittals must be in the English language.

DSCP does not “approve”, “rate”, or “endorse” any item, construction, proprietary device, or activity.

DSCP is not responsible for the accuracy or completeness of the information contained in this publication.

DSCP does not take any position with respect to the validity of any patent rights asserted in connection with any items mentioned in this document, and does not undertake to insure anyone utilizing a code, standard, or guide against liability for infringement of any applicable Letters Patent, nor assume any such liability. Users of code, standard, or guide are expressly advised that determination of the validity of any such patent rights, and the risk of infringement of such rights, is entirely their own responsibility.

DSCP reserves the right to monitor this document to ensure that it contains the listing of only bona-fide fastener manufacturers.

DSCP has solicited the assistance of the Defense Contract Management Agency (DCMA) and the Defense Management Command International (DCMCI) in an effort to identify non-manufacturers and remove them from the manufacturers’ listing. DCMA/DCMC’s evaluation of a company’s status is based on an in house capability to manufacture fasteners (screws, bolts, studs and nuts), with respect to space, equipment, and trained personnel. On an on-going basis, any company identified by DCAS/DCMCI as a non-manufacturer will be removed from the manufacturers’ database and MIL-HDBK-57C (IS).

MIL-HDBK-57G (IS)
INDEX A

INDEX A - MANUFACTURER

<u>Company Name</u>	<u>Page</u>
3 V FASTENERS	1
3D MACHINE COMPANY, INC.	1
A	
A & E MACH NED PRODUCTS INC SYSTEMS CORPORATION NORTHROP GRUM	1
A & G ENG NEERING CO., INC	1
A & M AEROSPACE, NC.	1
A & N PRECISION INDUSTR ES LTD	1
A & R MFG CO INC.	1
A & S PIN PRODUCTS INC.	1
A & W SCREW MACHINE PRODUCTS, INC.	1
A. AGRATI S.P.A.	2
A.M.I. ENGINEER NG CO.	2
A. P. M LLS INDUSTRIES FOR THE BLIND	2
A-1 NUT AND BOLT CO INC DIV OF GREENCO PACIFIC INC	2
A-1 THREAD ROLLING CO., INC.	2
AAP ACQUISITION CORP DBA ACH LLES AEROSPACE PRODUCTS	2
AASTRO ENGINEER NG	2
ABBOTT NTERFAST CORP.	2
ABBOTT PETER (AEROSPACE) 1982 LTD.	3
ABC TOOL & DIE ENGINEER NG & MANUFACTUR NG LLC	3
ABRASIVE CUTT NG CORP	3
ABSCOA INDUSTRIES	3
ACCUFORM, INC.	3
ACCURA INDUSTR ES, NC.	3
ACCURATE AUTOMATIC PARTS INC	3
ACCURATE PRECISION FASTENERS, NC.	3
ACCURATE SCREW MACHINE CORP DBA ASM	3
ACCURATE THREADED FASTENERS, NC. DIV OF BEATRICE FOODS CO	4
ACCURATE THREADED PRODUCTS CO.	4
ACCURATE TOOL CO INC	4
ACCU-TECH MANUFACTURING AND SUPPORT, INC.	4
ACCUTOOL SUBCON TOOL/ACCUTOOL MACHINE GROUP INC.	189
ACCUTURN CORPORATION	4
ACE GRINDING & MFG OF TEXAS INC DBA ACE GRINDING & MANUFACTURING (PLANT SEE SHAW)	4
ACE PRECISION INDUSTRIES, INC.	5
ACH LLES AEROSPACE PRODUCTS, NC.	5
ACI	5
ACIMET MFG	5
ACME INDUSTRIAL COMPANY	5
ACME MACH NE PRODUCTS	5
ACME RIVET & MACH NE CORP.	5
ACME SCREW COMPANY	5
ACRODYNE MFG CO	6
ACUFAST A RCRAFT PRODUCTS	6
ADAMS INDUSTR ES INC A SUB OF BANNER INDUSTRIES INC	6
ADAMS, EARL M. CO.	6
ADC COMMUNICATIONS CORP	6
ADI MANUFACTUR NG, NC.	6
ADJUSTABLE BUSHING CORP.	6
ADOM ENG NEERING	6
ADVANCE PATTERN CORP	6
ADVANCED CNC MANUFACTUR NG	7
ADVANCED MACH N NG & FABRICATING NC	7
ADVANCED MACH N NG & TOOLING, INC.	7
ADVANCED MACH N NG TECHNOLOGIES	7
ADVANCED PLASTICS NC DBA ADVANCED MACH N NG & FABRICATING NC.	7
AERCO RESEARCH	7
AERO & AUTO STUD SPEC.	7
AERO BUSHING AND COMPONENT	7
AERO COMPONENTS CO.	8
AERO DYNAMIC MACH N NG, NC.	8

<u>Company Name</u>	<u>Page</u>
AERO ENG NEERING & MANUFACTURING CO. OF CAL FORNIA DBA AERO ENG NEERING	8
AERO MECHANICAL FASTENING SYSTEMS	8
AEROBOLT MANUFACTURING, INC.	8
AERO-FAB, INC.	8
AEROFAST SUPPLY	8
AEROMAX INDUSTRIES NC. DBA AEROMAX INTERNATIONAL	8
AEROSPACE MACH NE PRODUCTS	9
AEROSPACE MANUFACTURING	9
AEROSPACE MARINE SPECIALTY FASTENERS & FITT NGS INC. DBA AMS FASTENERS	9
AEROSPACE PRODUCTS DIV OF APCO FASTENERS, NC	9
AEROSPACE PRODUCTS CO. DIV WBH	9
AEROSPACE PRODUCTS, INC.	9
AEROSPACE RIVET MFG CORP	9
AEROSTAR ENG NEERING & MANUFACTURING COMPANY	10
AEROSTAR FASTENER CORP.	10
AEROTECH FASTENERS, INC.	10
AEROW ND CORPORATION	10
AF FASTENERS LIMITED	10
AFAB PRECISION MACH N NG	10
AFI INDUSTR ES, NC.	10
AIHARA SEIBYO CO LTD	10
AIR INDUSTRIES CORPORATION	11
AIR LAND TURB NE SERVICES, INC	11
AIR PARTS MFG. CO.	11
AIR-COM, INC.	11
AIRCRAFT ENG NEERING PRODUCTS, INC	11
AIRCRAFT FUELSEAL FASTENERS, INC. AEROLITE BL ND RIVET DIVISION	11
AIRDROME PARTS CO.	11
AIRFASCO, INC.	12
AIRFASCO INDUSTRIES FASTENER GROUP	12
AIRFRAME NTERNATIONAL, INC.	12
AJ ASSOCIATES MFG & ENG COMPANY, NC	12
AIW-ALTON INC	12
AKKO FASTENER, NC.	12
ALAN, JEFFREY, MFG. & ENGR.	12
ALARD MACHINE PRODUCTS	12
ALBAR MACHINE CORPORATION	12
ALCO MACH NE CO.	13
ALCOA FASTEN NG SYSTSEMS	13
CAMLOC PRODUCTS	44, 167
HUCK AEROSPACE PRODUCTS	95
HUCK INDUSTRIAL PRODUCTS	95
KAYNAR PRODUCTS	107
KELOX/MICRODOT PRODUCTS	107
MECAERO PRODUCTS	131
RAM PRODUCTS	165
ROSAN PRODUCTS	171
SIMMONDS PRODUCTS	179
TRIDAIR PRODUCTS	167, 197
VOI-SHAN PRODUCTS	207
ALCOA GLOBAL FASTENERS INC	13
ALCOA-KOKEM KFT	13
ALEXANDER MANUFACTURING COMPANY INC DBA METRO TOOL & MANUFACTURING CO	133
ALL AUTOMATICS	13
ALL MANUFACTURERS INC DBA HARPER AEROSPACE FASTENERS	13
ALL PINS MANUFACTURING	13
ALL QUALITY SPARES INC. REMOVED - NOT A MANUFACTURER	14
ALLFAST FASTENING SYSTEMS, NC.	14
ALL ED NUT & BOLT CO., INC.	14
ALL ED PRECISION PRODUCTS, INC.	14
ALL-POWER MFG. CO.	14
ALL-PRO FASTENER & RIVET MFG. CO.	14
ALL-STATES NC.	14
ALPHA BOLT CO.	15
ALPHA FASTENERS	15
ALPHA MACHINING PRODUCTS & DEVELOPMENT	15
ALPINE MACH NE & TOOL CORP.	15
ALPS SEIKO CO., LTD. Plant - L DA FACTORY	15
AMACON CORP.	16

MIL-HDBK-57G (IS)
INDEX A

<u>Company Name</u>	<u>Page</u>	<u>Company Name</u>	<u>Page</u>	
AMANDA BENT BOLT CO	16	B		
AMATOM ELECTRONIC HARDWARE DIVISION OF QUINCY TECHNOLOGIES, INC.	16		B & B SPECIALTIES INC	25, 85
AMERICA AEROSPACE PRECISION MFG.	16		DBA G S AEROSPACE DIVISION	
AMERICAN AIRCRAFT PARTS MANUFACTURING COMPANY	16		B & D THREAD ROLLING	25
AMERICAN ELECTRIC CONSTRUCTION MATERIALS GROUP See THOMAS & BETTS CORP	194		B & E MACH NE SHOP & SHEET METAL FAB., NC.	25
AMERICAN FASTENER & SPECIALTY CO.	16		B & E MANUFACTURING CO., INC.	25
AMERICAN INTERNATIONAL AERO MFG. NC.	16		B & G MANUFACTURING CO., INC.	26
AMERICAN METAL BEARING COMPANY	17		B & N TOOL CO., NC.	26
AMERICAN QUALITY INDUSTRIES FASTENER DIVISION	17		B & R MACHINE AND TOOL CORP	26
AMERIFAST CORP.	17		B F GOODRICH CO. RIVNUT ENGINEERED FASTENERS, THE (AERO AND DEF DIV)	26
AMERITECH DIE & MOLD SOUTH INC.	17		B G ENGINEERING, INC.	26
AMERITECH FASTENER MFG. NC. DIVISION OF LONE STAR FASTENERS, LP	17		B G M FASTENER CO., INC.	26
AMMAC, NC.	17		B. V. FABRIK VAN KLINGNAGELS EN SCHROEFBOUTEN V/H SMIT	27
ANATASE PRODUCTS DIV OF HENWAY NC	17		BARCO ENGINEERING COMPANY, INC.	27
ANCHOR BOLT & SCREW CO.	18		BARNEGAT BAY NSCC, NC.	27
ANDERSON FORGE & MACHINE	18		DBA BB NSCC, NC.	
ANDROCK HARDWARE CORPORATION	18		BARRE PRECISION PRODUCTS INC	27
ANILLO INDUSTRIES, NC.	18		BAS AEROSPACE LIMITED	27
ANKIT FASTENERS PRIVATE LIMITED	18		BAUER & SCHAURTE KARCHER GMBH	27
ANOTHER SCREW MACH NE PRODUCT	18		BAY BOLT	27
ANTRIM MACHINE PRODUCTS, INC.	18		BBC FASTENERS, INC.	28
A-ONE MACHINE COMPANY	18		BEACH MACHINE	28
APEL LTD.	19		BEAVER PRODUCTS CORP.	28
APEX MFG. CO. NC.	19		BEL MACH NE PRODUCTS COMPANY	
APHEONIX CORPORATION	19		BEE INDUSTRIES, INC. (WISCONSIN CORPORATION)	28
ARCHER SCREW PRODUCTS	19		BEGONIA TOOL COMPANY	28
ARCO SALES CO.	19		BEK LEVEL 1 FASTENERS	29
ARDOR MFG. INC.	19		BEL-AIR MACH NE & PERFORMANCE	29
ARGARWAL INDUSTRIES	19		BELL FASTENERS	29
ARJAY PRECISION, INC.	20		ALBANY FASTENERS/PAWTUCKET FASTENER DIVISION (also see VERTEX)	
ARMSTRONG ATLAS BOLT	20		BELL PRECISION, NC.	30
ARMSTRONG FASTENING SYSTEMS	20		BELL-MEMPHIS, INC.	30
ARMSTRONG FASTENINGS LTD.	20		BEN YUAN ENTERPRISE CO., LTD.	30
ARNOLD KNIPPING GmbH	21		BENACO TOOLING RESEARCH & DEV. CORP	30
ARNOLD UMFORMTECHNIK GMBH & CO. KG	21		BEOTool CORP	30
ARNOLD WRAGG (BOLTS & NUTS) LTD	21		BERGNER, RICHARD GMBH & CO.	30
ARROW SCREW & MACHINE WORKS	21		BER-LOW MFG. NC.	31
ARTISAN SPECIALIST TECH, NC.	21		DBA BUTECH PRESSURE SYSTEMS	38
ARVAN, INC.	21		BERRY, JOHN DBA BERRY MANUFACTURING	31
ASAHI SCREWS MANUFACTURING CO., LTD	21		BERRY MANUFACTURING	31
ASAI TEKKO CO. LTD	22		BET-LAR SERVICES	31
ASI DESIGN & MANUFACTURING, NC.	22		(UPSTART ACQUISITIONS, CORP)	202
ASL MANUFACTURING, INC.	22		BETA CORP.	31
ASSOCIATED TOOL CO., INC.	22		BETA ENGINEERING, NC.	31
AST ASSOCIATES, INC.	22		BIG BOLT CORP.	31
ATF INC	22	BISHOP ENTERPRISES, INC.	31	
ATHENA INDUSTRIES	22	BLAINE TOOL CORP.	32	
ATLANTIC PRECISION SPRING, NC.	22	BLANC AERO INDUSTRIES	32	
ATLAS ENGINEERING, INC.	23	BLANC AIRCRAFT FASTENERS, NC.	32	
PENN ENGINEERING COMPANY	154	BLAND CO., THE	32	
ATLAS SPECIALTY PRODUCTS See CURTIS PRESTON ENTERPRISES INC	53	BLUE SKY INDUSTRIES, NC.	32	
AUGUST FREDBERG GMBH	23	BLUE TEE CORP	32	
AUGUST FREDBERG GmbH	23	DBA GEFCO/STECO		
AUTO BOLT AND NUT CO.	23	BOBCAT MANUFACTURING CO.	33	
AUTOMATED MANUFACTURING	23	BOGNER ENGINEERING CO.	33	
AUTOMATIC MACHINING AND MFG CO DBA AMMAC INC	23	BOLLHOFF & CO. GmbH & CO. KG	33	
AUTOMATIC MANUFACTURING COMPANY	23	BOLT & NUT CO.,	33	
AUTOMATIC SCREW MACH NE PRODUCTS CO.	24	BOLT FASTENER STUD/TECHNOLOGY	33	
AUTO SCREW, INC.	24	BOLTWORKS, NC.	33	
AVDEL INTERNATIONAL (AVDEL LTD)	24	BOMAR ENGINEERING, INC.	33	
AVIATION MANUFACTURING GROUP LLC DBA FREEMAN CO., THE	78	BOMBSHELL, INC.	33	
AVIBANK MANUFACTURING, NC. PRECISION CASTPARTS CORP	24	BONEAL INC.	34	
AVK INDUSTRIES PRODUCTS INC	25	BRACELENTE MANUFACTURING CO., INC.	34	
AZTECH ENGINEERING, INC.	25	BRADY MACHINE, INC.	34	
AZTECH LOCKNUT COMPANY	25	BRANCH MACH NE PARTS, NC	34	
		BRIDARWOOD FASTENERS, NC	34	
		BRIDEAN MACHINE & TOOL CO., INC.	34	
		BRIDGEVIEW MANUFACTURING CO. ILLINOIS CORPORATION	34	
		BRIGHT LIGHTS USA, INC.	34	
		BRINTCLIFFE TURNER LTD.	35	

MIL-HDBK-57G (IS)
INDEX A

Company Name	Page	Company Name	Page
BRISTOL INDUSTRIES	35	CHATHAM PRECISION, NC	47
BRISTOL LOCKNUT CO. NUT DIVISION	35	CHEMIQUIP PRODUCTS COMPANY	47
BROADSTONE TOOL & D E, NC.	35	CHEREK MACHINE & TOOL CO., NC	47
BROADWAY SCREW MACHINE INC.	35	CHEROKEE TOOL & ENGINEERING CO., NC	47
BROWN PRODUCTION, INC	35	CHIANG SHIN FASTENERS INDUSTRIES, LTD	48, 187
BRUNNER DRILLING & MFG. CO., INC.	36	CHICAGO FASTENER MANUFACTURING	48
BRUNNER MFG CO. NC	36	CHICAGO HARDWARE & FIXTURE CO	48
DBA BRUNNER MANUFACTURING DIVISION		CHICAGO NUT & BOLT NC	48
BRYCO MACH NE, INC.	36	CH IEF MFG.	48
BRYNOLF MANUFACTURING, INC.	36	CHOICE PRECISION MACHINE, NC	48
BUCK EYE FORGE, NC.	36	CHRIS MACHINE CO.	48
BUCKEYE MACHINING, INC.	36	CHU HUA INDUSTRIAL CO., LTD.	48
BUFFALO PUMPS, INC.	37	CHUN YU WORKS & CO., LTD.	49
SUBSIDIARY OF AMPCO-PITTSBURGH CORP.		CINCH MANUFACTUR NG	49
BULA FORGE INC.	37	CINCH-MANADNOCK	49
BULTEN TRADING AB	37	CLEVELAND HARDWARE & FORGING DBA GREEN BAY DROP FORGE CO	49, 83
BURROWS RESEARCH MACHINING, INC.	37	CLICK BOND, INC.	49
BUSAN INDUSTRIAL MACHINERY CO., LTD.	38	CLYDE FASTENERS LIMITED	49
BOLT DIVISION		CM MANUFACTURING, INC.	49
BUTECH PRESSURE SYSTEMS	31, 38	CNC MACHINING NC.	49
see BER-LOW MFG INC.		COAE BOLTS WORKS CO., LTD	50
BUTLER, INC.	38	COAST INDUSTRIAL SUPPLY CO NC	50
		SUB OF SPANDCO INDUSTRIES INC	
C		CODLING TOOL & MFG. INC.	50
C & A MACHINE CO.	38	COLD HEADING COMPANY, THE	50
C & D MACHINE TOLL, INC.	38	COLCOC MANUFACTURING	50
C & H MFG., INC.	38	DIVISION INGRAM INDUSTRIES, INC.	
C & S ENGINEERING LLC	38	COLTEC INDUSTRIES, NC.	50
C. E. MACH NE CO., INC.	39	dba FAIRBANKS MORSE ENGINE	
C.E.S. MACH NE PRODUCTS, INC	39	COMET MFG. CO. INC	50
C.J.'S GENERAL MACH NE WORKS	39	COMMAND ENTERPRISES	45, 51
C.R.D. MACHINING	39	COMPONENT PRODUCTS CORPORATION	51
CALABRESE & SONS, NC.	39	COMPULOGIC DESIGN CO (SEE R&I ENTERPRISES)	162
CALIFORNIA SCREW PRODUCTS CORP.	40	COMPUTA-BASE MACHINING, INC.	51
CAMBRIDGE SPECIALTY CO INC DBA POINT MACHINE COMPANY	40	CONNECTICUT AIRCRAFT PRODUCTS	51
CAMCAR DIVISION OF TEXTRON INC.	40 - 43	CONTINENTAL MACH NE PRODUCTS, INC.	51
AMSCO PRODUCTS	40	CONTINENTAL TOOL & MANUFACTURING	51
DR LLETITE PRODUCTS	41	CONTRACTING CNC MACHINING	51
RAYCARL PRODUCTS	41	CONQUEST MACHINE, NC	51
ROCKFORD HEADING PRODUCTS	41	CO-OP SCREW MANUFACTURING CORP.	51
SEMS PRODUCTS	42	COOPER POWER SYSTEMS INC	52
SOCKET SCREW PRODUCTS	42	MCGRAW EDISON POWER SYSTEMS	
TAPTITE PRODUCTS	42	COPELAND MANUFACTURING CORPORATION DIV JAMES DIVISION	52
TORX PRODUCTS	43	COPPER STATE BOLT & NUT COMPANY INC.	52
CAMCAR LLC	43	CORPUS CHRISTI GASKET & FASTENER LTD	52
CAMCAR SCREW AND MFG CO DIV OF TEXTRON NC	43	CREATIVE PRECISION INC	52
CAMLOC PRODUCTS	44, 167	DBA CREATIVE PRECISION WEST	
CAM-TECH INDUSTRIES	44	CRESENT MANUFACTURING CO.	52
CANADY MANUFACTURING CO. INC	44	CRS PRECISION CORP.	52
CAPRICE ENGINEERING CO., INC.	44	CRUM MFG.	53
CAPY MACH NE SHOP, NC.	44	CRYSTAL METAL PRODUCTS COMPANY, INC	53
CARDINAL FASTENER & SPECIALTY CO., ONC.	44	CSM FASTENER PRODUCTS CO	53
CARDINAL INDUSTRIAL PRODUCTS	45	CURTIS PRESTON ENTERPRISES NC	53
CARR CO.	45	DBA ATLAS SPECIALTY PRODUCTS	23
THE UNITED CARR DIV OF TRW		CUTTING EDGE ENTERPRISE, LLC	53
CATALINA INSTRUMENT CORPORATION	45	CUTTING EDGE MACHING INC	53
CBS FASTENERS NC.	45	NEVADA DIV WESTERN SCREW MACHINE PRODUCTS, INC.	210
CCB INDUSTRIES, INC	45	CUTTING EDGE MACHING SOLUTIONS, INC.	54
CCF ENTERPRISES INC	45	CWR MANUFACTURING CO DIVISION OF A.J. MUPHY CO., INC.	54
CEI NC.	45		
DBA COMMAND ENTERPRISES	51	D	
CELTECH ENTERPRISE	46	D & D MACHINERY AND SALES	54
CENTERLINE TOOL & ENGINEERING INC DBA MACH NE SHOP	46	D & D MANUFACTURING	54
CENTRAL OZARK MACH NE, INC.	46	D & D TOOL COMPANY, INC.	54
CENTRAL SCREW PRODUCTS	46	D & R MACHINE COMPANY	54
CENTURY METAL PARTS CORP.	46	D. C. MACHINING INC.	54
CER-MAC NC.	46	D.S.O. PLASTICS, INC.	54
CERNY MFG. CO.	46	DACK INDUSTRIES, INC.	55
CHAMPION COMMERCIAL INDUSTRIES, INC CHAMPION RIVET DIVISION	47	DAN EL CO., EDWARD W.	55
CHAMPION FASTENERS, INC.	47	DAN-LOC BOLT & GASKET NC.	55
CHANCE, A.B. COMPANY	47	DARCO PRODUCTS	55
CHANDLER PRODUCTS, NC.	47		

MIL-HDBK-57G (IS)
INDEX A

<u>Company Name</u>	<u>Page</u>	<u>Company Name</u>	<u>Page</u>
DAVE ALLEN ENTERPRISES	55	EDS ORDNANCE	64
DAVIES PRECISION MACHINING, INC.	55	ELASTIC STOP NUT	64,
DAVIS A RCRAFT PRODUCT CO., NC.	55	See MACLEAN-ESNA	125
DECKER MANUFACTURING CORP	56	ELCO INDUSTRIES, NC.	64
DEERE & CO	56	ELECTRO-FREETO MANUFACTURING COMPANY	64
DEFENSE AEROSPACE	56	ELITE FASTENERS	65
DEFENSE QUALITY MFG.	56	ELLIS PRECISION INDUSTRIES DBA E P IND.	65
DEFIANCE STAMPING CO., THE	57	EMERALD VALLEY MFG	65
DEHOUSSE (US NES)	57	EMHART CORP	65
DELL MFG. CO., INC.	57	GRIPCO FASTENER DIV PARKER-KALON DIVISION	
DELT INDUSTRIES, NC. AEROSPACE PRODUCTS DIVISION	57	EMP MANUFACTURING CO	66
DELTA MACHINE & TOOL CO., INC.	57	EMPIRE PRECISION MACHINING, INC.	66, 130
DEL-VAL FASTENER MANUFACTURING	57	ENGEL MANUFACTURING COMPANY, INC., THE	66
DEMAT	57	ENGINEERED BOLTING PRODUCTS, INC.	66
ALCOA FASTENING SYSTEMS TOUL		ENGINEERING MATERIALS CO., INC	66-67
DEPENDABLE MACHINE CO., INC.	58	FASTENER MANUFACTURING DIVISION	
DERBYSHIRE MACHINE & TOOL CO INC	58	ENGLE MANUFACTURING COMPANY, INC., THE	67
DBA DERBYSHIRE MARINE PRODUCTS		ENOMOTO INDUSTRIES CO., LTD.	67
DETROIT HEADING CO.	58	ENOMOTO FOUNDRY	
DEUTSCH COMPANY NC	58	ENVISION TECH, INC.	67
DBA DEUTSCH CO THE METAL COMPONENTS		ERICO FASTENING SYSTEMS	67
DFCI SOLUTIONS, NC	58	ERIE BOLT CORP	68
DHL ENTERPRISES	58	DBA EBC INDUSTRIES	63
DIAL SUPPLY AND MANUFACTURING, NC.	58	ESCO PRECISION, INC.	68
DIESEL PARTS COMPANY OF CALIFORNIA	58	ESMET, INC.	68
DIHARD COMPANY	59	DBA ELECTROLNETTUFLOC SUB OF UNMET CORP	
DISC-LOCK INTERNATIONAL	59	ESNA	68, 125
DIVERSIFIED FASTENING SYSTEMS, INC.	59	MACLEAN-FOGG COMPANY	
DIXON MACHINE & TOOL (see TROY D. RAY)	59,	ESP MANUFACTURING CO., INC	68
DBA DIXON MACHINE AND FABRICATION)	198	ESSENTIAL MACHINING	68
DO MANUFACTURING CORP	59	ESTA PRODUCTS COMPANY	68
DO-ALL PRECISION, NC.	59	EVERLOCK FASTENING SYSTEMS	69-70
DOMESTIC FASTENER & FORGE, INC.	59	EVERLOCK DETROIT DIVISION	
DOMESTIC FORGING, NC.	60	GREER STOP NUT (Greer-Smyrna Division)	
DONSON MACHINE	60	INTERNATIONAL SCREW DIVISION	
DOUBLECO INCORPORATED	60	EXCEL PRECISION PRODUCTS, INC.	70
DBA R & D FASTENERS	162	EXPERIMENTAL MACHINE CO.	70
DOUGLASS TOOL & ENGINEERING CO., INC.	60		
DRESSER INDUSTRIES, INC. DRESSER PUMP DIVISION	60	F	
D'SAMIC	60	FABER ENTERPRISES, INC	70
DTF MFG INC DIV OF FEDERAL SCREW AND SUPPLY CO	60	FABRICATION SPECIALTY, NC.	70
DUFFY ELECTRONICS & MFG. CO.	61	FABSCO CORP	70
DUNCAN ELECTRONICS & MFG. CO	61	FALCON CORP	70
DUNHAM PRODUCTS, INC	61	FALLING CO., GEORGE E	70
0020DUPONT, G B CO., NC.	61, 80, 106	FA RBANKS MORSE ENGINE see COLTEC INDUSTRIES, NC.	50
SEE KAMAX L P.		FALCON MANUFACTURING CORP.	70
DUSEVOIR METAL PRODUCTS, NC.	61	FALL RIVER MANUFACTURING CO., INC.	71
DUVE GmbH & CO. KG	61	FANG SHENG SCREW CO., LTD.	71
DYNACAST	61	FARIAS INDUSTRIAL MACHINING	71
INDUSTRIAL FASTENERS DIVISION		FARLO MACHINE & TOOL CO., NC	71
DYNAMIC ENGINEERING	62	FASSCO	71
DYSON CORP., THE	62	FASTENER & STEEL SUPPLY CO., LTD.	
Formerly JOS. DYSON & SONS, INC.		FASTCO INDUSTRIES, NC.	71
DZUS FASTENER CO., NC	62	FASTENAL COMPANY	72
DBA DFCI SOLUTIONS, NC		FASTENER BROKERAGE INC	72
		DBA INOFAST MANUFACTURING	99
E		FASTENER INNOVATION TECHNOLOGY INC	72
E. KOZAK PRECISION PRODUCTS CO.	62	DBA F.I.T.	
E.L.R. MACHINE AND TOOL	62	FASTENER TECHNOLOGY CORP.	72
EAGAN MACHINE CORP.	62	FASTENERS UNLIMITED, NC.	72
EAGLE PITCHER INDUSTRIES PRECISION PRODUCTS PLANT	62	FASTENING PRODUCTS CO., NC.	72
EAGLEHEAD MANUFACTURING COMPANY NC	63	FASTENING PRODUCTS OF LANCASTER, NC.	73
DBA DEJAK MACHINE TOOL CO. DIV DEJAK DRILLING		FASTENRATH BEFESTUGYBGSSTECGBUJ GMBH	73
EAST BAY MANUFACTURERS, NC.	63	FASTI-WERK CARL AUG. FASTENRATH GMBH & CO KG	73
EAST COAST METALS INC.	63	FASTRON COMPANY, THE	73
EASTERN SCREW CO., INC.	63	FEDERAL EQUIPMENT COMPANY	73
EASTWOOD MFG., CO.	63	FEDERAL MANUFACTURING CORP.	73
EATON AEROQUIP CORPORATION AEROSPACE DIVISION	63	FEDERAL SCREW WORKS	74
EBC INDUSTRIES	63,	BIG RAPIDS DIV	
FORMERLY ERIE BOLT CORP.	68	ROMULUS DIV	
EBERHARD BRUNINGHAUS	63	FENBAR PRECISION MACHINISTS, INC	74
ECENARRO S. COOP. LTDA.	64	FENTON HEADING	74, 168
		FERNDALE FASTENER	74, 168
		FERRIERE DI STABIO, S.A.	74
		FERRY CAP & SET SCREW CO., THE	75

MIL-HDBK-57G (IS)
INDEX A

<u>Company Name</u>	<u>Page</u>	<u>Company Name</u>	<u>Page</u>
F BAM COMPANHIA INDUSTRIAL	75	GSF FASTEN NG	85
F LETAGE INTERNATIONAL	75	ARMSTRONG FASTENING LTD.	
INTERNATIONAL THREAD INC.		GUARDIAN RIVET & FASTENER	86
F RST AMERICAN SALES CO.	75	GUARDIAN MFG. DIVISION	
FISCHER SPECIAL MFG. CO.	75	GUNNISON-INTERNATIONAL INC.	86
FITZ MANUFACTURING INDUSTRIES LTD	75		
DBA FMI		H	
FLAIG & HOMMEL	75	H C MERCHANDISERS INC	86
FLEXALLOY INC.	76	DBA H C PACIFIC	
FLORES ENTERPRISES	76	H C PACIFIC	86
FLUIDONICS INC.	76	H. MULL NS, LTD.	86
FLUIDYNE CORPORATION	76	BADE INDUSTRIAL ESTATE	
FMW, NC.	76	H. PAULIN & CO. LTD.	86
FOCUS HOPE	76	CAPITAL METAL INDUSTRIES DIVISION	
FOCUS HOPE	77	H. PRINZ GmbH FABRIK FUR VERBINDUNGSELEMENTE	86
FOLSOM TOOL & MOLD CORP.	77	HABINA ENGINEERING	87
FONTAL CONTROLS, INC.	77	HALL INDUSTRIES NC.	87
FONTANA LUIGI S p A	77	FORMERLY STANDARD TOOL & MACHINE COMPANY	185
FOREMOST PRECISION INSTRUMENT CORP.	78	HALLSIMS INDUSTRIAL COMPONENTS, INC.	87
FOREST FASTENERS	78	HAMANAKA (THAILAND), CO., LTD	87
FORMED FASTENER MANUFACTURING, INC	78	HAMANAKA NUT MFG. CO., LTD	
FPA MANUFACTURING	78	HANDI GADGETS CORP	87
DBA FPA MANUFACTURING AND SUPPLY		HANSAN SCREW CO., LTD.	87
FRANROE PRECISION MACHINE COMPANY	78	EXPORT NG DEPARTMENT	
FREEMAN COMPANY, THE	24, 78	HARDWARE SPECIALTY CO., NC	88
FRIEDR BOESNER GMBH	78	HARRISON BOLT AND NUT CO., THE	88
FRISBY AEROSPACE INC DE	79, 197	HARTFORD AIRCRAFT PRODUCTS, NC.	88
DIV TRIUMPH ACTUATION SYSTEMS -CLEMMONS		HARWOOD DESIGN, INC.	88
FRONT ER BOLT COMPANY OF TEXAS	79	HASKELL OF HUNTINGTON, INC.	88
FTB FASTENER TECHNOLOGY BESTAS	121	HASSALL, JOHN, INC.	88
SEE LISI AEROSPACE		HATCH INDUSTRIES	89
FUCHS SCHRAUBENWERK GmbH	79	HAWTHORNE BOLT WORKS	89
		HAYDON BOLTS, INC.	89
G		HAZE SE KO CO., LTD	89
G & R SCREW MACH NE PRODUCTS	79	HEARTLAND PRECISION FASTENERS INC	89
G & S MACHINE INC	80	HEIM'S MACH NE AND TOOL NC.	89
G. B. MACHINE PRECISION, INC.	80	HEITCO MANUFACTURING, INC.	90
G B. DUPONT CO., NC	61, 80, 106	HEMCO TOOL INC	90
GAITHER PATRICIA	80	HENWAY, NC.	90
DBA GAITHER MACHINE		HEPTNER MANUFACTURING COMPANY	90
GALAN PRECISION MACHINE CO.	80	HESSISCHE SCHRAUBENFABRIK WELTER GmbH & CO., KG	90
GALMAC MFG CO	80	HEWINS, EDMOND, C. JR.	90
GARCIA INDUSTRIES, INC	80	HEXAGON ENTERPRISES, INC	90
GARDINER MFG. CO.	80	HG AEROSPACE ENG NEERING LTD	90
GATES ALBERT, NC.	81	HI NDUSTRIAL TECHNOLOGIES	90
GATEWAY SCREW AND RIVET, INC.	81	HIGH QUALITY MACH NE SHOP INC	91
GEN FAST MANUFACTUR NG COMPANY	81	HIGH TECH ENTERPRISES	91
GENERAL AVIATION MFG., INC.	81	HIGHLAND PRODUCTS CORPORATION	91
GENERAL MACHINE PRODUCTS, NC	81	HIGHLAND THREADS, NC.	91
GENERAL SCREW AND SPECIALTY CO INC	81	FASTENER MANUFACTUR NG DIVISION	
GERMAN MACH NED PRODUCTS, NC	81	HILL AEROSPACE & DEFENSE LLC	91
GERTLER INDUSTRES, NC	81	HILL FASTENER CORP.	91
GFD LETAGE	82	HILL STAMPING & MANUFACTURING INC	91
G LL MACHINE TOOL CO	82	HILTI, INC	92
GL CNC SERVICES INC	82	HI-SHEAR CORP.	92, 121,
GMJ MACHINE COMPANY, INC.	82	DBA FOREIGN PARENT IS LISI PARIS FRANCE	196
GMP CO.CORPORATION	82	HLC NDUSTRIES NC	92
GOSHO WORKS, LTD.	82	HMS SERVICES LLC	93
GRACO INDUSTRIES, INC.	83	HO-HO-KUS, NC.	93
GRADON SCREW MACH NE CORP.	83	HO HONG WORKS CO., LTD	93
GRANDEUR FASTENERS, INC	83	HOFFMANN, RICHARD GmbH	93
GRAUCH ENTERPRISES	83	HOFFMANN MACHINE COMPANY, NC.	
GREATER MARYLAND TOOL & MFG., CORP.	83	DBA HOFFMAN, RICHARD GmbH	
GREEN BAY DROP FORGE CO	83	HOLLYWOOD MANUFACTUR NG INC.	93
DIV OF CLEVELAND HARDWARE & FORG NG	49	HOLO-KROME CO.	94
GREENFIELD MANUFACTURING CO., INC.	84	HORSPOOL & ROMINE MFG CO NC	94
GREER STOP NUT, NC.	69, 84	HORST ENG NEERING & MANUFACTURING CO.	94
GRIPCO, DIVISION OF BLACK & DECKER	84	HOUSTON FASTENER	94
GROOV-PIN CORPORATION	85	HOUSTON PRECISION FASTENERS	94
GRUPO RASSINI S.A. DE C A.	85	HOWARD TOOL CO., INC.	95
RASSINI NTERNATIONAL, INC.		HOWE MACHINE AND TOOL CORP.	95
		HOWELL PRECISION, INC.	95
GS AEROSPACE	25, 85	HOW E MANUFACTURING CO., INC.	95
DIVISION of B & B SPECIALT ES INC		HUCK AEROSPACE PRODUCTS	95
		HUCK INDUSTRIAL PRODUCTS	95

MIL-HDBK-57G (IS)
INDEX A

Company Name	Page
HUCK PRODUCTS	95
HUGGINS MFG	96
HUGO DURHOLT GMBH & CO. KG	96
HUNT VALVE COMPANY INC DBA WAECO VALVE DIVISION	96
HUNTER STEVENS CO INC	96
HUNT NGTON VALLEY INDUSTR ES, NC DBA HVI	96
HURON AUTOMATIC SCREW CO.	96
HURRICANE MACHINE COMPANY, L.L.C.	96
HYDRO FITTING MANUFACTURING CORPORATION	96
HYDROBOLT LIMITED	96

I

I.G.D. MACHINE & TOOL LTD.	97
IDEAL FASTENERS NC.	97
IFASTGROUPE 2004 LP	97
see INFASCO	99
see INFASCO NUT DIV	99
see INGERSOLL FASTENERS	99
IMPERIAL SUPPLIERS INC	97
INDIANA AIRCRAFT HARDWARE	97
INDUSTRIAL & AUTOMOTIVE FASTENERS DIVISION OF KEY MANUFACTUR NG GROUP, INC.	98
INDUSTRIAL FASTENERS CORP.	98
INDUSTRIAL FORGE, INC.	98
INDUSTRIAL NUT CORP.	98
INDUX, S.A DE C.V.	99
INFASCO DIV OF FASTGROUPE 2004 LP	99
INFASCO NUT DIV DIV OF NFASTGROUPE 2004 LP	99
INGERSOLL DIV OF FASTGROUPE LP, A HEICO COMPANY	99
INLAND MACHINE CO.	99
INOFAS MANUFACTUR NG INC.	72, 99
IN-SPECK CORP.	99
INSTRUMENT MACH N NG SERVICE LTD.	100
INTERFLEX MFG. CORP.	100
INTERSTATE FITT NGS INC.	100
IRON BOUND MANAGEMENT GROUP	100
IRVING MACHINE SERVICE, INC.	100
IRW N AUTOMATION, NC.	100
ISLAND ENGINEER NG DBA J SMITH MACH NE SHOP INC	100
ITT HARPER AEROSPACE FASTENER OPERATIONS AEROSPACE CONTROLS DIVISION	101
ITW BUILDDEX	101
ITW CIP	101
IVACO INC DBA INFASCO see IFASTGROUPE 2004 LP	101

J

J & M MACH NE INC	101
J & S PRECISION PRODUCTS	101
J.F. FREDERICKS TOOL CO.	102
J. G. FASTENERS	102
J. GEORG BIERBACH	102
J.M. PRECISION, INC.	102
J.P. PRODUCTS, INC. DBA SPECIALITES, UNLIMITED	102
JACOBSON MFG, LLC.	102
JACO ENG NEERING, INC.	102
JAM TECH CORP.	103
JAMES PPOLITO & CO., NC.	103
JAMES JACKSON DBA J J ENGINEER NG	103, 104
JAMISON INDUSTRIES INC	103
JANUS FASTENING SYSTEMS, INC.	103
JAY BEE MACHINE WORKS, NC.	103
JAY O MACH NE CO., INC.	103
JAYCO ENG NEERING	103
JEA ENTERPRISES, INC.	104
JERGENS INC DBA JERGENS INDUSTRIAL SUPPLY	104
JET MACHINE WORKS COMPANY SEE HEW NS, EDMOND, C. JR	90

Company Name	Page
JEWELL TOOL TECH	104
See KARMA INC	106
JINN HER ENTERPRISE CO., LTD.	104
JJ ENG NEERING JAMES JACKSON	103, 104
JJ SCREW PRODUCTS, NC.	104
JMT MACHINE COMPANY	104
JOHN R. BROM LEY COMPANY INC.	104
JOLICO/J-B TOOL INC.	105
JOSLYN CORP.	105
JUN PER ELBOW CO.	105
JUPITER WASHERS, INC.	105
JUST N TIME, INC DBA APSCO	105

K

K & K PRECISION ENTERPRISES NC	105
K.A.A. COMPANY LYNN ABADIE DBA K A A COMPANY	106
K.D.K. UPSET FORGING C O. INC.	106
KAMAX - WERKE RUDOLF KELLERMANN GMBH KAMAX L. P.	106
FORMERLY G B. DUPONT CO., NC.	106
KAMPWERK V EREGGE U. PICKARDT GMBH. & CO	106
KAPCO INDUSTRIES, INC	106
KARMA INC dba JEWELL TOOL TECH	104, 106
KATSURAGAWA MACHINE SCREW CO., LTD.	107
KAYGOR, INC.	107
KAYNAR PRODUCTS	107
KELLER ENG NEERING CO	107
KELOX/MICRODOT PRODUCTS	107
KEN FORGING, INC.	108
KERR CHARLES W	108, 129
KERR LAKES DE INC.	108
KEYSTONE BOLT & NUT COMPANY KEYSTONE THREADED PRODUCTS DIVISION	108
KEYSTONE TOOL AND MACHINE CO	108
KILBOURN ENGINEER NG CO.	108
KIRSTEN P PE CO. INC.	109
KLINCHER LOCKNUT CORP.	109
K.L.M. MACH NE INC.	109
KNIPPING-DORN GmbH KALTUMFORMTECHN K	109
KNOCH MANUFACTURING CO. LTD	109
KO AMS MACH NE PRODUCTS DBA KOAM MACHINE	109
KOBE FASTENER LIMITED	109
KOLB GMBH & CO. HERSTELLER VON VERBINDUNGSELEMENTEN	109
KONDOR TECHNOLOGIES, INC.	110
KONGO BYORA CO., LTD.	110
KOREA BOLT IND., CO., LTD. FOREIGN TRADE DEPARTMENT	110
KORODY COLYER CORP A CR INDUSTR ES CO	110
KOZAK E. PERCISION PRODUCTS CO	110
KPF	110
KREIS TOOL & MANUFACTURING CO INC	110
KROBACH MANUFACTURING CORP.	111
KSS SOCKET SCREW, NC	111
K-TECH MFG., INC.	111
KYOEI SEISAKUSHO CO., LTD.	111
KYOKUTO MFG CO LTD	111

L

L & C MFG CO INC	111
L & H THREADED RODS DIV OF GRAY AMERICA CORP	112
L & J FASTENERS, NC.	112
L & M ENTERPRISES INC	112
L. A. MARTIN COMPANY	112
L G MACHINE AND MFG INC	112
L H INDUSTR ES, NC. T P TOP TOOL CO.	112
L N AEROSPACE, NC.	112
L P R PRECISION PARTS AND TOOL CO INC	112

MIL-HDBK-57G (IS)
INDEX A

<u>Company Name</u>	<u>Page</u>	<u>Company Name</u>	<u>Page</u>
MNP CORPORATION	137	OBARS MACHINE & TOOL CO.	147
DBA MNP CORPORATION DIVISION 2		OCM MACHINE COMPANY, NC.	147
DBA MNP CORPORATION DIVISION 4		OHIO NUT & BOLT CO., THE	147
DBA MNP FASTENER DIVISION		DIV. OF FASTENERS INDUSTRIES, NC.	
MODERN METRIC MACH NE COMPANY INC	138	OHKAWA SCREW MFG. CO., LTD	148
MODFORM- LLINOIS INC	138	OKABE CO., INC.	148
MONADNOCK COMPANY THE	138	OKABE KIKO CO., LTD.	
DBA LISI AEROSPACE		OKAI IRON WORKS, NC	148
MONOGRAM AEROSPACE FASTENERS	138	OKAWA SCREW MANUFACTURING CO., LTD	148
MONROE MACHINED PRODUCTS NC	138	OMEGA THREAD ROLLING AND GRINDING INC.	148
MONTEREY MACHINE PRODUCTS	139	ONEIDA TOOL & MACHINE CORP.	148
MORTON FASTENERS INC.	139	ONO MANUFACTURER, INC.	149
MORTON MANUFACTURING	139	ONO MANUFACTURING CO., LTD	
DIVISION MORTON GRIND NG		ONTIC ENGINEERING & MANUFACTURING, NC.	149
MOSTAR GEAR & MACHINE MFG., CO.	139	ORANGE PRECISION PARTS	149
MOTOR WHEEL CORP.	139	ORC-O TOOL & MACHINE, INC.	149
MPIRE FASTENERS	139	ORDNANCE PARTS & ENGINEERING CO.	149
MRL MANUFACTURING CORP	139	ORLOTRONICS CORP.	149
		OSAKA SEIKI CO., LTD.	149
N		OSTEEN MACHINE SHOP	150
N.S.S. INDUSTRIES	140	OTO MELARA S.p.A.	150
NAFCO INDUSTRIES, INC.	140	F NKECCANICA COMPANY	
NAGOYA SCREW MANUFACTURING CO, LTD	140	OTT BROTHERS MACHINE CO., INC.	150
NAPIER'S AUTO BODY	140	OTTAWA PRODUCTS CO., NC.	150
NARRAGANSETT SCREW MFG CO	140	OWARI PRECISE PRODUCTS CO., LTD	150
NASSAN TOOL WORKS, INC.	140		
NASU DENKI-TEKKO CO., LTD.	141	P	
NATIONAL AEROSPACE FASTENERS CORPORATION	141	P & I ASSOCIATES, INC.	150
(NAFCO)		P & L ENTERPRISES	150
NATIONAL BOLTS AND RIVETS LTD	141	P.C.M., NC.	151
NATIONAL FASTENER CO., LTD.	141	P.S. MACHINE CO., INC.	151
NATIONAL THREADED FASTENERS CORP.	141	PABCOR, NC.	151
NAVPAR, INC.	141	PACER ALLOYS, INC.	151
NC AUTOMATED INDUSTRIES NC	141	PACIFIC FASTENERS, NC.	151
NCMI BRUEGGEMANN INC	142	PACIFIC SCIENTIFIC	151
ND INDUSTRIES INC	142	PACIFIC TOOL, INC.	151
DBA ND WESTERN FASTENER PROCESSING DIVISION		PADGETT MACHINE INC.	151
NEDSCHROEF HALMOND B.V.	142	PAINTER TOOL, INC.	152
NEKG HOLDINGS	142	PALNUT CO., THE	152
NELSON AEROSPACE INC.	142	UNITED CARR FASTENERS PALNUT DIV	
NELSON STUD WELDING DIVISION	142	PAOLO ASTORI SPA	152
NEUMAYER, ERICH GMBH & CO.KG	142	PARK PRECISION CORPORATION	152
NEVADA BOLT AND MFG CO NC	143	PATEREX, LTD	152
DBA SPS NON-FERROUS ENGINEERED FASTENERS		PATTERSON LAKE PRODUCTS	152
NEVILLE MACHINE SHOP	143	SUBSIDIARY OF COLUMBIA AUTO PARTS	
NEW HORIZON MACHINE CO., INC.	143	PAUL N. H. AND CO. LTD	152
NICE TOOL MFG., INC.	143	PB FASTENERS	153
NINGBO JINDONG FASTENING PIECE CO, LTD	143	DIVISION OF PAUL R. BRILES, NC.	
NIPPON MACHINE ENGINEERING, INC.	143	PECO AEROSPACE FASTENERS	153
NIPPON STEEL BOLTING CO., LTD.	144	PEERLESS SCREW PRODUCTS CORP.	153
NISCO, INC.	144	PEINER UMFORMTECHNIK GmbH	153
NISSAN SCREW CO. LTD.	144	PELHAM AUTO MATRIX PRECISION	154
SALES DEPT., FOREIGN TRADE SECTION		PENN CIGAR MACHINES INC	154
NOCHIA STEELWORKS	144	PEM NC	
NON-FERROUS BOLT & MANUFACTURING CO.	144	PENNENG ENGINEERING AUTOMOTIVE FASTENERS	154
NORTHBRIDGE FASTENERS	145	PENN ENGINEERING & MANUFACTURING CORP.	23, 154
NORTH EAST FASTENERS	145	ATLAS ENGINEERING INC.	
NORTHEAST METAL CO., INC.	145	PENN SCREW & MACHINE WORKS, INC.	154
NORTHERN SCREW CO., INC.	145	PEREZ MACHINE, NC.	155
NORTHSTAR ENGINEERING	145	PERIGEE MANUFACTURING COMPANY, INC.	155
NOVA MACHINE PRODUCTS, INC.	146	MICHIGAN CORPORATION	
A SUBSIDIARY OF CURTIS-WRIGHT FLOW CONTROL		PERKINS MACHINE CO.	155
SERVICE CORP.)		PHOENIX SPECIALTY MANUFACTURING CO., NC.	155
NSK INDUSTRIES, NC.	146	PILGRIM SCREW CORPORATION	155
NT ENGINEERING INC	146	PINE TAVERN MACHINE INC.	156
NUCOR CORP. (NUCOR FASTENER DIVISION)	146	PINEY RIDGE CO.	156
NUMERIC MACHINE PRODUCTS	146	PINTO PRODUCTS	156
NUTS INCORPORATED	146	PIONEER MACHINE PRODUCTS, INC.	156
DIVISION OF STANLOK		PIONEER SCREW & NUT CO.	156
NUTS, NC.	146	PLAINVILLE MANUFACTURING CO., NC.	156
NYLOK CORP.	147	PNEU-HYDRO PRODUCTS, INC.	156
		POINT MACHINE COMPANY	156
O		POLYTECHNIC INDUSTRIES	157
OAKTREE FASTENERS CO.	147	PORTLAND BOLT & MANUFACTURING CO INC	157

MIL-HDBK-57G (IS)
INDEX A

Company Name	Page	Company Name	Page
SHORELINE MACHINE PRODUCTS, NC.	178	SWISS TECHNOLOGY, INC.	190
SHUR-KUT SUPPLY CORPORATION	178		
SHUR-LOK COMPANY	178	T	
SPS FASTENERS DIVISION, A PCC COMPANY		T & E MACHINE CORP	190
SIERRA PACIFIC SUPPLY CO., NC.	179	T C QUALITY MACHINING NC	190
SIERRAC N/HARRISON	179	T R MACHINE NC	190
SIMMONDS PRODUCTS	179	TAIYO NUT MFG. CO., LTD.	190
SINN-TECH, INC.	179	TAKENAKA SEISAKUSHO CO., LTD.	191
SKY MANUFACTUR NG.	179	TANAKA LTD.	191
SKYLINE INDUSTRIES	179	T B & S MFG	191
SKYSPARES PARTS, INC.	179	TBCO THREADED FASTENERS	191
SLABE MACH NE PRODUCTS	180	DIVISION OF TENNESSEE BOLT & SCREW CO.	
SMALL PARTS MANUFACTURING CO., INC.	180	TECH WELDING AND MACH NE CO.	191
SMITH MACHINE & MANUFACTURING	180	TECHNICAL FASTENERS, INC.	191
SMITH WELD NG, NC.	180	TEK PRECISION CO., LTD.	191
SONFARREL, INC.	180	TELEFAST INDUSTRIES, NC.	192
SONIC INDUSTRIES, INC.	180	TENS MACHINE COMPANY, NC.	192
SOUTH BAY BOLT MANUFACTUR NG CO.	181	TERRY MACH NE CO.	192
SOUTHCO, INC.	181	See SPS TECHNOLOGY	183-184
SOUTHERN FASTENER CORPORATION	181	TERRYCABLE, INC.	192
SOUTHERN FASTENING SYSTEMS	181	TEXAS BOLT CO.	192
DIVISION OF FARLEY METALS, INC.		TEXAS PRECISION MFG., INC.	192
SOUTHWEST ALL ED PRODUCTS CO., NC.	181	TEXTRON FASTENING SYSTEMS	193
SOUTHWEST INDUSTRIAL SERVICES	181	AEROSPACE - SANTA ANA OPERATIONS	
SOUTHW ND INDUSTRIES, INC.	182	TFI AEROSPACE CORPORATION	193
SPACE AGE ENGINEERING, NC.	182	TFP CORP	193
SPACE SCREW, NC.	182	TRU-FIT PRODUCTS DIVISION	
SPACE-LOK, NC.	182	SPECIAL FASTENER DIVISION	
SPARTAN PRECISION MACHINE	182	THIANT (BOULONNERIE DE SA)	194
SPECIALS, NC.	182	THOMAS & BETTS CORPORATION	194
SPECIAL-T-METALS	182	FORMERLY AMERICAN ELECTRIC	16
SPECIALTY SCREW CORP.	183	THOMAS INSTRUMENT & MACH NE CO., INC.	194
SPIRAL TOOL CORP.	183	THOMAS MACHINING TECHNOLOGIES, INC.	194
SPS TECHNOLOG ES	183-184	THOMAS MFG, INC.	195
AFG DIV		TITAN FASTENER	188, 195
AEROSPACE PRODUCTS		TOG MANUFACTUR NG CO., INC.	195
SANTA ANA DIVISION		TOKOSHA METAL WORKS LTD.	195
SPS NC.		TONG HWEI ENTERPRISE CO., LTD.	195
T. J. BROOKS DIVISION		TOOLEX, NC	195
TERRY MACH NE		TOPURA CO., LTD.	195
UNITED KINGDOM CORPORATION		TORCO, INC.	196
METALAC SPS INDUSTRIA		TORONTO FASTENERS INDUSTRIES, INC.	92, 121,
UNBRACO PTY LTD. AUSTRALIA		SUBSIDIARY OF HI-SHEAR CORP., USA	196
SPURWAY COOKE INDUSTRIES PTE LTD	184	TORX PRODUCTS	196
SRI SAI INDUSTRIES CORPORATION	185	CAMCAR DIV/TEXTRON NC.	43
ST. LOUIS SCREW & BOLT CO.	185	TOWNE ROBINSON FASTENER CO.	196
STACY MACHINE & TOOLING, INC.	185	KEY MANUFACTUR NG GROUP, INC.	
STALKER & DYSTHE, INC.	185	TOWNSEND CO.	196
STANDARD LOCKNUT, NC.	185	CERRY RIVET DIVISION	
STANDARD NUT & BOLT, INC.	185	TOYO STEEL WIRE CO., LTD.	196
STANDARD TOOL & MACHINE CO.	185	TRI STATE TOOL & DIE CO., NC.	197
SEE HALL INDUSTRIES INC.	87	TRIAD PRODUCTS CORP.	192
STEADFAST CORPORATION	186	TRIDAIR PRODUCTS	167, 197
STEEL CITY BOLT & SCREW, NC.	186	TRIDENT MACHINE CO.	197
STEEL PRODUCTS OF MASSILLION	186	TRIEM INDUSTRIES, LLC	197
STEEL WAREHOUSE COMPANY, INC.	186	TRIUMPH GROUP OPERATIONS NC, THE	197
STELCO FASTENER & FORGING CO.	186-187	FRISBY AEROSPACE INC DE	97
STELFAST FASTENERS, INC.	187	TRIUMPH MANUFACTURING CO., INC.	197
DIVISION OF STELFAST FASTENERS, LTD.		TRONSON MANUFACTUR NG	197
STELFAST, NC.	187	TROY D. RAY	198
STERLING MACHINE COMPANY	187	DBA DIXON MACHINE & FABRICATION	59
STERLING MARKING PRODUCTS IC	188	TRW	198
STERLING MFG. & SUPPLY, NC.	188	FASTENER DIVISION	
STEVENS MFG. CO., INC.	188	TRY - AZTEC COMPANY	198
STLLWATER FASTENERS, NC.	188	TUFF FASTENERS CO.	198
STRENKERT MACH NE SHOP INC.	188	TURNAMICS, INC.	198
STURM MACH NE CO., INC.	189	TW DESIGN AND MANUFACTURING, L.L.C.	198
SUBCON TOOL / ACCUTOOL MACHINE GROUP NC.	189	TWIST TITE MFG. NC.	199
DBA ACCUTOOL	4		
SUBURBAN INDUSTRIES, NC.	189	U	
SULLIVAN BOLT CO., INC.	189	UDT, NC	199
SUNDRAM FASTENERS, LTD.	189	U.P. MACHINE & ENGINEERING CO.	199
SUNRISE PRECISION MFG.	189	U.S. BOLT MANUFACTUR NG, NC.	199
SUPERIOR TECHNOLOGY	189	ULTIMATE MACHINING & WELDING	199
SUPREME SCREW PRODUCTS, INC.	189	ULTRA SONIC MACH NE CO., INC	200
S V INDUSTRIES	190		

MIL-HDBK-57G (IS)
INDEX A

<u>Company Name</u>	<u>Page</u>	<u>Company Name</u>	<u>Page</u>
UMPCO CORP.	200	WHAIL BOLT IND. CO., LTD.	210
UN FLOW CORP.	200	WHELAN MACHINE & TOOL CO.	211
UN METERIC CORPORATION	200	WHITNEY SCREW CORP.	211
UNISTRUT CORP. (UNISTRUT PHILA)	200	WHITTET-HIGGINS CO.	211
UNITED BOLT & SCREW CORP.	200	WIGLEY MACHINE COMPANY	211
UNITED DRILL BUSHING CORP.	201	W LHELM SCHUMACHER SCHRAUBEN-FABRIK GmbH	211
UNITED PRECISION PRODUCTS CO., INC.	201	W LLIAM'S MACHINE & FABRICATION, INC.	211
UNITED STATES DEFENSE RESEARCH & SUPPLY	201	W L-NIC	211
UNITED STEEL & FASTENERS INC.	201	E D R. INDUSTRIES, NC DBA W L-NICO	211
UNIVERSAL MACHINE PRODUCTS	201	W LSON-GARNER CO.	212
UPB ENGINEERING	201	W LT PRECISION PRODUCTS	212
UPSTART ACQUISITIONS, CORP.	202	W NEGAR, INC.	212
DBA BET-LAR SERVICES	31	W NKER HERMANN GMBH & CO KG METALLWARENFABRIK	212
URANIA ENGINEERING CO., INC.	202	W NSLOW AUTOMATICS, NC	212
SPEC-NUT	202	WITTEN COMPANY, INC.	212
URBAN MANUFACTURING CO.	202	WODN, INC.	212
URBAN MFG. CO., NC.	202	WOLSTENHOLME MACHINE	213
US TOOL & DIE	202	DBA WM ROBOTS	213
UTAH TOOL & DIE, INC.	202	WOLTERS GMBH	213
V			
VALCOR ENGINEERING CORP.	203	WOLVERINE MACHINE PRODUCTS CO.	213
VALLEY FORGE AND BOLT MFG CO.	203	WOLVERINE NUT CO.	213
VALLEY-TODECO, NC.	203	WORTHY MACHINE	214
VAN PETTY MFG., INC.	203	WROUGHT WASHER MANUFACTURING, NC.	214
DBA J.W. MANUFACTURING INC	203	WYANDOTTE INDUSTRIES, NC.	214
V-B MACHINE CO., INC.	203	WYNNSON ENTERPRISES, NC.	214
FASTENER DIVISION	203	X	
VEGAS FASTENER MANUFACTURING	203	X-TECH INNOVATIONS INCORPORATED	214
VENUS FASTENERS CORP.	203	XCEL MFG., NC.	214
VERSATECH, INC.	203	Y	
VERTEX DISTRIBUTION	204	Y2K MACHINE SHOP, NC.	215
VICO PRODUCTS, CO.	204	YATES TOOL, INC.	215
VICTOR PRODUCTS CORP.	204	YOUNG ENGINEERS, NC, THE	215
VIP MFG. & ENGR. CORP.	204	YOW MENGI INDUSTRIAL CO., LTD.	215
VISSERIES & BOULONNERIES DE FOURMIES	204	Z	
VISTEK INDUSTRIES	205	Z & B GENERAL MACHINE	215
VITCO NUCLEAR PRODUCTS, NC.	205	ZAMON CO., INC.	215
VM MANUFACTURING CORPORATION	205	ZENEX CORPORATION	215
VMC INDUSTRIES, NC.	205-206	ZERO PRODUCTS, INC.	216
VOI-SHAN PRODUCTS	207	Z	
VORTEX MFG CO.	207	Z & B GENERAL MACHINE	215
VOSS INDUSTRIES, INC.	207	ZAMON CO., INC.	215
VOSS AEROSPACE DIVISION	207	ZENEX CORPORATION	215
VSI (AEROSPACE PRODUCTS DIVISION)	207	ZERO PRODUCTS, INC.	216
VULCAN RIVET & BOLT CORP.	208	Z	
W			
WA TAI INDUSTRIAL COMPANY, LTD.	208	Z & B GENERAL MACHINE	215
WALKER BOLT MANUFACTURING	208	ZAMON CO., INC.	215
DIVISION OF LONE STAR FASTENERS, LP	208	ZENEX CORPORATION	215
WALZ & KRENZER INC	208	ZERO PRODUCTS, INC.	216
DBA MAPECO PRODUCTS DIV MAPECO PRODUCTS	208	Z	
WARREN PUMPS LLC	208	Z & B GENERAL MACHINE	215
DIVISION OF COLFAX CORPORATION	208	ZAMON CO., INC.	215
WATERBURY BUCKLE CO.	208	ZENEX CORPORATION	215
WAYNE BOLT & NUT CO., NC.	208	ZERO PRODUCTS, INC.	216
WEAVER MANUFACTURING, NC.	209	Z	
WEBLUK MACHINE CORP.	209	Z & B GENERAL MACHINE	215
WELTER GMBH & CO. KG	209	ZAMON CO., INC.	215
WELTON ROLLED THREAD CORP.	209	ZENEX CORPORATION	215
WESLOK	209	ZERO PRODUCTS, INC.	216
DIVISION OF FALL RIVER MANUFACTURING	209	Z	
WEST COAST AEROSPACE, INC.	209	Z & B GENERAL MACHINE	215
WEST TENNESSEE LIONS BLIND INDUSTRIES INC	2, 209	ZAMON CO., INC.	215
DBA A P MILLS INDUSTRIES FOR THE BLIND	2, 209	ZENEX CORPORATION	215
WESTERN PACIFIC ENTERPRISES, W.P.E., INC.	210	ZERO PRODUCTS, INC.	216
WESTERN SCREW MACHINE PRODUCTS, INC.	210,	Z	
CUTTING EDGE MACHINE	53	Z & B GENERAL MACHINE	215
WESTERN SKY INDUSTRIES, INC.	210	ZAMON CO., INC.	215
DIVISION OF ATLAS CORP.	210	ZENEX CORPORATION	215
WESTFIELD FASTENERS	210	ZERO PRODUCTS, INC.	216
WESTLAND STEEL PRODUCTS, LTD.	210	Z	
WESTWOOD PRECISION, NC.	210	Z & B GENERAL MACHINE	215
		ZAMON CO., INC.	215
		ZENEX CORPORATION	215
		ZERO PRODUCTS, INC.	216

MIL-HDBK-57G (IS)
INDEX B
INDEX B - SYMBOL

SYMBOL	COMPANY NAME	PAGE
	A	
A-1	A-1 NUT AND BOLT CO., NC	2
A-1	A-1 THREAD ROLL NG CO., NC	2
	ALCO MACHINE CO.	13
A325	COAE BOLTS WORKS CO., LTD.	50
A+	ACCURATE TOOL CO., NC	4
A	AAP ACQUISITION CORP	2
	ABRASIVE CUTTING CORP.	3
A	ACCURATE PRECISION FASTENERS, INC.	3
	ACCUTURN CORPORATION	4
A	ACHILLES AEROSPACE PRODUCTS, NC.	5
	ACME INDUSTRIAL COMPANY	5
	ACME MACHINE PRODUCT	5
	ACME SCREW COMPANY	5
	ADAMS, EARL M. CO.	6
A	ADVANCED CNC MANUFACTUR NG	7
a	ADVANCED MACHINING & FABRICATING, INC.	7
a	ADVANCED PLASTICS, NC.	7
A A & A	AERO & AUTO STUD SPEC.	7
	AEROFAST SUPPLY	8
A	AEROSPACE MACHINE PRODUCTS	9
A	AEROSPACE PRODUCTS, NC.	9
	AEROSTAR FASTENER CORP.	10
A*	AEROWIND CORPORATION	10
	AFI INDUSTRIES, INC.	10
	A R INDUSTRIES CORPORATION	11
	A RCRAFT FUELSEAL FASTENERS, INC.	11
A	A RFASCO, NC.	12
	ALLIED NUT & BOLT CO., NC.	14
	ALPHA MACH N NG PRODUCTS & DEVELOPMENT	15

SYMBOL	COMPANY NAME	PAGE
A	ALPS SE KO CO.	15
	AMANDA BENT BOLT CO.	16
	AMERICAN ELECTRIC and THOMAS & BETTS CORPORATION	16, 194
	AMERICAN INTERNATIONAL AERO MFG NC	16
	ANDERSON FORGE & MACHINE	18
	A-ONE MACHINE COMPANY	18
A	ARNOLD UMFORMTECHNIK GMBH & CO. KG	21
	ARROW SCREW & MACHINE WORKS	21
	ASAHI SREWS MANUFACTUR NG CO., LTD	21
A	ASAI TEKKO CO. LTD	22
	ASSOCIATED TOOL CO., NC	22
A	BELL FASTENERS	29
A	CAMCAR DIVISION OF TEXTRON INC.	40-43
	EATON AEROQUIP CORPORATION	63
	GARCIA INDUSTRIES, NC.	80
A	MECAERO PRODUCTS ALCOA FASTENING SYSTEMS	131
A	PORTSMOUTH NAVAL SHIPYARD	157
	ALL AUTOMATICS	13
AAP	AV BANK MFG., NC.	24
AB	ABSCOA INDUSTRIES	3
	ADJUSTABLE BUSH NG CORP	6
AB	AV BANK MFG., NC.	24
	LENCH, THOMAS WILLIAM, LTD.	115
	PRECISE OF CALIFORNIA	158
ABC	ALPHA BOLT CO.	15
ABE	ADAMS INDUSTRIES, NC.	6
ABM	AEROBOLT MANUFACTUR NG, NC	8
	AUTO BOLT AND NUT CO.	23
Ac	ACRODYNE MFG CO.	6
	ACE PRECISION INDUSTRIES, INC.	5
ACI	ACI	5
	ACIMET MFG.	5

MIL-HDBK-57G (IS)
INDEX B

SYMBOL	COMPANY NAME	PAGE
	ACCU-TECH MANUFACTURING AND SUPPORT, INC.	4
AD	ADOM ENGINEERING	6
AD	AUTOMATIC SCREW MACHINE PRODUCTS CO.	24
ADB	AV BANK MFG., NC.	24
ADBB	AV BANK MFG., NC.	24
AD&M	AMERITECH DIE & MOLD SOUTH INC.	17
	ADOM ENGINEERING	6
	AERO DYNAMIC MACHINING INC.	8
ADP	AV BANK MFG., NC.	24
adc 	ADC COMMUNICATIONS CORP.	6
AE	A & E MACHINED PRODUCTS	1
	AASTRO ENGINEERING	2
	AERO ENGINEERING AND MANUFACTURING CO. OF CALIFORNIA	8
	ATLAS ENGINEERING, NC. and PENN ENGINEERING & MANUFACTURING CO.	23, 154
AEP AEP	AIRCRAFT ENGINEERING PRODUCTS, NC.	11
	AERO BUSHING AND COMPONENT	7
	ACCUFORM, NC.	3
	ACCURATE THREADED FASTENERS, INC.	4
AF	ACUFAST AIRCRAFT PRODUCTS	6
	AEROTECH FASTENERS, INC.	10
	AKKO FASTENER, INC.	12
	ALLFAST FASTENING SYSTEMS, NC.	14
	ALPHA FASTENERS	15
AF	ANKIT FASTENERS PRIVATE LIMITED	18
	ATF, INC.	22
	AUGUST FRIEDBERG GMBH	23
	AFAB PRECISION MACHINING	10
	ARFASCO, NC.	12
	AMERICAN FASTENER & SPECIALTY CO.	16
	AFS	16
AGC	ACE GRINDING & MFG. OF TEXAS	4
AGM	ACE GRINDING & MFG. OF TEXAS	4

SYMBOL	COMPANY NAME	PAGE
	AIRFRAME INTERNATIONAL, INC.	12
AI PLATE NUT A  ON ONE SIDE I  ON OPPOSITE SIDE HEX NUT	ARFASCO INDUSTRIES FASTENER GROUP	12
A/I	ARVAN, NC.	21
	ATHENA INDUSTRIES	22
A-I	AV BANK MFG., NC.	24
	A R-COM, INC.	11
	AJ ASSOCIATES MFG & ENG COMPANY, INC.	12
AK	ARNOLD KNIPPING GmbH	21
A-K	AV BANK MFG., NC.	24
A.L.	S.A.B.A. S.p.A. BULLONERIA E. AFFINI	173
	ALPINE MACHINE & TOOL CORP.	15
	ARLAND TURBINE SERVICES, INC.	11
	A & M AEROSPACE, INC.	1
AM	AEROSPACE MANUFACTURING AMACON CORP.	9
	AMACON CORP.	16
	AMERICAN FASTENER & SPECIALTY CO.	16
	AMMAC, INC.	17
	ARDOR MFG. NC.	19
	AUTOMATIC MANUFACTURING COMPANY	23
AM	AUTOMATED MANUFACTURING	23
	AUTOMATIC MACHINING AND MFG CO.	23
AMATOM	AMATOM ELECTRONIC HARDWARE	16
AMB	AMERICAN METAL BEARING COMPANY	17
AMC	ALBAR MACHINE CORPORATION	12
	SAI INDUSTRIES CORP.	174
		
AMI LOGO	A.M.I. ENGINEERING	2
AMP	AEROSPACE MACHINE PRODUCTS	9
	ALARD MACHINE PRODUCTS	12
	ANTRIM MACHINE PRODUCTS	18
	AERO MECHANICAL FASTENING SYSTEMS	8
AMS	AEROSPACE MARINE SPECIALTY FASTENERS & FITTINGS INC.	9

MIL-HDBK-57G (IS)
INDEX B

SYMBOL	COMPANY NAME	PAGE
AMSCO	ACCURATE SCREW MACHINE CO	3
AMT	ADVANCED MACHINING & TOOL NG, NC.	7
AMT-1 AMTxxxx-xxxx	ALPINE MACHINE & TOOL CORP.	15
A-N	AV BANK MFG., NC.	24
	A & N PRECISION INDUSTRIES	1
	AMERICAN QUALITY INDUSTRIES	17
AOL	ALL MANUFACTURERS NC.	13
AOL	ITT HARPER AEROSPACE FASTENER OPERATIONS	101
AP	ACCURATE AUTOMATIC PARTS CO	3
ap	ADVANCED PLASTICS, NC.	7
AP	AEROSPACE PRODUCTS CO.	9
	A R PARTS MFG. CO.	11
	A RDROME PARTS CO.	11
AP	ALL-POWER MFG. CO.	14
	ALL-PRO FASTENER & RIVET MFG. CO.	14
	ANATASE PRODUCTS	17
AP	APEX MFG. CO. INC.	19
AP	APHEONIX CORPORATION	19
A-P	AV BANK MFG., NC.	24
	P LGR M SCREW CORP.	155
APCO	AEROSPACE PRODUCTS	9
	APEL LTD.	19
APMI	A. P. MILLS INDUSTRIES FOR THE BLIND and WEST TENNESSEE LIONS BLIND IND. NC.	2, 209
APP	ALLIED PRECISION PRODUCTS, NC.	14
	ATLANTIC PRECISION SPRING, INC.	22
AR	A & R MFG CORP	1
	ACME RIVET & MACHINE CORP.	5
ARVAN, INC.	ARVAN, NC.	21
	A & S P N PRODUCTS NC.	1
	AEROSTAR ENGINEERING & MANUFACTURING COMPANY	10
	ALL-STATES INC.	14
AS	AV BANK MFG., NC.	24

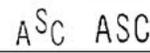
SYMBOL	COMPANY NAME	PAGE
	ARCO SALES CO.	19
	ASL MANUFACTURING NC.	22
ASP	ATLAS SPECIALTY PRODUCTS	23, 53
ASP	CURTIS PRESTON ENTERPRISES, NC.	23, 53
	ARTISAN SPECIALIST TECH, INC.	21
	AST ASSOCIATES, NC.	22
ATBO ATLAS	ARMSTRONG ATLAS BOLT	20
	AVDEL INTERNATIONAL	24
AV	AV BANK MFG., NC.	24
AVIBANK	AV BANK MFG., NC.	24
AVK	AV BANK MFG., NC.	24
	AVK INDUSTRIES PRODUCTS INC.	25
AVL	AV BANK MFG., NC.	24
	A & W SCREW MACHINE PRODUCTS, NC	1
	AIW-ALTON NC.	12
	ARNOLD WRAGG (BOLTS & NUTS) LTD	21
A-W	AV BANK MFG., NC.	24
AX	AEROMAX INDUSTRIES, NC.	8
B		
	B & E MACHINE SHOP & SHEET METAL FAB., NC.	25
	B & E MANUFACTURING CO., NC.	25
B	BELL FASTENERS	29
	BELL-MEMPHIS, NC.	30
	BERGNER, RICHARD GMBH & CO	30
	BETA ENGINEERING, NC.	31
	BLANC AIRCRAFT FASTENERS, INC.	32
	BOBCAT MANUFACTURING CO.	33
	BOLT FASTENER STUD/TECHNOLOGY	33
B B+ B1	BRISTOL INDUSTRIES	35
	BROADSTONE TOOL & DIE, INC.	35
	BRYNOLF MANUFACTURING, NC.	36
	BUCK EYE FORGE, INC.	36

MIL-HDBK-57G (IS)
INDEX B

SYMBOL	COMPANY NAME	PAGE
BALL-LOCK	AV BANK MFG., NC.	24
	BEL-AIR MACHINE & PERFORMANCE	29
	BARRE PRECISION PRODUCTS INC.	27
BAF	BLANC AIRCRAFT FASTENERS, INC.	32
BB	B & B SPECIALT ES, NC.	35
	BARNEGAT BAY NSCC, NC. DBA BB NSCC, INC.	27
BB <u>BB</u>	BIG BOLT CORP.	31
<u>BB</u> <u>BB</u> <u>BB</u> • • •		
	LISI AEROSPACE	120-121
	BETA CORP.	31
BCC	BBC FASTENERS, INC.	28
BD <u>BDM</u>	SAFETY SOCKET SCREW CORP.	173
BDM	BRUNNER DR LLING & MFG. CO., INC.	36
	BOGNER ENGINEER NG CO.	33
	BARCO ENG NEERING COMPANY, INC.	27
BEC	BEC MACHINE PRODUCTS COMPANY	28
BEI	ANOTHER SCREW MACHINE PRODUCT	18
	BOMAR ENGINEER NG, NC.	33
BEK	BEK LEVEL 1 FASTENERS and LEVEL 1 FASTENERS	29, 117
	BENACO TOOLING RESEARCH & DEV. CORP.	30
BFG+	B F GOODRICH CO. RIVNUT ENG NEERED FATSENERS, THE	26
BFI	BRIARWOOD FASTENERS, INC.	34
	B G ENG NEERING, INC.	26
	B G M FASTENER CO., NC.	26
BH	BULTEN TRADING AB	37
BI	BEE INDUSTRIES, INC.	28
BI	BRISTOL INDUSTR ES	35
	BRINTCLIFFE TURNER LTD.	35
BIM	BUSAN INDUSTRIAL MACHINERY CO., LTD.	38
BL	BLAND CO., THE	32
BL	BRIGHT LIGHTS USA, NC.	34
BLC	AV BANK MFG., NC.	24
BLSAVIBANK	AV BANK MFG., NC.	24

SYMBOL	COMPANY NAME	PAGE
	BEACH MACH NE	28
BM	BERRY, JOHN DBA BERRY MANUFACTUR NG	31
BM	BERRY MANUFACTUR NG	31
BM	BRUNNER DR LLING & MFG. CO., INC.	36
BM	BRUNNER MANUFACTUR NG CO. DBA BRUNNER MANUFACTUR NG DIVISION	36
BM	BRYCO MACHINE, NC.	36
BM	BUSAN INDUSTRIAL MACHINERY CO. LTD.	38
BMC INC.	BRACELENTE MANUFACTUR NG CO., NC.	34
	BUCKEYE MACH N NG, NC.	36
	BRADY MACH NE, INC.	34
	BRANCH MACHINE PARTS, INC.	34
	BOLT & NUT CO.	33
	BONEAL NC.	34
	B & N TOOL CO.,INC.	26
	FR EDR BOESNER GMBH	78
BOT	BEOTOOL CORP.	30
BP	BELL PRECISION, INC.	30
BP	BUFFALO PUMPS, NC.	37
B.P.C.	BEAVER PRODUCTS CORP.	28
BPG	FERRY CAP & SET SCREW CO., THE	75
	BROWN PRODUCTION, NC.	35
	BER-LOW MFG INC.	31, 38
	BUTECH PRESSURE SYSTEMS	31, 38
BR	B & R MACH NE AND TOOL CORP	26
	BRIDEAN MACH NE & TOOL CO., NC.	34
	BURROWERS RESEARCH MACHINING, NC.	37
	BROADWAY SCREW MACHINE INC.	35
BT	BEGONIA TOOL COMPANY	28
	BLAINE TOOL CORP.	32
	BAS AEROSPACE LIMITED	27
BUFO	BULTEN TRADING AB	37
BULA	BULA FORGE INC.	37
	BOLTWORKS, INC.	33
BVB	BRIDGEV EW MANUFACTUR NG CO.	34

MIL-HDBK-57G (IS)
INDEX B

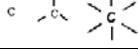
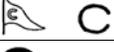
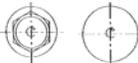
SYMBOL	COMPANY NAME	PAGE
B_X	ITW BU LDEX	101
BY	BEN YUAN ENTERPRISE CO. LTD.	30
	EBERHARD BRUN NGHAUS	63
C		
C&D MACH	C & D MACHINE TOLL, NC.	38
	CAMLOC PRODUCTS	44, 167
C	CARD NAL INDUSTRIAL PRODUCTS	45
	CHAMPION FASTENERS, NC.	47
C	CHANCE, A.B. COMPANY	47
	CHIEF MFG.	48
	CINCH MANUFACTUR NG	49
C	CNC MACHINING INC.	49
	COAE BOLTS WORKS CO., LTD.	50
	COAST INDUSTRIAL SUPPLY CO., INC	50
C	CO-OP SCREW MANUFACTUR NG CORP.	51
	CSM FASTENER PRODUCTS	53
C 	HAZE SEIKO CO., LTD.	89
	REXNORD	167
C	SPS TECHNOLOGIES	183-184
C	TEXTRON FASTEN NG SYSTEMS	193
C	TOWNSEND CO.	196
CA	C & A MACH NE CO.	38
CAL	BAY BOLT	27
CAMCAR	CAMCAR DIVISION OF TEXTRON INC.	40-43
CAMCAR	CAMCAR LLC	43
CAMLOC 	CAMLOC PRODUCTS, REXNORD	44, 167
	CAM-TECH INDUSTR ES	44
	CONNECTICUT AIRCRAFT PRODUCTS	51
	BOBCAT MANUFACTUR NG CO.	33
CB	CLICK BOND, NC.	49
CBM	COMPUTA-BASE MACHINING, INC.	51
CBS	CBS FASTENERS INC.	45
CbS		
CCB	CCB INDUSTR ES, NC.	45

SYMBOL	COMPANY NAME	PAGE
CCF	CCF ENTERPRISES NC.	45
CCM	CONTRACTING CNC MACHINING	51
CCS	SPS TECHNOLOGIES	183-184
	CAPRICE ENGINEERING CO., NC.	44
C. E. I	COMMAND ENTERPRISES	45, 51
CES	C.E.S. MACHINE PRODUCTS, NC	39
	CHICAGO FASTENER MANUFACTUR NG	48
CFL	CLYDE FASTENERS LIMITED	49
CFS	CARD NAL FASTENER & SPECIALTY CO., INC.	44
CCG	CORPUS CHRISTI GASKET & FASTENER LTD.	52
	CANADY MANUFACTUR NG CO. NC.	44
	CHU HUA INDUSTRIAL CO., LTD.	48
	COLD HEAD NG CO., THE	50
CHEREK	CHEREK MACHINE & TOOL CO., NC.	47
CHF	CHICAGO HARDWARE & FIXTURE CO.	48
CI	CATALINA INSTRUMENT CORPORATION	45
	SPS TECHNOLOGIES	183-184
	C. J.'S GENERAL MACHINE WORKS	39
	CENTERLINE TOOL & ENGINEERING, INC.	46
CM	CER-MAC INC.	46
C_M	CM MANUFACTUR NG, NC.	49
	CRESENT MANUFACTUR NG CO.	52
	CERNY MFG. CO.	46
	CHRIS MACH NE CO.	48
CMI	CONQUEST MACHINE, NC.	51
	CENTURY METAL PARTS CORP.	46
	CONT NENTAL MACHINE PRODUCTS, NC.	51
CNB	CHICAGO NUT & BOLT NC.	48
	CRYSTAL METAL PRODUCTS COMPANY, NC.	53
	CAPY MACHINE SHOP, NC.	44
	OWARI PRECISE PRODUCTS CO., LTD	150
	CENTRAL OZARK MACHINE, NC.	46

MIL-HDBK-57G (IS)
INDEX B

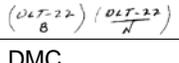
SYMBOL	COMPANY NAME	PAGE	SYMBOL	COMPANY NAME	PAGE
	COPELAND MFG. CORP.	52	D	DEMAT	57
CP	CHANDLER PRODUCTS, NC.	47		DERBYSH RE MACHINE & TOOL CO.	58
CPI	CREATIVE PRECISION NC.	52	D	DIESEL PARTS COMPANY OF CALIFORNIA	58
CPM	CHOICE PRECISION MACHINE, NC.	48	D	DIHARD COMPANY	59
	CHEMIQUIP PRODUCTS COMPANY	47		DIVERSIFIED FASTEN NG SYSTEMS, NC.	59
	C.R.D. MACHINING	39		DO MANUFACTURING CORP.	59
CRUM	CRUM MFG	53	D	DUPONT, G.B. CO., INC. and KAMAX L. P.	61, 80, 106
	CRS PRECISION CORP.	52		DUSEVOIR METAL PRODUCTS, NC.	61
	C & S ENGINEERING LLC	38	D	DUVE GmbH & CO. KG	61
CS C S	CALIFORNIA SCREW PRODUCTS CORP.	40		DYSON CORP THE	62
	COPPER STATE BOLT & NUT CO.	52		ONTIC ENGINEERING & MANUFACTUR NG, NC.	149
	CAMBRIDGE SPECIALTY COMPANY, INC.	40		STEEL WAREHOUSE COMPANY, INC.	186
C S D	CAMCAR DIVISION OF TEXTRON INC.	40-43	D A E	DAVE ALLEN ENTERPRISES	55
C-SI	CALABRESE & SONS, NC.	39	DAS 1	DEFENSE AEROSPACE	56
	CENTRAL SCREW PRODUCTS	46	DB	DAN-LOC BOLT & GASKET NC.	55
	CHEROKEE TOOL & ENGINEERING CO., INC.	47	DC	D. C. MACH N NG INC.	54
CTM	CONT NENTAL TOOL & MANUFACTUR NG	51	DDG	BLANC AERO INDUSTRIES and LISI	32 120
C W R C	CWR MANUFACTUR NG CO	54		DYNAMIC ENGINEERING	62
D			DF TM	DEUTSCH COMPANY NC., THE	58
	D & D MANUFACTURING	54	d	DTF MANUFACTURING, NC.	60
D & D	D & D TOOL COMPANY, NC.	54	DFC DFCI	DFCI SOLUTIONS, INC.	58
	B & D THREADED ROLLING	25		DETROIT HEADING CO.	58
d	DACK INDUSTR ES, NC.	55	DHL	DHL ENTERPRISES	58
	DANIEL CO., EDWARD W.	55		DIAL SUPPLY AND MANUFACTUR NG, NC.	58
D	DAN-LOC BOLT & GASKET NC.	55	D	DELT INDUSTRIES, INC.	57
D	DECKER MANUFACTUR NG CORP	56	DI	DUNCAN ELECTRONICS & MFG. CO	61
	DEFIANCE STAMPING COMPANY, THE	57	DF	DOMESTIC FORGING, NC.	60
D	DEHOUSSE (USINES)	57	DL	DISC-LOCK INTERNATIONAL	59
	DELL MFG. CO., INC.	57		M LLS, J. R. MACHINING, NC.	134
			DMC	DECKER MANUFACTUR NG CORP	56

MIL-HDBK-57G (IS)
INDEX B

SYMBOL	COMPANY NAME	PAGE
	DEPENDABLE MACHINE CO., NC.	58
DMC	DONSON MACHINE	60
	DELTA MACHINE & TOOL CO., NC.	57
DMT	DIXON MACHINE & TOOL and TROY D. RAY	59, 198
	KNIPP NG-DORN GmbH	109
	TRW	198
D P	DARCO PRODUCTS	55
DP	DUNHAM PRODUCTS, NC.	61
DPI	DUNHAM PRODUCTS, NC.	61
DPM	DAVIES PRECISION MACHINING, INC.	55
	DEFENSE QUALITY MFG.	56
	DOUBLECO INCORPORATED	60
	DEMAT	57
DTE	DOUGLASS TOOL & ENGINEERING CO., INC.	60
DTE	EMERALD VALLEY MFG	65
	DTF MANUFACTURING, NC	60
	DUFFY ELECTRONICS & MFG. CO.	61
	DUVE GmbH & CO. KG	61
DUVEX	DUVE GmbH & CO. KG	61
DV	DEL-VAL FASTENER MANUFACTURING	57
DX	DUVE GmbH & CO. KG	61
DYNACAST	DYNACAST	61
DZUS	DZUS FASTENER CO., NC.	62
E		
	EAGAN MACHINE CORP.	62
E	EAST COAST METALS NC.	63
	EASTERN SCREW CO., NC.	63
E	EBC INDUSTRIES (ERIE)	63, 68
E	ERIE BOLT CORP.	63, 68

SYMBOL	COMPANY NAME	PAGE
E	ELASTIC STOP NUT & ESNA	64, 68, 125
E	ELCO INDUSTRIES, INC.	64
	ELLIS PRECISION INDUSTRIES	65
E	ENGINEERING MATERIALS CO., INC.	66-67
	ENOMOTO INDUSTRIES CO., LTD.	67
	ERICO FASTENING SYSTEMS	67
	ESMET, NC.	68
E	NORTHBRIDGE FASTENERS	145
	R B & W CORPORATION	163
E A	VOSS INDUSTRIES, NC.	207
	SUPERIOR TECHNOLOGY	189
	EAST BAY MANUFACTURERS, INC.	63
EBM	EBERHARD BRUNNGHAUS	63
EBP	ENGINEERED BOLT NG PRODUCTS, NC.	66
	ELITE FASTENERS	65
	ELCO INDUSTRIES, INC.	64
	E. L. R. MACHINE AND TOOL	62
EM	EASTWOOD MFG., CO.	63
	ENGEL MANUFACTURING COMPANY, INC., THE	66
EM	ENGLE MANUFACTURING COMPANY, INC., THE	67
	ESSENTIAL MACHINING	68
	EXPERIMENTAL MACHINE CO.	70
EN	ELASTIC STOP NUT & ESNA	64, 68, 125
Ep	EAGLE PITCHER INDUSTRIES	62
	EMPRE PRECISION MACHINING and MD3 INDUSTRIES LTD.	66, 130

MIL-HDBK-57G (IS)
INDEX B

SYMBOL	COMPANY NAME	PAGE
EPI	ESCO PRECISION, NC.	68
ERIE	EBC INDUSTRIES (ERIE)	63, 68
ERIE	ERIE BOLT CORP.	63, 68
ESC	ECENARRO S. COOP. LTDA	64
ESNA	ELASTIC STOP NUT & ESNA	64, 68, 125
ESTA	ESTA PRODUCTS COMPANY	68
ET	AV BANK MFG., NC.	24
ETC	AV BANK MFG., NC.	24
ETI	ENVISION TECH, NC.	67
EΣΠ	ESP MANUFACTURING CO., NC	68
EWB	SPS TECHNOLOGIES	183-184
EWN	SPS TECHNOLOGIES	183-184
 EXPANDO	PRECISE OF CALIFORNIA	158
F		
F593	ENGLE MANUFACTURING COMPANY, INC., THE	67
F	AVIATION MANUFACTURING GROUP LLC (SEE DBA FREEMAN CO., THE)	24, 78
	BLUE TEE CORP DBA GEFCO/STECO	32
	FAILING CO., GEORGE E	70
f  	FALL RIVER MANUFACTURING CO., NC.	71
F F	(FASSCO) FASTENER & STEEL SUPPLY CO., LTD.	71
F	FASTENRATH BEFESTIGUNGSTECHNIK GmbH	73
F	FASTI-WERK CARL AUG. FASTENRATH GMBH & CO KG	73
F	FASTRON COMPANY, THE	73
  F	FEDERAL SCREW WORKS	74
	FENBAR PRECISION MACHINISTS, INC.	74
	FERNDALE FASTENER	74, 168
F	FREEMAN CO.	24, 78
F	LISI AEROSPACE	120-121
F	M & M MANUFACTURING CORPORATION	123
F	VISSER ES & BOULONNERES DE FOURMES	204
F	FONTANA LUIGI S.p.A.	77
2F 3F 4F 5F		

SYMBOL	COMPANY NAME	PAGE
	THIANT (BOULONNERIE DE SA)	194
FAH	FRISBY AEROSPACE NC DE and TRIUMPH GROUP OPERATIONS NC THE	79, 197
	FRONTIER BOLT COMPANY OF TEXAS	79
FC F-C	FERRY CAP & SET SCREW CO., THE	75
	FUCHS SCHRAUBENWERK GmbH	79
FCI	FONTAL CONTROLS, NC.	77
FDC	FLUIDYNE CORPORATION	76
	FABER ENTERPRISES, NC.	70
	FABSCO CORP.	70
	FLORES ENTERPRISES	76
FEC	FEDERAL EQUIPMENT COMPANY	73
6 0 5 8 7		
 FF	FOREST FASTENERS	78
	FORMED FASTENER MANUFACTURING, NC.	78
F.K	VISSER ES & BOULONNERES DE FOURMES	204
FH	FOCUS HOPE	76
FH	FOCUS HOPE	77
	FLAIG & HOMMEL	75
	FENTON HEAD NG	74, 168
	FASTCO INDUSTRIES, NC.	71
	FIBAM COMPANHIA INDUSTRIAL	75
FIT	FASTENER INNOVATION TECHNOLOGY, INC.	72
	FLUIDONICS NC.	76
	FALCON MANUFACTURING CORP.	70

MIL-HDBK-57G (IS)
INDEX B

SYMBOL	COMPANY NAME	PAGE
	FOLSOM TOOL & MOLD CORP.	77
	FEDERAL MANUFACTURING CORP.	73
	TRIAD PRODUCTS CORP.	197
	COLTEC INDUSTRIES, INC. dba FAIRBANKS MORSE ENGINE	50
	FMW, INC.	76
FN	AV BANK MFG., NC.	24
FNF	SPS TECHNOLOGIES	183-184
	FASTENAL COMPANY	72
FONTANA	FONTANA LUIGI S.p.A.	77
	FASTENING PRODUCTS OF LANCASTER, INC.	73
	FPA MANUFACTURING	78
	FASTENING PRODUCTS CO., INC.	72
	FOREMOST PRECISION INSTRUMENT CORP.	78
fr	FALL RIVER MANUFACTURING CO., NC.	71
	FRANROE PRECISION MACHINE COMPANY	78
FRIEDBERG	AUGUST FRIEDBERG GmbH	23
	FRANROE PRECISION MACHINE COMPANY	78
	FABRICATION SPECIALTY INC.	70
FS	FERRIERE DI STABIO, S.A.	74
	FLAIG & HOMMEL	75
f t	CAMCAR DIVISION OF TEXTRON INC.	40-43
	FASTENER TECHNOLOGY CORP.	72
FTZ	FITZ MANUFACTURING INDUSTRIES	75
	FUCHS SCHRAUBENWERK GmbH	79
FUN	FASTENERS UNLIMITED NC.	72
FX	FLEXALLOY NC.	76
	G	
G	EVERLOCK FASTENING SYSTEMS	69-70
	GALAN PRECISION MACHINE CO.	80
	GALMAC MFG CO.	80
	GATEWAY SCREW AND RIVET, NC.	81

SYMBOL	COMPANY NAME	PAGE
 	GENERAL MACHINE PRODUCTS, NC	81
	GILL MACHINE & TOOL CO.	82
	GOSHO WORKS, LTD.	82
	GRACO INDUSTRIES, NC.	83
	GREER STOP NUT	69, 84
 	GUARDIAN RIVET & FASTENER	86
GAI	GATES ALBERT NC.	81
	GARDINER MFG. CO.	80
	G. B. MACHINE PRECISION, INC.	80
	STERLING MARKING PRODUCTS IC.	188
	GRAUCH ENTERPRISES	83
GEBI 	J. GEORG BIERBACH	102
GF	GRANDEUR FASTENERS, INC.	83
	GR PCO, DIVISION OF BLACK & DECKER	84
GFM	GREENFIELD MANUFACTURING CO., NC.	84
G _H	EMHART CORP.	65
GII	GERTLER INDUSTRIES, NC.	81
 GLC 1	GL CNC SERVICE INC.	82
GMF	GAITHER PATRICIA	80
	GMJ MACHINE COMPANY, INC.	82
GMT	GREATER MARYLAND TOOL & MFG., CORP.	83
 	GR PCO, DIVISION OF BLACK & DECKER	84
	GOSHO WORKS, LTD.	82
	GOSHO WORKS, LTD.	82
G-P	GROOV-PIN CORPORATION	85
GPM	GALAN PRECISION MACHINE CO.	80
G & R	G & R SCREW MACHINE PRODUCTS	79
GR	RABOURDN	164
 GRMN 6	GERMAN MACHINED PRODUCTS, NC.	81
GS	B & B SPECIALTIES INC. and GS AEROSPACE TECHNOLOGY, INC.	25, 85

MIL-HDBK-57G (IS)
INDEX B

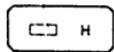
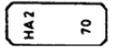
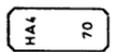
SYMBOL	COMPANY NAME	PAGE
G-S	G & S MACHINE NC.	80
GS	GENERAL SCREW & SPECIALTY CO., INC.	81
GSAT	GS AEROSPACE TECHNOLOGY, INC.	85
GSF	ARMSTRONG FASTENINGS LTD.	20
GSF	GSF FASTENING	85
GSI	GS AEROSPACE TECHNOLOGY, INC.	85
	SCHRAUBENFABRIK GUSTAV STERNBERG GmbH & CO. KG	175
GTT	GUNNISON-INTERNATIONAL INC.	86
H		
H	BEK LEVEL 1 FASTENERS and LEVEL 1 FASTENERS	29, 117
	FUCHS SCHRAUBENWERK GmbH	79
	HAMANAKA (THAILAND) CO., LTD.	87
H	HASKELL OF HUNTINGTON, INC	88
h	HAYDON BOLTS, INC.	89
	HEMCO TOOL NC.	90
HH	HEXAGON ENTERPRISES, INC.	90
	HILL FASTENER CORP.	91
H	HILTI, NC	92
H  	HI-SHEAR CORP. (LISI)	92, 121, 196
H	HOFFMANN, RICHARD GMBH CO. KG	93
H	HOLLYWOOD MANUFACTURING INC.	93
H	HUCK PRODUCTS	95
H	HUGGINS MFG.	96
H	HURON AUTOMATIC SCREW CO.	96
 H	MNP CORPORATION	137
 	FUCHS SCHRAUBENWERK GmbH	79
HA	HABINA ENGINEERING	87
	HARTFORD AIRCRAFT PRODUCTS, NC.	88
	HARRISON BOLT & NUT CO., THE	88
HB	HYDROBOLT LIMITED	96
HBN	MNP CORPORATION	137
HBW	HAWTHORNE BOLT WORKS	89
HC	H C MERCHANDISERS NC. and H C PACIFIC	86
HCP	H C MERCHANDISERS NC. and H C PACIFIC	86

SYMBOL	COMPANY NAME	PAGE
 HD	HUGO DURHOLT GMBH & CO. KG	96
HDI	HARWOOD DESIGN, NC.	88
HE HE	HORST ENGINEERING & MANUFACTURING CO.	94
HEM	HORST ENGINEERING & MANUFACTURING CO.	94
	HILL FASTENER CORP.	91
HF	HYDROFITTING MFG. CORP.	96
HG A	HG AEROSPACE ENGINEERING LTD	90
 HHW	HO HONG WORKS CO., LTD	93
	HI INDUSTRIAL TECHNOLOGIES	90
HIC	HALLS MS INDUSTRIAL COMPONENTS, INC.	87
	HILL AEROSPACE & DEFENSE LLC.	91
HILTI	HILTI, NC	92
HI PSI	SPS TECHNOLOGIES	183-184
HI TI	SPS TECHNOLOGIES	183-184
	HO-HO-KUS, INC.	93
HK HK H-K	HOLO-KROME CO.	94
HL	HLC INDUSTRIES INC.	92
HM	H. MULLINS, LTD.	86
	HOWIE MANUFACTURING CO., NC.	95
	HEIM'S MACHINE & TOOL, INC.	89
HMTC	HOWE MACHINE AND TOOL CORP.	95
	CAMCAR DIVISION OF TEXTRON INC.	40-43
	CAMCAR SCREW AND MFG CO	43
 	H. PRINZ GmbH	86
IP 	HENWAY, INC.	90
	HIGHLAND PRODUCTS CORPORATION	91
HP	HOWELL PRECISION, NC.	95
HP	MICRO SCREW MACHINE PRODUCTS, NC.	133
HPF	HOUSTON PRECISION FASTENERS	94
HPS	HILTI, NC	92
HQ	HIGH QUALITY MACHINE SHOP	91
HR HR	HORSPOOL & ROMINE MANUFACTURING CO., NC.	94

MIL-HDBK-57G (IS)
INDEX B

SYMBOL	COMPANY NAME	PAGE
	HARDWARE SPECIALTY CO, INC	88
HS	HILL STAMP NG & MFG., NC.	91
hs HS hs	HI-SHEAR CORP.	92, 121, 196
hs	LISI AEROSPACE	120-121
HSC	HUNTER STEVENS COMPANY	96
HSLG-R	HILTI, NC	92
	HAMANAKA (THAILAND) CO., LTD.	87
H	HIGHLAND THREADS, NC.	91
H _T	HOWARD TOOL CO., NC.	95
HTC	HEITCO MANUFACTUR NG, NC.	90
HTE.	HIGH TECH ENTERPRISES	91
	HATCH INDUSTRIES	89
	HUNT VALVE COMPANY, NC.	96
HVI	HUNTINGTON VALLEY INDUSTRIES, INC. DBA HVI	96
I	EVERLOCK FASTEN NG SYSTEMS	69-70
 Upper case  Lower case less	ALPHA BOLT CO.	15
	IMPERIAL SUPPLIERS, NC.	97
I	INDUSTRIAL & AUTOMOTIVE FASTENERS	98
	INTERSTATE FITTINGS NC.	100
	PIONEER SCREW & NUT CO.	156
IA	INDIANA AIRCRAFT HARDWARE	97
IAH	INDIANA AIRCRAFT HARDWARE	97
IF	IDEAL FASTENERS INC.	97
IF	INDUSTRIAL FORGE, NC.	98
	I.G.D. MACHINE & TOOL LTD.	97
	STERLING MARK NG PRODUCTS INC.	188
II	MACLEAN-FOGG CO.	125
	JUNIPER ELBOW CO.	105
III	COLOC MANUFACTUR NG	50
	CAMCAR DIVISION OF TETRON INC.	40-43
IM	INDIANLAND MACHINE CO.	99
IM	INDIANLAND MACHINE SERVICE, INC.	100

SYMBOL	COMPANY NAME	PAGE
	NTERFLEX MFG. CORP.	100
IMC	RON BOUND MANAGEMENT GROUP	100
IMG	INSTRUMENT MACHINING SERVICE LTD.	100
 	I.M.S.2	98
 or INC	INDUSTRIAL NUT CORP.	98
ICHO	A HARA SE BYO CO LTD	10
	ISLAND ENGINEERING BDA J. SMITH MACHINE SHOP INC.	100
IN	FASTENER BROKERAGE NC.	72
IN	NOFAST MANUFACTUR NG INC.	72, 99
INBUS	BAUER & SCHAURTE KARCHER GMBH	27
	N-SPECK CORP.	99
IT	AV BANK MFG., NC.	24
ITC	AV BANK MFG., NC.	24
IRW	RWIN AUTOMATION, NC.	100
J	AF FASTENERS LIMITED	10
 or 	B & G MANUFACTURING CO., NC.	26
J	HEWLETT, EDMOND, C. JR DBA JET MACHINE WORKS COMPANY	90
J	JACOBSON MFG., LLC.	102
J 	JANUS FASTEN NG SYSTEMS, NC.	103
J	JJ SCREW PRODUCTS, NC.	104
J	JOSLYN CORP.	105
	JUPITER WASHERS, NC.	105
J2H	B & G MANUFACTURING CO., NC.	26
J4	B & G MANUFACTURING CO., NC.	26
	JACO ENGINEERING, NC.	102
JB	BUTLER, NC.	38
B	JAY BEE MACHINE WORKS, NC.	103
JB7	B & G MANUFACTURING CO., NC.	26
JB16	B & G MANUFACTURING CO., NC.	26
	DEERE & CO.	56
JDF	NINGBO JINDING FASTENING PECE CO, LTD	143
	JAYCO ENGINEERING, NC.	103

MIL-HDBK-57G (IS)
INDEX B

SYMBOL	COMPANY NAME	PAGE
JEA	JEA ENTERPRISES, INC.	104
	JERGENS NC.	104
JF	ELECTRO-FREETO MANUFACTUR NG COMPANY	64
JG	J. G. FASTENERS	102
JH	J NN HER ENTERPRISE CO., LTD.	104
JH	HASSALL, JOHN, NC.	88
JL	JAMISON INDUSTR ES NC.	103
JIT	JUST IN T ME, NC.	105
	JAMES JACKSON DBA J J ENGINEERING	103, 104
	B & G MANUFACTURING CO., NC.	26
JP	J M. PRECISION, INC.	102
JNC	B & G MANUFACTURING CO., NC.	26
JOLICO	JOLICO/J-B TOOL NC	105
	JAY O MACHINE CO., NC.	103
JRB	JOHN R. BROMILEY COMPANY NC.	104
JS	B. V. FABRIEK VAN KLINKNAGELS EN SCHROEFBOUTEN V/H SMIT	27
J-S	J & S PRECISION PRODUCTS	101
JT	JAM TECH CORP.	103
	KARMA NC dba JEWELL TOOL TECH	106, 104
K		
K	ADI MANUFACTURING, NC	6
	KAYNAR PRODUCTS (ALCOA FASTENING SYSTEMS)	107 13
	(Previously KAYNAR TECHNOLOG ES, NC. DIV. OF MICRODOT	107, 133
K	KATSURAGAWA MACHINE SCREW CO., LTD.	107
K	KAYGOR, NC.	107
K	KEN FORGING, INC.	108
K	K LBOURN ENG NEERING CO.	108
	KEYSTONE BOLT & NUT COMPANY	108
	KEYSTONE TOOL & MACHINE CO.	108
	KNOCH MANUFACTUR NG CO. LTD.	109

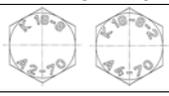
SYMBOL	COMPANY NAME	PAGE
	KOLB GMBH & CO.	109
K	KORODY COLYER CORP.	110
	KNOCH MANUFACTUR NG CO. LTD.	109
K	SPS TECHNOLOGIES	183-184
K-5673	SPS TECHNOLOGIES	183-184
KA	K A.A. COMPANY	106
KAMAX	KAMAX-WERKE RUDOLF KELLERMANN GmbH & CO. KG	106
KARRO®	BAUER & SCHAURTE KARCHER GMBH	27
KDK	K D K. UPSET FORG NG CO.	106
KE	KELLER ENGINEER NG	107
k+k	K & K PRECISION ENTERPRISES	105
	KYOKUTO MFG CO LTD.	111
KL	KLINCHER LOCKNUT CORP.	109
KLM	K L M. MACHINE INC.	109
	KERR LAKESIDE INC.	108
KO	KO AMS MACHINE PRODUCTS	109
KP	KAPCO INDUSTRIES, NC.	106
	K RSTEN PIPE CO. INC.	109
KPP	KOZAK, E. PERCISION PRODUCTS CO.	110
	KROBACH MANUFACTUR NG CORP.	111
	KONGO BYORA CO., LTD.	110
KNIPPING	ARNOLD KN PPING GmbH	21
KPP	E. KOZAK PRECISION PRODUCTS CO.	62
KS	SPS TECHNOLOGIES	183-184
	KSS SOCKET SCREW, NC	111
	K-TECH MFG., INC.	111
	TURNAMICS, NC.	198
KT	TURNAMICS, NC.	198
	TURNAMICS, NC.	198
KTI	KONDOR TECHNOLOG ES, NC.	110
KTM	KREIS TOOL & MFG., CO., NC.	110

MIL-HDBK-57G (IS)
INDEX B

SYMBOL	COMPANY NAME	PAGE
KX	KAMAX-WERKE RUDOLF KELLERMANN GmbH & CO. KG	106
	KYOEI SEISAKUSHO CO., LTD.	111
L	L	
L	CHUN YU WORKS & CO., LTD.	49
L	L & H THREADED RODS CORP.	112
 L	LAMSON AND SESSIONS OF CANADA LTD.	113
	LANIS MACHINE & MFG., CO.	114
	LAWSON PRECISION MACHINING, INC.	114
	LINREAD NORTHBRIDGE AIRCRAFT PRODUCT DIVISION	118
	LINREAD PUBLIC LIMITED CO.	119
L	LONE STAR FASTENERS, LP	122
L L1	LORD CORPORATION	123
	R B & W CORPORATION	163
	LEE AEROSPACE PRODUCTS, NC.	115
LL	LINREAD PUBLIC LIMITED CO.	119
LL or 	LONG-LOK FASTENERS CORP.	122
LAH LAH	LENTERN (AIRCRAFT) LTD.	115
LAM	L. A. MARTIN CO.	112
L B  <i>Raised letters</i>	LANARKSHIRE BOLT LTD.	114
	L & C MANUFACTURING CO., NC.	111
	LISI AEROSPACE	120-121
LE	LAKE ERIE SDREW CORP.	113
	LaMOTT ENTERPRISES, NC.	113
LE	LEP SPECIAL FASTENERS INC.	117
LE	LIPPISCHE EISEN INDUSTRIE GmbH	120
LE	WOLTERS GMBH	213
LG	L G MACHINE & MFG NC.	112
LFC	LFC INDUSTRIES NC.	118
	L H INDUSTRIES, INC.	112
LI	LANA INDUSTRIES	114
	TRW	198

SYMBOL	COMPANY NAME	PAGE
	L & J FASTENERS, INC.	112
L & M	L & M ENTERPRISES, NC.	112
	LEVINGSTON MACHINE COMPANY	117
LMC	LOUGHLIN MANUFACTURING CORP.	123
	LANUM METAL PRODUCTS, NC.	114
L.M.T.	LANUM METAL PRODUCTS, NC.	114
	LLOYD MACHINE & TOOL CO., NC.	122
LNA	L N AEROSPACE, INC.	122
LOBO	LOBO OFFICINE MECCANICHE SPA	122
	LOBO SYSTEMS LTD	122
LONG LOK	LONG-LOK FASTENERS CORP.	122
L. P. R.	L P R PRECISION PARTS AND TOOL COMPANY, NC.	112
LRA	AV BANK MFG., NC.	24
LRG	L R G CORPORATION	112
L.P.R.	PRECISION PARTS & TOOL CO., NC.	158
	R B & W CORPORATION	163
L-S-A	CEI INC.	45
L-S-A	LAND-SEA-AIR MACHINED PRODUCTS, NC.	114
	LEHNER SCREW MACHINE CO	115
		
L<W>M	LITTLE WORLD MANUFACTURING, NC.	122
M		
M	COOPER POWER SYSTEMS INC	52
M	DEMAT	57
	GFD LETAGE	82
M	HMS SERVICES LLC	93
	KELOX/MICRODOT PRODUCTS	107
	LISI AEROSPACE	120-121
M	MACKO INDUSTRIES	124
	MAGNUS TOOL & DIE CO., NC.	126
	MEACO PRODUCTS CORP.	130
M	MECAERO PRODUCTS	131
	MERCURY AEROSPACE NC.	132
		

MIL-HDBK-57G (IS)
INDEX B

SYMBOL	COMPANY NAME	PAGE
M	METALCRAFTERS	132
	METRIX MFG. CO.	133
	MI. ME. AF. S.r.1	133
	MICRODOT INC	133
	M DWEST ACORN NUT CO.	134
	M LITARY PRODUCTS GROUP, INC.	134
	M LLIPART, INC.	134
M	M NEBEA CO. LTD	135
M	M-MANUFACTURING	136
M 	MNP CORPORATION	137
 	MORTON MANUFACTURING	139
M	MRL MANUFACTURING CORP.	139
M	TWIST TITE MFG. INC.	199
 (M 1)	MACOR, INC.	126
	MIX TOOL CO.	136
	MODERN METRIC MACHINE COMPANY NC.	138
	NFASCO, NFASCO NUT and INGERSOLL FASTENERS	99
MA	M A.A. CORP.	123
	MAC FASTENERS, INC.	124
	MCCULLOUGH AERO CO.	130
 	ADAMS, EARL M. CO.	6
	MALLY MFG CO., NC.	126
MAX	M D-STATES SCREW CORP.	134
MC	ADI MANUFACTURING, NC	6
Mc	MCADAMS MACHINE AND TOOL CO.	129
MC	MECAERO CANADA INC.	131
MC	MECAIR AEROSPACE INDUSTRIES	131
MC	METALCRAFTERS	132
 	M D CONTINENT SCREW PRODUCTS CO.	134
MC	WROUGHT WASHER MANUFACTURING INC.	214

SYMBOL	COMPANY NAME	PAGE
	MART N-CHANDLER, NC.	127
MCO	MEACO PRODUCTS CORP.	130
 	McMELLON BROS NC.	130
MD	LEONARD JED CO MARYLAND BOLT AND NUT CO DIV	116-117 128
MD	MARYLAND BOLT & NUT CO., NC.	116-117 128
	MARVIN ENGINEERING, CO., INC.	127
..MEL-BA..	MEL-BA MANUFACTURING INC.	131
METRI	METRIX MFG. CO.	133
METRIX	METRIX MFG. CO.	133
MF	MACLEAN-FOGG CO.	125
MF	MP RE FASTENERS	139
MFI	MORTON FASTENERS NC.	139
MFR06320	PYE & HOGAN MACHINE CO.	160
MFR 1L071	M ROFINE COMPANY	135
MFR 27624	PB FASTENERS	153
MFR 29839	ADVANCE PATTERN CORP	6
MFR 3L665	C. E. MACHINE CO., INC.	39
MFR - 72905	ARJAY PRECISION, INC.	20
MFR 8F781	STEVENS MFG. CO., NC.	188
	MANUFACTURING ENGINEERING TECH.	126
	MOSTAR GEAR & MACHINE MFG., CO.	139
MI	MECHANICAL & INDUSTRIAL FASTENERS	131
M I	MECHANICAL INDUSTRIES LLC	131
	KELOX/MICRODOT PRODUCTS	107
	MICRODOT INC.	133
MIF MIF	MECHANICAL & INDUSTRIAL FASTENERS	131
	MODFORM-ILL NOIS, NC.	138
MI	MONOGRAM AEROSPACE FASTENERS	138
MI-TECH, INC.	MI-TECH, INC.	135
	MIX TOOL CO.	136
MK	LISI AEROSPACE	120-121
	MKM MACHINE TOOL COMPANY NC.	136
ML	LINREAD PUBLIC LIMITED CO.	119
ML	MCLANE MFG INC.	130

MIL-HDBK-57G (IS)
INDEX B

SYMBOL	COMPANY NAME	PAGE
MLI	MACHINING LOGISTICS, NC.	124
	M L.W. MANUFACTURING CO.	123
	MAR-BRO MFG., INC.	127
	M LE-HI MACHINE, INC.	134
	MACKSON MFG CORP.	124
MMG	MMG ENGINEERED COMPONENTS INC	137
M M M	HMS SERVICES LLC	93
	MODERN METRIC MACHINE COMPANY INC	138
	KERR, CHARLES W. and MAUI MEGA	108, 129
	MONROE MACHINED PRODUCTS, NC.	138
MMS	METHODS AND MACHINING SERVICES CO.	132
MMT	MA N MACHINE CO INC.	126
MNP	MNP CORPORATION	137
	LISI AEROSPACE	120-121
MONOGRAM	MONOGRAM AEROSPACE FASTENERS	138
	MAPECO PRODUCTS, NC.	127
MP	MERCER PRODUCTS & MFG. CO., INC.	132
MP	MONTEREY MACHINE PRODUCTS	139
	UMPCO CORP.	200
MR	MACHINERITE CORP.	124
	MASTER RESEARCH & MFG., INC.	129
MSA	M.S. AEROSPACE	123
MSF	M L-SPEC FASTENERS CORP.	135
	MANUFACTURING SALES AND SERVICE	126
MT	ALEXANDER MANUFACTURING COMPANY NC	13
MT	AV BANK MFG., NC.	24
MT	METAL-TECH MFG. INC.	132
MT	METRO TOOL & MANUFACTURING CO.	13, 133
	MASTERCRAFT TOOL COMPANY	129
	MERCURY TOOL & MACHINE, NC.	132

SYMBOL	COMPANY NAME	PAGE
	MANUFACTURING TECHNOLOGY SERVICES	127
MULTI-C	CARDINAL INDUSTRIAL PRODUCTS	45
	MOTOR WHEEL CORP.	139
MWORD		
N		
N	HANSAN SCREW CO., LTD.	87
	METALCRAFTERS	132
N	MITSUBOSHI INDUSTRIES, LTD.	136
N	MONOGRAM AEROSPACE FASTENERS	138
	N.S.S. INDUSTRIES	140
	NAFCO INDUSTRIES, NC.	140
	NAPIER'S AUTO BODY	140
	NELSON STUD WELDING DIVISION	142
	NEUMAYER, ERICH GMBH	142
	NISSAN SCREW CO. LTD.	144
	NOCHIA STEELWORKS	144
	NOVA MACHINE PRODUCTS CORPORATION	146
	NSK INDUSTRIES, INC.	146
	NUCOR CORP.	146
	NUTS INCORPORATED	146
	NUTS, INC.	146
	ONO MANUFACTURER, NC.	149
NA	NELSON AEROSPACE NC.	142
	NC AUTOMATED INDUSTRIES NC.	141
	LINREAD NORTHBRIDGE	118
	NATIONAL BOLTS & RIVETS LTD.	141
	NORTHBRIDGE FASTENERS	145
	ND INDUSTRIES	142
	NEVILLE MACHINE SHOP	143
NE	NEKG HOLDINGS	142
NEDIN	NEDSCHROEF	142
NEDLOY	NEDSCHROEF	142

MIL-HDBK-57G (IS)
INDEX B

SYMBOL	COMPANY NAME	PAGE
NEDUR	NEDSCHROEF	142
	NORTHEAST METAL CO., NC.	145
	NORTH EAST FASTENERS	145
NF	NEVADA BOLT AND MFG CO INC.	143
NF	NON-FERROUS BOLT & MANUFACTURING CO.	144
NFB	GREER STOP NUT	69, 84
NH	NEDSCHROEF	142
	NEW HORIZON MACHINE CO., INC.	143
	NAVPAR, NC.	141
NK	MITSUBOSHI INDUSTRIES LTD.	136
	NYLOK CORP.	147
NKYM	MITSUBOSHI INDUSTRIES, LTD.	136
	METALCRAFTERS	132
NMB	M NEBEA CO. LTD	135
	NIPPON MACHINE ENG NEERING, INC.	143
NMP	NUMERIC MACHINE PRODUCTS	146
NRS	NAGOYA SCREW MANUFACTURING CO, LTD.	140
	NARRAGANSETT SCREW MFG., CO.	140
	NISCO, INC.	144
NS	NORTHERN SCREW CO. , INC.	145
	NASU DENKI-TEKKO CO., LTD.	141
	NATIONAL THREADED FASTENERS CORP.	141
NT	NT ENGINEERING, NC.	146
NTF99	NORTHBRIDGE FASTENERS	145
NTW	NASSAN TOOL WORKS, NC.	140
	NUCOR CORP.	146
NYLOK	NYLOK CORP.	147
	O	
	KERR, CHARLES W. and MAUI MEGA	108, 129
	MARUYKO NUT CO., LTD.	127
	NATIONAL FASTENER CO., LTD.	141
	OBARS MACHINE & TOOL CO.	147
	OCM MACHINE COMPANY, INC.	147
	OHIO NUT & BOLT CO., THE	147
	ORANGE PRECISION PARTS	149

SYMBOL	COMPANY NAME	PAGE
	SCREWCORP.	176
	VOI-SHAN PRODUCTS	207
	PAOLO ASTORI SPA	152
OAV	A. AGRATI S.P.A.	2
OB	OTT BROTHERS MACHINE CO., INC.	150
OBMC	OTT BROTHERS MACHINE CO., INC.	150
OK	OKAI RON WORKS, INC	148
	OSTEEN MACH NE SHOP	150
	LOOS & CO., NC.	123
OP	ORANGE PRECISION PARTS	149
OPC	OTTAWA PRODUCTS CO., NC.	150
	ORDNANCE PARTS & ENG NEERING CO.	149
ORC-O	ORC-O TOOL & MACHINE, NC.	149
	OHKAWA SCREW MFG. CO., LTD. and OKAWA SCREW MANUFACTURING CO., LTD	148
(OTC)	ORLOTRONICS CORP	149
OTF	OAKTREE FASTENERS CO.	147
	P	
P	BELL FASTENERS	29
	BLANC AERO INDUSTRIES and LISI	32 120
P	H. PAULIN & CO. LTD.	86
	H. PR NZ GmbH	86
	LELAND-POWELL FASTENERS, INC.	115
P	LISI AEROSPACE	120-121
	LISI AEROSPACE	120-121
	LISI AEROSPACE FTB FASTENER TECHNOLOGY BESTAS	120-121
	OMEGA THREAD ROLLING AND GR NDING INC.	148
	PLAINVILLE MANUFACTURING CO., NC.	156
P	ORANGE PRECISION PARTS	149
	P.C M., INC.	151
P	PATEREX, LTD.	152
P	PAULIN, H. & CO., LTD.	152

MIL-HDBK-57G (IS)
INDEX B

SYMBOL	COMPANY NAME	PAGE
	PE NER UMFORMTECHNIK GmbH	153
	PENN CIGAR MACHINES NC (P.C.M INC)	154
	PERIGEE MANUFACTUR NG COMPANY, INC.	155
	PERKINS MACHINE CO.	155
	PIONEER SCREW & NUT CO.	156
	POLYTECHNIC INDUSTRIES	157
	PRECISION PIECE PARTS, INC.	158
	PRESTIGE STAMPING, NC.	159
	PROTO MACHINE CO., NC.	160
	PTM INTERNATIONAL NC	160
	PURITAS METAL PRODUCTS	160
	PABCOR, INC.	151
	PALNUT CO., THE	152
	TRW	198
	ABBOTT, PETER	3
	PRECISION AIRCRAFT MACHINING CO., NC. DBA PAMCO	158
	PRECISION AIRCRAFT MACHINING CO., NC. DBA PAMCO	158
	PRECISE AERO PRODUCTS	157
	PB FASTENERS	153
	PORTLAND BOLT & MFG., CO.	157
	UPB ENG NEERING	201
	LISI AEROSPACE	120-121
	PB FASTENERS	153
	APHEONIX CORPORATION	19
	PRODUCT DEVELOPMENT GROUP, NC.	159
	PENNENGINEER NG AUTOMOTIVE FASTENERS	154
	PENN ENGINEERING & MANUFACTUR NG	154
	PROMPTUS ELECTRONIC HARDWARE	160
	PE NER UMFORMTECHNIK	153

SYMBOL	COMPANY NAME	PAGE
	GmbH PENN ENGINEERING & MANUFACTUR NG CO.	154
	PRECISION FITTINGS, NC.	158
	PNEU-HYDRO PRODUCTS, NC.	156
	P & I ASSOCIATES, INC.	150
	POSIMECH, INC.	157
	AV BANK MFG., NC.	24
	KAPCO INDUSTRIES, NC.	106
	P & L ENTERPRISES	150
	H. PAULIN & CO. LTD.	86
	PAULIN, H. & CO., LTD.	152
	PRICE MANUFACTUR NG CO.	159
	BELL FASTENERS	29
	POINT MACHINE COMPANY	156
	PRECISIONMATICS CO., NC.	159
	PRIETO MACHINE COMPANY, INC.	159
	VERTEX DISTRIBUTION	204
	PADGETT MACHINE INC.	151
	PEREZ MACHINE, INC.	155
	PROFORMANCE MANUFACTUR NG, NC.	160
	PIONEER MACHINE PRODUCTS, NC.	156
	PURITAS METAL PRODUCTS	160
	PRO-MACHINE & TOOL COMPANY	160
	PATTERSON LAKE PRODUCTS	152
	PARK PRECISION CORPORATION	152
	POWERPARTS, NC.	157
	P NEY R DGE CO.	156
	PRD FASTENERS LTD.	157
	PRECI- MANUFACTUR NG, NC.	157
	H. PR NZ GmbH	86
	P.S. MACHINE CO., INC.	151
	PACIFIC SCIENTIFIC	151
	PEERLESS SCREW PRODUCTS	153

MIL-HDBK-57G (IS)
INDEX B

SYMBOL	COMPANY NAME	PAGE
	PHOENIX SPECIALTY MANUFACTURING CO., NC.	155
PSB	PRECISION SCREW & BOLT, NC.	158
PSM PSM	PENN SCREW & MACHINE WORKS, INC.	154
	PRODUCTION & TOOL COMPANY	160
	PACIFIC TOOL, NC.	151
PTI	PANTER TOOL, INC.	152
	PRECISION TECHNOLOGES, NC.	159
PTM	PNE TAVERN MACHINE NC.	156
PTX	PATEREX, LTD.	152
	TRW	198
Q		
	QSN MANUFACTURING, NC.	161
Q	QUALITY SCREW PRODUCTS, NC.	161
	ALL QUALITY SPARES, -NC.	14
QAS	QUALITY AIRCRAFT SCREWS, INC.	161
QB	QUALITY BOLT & SCREW CO.	161
	CELTECH ENTERPRISE	46
	QUALITY FABRICATIONS, INC.	161
	QUALITY MACHINE & MFG. NC.	161
	QUALITY SOCKET SCREW MANUFACTURING CORP.	161
QT	QUALITY THREADED PRODUCTS COMPANY	162
R		
R	R.E.C. CORP.	164
	RAHMEDE SCHRAUBENFABRIK	164
R	RAM THREADING, INC.	165
R	RAMAR NUTS, NC.	165

SYMBOL	COMPANY NAME	PAGE
r	RELLI TECHNOLOGY, NC.	167
R	REPUBLIC FASTENER MANUFACTURING CORP.	167
	RINCO TECHNOLOGES, NC.	168
	ROBBNS MANUFACTURING	169
	ROCKFORD BOLT & STEEL CO.	170
R	ROCKFORD FASTENERS INC.	170
	ROCKFORD PRODUCTS CORP.	170
	ROGG MANUFACTURING COMPANY	171
R	RONSON MANUFACTURING, NC.	171
	RUMCO, NC.	172
•R	UNIFLOW CORP.	200
R9	REID PRODUCT INC.	166
RAE	RAE MANUFACTURING CO.	164
RAM	RAM PRODUCTS	165
	R. BILD COMPANY, INC	163
	ROCKFORD BOLT & STEEL CO.	170
R B W	R B & W CORPORATION	163, 166
	R & D FASTENERS	60, 162
	R & D WELDING & MACHINE INC.	162
	RAMM DEFENSE PRODUCTS	165
RE	RAM ENTERPRISES	164
	REED INSTRUMENT CO.	166
REP	RIVNUT ENGINEERED PRODUCTS, NC.	169
	REXNORD	167
	ROBERT HENRY CO., NC.	170
RI	REXNORD	167
RI	ROSAN PRODUCTS	171

MIL-HDBK-57G (IS)
INDEX B

SYMBOL	COMPANY NAME	PAGE	SYMBOL	COMPANY NAME	PAGE
RI	RUDOLPH INSTRUMENTS, INC.	172		SEMCO FASTENER	168, 176
RIBE	BERGNER, RICHARD GMBH & CO.	30		SENG HENG ENGINEERING PTE LTD.	176
R.I.E.	R & I ENTERPRISES DBA COMPULOGIC DESIGN CO.	162		SONIC INDUSTRIES, NC.	180
RIPA	RIPA ENGINEERING CORP	169		SESCO INDUSTRIES, NC.	177
	R B & W CORPORATION	163, 166		SHACKELFORD MACHING, INC.	177
R/M	RICHARD MANNO & CO., NC.	168		SHEFFIELD, INC.	178
	RICHARD MFG. CO., INC.	168		SHIGA BOLT CO., LTD.	178
	RAINBOW MACHINE PRODUCTS, NC.	164		SERRACIN/HARRISON	179
RMS	RMS	169		SKYLINE INDUSTRIES	179
ROL	ROLAND AEROSPACE	171		SPECIALS, INC.	182
Rp	REID PRODUCT INC.	166		SPECIALTY SCREW CORP.	183
	R & R PRECISION	162		SPS TECHNOLOGIES	183-184
RR	GRUPO RASS NI S.A. de C.V.	85		SRI SAI INDUSTRIES CORPORATION	174, 185
RS 	RS MANUFACTURING, NC.	171		STANDARD NUT & BOLT, NC.	185
RT	AV BANK MFG., NC.	24		STELFAST FASTENERS, NC.	187
	RUSCOMB TOOL & MACHINE CO., INC.	172		STERLING MFG. & SUPPLY, INC.	188
RVT	RIVER VALLEY TOOL & MANUFACTURING	169		SULLIVAN BOLT CO., NC.	189
	RA-WHITE, NC.	165		U.S. BOLT MANUFACTURING, NC.	199
	RADAX INDUSTRIES, NC.	164		WILHELM SCHUMACHER SCHRAUBEN-FABRIK GmbH	211
S				BULTEN TRADING AB	37
S	BELL FASTENERS	29		SPACE AGE ENGINEERING, INC.	182
	STELFAST, INC. (ALSO SEE CHIANG SHIN FASTENERS INDUSTRIES, LTD)	187, 48		SAFETY SOCKET LLC.0	173
	CHIANG SHIN FASTENERS INDUSTRIES, LTD	48, 187		SANTA ANA GEAR & MACHINE	174
	J.P. PRODUCTS, NC.	102		D'SAMIC	60
	MNP CORPORATION	137		SOUTHWEST ALLIED PRODUCTS CO., INC.	181
	NIPPON STEEL BOLTEN CO., LTD.	144		SOUTH BAY BOLT MANUFACTURING CO.	181
	S.I. STUD, INC.	173		S. B. E. (ITALY CORPORATION)	172
S	SABRE MANUFACTURING, NC.	173			
	SAI INDUSTRIES CORP. EFT 2	174, 185			
S	SCHUHL & CO. GMBH	175			
•S•	SALES SYSTEM, LIMITED	174			

MIL-HDBK-57G (IS)
INDEX B

SYMBOL	COMPANY NAME	PAGE
S-C	SPS TECHNOLOGIES	183-184
SC	SHOPCO MANUFACTURING, NC.	178
	STERLING MACHINE COMPANY	187
SC	VOI-SHAN PRODUCTS	207
SCA	SCANDIA MFG. CO., NC.	175
SCB	STEEL CITY BOLT & SCREW, INC.	186
	SCOTT CRAFT CO.	176
	SPURWAY COOKE INDUSTRIES PTE LTD.	184
 SD	CAMCAR DIVISION OF TEXTRON INC.	40-43
SD	SEMMONDS PRODUCTS	179
SD	STALKER & DYSTHE, NC.	185
 SDC	TANAKA LTD.	191
SEMS	CAMCAR DIVISION OF TEXTRON INC.	40-43
SF	SOUTHERN FASTENER CORPORATION	181
	SONFARREL, NC.	180
	SHAMROCK FASTENER TECHNOLOGIES, LLC	177
	SAGA TEKKOSHO CO., LTD.	174
	SHUR-LOK CORP.	178
	SERRA PACIFIC SUPPLY CO., INC.	179
SI	SOUTHWEST INDUSTRIAL SERVICES	181
SII	SUBURBAN INDUSTRIES, INC.	189
	SHUR-KUT SUPPLY CORPORATION	178
S&L	S & L METAL PRODUCTS CORP.	172
SL	S & L TOOL	172
	SHUR-LOK COMPANY.	178
SL	ST. LOUIS SCREW & BOLT CO.	185
SG L	GREER STOP NUT	69, 84
SLI	SPACE-LOK, INC.	182
	STANDARD LOCKNUT, NC.	185
	SAMUEL MARSDEN & SON	174
SM	SKY MANUFACTURING	179

SYMBOL	COMPANY NAME	PAGE
	STURM MACHINE CO., NC.	189
SMF	SATAIR MANUFACTURING FACILITY	175
	SANDIK MANUFACTURING, NC.	174
SMP	SHORELINE MACHINE PRODUCTS, NC.	178
SM&M	SMITH MACHINE & MANUFACTURING	180
	SLABE MACHINE PRODUCTS	180
SMS	SALEM MANUFACTURING AND SALES, INC.	174
	STACY MACHINE & TOOLING, INC.	185
southco	SOUTHCO, INC.	181
	FILETAGE INTERNATIONAL	75
	SKYSPARES PARTS, NC.	179
SPG	SHAW PRECISION GRINDING ACE GRINDING & MFG. CO. OF TEXAS	177 4
SPM INC	SMALL PARTS MANUFACTURING CO., NC.	180
	SPARTAN PRECISION MACHINE	182
	STEEL PRODUCTS OF MASSILLION	186
SPS SPS	SPS TECHNOLOGIES	183-184
SpSC	SPACE SCREW, INC.	182
	MNP CORPORATION	137
	SOUTHERN FASTENING SYSTEMS	181
ST	AV BANK MFG., NC.	24
	SWISS TECHNOLOGY, NC.	190
	SPRAL TOOL CORP.	183
	STEADFAST CORPORATION	186
	SINN-TECH, NC.	179
	HALL INDUSTRIES INC. and STANDARD TOOL & MACHINE CO.	87, 185
STM	SPECIAL-T-METALS	182
STRUX (radial)	CAMCAR DIVISION OF TEXTRON INC.	40-43
SV	S V INDUSTRIES	190
SW	BELL FASTENERS	29

MIL-HDBK-57G (IS)
INDEX B

SYMBOL	COMPANY NAME	PAGE
	SMITH WELDING, INC.	180
SW	STILLWATER FASTENERS, INC.	188
	SOUTHWIND INDUSTRIES, INC.	182
T		
	ARCHER SCREW PRODUCTS	19
T	BLANC AERO INDUSTRIES	32
T	ENGLE MANUFACTURING COMPANY, INC., THE	67
	LISI AEROSPACE	120-121
T	M NEBEA CO. LTD	135
	OSAKA SEIKI CO., LTD.	149
	RING SCREW WORKS	168
T	SPS TECHNOLOGIES	183-184
	T & E MACHINE CORP.	190
	TORCO, NC.	196
	TAKENAKA SEISAKUSHO CO., LTD.	191
T	TECHNICAL FASTENERS, INC.	191
T	TELEFAST INDUSTRIES, NC.	192
T	TERRY MACHINE CO.	192
	TEXAS BOLT CO.	192
	TEXTRON FASTENING SYSTEMS	193
	TITAN FASTENER	168, 195
	TOPURA CO., LTD.	195
	TOWNSEND CO.	196
	TOYO STEEL WORKS CO., LTD.	196
	TRY - AZTEC COMPANY	198
TANSEY	ARVAN, NC.	21
	TEBCO THREADED FASTENERS	191
	TEXAS BOLT CO.	192
	T-B & S MFG.	191

SYMBOL	COMPANY NAME	PAGE
	SPS TECHNOLOGIES	183-184
TC	TERRYCABLE, INC.	192
TCQ	T C QUALITY MACHINING NC.	190
	T & E MACHINE CORP.	190
	TEK PRECISION CO., LTD.	191
TELLEP	SPS TECHNOLOGIES-METALAC SPS INDUSTRIA	183-184
TENS	TENS MACHINE CO., NC.	192
	TEXAS BOLT CO.	192
TEXAS BOLT		
T	HI-SHEAR CORP. and TORONTO FASTENERS INDUSTRIES INC.	92, 121, 196
TF	TELEFAST INDUSTRIES, NC.	192
	TFI AEROSPACE CORPORATION	193
	TFP CORP.	193
T	TUFF FASTENERS CO.	198
	TFI AEROSPACE CORPORATION	193
	TFP CORP.	193
TF USA	TELEFAST INDUSTRIES, NC.	192
THE	TONG HWEI ENTERPRISE CO., LTD.	195
	THIANT (BOULONNERIE DE SA)	194
THOMAS	THOMAS MFG, NC.	195
	THOMAS INSTRUMENT & MACHINE CO., NC.	194
	LEBRECHT TIGGES GmbH & CO. KG and SCHMICO GMBH SCHWEISSTECHNIK	114 175
TJB	SPS TECHNOLOGIES	183-184
TKS	TOKOSHA METAL WORKS LTD.	195
	TOOLEX, INC.	195
TLP	SPS TECHNOLOGIES	183-184
	SPS TECHNOLOGIES	183-184
	TERRY MACHINE CO.	192

MIL-HDBK-57G (IS)
INDEX B

SYMBOL	COMPANY NAME	PAGE
	TR DENT MACHINE CO.	197
TM	TRONSON MANUFACTURING	197
TM9	SPS TECHNOLOGIES	183-184
TMC	LISI AEROSPACE	120-121
	FARLO MACHINE & TOOL CO., NC.	71
TMS	MACHINE SHOP, INC., THE	124
T M T I	THOMAS MACHINING TECHNOLOGIES, NC.	194
TN	NICE TOOL MFG., INC.	143
	TOG MANUFACTURING CO., NC.	195
	OTO MELARA SpA.	150
TORX (radial)	CAMCAR DIVISION OF TEXTRON INC.	40-43
TOPURA	TOPURA CO., LTD.	195
TP	TOPURA CO., LTD.	195
	TEXAS PRECISION MFG., INC.	192
TR	T R MACHINE INC.	190
	TOWNE ROBINSON FASTENER CO.	196
TRI	TRIUMPH MANUFACTURING CO., NC.	197
Tridair 	REXNORD	167
TRIDAIR	TRIDAIR PRODUCTS	167, 197
	TRW	198
TT	TWIST TITE MFG., INC.	199
TTC	CAMCAR DIVISION OF TEXTRON INC.	40-43
TUZ	MAUDLE INDUSTRIAL CO., LTD.	129
	SUNDRAM FASTENERS, LTD.	189
TVS	TFP CORP.	193
	LENCH, THOMAS WILLIAM, LTD.	115
	YOUNG ENGINEERS NC, THE	215
U	OHKAWA SCREW MFG. CO., LTD. and OKAWA SCREW MANUFACTURING CO., LTD	148
		

SYMBOL	COMPANY NAME	PAGE
	OKABE CO., INC.	148
	R B & W CORPORATION	163, 166
U	SPS TECHNOLOGIES UNBRACO PTY LTD	183-184
U	UNIMETERIC CORPORATION	200
	UNITED DRILL BUSHING CORP.	201
	URANIA ENGINEERING CO., NC.	202
	URBAN MANUFACTURING CO.	202
	URBAN MFG. CO. INC.	202
U130	SPS TECHNOLOGIES	183-184
UA	UPSTART ACQUISITIONS CORP. DBA BET-LAR SERVICES	202 31
	UDT, INC.	199
UH	CHU HUA INDUSTRIAL CO., LTD.	48
UM	SPS TECHNOLOGIES UNBRACO PTY LTD.	183-184
UM	UNIVERSAL MACHINE PRODUCTS	201
	ULTIMATE MACHINING & WELDING	199
UNBRAKO	SPS TECHNOLOGIES	183-184
	SPS TECHNOLOGIES	183-184
	UNISTRUT CORP.	200
UNW	SPS TECHNOLOGIES	183-184
UP	UNITED PRECISION PRODUCTS CO., INC.	201
UPME	U.P. MACHINE & ENGINEERING CO.	199
	UNITED STATES DEFENSE RESEARCH & SUPPLY	201
	UNITED STEEL & FASTENERS INC.	201
	DOMESTIC FASTENER & FORGE, INC	59
	ULTRA SONIC MACHINE CO., NC	200
	US TOOL & DIE	202
V	AERCO RESEARCH	7

MIL-HDBK-57G (IS)
INDEX B

SYMBOL	COMPANY NAME	PAGE	SYMBOL	COMPANY NAME	PAGE
	AERO COMPONENTS CO	8		WALZ & KRENZER INC DBA MAPECO PRODUCTS	208
V	CHAMPION COMMERCIAL INDUSTRIES, INC.	47		WARREN PUMPS LLC	208
V	MNP CORPORATION	137		WATERBURY BUCKLE CO.	208
	PACER ALLOYS, NC.	151		WAYNE BOLT & NUT CO., NC.	208
	V-B MACHINE CO., NC.	203		WELTON ROLLED THREAD CORP.	209
V	VICO PRODUCTS, CO.	204		WESTLAND STEEL PRODUCTS, LTD.	210
	VICTOR PRODUCTS CORP.	204		WHELAN MACH NE & TOOL CO.	211
	VISTEK INDUSTRIES	205		WHITNEY SCREW CORP.	211
	VITCO NUCLEAR PRODUCTS INC.	205		WIGLEY MACHINE COMPANY	211
.V.	VMC INDUSTRIES, INC.	205- 206		WILLIAM'S MACHINE & FABRICATION, INC.	211
V	VOSS INDUSTR ES, NC.	207		WINKER HERMAN GMBH & CO. KG	212
V. V. 304 V.	VULCAN RIVET & BOLT CORP.	208		WITTEN COMPANY, INC.	212
VALCOR	VALCOR ENGINEERING CORP.	203		WODIN, NC.	212
VERBUS'	BAUER & SCHAURTE KARCHER GMBH	27		WOLTERS GMBH	213
VF 	MNP CORPORATION	137		WROUGHT WASHER MANUFACTUR NG INC.	214
	VALLEY FORGE AND BOLT MFG CO.	203		WYANDOTTE INDUSTRIES, INC.	214
	VENUS FASTENERS CORP.	203		WYNNSON ENTERPRISES, INC.	214
V F M	VEGAS FASTENER MANUFACTUR NG V P MFG. & ENGR. CORP.	203 204		WINSLOW AUTOMATICS, NC.	212
	VM MANUFACTURING CORP.	205		WALKER BOLT MANUFACTUR NG CO., NC.	208
	VMC INDUSTRIES, INC.	205- 206		WEBLUK MACHINE CORP.	209
VMC	VORTEX MFG CO.	207		WEST COAST AEROSPACE, INC.	209
	VOSS INDUSTR ES, NC.	207	W	WEDGELOCK	MONOGRAM AEROSPACE FASTENERS
vp	VAN PETTY MFG., INC.	203		WESLOK	WESLOK
VS VS VS	VOI-SHAN PRODUCTS	207			WESTF ELD FASTENERS
VS	VSI	207			WILSON-GARNER CO.
	VERSATECH, NC.	203			RATHMANN WALTER G. SEGMENT- KLAMMERSCHRAUBEN GMBH
	VALLEY-TODECO	203			
	W				
W	MEC WOLF SRL	130			

MIL-HDBK-57G (IS)
INDEX B

SYMBOL	COMPANY NAME	PAGE
	WHITTET-HIGG NS CO.	211
WH	WOLTERS GMBH	213
W	WINEGAR, NC	212
	WOLSTENHOLME MACHINE	213
WMI	WEAVER MANUFACTUR NG NC.	209
	WIL-NIC	211
	WESTERN PAC FIC ENTERPRISES, W.P E. NC.	210
	WESTWOOD PRECISION, NC.	210
<i>Wpp</i>	WILT PRECISION PRODUCTS	212
	CUTT NG EDGE MACHINING NC. and WESTERN SCREW MACHINE PRODUCTS, NC.	53, 210
WSI	WESTERN SKY INDUSTRIES, INC.	210
WSMP	WORTHEY MACH NE	214
	KAMPWERK VIEREGGE U. PICKARDT GMBH. & CO.	106
	WILHELM SCHUMACHER SCHRAUBEN-FABRIK GmbH	211
W	TW DESIGN AND MANUFACTUR NG, L.L.C.	198
	WA TAI INDUSTRIAL COMPANY, LTD	208
WWE	LINREAD PUBLIC LIMITED CO.	119
X		
X	X-TECH NNOVATIONS NCORPORATED	214
	EXCEL PRECISION PRODUCTS, INC.	70
XP	R B & W CORPORATION	163, 166
Y		
	YOW MENGI NDUSTRIAL CO., LTD.	215
Y 2 K	Y2K MACHINE SHOP	215
	FANG SHENG SCREW CO., LTD.	71
	YATES TOOL, NC.	215
Z		
Z	D.S.O. PLASTICS, NC.	54

SYMBOL	COMPANY NAME	PAGE
	FITZ MANUFACTURING INDUSTRIES LTD DBA FMI	75
	ZAMON CO., INC.	215
Z	ZERO PRODUCTS , NC.	216
	Z & B GENERAL MACHINE	215
ZENEX	ZENEX CORPORATION	215
	ZERO PRODUCTS , NC.	216
NUMBER		
	AERO-FAB, NC.	8
0F0Y2	ADVANCED MACHINING TECHNOLOG ES	7
0J8	ANATASE PRODUCTS	17
0XK38	NORTHSTAR ENG NEERING	145
01DC	RISCO, INCORPORATED	169
	MAC FASTENERS, INC.	124
01FO	ACCUTOOL	4
01FO	SUBCON TOOL/ACCUTOOL MACHINE GROUP NC. (DBA ACCUTOOL)	189 4
01IG	SEMS AND SPECIALS, NC.	176
01NU	EAGLEHEAD MANUFACTUR NG COMPANY	63
05DT8	FITZ MANUFACTURING INDUSTRIES LTD DBA FMI	75
05141	McMELLON BROS NC.	130
09094	QRP, INC.	161
1A249	ACCURATE THREADED PRODUCTS CO.	4
1EM77	GS AEROSPACE TECHNOLOGY, INC.	85
1HEW6	SHOPCO MANUFACTUR NG, NC.	178
1H423	J & M MACHINE INC.	101
1S5U7	AMERICA AEROSPACE PRECISION MFG	16
1st	FIRST AMERICAN SALES CO.	75
1Y128	D & D MACHINERY AND SALES	54
1YFG0	MAGNUM MACHINE SHOP	126
15077	NORTHBRIDGE FASTENERS	145
2	STERLING MACHINE COMPANY	187
2F 3F 4F 5F	FONTANA LUIGI S.p.A..	77
2A832	JMT MACH NE COMPANY	104
20733	NORTHBRIDGE FASTENERS	145
	UTAH TOOL & D E, NC.	202
28548	FABRICATION	70

MIL-HDBK-57G (IS)
INDEX B

SYMBOL	COMPANY NAME	PAGE
	SPECIALTY INC.	
	3D MACHINE COMPANY, NC	1
3D531	ALAN, JEFFREY, MFG. & ENGR	12
	MODERN METRIC MACHINE COMPANY INC.	138
30633	C & H MFG., NC.	38
32219	NORTHBRIDGE FASTENERS	145
33575	J.F. FREDERICKS TOOL CO.	102
4J952	GENERAL AVIATION MFG., INC.	81
4J976	REGAL AIR, INC	166
4N133	CHATHAM PRECISION, NC.	47
4T853	D & R MACHINE COMPANY	54
5N319	INDIANA AIRCRAFT HARDWARE	97
5T572	NORTHBRIDGE FASTENERS	145
509W0	BOMBSHELL, NC.	33
54878	ROTAIR INDUSTRIES, NC.	171
56878	SPS TECHNOLOGIES	183-184
6F140	COMPONENT PRODUCTS CORPORATION	51
	BISHOP ENTERPRISES, NC.	31
60529	STERLING MFG. & SUPPLY, INC.	188
61062	COMET MFG. CO., NC.	50
62206	B & B SPECIALTIES, NC.	25
7	HEPTNER MFG CO.	90
71838	SPS TECHNOLOGIES	183-184
8F781	STEVENS MFG. CO., INC.	188
8M938	PRODUCTS DESIGN & MFG. CORP.	160
8T968	ROMAC ELECTRONICS, NC.	171
80539	SPS TECHNOLOGIES	183-184
84256	AV BANK MFG., NC.	24
	THIANT (BOULONNERIE DE SA)	194
96458	JAMES IPPOLITO & CO., NC.	103
99106	AMERICAN AIRCRAFT PARTS MANUFACTURING COMPANY	16
9R	REID PRODUCT INC.	166
SYMBOL		
	3 V FASTENERS	1
	A & G ENGINEERING CO., NC	1
	ACCURA INDUSTRIES, NC.	3
	ACME RIVET & MACHINE CORP.	5

SYMBOL	COMPANY NAME	PAGE
	ACRODYNE MFG CO.	6
	AEROSPACE RIVET MFG CORP	9
	ALCOA FASTENING SYSTEMS	13
	KAYNAR PRODUCTS (Previously KAYNAR TECHNOLOGIES, NC DIV. OF MICRODOT	107 133
	ALCOA GLOBAL FASTENERS INC	13
	ALCOA-KOFEM KFT	13
	ALL PINS MANUFACTURING	13
	ALL-STATES INC.	14
	AMERITECH FASTENER MFG. NC.	17
	ANCHOR BOLT & SCREW CO.	18
	ANDROCK HARDWARE CORPORATION	18
	ANILLO INDUSTRIES, NC.	18
	ARGARWAL INDUSTRIES	19
	ARMSTRONG FASTENING SYSTEMS	20
	ASI DESIGN & MANUFACTURING, NC.	22
	AUTO SCREW, NC.	24
	AVDEL INTERNATIONAL	24
	AVK INDUSTRIES PRODUCTS INC.	25
	AV BANK MFG., NC.	24
	AZTECH ENGINEERING, NC.	25
	AZTECH LOCKNUT CO.	25
	BAUER & SCHAURTE KARCHER GMBH	27
	BOLLHOFF & CO. GmbH & CO. KG	33
	CARR CO.	45
	CLEVELAND HARDWARE & FORGING and GREEN BAY DROP FORGE	49, 83
	CODLING TOOL & MFG. NC.	50
	COLD HEADING CO., THE	50
	CUTTING EDGE MACHINING SOLUTIONS, NC	54
	DAVIS AIRCRAFT PRODUCT CO., INC.	55
	DO-ALL PRECISION, INC.	59

MIL-HDBK-57G (IS)
INDEX B

SYMBOL	COMPANY NAME	PAGE
	DRESSER INDUSTRIES, NC.	60
	EDS ORDNANCE	64
	ELCO INDUSTRIES, INC.	64
	GEN FAST MANUFACTURING COMPANY	81
	STELCO FASTENER & FORGING CO.	186-187
	EMHART CORP.	65
	FR EDR BOESNER GMBH	78
	FENTON HEAD NG	74, 168
	FERNDALE FASTENER	74, 168
	FISCHER SPECIAL MFG. CO.	75
	FOREST FASTENERS	78
	GMP CO. CORPORATION	82
	P LGR M SCREW CORP.	155
	GRADON SCREW MACHINE CORP.	83
	GROOV-PIN CORPORATION	85
	HANDI GADETS CORP.	87
	HEARTLAND PRECISION FASTENER	89
	HESSISCHE SCHRAUBENFABRIK WELTER GmbH & CO., KG	90
	WELTER GMBH & CO. KG	209
	HOUSTON FASTENER	94
	HUCK AEROSPACE PRODUCTS	95
	HUCK INDUSTRIAL PRODUCTS	95
	HURRICANE MACHINE COMPANY, L.L.C.	96
	NDUX, S A. DE C.E.	99
	NFASCO, NFASCO NUT and INGERSOLL FASTENERS	99

SYMBOL	COMPANY NAME	PAGE
	ITW C P	101
	KOBE FASTENER LIMITED	109
	KOREA BOLT ND., CO., LTD.	110
	KPF	110
	LBL PRODUCTS	114
	LINREAD NORTHBRIDGE AIRCRAFT PRODUCT DIVISION	118
	LISI AEROSPACE	120-121
	LISI AEROSPACE BLANC AERO INDUSTRIES VIGNOUX	120-121
	LISI AEROSPACE FTB FASTENER TECHNOLOGY BESTAS	121
	MACK, A. W. MFG CO.	124
	M NEBEA CO. LTD	135
	MNP CORPORATION	137
	NATIONAL AEROSPACE FASTENERS CORPORATION (NAFCO)	141
	NAGOYA SCREW MANUFACTURING CO., LTD.	140
	NCMI BRUEGGEMANN NC.	142
	ONE DA TOOL & MACHINE CORP.	148
	PAOLO ASTORI SPA	152
	PECO AEROSPACE FASTENERS	153
	PELHAM AUTO MATRIX PRECISION	154
	P NTO PRODUCTS	156
	PRECISION METAL PRODUCTS CO.	158
	PREM INDUSTRIES, INC.	159
	RELIANT FASTENER	167
	REXNORD	167
	TRIDAR PRODUCTS	167 197
	RING SCREW WORKS	168, 176

MIL-HDBK-57G (IS)
INDEX B

SYMBOL	COMPANY NAME	PAGE
	ROBB NS MANUFACTUR NG	169
 Rubber stamped on fasteners	ROTAIR INDUSTR ES, NC.	171
 ++	SANNOHASHI SEISAKUSHO CO., LTD.	174
	SANTA ANA SCREW PRODUCTS INC	175
	SATURN FASTENERS, NC.	175
	SET SCREW & MFG. CO.	177
	SHAMROCK FASTENER TECHNOLOG ES, LLC.	177
	SPS TECHNOLOGIES METALAC NDUSTRIA	183- 184
	STELFAST FASTENERS, NC.	187
	STILLWATER FASTENERS, INC.	188
	STRENKERT MACHINE SHOP INC.	188
	SUNRISE PRECISION MFG.	189
 EARTH	SUPERIOR TECHNOLOGY	189
	SUPREME SCREW PRODUCTS, NC.	189
 大	TAIYO NUT MFG. CO., LTD.	190
	TECH WELDING AND MACHINE CO.	191
	TENS MACHINE CO., NC.	192
	TFI AEROSPACE CORPORATION	193
	TOPURA CO., LTD.	195
	TOPURA CO., LTD.	195
	TRI STATE TOOL & DIE CO.	197
	TR EM INDUSTR ES, LLC	197
	UNITED BOLT & SCREW CORP.	200
	UNITED STEEL & FASTENERS INC.	201
	WHA L BOLT ND. CO., LTD	210

SYMBOL	COMPANY NAME	PAGE
	XCEL MFG., INC.	214
 (a dot)	CINCH-MONADNOCK	49
 (a dot) - (radial line)	DECKER MANUFACTUR NG CORP	56
 (a dot)	MONADNOCK COMPANY, THE	138
 (2 dots)	BELL FASTENERS	29
 (2 dots)	BRISTOL INDUSTR ES	35
 (2 dots)	CUTT NG EDGE ENTERPRISE, LLC	53
 (2 dots)	NORTH EAST FASTENERS	145
 (2 dots)	STILLWATER FASTENERS, INC.	188
 (2 dots)	CSM FASTENER PRODUCTS	53
	EMP MANUFACTURING CO.	66
	ERICO FASTENING SYSTEMS	67
 3 dots, centered on corner, equally spaced	WOLVER NE NUT CO.	213
 4 dots inline or radial	CAMCAR DIVISION OF TEXTRON INC.	40-43
 4 dots inline or radial	CAMCAR LLC	43
 4 dots inline or radial	CAMCAR SCREW AND MFG CO	43
 //	BRISTOL LOCKNUT CO.	35
 3 radial lines	CAMCAR DIVISION OF TEXTRON INC.	40-43
 3 radial lines	METALCRAFTERS	132
 = 2 parallel lines	CAMCAR DIVISION OF TEXTRON INC.	40-43
 = 2 parallel lines	CAMCAR SCREW AND MFG CO	43
 Three parallel lines spirak insert products only	MICRODOT INC.	133
	AMERIFAST CORP.	17
 Manufacturer identification: 2 raised ribs in (2) crimp depressions 1 raised rib in (1) crimp depression	GREER STOP NUT	69, 84
 "Dimple" trademark	PENN ENGINEERING & MANUFACTUR NG CO.	154
 Notches or Stakes cut into corners of nut	EVERLOCK FASTEN NG SYSTEMS	69-70
 2, 3, or 6 dots on corner of	FEDERAL SCREW WORKS	74

MIL-HDBK-57G (IS)
INDEX B

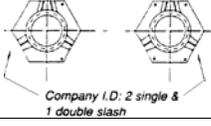
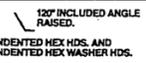
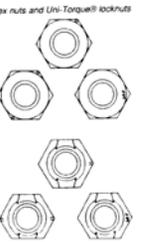
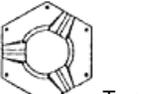
SYMBOL	COMPANY NAME	PAGE
nut 4 or 6 dots on flange of flange nuts		
	INDUSTRIAL & AUTOMOTIVE FASTENERS	98
Dots, slashes, and dots with slashes 2 - 8	R B & W CORPORATION	163, 166
Dots, slashes, and dots with slashes 2 - 8	STELCO FASTENER & FORGING CO.	186-187
<i>Raised or indented marks</i> 	INDUSTRIAL FASTENERS CORP.	98
	LAMSON AND SESSIONS OF CANADA LTD.	113
4 - 7 DOTS		
	INDUSTRIAL NUT CORP.	98
3, 4 or 6 equally spaced stakes		
 120° INCLUDED ANGLE RAISED. INDENTED HEX HDS. AND INDENTED HEX WASHER HDS.	LEWIS SREW COMPANY	118
 3 SLASH MARKS 120° APART RAISED. UNDER HEAD UPON REQUEST "NON-COUNTERSINK HEADS ONLY"	LEWIS SREW COMPANY	118
<i>Flange nuts less lock and with like Torquell® lock Two raised bars</i> 	MACLEAN-FOGG CO.	125
TWO RAISED BARS		
Three raised or depressed lines	THIANT (BOULONNERIE DE SA)	194
<i>Hex nuts and like Torquell® locknuts</i> 	MACLEAN-FOGG CO.	125
 INDENTED LOCK WITH TORQUELL	PACIFIC FASTENERS, NC.	151
 LOCKING COLLAR	TEXTRON FASTENING SYSTEMS	193
 Two lines in three pads	VMC INDUSTRIES, INC.	205-206

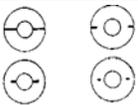
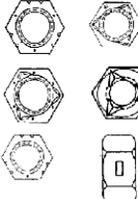
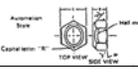
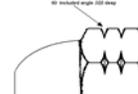
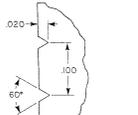
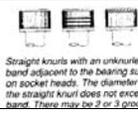
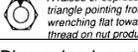
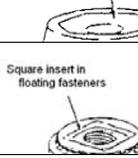
SYMBOL	COMPANY NAME	PAGE
	ELCO INDUSTRIES, INC.	64
	GR PCO, DIVISION OF BLACK & DECKER	84
	RAMCO SPECIALT ES, NC.	165
	RIPPA PRODUCTS	169
	SOUTHERN FASTENING SYSTEMS	181
	WOLVERINE MACHINE PRODUCTS CO.	213
	SPS TECHNOLOGIES	183-184
	SPS TECHNOLOGIES	183-184
Blue nylon insert	INDUSTRIAL NUT CORP.	98
Blue nylon locking element	NYLOK CORP.	147
Blue - nylon® hexagon locking element	PENN ENGINEERING & MANUFACTURING CO.	154
	PENN ENGINEERING & MANUFACTURING CO.	150
Green nylon insert	GREER STOP NUT	69, 84
Green nylon insert	EVERLOCK FASTENING SYSTEMS	69-70
Orange nylon insert	AZTECH LOCKNUT CO.	25
Red nylon insert	ELASTIC STOP NUT & ESNA	64, 68, 125
Tan nylon insert	VMC INDUSTRIES, INC.	205-206
Yellow nylon insert	ABBOTT INTERFAST CORP.	2

MIL-HDBK-57G (IS)

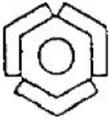
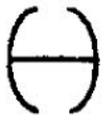
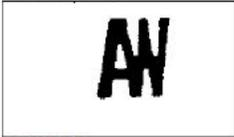
<p>3 V FASTENERS 320 REED CIRCLE CORONA, CA 92879-1349</p>  <p>CAGE code: 1ER65 <u>1/</u></p>	<p>A & M AEROSPACE, INC. 2332 SOUTH DELAWARE DENVER, CO 80223-4321</p> <p>A <u>A</u> & M A/M A&M M</p> <p>CAGE code: 6Z800 <u>1/</u></p>
<p>3D MACHINE COMPANY, INC. 5586 EAST LA PALMA AVENUE ANAHEIM, CA 92807-2108</p>  <p>CAGE code: 1K6P6 <u>2/</u></p>	<p>A & N PRECISION INDUSTRIES 65 FIRST STREET NEW ROCHVILLE, NY 10801-6118</p>  <p>CAGE code: 9Y423 <u>2/</u></p>
<p>A & E MACHINED PRODUCTS 93 PECK HILL ROAD JOHNSTON, RI 02919</p>  <p>CAGE code: 3MAH6 <u>2/</u></p>	<p>A & R MFG CORP. 1281 JOHN FITCH BLVD. SOUTH WINDSOR, CT 06074</p>  <p>CAGE code: 3X841 <u>2/</u></p>
<p>A & G ENGINEERING CO., INC 4640 EAST LAPALMA ANAHEIM, CA 92807</p>  <p>CAGE code: 4N135 <u>2/</u></p>	<p>A & S PIN PRODUCTS INC. 42 LAGRANGE ST. WORCESTER, MA 01610</p>  <p>CAGE code: 39YG0 <u>1/</u></p>
<p>A & W SCREW MACHINE PRODUCTS, INC. 3131 KANSAS AVE RIVERSIDE, CA 92507</p>  <p>CAGE code: 63035 <u>1/</u></p>	

1/ Information published in this revision was verified by direct contact with manufacturers.

2/ Information not verified to be current, no response from manufacturer. Information identical to that published in MIL-HDBK-57, Revision B.

MIL-HDBK-57G (IS)

A. AGRATI S.P.A.
VIA PAIVE 28/30
20050 VEDUGGIO CON COLZANO
MILANO, ITALY

Plant
AGRATI CORP.
925 Brewster Street
Bridgeport, CT 06605

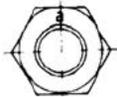

socket
head
cap
screw

CAGE code: A0698

2/

A.M.I ENGINEERING CO.
2904 OAK ST.
SANTA ANA, CA 92707

AMI LOGO

CAGE code: 4WDB5

1/

A. P. MILLS INDUSTRIES FOR
THE BLIND
346 ST. PAUL AVE.
P.O. BOX 2175
MEMPHIS, TN 38101

(See WEST TENNESSEE LIONS BLIND INDUSTRIES
INC.)

APMI

CAGE code: 5L565

2/

A-1 NUT AND BOLT CO, INC
DIVISION OF GREEN CO. PACIFIC INC.
3433 S. MALT AVENUE
COMMERCE, CA 90040

A 1

CAGE code: 1M493

2/

A-1 THREAD ROLLING CO., INC.
4933 MASON ST.
SOUTH GATE, CA 90280

A-1

CAGE code: 3N586

2/

AAP ACQUISITION CORP
2100 ENTERPRISE PKWY
TWINSBURG, OH 44087-2212

(SEE ACHILLES AEROSPACE PRODUCTS)

A

CAGE code: 0H380

2/

AASTRO ENGINEERING
1382 CORONADO AVE
LONG BEACH, CA 90804

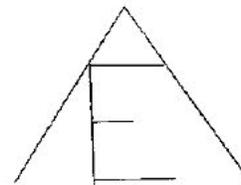

CAGE code: 01AL8

2/

ABBOTT INTERFAST CORP.
190 ABBOTT DRIVE
WHEELING, IL 60090

Yellow nylon insert identifies Abbott-Interfast
Corp.
as manufacturer



CAGE code: 08928

1/

1/ Information published in this revision was verified by direct contact with manufacturers.

2/ Information not verified to be current, no response from manufacturer. Information identical to that published in MIL-HDBK-57, Revision B.

MIL-HDBK-57G (IS)

<p>ABBOTT, PETER (AEROSPACE) 1982 LTD. 6 REPTON CLOSE BURNT MILLS, BASILDON, ESSEX SS13 ILE UNITED KINGDOM</p> <p>PAM PAM PAM</p> <p>CAGE code: OWL73 <u>2/</u></p>	<p>ACCURA INDUSTRIES, INC. 435 TRABOLD ROAD ROCHESTER, NY 14624</p>  <p>CAGE code: 6RX70 <u>1/</u></p>
<p>ABC TOOL AND DIE ENGINEERING & MANUFACTURING LLC 197 WALLIS STREET UNIT C EUGENE, OR 97402-5301</p> <p>No artwork for marking. Marks whatever the customer specifies.</p> <p>CAGE code: 0XJF0 <u>1/</u></p>	<p>ACCURATE AUTOMATIC PARTS CO. 2885 S. 163RD ST. NEW BERLIN, WI 53151</p> <p>AP</p> <p>CAGE code: 5S202 <u>2/</u></p>
<p>ABRASIVE CUTTING CORP 633 COMMERCE ST. THORNWOOD, NY 10594</p>  <p>CAGE code: 5DQB3 <u>1/</u></p>	<p>ACCURATE PRECISION FATSENERS, INC. P.O. BOX 5239 ENGLEWOOD, NJ 07631</p> <p>Plant 20 HONECK ST. ENGLEWOOD, NJ 07631</p> <p>A</p> <p>CAGE code: 28977 <u>2/</u></p>
<p>ABSCOA INDUSTRIES 1071 WEST ARBOR VITAE ST. INGLEWOOD, CA 90301</p> <p>AB</p> <p>CAGE code: <u>2/</u></p>	<p>ACCURATE SCREW MACHINE CO. (DBA ASM) P.O. 10095 10 AUDREY PL FAIRFIELD, NJ 07004-3402</p> <p>Plant 19 Baltimore St. Nutley, NJ 07110</p> <p>AMSCO</p> <p>5/16 LONG X 1/16 HIGH X .010 DEEP</p> <p>CAGE code: 51506 <u>2/</u></p>
<p>ACCUFORM, INC. P.O. BOX 307 BUS. HWY. 36 WEST MACON, MO 63552</p>   <p>CAGE code: <u>2/</u></p>	

1/ Information published in this revision was verified by direct contact with manufacturers.

2/ Information not verified to be current, no response from manufacturer. Information identical to that published in MIL-HDBK-57, Revision B.

MIL-HDBK-57G (IS)

ACCURATE THREADED FASTENERS, INC.
DIVISION OF BEATRICE FOODS CO.
(new company name see ATF, INC.)
3550 WEST PRATT AVE
LINCOLNWOOD, IL 60645

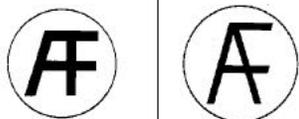

CAGE code: 95110

1/

ACCURATE THREADED PRODUCTS CO.
280 HARTFORD AVENUE
NEWINGTON, CT 06111

1A249

CAGE code: 1A249

2/

ACCURATE TOOL CO., INC.
891 FERNHILL RD
WEST CHESTER, PA 19380 - 4282

A+

CAGE code: 7N957

1/

ACCU-TECH MANUFACTURING AND
SUPPORT, INC.
8875 EAST AVENUE
MENTOR, OH 44060

Accu-TECH
MFG. & SUPPORT INC.

CAGE code: 1LLG8

2/

ACCUTOOL
(SUBCON TOOL/ACCUTOOL MACHINE
GROUP INC. DBA ACCUTOOL)
SEE SUBCON TOOL
5301 IROQUOIS AVENUE
ERIE, PA 16511-2529

01FO

CAGE code: 1UXM0

1/

ACCUTURN CORPORATION
6510 BOX SPRINGS BLVD., UNIT A
RIVERSIDE, CA 92507



CAGE code: 1XYA5

1/

ACE GRINDING & MFG. OF TEXAS
(formally ACE G & M CO. OF TEXAS)
2610 AERO DR.
GRAND PAIRIE, TX 75052

AGC

Plant (plant closed)
ACE GRINDING & MFG.
4937 EAST SLAUSON AVENUE
MAYWOOD, CA 90270
CAGE code: 2N509

AGM

*Plant (see SHAW PRECISION GRINDING
AND THREAD ROLLING)*
SHAW PRECISION GRINDING
6503 W. FRYE RD.
CHANDLER, AZ 85226

SPG

CAGE code: 5U074

1/

1/ Information published in this revision was verified by direct contact with manufacturers.

2/ Information not verified to be current, no response from manufacturer. Information identical to that published in MIL-HDBK-57, Revision B.

MIL-HDBK-57G (IS)

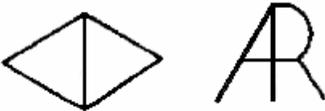
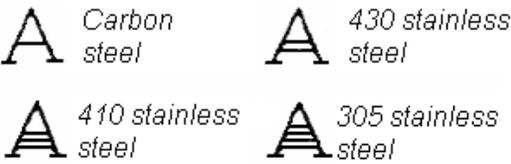
<p>ACE PRECISION INDUSTRIES, INC. 925 MOE DRIVE AKRON, OH 44310-2518</p>  <p>CAGE code: 3DTZ2 2/</p>	<p>ACME INDUSTRIAL COMPANY 441 MAPLE AVE CARPENTERSVILLE, IL 60110</p>  <p>CAGE code: 00175 1/</p>
<p>ACHILLES AEROSPACE PRODUCTS, INC. 2100 ENTERPRISE PKWY TWINSBURG, OH 44087-2212</p> <p>(SEE AAP)</p>  <p>CAGE code: 0H380 2/</p>	<p>ACME MACHINE PRODUCTS 500 SOUTH VARNEY STREET BURBANK, CA 91502</p>  <p>CAGE code: 4M256 2/</p>
<p>ACI 301 W. WILSON P.O. BOX 398 OTTAWA, KS 66067</p>  <p>CAGE code: 0AV61 2/</p>	<p>ACME RIVET & MACHINE CORP. 50 EMMETT ST. BRISTOL, CT 06010</p>  <p>CAGE code: 34482 2/</p>
<p>ACIMET MFG. 1710 CLARKSTONE RD. CLEVELAND, OH 44112</p>  <p>CAGE code: 6V869 2/</p>	<p>ACME SCREW COMPANY 1201 W. UNION AVE WHEATON, IL 60187-4879</p>  <p>CAGE code: 35EX5 2/</p>

1/ Information published in this revision was verified by direct contact with manufacturers.

2/ Information not verified to be current, no response from manufacturer. Information identical to that published in MIL-HDBK-57, Revision B.

MIL-HDBK-57G (IS)

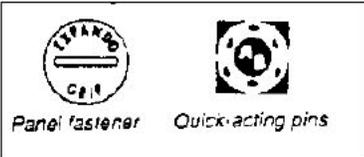
<p>ACRODYNE MFG CO. 41 KINGSTON AVE COLUMBUS, OH 43207-2438</p>  <p>Ac</p> <p>CAGE code: 9Y179 1/</p>	<p>ADI MANUFACTURING, INC. 33 HAMMOND, BLDG 201 IRVINE, CA 92718</p> <p>Plant 1243 TRANSIT STREET POMONA, CA 91766</p> <p>MC K</p> <p>CAGE code: 0YCU4 2/</p>
<p>ACUFEST AIRCRAFT PRODUCTS 12424 GLADSTONE AVE. SYLMAR, CA 91342</p> <p>AF</p> <p>CAGE code: 4GP55 1/</p>	<p>ADJUSTABLE BUSHING CORP. 8330 LANKERSHIM BLVD. NORTH HOLLYWOOD, CA 91605</p>  <p>CAGE code: 3V407 2/</p>
<p>ADAMS INDUSTRIES, INC. (A SUB OF BANNER INDUSTRIES INC.) 1160 SOUTH ST WINDSOR LOCKS, CT 06096</p> <p>ABE</p> <p>CAGE code: 33823 2/</p>	<p>ADOM ENGINEERING 131 AVCO ROAD HAVERHILL, MA 01835-5956</p> <p>AD <i>adm</i> (used formerly)</p> <p>CAGE code: 02GZ1 1/</p>
<p>ADAMS, EARL M. CO. 100 PECK HILL RD. JOHNSTON, RI 02919</p>  <p>CAGE code: 07123 2/</p>	<p>ADVANCE PATTERN CORP. 18564 FITZPATRICK DETROIT, MI 48228</p> <p>MFR 29839</p> <p>CAGE code: 29839 2/</p>
<p>ADC COMMUNICATIONS CORP. 17528 STUDEBAKER RD. CERRITOS, CA 90703-2637</p> <p>adc </p> <p>CAGE code: 9X383 2/</p>	

1/ Information published in this revision was verified by direct contact with manufacturers.

2/ Information not verified to be current, no response from manufacturer. Information identical to that published in MIL-HDBK-57, Revision B.

MIL-HDBK-57G (IS)

<p>ADVANCED CNC MANUFACTURING 7303 124TH AVENUE NORTH LARGO, FL 33773</p> <p style="text-align: center;">A</p> <p>CAGE code: 1YDC9 <u>1/</u></p>	<p>ADVANCED PLASTICS, INC. DBA ADVANCED MACHINING & FABRICATING, INC. 11212 E. 112th ST. N. OWASSA, OK 74055-5421</p> <p style="text-align: center;">ap a</p> <p>CAGE code: 45339 <u>1/</u></p>
<p>ADVANCED MACHINING & FABRICATING, INC. 11212 E. 112TH ST. N. OWASSO, OK 74055-5421</p> <p style="text-align: center;">a</p> <p>CAGE code: 0BD96 <u>1/</u></p>	<p>AERCO RESEARCH 295 OLD COUNTRY ROAD SUITE 10 SAN CARLOS, CA 94070-6240</p> <p style="text-align: center;">V</p> <p>CAGE code: 0KMN9 <u>1/</u></p>
<p>ADVANCED MACHINING & TOOLING, INC. 13535 DANIELSON ST. POWAY, CA 92064</p> <p style="text-align: center;">AMT</p> <p>CAGE code: 1N6C7 <u>1/</u></p>	<p>AERO & AUTO STUD SPEC. P.O. BOX 140 NEW HUDSON, MI 48165 Plant 56000 GRAND RIVER NEW HUDSON, MI 48165</p> <p>Studs \bar{A} Bolts \bar{A} or \bar{A} & \bar{A}</p> <p>CAGE code: 5DN08 <u>1/</u></p>
<p>ADVANCED MACHINING TECHNOLOGIES PO BOX 3351 WARMINISTER, PA 18974</p> <p style="text-align: center;">Plant 220 JACKSONVILLE RD. HATBORO, PA 19040</p> <p style="text-align: center;">OF0Y2</p> <p>CAGE code: OF0Y2 <u>1/</u></p>	<p>AERO BUSHING AND COMPONENT 15201 PIPELINE LN. HUNTINGTON BEACH, CA 92649</p> <p style="text-align: center;"></p> <p>CAGE code: <u>2/</u></p>

1/ Information published in this revision was verified by direct contact with manufacturers.

2/ Information not verified to be current, no response from manufacturer. Information identical to that published in MIL-HDBK-57, Revision B.

MIL-HDBK-57G (IS)

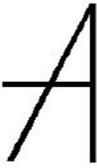
<p>AERO COMPONENTS CO. 5124 KALTENBRUN RD. FORT WORTH 76119 - 6400</p>  <p>CAGE code: 59213 <u>2/</u></p>	<p>AEROBOLT MANUFACTURING, INC. 4736 FELSPAR STREET RIVERSIDE, CA 92509-3068</p> <h1 style="text-align: center;">ABM</h1> <p>CAGE code: 08PH2 <u>2/</u></p>
<p>AERO DYNAMIC MACHINING, INC. 11791 MONARCH STREET GARDEN GROVE, CA 92841-1818</p>  <p>CAGE code: 1KSM2 <u>2/</u></p>	<p>AERO-FAB, INC. 8420 RED OAK STREET RANCHO CUCAMONGA, CA 91730</p>  <p>CAGE code: 0CAC0 <u>2/</u></p>
<p>AERO ENGINEERING AND MANUFACTURING CO. OF CALIFORNIA (DBA AERO ENGINEERING) 28217 AVENUE CROCKER VALENCIA, CA 91355-1249</p>  <p>CAGE code: 17772 <u>1/</u></p>	<p>AEROFAST SUPPLY 405 W 20TH ST SAN PEDRO, CA 90731</p>  <p>CAGE code: 2T830 <u>2/</u></p>
<p>AERO MECHANICAL FASTENING SYSTEMS 15481 WEST 110TH AVE SHAWNEE MISSION, KS 66219</p>  <p>CAGE code: 1FY45 <u>2/</u></p>	<p>AEROMAX INDUSTRIES, INC. DBA AEROMAX INTERNATIONAL 9546 TOPANGA CANYON BLVD. CHATSWORTH, CA 91311-4011</p> <h1 style="text-align: center;">AX</h1> <p>CAGE code: 40581 <u>1/</u></p>

1/ Information published in this revision was verified by direct contact with manufacturers.

2/ Information not verified to be current, no response from manufacturer. Information identical to that published in MIL-HDBK-57, Revision B.

MIL-HDBK-57G (IS)

AEROSPACE MACHINE PRODUCTS
 P.O. BOX 3046
 CUMMING, GA 30028
 plant
 61 PEARL INDSTRUAL AVE
 HOSCHTON, GA 30548

A AMP

CAGE CODE: 6KBV2 1/

AEROSPACE MANUFACTURING
 P.O. BOX 3398
 WALLINGTON, NJ 07057-1148

Plant
 80 VAN WINKLE AVE.
 WALLINGTON, NJ 07057-1148

AM

CAGE code: 0E0Z8 1/

AEROSPACE MARINE SPECIALTY
 FASTENERS & FITTINGS INC. DBA AMS
 FASTENERS
 1645 WEST 135ND STREET
 GARDENA, CA 90249-2505

AMS AMS

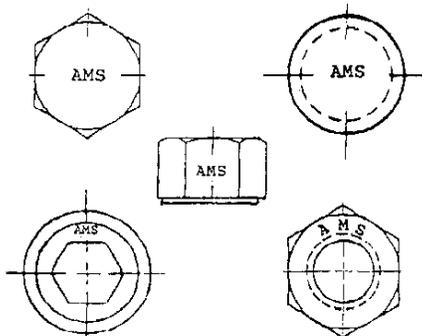

CAGE code: 1FGH9 2/

AEROSPACE PRODUCTS
 (DIV OF APCOA FASTENERS, INC)
 903 E. OHIO STREET
 P. O. BOX 796
 INDIANAPOLIS, IN 46202

APCO

CAGE code: 17140 2/

AEROSPACE PRODUCTS CO. DIV WBH
 (FORMERLY APCOA FASTENERS, INC.)
 P.O. BOX 796
 INDIANAPOLIS, IN 46206-0796

Plant
 123 NORTH PINE STREET
 INDIANAPOLIS, IN 46202-3844

AP

CAGE code: 59736 1/

AEROSPACE PRODUCTS, INC.
 5435 PERKINS RD.
 BEDFORD HEIGHTS, OH 44146

A

CAGE code: 2/

AEROSPACE RIVET MFG CORP
 8535 DICE ROAD
 SANTA FE SPRINGS, CA 90670



CAGE code: 64728 2/

1/ Information published in this revision was verified by direct contact with manufacturers.

2/ Information not verified to be current, no response from manufacturer. Information identical to that published in MIL-HDBK-57, Revision B.

MIL-HDBK-57G (IS)

AEROSTAR ENGINEERING &
MANUFACTURING COMPANY
25514 S. FRAMPTON AVENUE
HARBOR CITY, CA 90710-2907



No longer a fastener manufacturer

CAGE code: 0MXJ2 2/

AF FASTENERS LIMITED
UNIT 14 & 15
GLOSSOP BROOK BUSINESS PARK,
GLOSSOP, DERBYSHIRE SK13 7AJ,
UNITED KINGDOM



CAGE code: 1/

AEROSTAR FASTENER CORP.
712 W LACY ST
P.O. BOX 2201
PALESTINE, TX 75802



CAGE code: 0T218 2/

AFAB PRECISION MACHINING
20742 LINEAR LANE
LAKE FOREST, CA 92630



CAGE code: 1GSW1 2/

AEROTECH FASTENERS, INC.
ONE RIDGE ROAD
PUTNAM, CT 06260



CAGE code: 0TD46 1/

AFI INDUSTRIES, INC.
475 E. KEHOE BLVD
CAROL STREAM, IL 60188



CAGE code: 33PQ1 1/

AEROWIND CORPORATION
1959 JOHN TOWERS AVENUE
EL CAJON, CA 92020-1117



CAGE code: 1N021 1/

AIHARA SEIBYO CO LTD
2084 SHIN-MACHI
TANO-GUN, GUNMA, JAPAN 370-13

ICHO

CAGE code: 2/

1/ Information published in this revision was verified by direct contact with manufacturers.

2/ Information not verified to be current, no response from manufacturer. Information identical to that published in MIL-HDBK-57, Revision B.

MIL-HDBK-57G (IS)

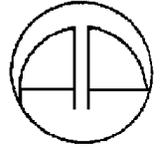
<p>AIR INDUSTRIES CORPORATION 12570 KNOTT STREET GARDEN GROVE, CA 92841-3932</p>  <p>CAGE code: 06725 <u>1/</u></p>	<p>AIR-COM, INC. 18105 S. HOBART BLVD. GARDENA, CA 90248-3617</p>  <p>CAGE code: 2Y870 <u>2/</u></p>
<p>AIR LAND TURBINE SERVICES, INC 7425 AIRPORT FREEWAY FORT WORTH, TX 76118</p>  <p>CAGE code: 1K1L5 <u>1/</u></p>	<p>AIRCRAFT ENGINEERING PRODUCTS, INC. 2 ACKERMAN AVENUE CLIFTON, NJ 07011</p>  <p>CAGE code: <u>2/</u></p>
<p>AIR PARTS MFG. CO. 1117 HARRISON AVE ARLINGTON, TX 76011</p>  <p>CAGE code: 8R401 <u>2/</u></p>	<p>AIRCRAFT FUELSEAL FASTENERS, INC. (AEROLITE BLIND RIVET DIVISION) 5271 ARGOSY AVENUE HUNTINGTON BEACH, CA 92649</p>  <p>CAGE code: 4K209 <u>2/</u></p>
	<p>AIRDROME PARTS CO. 3251 SCHNIEDER ROAD S.E. P.O. BOX 1867 NORTH CANTON, OH 44720</p>  <p>CAGE code: <u>2/</u></p>

1/ Information published in this revision was verified by direct contact with manufacturers.

2/ Information not verified to be current, no response from manufacturer. Information identical to that published in MIL-HDBK-57, Revision B.

MIL-HDBK-57G (IS)

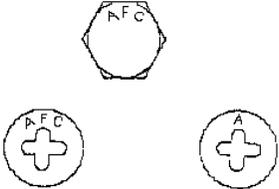
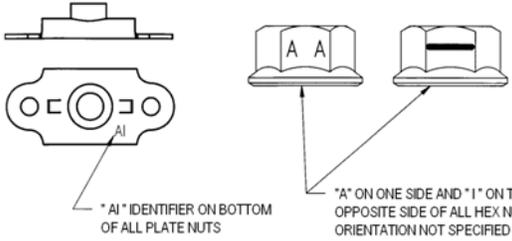
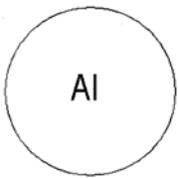
<p>AIRFASCO, INC. 2655 HARRISON AVE SW. CANTON, OH 44706-3047</p>  <p>CAGE code: 3Z958 <u>2/</u></p>	<p>AJ ASSOCIATES MFG & ENG COMPANY, INC. 11346 53rd STREET NORTH CLEARWATER, FL 33760</p>  <p>CAGE CODE: 3Z260 <u>1/</u></p>
<p>AIRFASCO INDUSTRIES FASTENER GROUP 2655 HARRISON AVE. CANTON, OHIO 44706</p>  <p>* AI* IDENTIFIER ON BOTTOM OF ALL PLATE NUTS</p> <p>* A* ON ONE SIDE AND *1* ON THE OPPOSITE SIDE OF ALL HEX NUTS. ORIENTATION NOT SPECIFIED</p> <p>CAGE code: 5NYP9 <u>1/</u></p>	<p>AKKO FASTENER, INC. 6855 CORNELL RD. CINCINNATI, OHIO 45242</p>  <p>CAGE code: 3M2H6 <u>1/</u></p>
<p>AIRFRAME INTERNATIONAL, INC. 7820 NW 74TH STREET MIAMI, FL 33166</p>  <p>CAGE code: 3ZKC5 <u>1/</u></p>	<p>ALAN, JEFFREY, MFG. & ENGR. 8625 LAPEER ROAD P.O. BOX # 8 GOODELLS, MI 48027-9766</p> <p>3D531</p> <p>CAGE code: 3D531 <u>2/</u></p>
<p>AIW-ALTON INC. 1475 PALISADO AVE. WINDSOR, CT 06095-5140</p>  <p>CAGE code: 84027 <u>2/</u></p>	<p>ALARD MACHINE PRODUCTS 1629 WEST 132ND STREET GARDENA, CA 90249-2005</p>  <p>CAGE code: 1FMQ2 <u>1/</u></p>
<p>AIW-ALTON INC. 1475 PALISADO AVE. WINDSOR, CT 06095-5140</p>  <p>CAGE code: 84027 <u>2/</u></p>	<p>ALBAR MACHINE CORPORATION RR3 BOX 2463 EFFORT, PA 18330-9450</p> <p>AMC</p> <p>CAGE code: 44248 <u>1/</u></p>

1/ Information published in this revision was verified by direct contact with manufacturers.

2/ Information not verified to be current, no response from manufacturer. Information identical to that published in MIL-HDBK-57, Revision B.

MIL-HDBK-57G (IS)

ALCO MACHINE CO.
27 SEARING AVENUE
HARRISON, NJ 07029



CAGE code: 2T918

2/

ALCOA FASTENING SYSTEMS
3016 WEST LOMITA BLVD.
TORRANCE, CA 90505

plants:

see CAMLOC PRODUCTS
see HUCK INDUSTRIAL PRODUCTS
see HUCK AEROSPACE PRODUCTS
see KAYNAR PRODUCTS
see KELOX/MICRODOT PRODUCTS
see MECAERO PRODUCTS
see RAM PRODUCTS
see ROSAN PRODUCTS
see SIMMONDS PRODUCTS
see TRIDAIR PRODUCTS
see VOI-SHAN PRODUCTS
CAGE code: 15653

1/

ALCOA GLOBAL FASTENERS INC
13001 EAST TEMPLE AVE
LA PUENTE, CA 91746-1417



CAGE code: 06950

2/

ALCOA-KOFEM KFT
AFS NEMESVAMOS OPERATION
H-8248 NEMESVAMOS
DOZSA GYORGY U. 2/A
HUNGARY



CAGE code: 0725V

1/

ALEXANDER MANUFACTURING COMPANY
INC. DBA METRO TOOL &
MANUFACTURING CO.
2402 ARKANSAS LANE
GRAND PRAIRIE, TX 75052-7203



CAGE code: 2M919

2/

ALL AUTOMATICS
8222 SORENSEN AVENUE
SANTA FE SPRINGS, CA 90670

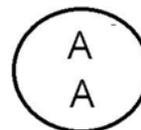

CAGE code: 0SSY5

1/

ALL MANUFACTURERS INC.
DBA HARPER AEROSPACE FASTENERS
2900 PALISADES DR
CORONA, CA 92880 – 9429



CAGE code: 57472

2/

ALL PINS MANUFACTURING
P.O. BOX 137
WILSEYVILLE, CA 95257

plant
5549 POOR MANS WAY
WILSEYVILLE, CA 95257

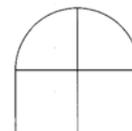

CAGE code: O8CZ5

1/ Information published in this revision was verified by direct contact with manufacturers.

2/ Information not verified to be current, no response from manufacturer. Information identical to that published in MIL-HDBK-57, Revision B.

MIL-HDBK-57G (IS)

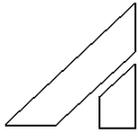
<p>ALL QUALITY SPARES, INC. 3 EAST BISHOP STREET WATERFORD, CT 06385</p> <p> REMOVED</p> <p>CAGE code: 1VGA2</p> <p>This company is a Non-Manufacturer</p>	<p>ALL-POWER MFG. CO. 13141 MOLETTE STREET SANTA FE SPRINGS, CA 90670-5500</p> <p>AP</p> <p>CAGE code: 70265 <u>1/</u></p>
<p>ALLFAST FASTENING SYSTEMS, INC. 15200 E DON JULLIAN RD P.O. BOX 3166 CITY OF INDUSTRY, CA 91745-1098</p> <p></p> <p>CAGE code: 53551 <u>1/</u></p>	<p>ALL-PRO FASTENER & RIVET MFG. CO. 10406 ENTERPRISE ST P.O. BOX 1525 RANCHO CUCAMONGA, CA 91730</p> <p>AP</p> <p>CAGE code: 1FH10 <u>2/</u></p>
<p>ALLIED NUT & BOLT CO., INC. 520 HERTZOG BOULEVARD P.O. BOX 670 KING OF PRUSSIA, PA 19406-2667</p> <p></p> <p>CAGE code: 4S191 <u>2/</u></p>	<p>ALL-STATES INC. 1801 WEST FOSTER AVE. CHICAGO, IL 60640</p> <p> ALL-STATES LOGO</p> <p> ALL-STATES IDENTIFICATION MARK</p> <p>CAGE code: 26863 <u>2/</u></p>
<p>ALLIED PRECISION PRODUCTS, INC. 600 SAN CHRISTOPHER DRIVE DUNEDIN, FL 34698-5095</p> <p>APP</p> <p>CAGE code: 24249 <u>1/</u></p>	

1/ Information published in this revision was verified by direct contact with manufacturers.

2/ Information not verified to be current, no response from manufacturer. Information identical to that published in MIL-HDBK-57, Revision B.

MIL-HDBK-57G (IS)

ALPHA BOLT CO.
1524 EAST 14 MILE ROAD
MADISON HEIGHTS, MI 48071

ABC

I

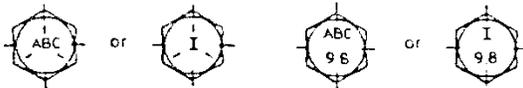

GRADE 5 BOLT

PROPERTY CLASS 9.8
METRIC BOLTS

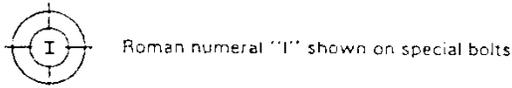

GRADE 8 BOLT

PROPERTY CLASS 10.9
METRIC BOLTS

CAGE code: 0R8B6 2/

ALPHA FASTENERS
154 EAST MERRICK ROAD
FREEPORT, NY 11520

**A
F**

CAGE code: 1UJ18 1/

ALPHA MACHINING PRODUCTS &
DEVELOPMENT
8651 PRODUCTION AVENUE
SAN DIEGO, CA 92126

Plant
7929 SILVERTON AVENUE
SUITE 610
SAN DEIGO, CA 92126

α

CAGE code: 3D6Q0 2/

ALPINE MACHINE & TOOL CORP.
42 BERGENLINE AVE.
WESTWOOD, NJ 07675

AMT - I

AMT xxxx - xxxx



CAGE code: 67339 2/

ALPS SEIKO CO. LTD.
41 HIGASHI-KANAE, KANAE
IIDA-SHI, NAGANO PREF.
395-0817, JAPAN

Plant
LIDA FACTORY
524-1, SHIMOTONOHKA
LIDA-SHI, NAGANO PREF.
395-0154 JAPAN

A

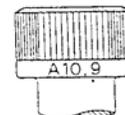

CAGE code: 1/

1/ Information published in this revision was verified by direct contact with manufacturers.

2/ Information not verified to be current, no response from manufacturer. Information identical to that published in MIL-HDBK-57, Revision B.

MIL-HDBK-57G (IS)

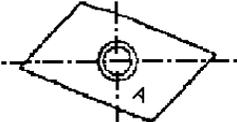
<p>AMACON CORP. 49 ALDER STREET WEST BABYLON, NY 11704</p>  <p>CAGE code: 54330 <u>2/</u></p>	<p>AMERICAN AIRCRAFT PARTS MANUFACTURING COMPANY 17917 MASONIC FRASER, MI 48026</p> <p>99106</p> <p>CAGE code: 99106 <u>2/</u></p>
<p>AMANDA BENT BOLT CO. 1120 C I C DR. LOGAN, OH 43138-9153</p>  <p>CAGE code: 22382 <u>2/</u></p>	<p>AMERICAN ELECTRIC (CONSTRUCTION MATERIALS GROUP) 1555 LYNNFIELD ROAD MEMPHIS, TN 38119</p> <p>(SEE THOMAS & BETTS CORP - CAGE 56501)</p>  <p>CAGE code: <u>1/</u></p>
<p>AMATOM ELECTRONIC HARDWARE (DIVISION OF QUINCY TECHNOLOGIES, INC.) 5 PASCO HILL ROAD CROMWELL, CT 06416-1012</p> <p style="text-align: center;">  AMATOM </p> <p>CAGE code: 1YGB8 <u>2/</u></p>	<p>AMERICAN FASTENER & SPECIALTY CO. 5900 PARK AVE. CLEVELAND, OHIO 44105</p> <div style="display: flex; justify-content: space-around; align-items: center;">   </div> <p>CAGE code: <u>2/</u></p>
<p>AMERICA AEROSPACE PRECISION MFG. 26254 HWY 281 NORTH SAN ANTONIO, TX 78258</p> <p style="text-align: center;">1S5U7</p> <p>CAGE code: 1S5U7 <u>1/</u></p>	<p>AMERICAN INTERNATIONAL AERO MFG INC. 6973 SOUTH 300 WEST MIDVALE, UTAH 84047</p>  <p>CAGE code: 0RBVB <u>2/</u></p>

1/ Information published in this revision was verified by direct contact with manufacturers.

2/ Information not verified to be current, no response from manufacturer. Information identical to that published in MIL-HDBK-57, Revision B.

MIL-HDBK-57G (IS)

AMERICAN METAL BEARING COMPANY
7191 ACACIA AVENUE
GARDEN GROVE, CA 92841

AMB



HEX SOCKET HEAD
SCREW

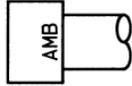

HEX SOCKET HEAD
SCREW



THREAD
OR
STUD END



HEX HEAD
SCREW
OR BOLT



HEX NUT



HEX NUT

CAGE code: 70508

1/

AMERICAN QUALITY INDUSTRIES
(FASTENER DIVISION)
411 BURNHAM STREET
EAST HARTFORD, CT 06108

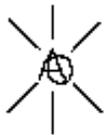

GRADE 8 BOLT

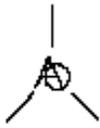

GRADE 5 BOLT

CAGE code: 1P581

1/

AMERIFAST CORP.
104 SYLVANNA RD.
SOUTH PLAINFIELD, NJ 07080-1448

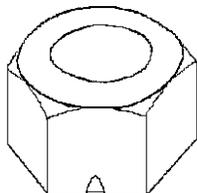

CAGE code: 0H4SO

1/

AMERITECH DIE & MOLD SOUTH INC.
6 EAST TOWER CIRCLE
ORMOND BEACH, FL 32174

AD&M

CAGE CODE: 5HPY1

1/

AMERITECH FASTENER MFG INC.
DIVISION OF LONE STAR FASTENERS, LP
6606 N GESSNER
HOUSTON, TX 77040

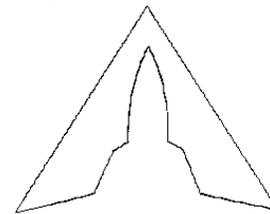

CAGE code: 0EUH2

1/

AMMAC, INC.
6000 SUSQUEHANNA PLAZA
YORK, PA 17406



CAGE code: 0NHU1

1/

ANATASE PRODUCTS
(DIV OF HENWAY INC)
1314 GOODRICK DR
TEHCHPI, CA 93561



CAGE code: 0MXJ8

1/

1/ Information published in this revision was verified by direct contact with manufacturers.

2/ Information not verified to be current, no response from manufacturer. Information identical to that published in MIL-HDBK-57, Revision B.

MIL-HDBK-57G (IS)

<p>ANCHOR BOLT & SCREW CO. 2001 N. CORNWELL MELROSE PARK, IL 60160-1081</p> <p> Hex cap and indented hex screws.</p> <p> Machine screws and Other products - 3 dots under head 120° apart</p> <p>CAGE code: 9C864 2/</p>	<p>ANKIT FASTENERS PRIVATE LIMITED 297 HARAGADDE VILLAGE, ROAD NO. 4 JIGNI INDUSTRIAL ESTATE PHASE - I BANGALORE 562 106, INDIA</p> <p style="text-align: center;"><u>AF</u></p> <p>CAGE code: SEM10 1/</p>
<p>ANDERSON FORGE & MACHINE 18500 S. W. PACIFIC HWY TUALATIN, OR 97062</p> <p style="text-align: center;"></p> <p>CAGE code: 7X566 2/</p>	<p>ANOTHER SCREW MACHINE PRODUCT EMERALD INDUSTRIAL PARK BOX 425 PONDERAY, ID 83852</p> <p style="text-align: center;">BEI</p> <p>CAGE code: 05RQ3 2/</p>
<p>ANDROCK HARDWARE CORPORATION 711 19th STREET ROCKFORD, IL 61104</p> <p style="text-align: center;"></p> <p style="text-align: center;">FILLED OVAL, .10" WIDE, .19" LONG</p> <p>CAGE: 0PD50 1/</p>	<p>ANTRIM MACHINE PRODUCTS, INC. P.O. BOX 379 MANCERLONA, MI 49659</p> <p style="text-align: center;">Plant 9142 JOHNSON RD. MANCERLONA, MI 49659</p> <p style="text-align: center;"></p> <p>CAGE code: 7U154 1/</p>
<p>ANILLO INDUSTRIES, INC. 2090 N. GLASSELL P.O. BOX 5586 ORANGE, CA 92865-3306</p> <p style="text-align: center;"></p> <p>CAGE code: 10630 1/</p>	<p>A-ONE MACHINE COMPANY R.R.1, BOX 1660 HOP BOTTOM, PA 18824</p> <p style="text-align: center;"></p> <p>CAGE code: 0AV84 1/</p>

1/ Information published in this revision was verified by direct contact with manufacturers.

2/ Information not verified to be current, no response from manufacturer. Information identical to that published in MIL-HDBK-57, Revision B.

MIL-HDBK-57G (IS)

APEL LTD.
 COUNTESS AVE., STANLEY GREEN
 TRADING ESTATE
 CHEADLE HULME, CHESHIRE, SK8 6QU
 UNITED KINGDOM



CAGE code: K5640

2/

APEX MFG. CO. INC.
 11686 TUXFORD ST
 SUN VALLEY, CA 91352-3134

AP

CAGE code: 2V343

1/

APHEONIX CORPORATION
 101 PECK HILL ROAD
 JOHNSTON, RI 02919

AP

PC

CAGE code: 08TF3

2/

ARCHER SCREW PRODUCTS
 11341 MELROSE STREET
 FRANKLIN PARK, IL 60131



CAGE code: 1HXL9

2/

ARCO SALES CO.
 2211 WAKELING STREET
 P.O. BOX 23001
 PHILADELPHIA, PA 19137-1214

ASC
 ASC

CAGE code: 5L063

1/

ARDOR MFG. INC.
 400 S. 1100 W.
 PROVO, UT 84603



CAGE code: 0CTH5

2/

ARGARWAL INDUSTRIES
 370 MARSHALL HOUSE
 25 STRAND ROAD
 CALCUTTA, INDIA 700 001



CAGE code:

2/

1/ Information published in this revision was verified by direct contact with manufacturers.

2/ Information not verified to be current, no response from manufacturer. Information identical to that published in MIL-HDBK-57, Revision B.

MIL-HDBK-57G (IS)

ARJAY PRECISION, INC.
524 SULLIVAN AVE
SUITE 15
SOUTH WINDSOR, CT 06074

MFR - 72905

CAGE code: 72905

2/

ARMSTRONG ATLAS BOLT
STATION STREET
DARLASTON, WEST MIDLANDS, WS10 8UL
GREAT BRITIN

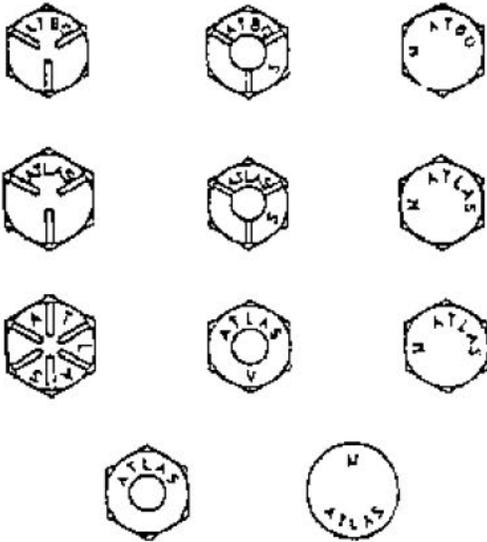

CAGE code:

2/

ARMSTRONG FASTENING SYSTEMS
FOSTER STREET STONEFERRY
BUSINESS PARK
HULL, GREAT BRITIAN, HU8 8BT
UNITED KINGDOM



Symbol may
be depressed
or raised

CAGE code: K1012

2/

(Continued)

(Continued)

ARMSTRONG FASTENINGS LTD.
FOSTER STREET STONEFERRY
BUSINESS PARK
HULL, GREAT BRITIAN, HU8 8BT
UNITED KINGDOM

GSF

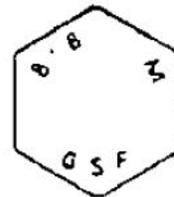

CAGE code: K1012

2/

1/ Information published in this revision was verified by direct contact with manufacturers.

2/ Information not verified to be current, no response from manufacturer. Information identical to that published in MIL-HDBK-57, Revision B.

MIL-HDBK-57G (IS)

ARNOLD KNIPPING GmbH
58557 KIERSPE
POSTFACH 14 48
GUMMERSBACH, GERMANY 5270

AK
KNIPPING

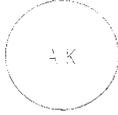

CAGE code: C4096

2/

ARNOLD UMFORMTECHNIK
GMBH & CO. KG
SINDRINGEN STR. 25
FORCHTENBERG, 74670
GERMANY

A

CAGE code: C3705

2/

ARNOLD WRAGG (BOLTS & NUTS) LTD
STANNINGTON ROAD
STANNINGTON, SHEFFIELD
ENGLAND, UK S6 6AG

AW

CAGE code: U2935

2/

ARROW SCREW & MACHINE WORKS
1037 GERMANTOWN AVENUE
PHILADELPHIA, PA 19123-1629



CAGE code: 03632

2/

ARTISAN SPECIALIST TECH, INC.
439 HIGH STREET
P.O. BOX 48060
PHILADELPHIA, PA 19144



CAGE code: 0RJ65

1/

ARVAN, INC.
14083 S NORMANDIE AVE
GARDENA, CA 90249

ARVAN, INC.

TANSEY

A/I

CAGE code: 29965

2/

ASAHI SREWS MANUFACTURING CO., LTD
101 KAWAMATA
HIGASHIOSAKA, JAPAN

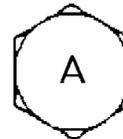

CAGE code:

2/

1/ Information published in this revision was verified by direct contact with manufacturers.

2/ Information not verified to be current, no response from manufacturer. Information identical to that published in MIL-HDBK-57, Revision B.

MIL-HDBK-57G (IS)

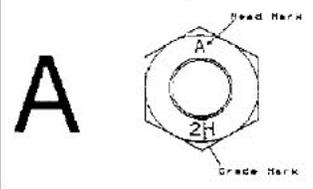
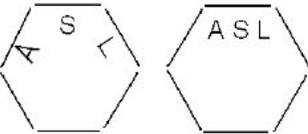
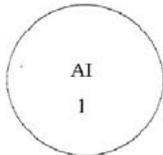
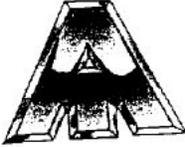
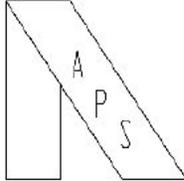
<p>ASAI TEKKO CO. LTD 2-14 TAJIKA SHODKAI HIRKATA-SHI OSAKA, JAPAN 573</p>  <p>CAGE code: <u>2/</u></p>	<p>AST ASSOCIATES, INC. 14 BETHEL ROAD GRISWOLD, CT 06351</p>  <p>CAGE code: 0WVW0 <u>1/</u></p>
<p>ASI DESIGN & MANUFACTURING, INC. 1070 HARDEES DRIVE P. O. BOX 957 ABERDEEN, MD 21001</p>  <p>CAGE code: 32971 <u>2/</u></p>	<p>ATF, INC. (formerly Accurate Threaded Fasteners, Inc.) 3550 WEST PRATT AVENUE LINCOLNWOOD, IL 60712</p>  <p>CAGE code: 95110 <u>1/</u></p>
<p>ASL MANUFACTURING INC. 60 S. POSADO CT. IVINS, UT 84738</p> <p>Plant 1074 W. 560N. ST. GEORGE, UT 84770</p>  <p>CAGE code: 1VED5 <u>1/</u></p>	<p>ATHENA INDUSTRIES 11710 SOUTHLAKE DRIVE, UNIT 57 HOUSTON, TX 77077</p>  <p>CAGE CODE: 5YJF9 <u>1/</u></p>
<p>ASSOCIATED TOOL CO., INC. 100 THOMAS DRIVE GADSDEN, AL 35901</p>  <p>CAGE code: 2U575 <u>2/</u></p>	<p>ATLANTIC PRECISION SPRING INC. 125 RONZO RD. BRISTOL, CT 06010</p>  <p>CAGE code: 6D788 <u>1/</u></p>

1/ Information published in this revision was verified by direct contact with manufacturers.

2/ Information not verified to be current, no response from manufacturer. Information identical to that published in MIL-HDBK-57, Revision B.

MIL-HDBK-57G (IS)

ATLAS ENGINEERING, INC.
(PENN ENGINEERING AND MFG. CO.)
5190 OLD EASTON RD.
DANBORO, PA 18916



CAGE code: 46384

1/

ATLAS SPECIALTY PRODUCTS
(SEE CURTIS PRESTON ENTERPRISES
INC.)
2299 E. WINSTON ROAD
ANAHEIM, CA 92806

ASP

CAGE code: 0TP31

1/

AUGUST FRIEDBERG GMBH
BELFORTER STRASSE 63
P. O. BOX 10 08 43
GELSENKIRCHEN, GERMANY 45884



AF

CAGE code:

2/

AUGUST FRIEDBERG GmbH
BELFORTER STRASSE 63
D-4650 GELSENKIRCHEN
ROTTHAUSEN, GERMANY

FRIEDBERG

CAGE code:

2/

AUTO BOLT AND NUT CO.
4619 PERKINS AVE
CLEVELAND, OH 44103

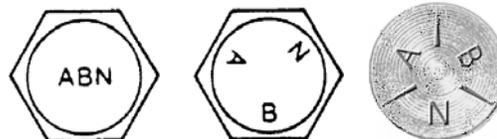

CAGE code: 0CUJ9

1/

AUTOMATED MANUFACTURING
8009 AUGUSTA ROAD
PIEDMONT, SC 29673-9369

AM

CAGE code: 1URY9

2/

AUTOMATIC MACHINING AND MFG CO
DBA AMMAC INC
6000 SUSQUEHANNA PLZ
YORK, PA 17406



CAGE code: 0NHU1

2/

AUTOMATIC MANUFACTURING COMPANY
300 SHADELAND AVENUE
EAST PITTSBURGH, PA 15112-1499



CAGE code: 18362

1/

1/ Information published in this revision was verified by direct contact with manufacturers.

2/ Information not verified to be current, no response from manufacturer. Information identical to that published in MIL-HDBK-57, Revision B.

MIL-HDBK-57G (IS)

AUTOMATIC SCREW MACHINE
PRODUCTS CO.
709 2ND AVE
P.O. BOX 1608
DECATUR, AL 35601

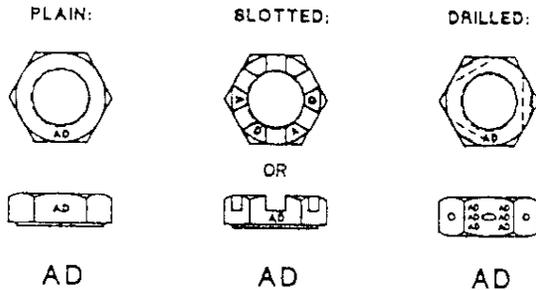

CAGE code: 92595

1/

AVIATION MANUFACTURING GROUP LLC
(SEE DBA FREEMAN CO., THE)
719 WALNUT ST
P. O. BOX 57
YANKTON, SD 57078-3542

F

CAGE code: 84596

1/

AUTO SCREW, INC.
LYNBROCK RD. & EASTERN BLVD.
P.O. BOX 4968
BALTIMORE, MD 21220

⌘

CAGE code: 84253

2/

AVDEL INTERNATIONAL (AVDEL LTD)
HERTFORD, AL 7 1EZ
GREAT BRITIAN

A

CAGE code:

2/

AVIBANK MANUFACTURING, INC.
PRECISION CASTPARTS CORP.
4650 SW MACADAM AVE. SUITE 440
PORTLAND, OR 97239-4262

Plant

AVIBANK MFG., INC.

11500 SHERMAN WAY, P.O. BOX 9909
NORTH HOLLYWOOD, CA 91609-1909**AB****ADB, ADBB, ADP, LRA****AAP****AS****AV****AVIBANK, BALL-LOK®,****BLC, BLS, PIP****AVL****AVK, ET, ETC, FN, IT,****ITC, MT, RT****ST****84256**

CAGE code: 84256

1/

^{1/} Information published in this revision was verified by direct contact with manufacturers.

^{2/} Information not verified to be current, no response from manufacturer. Information identical to that published in MIL-HDBK-57, Revision B.

MIL-HDBK-57G (IS)

AVK INDUSTRIES PRODUCTS INC.
4650 SW MACADAM AVE. SUITE 440
PORTLAND, OR 97239-4262

Plant
25323 RYE CANYON RD
VALENCIA, CA 91355

AVK AVK AVK AVK

AK AvK AVK 

CAGE code: 78276

1/

AZTECH ENGINEERING, INC.
1424 CENTRE CIR.
DOWNERGROVE, IL 60515



CAGE code: 0W426

2/

AZTECH LOCKNUT COMPANY
2675 WHITE OAK CIRCLE
AURORA, IL 60502

Orange nylon insert



CAGE code: 5CQW8

1/

B & B SPECIALTIES INC.
4321 E. LAPLMA AVE.
ANAHEIM, CA 92807

(see GS AEROSPACE)

- 1) PRIMARY - **BB**
2) SECONDARY - **62206**

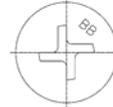

CAGE code: 0ZZU0

1/

Raised BB is for new manufactured parts.
Depressed BB is for old stock.

CAGE code: 62206

1/

B & D THREADED ROLLING
36820 VAN BORN ROAD
P.O. BOX 275
WAYNE, MI 48184



CAGE code: 00LR8

1/

B & E MACHINE SHOP & SHEET METAL
FAB., INC.
3059 SE MONROE ST.
STUART, FL 34997



CAGE code: 8W179

2/

B & E MANUFACTURING CO., INC.
7562 ORANGEWOOD AVE.
STANTON, CA 90680-3498



CAGE code: 59680

1/

1/ Information published in this revision was verified by direct contact with manufacturers.

2/ Information not verified to be current, no response from manufacturer. Information identical to that published in MIL-HDBK-57, Revision B.

MIL-HDBK-57G (IS)

B & G MANUFACTURING CO., INC.
3067 UNIONVILLE PIKE
P.O. BOX 269
HATFIELD, PA 19440-1822

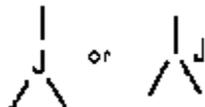

Grade 5

JB7 Grade B7
JB16 Grade B16
JNC Alloy 400



Alloy 500

J4 Grade 4
J2H Grade 2H

CAGE code: 84272 2/

B & N TOOL CO., INC.
44 ROCKWELL RD.
NEWINGTON, CT 06111



CAGE code: 0CMJO 2/

B & R MACHINE AND TOOL CORP
717 MAIN STREET
WESTBURY, NY 11590

BR

CAGE code: 66936 1/

B F GOODRICH CO. RIVNUT ENGINEERED
FATSENERS, THE
AEROSPACE AND DEFENSE DIVISION
250 NORTH CLEVELAND-MASSILLION RD.
AKRON, OH 44313

Plant
150 SPRINGSIDE DRIVE
AKRON, OH 44313-0501

BFG+

CAGE code: 2/

B G ENGINEERING, INC.
205 ARENA STREET
EL SEGUNDA, CA 90245



CAGE code: 0WL62 2/

B G M FASTENER CO., INC.
RR 5 BOX 1675
759 OLD WILLOW AVENUE
HONESDALE, PA 18431



CAGE code: 3Y498 1/

1/ Information published in this revision was verified by direct contact with manufacturers.

2/ Information not verified to be current, no response from manufacturer. Information identical to that published in MIL-HDBK-57, Revision B.

MIL-HDBK-57G (IS)

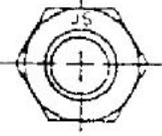
<p>B. V. FABRIEK VAN KLINKNAGELS EN SCHROEFBOUTEN V/H SMIT 2980 GB RIDDERKIRK P.O. BOX 4075 THE NETHERLANDS</p>  <p>JS</p> <p>CAGE code: <u>2/</u></p>	<p>BAS AEROSPACE LIMITED 2 CRAMPTONS ROAD SEVENOAKS, KENT N14 5EF UNITED KINGDOM</p>  <p>CAGE code: KCWE1 <u>1/</u></p>
<p>BARCO ENGINEERING COMPANY, INC. 505 W MAIN ST TILTON, NH 03276</p>  <p>CAGE code: 29214 <u>2/</u></p>	<p>BAUER & SCHAURTE KARCHER GMBH FURTHER STRASSE 24-26 POSTFACH 10 01 55 D-4040 NEUSS 1 FEDERAL REPUBLIC OF GERMANY</p>  <p>INBUS[®]</p> <p>VERBUS[®] KARRO[®]</p> <p>CAGE code: D2370 <u>2/</u></p>
<p>BARNEGAT BAY NSCC, INC. DBA BB NSCC, INC. 6432 DEVONSHIRE DR. FORT WORTH, TX 76180</p>  <p>CAGE code: 1SDGE <u>1/</u></p>	<p>BAY BOLT 4610 MALAT STREET OAKLAND, CA 94601</p> <p>CAL</p> <p>CAGE code: N/A <u>1/</u></p>
<p>BARRE PRECISION PRODUCTS INC. 199 HOPRIVER ROAD RTE. 6 BOLTON, CT 06043-7443</p>  <p>CAGE code: 7R902 <u>1/</u></p>	

1/ Information published in this revision was verified by direct contact with manufacturers.

2/ Information not verified to be current, no response from manufacturer. Information identical to that published in MIL-HDBK-57, Revision B.

MIL-HDBK-57G (IS)

BBC FASTENERS, INC.
4210 SHIRLEY LANE
ALSIP, IL 60658

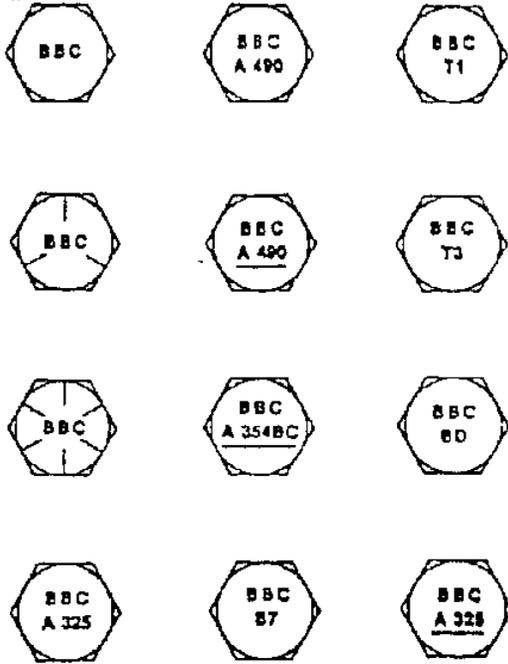

BBC

CAGE code: 2/

BEACH MACHINE
819 WALKER LN
NEW MARKET, AL 35761



CAGE code: 0TCDO 2/

BEAVER PRODUCTS CORP.
P.O. BOX 17279
ANAHEIM, CA 92817

B.P.C.

CAGE code: 4P584 2/

BEC MACHINE PRODUCTS COMPANY
171 RUTH ROAD
HARLEYSVILLE, PA 92806

BEC

CAGE code: 0JC12 2/

BEE INDUSTRIES, INC.
(WISCONSIN CORPORATION)
W6331 BEE ROAD
WATERTOWN, WI 53098

BI

CAGE code: 7V765 2/

BEGONIA TOOL COMPANY
53 MADISON RD
HERMINIE, PA 15637

BT

CAGE code: OL3V3 2/

1/ Information published in this revision was verified by direct contact with manufacturers.

2/ Information not verified to be current, no response from manufacturer. Information identical to that published in MIL-HDBK-57, Revision B.

MIL-HDBK-57G (IS)

BEK LEVEL 1 FASTENERS
300 THIRD AVE
HUNTINGTON, WV 25701

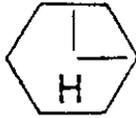

300 Series Stainless Steel



Type 316 Stainless Steel

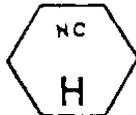

Nickel Copper (Monel)



Silicon Bronze

BEK LEVEL 1 FASTENERS
721 EAST COMPTON BOULEVARD
COMPTON, CA 90220

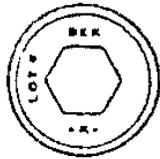

BEK

CAGE code:

2/

BEL-AIR MACHINE & PERFORMANCE
14181 FIR ST.
OREGON CITY, OR 97045



CAGE code: 5SJL1

1/

BELL FASTENERS (ALBANY
FASTENERS/PAWTUCKET FASTENER
DIVISION)
327 PINE STREET
PAWTUCKET, RI 02862

S

STILLWATER

B

BELL

PMC

PAWTUCKET MANUFACTURING CO.

P

PAWTUCKET

A

ALBANY

SW

ON TOP OF SCREW



(two dots) On the top of or bearing surface
of the screw

(SEE VERTEX)

CAGE code: 12360

2/

1/ Information published in this revision was verified by direct contact with manufacturers.

2/ Information not verified to be current, no response from manufacturer. Information identical to that published in MIL-HDBK-57, Revision B.

MIL-HDBK-57G (IS)

BELL PRECISION, INC.
131 N. DILLON AVE.
SAN JACINTO, CA 92383

BP

CAGE code: 56122 2/

BELL-MEMPHIS, INC.
1650 CHANNEL AVE
MEMPHIS, TN 38113-01871



CAGE code: 22277 1/

BEN YUAN ENTERPRISE CO, LTD.
NO. 113, CHI-NAN ROAD
TAI-SHIA VILLAGE, KAOHSIUNG HSIEN,
TAIWAN R. O. C.

BY

CAGE code: 2/

BENACO TOOLING RESEARCH & DEV.
CORP.
9287 MERCANTILE DR
MENTOR, OH 44060

BENACO

CAGE code: 5W644 2/

BEOTOOL CORP.
725 WHITNEY DR
BLUE BELL, PA 19422-1205

BOT

CAGE code: 2N084 2/

BERGNER, RICHARD GMBH & CO.
BAHNHOFSTRAUSSE 8-16
P.O. BOX 1180
SCHWABACH, 91126
GERMANY



RIBE

Where required and applicable, these fasteners types are also marked with the logo "RIBE" and/or capital "B" with screw in circle.

RIBE 
multiform

RIBE 
hombi

RIBE 
triform

RIBE 
triform db

RIBE 
plastroform

RIBE 
spertform

CAGE code: D2282 2/

1/ Information published in this revision was verified by direct contact with manufacturers.

2/ Information not verified to be current, no response from manufacturer. Information identical to that published in MIL-HDBK-57, Revision B.

MIL-HDBK-57G (IS)

<p>BER-LOW MFG INC. DBA BUTECH PRESSURE SYSTEMS 4928 PITTSBURGH AVE ERIE, PA 16509</p>  <p>CAGE code: 62295 <u>2/</u></p>
<p>BERRY, JOHN DBA BERRY MANUFACTURING 5505 BREWSTER ST SAN ANTONIO, TX 78233</p> <p style="text-align: center;">BM</p> <p>CAGE code: 65003 <u>1/</u></p>
<p>BERRY MANUFACTURING 1090 HWY 72, BOX 336 GOLDEN, CO 80403</p> <p style="text-align: center;">BM</p> <p>CAGE code: 65003 <u>1/</u></p>
<p>BET-LAR SERVICES</p> <p>See UPSTART ACQUISITIONS, CORP</p> <p style="text-align: right;"><u>1/</u></p>
<p>BETA CORP. 2332 S DELAWARE ST DENVER, CO 80223 - 4321</p>  <p>CAGE code: 06671 <u>2/</u></p>

<p>BETA ENGINEERING, INC. P.O. BOX 80 468 DODSON LAKE DRIVE ARLINGTON, TX 76012-3441</p>  <p>CAGE code: 33436 <u>1/</u></p>
<p>BIG BOLT CORP. 140 COVINGTON DRIVE BLOOMINGDALE, IL 60108-3105</p> <p style="text-align: center;">BB</p> <p style="text-align: center;"><u>BB</u></p> <p style="text-align: center;"><u>BB</u></p> <p style="text-align: center;">•</p> <p style="text-align: center;"><u>BB</u></p> <p style="text-align: center;">•</p> <p style="text-align: center;"><u>BB</u></p> <p style="text-align: center;">•</p> <p>CAGE code: 3Q6H0 <u>1/</u></p>
<p>BISHOP ENTERPRISES, INC. 10 EAST BISHOP ST. WATERFORD, CT 06385</p>  <p>CAGE code: 6Y882 <u>2/</u></p>

1/ Information published in this revision was verified by direct contact with manufacturers.

2/ Information not verified to be current, no response from manufacturer. Information identical to that published in MIL-HDBK-57, Revision B.

MIL-HDBK-57G (IS)

BLAINE TOOL CORP.
5024 FALL CREEK RD
INDIANAPOLIS, IN 46220-5344



CAGE code: 17027

2/

BLANC AERO INDUSTRIES
see LISI AEROSPACE

BLANC AERO INDUSTRIES
193 R DE BERCY
PARIS, FRANCE 75012

BLANC AERO INDUSTRIES
Saint Chamond Granat
18 20 Rue S-Hilaire
Saint Ouen L'Aumone, France 95310

7 (Sr Brieuc)
B (Paris)
P (Villefranche de
Rouergue)

ds. F

BLANC AERO INDUSTRIES
18,20 RUE ST. HILAIRE
SAINT OUEN L'AUMONE, FRANCE
95310

T

BLANC AERO INDUSTRIES
DECOLLETAGE MODERNE
5 BIS, PLACE LEON BLUM
75020- PARIS
FRANCE

DDG

CAGE code: F0188

2/

BLANC AIRCRAFT FASTENERS, INC.
203020 PRARIE ST
P.O. BOX 3819
CHATSWORTH, CA 91842



BAF

CAGE code:

2/

BLAND CO., THE
55 BROOK ST
P. O. BOX 330358
WEST HARTFORD, CT 06133

BL

CAGE code: 02991

1/

BLUE SKY INDUSTRIES, INC.
1230 MONTEREY PASS ROAD
MONTEREY PARK, CA 91754-3617

No Logo Listed

CAGE code: 1BRD5

2/

BLUE TEE CORP DBA GEFCO/ STECO
2215 S. VAN BUREN ST.
ENID, OK 73703-8218



CAGE code: 21363

2/

1/ Information published in this revision was verified by direct contact with manufacturers.

2/ Information not verified to be current, no response from manufacturer. Information identical to that published in MIL-HDBK-57, Revision B.

MIL-HDBK-57G (IS)

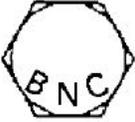
<p>BOBCAT MANUFACTURING CO. (PLANT) PECK HILL ROAD JOHNSTON, RI 02919</p>   <p>CAGE code: 8H536 <u>2/</u></p>	<p>BOLT FASTENER STUD/TECHNOLOGY 118 W NUGENT ST P.O. BOX 2569 LANCASTER, CA 93535</p> <p>Plant 210 EAST AVENUE LANCASTER, CA 93539</p>  <p>CAGE code: 31386 <u>2/</u></p>
<p>BOGNER ENGINEERING CO. 705 N. SPRINGFIELD STREET P. O. BOX 510 BERRYVILLE, AR 72616</p>  <p>CAGE code: 04BV8 <u>2/</u></p>	<p>BOLTWORKS, INC. 2150 WOODLAND WARRENDALE, PA 15086-7536</p>  <p>CAGE code: 3LYS4 <u>1/</u></p>
<p>BOLLHOFF & CO. GmbH & CO. KG ARCHIMDESTASSE 1-4 BIELEFELD, D-4800 14 GERMANY</p>  <p>CAGE code: <u>2/</u></p>	<p>BOMAR ENGINEERING, INC. 13385 PHILLIPPI AVE. SYLMAR, CA 91342</p>  <p>CAGE code: 3U494 <u>2/</u></p>
<p>BOLT & NUT CO. PARK LANE EAST TIPTON, WEST MIDLANDS, DY4 8RF GREAT BRITIAN</p>  <p>CAGE code: <u>2/</u></p>	<p>BOMBSHELL, INC. 9565 PATHWAY ST. #B SANTEE, CA 92071</p> <p>509W0</p> <p>CAGE code: 509W0 <u>1/</u></p>

1/ Information published in this revision was verified by direct contact with manufacturers.

2/ Information not verified to be current, no response from manufacturer. Information identical to that published in MIL-HDBK-57, Revision B.

MIL-HDBK-57G (IS)

BONEAL INC.
P.O. BOX 49
MEANS, KY 40346

Plant
126 INDUSTRIAL PARK RD.
MEANS, KY 40346

B N C
G

CAGE code: 5X802 1/

BRACELENTE MANUFACTURING CO., INC.
20 WEST CREAMERY ROAD
P.O. BOX 570
TRUMBAUERSVILLE, PA 18970-0570

BMC INC.

CAGE code: 2Y035 1/

BRADY MACHINE, INC.
6125 SKY ROAD
JOSHUA, TX 76058-4048

B M **B M**

CAGE code: 1HLW8 1/

BRANCH MACHINE PARTS, INC.
2419 EMPIRE AVE
BURBANK, CA 91504

BMP

CAGE code: 2/

BRIARWOOD FASTENERS, INC.
9701 OWENSMOUTH AVE.
UNIT 8
CHATSWORTH, CA 91311-4814

BFI

CAGE code: 3N278 1/

BRIDEAN MACHINE & TOOL CO., INC.
155 BANGOR STREET
LINDENHURST, NY 11757-3632

BRI
1

CAGE code: 1S023 1/

BRIDGEVIEW MANUFACTURING CO.
(ILLINOIS CORPORATION)
7320 S. FERDINAND AVENUE
BRIDGEVIEW, IL 60455-1111

BVB

CAGE code: 0ALM2 1/

BRIGHT LIGHTS USA, INC.
145 SHREVE AVE.
BARRINGTON, NJ 08007

BL

CAGE code: 0RMF7 1/

1/ Information published in this revision was verified by direct contact with manufacturers.

2/ Information not verified to be current, no response from manufacturer. Information identical to that published in MIL-HDBK-57, Revision B.

MIL-HDBK-57G (IS)

BRINTCLIFFE TURNER LTD.
CRAMPTONS ROAD
SEVENOAKS, KENT, TN14 5DS
GREAT BRITAIN

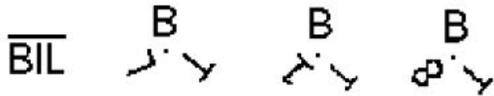

CAGE code: 2/

BRISTOL INDUSTRIES
630 EAST LAMBERT RD.
BREA, CA 92821

B+ CAPITAL B FOLLOWED BY PLUS SIGN
RAISED OR DEPRESSED

BI CAPITAL B FOLLOWED BY CAPITAL I
USED FOR EUROPEAN PARTS ONLY
RAISED OR DEPRESSED

● ● TWO ADJACENT DOTS
RAISED OR DEPRESSED



TWO ADJACENT DOTS
RAISED OR DEPRESSED

B - old callout no longer used on
new product

CAGE code: 27238 1/

BRISTOL LOCKNUT CO. (NUT DIVISION)
32451 N. AVIS DRIVE
MADISON HEIGHTS, MI 48071



CAGE code: 2/

BROADSTONE TOOL & DIE, INC.
R #1, BOX 986
MCARTHUR, OH 45651



CAGE code: 4Z678 2/

BROADWAY SCREW MACHINE INC.
64 NANCY ST. UNIT B
WEST BABYLON, NY 11704



CAGE code: 5CZ56 1/

BROWN PRODUCTION, INC.
804 W MEEKER ST.
KENT, WASHINGTON 98032-5702



CAGE code: 2D069 2/

1/ Information published in this revision was verified by direct contact with manufacturers.

2/ Information not verified to be current, no response from manufacturer. Information identical to that published in MIL-HDBK-57, Revision B.

MIL-HDBK-57G (IS)

BRUNNER DRILLING & MFG. CO., INC.
405 ELROY ST.
P.O. BOX 137
ELROY, WI 53929

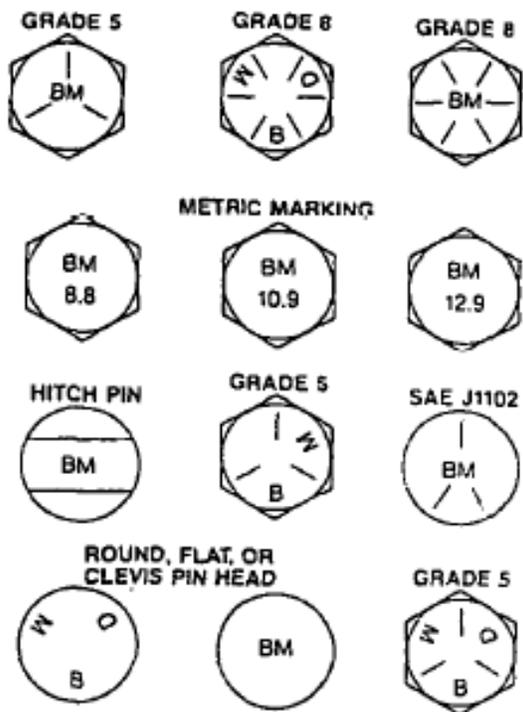

CAGE code: 24407 1/

BRUNNER MANUFACTURING CO.
DBA BRUNNER MANUFACTURING
DIVISION
1025 PARKER DR
MAUSTON, WI 53948 9381

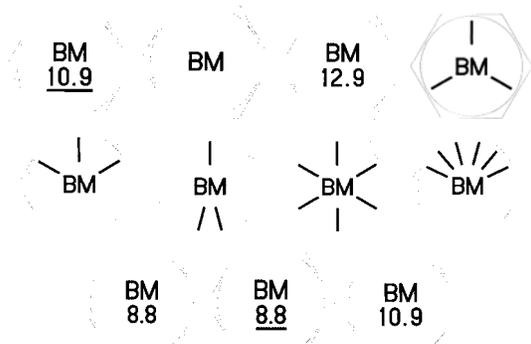

CAGE code: 3B7H2 1/

BRYCO MACHINE, INC.
7800 GRAPHICS DRIVE
TINLEY PARK, IL 60477

BM

CAGE code: 1WCD4 1/

BRYNOLF MANUFACTURING, INC.
5459 11TH STREET
ROCKFIRD, IL 61109

b

CAGE code: 4P7Y2 1/

BUCK EYE FORGE, INC.
11700 HARVARD AVE
CLEVELAND, OH 44105



CAGE code: 71177 2/

BUCKEYE MACHINING, INC.
25020 LAKELAND BLVD.
CLEVELAND, OH 44132



CAGE code: 8X808 2/

1/ Information published in this revision was verified by direct contact with manufacturers.

2/ Information not verified to be current, no response from manufacturer. Information identical to that published in MIL-HDBK-57, Revision B.

MIL-HDBK-57G (IS)

BUFFALO PUMPS, INC.
 (SUBSIDIARY OF AMPCO-PITTSBURGH
 CORP.)
 874 OLIVER STREET
 NORTH TONAWANDA, NY 14120-3210

BP

CAGE code: 83130

2/

BULA FORGE INC.
 2987 E 87TH ST
 CLEVELAND, OH 44104-4

BULA

CAGE code:

2/

BULTEN TRADING AB
 P.O. BOX 516
 734 01 HALLSTAHAMMAR
 SWEDEN

Bulten Stainless AB
 Ashammar Works
 810 25 Ashammar
 Sweden

Bulten Stainless AB
 Svartå Works
 710 11 Svartå
 Sweden

BH

BULTEN AB

BUFO

BULTEN AB

SÅ

BULTEN STAINLESS AB

CAGE code: N8286

2/

BURROWS RESEARCH MACHINING,
 INC.
 43 BRADFORD STREET
 P.O. BOX 1130
 CONCORD, MA 01742

BRM

CAGE code:

2/

^{1/} Information published in this revision was verified by direct contact with manufacturers.

^{2/} Information not verified to be current, no response from manufacturer. Information identical to that published in MIL-HDBK-57, Revision B.

MIL-HDBK-57G (IS)

BUSAN INDUSTRIAL MACHINERY CO.,
LTD.
BOLT DIVISION
456-9, NAE-DONG, CHANGWON
KYEONGSANGNAM-DO, KOREA

BM**BIM**CAGE code: 2/

BUTECH PRESSURE SYSTEMS
4928 PITTSBURGH AVE
ERIE, PA 16509

See BER-LOW MFG INC

BPSCAGE code: 62295 2/

BUTLER, INC.
1600 WEST 166TH STREET
GARDENA, CA 90247

JBCAGE code: 59053 1/

C & A MACHINE CO.
49 PROGRESS CIRCLE
NEWINGTON, CT 06111

CACAGE code: 1HXE7 1/

C & D MACHINE TOLL, INC.
726 COURT STREET
SPRINGFIELD, OH 45506

**C&D
MACH**CAGE code: 064X3 1/

C & H MFG., INC.
4280 E LOWELL ST
ONTARIO, CA 91761-1529

30633CAGE code: 30633 2/

C & S ENGINEERING LLC
15401 CARMENITA DR. (N)
SANTA FE SPRINGS, CA 90670

CSCAGE code: 4ZH03 1/1/ Information published in this revision was verified by direct contact with manufacturers.2/ Information not verified to be current, no response from manufacturer. Information identical to that published in MIL-HDBK-57, Revision B.

MIL-HDBK-57G (IS)

C. E. MACHINE CO., INC.
1741 SOUTH LEONINE
WICHITA, KS 67209-2813

MFR 3L665

CAGE code: 3L665

2/

C.E.S. MACHINE PRODUCTS, INC
8880 DOUBLE DIAMOND PKWY
RENO, NV 89521-5908

CES

CAGE code: 1WF66

2/

C. J.'S GENERAL MACHINE WORKS
15406 FOREST MIST
SAN ANTONIO, TX 78232-4137



CAGE code: 7W334

2/

C.R.D. MACHINING
366 W. 131ST ST.
LOS ANGELES, CA 90248

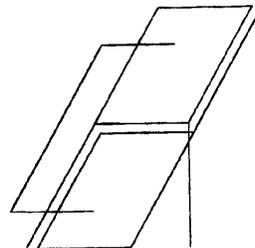

CAGE code: 1LA52

2/

CALABRESE & SONS, INC.
406 BRANDY LANE
P.O. BOX 1667
MECHANICSBURG, PA 17055-2800

C+SI

CAGE code: 07310

1/

1/ Information published in this revision was verified by direct contact with manufacturers.

2/ Information not verified to be current, no response from manufacturer. Information identical to that published in MIL-HDBK-57, Revision B.

MIL-HDBK-57G (IS)

CALIFORNIA SCREW PRODUCTS CORP.
 P.O. BOX 228
 PARAMOUNT, CA 90723

Plant
 14957 GWENCHRIS AVE.
 PARAMONT, CA 90723-3423

CS

C S

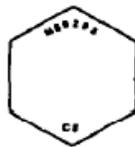

HEX. HEAD



HEX. HEAD

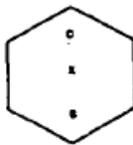

HEX. HEAD

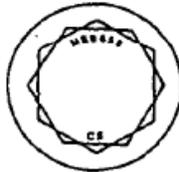

TWELVE POINTS



FLAT HEAD
PAN HEAD
ROUND HEAD
 (ALL TYPES OF RECESSED)

CAGE code: 8Z507

1/

CAMBRIDGE SPECIALTY COMPANY, INC.
 DBA POINT MACHINE CO.
 588 FOUR ROD RD
 BERLIN, CT 06037-2280



CAGE code: 9E232

2/

CAMCAR DIVISION OF TEXTRON INC.
 600 18th Ave.
 Rockford, IL 61101

Plant
 AMSCO PRODUCTS
 1818 CHRISTINA ST
 ROCKFORD, IL 24382
 CAGE code: 01536

Head markings

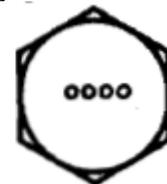

Vendor identification, "A" or four dots raised or depressed located as shown.

Under head markings



Vendor identification, four dots radially located as shown, depressed

CAGE code: 93907

2/

Continued

1/ Information published in this revision was verified by direct contact with manufacturers.

2/ Information not verified to be current, no response from manufacturer. Information identical to that published in MIL-HDBK-57, Revision B.

MIL-HDBK-57G (IS)

Continued

CAMCAR DIVISION OF TEXTRON INC.

Plant
 DRILLETITE PRODUCTS
 1304 KERR DR.
 DECORAH, IA 52101
 CAGE code: 0JMM5

Head markings

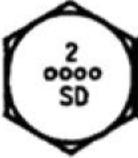

Vendor and customer
 Identification for stainless
 steel, drilled screws,
 raised or depressed

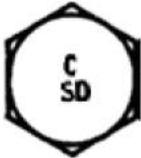

Vendor/Product
 Identification, raised or
 depressed
 Identifies "CAMCAR Self -
 Drilling Fastener."

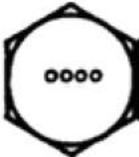

Vendor Identification,
 Four in-line dots, raised or
 depressed

Under head markings



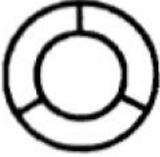

Vendor identification, four radial dots or three equally
 spaced radial lines, depressed

CAGE code: 93907 2/

Continued

Continued

CAMCAR DIVISION OF TEXTRON INC.

Plant
 RAYCARL PRODUCTS
 600 18th Ave.
 Rockford, IL 61101
 CAGE code: 6P253

Head markings





Vendor Identification, "CAMCAR" or four in-line dots,
 raised or depressed.

Under head markings



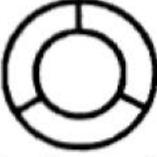

Vendor identification, four radial dots or three equally
 spaced radial lines, depressed

Plant
 ROCKFORD HEADED PRODUCTS
 29201 TELEGRAPH RD. SUITE 611
 SOUTHFIELD, IL 48034-1331

Head markings





Product Identification,
 "HP" raised or depressed

Product Identification,
 Four in-line dots, raised or
 depressed

Under head markings





Vendor identification, four radial dots or two parallel lines,
 raised or depressed

CAGE code: 6P253 2/

Continued

1/ Information published in this revision was verified by direct contact with manufacturers.

2/ Information not verified to be current, no response from manufacturer. Information identical to that published in MIL-HDBK-57, Revision B.

MIL-HDBK-57G (IS)

Continued
CAMCAR DIVISION OF TEXTRON INC.

Plant
SEMS PRODUCTS
1818 CHRISTINA ST
ROCKFORD, IL 61104
CAGE code: 01536

Head markings

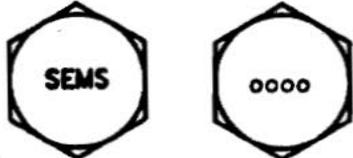

Vendor Identification, "SEMS" or four in-line dots, raised or depressed, located as shown.

Product Trademark Markings



INTERNAL TORX® RECESS
"TORX" and two dots raised or depressed, located as shown

EXTERNAL TORX® RECESS
"TORX" equally spaced on top of washer, raised or depressed.

TORXSTEM®
"TORX" equally spaced on END, raised or depressed.

Plant
SOCKET SCREW PRODUCTS
1302 KERR DRIVE
DECORAH, IA 52101
CAGE code: 0JMM5

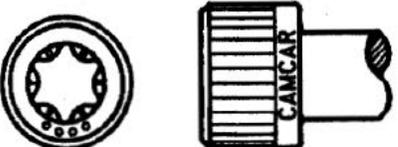

Letters "TORX" plus two dots raised or indented on recess countersink; locate as illustrated (Product Trademark)

Optional Identification, "CAMCAR", raised or indented as illustrated

Vendor Identification, Four radial dots raised or indented, located as shown

Continued 2/

Continued
CAMCAR DIVISION OF TEXTRON INC.

Plant
TAPTITE PRODUCTS
826 EAST MADISON ST
BELVIDERE, IL 61008

Head markings

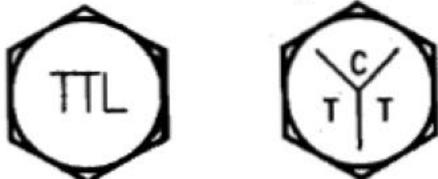

Product Identification, "TTL" raised or depressed

Vendor Identification, "CTY" and three radial lines, raised or depressed



Vendor Identification, Four in-line dots raised or depressed

Vendor Identification, three radial lines and circle, raised or depressed

Under head markings



Vendor identification, four radial dots or three equally spaced radial lines, depressed

Continued 2/

1/ Information published in this revision was verified by direct contact with manufacturers.

2/ Information not verified to be current, no response from manufacturer. Information identical to that published in MIL-HDBK-57, Revision B.

MIL-HDBK-57G (IS)

Continued

CAMCAR DIVISION OF TEXTRON INC.

Plant
 TORX PRODUCTS
 P.O. Box 607
 Rochester, IN 46975
 CAGE code: 6N040

Head markings

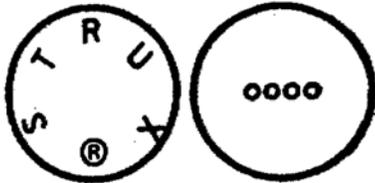

Product Identification, "STRUX ®" equally spaced raised or depressed or four in-line dots, raised or depressed.



Vendor Identification, superimposed "T" and "M" raised or depressed



Product Identification "f" and "t" located as shown, raised or depressed



Product Identification, TORX logo located as shown, raised or depressed.

Under head markings



Vendor Identification, four equally spaced radial lines, raised or depressed

Nut Markings

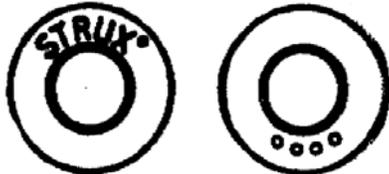

Product Identification, "STRUX ®" raised or depressed, located as shown or four radial dots, raised or depressed.

2/

CAMCAR LLC
 500 18TH AVENUE
 ROCKFORD, IL 61104

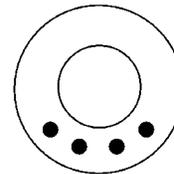

CAMCAR

CAGE code: 4WL75

1/

CAMCAR SCREW AND MFG CO DIV OF
 TEXTRON INC
 29201 TELEGRAPH RD., SUITE 611
 SOUTHFIELD, IL 48034 - 7649



PRODUCT IDENTIFICATION, "HP" RAISED OR DEPRESSED.



PRODUCT IDENTIFICATION, FOUR IN-LINE DOTS, RAISED OR DEPRESSED.

HEAD MARKINGS



VENDOR IDENTIFICATION, FOUR RADIAL DOTS, RAISED OR DEPRESSED.



VENDOR IDENTIFICATION, TWO PARALLEL LINES, RAISED OR DEPRESSED.

UNDER HEAD MARKINGS

CAGE code: 6P253

2/

1/ Information published in this revision was verified by direct contact with manufacturers.

2/ Information not verified to be current, no response from manufacturer. Information identical to that published in MIL-HDBK-57, Revision B.

MIL-HDBK-57G (IS)

CAMLOC PRODUCTS
AFS TORRANCE OPERATIONS
3014 WEST LOMITA BLVD.
TORRANCE, CA 90505-5103
CAGE code: 71286

AFS KELKHEIM OPERATIONS
INDUSTRIESTRASSE 6
D-65779 KELKHEIM, GERMANY
CAGE code: D0680

(Corporate office see ALCOA FASTENING SYSTEMS)

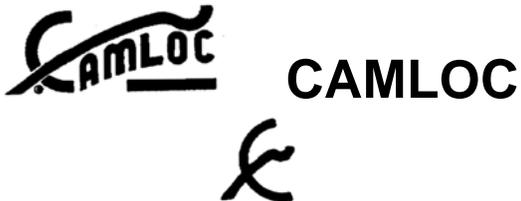

CAGE code: 71286, D0680

1/

CAM-TECH INDUSTRIES
95 ESTATES DR W
FAIRPORT, NY 14450-8425



CAGE code: 0GT70

2/

CANADY MANUFACTURING CO. INC.
500 FIFTH STREET
SAN FERNANDO, CA 91340-2225



CAGE code: 00678

2/

CAPRICE ENGINEERING CO., INC.
509 HINDRY AVE.
INGLEWOOD, CA 90301-2017



CAGE code: 52916

1/

CAPY MACHINE SHOP, INC.
114 SPAGNOLI ROAD
MELVILLE, NY 11747



CAGE code: 0BVP9

1/

CARDINAL FASTENER & SPECIALTY CO.,
INC.
5185 RICHMOND RD
BEDFORD HEIGHTS, OH 44146-1330

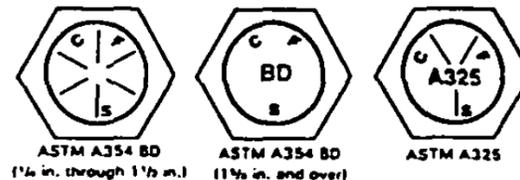

CAGE code: 2Y089

2/

1/ Information published in this revision was verified by direct contact with manufacturers.

2/ Information not verified to be current, no response from manufacturer. Information identical to that published in MIL-HDBK-57, Revision B.

MIL-HDBK-57G (IS)

CARDINAL INDUSTRIAL PRODUCTS
3873 WEST OQUENDO
LAS VEGAS, NV 89118-3010

C

A capital "C" to be applied to all standard ASME/ASTM bolting material.

MULTI-C

The word "MULTI" followed by a capital "C" to be applied to all ASME bolts manufactured to Nuclear Standards Associates or Cardinal Industrial Products, Inc. Standards.

CAGE code: 57454

2/

CARR CO.
(THE UNITED CARR DIV OF TRW)
31 AMES ST.
CAMBRIDGE, MA 02142



CAGE code: 78947

2/

CATALINA INSTRUMENT CORPORATION
44 SOUTH MALL
PLAINVIEW, NY 11803-4208

CI

CAGE code: 30225

1/

CBS FASTENERS INC.
1345 BRASHER STREET
ANAHEIM, CA 92807-2046

CBS
CbS

CAGE code: 0F620

1/

CCB INDUSTRIES, INC.
3200 STUART DRIVE
P.O. BOX 1158
FT. WORTH, TX 76101

CCB

CAGE code: 60763

1/

CCF ENTERPRISES INC.
2449 N.W. DALLAS STREET
GRAND PRARIE, TX 75050-4971

CCF

CAGE code: 08QQ4

2/

CEI INC.
DBA COMMAND ENTERPRISES
700 NORTH DELSEA DR
PITMAN, NJ 08071-1244

L-S-A

CAGE code: 6U479

2/

1/ Information published in this revision was verified by direct contact with manufacturers.

2/ Information not verified to be current, no response from manufacturer. Information identical to that published in MIL-HDBK-57, Revision B.

MIL-HDBK-57G (IS)

CELTECH ENTERPRISE
9774 CRESENT CTR DR
SUITE 506
RANCHO CUCAMONGA, CA 91730-5745



CAGE code: 0EFF7 2/

CENTERLINE TOOL & ENGINEERING, INC.
3107 29TH AVENUE E
BRADENTON, FL 34208-7420



Capital "C" and Capital "L" combined.

CAGE code: 0B5B0 2/

CENTRAL OZARK MACHINE, INC.
HWY 19 SOUTH & HH
P. O. BOX 347
ALTON, MO 65606-0347



CAGE code: 64896 2/

CENTRAL SCREW PRODUCTS
6425 EAST HILDALE
DETROIT, MI 48234



CAGE code: 1YCR3 1/

CENTURY METAL PARTS CORP.
230 SOUTH FEHRWAY
BAY SHORE, NY 11706-1208



CAGE code: 30396 1/

CER-MAC INC.
971 HORSHAM RD,
HORSHAM, PA 19044-1225



CAGE code: 53569 2/

CERNY MFG. CO.
4057 WEST 147TH STREET
LAWNDALE, CA 60260

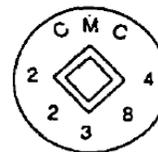

CMC ◊ 22384.

CAGE code: 22384 2/

1/ Information published in this revision was verified by direct contact with manufacturers.

2/ Information not verified to be current, no response from manufacturer. Information identical to that published in MIL-HDBK-57, Revision B.

MIL-HDBK-57G (IS)

CHAMPION COMMERCIAL INDUSTRIES,
INC
CHAMPION RIVET DIVISION
P.O. BOX 398
5137 INDIANAPOLIS BLVD
EAST CHICAGO, IN 46312-0398

V *Rivets only*

CAGE code: 4B951 2/

CHAMPION FASTENERS, INC.
707 SMITHVILLE RD
LUMBERTON, NJ 08048-5302

C

CAGE code: 0NXPO 1/

CHANCE, A.B. COMPANY
2201 LAKEVIEW RD
MEXICO, MO 65265-1360

C

CAGE code: 02TP8 2/

CHANDLER PRODUCTS, INC.
1491 CHARDON RD
CLEVELAND, OH 44117-1598

CP

CAGE code: 83386 1/

CHATHAM PRECISION, INC.
COMMERCE ST.
P.O. BOX 510
HINESBURG, VT 05461

4N133

CAGE code: 4N133 2/

CHEMIQUIP PRODUCTS COMPANY
56 2nd AVENUE
BROOKLYN, NY 11215



CAGE CODE: 99752 1/

CHEREK MACHINE & TOOL CO., INC.
835 SHERMAN AVENUE
HAMDEN, CT 06514-1149

CHEREK

CAGE code: 0YWD4 2/

CHEROKEE TOOL & ENGINEERING CO.,
INC.
P.O. BOX 227
CANTON, GA 30114

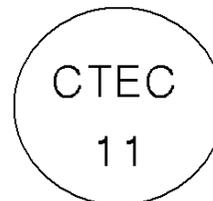

CAGE code: 30662 2/

1/ Information published in this revision was verified by direct contact with manufacturers.

2/ Information not verified to be current, no response from manufacturer. Information identical to that published in MIL-HDBK-57, Revision B.

MIL-HDBK-57G (IS)

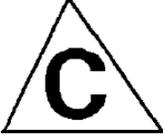
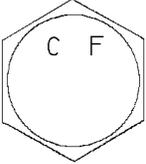
<p>CHIANG SHIN FASTENERS INDUSTRIES, LTD NO. 111 WANLI ROAD GANGSHAN TOWNSHIP, KAOHSIUNG COUNTRY 82050, TAIWAN (R.O.C)</p> <p> S</p> <p>(see Stelfast Inc.)</p> <p>CAGE code: SFV96 <u>1/</u></p>	<p>CHIEF MFG. 423B WEST FORK DRIVE ARLINGTON, TX 76012-3450</p> <p></p> <p>CAGE code: 00WU0 <u>1/</u></p>
<p>CHICAGO FASTENER MANUFACTURING 10902 WALNUT LANE MOKENA, IL 60448-8165</p> <p></p> <p>CAGE code: 05TL5 <u>1/</u></p>	<p>CHOICE PRECISION MACHINE, INC. 4280 COMMERCE DRIVE WHITEHALL, PA 18052</p> <p>CPM</p> <p>CAGE code: 1WAA0 <u>2/</u></p>
<p>CHICAGO HARDWARE & FIXTURE CO. 9100 PARK LANE FRANKLIN PARK, IL 60131-3054</p> <p>CHF</p> <p>CAGE code: 71747 <u>1/</u></p>	<p>CHRIS MACHINE CO. 110 DOYLE ST. DOYLESTOWN, PA 18901-1370</p> <p></p> <p>CAGE code: 2T317 <u>2/</u></p>
<p>CHICAGO NUT & BOLT INC. 150 COVINGTON DRIVE BLOOMINGDALE, IL 60108</p> <p>CNB</p> <p>CAGE code: 1C4D2 <u>1/</u></p>	<p>CHU HUA INDUSTRIAL CO., LTD. 800 FU SHING RD. LU CHU, KAOHSING, TAIWAN, 821 R.O.C.</p> <p></p> <p>UH</p> <p>CAGE code: <u>2/</u></p>

1/ Information published in this revision was verified by direct contact with manufacturers.

2/ Information not verified to be current, no response from manufacturer. Information identical to that published in MIL-HDBK-57, Revision B.

MIL-HDBK-57G (IS)

<p>CHUN YU WORKS & CO., LTD. 1 CIASHING KANGSHAN, TAIWAN</p> <p style="text-align: center;">L</p> <p>CAGE code: <u>2/</u></p>	<p>CLICK BOND, INC. 2151 LOCKHEED WAY CARSON CITY, NV 89706-0713</p> <p style="text-align: center;">CB</p> <p>CAGE code: 66530 <u>1/</u></p>
<p>CINCH MANUFACTURING 2610 S YALE ST SANTA ANA, CA 92704</p> <p style="text-align: center;">C</p> <p>CAGE code: <u>2/</u></p>	<p>CLYDE FASTENERS LIMITED 5 HAWBANK RD, EAST KILBRIDE, GLASGOW, SCOTLAND G74 5ET</p> <p style="text-align: center;">CFL</p> <p>CAGE code: <u>1/</u></p>
<p>CINCH-MONADNOCK 18301 ARENTH AVE CITY OF INDUSTRY, CA 91749</p> <p style="text-align: center;">● = (dot)</p> <p>CAGE code: <u>2/</u></p>	<p>CM MANUFACTURING, INC. 6333 BUTLER CREEK ROAD MISSOULA, MT 59808-8861</p> <p style="text-align: center;">CM</p> <p>CAGE code: 6Z056 <u>1/</u></p>
<p>CLEVELAND HARDWARE & FORGING DBA GREEN BAY DROP FORGE CO 1341 S. STATE ST P.O. BOX 11797 GREEN BAY, WI 54307-1797</p> <p style="text-align: center;">○ Circle with center dot</p> <p>CAGE code: 08277 <u>2/</u></p>	<p>CNC MACHINING INC. 109 PANE ROAD NEWINGTON CT 06111-1552</p> <p style="text-align: center;">C</p> <p>CAGE code: 2Y832 <u>2/</u></p>

1/ Information published in this revision was verified by direct contact with manufacturers.

2/ Information not verified to be current, no response from manufacturer. Information identical to that published in MIL-HDBK-57, Revision B.

MIL-HDBK-57G (IS)

COAE BOLTS WORKS CO., LTD
NO. 47 CHINAN ROAD, TASHE HSIANG
KOAHSIUNG HSIEN, TAIWAN



CAGE code: 2/

COAST INDUSTRIAL SUPPLY CO., INC.
SUB OF SPANDCO INDUSTRIES INC.
15959 PIUMA AVENUE
CERRITOS, CA 90701-1526



On head of silicon bronze and
aluminum hex head cap screws



On head of stainless steel, monel,
brass, naval bronze, chrome alloy,
hex head cap screws, and the end
of alloy steel studs.

CAGE code: 9U032 2/

CODLING TOOL & MFG. INC.
665 NE 42ND STREET
FORT LAUDERDALE, FL 33334



CAGE code: 0P3X2 2/

COLD HEADING CO., THE
21777 HOOVER RD.
WARREN, MI 48089-2544



CAGE code: 89657 1/

COLOC MANUFACTURING
DIVISION INGRAM INDUSTRIES, INC.
P.O. BOX 249
CANTON, TX 75103

Plant
465 VZ CR 2516
CANTON, TX 75103



CAGE code: 0M6Y0 1/

COLTEC INDUSTRIES, INC.
DBA FAIRBANKS MORSE ENGINE
701 WHITE AVENUE
BELOIT, WI 53511



CAGE code: 82796 1/

COMET MFG. CO., INC.
315 JOHN DOWNEY DRIVE
NEW BRITIAN, CT 06051

61062

CAGE code: 61062 2/

1/ Information published in this revision was verified by direct contact with manufacturers.

2/ Information not verified to be current, no response from manufacturer. Information identical to that published in MIL-HDBK-57, Revision B.

MIL-HDBK-57G (IS)

<p>COMMAND ENTERPRISES 700 NORTH DELSEA DR. PITMAN, NJ 08071 (see CEI, INC.)</p> <p style="text-align: center;">C. E. I</p> <p>CAGE code: <u>2/</u></p>	<p>CONTINENTAL MACHINE PRODUCTS, INC. 11 WALLEY STREET EAST BOSTON, MA 02128</p> <p style="text-align: center;"></p> <p>CAGE code: 0T1E0 <u>1/</u></p>
<p>COMPONENT PRODUCTS CORPORATION 11623 CYRUS WAY MUKILTEO, WA 98275</p> <p style="text-align: center;">6F140</p> <p>CAGE code: 6F140 <u>1/</u></p>	<p>CONTINENTAL TOOL & MANUFACTURING 15941 W. 108th STREET LENEXA, KS 66219</p> <p style="text-align: center;">CTM</p> <p>CAGE code: 63003 <u>1/</u></p>
<p>COMPUTA-BASE MACHINING, INC. 411 NORTH GROVE ST P.O. BOX 340 BERLIN, NJ 08009-9704</p> <p style="text-align: center;">CBM</p> <p>CAGE code: 0A396 <u>2/</u></p>	<p>CONTRACTING CNC MACHINING 8360 CURRENCY DR. UNIT #7 RIVIERA BEACH, FL 33404</p> <p style="text-align: center;">CCM</p> <p>CAGE code: 64M67 <u>1/</u></p>
<p>CONNECTICUT AIRCRAFT PRODUCTS 246 SHAKER ROAD ENFIELD, CT 06082-2366</p> <p style="text-align: center;"></p> <p>CAGE code: 0KA73 <u>2/</u></p>	<p>CONQUEST MACHINE, INC. 3655 RESEARCH DR. GENESIS A STE 106 LAS CURCES, NM 88003-1239</p> <p style="text-align: center;">CMI</p> <p>CAGE code: 0PNX2 <u>2/</u></p>
	<p>CO-OP SCREW MANUFACTURING CORP. 60 SINDLE AVE. LITTLE FALLS, NJ 07424-1649</p> <p style="text-align: center;">C</p> <p>CAGE code: 1FZ52 <u>2/</u></p>

1/ Information published in this revision was verified by direct contact with manufacturers.

2/ Information not verified to be current, no response from manufacturer. Information identical to that published in MIL-HDBK-57, Revision B.

MIL-HDBK-57G (IS)

COOPER POWER SYSTEMS INC
(MCGRAW EDISON POWER SYSTEMS)
NORTH BURSON STREET
EAST STROUDSBURG, PA 18301

M

CAGE code: 88424

2/

COPELAND MFG. CORP.
(JAMES DIVISION)
11222 E. PINE ST.
TULSA, OK 74116-1613



CAGE code: 0CM67

2/

COPPER STATE BOLT & NUT CO.
3602 N 35TH AVE.
3637 N 34TH AVE.
PHOENIX, AZ 85017-4408

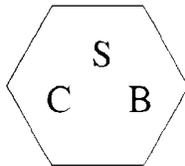

CAGE code: 0Z0Y2

2/

CORPUS CHRISTI GASKET & FASTENER
LTD.
341 WEST CHESTER RD.
P.O. BOX 4074
CORPUS CHRISTI, TX 78408

CCG

CAGE code: 008R2

1/

CREATIVE PRECISION INC.
DBA CREATIVE PRECISION WEST
2640 E. ROSE GARDEN LANE SUITE 6
PHOENIX, AZ 85050-4612

Plant
1501 BLUEBALL AVENUE
LINWOOD, PA 19061
CAGE code: 0F3N2

CPI

CAGE code: 1K0E5

1/

CRESENT MANUFACTURING CO.
P.O. BOX 1350
BUILINGTON, CT 06013-0350

Plant
700 GEORGE WASHINGTON TPKE
BUILINGTON, CT 06013-0350



CAGE code: 63020

1/

CRS PRECISION CORP.
640 WEST MERRICK ROAD
VALLEY STREAM, NY 11580-0482



CAGE code: 07QQ6

2/

1/ Information published in this revision was verified by direct contact with manufacturers.

2/ Information not verified to be current, no response from manufacturer. Information identical to that published in MIL-HDBK-57, Revision B.

MIL-HDBK-57G (IS)

CRUM MFG.
1265 WATERVILLE-MONCLOVA RD.
WATERVILLE, OH 43566



CAGE code: 57ZX3 1/

CRYSTAL METAL PRODUCTS COMPANY,
INC.
2700 E. CASTOR AVENUE
PHILADELPHIA, PA 191345



CAGE code: 0BPW8 2/

CSM FASTENER PRODUCTS
1133 BRTN MAWR AVE.
BENSENVILLE, IL 60106

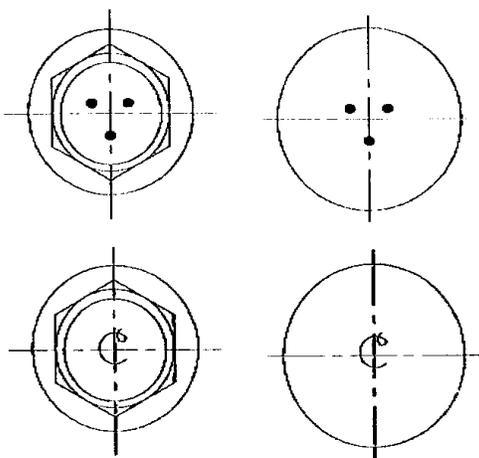

CAGE code: 1CJW4 1/

CURTIS PRESTON ENTERPRISES INC.
DBA ATLAS SPECIALTY PRODUCTS
2299 E WINSTON RD
ANAHEIM, CA 92806-5538



CAGE code: 0TP31 1/

CUTTING EDGE ENTERPRISE, LLC
2465 POLE LINE RD.
DECORAH, IOWA 52101

Plant
2509 172ND AVE.
DECORAH, IOWA 52101

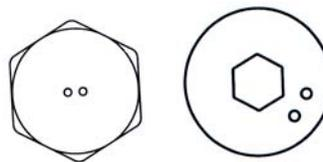

CAGE code: 52101 1/

CUTTING EDGE MACHINING INC.
NEVADA DIV
1625 LINDA WAY
SPARKS, NV 89431

See WESTERN SCREW MACHINE
PRODUCTS, INC.



CAGE code: 0ZV72 2/

1/ Information published in this revision was verified by direct contact with manufacturers.

2/ Information not verified to be current, no response from manufacturer. Information identical to that published in MIL-HDBK-57, Revision B.

MIL-HDBK-57G (IS)

<p>CUTTING EDGE MACHINING SOLUTIONS, INC. P.O. BOX 248 75 BASIN RUN ROAD DRIFTING, PA 16834</p>  <p>CAGE code: 3EQ16 1/</p>	<p>D & D TOOL COMPANY, INC. LEWIS STREET & MAPLE AVENUE EATONTOWN, NJ 07724</p> <p style="text-align: center;">D & D</p> <p>CAGE code: 30077 2/</p>
<p>CWR MANUFACTURING CO (DIVISION OF A.J. MUPHY CO., INC.) P.O. BOX 2669 SYRACUSE, NY 13220</p>  <p>CAGE code: 2/</p>	<p>D & R MACHINE COMPANY 2310 BIG OAK ROAD LANGHORNE, PA 19047-1910</p> <p style="text-align: center;">4T853</p> <p>CAGE code: 4T853 2/</p>
<p>D & D MACHINERY AND SALES 2420 W. R. LARSON ROAD SAN ANTONIO, TX 78261-2200</p> <p style="text-align: center;">1Y128</p> <p>CAGE code: 1Y128 2/</p>	<p>D. C. MACHINING INC. 1900 9TH AVE., SW WATERTOWN, SD 57201</p> <p style="text-align: center;">DC</p> <p>CAGE code: 0AUC7 2/</p>
<p>D & D MANUFACTURING 26199 JEFFERSON AVE. MORRIETA, CA 92562</p>  <p>CAGE code: NONE 1/</p>	<p>D.S.O. PLASTICS, INC. 1220 ROCK ST. ROCKFORD, IL 61101</p> <p style="text-align: center;">Z</p> <p>CAGE code: 2/</p>

1/ Information published in this revision was verified by direct contact with manufacturers.

2/ Information not verified to be current, no response from manufacturer. Information identical to that published in MIL-HDBK-57, Revision B.

MIL-HDBK-57G (IS)

DACK INDUSTRIES, INC.
P.O. BOX 427
FARMINGTON, CT 06034 - 0427



CAGE code: 0CZ42 2/

DANIEL CO., EDWARD W.
11700 HARVARD AVENUE
CLEVELAND, OH 441053



CAGE code: 73634 2/

DAN-LOC BOLT & GASKET INC.
FORMALLY
DANIEL INDUSTRIES, INC.
Bolt & Gasket Division
P.O. BOX 292
HOUSTON, TX 77001-0292

Plant
725 North Drennan
Houston, TX 77003

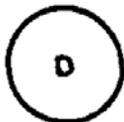

STUDS



HEX NUTS

CAGE code: 2/

DARCO PRODUCTS
8406 WASHINGTON PL NE
ALBUQUERQUE, NM 87113-1671



CAGE code: 1DL79 2/

DAVE ALLEN ENTERPRISES
10631 BLOOMFIELD AVENUE
UNIT 15
LOS ALAMITOS, CA 90720



CAGE code: 1NWX4 2/

DAVIES PRECISION MACHINING, INC.
2400 COLEBROOK RD.
LEBANON, PA 17042-9562



CAGE code: 7V760 2/

DAVIS AIRCRAFT PRODUCT CO., INC.
1150 WALNUT AVENUE
BOHEMIA, NY 11716-6216



CAGE code: 98313 2/

1/ Information published in this revision was verified by direct contact with manufacturers.

2/ Information not verified to be current, no response from manufacturer. Information identical to that published in MIL-HDBK-57, Revision B.

MIL-HDBK-57G (IS)

DECKER MANUFACTURING CORP
703 NORTH CLARK STREET
P.O. BOX 410
ALBION, MI 49224-1455



HEX WHEEL NUTS
(DEPRESSED "D" or "MDC")



AMERICAN STANDARD
SQUARE, HEX, AND ROUND WELD NUT
(SMALL RAISED DOT ON CHAMFER)



METRIC
SQUARE, HEX, AND ROUND WELD NUTS
(DEPRESSED LETTER "D" AND CLASS NO.)

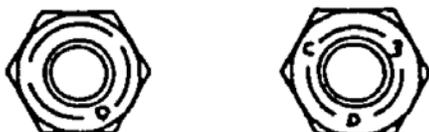

A-563
STRUCTURAL NUTS
(DEPRESSED "D" OR "DMC")

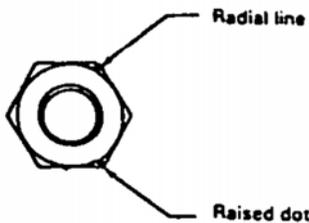

GRADE 5
HEX NUTS
(ONE RAISED RADIAL LINE 120°
COUNTERCLOCKWISE FROM ONE
RAISED DOT ON CHAMFER)

CAGE code: 12876

2/

DEERE & CO.
JOHN DEERE PLACE
MOLINE, IL 61265

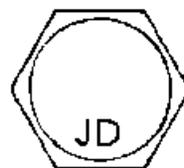

CAGE code: 75160

2/

DEFENSE AEROSPACE
MFG OF DEFENSE AEROSPACE
THREADED MACHINE PARTS
10841 NOEL ST. #104
LOS ALAMITOS, CA 90720-2527

DAS
1

CAGE code: 1W4A6

1/

DEFENSE QUALITY MFG.
40 SACCO RD.
ROYERSFORD, PA 19468-1030



DQ

CAGE code: 0B6M7

2/

1/ Information published in this revision was verified by direct contact with manufacturers.

2/ Information not verified to be current, no response from manufacturer. Information identical to that published in MIL-HDBK-57, Revision B.

MIL-HDBK-57G (IS)

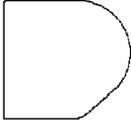
<p>DEFIANCE STAMPING COMPANY, THE P.O. BOX 506 DEFIANCE, OHIO 43512-2743</p> <p>PLANT 1090 PERRY ST DEFIANCE, OHIO 43512-2743</p>  <p>CAGE code: 6B357 2/</p>	<p>DELTA MACHINE & TOOL CO., INC. PARKMOUNT ROAD P.O. BOX 351 GLEN RIDDLE, PA 19037</p>  <p>CAGE code: 2/</p>
<p>DEHOUSSE (USINES) 64007 PAU FRANCE</p> <p style="text-align: center;">D</p> <p>CAGE code: BP714 2/</p>	<p>DEL-VAL FASTENER MANUFACTURING P.O. BOX 2901 21-D INDUSTRIAL DRIVE WARMINSTER, PA 18974</p> <p style="text-align: center;">DV</p> <p>CAGE code: 1EE10 2/</p>
<p>DELL MFG. CO., INC. 4 RIGHT LANE FARMINGTON, CT 06032-3195</p>  <p>CAGE code: 5A628 1/</p>	<p>DEMAT (CANCELLED AND REPLACED BY ALCOA FASTENER SYSTEMS) BD DU GRAND CASTAING ZI BD DU GRD CASTING ROQUES, FRANCE 31120</p>  <p style="text-align: center;">DT M</p> <p style="text-align: center;">D</p> <p>CAGE code: F7411 2/</p>
<p>DELT INDUSTRIES, INC. (AEROSPACE PRODUCTS DIVISION) 90 WEST EASY STREET, STE 2 P.O. BOX 940067 SIMI VALLEY, CA 93065-6206</p>  <p>CAGE code: 064T2 1/</p>	

1/ Information published in this revision was verified by direct contact with manufacturers.

2/ Information not verified to be current, no response from manufacturer. Information identical to that published in MIL-HDBK-57, Revision B.

MIL-HDBK-57G (IS)

DEPENDABLE MACHINE CO., INC.
1846 E 30TH ST
INDIANAPOLIS, IN 46218-2607



CAGE code: 14554

2/

DFCI SOLUTIONS, INC.
425 UNION BLVD.
WEST ISLIP, NY 11795-3183



CAGE code: 72794

1/

DERBYSHIRE MACHINE & TOOL CO.
DBA DERBYSHIRE MARINE PRODUCTS
5100 BELFIELD AVENUE
PHILADELPHIA, PA 19144-1788



CAGE code: 71905

1/

DHL ENTERPRISES
1260 E. WOODLAND AVENUE #46
P. O. BOX 295
MORTON, PA 19070

DHL

CAGE code: 0UGD5

2/

DETROIT HEADING CO.
6421 LYNCH RD.
DETROIT, MI 48234-4140



CAGE code: 0TUA2

2/

DIAL SUPPLY AND MFG., INC.
1315 FM 1187
#106
MANSFIELD, TX 76063



CAGE code: 9N473

1/

DEUTSCH COMPANY INC., THE
DBA DEUTSCH CO THE METAL
COMPONENT
14800 S. FIGUEROA STREET
GARDENA, CA 90248-1795



CAGE code: 14798

2/

DIESEL PARTS COMPANY OF CALIFORNIA
1900 EAST 12TH STREET
OAKLAND, CA 94606-4821

D

CAGE code: 24378

2/

1/ Information published in this revision was verified by direct contact with manufacturers.

2/ Information not verified to be current, no response from manufacturer. Information identical to that published in MIL-HDBK-57, Revision B.

MIL-HDBK-57G (IS)

DIHARD COMPANY
3161 MAJOR STREET
FORT WORTH, TX 76112 - 7020

D

CAGE code: 0F1U4 2/

DISC-LOCK INTERNATIONAL
1924 S PACIFIC COAST HWY SUITE F
REDONDO BEACH , CA 90277

DL

CAGE code: 72731 2/

DIVERSIFIED FASTENING SYSTEMS, INC.
P.O.BOX 339
CHARLES CITY, IA 50616

Plant
501 RICHINGS STREET
CHARLES CITY, IA 50616

D

CAGE CODE: 0S311 1/

DIXON MACHINE & TOOL
DBA DIXON MACH AND FABRICATION
6807 CHAPMAN HWY.
KNOXVILLE, TN 37920-6560

see TROY D. RAY

DMT

CAGE code: 1DEP3 2/

DO MANUFACTURING CORP.
P.O. BOX 2382
114 BROOKLYN ST
ROCKVILLE, CT 06066

PLANT
114 RROOKLYN ST.
ROCKVILLE, CT 06066

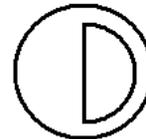

CAGE code: 1H312 2/

DO-ALL PRECISION, INC.
9 UNION AVENUE
MOUNT VERNON, NY 10550



CAGE code: 2/

DOMESTIC FASTENER & FORGE, INC.
P.O. BOX 14642
LENEXA, KS 66285

Plant
15850 W. 108TH STREET
LENEXA, KS 66219

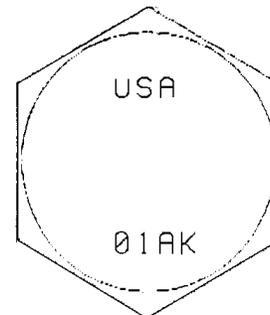

CAGE code: 09ML9 1/

1/ Information published in this revision was verified by direct contact with manufacturers.

2/ Information not verified to be current, no response from manufacturer. Information identical to that published in MIL-HDBK-57, Revision B.

MIL-HDBK-57G (IS)

DOMESTIC FORGING, INC.
P.O. BOX 693
NEW HAVEN, MI 48048



CAGE code: 2/

DONSON MACHINE
ALSIP MACHING GROUP
12416 S. KEDVALE AVENUE
ALSIP, IL 60803-1819

DMC

CAGE code: 0BHD5 1/

DOUBLECO INCORPORATED
DBA R & D FASTENERS
9444 9TH STREET
RANCHO CUCAMONGA, CA 91730



CAGE code: 1UKP3 1/

DOUGLASS TOOL & ENGINEERING CO.,
INC.
304 EAST DYER ROAD
SANTA ANA, CA 92707

DTE

Marking to be indented

CAGE code: 2/

DRESSER INDUSTRIES, INC.
DRESSER PUMP DIVISION
142 CLINTON ROAD
FAIRFIELD, NJ 07004

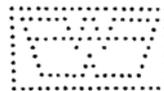

CAGE code: 0LNV2 2/

D'SAMIC
1261 HOBLITT AVE # 206
CLOVIE, CA 93612-2811



CAGE code: 2/

DTF MANUFACTURING, INC.
DIV OF FEDERAL SCREW AND SUPPLY
CO
P. O. BOX 329
146 ALBANY AVE.
LINDENHURST, NY 11757

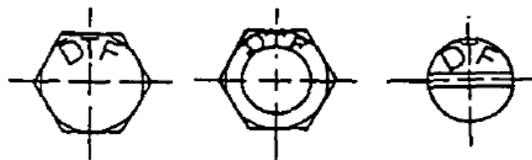

Standard: DTF
Large Dia: **DTF**
Micro Dia: **d**

CAGE code: 0H802 2/

1/ Information published in this revision was verified by direct contact with manufacturers.

2/ Information not verified to be current, no response from manufacturer. Information identical to that published in MIL-HDBK-57, Revision B.

MIL-HDBK-57G (IS)

DUFFY ELECTRONICS & MFG. CO.
50 BARNES PARK RD
WALLINGFORD, CT 06492



CAGE code: 2/

DUNCAN ELECTRONICS & MFG. CO.
701 SEVENTH AVE.
BELMAR, NJ 07719



CAGE code: 2/

DUNHAM PRODUCTS, INC.
7400 northfield rd.
Walton hills, ohio 44146



CAGE code: 1B4S0 1/

DUPONT, G.B. CO., INC.
(SEE KAMAX L. P.)
500 WEST LONG LAKE ROAD
TROY, MI 48098-4540



CAGE code: 1DWW1 1/

DUSEVOIR METAL PRODUCTS, INC.
1751 S TELEGRAPH RD
P.O. BOX 2158
DEARBORN, MI 41823



CAGE code: 97233 2/

DUVE GmbH & CO. KG
P.O. BOX 1240
NEUENRADE, GERMANY D-5982

- D** - All hexagon head screws and bolts made of high tensile steel grade 8.8 up to 12.8, and sealing fasteners made of case-hardened carbon steel
- DX** - Hexagon head sealing fasteners made of stainless steel
- DUVEX** - Hexagon head screws and bolts made of stainless steel (A2 + A4)
- DUVE** - DUVE DRIL-KWICK Self-Drilling Fastener (Screws)

CAGE code: 2/

DYNACAST
INDUSTRIAL FASTENERS DIVISION
1401 FRONT STREET
YORKTOWN HEIGHTS, NY 10598



CAGE code: 2/

1/ Information published in this revision was verified by direct contact with manufacturers.

2/ Information not verified to be current, no response from manufacturer. Information identical to that published in MIL-HDBK-57, Revision B.

MIL-HDBK-57G (IS)

DYNAMIC ENGINEERING
720 11TH AVE., S.E.
P.O. BOX 697
WATERTOWN, SD 57201-0697



CAGE code: 9U252 2/

DYSON CORP THE
formerly (JOS. DYSON & SONS, INC.)
53 FREEDOM RD
PLAINSVILLE, OH 44077-1232



CAGE code: 22132 2/

DZUS FASTENER CO., INC.
see DFCI SOLUTIONS, INC.
425 UNION BLVD
WEST ISLIP, NY 11795



CAGE code: 3L478
cancelled- replaced by 72794 2/

E. KOZAK PRECISION PRODUCTS CO.
45 WOODLAND AVE.
ROCKAWAY, NJ 07866



CAGE code: ICP43 2/

E.L.R. MACHINE AND TOOL
48 A VINCENT CIRCLE
IVYLAND, PA 18974



CAGE code: 2/

EAGAN MACHINE CORP.
135 CENTER STREET
BRISTOL, CT 06010



CAGE code: 2/

EAGLE Picher INDUSTRIES
(PRECISION PRODUCTS PLANT)
1927 W 4TH ST
P.O. BOX 1444
JOPLIN, MO 64801-3



CAGE code: 9L734 2/

1/ Information published in this revision was verified by direct contact with manufacturers.

2/ Information not verified to be current, no response from manufacturer. Information identical to that published in MIL-HDBK-57, Revision B.

MIL-HDBK-57G (IS)

<p>EAGLEHEAD MANUFACTURING COMPANY DBA DEJAK MACHINE TOOL COMPANY DIV DEJAK DRILLING 23555 EUCLID AVE EUCLID, OH 44117-1703</p> <p>Alphanumeric Designation</p> <p>01NU</p> <p>CAGE code: 1GVE5 <u>2/</u></p>	<p>EASTWOOD MFG., CO. P.O. BOX 231102 6825 BREEN RD HOUSTON, TX 77086-3719</p> <p>Plant 52 Lawndale Houston, TX 77023</p> <p>EM</p> <p>CAGE code: 77903 <u>2/</u></p>
<p>EAST BAY MANUFACTURERS INC. P.O. BOX 436 BRISTOL, RI 02809</p> <p>Plant 400 FRANKLIN STREET BRISTOL, RI 02809</p> <p>EM</p> <p>CAGE code: 5BE51 <u>1/</u></p>	<p>EATON AEROQUIP CORPORATION (AEROSPACE DIVISION) 300 S. EAST AVE. JACKSON, MICHIGAN 49203-1972</p> <p>≡A</p> <p>CAGE code: 00624 <u>2/</u></p>
<p>EAST COAST METALS INC. 171 RUTH ROAD HARLEYSVILLE, PA 19438</p> <p>E</p> <p>CAGE code: 4W058 <u>2/</u></p>	<p>EBC INDUSTRIES (FORMERLY ERIE BOLT CORP.) 1325 LIBERTY STREET ERIE, PA 16502-1641</p> <p>ERIE E</p> <p>CAGE code: 5G920 <u>1/</u></p>
<p>EASTERN SCREW CO., INC. 15 AMFLEX DRIVE CRANSTON, RI 02921-2028</p> <p>Plant 71 MILL STREET JOHNSON, CRANSTON, RI 02921-2028</p> <p>E</p> <p>CAGE code: 2L684 <u>1/</u></p>	<p>EBERHARD BRUNINGHAUS POSTFAUCH 12 06 1M DUDA2 NEUENRADE, FEDERAL REPUBLIC OF GERMANY D 5982</p> <p>B</p> <p>EBM</p> <p>CAGE code: <u>2/</u></p>

1/ Information published in this revision was verified by direct contact with manufacturers.

2/ Information not verified to be current, no response from manufacturer. Information identical to that published in MIL-HDBK-57, Revision B.

MIL-HDBK-57G (IS)

ECENARRO S. COOP. LTDA.
c/ AMILLAGA, 15.
BERGARA - GUIP'UZOCA,
SPAIN 20500

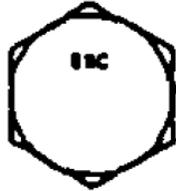

ESC

CAGE code: 2/

EDS ORDNANCE
644 C ANCHORS ST.
FT. WALTON BEACH, FL 32548



CAGE code: 1CA31 2/

ELASTIC STOP NUT
(Division of Harvard Industries, Inc.)

See MACLEAN-ESNA

Plant
2330 Vauxhall Road
Union, NJ 07083

2nd Plant
3200 Country Club Road
P.O. Box 988
Pocahontas, AR 72455

E, EN, or ESNA Red nylon insert in locknuts

Red nylon insert in locknuts identifies Esna as manufacturer



CAGE code: 2/

ELCO INDUSTRIES, INC.
1111 SAMUELSON RD
ROCKFORD, IL 61101

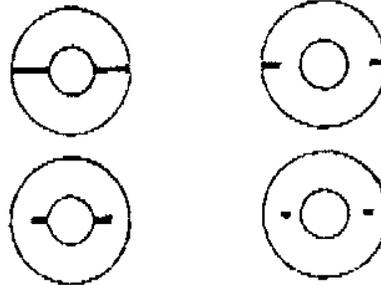

Underside of screw head



CAGE code: 83486 2/

ELECTRO-FREETO MANUFACTURING
COMPANY
37 POPE ROAD
HOLLISTON, MA 01746-2218

JF

CAGE code: 17401 2/

^{1/} Information published in this revision was verified by direct contact with manufacturers.

^{2/} Information not verified to be current, no response from manufacturer. Information identical to that published in MIL-HDBK-57, Revision B.

MIL-HDBK-57G (IS)

ELITE FASTENERS
6400 DALE STREET
BUENA PARK, CA 90621

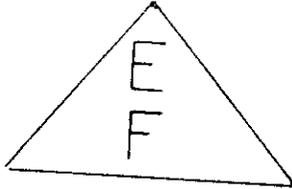

CAGE code: 0T3D2

2/

ELLIS PRECISION INDUSTRIES
DBA E P IND.
3133 RAMONA DR
FORT WORTH, TX 76116-5122

e



CAGE code: 9Z199

2/

EMERALD VALLEY MFG
3825 W. 11TH AVE
SUITE B
EUGENE, OR 97402

DTE

CAGE code: 4Y352

2/

EMHART CORP.
PARKER-KALON DIVISION
395 ROBERTS ROAD
CAMPBELLSVILLE, KY 42718



"TRIANGLE" MARKING

EMHART CORP
GRIPCO FASTENER DIVISION
111 EAST BROAD STREET
SOUTH WHITLEY, IN 46787



G_H raised or indented on
flange or bearing surface



G_H raised on head, both
inch and metric series e



G_H raised or indented on
flange or bearing surface

CAGE code: 73020

2/

^{1/} Information published in this revision was verified by direct contact with manufacturers.

^{2/} Information not verified to be current, no response from manufacturer. Information identical to that published in MIL-HDBK-57, Revision B.

MIL-HDBK-57G (IS)

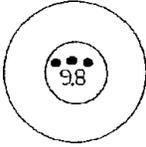
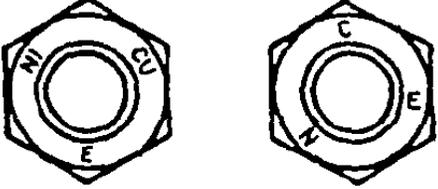
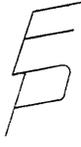
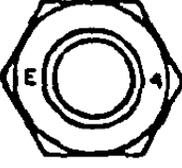
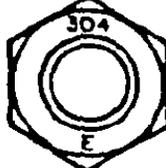
<p>EMP MANUFACTURING CO. 40935 PRODUCTION DR HARRISON TOWNSHIP, MI 48045-1351</p>  <p>CAGE code: 4G973 <u>2/</u></p>	<p>ENGINEERING MATERIALS CO., INC. FASTENER MANUFACTURING DIVISION 2055 WEST COWLES STREET LONG BEACH, CA 90813-1087</p>  <p>Mfr. Symbol/Logo embossed or intent marked. Letter "E" as shown on nut crown spaced 120 degrees from material symbol marking.</p>
<p>EMPIRE PRECISION MACHINING 108 W. HOLLOWAY DR. HURST, TX 76053-6807</p>  <p>CAGE code: 5V179 <u>1/</u></p>	 <p>Mfr. Symbol/Logo letter "E" as shown, opposite material symbol marking code on nut crown at corners.</p>
<p>ENGEL MANUFACTURING COMPANY, INC., THE 304 W. EWING AVENUE SOUTH BEND, IN 46613-2108</p>  <p>CAGE code: 0XYS0 <u>2/</u></p>	 <p>Mfr. Symbol/Logo letter "E", as shown on nut crown, 180 degrees opposite material symbol marking.</p>
<p>ENGINEERED BOLTING PRODUCTS, INC. P.O. BOX 7067 301 MONTGOMERY ST SHREVEPORT, LA 71137</p> <p>Plant 301 Montgomery St. Shreveport. LA 71107</p>  <p>CAGE code: 0K4X1 <u>2/</u></p>	 <p>Mfr. Symbol/Logo letter "E" marked opposite material symbol code marking on nut crown at one corner location.</p> <p>CAGE code: 19968 <u>1/</u> Continued</p>

1/ Information published in this revision was verified by direct contact with manufacturers.

2/ Information not verified to be current, no response from manufacturer. Information identical to that published in MIL-HDBK-57, Revision B.

MIL-HDBK-57G (IS)

Continued

ENGINEERING MATERIALS CO., INC.



Mfr. Symbol/Logo letter "E" marked opposite material symbol code marking on nut crown at one corner location.



Mfr. Symbol/Logo letter "E" marked on crown, 180 degrees opposite thread designation letter.



Mfr. Symbol/Logo letter "E" indent marked above material symbol.



Mfr. Symbol/Logo letter "E" as shown marked above material symbol marking on stud or rod end.

CAGE code: 19968

1/

ENGLE MANUFACTURING COMPANY,
INC., THE
304 W. ERVING AVE.
SOUTH BEND, IN 46613

EM
F593
T

CAGE code: 0XYS0

2/

ENOMOTO INDUSTRIES CO., LTD.
3-26 TAKASAGO, TAKAISHI-SHI,
OSAKA, 592
JAPAN



CAGE code: S0132

2/

ENVISION TECH, INC.
4404 S. 40TH TERRACE
ST. JOSEPH, MO 64503

ETI

CAGE code: 056X3

1/

ERICO FASTENING SYSTEMS
301 NEW ALBANY ROAD
MOORESTOWN, NJ 08057



CAGE code: 84483

2/

1/ Information published in this revision was verified by direct contact with manufacturers.

2/ Information not verified to be current, no response from manufacturer. Information identical to that published in MIL-HDBK-57, Revision B.

MIL-HDBK-57G (IS)

<p>ERIE BOLT CORP. 1325 LIBERTY STREET ERIE, PA 16502</p> <p>see EBC INDUSTRIES</p> <p>ERIE E</p> <p>CAGE code: 5G920 <u>2/</u></p>
<p>ESCO PRECISION, INC. 71 OLD CAMPLAIN RD. HILLSBOROUGH, NJ 08844</p> <p>EPI</p> <p>CAGE code: 1YRR0 <u>1/</u></p>
<p>ESMET, INC.</p> <p>DBA ELECTROLINE TTUFLOC 1406 5TH ST., S.W. CANTON, OH 44702-2062 CAGE code: 79931</p> <p>SUB OF UNIMET CORP 1406 5TH ST., S.W. CANTON, OH 44702-2062 CAGE code: 0EA31</p>  <p>CAGE code: 79931, 0EA31 <u>1/</u></p>

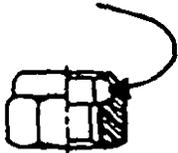
<p>ESNA (MACLEAN-FOGG COMPANY) 611 COUNTRY CLUB ROAD POCAHONTAS, AR 72455-8803</p> <p>E, EN, or ESNA Red nylon insert in locknuts</p> <p>Red nylon insert in locknuts identifies Esna as manufacturer</p>  <p>CAGE code: 019L2 <u>2/</u></p>
<p>ESP MANUFACTURING CO., INC. 2331 E. INTERSTATE 20 P O BOX 871 ODESSA, TX 79766-8827</p> <p>EΣΠ</p> <p>CAGE code: 7J504 <u>1/</u></p>
<p>ESSENTIAL MACHINING 354 HERBERTSVILLE ROAD BRICK, NJ 08724-1735</p>  <p>CAGE code: 0TR19 <u>1/</u></p>
<p>ESTA PRODUCTS COMPANY 16 MISSOURI DRIVE WARWICK, RI 02886-8117</p> <p>ESTA</p> <p>CAGE code: 8R230 <u>2/</u></p>

1/ Information published in this revision was verified by direct contact with manufacturers.

2/ Information not verified to be current, no response from manufacturer. Information identical to that published in MIL-HDBK-57, Revision B.

MIL-HDBK-57G (IS)

EVERLOCK FASTENING SYSTEMS
 EVERLOCK DETROIT DIVISION
 6567 SOUTH STERLING DRIVE
 STERLING HEIGHTS, MI 48077

Microlock



Prevailing torque surface

Hi-Hex Microlock



Flange Hi-Hex Microlock



Prevailing torque surface

Flange Toplock



Flange Nut



Nut and Washer Assembly



Standard Hex Nut



CAGE code:
Continued

2/

EVERLOCK FASTENING SYSTEMS
Continued

GREER STOP NUT
 (Greer-Smyrna Division)
 481 McNALLY DRIVE
 NASHVILLE, TN 37211

Green nylon insert
identifies Greer-Smyrna
as manufacturer

6 equally spaced
stakes identifies
Grade B

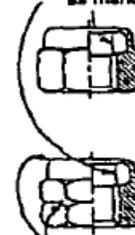

6 equally spaced stakes
plug notch in
corner of hex
identifies Grade C

NYLON INSERT



Grade B

Grade markings per IFI Standard
100 lines or two small notches
cut circumferentially into each
of the six corners at about
mid-height)



Grade C

CONELOK
INCH MARKINGS

Green nylon insert identifies
Greer-Smyrna as manufacturer
per IFI 514



Property Class 5, 9 and 10 markings per IFI 514 located
on bearing surface and/or hex flats



NYLON INSERT

Manufacturer's I.D. - letter "G" stamped on one hex flat
or on bearing surface



CONELOK - BEARING SURFACE

Class 5 METRIC MARKINGS Class 10
Class 9

CAGE code: 27687
Continued

2/

1/ Information published in this revision was verified by direct contact with manufacturers.

2/ Information not verified to be current, no response from manufacturer. Information identical to that published in MIL-HDBK-57, Revision B.

MIL-HDBK-57G (IS)

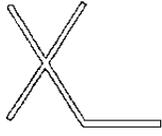
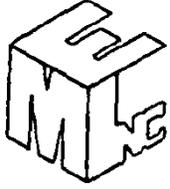
<p>Continued EVERLOCK FASTENING SYSTEMS</p> <p>INTERNATIONAL SCREW DIVISION 50631 EAST RUSSEL SCHMIDT BOULEVARD MOUNT CLEMENS, MI 48045</p> <div style="display: flex; justify-content: space-around; align-items: center;"> <div style="text-align: center;">  I Upper case </div> <div style="text-align: center;">  Lower case less </div> </div> <p>CAGE code: <u>2/</u></p>
<p>EXCEL PRECISION PRODUCT'S, INC. 2207 NW 30TH PL. POMPANO BEACH, FL 33069-1026</p> <div style="text-align: center;">  </div> <p>CAGE code: 1H4K6 <u>2/</u></p>
<p>EXPERIMENTAL MACHINE CO. 1412 SHOEMAKER RD. BALTIMORE, MD 21209</p> <div style="text-align: center;">  </div> <p>CAGE code: 0NAP8 <u>2/</u></p>
<p>FABER ENTERPRISES, INC. 6606 VARIEL AVE. CANOGA PARK, CA 91303-2808</p> <div style="text-align: center;">  </div> <p>CAGE code: 14397 <u>1/</u></p>

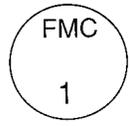
<p>FABRICATION SPECIALTY INC. 6530 SMOKY HILL CT. GRANBURY, TX 76049-7042</p> <p style="font-size: 2em; font-weight: bold;">FS or 28548</p> <p>CAGE code: 28548 <u>1/</u></p>
<p>FABSCO CORP. 1745 W. 124TH ST. CHICAGO, IL 60643-5345</p> <div style="text-align: center;">  </div> <p>CAGE code: 4S619 <u>2/</u></p>
<p>FAILING CO., GEORGE E. P.O. BOX 872 ENID, OK 73702</p> <div style="text-align: center;">  </div> <p>CAGE code: <u>2/</u></p>
<p>FALCON MANUFACTURING CORP. 10409-B OLD ATLANTA HWY. COVINGTON, GA 30014-0887</p> <div style="text-align: center;">  </div> <p>CAGE code: 0HM72 <u>2/</u></p>

1/ Information published in this revision was verified by direct contact with manufacturers.

2/ Information not verified to be current, no response from manufacturer. Information identical to that published in MIL-HDBK-57, Revision B.

MIL-HDBK-57G (IS)

FALL RIVER MANUFACTURING CO., INC.
540 CURRANT ROAD
FALL RIVER, MA 02720-4711



CAGE code: 1JWL5

1/

FANG SHENG SCREW CO., LTD.
#113 LANE 96 MINCHAUN ROAD
LU CHU HSIANG, KAOHSIUNG HSIEN,
821, TAIWAN



CAGE code: SJ544

2/

FARIAS INDUSTRIAL MACHINING
504 BRUNKEN AVENUE, STE L
SALINAS, CA 93901

(No artwork for marking. Marks whatever the customer specifies.)

CAGE code: 3KWY7

1/

FARLO MACHINE & TOOL CO., INC
340 CONSTANCE DR
BLDG # 7
WARMINSTER, PA 18974-2815



CAGE code: 7S305

2/

(FASSCO) FASTENER & STEEL SUPPLY
CO., LTD.
Quality Assurance Dept.
P.O. BOX 236
HATFIELD, PA 19440

Plant
2294 NORTH ROAD
HATFIELD, PA 19440



Latest marking used
on fasteners after
August 1, 1988



Previous marking
used on fasteners

CAGE code:

2/

FASTCO INDUSTRIES, INC.
P.O. BOX 141427
GRAND RAPIDS, MI 49514-1427

Plant
2685 MULLINS NW
GRAND RAPIDS, MI 49534



CAGE code: 56NH8

1/

1/ Information published in this revision was verified by direct contact with manufacturers.

2/ Information not verified to be current, no response from manufacturer. Information identical to that published in MIL-HDBK-57, Revision B.

MIL-HDBK-57G (IS)

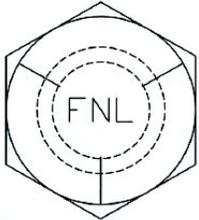
<p>FASTENAL COMPANY 2001 THEURER BLVD. WINONA, MN 55987-1500</p> <p>Plant FASTENAL COMPANY MFG DIV 1801 THEURER BLVD. WINONA, MN 55987-1500 CAGE code: 1QNZ3</p>   <p>CAGE code: 0Y3H3 1/</p>
<p>FASTENER BROKERAGE INC DBA INOFAST MANUFACTURING SUITE R 2880 BERGEY RD HATFIELD, PA 19440 - 3241</p> <p style="text-align: center; font-size: 2em; font-weight: bold;">IN</p> <p>CAGE code: 2T359 2/</p>
<p>FASTENER INNOVATION TECHNOLOGY, INC. DBA F.I.T. 14601 S. BROADWAY STREET GARDENA, CA 90248-1811</p> <p style="text-align: center; font-size: 2em; font-weight: bold;">FIT</p> <p>CAGE code: 58998 1/</p>

<p>FASTENER TECHNOLOGY CORP. 7415 FULTON AVE NORTH HOLLYWOOD, CA 91605-5411</p> <p style="text-align: center; font-size: 4em; font-weight: bold;">FT</p> <p>CAGE code: 58794 1/</p>
<p>FASTENING PRODUCTS CO.,INC. P.O. BOX 261 CLIFTON HIGHTS, PA 19018-0334</p> <p>Plant 3 MERION TERRACE CLIFTON HEIGHTS, PA 19018-0334</p>  <p>CAGE code: 6M389 1/</p>
<p>FASTENERS UNLIMITED INC. 2150 WOODLAND ROAD WARRENDALE, PA 15086</p> <p style="text-align: center; font-size: 2em; font-weight: bold;">FUN</p> <p>CAGE code: 47346 1/</p>

1/ Information published in this revision was verified by direct contact with manufacturers.

2/ Information not verified to be current, no response from manufacturer. Information identical to that published in MIL-HDBK-57, Revision B.

MIL-HDBK-57G (IS)

FASTENING PRODUCTS OF LANCASTER,
INC.
1980 OLD PHILADELPHIA PIKE
LANCASTER, PA 17602-3498

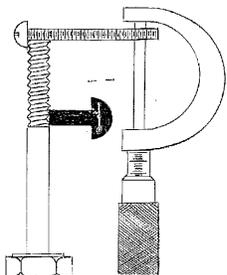

CAGE code: 4M097

1/

FASTENRATH BEFESTIGUNGSTECHNIK
GmbH
HERSCHEIDER STRABE 105
POSTFASH 51 42
58840 PLETTENBERG, HOLTAUSEN
FEDERAL REPUBLIC OF GERMANY

F

CAGE code:

1/

FASTI-WERK CARL AUG. FASTENRATH
GMBH & CO.KG
INDUSTRIEGEBIET ELBRINGHAUSEN
P.O. BOX 1250
WERMELSKIRCHEM, GERMANY 42929

F

CAGE code: D9500

2/

FASTRON COMPANY, THE
11800 FRANKLIN AVENUE
FRANKLIN PARK, IL 60131-1006

F

CAGE code: 24929

2/

FEDERAL EQUIPMENT COMPANY
707 CARR ST
CINCINNATI, OH 45203-1211

F E C

6 0 5 8 7

CAGE code: 60587

1/

FEDERAL MANUFACTURING CORP.
9825 DE SOTO AVENUE
CHATSWORTH, CA 91311-1441

F M C

CAGE code: 17943

2/

1/ Information published in this revision was verified by direct contact with manufacturers.

2/ Information not verified to be current, no response from manufacturer. Information identical to that published in MIL-HDBK-57, Revision B.

MIL-HDBK-57G (IS)

FEDERAL SCREW WORKS
2400 BUHL BUILDING
DETROIT, MI 48226

BIG RAPIDS DIVISION
400 NORTH DEKRAFT
BIG RAPIDS, MI 49307

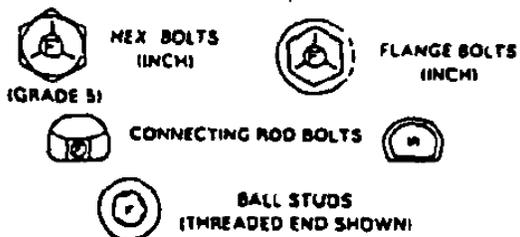

ROMULUS DIVISION
34846 GODDARD ROAD
ROMULUS, MI 48174-3400

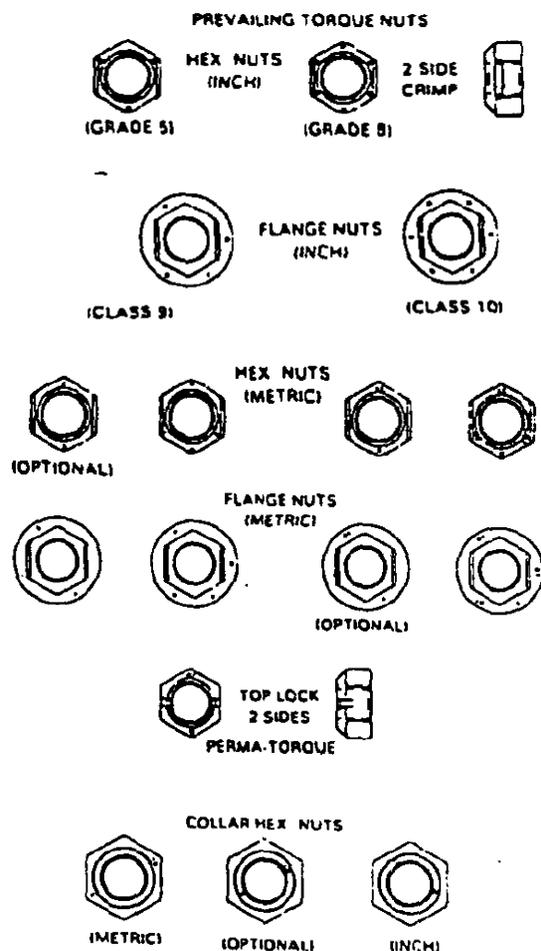

CAGE code: 21957

2/

FENBAR PRECISION MACHINISTS, INC
633 COMMERCE STREET
THORNWOOD, NY 10594-1348



CAGE code: IP472

1/

FENTON HEADING
2480 OWEN RD.
FENTON, MI 48430

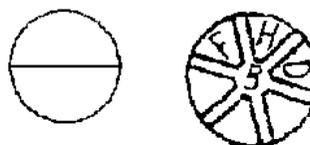

CAGE code:

1/

FERNDALE FASTENER
31600 STEPHENSON HIGHWAY
MADISON HEIGHTS, MI 48071

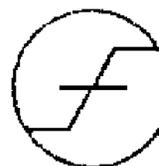

CAGE code:

2/

FERRIERE DI STABIO, S.A.
VIA LAVEGGIO 6/A
CH-6855 STABIO
SWITZERLAND



F S



CAGE code:

1/

1/ Information published in this revision was verified by direct contact with manufacturers.

2/ Information not verified to be current, no response from manufacturer. Information identical to that published in MIL-HDBK-57, Revision B.

MIL-HDBK-57G (IS)

FERRY CAP & SET SCREW CO., THE
2151 SCRANTON RD.
CLEVELAND, OH 44113-3578

FC · F-C
BPG

CAGE code: 84513

2/

FIBAM COMPANHIA INDUSTRIAL
SAO BERNARDO DO CAMPO
P.O. BOX 360
SAO PAULO, BRAZIL C.E.P.0
09701.907

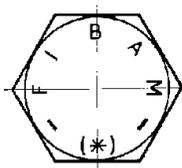

CAGE code:

1/

FILETAGE INTERNATIONAL
(INTERNATIONAL THREAD INC.)
2225 RUE MICHLIN
LAVAL, QUE, CANADA H7L9Z7



CAGE code:

2/

FIRST AMERICAN SALES CO.
2706 ST. LOUIS AVE.
LONG BEACH, CA 90806-2026

1st

CAGE code: 58251

2/

FISCHER SPECIAL MFG. CO.
11 INDUSTRIAL RD.
COLD SPRING, KY 41076-9796

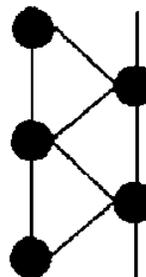

CAGE code: 73743

2/

FITZ MANUFACTURING INDUSTRIES LTD
DBA FMI
6625 IRON HORSE BLVD.
NORTH RICHLAND HILL, TX 76180

05DT8



FTZ

CAGE code: 05DT8

1/

FLAIG & HOMMEL
HEERSTRASSE 1
ALDINGEN, GERMANY 78554

FS

Company logo to be stamped and
used on all steel reusable FLAG
& HOMMEL lock nuts.

FH

Company logo to be stamped on
all none reusable (standard) nuts.

CAGE code: C3816

2/

1/ Information published in this revision was verified by direct contact with manufacturers.

2/ Information not verified to be current, no response from manufacturer. Information identical to that published in MIL-HDBK-57, Revision B.

MIL-HDBK-57G (IS)

FLEXALLOY INC.
26000 RICHMOND ROAD
BEDFORD, OH 44146



GRADE 5
HEX HEAD
CAP SCREW



GRADE 8
HEX HEAD
CAP SCREW



FX-180 HEX HEAD
CAP SCREW
(180,000 PSI
MINIMUM TENSILE
STRENGTH)



FX-180 HEX NUT
PROOF LOAD =
180,000 PSI



METRIC CAP SCREW,
PROPERTY CLASS 10.9

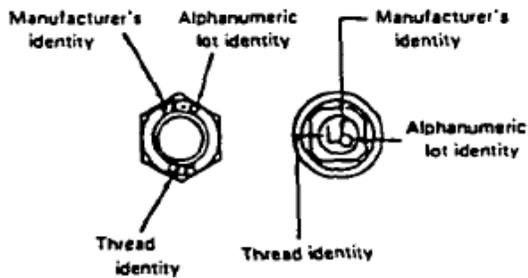

Outer Cap Wheel Nut Inner Cap Wheel Nut

WHEEL NUTS



HEX FLANGE SCREW GRADE 8

CAGE code: 0C9A2

2/

FLORES ENTERPRISES
1729 E. 28TH STREET
SIGNAL HILL, CA 0806-1923



CAGE code: 0V616

1/

FLUIDONICS INC.
205 W INDUSTRY CT
P. O. BOX 9020
DEER PARK, NY 11729



CAGE code: 58525

2/

FLUIDYNE CORPORATION
9100 COLLINS AVE.
PENNSAUKEN, NJ 08110



CAGE code: 9Y957

1/

FMW, INC.
7016 PUEBLO
WICHITA, KS 67209



CAGE CODE: 1QJK4

1/

FOCUS HOPE
13550 OAKMAN
DETROIT MICHIGAN 48238



CAGE code: 00P13

1/

1/ Information published in this revision was verified by direct contact with manufacturers.

2/ Information not verified to be current, no response from manufacturer. Information identical to that published in MIL-HDBK-57, Revision B.

MIL-HDBK-57G (IS)

FOCUS HOPE
1400 OAKMAN
DETROIT, MI 48238

FH

CAGE code 6KWK9 1/

FOLSOM TOOL & MOLD CORP.
12 MOUNT PLEASANT DR.
ASTON, PA 19014-4140

FMC
1

CAGE code: 6P049 2/

FONTAL CONTROLS, INC.
12725 ENCINITAS AVENUE
SYLMAR, CA 91342-3517

FCI

CAGE code: 0GNC3 2/

FONTANA S.A.
FONTANA LUIGI SPA
VIA PIAVE 29
VEDUGGIO MILANO,
ITALY 20050









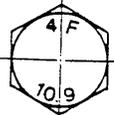

Bolts and screws
Hexagon Head
Strength Grade 10.9
Iso Metric Thread



Bolts and screws
Hexagon Head
Strength Grade 8.8
Iso Metric Thread

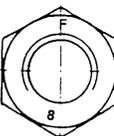

Nut
Strength Class 8
Iso Metric Thread

CAGE code: A4733 2/

1/ Information published in this revision was verified by direct contact with manufacturers.

2/ Information not verified to be current, no response from manufacturer. Information identical to that published in MIL-HDBK-57, Revision B.

MIL-HDBK-57G (IS)

FOREMOST PRECISION INSTRUMENT
CORP.
31 CARLETON AVE
MT VERNON, NY 10550-4617

F.P.I.C.

CAGE code: 33464 2/

FOREST FASTENERS
TREForest INDUSTRIAL ESTATE
PONTYPRIDD, MID. GLAMORGAN,
SOUTH WALES, GREAT BRITAIN
CF37 5YG



CAGE code: 2/

FORMED FASTENER MANUFACTURING,
INC.
7247 S. 78TH AVE
BRIDGEVIEW, IL 60455



CAGE code: 2/

FPA MANUFACTURING
DBA FPA MANUFACTURING AND SUPPLY
6733 S SEPULVEDA BLVD STE 245
LOS ANGELES, CA 90045-1525

FPA

CAGE code: 0J6Z1 2/

FRANROE PRECISION MACHINE
COMPANY
12 CHAMPION RD
GLOUCESTER CITY, NJ 08030

F.R.

F.R.P

CAGE code: 40650 2/

FREEMAN CO.
P. O. BOX 57
719 WALNUT ST
YANKTON, SD 57078

F

CAGE code: 84596 1/

FRIEDR BOESNER GMBH
AUGUSTHENALER STRABE
5450 NEUWIED 13
GERMANY

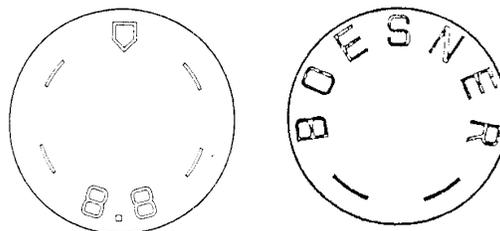

CAGE code: 2/

1/ Information published in this revision was verified by direct contact with manufacturers.

2/ Information not verified to be current, no response from manufacturer. Information identical to that published in MIL-HDBK-57, Revision B.

MIL-HDBK-57G (IS)

FRISBY AEROSPACE INC DE
DIV TRIUMPH ACTUATION SYSTEMS -
CLEMMONS
417 S.MAIN ST.
FREEPORT, NY 11520-5144

was FRISBY AIRBORNE HYDROLICS, INC

FAH

CAGE code: 26437

2/

FRONTIER BOLT COMPANY OF TEXAS
555 AIRPORT DRIVE
MANSFIELD, TX 76063-2715

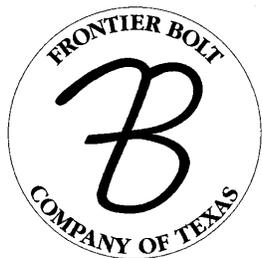

CAGE code: 1CE65

2/

FUCHS SCHRAUBENWERK GmbH
BISMARCKSTRASSE 24
5900 SIEGEN
GERMANY D-57076

Hex head/round head bolts, stud bolts



*T-head bolts,
hammer head/
hook head bolts*

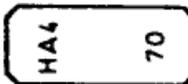
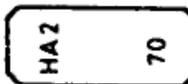
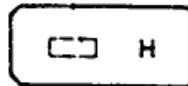

*High strength
structural bolts
(tension controlled/
twist off)*

CAGE code:

1/

G & R SCREW MACHINE PRODUCTS
21602 N. CENTRAL AVE.
SUITE 5
PHOENIX, AZ 85024

G & R

CAGE code: 7Y137

2/

1/ Information published in this revision was verified by direct contact with manufacturers.

2/ Information not verified to be current, no response from manufacturer. Information identical to that published in MIL-HDBK-57, Revision B.

MIL-HDBK-57G (IS)

G & S MACHINE INC.
2804 RENEE DRIVE
BEDFORD, TX 76021-5208

G-S

CAGE code: 62925

2/

G. B. MACHINE PRECISION, INC.
4140C AUSTIN BLVD
ISLAND PARK, NY 11558-1727

G.B.M

CAGE code: 03KF3

2/

G.B. DUPONT CO., INC
500 WEST LONG LAKE ROAD
TROY, MI 48098

D

CAGE code:

2/

GAITHER PATRICIA
DBA GAITHER MACHINE
201 PILGRIM LANE
P. O. BOX 202
MUNFORD, AL 36268-4212

GMF

CAGE code: 1BTX4

2/

GALAN PRECISION MACHINE CO.
8912 LANKERSHIM BLVD.
SUN VALLEY, CA 91352

G GPM

CAGE code: 0S1P8

2/

GALMAC MFG CO.
565 COVINA BOULEVARD
SAN DIMAS, CA 91773-2911



CAGE code: 4V765

2/

GARCIA INDUSTRIES, INC.
12345 FLORENCE AVENUE
SANTA FE SPRING, CA 90670-3807



CAGE code: 1RYN7

2/

GARDINER MFG. CO.
P.O. BOX 1499
OAKLAND, CA 94604

GARCO

CAGE code: 24042

2/

1/ Information published in this revision was verified by direct contact with manufacturers.

2/ Information not verified to be current, no response from manufacturer. Information identical to that published in MIL-HDBK-57, Revision B.

MIL-HDBK-57G (IS)

<p>GATES ALBERT, INC. 3434 UNION ST. NORTH CHILI, NY 14514-9731</p> <p style="text-align: center;">GAI</p> <p>CAGE code: 4ZBMI <u>1/</u></p>	<p>GENERAL MACHINE PRODUCTS, INC. 3525 VICKERY BLVD FORT WORTH, TX 76105</p> <div style="text-align: center;">   </div> <p>CAGE code: <u>2/</u></p>
<p>GATEWAY SCREW AND RIVET, INC. 2670 UNINTED LANE ELK GROVE VILLIAGE, IL 60007</p> <p style="text-align: center;">G</p> <p>CAGE code: <u>2/</u></p>	<p>GENERAL SCREW & SPECIALTY CO., INC. 14 N. BLEEKER ST. MT VERNON, NY 10550</p> <p style="text-align: center;">GS</p> <p>CAGE code: 26300 <u>2/</u></p>
<p>GEN FAST MANUFACTURING COMPANY 225 HENRY STREET, BLDG. 5 BRANTFORD, ONTARIO CANADA N3T 6H2</p> <div style="text-align: center;">  </div> <p>CAGE code: <u>2/</u></p>	<p>GERMAN MACHINED PRODUCTS, INC. 1208 S. HOOVER ST. GARDENA, CA 90247-1771</p> <div style="text-align: center;">  </div> <p>CAGE code: 65813 <u>2/</u></p>
<p>GENERAL AVIATION MFG., INC. 2693 PHILMONT AVE HUNTINGDON VALLEY, PA 19006-5301</p> <p style="text-align: center;">4J952</p> <p>CAGE code: 4J952 <u>2/</u></p>	<p>GERTLER INDUSTRIES, INC. 914 W. 17TH STREET COSTA MESA, CA 92627-4403</p> <p style="text-align: center;">GII</p> <p>CAGE code: 64445 <u>2/</u></p>

1/ Information published in this revision was verified by direct contact with manufacturers.

2/ Information not verified to be current, no response from manufacturer. Information identical to that published in MIL-HDBK-57, Revision B.

MIL-HDBK-57G (IS)

GFD LETAGE
 ZONE INDUSTRIELLE
 BP 63
 BOURGNE
 FRANCE 90140

Plant
 15. IMPASSE G. THIVOLLET
 P.O. BOX 26
 42011 SAINT ETIENNE CEDEX 2
 FRANCE



CAGE code: F1471

2/

GILL MACHINE & TOOL CO.
 200 PRAIRIE STREET
 ROCKFORD, IL 61107

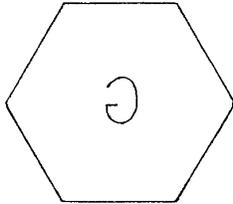

CAGE code: 0H8Y5

2/

GL CNC SERVICE INC.
 9860 OWENSMOUTH AVE #3
 CHATSWORTH, CA 91311-3852



CAGE code: 1DUA6

1/

GMJ MACHINE COMPANY, INC.
 251 STATE LINE RD S
 WILMER, AL 36587-7051



CAGE code: 8T119

2/

GMP CO. CORPORATION
 529 8TH AVE.
 BETHLEHEM, PA 18018-5008



CAGE code: 51867

2/

GOSHO WORKS, LTD.
 3-8-1 TARU-MACHI
 KOHOKU, YOKOHAMA
 222 JAPAN

G

Go

Gosho

CAGE code:

2/

1/ Information published in this revision was verified by direct contact with manufacturers.

2/ Information not verified to be current, no response from manufacturer. Information identical to that published in MIL-HDBK-57, Revision B.

MIL-HDBK-57G (IS)

GRACO INDUSTRIES, INC.
44605 MACOMB INDUSTRIAL DRIVE
CLINTON TOWNSHIP, MI 48096-1148



CAGE code: 1GT22

1/

GRAUCH ENTERPRISES
RR 1 BOX 37
1878 PORT MATILDA HWY
PHILLIPSBURG, PA 16866-3128



CAGE code: 1HU38

1/

GRADON SCREW MACHINE CORP.
P. O. BOX 1080
1411 EAST ST.
NEW BRITIAN, CT 06050-1080



CAGE code: 69870

2/

GREATER MARYLAND TOOL & MFG.,
CORP.
5 RESOURCE AVE
MOUNTAIN LAKE PARK, MD 21550-6362

GMT

CAGE code: 34549

1/

GRANDEUR FASTENERS, INC.
18798 E. HWY 10
DANVILLE, AR 72833-0658

GF

CAGE code: 3U752

1/

GREEN BAY DROP FORGE
DIV. OF CLEVELAND HARDWARE &
FORGING
1341 S. STATE ST.
P.O. BOX 11797
GREEN BAY, WI 54307-1797

See CLEVELAND HARDWARE & FORGING

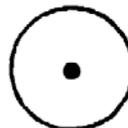

Circle with center dot

CAGE code: 08277

2/

1/ Information published in this revision was verified by direct contact with manufacturers.

2/ Information not verified to be current, no response from manufacturer. Information identical to that published in MIL-HDBK-57, Revision B.

MIL-HDBK-57G (IS)

GREENFIELD MANUFACTURING CO., INC.
920 LEVICK STREET
PHILADELPHIA, PA 19111-5422

GFM

CAGE code: 98320

2/

GREER STOP NUT
481 MCNALLY DRIVE
NASHVILLE, TN 37211-3311

G S_GL

Green nylon insert

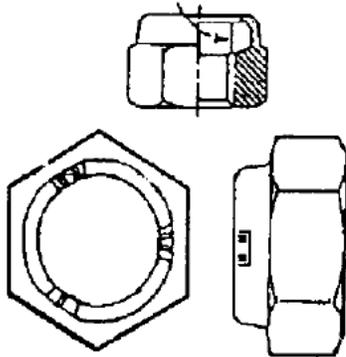

*Manufacturer identification:
2 raised ribs in (2) crimp depressions
1 raised rib in (1) crimp depression*

NFB

for head marking on
bolts and screws

CAGE code: 27687

1/

GRIPCO, DIVISION OF BLACK & DECKER
111 E. BROAD ST.
SOUTH WHITLEY, IN 46787

GN

*Raised or indented on flange or
bearing surface of bolts
Raised on head of bolts, inch or
metric
Raised or indented on flange or
bearing surface of nuts*

GF GN GN

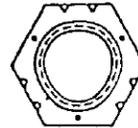

*Twin Delta
Crownlock grade
B inch locknut*

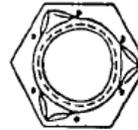

*Gripco Crown lock
Grade C inch
locknut*



*Twin Delta
Crownlock
Class 9 metric
locknut*



*Gripco
Crownlock
Class 10
metric locknut*



*Toplock
(3-6
Indentations)*



Centerlock

CAGE code: 0KS39

2/

1/ Information published in this revision was verified by direct contact with manufacturers.

2/ Information not verified to be current, no response from manufacturer. Information identical to that published in MIL-HDBK-57, Revision B.

MIL-HDBK-57G (IS)

GROOV-PIN CORPORATION
331 FARNUM PIKE
SMITHFIELD, RI 02917-1205

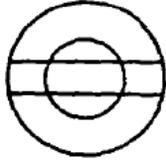

G-P

CAGE code: 73957

2/

GRUPO RASSINI S.A. de C.V.
RASSINI INTERNATIONAL, INC.
617 EAST HURON STREET
ANN HARBOR, MI 48104

Plant
TORNILLOS RASSINI S.A. de C.V.
AV. ELECTRICIDAD Y.E. PUGIBEL
CD. INDUSTRIAL, XALOSTOC
STA. CARLA, EDO DE MEXICO
APARTADO POSTAL 14-711
MEXICO D.F.

RR

Used to mark the following products:

hex cap screws
hex bolts
hex nuts
heavy hex structural bolts
heavy hex nuts
shackle bolts
hex cone nuts
wheelbolts

CAGE code:

2/

GS AEROSPACE
DIV. B & B SPECIALTIES INC
4321 E LA PALMA AVE.
ANAHEIM, CA 92807-1805

See B & B SPECIALTIES INC

1) PRIMARY - **GS**

2) SECONDARY - **GSAT**

3) SECONDARY - **1EM77**

4) SECONDARY - **GSI**
(OBSOLETE AS OF
JAN 1, 1988)

CAGE code: 1EM77

1/

GSF FASTENING
(see Armstrong Fastening Ltd.)
MIDLAND ROAD
DARLASTON
WEDNESBURY, WEST MIDLANDS WS10 8JN
GREAT BRITAIN



CAGE code:

2/

1/ Information published in this revision was verified by direct contact with manufacturers.

2/ Information not verified to be current, no response from manufacturer. Information identical to that published in MIL-HDBK-57, Revision B.

MIL-HDBK-57G (IS)

GUARDIAN RIVET & FASTENER
Guardian Mfg. Division
70 AIR PARK DRIVE
RONKONKOMA, NY 11779

Plant
201 TRADE ZONE DRIVE
RONKONKOMA, NY 11779

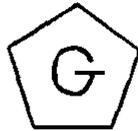

CAGE code: 2/

GUNNISON-INTERNATIONAL INC.
861 GIBBSBORO ROAD
CLEMONTON, NJ 08021-1207



CAGE code: 4G922 2/

H C MERCHANDISERS INC.
DBA H C PACIFIC
19844 QUIROZ CT
WALNUT, CA 91789-2828

HC
HCP

CAGE code: 53037 2/

H C PACIFIC
19844 QUIROZ CT
WALNUT, CA 91789 - 2828

HC HCP

CAGE code: 53037 2/

H. MULLINS, LTD.
(BADE INDUSTRIAL ESTATE)
JARROW TYNE AND WEAR CO
DURHAM, UNITED KINGDOM NE32 3EX

HM

CAGE code: 2/

H. PAULIN & CO. LTD.
(CAPITAL METAL INDUSTRIES DIVISION)
55 MILNE AVE.
SCARBOROUGH, ONTARIO
CANADA MIL 4N3



*Hex head cap
screws*



*Metric standard
hex head cap
screws*

CAGE code: 95119 2/

H. PRINZ GmbH FABRIK FUR
VERBINDUNGSELEMENTE
5970 PLETTENBERG
POSTBOX 5241
GERMANY



CAGE code: 2/

^{1/} Information published in this revision was verified by direct contact with manufacturers.

^{2/} Information not verified to be current, no response from manufacturer. Information identical to that published in MIL-HDBK-57, Revision B.

MIL-HDBK-57G (IS)

HABINA ENGINEERING
4740 COTTON BELT
SAN ANTONIO, TX 78219-2854

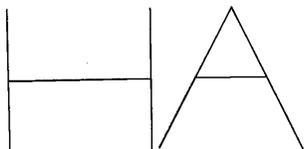

CAGE code: 1SZT7 1/

HALL INDUSTRIES INC.
(FORMERLY STANDARD TOOL & MACHINE
COMPANY)
514 MECKLEM LANE
ELLWOOD CITY, PA 16117-3028



CAGE code: 29281 1/

HALLSIMS INDUSTRIAL COMPONENTS,
INC.
37 TERRY DR.
TREVISOE, PA 19053

HIC

CAGE code: 8V986 2/

HAMANAKA (THAILAND). CO., LTD.
NO. 550 Moo6 TAIBAN ROAD
AMPHUR MUANG, SAMUTPRAKARN,
THAILAND



Plant
HAMANAKA NUT MFG. CO., LTD
KO-770 SHIRAHANA-CHO,
HIMEJI-SHI HYOGO, JAPAN



CAGE code: 5Z615 1/

HANDI GADETS CORP.
P.O. BOX 0938
LA CROSSE, WI 54603

Plant
1230 CLINTON ST.
LA CROSSE, WI 54603



CAGE code: 1M893 1/

HANSAN SCREW CO., LTD.
EXPORTING DEPARTMENT
974-7 YANG DUK-DONG
MASAN 610-00
KOREA

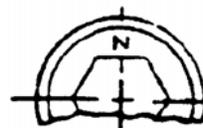

CAGE code: 2/

1/ Information published in this revision was verified by direct contact with manufacturers.

2/ Information not verified to be current, no response from manufacturer. Information identical to that published in MIL-HDBK-57, Revision B.

MIL-HDBK-57G (IS)

HARDWARE SPECIALTY CO, INC.
48-75 36TH STREET
LONG ISLAND CITY, NY 11101-1994



CAGE code: 07679

1/

HARRISON BOLT & NUT CO., THE
2781 WILKENS AVE.
BALTIMORE, MD 21223



CAGE code: 5B735

2/

HARTFORD AIRCRAFT PRODUCTS, INC.
94 OLD POQUONOCK ROAD
BLOOMFIELD, CT 06002-1427



CAGE code: 66861

2/

HARWOOD DESIGN, INC.
1507 CLYDE WAITE DRIVE
BRISTOL, PA 19007-2919

HDI

CAGE code: 1VQQ8

2/

HASKELL OF HUNTINGTON, INC.
P.O. BOX 119
HUNTINGTON, WV 25706-0119

Plant
300 THIRD AVENUE
HUNTINGTON, WV 25701



300 Series Stainless Steel



Type 316 Stainless Steel



Nickel Copper (Monel)

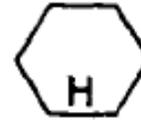

Silicon Bronze

CAGE code:

2/

HASSALL, JOHN, INC.
609-1 CANTIAGUE ROCK RD
WESTBURY, NY 11590-1721

H

CAGE code: 82224

1/

1/ Information published in this revision was verified by direct contact with manufacturers.

2/ Information not verified to be current, no response from manufacturer. Information identical to that published in MIL-HDBK-57, Revision B.

MIL-HDBK-57G (IS)

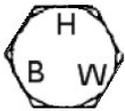
<p>HATCH INDUSTRIES 17000 S WSTN AVE STE 22 GARDENA, CA 90247-5262</p> <div style="text-align: center; margin: 20px 0;">  </div> <p>CAGE code: 03AJ8 <u>2/</u></p>
<p>HAWTHORNE BOLT WORKS P.O. BOX 474 VALLEY CITY, OH 44280</p> <p style="text-align: center; margin: 10px 0;">Plant 355 A LAKE RD. MEDINA, OH 44256</p> <div style="display: flex; justify-content: center; align-items: center; gap: 20px;"> <div style="text-align: center;">  GRADE 2 </div> <div style="text-align: center;">  GRADE 5 </div> <div style="text-align: center;">  GRADE 8 </div> </div> <p>CAGE code: 4TU98 <u>1/</u></p>
<p>HAYDON BOLTS, INC. 1181 UNITY ST PHILADELPHIA, PA 19124-3104</p> <div style="text-align: center; margin: 20px 0;">  </div> <p>CAGE code: 2S013 <u>2/</u></p>

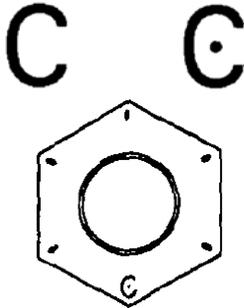
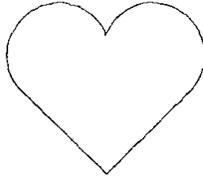
<p>HAZE SEIKO CO., LTD. KO 402 SHIRAHAMA- CHO HIMEJI-SHI, HYOUGO-KEN, JAPAN 672</p> <div style="text-align: center; margin: 20px 0;">  </div> <p>CAGE code: <u>2/</u></p>
<p>HEARTLAND PRECISION FASTENER 301 PRAIRIE VILLAGE DR NEW CENTURY, KS 66031-1121</p> <div style="text-align: center; margin: 20px 0;">  </div> <p>CAGE code: 0ZC92 <u>1/</u></p>
<p>HEIM'S MACHINE & TOOL, INC. 36 EVERGREEN ROAD LEBANON, PA 17042</p> <div style="text-align: center; margin: 20px 0;">  </div> <p>CAGE code: 0B117 <u>1/</u></p>

1/ Information published in this revision was verified by direct contact with manufacturers.

2/ Information not verified to be current, no response from manufacturer. Information identical to that published in MIL-HDBK-57, Revision B.

MIL-HDBK-57G (IS)

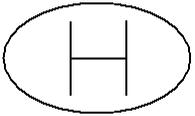
<p>HEITCO MANUFACTURING, INC. 60 TUTTLE ROAD MIDDLETOWN, CT 06457</p> <p style="text-align: center;">HTC</p> <p>CAGE code: <u>2/</u></p>	<p>HEWINS, EDMOND, C. JR. DBA JET MACHINE WORKS COMPANY 4519C WAYNE AVE PHILADELPHIA, PA 19144</p> <p style="text-align: center;">J</p> <p>CAGE code: 37KP5 <u>1/</u></p>
<p>HEMCO TOOL INC. 7 SOUTH MAPLE ST. P.O. BOX 326 WESTFIELD, MA 01085-4338</p> <p style="text-align: center;"></p> <p>CAGE code: 5R108 <u>2/</u></p>	<p>HEXAGON ENTERPRISES, INC. 256 MINNESOTA AVENUE TROY, MI 48083</p> <p style="text-align: center;">H</p> <p>CAGE code: <u>2/</u></p>
<p>HENWAY, INC. 1314 GOODRICK DRIVE P.O. BOX 1276 TEHACHAPI, CA 93561</p> <p style="text-align: center;">HP </p> <p>CAGE code: 0X6T3 <u>2/</u></p>	<p>HG AEROSPACE ENGINEERING LTD ST LEONARDS-ON-SEA EAST SUSSEX TN 389QS, ENGLAND</p> <p style="text-align: center;"></p> <p>CAGE CODE: KD652 <u>1/</u></p>
<p>HEPTNER MFG CO. RIVER ROAD BLDG. PP-1 JAY-CEE INDUSTRIAL PARK BRISTOL, PA 19007 - 6103</p> <p style="text-align: center;">7</p> <p>CAGE code: 05BZ4 <u>1/</u></p>	<p>HI INDUSTRIAL TECHNOLOGIES 241 WOODLAND AVE MORTON , PA 19070</p> <p style="text-align: center;"></p> <p>CAGE code: 0SS65 <u>2/</u></p>
<p>HESSISCHE SCHRAUBENFABRIK WELTER GmbH & CO., KG STEPHAN-NIDEREHE-STR. 6 P. O. BOX 13 40 MARBURG, GERMANY 35037</p> <p style="text-align: center;"></p> <p>CAGE code: D5396 <u>2/</u></p>	

^{1/} Information published in this revision was verified by direct contact with manufacturers.

^{2/} Information not verified to be current, no response from manufacturer. Information identical to that published in MIL-HDBK-57, Revision B.

MIL-HDBK-57G (IS)

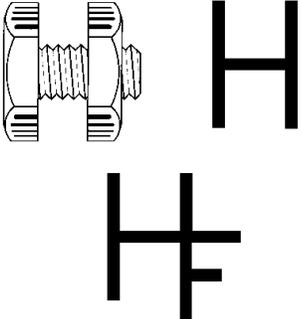
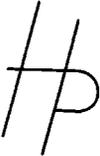
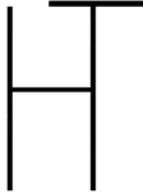
<p>HIGH QUALITY MACHINE SHOP 2775 WALSH ROAD SAN ANTONIO, TX 78224</p> <p>HQ</p> <p>CAGE code: 0B011 <u>2/</u></p>	<p>HILL AEROSPACE & DEFENSE LLC. 19734 DEARBORN STREET CHATSWORTH, CA 91311-6509</p> <p></p> <p>CAGE code: 55064 <u>2/</u></p>
<p>HIGH TECH ENTERPRISES 3299 SAN FERNANDO RD. UNIT 11 LOS ANGELES, CA 90065</p> <p>HTE.</p> <p>CAGE code: 0TSH2 <u>2/</u></p>	<p>HILL FASTENER CORP. P.O. BOX 399 ROCK FALLS, IL 61071</p> <p></p> <p>CAGE code: 4R119 <u>1/</u></p>
<p>HIGHLAND PRODUCTS CORPORATION 9331 MERCANTILE DRIVE MENTOR, OH 44060-0452</p> <p></p> <p>CAGE code: 0AKM4 <u>2/</u></p>	<p>HILL STAMPING & MFG., INC. 3202 C STREET N.E. AUBURN, WA 98002-1789</p> <p>HS</p> <p>CAGE code: 7M611 <u>1/</u></p>
<p>HIGHLAND THREADS, INC. (FASTENER MANUFACTURING DIVISION) 708 E. TIDWELL HOUSTON, TX 77022-1822</p> <p></p> <p>CAGE code: 1DT7C <u>2/</u></p>	

1/ Information published in this revision was verified by direct contact with manufacturers.

2/ Information not verified to be current, no response from manufacturer. Information identical to that published in MIL-HDBK-57, Revision B.

MIL-HDBK-57G (IS)

HILTI, INC.
5400 S. 122ND E. AVE
TULSA, OK 74121-6007

DX DIVISION

HILTI

H

ANCHOR DIVISION

HILTI
HEA M24 x 210
HILTI
HEA 3/4" x 6-5/8"

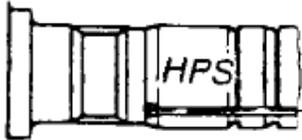

CAGE code: 11239

2/

HI-SHEAR CORP.
DBA FOREIGN PARENT IS LISI PARIS
FRANCE

See listing for LISI
2600 SKYPARK DRIVE
TORRANCE, CA 90505



hs HS

hs

Plant
TORONTO FASTENERS
INDUSTRIES, INC.
Subsidiary of Hi-Shear Corp., USA
19 CONSTELLATION COURT
REXDALE, ONTARIO M9W 1K4,
CANADA

F

CAGE code: 73197

1/

HLC INDUSTRIES INC.
6281 EMERALD LAKE DR
FARMINGTON HILLS, MI 48098



CAGE code: 0SC87

2/

1/ Information published in this revision was verified by direct contact with manufacturers.

2/ Information not verified to be current, no response from manufacturer. Information identical to that published in MIL-HDBK-57, Revision B.

MIL-HDBK-57G (IS)

HMS SERVICES LLC
 10039 WOLFRIVER
 PLYMOUTH, MI 48170-4542

M

This is the headmarking for bolts and screws.
 Headmark appears on the top of head.

M

M

M

This marking is for nuts. This mark
 appears on the side of hex nuts.

CAGE code: 1UYL6 2/

HO-HO-KUS, INC.
 189-201 LYON ST.
 PATERSON, NJ 07524

HK

CAGE code: 69370 1/

HO HONG WORKS CO., LTD
 10 CHUNG SHAN ROAD
 LU CHU VILLAGE, KAOHSIUNG
 HSIEN, TAIWAN 821

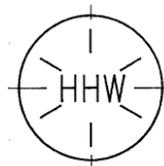

CAGE code: 1/

HOFFMANN, RICHARD GMBH CO. KG
 AM KIESWASSER 8-10
 D-5940 LENNESTADT-ELSPE MEISELTER
 WEG
 KYLLBURG, GERMANY 5524

Plant
 HOFFMANN MACHINE COMPANY,
 INC.
 1386 DREXEL ROAD
 VALDESE, NC 28690

H

CAGE code: 0HEK2 1/

HOLLYWOOD MANUFACTURING INC.
 11915 VOSE STREET
 NORHT HOLLYWOOD, CA 91605-5750

H

CAGE code: 7T729 2/

1/ Information published in this revision was verified by direct contact with manufacturers.

2/ Information not verified to be current, no response from manufacturer. Information identical to that published in MIL-HDBK-57, Revision B.

MIL-HDBK-57G (IS)

HOLO-KROME CO.
31 BROOK STREET
WEST HARTFORD, CT 06110-2385



*On some socket
screw products*



*1960 series cap
screws - old
design*



*1960 series cap
screws - present
design*



Metric socket cap



CAGE code: 74445

2/

HORSPOOL & ROMINE MANUFACTURING
CO., INC.
5850 MARSHALL STREET
OAKLAND, CA 94608-2696

HR HR

CAGE code: 95723

1/

HORST ENGINEERING &
MANUFACTURING CO.
P.O. BOX 280066
EAST HARTFORD, CT 06108-2003

Plant
36 CEDAR ST
EAST HARTFORD, CT 06108

HEM
HE HE

CAGE code: 05812

1/

HOUSTON FASTENER
(DIVISION OF WESTBROOK MFG)
1202 KRESS STREET
P.O. BOX 15614
HOUSTON, TX 77020

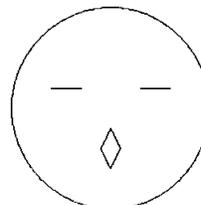

CAGE code: 0YN70

2/

HOUSTON PRECISION FASTENERS
10018 TANNER ROAD
HOUSTON, TX 77041

HPF

CAGE code: 1VSL7

1/

1/ Information published in this revision was verified by direct contact with manufacturers.

2/ Information not verified to be current, no response from manufacturer. Information identical to that published in MIL-HDBK-57, Revision B.

MIL-HDBK-57G (IS)

HOWARD TOOL CO., INC.
547 ODLIN ROAD
BANGOR, ME 04401-6707



CAGE code: 044B0 2/

HOWE MACHINE AND TOOL CORP.
236 PARK AVE.
BETHPAGE, NY 11714-3709

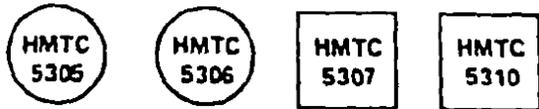

CAGE code: 65777 1/

HOWELL PRECISION, INC.
6 BROWN DRIVE
MOUND HOUSE, NV 89706-7744



CAGE code: 6Y774 1/

HOWIE MANUFACTURING CO., INC.
P.O. BOX 426
COLLINGSWOOD, NJ 08108

Plant
1227 MECHANIC ST.
CAMDEN, NJ 08104-1221



CAGE code: 9V802 1/

HUCK AEROSPACE PRODUCTS
AFS CARSON OPERATIONS
900 WATSON CENTER ROAD
CARSON, CA 90745-4201
CAGE code: 17446

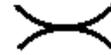

AFS TUCSON OPERATIONS
3724 E. COLUMBIA ST.
TUCSON, AZ 85714-3415
CAGE code: 0HDW7 (1G6U6 expired)

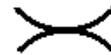

HUCK INDUSTRIAL PRODUCTS
AFS WACO OPERATIONS
8001 IMPERIAL DRIVE
WACO, TX 76714
CAGE code: 9K475

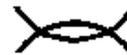

HUCK PRODUCTS
AFS US OPERATIONS
BP4, CLOS D'ASSEVILLE
95450 US PAR VIGNY
FRANCE
CAGE code: F6167



(Corporate office see ALCOA FASTENING SYSTEMS)

CAGE code: 17446, 1G6U6, 9K475,
F6167 1/

1/ Information published in this revision was verified by direct contact with manufacturers.

2/ Information not verified to be current, no response from manufacturer. Information identical to that published in MIL-HDBK-57, Revision B.

MIL-HDBK-57G (IS)

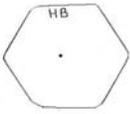
<p>HUGGINS MFG. 4314 GARLAND DR. FORT WORTH, TX 76117</p> <p style="text-align: center;">H</p> <p>CAGE code: 0TCV6 <u>2/</u></p>	<p>HURON AUTOMATIC SCREW CO. P.O. BOX 610068 4914 GRATIOT RD PORT HURON, MI 48061-0068</p> <p style="text-align: center;">H</p> <p>CAGE code: 00905 <u>2/</u></p>
<p>HUGO DURHOLT GMBH & CO. KG SCHRAUBENDREH-UND PREBWERK POSTFACH 16-80 D-5632 WERMELSKIRCHEN GERMANY</p> <p style="text-align: center;"> HD</p> <p>CAGE code: <u>1/</u></p>	<p>HURRICANE MACHINE COMPANY, L.L.C. 2644 FREEWOOD DRIVE DALLAS, TX 75220</p> <p style="text-align: center;">9</p> <p>CAGE code: 1H7G3 <u>2/</u></p>
<p>HUNT VALVE COMPANY, INC. DBA WAECO VALVE DIVISION 1913 EAST STATE STREET SALEM, OH 44460</p> <p style="text-align: center;"></p> <p>CAGE code: 11859 <u>2/</u></p>	<p>HYDRO FITTING MFG. CORP. 733 E. EDNA PLACE P.O. BOX 1558 COVINA, CA 91722-1409</p> <p style="text-align: center;">HF</p> <p>CAGE code: 13899 <u>2/</u></p>
<p>HUNTER STEVENS COMPANY 4003 FLEETWOOD AVE. FRANKLIN PARK, IL 60131</p> <p style="text-align: center;">HSC</p> <p>CAGE code: 48093 <u>2/</u></p>	<p>HYDROBOLT LIMITED GLOBAL SERVICE CENTRE, MONMORE BUSINESS PARK, DIXON STREET WOLVERHAMPTON, WV2 2EE. U. K.</p> <p style="text-align: center;"> HB</p> <p>CAGE code: <u>1/</u></p>
<p>HUNTINGTON VALLEY INDUSTRIES, INC DBA HVI 15182 TRITON LN 101 HUNTINGTON BEACH, CA 92649-1041</p> <p style="text-align: center;">HVI</p> <p>CAGE code: 9S754 <u>2/</u></p>	

1/ Information published in this revision was verified by direct contact with manufacturers.

2/ Information not verified to be current, no response from manufacturer. Information identical to that published in MIL-HDBK-57, Revision B.

MIL-HDBK-57G (IS)

I.G.D. MACHINE & TOOL LTD.
992 HUBREY ROAD
LONDON, ONTARIO, CANADA N6N 1B5



CAGE code: 2/

IDEAL FASTENERS INC.
3850 E MIRALOMA AVE
ANAHEIM, CA 92806



CAGE code: 6F810 1/

IFASTGROUPE 2004 LP
CANADA

SEE LISTINGS FOR:

INFASCO
700 OUELLETTE
MARIEVILLE, QUEBEC
CANADA
J3M 1P6
CAGE code: 1C225

INFASCO NUT
3990 NASHUA DRIVE
MISSISSAUGA, ONTARIO,
CANADA
L4VT 1P6
CAGE code: 06KL6

INGERSOLL FASTENERS
390 THOMAS STREET
INGERSOLL, ONTARIO
CANADA
N5C 3K3
CAGE code: 35571 1/

IMPERIAL SUPPLIERS, INC.
P.O. BOX 11008
789 PACKER DR
GREEN BAY, WI 54304-4527

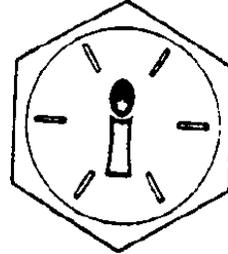

GRADE 8

CAGE code: 3A4R0 2/

INDIANA AIRCRAFT HARDWARE
221 SOUTH MAIN STREET
FORTVILLE, IN 46040-1514

IA

IAH

5N319

CAGE code: 5N319 1/

1/ Information published in this revision was verified by direct contact with manufacturers.

2/ Information not verified to be current, no response from manufacturer. Information identical to that published in MIL-HDBK-57, Revision B.

MIL-HDBK-57G (IS)

INDUSTRIAL & AUTOMOTIVE FASTENERS
(DIVISION OF KEY MANUFACTURING
GROUP, INC.
3200 W. FOURTEEN MILE RD.
ROYAL OAK, MI 48073

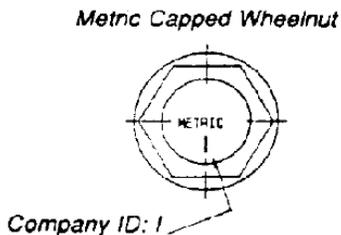
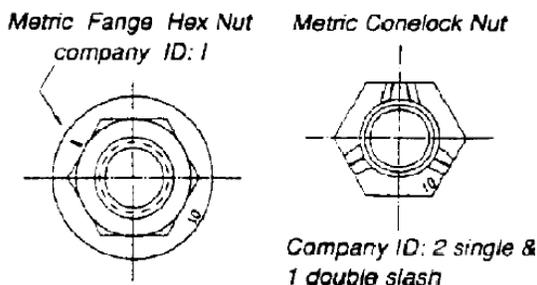
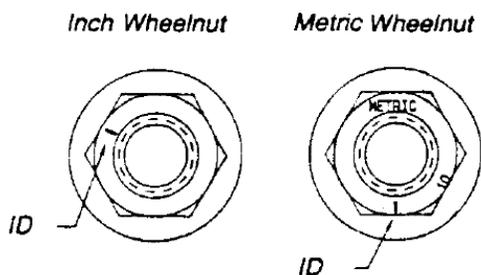
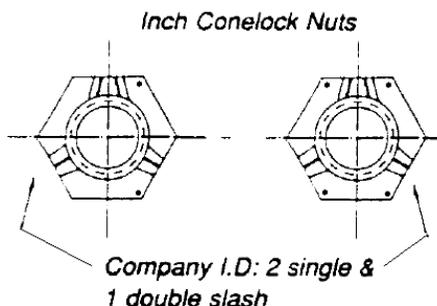

CAGE code: 2/

INDUSTRIAL FASTENERS CORP.
7 HARBOR PARK DR
PORT WASHINGTON, NY 11050

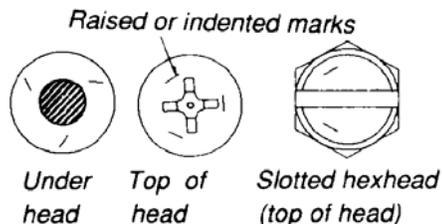

CAGE code: 84992 2/

INDUSTRIAL FORGE, INC.
832 LANTANA RD
LAKE WORTH 33462 - 1509



CAGE code: 0RY28 2/

INDUSTRIAL NUT CORP.
1425 TIFFIN AVE
SANDUSKY, OH 44870-2054

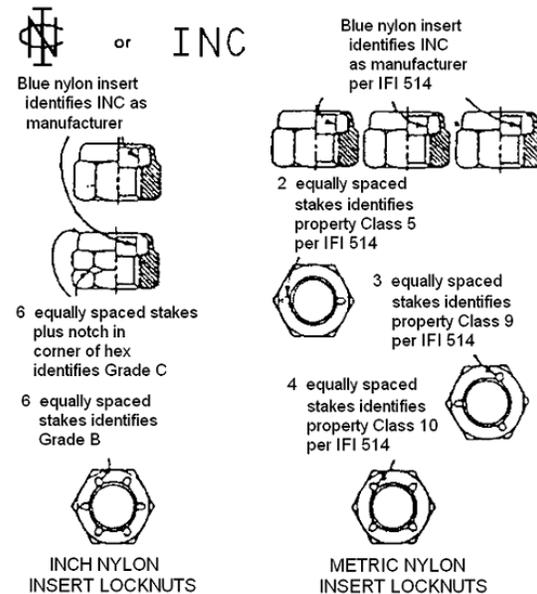

The blue insert is a trademark of Industrial Nut Corp. registered in the U.S. Patent & Trade Office.

CAGE code: 81198 1/

1/ Information published in this revision was verified by direct contact with manufacturers.

2/ Information not verified to be current, no response from manufacturer. Information identical to that published in MIL-HDBK-57, Revision B.

MIL-HDBK-57G (IS)

INDUX, S.A. DE C.V.
LAMINADORA 37
BELLAVISTA-TACUBAYA
MEXICO, D.F. 01140
MEXICO

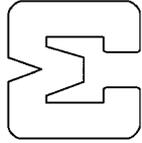

CAGE code: SDK76

1/

INFASCO
(see IFASTGROUPE 2004 LP)
700 OUELLETTE
MARIEVILLE, QUEBEC
CANADA
J3M 1P6

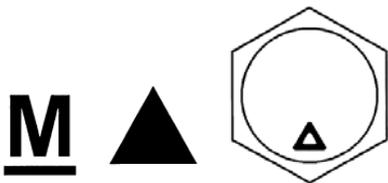

CAGE code: 1C225

1/

INFASCO NUT
(see IFASTGROUPE 2004 LP)
3990 NASHUA DRIVE
MISSISSAUGA, ONTARIO,
CANADA
L4VT IPG8

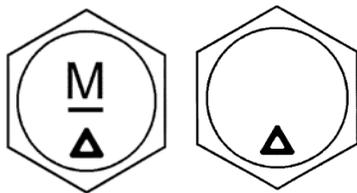

CAGE code: 06KL6

1/

INGERSOLL FASTENERS
(see IFASTGROUPE 2004 LP)
390 THOMAS STREET
INGERSOLL, ONTARIO
CANADA
N5C 3K3

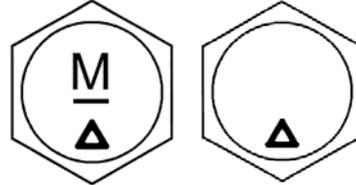

CAGE code: 35571

1/

INLAND MACHINE CO.
10762 EDISON CT.
RANCHO CUCAMONGA, CA 91730-4845



CAGE code: 6W617

2/

INOFASST MANUFACTURING INC.
1370 INDUSTRY RD.
HATFIELD, PA 19440



CAGE code: 2T359

2/

IN-SPECK CORP.
208 EAST PENN ST
NORRISTOWN, PA 19401-1471



CAGE code: 32904

2/

1/ Information published in this revision was verified by direct contact with manufacturers.

2/ Information not verified to be current, no response from manufacturer. Information identical to that published in MIL-HDBK-57, Revision B.

MIL-HDBK-57G (IS)

INSTRUMENT MACHINING SERVICE LTD.
HOWLETT WAY, THETFORD,
NORFOLK IP24 IHZ
UNITED KINGDOM



CAGE code: 2/

INTERFLEX MFG. CORP.
144 TOLEDO ST
FARMINGDALE, NY 75222-4429

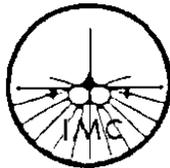

CAGE code: 0LD24 2/

INTERSTATE FITTINGS INC.
2200 SINGLETON BLVD.
DALLAS, TX 75212



CAGE code: 1EHF9 2/

IRON BOUND MANAGEMENT GROUP
79 SUMMIT AVE.
CHATHAM, NJ 07928

IMG

CAGE code: 5UKF4 1/

IRVING MACHINE SERVICE, INC.
451 MAIN STREET
P.O. BOX 94
IRVING, NY 14081

IM

CAGE code: 2/

IRWIN AUTOMATION, INC.
715 CLEVELAND STREET
GREENSBURG, PA 15601-1279

IRW

CAGE code: 7H803 1/

ISLAND ENGINEERING
DBA J SMITH MACHINE SHOP INC
153 S MAIN ST
FREEPORT, NY 11520-0384



CAGE code: 40137 2/

1/ Information published in this revision was verified by direct contact with manufacturers.

2/ Information not verified to be current, no response from manufacturer. Information identical to that published in MIL-HDBK-57, Revision B.

MIL-HDBK-57G (IS)

ITT HARPER AEROSPACE FASTENER
OPERATIONS
(AEROSPACE CONTROLS DIVISION)
28150 INDUSTRY DRIVE
VALENCIA, CA 91355

AOL

CAGE code: 2/

ITW BUILDEX
1349 WEST BRYN MAWR AVE.
ITASCA, IL 60143

B X

CAGE code: 2/

ITW CIP
850 STEAM PLANT ROAD
GALLATIN, TX 37066

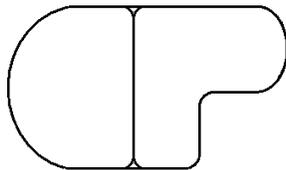

CAGE code: 50CR2 1/

IVACO INC.

(See IFASTGROUPE 2004 LP, CANADA)

See listings for:

INFASCO
700 OUELLETTE
MARIEVILLE, QUEBEC
CANADA
J3M 1P6
CAGE code: 1C225

INFASCO NUT
3990 NASHUA DRIVE
MISSISSAUGA, ONTARIO,
CANADA
L4VT 1P8
CAGE code: 06KL6

INGERSOLL FASTENERS
390 THOMAS STREET
INGERSOLL, ONTARIO
CANADA
N5C 3K3
CAGE code: 35571

CAGE code: 1C225 1/

J & M MACHINE INC.
1234 HIGH STREET
PAINESVILLE, OH 44077

1H423

CAGE code: 1H423 1/

J & S PRECISION PRODUCTS
16 EVESBORO RD.
MEDFORD, NJ 08055-9592



CAGE code: 8B865 2/

1/ Information published in this revision was verified by direct contact with manufacturers.

2/ Information not verified to be current, no response from manufacturer. Information identical to that published in MIL-HDBK-57, Revision B.

MIL-HDBK-57G (IS)

J.F. FREDERICKS TOOL CO.
25 SPRING LANE
FARMINGTON, CT 06032-31 96

33575

CAGE code: 33575

1/

J. G. FASTENERS
9720 COZYCROFT AVE
CHATSWORTH, CA 91311-4423

JG

CAGE code: 0VWM9

2/

J. GEORG BIERBACH
WERDOHLER STRASSE 23
ALTENA, GERMANY D-5990

G E B I



CAGE code:

2/

J.M. PRECISION, INC.
(FASTENER DIVISION)
9722 TOPANGA CANYON BLVD
CHATSWORTH, CA 913114015

JMP

CAGE code: 0JV78

1/

J.P. PRODUCTS, INC.
(DBA SPECIALITES, UNLIMITED)
P.O. BOX 427
WILLOUGHBY, OH 44094

S

CAGE code:

2/

JACOBSON MFG., LLC.
941-955 LAKE RD.
MEDINA, OH 44256

CAGE code: 58PU8

1/

Plant
JACOBSON MFG – TIFFIN, LLC.
1988 COUNTY ROAD #593
TIFFIN, OH 44883

J

CAGE code: 58UV4

1/

JACO ENGINEERING, INC.
879 SO. EAST STREET
ANAHEIM, CA 92805-5356

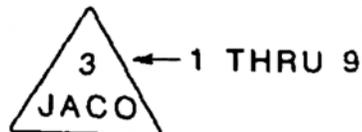

CAGE code: IH427

1/

1/ Information published in this revision was verified by direct contact with manufacturers.

2/ Information not verified to be current, no response from manufacturer. Information identical to that published in MIL-HDBK-57, Revision B.

MIL-HDBK-57G (IS)

JAM TECH CORP.
P.O. BOX 327
ESSINGTON, PA 19029

Plant
1260 East Woodland Avenue
Springfield, PA 19064

JT

CAGE code: IEM35 2/

JAMES IPPOLITO & CO., INC.
1069 CONNECTICUT AVE.
BRIDGEPORT, CT 06607

96458

CAGE code: 96458 1/

JAMES JACKSON
DBA J J ENGINEERING
11021 VIA EL MERCADO
LOS ALAMITOS, CA 90720-0281

JJE

CAGE code: 0CEP4 2/

JAMISON INDUSTRIES INC.
12669 DELTA ST
TAYLOR, MI 48180-6835

JI

CAGE code: 1Z781 1/

JANUS FASTENING SYSTEMS, INC.
2440 GERMAN ROAD, SUITE B5
CHANDLER, AZ 85286

J r

CAGE CODE: 58BQ5 1/

JAY BEE MACHINE WORKS, INC.
400 PIKE RD.
HUNTINGDON VALLEY, PA 19006-1610

B

CAGE code: 74954 1/

JAY O MACHINE CO., INC.
7685 HUB PARKWAY
VALLEY VIEW, OH 44125-5706

J O M

CAGE code: 5Z832 2/

JAYCO ENGINEERING, INC.
1660 BABCOCK AVENUE
COSTA MESA, CA 92627-4330

JE

CAGE code: 7J578 1/

1/ Information published in this revision was verified by direct contact with manufacturers.

2/ Information not verified to be current, no response from manufacturer. Information identical to that published in MIL-HDBK-57, Revision B.

MIL-HDBK-57G (IS)

<p>JEA ENTERPRISES, INC. P.O. BOX 512 MIDDLEBURY, CT 06762</p> <p>Plant 86 BESSON RD. MIDDLEBURY, CT 06762</p> <p style="text-align: center;">JEA</p> <p>CAGE code: 1S5U2 1/</p>	<p>JJ ENGINEERING (See JAMES JACKSON) 11021 VIA EL MERCADO LOS ALAMITOS, CA 90720-0281</p> <p style="text-align: center;"></p> <p>CAGE code: 0CEP4 2/</p>
<p>JERGENS INC. DBA JERGENS INDUSTRIAL SUPPLY 15700 S WATERLOO RD CLEVELAND, OH 44110-3814</p> <p style="text-align: center;"></p> <p>CAGE code: 94882 2/</p>	<p>JJ SCREW PRODUCTS, INC. 21519 PARTHENIA STREET CANOGA PARK, CA 91304</p> <p style="text-align: center;"></p> <p>CAGE code: 75209 2/</p>
<p>JEWELL TOOL TECH Doing business for KARMA INC 3129 STATE STREET BEHENDORF, IA 52722</p> <p style="text-align: center;"></p> <p>CAGE CODE: 1GW80 1/</p>	<p>JMT MACHINE COMPANY 9986 GANTRY ROAD PHILADELPHIA, PA 19115-1080</p> <p style="text-align: center;">2A832</p> <p>CAGE code: 2A832 2/</p>
<p>JINN HER ENTERPRISE CO., LTD. 107 SHIN LO STREET KANGSHAN CHEN, KAOHSIUNG HSIEN TAIWAN R.O.C.</p> <p style="text-align: center;">JH</p> <p>CAGE code: NONE 1/</p>	<p>JOHN R. BROMILEY COMPANY INC. 105 BRISTOL ROAD CHALFONT, PA 18914</p> <p style="text-align: center;">JRB</p> <p>CAGE code: 1EV05 1/</p>

1/ Information published in this revision was verified by direct contact with manufacturers.

2/ Information not verified to be current, no response from manufacturer. Information identical to that published in MIL-HDBK-57, Revision B.

MIL-HDBK-57G (IS)

JOLICO/J-B TOOL INC.
4325 E. 22 MILE ROAD
UTICA, MI 48317-1507

JOLICO

CAGE code: 19549 2/

JOSLYN CORP.
MACLEAN POWER SYSTEMS
11411 ADDISON STREET
FRANKLIN, IL 60131-1130

Plant
3700 SOUTH MORGAN STREET
CHICAGO, IL 60609-1461

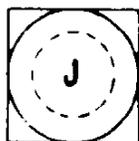

Machine bolts

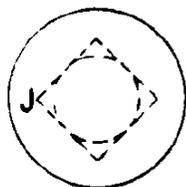

Carriage bolts

CAGE code: 74999 1/

JUNIPER ELBOW CO.
72-15 METROPOLITAN AVE.
MIDDLE VILLAGE, NY 11379



CAGE code: 97537 1/

JUPITER WASHERS, INC.
10-01 37TH AVE.
LONG ISLAND CITY, NY 11101-6014



CAGE code: 25900 2/

JUST IN TIME, INC.
DBA APSCO
2538 WEST LN., SUITE 16
STOCKTON, CA 95205

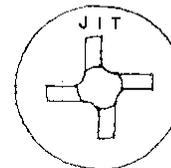
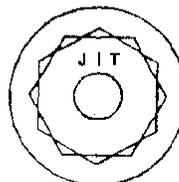
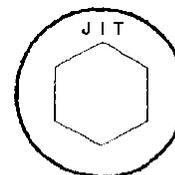
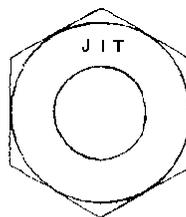

CAGE code: 0FVD5 2/

K & K PRECISION ENTERPRISES
60 STEAM WHISTLE DRIVE
WARMINSTER, PA 18974

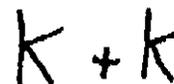

CAGE code: 1K6D9 2/

1/ Information published in this revision was verified by direct contact with manufacturers.

2/ Information not verified to be current, no response from manufacturer. Information identical to that published in MIL-HDBK-57, Revision B.

MIL-HDBK-57G (IS)

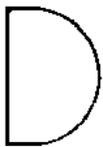
<p>K.A.A. COMPANY (LYNN ABADIE DBA K A A COMPANY) 1309 MADISON STREET WEATHERFORD, TX 76086-2144</p>  <p>CAGE code: 1XRQ5 2/</p>
<p>K.D.K. UPSET FORGING CO. 2645 W. 139TH ST. P.O. BOX 146 BLUE ISLAND, IL 60406-0146</p> <p style="text-align: center;">KDK</p> <p>CAGE code: 8P293 2/</p>
<p>KAMAX-WERKE RUDOLF KELLERMANN GmbH & CO. KG PETERSHUETTER ALLEE 29 OSTRODE, GERMANY 37520</p> <p style="text-align: center;">KAMAX KX</p> <p>CAGE code: C5315 2/</p>
<p>KAMAX L. P. (FORMERLY G.B. DUPONT CO., INC.) 500 WEST LONG LAKE ROAD TROY, MI 48098-4540</p>  <p>CAGE code: 1DWW1 1/</p>

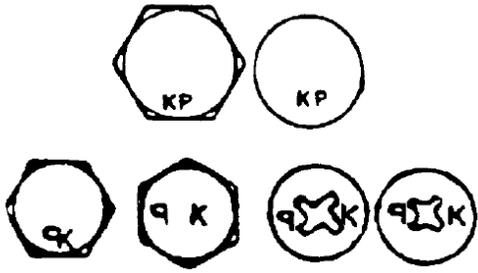
<p>KAMPWERK VIEREGGE U. PICKARDT GMBH. & CO P.O. BOX 5143 PLETTENBURG 5 G-5970</p>  <p>CAGE code: 2/</p>
<p>KAPCO INDUSTRIES, INC. 5660 KNOTT AVE BUENS PARK, CA 90621</p>  <p>CAGE code: 0BMF4 2/</p>
<p>KARMA INC dba JEWELL TOOL TECH 3129 STATE STREET BEHENDORF, IA 52722</p>  <p>CAGE CODE: 1GW80 1/</p>

1/ Information published in this revision was verified by direct contact with manufacturers.

2/ Information not verified to be current, no response from manufacturer. Information identical to that published in MIL-HDBK-57, Revision B.

MIL-HDBK-57G (IS)

KATSURAGAWA MACHINE SCREW CO.,
LTD.
3-24-1 YAGUCHI OHTA-KU
TOKYO 146
JAPAN

Plant
366-1, KOGOSYO
KAKEGAWA-SHI
SHIZUOKA-KEN 436
JAPAN

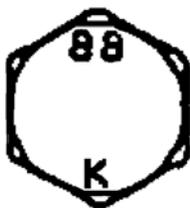

CAGE code: 2/

KAYGOR, INC.
1243 TRANSIT STREET
P.O. BOX 2950
POMONA, CA 91769-2950



CAGE code: 4H229 2/

KAYNAR PRODUCTS
800 S. STATE COLLEGE BLVD.
FULLERTON, CA 92831

(Corporate office see ALCOA FASTENING
SYSTEMS)

(Previously listed under MICRODOT INC.)

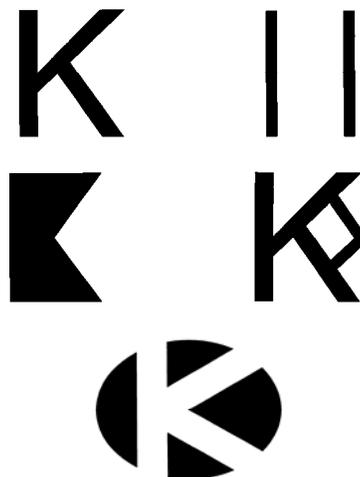

CAGE code: 15653 1/

KELLER ENGINEERING
136 W. 157TH STREET
GARDENA, CA 90248-2226



CAGE code: 4W941 2/

KELOX/MICRODOT PRODUCTS
AFS TORRANCE OPERATIONS
3020 WEST LOMITA BLVD.
TORRANCE, CA 90505-5103

(Corporate office see ALCOA FASTENING
SYSTEMS)



CAGE code: 75237 1/

1/ Information published in this revision was verified by direct contact with manufacturers.

2/ Information not verified to be current, no response from manufacturer. Information identical to that published in MIL-HDBK-57, Revision B.

MIL-HDBK-57G (IS)

KEN FORGING, INC.
1049 GRIGGS RD
P.O. BOX #277
JEFFERSON, OH 44047

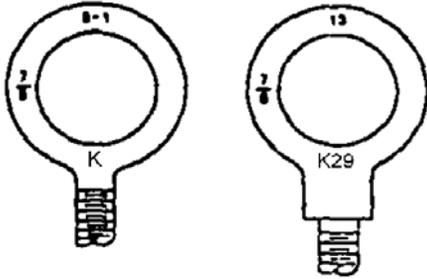

CAGE code: 1GMT9

1/

KERR, CHARLES W.
RIVER RD BLDG PP-1
JAY CEE INDUSTRIAL PK
BRISTOL, PA 19007

see MAUI MEGA



CAGE code: 0M4F0

2/

KERR LAKESIDE INC.
26841 TUNGSTEN RD.
P.O. BOX 32220
EUCLID, OH 44117-2680



CAGE code: 7P576

1/

KEYSTONE BOLT & NUT COMPANY
KEYSTONE THREADED PRODUCTS
DIVISION
P.O. BOX 31059
CLEVELAND, OH 44313-0059

Plant
7621 OLD ROCKSIDE RD.
CLEVELAND, OH 44131-0059

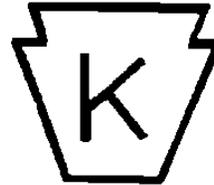

CAGE code: 4N487

1/

KEYSTONE TOOL & MACHINE CO.
108 N. McDADE BLVD.
DARBY, PA 19023



CAGE code: 7Y516

2/

KILBOURN ENGINEERING CO.
9226 WEST FLAGG AVE.
MILWAUKEE, WI 53225-2718



CAGE code: 8H824

2/

1/ Information published in this revision was verified by direct contact with manufacturers.

2/ Information not verified to be current, no response from manufacturer. Information identical to that published in MIL-HDBK-57, Revision B.

MIL-HDBK-57G (IS)

KIRSTEN PIPE CO. INC.
1807 NW DOCK PL
P.O. BOX 70526
SEATTLE, WA 98127-0526

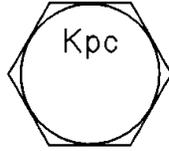

CAGE code: 5E704 2/

K.L.M. MACHINE INC.
711 COLONIA LANE EAST
NOKOMIS, FL 34275

KLM

CAGE code: 4NDJ6

KLINCHER LOCKNUT CORP.
2030 N. OXFORD ST.
P.O. BOX 18100
INDIANAPOLIS, IN 46218

KL

CAGE code: 2/

KNIPPING-DORN GmbH
KALTUMFORMTECHNIK
4690 HERNE 1
POSTFACH 1229
GERMANY

DORN

In connection with the identification mark of property class 3.6 up to and including 12.9

CAGE code: 2/

KNOCH MANUFACTURING CO. LTD.
1054 SHAW RD
DORCHESTER, CANADA N0L 1G4

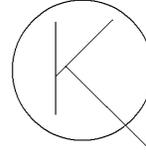

CAGE code: 1C763 2/

KO AMS MACHINE PRODUCTS
DBA KOAM MACHINE
915 BROOKS ST UNIT 102
ONTARIO, CA 91762-3603

KO

CAGE code: 0K7E0 2/

KOBE FASTENER LIMITED
654 HISBIE
HIGASBI OSAKA, 577
JAPAN

α

CAGE code: 2/

KOLB GMBH & CO.
HERSTELLER VON
VERBINDUNGSELEMENTEN
RATHENAU STRASSE 23
POSTFACH 24 02 53 WUPPERTAL
GERMANY 42277

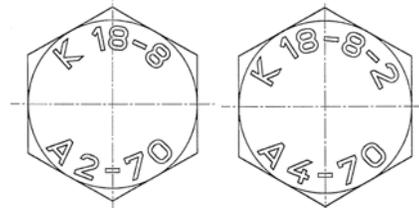

CAGE code: D0472 2/

1/ Information published in this revision was verified by direct contact with manufacturers.

2/ Information not verified to be current, no response from manufacturer. Information identical to that published in MIL-HDBK-57, Revision B.

MIL-HDBK-57G (IS)

KONDOR TECHNOLOGIES, INC.
206 CHRISTOPHER ST
RONKONKOMA, NY 11779-6921

KTI

CAGE code: 06ZB0 2/

KONGO BYORA CO., LTD.
2-1-27 SHITENNOJI
TENNOJI-KU
OSAKA 543 JAPAN

Plant
3-31 NAGATA-NISHI
HIGASHIOSAKA-SHI, OSAKA
577 JAPAN

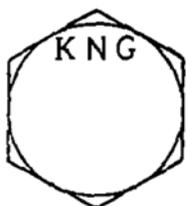

CAGE code: 2/

KOREA BOLT IND., CO., LTD.
(FOREIGN TRADE DEPARTMENT)
620-34 GURO-DONG, GURO-KU
SEOUL, KOREA

Plant
732-3 WONSI-DONG, ANSAN-CITY
GYUNGGI-DO, KOREA



CAGE code: 2/

KORODY COLYER CORP.
A CR INDUSTRIES COMPANY
5412 MCFADDEN AVE.
HUNTINGTON BEACH, CA 92649

K

CAGE code: 18954 2/

KOZAK, E. PERCISION PRODUCTS CO.
45 WOODLAND AVE.
ROCKAWAY, NJ 07866

KPP

CAGE code: 1CP43 2/

KPF
601 YOUNGTAN-DONG, CHUNGJU-CITY
CHUNGCHEONGBUK-DO 380-250, KOREA

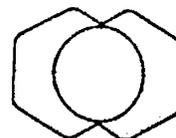

CAGE code: 1/

KREIS TOOL & MFG., CO., INC.
1615 CAMBRIDGE DR
ELGIN, IL 60123 - 3114

KTM

CAGE code: 64592 2/

1/ Information published in this revision was verified by direct contact with manufacturers.

2/ Information not verified to be current, no response from manufacturer. Information identical to that published in MIL-HDBK-57, Revision B.

MIL-HDBK-57G (IS)

KROBACH MANUFACTURING CORP.
3504 ARDEN RD.
HAYWARD, CA 94545-5390



CAGE code: 30828 1/

KSS SOCKET SCREW, INC.
3416 S. 48TH STREET SUITE #6
PHOENIX, AZ 85040

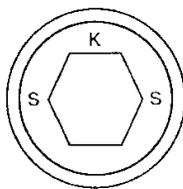

CAGE code: 0BMF5 2/

K-TECH MFG., INC.
288 HOLBROOK DRIVE
WHEELING, IL 60090

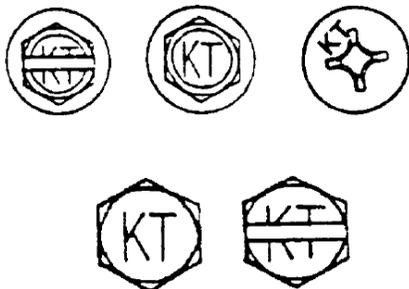

CAGE code: 2/

KYOEI SEISAKUSHO CO., LTD.
4-5-11 NUNOICHI-CHO
HIGASHIOSAKA-SHI,
OSAKA 579
JAPAN

Plant
MINAMISHINOZAKI
KAZSHI, SAILAMA-KEN
347 JAPAN



CAGE code: 2/

KYOKUTO MFG CO LTD.
3-5-29 WAKAEHONMACHI
HIGASHIOSAKA-SHI
OSAKA 578
JAPAN

Plant
1109-5 SHIBADE
KURAMOCHI-CHO,
NABARI-SHE, MIE-KEN 518-04
JAPAN

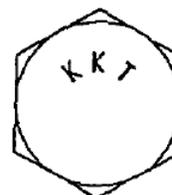

CAGE code: 2/

L & C MANUFACTURING CO., INC.
8610 S. 33RD W. AVENUE
TULSA, OK 74132-3403



CAGE code: 43813 2/

1/ Information published in this revision was verified by direct contact with manufacturers.

2/ Information not verified to be current, no response from manufacturer. Information identical to that published in MIL-HDBK-57, Revision B.

MIL-HDBK-57G (IS)

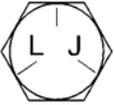
<p>L & H THREADED RODS CORP. DIV OF GRAY AMERICA CORP 3050 DRYDEN ROAD DAYTON, OH 45439</p> <p style="text-align: center;">L</p> <p>CAGE code: 0UH42 <u>2/</u></p>	<p>L H INDUSTRIES, INC. <i>TIP TOP TOOL CO.</i> 3513 NORTH 10th STREET PHILADELPHIA, PA 19140</p> <p style="text-align: center;">LH</p> <p>CAGE code: 0E7S8 <u>2/</u></p>
<p>L & J FASTENERS, INC. 3636 LACON ROAD HILLIARD, OH 43026-6122</p> <p style="text-align: center;"></p> <p>CAGE code: 1W358 <u>2/</u></p>	<p>L N AEROSPACE, INC. 6011 TENSION DRIVE FORT WORTH, TX 76112-2693</p> <p style="text-align: center;">LNA</p> <p>CAGE code: 1EB45 <u>2/</u></p>
<p>L & M ENTERPRISES, INC. 1910 NORTHERN WICHITA, KS 67216-2429</p> <p style="text-align: center;">L & M</p> <p>CAGE code: 0HDM5 <u>2/</u></p>	<p>L P R PRECISION PARTS AND TOOL COMPANY, INC. 108 ROME STREET FARMINGDALE, NY 11735-2136</p> <p style="text-align: center;">L. P. R.</p> <p>CAGE code: 31583 <u>2/</u></p>
<p>L. A. MARTIN CO. 14400 HENN STREET DEARBORN, MI 48126-1850</p> <p style="text-align: center;">LAM</p> <p>CAGE code: 9S775 <u>1/</u></p>	<p>L R G CORPORATION 210 MAGEE AVE JEANNETTE, PA 15644-2136</p> <p style="text-align: center;">LRG</p> <p>CAGE code: 75783 <u>2/</u></p>
<p>L G MACHINE & MFG INC. 1276 W. ARKANSAS LANE ARLINGTON, TX 76013-6235</p> <p style="text-align: center;">LG</p> <p>CAGE code: 0P4S2 <u>1/</u></p>	

1/ Information published in this revision was verified by direct contact with manufacturers.

2/ Information not verified to be current, no response from manufacturer. Information identical to that published in MIL-HDBK-57, Revision B.

MIL-HDBK-57G (IS)

LAKE ERIE SDREW CORP.
13001 ATHENS AVE.
LAKEWOOD, OH 44107-6201

LE

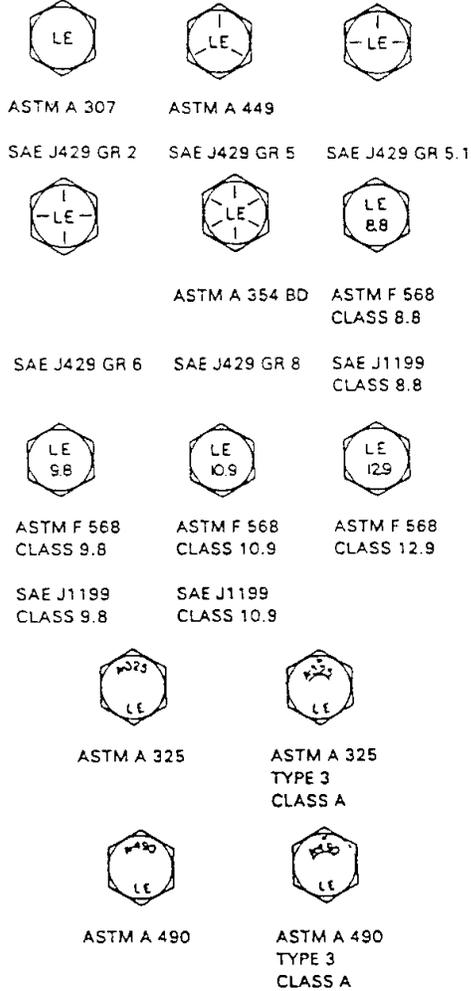

CAGE code: 8B911 1/

LaMOTT ENTERPRISES, INC.
3905 CALIFORNIA STREET NE
MINNEAPOLIS, MN 55421



CAGE code: 3MWQ3 1/

LAMSON AND SESSIONS OF CANADA LTD.
RB & W CORP. METAL FORMING DIVISION
8341 TYLER BOULEVARD
MENTOR, OH 44060

MANUFACTURER NUTS – Sales Office
Lamson & Sessions of Canada Ltd.
Toronto Plant – Canada
5190 Bradco Boulevard
Mississauga, Ontario L4W 1G7
CANADA

STOVER* PREVAILING TORQUE LOCKNUTS

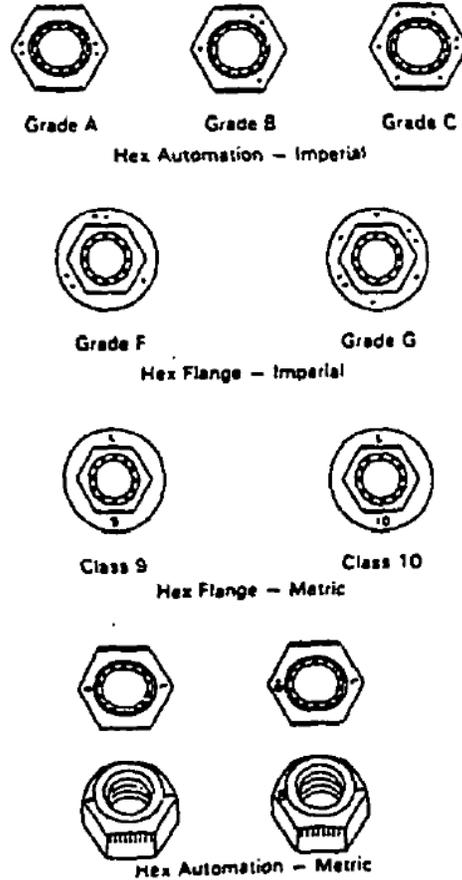

CAGE code: 2/

1/ Information published in this revision was verified by direct contact with manufacturers.

2/ Information not verified to be current, no response from manufacturer. Information identical to that published in MIL-HDBK-57, Revision B.

MIL-HDBK-57G (IS)

<p>LANA INDUSTRIES 4404-D MCLEAN DRIVE HALTOM CITY FORT WORTH, TX 76117</p> <p style="text-align: center;">LI</p> <p>CAGE code: <u>2/</u></p>
<p>LANARKSHIRE BOLT LTD. BURNBANK HAMILTON, LANARSHIRE ML3 OQU SCOTLAND</p> <p style="text-align: center;">L B </p> <p style="text-align: center;"><i>Raised letters</i></p> <p>CAGE code: K3565 <u>2/</u></p>
<p>LAND-SEA-AIR MACHINED PRODUCTS, INC. P.O. BOX H FLEMING PIKE WINSLOW, NJ 08095</p> <p style="text-align: center;">L-S-A</p> <p>CAGE code: 8U768 <u>2/</u></p>
<p>LANIS MACHINE & MFG., CO. 2506 S. COOPER #A-9 ARLINGTON, TX 76015-1608</p> <p style="text-align: center;"></p> <p>CAGE code: 8V177 <u>2/</u></p>

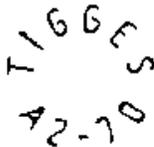
<p>LANUM METAL PRODUCTS, INC. 4100 N. 16TH STREET PHILADELPHIA, PA 19140-3008</p> <p style="text-align: center;"></p> <p style="text-align: center;">L.M.T.</p> <p>CAGE code: 0CY73 <u>2/</u></p>
<p>LAWSON PRECISION MACHING, INC. 2981 CREST LANE ROAD BUCYRUS, OH 44820</p> <p style="text-align: center;"></p> <p>CAGE CODE: 1STC4 <u>1/</u></p>
<p>LBL PRODUCTS 5395 INDUSTRIAL DRIVE UNIT A HUNTINGTON BEACH, CA 92649-1516</p> <p style="text-align: center;"></p> <p>CAGE code: 1HJ06 <u>2/</u></p>
<p>LEBRECHT TIGGES GmbH & CO. KG P.O. BOX 12 04 85 W 5600 WUPPERTAL 12-CRONENBERG GERMANY</p> <p style="text-align: center;"></p> <p>CAGE code: <u>2/</u></p>

^{1/} Information published in this revision was verified by direct contact with manufacturers.
^{2/} Information not verified to be current, no response from manufacturer. Information identical to that published in MIL-HDBK-57, Revision B.

MIL-HDBK-57G (IS)

LEE AEROSPACE PRODUCTS, INC.
 90 WEST EASY STREET, UNIT #5
 SIMI VALLEY, CA 93065



CAGE code: 9S874 1/

LEHNER SCREW MACHINE CO.
 71 SOUTH RIVER ROAD
 P.O. BOX 158
 MUNROE FALLS, OH 44262

Plant
 71 SOUTH RIVER ROAD
 MUNROE FALLS, OH 44262



CAGE code: 9G035 1/

LELAND-POWELL FASTENERS, INC.
 P.O. BOX 260
 MARTIN, TN 38237

Plant
 HIGHWAY 45 EAST SOUTH
 MARTIN, TN 38237



CAGE code: 2/

LENCH, THOMAS WILLIAM, LTD.
 P.O. BOX 31
 EXCELSIOR WORKS CARNEGIE ROAD,
 ROWLEY REGIS B65 8BZ
 UNITED KINGDOM



Raised letters



Indented letters



Raised or indented letters

CAGE code: U0039 2/

LENTERN (AIRCRAFT) LTD.
 MAIN RD, HAWKWELL,
 NR. HOCKLEY ESSEX SS5 4JJ
 GREAT BRITIAN, UK



CAGE code: 2/

1/ Information published in this revision was verified by direct contact with manufacturers.

2/ Information not verified to be current, no response from manufacturer. Information identical to that published in MIL-HDBK-57, Revision B.

MIL-HDBK-57G (IS)

LEONARD JED CO.
MARYLAND BOLT AND NUT CO DIV
(REPLACES MARYLAND BOLT & NUT CO.,
INC. -CAGE 76213)
1104 RUSSELL ST.
BALTIMORE, MD 21230 - 2622



SAE J429 Grade 5
ASTM A449
MIL-B-857-A Grade 5

NOTE: Also covers round head bolts,
i.e., carriage-plow and countersunk
styles, etc.



ASTM A193 Grade B-7
Alloy steel high temperature service
bolting

Tempered to 125 KSI tensile strength

NOTE: Also covers sq. head and
countersunk styles.

Heavy head hex or regular configura-
tions



ASTM A490 Type 1

NOTE: Also covers round head bolts,
i.e., carriage-plow and countersunk
styles, etc.



ASTM A394 Type T-0

Tower bolts: hex head, square head

Head markings also include: T-1 for
medium carbon and T-3 for weather-
ing alloy steel. Both require heat
treating

NOTE: Round head step bolts require
manufacturing head identification
and proper markings as above,
except length size



SAE J429 Grade 8
ASTM A354 Grade B0

Also (optional) that A354 is exhibited
on top of head

MIL-B-857-A Grade 8

NOTE: Also covers round head bolts,
i.e., carriage-plow and countersunk
styles, etc.

CAGE code: 52373

2/

Continued

Continued
LEONARD JED CO.
MARYLAND BOLT AND NUT CO DIV



ASTM A325 Type 1

NOTE: Also covers round head bolts,
i.e., carriage-plow and countersunk
styles, etc.



ASTM A325 Type 3

NOTE: Also covers round head bolts,
i.e., carriage-plow and countersunk
styles, etc.

With line under
A325 mark



SAE J429 Grade 2
ASTM A307 Grades A & B
MIL-B-857-A Type 2 (ADM/5)

No Grade mark
— only manu-
facturer's
symbol

NOTE: Also covers round head bolts,
i.e., carriage-plow and countersunk
styles, etc.



ASTM A490 Type 3

NOTE: Also covers round head bolts,
i.e., carriage-plow and countersunk
styles, etc.

With line under
A490 mark



ASTM A193 Grade B-7-M
Alloy steel high temperature service
bolting

Tempered to 100 ksi tensile strength

NOTE: Also covers SQ head and
countersunk styles

Heavy head hex or regular configura-
tions

Manufacturer's symbol and the num-
ber 3 or DH3 on face

For Grade C-3 three radial lines are
also required

Heavy hex applications for C-3 and
heavy or regular for DH3

Nuts for bolt applications

ASTM A325 type 3

ASTM A563 Grade CH3

Also covers square nut configurations



Heavy hex for
type C-3

Regular or
heavy for DH3

CAGE code: 52373

2/

Continued

1/ Information published in this revision was verified by direct contact with manufacturers.

2/ Information not verified to be current, no response from manufacturer. Information identical to that published in MIL-HDBK-57, Revision B.

MIL-HDBK-57G (IS)

Continued
LEONARD JED CO.
MARYLAND BOLT AND NUT CO DIV



Heavy or regular

Manufacturer's symbol and the 2H or DH marking
Also can be supplied in regular configurations
Suitable for all Grade 8 and A325 or A490 bolts
Nuts for bolt applications
ASTM A194 Grade 2H
ASTM A563 Grade DH
Also covers square nut configurations



Heavy hex only

Manufacturer's symbol and three radial lines
Heavy hex applications only
Nuts for bolt applications
ASTM A563 Grade C
For ASTM A325 bolts
Also covers square nut configurations

CAGE code: 52373

2/

LEP SPECIAL FASTENERS INC.
3281 W. COUNTY RD ON/S
FRANKFORT, IN 46041



LE

CAGE code: 8B911

1/

LEVEL 1 FASTENERS
300 THIRD AVE
HUNTINGTON, WV 25701



300 Series Stainless Steel

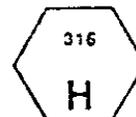

Type 316 Stainless Steel

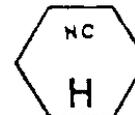

Nickel Copper (Monel)

BEK

CAGE code: 17283

1/

LEVINGSTON MACHINE COMPANY
2428 MINNIS DR.
HALTOM CITY, TX 76117-4856

LM

CAGE code: 46939

2/

1/ Information published in this revision was verified by direct contact with manufacturers.

2/ Information not verified to be current, no response from manufacturer. Information identical to that published in MIL-HDBK-57, Revision B.

MIL-HDBK-57G (IS)

LEWIS SREW COMPANY
 (DIV OF MEDALIST FASTENERS INC.)
 2550 S 27TH AVE.
 BROADVIEW, IL 60155 - 3851



LEWIS SCREW COMPANY
FASTENERS
THE FASTENER SPECIALIST

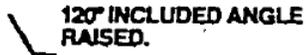

**INDENTED HEX HDS. AND
 INDENTED HEX WASHER HDS.**



LEWIS SCREW COMPANY
FASTENERS
THE FASTENER SPECIALIST



**3-DASH MARKS 120° APART
 RAISED**

**UNDER HEAD UPON REQUEST
 "NON-COUNTERSUNK HEADS ONLY"**

CAGE code: 1AW87

2/

LFC INDUSTRIES INC.
 (DIVISION RKR TECHNOLOGIES)
 P. O. BOX 5982
 1221 CORPORATE DRIVE WEST
 ARLINGTON, TX 76006-6103

LFC

CAGE code: 62384

1/

LINREAD NORTHBRIDGE
 LEICESTER, UK
 VIKING ROAD
 WIGSTON, LEICESTER
 ENGLAND LE18 2BL

NB

CAGE code: U6683

1/

LINREAD NORTHBRIDGE AIRCRAFT
 PRODUCT DIVISION
 CROSSGATE ROAD PARK FARM
 P.O. BOX 28
 REDDITCH
 WORCESTERSHIRE B98 7TD
 UK

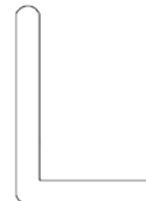
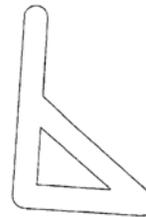

CAGE code: K8753

2/

1/ Information published in this revision was verified by direct contact with manufacturers.

2/ Information not verified to be current, no response from manufacturer. Information identical to that published in MIL-HDBK-57, Revision B.

MIL-HDBK-57G (IS)

LINREAD PUBLIC LIMITED CO.
 (AIRCRAFT PRODUCTS DIVISION)
 P.O. BOX 28, CROSSGATE ROAD
 PARK FARM INDUSTRIAL EST. REDDITCH,
 WORCESTERSHIRE B98 7TD
 UNITED KINGDOM



<u>Illustration No.</u>	<u>Notes</u>
1, 2	 = Unified S quality WWE = Linread Keeley St. (was Warne Wright Engineering and which no longer trades under that name) M = Metric screws and bolts 88 or 8.8 = Grade 8.8. Alternative markings such as 10.9 or 10.9 may appear as appropriate.



<u>Illustration No.</u>	<u>Notes</u>
3, 4	LL or L = Linread Ltd S = Unified S quality. Alternative letters such as R and T may appear as appropriate. M = Metric screws and bolts 88 or 8.8 = Grade 8.8. Alternative markings such as 10.9 or 10.9 may appear as appropriate.

<u>Illustration No.</u>	<u>Notes</u>
3, 4. (Cont'd)	 = Linread Pic



CAGE code: K8753

Continued

2/

Continued

LINREAD PUBLIC LIMITED CO.
 (AIRCRAFT PRODUCTS DIVISION)
 P.O. BOX 28, CROSSGATE ROAD
 PARK FARM INDUSTRIAL EST. REDDITCH,
 WORCESTERSHIRE B98 7TD
 UNITED KINGDOM

<u>Illustration No.</u>	<u>Notes</u>
5, 6	 = Linread Pic S = Unified S quality. Alternative letters such as R and T may appear as appropriate. M = Metric screws and bolts 88 or 8.8 = Grade 8.8. Alternative markings such as 10.9 or 10.9 may appear as appropriate.



<u>Illustration No.</u>	<u>Notes</u>
7, 8	 = Tribular screws and bolts. Various letters may appear, viz M = Metric. Absence of other letters indicate Duo-Taptite or Taptite parts. P = Powerlok C = Carbon restored surface, i.e., with no decarburization permitted but not case hardened. N = Neutral or through hardened I = Induction hardened lead threads S = Unified S quality. Alternative letters such as R and T may appear as appropriate. 88 or 8.8 = Grade 8.8. Alternative markings such as 10.9 or 10.9 may appear as appropriate.

CAGE code: K8753

2/

1/ Information published in this revision was verified by direct contact with manufacturers.

2/ Information not verified to be current, no response from manufacturer. Information identical to that published in MIL-HDBK-57, Revision B.

MIL-HDBK-57G (IS)

LIPPISCHE EISENINDUSTRIE GmbH
ALTER WEG 57
D-4930
GERMANY

LE

CAGE code: 2/

LISI AEROSPACE
LISI AEROSPACE CANADA
TOUR GAMMA A
193, RUE DE BERCY
75582 PARIS CEDEX 12
FRANCE

Plant
A1 TECHNOLOGIES
7022 ALONDRA BLVD
PARAMOUNT, CA 90723 3926

NO SYMBOL LISTED

CAGE code: 3N586

Plant
LISI AEROSPACE CANADA
2000, PLACE TRANSCANADIENNE
DORVAL (QUÉBEC) H9P 2K5
CANADA

L

CAGE code: L4528

Continued 1/

Continued

VAUS
see BLANC AERO INDUSTRIES

Plant
BLANC AERO INDUSTRIES
VILLEFRANCHE DE ROUERGUE
18, RUE JEAN VAURS
12200 VILLEFRANCHE DE ROUERGUE
FRANCE

P 

CAGE code: FAWT4

Plant
BLANC AERO INDUSTRIES RUGBY
RUGBY WARWICKSHIRE
CV21 3 RQ
ENGLAND

hs

CAGE code: U6300

Plant
BLANC AERO INDUSTRIES SAINT OUEN
L'AUMONE
95310 SAINT OUEN L'AUMONE
FRANCE

T 

T (Sr Brieuç)
B (Paris)
P (Villefranche de
Rouergue)

ds. F

CAGE code: F0188 1/

Continued

1/ Information published in this revision was verified by direct contact with manufacturers.

2/ Information not verified to be current, no response from manufacturer. Information identical to that published in MIL-HDBK-57, Revision B.

MIL-HDBK-57G (IS)

Continued

LISI AEROSPACE

Plant
BLANC AERO TECHNOLOGIES
B.P. 215
22002 SAINT BRIEUC CEDEX 1
FRANCE

CAGE code: F0188

Plant
BLANC AERO INDUSTRIES VIGNOUX
Z.A. La Landette
18500 VIGNOUX-SUR-BARANGEON
FRANCE

CAGE code: F6427 1/

Plant closed
DECOLLETAGE GENERAL MODERNE
DECOLLETAGE MODERNE 5 BIS, PLACE
LEON BLUM

Plant
FT BESTAS
35410 GAZIEMIR-IZMIR
TURKEY

CAGE code: T0802

Continued

Continued

Plant
FTB FASTENER TECHNOLOGY BESTAS
EGE SERBEST BOLGESI AYFER SOK NO 21
35410 GAZIEMIR-IZMIR
TURKEY

CAGE code: T0802 1/

Plant
HI-SHEAR CORPORATION
see HI-SHEAR
260 SKYPARK DR.
TORRANCE, CA 90509-2975

CAGE code: 73197 1/

LISI AEROSPACE

Plant
MONADNOCK
18301 EAST ARENTH AVE.
CITY OF INDUSTRY, CA 91748-1288

(a dot)

CAGE code: 60119 1/1/ Information published in this revision was verified by direct contact with manufacturers.2/ Information not verified to be current, no response from manufacturer. Information identical to that published in MIL-HDBK-57, Revision B.

MIL-HDBK-57G (IS)

LITTLE WORLD MANUFACTURING, INC.
1083 FOREST RD.
WEST CHESTER, PA 19380

Plant
525 WEST SOUTH STREET
KENNETT SQUARE, PA 19348

L<W>M

CAGE code: 6T569 2/

LLOYD MACHINE & TOOL CO., INC.
234 BROAD AVENUE
WILMINGTON, CA 90744-5812

LMT

CAGE code: 01334 2/

LN AEROSPACE, INC.
6011 TENSION DRIVE
FORT WORTH, TX 76112-2693

LNA

CAGE code: 1EB45 2/

LOBO OFFICINE MECCANICHE SPA
VIA T. EDISON
CORANAREDO, MILANO ITALY 20010

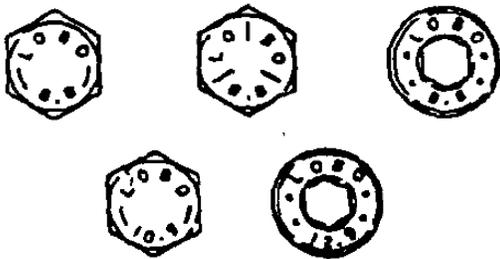

CAGE code: A1208 2/

LOBO SYSTEMS LTD
26 THE PARKER CENTRE
MANSFIELD ROAD
DERBY DE21 4SZ
ENGLAND

LOBO[™]

CAGE code: KE018 1/

LONE STAR FASTENERS, LP
(PREVIOUS LISTED AS LONE STAR
SCREW CO OF TEXAS INC
P.O. BOX 1149
SPRING, TX 77373

Plant
24131 HARDY ROAD
SPRING, TX 77373

L **Precedes grade marking
(example: LB7)**

CAGE code: 7H174 1/

LONG-LOK FASTENERS CORP.
10630 CHESTER RD
CINCINNATI, OH 45215-1206

Plant
14119 CHADRON AVE.
LOS ANGELES, CA 90250

CAGE code: 03038

LL *or* **LONG
LOK** *or* **LL**

CAGE code: 16941, plant 03038 1/

1/ Information published in this revision was verified by direct contact with manufacturers.

2/ Information not verified to be current, no response from manufacturer. Information identical to that published in MIL-HDBK-57, Revision B.

MIL-HDBK-57G (IS)

LOOS & CO., INC.
AEROSPACE FASTENERS DIVISION
ROUTE 101
POMFRERT, CT 06258-0098

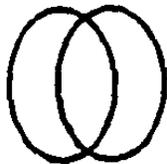

CAGE code: 59157 1/

LORD CORPORATION
AEROSPACE PRODUCTS DIVISION
1635 WEST 12TH STREET
P.O. BOX 3694
ERIE, PA 16508 - 0694

CAGE code: 0PJN4



Plant
MECHANICAL PRODUCTS
DIVISION
4644 WADSWORTH RD.
DAYTON, OH 45414 - 4220

CAGE code: 30061



CAGE code: 0PJN4, 30061 2/

LOUGHLIN MANUFACTURING CORP.
1580 RAILROAD AVE
HOLBROOK, N.Y. 11741-2301



CAGE code: 65782 1/

M & M MANUFACTURING CORPORATION
5611 KIMBALL CT
CHINO, CA 91710



CAGE code: 0X598 2/

M.A.A. CORP,
MID AMERICA AEROSPACE DIVISION
16201 WEST 110TH STREET
SHAWNEE MISSION, KS 66285



CAGE code: 2/

M.L.W. MANUFACTURING CO.
P.O. BOX 8445
NEW HAVEN, CT 06511

Plant
240 SARGENT DRIVE
NEW HAVEN, CT 06511



CAGE code: 0GH69 2/

M.S. AEROSPACE
13928 Balboa Blvd.
SYLMAR, CA 91342-1005



CAGE code: 0UCY9 1/

1/ Information published in this revision was verified by direct contact with manufacturers.

2/ Information not verified to be current, no response from manufacturer. Information identical to that published in MIL-HDBK-57, Revision B.

MIL-HDBK-57G (IS)

MAC FASTENERS, INC.
11110 ENTERPRISE ST.
OTTAWA, KS 66067-3803

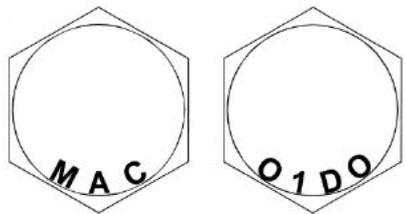

GOTHIC LETTERS "MAC"

GOTHIC LETTERS AND
NUMERAL "O1DO"

CAGE code: ORFT4

1/

MACK, A. W. MFG CO.
516 DUTCHESS TURNPIKE
POUGHKEEPSIE, NY 12603



CAGE code: 32448

2/

MACHINE SHOP, INC., THE
470 AIR PARK RD
ATWATER, CA 95301

TMS

CAGE code: 8T052

2/

MACKO INDUSTRIES
HWY 39 AT FM RD. 1340
P.O. BOX 170
HUNT, TX 78024-0170

M

CAGE code: 1CN43

2/

MACHINERITE CORP.
SYCAMORE & MILL RDS.
CLIFTON HTS, PA 19018

MR

CAGE code: 7J299

2/

MACKSON MFG CORP.
2338 SOUTHWAY DRIVE
ROCK HILL, SC 29730

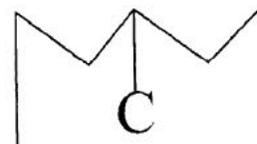

CAGE code: 093Y9

2/

MACHINING LOGISTICS, INC.
6640 VIEW PARK CT.
RIVERSIDE, CA 92503

MLI

CAGE code: 57LP7

1/

1/ Information published in this revision was verified by direct contact with manufacturers.

2/ Information not verified to be current, no response from manufacturer. Information identical to that published in MIL-HDBK-57, Revision B.

MIL-HDBK-57G (IS)

MACLEAN-ESNA
(formally Elastic Stop Nut)
611 COUNTRY CLUB RD.
POCAHONTAS, AR 72455

E

EN

ESNA

RED NYLON INSERT INDICATES
MACLEAN-ESNA AS
MANUFACTURER

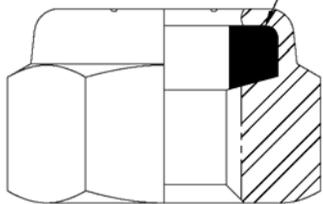

CAGE code: 019L2

1/

MACLEAN-FOGG CO.
2551 WACKER RD.
SAVANNA, IL 61074

*Flange nuts less lock and with
Uni-Torque® lock
Two raised bars*

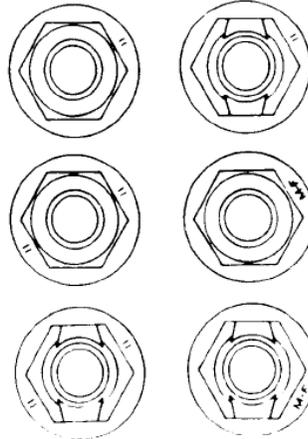

Hex and flange screws/bolts

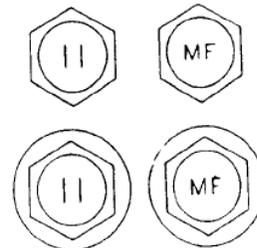

Hex nuts and Uni-Torque® locknuts

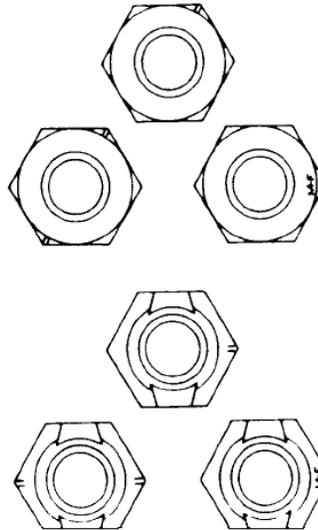

CAGE code: 0AMX8

2/

1/ Information published in this revision was verified by direct contact with manufacturers.

2/ Information not verified to be current, no response from manufacturer. Information identical to that published in MIL-HDBK-57, Revision B.

MIL-HDBK-57G (IS)

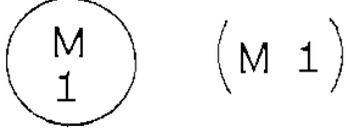
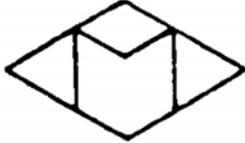
<p>MACOR, INC. 130 HOFFMAN LN CENTRAL ISLIP, NY 11722</p>  <p>CAGE code: 2A269 <u>2/</u></p>	<p>MAIN MACHINE CO INC. DBA MAIN MACHINE & TOOL CO 116 MARINE STREET FARMINGDALE, NY 11735-5608</p> <p style="text-align: center;">MMT</p> <p>CAGE code: 05879 <u>1/</u></p>
<p>MAGNUM MACHINE SHOP 768 HOMEWARD PL SAN JOSE, CA 95123-2906</p> <p style="text-align: center;">1YFG0</p> <p>CAGE code: 1YFG0 <u>2/</u></p>	<p>MANUFACTURING ENGINEERING TECH. 2758 AIELLO DR. SAN JOSE, CA 95111-2134</p>  <p>CAGE code: 1CC57 <u>2/</u></p>
<p>MAGNUS TOOL & DIE CO., INC. 256 SHEFFIELD ST. MOUNTAINSIDE, NJ 07092</p>  <p>CAGE code: 37752 <u>2/</u></p>	<p>MANUFACTURING SALES AND SERVICE 10631 BLOOMFIELD AVE #16 LOS ALAMITOS, CA 90720</p>  <p>CAGE code: 1S9V3 <u>2/</u></p>
<p>MAILLY MFG CO., INC. P. O. BOX 6143 45 WAKELEE ROAD WOLCOTT, CT 06716-2620</p>  <p>CAGE code: 3L606 <u>1/</u></p>	

1/ Information published in this revision was verified by direct contact with manufacturers.

2/ Information not verified to be current, no response from manufacturer. Information identical to that published in MIL-HDBK-57, Revision B.

MIL-HDBK-57G (IS)

<p>MANUFACTURING TECHNOLOGY SERVICES 111 CLINTON ROAD FAIRFIELD, NJ 07004</p>  <p>CAGE code: 4WCW0 <u>1/</u></p>	<p>MARTIN-CHANDLER, INC. 122 EAST ALONDRA BOULEVARD GARDENA, CA 902</p>  <p>CAGE code: 22625 <u>2/</u></p>
<p>MAPECO PRODUCTS, INC. 725 GLEN GLOVE AVE. P.O. BOX 6 GLEN HEAD, NY 11545</p>  <p>CAGE code: 4P839 <u>2/</u></p>	<p>MARUYKO NUT CO., LTD. 2-4-15 NAKANO-CHO, HIGASHI TONDABAYASHI-SHI OSAKA 584 JAPAN</p>  <p>CAGE code: <u>2/</u></p>
<p>MAR-BRO MFG., INC. 5717 W. WASHINGTON STREET PHOENIX, AZ 85043-3650</p>  <p>CAGE code: <u>2/</u></p>	<p>MARVIN ENGINEERING, CO., INC. 260 WEST BEACH AVENUE INGLEWOOD, CA 90302-2903</p>  <p>CAGE code: 32067 <u>2/</u></p>

1/ Information published in this revision was verified by direct contact with manufacturers.

2/ Information not verified to be current, no response from manufacturer. Information identical to that published in MIL-HDBK-57, Revision B.

MIL-HDBK-57G (IS)

MARYLAND BOLT & NUT CO., INC.
LEONARD JED CO
1104 RUSSELL ST.
BALTIMORE, MD 21230-2622



SAE J429 Grade 5
ASTM A448
MIL-B-857-A Grade 5

NOTE: Also covers round head bolts, i.e., carriage-pow and countersunk styles, etc.



ASTM A193 Grade B-7
Alloy steel high temperature service bolting
Tempered to 125 KSI tensile strength

NOTE: Also covers sq. head and countersunk styles.
Heavy head hex or regular configurations



ASTM A490 Type 1
NOTE: Also covers round head bolts, i.e., carriage-pow and countersunk styles, etc.



ASTM A394 Type T-0
Tower bolts: hex head, square head
Head markings also include: T-1 for medium carbon and T-3 for weathering alloy steel. Both require heat treating

NOTE: Round head step bolts require manufacturing head identification and proper markings as above, except length size

CAGE code: 76213(canceled)
Replaced by 52373

2/

Continued

Continued

MARYLAND BOLT & NUT CO., INC.



SAE J429 Grade 8
ASTM A354 Grade BD

Also (optional) that A354 is exhibited on top of head

MIL-B-857-A Grade 8

NOTE: Also covers round head bolts, i.e., carriage-pow and countersunk styles, etc.



ASTM A325 Type 1

NOTE: Also covers round head bolts, i.e., carriage-pow and countersunk styles, etc.



ASTM A325 Type 3

With line under A325 mark

NOTE: Also covers round head bolts, i.e., carriage-pow and countersunk styles, etc.



SAE J429 Grade 2
ASTM A307 Grades A & B

MIL-B-857-A Type 2 (ADM/5)

No Grade mark — only manufacturer's symbol

NOTE: Also covers round head bolts, i.e., carriage-pow and countersunk styles, etc.



ASTM A490 Type 3

With line under A490 mark

NOTE: Also covers round head bolts, i.e., carriage-pow and countersunk styles, etc.



ASTM A193 Grade B-7-M
Alloy steel high temperature service bolting
Tempered to 100 ksi tensile strength

Letters B7M on head

NOTE: Also covers SQ head and countersunk styles
Heavy head hex or regular configurations

CAGE code: 76213(canceled)
Replaced by 52373

2/

Continued

1/ Information published in this revision was verified by direct contact with manufacturers.

2/ Information not verified to be current, no response from manufacturer. Information identical to that published in MIL-HDBK-57, Revision B.

MIL-HDBK-57G (IS)

Continued

MARYLAND BOLT & NUT CO., INC.

Heavy hex for
type C-3Regular or
heavy for DH3**Manufacturer's symbol and the number 3 or DH3 on face**

For Grade C-3 three radial lines are also required

Heavy hex applications for C-3 and heavy or regular for DH3

Nuts for bolt applications

ASTM A325 type 3

ASTM A563 Grade DH3

Also covers square nut configurations

Heavy or
regular**Manufacturer's symbol and the 2H or DH marking**

Also can be supplied in regular configurations

Suitable for all Grade 8 and A325 or A490 bolts

Nuts for bolt applications

ASTM A194 Grade 2H

ASTM A563 Grade DH

Also covers square nut configurations



Heavy hex only

Manufacturer's symbol and three radial lines

Heavy hex applications only

Nuts for bolt applications

ASTM A563 Grade C

For ASTM A325 bolts

Also covers square nut configurations

CAGE code: 76213(canceled)
Replaced by 52373

2/

MASTER RESEARCH & MFG., INC.
13528 PUMICE ST
NORWALK, CA 90650 - 5249

CAGE code: 9U245

2/

MASTERCRAFT TOOL COMPANY
13743 SHORELINE CT E
EARTH CITY, MO 63045 - 1202

CAGE code: 2M351

2/

MAUDLE INDUSTRIAL CO., LTD.
1-20 TSAO HU ROAD
TALI CITY, TAIWAN 41245**TUZ**

CAGE code: SH978

2/

MAUI MEGA
DBA KERR CHARLES W
JAY-CEE INDUSTRIAL PARK
RIVER RD. BLDG. PP-1
BRISTOL, PA 19007

see KERR CHARLES W



CAGE code: 0M4F0

2/

MCADAMS MACHINE AND TOOL CO.
2853 E FLORENCE AVE
HUNTINGTON PARK, CA 90255**Mc**

CAGE code: 0UUE2

2/

1/ Information published in this revision was verified by direct contact with manufacturers.

2/ Information not verified to be current, no response from manufacturer. Information identical to that published in MIL-HDBK-57, Revision B.

MIL-HDBK-57G (IS)

MCCULLOUGH AERO CO.
DBA MCCULLOUGH & ASSOCIATES
23891 MADISON STREET
TORRANCE, CA 90505-6008



CAGE code: 04273 2/

MD3 INDUSTRIES LTD
108 W HOLLOWAY DR
HURST, TX 76053 - 6807

See EMPIRE PRECISION MACHINING

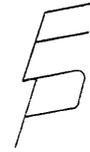

CAGE code: 1/

MCLANE MFG INC.
P. O. BOX 438
7210 ROSECRANS AVE.
PARAMOUNT, CA 90723 - 0438



CAGE code: 52706 2/

MEACO PRODUCTS CORP.
99 PECK HILL ROAD
JOHNSTON, RI 02919-4510

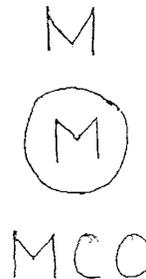

CAGE code: 032Z0 2/

McMELLON BROS INC.
915 HONEYSPOT RD.
STRATFORD, CT 06615 - 7192

05141



CAGE code: 05141 1/

MEC WOLF SRL
VIA MILANO, 5
22036 ERBA (CO) ITALY



The lot identification "xy" (letter + numb.) is embossed on the ring.

The manufacturer's mark "W" is embossed on the crown.

CAGE code: 2/

1/ Information published in this revision was verified by direct contact with manufacturers.

2/ Information not verified to be current, no response from manufacturer. Information identical to that published in MIL-HDBK-57, Revision B.

MIL-HDBK-57G (IS)

MECAERO PRODUCTS
AFS TOULOUSE OPERATIONS
BD DU GRAND CASTING
ROQUES-SUR-GARONNE
31128 PORTET SUR GARONNE CEDEX
FRANCE

(Corporate office see ALCOA FASTENING
SYSTEMS)



M

CAGE code: F7411

1/

MECAERO CANADA INC.
2250 COHEN
VILLE ST-LAURENT
QUEBEC, H4R 9Z7
CANADA

MC

CAGE code:

2/

MECAIR AEROSPACE INDUSTRIES
SUBSIDIARY OF SPS TECHNOLOGIES DIV
DIVISION OF SPS TECHNOLOGIES
DBA MECAIR INC
225 LABROSSE
PT. CLAIRE, CANADA H9R 1A3

MC

CAGE code: 0HL40

2/

MECHANICAL & INDUSTRIAL FASTENERS
1145 JANSEN FARM DRIVE
ELGIN, IL 60123

MI

MIF

MIF

CAGE code: 0P8N1

2/

MECHANICAL INDUSTRIES LLC
8900 NORTH 51ST STREET
MILWAUKEE, WISCONSIN 53223-2402

M I

CAGE code: 1U732

2/

MEL-BA MANUFACTURING INC.
777 SUGAR LN
ELYRIA , OH 44035 - 5631

..MEL-BA..

CAGE code: 3A092

2/

1/ Information published in this revision was verified by direct contact with manufacturers.

2/ Information not verified to be current, no response from manufacturer. Information identical to that published in MIL-HDBK-57, Revision B.

MIL-HDBK-57G (IS)

MERCER PRODUCTS & MFG. CO., INC.
401 S. WEBSTER STREET
SEATTLE, WA 98108 - 4137

MP

CAGE code: 30205 1/

MERCURY AEROSPACE INC.
20320 PRARIE STREET
CHATSWORTH, CA 91313

M M

M - Mercury
- Aerospace

CAGE code: 50945 2/

MERCURY TOOL & MACHINE, INC.
P.O. BOX 5190
WACO, TX 76708-5190

Plant
AIRPORT DRIVE & ZOO PARK DR.
WACO, TX 76708-5190

MTM

CAGE code: 01982 2/

METALCRAFTERS
(DIVISION OF KEYSTONE CONSOLIDATED
INDUSTRIES)
4500 KISHWAUKEE STREET
P.O. BOX 7005
ROCKFORD, IL 61125-7005

N or **M**

Indented hex & hex washer heads

N or **M**

Hex cap screws - low carbon steel



Mis. markings for screws & bolts

CAGE code: 2/

METAL-TECH MFG. INC.
1445 SOUTH 18TH ST.
CLINTON, IA 52732-6703

MT

CAGE code: 3BNL5 1/

METHODS AND MACHINING SERVICES CO.
140 UXBRIDGE ST
CRANSTON, RI 02920-4811

MMS

CAGE code: 0FYD8 2/

1/ Information published in this revision was verified by direct contact with manufacturers.

2/ Information not verified to be current, no response from manufacturer. Information identical to that published in MIL-HDBK-57, Revision B.

MIL-HDBK-57G (IS)

<p>METRO TOOL & MANUFACTURING CO. ALSO SEE ALEXANDER MANUFACTURING COMPANY INC 2402 ARKANSAS LANE GRAND PRAIRIE, TX 75052-7203</p> <p style="text-align: center;"></p> <p>CAGE code: 2M919 <u>1/</u></p>
<p>METRIX MFG. CO. 840 BRITTAN AVE. SAN CARLOS, CA 94070-4181</p> <p style="text-align: center;"> METRI METRIX</p> <p>CAGE code: <u>2/</u></p>
<p>Mi. ME. AF. S.r.1. C.so EUROPA, 240 24032 CALOZIOCORTE (BG) ITALY</p> <p style="text-align: center;"></p> <p>CAGE code: <u>2/</u></p>
<p>MICRO SCREW MACHINE PRODUCTS, INC. 71 ROOSEVELT AVE CARTERET , NJ 07008</p> <p style="text-align: center;"></p> <p>CAGE code: 43808 <u>2/</u></p>

<p>MICRODOT INC. MICRODOT AEROSPACE FASTENING SYSTEMS GROUP ADVANCED PRODUCTS DIV 190 W CROWTHER AVE PLACENTIA, CA 92670 - 5687</p> <p style="text-align: center;"></p> <p>KAYNAR TECHNOLOGIES INC MICRODOT DIV 800 SOUTH STATE COLLEGE BOULEVARD P.O. BOX 3001 PLACENTIA, CA 92670 - 5687 CAGE code: 1EJY4</p> <p>(SEE KAYNAR PRODUCTS CAGE code: 15653)</p> <p style="text-align: center;"></p> <p><i>Used on sheet metal or stamped products.</i></p> <p style="text-align: center;"></p> <p><i>Used on forged or foreign products</i></p> <p style="text-align: center;"></p> <p><i>Two parallel lines used on Spirallock® products only</i></p> <p style="text-align: center;"></p> <p><i>Used on metric products</i></p> <p style="text-align: center;"></p> <p><i>Used on miscellaneous and general Kaynar products</i></p> <p>MICRODOT INSERTS DEVISION 10 S. LA SALLE STREET SUITE 3500 CHICAGO, IL 60603 CAGE code: 51204</p> <p style="text-align: center;"> </p> <p><i>Three parallel lines spiralok insert products only</i></p> <p>CAGE code: 0BPE9 <u>2/</u></p>

1/ Information published in this revision was verified by direct contact with manufacturers.

2/ Information not verified to be current, no response from manufacturer. Information identical to that published in MIL-HDBK-57, Revision B.

MIL-HDBK-57G (IS)

MID CONTINENT SCREW PRODUCTS CO.
3701 WEST LUNT AVE.
LINCOLNWOOD, IL 60712



CAGE code: 1QMD3

2/

MID-STATES SCREW CORP.
(ILLINOIS CORPORATION)
1817 EIGHTEENTH AVENUE
ROCKFORD, IL 61101



CAGE code: 17264

2/

MIDWEST ACORN NUT CO.
256 MINNESOTA AVE.
TROY, MI 48083

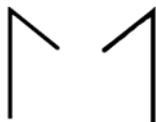

CAGE code: 98960

2/

MILE-HI MACHINE, INC.
6395 WEST 56TH AVE.
ARVADA, CO 80002



CAGE code: 1M949

1/

MILITARY PRODUCTS GROUP, INC.
37190 SUGAR RIDGE ROAD
NORTH RIDGEVILLE, OH 44039-3630



CAGE code: 3DJB1

1/

MILLIPART, INC.
412 W. CARTER DRIVE
GLEN DORA, CA 91740-5968



CAGE code: 31095

2/

MILLS, J. R. MACHINING, INC
815 McCORD HOLLOW ROAD
HOHENWALD, LEWIS, TN 38462

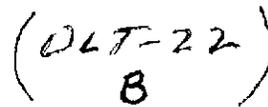

N⁻N

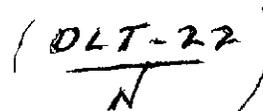

CAGE code: 0LT22

2/

1/ Information published in this revision was verified by direct contact with manufacturers.

2/ Information not verified to be current, no response from manufacturer. Information identical to that published in MIL-HDBK-57, Revision B.

MIL-HDBK-57G (IS)

MIL-SPEC FASTENERS CORP.
314 HANOVER PIKE
HAMPSTEAD, MD 21074-9999

MSF

CAGE code: 356S3

2/

MINEBEA CO. LTD
FUJISAWA MANUFACTURING UNIT
1-1-1 KATASE, FUJISAWA CITY
KANAGAWA 251-8531
JAPAN



Trademark, Takyo Rashi

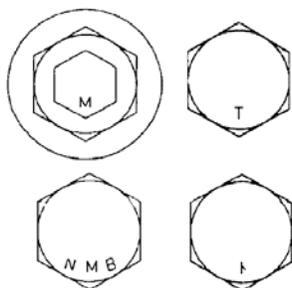

CAGE code: SB962

1/

MIROFINE COMPANY
1940 W. 144TH STREET
GARDENA, CA 90249-2928

MFR 1L071

CAGE code: 1L071

2/

MI-TECH, INC.
6685 JET PARK DRIVE
N. CHARLESTON, SC 29406-4700

MI-TECH, INC.

CAGE code: 9J758

2/

1/ Information published in this revision was verified by direct contact with manufacturers.

2/ Information not verified to be current, no response from manufacturer. Information identical to that published in MIL-HDBK-57, Revision B.

MIL-HDBK-57G (IS)

MITSUBOSHI INDUSTRIES, LTD.
 (OSAKA DIVISION)
 4-16-1 CHOME, MIDORIGI
 SUMINOE-KU, OSAKA 559
 JAPAN

N
NK
NKYM

CAGE code: 2/

MIX TOOL CO.
 212 E. CEDAR STREET
 COMPTON, CA 90220



CAGE code: 27643 2/

MKM MACHINE TOOL COMPANY INC.
 100 TECHNOLOGY WAY
 JEFFERSONVILLE, IN 47130-9644

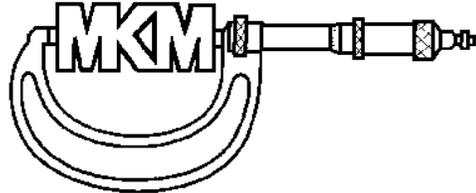

CAGE code: 8L583 2/

M-MANUFACTURING
 P.O. BOX 897
 ROANOKE, TX 76272

Plant
 HYW. 114 & DOVE RD.
 ROANOKE, TX 76262

M

CAGE code: 2/

1/ Information published in this revision was verified by direct contact with manufacturers.

2/ Information not verified to be current, no response from manufacturer. Information identical to that published in MIL-HDBK-57, Revision B.

MIL-HDBK-57G (IS)

MMG ENGINEERED COMPONENTS INC.
 DBA TOOLSOURCE
 3901 N. CARNATION
 FRANKLIN PARK, IL 60131-1201

SOCKET HEAD
 CAP SCREWS

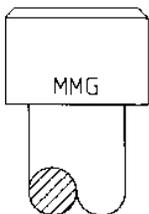
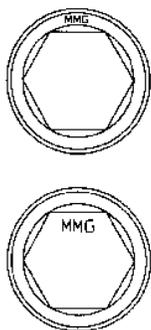

HEX HEADS
 (GRADE 8)

HEX HEADS
 (GRADE 5)

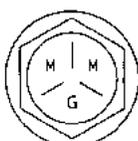

OTHER

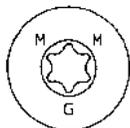
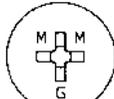

CAGE code: 3JMF9

1/

MNP CORPORATION
 P.O. BOX 189002
 UTICA, MI 48318-9002

MNP FASTENER DIVISION
 44225 UTICA RD
 UTICA, MI 48317
 CAGE code: 3R364

PLANT 2
 MNP CORPORATION DIVISION 2
 1524 E 14 MILE RD
 MADISON HEIGHTS, MI 48071-1542
 CAGE code: 064S9

PLANT 4
 MNP PRECISION PARTS
 1111 SAMUELSON RD.
 ROCKFORD, IL 61109
 CAGE code: 4S2M4



MNP fasteners



Highland bolts & nut



Small screw



Viking fasteners



CAGE code: 3R364, 064S9, 4S2M4

1/

1/ Information published in this revision was verified by direct contact with manufacturers.

2/ Information not verified to be current, no response from manufacturer. Information identical to that published in MIL-HDBK-57, Revision B.

MIL-HDBK-57G (IS)

MODERN METRIC MACHINE COMPANY
 INC
 101 W. NICHOLSON ROAD
 AUDOBON, NJ 08106-1411

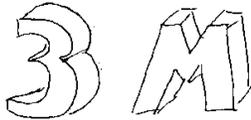
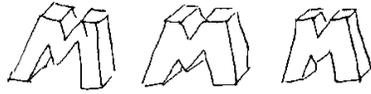

CAGE code: 1F6H56

2/

MODFORM-ILLINOIS, INC.
 500 36TH ST
 EAST MOLINE, IL 61244



CAGE code: 46501

2/

MONADNOCK COMPANY, THE
 DBA LISI AEROSPACE
 18301 ARENTH AVE.
 CITY OF INDUSTRY, CA 91748-1226

See LISI AEROSPACE

. (a dot)

CAGE code: 60119

1/

MONOGRAM AEROSPACE FASTENERS
 3423 SOUTH GARFIELD AVE.
 LOS ANGELES, CA 90040-3103

FASTENER HEAD MARKINGS



SCRIPT "N"

Used on Visu-Lok® blind fasteners



SCRIPT "MI"

Used on Composi-Lok®, OSI-Bolt®, Ti-OSI™, Radial-Lok®, Maf honeycomb pins, and other blind fasteners

BODY MARKINGS

**MONOGRAM
 WEDGELOCK**

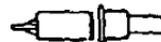

Trademark "Wedgeloek" or "Monogram", depressed. Used on temporary fasteners

CAGE code: 98524

1/

MONROE MACHINED PRODUCTS, INC.
 1422 S. 192nd ST
 SEATTLE, WA 98148-2314



CAGE code: 7F311

2/

1/ Information published in this revision was verified by direct contact with manufacturers.

2/ Information not verified to be current, no response from manufacturer. Information identical to that published in MIL-HDBK-57, Revision B.

MIL-HDBK-57G (IS)

MONTEREY MACHINE PRODUCTS
1504-A INDUSTRIAL PARK STREET
COVINA, CA 91722-3417

MP

CAGE code: 1UD00 2/

MORTON FASTENERS INC.
4544 RUNWAY DR.
LANCASTER, CA 93536

MFI

CAGE code: 4DU57 1/

MORTON MANUFACTURING
(DIVISION MORTON GRINDING)
17341 W. SIERRA HIGHWAY
SANTA CLARITA, CA 91351-1162

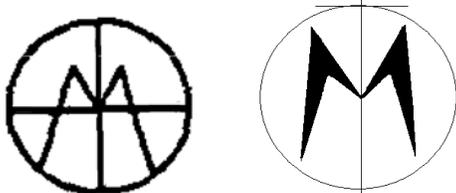

CAGE code: 2T498 1/

MOSTAR GEAR & MACHINE MFG., CO.
201 E. FRANKLIN
PALESTINE, IL 62451



CAGE code: OHN25 2/

MOTOR WHEEL CORP.
4000 COLLINS RD.
LANSING, MI 48910

Plant
1600 N. LARCH STREET
LANSING, MI 48906

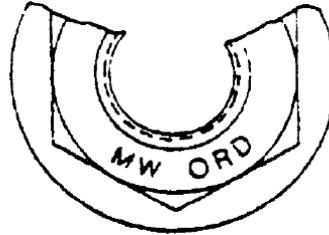

CAGE code: 4H871 2/

MPIRE FASTENERS
21446 HARVILL AVENUE
PERRIS, CA 92570

MF

CAGE code: 6D6C7 1/

MRL MANUFACTURING CORP.
P.O. BOX 8440
59 LEE AVE
HALEDON, NJ 07508

Plant
525 LAFAYETTE AVENUE
HAWTHORE, NJ 07506

M

CAGE code: 0GUF9 1/

1/ Information published in this revision was verified by direct contact with manufacturers.

2/ Information not verified to be current, no response from manufacturer. Information identical to that published in MIL-HDBK-57, Revision B.

MIL-HDBK-57G (IS)

N.S.S. INDUSTRIES
9075 GENERAL DRIVE
PLYMOUTH, MI 48170

N

CAGE code: 2/

NAFCO INDUSTRIES, INC.
P.O. BOX 1893
CARSON CITY, NV 89702

N

CAGE code: 32387 2/

NAGOYA SCREW MANUFACTURING CO,
LTD.
17-16 TSUBAKI-CHO I
NAKAMURA-KU NAGOYA-SHI
AICHI-KEN, JAPAN

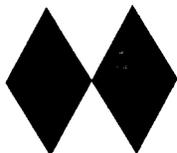

NRS

CAGE code: SC006 2/

NAPIER'S AUTO BODY
49879 HWY 101 STH.
P. O. BOX 278
BRANDON, OR 97411-1824

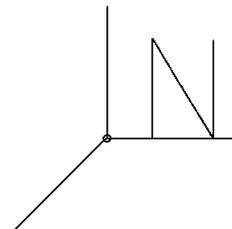

CAGE code: 1NXQ4 1/

NARRAGANSETT SCREW MFG., CO.
P.O. BOX 2242
119 ROWLEY ST
WINSTED, CT 06098 - 2068



CAGE code: OHP15 2/

NASSAN TOOL WORKS, INC.
34 LAMAR ST.
WEST BABYLON, NY 11704

NTW

CAGE code: 2M490 1/

1/ Information published in this revision was verified by direct contact with manufacturers.

2/ Information not verified to be current, no response from manufacturer. Information identical to that published in MIL-HDBK-57, Revision B.

MIL-HDBK-57G (IS)

NASU DENKI-TEKKO CO., LTD.
1-1-14 SHINJUKU, SHINJUKU-KU
TOKYO 160
JAPAN

SUNAMACHI FACTORY
3-5-28 SHINSUNA, ETO-KU,
TOKYO, JAPAN 136



CAGE code: 2/

NATIONAL AEROSPACE FASTENERS
CORPORATION (NAFCO)
NO 5 TAI-PING EAST ROAD, PING-JEN
CITY
TAO-YUN HSIEN, TAIWAN, #324, R.O.C

Plant
NO 1 and NO 5, TAI-PING EAST
ROAD, PING-JEN CITY
TAO-YUN HSIEN, TAIWAN, #324,
R.O.C



CAGE CODE: SF773 1/

NATIONAL BOLTS & RIVETS LTD.
P.O. BOX 5063,
BOKSBURG NORTH 1461
SOUTH AFRICA



CAGE code: V3674 2/

NATIONAL FASTENER CO., LTD.
#973 YANG DUCK-DANG
MASAN
REPUBLIC OF KOREA



CAGE code: 2/

NATIONAL THREADED FASTENERS CORP.
630 LIVELY BOULEVARD
ELK GROVE VILLAGE, IL 60007

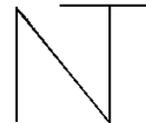

CAGE code: 2/

NAVPAR, INC.
11029 STATE ROUTE 128
BLDG C-1
HARRISON, OH 45030-9710



CAGE code: 0MHC4 1/

NC AUTOMATED INDUSTRIES INC.
90 DAYTON AVENUE
BLDG. 14E
PASSAIC, NJ 07055-7035



CAGE code: 1VPZ8 1/

1/ Information published in this revision was verified by direct contact with manufacturers.

2/ Information not verified to be current, no response from manufacturer. Information identical to that published in MIL-HDBK-57, Revision B.

MIL-HDBK-57G (IS)

NCMI BRUEGGEMANN INC.
1207 W. BROOKS STREET
ONTARIO, CA 91762-3609

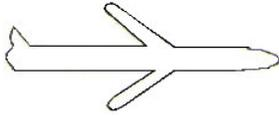

CAGE code: 0K292

1/

ND INDUSTRIES
DBA ND WESTERN FASTENER
PROCESSING DIVISION
13929 DINARD AVENUE
SANTA FE SPRINGS, CA 90670



CAGE code: 4Y667

2/

NEDSCHROEF
NEDSCHROEF HALMOND B.V.
P.O. BOX 29
5700 AA HELMOND
THE NETHERLANDS

Plant
KANAALDIJK NOORD WEST 71
5707 LC HELMOND
THE NETHERLANDS



Standard hexagon high tensile bolts and screws of all property classes



High strength friction grip bolts for structural bolting property class 10.9



Socket screws



Nuts and all other bolts and screws

CAGE code: HO871

2/

NEKG HOLDINGS
26709 SOUTH KIMBERLY
CHANNAHON, IL 26709

NE

CAGE code: 4YU01

1/

NELSON AEROSPACE INC.
10310 NORRIS AVE
PACOIMA, CA 91331-2219

NA

CAGE code: 52930

2/

NELSON STUD WELDING DIVISION
7900 W. RIDGE RD
ELYRIA, OH 44036-2019

N

CAGE code: 85105

2/

NEUMAYER, ERICH GMBH
POSTFACH 1160
WILHELM-ZANGEN-STRASSE 9
D-7613 HAUSACH
GERMANY

N

CAGE code: C1956

1/

1/ Information published in this revision was verified by direct contact with manufacturers.

2/ Information not verified to be current, no response from manufacturer. Information identical to that published in MIL-HDBK-57, Revision B.

MIL-HDBK-57G (IS)

NEVADA BOLT AND MFG CO INC.
DBA SPS NON-FERROUS ENGINEERED
FASTENERS
3850 W PONDEROSA WAY
LAS VEGAS, NV 89118

NF

CAGE code: 7U566

2/

NEVILLE MACHINE SHOP
P.O. BOX 22
RANGER, TX 76470-2722

Plant
406 E. HIWAY 80
RANGER, TX 76470-2722

ND

CAGE code: 8X524

2/

NEW HORIZON MACHINE CO., INC.
36 LUDLOW STREET
STAMFORD, CT 06902-2691

NH

CAGE code: 1VVZ7

2/

NICE TOOL MFG., INC.
3280 DIANA DR.
FORT WORTH, TX 76118-6237

NT

CAGE code: 5K517

2/

NINGBO JINDING FASTENING PIECE CO,
LTD
XI JING TANG JIULONGHU ZHENHAI
NINGBO, ZHEJIANG CHINA, PRC 315205

JDF

CAGE CODE: NONE

NIPPON MACHINE ENGINEERING, INC.
1311 EAST SAINT GERTRUDE PLACE
UNIT B
SANTA ANA, CA 92705



CAGE code: 49145

2/

^{1/} Information published in this revision was verified by direct contact with manufacturers.

^{2/} Information not verified to be current, no response from manufacturer. Information identical to that published in MIL-HDBK-57, Revision B.

MIL-HDBK-57G (IS)

NIPPON STEEL BOLTEN CO., LTD.
4-3-2 NISHIZUMI, YUKUHASHI,
FUKUOKA, JAPAN 824



CAGE code: 2/

NISCO, INC.
5F SHINGA BLDG. 1-3-10
UMEBAYASHI OUTSU-SHI
SHOGA-KEN 520, JAPAN

Plant
1018-1 ROKUJO CHUZU-CHO
YASU-GUM SHIGA-KEN
520-24 JAPAN



CAGE code: 2/

NISSAN SCREW CO. LTD.
SALES DEPT., FOREIGN TRADE SECTION
5-6-508 SHINKANAOKA-CHO
SAKAI-SHI-OASAKA 590 JAPAN

Plant
8-4-41 MIYAKE-NAKA
MATSUBARA-SHI, OSAKA 580
JAPAN



CAGE code: 1/

NOCHIA STEELWORKS
NYOGO, JAPAN

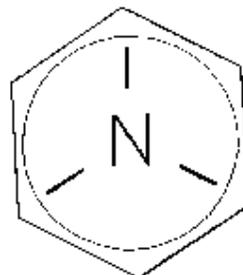

CAGE code: 2/

NON-FERROUS BOLT & MANUFACTURNG
CO.
4086 NEVSO DRIVE, SUITE C
LAS VEGAS, NV 89103

Plant
3850 WEST PONDEROSA LANE
LAS VEGAS, NV 89118



CAGE code: 2/

1/ Information published in this revision was verified by direct contact with manufacturers.

2/ Information not verified to be current, no response from manufacturer. Information identical to that published in MIL-HDBK-57, Revision B.

MIL-HDBK-57G (IS)

NORTHBRIDGE FASTENERS
VIKING ROAD
WIGSTON, LEICESTER
UNITED KINGDOM

NB



E – The plain letter E is used for Rolls Royce, UK supply and Europe and will be used in the absence of any customer allocated identification.



32219 – Allocated by Pratt & Whitney, East Hartford for supply to Pratt & Whitney, East Hartford



15077 – Allocated by Pratt & Whitney, Canada for supply to Pratt & Whitney, Canada



5T572 – Milscap No. for items supplied to U.S. Government



20733 – Allocated by Avco-Lycoming for supply to Avco-Lycoming



NTF99 – Allocated by General Electric for supply to Rolls Royce for joint projects with General Electric

CAGE code:

2/

NORTH EAST FASTENERS
8 TREMCO DRIVE
P. O .BOX 322
TERRYVILLE, CT 06786-0322



2 dots
either indented or raised.

CAGE code: 07ZN5

1/

NORTHEAST METAL CO., INC.
P.O. BOX 51754
34 FRONT STREET
INDIAN ORCHARD, MA 01151

Plant
AIRPORT DRIVE
WESTFIELD, MA 01085



CAGE code: 1C4F2

2/

NORTHERN SCREW CO. , INC.
8121 LAKEVIEW PARKWAY
PLEASANT PRAIRIE, WI 53158

NS

CAGE code:

2/

NORTHSTAR ENGINEERING
1911 LYNX PLACE
ONTARIO, CA 91761

0XK38

CAGE code: 0XK38

2/

1/ Information published in this revision was verified by direct contact with manufacturers.

2/ Information not verified to be current, no response from manufacturer. Information identical to that published in MIL-HDBK-57, Revision B.

MIL-HDBK-57G (IS)

NOVA MACHINE PRODUCTS
CORPORATION
A SUBSIDIARY OF CURTIS-WRIGHT FLOW
CONTROL SERVICE CORP.
18685 SHELDON ROAD
MIDDLEBURGE HEIGHTS, OH 44130-2465



CAGE code: 1EJ29

1/

NSK INDUSTRIES, INC.
150 ASCOT PARKWAY
CUYAHOGA FALLS, OH 44223



CAGE code: NONE

NT ENGINEERING, INC.
1050 "C" INDEPENDENCE AVE.
MOUNTAIN VIEW, CA 94043

NT

CAGE code: 0BEN1

2/

NUCOR CORP.
NUCOR FASTENER DIVISION
P.O. BOX 6100,
6730 COUNTY ROAD
ST. JOE, IN 46785

NUCOR

n

CAGE code: 0BEP9

1/

NUMERIC MACHINE PRODUCTS
1769 WEST AVE. K-11
LANCASTER, CA 93534

NMP

CAGE code: 5V524

2/

NUTS INCORPORATED
DIVISION OF STANLOK
1451 GRAFTON ST
P.O. BOX 2735
WORCHESTER, MASSACHUSETTS 01613

N

CAGE code: 02972

2/

NUTS, INC.
ROUTE 724 & 23
PHOENIXVILLE, PA 19460-1838

N

CAGE code: 6N185

2/

1/ Information published in this revision was verified by direct contact with manufacturers.

2/ Information not verified to be current, no response from manufacturer. Information identical to that published in MIL-HDBK-57, Revision B.

MIL-HDBK-57G (IS)

NYLOK CORP.
15260 HALLMARK DR.
MACOMB, MI 48042

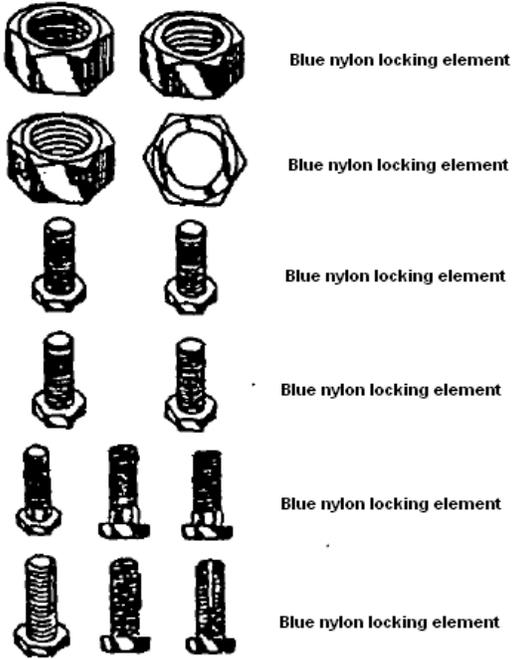

NK

NK

NYLOK

CAGE code: 59093

1/

OAKTREE FASTENERS CO.
12262 1/2 WOODRUFF AVE.
DOWNEY, CA 90241

OTF

CAGE code:

2/

OBARS MACHINE & TOOL CO.
115-126 N. WESTWOOD AVE.
TOLEDO, OH 43607

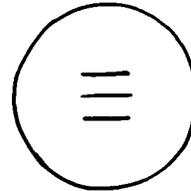

CAGE code: 0MKX0

2/

OCM MACHINE COMPANY, INC.
9601 HIGHWAY 80
FORT WORTH, TX 76116 - 2689



CAGE code: 06XQ6

2/

OHIO NUT & BOLT CO., THE
DIV. OF FASTENERS INDUSTRIES, INC.
33 LOU GROZA BLVD..
BEREA, OH 44017-1293



Small raised mark usually
on the underside of head

CAGE code: 76871

1/

1/ Information published in this revision was verified by direct contact with manufacturers.

2/ Information not verified to be current, no response from manufacturer. Information identical to that published in MIL-HDBK-57, Revision B.

MIL-HDBK-57G (IS)

OHKAWA SCREW MFG. CO., LTD.
2-25-16 MIDORIGAOKA,
MEGURO-KU, TOKYO
152 JAPAN

Plant
6357-1 OBA, OHMIYA-MACHI,
NAKA-GUN, LBARAGI-KEU
319-21 JAPAN

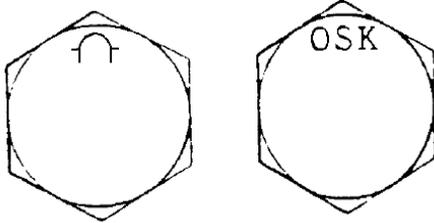

CAGE code: 2/

OKABE CO., INC.
OKABE KIKO CO., LTD. (PLANT)
4-21-15 MUKOJIMA
SUMIDA-KU, JAPAN 131-8505

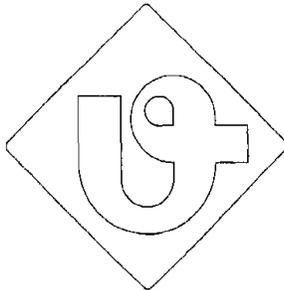

CAGE code: SP186 2/

OKAI IRON WORKS, INC.
12-41, 3 CHOME, TSURUHARA
IZUMISANO CITY
OSAKA, JAPAN 598

OK

CAGE code: 2/

OKAWA SCREW MANUFACTURING CO.,
LTD
2-20-4 HIGASHIGOTANDA
SHINAGAWA-KU, 141-0022
TOKYO

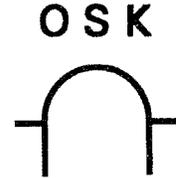

CAGE code: 1/

OMEGA THREAD ROLLING AND GRINDING
INC.
54 LEWIS STREET
P.O. BOX 129
PLAINVILLE, CT 06062-0129



CAGE code: 06KW4 2/

ONEIDA TOOL & MACHINE CORP.
837 AIR PARK RD.
RHINELANDER, WI 54501-8426

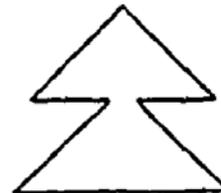

CAGE code: OJHAO 1/

1/ Information published in this revision was verified by direct contact with manufacturers.

2/ Information not verified to be current, no response from manufacturer. Information identical to that published in MIL-HDBK-57, Revision B.

MIL-HDBK-57G (IS)

ONO MANUFACTURER, INC.
602 FUJITA OKAYAMA-SHI,
OKAYAMA-KEN 701-0221
JAPAN

Plant
3-800-46 TAMAHARA TAMANO-
SHI, OKAYAMA-KEN 706-2555
JAPAN



CAGE code: 1/

ONTIC ENGINEERING &
MANUFACTURING, INC.
20360 PLUMMER ST.
NORTH HOLLYWOOD, CA 91609-0510

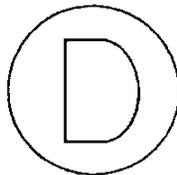

CAGE code: 45934 2/

ORANGE PRECISION PARTS
17632 METZLER LANE, #C
HUNTINGTON BEACH, CA 92647

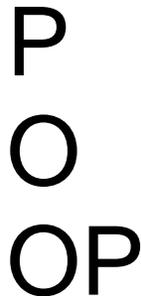

CAGE code: 9V210 2/

ORC-O TOOL & MACHINE, INC.
75 SHAMROCK DRIVE
SULLIVAN, MO 63080-2344



CAGE code: 0C1D0 2/

ORDNANCE PARTS & ENGINEERING CO.
P.O. BOX 8035
3152 C MAJOR ST
FORT WORTH, TX 76112



CAGE code: 20800 2/

ORLOTRONICS CORP.
401 E. FOURTH STREET
BRIDGEPORT, PA 19405-1815



CAGE code: 54267 1/

OSAKA SEIKI CO., LTD.
1-19-14, MITEJIMA
TOKYO 555
JAPAN

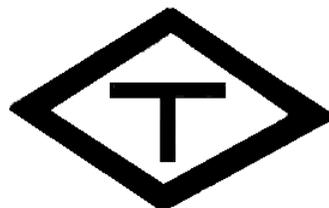

CAGE code: S4247 2/

1/ Information published in this revision was verified by direct contact with manufacturers.

2/ Information not verified to be current, no response from manufacturer. Information identical to that published in MIL-HDBK-57, Revision B.

MIL-HDBK-57G (IS)

OSTEEN MACHINE SHOP
RT. 1 BOX 2082
ALVARADO, TX 76009



CAGE code: 8Y546

2/

OTO MELARA S.p.A.
FINKECCANICA COMPANY
VIA VALDILOCCHI 15
LA SPEZIA 19136
ITALY



CAGE code: A0199

1/

OTT BROTHERS MACHINE CO., INC.
331 EAST 37TH STREET SOUTH
WICHITA, KS 67216

OB
OBMC

CAGE code: 09292

1/

OTTAWA PRODUCTS CO., INC.
1602 NORTH CURTICE RD.
CURTICE, OH 43412

OPC

CAGE code: 4JBK8

1/

OWARI PRECISE PRODUCTS CO., LTD
2-148 YADA-CHO HIGASHI-KU NAGOYA-
SHI
AICHI-KEN, JAPAN

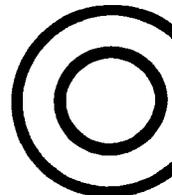

CAGE code: SC008

2/

P & I ASSOCIATES, INC.
26 WEST WAVERLY ROAD
P.O. BOX 413
GLENSIDE, PA 19038-4012

Plant
#1 LIMEKILN PIKE
GLENSIDE, PA 19038
(No mail to this address)



CAGE code: 0DH98

2/

P & L ENTERPRISES
111 CR 4614
CASTROVILLE, TX 78009

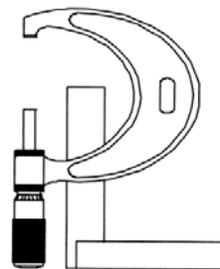

CAGE code: 058B7

1/

1/ Information published in this revision was verified by direct contact with manufacturers.

2/ Information not verified to be current, no response from manufacturer. Information identical to that published in MIL-HDBK-57, Revision B.

MIL-HDBK-57G (IS)

P.C.M., INC.
 (BETHLEHEM PIKE INDUSTRIAL CENTER)
 P.O. BOX 840
 60 PARRISH ST.
 WILKES BARRE, PA 18710

P

CAGE code: 2/

PACIFIC FASTENERS, INC.
 405 UNIVERSITY AVENUE
 ARLINGTON HEIGHTS, IL 60004

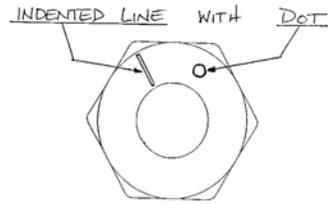

CAGE code: 42918 2/

P.S. MACHINE CO., INC.
 1505 JOHN FETCH BLVD.
 S. WINDSOR, CT 06074-1000

PS

CAGE code: 56839 1/

PACIFIC SCIENTIFIC
 22715 SAVI RANCH PARKWAY
 P.O. BOX 87019
 YORBA LINDA, CA 92686

PS

CAGE code: 45402 2/

PABCOR, INC.
 925 NORTH CEDAR STREET
 P.O. BOX 7528
 NEW CASTLE, PA 16107-1323

PABCOR

CAGE code: OAGN7 2/

PACIFIC TOOL, INC.
 15235 NE 92ND STREET
 REDMOND, WA 98052

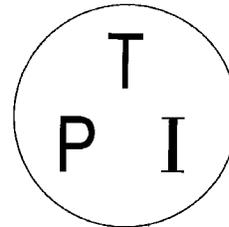

CAGE code: 62176 1/

PACER ALLOYS, INC.
 8681 SCRANTON STREET
 HOUSTON, TX 77075

V

CAGE code: 1/

PADGETT MACHINE INC.
 1226 NORTH 143rd EAST AVENUE
 TULSA, OK 74116-2120

PMI

CAGE code: 6W037 1/

1/ Information published in this revision was verified by direct contact with manufacturers.

2/ Information not verified to be current, no response from manufacturer. Information identical to that published in MIL-HDBK-57, Revision B.

MIL-HDBK-57G (IS)

PAINTER TOOL, INC.
1173 IRIS DRIVE
NORTH HUNTINGDON, PA 15642-4399

PTI

CAGE code: 34779 2/

PALNUT CO., THE
UNITED CARR FASTENERS PALNUT DIV
GLEN ROAD
MOUNTAINSIDE, NJ 07092

PAL

CAGE code: 2G832 2/

PAOLO ASTORI SPA
VIA MIRABELLA 9 - 28013
GATTICO - (NO)
ITALY

α

CAGE code: A3856 1/

PARK PRECISION CORPORATION
181 ELLIOT ST. UNIT 403
BEVERLY, MA 01915

-PPC-

CAGE code: OJWS2 2/

PATEREX, LTD.
CRAY AVE.,
ORPINGTON KENT BR5 3RR
UNITED KINGDOM

**P
PTX**

CAGE code: OBMF6 2/

PATTERSON LAKE PRODUCTS
(SUBSIDIARY OF COLUMBIA AUTO
PARTS)
P.O. BOX 200
PINCKNEY, MI 48169

BP

CAGE code: 5Y952 2/

PAULIN, H. & CO., LTD.
CAPITAL METAL INDUSTRIES DIVISION
55 MILNE AVENUE
SCARBOROUGH, ONTARIO MIL 4N3
CANADA



CAGE code: 95119 2/

1/ Information published in this revision was verified by direct contact with manufacturers.

2/ Information not verified to be current, no response from manufacturer. Information identical to that published in MIL-HDBK-57, Revision B.

MIL-HDBK-57G (IS)

PB FASTENERS
 (DIVISION OF PAUL R. BRILES, INC.)
 1700 WEST 132ND STREET
 GARDENA, CA 90249

MFR 27624



PBF

PB

CAGE code: 27624 1/

PECO AEROSPACE FASTENERS
 4707 SE 17th AVENUE
 PORTLAND, OR 97202
 plant
 361 S. SEQUOIA PRKWY
 CANBY, OR 97013

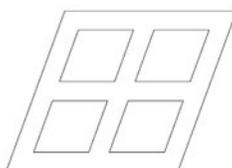

35° Rhombus with 4 smaller Rhombuses equally spaced, one in each quadrant of the larger Rhombus

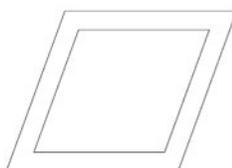

35° Rhombus with 4 smaller Rhombuses removed (design is for smaller size fasteners)

CAGE code: NONE 1/

PEERLESS SCREW PRODUCTS
 286 SANDBANK RD.
 P.O. BOX 236
 CHESHIRE, CT 06410-1537



CAGE code: 45950 1/

PEINER UMFORMTECHNIK GmbH
 WOLTORFER STRASSE 26
 PEINE, 31224
 GERMANY



Grade marking

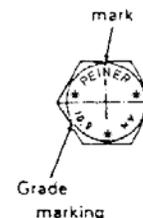

Grade marking



Grade marking

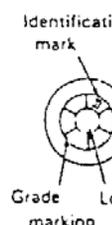

Grade marking Lot no.

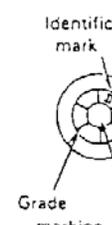

Grade marking Lot no.

CAGE code: D2742 2/

1/ Information published in this revision was verified by direct contact with manufacturers.

2/ Information not verified to be current, no response from manufacturer. Information identical to that published in MIL-HDBK-57, Revision B.

MIL-HDBK-57G (IS)

PELHAM AUTO MATRIX PRECISION
1 INDUSTRIAL DRIVE
PELHAM, NH 03076



CAGE code: 1CSJ5 2/

PENN CIGAR MACHINES INC (P.C.M INC)
P. O. BOX 1065
60 PARRISH STREET
WILKES BARRE, PA 18703



CAGE code: 7U218 2/

PENNGINEERING AUTOMOTIVE
FASTENERS
50625 DESIGN LANE
SHELBY TOWNSHIP, MI 48315

(Coporate see PENN ENGINEERING &
MANUFACTURING CORP.)



CAGE code: 50EB1 1/

PENN ENGINEERING & MANUFACTURING
CORP.
(see ATLAS ENGINEERING, INC.)
5190 OLD EASTON RD.
DANBORO, PA 18916

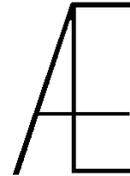

Square insert in
floating fasteners

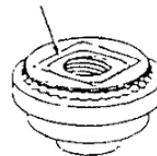

PEM trademark
Blue - nylon® hexagon
locking element

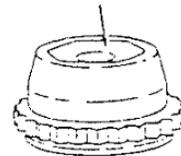

"Dimple" trademark



PEM 300™
identification mark

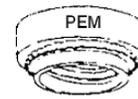
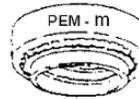
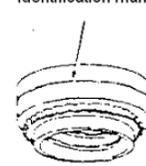

CAGE code: 46384 1/

PENN SCREW & MACHINE WORKS, INC.
3075 ADVANCE LN.
COLMAR, PA 18915



CAGE code: 82926 2/

1/ Information published in this revision was verified by direct contact with manufacturers.

2/ Information not verified to be current, no response from manufacturer. Information identical to that published in MIL-HDBK-57, Revision B.

MIL-HDBK-57G (IS)

PEREZ MACHINE, INC.
1501 W. 134TH STREET
GARDENA, CA 90249



CAGE code: 34393

1/

PERIGEE MANUFACTURING COMPANY,
INC. (MICHIGAN CORPORATION)
7519 INTERVALE
DETROIT, MI 48238-2401



CAGE code: 1X4X7

1/

PERKINS MACHINE CO.
1559 PINE STREET
OXNARD, CA 93030



CAGE code: 84749

2/

PHOENIX SPECIALTY MANUFACTURING
CO., INC.
P.O. BOX 418
BAMBERG, SC 29003

Plant
HIGHWAY 301 SOUTH
BAMBERG, SC 29003

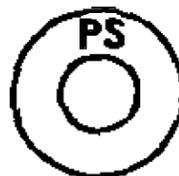

CAGE code: 66920

2/

PILGRIM SCREW CORP.
(PROVIDENCE DIVISION)
120 SPRAGUE STREET
PROVIDENCE, RI 02901

Plant
259 DEXTER ST.
PROVIDENCE, RI 02907
CAGE code: 47253



Plant 2
2875 WEST FRYE ROAD
CHANDLER, AZ CHANDLER, AZ
CAGE code: 1GP79

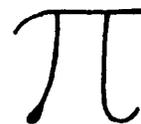

CAGE code: 47253, 1GP79

1/

1/ Information published in this revision was verified by direct contact with manufacturers.

2/ Information not verified to be current, no response from manufacturer. Information identical to that published in MIL-HDBK-57, Revision B.

MIL-HDBK-57G (IS)

PINE TAVERN MACHINE INC.
7851 PINE TAVERN ROAD
PERRY, NY 14530

PTM

CAGE code: 9J559

2/

PINEY RIDGE CO.
177 JOSHUA ROAD
SALUDA, SC 29138-7770

PR

CAGE code: 05DT2

1/

PINTO PRODUCTS
P.O. BOX 83
2011 PALMER STREET
KALAMAZOO, MI 49001



CAGE code: 0YJH8

2/

PIONEER MACHINE PRODUCTS, INC.
2200 DOLMAN
ST. LOUIS, MO 63104

PMP

CAGE code: 12829

2/

PIONEER SCREW & NUT CO.
2700 YORK ROAD
ELK GROVE VILLAGE, IL 60007



Indented hex heads and
indented hex washer
heads

All other head styles slash-
dot symbol to appear on
bearing surface upon
request

CAGE code: 4N311

2/

PLAINVILLE MANUFACTURING CO., INC.
48 LEWIS ST.
PLAINVILLE, CT 06062



CAGE code:

2/

PNEU-HYDRO PRODUCTS, INC.
353 RICHARD MINE ROAD
WHARTON, NJ 07885

PHP

CAGE code:

2/

POINT MACHINE COMPANY
P.O. BOX 8055
33 CAMBRIDGE HEIGHTS
KENSINGTON, CT 06037

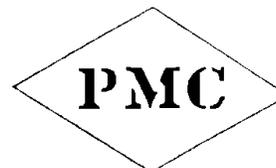

CAGE code: 9N716

2/

1/ Information published in this revision was verified by direct contact with manufacturers.

2/ Information not verified to be current, no response from manufacturer. Information identical to that published in MIL-HDBK-57, Revision B.

MIL-HDBK-57G (IS)

POLYTECHNIC INDUSTRIES
14 ROLAND AVE.
MOUNT LAUREL, NJ 08054



CAGE code: 4K539

1/

PORTLAND BOLT & MFG., CO.
P.O. BOX 2866
1210 NW JOHNSON ST
PORTLAND, OR 97208

Plant
3441 NW GUAM ST
PORTLAND, OR 97210-2688
CAGE code: 3QCS3

PB

CAGE code: 3S498, 3QCS3

1/

PORTSMOUTH NAVAL SHIPYARD
SEAVEY ISLAND
KITTEERY, ME 03904

A

CAGE code: 81316

1/

POSIMECH, INC.
15 INDUSTRIAL (SCOUTING) BLVD.
MEDFORD, NY 11763

P

CAGE code: 0AXM0

1/

POWERPARTS, INC.
P.O. BOX 38557
601 MCFARLAND STREET
HOUSTON, TEXAS 77011



CAGE code: 66297

2/

PRD FASTENERS LTD.
UNIT 10/15 MONMER CLOSE
WILLENHALL, WV12 1JR
ENGLAND

PRD

CAGE code: U8651

1/

PRECI-MANUFACTURING, INC.
400 WEAVER STREET
WINOOSKI, VT 05404-1391



CAGE code: 66841

1/

PRECISE AERO PRODUCTS
4120 INDUS WAY
RIVERSIDE, CA 92503-4808



CAGE code: 00AE2

1/

1/ Information published in this revision was verified by direct contact with manufacturers.

2/ Information not verified to be current, no response from manufacturer. Information identical to that published in MIL-HDBK-57, Revision B.

MIL-HDBK-57G (IS)

PRECISE OF CALIFORNIA
DIV OF ADJUSTABLE BUSHING CORP
8330 LANKERSHIM BLVD.
NORTH HOLLYWOOD, CA 91605



Panel fastener



Quick-acting pins

CAGE code: 62372

2/

PRECISION AIRCRAFT MACHINING CO.,
INC. DBA PAMCO
10640 ELKWOOD STREET
SUN VALLEY, CA 91352

PAMCO

PAM

CAGE code: 66774

1/

PRECISION FITTINGS, INC.
709 NORTH MAIN ST.
WELLINGTON, OH 44090

PF

CAGE code: 92192

1/

PRECISION METAL PRODUCTS CO.
#7 CENTENNIAL DRIVE
CENTENNIAL INDUSTRIAL PARK
PEABODY, MA 01961-6026



CAGE code: 4V472

2/

PRECISION PARTS & TOOL CO., INC.
108 ROME STREET
FARMINGDALE, NJ 11735

L.P.R.

CAGE code:

2/

PRECISION PIECE PARTS, INC.
712 S. LOGAN ST.
MISHAWAKA, IN 46544



CAGE code: 98072

2/

PRECISION SCREW & BOLT, INC.
1491 CHARDON ROAD
CLEVELAND, OH 44117-1598

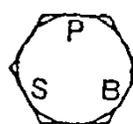

GRADE 2

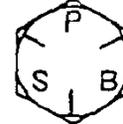

GRADE 5



GRADE 8

CAGE code: 02BC3

1/

1/ Information published in this revision was verified by direct contact with manufacturers.

2/ Information not verified to be current, no response from manufacturer. Information identical to that published in MIL-HDBK-57, Revision B.

MIL-HDBK-57G (IS)

PRECISION TECHNOLOGIES, INC.
1538 INDUSTRIAL AVE.
OTTAWA, KS 66067

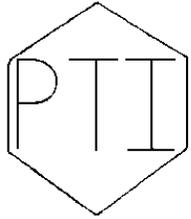

CAGE code: 2/

PRECISIONMATICS CO., INC.
HELMER AVE.
WEST WINFIELD, NY 13491

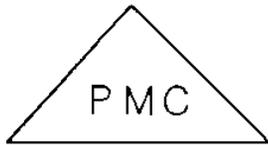

CAGE code: 2/

PREM INDUSTRIES, INC.
P.O. BOX 907
NIAGRA FALLS, NY 14302

Plant
574-56th ST.
NIAGRA FALLS, NY 14304



CAGE code: 4Y327 2/

PRESTIGE STAMPING, INC.
23513 GROESBECK HWY
WARREN, MI 48089



CAGE code: 0AAB6 1/

PRICE MANUFACTURING CO.
372 NORTH SMITH AVENUE
CORONA, CA 91720

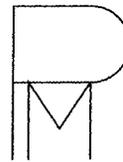

CAGE code: 1K6D8 1/

PRIETO MACHINE COMPANY, INC.
1785 STOUT DRIVE
UNIT D
WARMINSTER, PA 18974



CAGE code: 8Y298 1/

PRODUCT DEVELOPMENT GROUP, INC.
P.O. BOX 177
ROSE HILLS, KS 67133



CAGE code: OMAR7 2/

1/ Information published in this revision was verified by direct contact with manufacturers.

2/ Information not verified to be current, no response from manufacturer. Information identical to that published in MIL-HDBK-57, Revision B.

MIL-HDBK-57G (IS)

PRODUCTION & TOOL COMPANY
240 SARGENT DRIVE
NEW HAVEN, CT 06511



CAGE code: 8N334

2/

PRODUCTS DESIGN & MFG. CORP.
P.O. BOX 11429
NEWINGTON, CT 06111

Plant
76 STANWELL RD.
NEWINGTON, CT 06111

8M938

CAGE code:

2/

PROFORMANCE MANUFACTURING, INC.
1922 ELISE CIRCLE
CORONA, CA 92879

PMI

CAGE code: 62F29

1/

PRO-MACHINE & TOOL COMPANY
792 BLAKE BOTTOM RD.
HUNTSVILLE, AL 35806



CAGE code: IDS66

2/

PROMPTUS ELECTRONIC HARDWARE
520 HOMESTEAD AVENUE
MT. VERNON, NY 10550



CAGE code: 57177

2/

PROTO MACHINE CO., INC.
P.O. BOX 1240
1295 GOLDEN TRIANGLE BLVD.
KEELER, TX 76248



CAGE code: 0AWM2

2/

PTM INTERNATIONAL INC.
8050 NW 31ST
MIAMI, FL 33122



CAGE code: 0S6M6

2/

PURITAS METAL PRODUCTS
7720 RACE RD
NORTH RIDGEVILLE, OH 44039-3614

PMP

P

CAGE code: 04368

1/

PYE & HOGAN MACHINE CO.
P. O. BOX 832
167-1 ELM ST
OLD SAYBROOK, CT 06475-4134

MFR06320

CAGE code: 06320

1/

1/ Information published in this revision was verified by direct contact with manufacturers.

2/ Information not verified to be current, no response from manufacturer. Information identical to that published in MIL-HDBK-57, Revision B.

MIL-HDBK-57G (IS)

QRP, INC.
P.O. BOX 832
2307 MERCANTILE DR NE
LELAND, NC 28451-4065

09094

CAGE code: 09094

1/

QSN MANUFACTURING, INC.
201 FRONTIER WAY
BENSENVILLE, IL 60106

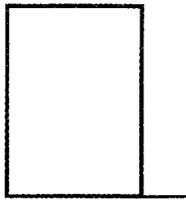

CAGE code: 0MDU6

2/

QUALITY AIRCRAFT SCREWS, INC.
1030-A ORTEGE WAY
PLACENTIA, CA 92670

QAS

CAGE code:

2/

QUALITY BOLT & SCREW CO.
10147 BRECKSVILLE RD.
BRECKSVILLE, OH 44141-3205

QB

CAGE code: 0BCN3

1/

QUALITY FABRICATIONS, INC.
3270 WROLSSEN DRIVE
SAUGERTIES, NY 12477



CAGE code: IJB77

2/

QUALITY MACHINE & MFG INC.
1316 BLACK VALLEY ROAD
LAFOLLETTE, TN 37766



CAGE code: 1DB71

2/

QUALITY SCREW PRODUCTS, INC.
P.O. BOX 2355
35101 SCHOOLCRAFT ROAD
LIVONIA, MI 48151



CAGE code: 4F051

2/

QUALITY SOCKET SCREW
MANUFACTURING CORP.
2790 NORTH AVE.
ENGLEWOOD, IL 34224

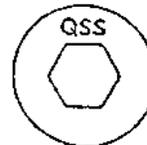

Socket head cap screw head
marked for I.D. QSS

CAGE code: 5N116

1/

1/ Information published in this revision was verified by direct contact with manufacturers.

2/ Information not verified to be current, no response from manufacturer. Information identical to that published in MIL-HDBK-57, Revision B.

MIL-HDBK-57G (IS)

QUALITY THREADED PRODUCTS
COMPANY
4734 HIGHWAY 157 N.
JUDSONIA, ARKANSAS 72081

QT

CAGE code: 0RXV6

2/

R & D FASTENERS
P. O. BOX 250
9604 7TH ST
RANCHO CUCAMONGA , CA 91730

R

CAGE code: 05BE3

2/

R & D WELDING & MACHINE INC.
1200 GEORGIA AVE.
WARNER ROBBINS, GA 31093

**R&D
WM
1**

CAGE code: 1H3J7

2/

R & I ENTERPRISES
DBA COMPULOGIC DESIGN CO.
233 PAREDES LINE RD.
BROWNSVILLE, TX 78521

R.I.E.

CAGE code: 1CHU5

1/

R & R PRECISION
604 S. 9TH ST.
GUNNISON, CO 81230

R & R

CAGE code: 0GKX6

2/

1/ Information published in this revision was verified by direct contact with manufacturers.

2/ Information not verified to be current, no response from manufacturer. Information identical to that published in MIL-HDBK-57, Revision B.

MIL-HDBK-57G (IS)

R B & W CORPORATION
 A PARK-OHIO COMPANY
 5190 BRADCO BLVD.
 TORONTO, ONTARIO
 CANADA

Plant
 DELAWARE CORPORATION
 8341 TYLER BLVD
 MENTOR, OH 44060

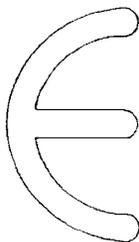

R B
 W

L S B L 9

XP exposure protected
 ASTM A325 Type 3
 bolts and nuts



UNA-DRIV[®]
 SYSTEM

RAI-LOCK[®]
 SYSTEM

LAMSEAL[®]
 SYSTEM



Castilled



Slotted



SAE J995
 Grade 5
 hex nuts



SAE J995
 Grade 8
 hex nuts

OVALOK[®] TRI-OVAL[®]
 prevailing torque
 locknuts

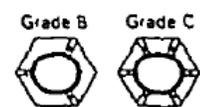

Grade B Grade C

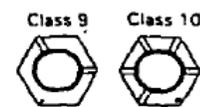

Class 9 Class 10

Stover[®] prevailing
 torque locknuts



RB&W Nuts

Not Otherwise
 Specified
 (Dots at 180°)

CAGE code: 52167

Continued

2/

Continued

R B & W CORPORATION



VIBRESIST[®]
 locking screws

Grade F



Grade G



Grade A



Grade B



Grade C



Grade 5

VIBRESIST[®] hex locknut



Class 5



Class 9



Class 10



Grade 5

VIBRESIST[®] hex locknut



Grade 8



Class 9



Class 10



Grade 8



Grade C



Class 9



Class 10



Class 9



Class 10



Type 'GT'

CAGE code: 52167

2/

R. BILD COMPANY, INC.
 15205 STAGG STREET
 VAN NUYS, CA 91405-1003



CAGE code: 04QM7

1/

1/ Information published in this revision was verified by direct contact with manufacturers.

2/ Information not verified to be current, no response from manufacturer. Information identical to that published in MIL-HDBK-57, Revision B.

MIL-HDBK-57G (IS)

R.E.C. CORP.
10 BEACH ST.
MOUNT VERNON, NY 10550

R

Used on all alloy and stainless steel bolts, studs, and nuts over ½ inch in diameter.

CAGE code: 86687

2/

RABOURDIN
ZI R DES MARAIS
P.O. BOX BP 157
ST. JUST EN CHAUSSEE,
FRANCE 60130

GR

CAGE code: F4870

2/

RADAX INDUSTRIES, INC.
700 BASKET ROAD
WEBSTER, NY 14580

RX

CAGE code: 6V794

2/

RAE MANUFACTURING CO.
1327-1331 CEDAR STREET
PORT HURON, MI 48060-6167



Grade 3

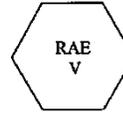

Grade 5



Grade 8

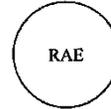

RAE

CAGE code: 3FDT8

1/

RAHMEDE SCHRAUBENFABRIK
WEFELSHOHLER STR 44
D-5880 LUDENSCHIED
GERMANY

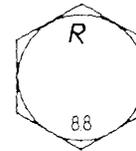

CAGE code: D9901

2/

RAINBOW MACHINE PRODUCTS, INC.
P.O. BOX 1906
226 WILLIS ROAD
YORK, PA 17405



CAGE code: 9S535

2/

RAM ENTERPRISES
1382 CORONADO ST
LONG BEACH, CA 90804

RE

CAGE code: OU3C8

2/

1/ Information published in this revision was verified by direct contact with manufacturers.

2/ Information not verified to be current, no response from manufacturer. Information identical to that published in MIL-HDBK-57, Revision B.

MIL-HDBK-57G (IS)

RAM PRODUCTS
AFS TORRANCE OPERATIONS
3016 WEST LOMITA BLVD.
TORRANCE, CA 90505-5103

(Corporate office see ALCOA FASTENING SYSTEMS)

RAM

CAGE code: 0CBU7

RAM THREADING, INC.
P.O. BOX 987
BEAUMONT, TEXAS 77704

Plant
2640 CROCKETT
BEAUMONT, TX 77701

R

Centered over grade of material being stamped

CAGE code: 1Y826

2/

RAMAR NUTS, INC.
18401 WEAVER ST.
DETROIT, MI 48228

R

CAGE code: 4L633

2/

RAMCO SPECIALTIES, INC.
5369 HUDSON DRIVE
HUDSON, OH 44236

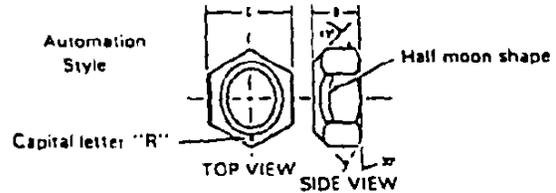

CAGE code: 6U460

1/

RAMM DEFENSE PRODUCTS
3161 D MAJOR ST
FORT WORTH, TX 76112-7270



CAGE code: 0BRC1

1/

RATHMANN WALTER G. SEGMENT-
KLAMMERSCHRAUBEN GMBH
ALTE EMSER STRASSE 32
KOBLENZ, 56077
GERMANY



CAGE code: C6486

2/

RA-WHITE, INC
967 WEST HYDE PARK BOULEVARD
INGLEWOOD, CA 90302

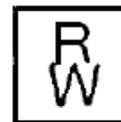

CAGE code: 5Y319

2/

1/ Information published in this revision was verified by direct contact with manufacturers.

2/ Information not verified to be current, no response from manufacturer. Information identical to that published in MIL-HDBK-57, Revision B.

MIL-HDBK-57G (IS)

RB & W CORP.
23001 EUCLID AVE.
CLEVELAND, OH 44117

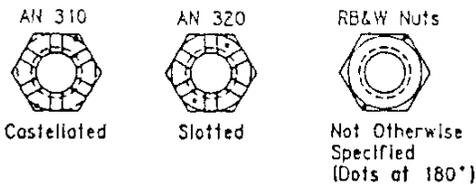
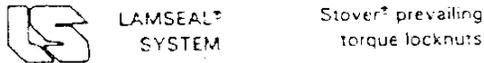
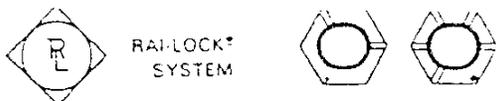
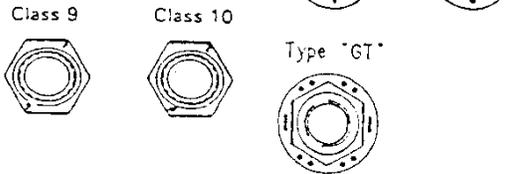
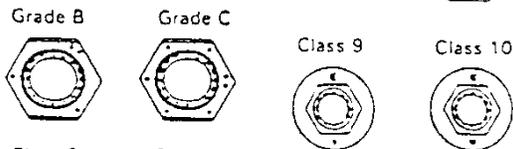
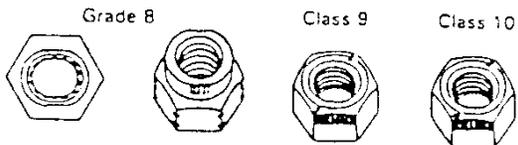
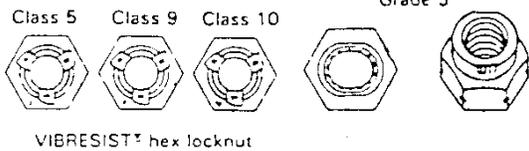
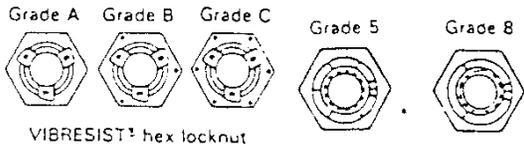
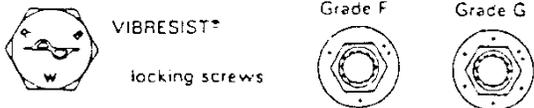

CAGE code: 0VZJ0 2/

REED INSTRUMENT CO.
1525 BLALOCK ROAD
HOUSTON, TX 77080



CAGE code: 3B132 2/

REGAL AIR, INC.
P.O. BOX 1011
108 E. ALABAMA
MT. PLEASANT, TX 75455

4J976

CAGE code: 4J976 2/

REID PRODUCT INC.
21430 WAALEW RD
APPLE VALLEY, CA 92307

Rp
9R
R9

CAGE code: 59563 1/

1/ Information published in this revision was verified by direct contact with manufacturers.

2/ Information not verified to be current, no response from manufacturer. Information identical to that published in MIL-HDBK-57, Revision B.

MIL-HDBK-57G (IS)

RELIANT FASTENER
201 E. 2ND STREET
ROCK FALLS, IL 61071

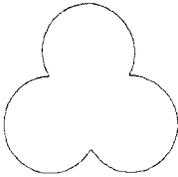

CAGE code: 2/

RELLI TECHNOLOGY, INC.
1200 SOUTH ROGERS CIRCLE
BOCA RATON, FL 33487

r

Raised or depressed character

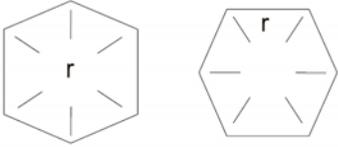

CAGE CODE: 57550 1/

REPUBLIC FASTENER MANUFACTURING CORP.
1300 RANCHO CONEJO BOULEVARD
NEWBURY PARK, CA 91320-1405

R

CAGE code: 52828, 71087 1/

(see ALCOA FASTENING SYSTEMS)

REXNORD
SPECIALITY FASTENERS DIVISION
(NOW: ALCOA FASTENING SYSTEMS,
TRIDAIR PRODUCTS)
3000 WEST LOMITA BLVD
TORRANCE, CA 90505



Tridair



(NOW: ALCOA FASTENING SYSTEMS)
CAMLOC PRODUCTS
601 ROUTE 46 WEST
HASBROUCK HEIGHTS, NJ 07604





(NOW: ALCOA FASTENING SYSTEMS)
ROSAN PRODUCTS
3130 W. HARVARD ST.
SANTA ANA, CA 92704

RI

CAGE code: 76017 2/

1/ Information published in this revision was verified by direct contact with manufacturers.

2/ Information not verified to be current, no response from manufacturer. Information identical to that published in MIL-HDBK-57, Revision B.

MIL-HDBK-57G (IS)

RICHARD MANNO & CO., INC.
42 LAMAR ST
WEST BABYLON, NY 11704

R/M

CAGE code: 0RGV4 & 3BFK5 1/

RICHARD MFG. CO., INC.
250 ROCK LANE
MILFORD, CT 06460-3853

RMCO

CAGE code: 4A014 1/

RINCO TECHNOLOGIES, INC.
10275 PHILADELPHIA CT.
RANCHO CUCAMONGA, CA 91730

R

CAGE code: 4NG33 1/

RING SCREW WORKS
10160 GAINEY RD
HOLLY, MI 48442 - 9331

FENTON HEADING
2480 OWEN RD.
FENTON, MI 48430-1769
CAGE code: 7M992

⊖

FERNDALE FASTENER
31600 STEPHENSON HIGHWAY
MADISON HEIGHTS, MI 48071

⊕

RING SCREW DEVISION
22100 SHERWOOD AVE.
WARREN, MI 48091

⊙

SEMCO FASTENER
4146 EAST BALDWIN RD.
HOLLY, MI 48442

⊕

TITAN FASTENER
10031 HOLLY RD.
HOLLY, MI 48442

⊕

CAGE code: 0B2C8 2/

1/ Information published in this revision was verified by direct contact with manufacturers.

2/ Information not verified to be current, no response from manufacturer. Information identical to that published in MIL-HDBK-57, Revision B.

MIL-HDBK-57G (IS)

RIPA ENGINEERING CORP.
9555 OWENSMOUTH AVE.
UNIT # 7 & 8
CHATSWORTH, CA 91311

RIPA

CAGE code: 3R930

1/

RIPPA PRODUCTS
P.O. BOX 328
5 MILE POINT RD
MOHAWK, MI 49950

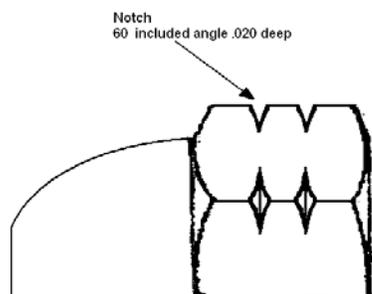

CAGE code: 0R7Z5

2/

RISCO, INCORPORATED
390 RISCO CIRCLE
BEAUMONT, CA 92223-2676

01DC

CAGE code: 6W027

1/

RIVER VALLEY TOOL & MANUFACTURING
P. O. BOX 64
260 AIRPORT INDUSTRIAL ROAD
PARIS, AR 72855

RVT

CAGE code: 3K1M6

1/

RIVNUT ENGINEERED PRODUCTS, INC.
2705 MARION DRIVE
KENDALLVILLE, IN 46755

REP

CAGE code: 0VK23

2/

RMS
1125 W ACACIA AVE
HEMET, CA 92543

RMS

CAGE code:

2/

ROBBINS MANUFACTURING
P.O. BOX 704
1200 AIRPORT ROAD
FALL RIVER, MA 02722



CAGE code: 8T312

1/

1/ Information published in this revision was verified by direct contact with manufacturers.

2/ Information not verified to be current, no response from manufacturer. Information identical to that published in MIL-HDBK-57, Revision B.

MIL-HDBK-57G (IS)

ROBERT HENRY CO., INC.
87 OPAL STREET
MILFORD, CT 06460

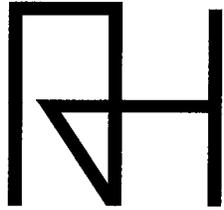

CAGE code: 9J112 2/

ROCKFORD BOLT & STEEL CO.
(SUBSIDIARY OF VARLEN CORPORATION)
126 MILL ST
ROCKFORD, IL 61101-1491



CAGE code: 90483 1/

ROCKFORD FASTENERS INC.
P.O. BOX 884
ROCKFORD, IL 61105

Plant
725 SOUTH STREET
ROCKFORD, IL 61102



CAGE code: 0B998 2/

ROCKFORD PRODUCTS CORP.
707 HARRISON AVE
ROCKFORD, IL 61108

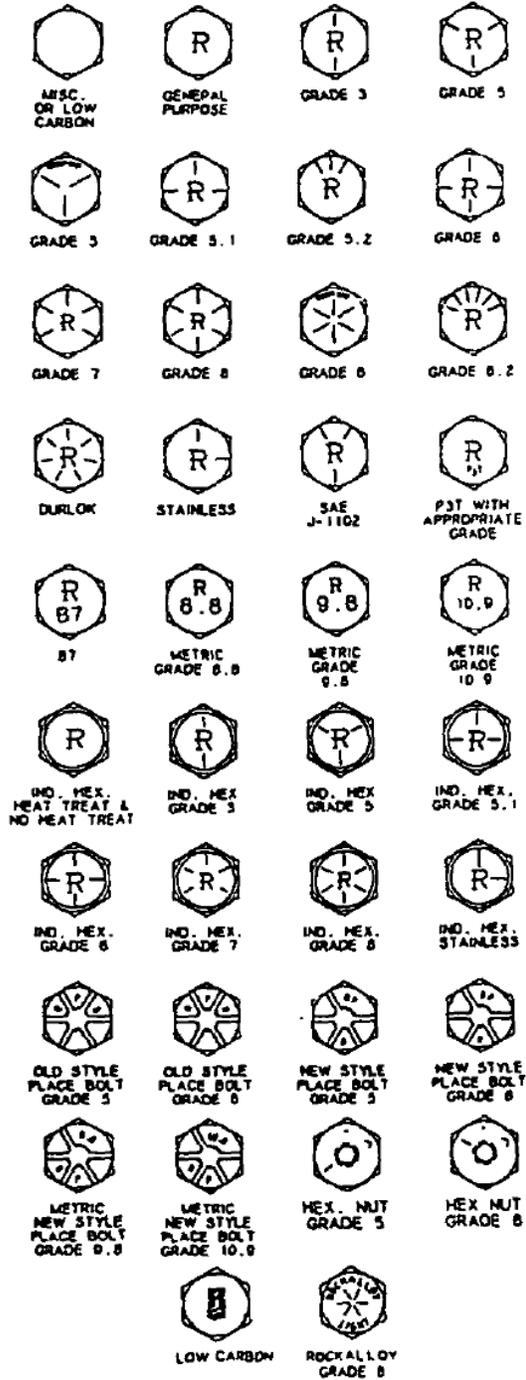

CAGE code: 77595 2/

1/ Information published in this revision was verified by direct contact with manufacturers.

2/ Information not verified to be current, no response from manufacturer. Information identical to that published in MIL-HDBK-57, Revision B.

MIL-HDBK-57G (IS)

ROGG MANUFACTURING COMPANY
600 DANBURY ROAD
NEW MILFORD, CT 06776

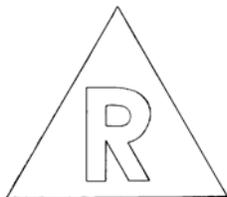

CAGE code: 08625

2/

ROLAND AEROSPACE
13429 SOUTH WESTERN AVENUE
UNIT G
GARDENA, CA 90249

ROL

CAGE code: 63EM5

1/

ROMAC ELECTRONICS, INC.
155 E. AMES CT.
PLAINVIEW, NY 11803

8T968

CAGE code: 8T968

2/

RONSON MANUFACTURING, INC.
9933 CHILLICOCTHE ROAD
KIRKLAND, OH 44094

R

CAGE code: 2X146

1/

ROSAN PRODUCTS
AFS TORRANCE OPERATIONS
3018 WEST LOMITA BLVD.
TORRANCE, CA 90505-5103

(Corporate office see ALCOA FASTENING SYSTEMS)

RI

CAGE code: 83324

1/

ROTAIR INDUSTRIES, INC.
P.O. BOX 4098
964 CRESCENT AVE
BRIDGEPORT, CT 06607-1025



Rubber stamped
on fasteners

54878

Commercial and Government Entity
(CAGE) number affixed or rubber

CAGE code: 54878

1/

RS MANUFACTURING, INC.
INDUSTRIAL PARK BLVD.
MENTOR, OH 44060

RS



CAGE code: 0MYK3

2/

1/ Information published in this revision was verified by direct contact with manufacturers.

2/ Information not verified to be current, no response from manufacturer. Information identical to that published in MIL-HDBK-57, Revision B.

MIL-HDBK-57G (IS)

RUDOLPH INSTRUMENTS, INC.
400 MORRIS AVE STE 120
DENVER, NJ 07834-1362

RI

CAGE code: 23262 2/

RUMCO, INC.
985 PAULY DR.
ELK GROVE VILLAGE, IL 60007-1312

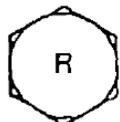

GRADE 2



GRADE 5

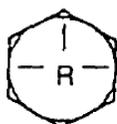

GRADE 5.1



GRADE 5.2

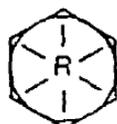

GRADE 8

CAGE code: 6Z992 2/

RUSCOMB TOOL & MACHNE CO., INC.
500 W. RUSCOMB STREET
PHILADELPHIA, PA 19120



RTM

CAGE code: 07952 2/

S & L METAL PRODUCTS CORP.
5829 57TH DR
MASPETH, NY 11378-2232

S&L

CAGE code: 05722 2/

S & L TOOL
36080 INDUSTRIAL ROAD
LIVONIA, MI 48150

SL

CAGE code: 5C304 1/

S. B. E. (ITALY CORPORATION)
VIA ENRICO DERMI
20019 SETTIMO
MILANESE, ITALY

SBE

CAGE code: 2/

1/ Information published in this revision was verified by direct contact with manufacturers.

2/ Information not verified to be current, no response from manufacturer. Information identical to that published in MIL-HDBK-57, Revision B.

MIL-HDBK-57G (IS)

S.A.B.A. S.p.A. BULLONERIA E. AFFINI
 VIA LIGURIA 11/13,
 20098 SESTO ULERIANO
 FRAZ. DI S. GUILLANO M.SE
 MILANO, ITALY

A.L.

CAGE code: 2/

S.I. STUD, INC.
 1127 SILBER RD.
 HOUSTON, TX 77055

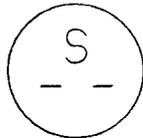

CAGE code: 2/

SABRE MANUFACTURING, INC.
 P.O. BOX 11386
 201 S. CHERRY ST.
 SOUTH BEND, IN 46601

S

CAGE code: 0GN74 2/

SAFETY SOCKET LLC.
 6501 N. AVONDALE AVENUE
 CHICAGO, IL 60631

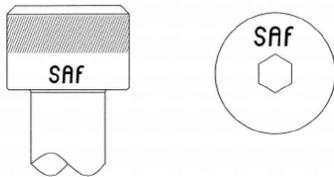

CAGE code: 82896 1/

SAFETY SOCKET SCREW CORP.
 (ENGINEERING DEPARTMENT)
 6501 NORTH AVONDALE AVE.
 CHICAGO, IL 60631

INCH SOCKET HEAD CAP SCREWS

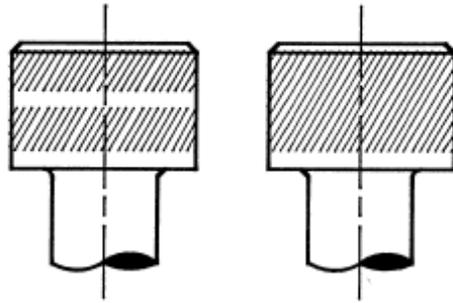

BUTTON HEAD
 CAP SCREWS

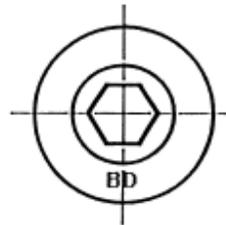

FLAT HEAD
 CAP SCREWS
 AND SOCKET
 HEAD SHOULDER
 SCREWS

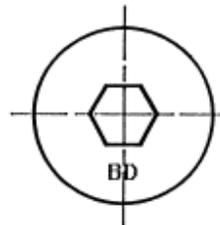

METRIC SOCKET HEAD CAP SCREWS

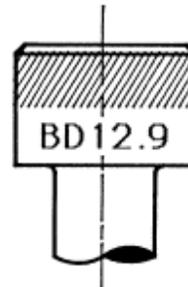

BD AND THE 60° DIAGONAL KNURL ARE
 REGISTERED TRADEMARKS OF
 SAFETY SOCKET SCREW CORPORATION
 FOR THE PURPOSE OF MANUFACTURERS
 IDENTIFICATION

BD BDM

CAGE code: 82896 2/

1/ Information published in this revision was verified by direct contact with manufacturers.

2/ Information not verified to be current, no response from manufacturer. Information identical to that published in MIL-HDBK-57, Revision B.

MIL-HDBK-57G (IS)

SAGA TEKKOSHO CO., LTD.
129-3 TAKAYA
FUJISAWA-CITY KANAGAWA PREF.,
JAPAN



CAGE code: 2/

SAMUEL MARSDEN & SON
WELLINGTON RD.
ASHTON UNDER LYNE,
LANCASHIRE OL6 7EG
UNITED KINGDOM

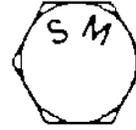

CAGE code: 2/

SAI INDUSTRIES CORP.
1207 FULTON AVENUE
SAN ANTONIO, TX 78201-4501

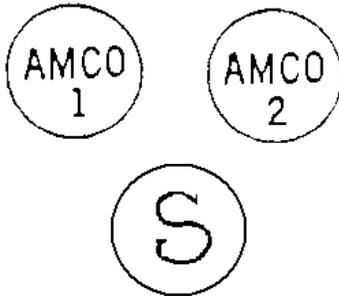

CAGE code: 1KQ10, 63095 2/

SANDIK MANUFACTURING, INC.
100 8TH STREET
PASSAIC, NJ 07055



CAGE code: 6U704 2/

SALEM MANUFACTURING AND SALES, INC.
2856 BANWICK RD.
COLUMBUS, OH 43232

SMS

CAGE code: 57140 1/

SANNOHASHI SEISAKUSHO CO., LTD.
2-1-18 OKINO ADACHI-KU
TOKYO 123
JAPAN

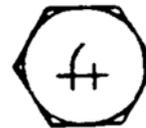

CAGE code: 2/

SALES SYSTEM, LIMITED
P.O. BOX 7006
700 FLORIDA AVE.
PORTSMOUTH, VA 23707-1918



CAGE code: 8F411 1/

SANTA ANA GEAR & MACHINE
15201 PIPELINE LN.
HUNTINGTON BEACH, CA 92649



CAGE code: 2/

1/ Information published in this revision was verified by direct contact with manufacturers.

2/ Information not verified to be current, no response from manufacturer. Information identical to that published in MIL-HDBK-57, Revision B.

MIL-HDBK-57G (IS)

SANTA ANA SCREW PRODUCTS INC.
SANTA ANA, CA 92701



CAGE code: 33644

2/

SATAIR MANUFACTURING FACILITY
PURDEYS WAY
PURDEYS INDUSTRIAL ESTATE
ROCHFORD
ESSEX
SS5 4JJ
UK

SMF

CAGE code: K4975

1/

SATURN FASTENERS, INC.
425 SO. VARNEY ST.
BURBANK, CA 91502-2125

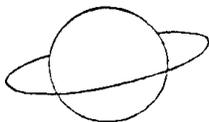

CAGE code: 0K6Z0

1/

SCANDIA MFG. CO., INC.
480 BRUNSWICK ST.
BALTIMORE, MD 21223-2745

SCA

CAGE code: 00997

1/

SCHMICO GMBH SCHWEISSTECHNIK
P. O. BOX 12 29
PETER-LINNARTZ-STRASSE
JUELICH 52428,
GERMANY



CAGE code: C15191

2/

SCHRAUBENFABRIK GUSTAV
STERNBERG GmbH & CO. KG
1000 BERLIN 27
BREITENBACHSTRASSE 11-12
GERMANY



Symbol may be raised or struck in.

CAGE code:

2/

SCHUHL & CO. GMBH
AUF DER HUTTE 31
WINTERBURG 59955
GERMANY

S

CAGE code: C3639

2/

1/ Information published in this revision was verified by direct contact with manufacturers.

2/ Information not verified to be current, no response from manufacturer. Information identical to that published in MIL-HDBK-57, Revision B.

MIL-HDBK-57G (IS)

SCOTT CRAFT CO.
P.O. BOX 430
BELL, CA 90201

Plant
4601 CECELIA STREET
CUDAHY, CA 90201

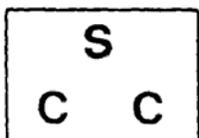

CAGE code: 28418

2/

SEMCO FASTENER
4146 EAST BALDWIN RD.
HOLLY, MI 48442

See RING SCREW WORKS

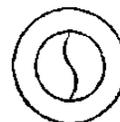

CAGE code: 0B2C8

1/

SCREWCORP.
(A DIVISION OF VSI)
13001 EAST TEMPLE AVE.
CITY OF INDUSTRY, CA 91714

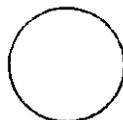

Indented circle on all fasteners,
except machine screws.

CAGE code: 9H901

2/

SEMS AND SPECIALS, INC.
6483 FALCON RD.
ROCKFORD, IL 61109

01IG

CAGE code: 5B4N5

1/

SEMBLEX CORP.
199 W. DIVERSEY AVE
ELMHURST, IL 60126

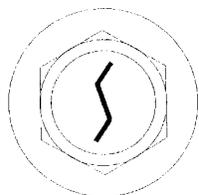

CAGE code: 4M343

1/

SENG HENG ENGINEERING PTE LTD.
NO. 3 EUNOS AVE. 8A
SINGAPORE 409458
REPUBLIC OF SINGAPORE



CAGE code:

1/

1/ Information published in this revision was verified by direct contact with manufacturers.

2/ Information not verified to be current, no response from manufacturer. Information identical to that published in MIL-HDBK-57, Revision B.

MIL-HDBK-57G (IS)

SESCO INDUSTRIES, INC.
P. O. BOX 242
110 - 19 15TH AVENUE
COLLEGE POINT, NY 11356



CAGE code: 0KH97

1/

SET SCREW & MFG. CO.
1210 ST. CHARLES STREET
ELGIN, IL 60120

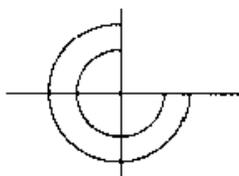

CAGE code: 1T4U7

1/

SHACKELFORD MACHINIG, INC.
2407 LUDELLE ST.
FORT WORTH, TX 76105-0755



CAGE code: 4K446

1/

SHAMROCK FASTENER TECHNOLOGIES,
LLC.
6125 18 MILE ROAD
STERLING HEIGHTS, MI 48314

SHAMROCK IN CIRCLE

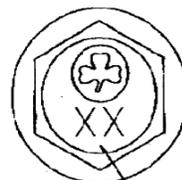

GRADE
DESIGNATION

SFT LDGO



GRADE
DESIGNATION

CAGE code: 05CF6

2/

SHAW PRECISION GRINDING &
THREADING
6503 W. FRYE RD.
SUITE 6
CHANDLER, AZ 85226

SALES ADDRESS SEE:
ACE GRINDING & MFG. OF TEXAS
2610 AERO DR.
GRAND PRAIRIE, TX 75052
CAGE code: 5U074

SPG

CAGE code: 1KRG8

1/

1/ Information published in this revision was verified by direct contact with manufacturers.

2/ Information not verified to be current, no response from manufacturer. Information identical to that published in MIL-HDBK-57, Revision B.

MIL-HDBK-57G (IS)

SHEFFIELD, INC.
1025 WINCHESTER AVE.
KANSAS CITY, MO 64126



CAGE code: 68567 2/

SHIGA BOLT CO., LTD.
OTSU 423 MINAMI-TSUCHIYAMA
TSUCHIYAMA-CHO, KOHGA-GUN SHIGA-
KEN 528-02
JAPAN

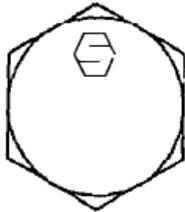

CAGE code: 2/

SHOPCO MANUFACTURING, INC.
1125 S. CEDAR HILL RD.
CEDAR HILL, TX 75104

SC OR 1HEW6
Contoured to fit parts

CAGE code: 1HEW6 1/

SHORELINE MACHINE PRODUCTS, INC.
19301 ST. CLAIR AVENUE
CLEVELAND, OH 44117

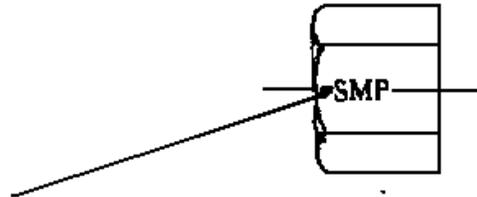

SMP will be applied to this surface to denote
Shoreline Machine Products as manufacturer.

CAGE code: 1VN42 1/

SHUR-KUT SUPPLY CORPORATION
7 MT. PLEASANT DR.
ASTON, PA 19014



CAGE code: 6R002 1/

SHUR-LOK COMPANY.
(SPS FASTENERS DIVISION , A PCC
COMPANY)
2541 WHITE ROAD
IRVINE, CA 92614 - 6235



CAGE code: 97393 1/

1/ Information published in this revision was verified by direct contact with manufacturers.

2/ Information not verified to be current, no response from manufacturer. Information identical to that published in MIL-HDBK-57, Revision B.

MIL-HDBK-57G (IS)

SIERRA PACIFIC SUPPLY CO., INC.
P. O. BOX 4848
COMPTON, CA 90224

Plant:
1801 W EL SEGUNDO BLVD
COMPTON, CA 90224

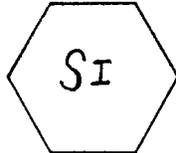

CAGE code: 5G098 1/

SIERRACIN/HARRISON
3020 EMPIRE AVENUE
BURBANK, CA 91504

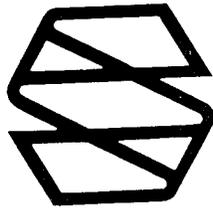

CAGE code: 08199 2/

SIMMONDS PRODUCTS
AFS ST. COSME OPERATIONS
9 RUE DES CRESSONNIERES
72110 ST. COSME-EN-VAIRAIS
FRANCE

(Corporate office see ALCOA FASTENING
SYSTEMS)

SD

CAGE code: F0224 1/

SINN-TECH, INC.
48 GLEAM STREET
WEST BABYLON, NY 11704



CAGE code: 9J550 1/

SKY MANUFACTURING
5989 RICCKENBACKER ROAD
COMMERCE, CA 90040

SM

CAGE code: 1CNU4 1/

SKYLINE INDUSTRIES
1201 FORUM WAY SOUTH
FORT WORTH, TX 76140

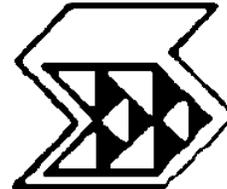

CAGE code: 09986 2/

SKYSPARES PARTS, INC.
6660 VIEW PARK COURT
RIVERSIDE, CA 92503

SP

CAGE code: 6M132 2/

1/ Information published in this revision was verified by direct contact with manufacturers.

2/ Information not verified to be current, no response from manufacturer. Information identical to that published in MIL-HDBK-57, Revision B.

MIL-HDBK-57G (IS)

SLABE MACHINE PRODUCTS
4659 HAMANN PARKWAY
WILLOUGHBY, OH 44094



CAGE code: 97139

1/

SMALL PARTS MANUFACTURING CO., INC.
4401 NE MLK JR. BLVD.
PORTLAND, OR 97211

SPM
INC

CAGE code: 3K749

1/

SMITH MACHINE & MANUFACTURING
RT. 4 P.O. BOX 283
CANTON, TX 75103

SM&M

CAGE code: 0MAJO

2/

SMITH WELDING, INC.
756 PRUNNER ROAD
RIDDLE, OR 97469



CAGE code: 1GQX1

1/

SONFARREL, INC.
3000-3010 LA JOLLA ST.
ANAHEIM, CA 92806



CAGE code: 09036

2/

SONIC INDUSTRIES, INC.
20030 SO. NORMANDIE AVE.
TORRANCE, CA 90502



CAGE code: 57928

1/

1/ Information published in this revision was verified by direct contact with manufacturers.

2/ Information not verified to be current, no response from manufacturer. Information identical to that published in MIL-HDBK-57, Revision B.

MIL-HDBK-57G (IS)

SOUTH BAY BOLT MANUFACTURING CO.
P.O. BOX 5805
COMPTON, CA 90224

Plant
1775 W. El Segundo Blvd.
Compton, CA 90222

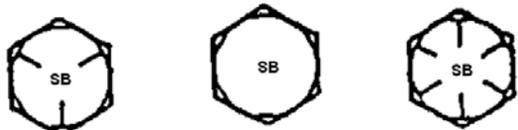

CAGE code: 2P339

2/

SOUTHERN FASTENING SYSTEMS
(DIVISION OF FARLEY METALS, INC.)
P.O. BOX 1360
STATESVILLE, NC 28677

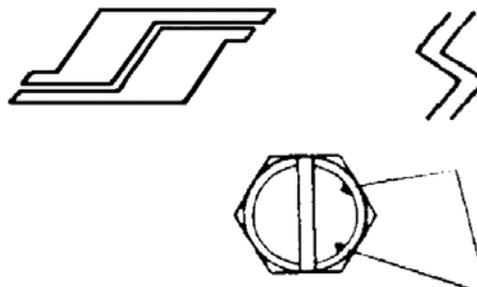

2 notches for slotted heads only

CAGE code: 87308

2/

SOUTHCO, INC.
210 N. BRINTON LAKE ROAD
CONCORDVILLE, PA 19331

Plant
SOUTHCO, INC. – TECATE
PROLONGACIAN, AV JUAREZ #999
FRACC. EL REFUGIO
TECATE, B.C., 21440 MEXICO

southco

CAGE code: SV287

1/

SOUTHWEST ALLIED PRODUCTS CO.,
INC.
299 HILL RD.
VANLEER, TN 37181



CAGE code: 6P461

2/

SOUTHERN FASTENER CORPORATION
P. O. BOX 1387
1641 CONCEPTION STREET ROAD
MOBILE, AL 36610

SF

CAGE code: 1K461

1/

SOUTHWEST INDUSTRIAL SERVICES
P. O. BOX 9084
FT. WORTH, TX 76147

Plant
2413 WHITMORE
FT. WORTH, TX 76147

SI

CAGE code: 6H920

2/

1/ Information published in this revision was verified by direct contact with manufacturers.

2/ Information not verified to be current, no response from manufacturer. Information identical to that published in MIL-HDBK-57, Revision B.

MIL-HDBK-57G (IS)

SOUTHWIND INDUSTRIES, INC.
P.O. BOX 98
1646 OILD BUTLER PLANK RD.
PITTSBURGH, PA 15200



CAGE code: 0DTJ0

2/

SPACE AGE ENGINEERING, INC.
4022 E. 26TH STREET
INDIANAPOLIS, IN 46218



CAGE code: 29953

2/

SPACE SCREW, INC.
106 STANDARD ST.
EL SEGUNDO, CA 90245



CAGE code: 0GE51

2/

SPACE-LOK, INC.
13306 HALDDALE AVE.
GARDENA, CA 90249



CAGE code: 16258

1/

SPARTAN PRECISION MACHINE
131 ALBANY AVE
FREEPORT, NY 11520



CAGE code: 2M198

2/

SPECIALS, INC.
P.O. BOX 514
103 MAINLINE DRIVE
WESTFIELD, MA 01086-0514



CAGE code: 0WVC1

1/

SPECIAL-T-METALS
P.O. BOX 14810
LENEXA, KS 66215

Plant
14740 WEST 101 TERRACE
LENEXA, KS 66215



CAGE code: 8U495

2/

1/ Information published in this revision was verified by direct contact with manufacturers.

2/ Information not verified to be current, no response from manufacturer. Information identical to that published in MIL-HDBK-57, Revision B.

MIL-HDBK-57G (IS)

SPECIALTY SCREW CORP.
P.O. BOX 5003
ROCKFORD, IL 61125

Plant
2801 HUFFMAN BLVD.
ROCKFORD, IL 61103

S

CAGE code: 1WQE5

2/

SPIRAL TOOL CORP.
761 ROUTE 6
SHOHOLA, PA 18458



CAGE code: 02108

1/

SPS TECHNOLOGIES
FASTENER DIVISION CORPORATE
HEADQUARTERS
JENKINTOWN, PA 19046-2630

SPS AREOSPACE FASTENER COPANIES

SPS TECHNOLOGIES (Cage 56878)
301 HIGHLAND AVENUE
JENKINTOWN, PA 19046-2630

The following characters (used alone or in combination with other digits/ letters which designate material, size, strength grade or part number) indicate SPS as manufacturing source:

C	K	U
CCS	K-5673	U130
EWB	KS	UNBRAKO
EWN	S	UNW
FNF	SPS	56878
HI PSI	TJB	71838
HI TI	TM9	80539

For "inch" socket head cap screws



Straight knurls with an unknurled band adjacent to the bearing surface on socket heads. The diameter over the straight knurl does not exceed the band. There may be 2 or 3 grooves near the band or a diamond knurl band at top of head.



A raised or depressed triangle pointing from the wrenching flat toward thread on nut products.



S-C used on metal nuts

SPS TECHNOLOGIES (Cage 80539)
SANTA ANA DIVISION
271 SO. HARBOR BLVD.
SANTA ANA, CA 92704-1259

SPS SPS S S

CAGE code: 56878, 80539,
Continued

1/

1/ Information published in this revision was verified by direct contact with manufacturers.

2/ Information not verified to be current, no response from manufacturer. Information identical to that published in MIL-HDBK-57, Revision B.

MIL-HDBK-57G (IS)

Continued

SPS TECHNOLOGIES (Cage K5673)
T. J. BROOKS DIVISION
191, BARKBY ROAD'
TROON INDUSTRIAL AREA
LEICESTER LE4 9HX
ENGLAND

TBJ

SPS ENGINEERED PRODUCTS GROUP

SPS TECHNOLOGIES (Cage 1C5D9)
NORTH AMERICAN FASTENERS
(AFG DIV)
4444 LEE ROAD
CLEVELAND, OH 44128-2902



UNB

SPS TECHNOLOGIES (Cage 495T1)
NORTH AMERICAN FASTENERS
DBA TERRY MACHINE
5331 DIXIE HWY
WATERFORD, MI 48329



SPS TECHNOLOGIES (Cage U3575)
P O BOX 38
BURNABY ROAD
COVENTRY CV 6 AE, ENGLAND

SPS INTERNATIONAL LTD. (Cage S3329)
UNBRACO SHANNON
BAYS 25-30 SHANNON INDUSTRIAL
ESTATE,
SHANNON, COUNTRY CLARE,
IRELAND

METALAC SPS INDUSTRIA E COMERCIO
LTDA.
AVENIDA ITAVUVU, 4690
18078-005 SOROCABA (SP),
BRAZIL

TELLEP TLP T

UNBRACO PTY LTD. AUSTRALIA
P.O. BOX 3138 NUNAWADING
VICTORIA 3131, AUSTRALIA

U UM

CAGE code: K5673, 1C5D9, 495T1, U3575,
S3329

1/

SPS TECHNOLOGIES LIMITED
T/A UNBRACO UK
CRANFORD STREET
SMETHWICK
B66 2TA
UNITED KINGDOM

TBJ

CAGE code: U3575

SPS TECHNOLOGIES LIMITED
TJ BROOKS DIVISION
(UNITED KINGDOM CORPORATION)
191 BARKBY ROAD
TROON INDUSTRIAL AREA
LEICESTER
LE4 9HX
UNITED KINGDOM

TBJ

CAGE code: K5673

2/

SPURWAY COOKE INDUSTRIES PTE LTD.
2, JOO KOON ROAD
JURONG SINGAPORE 628966
REPUBLIC OF SINGAPORE

**S
C I**

CAGE code:

1/

^{1/} Information published in this revision was verified by direct contact with manufacturers.

^{2/} Information not verified to be current, no response from manufacturer. Information identical to that published in MIL-HDBK-57, Revision B.

MIL-HDBK-57G (IS)

SRI SAI INDUSTRIES CORPORATION
1207 FULTON AVENUE
SAN ANTONIO, TX 78201-5104

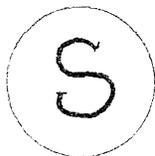

CAGE code: 63095

1/

ST. LOUIS SCREW & BOLT CO.
6900 NORTH BROADWAY
ST. LOUIS, MO 63147



TYPE I



TYPE III

CAGE code:

2/

STACY MACHINE & TOOLING, INC.
2810 INDUSTRIAL LANE
BROOMFIELD, CO 80020



CAGE CODE: 1TT84

1/

STALKER & DYSTHE, INC.
5100 E. WASHINGTON BLVD.
LOS ANGELES, CA 90040



CAGE code: 6D696

2/

STANDARD LOCKNUT, INC.
P. O. BOX 780
1045 EAST 169TH STREET
WESTFIELD, INDIANA 46074



CAGE code: 78507

2/

STANDARD NUT & BOLT, INC.
49 ABBOTT ST.
CUMBERLAND, RI 02864



CAGE code: 758C9

2/

STANDARD TOOL & MACHINE CO.
205 E. CARSON ST.
PITTSBURGH, PA 15219

Plant
208 WOODLAND RD.
BIAWNOX, PA 15238

See HALL INDUSTRIES



CAGE code: 0KA69

2/

1/ Information published in this revision was verified by direct contact with manufacturers.

2/ Information not verified to be current, no response from manufacturer. Information identical to that published in MIL-HDBK-57, Revision B.

MIL-HDBK-57G (IS)

STEADFAST CORPORATION
229 MARGINAL ST.
CHELSEA, MA 02150



CAGE code: 9X854 2/

STEEL CITY BOLT & SCREW, INC.
P.O. BOX 1747
BIRMINGHAM, AL 35201

Plant
230 WEST VALLEY AVE.
BIRMINGHAM, AL 35209



CAGE code: 3N642 2/

STEEL PRODUCTS OF MASSILLION
132 WALNUT RD S.W.
MASSILLION, OH 44646

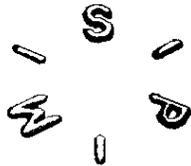

CAGE code: 0698X 2/

STEEL WAREHOUSE COMPANY, INC.
2722 WEST TUCKER DRIVE
BOX 1377
SOUTH BEND, IN 46624



CAGE code: 0R1J8 2/

STELCO FASTENER & FORGING CO.
1250 APPLEBY LINE
BULINGTON, ONTARIO L71 5G6
CANADA



Stelco trademark
for most
fasteners



Most other nuts
and bolts,
including metric



SAE Grade 5
hex nuts



SAE Grade 8
hex nuts

CONELOK LOCKNUTS
Inch series



Grade B



Grade C

Metric series



Class 5

Class 9

Class 10

Bearing surface

CAGE code:

Continued

2/

1/ Information published in this revision was verified by direct contact with manufacturers.

2/ Information not verified to be current, no response from manufacturer. Information identical to that published in MIL-HDBK-57, Revision B.

MIL-HDBK-57G (IS)

Continued

STELCO FASTENER & FORGING CO.
1250 APPLEBY LINE
BULINGTON, ONTARIO L71 5G6
CANADA

HI-HEX CONELOK LOCKNUTS

Inch series



Grade B



Grade C

Metric series



Class 5

Class 9

Class 10

Bearing surface

CAGE code:

2/

STELFAST, INC.
1090 MEYERSIDE DRIVE
MISSISSAUGA, ONTARIO L5T 1J4
CANADA



(see Chiang Shin Fasteners Industries)
DOING BUSINESS UNDER
STELFAST
CHIANG SHIN FASTENERS
INDUSTRIES, LTD
NO. 111 WANLI ROAD
GANGSHAN TOWNSHIP,
KAOHSIUNG COUNTRY 82050,
TAIWAN (R.O.C)

CAGE code: SFV96

CAGE code: L8367

1/

STELFAST FASTENERS, INC.
(DIVISION OF STELFAST FASTENERS,
LTD.)
1710 CLARKSTONE ROAD
CLEVELAND, OH 44112

1/4 in. through 3/4 in. hex cap screws, heavy hex bolts, square head bolts, and specialty externally threaded fasteners, cold headed.



3/4 in. through 2 1/4 in. reg. hex bolts, heavy hex bolts, square head bolts, and specialty externally threaded fasteners, hot headed.



1/4 in. through 2 1/2 in. studs.

2 3/8 in. through 3 in. reg. hex bolts, heavy hex bolts, square head bolts, hot headed, and specialty externally threaded fasteners.

CAGE code:

2/

STERLING MACHINE COMPANY
23 FARRAR STREET
LYNN, MA 01901-1699

2

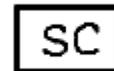

CAGE code: 03983

1/

1/ Information published in this revision was verified by direct contact with manufacturers.

2/ Information not verified to be current, no response from manufacturer. Information identical to that published in MIL-HDBK-57, Revision B.

MIL-HDBK-57G (IS)

STERLING MARKING PRODUCTS IC
 P.O. BOX 3360 STA A
 349 RIDOUT ST N
 LONDON, ONTARIO, CANADA NGA 4K3



CAGE code: 37084 2/

STERLING MFG. & SUPPLY, INC.
 P.O. BOX 8205
 FORT WORTH, TEXAS 76124

Plant
 3623 E. VICKERY BLVD.
 FORT WORTH, TX 76105

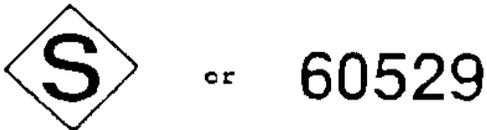

Steel stamped
 or
 Embossed
 or
 Rubber stamped

CAGE code: 60529 2/

STEVENS MFG. CO., INC.
 P.O. BOX 3041
 MILFORD, CT 06460

Plant
 280 ROCK LANE
 MILFORD, CT 06460

MFR 8F781

8F781

CAGE code: 8F781 2/

STILLWATER FASTENERS, INC.
 25 GURNEY ROAD
 EAST FREETOWN, MA 02717-1107



Symbols are "SW", ampersand ("&") or ".."

CAGE code: 1Y153 1/

STRENKERT MACHINE SHOP INC.
 RD #2, BOX 759
 INDIAN BROOK ROAD
 GREENE, NY 13778



CAGE code: 2T174 2/

1/ Information published in this revision was verified by direct contact with manufacturers.

2/ Information not verified to be current, no response from manufacturer. Information identical to that published in MIL-HDBK-57, Revision B.

MIL-HDBK-57G (IS)

STURM MACHINE CO., INC.
9846 OWENSMOUTH AVE.
CHATSWORTH, PA 91311



CAGE code: 64733 2/

SUBCON TOOL/ACCUTOOL MACHINE
GROUP INC. (DBA ACCUTOOL)
5301 IROQUOIS AVE
ERIE, PA 16511 - 2529
See ACCUTOOL

01FO

CAGE code: 1UMX0 1/

SUBURBAN INDUSTRIES, INC.
11901 FRANKLIN AVE
FRANKLIN PARK, IL 60131

SII

CAGE code: 89752 2/

SULLIVAN BOLT CO., INC.
3435 SOUTH MALT AVE.
COMMERCE, CA 90040

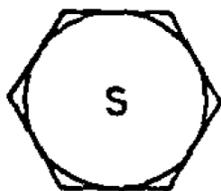

CAGE code: 6M158 2/

SUNDRAM FASTENERS, LTD.
MADRAS, INDIA

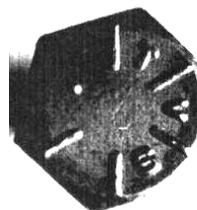

CAGE code: 2/

SUNRISE PRECISION MFG.
4406 ENTERPRISE PL, UNIT 3
FREMONT, CA 94538



CAGE code: 0UK47 2/

SUPERIOR TECHNOLOGY
11013 OLINDA STREET
SUN VALLEY, CA 91352



EARTH

CAGE code: 2/

SUPREME SCREW PRODUCTS, INC.
1368 CROMWELL AVENUE
BRONX, NY 10452

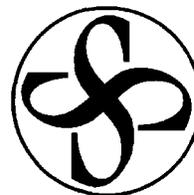

CAGE code: 1FMQ2 2/

1/ Information published in this revision was verified by direct contact with manufacturers.

2/ Information not verified to be current, no response from manufacturer. Information identical to that published in MIL-HDBK-57, Revision B.

MIL-HDBK-57G (IS)

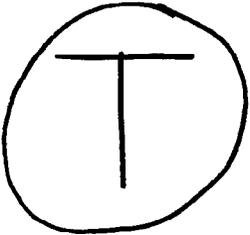
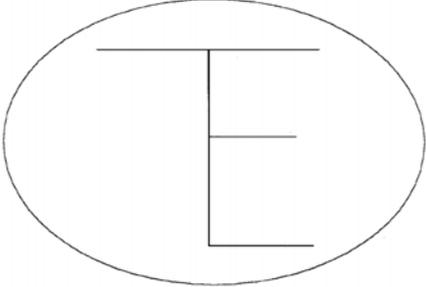
<p>S V INDUSTRIES 29280 YNEZ RD. TEMECULA, CA 92592</p> <p style="text-align: center;">SV</p> <p>CAGE code: OGVY7 <u>2/</u></p>
<p>SWISS TECHNOLOGY, INC. 9 BRIDEWELL PL. CLIFTON, NJ 07014</p> <p style="text-align: center;"></p> <p>CAGE code: 48406 <u>1/</u></p>
<p>T & E MACHINE CORP. 4519C WAYNE AVENUE PHILADELPHIA, PA 19144-3606</p> <p style="text-align: center;"> </p> <p>CAGE code: 059P5 <u>2/</u></p>

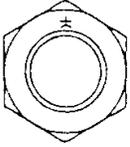
<p>T C QUALITY MACHINING INC. 12155 MAGNOLIA AVE STE 10D RIVERSIDE, CA 92503 - 4905</p> <p style="text-align: center;">TCQ</p> <p>CAGE code: 3H5W3 <u>1/</u></p>
<p>T R MACHINE INC. 103 STATE ROUTE 75 E DAVIS, IL 61019-9586</p> <p style="text-align: center;">TR</p> <p>CAGE code: 1YJV1 <u>1/</u></p>
<p>TAIYO NUT MFG. CO., LTD. 2-6-12 KOUZEN, IKARUGACHO IKOMA-GUN, NARA, JAPAN</p> <p style="text-align: center;"> </p> <p>CAGE code: <u>2/</u></p>

1/ Information published in this revision was verified by direct contact with manufacturers.

2/ Information not verified to be current, no response from manufacturer. Information identical to that published in MIL-HDBK-57, Revision B.

MIL-HDBK-57G (IS)

TAKENAKA SEISAKUSHO CO., LTD.
178 HISHIE
HIGASHI OSAKA CITY, JAPAN 578

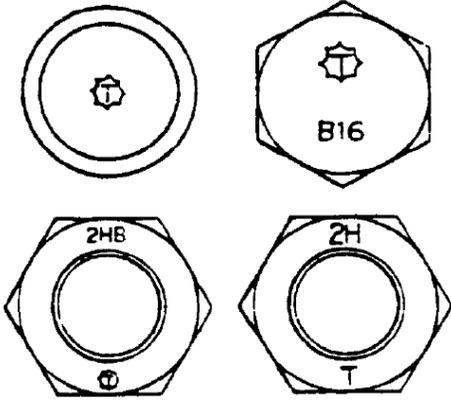

CAGE code: 2/

TANAKA LTD.
1-10-6 TEZUKAYAMA-NAKA
SUMIYOSHI-KU, OSAKA, JAPAN



CAGE code: SP833 2/

T-B & S MFG.
4404 GARLAND DRIVE
FORT WORTH, TX 76117

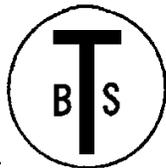

CAGE code: 2/

TEBCO THREADED FASTENERS
(DIVISION OF TENNESSEE BOLT &
SCREW CO.)
2700 SUMMER AVENUE
MEMPHIS, TN 38112

Plant
665 SCOTT STREET
MEMPHIS, TN 38112

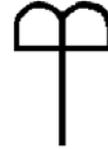

CAGE code: 4K536 2/

TECH WELDING AND MACHINE CO.
41 KINGSTON AVENUE
COLUMBUS, OH 43207

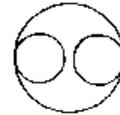

CAGE code: 9Y179 2/

TECHNICAL FASTENERS, INC.
1129 GRIMMITT DR
SHREVEPORT, LA 71107



CAGE code: 0GV34 2/

TEK PRECISION CO., LTD.
205 WEST INDUSTRY COURT
DEER PARK, NY 11729



CAGE code: 65780 1/

1/ Information published in this revision was verified by direct contact with manufacturers.

2/ Information not verified to be current, no response from manufacturer. Information identical to that published in MIL-HDBK-57, Revision B.

MIL-HDBK-57G (IS)

TELEFAST INDUSTRIES, INC.
777 W BAGLEY RD
BEREA, OH 44017-2901

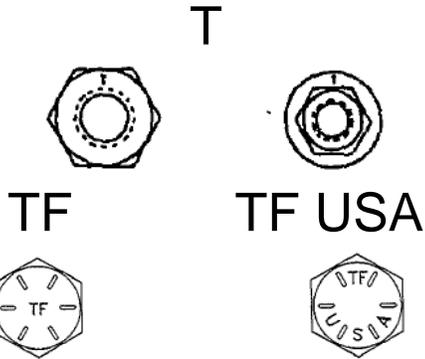

CAGE code: 3CW33 1/

TENS MACHINE CO., INC.
800 GRUNDY AVE.
HOLBROOK, NY 11741-2606



TENS

CAGE code: 8P689 1/

TERRY MACHINE CO.
P.O. BOX 487
5331 DIXIE HWY.
WATERFORD, MI 48095-1

See SPS TECHNOLOGIES



CAGE code: 87880 2/

TERRYCABLE, INC.
17376 EUCALYPTUS STREET
HESPERIA, CA 92345

TC

CAGE code: 0XZ68 2/

TEXAS BOLT CO.
P.O. BOX 1211
3235 W. 11TH ST.
HOUSTON, TX 77251



CAGE code: 27422 2/

TEXAS PRECISION MFG., INC.
P.O. BOX 3640
610 28TH ST
LUBBOCK, TX 79452

Plant
1204 E. 46TH STREET
LUBBACK, TX 79404

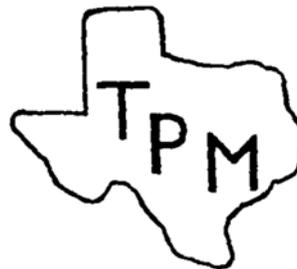

CAGE code: ICU57 2/

1/ Information published in this revision was verified by direct contact with manufacturers.

2/ Information not verified to be current, no response from manufacturer. Information identical to that published in MIL-HDBK-57, Revision B.

MIL-HDBK-57G (IS)

TEXTRON FASTENING SYSTEMS
 (AEROSPACE - SANTA ANA OPERATIONS)
 1224 E. WARNER AVENUE
 SANTA ANA, CA 92705

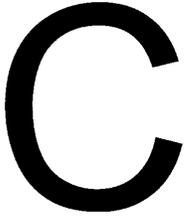

LOCKBOLTS
 Bold "C"

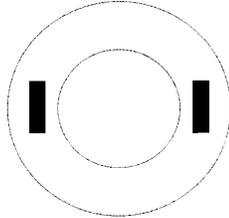

LOCKBOLT COLLARS
 Two Opposing Dashes

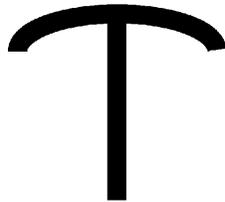

ALL PRODUCTS
 Lazy "T"

CAGE code: 11815

1/

TFI AEROSPACE CORPORATION
 19 CONSTELLATION CT.
 REXDALE, ONTARIO, CANADA

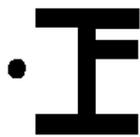

ALL NEW
 TOOLING



MODIFIED
 EXISTING
 TOOLING

CAGE code: L0336

2/

TFP CORP.
 (TRU-FIT PRODUCTS DIVISION)
 (SPECIAL FASTENER DIVISION)
 P. O. BOX 952
 MEDINA, OH 44258

Plant
 TRU-FIT STEEL WIRE CO.,LTD
 (TRU-WELD DIVISION)
 460 LAKE ROAD
 MEDINA, OH 44258

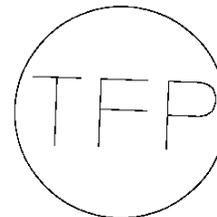
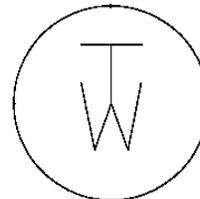
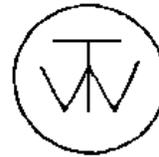

CAGE code: 31000

1/

1/ Information published in this revision was verified by direct contact with manufacturers.

2/ Information not verified to be current, no response from manufacturer. Information identical to that published in MIL-HDBK-57, Revision B.

MIL-HDBK-57G (IS)

THIANT (BOULONNERIE DE SA)
B.P. 4
FRANCE 59224



This marking appears on all hex nuts with or without deflection marks. The three raised lines in the corner indicate "Thiant" as manufacturer. (Clockwise system for grade.)



This marking appears on all flange nuts. The three raised lines on the flange indicate "Thiant" as manufacturer. (Clockwise system for grade.)

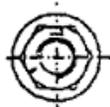

This marking appears on flange nuts when no mark is acceptable on the flange. Three depressed lines indicate "Thiant" as manufacturer. (Clockwise system for grade.)



This marking appears on flange nuts when raised marks are not accepted. Three depressed lines indicate "Thiant" as manufacturer. (Clockwise system for grade.)

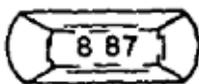

TRACKS FASTENERS



HIGH STRENGTH STRUCTURAL BOLT



HOT FORGED BOLTS

CAGE code:

2/

THOMAS & BETTS CORPORATION
(FORMERLY AMERICAN ELECTRIC)
8155 T AND B BLVD
MEMPHIS, TN 38125 - 8888

Plant 1
260 DENNIS STREET
ATHENS, TN 37303

Plant 2
8735 HAMILTON ROAD
SOUTHAVEN, MS 38671

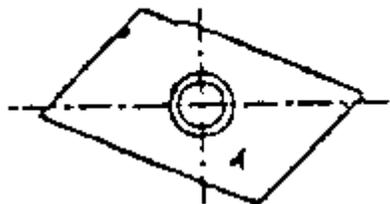

CAGE code: 56501

1/

THOMAS INSTRUMENT & MACHINE CO.,
INC.
3440 E FIRST ST
BROOKSHIRE, TX 77423 - 0999



CAGE code: 5H860

2/

THOMAS MACHINING TECHNOLOGIES,
INC.
12 COUNT ROAD 486
HANCEVILLE, AL 35077



CAGE code: 1VNC4

2/

1/ Information published in this revision was verified by direct contact with manufacturers.

2/ Information not verified to be current, no response from manufacturer. Information identical to that published in MIL-HDBK-57, Revision B.

MIL-HDBK-57G (IS)

THOMAS MFG, INC.
25125 W OUTER DR
MELVINDALE, MI 48122

THOMAS

CAGE code: 0NWS1

2/

TITAN FASTENER
10031 HOLLY ROAD
HOLLY, MI 48442

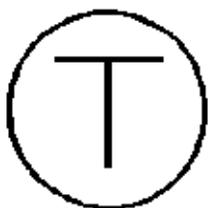

CAGE code:

2/

TOG MANUFACTURING CO., INC.
1454 SOUTH STATE STREET
NORTH ADAMS, MA 01247



CAGE code: 63649

1/

TOKOSHA METAL WORKS LTD.
NO. 7-22, 3-CHROME, NAKAGAMA-NISHI,
IKUNO-KU, OSAKA, JAPAN

TKS

CAGE code:

2/

TONG HWEI ENTERPRISE CO., LTD.
NO. 399 GANG YAN ROAD
GANG SHAN 820, KAOHSIUNG
TAIWAN, R.O.C.

THE

CAGE code: None

1/

TOOLEX, INC.
7570 MORLEY STREET
HOUSTON, TX 77061



CAGE code: 1W383

2/

TOPURA CO., LTD.
2050 YAJOI-CHO
HIGASHIOSAKA-SHI,
OSAKA, JAPAN 579

Plant
201 SOYA, HATANO,
KANAGAWA 257 JAPAN

TOPURA

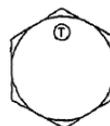
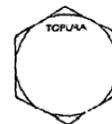

TP

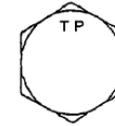
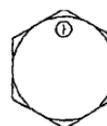

CAGE code:

2/

1/ Information published in this revision was verified by direct contact with manufacturers.

2/ Information not verified to be current, no response from manufacturer. Information identical to that published in MIL-HDBK-57, Revision B.

MIL-HDBK-57G (IS)

TORCO, INC.
P. O. BOX 4070
1330 OLD HIGHWAY 41
MARIETTA, GA 30061

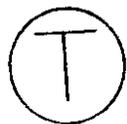

CAGE code: 07359

2/

TORONTO FASTENERS INDUSTRIES, INC.
(SUBSIDIARY OF HI-SHEAR CORP., USA)
7475 KIMBEL ST., UNIT 8
MISSISSAUGA, ONTARIO L5S1E7

See HI-SHEAR

Plant
19 CONSTELLATION CT.
REXDALE, ONTARIO,
CANADA M9W 1K4



CAGE code:

2/

TORX PRODUCTS
(CAMCAR DIVISION OF TEXTRON INC.)
P. O. BOX 607
HWY 31 N.
ROCHESTER, IN 46975

For head markings see:

CAMCAR Division of Textron, Inc.
Plant
TORX Products

CAGE code: 6N040

2/

TOWNE ROBINSON FASTENER CO.
KEY MANUFACTURING GROUP, INC.
P.O. BOX 232
24175 NORTHWESTERN HWY.
SOUTHFIELD, MI 48037

Plant
4401 WYOMING AVE.
P.O. BOX 188
DEARBORN, MI 48121



CAGE code: 94678

2/

TOWNSEND CO.
CERRY RIVET DIVISION
1224 E. WARNER AVE.
SANATA ANA, CA 92701

T Aircraft blind rivets.
C Aircraft lockbolts.

CAGE code: 7H092

2/

TOYO STEEL WIRE CO., LTD.
3-9-45 TSURUHARA
IZUMISANO-SHI, OSAKA,
598 JAPAN

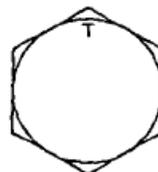

CAGE code:

1/

1/ Information published in this revision was verified by direct contact with manufacturers.

2/ Information not verified to be current, no response from manufacturer. Information identical to that published in MIL-HDBK-57, Revision B.

MIL-HDBK-57G (IS)

TRI STATE TOOL & DIE CO.
1396 NORTON RD
STOW, OH 44224-1333

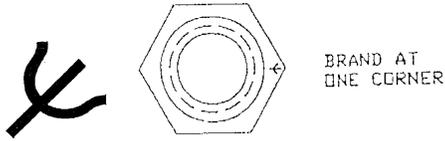

CAGE code: 06RM8 1/

TRIEM INDUSTRIES, LLC
208 CHRISTIAN STREET
OXFORD, CT 06478



CAGE CODE: 63TA9 1/

TRIAD PRODUCTS CORP.
15241 N.E. 92ND
REDMOND, WA 98052



CAGE code: 74468 2/

TRIUMPH GROUP OPERATIONS INC, THE
(FRISBY AEROSPACE INC DE)
417 S. MAIN ST.
FREEPORT, NY 11520-5144

Ssee FRISBY AEROSPACE INC DE

FAH

CAGE code: 26437 2/

TRIDAIR PRODUCTS
AFS TORRANCE OPERATIONS
3000 WEST LOMITA BLVD.
TORRANCE, CA 90505-5103

(Corporate office see ALCOA FASTENING
SYSTEMS)



CAGE code: 29372 1/

TRIUMPH MANUFACTURING CO., INC.
P.O. BOX 380148
750 TOLLAND ST.
EAST HARTFORD, CT 06138

TRI

CAGE code: 8X098 2/

TRIDENT MACHINE CO.
3491 N. MERIDIAN ROAD
ROCKFORD, IL 61101



CAGE code: 5N818 1/

TRONSON MANUFACTURING
45383 INDUSTRIAL PLACE #41
FREEMONT, CA 94538

TM

CAGE code: 1DPK8 2/

1/ Information published in this revision was verified by direct contact with manufacturers.

2/ Information not verified to be current, no response from manufacturer. Information identical to that published in MIL-HDBK-57, Revision B.

MIL-HDBK-57G (IS)

TROY D. RAY DBA DIXON MACHINE &
FABRICATION
6807 CHAPMAN HWY.
KNOXVILLE, TN 37920-6560

DMT

CAGE code: 1DEP3 2/

TRY - AZTEC COMPANY
P.O. BOX 6191
TEHACHAPI, CA 93561

JA or JA

CAGE code: 2/

TRW
(FASTENER DIVISION)
265 THIRD STREET
CAMBRIDGE, MA 02142

PAL

Logo Stampings Used on
Brass Snap Fastener Components

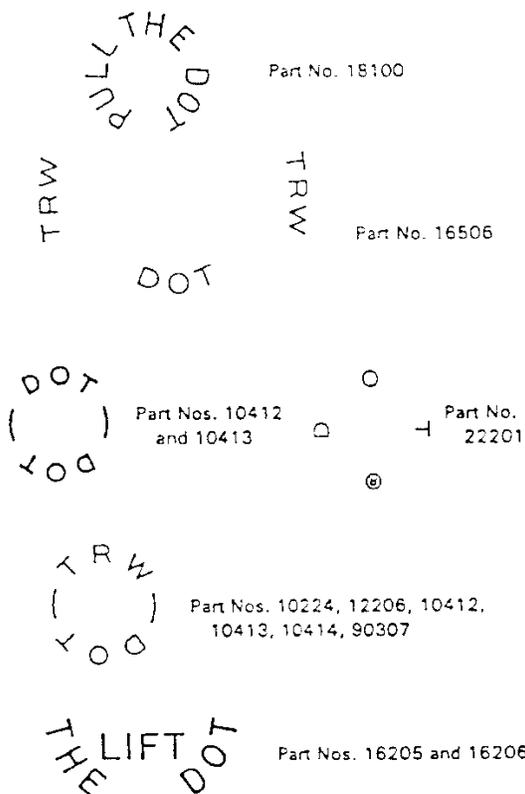

CAGE code: 83058 2/

TUFF FASTENERS CO.
10724 GARWICK PLACE
SOUTH GATE, CA 90280-7332

T

CAGE code: 5V629 2/

TURNAMICS, INC.
92 NEW LIECHESTER HWY
ASHVILLE, NC 28806

K&T

CAGE code: 1CWU8 2/

TW DESIGN AND MANUFACTURING, L.L.C.
P. O. BOX 310
33 WEST STREET
MONTELLO, WI 53949

W

CAGE code: 0X311 2/

1/ Information published in this revision was verified by direct contact with manufacturers.

2/ Information not verified to be current, no response from manufacturer. Information identical to that published in MIL-HDBK-57, Revision B.

MIL-HDBK-57G (IS)

TWIST TITE MFG. INC.
13649 PUMICE STREET
SANTA FE SPRINGS, CA 90670

M or TT

CAGE code: 007R1

1/

UDT, INC.
2304 GRANT AVENUE
PANAMA CITY, FL 32405



CAGE code: 57547

1/

U.P. MACHINE & ENGINEERING CO.
P.O. BOX 400
210 NORTH THIRD STREET
POWERS, MI 49874

UPME

CAGE code: 5H091

2/

U.S. BOLT MANUFACTURING, INC.
12895 SOUTH MAIN
HOUSTON, TX 77035



CAGE code: 0UZJ8

2/

ULTIMATE MACHINING & WELDING
1003 ARGUELLO STREET
REDWOOD CITY, CA 94063



CAGE code: OXXP2

2/

1/ Information published in this revision was verified by direct contact with manufacturers.

2/ Information not verified to be current, no response from manufacturer. Information identical to that published in MIL-HDBK-57, Revision B.

MIL-HDBK-57G (IS)

ULTRA SONIC MACHINE CO., INC.
1313 WEST 135TH STREET
GARDENA, CA 90247

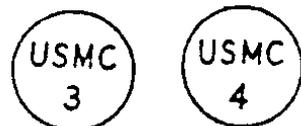
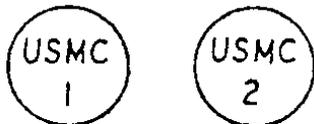

CAGE code: 4F713

2/

UMPCO CORP.
P.O. BOX 5158
7100 LAMPSON AVE.
GARDEN GROVE, CA 92841



CAGE code: 18076

2/

UNIFLOW CORP.
P.O. BOX 705
26600 HEYN DRIVE
NEW HAVEN, MI 48050

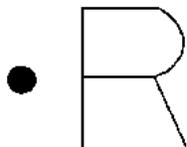

CAGE code: 4S622

2/

UNIMETERIC CORPORATION
P.O. BOX 4529
5 TRIPPS LANE
EAST PROVIDENCE, RI 02915



CAGE code: 7U319

2/

UNISTRUT CORP.
(UNISTRUT PHILA)
761 FIFTH AVE
KING OF PRUSSIA, PA 19406

Plant
UNISTRUT CORP.
WAYNE MFG. DIV.
35660 CLINTON
WAYNE, MI 48184

UNISTRUT



CAGE code: 96195

2/

UNITED BOLT & SCREW CORP.
1055 HAGGERTY AVE.
DEARBORN, MI 48126



CAGE code: 8G949

2/

1/ Information published in this revision was verified by direct contact with manufacturers.

2/ Information not verified to be current, no response from manufacturer. Information identical to that published in MIL-HDBK-57, Revision B.

MIL-HDBK-57G (IS)

UNITED DRILL BUSHING CORP.
12200 WOODRUFF AVE
DOWNEY, CA 90241



CAGE code: 52369 2/

UNITED PRECISION PRODUCTS CO., INC.
25040 VAN BORN ROAD
DEARBORN HEIGHTS, MI 48125



CAGE code: 17328 1/

UNITED STATES DEFENSE RESEARCH &
SUPPLY
311 EASTRIDGE ROAD
GRANDBURY, TX 76049



CAGE code: 0XVD5 2/

UNITED STEEL & FASTENERS INC.
1500 INDUSTRIAL DRIVE
ITASCA, IL 60143

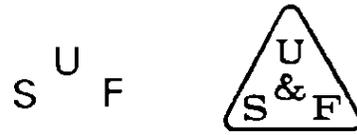

Identification used on all large bolts



Identification used on all small bolts and
on the shoulders of nuts



CAGE code: 2R938 1/

UNIVERSAL MACHINE PRODUCTS
480 SURF AVENUE
STRATFORD, CT 06497



CAGE code: 0Y156 2/

UPB ENGINEERING
13060 TOM WHITE WAY
"UNIT F"
NORWALK, CA 90650

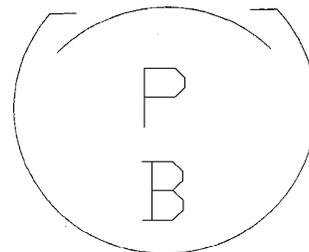

CAGE code: 1BER9 2/

1/ Information published in this revision was verified by direct contact with manufacturers.

2/ Information not verified to be current, no response from manufacturer. Information identical to that published in MIL-HDBK-57, Revision B.

MIL-HDBK-57G (IS)

UPSTART ACQUISITIONS, CORP.
DBA BET-LAR SERVICES
10825 BARELEY LANE
SUITE P
HOUSTON, TX 77070

UA

CAGE code: 5F5J7

1/

URANIA ENGINEERING CO., INC.
SPEC-NUT®
198 SOUTH POPLAR STREET
HAZLETON, PA 18201

U

CAGE code: 30279

2/

URBAN MANUFACTURING CO.
P.O. BOX 4260
100 W. BERKLEY ST
PHILADELPHIA, PA 19144

U

CAGE code: OW5R7

2/

URBAN MFG. CO. INC.
P.O. BOX 1070
529 FORREST AVE.
DREXEL HILL, PA 19026

U

CAGE code: 9Y188

2/

US TOOL & DIE
23282 VERDUGO DR
LAGUNA HILLS, CA 92653-1335

**US
T**

CAGE code: 3LJM2

1/

UTAH TOOL & DIE, INC.
P.O. BOX 969
850 NO WESTERN PRECISION PARKWAY
WEST JORDAN, UTAH 84084

23509

CAGE code: 23509

2/

1/ Information published in this revision was verified by direct contact with manufacturers.

2/ Information not verified to be current, no response from manufacturer. Information identical to that published in MIL-HDBK-57, Revision B.

MIL-HDBK-57G (IS)

VALCOR ENGINEERING CORP.
2 LAWRENCE ROAD
SPRINGFIELD, NJ 07081

VALCOR

CAGE code: 96487

2/

VALLEY FORGE AND BOLT MFG CO.
1825 S. 27th AVENUE
PHOENIX, AZ 85009-6417



CAGE code: 02UA5

1/

VALLEY-TODECO
12975 BRADLEY AVE.
SYLMAR, CA 91342



CAGE code: 06710

1/

VAN PETTY MFG., INC.
DBA J.W. MANUFACTURING INC
2517 AZURITE CIRCLE
NEWBURY PARK, CA 91320



CAGE code: 23899

1/

V-B MACHINE CO., INC.
FASTENER DIVISION
1645 W. 135TH STREET
GARDENA, CA 90249



CAGE code: 60682

2/

VEGAS FASTENER MANUFACTURING
3873 W. OQUENDO ROAD
LAS VEGAS, NV 89118

V F M

CAGE code: 1U1Z3

2/

VENUS FASTENERS CORP.
154 MERRICK RD
FREEPORT, NY 11520



CAGE code: 045B2

2/

VERSATECH, INC.
P.O. BOX 608
6012 ENTERPRISE DR.,
WESTMORELAND INDUSTRIAL PARK III
EXPORT, PA 15632



CAGE code: 0CHD0

2/

1/ Information published in this revision was verified by direct contact with manufacturers.

2/ Information not verified to be current, no response from manufacturer. Information identical to that published in MIL-HDBK-57, Revision B.

MIL-HDBK-57G (IS)

VERTEX DISTRIBUTION
 P. O. BOX 879
 327 PINE STREET
 PAWTUCKET, R 02860

(see BELL FASTENERS)

PMC

CAGE code: 1/

VICO PRODUCTS, CO.
 41555 E. ANN ARBOR ROAD
 PLYMOUTH, MI 48170

V

The "V" is either raised or indented.

CAGE code: 0CG15 2/

VICTOR PRODUCTS CORP.
 2635 WEST BELMONT
 CHICAGO, IL 60618

V 

CAGE code: 63045 2/

VIP MFG. & ENGR. CORP.
 1084 MARTIN AVE.
 SANTA CLARA, CA 95050

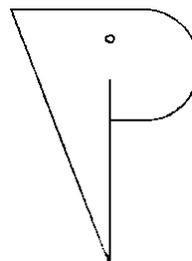

CAGE code: 8M774 1/

VISSERIES & BOULONNERIES DE
 FOURMIES
 2 RUE DU CHAUFFOUR
 FOURMIES, FRANCE 69610

F

F.K

Grade 8.8 and over

CAGE code: F8388 2/

1/ Information published in this revision was verified by direct contact with manufacturers.

2/ Information not verified to be current, no response from manufacturer. Information identical to that published in MIL-HDBK-57, Revision B.

MIL-HDBK-57G (IS)

VISTEK INDUSTRIES
153 RAILROAD DR
IVYLAND, PA 18974-1448

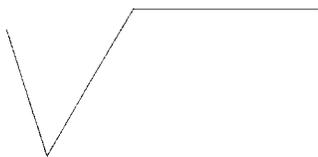

CAGE code: 79735

2/

VITCO NUCLEAR PRODUCTS INC.
8171 TYLER BLVD
MENTOR, OH 44060



CAGE code: 9L424

2/

VM MANUFACTURING CORP.
1536 RAILROAD AVENUE
HOLBROOK, NY 11741-2301



CAGE code: 1NUW9

1/

VMC INDUSTRIES, INC.
20 CORPORATE DRIVE
AUBURN HILLS, MI 48326

.V. OR VMC

FEMALE FASTENERS

PREVAILING TORQUE NUTS

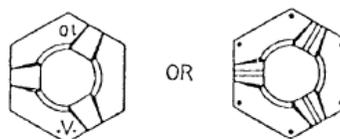

.V. OR TWO LINES IN THREE PADS
WITH APPROPRIATE GRADE OR CLASS MARKINGS

INSERT TYPE
PREVAILING TORQUE NUTS



TAN NYLON IDENTIFIES VMC AS MANUFACTURER
WITH APPROPRIATE GRADE OR CLASS MARKINGS

SLOTTED NUTS

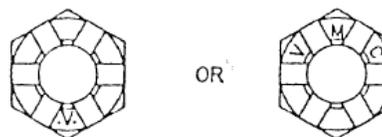

.V. OR VMC
WITH APPROPRIATE GRADE OR CLASS MARKINGS

CAGE code: 0SFN8

Continued

2/

1/ Information published in this revision was verified by direct contact with manufacturers.

2/ Information not verified to be current, no response from manufacturer. Information identical to that published in MIL-HDBK-57, Revision B.

MIL-HDBK-57G (IS)

Continued

VMC INDUSTRIES, INC.

FEMALE FASTENERS (CONT.)

NUT & WASHER ASSEMBLY

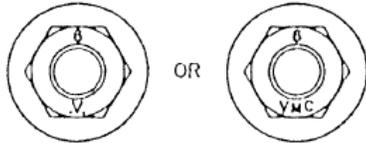

".V." OR "VMC" WITH APPROPRIATE GRADE OR CLASS MARKINGS

FLANGE NUTS

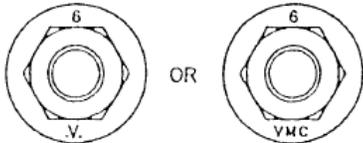

".V." OR "VMC" WITH APPROPRIATE GRADE OR CLASS MARKINGS

HEX NUTS

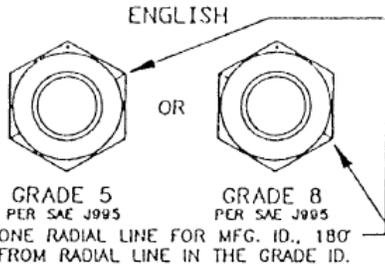

METRIC

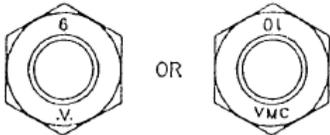

CLASS 9 CLASS 10
".V." OR "VMC" WITH APPROPRIATE GRADE OR CLASS MARKINGS

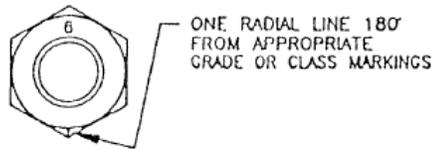

ONE RADIAL LINE 180° FROM APPROPRIATE GRADE OR CLASS MARKINGS

CAGE code: 0SFN8

2/

Continued

Continued

VMC INDUSTRIES, INC.

FEMALE FASTENERS (CONT.)

OTHER TYPE NUTS

WHEEL NUTS, HEX AND SQUARE WELD NUTS AND OTHER TYPE NUTS NOT SPECIFIED.
".V." OR "VMC" WITH APPROPRIATE GRADE OR CLASS MARKINGS

MALE FASTENERS

SOCKET HEADS

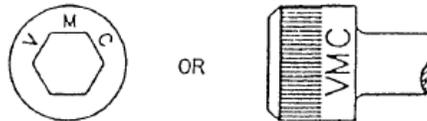

HEX HEADS

INDENTED, TRIMMED, WASHER OR FLANGED.

METRIC

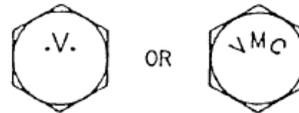

ENGLISH

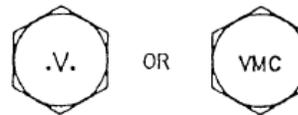

".V." OR "VMC" WITH APPROPRIATE GRADE OR CLASS MARKINGS

CAGE code: 0SFN8

2/

1/ Information published in this revision was verified by direct contact with manufacturers.

2/ Information not verified to be current, no response from manufacturer. Information identical to that published in MIL-HDBK-57, Revision B.

MIL-HDBK-57G (IS)

VOI-SHAN PRODUCTS
 AFS TORRANCE OPERATIONS
 3000 WEST LOMITA BLVD.
 TORRANCE, CA 90505-5103
 CAGE code: 5M902

VS

AFS COI OPERATIONS
 135 N. UNRUH AVE.
 CITY OF INDUSTRY, CA 91744
 CAGE code: 06950, IRC86

VS

O

SC

AFS HILDESHEIM OPERATIONS
 STEVEN 3
 31135 HILDESHEIM-BEVENSTEDT,
 GERMANY
 CAGE code: C4293

VS

(Corporate office see ALCOA FASTENING
 SYSTEMS)

CAGE code: 5M902, 06950, IRC86,
 C4293

1/

VORTEX MFG CO.
 60 SUNSHINE FARM DRIVE
 SOMERS, CT 06071

VMC

CAGE code: 4AUV8

1/

VOSS INDUSTRIES, INC.
 VOSS AEROSPACE DIVISION
 2168 WEST 25TH STREET
 CLEVELAND, OH 44113



E A

V

CAGE code: 14242

1/

VSI
 AEROSPACE PRODUCTS DIVISION
 557 S. DOUGLAS ST.
 EL SEGUNDO, CA 90245

Plant
 VOI-SHAN DIVISION
 4001 INGLEWOOD AVE.
 REDONDO BEACH, CA 90278

VS

CAGE code: 6A768

2/

1/ Information published in this revision was verified by direct contact with manufacturers.

2/ Information not verified to be current, no response from manufacturer. Information identical to that published in MIL-HDBK-57, Revision B.

MIL-HDBK-57G (IS)

<p>VULCAN RIVET & BOLT CORP. P.O. BOX 170129 BIRMINGHAM, AL 35217</p> <p>V.</p> <p>All fasteners marked with the letter "V" followed by a period (.)</p> <p><u>V.</u></p> <p>Fasteners manufactured from special alloy steels are identified with the letter "V" followed by a period (.) and a line under the letter "V"</p> <p>304 V.</p> <p>Stainless steel fasteners are marked with the letter "V" followed by a period (.) with the type of stainless</p> <p>CAGE code: 0GEW3 <u>2/</u></p>
<p>WA TAI INDUSTRIAL COMPANY, LTD NO 2, LANE 29 MIN-CHUAN ROAD, LU-CHU HSIANG, KAOHSIUNGHSIEN, TAIWAN, ROC</p> <p>W T </p> <p>CAGE code: NONE <u>1/</u></p>
<p>WALKER BOLT MANUFACTURING CO., INC. DIVISION OF LONE STAR FASTENERS, LP P.O. BOX 1149 10202 AIRLINE CRIVE HOUSTON, TX 77037</p> <p>WB</p> <p>CAGE code: 39782 <u>1/</u></p>

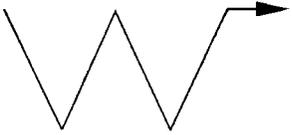
<p>WALZ & KRENZER INC. DBA MAPECO PRODUCTS DIV MAPECO PRODUCTS 91 WILLENBROCK RD STE B4 OXFORD, CT 06478-1036</p>  <p>CAGE code: 87045 <u>2/</u></p>
<p>WARREN PUMPS LLC. (DIVISION OF COLFAX CORPORATION) P.O. BOX 969 82 BRIDGES AVENUE WARREN, MA 01083</p>  <p>CAGE code: 63857 <u>1/</u></p>
<p>WATERBURY BUCKLE CO. 952 S. MAIN STREET WATERBURY, CT 06721</p>  <p>CAGE code: 82399 <u>2/</u></p>
<p>WAYNE BOLT & NUT CO., INC. 14471 LIVERNOIS AVE. DETROIT, MI 48238-2097</p>  <p>CAGE code: 5Z751 <u>1/</u></p>

1/ Information published in this revision was verified by direct contact with manufacturers.

2/ Information not verified to be current, no response from manufacturer. Information identical to that published in MIL-HDBK-57, Revision B.

MIL-HDBK-57G (IS)

WEAVER MANUFACTURING, INC.
1005 E. 17TH STREET
WICHITA, KS 67214

WMI

CAGE code: 16345

2/

WEBLUK MACHINE CORP.
4959 COMMERCE PARKWAY
WARRENSVILLE HEIGHTS, OH 44128



CAGE code: 0C095

2/

WELTER GMBH & CO. KG
BONNER RING 49
P. O. BOX 1311
ERFTSTADT, GERMANY 50374



CAGE code: C3486

2/

WELTON ROLLED THREAD CORP.
1818 GLENDALE BLVD
LOS ANGELES, CA 90026

W

CAGE code: 27871

2/

WESLOK
(DIVISION OF FALL RIVER
MANUFACTURING)
4160 S. 13TH STREET
MILWAUKEE, WI 53221

WESLOK

CAGE code:

2/

WEST COAST AEROSPACE, INC.
24224 BROAD STREET
CARSON, CA 90745

Plant
220 WEST E. STREET
WILMINGTON, CA 90744



W C

CAGE code: 60516

1/

WEST TENNESEE LIONS BLIND IND. INC.
P.O. BOX 2175
346 ST PAUL AVENUE
MEMPHIS, TN 38101-2175

(See A P MILLS INDUSTRIES FOR THE BLIND)

APMI

CAGE code: 6Y776

2/

1/ Information published in this revision was verified by direct contact with manufacturers.

2/ Information not verified to be current, no response from manufacturer. Information identical to that published in MIL-HDBK-57, Revision B.

MIL-HDBK-57G (IS)

WESTERN PACIFIC ENTERPRISES, W.P.E.
INC.
8110 REMMET AVE.
CANOGA PARK, CA 91304



CAGE code: 5N444 1/

WESTERN SCREW MACHINE PRODUCTS,
INC. (CUTTING EDGE MACHINING)
1625 LINDA WAY
SPARKS, NV 89431

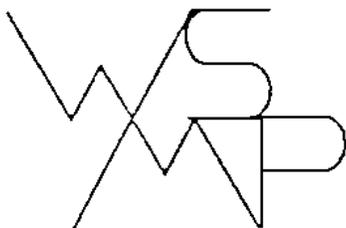

CAGE code: OZV72 2/

WESTERN SKY INDUSTRIES, INC.
(DIVISION OF ATLAS CORP.)
21300 CLOUDWAY
HAYWARD, CA 94545



CAGE code: 04169 2/

WESTFIELD FASTENERS
202 UNION STREET
WESTFIELD, MA 01085



CAGE code: 1/

WESTLAND STEEL PRODUCTS, LTD.
P. O. BOX 1052
165 CORDITE ROAD
WINNIPEG, MANITOBA, CANADA R3C 2X4



CAGE code: 0NWY5 2/

WESTWOOD PRECISION, INC.
7509 HARDESON ROAD
EVERETT, WA 98203



CAGE code: 0PL34 1/

WHAIL BOLT IND. CO., LTD
779-2, WONSI-DONG, ANSAN
KYUGKI-DO, KOREA



GRADE 5 HEX
CAP SCREWS

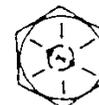

GRADE 8 HEX
CAP SCREWS

CAGE code: 2/

1/ Information published in this revision was verified by direct contact with manufacturers.

2/ Information not verified to be current, no response from manufacturer. Information identical to that published in MIL-HDBK-57, Revision B.

MIL-HDBK-57G (IS)

WHELAN MACHINE & TOOL CO.
134 ROCHESTER DR
LOUISVILLE, KY 40214-2681



Aerial-Bold letter "W" enclosed with a circle

CAGE code: 0MB07

1/

WHITNEY SCREW CORP.
P.O. BOX 784
14A BROAD STREET
NASHUA, NH 03061



CAGE code: 87181

2/

WHITTET-HIGGINS CO.
33 HIGGINSON AVE.
CENTRAL FALLS, RI 02863



CAGE code: 79568

2/

WIGLEY MACHINE COMPANY
2007 WEST 2ND AVENUE
CORSICANA, TX 75110



CAGE code: 0UBT5

2/

WILHELM SCHUMACHER SCHRAUBEN-
FABRIK GmbH
POSTFACH 12 80,
AM PREIST 5
D-5912 HILCHENBACH,
GERMANY



Hex head
screws and
bolts



Machine screws
and other
products

CAGE code:

2/

WILLIAM'S MACHINE & FABRICATION, INC.
P.O. BOX 22235
700 DELAY DRIVE
EUGENE, OR 97402

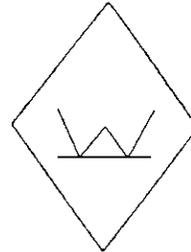

CAGE code: 0NNK2

2/

WIL-NIC
(E D R INDUSTRIES INC)
DBA WIL-NICO
100 COMMERCIAL STREET
FREEPORT, NY 11520-2832



CAGE code: 8P827

2/

1/ Information published in this revision was verified by direct contact with manufacturers.

2/ Information not verified to be current, no response from manufacturer. Information identical to that published in MIL-HDBK-57, Revision B.

MIL-HDBK-57G (IS)

WILSON-GARNER CO.
40935 PRODUCTION DR
HARRISON TOWNSHIP, MI 48045-1351

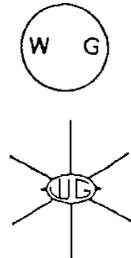

CAGE code: 7E548

1/

WILT PRECISION PRODUCTS
P.O. BOX 69
DOVER, PA 17315



CAGE code: 34282

2/

WINEGAR, INC.
1209 SOUTH STATE STREET
WASECA, MN 56093



CAGE code: 3F2Y1

1/

WINKER HERMAN GMBH & CO. KG
METALLWARENFABRIK
P.O. BOC 1356
DELLINGER WEG 1
SPAICHINGEN, 78549
GERMANY

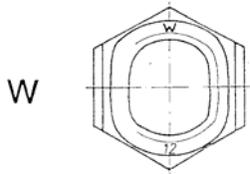

CAGE code: D2362

2/

WINSLOW AUTOMATICS, INC.
23 ST. CLAIR AVENUE
NEW BRITAIN, CT 06051



CAGE code: 7W515

1/

WITTEN COMPANY, INC
P.O. BOX269
OWASSO, OK 74055

Plant
8199 N. 116TH E. AVE.
OWASSO, OK 74055



CAGE code: 0JHK5

1/

WODIN, INC.
5441 PERKINS ROAD
BEDFORD HEIGHTS, OH 44146



CAGE code: 5V334

1/

1/ Information published in this revision was verified by direct contact with manufacturers.

2/ Information not verified to be current, no response from manufacturer. Information identical to that published in MIL-HDBK-57, Revision B.

MIL-HDBK-57G (IS)

WOLSTENHOLME MACHINE
(DBA WM ROBOTS)
3075 ADVANCE LANE
COLMAR, PA 18915-9420



CAGE code: 68531

1/

WOLTERS GMBH
OTTILIENSTR 19
D-GUTERSLOH
WEST GERMANY



WH

LE

CAGE code:

2/

WOLVERINE MACHINE PRODUCTS CO.
P.O. BOX 209
319 COGSHALL ST.
HOLLY, MI 48442

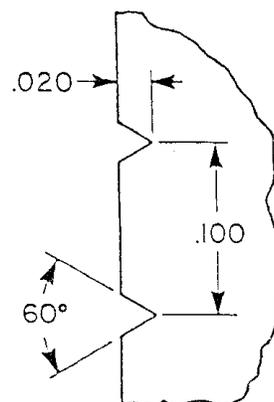

CAGE code: 2T549

2/

WOLVERINE NUT CO.
6556 EAST McNICHOLS
DETROIT, MI 48212



3 dots, centered on corner,
equally spaced

CAGE code: 87824

2/

1/ Information published in this revision was verified by direct contact with manufacturers.

2/ Information not verified to be current, no response from manufacturer. Information identical to that published in MIL-HDBK-57, Revision B.

MIL-HDBK-57G (IS)

WORTHEY MACHINE
 P. O. BOX 70
 3000 US HWY 72 E
 PAINT ROCK, AL 35764-0070

WSMP

CAGE code: 5S740 2/

WROUGHT WASHER MANUFACTURING
 INC.
 2100 SOUTH BAY STREET
 MILWAUKEE, WI 53207

MC

Marking for medium carbon heat treated washers compatible
 with Grade 5 and Grade 8 bolts.

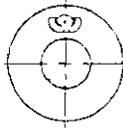

Marking for low carbon washers.

CAGE code: 79807 2/

WYANDOTTE INDUSTRIES, INC.
 4625 13TH STREET
 WYANDOTTE, MI 48192

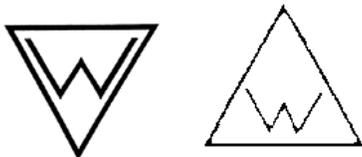

CAGE code: 54151 1/

WYNNSON ENTERPRISES, INC.
 P. O. BOX 440
 12039 HWY 239-431 N.
 MERIDIANVILLE, AL 35759-1201



CAGE code: 39484 1/

X-TECH INNOVATIONS INCORPORATED
 424 18th AVENUE
 ROCKFORD, IL 61104

X

CAGE CODE: 5ZZR7

XCEL MFG., INC.
 P.O. BOX 239
 ELYRIA, OH 44036

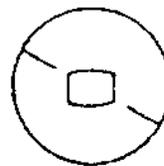

CAGE code: 2/

1/ Information published in this revision was verified by direct contact with manufacturers.

2/ Information not verified to be current, no response from manufacturer. Information identical to that published in MIL-HDBK-57, Revision B.

MIL-HDBK-57G (IS)

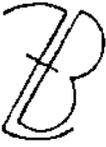
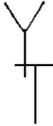
<p>Y2K MACHINE SHOP 106 WALSH ROAD SAN ANTONIO, TX 78224</p> <p style="text-align: center;">Y 2 K</p> <p>CAGE code: 1TMD7 <u>1/</u></p>	<p>Z & B GENERAL MACHINE 569 HULMEVILLE AVE. PENNDL, PA 19047</p>  <p>CAGE code: 5T735 <u>2/</u></p>
<p>YATES TOOL, INC. 2425 MEDINA ROAD MEDINA, OH 44256</p>  <p>Either electroetched, steel stamped, vibropeened, or ink stamped</p> <p>CAGE code: IDV02 <u>2/</u></p>	<p>ZAMON CO., INC. ENDICOTT ST., BLDG. 23 NORWOOD, MA 02062</p>  <p>CAGE code: 5Z471 <u>2/</u></p>
<p>YOUNG ENGINEERS INC, THE 25841 COMMERCENTRE DRIVE LAKE FOREST, CA 92630-8812</p> <p style="text-align: center;">TYE</p> <p>CAGE code: 56958 <u>1/</u></p>	<p>ZENEX CORPORATION 850 ELMHURST RD. ELK GROVE VILLAGE, IL 60007</p> <p style="text-align: center;">ZENEX</p> <p>CAGE code: 25723 <u>2/</u></p>
<p>YOW MENGI INDUSTRIAL CO., LTD. NO. 180 WUN-AN RD., EAST SEC. MI-TUO HSIANG 82704 KAOHSIUNG HSIEN, TAIWAN, R.O.C.</p>  <p>CAGE code: <u>2/</u></p>	

1/ Information published in this revision was verified by direct contact with manufacturers.

2/ Information not verified to be current, no response from manufacturer. Information identical to that published in MIL-HDBK-57, Revision B.

MIL-HDBK-57G (IS)

ZERO PRODUCTS , INC.
219 BAYWOOD ST
HOUSTON, TEXAS 77011



Z

CAGE code: 3JC57

2/

1/ Information published in this revision was verified by direct contact with manufacturers.

2/ Information not verified to be current, no response from manufacturer. Information identical to that published in MIL-HDBK-57, Revision B.

MIL-HDBK-57G (IS)

MIL-HDBK-57 FASTENER IDENTIFICATION SYMBOL CONFIRMATION

Complete this form and email to [alonzo miller@dla mil](mailto:alonzo.miller@dla.mil), along with a separate PDF file containing artwork of your fastener head marking.

(Company name as it will appear in the listing) _____

(Department, Division, etc., if it is to appear in the listing)

Corporate/Mailing Address

Plant Location (if different)

Our Company is a fastener manufacturer YES () NO ()

NOTE: MIL-HDBK-57 requires the sources listed to have an inherent capability to manufacture fasteners out of raw material.

Telephone: _____

FAX Number: _____

Contact Name: _____

CAGE code: _____

Title: _____

DUNS Number: _____

Email: _____

Website URL: _____

1. Fastener head marking artwork that is submitted electronically shall be provided in a PDF file. A resolution of 100 dpi (dots per inch) minimum shall be used for artwork that is scanned. Provide only one marking per file submitted. Include the company name and plant location in this file, along with a written description of the fastener head marking. (For example "*the script upper case letter A*", or "*the number 3 enclosed by a circle.*")
2. If your company has plants in various locations, please provide DSCP-NASA with the symbol(s) used for each location, as well as the CAGE code, point of contact, and phone number for each point of contact.
3. All information must be supplied in the English language.
4. Submit this form and artwork to [alonzo miller@dla mil](mailto:alonzo.miller@dla.mil).

NOTE: We encourage you to duplicate this form and forward it to your various plants, as necessary.

SUBMITTED BY: _____

TITLE: _____

DATE (mm/dd /yyyy): _____

PLEASE SUBMIT LOGO (HEAD MARKING) ON A SEPARATE SHEET.

MIL-HDBK-57G (IS)

Subject term (key word) listing:

Fastener
Head marking
Logo
Symbol

Changes from previous issue. Marginal notations are not used in this revision to identify changes with respect to the previous issue due to the extent of the changes.

Preparing Activity:
DLA-IS

(Project No. 53GP-2012-001)

NOTE: The activities listed above were interested in this document as of the date of this document. Since organizations and responsibilities can change, you should verify the currency of the information above using the ASSIST Online database at <https://assist.dla.mil>.