

NOT MEASUREMENT  
SENSITIVE

MIL-HDBK-57F (IS)  
21 JUNE 2011  
SUPERSEDING  
MIL-HDBK-57E (IS)  
25 NOVEMBER 2008

# DEPARTMENT OF DEFENSE HANDBOOK

## LISTING OF FASTENER MANUFACTURER'S IDENTIFICATION SYMBOLS



**This handbook is for guidance only.  
Do not cite this document as a requirement.**

MIL-HDBK-57F (IS)

DEPARTMENT OF DEFENSE  
WASHINGTON, D.C. 20301

FORWARD

Listing of Fastener Manufacturer's Identification Symbols

MIL-HDBK-57D(IS)

1. This Military Handbook
2. Comments, suggestions, or questions on this document should be addressed to Defense Supply Center Philadelphia (DSCP), ATTN: DSCP-NASA, 700 Robbins Avenue., Philadelphia, PA 19111-5096 or e-mail to [dscpg&inspeccomments@dla.mil](mailto:dscpg&inspeccomments@dla.mil). Since contact information can change, you may want to verify the currency of this address information using the ASSIST Online database at <https://assist.daps.dla.mil>.
3. Copies of these documents are available online at <https://assist.daps.dla.mil/quicksearch/> or from the Standardization Document Order Desk, 700 Robbins Avenue, Building 4D, Philadelphia, PA 19111-5094

## MIL-HDBK-57F (IS)

### FORWARD

This handbook is a compilation of the identifying symbols of fastener manufacturers as provided by the manufacturers themselves. This issue contains the names, addresses, and the symbols of all fastener manufacturers whose identifying symbols were received by 30 November, 2006. Each manufacturer who was listed in Revision B of this document was contacted to confirm the accuracy of the published information. We have annotated the listing to indicate those manufacturers that have responded to confirm or update appropriate information. The listing also annotates which manufacturers have not responded. Information about manufacturers who have not responded is still maintained in this latest revision. For the purpose of this handbook, a manufacturer is defined as the source which substantially makes the supplies, either by hand or machinery out of raw materials. Fasteners, as defined for the purpose of this handbook, refer to those threaded items included in Federal Supply Class (FSC) 5305 – Screws, 5306 – Bolts, 5307 – Studs, and 5310 – Nuts. As additional manufacturers submit their markings, the handbook will be updated.

All requests to be listed in the handbook should be addressed to:

Defense Supply Center Philadelphia (DSCP)  
Attention: DSCP-NASA  
700 Robbins Avenue.  
Philadelphia, PA 19111-5096  
or e-mail to [dscpg&inspeccomments@dla.mil](mailto:dscpg&inspeccomments@dla.mil).

In addition to the alphabetic index of manufacturers (Index A), this revision of the handbook incorporates a listing of manufacturers indexed by their identification symbol (index B).

At the back of this handbook is a registration form. Manufacturers wishing to be listed must complete this form and return it to DSCP. Submit the completed form, along with your fastener identification symbol artwork used on the fastener. All submittals must be in the English language.

DSCP does not “approve”, “rate”, or “endorse” any item, construction, proprietary device, or activity.

DSCP is not responsible for the accuracy or completeness of the information contained in this publication.

DSCP does not take any position with respect to the validity of any patent rights asserted in connection with any items mentioned in this document, and does not undertake to insure anyone utilizing a code, standard, or guide against liability for infringement of any applicable Letters Patent, nor assume any such liability. Users of code, standard, or guide are expressly advised that determination of the validity of any such patent rights, and the risk of infringement of such rights, is entirely their own responsibility.

DSCP reserves the right to monitor this document to ensure that it contains the listing of only bona-fide fastener manufacturers.

DSCP has solicited the assistance of the Defense Contract Management Agency (DCMA) and the Defense Management Command International (DCMCI) in an effort to identify non-manufacturers and remove them from the manufacturers’ listing. DCMA/DCMC’s evaluation of a company’s status is based on an in house capability to manufacture fasteners (screws, bolts, studs and nuts), with respect to space, equipment, and trained personnel. On an on-going basis, any company identified by DCAS/DCMCI as a non-manufacturer will be removed from the manufacturers’ database and MIL-HDBK-57C (IS).

MIL-HDBK-57F (IS)  
INDEX A

## INDEX A - MANUFACTURER

Company Name		Page	Company Name		Page
3 V FASTENERS		1	AERO ENGINEERING & MANUFACTURING CO OF CALIFORNIA	8	
3D MACHINE COMPANY, INC.		1	DBA AERO ENGINEERING	8	
<b>A</b>			AERO MECHANICAL FASTENING SYSTEMS	8	
A & E MACHINED PRODUCTS INC SYSTEMS CORPORATION		1	AEROBOLT MANUFACTURING, INC.	8	
NORTHROP GRUM		1	AERO-FAB, INC.	8	
A & G ENGINEERING CO., INC.		1	AEROFAST SUPPLY	8	
A & M AEROSPACE, INC.		1	AEROMAX INDUSTRIES INC DBA AEROMAX INTERNATIONAL	8	
A & N PRECISION INDUSTRIES LTD		1	AEROSPACE MANUFACTURING	8	
A & R MFG CO INC.		1	AEROSPACE MARINE SPECIALTY FASTENERS & FITTINGS	9	
A & S PIN PRODUCTS INC.		1	INC. DBA AMS FASTENERS	9	
A & W SCREW MACHINE PRODUCTS, INC.		1	AEROSPACE PRODUCTS	9	
A. AGRATI S.P.A.		2	DIV OF APCO FASTENERS, INC	9	
A.M.I. ENGINEERING CO.		2	AEROSPACE PRODUCTS CO. DIV WBH	9	
A. P. MILLS INDUSTRIES FOR THE BLIND		2	AEROSPACE PRODUCTS, INC.	9	
A-1 NUT AND BOLT CO INC		2	AEROSPACE RIVET MFG CORP	9	
DIV OF GREENCO PACIFIC INC		2	AEROSTAR ENGINEERING & MANUFACTURING COMPANY	9	
A-1 THREAD ROLLING CO., INC.		2	AEROSTAR FASTENER CORP.	9	
AAP ACQUISITION CORP		2	AEROTECH FASTENERS, INC.	10	
DBA ACHILLES AEROSPACE PRODUCTS		2	AEROWIND CORPORATION	10	
AASTRO ENGINEERING		2	AF FASTENERS LIMITED	10	
ABBOTT INTERFAST CORP.		2	AFAB PRECISION MACHINING	10	
ABBOTT PETER (AEROSPACE) 1982 LTD.		3	AFI INDUSTRIES, INC.	10	
ABC TOOL & DIE ENGINEERING & MANUFACTURING LLC		3	AIHARA SEIBYO CO LTD	10	
ABRASIVE CUTTING CORP		3	AIR INDUSTRIES CORPORATION	10	
ABSCOA INDUSTRIES		3	AIR PARTS MFG. CO.	10	
ACCUFORM, INC.		3	AIR-COM, INC.	11	
ACCURATE AUTOMATIC PARTS INC		3	AIRCRAFT ENGINEERING PRODUCTS, INC	11	
ACCURATE PRECISION FASTENERS, INC.		3	AIRCRAFT FUELSEAL FASTENERS, INC.	11	
ACCURATE SCREW MACHINE CORP DBA ASM		3	AEROLITE BLIND RIVET DIVISION	11	
ACCURATE THREADED FASTENERS, INC.		4	AIRDROME PARTS CO.	11	
DIV OF BEATRICE FOODS CO		4	AIRFASCO, INC.	11	
ACCURATE THREADED PRODUCTS CO.		4	AIRFASCO INDUSTRIES FASTENER GROUP	11	
ACCURATE TOOL CO INC		4	AIRFRAME INTERNATIONAL, INC.	11	
ACCU-TECH MANUFACTURING AND SUPPORT, INC.		4	AIW-ALTON INC	11	
ACCUTOOL		4	AKKO FASTENER, INC.	12	
SUBCON TOOL/ACCUTOOL MACHINE GROUP INC.		2	ALAN, JEFFREY, MFG. & ENGR.	12	
SEE SUBCON TOOL		2	ALARD MACHINE PRODUCTS	12	
ACCTURN CORPORATION		4	ALBAR MACHINE CORPORATION	12	
ACE G & M COMPANY OF TEXAS INC		4	ALCO MACHINE CO.	12	
DBA ACE GRINDING & MANUFACTURING		4	ALCOA FASTENING SYSTEMS	12	
(PLANT SEE SHAW)		4	CAMLOC PRODUCTS	42	
ACE GRINDING CO INC		4	HUCK AEROSPACE PRODUCTS	92	
ACE PRECISION INDUSTRIES, INC.		5	HUCK INDUSTRIAL PRODUCTS	92	
ACHILLES AEROSPACE PRODUCTS, INC.		4	KAYNAR PRODUCTS	104	
ACI		5	KELOX/MICRODOT PRODUCTS	104	
ACIMET MFG.		5	MECAERO PRODUCTS	127	
ACME MACHINE PRODUCTS		5	RAM PRODUCTS	160	
ACME RIVET & MACHINE CORP.		5	ROSAN PRODUCTS	166	
ACME SCREW COMPANY		5	SIMMONDS PRODUCTS	174	
ACRODYNE MFG CO		5	TRIDAIR PRODUCTS	192	
ACUFAST AIRCRAFT PRODUCTS		6	VOI-SHAN PRODUCTS	201	
ADAMS INDUSTRIES INC		6	ALCOA GLOBAL FASTENERS INC	12	
A SUB OF BANNER INDUSTRIES INC		6	ALCOA-KOKEM KFT	12	
ADAMS, EARL M. CO.		6	ALEXANDER MANUFACTURING COMPANY INC	12	
ADC COMMUNICATIONS CORP		6	DBA METRO TOOL & MANUFACTURING CO	13	
ADI MANUFACTURING, INC.		6	ALL MANUFACTURERS INC	13	
ADJUSTABLE BUSHING CORP.		6	DBA HARPER AEROSPACE FASTENERS	13	
ADOM ENGINEERING		6	ALL PINS MANUFACTURING	13	
ADVANCE PATTERN CORP		6	ALL QUALITY SPARES, INC. REMOVED - NOT A MANUFACTURER	13	
ADVANCED CNC MANUFACTURING		6	ALLFAST FASTENING SYSTEMS, INC.	13	
ADVANCED MACHINING & FABRICATING INC		6	ALLIED NUT & BOLT CO., INC.	13	
ADVANCED MACHINING & TOOLONG, INC.		7	ALLIED PRECISION PRODUCTS, INC.	13	
ADVANCED MACHINING TECHNOLOGIES		7	ALL-POWER MFG. CO.	13	
ADVANCED PLASTICS INC		7	ALL-PRO FASTENER & RIVET MFG. CO.	13	
DBA ADVANCED MCHNING FBRCTIONG INC		7	ALL-STATES INC.	14	
AERCO RESEARCH		7	ALPHA BOLT CO.	14	
AERO & AUTO STUD SPEC.		7	ALPHA FASTENERS	14	
AERO BUSHING AND COMPONENT		7	ALPHA MACHINING PRODUCTS & DEVELOPMENT	14	
AERO COMPONENTS CO.		7	ALPINE MACHINE & TOOL CORP.	14	
AERO DYNAMIC MACHINING, INC.		7	ALPS SEIKO CO., LTD.	15	
			Plant - LIDA FACTORY		
			AMACON CORP.	15	
			AMANDA BENT BOLT CO	15	
			AMATOM ELECTRONIC HARDWARE	15	
			DIVISION OF QUINCY TECHNOLOGIES, INC.		
			AMERICAN AIRCRAFT PARTS MANUFACTURING COMPANY	15	

MIL-HDBK-57F (IS)  
INDEX A

Company Name	Page	Company Name	Page
AMERICAN ELECTRIC	15	B & R MACHINE AND TOOL CORP	24
CONSTRUCTION MATERIALS GROUP See THOMAS & BETTS CORP		B F GOODRICH CO. RIVNUT ENGINEERED FASTENERS, THE (AERO AND DEF DIV	24
AMERICAN FASTENER & SPECIALTY CO.	15	B G ENGINEERING, INC.	24
AMERICAN INTERNATIONAL AERO MFG INC	15	B G M FASTENER CO., INC.	25
AMERICAN METAL BEARING COMPANY	16	B. V. FABRIEK VAN KLINGNAGELS EN SCHROEFBOUTEN V/H SMT	25
AMERICAN QUALITY INDUSTRIES FASTENER DIVISION	16	BARCO ENGINEERING COMPANY, INC.	25
AMERIFAST CORP.	16	BARNEGAT BAY NSCC, INC. DBA BB NSCC, INC.	25
AMERITECH FASTENER MFG INC DIVISION OF LONE STAR FASTENERS, LP	16	BARRE PRECISION PRODUCTS INC	25
AMMAC, INC.	16	BAS AEROSPACE LIMITED	25
ANATASE PRODUCTS DIV OF HENWAY INC	16	BAUER & SCHAURTE KARCHER GMBH	25
ANCHOR BOLT & SCREW CO.	17	BAY BOLT	25
ANDERSON FORGE & MACHINE	17	BBC FASTENERS, INC.	26
ANILLO INDUSTRIES, INC.	17	BEACH MACHINE	26
ANKIT FASTENERS PRIVATE LIMITED	17	BEAVER PRODUCTS CORP.	26
ANOTHER SCREW MACHINE PRODUCT	17	BEC MACHINE PRODUCTS COMPANY	26
ANTRIM MACHINE PRODUCTS, INC.	17	BEE INDUSTRIES, INC. (WISCONSIN CORPORATION)	26
A-ONE MACHINE COMPANY	17	BEGONIA TOOL COMPANY	26
APEL LTD.	17	BEK LEVEL 1 FASTENERS	27
APEX MFG. CO. INC	18	BEL-AIR MACHINE & PERFORMANCE	27
APHEONIX CORPORATION	18	BELL FASTENERS	27
ARCHER SCREW PRODUCTS	18	ALBANY FASTENERS/PAWTUCKET FASTENER DIVISION (also see VERTEX)	
ARCO SALES CO.	18	BELL PRECISION, INC.	28
ARDOR MFG. INC.	18	BELL-MEMPHIS, INC.	28
ARGARWAL INDUSTRIES	18	BEN YUAN ENTERPRISE CO. LTD.	28
ARJAY PRECISION, INC.	18	BENACO TOOLING RESEARCH & DEV. CORP	28
ARMSTRONG ATLAS BOLT	19	BEOTOL CORP.	28
ARMSTRONG FASTENING SYSTEMS	19	BERGNER, RICHARD GMBH & CO.	28
ARMSTRONG FASTENINGS LTD.	19	BER-LOW MFG INC	29
ARNOLD KNIPPING GmbH	19	DBA BUTECH PRESSURE SYSTEMS	
ARNOLD UMFORMTECHNIK GMBH & CO. KG	19	BERRY, JOHN DBA BERRY MANUFACTURING	29
ARNOLD WRAGG (BOLTS & NUTS) LTD	20	BERRY MANUFACTURING	29
ARROW SCREW & MACHINE WORKS	20	BET-LAR SERVICES (UPSTART ACQUISITIONS, CORP)	
ARTISAN SPECIALIST TECH, INC	20	BETA CORP.	29
ARVAN, INC.	20	BETA ENGINEERING, INC.	29
ASAH SREWS MANUFACTURING CO., LTD	20	BIG BOLT CORP.	29
ASAI TEKKO CO. LTD	20	BISHOP ENTERPRISES, INC.	29
ASI DESIGN & MANUFACTURING, INC.	20	BLAINE TOOL CORP.	30
ASL MANUFACTURING, INC.	20	BLANC AERO INDUSTRIES	29
ASSOCIATED TOOL CO., INC.	21	BLANC AIRCRAFT FASTENERS, INC.	30
ATF INC	21	BLAND CO., THE	30
ATLANTIC PRECISION SPRING, INC.	21	BLUE SKY INDUSTRIES, INC.	30
ATLAS ENGINEERING, INC. PENN ENGINEERING COMPANY	21	BLUE TEE CORP	30
ATLAS SPECIALTY PRODUCTS See CURTIS PRESTON ENTERPRISES INC	21	DBA GEFCO/STECO	
AUGUST FRIEDBERG GMBH	21	BOBCAT MANUFACTURING CO.	31
AUGUST FRIEDBERG GmbH	21	BOGNER ENGINEERING CO.	30
AUTO BOLT AND NUT CO.	21	BOLLHOFF & CO. GmbH & CO. KG	30
AUTOMATED MANUFACTURING	22	BOLT & NUT CO.,	30
AUTOMATIC MACHINING AND MFG CO DBA AMMAC INC	22	BOLT FASTENER STUD/TECHNOLOGY	31
AUTOMATIC MANUFACTURING COMPANY	22	BOLTWORKS, INC.	31
AUTOMATIC SCREW MACHINE PRODUCTS CO.	22	BOMAR ENGINEERING, INC.	31
AUTO SCREW, INC.	22	BOMBSHELL, INC.	31
AVDEL INTERNATIONAL (AVDEL LTD)	22	BONEAL INC.	32
AVIATION MANUFACTURING GROUP LLC DBA FREEMAN CO., THE	22	BRACELENTE MANUFACTURING CO., INC.	32
AVIBANK MANUFACTURING, INC. PRECISION CASTPARTS CORP.	23	BRADY MACHINE, INC.	32
AVK INDUSTRIES PRODUCTS INC	23	BRANCH MACHINE PARTS, INC	32
AZTECH ENGINEERING, INC	23	BRIARWOOD FASTENERS, INC	32
AZTECH LOCKNUT COMPANY	23	BRIDEAN MACHINE & TOOL CO., INC.	32
		BRIDGEVIEW MANUFACTURING CO. ILLINOIS CORPORATION	32
<b>B</b>		BRIGHT LIGHTS USA, INC.	32
B & B SPECIALTIES INC DBA G S AEROSPACE DIVISION .	23	BRINTCLIFFE TURNER LTD.	33
B & D THREAD ROLLING	23	BRISTOL INDUSTRIES	33
B & E MACHINE SHOP & SHEET METAL FAB., INC.	24	BRISTOL LOCKNUT CO. NUT DIVISION	33
B & E MANUFACTURING CO., INC	24	BROADSTONE TOOL & DIE, INC.	33
B & G MANUFACTURING CO., INC.	24	BROADWAY SCREW MACHINE INC.	33
B & N TOOL CO., INC.	24	BROWN PRODUCTION, INC	33
		BRUNNER DRILLING & MFG. CO., INC.	34
		BRUNNER MFG CO. INC. DBA BRUNNER MANUFACTURING DIVISION	34

MIL-HDBK-57F (IS)  
INDEX A

<u>Company Name</u>	<u>Page</u>	<u>Company Name</u>	<u>Page</u>
BRYCO MACHINE, INC.	34	CHRIS MACHINE CO	46
BRYNOLF MANUFACTURING, INC.	34	CHU HUA INDUSTRIAL CO., LTD.	46
BUCK EYE FORGE, INC.	34	CHUN YU WORKS & CO., LTD.	46
BUCKEYE MACHINING, INC.	34	CINCH MANUFACTURING	47
BUFFALO PUMPS, INC.	35	CINCH-MANADNOCK	47
SUBSIDIARY OF AMPCO-PITTSBURGH CORP.		CLEVELAND HARDWARE & FORGING	47
BULA FORGE INC.	35	DBA GREEN BAY DROP FORGE CO	
BULTEN TRADING AB	35	CLICK BOND, INC.	47
BURROWERS RESEARCH MACHINING, INC.	35	CLYDE FASTENERS LIMITED	47
BUSAN INDUSTRIAL MACHINERY CO., LTD.	36	CM MANUFACTURING, INC.	47
BOLT DIVISION		CNC MACHINING INC.	47
BUTECH PRESSURE SYSTEMS	36	COAE BOLTS WORKS CO., LTD	47
see BER-LOW MFG INC.		COAST INDUSTRIAL SUPPLY CO INC	48
BUTLER, INC.	36	SUB OF SPANDCO INDUSTRIES INC	
<b>C</b>			
C & A MACHINE CO.	36	CODLING TOOL & MFG. INC.	48
C & D MACHINE TOLL, INC.	36	COLD HEADING COMPANY, THE	48
C & H MFG., INC.	36	COLOC MANUFACTURING,	48
C & S ENGINEERING LLC	36	DIVISION INGRAM INDUSTRIES, INC.	
C. E. MACHINE CO., INC.	37	COMET MFG. CO., INC	48
C.E.S. MACHINE PRODUCTS, INC	37	COMMAND ENTERPRISES	48
C.J.'S GENERAL MACHINE WORKS	37	COMPONENT PRODUCTS CORPORATION	48
C.R.D. MACHINING	37	COMPULOGIC DESIGN CO. (SEE R&I ENTERPRISES)	158
CALABRESE & SONS, INC.	37	COMPUTA-BASE MACHINING, INC.	49
CALIFORNIA SCREW PRODUCTS CORP.	38	CONNECTICUT AIRCRAFT PRODUCTS	49
CAMBRIDGE SPECIALTY CO INC DBA POINT MACHINE COMPANY	38	CONTINENTAL MACHINE PRODUCTS, INC.	49
CAMCAR DIVISION OF TEXTRON INC.	38	CONTINENTAL TOOL & MANUFACTURING.	49
AMSCO PRODUCTS	38	CONTRACTING CNC MACHINING	49
DRILLETITE PRODUCTS	39	CONQUEST MACHINE, INC	49
RAYCARL PRODUCTS	39	CO-OP SCREW MANUFACTURING CORP.	49
ROCKFORD HEADING PRODUCTS	39	COOPER POWER SYSTEMS INC	49
SEMS PRODUCTS	40	MCGRAW EDISON POWER SYSTEMS	
SOCKET SCREW PRODUCTS	40	COPELAND MANUFACTURING CORPORATION DIV JAMES DIVISION	49
TAPTITE PRODUCTS	40	COPPER STATE BOLT & NUT COMPANY INC.	49
TORX PRODUCTS	41	CORPUS CHRISTI GASKET & FASTENER LTD	50
CAMCAR LLC	41	CREATIVE PRECISION INC	50
CAMCAR SCREW AND MFG CO DIV OF TEXTRON INC	41	DBA CREATIVE PRECISION WEST	
CAMLOC PRODUCTS	42	CRESCENT MANUFACTURING CO.	50
CAM-TECH INDUSTRIES	42	CRS PRECISION CORP.	50
CANADY MANUFACTURING CO. INC	42	CRUM MFG	50
CAPRICE ENGINEERING CO., INC.	42	CRYSTAL METAL PRODUCTS COMPANY, INC	50
CAPY MACHINE SHOP, INC.	42	CSM FASTENER PRODUCTS CO.	51
CARDINAL FASTENER & SPECIALTY CO., ONC.	42	CURTIS PRESTON ENTERPRISES INC	51
CARDINAL INDUSTRIAL PRODUCTS	43	DBA ATLAS SPECIALTY PRODUCTS	
CARR CO.	43	CUTTING EDGE ENTERPRISE, LLC	51
THE UNITED CARR DIV OF TRW		CUTTING EDGE MACHINING INC	51
CATALINA INSTRUMENT CORPORATION	43	NEVADA DIV	
CBS FASTENERS INC.	43	WESTERN SCREW MACHINE PRODUCTS, INC.	
CCB INDUSTRIES, INC	43	CUTTING EDGE MACHINING SOLUTIONS, INC.	51
CCF ENTERPRISES INC	43	CWR MANUFACTURING CO	51
CEI INC	43	DIVISION OF A.J. MUPHY CO., INC.	
DBA COMMAND ENTERPRISES		<b>D</b>	
CELTECH ENTERPRISE	44	D & D MACHINERY AND SALES	51
CENTERLINE TOOL & ENGINEERING INC	44	D & D MANUFACTURING	52
DBA MACHINE SHOP		D & D TOOL COMPANY, INC.	52
CENTRAL OZARK MACHINE, INC.	44	D & R MACHINE COMPANY	52
CENTRAL SCREW PRODUCTS	44	D. C. MACHINING INC.	52
CENTURY METAL PARTS CORP.	44	D.S.O. PLASTICS, INC.	52
CER-MAC INC.	44	DACK INDUSTRIES, INC.	52
CERNY MFG. CO.	44	DANIEL CO., EDWARD W.	52
CHAMPION COMMERCIAL INDUSTRIES, INC	45	DAN-LOC BOLT & GASKET INC.	52
CHAMPION RIVET DIVISION		DARCO PRODUCTS	53
CHAMPION FASTENERS, INC.	45	DAVE ALLEN ENTERPRISES	53
CHANCE, A.B. COMPANY	45	DAVIES PRECISION MACHINING, INC.	53
CHANDLER PRODUCTS, INC.	45	DAVIS AIRCRAFT PRODUCT CO., INC.	53
CHATHAM PRECISION, INC.	45	DECKER MANUFACTURING CORP	53
CHEREK MACHINE & TOOL CO., INC.	45	DEERE & CO	54
CHEROKEE TOOL & ENGINEERING CO., INC.	45	DEFENSE AEROSPACE	54
CHIANG SHIN FAFTENERS INDUSTRIES, LTD	45	DEFENSE QUALITY MFG.	54
CHICAGO FASTENER MANUFACTURING	46	DEFIANCE STAMPING CO., THE	54
CHICAGO HARDWARE & FIXTURE CO.	46	DEHOUSSE (USINES)	54
CHICAGO NUT & BOLT INC.	46	DELL MFG. CO., INC.	54
CHIEF MFG.	46	DELT INDUSTRIES, INC.	54
CHOICE PRECISION MACHINE, INC.	46		

MIL-HDBK-57F (IS)  
INDEX A

<u>Company Name</u>	<u>Page</u>	<u>Company Name</u>	<u>Page</u>
AEROSPACE PRODUCTS DIVISION		EMP MANUFACTURING CO	63
DELTA MACHINE & TOOL CO., INC	55	EMPIRE PRECISION MACHINING, INC.	63
DEL-VAL FASTENER MANUFACTURING	55	ENGEL MANUFACTURING COMPANY, INC., THE	63
DEMAT	55	ENGINEERED BOLTING PRODUCTS, INC.	63
MECAERO ALCOA FASTENING SYSTEMS TOUL		ENGINEERING MATERIALS CO., INC	64
DEPENDABLE MACHINE CO., INC.	55	FASTENER MANUFACTURING DIVISION	
DERBYSHIRE MACHINE & TOOL CO INC	55	ENGL MANUFACTURING COMPANY, INC., THE	65
DBA DERBYSHIRE MARINE PRODUCTS		ENOMOTO INDUSTRIES CO., LTD.	65
DETROIT HEADING CO.	55	ENOMOTO FOUNDRY	
DEUTSCH COMPANY INC	55	ENVISION TECH, INC.	65
DBA DEUTSCH CO THE METAL COMPONENTS		ERICO FASTENING SYSTEMS	65
DFCI SOLUTIONS, INC	56	ERIE BOLT CORP	65
DHL ENTERPRISES	56	DBA EBC INDUSTRIES	
DIAL SUPPLY AND MANUFACTURING, INC.	56	ESCO PRECISION, INC.	65
DIESEL PARTS COMPANY OF CALIFORNIA	56	ESMET INC	65
DIHARD COMPANY	56	DBA ELECTROLINE TTUFLOC	
DISC-LOCK INTERNATIONAL	56	SUB OF UNIMET CORP	
DIXON MACHINE & TOOL (see TROY D. RAY)	56	ESNA	66
DBA DIXON MACH AND FABRICATION)		MACLEAN-FOGG COMPANY	
DO MANUFACTURING COPR	56	ESP MANUFACTURING CO., INC	66
DO-ALL PRECISION, INC.	57	ESSENTIAL MACHINING	66
DOMESTIC FASTENER & FORGE, INC.	57	ESTA PRODUCTS COMPANY	66
DOMESTIC FORGING, INC.	57	EVERLOCK FASTENING SYSTEMS	67
DONSON MACHINE	57	EVERLOCK DETROIT DIVISION	
DOUBLECO INCORPORATED	57	GREER STOP NUT (Greer-Smyrna Division)	
DBA R & D FASTENERS		INTERNATIONAL SCREW DIVISION	
DOUGLASS TOOL & ENGINEERING CO., INC.	57	EXCEL PRECISION PRODUCTS, INC.	67
DRESSER INDUSTRIES, INC.	57	EXPERIMENTAL MACHINE CO.	67
DRESSER PUMP DIVISION			
D'SAMIC	57	<b>F</b>	
DTF MFG INC DIV OF FEDERAL SCREW AND SUPPLY CO	58	FABER ENTERPRISES, INC	67
DUFFY ELECTRONICS & MFG. CO.	58	FABRICATION SPECIALTY INC.	68
DUNCAN ELECTRONICS & MFG. CO	58	FABSCO CORP.	68
DUNHAM PRODUCTS, INC	58	FAILING CO., GEORGE E	68
DUPONT, G.B. CO., INC.	58	FALCON MANUFACTURING CORP.	68
SEE AMAX L. P.		FALL RIVER MANUFACTURING CO., INC.	68
DUSEVOIR METAL PRODUCTS, INC.	58	FANG SHENG SCREW CO., LTD.	68
DUVE GmbH & CO. KG	59	FARIAS INDUSTRIAL MACHINING	68
DYNACAST	59	FARLO MACHINE & TOOL CO., INC	68
INDUSTRIAL FASTENERS DIVISION		FASSCO	69
DYNAMIC ENGINEERING	59	FASTENER & STEEL SUPPLY CO., LTD.	
DYSON CORP., THE	59	FASTCO INDUSTRIES, INC.	69
Formerly JOS. DYSON & SONS, INC.		FASTENAL COMPANY	69
DZUS FASTENER CO., INC	59	FASTENER BROKERAGE INC	69
DBA DFCI SOLUTIONS, INC		DBA INOFAST MANUFACTURING	
		FASTENER INNOVATION TECHNOLOGY INC	69
<b>E</b>		DBA F.I.T.	
E. KOZAK PRECISION PRODUCTS CO.	59	FASTENER TECHNOLOGY CORP.	70
E.L.R. MACHINE AND TOOL	59	FASTENERS UNLIMITED INC.	70
EAGAN MACHINE CORP.	60	FASTENING PRODUCTS CO., INC.	70
EAGLE PICHER INDUSTRIES	60	FASTENING PRODUCTS OF LANCASTER, INC.	70
PRECISION PRODUCTS PLANT		FASTENRATH BEFESTUGYBGSTECGBUJ GMBH	70
EAGLEHEAD MANUFACTURING COMPANY INC	60	FAST-WERK CARL AUG. FASTENRATH GMBH & CO.KG	70
DBA DEJAK MACHINE TOOL CO. DIV DEJAK DRILLING		FASTRON COMPANY, THE	71
EAST BAY MANUFACTURERS, INC.	60	FEDERAL EQUIPMENT COMPANY	71
EAST COAST METALS INC.	60	FEDERAL MANUFACTURING CORP.	71
EASTERN SCREW CO., INC.	60	FEDERAL SCREW WORKS	71
EASTWOOD MFG. CO.	60	BIG RAPIDS DIV	
EATON AEROQUIP CORPORATION	60	ROMULUS DIV	
AEROSPACE DIVISION		FENBAR PRECISION MACHINISTS, INC	72
EBC INDUSTRIES	61	FENTON HEADING	72
FORMERLY ERIE BOLT CORP.		FERNDALE FASTENER	72
EBERHARD BRUNINGHAUS	61	FERRIERE DI STABIO, S.A.	72
ECENARRO S. COOP. LTDA.	61	FERRY CAP & SET SCREW CO., THE	72
EDS ORDNANCE	61	FIBAM COMPANHIA INDUSTRIAL	72
ELASTIC STOP NUT	61	FILETAG INTERNATIONAL	72
See MACLEAN-ESNA		INTERNATIONAL THREAD INC.	
ELCO INDUSTRIES, INC.	62	FIRST AMERICAN SALES CO.	72
ELECTRO-FREETO MANUFACTURING COMPANY	62	FISCHER SPECIAL MFG. CO.	73
ELITE FASTENERS	62	FITZ MANUFACTURING INDUSTRIES LTD	73
ELLIS PRECISION INDUSTRIES DBA E P IND.	62	DBA FMI	
EMERALD VALLEY MFG	62	FLAIG & HOMMEL	73
EMHART CORP	63	FLEXALLOY INC.	73
GRIPCO FASTENER DIV		FLORES ENTERPRISES	73
PARKER-KALON DIVISION		FLUIDONICS INC.	74
		FLUIDYNE CORPORATION	74

MIL-HDBK-57F (IS)  
INDEX A

Company Name	Page	Company Name	Page
FOCUS HOPE	74	FORMERLY STANDARD TOOL & MACHINE COMPANY	
FOLSOM TOOL & MOLD CORP.	74	HALLSIMS INDUSTRIAL COMPONENTS, INC.	84
FONTAL CONTROLS, INC.	74	HAMANAKA (THAILAND), CO., LTD	84
FONTANA LUIGI S.p.A	74	HAMANAKA NUT MFG. CO., LTD	
FOREMOST PRECISION INSTRUMENT CORP.	75	HANDI GADGETS CORP.	84
FOREST FASTENERS	75	HANSAN SCREW CO., LTD.	84
FORMED FASTENER MANUFACTURING, INC	75	EXPORTING DEPARTMENT	
FPA MANUFACTURING	75	HARDWARE SPECIALTY CO, INC	85
DBA FPA MANUFACTURING AND SUPPLY		HARRISON BOLT AND NUT CO., THE	85
FRANROE PRECISION MACHINE COMPANY	75	HARTFORD AIRCRAFT PRODUCTS, INC.	85
FREEMAN COMPANY, THE	75	HARWOOD DESIGN, INC.	85
FRIEDR BOESNER GMBH	75	HASKELL OF HUNTINGTON, INC.	85
FRISBY AEROSPACE INC DE	76	HASSALL, JOHN, INC.	85
DIV TRIUMPH ACTUATION SYSTEMS -CLEMMONS		HATCH INDUSTRIES	86
FRONTIER BOLT COMPANY OF TEXAS	76	HAWTHORNE BOLT WORKS	86
FUCHS SCHRAUBENWERK GmbH	76	HAYDON BOLTS, INC.	86
		HAZE SEIKO CO., LTD	86
<b>G</b>		HEARTLAND PRECISION FASTENERS INC	86
G & R SCEW MACHINE PRODUCTS	76	HEIMS MACHINE AND TOOL INC.	86
G & S MACHINE INC	77	HEITCO MANUFACTURING, INC.	87
G. B. MACHINE PRECISION, INC.	77	HEMCO TOOL INC	87
G.B. DUPONT CO., INC	77	HENWAY, INC.	87
GAITHER PATRICIA	77	HEPTNER MANUFACTURING COMPANY	87
DBA GAITHER MACHINE		HESSISCHE SCHRAUBENFABRIK WELTER GmbH & CO., KG	87
GALAN PRECISION MACHINE CO.	77	HEWINS, EDMOND, C. JR.	87
GALMAC MFG CO	77	HEXAGON ENTERPRISES, INC	87
GARCIA INDUSTRIES, INC	77	HI INDUSTRIAL TECHNOLOGIES	87
GARDINER MFG. CO.	77	HIGH QUALITY MACHINE SHOP INC	87
GATES ALBERT, INC.	78	HIGH TECH ENTERPRISES	88
GATEWAY SCREW AND RIVET, INC.	78	HIGHLAND PRODUCTS CORPORATION	88
GEN FAST MANUFACTURING COMPANY	78	HIGHLAND THREADS, INC	88
GENERAL AVIATION MFG., INC.	78	FASTENER MANUFACTURING DIVISION	
GENERAL MACHINE PRODUCTS, INC	78	HILL AEROSPACE & DEFENSE LLC	88
GENERAL SCREW AND SPECIALTY CO INC	78	HILL FASTENER CORP	88
GERMAN MACHINED PRODUCTS, INC	78	HILL STAMPING & MANUFACTURING INC	88
GERTLER INDUSTRIES, INC	78	HILTI, INC	89
GFD LETAGE	79	HI-SHEAR CORP.	89
GILL MACHINE TOOL CO	79	DBA FOREIGN PARENT IS LISI PARIS FRANCE	
GL CNC SERVICES INC	79	HLC INDUSTRIES INC	89
GMJ MACHINE COMPANY, INC.	79	HMS SERVICES LLC	90
GMP CO.CORPORATION	79	HO-HO-KUS, INC.	90
GOSHO WORKS, LTD.	79	HO HONG WORKS CO., LTD	90
GRACO INDUSTRIES, INC.	80	HOFFMANN, RICHARD GmbH	90
GRADON SCREW MACHINE CORP.	80	HOFFMANN MACHINE COMPANY, INC.	
GRANDEUR FASTENERS, INC	80	DBA HOFFMAN, RICHARD GmbH	
GRAUCH ENTERPRISES	80	HOLLYWOOD MANUFACTURING INC.	90
GREATER MARYLAND TOOL & MFG., CORP.	80	HOLO-KROME CO.	91
GREEN BAY DROP FORGE CO	80		
DIV OF CLEVELAND HARDWARE & FORGING		HORSPOOL AND ROMINE MFG CO INC	91
GREENFIELD MANUFACTURING CO., INC.	81	HORST ENGINEERING & MANUFACTURING CO.	91
GREER STOP NUT, INC.	81	HOUSTON FASTENER	91
GRIPCO, DIVISION OF BLACK & DECKER	81	HOUSTON PRECISION FASTENERS	91
GROOV-PIN CORPORATION	81	HOWARD TOOL CO., INC.	92
GRUPO RASSINI S.A. DE C.A.	82	HOWE MACHINE AND TOOL CORP.	92
RASSINI INTERNATIONAL, INC.		HOWELL PRECISION, INC.	92
GS AEROSPACE	82	HOWIE MANUFACTURING CO., INC.	92
DIVISION OF B & B SPECIALTIES INC		HUCK AEROSPACE PRODUCTS	92
GSF FASTENING	82	HUCK INDUSTRIAL PRODUCTS	92
ARMSTRONG FASTENING LTD.		HUCK PRODUCTS	92
GUARDIAN RIVET & FASTENER	83	HUGGINS MFG	93
GUARDIAN MFG. DIVISION		HUGO DURHOLT GMBH & CO. KG	93
GUNNISON-INTERNATIONAL INC.	83	HUNT VALVE COMPANY INC	93
		DBA WAECO VALVE DIVISION	
<b>H</b>		HUNTER-STEVENS CO INC	93
H C MERCHANDISERS INC	83	HUNTINGTON VALLEY INDUSTRIES, INC DBA HVI	93
DBA H C PACIFIC		HURON AUTOMATIC SCREW CO.	93
H C PACIFIC	83	HURRICANE MACHINE COMPANY, L.L.C.	93
H. MULLINS, LTD.	83	HYDRO FITTING MANUFACTURING CORPORATION	93
BADE INDUSTRIAL ESTATE		HYDROBOLT LIMITED	93
H. PAULIN & CO. LTD.	83		
CAPITAL METAL INDUSTRIES DIVISION		<b>I</b>	
H. PRINZ GmbH FABRIK FUR VERBINDUNGSELEMENTE	83	I.G.D. MACHINE & TOOL LTD.	94
HABINA ENGINEERING	84	IDEAL FASTENERS INC.	94
HALL INDUSTRIES INC.	84	IFASTGROUPE 2004 LP	94
		see INFASCO	



MIL-HDBK-57F (IS)  
INDEX A

Company Name	Page	Company Name	Page
see INFASCO NUT DIV		K.D.K. UPSET FORGING C O. INC.	102
see INGERSOLL FASTENERS		KAMAX - WERKE RUDOLF KELLERMANN GMBH	102
IMPERIAL SUPPLIERS LLC	94	KAMAX L P	103
INDIANA AIRCRAFT HARDWARE INC	94	FORMERLY G.B. DUPONT CO., INC.	
INDUSTRIAL & AUTOMOTIVE FASTENERS	95	KAMPWERK VIIEGEGE U. PICKARDT GMBH. & CO	103
DIVISION OF KEY MANUFACTURING GROUP, INC.		KAPCO INDUSTRIES, INC	103
INDUSTRIAL FASTENERS CORP.	95	KATSURAGAWA MACHINE SCREW CO., LTD.	103
INDUSTRIAL FORGE, INC.	95	KAYGOR, INC.	103
INDUSTRIAL NUT CORP.	95	KAYNAR PRODUCTS	104
INDUX, S.A DE C.V.	96	KELLER ENGINEERING CO	104
INFASCO	96	KELOX/MICRODOT PRODUCTS	104
DIV OF IFASTGROUPE 2004 LP		KEN FORGING, INC.	104
INFASCO NUT DIV	96	KERR CHARLES W	104
DIV OF IFASTGROUPE 2004 LP		KERR LAKESIDE INC.	104
INGERSOLL	96	KEYSTONE BOLT & NUT COMPANY	105
DIV OF IFASTGROUPE LP, A HEICO COMPANY		KEYSTONE THREADED PRODUCTS DIVISION	
INLAND MACHINE CO.	96	KEYSTONE TOOL AND MACHINE CO	105
INOFASST MANUFACTURING INC.	96	KILBOURN ENGINEERING CO.	105
IN-SPECK CORP.	96	KIRSTEN PIPE CO. INC.	105
INSTRUMENT MACHINING SERVICE LTD.	97	KLINCHER LOCKNUT CORP.	105
INTERFLEX MFG. CORP.	97	K.L.M. MACHINE INC.	105
INTERSTATE FITTINGS INC.	97	KNIPPING-DORN GmbH KALTUMFORMTECHNIK	105
IRON BOUND MANAGEMENT GROUP	97	KNOCH MANUFACTURING CO. LTD	106
IRVING MACHINE SERVICE, INC.	97	KO AMS MACHINE PRODUCTS	106
IRWIN AUTOMATION, INC.	97	DBA KOAM MACHINE	
ISLAND ENGINEERING DBA J SMITH MACHINE SHOP INC	97	KOBE FASTENER LIMITED	106
ITT HARPER AEROSPACE FASTENER OPERATIONS	98	KOLB GMBH & CO. HERSTELLER VON	106
AEROSPACE CONTROLS DIVISION		VERBINDUNGSELEMENTEN	
ITW BUILDEX	98	KONDOR TECHNOLOGIES, INC.	106
ITW CIP	98	KONGO BYORA CO., LTD.	106
IVACO INC	98	KOREA BOLT IND., CO., LTD.	106
DBA INFASCO see IFASTGROUPE 2004 LP		FOREIGN TRADE DEPARTMENT	
		KORODY-COLYER CORP A CR INDUSTRIES CO	107
<b>J</b>		KOZAK, E. PERCISION PRODUCTS CO	107
J & M MACHINE INC	98	KPF	107
J & S PRECISION PRODUCTS	98	KREIS TOOL & MANUFACTURING CO INC	107
J.F. FREDERICKS TOOL CO.	99	KROBACH MANUFACTURING CORP.	107
J. G. FASTENERS	99	KSS SOCKET SCREW, INC	107
J. GEORG BIERBACH	99	K-TECH MFG., INC.	107
J.M. PRECISION, INC.	99	KYOEI SEISAKUSHO CO., LTD.	108
J.P. PRODUCTS, INC.	99	KYOKUTO MFG CO LTD	108
DBA SPECIALITES, UNLIMITED			
JACOBSON MFG, LLC.	99	<b>L</b>	
JACO ENGINEERING, INC.	99	L & C MFG CO INC	108
JAM TECH CORP.	100	L & H THREADED RODS	108
JAMES IPPOLITO & CO., INC.	100	DIV OF GRAY AMERICA CORP	
JAMES JACKSON	100	L & J FASTENERS, INC.	108
DBA J J ENGINEERING		L & M ENTERPRISES INC	108
JAMISON INDUSTRIES INC	100	L A MARTIN COMPANY	108
JAY BEE MACHINE WORKS, INC.	100	L G MACHINE AND MFG INC	108
JAY O MACHINE CO., INC.	100	L H INDUSTRIES, INC.	109
JAYCO ENGINEERING	100	TIP TOP TOOL CO.	
JE A ENTERPRISES, INC.	100	L N AEROSPACE, INC.	109
JERGENS INC	101	L P R PRECISION PARTS AND TOOL CO INC	109
DBA JERGENS INDUSTRIAL SUPPLY		L R G CORPORATION	109
JET MACHINE WORKS COMPANY	101	LAKE ERIE PRODUCTS, INC.	109
SEE HEWINS, EDMOND, C. JR		LaMOTT ENTERPRISES, INC.	109
JINN HER ENTERPRISE CO., LTD.	101	LAMSON AND SESSIONS OF CANADA LTD.	110
JJ ENGINEERING	101	RB & W CORP. METAL FORMING DIVISION	
JAMES JACKSON		LANA INDUSTRIES	110
JJ SCREW PRODUCTS, INC.	101	LANARKSHIRE BOLT LTD.	110
JMT MACHINE COMPANY	101	LAND-SEA-AIR MACHINED PRODUCTS INC	110
JOHN R. BROMLEY COMPANY INC.	101	LANIS MACHINE AND MFG CO	110
JOLICO/J-B TOOL INC.	101	LANUM METAL PRODUCTS LLC	111
JOSLYN CORP.	101	LBL PRODUCTS	111
JUNIPER ELBOW CO.	102	LEBRECHT TIGGES GmbH & CO. KG	111
JUPITER WASHERS, INC.	102	LEHNER SCREW MACHINE CO.	111
JUST IN TIME INC	102	LELAND-POWELL FASTENERS, INC.	111
DBA APSCO		LENCH, THOMAS WILLIAM, LTD	112
		LENTERN AIRCRAFT LTD.	112
<b>K</b>		LEONARD JED CO	112-113
K & K PRECISION ENTERPRISES INC	102	MARYLAND BOLT AND NUT CO DIV	
K.A.A. COMPANY	102	LEP SPECIAL FASTENERS INC.	113
LYNN ABADIE DBA K A A COMPANY		LEVEL 1 FASTENERS	114

MIL-HDBK-57F (IS)  
INDEX A

<u>Company Name</u>	<u>Page</u>	<u>Company Name</u>	<u>Page</u>
LEIVINGSTON MACHINE COMPANY	114	DBA MCCULLOUGH & ASSOCIATES	
LEWIS SCREW CO	114	MCLANE MFG INC	126
DIV OF MEDALIST FASTENERS INC		McMELLON BROS INC.	126
LFC INDUSTRIES	114	MD3 INDUSTRIES LTD	127
DIVISION RKR TECHNOLOGIES		DBA EMPIRE PRECISION MACHINING	
LINREAD NORTHBRIDGE	115	MEACO PRODUCTS CORP	127
LEICESTER, UK		MEC WOLF SRL	127
LINREAD NORTHBRIDGE AIRCRAFT PRODUCT DIVISION	115	MECAERO PRODUCTS	127
LINREAD PUBLIC LIMITED CO.	115-116	MECAERO CANADA INC.	127
AIRCRAFT PRODUCTS DIVISION		MECAIR AEROSPACE INDUSTRIES	127
LIPPISCHE EISENINDUSTRIE GmbH	116	SUBSIDIARY OF SPS TECHNOLOGIES DIV	
		DBA MECAIR INC	
LISI AEROSPACE	116-118	MECHANICAL AND INDUSTRIAL FASTENERS	128
A1 TECHNOLOGIES		MECHANICAL INDUSTRIES LLC	128
BLANC AERO INDUSTRIES		MEL-BA MANUFACTURING INC	128
BLANC AERO INDUSTRIES RUGBY		MERCER PRODUCTS & MFG. CO., INC.	128
BLANC AERO SAINT CHAMOND GRANAT		MERCURY AEROSPACE FASTENERS INC	128
BLANC AERO TECHNOLOGIES		LISI AEROSPACE	
DECOLLETAGE GENERAL MODERNE		MERCURY TOOL & MACHINE, INC.	128
FT BESTAS		METALCRAFTERS	129
HI-SHEAR CORPORATION		DIVISION OF KEYSTONE CONSOLIDATED INDUSTRIES	
LISI AEROSPACE CANADA		METAL-TECH MFG. INC.	129
MONADNOCK COMPANY THE		METHODS AND MACHINING SERVICES INC.	129
LITTLE WORLD MFG INC	118	METRO TOOL AND MANUFACTURING CO.	129
LLOYD MACHINE & TOOL CO., INC.	118	ALEXANDER MANUFACTURING COMPANY INC	
LN AEROSPACE, INC	118	METRIX MFG. CO.	129
LOBO OFFICINE MECCANICHE SPA	118	MI. ME. AF. S.r.l.	129
LOBO SYSTEMS LTD	119	MICRO SCREW MACHINE PRODUCTS, INC.	129
LONE STAR FASTENERS, LP	119	MICRODOT INC.	130
FORMALLY LONE STAR SCREW CO OF TEXAS INC		MICRODOT AEROSPACE FASTENING SYSTEMS GROUP	
LONG-LOK FASTENERS CORP.	119	ADVANCED PRODUCTS DIV	
LOOS & CO., INC.	119	MICRODOT INSERTS DIVISION	
AEROSPACE FASTENERS DIVISION		KAYNAR MFG. DIVISION	
LORD CORPORATION	119	MID CONTINENT SCREW PRODUCTS CO.	130
AEROSPACE PRODUCTS DIVISION		MID-STATES SCREW CORP.	130
(PLANT)_ DBA MECHANICAL PRODUCTS DIVISION		ILLINOIS CORPORATION	
LOUGHLIN MANUFACTURING CORP	119	MIDWEST ACORN NUT CO.	130
		MILE-HI MACHINE, INC.	130
<b>M</b>		MILITARY PRODUCTS GROUP, INC.	131
M & M MANUFACTURING CORPORATION	120	MILLIPART, INC.	131
M.A.A. CORP.	120	MILLS, J. R. MACHINING, INC	131
MID AMERICA AEROSPACE DIVISION		MIL-SPEC FASTENERS CORP.	131
M.L.W. MANUFACTURING CO.	120	MINEBEA CO LTD	131
M.S. AEROSPACE	120	FUJISAWA MANUFACTURING UNIT	
MAC FASTENERS, INC.	120	MIROFINE COMPANY	132
MACHINE SHOP, INC., THE	120	MI-TECH, INC.	132
MACHINERITE CORP.	120	MITSUBOSHI INDUSTRIES, LTD.	132
MACHINING LOGISTICS, INC.	120	OSAKA DIVISION	
MACK A W MFG COMPANY INC	121	MIX TOOL CO.	132
MACKO INDUSTRIES	121	MKM MACHINE TOOL CO INC	133
MACKSON MFG CORP	121	M-MANUFACTURING	133
MACLEAN-ESNA	121	MMG ENGINEERED COMPONENTS INC	133
MACLEAN-FOGG CO.		DBA TOOLSOURCE	
MACLEAN-FOGG CO.	122	MNP CORPORATION	134
MACOR, INC.	122	DBA MNP CORPORATION DIVISION 2	
MAGNUM MACHINE SHOP	122	DBA MNP CORPORATION DIVISION 4	
MAGNUS TOOL & DIE CO., INC.	122	DBA MNP FASTENER DIVISION	
MAILLY MFG CO., INC.	122	MODERN METRIC MACHINE COMPANY INC	134
MAIN MACHINE CO INC	123	MODFORM-ILLINOIS INC	134
DBA MAIN MACHINE & TOOL CO		MONADNOCK COMPANY THE	134
MANUFACTURING ENGINEERING TECH.	123	DBA LISI AEROSPACE	
MANUFACTURING SALES AND SERVICE	123	MONOGRAM AEROSPACE FASTENERS	135
MANUFACTURING TECHNOLOGY SERVICES	123	MONROE MACHINED PRODUCTS INC	135
MAPECO PRODUCTS, INC.	123	MONTEREY MACHINE PRODUCTS	135
MAR-BRO MFG., INC.	123	MORTON FASTENERS INC.	135
MARTIN-CHANDLER, INC	124		
MARUYKO NUT CO., LTD.	124	MORTON MANUFACTURING	135
MARVIN ENGINEERING, CO., INC.	124	DIVISION MORTON GRINDING	
MARYLAND BOLT & NUT CO., INC.	124-125	MOSTAR GEAR & MACHINE MFG., CO.	135
LEONARD JED CO		MOTOR WHEEL CORP.	136
MASTER RESEARCH & MFG., INC.	125	MRL MANUFACTURING CORP	136
MASTERCRAFT TOOL COMPANY	126		
MAUDLE INDUSTRIAL CO., LTD.	126	<b>N</b>	
MAUI MEGA	126	N.S.S. INDUSTRIES	136
DBA KERR, CHARLES W		NAFCO INDUSTRIES, INC.	136
MCADAMS MACHINE AND TOOL CO INC	126	NAGOYA SCREW MANUFACTURING CO, LTD	136
MCCULLOUGH AERO CO	126	NAPIER'S AUTO BODY	136

MIL-HDBK-57F (IS)  
INDEX A

<u>Company Name</u>	<u>Page</u>	<u>Company Name</u>	<u>Page</u>
NARRAGANSETT SCREW MFG CO	137	P & I ASSOCIATES, INC.	146
NASSAN TOOL WORKS, INC.	137	P & L ENTERPRISES	146
NASU DENKI-TEKKO CO., LTD.	137	P.C.M., INC.	147
NATIONAL BOLTS AND RIVETS LTD	137	P.S. MACHINE CO., INC.	147
NATIONAL FASTENER CO., LTD.	137	PACOR, INC.	147
NATIONAL THREADED FASTENERS CORP.	137	PACER ALLOYS, INC.	147
NAVPAR, INC.	137	PACIFIC FASTENERS, INC.	147
NC AUTOMATED INDUSTRIES INC	138	PACIFIC SCIENTIFIC	147
NEMI BRUEGGEMANN INC	138	PACIFIC TOOL, INC.	147
ND INDUSTRIES INC	138	PADGETT MACHINE INC.	147
DBA ND WESTERN FASTENER PROCESSING DIVISION		PAINTER TOOL, INC.	148
NEDSCHROEF HALMOND B.V.	138	PALNUT CO., THE	148
NEKG HOLDINGS	138	UNITED CARR FASTENERS PALNUT DIV	
NELSON AEROSPACE INC.	138	PAOLO ASTORI SPA	148
NELSON STUD WELDING DIVISION	139	PARK PRECISION CORPORATION	148
NEUMAYER, ERICH GMBH & CO.KG	139	PATEREX, LTD	148
NEVADA BOLT AND MFG CO INC	139	PATTERSON LAKE PRODUCTS	148
DBA SPS NON-FERROUS ENGINEERED FASTENERS		SUBSIDIARY OF COLUMBIA AUTO PARTS	
NEVILLE MACHINE SHOP	139	PAULIN H AND CO LTD	148
NEW HORIZON MACHINE CO., INC.	139	PB FASTENERS	149
NICE TOOL MFG., INC.	139	DIVISION OF PAUL R. BRILES, INC.	
NIPPON MACHINE ENGINEERING, INC.	140	PEERLESS SCREW PRODUCTS CORP.	149
NIPPON STEEL BOLTEN CO., LTD.	140	PEINER UMFORMTECHNIK GmbH	149
NISCO, INC.	140	PELHAM AUTO MATRIX PRECISION	149
NISSAN SCREW CO. LTD.	140	PENN CIGAR MACHINES INC	149
SALES DEPT., FOREIGN TRADE SECTION		PEM INC	
NOCHIA STEELWORKS	140	PENNINGENGINEERING AUTOMOTIVE FASTENERS	150
NON-FERROUS BOLT & MANUFACTURNG CO.	140	PENN ENGINEERING & MANUFACTURING CORP.	150
NORTHBRIDGE FASTENERS	141	ATLAS ENGINEERING INC.	
NORTHEAST FASTENERS	141	PENN SCREW & MACHINE WORKS, INC.	150
NORTHEAST METAL CO., INC.	141	PEREZ MACHINE, INC.	150
NORTHERN SCREW CO., INC.	141	PERIGEE MANUFACTURING COMPANY, INC.	150
NORTHSTAR ENGINEERING	141	MICHIGAN CORPORATION	
NOVA MACHINE PRODUCTS, INC.	142	PERKINS MACHINE CO.	150
A SUBSIDIARY OF CURTIS-WRIGHT FLOW CONTROL SERVICE CORP.)		PHOENIX SPECIALTY MANUFACTURING CO., INC.	151
NT ENGINEERING INC	142	PILGRIM SCREW CORPORATION	151
NUCOR FASTENER DIVISION (DIVISION OF NUCOR CORPORATION)	142	PINE TAVERN MACHINE INC.	151
NUMERIC MACHINE PRODUCTS	142	PINEY RIDGE CO.	151
NUTS INCORPORATED	142	PINTO PRODUCTS	151
DIVISION OF STANLOK		PIONEER MACHINE PRODUCTS, INC.	151
NUTS, INC.	142	PIONEER SCREW & NUT CO.	152
NYLOK CORP.	143	PLAINVILLE MANUFACTURING CO., INC.	152
		PNEU-HYDRO PRODUCTS, INC.	152
<b>O</b>		POINT MACHINE COMPANY	152
OAKTREE FASTENERS CO.	143	POLYTECHNIC INDUSTRIES	152
OBARS MACHINE & TOOL CO.	143	PORTLAND BOLT & MANUFACTURING CO INC	152
OCM MACHINE COMPANY, INC.	143	PORTSMOUTH NAVAL SHIPYARD	152
OHIO NUT & BOLT CO., THE	143	POSIMECH, INC.	152
DIV. OF FASTENERS INDUSTRIES, INC.		POWERPARTS, INC.	153
OHKAWA SCREW MFG. CO., LTD	144	PRD FASTENERS LTD	153
OKABE CO., INC.	144	PRECI-MANUFACTURING, INC.	153
OKABE KIKO CO., LTD.	144	PRECISE AERO PRODUCTS	153
OKAI IRON WORKS, INC.	144	PRECISE OF CALIFORNIA	153
OKAWA SCREW MANUFACTURING CO., LTD	144	DIV OF ADJUSTABLE BUSHING CORP	
OMEGA THREAD ROLLING AND GRINDING INC.	144	PRECISION AIRCRAFT MACHINING CO., INC. DBA PAMCO	153
ONEIDA TOOL & MACHINE CORP.	144	PRECISION FITTINGS, INC.	153
ONO MANUFACTURER, INC.	145	PRECISION METAL PRODUCTS CO.	154
ONO MANUFACTURING CO., LTD	145	PRECISION PARTS & TOOL CO., INC.	154
ONTIC ENGINEERING & MANUFACTURING, INC.	145	PRECISION PIECE PARTS, INC.	154
ORANGE PRECISION PARTS	145	PRECISION SCREW & BOLT, INC.	154
ORC-O TOOL & MACHINE, INC.	145	PRECISION TECHNOLOGIES, INC.	154
ORDNANCE PARTS & ENGINEERING CO.	145	PRECISIONMATICS CO., INC	154
ORLOTRONICS CORP.	145	PREM INDUSTRIES, INC.	154
OSAKA SEIKI CO., LTD.	145	PRESTIGE STAMPING, INC.	155
OSTEEN MACHINE SHOP	146	PRICE MANUFACTURING CO.	155
OTO MELARA S.p.A.	146	PRIETO MACHINE COMPANY, INC	155
FINKECCANICA COMPANY		PRODUCT DEVELOPMENT GROUP, INC.	155
OTT BROTHERS MACHINE CO., INC.	146	PRODUCTION & TOOL COMPANY	155
OTTAWA PRODUCTS CO., INC.	146	PRODUCTS DESIGN & MFG. CORP.	155
OWARI PRECISE PRODUCTS CO., LTD	146	PRO-MACHINE & TOOL COMPANY	155
		PROMPTUS ELECTRONIC HARDWARE	155
		PROTO MACHINE CO., INC.	156
<b>P</b>		PTM INTERNATIONAL INC	156
		PURITAS METAL PRODUCTS, INC.	156

MIL-HDBK-57F (IS)  
INDEX A

Company Name	Page	Company Name	Page
PYE & HOGAN LLC	156		
<b>Q</b>		<b>S</b>	
QRP, INC.	156	S & L METAL PRODUCTS CORP	167
QSN MANUFACTURING, INC.	156	S. B. E. (ITALY CORPORATION)	167
QUALITY AIRCRAFT SCREWS, INC	156	S.A.B.A. S.p.A. BULLONERIA E AFFINI	167
QUALITY BOLT & SCREW CO.	156	S.I. STUD, INC.	168
QUALITY FABRICATIONS, INC.	157	SABRE MANUFACTURING, INC.	168
QUALITY MACHINE & MFG INC	157	SAFETY SOCKET LLC	168
QUALITY SCREW PRODUCTS, INC.	157	SAFETY SOCKET SCREW CORP.	168
QUALITY SOCKET SCREW MANUFACTURING CORP.	157	SAGA TEKKOSHO CO., LTD	169
QUALITY THREADED PRODUCTS COMPANY	157	SAI INDUSTRIES	169
<b>R</b>		SALEM MANUFACTURING AND SALES, INC.	169
R & D FASTENERS	157	SALES SYSTEM, LIMITED	169
R & D WELDING & MACHINE INC.	157	SAMUEL MARSDEN & SON	169
R & I ENTERPRISES DBA COMPULOGIC DESIGN CO.	158	SANDIK MANUFACTURING, INC.	169
R & R PRECISION	158	SANNOHASHI SEISAKUSHO CO., LTD.	169
R B & W CORPORATION	158-159	SANTA ANA GEAR & MACHINE	169
R. BILD COMPANY, INC	159	SANTA ANA SCREW PRODUCTS INC	170
R.E.C. CORP.	159	SATAIR MANUFACTURING FACILITY	170
RABOURDIN	159	SATURN FASTENERS, INC.	170
RADAX INDUSTRIES, INC.	159	SCANDIA MFG. CO., INC.	170
RAE MANUFACTURING CO.	160	SCHMICO GMBH SCHWEISSTECHNIK	170
RAHMEDE SCHRAUBENFABRIK	160	SCHRAUBENFABRIK GUSTAV STERNBERG GmbH & CO. KG	170
RAINBOW MACHINE PRODUCTS, INC.	160	SCHUHL & CO. GMBH	170
RAM ENTERPRISES	160	SCOTT CRAFT CO.	171
RAM PRODUCTS	160	SCREW CORP.	171
RAM THREADING, INC.	160	A DIVISION OF VSI	
RAMAR NUTS, INC.	160	SEMBLEX CORP	171
RAMCO SPECIALTIES, INC.	161	SEMCO	171
RAMM DEFENSE PRODUCTS	161	RING SCREW WORKS	
RATHMANN WALTER G. SEGMENT-KLAMMERSCHRAUBEN GMBH	161	SEMS AND SPECIALS, INC.	171
RA-WHITE, INC	161	SENG HENG ENGINEERING PTE LTD.	171
RB & W CORP.	161	SESCO INDUSTRIES, INC.	172
REED INSTRUMENT CO.	162	SET SCREW & MGG. CO.	172
REGAL AIR, INC	162	SHACKELFORD MACHINIG, INC.	172
REID PRODUCTS INC.	162	SHAMROCK FASTENER TECHNOLOGIES, LLC	172
RELIANT FASTENER	162	SHAW PRECISION GRINDING & THREAD ROLLING	172
REPUBLIC FASTENER MANUFACTURING CORP.	162	ACE GRINDING & MANUFACTURING CO. OF TEXAS INC	
REXNORD	162	SHEFFIELD, INC.	173
SPECIALITY FASTENERS DIVISION		SHIGA BOLT CO., LTD	173
RICHARD MANN CO.	163	SHOPCO MANUFACTURING, INC.	173
RICHARD MFG. CO., INC.	163	SHORELINE PRODUCTS, INC.	173
RICNO TECHNOLOGIES, INC.	163	SHUR-KUT SUPPLY CORPORATION	173
RING SCREW WORKS	163	SHUR-LOK COMPANY.	173
RING SCREW DIVISION		SPS FASTENERS DIVISION , A PCC COMPANY	
FENTON HEADING DIV.		SIERRA PACIFIC SUPPLY CO., INC.	174
FRENDALE FASTENER		SIERRACIN/HARRISON	174
SEMCO FASTENER DIV		SIMMONDS PRODUCTS	174
TITAN FASTENER		SINN-TECH, INC.	174
RIPA ENGINEERING CORP.	164	SKY MANUFACTURING.	174
RIPPA PRODUCTS	164	SKYLINE INDUSTRIES	174
RISCO, INCORPORATED	164	SKYSPARES PARTS, INC.	174
RIVER VALLEY TOOL & MANUFACTURING	164	SLABE MACHINE PRODUCTS	175
RIVNUT ENGINEERED PRODUCTS, INC.	164	SMALL PARTS MANUFACTURING CO., INC.	175
RMS	164	SMITH MACHINE & MANUFACTURING	175
ROBBINS MANUFACTURING CO., INC.	164	SMITH WELDING, INC.	175
ROBERT HENRY CO., INC.	165	SONFARREL, INC.	175
ROCKFORD BOLT & STEEL CO.	165	SONIC INDUSTRIES, INC.	175
SUBSIDIARY OF VARLEN CORPORATION		SOUTH BAY BOLT MANUFACTURING CO.	176
ROCKFORD FASTENERS INC.	165	SOUTHCO, INC.	176
ROCKFORD PRODUCTS CORP.	165	SOUTHERN FASTENER CORPORATION	176
ROGG MANUFACTURING COMPANY	166	SOUTHERN FASTENING SYSTEMS	176
ROMAC ELECTRONICS, INC.	166	DIVISION OF FARLEY METALS, INC.	
RONSON MANUFACTURING, INC.	166	SOUTHWEST ALLIED PRODUCTS CO., INC.	176
ROSAN PRODUCTS	166	SOUTHWEST INDUSTRIAL SERVICES	176
ROTAIR INDUSTRIES, INC.	166	SOUTHWIND INDUSTRIES, INC.	177
RS MANUFACTURING, INC.	166	SPACE AGE ENGINEERING, INC.	177
RUDOLPH INSTRUMENTS, INC.	166	SPACE SCREW, INC.	177
RUMCO, INC.	167	SPACE-LOK, INC.	177
RUSCOMB TOOL & MACHNE CO., INC.	167	SPARTAN PRECISION MACHINE	177
		SPECIAL S, INC.	177
		SPECIAL-T-METALS	177
		SPECIALTY SCREW CORP	178

MIL-HDBK-57F (IS)  
INDEX A

Company Name	Page	Company Name	Page
SPIRAL TOOL CORP.	178	THOMAS MFG. INC.	190
SPS TECHNOLOGIES	178-179	TITAN FASTENER	190
AFG DIV		TO'S MANUFACTURING CO., INC.	190
AEROSPACE PRODUCTS		TOKOSHA METAL WORKS LTD.	190
SANTA ANA DIVISION		TONG HWEI ENTERPRISE CO., LTD.	190
SPS INC.		TOOLEX, INC.	190
T. J. BROOKS DIVISION		TOPURA CO., LTD.	190
TERRY MACHINE		TORCO, INC.	191
UNITED KINGDOM CORPORATION			
SPS TECHNOLOGIES (continued)		TORONTO FASTENERS INDUSTRIES, INC.	191
METALAC SPS INDUSTRIA		SUBSIDIARY OF HI-SHEAR CORP., USA	
UNBRACO PTY LTD. AUSTRALIA		TORX PRODUCTS	191
SPURWAY COOKE INDUSTRIES PTE LTD	179	CAMCAR DIV/TEXTRON INC.	
SRI SAI INDUSTRIES CORPORATION	180	TOWNE ROBINSON FASTENER CO.	191
ST. LOUIS SCREW & BOLT CO.	180	KEY MANUFACTURING GROUP, INC.	
STALKER & DYSTHE, INC.	180	TOWNSEND CO.	191
STANDARD LOCKNUT, INC.	180	CERRY RIVET DIVISION	
STANDARD NUT & BOLT, INC.	180	TOYO STEEL WIRE CO., LTD.	191
STANDARD TOOL & MACHINE CO.	180	TRI STATE TOOL & DIE CO., INC.	192
SEE HALL INDUSTRIES INC.		TRIAD PRODUCTS CORP.	192
STEADFAST CORPORATION	180	TRIDAIR PRODUCTS	192
STEEL CITY BOLT & SCREW, INC.	181	TRIDENT MACHINE CO.	192
STEEL PRODUCTS OF MASSILLION	181	TRIUMPH GROUP OPERATIONS INC, THE	192
STEEL WAREHOUSE COMPANY, INC.	181	FRISBY AEROSPACE INC DE	
STELCO FASTENER & FORGING CO.	181-182	TRIUMPH MANUFACTURING CO., INC.	192
STELFAST FASTENERS, INC.	182	TRONSON MANUFACTURING	192
DIVISION OF STELFAST FASTENERS, LTD.		TROY D. RAY	192
STELFAST, INC.	182	DBA DIXON MACHINE & FABRICATION	
STERLING MACHINE COMPANY	182	TRW	193
STERLING MARKING PRODUCTS IC	183	FASTENER DIVISION	
STERLING MFG. & SUPPLY, INC.	183	TRY - AZTEC COMPANY	193
STEVENS MFG. CO., INC.	183	TUFF FASTENERS CO.	193
STILLWATER FASTENERS, INC.	183	TURNAMICS, INC.	193
STRENKERT MACHINE SHOP INC.	183	TW DESIGN AND MANUFACTURING, L.L.C.	193
STURM MACHINE CO., INC.	184	TWIST TITE MFG. INC.	193
SUBCON TOOL / ACCUTOOL MACHINE GROUP INC.	184		
DBA ACCUTOOL		<b>U</b>	
SUBURBAN INDUSTRIES, INC.	184	U.P. MACHINE & ENGINEERING CO.	194
SULLIVAN BOLT CO., INC.	184	U.S. BOLT MANUFACTURING, INC.	194
SUNDRAM FASTENERS, LTD.	184	ULTIMATE MACHINING & WELDING	194
SUNRISE PRECISION MFG.	184	ULTRA SONIC MACHINE CO., INC	194
SUPERIOR TECHNOLOGY	184	UMPCO CORP.	194
SUPREME SCREW PRODUCTS, INC.	184	UNIFLOW CORP.	194
SV INDUSTRIES	185	UNIMETERIC CORPORATION	195
SWISS TECHNOLOGY, INC.	185	UNISTRUT CORP. (UNISTRUT PHILA)	195
		UNITED BOLT & SCREW CORP.	195
<b>T</b>		UNITED DRILL BUSHING CORP	195
T & E MACHINE CORP	185	UNITED PRECISION PRODUCTS CO., INC.	195
T C QUALITY MACHINING INC	185	UNITED STATES DEFENSE RESEARCH & SUPPLY	195
T R MACHINE INC	185	UNITED STEEL & FASTENERS INC	196
TAIYO NUT MFG. CO., LTD.	185	UNIVERSAL MACHINE PRODUCTS	196
TAKENAKA SEISAKUSHO CO., LTD.	186	UPB ENGINEERING	196
TANAKA LTD.	186	UPSTART ACQUISITIONS, CORP.	196
T-B & S MFG	186	DBA BET-LAR SERVICES	
TEBCO THREADED FASTENERS	186	URANIA ENGINEERING CO., INC.	196
DIVISION OF TENNESSEE BOLT & SCREW CO.		SPEC-NUT	
TECH WELDING AND MACHINE CO.	186	URBAN MANUFACTURING CO.	196
TECHNICAL FASTENERS, INC.	186	URBAN MFG. CO. INC.	197
TEK PRECISION CO., LTD	186	US TOOL & DIE	197
TELEFAST INDUSTRIES, INC.	187	UTAH TOOL & DIE, INC.	197
TENS MACHINE COMPANY, INC.	187		
TERRY MACHINE CO.	187	<b>V</b>	
See SPS TECHNOLOGY		VALCOR ENGINEERING CORP.	197
TERRYCABLE, INC.	187	VALLEY FORGE AND BOLT MFG CO	197
TEXAS BOLT CO.	187	VALLEY-TODECO, INC.	197
TEXAS PRECISION MFG., INC.	187	VAN PETTY MFG., INC.	197
TEXTRON FASTENING SYSTEMS	188	DBA J.W. MANUFACTURING INC	
AEROSPACE - SANTA ANA OPERATIONS		V-B MACHINE CO., INC.	198
TFI AEROSPACE CORPORATION	188	FASTENER DIVISION	
TFP CORP	188	VEGAS FASTENER MANUFACTURING	198
TRU-FIT PRODUCTS DIVISION		VENUS FASTENERS CORP.	198
SPECIAL FASTENER DIVISION		VERSATECH, INC.	198
THIANT (BOULONNERIE DE SA)	189	VERTEX DISTRIBUTION	198
THOMAS & BETTS CORPORATION	189	VICO PRODUCTS, CO.	198
FORMERLY AMERICAN ELECTRIC			
THOMAS INSTRUMENT & MACHINE CO., INC.	189		
THOMAS MACHINING TECHNOLOGIES, INC.	189		

MIL-HDBK-57F (IS)  
INDEX A

Company Name	Page
VICTOR PRODUCTS CORP.	198
VIP MFG. & ENGR. CORP.	199
VISSERIES & BOULONNERIES DE FOURMIES	199
VISTEK INDUSTRIES	199
VITCO NUCLEAR PRODUCTS INC.	199
VM MANUFACTURING CORPORATION	199
VMC INDUSTRIES, INC.	200-201
VOI-SHAN PRODUCTS	201
VOSS INDUSTRIES, INC.	201
VOSS AEROSPACE DIVISION	
VSI (AEROSPACE PRODUCTS DIVISION)	202
VULCAN RIVET & BOLT CORP.	202

**W**

WALKER BOLT MANUFACTURING DIVISION OF LONE STAR FASTENERS, LP	202
WALZ & KRENZER INC DBA MAPECO PRODUCTS DIV MAPECO PRODUCTS	202
WARREN PUMPS LLC DIVISION OF COLFAX CORPORATION	202
WATERBURY BUCKLE CO.	202
WAYNE BOLT & NUT CO., INC.	202
WEAVER MANUFACTURING, INC.	203
WEBLUK MACHINE CORP.	203
WELTER GMBH & CO. KG	203
WELTON ROLLED THREAD CORP.	203
WESLOK DIVISION OF FALL RIVER MANUFACTURING	203
WEST COAST AEROSPACE, INC.	203
WEST TENNESSEE LIONS BLIND INDUSTRIES INC DBA A P MILLS INDUSTRIES FOR THE BLIND	203
WESTERN PACIFIC ENTERPRISES, W.P.E., INC.	204
WESTERN SCREW MACHINE PRODUCTS, INC CUTTING EDGE MACHINING	204
WESTERN SKY INDUSTRIES, INC. DIVISION OF ATLAS CORP.	204
WESTFIELD FASTENERS	204
WESTLAND STEEL PRODUCTS, LTD.	204
WESTWOOD PRECISION, INC.	204
WHAIL BOLT IND. CO., LTD	204
WHELAN MACHINE & TOOL CO	205
WHITNEY SCREW CORP.	205
WHITTET-HIGGINS CO.	205
WIGLEY MACHINE COMPANY	205
WILHELM SCHUMACHER SCHRAUBEN-FABRIK GmbH	205
WILLIAM'S MACHINE & FABRICATION, INC.	205
WIL-NIC E D R INDUSTRIES INC DBA WIL-NICO	205
WILSON-GARNER CO.	206
WILT PRECISION PRODUCTS	206
WINKER HERMANN GMBH & CO KG METALLWARENFABRIK	206
WINSLOW AUTOMATICS, INC	206
WITTEN COMPANY, INC.	206
WODIN, INC.	206
WOLSTENHOLME MACHINE DBA WM ROBOTS	207
WOLTERS GMBH	207
WOLVERINE MACHINE PRODUCTS CO.	207
WOLVERINE NUT CO.	207
WORTHY MACHINE	208
WROUGHT WASHER MANUFACTURING INC.	208
WYANDOTTE INDUSTRIES, INC.	208
WYNNSON ENTERPRISES, INC.	208

**X**

XCEL MFG., INC	208
----------------	-----













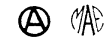

**Y**















Y2K MACHINE SHOP, INC.	208
YATES TOOL, INC.	209
YOUNG ENGINEERS INC, THE	209
YOW MENG INDUSTRIAL CO., LTD.	209

Company Name	Page
<b>Z</b>	
Z & B GENERAL MACHINE	209
ZAMON CO., INC.	209
ZENEX CORPORATION	209
ZERO PRODUCTS, INC.	209

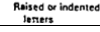























MIL-HDBK-57F (IS)  
INDEX B



















## INDEX B - SYMBOL

SYMBOL	COMPANY NAME	PAGE
	<b>A</b>	
A-1	A-1 NUT AND BOLT CO, INC	2
A-1	A-1 THREAD ROLLING CO., INC	2
	ALCO MACHINE CO.	12
A325	COAE BOLTS WORKS CO., LTD.	47
A+	ACCURATE TOOL CO., INC	4
A	AAP ACQUISITION CORP	2
	ABRASIVE CUTTING CORP.	3
A	ACCURATE PRECISION FASTENERS, INC.	3
	ACCUTURN CORPORATION	4
A	ACHILLES AEROSPACE PRODUCTS, INC.	5
	ACME MACHINE PRODUCT	5
	ACME SCREW COMPANY	5
	ADAMS, EARL M. CO.	6
A	ADVANCED CNC MANUFACTURING	6
a	ADVANCED MACHINING & FABRICATING, INC.	6
a	ADVANCED PLASTICS, INC.	7
A    A & A	AERO & AUTO STUD SPEC.	7
	AEROFASST SUPPLY	8
A	AEROSPACE PRODUCTS, INC.	9
	AEROSTAR FASTENER CORP.	9
A*	AEROWIND CORPORATION	10
	AFI INDUSTRIES, INC.	10
	AIR INDUSTRIES CORPORATION	10
	AIRCRAFT FUELSEAL FASTENERS, INC.	11
	ALLIED NUT & BOLT CO., INC.	13
	ALPHA MACHINING PRODUCTS & DEVELOPMENT	14
A	ALPS SEIKO CO.	15
	AMANDA BENT BOLT CO.	15
	AMERICAN ELECTRIC and THOMAS & BETTS CORPORATION	15, 189

SYMBOL	COMPANY NAME	PAGE
	AMERICAN INTERNATIONAL AERO MFG INC	15
	ANDERSON FORGE & MACHINE	17
	A-ONE MACHINE COMPANY	17
A	ARNOLD UMFORMTECHNIK GMBH & CO. KG	19
	ARROW SCREW & MACHINE WORKS	20
A	ASAI TEKKO CO. LTD	20
	ASSOCIATED TOOL CO., INC	21
A	BELL FASTENERS	27
A	CAMCAR DIVISION OF TETRON INC.	39
	EATON AEROQUIP CORPORATION	60
	GARCIA INDUSTRIES, INC.	77
A	MECAERO ALCOA FASTENING SYSTEMS TOUL SE	127
A	PORTSMOUTH NAVAL SHIPYARD	152
AAP	AVIBANK MFG., INC.	23
AB	ABSCOA INDUSTRIES	3
	ADJUSTABLE BUSHING CORP	6
AB	AVIBANK MFG., INC.	23
	LENCH, THOMAS WILLIAM, LTD.	112
	PRECISE OF CALIFORNIA	153
		
ABC	ALPHA BOLT CO.	14
ABE	ADAMS INDUSTRIES, INC.	6
ABM	AEROBOLT MANUFACTURING, INC	8
	AUTO BOLT AND NUT CO.	21
Ac	ACRODYNE MFG CO.	5
	ACE PRECISION INDUSTRIES, INC.	5
ACI	ACI	5
	ACIMET MFG.	5
	ACCU-TECH MANUFACTURING AND SUPPORT, INC	4
AD	ADOM ENGINEERING	6
AD	AUTOMATIC SCREW MACHINE PRODUCTS CO.	22
ADB	AVIBANK MFG., INC.	23
ADBB	AVIBANK MFG., INC.	23
adm	ADOM ENGINEERING	6















MIL-HDBK-57F (IS)  
INDEX B

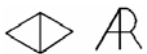



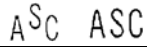
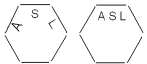













SYMBOL	COMPANY NAME	PAGE
	AERO DYNAMIC MACHINING, INC.	7
ADP	AVIBANK MFG., INC.	23
	ADC COMMUNICATIONS CORP.	6
AE	A & E MACHINED PRODUCTS	1
	AASTRO ENGINEERING	2
	AERO ENGINEERING AND MANUFACTURING CO. OF CALIFORNIA	8
	ATLAS ENGINEERING, INC. and PENN ENGINEERING & MANUFACTURING CO.	21, 150
AEP 	AIRCRAFT ENGINEERING PRODUCTS, INC.	11
	AERO BUSHING AND COMPONENT	7
	ACCUFORM, INC.	3
 	ACCURATE THREADED FASTENERS, INC.	4
AF	ACUFAST AIRCRAFT PRODUCTS	6
	AEROTECH FASTENERS, INC.	10
	AKKO FASTENER, INC.	12
	ALLFAST FASTENING SYSTEMS, INC.	13
	ALPHA FASTENERS	14
	ANKIT FASTENERS PRIVATE LIMITED	17
	ATF, INC.	21
 	AUGUST FRIEDBERG GMBH	21
	AFAB PRECISION MACHINING	10
  	AIRFASCO, INC.	11
 	AMERICAN FASTENER & SPECIALTY CO.	15
AGC	ACE GRINDING & MFG. OF TEXAS	4
AGM	ACE GRINDING & MFG. OF TEXAS	4
	AIRFRAME INTERNATIONAL, INC.	11
AI PLATE NUT A ON ONE SIDE I ON OPPOSITE SIDE HEX NUT	AIRFASCO INDUSTRIES FASTENER GROUP	11
A/I	ARVAN, INC.	20
A-I	AVIBANK MFG., INC.	23

SYMBOL	COMPANY NAME	PAGE
	AIR-COM, INC.	11
AK	ARNOLD KNIPPING GmbH	19
A-K	AVIBANK MFG., INC.	23
A.L.	S.A.B.A. S.p.A. BULLONERIA E. AFFINI	167
	ALPINE MACHINE & TOOL CORP.	14
  	A & M AEROSPACE, INC.	1
AM	AEROSPACE MANUFACTURING	8
	AMACON CORP.	15
	AMERICAN FASTENER & SPECIALTY CO.	15
	AMMAC, INC.	16
	ARDOR MFG. INC.	18
	AUTOMATIC MANUFACTURING COMPANY	22
AM	AUTOMATED MANUFACTURING	22
	AUTOMATIC MACHINING AND MFG CO	22
AMATOM	AMATOM ELECTRONIC HARDWARE	15
AMB	AMERICAN METAL BEARING COMPANY	16
AMC	ALBAR MACHINE CORPORATION	12
 	SAI INDUSTRIES CORP.	169
AMI LOGO	A.M.I ENGINEERING	2
	ALARD MACHINE PRODUCTS	12
	ANTRIM MACHINE PRODUCTS	17
	AERO MECHANICAL FASTENING SYSTEMS	8
AMS	AEROSPACE MARINE SPECIALTY FASTENERS & FITTINGS INC.	9
AMSCO	ACCURATE SCREW MACHINE CO	3
AMT	ADVANCED MACHINING & TOOLONG, INC.	7
AMT - I AMT xxxx-xxxx	ALPINE MACHINE & TOOL CORP.	14
A-N	AVIBANK MFG., INC.	23
	A & N PRECISION INDUSTRIES	1
 	AMERICAN QUALITY INDUSTRIES	16
AOL	ALL MANUFACTURERS INC.	13
AOL	ITT HARPER AEROSPACE FASTENER OPERATIONS	98
AP	ACCURATE AUTOMATIC PARTS CO	3
ap	ADVANCED PLASTICS, INC.	7

































MIL-HDBK-57F (IS)  
INDEX B











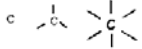
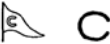



SYMBOL	COMPANY NAME	PAGE
AP	AEROSPACE PRODUCTS CO.	9
	AIR PARTS MFG. CO.	10
	AIRDROME PARTS CO.	11
<b>AP</b>	ALL-POWER MFG. CO.	13
	ALL-PRO FASTENER & RIVET MFG. CO.	13
	ANATASE PRODUCTS	16
AP	APEX MFG. CO. INC.	18
AP	APHEONIX CORPORATION	18
A-P	AVIBANK MFG., INC.	23
	PILGRIM SCREW CORP.	151
APCO	AEROSPACE PRODUCTS	9
	APEL LTD.	17
<b>APMI</b>	A. P. MILLS INDUSTRIES FOR THE BLIND and WEST TENNESEE LIONS BLIND IND. INC.	2, 203
<b>APP</b>	ALLIED PRECISION PRODUCTS, INC.	13
	ATLANTIC PRECISION SPRING, INC.	21
<b>AR</b>	A & R MFG CORP	1
	ACME RIVET & MACHINE CORP.	5
ARVAN, INC.	ARVAN, INC.	20
	A & S PIN PRODUCTS INC.	1
	AEROSTAR ENGINEERING & MANUFACTURING COMPANY	9
	ALL-STATES INC.	14
AS	AVIBANK MFG., INC.	23
	ARCO SALES CO.	18
	ASL MANUFACTURING INC.	20
ASP	ATLAS SPECIALTY PRODUCTS	21
<b>ASP</b>	CURTIS PRESTON ENTERPRISES INC.	51
	ARTISAN SPECIALIST TECH, INC.	20
ATBO ATLAS	ARMSTRONG ATLAS BOLT	19
	AVDEL INTERNATIONAL	22
AV	AVIBANK MFG., INC.	23
AVIBANK	AVIBANK MFG., INC.	23
AVK	AVIBANK MFG., INC.	23
	AVK INDUSTRIES PRODUCTS INC.	23



















SYMBOL	COMPANY NAME	PAGE
		
AVL	AVIBANK MFG., INC.	23
<b>AW</b>	A & W SCREW MACHINE PRODUCTS, INC	1
	AIW-ALTON INC.	11
	ARNOLD WRAGG (BOLTS & NUTS) LTD	20
A-W	AVIBANK MFG., INC.	23
AX	AEROMAX INDUSTRIES, INC.	8
<b>B</b>		
	B & E MACHINE SHOP & SHEET METAL FAB., INC.	24
	B & E MANUFACTURING CO., INC.	24
B	BELL FASTENERS	27
	BELL-MEMPHIS, INC.	28
	BERGNER, RICHARD GMBH & CO	28
	BETA ENGINEERING, INC.	29
	BLANC AIRCRAFT FASTENERS, INC.	30
	BOBCAT MANUFACTURING CO.	31
	BOLT FASTENER STUD/TECHNOLOGY	31
B B+ B1	BRISTOL INDUSTRIES	33
	BROADSTONE TOOL & DIE, INC.	33
	BRYNOLF MANUFACTURING, INC.	34
	BUCK EYE FORGE, INC.	34
BALL-LOCK	AVIBANK MFG., INC.	23
	BEL-AIR MACHINE & PERFORMANCE	27
	BARRE PRECISION PRODUCTS INC.	25
<b>BAF</b>	BLANC AIRCRAFT FASTENERS, INC.	30
BB	B & B SPECIALTIES, INC.	23
	BARNEGAT BAY NSCC, INC. DBA BB NSCC, INC.	25
BB <u>BB</u>	BIG BOLT CORP.	29
<u>BB</u> <u>BB</u> <u>BB</u> • • •		
	LISI AEROSPACE	117
	BETA CORP.	29
BCC	BBC FASTENERS, INC.	26

MIL-HDBK-57F (IS)  
INDEX B















SYMBOL	COMPANY NAME	PAGE	SYMBOL	COMPANY NAME	PAGE
				BOLT & NUT CO.	30
BD BDM	SAFETY SOCKET SCREW CORP.	168		BONEAL INC.	32
<b>BDM</b>	BRUNNER DRILLING & MFG. CO., INC.	34		B & N TOOL CO., INC.	24
	BOGNER ENGINEERING CO.	30		FRIEDR BOESNER GMBH	75
	BARCO ENGINEERING COMPANY, INC.	25	<b>BOT</b>	BEOTOL CORP.	28
<b>BEC</b>	BEC MACHINE PRODUCTS COMPANY	26	<b>BP</b>	BELL PRECISION, INC.	28
<b>BEI</b>	ANOTHER SCREW MACHINE PRODUCT	17	<b>BP</b>	BUFFALO PUMPS, INC.	35
	BOMAR ENGINEERING, INC.	31	<b>B.P.C.</b>	BEAVER PRODUCTS CORP.	26
<b>BEK</b>	BEK LEVEL 1 FASTENERS and LEVEL 1 FASTENERS	27, 114		FERRY CAP & SET SCREW CO., THE	72
	BENACO TOOLING RESEARCH & DEV. CORP.	28		BROWN PRODUCTION, INC.	33
<b>BFG+</b>	B F GOODRICH CO. RIVNUT ENGINEERED FASTENERS, THE	24		BER-LOW MFG INC.	29
<b>BFI</b>	BRIARWOOD FASTENERS, INC.	32		BUTECH PRESSURE SYSTEMS	36
	B G ENGINEERING, INC.	24	<b>BR</b>	B & R MACHINE AND TOOL CORP	24
	B G M FASTENER CO., INC.	25		BRIDEAN MACHINE & TOOL CO., INC.	32
<b>BH</b>	BULTEN TRADING AB	35		BURROWERS RESEARCH MACHINING, INC.	35
<b>BI</b>	BEE INDUSTRIES, INC.	26		BROADWAY SCREW MACHINE INC.	33
<b>BI</b>	BRISTOL INDUSTRIES	33	<b>BT</b>	BEGONIA TOOL COMPANY	26
	BRINTCLIFFE TURNER LTD.	33		BLAINE TOOL CORP.	30
<b>BIM</b>	BUSAN INDUSTRIAL MACHINERY CO., LTD.	36		BAS AEROSPACE LIMITED	25
<b>BL</b>	BLAND CO., THE	30	<b>BUFO</b>	BULTEN TRADING AB	35
<b>BL</b>	BRIGHT LIGHTS USA, INC.	32	<b>BULA</b>	BULA FORGE INC.	35
<b>BLC</b>	AVIBANK MFG., INC.	23		BOLTWORKS, INC.	31
<b>BLSAVIBANK</b>	AVIBANK MFG., INC.	23	<b>BVB</b>	BRIDGEVIEW MANUFACTURING CO.	32
	BEACH MACHINE	26	<b>B<sub>X</sub></b>	ITW BUILDIX	98
<b>BM</b>	BERRY, JOHN DBA BERRY MANUFACTURING	29	<b>BY</b>	BEN YUAN ENTERPRISE CO, LTD.	28
<b>BM</b>	BERRY MANUFACTURING	29		EBERHARD BRUNINGHAUS	61
<b>BM</b>	BRUNNER DRILLING & MFG. CO., INC.	34			
<b>BM</b>	BRUNNER MANUFACTURING CO. DBA BRUNNER MANUFACTURING DIVISION	34		<b>C</b>	
<b>BM</b>	BRYCO MACHINE, INC.	34	<b>C&amp;D MACH</b>	C & D MACHINE TOLL, INC.	36
<b>BM</b>	BUSAN INDUSTRIAL MACHINERY CO., LTD.	36		CAMLOC PRODUCTS	42
<b>BMC INC.</b>	BRACELENTE MANUFACTURING CO., INC.	32	<b>C</b>	CARDINAL INDUSTRIAL PRODUCTS	43
	BUCKEYE MACHINING, INC.	34		CHAMPION FASTENERS, INC.	45
	BRADY MACHINE, INC.	32	<b>C</b>	CHANCE, A.B. COMPANY	45
	BRANCH MACHINE PARTS, INC.	32		CHIEF MFG.	46
				CINCH MANUFACTURING	47











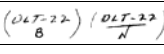

MIL-HDBK-57F (IS)  
INDEX B

SYMBOL	COMPANY NAME	PAGE
C	CNC MACHINING INC.	47
	COAE BOLTS WORKS CO., LTD.	47
	COAST INDUSTRIAL SUPPLY CO., INC	48
	CO-OP SCREW MANUFACTURING CORP.	49
	CSM FASTENER PRODUCTS	51
	HAZE SEIKO CO., LTD.	86
	REXNORD	162
C	SPS TECHNOLOGIES	178
	TEXTRON FASTENING SYSTEMS	188
	TOWNSEND CO.	191
CA	C & A MACHINE CO.	36
CAL	BAY BOLT	25
CAMCAR	CAMCAR DIVISION OF TEXTRON INC.	39-41
CAMCAR	CAMCAR LLC	41
	CAMLOC PRODUCTS, REXNORD	42, 162
	CAM-TECH INDUSTRIES	42
	CONNECTICUT AIRCRAFT PRODUCTS	49
	BOBCAT MANUFACTURING CO.	31
CB	CLICK BOND, INC.	47
CBM	COMPUTA-BASE MACHINING, INC.	49
CBS	CBS FASTENERS INC.	43
Cbs		
CCB	CCB INDUSTRIES, INC.	43
CCF	CCF ENTERPRISES INC.	43
CCM	CONTRACTING CNC MACHINING	49
CCS	SPS TECHNOLOGIES	178
	CAPRICE ENGINEERING CO., INC.	42
C. E. I	COMMAND ENTERPRISES	48
CES	C.E.S. MACHINE PRODUCTS, INC	37
	CHICAGO FASTENER MANUFACTURING	46
CFL	CLYDE FASTENERS LIMITED	47
CFS	CARDINAL FASTENER & SPECIALTY CO., INC.	42
CCG	CORPUS CHRISTI GASKET & FASTENER LTD.	50
	CANADY MANUFACTURING CO. INC.	42
	CHU HUA INDUSTRIAL CO., LTD.	46



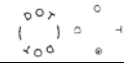







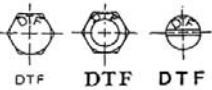











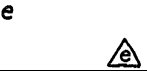

SYMBOL	COMPANY NAME	PAGE
	COLD HEADING CO., THE	48
CHEREK	CHEREK MACHINE & TOOL CO., INC.	45
CHF	CHICAGO HARDWARE & FIXTURE CO.	46
CI	CATALINA INSTRUMENT CORPORATION	43
	SPS TECHNOLOGIES	178
	C. J.'S GENERAL MACHINE WORKS	37
	CENTERLINE TOOL & ENGINEERING, INC.	44
CM	CER-MAC INC.	44
	CM MANUFACTURING, INC.	47
	CRESENT MANUFACTURING CO.	50
	CERNY MFG. CO.	44
	CHRIS MACHINE CO.	46
CMI	CONQUEST MACHINE, INC.	49
	CENTURY METAL PARTS CORP.	44
	CONTINENTAL MACHINE PRODUCTS, INC.	49
CNB	CHICAGO NUT & BOLT INC.	46
	CRYSTAL METAL PRODUCTS COMPANY, INC.	50
	CAPY MACHINE SHOP, INC.	42
	OWARI PRECISE PRODUCTS CO., LTD	146
	CENTRAL OZARK MACHINE, INC.	44
	COPELAND MFG. CORP.	49
CP	CHANDLER PRODUCTS, INC.	45
CPI	CREATIVE PRECISION INC.	50
CPM	CHOICE PRECISION MACHINE, INC.	46
	C.R.D. MACHINING	37
CRUM	CRUM MFG	50
	CRS PRECISION CORP.	50
	C & S ENGINEERING LLC	36
CS	CALIFORNIA SCREW PRODUCTS CORP.	38
C S		
	COPPER STATE BOLT & NUT CO.	49





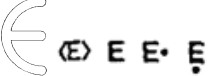





















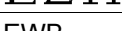

MIL-HDBK-57F (IS)  
INDEX B

SYMBOL	COMPANY NAME	PAGE
	CAMBRIDGE SPECIALTY COMPANY, INC.	38
C S D	CAMCAR DIVISION OF TEXTRON INC.	39-41
<b>C-SI</b>	CALABRESE & SONS, INC.	37
	CENTRAL SCREW PRODUCTS	44
	CHEROKEE TOOL & ENGINEERING CO., INC.	45
<b>CTM</b>	CONTINENTAL TOOL & MANUFACTURING	49
C W R C	CWR MANUFACTURING CO	51
<b>D</b>		
	D & D MANUFACTURING	52
D & D	D & D TOOL COMPANY, INC.	52
	B & D THREADED ROLLING	23
<b>d</b>	DACK INDUSTRIES, INC.	52
	DANIEL CO., EDWARD W.	52
D	DAN-LOC BOLT & GASKET INC.	52
D	DECKER MANUFACTURING CORP	53
	DEFIANCE STAMPING COMPANY, THE	54
D	DEHOUSSE (USINES)	54
	DELL MFG. CO., INC.	54
D	DEMAT	55
	DERBYSHIRE MACHINE & TOOL CO.	55
D	DIESEL PARTS COMPANY OF CALIFORNIA	56
D	DIHARD COMPANY	56
	DO MANUFACTURING CORP.	56
D	DUPONT, G.B. CO., INC. and KAMAX L. P	58, 77, 103
	DUSEVOIR METAL PRODUCTS, INC.	58
D	DUVE GmbH & CO. KG	59
	DYSON CORP THE	59
	ONTIC ENGINEERING & MANUFACTURING, INC.	145
	STEEL WAREHOUSE COMPANY, INC.	181
D A E	DAVE ALLEN ENTERPRISES	53









SYMBOL	COMPANY NAME	PAGE
<b>DAS</b> 1	DEFENSE AEROSPACE	54
DB	DAN-LOC BOLT & GASKET INC.	52
<b>DC</b>	D. C. MACHINING INC.	52
<b>DDG</b>	BLANC AERO INDUSTRIES and LISI	29, 117
	DYNAMIC ENGINEERING	59
<b>DF</b>	DEUTSCH COMPANY INC., THE	55
<b>d</b>	DTF MANUFACTURING, INC.	58
	DFCI SOLUTIONS, INC.	56
	DETROIT HEADING CO.	55
<b>DHL</b>	DHL ENTERPRISES	56
	DIAL SUPPLY AND MANUFACTURING, INC.	56
<b>D</b>	DELT INDUSTRIES, INC.	54
<b>DI</b>	DUNCAN ELECTRONICS & MFG. CO	58
	DOMESTIC FORGING, INC.	57
<b>DL</b>	DISC-LOCK INTERNATIONAL	56
	MILLS, J. R. MACHINING, INC.	131
<b>DMC</b>	DECKER MANUFACTURING CORP	53
	DEPENDABLE MACHINE CO., INC.	55
	DELTA MACHINE & TOOL CO., INC.	55
<b>DMT</b>	DIXON MACHINE & TOOL and TROY D. RAY	56, 192
	KNIPPING-DORN GmbH	105
	TRW	193
D P	DARCO PRODUCTS	53
DP	DUNHAM PRODUCTS, INC.	58
DPI	DUNHAM PRODUCTS, INC.	58
<b>DPM</b>	DAVIES PRECISION MACHINING, INC.	53
	DEFENSE QUALITY MFG.	54
	DOUBLECO INCORPORATED	57
	DEMAT	55
<b>DT</b>	DOUGLASS TOOL & ENGINEERING CO., INC.	57
<b>DTE</b>	EMERALD VALLEY MFG	62











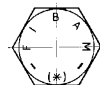

MIL-HDBK-57F (IS)  
INDEX B

SYMBOL	COMPANY NAME	PAGE
	DTF MANUFACTURING, INC.	58
	DUFFY ELECTRONICS & MFG. CO.	58
	DUVE GmbH & CO. KG	59
	DUVE GmbH & CO. KG	59
	DEL-VAL FASTENER MANUFACTURING	55
	DUVE GmbH & CO. KG	59
	DYNACAST	59
	DZUS FASTENER CO., INC.	59
<b>E</b>		
	EAGAN MACHINE CORP.	60
	EAST COAST METALS INC.	60
	EASTERN SCREW CO., INC.	60
	EBC INDUSTRIES (ERIE)	61
	ERIE BOLT CORP.	65
	ELASTIC STOP NUT & ESNA	61, 66, 121
	ELCO INDUSTRIES, INC.	62
	ELLIS PRECISION INDUSTRIES	62
	ENGINEERING MATERIALS CO., INC.	64
	ENOMOTO INDUSTRIES CO., LTD.	65
	ERICO FASTENING SYSTEMS	65
	ESMET, INC.	65
	NORTHBRIDGE FASTENERS	141
	R B & W CORPORATION	158-159
	VOSS INDUSTRIES, INC.	201
	SUPERIOR TECHNOLOGY	184
	EAST BAY MANUFACTURERS, INC.	60











SYMBOL	COMPANY NAME	PAGE
	EBERHARD BRUNINGHAUS	61
	ENGINEERED BOLTING PRODUCTS, INC.	63
	ELCO INDUSTRIES, INC.	62
	E.L.R. MACHINE AND TOOL	59
	EASTWOOD MFG., CO.	60
	ENGEL MANUFACTURING COMPANY, INC., THE	65
	ENGLE MANUFACTURING COMPANY, INC., THE	65
	ESSENTIAL MACHINING	66
	EXPERIMENTAL MACHINE CO.	67
	ELASTIC STOP NUT & ESNA	61, 66, 121
	EAGLE PICHER INDUSTRIES	60
	EMPIRE PRECISION MACHINING and MD3 INDUSTRIES LTD.	63, 127
	ESCO PRECISION, INC.	65
	EBC INDUSTRIES (ERIE)	61
	ERIE BOLT CORP.	65
	ECENARRO S. COOP. LTDA	61
	ELASTIC STOP NUT & ESNA	61, 66, 121
	ESTA PRODUCTS COMPANY	66
	AVIBANK MFG., INC.	23
	AVIBANK MFG., INC.	23
	ENVISION TECH, INC.	65
	ESP MANUFACTURING CO., INC	66
	SPS TECHNOLOGIES	178
	SPS TECHNOLOGIES	178
	PRECISE OF CALIFORNIA	153
<b>F</b>		
	ENGLE MANUFACTURING COMPANY, INC., THE	65
	AVIATION MANUFACTURING GROUP LLC (SEE DBA FREEMAN CO., THE)	22
	BLUE TEE CORP DBA GEFCO/ STECO	30
	FAILING CO., GEORGE E	68



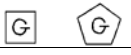



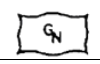

MIL-HDBK-57F (IS)  
INDEX B

SYMBOL	COMPANY NAME	PAGE
f 	FALL RIVER MANUFACTURING CO., INC.	68
<b>F F</b>	(FASSCO) FASTENER & STEEL SUPPLY CO., LTD.	69
<b>F</b>	FASTENRATH BEFESTIGUNGSTECHNIK GmbH	70
<b>F</b>	FASTI-WERK CARL AUG. FASTENRATH GMBH & CO.KG	70
<b>F</b>	FASTRON COMPANY, THE	71
	FEDERAL SCREW WORKS	71
	FENBAR PRECISION MACHINISTS, INC.	72
	FERNDALE FASTENER	72
<b>F</b>	FREEMAN CO.	75
<b>F</b>	LISI AEROSPACE	118
<b>F</b>	M & M MANUFACTURING CORPORATION	120
<b>F</b>	VISSERIES & BOULONNERIES DE FOURMIES	119
<b>F</b> <b>2F 3F 4F 5F</b>	FONTANA LUIGI S.p.A.	74
	THIANT (BOULONNERIE DE SA)	189
<b>FAH</b>	FRISBY AEROSPACE INC DE and TRIUMPH GROUP OPERATIONS INC, THE	76, 192
	FRONTIER BOLT COMPANY OF TEXAS	76
<b>FC F-C</b>	FERRY CAP & SET SCREW CO., THE	72
	FUCHS SCHRAUBENWERK GmbH	76
<b>FCI</b>	FONTAL CONTROLS, INC.	74
<b>FDC</b>	FLUIDYNE CORPORATION	74
	FABER ENTERPRISES, INC.	67
<b>FE</b>	FABSCO CORP.	68
	FLORES ENTERPRISES	73
<b>F E C</b>	FEDERAL EQUIPMENT COMPANY	71
6 0 5 8 7		

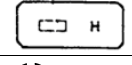







SYMBOL	COMPANY NAME	PAGE
 <b>FF</b>	FOREST FASTENERS	75
	FORMED FASTENER MANUFACTURING, INC.	75
<b>F.K</b>	VISSERIES & BOULONNERIES DE FOURMIES	199
<b>FH</b>	FOCUS HOPE	74
	FLAIG & HOMMEL	73
	FENTON HEADING	72
	FASTCO INDUSTRIES, INC.	69
	FIBAM COMPANHIA INDUSTRIAL	72
<b>FIT</b>	FASTENER INNOVATION TECHNOLOGY, INC.	69
	FLUIDONICS INC.	74
	FALCON MANUFACTURING CORP.	68
	FOLSOM TOOL & MOLD CORP.	74
<b>F M C</b>	FEDERAL MANUFACTURING CORP.	71
	TRIAD PRODUCTS CORP.	192
<b>FN</b>	AVIBANK MFG., INC.	23
<b>FNF</b>	SPS TECHNOLOGIES	178
	FASTENAL COMPANY	69
<b>FONTANA</b>	FONTANA LUIGI S.p.A.	74
	FASTENING PRODUCTS OF LANCASTER, INC.	70
<b>FPA</b>	FPA MANUFACTURING	75
	FASTENING PRODUCTS CO.,INC.	70
<b>FPIC</b>	FOREMOST PRECISION INSTRUMENT CORP.	75
<b>fr</b>	FALL RIVER MANUFACTURING CO., INC.	68
<b>F.R.</b>	FRANROE PRECISION MACHINE COMPANY	75
<b>FRIEDBERG</b>	AUGUST FRIEDBERG GmbH	21
<b>F.R.P</b>	FRANROE PRECISION MACHINE COMPANY	75

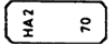
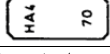











MIL-HDBK-57F (IS)  
INDEX B

SYMBOL	COMPANY NAME	PAGE
<b>FS</b>	FABRICATION SPECIALTY INC.	68
<b>F S</b>	FERRIERE DI STABIO, S.A.	72
<b>FS</b>	FLAIG & HOMMEL	73
<b>f t</b>	CAMCAR DIVISION OF TEXTRON INC.	41
<b>FT</b>	FASTENER TECHNOLOGY CORP.	70
	FUCHS SCHRAUBENWERK GmbH	76
<b>FUN</b>	FASTENERS UNLIMITED INC.	70
<b>FX</b>	FLEXALLOY INC.	7173
<b>G</b>		
<b>G</b>	EVERLOCK FASTENING SYSTEMS	67
<b>G</b>	GALAN PRECISION MACHINE CO.	77
	GALMAC MFG CO.	77
<b>G</b>	GATEWAY SCREW AND RIVET, INC.	78
	GENERAL MACHINE PRODUCTS, INC	78
	GILL MACHINE & TOOL CO.	79
<b>G</b>	GOSHO WORKS, LTD.	79
	GRACO INDUSTRIES, INC.	80
<b>G</b>	GREER STOP NUT	81
	GUARDIAN RIVET & FASTENER	83
<b>GAI</b>	GATES ALBERT INC.	78
	GARDINER MFG. CO.	77
<b>G.B.M</b>	G. B. MACHINE PRECISION, INC.	77
	STERLING MARKING PRODUCTS IC.	183
	GRAUCH ENTERPRISES	80
<b>GEBI</b> 	J. GEORG BIERBACH	99
<b>GF</b>	GRANDEUR FASTENERS, INC.	80
<b>Gf</b>	GRIPCO, DIVISION OF BLACK & DECKER	81
<b>GFM</b>	GREENFIELD MANUFACTURING CO., INC.	81
<b>G<sub>H</sub></b>	EMHART CORP.	63
<b>GII</b>	GERTLER INDUSTRIES, INC.	78
	GL CNC SERVICE INC.	79

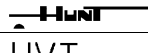
SYMBOL	COMPANY NAME	PAGE
<b>GMF</b>	GAITHER PATRICIA	77
	GMJ MACHINE COMPANY, INC.	79
<b>GMT</b>	GREATER MARYLAND TOOL & MFG., CORP.	80
	GRIPCO, DIVISION OF BLACK & DECKER	81
<b>Go</b>	GOSHO WORKS, LTD.	79
<b>Gosho</b>	GOSHO WORKS, LTD.	79
<b>G-P</b>	GROOV-PIN CORPORATION	81
<b>GPM</b>	GALAN PRECISION MACHINE CO.	77
<b>G&amp;R</b>	G & R SCREW MACHINE PRODUCTS	76
<b>GR</b>	RABOURDIN	159
	GERMAN MACHINED PRODUCTS, INC.	78
<b>GS</b>	B & B SPECIALTIES INC. and GS AEROSPACE TECHNOLOGY, INC.	23, 82
<b>G-S</b>	G & S MACHINE INC.	77
<b>GS</b>	GENERAL SCREW & SPECIALTY CO., INC.	78
<b>GSAT</b>	GS AEROSPACE TECHNOLOGY, INC.	82
<b>GSF</b>	ARMSTRONG FASTENINGS LTD.	19
<b>GSF</b>	GSF FASTENING	82
<b>GSI</b>	GS AEROSPACE TECHNOLOGY, INC.	82
	SCHRAUBENFABRIK GUSTAV STERNBERG GmbH & CO. KG	170
<b>GTT</b>	GUNNISON-INTERNATIONAL INC.	83
<b>H</b>		
<b>H</b>	BEK LEVEL 1 FASTENERS and LEVEL 1 FASTENERS	27, 114
	FUCHS SCHRAUBENWERK GmbH	76
	HAMANAKA (THAILAND) CO., LTD.	84
<b>H</b>	HASKELL OF HUNTINGTON, INC	85
<b>h</b>	HAYDON BOLTS, INC.	86
	HEMCO TOOL INC.	87
<b>H</b>	HEXAGON ENTERPRISES, INC.	87
	HILL FASTENER CORP.	88
<b>H</b>	HILTI, INC	89
<b>H</b>  	HI-SHEAR CORP. (LISI)	89
<b>H</b>	HOFFMANN, RICHARD GMBH CO. KG	90
<b>H</b>	HOLLYWOOD MANUFACTURING INC.	90













MIL-HDBK-57F (IS)  
INDEX B









SYMBOL	COMPANY NAME	PAGE
<b>H</b>	HUCK PRODUCTS	92
<b>H</b>	HUGGINS MFG.	93
<b>H</b>	HURON AUTOMATIC SCREW CO.	93
 <b>H</b>	MNP CORPORATION	134
 	FUCHS SCHRAUBENWERK GmbH	76
<b>HA</b>	HABINA ENGINEERING	84
	HARTFORD AIRCRAFT PRODUCTS, INC.	85
	HARRISON BOLT & NUT CO., THE	85
<b>HB</b>	HYDROBOLT LIMITED	93
<b>HBN</b>	MNP CORPORATION	134
<b>HBW</b>	HAWTHORNE BOLT WORKS	86
<b>HC</b>	H C MERCHANDISERS INC. and H C PACIFIC	83
<b>HCP</b>	H C MERCHANDISERS INC. and H C PACIFIC	83
 <b>HD</b>	HUGO DURHOLT GMBH & CO. KG	93
<b>HDI</b>	HARWOOD DESIGN, INC.	85
<b>HE H</b>	HORST ENGINEERING & MANUFACTURING CO.	91
<b>HEM</b>	HORST ENGINEERING & MANUFACTURING CO.	91
<b>H</b>	HILL FASTENER CORP.	88
<b>HF</b>	HYDRO FITTING MFG. CORP.	93
 <b>HHW</b>	HO HONG WORKS CO., LTD	90
	HI INDUSTRIAL TECHNOLOGIES	87
<b>HIC</b>	HALLSIMS INDUSTRIAL COMPONENTS, INC.	84
	HILL AEROSPACE & DEFENSE LLC.	88
<b>HILTI</b>	HILTI, INC	89
<b>HI PSI</b>	SPS TECHNOLOGIES	178
<b>HI TI</b>	SPS TECHNOLOGIES	178
<b>HK</b>	HO-HO-KUS, INC.	90
<b>HK HK H-K</b>	HOLO-KROME CO.	91
<b>HL</b>	HLC INDUSTRIES INC.	89
<b>HM</b>	H. MULLINS, LTD.	83
<b>hmc</b>	HOWIE MANUFACTURING CO., INC.	92
	HEIM'S MACHINE & TOOL, INC.	86
<b>HMTC</b>	HOWE MACHINE AND TOOL CORP.	92

SYMBOL	COMPANY NAME	PAGE
	CAMCAR DIVISION OF TETRAXON INC.	39-41
	H. PRINZ GmbH	83
	HENWAY, INC.	87
<b>H</b>	HIGHLAND PRODUCTS CORPORATION	88
<b>HP</b>	HOWELL PRECISION, INC.	92
<b>HP</b>	MICRO SCREW MACHINE PRODUCTS, INC.	129
<b>HPF</b>	HOUSTON PRECISION FASTENERS	91
<b>HPS</b>	HILTI, INC	89
<b>HQ</b>	HIGH QUALITY MACHINE SHOP	87
<b>HR HR</b>	HORSPOOL & ROMINE MANUFACTURING CO., INC.	91
	HARDWARE SPECIALTY CO, INC	85
<b>HS</b>	HILL STAMPING & MFG., INC.	88
<b>hs HS hs</b>	HI-SHEAR CORP.	89
<b>hs</b>	LISI AEROSPACE	117
<b>HSC</b>	HUNTER STEVENS COMPANY	93
<b>HSLG-R</b>	HILTI, INC	89
	HAMANAKA (THAILAND). CO., LTD.	84
<b>H</b>	HIGHLAND THREADS, INC.	88
<b>HT</b>	HOWARD TOOL CO., INC.	92
<b>HTC</b>	HEITCO MANUFACTURING, INC.	87
<b>HTE.</b>	HIGH TECH ENTERPRISES	88
	HATCH INDUSTRIES	86
	HUNT VALVE COMPANY, INC.	93
<b>HVI</b>	HUNTINGTON VALLEY INDUSTRIES, INC. DBA HVI	93
<b>I</b>		
 <small>Upper case</small>	EVERLOCK FASTENING SYSTEMS	67
 <small>Lower case less</small>		
<b>I</b>	ALPHA BOLT CO.	14
	IMPERIAL SUPPLIERS, INC.	94
<b>I</b>	INDUSTRIAL & AUTOMOTIVE FASTENERS	95
	INTERSTATE FITTINGS INC.	97
	PIONEER SCREW & NUT CO.	152
<b>IA</b>	INDIANA AIRCRAFT HARDWARE	94
<b>IAH</b>	INDIANA AIRCRAFT HARDWARE	94





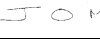















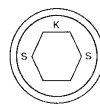

MIL-HDBK-57F (IS)  
INDEX B

SYMBOL	COMPANY NAME	PAGE
IF	IDEAL FASTENERS INC.	94
<b>F</b>	INDUSTRIAL FORGE, INC.	95
	I.G.D. MACHINE & TOOL LTD.	94
	STERLING MARKING PRODUCTS IC.	183
II	MACLEAN-FOGG CO.	126
	JUNIPER ELBOW CO.	102
III	COLOC MANUFACTURING	48
	CAMCAR DIVISION OF TETRON INC.	38-41
IM	INLAND MACHINE CO.	96
<b>IM</b>	IRVING MACHINE SERVICE, INC.	97
	INTERFLEX MFG. CORP.	97
<b>IMG</b>	IRON BOUND MANAGEMENT GROUP	97
 	INSTRUMENT MACHINING SERVICE LTD.	97
I.M.S.2		
 or <b>INC</b>	INDUSTRIAL NUT CORP.	95
ICHO	AIHARA SEIBYO CO LTD	10
	ISLAND ENGINEERING BDA J. SMITH MACHINE SHOP INC.	97
<b>IN</b>	FASTENER BROKERAGE INC.	69
<b>IN</b>	INOFAS <sup>T</sup> MANUFACTURING INC.	96
<b>INBUS</b>	BAUER & SCHAURTE KARCHER GMBH	25
	IN-SPECK CORP.	96
IT	AVIBANK MFG., INC.	23
ITC	AVIBANK MFG., INC.	23
<b>IRW</b>	IRWIN AUTOMATION, INC.	97
<b>J</b>		
<b>J</b>	AF FASTENERS LIMITED	10
 or 	B & G MANUFACTURING CO., INC.	24
<b>J</b>	HEWINS, EDMOND, C. JR DBA JET MACHINE WORKS COMPANY	87
<b>J</b>	JACOBSON MFG., LLC.	99
<b>J</b>	JJ SCREW PRODUCTS, INC.	101
<b>J</b>	JOSLYN CORP.	101
	JUPITER WASHERS, INC.	102
J2H	B & G MANUFACTURING CO., INC.	24
J4	B & G MANUFACTURING CO., INC.	24



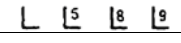





SYMBOL	COMPANY NAME	PAGE
	JACO ENGINEERING, INC.	99
<b>JB</b>	BUTLER, INC.	36
<b>B</b>	JAY BEE MACHINE WORKS, INC.	100
JB7	B & G MANUFACTURING CO., INC.	24
JB16	B & G MANUFACTURING CO., INC.	24
	DEERE & CO.	54
	JAYCO ENGINEERING, INC.	100
<b>JEA</b>	JEA ENTERPRISES, INC.	100
	JERGENS INC.	101
<b>JF</b>	ELECTRO-FREETO MANUFACTURING COMPANY	62
<b>JG</b>	J. G. FASTENERS	99
JH	JINN HER ENTERPRISE CO., LTD.	101
<b>H</b>	HASSALL, JOHN, INC.	85
<b>JI</b>	JAMISON INDUSTRIES INC.	100
JIT	JUST IN TIME, INC.	102
	JAMES JACKSON DBA J J ENGINEERING	100, 101
	B & G MANUFACTURING CO., INC.	24
	J.M. PRECISION, INC.	99
JNC	B & G MANUFACTURING CO., INC.	24
<b>JOLICO</b>	JOLICO/J-B TOOL INC	101
	JAY O MACHINE CO., INC.	100
JRB	JOHN R. BROMILEY COMPANY INC.	101
JS	B. V. FABRIEK VAN KLINKNAGELS EN SCHROEFBOUTEN V/H SMIT	25
J-S	J & S PRECISION PRODUCTS	98
<b>JT</b>	JAM TECH CORP.	100
<b>K</b>		
<b>K</b>	ADI MANUFACTURING, INC	6
	KAYNAR PRODUCTS (ALCOA FASTENING SYSTEMS)	104 12
	(Previously KAYNAR TECHNOLOGIES, INC. DIV. OF MICRODOT)	130
<b>K</b>	KATSURAGAWA MACHINE SCREW CO., LTD.	103
<b>K</b>	KAYGOR, INC.	103

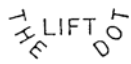







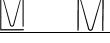









MIL-HDBK-57F (IS)  
INDEX B

SYMBOL	COMPANY NAME	PAGE
K	KEN FORGING, INC.	104
K	KILBOURN ENGINEERING CO.	105
	KEYSTONE BOLT & NUT COMPANY	105
	KEYSTONE TOOL & MACHINE CO.	105
	KNOCH MANUFACTURING CO. LTD.	106
	KOLB GMBH & CO.	106
K	KORODY COLYER CORP.	107
	KNOCH MANUFACTURING CO. LTD.	106
K	SPS TECHNOLOGIES	178
K-5673	SPS TECHNOLOGIES	178
KA	K.A.A. COMPANY	102
KAMAX	KAMAX-WERKE RUDOLF KELLERMANN GmbH & CO. KG	102
KARRO®	BAUER & SCHAURTE KARCHER GMBH	25
KDK	K.D.K. UPSET FORGING CO.	102
KE	KELLER ENGINEERING	104
K+k	K & K PRECISION ENTERPRISES	102
	KYOKUTO MFG CO LTD.	108
<b>KL</b>	KLINCHER LOCKNUT CORP.	105
KLM	K.L.M. MACHINE INC.	105
	KERR LAKESIDE INC.	104
<b>KO</b>	KO AMS MACHINE PRODUCTS	106
KP	KAPCO INDUSTRIES, INC.	103
	KIRSTEN PIPE CO. INC.	105
<b>KPP</b>	KOZAK, E. PERCISION PRODUCTS CO.	107
	KROBACH MANUFACTURING CORP.	107
	KONGO BYORA CO., LTD.	106
KNIPPING	ARNOLD KNIPPING GmbH	19
KPP	E. KOZAK PRECISION PRODUCTS CO.	54
KS	SPS TECHNOLOGIES	178





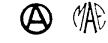





SYMBOL	COMPANY NAME	PAGE
 KSS	KSS SOCKET SCREW, INC	107
 KT	K-TECH MFG., INC.	107
	TURNAMICS, INC.	193
<b>KTI</b>	KONDOR TECHNOLOGIES, INC.	106
<b>KTM</b>	KREIS TOOL & MFG., CO., INC.	107
KX	KAMAX-WERKE RUDOLF KELLERMANN GmbH & CO. KG	102
	KYOEI SEISAKUSHO CO., LTD.	108
<b>L</b>		
<b>L</b>	CHUN YU WORKS & CO., LTD.	46
<b>L</b>	L & H THREADED RODS CORP.	108
 L	LAMSON AND SESSIONS OF CANADA LTD.	110
	LANIS MACHINE & MFG., CO.	110
<b>L</b>	LINREAD NORTHBRIDGE AIRCRAFT PRODUCT DIVISION	115
	LINREAD PUBLIC LIMITED CO.	115-116
<b>L</b>	LONE STAR FASTENERS, LP	119
<b>L L1</b>	LORD CORPORATION	119
	R B & W CORPORATION	191
<b>LL</b>	LINREAD PUBLIC LIMITED CO.	115-116
<b>LL or L<sub>L</sub></b>	LONG-LOK FASTENERS CORP.	119
<b>LAH LAH</b>	LENTERN (AIRCRAFT) LTD.	112
<b>LAM</b>	L. A. MARTIN CO.	108
<b>L B</b>  Raised letters	LANARKSHIRE BOLT LTD.	110
	L & C MANUFACTURING CO., INC.	108
<b>L</b>	LISI AEROSPACE	116-118
<b>LE</b>	LAKE ERIE SDREW CORP.	109
	LaMOTT ENTERPRISES, INC.	109
<b>LE</b>	LEP SPECIAL FASTENERS INC.	113
<b>LE</b>	LIPPISCHE EISENINDUSTRIE GmbH	116
<b>LE</b>	WOLTERS GMBH	207











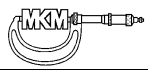

MIL-HDBK-57F (IS)  
INDEX B

SYMBOL	COMPANY NAME	PAGE
<b>LG</b>	L G MACHINE & MFG INC.	108
<b>LFC</b>	LFC INDUSTRIES INC.	114
<b>LH</b>	L H INDUSTRIES, INC.	109
<b>LI</b>	LANA INDUSTRIES	110
	TRW	193
	L & J FASTENERS, INC.	108
<b>L &amp; M</b>	L & M ENTERPRISES, INC.	108
<b>LM</b>	LEVINGSTON MACHINE COMPANY	114
<b>LMC</b>	LOUGHLIN MANUFACTURING CORP.	119
	LANUM METAL PRODUCTS, INC.	111
<b>L.M.T.</b>	LANUM METAL PRODUCTS, INC.	111
	LLOYD MACHINE & TOOL CO., INC.	118
<b>LNA</b>	L N AEROSPACE, INC.	118
<b>LOBO</b>	LOBO OFFICINE MECCANICHE SPA	118
	LOBO SYSTEMS LTD	119
<b>LONG LOK</b>	LONG-LOK FASTENERS CORP.	119
<b>L.P.R.</b>	L P R PRECISION PARTS AND TOOL COMPANY, INC.	109
<b>LRA</b>	AVIBANK MFG., INC.	23
<b>LRG</b>	L R G CORPORATION	109
<b>L.P.R.</b>	PRECISION PARTS & TOOL CO., INC.	154
	R B & W CORPORATION	158-159
<b>L-S-A</b>	CEI INC.	43
<b>L-S-A</b>	LAND-SEA-AIR MACHINED PRODUCTS, INC.	110
	LEHNER SCREW MACHINE CO	111
<b>L&lt;W&gt;M</b>	LITTLE WORLD MANUFACTURING, INC.	118
<b>M</b>		
<b>M</b>	COOPER POWER SYSTEMS INC	49
<b>M</b>	DEMAT	55
	GFD LETAGE	79
<b>M</b>	HMS SERVICES LLC	90
	KELOX/MICRODOT PRODUCTS	104
	LISI AEROSPACE	116-118
<b>M</b>	MACKO INDUSTRIES	121



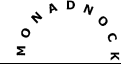







SYMBOL	COMPANY NAME	PAGE
	MAGNUS TOOL & DIE CO., INC.	122
	MEACO PRODUCTS CORP.	127
<b>M</b>	MECAERO PRODUCTS	127
	MERCURY AREOSPACE INC.	128
<b>M</b>	METALCRAFTERS	129
	METRIX MFG. CO.	129
	MI. ME. AF. S.r.l	129
	MICRODOT INC	130
	MIDWEST ACORN NUT CO.	130
	MILITARY PRODUCTS GROUP, INC.	131
	MILLIPART, INC.	131
<b>M</b>	MINEBEA CO. LTD	131
<b>M</b>	M-MANUFACTURING	133
	MNP CORPORATION	134
	MORTON MANUFACTURING	135
<b>M</b>	MRL MANUFACTURING CORP.	136
<b>M</b>	TWIST TITE MFG. INC.	193
	MACOR, INC.	122
	MIX TOOL CO.	132
	MODERN METRIC MACHINE COMPANY INC.	134
	INFASCO, INFASCO NUT and INGERSOLL FASTENERS	96
<b>MA</b>	M.A.A. CORP.	120
	MAC FASTENERS, INC.	120
	MCCULLOUGH AERO CO.	126
	ADAMS, EARL M. CO.	6
	MALLY MFG CO., INC.	122
<b>MAX</b>	MID-STATES SCREW CORP.	130
<b>MC</b>	ADI MANUFACTURING, INC	6
	MCADAMS MACHINE AND TOOL CO.	126













MIL-HDBK-57F (IS)  
INDEX B

SYMBOL	COMPANY NAME	PAGE
<b>MC</b>	MECAERO CANADA INC.	127
<b>MC</b>	MECAIR AEROSPACE INDUSTRIES	127
<b>MC</b>	METALCRAFTERS	129
<b>MC</b> 	MID CONTINENT SCREW PRODUCTS CO.	130
<b>MC</b>	WROUGHT WASHER MANUFACTURING INC.	208
	MARTIN-CHANDLER, INC.	124
<b>MCO</b>	MEACO PRODUCTS CORP.	127
 	McMELLON BROS INC.	126
<b>MD</b>	LEONARD JED CO MARYLAND BOLT AND NUT CO DIV	112-113
<b>MD</b>	MARYLAND BOLT & NUT CO., INC.	124-125
<b>..MEL-BA..</b>	MEL-BA MANUFACTURING INC.	128
<b>METRI</b>	METRIX MFG. CO.	129
<b>METRIX</b>	METRIX MFG. CO.	129
<b>MF</b>	MACLEAN-FOGG CO.	122
<b>MFI</b>	MORTON FASTENERS INC.	135
<b>MFR06320</b>	PYE & HOGAN MACHINE CO.	156
<b>MFR 1L071</b>	MIROFINE COMPANY	132
<b>MFR 27624</b>	PB FASTENERS	149
<b>MFR 29839</b>	ADVANCE PATTERN CORP	6
<b>MFR 3L665</b>	C. E. MACHINE CO., INC.	37
<b>MFR - 72905</b>	ARJAY PRECISION, INC.	18
<b>MFR 8F781</b>	STEVENS MFG. CO., INC.	183
	MANUFACTURING ENGINEERING TECH.	123
	MOSTAR GEAR & MACHINE MFG., CO.	135
<b>MI</b>	MECHANICAL & INDUSTRIAL FASTENERS	128
<b>M I</b>	MECHANICAL INDUSTRIES LLC	128
	KELOX/MICRODOT PRODUCTS	104
	MICRODOT INC.	130
<b>MIF</b> <b>MIF</b>	MECHANICAL & INDUSTRIAL FASTENERS	128
	MODFORM-ILLINOIS, INC.	134
<b>MI</b>	MONOGRAM AEROSPACE FASTENERS	135
<b>MI-TECH, INC.</b>	MI-TECH, INC.	132
	MIX TOOL CO.	132
<b>MK</b>	LISI AEROSPACE	118

SYMBOL	COMPANY NAME	PAGE
	MKM MACHINE TOOL COMPANY INC.	133
<b>ML</b>	LINREAD PUBLIC LIMITED CO.	115-116
<b>ML</b>	MCLANE MFG INC.	126
<b>MLI</b>	MACHINING LOGISTICS, INC.	120
	M.L.W. MANUFACTURING CO.	120
	MAR-BRO MFG., INC.	123
	MILE-HI MACHINE, INC.	130
	MACKSON MFG CORP.	121
<b>MMG</b>	MMG ENGINEERED COMPONENTS INC	133
<b>M</b> <b>M</b> <b>M</b>	HMS SERVICES LLC	90
	MODERN METRIC MACHINE COMPANY INC	134
	KERR, CHARLES W. and MAUI MEGA	104, 126
	MONROE MACHINED PRODUCTS, INC.	135
<b>MMS</b>	METHODS AND MACHINING SERVICES CO.	129
<b>MMT</b>	MAIN MACHINE CO INC.	123
<b>MNP</b>	MNP CORPORATION	134
	LISI AEROSPACE	118
<b>MONOGRAM</b>	MONOGRAM AEROSPACE FASTENERS	135
	MAPECO PRODUCTS, INC.	123
<b>MP</b>	MERCER PRODUCTS & MFG. CO., INC.	128
<b>MP</b>	MONTEREY MACHINE PRODUCTS	135
	UMPCO CORP.	194
<b>MR</b>	MACHINERITE CORP.	120
	MASTER RESEARCH & MFG., INC.	125
<b>MSA</b>	M.S. AEROSPACE	120
<b>MSF</b>	MIL-SPEC FASTENERS CORP.	131
	MANUFACTURING SALES AND SERVICE	123
<b>MT</b>	ALEXANDER MANUFACTURING COMPANY INC	12
<b>MT</b>	AVIBANK MFG., INC.	23

MIL-HDBK-57F (IS)  
INDEX B

SYMBOL	COMPANY NAME	PAGE
<b>MT</b>	METAL-TECH MFG. INC.	129
<b>MT</b>	METRO TOOL & MANUFACTURING CO.	129
	MASTERCRAFT TOOL COMPANY	126
	MERCURY TOOL & MACHINE, INC.	128
	MANUFACTURING TECHNOLOGY SERVICES	123
MULTI-C	CARDINAL INDUSTRIAL PRODUCTS	43
	MOTOR WHEEL CORP.	136
MW ORD		
<b>N</b>		
<b>N</b>	HANSAN SCREW CO., LTD.	84
<b>N</b>	METALCRAFTERS	129
<b>N</b>	MITSUBOSHI INDUSTRIES, LTD.	132
<b>N</b>	MONOGRAM AEROSPACE FASTENERS	135
<b>N</b>	N.S.S. INDUSTRIES	136
<b>N</b>	NAFCO INDUSTRIES, INC.	136
	NAPIER'S AUTO BODY	136
<b>N</b>	NELSON STUD WELDING DIVISION	139
<b>N</b>	NEUMAYER, ERICH GMBH	139
<b>N</b>	NISSAN SCREW CO. LTD.	140
	NOCHIA STEELWORKS	140
	NOVA MACHINE PRODUCTS CORPORATION	142
<b>N</b>	NUCOR CORP.	142
<b>N</b>	NUTS INCORPORATED	142
<b>N</b>	NUTS, INC.	142
	ONO MANUFACTURER, INC.	145
<b>NA</b>	NELSON AEROSPACE INC.	138
<b>NAC</b>	NC AUTOMATED INDUSTRIES INC.	138
<b>NB</b>	LINREAD NORTHBRIDGE	115
	NATIONAL BOLTS & RIVETS LTD.	137
<b>NB</b>	NORTHBRIDGE FASTENERS	135141
	ND INDUSTRIES	138

















SYMBOL	COMPANY NAME	PAGE
	NEVILLE MACHINE SHOP	139
<b>NE</b>	NEKG HOLDINGS	138
<b>NEDIN</b>	NEDSCHROEF	138
<b>NEDLOY</b>	NEDSCHROEF	138
<b>NEDUR</b>	NEDSCHROEF	138
	NORTHEAST METAL CO., INC.	141
	NORTHEAST FASTENERS	141
<b>NF</b>	NEVADA BOLT AND MFG CO INC.	139
<b>NF</b>	NON-FERROUS BOLT & MANUFACTURING CO.	140
<b>NFB</b>	GREER STOP NUT	81
<b>NH</b>	NEDSCHROEF	138
<b>NH</b>	NEW HORIZON MACHINE CO., INC.	139
<b>NI</b>	NAVPAR, INC.	137
<b>NK</b>	MITSUBOSHI INDUSTRIES, LTD.	132
<b>NK NK</b>	NYLOK CORP.	143
<b>NKYM</b>	MITSUBOSHI INDUSTRIES, LTD.	132
	METALCRAFTERS	129
<b>NMB</b>	MINEBEA CO. LTD	131
	NIPPON MACHINE ENGINEERING, INC.	140
<b>NMP</b>	NUMERIC MACHINE PRODUCTS	142
<b>NRS</b>	NAGOYA SCREW MANUFACTURING CO, LTD.	136
	NARRAGANSETT SCREW MFG., CO.	137
	NISCO, INC.	140
<b>NS</b>	NORTHERN SCREW CO. , INC.	141
	NASU DENKI-TEKKO CO., LTD.	137
<b>NT</b>	NATIONAL THREADED FASTENERS CORP.	137
<b>NT</b>	NT ENGINEERING, INC.	142
<b>NTF99</b>	NORTHBRIDGE FASTENERS	141
<b>NTW</b>	NASSAN TOOL WORKS, INC.	137
	NUCOR CORP.	142
<b>NYLOK</b>	NYLOK CORP.	143
<b>O</b>		
	KERR, CHARLES W. and MAUI MEGA	104, 126
	MARUYKO NUT CO., LTD.	124
	NATIONAL FASTENER CO., LTD.	137
	OBARS MACHINE & TOOL CO.	143















MIL-HDBK-57F (IS)  
INDEX B

SYMBOL	COMPANY NAME	PAGE
	OCM MACHINE COMPANY, INC.	143
	OHIO NUT & BOLT CO., THE	143
	ORANGE PRECISION PARTS	145
	SCREWCORP.	171
	VOI-SHAN PRODUCTS	201
	PAOLO ASTORI SPA	148
OAV	A. AGRATI S.P.A.	2
OB	OTT BROTHERS MACHINE CO., INC.	146
OBMC	OTT BROTHERS MACHINE CO., INC.	146
OK	OKAI IRON WORKS, INC	144
	OSTEEN MACHINE SHOP	146
	LOOS & CO., INC.	119
OP	ORANGE PRECISION PARTS	145
OPC	OTTAWA PRODUCTS CO., INC.	146
	ORDNANCE PARTS & ENGINEERING CO.	145
<b>ORC-O</b>	ORC-O TOOL & MACHINE, INC.	145
	OHKAWA SCREW MFG. CO., LTD. and OKAWA SCREW MANUFACTURING CO., LTD	144
<b>(OTC)</b>	ORLOTRONICS CORP	145
OTF	OAKTREE FASTENERS CO.	143
	<b>P</b>	
P	BELL FASTENERS	27
	BLANC AERO INDUSTRIES and LISI	29, 117
P	H. PAULIN & CO. LTD.	83
	H. PRINZ GmbH	83
	LELAND-POWELL FASTENERS, INC.	111
	LISI AEROSPACE	117
	LISI AEROSPACE	117
	OMEGA THREAD ROLLING AND GRINDING INC.	144
	PLAINVILLE MANUFACTURING CO., INC.	152
P	ORANGE PRECISION PARTS	145
	P.C.M., INC.	147
<b>P</b>	PATEREX, LTD.	148

























SYMBOL	COMPANY NAME	PAGE
<b>P</b>	PAULIN, H. & CO., LTD.	148
	PEINER UMFORMTECHNIK GmbH	149
	PENN CIGAR MACHINES INC (P.C.M INC)	149
	PERIGEE MANUFACTURING COMPANY, INC.	150
	PERKINS MACHINE CO.	150
	PIONEER SCREW & NUT CO.	152
	POLYTECHNIC INDUSTRIES	152
	PRECISION PIECE PARTS, INC.	154
P	PRESTIGE STAMPING, INC.	155
	PROTO MACHINE CO., INC.	155
	PTM INTERNATIONAL INC	156
P	PURITAS METAL PRODUCTS	156
<b>PABCOR</b>	PABCOR, INC.	147
<b>PAL</b>	PALNUT CO., THE	148
<b>PAL</b>	TRW	193
PAM	ABBOTT, PETER	3
<b>PAM</b>	PRECISION AIRCRAFT MACHINING CO., INC. DBA PAMCO	153
<b>PAMCO</b>	PRECISION AIRCRAFT MACHINING CO., INC. DBA PAMCO	153
	PRECISE AERO PRODUCTS	153
<b>PB</b>	PB FASTENERS	149
<b>PB</b>	PORTLAND BOLT & MFG., CO.	152
	UPB ENGINEERING	196
<b>PBB</b>	LISI AEROSPACE	117
	PB FASTENERS	149
<b>PBF</b>		
PC	APHEONIX CORPORATION	18
	PRODUCT DEVELOPMENT GROUP, INC.	155
<b>PE</b>	PENENGINEERING AUTOMOTIVE FASTENERS	150
	PROMPTUS ELECTRONIC HARDWARE	155
<b>PEINER</b>	PEINER UMFORMTECHNIK GmbH	149

















MIL-HDBK-57F (IS)  
INDEX B

SYMBOL	COMPANY NAME	PAGE
	PENN ENGINEERING & MANUFACTURING CO.	150
PF	PRECISION FITTINGS, INC.	153
PHP	PNEU-HYDRO PRODUCTS, INC.	152
	P & I ASSOCIATES, INC.	146
	POSIMECH, INC.	152
PIP	AVIBANK MFG., INC.	23
	KAPCO INDUSTRIES, INC.	103
	P & L ENTERPRISES	146
PM	H. PAULIN & CO. LTD.	83
PM	PAULIN, H. & CO., LTD.	148
	PRICE MANUFACTURING CO.	155
PMC	BELL FASTENERS	27
	POINT MACHINE COMPANY	152
	PRECISIONMATICS CO., INC.	154
	PRIETO MACHINE COMPANY, INC.	155
PMC	VERTEX DISTRIBUTION	198
PMI	PADGETT MACHINE INC.	147
	PEREZ MACHINE, INC.	150
PMP	PIONEER MACHINE PRODUCTS, INC.	151
PMP	PURITAS METAL PRODUCTS	156
	PRO-MACHINE & TOOL COMPANY	155
	PATTERSON LAKE PRODUCTS	148
-PPC-	PARK PRECISION CORPORATION	148
	POWERPARTS, INC.	153
PR	PINEY RIDGE CO.	151
PRD	PRD FASTENERS LTD.	153
	PRECI-MANUFACTURING, INC.	153
	H. PRINZ GmbH	83
	P.S. MACHINE CO., INC.	147
PS	PACIFIC SCIENTIFIC	147
	PEERLESS SCREW PRODUCTS	149

SYMBOL	COMPANY NAME	PAGE
	PHOENIX SPECIALTY MANUFACTURING CO., INC.	151
	PRECISION SCREW & BOLT, INC.	154
	PENN SCREW & MACHINE WORKS, INC.	150
	PRODUCTION & TOOL COMPANY	155
(a) REMOVED – NOT A MANUFACTURER	PACIFIC TOOL, INC.	147
PTI	PAINTER TOOL, INC.	148
	PRECISION TECHNOLOGIES, INC.	159
PTM	PINE TAVERN MACHINE INC.	151
PTX	PATEREX, LTD.	148
	TRW	193
<b>Q</b>		
	QSN MANUFACTURING, INC.	156
	QUALITY SCREW PRODUCTS, INC.	157
(a) REMOVED – NOT A MANUFACTURER	ALL QUALITY SPARES, INC.	13
QAS	QUALITY AIRCRAFT SCREWS, INC.	156
QB	QUALITY BOLT & SCREW CO.	156
	CELTECH ENTERPRISE	44
	QUALITY FABRICATIONS, INC.	157
	QUALITY MACHINE & MFG INC.	157
	QUALITY SOCKET SCREW MANUFACTURING CORP.	157
QT	QUALITY THREADED PRODUCTS COMPANY	157
<b>R</b>		
R	R.E.C. CORP.	159
	RAHMEDE SCHRAUBENFABRIK	160
R	RAM THREADING, INC.	160
	RAMAR NUTS, INC.	160

MIL-HDBK-57F (IS)  
INDEX B

SYMBOL	COMPANY NAME	PAGE
<b>R</b>	REPUBLIC FASTENER MANUFACTURING CORP.	162
	RINCO TECHNOLOGIES, INC.	163
	ROBBINS MANUFACTURING	164
	ROCKFORD BOLT & STEEL CO.	165
	ROCKFORD FASTENERS INC.	165
 	ROCKFORD PRODUCTS CORP.	165
	ROGG MANUFACTURING COMPANY	166
<b>R</b>	RONSON MANUFACTURING, INC.	166
    	RUMCO, INC.	167
	UNIFLOW CORP.	194
<b>R9</b>	REID PRODUCT INC.	162
<b>RAE</b>	RAE MANUFACTURING CO.	160
<b>RAM</b>	RAM PRODUCTS	160
	R. BILD COMPANY, INC	159
  	ROCKFORD BOLT & STEEL CO.	165
<b>R B</b> 	R B & W CORPORATION	158-159
	R & D FASTENERS	157
	R & D WELDING & MACHINE INC.	157
	RAMM DEFENSE PRODUCTS	161
<b>RE</b>	RAM ENTERPRISES	160
	REED INSTRUMENT CO.	162
<b>REP</b>	RIVNUT ENGINEERED PRODUCTS, INC.	164
	REXNORD	162
	ROBERT HENRY CO., INC.	165
<b>RI</b>	REXNORD	162
<b>RI</b>	ROSAN PRODUCTS	166
<b>RI</b>	RUDOLPH INSTRUMENTS, INC.	166
<b>RIBE</b>	BERGNER, RICHARD GMBH & CO.	28

SYMBOL	COMPANY NAME	PAGE
<b>R.I.E.</b>	R & I ENTERPRISES DBA COMPULOGIC DESIGN CO.	158
<b>RIPA</b>	RIPA ENGINEERING CORP	164
	R B & W CORPORATION	158-159
<b>R/M</b>	RICHARD MANNO & CO., INC.	163
	RICHARD MFG. CO., INC.	163
	RAINBOW MACHINE PRODUCTS, INC.	160
<b>RMS</b>	RMS	164
<b>Rp</b>	REID PRODUCT INC.	162
	R & R PRECISION	158
<b>RR</b>	GRUPO RASSINI S.A. de C.V.	82
<b>RS</b> 	RS MANUFACTURING, INC.	166
<b>RT</b>	AVIBANK MFG., INC.	23
	RUSCOMB TOOL & MACHNE CO., INC.	167
<b>RVT</b>	RIVER VALLEY TOOL & MANUFACTURING	164
	RA-WHITE, INC.	161
	RADAX INDUSTRIES, INC.	159
<b>S</b>		
<b>S</b>	BELL FASTENERS	27
	STELFAST, INC. (ALSO SEE CHIANG SHIN FASTENERS INDUSTRIES, LTD)	182
	CHIANG SHIN FASTENERS INDUSTRIES, LTD	45
<b>S</b>	J.P. PRODUCTS, INC.	99
	MNP CORPORATION	134
	NIPPON STEEL BOLTEN CO., LTD.	140
	S.I. STUD, INC.	168
<b>S</b>	SABRE MANUFACTURING, INC.	168
	SAI INDUSTRIES CORP. EFT 2	169
<b>S</b>	SCHUHL & CO. GMBH	170
	SALES SYSTEM, LIMITED	169
	SEMBLEX CORP.	171
	SEMCO FASTENER	171





































MIL-HDBK-57F (IS)  
INDEX B

SYMBOL	COMPANY NAME	PAGE
	SENG HENG ENGINEERING PTE LTD.	171
	SONIC INDUSTRIES, INC.	175
	SESCO INDUSTRIES, INC.	172
	SHACKELFORD MACHINIG, INC.	172
	SHEFFIELD, INC.	173
	SHIGA BOLT CO., LTD.	173
	SIERRACIN/HARRISON	174
	SKYLINE INDUSTRIES	174
	SPECIALS, INC.	177
	SPECIALTY SCREW CORP.	178
	SPS TECHNOLOGIES	178-179
	SRI SAI INDUSTRIES CORPORATION	180
	STANDARD NUT & BOLT, INC.	180
	STELFAST FASTENERS, INC.	182
	STERLING MFG. & SUPPLY, INC.	183
	SULLIVAN BOLT CO., INC.	184
	U.S. BOLT MANUFACTURING, INC.	194
	WILHELM SCHUMACHER SCHRAUBEN-FABRIK GmbH	205
	BULTEN TRADING AB	35
	SPACE AGE ENGINEERING, INC.	177
	SAFETY SOCKET LLC.0	168
	SANTA ANA GEAR & MACHINE	170
	D'SAMIC	57
	SOUTHWEST ALLIED PRODUCTS CO., INC.	176
	SOUTH BAY BOLT MANUFACTURING CO.	176
	S. B. E. (ITALY CORPORATION)	167
	SPS TECHNOLOGIES	178-179
	SHOPCO MANUFACTURING, INC.	173
	STERLING MACHINE COMPANY	182

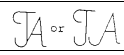













SYMBOL	COMPANY NAME	PAGE
	VOI-SHAN PRODUCTS	201
	SCANDIA MFG. CO., INC.	170
	STEEL CITY BOLT & SCREW, INC.	181
	SCOTT CRAFT CO.	171
	SPURWAY COOKE INDUSTRIES PTE LTD.	179
	CAMCAR DIVISION OF TEXTRON INC.	38-41
	SIMMONDS PRODUCTS	174
	STALKER & DYSTHE, INC.	180
	TANAKA LTD.	186
	CAMCAR DIVISION OF TEXTRON INC.	38-41
	SOUTHERN FASTENER CORPORATION	176
	SONFARREL, INC.	175
	SHAMROCK FASTENER TECHNOLOGIES, LLC	172
	SAGA TEKKOSHO CO., LTD.	169
	SHUR-LOK CORP.	173
	SIERRA PACIFIC SUPPLY CO., INC.	174
	SOUTHWEST INDUSTRIAL SERVICES	176
	SUBURBAN INDUSTRIES, INC.	184
	SHUR-KUT SUPPLY CORPORATION	173
	S & L METAL PRODUCTS CORP.	167
	SHUR-LOK COMPANY.	173
	ST. LOUIS SCREW & BOLT CO.	180
	GREER STOP NUT	81
	SPACE-LOK, INC.	177
	STANDARD LOCKNUT, INC.	180
	SAMUEL MARSDEN & SON	169
	SKY MANUFACTURING	174
	STURM MACHINE CO., INC.	184
	SATAIR MANUFACTURING FACILITY	170
	SANDIK MANUFACTURING, INC.	169















MIL-HDBK-57F (IS)  
INDEX B

SYMBOL	COMPANY NAME	PAGE
SMP	SHORELINE MACHINE PRODUCTS, INC.	173
SM&M	SMITH MACHINE & MANUFACTURING	175
	SLABE MACHINE PRODUCTS	175
SMS	SALEM MANUFACTURING AND SALES, INC.	169
southco	SOUTHCO, INC.	176
	FILETAG INTERNATIONAL	72
	SKYSPARES PARTS, INC.	174
SPG	SHAW PRECISION GRINDING ACE GRINDING & MFG. CO. OF TEXAS	172 4
SPM INC	SMALL PARTS MANUFACTURING CO., INC.	175
	SPARTAN PRECISION MACHINE	177
	STEEL PRODUCTS OF MASSILLION	181
SPS SPS	SPS TECHNOLOGIES	178-179
SPSC	SPACE SCREW, INC.	177
	MNP CORPORATION	134
	SOUTHERN FASTENING SYSTEMS	176
ST	AVIBANK MFG., INC.	23
	SWISS TECHNOLOGY, INC.	185
	SPIRAL TOOL CORP.	178
	STEADFAST CORPORATION	180
	SINN-TECH, INC.	174
	HALL INDUSTRIES INC. and STANDARD TOOL & MACHINE CO.	84, 180
STM	SPECIAL-T-METALS	177
STRUX (radial)	CAMCAR DIVISION OF TEXTRON INC.	38-41
SV	S V INDUSTRIES	185
SW	BELL FASTENERS	27
	SMITH WELDING, INC.	175
SW	STILLWATER FASTENERS, INC.	183
	SOUTHWIND INDUSTRIES, INC.	177
	<b>T</b>	

SYMBOL	COMPANY NAME	PAGE
	ARCHER SCREW PRODUCTS	18
T	BLANC AERO INDUSTRIES	29
T	ENGLE MANUFACTURING COMPANY, INC., THE	65
	LISI AEROSPACE	116-118
T	MINEBEA CO. LTD	131
	OSAKA SEIKI CO., LTD.	145
	RING SCREW WORKS	163
T	SPS TECHNOLOGIES	178-179
	T & E MACHINE CORP.	185
	TORCO, INC.	191
	TAKENAKA SEISAKUSHO CO., LTD.	186
	TECHNICAL FASTENERS, INC.	186
T	TELEFAST INDUSTRIES, INC.	187
T	TERRY MACHINE CO.	187
	TEXAS BOLT CO.	187
	TEXTRON FASTENING SYSTEMS	188
	TITAN FASTENER	190
	TOPURA CO., LTD.	190
	TOWNSEND CO.	191
	TOYO STEEL WIRE CO., LTD.	191
	TRY - AZTEC COMPANY	193
TANSEY	ARVAN, INC.	20
	TEBCO THREADED FASTENERS	186
	TEXAS BOLT CO.	187
	T-B & S MFG.	186
	SPS TECHNOLOGIES	178-179
	TERRYCABLE, INC.	187
TCQ	T C QUALITY MACHINING INC.	185
	T & E MACHINE CORP.	185

MIL-HDBK-57F (IS)  
INDEX B

SYMBOL	COMPANY NAME	PAGE
	TEK PRECISION CO., LTD.	186
<b>TELLEP</b>	SPS TECHNOLOGIES-METALAC SPS INDUSTRIA	178179
<b>TENS</b>	TENS MACHINE CO., INC.	187
	TEXAS BOLT CO.	187
TEXAS BOLT		
TF	TELEFAST INDUSTRIES, INC.	187
<b>F</b>	HI-SHEAR CORP. and TORONTO FASTENERS INDUSTRIES, INC.	89, 191
	TFI AEROSPACE CORPORATION	188
	TFP CORP.	188
	TUFF FASTENERS CO.	193
	TFI AEROSPACE CORPORATION	188
	TFP CORP.	188
<b>THE</b>	TONG HWEI ENTERPRISE CO., LTD.	190
	THIANT (BOULONNERIE DE SA)	189
<b>THOMAS</b>	THOMAS MFG, INC.	190
	THOMAS INSTRUMENT & MACHINE CO., INC.	189
	LEBRECHT TIGGES GmbH & CO. KG and SCHMICO GMBH SCHWEISSTECHNIK	111 170
<b>TJB</b>	SPS TECHNOLOGIES	178-179
<b>TKS</b>	TOKOSHA METAL WORKS LTD.	190
	TOOLEX, INC.	190
<b>TLP</b>	SPS TECHNOLOGIES	178-179
	SPS TECHNOLOGIES	178-179
	TERRY MACHINE CO.	178
	TRIDENT MACHINE CO.	192
<b>TM</b>	TRONSON MANUFACTURING	192
<b>TM9</b>	SPS TECHNOLOGIES	178-179
<b>TMC</b>	LISI AEROSPACE	116-118
	FARLO MACHINE & TOOL CO., INC.	68



















SYMBOL	COMPANY NAME	PAGE
<b>TMS</b>	MACHINE SHOP, INC., THE	120
<b>TMTI</b>	THOMAS MACHINING TECHNOLOGIES, INC.	189
	NICE TOOL MFG., INC.	139
	TOG MANUFACTURING CO., INC.	190
	OTO MELARA S.p.A.	146
<b>TORX (radial)</b>	CAMCAR DIVISION OF TEXTRON INC.	38-41
<b>TOPURA</b>	TOPURA CO., LTD.	190
<b>TP</b>	TOPURA CO., LTD.	190
	TEXAS PRECISION MFG., INC.	187
<b>TR</b>	T R MACHINE INC.	185
	TOWNE ROBINSON FASTENER CO.	191
<b>TRI</b>	TRIUMPH MANUFACTURING CO., INC.	192
<b>Tridair</b>	REXNORD	162
		
<b>TRIDAIR</b>	TRIDAIR PRODUCTS	192
	TRW	193
<b>TT</b>	TWIST TITE MFG., INC.	193
<b>TTC</b>	CAMCAR DIVISION OF TEXTRON INC.	38-41
<b>TUZ</b>	MAUDLE INDUSTRIAL CO., LTD.	126
	SUNDRAM FASTENERS, LTD.	187
	TFP CORP.	188
	LENCH, THOMAS WILLIAM, LTD.	112
<b>TYE</b>	YOUNG ENGINEERS INC, THE	209
<b>U</b>		
	OHKAWA SCREW MFG. CO., LTD. and OKAWA SCREW MANUFACTURING CO., LTD	144
	OKABE CO., INC.	144
	R B & W CORPORATION	158-159
<b>U</b>	SPS TECHNOLOGIES UNBRACO PTY LTD	178-179
<b>U</b>	UNIMETERIC CORPORATION	195
	UNITED DRILL BUSHING CORP.	195

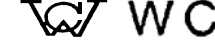













MIL-HDBK-57F (IS)  
INDEX B

SYMBOL	COMPANY NAME	PAGE
	URANIA ENGINEERING CO., INC.	196
	URBAN MANUFACTURING CO.	196
	URBAN MFG. CO. INC.	197
U130	SPS TECHNOLOGIES	178-179
UA	UPSTART ACQUISITIONS CORP. DBA BET-LAR SERVICES	196
UH	CHU HUA INDUSTRIAL CO., LTD.	46
UM	SPS TECHNOLOGIES UNBRACO PTY LTD.	178-179
UM	UNIVERSAL MACHINE PRODUCTS	196
	ULTIMATE MACHINING & WELDING	194
UNBRAKO	SPS TECHNOLOGIES	178-179
	SPS TECHNOLOGIES	179
	UNISTRUT CORP.	195
UNW	SPS TECHNOLOGIES	178-179
UP	UNITED PRECISION PRODUCTS CO., INC.	195
UPME	U.P. MACHINE & ENGINEERING CO.	194
	UNITED STATES DEFENSE RESEARCH & SUPPLY	195
	UNITED STEEL & FASTENERS INC.	196
	DOMESTIC FASTENER & FORGE, INC	57
USA 01AK		
USMC	ULTRA SONIC MACHINE CO., INC	194
	US TOOL & DIE	197
	<b>V</b>	
	AERCO RESEARCH	7
	AERO COMPONENTS CO	7
V	CHAMPION COMMERCIAL INDUSTRIES, INC.	45
	MNP CORPORATION	134
	PACER ALLOYS, INC.	147
	V-B MACHINE CO., INC.	198
V	VICO PRODUCTS, CO.	198



SYMBOL	COMPANY NAME	PAGE
	VICTOR PRODUCTS CORP.	198
	VISTEK INDUSTRIES	199
	VITCO NUCLEAR PRODUCTS INC.	199
.V.	VMC INDUSTRIES, INC.	200-201
V	VOSS INDUSTRIES, INC.	201
V. V. 304 V.	VULCAN RIVET & BOLT CORP.	202
<b>VALCOR</b>	VALCOR ENGINEERING CORP.	197
<b>VERBUS</b>	BAUER & SCHAURTE KARCHER GMBH	25
	MNP CORPORATION	134
	VALLEY FORGE AND BOLT MFG CO.	197
	VENUS FASTENERS CORP.	198
V F M	VEGAS FASTENER MANUFACTURING VIP MFG. & ENGR. CORP.	198-199
	VM MANUFACTURING CORP.	199
<b>VMC</b>	VMC INDUSTRIES, INC.	200-201
	VOSS INDUSTRIES, INC.	201
	VAN PETTY MFG., INC.	197
VS VS VS	VOI-SHAN PRODUCTS	201
<b>VS</b>	VSI	202
	VERSATECH, INC.	198
	VALLEY-TODECO	197
	<b>W</b>	
W	MEC WOLF SRL	127
	WALZ & KRENZER INC DBA MAPECO PRODUCTS	202
	WARREN PUMPS LLC	202
	WATERBURY BUCKLE CO.	202
	WAYNE BOLT & NUT CO., INC.	202
	WELTON ROLLED THREAD CORP.	203
	WESTLAND STEEL PRODUCTS, LTD.	204
	WHELAN MACHINE & TOOL CO.	205
	WHITNEY SCREW CORP.	205











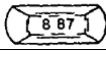

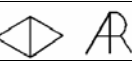

MIL-HDBK-57F (IS)  
INDEX B

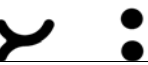
SYMBOL	COMPANY NAME	PAGE
	WIGLEY MACHINE COMPANY	205
	WILLIAM'S MACHINE & FABRICATION, INC.	205
W	WINKER HERMAN GMBH & CO. KG	206
	WITTEN COMPANY, INC.	206
	WODIN, INC.	206
	WOLTERS GMBH	207
	WROUGHT WASHER MANUFACTURING INC.	208
	WYANDOTTE INDUSTRIES, INC.	208
	WYNNSON ENTERPRISES, INC.	208
	WINSLOW AUTOMATICS, INC.	206
WB	WALKER BOLT MANUFACTURING CO., INC.	202
	WEBLUK MACHINE CORP.	203
	WEST COAST AEROSPACE, INC.	203
WEDGELOCK	MONOGRAM AEROSPACE FASTENERS	135
WESLOK	WESLOK	203
	WESTFIELD FASTENERS	204
	WILSON-GARNER CO.	206
	RATHMANN WALTER G. SEGMENT-KLAMMERSCHRAUBEN GMBH	161
	WHITTET-HIGGINS CO.	205
WH	WOLTERS GMBH	207
	WOLSTENHOLME MACHINE	207
WMI	WEAVER MANUFACTURING, INC.	203
	WIL-NIC	205
	WESTERN PACIFIC ENTERPRISES, W.P.E. INC.	204
	WESTWOOD PRECISION, INC.	204

SYMBOL	COMPANY NAME	PAGE
<i>WPP</i>	WILT PRECISION PRODUCTS	206
	CUTTING EDGE MACHINING INC. and WESTERN SCREW MACHINE PRODUCTS, INC.	51 204
WSI	WESTERN SKY INDUSTRIES, INC.	204
WSMP	WORTHEY MACHINE	208
	KAMPWERK VIEREGGE U. PICKARDT GMBH. & CO.	103
	WILHELM SCHUMACHER SCHRAUBEN-FABRIK GmbH	205
	TW DESIGN AND MANUFACTURING, L.L.C.	193
WWE	LINREAD PUBLIC LIMITED CO.	115
<b>X</b>		
	EXCEL PRECISION PRODUCT'S, INC.	67
XP	R B & W CORPORATION	158-159
<b>Y</b>		
	YOW MENGI INDUSTRIAL CO., LTD.	209
Y 2 K	Y2K MACHINE SHOP	208
	FANG SHENG SCREW CO., LTD.	68
	YATES TOOL, INC.	209
<b>Z</b>		
Z	D.S.O. PLASTICS, INC.	52
	FITZ MANUFACTURING INDUSTRIES LTD DBA FMI	73
	ZAMON CO., INC.	209
Z	ZERO PRODUCTS, INC.	209
	Z & B GENERAL MACHINE	209
ZENEX	ZENEX CORPORATION	209
	ZERO PRODUCTS, INC.	209
<b>NUMBER</b>		
	AERO-FAB, INC.	8
0F0Y2	ADVANCED MACHINING TECHNOLOGIES	7
0XK38	NORTHSTAR ENGINEERING	141
01DC	RISCO, INCORPORATED	164
	MAC FASTENERS, INC.	120

MIL-HDBK-57F (IS)  
INDEX B

SYMBOL	COMPANY NAME	PAGE
01FO	ACCUTOOL	4
01FO	SUBCON TOOL/ACCUTOOL MACHINE GROUP INC. (DBA ACCUTOOL)	184
01IG	SEMS AND SPECIALS, INC.	171
01NU	EAGLEHEAD MANUFACTURING COMPANY	60
05DT8	FITZ MANUFACTURING INDUSTRIES LTD DBA FMI	73
05141	McMELLON BROS INC.	126
09094	QRP, INC.	156
1A249	ACCURATE THREADED PRODUCTS CO.	4
1EM77	GS AEROSPACE TECHNOLOGY, INC.	82
1HEW6	SHOPCO MANUFACTURING, INC.	173
1H423	J & M MACHINE INC.	98
1st	FIRST AMERICAN SALES CO.	72
1Y128	D & D MACHINERY AND SALES	51
1YFG0	MAGNUM MACHINE SHOP	122
15077	NORTHBRIDGE FASTENERS	141
2	STERLING MACHINE COMPANY	182
2F 3F 4F 5F	FONTANA LUIGI S.p.A.	74
2A832	JMT MACHINE COMPANY	101
20733	NORTHBRIDGE FASTENERS	141
	UTAH TOOL & DIE, INC.	197
28548	FABRICATION SPECIALTY INC.	68
	3D MACHINE COMPANY, INC	1
3D531	ALAN, JEFFREY, MFG. & ENGR	12
	MODERN METRIC MACHINE COMPANY INC.	134
30633	C & H MFG., INC.	36
32219	NORTHBRIDGE FASTENERS	141
33575	J.F. FREDERICKS TOOL CO.	99
4J952	GENERAL AVIATION MFG., INC.	78
4J976	REGAL AIR, INC	162
4N133	CHATHAM PRECISION, INC.	45
4T853	D & R MACHINE COMPANY	52
5N319	INDIANA AIRCRAFT HARDWARE	94
5T572	NORTHBRIDGE FASTENERS	141
509W0	BOMBHELL, INC.	31
54878	ROTAIR INDUSTRIES, INC.	166
56878	SPS TECHNOLOGIES	178- 179
6F140	COMPONENT PRODUCTS CORPORATION	48

SYMBOL	COMPANY NAME	PAGE
	BISHOP ENTERPRISES, INC.	29
60529	STERLING MFG. & SUPPLY, INC.	183
61062	COMET MFG. CO., INC.	48
62206	B & B SPECIALTIES, INC.	23
7	HEPTNER MFG CO.	87
71838	SPS TECHNOLOGIES	178- 179
8F781	STEVENS MFG. CO., INC.	183
8M938	PRODUCTS DESIGN & MFG. CORP.	155
8T968	ROMAC ELECTRONICS, INC.	166
80539	SPS TECHNOLOGIES	178- 179
84256	AVIBANK MFG., INC.	23
	THIANT (BOULONNERIE DE SA)	189
96458	JAMES IPPOLITO & CO., INC.	100
99106	AMERICAN AIRCRAFT PARTS MANUFACTURING COMPANY	15
9R	REID PRODUCT INC.	162
SYMBOL		
	3 V FASTENERS	1
	A & G ENGINEERING CO., INC	1
	ACME RIVET & MACHINE CORP.	5
	ACRODYNE MFG CO.	5
	AEROSPACE RIVET MFG CORP	9
	ALCOA FASTENING SYSTEMS	12
	KAYNAR PRODUCTS (Previously KAYNAR TECHNOLOGIES, INC DIV. OF MICRODOT	104 130
	ALCOA GLOBAL FASTENERS INC	12
	ALCOA-KOFEM KFT	12
	ALL PINS MANUFACTURING	13
=	ALL-STATES INC.	14
	AMERITECH FASTNER MFG INC.	16
	ANCHOR BOLT & SCREW CO.	17
	ANILLO INDUSTRIES, INC.	17
	ARGARWAL INDUSTRIES	18
	ARMSTRONG FASTENING SYSTEMS	19
	ASI DESIGN & MANUFACTURING, INC.	20

MIL-HDBK-57F (IS)  
INDEX B

SYMBOL	COMPANY NAME	PAGE	SYMBOL	COMPANY NAME	PAGE
	AUTO SCREW, INC.	22		PILGRIM SCREW CORP.	151
	AVDEL INTERNATIONAL	22		GRADON SCREW MACHINE CORP.	80
	AVK INDUSTRIES PRODUCTS INC.	23		GROOV-PIN CORPORATION	81
	AVIBANK MFG., INC.	23		HANDI GADETS CORP.	84
	AZTECH ENGINEERING, INC.	23		HEARTLAND PRECISION FASTENER	86
	AZTECH LOCKNUT CO.	23		HESSISCHE SCHRAUBENFABRIK WELTER GmbH & CO., KG	87
	BAUER & SCHAURTE KARCHER GMBH	25		WELTER GMBH & CO. KG	203
	BOLLHOFF & CO. GmbH & CO. KG	30		HOUSTON FASTENER	91
	CARR CO.	43		HUCK AEROSPACE PRODUCTS HUCK INTERNATIONAL PRODUCTS	92 92
	CLEVELAND HARDWARE & FORGING and GREEN BAY DROP FORGE	47, 80		HURRICANE MACHINE COMPANY, L.L.C.	93
	CODLING TOOL & MFG. INC.	48		INDUX, S.A. DE C.E.	96
	COLD HEADING CO., THE	48		INFASCO, INFASCO NUT and INGERSOLL FASTENERS	96
	CUTTING EDGE MACHINING SOLUTIONS, INC	51		ITW CIP	98
	DAVIS AIRCRAFT PRODUCT CO., INC.	53		KOBE FASTENER LIMITED	106
	DO-ALL PRECISION, INC.	57		KOREA BOLT IND., CO., LTD.	106
	DRESSER INDUSTRIES, INC.	57		KPF	107
	EDS ORDNANCE	61		LBL PRODUCTS	111
	ELCO INDUSTRIES, INC.	62		LINREAD NORTHBRIDGE AIRCRAFT PRODUCT DIVISION	115
	GEN FAST MANUFACTURING COMPANY	78		LISI AEROSPACE	116-118
	STELCO FASTENER & FORGING CO.	181-182		MACK, A. W. MFG CO.	121
	EMHART CORP.	63		MINEBEA CO. LTD	131
	FRIEDR BOESNER GMBH	75		MNP CORPORATION	134
	FENTON HEADING	72		NAGOYA SCREW MANUFACTURING CO, LTD.	136
	FERNDALE FASTENER	72		NCMI BRUEGGEMANN INC.	138
	FISCHER SPECIAL MFG. CO.	73		ONEIDA TOOL & MACHINE CORP.	144
	FOREST FASTENERS	75		PAOLO ASTORI SPA	148
	GMP CO. CORPORATION	79			











MIL-HDBK-57F (IS)  
INDEX B

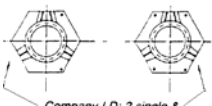



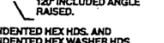

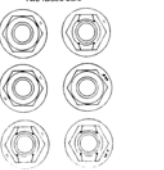
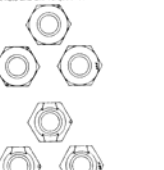

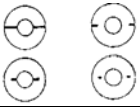
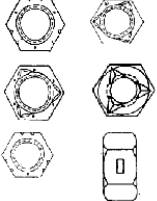

SYMBOL	COMPANY NAME	PAGE
	PELHAM AUTO MATRIX PRECISION	149
	PINTO PRODUCTS	151
	PRECISION METAL PRODUCTS CO.	154
	PREM INDUSTRIES, INC.	154
	RELIANT FASTENER	162
	REXNORD	162
	TRIDAIR PRODUCTS	192
	RING SCREW WORKS	163
	ROBBINS MANUFACTURING	164
Rubber stamped on fasteners	ROTAIR INDUSTRIES, INC.	166
	SANNOHASHI SEISAKUSHO CO., LTD.	169
	SANTA ANA SCREW PRODUCTS INC	170
	SATURN FASTENERS, INC.	170
	SET SCREW & MFG. CO.	172
	SHAMROCK FASTENER TECHNOLOGIES, LLC.	172
	SPS TECHNOLOGIES	178-
	METALAC INDUSTRIA	179
	STELFAST FASTENERS, INC.	182
	STILLWATER FASTENERS, INC.	183
	STRENKERT MACHINE SHOP INC.	183
	SUNRISE PRECISION MFG.	184
	SUPERIOR TECHNOLOGY	184
	SUPREME SCREW PRODUCTS, INC.	184
	TAIYO NUT MFG. CO., LTD.	185
	TECH WELDING AND MACHINE CO.	186
	TENS MACHINE CO., INC.	187
	TFI AEROSPACE CORPORATION	188

SYMBOL	COMPANY NAME	PAGE
	TOPURA CO., LTD.	190
	TOPURA CO., LTD.	190
	TRI STATE TOOL & DIE CO.	192
	UNITED BOLT & SCREW CORP.	195
	UNITED STEEL & FASTENERS INC.	196
	WHAIL BOLT IND. CO., LTD	204
	XCEL MFG., INC.	208
• (a dot)	CINCH-MONADNOCK	47
• (a dot) - (radial line)	DECKER MANUFACTURING CORP	53
• (a dot)	MONADNOCK COMPANY, THE	134
•• (2 dots)	BELL FASTENERS	27
•• (2 dots)	BRISTOL INDUSTRIES	33
	CUTTING EDGE ENENTERPRISE, LLC	51
•• (2 dots)	NORTH EAST FASTENERS	141
•• (2 dots)	STILLWATER FASTENERS, INC.	183
	CSM FASTENER PRODUCTS	51
	EMP MANUFACTURING CO.	63
	ERICO FASTENING SYSTEMS	65
	WOLVERINE NUT CO.	207
3 dots, centered on corner, equally spaced		
••••	CAMCAR DIVISION OF TEXTRON INC.	38-41
4 dots inline or radial	CAMCAR LLC	41
//	BRISTOL LOCKNUT CO.	33
	CAMCAR DIVISION OF TEXTRON INC.	38-41
	METALCRAFTERS	129
= 2 parallel lines	CAMCAR DIVISION OF TEXTRON INC.	38-41
	MICRODOT INC.	130
Three parallel lines spirals insert products only	AMERIFAST CORP.	16



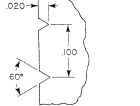

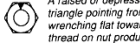

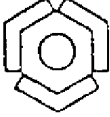
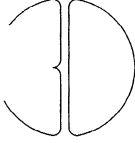

MIL-HDBK-57F (IS)  
INDEX B

SYMBOL	COMPANY NAME	PAGE
 <i>Manufacturer identification: 2 raised ribs in (2) crimp depressions 1 raised rib in (1) crimp depression</i>	GREER STOP NUT	81
"Dimple" trademark 	PENN ENGINEERING & MANUFACTURING CO.	150
Notches or Stakes cut into corners of nut	EVERLOCK FASTENING SYSTEMS	67
2, 3, or 6 dots on corner of nut 4 or 6 dots on flange of flange nuts	FEDERAL SCREW WORKS	71
 <i>Company I.D.: 2 single &amp; 1 double slash</i>	INDUSTRIAL & AUTOMOTIVE FASTENERS	95
Dots, slashes, and dots with slashes 2 - 8	R B & W CORPORATION	158-159
Dots, slashes, and dots with slashes 2 - 8	STELCO FASTENER & FORGING CO.	181-182
 <i>Raised or indented marks Under head Top of head Slotted hexhead (top of head)</i>	INDUSTRIAL FASTENERS CORP.	95
	LAMSON AND SESSIONS OF CANADA LTD.	110
4 - 7 DOTS		
	INDUSTRIAL NUT CORP.	95
3, 4 or 6 equally spaced stakes		
 <i>120° INCLUDED ANGLE RAISED. INDENTED HEX HDS. AND INDENTED HEX WASHER HDS.</i>	LEWIS SREW COMPANY	114
 <i>3/8" MARKS 120° APART RAISED UNDER HEAD UPON REQUEST "NON-COUNTERMARK HEADS ONLY"</i>	LEWIS SREW COMPANY	114
 <i>Flange nuts into lock and with Live-Tongue® lock Two raised bars</i>	MACLEAN-FOGG CO.	122
TWO RAISED BARS		
Three raised or depressed lines	THIANT (BOULONNERIE DE SA)	189
 <i>Hex nuts and Live-Tongue® locknuts</i>	MACLEAN-FOGG CO.	122
 <i>RAISED LOCK WIRE DENT</i>	PACIFIC FASTENERS, INC.	147

SYMBOL	COMPANY NAME	PAGE
	TEXTRON FASTENING SYSTEMS	188
 Two lines in three pads	VMC INDUSTRIES, INC.	200-201
	ELCO INDUSTRIES, INC.	62
	GRIPCO, DIVISION OF BLACK & DECKER	81
 <i>Appearance: Round Central hole: 1/8" Half moon shape 100-100M</i>	RAMCO SPECIALTIES, INC.	161
 <i>Notch: 90° Notch made 90° deep</i>	RIPPA PRODUCTS	164
 2 notches for slotted heads only	SOUTHERN FASTENING SYSTEMS	176
 <i>60°</i>	WOLVERINE MACHINE PRODUCTS CO.	207
 <i>Straight knurls with an unknurled band adjacent to the bearing surface on socket heads. The diameter over the straight knurl does not exceed the band. There may be 2 or 3 grooves.</i>	SPS TECHNOLOGIES	178-179
 <i>A raised or depressed triangle pointing from the wrenching flat toward thread on nut products.</i>	SPS TECHNOLOGIES	178-179
Blue nylon insert	INDUSTRIAL NUT CORP.	95
Blue nylon locking element	NYLOK CORP.	143
Blue - nylon® hexagon locking element	PENN ENGINEERING & MANUFACTURING CO.	150
		
Square insert in floating fasteners	PENN ENGINEERING & MANUFACTURING CO.	150
Green nylon insert	GREER STOP NUT	81
Green nylon insert	EVERLOCK FASTENING SYSTEMS	67
Orange nylon insert	AZTECH LOCKNUT CO.	23
Red nylon insert	ELASTIC STOP NUT & ESNA	61, 122
Tan nylon insert	VMC INDUSTRIES, INC.	200-201
Yellow nylon insert	ABBOTT INTERFAST CORP.	2

## MIL-HDBK-57F (IS)

<p>3 V FASTENERS 320 REED CIRCLE CORONA, CA 92879-1349</p>  <p>CAGE code: 1ER65 <span style="float: right;"><u>1/</u></span></p>	<p>A &amp; M AEROSPACE, INC. 2332 SOUTH DELAWARE DENVER, CO 80223-4321</p> <p>A      <u>A</u> &amp;      M      A/M      A&amp;M M</p> <p>CAGE code: 6Z800 <span style="float: right;"><u>1/</u></span></p>
<p>3D MACHINE COMPANY, INC. 5586 EAST LA PALMA AVENUE ANAHEIM, CA 92807-2108</p>  <p>CAGE code: 1K6P6 <span style="float: right;"><u>2/</u></span></p>	<p>A &amp; N PRECISION INDUSTRIES 65 FIRST STREET NEW ROCHVILLE, NY 10801-6118</p>  <p>CAGE code: 9Y423 <span style="float: right;"><u>2/</u></span></p>
<p>A &amp; E MACHINED PRODUCTS 93 PECK HILL ROAD JOHNSTON, RI 02919</p>  <p>CAGE code: 3MAH6 <span style="float: right;"><u>2/</u></span></p>	<p>A &amp; R MFG CORP. 1281 JOHN FITCH BLVD. SOUTH WINDSOR, CT 06074</p>  <p>CAGE code: 3X841 <span style="float: right;"><u>2/</u></span></p>
<p>A &amp; G ENGINEERING CO., INC 4640 EAST LAPALMA ANAHEIM, CA 92807</p>  <p>CAGE code: 4N135 <span style="float: right;"><u>2/</u></span></p>	<p>A &amp; S PIN PRODUCTS INC. 42 LAGRANGE ST. WORCESTER, MA 01610</p>  <p>CAGE code: 39YG0 <span style="float: right;"><u>1/</u></span></p>
	<p>A &amp; W SCREW MACHINE PRODUCTS, INC. 3131 KANSAS AVE RIVERSIDE, CA 92507</p>  <p>CAGE code: 63035 <span style="float: right;"><u>1/</u></span></p>

1/ Information published in this revision was verified by direct contact with manufacturers.

2/ Information not verified to be current, no response from manufacturer. Information identical to that published in MIL-HDBK-57, Revision B.

## MIL-HDBK-57F (IS)

A. AGRATI S.P.A.  
VIA PAIVE 28/30  
20050 VEDUGGIO CON COLZANO  
MILANO, ITALY

Plant  
AGRATI CORP.  
925 Brewster Street  
Bridgeport, CT 06605

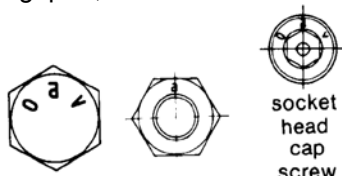

socket  
head  
cap  
screw

CAGE code: A0698

2/

A.M.I ENGINEERING CO.  
2904 OAK ST.  
SANTA ANA, CA 92707

**AMI LOGO**

CAGE code: 4WDB5

1/

A. P. MILLS INDUSTRIES FOR  
THE BLIND  
346 ST. PAUL AVE.  
P.O. BOX 2175  
MEMPHIS, TN 38101

(See WEST TENNESSEE LIONS BLIND INDUSTRIES  
INC.)

**APMI**

CAGE code: 5L565

2/

A-1 NUT AND BOLT CO, INC  
DIVISION OF GREEN CO. PACIFIC INC.  
3433 S. MALT AVENUE  
COMMERCE, CA 90040

**A 1**

CAGE code: 1M493

2/

A-1 THREAD ROLLING CO., INC.  
4933 MASON ST.  
SOUTH GATE, CA 90280

**A-1**

CAGE code: 3N586

2/

AAP ACQUISITION CORP  
2100 ENTERPRISE PKWY  
TWINSBURG, OH 44087-2212

(SEE ACHILLES AEROSPACE PRODUCTS)

**A**

CAGE code: 0H380

2/

AASTRO ENGINEERING  
1382 CORONADO AVE  
LONG BEACH, CA 90804

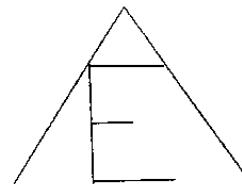

CAGE code: 01AL8

2/

ABBOTT INTERFAST CORP.  
190 ABBOTT DRIVE  
WHEELING, IL 60090

Yellow nylon insert identifies Abbott-Interfast  
Corp.  
as manufacturer

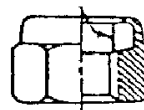

CAGE code: 08928

1/

1/ Information published in this revision was verified by direct contact with manufacturers.

2/ Information not verified to be current, no response from manufacturer. Information identical to that published in MIL-HDBK-57, Revision B.

## MIL-HDBK-57F (IS)

<p>ABBOTT, PETER (AEROSPACE) 1982 LTD. 6 REPTON CLOSE BURNT MILLS, BASILDON, ESSEX SS13 ILE UNITED KINGDOM</p> <p style="text-align: center;"><b>PAM</b> <b>PAM</b> <b>PAM</b></p> <p>CAGE code: 0WL73 <span style="float: right;">2/</span></p>	<p>ACCUFORM, INC. P.O. BOX 307 BUS. HWY. 36 WEST MACON, MO 63552</p> <p style="text-align: center;"><b>AF</b>      <b>AF</b></p> <p>CAGE code: <span style="float: right;">2/</span></p>
<p>ABC TOOL AND DIE ENGINEERING &amp; MANUFACTURING LLC 197 WALLIS STREET UNIT C EUGENE, OR 97402-5301</p> <p style="text-align: center;">No artwork for marking. Marks whatever the customer specifies.</p> <p>CAGE code: 0XJF0 <span style="float: right;">1/</span></p>	<p>ACCURATE AUTOMATIC PARTS CO. 2885 S. 163RD ST. NEW BERLIN, WI 53151</p> <p style="text-align: center;"><b>AP</b></p> <p>CAGE code: 5S202 <span style="float: right;">2/</span></p>
<p>ABRASIVE CUTTING CORP 633 COMMERCE ST. THORNWOOD, NY 10594</p> <p style="text-align: center;"></p> <p>CAGE code: 5DQB3 <span style="float: right;">1/</span></p>	<p>ACCURATE PRECISION FATSENER, INC. P.O. BOX 5239 ENGLEWOOD, NJ 07631</p> <p style="text-align: center;">Plant 20 HONECK ST. ENGLEWOOD, NJ 07631</p> <p style="text-align: center;"><b>A</b></p> <p>CAGE code: 28977 <span style="float: right;">2/</span></p>
<p>ABSCOA INDUSTRIES 1071 WEST ARBOR VITAE ST. INGLEWOOD, CA 90301</p> <p style="text-align: center;"><b>AB</b></p> <p>CAGE code: <span style="float: right;">2/</span></p>	<p>ACCURATE SCREW MACHINE CO. (DBA ASM) P.O. 10095 10 AUDREY PL FAIRFIELD, NJ 07004-3402</p> <p style="text-align: center;">Plant 19 Baltimore St. Nutley, NJ 07110</p> <p style="text-align: center;"><b>AMSCO</b> 5/16 LONG X 1/16 HIGH X .010 DEEP</p> <p>CAGE code: 51506 <span style="float: right;">2/</span></p>

1/ Information published in this revision was verified by direct contact with manufacturers.

2/ Information not verified to be current, no response from manufacturer. Information identical to that published in MIL-HDBK-57, Revision B.

## MIL-HDBK-57F (IS)

ACCURATE THREADED FASTENERS, INC.  
DIVISION OF BEATRICE FOODS CO.  
(new company name see ATF, INC.)  
3550 WEST PRATT AVE  
LINCOLNWOOD, IL 60645

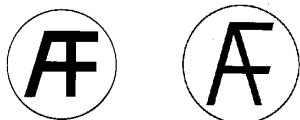

CAGE code: 95110 1/

ACCURATE THREADED PRODUCTS CO.  
280 HARTFORD AVENUE  
NEWINGTON, CT 06111

**1A249**

CAGE code: 1A249 2/

ACCURATE TOOL CO., INC.  
891 FERNHILL RD  
WEST CHESTER, PA 19380 - 4282

**A+**

CAGE code: 7N957 1/

ACCU-TECH MANUFACTURING AND  
SUPPORT, INC.  
8875 EAST AVENUE  
MENTOR, OH 44060

**Accu-TECH**  
MFG. & SUPPORT INC.

CAGE code: 1LLG8 2/

ACCUTOOL  
(SUBCON TOOL/ACCUTOOL MACHINE  
GROUP INC. DBA ACCUTOOL)  
SEE SUBCON TOOL  
5301 IROQUOIS AVENUE  
ERIE, PA 16511-2529

**01FO**

CAGE code: 1UXM0 1/

ACCUTURN CORPORATION  
6510 BOX SPRINGS BLVD., UNIT A  
RIVERSIDE, CA 92507



CAGE code: 1XYA5 1/

ACE GRINDING & MFG. OF TEXAS  
(formally ACE G & M CO. OF TEXAS)  
2610 AERO DR.  
GRAND PAIRIE, TX 75052

**AGC**

*Plant (plant closed)*  
ACE GRINDING & MFG.  
4937 EAST SLAUSON AVENUE  
MAYWOOD, CA 90270  
CAGE code: 2N509

**AGM**

Plant (see SHAW PRECISION GRINDING  
AND THREAD ROLLING)  
SHAW PRECISION GRINDING  
6503 W. FRYE RD.  
CHANDLER, AZ 85226







**SPG**

CAGE code: 5U074 1/

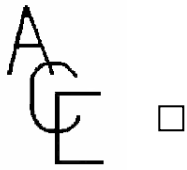
1/ Information published in this revision was verified by direct contact with manufacturers.

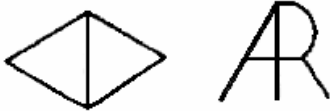
2/ Information not verified to be current, no response from manufacturer. Information identical to that published in MIL-HDBK-57, Revision B.

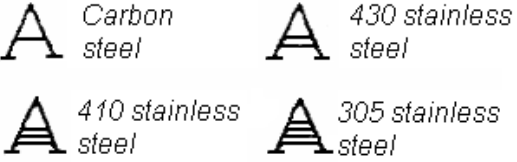



## MIL-HDBK-57F (IS)

<p>ACE PRECISION INDUSTRIES, INC. 925 MOE DRIVE AKRON, OH 44310-2518</p>  <p>CAGE code: 3DTZ2 <span style="float: right;"><u>2/</u></span></p>	<p>ACME MACHINE PRODUCTS 500 SOUTH VARNEY STREET BURBANK, CA 91502</p>  <p>CAGE code: 4M256 <span style="float: right;"><u>2/</u></span></p>
<p>ACHILLES AEROSPACE PRODUCTS, INC. 2100 ENTERPRISE PKWY TWINSBURG, OH 44087-2212</p> <p>(SEE AAP)</p>  <p>CAGE code: 0H380 <span style="float: right;"><u>2/</u></span></p>	<p>ACME RIVET &amp; MACHINE CORP. 50 EMMETT ST. BRISTOL, CT 06010</p>  <p>CAGE code: 34482 <span style="float: right;"><u>2/</u></span></p>
<p>ACI 301 W. WILSON P.O. BOX 398 OTTAWA, KS 66067</p>  <p>CAGE code: 0AV61 <span style="float: right;"><u>2/</u></span></p>	<p>ACME SCREW COMPANY 1201 W. UNION AVE WHEATON, IL 60187-4879</p>  <p>CAGE code: 35EX5 <span style="float: right;"><u>2/</u></span></p>
<p>ACIMET MFG. 1710 CLARKSTONE RD. CLEVELAND, OH 44112</p>  <p>CAGE code: 6V869 <span style="float: right;"><u>2/</u></span></p>	<p>ACRODYNE MFG CO. 41 KINGSTON AVE COLUMBUS, OH 43207-2438</p>  <p>CAGE code: 9Y179 <span style="float: right;"><u>1/</u></span></p>

1/ Information published in this revision was verified by direct contact with manufacturers.

2/ Information not verified to be current, no response from manufacturer. Information identical to that published in MIL-HDBK-57, Revision B.

## MIL-HDBK-57F (IS)

<p>ACUFAST AIRCRAFT PRODUCTS 12424 GLADSTONE AVE. SYLMAR, CA 91342</p> <p style="text-align: center;"><b>AF</b></p> <p>CAGE code: 4GP55 <span style="float: right;"><u>1/</u></span></p>	<p>ADJUSTABLE BUSHING CORP. 8330 LANKERSHIM BLVD. NORTH HOLLYWOOD, CA 91605</p> <div style="display: flex; justify-content: space-around; align-items: center;">   </div> <p style="display: flex; justify-content: space-around; font-size: small;"> <span>Panel fastener</span> <span>Quick-acting pins</span> </p> <p>CAGE code: 3V407 <span style="float: right;"><u>2/</u></span></p>
<p>ADAMS INDUSTRIES, INC. (A SUB OF BANNER INDUSTRIES INC.) 1160 SOUTH ST WINDSOR LOCKS, CT 06096</p> <p style="text-align: center;"><b>ABE</b></p> <p>CAGE code: 33823 <span style="float: right;"><u>2/</u></span></p>	<p>ADOM ENGINEERING 131 AVCO ROAD HAVERHILL, MA 01835-5956</p> <div style="display: flex; justify-content: space-around; align-items: center;"> <p style="font-size: 2em;"><b>AD</b></p> <p style="font-size: 2em;"><i>adm</i></p> </div> <p style="text-align: center; font-size: small;">(used formerly)</p> <p>CAGE code: 02GZ1 <span style="float: right;"><u>1/</u></span></p>
<p>ADAMS, EARL M. CO. 100 PECK HILL RD. JOHNSTON, RI 02919</p> <div style="display: flex; justify-content: center; gap: 20px;">   </div> <p>CAGE code: 07123 <span style="float: right;"><u>2/</u></span></p>	<p>ADVANCE PATTERN CORP. 18564 FITZPATRICK DETROIT, MI 48228</p> <p style="text-align: center; font-size: 1.5em;"><b>MFR 29839</b></p> <p>CAGE code: 29839 <span style="float: right;"><u>2/</u></span></p>
<p>ADC COMMUNICATIONS CORP. 17528 STUDEBAKER RD. CERRITOS, CA 90703-2637</p> <div style="display: flex; justify-content: center; gap: 20px;"> <p style="font-size: 1.5em;"><b>adc</b></p>  </div> <p>CAGE code: 9X383 <span style="float: right;"><u>2/</u></span></p>	<p>ADVANCED CNC MANUFACTURING 7303 124TH AVENUE NORTH LARGO, FL 33773</p> <p style="text-align: center; font-size: 2em;"><b>A</b></p> <p>CAGE code: 1YDC9 <span style="float: right;"><u>1/</u></span></p>
<p>ADI MANUFACTURING, INC. 33 HAMMOND, BLDG 201 IRVINE, CA 92718</p> <p style="text-align: center; font-size: small;">Plant 1243 TRANSIT STREET POMONA, CA 91766</p> <div style="display: flex; justify-content: space-around; font-size: 2em;"> <p><b>MC</b></p> <p><b>K</b></p> </div> <p>CAGE code: 0YCU4 <span style="float: right;"><u>2/</u></span></p>	<p>ADVANCED MACHINING &amp; FABRICATING, INC. 11212 E. 112TH ST. N. OWASSO, OK 74055-5421</p> <p style="text-align: center; font-size: 2em;"><i>a</i></p> <p>CAGE code: 0BD96 <span style="float: right;"><u>1/</u></span></p>

1/ Information published in this revision was verified by direct contact with manufacturers.

2/ Information not verified to be current, no response from manufacturer. Information identical to that published in MIL-HDBK-57, Revision B.

## MIL-HDBK-57F (IS)

ADVANCED MACHINING & TOOLING, INC.  
13535 DANIELSON ST.  
POWAY, CA 92064

**AMT**

CAGE code: 1N6C7 1/

ADVANCED MACHINING TECHNOLOGIES  
PO BOX 3351  
WARMINISTER, PA 18974

Plant  
220 JACKSONVILLE RD.  
HATBORO, PA 19040

**OF0Y2**

CAGE code: OF0Y2 1/

ADVANCED PLASTICS, INC.  
DBA ADVANCED MACHINING &  
FABRICATING, INC.  
11212 E. 112<sup>th</sup> ST. N.  
OWASSA, OK 74055-5421

**ap  
a**

CAGE code: 45339 1/

AERCO RESEARCH  
295 OLD COUNTRY ROAD  
SUITE 10  
SAN CARLOS, CA 94070-6240

**V**

CAGE code: 0KMN9 1/

AERO & AUTO STUD SPEC.  
P.O. BOX 140  
NEW HUDSON, MI 48165  
Plant  
56000 GRAND RIVER  
NEW HUDSON, MI 48165

Studs **A**

Bolts **A** or **A** & **A**

CAGE code: 5DN08 1/

AERO BUSHING AND COMPONENT  
15201 PIPELINE LN.  
HUNTINGTON BEACH, CA 92649

**Aero**

CAGE code: 2/

AERO COMPONENTS CO.  
5124 KALTENBRUN RD.  
FORT WORTH 76119 - 6400

**✓**

CAGE code: 59213 2/

AERO DYNAMIC MACHINING, INC.  
11791 MONARCH STREET  
GARDEN GROVE, CA 92841-1818

**ADM**

CAGE code: 1KSM2 2/

1/ Information published in this revision was verified by direct contact with manufacturers.

2/ Information not verified to be current, no response from manufacturer. Information identical to that published in MIL-HDBK-57, Revision B.



## MIL-HDBK-57F (IS)

AERO ENGINEERING AND  
MANUFACTURING CO. OF CALIFORNIA  
(DBA AERO ENGINEERING)  
28217 AVENUE CROCKER  
VALENCIA, CA 91355-1249



CAGE code: 17772

1/

AERO MECHANICAL FASTENING  
SYSTEMS  
15481 WEST 110TH AVE  
SHAWNEE MISSION, KS 66219



CAGE code: 1FY45

2/

AEROBOLT MANUFACTURING, INC.  
4736 FELSPAR STREET  
RIVERSIDE, CA 92509-3068

**ABM**

CAGE code: 08PH2

2/

AERO-FAB, INC.  
8420 RED OAK STREET  
RANCHO CUCAMONGA, CA 91730



CAGE code: 0CAC0

2/

AEROFAST SUPPLY  
405 W 20TH ST  
SAN PEDRO, CA 90731

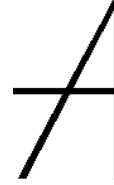

CAGE code: 2T830

2/

AEROMAX INDUSTRIES, INC.  
DBA AEROMAX INTERNATIONAL  
9546 TOPANGA CANYON BLVD.  
CHATSWORTH, CA 91311-4011

**AX**

CAGE code: 40581

1/

AEROSPACE MANUFACTURING  
P.O. BOX 3398  
WALLINGTON, NJ 07057-1148

Plant  
80 VAN WINKLE AVE.  
WALLINGTON, NJ 07057-1148

**AM**

CAGE code: 0E0Z8

1/

1/ Information published in this revision was verified by direct contact with manufacturers.

2/ Information not verified to be current, no response from manufacturer. Information identical to that published in MIL-HDBK-57, Revision B.

## MIL-HDBK-57F (IS)

AEROSPACE MARINE SPECIALTY  
FASTENERS & FITTINGS INC. DBA AMS  
FASTENERS  
1645 WEST 135ND STREET  
GARDENA, CA 90249-2505

**AMS** **A M S**

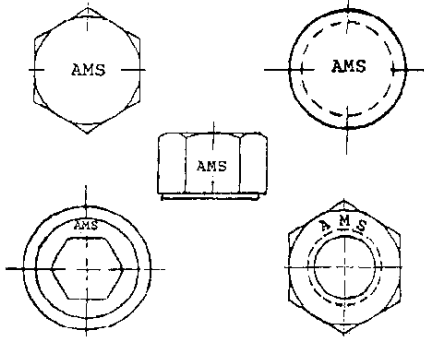

CAGE code: 1FGH9

2/

AEROSPACE PRODUCTS  
(DIV OF APCOA FASTENERS, INC)  
903 E. OHIO STREET  
P. O. BOX 796  
INDIANAPOLIS, IN 46202

**APCO**

CAGE code: 17140

2/

AEROSPACE PRODUCTS CO. DIV WBH  
(FORMERLY APCOA FASTENERS, INC.)  
P.O. BOX 796  
INDIANAPOLIS, IN 46206-0796

Plant  
123 NORTH PINE STREET  
INDIANAPOLIS, IN 46202-3844

**AP**

CAGE code: 59736

1/

AEROSPACE PRODUCTS, INC.  
5435 PERKINS RD.  
BEDFORD HEIGHTS, OH 44146

**A**

CAGE code:

2/

AEROSPACE RIVET MFG CORP  
8535 DICE ROAD  
SANTA FE SPRINGS, CA 90670



CAGE code: 64728

2/

AEROSTAR ENGINEERING &  
MANUFACTURING COMPANY  
25514 S. FRAMPTON AVENUE  
HARBOR CITY, CA 90710-2907



No longer a fastener manufacturer

CAGE code: 0MXJ2

2/

AEROSTAR FASTENER CORP.  
712 W LACY ST  
P.O. BOX 2201  
PALESTINE, TX 75802









CAGE code: 0T218

2/

1/ Information published in this revision was verified by direct contact with manufacturers.

2/ Information not verified to be current, no response from manufacturer. Information identical to that published in MIL-HDBK-57, Revision B.

## MIL-HDBK-57F (IS)

<p>AEROTECH FASTENERS, INC. ONE RIDGE ROAD PUTNAM, CT 06260</p>  <p>CAGE code: 0TD46 <span style="float: right;"><u>1/</u></span></p>	<p>AFI INDUSTRIES, INC. 475 E. KEHOE BLVD CAROL STREAM, IL 60188</p>  <p>CAGE code: 33PQ1 <span style="float: right;"><u>1/</u></span></p>
<p>AEROWIND CORPORATION 1959 JOHN TOWERS AVENUE EL CAJON, CA 92020-1117</p>  <p>CAGE code: 1N021 <span style="float: right;"><u>1/</u></span></p>	<p>AIHARA SEIBYO CO LTD 2084 SHIN-MACHI TANO-GUN, GUNMA, JAPAN 370-13</p> <p style="text-align: center;"><b>ICHO</b></p> <p>CAGE code: <span style="float: right;"><u>2/</u></span></p>
<p>AF FASTENERS LIMITED UNIT 14 &amp; 15 GLOSSOP BROOK BUSINESS PARK, GLOSSOP, DERBYSHIRE SK13 7AJ, UNITED KINGDOM</p>  <p>CAGE code: <span style="float: right;"><u>1/</u></span></p>	<p>AIR INDUSTRIES CORPORATION 12570 KNOTT STREET GARDEN GROVE, CA 92841-3932</p>  <p>CAGE code: 06725 <span style="float: right;"><u>1/</u></span></p>
<p>AFAB PRECISION MACHINING 20742 LINEAR LANE LAKE FOREST, CA 92630</p>  <p>CAGE code: 1GSW1 <span style="float: right;"><u>2/</u></span></p>	<p>AIR PARTS MFG. CO. 1117 HARRISON AVE ARLINGTON, TX 76011</p>  <p>CAGE code: 8R401 <span style="float: right;"><u>2/</u></span></p>

1/ Information published in this revision was verified by direct contact with manufacturers.

2/ Information not verified to be current, no response from manufacturer. Information identical to that published in MIL-HDBK-57, Revision B.

MIL-HDBK-57F (IS)

AIR-COM, INC.  
18105 S. HOBART BLVD.  
GARDENA, CA 90248-3617



CAGE code: 2Y870 2/

AIRFASCO, INC.  
2655 HARRISON AVE SW.  
CANTON, OH 44706-3047

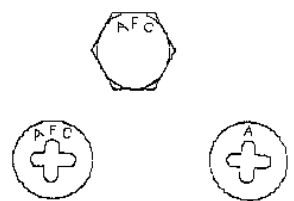

CAGE code: 3Z958 2/

AIRCRAFT ENGINEERING PRODUCTS, INC.  
2 ACKERMAN AVENUE  
CLIFTON, NJ 07011



CAGE code: 2/

AIRFASCO INDUSTRIES FASTENER GROUP  
2655 HARRISON AVE.  
CANTON, OHIO 44706

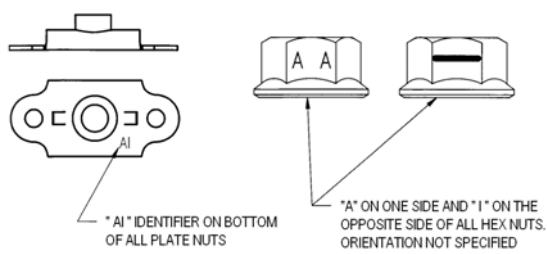

\*AI\* IDENTIFIER ON BOTTOM OF ALL PLATE NUTS  
\*A\* ON ONE SIDE AND \*I\* ON THE OPPOSITE SIDE OF ALL HEX NUTS. ORIENTATION NOT SPECIFIED

CAGE code: 5NYP9 1/

AIRCRAFT FUELSEAL FASTENERS, INC.  
(AEROLITE BLIND RIVET DIVISION)  
5271 ARGOSY AVENUE  
HUNTINGTON BEACH, CA 92649



CAGE code: 4K209 2/

AIRFRAME INTERNATIONAL, INC.  
7820 NW 74<sup>TH</sup> STREET  
MIAMI, FL 33166

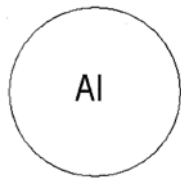

CAGE code: 3ZKC5 1/

AIRDROME PARTS CO.  
3251 SCHNIEDER ROAD S.E.  
P.O. BOX 1867  
NORTH CANTON, OH 44720



CAGE code: 2/

AIW-ALTON INC.  
1475 PALISADO AVE.  
WINDSOR, CT 06095-5140









CAGE code: 84027 2/

1/ Information published in this revision was verified by direct contact with manufacturers.

2/ Information not verified to be current, no response from manufacturer. Information identical to that published in MIL-HDBK-57, Revision B.

## MIL-HDBK-57F (IS)

<p>AKKO FASTENER, INC. 6855 CORNELL RD. CINCINNATI, OHIO 45242</p>  <p>CAGE code: 3M2H6 <span style="float: right;"><u>1/</u></span></p>	<p>ALCOA FASTENING SYSTEMS 3016 WEST LOMITA BLVD. TORRANCE, CA 90505</p> <p>plants:</p> <p>see CAMLOC PRODUCTS see HUCK INDUSTRIAL PRODUCTS see HUCK AEROSPACE PRODUCTS see KAYNAR PRODUCTS see KELOX/MICRODOT PRODUCTS see MECAERO PRODUCTS see RAM PRODUCTS see ROSAN PRODUCTS see SIMMONDS PRODUCTS see TRIDAIR PRODUCTS see VOI-SHAN PRODUCTS CAGE code: 15653 <span style="float: right;"><u>1/</u></span></p>
<p>ALAN, JEFFREY, MFG. &amp; ENGR. 8625 LAPEER ROAD P.O. BOX # 8 GOODELLS, MI 48027-9766</p> <p style="text-align: center;"><b>3D531</b></p> <p>CAGE code: 3D531 <span style="float: right;"><u>2/</u></span></p>	<p>ALCOA GLOBAL FASTENERS INC 13001 EAST TEMPLE AVE LA PUENTE, CA 91746-1417</p>  <p>CAGE code: 06950 <span style="float: right;"><u>2/</u></span></p>
<p>ALARD MACHINE PRODUCTS 1629 WEST 132ND STREET GARDENA, CA 90249-2005</p>  <p>CAGE code: 1FMQ2 <span style="float: right;"><u>1/</u></span></p>	<p>ALCOA-KOFEM KFT AFS NEMESVAMOS OPERATION H-8248 NEMESVAMOS DOZSA GYORGY U. 2/A HUNGARY</p>  <p>CAGE code: 0725V <span style="float: right;"><u>1/</u></span></p>
<p>ALBAR MACHINE CORPORATION RR3 BOX 2463 EFFORT, PA 18330-9450</p> <p style="text-align: center;"><b>AMC</b></p> <p>CAGE code: 44248 <span style="float: right;"><u>1/</u></span></p>	<p>ALEXANDER MANUFACTURING COMPANY INC. DBA METRO TOOL &amp; MANUFACTURING CO. 2402 ARKANSAS LANE GRAND PRAIRIE, TX 75052-7203</p>  <p>CAGE code: 2M919 <span style="float: right;"><u>2/</u></span></p>
<p>ALCO MACHINE CO. 27 SEARING AVENUE HARRISON, NJ 07029</p>  <p>CAGE code: 2T918 <span style="float: right;"><u>2/</u></span></p>	

1/ Information published in this revision was verified by direct contact with manufacturers.

2/ Information not verified to be current, no response from manufacturer. Information identical to that published in MIL-HDBK-57, Revision B.

## MIL-HDBK-57F (IS)

ALL MANUFACTURERS INC.  
DBA HARPER AEROSPACE FASTENERS  
2900 PALISADES DR  
CORONA, CA 92880 – 9429

# AOL

CAGE code: 57472

2/

ALL PINS MANUFACTURING  
P.O. BOX 137  
WILSEYVILLE, CA 95257

plant  
5549 POOR MANS WAY  
WILSEYVILLE, CA 95257

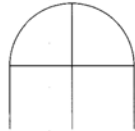

CAGE code: O8CZ5

~~ALL QUALITY SPARES, INC.  
3 EAST BISHOP STREET  
WATERFORD, CT 06385~~



**REMOVED**

~~CAGE code: 1VGA2~~

**This company is a Not a-Manufacturer**

ALLFAST FASTENING SYSTEMS, INC.  
15200 E DON JULLIAN RD  
P.O. BOX 3166  
CITY OF INDUSTRY, CA 91745-1098



CAGE code: 53551

1/

ALLIED NUT & BOLT CO., INC.  
520 HERTZOG BOULEVARD  
P.O. BOX 670  
KING OF PRUSSIA, PA 19406-2667

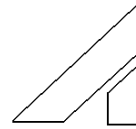

CAGE code: 4S191

2/

ALLIED PRECISION PRODUCTS, INC.  
600 SAN CHRISTOPHER DRIVE  
DUNEDIN, FL 34698-5095

# APP

CAGE code: 24249

1/

ALL-POWER MFG. CO.  
13141 MOLETTE STREET  
SANTA FE SPRINGS, CA 90670-5500

# AP

CAGE code: 70265

1/

ALL-PRO FASTENER & RIVET MFG. CO.  
10406 ENTERPRISE ST  
P.O. BOX 1525  
RANCHO CUCAMONGA, CA 91730

# AP

CAGE code: 1FH10

2/

<sup>1/</sup> Information published in this revision was verified by direct contact with manufacturers.

<sup>2/</sup> Information not verified to be current, no response from manufacturer. Information identical to that published in MIL-HDBK-57, Revision B.

MIL-HDBK-57F (IS)

ALL-STATES INC.  
1801 WEST FOSTER AVE.  
CHICAGO, IL 60640



ALL-STATES LOGO



ALL-STATES IDENTIFICATION MARK

CAGE code: 26863 2/

ALPHA BOLT CO.  
1524 EAST 14 MILE ROAD  
MADISON HEIGHTS, MI 48071

ABC

I

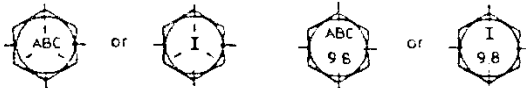

GRADE 5 BOLT

PROPERTY CLASS 9.8 METRIC BOLTS

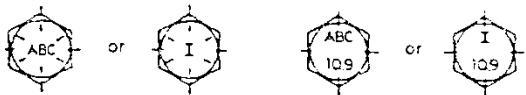
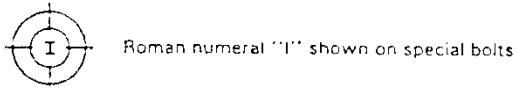

GRADE 8 BOLT

PROPERTY CLASS 10.9 METRIC BOLTS

CAGE code: 0R8B6 2/

ALPHA FASTENERS  
154 EAST MERRICK ROAD  
FREEPORT, NY 11520



CAGE code: 1UJ18 1/

ALPHA MACHINING PRODUCTS & DEVELOPMENT  
8651 PRODUCTION AVENUE  
SAN DIEGO, CA 92126

Plant  
7929 SILVERTON AVENUE  
SUITE 610  
SAN DEIGO, CA 92126



CAGE code: 3D6Q0 2/

ALPINE MACHINE & TOOL CORP.  
42 BERGENLINE AVE.  
WESTWOOD, NJ 07675

AMT-I

AMT x x x x - x x x x



CAGE code: 67339 2/

1/ Information published in this revision was verified by direct contact with manufacturers.

2/ Information not verified to be current, no response from manufacturer. Information identical to that published in MIL-HDBK-57, Revision B.

MIL-HDBK-57F (IS)

ALPS SEIKO CO. LTD.  
41 HIGASHI-KANAE, KANAE  
IIDA-SHI, NAGANO PREF.  
395-0817, JAPAN

Plant  
LIDA FACTORY  
524-1, SHIMOTONOHKA  
LIDA-SHI, NAGANO PREF.  
395-0154 JAPAN

**A**

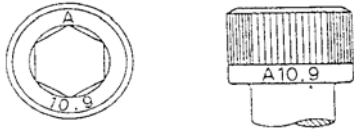

CAGE code: 1/

AMACON CORP.  
49 ALDER STREET  
WEST BABYLON, NY 11704



CAGE code: 54330 2/

AMANDA BENT BOLT CO.  
1120 C I C DR.  
LOGAN, OH 43138-9153



CAGE code: 22382 2/

AMATOM ELECTRONIC HARDWARE  
(DIVISION OF QUINCY TECHNOLOGIES, INC.)  
5 PASCO HILL ROAD  
CROMWELL, CT 06416-1012



CAGE code: 1YGB8 2/

AMERICAN AIRCRAFT PARTS  
MANUFACTURING COMPANY  
17917 MASONIC  
FRASER, MI 48026

**99106**

CAGE code: 99106 2/

AMERICAN ELECTRIC  
(CONSTRUCTION MATERIALS GROUP)  
1555 LYNNFIELD ROAD  
MEMPHIS, TN 38119

(SEE THOMAS & BETTS CORP - CAGE 56501)

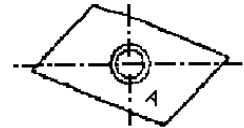

CAGE code: 1/

AMERICAN FASTENER & SPECIALTY CO.  
5900 PARK AVE.  
CLEVELAND, OHIO 44105



CAGE code: 2/

AMERICAN INTERNATIONAL AERO MFG  
INC.  
6973 SOUTH 300 WEST  
MIDVALE, UTAH 84047



CAGE code: 0RBVB 2/

1/ Information published in this revision was verified by direct contact with manufacturers.

2/ Information not verified to be current, no response from manufacturer. Information identical to that published in MIL-HDBK-57, Revision B.



MIL-HDBK-57F (IS)

AMERICAN METAL BEARING COMPANY  
7191 ACACIA AVENUE  
GARDEN GROVE, CA 92841

**AMB**



HEX SOCKET HEAD  
SCREW

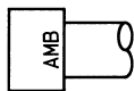

HEX SOCKET HEAD  
SCREW



THREAD  
OR  
STUD END



HEX HEAD  
SCREW  
OR BOLT



HEX NUT



HEX NUT

CAGE code: 70508

1/

AMERICAN QUALITY INDUSTRIES  
(FASTENER DIVISION)  
411 BURNHAM STREET  
EAST HARTFORD, CT 06108



GRADE 8 BOLT



GRADE 5 BOLT

CAGE code: 1P581

1/

AMERIFAST CORP.  
104 SYLVANNA RD.  
SOUTH PLAINFIELD, NJ 07080-1448

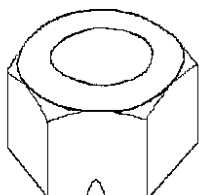

CAGE code: 0H4SO

1/

AMERITECH FASTNER MFG INC.  
DIVISION OF LONE STAR FASTENERS, LP  
6606 N GESSNER  
HOUSTON, TX 77040

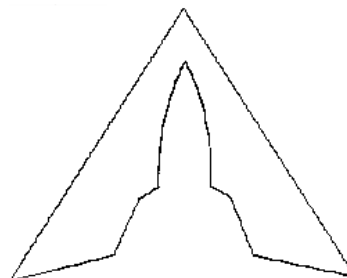

CAGE code: 0EUH2

1/

AMMAC, INC.  
6000 SUSQUEHANNA PLAZA  
YORK, PA 17406



CAGE code: 0NHU1

1/

ANATASE PRODUCTS  
(DIV OF HENWAY INC)  
1314 GOODRICK DR  
TEHCHPI, CA 93561



CAGE code: 0MXJ8

1/

1/ Information published in this revision was verified by direct contact with manufacturers.

2/ Information not verified to be current, no response from manufacturer. Information identical to that published in MIL-HDBK-57, Revision B.

## MIL-HDBK-57F (IS)

ANCHOR BOLT & SCREW CO.  
2001 N. CORNWELL  
MELROSE PARK, IL 60160-1081



Hex cap and indented  
hex screws.



Machine screws and  
Other products -  
3 dots under head  
120° apart

CAGE code: 9C864 2/

ANDERSON FORGE & MACHINE  
18500 S. W. PACIFIC HWY  
TUALATIN, OR 97062



CAGE code: 7X566 2/

ANILLO INDUSTRIES, INC.  
2090 N. GLASSELL  
P.O. BOX 5586  
ORANGE, CA 92865-3306



CAGE code: 10630 1/

ANKIT FASTENERS PRIVATE LIMITED  
297 HARAGADDE VILLAGE, ROAD NO. 4  
JIGNI INDUSTRIAL ESTATE PHASE - I  
BANGALORE 562 106, INDIA



CAGE code: SEM10 1/

ANOTHER SCREW MACHINE PRODUCT  
EMERALD INDUSTRIAL PARK BOX 425  
PONDERAY, ID 83852

**BEI**

CAGE code: 05RQ3 2/

ANTRIM MACHINE PRODUCTS, INC.  
P.O. BOX 379  
MANCERLONA, MI 49659

Plant  
9142 JOHNSON RD.  
MANCERLONA, MI 49659



CAGE code: 7U154 1/

A-ONE MACHINE COMPANY  
R.R.1, BOX 1660  
HOP BOTTOM, PA 18824



CAGE code: 0AV84 1/

APEL LTD.  
COUNTLESS AVE., STANLEY GREEN  
TRADING ESTATE  
CHEADLE HULME, CHESHIRE, SK8 6QU  
UNITED KINGDOM



CAGE code: K5640 2/

1/ Information published in this revision was verified by direct contact with manufacturers.

2/ Information not verified to be current, no response from manufacturer. Information identical to that published in MIL-HDBK-57, Revision B.

## MIL-HDBK-57F (IS)

APEX MFG. CO. INC.  
11686 TUXFORD ST  
SUN VALLEY, CA 91352-3134

AP

CAGE code: 2V343 1/

APHEONIX CORPORATION  
101 PECK HILL ROAD  
JOHNSTON, RI 02919

AP

PC

CAGE code: 08TF3 2/

ARCHER SCREW PRODUCTS  
11341 MELROSE STREET  
FRANKLIN PARK, IL 60131



CAGE code: 1HXL9 2/

ARCO SALES CO.  
2211 WAKELING STREET  
P.O. BOX 23001  
PHILADELPHIA, PA 19137-1214

ASC

ASC

CAGE code: 5L063 1/

ARDOR MFG. INC.  
400 S. 1100 W.  
PROVO, UT 84603



CAGE code: 0CTH5 2/

ARGARWAL INDUSTRIES  
370 MARSHALL HOUSE  
25 STRAND ROAD  
CALCUTTA, INDIA 700 001



CAGE code: 2/

ARJAY PRECISION, INC.  
524 SULLIVAN AVE  
SUITE 15  
SOUTH WINDSOR, CT 06074

MFR - 72905

CAGE code: 72905 2/

1/ Information published in this revision was verified by direct contact with manufacturers.

2/ Information not verified to be current, no response from manufacturer. Information identical to that published in MIL-HDBK-57, Revision B.

MIL-HDBK-57F (IS)

ARMSTRONG ATLAS BOLT  
 STATION STREET  
 DARLASTON, WEST MIDLANDS, WS10 8UL  
 GREAT BRITIN

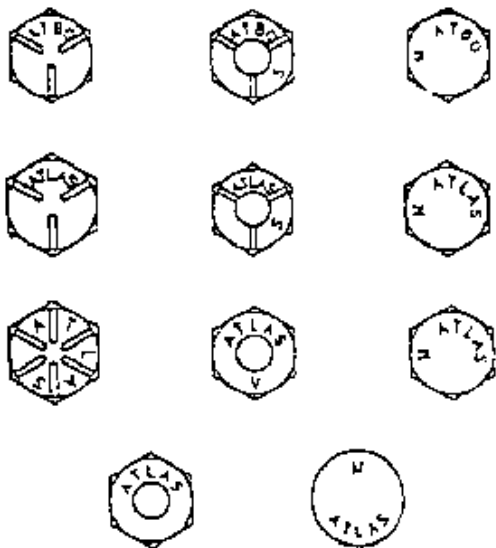

CAGE code: 2/

ARMSTRONG FASTENING SYSTEMS  
 FOSTER STREET STONEFERRY  
 BUSINESS PARK  
 HULL, GREAT BRITIAN, HU8 8BT  
 UNITED KINGDOM



Symbol may  
 be depressed  
 or raised

CAGE code: K1012 2/

(Continued)

(Continued)

ARMSTRONG FASTENINGS LTD.  
 FOSTER STREET STONEFERRY  
 BUSINESS PARK  
 HULL, GREAT BRITIAN, HU8 8BT  
 UNITED KINGDOM

**GSF**



CAGE code: K1012 2/

ARNOLD KNIPPING GmbH  
 58557 KIERSPE  
 POSTFACH 14 48  
 GUMMERSBACH, GERMANY 5270

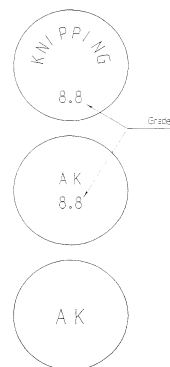

AK  
 KNIPPING

CAGE code: C4096 2/

ARNOLD UMFORMTECHNIK  
 GMBH & CO. KG  
 SINDRINGEN STR. 25  
 FORCHTENBERG, 74670  
 GERMANY





**A**

CAGE code: C3705 2/

1/ Information published in this revision was verified by direct contact with manufacturers.

2/ Information not verified to be current, no response from manufacturer. Information identical to that published in MIL-HDBK-57, Revision B.

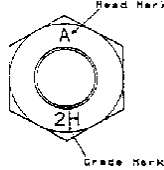
## MIL-HDBK-57F (IS)

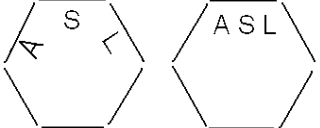
<p>ARNOLD WRAGG (BOLTS &amp; NUTS) LTD STANNINGTON ROAD STANNINGTON, SHEFFIELD ENGLAND, UK S6 6AG</p>  <p>CAGE code: U2935 <span style="float: right;"><u>2/</u></span></p>	<p>ASAHI SREWS MANUFACTURING CO., LTD 101 KAWAMATA HIGASHIOSAKA, JAPAN</p>  <p>CAGE code: <span style="float: right;"><u>2/</u></span></p>
<p>ARROW SCREW &amp; MACHINE WORKS 1037 GERMANTOWN AVENUE PHILADELPHIA, PA 19123-1629</p>  <p>CAGE code: 03632 <span style="float: right;"><u>2/</u></span></p>	<p>ASAI TEKKO CO. LTD 2-14 TAJIKA SHODKAI HIRKATA-SHI OSAKA, JAPAN 573</p>  <p>CAGE code: <span style="float: right;"><u>2/</u></span></p>
<p>ARTISAN SPECIALIST TECH, INC. 439 HIGH STREET P.O. BOX 48060 PHILADELPHIA, PA 19144</p>  <p><i>Artisan Specialist Tech, Inc</i></p> <p>CAGE code: 0RJ65 <span style="float: right;"><u>1/</u></span></p>	<p>ASI DESIGN &amp; MANUFACTURING, INC. 1070 HARDEES DRIVE P. O. BOX 957 ABERDEEN, MD 21001</p>  <p>CAGE code: 32971 <span style="float: right;"><u>2/</u></span></p>
<p>ARVAN, INC. 14083 S NORMANDIE AVE GARDENA, CA 90249</p> <p>ARVAN, INC. TANSEY A/I</p> <p>CAGE code: 29965 <span style="float: right;"><u>2/</u></span></p>	<p>ASL MANUFACTURING INC. 60 S. POSADO CT. IVINS, UT 84738</p> <p>Plant 1074 W. 560N. ST. GEORGE, UT 84770</p>  <p>CAGE code: 1VED5 <span style="float: right;"><u>1/</u></span></p>

1/ Information published in this revision was verified by direct contact with manufacturers.

2/ Information not verified to be current, no response from manufacturer. Information identical to that published in MIL-HDBK-57, Revision B.

## MIL-HDBK-57F (IS)

ASSOCIATED TOOL CO., INC.  
100 THOMAS DRIVE  
GADSDEN, AL 35901

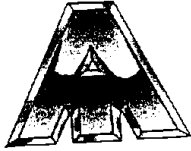

CAGE code: 2U575 2/

ATF, INC.  
(formerly Accurate Threaded Fasteners, Inc.)  
3550 WEST PRATT AVENUE  
LINCOLNWOOD, IL 60712



CAGE code: 95110 1/

ATLANTIC PRECISION SPRING INC.  
125 RONZO RD.  
BRISTOL, CT 06010

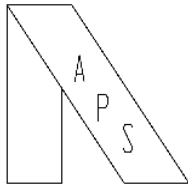

CAGE code: 6D788 1/

ATLAS ENGINEERING, INC.  
(PENN ENGINEERING AND MFG. CO.)  
5190 OLD EASTON RD.  
DANBORO, PA 18916



CAGE code: 46384 1/

ATLAS SPECIALTY PRODUCTS  
(SEE CURTIS PRESTON ENTERPRISES  
INC. )  
2299 E. WINSTON ROAD  
ANAHEIM, CA 92806

**ASP**

CAGE code: 0TP31 1/

AUGUST FRIEDBERG GMBH  
BELFORTER STRASSE 63  
P. O. BOX 10 08 43  
GELSENKIRCHEN, GERMANY 45884



**AF**

CAGE code: 2/

AUGUST FRIEDBERG GmbH  
BELFORTER STRASSE 63  
D-4650 GELSENKIRCHEN  
ROTTHAUSEN, GERMANY

**FRIEDBERG**

CAGE code: 2/

AUTO BOLT AND NUT CO.  
4619 PERKINS AVE  
CLEVELAND, OH 44103

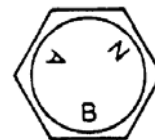
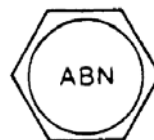

CAGE code: 0CUJ9 1/

1/ Information published in this revision was verified by direct contact with manufacturers.

2/ Information not verified to be current, no response from manufacturer. Information identical to that published in MIL-HDBK-57, Revision B.

MIL-HDBK-57F (IS)

AUTOMATED MANUFACTURING  
8009 AUGUSTA ROAD  
PIEDMONT, SC 29673-9369

A M

CAGE code: 1URY9 2/

AUTOMATIC MACHINING AND MFG CO  
DBA AMMAC INC  
6000 SUSQUEHANNA PLZ  
YORK, PA 17406







CAGE code: 0NHU1 2/

AUTOMATIC MANUFACTURING COMPANY  
300 SHADELAND AVENUE  
EAST PITTSBURGH, PA 15112-1499

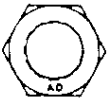
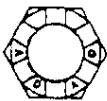

CAGE code: 18362 1/

AUTOMATIC SCREW MACHINE  
PRODUCTS CO.  
709 2ND AVE  
P.O. BOX 1608  
DECATUR, AL 35601

PLAIN:	SLOTTED:	DRILLED:
		
	OR	
		
AD	AD	AD

CAGE code: 92595 1/

AUTO SCREW, INC.  
LYNBROCK RD. & EASTERN BLVD.  
P.O. BOX 4968  
BALTIMORE, MD 21220



CAGE code: 84253 2/

AVDEL INTERNATIONAL (AVDEL LTD)  
HERTFORD, AL 7 1EZ  
GREAT BRITIAN



CAGE code: 2/

AVIATION MANUFACTURING GROUP LLC  
(SEE DBA FREEMAN CO., THE)  
719 WALNUT ST  
P. O. BOX 57  
YANKTON, SD 57078-3542



CAGE code: 84596 1/

1/ Information published in this revision was verified by direct contact with manufacturers.

2/ Information not verified to be current, no response from manufacturer. Information identical to that published in MIL-HDBK-57, Revision B.

MIL-HDBK-57F (IS)

AVIBANK MANUFACTURING, INC.  
PRECISION CASTPARTS CORP.  
4650 SW MACADAM AVE. SUITE 440  
PORTLAND, OR 97239-4262

Plant  
AVIBANK MFG., INC.  
11500 SHERMAN WAY, P.O. BOX 9909  
NORTH HOLLYWOOD, CA 91609-1909

**AB**  
**ADB, ADBB, ADP, LRA**  
**AAP**  
**AS**  
**AV**  
**AVIBANK, BALL-  
LOK®, BLC, BLS, PIP**  
**AVL**  
**AVK, ET, ETC, FN, IT,  
ITC, MT, RT**  
**ST**  
**84256**

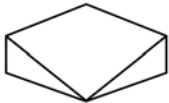

CAGE code: 84256 1/

AVK INDUSTRIES PRODUCTS INC.  
4650 SW MACADAM AVE. SUITE 440  
PORTLAND, OR 97239-4262

Plant  
25323 RYE CANYON RD  
VALENCIA, CA 91355



CAGE code: 78276 1/

AZTECH ENGINEERING, INC.  
1424 CENTRE CIR.  
DOWNERGROVE, IL 60515



CAGE code: 0W426 2/

AZTECH LOCKNUT COMPANY  
2675 WHITE OAK CIRCLE  
AURORA, IL 60502

Orange nylon insert

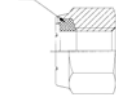

CAGE code: 5CQW8 1/

B & B SPECIALTIES INC.  
4321 E. LAPLMA AVE.  
ANAHEIM, CA 92807

(see GS AEROSPACE)

- 1) PRIMARY - **BB**
- 2) SECONDARY - **62206**

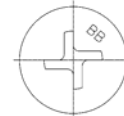

CAGE code: 62206 1/

Raised BB is for new manufactured parts.  
Depressed BB is for old stock.

CAGE code: 62206 1/

B & D THREADED ROLLING  
36820 VAN BORN ROAD  
P.O. BOX 275  
WAYNE, MI 48184







CAGE code: 00LR8 1/

1/ Information published in this revision was verified by direct contact with manufacturers.

2/ Information not verified to be current, no response from manufacturer. Information identical to that published in MIL-HDBK-57, Revision B.

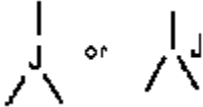
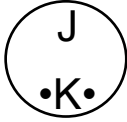

## MIL-HDBK-57F (IS)

<p>B &amp; E MACHINE SHOP &amp; SHEET METAL FAB., INC. 3059 SE MONROE ST. STUART, FL 34997</p>  <p>CAGE code: 8W179 <span style="float: right;">2/</span></p>	<p>B &amp; N TOOL CO., INC. 44 ROCKWELL RD. NEWINGTON, CT 06111</p>  <p>CAGE code: 0CMJO <span style="float: right;">2/</span></p>
<p>B &amp; E MANUFACTURING CO., INC. 7562 ORANGEWOOD AVE. STANTON, CA 90680-3498</p>  <p>CAGE code: 59680 <span style="float: right;">1/</span></p>	<p>B &amp; R MACHINE AND TOOL CORP 717 MAIN STREET WESTBURY, NY 11590</p> <p style="text-align: center;"><b>BR</b></p> <p>CAGE code: 66936 <span style="float: right;">1/</span></p>
<p>B &amp; G MANUFACTURING CO., INC. 3067 UNIONVILLE PIKE P.O. BOX 269 HATFIELD, PA 19440-1822</p>  <p style="text-align: center;">Grade 5</p> <p>JB7 <span style="float: right;">Grade B7</span> JB16 <span style="float: right;">Grade B16</span> JNC <span style="float: right;">Alloy 400</span></p>  <p style="text-align: center;">Alloy 500</p> <p>J4 <span style="float: right;">Grade 4</span> J2H <span style="float: right;">Grade 2H</span></p> <p>CAGE code: 84272 <span style="float: right;">2/</span></p>	<p>B F GOODRICH CO. RIVNUT ENGINEERED FATSEENERS, THE AEROSPACE AND DEFENSE DIVISION 250 NORTH CLEVELAND-MASSILLION RD. AKRON, OH 44313</p> <p style="text-align: center;">Plant 150 SPRINGSIDE DRIVE AKRON, OH 44313-0501</p> <p style="text-align: center;"><b>BFG+</b></p> <p>CAGE code: <span style="float: right;">2/</span></p> <p>B G ENGINEERING, INC. 205 ARENA STREET EL SEGUNDA, CA 90245</p>  <p>CAGE code: 0WL62 <span style="float: right;">2/</span></p>

1/ Information published in this revision was verified by direct contact with manufacturers.

2/ Information not verified to be current, no response from manufacturer. Information identical to that published in MIL-HDBK-57, Revision B.

## MIL-HDBK-57F (IS)

B G M FASTENER CO., INC.  
RR 5 BOX 1675  
759 OLD WILLOW AVENUE  
HONESDALE, PA 18431



CAGE code: 3Y498

1/

B. V. FABRIEK VAN KLINKNAGELS EN  
SCHROEFBOUTEN V/H SMIT  
2980 GB RIDDERKIRK  
P.O. BOX 4075  
THE NETHERLANDS

**JS**

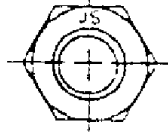

CAGE code:

2/

BARCO ENGINEERING COMPANY, INC.  
505 W MAIN ST  
TILTON, NH 03276



CAGE code: 29214

2/

BARNEGAT BAY NSCC, INC.  
DBA BB NSCC, INC.  
6432 DEVONSHIRE DR.  
FORT WORTH, TX 76180



CAGE code: 1SDGE

1/

BARRE PRECISION PRODUCTS INC.  
199 HOPRIVER ROAD RTE. 6  
BOLTON, CT 06043-7443



CAGE code: 7R902

1/

BAS AEROSPACE LIMITED  
2 CRAMPTONS ROAD  
SEVENOAKS, KENT N14 5EF  
UNITED KINGDOM

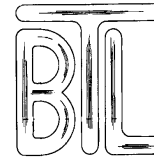

CAGE code: KCWE1

1/

BAUER & SCHAURTE KARCHER GMBH  
FURTHER STRASSE 24-26  
POSTFACH 10 01 55  
D-4040 NEUSS 1  
FEDERAL REPUBLIC OF GERMANY



**VERBUS® KARRO®**

CAGE code: D2370

2/

BAY BOLT  
4610 MALAT STREET  
OAKLAND, CA 94601

**CAL**

CAGE code: N/A

1/

1/ Information published in this revision was verified by direct contact with manufacturers.

2/ Information not verified to be current, no response from manufacturer. Information identical to that published in MIL-HDBK-57, Revision B.

MIL-HDBK-57F (IS)

BBC FASTENERS, INC.  
4210 SHIRLEY LANE  
ALSIP, IL 60658

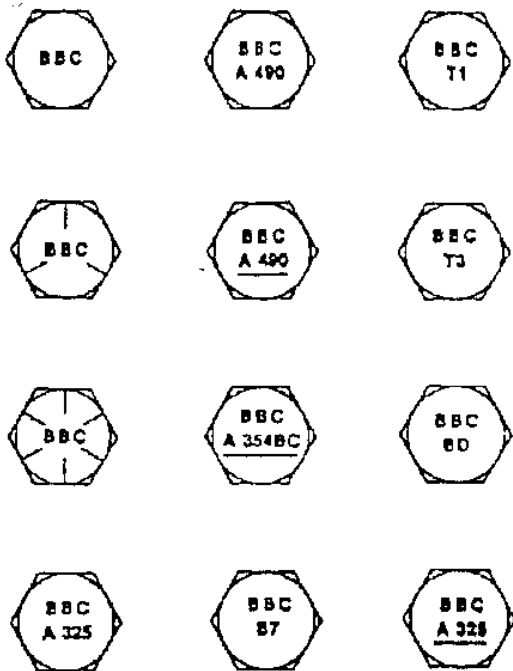

**BBC**

CAGE code: 2/

BEACH MACHINE  
819 WALKER LN  
NEW MARKET, AL 35761



CAGE code: 0TCDO 2/

BEAVER PRODUCTS CORP.  
P.O. BOX 17279  
ANAHEIM, CA 92817

**B.P.C.**

CAGE code: 4P584 2/

BEC MACHINE PRODUCTS COMPANY  
171 RUTH ROAD  
HARLEYSVILLE, PA 92806

**BEC**

CAGE code: 0JC12 2/

BEE INDUSTRIES, INC.  
(WISCONSIN CORPORATION)  
W6331 BEE ROAD  
WATERTOWN, WI 53098

**BI**

CAGE code: 7V765 2/

BEGONIA TOOL COMPANY  
53 MADISON RD  
HERMINIE, PA 15637

**BT**

CAGE code: OL3V3 2/

1/ Information published in this revision was verified by direct contact with manufacturers.

2/ Information not verified to be current, no response from manufacturer. Information identical to that published in MIL-HDBK-57, Revision B.

MIL-HDBK-57F (IS)

BEK LEVEL 1 FASTENERS  
300 THIRD AVE  
HUNTINGTON, WV 25701

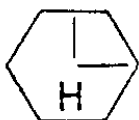

300 Series Stainless Steel

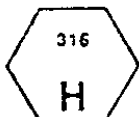

Type 316 Stainless Steel

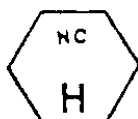
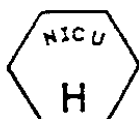

Nickel Copper (Monel)

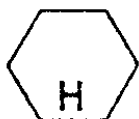

Silicon Bronze

BEK LEVEL 1 FASTENERS  
721 EAST COMPTON BOULEVARD  
COMPTON, CA 90220

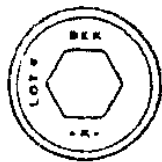
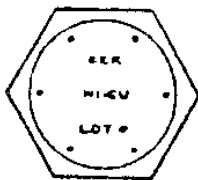

BEK

CAGE code:

2/

BEL-AIR MACHINE & PERFORMANCE  
14181 FIR ST.  
OREGON CITY, OR 97045



CAGE code: 5SJL1

1/

BELL FASTENERS (ALBANY  
FASTENERS/PAWTUCKET FASTENER  
DIVISION)  
327 PINE STREET  
PAWTUCKET, RI 02862

**S**

STILLWATER

**B**

BELL

**PMC**

PAWTUCKET MANUFACTURING CO.

**P**

PAWTUCKET

**A**

ALBANY

**SW**

ON TOP OF SCREW



(two dots) On the top of or bearing surface  
of the screw

(SEE VERTEX)

CAGE code: 12360

2/

1/ Information published in this revision was verified by direct contact with manufacturers.

2/ Information not verified to be current, no response from manufacturer. Information identical to that published in MIL-HDBK-57, Revision B.

## MIL-HDBK-57F (IS)

BELL PRECISION, INC.  
131 N. DILLON AVE.  
SAN JACINTO, CA 92383

# BP

CAGE code: 56122 2/

BELL-MEMPHIS, INC.  
1650 CHANNEL AVE  
MEMPHIS, TN 38113-01871



CAGE code: 22277 1/

BEN YUAN ENTERPRISE CO, LTD.  
NO. 113, CHI-NAN ROAD  
TAI-SHIA VILLAGE, KAOHSIUNG HSIEN,  
TAIWAN R. O. C.

# BY

CAGE code: 2/

BENACO TOOLING RESEARCH & DEV.  
CORP.  
9287 MERCANTILE DR  
MENTOR, OH 44060

# BENACO

CAGE code: 5W644 2/

BEOTOOL CORP.  
725 WHITNEY DR  
BLUE BELL, PA 19422-1205

# BOT

CAGE code: 2N084 2/

BERGNER, RICHARD GMBH & CO.  
BAHNHOFSTRAUSSE 8-16  
P.O. BOX 1180  
SCHWABACH, 91126  
GERMANY



# RIBE

Where required and applicable, these fasteners types are also marked with the logo "RIBE" and/or capital "B" with screw in circle.

RIBE  multiform

RIBE  hombi

RIBE  triform

RIBE  triform db

RIBE  plastroform

RIBE  spertform

CAGE code: D2282 2/

1/ Information published in this revision was verified by direct contact with manufacturers.

2/ Information not verified to be current, no response from manufacturer. Information identical to that published in MIL-HDBK-57, Revision B.

MIL-HDBK-57F (IS)

BER-LOW MFG INC.  
DBA BUTECH PRESSURE SYSTEMS  
4928 PITTSBURGH AVE  
ERIE, PA 16509



CAGE code: 62295 2/

BERRY, JOHN  
DBA BERRY MANUFACTURING  
5505 BREWSTER ST  
SAN ANTONIO, TX 78233

**BM**

CAGE code: 65003 1/

BERRY MANUFACTURING  
1090 HWY 72, BOX 336  
GOLDEN, CO 80403

**BM**

CAGE code: 65003 1/

BET-LAR SERVICES

See UPSTART ACQUISITIONS, CORP

1/

BETA CORP.  
2332 S DELAWARE ST  
DENVER, CO 80223 - 4321



CAGE code: 06671 2/

BETA ENGINEERING, INC.  
P.O. BOX 80  
468 DODSON LAKE DRIVE  
ARLINGTON, TX 76012-3441



CAGE code: 33436 1/

BIG BOLT CORP.  
140 COVINGTON DRIVE  
BLOOMINGDALE, IL 60108-3105

**BB**

**BB**  
—————

**BB**  
—————  
•

**BB**  
—————  
•

**BB**  
—————  
•

CAGE code: 3Q6H0 1/

BISHOP ENTERPRISES, INC.  
10 EAST BISHOP ST.  
WATERFORD, CT 06385



CAGE code: 6Y882 2/

1/ Information published in this revision was verified by direct contact with manufacturers.

2/ Information not verified to be current, no response from manufacturer. Information identical to that published in MIL-HDBK-57, Revision B.

## MIL-HDBK-57F (IS)

BLAINE TOOL CORP.  
5024 FALL CREEK RD  
INDIANAPOLIS, IN 46220-5344



CAGE code: 17027

2/

BLANC AERO INDUSTRIES  
see LISI AEROSPACE

BLANC AERO INDUSTRIES  
193 R DE BERCY  
PARIS, FRANCE 75012

BLANC AERO INDUSTRIES  
Saint Chamond Granat  
18 20 Rue S-Hilaire  
Saint Ouen L'Aumone, France 95310

7 (Sr Brieuç)  
B (Paris)  
P (Villefranche de  
Rouergue)

ds. F

BLANC AERO INDUSTRIES  
18,20 RUE ST. HILAIRE  
SAINT OUEN L'AUMONE, FRANCE  
95310

**T**

BLANC AERO INDUSTRIES  
DECOLLETAGE MODERNE  
5 BIS, PLACE LEON BLUM  
75020- PARIS  
FRANCE

**DDG**

CAGE code: F0188

2/

BLANC AIRCRAFT FASTENERS, INC.  
203020 PRARIE ST  
P.O. BOX 3819  
CHATSWORTH, CA 91842



**BAF**

CAGE code:

2/

BLAND CO., THE  
55 BROOK ST  
P. O. BOX 330358  
WEST HARTFORD, CT 06133

**BL**

CAGE code: 02991

1/

BLUE SKY INDUSTRIES, INC.  
1230 MONTEREY PASS ROAD  
MONTEREY PARK, CA 91754-3617

*No Logo Listed*

CAGE code: 1BRD5

2/

BLUE TEE CORP DBA GEFCO/ STECO  
2215 S. VAN BUREN ST.  
ENID, OK 73703-8218











CAGE code: 21363

2/

1/ Information published in this revision was verified by direct contact with manufacturers.

2/ Information not verified to be current, no response from manufacturer. Information identical to that published in MIL-HDBK-57, Revision B.

## MIL-HDBK-57F (IS)

<p>BOBCAT MANUFACTURING CO. (PLANT) PECK HILL ROAD JOHNSTON, RI 02919</p>   <p>CAGE code: 8H536 <span style="float: right;"><u>2/</u></span></p>	<p>BOLT FASTENER STUD/TECHNOLOGY 118 W NUGENT ST P.O. BOX 2569 LANCASTER, CA 93535</p> <p>Plant 210 EAST AVENUE LANCASTER, CA 93539</p>  <p>CAGE code: 31386 <span style="float: right;"><u>2/</u></span></p>
<p>BOGNER ENGINEERING CO. 705 N. SPRINGFIELD STREET P. O. BOX 510 BERRYVILLE, AR 72616</p>  <p>CAGE code: 04BV8 <span style="float: right;"><u>2/</u></span></p>	<p>BOLTWORKS, INC. 2150 WOODLAND WARRENDALE, PA 15086-7536</p>  <p>CAGE code: 3LYS4 <span style="float: right;"><u>1/</u></span></p>
<p>BOLLHOFF &amp; CO. GmbH &amp; CO. KG ARCHIMDESTASSE 1-4 BIELEFELD, D-4800 14 GERMANY</p>  <p>CAGE code: <span style="float: right;"><u>2/</u></span></p>	<p>BOMAR ENGINEERING, INC. 13385 PHILLIPPI AVE. SYLMAR, CA 91342</p>  <p>CAGE code: 3U494 <span style="float: right;"><u>2/</u></span></p>
<p>BOLT &amp; NUT CO. PARK LANE EAST TIPTON, WEST MIDLANDS, DY4 8RF GREAT BRITIAN</p>  <p>CAGE code: <span style="float: right;"><u>2/</u></span></p>	<p>BOMBSHELL, INC. 9565 PATHWAY ST. #B SANTEE, CA 92071</p> <p><b>509W0</b></p> <p>CAGE code: 509W0 <span style="float: right;"><u>1/</u></span></p>

1/ Information published in this revision was verified by direct contact with manufacturers.

2/ Information not verified to be current, no response from manufacturer. Information identical to that published in MIL-HDBK-57, Revision B.



## MIL-HDBK-57F (IS)

BONEAL INC.  
P.O. BOX 49  
MEANS, KY 40346

Plant  
126 INDUSTRIAL PARK RD.  
MEANS, KY 40346

**B N C**  
**G**

CAGE code: 5X802 1/

BRACELENTE MANUFACTURING CO., INC.  
20 WEST CREAMERY ROAD  
P.O. BOX 570  
TRUMBAUERSVILLE, PA 18970-0570

**BMC INC.**

CAGE code: 2Y035 1/

BRADY MACHINE, INC.  
6125 SKY ROAD  
JOSHUA, TX 76058-4048

**B M** **B M**

CAGE code: 1HLW8 1/

BRANCH MACHINE PARTS, INC.  
2419 EMPIRE AVE  
BURBANK, CA 91504

**BMP**

CAGE code: 2/

BRIARWOOD FASTENERS, INC.  
9701 OWENSMOUTH AVE.  
UNIT 8  
CHATSWORTH, CA 91311-4814

**BFI**

CAGE code: 3N278 1/

BRIDEAN MACHINE & TOOL CO., INC.  
155 BANGOR STREET  
LINDENHURST, NY 11757-3632

**BRI**  
**1**

CAGE code: 1S023 1/

BRIDGEVIEW MANUFACTURING CO.  
(ILLINOIS CORPORATION)  
7320 S. FERDINAND AVENUE  
BRIDGEVIEW, IL 60455-1111

**BVB**

CAGE code: 0ALM2 1/

BRIGHT LIGHTS USA, INC.  
145 SHREVE AVE.  
BARRINGTON, NJ 08007

**BL**

CAGE code: 0RMF7 1/

1/ Information published in this revision was verified by direct contact with manufacturers.

2/ Information not verified to be current, no response from manufacturer. Information identical to that published in MIL-HDBK-57, Revision B.

MIL-HDBK-57F (IS)

BRINTCLIFFE TURNER LTD.  
CRAMPTONS ROAD  
SEVENOAKS, KENT, TN14 5DS  
GREAT BRITAIN

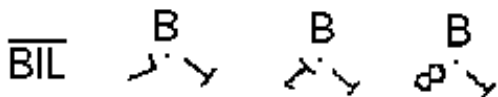

CAGE code: 2/

BRISTOL INDUSTRIES  
630 EAST LAMBERT RD.  
BREA, CA 92821

**B+** CAPITAL B FOLLOWED BY PLUS SIGN  
RAISED OR DEPRESSED

**BI** CAPITAL B FOLLOWED BY CAPITAL I  
USED FOR EUROPEAN PARTS ONLY  
RAISED OR DEPRESSED

● ● TWO ADJACENT DOTS  
RAISED OR DEPRESSED



TWO ADJACENT DOTS  
RAISED OR DEPRESSED

**B** - old callout no longer used on  
new product

CAGE code: 27238 1/

BRISTOL LOCKNUT CO. (NUT DIVISION)  
32451 N. AVIS DRIVE  
MADISON HEIGHTS, MI 48071



CAGE code: 2/

BROADSTONE TOOL & DIE, INC.  
R #1, BOX 986  
MCARTHUR, OH 45651

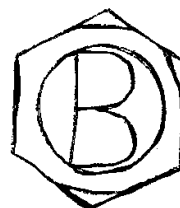

CAGE code: 4Z678 2/

BROADWAY SCREW MACHINE INC.  
64 NANCY ST. UNIT B  
WEST BABYLON, NY 11704



CAGE code: 5CZ56 1/

BROWN PRODUCTION, INC.  
804 W MEEKER ST.  
KENT, WASHINGTON 98032-5702



CAGE code: 2D069 2/

1/ Information published in this revision was verified by direct contact with manufacturers.

2/ Information not verified to be current, no response from manufacturer. Information identical to that published in MIL-HDBK-57, Revision B.

MIL-HDBK-57F (IS)

BRUNNER DRILLING & MFG. CO., INC.  
405 ELROY ST.  
P.O. BOX 137  
ELROY, WI 53929

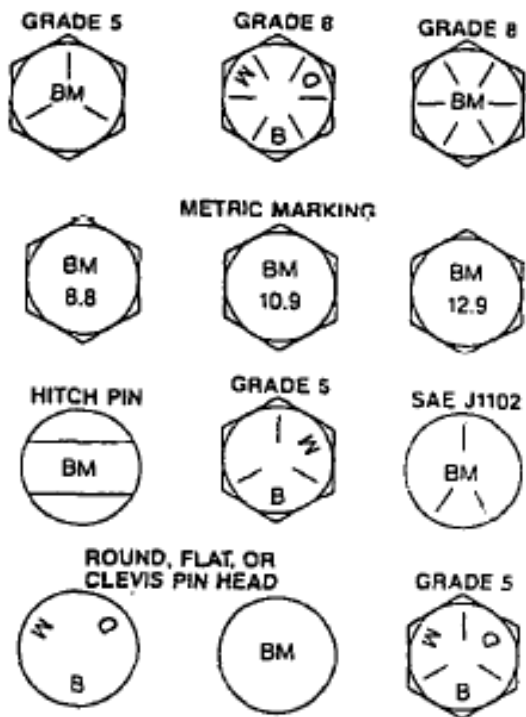

CAGE code: 24407 1/

BRUNNER MANUFACTURING CO.  
DBA BRUNNER MANUFACTURING  
DIVISION  
1025 PARKER DR  
MAUSTON , WI 53948 9381

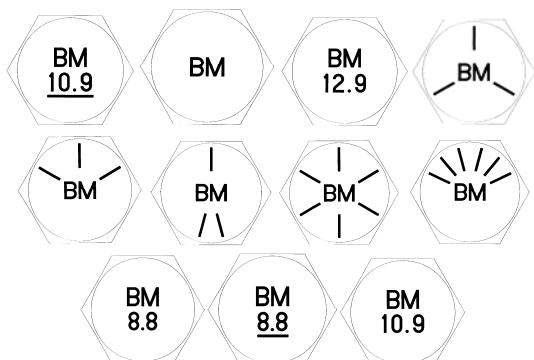

CAGE code: 3B7H2 1/

BRYCO MACHINE, INC.  
7800 GRAPHICS DRIVE  
TINLEY PARK, IL 60477

**BM**

CAGE code: 1WCD4 1/

BRYNOLF MANUFACTURING, INC.  
5459 11<sup>TH</sup> STREET  
ROCKFIRD, IL 61109

**b**

CAGE code: 4P7Y2 1/

BUCK EYE FORGE, INC.  
11700 HARVARD AVE  
CLEVELAND, OH 44105



CAGE code: 71177 2/

BUCKEYE MACHINING, INC.  
25020 LAKELAND BLVD.  
CLEVELAND, OH 44132



CAGE code: 8X808 2/

1/ Information published in this revision was verified by direct contact with manufacturers.

2/ Information not verified to be current, no response from manufacturer. Information identical to that published in MIL-HDBK-57, Revision B.

## MIL-HDBK-57F (IS)

BUFFALO PUMPS, INC.  
 (SUBSIDIARY OF AMPCO-PITTSBURGH  
 CORP.)  
 874 OLIVER STREET  
 NORTH TONAWANDA, NY 14120-3210

**BP**

CAGE code: 83130

2/

BULA FORGE INC.  
 2987 E 87TH ST  
 CLEVELAND, OH 44104-4

**BULA**

CAGE code:

2/

BULTEN TRADING AB  
 P.O. BOX 516  
 734 01 HALLSTAHAMMAR  
 SWEDEN

*Bulten Stainless AB*  
 Ashammar Works  
 810 25 Ashammar  
 Sweden

*Bulten Stainless AB*  
 Svartå Works  
 710 11 Svartå  
 Sweden

**BH**

BULTEN AB

**BUFO**

BULTEN AB

**SÅ**

BULTEN STAINLESS AB

CAGE code: N8286

2/

BURROWS RESEARCH MACHINING,  
 INC.  
 43 BRADFORD STREET  
 P.O. BOX 1130  
 CONCORD, MA 01742

**BRM**

CAGE code:

2/

1/ Information published in this revision was verified by direct contact with manufacturers.

2/ Information not verified to be current, no response from manufacturer. Information identical to that published in MIL-HDBK-57, Revision B.

## MIL-HDBK-57F (IS)

BUSAN INDUSTRIAL MACHINERY CO.,  
LTD.  
*BOLT DIVISION*  
456-9, NAE-DONG, CHANGWON  
KYEONGSANGNAM-DO, KOREA

**BM****BIM**CAGE code: 2/

BUTECH PRESSURE SYSTEMS  
4928 PITTSBURGH AVE  
ERIE, PA 16509

See BER-LOW MFG INC

CAGE code: 62295 2/

BUTLER, INC.  
1600 WEST 166TH STREET  
GARDENA, CA 90247

**JB**CAGE code: 59053 1/

C & A MACHINE CO.  
49 PROGRESS CIRCLE  
NEWINGTON, CT 06111

**CA**CAGE code: 1HXE7 1/

C & D MACHINE TOLL, INC.  
726 COURT STREET  
SPRINGFIELD, OH 45506

**C&D  
MACH**CAGE code: 064X3 1/

C & H MFG., INC.  
4280 E LOWELL ST  
ONTARIO, CA 91761-1529

**30633**CAGE code: 30633 2/

C & S ENGINEERING LLC  
15401 CARMENITA DR. (N)  
SANTA FE SPRINGS, CA 90670

CAGE code: 4ZH03 1/1/ Information published in this revision was verified by direct contact with manufacturers.2/ Information not verified to be current, no response from manufacturer. Information identical to that published in MIL-HDBK-57, Revision B.

## MIL-HDBK-57F (IS)

C. E. MACHINE CO., INC.  
1741 SOUTH LEONINE  
WICHITA, KS 67209-2813

**MFR 3L665**

CAGE code: 3L665

2/

C.E.S. MACHINE PRODUCTS, INC  
8880 DOUBLE DIAMOND PKWY  
RENO, NV 89521-5908

**CES**

CAGE code: 1WF66

2/

C. J.'S GENERAL MACHINE WORKS  
15406 FOREST MIST  
SAN ANTONIO, TX 78232-4137



CAGE code: 7W334

2/

C.R.D. MACHINING  
366 W. 131<sup>ST</sup> ST.  
LOS ANGELES, CA 90248

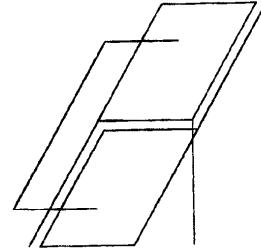

CAGE code: 1LA52

2/

CALABRESE & SONS, INC.  
406 BRANDY LANE  
P.O. BOX 1667  
MECHANICSBURG, PA 17055-2800

**C+SI**

CAGE code: 07310

1/

1/ Information published in this revision was verified by direct contact with manufacturers.

2/ Information not verified to be current, no response from manufacturer. Information identical to that published in MIL-HDBK-57, Revision B.

MIL-HDBK-57F (IS)

CALIFORNIA SCREW PRODUCTS CORP.  
 P.O. BOX 228  
 PARAMOUNT, CA 90723

*Plant*  
 14957 GWENCHRIS AVE.  
 PARAMONT, CA 90723-3423

**CS**

**C S**



HEX. HEAD



HEX. HEAD

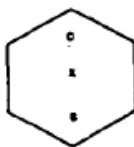

HEX. HEAD

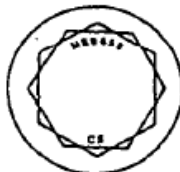

TWELVE POINTS



FLAT HEAD  
PAN HEAD  
ROUND HEAD  
 (ALL TYPES OF RECESSED)

CAGE code: 8Z507

1/

CAMBRIDGE SPECIALTY COMPANY, INC.  
 DBA POINT MACHINE CO.  
 588 FOUR ROD RD  
 BERLIN, CT 06037-2280



CAGE code: 9E232

2/

CAMCAR DIVISION OF TEXTRON INC.  
 600 18<sup>th</sup> Ave.  
 Rockford, IL 61101

*Plant*  
 AMSCO PRODUCTS  
 1818 CHRISTINA ST  
 ROCKFORD, IL 24382  
 CAGE code: 01536

*Head markings*

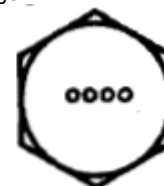

Vendor identification, "A" or four dots raised or depressed located as shown.

*Under head markings*



Vendor identification, four dots radially located as shown, depressed

CAGE code: 93907

2/

Continued

1/ Information published in this revision was verified by direct contact with manufacturers.

2/ Information not verified to be current, no response from manufacturer. Information identical to that published in MIL-HDBK-57, Revision B.

MIL-HDBK-57F (IS)

Continued

CAMCAR DIVISION OF TEXTRON INC.

Plant  
 DRILLETITE PRODUCTS  
 1304 KERR DR.  
 DECORAH, IA 52101  
 CAGE code: 0JMM5

Head markings

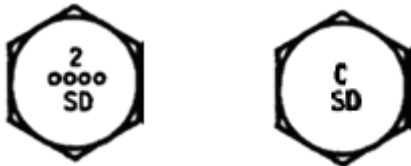

Vendor and customer  
 Identification for stainless  
 steel, drilled screws,  
 raised or depressed

Vendor/Product  
 Identification, raised or  
 depressed  
 Identifies "CAMCAR Self -  
 Drilling Fastener."

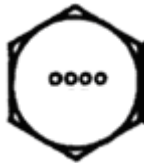

Vendor Identification,  
 Four in-line dots, raised or  
 depressed

Under head markings

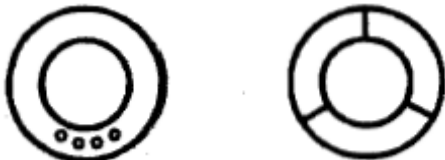

Vendor identification, four radial dots or three equally  
 spaced radial lines, depressed

CAGE code: 93907

2/

Continued

Continued

CAMCAR DIVISION OF TEXTRON INC.

Plant  
 RAYCARL PRODUCTS  
 600 18<sup>th</sup> Ave.  
 Rockford, IL 61101  
 CAGE code: 6P253

Head markings



Vendor Identification, "CAMCAR" or four in-line dots,  
 raised or depressed.

Under head markings

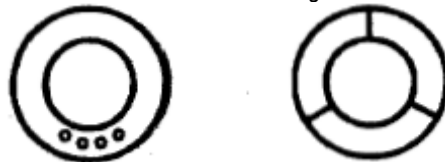

Vendor identification, four radial dots or three equally  
 spaced radial lines, depressed

Plant  
 ROCKFORD HEADED PRODUCTS  
 29201 TELEGRAPH RD. SUITE 611  
 SOUTHFIELD, IL 48034-1331

Head markings

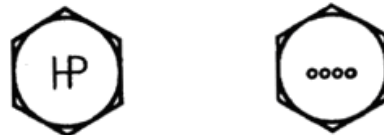

Product Identification,  
 "HP" raised or depressed

Product Identification,  
 Four in-line dots, raised or  
 depressed

Under head markings



Vendor identification, four radial dots or two parallel lines,  
 raised or depressed

CAGE code: 6P253

2/

Continued

1/ Information published in this revision was verified by direct contact with manufacturers.

2/ Information not verified to be current, no response from manufacturer. Information identical to that published in MIL-HDBK-57, Revision B.



MIL-HDBK-57F (IS)

Continued  
CAMCAR DIVISION OF TEXTRON INC.

Plant  
SEMS PRODUCTS  
1818 CHRISTINA ST  
ROCKFORD, IL 61104  
CAGE code: 01536

*Head markings*

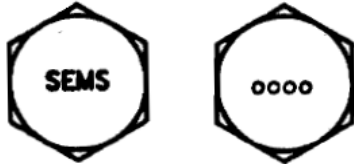

Vendor Identification, "SEMS" or four in-line dots, raised or depressed, located as shown.

*Product Trademark Markings*



INTERNAL TORX ® RECESS  
"TORX" and two dots raised or depressed, located as shown



EXTERNAL TORX ® RECESS  
"TORX" equally spaced on top of washer, raised or depressed.



TORXSTEM ®  
"TORX" equally spaced on END, raised or depressed.

Plant  
SOCKET SCREW PRODUCTS  
1302 KERR DRIVE  
DECORAH, IA 52101  
CAGE code: 0JMM5



Letters "TORX" plus two dots raised or indented on recess countersink; locate as illustrated (Product Trademark)

Vendor Identification, Four radial dots raised or indented, located as shown

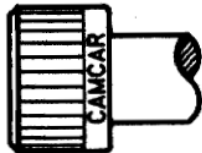

Optional Identification, "CAMCAR", raised or indented as illustrated

Continued

2/

Continued

CAMCAR DIVISION OF TEXTRON INC.

Plant  
TAPTITE PRODUCTS  
826 EAST MADISON ST  
BELVIDERE, IL 61008

*Head markings*



Product Identification, "TTL" raised or depressed

Vendor Identification, "CTY" and three radial lines, raised or depressed

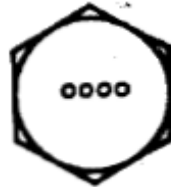

Vendor Identification, Four in-line dots raised or depressed



Vendor Identification, three radial lines and circle, raised or depressed

*Under head markings*



Vendor identification, four radial dots or three equally spaced radial lines, depressed



Continued

2/

1/ Information published in this revision was verified by direct contact with manufacturers.

2/ Information not verified to be current, no response from manufacturer. Information identical to that published in MIL-HDBK-57, Revision B.

MIL-HDBK-57F (IS)

Continued

CAMCAR DIVISION OF TEXTRON INC.

Plant  
 TORX PRODUCTS  
 P.O. Box 607  
 Rochester, IN 46975  
 CAGE code: 6N040

*Head markings*

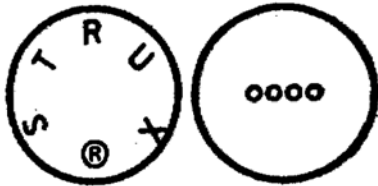

Product Identification, "STRUX ®" equally spaced raised or depressed or four in-line dots, raised or depressed.



Vendor Identification, superimposed "I" and "M" raised or depressed



Product Identification "f" and "t" located as shown, raised or depressed



Product Identification, TORX logo located as shown, raised or depressed.

*Under head markings*



Vendor Identification, four equally spaced radial lines, raised or depressed

*Nut Markings*

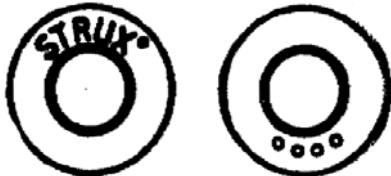

Product Identification, "STRUX ®" raised or depressed, located as shown or four radial dots, raised or depressed.

2/

CAMCAR LLC  
 500 18<sup>TH</sup> AVENUE  
 ROCKFORD, IL 61104

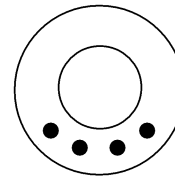

**CAMCAR**

CAGE code: 4WL75

1/

CAMCAR SCREW AND MFG CO DIV OF  
 TEXTRON INC  
 29201 TELEGRAPH RD., SUITE 611  
 SOUTHFIELD, IL 48034 - 7649



PRODUCT IDENTIFICATION, "HP" RAISED OR DEPRESSED.



PRODUCT IDENTIFICATION, FOUR IN-LINE DOTS, RAISED OR DEPRESSED.

HEAD MARKINGS



VENDOR IDENTIFICATION, FOUR RADIAL DOTS, RAISED OR DEPRESSED.



VENDOR IDENTIFICATION, TWO PARALLEL LINES, RAISED OR DEPRESSED.

UNDER HEAD MARKINGS

CAGE code: 6P253

2/

1/ Information published in this revision was verified by direct contact with manufacturers.

2/ Information not verified to be current, no response from manufacturer. Information identical to that published in MIL-HDBK-57, Revision B.

## MIL-HDBK-57F (IS)

CAMLOC PRODUCTS  
AFS TORRANCE OPERATIONS  
3014 WEST LOMITA BLVD.  
TORRANCE, CA 90505-5103  
CAGE code: 71286

AFS KELKHEIM OPERATIONS  
INDUSTRIESTRASSE 6  
D-65779 KELKHEIM, GERMANY  
CAGE code: D0680

(Corporate office see ALCOA FASTENING SYSTEMS)



CAGE code: 71286, D0680

1/

CAM-TECH INDUSTRIES  
95 ESTATES DR W  
FAIRPORT, NY 14450-8425



CAGE code: 0GT70

2/

CANADY MANUFACTURING CO. INC.  
500 FIFTH STREET  
SAN FERNANDO, CA 91340-2225



CAGE code: 00678

2/

CAPRICE ENGINEERING CO., INC.  
509 HINDRY AVE.  
INGLEWOOD, CA 90301-2017



CAGE code: 52916

1/

CAPY MACHINE SHOP, INC.  
114 SPAGNOLI ROAD  
MELVILLE, NY 11747



CAGE code: 0BVP9

1/

CARDINAL FASTENER & SPECIALTY CO.,  
INC.  
5185 RICHMOND RD  
BEDFORD HEIGHTS, OH 44146-1330

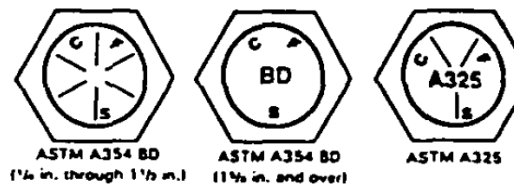

CAGE code: 2Y089

2/

1/ Information published in this revision was verified by direct contact with manufacturers.

2/ Information not verified to be current, no response from manufacturer. Information identical to that published in MIL-HDBK-57, Revision B.

## MIL-HDBK-57F (IS)

CARDINAL INDUSTRIAL PRODUCTS  
3873 WEST OQUENDO  
LAS VEGAS, NV 89118-3010

**C**

A capital "C" to be applied to all standard ASME/ASTM bolting material.

**MULTI-C**

The word "MULTI" followed by a capital "C" to be applied to all ASME bolts manufactured to Nuclear Standards Associates or Cardinal Industrial Products, Inc. Standards.

CAGE code: 57454

2/

CARR CO.  
(THE UNITED CARR DIV OF TRW)  
31 AMES ST.  
CAMBRIDGE, MA 02142



CAGE code: 78947

2/

CATALINA INSTRUMENT CORPORATION  
44 SOUTH MALL  
PLAINVIEW, NY 11803-4208

**CI**

CAGE code: 30225

1/

CBS FASTENERS INC.  
1345 BRASHER STREET  
ANAHEIM, CA 92807-2046

**CBS**  
**CbS**

CAGE code: 0F620

1/

CCB INDUSTRIES, INC.  
3200 STUART DRIVE  
P.O. BOX 1158  
FT. WORTH, TX 76101

**CCB**

CAGE code: 60763

1/

CCF ENTERPRISES INC.  
2449 N.W. DALLAS STREET  
GRAND PRARIE, TX 75050-4971

**CCF**

CAGE code: 08QQ4

2/

CEI INC.  
DBA COMMAND ENTERPRISES  
700 NORTH DELSEA DR  
PITMAN, NJ 08071-1244

**L-S-A**

CAGE code: 6U479

2/

1/ Information published in this revision was verified by direct contact with manufacturers.

2/ Information not verified to be current, no response from manufacturer. Information identical to that published in MIL-HDBK-57, Revision B.

## MIL-HDBK-57F (IS)

CELTECH ENTERPRISE  
9774 CRESENT CTR DR  
SUITE 506  
RANCHO CUCAMONGA, CA 91730-5745



CAGE code: 0EFF7 2/

CENTERLINE TOOL & ENGINEERING, INC.  
3107 29TH AVENUE E  
BRADENTON, FL 34208-7420



Capital "C" and Capital "L" combined.

CAGE code: 0B5B0 2/

CENTRAL OZARK MACHINE, INC.  
HWY 19 SOUTH & HH  
P. O. BOX 347  
ALTON, MO 65606-0347



CAGE code: 64896 2/

CENTRAL SCREW PRODUCTS  
6425 EAST HILDALE  
DETROIT, MI 48234



CAGE code: 1YCR3 1/

CENTURY METAL PARTS CORP.  
230 SOUTH FEHRWAY  
BAY SHORE, NY 11706-1208



CAGE code: 30396 1/

CER-MAC INC.  
971 HORSHAM RD,  
HORSHAM, PA 19044-1225



CAGE code: 53569 2/

CERNY MFG. CO.  
4057 WEST 147TH STREET  
LAWNDALE, CA 60260

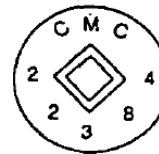

CMC ◊ 22384.

CAGE code: 22384 2/

1/ Information published in this revision was verified by direct contact with manufacturers.

2/ Information not verified to be current, no response from manufacturer. Information identical to that published in MIL-HDBK-57, Revision B.

## MIL-HDBK-57F (IS)

CHAMPION COMMERCIAL INDUSTRIES,  
INC  
CHAMPION RIVET DIVISION  
P.O. BOX 398  
5137 INDIANAPOLIS BLVD  
EAST CHICAGO, IN 46312-0398

**V** *Rivets only*

CAGE code: 4B951 2/

CHAMPION FASTENERS, INC.  
707 SMITHVILLE RD  
LUMBERTON, NJ 08048-5302

**C**

CAGE code: 0NXPO 1/

CHANCE, A.B. COMPANY  
2201 LAKEVIEW RD  
MEXICO, MO 65265-1360

**C**

CAGE code: 02TP8 2/

CHANDLER PRODUCTS, INC.  
1491 CHARDON RD  
CLEVELAND, OH 44117-1598

**CP**

CAGE code: 83386 1/

CHATHAM PRECISION, INC.  
COMMERCE ST.  
P.O. BOX 510  
HINESBURG, VT 05461

**4N133**

CAGE code: 4N133 2/

CHEREK MACHINE & TOOL CO., INC.  
835 SHERMAN AVENUE  
HAMDEN, CT 06514-1149

**CHEREK**

CAGE code: 0YWD4 2/

CHEROKEE TOOL & ENGINEERING CO.,  
INC.  
P.O. BOX 227  
CANTON, GA 30114

**CTEC**  
**11**

CAGE code: 30662 2/

CHIANG SHIN FASTENERS INDUSTRIES,  
LTD  
NO. 111 WANLI ROAD  
GANGSHAN TOWNSHIP, KAOHSIUNG  
COUNTRY 82050, TAIWAN (R.O.C)

**~~S~~ S**





(see Stelfast Inc.)

CAGE code: SFV96 1/

1/ Information published in this revision was verified by direct contact with manufacturers.

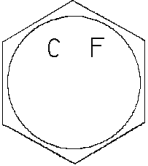
2/ Information not verified to be current, no response from manufacturer. Information identical to that published in MIL-HDBK-57, Revision B.

## MIL-HDBK-57F (IS)

<p>CHICAGO FASTENER MANUFACTURING 10902 WALNUT LANE MOKENA, IL 60448-8165</p>  <p>CAGE code: 05TL5 <span style="float: right;"><u>1/</u></span></p>	<p>CHOICE PRECISION MACHINE, INC. 4280 COMMERCE DRIVE WHITEHALL, PA 18052</p> <p style="text-align: center;"><b>CPM</b></p> <p>CAGE code: 1WAA0 <span style="float: right;"><u>2/</u></span></p>
<p>CHICAGO HARDWARE &amp; FIXTURE CO. 9100 PARK LANE FRANKLIN PARK, IL 60131-3054</p> <p style="text-align: center;"><b>CHF</b></p> <p>CAGE code: 71747 <span style="float: right;"><u>1/</u></span></p>	<p>CHRIS MACHINE CO. 110 DOYLE ST. DOYLESTOWN, PA 18901-1370</p>  <p>CAGE code: 2T317 <span style="float: right;"><u>2/</u></span></p>
<p>CHICAGO NUT &amp; BOLT INC. 150 COVINGTON DRIVE BLOOMINGDALE, IL 60108</p> <p style="text-align: center;"><b>CNB</b></p> <p>CAGE code: 1C4D2 <span style="float: right;"><u>1/</u></span></p>	<p>CHU HUA INDUSTRIAL CO., LTD. 800 FU SHING RD. LU CHU, KAOHSING, TAIWAN, 821 R.O.C.</p>  <p style="text-align: right;"><b>UH</b></p> <p>CAGE code: <span style="float: right;"><u>2/</u></span></p>
<p>CHIEF MFG. 423B WEST FORK DRIVE ARLINGTON, TX 76012-3450</p>  <p>CAGE code: 00WU0 <span style="float: right;"><u>1/</u></span></p>	<p>CHUN YU WORKS &amp; CO., LTD. 1 CIASHING KANGSHAN, TAIWAN</p> <p style="text-align: center;"><b>L</b></p> <p>CAGE code: <span style="float: right;"><u>2/</u></span></p>

1/ Information published in this revision was verified by direct contact with manufacturers.

2/ Information not verified to be current, no response from manufacturer. Information identical to that published in MIL-HDBK-57, Revision B.

MIL-HDBK-57F (IS)

CINCH MANUFACTURING  
2610 S YALE ST  
SANTA ANA, CA 92704



CAGE code: 2/

CINCH-MONADNOCK  
18301 ARENTH AVE  
CITY OF INDUSTRY, CA 91749

 = (dot)

CAGE code: 2/

CLEVELAND HARDWARE & FORGING  
DBA GREEN BAY DROP FORGE CO  
1341 S. STATE ST  
P.O. BOX 11797  
GREEN BAY, WI 54307-1797

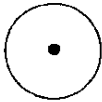
 Circle with center dot

CAGE code: 08277 2/

CLICK BOND, INC.  
2151 LOCKHEED WAY  
CARSON CITY, NV 89706-0713

**CB**

CAGE code: 66530 1/

CLYDE FASTENERS LIMITED  
5 HAWBANK RD,  
EAST KILBRIDE, GLASGOW, SCOTLAND  
G74 5ET

**CFL**

CAGE code: 1/

CM MANUFACTURING, INC.  
6333 BUTLER CREEK ROAD  
MISSOULA, MT 59808-8861

**CM**

CAGE code: 6Z056 1/

CNC MACHINING INC.  
109 PANE ROAD  
NEWINGTON CT 06111-1552

**C**

CAGE code: 2Y832 2/

COAE BOLTS WORKS CO., LTD  
NO. 47 CHINAN ROAD, TASHE HSIANG  
KOAHSIUNG HSIEN, TAIWAN

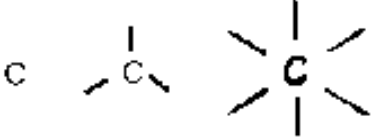
 **A325**

CAGE code: 2/

1/ Information published in this revision was verified by direct contact with manufacturers.

2/ Information not verified to be current, no response from manufacturer. Information identical to that published in MIL-HDBK-57, Revision B.



## MIL-HDBK-57F (IS)

COAST INDUSTRIAL SUPPLY CO., INC.  
SUB OF SPANDCO INDUSTRIES INC.  
15959 PIUMA AVENUE  
CERRITOS, CA 90701-1526



On head of silicon bronze and  
aluminum hex head cap screws



On head of stainless steel, monel,  
brass, naval bronze, chrome alloy,  
hex head cap screws, and the end  
of alloy steel studs.

CAGE code: 9U032

2/

CODLING TOOL & MFG. INC.  
665 NE 42ND STREET  
FORT LAUDERDALE, FL 33334



CAGE code: 0P3X2

2/

COLD HEADING CO., THE  
21777 HOOVER RD.  
WARREN, MI 48089-2544

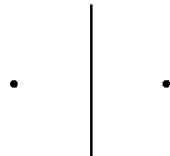

CAGE code: 89657

1/

COLOC MANUFACTURING  
DIVISION INGRAM INDUSTRIES, INC.  
P.O. BOX 249  
CANTON, TX 75103

Plant  
465 VZ CR 2516  
CANTON, TX 75103

III

CAGE code: 0M6Y0

1/

COMET MFG. CO., INC.  
315 JOHN DOWNEY DRIVE  
NEW BRITIAN, CT 06051

61062

CAGE code: 61062

2/

COMMAND ENTERPRISES  
700 NORTH DELSEA DR.  
PITMAN, NJ 08071  
(see CEI, INC.)

C. E. I

CAGE code:

2/

COMPONENT PRODUCTS CORPORATION  
11623 CYRUS WAY  
MUKILTEO, WA 98275

6F140





CAGE code: 6F140

1/

1/ Information published in this revision was verified by direct contact with manufacturers.

2/ Information not verified to be current, no response from manufacturer. Information identical to that published in MIL-HDBK-57, Revision B.

## MIL-HDBK-57F (IS)

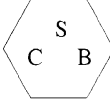
<p>COMPUTA-BASE MACHINING, INC. 411 NORTH GROVE ST P.O. BOX 340 BERLIN, NJ 08009-9704</p> <p style="text-align: center;"><b>CBM</b></p> <p>CAGE code: 0A396 <span style="float: right;"><u>2/</u></span></p>	<p>CONQUEST MACHINE, INC. 3655 RESEARCH DR. GENESIS A STE 106 LAS CURCES, NM 88003-1239</p> <p style="text-align: center;"><b>CMI</b></p> <p>CAGE code: 0PNX2 <span style="float: right;"><u>2/</u></span></p>
<p>CONNECTICUT AIRCRAFT PRODUCTS 246 SHAKER ROAD ENFIELD, CT 06082-2366</p> <p style="text-align: center;"></p> <p>CAGE code: 0KA73 <span style="float: right;"><u>2/</u></span></p>	<p>CO-OP SCREW MANUFACTURING CORP. 60 SINDLE AVE. LITTLE FALLS, NJ 07424-1649</p> <p style="text-align: center;"><b>C</b></p> <p>CAGE code: 1FZ52 <span style="float: right;"><u>2/</u></span></p>
<p>CONTINENTAL MACHINE PRODUCTS, INC. 11 WALLEY STREET EAST BOSTON, MA 02128</p> <p style="text-align: center;"></p> <p>CAGE code: 0T1E0 <span style="float: right;"><u>1/</u></span></p>	<p>COOPER POWER SYSTEMS INC (MCGRAW EDISON POWER SYSTEMS) NORTH BURSON STREET EAST STROUDSBURG, PA 18301</p> <p style="text-align: center;"><b>M</b></p> <p>CAGE code: 88424 <span style="float: right;"><u>2/</u></span></p>
<p>CONTINENTAL TOOL &amp; MANUFACTURING 15941 W. 108<sup>th</sup> STREET LENEXA, KS 66219</p> <p style="text-align: center;"><b>CTM</b></p> <p>CAGE code: 63003 <span style="float: right;"><u>1/</u></span></p>	<p>COPELAND MFG. CORP. (JAMES DIVISION) 11222 E. PINE ST. TULSA, OK 74116-1613</p> <p style="text-align: center;"> </p> <p>CAGE code: 0CM67 <span style="float: right;"><u>2/</u></span></p>
<p>CONTRACTING CNC MACHINING 8360 CURRENCY DR. UNIT #7 RIVIERA BEACH, FL 33404</p> <p style="text-align: center;"><b>CCM</b></p> <p>CAGE code: 64M67 <span style="float: right;"><u>1/</u></span></p>	<p>COPPER STATE BOLT &amp; NUT CO. 3602 N 35TH AVE. 3637 N 34TH AVE. PHOENIX, AZ 85017-4408</p> <p style="text-align: center;"></p> <p>CAGE code: 0Z0Y2 <span style="float: right;"><u>2/</u></span></p>

1/ Information published in this revision was verified by direct contact with manufacturers.

2/ Information not verified to be current, no response from manufacturer. Information identical to that published in MIL-HDBK-57, Revision B.

## MIL-HDBK-57F (IS)

CORPUS CHRISTI GASKET & FASTENER  
LTD.  
341 WEST CHESTER RD.  
P.O. BOX 4074  
CORPUS CHRISTI, TX 78408

**CCG**

CAGE code: 008R2 1/

CRS PRECISION CORP.  
640 WEST MERRICK ROAD  
VALLEY STREAM, NY 11580-0482

**CRS**  
PRECISION CORP.

CAGE code: 07QQ6 2/

CREATIVE PRECISION INC.  
DBA CREATIVE PRECISION WEST  
2640 E. ROSE GARDEN LANE SUITE 6  
PHOENIX, AZ 85050-4612

Plant  
1501 BLUEBALL AVENUE  
LINWOOD, PA 19061  
CAGE code: 0F3N2

**CPI**

CAGE code: 1K0E5 1/

CRUM MFG.  
1265 WATERVILLE-MONCLOVA RD.  
WATERVILLE, OH 43566

**CRUM**

CAGE code: 57ZX3 1/

CRESENT MANUFACTURING CO.  
P.O. BOX 1350  
BUILINGTON, CT 06013-0350

Plant  
700 GEORGE WASHINGTON TPKE  
BUILINGTON, CT 06013-0350

**CMA**

CAGE code: 63020 1/

CRYSTAL METAL PRODUCTS COMPANY,  
INC.  
2700 E. CASTOR AVENUE  
PHILADELPHIA, PA 191345

**CMP**

CAGE code: 0BPW8 2/

1/ Information published in this revision was verified by direct contact with manufacturers.

2/ Information not verified to be current, no response from manufacturer. Information identical to that published in MIL-HDBK-57, Revision B.

## MIL-HDBK-57F (IS)

CSM FASTENER PRODUCTS  
1133 BRTN MAWR AVE.  
BENSENVILLE, IL 60106

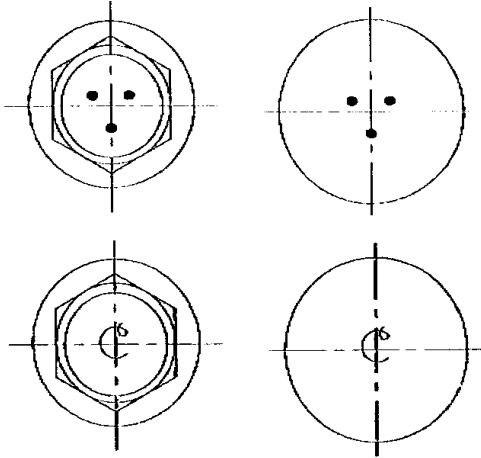

CAGE code: 1CJW4

1/

CURTIS PRESTON ENTERPRISES INC.  
DBA ATLAS SPECIALTY PRODUCTS  
2299 E WINSTON RD  
ANAHEIM, CA 92806-5538

**ASP**

CAGE code: 0TP31

1/

CUTTING EDGE ENTERPRISE, LLC  
2465 POLE LINE RD.  
DECORAH, IOWA 52101

Plant  
2509 172<sup>ND</sup> AVE.  
DECORAH, IOWA 52101

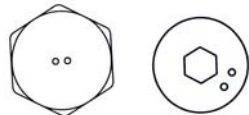

CAGE code: 52101

1/

CUTTING EDGE MACHINING INC.  
NEVADA DIV  
1625 LINDA WAY  
SPARKS, NV 89431

See WESTERN SCREW MACHINE  
PRODUCTS, INC.



CAGE code: 0ZV72

2/

CUTTING EDGE MACHINING SOLUTIONS,  
INC.  
P.O. BOX 248  
75 BASIN RUN ROAD  
DRIFTING, PA 16834



CAGE code: 3EQ16

1/

CWR MANUFACTURING CO  
(DIVISION OF A.J. MUPHY CO., INC.)  
P.O. BOX 2669  
SYRACUSE, NY 13220

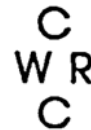

CAGE code:

2/

D & D MACHINERY AND SALES  
2420 W. R. LARSON ROAD  
SAN ANTONIO, TX 78261-2200

**1Y128**





CAGE code: 1Y128

2/

1/ Information published in this revision was verified by direct contact with manufacturers.

2/ Information not verified to be current, no response from manufacturer. Information identical to that published in MIL-HDBK-57, Revision B.

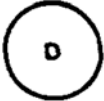
## MIL-HDBK-57F (IS)

<p>D &amp; D MANUFACTURING 26199 JEFFERSON AVE. MORRIETA, CA 92562</p> <p style="text-align: center;"></p> <p>CAGE code: NONE <span style="float: right;"><u>1/</u></span></p>	<p>D.S.O. PLASTICS, INC. 1220 ROCK ST. ROCKFORD, IL 61101</p> <p style="text-align: center;"><b>Z</b></p> <p>CAGE code: <span style="float: right;"><u>2/</u></span></p>
<p>D &amp; D TOOL COMPANY, INC. LEWIS STREET &amp; MAPLE AVENUE EATONTOWN, NJ 07724</p> <p style="text-align: center;"><b>D &amp; D</b></p> <p>CAGE code: 30077 <span style="float: right;"><u>2/</u></span></p>	<p>DACK INDUSTRIES, INC. P.O. BOX 427 FARMINGTON , CT 06034 - 0427</p> <p style="text-align: center;"><b>d</b></p> <p>CAGE code: 0CZ42 <span style="float: right;"><u>2/</u></span></p>
<p>D &amp; R MACHINE COMPANY 2310 BIG OAK ROAD LANGHORNE, PA 19047-1910</p> <p style="text-align: center;"><b>4T853</b></p> <p>CAGE code: 4T853 <span style="float: right;"><u>2/</u></span></p>	<p>DANIEL CO., EDWARD W. 11700 HARVARD AVENUE CLEVELAND, OH 441053</p> <p style="text-align: center;"></p> <p>CAGE code: 73634 <span style="float: right;"><u>2/</u></span></p>
<p>D. C. MACHINING INC. 1900 9TH AVE., SW WATERTOWN, SD 57201</p> <p style="text-align: center;"><b>DC</b></p> <p>CAGE code: 0AUC7 <span style="float: right;"><u>2/</u></span></p>	<p>DAN-LOC BOLT &amp; GASKET INC. FORMALLY <i>DANIEL INDUSTRIES, INC.</i> Bolt &amp; Gasket Division P.O. BOX 292 HOUSTON, TX 77001-0292</p> <p style="text-align: center;">Plant 725 North Drennan Houston, TX 77003</p> <p style="text-align: center;">   </p> <p style="text-align: center;"><b>STUDS</b> <span style="margin-left: 100px;"><b>HEX NUTS</b></span></p> <p>CAGE code: <span style="float: right;"><u>2/</u></span></p>

1/ Information published in this revision was verified by direct contact with manufacturers.

2/ Information not verified to be current, no response from manufacturer. Information identical to that published in MIL-HDBK-57, Revision B.

MIL-HDBK-57F (IS)

DARCO PRODUCTS  
8406 WASHINGTON PL NE  
ALBUQUERQUE, NM 87113-1671

D P

CAGE code: 1DL79 2/

DAVE ALLEN ENTERPRISES  
10631 BLOOMFIELD AVENUE  
UNIT 15  
LOS ALAMITOS, CA 90720

DAE

CAGE code: 1NWX4 2/

DAVIES PRECISION MACHINING, INC.  
2400 COLEBROOK RD.  
LEBANON, PA 17042-9562

DPM

CAGE code: 7V760 2/

DAVIS AIRCRAFT PRODUCT CO., INC.  
1150 WALNUT AVENUE  
BOHEMIA, NY 11716-6216



CAGE code: 98313 2/

DECKER MANUFACTURING CORP  
703 NORTH CLARK STREET  
P.O. BOX 410  
ALBION, MI 49224-1455

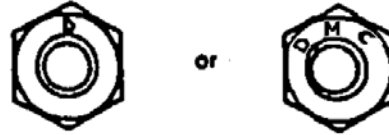

HEX WHEEL NUTS  
(DEPRESSED "D" or "MDC")



AMERICAN STANDARD  
SQUARE, HEX, AND ROUND WELD NUT  
(SMALL RAISED DOR ON CHAMFER)

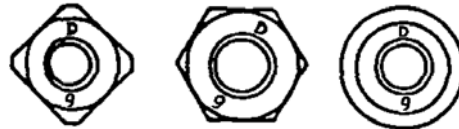

METRIC  
SQUARE, HEX, AND ROUND WELD NUTS  
(DEPRESSED LETTER "D" AND CLASS NO.)



A-563  
STRUCTURAL NUTS  
(DEPRESSED "D" OR "DMC")

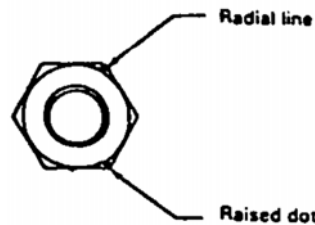





GRADE 5  
HEX NUTS  
(ONE RAISED RADIAL LINE 120°  
COUNTERCLOCKWISE FROM ONE  
RAISED DOT ON CHAMFER)

CAGE code: 12876 2/

1/ Information published in this revision was verified by direct contact with manufacturers.

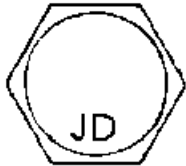
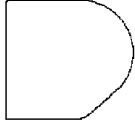
2/ Information not verified to be current, no response from manufacturer. Information identical to that published in MIL-HDBK-57, Revision B.

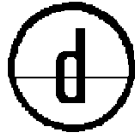
## MIL-HDBK-57F (IS)

<p>DEERE &amp; CO. JOHN DEERE PLACE MOLINE, IL 61265</p>  <p>CAGE code: 75160 <span style="float: right;"><u>2/</u></span></p>	<p>DEFIANCE STAMPING COMPANY, THE P.O. BOX 506 DEFIANCE, OHIO 43512-2743</p> <p>PLANT 1090 PERRY ST DEFIANCE, OHIO 43512-2743</p>  <p>CAGE code: 6B357 <span style="float: right;"><u>2/</u></span></p>
<p>DEFENSE AEROSPACE <i>MFG OF DEFENSE AEROSPACE THREADED MACHINE PARTS</i> 10841 NOEL ST. #104 LOS ALAMITOS, CA 90720-2527</p> <p style="text-align: center;"><b>DAS</b> <b>1</b></p> <p>CAGE code: 1W4A6 <span style="float: right;"><u>1/</u></span></p>	<p>DEHOUSSE (USINES) 64007 PAU FRANCE</p> <p style="text-align: center;"><b>D</b></p> <p>CAGE code: BP714 <span style="float: right;"><u>2/</u></span></p>
<p>DEFENSE QUALITY MFG. 40 SACCO RD. ROYERSFORD, PA 19468-1030</p>  <p style="text-align: center;"><b>DQ</b></p> <p>CAGE code: 0B6M7 <span style="float: right;"><u>2/</u></span></p>	<p>DELL MFG. CO., INC. 4 RIGHT LANE FARMINGTON, CT 06032-3195</p>  <p>CAGE code: 5A628 <span style="float: right;"><u>1/</u></span></p>
<p>DELT INDUSTRIES, INC. (AEROSPACE PRODUCTS DIVISION) 90 WEST EASY STREET, STE 2 P.O. BOX 940067 SIMI VALLEY, CA 93065-6206</p>  <p>CAGE code: 064T2 <span style="float: right;"><u>1/</u></span></p>	

1/ Information published in this revision was verified by direct contact with manufacturers.

2/ Information not verified to be current, no response from manufacturer. Information identical to that published in MIL-HDBK-57, Revision B.

## MIL-HDBK-57F (IS)

DELTA MACHINE & TOOL CO., INC.  
PARKMOUNT ROAD  
P.O. BOX 351  
GLEN RIDDLE, PA 19037



CAGE code: 2/

DEL-VAL FASTENER MANUFACTURING  
P.O. BOX 2901  
21-D INDUSTRIAL DRIVE  
WARMINSTER, PA 18974

**DV**

CAGE code: 1EE10 2/

DEMAT  
(CANCELLED AND REPLACED BY ALCOA  
FASTENER SYSTEMS)  
BD DU GRAND CASTAING ZI  
BD DU GRD CASTING  
ROQUES, FRANCE 31120



**DT M**

**D**

CAGE code: F7411 2/

DEPENDABLE MACHINE CO., INC.  
1846 E 30TH ST  
INDIANAPOLIS, IN 46218-2607



CAGE code: 14554 2/

DERBYSHIRE MACHINE & TOOL CO.  
DBA DERBYSHIRE MARINE PRODUCTS  
5100 BELFIELD AVENUE  
PHILADELPHIA, PA 19144-1788



CAGE code: 71905 1/

DETROIT HEADING CO.  
6421 LYNCH RD.  
DETROIT, MI 48234-4140



CAGE code: 0TUA2 2/

DEUTSCH COMPANY INC., THE  
DBA DEUTSCH CO THE METAL  
COMPONENT  
14800 S. FIGUEROA STREET  
GARDENA, CA 90248-1795



CAGE code: 14798 2/

1/ Information published in this revision was verified by direct contact with manufacturers.

2/ Information not verified to be current, no response from manufacturer. Information identical to that published in MIL-HDBK-57, Revision B.



## MIL-HDBK-57F (IS)

DFCI SOLUTIONS, INC.  
425 UNION BLVD.  
WEST ISLIP, NY 11795-3183



CAGE code: 72794 1/

DHL ENTERPRISES  
1260 E. WOODLAND AVENUE #46  
P. O. BOX 295  
MORTON, PA 19070

**DHL**

CAGE code: 0UGD5 2/

DIAL SUPPLY AND MFG., INC.  
1315 FM 1187  
#106  
MANSFIELD, TX 76063



CAGE code: 9N473 1/

DIESEL PARTS COMPANY OF CALIFORNIA  
1900 EAST 12TH STREET  
OAKLAND, CA 94606-4821

**D**

CAGE code: 24378 2/

DIHARD COMPANY  
3161 MAJOR STREET  
FORT WORTH, TX 76112 - 7020

**D**

CAGE code: 0F1U4 2/

DISC-LOCK INTERNATIONAL  
1924 S PACIFIC COAST HWY SUITE F  
REDONDO BEACH, CA 90277

**DL**

CAGE code: 72731 2/

DIXON MACHINE & TOOL  
DBA DIXON MACH AND FABRICATION  
6807 CHAPMAN HWY.  
KNOXVILLE, TN 37920-6560

see TROY D. RAY

**DMT**

CAGE code: 1DEP3 2/

DO MANUFACTURING CORP.  
P.O. BOX 2382  
114 BROOKLYN ST  
ROCKVILLE, CT 06066

*PLANT*  
114 BROOKLYN ST.  
ROCKVILLE, CT 06066



CAGE code: 1H312 2/

1/ Information published in this revision was verified by direct contact with manufacturers.

2/ Information not verified to be current, no response from manufacturer. Information identical to that published in MIL-HDBK-57, Revision B.

## MIL-HDBK-57F (IS)

DO-ALL PRECISION, INC.  
9 UNION AVENUE  
MOUNT VERNON, NY 10550



CAGE code: 2/

DOMESTIC FASTENER & FORGE, INC.  
P.O. BOX 14642  
LENEXA, KS 66285

Plant  
15850 W. 108<sup>TH</sup> STREET  
LENEXA, KS 66219

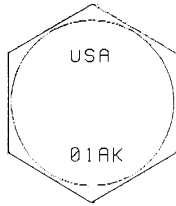

CAGE code: 09ML9 1/

DOMESTIC FORGING, INC.  
P.O. BOX 693  
NEW HAVEN, MI 48048



CAGE code: 2/

DONSON MACHINE  
ALSIP MACHING GROUP  
12416 S. KEDVALE AVENUE  
ALSIP, IL 60803-1819

**DMC**

CAGE code: 0BHD5 1/

DOUBLECO INCORPORATED  
DBA R & D FASTENERS  
9444 9TH STREET  
RANCHO CUCAMONGA, CA 91730



CAGE code: 1UKP3 1/

DOUGLASS TOOL & ENGINEERING CO.,  
INC.  
304 EAST DYER ROAD  
SANTA ANA, CA 92707

**DTE**

Marking to be indented

CAGE code: 2/

DRESSER INDUSTRIES, INC.  
DRESSER PUMP DIVISION  
142 CLINTON ROAD  
FAIRFIELD, NJ 07004

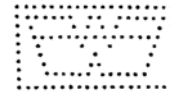

CAGE code: 0LNV2 2/

D'SAMIC  
1261 HOBLITT AVE # 206  
CLOVIE, CA 93612-2811



CAGE code: 2/

1/ Information published in this revision was verified by direct contact with manufacturers.

2/ Information not verified to be current, no response from manufacturer. Information identical to that published in MIL-HDBK-57, Revision B.

## MIL-HDBK-57F (IS)

DTF MANUFACTURING, INC.  
 DIV OF FEDERAL SCREW AND SUPPLY  
 CO  
 P. O. BOX 329  
 146 ALBANY AVE.  
 LINDENHURST, NY 11757

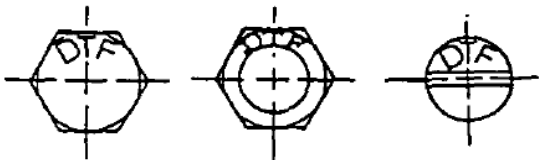

Standard: DTF  
 Large Dia: DTF  
 DTF  
 Micro Dia: d

CAGE code: 0H802

2/

DUFFY ELECTRONICS & MFG. CO.  
 50 BARNES PARK RD  
 WALLINGFORD, CT 06492



CAGE code:

2/

DUNCAN ELECTRONICS & MFG. CO.  
 701 SEVENTH AVE.  
 BELMAR, NJ 07719



CAGE code:

2/

DUNHAM PRODUCTS, INC.  
 7400 northfield rd.  
 Walton hills, ohio 44146

DP  
 DPI

CAGE code: 1B4S0

1/

DUPONT, G.B. CO., INC.  
 (SEE KAMAX L. P.)  
 500 WEST LONG LAKE ROAD  
 TROY, MI 48098-4540



CAGE code: 1DWW1

1/

DUSEVOIR METAL PRODUCTS, INC.  
 1751 S TELEGRAPH RD  
 P.O. BOX 2158  
 DEARBORN, MI 41823



CAGE code: 97233

2/

1/ Information published in this revision was verified by direct contact with manufacturers.

2/ Information not verified to be current, no response from manufacturer. Information identical to that published in MIL-HDBK-57, Revision B.

## MIL-HDBK-57F (IS)

DUVE GmbH & CO. KG  
P.O. BOX 1240  
NEUENRADE, GERMANY D-5982

**D** - All hexagon head screws and bolts made of high tensile steel grade 8.8 up to 12.8, and sealing fasteners made of case-hardened carbon steel

**DX** - Hexagon head sealing fasteners made of stainless steel

**DUVEX** - Hexagon head screws and bolts made of stainless steel (A2 + A4)

**DUVE** - DUVE DRIL-KWICK Self-Drilling Fastener (Screws)

**DUVE**

CAGE code: 2/

DYNACAST  
INDUSTRIAL FASTENERS DIVISION  
1401 FRONT STREET  
YORKTOWN HEIGHTS, NY 10598

**DYNACAST**

CAGE code: 2/

DYNAMIC ENGINEERING  
720 11TH AVE., S.E.  
P.O. BOX 697  
WATERTOWN, SD 57201-0697



CAGE code: 9U252 2/

DYSON CORP THE  
formerly (JOS. DYSON & SONS, INC.)  
53 FREEDOM RD  
PLAINSVILLE, OH 44077-1232



CAGE code: 22132 2/

DZUS FASTENER CO., INC.  
see DFCI SOLUTIONS, INC.  
425 UNION BLVD  
WEST ISLIP, NY 11795

**DZUS** **DZUS**

CAGE code: 3L478  
cancelled- replaced by 72794 2/

E. KOZAK PRECISION PRODUCTS CO.  
45 WOODLAND AVE.  
ROCKAWAY, NJ 07866

**KPP**

CAGE code: ICP43 2/

E.L.R. MACHINE AND TOOL  
48 A VINCENT CIRCLE  
IVYLAND, PA 18974









CAGE code: 2/

<sup>1/</sup> Information published in this revision was verified by direct contact with manufacturers.

<sup>2/</sup> Information not verified to be current, no response from manufacturer. Information identical to that published in MIL-HDBK-57, Revision B.

## MIL-HDBK-57F (IS)

<p>EAGAN MACHINE CORP. 135 CENTER STREET BRISTOL, CT 06010</p>  <p>CAGE code: <u>2/</u></p>	<p>EAST COAST METALS INC. 171 RUTH ROAD HARLEYSVILLE, PA 19438</p>  <p>CAGE code: 4W058 <u>2/</u></p>
<p>EAGLE PICHER INDUSTRIES (PRECISION PRODUCTS PLANT) 1927 W 4TH ST P.O. BOX 1444 JOPLIN, MO 64801-3</p>  <p>CAGE code: 9L734 <u>2/</u></p>	<p>EASTERN SCREW CO., INC. 15 AMFLEX DRIVE CRANSTON, RI 02921-2028</p> <p>Plant 71 MILL STREET JOHNSON, CRANSTON, RI 02921-2028</p>  <p>CAGE code: 2L684 <u>1/</u></p>
<p>EAGLEHEAD MANUFACTURING COMPANY DBA DEJAK MACHINE TOOL COMPANY DIV DEJAK DRILLING 23555 EUCLID AVE EUCLID, OH 44117-1703</p> <p>Alphanumeric Designation</p> <p>01NU</p> <p>CAGE code: 1GVE5 <u>2/</u></p>	<p>EASTWOOD MFG., CO. P.O. BOX 231102 6825 BREEN RD HOUSTON, TX 77086-3719</p> <p>Plant 52 Lawndale Houston, TX 77023</p>  <p>CAGE code: 77903 <u>2/</u></p>
<p>EAST BAY MANUFACTURERS INC. P.O. BOX 436 BRISTOL, RI 02809</p> <p>Plant 400 FRANKLIN STREET BRISTOL, RI 02809</p>  <p>CAGE code: 5BE51 <u>1/</u></p>	<p>EATON AEROQUIP CORPORATION (AEROSPACE DIVISION) 300 S. EAST AVE. JACKSON, MICHIGAN 49203-1972</p>  <p>CAGE code: 00624 <u>2/</u></p>

1/ Information published in this revision was verified by direct contact with manufacturers.

2/ Information not verified to be current, no response from manufacturer. Information identical to that published in MIL-HDBK-57, Revision B.

## MIL-HDBK-57F (IS)

EBC INDUSTRIES  
(FORMERLY ERIE BOLT CORP.)  
1325 LIBERTY STREET  
ERIE, PA 16502-1641

**ERIE E**

CAGE code: 5G920

1/

EBERHARD BRUNINGHAUS  
POSTFAUCH 12 06 1M DUDA2  
NEUENRADE, FEDERAL REPUBLIC OF  
GERMANY D 5982



**EBM**

CAGE code:

2/

ECENARRO S. COOP. LTDA.  
c/ AMILLAGA, 15.  
BERGARA - GUIP'UZOCA,  
SPAIN 20500

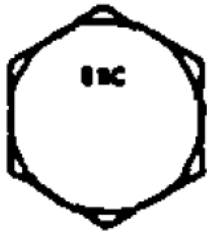

**ESC**

CAGE code:

2/

EDS ORDNANCE  
644 C ANCHORS ST.  
FT. WALTON BEACH, FL 32548



CAGE code: 1CA31

2/

ELASTIC STOP NUT  
(Division of Harvard Industries, Inc.)

See MACLEAN-ESNA

Plant  
2330 Vauxhall Road  
Union, NJ 07083

2<sup>nd</sup> Plant  
3200 Country Club Road  
P.O. Box 988  
Pocahontas, AR 72455

**E, EN, or ESNA** Red nylon insert in locknuts

Red nylon insert in locknuts identifies Esna as  
manufacturer



CAGE code:

2/

1/ Information published in this revision was verified by direct contact with manufacturers.

2/ Information not verified to be current, no response from manufacturer. Information identical to that published in MIL-HDBK-57, Revision B.

MIL-HDBK-57F (IS)

ELCO INDUSTRIES, INC.  
1111 SAMUELSON RD  
ROCKFORD, IL 61101

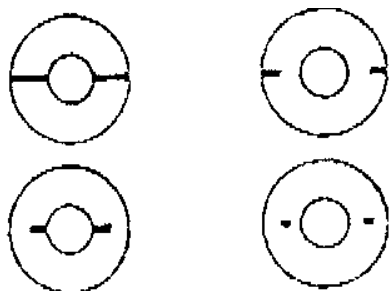

Underside of screw head



CAGE code: 83486

2/

ELECTRO-FREETO MANUFACTURING  
COMPANY  
37 POPE ROAD  
HOLLISTON, MA 01746-2218

**JF**

CAGE code: 17401

2/

ELITE FASTENERS  
6400 DALE STREET  
BUENA PARK, CA 90621

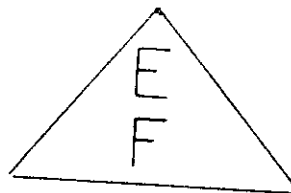

CAGE code: 0T3D2

2/

ELLIS PRECISION INDUSTRIES  
DBA E P IND.  
3133 RAMONA DR  
FORT WORTH, TX 76116-5122

**e**



CAGE code: 9Z199

2/

EMERALD VALLEY MFG  
3825 W. 11TH AVE  
SUITE B  
EUGENE, OR 97402

**DTE**

CAGE code: 4Y352

2/

<sup>1/</sup> Information published in this revision was verified by direct contact with manufacturers.

<sup>2/</sup> Information not verified to be current, no response from manufacturer. Information identical to that published in MIL-HDBK-57, Revision B.

MIL-HDBK-57F (IS)

EMHART CORP.  
PARKER-KALON DIVISION  
395 ROBERTS ROAD  
CAMPBELLSVILLE, KY 42718

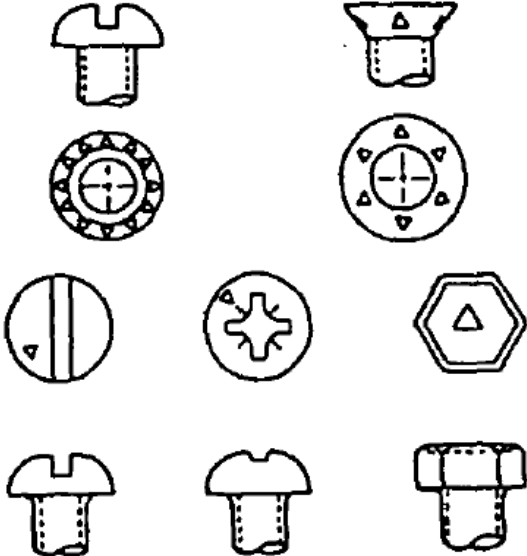

"TRIANGLE" MARKING

EMHART CORP  
GRIPCO FASTENER DIVISION  
111 EAST BROAD STREET  
SOUTH WHITLEY, IN 46787



G<sub>H</sub> raised or indented on  
flange or bearing surface



G<sub>H</sub> raised on head, both  
inch and metric series e



G<sub>H</sub> raised or indented on  
flange or bearing surface

CAGE code: 73020

2/

EMP MANUFACTURING CO.  
40935 PRODUCTION DR  
HARRISON TOWNSHIP, MI 48045-1351

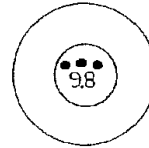

CAGE code: 4G973

2/

EMPIRE PRECISION MACHINING  
108 W. HOLLOWAY DR.  
HURST, TX 76053-6807



CAGE code: 5V179

1/

ENGEL MANUFACTURING COMPANY,  
INC., THE  
304 W. EWING AVENUE  
SOUTH BEND, IN 46613-2108



CAGE code: 0XYS0

2/

ENGINEERED BOLTING PRODUCTS, INC.  
P.O. BOX 7067  
301 MONTGOMERY ST  
SHREVEPORT, LA 71137

Plant  
301 Montgomery St.  
Shreveport, LA 71107

**EBP**

CAGE code: 0K4X1

2/

<sup>1/</sup> Information published in this revision was verified by direct contact with manufacturers.

<sup>2/</sup> Information not verified to be current, no response from manufacturer. Information identical to that published in MIL-HDBK-57, Revision B.



MIL-HDBK-57F (IS)

ENGINEERING MATERIALS CO., INC.  
 FASTENER MANUFACTURING DIVISION  
 2055 WEST COWLES STREET  
 LONG BEACH, CA 90813-1087

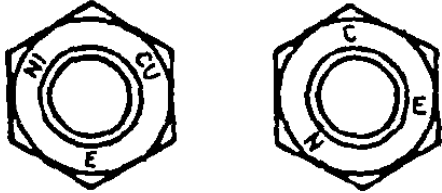

Mfr. Symbol/Logo embossed or intent marked. Letter "E" as shown on nut crown spaced 120 degrees from material symbol marking.

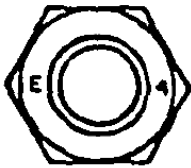

Mfr. Symbol/Logo letter "E" as shown, opposite material symbol marking code on nut crown at corners.

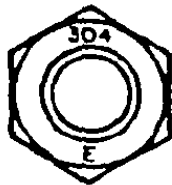

Mfr. Symbol/Logo letter "E", as shown on nut crown, 180 degrees opposite material symbol marking.



Mfr. Symbol/Logo letter "E" marked opposite material symbol code marking on nut crown at one corner location.

CAGE code: 19968  
 Continued

1/

Continued

ENGINEERING MATERIALS CO., INC.



Mfr. Symbol/Logo letter "E" marked opposite material symbol code marking on nut crown at one corner location.



Mfr. Symbol/Logo letter "E" marked on crown, 180 degrees opposite thread designation letter.



Mfr. Symbol/Logo letter "E" indent marked above material symbol.

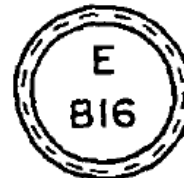

Mfr. Symbol/Logo letter "E" as shown marked above material symbol marking on stud or rod end.

CAGE code: 19968

1/

<sup>1/</sup> Information published in this revision was verified by direct contact with manufacturers.

<sup>2/</sup> Information not verified to be current, no response from manufacturer. Information identical to that published in MIL-HDBK-57, Revision B.

## MIL-HDBK-57F (IS)

ENGLE MANUFACTURING COMPANY,  
INC., THE  
304 W. ERVING AVE.  
SOUTH BEND, IN 46613

**EM**  
**F593**  
**T**

CAGE code: 0XYS0 2/

ENOMOTO INDUSTRIES CO., LTD.  
3-26 TAKASAGO, TAKAISHI-SHI,  
OSAKA, 592  
JAPAN



CAGE code: S0132 2/

ENVISION TECH, INC.  
4404 S. 40<sup>TH</sup> TERRACE  
ST. JOSEPH, MO 64503

**ETI**

CAGE code: 056X3 1/

ERICO FASTENING SYSTEMS  
301 NEW ALBANY ROAD  
MOORESTOWN, NJ 08057



CAGE code: 84483 2/

ERIE BOLT CORP.  
1325 LIBERTY STREET  
ERIE, PA 16502

see EBC INDUSTRIES

**ERIE E**

CAGE code: 5G920 2/

ESCO PRECISION, INC.  
71 OLD CAMPLAIN RD.  
HILLSBOROUGH, NJ 08844

**EPI**

CAGE code: 1YRR0 1/

ESMET, INC.

DBA ELECTROLINE TTUFLOC  
1406 5TH ST., S.W.  
CANTON, OH 44702-2062  
CAGE code: 79931

SUB OF UNIMET CORP  
1406 5TH ST., S.W.  
CANTON, OH 44702-2062  
CAGE code: 0EA31











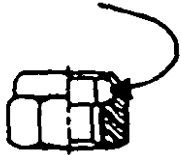



CAGE code: 79931, 0EA31 1/

1/ Information published in this revision was verified by direct contact with manufacturers.

2/ Information not verified to be current, no response from manufacturer. Information identical to that published in MIL-HDBK-57, Revision B.

MIL-HDBK-57F (IS)

<p>ESNA (MACLEAN-FOGG COMPANY) 611 COUNTRY CLUB ROAD POCAHONTAS, AR 72455-8803</p>
<p><b>E, EN, or ESNA</b> Red nylon insert in locknuts</p> <p>Red nylon insert in locknuts identifies Esna as manufacturer</p> 
<p>CAGE code: 019L2 <span style="float: right;">2/</span></p>
<p>ESP MANUFACTURING CO., INC. 2331 E. INTERSTATE 20 P O BOX 871 ODESSA, TX 79766-8827</p>
<p style="text-align: center;"><b>ESP</b></p>
<p>CAGE code: 7J504 <span style="float: right;">1/</span></p>
<p>ESSENTIAL MACHINING 354 HERBERTSVILLE ROAD BRICK, NJ 08724-1735</p>

<p>CAGE code: 0TR19 <span style="float: right;">1/</span></p>
<p>ESTA PRODUCTS COMPANY 16 MISSOURI DRIVE WARWICK, RI 02886-8117</p>
<p style="text-align: center;"><b>ESTA</b></p>
<p>CAGE code: 8R230 <span style="float: right;">2/</span></p>

<p>EVERLOCK FASTENING SYSTEMS EVERLOCK DETROIT DIVISION 6567 SOUTH STERLING DRIVE STERLING HEIGHTS, MI 48077</p>	
<p>Microlock</p>	<p>Hi-Hex Microlock</p>
	
<p>Prevailing torque surface</p>	
<p>Flange Hi-Hex Microlock</p>	
	
<p>Prevailing torque surface</p>	
<p>Flange Toplock</p>	
	
<p>Flange Nut</p>	
	
<p>Nut and Washer Assembly</p>	
	
<p>Standard Hex Nut</p>	
	
<p>CAGE code: Continued</p>	<p>2/</p>

1/ Information published in this revision was verified by direct contact with manufacturers.

2/ Information not verified to be current, no response from manufacturer. Information identical to that published in MIL-HDBK-57, Revision B.

MIL-HDBK-57F (IS)

EVERLOCK FASTENING SYSTEMS  
Continued

GREER STOP NUT  
(Greer-Smyrna Division)  
481 McNALLY DRIVE  
NASHVILLE, TN 37211

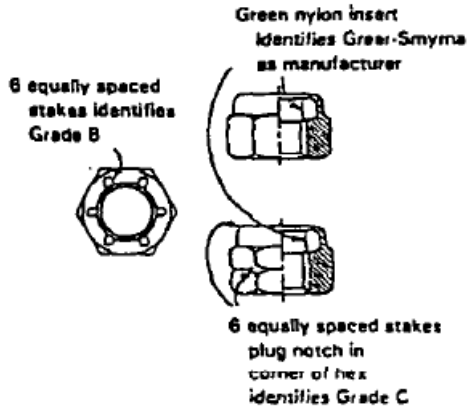

NYLON INSERT

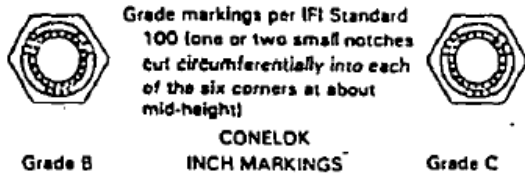

Green nylon insert identifies Greer-Smyrna as manufacturer per IFI 514



Property Class 5, 9 and 10 markings per IFI 514 located on bearing surface and/or hex flats



NYLON INSERT

Manufacturer's I.D. - letter "G" stamped on one hex flat or on bearing surface



CONELOCK - BEARING SURFACE

Class 5 METRIC MARKINGS Class 10 Class 9

CAGE code: 27687  
Continued

2/

Continued  
EVERLOCK FASTENING SYSTEMS

INTERNATIONAL SCREW DIVISION  
50631 EAST RUSSEL SCHMIDT BOULEVARD  
MOUNT CLEMENS, MI 48045

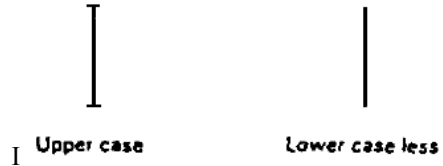

CAGE code: 2/

EXCEL PRECISION PRODUCT'S, INC.  
2207 NW 30TH PL.  
POMPANO BEACH, FL 33069-1026

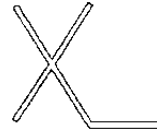

CAGE code: 1H4K6 2/

EXPERIMENTAL MACHINE CO.  
1412 SHOEMAKER RD.  
BALTIMORE, MD 21209

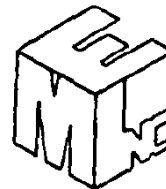

CAGE code: 0NAP8 2/

FABER ENTERPRISES, INC.  
6606 VARIEL AVE.  
CANOGA PARK, CA 91303-2808









CAGE code: 14397 1/

1/ Information published in this revision was verified by direct contact with manufacturers.

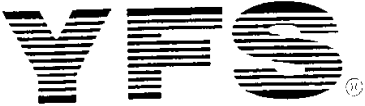
2/ Information not verified to be current, no response from manufacturer. Information identical to that published in MIL-HDBK-57, Revision B.

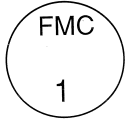
## MIL-HDBK-57F (IS)

<p>FABRICATION SPECIALTY INC. 6530 SMOKY HILL CT. GRANBURY, TX 76049-7042</p> <p>FS or 28548</p> <p>CAGE code: 28548 <span style="float: right;">1/</span></p>	<p>FALL RIVER MANUFACTURING CO., INC. 540 CURRANT ROAD FALL RIVER, MA 02720-4711</p> <p>fr f  </p> <p>CAGE code: 1JWL5 <span style="float: right;">1/</span></p>
<p>FABSCO CORP. 1745 W. 124TH ST. CHICAGO, IL 60643-5345</p> <p></p> <p>CAGE code: 4S619 <span style="float: right;">2/</span></p>	<p>FANG SHENG SCREW CO., LTD. #113 LANE 96 MINCHAUN ROAD LU CHU HSIANG, KAOHSIUNG HSIEN, 821, TAIWAN</p> <p> FANG SHENG SCREW CO. LTD</p> <p>CAGE code: SJ544 <span style="float: right;">2/</span></p>
<p>FAILING CO., GEORGE E. P.O. BOX 872 ENID, OK 73702</p> <p></p> <p>CAGE code: <span style="float: right;">2/</span></p>	<p>FARIAS INDUSTRIAL MACHINING 504 BRUNKEN AVENUE, STE L SALINAS, CA 93901</p> <p>(No artwork for marking. Marks whatever the customer specifies.)</p> <p>CAGE code: 3KWY7 <span style="float: right;">1/</span></p>
<p>FALCON MANUFACTURING CORP. 10409-B OLD ATLANTA HWY. COVINGTON, GA 30014-0887</p> <p></p> <p>CAGE code: 0HM72 <span style="float: right;">2/</span></p>	<p>FARLO MACHINE &amp; TOOL CO., INC 340 CONSTANCE DR BLDG # 7 WARMINSTER, PA 18974-2815</p> <p></p> <p>CAGE code: 7S305 <span style="float: right;">2/</span></p>

1/ Information published in this revision was verified by direct contact with manufacturers.

2/ Information not verified to be current, no response from manufacturer. Information identical to that published in MIL-HDBK-57, Revision B.

MIL-HDBK-57F (IS)

(FASSCO) FASTENER & STEEL SUPPLY  
CO., LTD.  
Quality Assurance Dept.  
P.O. BOX 236  
HATFIELD, PA 19440

Plant  
2294 NORTH ROAD  
HATFIELD, PA 19440





Latest marking used  
on fasteners after  
August 1, 1988

Previous marking  
used on fasteners

CAGE code: 2/

FASTCO INDUSTRIES, INC.  
P.O. BOX 141427  
GRAND RAPIDS, MI 49514-1427

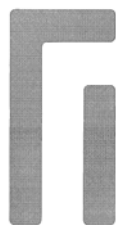
Plant  
2685 MULLINS NW  
GRAND RAPIDS, MI 49534



CAGE code: 56NH8 1/

FASTENAL COMPANY  
2001 THEURER BLVD.  
WINONA, MN 55987-1500

Plant  
FASTENAL COMPANY MFG DIV  
1801 THEURER BLVD.  
WINONA, MN 55987-1500  
CAGE code: 1QNZ3

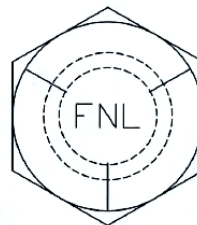

CAGE code: 0Y3H3 1/

FASTENER BROKERAGE INC  
DBA INOFAST MANUFACTURING  
SUITE R 2880 BERGEY RD  
HATFIELD, PA 19440 - 3241



CAGE code: 2T359 2/

FASTENER INNOVATION TECHNOLOGY,  
INC.  
DBA F.I.T.  
14601 S. BROADWAY STREET  
GARDENA, CA 90248-1811



CAGE code: 58998 1/

1/ Information published in this revision was verified by direct contact with manufacturers.

2/ Information not verified to be current, no response from manufacturer. Information identical to that published in MIL-HDBK-57, Revision B.

## MIL-HDBK-57F (IS)

FASTENER TECHNOLOGY CORP.  
7415 FULTON AVE  
NORTH HOLLYWOOD, CA 91605-5411

FT

CAGE code: 58794

1/

FASTENING PRODUCTS CO.,INC.  
P.O. BOX 261  
CLIFTON HIGHTS, PA 19018-0334

Plant  
3 MERION TERRACE  
CLIFTON HEIGHTS, PA 19018-0334

FPC

CAGE code: 6M389

1/

FASTENERS UNLIMITED INC.  
2150 WOODLAND ROAD  
WARRENDALE, PA 15086

FUN

CAGE code: 47346

1/

FASTENING PRODUCTS OF LANCASTER,  
INC.  
1980 OLD PHILADELPHIA PIKE  
LANCASTER, PA 17602-3498

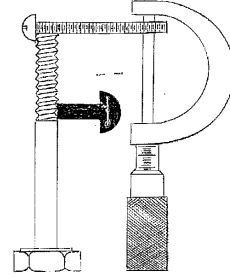

CAGE code: 4M097

1/

FASTENRATH BEFESTIGUNGSTECHNIK  
GmbH  
HERSCHEIDER STRABE 105  
POSTFASH 51 42  
58840 PLETTENBERG, HOLTAUSEN  
FEDERAL REPUBLIC OF GERMANY

F

CAGE code:

1/

FASTI-WERK CARL AUG. FASTENRATH  
GMBH & CO.KG  
INDUSTRIEGEBIET ELBRINGHAUSEN  
P.O. BOX 1250  
WERMELSKIRCHEM, GERMANY 42929

F

CAGE code: D9500

2/

1/ Information published in this revision was verified by direct contact with manufacturers.

2/ Information not verified to be current, no response from manufacturer. Information identical to that published in MIL-HDBK-57, Revision B.

MIL-HDBK-57F (IS)

FASTRON COMPANY, THE  
11800 FRANKLIN AVENUE  
FRANKLIN PARK, IL 60131-1006

**F**

CAGE code: 24929

2/

FEDERAL EQUIPMENT COMPANY  
707 CARR ST  
CINCINNATI, OH 45203-1211

F E C

6 0 5 8 7

CAGE code: 60587

1/

FEDERAL MANUFACTURING CORP.  
9825 DE SOTO AVENUE  
CHATSWORTH, CA 91311-1441

**F M C**

CAGE code: 17943

2/

FEDERAL SCREW WORKS  
2400 BUHL BUILDING  
DETROIT, MI 48226

BIG RAPIDS DIVISION  
400 NORTH DEKRAFT  
BIG RAPIDS, MI 49307

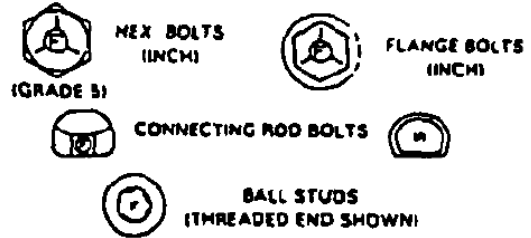

ROMULUS DIVISION  
34846 GODDARD ROAD  
ROMULUS, MI 48174-3400

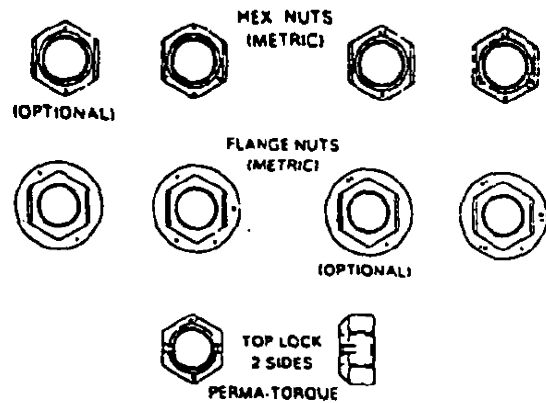
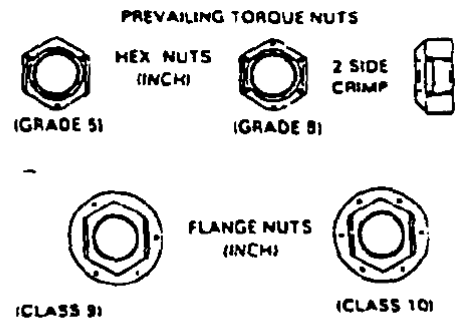

CAGE code: 21957

2/

1/ Information published in this revision was verified by direct contact with manufacturers.

2/ Information not verified to be current, no response from manufacturer. Information identical to that published in MIL-HDBK-57, Revision B.



## MIL-HDBK-57F (IS)

FENBAR PRECISION MACHINISTS, INC  
633 COMMERCE STREET  
THORNWOOD, NY 10594-1348



CAGE code: IP472

1/

FENTON HEADING  
2480 OWEN RD.  
FENTON, MI 48430

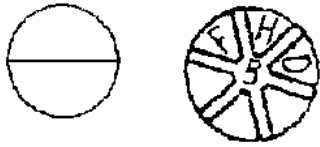

CAGE code:

1/

FERNDALE FASTENER  
31600 STEPHENSON HIGHWAY  
MADISON HEIGHTS, MI 48071

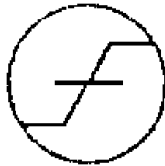

CAGE code:

2/

FERRIERE DI STABIO, S.A.  
VIA LAVEGGIO 6/A  
CH-6855 STABIO  
SWITZERLAND



**F S**



CAGE code:

1/

FERRY CAP & SET SCREW CO., THE  
2151 SCRANTON RD.  
CLEVELAND, OH 44113-3578

F C · F-C  
B P G

CAGE code: 84513

2/

FIBAM COMPANHIA INDUSTRIAL  
SAO BERNARDO DO CAMPO  
P.O. BOX 360  
SAO PAULO, BRAZIL C.E.P.0  
09701.907

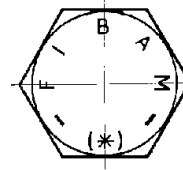

CAGE code:

1/

FILETAGE INTERNATIONAL  
(INTERNATIONAL THREAD INC.)  
2225 RUE MICHLIN  
LAVAL, QUE, CANADA H7L9Z7



CAGE code:

2/

FIRST AMERICAN SALES CO.  
2706 ST. LOUIS AVE.  
LONG BEACH, CA 90806-2026

**1st**

CAGE code: 58251

2/

1/ Information published in this revision was verified by direct contact with manufacturers.

2/ Information not verified to be current, no response from manufacturer. Information identical to that published in MIL-HDBK-57, Revision B.

MIL-HDBK-57F (IS)

FISCHER SPECIAL MFG. CO.  
11 INDUSTRIAL RD.  
COLD SPRING, KY 41076-9796

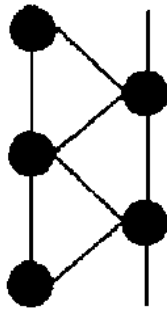

CAGE code: 73743

2/

FITZ MANUFACTURING INDUSTRIES LTD  
DBA FMI  
6625 IRON HORSE BLVD.  
NORTH RICHLAND HILL, TX 76180

05DT8



CAGE code: 05DT8

1/

FLAIG & HOMMEL  
HEERSTRASSE 1  
ALDINGEN, GERMANY 78554



Company logo to be stamped and used on all steel reusable FLAG & HOMMEL lock nuts.



Company logo to be stamped on all none reusable (standard) nuts.

CAGE code: C3816

2/

FLEXALLOY INC.  
26000 RICHMOND ROAD  
BEDFORD, OH 44146



GRADE 5  
HEX HEAD  
CAP SCREW



GRADE 8  
HEX HEAD  
CAP SCREW



FX-180 HEX HEAD  
CAP SCREW  
(180,000 PSI  
MINIMUM TENSILE  
STRENGTH)



FX-180 HEX NUT  
PROOF LOAD =  
180,000 PSI



METRIC CAP SCREW,  
PROPERTY CLASS 10.9

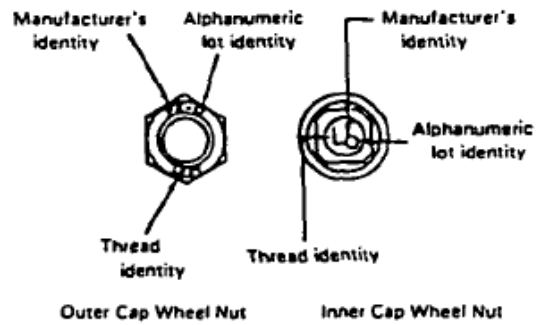

WHEEL NUTS



HEX FLANGE SCREW GRADE 8

CAGE code: 0C9A2

2/

FLORES ENTERPRISES  
1729 E. 28TH STREET  
SIGNAL HILL, CA 0806-1923



CAGE code: 0V616

1/

1/ Information published in this revision was verified by direct contact with manufacturers.

2/ Information not verified to be current, no response from manufacturer. Information identical to that published in MIL-HDBK-57, Revision B.

MIL-HDBK-57F (IS)

FLUIDONICS INC.  
205 W INDUSTRY CT  
P. O. BOX 9020  
DEER PARK, NY 11729



CAGE code: 58525 2/

---

FLUIDYNE CORPORATION  
9100 COLLINS AVE.  
PENNSAUKEN, NJ 08110



CAGE code: 9Y957 1/

---

FOCUS HOPE  
13550 OAKMAN  
DETROIT MICHIGAN 48238



CAGE code: 00P13 1/

---

FOLSOM TOOL & MOLD CORP.  
# 12 MOUNT PLEASANT DR.  
ASTON, PA 19014-4140



CAGE code: 6P049 2/

FONTAL CONTROLS, INC.  
12725 ENCINITAS AVENUE  
SYLMAR, CA 91342-3517



CAGE code: 0GNC3 2/

---

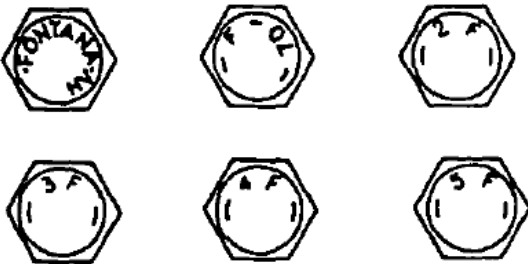
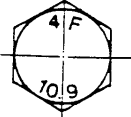

FONTANA S.A.  
FONTANA LUIGI SPA  
VIA PIAVE 29  
VEDUGGIO MILANO,  
ITALY 20050

Bolts and screws  
Hexagon Head  
Strength Grade 10.9  
Iso Metric Thread

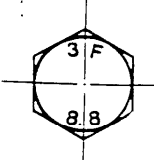

Bolts and screws  
Hexagon Head  
Strength Grade 8.8  
Iso Metric Thread

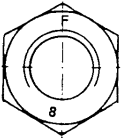
Nut  
Strength Class 8  
Iso Metric Thread

CAGE code: A4733 2/

1/ Information published in this revision was verified by direct contact with manufacturers.

2/ Information not verified to be current, no response from manufacturer. Information identical to that published in MIL-HDBK-57, Revision B.

## MIL-HDBK-57F (IS)

FOREMOST PRECISION INSTRUMENT  
CORP.  
31 CARLETON AVE  
MT VERNON, NY 10550-4617

FPIC

CAGE code: 33464

2/

FOREST FASTENERS  
TREForest INDUSTRIAL ESTATE  
PONTYPRIDD, MID. GLAMORGAN,  
SOUTH WALES, GREAT BRITAIN  
CF37 5YG



CAGE code:

2/

FORMED FASTENER MANUFACTURING,  
INC.  
7247 S. 78TH AVE  
BRIDGEVIEW, IL 60455



CAGE code:

2/

FPA MANUFACTURING  
DBA FPA MANUFACTURING AND SUPPLY  
6733 S SEPULVEDA BLVD STE 245  
LOS ANGELES, CA 90045-1525

FPA

CAGE code: 0J6Z1

2/

FRANROE PRECISION MACHINE  
COMPANY  
12 CHAMPION RD  
GLOUCESTER CITY, NJ 08030

F.R.

F.R.P

CAGE code: 40650

2/

FREEMAN CO.  
P. O. BOX 57  
719 WALNUT ST  
YANKTON, SD 57078

F

CAGE code: 84596

1/

FRIEDR BOESNER GMBH  
AUGUSTHENALER STRABE  
5450 NEUWIED 13  
GERMANY

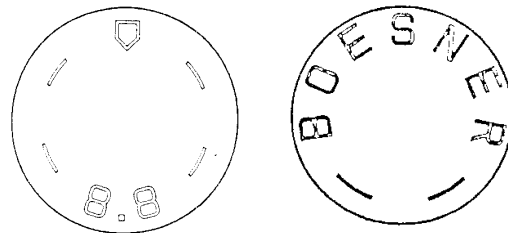

CAGE code:

2/

1/ Information published in this revision was verified by direct contact with manufacturers.

2/ Information not verified to be current, no response from manufacturer. Information identical to that published in MIL-HDBK-57, Revision B.

MIL-HDBK-57F (IS)

FRISBY AEROSPACE INC DE  
 DIV TRIUMPH ACTUATION SYSTEMS -  
 CLEMMONS  
 417 S.MAIN ST.  
 FREEPORT, NY 11520-5144

was FRISBY AIRBORNE HYDROLICS, INC

**FAH**

CAGE code: 26437

2/

FRONTIER BOLT COMPANY OF TEXAS  
 555 AIRPORT DRIVE  
 MANSFIELD, TX 76063-2715

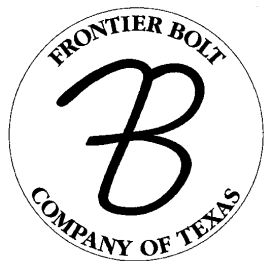

CAGE code: 1CE65

2/

FUCHS SCHRAUBENWERK GmbH  
 BISMARCKSTRASSE 24  
 5900 SIEGEN  
 GERMANY D-57076

*Hex head/round head bolts, stud bolts*



*T-head bolts, hammer head/ hook head bolts*

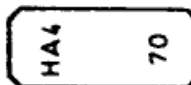
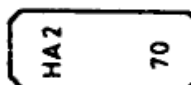
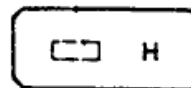

*High strength structural bolts (tension controlled/ twist off)*

CAGE code:

1/

G & R SCREW MACHINE PRODUCTS  
 21602 N. CENTRAL AVE.  
 SUITE 5  
 PHOENIX, AZ 85024

**G & R**

CAGE code: 7Y137

2/

1/ Information published in this revision was verified by direct contact with manufacturers.

2/ Information not verified to be current, no response from manufacturer. Information identical to that published in MIL-HDBK-57, Revision B.

## MIL-HDBK-57F (IS)

G & S MACHINE INC.  
2804 RENEE DRIVE  
BEDFORD, TX 76021-5208

**G-S**

CAGE code: 62925

2/

G. B. MACHINE PRECISION, INC.  
4140C AUSTIN BLVD  
ISLAND PARK, NY 11558-1727

**G.B.M**

CAGE code: 03KF3

2/

G.B. DUPONT CO., INC  
500 WEST LONG LAKE ROAD  
TROY, MI 48098

**D**

CAGE code:

2/

GAITHER PATRICIA  
DBA GAITHER MACHINE  
201 PILGRIM LANE  
P. O. BOX 202  
MUNFORD, AL 36268-4212

**GMF**

CAGE code: 1BTX4

2/

GALAN PRECISION MACHINE CO.  
8912 LANKERSHIM BLVD.  
SUN VALLEY, CA 91352

**G GPM**

CAGE code: 0S1P8

2/

GALMAC MFG CO.  
565 COVINA BOULEVARD  
SAN DIMAS, CA 91773-2911



CAGE code: 4V765

2/

GARCIA INDUSTRIES, INC.  
12345 FLORENCE AVENUE  
SANTA FE SPRING, CA 90670-3807



CAGE code: 1RYN7

2/

GARDINER MFG. CO.  
P.O. BOX 1499  
OAKLAND, CA 94604

**GARCO**

CAGE code: 24042

2/

1/ Information published in this revision was verified by direct contact with manufacturers.

2/ Information not verified to be current, no response from manufacturer. Information identical to that published in MIL-HDBK-57, Revision B.

## MIL-HDBK-57F (IS)

GATES ALBERT, INC.  
3434 UNION ST.  
NORTH CHILI, NY 14514-9731

**GAI**

CAGE code: 4ZBMI 1/

GATEWAY SCREW AND RIVET, INC.  
2670 UNINTED LANE  
ELK GROVE VILLIAGE, IL 60007

**G**

CAGE code: 2/

GEN FAST MANUFACTURING COMPANY  
225 HENRY STREET, BLDG. 5  
BRANTFORD, ONTARIO CANADA N3T 6H2



CAGE code: 2/

GENERAL AVIATION MFG., INC.  
2693 PHILMONT AVE  
HUNTINGDON VALLEY, PA 19006-5301

**4J952**

CAGE code: 4J952 2/

GENERAL MACHINE PRODUCTS, INC.  
3525 VICKERY BLVD  
FORT WORTH, TX 76105



CAGE code: 2/

GENERAL SCREW & SPECIALTY CO., INC.  
14 N. BLEEKER ST.  
MT VERNON, NY 10550

**GS**

CAGE code: 26300 2/

GERMAN MACHINED PRODUCTS, INC.  
1208 S. HOOVER ST.  
GARDENA, CA 90247-1771



CAGE code: 65813 2/

GERTLER INDUSTRIES, INC.  
914 W. 17TH STREET  
COSTA MESA, CA 92627-4403

**GII**

CAGE code: 64445 2/

1/ Information published in this revision was verified by direct contact with manufacturers.

2/ Information not verified to be current, no response from manufacturer. Information identical to that published in MIL-HDBK-57, Revision B.

## MIL-HDBK-57F (IS)

GFD LETAGE  
 ZONE INDUSTRIELLE  
 BP 63  
 BOURGNE  
 FRANCE 90140

Plant  
 15. IMPASSE G. THIVOLLET  
 P.O. BOX 26  
 42011 SAINT ETIENNE CEDEX 2  
 FRANCE



CAGE code: F1471

2/

GILL MACHINE & TOOL CO.  
 200 PRAIRIE STREET  
 ROCKFORD, IL 61107

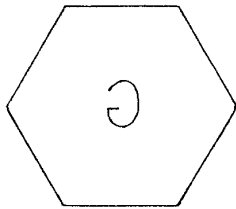

CAGE code: 0H8Y5

2/

GL CNC SERVICE INC.  
 9860 OWENSMOUTH AVE #3  
 CHATSWORTH, CA 91311-3852



CAGE code: 1DUA6

1/

GMJ MACHINE COMPANY, INC.  
 251 STATE LINE RD S  
 WILMER, AL 36587-7051



CAGE code: 8T119

2/

GMP CO. CORPORATION  
 529 8TH AVE.  
 BETHLEHEM, PA 18018-5008



CAGE code: 51867

2/

GOSHO WORKS, LTD.  
 3-8-1 TARU-MACHI  
 KOHOKU, YOKOHAMA  
 222 JAPAN

**G**

**Go**

**Gosho**

CAGE code:

2/

1/ Information published in this revision was verified by direct contact with manufacturers.

2/ Information not verified to be current, no response from manufacturer. Information identical to that published in MIL-HDBK-57, Revision B.



## MIL-HDBK-57F (IS)

GRACO INDUSTRIES, INC.  
44605 MACOMB INDUSTRIAL DRIVE  
CLINTON TOWNSHIP, MI 48096-1148



CAGE code: 1GT22

1/

GRADON SCREW MACHINE CORP.  
P. O. BOX 1080  
1411 EAST ST.  
NEW BRITIAN, CT 06050-1080



CAGE code: 69870

2/

GRANDEUR FASTENERS, INC.  
18798 E. HWY 10  
DANVILLE, AR 72833-0658

GF

CAGE code: 3U752

1/

GRAUCH ENTERPRISES  
RR 1 BOX 37  
1878 PORT MATILDA HWY  
PHILLIPSBURG, PA 16866-3128



CAGE code: 1HU38

1/

GREATER MARYLAND TOOL & MFG.,  
CORP.  
5 RESOURCE AVE  
MOUNTAIN LAKE PARK, MD 21550-6362

GMT

CAGE code: 34549

1/

GREEN BAY DROP FORGE  
DIV. OF CLEVELAND HARDWARE &  
FORGING  
1341 S. STATE ST.  
P.O. BOX 11797  
GREEN BAY, WI 54307-1797

See CLEVELAND HARDWARE & FORGING



*Circle with center dot*

CAGE code: 08277

2/

1/ Information published in this revision was verified by direct contact with manufacturers.

2/ Information not verified to be current, no response from manufacturer. Information identical to that published in MIL-HDBK-57, Revision B.

MIL-HDBK-57F (IS)

GREENFIELD MANUFACTURING CO., INC.  
920 LEVICK STREET  
PHILADELPHIA, PA 19111-5422

GFM

CAGE code: 98320

2/

GREER STOP NUT  
481 MCNALLY DRIVE  
NASHVILLE, TN 37211-3311

G S<sub>G</sub>L

Green nylon insert

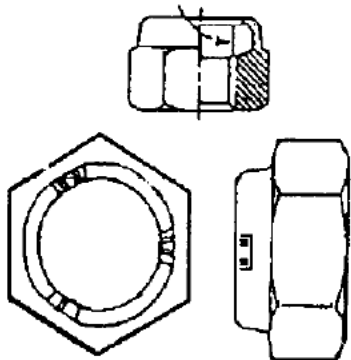

Manufacturer identification:  
2 raised ribs in (2) crimp depressions  
1 raised rib in (1) crimp depression

NFB

for head marking on  
bolts and screws

CAGE code: 27687

1/

GRIPCO, DIVISION OF BLACK & DECKER  
111 E. BROAD ST.  
SOUTH WHITLEY, IN 46787

GN

*Raised or indented on flange or  
bearing surface of bolts  
Raised on head of bolts, inch or  
metric  
Raised or indented on flange or  
bearing surface of nuts*

GF GN GN

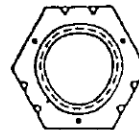

Twin Delta  
Crownlock grade  
B inch locknut

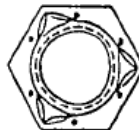

Gripco Crown lock  
Grade C inch  
locknut

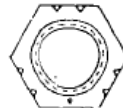

Twin Delta  
Crownlock  
Class 9 metric  
locknut



Gripco  
Crownlock  
Class 10  
metric locknut



Toplock  
(3-6  
Indentations)



Centerlock

CAGE code: 0KS39

2/

1/ Information published in this revision was verified by direct contact with manufacturers.

2/ Information not verified to be current, no response from manufacturer. Information identical to that published in MIL-HDBK-57, Revision B.

## MIL-HDBK-57F (IS)

GROOV-PIN CORPORATION  
331 FARNUM PIKE  
SMITHFIELD, RI 02917-1205

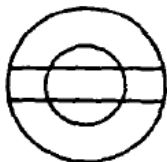

**G-P**

CAGE code: 73957

2/

GRUPO RASSINI S.A. de C.V.  
RASSINI INTERNATIONAL, INC.  
617 EAST HURON STREET  
ANN HARBOR, MI 48104

Plant  
TORNILLOS RASSINI S.A. de C.V.  
AV. ELECTRICIDAD Y.E. PUGIBEL  
CD. INDUSTRIAL, XALOSTOC  
STA. CARLA, EDO DE MEXICO  
APARTADO POSTAL 14-711  
MEXICO D.F.

**RR**

Used to mark the following products:

hex cap screws  
hex bolts  
hex nuts  
heavy hex structural bolts  
heavy hex nuts  
shackle bolts  
hex cone nuts  
wheelbolts

CAGE code:

2/

GS AEROSPACE  
DIV. B & B SPECIALTIES INC  
4321 E LA PALMA AVE.  
ANAHEIM, CA 92807-1805

See B & B SPECIALTIES INC

1) PRIMARY - **GS**

2) SECONDARY - **GSAT**

3) SECONDARY - **1EM77**

4) SECONDARY - **GSI**  
(OBSOLETE AS OF  
JAN 1, 1988)

CAGE code: 1EM77

1/

GSF FASTENING (Armstrong Fastening Ltd.)  
MIDLAND ROAD  
DARLASTON  
WEDNESBURY, WEST MIDLANDS WS10 8JN  
GREAT BRITAIN



CAGE code:

2/

1/ Information published in this revision was verified by direct contact with manufacturers.

2/ Information not verified to be current, no response from manufacturer. Information identical to that published in MIL-HDBK-57, Revision B.

## MIL-HDBK-57F (IS)

GUARDIAN RIVET & FASTENER  
Guardian Mfg. Division  
70 AIR PARK DRIVE  
RONKONKOMA, NY 11779

Plant  
201 TRADE ZONE DRIVE  
RONKONKOMA, NY 11779



CAGE code: 2/

GUNNISON-INTERNATIONAL INC.  
861 GIBBSBORO ROAD  
CLEMENTON, NJ 08021-1207



CAGE code: 4G922 2/

H C MERCHANDISERS INC.  
DBA H C PACIFIC  
19844 QUIROZ CT  
WALNUT, CA 91789-2828

**HC**  
**HCP**

CAGE code: 53037 2/

H C PACIFIC  
19844 QUIROZ CT  
WALNUT, CA 91789 - 2828

**HC HCP**

CAGE code: 53037 2/

H. MULLINS, LTD.  
(BADE INDUSTRIAL ESTATE)  
JARROW TYNE AND WEAR CO  
DURHAM, UNITED KINGDOM NE32 3EX

**HM**

CAGE code: 2/

H. PAULIN & CO. LTD.  
(CAPITAL METAL INDUSTRIES DIVISION)  
55 MILNE AVE.  
SCARBOROUGH, ONTARIO  
CANADA MIL 4N3



*Hex head cap  
screws*



*Metric standard  
hex head cap  
screws*

CAGE code: 95119 2/

H. PRINZ GmbH FABRIK FUR  
VERBINDUNGSELEMENTE  
5970 PLETTENBERG  
POSTBOX 5241  
GERMANY



CAGE code: 2/

<sup>1/</sup> Information published in this revision was verified by direct contact with manufacturers.

<sup>2/</sup> Information not verified to be current, no response from manufacturer. Information identical to that published in MIL-HDBK-57, Revision B.

## MIL-HDBK-57F (IS)

HABINA ENGINEERING  
4740 COTTON BELT  
SAN ANTONIO, TX 78219-2854

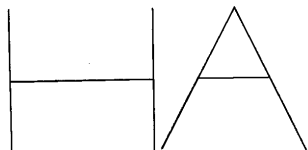

CAGE code: 1SZT7

1/

HALL INDUSTRIES INC.  
(FORMERLY STANDARD TOOL & MACHINE  
COMPANY)  
514 MECKLEM LANE  
ELLWOOD CITY, PA 16117-3028



CAGE code: 29281

1/

HALLSIMS INDUSTRIAL COMPONENTS,  
INC.  
37 TERRY DR.  
TREVISOE, PA 19053

**HIC**

CAGE code: 8V986

2/

HAMANAKA (THAILAND). CO., LTD.  
NO. 550 Moo6 TAIBAN ROAD  
AMPHUR MUANG, SAMUTPRAKARN,  
THAILAND



Plant  
HAMANAKA NUT MFG. CO., LTD  
KO-770 SHIRAHANA-CHO,  
HIMEJI-SHI HYOGO, JAPAN

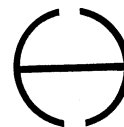

CAGE code: 5Z615

1/

HANDI GADETS CORP.  
P.O. BOX 0938  
LA CROSSE, WI 54603

Plant  
1230 CLINTON ST.  
LA CROSSE, WI 54603



CAGE code: 1M893

1/

HANSAN SCREW CO., LTD.  
EXPORTING DEPARTMENT  
974-7 YANG DUK-DONG  
MASAN 610-00  
KOREA

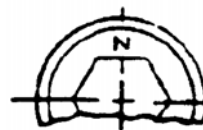

CAGE code:

2/

1/ Information published in this revision was verified by direct contact with manufacturers.

2/ Information not verified to be current, no response from manufacturer. Information identical to that published in MIL-HDBK-57, Revision B.

## MIL-HDBK-57F (IS)

HARDWARE SPECIALTY CO, INC.  
48-75 36TH STREET  
LONG ISLAND CITY, NY 11101-1994



CAGE code: 07679

1/

HARRISON BOLT & NUT CO., THE  
2781 WILKENS AVE.  
BALTIMORE, MD 21223



CAGE code: 5B735

2/

HARTFORD AIRCRAFT PRODUCTS, INC.  
94 OLD POQUONOCK ROAD  
BLOOMFIELD, CT 06002-1427



CAGE code: 66861

2/

HARWOOD DESIGN, INC.  
1507 CLYDE WAITE DRIVE  
BRISTOL, PA 19007-2919

**HDI**

CAGE code: 1VQQ8

2/

HASKELL OF HUNTINGTON, INC.  
P.O. BOX 119  
HUNTINGTON, WV 25706-0119

Plant  
300 THIRD AVENUE  
HUNTINGTON, WV 25701



**300 Series Stainless Steel**

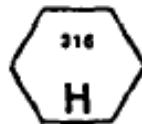

**Type 316 Stainless Steel**

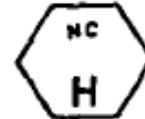

**Nickel Copper (Monel)**

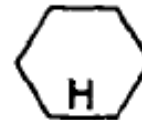

**Silicon Bronze**

CAGE code:

2/

HASSALL, JOHN, INC.  
609-1 CANTIAGUE ROCK RD  
WESTBURY, NY 11590-1721

**H**

CAGE code: 82224

1/

1/ Information published in this revision was verified by direct contact with manufacturers.

2/ Information not verified to be current, no response from manufacturer. Information identical to that published in MIL-HDBK-57, Revision B.

## MIL-HDBK-57F (IS)

HATCH INDUSTRIES  
17000 S WSTN AVE STE 22  
GARDENA, CA 90247-5262



CAGE code: 03AJ8

2/

HAWTHORNE BOLT WORKS  
P.O. BOX 474  
VALLEY CITY, OH 44280

Plant  
355 A LAKE RD.  
MEDINA, OH 44256

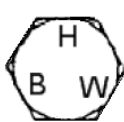

GRADE 2



GRADE 5



GRADE 8

CAGE code: 4TU98

1/

HAYDON BOLTS, INC.  
1181 UNITY ST  
PHILADELPHIA, PA 19124-3104



CAGE code: 2S013

2/

HAZE SEIKO CO., LTD.  
KO 402 SHIRAHAMA- CHO  
HIMEJI-SHI, HYOUGO-KEN, JAPAN 672

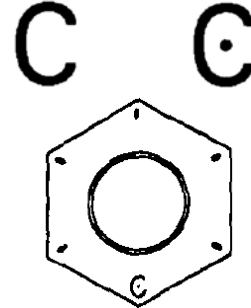

CAGE code:

2/

HEARTLAND PRECISION FASTENER  
301 PRAIRIE VILLAGE DR  
NEW CENTURY, KS 66031-1121

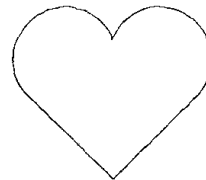

CAGE code: 0ZC92

1/

HEIM'S MACHINE & TOOL, INC.  
36 EVERGREEN ROAD  
LEBANON, PA 17042

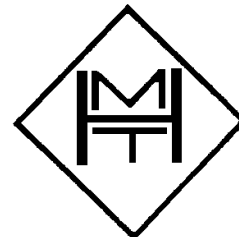





CAGE code: 0B117

1/

1/ Information published in this revision was verified by direct contact with manufacturers.

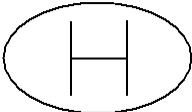
2/ Information not verified to be current, no response from manufacturer. Information identical to that published in MIL-HDBK-57, Revision B.

## MIL-HDBK-57F (IS)

<p>HEITCO MANUFACTURING, INC. 60 TUTTLE ROAD MIDDLETOWN, CT 06457</p> <p style="text-align: center;"><b>HTC</b></p> <p>CAGE code: <span style="float: right;"><u>2/</u></span></p>	<p>HEWINS, EDMOND, C. JR. DBA JET MACHINE WORKS COMPANY 4519C WAYNE AVE PHILADELPHIA, PA 19144</p> <p style="text-align: center;"><b>J</b></p> <p>CAGE code: 37KP5 <span style="float: right;"><u>1/</u></span></p>
<p>HEMCO TOOL INC. 7 SOUTH MAPLE ST. P.O. BOX 326 WESTFIELD, MA 01085-4338</p> <p style="text-align: center;"></p> <p>CAGE code: 5R108 <span style="float: right;"><u>2/</u></span></p>	<p>HEXAGON ENTERPRISES, INC. 256 MINNESOTA AVENUE TROY, MI 48083</p> <p style="text-align: center;"><b>H I</b></p> <p>CAGE code: <span style="float: right;"><u>2/</u></span></p>
<p>HENWAY, INC. 1314 GOODRICK DRIVE P.O. BOX 1276 TEHACHAPI, CA 93561</p> <p style="text-align: center;"><b>HP</b> </p> <p>CAGE code: 0X6T3 <span style="float: right;"><u>2/</u></span></p>	<p>HI INDUSTRIAL TECHNOLOGIES 241 WOODLAND AVE MORTON , PA 19070</p> <p style="text-align: center;"></p> <p>CAGE code: 0SS65 <span style="float: right;"><u>2/</u></span></p>
<p>HEPTNER MFG CO. RIVER ROAD BLDG. PP-1 JAY-CEE INDUSTRIAL PARK BRISTOL, PA 19007 - 6103</p> <p style="text-align: center;"><b>7</b></p> <p>CAGE code: 05BZ4 <span style="float: right;"><u>1/</u></span></p>	<p>HIGH QUALITY MACHINE SHOP 2775 WALSH ROAD SAN ANTONIO, TX 78224</p> <p style="text-align: center;"><b>HQ</b></p> <p>CAGE code: 0B011 <span style="float: right;"><u>2/</u></span></p>
<p>HESSISCHE SCHRAUBENFABRIK WELTER GmbH &amp; CO., KG STEPHAN-NIDEREHE-STR. 6 P. O. BOX 13 40 MARBURG, GERMANY 35037</p> <p style="text-align: center;"></p> <p>CAGE code: D5396 <span style="float: right;"><u>2/</u></span></p>	

1/ Information published in this revision was verified by direct contact with manufacturers.

2/ Information not verified to be current, no response from manufacturer. Information identical to that published in MIL-HDBK-57, Revision B.



## MIL-HDBK-57F (IS)

HIGH TECH ENTERPRISES  
3299 SAN FERNANDO RD.  
UNIT 11  
LOS ANGELES, CA 90065

**HTE.**

CAGE code: 0TSH2 2/

HILL AEROSPACE & DEFENSE LLC.  
19734 DEARBORN STREET  
CHATSWORTH, CA 91311-6509



CAGE code: 55064 2/

HIGHLAND PRODUCTS CORPORATION  
9331 MERCANTILE DRIVE  
MENTOR, OH 44060-0452

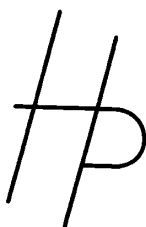

CAGE code: 0AKM4 2/

HILL FASTENER CORP.  
P.O. BOX 399  
ROCK FALLS, IL 61071

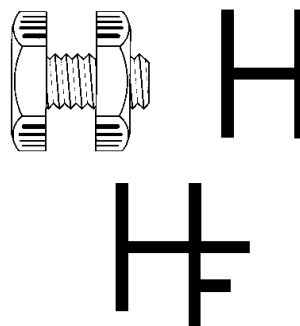

CAGE code: 4R119 1/

HIGHLAND THREADS, INC.  
(FASTENER MANUFACTURING DIVISION)  
708 E. TIDWELL  
HOUSTON, TX 77022-1822

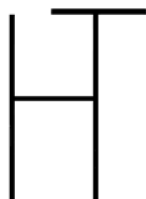

CAGE code: 1DT7C 2/

HILL STAMPING & MFG., INC.  
3202 C STREET N.E.  
AUBURN, WA 98002-1789



CAGE code: 7M611 1/

1/ Information published in this revision was verified by direct contact with manufacturers.

2/ Information not verified to be current, no response from manufacturer. Information identical to that published in MIL-HDBK-57, Revision B.

MIL-HDBK-57F (IS)

HILTI, INC.  
5400 S. 122ND E. AVE  
TULSA, OK 74121-6007

DX DIVISION

**HILTI**

**H**

ANCHOR DIVISION

**HILTI**

HEA M24 x 210

**HILTI**

HEA 3/4" x 6-5/8"

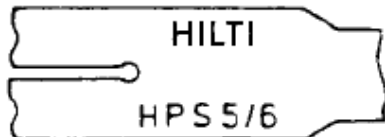
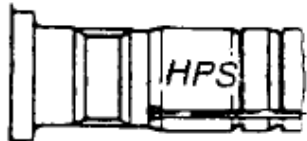

CAGE code: 11239

2/

HI-SHEAR CORP.  
DBA FOREIGN PARENT IS LISI PARIS  
FRANCE

See listing for LISI  
2600 SKYPARK DRIVE  
TORRANCE, CA 90505



**hs HS**

**hs**

Plant  
TORONTO FASTENERS  
INDUSTRIES, INC.  
Subsidiary of Hi-Shear Corp., USA  
19 CONSTELLATION COURT  
REXDALE, ONTARIO M9W 1K4,  
CANADA

**F**

CAGE code: 73197

1/

HLC INDUSTRIES INC.  
6281 EMERALD LAKE DR  
FARMINGTON HILLS, MI 48098

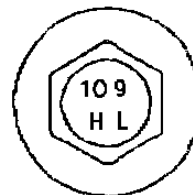

CAGE code: 0SC87

2/

1/ Information published in this revision was verified by direct contact with manufacturers.

2/ Information not verified to be current, no response from manufacturer. Information identical to that published in MIL-HDBK-57, Revision B.

## MIL-HDBK-57F (IS)

HMS SERVICES LLC  
10039 WOLFRIVER  
PLYMOUTH, MI 48170-4542

**M**

This is the headmarking for bolts and screws.  
Headmark appears on the top of head.

**M**

**M**

**M**

This marking is for nuts. This mark  
appears on the side of hex nuts.

CAGE code: 1UYL6 2/

HO-HO-KUS, INC.  
189-201 LYON ST.  
PATERSON, NJ 07524

**HK**

CAGE code: 69370 1/

HO HONG WORKS CO., LTD  
10 CHUNG SHAN ROAD  
LU CHU VILLAGE, KAOHSIUNG  
HSIEN, TAIWAN 821

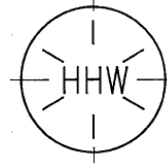

CAGE code: 1/

HOFFMANN, RICHARD GMBH CO. KG  
AM KIESWASSER 8-10  
D-5940 LENNESTADT-ELSPE MEISELTER  
WEG  
KYLLEBURG, GERMANY 5524

Plant  
HOFFMANN MACHINE COMPANY,  
INC.  
1386 DREXEL ROAD  
VALDESE, NC 28690

**H**

CAGE code: 0HEK2 1/

HOLLYWOOD MANUFACTURING INC.  
11915 VOSE STREET  
NORHT HOLLYWOOD, CA 91605-5750

**H**

CAGE code: 7T729 2/

1/ Information published in this revision was verified by direct contact with manufacturers.

2/ Information not verified to be current, no response from manufacturer. Information identical to that published in MIL-HDBK-57, Revision B.

MIL-HDBK-57F (IS)

HOLO-KROME CO.  
31 BROOK STREET  
WEST HARTFORD, CT 06110-2385



*On some socket  
screw products*



*1960 series cap  
screws - old  
design*



*1960 series cap  
screws - present  
design*



*Metric socket cap*



CAGE code: 74445

2/

HORSPPOOL & ROMINE MANUFACTURING  
CO., INC.  
5850 MARSHALL STREET  
OAKLAND, CA 94608-2696

HR HR

CAGE code: 95723

1/

HORST ENGINEERING &  
MANUFACTURING CO.  
P.O. BOX 280066  
EAST HARTFORD, CT 06108-2003

Plant  
36 CEDAR ST  
EAST HARTFORD, CT 06108

HEM  
HE HE

CAGE code: 05812

1/

HOUSTON FASTENER  
(DIVISION OF WESTBROOK MFG)  
1202 KRESS STREET  
P.O. BOX 15614  
HOUSTON, TX 77020

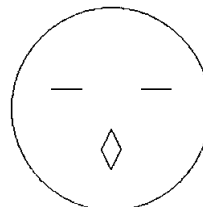

CAGE code: 0YN70

2/

HOUSTON PRECISION FASTENERS  
10018 TANNER ROAD  
HOUSTON, TX 77041

HPF

CAGE code: 1VSL7

1/

1/ Information published in this revision was verified by direct contact with manufacturers.

2/ Information not verified to be current, no response from manufacturer. Information identical to that published in MIL-HDBK-57, Revision B.

## MIL-HDBK-57F (IS)

HOWARD TOOL CO., INC.  
547 ODLIN ROAD  
BANGOR, ME 04401-6707

CAGE code: 044B0 2/

HOWE MACHINE AND TOOL CORP.  
236 PARK AVE.  
BETHPAGE, NY 11714-3709

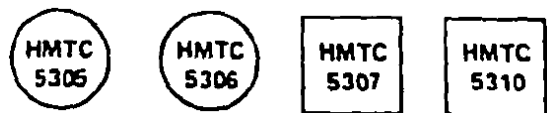

CAGE code: 65777 1/

HOWELL PRECISION, INC.  
6 BROWN DRIVE  
MOUND HOUSE, NV 89706-7744

CAGE code: 6Y774 1/

HOWIE MANUFACTURING CO., INC.  
P.O. BOX 426  
COLLINGSWOOD, NJ 08108

Plant  
1227 MECHANIC ST.  
CAMDEN, NJ 08104-1221

CAGE code: 9V802 1/

HUCK AEROSPACE PRODUCTS  
AFS CARSON OPERATIONS  
900 WATSON CENTER ROAD  
CARSON, CA 90745-4201  
CAGE code: 17446

AFS TUCSON OPERATIONS  
3724 E. COLUMBIA ST.  
TUCSON, AZ 85714-3415  
CAGE code: 0HDW7 (1G6U6 expired)

HUCK INDUSTRIAL PRODUCTS  
AFS WACO OPERATIONS  
8001 IMPERIAL DRIVE  
WACO, TX 76714  
CAGE code: 9K475

HUCK PRODUCTS  
AFS US OPERATIONS  
BP4, CLOS D'ASSEVILLE  
95450 US PAR VIGNY  
FRANCE  
CAGE code: F6167



(Corporate office see ALCOA FASTENING SYSTEMS)

CAGE code: 17446, 1G6U6, 9K475,  
F6167 1/

1/ Information published in this revision was verified by direct contact with manufacturers.

2/ Information not verified to be current, no response from manufacturer. Information identical to that published in MIL-HDBK-57, Revision B.

## MIL-HDBK-57F (IS)

<p>HUGGINS MFG. 4314 GARLAND DR. FORT WORTH, TX 76117</p> <p style="text-align: center;"><b>H</b></p> <p>CAGE code: 0TCV6 <span style="float: right;"><u>2/</u></span></p>	<p>HURON AUTOMATIC SCREW CO. P.O. BOX 610068 4914 GRATIOT RD PORT HURON, MI 48061-0068</p> <p style="text-align: center;"><b>H</b></p> <p>CAGE code: 00905 <span style="float: right;"><u>2/</u></span></p>
<p>HUGO DURHOLT GMBH &amp; CO. KG SCHRAUBENDREH-UND PREBWERK POSTFACH 16-80 D-5632 WERMELSKIRCHEN GERMANY</p> <p style="text-align: center;"> <b>HD</b></p> <p>CAGE code: <span style="float: right;"><u>1/</u></span></p>	<p>HURRICANE MACHINE COMPANY, L.L.C. 2644 FREEWOOD DRIVE DALLAS, TX 75220</p> <p style="text-align: center;"><b>9</b></p> <p>CAGE code: 1H7G3 <span style="float: right;"><u>2/</u></span></p>
<p>HUNT VALVE COMPANY, INC. DBA WAECO VALVE DIVISION 1913 EAST STATE STREET SALEM, OH 44460</p> <p style="text-align: center;"></p> <p>CAGE code: 11859 <span style="float: right;"><u>2/</u></span></p>	<p>HYDRO FITTING MFG. CORP. 733 E. EDNA PLACE P.O. BOX 1558 COVINA, CA 91722-1409</p> <p style="text-align: center;"><b>HF</b></p> <p>CAGE code: 13899 <span style="float: right;"><u>2/</u></span></p>
<p>HUNTER STEVENS COMPANY 4003 FLEETWOOD AVE. FRANKLIN PARK, IL 60131</p> <p style="text-align: center;"><b>HSC</b></p> <p>CAGE code: 48093 <span style="float: right;"><u>2/</u></span></p>	<p>HYDROBOLT LIMITED GLOBAL SERVICE CENTRE, MONMORE BUSINESS PARK, DIXON STREET WOLVERHAMPTON, WV2 2EE. U. K.</p> <p style="text-align: center;"> <b>HB</b></p> <p>CAGE code: <span style="float: right;"><u>1/</u></span></p>
<p>HUNTINGTON VALLEY INDUSTRIES, INC DBA HVI 15182 TRITON LN 101 HUNTINGTON BEACH, CA 92649-1041</p> <p style="text-align: center;"><b>HVI</b></p> <p>CAGE code: 9S754 <span style="float: right;"><u>2/</u></span></p>	

1/ Information published in this revision was verified by direct contact with manufacturers.

2/ Information not verified to be current, no response from manufacturer. Information identical to that published in MIL-HDBK-57, Revision B.

## MIL-HDBK-57F (IS)

I.G.D. MACHINE & TOOL LTD.  
992 HUBREY ROAD  
LONDON, ONTARIO, CANADA N6N 1B5



CAGE code: 2/

IDEAL FASTENERS INC.  
3850 E MIRALOMA AVE  
ANAHEIM, CA 92806



CAGE code: 6F810 1/

IFASTGROUPE 2004 LP  
CANADA

SEE LISTINGS FOR:

INFASCO  
700 OUELLETTE  
MARIEVILLE, QUEBEC  
CANADA  
J3M 1P6  
CAGE code: 1C225

INFASCO NUT  
3990 NASHUA DRIVE  
MISSISSAUGA, ONTARIO,  
CANADA  
L4VT IPG8  
CAGE code: 06KL6

INGERSOLL FASTENERS  
390 THOMAS STREET  
INGERSOLL, ONTARIO  
CANADA  
N5C 3K3  
CAGE code: 35571 1/

IMPERIAL SUPPLIERS, INC.  
P.O. BOX 11008  
789 PACKER DR  
GREEN BAY, WI 54304-4527

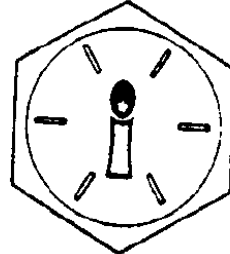

**GRADE 8**

CAGE code: 3A4R0 2/

INDIANA AIRCRAFT HARDWARE  
221 SOUTH MAIN STREET  
FORTVILLE, IN 46040-1514

**IA**

**IAH**

**5N319**

CAGE code: 5N319 1/

1/ Information published in this revision was verified by direct contact with manufacturers.

2/ Information not verified to be current, no response from manufacturer. Information identical to that published in MIL-HDBK-57, Revision B.

MIL-HDBK-57F (IS)

INDUSTRIAL & AUTOMOTIVE FASTENERS  
(DIVISION OF KEY MANUFACTURING  
GROUP, INC.  
3200 W. FOURTEEN MILE RD.  
ROYAL OAK, MI 48073

*Inch Conelock Nuts*

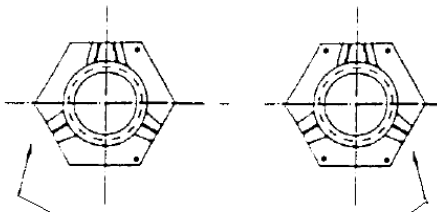

*Company I.D.: 2 single & 1 double slash*

*Inch Wheelnut*

*Metric Wheelnut*

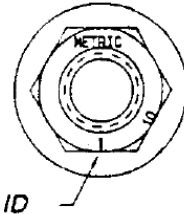
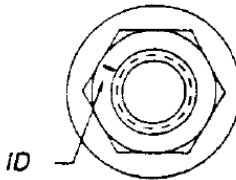

*Metric Flange Hex Nut  
company ID: 1*

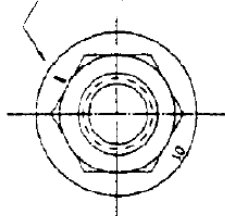

*Metric Conelock Nut*

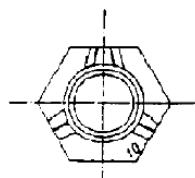

*Company ID: 2 single & 1 double slash*

*Metric Capped Wheelnut*

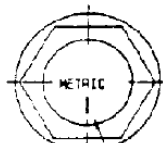

*Company ID: 1*

CAGE code:

2/

INDUSTRIAL FASTENERS CORP.  
7 HARBOR PARK DR  
PORT WASHINGTON, NY 11050

*Raised or indented marks*

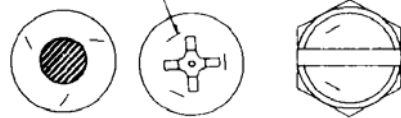

*Under head*

*Top of head*

*Slotted hexhead  
(top of head)*

CAGE code: 84992

2/

INDUSTRIAL FORGE, INC.  
832 LANTANA RD  
LAKE WORTH 33462 - 1509

**IF**

CAGE code: 0RY28

2/

INDUSTRIAL NUT CORP.  
1425 TIFFIN AVE  
SANDUSKY, OH 44870-2054



or **INC**

Blue nylon insert identifies INC as manufacturer



6 equally spaced stakes plus notch in corner of hex identifies Grade C

6 equally spaced stakes identifies Grade B



INCH NYLON INSERT LOCKNUTS

Blue nylon insert identifies INC as manufacturer per IFI 514



2 equally spaced stakes identifies property Class 5 per IFI 514



3 equally spaced stakes identifies property Class 9 per IFI 514



4 equally spaced stakes identifies property Class 10 per IFI 514



METRIC NYLON INSERT LOCKNUTS

The blue insert is a trademark of Industrial Nut Corp. registered in the U.S. Patent & Trade Office.

CAGE code: 81198

1/

1/ Information published in this revision was verified by direct contact with manufacturers.

2/ Information not verified to be current, no response from manufacturer. Information identical to that published in MIL-HDBK-57, Revision B.



## MIL-HDBK-57F (IS)

INDUX, S.A. DE C.V.  
LAMINADORA 37  
BELLAVISTA-TACUBAYA  
MEXICO, D.F. 01140  
MEXICO

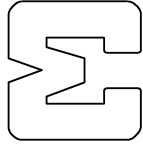

CAGE code: SDK76

1/

INFASCO  
(see IFASTGROUPE 2004 LP)  
700 OUELLETTE  
MARIEVILLE, QUEBEC  
CANADA  
J3M 1P6

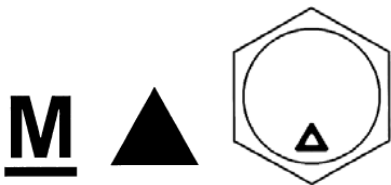

CAGE code: 1C225

1/

INFASCO NUT  
(see IFASTGROUPE 2004 LP)  
3990 NASHUA DRIVE  
MISSISSAUGA, ONTARIO,  
CANADA  
L4VT 1P6

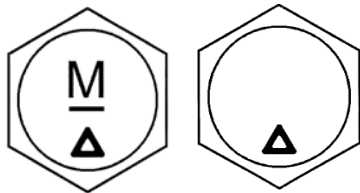

CAGE code: 06KL6

1/

INGERSOLL FASTENERS  
(see IFASTGROUPE 2004 LP)  
390 THOMAS STREET  
INGERSOLL, ONTARIO  
CANADA  
N5C 3K3

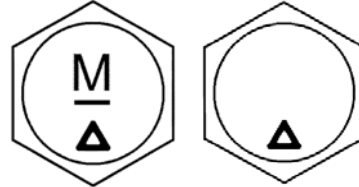

CAGE code: 35571

1/

INLAND MACHINE CO.  
10762 EDISON CT.  
RANCHO CUCAMONGA, CA 91730-4845



CAGE code: 6W617

2/

INOFASST MANUFACTURING INC.  
1370 INDUSTRY RD.  
HATFIELD, PA 19440



CAGE code: 2T359

2/

IN-SPECK CORP.  
208 EAST PENN ST  
NORRISTOWN, PA 19401-1471



CAGE code: 32904

2/

1/ Information published in this revision was verified by direct contact with manufacturers.

2/ Information not verified to be current, no response from manufacturer. Information identical to that published in MIL-HDBK-57, Revision B.

## MIL-HDBK-57F (IS)

INSTRUMENT MACHINING SERVICE LTD.  
HOWLETT WAY, THETFORD,  
NORFOLK IP24 IHZ  
UNITED KINGDOM



CAGE code: 2/

INTERFLEX MFG. CORP.  
144 TOLEDO ST  
FARMINGDALE, NY 75222-4429

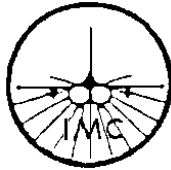

CAGE code: 0LD24 2/

INTERSTATE FITTINGS INC.  
2200 SINGLETON BLVD.  
DALLAS, TX 75212



CAGE code: 1EHF9 2/

IRON BOUND MANAGEMENT GROUP  
79 SUMMIT AVE.  
CHATHAM, NJ 07928

**IMG**

CAGE code: 5UKF4 1/

IRVING MACHINE SERVICE, INC.  
451 MAIN STREET  
P.O. BOX 94  
IRVING, NY 14081

**IM**

CAGE code: 2/

IRWIN AUTOMATION, INC.  
715 CLEVELAND STREET  
GREENSBURG, PA 15601-1279

**IRW**

CAGE code: 7H803 1/

ISLAND ENGINEERING  
DBA J SMITH MACHINE SHOP INC  
153 S MAIN ST  
FREEPORT, NY 11520-0384



CAGE code: 40137 2/

1/ Information published in this revision was verified by direct contact with manufacturers.

2/ Information not verified to be current, no response from manufacturer. Information identical to that published in MIL-HDBK-57, Revision B.

## MIL-HDBK-57F (IS)

ITT HARPER AEROSPACE FASTENER  
OPERATIONS  
(AEROSPACE CONTROLS DIVISION)  
28150 INDUSTRY DRIVE  
VALENCIA, CA 91355

**AOL**

CAGE code: 2/

ITW BUILDEX  
1349 WEST BRYN MAWR AVE.  
ITASCA, IL 60143

**B  
X**

CAGE code: 2/

ITW CIP  
850 STEAM PLANT ROAD  
GALLATIN, TX 37066

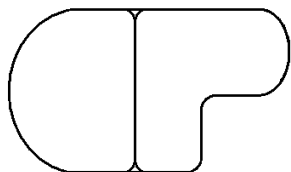

CAGE code: 50CR2 1/

IVACO INC.

( See IFASTGROUPE 2004 LP, CANADA)

See listings for:

INFASCO  
700 OUELLETTE  
MARIEVILLE, QUEBEC  
CANADA  
J3M 1P6  
CAGE code: 1C225

INFASCO NUT  
3990 NASHUA DRIVE  
MISSISSAUGA, ONTARIO,  
CANADA  
L4VT 1P8  
CAGE code: 06KL6

INGERSOLL FASTENERS  
390 THOMAS STREET  
INGERSOLL, ONTARIO  
CANADA  
N5C 3K3  
CAGE code: 35571

CAGE code: 1C225 1/

J & M MACHINE INC.  
1234 HIGH STREET  
PAINESVILLE, OH 44077

**1H423**

CAGE code: 1H423 1/

J & S PRECISION PRODUCTS  
16 EVESBORO RD.  
MEDFORD, NJ 08055-9592



CAGE code: 8B865 2/

1/ Information published in this revision was verified by direct contact with manufacturers.

2/ Information not verified to be current, no response from manufacturer. Information identical to that published in MIL-HDBK-57, Revision B.

## MIL-HDBK-57F (IS)

J.F. FREDERICKS TOOL CO.  
25 SPRING LANE  
FARMINGTON, CT 06032-31 96

**33575**

CAGE code: 33575

1/

J. G. FASTENERS  
9720 COZYCROFT AVE  
CHATSWORTH, CA 91311-4423

**JG**

CAGE code: 0VWM9

2/

J. GEORG BIERBACH  
WERDOHLER STRASSE 23  
ALTENA, GERMANY D-5990

**G E B I**



CAGE code:

2/

J.M. PRECISION, INC.  
(FASTENER DIVISION)  
9722 TOPANGA CANYON BLVD  
CHATSWORTH, CA 913114015

**JMP**

CAGE code: 0JV78

1/

J.P. PRODUCTS, INC.  
( DBA SPECIALITES, UNLIMITED)  
P.O. BOX 427  
WILLOUGHBY, OH 44094

**S**

CAGE code:

2/

JACOBSON MFG., LLC.  
941-955 LAKE RD.  
MEDINA, OH 44256

CAGE code: 58PU8

1/

Plant  
JACOBSON MFG – TIFFIN, LLC.  
1988 COUNTY ROAD #593  
TIFFIN, OH 44883

**J**

CAGE code: 58UV4

1/

JACO ENGINEERING, INC.  
879 SO. EAST STREET  
ANAHEIM, CA 92805-5356

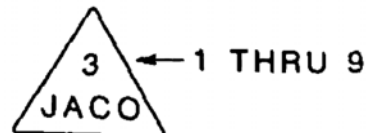

CAGE code: IH427

1/

1/ Information published in this revision was verified by direct contact with manufacturers.

2/ Information not verified to be current, no response from manufacturer. Information identical to that published in MIL-HDBK-57, Revision B.

## MIL-HDBK-57F (IS)

JAM TECH CORP.  
P.O. BOX 327  
ESSINGTON, PA 19029

Plant  
1260 East Woodland Avenue  
Springfield, PA 19064

**JT**

CAGE code: IEM35 2/

JAMES IPPOLITO & CO., INC.  
1069 CONNECTICUT AVE.  
BRIDGEPORT, CT 06607

**96458**

CAGE code: 96458 1/

JAMES JACKSON  
DBA J J ENGINEERING  
11021 VIA EL MERCADO  
LOS ALAMITOS, CA 90720-0281

**JJE**

CAGE code: 0CEP4 2/

JAMISON INDUSTRIES INC.  
12669 DELTA ST  
TAYLOR, MI 48180-6835

**JJ**

CAGE code: 1Z781 1/

JAY BEE MACHINE WORKS, INC.  
400 PIKE RD.  
HUNTINGDON VALLEY, PA 19006-1610

**B**

CAGE code: 74954 1/

JAY O MACHINE CO., INC.  
7685 HUB PARKWAY  
VALLEY VIEW, OH 44125-5706

**J O M**

CAGE code: 5Z832 2/

JAYCO ENGINEERING, INC.  
1660 BABCOCK AVENUE  
COSTA MESA, CA 92627-4330

**JE**

CAGE code: 7J578 1/

JEA ENTERORISES, INC.  
P.O. BOX 512  
MIDDLEBURY, CT 06762

Plant  
86 BESSON RD.  
MIDDLEBURY, CT 06762

**JEA**

CAGE code: 1S5U2 1/

1/ Information published in this revision was verified by direct contact with manufacturers.

2/ Information not verified to be current, no response from manufacturer. Information identical to that published in MIL-HDBK-57, Revision B.

## MIL-HDBK-57F (IS)

JERGENS INC.  
DBA JERGENS INDUSTRIAL SUPPLY  
15700 S WATERLOO RD  
CLEVELAND, OH 44110-3814



CAGE code: 94882 2/

JINN HER ENTERPRISE CO., LTD.  
107 SHIN LO STREET  
KANGSHAN CHEN, KAOHSIUNG HSIEN  
TAIWAN R.O.C.

**J H**

CAGE code: NONE 1/

JJ ENGINEERING  
(See JAMES JACKSON)  
11021 VIA EL MERCADO  
LOS ALAMITOS, CA 90720-0281



CAGE code: 0CEP4 2/

JJ SCREW PRODUCTS, INC.  
21519 PARTHENIA STREET  
CANOGA PARK, CA 91304



CAGE code: 75209 2/

JOHN R. BROMILEY COMPANY INC.  
105 BRISTOL ROAD  
CHALFONT, PA 18914

**JRB**

CAGE code: 1EV05 1/

JMT MACHINE COMPANY  
9986 GANTRY ROAD  
PHILADELPHIA, PA 19115-1080

**2A832**

CAGE code: 2A832 2/

JOLICO/J-B TOOL INC.  
4325 E. 22 MILE ROAD  
UTICA, MI 48317-1507

**JOLICO**

CAGE code: 19549 2/

JOSLYN CORP.  
MACLEAN POWER SYSTEMS  
11411 ADDISON STREET  
FRANKLIN, IL 60131-1130

Plant  
3700 SOUTH MORGAN STREET  
CHICAGO, IL 60609-1461

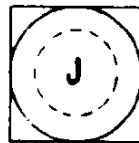

**Machine bolts**

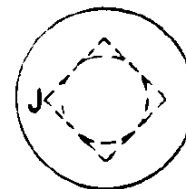

**Carriage bolts**

CAGE code: 74999 1/

1/ Information published in this revision was verified by direct contact with manufacturers.

2/ Information not verified to be current, no response from manufacturer. Information identical to that published in MIL-HDBK-57, Revision B.

MIL-HDBK-57F (IS)

JUNIPER ELBOW CO.  
72-15 METROPOLITAN AVE.  
MIDDLE VILLAGE, NY 11379



CAGE code: 97537 1/

---

JUPITER WASHERS, INC.  
10-01 37TH AVE.  
LONG ISLAND CITY, NY 11101-6014



CAGE code: 25900 2/

---

JUST IN TIME, INC.  
DBA APSCO  
2538 WEST LN., SUITE 16  
STOCKTON, CA 95205

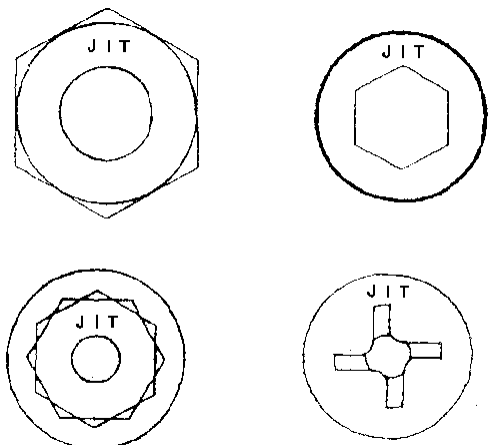

CAGE code: 0FVD5 2/

K & K PRECISION ENTERPRISES  
60 STEAM WHISTLE DRIVE  
WARMINSTER, PA 18974



CAGE code: 1K6D9 2/

---

K.A.A. COMPANY  
(LYNN ABADIE DBA K A A COMPANY)  
1309 MADISON STREET  
WEATHERFORD, TX 76086-2144



CAGE code: 1XRQ5 2/

---

K.D.K. UPSET FORGING CO.  
2645 W. 139TH ST.  
P.O. BOX 146  
BLUE ISLAND, IL 60406-0146



CAGE code: 8P293 2/

---

KAMAX-WERKE RUDOLF KELLERMANN  
GmbH & CO. KG  
PETERSHUETTER ALLEE 29  
OSTRODE, GERMANY 37520

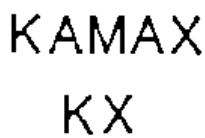

CAGE code: C5315 2/

1/ Information published in this revision was verified by direct contact with manufacturers.

2/ Information not verified to be current, no response from manufacturer. Information identical to that published in MIL-HDBK-57, Revision B.

## MIL-HDBK-57F (IS)

KAMAX L. P. (FORMERLY G.B. DUPONT  
CO., INC.)  
500 WEST LONG LAKE ROAD  
TROY, MI 48098-4540



CAGE code: 1DWW1

1/

KAMPWERK VIEREGGE U. PICKARDT  
GMBH. & CO  
P.O. BOX 5143  
PLETTENBURG 5 G-5970



CAGE code:

2/

KAPCO INDUSTRIES, INC.  
5660 KNOTT AVE  
BUENS PARK, CA 90621

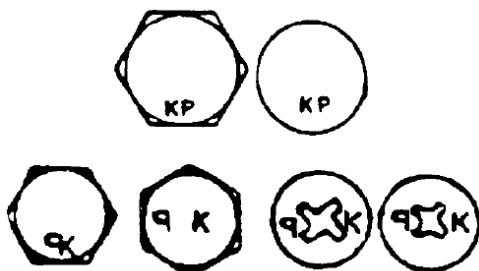

CAGE code: 0BMF4

2/

KATSURAGAWA MACHINE SCREW CO.,  
LTD.  
3-24-1 YAGUCHI OHTA-KU  
TOKYO 146  
JAPAN

Plant  
366-1, KOGOSYO  
KAKEGAWA-SHI  
SHIZUOKA-KEN 436  
JAPAN

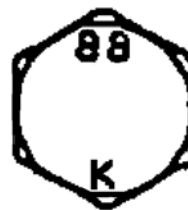

CAGE code:

2/

KAYGOR, INC.  
1243 TRANSIT STREET  
P.O. BOX 2950  
POMONA, CA 91769-2950



CAGE code: 4H229

2/

1/ Information published in this revision was verified by direct contact with manufacturers.

2/ Information not verified to be current, no response from manufacturer. Information identical to that published in MIL-HDBK-57, Revision B.



## MIL-HDBK-57F (IS)

KAYNAR PRODUCTS  
800 S. STATE COLLEGE BLVD.  
FULLERTON, CA 92831

(Corporate office see ALCOA FASTENING SYSTEMS)

(Previously listed under MICRODOT INC.)

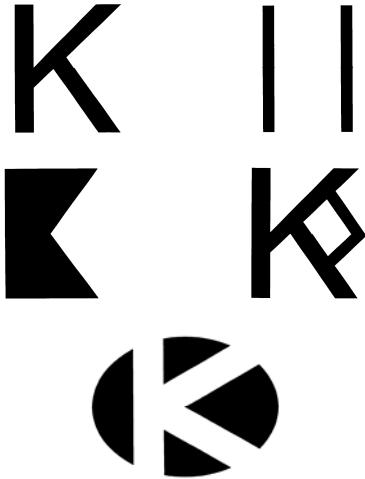

CAGE code: 15653

1/

KELLER ENGINEERING  
136 W. 157TH STREET  
GARDENA, CA 90248-2226

KE

CAGE code: 4W941

2/

KELOX/MICRODOT PRODUCTS  
AFS TORRANCE OPERATIONS  
3020 WEST LOMITA BLVD.  
TORRANCE, CA 90505-5103

(Corporate office see ALCOA FASTENING SYSTEMS)



CAGE code: 75237

1/

KEN FORGING, INC.  
1049 GRIGGS RD  
P.O. BOX #277  
JEFFERSON, OH 44047

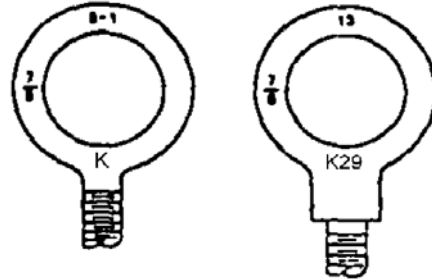

CAGE code: 1GMT9

1/

KERR, CHARLES W.  
RIVER RD BLDG PP-1  
JAY CEE INDUSTRIAL PK  
BRISTOL, PA 19007

see MAUI MEGA



CAGE code: 0M4F0

2/

KERR LAKESIDE INC.  
26841 TUNGSTEN RD.  
P.O. BOX 32220  
EUCLID, OH 44117-2680



CAGE code: 7P576

1/

1/ Information published in this revision was verified by direct contact with manufacturers.

2/ Information not verified to be current, no response from manufacturer. Information identical to that published in MIL-HDBK-57, Revision B.

## MIL-HDBK-57F (IS)

KEYSTONE BOLT & NUT COMPANY  
KEYSTONE THREADED PRODUCTS  
DIVISION  
P.O. BOX 31059  
CLEVELAND, OH 44313-0059

Plant  
7621 OLD ROCKSIDE RD.  
CLEVELAND, OH 44131-0059

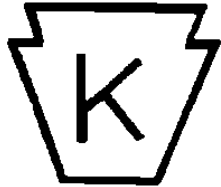

CAGE code: 4N487

1/

KEYSTONE TOOL & MACHINE CO.  
108 N. McDADE BLVD.  
DARBY, PA 19023



CAGE code: 7Y516

2/

KILBOURN ENGINEERING CO.  
9226 WEST FLAGG AVE.  
MILWAUKEE, WI 53225-2718



CAGE code: 8H824

2/

KIRSTEN PIPE CO. INC.  
1807 NW DOCK PL  
P.O. BOX 70526  
SEATTLE, WA 98127-0526

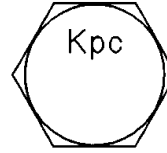

CAGE code: 5E704

2/

K.L.M. MACHINE INC.  
711 COLONIA LANE EAST  
NOKOMIS, FL 34275

**KLM**

CAGE code: 4NDJ6

KLINCHER LOCKNUT CORP.  
2030 N. OXFORD ST.  
P.O. BOX 18100  
INDIANAPOLIS, IN 46218

**KL**

CAGE code:

2/

KNIPPING-DORN GmbH  
KALTUMFORMTECHNIK  
4690 HERNE 1  
POSTFACH 1229  
GERMANY

D O R N

In connection with the identification mark of property class 3.6 up to and including 12.9

CAGE code:

2/

1/ Information published in this revision was verified by direct contact with manufacturers.

2/ Information not verified to be current, no response from manufacturer. Information identical to that published in MIL-HDBK-57, Revision B.

## MIL-HDBK-57F (IS)

KNOCH MANUFACTURING CO. LTD.  
1054 SHAW RD  
DORCHESTER, CANADA N0L 1G4

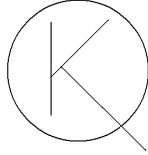

CAGE code: 1C763

2/

KO AMS MACHINE PRODUCTS  
DBA KOAM MACHINE  
915 BROOKS ST UNIT 102  
ONTARIO, CA 91762-3603

**KO**

CAGE code: 0K7E0

2/

KOBE FASTENER LIMITED  
654 HISBIE  
HIGASBI OSAKA, 577  
JAPAN

*α*

CAGE code:

2/

KOLB GMBH & CO.  
HERSTELLER VON  
VERBINDUNGSELEMENTEN  
RATHENAU STRASSE 23  
POSTFACH 24 02 53 WUPPERTAL  
GERMANY 42277

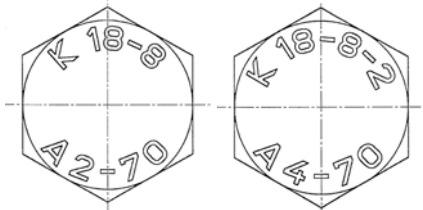

CAGE code: D0472

2/

KONDOR TECHNOLOGIES, INC.  
206 CHRISTOPHER ST  
RONKONKOMA, NY 11779-6921

**KTI**

CAGE code: 06ZB0

2/

KONGO BYORA CO., LTD.  
2-1-27 SHITENNOJI  
TENNOJI-KU  
OSAKA 543 JAPAN

Plant  
3-31 NAGATA-NISHI  
HIGASHIOSAKA-SHI, OSAKA  
577 JAPAN

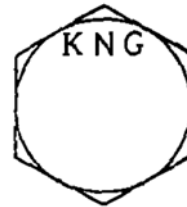

CAGE code:

2/

KOREA BOLT IND., CO., LTD.  
(FOREIGN TRADE DEPARTMENT)  
620-34 GURO-DONG, GURO-KU  
SEOUL, KOREA

Plant  
732-3 WONSI-DONG, ANSAN-CITY  
GYUNGGI-DO, KOREA



CAGE code:

2/

1/ Information published in this revision was verified by direct contact with manufacturers.

2/ Information not verified to be current, no response from manufacturer. Information identical to that published in MIL-HDBK-57, Revision B.

## MIL-HDBK-57F (IS)

KORODY COLYER CORP.  
A CR INDUSTRIES COMPANY  
5412 MCFADDEN AVE.  
HUNTINGTON BEACH, CA 92649

**K**

CAGE code: 18954 2/

KOZAK, E. PERCISION PRODUCTS CO.  
45 WOODLAND AVE.  
ROCKAWAY, NJ 07866

**KPP**

CAGE code: 1CP43 2/

KPF  
601 YOUNGTAN-DONG, CHUNGJU-CITY  
CHUNGCHEONGBUK-DO 380-250, KOREA

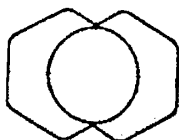

CAGE code: 1/

KREIS TOOL & MFG., CO., INC.  
1615 CAMBRIDGE DR  
ELGIN, IL 60123 - 3114

**KTM**

CAGE code: 64592 2/

KROBACH MANUFACTURING CORP.  
3504 ARDEN RD.  
HAYWARD, CA 94545-5390



CAGE code: 30828 1/

KSS SOCKET SCREW, INC.  
3416 S. 48TH STREET SUITE #6  
PHOENIX, AZ 85040

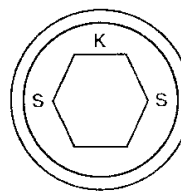

CAGE code: 0BMF5 2/

K-TECH MFG., INC.  
288 HOLBROOK DRIVE  
WHEELING, IL 60090

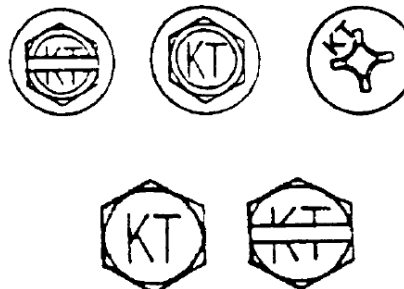

CAGE code: 2/

1/ Information published in this revision was verified by direct contact with manufacturers.

2/ Information not verified to be current, no response from manufacturer. Information identical to that published in MIL-HDBK-57, Revision B.

## MIL-HDBK-57F (IS)

KYOEI SEISAKUSHO CO., LTD.  
4-5-11 NUNOICHI-CHO  
HIGASHIOSAKA-SHI,  
OSAKA 579  
JAPAN

Plant  
MINAMISHINOZAKI  
KAZSHI, SAILAMA-KEN  
347 JAPAN



CAGE code: 2/

KYOKUTO MFG CO LTD.  
3-5-29 WAKAEHONMACHI  
HIGASHIOSAKA-SHI  
OSAKA 578  
JAPAN

Plant  
1109-5 SHIBADE  
KURAMOCHI-CHO,  
NABARI-SHE, MIE-KEN 518-04  
JAPAN

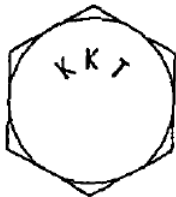

CAGE code: 2/

L & C MANUFACTURING CO., INC.  
8610 S. 33RD W. AVENUE  
TULSA, OK 74132-3403



CAGE code: 43813 2/

L & H THREADED RODS CORP.  
DIV OF GRAY AMERICA CORP  
3050 DRYDEN ROAD  
DAYTON, OH 45439



CAGE code: 0UH42 2/

L & J FASTENERS, INC.  
3636 LACON ROAD  
HILLIARD, OH 43026-6122

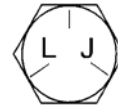

CAGE code: 1W358 2/

L & M ENTERPRISES, INC.  
1910 NORTHERN  
WICHITA, KS 67216-2429



CAGE code: 0HDM5 2/

L. A. MARTIN CO.  
14400 HENN STREET  
DEARBORN, MI 48126-1850



CAGE code: 9S775 1/

L G MACHINE & MFG INC.  
1276 W. ARKANSAS LANE  
ARLINGTON, TX 76013-6235



CAGE code: 0P4S2 1/

1/ Information published in this revision was verified by direct contact with manufacturers.

2/ Information not verified to be current, no response from manufacturer. Information identical to that published in MIL-HDBK-57, Revision B.

## MIL-HDBK-57F (IS)

L H INDUSTRIES, INC.  
 TIP TOP TOOL CO.  
 3513 NORTH 10<sup>th</sup> STREET  
 PHILADELPHIA, PA 19140

44

CAGE code: 0E7S8

2/

L N AEROSPACE, INC.  
 6011 TENSION DRIVE  
 FORT WORTH, TX 76112-2693

LNA

CAGE code: 1EB45

2/

L P R PRECISION PARTS AND TOOL  
 COMPANY, INC.  
 108 ROME STREET  
 FARMINGDALE, NY 11735-2136

L. P. R.

CAGE code: 31583

2/

L R G CORPORATION  
 210 MAGEE AVE  
 JEANNETTE, PA 15644-2136

LRG

CAGE code: 75783

2/

LAKE ERIE SDREW CORP.  
 13001 ATHENS AVE.  
 LAKEWOOD, OH 44107-6201

LE



ASTM A 307



ASTM A 449



SAE J429 GR 2

SAE J429 GR 5

SAE J429 GR 5.1



ASTM A 354 BD

ASTM F 568  
 CLASS 8.8

SAE J429 GR 6

SAE J429 GR 8

SAE J1199  
 CLASS 8.8



ASTM F 568  
 CLASS 9.8

ASTM F 568  
 CLASS 10.9

ASTM F 568  
 CLASS 12.9

SAE J1199  
 CLASS 9.8

SAE J1199  
 CLASS 10.9



ASTM A 325



ASTM A 325  
 TYPE 3  
 CLASS A



ASTM A 490



ASTM A 490  
 TYPE 3  
 CLASS A

CAGE code: 8B911

1/

LaMOTT ENTERPRISES, INC.  
 3905 CALIFORNIA STREET NE  
 MINNEAPOLIS, MN 55421



CAGE code: 3MWQ3

1/

1/ Information published in this revision was verified by direct contact with manufacturers.

2/ Information not verified to be current, no response from manufacturer. Information identical to that published in MIL-HDBK-57, Revision B.

MIL-HDBK-57F (IS)

LAMSON AND SESSIONS OF CANADA LTD.  
 RB & W CORP. METAL FORMING DIVISION  
 8341 TYLER BOULEVARD  
 MENTOR, OH 44060

MANUFACTURER NUTS – Sales Office  
 Lamson & Sessions of Canada Ltd.  
 Toronto Plant – Canada  
 5190 Bradco Boulevard  
 Mississauga, Ontario L4W 1G7  
 CANADA

**STOVER\* PREVAILING TORQUE LOCKNUTS**



Grade A



Grade B



Grade C

Hex Automation – Imperial



Grade F



Grade G

Hex Flange – Imperial



Class 9



Class 10

Hex Flange – Metric



Hex Automation – Metric

CAGE code: 2/

LANA INDUSTRIES  
 4404-D MCLEAN DRIVE  
 HALTOM CITY  
 FORT WORTH, TX 76117



CAGE code: 2/

LANARKSHIRE BOLT LTD.  
 BURNBANK  
 HAMILTON, LANARSHIRE ML3 OQU  
 SCOTLAND

**L B**



Raised letters

CAGE code: K3565 2/

LAND-SEA-AIR MACHINED PRODUCTS, INC.  
 P.O. BOX H  
 FLEMING PIKE  
 WINSLOW, NJ 08095

**L-S-A**

CAGE code: 8U768 2/

LANIS MACHINE & MFG., CO.  
 2506 S. COOPER #A-9  
 ARLINGTON, TX 76015-1608



CAGE code: 8V177 2/

1/ Information published in this revision was verified by direct contact with manufacturers.

2/ Information not verified to be current, no response from manufacturer. Information identical to that published in MIL-HDBK-57, Revision B.

MIL-HDBK-57F (IS)

LANUM METAL PRODUCTS, INC.  
4100 N. 16TH STREET  
PHILADELPHIA, PA 19140-3008



L.M.T.

CAGE code: 0CY73 2/

---

LBL PRODUCTS  
5395 INDUSTRIAL DRIVE  
UNIT A  
HUNTINGTON BEACH, CA 92649-1516



CAGE code: 1HJ06 2/

---



LEBRECHT TIGGES GmbH & CO. KG  
P.O. BOX 12 04 85  
W 5600 WUPPERTAL 12-CRONENBERG  
GERMANY



CAGE code: 2/

LEHNER SCREW MACHINE CO.  
71 SOUTH RIVER ROAD  
P.O. BOX 158  
MUNROE FALLS, OH 44262

Plant  
71 SOUTH RIVER ROAD  
MUNROE FALLS, OH 44262





CAGE code: 9G035 1/

---

LELAND-POWELL FASTENERS, INC.  
P.O. BOX 260  
MARTIN, TN 38237

Plant  
HIGHWAY 45 EAST SOUTH  
MARTIN, TN 38237



CAGE code: 2/

1/ Information published in this revision was verified by direct contact with manufacturers.

2/ Information not verified to be current, no response from manufacturer. Information identical to that published in MIL-HDBK-57, Revision B.



## MIL-HDBK-57F (IS)

LENCH, THOMAS WILLIAM, LTD.  
P.O. BOX 31  
EXCELSIOR WORKS CARNEGIE ROAD,  
ROWLEY REGIS B65 8BZ  
UNITED KINGDOM



Raised letters



Indented letters

Raised or indented  
letters

CAGE code: U0039

2/

LENTERN (AIRCRAFT) LTD.  
MAIN RD, HAWKWELL,  
NR. HOCKLEY ESSEX SS5 4JJ  
GREAT BRITIAN, UK

**LAH**

CAGE code:

2/

LEONARD JED CO MARYLAND BOLT AND  
NUT CO DIV  
(REPLACES MARYLAND BOLT & NUT CO.,  
INC. -CAGE 76213)  
1104 RUSSELL ST.  
BALTIMORE, MD 21230 - 2622



SAE J429 Grade 5  
ASTM A449  
MIL-B-857-A Grade 5

NOTE: Also covers round head bolts,  
i.e., carriage-plow and countersunk  
styles, etc.



ASTM A193 Grade B-7

Alloy steel high temperature service  
bolting

Tempered to 125 KSI tensile strength

NOTE: Also covers sq. head and  
countersunk styles.Heavy head hex or regular configura-  
tions

ASTM A490 Type 1

NOTE: Also covers round head bolts,  
i.e., carriage-plow and countersunk  
styles, etc.

ASTM A394 Type T-0

Tower bolts: hex head, square head

Head markings also include: T-1 for  
medium carbon and T-3 for weather-  
ing alloy steel. Both require heat  
treatingNOTE: Round head step bolts require  
manufacturing head identification  
and proper markings as above,  
except length size

SAE J429 Grade 8  
ASTM A354 Grade B0

Also (optional) that A354 is exhibited  
on top of head

MIL-B-857-A Grade 8

NOTE: Also covers round head bolts,  
i.e., carriage-plow and countersunk  
styles, etc.

CAGE code: 52373

2/

Continued

1/ Information published in this revision was verified by direct contact with manufacturers.

2/ Information not verified to be current, no response from manufacturer. Information identical to that published in MIL-HDBK-57, Revision B.

MIL-HDBK-57F (IS)

Continued  
LEONARD JED CO MARYLAND BOLT AND  
NUT CO DIV



ASTM A325 Type 1  
NOTE: Also covers round head bolts,  
i.e., carriage-plow and countersunk  
styles, etc.



With line under  
A325 mark

ASTM A325 Type 3  
NOTE: Also covers round head bolts,  
i.e., carriage-plow and countersunk  
styles, etc.



No Grade mark  
— only manu-  
facturer's  
symbol

SAE J429 Grade 2  
ASTM A307 Grades A & B  
MIL-B-857-A Type 2 (ADM/5)  
NOTE: Also covers round head bolts,  
i.e., carriage-plow and countersunk  
styles, etc.



With line under  
A490 mark

ASTM A490 Type 3  
NOTE: Also covers round head bolts,  
i.e., carriage-plow and countersunk  
styles, etc.



Letters B7M on  
head

ASTM A193 Grade B-7-M  
Alloy steel high temperature service  
bolting  
Tempered to 100 ksi tensile strength  
NOTE: Also covers SQ head and  
countersunk styles  
Heavy head hex or regular configura-  
tions



Heavy hex for  
type C-3  
Regular or  
heavy for DH3

Manufacturer's symbol and the num-  
ber 3 or DH3 on face  
For Grade C-3 three radial lines are  
also required  
Heavy hex applications for C-3 and  
heavy or regular for DH3  
Nuts for bolt applications  
ASTM A325 type 3  
ASTM A563 Grade CH3  
Also covers square nut configurations

CAGE code: 52373

2/

Continued

Continued  
LEONARD JED CO MARYLAND BOLT AND  
NUT CO DIV



Heavy or  
regular

Manufacturer's symbol and the 2H or  
DH marking  
Also can be supplied in regular confi-  
gurations  
Suitable for all Grade B and A325 or  
A490 bolts  
Nuts for bolt applications  
ASTM A194 Grade 2H  
ASTM A563 Grade DH  
Also covers square nut configurations



Heavy hex only

Manufacturer's symbol and three radial  
lines  
Heavy hex applications only  
Nuts for bolt applications  
ASTM A563 Grade C  
For ASTM A325 bolts  
Also covers square nut configurations

CAGE code: 52373

2/

LEP SPECIAL FASTENERS INC.  
3281 W. COUNTY RD ON/S  
FRANKFORT, IN 46041



LE

CAGE code: 8B911

1/

1/ Information published in this revision was verified by direct contact with manufacturers.

2/ Information not verified to be current, no response from manufacturer. Information identical to that published in MIL-HDBK-57, Revision B.

MIL-HDBK-57F (IS)

LEVEL 1 FASTENERS  
300 THIRD AVE  
HUNTINGTON, WV 25701



300 Series Stainless Steel

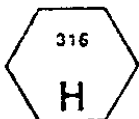

Type 316 Stainless Steel

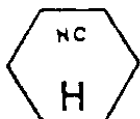
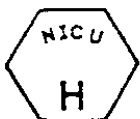

Nickel Copper (Monel)

**BEK**

CAGE code: 17283

1/

LEVINGSTON MACHINE COMPANY  
2428 MINNIS DR.  
HALTOM CITY, TX 76117-4856

**LM**

CAGE code: 46939

2/

LEWIS SREW COMPANY  
(DIV OF MEDALIST FASTENERS INC.)  
2550 S 27TH AVE.  
BROADVIEW, IL 60155 - 3851



**LEWIS SCREW COMPANY**  
*THE FASTENER SPECIALIST*

120° INCLUDED ANGLE  
RAISED.

INDENTED HEX HDS. AND  
INDENTED HEX WASHER HDS.



**LEWIS SCREW COMPANY**  
*THE FASTENER SPECIALIST*



3-DASH MARKS 120° APART  
RAISED

UNDER HEAD UPON REQUEST  
"NON-COUNTERSUNK HEADS ONLY"

CAGE code: 1AW87

2/

LFC INDUSTRIES INC.  
(DIVISION RKR TECHNOLOGIES)  
P. O. BOX 5982  
1221 CORPORATE DRIVE WEST  
ARLINGTON, TX 76006-6103

**LFC**

CAGE code: 62384

1/

1/ Information published in this revision was verified by direct contact with manufacturers.

2/ Information not verified to be current, no response from manufacturer. Information identical to that published in MIL-HDBK-57, Revision B.

MIL-HDBK-57F (IS)

LINREAD NORTHBRIDGE  
LEICESTER, UK  
VIKING ROAD  
WIGSTON, LEICESTER  
ENGLAND LE18 2BL

**NB**

CAGE code: U6683

1/

LINREAD NORTHBRIDGE AIRCRAFT  
PRODUCT DIVISION  
CROSSGATE ROAD PARK FARM  
P.O. BOX 28  
REDDITCH  
WORCESTERSHIRE B98 7TD  
UK

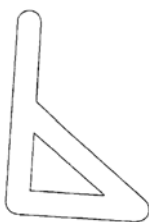

CAGE code: K8753

2/

LINREAD PUBLIC LIMITED CO.  
(AIRCRAFT PRODUCTS DIVISION)  
P.O. BOX 28, CROSSGATE ROAD  
PARK FARM INDUSTRIAL EST. REDDITCH,  
WORCESTERSHIRE B98 7TD  
UNITED KINGDOM



Illustration  
No.

Notes

1, 2

= Unified S quality

WWE = Linread Keeley St. (was  
Warne Wright Engineering  
and which no longer trades  
under that name)

M = Metric screws and bolts  
8.8 or 8.8 = Grade 8.8. Alternative mark-  
ings such as 10.9 or 10.9  
may appear as appropriate.



Illustration  
No.

Notes

3, 4

LL or L = Linread Ltd  
S = Unified S quality. Alternative  
letters such as R and T may  
appear as appropriate.

M = Metric screws and bolts  
8.8 or 8.8 = Grade 8.8. Alternative mark-  
ings such as 10.9 or 10.9  
may appear as appropriate.

Illustration  
No.

Notes

3, 4,  
(Cont'd)

= Linread Pic



CAGE code: K8753

Continued

2/

1/ Information published in this revision was verified by direct contact with manufacturers.

2/ Information not verified to be current, no response from manufacturer. Information identical to that published in MIL-HDBK-57, Revision B.

## MIL-HDBK-57F (IS)

Continued

LINREAD PUBLIC LIMITED CO.  
(AIRCRAFT PRODUCTS DIVISION)  
P.O. BOX 28, CROSSGATE ROAD  
PARK FARM INDUSTRIAL EST. REDDITCH,  
WORCESTERSHIRE B98 7TD  
UNITED KINGDOM

Illustration  
No.

Notes

5, 6

 = Linread Plc

- S** = Unified S quality. Alternative letters such as R and T may appear as appropriate.
- M** = Metric screws and bolts
- 8B or 8.8** = Grade 8.8. Alternative markings such as 10.9 or 10.9 may appear as appropriate.



Illustration  
No.

Notes

7, 8

 = Tribular screws and bolts. Various letters may appear, viz

- M** = Metric. Absence of other letters indicate Duo-Taptite or Taptite parts.
- P** = Powerlok
- C** = Carbon restored surface, i.e., with no decarburization permitted but not case hardened.
- N** = Neutral or through hardened
- I** = Induction hardened lead threads
- S** = Unified S quality. Alternative letters such as R and T may appear as appropriate.
- 8B or 8.8** = Grade 8.8. Alternative markings such as 10.9 or 10.9 may appear as appropriate.

CAGE code: K8753

2/

LIPPISCHE EISENINDUSTRIE GmbH  
ALTER WEG 57  
D-4930  
GERMANY

**LE**

CAGE code:

2/

LISI AEROSPACE  
LISI AEROSPACE CANADA  
TOUR GAMMA A  
193, RUE DE BERCY  
75582 PARIS CEDEX 12  
FRANCE

*Plant*

A1 TECHNOLOGIES  
7022 ALONDRA BLVD  
PARAMOUNT, CA 90723 3926

NO SYMBOL LISTED

CAGE code:

*Plant*

LISI AEROSPACE CANADA  
2000, PLACE TRANSCANADIENNE  
DORVAL (QUÉBEC) H9P 2K5  
CANADA

**L**

CAGE code: L4528

Continued

1/

<sup>1/</sup> Information published in this revision was verified by direct contact with manufacturers.

<sup>2/</sup> Information not verified to be current, no response from manufacturer. Information identical to that published in MIL-HDBK-57, Revision B.

## MIL-HDBK-57F (IS)

Continued

LISI AEROSPACE  
see BLANC AERO INDUSTRIES

*Plant*  
BLANC AERO INDUSTRIES  
VILLEFRANCHE DE ROUERGUE  
18, RUE JEAN VAURS  
12200 VILLEFRANCHE DE ROUERGUE  
FRANCE

CAGE code: F0188

*Plant*  
BLANC AERO INDUSTRIES RUGBY  
RUGBY WARWICKSHIRE  
CV21 3 RQ  
ENGLAND

CAGE code: U6300

*Plant*  
BLANC AERO INDUSTRIES SAINT OUEN  
L'AUMONE  
95310 SAINT OUEN L'AUMONE  
FRANCE

ɸ (St Brieuç)  
B (Paris)  
P (Villefranche de  
Rouergue)

ds. F

CAGE code: F0188

1/

Continued

Continued

LISI AEROSPACE

*Plant*  
BLANC AERO TECHNOLOGIES  
B.P. 215  
22002 SAINT BRIEUC CEDEX 1  
FRANCE

CAGE code: F0188

*Plant closed*  
DECOLLETAGE GENERAL MODERNE  
DECOLLETAGE MODERNE 5 BIS, PLACE  
LEON BLUM

*Plant*  
FT BESTAS  
35410 GAZIEMIR-IZMIR  
TURKEY

CAGE code: T0802

*Plant*  
HI-SHEAR CORPORATION  
see HI-SHEAR  
260 SKYPARK DR.  
TORRANCE, CA 90509-2975

CAGE code: 73197

1/

Continued

1/ Information published in this revision was verified by direct contact with manufacturers.

2/ Information not verified to be current, no response from manufacturer. Information identical to that published in MIL-HDBK-57, Revision B.

## MIL-HDBK-57F (IS)

Continued

LISI AEROSPACE

*Plant*  
 MONADNOCK  
 18301 EAST ARENTH AVE.  
 CITY OF INDUSTRY, CA 91748-1288

• (a dot)

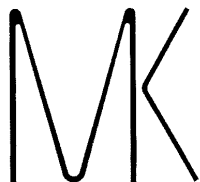

M O N A D N O C K

**TMC**

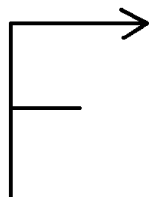

CAGE code: 60119

1/

LITTLE WORLD MANUFACTURING, INC.  
 1083 FOREST RD.  
 WEST CHESTER, PA 19380

*Plant*  
 525 WEST SOUTH STREET  
 KENNETT SQUARE, PA 19348

**L<W>M**

CAGE code: 6T569

2/

LLOYD MACHINE & TOOL CO., INC.  
 234 BROAD AVENUE  
 WILMINGTON, CA 90744-5812

**LM**

CAGE code: 01334

2/

LN AEROSPACE, INC.  
 6011 TENSION DRIVE  
 FORT WORTH, TX 76112-2693

**LNA**

CAGE code: 1EB45

2/

LOBO OFFICINE MECCANICHE SPA  
 VIA T. EDISON  
 CORANAREDO, MILANO ITALY 20010

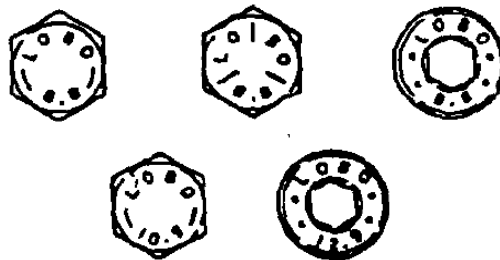

CAGE code: A1208

2/

1/ Information published in this revision was verified by direct contact with manufacturers.

2/ Information not verified to be current, no response from manufacturer. Information identical to that published in MIL-HDBK-57, Revision B.

## MIL-HDBK-57F (IS)

LOBO SYSTEMS LTD  
26 THE PARKER CENTRE  
MANSFIELD ROAD  
DERBY DE21 4SZ  
ENGLAND

**LOBO**™

CAGE code: KE018 1/

LONE STAR FASTENERS, LP  
(PREVIOUS LISTED AS LONE STAR  
SCREW CO OF TEXAS INC  
P.O. BOX 1149  
SPRING, TX 77373

Plant  
24131 HARDY ROAD  
SPRING, TX 77373

**L**

Precedes grade marking  
(example: LB7)

CAGE code: 7H174 1/

LONG-LOK FASTENERS CORP.  
10630 CHESTER RD  
CINCINNATI, OH 45215-1206

Plant  
14119 CHADRON AVE.  
LOS ANGELES, CA 90250

CAGE code: 03038

**LL** or **LONG** or **LL**  
**LOK**

CAGE code: 16941, plant 03038 1/

LOOS & CO., INC.  
AEROSPACE FASTENERS DIVISION  
ROUTE 101  
POMFRERT, CT 06258-0098

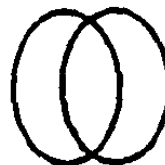

CAGE code: 59157 1/

LORD CORPORATION  
AEROSPACE PRODUCTS DIVISION  
1635 WEST 12<sup>TH</sup> STREET  
P.O. BOX 3694  
ERIE, PA 16508 – 0694

CAGE code: 0PJN4

**L**

Plant  
MECHANICAL PRODUCTS  
DIVISION  
4644 WADSWORTH RD.  
DAYTON, OH 45414 – 4220

CAGE code: 30061

**L1**

CAGE code: 0PJN4, 30061 2/

LOUGHLIN MANUFACTURING CORP.  
1580 RAILROAD AVE  
HOLBROOK, N.Y. 11741-2301

**LMC**

CAGE code: 65782 1/

1/ Information published in this revision was verified by direct contact with manufacturers.

2/ Information not verified to be current, no response from manufacturer. Information identical to that published in MIL-HDBK-57, Revision B.



## MIL-HDBK-57F (IS)

M & M MANUFACTURING CORPORATION  
5611 KIMBALL CT  
CHINO , CA 91710

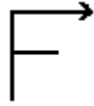

CAGE code: 0X598

2/

M.A.A. CORP,  
MID AMERICA AEROSPACE DIVISION  
16201 WEST 110TH STREET  
SHAWNEE MISSION, KS 66285



CAGE code:

2/

M.L.W. MANUFACTURING CO.  
P.O. BOX 8445  
NEW HAVEN, CT 06511

Plant  
240 SARGENT DRIVE  
NEW HAVEN, CT 06511



CAGE code: 0GH69

2/

M.S. AEROSPACE  
3150 DAMON WAY  
SYLMAR, CA 91342-1005



CAGE code: OUCY9

1/

MAC FASTENERS, INC.  
11110 ENTERPRISE ST.  
OTTAWA, KS 66067-3803

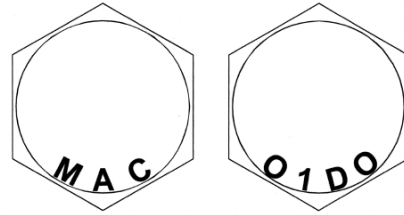

GOTHIC LETTERS "MAC"

GOTHIC LETTERS AND  
NUMERAL "O1DO"

CAGE code: ORFT4

1/

MACHINE SHOP, INC., THE  
470 AIR PARK RD  
ATWATER, CA 95301



CAGE code: 8T052

2/

MACHINERITE CORP.  
SYCAMORE & MILL RDS.  
CLIFTON HTS, PA 19018



CAGE code: 7J299

2/

MACHINING LOGISTICS, INC.  
6640 VIEW PARK CT.  
RIVERSIDE, CA 92503



CAGE code: 57LP7

1/

1/ Information published in this revision was verified by direct contact with manufacturers.

2/ Information not verified to be current, no response from manufacturer. Information identical to that published in MIL-HDBK-57, Revision B.

MIL-HDBK-57F (IS)

MACK, A. W. MFG CO.  
516 DUTCHESS TURNPIKE  
POUGHKEEPSIE, NY 12603



CAGE code: 32448 2/

MACKO INDUSTRIES  
HWY 39 AT FM RD. 1340  
P.O. BOX 170  
HUNT, TX 78024-0170



CAGE code: 1CN43 2/

MACKSON MFG CORP.  
2338 SOUTHWAY DRIVE  
ROCK HILL, SC 29730

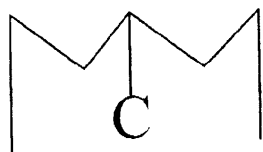

CAGE code: 093Y9 2/

MACLEAN-ESNA  
(formally Elastic Stop Nut)  
611 COUNTRY CLUB RD.  
POCAHONTAS, AR 72455



RED NYLON INSERT INDICATES  
MACLEAN-ESNA AS  
MANUFACTURER

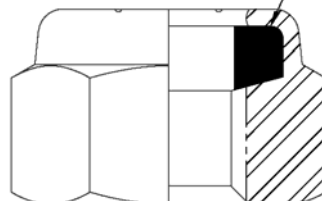

CAGE code: 019L2 1/

1/ Information published in this revision was verified by direct contact with manufacturers.

2/ Information not verified to be current, no response from manufacturer. Information identical to that published in MIL-HDBK-57, Revision B.

MIL-HDBK-57F (IS)

MACLEAN-FOGG CO.  
2551 WACKER RD.  
SAVANNA, IL 61074

*Flange nuts less lock and with  
Uni-Torque® lock  
Two raised bars*

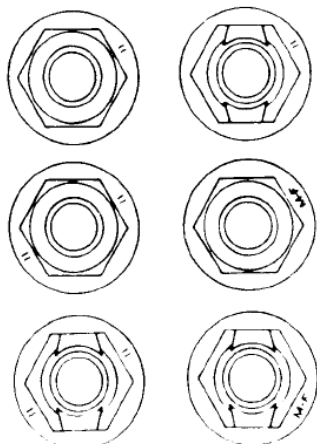

*Hex and flange screws/bolts*

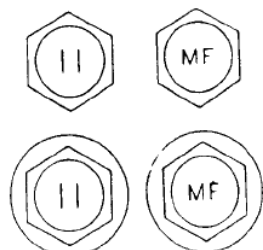

*Hex nuts and Uni-Torque® locknuts*

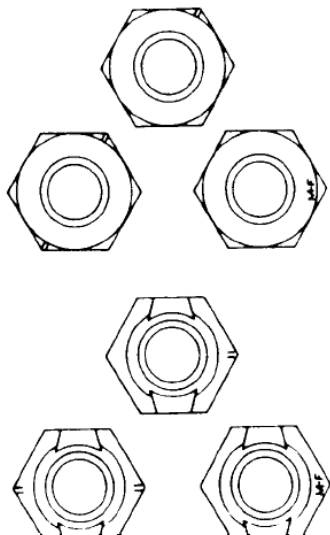

CAGE code: 0AMX8

2/

MACOR, INC.  
130 HOFFMAN LN  
CENTRAL ISLIP, NY 11722

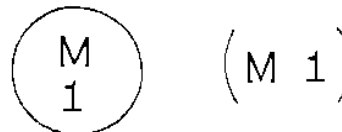

CAGE code: 2A269

2/

MAGNUM MACHINE SHOP  
768 HOMEWARD PL  
SAN JOSE, CA 95123-2906

**1YFG0**

CAGE code: 1YFG0

2/

MAGNUS TOOL & DIE CO., INC.  
256 SHEFFIELD ST.  
MOUNTAINSIDE, NJ 07092



CAGE code: 37752

2/

MAILLY MFG CO., INC.  
P. O. BOX 6143  
45 WAKELEE ROAD  
WOLCOTT, CT 06716-2620



CAGE code: 3L606

1/

1/ Information published in this revision was verified by direct contact with manufacturers.

2/ Information not verified to be current, no response from manufacturer. Information identical to that published in MIL-HDBK-57, Revision B.

## MIL-HDBK-57F (IS)

MAIN MACHINE CO INC.  
DBA MAIN MACHINE & TOOL CO  
116 MARINE STREET  
FARMINGDALE, NY 11735-5608

**MMT**

CAGE code: 05879 1/

MANUFACTURING TECHNOLOGY  
SERVICES  
111 CLINTON ROAD  
FAIRFIELD, NJ 07004

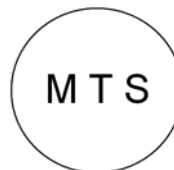

CAGE code: 4WCW0 1/

MANUFACTURING ENGINEERING TECH.  
2758 AIELLO DR.  
SAN JOSE, CA 95111-2134



CAGE code: 1CC57 2/

MAPECO PRODUCTS, INC.  
725 GLEN GLOVE AVE.  
P.O. BOX 6  
GLEN HEAD, NY 11545



CAGE code: 4P839 2/

MANUFACTURING SALES AND SERVICE  
10631 BLOOMFIELD AVE #16  
LOS ALAMITOS, CA 90720



CAGE code: 1S9V3 2/

MAR-BRO MFG., INC.  
5717 W. WASHINGTON STREET  
PHOENIX, AZ 85043-3650



CAGE code: 2/

1/ Information published in this revision was verified by direct contact with manufacturers.

2/ Information not verified to be current, no response from manufacturer. Information identical to that published in MIL-HDBK-57, Revision B.

## MIL-HDBK-57F (IS)

MARTIN-CHANDLER, INC.  
122 EAST ALONDRA BOULEVARD  
GARDENA, CA 902



CAGE code: 22625

2/

MARUYKO NUT CO., LTD.  
2-4-15 NAKANO-CHO, HIGASHI  
TONDABAYASHI-SHI  
OSAKA 584  
JAPAN



CAGE code:

2/

MARVIN ENGINEERING, CO., INC.  
260 WEST BEACH AVENUE  
INGLEWOOD, CA 90302-2903



CAGE code: 32067

2/

MARYLAND BOLT & NUT CO., INC.  
LEONARD JED CO  
1104 RUSSELL ST.  
BALTIMORE, MD 21230-2622



SAE J429 Grade 5  
ASTM A448  
MIL-B-857-A Grade 5

NOTE: Also covers round head bolts,  
i.e., carriage-plow and countersunk  
styles, etc.



ASTM A193 Grade B-7

Alloy steel high temperature service  
bolting

Tempered to 125 KSI tensile strength

NOTE: Also covers sq. head and  
countersunk styles.

Heavy head hex or regular configura-  
tions



ASTM A490 Type 1

NOTE: Also covers round head bolts,  
i.e., carriage-plow and countersunk  
styles, etc.



ASTM A394 Type T-0

Tower bolts: hex head, square head

Head markings also include: T-1 for  
medium carbon and T-3 for weather-  
ing alloy steel. Both require heat  
treating

NOTE: Round head step bolts require  
manufacturing head identification  
and proper markings as above,  
except length size

CAGE code: 76213(canceled)  
Replaced by 52373

2/

Continued

<sup>1/</sup> Information published in this revision was verified by direct contact with manufacturers.

<sup>2/</sup> Information not verified to be current, no response from manufacturer. Information identical to that published in MIL-HDBK-57, Revision B.

MIL-HDBK-57F (IS)

Continued

MARYLAND BOLT & NUT CO., INC.



SAE J429 Grade 8  
ASTM A354 Grade BD

Also (optional) that A354 is exhibited on top of head

MIL-B-857-A Grade 8

NOTE: Also covers round head bolts, i.e., carriage-plow and countersunk styles, etc.



ASTM A325 Type 1

NOTE: Also covers round head bolts, i.e., carriage-plow and countersunk styles, etc.



ASTM A325 Type 3

NOTE: Also covers round head bolts, i.e., carriage-plow and countersunk styles, etc.

With line under A325 mark



SAE J429 Grade 2  
ASTM A307 Grades A & B  
MIL-B-857-A Type 2 (ADM/5)

NOTE: Also covers round head bolts, i.e., carriage-plow and countersunk styles, etc.

No Grade mark - only manufacturer's symbol



ASTM A490 Type 3

NOTE: Also covers round head bolts, i.e., carriage-plow and countersunk styles, etc.

With line under A490 mark



ASTM A193 Grade B-7-M  
Alloy steel high temperature service bolting  
Tempered to 100 ksi tensile strength

NOTE: Also covers SQ head and countersunk styles  
Heavy head hex or regular configurations

Letters B7M on head

CAGE code: 76213(canceled)  
Replaced by 52373 2/

Continued

Continued

MARYLAND BOLT & NUT CO., INC.



Manufacturer's symbol and the number 3 or DH3 on face

For Grade C-3 three radial lines are also required

Heavy hex applications for C-3 and heavy or regular for DH3

Nuts for bolt applications

ASTM A325 type 3

ASTM A563 Grade DH3

Also covers square nut configurations

Heavy hex for type C-3

Regular or heavy for DH3



Manufacturer's symbol and the 2H or DH marking

Also can be supplied in regular configurations

Suitable for all Grade 8 and A325 or A490 bolts

Nuts for bolt applications

ASTM A194 Grade 2H

ASTM A563 Grade DH

Also covers square nut configurations

Heavy or regular



Manufacturer's symbol and three radial lines

Heavy hex applications only

Nuts for bolt applications

ASTM A563 Grade C

For ASTM A325 bolts

Also covers square nut configurations

Heavy hex only

CAGE code: 76213(canceled)  
Replaced by 52373 2/

---

MASTER RESEARCH & MFG., INC.  
13528 PUMICE ST  
NORWALK, CA 90650 - 5249



CAGE code: 9U245 2/

1/ Information published in this revision was verified by direct contact with manufacturers.

2/ Information not verified to be current, no response from manufacturer. Information identical to that published in MIL-HDBK-57, Revision B.

## MIL-HDBK-57F (IS)

MASTERCRAFT TOOL COMPANY  
13743 SHORELINE CT E  
EARTH CITY, MO 63045 - 1202



CAGE code: 2M351 2/

MAUDLE INDUSTRIAL CO., LTD.  
1-20 TSAO HU ROAD  
TALI CITY, TAIWAN 41245

**TUZ**

CAGE code: SH978 2/

MAUI MEGA  
DBA KERR CHARLES W  
JAY-CEE INDUSTRIAL PARK  
RIVER RD. BLDG. PP-1  
BRISTOL, PA 19007

see KERR CHARLES W

O

MMP

CAGE code: 0M4F0 2/

MCADAMS MACHINE AND TOOL CO.  
2853 E FLORENCE AVE  
HUNTINGTON PARK, CA 90255

**Mc**

CAGE code: 0UUE2 2/

MCCULLOUGH AERO CO.  
DBA MCCULLOUGH & ASSOCIATES  
23891 MADISON STREET  
TORRANCE, CA 90505-6008



CAGE code: 04273 2/

MCLANE MFG INC.  
P. O. BOX 438  
7210 ROSECRANS AVE.  
PARAMOUNT, CA 90723 - 0438

**ML**

CAGE code: 52706 2/

McMELLON BROS INC.  
915 HONEYSPOT RD.  
STRATFORD, CT 06615 - 7192

05141



CAGE code: 05141 1/

1/ Information published in this revision was verified by direct contact with manufacturers.

2/ Information not verified to be current, no response from manufacturer. Information identical to that published in MIL-HDBK-57, Revision B.

MIL-HDBK-57F (IS)

MD3 INDUSTRIES LTD  
108 W HOLLOWAY DR  
HURST, TX 76053 - 6807

See EMPIRE PRECISION MACHINING

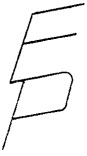

CAGE code: 1/

---

MEACO PRODUCTS CORP.  
99 PECK HILL ROAD  
JOHNSTON, RI 02919-4510

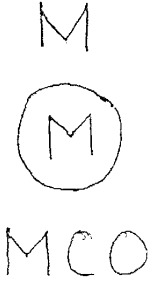

CAGE code: 032Z0 2/

---

MEC WOLF SRL  
VIA MILANO, 5  
22036 ERBA (CO) ITALY

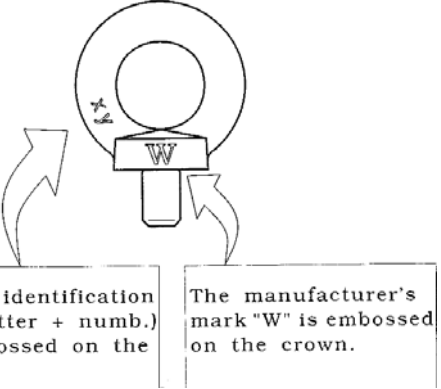

The lot identification "xy" (letter + numb.) is embossed on the ring.

The manufacturer's mark "W" is embossed on the crown.

CAGE code: 2/

MECAERO PRODUCTS  
AFS TOULOUSE OPERATIONS  
BD DU GRAND CASTING  
ROQUES-SUR-GARONNE  
31128 PORTET SUR GARONNE CEDEX  
FRANCE

(Corporate office see ALCOA FASTENING SYSTEMS)



CAGE code: F7411 1/

---

MECAERO CANADA INC.  
2250 COHEN  
VILLE ST-LAURENT  
QUEBEC, H4R 9Z7  
CANADA



CAGE code: 2/

---

MECAIR AEROSPACE INDUSTRIES  
SUBSIDIARY OF SPS TECHNOLOGIES DIV  
DIVISION OF SPS TECHNOLOGIES  
DBA MECAIR INC  
225 LABROSSE  
PT. CLAIRE, CANADA H9R 1A3



CAGE code: 0HL40 2/

1/ Information published in this revision was verified by direct contact with manufacturers.

2/ Information not verified to be current, no response from manufacturer. Information identical to that published in MIL-HDBK-57, Revision B.



## MIL-HDBK-57F (IS)

MECHANICAL & INDUSTRIAL FASTENERS  
1145 JANSEN FARM DRIVE  
ELGIN, IL 60123

**MI**  
**MIF**  
**MIF**

CAGE code: 0P8N1

2/

MECHANICAL INDUSTRIES LLC  
8900 NORTH 51ST STREET  
MILWAUKEE, WISCONSIN 53223-2402

**M I**

CAGE code: 1U732

2/

MEL-BA MANUFACTURING INC.  
777 SUGAR LN  
ELYRIA, OH 44035 - 5631

**..MEL-BA..**

CAGE code: 3A092

2/

MERCER PRODUCTS & MFG. CO., INC.  
401 S. WEBSTER STREET  
SEATTLE, WA 98108 - 4137

**MP**

CAGE code: 30205

1/

MERCURY AREOSPACE INC.  
20320 PRARIE STREET  
CHATSWORTH, CA 91313

**M M**  
**M - Mercury**  
**- Aerospace**

CAGE code: 50945

2/

MERCURY TOOL & MACHINE, INC.  
P.O. BOX 5190  
WACO, TX 76708-5190

Plant  
AIRPORT DRIVE & ZOO PARK DR.  
WACO, TX 76708-5190

**MTM**

CAGE code: 01982

2/

1/ Information published in this revision was verified by direct contact with manufacturers.

2/ Information not verified to be current, no response from manufacturer. Information identical to that published in MIL-HDBK-57, Revision B.

## MIL-HDBK-57F (IS)

METALCRAFTERS  
(DIVISION OF KEYSTONE CONSOLIDATED  
INDUSTRIES)  
4500 KISHWAUKEE STREET  
P.O. BOX 7005  
ROCKFORD, IL 61125-7005

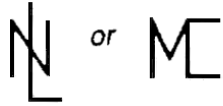
 *N* or *M*

*Indented hex & hex washer heads*

*N* or *M*

*Hex cap screws - low carbon steel*



*Mis. markings for screws & bolts*

CAGE code: 2/

METAL-TECH MFG. INC.  
1445 SOUTH 18TH ST.  
CLINTON, IA 52732-6703

**M T**

CAGE code: 3BNL5 1/

METHODS AND MACHINING SERVICES CO.  
140 UXBRIDGE ST  
CRANSTON, RI 02920-4811

**MMS**

CAGE code: 0FYD8 2/

METRO TOOL & MANUFACTURING CO.  
ALSO SEE ALEXANDER MANUFACTURING  
COMPANY INC  
2402 ARKANSAS LANE  
GRAND PRAIRIE, TX 75052-7203

**MT**

CAGE code: 2M919 1/

METRIX MFG. CO.  
840 BRITTAN AVE.  
SAN CARLOS, CA 94070-4181



METRI

METRIX

CAGE code: 2/

Mi. ME. AF. S.r.1.  
C.so EUROPA, 240  
24032 CALOZIOCORTE (BG)  
ITALY



CAGE code: 2/

MICRO SCREW MACHINE PRODUCTS,  
INC.  
71 ROOSEVELT AVE  
CARTERET, NJ 07008

**HP**

CAGE code: 43808 2/

1/ Information published in this revision was verified by direct contact with manufacturers.

2/ Information not verified to be current, no response from manufacturer. Information identical to that published in MIL-HDBK-57, Revision B.

## MIL-HDBK-57F (IS)

MICRODOT INC.  
MICRODOT AEROSPACE FASTENING  
SYSTEMS GROUP ADVANCED PRODUCTS  
DIV  
190 W CROWTHER AVE  
PLACENTIA, CA 92670 - 5687



KAYNAR TECHNOLOGIES INC  
MICRODOT DIV  
800 SOUTH STATE COLLEGE  
BOULEVARD  
P.O. BOX 3001  
PLACENTIA, CA 92670 - 5687  
CAGE code: 1EJY4

(SEE KAYNAR PRODUCTS  
CAGE code: 15653)



*Used on sheet metal or stamped  
products.*



*Used on forged or foreign products*



*Two parallel lines used on Spirallock®  
products only*



*Used on metric products*



*Used on miscellaneous and general  
Kaynar products*

MICRODOT INSERTS DEVISION  
10 S. LA SALLE STREET  
SUITE 3500  
CHICAGO, IL 60603  
CAGE code: 51204



*Three parallel lines spiralok insert  
products only*

CAGE code: 0BPE9

2/

MID CONTINENT SCREW PRODUCTS CO.  
3701 WEST LUNT AVE.  
LINCOLNWOOD, IL 60712



CAGE code: 1QMD3

2/

MID-STATES SCREW CORP.  
(ILLINOIS CORPORATION)  
1817 EIGHTEENTH AVENUE  
ROCKFORD, IL 61101



CAGE code: 17264

2/

MIDWEST ACORN NUT CO.  
256 MINNESOTA AVE.  
TROY, MI 48083



CAGE code: 98960

2/

MILE-HI MACHINE, INC.  
6395 WEST 56<sup>TH</sup> AVE.  
ARVADA, CO 80002



CAGE code: 1M949

1/

1/ Information published in this revision was verified by direct contact with manufacturers.

2/ Information not verified to be current, no response from manufacturer. Information identical to that published in MIL-HDBK-57, Revision B.

MIL-HDBK-57F (IS)

MILITARY PRODUCTS GROUP, INC.  
37190 SUGAR RIDGE ROAD  
NORTH RIDGEVILLE, OH 44039-3630



CAGE code: 3DJB1 1/

MILLIPART, INC.  
412 W. CARTER DRIVE  
GLEN DORA, CA 91740-5968



CAGE code: 31095 2/

MILLS, J. R. MACHINING, INC  
815 McCORD HOLLOW ROAD  
HOHENWALD, LEWIS, TN 38462

*(DLT-22)*  
*B*

*N N*

*(DLT-22)*  
*N*

CAGE code: 0LT22 2/

MIL-SPEC FASTENERS CORP.  
314 HANOVER PIKE  
HAMPSTEAD, MD 21074-9999

**MSF**

CAGE code: 356S3 2/

MINEBEA CO. LTD  
FUJISAWA MANUFACTURING UNIT  
1-1-1 KATASE, FUJISAWA CITY  
KANAGAWA 251-8531  
JAPAN



Trademark, Takyo Rashi

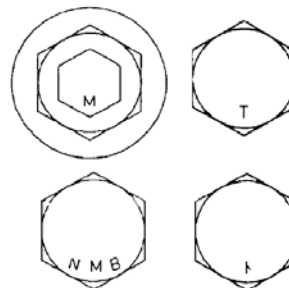

CAGE code: SB962 1/

1/ Information published in this revision was verified by direct contact with manufacturers.

2/ Information not verified to be current, no response from manufacturer. Information identical to that published in MIL-HDBK-57, Revision B.

MIL-HDBK-57F (IS)

MIROFINE COMPANY  
1940 W. 144TH STREET  
GARDENA, CA 90249-2928

**MFR 1L071**

CAGE code: 1L071

2/

MI-TECH, INC.  
6685 JET PARK DRIVE  
N. CHARLESTON, SC 29406-4700

MI-TECH, INC.

CAGE code: 9J758

2/

MITSUBOSHI INDUSTRIES, LTD.  
(OSAKA DIVISION)  
4-16-1 CHOME, MIDORIGI  
SUMINOE-KU, OSAKA 559  
JAPAN

**N**

**NK**

**NKYM**

CAGE code:

2/

MIX TOOL CO.  
212 E. CEDAR STREET  
COMPTON, CA 90220



CAGE code: 27643

2/

1/ Information published in this revision was verified by direct contact with manufacturers.

2/ Information not verified to be current, no response from manufacturer. Information identical to that published in MIL-HDBK-57, Revision B.

MIL-HDBK-57F (IS)

MKM MACHINE TOOL COMPANY INC.  
100 TECHNOLOGY WAY  
JEFFERSONVILLE, IN 47130-9644

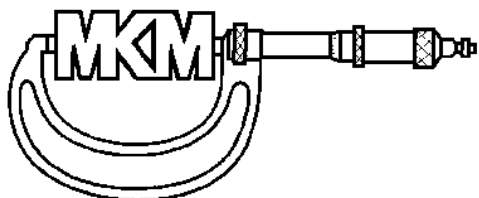

CAGE code: 8L583

2/

M-MANUFACTURING  
P.O. BOX 897  
ROANOKE, TX 76272

Plant  
HYW. 114 & DOVE RD.  
ROANOKE, TX 76262



CAGE code:

2/

MMG ENGINEERED COMPONENTS INC.  
DBA TOOLSOURCE  
3901 N. CARNATION  
FRANKLIN PARK, IL 60131-1201

SOCKET HEAD  
CAP SCREWS

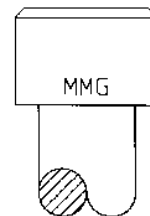
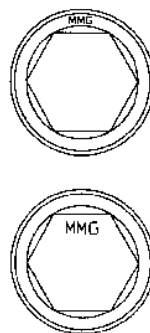

HEX HEADS  
(GRADE 8)

HEX HEADS  
(GRADE 5)

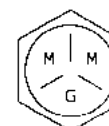
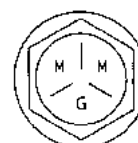

OTHER

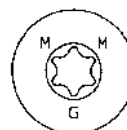
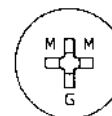

CAGE code: 3JMF9

1/

1/ Information published in this revision was verified by direct contact with manufacturers.

2/ Information not verified to be current, no response from manufacturer. Information identical to that published in MIL-HDBK-57, Revision B.

MIL-HDBK-57F (IS)

MNP CORPORATION  
P.O. BOX 189002  
UTICA, MI 48318-9002

MNP FASTENER DIVISION  
44225 UTICA RD  
UTICA, MI 48317  
CAGE code: 3R364

PLANT 2  
MNP CORPORATION DIVISION 2  
1524 E 14 MILE RD  
MADISON HEIGHTS, MI 48071-1542  
CAGE code: 064S9

PLANT 4  
MNP PRECISION PARTS  
1111 SAMUELSON RD.  
ROCKFORD, IL 61109  
CAGE code: 4S2M4

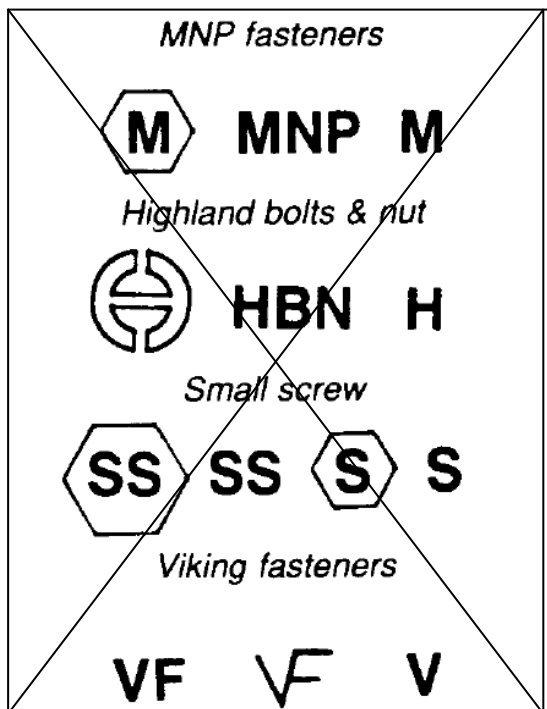

CAGE code: 3R364, 064S9, 4S2M4 1/

MODERN METRIC MACHINE COMPANY  
INC  
101 W. NICHOLSON ROAD  
AUDOBON, NJ 08106-1411



CAGE code: 1F6H56 2/

MODFORM-ILLINOIS, INC.  
500 36TH ST  
EAST MOLINE, IL 61244



CAGE code: 46501 2/

MONADNOCK COMPANY, THE  
DBA LISI AEROSPACE  
18301 ARENTH AVE.  
CITY OF INDUSTRY, CA 91748-1226

See LISI AEROSPACE

. (a dot)

CAGE code: 60119 1/

1/ Information published in this revision was verified by direct contact with manufacturers.

2/ Information not verified to be current, no response from manufacturer. Information identical to that published in MIL-HDBK-57, Revision B.

## MIL-HDBK-57F (IS)

MONOGRAM AEROSPACE FASTENERS  
3423 SOUTH GARFIELD AVE.  
LOS ANGELES, CA 90040-3103

## FASTENER HEAD MARKINGS

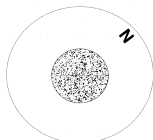

## SCRIPT "N"

Used on Visu-Lok® blind fasteners

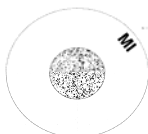

## SCRIPT "MI"

Used on Composi-Lok®, OSI-Bolt®, Ti-OSI™, Radial-Lok®, Maf honeycomb pins, and other blind fasteners

## BODY MARKINGS

**MONOGRAM**  
**WEDGELOCK**



Trademark "Wedgeloek" or "Monogram", depressed. Used on temporary fasteners

CAGE code: 98524

1/

MONROE MACHINED PRODUCTS, INC.  
1422 S. 192nd ST  
SEATTLE, WA 98148-2314



CAGE code: 7F311

2/

MONTEREY MACHINE PRODUCTS  
1504-A INDUSTRIAL PARK STREET  
COVINA, CA 91722-3417

**MP**

CAGE code: 1UD00

2/

MORTON FASTENERS INC.  
4544 RUNWAY DR.  
LANCASTER, CA 93536

**MFI**

CAGE code: 4DU57

1/

MORTON MANUFACTURING  
(DIVISION MORTON GRINDING)  
17341 W. SIERRA HIGHWAY  
SANTA CLARITA, CA 91351-1162

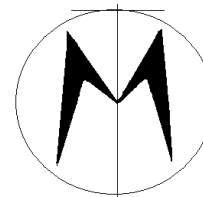

CAGE code: 2T498

1/

MOSTAR GEAR & MACHINE MFG., CO.  
201 E. FRANKLIN  
PALESTINE, IL 62451



CAGE code: OHN25

2/

1/ Information published in this revision was verified by direct contact with manufacturers.

2/ Information not verified to be current, no response from manufacturer. Information identical to that published in MIL-HDBK-57, Revision B.



## MIL-HDBK-57F (IS)

MOTOR WHEEL CORP.  
4000 COLLINS RD.  
LANSING, MI 48910

Plant  
1600 N. LARCH STREET  
LANSING, MI 48906

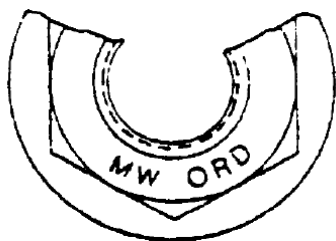

CAGE code: 4H871

2/

MRL MANUFACTURING CORP.  
P.O. BOX 8440  
59 LEE AVE  
HALEDON, NJ 07508

Plant  
525 LAFAYETTE AVENUE  
HAWTHORE, NJ 07506

**M**

CAGE code: 0GUF9

1/

N.S.S. INDUSTRIES  
9075 GENERAL DRIVE  
PLYMOUTH, MI 48170

**N**

CAGE code:

2/

NAFCO INDUSTRIES, INC.  
P.O. BOX 1893  
CARSON CITY, NV 89702

**N**

CAGE code: 32387

2/

NAGOYA SCREW MANUFACTURING CO,  
LTD.  
17-16 TSUBAKI-CHO I  
NAKAMURA-KU NAGOYA-SHI  
AICHI-KEN, JAPAN

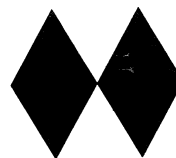

**NRS**

CAGE code: SC006

2/

NAPIER'S AUTO BODY  
49879 HWY 101 STH.  
P. O. BOX 278  
BRANDON, OR 97411-1824

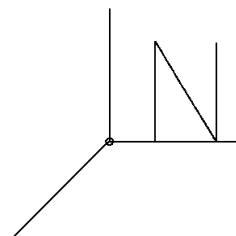

CAGE code: 1NXQ4

1/

1/ Information published in this revision was verified by direct contact with manufacturers.

2/ Information not verified to be current, no response from manufacturer. Information identical to that published in MIL-HDBK-57, Revision B.

## MIL-HDBK-57F (IS)

NARRAGANSETT SCREW MFG., CO.  
P.O. BOX 2242  
119 ROWLEY ST  
WINSTED, CT 06098 - 2068



CAGE code: OHP15 2/

NASSAN TOOL WORKS, INC.  
34 LAMAR ST.  
WEST BABYLON, NY 11704

**NTW**

CAGE code: 2M490 1/

NASU DENKI-TEKKO CO., LTD.  
1-1-14 SHINJUKU, SHINJUKU-KU  
TOKYO 160  
JAPAN

SUNAMACHI FACTORY  
3-5-28 SHINSUNA, ETO-KU,  
TOKYO, JAPAN 136



CAGE code: 2/

NATIONAL BOLTS & RIVETS LTD.  
P.O. BOX 5063,  
BOKSBURG NORTH 1461  
SOUTH AFRICA



CAGE code: V3674 2/

NATIONAL FASTENER CO., LTD.  
#973 YANG DUCK-DANG  
MASAN  
REPUBLIC OF KOREA



CAGE code: 2/

NATIONAL THREADED FASTENERS CORP.  
630 LIVELY BOULEVARD  
ELK GROVE VILLAGE, IL 60007

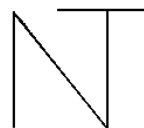

CAGE code: 2/

NAVPAR, INC.  
11029 STATE ROUTE 128  
BLDG C-1  
HARRISON, OH 45030-9710



CAGE code: 0MHC4 1/

1/ Information published in this revision was verified by direct contact with manufacturers.

2/ Information not verified to be current, no response from manufacturer. Information identical to that published in MIL-HDBK-57, Revision B.

## MIL-HDBK-57F (IS)

NC AUTOMATED INDUSTRIES INC.  
90 DAYTON AVENUE  
BLDG. 14E  
PASSAIC, NJ 07055-7035

**NAC**

CAGE code: 1VPZ8

1/

NCMI BRUEGGEMANN INC.  
1207 W. BROOKS STREET  
ONTARIO, CA 91762-3609

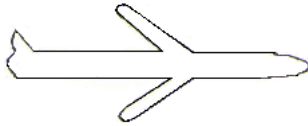

CAGE code: 0K292

1/

ND INDUSTRIES  
DBA ND WESTERN FASTENER  
PROCESSING DIVISION  
13929 DINARD AVENUE  
SANTA FE SPRINGS, CA 90670

**ND**  
INDUSTRIES

CAGE code: 4Y667

2/

NEDSCHROEF  
NEDSCHROEF HALMOND B.V.  
P.O. BOX 29  
5700 AA HELMOND  
THE NETHERLANDS

Plant  
KANAALDIJK NOORD WEST 71  
5707 LC HELMOND  
THE NETHERLANDS



Standard hexagon high tensile  
bolts and screws of all prop-  
erty classes



High strength friction grip bolts  
for structural bolting property  
class 10.9



Socket screws



Nuts and all other bolts and  
screws

CAGE code: HO871

2/

NEKG HOLDINGS  
26709 SOUTH KIMBERLY  
CHANNAHON, IL 26709

**NE**

CAGE code: 4YU01

1/

NELSON AEROSPACE INC.  
10310 NORRIS AVE  
PACOIMA, CA 91331-2219

**NA**

CAGE code: 52930

2/

1/ Information published in this revision was verified by direct contact with manufacturers.

2/ Information not verified to be current, no response from manufacturer. Information identical to that published in MIL-HDBK-57, Revision B.

## MIL-HDBK-57F (IS)

NELSON STUD WELDING DIVISION  
7900 W. RIDGE RD  
ELYRIA, OH 44036-2019

**N**

CAGE code: 85105

2/

NEUMAYER, ERICH GMBH  
POSTFACH 1160  
WILHELM-ZANGEN-STRASSE 9  
D-7613 HAUSACH  
GERMANY

**N**

CAGE code: C1956

1/

NEVADA BOLT AND MFG CO INC.  
DBA SPS NON-FERROUS ENGINEERED  
FASTENERS  
3850 W PONDEROSA WAY  
LAS VEGAS, NV 89118

**NF**

CAGE code: 7U566

2/

NEVILLE MACHINE SHOP  
P.O. BOX 22  
RANGER, TX 76470-2722

Plant  
406 E. HIWAY 80  
RANGER, TX 76470-2722

**ND**

CAGE code: 8X524

2/

NEW HORIZON MACHINE CO., INC.  
36 LUDLOW STREET  
STAMFORD, CT 06902-2691

**NH**

CAGE code: 1VVZ7

2/

NICE TOOL MFG., INC.  
3280 DIANA DR.  
FORT WORTH, TX 76118-6237

**TN**

CAGE code: 5K517

2/

1/ Information published in this revision was verified by direct contact with manufacturers.

2/ Information not verified to be current, no response from manufacturer. Information identical to that published in MIL-HDBK-57, Revision B.

## MIL-HDBK-57F (IS)

NIPPON MACHINE ENGINEERING, INC.  
1311 EAST SAINT GERTRUDE PLACE  
UNIT B  
SANTA ANA, CA 92705

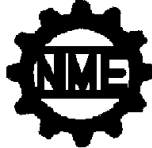

CAGE code: 49145

2/

NIPPON STEEL BOLTEN CO., LTD.  
4-3-2 NISHIZUMI, YUKUHASHI,  
FUKUOKA, JAPAN 824



CAGE code:

2/

NISCO, INC.  
5F SHINGA BLDG. 1-3-10  
UMEBAYASHI OUTSU-SHI  
SHOGA-KEN 520, JAPAN

Plant  
1018-1 ROKUJO CHUZU-CHO  
YASU-GUM SHIGA-KEN  
520-24 JAPAN

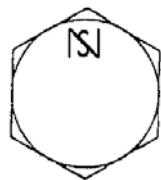

CAGE code:

2/

NISSAN SCREW CO. LTD.  
SALES DEPT., FOREIGN TRADE SECTION  
5-6-508 SHINKANAOKA-CHO  
SAKAI-SHI-OASAKA 590 JAPAN

Plant  
8-4-41 MIYAKE-NAKA  
MATSUBARA-SHI, OSAKA 580  
JAPAN

**N**

CAGE code:

1/

NOCHIA STEELWORKS  
NYOGO, JAPAN

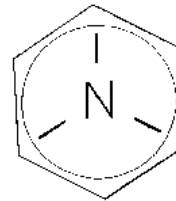

CAGE code:

2/

NON-FERROUS BOLT & MANUFACTURING  
CO.  
4086 NEVSO DRIVE, SUITE C  
LAS VEGAS, NV 89103

Plant  
3850 WEST PONDEROSA LANE  
LAS VEGAS, NV 89118

**NF**

CAGE code:

2/

1/ Information published in this revision was verified by direct contact with manufacturers.

2/ Information not verified to be current, no response from manufacturer. Information identical to that published in MIL-HDBK-57, Revision B.

## MIL-HDBK-57F (IS)

NORTHBRIDGE FASTENERS  
VIKING ROAD  
WIGSTON, LEICESTER  
UNITED KINGDOM

**NB**



**E** – The plain letter E is used for Rolls Royce, UK supply and Europe and will be used in the absence of any customer allocated identification.



**32219** – Allocated by Pratt & Whitney, East Hartford for supply to Pratt & Whitney, East Hartford



**15077** – Allocated by Pratt & Whitney, Canada for supply to Pratt & Whitney, Canada



**5T572** – Milscap No. for items supplied to U.S. Government



**20733** – Allocated by Avco-Lycoming for supply to Avco-Lycoming



**NTF99** – Allocated by General Electric for supply to Rolls Royce for joint projects with General Electric

CAGE code: 2/

NORTH EAST FASTENERS  
8 TREMCO DRIVE  
P. O. BOX 322  
TERRYVILLE, CT 06786-0322



• •  
2 dots  
either indented or raised.

CAGE code: 07ZN5 1/

NORTHEAST METAL CO., INC.  
P.O. BOX 51754  
34 FRONT STREET  
INDIAN ORCHARD, MA 01151

Plant  
AIRPORT DRIVE  
WESTFIELD, MA 01085

**NET**↑

CAGE code: 1C4F2 2/

NORTHERN SCREW CO., INC.  
8121 LAKEVIEW PARKWAY  
PLEASANT PRAIRIE, WI 53158

**NS**

CAGE code: 2/

NORTHSTAR ENGINEERING  
1911 LYNX PLACE  
ONTARIO, CA 91761

**0XK38**

CAGE code: 0XK38 2/

1/ Information published in this revision was verified by direct contact with manufacturers.

2/ Information not verified to be current, no response from manufacturer. Information identical to that published in MIL-HDBK-57, Revision B.

## MIL-HDBK-57F (IS)

NOVA MACHINE PRODUCTS  
CORPORATION  
A SUBSIDIARY OF CURTIS-WRIGHT FLOW  
CONTROL SERVICE CORP.  
18685 SHELDON ROAD  
MIDDLEBURGE HEIGHTS, OH 44130-2465



CAGE code: 1EJ29

1/

NT ENGINEERING, INC.  
1050 "C" INDEPENDENCE AVE.  
MOUNTAIN VIEW, CA 94043

**NT**

CAGE code: 0BEN1

2/

NUCOR CORP.  
NUCOR FASTENER DIVISION  
P.O. BOX 6100,  
6730 COUNTY ROAD  
ST. JOE, IN 46785

**NUCOR**

**n**

CAGE code: 0BEP9

1/

NUMERIC MACHINE PRODUCTS  
1769 WEST AVE. K-11  
LANCASTER, CA 93534

**NMP**

CAGE code: 5V524

2/

NUTS INCORPORATED  
DIVISION OF STANLOK  
1451 GRAFTON ST  
P.O. BOX 2735  
WORCHESTER, MASSACHUSETTS 01613

**N**

CAGE code: 02972

2/

NUTS, INC.  
ROUTE 724 & 23  
PHOENIXVILLE, PA 19460-1838

**N**

CAGE code: 6N185

2/

1/ Information published in this revision was verified by direct contact with manufacturers.

2/ Information not verified to be current, no response from manufacturer. Information identical to that published in MIL-HDBK-57, Revision B.

MIL-HDBK-57F (IS)

NYLOK CORP.  
15260 HALLMARK DR.  
MACOMB, MI 48042

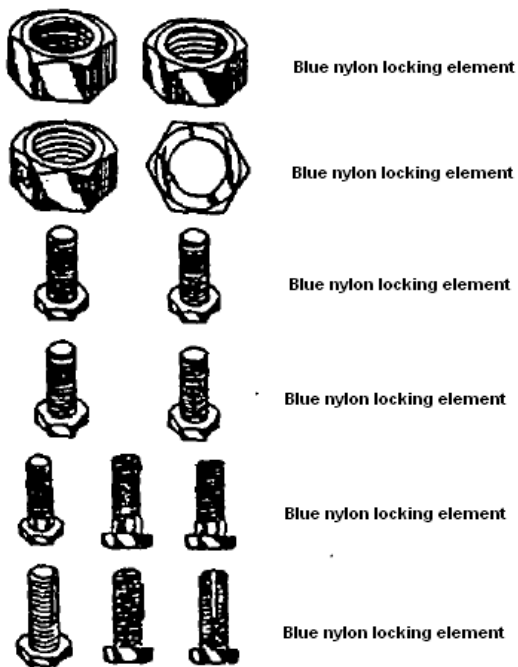

NK

NK

NYLOK

CAGE code: 59093

1/

OAKTREE FASTENERS CO.  
12262 1/2 WOODRUFF AVE.  
DOWNEY, CA 90241

**OTF**

CAGE code:

2/

OBARS MACHINE & TOOL CO.  
115-126 N. WESTWOOD AVE.  
TOLEDO, OH 43607

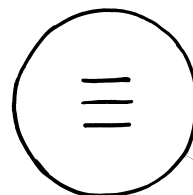

CAGE code: 0MKX0

2/

OCM MACHINE COMPANY, INC.  
9601 HIGHWAY 80  
FORT WORTH, TX 76116 - 2689



CAGE code: 06XQ6

2/

OHIO NUT & BOLT CO., THE  
DIV. OF FASTENERS INDUSTRIES, INC.  
33 LOU GROZA BLVD..  
BEREA, OH 44017-1293



Small raised mark usually  
on the underside of head

CAGE code: 76871

1/

1/ Information published in this revision was verified by direct contact with manufacturers.

2/ Information not verified to be current, no response from manufacturer. Information identical to that published in MIL-HDBK-57, Revision B.



## MIL-HDBK-57F (IS)

OHKAWA SCREW MFG. CO., LTD.  
2-25-16 MIDORIGAOKA,  
MEGURO-KU, TOKYO  
152 JAPAN

Plant  
6357-1 OBA, OHMIYA-MACHI,  
NAKA-GUN, LBARAGI-KEU  
319-21 JAPAN

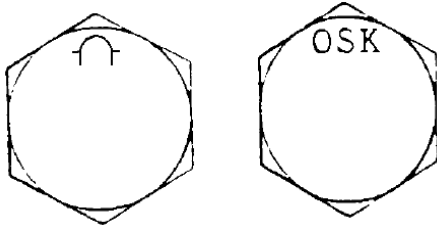

CAGE code: 2/

OKABE CO., INC.  
OKABE KIKO CO., LTD. (PLANT)  
4-21-15 MUKOJIMA  
SUMIDA-KU, JAPAN 131-8505

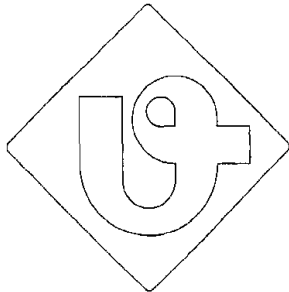

CAGE code: SP186 2/

OKAI IRON WORKS, INC.  
12-41, 3 CHOME, TSURUHARA  
IZUMISANO CITY  
OSAKA, JAPAN 598

**OK**

CAGE code: 2/

OKAWA SCREW MANUFACTURING CO.,  
LTD  
2-20-4 HIGASHIGOTANDA  
SHINAGAWA-KU, 141-0022  
TOKYO

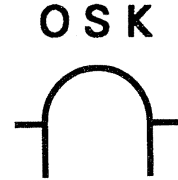

CAGE code: 1/

OMEGA THREAD ROLLING AND GRINDING  
INC.  
54 LEWIS STREET  
P.O. BOX 129  
PLAINVILLE, CT 06062-0129



CAGE code: 06KW4 2/

ONEIDA TOOL & MACHINE CORP.  
837 AIR PARK RD.  
RHINELANDER, WI 54501-8426

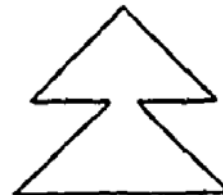

CAGE code: OJHAO 1/

1/ Information published in this revision was verified by direct contact with manufacturers.

2/ Information not verified to be current, no response from manufacturer. Information identical to that published in MIL-HDBK-57, Revision B.

## MIL-HDBK-57F (IS)

ONO MANUFACTURER, INC.  
602 FUJITA OKAYAMA-SHI,  
OKAYAMA-KEN 701-0221  
JAPAN

Plant  
3-800-46 TAMAHARA TAMANO-  
SHI, OKAYAMA-KEN 706-2555  
JAPAN



CAGE code: 1/

ONTIC ENGINEERING &  
MANUFACTURING, INC.  
20360 PLUMMER ST.  
NORTH HOLLYWOOD, CA 91609-0510

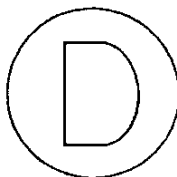

CAGE code: 45934 2/

ORANGE PRECISION PARTS  
17632 METZLER LANE, #C  
HUNTINGTON BEACH, CA 92647

P  
O  
OP

CAGE code: 9V210 2/

ORC-O TOOL & MACHINE, INC.  
75 SHAMROCK DRIVE  
SULLIVAN, MO 63080-2344

**ORC-O**

CAGE code: 0C1D0 2/

ORDNANCE PARTS & ENGINEERING CO.  
P.O. BOX 8035  
3152 C MAJOR ST  
FORT WORTH, TX 76112

OP  
E

CAGE code: 20800 2/

ORLOTRONICS CORP.  
401 E. FOURTH STREET  
BRIDGEPORT, PA 19405-1815

**(OTC)**

CAGE code: 54267 1/

OSAKA SEIKI CO., LTD.  
1-19-14, MITEJIMA  
TOKYO 555  
JAPAN

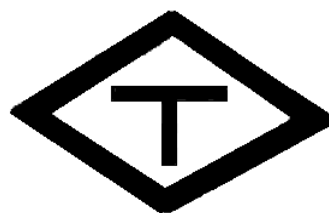

CAGE code: S4247 2/

1/ Information published in this revision was verified by direct contact with manufacturers.

2/ Information not verified to be current, no response from manufacturer. Information identical to that published in MIL-HDBK-57, Revision B.

## MIL-HDBK-57F (IS)

OSTEEN MACHINE SHOP  
RT. 1 BOX 2082  
ALVARADO, TX 76009



CAGE code: 8Y546

2/

OTO MELARA S.p.A.  
FINKECCANICA COMPANY  
VIA VALDILOCCHI 15  
LA SPEZIA 19136  
ITALY



CAGE code: A0199

1/

OTT BROTHERS MACHINE CO., INC.  
331 EAST 37TH STREET SOUTH  
WICHITA, KS 67216

**OB**  
**OBMC**

CAGE code: 09292

1/

OTTAWA PRODUCTS CO., INC.  
1602 NORTH CURTICE RD.  
CURTICE, OH 43412

**OPC**

CAGE code: 4JBK8

1/

OWARI PRECISE PRODUCTS CO., LTD  
2-148 YADA-CHO HIGASHI-KU NAGOYA-  
SHI  
AICHI-KEN, JAPAN

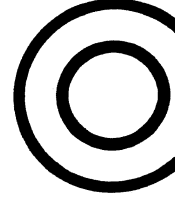

CAGE code: SC008

2/

P & I ASSOCIATES, INC.  
26 WEST WAVERLY ROAD  
P.O. BOX 413  
GLENSIDE, PA 19038-4012

Plant  
#1 LIMEKILN PIKE  
GLENSIDE, PA 19038  
(No mail to this address)



CAGE code: 0DH98

2/

P & L ENTERPRISES  
111 CR 4614  
CASTROVILLE, TX 78009

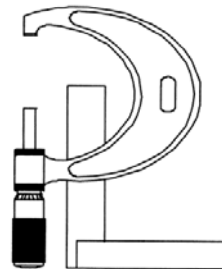

CAGE code: 058B7

1/

1/ Information published in this revision was verified by direct contact with manufacturers.

2/ Information not verified to be current, no response from manufacturer. Information identical to that published in MIL-HDBK-57, Revision B.

## MIL-HDBK-57F (IS)

P.C.M., INC.  
 (BETHLEHEM PIKE INDUSTRIAL CENTER)  
 P.O. BOX 840  
 60 PARRISH ST.  
 WILKES BARRE, PA 18710

P

CAGE code: 2/

PACIFIC FASTENERS, INC.  
 405 UNIVERSITY AVENUE  
 ARLINGTON HEIGHTS, IL 60004

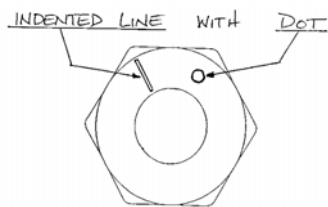

CAGE code: 42918 2/

P.S. MACHINE CO., INC.  
 1505 JOHN FETCH BLVD.  
 S. WINDSOR, CT 06074-1000

PS

CAGE code: 56839 1/

PACIFIC SCIENTIFIC  
 22715 SAVI RANCH PARKWAY  
 P.O. BOX 87019  
 YORBA LINDA, CA 92686

PS

CAGE code: 45402 2/

PABCOR, INC.  
 925 NORTH CEDAR STREET  
 P.O. BOX 7528  
 NEW CASTLE, PA 16107-1323

PABCOR

CAGE code: OAGN7 2/

PACIFIC TOOL, INC.  
 15235 NE 92ND STREET  
 REDMOND, WA 98052

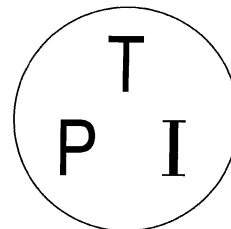

CAGE code: 62176 1/

PACER ALLOYS, INC.  
 8681 SCRANTON STREET  
 HOUSTON, TX 77075

V

CAGE code: 1/

PADGETT MACHINE INC.  
 1226 NORTH 143rd EAST AVENUE  
 TULSA, OK 74116-2120

PMI

CAGE code: 6W037 1/

1/ Information published in this revision was verified by direct contact with manufacturers.

2/ Information not verified to be current, no response from manufacturer. Information identical to that published in MIL-HDBK-57, Revision B.

## MIL-HDBK-57F (IS)

PAINTER TOOL, INC.  
1173 IRIS DRIVE  
NORTH HUNTINGDON, PA 15642-4399

**PTI**

CAGE code: 34779 2/

PALNUT CO., THE  
UNITED CARR FASTENERS PALNUT DIV  
GLEN ROAD  
MOUNTAINSIDE, NJ 07092

**PAL**

CAGE code: 2G832 2/

PAOLO ASTORI SPA  
VIA MIRABELLA 9 - 28013  
GATTICO - (NO)  
ITALY

**α**

CAGE code: A3856 1/

PARK PRECISION CORPORATION  
181 ELLIOT ST. UNIT 403  
BEVERLY, MA 01915

**-PPC-**

CAGE code: OJWS2 2/

PATEREX, LTD.  
CRAY AVE.,  
ORPINGTON KENT BR5 3RR  
UNITED KINGDOM

**P**  
**PTX**

CAGE code: OBMF6 2/

PATTERSON LAKE PRODUCTS  
(SUBSIDIARY OF COLUMBIA AUTO  
PARTS)  
P.O. BOX 200  
PINCKNEY, MI 48169

**Pp**

CAGE code: 5Y952 2/

PAULIN, H. & CO., LTD.  
CAPITAL METAL INDUSTRIES DIVISION  
55 MILNE AVENUE  
SCARBOROUGH, ONTARIO MIL 4N3  
CANADA



CAGE code: 95119 2/

1/ Information published in this revision was verified by direct contact with manufacturers.

2/ Information not verified to be current, no response from manufacturer. Information identical to that published in MIL-HDBK-57, Revision B.

MIL-HDBK-57F (IS)

PB FASTENERS  
 (DIVISION OF PAUL R. BRILES, INC.)  
 1700 WEST 132ND STREET  
 GARDENA, CA 90249

**MFR 27624**



**PBF**

**PB**

CAGE code: 27624 1/

PEERLESS SCREW PRODUCTS  
 286 SANDBANK RD.  
 P.O. BOX 236  
 CHESIRE, CT 06410-1537



CAGE code: 45950 1/

PEINER UMFORMTECHNIK GmbH  
 WOLTORFER STRASSE 26  
 PEINE, 31224  
 GERMANY

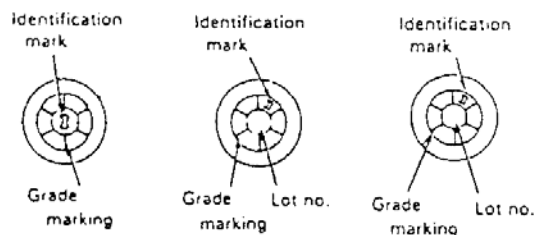
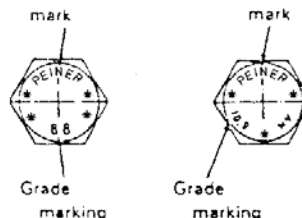

CAGE code: D2742 2/

PELHAM AUTO MATRIX PRECISION  
 1 INDUSTRIAL DRIVE  
 PELHAM, NH 03076



CAGE code: 1CSJ5 2/

PENN CIGAR MACHINES INC (P.C.M INC)  
 P. O. BOX 1065  
 60 PARRISH STREET  
 WILKES BARRE, PA 18703



CAGE code: 7U218 2/

1/ Information published in this revision was verified by direct contact with manufacturers.

2/ Information not verified to be current, no response from manufacturer. Information identical to that published in MIL-HDBK-57, Revision B.

MIL-HDBK-57F (IS)

PENNGENGINEERING AUTOMOTIVE  
FASTENERS  
50625 DESIGN LANE  
SHELBY TOWNSHIP, MI 48315

(Coporate see PENN ENGINEERING &  
MANUFACTURING CORP.)

**PE**

CAGE code: 50EB1 1/

PENN SCREW & MACHINE WORKS, INC.  
3075 ADVANCE LN.  
COLMAR, PA 18915

**PSM**  
**PSM**

CAGE code: 82926 2/

PENN ENGINEERING & MANUFACTURING  
CORP.  
(see ATLAS ENGINEERING, INC.)  
5190 OLD EASTON RD.  
DANBORO, PA 18916

**A**

PEREZ MACHINE, INC.  
1501 W. 134TH STREET  
GARDENA, CA 90249

**pmi**

CAGE code: 34393 1/

PERIGEE MANUFACTURING COMPANY,  
INC. (MICHIGAN CORPORATION)  
7519 INTERVALE  
DETROIT, MI 48238-2401

**P**

CAGE code: 1X4X7 1/

Square insert in  
floating fasteners

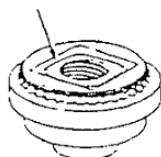

PEM trademark  
Blue - nylon® hexagon  
locking element

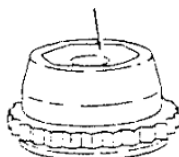

"Dimple" trademark

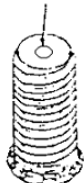

PEM 300™  
identification mark

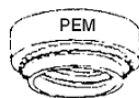
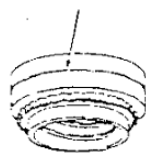

CAGE code: 46384 1/

PERKINS MACHINE CO.  
1559 PINE STREET  
OXNARD, CA 93030

**P**

CAGE code: 84749 2/

1/ Information published in this revision was verified by direct contact with manufacturers.

2/ Information not verified to be current, no response from manufacturer. Information identical to that published in MIL-HDBK-57, Revision B.

## MIL-HDBK-57F (IS)

PHOENIX SPECIALTY MANUFACTURING  
CO., INC.  
P.O. BOX 418  
BAMBERG, SC 29003

Plant  
HIGHWAY 301 SOUTH  
BAMBERG, SC 29003

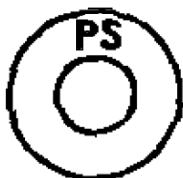

CAGE code: 66920

2/

PILGRIM SCREW CORP.  
(PROVIDENCE DIVISION)  
120 SPRAGUE STREET  
PROVIDENCE, RI 02901

Plant  
259 DEXTER ST.  
PROVIDENCE, RI 02907  
CAGE code: 47253



Plant 2  
2875 WEST FRYE ROAD  
CHANDLER, AZ CHANDLER, AZ  
CAGE code: 1GP79

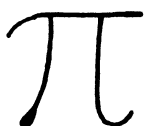

CAGE code: 47253, 1GP79

1/

PINE TAVERN MACHINE INC.  
7851 PINE TAVERN ROAD  
PERRY, NY 14530

**PTM**

CAGE code: 9J559

2/

PINEY RIDGE CO.  
177 JOSHUA ROAD  
SALUDA, SC 29138-7770

**PR**

CAGE code: 05DT2

1/

PINTO PRODUCTS  
P.O. BOX 83  
2011 PALMER STREET  
KALAMAZOO, MI 49001



CAGE code: 0YJH8

2/

PIONEER MACHINE PRODUCTS, INC.  
2200 DOLMAN  
ST. LOUIS, MO 63104

**PMP**

CAGE code: 12829









2/

1/ Information published in this revision was verified by direct contact with manufacturers.

2/ Information not verified to be current, no response from manufacturer. Information identical to that published in MIL-HDBK-57, Revision B.



## MIL-HDBK-57F (IS)

<p>PIONEER SCREW &amp; NUT CO. 2700 YORK ROAD ELK GROVE VILLAGE, IL 60007</p> <div style="display: flex; justify-content: space-around; align-items: center;"> <div style="text-align: center;">  <p>Indented hex heads and indented hex washer heads</p> </div> <div style="text-align: center;">  <p>All other head styles slash- dot symbol to appear on bearing surface upon request</p> </div> </div> <p>CAGE code: 4N311 <span style="float: right;"><u>2/</u></span></p>	<p>POLYTECHNIC INDUSTRIES 14 ROLAND AVE. MOUNT LAUREL, NJ 08054</p> <div style="text-align: center;">  </div> <p>CAGE code: 4K539 <span style="float: right;"><u>1/</u></span></p>
<p>PLAINVILLE MANUFACTURING CO., INC. 48 LEWIS ST. PLAINVILLE, CT 06062</p> <div style="text-align: center;">  </div> <p>CAGE code: <span style="float: right;"><u>2/</u></span></p>	<p>PORTLAND BOLT &amp; MFG., CO. P.O. BOX 2866 1210 NW JOHNSON ST PORTLAND, OR 97208</p> <p style="text-align: center;">Plant 3441 NW GUAM ST PORTLAND, OR 97210-2688 CAGE code: 3QCS3</p> <div style="text-align: center;">  </div> <p>CAGE code: 3S498, 3QCS3 <span style="float: right;"><u>1/</u></span></p>
<p>PNEU-HYDRO PRODUCTS, INC. 353 RICHARD MINE ROAD WHARTON, NJ 07885</p> <div style="text-align: center;">  </div> <p>CAGE code: <span style="float: right;"><u>2/</u></span></p>	<p>PORTSMOUTH NAVAL SHIPYARD SEAVEY ISLAND KITTERY, ME 03904</p> <div style="text-align: center;">  </div> <p>CAGE code: 81316 <span style="float: right;"><u>1/</u></span></p>
<p>POINT MACHINE COMPANY P.O. BOX 8055 33 CAMBRIDGE HEIGHTS KENSINGTON, CT 06037</p> <div style="text-align: center;">  </div> <p>CAGE code: 9N716 <span style="float: right;"><u>2/</u></span></p>	<p>POSIMECH, INC. 15 INDUSTRIAL (SCOUTING) BLVD. MEDFORD, NY 11763</p> <div style="text-align: center;">  </div> <p>CAGE code: 0AXM0 <span style="float: right;"><u>1/</u></span></p>

1/ Information published in this revision was verified by direct contact with manufacturers.

2/ Information not verified to be current, no response from manufacturer. Information identical to that published in MIL-HDBK-57, Revision B.

## MIL-HDBK-57F (IS)

POWERPARTS, INC.  
P.O. BOX 38557  
601 MCFARLAND STREET  
HOUSTON, TEXAS 77011



CAGE code: 66297

2/

PRD FASTENERS LTD.  
UNIT 10/15 MONMER CLOSE  
WILLENHALL, WV12 1JR  
ENGLAND

**PRD**

CAGE code: U8651

1/

PRECI-MANUFACTURING, INC.  
400 WEAVER STREET  
WINOOSKI, VT 05404-1391



CAGE code: 66841

1/

PRECISE AERO PRODUCTS  
4120 INDUS WAY  
RIVERSIDE, CA 92503-4808



CAGE code: 00AE2

1/

PRECISE OF CALIFORNIA  
DIV OF ADJUSTABLE BUSHING CORP  
8330 LANKERSHIM BLVD.  
NORTH HOLLYWOOD, CA 91605



*Panel fastener*



*Quick-acting pins*

CAGE code: 62372

2/

PRECISION AIRCRAFT MACHINING CO.,  
INC. DBA PAMCO  
10640 ELKWOOD STREET  
SUN VALLEY, CA 91352

**PAMCO**

**PAM**

CAGE code: 66774

1/

PRECISION FITTINGS, INC.  
709 NORTH MAIN ST.  
WELLINGTON, OH 44090

**PF**

CAGE code: 92192

1/

1/ Information published in this revision was verified by direct contact with manufacturers.

2/ Information not verified to be current, no response from manufacturer. Information identical to that published in MIL-HDBK-57, Revision B.

## MIL-HDBK-57F (IS)

PRECISION METAL PRODUCTS CO.  
#7 CENTENNIAL DRIVE  
CENTENNIAL INDUSTRIAL PARK  
PEABODY, MA 01961-6026



CAGE code: 4V472

2/

PRECISION TECHNOLOGIES, INC.  
1538 INDUSTRIAL AVE.  
OTTAWA, KS 66067

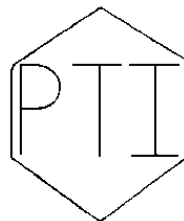

CAGE code:

2/

PRECISION PARTS & TOOL CO., INC.  
108 ROME STREET  
FARMINGDALE, NJ 11735

**L.P.R.**

CAGE code:

2/

PRECISIONMATICS CO., INC.  
HELMER AVE.  
WEST WINFIELD, NY 13491

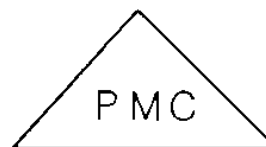

CAGE code:

2/

PRECISION PIECE PARTS, INC.  
712 S. LOGAN ST.  
MISHAWAKA, IN 46544



CAGE code: 98072

2/

PREM INDUSTRIES, INC.  
P.O. BOX 907  
NIAGRA FALLS, NY 14302

Plant  
574-56<sup>th</sup> ST.  
NIAGRA FALLS, NY 14304



CAGE code: 4Y327

2/

PRECISION SCREW & BOLT, INC.  
1491 CHARDON ROAD  
CLEVELAND, OH 44117-1598

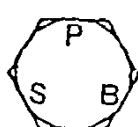

GRADE 2

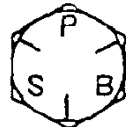

GRADE 5



GRADE 8





CAGE code: 02BC3

1/

1/ Information published in this revision was verified by direct contact with manufacturers.

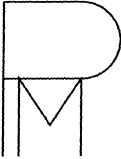
2/ Information not verified to be current, no response from manufacturer. Information identical to that published in MIL-HDBK-57, Revision B.

## MIL-HDBK-57F (IS)

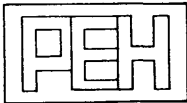
<p>PRESTIGE STAMPING, INC. 23513 GROESBECK HWY WARREN, MI 48089</p> <p style="text-align: center;"><b>P</b></p> <p>CAGE code: 0AAB6 <span style="float: right;"><u>1/</u></span></p>	<p>PRODUCTION &amp; TOOL COMPANY 240 SARGENT DRIVE NEW HAVEN, CT 06511</p> <p style="text-align: center;"></p> <p>CAGE code: 8N334 <span style="float: right;"><u>2/</u></span></p>
<p>PRICE MANUFACTURING CO. 372 NORTH SMITH AVENUE CORONA, CA 91720</p> <p style="text-align: center;"></p> <p>CAGE code: 1K6D8 <span style="float: right;"><u>1/</u></span></p>	<p>PRODUCTS DESIGN &amp; MFG. CORP. P.O. BOX 11429 NEWINGTON, CT 06111</p> <p style="text-align: center;">Plant 76 STANWELL RD. NEWINGTON, CT 06111</p> <p style="text-align: center;"><b>8M938</b></p> <p>CAGE code: <span style="float: right;"><u>2/</u></span></p>
<p>PRIETO MACHINE COMPANY, INC. 1785 STOUT DRIVE UNIT D WARMINSTER, PA 18974</p> <p style="text-align: center;"></p> <p>CAGE code: 8Y298 <span style="float: right;"><u>1/</u></span></p>	<p>PRO-MACHINE &amp; TOOL COMPANY 792 BLAKE BOTTOM RD. HUNTSVILLE, AL 35806</p> <p style="text-align: center;"></p> <p>CAGE code: IDS66 <span style="float: right;"><u>2/</u></span></p>
<p>PRODUCT DEVELOPMENT GROUP, INC. P.O. BOX 177 ROSE HILLS, KS 67133</p> <p style="text-align: center;"></p> <p>CAGE code: OMAR7 <span style="float: right;"><u>2/</u></span></p>	<p>PROMPTUS ELECTRONIC HARDWARE 520 HOMESTEAD AVENUE MT. VERNON, NY 10550</p> <p style="text-align: center;"></p> <p>CAGE code: 57177 <span style="float: right;"><u>2/</u></span></p>

1/ Information published in this revision was verified by direct contact with manufacturers.

2/ Information not verified to be current, no response from manufacturer. Information identical to that published in MIL-HDBK-57, Revision B.

## MIL-HDBK-57F (IS)

PROTO MACHINE CO., INC.  
P.O. BOX 1240  
1295 GOLDEN TRIANGLE BLVD.  
KEELER, TX 76248



CAGE code: 0AWM2 2/

PTM INTERNATIONAL INC.  
8050 NW 31ST  
MIAMI, FL 33122



CAGE code: 0S6M6 2/

PURITAS METAL PRODUCTS  
7720 RACE RD  
NORTH RIDGEVILLE, OH 44039-3614



CAGE code: 04368 1/

PYE & HOGAN MACHINE CO.  
P. O. BOX 832  
167-1 ELM ST  
OLD SAYBROOK, CT 06475-4134

**MFR06320**

CAGE code: 06320 1/

QRP, INC.  
P.O. BOX 832  
2307 MERCANTILE DR NE  
LELAND, NC 28451-4065

**09094**

CAGE code: 09094 1/

QSN MANUFACTURING, INC.  
201 FRONTIER WAY  
BENSENVILLE, IL 60106

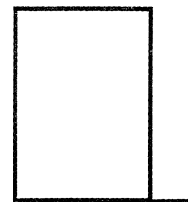

CAGE code: 0MDU6 2/

QUALITY AIRCRAFT SCREWS, INC.  
1030-A ORTEGE WAY  
PLACENTIA, CA 92670

**QAS**

CAGE code: 2/

QUALITY BOLT & SCREW CO.  
10147 BRECKSVILLE RD.  
BRECKSVILLE, OH 44141-3205





**QB**

CAGE code: 0BCN3 1/

1/ Information published in this revision was verified by direct contact with manufacturers.

2/ Information not verified to be current, no response from manufacturer. Information identical to that published in MIL-HDBK-57, Revision B.

## MIL-HDBK-57F (IS)

<p>QUALITY FABRICATIONS, INC. 3270 WROLSSEN DRIVE SAUGERTIES, NY 12477</p>  <p>CAGE code: IJB77 <span style="float: right;">2/</span></p>	<p>QUALITY THREADED PRODUCTS COMPANY 4734 HIGHWAY 157 N. JUDSONIA, ARKANSAS 72081</p> <p style="text-align: center; font-size: 2em;"><b>QT</b></p> <p>CAGE code: 0RXV6 <span style="float: right;">2/</span></p>
<p>QUALITY MACHINE &amp; MFG INC. 1316 BLACK VALLEY ROAD LAFOLLETTE, TN 37766</p>  <p>CAGE code: 1DB71 <span style="float: right;">2/</span></p>	<p>R &amp; D FASTENERS P. O. BOX 250 9604 7TH ST RANCHO CUCAMONGA , CA 91730</p>  <p>CAGE code: 05BE3 <span style="float: right;">2/</span></p>
<p>QUALITY SCREW PRODUCTS, INC. P.O. BOX 2355 35101 SCHOOLCRAFT ROAD LIVONIA, MI 48151</p> <p style="text-align: center; font-size: 2em;"><b>Q</b></p> <p>CAGE code: 4F051 <span style="float: right;">2/</span></p>	<p>R &amp; D WELDING &amp; MACHINE INC. 1200 GEORGIA AVE. WARNER ROBBINS, GA 31093</p>  <p>CAGE code: 1H3J7 <span style="float: right;">2/</span></p>
<p>QUALITY SOCKET SCREW MANUFACTURING CORP. 2790 NORTH AVE. ENGLEWOOD, IL 34224</p>  <p style="text-align: center;">Socket head cap screw head marked for I.D. QSS</p> <p>CAGE code: 5N116 <span style="float: right;">1/</span></p>	

1/ Information published in this revision was verified by direct contact with manufacturers.

2/ Information not verified to be current, no response from manufacturer. Information identical to that published in MIL-HDBK-57, Revision B.

MIL-HDBK-57F (IS)

R & I ENTERPRISES  
 DBA COMPULOGIC DESIGN CO.  
 233 PAREDES LINE RD.  
 BROWNSVILLE, TX 78521

R.I.E.

CAGE code: 1CHU5

1/

R & R PRECISION  
 604 S. 9TH ST.  
 GUNNISON, CO 81230



CAGE code: 0GKX6

2/

R B & W CORPORATION  
 A PARK-OHIO COMPANY  
 5190 BRADCO BLVD.  
 TORONTO, ONTARIO  
 CANADA

Plant  
 DELAWARE CORPORATION  
 8341 TYLER BLVD  
 MENTOR, OH 44060

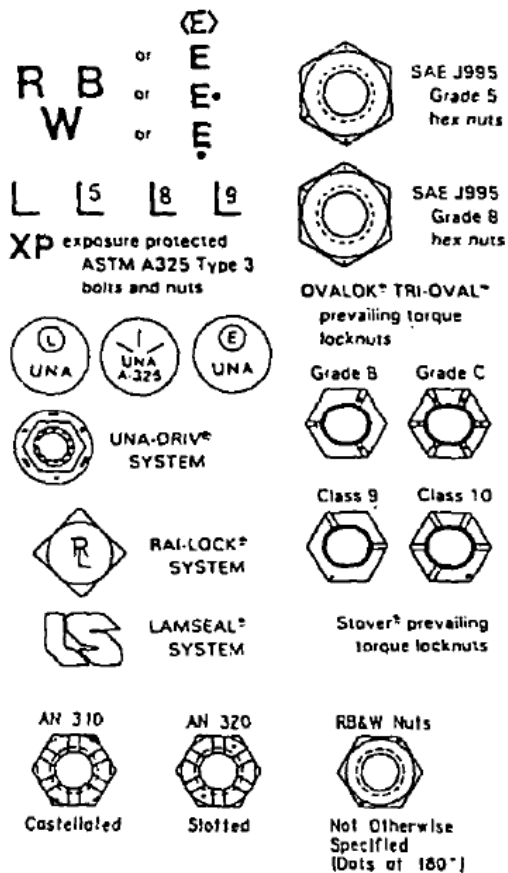
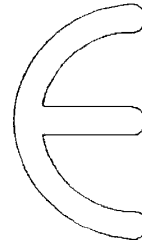

CAGE code: 52167

Continued

2/

<sup>1/</sup> Information published in this revision was verified by direct contact with manufacturers.

<sup>2/</sup> Information not verified to be current, no response from manufacturer. Information identical to that published in MIL-HDBK-57, Revision B.

MIL-HDBK-57F (IS)

Continued

R B & W CORPORATION

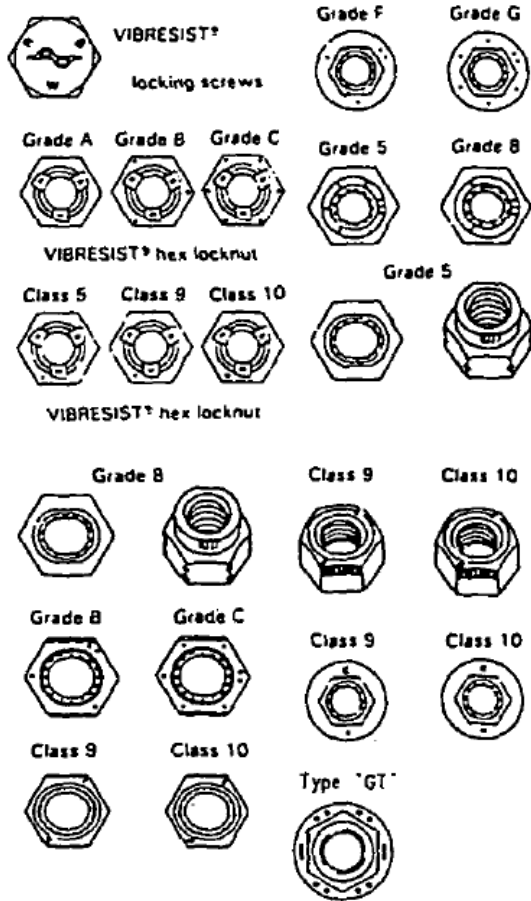

CAGE code: 52167 2/

R. BILD COMPANY, INC.  
15205 STAGG STREET  
VAN NUYS, CA 91405-1003



CAGE code: 04QM7 1/

R.E.C. CORP.  
10 BEACH ST.  
MOUNT VERNON, NY 10550



Used on all alloy and stainless steel bolts, studs, and nuts over 1/2 inch in diameter.

CAGE code: 86687 2/

RABOURDIN  
ZI R DES MARAIS  
P.O. BOX BP 157  
ST. JUST EN CHAUSSEE,  
FRANCE 60130



CAGE code: F4870 2/

RADAX INDUSTRIES, INC.  
700 BASKET ROAD  
WEBSTER, NY 14580



CAGE code: 6V794 2/

1/ Information published in this revision was verified by direct contact with manufacturers.

2/ Information not verified to be current, no response from manufacturer. Information identical to that published in MIL-HDBK-57, Revision B.



## MIL-HDBK-57F (IS)

RAE MANUFACTURING CO.  
1327-1331 CEDAR STREET  
PORT HURON, MI 48060-6167

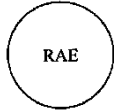
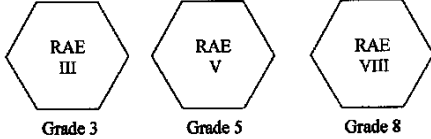

CAGE code: 3FDT8

1/

RAHMEDE SCHRAUBENFABRIK  
WEFELSHOHLER STR 44  
D-5880 LUDENSCHIED  
GERMANY

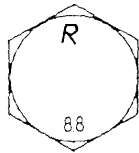

CAGE code: D9901

2/

RAINBOW MACHINE PRODUCTS, INC.  
P.O. BOX 1906  
226 WILLIS ROAD  
YORK, PA 17405



CAGE code: 9S535

2/

RAM ENTERPRISES  
1382 CORONADO ST  
LONG BEACH, CA 90804

**RE**

CAGE code: OU3C8

2/

RAM PRODUCTS  
AFS TORRANCE OPERATIONS  
3016 WEST LOMITA BLVD.  
TORRANCE, CA 90505-5103

(Corporate office see ALCOA FASTENING SYSTEMS)

**RAM**

CAGE code: 0CBU7

RAM THREADING, INC.  
P.O. BOX 987  
BEAUMONT, TEXAS 77704

Plant  
2640 CROCKETT  
BEAUMONT, TX 77701

**R**

Centered over grade of material being stamped

CAGE code: 1Y826

2/

RAMAR NUTS, INC.  
18401 WEAVER ST.  
DETROIT, MI 48228

**R**

CAGE code: 4L633

2/

1/ Information published in this revision was verified by direct contact with manufacturers.

2/ Information not verified to be current, no response from manufacturer. Information identical to that published in MIL-HDBK-57, Revision B.

MIL-HDBK-57F (IS)

RAMCO SPECIALTIES, INC.  
5369 HUDSON DRIVE  
HUDSON, OH 44236

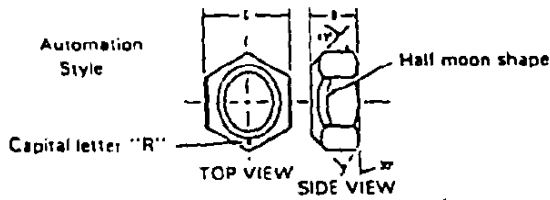

CAGE code: 6U460 1/

RAMM DEFENSE PRODUCTS  
3161 D MAJOR ST  
FORT WORTH, TX 76112-7270



CAGE code: 0BRC1 1/

RATHMANN WALTER G. SEGMENT-  
KLAMMERSCHRAUBEN GMBH  
ALTE EMSER STRASSE 32  
KOBLENZ, 56077  
GERMANY



CAGE code: C6486 2/

RA-WHITE, INC  
967 WEST HYDE PARK BOULEVARD  
INGLEWOOD, CA 90302



CAGE code: 5Y319 2/

RB & W CORP.  
23001 EUCLID AVE.  
CLEVELAND, OH 44117

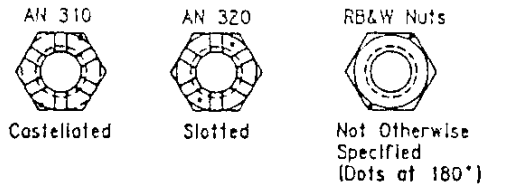
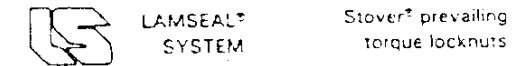
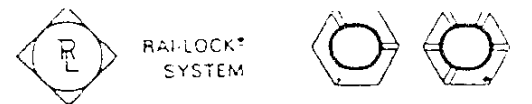
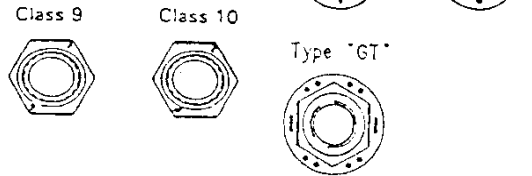
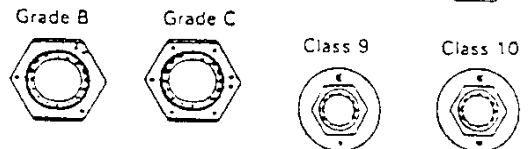
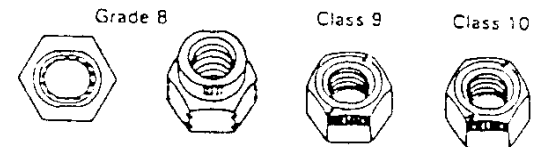
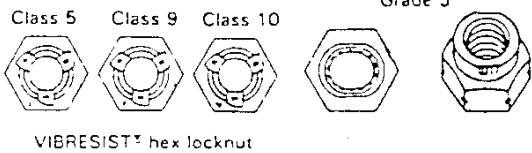
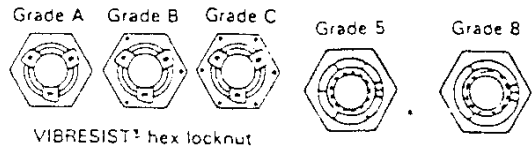
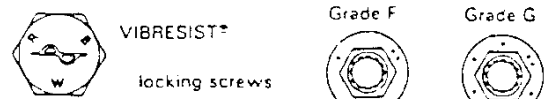

CAGE code: 0VZJ0 2/

1/ Information published in this revision was verified by direct contact with manufacturers.

2/ Information not verified to be current, no response from manufacturer. Information identical to that published in MIL-HDBK-57, Revision B.

## MIL-HDBK-57F (IS)

REED INSTRUMENT CO.  
1525 BLALOCK ROAD  
HOUSTON, TX 77080



CAGE code: 3B132

2/

REGAL AIR, INC.  
P.O. BOX 1011  
108 E. ALABAMA  
MT. PLEASANT, TX 75455

**4J976**

CAGE code: 4J976

2/

REID PRODUCT INC.  
21430 WAALEW RD  
APPLE VALLEY, CA 92307

**Rp 9R R9**

CAGE code: 59563

1/

RELIANT FASTENER  
201 E. 2ND STREET  
ROCK FALLS, IL 61071

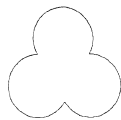

CAGE code:

2/

REPUBLIC FASTENER MANUFACTURING  
CORP.  
1300 RANCHO CONEJO BOULEVARD  
NEWBURY PARK, CA 91320-1405

**R**

CAGE code: 52828, 71087

1/

(see ALCOA FASTENING SYSTEMS)

REXNORD  
SPECIALITY FASTENERS DIVISION  
(NOW: ALCOA FASTENING SYSTEMS,  
TRIDAIR PRODUCTS)  
3000 WEST LOMITA BLVD  
TORRANCE, CA 90505



**Tridair**



(NOW: ALCOA FASTENING SYSTEMS)  
CAMLOC PRODUCTS  
601 ROUTE 46 WEST  
HASBROUCK HEIGHTS, NJ 07604



(NOW: ALCOA FASTENING SYSTEMS)  
ROSAN PRODUCTS  
3130 W. HARVARD ST.  
SANTA ANA, CA 92704

**RI**

CAGE code: 76017

2/

<sup>1/</sup> Information published in this revision was verified by direct contact with manufacturers.

<sup>2/</sup> Information not verified to be current, no response from manufacturer. Information identical to that published in MIL-HDBK-57, Revision B.

## MIL-HDBK-57F (IS)

RICHARD MANNO & CO., INC.  
42 LAMAR ST  
WEST BABYLON, NY 11704

**R/M**

CAGE code: 0RGV4 & 3BFK5

1/

RICHARD MFG. CO., INC.  
250 ROCK LANE  
MILFORD, CT 06460-3853

**RMCO**

CAGE code: 4A014

1/

RINCO TECHNOLOGIES, INC.  
10275 PHILADELPHIA CT.  
RANCHO CUCAMONGA, CA 91730

**R**

CAGE code: 4NG33

1/

RING SCREW WORKS  
10160 GAINEY RD  
HOLLY, MI 48442 - 9331

FENTON HEADING  
2480 OWEN RD.  
FENTON, MI 48430-1769  
CAGE code: 7M992

**⊖**

FERNDALE FASTENER  
31600 STEPHENSON HIGHWAY  
MADISON HEIGHTS, MI 48071

**Ⓡ**

RING SCREW DEVISION  
22100 SHERWOOD AVE.  
WARREN, MI 48091

**⊙**

SEMCO FASTENER  
4146 EAST BALDWIN RD.  
HOLLY, MI 48442

**Ⓢ**

TITAN FASTENER  
10031 HOLLY RD.  
HOLLY, MI 48442

**Ⓣ**

CAGE code: 0B2C8

2/

1/ Information published in this revision was verified by direct contact with manufacturers.

2/ Information not verified to be current, no response from manufacturer. Information identical to that published in MIL-HDBK-57, Revision B.

## MIL-HDBK-57F (IS)

RIPA ENGINEERING CORP.  
9555 OWENSMOUTH AVE.  
UNIT # 7 & 8  
CHATSWORTH, CA 91311

# RIPA

CAGE code: 3R930

1/

RIPPA PRODUCTS  
P.O. BOX 328  
5 MILE POINT RD  
MOHAWK, MI 49950

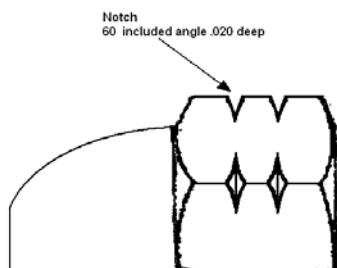

CAGE code: 0R7Z5

2/

RISCO, INCORPORATED  
390 RISCO CIRCLE  
BEAUMONT, CA 92223-2676

# 01DC

CAGE code: 6W027

1/

RIVER VALLEY TOOL & MANUFACTURING  
P. O. BOX 64  
260 AIRPORT INDUSTRIAL ROAD  
PARIS, AR 72855

# RVT

CAGE code: 3K1M6

1/

RIVNUT ENGINEERED PRODUCTS, INC.  
2705 MARION DRIVE  
KENDALLVILLE, IN 46755

# REP

CAGE code: 0VK23

2/

RMS  
1125 W ACACIA AVE  
HEMET, CA 92543

# RMS

CAGE code:

2/

ROBBINS MANUFACTURING  
P.O. BOX 704  
1200 AIRPORT ROAD  
FALL RIVER, MA 02722



CAGE code: 8T312

1/

1/ Information published in this revision was verified by direct contact with manufacturers.

2/ Information not verified to be current, no response from manufacturer. Information identical to that published in MIL-HDBK-57, Revision B.

MIL-HDBK-57F (IS)

ROBERT HENRY CO., INC.  
87 OPAL STREET  
MILFORD, CT 06460

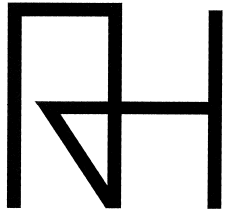

CAGE code: 9J112 2/

---

ROCKFORD BOLT & STEEL CO.  
(SUBSIDIARY OF VARLEN CORPORATION)  
126 MILL ST  
ROCKFORD, IL 61101-1491

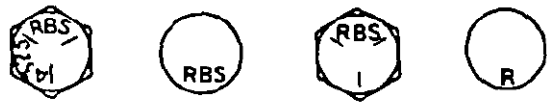

CAGE code: 90483 1/

---







































ROCKFORD FASTENERS INC.  
P.O. BOX 884  
ROCKFORD, IL 61105

Plant  
725 SOUTH STREET  
ROCKFORD, IL 61102



CAGE code: 0B998 2/

ROCKFORD PRODUCTS CORP.  
707 HARRISON AVE  
ROCKFORD, IL 61108

 MISC. OR LOW CARBON	 GENERAL PURPOSE	 GRADE 3	 GRADE 5
 GRADE 5	 GRADE 5.1	 GRADE 5.2	 GRADE 8
 GRADE 7	 GRADE 8	 GRADE 9	 GRADE 8.2
 DURLOK	 STAINLESS	 SAE J-1102	 P3T WITH APPROPRIATE GRADE
 87	 METRIC GRADE 8.8	 METRIC GRADE 9.8	 METRIC GRADE 10.9
 IND. HEX. HEAT TREAT & NO HEAT TREAT	 IND. HEX. GRADE 3	 IND. HEX. GRADE 5	 IND. HEX. GRADE 5.1
 IND. HEX. GRADE 6	 IND. HEX. GRADE 7	 IND. HEX. GRADE 8	 IND. HEX. STAINLESS
 OLD STYLE PLACE BOLT GRADE 5	 OLD STYLE PLACE BOLT GRADE 8	 NEW STYLE PLACE BOLT GRADE 5	 NEW STYLE PLACE BOLT GRADE 8
 METRIC NEW STYLE PLACE BOLT GRADE 8.8	 METRIC NEW STYLE PLACE BOLT GRADE 10.9	 HEX. NUT GRADE 5	 HEX NUT GRADE 8
 LOW CARBON	 ROCKALLOY GRADE 8		

CAGE code: 77595 2/

1/ Information published in this revision was verified by direct contact with manufacturers.

2/ Information not verified to be current, no response from manufacturer. Information identical to that published in MIL-HDBK-57, Revision B.

## MIL-HDBK-57F (IS)

ROGG MANUFACTURING COMPANY  
600 DANBURY ROAD  
NEW MILFORD, CT 06776

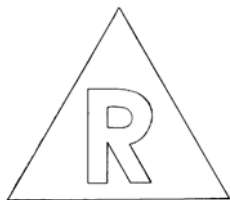

CAGE code: 08625

2/

ROMAC ELECTRONICS, INC.  
155 E. AMES CT.  
PLAINVIEW, NY 11803

**8T968**

CAGE code: 8T968

2/

RONSON MANUFACTURING, INC.  
9933 CHILLICOCTHE ROAD  
KIRKLAND, OH 44094

**R**

CAGE code: 2X146

1/

ROSAN PRODUCTS  
AFS TORRANCE OPERATIONS  
3018 WEST LOMITA BLVD.  
TORRANCE, CA 90505-5103

(Corporate office see ALCOA FASTENING  
SYSTEMS)

**RI**

CAGE code: 83324

1/

ROTAIR INDUSTRIES, INC.  
P.O. BOX 4098  
964 CRESCENT AVE  
BRIDGEPORT, CT 06607-1025



Rubber stamped  
on fasteners

**54878**

Commercial and Government Entity  
(CAGE) number affixed or rubber

CAGE code: 54878

1/

RS MANUFACTURING, INC.  
INDUSTRIAL PARK BLVD.  
MENTOR, OH 44060

**RS**



CAGE code: 0MYK3

2/

RUDOLPH INSTRUMENTS, INC.  
400 MORRIS AVE STE 120  
DENVER, NJ 07834-1362

**RI**

CAGE code: 23262

2/

1/ Information published in this revision was verified by direct contact with manufacturers.

2/ Information not verified to be current, no response from manufacturer. Information identical to that published in MIL-HDBK-57, Revision B.

## MIL-HDBK-57F (IS)

RUMCO, INC.  
985 PAULY DR.  
ELK GROVE VILLAGE, IL 60007-1312

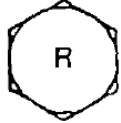

GRADE 2



GRADE 5

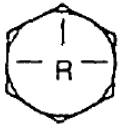

GRADE 5.1



GRADE 5.2



GRADE 8

CAGE code: 6Z992

2/

RUSCOMB TOOL & MACHNE CO., INC.  
500 W. RUSCOMB STREET  
PHILADELPHIA, PA 19120

**RTM**

CAGE code: 07952

2/

S & L METAL PRODUCTS CORP.  
5829 57TH DR  
MASPETH, NY 11378-2232

**S&L**

CAGE code: 05722

2/

S. B. E. (ITALY CORPORATION)  
VIA ENRICO DERMI  
20019 SETTIMO  
MILANESE, ITALY

**SBE**

CAGE code:

2/

S.A.B.A. S.p.A. BULLONERIA E. AFFINI  
VIA LIGURIA 11/13,  
20098 SESTO ULERIANO  
FRAZ. DI S. GUILLANO M.SE  
MILANO, ITALY

**A.L.**

CAGE code:

2/

1/ Information published in this revision was verified by direct contact with manufacturers.

2/ Information not verified to be current, no response from manufacturer. Information identical to that published in MIL-HDBK-57, Revision B.



MIL-HDBK-57F (IS)

S.I. STUD, INC.  
1127 SILBER RD.  
HOUSTON, TX 77055

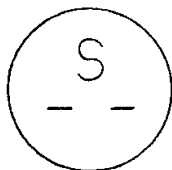

CAGE code: 2/

SABRE MANUFACTURING, INC.  
P.O. BOX 11386  
201 S. CHERRY ST.  
SOUTH BEND, IN 46601



CAGE code: 0GN74 2/

SAFETY SOCKET LLC.  
6501 N. AVONDALE AVENUE  
CHICAGO, IL 60631

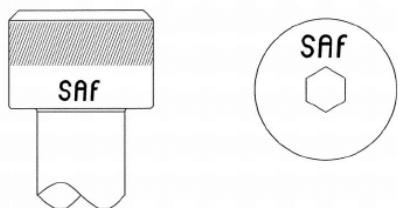

CAGE code: 82896 1/

SAFETY SOCKET SCREW CORP.  
(ENGINEERING DEPARTMENT)  
6501 NORTH AVONDALE AVE.  
CHICAGO, IL 60631

INCH SOCKET HEAD CAP SCREWS

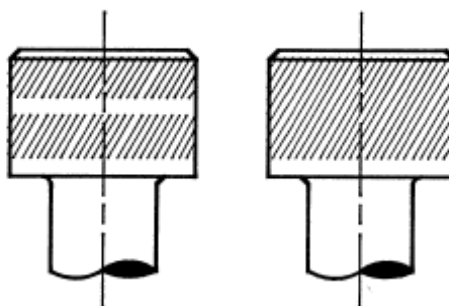

BUTTON HEAD CAP SCREWS

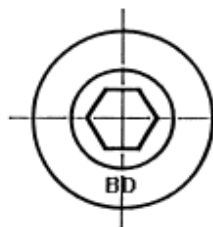

FLAT HEAD CAP SCREWS AND SOCKET HEAD SHOULDER SCREWS

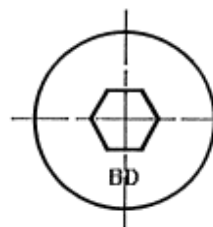

METRIC SOCKET HEAD CAP SCREWS

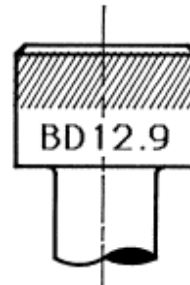

\*BD\* AND THE 60° DIAGONAL KNURL ARE REGISTERED TRADEMARKS OF SAFETY SOCKET SCREW CORPORATION FOR THE PURPOSE OF MANUFACTURERS IDENTIFICATION

BD BDM

CAGE code: 82896 2/

1/ Information published in this revision was verified by direct contact with manufacturers.

2/ Information not verified to be current, no response from manufacturer. Information identical to that published in MIL-HDBK-57, Revision B.

## MIL-HDBK-57F (IS)

SAGA TEKKOSHO CO., LTD.  
129-3 TAKAYA  
FUJISAWA-CITY KANAGAWA PREF.,  
JAPAN



CAGE code: 2/

SAMUEL MARSDEN & SON  
WELLINGTON RD.  
ASHTON UNDER LYNE,  
LANCASHIRE OL6 7EG  
UNITED KINGDOM



CAGE code: 2/

SAI INDUSTRIES CORP.  
1207 FULTON AVENUE  
SAN ANTONIO, TX 78201-4501

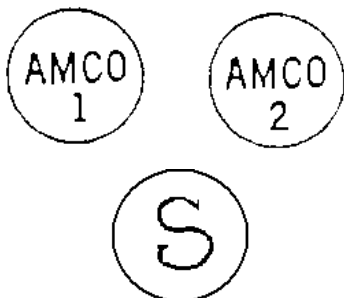

CAGE code: 1KQ10, 63095 2/

SANDIK MANUFACTURING, INC.  
100 8TH STREET  
PASSAIC, NJ 07055



CAGE code: 6U704 2/

SALEM MANUFACTURING AND SALES, INC.  
2856 BANWICK RD.  
COLUMBUS, OH 43232

SMS

CAGE code: 57140 1/

SANNOHASHI SEISAKUSHO CO., LTD.  
2-1-18 OKINO ADACHI-KU  
TOKYO 123  
JAPAN



CAGE code: 2/

SALES SYSTEM, LIMITED  
P.O. BOX 7006  
700 FLORIDA AVE.  
PORTSMOUTH, VA 23707-1918



CAGE code: 8F411 1/

SANTA ANA GEAR & MACHINE  
15201 PIPELINE LN.  
HUNTINGTON BEACH, CA 92649



CAGE code: 2/

1/ Information published in this revision was verified by direct contact with manufacturers.

2/ Information not verified to be current, no response from manufacturer. Information identical to that published in MIL-HDBK-57, Revision B.

## MIL-HDBK-57F (IS)

SANTA ANA SCREW PRODUCTS INC.  
SANTA ANA, CA 92701



CAGE code: 33644

2/

SATAIR MANUFACTURING FACILITY  
PURDEYS WAY  
PURDEYS INDUSTRIAL ESTATE  
ROCHFORD  
ESSEX  
SS5 4JJ  
UK

**SMF**

CAGE code: K4975

1/

SATURN FASTENERS, INC.  
425 SO. VARNEY ST.  
BURBANK, CA 91502-2125

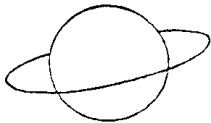

CAGE code: 0K6Z0

1/

SCANDIA MFG. CO., INC.  
480 BRUNSWICK ST.  
BALTIMORE, MD 21223-2745

**SCA**

CAGE code: 00997

1/

SCHMICO GMBH SCHWEISSTECHNIK  
P. O. BOX 12 29  
PETER-LINNARTZ-STRASSE  
JUELICH 52428,  
GERMANY



CAGE code: C15191

2/

SCHRAUBENFABRIK GUSTAV  
STERNBERG GmbH & CO. KG  
1000 BERLIN 27  
BREITENBACHSTRASSE 11-12  
GERMANY

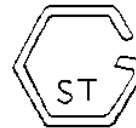

Symbol may be raised or struck in.

CAGE code:

2/

SCHUHL & CO. GMBH  
AUF DER HUTTE 31  
WINTERBURG 59955  
GERMANY

**S**

CAGE code: C3639

2/

1/ Information published in this revision was verified by direct contact with manufacturers.

2/ Information not verified to be current, no response from manufacturer. Information identical to that published in MIL-HDBK-57, Revision B.

## MIL-HDBK-57F (IS)

SCOTT CRAFT CO.  
P.O. BOX 430  
BELL, CA 90201

Plant  
4601 CECELIA STREET  
CUDAHY, CA 90201

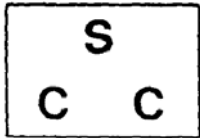

CAGE code: 28418

2/

SEMCO FASTENER  
4146 EAST BALDWIN RD.  
HOLLY, MI 48442

See RING SCREW WORKS



CAGE code: 0B2C8

1/

SCREWCORP.  
( A DIVISION OF VSI)  
13001 EAST TEMPLE AVE.  
CITY OF INDUSTRY, CA 91714

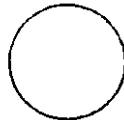

Indented circle on all fasteners,  
except machine screws.

CAGE code: 9H901

2/

SEMS AND SPECIALS, INC.  
6483 FALCON RD.  
ROCKFORD, IL 61109

01IG

CAGE code: 5B4N5

1/

SEMBLEX CORP.  
199 W. DIVERSEY AVE  
ELMHURST, IL 60126

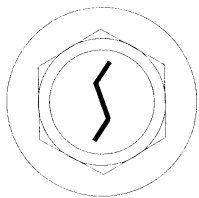

CAGE code: 4M343

1/

SENG HENG ENGINEERING PTE LTD.  
NO. 3 EUNOS AVE. 8A  
SINGAPORE 409458  
REPUBLIC OF SINGAPORE



CAGE code:

1/

1/ Information published in this revision was verified by direct contact with manufacturers.

2/ Information not verified to be current, no response from manufacturer. Information identical to that published in MIL-HDBK-57, Revision B.

## MIL-HDBK-57F (IS)

SESCO INDUSTRIES, INC.  
P. O. BOX 242  
110 - 19 15TH AVENUE  
COLLEGE POINT, NY 11356



CAGE code: 0KH97

1/

SET SCREW & MFG. CO.  
1210 ST. CHARLES STREET  
ELGIN, IL 60120

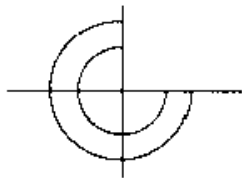

CAGE code: 1T4U7

1/

SHACKELFORD MACHINIG, INC.  
2407 LUDELLE ST.  
FORT WORTH, TX 76105-0755



CAGE code: 4K446

1/

SHAMROCK FASTENER TECHNOLOGIES,  
LLC.  
6125 18 MILE ROAD  
STERLING HEIGHTS, MI 48314

SHAMROCK IN CIRCLE

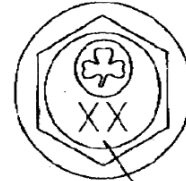

GRADE  
DESIGNATION

SFT LDGO



GRADE  
DESIGNATION

CAGE code: 05CF6

2/

SHAW PRECISION GRINDING &  
THREADING  
6503 W. FRYE RD.  
SUITE 6  
CHANDLER, AZ 85226

SALES ADDRESS SEE:  
ACE GRINDING & MFG. OF TEXAS  
2610 AERO DR.  
GRAND PRAIRIE, TX 75052  
CAGE code: 5U074

**SPG**

CAGE code: 1KRG8

1/

1/ Information published in this revision was verified by direct contact with manufacturers.

2/ Information not verified to be current, no response from manufacturer. Information identical to that published in MIL-HDBK-57, Revision B.

## MIL-HDBK-57F (IS)

SHEFFIELD, INC.  
1025 WINCHESTER AVE.  
KANSAS CITY, MO 64126



CAGE code: 68567

2/

SHIGA BOLT CO., LTD.  
OTSU 423 MINAMI-TSUCHIYAMA  
TSUCHIYAMA-CHO, KOHGA-GUN SHIGA-  
KEN 528-02  
JAPAN

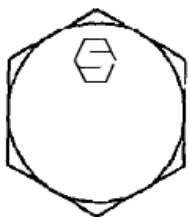

CAGE code:

2/

SHOPCO MANUFACTURING, INC.  
1125 S. CEDAR HILL RD.  
CEDAR HILL, TX 75104

**SC OR 1HEW6**  
Contoured to fit parts

CAGE code: 1HEW6

1/

SHORELINE MACHINE PRODUCTS, INC.  
19301 ST. CLAIR AVENUE  
CLEVELAND, OH 44117

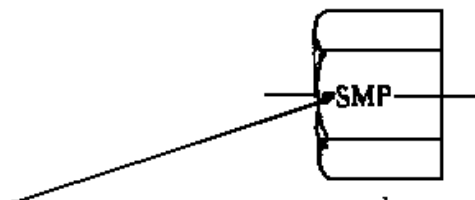

SMP will be applied to this surface to denote  
Shoreline Machine Products as manufacturer.

CAGE code: 1VN42

1/

SHUR-KUT SUPPLY CORPORATION  
7 MT. PLEASANT DR.  
ASTON, PA 19014



CAGE code: 6R002

1/

SHUR-LOK COMPANY.  
(SPS FASTENERS DIVISION, A PCC  
COMPANY)  
2541 WHITE ROAD  
IRVINE, CA 92614 - 6235



CAGE code: 97393

1/

1/ Information published in this revision was verified by direct contact with manufacturers.

2/ Information not verified to be current, no response from manufacturer. Information identical to that published in MIL-HDBK-57, Revision B.

## MIL-HDBK-57F (IS)

SIERRA PACIFIC SUPPLY CO., INC.  
P. O. BOX 4848  
COMPTON, CA 90224

Plant:  
1801 W EL SEGUNDO BLVD  
COMPTON, CA 90224

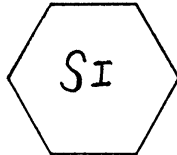

CAGE code: 5G098 1/

SIERRACIN/HARRISON  
3020 EMPIRE AVENUE  
BURBANK, CA 91504

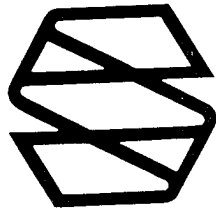

CAGE code: 08199 2/

SIMMONDS PRODUCTS  
AFS ST. COSME OPERATIONS  
9 RUE DES CRESSONNIERES  
72110 ST. COSME-EN-VAIRAIS  
FRANCE

(Corporate office see ALCOA FASTENING  
SYSTEMS)

**SD**

CAGE code: F0224 1/

SINN-TECH, INC.  
48 GLEAM STREET  
WEST BABYLON, NY 11704



CAGE code: 9J550 1/

SKY MANUFACTURING  
5989 RICCKENBACKER ROAD  
COMMERCE, CA 90040

**SM**

CAGE code: 1CNU4 1/

SKYLINE INDUSTRIES  
1201 FORUM WAY SOUTH  
FORT WORTH, TX 76140



CAGE code: 09986 2/

SKYSPARES PARTS, INC.  
6660 VIEW PARK COURT  
RIVERSIDE, CA 92503

**SP**

CAGE code: 6M132 2/

1/ Information published in this revision was verified by direct contact with manufacturers.

2/ Information not verified to be current, no response from manufacturer. Information identical to that published in MIL-HDBK-57, Revision B.

## MIL-HDBK-57F (IS)

SLABE MACHINE PRODUCTS  
4659 HAMANN PARKWAY  
WILLOUGHBY, OH 44094



CAGE code: 97139

1/

SMALL PARTS MANUFACTURING CO., INC.  
4401 NE MLK JR. BLVD.  
PORTLAND, OR 97211

SPM  
INC

CAGE code: 3K749

1/

SMITH MACHINE & MANUFACTURING  
RT. 4 P.O. BOX 283  
CANTON, TX 75103

SM&M

CAGE code: 0MAJO

2/

SMITH WELDING, INC.  
756 PRUNNER ROAD  
RIDDLE, OR 97469



CAGE code: 1GQX1

1/

SONFARREL, INC.  
3000-3010 LA JOLLA ST.  
ANAHEIM, CA 92806



CAGE code: 09036

2/

SONIC INDUSTRIES, INC.  
20030 SO. NORMANDIE AVE.  
TORRANCE, CA 90502



CAGE code: 57928

1/

1/ Information published in this revision was verified by direct contact with manufacturers.

2/ Information not verified to be current, no response from manufacturer. Information identical to that published in MIL-HDBK-57, Revision B.



## MIL-HDBK-57F (IS)

SOUTH BAY BOLT MANUFACTURING CO.  
P.O. BOX 5805  
COMPTON, CA 90224

Plant  
1775 W. El Segundo Blvd.  
Compton, CA 90222

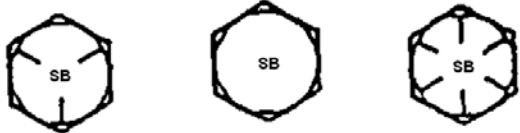

CAGE code: 2P339

2/

SOUTHERN FASTENING SYSTEMS  
(DIVISION OF FARLEY METALS, INC.)  
P.O. BOX 1360  
STATESVILLE, NC 28677

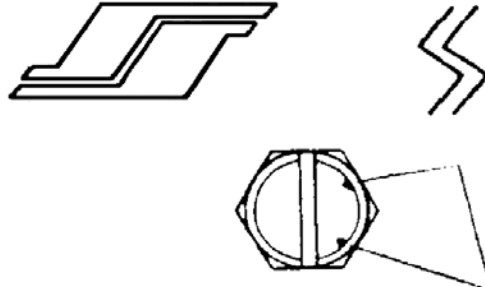

*2 notches for slotted heads only*

CAGE code: 87308

2/

SOUTHCO INC.  
210 N. BRINTON LAKE ROAD  
CONCORDVILLE, PA 19331

Plant  
SOUTHCO INC. – TECATE  
PROLONGACIAN, AV JUAREZ #999  
FRACC. EL REFUGIO  
TECATE, B.C., 21440 MEXICO

**southco**

CAGE code: SV287

1/

SOUTHWEST ALLIED PRODUCTS CO.,  
INC.  
299 HILL RD.  
VANLEER, TN 37181



CAGE code: 6P461

2/

SOUTHERN FASTENER CORPORATION  
P. O. BOX 1387  
1641 CONCEPTION STREET ROAD  
MOBILE, AL 36610

**SF**

CAGE code: 1K461

1/

SOUTHWEST INDUSTRIAL SERVICES  
P. O. BOX 9084  
FT. WORTH, TX 76147

Plant  
2413 WHITMORE  
FT. WORTH, TX 76147

**SI**

CAGE code: 6H920

2/

1/ Information published in this revision was verified by direct contact with manufacturers.

2/ Information not verified to be current, no response from manufacturer. Information identical to that published in MIL-HDBK-57, Revision B.

## MIL-HDBK-57F (IS)

SOUTHWIND INDUSTRIES, INC.  
P.O. BOX 98  
1646 OILD BUTLER PLANK RD.  
PITTSBURGH, PA 15200



CAGE code: 0DTJ0 2/

SPACE AGE ENGINEERING, INC.  
4022 E. 26TH STREET  
INDIANAPOLIS, IN 46218



CAGE code: 29953 2/

SPACE SCREW, INC.  
106 STANDARD ST.  
EL SEGUNDO, CA 90245



CAGE code: 0GE51 2/

SPACE-LOK, INC.  
13306 HALLDALE AVE.  
GARDENA, CA 90249



CAGE code: 16258 1/

SPARTAN PRECISION MACHINE  
131 ALBANY AVE  
FREEPORT, NY 11520



CAGE code: 2M198 2/

SPECIALS, INC.  
P.O. BOX 514  
103 MAINLINE DRIVE  
WESTFIELD, MA 01086-0514



CAGE code: 0WVC1 1/

SPECIAL-T-METALS  
P.O. BOX 14810  
LENEXA, KS 66215

Plant  
14740 WEST 101 TERRACE  
LENEXA, KS 66215



CAGE code: 8U495 2/

1/ Information published in this revision was verified by direct contact with manufacturers.

2/ Information not verified to be current, no response from manufacturer. Information identical to that published in MIL-HDBK-57, Revision B.

MIL-HDBK-57F (IS)

SPECIALTY SCREW CORP.  
P.O. BOX 5003  
ROCKFORD, IL 61125

Plant  
2801 HUFFMAN BLVD.  
ROCKFORD, IL 61103

S

CAGE code: 1WQE5

2/

SPIRAL TOOL CORP.  
761 ROUTE 6  
SHOHOLA, PA 18458



CAGE code: 02108

1/

SPS TECHNOLOGIES  
FASTENER DIVISION CORPORATE  
HEADQUARTERS  
JENKINTOWN, PA 19046-2630

SPS AREOSPACE FASTENER COPANIES

SPS TECHNOLOGIES (Cage 56878)  
301 HIGHLAND AVENUE  
JENKINTOWN, PA 19046-2630

*The following characters (used alone or in combination with other digits/ letters which designate material, size, strength grade or part number) indicate SPS as manufacturing source:*

C	K	U
CCS	K-5673	U130
EWB	KS	UNBRAKO
EWN	S	UNW
FNF	SPS	56878
HI PSI	TJB	71838
HI TI	TM9	80539

*For "inch" socket head cap screws*

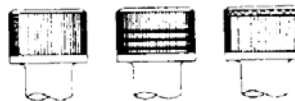

*Straight knurls with an unknurled band adjacent to the bearing surface on socket heads. The diameter over the straight knurl does not exceed the band. There may be 2 or 3 grooves near the band or a diamond knurl band at top of head.*



*A raised or depressed triangle pointing from the wrenching flat toward thread on nut products.*



**S-C** used on metal nuts

SPS TECHNOLOGIES (Cage 80539)  
SANTA ANA DIVISION  
271 SO. HARBOR BLVD.  
SANTA ANA, CA 92704-1259

**SPS SPS S S**

CAGE code: 56878, 80539,  
Continued

1/

1/ Information published in this revision was verified by direct contact with manufacturers.

2/ Information not verified to be current, no response from manufacturer. Information identical to that published in MIL-HDBK-57, Revision B.

## MIL-HDBK-57F (IS)

Continued

SPS TECHNOLOGIES (Cage K5673)  
T. J. BROOKS DIVISION  
191, BARKBY ROAD'  
TROON INDUSTRIAL AREA  
LEICESTER LE4 9HX  
ENGLAND

**TBJ**

SPS ENGINEERED PRODUCTS GROUP

SPS TECHNOLOGIES (Cage 1C5D9)  
NORTH AMERICAN FASTENERS  
(AFG DIV)  
4444 LEE ROAD  
CLEVELAND, OH 44128-2902

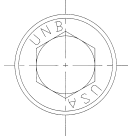

UNB

SPS TECHNOLOGIES (Cage 495T1)  
NORTH AMERICAN FASTENERS  
DBA TERRY MACHINE  
5331 DIXIE HWY  
WATERFORD, MI 48329



SPS TECHNOLOGIES (Cage U3575)  
P O BOX 38  
BURNABY ROAD  
COVENTRY CV 6 AE, ENGLAND

SPS INTERNATIONAL LTD. (Cage S3329)  
UNBRACO SHANNON  
BAYS 25-30 SHANNON INDUSTRIAL  
ESTATE,  
SHANNON, COUNTRY CLARE,  
IRELAND

METALAC SPS INDUSTRIA E COMERCIO  
LTDA.  
AVENIDA ITAVUVU, 4690  
18078-005 SOROCABA (SP),  
BRAZIL

**TELLEP TLP T**

UNBRACO PTY LTD. AUSTRALIA  
P.O. BOX 3138 NUNAWADING  
VICTORIA 3131, AUSTRALIA

**U UM**

CAGE code: K5673, 1C5D9, 495T1, U3575,  
S3329

1/

SPS TECHNOLOGIES LIMITED  
T/A UNBRACO UK  
CRANFORD STREET  
SMETHWICK  
B66 2TA  
UNITED KINGDOM

**TBJ**

CAGE code: U3575

SPS TECHNOLOGIES LIMITED  
TJ BROOKS DIVISION  
(UNITED KINGDOM CORPORATION)  
191 BARKBY ROAD  
TROON INDUSTRIAL AREA  
LEICESTER  
LE4 9HX  
UNITED KINGDOM

**TBJ**

CAGE code: K5673

2/

SPURWAY COOKE INDUSTRIES PTE LTD.  
2, JOO KOON ROAD  
JURONG SINGAPORE 628966  
REPUBLIC OF SINGAPORE

**S  
C I**

CAGE code:

1/

1/ Information published in this revision was verified by direct contact with manufacturers.

2/ Information not verified to be current, no response from manufacturer. Information identical to that published in MIL-HDBK-57, Revision B.

## MIL-HDBK-57F (IS)

SRI SAI INDUSTRIES CORPORATION  
1207 FULTON AVENUE  
SAN ANTONIO, TX 78201-5104

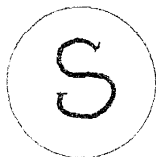

CAGE code: 63095

1/

ST. LOUIS SCREW & BOLT CO.  
6900 NORTH BROADWAY  
ST. LOUIS, MO 63147



TYPE I



TYPE III

CAGE code:

2/

STALKER & DYSTHE, INC.  
5100 E. WASHINGTON BLVD.  
LOS ANGELES, CA 90040

SD

CAGE code: 6D696

2/

STANDARD LOCKNUT, INC.  
P. O. BOX 780  
1045 EAST 169TH STREET  
WESTFIELD, INDIANA 46074



CAGE code: 78507

2/

STANDARD NUT & BOLT, INC.  
49 ABBOTT ST.  
CUMBERLAND, RI 02864

S

CAGE code: 758C9

2/

STANDARD TOOL & MACHINE CO.  
205 E. CARSON ST.  
PITTSBURGH, PA 15219

Plant  
208 WOODLAND RD.  
BIAWNOX, PA 15238

See HALL INDUSTRIES



CAGE code: 0KA69

2/

STEADFAST CORPORATION  
229 MARGINAL ST.  
CHELSEA, MA 02150



CAGE code: 9X854

2/

1/ Information published in this revision was verified by direct contact with manufacturers.

2/ Information not verified to be current, no response from manufacturer. Information identical to that published in MIL-HDBK-57, Revision B.

MIL-HDBK-57F (IS)

STEEL CITY BOLT & SCREW, INC.  
 P.O. BOX 1747  
 BIRMINGHAM, AL 35201

Plant  
 230 WEST VALLEY AVE.  
 BIRMINGHAM, AL 35209

**SCB**

CAGE code: 3N642

2/

STEEL PRODUCTS OF MASSILLION  
 132 WALNUT RD S.W.  
 MASSILLION, OH 44646

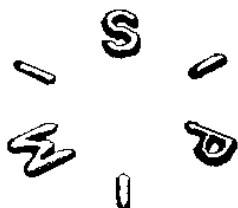

CAGE code: 0698X

2/

STEEL WAREHOUSE COMPANY, INC.  
 2722 WEST TUCKER DRIVE  
 BOX 1377  
 SOUTH BEND, IN 46624

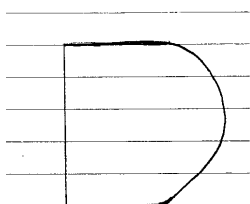

CAGE code: 0R1J8

2/

STELCO FASTENER & FORGING CO.  
 1250 APPLEBY LINE  
 BULINGTON, ONTARIO L71 5G6  
 CANADA



Stelco trademark  
 for most  
 fasteners



Most other nuts  
 and bolts,  
 including metric



SAE Grade 5  
 hex nuts



SAE Grade 8  
 hex nuts

CONELOK LOCKNUTS  
 Inch series



Grade B



Grade C

Metric series



Class 5

Class 9

Class 10

Bearing surface

CAGE code:

Continued

2/

1/ Information published in this revision was verified by direct contact with manufacturers.

2/ Information not verified to be current, no response from manufacturer. Information identical to that published in MIL-HDBK-57, Revision B.

MIL-HDBK-57F (IS)

Continued

STELCO FASTENER & FORGING CO.  
1250 APPLEBY LINE  
BULINGTON, ONTARIO L71 5G6  
CANADA

**HI-HEX CONELOK LOCKNUTS**

Inch series



Grade B



Grade C

Metric series



Class 5

Class 9

Class 10

Bearing surface

CAGE code:

2/

STELFAST, INC.  
1090 MEYERSIDE DRIVE  
MISSISSAUGA, ONTARIO L5T 1J4  
CANADA



(see Chiang Shin Fasteners Industries)  
DOING BUSINESS UNDER  
STELFAST  
CHIANG SHIN FASTENERS  
INDUSTRIES, LTD  
NO. 111 WANLI ROAD  
GANGSHAN TOWNSHIP,  
KAOHSIUNG COUNTRY 82050,  
TAIWAN (R.O.C)

CAGE code: SFV96

CAGE code: L8367

1/

STELFAST FASTENERS, INC.  
(DIVISION OF STELFAST FASTENERS,  
LTD.)  
1710 CLARKSTONE ROAD  
CLEVELAND, OH 44112

1/4 in. through 3/4 in. hex cap screws, heavy hex bolts, square head bolts, and specialty externally threaded fasteners, cold headed.



3/4 in. through 2 1/4 in reg. hex bolts, heavy hex bolts, square head bolts, and specialty externally threaded fasteners, hot headed.



1/4 in. through 2 1/2 in studs.

2 3/8 in. through 3 in. reg. hex bolts, heavy hex bolts, square head bolts, hot headed, and specialty externally threaded fasteners.

CAGE code:

2/

STERLING MACHINE COMPANY  
23 FARRAR STREET  
LYNN, MA 01901-1699

2

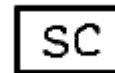

CAGE code: 03983

1/

1/ Information published in this revision was verified by direct contact with manufacturers.

2/ Information not verified to be current, no response from manufacturer. Information identical to that published in MIL-HDBK-57, Revision B.

## MIL-HDBK-57F (IS)

STERLING MARKING PRODUCTS IC  
 P.O. BOX 3360 STA A  
 349 RIDOUT ST N  
 LONDON, ONTARIO, CANADA NGA 4K3



CAGE code: 37084

2/

STERLING MFG. & SUPPLY, INC.  
 P.O. BOX 8205  
 FORT WORTH, TEXAS 76124

Plant  
 3623 E. VICKERY BLVD.  
 FORT WORTH, TX 76105



or

60529

Steel stamped  
 or  
 Embossed  
 or  
 Rubber stamped

CAGE code: 60529

2/

STEVENS MFG. CO., INC.  
 P.O. BOX 3041  
 MILFORD, CT 06460

Plant  
 280 ROCK LANE  
 MILFORD, CT 06460

MFR 8F781

8F781

CAGE code: 8F781

2/

STILLWATER FASTENERS, INC.  
 25 GURNEY ROAD  
 EAST FREETOWN, MA 02717-1107

SW & ..

Symbols are "SW", ampersand ("&") or ".."

CAGE code: 1Y153

1/

STRENKERT MACHINE SHOP INC.  
 RD #2, BOX 759  
 INDIAN BROOK ROAD  
 GREENE, NY 13778

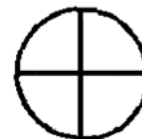

CAGE code: 2T174

2/

1/ Information published in this revision was verified by direct contact with manufacturers.

2/ Information not verified to be current, no response from manufacturer. Information identical to that published in MIL-HDBK-57, Revision B.



## MIL-HDBK-57F (IS)

STURM MACHINE CO., INC.  
9846 OWENSMOUTH AVE.  
CHATSWORTH, PA 91311



CAGE code: 64733 2/

SUBCON TOOL/ACCUTOOL MACHINE  
GROUP INC. (DBA ACCUTOOL)  
5301 IROQUOIS AVE  
ERIE, PA 16511 - 2529  
See ACCUTOOL

**01FO**

CAGE code: 1UMX0 1/

SUBURBAN INDUSTRIES, INC.  
11901 FRANKLIN AVE  
FRANKLIN PARK, IL 60131

**SII**

CAGE code: 89752 2/

SULLIVAN BOLT CO., INC.  
3435 SOUTH MALT AVE.  
COMMERCE, CA 90040

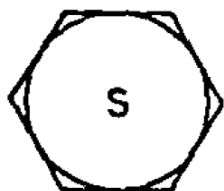

CAGE code: 6M158 2/

SUNDRAM FASTENERS, LTD.  
MADRAS, INDIA

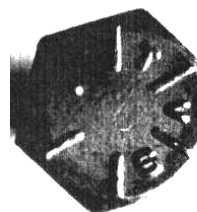

CAGE code: 2/

SUNRISE PRECISION MFG.  
4406 ENTERPRISE PL, UNIT 3  
FREMONT, CA 94538



CAGE code: 0UK47 2/

SUPERIOR TECHNOLOGY  
11013 OLINDA STREET  
SUN VALLEY, CA 91352



**EARTH**

CAGE code: 2/

SUPREME SCREW PRODUCTS, INC.  
1368 CROMWELL AVENUE  
BRONX, NY 10452

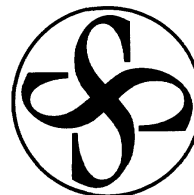

CAGE code: 1FMQ2 2/

1/ Information published in this revision was verified by direct contact with manufacturers.

2/ Information not verified to be current, no response from manufacturer. Information identical to that published in MIL-HDBK-57, Revision B.

## MIL-HDBK-57F (IS)

S V INDUSTRIES  
29280 YNEZ RD.  
TEMECULA, CA 92592

**SV**

CAGE code: OGVY7 2/

SWISS TECHNOLOGY, INC.  
9 BRIDEWELL PL.  
CLIFTON, NJ 07014



CAGE code: 48406 1/

T & E MACHINE CORP.  
4519C WAYNE AVENUE  
PHILADELPHIA, PA 19144-3606

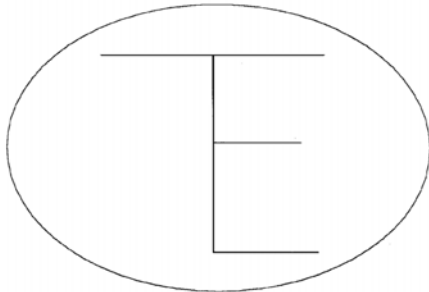
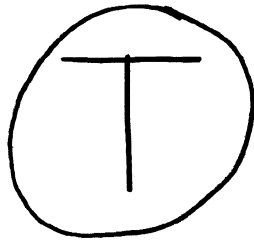

CAGE code: 059P5 2/

T C QUALITY MACHINING INC.  
12155 MAGNOLIA AVE STE 10D  
RIVERSIDE, CA 92503 - 4905

**TCQ**

CAGE code: 3H5W3 1/

T R MACHINE INC.  
103 STATE ROUTE 75 E  
DAVIS, IL 61019-9586

**TR**

CAGE code: 1YJV1 1/

TAIYO NUT MFG. CO., LTD.  
2-6-12 KOUZEN, IKARUGACHO  
IKOMA-GUN, NARA, JAPAN

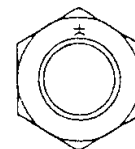

CAGE code: 2/

1/ Information published in this revision was verified by direct contact with manufacturers.

2/ Information not verified to be current, no response from manufacturer. Information identical to that published in MIL-HDBK-57, Revision B.

MIL-HDBK-57F (IS)

TAKENAKA SEISAKUSHO CO., LTD.  
178 HISHIE  
HIGASHI OSAKA CITY, JAPAN 578

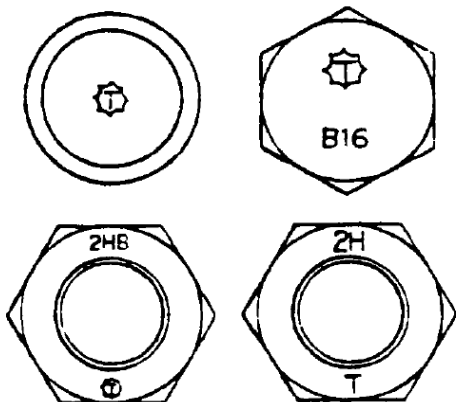

CAGE code: 2/

TANAKA LTD.  
1-10-6 TEZUKAYAMA-NAKA  
SUMIYOSHI-KU, OSAKA, JAPAN

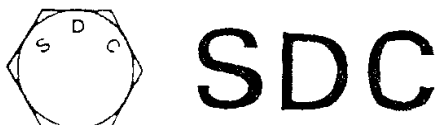

CAGE code: SP833 2/

T-B & S MFG.  
4404 GARLAND DRIVE  
FORT WORTH, TX 76117

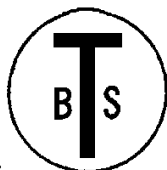

CAGE code: 2/

TEBCO THREADED FASTENERS  
(DIVISION OF TENNESSEE BOLT &  
SCREW CO.)  
2700 SUMMER AVENUE  
MEMPHIS, TN 38112

Plant  
665 SCOTT STREET  
MEMPHIS, TN 38112



CAGE code: 4K536 2/

TECH WELDING AND MACHINE CO.  
41 KINGSTON AVENUE  
COLUMBUS, OH 43207



CAGE code: 9Y179 2/

TECHNICAL FASTENERS, INC.  
1129 GRIMMITT DR  
SHREVEPORT, LA 71107



CAGE code: 0GV34 2/

TEK PRECISION CO., LTD.  
205 WEST INDUSTRY COURT  
DEER PARK, NY 11729



CAGE code: 65780 1/

1/ Information published in this revision was verified by direct contact with manufacturers.

2/ Information not verified to be current, no response from manufacturer. Information identical to that published in MIL-HDBK-57, Revision B.

MIL-HDBK-57F (IS)

TELEFAST INDUSTRIES, INC.  
777 W BAGLEY RD  
BEREA, OH 44017-2901

T



TF

CAGE code: 3CW33 1/

TENS MACHINE CO., INC.  
800 GRUNDY AVE.  
HOLBROOK, NY 11741-2606



**TENS**

CAGE code: 8P689 1/

TERRY MACHINE CO.  
P.O. BOX 487  
5331 DIXIE HWY.  
WATERFORD, MI 48095-1

See SPS TECHNOLOGIES



CAGE code: 87880 2/

TERRYCABLE, INC.  
17376 EUCALYPTUS STREET  
HESPERIA, CA 92345

**TC**

CAGE code: 0XZ68 2/

TEXAS BOLT CO.  
P.O. BOX 1211  
3235 W. 11TH ST.  
HOUSTON, TX 77251



CAGE code: 27422 2/

TEXAS PRECISION MFG., INC.  
P.O. BOX 3640  
610 28TH ST  
LUBBOCK, TX 79452

Plant  
1204 E. 46<sup>TH</sup> STREET  
LUBBACK, TX 79404

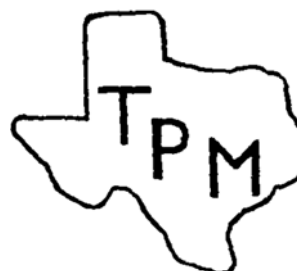

CAGE code: ICU57 2/

1/ Information published in this revision was verified by direct contact with manufacturers.

2/ Information not verified to be current, no response from manufacturer. Information identical to that published in MIL-HDBK-57, Revision B.

MIL-HDBK-57F (IS)

TEXTRON FASTENING SYSTEMS  
 (AEROSPACE - SANTA ANA OPERATIONS)  
 1224 E. WARNER AVENUE  
 SANTA ANA, CA 92705

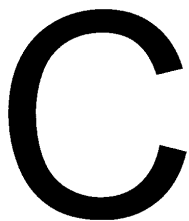

LOCKBOLTS  
 Bold "C"

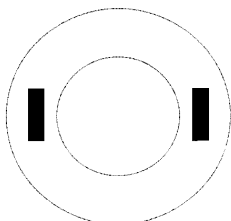

LOCKBOLT COLLARS  
 Two Opposing Dashes

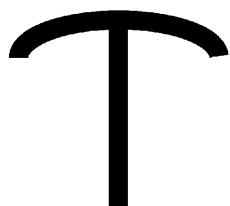

ALL PRODUCTS  
 Lazy "T"

CAGE code: 11815

1/

TFI AEROSPACE CORPORATION  
 19 CONSTELLATION CT.  
 REXDALE, ONTARIO, CANADA



ALL NEW  
 TOOLING



MODIFIED  
 EXISTING  
 TOOLING

CAGE code: L0336

2/

TFP CORP.  
 (TRU-FIT PRODUCTS DIVISION)  
 (SPECIAL FASTENER DIVISION)  
 P. O. BOX 952  
 MEDINA, OH 44258

Plant  
 TRU-FIT STEEL WIRE CO.,LTD  
 (TRU-WELD DIVISION)  
 460 LAKE ROAD  
 MEDINA, OH 44258

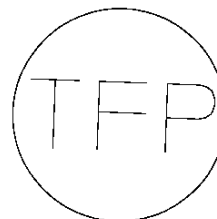
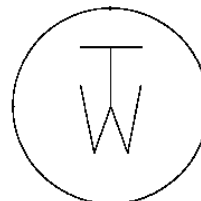
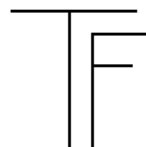

CAGE code: 31000

1/

1/ Information published in this revision was verified by direct contact with manufacturers.

2/ Information not verified to be current, no response from manufacturer. Information identical to that published in MIL-HDBK-57, Revision B.

MIL-HDBK-57F (IS)

THIANT (BOULONNERIE DE SA)  
B.P. 4  
FRANCE 59224



This marking appears on all hex nuts with or without deflection marks. The three raised lines in the corner indicate "Thiant" as manufacturer. (Clockwise system for grade.)



This marking appears on all flange nuts. The three raised lines on the flange indicate "Thiant" as manufacturer. (Clockwise system for grade.)



This marking appears on flange nuts when no mark is acceptable on the flange. Three depressed lines indicate "Thiant" as manufacturer. (Clockwise system for grade.)



This marking appears on flange nuts when raised marks are not accepted. Three depressed lines indicate "Thiant" as manufacturer. (Clockwise system for grade.)

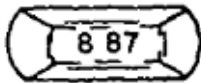

TRACKS FASTENERS



HIGH STRENGTH STRUCTURAL BOLT



HOT FORGED BOLTS

CAGE code:

2/

THOMAS & BETTS CORPORATION  
(FORMERLY AMERICAN ELECTRIC)  
8155 T AND B BLVD  
MEMPHIS, TN 38125 - 8888

Plant 1  
260 DENNIS STREET  
ATHENS, TN 37303

Plant 2  
8735 HAMILTON ROAD  
SOUTHAVEN, MS 38671

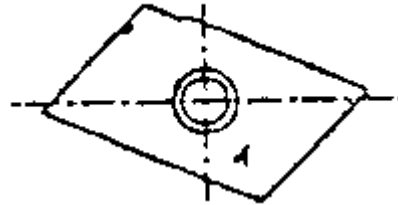

CAGE code: 56501

1/

THOMAS INSTRUMENT & MACHINE CO.,  
INC.  
3440 E FIRST ST  
BROOKSHIRE, TX 77423 - 0999



CAGE code: 5H860

2/

THOMAS MACHINING TECHNOLOGIES,  
INC.  
12 COUNT ROAD 486  
HANCEVILLE, AL 35077



CAGE code: 1VNC4

2/

1/ Information published in this revision was verified by direct contact with manufacturers.

2/ Information not verified to be current, no response from manufacturer. Information identical to that published in MIL-HDBK-57, Revision B.

## MIL-HDBK-57F (IS)

THOMAS MFG, INC.  
25125 W OUTER DR  
MELVINDALE, MI 48122

# THOMAS

CAGE code: 0NWS1

2/

TITAN FASTENER  
10031 HOLLY ROAD  
HOLLY, MI 48442

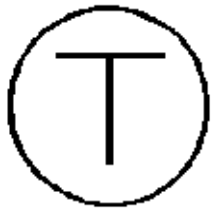

CAGE code:

2/

TOG MANUFACTURING CO., INC.  
1454 SOUTH STATE STREET  
NORTH ADAMS, MA 01247



CAGE code: 63649

1/

TOKOSHA METAL WORKS LTD.  
NO. 7-22, 3-CHROME, NAKAGAMA-NISHI,  
IKUNO-KU, OSAKA, JAPAN

# TKS

CAGE code:

2/

TONG HWEI ENTERPRISE CO., LTD.  
NO. 399 GANG YAN ROAD  
GANG SHAN 820, KAOHSIUNG  
TAIWAN, R.O.C.

# THE

CAGE code: None

1/

TOOLEX, INC.  
7570 MORLEY STREET  
HOUSTON, TX 77061



CAGE code: 1W383

2/

TOPURA CO., LTD.  
2050 YAJOI-CHO  
HIGASHIOSAKA-SHI,  
OSAKA, JAPAN 579

Plant  
201 SOYA, HATANO,  
KANAGAWA 257 JAPAN

# TOPURA

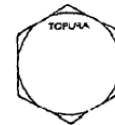

トプーラ

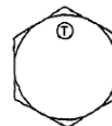

TP

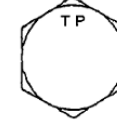
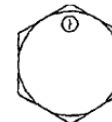

CAGE code:

2/

1/ Information published in this revision was verified by direct contact with manufacturers.

2/ Information not verified to be current, no response from manufacturer. Information identical to that published in MIL-HDBK-57, Revision B.

## MIL-HDBK-57F (IS)

TORCO, INC.  
P. O. BOX 4070  
1330 OLD HIGHWAY 41  
MARIETTA, GA 30061

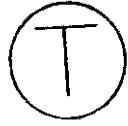

CAGE code: 07359

2/

TORONTO FASTENERS INDUSTRIES, INC.  
(SUBSIDIARY OF HI-SHEAR CORP., USA)  
7475 KIMBEL ST., UNIT 8  
MISSISSAUGA, ONTARIO L5S1E7

See HI-SHEAR

Plant  
19 CONSTELLATION CT.  
REXDALE, ONTARIO,  
CANADA M9W 1K4



CAGE code:

2/

TORX PRODUCTS  
(CAMCAR DIVISION OF TEXTRON INC.)  
P. O. BOX 607  
HWY 31 N.  
ROCHESTER, IN 46975

For head markings see:

CAMCAR Division of Textron, Inc.  
Plant  
TORX Products

CAGE code: 6N040

2/

TOWNE ROBINSON FASTENER CO.  
KEY MANUFACTURING GROUP, INC.  
P.O. BOX 232  
24175 NORTHWESTERN HWY.  
SOUTHFIELD, MI 48037

Plant  
4401 WYOMING AVE.  
P.O. BOX 188  
DEARBORN, MI 48121



CAGE code: 94678

2/

TOWNSEND CO.  
CERRY RIVET DIVISION  
1224 E. WARNER AVE.  
SANATA ANA, CA 92701

**T** Aircraft blind rivets.  
**C** Aircraft lockbolts.

CAGE code: 7H092

2/

TOYO STEEL WIRE CO., LTD.  
3-9-45 TSURUHARA  
IZUMISANO-SHI, OSAKA,  
598 JAPAN

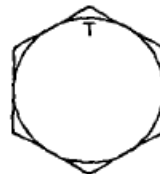

CAGE code:

1/

1/ Information published in this revision was verified by direct contact with manufacturers.

2/ Information not verified to be current, no response from manufacturer. Information identical to that published in MIL-HDBK-57, Revision B.



## MIL-HDBK-57F (IS)

TRI STATE TOOL & DIE CO.  
1396 NORTON RD  
STOW, OH 44224-1333

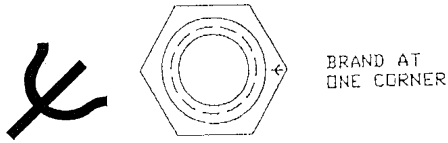

CAGE code: 06RM8 1/

TRIAD PRODUCTS CORP.  
15241 N.E. 92ND  
REDMOND, WA 98052



CAGE code: 74468 2/

TRIDAIR PRODUCTS  
AFS TORRANCE OPERATIONS  
3000 WEST LOMITA BLVD.  
TORRANCE, CA 90505-5103

(Corporate office see ALCOA FASTENING SYSTEMS)



CAGE code: 29372 1/

TRIDENT MACHINE CO.  
3491 N. MERIDIAN ROAD  
ROCKFORD, IL 61101



CAGE code: 5N818 1/

TRIUMPH GROUP OPERATIONS INC, THE  
(FRISBY AEROSPACE INC DE)  
417 S. MAIN ST.  
FREEPORT, NY 11520-5144

Ssee FRISBY AEROSPACE INC DE

**FAH**

CAGE code: 26437 2/

TRIUMPH MANUFACTURING CO., INC.  
P.O. BOX 380148  
750 TOLLAND ST.  
EAST HARTFORD, CT 06138

**TRI**

CAGE code: 8X098 2/

TRONSON MANUFACTURING  
45383 INDUSTRIAL PLACE #41  
FREEMONT, CA 94538

**TM**

CAGE code: 1DPK8 2/

TROY D. RAY DBA DIXON MACHINE &  
FABRICATION  
6807 CHAPMAN HWY.  
KNOXVILLE, TN 37920-6560

**DMT**

CAGE code: 1DEP3 2/

1/ Information published in this revision was verified by direct contact with manufacturers.

2/ Information not verified to be current, no response from manufacturer. Information identical to that published in MIL-HDBK-57, Revision B.

MIL-HDBK-57F (IS)

TRW  
(FASTENER DIVISION)  
265 THIRD STREET  
CAMBRIDGE, MA 02142

PAL

Logo Stampings Used on  
Brass Snap Fastener Components

THE  
DOT

Part No. 18100

TRW

TRW

Part No. 16506

DOT

DOT  
( )  
DOT

Part Nos. 10412  
and 10413

○

Part No.  
22201

TRW  
( )  
DOT

Part Nos. 10224, 12206, 10412,  
10413, 10414, 90307

THE  
LIFT  
DOT

Part Nos. 16205 and 16206

CAGE code: 83058

2/

TRY - AZTEC COMPANY  
P.O. BOX 6191  
TEHACHAPI, CA 93561

JA or JA

CAGE code:

2/

TUFF FASTENERS CO.  
10724 GARWICK PLACE  
SOUTH GATE, CA 90280-7332

T

CAGE code: 5V629

2/

TURNAMICS, INC.  
92 NEW LIECHESTER HWY  
ASHVILLE, NC 28806

K&T

CAGE code: 1CWU8

2/

TW DESIGN AND MANUFACTURING, L.L.C.  
P. O. BOX 310  
33 WEST STREET  
MONTELLO, WI 53949

W

CAGE code: 0X311

2/

TWIST TITE MFG. INC.  
13649 PUMICE STREET  
SANTA FE SPRINGS, CA 90670

M or TT

CAGE code: 007R1

1/

1/ Information published in this revision was verified by direct contact with manufacturers.

2/ Information not verified to be current, no response from manufacturer. Information identical to that published in MIL-HDBK-57, Revision B.

## MIL-HDBK-57F (IS)

U.P. MACHINE & ENGINEERING CO.  
P.O. BOX 400  
210 NORTH THIRD STREET  
POWERS, MI 49874

UPME

CAGE code: 5H091

2/

U.S. BOLT MANUFACTURING, INC.  
12895 SOUTH MAIN  
HOUSTON, TX 77035



CAGE code: 0UZJ8

2/

ULTIMATE MACHINING & WELDING  
1003 ARGUELLO STREET  
REDWOOD CITY, CA 94063



CAGE code: OXXP2

2/

ULTRA SONIC MACHINE CO., INC.  
1313 WEST 135TH STREET  
GARDENA, CA 90247



CAGE code: 4F713

2/

UMPCO CORP.  
P.O. BOX 5158  
7100 LAMPSON AVE.  
GARDEN GROVE, CA 92841



CAGE code: 18076

2/

UNIFLOW CORP.  
P.O. BOX 705  
26600 HEYN DRIVE  
NEW HAVEN, MI 48050

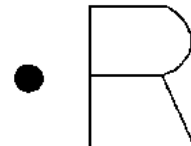

CAGE code: 4S622

2/

1/ Information published in this revision was verified by direct contact with manufacturers.

2/ Information not verified to be current, no response from manufacturer. Information identical to that published in MIL-HDBK-57, Revision B.

## MIL-HDBK-57F (IS)

UNIMETERIC CORPORATION  
P.O. BOX 4529  
5 TRIPPS LANE  
EAST PROVIDENCE, RI 02915



CAGE code: 7U319

2/

UNISTRUT CORP.  
(UNISTRUT PHILA)  
761 FIFTH AVE  
KING OF PRUSSIA, PA 19406

Plant  
UNISTRUT CORP.  
WAYNE MFG. DIV.  
35660 CLINTON  
WAYNE, MI 48184

UNISTRUT



CAGE code: 96195

2/

UNITED BOLT & SCREW CORP.  
1055 HAGGERTY AVE.  
DEARBORN, MI 48126



CAGE code: 8G949

2/

UNITED DRILL BUSHING CORP.  
12200 WOODRUFF AVE  
DOWNEY, CA 90241

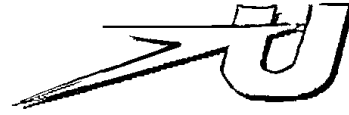

CAGE code: 52369

2/

UNITED PRECISION PRODUCTS CO., INC.  
25040 VAN BORN ROAD  
DEARBORN HEIGHTS, MI 48125



CAGE code: 17328

1/

UNITED STATES DEFENSE RESEARCH &  
SUPPLY  
311 EASTRIDGE ROAD  
GRANDBURY, TX 76049



CAGE code: 0XVD5

2/

1/ Information published in this revision was verified by direct contact with manufacturers.

2/ Information not verified to be current, no response from manufacturer. Information identical to that published in MIL-HDBK-57, Revision B.



## MIL-HDBK-57F (IS)

URBAN MFG. CO. INC.  
P.O. BOX 1070  
529 FORREST AVE.  
DREXEL HILL, PA 19026



CAGE code: 9Y188

2/

US TOOL & DIE  
23282 VERDUGO DR  
LAGUNA HILLS, CA 92653-1335



CAGE code: 3LJM2

1/

UTAH TOOL & DIE, INC.  
P.O. BOX 969  
850 NO WESTERN PRECISION PARKWAY  
WEST JORDAN, UTAH 84084



CAGE code: 23509

2/

VALCOR ENGINEERING CORP.  
2 LAWRENCE ROAD  
SPRINGFIELD, NJ 07081

**VALCOR**

CAGE code: 96487

2/

VALLEY FORGE AND BOLT MFG CO.  
1825 S. 27th AVENUE  
PHOENIX, AZ 85009-6417



CAGE code: 02UA5

1/

VALLEY-TODECO  
12975 BRADLEY AVE.  
SYLMAR, CA 91342

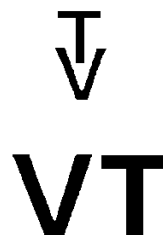

CAGE code: 06710

1/

VAN PETTY MFG., INC.  
DBA J.W. MANUFACTURING INC  
2517 AZURITE CIRCLE  
NEWBURY PARK, CA 91320



CAGE code: 23899

1/

1/ Information published in this revision was verified by direct contact with manufacturers.

2/ Information not verified to be current, no response from manufacturer. Information identical to that published in MIL-HDBK-57, Revision B.

## MIL-HDBK-57F (IS)

V-B MACHINE CO., INC.  
FASTENER DIVISION  
1645 W. 135TH STREET  
GARDENA, CA 90249



CAGE code: 60682

2/

VEGAS FASTENER MANUFACTURING  
3873 W. OQUENDO ROAD  
LAS VEGAS, NV 89118

**V F M**

CAGE code: 1U1Z3

2/

VENUS FASTENERS CORP.  
154 MERRICK RD  
FREEPORT, NY 11520



CAGE code: 045B2

2/

VERSATECH, INC.  
P.O. BOX 608  
6012 ENTERPRISE DR.,  
WESTMORELAND INDUSTRIAL PARK III  
EXPORT, PA 15632



CAGE code: 0CHD0

2/

VERTEX DISTRIBUTION  
P. O. BOX 879  
327 PINE STREET  
PAWTUCKET, R 02860

(see BELL FASTENERS)

**PMC**

CAGE code:

1/

VICO PRODUCTS, CO.  
41555 E. ANN ARBOR ROAD  
PLYMOUTH, MI 48170



The "V" is either raised or indented.

CAGE code: 0CG15

2/

VICTOR PRODUCTS CORP.  
2635 WEST BELMONT  
CHICAGO, IL 60618



CAGE code: 63045

2/

1/ Information published in this revision was verified by direct contact with manufacturers.

2/ Information not verified to be current, no response from manufacturer. Information identical to that published in MIL-HDBK-57, Revision B.

MIL-HDBK-57F (IS)

VIP MFG. & ENGR. CORP.  
1084 MARTIN AVE.  
SANTA CLARA, CA 95050

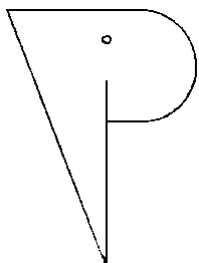

CAGE code: 8M774

1/

VISSERIES & BOULONNERIES DE  
FOURMIES  
2 RUE DU CHAUFFOUR  
FOURMIES, FRANCE 69610

**F**

**F.K**

Grade 8.8 and over

CAGE code: F8388

2/

VISTEK INDUSTRIES  
153 RAILROAD DR  
IVYLAND, PA 18974-1448

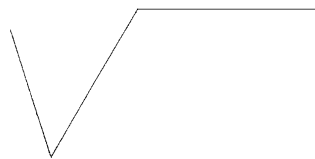

CAGE code: 79735

2/

VITCO NUCLEAR PRODUCTS INC.  
8171 TYLER BLVD  
MENTOR, OH 44060



CAGE code: 9L424

2/

VM MANUFACTURING CORP.  
1536 RAILROAD AVENUE  
HOLBROOK, NY 11741-2301



CAGE code: 1NUW9

1/

1/ Information published in this revision was verified by direct contact with manufacturers.

2/ Information not verified to be current, no response from manufacturer. Information identical to that published in MIL-HDBK-57, Revision B.



MIL-HDBK-57F (IS)

VMC INDUSTRIES, INC.  
20 CORPORATE DRIVE  
AUBURN HILLS, MI 48326

.V. OR VMC

FEMALE FASTENERS

PREVAILING TORQUE NUTS

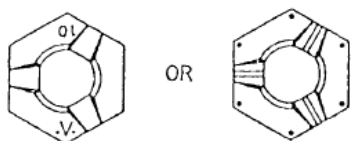

.V. OR TWO LINES IN THREE PADS  
WITH APPROPRIATE GRADE OR CLASS MARKINGS

INSERT TYPE  
PREVAILING TORQUE NUTS



TAN NYLON IDENTIFIES VMC AS MANUFACTURER  
WITH APPROPRIATE GRADE OR CLASS MARKINGS

SLOTTED NUTS

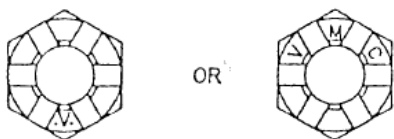

.V. OR VMC  
WITH APPROPRIATE GRADE OR CLASS MARKINGS

CAGE code: 0SFN8

Continued

2/

Continued

VMC INDUSTRIES, INC.

FEMALE FASTENERS (CONT.)

NUT & WASHER ASSEMBLY

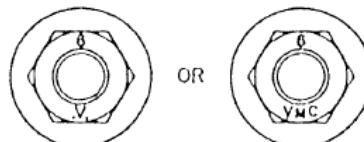

".V." OR "VMC" WITH APPROPRIATE  
GRADE OR CLASS MARKINGS

FLANGE NUTS

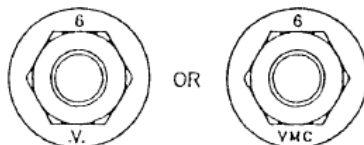

".V." OR "VMC" WITH APPROPRIATE  
GRADE OR CLASS MARKINGS

HEX NUTS

ENGLISH

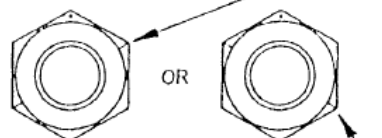

GRADE 5 PER SAE J995 OR GRADE 8 PER SAE J995  
ONE RADIAL LINE FOR MFG. ID., 180°  
FROM RADIAL LINE IN THE GRADE ID.

METRIC

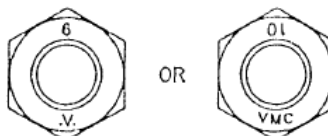

CLASS 9 OR CLASS 10  
".V." OR "VMC" WITH APPROPRIATE  
GRADE OR CLASS MARKINGS

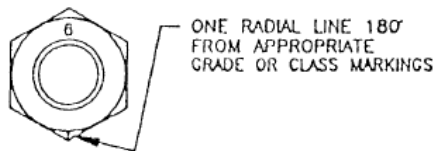

CAGE code: 0SFN8

Continued

2/

1/ Information published in this revision was verified by direct contact with manufacturers.

2/ Information not verified to be current, no response from manufacturer. Information identical to that published in MIL-HDBK-57, Revision B.

MIL-HDBK-57F (IS)

Continued

VMC INDUSTRIES, INC.

FEMALE FASTENERS (CONT.)

OTHER TYPE NUTS

WHEEL NUTS, HEX AND SQUARE WELD NUTS AND OTHER TYPE NUTS NOT SPECIFIED.  
".V." OR "VMC" WITH APPROPRIATE GRADE OR CLASS MARKINGS

MALE FASTENERS

SOCKET HEADS

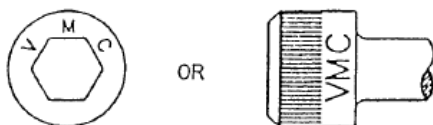

HEX HEADS

INDENTED, TRIMMED, WASHER OR FLANGED.

METRIC

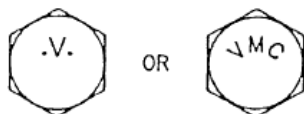

ENGLISH

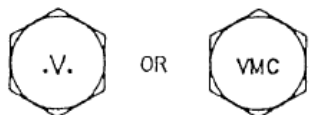

".V." OR "VMC" WITH APPROPRIATE GRADE OR CLASS MARKINGS

CAGE code: 0SFN8

2/

VOI-SHAN PRODUCTS  
AFS TORRANCE OPERATIONS  
3000 WEST LOMITA BLVD.  
TORRANCE, CA 90505-5103  
CAGE code: 5M902

VS

AFS COI OPERATIONS  
135 N. UNRUH AVE.  
CITY OF INDUSTRY, CA 91744  
CAGE code: 06950, IRC86

VS O SC

AFS HILDESHEIM OPERATIONS  
STEVEN 3  
31135 HILDESHEIM-BEVENSTEDT,  
GERMANY  
CAGE code: C4293

VS

(Corporate office see ALCOA FASTENING SYSTEMS)

CAGE code: 5M902, 06950, IRC86,  
C4293

1/

VOSS INDUSTRIES, INC.  
VOSS AEROSPACE DIVISION  
2168 WEST 25TH STREET  
CLEVELAND, OH 44113



E A

V

CAGE code: 14242

1/

1/ Information published in this revision was verified by direct contact with manufacturers.

2/ Information not verified to be current, no response from manufacturer. Information identical to that published in MIL-HDBK-57, Revision B.

## MIL-HDBK-57F (IS)

VSI  
AEROSPACE PRODUCTS DIVISION  
557 S. DOUGLAS ST.  
EL SEGUNDO, CA 90245

Plant  
VOI-SHAN DIVISION  
4001 INGLEWOOD AVE.  
REDONDO BEACH, CA 90278

**VS**

CAGE code: 6A768

2/

WALZ & KRENZER INC DBA MAPECO  
PRODUCTS DIV MAPECO PRODUCTS  
91 WILLENBROCK RD STE B4  
OXFORD, CT 06478-1036



CAGE code: 87045

2/

VULCAN RIVET & BOLT CORP.  
P.O. BOX 170129  
BIRMINGHAM, AL 35217

**V.**

All fasteners marked with the letter "V" followed by a period (.)

**V.**

Fasteners manufactured from special alloy steels are identified with the letter "V" followed by a period (.) and a line under the letter "V"

**304  
V.**

Stainless steel fasteners are marked with the letter "V" followed by a period (.) with the type of stainless

CAGE code: 0GEW3

2/

WARREN PUMPS LLC.  
(DIVISION OF COLFAX CORPORATION)  
P.O. BOX 969  
82 BRIDGES AVENUE  
WARREN, MA 01083



CAGE code: 63857

1/

WATERBURY BUCKLE CO.  
952 S. MAIN STREET  
WATERBURY, CT 06721



CAGE code: 82399

2/

WALKER BOLT MANUFACTURING CO.,  
INC.  
DIVISION OF LONE STAR FASTENERS, LP  
P.O. BOX 1149  
10202 AIRLINE CRIVE  
HOUSTON, TX 77037

**WB**

CAGE code: 39782

1/

WAYNE BOLT & NUT CO., INC.  
14471 LIVERNOIS AVE.  
DETROIT, MI 48238-2097



CAGE code: 5Z751

1/

1/ Information published in this revision was verified by direct contact with manufacturers.

2/ Information not verified to be current, no response from manufacturer. Information identical to that published in MIL-HDBK-57, Revision B.

## MIL-HDBK-57F (IS)

WEAVER MANUFACTURING, INC.  
1005 E. 17TH STREET  
WICHITA, KS 67214

**WMI**

CAGE code: 16345 2/

WEBLUK MACHINE CORP.  
4959 COMMERCE PARKWAY  
WARRENSVILLE HEIGHTS, OH 44128



CAGE code: 0C095 2/

WELTER GMBH & CO. KG  
BONNER RING 49  
P. O. BOX 1311  
ERFTSTADT, GERMANY 50374

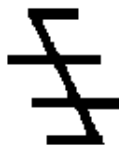

CAGE code: C3486 2/

WELTON ROLLED THREAD CORP.  
1818 GLENDALE BLVD  
LOS ANGELES, CA 90026

**W**

CAGE code: 27871 2/

WESLOK  
(DIVISION OF FALL RIVER  
MANUFACTURING)  
4160 S. 13TH STREET  
MILWAUKEE, WI 53221

**WESLOK**

CAGE code: 2/

WEST COAST AEROSPACE, INC.  
24224 BROAD STREET  
CARSON, CA 90745

Plant  
220 WEST E. STREET  
WILMINGTON, CA 90744



**W C**

CAGE code: 60516 1/

WEST TENNESEE LIONS BLIND IND. INC.  
P.O. BOX 2175  
346 ST PAUL AVENUE  
MEMPHIS, TN 38101-2175

(See A P MILLS INDUSTRIES FOR THE BLIND)

**APMI**

CAGE code: 6Y776 2/

1/ Information published in this revision was verified by direct contact with manufacturers.

2/ Information not verified to be current, no response from manufacturer. Information identical to that published in MIL-HDBK-57, Revision B.

## MIL-HDBK-57F (IS)

WESTERN PACIFIC ENTERPRISES, W.P.E.  
INC.  
8110 REMMET AVE.  
CANOGA PARK, CA 91304



CAGE code: 5N444 1/

WESTERN SCREW MACHINE PRODUCTS,  
INC. (CUTTING EDGE MACHINING)  
1625 LINDA WAY  
SPARKS, NV 89431

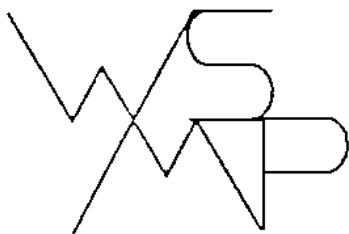

CAGE code: OZV72 2/

WESTERN SKY INDUSTRIES, INC.  
(DIVISION OF ATLAS CORP.)  
21300 CLOUDWAY  
HAYWARD, CA 94545

**WSI**

CAGE code: 04169 2/

WESTFIELD FASTENERS  
202 UNION STREET  
WESTFIELD, MA 01085



CAGE code: 1/

WESTLAND STEEL PRODUCTS, LTD.  
P. O. BOX 1052  
165 CORDITE ROAD  
WINNIPEG, MANITOBA, CANADA R3C 2X4



CAGE code: 0NWY5 2/

WESTWOOD PRECISION, INC.  
7509 HARDESON ROAD  
EVERETT, WA 98203



CAGE code: 0PL34 1/

WHAIL BOLT IND. CO., LTD  
779-2, WONSI-DONG, ANSAN  
KYUGKI-DO, KOREA



GRADE 5 HEX  
CAP SCREWS

GRADE 8 HEX  
CAP SCREWS

CAGE code: 2/

1/ Information published in this revision was verified by direct contact with manufacturers.

2/ Information not verified to be current, no response from manufacturer. Information identical to that published in MIL-HDBK-57, Revision B.

## MIL-HDBK-57F (IS)

WHELAN MACHINE & TOOL CO.  
134 ROCHESTER DR  
LOUISVILLE, KY 40214-2681



Aerial-Bold letter "W" enclosed with a circle

CAGE code: 0MB07

1/

WHITNEY SCREW CORP.  
P.O. BOX 784  
14A BROAD STREET  
NASHUA, NH 03061



CAGE code: 87181

2/

WHITTET-HIGGINS CO.  
33 HIGGINSON AVE.  
CENTRAL FALLS, RI 02863



CAGE code: 79568

2/

WIGLEY MACHINE COMPANY  
2007 WEST 2ND AVENUE  
CORSICANA, TX 75110



CAGE code: 0UBT5

2/

WILHELM SCHUMACHER SCHRAUBEN-  
FABRIK GmbH  
POSTFACH 12 80,  
AM PREIST 5  
D-5912 HILCHENBACH,  
GERMANY



Hex head  
screws and  
bolts



Machine screws  
and other  
products

CAGE code:

2/

WILLIAM'S MACHINE & FABRICATION, INC.  
P.O. BOX 22235  
700 DELAY DRIVE  
EUGENE, OR 97402

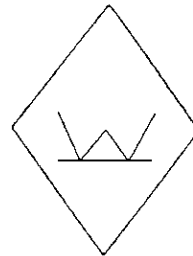

CAGE code: 0NNK2

2/

WIL-NIC  
(E D R INDUSTRIES INC)  
DBA WIL-NICO  
100 COMMERCIAL STREET  
FREEPORT, NY 11520-2832

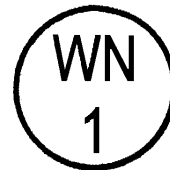

CAGE code: 8P827

2/

1/ Information published in this revision was verified by direct contact with manufacturers.

2/ Information not verified to be current, no response from manufacturer. Information identical to that published in MIL-HDBK-57, Revision B.

## MIL-HDBK-57F (IS)

WILSON-GARNER CO.  
40935 PRODUCTION DR  
HARRISON TOWNSHIP, MI 48045-1351

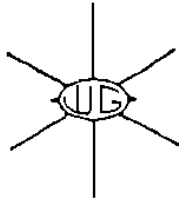

CAGE code: 7E548

1/

WILT PRECISION PRODUCTS  
P.O. BOX 69  
DOVER, PA 17315

*WPP*

CAGE code: 34282

2/

WINKER HERMAN GMBH & CO. KG  
METALLWARENFABRIK  
P.O. BOC 1356  
DELLINGER WEG 1  
SPAICHINGEN, 78549  
GERMANY

W

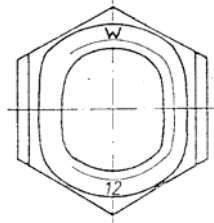

CAGE code: D2362

2/

WINSLOW AUTOMATICS, INC.  
23 ST. CLAIR AVENUE  
NEW BRITAIN, CT 06051



CAGE code: 7W515

1/

WITTEN COMPANY, INC  
P.O. BOX269  
OWASSO, OK 74055

Plant  
8199 N. 116<sup>TH</sup> E. AVE.  
OWASSO, OK 74055



CAGE code: 0JHK5

1/

WODIN, INC.  
5441 PERKINS ROAD  
BEDFORD HEIGHTS, OH 44146



CAGE code: 5V334

1/

1/ Information published in this revision was verified by direct contact with manufacturers.

2/ Information not verified to be current, no response from manufacturer. Information identical to that published in MIL-HDBK-57, Revision B.

MIL-HDBK-57F (IS)

WOLSTENHOLME MACHINE  
 (DBA WM ROBOTS)  
 3075 ADVANCE LANE  
 COLMAR, PA 18915-9420



CAGE code: 68531

1/

WOLVERINE MACHINE PRODUCTS CO.  
 P.O. BOX 209  
 319 COGSHALL ST.  
 HOLLY, MI 48442

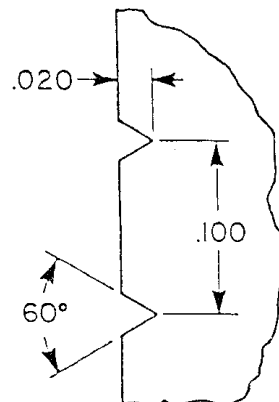

CAGE code: 2T549

2/

WOLTERS GMBH  
 OTTILIENSTR 19  
 D-GUTERSLOH  
 WEST GERMANY



WH

LE

CAGE code:

2/

WOLVERINE NUT CO.  
 6556 EAST McNICHOLS  
 DETROIT, MI 48212



3 dots, centered on corner,  
 equally spaced

CAGE code: 87824

2/

1/ Information published in this revision was verified by direct contact with manufacturers.

2/ Information not verified to be current, no response from manufacturer. Information identical to that published in MIL-HDBK-57, Revision B.



## MIL-HDBK-57F (IS)

WORTHEY MACHINE  
P. O. BOX 70  
3000 US HWY 72 E  
PAINT ROCK, AL 35764-0070

# WSMP

CAGE code: 5S740

2/

WROUGHT WASHER MANUFACTURING  
INC.  
2100 SOUTH BAY STREET  
MILWAUKEE, WI 53207

# MC

Marking for medium carbon heat treated washers compatible  
with Grade 5 and Grade 8 bolts.

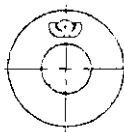

Marking for low carbon washers.

CAGE code: 79807

2/

WYANDOTTE INDUSTRIES, INC.  
4625 13TH STREET  
WYANDOTTE, MI 48192

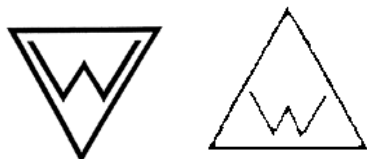

CAGE code: 54151

1/

WYNNSON ENTERPRISES, INC.  
P. O. BOX 440  
12039 HWY 239-431 N.  
MERIDIANVILLE, AL 35759-1201



CAGE code: 39484

1/

XCEL MFG., INC.  
P.O. BOX 239  
ELYRIA, OH 44036

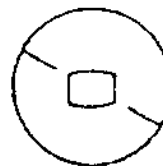

CAGE code:

2/

Y2K MACHINE SHOP  
106 WALSH ROAD  
SAN ANTONIO, TX 78224

# Y 2 K

CAGE code: 1TMD7

1/

1/ Information published in this revision was verified by direct contact with manufacturers.

2/ Information not verified to be current, no response from manufacturer. Information identical to that published in MIL-HDBK-57, Revision B.

## MIL-HDBK-57F (IS)

YATES TOOL, INC.  
2425 MEDINA ROAD  
MEDINA, OH 44256



Either electroetched, steel stamped,  
vibropeened, or ink stamped

CAGE code: IDV02 2/

YOUNG ENGINEERS INC, THE  
25841 COMMERCENTRE DRIVE  
LAKE FOREST, CA 92630-8812

TYE

CAGE code: 56958 1/

YOW MENGI INDUSTRIAL CO., LTD.  
NO. 180 WUN-AN RD., EAST SEC.  
MI-TUO HSIANG 82704  
KAOHSIUNG HSIEN,  
TAIWAN, R.O.C.



CAGE code: 2/

Z & B GENERAL MACHINE  
569 HULMEVILLE AVE.  
PENNDL, PA 19047



CAGE code: 5T735 2/

ZAMON CO., INC.  
ENDICOTT ST., BLDG. 23  
NORWOOD, MA 02062



CAGE code: 5Z471 2/

ZENEX CORPORATION  
850 ELMHURST RD.  
ELK GROVE VILLAGE, IL 60007

ZENEX

CAGE code: 25723 2/

ZERO PRODUCTS, INC.  
219 BAYWOOD ST  
HOUSTON, TEXAS 77011



Z

CAGE code: 3JC57 2/

1/ Information published in this revision was verified by direct contact with manufacturers.

2/ Information not verified to be current, no response from manufacturer. Information identical to that published in MIL-HDBK-57, Revision B.

MIL-HDBK-57F (IS)

**MIL-HDBK-57 FASTENER IDENTIFICATION SYMBOL CONFIRMATION**

Complete this form and email to [alonzo.miller@dla.mil](mailto:alonzo.miller@dla.mil), along with a separate PDF file containing artwork of your fastener head marking.

(Company name as it will appear in the listing) \_\_\_\_\_

(Department, Division, etc., if it is to appear in the listing)

Corporate/Mailing Address	Plant Location (if different)
_____	_____
_____	_____
_____	_____
_____	_____

Our Company is a fastener manufacturer YES ( ) NO ( )

**NOTE:** MIL-HDBK-57 requires the sources listed to have an inherent capability to manufacture fasteners out of raw material.

Telephone: \_\_\_\_\_ FAX Number: \_\_\_\_\_

Contact Name: \_\_\_\_\_ CAGE code: \_\_\_\_\_

Title: \_\_\_\_\_ DUNS Number: \_\_\_\_\_

Email: \_\_\_\_\_ Website URL: \_\_\_\_\_

1. Fastener head marking artwork that is submitted electronically should be provided in a PDF file. A resolution of 100 dpi (dots per inch) minimum should be used for artwork that is scanned. Provide only one marking per file submitted. Include the company name and plant location in this file, along with a written description of the fastener head marking. (For example "the script upper case letter A", or "the number 3 enclosed by a circle.")
2. If your company has plants in various locations, please provide DSCP-NASA with the symbol(s) used for each location, as well as the CAGE code, point of contact, and phone number for each point of contact.
3. All information must be supplied in the English language.
4. Submit this form and artwork to [alonzo.miller@dla.mil](mailto:alonzo.miller@dla.mil)

**NOTE:** We encourage you to duplicate this form and forward it to your various plants, as necessary.

SUBMITTED BY: \_\_\_\_\_

TITLE: \_\_\_\_\_

DATE (mm/dd /yyyy): \_\_\_\_\_

**PLEASE SUBMIT LOGO (HEAD MARKING) ON A SEPARATE SHEET.**

MIL-HDBK-57F (IS)

Subject term (key word) listing:

Head mark  
Head marking  
Logo

Changes from previous issue. Marginal notations are not used in this revision to identify changes with respect to the previous issue due to the extent of the changes.

Preparing Activity:  
DLA-IS

(Project No. 53GP-2011-001)

NOTE: The activities listed above were interested in this document as of the date of this document. Since organizations and responsibilities can change, you should verify the currency of the information above using the ASSIST Online database at <https://assist.daps.dla.mil>.