

NOT MEASUREMENT  
SENSITIVE

MIL-HDBK-57D (IS)  
4 JUNE 2008  
SUPERSEDING  
MIL-HDBK-57C (IS)  
5 APRIL 2007

# DEPARTMENT OF DEFENSE HANDBOOK

## LISTING OF FASTENER MANUFACTURER'S IDENTIFICATION SYMBOLS



**This handbook is for guidance only.  
Do not cite this document as a requirement.**

MIL-HDBK-57D(IS)

DEPARTMENT OF DEFENSE  
WASHINGTON, D.C. 20301

FORWARD

Listing of Fastener Manufacturer's Identification Symbols

MIL-HDBK-57D(IS)

1. This Military Handbook
2. Comments, suggestions, or questions on this document should be addressed to Defense Supply Center Philadelphia (DSCP), ATTN: DSCP-NASA, 700 Robbins Avenue., Philadelphia, PA 19111-5096 or e-mail to [dscpg&inspeccomments@dla.mil](mailto:dscpg&inspeccomments@dla.mil). Since contact information can change, you may want to verify the currency of this address information using the ASSIST Online database at <http://assist.daps.dla.mil>.
3. Copies of these documents are available online at <http://assist.daps.dla.mil/quicksearch/> or from the Standardization Document Order Desk, 700 Robbins Avenue, Building 4D, Philadelphia, PA 19111-5094

## MIL-HDBK-57D(IS)

### FORWARD

This handbook is a compilation of the identifying symbols of fastener manufacturers as provided by the manufacturers themselves. This issue contains the names, addresses, and the symbols of all fastener manufacturers whose identifying symbols were received by 30 November, 2006. Each manufacturer who was listed in Revision B of this document was contacted to confirm the accuracy of the published information. We have annotated the listing to indicate those manufacturers that have responded to confirm or update appropriate information. The listing also annotates which manufacturers have not responded. Information about manufacturers who have not responded is still maintained in this latest revision. For the purpose of this handbook, a manufacturer is defined as the source which substantially makes the supplies, either by hand or machinery out of raw materials. Fasteners, as defined for the purpose of this handbook, refer to those threaded items included in Federal Supply Class (FSC) 5305 – Screws, 5306 – Bolts, 5307 – Studs, and 5310 – Nuts. As additional manufacturers submit their markings, the handbook will be updated.

All requests to be listed in the handbook should be addressed to:

Defense Supply Center Philadelphia (DSCP)  
Attention: DSCP-NASA  
700 Robbins Avenue.  
Philadelphia, PA 19111-5096  
or e-mail to [dscpg&inspeccomments@dla.mil](mailto:dscpg&inspeccomments@dla.mil).

In addition to the alphabetic index of manufacturers (Index A), this revision of the handbook incorporates a listing of manufacturers indexed by their identification symbol (index B).

At the back of this handbook is a registration form. Manufacturers wishing to be listed must complete this form and return it to DSCP. Submit the completed form, along with your fastener identification symbol artwork used on the fastener. All submittals must be in the English language.

DSCP does not “approve”, “rate”, or “endorse” any item, construction, proprietary device, or activity.

DSCP is not responsible for the accuracy or completeness of the information contained in this publication.

DSCP does not take any position with respect to the validity of any patent rights asserted in connection with any items mentioned in this document, and does not undertake to insure anyone utilizing a code, standard, or guide against liability for infringement of any applicable Letters Patent, nor assume any such liability. Users of code, standard, or guide are expressly advised that determination of the validity of any such patent rights, and the risk of infringement of such rights, is entirely their own responsibility.

DSCP reserves the right to monitor this document to ensure that it contains the listing of only bona-fide fastener manufacturers.

DSCP has solicited the assistance of the Defense Contract Management Agency (DCMA) and the Defense Management Command International (DCMCI) in an effort to identify non-manufacturers and remove them from the manufacturers’ listing. DCMA/DCMC’s evaluation of a company’s status is based on an in house capability to manufacture fasteners (screws, bolts, studs and nuts), with respect to space, equipment, and trained personnel. On an on-going basis, any company identified by DCAS/DCMCI as a non-manufacturer will be removed from the manufacturers’ database and MIL-HDBK-57C (IS).



## MIL-HDBK-57D(IS)

Company Name	Page	Company Name	Page
DIVISION OF LONE STAR FASTENERS, LP		BEAVER PRODUCTS CORP.	26
AMMAC, INC.	16	BEC MACHINE PRODUCTS COMPANY	26
ANATASE PRODUCTS	16	BEE INDUSTRIES, INC. (WISCONSIN CORPORATION)	26
DIV OF HENWAY INC		BEGONIA TOOL COMPANY	26
ANCHOR BOLT & SCREW CO.	16	BEK LEVEL 1 FASTENERS	26
ANDERSON FORGE & MACHINE	16	BELL FASTENERS	27
ANILLO INDUSTRIES, INC	16	ALBANY FATENERS/PAWTUCKET FASTENER DIVISION	
ANOTHER SCREW MACHINE PRODUCT	16	(also see VERTEX)	
A-ONE MACHINE COMPANY	16	BELL PRECISION, INC.	27
APEL LTD.	16	BELL-MEMPHIS, INC.	27
APEX MFG. CO. INC	17	BEN YUAN ENTERPRISE CO. LTD.	27
APHEONIX CORPORATION	17	BENACO TOOLING RESEARCH & DEV. CORP	27
ARCHER SCREW PRODUCTS	17	BEOTool CORP.	27
ARCO SALES CO.	17	BERGNER, RICHARD GMBH & CO.	28
ARDOR MFG. INC.	17	BER-LOW MFG INC	28
ARGARWAL INDUSTRIES	17	DBA BUTECH PRESSURE SYSTEMS	
ARJAY PRECISION, INC.	17	BERRY, JOHN DBA BERRY MANUFACTURING	28
ARMSTRONG ATLAS BOLT	18	BERRY MANUFACTURING	28
ARMSTRONG FASTENING SYSTEMS	18	BETA CORP.	28
ARMSTRONG FASTENINGS LTD.	18	BETA ENGINEERING, INC.	28
ARNOLD KNIPPING GmbH	18	BIG BOLT CORP.	29
ARNOLD UMFORMTECHNIK GMBH & CO. KG	18	BISHOP ENTERPRISES, INC.	29
ARNOLD WRAGG (BOLTS & NUTS) LTD	19	BLAINE TOOL CORP.	29
ARROW SCREW & MACHINE WORKS	19	BLANC AERO INDUSTRIES	29
ARTISAN SPECIALIST TECH, INC	19	BLANC AIRCRAFT FASTENERS, INC.	30
ARVAN, INC.	19	BLAND CO., THE	30
ASAHI SREWS MANUFACTURING CO., LTD	19	BLUE SKY INDUSTRIES, INC.	30
ASAI TEKKO CO. LTD	19	BLUE TEE CORP	30
ASI DESIGN & MANUFACTURING, INC.	19	DBA GEFCO/STECO	
ASSOCIATED TOOL CO., INC.	19	BOBCAT MANUFACTURING CO.	30
ATF INC	20	BOGNER ENGINEERING CO.	30
ATLAS ENGINEERING, INC.	20	BOLLHOFF & CO. GmbH & CO. KG	30
PENN ENGINEERING COMPANY		BOLT & NUT CO.,	30
ATLAS SPECIALTY PRODUCTS	20	BOLT FASTENER STUD/TECHNOLOGY	31
See CURTIS PRESTON ENTERPRISES INC		BOLTWORKS, INC.	31
AUGUST FRIEDBERG GMBH	20	BOMAR ENGINEERING, INC.	31
AUGUST FRIEDBERG GmbH	20	BOMBSHELL, INC.	31
AUTO BOLT AND NUT CO.	20	BRACELENTE MANUFACTURING CO., INC.	31
AUTOMATED MANUFACTURING	21	BRADY MACHINE, INC.	31
AUTOMATIC MACHINING AND MFG CO DBA AMMAC INC	21	BRANCH MACHINE PARTS, INC	31
AUTOMATIC MANUFACTURING COMPANY	21	BRIARWOOD FASTENERS, INC	31
AUTOMATIC SCREW MACHINE PRODUCTS CO.	21	BRIDEAN MACHINE & TOOL CO., INC.	32
AUTO SCREW, INC.	21	BRIDGEVIEW MANUFACTURING CO.	32
AVDEL INTERNATIONAL (AVDEL LTD)	21	ILLINOIS CORPORATION	
AVIATION MANUFACTURING GROUP LLC	21	BRIGHT LIGHTS USA, INC.	32
DBA FREEMAN CO., THE		BRINTCLIFFE TURNER LTD.	32
AVIBANK MANUFACTURING, INC.	22	BRISTOL INDUSTRIES	32
PRECISION CASTPARTS CORP.		BRISTOL LOCKNUT CO.	33
AVK INDUSTRIES PRODUCTS INC	22	NUT DIVISION	
AZTECH ENGINEERING, INC	22	BROADSTONE TOOL & DIE, INC.	33
		BROWN PRODUCTION, INC	33
<b>B</b>		BRUNNER DRILLING & MFG. CO., INC.	33
B & B SPECIALTIES INC	22-23	BRUNNER MFG CO. INC.	33
DBA G S AEROSPACE DIVISION .		DBA BRUNNER MANUFACTURING DIVISION	
B & D THREAD ROLLING	23	BRYCO MACHINE, INC.	34
B & E MACHINE SHOP & SHEET METAL FAB., INC.	23	BUCK EYE FORGE, INC.	34
B & E MANUFACTURING CO., INC	23	BUCKEYE MACHINING, INC.	34
B & G MANUFACTURING CO., INC.	23	BUFFALO PUMPS, INC.	34
B & N TOOL CO.,INC.	23	SUBSIDIARY OF AMPCO-PITTSBURGH CORP.	
B & R MACHINE AND TOOL CORP	23	BULA FORGE INC.	34
B F GOODRICH CO. RIVNUT ENGINEERED FASTENERS, THE	24	BULTEN TRADING AB	35
(AERO AND DEF DIV		BURROWERS RESEARCH MACHINING, INC.	35
B G ENGINEERING, INC.	24	BUSAN INDUSTRIAL MACHINERY CO., LTD.	35
B G M FASTENER CO., INC.	24	BOLT DIVISION	
B. V. FABRIEK VAN KLINKNAGELS EN SCHROEFBOUTEN V/H	24	BUTECH PRESSURE SYSTEMS	35
SMIT		see BER-LOW MFG INC.	
BARCO ENGINEERING COMPANY, INC.	24	BUTLER, INC.	35
BARNEGAT BAY NSCC, INC.	24		
DBA BB NSCC, INC.		<b>C</b>	
BARRE PRECISION PRODUCTS INC	24	C & D MACHINE TOLL, INC.	36
BAS AEROSPACE LIMITED	25	C & H MFG., INC.	36
BAUER & SCHAURTE KARCHER GMBH	25	C & S ENGINEERING LLC	36
BBC FASTENERS, INC.	25	C. E. MACHINE CO., INC.	36
BEACH MACHINE	25	C.E.S. MACHINE PRODUCTS, INC	36
		C.J.'S GENERAL MACHINE WORKS	36





## MIL-HDBK-57D(IS)

Company Name	Page	Company Name	Page
DUPONT, G.B. CO., INC. SEE AMAX L. P.	57	FASTENER & STEEL SUPPLY CO., LTD.	67
	57	FASTENAL COMPANY	67
DUVE GmbH & CO. KG	57	FASTENER BROKERAGE INC	67
	57	DBA INOFAST MANUFACTURING	67
	57	FASTENER INNOVATION TECHNOLOGY INC	67
DYSON CORP., THE Formerly JOS. DYSON & SONS, INC.	58	DBA F.I.T.	67
DZUS FASTENER CO., INC DBA DFCI SOLUTIONS, INC	58	FASTENER TECHNOLOGY CORP.	67
		FASTENING PRODUCTS CO.,INC.	67
<b>E</b>		FASTENING PRODUCTS OF LANCASTER, INC.	68
E. KOZAK PRECISION PRODUCTS CO.	58	FASTENRATH BEFESTUGYBGSTECGBUJ GMBH	68
E.L.R. MACHINE AND TOOL	58	FASTI-WERK CARL AUG. FASTENRATH GMBH & CO.KG	68
EAGAN MACHINE CORP.	58	FASTRON COMPANY, THE	68
EAGLE PICHER INDUSTRIES PRECISION PRODUCTS PLANT	58	FEDERAL EQUIPMENT COMPANY	68
EAGLEHEAD MANUFACTURING COMPANY INC DBA DEJAK MACHINE TOOL CO. DIV DEJAK DRILLING	58	FEDERAL MANUFACTURING CORP.	68
EAST COAST METALS INC.	58	FEDERAL SCREW WORKS	69
EASTERN SCREW CO., INC.	59	BIG RAPIDS DIV	69
EASTWOOD MFG., CO.	59	ROMULUS DIV	69
EATON AEROQUIP CORPORATION AEROSPACE DIVISION	59	FENBAR PRECISION MACHINISTS, INC	69
EBC INDUSTRIES FORMERLY ERIE BOLT CORP.	59	FENTON HEADING	69
EBERHARD BRUNINGHAUS	59	FERNDALE FASTENER	69
ECENARRO S. COOP. LTDA.	59	FERRIERE DI STABIO, S.A.	69
EDS ORDNANCE	59	FERRY CAP & SET SCREW CO., THE	70
ELASTIC STOP NUT See MACLEAN-ESNA	60	FIBAM COMPANHIA INDUSTRIAL	70
ELCO INDUSTRIES, INC.	60	FILETAGE INTERNATIONAL	70
ELECTRO-FREETO MANUFACTURING COMPANY	60	INTERNATIONAL THREAD INC.	70
ELITE FASTENERS	60	FIRST AMERICAN SALES CO.	70
ELLIS PRECISION INDUSTRIES DBA E P IND.	60	FISCHER SPECIAL MFG. CO.	70
EMERALD VALLEY MFG	60	FITZ MANUFACTURING INDUSTRIES LTD DBA FMI	70
EMHART CORP GRIPCO FASTENER DIV PARKER-KALON DIVISION	61	FLAIG & HOMMEL	70
EMP MANUFACTURING CO	61	FLEXALLOY INC.	71
EMPIRE PRECISION MACHINING, INC.	61	FLORES ENTERPRISES	71
ENGEL MANUFACTURING COMPANY, INC., THE	61	FLUIDONICS INC.	71
ENGINEERED BOLTING PRODUCTS, INC.	61	FLUIDDYNE CORPORATION	71
ENGINEERING MATERIALS CO., INC FASTENER MANUFACTURING DIVISION	62	FOLSOM TOOL & MOLD CORP.	71
ENGLE MANUFACTURING COMPANY, INC., THE	63	FONTAL CONTROLS, INC.	71
ENOMOTO INDUSTRIES CO., LTD. ENOMOTO FOUNDRY	63	FONTANA LUIGI S.p.A	72
ERICO FASTENING SYSTEMS	63	FOREMOST PRECISION INSTRUMENT CORP.	72
ERIE BOLT CORP DBA EBC INDUSTRIES.	63	FOREST FASTENERS	72
ESMET INC DBA ELECTROLINE TTUFLOC SUB OF UNIMET CORP	63	FORMED FASTENER MANUFACTURING, INC	72
ESNA MACLEAN-FOGG COMPANY	64	FPA MANUFACTURING DBA FPA MANUFACTURING AND SUPPLY	72
ESP MANUFACTURING CO., INC	64	FRANROE PRECISION MACHINE COMPANY	72
ESSENTIAL MACHINING	64	FREEMAN COMPANY, THE	73
ESTA PRODUCTS COMPANY	64	FRIEDR BOESNER GMBH	73
EVERLOCK FASTENING SYSTEMS EVERLOCK DETROIT DIVISION	64	FRISBY AEROSPACE INC DE DIV TRIUMPH ACTUATION SYSTEMS -CLEMMONS	73
GREER STOP NUT (Greer-Smyrna Division)	65	FRONTIER BOLT COMPANY OF TEXAS	73
INTERNATIONAL SCREW DIVISION	65	FUCHS SCHRAUBENWERK GmbH	73
EXCEL PRECISION PRODUCTS, INC.	65		
EXPERIMENTAL MACHINE CO.	65	<b>G</b>	
<b>F</b>		G & R SCEW MACHINE PRODUCTS	74
FABER ENTERPRISES, INC	65	G & S MACHINE INC	74
FABSCO CORP.	66	G. B. MACHINE PRECISION, INC.	74
FAILING CO., GEORGE E	66	G.B. DUPONT CO., INC	74
FALCON MANUFACTURING CORP.	66	GAITHER PATRICIA DBA GAITHER MACHINE	74
FALL RIVER MANUFACTURING CO., INC.	66	GALAN PRECISION MACHINE CO.	74
FANG SHENG SCREW CO., LTD.	66	GALMAC MFG CO	74
FARIAS INDUSTRIAL MACHINING	66	GARCIA INDUSTRIES, INC	74
FARLO MACHINE & TOOL CO., INC	66	GARDINER MFG. CO.	75
FASSCO	67	GATEWAY SCREW AND RIVET, INC.	75
		GEN FAST MANUFACTURING COMPANY	75
		GENERAL AVIATION	75
		GENERAL MACHINE PRODUCTS, INC	75
		GENERAL SCREW AND SPECIALTY CO INC	75
		GERMAN MACHINED PRODUCTS, INC	75
		GERTLER INDUSTRIES, INC	75
		GFD LETAGE	76
		GILL MACHINE TOOL CO	76
		GL CNC SERVICES INC	76
		GMJ MACHINE COMPANY, INC.	76
		GMP CO.CORPORATION	76
		GOSHIO WORKS, LTD.	76





## MIL-HDBK-57D(IS)

Company Name	Page	Company Name	Page
JAYCO ENGINEERING	96	LANA INDUSTRIES	106
JERGENS INC	97	LANARKSHIRE BOLT LTD.	106
DBA JERGENS INDUSTRIAL SUPPLY		LAND-SEA-AIR MACHINED PRODUCTS INC	106
JJ ENGINEERING	97	LANIS MACHINE AND MFG CO	106
JAMES JACKSON		LANUM METAL PRODUCTS LLC	106
JJ SCREW PRODUCTS, INC.	97	LBL PRODUCTS	106
JMT MACHINE COMPANY	97	LEBRECHT TIGGES GmbH & CO. KG	106
JOLICO/J-B TOOL INC.	97	LELAND-POWELL FASTENERS, INC.	107
JOSLYN CORP.	97	LENCH, THOMAS WILLIAM, LTD	107
JUPITER WASHERS, INC.	97	LENTERN AIRCRAFT LTD.	107
JUST IN TIME INC	98	LEONARD JED CO	107 - 108
DBA APSCO		MARYLAND BOLT AND NUT CO DIV	
<b>K</b>			
K & K PRECISION ENTERPRISES INC	98	LEVEL 1 FASTENERS	108
K.A.A. COMPANY	98	LEVINGSTON MACHINE COMPANY	109
LYNN ABADIE DBA K A A COMPANY		LEWIS SCREW CO	109
K.D.K. UPSET FORGING CO. INC.	98	DIV OF MEDALIST FASTENERS INC	
KAMAX - WERKE RUDOLF KELLERMANN GMBH	98	LFC INDUSTRIES	109
KAMAX L. P.	98	DIVISION RKR TECHNOLOGIES	
FORMERLY G.B. DUPONT CO., INC.		LINREAD NORTHBRIDGE	109
KAMPWERK VIEREGGE U. PICKARDT GMBH. & CO	98	LEICESTER, UK	
KAPCO INDUSTRIES, INC	99	LINREAD NORTHBRIDGE AIRCRAFT PRODUCT DIVISION	109
KATSURAGAWA MACHINE SCREW CO., LTD.	99	LINREAD PUBLIC LIMITED CO.	110
KAYGOR, INC.	99	AIRCRAFT PRODUCTS DIVISION	
KAYNAR PRODUCTS	99	LIPPISCHE EISENINDUSTRIE GmbH	111
KELLER ENGINEERING CO	99	LSI AEROSPACE	111 - 112
KELOX/MICRODOT PRODUCTS	99	A1 TECHNOLOGIES	
KEN FORGING, INC.	100	BLANC AERO INDUSTRIES	
KERR CHARLES W	100	BLANC AERO INDUSTRIES RUGBY	
KERR LAKESIDE INC.	100	BLANC AERO SAINT CHAMOND GRANAT	
KEYSTONE BOLT & NUT COMPANY	100	BLANC AERO TECHNOLOGIES	
KEYSTONE THREADED PRODUCTS DIVISION		DECOLLETAGE GENERAL MODERNE	
KEYSTONE TOOL AND MACHINE CO	100	FT BESTAS	
KILBOURN ENGINEERING CO.	100	HI-SHEAR CORPORATION	
KIRSTEN PIPE CO. INC.	101	LSI AEROSPACE CANADA	
KLINCHER LOCKNUT CORP.	101	MONADNOCK COMPANY THE	
KNIPPING-DORN GmbH KALTUMFORMTECHNIK	101	LITTLE WORLD MFG INC	113
KNOCH MANUFACTURING CO. LTD	101	LLOYD MACHINE & TOOL CO., INC.	113
KO AMS MACHINE PRODUCTS	101	LN AEROSPACE, INC	113
DBA KOAM MACHINE		LOBO OFFICINE MECCANICHE SPA	113
KOBE FASTENER LIMITED	101	LOBO SYSTEMS LTD	113
KOLB GMBH & CO. HERSTELLER VON	101	LONE STAR FASTENERS, LP	113
VERBINDUNGSELEMENTEN		FORMALLY LONE STAR SCREW CO OF TEXAS INC	
KONDOR TECHNOLOGIES, INC.	102	LONG-LOK FASTENERS CORP.	113
KONGO BYORA CO., LTD.	102	LOOS & CO., INC.	114
KOREA BOLT IND., CO., LTD.	102	AEROSPACE FASTENERS DIVISION	
FOREIGN TRADE DEPARTMENT		LORD CORPORATION	114
KORODY-COLYER CORP A CR INDUSTRIES CO	102	AEROSPACE PRODUCTS DIVISION	
KOZAK, E. PERCISION PRODUCTS CO	102	(PLANT) DBA MECHANICAL PRODUCTS DIVISION	
KPF	102	LOUGHLIN MANUFACTURING CORP	114
KREIS TOOL & MANUFACTURING CO INC	102	<b>M</b>	
KROBACH MANUFACTURING CORP.	103	M & M MANUFACTURING CORPORATION	114
KSS SOCKET SCREW, INC	103	M.A.A. CORP.	114
K-TECH MFG., INC.	103	MID AMERICA AEROSPACE DIVISION	
KYOEI SEISAKUSHO CO., LTD.	103	M.L.W. MANUFACTURING CO.	114
KYOKUTO MFG CO LTD	103	M.S. AEROSPACE	114
<b>L</b>			
L & C MFG CO INC	103	MAC FASTENERS, INC.	115
L & H THREADED RODS	104	MACHINE SHOP, INC., THE	115
DIV OF GRAY AMERICA CORP		MACHINERITE CORP.	115
L & J FASTENERS, INC.	104	MACK A W MFG COMPANY INC	115
L & M ENTERPRISES INC	104	MACKO INDUSTRIES	115
L A MARTIN COMPANY	104	MACKSON MFG CORP	115
L G MACHINE AND MFG INC	104	MACLEAN-ESNA	116
L H INDUSTRIES, INC.	104	MACLEAN-FOGG CO.	
TIP TOP TOOL CO.		MACLEAN-FOGG CO.	116
LN AEROSPACE, INC.	104	MACOR, INC.	117
L P R PRECISION PARTS AND TOOL CO INC	104	MAGNUM MACHINE SHOP	117
LR G CORPORATION	104	MAGNUS TOOL & DIE CO., INC.	117
LAKE ERIE PRODUCTS, INC.	105	MAILLY MFG CO., INC.	117
LAMSON AND SESSIONS OF CANADA LTD.	105	MAIN MACHINE CO INC	117
RB & W CORP. METAL FORMING DIVISION		DBA MAIN MACHINE & TOOL CO	
		MANNING RICHARD & CO., INC.	117
		MANUFACTURING ENGINEERING TECH.	117
		MANUFACTURING SALES AND SERVICE	117
		MANUFACTURING TECHNOLOGY SERVICES	118
		MAPECO PRODUCTS, INC.	118

## MIL-HDBK-57D(IS)

Company Name	Page	Company Name	Page
MAR-BRO MFG., INC.	118	MORTON MANUFACTURING	129
MARTIN-CHANDLER, INC.	118	DIVISION MORTON GRINDING	
MARYKO NUT CO., LTD.	118	MOSTAR GEAR & MACHINE MFG., CO.	129
MARVIN ENGINEERING, CO., INC.	118	MOTOR WHEEL CORP.	130
MARYLAND BOLT & NUT CO., INC.	119 - 120	MRL MANUFACTURING CORP.	130
LEONARD JED CO			
MASTER RESEARCH & MFG., INC.	120	<b>N</b>	
MASTERCRAFT TOOL COMPANY	120	N.S.S. INDUSTRIES	130
MAUDLE INDUSTRIAL CO., LTD.	120	NAFCO INDUSTRIES, INC.	130
MAUI MEGA	120	NAGOYA SCREW MANUFACTURING CO. LTD	130
DBA KERR, CHARLES W		NAPIER AUTO BODY	130
MCADAMS MACHINE AND TOOL CO INC	120	NARRAGANSETT SCREW MFG CO	131
MCCULLOUGH AERO CO	121	NASSAN TOOL WORKS, INC.	131
DBA MCCULLOUGH & ASSOCIATES		NASU DENKI-TEKKO CO., LTD.	131
MCLANE MFG INC	121	NATIONAL BOLTS AND RIVETS LTD	131
McMELLON BROS INC.	121	NATIONAL FASTENER CO., LTD.	131
MD3 INDUSTRIES LTD	121	NATIONAL THREADED FASTENERS CORP.	131
DBA EMPIRE PRECISION MACHINING		NAVPAR, INC.	131
MEACO PRODUCTS CORP.	121	NC AUTOMATED INDUSTRIES INC	132
MEC WOLF SRL	121	NCMI BRUEGGEMANN INC	132
MECAERO PRODUCTS	122	ND INDUSTRIES INC	132
MECAERO CANADA INC.	122	DBA ND WESTERN FASTENER PROCESSING DIVISION	
MECAIR AEROSPACE INDUSTRIES	122	NEDSCHROEF HALMOND B.V.	132
SUBSIDIARY OF SPS TECHNOLOGIES DIV		NEKG HOLDINGS	132
DBA MECAIR INC		NELSON AEROSPACE INC.	132
MECHANICAL AND INDUSTRIAL FASTENERS	122	NELSON STUD WELDING DIVISION	133
MECHANICAL INDUSTRIES LLC	122	NEUMAYER, ERICH GMBH & CO.KG	133
MEL-BA MANUFACTURING INC	122	NEVADA BOLT AND MFG CO INC	133
MERCER PRODUCTS & MFG. CO., INC.	123	DBA SPS NON-FERROUS ENGINEERED FASTENERS	
MERCURY AEROSPACE FASTENERS INC	123	NEVILLE MACHINE SHOP	133
LISI AEROSPACE		NEW HORIZON MACHINE CO., INC.	133
MERCURY TOOL & MACHINE, INC.	123	NICE TOOL MFG., INC.	133
METALCRAFTERS	123	NIPPON MACHINE ENGINEERING, INC.	134
DIVISION OF KEYSTONE CONSOLIDATED INDUSTRIES		NIPPON STEEL BOLTEN CO., LTD.	134
METAL-TECH MFG. INC.	123	NISCO, INC.	134
METHODS AND MACHINING SERVICES INC.	123	NISSAN SCREW CO. LTD.	134
METRO TOOL AND MANUFACTURING CO.	124	SALES DEPT., FOREIGN TRADE SECTION	
ALEXANDER MANUFACTURING COMPANY INC		NOCHIA STEELWORKS	134
METRIX MFG. CO.	124	NON-FERROUS BOLT & MANUFACTURNG CO.	134
MI. ME. AF. S.r.l.	124	NORTHBRIDGE FASTENERS	135
MICRO SCREW MACHINE PRODUCTS, INC.	124	NORTHEAST FASTENERS	135
MICRODOT INC.	124	NORTHEAST METAL CO., INC.	135
MICRODOT AEROSPACE FASTENING SYSTEMS GROUP		NORTHERN SCREW CO., INC.	135
ADVANCED PRODUCTS DIV		NORTHSTAR ENGINEERING	135
MICRODOT INSERTS DIVISION		NOVA MACHINE PRODUCTS, INC.	136
KAYNAR MFG. DIVISION		A SUBSIDIARY OF CURTIS-WRIGHT FLOW CONTROL SERVICE CORP.)	
MID CONTINENT SCREW PRODUCTS CO.	125	NT ENGINEERING INC	136
MID-STATES SCREW CORP.	125	NUCOR FASTENER DIVISION (DIVISION OF NUCOR CORPORATION)	136
ILLINOIS CORPORATION		NUMERIC MACHINE PRODUCTS	136
MIDWEST ACORN NUT CO.	125	NUTS INCORPORATED	136
MILE-HI MACHINE, INC.	125	DIVISION OF STANLOK	
MILLIPART, INC.	125	NUTS, INC.	136
MILLS, J. R. MACHINING, INC	125	NYLOK CORP.	137
MIL-SPEC FASTENERS CORP.	125		
MINEBEA CO LTD	126	<b>O</b>	
FUJISAWA MANUFACTURING UNIT		OAKTREE FASTENERS CO.	137
MIROFINE COMPANY	126	OBARS MACHINE & TOOL CO.	137
MI-TECH, INC.	126	OCM MACHINE COMPANY, INC.	137
MITSUBOSHI INDUSTRIES, LTD.	126	OHIO NUT & BOLT CO., THE	137
OSAKA DIVISION		DIV. OF FASTENERS INDUSTRIES, INC.	
MIX TOOL CO.	126	OHKAWA SCREW MFG. CO., LTD	138
MKM MACHINE TOOL CO INC	127	OKABE CO., INC.	138
M-MANUFACTURING	127	OKABE KIKO CO., LTD.	138
MMG ENGINEERED COMPONENTS INC	127	OKAI IRON WORKS, INC	138
DBA TOOLSOURCE		OKAWA SCREW MANUFACTURING CO., LTD	138
MNP CORPORATION	128	OMEGA THREAD ROLLING AND GRINDING INC.	138
DBA MNP CORPORATION DIVISION 2		ONEIDA TOOL & MACHINE CORP.	138
DBA MNP CORPORATION DIVISION 4		ONO MANUFACTURER, INC.	139
DBA MNP FASTENER DIVISION		ONO MANUFACTURING CO., LTD	
MODERN METRIC MACHINE COMPANY INC	128	ONTIC ENGINEERING & MANUFACTURING, INC.	139
MODFORM-ILLINOIS INC	128	ORANGE PRECISION PARTS	139
MONADNOCK COMPANY THE	128	ORC-O TOOL & MACHINE, INC.	139
DBA LISI AEROSPACE			
MONOGRAM AEROSPACE FASTENERS	129		
MONROE MACHINED PRODUCTS INC	129		
MONTEREY MACHINE PRODUCTS	129		
MORTON FASTENERS INC.	129		

## MIL-HDBK-57D(IS)

Company Name	Page	Company Name	Page
ORDNANCE PARTS & ENGINEERING CO.	139	PRO-MACHINE & TOOL COMPANY	149
ORLOTRONICS CORP.	139	PROMPTUS ELECTRONIC HARDWARE	149
OSAKA SEIKI CO., LTD.	139	PROTO MACHINE CO., INC.	149
OSTEEN MACHINE SHOP	140	PTM INTERNATIONAL INC	149
OTO MELARA S.p.A.	140	PURITAS METAL PRODUCTS, INC.	149
FINKECCANICA COMPANY		PYE & HOGAN LLC	149
OTT BROTHERS MACHINE CO., INC.	140		
OWARI PRECISE PRODUCTS CO., LTD	140	<b>Q</b>	
<b>P</b>		QRP, INC.	149
P & I ASSOCIATES, INC.	140	QSN MANUFACTURING, INC.	150
P & L ENTERPRISES	140	QUALITY AIRCRAFT SCREWS, INC	150
P.C.M., INC.	140	QUALITY FABRICATIONS, INC.	150
P.S. MACHINE CO., INC.	141	QUALITY MACHINE & MFG INC	150
PABCOR, INC.	141	QUALITY SCREW PRODUCTS, INC.	150
PACER ALLOYS, INC.	141	QUALITY SOCKET SCREW MANUFACTURING CORP.	150
PACIFIC FASTENERS, INC.	141	QUALITY THREADED PRODUCTS COMPANY	150
PACIFIC SCIENTIFIC	141		
PACIFIC TOOL, INC.	141	<b>R</b>	
PADGETT MACHINE INC.	141	R & D FASTENERS	151
PAINTER TOOL, INC.	141	R & D WELDING & MACHINE INC.	151
PALNUT CO., THE	142	R & R PRECISION	151
UNITED CARR FASTENERS PALNUT DIV		R B & W CORPORATION	151-152
PARK PRECISION CORPORATION	142	R. BILD COMPANY, INC	152
PATEREX, LTD	142	R.E.C. CORP.	152
PATTERSON LAKE PRODUCTS SUBSIDIARY OF COLUMBIA AUTO PARTS	142	RABOURDIN	152
PAULIN H AND CO LTD	142	RADAX INDUSTRIES, INC.	152
PB FASTENERS DIVISION OF PAUL R. BRILES, INC.	142	RAE MANUFACTURING CO.	153
PEERLESS SCREW PRODUCTS CORP.	142	RAHMEDE SCHRAUBENFABRIK	153
PEINER UMFORMTECHNIK GmbH	143	RAINBOW MACHINE PRODUCTS, INC.	153
PELHAM AUTO MATRIX PRECISION	143	RAM ENTERPRISES	153
PENN CIGAR MACHINES INC PEM INC	143	RAM PRODUCTS	153
PENNENGINEERING AUTOMOTIVE FASTENERS	143	RAM THREADING, INC.	153
PENN ENGINEERING & MANUFACTURING CORP. ATLAS ENGINEERING INC.	143	RAMAR NUTS, INC.	153
PENN SCREW & MACHINE WORKS, INC.	144	RAMCO SPECIALTIES, INC.	154
PEREZ MACHINE, INC.	144	RAMM DEFENSE PRODUCTS	154
PERIGEE MANUFACTURING COMPANY, INC. MICHIGAN CORPORATION	144	RATHMANN WALTER G. SEGMENT-KLAMMERSCHRAUBEN GMBH	154
PERKINS MACHINE CO.	144	RA-WHITE, INC	154
PHOENIX SPECIALTY MANUFACTURING CO., INC.	144	RB & W CORP.	154
PILGRIM SCREW CORPORATION	144	RED INSTRUMENT CO	155
PINE TAVERN MACHINE INC.	145	REGAL AIR, INC	155
PINEY RIDGE CO.	145	REID PRODUCTS INC.	155
PINTO PRODUCTS	145	RELIANT FASTENER	155
PIONEER MACHINE PRODUCTS, INC.	145	REPUBLIC FASTENER MANUFACTURING CORP.	155
PIONEER SCREW & NUT CO.	145	REXNORD	155
PLAINVILLE MANUFACTURING CO., INC.	145	SPECIALTY FASTENERS DIVISION	
PNEU-HYDRO PRODUCTS, INC.	145	RICHARD MFG. CO., INC.	155
POINT MACHINE COMPANY	145	RING SCREW WORKS	156
PORTLAND BOLT & MANUFACTURING CO INC	146	RING SCREW DIVISION	
PORTSMOUTH NAVAL SHIPYARD	146	FENTON HEADING DIV.	
POWERPARTS, INC.	146	FRENDALE FASTENER	
PRD FASTENERS LTD	146	SEMCO FASTENER DIV	
PRECI-MANUFACTURING, INC.	146	TITAN FASTENER	
PRECISE AERO PRODUCTS	146	RIPPA PRODUCTS	156
PRECISE OF CALIFORNIA DIV OF ADJUSTABLE BUSHING CORP	147	RISCO, INCORPORATED	156
PRECISION AIRCRAFT MACHINING CO., INC. DBA PAMCO	147	RIVER VALLEY TOOL & MANUFACTURING	156
PRECISION METAL PRODUCTS CO.	147	RIVNUT ENGINEERED PRODUCTS, INC.	157
PRECISION PARTS & TOOL CO., INC.	147	RMS	157
PRECISION PIECE PARTS, INC	147	ROBBINS MANUFACTURING CO., INC.	157
PRECISION SCREW & BOLT, INC.	147	ROBERT HENRY CO., INC.	157
PRECISION TECHNOLOGIES, INC.	147	ROCKFORD BOLT & STEEL CO. SUBSIDIARY OF VARLEN CORPORATION	157
PRECISIONMATICS CO., INC	148	ROCKFORD FASTENERS INC.	157
PREM INDUSTRIES, INC.	148	ROCKFORD PRODUCTS CORP.	158
PRICE MANUFACTURING CO.	148	ROGG MANUFACTURING COMPANY	158
PRIETO MACHINE COMPANY, INC	148	ROMAC ELECTRONICS, INC.	158
PRODUCT DEVELOPMENT GROUP, INC.	148	RONSON MANUFACTURING, INC.	158
PRODUCTION & TOOL COMPANY	148	ROSAN PRODUCTS	158
PRODUCTS DESIGN & MFG. CORP.	149	ROTAIR INDUSTRIES, INC.	159
		RS MANUFACTURING, INC.	159
		RUDOLPH INSTRUMENTS, INC.	159
		RUMCO, INC.	159
		RUSCOMB TOOL & MACHNE CO., INC.	159

## MIL-HDBK-57D(IS)

Company Name	Page	Company Name	Page
<b>S</b>			
S & L METAL PRODUCTS CORP	159	SPS TECHNOLOGIES (continued)	169 - 170
S. B. E. (ITALY CORPORATION)	160	METALAC SPS INDUSTRIA	
S.A.B.A. S.p.A. BULLONERIA E AFFINI	160	UNBRACO PTY LTD. AUSTRALIA	
S.I. STUD, INC.	160	SPURWAY COOKE INDUSTRIES PTE LTD	170
SABRE MANUFACTURING, INC.	160	SRI SAI INDUSTRIES CORPORATION	170
SAFETY SOCKET SCREW CORP.	160	ST. LOUIS SCREW & BOLT CO.	170
SAGA TEKKOSHO CO., LTD	161	STALKER & DYSTHE, INC.	170
SAI INDUSTRIES	161	STANDARD LOCKNUT, INC.	171
SALES SYSTEM, LIMITED	161	STANDARD NUT & BOLT, INC.	171
SAMUEL MARSDEN & SON	161	STANDARD TOOL & MACHINE CO.	171
SANDIK MANUFACTURING, INC.	161	SEE HALL INDUSTRIES INC.	
SANNOHASHI SEISAKUSHO CO., LTD.	161	STEADFAST CORPORATION	171
SANTA ANA GEAR & MACHINE	161	STEEL CITY BOLT & SCREW, INC.	171
SANTA ANA SCREW PRODUCTS INC	161	STEEL PRODUCTS OF MASSILLION	171
SATAIR MANUFACTURING FACILITY	162	STEEL WAREHOUSE COMPANY, INC.	171
SATURN FASTENERS, INC.	162	STELCO FASTENER & FORGING CO.	172
SCANDIA MFG. CO., INC.	162	STELFAST FASTENERS, INC.	172
SCHMICO GMBH SCHWEISSTECHNIK	162	DIVISION OF STELFAST FASTENERS, LTD.	
SCHRAUBENFABRIK GUSTAV STERNBERG GmbH & CO. KG	162	STERLING MACHINE COMPANY	173
SCHUHL & CO. GMBH	162	STERLING MARKING PRODUCTS IC	173
SCOTT CRAFT CO.	162	STERLING MFG. & SUPPLY, INC.	173
SCREWCORP.	163	STEVENS MFG. CO., INC.	173
A DIVISION OF VSI		STILLWATER FASTENERS, INC.	173
SEMBLEX CORP	163	STREKERT MACHINE SHOP INC.	173
SEMCO	163	STURM MACHINE CO., INC.	174
RING SCREW WORKS		SUBCON TOOL / ACCUTOOL MACHINE GROUP INC.	174
SENG HENG ENGINEERING PTE LTD.	163	DBA ACCUTOOL	
SESCO INDUSTRIES, INC.	163	SUBURBAN INDUSTRIES, INC.	174
SHACKELFORD MACHING, INC.	163	SULLIVAN BOLT CO., INC.	174
SHAMROCK FASTENER TECHNOLOGIES, LLC	163	SUNDRAM FASTENERS, LTD.	174
SHAW PRECISION GRINDING & THREAD ROLLING	164	SUNRISE PRECISION MFG.	174
ACE GRINDING & MANUFACTURING CO. OF TEXAS INC		SUPERIOR TECHNOLOGY	174
SHEFFIELD, INC.	164	SUPREME SCREW PRODUCTS, INC.	174
SHIGA BOLT CO., LTD	164	SV INDUSTRIES	175
SHORELINE PRODUCTS, INC.	164	SWISS TECHNOLOGY, INC.	175
SHUR-KUT SUPPLY CORPORATION	164	<b>T</b>	
SHUR-LOK COMPANY.	164	T & E MACHINE CORP	175
SPS FASTENERS DIVISION, A PCC COMPANY		T C QUALITY MACHINING INC	175
SIERRA PACIFIC SUPPLY CO., INC.	165	T R MACHINE INC	175
SIERRACIN/HARRISON	165	TAIYO NUT MFG. CO., LTD.	175
SIMMONDS PRODUCTS	165	TAKENAKA SEISAKUSHO CO., LTD.	176
SINN-TECH, INC.	165	TANAKA LTD.	176
SKY MANUFACTURING.	165	T-B & S MFG	176
SKYLINE INDUSTRIES	165	TBECO THREADED FASTENERS	176
SKYSPARES PARTS, INC.	165	DIVISION OF TENNESSEE BOLT & SCREW CO.	
SLABE MACHINE PRODUCTS	166	TECH WELDING AND MACHINE CO.	176
SMITH MACHINE & MANUFACTURING	166	TECHNICAL FASTENERS, INC.	176
SMITH WELDING, INC.	166	TEK PRECISION CO., LTD	176
SONFARREL, INC.	166	TELEFAST INDUSTRIES, INC.	177
SONIC INDUSTRIES, INC.	166	TENS MACHINE COMPANY, INC.	177
SOUTH BAY BOLT MANUFACTURING CO.	166	TERRY MACHINE CO.	177
SOUTHERN FASTENER CORPORATION	167	See SPS TECHNOLOGY	
SOUTHERN FASTENING SYSTEMS	167	TERRYCABLE, INC.	177
DIVISION OF FARLEY METALS, INC.		TEXAS BOLT CO.	177
SOUTHWEST ALLIED PRODUCTS CO., INC.	167	TEXAS PRECISION MFG., INC.	177
SOUTHWEST INDUSTRIAL SERVICES	167	TEXTRON FASTENING SYSTEMS	178
SOUTHWIND INDUSTRIES, INC.	167	AEROSPACE - SANTA ANA OPERATIONS	
SPACE AGE ENGINEERING, INC.	167	TFI AEROSPACE CORPORATION	178
SPACE SCREW, INC.	167	TFP CORP	178
SPACE-LOK, INC.	168	TRU-FIT PRODUCTS DIVISION	
SPARTAN PRECISION MACHINE	168	SPECIAL FASTENER DIVISION	
SPECIALS, INC.	168	THIANT (BOULONNERIE DE SA)	179
SPECIAL-T-METALS	168	THOMAS & BETTS CORPORATION	179
SPECIALTY SCREW CORP.	168	FORMERLY AMERICAN ELECTRIC	
SPIRAL TOOL CORP.	168	THOMAS INSTRUMENT & MACHINE CO., INC.	179
SPS TECHNOLOGIES	169 - 170	THOMAS MACHINING TECHNOLOGIES, INC.	179
AFG DIV		THOMAS MFG, INC.	180
AEROSPACE PRODUCTS		TITAN FASTENER	180
SANTA ANA DIVISION		TOG MANUFACTURING CO., INC.	180
SPS INC.		TOKOSHA METAL WORKS LTD.	180
T. J. BROOKS DIVISION		TOOLEX, INC	180
TERRY MACHINE		TOPURA CO., LTD.	180
UNITED KINGDOM CORPORATION		TORCO, INC.	181























## MIL-HDBK-57D(IS)



















Company Name	Page	Company Name	Page
TORONTO FASTENERS INDUSTRIES, INC. SUBSIDIARY OF HI-SHEAR CORP., USA	181	VULCAN RIVET & BOLT CORP.	191
TORX PRODUCTS CAMCAR DIV/TEXTRON INC.	181	<b>W</b>	
TOWNE ROBINSON FASTENER CO. KEY MANUFACTURING GROUP, INC.	181	WALKER BOLT MANUFACTURING DIVISION OF LONE STAR FASTENERS, LP	191
TOWNSEND CO. CERRY RIVET DIVISION	181	WALZ & KRENZER INC DBA MAPECO PRODUCTS DIV MAPECO PRODUCTS	192
TOYO STEEL WIRE CO., LTD.	181	WARREN PUMPS LLC DIVISION OF COLFAX CORPORATION	192
TRI STATE TOOL & DIE CO., INC.	182	WATERBURY BUCKLE CO.	192
TRIAD PRODUCTS CORP.	182	WAYNE BOLT & NUT CO., INC.	192
TRIDAIR PRODUCTS	182	WEAVER MANUFACTURING, INC.	192
TRIDENT MACHINE CO.	182	WEBLUK MACHINE CORP.	192
TRIUMPH GROUP OPERATIONS INC, THE FRISBY AEROSPACE INC DE	182	WELTER GMBH & CO. KG	192
TRIUMPH MANUFACTURING CO., INC.	182	WELTON ROLLED THREAD CORP.	192
TRONSON MANUFACTURING	182	WESLOK	193
TROY D. RAY DBA DIXON MACHINE & FABRICATION	182	DIVISION OF FALL RIVER MANUFACTURING	
TRW FASTENER DIVISION	183	WEST COAST AEROSPACE, INC.	193
TRY - AZTEC COMPANY	183	WEST TENNESSEE LIONS BLIND INDUSTRIES INC DBA A P MILLS INDUSTRIES FOR THE BLIND	193
TUFF FASTENERS CO.	183	WESTERN PACIFIC ENTERPRISES, W.P.E., INC.	193
TURNAMICS, INC.	183	WESTERN SCREW MACHINE PRODUCTS, INC CUTTING EDGE MACHINING	193
TW DESIGN AND MANUFACTURING, L.L.C.	183	WESTERN SKY INDUSTRIES, INC. DIVISION OF ATLAS CORP.	193
TWIST TITE MFG. INC.	183	WESTFIELD FASTENERS	194
<b>U</b>		WESTLAND STEEL PRODUCTS, LTD.	194
U.P. MACHINE & ENGINEERING CO.	184	WESTWOOD PRECISION, INC.	194
U.S. BOLT MANUFACTURING, INC.	184	WHAIL BOLT IND. CO., LTD	194
ULTIMATE MACHINING & WELDING	184	WHELAN MACHINE & TOOL CO	194
ULTRA SONIC MACHINE CO., INC	184	WHITNEY SCREW CORP.	194
UMPCO CORP.	184	WHITTET-HIGGINS CO.	194
UNIFLOW CORP.	184	WIGLEY MACHINE COMPANY	194
UNIMETERIC CORPORATION	185	WILHELM SCHUMACHER SCHRAUBEN-FABRIK GmbH	195
UNISTRUT CORP. (UNISTRUT PHILA)	185	WILLIAM'S MACHINE & FABRICATION, INC.	195
UNITED BOLT & SCREW CORP.	185	WIL-NIC	195
UNITED DRILL BUSHING CORP	185	E D R INDUSTRIES INC DBA WIL-NICO	
UNITED PRECISION PRODUCTS CO., INC.	185	WILSON-GARNER CO.	195
UNITED STATES DEFENSE RESEARCH & SUPPLY	185	WILT PRECISION PRODUCTS	195
UNITED STEEL & FASTENERS INC.	186	WINKER HERMANN GMBH & CO KG METALLWARENFABRIK	195
UNIVERSAL MACHINE PRODUCTS	186	WINSLOW AUTOMATICS, INC	196
UPB ENGINEERING	186	WODIN, INC.	196
URANIA ENGINEERING CO., INC. SPEC-NUT	186	WOLSTENHOLME MACHINE DBA WM ROBOTS	196
URBAN MANUFACTURING CO.	186	WOLTERS GMBH	196
URBAN MFG. CO. INC.	186	WOLVERINE MACHINE PRODUCTS CO.	196
US TOOL & DIE	187	WOLVERINE NUT CO.	197
UTAH TOOL & DIE, INC.	187	WORTHY MACHINE	197
<b>V</b>		WROUGHT WASHER MANUFACTURING INC	197
VALCOR ENGINEERING CORP.	187	WYANDOTTE INDUSTRIES, INC.	197
VALLEY FORGE AND BOLT MFG CO	187	WYNNSON ENTERPRISES, INC.	197
VALLEY-TODECO, INC.	187	<b>X</b>	
VAN PETTY MFG., INC. DBA J.W. MANUFACTURING INC	187	XCEL MFG., INC	197
V-B MACHINE CO., INC. FASTENER DIVISION	187	<b>Y</b>	
VEGAS FASTENER MANUFACTURING	187	Y2K MACHINE SHOP, INC.	197
VENUS FASTENERS CORP.	188	YATES TOOL, INC.	198
VERSATECH, INC.	188	YOUNG ENGINEERS INC, THE	198
VERTEX DISTRIBUTION	188	YOW MENG INDUSTRIAL CO., LTD.	198
VICO PRODUCTS, CO.	188	<b>Z</b>	
VICTOR PRODUCTS CORP.	188	Z & B GENERAL MACHINE	198
VIP MFG. & ENGR. CORP.	188	ZAMON CO., INC.	198
VISSERIES & BOULONNERIES DE FOURMIES	188	ZENEX CORPORATION	198
VISTEK INDUSTRIES	189	ZERO PRODUCTS, INC.	198
VITCO NUCLEAR PRODUCTS INC.	189		
VM MANUFACTURING CORPORATION	189		
VMC INDUSTRIES, INC.	189 - 190		
VOI-SHAN PRODUCTS	191		
VOSS INDUSTRIES, INC. VOSS AEROSPACE DIVISION	191		
VSI (AEROSPACE PRODUCTS DIVISION)	191		

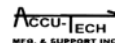

## MIL-HDBK-57D(IS)

## INDEX B - SYMBOL

SYMBOL	COMPANY NAME	PAGE
<b>A</b>		
A-1	A-1 NUT AND BOLT CO, INC	2
A-1	A-1 THREAD ROLLING CO., INC	2
	ALCO MACHINE CO.	11
A325	COAE BOLTS WORKS CO., LTD.	49
A+	ACCURATE TOOL CO., INC	4
A	AAP ACQUISITION CORP	2
A	ACCURATE PRECISION FASTENERS, INC.	3
A	ACHILLES AEROSPACE PRODUCTS, INC.	4
	ACME MACHINE PRODUCT	5
   	ACME SCREW COMPANY	5
 	ADAMS, EARL M. CO.	6
A	ADVANCED CNC MANUFACTURING	6
a	ADVANCED MACHINING & FABRICATING, INC.	6
a	ADVANCED PLASTICS, INC.	6
	AEROFAST SUPPLY	8
A	AEROSPACE PRODUCTS, INC.	9
 A	AEROSTAR FASTENER CORP.	9
A*	AEROWIND CORPORATION	9
 	AFI INDUSTRIES, INC.	10
	AIR INDUSTRIES CORPORATION	10
	AIRCRAFT FUELSEAL FASTENERS, INC.	10
	ALLIED NUT & BOLT CO., INC.	12
	ALPHA MACHINING PRODUCTS & DEVELOPMENT	13
A	ALPS SEIKO CO.	14
	AMANDA BENT BOLT CO.	14
	AMERICAN ELECTRIC and THOMAS & BETTS CORPORATION	14, 179
	AMERICAN INTERNATIONAL AERO MFG INC	15
	ANDERSON FORGE & MACHINE	16
	A-ONE MACHINE COMPANY	16
A	ARNOLD UMFORMTECHNIK GMBH & CO. KG	18

SYMBOL	COMPANY NAME	PAGE
	ARROW SCREW & MACHINE WORKS	19
A	ASAI TEKKO CO. LTD	19
	ASSOCIATED TOOL CO., INC	19
A	BELL FASTENERS	27
A	CAMCAR DIVISION OF TEXTRON INC.	39
	EATON AEROQUIP CORPORATION	59
	GARCIA INDUSTRIES, INC.	74
A	MECAERO ALCOA FASTENING SYSTEMS TOUL SE	122
A	PORTSMOUTH NAVAL SHIPYARD	146
AAP	AVIBANK MFG., INC.	22
AB	ABSCOA INDUSTRIES	3
AB  	ADJUSTABLE BUSHING CORP	6
AB  	AVIBANK MFG., INC.	22
	LENCH, THOMAS WILLIAM, LTD.	107
	PRECISE OF CALIFORNIA	147
ABC	ALPHA BOLT CO.	13
ABE	ADAMS INDUSTRIES, INC.	5
ABM	AEROBOLT MANUFACTURING, INC	7
 	AUTO BOLT AND NUT CO.	20
	ACE PRECISION INDUSTRIES, INC.	4
ACI	ACI	5
 	ACIMET MFG.	5
	ACCU-TECH MANUFACTURING AND SUPPORT, INC	4
AD	ADOM ENGINEERING	6
AD	AUTOMATIC SCREW MACHINE PRODUCTS CO.	21
ADB	AVIBANK MFG., INC.	22
ADBB	AVIBANK MFG., INC.	22
adm	ADOM ENGINEERING	6
	AERO DYNAMIC MACHINING, INC	7
ADP	AVIBANK MFG., INC.	22
adc 	ADC COMMUNICATIONS CORP	6
AE	A & E MACHINED PRODUCTS	1
	AASTRO ENGINEERING	2

## MIL-HDBK-57D(IS)

SYMBOL	COMPANY NAME	PAGE
	AERO ENGINEERING AND MANUFACTURING CO. OF CALIFORNIA	7
	ATLAS ENGINEERING, INC. and PENN ENGINEERING & MANUFACTURING CO.	20, 143
	AIRCRAFT ENGINEERING PRODUCTS, INC.	10
	AERO BUSHING AND COMPONENT	7
	ACCUFORM, INC.	3
	ACCURATE THREADED FASTENERS, INC	3
AF	ACUFAST AIRCRAFT PRODUCTS	5
	AEROTECH FASTENERS, INC	9
	ALLFAST FASTENING SYSTEMS, INC.	12
	ALPHA FASTENERS	13
	ATF, INC.	20
	AUGUST FRIEDBERG GMBH	20
	AFAB PRECISION MACHINING	9
	AIRFASCO, INC.	11
	AMERICAN FASTENER & SPECIALTY CO.	15
AGC	ACE GRINDING & MFG. OF TEXAS	4
AGM	ACE GRINDING & MFG. OF TEXAS	4
A/I	ARVAN, INC.	19
A-I	AVIBANK MFG., INC.	22
	AIR-COM, INC.	10
AK	ARNOLD KNIPPING GmbH	18
A-K	AVIBANK MFG., INC.	22
A.L.	S.A.B.A. S.p.A. BULLONERIA E. AFFINI	160
	ALPINE MACHINE & TOOL CORP.	14
	A & M AEROSPACE, INC.	1
AM	AEROSPACE MANUFACTURING AMACON CORP.	8
	AMERICAN FASTENER & SPECIALTY CO.	15
	AMMAC, INC.	16
	ARDOR MFG. INC.	17
	AUTOMATIC MANUFACTURING COMPANY	21
AM	AUTOMATED MANUFACTURING	21

















SYMBOL	COMPANY NAME	PAGE
	AUTOMATIC MACHINING AND MFG CO	21
AMATOM	AMATOM ELECTRONIC HARDWARE	14
AMB	AMERICAN METAL BEARING COMPANY	15
AMC	ALBAR MACHINE CORPORATION	11
	SAI INDUSTRIES CORP. EFT 2	161
	ALARD MACHINE PRODUCTS	11
	AERO MECHANICAL FASTENING SYSTEMS	7
AMS	AEROSPACE MARINE SPECIALTY FASTENERS & FITTINGS INC.	8
AMSCO	ACCURATE SCREW MACHINE CO	3
AMT - I AMT xxx x - xxx x	ALPINE MACHINE & TOOL CORP.	14
A-N	AVIBANK MFG., INC.	22
	A & N PRECISION INDUSTRIES	1
	AMERICAN QUALITY INDUSTRIES	15
AOL	ALL MANUFACTURERS INC.	12
AOL	ITT HARPER AEROSPACE FASTENER OPERATIONS	94
AP	ACCURATE AUTOMATIC PARTS CO	3
ap	ADVANCED PLASTICS, INC.	6
AP	AEROSPACE PRODUCTS CO.	8
	AIR PARTS MFG. CO.	10
	AIRDROME PARTS CO.	10
AP	ALL-POWER MFG. CO.	12
AP	ALL-PRO FASTENER & RIVET MFG. CO.	13
AP	ANATASE PRODUCTS	16
AP	APEX MFG. CO. INC.	17
AP	APHEONIX CORPORATION	17
A-P	AVIBANK MFG., INC.	22
AP	PILGRIM SCREW CORP.	144
APCO	AEROSPACE PRODUCTS	8
	APEL LTD.	16
APMI	A. P. MILLS INDUSTRIES FOR THE BLIND and WEST TENNESSEE LIONS BLIND IND. INC.	2, 193
APP	ALLIED PRECISION PRODUCTS, INC.	12
AR	A & R MFG CORP	1















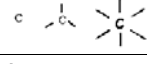
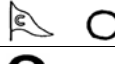

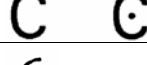
## MIL-HDBK-57D(IS)

SYMBOL	COMPANY NAME	PAGE
	ACME RIVET & MACHINE CORP.	5
ARVAN, INC.	ARVAN, INC.	19
	AEROSTAR ENGINEERING & MANUFACTURING COMPANY	9
	ALL-STATES INC.	13
AS	AVIBANK MFG., INC.	22
<b>B</b>		
	ARCO SALES CO.	17
ASP	ATLAS SPECIALTY PRODUCTS	20
ASP	CURTIS PRESTON ENTERPRISES INC.	51
	ARTISAN SPECIALIST TECH, INC.	19
ATBO ATLAS	ARMSTRONG ATLAS BOLT	18
	AVDEL INTERNATIONAL	21
AV	AVIBANK MFG., INC.	22
AVIBANK	AVIBANK MFG., INC.	22
AVK	AVIBANK MFG., INC.	22
	AVK INDUSTRIES PRODUCTS INC.	22
AVL	AVIBANK MFG., INC.	22
<b>A</b>		
	A & W SCREW MACHINE PRODUCTS, INC.	1
	AIW-ALTON INC.	11
	ARNOLD WRAGG (BOLTS & NUTS) LTD	19
A-W	AVIBANK MFG., INC.	22
AX	AEROMAX INDUSTRIES, INC.	8
<b>B</b>		
	B & E MACHINE SHOP & SHEET METAL FAB., INC.	23
	B & E MANUFACTURING CO., INC.	23
B	BELL FASTENERS	27
	BELL-MEMPHIS, INC.	27
	BERGNER, RICHARD GMBH & CO	28
	BETA ENGINEERING, INC.	28
	BLANC AIRCRAFT FASTENERS, INC.	30
	BOBCAT MANUFACTURING CO.	30
	BOLT FASTENER STUD/TECHNOLOGY	31
B B+	BRISTOL INDUSTRIES	32
B1		



















SYMBOL	COMPANY NAME	PAGE
	BROADSTONE TOOL & DIE, INC.	33
	BUCK EYE FORGE, INC.	34
BALL-LOCK	AVIBANK MFG., INC.	22
	BARRE AEROSPACE PRODUCTS INC.	24
BAF	BLANC AIRCRAFT FASTENERS, INC.	30
BB	B & B SPECIALTIES, INC.	22
	BARNEGAT BAY NSCC, INC. DBA BB NSCC, INC.	24
BB BB	BIG BOLT CORP.	29
	LISI AEROSPACE	112
	BETA CORP.	28
BCC	BBC FASTENERS, INC.	25
BD BDM	SAFETY SOCKET SCREW CORP.	160
BDM	BRUNNER DRILLING & MFG. CO., INC.	33
	BOGNER ENGINEERING CO.	30
	BARCO ENGINEERING COMPANY, INC.	24
BEC	BEC MACHINE PRODUCTS COMPANY	26
BEI	ANOTHER SCREW MACHINE PRODUCT	16
	BOMAR ENGINEERING, INC.	31
BEK	BEK LEVEL 1 FASTENERS and LEVEL 1 FASTENERS	26, 108
	BENACO TOOLING RESEARCH & DEV. CORP.	27
BFG+	B F GOODRICH CO. RIVNUT ENGINEERED FASTENERS, THE	24
BFI	BRIARWOOD FASTENERS, INC.	31
	B G ENGINEERING, INC.	24
	B G M FASTENER CO., INC.	24
BH	BULTEN TRADING AB	35
BI	BEE INDUSTRIES, INC.	26
BI	BRISTOL INDUSTRIES	32
	BRINTCLIFFE TURNER LTD.	32
BIM	BUSAN INDUSTRIAL MACHINERY CO., LTD.	35
BL	BLAND CO., THE	30
BL	BRIGHT LIGHTS USA, INC.	32
BLC	AVIBANK MFG., INC.	22
BLSAVIBANK	AVIBANK MFG., INC.	22
	BEACH MACHINE	25















## MIL-HDBK-57D(IS)

SYMBOL	COMPANY NAME	PAGE
BM	BERRY, JOHN DBA BERRY MANUFACTURING	28
BM	BERRY MANUFACTURING	28
BM	BRUNNER DRILLING & MFG. CO., INC.	33
BM	BRUNNER MANUFACTURING CO. DBA BRUNNER MANUFACTURING DIVISION	33
BM	BRYCO MACHINE, INC.	34
<b>BM</b>	BUSAN INDUSTRIAL MACHINERY CO., LTD.	35
<b>BMC INC.</b>	BRACELENTE MANUFACTURING CO., INC.	31
	BUCKEYE MACHINING, INC.	34
	BRADY MACHINE, INC.	31
	BRANCH MACHINE PARTS, INC.	31
	BOLT & NUT CO.	30
	B & N TOOL CO., INC.	23
	FRIEDR BOESNER GMBH	73
BOT	BEOTOOL CORP.	27
BP	BELL PRECISION, INC.	27
<b>BP</b>	BUFFALO PUMPS, INC.	34
<b>B.P.C.</b>	BEAVER PRODUCTS CORP.	26
	FERRY CAP & SET SCREW CO., THE	70
	BROWN PRODUCTION, INC.	33
	BER-LOW MFG INC.	28
	BUTECH PRESSURE SYSTEMS	35
<b>BR</b>	B & R MACHINE AND TOOL CORP	23
	BRIDEAN MACHINE & TOOL CO., INC.	32
	BURROWERS RESEARCH MACHINING, INC.	35
<b>BT</b>	BEGONIA TOOL COMPANY	26
	BLAINE TOOL CORP.	29
	BAS AEROSPACE LIMITED	25
<b>BUFO</b>	BULTEN TRADING AB	35
<b>B U L A</b>	BULA FORGE INC.	34
	BOLTWORKS, INC.	31
<b>BVB</b>	BRIDGEVIEW MANUFACTURING CO.	32
	ITW BUILDX	94
<b>BY</b>	BEN YUAN ENTERPRISE CO, LTD.	27
	EBERHARD BRUNINGHAUS	59
<b>C</b>		
<b>C&amp;D MACH</b>	C & D MACHINE TOLL, INC.	36

SYMBOL	COMPANY NAME	PAGE
	CAMLOC PRODUCTS	41
<b>C</b>	CARDINAL INDUSTRIAL PRODUCTS	42
	CHAMPION FASTENERS, INC.	44
	CHANCE, A.B. COMPANY	44
	CHIEF MFG.	45
	CINCH MANUFACTURING	46
<b>C</b>	CNC MACHINING INC.	47
	COAE BOLTS WORKS CO., LTD.	47
	COAST INDUSTRIAL SUPPLY CO., INC	47
	CO-OP SCREW MANUFACTURING CORP.	48
	CSM FASTENER PRODUCTS	49
	HAZE SEIKO CO., LTD.	83
	REXNORD	155
<b>C</b>	SPS TECHNOLOGIES	169
	TEXTRON FASTENING SYSTEMS	178
	TOWNSEND CO.	181
<b>CAMCAR</b>	CAMCAR DIVISION OF TEXTRON INC.	38-40
<b>CAMCAR</b>	CAMCAR LLC	41
	CAMLOC PRODUCTS, REXNORD	41,155
	CAM-TECH INDUSTRIES	41
	CONNECTICUT AIRCRAFT PRODUCTS	48
	BOBCAT MANUFACTURING CO.	30
<b>CB</b>	CLICK BOND, INC.	46
<b>CBM</b>	COMPUTA-BASE MACHINING, INC.	48
<b>CBS</b>	CBS FASTENERS INC.	43
<b>CbS</b>		
<b>CCB</b>	CCB INDUSTRIES, INC.	43
<b>CCF</b>	CCF ENTERPRISES INC.	43
<b>CCS</b>	SPS TECHNOLOGIES	169
	CAPRICE ENGINEERING CO., INC.	42
<b>C. E. I</b>	COMMAND ENTERPRISES	47
<b>CES</b>	C.E.S. MACHINE PRODUCTS, INC	36
	CHICAGO FASTENER MANUFACTURING	45
<b>CFL</b>	CLYDE FASTENERS LIMITED	46











## MIL-HDBK-57D(IS)

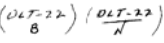



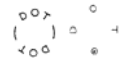





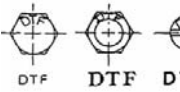

SYMBOL	COMPANY NAME	PAGE
CFS	CARDINAL FASTENER & SPECIALTY CO., INC.	42
CCG	CORPUS CHRISTI GASKET & FASTENER LTD.	48
	CANADY MANUFACTURING CO. INC.	41
	CHU HUA INDUSTRIAL CO., LTD.	46
	COLD HEADING CO., THE	47
CHEREK	CHEREK MACHINE & TOOL CO., INC.	45
CHF	CHICAGO HARDWARE & FIXTURE CO.	45
CI	CATALINA INSTRUMENT CORPORATION	42
	SPS TECHNOLOGIES	169
	C. J.'S GENERAL MACHINE WORKS	36
	CENTERLINE TOOL & ENGINEERING, INC.	43
CM	CER-MAC INC.	44
	CM MANUFACTURING, INC.	46
	CRESENT MANUFACTURING CO.	49
	CERNY MFG. CO.	44
	CHRIS MACHINE CO.	45
CM I	CONQUEST MACHINE, INC.	48
	CENTURY METAL PARTS CORP.	44
	CRYSTAL METAL PRODUCTS COMPANY, INC.	49
	CAPY MACHINE SHOP, INC.	42
	OWARI PRECISE PRODUCTS CO., LTD	140
	CENTRAL OZARK MACHINE, INC.	43
	COPELAND MFG. CORP.	48
CP	CHANDLER PRODUCTS, INC.	44
CPI	CREATIVE PRECISION INC.	49
CPM	CHOICE PRECISION MACHINE, INC.	45
	C.R.D. MACHINING	36
	CRS PRECISION CORP.	49
	C & S ENGINEERING LLC	36
CS	CALIFORNIA SCREW PRODUCTS CORP.	37
C S	COPPER STATE BOLT & NUT CO.	48

SYMBOL	COMPANY NAME	PAGE
	CAMBRIDGE SPECIALTY COMPANY, INC.	38
C S D	CAMCAR DIVISION OF TEXTRON INC.	38-40
C-SI	CALABRESE & SONS, INC.	37
	CENTRAL SCREW PRODUCTS	44
	CHEROKEE TOOL & ENGINEERING CO., INC.	45
C W R C	CWR MANUFACTURING CO	50
<b>D</b>		
D & D	D & D TOOL COMPANY, INC.	50
	B & D THREADED ROLLING	23
	DACK INDUSTRIES, INC.	51
	DANIEL CO., EDWARD W.	51
D	DAN-LOC BOLT & GASKET INC.	51
D	DECKER MANUFACTURING CORP	52
	DEFIANCE STAMPING COMPANY, THE	53
D	DEHOUSSE (USINES)	53
	DELL MFG. CO., INC.	53
D	DEMAT	53
	DERBYSHIRE MACHINE & TOOL CO.	54
D	DIESEL PARTS COMPANY OF CALIFORNIA	54
D	DIHARD COMPANY	55
	DO MANUFACTURING CORP.	55
D	DUPONT, G.B. CO., INC. and KAMAX L. P	57, 74, 98
	DUSEVOIR METAL PRODUCTS, INC.	57
D	DUVE GmbH & CO. KG	57
	DYSON CORP THE	58
	ONTIC ENGINEERING & MANUFACTURING, INC.	139
	STEEL WAREHOUSE COMPANY, INC.	171
D A E	DAVE ALLEN ENTERPRISES	51
DAS	DEFENSE AEROSPACE	52
1	DAN-LOC BOLT & GASKET INC.	51
DB	DAN-LOC BOLT & GASKET INC.	51

























MIL-HDBK-57D(IS)

SYMBOL	COMPANY NAME	PAGE
<b>DC</b>	D. C. MACHINING INC.	50
<b>DDG</b>	BLANC AERO INDUSTRIES and LISI	29, 112
	DYNAMIC ENGINEERING	57
<b>DF™</b>	DEUTSCH COMPANY INC., THE	54
<b>d</b>	DTF MANUFACTURING, INC.	56
<b>DFCI</b> <i>DFCI</i>	DFCI SOLUTIONS, INC.	54
	DETROIT HEADING CO.	54
<b>DHL</b>	DHL ENTERPRISES	54
	DIAL SUPPLY AND MANUFACTURING, INC.	54
<b>D</b>	DELT INDUSTRIES, INC.	53
<b>DI</b>	DUNCAN ELECTRONICS & MFG. CO	56
<b>DF</b>	DOMESTIC FORGING, INC.	55
<b>DL</b>	DISC-LOCK INTERNATIONAL	55
	MILLS, J. R. MACHINING, INC.	125
<b>DMC</b>	DECKER MANUFACTURING CORP	52
	DEPENDABLE MACHINE CO., INC.	54
	DELTA MACHINE & TOOL CO., INC.	53
<b>DMT</b>	DIXON MACHINE & TOOL and TROY D. RAY	55, 182
	KNIPPING-DORN GmbH	101
	TRW	183
<b>D P</b>	DARCO PRODUCTS	51
<b>DP</b>	DUNHAM PRODUCTS, INC.	57
<b>DPM</b>	DAVIES PRECISION MACHINING, INC.	51
	DEFENSE QUALITY MFG.	52
	DOUBLECO INCORPORATED	56
	DEMAT	53
<b>DT</b>		
<b>DTE</b>	DOUGLASS TOOL & ENGINEERING CO., INC.	56
<b>DTE</b>	EMERALD VALLEY MFG	60











SYMBOL	COMPANY NAME	PAGE
	DTF MANUFACTURING, INC	56
	DUFFY ELECTRONICS & MFG. CO.	56
<b>DUVE</b> <i>DUVE</i>	DUVE GmbH & CO. KG	57
<b>DUVEX</b>	DUVE GmbH & CO. KG	57
<b>DV</b>	DEL-VAL FASTENER MANUFACTURING	53
<b>DX</b>	DUVE GmbH & CO. KG	57
	DYNACAST	57
<b>DZUS</b> <i>DZUS</i>	DZUS FASTENER CO., INC.	58
<b>E</b>		
	EAGAN MACHINE CORP.	58
<b>E</b>	EAST COAST METALS INC.	58
	EASTERN SCREW CO., INC.	59
<b>E</b>	EBC INDUSTRIES (ERIE)	59
<b>E</b>	ERIE BOLT CORP.	63
<b>E</b>	ELASTIC STOP NUT & ESNA	60, 116
<b>E</b>	ELCO INDUSTRIES, INC.	60
<b>e</b>	ELLIS PRECISION INDUSTRIES	60
		
<b>E</b>	ENGINEERING MATERIALS CO., INC.	62-62
	ENOMOTO INDUSTRIES CO., LTD.	63
<b>E</b> 	ERICO FASTENING SYSTEMS	63
	ESMET, INC.	63
<b>E</b>	NORTHBRIDGE FASTENERS	135
	R B & W CORPORATION	151
		
<b>E A</b>	VOSS INDUSTRIES, INC.	191
	SUPERIOR TECHNOLOGY	174













## MIL-HDBK-57D(IS)

SYMBOL	COMPANY NAME	PAGE
<b>EBM</b>	EBERHARD BRUNINGHAUS	59
<b>EBP</b>	ENGINEERED BOLTING PRODUCTS, INC.	61
	ELCO INDUSTRIES, INC.	60
	E.L.R. MACHINE AND TOOL	58
<b>EM</b>	EASTWOOD MFG., CO.	59
	ENGEL MANUFACTURING COMPANY, INC., THE	61
EM	ENGLE MANUFACTURING COMPANY, INC., THE	63
	ESSENTIAL MACHINING	64
	EXPERIMENTAL MACHINE CO.	65
EN	ELASTIC STOP NUT & ESNA	60, 116
<b>Ep</b>	EAGLE PICHER INDUSTRIES	58
	EMPIRE PRECISION MACHINING and MD3 INDUSTRIES LTD.	61, 121
<b>ERIE</b>	EBC INDUSTRIES (ERIE)	59
<b>ERIE</b>	ERIE BOLT CORP.	63
ESC	ECENARRO S. COOP. LTDA	59
ESNA	ELASTIC STOP NUT & ESNA	60, 116
ESTA	ESTA PRODUCTS COMPANY	64
ET	AVIBANK MFG., INC.	22
ETC	AVIBANK MFG., INC.	22
<b>EΣΠ</b>	ESP MANUFACTURING CO., INC	64
EWB	SPS TECHNOLOGIES	169
EWN	SPS TECHNOLOGIES	169
	PRECISE OF CALIFORNIA	147
	<b>F</b>	
F593	ENGLE MANUFACTURING COMPANY, INC., THE	63
<b>F</b>	AVIATION MANUFACTURING GROUP LLC (SEE DBA FREEMAN CO., THE)	21
	BLUE TEE CORP DBA GEFCO/STECO	30
	FAILING CO., GEORGE E	66
f	FALL RIVER MANUFACTURING CO., INC.	66
<b>F F</b>	(FASSCO) FASTENER & STEEL SUPPLY CO., LTD.	67
<b>F</b>	FASTENRATH BEFESTIGUNGSTECHNIK GmbH	68











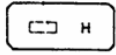

SYMBOL	COMPANY NAME	PAGE
<b>F</b>	FASTI-WERK CARL AUG. FASTENRATH GMBH & CO.KG	68
<b>F</b>	FASTRON COMPANY, THE	68
  F	FEDERAL SCREW WORKS	69
	FENBAR PRECISION MACHINISTS, INC.	69
	FERNDALE FASTENER	69
<b>F</b>	FREEMAN CO.	73
	LISI AEROSPACE	112
	M & M MANUFACTURING CORPORATION	114
<b>F</b>	VISSERIES & BOULONNERIES DE FOURMIES	188
<b>F</b>	FONTANA S.A.	72
<b>2F 3F 4F 5F</b>		
	THIANT (BOULONNERIE DE SA)	179
<b>FAH</b>	FRISBY AEROSPACE INC DE and TRIUMPH GROUP OPERATIONS INC. THE	73, 182
	FRONTIER BOLT COMPANY OF TEXAS	73
<b>FC F-C</b>	FERRY CAP & SET SCREW CO., THE	70
	FUCHS SCHRAUBENWERK GmbH	73
<b>FCI</b>	FONTAL CONTROLS, INC.	71
<b>FDC</b>	FLUIDYNE CORPORATION	71
	FABER ENTERPRISES, INC.	65
<b>FE</b>	FABSCO CORP.	66
	FLORES ENTERPRISES	71
<b>FEC</b>	FEDERAL EQUIPMENT COMPANY	68
6 0 5 8 7		
	FOREST FASTENERS	72
	FORMED FASTENER MANUFACTURING, INC.	72
<b>F.K</b>	VISSERIES & BOULONNERIES DE FOURMIES	188





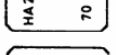
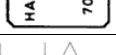







## MIL-HDBK-57D(IS)

SYMBOL	COMPANY NAME	PAGE
	FLAIG & HOMMEL	70
	FENTON HEADING	69
	FIBAM COMPANHIA INDUSTRIAL	70
FIT	FASTENER INNOVATION TECHNOLOGY, INC.	67
	FLUIDONICS INC.	71
	FALCON MANUFACTURING CORP.	66
	FOLSOM TOOL & MOLD CORP.	71
FMC	FEDERAL MANUFACTURING CORP.	68
	TRIAD PRODUCTS CORP.	182
FN	AVIBANK MFG., INC.	22
FNF	SPS TECHNOLOGIES	169
	FASTENAL COMPANY	67
FONTANA	FONTANA S.A.	72
	FASTENING PRODUCTS OF LANCASTER, INC.	68
FPA	FPA MANUFACTURING	72
	FASTENING PRODUCTS CO., INC.	68
FPIC	FOREMOST PRECISION INSTRUMENT CORP.	72
fr	FALL RIVER MANUFACTURING CO., INC.	66
F.R.	FRANROE PRECISION MACHINE COMPANY	72
FRIEDBERG	AUGUST FRIEDBERG GmbH	20
F.R.P	FRANROE PRECISION MACHINE COMPANY	72
F S	FERRIERE DI STABIO, S.A.	69
FS	FLAIG & HOMMEL	70
f t	CAMCAR DIVISION OF TEXTRON INC.	38-40
FT	FASTENER TECHNOLOGY CORP.	67
	FUCHS SCHRAUBENWERK GmbH	73
FX	FLEXALLOY INC.	71
<b>G</b>		
G	EVERLOCK FASTENING SYSTEMS	64,65

SYMBOL	COMPANY NAME	PAGE
<b>G</b>	GALAN PRECISION MACHINE CO.	74
	GALMAC MFG CO.	74
<b>G</b>	GATEWAY SCREW AND RIVET, INC.	75
	GENERAL MACHINE PRODUCTS, INC	75
	GILL MACHINE & TOOL CO.	76
<b>G</b>	GOSHO WORKS, LTD.	76
	GRACO INDUSTRIES, INC.	77
<b>G</b>	GREER STOP NUT	78
	GUARDIAN RIVET & FASTENER	80
	GARDINER MFG. CO.	75
G.B.M	G. B. MACHINE PRECISION, INC.	74
	STERLING MARKING PRODUCTS IC.	173
	GRAUCH ENTERPRISES	77
GEBI 	J. GEORG BIERBACH	95
GF	GRANDUER FASTENERS, INC.	77
	GRIPCO, DIVISION OF BLACK & DECKER	78
GFM	GREENFIELD MANUFACTURING CO., INC.	78
G <sub>H</sub>	EMHART CORP.	61
GII	GERTLER INDUSTRIES, INC.	75
	GL CNC SERVICE INC.	76
GLC 1		
GMF	GAITHER PATRICIA	74
	GMJ MACHINE COMPANY, INC.	76
GMT	GREATER MARYLAND TOOL & MFG., CORP.	77
	GRIPCO, DIVISION OF BLACK & DECKER	78
<b>Go</b>	GOSHO WORKS, LTD.	76
<b>Gosho</b>	GOSHO WORKS, LTD.	76
<b>G-P</b>	GROOV-PIN CORPORATION	79
<b>GPM</b>	GALAN PRECISION MACHINE CO.	74
<b>G&amp;R</b>	G & R SCREW MACHINE PRODUCTS	74
<b>GR</b>	RABOURDIN	152

## MIL-HDBK-57D(IS)

SYMBOL	COMPANY NAME	PAGE
 GRMN 6	GERMAN MACHINED PRODUCTS, INC.	75
GS	B & B SPECIALTIES INC. and GS AEROSPACE TECHNOLOGY, INC.	22, 79
G-S	G & S MACHINE INC.	74
GS	GENERAL SCREW & SPECIALTY CO., INC.	75
GSAT	GS AEROSPACE TECHNOLOGY, INC.	79
GSF	ARMSTRONG FASTENINGS LTD.	18
GSF	GSF FASTENING	79
GSI	GS AEROSPACE TECHNOLOGY, INC.	79
	SCHRAUBENFABRIK GUSTAV STERNBERG GmbH & CO. KG	162
	GUNNISON-INTERNATIONAL INC.	80
<b>H</b>		
H	BEK LEVEL 1 FASTENERS and LEVEL 1 FASTENERS	26, 108
	FUCHS SCHRAUBENWERK GmbH	73
	HAMANAKA (THAILAND). CO., LTD.	81
H	HASKELL OF HUNTINGTON, INC	82
	HAYDON BOLTS, INC.	83
	HEMCO TOOL INC.	84
HH	HEXAGON ENTERPRISES, INC.	84
	HILL FASTENER CORP.	85
H	HILTI, INC	86
	HI-SHEAR CORP. (LISI)	86
H	HOFFMANN, RICHARD GMBH CO. KG	87
H	HOLLYWOOD MANUFACTURING INC.	87
H	HUCK PRODUCTS	89
H	HUGGINS MFG.	89
H	HURON AUTOMATIC SCREW CO.	89
 H	MNP CORPORATION	128
	FUCHS SCHRAUBENWERK GmbH	73
	FUCHS SCHRAUBENWERK GmbH	73
	HABINA ENGINEERING	81
	HARTFORD AIRCRAFT PRODUCTS, INC.	82
	HARRISON BOLT & NUT CO., THE	82
HB	HYDROBOLT LIMITED	90
HBN	MNP CORPORATION	128

SYMBOL	COMPANY NAME	PAGE
HBW	HAWTHORNE BOLT WORKS	
HC	H C MERCHANDISERS INC. and H C PACIFIC	80
HCP	H C MERCHANDISERS INC. and H C PACIFIC	80
 HD	HUGO DURHOLT GMBH & CO. KG	89
HDI	HARWOOD DESIGN, INC.	82
HE HE	HORST ENGINEERING & MANUFACTURING CO.	88
HEM	HORST ENGINEERING & MANUFACTURING CO.	88
HF	HILL FASTENER CORP.	85
HF	HYDRO FITTING MFG. CORP.	90
 HHW	HO HONG WORKS CO., LTD	87
	HI INDUSTRIAL TECHNOLOGIES	84
HIC	HALLSIMS INDUSTRIAL COMPONENTS, INC.	81
	HILL AEROSPACE & DEFENSE LLC.	85
HILTI	HILTI, INC	86
HI PSI	SPS TECHNOLOGIES	169
HI TI	SPS TECHNOLOGIES	169
HK HK H-K	HOLO-KROME CO.	87
HL	HLC INDUSTRIES INC.	86
HM	H. MULLINS, LTD.	80
	HOWIE MANUFACTURING CO., INC.	88
	HEIM'S MACHINE & TOOL, INC.	83
HMTC	HOWE MACHINE AND TOOL CORP.	88
	CAMCAR DIVISION OF TEXTRON INC.	38-40
	H. PRINZ GmbH	80
	HENWAY, INC.	84
	HIGHLAND PRODUCTS CORPORATION	85
	MICRO SCREW MACHINE PRODUCTS, INC.	124
HPF	HOUSTON PRECISION FASTENERS	88
HPS	HILTI, INC	86
HQ	HIGH QUALITY MACHINE SHOP	84
HR HR	HORSPOLL & ROMINE MANUFACTURING CO., INC.	87
	HARDWARE SPECIALTY CO, INC	82
HS	HILL STAMPING & MFG., INC.	85
	HI-SHEAR CORP.	86













## MIL-HDBK-57D(IS)















SYMBOL	COMPANY NAME	PAGE
<b>hs</b>	LISI AEROSPACE	111
<b>HSC</b>	HUNTER STEVENS COMPANY	89
<b>HSLG-R</b>	HILTI, INC	86
	HAMANAKA (THAILAND). CO., LTD.	81
	HIGHLAND THREADS, INC.	85
<b>H<sub>T</sub></b>	HOWARD TOOL CO., INC.	88
<b>HTC</b>	HEITCO MANUFACTURING, INC.	84
<b>HTE.</b>	HIGH TECH ENTERPRISES	85
	HATCH INDUSTRIES	83
	HUNT VALVE COMPANY, INC.	89
<b>HVI</b>	HUNTINGTON VALLEY INDUSTRIES, INC. DBA HVI	90
<b>I</b>		
	EVERLOCK FASTENING SYSTEMS	65
<b>I</b>	ALPHA BOLT CO.	13
	IMPERIAL SUPPLIERS, INC.	91
<b>I</b>	INDUSTRIAL & AUTOMOTIVE FASTENERS	91
	INTERSTATE FITTINGS INC.	93
	PIONEER SCREW & NUT CO.	145
<b>II</b>	MACLEAN-FOGG CO.	116
<b>IAH</b>	INDIANA AIRCRAFT HARDWARE	91
<b>IF</b>	IDEAL FASTENERS INC.	90
<b>IF</b>	INDUSTRIAL FORGE, INC.	92
	I.G.D. MACHINE & TOOL LTD.	90
	STERLING MARKING PRODUCTS IC.	173
	CAMCAR DIVISION OF TEXTRON INC.	38-40
<b>IM</b>	INLAND MACHINE CO.	93
<b>IM</b>	IRVING MACHINE SERVICE, INC.	93
	INTERFLEX MFG. CORP.	93
	INSTRUMENT MACHINING SERVICE LTD.	93
<b>I.M.S.2</b>		
	INDUSTRIAL NUT CORP.	92
<b>ICHO</b>	AIHARA SEIBYO CO LTD	10
	ISLAND ENGINEERING	94

SYMBOL	COMPANY NAME	PAGE
<b>IN</b>	FASTENER BROKERAGE INC.	67
<b>IN</b>	INOFASST MANUFACTURING INC.	93
<b>INBUS</b>	BAUER & SCHAURTE KARCHER GMBH	25
	IN-SPECK CORP.	93
<b>IT</b>	AVIBANK MFG., INC.	22
<b>ITC</b>	AVIBANK MFG., INC.	22
<b>IRW</b>	IRWIN AUTOMATION, INC.	94
<b>J</b>		
<b>J</b>	AF FASTENERS LIMITED	9
	B & G MANUFACTURING CO., INC.	23
<b>J</b>	JJ SCREW PRODUCTS, INC.	97
<b>J</b>	JOSLYN CORP.	97
	JUPITER WASHERS, INC.	97
<b>J2H</b>	B & G MANUFACTURING CO., INC.	23
<b>J4</b>	B & G MANUFACTURING CO., INC.	23
	JACO ENGINEERING, INC.	96
<b>JB</b>	BUTLER, INC.	35
<b>B</b>	JAY BEE MACHINE WORKS, INC.	96
<b>JB7</b>	B & G MANUFACTURING CO., INC.	23
<b>JB16</b>	B & G MANUFACTURING CO., INC.	23
	DEERE & CO.	52
	JAYCO ENGINEERING, INC.	96
	JERGENS INC.	97
<b>JF</b>	ELECTRO-FREETO MANUFACTURING COMPANY	60
<b>JG</b>	J. G. FASTENERS	95
<b>H</b>	HASSALL, JOHN, INC.	82
<b>JI</b>	JAMISON INDUSTRIES INC.	96
<b>JIT</b>	JUST IN TIME, INC.	98
	JAMES JACKSON DBA J J ENGINEERING	96, 97
	B & G MANUFACTURING CO., INC.	23
<b>JP</b>	J.M. PRECISION, INC.	95
<b>JNC</b>	B & G MANUFACTURING CO., INC.	23
<b>JOLICO</b>	JOLICO/J-B TOOL INC	97
	JAY O MACHINE CO., INC.	96























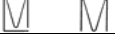

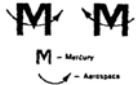





## MIL-HDBK-57D(IS)

SYMBOL	COMPANY NAME	PAGE
JS	B. V. FABRIEK VAN KLINKNAGELS EN SCHROEFBOUTEN V/H SMIT	24
J-S	J & S PRECISION PRODUCTS	95
<i>JT</i>	JAM TECH CORP.	96
<b>K</b>		
K	ADI MANUFACTURING, INC	6
	KAYNAR PRODUCTS	99
	(ALCOA FASTENING SYSTEMS)	11
	(Previously KAYNAR TECHNOLOGIES, INC. DIV. OF MICRODOT)	124
K	KATSURAGAWA MACHINE SCREW CO., LTD.	99
<b>K</b>	KAYGOR, INC.	99
K	KEN FORGING, INC.	100
K	KILBOURN ENGINEERING CO.	100
	KEYSTONE BOLT & NUT COMPANY	100
	KEYSTONE TOOL & MACHINE CO.	100
	KNOCH MANUFACTURING CO. LTD.	101
	KOLB GMBH & CO.	101
		
		
K	KORODY COLYER CORP.	102
	KNOCH MANUFACTURING CO. LTD.	101
K	SPS TECHNOLOGIES	169
K-5673	SPS TECHNOLOGIES	169
KA	K.A.A. COMPANY	98
KAMAX	KAMAX-WERKE RUDOLF KELLERMANN GmbH & CO. KG	98
KARRO®	BAUER & SCHAURTE KARCHER GMBH	25
KDK	K.D.K. UPSET FORGING CO.	98
KE	KELLER ENGINEERING	99
k+k	K & K PRECISION ENTERPRISES	98
	KYOKUTO MFG CO LTD.	103
<b>KL</b>	KLINCHER LOCKNUT CORP.	101
	KERR LAKESIDE INC.	100
		
<b>KO</b>	KO AMS MACHINE PRODUCTS	101

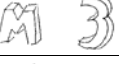















SYMBOL	COMPANY NAME	PAGE
KP	KAPCO INDUSTRIES, INC.	99
	KIRSTEN PIPE CO. INC.	101
<b>KPP</b>	KOZAK, E. PERCISION PRODUCTS CO.	102
	KROBACH MANUFACTURING CORP.	103
	KONGO BYORA CO., LTD.	102
KNIPPING	ARNOLD KNIPPING GmbH	18
KPP	E. KOZAK PRECISION PRODUCTS CO.	58
KS	SPS TECHNOLOGIES	169
	KSS SOCKET SCREW, INC	103
	K-TECH MFG., INC.	103
		
		
KT	TURNAMICS, INC.	183
		
<b>KTI</b>	KONDOR TECHNOLOGIES, INC.	102
<b>KTM</b>	KREIS TOOL & MFG., CO., INC.	102
KX	KAMAX-WERKE RUDOLF KELLERMANN GmbH & CO. KG	98
	KYOEI SEISAKUSHO CO., LTD.	103
<b>L</b>		
<b>L</b>	CHUN YU WORKS & CO., LTD.	46
<b>L</b>	L & H THREADED RODS CORP.	104
	LAMSON AND SESSIONS OF CANADA LTD.	105
	LANIS MACHINE & MFG., CO.	106
	LINREAD NORTHBRIDGE AIRCRAFT PRODUCT DIVISION	109
	LINREAD PUBLIC LIMITED CO.	110
<b>L</b>	LONE STAR FASTENERS, LP	113
<b>L L1</b>	LORD CORPORATION	114
	R B & W CORPORATION	151
<b>LL</b>	LINREAD PUBLIC LIMITED CO.	110
<b>LL or LL</b>	LONG-LOK FASTENERS CORP.	113
<b>LAH LAH</b>	LENTERN (AIRCRAFT) LTD.	107
<b>LAM</b>	L. A. MARTIN CO.	104















## MIL-HDBK-57D(IS)

SYMBOL	COMPANY NAME	PAGE
<b>L B</b>  Raised letters	LANARKSHIRE BOLT LTD.	106
	L & C MANUFACTURING CO., INC.	103
<b>LC</b>	LISI AEROSPACE	111
<b>LE</b>	LAKE ERIE SDREW CORP.	105
<b>LE</b>	LIPPISCHE EISENINDUSTRIE GmbH	111
<b>LE</b>	WOLTERS GMBH	196
<b>LG</b>	L G MACHINE & MFG INC.	104
<b>LFC</b>	LFC INDUSTRIES INC.	109
	L H INDUSTRIES, INC.	104
<b>LI</b>	LANA INDUSTRIES	106
	TRW	183
	L & J FASTENERS, INC.	104
<b>L &amp; M</b>	L & M ENTERPRISES, INC.	104
<b>LM</b>	LEVINGSTON MACHINE COMPANY	109
<b>LMC</b>	LOUGHLIN MANUFACTURING CORP.	114
	LANUM METAL PRODUCTS, INC.	106
<b>L.M.T.</b>	LANUM METAL PRODUCTS, INC.	106
	LLOYD MACHINE & TOOL CO., INC.	113
<b>LNA</b>	L N AEROSPACE, INC.	104, 113
<b>LOBO</b>	LOBO OFFICINE MECCANICHE SPA	113
	LOBO SYSTEMS LTD	113
<b>LONG LOK</b>	LONG-LOK FASTENERS CORP.	113
<b>L.P.R.</b>	L P R PRECISION PARTS AND TOOL COMPANY, INC.	104
<b>LRA</b>	AVIBANK MFG., INC.	22
<b>LRG</b>	L R G CORPORATION	104
<b>L.P.R.</b>	PRECISION PARTS & TOOL CO., INC.	147
	R B & W CORPORATION	151
<b>L-S-A</b>	CEI INC.	43
<b>L-S-A</b>	LAND-SEA-AIR MACHINED PRODUCTS, INC.	106
<b>L&lt;W&gt;M</b>	LITTLE WORLD MANUFACTURING, INC.	113
<b>M</b>		
<b>M</b>	COOPER POWER SYSTEMS INC	48
<b>M</b>	DEMAT	53
	GFD LETAGE	76











SYMBOL	COMPANY NAME	PAGE
<b>M</b>	HMS SERVICES LLC	87
	KELOX/MICRODOT PRODUCTS	99
	LISI AEROSPACE	112
<b>M</b>	MACKO INDUSTRIES	115
	MAGNUS TOOL & DIE CO., INC.	117
	MEACO PRODUCTS CORP.	122
<b>M</b>	MECAERO PRODUCTS	122
 M - Mercury - Aerospace	MERCURY AREOSPACE INC.	123
<b>M</b>	METALCRAFTERS	123
	METRIX MFG. CO.	124
	MI. ME. AF. S.r.l	124
	MICRODOT INC	124
	MIDWEST ACORN NUT CO.	125
	MILLIPART, INC.	125
<b>M</b>	MINEBEA CO. LTD	126
<b>M</b>	M-MANUFACTURING	127
	MNP CORPORATION	128
	MORTON MANUFACTURING	129
<b>M</b>	MRL MANUFACTURING CORP.	130
	MACOR, INC.	117
	MIX TOOL CO.	126
	MODERN METRIC MACHINE COMPANY INC.	128
	INFASCO, NFASCO NUT and INGERSOLL FASTENERS	93
<b>MA</b>	M.A.A. CORP.	114
	MAC FASTENERS, INC.	115
	MCCULLOUGH AERO CO.	121
	ADAMS, EARL M. CO.	6
	MAILLY MFG CO., INC.	117













## MIL-HDBK-57D(IS)

SYMBOL	COMPANY NAME	PAGE
	MID-STATES SCREW CORP.	125
MC	ADI MANUFACTURING, INC	6
	MCADAMS MACHINE AND TOOL CO.	120
	MECAERO CANADA INC.	122
	MECAIR AEROSPACE INDUSTRIES	122
	METALCRAFTERS	123
 	MID CONTINENT SCREW PRODUCTS CO.	125
	WROUGHT WASHER MANUFACTURING INC.	197
	MARTIN-CHANDLER, INC.	118
MCO	MEACO PRODUCTS CORP.	121
 	McMELLON BROS INC.	121
MD	LEONARD JED CO MARYLAND BOLT AND NUT CO DIV	107-108
MD	MARYLAND BOLT & NUT CO., INC.	119, 120
..MEL-BA..	MEL-BA MANUFACTURING INC.	122
<b>METRI</b>	METRIX MFG. CO.	124
<b>METRIX</b>	METRIX MFG. CO.	124
MF	MACLEAN-FOGG CO.	116
<b>MFI</b>	MORTON FASTENERS INC.	129
MFR06320	PYE & HOGAN MACHINE CO.	149
MFR 1L071	MIROFINE COMPANY	126
<b>MFR 27624</b>	PB FASTENERS	142
<b>MFR 29839</b>	ADVANCE PATTERN CORP	6
MFR 3L665	C. E. MACHINE CO., INC.	36
MFR - 72905	ARJAY PRECISION, INC.	17
MFR 8F781	STEVENS MFG. CO., INC.	173
	MANUFACTURING ENGINEERING TECH.	117
	MOSTAR GEAR & MACHINE MFG., CO.	129
<b>MI</b>	MECHANICAL & INDUSTRIAL FASTENERS	122
<b>M I</b>	MECHANICAL INDUSTRIES LLC	122
	KELOX/MICRODOT PRODUCTS	99
	MICRODOT INC.	124
<b>MIF</b> <b>MIF</b>	MECHANICAL & INDUSTRIAL FASTENERS	122
	MODFORM-ILLINOIS, INC.	128
MI	MONOGRAM AEROSPACE FASTENERS	129
MI-TECH, INC	MI-TECH, INC.	126



















SYMBOL	COMPANY NAME	PAGE
	MIX TOOL CO.	126
	LISI AEROSPACE	112
	MKM MACHINE TOOL COMPANY INC.	127
ML	LINREAD PUBLIC LIMITED CO.	110
<b>ML</b>	MCLANE MFG INC.	121
	M.L.W. MANUFACTURING CO.	114
	MAR-BRO MFG., INC.	118
	MILE-HI MACHINE, INC.	125
	MACKSON MFG CORP.	115
<b>MMG</b>	MMG ENGINEERED COMPONENTS INC	127
M M M	HMS SERVICES LLC	87
	MODERN METRIC MACHINE COMPANY INC	128
	KERR, CHARLES W. and MAUI MEGA	100, 120
	MONROE MACHINED PRODUCTS, INC.	129
<b>MMS</b>	METHODS AND MACHINING SERVICES CO.	123
MMT	MAIN MACHINE CO INC.	117
<b>MNP</b>	MNP CORPORATION	128
	LISI AEROSPACE	112
<b>MONOGRAM</b>	MONOGRAM AEROSPACE FASTENERS	129
	MAPECO PRODUCTS, INC.	118
<b>MP</b>	MERCER PRODUCTS & MFG. CO., INC.	123
<b>MP</b>	MONTEREY MACHINE PRODUCTS	129
	UMPCO CORP.	184
<b>MR</b>	MACHINERITE CORP.	115
	MASTER RESEARCH & MFG., INC.	120
<b>MSA</b>	M.S. AEROSPACE	114
<b>MSF</b>	MIL-SPEC FASTENERS CORP.	125
	MANUFACTURING SALES AND SERVICE	117
<b>MT</b>	ALEXANDER MANUFACTURING COMPANY INC	12
<b>MT</b>	AVIBANK MFG., INC.	22















## MIL-HDBK-57D(IS)

SYMBOL	COMPANY NAME	PAGE
<b>MT</b>	METAL-TECH MFG. INC.	123
<b>MT</b>	METRO TOOL & MANUFACTURING CO.	124
	MASTERCRAFT TOOL COMPANY	120
	MERCURY TOOL & MACHINE, INC.	123
	MANUFACTURING TECHNOLOGY SERVICES	118
	TWIST TITE MFG. INC.	183
<b>MULTI-C</b>	CARDINAL INDUSTRIAL PRODUCTS	42
	MOTOR WHEEL CORP.	130
<b>MW ORD</b>		
<b>N</b>		
<b>N</b>	HANSAN SCREW CO., LTD.	81
<b>N</b>	METALCRAFTERS	123
<b>N</b>	MITSUBOSHI INDUSTRIES, LTD.	126
<b>N</b>	MONOGRAM AEROSPACE FASTENERS	129
<b>N</b>	N.S.S. INDUSTRIES	130
<b>N</b>	NAFCO INDUSTRIES, INC.	130
	NAPIER'S AUTO BODY	130
<b>N</b>	NELSON STUD WELDING DIVISION	133
<b>NN</b>	NEUMAYER, ERICH GMBH	133
<b>NN</b>	NISSAN SCREW CO. LTD.	134
	NOCHIA STEELWORKS	134
	NOVA MACHINE PRODUCTS CORPORATION	136
<b>N</b>	NUCOR CORP.	136
<b>NN</b>	NUTS INCORPORATED	136
<b>N</b>	NUTS, INC.	136
	ONO MANUFACTURER, INC.	139
<b>NA</b>	NELSON AEROSPACE INC.	132
<b>NAC</b>	NC AUTOMATED INDUSTRIES INC.	132
<b>NB</b>	LINREAD NORTHBRIDGE	109
	NATIONAL BOLTS & RIVETS LTD.	131
<b>NB</b>	NORTHBRIDGE FASTENERS	135















SYMBOL	COMPANY NAME	PAGE
	ND INDUSTRIES	132
	NEVILLE MACHINE SHOP	133
<b>NE</b>	NEKG HOLDINGS	
<b>NEDIN</b>	NEDSCHROEF	132
<b>NEDLOY</b>	NEDSCHROEF	132
<b>NEDUR</b>	NEDSCHROEF	132
	NORTHEAST METAL CO., INC.	135
	NORTHEAST FASTENERS	135
<b>NF</b>	NEVADA BOLT AND MFG CO INC.	133
<b>NF</b>	NON-FERROUS BOLT & MANUFACTURING CO.	134
<b>NFB</b>	GREER STOP NUT	78
<b>NH</b>	NEDSCHROEF	132
<b>NH</b>	NEW HORIZON MACHINE CO., INC.	133
<b>NI</b>	NAVPAR, INC.	131
<b>NK</b>	MITSUBOSHI INDUSTRIES, LTD.	126
<b>NK NK</b>	NYLOK CORP.	137
<b>NKYM</b>	MITSUBOSHI INDUSTRIES, LTD.	126
	METALCRAFTERS	123
<b>NMB</b>	MINEBEA CO. LTD	126
	NIPPON MACHINE ENGINEERING, INC.	134
<b>NMP</b>	NUMERIC MACHINE PRODUCTS	136
<b>NRS</b>	NAGOYA SCREW MANUFACTURING CO. LTD.	130
	NARRAGANSETT SCREW MFG., CO.	131
	NISCO, INC.	134
<b>NS</b>	NORTHERN SCREW CO., INC.	135
	NASU DENKI-TEKKO CO., LTD.	131
<b>NT</b>	NATIONAL THREADED FASTENERS CORP.	131
<b>NT</b>	NT ENGINEERING, INC.	136
<b>NTF99</b>	NORTHBRIDGE FASTENERS	135
<b>NTW</b>	NASSAN TOOL WORKS, INC.	131
	NUCOR CORP.	136
<b>NYLOK</b>	NYLOK CORP.	137
<b>O</b>		
	KERR, CHARLES W. and MAUI MEGA	100, 120
	MARUYKO NUT CO., LTD.	118
	NATIONAL FASTENER CO., LTD.	131

















## MIL-HDBK-57D(IS)

SYMBOL	COMPANY NAME	PAGE
	OBARS MACHINE & TOOL CO.	137
	OCM MACHINE COMPANY, INC.	137
	OHIO NUT & BOLT CO., THE	137
	ORANGE PRECISION PARTS	139
	SCREWCORP.	163
	VOI-SHAN PRODUCTS	191
OAV	A. AGRATI S.P.A.	2
OB	OTT BROTHERS MACHINE CO., INC.	140
OBMC	OTT BROTHERS MACHINE CO., INC.	140
O K	OKAI IRON WORKS, INC	138
	OSTEEN MACHINE SHOP	140
	LOOS & CO., INC.	114
OP	ORANGE PRECISION PARTS	139
	ORDNANCE PARTS & ENGINEERING CO.	139
<b>ORC-O</b>	ORC-O TOOL & MACHINE, INC.	139
	OHKAWA SCREW MFG. CO., LTD. and OKAWA SCREW MANUFACTURING CO., LTD	138, 138
<b>(OTC)</b>	ORLOTRONICS CORP	139
<b>OTF</b>	OAKTREE FASTENERS CO.	137
<b>P</b>		
P	BELL FASTENERS	27
	BLANC AERO INDUSTRIES and LISI	29, 111
P	H. PAULIN & CO. LTD.	80
	H. PRINZ GmbH	80
	LELAND-POWELL FASTENERS, INC.	107
	LISI AEROSPACE	111
	LISI AEROSPACE	112
	OMEGA THREAD ROLLING AND GRINDING INC.	138
	PLAINVILLE MANUFACTURING CO., INC.	145
P	ORANGE PRECISION PARTS	139
	P.C.M., INC.	140
	PENN CIGAR MACHINES INC (P.C.M INC)	143
<b>P</b>	PATEREX, LTD.	142
<b>P</b>	PAULIN, H. & CO., LTD.	142

SYMBOL	COMPANY NAME	PAGE
	PEINER UMFORMTECHNIK GmbH	143
	PERIGEE MANUFACTURING COMPANY, INC.	144
	PERKINS MACHINE CO.	144
	PIONEER SCREW & NUT CO.	145
	PRECISION PIECE PARTS, INC.	147
	PROTO MACHINE CO., INC.	149
	PTM INTERNATIONAL INC	149
<b>P</b>	PURITAS METAL PRODUCTS	149
<b>PABCOR</b>	PABCOR, INC.	141
<b>PAL</b>	PALNUT CO., THE	142
<b>PAL</b>	TRW	183
<b>PAM</b>	ABBOTT, PETER	3
<b>PAM</b>	PRECISION AIRCRAFT MACHINING CO., INC. DBA PAMCO	
<b>PAMCO</b>	PRECISION AIRCRAFT MACHINING CO., INC. DBA PAMCO	
	PRECISE AERO PRODUCTS	146
<b>PB</b>	PB FASTENERS	
<b>PB</b>	PORTLAND BOLT & MFG., CO.	146
	UPB ENGINEERING	186
<b>PBB</b>	LISI AEROSPACE	112
	PB FASTENERS	
		
<b>PBF</b>		
<b>PC</b>	APHEONIX CORPORATION	17
	PRODUCT DEVELOPMENT GROUP, INC.	148
<b>PE</b>	PENNINGENGINEERING AUTOMOTIVE FASTENERS	
	PROMPTUS ELECTRONIC HARDWARE	149
<b>PEINER</b>	PEINER UMFORMTECHNIK GmbH	143
	PENN ENGINEERING & MANUFACTURING CO.	143
<b>PHP</b>	PNEU-HYDRO PRODUCTS, INC.	145
	P & I ASSOCIATES, INC.	140

## MIL-HDBK-57D(IS)

SYMBOL	COMPANY NAME	PAGE
PIP	AVIBANK MFG., INC.	22
	KAPCO INDUSTRIES, INC.	99
	P & L ENTERPRISES	140
PM	H. PAULIN & CO. LTD.	80
PM	PAULIN, H. & CO., LTD.	142
	PRICE MANUFACTURING CO.	148
PMC	BELL FASTENERS	27
	POINT MACHINE COMPANY	145
	PRECISIONMATICS CO., INC.	148
	PRIETO MACHINE COMPANY, INC.	148
PMC	VERTEX DISTRIBUTION	188
<b>PMI</b>	PADGETT MACHINE INC.	141
<b>pmi</b>	PEREZ MACHINE, INC.	144
<b>PMP</b>	PIONEER MACHINE PRODUCTS, INC.	145
<b>PMP</b>	PURITAS METAL PRODUCTS	149
	PRO-MACHINE & TOOL COMPANY	149
	PATTERSON LAKE PRODUCTS	142
-PPC-	PARK PRECISION CORPORATION	142
	POWERPARTS, INC.	146
<b>PR</b>	PINEY RIDGE CO.	145
PRD	PRD FASTENERS LTD.	146
	PRECI-MANUFACTURING, INC.	146
	H. PRINZ GmbH	80
	P.S. MACHINE CO., INC.	141
<b>P S</b>	PACIFIC SCIENTIFIC	141
	PEERLESS SCREW PRODUCTS	142
	PHOENIX SPECIALTY MANUFACTURING CO., INC.	144
	PRECISION SCREW & BOLT, INC.	147
<b>PSM</b> <b>PSM</b>	PENN SCREW & MACHINE WORKS, INC.	144

SYMBOL	COMPANY NAME	PAGE
	PRODUCTION & TOOL COMPANY	148
	PACIFIC TOOL, INC.	141
<b>PTI</b>	PAINTER TOOL, INC.	141
	PRECISION TECHNOLOGIES, INC.	147
<b>PTM</b>	PINE TAVERN MACHINE INC.	145
<b>PTX</b>	PATEREX, LTD.	142
	TRW	183
<b>Q</b>		
	QSN MANUFACTURING, INC.	150
<b>Q</b>	QUALITY SCREW PRODUCTS, INC.	150
	ALL QUALITY SPARES, INC.	12
<b>QAS</b>	QUALITY AIRCRAFT SCREWS, INC.	150
	CELTECH ENTERPRISE	43
	QUALITY FABRICATIONS, INC.	150
	QUALITY MACHINE & MFG INC.	150
	QUALITY SOCKET SCREW MANUFACTURING CORP.	150
<b>QSS</b>		
<b>QT</b>	QUALITY THREADED PRODUCTS COMPANY	150
<b>R</b>		
<b>R</b>	R.E.C. CORP.	152
	RAHMEDE SCHRAUBENFABRIK	153
<b>R</b>	RAM THREADING, INC.	153
<b>R</b>	RAMAR NUTS, INC.	153
<b>R</b>	REPUBLIC FASTENER MANUFACTURING CORP.	155
	ROBBINS MANUFACTURING	157
	ROCKFORD BOLT & STEEL CO.	157
	ROCKFORD FASTENERS INC.	157
	ROCKFORD PRODUCTS CORP.	158
	ROGG MANUFACTURING COMPANY	158



































## MIL-HDBK-57D(IS)

SYMBOL	COMPANY NAME	PAGE
<b>R</b>	RONSON MANUFACTURING, INC.	158
	RUMCO, INC.	159
<b>•R</b>	UNIFLOW CORP.	184
<b>R9</b>	REID PRODUCT INC.	
<b>RAE</b>	RAE MANUFACTURING CO.	153
<b>RAM</b>	RAM PRODUCTS	153
	R. BILD COMPANY, INC	152
	ROCKFORD BOLT & STEEL CO.	157
<b>R B W</b> 	R B & W CORPORATION	151,152
	R & D FASTENERS	151
	R & D WELDING & MACHINE INC.	151
	RAMM DEFENSE PRODUCTS	154
<b>RE</b>	RAM ENTERPRISES	153
	REED INSTRUMENT CO.	155
<b>REP</b>	RIVNUT ENGINEERED PRODUCTS, INC.	157
	REXNORD	155
<b>RH</b>	ROBERT HENRY CO., INC.	157
<b>RI</b>	REXNORD	155
<b>RI</b>	ROSAN PRODUCTS	158
<b>RI</b>	RUDOLPH INSTRUMENTS, INC.	159
<b>RIBE</b>	BERGNER, RICHARD GMBH & CO.	28
	R B & W CORPORATION	151,152
<b>R/M</b>	MANNO, RICHARD & CO., INC.	117
	RICHARD MFG. CO., INC.	155
	RAINBOW MACHINE PRODUCTS, INC.	153
<b>RMS</b>	RMS	157
<b>Rp</b>	REID PRODUCT INC.	155

















SYMBOL	COMPANY NAME	PAGE
	R & R PRECISION	151
<b>RR</b>	GRUPO RASSINI S.A. de C.V.	79
<b>RS</b>	RS MANUFACTURING, INC.	159
<b>RT</b>	AVIBANK MFG., INC.	22
	RUSCOMB TOOL & MACHNE CO., INC.	159
<b>RVT</b>	RIVER VALLEY TOOL & MANUFACTURING	156
	RA-WHITE, INC.	154
	RADAX INDUSTRIES, INC.	152
<b>S</b>		
<b>S</b>	BELL FASTENERS	27
<b>S</b>	J.P. PRODUCTS, INC.	96
	MNP CORPORATION	128
	NIPPON STEEL BOLTEN CO., LTD.	134
	S.I. STUD, INC.	160
<b>S</b>	SABRE MANUFACTURING, INC.	160
	SAI INDUSTRIES CORP. EFT 2	161
<b>S</b>	SCHUHL & CO. GMBH	162
<b>•S•</b>	SALES SYSTEM, LIMITED	161
	SEMBLEX CORP.	163
	SEMCO FASTENER	163
<b>\$</b>	SENG HENG ENGINEERING PTE LTD.	163
<b>\$</b>	SONIC INDUSTRIES, INC.	166
	SESCO INDUSTRIES, INC.	163
<b>S</b>	SHACKELFORD MACHING, INC.	163
<b>S</b>	SHEFFIELD, INC.	164
	SHIGA BOLT CO., LTD.	164
	SIERRACIN/HARRISON	165
	SKYLINE INDUSTRIES	165
	SPECIALS, INC.	168
<b>S</b>	SPECIALTY SCREW CORP.	168
<b>S S</b>	SPS TECHNOLOGIES	169















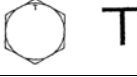
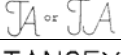

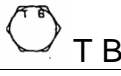

## MIL-HDBK-57D(IS)

SYMBOL	COMPANY NAME	PAGE
	SRI SAI INDUSTRIES CORPORATION	170
<b>S</b>	STANDARD NUT & BOLT, INC.	171
<b>S</b>	STELFAST FASTENERS, INC.	172
	STERLING MFG. & SUPPLY, INC.	173
	SULLIVAN BOLT CO., INC.	174
	U.S. BOLT MANUFACTURING, INC.	184
	WILHELM SCHUMACHER SCHRAUBEN-FABRIK GmbH	195
<b>SA</b>	BULTEN TRADING AB	35
	SPACE AGE ENGINEERING, INC.	167
	SANTA ANA GEAR & MACHINE	161
	D'SAMIC	56
	SOUTHWEST ALLIED PRODUCTS CO., INC.	167
	SOUTH BAY BOLT MANUFACTURING CO.	166
<b>SBE</b>	S. B. E. (ITALY CORPORATION)	160
<b>S-C</b>	SPS TECHNOLOGIES	169
<b>SC</b>	VOI-SHAN PRODUCTS	191
	STERLING MACHINE COMPANY	173
<b>SCA</b>	SCANDIA MFG. CO., INC.	162
<b>SCB</b>	STEEL CITY BOLT & SCREW, INC.	171
	SCOTT CRAFT CO.	162
	SPURWAY COOKE INDUSTRIES PTE LTD.	170
	CAMCAR DIVISION OF TEXTRON INC.	38-40
<b>SD</b>	SIMMONDS PRODUCTS	165
<b>SD</b>	STALKER & DYSTHE, INC.	170
	TANAKA LTD.	176
<b>SEMS</b>	CAMCAR DIVISION OF TEXTRON INC.	38-40
<b>SF</b>	SOUTHERN FASTENER CORPORATION	167
	SONFARREL, INC.	166







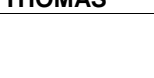







SYMBOL	COMPANY NAME	PAGE
	SHAMROCK FASTENER TECHNOLOGIES, LLC	163
	SAGA TEKKOSHO CO., LTD.	161
	SHUR-LOK CORP.	164
	SIERRA PACIFIC SUPPLY CO., INC.	165
<b>SI</b>	SOUTHWEST INDUSTRIAL SERVICES	167
<b>SII</b>	SUBURBAN INDUSTRIES, INC.	174
	SHUR-KUT SUPPLY CORPORATION	164
<b>S&amp;L</b>	S & L METAL PRODUCTS CORP.	159
	SHUR-LOK COMPANY.	164
<b>SL</b>	ST. LOUIS SCREW & BOLT CO.	170
<b>SG L</b>	GREER STOP NUT	78
<b>SLI</b>	SPACE-LOK, INC.	168
	STANDARD LOCKNUT, INC.	171
	SAMUEL MARSDEN & SON	161
<b>SM</b>	SKY MANUFACTURING	165
	STURM MACHINE CO., INC.	174
<b>SMF</b>	SATAIR MANUFACTURING FACILITY	162
	SANDIK MANUFACTURING, INC.	161
<b>SMP</b>	SHORELINE MACHINE PRODUCTS, INC.	164
<b>SM&amp;M</b>	SMITH MACHINE & MANUFACTURING	166
	SLABE MACHINE PRODUCTS	166
	FILETAGE INTERNATIONAL	70
	SKYSPARES PARTS, INC.	165
<b>SPG</b>	SHAW PRECISION GRINDING	4, 164
	SPARTAN PRECISION MACHINE	168
	STEEL PRODUCTS OF MASSILLION	171
<b>SPS SPS</b>	SPS TECHNOLOGIES	169
	SPACE SCREW, INC.	167
	MNP CORPORATION	128























## MIL-HDBK-57D(IS)

SYMBOL	COMPANY NAME	PAGE
	SOUTHERN FASTENING SYSTEMS	167
ST	AVIBANK MFG., INC.	22
	SWISS TECHNOLOGY, INC.	175
	SPIRAL TOOL CORP.	168
	STEADFAST CORPORATION	171
	SINN-TECH, INC.	165
	HALL INDUSTRIES INC. and STANDARD TOOL & MACHINE CO.	81, 171
STM	SPECIAL-T-METALS	168
STRUX (radial)	CAMCAR DIVISION OF TEXTRON INC.	38-40
SV	S V INDUSTRIES	175
SW	BELL FASTENERS	27
	SMITH WELDING, INC.	166
SW	STILLWATER FASTENERS, INC.	173
	SOUTHWIND INDUSTRIES, INC.	167
<b>T</b>		
	ARCHER SCREW PRODUCTS	17
T	BLANC AERO INDUSTRIES	29
T	ENGLE MANUFACTURING COMPANY, INC., THE	63
	LISI AEROSPACE	111
T	MINEBEA CO. LTD	126
	OSAKA SEIKI CO., LTD.	139
	RING SCREW WORKS	156
T	SPS TECHNOLOGIES	169
	T & E MACHINE CORP.	175
	TORCO, INC.	181
	TAKENAKA SEISAKUSHO CO., LTD.	176
	TECHNICAL FASTENERS, INC.	176
T	TELEFAST INDUSTRIES, INC.	177
T	TERRY MACHINE CO.	177
	TEXAS BOLT CO.	177

















SYMBOL	COMPANY NAME	PAGE
	TEXTRON FASTENING SYSTEMS	178
	TITAN FASTENER	180
	TOPURA CO., LTD.	180
	TOWNSEND CO.	181
	TOYO STEEL WIRE CO., LTD.	181
	TRY - AZTEC COMPANY	183
TANSEY	ARVAN, INC.	19
	TEBCO THREADED FASTENERS	176
	TEXAS BOLT CO.	177
	T-B & S MFG.	176
	SPS TECHNOLOGIES	169, 170
	TERRYCABLE, INC.	177
TCQ	T C QUALITY MACHINING INC.	175
	T & E MACHINE CORP.	175
	TEK PRECISION CO., LTD.	176
TELLEP	SPS TECHNOLOGIES-METALAC SPS INDUSTRIA	169
TENS	TENS MACHINE CO., INC.	177
	TEXAS BOLT CO.	177
TEXAS BOLT		
TF	TELEFAST INDUSTRIES, INC.	177
	HI-SHEAR CORP. and TORONTO FASTENERS INDUSTRIES, INC.	86, 181
	TFI AEROSPACE CORPORATION	178
	TFP CORP.	178
	TUFF FASTENERS CO.	183
	TFI AEROSPACE CORPORATION	178
	TFP CORP.	178
	THIANT (BOULONNERIE DE SA)	179
<b>THOMAS</b>	THOMAS MFG, INC.	180

























## MIL-HDBK-57D(IS)

SYMBOL	COMPANY NAME	PAGE
	THOMAS INSTRUMENT & MACHINE CO., INC.	179
	LEBRECHT TIGGES GmbH & CO. KG and SCHMICO GMBH SCHWEISSTECHNIK	106, 162
TJB	SPS TECHNOLOGIES	169
TKS	TOKOSHA METAL WORKS LTD.	180
	TOOLEX, INC.	180
TLP	SPS TECHNOLOGIES	169
	SPS TECHNOLOGIES	169
	TERRY MACHINE CO.	177
	TRIDENT MACHINE CO.	182
	TRONSON MANUFACTURING	182
TM9	SPS TECHNOLOGIES	169
TMC	LISI AEROSPACE	112
	FARLO MACHINE & TOOL CO., INC.	66
TMS	MACHINE SHOP, INC., THE	115
TMTI	THOMAS MACHINING TECHNOLOGIES, INC.	179
	NICE TOOL MFG., INC.	133
	TOG MANUFACTURING CO., INC.	180
	OTO MELARA S.p.A.	140
TORX (radial)	CAMCAR DIVISION OF TEXTRON INC.	38-40
TOPURA	TOPURA CO., LTD.	180
TP	TOPURA CO., LTD.	180
	TEXAS PRECISION MFG., INC.	177
TR	T R MACHINE INC.	175
	TOWNE ROBINSON FASTENER CO.	181
TRI	TRIUMPH MANUFACTURING CO., INC.	182
Tridair	REXNORD	155
		
TRIDAIR	TRIDAIR PRODUCTS	182
	TRW	183
TTC	CAMCAR DIVISION OF TEXTRON INC.	38-40

SYMBOL	COMPANY NAME	PAGE
<b>TUZ</b>	MAUDLE INDUSTRIAL CO., LTD.	120
	SUNDRAM FASTENERS, LTD.	174
<b>TVS</b>	TFP CORP.	178
		
		
		
		
<small>Raised letters</small>		
<small>Indented letters</small>		
<b>TYE</b>	YOUNG ENGINEERS INC, THE	198
<b>U</b>		
	OHKAWA SCREW MFG. CO., LTD. and OKAWA SCREW MANUFACTURING CO., LTD	138
	OKABE CO., INC.	138
		
		
		
<b>U</b>	SPS TECHNOLOGIES	169
	UNBRACO PTY LTD	169
<b>U</b>	UNIMETERIC CORPORATION	185
	UNITED DRILL BUSHING CORP.	185
	URANIA ENGINEERING CO., INC.	186
	URBAN MANUFACTURING CO.	186
	URBAN MFG. CO. INC.	186
<b>U130</b>	SPS TECHNOLOGIES	169
<b>UM</b>	SPS TECHNOLOGIES	169
	UNBRACO PTY LTD.	169
<b>UM</b>	UNIVERSAL MACHINE PRODUCTS	186
		
	ULTIMATE MACHINING & WELDING	184
<b>UNBRAKO</b>	SPS TECHNOLOGIES	169
	SPS TECHNOLOGIES	169
		
<b>UNISTRUT</b>	UNISTRUT CORP.	185
		
<b>UNW</b>	SPS TECHNOLOGIES	169
<b>UP</b>	UNITED PRECISION PRODUCTS CO., INC.	185
<b>UPME</b>	U.P. MACHINE & ENGINEERING CO.	184
	UNITED STATES DEFENSE RESEARCH & SUPPLY	185
		
		
		
	UNITED STEEL & FASTENERS INC.	186

















## MIL-HDBK-57D(IS)









SYMBOL	COMPANY NAME	PAGE
 USA 01AK	DOMESTIC FASTENER & FORGE, INC	55
USMC	ULTRA SONIC MACHINE CO., INC	184
	US TOOL & DIE	187
<b>V</b>		
V	AERCO RESEARCH	7
	AERO COMPONENTS CO	7
V	CHAMPION COMMERCIAL INDUSTRIES, INC.	44
	MNP CORPORATION	128
V	PACER ALLOYS, INC.	141
 V	V-B MACHINE CO., INC.	187
V	VICO PRODUCTS, CO.	188
 V	VICTOR PRODUCTS CORP.	188
	VISTEK INDUSTRIES	189
	VITCO NUCLEAR PRODUCTS INC.	189
.V.	VMC INDUSTRIES, INC.	189
V	VOSS INDUSTRIES, INC.	191
 V.  V. 304 V.	VULCAN RIVET & BOLT CORP.	191
<b>VALCOR</b>	VALCOR ENGINEERING CORP.	187
<b>VERBUS'</b>	BAUER & SCHAURTE KARCHER GMBH	25
 VF 	MNP CORPORATION	128
	VALLEY FORGE AND BOLT MFG CO.	187
	VENUS FASTENERS CORP.	188
V F M	VEGAS FASTENER MANUFACTURING VIP MFG. & ENGR. CORP.	187 188
	VM MANUFACTURING CORP.	189
	VMC INDUSTRIES, INC.	189
	VOSS INDUSTRIES, INC.	191

SYMBOL	COMPANY NAME	PAGE
	VAN PETTY MFG., INC.	187
	VOI-SHAN PRODUCTS	191
<b>VS</b>	VSI	191
	VERSATECH, INC.	188
 VT	VALLEY-TODECO	187
<b>W</b>		
W	MEC WOLF SRL	121
 W	WALZ & KRENZER INC DBA MAPECO PRODUCTS	192
	WARREN PUMPS LLC	192
	WATERBURY BUCKLE CO.	192
	WAYNE BOLT & NUT CO., INC.	192
	WELTON ROLLED THREAD CORP.	192
	WESTLAND STEEL PRODUCTS, LTD.	194
	WHELAN MACHINE & TOOL CO.	194
	WHITNEY SCREW CORP.	194
	WIGLEY MACHINE COMPANY	194
	WILLIAM'S MACHINE & FABRICATION, INC.	195
W	WINKER HERMAN GMBH & CO. KG	195
 	WODIN, INC.	196
	WOLTERS GMBH	196
	WROUGHT WASHER MANUFACTURING INC.	197
	WYANDOTTE INDUSTRIES, INC.	197
	WYNNSON ENTERPRISES, INC.	197
	WINSLOW AUTOMATICS, INC.	196
	WALKER BOLT MANUFACTURING CO., INC.	191
	WEBLUK MACHINE CORP.	192
	WEST COAST AEROSPACE, INC.	193











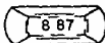































## MIL-HDBK-57D(IS)

SYMBOL	COMPANY NAME	PAGE
WEDGELOCK	MONOGRAM AEROSPACE FASTENERS	129
WESLOK	WESLOK	193
	WESTFIELD FASTENERS	194
 	WILSON-GARNER CO.	195
	RATHMANN WALTER G. SEGMENT-KLAMMERSCHRAUBEN GMBH	154
	WHITTET-HIGGINS CO.	194
WH	WOLTERS GMBH	196
	WOLSTENHOLME MACHINE	196
WMI	WEAVER MANUFACTURING, INC.	192
	WIL-NIC	195
	WESTERN PACIFIC ENTERPRISES, W.P.E. INC.	193
	WESTWOOD PRECISION, INC.	194
<i>Wpp</i>	WILT PRECISION PRODUCTS	195
	CUTTING EDGE MACHINING INC. and WESTERN SCREW MACHINE PRODUCTS, INC.	50, 193
WSI	WESTERN SKY INDUSTRIES, INC.	193
WSMP	WORTHEY MACHINE	197
	KAMPWERK VIEREGGE U. PICKARDT GMBH. & CO.	98
	WILHELM SCHUMACHER SCHRAUBEN-FABRIK GmbH	195
	TW DESIGN AND MANUFACTURING, L.L.C.	183
WWE	LINREAD PUBLIC LIMITED CO.	110
<b>X</b>		
	EXCEL PRECISION PRODUCTS, INC.	65
XP	R B & W CORPORATION	151
<b>Y</b>		
	YOW MENGI INDUSTRIAL CO., LTD.	198
<b>Y 2 K</b>	Y2K MACHINE SHOP	197
	FANG SHENG SCREW CO., LTD.	66























SYMBOL	COMPANY NAME	PAGE
	YATES TOOL, INC.	198
<b>Z</b>		
<b>Z</b>	D.S.O. PLASTICS, INC.	50
	ZAMON CO., INC.	198
<b>Z</b>	ZERO PRODUCTS, INC.	198
	Z & B GENERAL MACHINE	198
<b>ZENEX</b>	ZENEX CORPORATION	198
	ZERO PRODUCTS, INC.	198
<b>NUMBER</b>		
	AERO-FAB, INC.	7
<b>0XK38</b>	NORTHSTAR ENGINEERING	135
<b>01DC</b>	RISCO, INCORPORATED	156
	MAC FASTENERS, INC.	115
<b>01FO</b>	ACCUTOOL	4
<b>01FO</b>	SUBCON TOOL/ACCUTOOL MACHINE GROUP INC. (DBA ACCUTOOL)	174
<b>0F0Y2</b>	ADVANCED MACHINING TECHNOLOGIES	6
<b>01NU</b>	EAGLEHEAD MANUFACTURING COMPANY	58
<b>05DT8</b>	FITZ MANUFACTURING INDUSTRIES LTD DBA FMI	70
<b>05141</b>	McMELLON BROS INC.	121
<b>09094</b>	QRP, INC.	149
<b>1A249</b>	ACCURATE THREADED PRODUCTS CO.	4
<b>1EM77</b>	GS AEROSPACE TECHNOLOGY, INC.	79
<b>1H423</b>	J & M MACHINE INC.	95
<b>1st</b>	FIRST AMERICAN SALES CO.	70
<b>1Y128</b>	D & D MACHINERY AND SALES	50
<b>1YFG0</b>	MAGNUM MACHINE SHOP	117
<b>15077</b>	NORTHBRIDGE FASTENERS	135
<b>2</b>	STERLING MACHINE COMPANY	173
<b>2F 3F 4F 5F</b>	FONTANA S.A.	72
<b>2A832</b>	JMT MACHINE COMPANY	97
<b>20733</b>	NORTHBRIDGE FASTENERS	135
	UTAH TOOL & DIE, INC.	187
	3D MACHINE COMPANY, INC	1
<b>3D531</b>	ALAN, JEFFREY, MFG. & ENGR	11
	MODERN METRIC MACHINE COMPANY INC.	128
<b>30633</b>	C & H MFG., INC.	36

## MIL-HDBK-57D(IS)

SYMBOL	COMPANY NAME	PAGE
32219	NORTHBRIDGE FASTENERS	135
<b>4J952</b>	GENERAL AVIATION MFG., INC.	75
4J976	REGAL AIR, INC	155
<b>4N133</b>	CHATHAM PRECISION, INC.	45
4T853	D & R MACHINE COMPANY	50
5T572	NORTHBRIDGE FASTENERS	135
509W0	BOMBSHELL, INC.	31
54878	ROTAIR INDUSTRIES, INC.	159
56878	SPS TECHNOLOGIES	169
	BISHOP ENTERPRISES, INC.	29
60529	STERLING MFG. & SUPPLY, INC.	173
61062	COMET MFG. CO., INC.	47
62206	B & B SPECIALTIES, INC.	22
7	HEPTNER MFG CO.	84
71838	SPS TECHNOLOGIES	169
8F781	STEVENS MFG. CO., INC.	173
8M938	PRODUCTS DESIGN & MFG. CORP.	149
8T968	ROMAC ELECTRONICS, INC.	158
80539	SPS TECHNOLOGIES	169
84256	AVIBANK MFG., INC.	22
	THIANT (BOULONNERIE DE SA)	179
99106	AMERICAN AIRCRAFT PARTS MANUFACTURING COMPANY	14
9R	REID PRODUCT INC.	
<b>SYMBOL</b>		
	3 V FASTENERS	1
	A & G ENGINEERING CO., INC	1
	ACME RIVET & MACHINE CORP.	5
	AVDEL INTERNATIONAL	21
	ACRODYNE MFG CO.	5
	AEROSPACE RIVET MFG CORP	9
	ALCOA FASTENING SYSTEMS	11
	KAYNAR PRODUCTS	99
	(Previously KAYNAR TECHNOLOGIES, INC DIV. OF MICRODOT	124
	ALCOA GLOBAL FASTENERS INC	12
	ALL PINS MANUFACTURING	12
	ALL-STATES INC.	13
	ANCHOR BOLT & SCREW CO.	16
	ANILLO INDUSTRIES, INC.	16
	ARMSTRONG FASTENING SYSTEMS	18

SYMBOL	COMPANY NAME	PAGE
	ASI DESIGN & MANUFACTURING, INC.	19
	AUTO SCREW, INC.	21
	AMERITECH FASTNER MFG INC.	15
	ARGARWAL INDUSTRIES	17
	AVIBANK MFG., INC.	22
	AZTECH ENGINEERING, INC.	22
	BAUER & SCHAURTE KARCHER GMBH	25
	BOLLHOFF & CO. GmbH & CO. KG	30
	CARR CO.	42
	CLEVELAND HARDWARE & FORGING and GREEN BAY DROP FORGE	46, 77
	CODLING TOOL & MFG. INC.	47
	COLD HEADING CO., THE	47
	DAVIS AIRCRAFT PRODUCT CO., INC.	51
	DO-ALL PRECISION, INC.	55
	DRESSER INDUSTRIES, INC.	56
	EDS ORDNANCE	59
	ELCO INDUSTRIES, INC.	60
	GEN FAST MANUFACTURING COMPANY	75
	STELCO FASTENER & FORGING CO.	172
	EMHART CORP.	61
	FRIEDR BOESNER GMBH	73
	INFASCO, NFASCO NUT and INGERSOLL FASTENERS	93
	FENTON HEADING	69
	FERNDALE FASTENER	69
	FISCHER SPECIAL MFG. CO.	70
	PRECISION METAL PRODUCTS CO.	147

## MIL-HDBK-57D(IS)

SYMBOL	COMPANY NAME	PAGE
	FOREST FASTENERS	72
$\gamma$ $\Gamma$	GMP CO. CORPORATION	76
$\pi$	PILGRIM SCREW CORP.	144
	GRADON SCREW MACHINE CORP.	77
	GROOV-PIN CORPORATION	79
	HANDI GADETS CORP.	81
	HEARTLAND PRECISION FASTENER	83
	HESSISCHE SCHRAUBENFABRIK WELTER GmbH & CO., KG	84
	WELTER GMBH & CO. KG	192
	HOUSTON FASTENER	85
	HUCK AEROSPACE PRODUCTS	89
	HUCK INTERNATIONAL PRODUCTS	89
<b>9</b>	HURRICANE MACHINE COMPANY, L.L.C.	90
	INDUX, S.A. DE C.E.	92
	ITW CIP	94
$\alpha$	KOBE FASTENER LIMITED	101
	KOREA BOLT IND., CO., LTD.	102
	KPF	102
	LBL PRODUCTS	106
	LINREAD NORTHBRIDGE AIRCRAFT PRODUCT DIVISION	109
	LISI AEROSPACE	111
	MACK, A. W. MFG CO.	115
	MINEBEA CO. LTD	126
	NAGOYA SCREW MANUFACTURING CO, LTD.	130
	NCSI BRUEGGEMANN INC.	132
	ONEIDA TOOL & MACHINE CORP.	138
	PELHAM AUTO MATRIX PRECISION	143







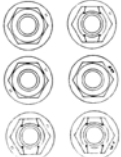
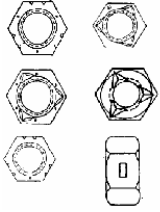
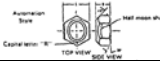
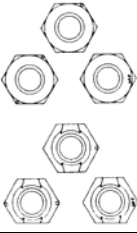
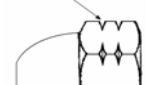

SYMBOL	COMPANY NAME	PAGE
	PINTO PRODUCTS	145
	PREM INDUSTRIES, INC.	148
	RELIANT FASTENER	155
	REXNORD	155
	TRIDAIR PRODUCTS	182
  	RING SCREW WORKS	156
	ROBBINS MANUFACTURING	157
 	ROTAIR INDUSTRIES, INC. <small>Rubber stamped on fasteners</small>	159
	SANNOHASHI SEISAKUSHO CO., LTD.	161
	SANTA ANA SCREW PRODUCTS INC	161
	SATURN FASTENERS, INC.	162
	SHAMROCK FASTENER TECHNOLOGIES, LLC.	163
	SPS TECHNOLOGIES METALAC INDUSTRIA	169
	STELFAST FASTENERS, INC.	172
<b>&amp;</b>	STILLWATER FASTENERS, INC.	173
	STRENKERT MACHINE SHOP INC.	173
	SUNRISE PRECISION MFG.	174
 <b>EARTH</b>	SUPERIOR TECHNOLOGY	174
	SUPREME SCREW PRODUCTS, INC.	174
 	TAIYO NUT MFG. CO., LTD.	175
	TECH WELDING AND MACHINE CO.	176
	TENS MACHINE CO., INC.	177
	TFI AEROSPACE CORPORATION	178
	TOPURA CO., LTD.	180

MIL-HDBK-57D(IS)

SYMBOL	COMPANY NAME	PAGE
	TOPURA CO., LTD.	180
	TRI STATE TOOL & DIE CO.	182
	UNITED BOLT & SCREW CORP.	185
	UNITED STEEL & FASTENERS INC.	186
	WHAIL BOLT IND. CO., LTD	194
	XCEL MFG., INC.	197
• (a dot)	CINCH-MONADNOCK	46
• (a dot)	DECKER MANUFACTURING CORP	52
- (radial line)	MONADNOCK COMPANY, THE	128
• (a dot)	MONADNOCK COMPANY, THE	128
•• (2 dots)	BELL FASTENERS	27
•• (2 dots)	BRISTOL INDUSTRIES	32
	CUTTING EDGE ENTERPRISE, LLC	50
•• (2 dots)	STILLWATER FASTENERS, INC.	173
	CSM FASTENER PRODUCTS	49
	EMP MANUFACTURING CO.	61
	ERICO FASTENING SYSTEMS	63
	WOLVERINE NUT CO.	197
3 dots, centered on corner, equally spaced		
••••	CAMCAR DIVISION OF TEXTRON INC.	38-40
4 dots inline or radial		
	CAMCAR LLC	41
//	BRISTOL LOCKNUT CO.	33
	CAMCAR DIVISION OF TEXTRON INC.	38-40
3 radial lines		
	METALCRAFTERS	123
= 2 parallel lines	CAMCAR DIVISION OF TEXTRON INC.	38-40
	MICRODOT INC.	124
Three parallel lines spirak insert products only		
	AMERIFAST CORP.	15

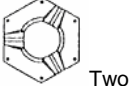
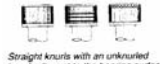
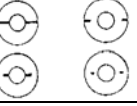
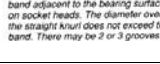

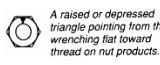
SYMBOL	COMPANY NAME	PAGE
	GREER STOP NUT	78
Manufacturer identification: 2 raised ribs in (2) crimp depressions 1 raised rib in (1) crimp depression		
"Dimple" trademark	PENN ENGINEERING & MANUFACTURING CO.	143
Notches or Stakes cut into corners of nut	EVERLOCK FASTENING SYSTEMS	64,65
2, 3, or 6 dots on corner of nut 4 or 6 dots on flange of flange nuts	FEDERAL SCREW WORKS	69
	INDUSTRIAL & AUTOMOTIVE FASTENERS	91
Company I.D. - 2 single & 1 double slash		
Dots, slashes, and dots with slashes 2 - 8	R B & W CORPORATION	151, 152
Dots, slashes, and dots with slashes 2 - 8	STELCO FASTENER & FORGING CO.	172
Raised or indented marks	INDUSTRIAL FASTENERS CORP.	92
Under head Top of head Slotted hex/head (top of head)		
	LAMSON AND SESSIONS OF CANADA LTD.	105
4 - 7 DOTS		
	INDUSTRIAL NUT CORP.	92
3, 4 or 6 equally spaced stakes		
120° INCLUDED ANGLE RAISED. INDENTED HEX NDS. AND INDENTED HEX WASHER NDS.	LEWIS SREW COMPANY	109
3-DASH MARKS 120° APART RAISED. UNDER HEAD UPON REQUEST "NON-COUNTERSINK HEADS ONLY"	LEWIS SREW COMPANY	109

## MIL-HDBK-57D(IS)

SYMBOL	COMPANY NAME	PAGE	SYMBOL	COMPANY NAME	PAGE
<p>Flange nuts also lock and with Uni-Torque® lock Two raised bars</p>  <p><b>TWO RAISED BARS</b></p>	MACLEAN-FOGG CO.	116		GRIPCO, DIVISION OF BLACK & DECKER	78
<p>Three raised or depressed lines</p>	THIANT (BOULONNERIE DE SA)	179		RAMCO SPECIALTIES, INC.	148
<p>Hex nuts and Uni-Torque® locknuts</p> 	MACLEAN-FOGG CO.	116		RIPPA PRODUCTS	156
<p>INTERFAS Lock Nut &amp; Bolt</p> 	PACIFIC FASTENERS, INC.	141	 <p>2 notches for slotted heads only</p>	SOUTHERN FASTENING SYSTEMS	167
	TEXTRON FASTENING SYSTEMS	178		WOLVERINE MACHINE PRODUCTS CO.	196
 <p>Two lines in three pads</p>	VMC INDUSTRIES, INC.	189		SPS TECHNOLOGIES	169
	ELCO INDUSTRIES, INC.	60	 <p>Straight knurls with an unknurled band adjacent to the bearing surface on socket heads. The diameter over the straight knurl does not exceed the band. There may be 2 or 3 grooves.</p>	SPS TECHNOLOGIES	169
<p>Blue - nylon® hexagon locking element</p> 	PENN ENGINEERING & MANUFACTURING CO.	143	 <p>A raised or depressed triangle pointing from the wrenching flat toward thread on nut products.</p>	SPS TECHNOLOGIES	169
<p>Green nylon insert</p>	GREER STOP NUT	75	<p>Blue nylon insert</p>	INDUSTRIAL NUT CORP.	92
<p>Green nylon insert</p>	EVERLOCK FASTENING SYSTEMS	65	<p>Blue nylon locking element</p>	NYLOK CORP.	137
<p>Red nylon insert</p>	ELASTIC STOP NUT & ESNA	60, 116			
<p>Tan nylon insert</p>	VMC INDUSTRIES, INC.	183			
<p>Yellow nylon insert</p>	ABBOTT INTERFAST CORP.	2			
<p>Square insert in floating fasteners</p> 	PENN ENGINEERING & MANUFACTURING CO.	143			

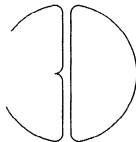

## MIL-HDBK-57D(IS)

<p>3 V FASTENERS 320 REED CIRCLE CORONA, CA 92879-1349</p>  <p>CAGE code: 1ER65 <span style="float: right;"><u>1/</u></span></p>	<p>A &amp; M AEROSPACE, INC. 2332 SOUTH DELAWARE DENVER, CO 80223-4321</p> <p>A      A &amp;      M      A/M      A&amp;M M</p> <p>CAGE code: 6Z800 <span style="float: right;"><u>1/</u></span></p>
<p>3D MACHINE COMPANY, INC. 5586 EAST LA PALMA AVENUE ANAHEIM, CA 92807-2108</p>  <p>CAGE code: 1K6P6 <span style="float: right;"><u>2/</u></span></p>	<p>A &amp; N PRECISION INDUSTRIES 65 FIRST STREET NEW ROCHVILLE, NY 10801-6118</p>  <p>CAGE code: 9Y423 <span style="float: right;"><u>2/</u></span></p>
<p>A &amp; E MACHINED PRODUCTS 93 PECK HILL ROAD JOHNSTON, RI 02919</p> <p style="text-align: center;"><b>AE</b></p> <p>CAGE code: 3MAH6 <span style="float: right;"><u>2/</u></span></p>	<p>A &amp; R MFG CORP. 1281 JOHN FITCH BLVD. SOUTH WINDSOR, CT 06074</p> <p style="text-align: center;"><b>AR</b></p> <p>CAGE code: 3X841 <span style="float: right;"><u>2/</u></span></p>
<p>A &amp; G ENGINEERING CO., INC 4640 EAST LAPALMA ANAHEIM, CA 92807</p>  <p>CAGE code: 4N135 <span style="float: right;"><u>2/</u></span></p>	<p>A &amp; W SCREW MACHINE PRODUCTS, INC. 3131 KANSAS AVE RIVERSIDE, CA 92507</p> <p style="text-align: center;"><b>AW</b></p> <p>CAGE code: 63035 <span style="float: right;"><u>1/</u></span></p>

1/ Information published in this revision was verified by direct contact with manufacturers.

2/ Information not verified to be current, no response from manufacturer. Information identical to that published in MIL-HDBK-57, Revision B.

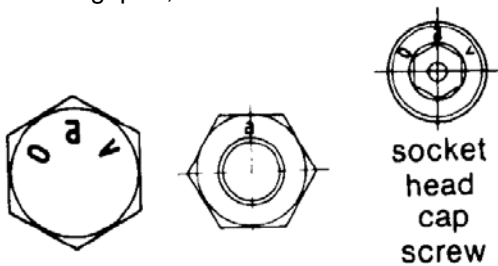
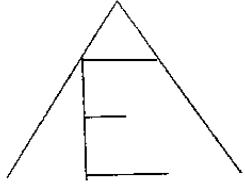
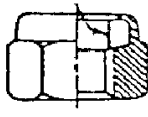

## MIL-HDBK-57D(IS)

<p>A. AGRATI S.P.A. VIA PAIVE 28/30 20050 VEDUGGIO CON COLZANO MILANO, ITALY</p> <p>Plant AGRATI CORP. 925 Brewster Street Bridgeport, CT 06605</p>  <p>socket head cap screw</p> <p>CAGE code: A0698 <span style="float: right;">2/</span></p>	<p>A-1 THREAD ROLLING CO., INC. 4933 MASON ST. SOUTH GATE, CA 90280</p> <p style="text-align: center; font-size: 2em;"><b>A-1</b></p> <p>CAGE code: 3N586 <span style="float: right;">2/</span></p>
<p>A. P. MILLS INDUSTRIES FOR THE BLIND 346 ST. PAUL AVE. P.O. BOX 2175 MEMPHIS, TN 38101</p> <p>(See WEST TENNESSEE LIONS BLIND INDUSTRIES INC.)</p> <p style="text-align: center; font-size: 3em;"><b>APMI</b></p> <p>CAGE code: 5L565 <span style="float: right;">2/</span></p>	<p>AAP ACQUISITION CORP 2100 ENTERPRISE PKWY TWINSBURG, OH 44087-2212</p> <p>(SEE ACHILLES AEROSPACE PRODUCTS)</p> <p style="text-align: center; font-size: 3em;"><b>A</b></p> <p>CAGE code: 0H380 <span style="float: right;">2/</span></p>
<p>A-1 NUT AND BOLT CO, INC DIVISION OF GREEN CO. PACIFIC INC. 3433 S. MALT AVENUE COMMERCE, CA 90040</p> <p style="text-align: center; font-size: 3em;"><b>A 1</b></p> <p>CAGE code: 1M493 <span style="float: right;">2/</span></p>	<p>AASTRO ENGINEERING 1382 CORONADO AVE LONG BEACH, CA 90804</p>  <p>CAGE code: 01AL8 <span style="float: right;">2/</span></p> <p>ABBOTT INTERFAST CORP. 190 ABBOTT DRIVE WHEELING, IL 60090</p> <p>Yellow nylon insert identifies Abbott-Interfast Corp. as manufacturer</p>  <p>CAGE code: 08928 <span style="float: right;">1/</span></p>

1/ Information published in this revision was verified by direct contact with manufacturers.

2/ Information not verified to be current, no response from manufacturer. Information identical to that published in MIL-HDBK-57, Revision B.

## MIL-HDBK-57D(IS)

<p>ABBOTT, PETER (AEROSPACE) 1982 LTD. 6 REPTON CLOSE BURNT MILLS, BASILDON, ESSEX SS13 ILE UNITED KINGDOM</p> <p style="text-align: center;"><b>PAM</b> <b>PAM</b> <b>PAM</b></p> <p>CAGE code: 0WL73 <span style="float: right;">2/</span></p>	<p>ACCURATE AUTOMATIC PARTS CO. 2885 S. 163RD ST. NEW BERLIN, WI 53151</p> <p style="text-align: center;"><b>AP</b></p> <p>CAGE code: 5S202 <span style="float: right;">2/</span></p>
<p>ABC TOOL AND DIE ENGINEERING &amp; MANUFACTURING LLC 197 WALLIS STREET UNIT C EUGENE, OR 97402-5301</p> <p style="text-align: center;">No artwork for marking. Marks whatever the customer specifies.</p> <p>CAGE code: 0XJF0 <span style="float: right;">1/</span></p>	<p>ACCURATE PRECISION FASTENERS, INC. P.O. BOX 5239 ENGLEWOOD, NJ 07631</p> <p style="text-align: center;">Plant 20 HONECK ST. ENGLEWOOD, NJ 07631</p> <p style="text-align: center;"><b>A</b></p> <p>CAGE code: 28977 <span style="float: right;">2/</span></p>
<p>ABSCOA INDUSTRIES 1071 WEST ARBOR VITAE ST. INGLEWOOD, CA 90301</p> <p style="text-align: center;"><b>AB</b></p> <p>CAGE code: <span style="float: right;">2/</span></p>	<p>ACCURATE SCREW MACHINE CO. (DBA ASM) P.O. 10095 10 AUDREY PL FAIRFIELD, NJ 07004-3402</p> <p style="text-align: center;">Plant 19 Baltimore St. Nutley, NJ 07110</p> <p style="text-align: center;"><b>AMSCO</b></p> <p style="text-align: center;">5/16 LONG X 1/16 HIGH X .010 DEEP</p> <p>CAGE code: 51506 <span style="float: right;">2/</span></p>
<p>ACCUFORM, INC. P.O. BOX 307 BUS. HWY. 36 WEST MACON, MO 63552</p> <p style="text-align: center;"><b>AF</b>      <b>AF</b></p> <p>CAGE code: <span style="float: right;">2/</span></p>	<p>ACCURATE THREADED FASTENERS, INC. DIVISION OF BEATRICE FOODS CO. (new company name see ATF, INC.) 3550 WEST PRATT AVE LINCOLNWOOD, IL 60645</p> <p style="text-align: center;">      </p> <p>CAGE code: 95110 <span style="float: right;">1/</span></p>

1/ Information published in this revision was verified by direct contact with manufacturers.

2/ Information not verified to be current, no response from manufacturer. Information identical to that published in MIL-HDBK-57, Revision B.











MIL-HDBK-57D(IS)

<p>ACCURATE THREADED PRODUCTS CO. 280 HARTFORD AVENUE NEWINGTON, CT 06111</p> <p><b>1A249</b></p> <p>CAGE code: 1A249 <u>2/</u></p>	<p>ACE GRINDING &amp; MFG. OF TEXAS (formally ACE G &amp; M CO. OF TEXAS) 2610 AERO DR. GRAND PAIRIE, TX 75052</p> <p><b>AGC</b></p> <p><i>Plant (plant closed)</i> <i>ACE GRINDING &amp; MFG.</i> <i>4937 EAST SLAUSON AVENUE</i> <i>MAYWOOD, CA 90270</i> <i>CAGE code: 2N509</i></p> <p><b>AGM</b></p> <p>Plant (see SHAW PRECISION GRINDING AND THREAD ROLLING) SHAW PRECISION GRINDING 6503 W. FRYE RD. CHANDLER, AZ 85226</p> <p><b>SPG</b></p> <p>CAGE code: 5U074 <u>1/</u></p>
<p>ACCURATE TOOL CO., INC. 891 FERNHILL RD WEST CHESTER, PA 19380 - 4282</p> <p><b>A+</b></p> <p>CAGE code: 7N957 <u>1/</u></p>	<p>ACE PRECISION INDUSTRIES, INC. 925 MOE DRIVE AKRON, OH 44310-2518</p> <p><b>ACE</b></p> <p>CAGE code: 3DTZ2 <u>2/</u></p>
<p>ACCU-TECH MANUFACTURING AND SUPPORT, INC. 8875 EAST AVENUE MENTOR, OH 44060</p> <p><b>Accu-Tech</b> MFG. &amp; SUPPORT INC.</p> <p>CAGE code: 1LLG8 <u>2/</u></p>	<p>ACHILLES AEROSPACE PRODUCTS, INC. 2100 ENTERPRISE PKWY TWINSBURG, OH 44087-2212</p> <p>(SEE AAP)</p> <p><b>A</b></p> <p>CAGE code: 0H380 <u>2/</u></p>
<p>ACCUTOOL (SUBCON TOOL/ACCUTOOL MACHINE GROUP INC. DBA ACCUTOOL) SEE SUBCON TOOL 5301 IROQUOIS AVENUE ERIE, PA 16511-2529</p> <p><b>01FO</b></p> <p>CAGE code: 1UXM0 <u>1/</u></p>	

1/ Information published in this revision was verified by direct contact with manufacturers.

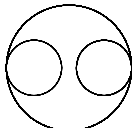
2/ Information not verified to be current, no response from manufacturer. Information identical to that published in MIL-HDBK-57, Revision B.







## MIL-HDBK-57D(IS)

<p>ACI 301 W. WILSON P.O. BOX 398 OTTAWA, KS 66067</p> <p style="text-align: center;"><b>ACI</b></p> <p>CAGE code: 0AV61 <span style="float: right;"><u>2/</u></span></p>	<p>ACME SCREW COMPANY 1201 W. UNION AVE WHEATON, IL 60187-4879</p> <p>  Carbon steel          430 stainless steel       </p> <p>  410 stainless steel          305 stainless steel       </p> <p>CAGE code: 35EX5 <span style="float: right;"><u>2/</u></span></p>
<p>ACIMET MFG. 1710 CLARKSTONE RD. CLEVELAND, OH 44112</p> <p style="text-align: center;">   </p> <p>CAGE code: 6V869 <span style="float: right;"><u>2/</u></span></p>	<p>ACRODYNE MFG CO. (DIVISION OF MACK INTERNATIONAL OPERATIONS) 41 KINGSTON AVE COLUMBUS, OH 43207-2438</p> <p style="text-align: center;">  </p> <p>CAGE code: 9Y179 <span style="float: right;"><u>2/</u></span></p>
<p>ACME MACHINE PRODUCTS 500 SOUTH VARNEY STREET BURBANK, CA 91502</p> <p style="text-align: center;">  </p> <p>CAGE code: 4M256 <span style="float: right;"><u>2/</u></span></p>	<p>ACUFAST AIRCRAFT PRODUCTS 12424 GLADSTONE AVE. SYLMAR, CA 91342</p> <p style="text-align: center;"><b>AF</b></p> <p>CAGE code: 4GP55 <span style="float: right;"><u>1/</u></span></p>
<p>ACME RIVET &amp; MACHINE CORP. 50 EMMETT ST. BRISTOL, CT 06010</p> <p style="text-align: center;">   </p> <p>CAGE code: 34482 <span style="float: right;"><u>2/</u></span></p>	<p>ADAMS INDUSTRIES, INC. (A SUB OF BANNER INDUSTRIES INC.) 1160 SOUTH ST WINDSOR LOCKS, CT 06096</p> <p style="text-align: center;"><b>ABE</b></p> <p>CAGE code: 33823 <span style="float: right;"><u>2/</u></span></p>

1/ Information published in this revision was verified by direct contact with manufacturers.

2/ Information not verified to be current, no response from manufacturer. Information identical to that published in MIL-HDBK-57, Revision B.

## MIL-HDBK-57D(IS)









<p>ADAMS, EARL M. CO. 100 PECK HILL RD. JOHNSTON, RI 02919</p>   <p>CAGE code: 07123 <u>2/</u></p>	<p>ADVANCE PATTERN CORP. 18564 FITZPATRICK DETROIT, MI 48228</p> <p><b>MFR 29839</b></p> <p>CAGE code: 29839 <u>2/</u></p>
<p>ADC COMMUNICATIONS CORP. 17528 STUDEBAKER RD. CERRITOS, CA 90703-2637</p>   <p>CAGE code: 9X383 <u>2/</u></p>	<p>ADVANCED CNC MANUFACTURING 7303 124TH AVENUE NORTH LARGO, FL 33773</p> <p><b>A</b></p> <p>CAGE code: 1YDC9 <u>1/</u></p>
<p>ADI MANUFACTURING, INC. 33 HAMMOND, BLDG 201 IRVINE, CA 92718</p> <p>Plant 1243 TRANSIT STREET POMONA, CA 91766</p> <p><b>MC</b> <b>K</b></p> <p>CAGE code: 0YCU4 <u>2/</u></p>	<p>ADVANCED MACHINING &amp; FABRICATING, INC. 11212 E. 112TH ST. N. OWASSO, OK 74055-5421</p> <p><b>a</b></p> <p>CAGE code: 0BD96 <u>1/</u></p>
<p>ADJUSTABLE BUSHING CORP. 8330 LANKERSHIM BLVD. NORTH HOLLYWOOD, CA 91605</p>   <p><i>Panel fastener</i> <i>Quick-acting pins</i></p> <p>CAGE code: 3V407 <u>2/</u></p>	<p>ADVANCED MACHINING TECHNOLOGIES PO BOX 3351 WARMINISTER, PA 18974</p> <p>Plant 220 JACKSONVILLE RD. HATBORO, PA 19040</p> <p><b>0F0Y2</b></p> <p>CAGE code: 0F0Y2 <u>1/</u></p>
<p>ADOM ENGINEERING 131 AVCO ROAD HAVERHILL, MA 01835-5956</p> <p><b>AD</b> <b>adm</b> (used formerly)</p> <p>CAGE code: 02GZ1 <u>1/</u></p>	<p>ADVANCED PLASTICS, INC. DBA ADVANCED MACHINING &amp; FABRICATING, INC. 11212 E. 112<sup>th</sup> ST. N. OWASSA, OK 74055-5421</p> <p><b>ap</b> <b>a</b></p> <p>CAGE code: 45339 <u>1/</u></p>

1/ Information published in this revision was verified by direct contact with manufacturers.

2/ Information not verified to be current, no response from manufacturer. Information identical to that published in MIL-HDBK-57, Revision B.



## MIL-HDBK-57D(IS)

<p>AERCO RESEARCH 295 OLD COUNTRY ROAD SUITE 10 SAN CARLOS, CA 94070-6240</p>  <p>CAGE code: 0KMN9 <span style="float: right;">1/</span></p>	<p>AERO ENGINEERING AND MANUFACTURING CO. OF CALIFORNIA (DBA AERO ENGINEERING) 28217 AVENUE CROCKER VALENCIA, CA 91355-1249</p>  <p>CAGE code: 17772 <span style="float: right;">1/</span></p>
<p>AERO BUSHING AND COMPONENT 15201 PIPELINE LN. HUNTINGTON BEACH, CA 92649</p>  <p>CAGE code: <span style="float: right;">2/</span></p>	<p>AERO MECHANICAL FASTENING SYSTEMS 15481 WEST 110TH AVE SHAWNEE MISSION, KS 66219</p>  <p>CAGE code: 1FY45 <span style="float: right;">2/</span></p>
<p>AERO COMPONENTS CO. 5124 KALTENBRUN RD. FORT WORTH 76119 - 6400</p>  <p>CAGE code: 59213 <span style="float: right;">2/</span></p>	<p>AEROBOLT MANUFACTURING, INC. 4736 FELSPAR STREET RIVERSIDE, CA 92509-3068</p>  <p>CAGE code: 08PH2 <span style="float: right;">2/</span></p>
<p>AERO DYNAMIC MACHINING, INC. 11791 MONARCH STREET GARDEN GROVE, CA 92841-1818</p>  <p>CAGE code: 1KSM2 <span style="float: right;">2/</span></p>	<p>AERO-FAB, INC. 8420 RED OAK STREET RANCHO CUCAMONGA, CA 91730</p>  <p>CAGE code: 0CAC0 <span style="float: right;">2/</span></p>

1/ Information published in this revision was verified by direct contact with manufacturers.

2/ Information not verified to be current, no response from manufacturer. Information identical to that published in MIL-HDBK-57, Revision B.



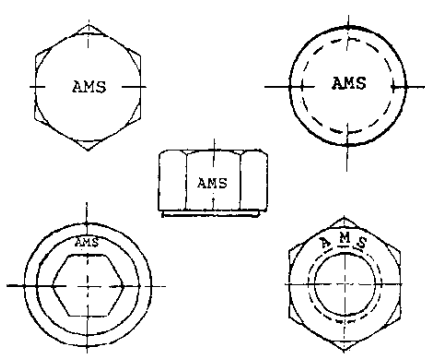



## MIL-HDBK-57D(IS)

<p>AEROFAST SUPPLY 405 W 20TH ST SAN PEDRO, CA 90731</p> <p style="text-align: center;"><b>A</b></p> <p>CAGE code: 2T830 <span style="float: right;"><u>2/</u></span></p>	<p>AEROSPACE MARINE SPECIALTY FASTENERS &amp; FITTINGS INC. DBA AMS FASTENERS 1645 WEST 135ND STREET GARDENA, CA 90249-2505</p> <p style="text-align: center;"><b>AMS</b>      <b>A M S</b></p>  <p>CAGE code: 1FGH9 <span style="float: right;"><u>2/</u></span></p>
<p>AEROMAX INDUSTRIES, INC. DBA AEROMAX INTERNATIONAL 9546 TOPANGA CANYON BLVD. CHATSWORTH, CA 91311-4011</p> <p style="text-align: center;"><b>AX</b></p> <p>CAGE code: 40581 <span style="float: right;"><u>1/</u></span></p>	<p>AEROSPACE PRODUCTS (DIV OF APCOA FASTENERS, INC) 903 E. OHIO STREET P. O. BOX 796 INDIANAPOLIS, IN 46202</p> <p style="text-align: center;"><b>APCO</b></p> <p>CAGE code: 17140 <span style="float: right;"><u>2/</u></span></p>
<p>AEROSPACE MANUFACTURING P.O. BOX 3398 WALLINGTON, NJ 07057-1148</p> <p style="text-align: center;">Plant 80 VAN WINKLE AVE. WALLINGTON, NJ 07057-1148</p> <p style="text-align: center;"><b>AM</b></p> <p>CAGE code: 0E0Z8 <span style="float: right;"><u>1/</u></span></p>	<p>AEROSPACE PRODUCTS CO. DIV WBH (FORMERLY APCOA FASTENERS, INC.) P.O. BOX 796 INDIANAPOLIS, IN 46206-0796</p> <p style="text-align: center;">Plant 123 NORTH PINE STREET INDIANAPOLIS, IN 46202-3844</p> <p style="text-align: center;"><b>AP</b></p> <p>CAGE code: 59736 <span style="float: right;"><u>1/</u></span></p>

1/ Information published in this revision was verified by direct contact with manufacturers.

2/ Information not verified to be current, no response from manufacturer. Information identical to that published in MIL-HDBK-57, Revision B.







## MIL-HDBK-57D(IS)

<p>AEROSPACE PRODUCTS, INC. 5435 PERKINS RD. BEDFORD HEIGHTS, OH 44146</p> <p style="text-align: center;"><b>A</b></p> <p>CAGE code: <span style="float: right;"><u>2/</u></span></p>	<p>AEROTECH FASTENERS, INC. ONE RIDGE ROAD PUTNAM, CT 06260</p> <p style="text-align: center;"></p> <p>CAGE code: 0TD46 <span style="float: right;"><u>1/</u></span></p>
<p>AEROSPACE RIVET MFG CORP 8535 DICE ROAD SANTA FE SPRINGS, CA 90670</p> <p style="text-align: center;"></p> <p>CAGE code: 64728 <span style="float: right;"><u>2/</u></span></p>	<p>AEROWIND CORPORATION 1959 JOHN TOWERS AVENUE EL CAJON, CA 92020-1117</p> <p style="text-align: center;"><b>A</b> </p> <p>CAGE code: 1N021 <span style="float: right;"><u>1/</u></span></p>
<p>AEROSTAR ENGINEERING &amp; MANUFACTURING COMPANY 25514 S. FRAMPTON AVENUE HARBOR CITY, CA 90710-2907</p> <p style="text-align: center;"></p> <p>No longer a fastener manufacturer</p> <p>CAGE code: 0MXJ2 <span style="float: right;"><u>2/</u></span></p>	<p>AF FASTENERS LIMITED UNIT 14 &amp; 15 GLOSSOP BROOK BUSINESS PARK, GLOSSOP, DERBYSHIRE SK13 7AJ, UNITED KINGDOM</p> <p style="text-align: center;"><b>J</b></p> <p>CAGE code: <span style="float: right;"><u>1/</u></span></p>
<p>AEROSTAR FASTENER CORP. 712 W LACY ST P.O. BOX 2201 PALESTINE, TX 75802</p> <p style="text-align: center;"></p> <p>CAGE code: 0T218 <span style="float: right;"><u>2/</u></span></p>	<p>AFAB PRECISION MACHINING 20742 LINEAR LANE LAKE FOREST, CA 92630</p> <p style="text-align: center;"></p> <p>CAGE code: 1GSW1 <span style="float: right;"><u>2/</u></span></p>

1/ Information published in this revision was verified by direct contact with manufacturers.

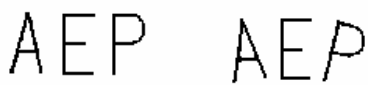
2/ Information not verified to be current, no response from manufacturer. Information identical to that published in MIL-HDBK-57, Revision B.





## MIL-HDBK-57D(IS)

<p>AFI INDUSTRIES, INC. 475 E. KEHOE BLVD CAROL STREAM, IL 60188</p> <p> </p> <p>CAGE code: 33PQ1 <span style="float: right;"><u>1/</u></span></p>	<p>AIR-COM, INC. 18105 S. HOBART BLVD. GARDENA, CA 90248-3617</p> <p></p> <p>CAGE code: 2Y870 <span style="float: right;"><u>2/</u></span></p>
<p>AIHARA SEIBYO CO LTD 2084 SHIN-MACHI TANO-GUN, GUNMA, JAPAN 370-13</p> <p><b>ICHO</b></p> <p>CAGE code: <span style="float: right;"><u>2/</u></span></p>	<p>AIRCRAFT ENGINEERING PRODUCTS, INC. 2 ACKERMAN AVENUE CLIFTON, NJ 07011</p> <p></p> <p>CAGE code: <span style="float: right;"><u>2/</u></span></p>
<p>AIR INDUSTRIES CORPORATION 12570 KNOTT STREET GARDEN GROVE, CA 92841-3932</p> <p></p> <p>CAGE code: 06725 <span style="float: right;"><u>1/</u></span></p>	<p>AIRCRAFT FUELSEAL FASTENERS, INC. (AEROLITE BLIND RIVET DIVISION) 5271 ARGOSY AVENUE HUNTINGTON BEACH, CA 92649</p> <p></p> <p>CAGE code: 4K209 <span style="float: right;"><u>2/</u></span></p>
<p>AIR PARTS MFG. CO. 1117 HARRISON AVE ARLINGTON, TX 76011</p> <p></p> <p>CAGE code: 8R401 <span style="float: right;"><u>2/</u></span></p>	<p>AIRDROME PARTS CO. 3251 SCHNIEDER ROAD S.E. P.O. BOX 1867 NORTH CANTON, OH 44720</p> <p></p> <p>CAGE code: <span style="float: right;"><u>2/</u></span></p>

1/ Information published in this revision was verified by direct contact with manufacturers.

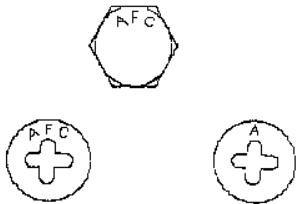
2/ Information not verified to be current, no response from manufacturer. Information identical to that published in MIL-HDBK-57, Revision B.







## MIL-HDBK-57D(IS)

<p>AIRFASCO, INC. 2655 HARRISON AVE SW. CANTON, OH 44706-3047</p>  <p>CAGE code: 3Z958 <span style="float: right;"><u>2/</u></span></p>	<p>ALBAR MACHINE CORPORATION RR3 BOX 2463 EFFORT, PA 18330-9450</p> <p style="text-align: center;"><b>AMC</b></p> <p>CAGE code: 44248 <span style="float: right;"><u>1/</u></span></p>
<p>AIW-ALTON INC. 1475 PALISADO AVE. WINDSOR, CT 06095-5140</p>  <p>CAGE code: 84027 <span style="float: right;"><u>2/</u></span></p>	<p>ALCO MACHINE CO. 27 SEARING AVENUE HARRISON, NJ 07029</p>  <p>CAGE code: 2T918 <span style="float: right;"><u>2/</u></span></p>
<p>ALAN, JEFFREY, MFG. &amp; ENGR. 8625 LAPEER ROAD P.O. BOX # 8 GOODELLS, MI 48027-9766</p> <p style="text-align: center;"><b>3D531</b></p> <p>CAGE code: 3D531 <span style="float: right;"><u>2/</u></span></p>	<p>ALCOA FASTENING SYSTEMS 3016 WEST LOMITA BLVD. TORRANCE, CA 90505</p> <p>plants:</p> <p>see CAMLOC PRODUCTS</p> <p>see HUCK INDUSTRIAL PRODUCTS</p> <p>see HUCK AEROSPACE PRODUCTS</p> <p>see KAYNAR PRODUCTS</p> <p>see KELOX/MICRODOT PRODUCTS</p> <p>see MECAERO PRODUCTS</p> <p>see RAM PRODUCTS</p> <p>see ROSAN PRODUCTS</p> <p>see SIMMONDS PRODUCTS</p> <p>see TRIDAIR PRODUCTS</p> <p>see VOI-SHAN PRODUCTS</p> <p>CAGE code: 15653 <span style="float: right;"><u>1/</u></span></p>
<p>ALARD MACHINE PRODUCTS 1629 WEST 132ND STREET GARDENA, CA 90249-2005</p>  <p>CAGE code: 1FMQ2 <span style="float: right;"><u>1/</u></span></p>	

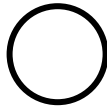
1/ Information published in this revision was verified by direct contact with manufacturers.

2/ Information not verified to be current, no response from manufacturer. Information identical to that published in MIL-HDBK-57, Revision B.

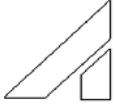
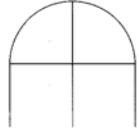
## MIL-HDBK-57D(IS)

<p>ALCOA GLOBAL FASTENERS INC 13001 EAST TEMPLE AVE LA PUENTE, CA 91746-1417</p>  <p>CAGE code: 06950 <span style="float: right;"><u>2/</u></span></p>	<p>ALL QUALITY SPARES, INC. 3 EAST BISHOP STREET WATERFORD, CT 06385</p>  <p>CAGE code: 1VGA2 <span style="float: right;"><u>1/</u></span></p>
<p>ALEXANDER MANUFACTURING COMPANY INC. DBA METRO TOOL &amp; MANUFACTURING CO. 2402 ARKANSAS LANE GRAND PRAIRIE, TX 75052-7203</p>  <p>CAGE code: 2M919 <span style="float: right;"><u>2/</u></span></p>	<p>ALLFAST FASTENING SYSTEMS, INC. 15200 E DON JULLIAN RD P.O. BOX 3166 CITY OF INDUSTRY, CA 91745-1098</p>  <p>CAGE code: 53551 <span style="float: right;"><u>1/</u></span></p>
<p>ALL MANUFACTURERS INC. DBA HARPER AEROSPACE FASTENERS 2900 PALISADES DR CORONA, CA 92880 – 9429</p>  <p>CAGE code: 57472 <span style="float: right;"><u>2/</u></span></p>	<p>ALLIED NUT &amp; BOLT CO., INC. 520 HERTZOG BOULEVARD P.O. BOX 670 KING OF PRUSSIA, PA 19406-2667</p>  <p>CAGE code: 4S191 <span style="float: right;"><u>2/</u></span></p>
<p>ALL PINS MANUFACTURING P.O. BOX 137 WILSEYVILLE, CA 95257</p> <p>plant 5549 POOR MANS WAY WILSEYVILLE, CA 95257</p>  <p>CAGE code: O8CZ5</p>	<p>ALLIED PRECISION PRODUCTS, INC. 600 SAN CHRISTOPHER DRIVE DUNEDIN, FL 34698-5095</p>  <p>CAGE code: 24249 <span style="float: right;"><u>1/</u></span></p>
	<p>ALL-POWER MFG. CO. 13141 MOLETTE STREET SANTA FE SPRINGS, CA 90670-5500</p>  <p>CAGE code: 70265 <span style="float: right;"><u>1/</u></span></p>

1/ Information published in this revision was verified by direct contact with manufacturers.

2/ Information not verified to be current, no response from manufacturer. Information identical to that published in MIL-HDBK-57, Revision B.



MIL-HDBK-57D(IS)

ALL-PRO FASTENER & RIVET MFG. CO.  
10406 ENTERPRISE ST  
P.O. BOX 1525  
RANCHO CUCAMONGA, CA 91730

**AP**

CAGE code: 1FH10 2/

---

ALL-STATES INC.  
1801 WEST FOSTER AVE.  
CHICAGO, IL 60640

  
ALL-STATES LOGO

**=**  
ALL-STATES  
IDENTIFICATION MARK

CAGE code: 26863 2/

---

ALPHA BOLT CO.  
1524 EAST 14 MILE ROAD  
MADISON HEIGHTS, MI 48071

**ABC**

**I**

CAGE code: 0R8B6 2/

Continued

Continued

ALPHA BOLT CO.

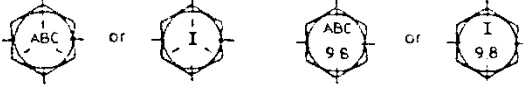

GRADE 5 BOLT                      PROPERTY CLASS 9.8  
METRIC BOLTS

 Roman numeral "I" shown on special bolts

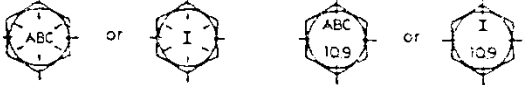

GRADE 8 BOLT                      PROPERTY CLASS 10.9  
METRIC BOLTS

CAGE code: 0R8B6 2/

---

ALPHA FASTENERS  
154 EAST MERRICK ROAD  
FREEPORT, NY 11520

**A  
F**

CAGE code: 1UJ18 1/

---

ALPHA MACHINING PRODUCTS &  
DEVELOPMENT  
8651 PRODUCTION AVENUE  
SAN DIEGO, CA 92126





Plant  
7929 SILVERTON AVENUE  
SUITE 610  
SAN DEIGO, CA 92126

**α**

CAGE code: 3D6Q0 2/

1/ Information published in this revision was verified by direct contact with manufacturers.  
2/ Information not verified to be current, no response from manufacturer. Information identical to that published in MIL-HDBK-57, Revision B.

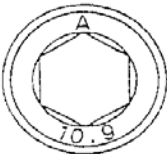
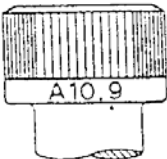
## MIL-HDBK-57D(IS)

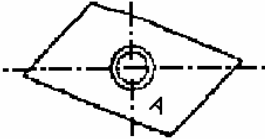
<p>ALPINE MACHINE &amp; TOOL CORP. 42 BERGENLINE AVE. WESTWOOD, NJ 07675</p> <p>AMT - I</p> <p>AMT x x x x - x x x x</p>  <p>CAGE code: 67339 <u>2/</u></p>	<p>AMANDA BENT BOLT CO. 1120 C I C DR. LOGAN, OH 43138-9153</p>  <p>CAGE code: 22382 <u>2/</u></p>
<p>ALPS SEIKO CO. LTD. 41 HIGASHI-KANAE, KANAE IIDA-SHI, NAGANO PREF. 395-0817, JAPAN</p> <p>Plant LIDA FACTORY 524-1, SHIMOTONOHKA LIDA-SHI, NAGANO PREF. 395-0154 JAPAN</p> <p>A</p>   <p>CAGE code: <u>1/</u></p>	<p>AMATOM ELECTRONIC HARDWARE (DIVISION OF QUINCY TECHNOLOGIES, INC.) 5 PASCO HILL ROAD CROMWELL, CT 06416-1012</p> <p>A M A T O M</p> <p>AMATOM</p> <p>CAGE code: 1YGB8 <u>2/</u></p>
<p>AMACON CORP. 49 ALDER STREET WEST BABYLON, NY 11704</p>  <p>CAGE code: 54330 <u>2/</u></p>	<p>AMERICAN AIRCRAFT PARTS MANUFACTURING COMPANY 17917 MASONIC FRASER, MI 48026</p> <p><b>99106</b></p> <p>CAGE code: 99106 <u>2/</u></p> <p>AMERICAN ELECTRIC (CONSTRUCTION MATERIALS GROUP) 1555 LYNNFIELD ROAD MEMPHIS, TN 38119</p> <p>(SEE THOMAS &amp; BETTS CORP - CAGE 56501)</p>  <p>CAGE code: <u>1/</u></p>

1/ Information published in this revision was verified by direct contact with manufacturers.

2/ Information not verified to be current, no response from manufacturer. Information identical to that published in MIL-HDBK-57, Revision B.

MIL-HDBK-57D(IS)

AMERICAN FASTENER & SPECIALTY CO.  
5900 PARK AVE.  
CLEVELAND, OHIO 44105



CAGE code: 2/

---

AMERICAN INTERNATIONAL AERO MFG INC.  
6973 SOUTH 300 WEST  
MIDVALE, UTAH 84047



CAGE code: 0RBVB 2/

---

AMERICAN METAL BEARING COMPANY  
7191 ACACIA AVENUE  
GARDEN GROVE, CA 92841

**AMB**

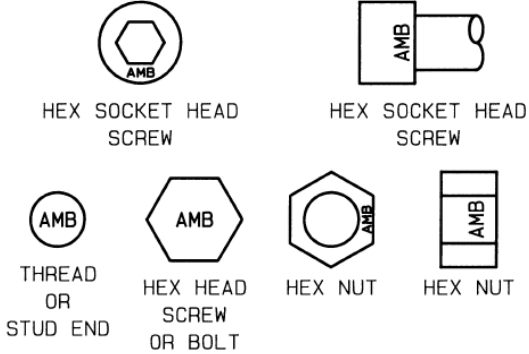

HEX SOCKET HEAD SCREW      HEX SOCKET HEAD SCREW

THREAD OR STUD END      HEX HEAD SCREW OR BOLT      HEX NUT      HEX NUT

CAGE code: 70508 1/

AMERICAN QUALITY INDUSTRIES  
(FASTENER DIVISION)  
411 BURNHAM STREET  
EAST HARTFORD, CT 06108



GRADE 8 BOLT      GRADE 5 BOLT

CAGE code: 1P581 1/

---

AMERIFAST CORP.  
104 SYLVANNA RD.  
SOUTH PLAINSFIELD, NJ 07080-1448

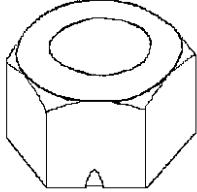

CAGE code: 0H4SO 1/

---

AMERITECH FASTNER MFG INC.  
DIVISION OF LONE STAR FASTENERS, LP  
6606 N GESSNER  
HOUSTON, TX 77040

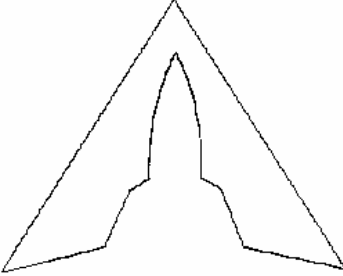









CAGE code: 0EUH2 1/

1/ Information published in this revision was verified by direct contact with manufacturers.

2/ Information not verified to be current, no response from manufacturer. Information identical to that published in MIL-HDBK-57, Revision B.



## MIL-HDBK-57D(IS)

<p>AMMAC, INC. 6000 SUSQUEHANNA PLAZA YORK, PA 17406</p>  <p>CAGE code: 0NHU1 <span style="float: right;">1/</span></p>	<p>ANILLO INDUSTRIES, INC. 2090 N. GLASSELL P.O. BOX 5586 ORANGE, CA 92865-3306</p>  <p>CAGE code: 10630 <span style="float: right;">1/</span></p>
<p>ANATASE PRODUCTS (DIV OF HENWAY INC) 1314 GOODRICK DR TEHCHPI, CA 93561</p>  <p>CAGE code: 0MXJ8 <span style="float: right;">1/</span></p>	<p>ANOTHER SCREW MACHINE PRODUCT EMERALD INDUSTRIAL PARK BOX 425 PONDERAY, ID 83852</p> <p style="text-align: center;"><b>BEI</b></p> <p>CAGE code: 05RQ3 <span style="float: right;">2/</span></p>
<p>ANCHOR BOLT &amp; SCREW CO. 2001 N. CORNWELL MELROSE PARK, IL 60160-1081</p>  <p>Hex cap and indented hex screws.</p>  <p>Machine screws and Other products - 3 dots under head 120° apart</p> <p>CAGE code: 9C864 <span style="float: right;">2/</span></p>	<p>A-ONE MACHINE COMPANY R.R.1, BOX 1660 HOP BOTTOM, PA 18824</p>  <p>CAGE code: 0AV84 <span style="float: right;">1/</span></p>
<p>ANDERSON FORGE &amp; MACHINE 18500 S. W. PACIFIC HWY TUALATIN, OR 97062</p>  <p>CAGE code: 7X566 <span style="float: right;">2/</span></p>	<p>APEL LTD. COUNTRESS AVE., STANLEY GREEN TRADING ESTATE CHEADLE HULME, CHESHIRE, SK8 6QU UNITED KINGDOM</p>  <p>CAGE code: K5640 <span style="float: right;">2/</span></p>

1/ Information published in this revision was verified by direct contact with manufacturers.

2/ Information not verified to be current, no response from manufacturer. Information identical to that published in MIL-HDBK-57, Revision B.

## MIL-HDBK-57D(IS)

<p>APEX MFG. CO. INC. 11686 TUXFORD ST SUN VALLEY, CA 91352-3134</p> <p style="text-align: center;"><b>AP</b></p> <p>CAGE code: 2V343 <span style="float: right;"><u>1/</u></span></p>	<p>ARDOR MFG. INC. 400 S. 1100 W. PROVO, UT 84603</p> <p style="text-align: center;"></p> <p>CAGE code: 0CTH5 <span style="float: right;"><u>2/</u></span></p>
<p>APHEONIX CORPORATION 101 PECK HILL ROAD JOHNSTON, RI 02919</p> <p style="text-align: center;"><b>AP</b></p> <p style="text-align: center;"><b>PC</b></p> <p>CAGE code: 08TF3 <span style="float: right;"><u>2/</u></span></p>	<p>ARGARWAL INDUSTRIES 370 MARSHALL HOUSE 25 STRAND ROAD CALCUTTA, INDIA 700 001</p> <p style="text-align: center;"></p> <p>CAGE code: <span style="float: right;"><u>2/</u></span></p>
<p>ARCHER SCREW PRODUCTS 11341 MELROSE STREET FRANKLIN PARK, IL 60131</p> <p style="text-align: center;"></p> <p>CAGE code: 1HXL9 <span style="float: right;"><u>2/</u></span></p>	<p>ARJAY PRECISION, INC. 524 SULLIVAN AVE SUITE 15 SOUTH WINDSOR, CT 06074</p> <p style="text-align: center;"><b>MFR - 72905</b></p> <p>CAGE code: 72905 <span style="float: right;"><u>2/</u></span></p>
<p>ARCO SALES CO. 2211 WAKELING STREET P.O. BOX 23001 PHILADELPHIA, PA 19137-1214</p> <p style="text-align: center;"><b>ASC</b></p> <p style="text-align: center;"><b>ASC</b></p> <p>CAGE code: 5L063 <span style="float: right;"><u>1/</u></span></p>	

1/ Information published in this revision was verified by direct contact with manufacturers.

2/ Information not verified to be current, no response from manufacturer. Information identical to that published in MIL-HDBK-57, Revision B.

MIL-HDBK-57D(IS)

ARMSTRONG ATLAS BOLT  
STATION STREET  
DARLASTON, WEST MIDLANDS, WS10 8UL  
GREAT BRITIN

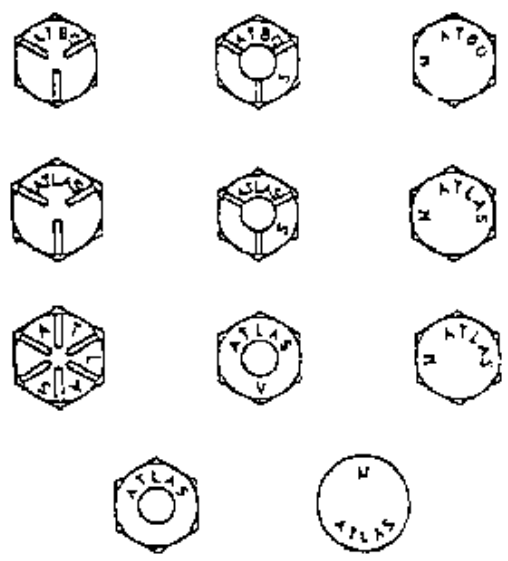

CAGE code: 2/

---

ARMSTRONG FASTENING SYSTEMS  
FOSTER STREET STONEFERRY  
BUSINESS PARK  
HULL, GREAT BRITIAN, HU8 8BT  
UNITED KINGDOM



Symbol may be depressed or raised

CAGE code: K1012 2/  
(Continued)

(Continued)

ARMSTRONG FASTENINGS LTD.  
FOSTER STREET STONEFERRY  
BUSINESS PARK  
HULL, GREAT BRITIAN, HU8 8BT  
UNITED KINGDOM

**GSF**



CAGE code: K1012 2/

---

ARNOLD KNIPPING GmbH  
58557 KIERSPE  
POSTFACH 14 48  
GUMMERSBACH, GERMANY 5270

AK  
KNIPPING



CAGE code: C4096 2/

---

ARNOLD UMFORMTECHNIK  
GMBH & CO. KG  
SINDRINGEN STR. 25  
FORCHTENBERG, 74670  
GERMANY

**A**





CAGE code: C3705 2/

1/ Information published in this revision was verified by direct contact with manufacturers.

2/ Information not verified to be current, no response from manufacturer. Information identical to that published in MIL-HDBK-57, Revision B.



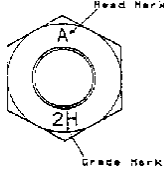

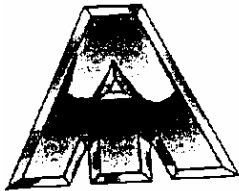



## MIL-HDBK-57D(IS)

<p>ARNOLD WRAGG (BOLTS &amp; NUTS) LTD STANNINGTON ROAD STANNINGTON, SHEFFIELD ENGLAND, UK S6 6AG</p>  <p>CAGE code: U2935 <span style="float: right;">2/</span></p>	<p>ASAHI SREWS MANUFACTURING CO., LTD 101 KAWAMATA HIGASHIOSAKA, JAPAN</p>  <p>CAGE code: <span style="float: right;">2/</span></p>
<p>ARROW SCREW &amp; MACHINE WORKS 1037 GERMANTOWN AVENUE PHILADELPHIA, PA 19123-1629</p>  <p>CAGE code: 03632 <span style="float: right;">2/</span></p>	<p>ASAI TEKKO CO. LTD 2-14 TAJIKA SHODKAI HIRKATA-SHI OSAKA, JAPAN 573</p>  <p>CAGE code: <span style="float: right;">2/</span></p>
<p>ARTISAN SPECIALIST TECH, INC. 439 HIGH STREET P.O. BOX 48060 PHILADELPHIA, PA 19144</p>  <p>CAGE code: 0RJ65 <span style="float: right;">1/</span></p>	<p>ASI DESIGN &amp; MANUFACTURING, INC. 1070 HARDEES DRIVE P. O. BOX 957 ABERDEEN, MD 21001</p>  <p>CAGE code: 32971 <span style="float: right;">2/</span></p>
<p>ARVAN, INC. 14083 S NORMANDIE AVE GARDENA, CA 90249</p> <p style="text-align: center;">ARVAN, INC. TANSEY A/I</p> <p>CAGE code: 29965 <span style="float: right;">2/</span></p>	<p>ASSOCIATED TOOL CO., INC. 100 THOMAS DRIVE GADSDEN, AL 35901</p>  <p>CAGE code: 2U575 <span style="float: right;">2/</span></p>

1/ Information published in this revision was verified by direct contact with manufacturers.

2/ Information not verified to be current, no response from manufacturer. Information identical to that published in MIL-HDBK-57, Revision B.

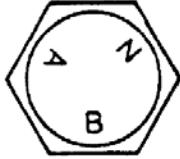
## MIL-HDBK-57D(IS)

<p>ATF, INC. (formerly Accurate Threaded Fasteners, Inc.) 3550 WEST PRATT AVENUE LINCOLNWOOD, IL 60712</p>  <p>CAGE code: 95110 <span style="float: right;"><u>1/</u></span></p>	<p>AUGUST FRIEDBERG GMBH BELFORTER STRASSE 63 P. O. BOX 10 08 43 GELSENKIRCHEN, GERMANY 45884</p>   <p>CAGE code: <span style="float: right;"><u>2/</u></span></p>
<p>ATLAS ENGINEERING, INC. (PENN ENGINEERING AND MFG. CO.) 5190 OLD EASTON RD. DANBORO, PA 18916</p>  <p>CAGE code: 46384 <span style="float: right;"><u>1/</u></span></p>	<p>AUGUST FRIEDBERG GmbH BELFORTER STRASSE 63 D-4650 GELSENKIRCHEN ROTTHAUSEN, GERMANY</p> <p style="text-align: center;"><b>FRIEDBERG</b></p> <p>CAGE code: <span style="float: right;"><u>2/</u></span></p>
<p>ATLAS SPECIALTY PRODUCTS (SEE CURTIS PRESTON ENTERPRISES INC. ) 2299 E. WINSTON ROAD ANAHEIM, CA 92806</p> <p style="text-align: center;"><b>ASP</b></p> <p>CAGE code: 0TP31 <span style="float: right;"><u>1/</u></span></p>	<p>AUTO BOLT AND NUT CO. 4619 PERKINS AVE CLEVELAND, OH 44103</p>    <p>CAGE code: 0CUJ9 <span style="float: right;"><u>1/</u></span></p>

1/ Information published in this revision was verified by direct contact with manufacturers.

2/ Information not verified to be current, no response from manufacturer. Information identical to that published in MIL-HDBK-57, Revision B.

MIL-HDBK-57D(IS)

AUTOMATED MANUFACTURING  
8009 AUGUSTA ROAD  
PIEDMONT, SC 29673-9369

A M

CAGE code: 1URY9 2/

---

AUTOMATIC MACHINING AND MFG CO  
DBA AMMAC INC  
6000 SUSQUEHANNA PLZ  
YORK, PA 17406



CAGE code: 0NHU1 2/

---





AUTOMATIC MANUFACTURING COMPANY  
300 SHADELAND AVENUE  
EAST PITTSBURGH, PA 15112-1499

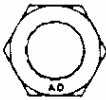
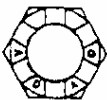

CAGE code: 18362 1/

---

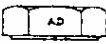
AUTOMATIC SCREW MACHINE  
PRODUCTS CO.  
709 2ND AVE  
P.O. BOX 1608  
DECATUR, AL 35601

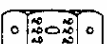
PLAIN:	SLOTTED:	DRILLED:
		
	OR	
		
AD	AD	AD

CAGE code: 92595 1/

AUTO SCREW, INC.  
LYNBROCK RD. & EASTERN BLVD.  
P.O. BOX 4968  
BALTIMORE, MD 21220



CAGE code: 84253 2/

---

AVDEL INTERNATIONAL (AVDEL LTD)  
HERTFORD, AL 7 1EZ  
GREAT BRITIAN



CAGE code: 2/

---

AVIATION MANUFACTURING GROUP LLC  
(SEE DBA FREEMAN CO., THE)  
719 WALNUT ST  
P. O. BOX 57  
YANKTON, SD 57078-3542

F

CAGE code: 84596 1/

1/ Information published in this revision was verified by direct contact with manufacturers.

2/ Information not verified to be current, no response from manufacturer. Information identical to that published in MIL-HDBK-57, Revision B.

MIL-HDBK-57D(IS)

AVIBANK MANUFACTURING, INC.  
PRECISION CASTPARTS CORP.  
4650 SW MACADAM AVE. SUITE 440  
PORTLAND, OR 97239-4262

Plant

AVIBANK MFG., INC.  
11500 SHERMAN WAY, P.O. BOX 9909  
NORTH HOLLYWOOD, CA 91609-1909

**AB**

**ADB, ADBB, ADP,**

**LRA**

**AAP**

**AS**

**AV**

**AVIBANK, BALL-**

**LOK® , BLC, BLS,**

**PIP**

**AVL**

**AVK, ET, ETC, FN,**

**IT, ITC, MT, RT**

**ST**

**84256**

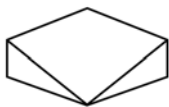

CAGE code: 84256

1/

AVK INDUSTRIES PRODUCTS INC.  
25323 RYE CANYON RD  
VALENCIA, CA 91355

**AVK**

CAGE code: 2K288

2/

AZTECH ENGINEERING, INC.  
1424 CENTRE CIR.  
DOWNERGROVE, IL 60515



CAGE code: 0W426

2/

B & B SPECIALTIES INC.  
4321 E. LAPLMA AVE.  
ANAHIEM, CA 92807

(see GS AEROSPACE)

1) PRIMARY - **BB**

2) SECONDARY - **62206**

CAGE code: 62206





1/

Continued

1/ Information published in this revision was verified by direct contact with manufacturers.

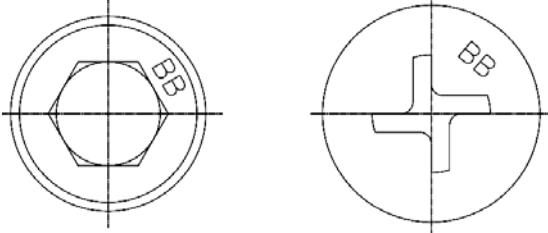
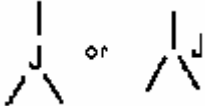
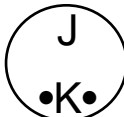
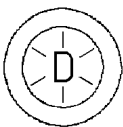
2/ Information not verified to be current, no response from manufacturer. Information identical to that published in MIL-HDBK-57, Revision B.

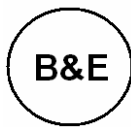





## MIL-HDBK-57D(IS)

<p>Continued</p> <p><b>B &amp; B SPECIALTIES INC</b> 4321 E. LAPLMA AVE. ANAHIEM, CA 92807</p>  <p>Raised BB is for new manufactured parts. Depressed BB is for old stock.</p> <p>CAGE code: 62206 <span style="float: right;">1/</span></p>	<p><b>B &amp; G MANUFACTURING CO., INC.</b> 3067 UNIONVILLE PIKE P.O. BOX 269 HATFIELD, PA 19440-1822</p>  <p>Grade 5</p> <p><b>JB7</b>                      Grade B7 <b>JB16</b>                     Grade B16 <b>JNC</b>                        Alloy 400</p>  <p>Alloy 500</p> <p><b>J4</b>                         Grade 4 <b>J2H</b>                        Grade 2H</p> <p>CAGE code: 84272 <span style="float: right;">2/</span></p>
<p><b>B &amp; D THREADED ROLLING</b> 36820 VAN BORN ROAD P.O. BOX 275 WAYNE, MI 48184</p>  <p>CAGE code: 00LR8 <span style="float: right;">1/</span></p>	<p><b>B &amp; N TOOL CO., INC.</b> 44 ROCKWELL RD. NEWINGTON, CT 06111</p>  <p>CAGE code: 0CMJO <span style="float: right;">2/</span></p>
<p><b>B &amp; E MACHINE SHOP &amp; SHEET METAL FAB., INC.</b> 3059 SE MONROE ST. STUART, FL 34997</p>  <p>CAGE code: 8W179 <span style="float: right;">2/</span></p>	<p><b>B &amp; R MACHINE AND TOOL CORP</b> 717 MAIN STREET WESTBURY, NY 11590</p>  <p>CAGE code: 66936 <span style="float: right;">1/</span></p>
<p><b>B &amp; E MANUFACTURING CO., INC.</b> 7562 ORANGEWOOD AVE. STANTON, CA 90680-3498</p>  <p>CAGE code: 59680 <span style="float: right;">1/</span></p>	

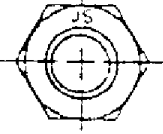
1/ Information published in this revision was verified by direct contact with manufacturers.

2/ Information not verified to be current, no response from manufacturer. Information identical to that published in MIL-HDBK-57, Revision B.

## MIL-HDBK-57D(IS)

<p>B F GOODRICH CO. RIVNUT ENGINEERED FATSEENERS, THE AEROSPACE AND DEFENSE DIVISION 250 NORTH CLEVELAND-MASSILLION RD. AKRON, OH 44313</p> <p>Plant 150 SPRINGSIDE DRIVE AKRON, OH 44313-0501</p> <p><b>BFG+</b></p> <p>CAGE code: <u>2/</u></p>	<p>B. V. FABRIEK VAN KLINKNAGELS EN SCHROEFBOUTEN V/H SMIT 2980 GB RIDDERKIRK P.O. BOX 4075 THE NETHERLANDS</p> <p><b>JS</b></p>  <p>CAGE code: <u>2/</u></p>
<p>B G ENGINEERING, INC. 205 ARENA STREET EL SEGUNDA, CA 90245</p>  <p>CAGE code: 0WL62 <u>2/</u></p>	<p>BARCO ENGINEERING COMPANY, INC. 505 W MAIN ST TILTON, NH 03276</p>  <p>CAGE code: 29214 <u>2/</u></p>
<p>B G M FASTENER CO., INC. RR 5 BOX 1675 759 OLD WILLOW AVENUE HONESDALE, PA 18431</p>  <p>CAGE code: 3Y498 <u>1/</u></p>	<p>BARNEGAT BAY NSCC, INC. DBA BB NSCC, INC. 6432 DEVONSHIRE DR. FORT WORTH, TX 76180</p>  <p>CAGE code: 1SDGE <u>1/</u></p>
<p>B G M FASTENER CO., INC. RR 5 BOX 1675 759 OLD WILLOW AVENUE HONESDALE, PA 18431</p>  <p>CAGE code: 3Y498 <u>1/</u></p>	<p>BARRE PRECISION PRODUCTS INC. 199 HOPRIVER ROAD RTE. 6 BOLTON, CT 06043-7443</p>  <p>CAGE code: 7R902 <u>1/</u></p>

1/ Information published in this revision was verified by direct contact with manufacturers.

2/ Information not verified to be current, no response from manufacturer. Information identical to that published in MIL-HDBK-57, Revision B.

MIL-HDBK-57D(IS)

BAS AEROSPACE LIMITED  
 2 CRAMPTONS ROAD  
 SEVENOAKS, KENT N14 5EF  
 UNITED KINGDOM



CAGE code: KCWE1 1/

BAUER & SCHAURTE KARCHER GMBH  
 FURTHER STRASSE 24-26  
 POSTFACH 10 01 55  
 D-4040 NEUSS 1  
 FEDERAL REPUBLIC OF GERMANY



**INBUS<sup>®</sup>**

**VERBUS<sup>®</sup> KARRO<sup>®</sup>**

CAGE code: D2370 2/

BBC FASTENERS, INC.  
 4210 SHIRLEY LANE  
 ALSIP, IL 60658

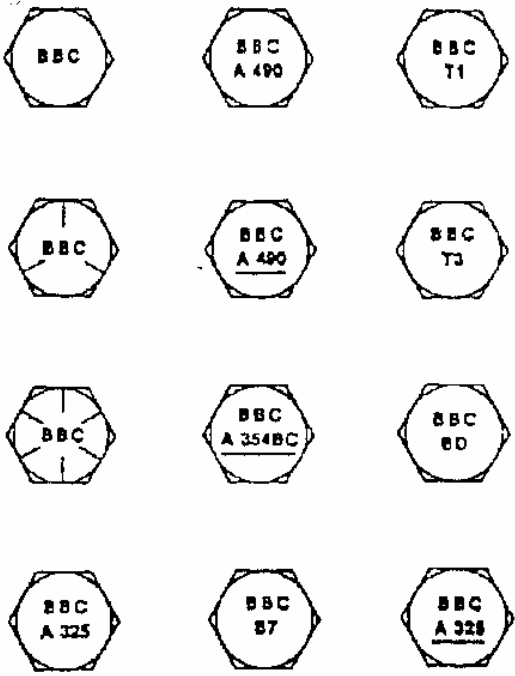

**BBC**

CAGE code: 2/

BEACH MACHINE  
 819 WALKER LN  
 NEW MARKET, AL 35761

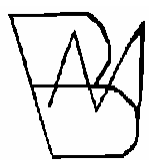

CAGE code: 0TCDO 2/







1/ Information published in this revision was verified by direct contact with manufacturers.

2/ Information not verified to be current, no response from manufacturer. Information identical to that published in MIL-HDBK-57, Revision B.

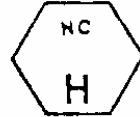

MIL-HDBK-57D(IS)

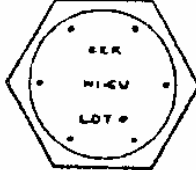
<p>BEAVER PRODUCTS CORP. P.O. BOX 17279 ANAHIEM, CA 92817</p> <p style="text-align: center;"><b>B.P.C.</b></p> <p>CAGE code: 4P584 <span style="float: right;"><u>2/</u></span></p>
<p>BEC MACHINE PRODUCTS COMPANY 171 RUTH ROAD HARLEYSVILLE, PA 92806</p> <p style="text-align: center;"><b>BEC</b></p> <p>CAGE code: 0JC12 <span style="float: right;"><u>2/</u></span></p>
<p>BEE INDUSTRIES, INC. (WISCONSIN CORPORATION) W6331 BEE ROAD WATERTOWN, WI 53098</p> <p style="text-align: center;"><b>BI</b></p> <p>CAGE code: 7V765 <span style="float: right;"><u>2/</u></span></p>
<p>BEGONIA TOOL COMPANY 53 MADISON RD HERMINIE, PA 15637</p> <p style="text-align: center;"><b>BT</b></p> <p>CAGE code: OL3V3 <span style="float: right;"><u>2/</u></span></p>

<p>BEK LEVEL 1 FASTENERS 300 THIRD AVE HUNTINGTON, WV 25701</p> <div style="text-align: center;">  <p><b>300 Series Stainless Steel</b></p>  <p><b>Type 316 Stainless Steel</b></p> <div style="display: flex; justify-content: space-around;">   </div> <p><b>Nickel Copper (Monel)</b></p>  <p><b>Silicon Bronze</b></p> </div>
<p>BEK LEVEL 1 FASTENERS 721 EAST COMPTON BOULEVARD COMPTON, CA 90220</p> <div style="text-align: center;">   <p><b>BEK</b></p> <p>CAGE code: <span style="float: right;"><u>2/</u></span></p> </div>

<sup>1/</sup> Information published in this revision was verified by direct contact with manufacturers.

<sup>2/</sup> Information not verified to be current, no response from manufacturer. Information identical to that published in MIL-HDBK-57, Revision B.

## MIL-HDBK-57D(IS)

<p>BELL FASTENERS (ALBANY FASTENERS/PAWTUCKET FASTENER DIVISION) 327 PINE STREET PAWTUCKET, RI 02862</p> <p><b>S</b>                      <b>B</b> STILLWATER                      BELL</p> <p><b>PMC</b> PAWTUCKET MANUFACTURING CO.</p> <p><b>P</b>                      <b>A</b> PAWTUCKET                      ALBANY</p> <p><b>SW</b> ON TOP OF SCREW</p> <p>••</p> <p>(two dots) On the top of or bearing surface of the screw</p> <p>(SEE VERTEX)</p> <p>CAGE code: 12360 <span style="float: right;">2/</span></p>	<p>BELL-MEMPHIS, INC. 1650 CHANNEL AVE MEMPHIS, TN 38113-01871</p>  <p>CAGE code: 22277 <span style="float: right;">1/</span></p>
<p>BELL PRECISION, INC. 131 N. DILLON AVE. SAN JACINTO, CA 92383</p> <p><b>BP</b></p> <p>CAGE code: 56122 <span style="float: right;">2/</span></p>	<p>BEN YUAN ENTERPRISE CO, LTD. NO. 113, CHI-NAN ROAD TAI-SHIA VILLAGE, KAOHSIUNG HSIEN, TAIWAN R. O. C.</p> <p><b>BY</b></p> <p>CAGE code: <span style="float: right;">2/</span></p>
	<p>BENACO TOOLING RESEARCH &amp; DEV. CORP. 9287 MERCANTILE DR MENTOR, OH 44060</p>  <p>CAGE code: 5W644 <span style="float: right;">2/</span></p>
	<p>BEOTOOL CORP. 725 WHITNEY DR BLUE BELL, PA 19422-1205</p> <p><b>BOT</b></p> <p>CAGE code: 2N084 <span style="float: right;">2/</span></p>

1/ Information published in this revision was verified by direct contact with manufacturers.

2/ Information not verified to be current, no response from manufacturer. Information identical to that published in MIL-HDBK-57, Revision B.

MIL-HDBK-57D(IS)

BERGNER, RICHARD GMBH & CO.  
 BAHNHOFSTRAUSSE 8-16  
 P.O. BOX 1180  
 SCHWABACH, 91126  
 GERMANY



RIBE

Where required and applicable, these fasteners types are also marked with the logo "RIBE" and/or capital "B" with screw in circle.



CAGE code: D2282 2/

BER-LOW MFG INC.  
 DBA BUTECH PRESSURE SYSTEMS  
 4928 PITTSBURGH AVE  
 ERIE, PA 16509



CAGE code: 62295 2/

BERRY, JOHN  
 DBA BERRY MANUFACTURING  
 5505 BREWSTER ST  
 SAN ANTONIO, TX 78233

**BM**

CAGE code: 65003 1/

BERRY MANUFACTURING  
 1090 HWY 72, BOX 336  
 GOLDEN, CO 80403

**BM**

CAGE code: 65003 1/

BETA CORP.  
 2332 S DELAWARE ST  
 DENVER, CO 80223 - 4321



CAGE code: 06671 2/

BETA ENGINEERING, INC.  
 P.O. BOX 80  
 468 DODSON LAKE DRIVE  
 ARLINGTON, TX 76012-3441



CAGE code: 33436 1/

1/ Information published in this revision was verified by direct contact with manufacturers.

2/ Information not verified to be current, no response from manufacturer. Information identical to that published in MIL-HDBK-57, Revision B.

MIL-HDBK-57D(IS)

BIG BOLT CORP.  
140 COVINGTON DRIVE  
BLOOMINGDALE, IL 60108-3105

BB

BB

BB  
•

BB  
•

BB  
•

CAGE code: 3Q6H0 1/

---

BISHOP ENTERPRISES, INC.  
10 EAST BISHOP ST.  
WATERFORD, CT 06385



CAGE code: 6Y882 2/

---

BLAINE TOOL CORP.  
5024 FALL CREEK RD  
INDIANAPOLIS, IN 46220-5344



CAGE code: 17027 2/

BLANC AERO INDUSTRIES  
see LISI AEROSPACE

BLANC AERO INDUSTRIES  
193 R DE BERCY  
PARIS, FRANCE 75012

BLANC AERO INDUSTRIES  
Saint Chamond Granat  
18 20 Rue S-Hilaire  
Saint Ouen L'Aumone, France 95310

P (Sr Briec)  
B (Paris)  
P (Villefranche de  
Rouergue)  
ds. F

BLANC AERO INDUSTRIES  
18,20 RUE ST. HILAIRE  
SAINT OUEN L'AUMONE, FRANCE  
95310



BLANC AERO INDUSTRIES  
DECOLLETAGE MODERNE  
5 BIS, PLACE LEON BLUM  
75020- PARIS  
FRANCE









CAGE code: F0188 2/

1/ Information published in this revision was verified by direct contact with manufacturers.

2/ Information not verified to be current, no response from manufacturer. Information identical to that published in MIL-HDBK-57, Revision B.





## MIL-HDBK-57D(IS)

<p>BLANC AIRCRAFT FASTENERS, INC. 203020 PRARIE ST P.O. BOX 3819 CHATSWORTH, CA 91842</p> <p style="text-align: center;"></p> <p style="text-align: center;"><b>BAF</b></p> <p>CAGE code: <span style="float: right;"><u>2/</u></span></p>	<p>BOBCAT MANUFACTURING CO. (PLANT) PECK HILL ROAD JOHNSTON, RI 02919</p> <p style="text-align: center;"> </p> <p>CAGE code: 8H536 <span style="float: right;"><u>2/</u></span></p>
<p>BLAND CO., THE 55 BROOK ST P. O. BOX 330358 WEST HARTFORD, CT 06133</p> <p style="text-align: center;"><b>BL</b></p> <p>CAGE code: 02991 <span style="float: right;"><u>1/</u></span></p>	<p>BOGNER ENGINEERING CO. 705 N. SPRINGFIELD STREET P. O. BOX 510 BERRYVILLE, AR 72616</p> <p style="text-align: center;"></p> <p>CAGE code: 04BV8 <span style="float: right;"><u>2/</u></span></p>
<p>BLUE SKY INDUSTRIES, INC. 1230 MONTEREY PASS ROAD MONTEREY PARK, CA 91754-3617</p> <p style="text-align: center;"><i>No Logo Listed</i></p> <p>CAGE code: 1BRD5 <span style="float: right;"><u>2/</u></span></p>	<p>BOLLHOFF &amp; CO. GmbH &amp; CO. KG ARCHIMDESTRASSE 1-4 BIELEFELD, D-4800 14 GERMANY</p> <p style="text-align: center;"></p> <p>CAGE code: <span style="float: right;"><u>2/</u></span></p>
<p>BLUE TEE CORP DBA GEFCO/ STECO 2215 S. VAN BUREN ST. ENID, OK 73703-8218</p> <p style="text-align: center;"></p> <p>CAGE code: 21363 <span style="float: right;"><u>2/</u></span></p>	<p>BOLT &amp; NUT CO. PARK LANE EAST TIPTON, WEST MIDLANDS, DY4 8RF GREAT BRITIAN</p> <p style="text-align: center;"></p> <p>CAGE code: <span style="float: right;"><u>2/</u></span></p>

1/ Information published in this revision was verified by direct contact with manufacturers.

2/ Information not verified to be current, no response from manufacturer. Information identical to that published in MIL-HDBK-57, Revision B.

## MIL-HDBK-57D(IS)



<p>BOLT FASTENER STUD/TECHNOLOGY 118 W NUGENT ST P.O. BOX 2569 LANCASTER, CA 93535</p> <p>Plant 210 EAST AVENUE LANCASTER, CA 93539</p>  <p>CAGE code: 31386 <span style="float: right;"><u>2/</u></span></p>	<p>BRACELENTE MANUFACTURING CO., INC. 20 WEST CREAMERY ROAD P.O. BOX 570 TRUMBAUERSVILLE, PA 18970-0570</p> <p style="text-align: center;"><b>BMC INC.</b></p> <p>CAGE code: 2Y035 <span style="float: right;"><u>1/</u></span></p>
<p>BOLTWORKS, INC. 2150 WOODLAND WARRENDALE, PA 15086-7536</p>  <p>CAGE code: 3LYS4 <span style="float: right;"><u>1/</u></span></p>	<p>BRADY MACHINE, INC. 6125 SKY ROAD JOSHUA, TX 76058-4048</p>  <p>CAGE code: 1HLW8 <span style="float: right;"><u>1/</u></span></p>
<p>BOMAR ENGINEERING, INC. 13385 PHILLIPPI AVE. SYLMAR, CA 91342</p>  <p>CAGE code: 3U494 <span style="float: right;"><u>2/</u></span></p>	<p>BRANCH MACHINE PARTS, INC. 2419 EMPIRE AVE BURBANK, CA 91504</p>  <p>CAGE code: <span style="float: right;"><u>2/</u></span></p>
<p>BOMBSHELL, INC. 9565 PATHWAY ST. #B SANTEE, CA 92071</p> <p style="text-align: center;">509W0</p> <p>CAGE code: 509W0 <span style="float: right;"><u>1/</u></span></p>	<p>BRIARWOOD FASTENERS, INC. 9701 OWENSMOUTH AVE. UNIT 8 CHATSWORTH, CA 91311-4814</p> <p style="text-align: center;"><b>BFI</b></p> <p>CAGE code: 3N278 <span style="float: right;"><u>1/</u></span></p>

1/ Information published in this revision was verified by direct contact with manufacturers.

2/ Information not verified to be current, no response from manufacturer. Information identical to that published in MIL-HDBK-57, Revision B.

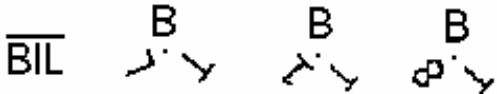
MIL-HDBK-57D(IS)

<p>BRIDEAN MACHINE &amp; TOOL CO., INC. 155 BANGOR STREET LINDENHURST, NY 11757-3632</p> <p style="text-align: center;">  </p> <p>CAGE code: 1S023 <span style="float: right;"><u>1/</u></span></p>
<p>BRIDGEVIEW MANUFACTURING CO. (ILLINOIS CORPORATION) 7320 S. FERDINAND AVENUE BRIDGEVIEW, IL 60455-1111</p> <p style="text-align: center;"><b>BVB</b></p> <p>CAGE code: 0ALM2 <span style="float: right;"><u>1/</u></span></p>
<p>BRIGHT LIGHTS USA, INC. 145 SHREVE AVE. BARRINGTON, NJ 08007</p> <p style="text-align: center;"><b>BL</b></p> <p>CAGE code: 0RMF7 <span style="float: right;"><u>1/</u></span></p>
<p>BRINTCLIFFE TURNER LTD. CRAMPTONS ROAD SEVENOAKS, KENT, TN14 5DS GREAT BRITAIN</p> <p style="text-align: center;">  </p> <p>CAGE code: <span style="float: right;"><u>2/</u></span></p>

<p>BRISTOL INDUSTRIES 630 EAST LAMBERT RD. BREA, CA 92821</p> <p><b>B+</b> CAPITAL B FOLLOWED BY PLUS SIGN RAISED OR DEPRESSED</p> <p><b>BI</b> CAPITAL B FOLLOWED BY CAPITAL I USED FOR EUROPEAN PARTS ONLY RAISED OR DEPRESSED</p> <p>  TWO ADJACENT DOTS RAISED OR DEPRESSED         </p> <p style="text-align: center;">  </p> <p style="text-align: center;">TWO ADJACENT DOTS RAISED OR DEPRESSED</p> <p><b>B</b> - old callout no longer used on new product</p> <p>CAGE code: 27238 <span style="float: right;"><u>1/</u></span></p>
--

1/ Information published in this revision was verified by direct contact with manufacturers.

2/ Information not verified to be current, no response from manufacturer. Information identical to that published in MIL-HDBK-57, Revision B.



MIL-HDBK-57D(IS)

BRISTOL LOCKNUT CO. (NUT DIVISION)  
 32451 N. AVIS DRIVE  
 MADISON HEIGHTS, MI 48071



CAGE code: \_\_\_\_\_ 2/

---

BROADSTONE TOOL & DIE, INC.  
 R #1, BOX 986  
 MCARTHUR, OH 45651



CAGE code: 4Z678 2/



---

BROWN PRODUCTION, INC.  
 804 W MEEKER ST.  
 KENT, WASHINGTON 98032-5702



CAGE code: 2D069 2/

BRUNNER DRILLING & MFG. CO., INC.  
 405 ELROY ST.  
 P.O. BOX 137  
 ELROY, WI 53929

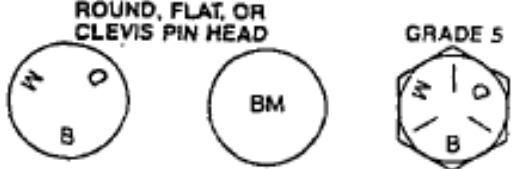
CAGE code: 24407 1/

---

BRUNNER MANUFACTURING CO.  
 DBA BRUNNER MANUFACTURING  
 DIVISION  
 1025 PARKER DR  
 MAUSTON, WI 53948 9381



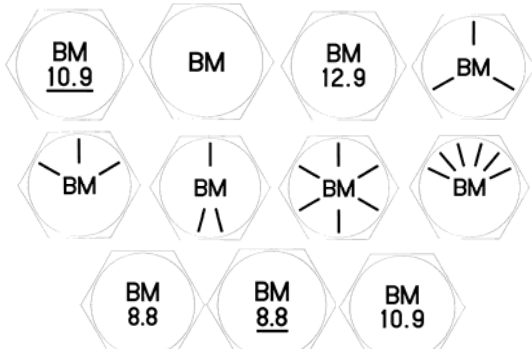

CAGE code: 3B7H2 1/

1/ Information published in this revision was verified by direct contact with manufacturers.

2/ Information not verified to be current, no response from manufacturer. Information identical to that published in MIL-HDBK-57, Revision B.

## MIL-HDBK-57D(IS)

<p>BRYCO MACHINE, INC. 7800 GRAPHICS DRIVE TINLEY PARK, IL 60477</p> <p style="text-align: center;"><b>BM</b></p> <p>CAGE code: 1WCD4 <span style="float: right;"><u>1/</u></span></p>	<p>BUFFALO PUMPS, INC. (SUBSIDIARY OF AMPCO-PITTSBURGH CORP.) 874 OLIVER STREET NORTH TONAWANDA, NY 14120-3210</p> <p style="text-align: center;"><b>BP</b></p> <p>CAGE code: 83130 <span style="float: right;"><u>2/</u></span></p>
<p>BUCK EYE FORGE, INC. 11700 HARVARD AVE CLEVELAND, OH 44105</p> <p style="text-align: center;"></p> <p>CAGE code: 71177 <span style="float: right;"><u>2/</u></span></p>	<p>BULA FORGE INC. 2987 E 87TH ST CLEVELAND, OH 44104-4</p> <p style="text-align: center;"><b>BULA</b></p> <p>CAGE code: <span style="float: right;"><u>2/</u></span></p>
<p>BUCKEYE MACHINING, INC. 25020 LAKELAND BLVD. CLEVELAND, OH 44132</p> <p style="text-align: center;"></p> <p>CAGE code: 8X808 <span style="float: right;"><u>2/</u></span></p>	

1/ Information published in this revision was verified by direct contact with manufacturers.

2/ Information not verified to be current, no response from manufacturer. Information identical to that published in MIL-HDBK-57, Revision B.

## MIL-HDBK-57D(IS)

BULTEN TRADING AB  
P.O. BOX 516  
734 01 HALLSTAHAMMAR  
SWEDEN

*Bulten Stainless AB*  
Ashammar Works  
810 25 Ashammar  
Sweden

*Bulten Stainless AB*  
Svartå Works  
710 11 Svartå  
Sweden

**BH**

BULTEN AB

**BUFO**

BULTEN AB

**SÅ**

BULTEN STAINLESS AB

CAGE code: N8286

2/

BURROWERS RESEARCH MACHINING,  
INC.  
43 BRADFORD STREET  
P.O. BOX 1130  
CONCORD, MA 01742

**BRM**

CAGE code:

2/

BUSAN INDUSTRIAL MACHINERY CO.,  
LTD.  
*BOLT DIVISION*  
456-9, NAE-DONG, CHANGWON  
KYEONGSANGNAM-DO, KOREA

**BM**

**BIM**

CAGE code:

2/

BUTECH PRESSURE SYSTEMS  
4928 PITTSBURGH AVE  
ERIE, PA 16509

See BER-LOW MFG INC

**BPS**

CAGE code: 62295

2/

BUTLER, INC.  
1600 WEST 166TH STREET  
GARDENA, CA 90247

**JB**



CAGE code: 59053

1/

1/ Information published in this revision was verified by direct contact with manufacturers.

2/ Information not verified to be current, no response from manufacturer. Information identical to that published in MIL-HDBK-57, Revision B.

## MIL-HDBK-57D(IS)

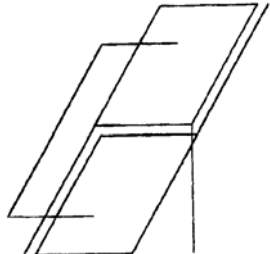
<p>C &amp; D MACHINE TOLL, INC. 726 COURT STREET SPRINGFIELD, OH 45506</p> <p style="text-align: center;"><b>C&amp;D MACH</b></p> <p>CAGE code: 064X3 <span style="float: right;"><u>1/</u></span></p>	<p>C.E.S. MACHINE PRODUCTS, INC 8880 DOUBLE DIAMOND PKWY RENO, NV 89521-5908</p> <p style="text-align: center;"><b>CES</b></p> <p>CAGE code: 1WF66 <span style="float: right;"><u>2/</u></span></p>
<p>C &amp; H MFG., INC. 4280 E LOWELL ST ONTARIO, CA 91761-1529</p> <p style="text-align: center;"><b>30633</b></p> <p>CAGE code: 30633 <span style="float: right;"><u>2/</u></span></p>	<p>C. J.'S GENERAL MACHINE WORKS 15406 FOREST MIST SAN ANTONIO, TX 78232-4137</p> <p style="text-align: center;"></p> <p>CAGE code: 7W334 <span style="float: right;"><u>2/</u></span></p>
<p>C &amp; S ENGINEERING LLC 15401 CARMENITA DR. (N) SANTA FE SPRINGS, CA 90670</p> <p style="text-align: center;"></p> <p>CAGE code: 4ZH03 <span style="float: right;"><u>1/</u></span></p>	<p>C.R.D. MACHINING 366 W. 131<sup>ST</sup> ST. LOS ANGELES, CA 90248</p> <p style="text-align: center;"></p> <p>CAGE code: 1LA52 <span style="float: right;"><u>2/</u></span></p>
<p>C. E. MACHINE CO., INC. 1741 SOUTH LEONINE WICHITA, KS 67209-2813</p> <p style="text-align: center;"><b>MFR 3L665</b></p> <p>CAGE code: 3L665 <span style="float: right;"><u>2/</u></span></p>	

1/ Information published in this revision was verified by direct contact with manufacturers.

2/ Information not verified to be current, no response from manufacturer. Information identical to that published in MIL-HDBK-57, Revision B.

MIL-HDBK-57D(IS)

CALABRESE & SONS, INC.  
 406 BRANDY LANE  
 P.O. BOX 1667  
 MECHANICSBURG, PA 17055-2800



CAGE code: 07310

1/

CALIFORNIA SCREW PRODUCTS CORP.  
 P.O. BOX 228  
 PARAMOUNT, CA 90723

*Plant*  
 14957 GWENCHRIS AVE.  
 PARAMONT, CA 90723-3423

**CS**

**C S**

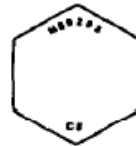

HEX. HEAD



HEX. HEAD

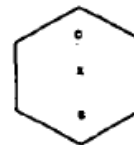

HEX. HEAD

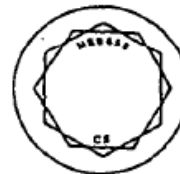

TWELVE POINTS



FLAT HEAD  
PAN HEAD  
ROUND HEAD  
 (ALL TYPES OF HEADS)

CAGE code: 8Z507

1/

1/ Information published in this revision was verified by direct contact with manufacturers.

2/ Information not verified to be current, no response from manufacturer. Information identical to that published in MIL-HDBK-57, Revision B.

MIL-HDBK-57D(IS)

CAMBRIDGE SPECIALTY COMPANY, INC.  
 DBA POINT MACHINE CO.  
 588 FOUR ROD RD  
 BERLIN, CT 06037-2280



CAGE code: 9E232 2/

CAMCAR DIVISION OF TEXTRON INC.  
 600 18<sup>th</sup> Ave.  
 Rockford, IL 61101

Plant  
 AMSCO PRODUCTS  
 1818 CHRISTINA ST  
 ROCKFORD, IL 24382  
 CAGE code: 01536

*Head markings*



Vendor identification, "A" or four dots raised or depressed located as shown.

*Under head markings*



Vendor identification, four dots radially located as shown, depressed

CAGE code: 93907 2/

Continued

Continued

CAMCAR DIVISION OF TEXTRON INC.

Plant  
 DRILLETITE PRODUCTS  
 1304 KERR DR.  
 DECORAH, IA 52101  
 CAGE code: 0JMM5

*Head markings*



Vendor and customer Identification for stainless steel, drilled screws, raised or depressed      Vendor/Product Identification, raised or depressed Identifies "CAMCAR Self – Drilling Fastener."

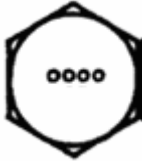

Vendor Identification, Four in-line dots, raised or depressed

*Under head markings*

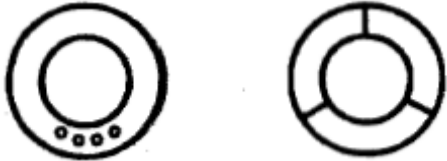

Vendor identification, four radial dots or three equally spaced radial lines, depressed

CAGE code: 93907 2/

Continued

1/ Information published in this revision was verified by direct contact with manufacturers.

2/ Information not verified to be current, no response from manufacturer. Information identical to that published in MIL-HDBK-57, Revision B.

MIL-HDBK-57D(IS)

Continued

**CAMCAR DIVISION OF TEXTRON INC.**

Plant  
**RAYCARL PRODUCTS**  
 600 18<sup>th</sup> Ave.  
 Rockford, IL 61101  
 CAGE code: 6P253

*Head markings*



Vendor Identification, "CAMCAR" or four in-line dots, raised or depressed.

*Under head markings*

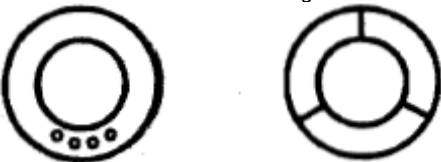

Vendor identification, four radial dots or three equally spaced radial lines, depressed

Plant  
**ROCKFORD HEADED PRODUCTS**  
 29201 TELEGRAPH RD. SUITE 611  
 SOUTHFIELD, IL 48034-1331

*Head markings*



Product Identification, "HP" raised or depressed      Product Identification, Four in-line dots, raised or depressed

*Under head markings*

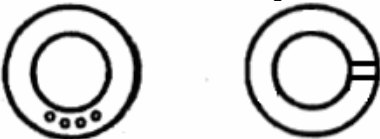

Vendor identification, four radial dots or two parallel lines, raised or depressed

CAGE code: 6P253 2/

Continued

Continued

**CAMCAR DIVISION OF TEXTRON INC.**

Plant  
**SEMS PRODUCTS**  
 1818 CHRISTINA ST  
 ROCKFORD, IL 61104  
 CAGE code: 01536

*Head markings*

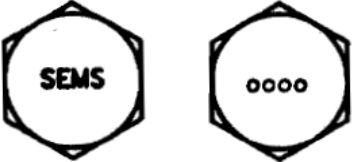

Vendor Identification, "SEMS" or four in-line dots, raised or depressed, located as shown.

*Product Trademark Markings*



INTERNAL TORX ® RECESS "TORX" and two dots raised or depressed, located as shown



EXTERNAL TORX ® RECESS "TORX" equally spaced on top of washer, raised or depressed.



TORXSTEM ® "TORX" equally spaced on END, raised or depressed.

Plant  
**SOCKET SCREW PRODUCTS**  
 1302 KERR DRIVE  
 DECORAH, IA 52101  
 CAGE code: 0JMM5

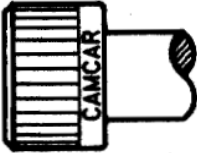
Letters "TORX" plus two dots raised or indented on recess countersink; locate as illustrated (Product Trademark)

Optional Identification, "CAMCAR", raised or indented as illustrated

Vendor Identification, Four radial dots raised or indented, located as shown

Continued 2/

1/ Information published in this revision was verified by direct contact with manufacturers.

2/ Information not verified to be current, no response from manufacturer. Information identical to that published in MIL-HDBK-57, Revision B.

MIL-HDBK-57D(IS)

Continued

CAMCAR DIVISION OF TEXTRON INC.

Plant  
TAPTITE PRODUCTS  
826 EAST MADISON ST  
BELVIDERE, IL 61008

*Head markings*

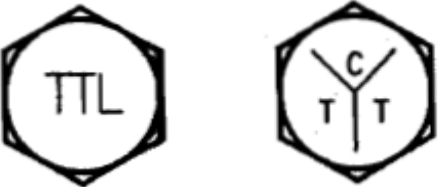

Product Identification, "TTL" raised or depressed      Vendor Identification, "CTY" and three radial lines, raised or depressed



Vendor Identification, Four in-line dots raised or depressed      Vendor Identification, three radial lines and circle, raised or depressed

*Under head markings*

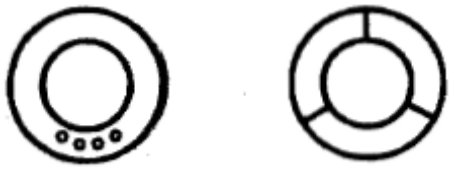

Vendor identification, four radial dots or three equally spaced radial lines, depressed

Continued 2/

Continued

CAMCAR DIVISION OF TEXTRON INC.

Plant  
TORX PRODUCTS  
P.O. Box 607  
Rochester, IN 46975  
CAGE code: 6N040

*Head markings*

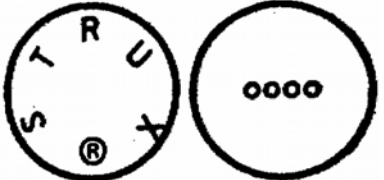

Product Identification, "STRUX ®" equally spaced raised or depressed or four in-line dots, raised or depressed.

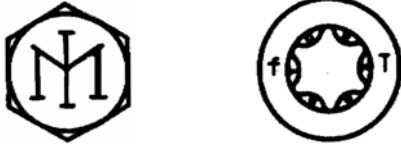

Vendor Identification, superimposed "T" and "M" raised or depressed      Product Identification "f" and "t" located as shown, raised or depressed



Product Identification, TORX logo located as shown, raised or depressed.

*Under head markings*



Vendor Identification, four equally spaced radial lines, raised or depressed

*Nut Markings*

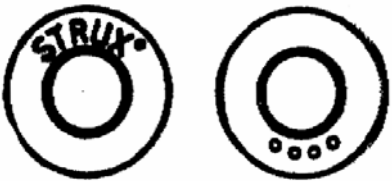

Product Identification, "STRUX ®" raised or depressed, located as shown or four radial dots, raised or depressed.

Continued 2/

1/ Information published in this revision was verified by direct contact with manufacturers.

2/ Information not verified to be current, no response from manufacturer. Information identical to that published in MIL-HDBK-57, Revision B.



MIL-HDBK-57D(IS)

CAMCAR LLC  
500 18<sup>TH</sup> AVENUE  
ROCKFORD, IL 61104

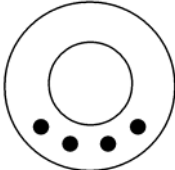



**CAMCAR**

CAGE code: 4WL75 1/

---



CAMCAR SCREW AND MFG CO DIV OF  
TEXTRON INC  
29201 TELEGRAPH RD., SUITE 611  
SOUTHFIELD, IL 48034 - 7649

HEAD MARKINGS

PRODUCT IDENTIFICATION, 'HP' RAISED OR DEPRESSED.

PRODUCT IDENTIFICATION, FOUR IN-LINE DOTS RAISED OR DEPRESSED.

UNDER HEAD MARKINGS

VENDOR IDENTIFICATION, FOUR RADIAL DOTS RAISED OR DEPRESSED.

VENDOR IDENTIFICATION, TWO PARALLEL LINES RAISED OR DEPRESSED.

CAGE code: 6P253 2/

CAMLOC PRODUCTS  
AFS TORRANCE OPERATIONS  
3014 WEST LOMITA BLVD.  
TORRANCE, CA 90505-5103  
CAGE code: 71286

AFS KELKHEIM OPERATIONS  
INDUSTRIESTRASSE 6  
D-65779 KELKHEIM, GERMANY  
CAGE code: D0680

(Corporate office see ALCOA FASTENING SYSTEMS)



**CAMLOC**



CAGE code: 71286, D0680 1/

---

CAM-TECH INDUSTRIES  
95 ESTATES DR W  
FAIRPORT, NY 14450-8425



**CAM-TECH**  
INDUSTRIES, INCORPORATED

CAGE code: 0GT70 2/

---

CANADY MANUFACTURING CO. INC.  
500 FIFTH STREET  
SAN FERNANDO, CA 91340-2225



CAGE code: 00678 2/

1/ Information published in this revision was verified by direct contact with manufacturers.

2/ Information not verified to be current, no response from manufacturer. Information identical to that published in MIL-HDBK-57, Revision B.

MIL-HDBK-57D(IS)

CAPRICE ENGINEERING CO., INC.  
509 HINDRY AVE.  
INGLEWOOD, CA 90301-2017



CAGE code: 52916 1/

---

CAPY MACHINE SHOP, INC.  
114 SPAGNOLI ROAD  
MELVILLE, NY 11747



CAGE code: 0BVP9 1/

---

CARDINAL FASTENER & SPECIALTY CO., INC.  
5185 RICHMOND RD  
BEDFORD HEIGHTS, OH 44146-1330



CAGE code: 2Y089 2/

CARDINAL INDUSTRIAL PRODUCTS  
3873 WEST OQUENDO  
LAS VEGAS, NV 89118-3010



A capital "C" to be applied to all standard ASME/ASTM bolting material.

# MULTI-C

The word "MULTI" followed by a capital "C" to be applied to all ASME bolts manufactured to Nuclear Standards Associates or Cardinal Industrial Products, Inc. Standards.

CAGE code: 57454 2/

---

CARR CO.  
(THE UNITED CARR DIV OF TRW)  
31 AMES ST.  
CAMBRIDGE, MA 02142



CAGE code: 78947 2/

---

CATALINA INSTRUMENT CORPORATION  
44 SOUTH MALL  
PLAINVIEW, NY 11803-4208





CAGE code: 30225 1/

1/ Information published in this revision was verified by direct contact with manufacturers.

2/ Information not verified to be current, no response from manufacturer. Information identical to that published in MIL-HDBK-57, Revision B.







## MIL-HDBK-57D(IS)

<p>CBS FASTENERS INC. 1345 BRASHER STREET ANAHIEM, CA 92807-2046</p> <p><b>CBS CbS</b></p> <p>CAGE code: 0F620 <span style="float: right;"><u>1/</u></span></p>	<p>CELTECH ENTERPRISE 9774 CRESENT CTR DR SUITE 506 RANCHO CUCAMONGA, CA 91730-5745</p>  <p>CAGE code: 0EFF7 <span style="float: right;"><u>2/</u></span></p>
<p>CCB INDUSTRIES, INC. 3200 STUART DRIVE P.O. BOX 1158 FT. WORTH, TX 76101</p> <p><b>CCB</b></p> <p>CAGE code: 60763 <span style="float: right;"><u>1/</u></span></p>	<p>CENTERLINE TOOL &amp; ENGINEERING, INC. 3107 29TH AVENUE E BRADENTON, FL 34208-7420</p>  <p>Capital "C" and Capital "L" combined.</p> <p>CAGE code: 0B5B0 <span style="float: right;"><u>2/</u></span></p>
<p>CCF ENTERPRISES INC. 2449 N.W. DALLAS STREET GRAND PRARIE, TX 75050-4971</p> <p><b>CCF</b></p> <p>CAGE code: 08QQ4 <span style="float: right;"><u>2/</u></span></p>	<p>CENTRAL OZARK MACHINE, INC. HWY 19 SOUTH &amp; HH P. O. BOX 347 ALTON, MO 65606-0347</p>  <p>CAGE code: 64896 <span style="float: right;"><u>2/</u></span></p>
<p>CEI INC. DBA COMMAND ENTERPRISES 700 NORTH DELSEA DR PITMAN, NJ 08071-1244</p> <p><b>L-S-A</b></p> <p>CAGE code: 6U479 <span style="float: right;"><u>2/</u></span></p>	

1/ Information published in this revision was verified by direct contact with manufacturers.

2/ Information not verified to be current, no response from manufacturer. Information identical to that published in MIL-HDBK-57, Revision B.



## MIL-HDBK-57D(IS)

<p>CENTRAL SCREW PRODUCTS 6425 EAST HILDALE DETROIT, MI 48234</p>  <p>CAGE code: 1YCR3 <span style="float: right;"><u>1/</u></span></p>	<p>CHAMPION COMMERCIAL INDUSTRIES, INC CHAMPION RIVET DIVISION P.O. BOX 398 5137 INDIANAPOLIS BLVD EAST CHICAGO, IN 46312-0398</p> <p style="text-align: center;"><b>V</b> <i>Rivets only</i></p> <p>CAGE code: 4B951 <span style="float: right;"><u>2/</u></span></p>
<p>CENTURY METAL PARTS CORP. 230 SOUTH FEHRWAY BAY SHORE, NY 11706-1208</p>  <p>CAGE code: 30396 <span style="float: right;"><u>1/</u></span></p>	<p>CHAMPION FASTENERS, INC. 707 SMITHVILLE RD LUMBERTON, NJ 08048-5302</p>  <p>CAGE code: 0NXPO <span style="float: right;"><u>1/</u></span></p>
<p>CER-MAC INC. 971 HORSHAM RD, HORSHAM, PA 19044-1225</p>  <p>CAGE code: 53569 <span style="float: right;"><u>2/</u></span></p>	<p>CHANCE, A.B. COMPANY 2201 LAKEVIEW RD MEXICO, MO 65265-1360</p>  <p>CAGE code: 02TP8 <span style="float: right;"><u>2/</u></span></p>
<p>CERNY MFG. CO. 4057 WEST 147TH STREET LAWNDALE, CA 60260</p>  <p style="text-align: center;">CMC ◊ 22384.</p> <p>CAGE code: 22384 <span style="float: right;"><u>2/</u></span></p>	<p>CHANDLER PRODUCTS, INC. 1491 CHARDON RD CLEVELAND, OH 44117-1598</p>  <p>CAGE code: 83386 <span style="float: right;"><u>1/</u></span></p>

1/ Information published in this revision was verified by direct contact with manufacturers.

2/ Information not verified to be current, no response from manufacturer. Information identical to that published in MIL-HDBK-57, Revision B.

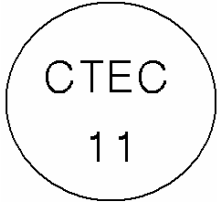
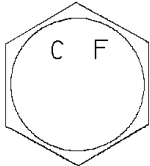





## MIL-HDBK-57D(IS)

<p>CHATHAM PRECISION, INC. COMMERCE ST. P.O. BOX 510 HINESBURG, VT 05461</p> <p style="text-align: center;"><b>4 N 1 3 3</b></p> <p>CAGE code: 4N133 <span style="float: right;"><u>2/</u></span></p>	<p>CHICAGO HARDWARE &amp; FIXTURE CO. 9100 PARK LANE FRANKLIN PARK, IL 60131-3054</p> <p style="text-align: center;"><b>CHF</b></p> <p>CAGE code: 71747 <span style="float: right;"><u>1/</u></span></p>
<p>CHEREK MACHINE &amp; TOOL CO., INC. 835 SHERMAN AVENUE HAMDEN, CT 06514-1149</p> <p style="text-align: center;"><b>CHEREK</b></p> <p>CAGE code: 0YWD4 <span style="float: right;"><u>2/</u></span></p>	<p>CHIEF MFG. 423B WEST FORK DRIVE ARLINGTON, TX 76012-3450</p> <p style="text-align: center;"></p> <p>CAGE code: 00WU0 <span style="float: right;"><u>1/</u></span></p>
<p>CHEROKEE TOOL &amp; ENGINEERING CO., INC. P.O. BOX 227 CANTON, GA 30114</p> <p style="text-align: center;"></p> <p>CAGE code: 30662 <span style="float: right;"><u>2/</u></span></p>	<p>CHOICE PRECISION MACHINE, INC. 4280 COMMERCE DRIVE WHITEHALL, PA 18052</p> <p style="text-align: center;"><b>CPM</b></p> <p>CAGE code: 1WAA0 <span style="float: right;"><u>2/</u></span></p>
<p>CHICAGO FASTENER MANUFACTURING 10902 WALNUT LANE MOKENA, IL 60448-8165</p> <p style="text-align: center;"></p> <p>CAGE code: 05TL5 <span style="float: right;"><u>1/</u></span></p>	<p>CHRIS MACHINE CO. 110 DOYLE ST. DOYLESTOWN, PA 18901-1370</p> <p style="text-align: center;"></p> <p>CAGE code: 2T317 <span style="float: right;"><u>2/</u></span></p>

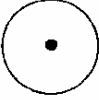
1/ Information published in this revision was verified by direct contact with manufacturers.

2/ Information not verified to be current, no response from manufacturer. Information identical to that published in MIL-HDBK-57, Revision B.

## MIL-HDBK-57D(IS)

<p>CHU HUA INDUSTRIAL CO., LTD. 800 FU SHING RD. LU CHU, KAOHSING, TAIWAN, 821 R.O.C.</p>  <p>CAGE code: <u>2/</u></p>	<p>CLEVELAND HARDWARE &amp; FORGING DBA GREEN BAY DROP FORGE CO 1341 S. STATE ST P.O. BOX 11797 GREEN BAY, WI 54307-1797</p>  <p>Circle with center dot</p> <p>CAGE code: 08277 <u>2/</u></p>
<p>CHUN YU WORKS &amp; CO., LTD. 1 CIASHING KANGSHAN, TAIWAN</p>  <p>CAGE code: <u>2/</u></p>	<p>CLICK BOND, INC. 2151 LOCKHEED WAY CARSON CITY, NV 89706-0713</p>  <p>CAGE code: 66530 <u>1/</u></p>
<p>CINCH MANUFACTURING 2610 S YALE ST SANTA ANA, CA 92704</p>  <p>CAGE code: <u>2/</u></p>	<p>CLYDE FASTENERS LIMITED 5 HAWBANK RD, EAST KILBRIDE, GLASGOW, SCOTLAND G74 5ET</p>  <p>CAGE code: <u>1/</u></p>
<p>CINCH-MONADNOCK 18301 ARENTH AVE CITY OF INDUSTRY, CA 91749</p>  <p>= (dot)</p> <p>CAGE code: <u>2/</u></p>	<p>CM MANUFACTURING, INC. 6333 BUTLER CREEK ROAD MISSOULA, MT 59808-8861</p>  <p>CAGE code: 6Z056 <u>1/</u></p>

1/ Information published in this revision was verified by direct contact with manufacturers.

2/ Information not verified to be current, no response from manufacturer. Information identical to that published in MIL-HDBK-57, Revision B.

MIL-HDBK-57D(IS)

CNC MACHINING INC.  
109 PANE ROAD  
NEWINGTON CT 06111-1552

**C**

CAGE code: 2Y832 2/

---

COAE BOLTS WORKS CO., LTD  
NO. 47 CHINAN ROAD, TASHE HSIANG  
KOAHSIUNG HSIEN, TAIWAN

C  
┌─┴─┐  
└─┬─┘  
C  
┌─┴─┐  
└─┬─┘  
C  
┌─┴─┐  
└─┬─┘  
C

**A325**

CAGE code: 2/

---

COAST INDUSTRIAL SUPPLY CO., INC.  
SUB OF SPANDCO INDUSTRIES INC.  
15959 PIUMA AVENUE  
CERRITOS, CA 90701-1526

 On head of silicon bronze and aluminum hex head cap screws

 On head of stainless steel, monel, brass, naval bronze, chrome alloy, hex head cap screws, and the end of alloy steel studs.

CAGE code: 9U032 2/

CODLING TOOL & MFG. INC.  
665 NE 42ND STREET  
FORT LAUDERDALE, FL 33334



CAGE code: 0P3X2 2/

---

COLD HEADING CO., THE  
21777 HOOVER RD.  
WARREN, MI 48089-2544

 . | .

CAGE code: 89657 1/

---

COMET MFG. CO., INC.  
315 JOHN DOWNEY DRIVE  
NEW BRITIAN, CT 06051

**61062**

CAGE code: 61062 2/

---

COMMAND ENTERPRISES  
700 NORTH DELSEA DR.  
PITMAN, NJ 08071  
(see CEI, INC.)



**C . E . I**

CAGE code: 2/

1/ Information published in this revision was verified by direct contact with manufacturers.

2/ Information not verified to be current, no response from manufacturer. Information identical to that published in MIL-HDBK-57, Revision B.

## MIL-HDBK-57D(IS)

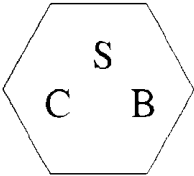



<p>COMPUTA-BASE MACHINING, INC. 411 NORTH GROVE ST P.O. BOX 340 BERLIN, NJ 08009-9704</p> <p style="text-align: center;"><b>CBM</b></p> <p>CAGE code: 0A396 <span style="float: right;"><u>2/</u></span></p>	<p>COPELAND MFG. CORP. (JAMES DIVISION) 11222 E. PINE ST. TULSA, OK 74116-1613</p> <p style="text-align: center;"></p> <p style="text-align: center;"></p> <p>CAGE code: 0CM67 <span style="float: right;"><u>2/</u></span></p>
<p>CONNECTICUT AIRCRAFT PRODUCTS 246 SHAKER ROAD ENFIELD, CT 06082-2366</p> <p style="text-align: center;"></p> <p>CAGE code: 0KA73 <span style="float: right;"><u>2/</u></span></p>	<p>COPPER STATE BOLT &amp; NUT CO. 3602 N 35TH AVE. 3637 N 34TH AVE. PHOENIX, AZ 85017-4408</p> <p style="text-align: center;"></p> <p>CAGE code: 0Z0Y2 <span style="float: right;"><u>2/</u></span></p>
<p>CONQUEST MACHINE, INC. 3655 RESEARCH DR. GENESIS A STE 106 LAS CURCES, NM 88003-1239</p> <p style="text-align: center;"><b>CMI</b></p> <p>CAGE code: 0PNX2 <span style="float: right;"><u>2/</u></span></p>	<p>CORPUS CHRISTI GASKET &amp; FASTENER LTD. 341 WEST CHESTER RD. P.O. BOX 4074 CORPUS CHRISTI, TX 78408</p> <p style="text-align: center;"><b>CCG</b></p> <p>CAGE code: 008R2 <span style="float: right;"><u>1/</u></span></p>
<p>CO-OP SCREW MANUFACTURING CORP. 60 SINDLE AVE. LITTLE FALLS, NJ 07424-1649</p> <p style="text-align: center;"><b>C</b></p> <p>CAGE code: 1FZ52 <span style="float: right;"><u>2/</u></span></p>	<p>COOPER POWER SYSTEMS INC (MCGRAW EDISON POWER SYSTEMS) NORTH BURSON STREET EAST STROUDSBURG, PA 18301</p> <p style="text-align: center;"><b>M</b></p> <p>CAGE code: 88424 <span style="float: right;"><u>2/</u></span></p>

1/ Information published in this revision was verified by direct contact with manufacturers.

2/ Information not verified to be current, no response from manufacturer. Information identical to that published in MIL-HDBK-57, Revision B.



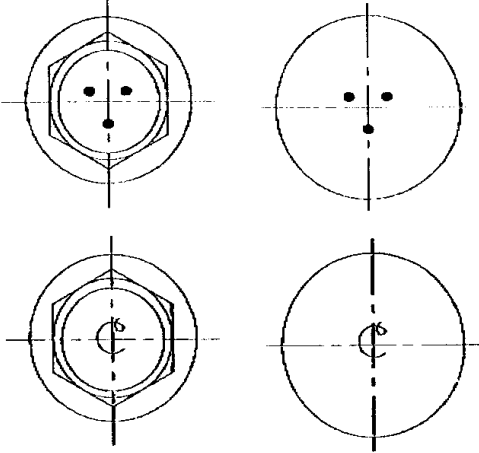

## MIL-HDBK-57D(IS)

<p>CREATIVE PRECISION INC. DBA CREATIVE PRECISION WEST 2640 E. ROSE GARDEN LANE SUITE 6 PHOENIX, AZ 85050-4612</p> <p>Plant 1501 BLUEBALL AVENUE LINWOOD, PA 19061 CAGE code: 0F3N2</p> <p><b>CPI</b></p> <p>CAGE code: 1K0E5 <span style="float: right;">1/</span></p>	<p>CRYSTAL METAL PRODUCTS COMPANY, INC. 2700 E. CASTOR AVENUE PHILADELPHIA, PA 191345</p> <p></p> <p>CAGE code: 0BPW8 <span style="float: right;">2/</span></p>
<p>CRESENT MANUFACTURING CO. P.O. BOX 1350 BUILINGTON, CT 06013-0350</p> <p>Plant 700 GEORGE WASHINGTON TPKE BUILINGTON, CT 06013-0350</p> <p></p> <p>CAGE code: 63020 <span style="float: right;">1/</span></p>	<p>CSM FASTENER PRODUCTS 1133 BRTN MAWR AVE. BENSENVILLE, IL 60106</p> <p></p> <p>CAGE code: 1CJW4 <span style="float: right;">1/</span></p>
<p>CRS PRECISION CORP. 640 WEST MERRICK ROAD VALLEY STREAM, NY 11580-0482</p> <p></p> <p>CAGE code: 07QQ6 <span style="float: right;">2/</span></p>	<p>CURTIS PRESTON ENTERPRISES INC. DBA ATLAS SPECIALTY PRODUCTS 2299 E WINSTON RD ANAHEIM, CA 92806-5538</p> <p><b>ASP</b></p> <p>CAGE code: 0TP31 <span style="float: right;">1/</span></p>

1/ Information published in this revision was verified by direct contact with manufacturers.

2/ Information not verified to be current, no response from manufacturer. Information identical to that published in MIL-HDBK-57, Revision B.

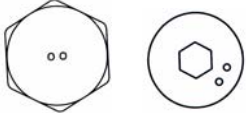

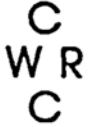
## MIL-HDBK-57D(IS)

<p>CUTTING EDGE ENTERPRISE, LLC 2465 POLE LINE RD. DECORAH, IOWA 52101</p> <p>Plant 2509 172<sup>ND</sup> AVE. DECORAH, IOWA 52101</p>  <p>CAGE code: 52101 <span style="float: right;">1/</span></p>	<p>D &amp; D TOOL COMPANY, INC. LEWIS STREET &amp; MAPLE AVENUE EATONTOWN, NJ 07724</p> <p style="text-align: center;"><b>D &amp; D</b></p> <p>CAGE code: 30077 <span style="float: right;">2/</span></p>
<p>CUTTING EDGE MACHINING INC. NEVADA DIV 1625 LINDA WAY SPARKS, NV 89431</p> <p>See WESTERN SCREW MACHINE PRODUCTS, INC.</p>  <p>CAGE code: 0ZV72 <span style="float: right;">2/</span></p>	<p>D &amp; R MACHINE COMPANY 2310 BIG OAK ROAD LANGHORNE, PA 19047-1910</p> <p style="text-align: center;"><b>4T853</b></p> <p>CAGE code: 4T853 <span style="float: right;">2/</span></p>
<p>CWR MANUFACTURING CO (DIVISION OF A.J. MUPHY CO., INC.) P.O. BOX 2669 SYRACUSE, NY 13220</p>  <p>CAGE code: <span style="float: right;">2/</span></p>	<p>D. C. MACHINING INC. 1900 9TH AVE., SW WATERTOWN, SD 57201</p> <p style="text-align: center;"><b>DC</b></p> <p>CAGE code: 0AUC7 <span style="float: right;">2/</span></p>
<p>D &amp; D MACHINERY AND SALES 2420 W. R. LARSON ROAD SAN ANTONIO, TX 78261-2200</p> <p style="text-align: center;"><b>1Y128</b></p> <p>CAGE code: 1Y128 <span style="float: right;">2/</span></p>	<p>D.S.O. PLASTICS, INC. 1220 ROCK ST. ROCKFORD, IL 61101</p> <p style="text-align: center;"><b>Z</b></p> <p>CAGE code: <span style="float: right;">2/</span></p>

1/ Information published in this revision was verified by direct contact with manufacturers.

2/ Information not verified to be current, no response from manufacturer. Information identical to that published in MIL-HDBK-57, Revision B.

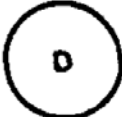
## MIL-HDBK-57D(IS)

<p>DACK INDUSTRIES, INC. P.O. BOX 427 FARMINGTON , CT 06034 - 0427</p> <p style="text-align: center;"><b>d</b></p> <p>CAGE code: 0CZ42 <span style="float: right;"><u>2/</u></span></p>	<p>DARCO PRODUCTS 8406 WASHINGTON PL NE ALBUQUERQUE, NM 87113-1671</p> <p style="text-align: center;"><b>D P</b></p> <p>CAGE code: 1DL79 <span style="float: right;"><u>2/</u></span></p>
<p>DANIEL CO., EDWARD W. 11700 HARVARD AVENUE CLEVELAND, OH 441053</p> <p style="text-align: center;"></p> <p>CAGE code: 73634 <span style="float: right;"><u>2/</u></span></p>	<p>DAVE ALLEN ENTERPRISES 10631 BLOOMFIELD AVENUE UNIT 15 LOS ALAMITOS, CA 90720</p> <p style="text-align: center;"><b>DAE</b></p> <p>CAGE code: 1NWX4 <span style="float: right;"><u>2/</u></span></p>
<p>DAN-LOC BOLT &amp; GASKET INC. FORMALLY <i>DANIEL INDUSTRIES, INC.</i> Bolt &amp; Gasket Division P.O. BOX 292 HOUSTON, TX 77001-0292</p> <p style="text-align: center;">Plant 725 North Drennan Houston, TX 77003</p> <p style="text-align: center;"> <b>STUDS</b>       <b>HEX NUTS</b></p> <p>CAGE code: <span style="float: right;"><u>2/</u></span></p>	<p>DAVIES PRECISION MACHINING, INC. 2400 COLEBROOK RD. LEBANON, PA 17042-9562</p> <p style="text-align: center;"><b>DPM</b></p> <p>CAGE code: 7V760 <span style="float: right;"><u>2/</u></span></p>
	<p>DAVIS AIRCRAFT PRODUCT CO., INC. 1150 WALNUT AVENUE BOHEMIA, NY 11716-6216</p> <p style="text-align: center;"></p> <p>CAGE code: 98313 <span style="float: right;"><u>2/</u></span></p>

1/ Information published in this revision was verified by direct contact with manufacturers.

2/ Information not verified to be current, no response from manufacturer. Information identical to that published in MIL-HDBK-57, Revision B.

MIL-HDBK-57D(IS)

DECKER MANUFACTURING CORP  
703 NORTH CLARK STREET  
P.O. BOX 410  
ALBION, MI 49224-1455

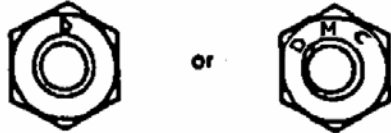

HEX WHEEL NUTS  
(DEPRESSED "D" or "MDC")



AMERICAN STANDARD  
SQUARE, HEX, AND ROUND WELD NUT  
(SMALL RAISED DOT ON CHAMFER)



METRIC  
SQUARE, HEX, AND ROUND WELD NUTS  
(DEPRESSED LETTER "D" AND CLASS NO.)

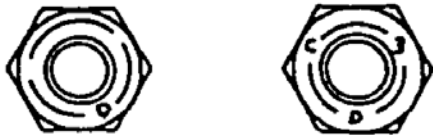

A-563  
STRUCTURAL NUTS  
(DEPRESSED "D" OR "DMC")

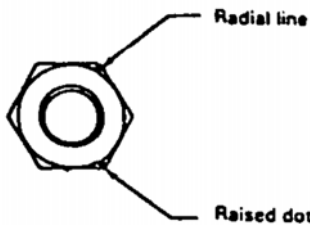

GRADE 5  
HEX NUTS  
(ONE RAISED RADIAL LINE 120°  
COUNTERCLOCKWISE FROM ONE  
RAISED DOT ON CHAMFER)

CAGE code: 12876

2/

DEERE & CO.  
JOHN DEERE PLACE  
MOLINE, IL 61265

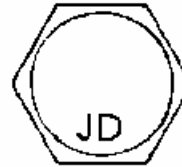

CAGE code: 75160

2/

DEFENSE AEROSPACE  
MFG OF DEFENSE AEROSPACE  
THREADED MACHINE PARTS  
10841 NOEL ST. #104  
LOS ALAMITOS, CA 90720-2527

**DAS**  
**1**

CAGE code: 1W4A6

1/

DEFENSE QUALITY MFG.  
40 SACCO RD.  
ROYERSFORD, PA 19468-1030



DQ





CAGE code: 0B6M7

2/

1/ Information published in this revision was verified by direct contact with manufacturers.

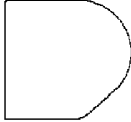
2/ Information not verified to be current, no response from manufacturer. Information identical to that published in MIL-HDBK-57, Revision B.







## MIL-HDBK-57D(IS)

<p>DEFIANCE STAMPING COMPANY, THE P.O. BOX 506 DEFIANCE, OHIO 43512-2743</p> <p>PLANT 1090 PERRY ST DEFIANCE, OHIO 43512-2743</p>  <p>CAGE code: 6B357 <span style="float: right;"><u>2/</u></span></p>	<p>DELTA MACHINE &amp; TOOL CO., INC. PARKMOUNT ROAD P.O. BOX 351 GLEN RIDDLE, PA 19037</p>  <p>CAGE code: <span style="float: right;"><u>2/</u></span></p>
<p>DEHOUSSE (USINES) 64007 PAU FRANCE</p> <p style="text-align: center;"><b>D</b></p> <p>CAGE code: BP714 <span style="float: right;"><u>2/</u></span></p>	<p>DEL-VAL FASTENER MANUFACTURING P.O. BOX 2901 21-D INDUSTRIAL DRIVE WARMINSTER, PA 18974</p> <p style="text-align: center;"><b>DV</b></p> <p>CAGE code: 1EE10 <span style="float: right;"><u>2/</u></span></p>
<p>DELL MFG. CO., INC. 4 RIGHT LANE FARMINGTON, CT 06032-3195</p>  <p>CAGE code: 5A628 <span style="float: right;"><u>1/</u></span></p>	<p>DEMAT (CANCELLED AND REPLACED BY ALCOA FASTENER SYSTEMS) BD DU GRAND CASTAING ZI BD DU GRD CASTING ROQUES, FRANCE 31120</p>  <p style="text-align: center;"><b>DT M</b></p> <p style="text-align: center;"><b>D</b></p> <p>CAGE code: F7411 <span style="float: right;"><u>2/</u></span></p>
<p>DELT INDUSTRIES, INC. (AEROSPACE PRODUCTS DIVISION) 90 WEST EASY STREET, STE 2 P.O. BOX 940067 SIMI VALLEY, CA 93065-6206</p>  <p>CAGE code: 064T2 <span style="float: right;"><u>1/</u></span></p>	

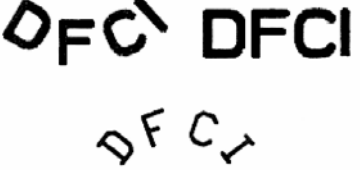
1/ Information published in this revision was verified by direct contact with manufacturers.

2/ Information not verified to be current, no response from manufacturer. Information identical to that published in MIL-HDBK-57, Revision B.



## MIL-HDBK-57D(IS)

<p>DEPENDABLE MACHINE CO., INC. 1846 E 30TH ST INDIANAPOLIS, IN 46218-2607</p>  <p>CAGE code: 14554 <u>2/</u></p>	<p>DFCI SOLUTIONS, INC. 425 UNION BLVD. WEST ISLIP, NY 11795-3183</p>  <p>CAGE code: 72794 <u>1/</u></p>
<p>DERBYSHIRE MACHINE &amp; TOOL CO. DBA DERBYSHIRE MARINE PRODUCTS 5100 BELFIELD AVENUE PHILADELPHIA, PA 19144-1788</p>  <p>CAGE code: 71905 <u>1/</u></p>	<p>DHL ENTERPRISES 1260 E. WOODLAND AVENUE #46 P. O. BOX 295 MORTON, PA 19070</p>  <p>CAGE code: 0UGD5 <u>2/</u></p>
<p>DETROIT HEADING CO. 6421 LYNCH RD. DETROIT, MI 48234-4140</p>  <p>CAGE code: 0TUA2 <u>2/</u></p>	<p>DIAL SUPPLY AND MFG., INC. 1315 FM 1187 #106 MANSFIELD, TX 76063</p>  <p>CAGE code: 9N473 <u>1/</u></p>
<p>DEUTSCH COMPANY INC., THE DBA DEUTSCH CO THE METAL COMPONENT 14800 S. FIGUEROA STREET GARDENA, CA 90248-1795</p>  <p>CAGE code: 14798 <u>2/</u></p>	<p>DIESEL PARTS COMPANY OF CALIFORNIA 1900 EAST 12TH STREET OAKLAND, CA 94606-4821</p>  <p>CAGE code: 24378 <u>2/</u></p>

1/ Information published in this revision was verified by direct contact with manufacturers.

2/ Information not verified to be current, no response from manufacturer. Information identical to that published in MIL-HDBK-57, Revision B.

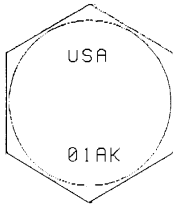



## MIL-HDBK-57D(IS)

<p>DIHARD COMPANY 3161 MAJOR STREET FORT WORTH, TX 76112 - 7020</p> <p style="text-align: center;"><b>D</b></p> <p>CAGE code: 0F1U4 <span style="float: right;"><u>2/</u></span></p>	<p>DO-ALL PRECISION, INC. 9 UNION AVENUE MOUNT VERNON, NY 10550</p>  <p>CAGE code: <span style="float: right;"><u>2/</u></span></p>
<p>DISC-LOCK INTERNATIONAL 1924 S PACIFIC COAST HWY SUITE F REDONDO BEACH , CA 90277</p> <p style="text-align: center;"><b>DL</b></p> <p>CAGE code: 72731 <span style="float: right;"><u>2/</u></span></p>	<p>DOMESTIC FASTENER &amp; FORGE, INC. P.O. BOX 14642 LENEXA, KS 66285</p> <p>Plant 15850 W. 108<sup>TH</sup> STREET LENEXA, KS 66219</p>  <p>CAGE code: 09ML9 <span style="float: right;"><u>1/</u></span></p>
<p>DIXON MACHINE &amp; TOOL DBA DIXON MACH AND FABRICATION 6807 CHAPMAN HWY. KNOXVILLE, TN 37920-6560</p> <p>see TROY D. RAY</p> <p style="text-align: center;"><b>DMT</b></p> <p>CAGE code: 1DEP3 <span style="float: right;"><u>2/</u></span></p>	<p>DOMESTIC FORGING, INC. P.O. BOX 693 NEW HAVEN, MI 48048</p>  <p>CAGE code: <span style="float: right;"><u>2/</u></span></p>
<p>DO MANUFACTURING CORP. P.O. BOX 2382 114 BROOKLYN ST ROCKVILLE, CT 06066</p> <p style="text-align: center;"><i>PLANT</i> 114 BROOKLYN ST. ROCKVILLE, CT 06066</p>  <p>CAGE code: 1H312 <span style="float: right;"><u>2/</u></span></p>	<p>DONSON MACHINE ALSIP MACHING GROUP 12416 S. KEDVALE AVENUE ALSIP, IL 60803-1819</p> <p style="text-align: center;"><b>DMC</b></p> <p>CAGE code: 0BHD5 <span style="float: right;"><u>1/</u></span></p>

1/ Information published in this revision was verified by direct contact with manufacturers.

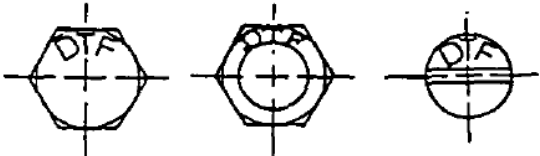
2/ Information not verified to be current, no response from manufacturer. Information identical to that published in MIL-HDBK-57, Revision B.

## MIL-HDBK-57D(IS)

<p>DOUBLECO INCORPORATED DBA R &amp; D FASTENERS 9444 9TH STREET RANCHO CUCAMONGA, CA 91730</p>  <p>CAGE code: 1UKP3 <span style="float: right;">1/</span></p>	<p>DTF MANUFACTURING, INC. DIV OF FEDERAL SCREW AND SUPPLY CO P. O. BOX 329 146 ALBANY AVE. LINDENHURST, NY 11757</p>  <p>Standard: DTF Large Dia: DTF DTF Micro Dia: d</p> <p>CAGE code: 0H802 <span style="float: right;">2/</span></p>
<p>DOUGLASS TOOL &amp; ENGINEERING CO., INC. 304 EAST DYER ROAD SANTA ANA, CA 92707</p> <p style="text-align: center;"><b>DTE</b> Marking to be indented</p> <p>CAGE code: <span style="float: right;">2/</span></p>	<p>DUFFY ELECTRONICS &amp; MFG. CO. 50 BARNES PARK RD WALLINGFORD, CT 06492</p>  <p>CAGE code: <span style="float: right;">2/</span></p>
<p>DRESSER INDUSTRIES, INC. DRESSER PUMP DIVISION 142 CLINTON ROAD FAIRFIELD, NJ 07004</p>  <p>CAGE code: 0LNV2 <span style="float: right;">2/</span></p>	<p>DUNCAN ELECTRONICS &amp; MFG. CO. 701 SEVENTH AVE. BELMAR, NJ 07719</p>  <p>CAGE code: <span style="float: right;">2/</span></p>
<p>D'SAMIC 1261 HOBLITT AVE # 206 CLOVIE, CA 93612-2811</p>  <p>CAGE code: <span style="float: right;">2/</span></p>	

1/ Information published in this revision was verified by direct contact with manufacturers.

2/ Information not verified to be current, no response from manufacturer. Information identical to that published in MIL-HDBK-57, Revision B.



MIL-HDBK-57D(IS)



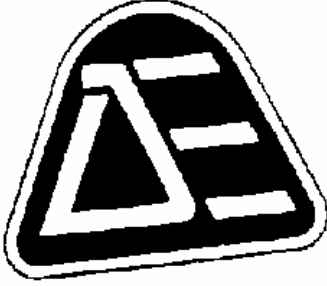



<p>DUNHAM PRODUCTS, INC. 6 INDUSTRIAL DRIVE BEDFORD, OH 44146-4414</p> <p style="text-align: center;"><b>DP</b></p> <p>CAGE code: 1B4S0 <span style="float: right;"><u>2/</u></span></p>
<p>DUPONT, G.B. CO., INC. (SEE KAMAX L. P.) 500 WEST LONG LAKE ROAD TROY, MI 48098-4540</p> <p style="text-align: center;"><b>D</b></p> <p>CAGE code: 1DWW1 <span style="float: right;"><u>1/</u></span></p>
<p>DUSEVOIR METAL PRODUCTS, INC. 1751 S TELEGRAPH RD P.O. BOX 2158 DEARBORN, MI 41823</p> <p style="text-align: center;"></p> <p>CAGE code: 97233 <span style="float: right;"><u>2/</u></span></p>

<p>DUVE GmbH &amp; CO. KG P.O. BOX 1240 NEUENRADE, GERMANY D-5982</p> <p><b>D</b> - All hexagon head screws and bolts made of high tensile steel grade 8.8 up to 12.8, and sealing fasteners made of case-hardened carbon steel</p> <p><b>DX</b> - Hexagon head sealing fasteners made of stainless steel</p> <p><b>DUVEX</b> - Hexagon head screws and bolts made of stainless steel (A2 + A4)</p> <p><b>DUVE</b> - DUVE DRIL-KWICK Self-Drilling Fastener (Screws)</p> <p style="text-align: center;"><b>DUVE</b></p> <p>CAGE code: <span style="float: right;"><u>2/</u></span></p>
<p>DYNACAST INDUSTRIAL FASTENERS DIVISION 1401 FRONT STREET YORKTOWN HEIGHTS, NY 10598</p> <p style="text-align: center;"></p> <p>CAGE code: <span style="float: right;"><u>2/</u></span></p>
<p>DYNAMIC ENGINEERING 720 11TH AVE., S.E. P.O. BOX 697 WATERTOWN, SD 57201-0697</p> <p style="text-align: center;"></p> <p>CAGE code: 9U252 <span style="float: right;"><u>2/</u></span></p>

1/ Information published in this revision was verified by direct contact with manufacturers.

2/ Information not verified to be current, no response from manufacturer. Information identical to that published in MIL-HDBK-57, Revision B.





## MIL-HDBK-57D(IS)

<p>DYSON CORP THE formerly (JOS. DYSON &amp; SONS, INC.) 53 FREEDOM RD PLAINSVILLE, OH 44077-1232</p>  <p>CAGE code: 22132 <u>2/</u></p>	<p>EAGAN MACHINE CORP. 135 CENTER STREET BRISTOL, CT 06010</p>  <p>CAGE code: <u>2/</u></p>
<p>DZUS FASTENER CO., INC. see DFCI SOLUTIONS, INC. 425 UNION BLVD WEST ISLIP, NY 11795</p>  <p>CAGE code: 3L478 cancelled- replaced by 72794 <u>2/</u></p>	<p>EAGLE PICHER INDUSTRIES (PRECISION PRODUCTS PLANT) 1927 W 4TH ST P.O. BOX 1444 JOPLIN, MO 64801-3</p>  <p>CAGE code: 9L734 <u>2/</u></p>
<p>E. KOZAK PRECISION PRODUCTS CO. 45 WOODLAND AVE. ROCKAWAY, NJ 07866</p>  <p>CAGE code: ICP43 <u>2/</u></p>	<p>EAGLEHEAD MANUFACTURING COMPANY DBA DEJAK MACHINE TOOL COMPANY DIV DEJAK DRILLING 23555 EUCLID AVE EUCLID, OH 44117-1703</p> <p>Alphanumeric Designation</p> <p>01NU</p> <p>CAGE code: 1GVE5 <u>2/</u></p>
<p>E.L.R. MACHINE AND TOOL 48 A VINCENT CIRCLE IVYLAND, PA 18974</p>  <p>CAGE code: <u>2/</u></p>	<p>EAST COAST METALS INC. 171 RUTH ROAD HARLEYSVILLE, PA 19438</p>  <p>CAGE code: 4W058 <u>2/</u></p>

1/ Information published in this revision was verified by direct contact with manufacturers.

2/ Information not verified to be current, no response from manufacturer. Information identical to that published in MIL-HDBK-57, Revision B.

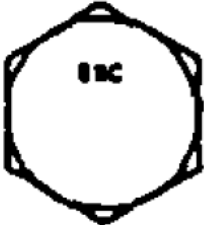
## MIL-HDBK-57D(IS)

<p>EASTERN SCREW CO., INC. 15 AMFLEX DRIVE CRANSTON, RI 02921-2028</p> <p>Plant 71 MILL STREET JOHNSON, CRANSTON, RI 02921-2028</p>  <p>CAGE code: 2L684 <span style="float: right;"><u>1/</u></span></p>	<p>EBERHARD BRUNINGHAUS POSTFAUCH 12 06 1M DUDA2 NEUENRADE, FEDERAL REPUBLIC OF GERMANY D 5982</p>  <p><b>EBM</b></p> <p>CAGE code: <span style="float: right;"><u>2/</u></span></p>
<p>EASTWOOD MFG., CO. P.O. BOX 231102 6825 BREEN RD HOUSTON, TX 77086-3719</p> <p>Plant 52 Lawndale Houston, TX 77023</p>  <p>CAGE code: 77903 <span style="float: right;"><u>2/</u></span></p>	<p>ECENARRO S. COOP. LTDA. c/ AMILLAGA, 15. BERGARA - GUIP'UZOCA, SPAIN 20500</p>  <p><b>ESC</b></p> <p>CAGE code: <span style="float: right;"><u>2/</u></span></p>
<p>EATON AEROQUIP CORPORATION (AEROSPACE DIVISION) 300 S. EAST AVE. JACKSON, MICHIGAN 49203-1972</p>  <p>CAGE code: 00624 <span style="float: right;"><u>2/</u></span></p>	<p>EDS ORDNANCE 644 C ANCHORS ST. FT. WALTON BEACH, FL 32548</p>  <p>CAGE code: 1CA31 <span style="float: right;"><u>2/</u></span></p>
<p>EBC INDUSTRIES (FORMERLY ERIE BOLT CORP.) 1325 LIBERTY STREET ERIE, PA 16502-1641</p> <p><b>ERIE</b> <u><b>E</b></u></p> <p>CAGE code: 5G920 <span style="float: right;"><u>1/</u></span></p>	

1/ Information published in this revision was verified by direct contact with manufacturers.

2/ Information not verified to be current, no response from manufacturer. Information identical to that published in MIL-HDBK-57, Revision B.

MIL-HDBK-57D(IS)

**ELASTIC STOP NUT**  
(Division of Harvard Industries, Inc.)

See MACLEAN-ESNA

Plant  
2330 Vauxhall Road  
Union, NJ 07083

2<sup>nd</sup> Plant  
3200 Country Club Road  
P.O. Box 988  
Pocahontas, AR 72455

**E, EN, or ESNA** Red nylon insert in locknuts

Red nylon insert in locknuts identifies Esna as manufacturer

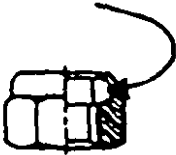

CAGE code: 2/

**ELCO INDUSTRIES, INC.**  
1111 SAMUELSON RD  
ROCKFORD, IL 61101

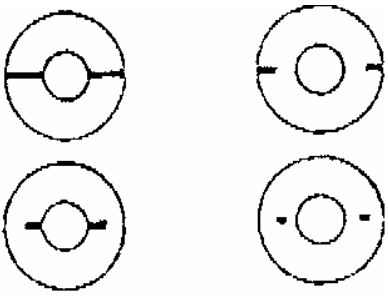

Underside of screw head



CAGE code: 83486 2/

**ELECTRO-FREETO MANUFACTURING COMPANY**  
37 POPE ROAD  
HOLLISTON, MA 01746-2218

**JF**

CAGE code: 17401 2/

**ELITE FASTENERS**  
6400 DALE STREET  
BUENA PARK, CA 90621



CAGE code: 0T3D2 2/

**ELLIS PRECISION INDUSTRIES**  
DBA E P IND.  
3133 RAMONA DR  
FORT WORTH, TX 76116-5122

**e**



CAGE code: 9Z199 2/

**EMERALD VALLEY MFG**  
3825 W. 11TH AVE  
SUITE B  
EUGENE, OR 97402

**DTE**

CAGE code: 4Y352 2/

1/ Information published in this revision was verified by direct contact with manufacturers.

2/ Information not verified to be current, no response from manufacturer. Information identical to that published in MIL-HDBK-57, Revision B.

MIL-HDBK-57D(IS)

EMHART CORP.  
PARKER-KALON DIVISION  
395 ROBERTS ROAD  
CAMPBELLSVILLE, KY 42718

**"TRIANGLE" MARKING**

EMHART CORP  
GRIPCO FASTENER DIVISION  
111 EAST BROAD STREET  
SOUTH WHITLEY, IN 46787

$G_H$  raised or indented on flange or bearing surface

$G_H$  raised on head, both inch and metric series e

$G_H$  raised or indented on flange or bearing surface

CAGE code: 73020 2/

EMP MANUFACTURING CO.  
40935 PRODUCTION DR  
HARRISON TOWNSHIP, MI 48045-1351

CAGE code: 4G973 2/

---

EMPIRE PRECISION MACHINING  
108 W. HOLLOWAY DR.  
HURST, TX 76053-6807

CAGE code: 5V179 1/

---

ENGEL MANUFACTURING COMPANY, INC., THE  
304 W. EWING AVENUE  
SOUTH BEND, IN 46613-2108

CAGE code: 0XYS0 2/

---

ENGINEERED BOLTING PRODUCTS, INC.  
P.O. BOX 7067  
301 MONTGOMERY ST  
SHREVEPORT, LA 71137

Plant  
301 Montgomery St.  
Shreveport, LA 71107

**EBP**

CAGE code: 0K4X1 2/

1/ Information published in this revision was verified by direct contact with manufacturers.

2/ Information not verified to be current, no response from manufacturer. Information identical to that published in MIL-HDBK-57, Revision B.

MIL-HDBK-57D(IS)

ENGINEERING MATERIALS CO., INC.  
 FASTENER MANUFACTURING DIVISION  
 2055 WEST COWLES STREET  
 LONG BEACH, CA 90813-1087

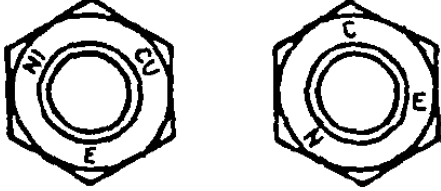

Mfr. Symbol/Logo embossed or intent marked. Letter "E" as shown on nut crown spaced 120 degrees from material symbol marking.



Mfr. Symbol/Logo letter "E" as shown, opposite material symbol marking code on nut crown at corners.



Mfr. Symbol/Logo letter "E", as shown on nut crown, 180 degrees opposite material symbol marking.



Mfr. Symbol/Logo letter "E" marked opposite material symbol code marking on nut crown at one corner location.

CAGE code: 19968 1/  
 Continued

Continued

ENGINEERING MATERIALS CO., INC.



Mfr. Symbol/Logo letter "E" marked opposite material symbol code marking on nut crown at one corner location.



Mfr. Symbol/Logo letter "E" marked on crown, 180 degrees opposite thread designation letter.



Mfr. Symbol/Logo letter "E" indent marked above material symbol.



Mfr. Symbol/Logo letter "E" as shown marked above material symbol marking on stud or rod end.

CAGE code: 19968 1/

1/ Information published in this revision was verified by direct contact with manufacturers.

2/ Information not verified to be current, no response from manufacturer. Information identical to that published in MIL-HDBK-57, Revision B.

## MIL-HDBK-57D(IS)











<p>ENGLE MANUFACTURING COMPANY, INC., THE 304 W. ERVING AVE. SOUTH BEND, IN 46613</p> <p style="text-align: center;"><b>EM</b> <b>F593</b> <b>T</b></p> <p>CAGE code: 0XYS0 <span style="float: right;">2/</span></p>	<p>ERIE BOLT CORP. 1325 LIBERTY STREET ERIE, PA 16502</p> <p>see EBC INDUSTRIES</p> <p style="text-align: center;"><b>ERIE</b> <b><u>E</u></b></p> <p>CAGE code: 5G920 <span style="float: right;">2/</span></p>
<p>ENOMOTO INDUSTRIES CO., LTD. 3-26 TAKASAGO, TAKAISHI-SHI, OSAKA, 592 JAPAN</p> <p style="text-align: center;"></p> <p>CAGE code: S0132 <span style="float: right;">2/</span></p>	<p>ESMET, INC.</p> <p>DBA ELECTROLINE TTUFLOC 1406 5TH ST., S.W. CANTON, OH 44702-2062 CAGE code: 79931</p> <p>SUB OF UNIMET CORP 1406 5TH ST., S.W. CANTON, OH 44702-2062 CAGE code: 0EA31</p> <p style="text-align: center;"></p> <p>CAGE code: 79931, 0EA31 <span style="float: right;">1/</span></p>
<p>ERICO FASTENING SYSTEMS 301 NEW ALBANY ROAD MOORESTOWN, NJ 08057</p> <p style="text-align: center;"><b>E</b>    E             E    E        </p> <p>CAGE code: 84483 <span style="float: right;">2/</span></p>	

1/ Information published in this revision was verified by direct contact with manufacturers.

2/ Information not verified to be current, no response from manufacturer. Information identical to that published in MIL-HDBK-57, Revision B.

MIL-HDBK-57D(IS)

<p>ESNA (MACLEAN-FOGG COMPANY) 611 COUNTRY CLUB ROAD POCAHONTAS, AR 72455-8803</p> <p><b>E, EN, or ESNA</b>    Red nylon insert in locknuts</p> <p>Red nylon insert in locknuts identifies Esna as manufacturer</p>  <p>CAGE code: 019L2 <span style="float: right;">2/</span></p>
<p>ESP MANUFACTURING CO., INC. 2331 E. INTERSTATE 20 P O BOX 871 ODESSA, TX 79766-8827</p> <p style="text-align: center; font-size: 2em; font-weight: bold;">EΣΠ</p> <p>CAGE code: 7J504 <span style="float: right;">1/</span></p>
<p>ESSENTIAL MACHINING 354 HERBERTSVILLE ROAD BRICK, NJ 08724-1735</p>  <p>CAGE code: 0TR19 <span style="float: right;">1/</span></p>
<p>ESTA PRODUCTS COMPANY 16 MISSOURI DRIVE WARWICK, RI 02886-8117</p> <p style="text-align: center; font-size: 2em; font-weight: bold;">ESTA</p> <p>CAGE code: 8R230 <span style="float: right;">2/</span></p>

<p>EVERLOCK FASTENING SYSTEMS EVERLOCK DETROIT DIVISION 6567 SOUTH STERLING DRIVE STERLING HEIGHTS, MI 48077</p>	
<p>Microlock</p>  <p>Prevailing torque surface</p>	<p>Hi-Hex Microlock</p>  <p>Prevailing torque surface</p>
<p>Flange Hi-Hex Microlock</p>  <p>Prevailing torque surface</p>	
<p>Flange Toplock</p>  	
<p>Flange Nut</p>  	
<p>Nut and Washer Assembly</p>  	
<p>Standard Hex Nut</p>  	
<p>CAGE code: Continued <span style="float: right;">2/</span></p>	

1/ Information published in this revision was verified by direct contact with manufacturers.

2/ Information not verified to be current, no response from manufacturer. Information identical to that published in MIL-HDBK-57, Revision B.



MIL-HDBK-57D(IS)

**EVERLOCK FASTENING SYSTEMS**  
Continued

**GREER STOP NUT**  
(Greer-Smyrna Division)  
481 McNALLY DRIVE  
NASHVILLE, TN 37211

Green nylon insert identifies Greer-Smyrna as manufacturer

6 equally spaced stakes identifies Grade B

6 equally spaced stakes plug notch in corner of hex identifies Grade C

**NYLON INSERT**

Grade markings per IFI Standard 100 (one or two small notches cut circumferentially into each of the six corners at about mid-height)

**Grade B CONELOK INCH MARKINGS Grade C**

Green nylon insert identifies Greer-Smyrna as manufacturer per IFI 514

Property Class 5, 9 and 10 markings per IFI 514 located on bearing surface and/or hex flats

**NYLON INSERT**

Manufacturer's I.D. - letter "G" stamped on one hex flat or on bearing surface

**CONELOK - BEARING SURFACE**  
Class 5 METRIC MARKINGS Class 10 Class 9

CAGE code: 27687 2/  
Continued

Continued  
**EVERLOCK FASTENING SYSTEMS**

INTERNATIONAL SCREW DIVISION  
50631 EAST RUSSEL SCHMIDT BOULEVARD  
MOUNT CLEMENS, MI 48045

I Upper case      Lower case less

CAGE code: 2/

EXCEL PRECISION PRODUCTS, INC.  
2207 NW 30TH PL.  
POMPANO BEACH, FL 33069-1026

X

CAGE code: 1H4K6 2/

EXPERIMENTAL MACHINE CO.  
1412 SHOEMAKER RD.  
BALTIMORE, MD 21209

EMC

CAGE code: 0NAP8 2/

FABER ENTERPRISES, INC.  
6606 VARIEL AVE.  
CANOGA PARK, CA 91303-2808





FE

CAGE code: 14397 1/

1/ Information published in this revision was verified by direct contact with manufacturers.

2/ Information not verified to be current, no response from manufacturer. Information identical to that published in MIL-HDBK-57, Revision B.

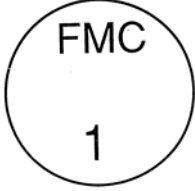
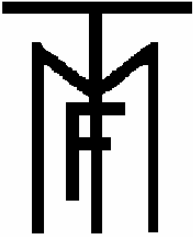



## MIL-HDBK-57D(IS)

<p>FABSCO CORP. 1745 W. 124TH ST. CHICAGO, IL 60643-5345</p>  <p>CAGE code: 4S619 <span style="float: right;"><u>2/</u></span></p>	<p>FANG SHENG SCREW CO., LTD. #113 LANE 96 MINCHAUN ROAD LU CHU HSIANG, KAOHSIUNG HSIEN, 821, TAIWAN</p>  <p>CAGE code: SJ544 <span style="float: right;"><u>2/</u></span></p>
<p>FAILING CO., GEORGE E. P.O.BOX 872 ENID, OK 73702</p>  <p>CAGE code: <span style="float: right;"><u>2/</u></span></p>	<p>FARIAS INDUSTRIAL MACHINING 504 BRUNKEN AVENUE, STE L SALINAS, CA 93901</p> <p>(No artwork for marking. Marks whatever the customer specifies.)</p> <p>CAGE code: 3KWY7 <span style="float: right;"><u>1/</u></span></p>
<p>FALCON MANUFACTURING CORP. 10409-B OLD ATLANTA HWY. COVINGTON, GA 30014-0887</p>  <p>CAGE code: 0HM72 <span style="float: right;"><u>2/</u></span></p>	<p>FARLO MACHINE &amp; TOOL CO., INC 340 CONSTANCE DR BLDG # 7 WARMINSTER, PA 18974-2815</p>  <p>CAGE code: 7S305 <span style="float: right;"><u>2/</u></span></p>
<p>FALL RIVER MANUFACTURING CO., INC. 540 CURRANT ROAD FALL RIVER, MA 02720-4711</p>  <p>CAGE code: 1JWL5 <span style="float: right;"><u>1/</u></span></p>	

1/ Information published in this revision was verified by direct contact with manufacturers.

2/ Information not verified to be current, no response from manufacturer. Information identical to that published in MIL-HDBK-57, Revision B.

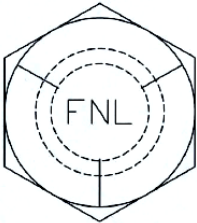
## MIL-HDBK-57D(IS)

<p>(FASSCO) FASTENER &amp; STEEL SUPPLY CO., LTD. Quality Assurance Dept. P.O. BOX 236 HATFIELD, PA 19440</p> <p>Plant 2294 NORTH ROAD HATFIELD, PA 19440</p> <div style="display: flex; justify-content: space-around; align-items: center;"> <div style="text-align: center;">  <p>Latest marking used on fasteners after August 1, 1988</p> </div> <div style="text-align: center;">  <p>Previous marking used on fasteners</p> </div> </div> <p>CAGE code: <span style="float: right;"><u>2/</u></span></p>	<p>FASTENER BROKERAGE INC DBA INOFAST MANUFACTURING SUITE R 2880 BERGEY RD HATFIELD, PA 19440 - 3241</p> <p style="text-align: center; font-size: 2em;"><b>IN</b></p> <p>CAGE code: 2T359 <span style="float: right;"><u>2/</u></span></p>
<p>FASTENAL COMPANY 2001 THEURER BLVD. WINONA, MN 55987-1500</p> <p>Plant FASTENAL COMPANY MFG DIV 1801 THEURER BLVD. WINONA, MN 55987-1500 CAGE code: 1QNZ3</p> <div style="text-align: center;">  </div> <p>CAGE code: 0Y3H3 <span style="float: right;"><u>1/</u></span></p>	<p>FASTENER INNOVATION TECHNOLOGY, INC. DBA F.I.T. 14601 S. BROADWAY STREET GARDENA, CA 90248-1811</p> <p style="text-align: center; font-size: 2em;"><b>FIT</b></p> <p>CAGE code: 58998 <span style="float: right;"><u>1/</u></span></p>
	<p>FASTENER TECHNOLOGY CORP. 7415 FULTON AVE NORTH HOLLYWOOD, CA 91605-5411</p> <p style="text-align: center; font-size: 2em;"><b>FT</b></p> <p>CAGE code: 58794 <span style="float: right;"><u>1/</u></span></p>
	<p>FASTENING PRODUCTS CO.,INC. P.O. BOX 261 CLIFTON HIGHTS, PA 19018-0334</p> <p>Plant 3 MERION TERRACE CLIFTON HEIGHTS, PA 19018-0334</p> <div style="text-align: center;">  </div> <p>CAGE code: 6M389 <span style="float: right;"><u>1/</u></span></p>

1/ Information published in this revision was verified by direct contact with manufacturers.

2/ Information not verified to be current, no response from manufacturer. Information identical to that published in MIL-HDBK-57, Revision B.



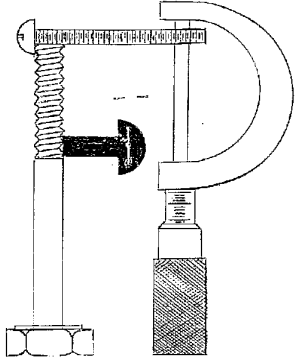

## MIL-HDBK-57D(IS)

<p>FASTENING PRODUCTS OF LANCASTER, INC. 1980 OLD PHILADELPHIA PIKE LANCASTER, PA 17602-3498</p>  <p>CAGE code: 4M097 <span style="float: right;">1/</span></p>	<p>FASTRON COMPANY, THE 11800 FRANKLIN AVENUE FRANKLIN PARK, IL 60131-1006</p> <p style="text-align: center;"><b>F</b></p> <p>CAGE code: 24929 <span style="float: right;">2/</span></p>
<p>FASTENRATH BEFESTIGUNGSTECHNIK GmbH HERSCHEIDER STRABE 105 POSTFASH 51 42 58840 PLETTENBERG, HOLTAUSEN FEDERAL REPUBLIC OF GERMANY</p> <p style="text-align: center;"><b>F</b></p> <p>CAGE code: <span style="float: right;">1/</span></p>	<p>FEDERAL EQUIPMENT COMPANY 707 CARR ST CINCINNATI, OH 45203-1211</p> <p style="text-align: center;">F E C  6 0 5 8 7</p> <p>CAGE code: 60587 <span style="float: right;">1/</span></p>
<p>FASTI-WERK CARL AUG. FASTENRATH GMBH &amp; CO.KG INDUSTRIEGEBIET ELBRINGHAUSEN P.O. BOX 1250 WERMELSKIRCHEM, GERMANY 42929</p> <p style="text-align: center;"><b>F</b></p> <p>CAGE code: D9500 <span style="float: right;">2/</span></p>	<p>FEDERAL MANUFACTURING CORP. 9825 DE SOTO AVENUE CHATSWORTH, CA 91311-1441</p> <p style="text-align: center;"><b>F M C</b></p> <p>CAGE code: 17943 <span style="float: right;">2/</span></p>

1/ Information published in this revision was verified by direct contact with manufacturers.

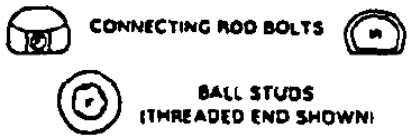
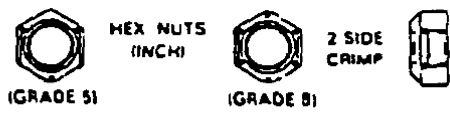
2/ Information not verified to be current, no response from manufacturer. Information identical to that published in MIL-HDBK-57, Revision B.

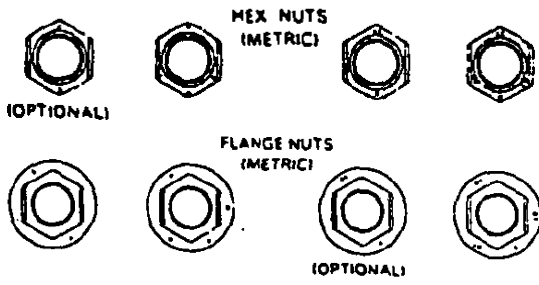
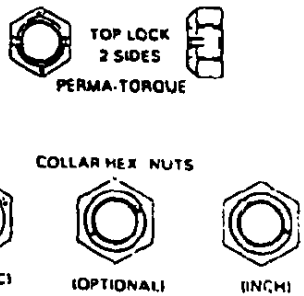

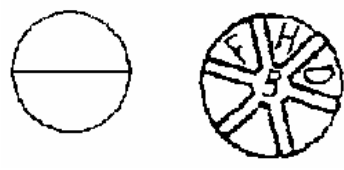
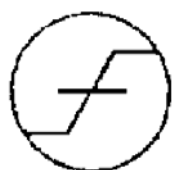
MIL-HDBK-57D(IS)

<p>FEDERAL SCREW WORKS 2400 BUHL BUILDING DETROIT, MI 48226</p> <p>BIG RAPIDS DIVISION 400 NORTH DEKRAFT BIG RAPIDS, MI 49307</p>  <p>HEX BOLTS (INCH) (GRADE 5)      FLANGE BOLTS (INCH)</p>  <p>CONNECTING ROD BOLTS      BALL STUDS (THREADED END SHOWN)</p> <p>ROMULUS DIVISION 34846 GODDARD ROAD ROMULUS, MI 48174-3400</p> <p>PREVAILING TORQUE NUTS</p>  <p>HEX NUTS (INCH) (GRADE 5)      2 SIDE CRIMP</p>  <p>FLANGE NUTS (INCH) (CLASS 9)      (CLASS 10)</p>  <p>HEX NUTS (METRIC) (OPTIONAL)      FLANGE NUTS (METRIC) (OPTIONAL)</p>  <p>TOP LOCK 2 SIDES PERMA-TORQUE      COLLAR HEX NUTS (METRIC) (OPTIONAL) (INCH)</p> <p>CAGE code: 21957 <span style="float: right;">2/</span></p>	<p>FENBAR PRECISION MACHINISTS, INC 633 COMMERCE STREET THORNWOOD, NY 10594-1348</p>  <p>CAGE code: IP472 <span style="float: right;">1/</span></p> <hr/> <p>FENTON HEADING 2480 OWEN RD. FENTON, MI 48430</p>  <p>CAGE code: <span style="float: right;">1/</span></p> <hr/> <p>FERNDALE FASTENER 31600 STEPHENSON HIGHWAY MADISON HEIGHTS, MI 48071</p>  <p>CAGE code: <span style="float: right;">2/</span></p> <hr/> <p>FERRIERE DI STABIO, S.A. VIA AL MULINO STABIO, SWITZERLAND CH-6855</p> <p style="text-align: center; font-size: 2em; font-weight: bold;">F S</p> <p>CAGE code: <span style="float: right;">2/</span></p>
--	--

1/ Information published in this revision was verified by direct contact with manufacturers.

2/ Information not verified to be current, no response from manufacturer. Information identical to that published in MIL-HDBK-57, Revision B.

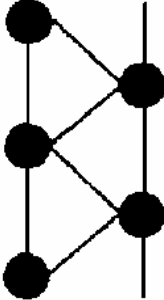
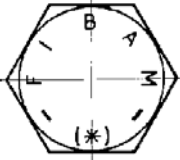
## MIL-HDBK-57D(IS)

<p>FERRY CAP &amp; SET SCREW CO., THE 2151 SCRANTON RD. CLEVELAND, OH 44113-3578</p> <p>FC · F-C BPG</p> <p>CAGE code: 84513 <u>2/</u></p>	<p>FISCHER SPECIAL MFG. CO. 11 INDUSTRIAL RD. COLD SPRING, KY 41076-9796</p>  <p>CAGE code: 73743 <u>2/</u></p>
<p>FIBAM COMPANHIA INDUSTRIAL SAO BERNARDO DO CAMPO P.O. BOX 360 SAO PAULO, BRAZIL C.E.P.0 09701.907</p>  <p>CAGE code: <u>1/</u></p>	<p>FITZ MANUFACTURING INDUSTRIES LTD DBA FMI 4212 MCLEAN ROAD FORT WORTH, TX 76114-1006</p> <p>05DT8</p> <p>CAGE code: 05DT8 <u>2/</u></p>
<p>FILETAGE INTERNATIONAL (INTERNATIONAL THREAD INC.) 2225 RUE MICHLIN LAVAL, QUE, CANADA H7L9Z7</p>  <p>CAGE code: <u>2/</u></p>	<p>FLAIG &amp; HOMMEL HEERSTRASSE 1 ALDINGEN, GERMANY 78554</p> <p><b>FS</b> Company logo to be stamped and used on all steel reusable FLAG &amp; HOMMEL lock nuts.</p> <p><b>FH</b> Company logo to be stamped on all none reusable (standard) nuts.</p> <p>CAGE code: C3816 <u>2/</u></p>
<p>FIRST AMERICAN SALES CO. 2706 ST. LOUIS AVE. LONG BEACH, CA 90806-2026</p> <p>1st</p> <p>CAGE code: 58251 <u>2/</u></p>	

1/ Information published in this revision was verified by direct contact with manufacturers.

2/ Information not verified to be current, no response from manufacturer. Information identical to that published in MIL-HDBK-57, Revision B.

MIL-HDBK-57D(IS)

FLEXALLOY INC.  
26000 RICHMOND ROAD  
BEDFORD, OH 44146



GRADE 5  
HEX HEAD  
CAP SCREW

GRADE 8  
HEX HEAD  
CAP SCREW

FX-180 HEX HEAD  
CAP SCREW  
(180,000 PSI  
MINIMUM TENSILE  
STRENGTH)



FX-180 HEX NUT  
PROOF LOAD =  
180,000 PSI



METRIC CAP SCREW,  
PROPERTY CLASS 10.9

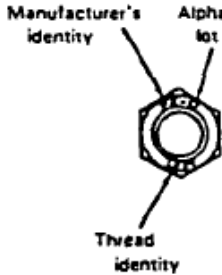

Outer Cap Wheel Nut

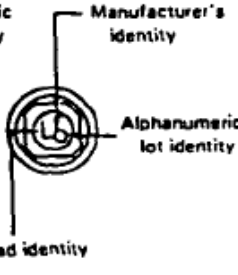

Inner Cap Wheel Nut

WHEEL NUTS



HEX FLANGE SCREW GRADE 8

CAGE code: 0C9A2 2/

---

FLORES ENTERPRISES  
1729 E. 28TH STREET  
SIGNAL HILL, CA 0806-1923



CAGE code: 0V616 1/

FLUIDONICS INC.  
205 W INDUSTRY CT  
P. O. BOX 9020  
DEER PARK, NY 11729



CAGE code: 58525 2/

---

FLUIDYNE CORPORATION  
9100 COLLINS AVE.  
PENNSAUKEN, NJ 08110



CAGE code: 9Y957 1/

---

FOLSOM TOOL & MOLD CORP.  
# 12 MOUNT PLEASANT DR.  
ASTON, PA 19014-4140



CAGE code: 6P049 2/

---

FONTAL CONTROLS, INC.  
12725 ENCINITAS AVENUE  
SYLMAR, CA 91342-3517



CAGE code: 0GNC3 2/

1/ Information published in this revision was verified by direct contact with manufacturers.

2/ Information not verified to be current, no response from manufacturer. Information identical to that published in MIL-HDBK-57, Revision B.

MIL-HDBK-57D(IS)

FONTANA S.A.  
 FONTANA LUIGI SPA  
 VIA PIAVE 29  
 VEDUGGIO MILANO,  
 ITALY 20050

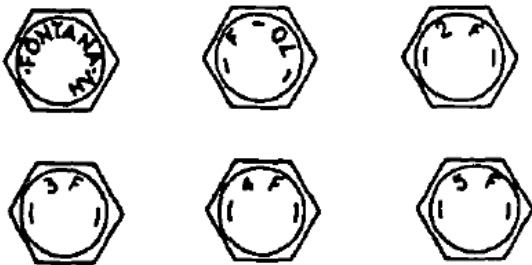
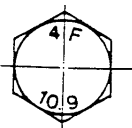
Bolts and screws  
 Hexagon Head  
 Strength Grade 10.9  
 Iso Metric Thread

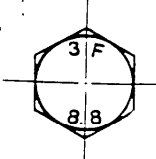

Bolts and screws  
 Hexagon Head  
 Strength Grade 8.8  
 Iso Metric Thread

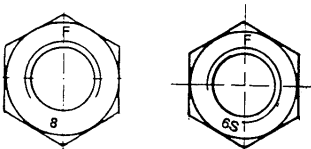

Nut  
 Strength Class 8  
 Iso Metric Thread

CAGE code: A4733 2/

FOREMOST PRECISION INSTRUMENT  
 CORP.  
 31 CARLETON AVE  
 MT VERNON, NY 10550-4617

FPIC

CAGE code: 33464 2/

FOREST FASTENERS  
 TREForest INDUSTRIAL ESTATE  
 PONTYPRIDD, MID. GLAMORGAN,  
 SOUTH WALES, GREAT BRITAIN  
 CF37 5YG



CAGE code: 2/

FORMED FASTENER MANUFACTURING,  
 INC.  
 7247 S. 78TH AVE  
 BRIDGEVIEW, IL 60455

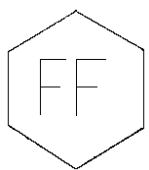

CAGE code: 2/

FPA MANUFACTURING  
 DBA FPA MANUFACTURING AND SUPPLY  
 6733 S SEPULVEDA BLVD STE 245  
 LOS ANGELES, CA 90045-1525

FPA

CAGE code: 0J6Z1 2/

FRANROE PRECISION MACHINE  
 COMPANY  
 12 CHAMPION RD  
 GLOUCESTER CITY, NJ 08030

F.R.  
 F.R.P

CAGE code: 40650 2/

1/ Information published in this revision was verified by direct contact with manufacturers.

2/ Information not verified to be current, no response from manufacturer. Information identical to that published in MIL-HDBK-57, Revision B.



MIL-HDBK-57D(IS)

FREEMAN CO.  
P. O. BOX 57  
719 WALNUT ST  
YANKTON, SD 57078

**F**

CAGE code: 84596 1/

---

FRIEDR BOESNER GMBH  
AUGUSTHENALER STRABE  
5450 NEUWIED 13  
GERMANY



CAGE code: 2/

---

FRISBY AEROSPACE INC DE  
DIV TRIUMPH ACTUATION SYSTEMS -  
CLEMMONS  
417 S.MAIN ST.  
FREEPORT, NY 11520-5144

was FRISBY AIRBORNE HYDROLICS, INC

**FAH**

CAGE code: 26437 2/

FRONTIER BOLT COMPANY OF TEXAS  
555 AIRPORT DRIVE  
MANSFIELD, TX 76063-2715





CAGE code: 1CE65 2/

---

FUCHS SCHRAUBENWERK GmbH  
BISMARCKSTRASSE 24  
5900 SIEGEN  
GERMANY D-57076

*Hex head/round head bolts, stud bolts*

*T-head bolts, hammer head/ hook head bolts*

*High strength structural bolts (tension controlled/ twist off)*

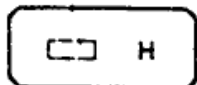
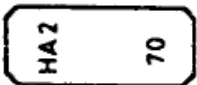
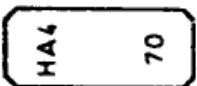



CAGE code: 1/

1/ Information published in this revision was verified by direct contact with manufacturers.

2/ Information not verified to be current, no response from manufacturer. Information identical to that published in MIL-HDBK-57, Revision B.









## MIL-HDBK-57D(IS)

<p>G &amp; R SCREW MACHINE PRODUCTS 21602 N. CENTRAL AVE. SUITE 5 PHOENIX, AZ 85024</p> <p><b>G &amp; R</b></p> <p>CAGE code: 7Y137 <span style="float: right;"><u>2/</u></span></p>	<p>GAITHER PATRICIA DBA GAITHER MACHINE 201 PILGRIM LANE P. O. BOX 202 MUNFORD, AL 36268-4212</p> <p><b>GMF</b></p> <p>CAGE code: 1BTX4 <span style="float: right;"><u>2/</u></span></p>
<p>G &amp; S MACHINE INC. 2804 RENEE DRIVE BEDFORD, TX 76021-5208</p> <p><b>G-S</b></p> <p>CAGE code: 62925 <span style="float: right;"><u>2/</u></span></p>	<p>GALAN PRECISION MACHINE CO. 8912 LANKERSHIM BLVD. SUN VALLEY, CA 91352</p> <p><b>G GPM</b></p> <p>CAGE code: 0S1P8 <span style="float: right;"><u>2/</u></span></p>
<p>G. B. MACHINE PRECISION, INC. 4140C AUSTIN BLVD ISLAND PARK, NY 11558-1727</p> <p><b>G.B.M</b></p> <p>CAGE code: 03KF3 <span style="float: right;"><u>2/</u></span></p>	<p>GALMAC MFG CO. 565 COVINA BOULEVARD SAN DIMAS, CA 91773-2911</p>  <p>CAGE code: 4V765 <span style="float: right;"><u>2/</u></span></p>
<p>G.B. DUPONT CO., INC 500 WEST LONG LAKE ROAD TROY, MI 48098</p>  <p>CAGE code: <span style="float: right;"><u>2/</u></span></p>	<p>GARCIA INDUSTRIES, INC. 12345 FLORENCE AVENUE SANTA FE SPRING, CA 90670-3807</p>  <p>CAGE code: 1RYN7 <span style="float: right;"><u>2/</u></span></p>

1/ Information published in this revision was verified by direct contact with manufacturers.

2/ Information not verified to be current, no response from manufacturer. Information identical to that published in MIL-HDBK-57, Revision B.







## MIL-HDBK-57D(IS)

<p>GARDINER MFG. CO. P.O. BOX 1499 OAKLAND, CA 94604</p> <p style="text-align: center;"></p> <p>CAGE code: 24042 <span style="float: right;"><u>2/</u></span></p>	<p>GENERAL MACHINE PRODUCTS, INC. 3525 VICKERY BLVD FORT WORTH, TX 76105</p> <p style="text-align: center;"> </p> <p>CAGE code: <span style="float: right;"><u>2/</u></span></p>
<p>GATEWAY SCREW AND RIVET, INC. 2670 UNINTED LANE ELK GROVE VILLIAGE, IL 60007</p> <p style="text-align: center;"></p> <p>CAGE code: <span style="float: right;"><u>2/</u></span></p>	<p>GENERAL SCREW &amp; SPECIALTY CO., INC. 14 N. BLEEKER ST. MT VERNON, NY 10550</p> <p style="text-align: center;"></p> <p>CAGE code: 26300 <span style="float: right;"><u>2/</u></span></p>
<p>GEN FAST MANUFACTURING COMPANY 225 HENRY STREET, BLDG. 5 BRANTFORD, ONTARIO CANADA N3T 6H2</p> <p style="text-align: center;"></p> <p>CAGE code: <span style="float: right;"><u>2/</u></span></p>	<p>GERMAN MACHINED PRODUCTS, INC. 1208 S. HOOVER ST. GARDENA, CA 90247-1771</p> <p style="text-align: center;"></p> <p>CAGE code: 65813 <span style="float: right;"><u>2/</u></span></p>
<p>GENERAL AVIATION MFG., INC. 2693 PHILMONT AVE HUNTINGDON VALLEY, PA 19006-5301</p> <p style="text-align: center;"></p> <p>CAGE code: 4J952 <span style="float: right;"><u>2/</u></span></p>	<p>GERTLER INDUSTRIES, INC. 914 W. 17TH STREET COSTA MESA, CA 92627-4403</p> <p style="text-align: center;"></p> <p>CAGE code: 64445 <span style="float: right;"><u>2/</u></span></p>

1/ Information published in this revision was verified by direct contact with manufacturers.

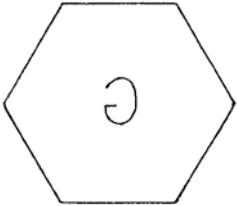
2/ Information not verified to be current, no response from manufacturer. Information identical to that published in MIL-HDBK-57, Revision B.

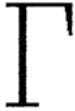



## MIL-HDBK-57D(IS)

<p>GFD LETAGE ZONE INDUSTRIELLE BP 63 BOURGNE FRANCE 90140</p> <p>Plant 15. IMPASSE G. THIVOLLET P.O. BOX 26 42011 SAINT ETIENNE CEDEX 2 FRANCE</p>  <p>CAGE code: F1471 <span style="float: right;">2/</span></p>	<p>GMJ MACHINE COMPANY, INC. 251 STATE LINE RD S WILMER, AL 36587-7051</p>  <p>CAGE code: 8T119 <span style="float: right;">2/</span></p>
<p>GILL MACHINE &amp; TOOL CO. 200 PRAIRIE STREET ROCKFORD, IL 61107</p>  <p>CAGE code: 0H8Y5 <span style="float: right;">2/</span></p>	<p>GMP CO. CORPORATION 529 8TH AVE. BETHLEHEM, PA 18018-5008</p>   <p>CAGE code: 51867 <span style="float: right;">2/</span></p>
<p>GL CNC SERVICE INC. 9860 OWENSMOUTH AVE #3 CHATSWORTH, CA 91311-3852</p>  <p>CAGE code: 1DUA6 <span style="float: right;">1/</span></p>	<p>GOSHO WORKS, LTD. 3-8-1 TARU-MACHI KOHOKU, YOKOHAMA 222 JAPAN</p>  <p>CAGE code: <span style="float: right;">2/</span></p>

1/ Information published in this revision was verified by direct contact with manufacturers.

2/ Information not verified to be current, no response from manufacturer. Information identical to that published in MIL-HDBK-57, Revision B.

## MIL-HDBK-57D(IS)

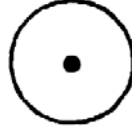
<p>GRACO INDUSTRIES, INC. 44605 MACOMB INDUSTRIAL DRIVE CLINTON TOWNSHIP, MI 48096-1148</p>  <p>CAGE code: 1GT22 <span style="float: right;"><u>1/</u></span></p>	<p>GRAUCH ENTERPRISES RR 1 BOX 37 1878 PORT MATILDA HWY PHILLIPSBURG, PA 16866-3128</p>  <p>CAGE code: 1HU38 <span style="float: right;"><u>1/</u></span></p>
<p>GRADON SCREW MACHINE CORP. P. O. BOX 1080 1411 EAST ST. NEW BRITIAN, CT 06050-1080</p>  <p>CAGE code: 69870 <span style="float: right;"><u>2/</u></span></p>	<p>GREATER MARYLAND TOOL &amp; MFG., CORP. 5 RESOURCE AVE MOUNTAIN LAKE PARK, MD 21550-6362</p>  <p>CAGE code: 34549 <span style="float: right;"><u>1/</u></span></p>
<p>GRANDUER FASTENERS, INC. 18798 E. HWY 10 DANVILLE, AR 72833-0658</p>  <p>CAGE code: 3U752 <span style="float: right;"><u>1/</u></span></p>	<p>GREEN BAY DROP FORGE DIV. OF CLEVELAND HARDWARE &amp; FORGING 1341 S. STATE ST. P.O. BOX 11797 GREEN BAY, WI 54307-1797</p> <p>See CLEVELAND HARDWARE &amp; FORGING</p>  <p><i>Circle with center dot</i></p> <p>CAGE code: 08277 <span style="float: right;"><u>2/</u></span></p>

1/ Information published in this revision was verified by direct contact with manufacturers.

2/ Information not verified to be current, no response from manufacturer. Information identical to that published in MIL-HDBK-57, Revision B.

MIL-HDBK-57D(IS)

GREENFIELD MANUFACTURING CO., INC.  
 920 LEVICK STREET  
 PHILADELPHIA, PA 19111-5422

GFM

CAGE code: 98320 2/

GREER STOP NUT  
 481 MCNALLY DRIVE  
 NASHVILLE, TN 37211-3311

G S L  
 G L

*Green nylon insert*

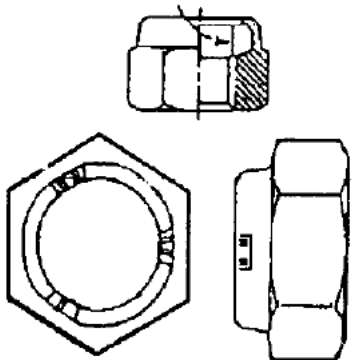

*Manufacturer identification:  
 2 raised ribs in (2) crimp depressions  
 1 raised rib in (1) crimp depression*

NFB

for head marking on  
 bolts and screws

CAGE code: 27687 1/

GRIPCO, DIVISION OF BLACK & DECKER  
 111 E. BROAD ST.  
 SOUTH WHITLEY, IN 46787

GN

*Raised or indented on flange or bearing surface of bolts  
 Raised on head of bolts, inch or metric  
 Raised or indented on flange or bearing surface of nuts*



GF

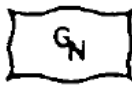

GN



GN

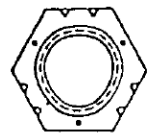

*Twin Delta  
 Crownlock grade  
 B inch locknut*

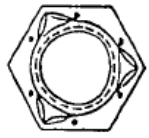

*Gripco Crown lock  
 Grade C inch  
 locknut*



*Twin Delta  
 Crownlock  
 Class 9 metric  
 locknut*

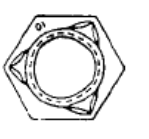

*Gripco  
 Crownlock  
 Class 10  
 metric locknut*



*Toplock  
 (3-6  
 indentations)*



*Centerlock*

CAGE code: 0KS39 2/

1/ Information published in this revision was verified by direct contact with manufacturers.

2/ Information not verified to be current, no response from manufacturer. Information identical to that published in MIL-HDBK-57, Revision B.

## MIL-HDBK-57D(IS)

GROOV-PIN CORPORATION  
331 FARNUM PIKE  
SMITHFIELD, RI 02917-1205

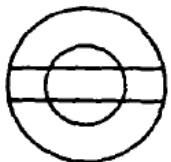

**G-P**

CAGE code: 73957

2/

GRUPO RASSINI S.A. de C.V.  
RASSINI INTERNATIONAL, INC.  
617 EAST HURON STREET  
ANN HARBOR, MI 48104

Plant  
TORNILLOS RASSINI S.A. de C.V.  
AV. ELECTRICIDAD Y.E. PUGIBEL  
CD. INDUSTRIAL, XALOSTOC  
STA. CARLA, EDO DE MEXICO  
APARTADO POSTAL 14-711  
MEXICO D.F.

**RR**

Used to mark the following products:

hex cap screws  
hex bolts  
hex nuts  
heavy hex structural bolts  
heavy hex nuts  
shackle bolts  
hex cone nuts  
wheelbolts

CAGE code:

2/

GS AEROSPACE  
DIV. B & B SPECIALTIES INC  
4321 E LA PALMA AVE.  
ANAHEIM, CA 92807-1805

See B & B SPECIALTIES INC

1) PRIMARY - **GS**

2) SECONDARY - **GSAT**

3) SECONDARY - **1EM77**

4) SECONDARY - **GSI**  
(OBSOLETE AS OF  
JAN 1, 1988)

CAGE code: 1EM77

1/

GSF FASTENING (Armstrong Fastening Ltd.)  
MIDLAND ROAD  
DARLASTON  
WEDNESBURY, WEST MIDLANDS WS10 8JN  
GREAT BRITAIN











CAGE code:

2/

1/ Information published in this revision was verified by direct contact with manufacturers.

2/ Information not verified to be current, no response from manufacturer. Information identical to that published in MIL-HDBK-57, Revision B.

## MIL-HDBK-57D(IS)







<p>GUARDIAN RIVET &amp; FASTENER Guardian Mfg. Division 70 AIR PARK DRIVE RONKONKOMA, NY 11779</p> <p>Plant 201 TRADE ZONE DRIVE RONKONKOMA, NY 11779</p>   <p>CAGE code: <u>2/</u></p>	<p>H. MULLINS, LTD. (BADE INDUSTRIAL ESTATE) JARROW TYNE AND WEAR CO DURHAM, UNITED KINGDOM NE32 3EX</p>  <p>CAGE code: <u>2/</u></p>
<p>GUNNISON-INTERNATIONAL INC. 861 GIBBSBORO ROAD CLEMENTON, NJ 08021-1207</p>  <p>CAGE code: 4G922 <u>2/</u></p>	<p>H. PAULIN &amp; CO. LTD. (CAPITAL METAL INDUSTRIES DIVISION) 55 MILNE AVE. SCARBOROUGH, ONTARIO CANADA MIL 4N3</p>   <p><i>Hex head cap screws</i>      <i>Metric standard hex head cap screws</i></p> <p>CAGE code: 95119 <u>2/</u></p>
<p>H C MERCHANDISERS INC. DBA H C PACIFIC 19844 QUIROZ CT WALNUT, CA 91789-2828</p>  <p>CAGE code: 53037 <u>2/</u></p>	<p>H. PRINZ GmbH FABRIK FUR VERBINDUNGSELEMENTE 5970 PLETTENBERG POSTBOX 5241 GERMANY</p>  <p>CAGE code: <u>2/</u></p>
<p>H C PACIFIC 19844 QUIROZ CT WALNUT, CA 91789 - 2828</p>  <p>CAGE code: 53037 <u>2/</u></p>	

1/ Information published in this revision was verified by direct contact with manufacturers.

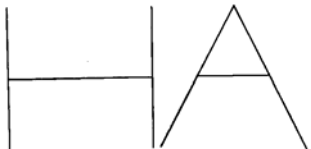
2/ Information not verified to be current, no response from manufacturer. Information identical to that published in MIL-HDBK-57, Revision B.





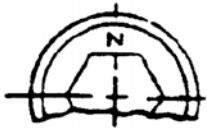





## MIL-HDBK-57D(IS)

<p>HABINA ENGINEERING 4740 COTTON BELT SAN ANTONIO, TX 78219-2854</p>  <p>CAGE code: 1SZT7 <span style="float: right;">1/</span></p>	<p>HAMANAKA (THAILAND). CO., LTD. NO. 550 Moo6 TAIBAN ROAD AMPHUR MUANG, SAMUTPRAKARN, THAILAND</p>  <p>Plant HAMANAKA NUT MFG. CO., LTD KO-770 SHIRAHANA-CHO, HIMEJI-SHI HYOGO, JAPAN</p>  <p>CAGE code: 5Z615 <span style="float: right;">1/</span></p>
<p>HALL INDUSTRIES INC. (FORMERLY STANDARD TOOL &amp; MACHINE COMPANY) 514 MECKLEM LANE ELLWOOD CITY, PA 16117-3028</p>  <p>CAGE code: 29281 <span style="float: right;">1/</span></p>	<p>HANDI GADETS CORP. P.O. BOX 0938 LA CROSSE, WI 54603</p> <p>Plant 1230 CLINTON ST. LA CROSSE, WI 54603</p>  <p>CAGE code: 1M893 <span style="float: right;">1/</span></p>
<p>HALLSIMS INDUSTRIAL COMPONENTS, INC. 37 TERRY DR. TREVOSE, PA 19053</p>  <p>CAGE code: 8V986 <span style="float: right;">2/</span></p>	<p>HANSAN SCREW CO., LTD. EXPORTING DEPARTMENT 974-7 YANG DUK-DONG MASAN 610-00 KOREA</p>  <p>CAGE code: <span style="float: right;">2/</span></p>

1/ Information published in this revision was verified by direct contact with manufacturers.

2/ Information not verified to be current, no response from manufacturer. Information identical to that published in MIL-HDBK-57, Revision B.





## MIL-HDBK-57D(IS)

<p>HARDWARE SPECIALTY CO, INC. 48-75 36TH STREET LONG ISLAND CITY, NY 11101-1994</p>  <p>CAGE code: 07679 <span style="float: right;"><u>1/</u></span></p>	<p>HASKELL OF HUNTINGTON, INC. P.O. BOX 119 HUNTINGTON, WV 25706-0119</p> <p>Plant 300 THIRD AVENUE HUNTINGTON, WV 25701</p>  <p><b>300 Series Stainless Steel</b></p>  <p><b>Type 316 Stainless Steel</b></p>   <p><b>Nickel Copper (Monel)</b></p>  <p><b>Silicon Bronze</b></p> <p>CAGE code: <span style="float: right;"><u>2/</u></span></p>
<p>HARRISON BOLT &amp; NUT CO., THE 2781 WILKENS AVE. BALTIMORE, MD 21223</p>  <p>CAGE code: 5B735 <span style="float: right;"><u>2/</u></span></p>	<p>HASSALL, JOHN, INC. 609-1 CANTIAGUE ROCK RD WESTBURY, NY 11590-1721</p>  <p>CAGE code: 82224 <span style="float: right;"><u>1/</u></span></p>
<p>HARTFORD AIRCRAFT PRODUCTS, INC. 94 OLD POQUONOCK ROAD BLOOMFIELD, CT 06002-1427</p>  <p>CAGE code: 66861 <span style="float: right;"><u>2/</u></span></p>	
<p>HARWOOD DESIGN, INC. 1507 CLYDE WAITE DRIVE BRISTOL, PA 19007-2919</p> <p><b>HDI</b></p> <p>CAGE code: 1VQQ8 <span style="float: right;"><u>2/</u></span></p>	

1/ Information published in this revision was verified by direct contact with manufacturers.

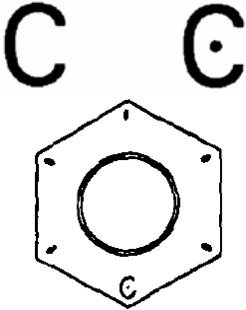
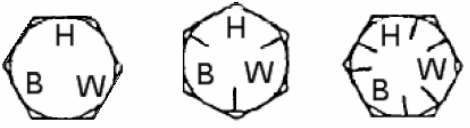
2/ Information not verified to be current, no response from manufacturer. Information identical to that published in MIL-HDBK-57, Revision B.







## MIL-HDBK-57D(IS)

<p>HATCH INDUSTRIES 17000 S WSTN AVE STE 22 GARDENA, CA 90247-5262</p>  <p>CAGE code: 03AJ8 <u>2/</u></p>	<p>HAZE SEIKO CO., LTD. KO 402 SHIRAHAMA- CHO HIMEJI-SHI, HYOUGO-KEN, JAPAN 672</p>  <p>CAGE code: <u>2/</u></p>
<p>HAWTHORNE BOLT WORKS P.O. BOX 474 VALLEY CITY, OH 44280</p> <p>Plant 355 A LAKE RD. MEDINA, OH 44256</p>  <p>GRADE 2      GRADE 5      GRADE 8</p> <p>CAGE code: 4TU98 <u>1/</u></p>	<p>HEARTLAND PRECISION FASTENER 301 PRAIRIE VILLAGE DR NEW CENTURY, KS 66031-1121</p>  <p>CAGE code: 0ZC92 <u>1/</u></p>
<p>HAYDON BOLTS, INC. 1181 UNITY ST PHILADELPHIA, PA 19124-3104</p>  <p>CAGE code: 2S013 <u>2/</u></p>	<p>HEIM'S MACHINE &amp; TOOL, INC. 36 EVERGREEN ROAD LEBANON, PA 17042</p>  <p>CAGE code: 0B117 <u>1/</u></p>

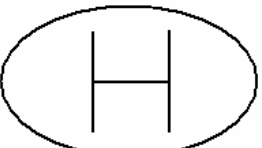
1/ Information published in this revision was verified by direct contact with manufacturers.

2/ Information not verified to be current, no response from manufacturer. Information identical to that published in MIL-HDBK-57, Revision B.





## MIL-HDBK-57D(IS)

<p>HEITCO MANUFACTURING, INC. 60 TUTTLE ROAD MIDDLETOWN, CT 06457</p> <p style="text-align: center;"><b>HTC</b></p> <p>CAGE code: <span style="float: right;">2/</span></p>	<p>HESSISCHE SCHRAUBENFABRIK WELTER GmbH &amp; CO., KG STEPHAN-NIDEREHE-STR. 6 P. O. BOX 13 40 MARBURG, GERMANY 35037</p> <p style="text-align: center;"></p> <p>CAGE code: D5396 <span style="float: right;">2/</span></p>
<p>HEMCO TOOL INC. 7 SOUTH MAPLE ST. P.O. BOX 326 WESTFIELD, MA 01085-4338</p> <p style="text-align: center;"></p> <p>CAGE code: 5R108 <span style="float: right;">2/</span></p>	<p>HEXAGON ENTERPRISES, INC. 256 MINNESOTA AVENUE TROY, MI 48083</p> <p style="text-align: center;"></p> <p>CAGE code: <span style="float: right;">2/</span></p>
<p>HENWAY, INC. 1314 GOODRICK DRIVE P.O. BOX 1276 TEHACHAPI, CA 93561</p> <p style="text-align: center;"></p> <p>CAGE code: 0X6T3 <span style="float: right;">2/</span></p>	<p>HI INDUSTRIAL TECHNOLOGIES 241 WOODLAND AVE MORTON, PA 19070</p> <p style="text-align: center;"></p> <p>CAGE code: 0SS65 <span style="float: right;">2/</span></p>
<p>HEPTNER MFG CO. RIVER ROAD BLDG. PP-1 JAY-CEE INDUSTRIAL PARK BRISTOL, PA 19007 - 6103</p> <p style="text-align: center;"></p> <p>CAGE code: 05BZ4 <span style="float: right;">1/</span></p>	<p>HIGH QUALITY MACHINE SHOP 2775 WALSH ROAD SAN ANTONIO, TX 78224</p> <p style="text-align: center;"></p> <p>CAGE code: 0B011 <span style="float: right;">2/</span></p>

1/ Information published in this revision was verified by direct contact with manufacturers.

2/ Information not verified to be current, no response from manufacturer. Information identical to that published in MIL-HDBK-57, Revision B.

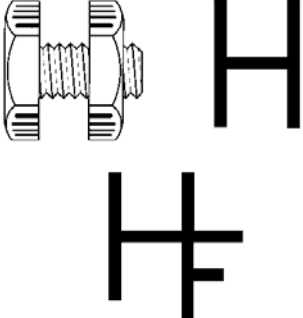
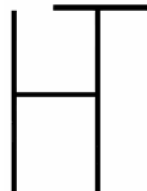
## MIL-HDBK-57D(IS)

<p>HIGH TECH ENTERPRISES 3299 SAN FERNANDO RD. UNIT 11 LOS ANGELES, CA 90065</p> <p><b>HTE.</b></p> <p>CAGE code: 0TSH2 <span style="float: right;"><u>2/</u></span></p>	<p>HILL AEROSPACE &amp; DEFENSE LLC. 19734 DEARBORN STREET CHATSWORTH, CA 91311-6509</p>  <p>CAGE code: 55064 <span style="float: right;"><u>2/</u></span></p>
<p>HIGHLAND PRODUCTS CORPORATION 9331 MERCANTILE DRIVE MENTOR, OH 44060-0452</p>  <p>CAGE code: 0AKM4 <span style="float: right;"><u>2/</u></span></p>	<p>HILL FASTENER CORP. P.O. BOX 399 ROCK FALLS, IL 61071</p>  <p>CAGE code: 4R119 <span style="float: right;"><u>1/</u></span></p>
<p>HIGHLAND THREADS, INC. (FASTENER MANUFACTURING DIVISION) 708 E. TIDWELL HOUSTON, TX 77022-1822</p>  <p>CAGE code: 1DT7C <span style="float: right;"><u>2/</u></span></p>	<p>HILL STAMPING &amp; MFG., INC. 3202 C STREET N.E. AUBURN, WA 98002-1789</p>  <p>CAGE code: 7M611 <span style="float: right;"><u>1/</u></span></p>

1/ Information published in this revision was verified by direct contact with manufacturers.

2/ Information not verified to be current, no response from manufacturer. Information identical to that published in MIL-HDBK-57, Revision B.

MIL-HDBK-57D(IS)



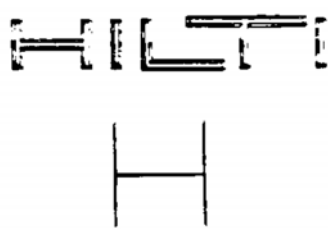

HILTI, INC.  
 5400 S. 122ND E. AVE  
 TULSA, OK 74121-6007

DX DIVISION

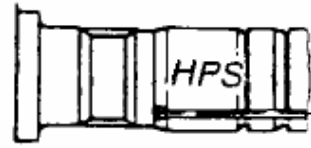

ANCHOR DIVISION

**HILTI**  
 HEA M24 x 210  
**HILTI**  
 HEA 3/4" x 6-5/8"







CAGE code: 11239 2/

HI-SHEAR CORP.  
 DBA FOREIGN PARENT IS LISI PARIS  
 FRANCE  
 See listing for LISI  
 2600 SKYPARK DRIVE  
 TORRANCE, CA 90505



Plant  
 TORONTO FASTENERS  
 INDUSTRIES, INC.  
 Subsidiary of Hi-Shear Corp., USA  
 19 CONSTELLATION COURT  
 REXDALE, ONTARIO M9W 1K4,  
 CANADA



CAGE code: 73197 1/

HLC INDUSTRIES INC.  
 6281 EMERALD LAKE DR  
 FARMINGTON HILLS, MI 48098







CAGE code: 0SC87 2/

1/ Information published in this revision was verified by direct contact with manufacturers.

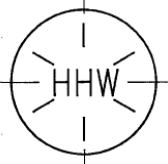
2/ Information not verified to be current, no response from manufacturer. Information identical to that published in MIL-HDBK-57, Revision B.

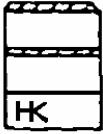
## MIL-HDBK-57D(IS)

<p>HMS SERVICES LLC 10039 WOLFRIVER PLYMOUTH, MI 48170-4542</p> <p style="text-align: center;"><b>M</b></p> <p style="text-align: center;">This is the headmarking for bolts and screws. Headmark appears on the top of head.</p> <p style="text-align: center;"><b>M</b> <b>M</b> <b>M</b></p> <p style="text-align: center;">This marking is for nuts. This mark appears on the side of hex nuts.</p> <p>CAGE code: 1UYL6 <span style="float: right;">2/</span></p>	<p>HOLLYWOOD MANUFACTURING INC. 11915 VOSE STREET NORHT HOLLYWOOD, CA 91605-5750</p> <p style="text-align: center;"><b>H</b></p> <p>CAGE code: 7T729 <span style="float: right;">2/</span></p>
<p>HO HONG WORKS CO., LTD 10 CHUNG SHAN ROAD LU CHU VILLAGE, KAOHSIUNG HSIEN, TAIWAN 821</p> <p style="text-align: center;"></p> <p>CAGE code: <span style="float: right;">1/</span></p>	<p>HOLO-KROME CO. 31 BROOK STREET WEST HARTFORD, CT 06110-2385</p> <p style="text-align: center;"><b>HK</b> <i>On some socket screw products</i></p> <p style="text-align: center;"> <i>1960 series cap screws - old design</i></p> <p style="text-align: center;"> <i>1960 series cap screws - present design</i></p> <p style="text-align: center;"> <i>Metric socket cap</i></p> <p style="text-align: center;"> </p> <p>CAGE code: 74445 <span style="float: right;">2/</span></p>
<p>HOFFMANN, RICHARD GMBH CO. KG AM KIESWASSER 8-10 D-5940 LENNESTADT-ELSPE MEISELTER WEG KYLLEBURG, GERMANY 5524</p> <p style="text-align: center;">Plant HOFFMANN MACHINE COMPANY, INC. 1386 DREXEL ROAD VALDESE, NC 28690</p> <p style="text-align: center;"><b>H</b></p> <p>CAGE code: 0HEK2 <span style="float: right;">1/</span></p>	<p>HORSPOL &amp; ROMINE MANUFACTURING CO., INC. 5850 MARSHALL STREET OAKLAND, CA 94608-2696</p> <p style="text-align: center;"><b>HR</b>      <b>HR</b></p> <p>CAGE code: 95723 <span style="float: right;">1/</span></p>

1/ Information published in this revision was verified by direct contact with manufacturers.

2/ Information not verified to be current, no response from manufacturer. Information identical to that published in MIL-HDBK-57, Revision B.

## MIL-HDBK-57D(IS)

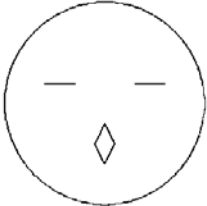
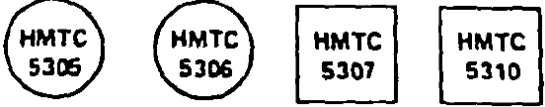



<p>HORST ENGINEERING &amp; MANUFACTURING CO. P.O. BOX 280066 EAST HARTFORD, CT 06108-2003</p> <p>Plant 36 CEDAR ST EAST HARTFORD, CT 06108</p> <p><b>HEM</b></p> <p><b>HE HE</b></p> <p>CAGE code: 05812 <u>1/</u></p>	<p>HOWARD TOOL CO., INC. 547 ODLIN ROAD BANGOR, ME 04401-6707</p> <p><b>HT</b></p> <p>CAGE code: 044B0 <u>2/</u></p>
<p>HOUSTON FASTENER (DIVISION OF WESTBROOK MFG) 1202 KRESS STREET P.O. BOX 15614 HOUSTON, TX 77020</p>  <p>CAGE code: 0YN70 <u>2/</u></p>	<p>HOWE MACHINE AND TOOL CORP. 236 PARK AVE. BETHPAGE, NY 11714-3709</p>  <p>CAGE code: 65777 <u>1/</u></p>
<p>HOUSTON PRECISION FASTENERS 10018 TANNER ROAD HOUSTON, TX 77041</p> <p><b>HPF</b></p> <p>CAGE code: 1VSL7 <u>1/</u></p>	<p>HOWIE MANUFACTURING CO., INC. P.O. BOX 426 COLLINGSWOOD, NJ 08108</p> <p>Plant 1227 MECHANIC ST. CAMDEN, NJ 08104-1221</p> <p><b>hmc</b></p> <p>CAGE code: 9V802 <u>1/</u></p>

1/ Information published in this revision was verified by direct contact with manufacturers.

2/ Information not verified to be current, no response from manufacturer. Information identical to that published in MIL-HDBK-57, Revision B.





## MIL-HDBK-57D(IS)

<p>HUCK AEROSPACE PRODUCTS AFS CARSON OPERATIONS 900 WATSON CENTER ROAD CARSON, CA 90745-4201 CAGE code: 17446</p>  <p>AFS TUCSON OPERATIONS 3724 E. COLUMBIA ST. TUCSON, AZ 85714-3415 CAGE code: 1G6U6</p>  <p>HUCK INDUSTRIAL PRODUCTS AFS WACO OPERATIONS 8001 IMPERIAL DRIVE WACO, TX 76714 CAGE code: 9K475</p>  <p>HUCK PRODUCTS AFS US OPERATIONS BP4, CLOS D'ASSEVILLE 95450 US PAR VIGNY FRANCE CAGE code: F6167</p> <p style="text-align: center;"><b>H</b></p> <p>(Corporate office see ALCOA FASTENING SYSTEMS)</p> <p>CAGE code: 17446, 1G6U6, 9K475, F6167 <span style="float: right;">1/</span></p>	<p>HUGGINS MFG. 4314 GARLAND DR. FORT WORTH, TX 76117</p> <p style="text-align: center;"><b>H</b></p> <p>CAGE code: 0TCV6 <span style="float: right;">2/</span></p> <hr/> <p>HUGO DURHOLT GMBH &amp; CO. KG SCHRAUBENDREH-UND PREBWERK POSTFACH 16-80 D-5632 WERMELSKIRCHEN GERMANY</p>  <p>CAGE code: <span style="float: right;">1/</span></p> <hr/> <p>HUNT VALVE COMPANY, INC. DBA WAECO VALVE DIVISION 1913 EAST STATE STREET SALEM, OH 44460</p>  <p>CAGE code: 11859 <span style="float: right;">2/</span></p> <hr/> <p>HUNTER STEVENS COMPANY 4003 FLEETWOOD AVE. FRANKLIN PARK, IL 60131</p> <p style="text-align: center;"><b>HSC</b></p> <p>CAGE code: 48093 <span style="float: right;">2/</span></p> <hr/> <p>HUNTINGTON VALLEY INDUSTRIES, INC DBA HVI 15182 TRITON LN 101 HUNTINGTON BEACH, CA 92649-1041</p> <p style="text-align: center;"><b>HVI</b></p> <p>CAGE code: 9S754 <span style="float: right;">2/</span></p>
--	---

1/ Information published in this revision was verified by direct contact with manufacturers.

2/ Information not verified to be current, no response from manufacturer. Information identical to that published in MIL-HDBK-57, Revision B.

## MIL-HDBK-57D(IS)

<p>HURON AUTOMATIC SCREW CO. P.O. BOX 610068 4914 GRATIOT RD PORT HURON, MI 48061-0068</p> <p style="text-align: center;"><b>H</b></p> <p>CAGE code: 00905 <span style="float: right;"><u>2/</u></span></p>	<p>I.G.D. MACHINE &amp; TOOL LTD. 992 HUBREY ROAD LONDON, ONTARIO, CANADA N6N 1B5</p> <p style="text-align: center;"></p> <p>CAGE code: <span style="float: right;"><u>2/</u></span></p>
<p>HURRICANE MACHINE COMPANY, L.L.C. 2644 FREEWOOD DRIVE DALLAS, TX 75220</p> <p style="text-align: center;"><b>9</b></p> <p>CAGE code: 1H7G3 <span style="float: right;"><u>2/</u></span></p>	<p>IDEAL FASTENERS INC. 3850 E MIRALOMA AVE ANAHEIM, CA 92806</p> <p style="text-align: center;"></p> <p>CAGE code: 6F810 <span style="float: right;"><u>1/</u></span></p>
<p>HYDRO FITTING MFG. CORP. 733 E. EDNA PLACE P.O. BOX 1558 COVINA, CA 91722-1409</p> <p style="text-align: center;"><b>HF</b></p> <p>CAGE code: 13899 <span style="float: right;"><u>2/</u></span></p>	<p>IFASTGROUPE 2004 LP CANADA</p> <p>SEE LISTINGS FOR:</p> <p style="padding-left: 40px;">INFASCO 700 OUELLETTE MARIEVILLE, QUEBEC CANADA J3M 1P6 CAGE code: 1C225</p> <p style="padding-left: 40px;">INFASCO NUT 3990 NASHUA DRIVE MISSISSAUGA, ONTARIO, CANADA L4VT IPG8 CAGE code: 06KL6</p> <p style="padding-left: 40px;">INGERSOLL FASTENERS 390 THOMAS STREET INGERSOLL, ONTARIO CANADA N5C 3K3 CAGE code: 35571 <span style="float: right;"><u>1/</u></span></p>
<p>HYDROBOLT LIMITED GLOBAL SERVICE CENTRE, MONMORE BUSINESS PARK, DIXON STREET WOLVERHAMPTON, WV2 2EE. U. K.</p> <p style="text-align: center;"> <b>HB</b></p> <p>CAGE code: <span style="float: right;"><u>1/</u></span></p>	

1/ Information published in this revision was verified by direct contact with manufacturers.

2/ Information not verified to be current, no response from manufacturer. Information identical to that published in MIL-HDBK-57, Revision B.

MIL-HDBK-57D(IS)

IMPERIAL SUPPLIERS, INC.  
 P.O. BOX 11008  
 789 PACKER DR  
 GREEN BAY, WI 54304-4527

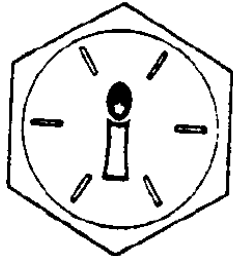

**GRADE 8**

CAGE code: 3A4R0

2/

INDIANA AIRCRAFT HARDWARE  
 221 SOUTH MAIN STREET  
 FORTVILLE, IN 46040-1514

**IAH**

CAGE code: 5N319

1/

INDUSTRIAL & AUTOMOTIVE FASTENERS  
 (DIVISION OF KEY MANUFACTURING  
 GROUP, INC.)  
 3200 W. FOURTEEN MILE RD.  
 ROYAL OAK, MI 48073

*Inch Conelock Nuts*

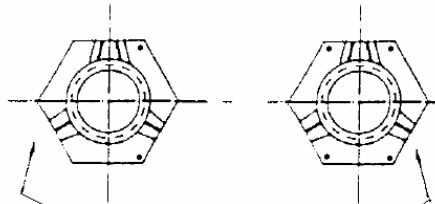

*Company I.D.: 2 single & 1 double slash*

*Inch Wheelnut*

*Metric Wheelnut*

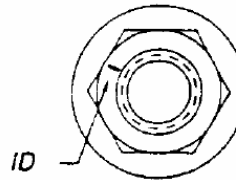

ID

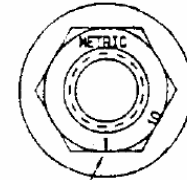

ID

*Metric Flange Hex Nut*  
*company ID: 1*

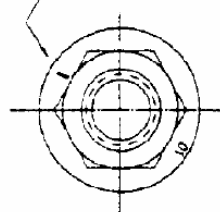

*Metric Conelock Nut*

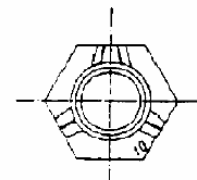

*Company ID: 2 single & 1 double slash*

*Metric Capped Wheelnut*

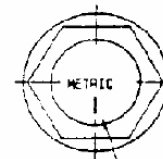

*Company ID: 1*

CAGE code:

2/

1/ Information published in this revision was verified by direct contact with manufacturers.

2/ Information not verified to be current, no response from manufacturer. Information identical to that published in MIL-HDBK-57, Revision B.

MIL-HDBK-57D(IS)

INDUSTRIAL FASTENERS CORP.  
7 HARBOR PARK DR  
PORT WASHINGTON, NY 11050

*Raised or indented marks*

*Under head    Top of head    Slotted hexhead (top of head)*

CAGE code: 84992 2/

INDUX, S.A. DE C.V.  
LAMINADORA 37  
BELLAVISTA-TACUBAYA  
MEXICO, D.F. 01140  
MEXICO

CAGE code: SDK76 1/

INDUSTRIAL FORGE, INC.  
832 LANTANA RD  
LAKE WORTH 33462 - 1509

CAGE code: 0RY28 2/

INFASCO  
(see IFASTGROUPE 2004 LP)  
700 OUELLETTE  
MARIEVILLE, QUEBEC  
CANADA  
J3M 1P6

CAGE code: 1C225 1/

INDUSTRIAL NUT CORP.  
1425 TIFFIN AVE  
SANDUSKY, OH 44870-2054

Blue nylon insert identifies INC as manufacturer

Blue nylon insert identifies INC as manufacturer per IFI 514

2 equally spaced stakes identifies property Class 5 per IFI 514

3 equally spaced stakes identifies property Class 9 per IFI 514

4 equally spaced stakes identifies property Class 10 per IFI 514

6 equally spaced stakes plus notch in corner of hex identifies Grade C

6 equally spaced stakes identifies Grade B

INCH NYLON INSERT LOCKNUTS      METRIC NYLON INSERT LOCKNUTS

The blue insert is a trademark of Industrial Nut Corp. registered in the U.S. Patent & Trade Office.

CAGE code: 81198 1/







INFASCO NUT  
(see IFASTGROUPE 2004 LP)  
3990 NASHUA DRIVE  
MISSISSAUGA, ONTARIO,  
CANADA  
L4VT IPG8

CAGE code: 06KL6 1/

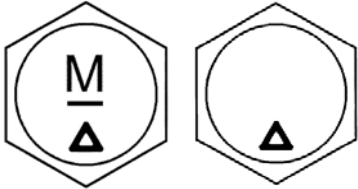
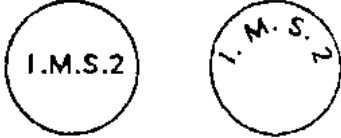
1/ Information published in this revision was verified by direct contact with manufacturers.

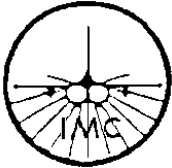
2/ Information not verified to be current, no response from manufacturer. Information identical to that published in MIL-HDBK-57, Revision B.

## MIL-HDBK-57D(IS)

<p>INGERSOLL FASTENERS (see IFASTGROUPE 2004 LP) 390 THOMAS STREET INGERSOLL, ONTARIO CANADA N5C 3K3</p>  <p>CAGE code: 35571 <span style="float: right;">1/</span></p>	<p>INSTRUMENT MACHINING SERVICE LTD. HOWLETT WAY, THETFORD, NORFOLK IP24 IHZ UNITED KINGDOM</p>  <p>CAGE code: <span style="float: right;">2/</span></p>
<p>INLAND MACHINE CO. 10762 EDISON CT. RANCHO CUCAMONGA, CA 91730-4845</p>  <p>CAGE code: 6W617 <span style="float: right;">2/</span></p>	<p>INTERFLEX MFG. CORP. 144 TOLEDO ST FARMINGDALE, NY 75222-4429</p>  <p>CAGE code: 0LD24 <span style="float: right;">2/</span></p>
<p>INOFAST MANUFACTURING INC. 1370 INDUSTRY RD. HATFIELD, PA 19440</p>  <p>CAGE code: 2T359 <span style="float: right;">2/</span></p>	<p>INTERSTATE FITTINGS INC. 2200 SINGLETON BLVD. DALLAS, TX 75212</p>  <p>CAGE code: 1EHF9 <span style="float: right;">2/</span></p>
<p>IN-SPECK CORP. 208 EAST PENN ST NORRISTOWN, PA 19401-1471</p>  <p>CAGE code: 32904 <span style="float: right;">2/</span></p>	<p>IRVING MACHINE SERVICE, INC. 451 MAIN STREET P.O. BOX 94 IRVING, NY 14081</p>  <p>CAGE code: <span style="float: right;">2/</span></p>

1/ Information published in this revision was verified by direct contact with manufacturers.

2/ Information not verified to be current, no response from manufacturer. Information identical to that published in MIL-HDBK-57, Revision B.

## MIL-HDBK-57D(IS)

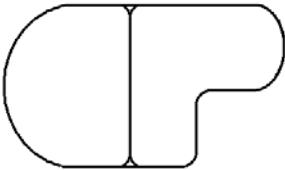
<p>IRWIN AUTOMATION, INC. 715 CLEVELAND STREET GREENSBURG, PA 15601-1279</p> <p style="text-align: center;"><b>IRW</b></p> <p>CAGE code: 7H803 <span style="float: right;"><u>1/</u></span></p>	<p>ITW BUILDEX 1349 WEST BRYN MAWR AVE. ITASCA, IL 60143</p> <p style="text-align: center;"><b>B X</b></p> <p>CAGE code: <span style="float: right;"><u>2/</u></span></p>
<p>ISLAND ENGINEERING DBA J SMITH MACHINE SHOP INC 153 S MAIN ST FREEPORT, NY 11520-0384</p> <p style="text-align: center;"></p> <p>CAGE code: 40137 <span style="float: right;"><u>2/</u></span></p>	<p>ITW CIP 2002 STEPHENSON HWY. TROY, MI 48083</p> <p style="padding-left: 40px;">Plant ITW CIP CA 11525 S. SHOEMAKER AVE. SANTA FE SPRINGS, CA 90670</p> <p style="text-align: center;"></p> <p>CAGE code: Applied for <span style="float: right;"><u>1/</u></span></p>
<p>ITT HARPER AEROSPACE FASTENER OPERATIONS (AEROSPACE CONTROLS DIVISION) 28150 INDUSTRY DRIVE VALENCIA, CA 91355</p> <p style="text-align: center;"><b>AOL</b></p> <p>CAGE code: <span style="float: right;"><u>2/</u></span></p>	

1/ Information published in this revision was verified by direct contact with manufacturers.

2/ Information not verified to be current, no response from manufacturer. Information identical to that published in MIL-HDBK-57, Revision B.





## MIL-HDBK-57D(IS)

<p>IVACO INC. ( See IFASTGROUPE 2004 LP, CANADA)</p> <p>See listings for:</p> <p>INFASCO 700 OUELLETTE MARIEVILLE, QUEBEC CANADA J3M 1P6 CAGE code: 1C225</p> <p>INFASCO NUT 3990 NASHUA DRIVE MISSISSAUGA, ONTARIO, CANADA L4VT IPG8 CAGE code: 06KL6</p> <p>INGERSOLL FASTENERS 390 THOMAS STREET INGERSOLL, ONTARIO CANADA N5C 3K3 CAGE code: 35571</p> <p>CAGE code: 1C225 <u>1/</u></p>	<p>J. G. FASTENERS 9720 COZYCROFT AVE CHATSWORTH, CA 91311-4423</p>  <p>CAGE code: 0VWM9 <u>2/</u></p>
<p>J &amp; M MACHINE INC. 1234 HIGH STREET PAINESVILLE, OH 44077</p> <p><b>1H423</b></p> <p>CAGE code: 1H423 <u>1/</u></p>	<p>J. GEORG BIERBACH WERDOHLER STRASSE 23 ALTENA, GERMANY D-5990</p> <p><b>G E B I</b></p>  <p>CAGE code: <u>2/</u></p>
<p>J &amp; S PRECISION PRODUCTS 16 EVESBORO RD. MEDFORD, NJ 08055-9592</p>  <p>CAGE code: 8B865 <u>2/</u></p>	<p>J.M. PRECISION, INC. (FASTENER DIVISION) 9722 TOPANGA CANYON BLVD CHATSWORTH, CA 913114015</p>  <p>CAGE code: 0JV78 <u>1/</u></p>

1/ Information published in this revision was verified by direct contact with manufacturers.

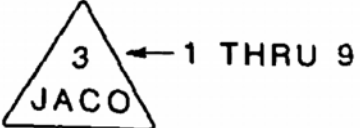
2/ Information not verified to be current, no response from manufacturer. Information identical to that published in MIL-HDBK-57, Revision B.

## MIL-HDBK-57D(IS)





<p>J.P. PRODUCTS, INC. ( DBA SPECIALITES, UNLIMITED) P.O. BOX 427 WILLOUGHBY, OH 44094</p> <p style="text-align: center;"><b>S</b></p> <p>CAGE code: <span style="float: right;"><u>2/</u></span></p>	<p>JAMISON INDUSTRIES INC. 12669 DELTA ST TAYLOR, MI 48180-6835</p> <p style="text-align: center;"><b>JI</b></p> <p>CAGE code: 1Z781 <span style="float: right;"><u>1/</u></span></p>
<p>JACO ENGINEERING, INC. 879 SO. EAST STREET ANAHEIM, CA 92805-5356</p> <p style="text-align: center;">  </p> <p>CAGE code: IH427 <span style="float: right;"><u>1/</u></span></p>	<p>JAY BEE MACHINE WORKS, INC. 400 PIKE RD. HUNTINGDON VALLEY, PA 19006-1610</p> <p style="text-align: center;"><b>B</b></p> <p>CAGE code: 74954 <span style="float: right;"><u>1/</u></span></p>
<p>JAM TECH CORP. P.O. BOX 327 ESSINGTON, PA 19029</p> <p style="text-align: center;">Plant 1260 East Woodland Avenue Springfield, PA 19064</p> <p style="text-align: center;"><b>JT</b></p> <p>CAGE code: IEM35 <span style="float: right;"><u>2/</u></span></p>	<p>JAY O MACHINE CO., INC. 7685 HUB PARKWAY VALLEY VIEW, OH 44125-5706</p> <p style="text-align: center;">  </p> <p>CAGE code: 5Z832 <span style="float: right;"><u>2/</u></span></p>
<p>JAMES JACKSON DBA J J ENGINEERING 11021 VIA EL MERCADO LOS ALAMITOS, CA 90720-0281</p> <p style="text-align: center;">  </p> <p>CAGE code: 0CEP4 <span style="float: right;"><u>2/</u></span></p>	<p>JAYCO ENGINEERING, INC. 1660 BABCOCK AVENUE COSTA MESA, CA 92627-4330</p> <p style="text-align: center;">  </p> <p>CAGE code: 7J578 <span style="float: right;"><u>1/</u></span></p>

1/ Information published in this revision was verified by direct contact with manufacturers.

2/ Information not verified to be current, no response from manufacturer. Information identical to that published in MIL-HDBK-57, Revision B.



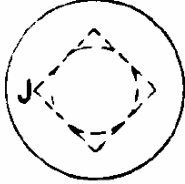

## MIL-HDBK-57D(IS)

<p>JERGENS INC. DBA JERGENS INDUSTRIAL SUPPLY 15700 S WATERLOO RD CLEVELAND, OH 44110-3814</p>  <p>CAGE code: 94882 <span style="float: right;">2/</span></p>	<p>JOLICO/J-B TOOL INC. 4325 E. 22 MILE ROAD UTICA, MI 48317-1507</p> <h2 style="text-align: center;">JOLICO</h2> <p>CAGE code: 19549 <span style="float: right;">2/</span></p>
<p>JJ ENGINEERING (See JAMES JACKSON) 11021 VIA EL MERCADO LOS ALAMITOS, CA 90720-0281</p>  <p>CAGE code: 0CEP4 <span style="float: right;">2/</span></p>	<p>JOSLYN CORP. MACLEAN POWER SYSTEMS 11411 ADDISON STREET FRANKLIN, IL 60131-1130</p> <p style="text-align: center;">Plant 3700 SOUTH MORGAN STREET CHICAGO, IL 60609-1461</p> <div style="display: flex; justify-content: space-around; align-items: center;"> <div style="text-align: center;">  <p><b>Machine bolts</b></p> </div> <div style="text-align: center;">  <p><b>Carriage bolts</b></p> </div> </div> <p>CAGE code: 74999 <span style="float: right;">1/</span></p>
<p>JJ SCREW PRODUCTS, INC. 21519 PARTHENIA STREET CANOGA PARK, CA 91304</p>  <p>CAGE code: 75209 <span style="float: right;">2/</span></p>	<p>JUPITER WASHERS, INC. 10-01 37TH AVE. LONG ISLAND CITY, NY 11101-6014</p>  <p>CAGE code: 25900 <span style="float: right;">2/</span></p>
<p>JMT MACHINE COMPANY 9986 GANTRY ROAD PHILADELPHIA, PA 19115-1080</p> <h2 style="text-align: center;">2A832</h2> <p>CAGE code: 2A832 <span style="float: right;">2/</span></p>	

1/ Information published in this revision was verified by direct contact with manufacturers.

2/ Information not verified to be current, no response from manufacturer. Information identical to that published in MIL-HDBK-57, Revision B.

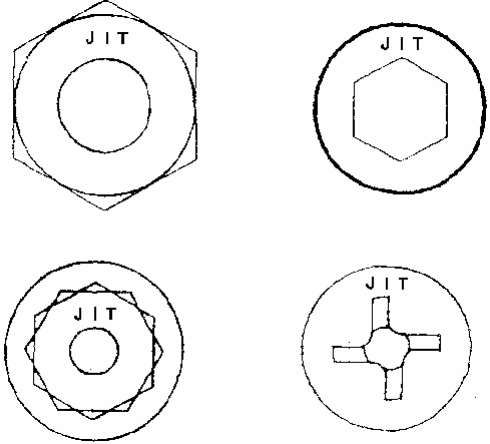

## MIL-HDBK-57D(IS)

<p>JUST IN TIME, INC. DBA APSCO 2538 WEST LN., SUITE 16 STOCKTON, CA 95205</p>  <p>CAGE code: 0FVD5 <span style="float: right;">2/</span></p>	<p>K.D.K. UPSET FORGING CO. 2645 W. 139TH ST. P.O. BOX 146 BLUE ISLAND, IL 60406-0146</p> <p style="text-align: center;"><b>KDK</b></p> <p>CAGE code: 8P293 <span style="float: right;">2/</span></p>
<p>K &amp; K PRECISION ENTERPRISES 60 STEAM WHISTLE DRIVE WARMINSTER, PA 18974</p> <p style="text-align: center;"><b>k + k</b></p> <p>CAGE code: 1K6D9 <span style="float: right;">2/</span></p>	<p>KAMAX-WERKE RUDOLF KELLERMANN GmbH &amp; CO. KG PETERSHUETTER ALLEE 29 OSTRODE, GERMANY 37520</p> <p style="text-align: center;"><b>KAMAX</b> <b>KX</b></p> <p>CAGE code: C5315 <span style="float: right;">2/</span></p>
<p>K.A.A. COMPANY (LYNN ABADIE DBA K A A COMPANY) 1309 MADISON STREET WEATHERFORD, TX 76086-2144</p>  <p>CAGE code: 1XRQ5 <span style="float: right;">2/</span></p>	<p>KAMAX L. P. (FORMERLY G.B. DUPONT CO., INC.) 500 WEST LONG LAKE ROAD TROY, MI 48098-4540</p> <p style="text-align: center;"><b>D</b></p> <p>CAGE code: 1DWW1 <span style="float: right;">1/</span></p> <p>KAMPWERK VIEREGGE U. PICKARDT GMBH. &amp; CO P.O. BOX 5143 PLETTENBURG 5 G-5970</p>  <p>CAGE code: <span style="float: right;">2/</span></p>

1/ Information published in this revision was verified by direct contact with manufacturers.

2/ Information not verified to be current, no response from manufacturer. Information identical to that published in MIL-HDBK-57, Revision B.

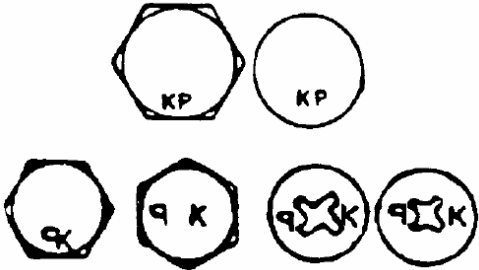
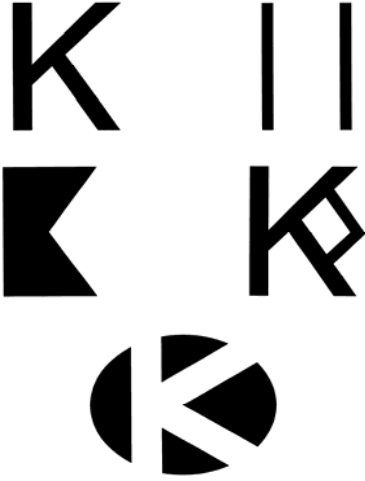
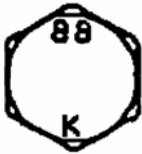



## MIL-HDBK-57D(IS)

<p>KAPCO INDUSTRIES, INC. 5660 KNOTT AVE BUENS PARK, CA 90621</p>  <p>CAGE code: 0BMF4 <span style="float: right;">2/</span></p>	<p>KAYNAR PRODUCTS 800 S. STATE COLLEGE BLVD. FULLERTON, CA 92831</p> <p>(Corporate office see ALCOA FASTENING SYSTEMS)</p> <p>(Previously listed under MICRODOT INC.)</p>  <p>CAGE code: 15653 <span style="float: right;">1/</span></p>
<p>KATSURAGAWA MACHINE SCREW CO., LTD. 3-24-1 YAGUCHI OHTA-KU TOKYO 146 JAPAN</p> <p>Plant 366-1, KOGOSYO KAKEGAWA-SHI SHIZUOKA-KEN 436 JAPAN</p>  <p>CAGE code: <span style="float: right;">2/</span></p>	<p>KELLER ENGINEERING 136 W. 157TH STREET GARDENA, CA 90248-2226</p> <p style="text-align: center;">KE</p> <p>CAGE code: 4W941 <span style="float: right;">2/</span></p>
<p>KAYGOR, INC. 1243 TRANSIT STREET P.O. BOX 2950 POMONA, CA 91769-2950</p> <p style="text-align: center;">K</p> <p>CAGE code: 4H229 <span style="float: right;">2/</span></p>	<p>KELOX/MICRODOT PRODUCTS AFS TORRANCE OPERATIONS 3020 WEST LOMITA BLVD. TORRANCE, CA 90505-5103</p> <p>(Corporate office see ALCOA FASTENING SYSTEMS)</p>  <p>CAGE code: 75237 <span style="float: right;">1/</span></p>

1/ Information published in this revision was verified by direct contact with manufacturers.

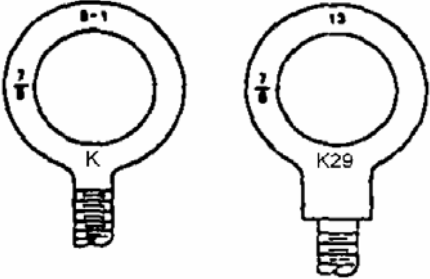
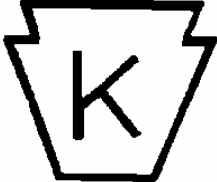
2/ Information not verified to be current, no response from manufacturer. Information identical to that published in MIL-HDBK-57, Revision B.







## MIL-HDBK-57D(IS)

<p>KEN FORGING, INC. 1049 GRIGGS RD P.O. BOX #277 JEFFERSON, OH 44047</p>  <p>CAGE code: 1GMT9 <span style="float: right;">1/</span></p>	<p>KEYSTONE BOLT &amp; NUT COMPANY KEYSTONE THREADED PRODUCTS DIVISION P.O. BOX 31059 CLEVELAND, OH 44313-0059</p> <p>Plant 7621 OLD ROCKSIDE RD. CLEVELAND, OH 44131-0059</p>  <p>CAGE code: 4N487 <span style="float: right;">1/</span></p>
<p>KERR, CHARLES W. RIVER RD BLDG PP-1 JAY CEE INDUSTRIAL PK BRISTOL, PA 19007</p> <p>see MAUI MEGA</p>  <p>CAGE code: 0M4F0 <span style="float: right;">2/</span></p>	<p>KEYSTONE TOOL &amp; MACHINE CO. 108 N. McDADE BLVD. DARBY, PA 19023</p>  <p>CAGE code: 7Y516 <span style="float: right;">2/</span></p>
<p>KERR LAKESIDE INC. 26841 TUNGSTEN RD. P.O. BOX 32220 EUCLID, OH 44117-2680</p>  <p>CAGE code: 7P576 <span style="float: right;">1/</span></p>	<p>KILBOURN ENGINEERING CO. 9226 WEST FLAGG AVE. MILWAUKEE, WI 53225-2718</p>  <p>CAGE code: 8H824 <span style="float: right;">2/</span></p>

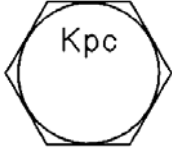
1/ Information published in this revision was verified by direct contact with manufacturers.

2/ Information not verified to be current, no response from manufacturer. Information identical to that published in MIL-HDBK-57, Revision B.

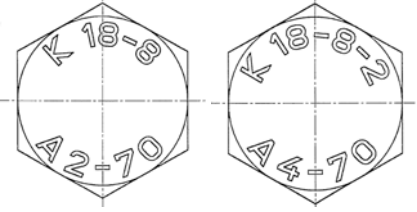

## MIL-HDBK-57D(IS)

<p>KIRSTEN PIPE CO. INC. 1807 NW DOCK PL P.O. BOX 70526 SEATTLE, WA 98127-0526</p>  <p>CAGE code: 5E704 <u>2/</u></p>	<p>KNOCH MANUFACTURING CO. LTD. 1054 SHAW RD DORCHESTER, CANADA N0L 1G4</p>  <p>CAGE code: 1C763 <u>2/</u></p>
<p>KLINCHER LOCKNUT CORP. 2030 N. OXFORD ST. P.O. BOX 18100 INDIANAPOLIS, IN 46218</p>  <p>CAGE code: <u>2/</u></p>	<p>KO AMS MACHINE PRODUCTS DBA KOAM MACHINE 915 BROOKS ST UNIT 102 ONTARIO, CA 91762-3603</p>  <p>CAGE code: 0K7E0 <u>2/</u></p>
<p>KNIPPING-DORN GmbH KALTUMFORMTECHNIK 4690 HERNE 1 POSTFACH 1229 GERMANY</p>  <p>In connection with the identification mark of property class 3.6 up to and including 12.9</p> <p>CAGE code: <u>2/</u></p>	<p>KOBE FASTENER LIMITED 654 HISBIE HIGASBI OSAKA, 577 JAPAN</p>  <p>CAGE code: <u>2/</u></p> <p>KOLB GMBH &amp; CO. HERSTELLER VON VERBINDUNGSELEMENTEN RATHENAU STRASSE 23 POSTFACH 24 02 53 WUPPERTAL GERMANY 42277</p>  <p>CAGE code: D0472 <u>2/</u></p>

1/ Information published in this revision was verified by direct contact with manufacturers.

2/ Information not verified to be current, no response from manufacturer. Information identical to that published in MIL-HDBK-57, Revision B.



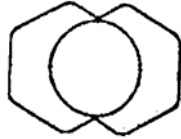



## MIL-HDBK-57D(IS)

<p>KONDOR TECHNOLOGIES, INC. 206 CHRISTOPHER ST RONKONKOMA, NY 11779-6921</p> <p style="text-align: center;"><b>KTI</b></p> <p>CAGE code: 06ZB0 <span style="float: right;"><u>2/</u></span></p>	<p>KORODY COLYER CORP. A CR INDUSTRIES COMPANY 5412 MCFADDEN AVE. HUNTINGTON BEACH, CA 92649</p> <p style="text-align: center;"><b>K</b></p> <p>CAGE code: 18954 <span style="float: right;"><u>2/</u></span></p>
<p>KONGO BYORA CO., LTD. 2-1-27 SHITENNOJI TENNOJI-KU OSAKA 543 JAPAN</p> <p style="text-align: center;">Plant 3-31 NAGATA-NISHI HIGASHIOSAKA-SHI, OSAKA 577 JAPAN</p> <p style="text-align: center;"></p> <p>CAGE code: <span style="float: right;"><u>2/</u></span></p>	<p>KOZAK, E. PERCISION PRODUCTS CO. 45 WOODLAND AVE. ROCKAWAY, NJ 07866</p> <p style="text-align: center;"><b>KPP</b></p> <p>CAGE code: 1CP43 <span style="float: right;"><u>2/</u></span></p>
<p>KOREA BOLT IND., CO., LTD. (FOREIGN TRADE DEPARTMENT) 620-34 GURO-DONG, GURO-KU SEOUL, KOREA</p> <p style="text-align: center;">Plant 732-3 WONSI-DONG, ANSAN-CITY GYUNGGI-DO, KOREA</p> <p style="text-align: center;"></p> <p>CAGE code: <span style="float: right;"><u>2/</u></span></p>	<p>KPF 601 YOUNGTAN-DONG, CHUNGJU-CITY CHUNGCHONGBUK-DO 380-250, KOREA</p> <p style="text-align: center;"></p> <p>CAGE code: <span style="float: right;"><u>1/</u></span></p>
<p>KREIS TOOL &amp; MFG., CO., INC. 1615 CAMBRIDGE DR ELGIN, IL 60123 - 3114</p> <p style="text-align: center;"><b>KTM</b></p> <p>CAGE code: 64592 <span style="float: right;"><u>2/</u></span></p>	

1/ Information published in this revision was verified by direct contact with manufacturers.

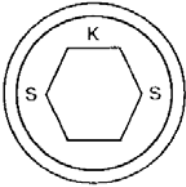
2/ Information not verified to be current, no response from manufacturer. Information identical to that published in MIL-HDBK-57, Revision B.

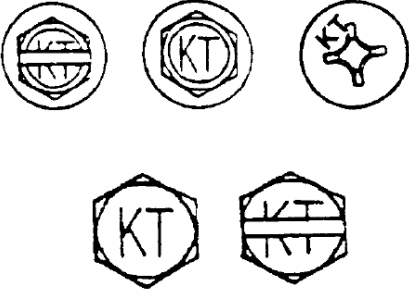
## MIL-HDBK-57D(IS)

<p>KROBACH MANUFACTURING CORP. 3504 ARDEN RD. HAYWARD, CA 94545-5390</p>  <p>CAGE code: 30828 <span style="float: right;"><u>1/</u></span></p>	<p>KYOEI SEISAKUSHO CO., LTD. 4-5-11 NUNOICHI-CHO HIGASHIOSAKA-SHI, OSAKA 579 JAPAN</p> <p>Plant MINAMISHINOZAKI KAZSHI, SAILAMA-KEN 347 JAPAN</p>  <p>CAGE code: <span style="float: right;"><u>2/</u></span></p>
<p>KSS SOCKET SCREW, INC. 3416 S. 48TH STREET SUITE #6 PHOENIX, AZ 85040</p>  <p>CAGE code: 0BMF5 <span style="float: right;"><u>2/</u></span></p>	<p>KYOKUTO MFG CO LTD. 3-5-29 WAKAEHONMACHI HIGASHIOSAKA-SHI OSAKA 578 JAPAN</p> <p>Plant 1109-5 SHIBADE KURAMOCHI-CHO, NABARI-SHE, MIE-KEN 518-04 JAPAN</p>  <p>CAGE code: <span style="float: right;"><u>2/</u></span></p>
<p>K-TECH MFG., INC. 288 HOLBROOK DRIVE WHEELING, IL 60090</p>  <p>CAGE code: <span style="float: right;"><u>2/</u></span></p>	<p>L &amp; C MANUFACTURING CO., INC. 8610 S. 33RD W. AVENUE TULSA, OK 74132-3403</p>  <p>CAGE code: 43813 <span style="float: right;"><u>2/</u></span></p>

1/ Information published in this revision was verified by direct contact with manufacturers.

2/ Information not verified to be current, no response from manufacturer. Information identical to that published in MIL-HDBK-57, Revision B.

## MIL-HDBK-57D(IS)

<p>L &amp; H THREADED RODS CORP. DIV OF GRAY AMERICA CORP 3050 DRYDEN ROAD DAYTON, OH 45439</p> <p style="text-align: center;"><b>L</b></p> <p>CAGE code: 0UH42 <span style="float: right;"><u>2/</u></span></p>	<p>L H INDUSTRIES, INC. <i>TIP TOP TOOL CO.</i> 3513 NORTH 10<sup>th</sup> STREET PHILADELPHIA, PA 19140</p> <p style="text-align: center;"><b>LH</b></p> <p>CAGE code: 0E7S8 <span style="float: right;"><u>2/</u></span></p>
<p>L &amp; J FASTENERS, INC. 3636 LACON ROAD HILLIARD, OH 43026-6122</p> <p style="text-align: center;"></p> <p>CAGE code: 1W358 <span style="float: right;"><u>2/</u></span></p>	<p>L N AEROSPACE, INC. 6011 TENSION DRIVE FORT WORTH, TX 76112-2693</p> <p style="text-align: center;"><b>LNA</b></p> <p>CAGE code: 1EB45 <span style="float: right;"><u>2/</u></span></p>
<p>L &amp; M ENTERPRISES, INC. 1910 NORTHERN WICHITA, KS 67216-2429</p> <p style="text-align: center;"><b>L &amp; M</b></p> <p>CAGE code: 0HDM5 <span style="float: right;"><u>2/</u></span></p>	<p>L P R PRECISION PARTS AND TOOL COMPANY, INC. 108 ROME STREET FARMINGDALE, NY 11735-2136</p> <p style="text-align: center;"><b>L. P. R.</b></p> <p>CAGE code: 31583 <span style="float: right;"><u>2/</u></span></p>
<p>L. A. MARTIN CO. 14400 HENN STREET DEARBORN, MI 48126-1850</p> <p style="text-align: center;"><b>LAM</b></p> <p>CAGE code: 9S775 <span style="float: right;"><u>1/</u></span></p>	<p>L R G CORPORATION 210 MAGEE AVE JEANNETTE, PA 15644-2136</p> <p style="text-align: center;"><b>LRG</b></p> <p>CAGE code: 75783 <span style="float: right;"><u>2/</u></span></p>
<p>L G MACHINE &amp; MFG INC. 1276 W. ARKANSAS LANE ARLINGTON, TX 76013-6235</p> <p style="text-align: center;"><b>LG</b></p> <p>CAGE code: 0P4S2 <span style="float: right;"><u>1/</u></span></p>	

1/ Information published in this revision was verified by direct contact with manufacturers.

2/ Information not verified to be current, no response from manufacturer. Information identical to that published in MIL-HDBK-57, Revision B.



MIL-HDBK-57D(IS)

LAKE ERIE SDREW CORP.  
13001 ATHENS AVE.  
LAKEWOOD, OH 44107-6201

**LE**



ASTM A 307



ASTM A 449



SAE J429 GR 5.1



SAE J429 GR 2



SAE J429 GR 5



ASTM F 568  
CLASS 8.8

ASTM A 354 BD



SAE J429 GR 6



SAE J429 GR 8



SAE J1199  
CLASS 8.8

ASTM F 568  
CLASS 9.8

ASTM F 568  
CLASS 10.9

ASTM F 568  
CLASS 12.9

SAE J1199  
CLASS 9.8

SAE J1199  
CLASS 10.9



ASTM A 325



ASTM A 325  
TYPE 3  
CLASS A



ASTM A 490



ASTM A 490  
TYPE 3  
CLASS A

CAGE code: 8B911

1/

LAMSON AND SESSIONS OF CANADA  
LTD.  
RB & W CORP. METAL FORMING DIVISION  
8341 TYLER BOULEVARD  
MENTOR, OH 44060

MANUFACTURER NUTS – Sales Office  
Lamson & Sessions of Canada Ltd.  
Toronto Plant – Canada  
5190 Bradco Boulevard  
Mississauga, Ontario L4W 1G7  
CANADA

**STOVER<sup>†</sup> PREVAILING TORQUE LOCKNUTS**



Grade A



Grade B



Grade C

Hex Automation – Imperial



Grade F



Grade G

Hex Flange – Imperial



Class 9

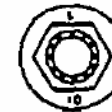

Class 10

Hex Flange – Metric



Hex Automation – Metric





CAGE code:

2/

1/ Information published in this revision was verified by direct contact with manufacturers.

2/ Information not verified to be current, no response from manufacturer. Information identical to that published in MIL-HDBK-57, Revision B.

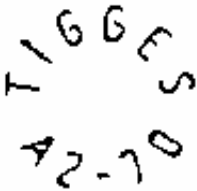







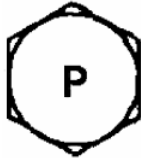

## MIL-HDBK-57D(IS)

<p>LANA INDUSTRIES 4404-D MCLEAN DRIVE HALTOM CITY FORT WORTH, TX 76117</p> <p style="text-align: center;"><b>LI</b></p> <p>CAGE code: <span style="float: right;"><u>2/</u></span></p>	<p>LANUM METAL PRODUCTS, INC. 4100 N. 16TH STREET PHILADELPHIA, PA 19140-3008</p> <p style="text-align: center;"></p> <p style="text-align: center;"><b>L.M.T.</b></p> <p>CAGE code: 0CY73 <span style="float: right;"><u>2/</u></span></p>
<p>LANARKSHIRE BOLT LTD. BURNBANK HAMILTON, LANARSHIRE ML3 OQU SCOTLAND</p> <p style="text-align: center;"><b>L B</b> </p> <p style="text-align: center;"><i>Raised letters</i></p> <p>CAGE code: K3565 <span style="float: right;"><u>2/</u></span></p>	<p>LBL PRODUCTS 5395 INDUSTRIAL DRIVE UNIT A HUNTINGTON BEACH, CA 92649-1516</p> <p style="text-align: center;"></p> <p>CAGE code: 1HJ06 <span style="float: right;"><u>2/</u></span></p>
<p>LAND-SEA-AIR MACHINED PRODUCTS, INC. P.O. BOX H FLEMING PIKE WINSLOW, NJ 08095</p> <p style="text-align: center;"><b>L-S-A</b></p> <p>CAGE code: 8U768 <span style="float: right;"><u>2/</u></span></p>	<p>LEBRECHT TIGGES GmbH &amp; CO. KG P.O. BOX 12 04 85 W 5600 WUPPERTAL 12-CRONENBERG GERMANY</p> <p style="text-align: center;"></p> <p>CAGE code: <span style="float: right;"><u>2/</u></span></p>
<p>LANIS MACHINE &amp; MFG., CO. 2506 S. COOPER #A-9 ARLINGTON, TX 76015-1608</p> <p style="text-align: center;"></p> <p>CAGE code: 8V177 <span style="float: right;"><u>2/</u></span></p>	

<sup>1/</sup> Information published in this revision was verified by direct contact with manufacturers.

<sup>2/</sup> Information not verified to be current, no response from manufacturer. Information identical to that published in MIL-HDBK-57, Revision B.

## MIL-HDBK-57D(IS)







<p>LELAND-POWELL FASTENERS, INC. P.O. BOX 260 MARTIN, TN 38237</p> <p>Plant HIGHWAY 45 EAST SOUTH MARTIN, TN 38237</p>  <p>CAGE code: <u>2/</u></p>	<p>LEONARD JED CO MARYLAND BOLT AND NUT CO DIV (REPLACES MARYLAND BOLT &amp; NUT CO., INC. -CAGE 76213) 1104 RUSSELL ST. BALTIMORE, MD 21230 - 2622</p>  <p>SAE J429 Grade 5 ASTM A449 MIL-B-857-A Grade 5</p> <p>NOTE: Also covers round head bolts, i.e., carriage-plow and countersunk styles, etc.</p>  <p>ASTM A193 Grade B-7 Alloy steel high temperature service bolting Tempered to 125 KSI tensile strength</p> <p>NOTE: Also covers sq. head and countersunk styles. Heavy head hex or regular configurations</p>
<p>LENCH, THOMAS WILLIAM, LTD. P.O. BOX 31 EXCELSIOR WORKS CARNEGIE ROAD, ROWLEY REGIS B65 8BZ UNITED KINGDOM</p>  <p>Raised letters</p>  <p>Indented letters</p>  <p>Raised or indented letters</p> <p>CAGE code: U0039 <u>2/</u></p>	 <p>ASTM A490 Type 1</p> <p>NOTE: Also covers round head bolts, i.e., carriage-plow and countersunk styles, etc.</p>  <p>ASTM A394 Type T-0 Tower bolts: hex head, square head Head markings also include: T-1 for medium carbon and T-3 for weathering alloy steel. Both require heat treating</p> <p>NOTE: Round head step bolts require manufacturing head identification and proper markings as above, except length size</p>
<p>LENTERN (AIRCRAFT) LTD. MAIN RD, HAWKWELL, NR. HOCKLEY ESSEX SS5 4JJ GREAT BRITIAN, UK</p>  <p>CAGE code: <u>2/</u></p>	 <p>SAE J429 Grade 8 ASTM A354 Grade B0 Also (optional) that A354 is exhibited on top of head MIL-B-857-A Grade 8</p> <p>NOTE: Also covers round head bolts, i.e., carriage-plow and countersunk styles, etc.</p> <p>CAGE code: 52373 <u>2/</u></p> <p>Continued</p>

1/ Information published in this revision was verified by direct contact with manufacturers.







2/ Information not verified to be current, no response from manufacturer. Information identical to that published in MIL-HDBK-57, Revision B.

MIL-HDBK-57D(IS)

Continued  
LEONARD JED CO MARYLAND BOLT AND  
NUT CO DIV

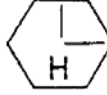
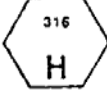
	ASTM A325 Type 1 NOTE: Also covers round head bolts, i.e., carriage-plow and countersunk styles, etc.
	ASTM A325 Type 3 NOTE: Also covers round head bolts, i.e., carriage-plow and countersunk styles, etc.
<p>With line under A325 mark</p>	
	SAE J429 Grade 2 ASTM A307 Grades A & B MIL-B-857-A Type 2 (ADM/5) NOTE: Also covers round head bolts, i.e., carriage-plow and countersunk styles, etc.
<p>No Grade mark — only manu- facturer's symbol</p>	
	ASTM A490 Type 3 NOTE: Also covers round head bolts, i.e., carriage-plow and countersunk styles, etc.
<p>With line under A490 mark</p>	
	ASTM A193 Grade B-7-M Alloy steel high temperature service bolting Tempered to 100 ksi tensile strength NOTE: Also covers SQ head and countersunk styles Heavy head hex or regular configura- tions
<p>Letters B7M on head</p>	
	Manufacturer's symbol and the num- ber 3 or DH3 on face For Grade C-3 three radial lines are also required Heavy hex applications for C-3 and heavy or regular for DH3 Nuts for bolt applications ASTM A325 type 3 ASTM A563 Grade C-3 Also covers square nut configurations
<p>Heavy hex for type C-3 Regular or heavy for DH3</p>	
CAGE code: 52373 <span style="float: right;">2/</span>	
Continued	

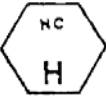





Continued  
LEONARD JED CO MARYLAND BOLT AND  
NUT CO DIV

	Manufacturer's symbol and the 2H or DH marking Also can be supplied in regular config- urations Suitable for all Grade B and A325 or A490 bolts Nuts for bolt applications ASTM A194 Grade 2H ASTM A563 Grade DH Also covers square nut configurations
<p>Heavy or regular</p>	
	Manufacturer's symbol and three radial lines Heavy hex applications only Nuts for bolt applications ASTM A563 Grade C For ASTM A325 bolts Also covers square nut configurations
<p>Heavy hex only</p>	
CAGE code: 52373 <span style="float: right;">2/</span>	
LEVEL 1 FASTENERS 300 THIRD AVE HUNTINGTON, WV 25701	
	300 Series Stainless Steel
	Type 316 Stainless Steel
	Nickel Copper (Monel)
	
	
CAGE code: 17283 <span style="float: right;">1/</span>	

1/ Information published in this revision was verified by direct contact with manufacturers.

2/ Information not verified to be current, no response from manufacturer. Information identical to that published in MIL-HDBK-57, Revision B.

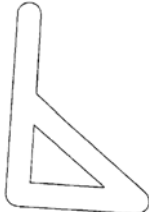
## MIL-HDBK-57D(IS)

<p>LEVINGSTON MACHINE COMPANY 2428 MINNIS DR. HALTOM CITY, TX 76117-4856</p> <p style="text-align: center;"><b>LM</b></p> <p>CAGE code: 46939 <span style="float: right;">2/</span></p>	<p>LINREAD NORTHBRIDGE LEICESTER, UK VIKING ROAD WIGSTON, LEICESTER ENGLAND LE18 2BL</p> <p style="text-align: center;"><b>NB</b></p> <p>CAGE code: U6683 <span style="float: right;">1/</span></p>
<p>LEWIS SREW COMPANY (DIV OF MEDALIST FASTENERS INC.) 2550 S 27TH AVE. BROADVIEW, IL 60155 - 3851</p> <p> <b>LEWIS SCREW COMPANY</b> THE FASTENER SPECIALIST</p> <p> <b>120° INCLUDED ANGLE RAISED.</b></p> <p><b>INDENTED HEX HDS. AND INDENTED HEX WASHER HDS.</b></p> <p> <b>LEWIS SCREW COMPANY</b> THE FASTENER SPECIALIST</p> <p> <b>3-DASH MARKS 120° APART RAISED</b></p> <p><b>UNDER HEAD UPON REQUEST "NON-COUNTERSUNK HEADS ONLY"</b></p> <p>CAGE code: 1AW87 <span style="float: right;">2/</span></p>	<p>LINREAD NORTHBRIDGE AIRCRAFT PRODUCT DIVISION CROSSGATE ROAD PARK FARM P.O. BOX 28 REDDITCH WORCESTERSHIRE B98 7TD UK</p> <p></p> <p></p> <p>CAGE code: K8753 <span style="float: right;">2/</span></p>
<p>LFC INDUSTRIES INC. (DIVISION RKR TECHNOLOGIES) P. O. BOX 5982 1221 CORPORATE DRIVE WEST ARLINGTON, TX 76006-6103</p> <p style="text-align: center;"><b>LFC</b></p> <p>CAGE code: 62384 <span style="float: right;">1/</span></p>	

1/ Information published in this revision was verified by direct contact with manufacturers.

2/ Information not verified to be current, no response from manufacturer. Information identical to that published in MIL-HDBK-57, Revision B.

MIL-HDBK-57D(IS)

LINREAD PUBLIC LIMITED CO.  
(AIRCRAFT PRODUCTS DIVISION)  
P.O. BOX 28, CROSSGATE ROAD  
PARK FARM INDUSTRIAL EST. REDDITCH,  
WORCESTERSHIRE B98 7TD  
UNITED KINGDOM



Illustration No.	Notes
1, 2	<p>Y = Unified S quality</p> <p>WWE = Linread Keeley St. (was Warne Wright Engineering and which no longer trades under that name)</p> <p>M = Metric screws and bolts</p> <p>88 or 8.8 = Grade 8.8. Alternative markings such as 10.9 or 10.9 may appear as appropriate.</p>

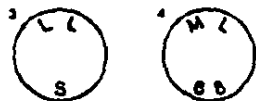

Illustration No.	Notes
3, 4	<p>LL or L = Linread Ltd</p> <p>S = Unified S quality. Alternative letters such as R and T may appear as appropriate.</p> <p>M = Metric screws and bolts</p> <p>88 or 8.8 = Grade 8.8. Alternative markings such as 10.9 or 10.9 may appear as appropriate.</p>

Illustration No.	Notes
3, 4. (Cont'd)	<p>↳ = Linread Plc</p>



CAGE code: K8753

Continued

2/

Continued

LINREAD PUBLIC LIMITED CO.  
(AIRCRAFT PRODUCTS DIVISION)  
P.O. BOX 28, CROSSGATE ROAD  
PARK FARM INDUSTRIAL EST. REDDITCH,  
WORCESTERSHIRE B98 7TD  
UNITED KINGDOM

Illustration No.	Notes
5, 6	<p>↳ = Linread Plc</p> <p>S = Unified S quality. Alternative letters such as R and T may appear as appropriate.</p> <p>M = Metric screws and bolts</p> <p>88 or 8.8 = Grade 8.8. Alternative markings such as 10.9 or 10.9 may appear as appropriate.</p>

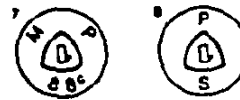

Illustration No.	Notes
7, 8	<p>↳ = Trilobular screws and bolts. Various letters may appear, viz</p> <p>M = Metric. Absence of other letters indicate Duo-Tapite or Tapite parts.</p> <p>P = Powerlok</p> <p>C = Carbon restored surface, i.e., with no decarburization permitted but not case hardened.</p> <p>N = Neutral or through hardened</p> <p>I = Induction hardened lead threads</p> <p>S = Unified S quality. Alternative letters such as R and T may appear as appropriate.</p> <p>88 or 8.8 = Grade 8.8. Alternative markings such as 10.9 or 10.9 may appear as appropriate.</p>



CAGE code: K8753

2/

1/ Information published in this revision was verified by direct contact with manufacturers.

2/ Information not verified to be current, no response from manufacturer. Information identical to that published in MIL-HDBK-57, Revision B.

## MIL-HDBK-57D(IS)

<p>LIPPISCHE EISENINDUSTRIE GmbH ALTER WEG 57 D-4930 GERMANY</p> <p style="text-align: center;"><b>LE</b></p> <p>CAGE code: <span style="float: right;">2/</span></p>	<p>Continued</p> <p>LISI AEROSPACE see BLANC AERO INDUSTRIES</p> <p><i>Plant</i> BLANC AERO INDUSTRIES VILLEFRANCHE DE ROUERGUE 18, RUE JEAN VAURS 12200 VILLEFRANCHE DE ROUERGUE FRANCE</p> <p style="text-align: center;"><b>P</b> </p> <p>CAGE code: F0188</p>
<p>LISI AEROSPACE LISI AEROSPACE CANADA TOUR GAMMA A 193, RUE DE BERCY 75582 PARIS CEDEX 12 FRANCE</p> <p><i>Plant</i> A1 TECHNOLOGIES 7022 ALONDRA BLVD PARAMOUNT, CA 90723 3926</p> <p>NO SYMBOL LISTED</p> <p>CAGE code:</p>	<p><i>Plant</i> BLANC AERO INDUSTRIES RUGBY RUGBY WARWICKSHIRE CV21 3 RQ ENGLAND</p> <p style="text-align: center;"><b><u>hs</u></b></p> <p>CAGE code: U6300</p>
<p><i>Plant</i> LISI AEROSPACE CANADA 2000, PLACE TRANSCANADIENNE DORVAL (QUÉBEC) H9P 2K5 CANADA</p> <p style="text-align: center;"><b>L</b></p> <p>CAGE code: L4528</p> <p>Continued <span style="float: right;">1/</span></p>	<p><i>Plant</i> BLANC AERO INDUSTRIES SAINT OUEN L'AUMONE 95310 SAINT OUEN L'AUMONE FRANCE</p> <p style="text-align: center;"><b>T</b> </p> <p><u>T</u> (St Briec) B (Paris) P (Villefranche de Rouergue)</p> <p>ds. F</p> <p>CAGE code: F0188 <span style="float: right;">1/</span></p> <p>Continued</p>

1/ Information published in this revision was verified by direct contact with manufacturers.

2/ Information not verified to be current, no response from manufacturer. Information identical to that published in MIL-HDBK-57, Revision B.

## MIL-HDBK-57D(IS)

Continued

LISI AEROSPACE

*Plant*  
BLANC AERO TECHNOLOGIES  
B.P. 215  
22002 SAINT BRIEUC CEDEX 1  
FRANCE

CAGE code: F0188

*Plant closed*  
DECOLLETAGE GENERAL MODERNE  
DECOLLETAGE MODERNE 5 BIS, PLACE  
LEON BLUM

*Plant*  
FT BESTAS  
35410 GAZIEMIR-IZMIR  
TURKEY

CAGE code: T0802

*Plant*  
HI-SHEAR CORPORATION  
see HI-SHEAR  
260 SKYPARK DR.  
TORRANCE, CA 90509-2975

CAGE code: 73197  
Continued1/

Continued

LISI AEROSPACE

*Plant*  
MONADNOCK  
18301 EAST ARENTH AVE.  
CITY OF INDUSTRY, CA 91748-1288

(a dot)

CAGE code: 60119

1/1/ Information published in this revision was verified by direct contact with manufacturers.2/ Information not verified to be current, no response from manufacturer. Information identical to that published in MIL-HDBK-57, Revision B.





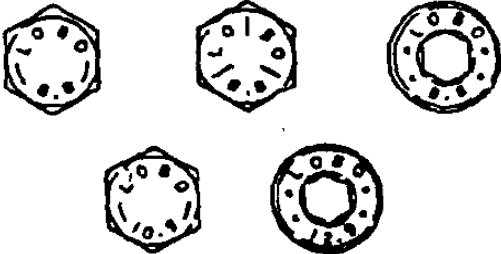



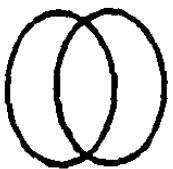

## MIL-HDBK-57D(IS)

<p>LITTLE WORLD MANUFACTURING, INC. 1083 FOREST RD. WEST CHESTER, PA 19380</p> <p>Plant 525 WEST SOUTH STREET KENNETT SQUARE, PA 19348</p> <p><b>L&lt;W&gt;M</b></p> <p>CAGE code: 6T569 <span style="float: right;">2/</span></p>	<p>LOBO SYSTEMS LTD 26 THE PARKER CENTRE MANSFIELD ROAD DERBY DE21 4SZ ENGLAND</p> <p><b>LOBO™</b></p> <p>CAGE code: KE018 <span style="float: right;">1/</span></p>
<p>LLOYD MACHINE &amp; TOOL CO., INC. 234 BROAD AVENUE WILMINGTON, CA 90744-5812</p> <p><b>LMT</b></p> <p>CAGE code: 01334 <span style="float: right;">2/</span></p>	<p>LONE STAR FASTENERS, LP (PREVIOUS LISTED AS LONE STAR SCREW CO OF TEXAS INC P.O. BOX 1149 SPRING, TX 77373</p> <p>Plant 24131 HARDY ROAD SPRING, TX 77373</p> <p><b>L</b> <b>Precedes grade marking (example: LB7)</b></p> <p>CAGE code: 7H174 <span style="float: right;">1/</span></p>
<p>LN AEROSPACE, INC. 6011 TENSION DRIVE FORT WORTH, TX 76112-2693</p> <p><b>LNA</b></p> <p>CAGE code: 1EB45 <span style="float: right;">2/</span></p>	<p>LONG-LOK FASTENERS CORP. 10630 CHESTER RD CINCINNATI, OH 45215-1206</p> <p>Plant 14119 CHADRON AVE. LOS ANGELES, CA 90250</p> <p>CAGE code: 03038</p> <p><b>LL or LONG or LL</b> <b>LOK</b></p> <p>CAGE code: 16941, plant 03038 <span style="float: right;">1/</span></p>
<p>LOBO OFFICINE MECCANICHE SPA VIA T. EDISON CORANAREDO, MILANO ITALY 20010</p>  <p>CAGE code: A1208 <span style="float: right;">2/</span></p>	

1/ Information published in this revision was verified by direct contact with manufacturers.

2/ Information not verified to be current, no response from manufacturer. Information identical to that published in MIL-HDBK-57, Revision B.







## MIL-HDBK-57D(IS)

<p>LOOS &amp; CO., INC. AEROSPACE FASTENERS DIVISION ROUTE 101 POMFRERT, CT 06258-0098</p>  <p>CAGE code: 59157 <span style="float: right;"><u>1/</u></span></p>	<p>M &amp; M MANUFACTURING CORPORATION 5611 KIMBALL CT CHINO , CA 91710</p>  <p>CAGE code: 0X598 <span style="float: right;"><u>2/</u></span></p>
<p>LORD CORPORATION AEROSPACE PRODUCTS DIVISION 1635 WEST 12<sup>TH</sup> STREET P.O. BOX 3694 ERIE, PA 16508 – 0694</p> <p>CAGE code: 0PJN4</p>  <p>Plant MECHANICAL PRODUCTS DIVISION 4644 WADSWORTH RD. DAYTON, OH 45414 – 4220</p> <p>CAGE code: 30061</p>  <p>CAGE code: 0PJN4, 30061 <span style="float: right;"><u>2/</u></span></p>	<p>M.A.A. CORP, MID AMERICA AEROSPACE DIVISION 16201 WEST 110TH STREET SHAWNEE MISSION, KS 66285</p>  <p>CAGE code: <span style="float: right;"><u>2/</u></span></p>
<p>LOUGHLIN MANUFACTURING CORP. 1580 RAILROAD AVE HOLBROOK, N.Y. 11741-2301</p>  <p>CAGE code: 65782 <span style="float: right;"><u>1/</u></span></p>	<p>M.L.W. MANUFACTURING CO. P.O. BOX 8445 NEW HAVEN, CT 06511</p> <p>Plant 240 SARGENT DRIVE NEW HAVEN, CT 06511</p>  <p>CAGE code: 0GH69 <span style="float: right;"><u>2/</u></span></p>
<p>M.S. AEROSPACE 3150 DAMON WAY SYLMAR, CA 91342-1005</p>  <p>CAGE code: OUCY9 <span style="float: right;"><u>1/</u></span></p>	

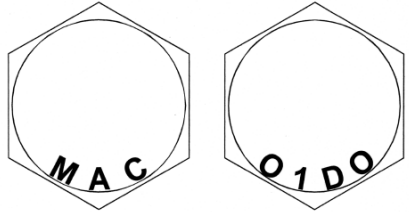
1/ Information published in this revision was verified by direct contact with manufacturers.

2/ Information not verified to be current, no response from manufacturer. Information identical to that published in MIL-HDBK-57, Revision B.

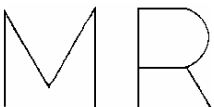
## MIL-HDBK-57D(IS)

<p>MAC FASTENERS, INC. 11110 ENTERPRISE ST. OTTAWA, KS 66067-3803</p>  <p>GOTHIC LETTERS "MAC"      GOTHIC LETTERS AND NUMERAL "O1DO"</p> <p>CAGE code: ORFT4 <span style="float: right;">1/</span></p>	<p>MACK, A. W. MFG CO. 516 DUTCHESS TURNPIKE POUGHKEEPSIE, NY 12603</p>  <p>CAGE code: 32448 <span style="float: right;">2/</span></p>
<p>MACHINE SHOP, INC., THE 470 AIR PARK RD ATWATER, CA 95301</p>  <p>CAGE code: 8T052 <span style="float: right;">2/</span></p>	<p>MACKO INDUSTRIES HWY 39 AT FM RD. 1340 P.O. BOX 170 HUNT, TX 78024-0170</p>  <p>CAGE code: 1CN43 <span style="float: right;">2/</span></p>
<p>MACHINERITE CORP. SYCAMORE &amp; MILL RDS. CLIFTON HTS, PA 19018</p>  <p>CAGE code: 7J299 <span style="float: right;">2/</span></p>	<p>MACKSON MFG CORP. 2338 SOUTHWAY DRIVE ROCK HILL, SC 29730</p>  <p>CAGE code: 093Y9 <span style="float: right;">2/</span></p>

1/ Information published in this revision was verified by direct contact with manufacturers.

2/ Information not verified to be current, no response from manufacturer. Information identical to that published in MIL-HDBK-57, Revision B.

MIL-HDBK-57D(IS)

MACLEAN-ESNA  
 (formally Elastic Stop Nut)  
 611 COUNTRY CLUB RD.  
 POCAHONTAS, AR 72455

**E**  
  
**EN**  
  
**ESNA**

RED NYLON INSERT INDICATES  
 MACLEAN-ESNA AS  
 MANUFACTURER

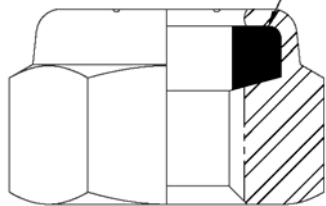

CAGE code: 019L2

1/

MACLEAN-FOGG CO.  
 2551 WACKER RD.  
 SAVANNA, IL 61074

*Flange nuts less lock and with  
 Uni-Torque® lock  
 Two raised bars*

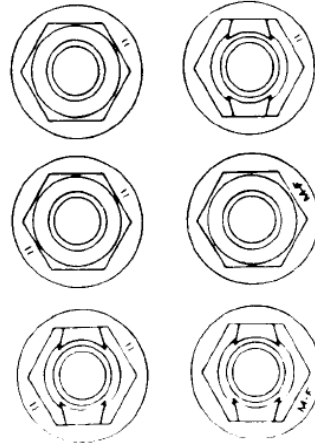

*Hex and flange screws/bolts*

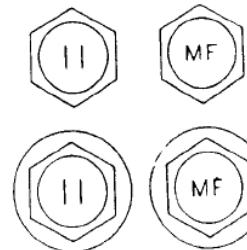

*Hex nuts and Uni-Torque® locknuts*

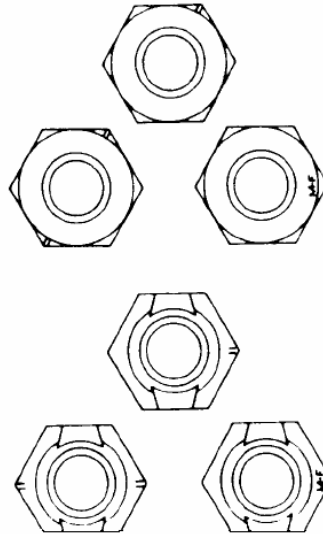





CAGE code: 0AMX8

2/

1/ Information published in this revision was verified by direct contact with manufacturers.

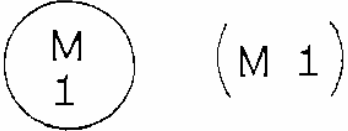
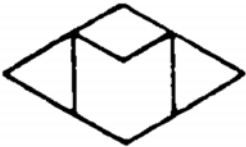
2/ Information not verified to be current, no response from manufacturer. Information identical to that published in MIL-HDBK-57, Revision B.







## MIL-HDBK-57D(IS)

<p>MACOR, INC. 130 HOFFMAN LN CENTRAL ISLIP, NY 11722</p>  <p>CAGE code: 2A269 <span style="float: right;">2/</span></p>	<p>MAIN MACHINE CO INC. DBA MAIN MACHINE &amp; TOOL CO 116 MARINE STREET FARMINGDALE, NY 11735-5608</p> <p style="text-align: center;"><b>MMT</b></p> <p>CAGE code: 05879 <span style="float: right;">1/</span></p>
<p>MAGNUM MACHINE SHOP 768 HOMEWARD PL SAN JOSE, CA 95123-2906</p> <p style="text-align: center;"><b>1YFG0</b></p> <p>CAGE code: 1YFG0 <span style="float: right;">2/</span></p>	<p>MANNO, RICHARD &amp; CO., INC. 42 LAMAR ST NORTH BABYLON, NY 11704</p> <p style="text-align: center;"><b>R/M</b></p> <p>CAGE code: 0RGV4 <span style="float: right;">2/</span></p>
<p>MAGNUS TOOL &amp; DIE CO., INC. 256 SHEFFIELD ST. MOUNTAINSIDE, NJ 07092</p>  <p>CAGE code: 37752 <span style="float: right;">2/</span></p>	<p>MANUFACTURING ENGINEERING TECH. 2758 AIELLO DR. SAN JOSE, CA 95111-2134</p>  <p>CAGE code: 1CC57 <span style="float: right;">2/</span></p>
<p>MAILLY MFG CO., INC. P. O. BOX 6143 45 WAKELEE ROAD WOLCOTT, CT 06716-2620</p>  <p>CAGE code: 3L606 <span style="float: right;">1/</span></p>	<p>MANUFACTURING SALES AND SERVICE 10631 BLOOMFIELD AVE #16 LOS ALAMITOS, CA 90720</p>  <p>CAGE code: 1S9V3 <span style="float: right;">2/</span></p>

1/ Information published in this revision was verified by direct contact with manufacturers.

2/ Information not verified to be current, no response from manufacturer. Information identical to that published in MIL-HDBK-57, Revision B.











## MIL-HDBK-57D(IS)

<p>MANUFACTURING TECHNOLOGY SERVICES 111 CLINTON ROAD FAIRFIELD, NJ 07004</p>  <p>CAGE code: 4WCW0 <u>1/</u></p>	<p>MARTIN-CHANDLER, INC. 122 EAST ALONDRA BOULEVARD GARDENA, CA 902</p>  <p>CAGE code: 22625 <u>2/</u></p>
<p>MAPECO PRODUCTS, INC. 725 GLEN GLOVE AVE. P.O. BOX 6 GLEN HEAD, NY 11545</p>  <p>CAGE code: 4P839 <u>2/</u></p>	<p>MARUYKO NUT CO., LTD. 2-4-15 NAKANO-CHO, HIGASHI TONDABAYASHI-SHI OSAKA 584 JAPAN</p>  <p>CAGE code: <u>2/</u></p>
<p>MAR-BRO MFG., INC. 5717 W. WASHINGTON STREET PHOENIX, AZ 85043-3650</p>  <p>CAGE code: <u>2/</u></p>	<p>MARVIN ENGINEERING, CO., INC. 260 WEST BEACH AVENUE INGLEWOOD, CA 90302-2903</p>  <p>CAGE code: 32067 <u>2/</u></p>

1/ Information published in this revision was verified by direct contact with manufacturers.

2/ Information not verified to be current, no response from manufacturer. Information identical to that published in MIL-HDBK-57, Revision B.

## MIL-HDBK-57D(IS)

<p>MARYLAND BOLT &amp; NUT CO., INC. LEONARD JED CO 1104 RUSSELL ST. BALTIMORE, MD 21230-2622</p> <p> SAE J429 Grade 5 ASTM A448 MIL-B-857-A Grade 5</p> <p>NOTE: Also covers round head bolts, i.e., carriage-plow and countersunk styles, etc.</p> <p> ASTM A193 Grade B-7 Alloy steel high temperature service bolting Tempered to 125 KSI tensile strength</p> <p>NOTE: Also covers sq. head and countersunk styles. Heavy head hex or regular configurations</p> <p> ASTM A490 Type 1</p> <p>NOTE: Also covers round head bolts, i.e., carriage-plow and countersunk styles, etc.</p> <p> ASTM A394 Type T-0 Tower bolts: hex head, square head Head markings also include: T-1 for medium carbon and T-3 for weathering alloy steel. Both require heat treating</p> <p>NOTE: Round head step bolts require manufacturing head identification and proper markings as above, except length size</p> <p>CAGE code: 76213(canceled) Replaced by 52373 <u>2/</u></p> <p>Continued</p>	<p>Continued</p> <p>MARYLAND BOLT &amp; NUT CO., INC.</p> <p> SAE J429 Grade 8 ASTM A354 Grade BD</p> <p>Also (optional) that A354 is exhibited on top of head MIL-B-857-A Grade 8</p> <p>NOTE: Also covers round head bolts, i.e., carriage-plow and countersunk styles, etc.</p> <p> ASTM A325 Type 1</p> <p>NOTE: Also covers round head bolts, i.e., carriage-plow and countersunk styles, etc.</p> <p> ASTM A325 Type 3</p> <p>NOTE: Also covers round head bolts, i.e., carriage-plow and countersunk styles, etc.</p> <p>With line under A325 mark</p> <p> SAE J429 Grade 2 ASTM A307 Grades A &amp; B MIL-B-857-A Type 2 (ADM/5)</p> <p>NOTE: Also covers round head bolts, i.e., carriage-plow and countersunk styles, etc.</p> <p>No Grade mark - only manufacturer's symbol</p> <p> ASTM A490 Type 3</p> <p>NOTE: Also covers round head bolts, i.e., carriage-plow and countersunk styles, etc.</p> <p>With line under A490 mark</p> <p> ASTM A193 Grade B-7-M Alloy steel high temperature service bolting Tempered to 100 ksi tensile strength</p> <p>NOTE: Also covers SQ head and countersunk styles Heavy head hex or regular configurations</p> <p>Letters B7M on head</p> <p>CAGE code: 76213(canceled) Replaced by 52373 <u>2/</u></p> <p>Continued</p>
--	---

1/ Information published in this revision was verified by direct contact with manufacturers.

2/ Information not verified to be current, no response from manufacturer. Information identical to that published in MIL-HDBK-57, Revision B.

MIL-HDBK-57D(IS)

Continued

MARYLAND BOLT & NUT CO., INC.



Manufacturer's symbol and the number 3 or DH3 on face

For Grade C-3 three radial lines are also required

Heavy hex applications for C-3 and heavy or regular for DH3

Nuts for bolt applications

ASTM A325 type 3

ASTM A563 Grade DH3

Also covers square nut configurations

Heavy hex for type C-3

Regular or heavy for DH3

CAGE code: 76213(canceled)  
Replaced by 52373 2/

---



Manufacturer's symbol and the 2H or DH marking

Also can be supplied in regular configurations

Suitable for all Grade 8 and A325 or A490 bolts

Nuts for bolt applications

ASTM A194 Grade 2H

ASTM A563 Grade DH

Also covers square nut configurations

Heavy or regular

CAGE code: 76213(canceled)  
Replaced by 52373 2/

---



Manufacturer's symbol and three radial lines

Heavy hex applications only

Nuts for bolt applications

ASTM A563 Grade C

For ASTM A325 bolts

Also covers square nut configurations

Heavy hex only

CAGE code: 76213(canceled)  
Replaced by 52373 2/

MASTER RESEARCH & MFG., INC.

13528 PUMICE ST  
NORWALK, CA 90650 - 5249



CAGE code: 9U245 2/

MASTERCRAFT TOOL COMPANY  
13743 SHORELINE CT E  
EARTH CITY, MO 63045 - 1202



CAGE code: 2M351 2/

MAUDLE INDUSTRIAL CO., LTD.  
1-20 TSAO HU ROAD  
TALI CITY, TAIWAN 41245



CAGE code: SH978 2/

MAUI MEGA  
DBA KERR CHARLES W  
JAY-CEE INDUSTRIAL PARK  
RIVER RD. BLDG. PP-1  
BRISTOL, PA 19007

see KERR CHARLES W



CAGE code: 0M4F0 2/

MCADAMS MACHINE AND TOOL CO.  
2853 E FLORENCE AVE  
HUNTINGTON PARK, CA 90255









CAGE code: 0UUE2 2/

1/ Information published in this revision was verified by direct contact with manufacturers.

2/ Information not verified to be current, no response from manufacturer. Information identical to that published in MIL-HDBK-57, Revision B.



## MIL-HDBK-57D(IS)

<p>MCCULLOUGH AERO CO. DBA MCCULLOUGH &amp; ASSOCIATES 23891 MADISON STREET TORRANCE, CA 90505-6008</p>  <p>CAGE code: 04273 <span style="float: right;"><u>2/</u></span></p>	<p>MD3 INDUSTRIES LTD 108 W HOLLOWAY DR HURST, TX 76053 - 6807</p> <p>See EMPIRE PRECISION MACHINING</p>  <p>CAGE code: <span style="float: right;"><u>1/</u></span></p>
<p>MCLANE MFG INC. P. O. BOX 438 7210 ROSECRANS AVE. PARAMOUNT, CA 90723 - 0438</p>  <p>CAGE code: 52706 <span style="float: right;"><u>2/</u></span></p>	<p>MEACO PRODUCTS CORP. 99 PECK HILL ROAD JOHNSTON, RI 02919-4510</p>  <p>CAGE code: 032Z0 <span style="float: right;"><u>2/</u></span></p>
<p>McMELLON BROS INC. 915 HONEYSPOT RD. STRATFORD, CT 06615 - 7192</p> <p>05141</p>   <p>CAGE code: 05141 <span style="float: right;"><u>1/</u></span></p>	<p>MEC WOLF SRL VIA MILANO, 5 22036 ERBA (CO) ITALY</p>  <div style="display: flex; justify-content: space-around;"> <div data-bbox="889 1675 1138 1801" style="border: 1px solid black; padding: 5px;"> <p>The lot identification "xy" (letter + numb.) is embossed on the ring.</p> </div> <div data-bbox="1166 1675 1414 1801" style="border: 1px solid black; padding: 5px;"> <p>The manufacturer's mark "W" is embossed on the crown.</p> </div> </div> <p>CAGE code: <span style="float: right;"><u>2/</u></span></p>

1/ Information published in this revision was verified by direct contact with manufacturers.

2/ Information not verified to be current, no response from manufacturer. Information identical to that published in MIL-HDBK-57, Revision B.



## MIL-HDBK-57D(IS)



<p>MECAERO PRODUCTS AFS TOULOUSE OPERATIONS BD DU GRAND CASTING ROQUES-SUR-GARONNE 31128 PORTET SUR GARONNE CEDEX FRANCE</p> <p>(Corporate office see ALCOA FASTENING SYSTEMS)</p>  <p><b>M</b></p> <p>CAGE code: F7411 <span style="float: right;">1/</span></p>	<p>MECHANICAL &amp; INDUSTRIAL FASTENERS 1145 JANSEN FARM DRIVE ELGIN, IL 60123</p> <p><b>MI</b></p> <p><b>MIF</b></p> <p><b>MIF</b></p> <p>CAGE code: 0P8N1 <span style="float: right;">2/</span></p>
<p>MECAERO CANADA INC. 2250 COHEN VILLE ST-LAURENT QUEBEC, H4R 9Z7 CANADA</p> <p><b>MC</b></p> <p>CAGE code: <span style="float: right;">2/</span></p>	<p>MECHANICAL INDUSTRIES LLC 8900 NORTH 51ST STREET MILWAUKEE, WISCONSIN 53223-2402</p> <p><b>M I</b></p> <p>CAGE code: 1U732 <span style="float: right;">2/</span></p>
<p>MECAIR AEROSPACE INDUSTRIES SUBSIDIARY OF SPS TECHNOLOGIES DIV DIVISION OF SPS TECHNOLOGIES DBA MECAIR INC 225 LABROSSE PT. CLAIRE, CANADA H9R 1A3</p> <p><b>MC</b></p> <p>CAGE code: 0HL40 <span style="float: right;">2/</span></p>	<p>MEL-BA MANUFACTURING INC. 777 SUGAR LN ELYRIA , OH 44035 - 5631</p> <p><b>..MEL-BA..</b></p> <p>CAGE code: 3A092 <span style="float: right;">2/</span></p>

1/ Information published in this revision was verified by direct contact with manufacturers.

2/ Information not verified to be current, no response from manufacturer. Information identical to that published in MIL-HDBK-57, Revision B.

MIL-HDBK-57D(IS)

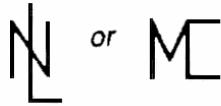
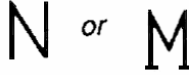











<p>MERCER PRODUCTS &amp; MFG. CO., INC. 401 S. WEBSTER STREET SEATTLE, WA 98108 - 4137</p> <p style="text-align: center;"><b><u>MP</u></b></p> <p>CAGE code: 30205 <span style="float: right;">1/</span></p>
<p>MERCURY AREOSPACE INC. 20320 PRARIE STREET CHATSWORTH, CA 91313</p> <p style="text-align: center;">   <b>M</b> - Mercury   - Aerospace         </p> <p>CAGE code: 50945 <span style="float: right;">2/</span></p>
<p>MERCURY TOOL &amp; MACHINE, INC. P.O. BOX 5190 WACO, TX 76708-5190</p> <p style="text-align: center;">Plant AIRPORT DRIVE &amp; ZOO PARK DR. WACO, TX 76708-5190</p> <p style="text-align: center;"><b>MTM</b></p> <p>CAGE code: 01982 <span style="float: right;">2/</span></p>

<p>METALCRAFTERS (DIVISION OF KEYSTONE CONSOLIDATED INDUSTRIES) 4500 KISHWAUKEE STREET P.O. BOX 7005 ROCKFORD, IL 61125-7005</p> <p style="text-align: center;">  </p> <p style="text-align: center;"><i>Indented hex &amp; hex washer heads</i></p> <p style="text-align: center;">  </p> <p style="text-align: center;"><i>Hex cap screws - low carbon steel</i></p> <p style="text-align: center;">  </p> <p style="text-align: center;"><i>Mis. markings for screws &amp; bolts</i></p> <p>CAGE code: <span style="float: right;">2/</span></p>
<p>METAL-TECH MFG. INC. 1445 SOUTH 18TH ST. CLINTON, IA 52732-6703</p> <p style="text-align: center;"><b>MT</b></p> <p>CAGE code: 3BNL5 <span style="float: right;">1/</span></p>
<p>METHODS AND MACHINING SERVICES CO. 140 UXBRIDGE ST CRANSTON, RI 02920-4811</p> <p style="text-align: center;"><b>MMS</b></p> <p>CAGE code: 0FYD8 <span style="float: right;">2/</span></p>

1/ Information published in this revision was verified by direct contact with manufacturers.

2/ Information not verified to be current, no response from manufacturer. Information identical to that published in MIL-HDBK-57, Revision B.







## MIL-HDBK-57D(IS)

<p>METRO TOOL &amp; MANUFACTURING CO. ALSO SEE ALEXANDER MANUFACTURING COMPANY INC 2402 ARKANSAS LANE GRAND PRAIRIE, TX 75052-7203</p> <p style="text-align: center;"></p> <p>CAGE code: 2M919 <span style="float: right;"><u>1/</u></span></p>	<p>MICRODOT INC. MICRODOT AEROSPACE FASTENING SYSTEMS GROUP ADVANCED PRODUCTS DIV 190 W CROWTHER AVE PLACENTIA, CA 92670 - 5687</p> <p style="text-align: center;"></p>
<p>METRIX MFG. CO. 840 BRITTAN AVE. SAN CARLOS, CA 94070-4181</p> <p style="text-align: center;"> METRI METRIX</p> <p>CAGE code: <span style="float: right;"><u>2/</u></span></p>	<p>KAYNAR TECHNOLOGIES INC MICRODOT DIV 800 SOUTH STATE COLLEGE BOULEVARD P.O. BOX 3001 PLACENTIA, CA 92670 - 5687 CAGE code: 1EJY4</p> <p>(SEE KAYNAR PRODUCTS CAGE code: 15653)</p> <p style="text-align: center;"></p> <p><i>Used on sheet metal or stamped products.</i></p>
<p>MI. ME. AF. S.r.1. C.so EUROPA, 240 24032 CALOZIOCORTE (BG) ITALY</p> <p style="text-align: center;"></p> <p>CAGE code: <span style="float: right;"><u>2/</u></span></p>	<p style="text-align: center;"></p> <p><i>Used on forged or foreign products</i></p> <p style="text-align: center;"></p> <p><i>Two parallel lines used on Spirallock® products only</i></p> <p style="text-align: center;"></p> <p><i>Used on metric products</i></p>
<p>MICRO SCREW MACHINE PRODUCTS, INC. 71 ROOSEVELT AVE CARTERET , NJ 07008</p> <p style="text-align: center;"></p> <p>CAGE code: 43808 <span style="float: right;"><u>2/</u></span></p>	<p style="text-align: center;"></p> <p><i>Used on miscellaneous and general Kaynar products</i></p> <p>MICRODOT INSERTS DEVISION 10 S. LA SALLE STREET SUITE 3500 CHICAGO, IL 60603 CAGE code: 51204</p> <p style="text-align: center;"> </p> <p><i>Three parallel lines spiralok insert products only</i></p> <p>CAGE code: 0BPE9 <span style="float: right;"><u>2/</u></span></p>

1/ Information published in this revision was verified by direct contact with manufacturers.

2/ Information not verified to be current, no response from manufacturer. Information identical to that published in MIL-HDBK-57, Revision B.

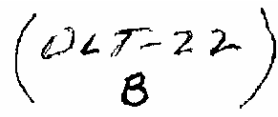
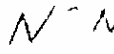
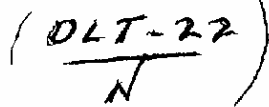
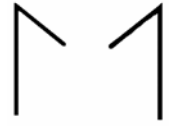

## MIL-HDBK-57D(IS)

<p>MID CONTINENT SCREW PRODUCTS CO. 3701 WEST LUNT AVE. LINCOLNWOOD, IL 60712</p>   <p>CAGE code: 1QMD3 <span style="float: right;">2/</span></p>	<p>MILLIPART, INC. 412 W. CARTER DRIVE GLENORA, CA 91740-5968</p>  <p>CAGE code: 31095 <span style="float: right;">2/</span></p>
<p>MID-STATES SCREW CORP. (ILLINOIS CORPORATION) 1817 EIGHTEENTH AVENUE ROCKFORD, IL 61101</p>  <p>CAGE code: 17264 <span style="float: right;">2/</span></p>	<p>MILLS, J. R. MACHINING, INC 815 McCORD HOLLOW ROAD HOHENWALD, LEWIS, TN 38462</p>    <p>CAGE code: 0LT22 <span style="float: right;">2/</span></p>
<p>MIDWEST ACORN NUT CO. 256 MINNESOTA AVE. TROY, MI 48083</p>  <p>CAGE code: 98960 <span style="float: right;">2/</span></p>	<p>MIL-SPEC FASTENERS CORP. 314 HANOVER PIKE HAMPSTEAD, MD 21074-9999</p>  <p>CAGE code: 356S3 <span style="float: right;">2/</span></p>
<p>MILE-HI MACHINE, INC. 6395 WEST 56<sup>TH</sup> AVE. ARVADA, CO 80002</p>  <p>CAGE code: 1M949 <span style="float: right;">1/</span></p>	

1/ Information published in this revision was verified by direct contact with manufacturers.

2/ Information not verified to be current, no response from manufacturer. Information identical to that published in MIL-HDBK-57, Revision B.

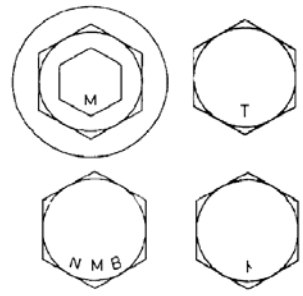
## MIL-HDBK-57D(IS)

<p>MINEBEA CO. LTD FUJISAWA MANUFACTURING UNIT 1-1-1 KATASE, FUJISAWA CITY KANAGAWA 251-8531 JAPAN</p>  <p>Trademark, Takyo Rashi</p>  <p>CAGE code: SB962 <span style="float: right;">1/</span></p>	<p>mitsubishi industries, ltd. (OSAKA DIVISION) 4-16-1 CHOME, MIDORIGI SUMINOE-KU, OSAKA 559 JAPAN</p> <p style="text-align: center;"><b>N</b></p> <p style="text-align: center;"><b>NK</b></p> <p style="text-align: center;"><b>NKYM</b></p> <p>CAGE code: <span style="float: right;">2/</span></p>
<p>MIROFINE COMPANY 1940 W. 144TH STREET GARDENA, CA 90249-2928</p> <p style="text-align: center;"><b>MFR 1L071</b></p> <p>CAGE code: 1L071 <span style="float: right;">2/</span></p>	<p>MIX TOOL CO. 212 E. CEDAR STREET COMPTON, CA 90220</p>   <p>CAGE code: 27643 <span style="float: right;">2/</span></p>
<p>MI-TECH, INC. 6685 JET PARK DRIVE N. CHARLESTON, SC 29406-4700</p> <p style="text-align: center;">MI-TECH, INC.</p> <p>CAGE code: 9J758 <span style="float: right;">2/</span></p>	

1/ Information published in this revision was verified by direct contact with manufacturers.

2/ Information not verified to be current, no response from manufacturer. Information identical to that published in MIL-HDBK-57, Revision B.

MIL-HDBK-57D(IS)

MKM MACHINE TOOL COMPANY INC.  
 100 TECHNOLOGY WAY  
 JEFFERSONVILLE, IN 47130-9644

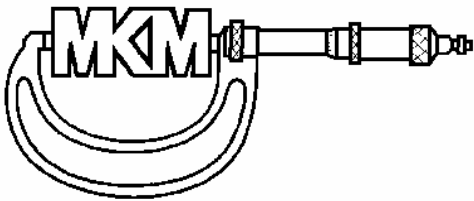

CAGE code: 8L583 2/

M-MANUFACTURING  
 P.O. BOX 897  
 ROANOKE, TX 76272

Plant  
 HYW. 114 & DOVE RD.  
 ROANOKE, TX 76262



CAGE code: 2/

MMG ENGINEERED COMPONENTS INC.  
 DBA TOOLSOURCE  
 3901 N. CARNATION  
 FRANKLIN PARK, IL 60131-1201

SOCKET HEAD  
 CAP SCREWS

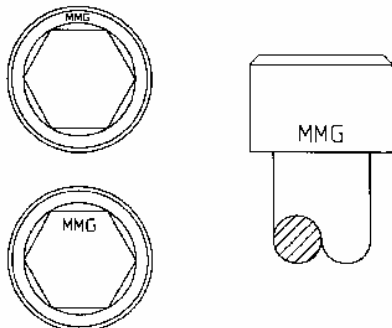

HEX HEADS  
 (GRADE 8)

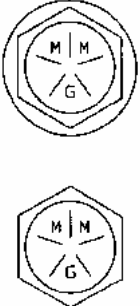

HEX HEADS  
 (GRADE 5)

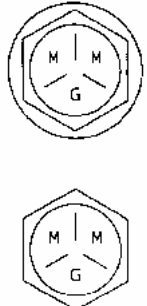

OTHER

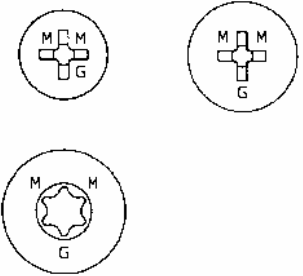

CAGE code: 3JMF9 1/

1/ Information published in this revision was verified by direct contact with manufacturers.

2/ Information not verified to be current, no response from manufacturer. Information identical to that published in MIL-HDBK-57, Revision B.

MIL-HDBK-57D(IS)

MNP CORPORATION  
 P.O. BOX 189002  
 UTICA, MI 48318-9002

MNP FASTENER DIVISION  
 44225 UTICA RD  
 UTICA, MI 48318-9002  
 CAGE code: 3R364

PLANT 2  
 MNP CORPORATION DIVISION 2  
 1524 E 14 MILE RD  
 MADISON HEIGHTS, MI 48071-1542  
 CAGE code: 064S9

PLANT 4  
 MNP CORPORATION DIVISION 4  
 2211 BEARD STREET  
 PORT HURON, MI 48060-6424  
 CAGE code: 1U3X0

*MNP fasteners*



*Highland bolts & nut*



*Small screw*



*Viking fasteners*



CAGE code: 3R364, 064S9, 1U3X0 1/

MODERN METRIC MACHINE COMPANY  
 INC  
 101 W. NICHOLSON ROAD  
 AUDOBON, NJ 08106-1411



CAGE code: 1F6H56 2/

MODFORM-ILLINOIS, INC.  
 500 36TH ST  
 EAST MOLINE, IL 61244



CAGE code: 46501 2/

MONADNOCK COMPANY, THE  
 DBA LISI AEROSPACE  
 18301 ARENTH AVE.  
 CITY OF INDUSTRY, CA 91748-1226

See LISI AEROSPACE

. (a dot)

CAGE code: 60119 1/

1/ Information published in this revision was verified by direct contact with manufacturers.

2/ Information not verified to be current, no response from manufacturer. Information identical to that published in MIL-HDBK-57, Revision B.



MIL-HDBK-57D(IS)

MONOGRAM AEROSPACE FASTENERS  
3423 SOUTH GARFIELD AVE.  
LOS ANGELES, CA 90040-3103

FASTENER HEAD MARKINGS



SCRIPT "N"  
Used on Visu-Lok® blind fasteners



SCRIPT "MI"  
Used on Composi-Lok®, OSI-Bolt®, Ti-OSI™, Radial-Lok®, Maf honeycomb pins, and other blind fasteners

BODY MARKINGS

**MONOGRAM  
WEDGELOCK**



Trademark "WedgeloK" or "Monogram", depressed. Used on temporary fasteners

CAGE code: 98524 1/

---

MONROE MACHINED PRODUCTS, INC.  
1422 S. 192nd ST  
SEATTLE, WA 98148-2314



CAGE code: 7F311 2/

MONTEREY MACHINE PRODUCTS  
1504-A INDUSTRIAL PARK STREET  
COVINA, CA 91722-3417

**MP**

CAGE code: 1UD00 2/

---

MORTON FASTENERS INC.  
4544 RUNWAY DR.  
LANCASTER, CA 93536

**MFI**

CAGE code: 4DU57 1/

---

MORTON MANUFACTURING  
(DIVISION MORTON GRINDING)  
17341 W. SIERRA HIGHWAY  
SANTA CLARITA, CA 91351-1162

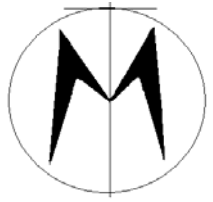
CAGE code: 2T498 1/

---

MOSTAR GEAR & MACHINE MFG., CO.  
201 E. FRANKLIN  
PALESTINE, IL 62451



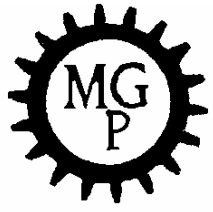

CAGE code: OHN25 2/

1/ Information published in this revision was verified by direct contact with manufacturers.

2/ Information not verified to be current, no response from manufacturer. Information identical to that published in MIL-HDBK-57, Revision B.

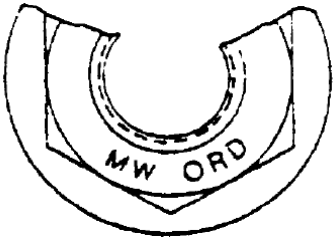

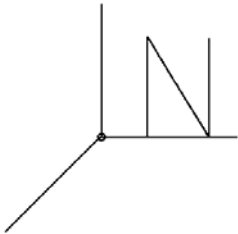

## MIL-HDBK-57D(IS)

<p>MOTOR WHEEL CORP. 4000 COLLINS RD. LANSING, MI 48910</p> <p>Plant 1600 N. LARCH STREET LANSING, MI 48906</p>  <p>CAGE code: 4H871 <span style="float: right;">2/</span></p>	<p>NAFCO INDUSTRIES, INC. P.O. BOX 1893 CARSON CITY, NV 89702</p> <p style="text-align: center;"><b>N</b></p> <p>CAGE code: 32387 <span style="float: right;">2/</span></p>
<p>MRL MANUFACTURING CORP. P.O. BOX 8440 59 LEE AVE HALEDON, NJ 07508</p> <p>Plant 525 LAFAYETTE AVENUE HAWTHORE, NJ 07506</p> <p style="text-align: center;"><b>M</b></p> <p>CAGE code: 0GUF9 <span style="float: right;">1/</span></p>	<p>NAGOYA SCREW MANUFACTURING CO, LTD. 17-16 TSUBAKI-CHO I NAKAMURA-KU NAGOYA-SHI AICHI-KEN, JAPAN</p>  <p style="text-align: center;"><b>NRS</b></p> <p>CAGE code: SC006 <span style="float: right;">2/</span></p>
<p>N.S.S. INDUSTRIES 9075 GENERAL DRIVE PLYMOUTH, MI 48170</p> <p style="text-align: center;"><b>N</b></p> <p>CAGE code: <span style="float: right;">2/</span></p>	<p>NAPIER'S AUTO BODY 49879 HWY 101 STH. P. O. BOX 278 BRANDON, OR 97411-1824</p>  <p>CAGE code: 1NXQ4 <span style="float: right;">1/</span></p>

1/ Information published in this revision was verified by direct contact with manufacturers.

2/ Information not verified to be current, no response from manufacturer. Information identical to that published in MIL-HDBK-57, Revision B.

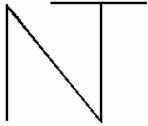



## MIL-HDBK-57D(IS)

<p>NARRAGANSETT SCREW MFG., CO. P.O. BOX 2242 119 ROWLEY ST WINSTED, CT 06098 - 2068</p> <p style="text-align: center;"><b>NS</b></p> <p>CAGE code: OHP15 <span style="float: right;"><u>2/</u></span></p>	<p>NATIONAL BOLTS &amp; RIVETS LTD. P.O. BOX 5063, BOKSBURG NORTH 1461 SOUTH AFRICA</p> <p style="text-align: center;"></p> <p>CAGE code: V3674 <span style="float: right;"><u>2/</u></span></p>
<p>NASSAN TOOL WORKS, INC. 34 LAMAR ST. WEST BABYLON, NY 11704</p> <p style="text-align: center;"><b>NTW</b></p> <p>CAGE code: 2M490 <span style="float: right;"><u>1/</u></span></p>	<p>NATIONAL FASTENER CO., LTD. #973 YANG DUCK-DANG MASAN REPUBLIC OF KOREA</p> <p style="text-align: center;"><b>O</b></p> <p>CAGE code: <span style="float: right;"><u>2/</u></span></p>
<p>NASU DENKI-TEKKO CO., LTD. 1-1-14 SHINJUKU, SHINJUKU-KU TOKYO 160 JAPAN</p> <p style="padding-left: 40px;">SUNAMACHI FACTORY 3-5-28 SHINSUNA, ETO-KU, TOKYO, JAPAN 136</p> <p style="text-align: center;"></p> <p>CAGE code: <span style="float: right;"><u>2/</u></span></p>	<p>NATIONAL THREADED FASTENERS CORP. 630 LIVELY BOULEVARD ELK GROVE VILLAGE, IL 60007</p> <p style="text-align: center;"></p> <p>CAGE code: <span style="float: right;"><u>2/</u></span></p>
<p>NAVPAR, INC. 11029 STATE ROUTE 128 BLDG C-1 HARRISON, OH 45030-9710</p> <p style="text-align: center;"><b>NI</b></p> <p>CAGE code: 0MHC4 <span style="float: right;"><u>1/</u></span></p>	<p>NAVPAR, INC. 11029 STATE ROUTE 128 BLDG C-1 HARRISON, OH 45030-9710</p> <p style="text-align: center;"></p> <p>CAGE code: 0MHC4 <span style="float: right;"><u>1/</u></span></p>

1/ Information published in this revision was verified by direct contact with manufacturers.

2/ Information not verified to be current, no response from manufacturer. Information identical to that published in MIL-HDBK-57, Revision B.

## MIL-HDBK-57D(IS)

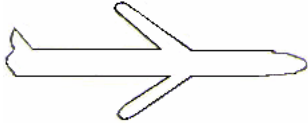
<p>NC AUTOMATED INDUSTRIES INC. 90 DAYTON AVENUE BLDG. 14E PASSAIC, NJ 07055-7035</p> <p style="text-align: center;"><b>NAC</b></p> <p>CAGE code: 1VPZ8 <span style="float: right;">1/</span></p>	<p>NEDSCHROEF NEDSCHROEF HALMOND B.V. P.O. BOX 29 5700 AA HELMOND THE NETHERLANDS</p> <p>Plant KANAALDIJK NOORD WEST 71 5707 LC HELMOND THE NETHERLANDS</p> <p> Standard hexagon high tensile bolts and screws of all property classes</p> <p> High strength friction grip bolts for structural bolting property class 10.9</p> <p> Socket screws</p> <p> Nuts and all other bolts and screws</p> <p>CAGE code: HO871 <span style="float: right;">2/</span></p>
<p>NCMI BRUEGGEMANN INC. 1207 W. BROOKS STREET ONTARIO, CA 91762-3609</p> <p style="text-align: center;"></p> <p>CAGE code: 0K292 <span style="float: right;">1/</span></p>	<p>NEKG HOLDINGS 26709 SOUTH KIMBERLY CHANNAHON, IL 26709</p> <p style="text-align: center;"><b>NE</b></p> <p>CAGE code: 4YU01 <span style="float: right;">1/</span></p>
<p>ND INDUSTRIES DBA ND WESTERN FASTENER PROCESSING DIVISION 13929 DINARD AVENUE SANTA FE SPRINGS, CA 90670</p> <p style="text-align: center;"><b>ND</b> INDUSTRIES</p> <p>CAGE code: 4Y667 <span style="float: right;">2/</span></p>	<p>NELSON AEROSPACE INC. 10310 NORRIS AVE PACOIMA, CA 91331-2219</p> <p style="text-align: center;"><b>NA</b></p> <p>CAGE code: 52930 <span style="float: right;">2/</span></p>

1/ Information published in this revision was verified by direct contact with manufacturers.

2/ Information not verified to be current, no response from manufacturer. Information identical to that published in MIL-HDBK-57, Revision B.





## MIL-HDBK-57D(IS)

<p>NELSON STUD WELDING DIVISION 7900 W. RIDGE RD ELYRIA, OH 44036-2019</p> <p style="text-align: center;"><b>N</b></p> <p>CAGE code: 85105 <span style="float: right;"><u>2/</u></span></p>	<p>NEVILLE MACHINE SHOP P.O. BOX 22 RANGER, TX 76470-2722</p> <p style="text-align: center;">Plant 406 E. HIWAY 80 RANGER, TX 76470-2722</p> <p style="text-align: center;"><b>ND</b></p> <p>CAGE code: 8X524 <span style="float: right;"><u>2/</u></span></p>
<p>NEUMAYER, ERICH GMBH POSTFACH 1160 WILHELM-ZANGEN-STRASSE 9 D-7613 HAUSACH GERMANY</p> <p style="text-align: center;"><b>N</b></p> <p>CAGE code: C1956 <span style="float: right;"><u>1/</u></span></p>	<p>NEW HORIZON MACHINE CO., INC. 36 LUDLOW STREET STAMFORD, CT 06902-2691</p> <p style="text-align: center;"><b>NH</b></p> <p>CAGE code: 1VVZ7 <span style="float: right;"><u>2/</u></span></p>
<p>NEVADA BOLT AND MFG CO INC. DBA SPS NON-FERROUS ENGINEERED FASTENERS 3850 W PONDEROSA WAY LAS VEGAS, NV 89118</p> <p style="text-align: center;"><b>NF</b></p> <p>CAGE code: 7U566 <span style="float: right;"><u>2/</u></span></p>	<p>NICE TOOL MFG., INC. 3280 DIANA DR. FORT WORTH, TX 76118-6237</p> <p style="text-align: center;"><b>NT</b></p> <p>CAGE code: 5K517 <span style="float: right;"><u>2/</u></span></p>

1/ Information published in this revision was verified by direct contact with manufacturers.

2/ Information not verified to be current, no response from manufacturer. Information identical to that published in MIL-HDBK-57, Revision B.

## MIL-HDBK-57D(IS)

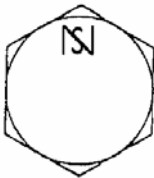
<p>NIPPON MACHINE ENGINEERING, INC. 1311 EAST SAINT GERTRUDE PLACE UNIT B SANTA ANA, CA 92705</p>   <p>CAGE code: 49145 <span style="float: right;"><u>2/</u></span></p>	<p>NISSAN SCREW CO. LTD. SALES DEPT., FOREIGN TRADE SECTION 5-6-508 SHINKANAOKA-CHO SAKAI-SHI-OASAKA 590 JAPAN</p> <p>Plant 8-4-41 MIYAKE-NAKA MATSUBARA-SHI, OSAKA 580 JAPAN</p> <p style="font-size: 2em; text-align: center;">N</p> <p>CAGE code: <span style="float: right;"><u>1/</u></span></p>
<p>NIPPON STEEL BOLTEN CO., LTD. 4-3-2 NISHIZUMI, YUKUHASHI, FUKUOKA, JAPAN 824</p>  <p>CAGE code: <span style="float: right;"><u>2/</u></span></p>	<p>NOCHIA STEELWORKS NYOGO, JAPAN</p>  <p>CAGE code: <span style="float: right;"><u>2/</u></span></p>
<p>NISCO, INC. 5F SHINGA BLDG. 1-3-10 UMEBAYASHI OUTSU-SHI SHOGA-KEN 520, JAPAN</p> <p>Plant 1018-1 ROKUJO CHUZU-CHO YASU-GUM SHIGA-KEN 520-24 JAPAN</p>   <p>CAGE code: <span style="float: right;"><u>2/</u></span></p>	<p>NON-FERROUS BOLT &amp; MANUFACTURNG CO. 4086 NEVSO DRIVE, SUITE C LAS VEGAS, NV 89103</p> <p>Plant 3850 WEST PONDEROSA LANE LAS VEGAS, NV 89118</p> <p style="font-size: 2em; text-align: center;">NF</p> <p>CAGE code: <span style="float: right;"><u>2/</u></span></p>

1/ Information published in this revision was verified by direct contact with manufacturers.

2/ Information not verified to be current, no response from manufacturer. Information identical to that published in MIL-HDBK-57, Revision B.

## MIL-HDBK-57D(IS)

NORTHBRIDGE FASTENERS  
VIKING ROAD  
WIGSTON, LEICESTER  
UNITED KINGDOM

**NB**



**E** – The plain letter E is used for Rolls Royce, UK supply and Europe and will be used in the absence of any customer allocated identification.



**32219** – Allocated by Pratt & Whitney, East Hartford for supply to Pratt & Whitney, East Hartford



**15077** – Allocated by Pratt & Whitney, Canada for supply to Pratt & Whitney, Canada



**5T572** – Milsap No. for items supplied to U.S. Government



**20733** – Allocated by Avco-Lycoming for supply to Avco-Lycoming



**NTF99** – Allocated by General Electric for supply to Rolls Royce for joint projects with General Electric

CAGE code:

2/

NORTHEAST FASTENERS  
8 TREMCO DRIVE  
P. O. BOX 322  
TERRYVILLE, CT 06786-0322

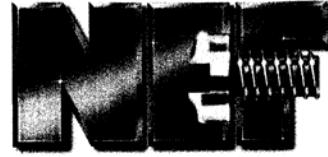

CAGE code: 07ZN5

1/

NORTHEAST METAL CO., INC.  
P.O. BOX 51754  
34 FRONT STREET  
INDIAN ORCHARD, MA 01151

Plant  
AIRPORT DRIVE  
WESTFIELD, MA 01085



CAGE code: 1C4F2

2/

NORTHERN SCREW CO., INC.  
8121 LAKEVIEW PARKWAY  
PLEASANT PRAIRIE, WI 53158

**NS**

CAGE code:

2/

NORTHSTAR ENGINEERING  
1911 LYNX PLACE  
ONTARIO, CA 91761

**0XK38**

CAGE code: 0XK38

2/

1/ Information published in this revision was verified by direct contact with manufacturers.

2/ Information not verified to be current, no response from manufacturer. Information identical to that published in MIL-HDBK-57, Revision B.

## MIL-HDBK-57D(IS)

<p>NOVA MACHINE PRODUCTS CORPORATION A SUBSIDIARY OF CURTIS-WRIGHT FLOW CONTROL SERVICE CORP. 18685 SHELDON ROAD MIDDLEBURGE HEIGHTS, OH 44130-2465</p>  <p>CAGE code: 1EJ29 <span style="float: right;">1/</span></p>	<p>NUMERIC MACHINE PRODUCTS 1769 WEST AVE. K-11 LANCASTER, CA 93534</p> <p style="text-align: center;"><b>NMP</b></p> <p>CAGE code: 5V524 <span style="float: right;">2/</span></p>
<p>NT ENGINEERING, INC. 1050 "C" INDEPENDENCE AVE. MOUNTAIN VIEW, CA 94043</p> <p style="text-align: center;"><b>NT</b></p> <p>CAGE code: 0BEN1 <span style="float: right;">2/</span></p>	<p>NUTS INCORPORATED DIVISION OF STANLOK 1451 GRAFTON ST P.O. BOX 2735 WORCHESTER, MASSACHUSETTS 01613</p> <p style="text-align: center;"><b>N</b></p> <p>CAGE code: 02972 <span style="float: right;">2/</span></p>
<p>NUCOR CORP. NUCOR FASTENER DIVISION P.O. BOX 6100, 6730 COUNTY ROAD ST. JOE, IN 46785</p>  <p>CAGE code: 0BEP9 <span style="float: right;">1/</span></p>	<p>NUTS, INC. ROUTE 724 &amp; 23 PHOENIXVILLE, PA 19460-1838</p> <p style="text-align: center;"><b>N</b></p> <p>CAGE code: 6N185 <span style="float: right;">2/</span></p>

1/ Information published in this revision was verified by direct contact with manufacturers.

2/ Information not verified to be current, no response from manufacturer. Information identical to that published in MIL-HDBK-57, Revision B.



MIL-HDBK-57D(IS)

NYLOK CORP.  
15260 HALLMARK DR.  
MACOMB, MI 48042

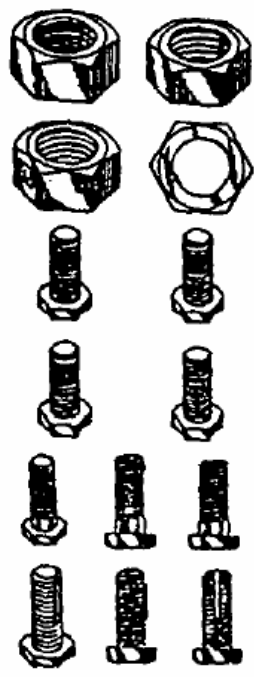

Blue nylon locking element

Blue nylon locking element

Blue nylon locking element

Blue nylon locking element

Blue nylon locking element

Blue nylon locking element

NK

NK

NYLOK

CAGE code: 59093 1/

OAKTREE FASTENERS CO.  
12262 1/2 WOODRUFF AVE.  
DOWNEY, CA 90241

**OTF**

CAGE code: 2/

---

OBARS MACHINE & TOOL CO.  
115-126 N. WESTWOOD AVE.  
TOLEDO, OH 43607

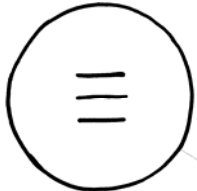

CAGE code: 0MKX0 2/

---

OCM MACHINE COMPANY, INC.  
9601 HIGHWAY 80  
FORT WORTH, TX 76116 - 2689

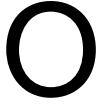

CAGE code: 06XQ6 2/

---

OHIO NUT & BOLT CO., THE  
DIV. OF FASTENERS INDUSTRIES, INC.  
33 LOU GROZA BLVD..  
BEREA, OH 44017-1293







Small raised mark usually  
on the underside of head

CAGE code: 76871 1/

1/ Information published in this revision was verified by direct contact with manufacturers.

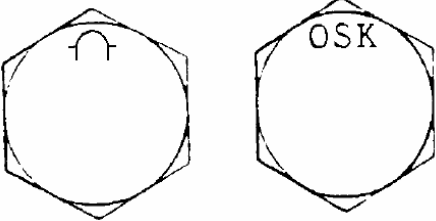
2/ Information not verified to be current, no response from manufacturer. Information identical to that published in MIL-HDBK-57, Revision B.

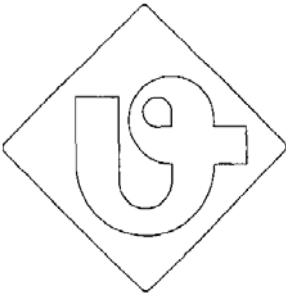

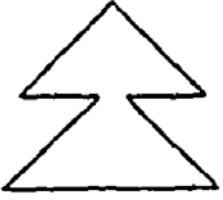
## MIL-HDBK-57D(IS)

<p>OHKAWA SCREW MFG. CO., LTD. 2-25-16 MIDORIGAOKA, MEGURO-KU, TOKYO 152 JAPAN</p> <p>Plant 6357-1 OBA, OHMIYA-MACHI, NAKA-GUN, LBARAGI-KEU 319-21 JAPAN</p>  <p>CAGE code: <u>2/</u></p>	<p>OKAWA SCREW MANUFACTURING CO., LTD 2-20-4 HIGASHIGOTANDA SHINAGAWA-KU, 141-0022 TOKYO</p> <p><b>OSK</b></p>  <p>CAGE code: <u>1/</u></p>
<p>OKABE CO., INC. OKABE KIKO CO., LTD. (PLANT) 4-21-15 MUKOJIMA SUMIDA-KU, JAPAN 131-8505</p>  <p>CAGE code: SP186 <u>2/</u></p>	<p>OMEGA THREAD ROLLING AND GRINDING INC. 54 LEWIS STREET P.O. BOX 129 PLAINVILLE, CT 06062-0129</p>  <p>CAGE code: 06KW4 <u>2/</u></p>
<p>OKAI IRON WORKS, INC. 12-41, 3 CHOME, TSURUHARA IZUMISANO CITY OSAKA, JAPAN 598</p> <p><b>OK</b></p> <p>CAGE code: <u>2/</u></p>	<p>ONEIDA TOOL &amp; MACHINE CORP. 837 AIR PARK RD. RHINELANDER, WI 54501-8426</p>  <p>CAGE code: OJHAO <u>1/</u></p>

1/ Information published in this revision was verified by direct contact with manufacturers.

2/ Information not verified to be current, no response from manufacturer. Information identical to that published in MIL-HDBK-57, Revision B.

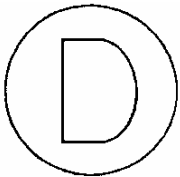

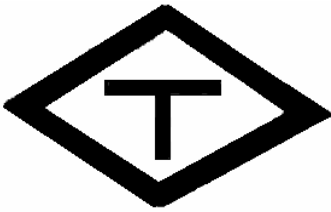

## MIL-HDBK-57D(IS)

<p>ONO MANUFACTURER, INC. 602 FUJITA OKAYAMA-SHI, OKAYAMA-KEN 701-0221 JAPAN</p> <p>Plant 3-800-46 TAMAHARA TAMANO-SHI, OKAYAMA-KEN 706-2555 JAPAN</p>  <p>CAGE code: <span style="float: right;">1/</span></p>	<p>ORC-O TOOL &amp; MACHINE, INC. 75 SHAMROCK DRIVE SULLIVAN, MO 63080-2344</p> <p style="text-align: center;"><b>ORC-O</b></p> <p>CAGE code: 0C1D0 <span style="float: right;">2/</span></p>
<p>ONTIC ENGINEERING &amp; MANUFACTURING, INC. 20360 PLUMMER ST. NORTH HOLLYWOOD, CA 91609-0510</p>  <p>CAGE code: 45934 <span style="float: right;">2/</span></p>	<p>ORDNANCE PARTS &amp; ENGINEERING CO. P.O. BOX 8035 3152 C MAJOR ST FORT WORTH, TX 76112</p>  <p>CAGE code: 20800 <span style="float: right;">2/</span></p>
<p>ORANGE PRECISION PARTS 17632 METZLER LANE, #C HUNTINGTON BEACH, CA 92647</p> <p style="text-align: center;"><b>P O OP</b></p> <p>CAGE code: 9V210 <span style="float: right;">2/</span></p>	<p>ORLOTRONICS CORP. 401 E. FOURTH STREET BRIDGEPORT, PA 19405-1815</p> <p style="text-align: center;"><b>(OTC)</b></p> <p>CAGE code: 54267 <span style="float: right;">1/</span></p>
	<p>OSAKA SEIKI CO., LTD. 1-19-14, MITEJIMA TOKYO 555 JAPAN</p>  <p>CAGE code: S4247 <span style="float: right;">2/</span></p>

1/ Information published in this revision was verified by direct contact with manufacturers.

2/ Information not verified to be current, no response from manufacturer. Information identical to that published in MIL-HDBK-57, Revision B.

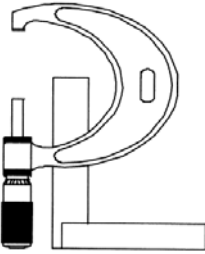
## MIL-HDBK-57D(IS)

<p>OSTEEN MACHINE SHOP RT. 1 BOX 2082 ALVARADO, TX 76009</p>  <p>CAGE code: 8Y546 <span style="float: right;"><u>2/</u></span></p>	<p>P &amp; I ASSOCIATES, INC. 26 WEST WAVERLY ROAD P.O. BOX 413 GLENSIDE, PA 19038-4012</p> <p>Plant #1 LIMEKILN PIKE GLENSIDE, PA 19038 (No mail to this address)</p>  <p>CAGE code: 0DH98 <span style="float: right;"><u>2/</u></span></p>
<p>OTO MELARA S.p.A. FINKECCANICA COMPANY VIA VALDILOCCHI 15 LA SPEZIA 19136 ITALY</p>  <p>CAGE code: A0199 <span style="float: right;"><u>1/</u></span></p>	<p>P &amp; L ENTERPRISES 111 CR 4614 CASTROVILLE, TX 78009</p>  <p>CAGE code: 058B7 <span style="float: right;"><u>1/</u></span></p>
<p>OTT BROTHERS MACHINE CO., INC. 331 EAST 37TH STREET SOUTH WICHITA, KS 67216</p> <p><b>OB OBMC</b></p> <p>CAGE code: 09292 <span style="float: right;"><u>1/</u></span></p>	<p>P.C.M., INC. (BETHLEHEM PIKE INDUSTRIAL CENTER) P.O. BOX 840 60 PARRISH ST. WILKES BARRE, PA 18710</p>  <p>CAGE code: <span style="float: right;"><u>2/</u></span></p>
<p>OWARI PRECISE PRODUCTS CO., LTD 2-148 YADA-CHO HIGASHI-KU NAGOYA-SHI AICHI-KEN, JAPAN</p>  <p>CAGE code: SC008 <span style="float: right;"><u>2/</u></span></p>	

1/ Information published in this revision was verified by direct contact with manufacturers.

2/ Information not verified to be current, no response from manufacturer. Information identical to that published in MIL-HDBK-57, Revision B.



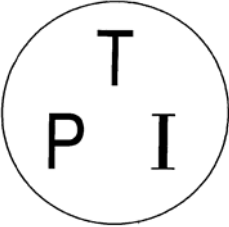
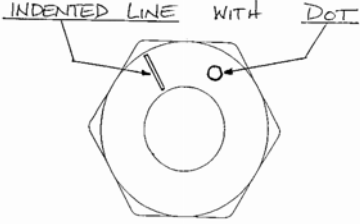

## MIL-HDBK-57D(IS)

<p>P.S. MACHINE CO., INC. 1505 JOHN FETCH BLVD. S. WINDSOR, CT 06074-1000</p> <div style="text-align: center; border: 1px solid black; width: 80px; margin: 20px auto; padding: 5px;">PS</div> <p>CAGE code: 56839 <span style="float: right;">1/</span></p>	<p>PACIFIC SCIENTIFIC 22715 SAVI RANCH PARKWAY P.O. BOX 87019 YORBA LINDA, CA 92686</p> <div style="text-align: center; font-size: 48px; font-weight: bold; margin: 20px auto;">P S</div> <p>CAGE code: 45402 <span style="float: right;">2/</span></p>
<p>PABCOR, INC. 925 NORTH CEDAR STREET P.O. BOX 7528 NEW CASTLE, PA 16107-1323</p> <div style="text-align: center; font-size: 48px; font-weight: bold; margin: 20px auto;">PABCOR</div> <p>CAGE code: OAGN7 <span style="float: right;">2/</span></p>	<p>PACIFIC TOOL, INC. 15235 NE 92ND STREET REDMOND, WA 98052</p> <div style="text-align: center; margin: 20px auto;">  </div> <p>CAGE code: 62176 <span style="float: right;">1/</span></p>
<p>PACER ALLOYS, INC. 8681 SCRANTON STREET HOUSTON, TX 77075</p> <div style="text-align: center; font-size: 48px; font-weight: bold; margin: 20px auto;">V</div> <p>CAGE code: <span style="float: right;">1/</span></p>	<p>PADGETT MACHINE INC. 1226 NORTH 143rd EAST AVENUE TULSA, OK 74116-2120</p> <div style="text-align: center; font-size: 48px; font-weight: bold; margin: 20px auto;">PMI</div> <p>CAGE code: 6W037 <span style="float: right;">1/</span></p>
<p>PACIFIC FASTENERS, INC. 405 UNIVERSITY AVENUE ARLINGTON HEIGHTS, IL 60004</p> <div style="text-align: center; margin: 20px auto;">  </div> <p>CAGE code: 42918 <span style="float: right;">2/</span></p>	<p>PAINTER TOOL, INC. 1173 IRIS DRIVE NORTH HUNTINGDON, PA 15642-4399</p> <div style="text-align: center; font-size: 48px; font-weight: bold; margin: 20px auto;">PTI</div> <p>CAGE code: 34779 <span style="float: right;">2/</span></p>

1/ Information published in this revision was verified by direct contact with manufacturers.

2/ Information not verified to be current, no response from manufacturer. Information identical to that published in MIL-HDBK-57, Revision B.

## MIL-HDBK-57D(IS)

<p>PALNUT CO. , THE UNITED CARR FASTENERS PALNUT DIV GLEN ROAD MOUNTAINSIDE, NJ 07092</p> <p><b>PAL</b></p> <p>CAGE code: 2G832 <u>2/</u></p>	<p>PAULIN, H. &amp; CO., LTD. CAPITAL METAL INDUSTRIES DIVISION 55 MILNE AVENUE SCARBOROUGH, ONTARIO MIL 4N3 CANADA</p>  <p>CAGE code: 95119 <u>2/</u></p>
<p>PARK PRECISION CORPORATION 181 ELLIOT ST. UNIT 403 BEVERLY, MA 01915</p> <p><b>-PPC-</b></p> <p>CAGE code: OJWS2 <u>2/</u></p>	<p>PB FASTENERS (DIVISION OF PAUL R. BRILES, INC.) 1700 WEST 132ND STREET GARDENA, CA 90249</p> <p><b>MFR 27624</b></p>  <p><b>PBA</b> <b>PBF</b> <b>PB</b></p> <p>CAGE code: 27624 <u>1/</u></p>
<p>PATEREX, LTD. CRAY AVE., ORPINGTON KENT BR5 3RR UNITED KINGDOM</p> <p><b>P</b> <b>PTX</b></p> <p>CAGE code: OBMF6 <u>2/</u></p>	<p>PEERLESS SCREW PRODUCTS 286 SANDBANK RD. P.O. BOX 236 CHESIRE, CT 06410-1537</p>  <p>CAGE code: 45950 <u>1/</u></p>
<p>PATTERSON LAKE PRODUCTS (SUBSIDIARY OF COLUMBIA AUTO PARTS) P.O. BOX 200 PINCKNEY, MI 48169</p>  <p>CAGE code: 5Y952 <u>2/</u></p>	

1/ Information published in this revision was verified by direct contact with manufacturers.

2/ Information not verified to be current, no response from manufacturer. Information identical to that published in MIL-HDBK-57, Revision B.

MIL-HDBK-57D(IS)

PEINER UMFORMTECHNIK GmbH  
 WOLTORFER STRASSE 26  
 PEINE, 31224  
 GERMANY

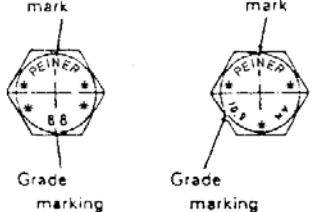
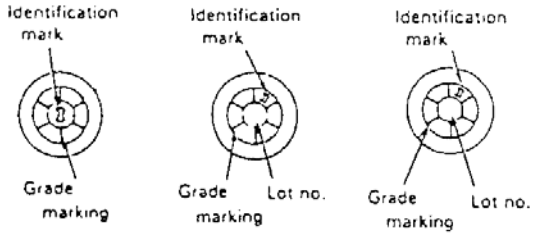
CAGE code: D2742 2/

PELHAM AUTO MATRIX PRECISION  
 1 INDUSTRIAL DRIVE  
 PELHAM, NH 03076



CAGE code: 1CSJ5 2/

PENN CIGAR MACHINES INC (P.C.M INC)  
 P. O. BOX 1065  
 60 PARRISH STREET  
 WILKES BARRE, PA 18703



CAGE code: 7U218 2/



PENNENGINEERING AUTOMOTIVE  
 FASTENERS  
 50625 DESIGN LANE  
 SHELBY TOWNSHIP, MI 48315

(Coporate see PENN ENGINEERING &  
 MANUFACTURING CORP.)

**PE**

CAGE code: 50EB1 1/

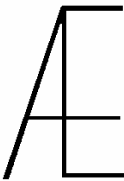
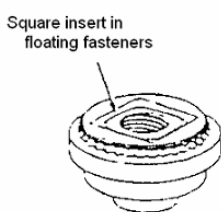
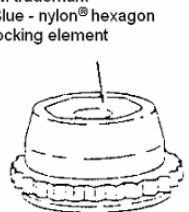
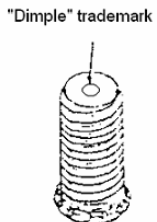
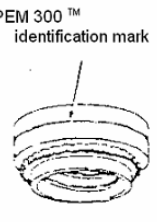
PENN ENGINEERING & MANUFACTURING  
 CORP.  
 (see ATLAS ENGINEERING, INC.)  
 5190 OLD EASTON RD.  
 DANBORO, PA 18916

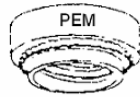









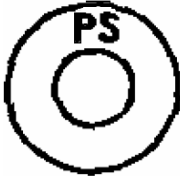

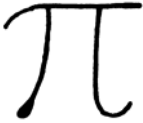
CAGE code: 46384 1/

1/ Information published in this revision was verified by direct contact with manufacturers.

2/ Information not verified to be current, no response from manufacturer. Information identical to that published in MIL-HDBK-57, Revision B.

## MIL-HDBK-57D(IS)





<p>PENN SCREW &amp; MACHINE WORKS, INC. 3075 ADVANCE LN. COLMAR, PA 18915</p> <p>PSM PSM</p> <p>CAGE code: 82926 <u>2/</u></p>	<p>PHOENIX SPECIALTY MANUFACTURING CO., INC. P.O. BOX 418 BAMBERG, SC 29003</p> <p>Plant HIGHWAY 301 SOUTH BAMBERG, SC 29003</p>  <p>CAGE code: 66920 <u>2/</u></p>
<p>PEREZ MACHINE, INC. 1501 W. 134TH STREET GARDENA, CA 90249</p>  <p>CAGE code: 34393 <u>1/</u></p>	<p>PILGRIM SCREW CORP. (PROVIDENCE DIVISION) 120 SPRAGUE STREET PROVIDENCE, RI 02901</p> <p>Plant 259 DEXTER ST. PROVIDENCE, RI 02907 CAGE code: 47253</p>  <p>Plant 2 2875 WEST FRYE ROAD CHANDLER, AZ CHANDLER, AZ CAGE code: 1GP79</p>  <p>CAGE code: 47253, 1GP79 <u>1/</u></p>
<p>PERIGEE MANUFACTURING COMPANY, INC. (MICHIGAN CORPORATION) 7519 INTERVALE DETROIT, MI 48238-2401</p>  <p>CAGE code: 1X4X7 <u>1/</u></p>	
<p>PERKINS MACHINE CO. 1559 PINE STREET OXNARD, CA 93030</p>  <p>CAGE code: 84749 <u>2/</u></p>	

1/ Information published in this revision was verified by direct contact with manufacturers.

2/ Information not verified to be current, no response from manufacturer. Information identical to that published in MIL-HDBK-57, Revision B.





## MIL-HDBK-57D(IS)

<p>PINE TAVERN MACHINE INC. 7851 PINE TAVERN ROAD PERRY, NY 14530</p> <p><b>PTM</b></p> <p>CAGE code: 9J559 <u>2/</u></p>	<p>PIONEER SCREW &amp; NUT CO. 2700 YORK ROAD ELK GROVE VILLAGE, IL 60007</p> <div style="display: flex; justify-content: space-around;">   </div> <p>Indented hex heads and indented hex washer heads</p> <p>All other head styles slash-dot symbol to appear on bearing surface upon request</p> <p>CAGE code: 4N311 <u>2/</u></p>
<p>PINEY RIDGE CO. 177 JOSHUA ROAD SALUDA, SC 29138-7770</p> <p><b>PR</b></p> <p>CAGE code: 05DT2 <u>1/</u></p>	<p>PLAINVILLE MANUFACTURING CO., INC. 48 LEWIS ST. PLAINVILLE, CT 06062</p> <div style="text-align: center;">  </div> <p>CAGE code: <u>2/</u></p>
<p>PINTO PRODUCTS P.O. BOX 83 2011 PALMER STREET KALAMAZOO, MI 49001</p> <div style="text-align: center;">  </div> <p>CAGE code: 0YJH8 <u>2/</u></p>	<p>PNEU-HYDRO PRODUCTS, INC. 353 RICHARD MINE ROAD WHARTON, NJ 07885</p> <p><b>PHP</b></p> <p>CAGE code: <u>2/</u></p>
<p>PIONEER MACHINE PRODUCTS, INC. 2200 DOLMAN ST. LOUIS, MO 63104</p> <p><b>PMP</b></p> <p>CAGE code: 12829 <u>2/</u></p>	<p>POINT MACHINE COMPANY P.O. BOX 8055 33 CAMBRIDGE HEIGHTS KENSINGTON, CT 06037</p> <div style="text-align: center;">  </div> <p>CAGE code: 9N716 <u>2/</u></p>

1/ Information published in this revision was verified by direct contact with manufacturers.

2/ Information not verified to be current, no response from manufacturer. Information identical to that published in MIL-HDBK-57, Revision B.



## MIL-HDBK-57D(IS)

<p>PORTLAND BOLT &amp; MFG., CO. P.O. BOX 2866 1210 NW JOHNSON ST PORTLAND, OR 97208</p> <p>Plant 3441 NW GUAM ST PORTLAND, OR 97210-2688 CAGE code: 3QCS3</p> <p><b>PB</b></p> <p>CAGE code: 3S498, 3QCS3 <u>1/</u></p>	<p>PRD FASTENERS LTD. UNIT 10/15 MONMER CLOSE WILLENHALL, WV12 1JR ENGLAND</p> <p><b>PRD</b></p> <p>CAGE code: U8651 <u>1/</u></p>
<p>PORTSMOUTH NAVAL SHIPYARD SEAVEY ISLAND KITTERY, ME 03904</p> <p><b>A</b></p> <p>CAGE code: 81316 <u>1/</u></p>	<p>PRECI-MANUFACTURING, INC. 400 WEAVER STREET WINOOSKI, VT 05404-1391</p>  <p>CAGE code: 66841 <u>1/</u></p>
<p>POWERPARTS, INC. P.O. BOX 38557 601 MCFARLAND STREET HOUSTON, TEXAS 77011</p>  <p>CAGE code: 66297 <u>2/</u></p>	<p>PRECISE AERO PRODUCTS 4120 INDUS WAY RIVERSIDE, CA 92503-4808</p>  <p>CAGE code: 00AE2 <u>1/</u></p>

1/ Information published in this revision was verified by direct contact with manufacturers.

2/ Information not verified to be current, no response from manufacturer. Information identical to that published in MIL-HDBK-57, Revision B.



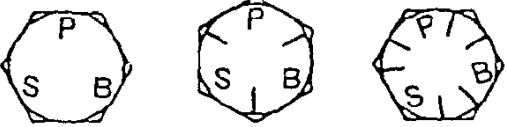
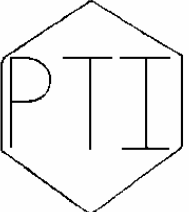

## MIL-HDBK-57D(IS)

<p>PRECISE OF CALIFORNIA DIV OF ADJUSTABLE BUSHING CORP 8330 LANKERSHIM BLVD. NORTH HOLLYWOOD, CA 91605</p>   <p><i>Panel fastener    Quick-acting pins</i></p> <p>CAGE code: 62372 <span style="float: right;">2/</span></p>	<p>PRECISION PARTS &amp; TOOL CO., INC. 108 ROME STREET FARMINGDALE, NJ 11735</p> <p style="text-align: center;"><b>L.P.R.</b></p> <p>CAGE code: <span style="float: right;">2/</span></p>
<p>PRECISION AIRCRAFT MACHINING CO., INC. DBA PAMCO 10640 ELKWOOD STREET SUN VALLEY, CA 91352</p> <p style="text-align: center;"><b>PAMCO</b></p> <p style="text-align: center;"><b>PAM</b></p> <p>CAGE code: 66774 <span style="float: right;">1/</span></p>	<p>PRECISION PIECE PARTS, INC. 712 S. LOGAN ST. MISHAWAKA, IN 46544</p>  <p>CAGE code: 98072 <span style="float: right;">2/</span></p>
<p>PRECISION METAL PRODUCTS CO. #7 CENTENNIAL DRIVE CENTENNIAL INDUSTRIAL PARK PEABODY, MA 01961-6026</p>  <p>CAGE code: 4V472 <span style="float: right;">2/</span></p>	<p>PRECISION SCREW &amp; BOLT, INC. 1491 CHARDON ROAD CLEVELAND, OH 44117-1598</p>  <p>GRADE 2    GRADE 5    GRADE 8</p> <p>CAGE code: 02BC3 <span style="float: right;">1/</span></p>
<p>PRECISION TECHNOLOGIES, INC. 1538 INDUSTRIAL AVE. OTTAWA, KS 66067</p>  <p>CAGE code: <span style="float: right;">2/</span></p>	<p>PRECISION TECHNOLOGIES, INC. 1538 INDUSTRIAL AVE. OTTAWA, KS 66067</p>  <p>CAGE code: <span style="float: right;">2/</span></p>

1/ Information published in this revision was verified by direct contact with manufacturers.

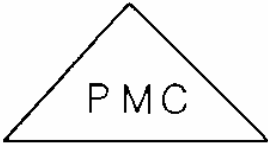
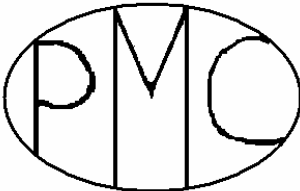
2/ Information not verified to be current, no response from manufacturer. Information identical to that published in MIL-HDBK-57, Revision B.

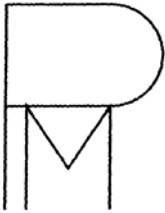



## MIL-HDBK-57D(IS)

<p>PRECISIONMATICS CO., INC. HELMER AVE. WEST WINFIELD, NY 13491</p>  <p>CAGE code: <u>2/</u></p>	<p>PRIETO MACHINE COMPANY, INC. 1785 STOUT DRIVE UNIT D WARMINSTER, PA 18974</p>  <p>CAGE code: 8Y298 <u>1/</u></p>
<p>PREM INDUSTRIES, INC. P.O. BOX 907 NIAGRA FALLS, NY 14302</p> <p>Plant 574-56<sup>th</sup> ST. NIAGRA FALLS, NY 14304</p>  <p>CAGE code: 4Y327 <u>2/</u></p>	<p>PRODUCT DEVELOPMENT GROUP, INC. P.O. BOX 177 ROSE HILLS, KS 67133</p>  <p>CAGE code: OMAR7 <u>2/</u></p>
<p>PRICE MANUFACTURING CO. 372 NORTH SMITH AVENUE CORONA, CA 91720</p>  <p>CAGE code: 1K6D8 <u>1/</u></p>	<p>PRODUCTION &amp; TOOL COMPANY 240 SARGENT DRIVE NEW HAVEN, CT 06511</p>  <p>CAGE code: 8N334 <u>2/</u></p>

1/ Information published in this revision was verified by direct contact with manufacturers.

2/ Information not verified to be current, no response from manufacturer. Information identical to that published in MIL-HDBK-57, Revision B.

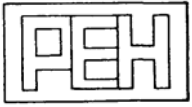





## MIL-HDBK-57D(IS)

<p>PRODUCTS DESIGN &amp; MFG. CORP. P.O. BOX 11429 NEWINGTON, CT 06111</p> <p>Plant 76 STANWELL RD. NEWINGTON, CT 06111</p> <p><b>8M938</b></p> <p>CAGE code: <span style="float: right;"><u>2/</u></span></p>	<p>PTM INTERNATIONAL INC. 8050 NW 31ST MIAMI, FL 33122</p> <p style="text-align: center;"></p> <p>CAGE code: 0S6M6 <span style="float: right;"><u>2/</u></span></p>
<p>PRO-MACHINE &amp; TOOL COMPANY 792 BLAKE BOTTOM RD. HUNTSVILLE, AL 35806</p> <p style="text-align: center;"></p> <p>CAGE code: IDS66 <span style="float: right;"><u>2/</u></span></p>	<p>PURITAS METAL PRODUCTS 7720 RACE RD NORTH RIDGEVILLE, OH 44039-3614</p> <p style="text-align: center;"><b>PMP</b></p> <p style="text-align: center;"><b>P</b></p> <p>CAGE code: 04368 <span style="float: right;"><u>1/</u></span></p>
<p>PROMPTUS ELECTRONIC HARDWARE 520 HOMESTEAD AVENUE MT. VERNON, NY 10550</p> <p style="text-align: center;"></p> <p>CAGE code: 57177 <span style="float: right;"><u>2/</u></span></p>	<p>PYE &amp; HOGAN MACHINE CO. P. O. BOX 832 167-1 ELM ST OLD SAYBROOK, CT 06475-4134</p> <p style="text-align: center;"><b>MFR06320</b></p> <p>CAGE code: 06320 <span style="float: right;"><u>1/</u></span></p>
<p>PROTO MACHINE CO., INC. P.O. BOX 1240 1295 GOLDEN TRIANGLE BLVD. KEELER, TX 76248</p> <p style="text-align: center;"></p> <p>CAGE code: 0AWM2 <span style="float: right;"><u>2/</u></span></p>	<p>QRP, INC. P.O. BOX 832 2307 MERCANTILE DR NE LELAND, NC 28451-4065</p> <p style="text-align: center;"><b>09094</b></p> <p>CAGE code: 09094 <span style="float: right;"><u>1/</u></span></p>

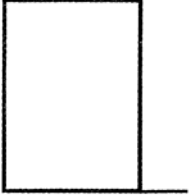
1/ Information published in this revision was verified by direct contact with manufacturers.

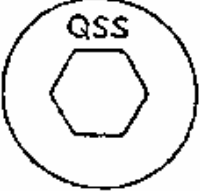
2/ Information not verified to be current, no response from manufacturer. Information identical to that published in MIL-HDBK-57, Revision B.

## MIL-HDBK-57D(IS)

<p>QSN MANUFACTURING, INC. 201 FRONTIER WAY BENSENVILLE, IL 60106</p>  <p>CAGE code: 0MDU6 <span style="float: right;"><u>2/</u></span></p>	<p>QUALITY SCREW PRODUCTS, INC. P.O. BOX 2355 35101 SCHOOLCRAFT ROAD LIVONIA, MI 48151</p>  <p>CAGE code: 4F051 <span style="float: right;"><u>2/</u></span></p>
<p>QUALITY AIRCRAFT SCREWS, INC. 1030-A ORTEGE WAY PLACENTIA, CA 92670</p>  <p>CAGE code: <span style="float: right;"><u>2/</u></span></p>	<p>QUALITY SOCKET SCREW MANUFACTURING CORP. 2790 NORTH AVE. ENGLEWOOD, IL 34224</p>  <p>Socket head cap screw head marked for I.D. QSS</p> <p>CAGE code: 5N116 <span style="float: right;"><u>1/</u></span></p>
<p>QUALITY FABRICATIONS, INC. 3270 WROLSSEN DRIVE SAUGERTIES, NY 12477</p>  <p>CAGE code: IJB77 <span style="float: right;"><u>2/</u></span></p>	<p>QUALITY THREADED PRODUCTS COMPANY 4734 HIGHWAY 157 N. JUDSONIA, ARKANSAS 72081</p>  <p>CAGE code: 0RXV6 <span style="float: right;"><u>2/</u></span></p>
<p>QUALITY MACHINE &amp; MFG INC. 1316 BLACK VALLEY ROAD LAFOLLETTE, TN 37766</p>  <p>CAGE code: 1DB71 <span style="float: right;"><u>2/</u></span></p>	

1/ Information published in this revision was verified by direct contact with manufacturers.

2/ Information not verified to be current, no response from manufacturer. Information identical to that published in MIL-HDBK-57, Revision B.

MIL-HDBK-57D(IS)

R & D FASTENERS  
 P. O. BOX 250  
 9604 7TH ST  
 RANCHO CUCAMONGA , CA 91730



CAGE code: 05BE3 2/

---

R & D WELDING & MACHINE INC.  
 1200 GEORGIA AVE.  
 WARNER ROBBINS, GA 31093

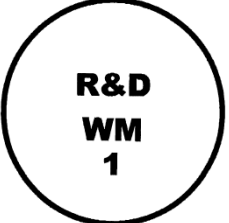

CAGE code: 1H3J7 2/

---

R & R PRECISION  
 604 S. 9TH ST.  
 GUNNISON, CO 81230



CAGE code: 0GKX6 2/

R B & W CORPORATION  
 A PARK-OHIO COMPANY  
 5190 BRADCO BLVD.  
 TORONTO, ONTARIO  
 CANADA

Plant  
 DELAWARE CORPORATION  
 8341 TYLER BLVD  
 MENTOR, OH 44060

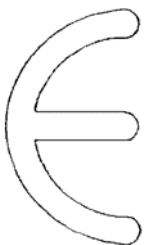

R B W or E E. E.

L S B L 9

XP exposure protected  
 ASTM A325 Type 3  
 bolts and nuts

UNA A-325 E UNA

UNA-DRIV<sup>®</sup> SYSTEM

RAI-LOCK<sup>®</sup> SYSTEM

LAMSEAL<sup>®</sup> SYSTEM

AN 310 AN 320

Castellated Slotted

RB&W Nuts  
 Not Otherwise Specified  
 (Dots at 180°)

SAE J995 Grade 5 hex nuts

SAE J995 Grade 8 hex nuts

OVALOK<sup>®</sup> TRI-OVAL<sup>®</sup> prevailing torque locknuts

Grade B Grade C

Class 9 Class 10

Stover<sup>®</sup> prevailing torque locknuts

CAGE code: 52167

Continued 2/

1/ Information published in this revision was verified by direct contact with manufacturers.

2/ Information not verified to be current, no response from manufacturer. Information identical to that published in MIL-HDBK-57, Revision B.

MIL-HDBK-57D(IS)

Continued

R B & W CORPORATION

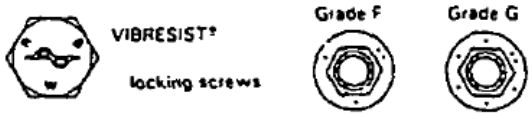

VIBRESIST<sup>®</sup> locking screws

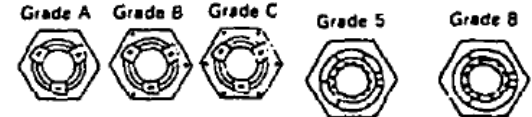

VIBRESIST<sup>®</sup> hex locknut

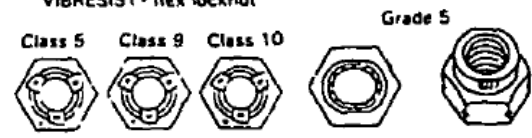

VIBRESIST<sup>®</sup> hex locknut

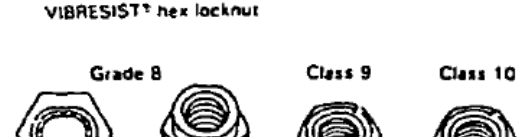
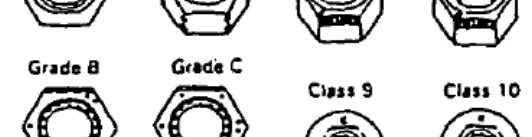
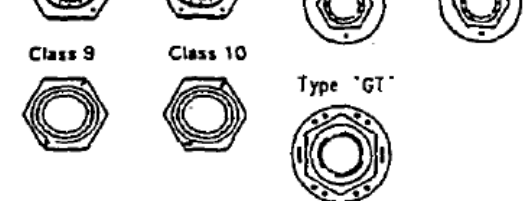
CAGE code: 52167 2/

R. BILD COMPANY, INC.  
15205 STAGG STREET  
VAN NUYS, CA 91405-1003



CAGE code: 04QM7 1/

R.E.C. CORP.  
10 BEACH ST.  
MOUNT VERNON, NY 10550



Used on all alloy and stainless steel bolts, studs, and nuts over 1/2 inch in diameter.

CAGE code: 86687 2/

RABOURDIN  
ZI R DES MARAIS  
P.O. BOX BP 157  
ST. JUST EN CHAUSSEE,  
FRANCE 60130



CAGE code: F4870 2/

RADAX INDUSTRIES, INC.  
700 BASKET ROAD  
WEBSTER, NY 14580





CAGE code: 6V794 2/

1/ Information published in this revision was verified by direct contact with manufacturers.

2/ Information not verified to be current, no response from manufacturer. Information identical to that published in MIL-HDBK-57, Revision B.

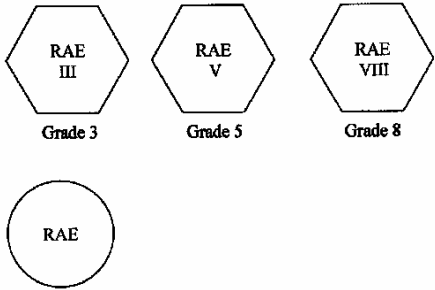

## MIL-HDBK-57D(IS)

<p>RAE MANUFACTURING CO. 1327-1331 CEDAR STREET PORT HURON, MI 48060-6167</p>  <p>Grade 3      Grade 5      Grade 8</p> <p>CAGE code: 3FDT8 <span style="float: right;"><u>1/</u></span></p>	<p>RAM PRODUCTS AFS TORRANCE OPERATIONS 3016 WEST LOMITA BLVD. TORRANCE, CA 90505-5103</p> <p>(Corporate office see ALCOA FASTENING SYSTEMS)</p> <h2 style="text-align: center;">RAM</h2> <p>CAGE code: 0CBU7</p>
<p>RAHMEDE SCHRAUBENFABRIK WEFELSHOHLER STR 44 D-5880 LUDENSCHIED GERMANY</p>  <p>CAGE code: D9901 <span style="float: right;"><u>2/</u></span></p>	<p>RAM THREADING, INC. P.O. BOX 987 BEAUMONT, TEXAS 77704</p> <p style="text-align: center;">Plant 2640 CROCKETT BEAUMONT, TX 77701</p> <h2 style="text-align: center;">R</h2> <p style="text-align: center;">Centered over grade of material being stamped</p> <p>CAGE code: 1Y826 <span style="float: right;"><u>2/</u></span></p>
<p>RAINBOW MACHINE PRODUCTS, INC. P.O. BOX 1906 226 WILLIS ROAD YORK, PA 17405</p>  <p>CAGE code: 9S535 <span style="float: right;"><u>2/</u></span></p>	<p>RAMAR NUTS, INC. 18401 WEAVER ST. DETROIT, MI 48228</p> <h2 style="text-align: center;">R</h2> <p>CAGE code: 4L633 <span style="float: right;"><u>2/</u></span></p>
<p>RAM ENTERPRISES 1382 CORONADO ST LONG BEACH, CA 90804</p> <h2 style="text-align: center;">RE</h2> <p>CAGE code: OU3C8 <span style="float: right;"><u>2/</u></span></p>	

1/ Information published in this revision was verified by direct contact with manufacturers.

2/ Information not verified to be current, no response from manufacturer. Information identical to that published in MIL-HDBK-57, Revision B.

MIL-HDBK-57D(IS)

RAMCO SPECIALTIES, INC.  
5369 HUDSON DRIVE  
HUDSON, OH 44236

CAGE code: 6U460 1/

---

RAMM DEFENSE PRODUCTS  
3161 D MAJOR ST  
FORT WORTH, TX 76112-7270

CAGE code: 0BRC1 1/

---

RATHMANN WALTER G. SEGMENT-  
KLAMMERSCHRAUBEN GMBH  
ALTE EMSER STRASSE 32  
KOBLENZ, 56077  
GERMANY

CAGE code: C6486 2/

---

RA-WHITE, INC  
967 WEST HYDE PARK BOULEVARD  
INGLEWOOD, CA 90302

CAGE code: 5Y319 2/

RB & W CORP.  
23001 EUCLID AVE.  
CLEVELAND, OH 44117

VIBRESIST<sup>®</sup> locking screws

VIBRESIST<sup>®</sup> hex locknut

VIBRESIST<sup>®</sup> hex locknut

CAGE code: 0VZJ0 2/

1/ Information published in this revision was verified by direct contact with manufacturers.

2/ Information not verified to be current, no response from manufacturer. Information identical to that published in MIL-HDBK-57, Revision B.

## MIL-HDBK-57D(IS)

<p>REED INSTRUMENT CO. 1525 BLALOCK ROAD HOUSTON, TX 77080</p>  <p>CAGE code: 3B132 <span style="float: right;">2/</span></p>	<p>(see ALCOA FASTENING SYSTEMS)</p> <p>REXNORD SPECIALITY FASTENERS DIVISION (NOW: ALCOA FASTENING SYSTEMS, TRIDAIR PRODUCTS) 3000 WEST LOMITA BLVD TORRANCE, CA 90505</p>
<p>REGAL AIR, INC. P.O. BOX 1011 108 E. ALABAMA MT. PLEASANT, TX 75455</p> <p style="text-align: center;"><b>4J976</b></p> <p>CAGE code: 4J976 <span style="float: right;">2/</span></p>	   <p>(NOW: ALCOA FASTENING SYSTEMS) CAMLOC PRODUCTS 601 ROUTE 46 WEST HASBROUCK HEIGHTS, NJ 07604</p>
<p>REID PRODUCT INC. 21430 WAALEW RD APPLE VALLEY, CA 92307</p> <p style="text-align: center;"><b>Rp 9R R9</b></p> <p>CAGE code: 59563 <span style="float: right;">1/</span></p>	  <p>(NOW: ALCOA FASTENING SYSTEMS) ROSAN PRODUCTS 3130 W. HARVARD ST. SANTA ANA, CA 92704</p>
<p>RELIANT FASTENER 201 E. 2ND STREET ROCK FALLS, IL 61071</p>  <p>CAGE code: <span style="float: right;">2/</span></p>	<p style="text-align: center;"><b>RI</b></p> <p>CAGE code: 76017 <span style="float: right;">2/</span></p>
<p>REPUBLIC FASTENER MANUFACTURING CORP. 1300 RANCHO CONEJO BOULEVARD NEWBURY PARK, CA 91320-1405</p> <p style="text-align: center;"><b>R</b></p> <p>CAGE code: 52828, 71087 <span style="float: right;">1/</span></p>	<p>RICHARD MFG. CO., INC. 250 ROCK LANE MILFORD, CT 06460-3853</p>  <p>CAGE code: 4A014 <span style="float: right;">1/</span></p>

1/ Information published in this revision was verified by direct contact with manufacturers.

2/ Information not verified to be current, no response from manufacturer. Information identical to that published in MIL-HDBK-57, Revision B.

MIL-HDBK-57D(IS)

RING SCREW WORKS  
10160 GAINEY RD  
HOLLY, MI 48442 - 9331

FENTON HEADING  
2480 OWEN RD.  
FENTON, MI 48430-1769  
CAGE code: 7M992

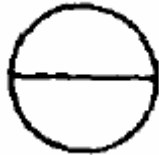

FERNDALE FASTENER  
31600 STEPHENSON HIGHWAY  
MADISON HEIGHTS, MI 48071



RING SCREW DEVISION  
22100 SHERWOOD AVE.  
WARREN, MI 48091



SEMCO FASTENER  
4146 EAST BALDWIN RD.  
HOLLY, MI 48442



TITAN FASTENER  
10031 HOLLY RD.  
HOLLY, MI 48442



CAGE code: 0B2C8

2/

RIPPA PRODUCTS  
P.O. BOX 328  
5 MILE POINT RD  
MOHAWK, MI 49950

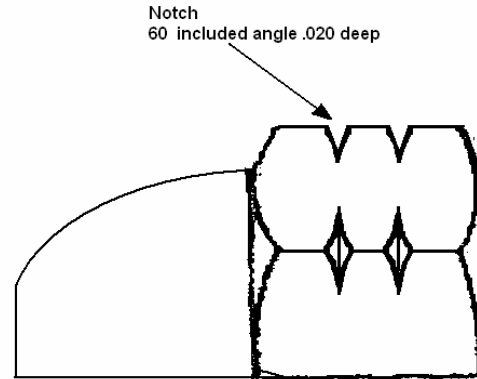

CAGE code: 0R7Z5

2/

RISCO, INCORPORATED  
390 RISCO CIRCLE  
BEAUMONT, CA 92223-2676

**01DC**

CAGE code: 6W027

2/

RIVER VALLEY TOOL & MANUFACTURING  
P. O. BOX 64  
260 AIRPORT INDUSTRIAL ROAD  
PARIS, AR 72855

**RVT**

CAGE code: 3K1M6

1/

1/ Information published in this revision was verified by direct contact with manufacturers.

2/ Information not verified to be current, no response from manufacturer. Information identical to that published in MIL-HDBK-57, Revision B.

MIL-HDBK-57D(IS)

RIVNUT ENGINEERED PRODUCTS, INC.  
2705 MARION DRIVE  
KENDALLVILLE, IN 46755

**REP**

CAGE code: 0VK23 2/

---

RMS  
1125 W ACACIA AVE  
HEMET, CA 92543

**R M S**

CAGE code: 2/

---

ROBBINS MANUFACTURING  
P.O. BOX 704  
1200 AIRPORT ROAD  
FALL RIVER, MA 02722





CAGE code: 8T312 1/

ROBERT HENRY CO., INC.  
87 OPAL STREET  
MILFORD, CT 06460



CAGE code: 9J112 2/

---

ROCKFORD BOLT & STEEL CO.  
(SUBSIDIARY OF VARLEN CORPORATION)  
126 MILL ST  
ROCKFORD, IL 61101-1491



CAGE code: 90483 1/

---

ROCKFORD FASTENERS INC.  
P.O. BOX 884  
ROCKFORD, IL 61105

Plant  
725 SOUTH STREET  
ROCKFORD, IL 61102



CAGE code: 0B998 2/

1/ Information published in this revision was verified by direct contact with manufacturers.

2/ Information not verified to be current, no response from manufacturer. Information identical to that published in MIL-HDBK-57, Revision B.

MIL-HDBK-57D(IS)

ROCKFORD PRODUCTS CORP.  
707 HARRISON AVE  
ROCKFORD, IL 61108

CAGE code: 77595 2/

ROGG MANUFACTURING COMPANY  
600 DANBURY ROAD  
NEW MILFORD, CT 06776

CAGE code: 08625 2/

---

ROMAC ELECTRONICS, INC.  
155 E. AMES CT.  
PLAINVIEW, NY 11803

# 8T968

CAGE code: 8T968 2/

---

RONSON MANUFACTURING, INC.  
9933 CHILLICOCTHE ROAD  
KIRKLAND, OH 44094

# R

CAGE code: 2X146 1/

---

ROSAN PRODUCTS  
AFS TORRANCE OPERATIONS  
3018 WEST LOMITA BLVD.  
TORRANCE, CA 90505-5103

(Corporate office see ALCOA FASTENING SYSTEMS)

# RI

CAGE code: 83324 1/

1/ Information published in this revision was verified by direct contact with manufacturers.

2/ Information not verified to be current, no response from manufacturer. Information identical to that published in MIL-HDBK-57, Revision B.

MIL-HDBK-57D(IS)

ROTAIR INDUSTRIES, INC.  
 P.O. BOX 4098  
 964 CRESCENT AVE  
 BRIDGEPORT, CT 06607-1025

 Rubber stamped  
 on fasteners

**54878**

Commercial and Government Entity  
 (CAGE) number affixed or rubber

CAGE code: 54878 1/

---

RS MANUFACTURING, INC.  
 INDUSTRIAL PARK BLVD.  
 MENTOR, OH 44060

**RS** 

CAGE code: 0MYK3 2/

---

RUDOLPH INSTRUMENTS, INC.  
 400 MORRIS AVE STE 120  
 DENVER, NJ 07834-1362

**RI**

CAGE code: 23262 2/

RUMCO, INC.  
 985 PAULY DR.  
 ELK GROVE VILLAGE, IL 60007-1312

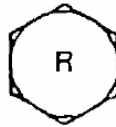
 GRADE 2

 GRADE 5

 GRADE 5.1

 GRADE 5.2

 GRADE 8

CAGE code: 6Z992 2/

---

RUSCOMB TOOL & MACHNE CO., INC.  
 500 W. RUSCOMB STREET  
 PHILADELPHIA, PA 19120

  
**RTM**

CAGE code: 07952 2/

---

S & L METAL PRODUCTS CORP.  
 5829 57TH DR  
 MASPETH, NY 11378-2232

**S&L**

CAGE code: 05722 2/

1/ Information published in this revision was verified by direct contact with manufacturers.

2/ Information not verified to be current, no response from manufacturer. Information identical to that published in MIL-HDBK-57, Revision B.

MIL-HDBK-57D(IS)

<p>S. B. E. (ITALY CORPORATION) VIA ENRICO DERMI 20019 SETTIMO MILANESE, ITALY</p> <p style="text-align: center;"><b>SBE</b></p> <p>CAGE code: <span style="float: right;">2/</span></p>
<p>S.A.B.A. S.p.A. BULLONERIA E. AFFINI VIA LIGURIA 11/13, 20098 SESTO ULERIANO FRAZ. DI S. GUILLANO M.SE MILANO, ITALY</p> <p style="text-align: center;"><b>A.L.</b></p> <p>CAGE code: <span style="float: right;">2/</span></p>
<p>S.I. STUD, INC. 1127 SILBER RD. HOUSTON, TX 77055</p> <p style="text-align: center;"></p> <p>CAGE code: <span style="float: right;">2/</span></p>
<p>SABRE MANUFACTURING, INC. P.O. BOX 11386 201 S. CHERRY ST. SOUTH BEND, IN 46601</p> <p style="text-align: center;"><b>S</b></p> <p>CAGE code: 0GN74 <span style="float: right;">2/</span></p>

SAFETY SOCKET SCREW CORP.  
(ENGINEERING DEPARTMENT)  
6501 NORTH AVONDALE AVE.  
CHICAGO, IL 60631

INCH SOCKET HEAD CAP SCREWS

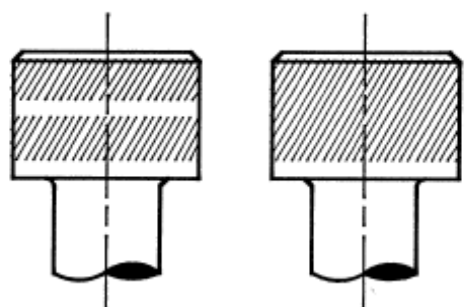

BUTTON HEAD CAP SCREWS      FLAT HEAD CAP SCREWS AND SOCKET HEAD SHOULDER SCREWS

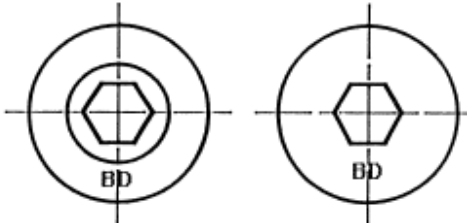

METRIC SOCKET HEAD CAP SCREWS

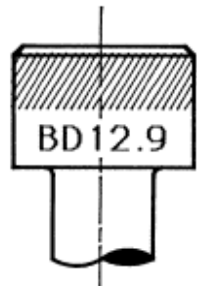

\*BD\* AND THE 60° DIAGONAL KNURL ARE REGISTERED TRADEMARKS OF SAFETY SOCKET SCREW CORPORATION FOR THE PURPOSE OF MANUFACTURERS IDENTIFICATION

BD      BDM









CAGE code: 82896 2/

1/ Information published in this revision was verified by direct contact with manufacturers.

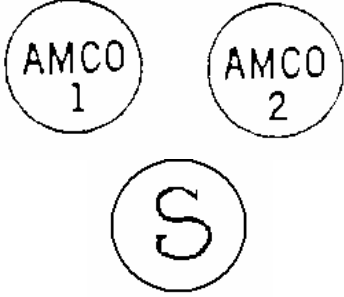
2/ Information not verified to be current, no response from manufacturer. Information identical to that published in MIL-HDBK-57, Revision B.



## MIL-HDBK-57D(IS)

<p>SAGA TEKKOSHO CO., LTD. 129-3 TAKAYA FUJISAWA-CITY KANAGAWA PREF., JAPAN</p>  <p>CAGE code: <span style="float: right;"><u>2/</u></span></p>	<p>SANDIK MANUFACTURING, INC. 100 8TH STREET PASSAIC, NJ 07055</p>  <p>CAGE code: 6U704 <span style="float: right;"><u>2/</u></span></p>
<p>SAI INDUSTRIES CORP. 1207 FULTON AVENUE SAN ANTONIO, TX 78201-4501</p>  <p>CAGE code: 1KQ10, 63095 <span style="float: right;"><u>2/</u></span></p>	<p>SANNOHASHI SEISAKUSHO CO., LTD. 2-1-18 OKINO ADACHI-KU TOKYO 123 JAPAN</p>  <p>CAGE code: <span style="float: right;"><u>2/</u></span></p>
<p>SALES SYSTEM, LIMITED P.O. BOX 7006 700 FLORIDA AVE. PORTSMOUTH, VA 23707-1918</p>  <p>CAGE code: 8F411 <span style="float: right;"><u>1/</u></span></p>	<p>SANTA ANA GEAR &amp; MACHINE 15201 PIPELINE LN. HUNTINGTON BEACH, CA 92649</p>  <p>CAGE code: <span style="float: right;"><u>2/</u></span></p>
<p>SAMUEL MARSDEN &amp; SON WELLINGTON RD. ASHTON UNDER LYNE, LANCASHIRE OL6 7EG UNITED KINGDOM</p>  <p>CAGE code: <span style="float: right;"><u>2/</u></span></p>	<p>SANTA ANA SCREW PRODUCTS INC. SANTA ANA, CA 92701</p>  <p>CAGE code: 33644 <span style="float: right;"><u>2/</u></span></p>

1/ Information published in this revision was verified by direct contact with manufacturers.

2/ Information not verified to be current, no response from manufacturer. Information identical to that published in MIL-HDBK-57, Revision B.



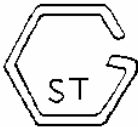
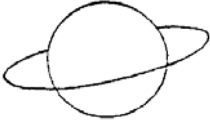
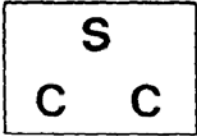
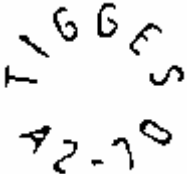



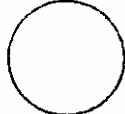

## MIL-HDBK-57D(IS)

<p>SATAIR MANUFACTURING FACILITY PURDEYS WAY PURDEYS INDUSTRIAL ESTATE ROCHFORD ESSEX SS5 4JJ UK</p> <p style="text-align: center;"><b>SMF</b></p> <p>CAGE code: K4975 <span style="float: right;">1/</span></p>	<p>SCHRAUBENFABRIK GUSTAV STERNBERG GmbH &amp; CO. KG 1000 BERLIN 27 BREITENBACHSTRASSE 11-12 GERMANY</p> <p style="text-align: center;"></p> <p style="text-align: center;">Symbol may be raised or struck in.</p> <p>CAGE code: <span style="float: right;">2/</span></p>
<p>SATURN FASTENERS, INC. 425 SO. VARNEY ST. BURBANK, CA 91502-2125</p> <p style="text-align: center;"></p> <p>CAGE code: 0K6Z0 <span style="float: right;">1/</span></p>	<p>SCHUHL &amp; CO. GMBH AUF DER HUTTE 31 WINTERBURG 59955 GERMANY</p> <p style="text-align: center;"><b>S</b></p> <p>CAGE code: C3639 <span style="float: right;">2/</span></p>
<p>SCANDIA MFG. CO., INC. 480 BRUNSWICK ST. BALTIMORE, MD 21223-2745</p> <p style="text-align: center;"><b>SCA</b></p> <p>CAGE code: 00997 <span style="float: right;">1/</span></p>	<p>SCOTT CRAFT CO. P.O. BOX 430 BELL, CA 90201</p> <p style="text-align: center;">Plant 4601 CECELIA STREET CUDAHY, CA 90201</p> <p style="text-align: center;"></p> <p>CAGE code: 28418 <span style="float: right;">2/</span></p>
<p>SCHMICO GMBH SCHWEISSTECHNIK P. O. BOX 12 29 PETER-LINNARTZ-STRASSE JUELICH 52428, GERMANY</p> <p style="text-align: center;"></p> <p>CAGE code: C15191 <span style="float: right;">2/</span></p>	

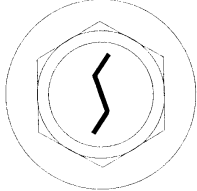
1/ Information published in this revision was verified by direct contact with manufacturers.

2/ Information not verified to be current, no response from manufacturer. Information identical to that published in MIL-HDBK-57, Revision B.



## MIL-HDBK-57D(IS)

<p>SCREWCORP. ( A DIVISION OF VSI) 13001 EAST TEMPLE AVE. CITY OF INDUSTRY, CA 91714</p>  <p>Indented circle on all fasteners, except machine screws.</p> <p>CAGE code: 9H901 <span style="float: right;">2/</span></p>	<p>SESCO INDUSTRIES, INC. P. O. BOX 242 110 - 19 15TH AVENUE COLLEGE POINT, NY 11356</p>  <p>CAGE code: 0KH97 <span style="float: right;">1/</span></p>
<p>SEMBLEX CORP. 199 W. DIVERSEY AVE ELMHURST, IL 60126</p>  <p>CAGE code: 4M343 <span style="float: right;">1/</span></p>	<p>SHACKELFORD MACHINIG, INC. 2407 LUDELLE ST. FORT WORTH, TX 76105-0755</p>  <p>CAGE code: 4K446 <span style="float: right;">1/</span></p>
<p>SEMCO FASTENER 4146 EAST BALDWIN RD. HOLLY, MI 48442</p> <p>See RING SCREW WORKS</p>  <p>CAGE code: 0B2C8 <span style="float: right;">1/</span></p>	<p>SHAMROCK FASTENER TECHNOLOGIES, LLC. 6125 18 MILE ROAD STERLING HEIGHTS, MI 48314</p> <p>SHAMROCK IN CIRCLE</p>  <p>SFT LDGO</p>  <p>CAGE code: 05CF6 <span style="float: right;">2/</span></p>
<p>SENG HENG ENGINEERING PTE LTD. NO. 3 EUNOS AVE. 8A SINGAPORE 409458 REPUBLIC OF SINGAPORE</p>  <p>CAGE code: <span style="float: right;">1/</span></p>	

1/ Information published in this revision was verified by direct contact with manufacturers.

2/ Information not verified to be current, no response from manufacturer. Information identical to that published in MIL-HDBK-57, Revision B.

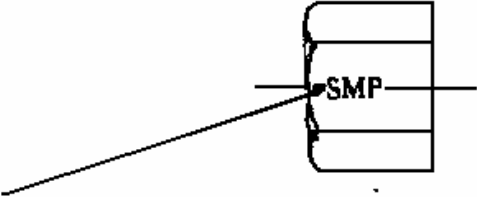

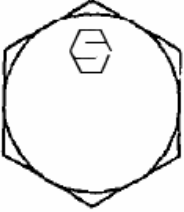
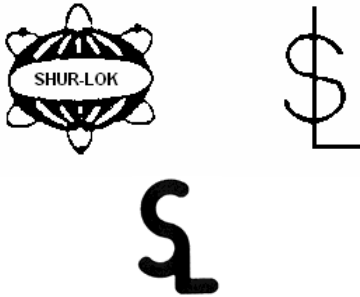



## MIL-HDBK-57D(IS)

<p>SHAW PRECISION GRINDING &amp; THREADING 6503 W. FRYE RD. SUITE 6 CHANDLER, AZ 85226</p> <p>SALES ADDRESS SEE: ACE GRINDING &amp; MFG. OF TEXAS 2610 AERO DR. GRAND PRAIRIE, TX 75052 CAGE code: 5U074</p> <p><b>SPG</b></p> <p>CAGE code: 1KRG8 <u>1/</u></p>	<p>SHORELINE MACHINE PRODUCTS, INC. 19301 ST. CLAIR AVENUE CLEVELAND, OH 44117</p>  <p>SMP will be applied to this surface to denote Shoreline Machine Products as manufacturer.</p> <p>CAGE code: 1VN42 <u>1/</u></p>
<p>SHEFFIELD, INC. 1025 WINCHESTER AVE. KANSAS CITY, MO 64126</p> <p><b>S</b></p> <p>CAGE code: 68567 <u>2/</u></p>	<p>SHUR-KUT SUPPLY CORPORATION P.O. BOX 119 241 WOOLDAND AVENUE MORTON, PA 19070</p>  <p>CAGE code: 6R002 <u>2/</u></p>
<p>SHIGA BOLT CO., LTD. OTSU 423 MINAMI-TSUCHIYAMA TSUCHIYAMA-CHO, KOHGA-GUN SHIGA- KEN 528-02 JAPAN</p>  <p>CAGE code: <u>2/</u></p>	<p>SHUR-LOK COMAPNY. (SPS FASTENERS DIVISION , A PCC COMPANY) 2541 WHITE ROAD IRVINE, CA 92614 - 6235</p>  <p>CAGE code: 97393 <u>1/</u></p>

1/ Information published in this revision was verified by direct contact with manufacturers.

2/ Information not verified to be current, no response from manufacturer. Information identical to that published in MIL-HDBK-57, Revision B.

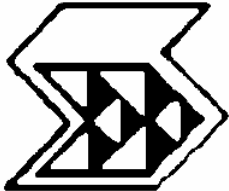
## MIL-HDBK-57D(IS)

<p>SIERRA PACIFIC SUPPLY CO., INC. P. O. BOX 4848 COMPTON, CA 90224</p> <p>Plant: 1801 W EL SEGUNDO BLVD COMPTON, CA 90224</p>  <p>CAGE code: 5G098 <span style="float: right;">1/</span></p>	<p>SINN-TECH, INC. 48 GLEAM STREET WEST BABYLON, NY 11704</p>  <p>CAGE code: 9J550 <span style="float: right;">1/</span></p>
<p>SIERRACIN/HARRISON 3020 EMPIRE AVENUE BURBANK, CA 91504</p>  <p>CAGE code: 08199 <span style="float: right;">2/</span></p>	<p>SKY MANUFACTURING 5989 RICCKENBACKER ROAD COMMERCE, CA 90040</p>  <p>CAGE code: 1CNU4 <span style="float: right;">1/</span></p>
<p>SIMMONDS PRODUCTS AFS ST. COSME OPERATIONS 9 RUE DES CRESSONNIERES 72110 ST. COSME-EN-VAIRAIS FRANCE</p> <p>(Corporate office see ALCOA FASTENING SYSTEMS)</p>  <p>CAGE code: F0224 <span style="float: right;">1/</span></p>	<p>SKYLINE INDUSTRIES 1201 FORUM WAY SOUTH FORT WORTH, TX 76140</p>  <p>CAGE code: 09986 <span style="float: right;">2/</span></p> <p>SKYSPARES PARTS, INC. 6660 VIEW PARK COURT RIVERSIDE, CA 92503</p>  <p>CAGE code: 6M132 <span style="float: right;">2/</span></p>

1/ Information published in this revision was verified by direct contact with manufacturers.

2/ Information not verified to be current, no response from manufacturer. Information identical to that published in MIL-HDBK-57, Revision B.





## MIL-HDBK-57D(IS)

<p>SLABE MACHINE PRODUCTS 4659 HAMANN PARKWAY WILLOUGHBY, OH 44094</p>  <p>CAGE code: 97139 <span style="float: right;">1/</span></p>	<p>SONFARREL, INC. 3000-3010 LA JOLLA ST. ANAHEIM, CA 92806</p>  <p>CAGE code: 09036 <span style="float: right;">2/</span></p>
<p>SMITH MACHINE &amp; MANUFACTURING RT. 4 P.O. BOX 283 CANTON, TX 75103</p>  <p>CAGE code: 0MAJO <span style="float: right;">2/</span></p>	<p>SONIC INDUSTRIES, INC. 20030 SO. NORMANDIE AVE. TORRANCE, CA 90502</p>  <p>CAGE code: 57928 <span style="float: right;">1/</span></p>
<p>SMITH WELDING, INC. 756 PRUNNER ROAD RIDDLE, OR 97469</p>  <p>CAGE code: 1GQX1 <span style="float: right;">1/</span></p>	<p>SOUTH BAY BOLT MANUFACTURING CO. P.O. BOX 5805 COMPTON, CA 90224</p> <p>Plant 1775 W. El Segundo Blvd. Compton, CA 90222</p>  <p>CAGE code: 2P339 <span style="float: right;">2/</span></p>

1/ Information published in this revision was verified by direct contact with manufacturers.

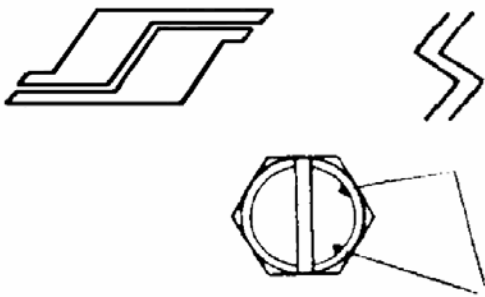
2/ Information not verified to be current, no response from manufacturer. Information identical to that published in MIL-HDBK-57, Revision B.



## MIL-HDBK-57D(IS)

<p>SOUTHERN FASTENER CORPORATION P. O. BOX 1387 1641 CONCEPTION STREET ROAD MOBILE, AL 36610</p> <p style="text-align: center;"><b>SF</b></p> <p>CAGE code: 1K461 <span style="float: right;"><u>1/</u></span></p>	<p>SOUTHWEST INDUSTRIAL SERVICES P. O. BOX 9084 FT. WORTH, TX 76147</p> <p style="text-align: center;">Plant 2413 WHITMORE FT. WORTH, TX 76147</p> <p style="text-align: center; font-size: 2em;">SI</p> <p>CAGE code: 6H920 <span style="float: right;"><u>2/</u></span></p>
<p>SOUTHERN FASTENING SYSTEMS (DIVISION OF FARLEY METALS, INC.) P.O. BOX 1360 STATESVILLE, NC 28677</p>  <p style="text-align: center;"><i>2 notches for slotted heads only</i></p> <p>CAGE code: 87308 <span style="float: right;"><u>2/</u></span></p>	<p>SOUTHWIND INDUSTRIES, INC. P.O. BOX 98 1646 OILD BUTLER PLANK RD. PITTSBURGH, PA 15200</p>  <p>CAGE code: 0DTJ0 <span style="float: right;"><u>2/</u></span></p> <p>SPACE AGE ENGINEERING, INC. 4022 E. 26TH STREET INDIANAPOLIS, IN 46218</p>  <p>CAGE code: 29953 <span style="float: right;"><u>2/</u></span></p>
<p>SOUTHWEST ALLIED PRODUCTS CO., INC. 299 HILL RD. VANLEER, TN 37181</p>  <p>CAGE code: 6P461 <span style="float: right;"><u>2/</u></span></p>	<p>SPACE SCREW, INC. 106 STANDARD ST. EL SEGUNDO, CA 90245</p> <p style="text-align: center; font-size: 2em;">SpSc</p> <p>CAGE code: 0GE51 <span style="float: right;"><u>2/</u></span></p>

1/ Information published in this revision was verified by direct contact with manufacturers.

2/ Information not verified to be current, no response from manufacturer. Information identical to that published in MIL-HDBK-57, Revision B.

## MIL-HDBK-57D(IS)

<p>SPACE-LOK, INC. 13306 HALLDALE AVE. GARDENA, CA 90249</p> <p style="text-align: center;"><b>SLI</b></p> <p>CAGE code: 16258 <span style="float: right;"><u>1/</u></span></p>	<p>SPECIAL-T-METALS P.O. BOX 14810 LENEXA, KS 66215</p> <p style="text-align: center;">Plant 14740 WEST 101 TERRACE LENEXA, KS 66215</p> <p style="text-align: center;"><b>STM</b></p> <p>CAGE code: 8U495 <span style="float: right;"><u>2/</u></span></p>
<p>SPARTAN PRECISION MACHINE 131 ALBANY AVE FREEPORT, NY 11520</p> <p style="text-align: center;"></p> <p>CAGE code: 2M198 <span style="float: right;"><u>2/</u></span></p>	<p>SPECIALTY SCREW CORP. P.O. BOX 5003 ROCKFORD, IL 61125</p> <p style="text-align: center;">Plant 2801 HUFFMAN BLVD. ROCKFORD, IL 61103</p> <p style="text-align: center;"><b>S</b></p> <p>CAGE code: 1WQE5 <span style="float: right;"><u>2/</u></span></p>
<p>SPECIALS, INC. P.O. BOX 514 103 MAINLINE DRIVE WESTFIELD, MA 01086-0514</p> <p style="text-align: center;"></p> <p>CAGE code: 0WVC1 <span style="float: right;"><u>1/</u></span></p>	<p>SPIRAL TOOL CORP. 761 ROUTE 6 SHOHOLA, PA 18458</p> <p style="text-align: center;"></p> <p>CAGE code: 02108 <span style="float: right;"><u>1/</u></span></p>

1/ Information published in this revision was verified by direct contact with manufacturers.2/ Information not verified to be current, no response from manufacturer. Information identical to that published in MIL-HDBK-57, Revision B.



## MIL-HDBK-57D(IS)

SPS TECHNOLOGIES  
FASTENER DIVISION CORPORATE  
HEADQUARTERS  
JENKINTOWN, PA 19046-2630

## SPS AREOSPACE FASTENER COPANIES

SPS TECHNOLOGIES (Cage 56878)  
301 HIGHLAND AVENUE  
JENKINTOWN, PA 19046-2630

*The following characters (used alone or in combination with other digits/ letters which designate material, size, strength grade or part number) indicate SPS as manufacturing source:*

C	K	U
CCS	K-5673	U130
EWB	KS	UNBRAKO
EWN	S	UNW
FNF	SPS	56878
HI PSI	TJB	71838
HI TI	TM9	80539

For "inch" socket head cap screws



*Straight knurls with an unknurled band adjacent to the bearing surface on socket heads. The diameter over the straight knurl does not exceed the band. There may be 2 or 3 grooves near the band or a diamond knurl band at top of head.*



*A raised or depressed triangle pointing from the wrenching flat toward thread on nut products.*



**S-C** used on metal nuts

SPS TECHNOLOGIES (Cage 80539)  
SANTA ANA DIVISION  
271 SO. HARBOR BLVD.  
SANTA ANA, CA 92704-1259

**SPS SPS S S**

CAGE code: 56878, 80539,  
Continued

1/

Continued

SPS TECHNOLOGIES (Cage K5673)  
T. J. BROOKS DIVISION  
191, BARKBY ROAD'  
TROON INDUSTRIAL AREA  
LEICESTER LE4 9HX  
ENGLAND

**TJB**

## SPS ENGINEERED PRODUCTS GROUP

SPS TECHNOLOGIES (Cage 1C5D9)  
NORTH AMERICAN FASTENERS  
(AFG DIV)  
4444 LEE ROAD  
CLEVELAND, OH 44128-2902



**UNB**

SPS TECHNOLOGIES (Cage 495T1)  
NORTH AMERICAN FASTENERS  
DBA TERRY MACHINE  
5331 DIXIE HWY  
WATERFORD, MI 48329



SPS TECHNOLOGIES (Cage U3575)  
P O BOX 38  
BURNABY ROAD  
COVENTRY CV 6 AE, ENGLAND

SPS INTERNATIONAL LTD. (Cage S3329)  
UNBRAKO SHANNON  
BAYS 25-30 SHANNON INDUSTRIAL  
ESTATE,  
SHANNON, COUNTRY CLARE,  
IRELAND

METALAC SPS INDUSTRIA E COMERCIO  
LTDA.  
AVENIDA ITAVUVU, 4690  
18078-005 SOROCABA (SP),  
BRAZIL

**TELLEP TLP T**



UNBRAKO PTY LTD. AUSTRALIA  
P.O. BOX 3138 NUNAWADING  
VICTORIA 3131, AUSTRALIA

**U UM**



CAGE code: K5673, IC5D9, 495T1, U3575,  
S3329

1/

<sup>1/</sup> Information published in this revision was verified by direct contact with manufacturers.

<sup>2/</sup> Information not verified to be current, no response from manufacturer. Information identical to that published in MIL-HDBK-57, Revision B.

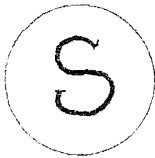
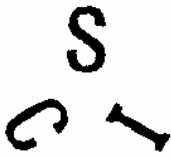





## MIL-HDBK-57D(IS)

<p>SPS TECHNOLOGIES LIMITED T/A UNBRACO UK CRANFORD STREET SMETHWICK B66 2TA UNITED KINGDOM</p> <p style="text-align: center;"><b>TBJ</b></p> <p>CAGE code: U3575</p> <p>SPS TECHNOLOGIES LIMITED TJ BROOKS DIVISION (UNITED KINGDOM CORPORATION) 191 BARKBY ROAD TROON INDUSTRIAL AREA LEICESTER LE4 9HX UNITED KINGDOM</p> <p style="text-align: center;"><b>TBJ</b></p> <p>CAGE code: K5673 <span style="float: right;"><u>2/</u></span></p>	<p>SRI SAI INDUSTRIES CORPORATION 1207 FULTON AVENUE SAN ANTONIO, TX 78201-5104</p> <p style="text-align: center;"></p> <p>CAGE code: 63095 <span style="float: right;"><u>1/</u></span></p>
<p>SPURWAY COOKE INDUSTRIES PTE LTD. 2, JOO KOON ROAD JURONG SINGAPORE 628966 REPUBLIC OF SINGAPORE</p> <p style="text-align: center;"></p> <p>CAGE code: <span style="float: right;"><u>1/</u></span></p>	<p>ST. LOUIS SCREW &amp; BOLT CO. 6900 NORTH BROADWAY ST. LOUIS, MO 63147</p> <p style="text-align: center;"> TYPE I</p> <p style="text-align: center;"> TYPE III</p> <p>CAGE code: <span style="float: right;"><u>2/</u></span></p>
	<p>STALKER &amp; DYSTHE, INC. 5100 E. WASHINGTON BLVD. LOS ANGELES, CA 90040</p> <p style="text-align: center;"><b>SD</b></p> <p>CAGE code: 6D696 <span style="float: right;"><u>2/</u></span></p>

1/ Information published in this revision was verified by direct contact with manufacturers.

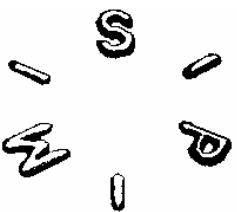
2/ Information not verified to be current, no response from manufacturer. Information identical to that published in MIL-HDBK-57, Revision B.

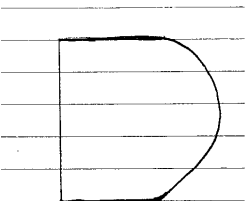
## MIL-HDBK-57D(IS)

<p>STANDARD LOCKNUT, INC. P. O. BOX 780 1045 EAST 169TH STREET WESTFIELD, INDIANA 46074</p>  <p>CAGE code: 78507 <u>2/</u></p>	<p>STEEL CITY BOLT &amp; SCREW, INC. P.O. BOX 1747 BIRMINGHAM, AL 35201</p> <p>Plant 230 WEST VALLEY AVE. BIRMINGHAM, AL 35209</p>  <p>CAGE code: 3N642 <u>2/</u></p>
<p>STANDARD NUT &amp; BOLT, INC. 49 ABBOTT ST. CUMBERLAND, RI 02864</p>  <p>CAGE code: 758C9 <u>2/</u></p>	<p>STEEL PRODUCTS OF MASSILLION 132 WALNUT RD S.W. MASSILLION, OH 44646</p>  <p>CAGE code: 0698X <u>2/</u></p>
<p>STANDARD TOOL &amp; MACHINE CO. 205 E. CARSON ST. PITTSBURGH, PA 15219</p> <p>Plant 208 WOODLAND RD. BIAWNOX, PA 15238</p> <p>See HALL INDUSTRIES</p>  <p>CAGE code: 0KA69 <u>2/</u></p>	<p>STEEL WAREHOUSE COMPANY, INC. 2722 WEST TUCKER DRIVE BOX 1377 SOUTH BEND, IN 46624</p>  <p>CAGE code: 0R1J8 <u>2/</u></p>
<p>STEADFAST CORPORATION 229 MARGINAL ST. CHELSEA, MA 02150</p>  <p>CAGE code: 9X854 <u>2/</u></p>	

1/ Information published in this revision was verified by direct contact with manufacturers.

2/ Information not verified to be current, no response from manufacturer. Information identical to that published in MIL-HDBK-57, Revision B.

MIL-HDBK-57D(IS)

STELCO FASTENER & FORGING CO.  
 1250 APPLEBY LINE  
 BULINGTON, ONTARIO L71 5G6  
 CANADA



Stelco trademark for most fasteners



Most other nuts and bolts, including metric



SAE Grade 5 hex nuts



SAE Grade 8 hex nuts

**CONELOK LOCKNUTS**  
 Inch series



Grade B



Grade C

Metric series



Class 5



Class 9



Class 10

Bearing surface

CAGE code: \_\_\_\_\_

Continued 2/

Continued

STELCO FASTENER & FORGING CO.  
 1250 APPLEBY LINE  
 BULINGTON, ONTARIO L71 5G6  
 CANADA

**HI-HEX CONELOK LOCKNUTS**  
 Inch series



Grade B



Grade C

Metric series



Class 5

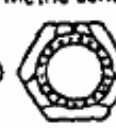

Class 9



Class 10

Bearing surface

CAGE code: \_\_\_\_\_ 2/

STELFAST FASTENERS, INC.  
 (DIVISION OF STELFAST FASTENERS, LTD.)  
 1710 CLARKSTONE ROAD  
 CLEVELAND, OH 44112



1/4 in. through 3/4 in. hex cap screws, heavy hex bolts, square head bolts, and specialty externally threaded fasteners, cold headed.



3/4 in. through 2 1/4 in reg. hex bolts, heavy hex bolts, square head bolts, and specialty externally threaded fasteners, hot headed.

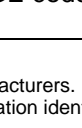

1/4 in. through 2 1/2 in studs.  
 2 3/8 in. through 3 in. reg. hex bolts, heavy hex bolts, square head bolts, hot headed, and specialty externally threaded fasteners.

CAGE code: \_\_\_\_\_ 2/

1/ Information published in this revision was verified by direct contact with manufacturers.

2/ Information not verified to be current, no response from manufacturer. Information identical to that published in MIL-HDBK-57, Revision B.





## MIL-HDBK-57D(IS)

<p>STERLING MACHINE COMPANY 23 FARRAR STREET LYNN, MA 01901-1699</p> <p style="text-align: center;">2</p> <p style="text-align: center;"></p> <p>CAGE code: 03983 <span style="float: right;"><u>1/</u></span></p>	<p>STEVENS MFG. CO., INC. P.O. BOX 3041 MILFORD, CT 06460</p> <p style="text-align: center;">Plant 280 ROCK LANE MILFORD, CT 06460</p> <p style="text-align: center;">MFR 8F781</p> <p style="text-align: center;">8F781</p> <p>CAGE code: 8F781 <span style="float: right;"><u>2/</u></span></p>
<p>STERLING MARKING PRODUCTS IC P.O. BOX 3360 STA A 349 RIDOUT ST N LONDON, ONTARIO, CANADA NGA 4K3</p> <p style="text-align: center;"></p> <p style="text-align: center;"></p> <p>CAGE code: 37084 <span style="float: right;"><u>2/</u></span></p>	<p>STILLWATER FASTENERS, INC. 25 GURNEY ROAD EAST FREETOWN, MA 02717-1107</p> <p style="text-align: center;"><b>SW &amp; ..</b></p> <p style="text-align: center;">Symbols are "SW", ampersand ("&amp;") or ".."</p> <p>CAGE code: 1Y153 <span style="float: right;"><u>1/</u></span></p>
<p>STERLING MFG. &amp; SUPPLY, INC. P.O. BOX 8205 FORT WORTH, TEXAS 76124</p> <p style="text-align: center;">Plant 3623 E. VICKERY BLVD. FORT WORTH, TX 76105</p> <p style="text-align: center;"> or 60529</p> <p style="text-align: center;">Steel stamped or Embossed or Rubber stamped</p> <p>CAGE code: 60529 <span style="float: right;"><u>2/</u></span></p>	<p>STRENKERT MACHINE SHOP INC. RD #2, BOX 759 INDIAN BROOK ROAD GREENE, NY 13778</p> <p style="text-align: center;"></p> <p>CAGE code: 2T174 <span style="float: right;"><u>2/</u></span></p>

1/ Information published in this revision was verified by direct contact with manufacturers.

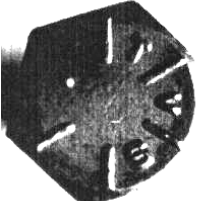
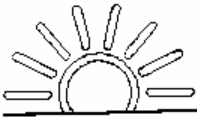
2/ Information not verified to be current, no response from manufacturer. Information identical to that published in MIL-HDBK-57, Revision B.

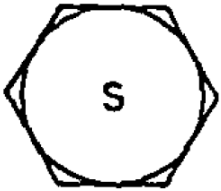

## MIL-HDBK-57D(IS)

<p>STURM MACHINE CO., INC. 9846 OWENSMOUTH AVE. CHATSWORTH, PA 91311</p>  <p>CAGE code: 64733 <u>2/</u></p>	<p>SUNDRAM FASTENERS, LTD. MADRAS, INDIA</p>  <p>CAGE code: <u>2/</u></p>
<p>SUBCON TOOL/ACCUTOOL MACHINE GROUP INC. (DBA ACCUTOOL) 5301 IROQUOIS AVE ERIE, PA 16511 - 2529 See ACCUTOOL</p> <p><b>01FO</b></p> <p>CAGE code: 1UMX0 <u>1/</u></p>	<p>SUNRISE PRECISION MFG. 4406 ENTERPRISE PL, UNIT 3 FREMONT, CA 94538</p>  <p>CAGE code: 0UK47 <u>2/</u></p>
<p>SUBURBAN INDUSTRIES, INC. 11901 FRANKLIN AVE FRANKLIN PARK, IL 60131</p> <p><b>SII</b></p> <p>CAGE code: 89752 <u>2/</u></p>	<p>SUPERIOR TECHNOLOGY 11013 OLINDA STREET SUN VALLEY, CA 91352</p>  <p><b>EARTH</b></p> <p>CAGE code: <u>2/</u></p>
<p>SULLIVAN BOLT CO., INC. 3435 SOUTH MALT AVE. COMMERCE, CA 90040</p>  <p>CAGE code: 6M158 <u>2/</u></p>	<p>SUPREME SCREW PRODUCTS, INC. 1368 CROMWELL AVENUE BRONX, NY 10452</p>  <p>CAGE code: 1FMQ2 <u>2/</u></p>

1/ Information published in this revision was verified by direct contact with manufacturers.

2/ Information not verified to be current, no response from manufacturer. Information identical to that published in MIL-HDBK-57, Revision B.

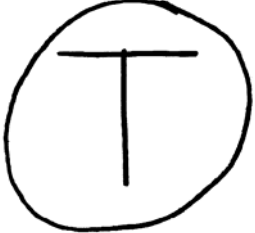
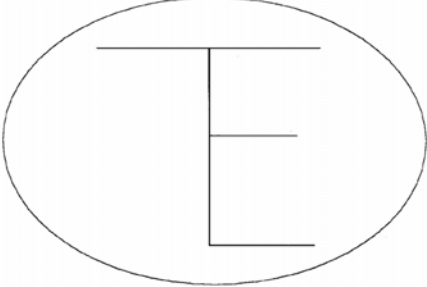
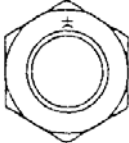





## MIL-HDBK-57D(IS)

<p>S V INDUSTRIES 29280 YNEZ RD. TEMECULA, CA 92592</p> <p style="text-align: center;"><b>SV</b></p> <p>CAGE code: OGVY7 <span style="float: right;"><u>2/</u></span></p>	<p>T C QUALITY MACHINING INC. 12155 MAGNOLIA AVE STE 10D RIVERSIDE, CA 92503 - 4905</p> <p style="text-align: center;"><b>TCQ</b></p> <p>CAGE code: 3H5W3 <span style="float: right;"><u>1/</u></span></p>
<p>SWISS TECHNOLOGY, INC. 150 ST. CHARLES STREET NEWARK, NJ 07105</p> <p style="text-align: center;"></p> <p>CAGE code: 48406 <span style="float: right;"><u>2/</u></span></p>	<p>T R MACHINE INC. 103 STATE ROUTE 75 E DAVIS, IL 61019-9586</p> <p style="text-align: center;"><b>TR</b></p> <p>CAGE code: 1YJV1 <span style="float: right;"><u>1/</u></span></p>
<p>T &amp; E MACHINE CORP. 4519C WAYNE AVENUE PHILADELPHIA, PA 19144-3606</p> <p style="text-align: center;"> </p> <p>CAGE code: 059P5 <span style="float: right;"><u>2/</u></span></p>	<p>TAIYO NUT MFG. CO., LTD. 2-6-12 KOUZEN, IKARUGACHO IKOMA-GUN, NARA, JAPAN</p> <p style="text-align: center;"> </p> <p>CAGE code: <span style="float: right;"><u>2/</u></span></p>

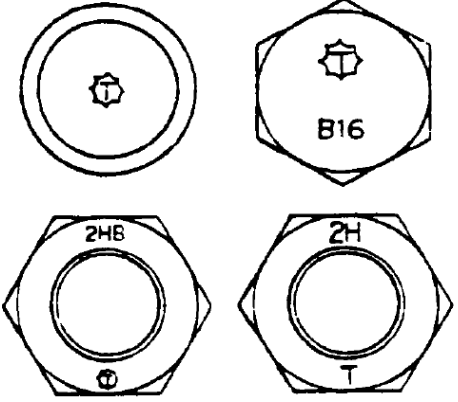
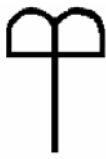
1/ Information published in this revision was verified by direct contact with manufacturers.

2/ Information not verified to be current, no response from manufacturer. Information identical to that published in MIL-HDBK-57, Revision B.

MIL-HDBK-57D(IS)

<p>TAKENAKA SEISAKUSHO CO., LTD. 178 HISHIE HIGASHI OSAKA CITY, JAPAN 578</p>  <p>CAGE code: <u>2/</u></p>	<p>TEBCO THREADED FASTENERS (DIVISION OF TENNESSEE BOLT &amp; SCREW CO.) 2700 SUMMER AVENUE MEMPHIS, TN 38112</p> <p>Plant 665 SCOTT STREET MEMPHIS, TN 38112</p>  <p>CAGE code: 4K536 <u>2/</u></p>
<p>TANAKA LTD. 1-10-6 TEZUKAYAMA-NAKA SUMIYOSHI-KU, OSAKA, JAPAN</p>  <p>CAGE code: SP833 <u>2/</u></p>	<p>TECH WELDING AND MACHINE CO. 41 KINGSTON AVENUE COLUMBUS, OH 43207</p>  <p>CAGE code: 9Y179 <u>2/</u></p>
<p>T-B &amp; S MFG. 4404 GARLAND DRIVE FORT WORTH, TX 76117</p>  <p>CAGE code: <u>2/</u></p>	<p>TECHNICAL FASTENERS, INC. 1129 GRIMMITT DR SHREVEPORT, LA 71107</p>  <p>CAGE code: 0GV34 <u>2/</u></p>
<p>T-B &amp; S MFG. 4404 GARLAND DRIVE FORT WORTH, TX 76117</p>  <p>CAGE code: <u>2/</u></p>	<p>TEK PRECISION CO., LTD. 205 WEST INDUSTRY COURT DEER PARK, NY 11729</p>  <p>CAGE code: 65780 <u>1/</u></p>

1/ Information published in this revision was verified by direct contact with manufacturers.

2/ Information not verified to be current, no response from manufacturer. Information identical to that published in MIL-HDBK-57, Revision B.



MIL-HDBK-57D(IS)

TELEFAST INDUSTRIES, INC.  
777 W BAGLEY RD  
BEREA, OH 44017-2901

T



TF

CAGE code: 3CW33 1/

TENS MACHINE CO., INC.  
800 GRUNDY AVE.  
HOLBROOK, NY 11741-2606



**TENS**

CAGE code: 8P689 1/

TERRY MACHINE CO.  
P.O. BOX 487  
5331 DIXIE HWY.  
WATERFORD, MI 48095-1

See SPS TECHNOLOGIES



CAGE code: 87880 2/

TERRYCABLE, INC.  
17376 EUCALYPTUS STREET  
HESPERIA, CA 92345

**TC**

CAGE code: 0XZ68 2/

TEXAS BOLT CO.  
P.O. BOX 1211  
3235 W. 11TH ST.  
HOUSTON, TX 77251



CAGE code: 27422 2/

TEXAS PRECISION MFG., INC.  
P.O. BOX 3640  
610 28TH ST  
LUBBOCK, TX 79452

Plant  
1204 E. 46<sup>TH</sup> STREET  
LUBBACK, TX 79404

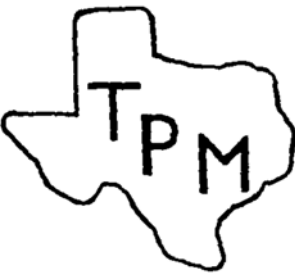

CAGE code: ICU57 2/

1/ Information published in this revision was verified by direct contact with manufacturers.

2/ Information not verified to be current, no response from manufacturer. Information identical to that published in MIL-HDBK-57, Revision B.

MIL-HDBK-57D(IS)

TEXTRON FASTENING SYSTEMS  
 (AEROSPACE - SANTA ANA OPERATIONS)  
 1224 E. WARNER AVENUE  
 SANTA ANA, CA 92705



LOCKBOLTS  
 Bold "C"

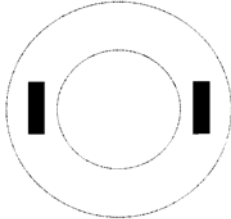

LOCKBOLT COLLARS  
 Two Opposing Dashes

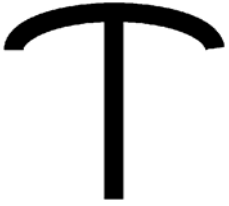

ALL PRODUCTS  
 Lazy "T"

CAGE code: 11815 1/

TFI AEROSPACE CORPORATION  
 19 CONSTELLATION CT.  
 REXDALE, ONTARIO, CANADA



ALL NEW  
 TOOLING

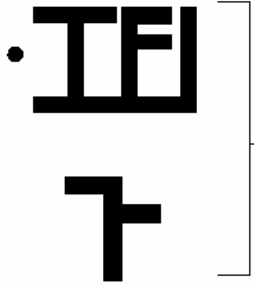



MODIFIED  
 EXISTING  
 TOOLING

CAGE code: L0336 2/

TFP CORP.  
 (TRU-FIT PRODUCTS DIVISION)  
 (SPECIAL FASTENER DIVISION)  
 P. O. BOX 952  
 MEDINA, OH 44258

Plant  
 TRU-FIT STEEL WIRE CO.,LTD  
 (TRU-WELD DIVISION)  
 460 LAKE ROAD  
 MEDINA, OH 44258

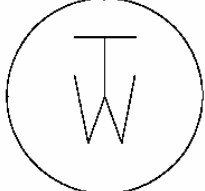
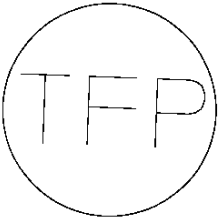
CAGE code: 31000 1/

1/ Information published in this revision was verified by direct contact with manufacturers.

2/ Information not verified to be current, no response from manufacturer. Information identical to that published in MIL-HDBK-57, Revision B.

MIL-HDBK-57D(IS)

THIANT (BOULONNERIE DE SA)  
 B.P. 4  
 FRANCE 59224



This marking appears on all hex nuts with or without deflection marks. The three raised lines in the corner indicate "Thiant" as manufacturer. (Clockwise system for grade.)



This marking appears on all flange nuts. The three raised lines on the flange indicate "Thiant" as manufacturer. (Clockwise system for grade.)



This marking appears on flange nuts when no mark is acceptable on the flange. Three depressed lines indicate "Thiant" as manufacturer. (Clockwise system for grade.)



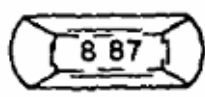

This marking appears on flange nuts when raised marks are not accepted. Three depressed lines indicate "Thiant" as manufacturer. (Clockwise system for grade.)

TRACKS FASTENERS



HIGH STRENGTH STRUCTURAL BOLT

HOT FORGED BOLTS

CAGE code: 2/

THOMAS & BETTS CORPORATION  
 (FORMERLY AMERICAN ELECTRIC)  
 8155 T AND B BLVD  
 MEMPHIS, TN 38125 - 8888

Plant 1  
 260 DENNIS STREET  
 ATHENS, TN 37303

Plant 2  
 8735 HAMILTON ROAD  
 SOUTHAVEN, MS 38671

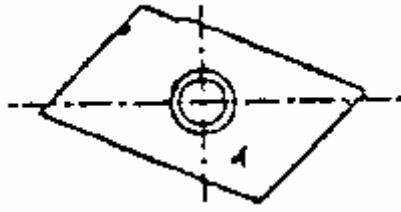

CAGE code: 56501 1/

THOMAS INSTRUMENT & MACHINE CO.,  
 INC.  
 3440 E FIRST ST  
 BROOKSHIRE, TX 77423 - 0999



CAGE code: 5H860 2/

THOMAS MACHINING TECHNOLOGIES,  
 INC.  
 12 COUNT ROAD 486  
 HANCEVILLE, AL 35077



CAGE code: 1VNC4 2/

1/ Information published in this revision was verified by direct contact with manufacturers.

2/ Information not verified to be current, no response from manufacturer. Information identical to that published in MIL-HDBK-57, Revision B.

MIL-HDBK-57D(IS)

THOMAS MFG, INC.  
25125 W OUTER DR  
MELVINDALE, MI 48122

**THOMAS**

CAGE code: 0NWS1 2/

---

TITAN FASTENER  
10031 HOLLY ROAD  
HOLLY, MI 48442

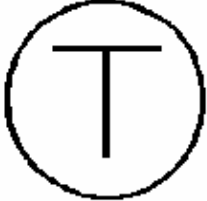

CAGE code: 2/

---

TOG MANUFACTURING CO., INC.  
1454 SOUTH STATE STREET  
NORTH ADAMS, MA 01247



CAGE code: 63649 1/

TOKOSHA METAL WORKS LTD.  
NO. 7-22, 3-CHROME, NAKAGAMA-NISHI,  
IKUNO-KU, OSAKA, JAPAN

**TKS**

CAGE code: 2/

---

TOOLEX, INC.  
7570 MORLEY STREET  
HOUSTON, TX 77061



CAGE code: 1W383 2/

---

TOPURA CO., LTD.  
2050 YAJOI-CHO  
HIGASHIOSAKA-SHI,  
OSAKA, JAPAN 579

Plant  
201 SOYA, HATANO,  
KANAGAWA 257 JAPAN

**TOPURA**

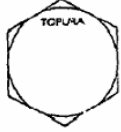

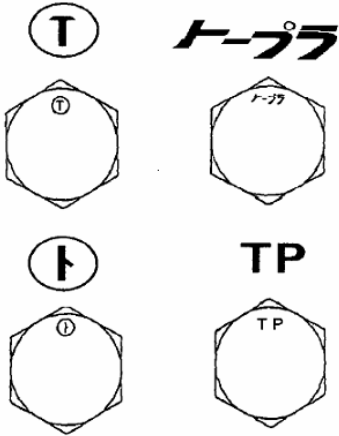





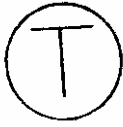

CAGE code: 2/

1/ Information published in this revision was verified by direct contact with manufacturers.

2/ Information not verified to be current, no response from manufacturer. Information identical to that published in MIL-HDBK-57, Revision B.

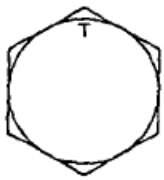



## MIL-HDBK-57D(IS)

<p>TORCO, INC. P. O. BOX 4070 1330 OLD HIGHWAY 41 MARIETTA, GA 30061</p>  <p>CAGE code: 07359 <u>2/</u></p>	<p>TOWNE ROBINSON FASTENER CO. KEY MANUFACTURING GROUP, INC. P.O. BOX 232 24175 NORTHWESTERN HWY. SOUTHFIELD, MI 48037</p> <p>Plant 4401 WYOMING AVE. P.O. BOX 188 DEARBORN, MI 48121</p>  <p>CAGE code: 94678 <u>2/</u></p>
<p>TORONTO FASTENERS INDUSTRIES, INC. (SUBSIDIARY OF HI-SHEAR CORP., USA) 7475 KIMBEL ST., UNIT 8 MISSISSAUGA, ONTARIO L5S1E7</p> <p>See HI-SHEAR</p> <p>Plant 19 CONSTELLATION CT. REXDALE, ONTARIO, CANADA M9W 1K4</p>  <p>CAGE code: <u>2/</u></p>	<p>TOWNSEND CO. CERRY RIVET DIVISION 1224 E. WARNER AVE. SANATA ANA, CA 92701</p> <p> Aircraft blind rivets.  Aircraft lockbolts.</p> <p>CAGE code: 7H092 <u>2/</u></p>
<p>TORX PRODUCTS (CAMCAR DIVISION OF TEXTRON INC.) P. O. BOX 607 HWY 31 N. ROCHESTER, IN 46975</p> <p>For head markings see:</p> <p>CAMCAR Division of Textron, Inc. Plant TORX Products</p> <p>CAGE code: 6N040 <u>2/</u></p>	<p>TOYO STEEL WIRE CO., LTD. 3-9-45 TSURUHARA IZUMISANO-SHI, OSAKA, 598 JAPAN</p>   <p>CAGE code: <u>1/</u></p>

1/ Information published in this revision was verified by direct contact with manufacturers.

2/ Information not verified to be current, no response from manufacturer. Information identical to that published in MIL-HDBK-57, Revision B.

## MIL-HDBK-57D(IS)

<p>TRI STATE TOOL &amp; DIE CO. 1396 NORTON RD STOW, OH 44224-1333</p>  <p>BRAND AT ONE CORNER</p> <p>CAGE code: 06RM8 <span style="float: right;">1/</span></p>	<p>TRIUMPH GROUP OPERATIONS INC, THE (FRISBY AEROSPACE INC DE) 417 S. MAIN ST. FREEPORT, NY 11520-5144</p> <p>Ssee FRISBY AEROSPACE INC DE</p> <h1 style="text-align: center;">FAH</h1> <p>CAGE code: 26437 <span style="float: right;">2/</span></p>
<p>TRIAD PRODUCTS CORP. 15241 N.E. 92ND REDMOND, WA 98052</p>  <p>CAGE code: 74468 <span style="float: right;">2/</span></p>	<p>TRIUMPH MANUFACTURING CO., INC. P.O. BOX 380148 750 TOLLAND ST. EAST HARTFORD, CT 06138</p> <h1 style="text-align: center;">TRI</h1> <p>CAGE code: 8X098 <span style="float: right;">2/</span></p>
<p>TRIDAIR PRODUCTS AFS TORRANCE OPERATIONS 3000 WEST LOMITA BLVD. TORRANCE, CA 90505-5103</p> <p>(Corporate office see ALCOA FASTENING SYSTEMS)</p>  <p>CAGE code: 29372 <span style="float: right;">1/</span></p>	<p>TRONSON MANUFACTURING 45383 INDUSTRIAL PLACE #41 FREEMONT, CA 94538</p> <h1 style="text-align: center;">TM</h1> <p>CAGE code: 1DPK8 <span style="float: right;">2/</span></p>
<p>TRIDENT MACHINE CO. 3491 N. MERIDIAN ROAD ROCKFORD, IL 61101</p>  <p>CAGE code: 5N818 <span style="float: right;">1/</span></p>	<p>TROY D. RAY DBA DIXON MACHINE &amp; FABRICATION 6807 CHAPMAN HWY. KNOXVILLE, TN 37920-6560</p> <h1 style="text-align: center;">DMT</h1> <p>CAGE code: 1DEP3 <span style="float: right;">2/</span></p>

1/ Information published in this revision was verified by direct contact with manufacturers.

2/ Information not verified to be current, no response from manufacturer. Information identical to that published in MIL-HDBK-57, Revision B.

MIL-HDBK-57D(IS)

TRW  
(FASTENER DIVISION)  
265 THIRD STREET  
CAMBRIDGE, MA 02142

**PAL**

Logo Stampings Used on  
Brass Snap Fastener Components

 Part No. 15100

 Part No. 16506

 Part Nos. 10412 and 10413

 Part Nos. 10224, 12206, 10412, 10413, 10414, 90307

 Part Nos. 16205 and 16206

CAGE code: 83058 2/

---

TRY - AZTEC COMPANY  
P.O. BOX 6191  
TEHACHAPI, CA 93561

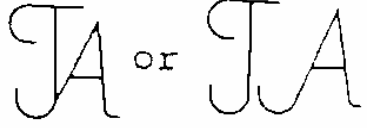

CAGE code: 2/

TUFF FASTENERS CO.  
10724 GARWICK PLACE  
SOUTH GATE, CA 90280-7332



CAGE code: 5V629 2/

---

TURNAMICS, INC.  
92 NEW LIECHESTER HWY  
ASHVILLE, NC 28806



CAGE code: 1CWU8 2/

---

TW DESIGN AND MANUFACTURING, L.L.C.  
P. O. BOX 310  
33 WEST STREET  
MONTELLO, WI 53949



CAGE code: 0X311 2/

---

TWIST TITE MFG. INC.  
13649 PUMICE STREET  
SANTA FE SPRINGS, CA 90670











CAGE code: 007R1 1/

1/ Information published in this revision was verified by direct contact with manufacturers.

2/ Information not verified to be current, no response from manufacturer. Information identical to that published in MIL-HDBK-57, Revision B.

## MIL-HDBK-57D(IS)





<p>U.P. MACHINE &amp; ENGINEERING CO. P.O. BOX 400 210 NORTH THIRD STREET POWERS, MI 49874</p> <p style="text-align: center;"><b>UPME</b></p> <p>CAGE code: 5H091 <span style="float: right;"><u>2/</u></span></p>	<p>ULTRA SONIC MACHINE CO., INC. 1313 WEST 135TH STREET GARDENA, CA 90247</p> <div style="display: flex; justify-content: space-around; align-items: center;"> <div style="text-align: center;"></div> <div style="text-align: center;"></div> </div> <div style="display: flex; justify-content: space-around; align-items: center; margin-top: 20px;"> <div style="text-align: center;"></div> <div style="text-align: center;"></div> </div> <p>CAGE code: 4F713 <span style="float: right;"><u>2/</u></span></p>
<p>U.S. BOLT MANUFACTURING, INC. 12895 SOUTH MAIN HOUSTON, TX 77035</p> <div style="text-align: center;"></div> <p>CAGE code: 0UZJ8 <span style="float: right;"><u>2/</u></span></p>	<p>UMPCO CORP. P.O. BOX 5158 7100 LAMPSON AVE. GARDEN GROVE, CA 92841</p> <div style="text-align: center;"></div> <p>CAGE code: 18076 <span style="float: right;"><u>2/</u></span></p>
<p>ULTIMATE MACHINING &amp; WELDING 1003 ARGUELLO STREET REDWOOD CITY, CA 94063</p> <div style="text-align: center;"></div> <p>CAGE code: OXXP2 <span style="float: right;"><u>2/</u></span></p>	<p>UNIFLOW CORP. P.O. BOX 705 26600 HEYN DRIVE NEW HAVEN, MI 48050</p> <div style="text-align: center;"></div> <p>CAGE code: 4S622 <span style="float: right;"><u>2/</u></span></p>

1/ Information published in this revision was verified by direct contact with manufacturers.

2/ Information not verified to be current, no response from manufacturer. Information identical to that published in MIL-HDBK-57, Revision B.

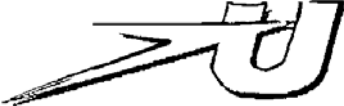



## MIL-HDBK-57D(IS)

<p>UNIMETERIC CORPORATION P.O. BOX 4529 5 TRIPPS LANE EAST PROVIDENCE, RI 02915</p> <p style="text-align: center;"><b>U</b></p> <p>CAGE code: 7U319 <span style="float: right;"><u>2/</u></span></p>	<p>UNITED DRILL BUSHING CORP. 12200 WOODRUFF AVE DOWNEY, CA 90241</p> <p style="text-align: center;"></p> <p>CAGE code: 52369 <span style="float: right;"><u>2/</u></span></p>
<p>UNISTRUT CORP. (UNISTRUT PHILA) 761 FIFTH AVE KING OF PRUSSIA, PA 19406</p> <p style="margin-left: 40px;">Plant UNISTRUT CORP. WAYNE MFG. DIV. 35660 CLINTON WAYNE, MI 48184</p> <p style="text-align: center;">UNISTRUT </p> <p>CAGE code: 96195 <span style="float: right;"><u>2/</u></span></p>	<p>UNITED PRECISION PRODUCTS CO., INC. 25040 VAN BORN ROAD DEARBORN HEIGHTS, MI 48125</p> <p style="text-align: center;"><b>UP</b></p> <p>CAGE code: 17328 <span style="float: right;"><u>1/</u></span></p>
<p>UNITED BOLT &amp; SCREW CORP. 1055 HAGGERTY AVE. DEARBORN, MI 48126</p> <p style="text-align: center;">  </p> <p>CAGE code: 8G949 <span style="float: right;"><u>2/</u></span></p>	<p>UNITED STATES DEFENSE RESEARCH &amp; SUPPLY 311 EASTRIDGE ROAD GRANDBURY, TX 76049</p> <p style="text-align: center;"></p> <p>CAGE code: 0XVD5 <span style="float: right;"><u>2/</u></span></p>

1/ Information published in this revision was verified by direct contact with manufacturers.

2/ Information not verified to be current, no response from manufacturer. Information identical to that published in MIL-HDBK-57, Revision B.



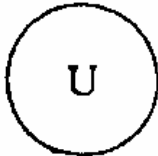
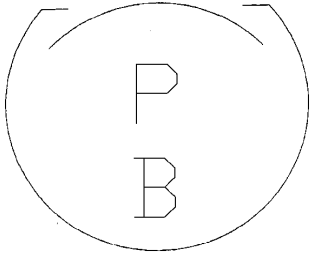
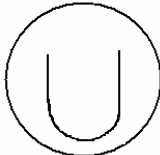





## MIL-HDBK-57D(IS)

<p>UNITED STEEL &amp; FASTENERS INC. 1500 INDUSTRIAL DRIVE ITASCA, IL 60143</p> <p>S<sup>U</sup>F      </p> <p>Identification used on all large bolts      S<sup>U</sup>F ▲</p> <p>Identification used on all small bolts and on the shoulders of nuts      ▲</p> <p>CAGE code: 2R938      <u>1/</u></p>	<p>URANIA ENGINEERING CO., INC. SPEC-NUT® 198 SOUTH POPLAR STREET HAZLETON, PA 18201</p> <p></p> <p>CAGE code: 30279      <u>2/</u></p>
<p>UNIVERSAL MACHINE PRODUCTS 480 SURF AVENUE STRATFORD, CT 06497</p> <p>UM</p> <p>CAGE code: 0Y156      <u>2/</u></p>	<p>URBAN MANUFACTURING CO. P.O. BOX 4260 100 W. BERKLEY ST PHILADELPHIA, PA 19144</p> <p></p> <p>CAGE code: OW5R7      <u>2/</u></p>
<p>UPB ENGINEERING 13060 TOM WHITE WAY "UNIT F" NORWALK, CA 90650</p> <p></p> <p>CAGE code: 1BER9      <u>2/</u></p>	<p>URBAN MFG. CO. INC. P.O. BOX 1070 529 FORREST AVE. DREXEL HILL, PA 19026</p> <p></p> <p>CAGE code: 9Y188      <u>2/</u></p>

1/ Information published in this revision was verified by direct contact with manufacturers.

2/ Information not verified to be current, no response from manufacturer. Information identical to that published in MIL-HDBK-57, Revision B.







## MIL-HDBK-57D(IS)

<p>US TOOL &amp; DIE 23282 VERDUGO DR LAGUNA HILLS, CA 92653-1335</p>  <p>CAGE code: 3LJM2 <span style="float: right;"><u>1/</u></span></p>	<p>VALLEY-TODECO 12975 BRADLEY AVE. SYLMAR, CA 91342</p>  <p>CAGE code: 06710 <span style="float: right;"><u>1/</u></span></p>
<p>UTAH TOOL &amp; DIE, INC. P.O. BOX 969 850 NO WESTERN PRECISION PARKWAY WEST JORDAN, UTAH 84084</p>  <p>CAGE code: 23509 <span style="float: right;"><u>2/</u></span></p>	<p>VAN PETTY MFG., INC. DBA J.W. MANUFACTURING INC 2517 AZURITE CIRCLE NEWBURY PARK, CA 91320</p>  <p>CAGE code: 23899 <span style="float: right;"><u>1/</u></span></p>
<p>VALCOR ENGINEERING CORP. 2 LAWRENCE ROAD SPRINGFIELD, NJ 07081</p>  <p>CAGE code: 96487 <span style="float: right;"><u>2/</u></span></p>	<p>V-B MACHINE CO., INC. FASTENER DIVISION 1645 W. 135TH STREET GARDENA, CA 90249</p>  <p>CAGE code: 60682 <span style="float: right;"><u>2/</u></span></p>
<p>VALLEY FORGE AND BOLT MFG CO. 1825 S. 27th AVENUE PHOENIX, AZ 85009-6417</p>  <p>CAGE code: 02UA5 <span style="float: right;"><u>1/</u></span></p>	<p>VEGAS FASTENER MANUFACTURING 3873 W. OQUENDO ROAD LAS VEGAS, NV 89118</p>  <p>CAGE code: 1U1Z3 <span style="float: right;"><u>2/</u></span></p>

1/ Information published in this revision was verified by direct contact with manufacturers.

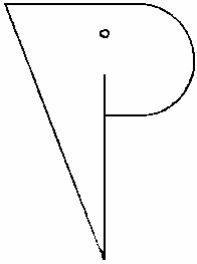
2/ Information not verified to be current, no response from manufacturer. Information identical to that published in MIL-HDBK-57, Revision B.



## MIL-HDBK-57D(IS)



<p>VENUS FASTENERS CORP. 154 MERRICK RD FREEPORT, NY 11520</p>  <p>CAGE code: 045B2 <span style="float: right;"><u>2/</u></span></p>	<p>VICTOR PRODUCTS CORP. 2635 WEST BELMONT CHICAGO, IL 60618</p>  <p>CAGE code: 63045 <span style="float: right;"><u>2/</u></span></p>
<p>VERSATECH, INC. P.O. BOX 608 6012 ENTERPRISE DR., WESTMORELAND INDUSTRIAL PARK III EXPORT, PA 15632</p>  <p>CAGE code: 0CHD0 <span style="float: right;"><u>2/</u></span></p>	<p>VIP MFG. &amp; ENGR. CORP. 1084 MARTIN AVE. SANTA CLARA, CA 95050</p>  <p>CAGE code: 8M774 <span style="float: right;"><u>1/</u></span></p>
<p>VERTEX DISTRIBUTION P. O. BOX 879 327 PINE STREET PAWTUCKET, R 02860</p> <p>(see BELL FASTENERS)</p>  <p>CAGE code: <span style="float: right;"><u>1/</u></span></p>	<p>VISSERIES &amp; BOULONNERIES DE FOURMIES 2 RUE DU CHAUFFOUR FOURMIES, FRANCE 69610</p>  <p>Grade 8.8 and over</p> <p>CAGE code: F8388 <span style="float: right;"><u>2/</u></span></p>
<p>VICO PRODUCTS, CO. 41555 E. ANN ARBOR ROAD PLYMOUTH, MI 48170</p>  <p>The "V" is either raised or indented.</p> <p>CAGE code: 0CG15 <span style="float: right;"><u>2/</u></span></p>	

1/ Information published in this revision was verified by direct contact with manufacturers.

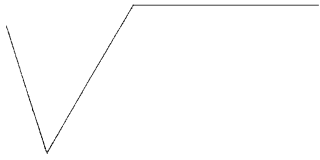
2/ Information not verified to be current, no response from manufacturer. Information identical to that published in MIL-HDBK-57, Revision B.

MIL-HDBK-57D(IS)

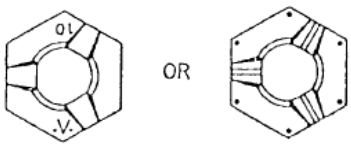
<p>VISTEK INDUSTRIES 153 RAILROAD DR IVYLAND, PA 18974-1448</p>  <p>CAGE code: 79735 <span style="float: right;">2/</span></p>
<p>VITCO NUCLEAR PRODUCTS INC. 8171 TYLER BLVD MENTOR, OH 44060</p>  <p>CAGE code: 9L424 <span style="float: right;">2/</span></p>
<p>VM MANUFACTURING CORP. 1536 RAILROAD AVENUE HOLBROOK, NY 11741-2301</p>  <p>CAGE code: 1NUW9 <span style="float: right;">1/</span></p>

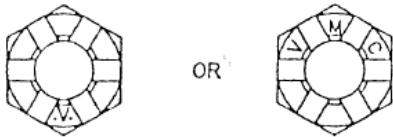
<p>VMC INDUSTRIES, INC. 20 CORPORATE DRIVE AUBURN HILLS, MI 48326</p> <p style="text-align: center;">.V. OR VMC</p> <p style="text-align: center;"><u>FEMALE FASTENERS</u></p> <p style="text-align: center;"><u>PREVAILING TORQUE NUTS</u></p>  <p style="text-align: center;">.V. OR TWO LINES IN THREE PADS WITH APPROPRIATE GRADE OR CLASS MARKINGS</p> <p style="text-align: center;"><u>INSERT TYPE</u></p> <p style="text-align: center;"><u>PREVAILING TORQUE NUTS</u></p>  <p style="text-align: center;">TAN NYLON IDENTIFIES VMC AS MANUFACTURER WITH APPROPRIATE GRADE OR CLASS MARKINGS</p> <p style="text-align: center;"><u>SLOTTED NUTS</u></p>  <p style="text-align: center;">.V. OR VMC WITH APPROPRIATE GRADE OR CLASS MARKINGS</p> <p>CAGE code: 0SFN8</p> <p>Continued <span style="float: right;">2/</span></p>
---

1/ Information published in this revision was verified by direct contact with manufacturers.

2/ Information not verified to be current, no response from manufacturer. Information identical to that published in MIL-HDBK-57, Revision B.

MIL-HDBK-57D(IS)

Continued

VMC INDUSTRIES, INC.

FEMALE FASTENERS (CONT.)

NUT & WASHER ASSEMBLY

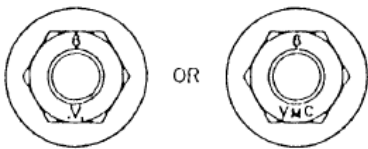

OR

“.V.” OR “VMC” WITH APPROPRIATE GRADE OR CLASS MARKINGS

FLANGE NUTS

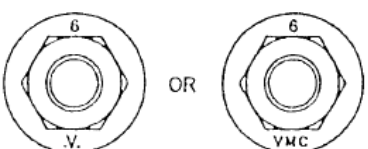

OR

“.V.” OR “VMC” WITH APPROPRIATE GRADE OR CLASS MARKINGS

HEX NUTS

ENGLISH

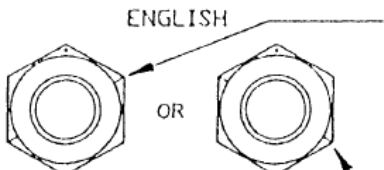

OR

GRADE 5 PER SAE J995  
GRADE 8 PER SAE J995  
ONE RADIAL LINE FOR MFG. ID., 180° FROM RADIAL LINE IN THE GRADE ID.

METRIC

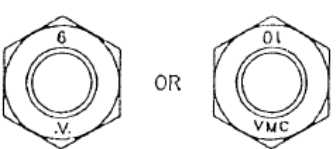

OR

CLASS 9 CLASS 10  
“.V.” OR “VMC” WITH APPROPRIATE GRADE OR CLASS MARKINGS

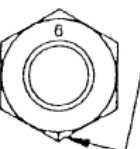

ONE RADIAL LINE 180° FROM APPROPRIATE GRADE OR CLASS MARKINGS

CAGE code: 0SFN8 2/

Continued

Continued

VMC INDUSTRIES, INC.

FEMALE FASTENERS (CONT.)

OTHER TYPE NUTS

WHEEL NUTS, HEX AND SQUARE WELD NUTS AND OTHER TYPE NUTS NOT SPECIFIED.  
“.V.” OR “VMC” WITH APPROPRIATE GRADE OR CLASS MARKINGS

MALE FASTENERS

SOCKET HEADS

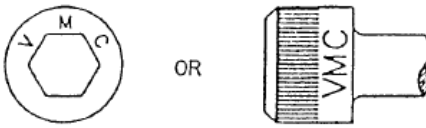

OR

HEX HEADS

INDENTED, TRIMMED, WASHER OR FLANGED.

METRIC

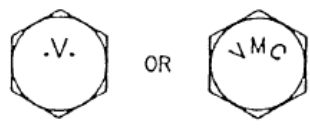

OR

ENGLISH

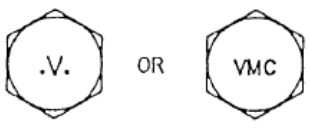

OR

“.V.” OR “VMC” WITH APPROPRIATE GRADE OR CLASS MARKINGS

CAGE code: 0SFN8 2/

1/ Information published in this revision was verified by direct contact with manufacturers.

2/ Information not verified to be current, no response from manufacturer. Information identical to that published in MIL-HDBK-57, Revision B.

## MIL-HDBK-57D(IS)

VOI-SHAN PRODUCTS  
AFS TORRANCE OPERATIONS  
3000 WEST LOMITA BLVD.  
TORRANCE, CA 90505-5103  
CAGE code: 5M902

**VS**

AFS COI OPERATIONS  
135 N. UNRUH AVE.  
CITY OF INDUSTRY, CA 91744  
CAGE code: 06950, IRC86

**VS O SC**

AFS HILDESHEIM OPERATIONS  
STEVEN 3  
31135 HILDESHEIM-BEVENSTEDT,  
GERMANY  
CAGE code: C4293

**VS**

(Corporate office see ALCOA FASTENING  
SYSTEMS)

CAGE code: 5M902, 06950, IRC86,  
C4293

1/

VOSS INDUSTRIES, INC.  
VOSS AEROSPACE DIVISION  
2168 WEST 25TH STREET  
CLEVELAND, OH 44113



**E A**

**V**

CAGE code: 14242

1/

VSI  
AEROSPACE PRODUCTS DIVISION  
557 S. DOUGLAS ST.  
EL SEGUNDO, CA 90245

Plant  
VOI-SHAN DIVISION  
4001 INGLEWOOD AVE.  
REDONDO BEACH, CA 90278

**VS**

CAGE code: 6A768

2/

VULCAN RIVET & BOLT CORP.  
P.O. BOX 170129  
BIRMINGHAM, AL 35217

**V.**

All fasteners marked with the letter "V" followed by a  
period (.)

**V.**

Fasteners manufactured from special alloy steels are  
identified with the letter "V" followed by a period (.) and  
a line under the letter "V"

**304  
V.**

Stainless steel fasteners are marked with the letter "V"  
followed by a period (.) with the type of stainless

CAGE code: 0GEW3

2/

WALKER BOLT MANUFACTURING CO.,  
INC.  
DIVISION OF LONE STAR FASTENERS, LP  
P.O. BOX 1149  
10202 AIRLINE CRIVE  
HOUSTON, TX 77037

**WB**









CAGE code: 39782

1/

1/ Information published in this revision was verified by direct contact with manufacturers.

2/ Information not verified to be current, no response from manufacturer. Information identical to that published in MIL-HDBK-57, Revision B.

## MIL-HDBK-57D(IS)



<p>WALZ &amp; KRENZER INC DBA MAPECO PRODUCTS DIV MAPECO PRODUCTS 91 WILLENBROCK RD STE B4 OXFORD, CT 06478-1036</p>  <p>CAGE code: 87045 <span style="float: right;"><u>2/</u></span></p>	<p>WEAVER MANUFACTURING, INC. 1005 E. 17TH STREET WICHITA, KS 67214</p>  <p>CAGE code: 16345 <span style="float: right;"><u>2/</u></span></p>
<p>WARREN PUMPS LLC. (DIVISION OF COLFAX CORPORATION) P.O. BOX 969 82 BRIDGES AVENUE WARREN, MA 01083</p>  <p>CAGE code: 63857 <span style="float: right;"><u>1/</u></span></p>	<p>WEBLUK MACHINE CORP. 4959 COMMERCE PARKWAY WARRENSVILLE HEIGHTS, OH 44128</p>  <p>CAGE code: 0C095 <span style="float: right;"><u>2/</u></span></p>
<p>WATERBURY BUCKLE CO. 952 S. MAIN STREET WATERBURY, CT 06721</p>  <p>CAGE code: 82399 <span style="float: right;"><u>2/</u></span></p>	<p>WELTER GMBH &amp; CO. KG BONNER RING 49 P. O. BOX 1311 ERFTSTADT, GERMANY 50374</p>  <p>CAGE code: C3486 <span style="float: right;"><u>2/</u></span></p>
<p>WAYNE BOLT &amp; NUT CO., INC. 14471 LIVERNOIS AVE. DETROIT, MI 48238-2097</p>  <p>CAGE code: 5Z751 <span style="float: right;"><u>1/</u></span></p>	<p>WELTON ROLLED THREAD CORP. 1818 GLENDALE BLVD LOS ANGELES, CA 90026</p>  <p>CAGE code: 27871 <span style="float: right;"><u>2/</u></span></p>

1/ Information published in this revision was verified by direct contact with manufacturers.

2/ Information not verified to be current, no response from manufacturer. Information identical to that published in MIL-HDBK-57, Revision B.





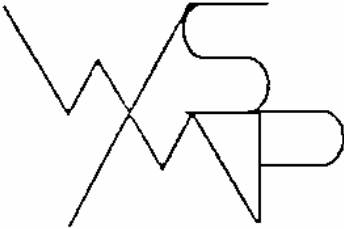







## MIL-HDBK-57D(IS)

<p>WESLOK (DIVISION OF FALL RIVER MANUFACTURING) 4160 S. 13TH STREET MILWAUKEE, WI 53221</p> <p style="text-align: center;"><b>WESLOK</b></p> <p>CAGE code: <span style="float: right;"><u>2/</u></span></p>	<p>WESTERN PACIFIC ENTERPRISES, W.P.E. INC. 8110 REMMET AVE. CANOGA PARK, CA 91304</p> <p style="text-align: center;"></p> <p>CAGE code: 5N444 <span style="float: right;"><u>1/</u></span></p>
<p>WEST COAST AEROSPACE, INC. 24224 BROAD STREET CARSON, CA 90745</p> <p style="padding-left: 40px;">Plant 220 WEST E. STREET WILMINGTON, CA 90744</p> <p style="text-align: center;"></p> <p>CAGE code: 60516 <span style="float: right;"><u>1/</u></span></p>	<p>WESTERN SCREW MACHINE PRODUCTS, INC. (CUTTING EDGE MACHINING) 1625 LINDA WAY SPARKS, NV 89431</p> <p style="text-align: center;"></p> <p>CAGE code: OZV72 <span style="float: right;"><u>2/</u></span></p>
<p>WEST TENNESEE LIONS BLIND IND. INC. P.O. BOX 2175 346 ST PAUL AVENUE MEMPHIS, TN 38101-2175</p> <p>(See A P MILLS INDUSTRIES FOR THE BLIND)</p> <p style="text-align: center;"><b>APMI</b></p> <p>CAGE code: 6Y776 <span style="float: right;"><u>2/</u></span></p>	<p>WESTERN SKY INDUSTRIES, INC. (DIVISION OF ATLAS CORP.) 21300 CLOUDWAY HAYWARD, CA 94545</p> <p style="text-align: center;"><b>WSI</b></p> <p>CAGE code: 04169 <span style="float: right;"><u>2/</u></span></p>

1/ Information published in this revision was verified by direct contact with manufacturers.

2/ Information not verified to be current, no response from manufacturer. Information identical to that published in MIL-HDBK-57, Revision B.





## MIL-HDBK-57D(IS)

<p>WESTFIELD FASTENERS 202 UNION STREET WESTFIELD, MA 01085</p>  <p>CAGE code: <u>1/</u></p>	<p>WHELAN MACHINE &amp; TOOL CO. 134 ROCHESTER DR LOUISVILLE, KY 40214-2681</p>  <p><small>Aerial-Bold letter "W" enclosed with a circle</small></p> <p>CAGE code: 0MB07 <u>1/</u></p>
<p>WESTLAND STEEL PRODUCTS, LTD. P. O. BOX 1052 165 CORDITE ROAD WINNIPEG, MANITOBA, CANADA R3C 2X4</p>  <p>CAGE code: 0NWX5 <u>2/</u></p>	<p>WHITNEY SCREW CORP. P.O. BOX 784 14A BROAD STREET NASHUA, NH 03061</p>  <p>CAGE code: 87181 <u>2/</u></p>
<p>WESTWOOD PRECISION, INC. 7509 HARDESON ROAD EVERETT, WA 98203</p>  <p>CAGE code: 0PL34 <u>1/</u></p>	<p>WHITTET-HIGGINS CO. 33 HIGGINSON AVE. CENTRAL FALLS, RI 02863</p>  <p>CAGE code: 79568 <u>2/</u></p>
<p>WHAIL BOLT IND. CO., LTD 779-2, WONSI-DONG, ANSAN KYUGKI-DO, KOREA</p>    <p>GRADE 5 HEX CAP SCREWS</p> <p>GRADE 8 HEX CAP SCREWS</p> <p>CAGE code: <u>2/</u></p>	<p>WIGLEY MACHINE COMPANY 2007 WEST 2ND AVENUE CORSICANA, TX 75110</p>  <p>CAGE code: 0UBT5 <u>2/</u></p>

1/ Information published in this revision was verified by direct contact with manufacturers.

2/ Information not verified to be current, no response from manufacturer. Information identical to that published in MIL-HDBK-57, Revision B.

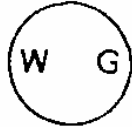
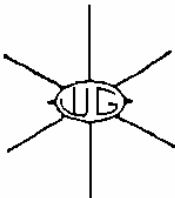
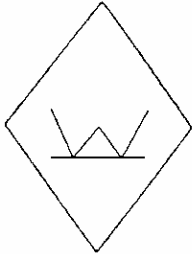

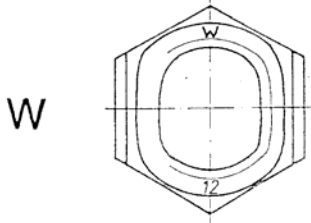

## MIL-HDBK-57D(IS)

<p>WILHELM SCHUMACHER SCHRAUBEN-FABRIK GmbH POSTFACH 12 80, AM PREIST 5 D-5912 HILCHENBACH, GERMANY</p> <p> Hex head screws and bolts       Machine screws and other products</p> <p>CAGE code: _____ <u>2/</u></p>	<p>WILSON-GARNER CO. 40935 PRODUCTION DR HARRISON TOWNSHIP, MI 48045-1351</p> <p></p> <p></p> <p>CAGE code: 7E548 <u>1/</u></p>
<p>WILLIAM'S MACHINE &amp; FABRICATION, INC. P.O. BOX 22235 700 DELAY DRIVE EUGENE, OR 97402</p> <p></p> <p>CAGE code: 0NNK2 <u>2/</u></p>	<p>WILT PRECISION PRODUCTS P.O. BOX 69 DOVER, PA 17315</p> <p></p> <p>CAGE code: 34282 <u>2/</u></p>
<p>WIL-NIC (E D R INDUSTRIES INC) DBA WIL-NICO 100 COMMERCIAL STREET FREEPORT, NY 11520-2832</p> <p></p> <p>CAGE code: 8P827 <u>2/</u></p>	<p>WINKER HERMAN GMBH &amp; CO. KG METALLWARENFABRIK P.O. BOC 1356 DELLINGER WEG 1 SPAICHINGEN, 78549 GERMANY</p> <p></p> <p>CAGE code: D2362 <u>2/</u></p>

1/ Information published in this revision was verified by direct contact with manufacturers.

2/ Information not verified to be current, no response from manufacturer. Information identical to that published in MIL-HDBK-57, Revision B.

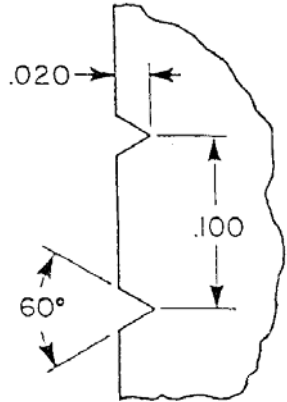

## MIL-HDBK-57D(IS)

<p>WINSLOW AUTOMATICS, INC. 23 ST. CLAIR AVENUE NEW BRITAIN, CT 06051</p>  <p>CAGE code: 7W515 <span style="float: right;"><u>1/</u></span></p>	<p>WOLTERS GMBH OTTILIENSTR 19 D-GUTERSLOH WEST GERMANY</p>  <p>CAGE code: <span style="float: right;"><u>2/</u></span></p>
<p>WODIN, INC. 5441 PERKINS ROAD BEDFORD HEIGHTS, OH 44146</p>  <p>CAGE code: 5V334 <span style="float: right;"><u>1/</u></span></p>	<p>WOLVERINE MACHINE PRODUCTS CO. P.O. BOX 209 319 COGSHALL ST. HOLLY, MI 48442</p>  <p>CAGE code: 2T549 <span style="float: right;"><u>2/</u></span></p>
<p>WOLSTENHOLME MACHINE (DBA WM ROBOTS) 3075 ADVANCE LANE COLMAR, PA 18915-9420</p>  <p>CAGE code: 68531 <span style="float: right;"><u>1/</u></span></p>	

1/ Information published in this revision was verified by direct contact with manufacturers.

2/ Information not verified to be current, no response from manufacturer. Information identical to that published in MIL-HDBK-57, Revision B.

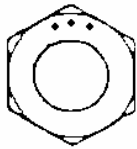
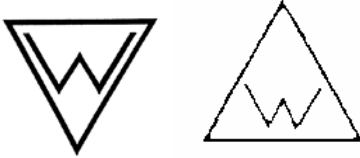

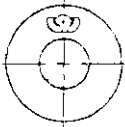
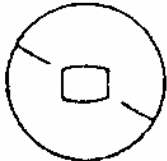



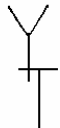

## MIL-HDBK-57D(IS)

<p>WOLVERINE NUT CO. 6556 EAST McNICHOLS DETROIT, MI 48212</p>  <p>3 dots, centered on corner, equally spaced</p> <p>CAGE code: 87824 <u>2/</u></p>	<p>WYANDOTTE INDUSTRIES, INC. 4625 13TH STREET WYANDOTTE, MI 48192</p>  <p>CAGE code: 54151 <u>1/</u></p>
<p>WORTHEY MACHINE P. O. BOX 70 3000 US HWY 72 E PAINT ROCK, AL 35764-0070</p> <p><b>WSMP</b></p> <p>CAGE code: 5S740 <u>2/</u></p>	<p>WYNNSON ENTERPRISES, INC. P. O. BOX 440 12039 HWY 239-431 N. MERIDIANVILLE, AL 35759-1201</p>  <p>CAGE code: 39484 <u>1/</u></p>
<p>WROUGHT WASHER MANUFACTURING INC. 2100 SOUTH BAY STREET MILWAUKEE, WI 53207</p>  <p>Marking for medium carbon heat treated washers compatible with Grade 5 and Grade 8 bolts.</p>  <p>Marking for low carbon washers.</p> <p>CAGE code: 79807 <u>2/</u></p>	<p>XCEL MFG., INC. P.O. BOX 239 ELYRIA, OH 44036</p>  <p>CAGE code: <u>2/</u></p> <p>Y2K MACHINE SHOP 106 WALSH ROAD SAN ANTONIO, TX 78224</p> <p><b>Y 2 K</b></p> <p>CAGE code: 1TMD7 <u>1/</u></p>

1/ Information published in this revision was verified by direct contact with manufacturers.

2/ Information not verified to be current, no response from manufacturer. Information identical to that published in MIL-HDBK-57, Revision B.

## MIL-HDBK-57D(IS)

<p>YATES TOOL, INC. 2425 MEDINA ROAD MEDINA, OH 44256</p>  <p>Either electroetched, steel stamped, vibropeened, or ink stamped</p> <p>CAGE code: IDV02 <span style="float: right;">2/</span></p>	<p>ZAMON CO., INC. ENDICOTT ST., BLDG. 23 NORWOOD, MA 02062</p>  <p>CAGE code: 5Z471 <span style="float: right;">2/</span></p>
<p>YOUNG ENGINEERS INC, THE 25841 COMMERCENTRE DRIVE LAKE FOREST, CA 92630-8812</p>  <p>CAGE code: 56958 <span style="float: right;">1/</span></p>	<p>ZENEX CORPORATION 850 ELMHURST RD. ELK GROVE VILLAGE, IL 60007</p>  <p>CAGE code: 25723 <span style="float: right;">2/</span></p>
<p>YOW MENG I INDUSTRIAL CO., LTD. NO. 180 WUN-AN RD., EAST SEC. MI-TUO HSIANG 82704 KAOHSIUNG HSIEN, TAIWAN, R.O.C.</p>  <p>CAGE code: <span style="float: right;">2/</span></p>	<p>ZERO PRODUCTS, INC. 219 BAYWOOD ST HOUSTON, TEXAS 77011</p>   <p>CAGE code: 3JC57 <span style="float: right;">2/</span></p>
<p>Z &amp; B GENERAL MACHINE 569 HULMEVILLE AVE. PENNDL, PA 19047</p>  <p>CAGE code: 5T735 <span style="float: right;">2/</span></p>	

1/ Information published in this revision was verified by direct contact with manufacturers.

2/ Information not verified to be current, no response from manufacturer. Information identical to that published in MIL-HDBK-57, Revision B.

MIL-HDBK-57D(IS)

**MIL-HDBK-57 FASTENER IDENTIFICATION SYMBOL CONFIRMATION**

Complete this form and email to [alonzo.miller@dla.mil](mailto:alonzo.miller@dla.mil), along with a separate PDF file containing artwork of your fastener head marking.

(Company name as it will appear in the listing) \_\_\_\_\_

(Department, Division, etc., if it is to appear in the listing)

Corporate/Mailing Address

Plant Location (if different)

\_\_\_\_\_  
 \_\_\_\_\_  
 \_\_\_\_\_  
 \_\_\_\_\_

\_\_\_\_\_  
 \_\_\_\_\_  
 \_\_\_\_\_  
 \_\_\_\_\_

Our Company is a fastener manufacturer YES ( ) NO ( )

**NOTE:** MIL-HDBK-57 requires the sources listed to have an inherent capability to manufacture fasteners out of raw material.

Telephone: \_\_\_\_\_

FAX Number: \_\_\_\_\_

Contact Name: \_\_\_\_\_

CAGE code: \_\_\_\_\_

Title: \_\_\_\_\_

DUNS Number: \_\_\_\_\_

Email: \_\_\_\_\_

Website URL: \_\_\_\_\_

1. Fastener head marking artwork that is submitted electronically shall be provided in a PDF file. A resolution of 100 dpi (dots per inch) minimum shall be used for artwork that is scanned. Provide only one marking per file submitted. Include the company name and plant location in this file, along with a written description of the fastener head marking. (For example "the script upper case letter A", or "the number 3 enclosed by a circle.")
2. If your company has plants in various locations, please provide DSCP-NASA with the symbol(s) used for each location, as well as the CAGE code, point of contact, and phone number for each point of contact.
3. All information must be supplied in the English language.
4. Submit this form and artwork to [alonzo.miller@dla.mil](mailto:alonzo.miller@dla.mil)

**NOTE:** We encourage you to duplicate this form and forward it to your various plants, as necessary.

SUBMITTED BY: \_\_\_\_\_

TITLE: \_\_\_\_\_

DATE (mm/dd /yyyy): \_\_\_\_\_

**PLEASE SUBMIT LOGO (HEAD MARKING) ON A SEPARATE SHEET.**

MIL-HDBK-57D(IS)

Subject term (key word) listing:

Fastener  
Head marking  
Logo  
Symbol

Changes from previous issue. Marginal notations are not used in this revision to identify changes with respect to the previous issue due to the extent of the changes.

Preparing Activity:  
DLA-IS

(Project No. 53GP-2008-001)

NOTE: The activities listed above were interested in this document as of the date of this document. Since organizations and responsibilities can change, you should verify the currency of the information above using the ASSIST Online database at <http://assist.daps.dla.mil>.