

NOT MEASUREMENT
SENSITIVE

MIL-HDBK-57C(IS)
5 APRIL 2007
SUPERSEDING
MIL-HDBK-57B(IS)
30 NOVEMBER 1990

DEPARTMENT OF DEFENSE HANDBOOK

LISTING OF FASTENER MANUFACTURER'S IDENTIFICATION SYMBOLS



MIL-HDBK-57C(IS)

DEPARTMENT OF DEFENSE
WASHINGTON, D.C. 20301

FORWARD

Listing of Fastener Manufacturer's Identification Symbols

MIL-HDBK-57C(IS)

1. This Military Handbook
2. Comments, suggestions, or questions on this document should be addressed to Defense Supply Center Philadelphia (DSCP), ATTN: DSCP-NASA, 700 Robbins Avenue., Philadelphia, PA 19111-5096 or e-mail to dscpg&inspeccomments@dla.mil. Since contact information can change, you may want to verify the currency of this address information using the ASSIST Online database at <http://assist.daps.dla.mil>.
3. Copies of these documents are available online at <http://assist.daps.dla.mil/quicksearch/> or from the Standardization Document Order Desk, 700 Robbins Avenue, Building 4D, Philadelphia, PA 19111-5094

MIL-HDBK-57C(IS)

FORWARD

This handbook is a compilation of the identifying symbols of fastener manufacturers as provided by the manufacturers themselves. This issue contains the names, addresses, and the symbols of all fastener manufacturers whose identifying symbols were received by 30 November, 2006. Each manufacturer who was listed in Revision B of this document was contacted to confirm the accuracy of the published information. We have annotated the listing to indicate those manufacturers that have responded to confirm or update appropriate information. The listing also annotates which manufacturers have not responded. Information about manufacturers who have not responded is still maintained in this latest revision. For the purpose of this handbook, a manufacturer is defined as the source which substantially makes the supplies, either by hand or machinery out of raw materials. Fasteners, as defined for the purpose of this handbook, refer to those threaded items included in Federal Supply Class (FSC) 5305 – Screws, 5306 – Bolts, 5307 – Studs, and 5310 – Nuts. As additional manufacturers submit their markings, the handbook will be updated.

All requests to be listed in the handbook shall be addressed to:

Defense Supply Center Philadelphia (DSCP)
Attention: DSCP-NASA
700 Robbins Avenue.
Philadelphia, PA 19111-5096
or e-mail to dscpg&inspeccomments@dla.mil.

In addition to the alphabetic index of manufacturers (Index A), this revision of the handbook incorporates a listing of manufacturers indexed by their identification symbol (index B).

At the back of this handbook is a registration form. Manufacturers wishing to be listed must complete this form and return it to DSCP. Submit the completed form, along with your fastener identification symbol artwork used on the fastener. All submittals must be in the English language.

DSCP does not “approve”, “rate”, or “endorse” any item, construction, proprietary device, or activity.

DSCP is not responsible for the accuracy or completeness of the information contained in this publication.

DSCP does not take any position with respect to the validity of any patent rights asserted in connection with any items mentioned in this document, and does not undertake to insure anyone utilizing a code, standard, or guide against liability for infringement of any applicable Letters Patent, nor assume any such liability. Users of code, standard, or guide are expressly advised that determination of the validity of any such patent rights, and the risk of infringement of such rights, is entirely their own responsibility.

DSCP reserves the right to monitor this document to ensure that it contains the listing of only bona-fide fastener manufacturers.

DSCP has solicited the assistance of the Defense Contract Management Agency (DCMA) and the Defense Management Command International (DCMCI) in an effort to identify non-manufacturers and remove them from the manufacturers’ listing. DCMA/DCMC’s evaluation of a company’s status is based on an in house capability to manufacture fasteners (screws, bolts, studs and nuts), with respect to space, equipment, and trained personnel. On an on-going basis, any company identified by DCAS/DCMCI as a non-manufacturer will be removed from the manufacturers’ database and MIL-HDBK-57C (IS).

MIL-HDBK-57C(IS)

INDEX A - MANUFACTURER

Company Name	Page
3 V FASTENERS	1
3D MACHINE COMPANY, INC.	1
A	
A & E MACHINED PRODUCTS INC SYSTEMS CORPORATION NORTHROP GRUM	1
A & G ENGINEERING CO., INC	1
A & M AEROSPACE, INC.	1
A & N PRECISION INDUSTRIES LTD	1
A & R MFG CO INC.	1
A & W SCREW MACHINE PRODUCTS, INC.	1
A. AGRATI S.P.A.	2
A. P. MILLS INDUSTRIES FOR THE BLIND	2
A-1 NUT AND BOLT CO INC DIV OF GREENCO PACIFIC INC	2
A-1 THREAD ROLLING CO., INC.	2
AAP ACQUISITION CORP DBA ACHILLES AEROSPACE PRODUCTS	2
AASTRO ENGINEERING	2
ABBOTT INTERFAST CORP.	2
ABBOTT PETER (AEROSPACE) 1982 LTD.	3
ABC TOOL & DIE ENGINEERING & MANUFACTURING LLC	3
ABSCOA INDUSTRIES	3
ACCUFORM, INC.	3
ACCURATE AUTOMATIC PARTS INC	3
ACCURATE PRECISION FASTENERS, INC.	3
ACCURATE SCREW MACHINE CORP DBA ASM	3
ACCURATE THREADED FASTENS DIV OF BEATRICE FOODS CO	3
ACCURATE THREADED PRODUCTS CO.	4
ACCURATE TOOL CO INC	4
ACCU-TECH MANUFACTURING AND SUPPORT, INC.	4
ACCUTOOL SUBCON TOOL/ACCUTOOL MACHINE GROUP INC. SEE SUBCON TOOL	4
ACE G & M COMPANY OF TEXAS INC DBA ACE GRINDING & MANUFACTURING (PLANT SEE SHAW)	4
ACE GRINDING CO INC	4
ACE PRECISION INDUSTRIES, INC.	4
ACHILLES AEROSPACE PRODUCTS, INC.	4
ACI	5
ACIMET MFG.	5
ACME MACHINE PRODUCTS	5
ACME RIVET & MACHINE CORP.	5
ACME SCREW COMPANY	5
ACRODYNE MFG CO DIV MACK INTERNATIONAL OPERATIONS	5
ACUFAST AIRCRAFT PRODUCTS	5
ADAMS INDUSTRIES INC A SUB OF BANNER INDUSTRIES INC	5
ADAMS, EARL M. CO.	6
ADC COMMUNICATIONS CORP	6
ADI MANUFACTURING, INC.	6
ADJUSTABLE BUSHING CORP.	6
ADOM ENGINEERING	6
ADVANCE PATTERN CORP	6
ADVANCED CNC MANUFACTURING	6
ADVANCED MACHINING & FABRICATING INC	6
ADVANCED PLASTICS INC DBA ADVANCED MCHNING FBRCTIONG INC	6
AERCO RESEARCH	7
AERO BUSHING AND COMPONENT	7
AERO COMPONENTS CO.	7
AERO DYNAMIC MACHINING, INC.	7
AERO ENGINEERING & MANUFACTURING CO OF CALIFORNIA DBA AERO ENGINEERING	7
AERO MECHANICAL FASTENING SYSTEMS	7
AEROBOLT MANUFACTURING, INC.	7
AERO-FAB, INC.	7
AEROFAST SUPPLY	8

Company Name	Page
AEROMAX INDUSTRIES INC DBA AEROMAX INTERNATIONAL	8
AEROSPACE MANUFACTURING	8
AEROSPACE MARINE SPECIALTY FASTENERS & FITTINGS INC. DBA AMS FASTENERS	8
AEROSPACE PRODUCTS DIV OF APCO FASTENERS, INC	8
AEROSPACE PRODUCTS CO. DIV WBH	8
AEROSPACE PRODUCTS, INC.	9
AEROSPACE RIVET MFG CORP	9
AEROSTAR ENGINEERING & MANUFACTURING COMPANY	9
AEROSTAR FASTENER CORP.	9
AEROTECH FASTENERS, INC.	9
AEROWIND CORPORATION	9
AF FASTENERS LIMITED	9
AFAB PRECISION MACHINING	9
AFI INDUSTRIES, INC.	10
AIHARA SEIBYO CO LTD	10
AIR INDUSTRIES CORPORATION	10
AIR PARTS MFG. CO.	10
AIR-COM, INC.	10
AIRCRAFT ENGINEERING PRODUCTS, INC	10
AIRCRAFT FUELSEAL FASTENERS, INC. AEROLITE BLIND RIVET DIVISION	10
AIRDROME PARTS CO.	10
AIRFASCO, INC.	11
AIW-ALTON INC	11
ALAN, JEFFREY, MFG. & ENGR.	11
ALARD MACHINE PRODUCTS	11
ALBAR MACHINE CORPORATION	11
ALCO MACHINE CO.	11
ALCOA FASTENING SYSTSEMS CAMLOC PRODUCTS	11
HUCK AEROSPACE PRODUCTS	39
HUCK INDUSTRIAL PRODUCTS	86
KELOX/MICRODOT PRODUCTS	96
MECAERO PRODUCTS	117
RAM PRODUCTS	147
ROSAN PRODUCTS	152
SIMMONDS PRODUCTS	159
TRIDAIR PRODUCTS	176
VOI-SHAN PRODUCTS	185
ALCOA GLOBAL FASTENERS INC	12
ALEXANDER MANUFACTURING COMPANY INC DBA METRO TOOL & MANUFACTURING CO	12
ALL MANUFACTURERS INC DBA HARPER AEROSPACE FASTENERS	12
ALL PINS MANUFACTURING	12
ALL QUALITY SPARES, INC.	12
ALLFAST FASTENING SYSTEMS, INC.	12
ALLIED NUT & BOLT CO., INC.	12
ALLIED PRECISION PRODUCTS, INC.	12
ALL-POWER MFG. CO.	12
ALL-PRO FASTENER & RIVET MFG. CO.	13
ALL-STATES INC.	13
ALPHA BOLT CO.	13
ALPHA FASTENERS	13
ALPHA MACHINING PRODUCTS & DEVELOPMENT	13
ALPINE MACHINE & TOOL CORP.	14
ALPS SEIKO CO., LTD. Plant - LIDA FACTORY	14
AMACON CORP.	14
AMANDA BENT BOLT CO	14
AMATOM ELECTRONIC HARDWARE DIVISION OF QUINCY TECHNOLOGIES, INC.	14
AMERICAN AIRCRAFT PARTS MANUFACTURING COMPANY	14
AMERICAN ELECTRIC CONSTRUCTION MATERIALS GROUP See THOMAS & BETTS CORP	14
AMERICAN FASTENER & SPECIALTY CO.	15
AMERICAN INTERNATIONAL AERO MFG INC	15
AMERICAN METAL BEARING COMPANY	15
AMERICAN QUALITY INDUSTRIES FASTENER DIVISION	15
AMERIFAST CORP.	15
AMERITECH FASTENER MFG INC DIVISION OF LONE STAR FASTENERS, LP	15
AMMAC, INC.	16

MIL-HDBK-57C(IS)

Company Name	Page	Company Name	Page
ANATASE PRODUCTS	16	BEK LEVEL 1 FASTENERS	26
DIV OF HENWAY INC		BELL FASTENERS	26
ANCHOR BOLT & SCREW CO.	16	ALBANY FATENERS/PAWTUCKET FASTENER DIVISION	
ANDERSON FORGE & MACHINE	16	(also see VERTEX)	
ANILLO INDUSTRIES, INC	16	BELL PRECISION, INC.	27
ANOTHER SCREW MACHINE PRODUCT	16	BELL-MEMPHIS, INC.	27
A-ONE MACHINE COMPANY	16	BEN YUAN ENTERPRISE CO, LTD.	27
APEL LTD.	16	BENACO TOOLING RESEARCH & DEV. CORP	27
APEX MFG. CO. INC	17	BEOTOL CORP.	27
APHEONIX CORPORATION	17	BERGNER, RICHARD GMBH & CO.	27
ARCHER SCREW PRODUCTS	17	BER-LOW MFG INC	28
ARCO SALES CO.	17	DBA BUTECH PRESSURE SYSTEMS	
ARDOR MFG. INC.	17	BERRY, JOHN DBA BERRY MANUFACTURING	28
ARGARWAL INDUSTRIES	17	BERRY MANUFACTURING	28
ARJAY PRECISION, INC.	17	BETA CORP.	28
ARMSTRONG ATLAS BOLT	18	BETA ENGINEERING, INC.	28
ARMSTRONG FASTENING SYSTEMS	18	BIG BOLT CORP.	28
ARMSTRONG FASTENINGS LTD.	18	BISHOP ENTERPRISES, INC.	28
ARNOLD KNIPPING GmbH	18	BLAINE TOOL CORP.	28
ARNOLD UMFORMTECHNIK GMBH & CO. KG	18	BLANC AERO INDUSTRIES	29
ARNOLD WRAGG (BOLTS & NUTS) LTD	19	BLANC AIRCRAFT FASTENERS, INC.	29
ARROW SCREW & MACHINE WORKS	19	BLAND CO., THE	29
ARTISAN SPECIALIST TECH, INC	1919	BLUE SKY INDUSTRIES, INC.	29
ARVAN, INC.	19	BLUE TEE CORP	29
ASAHI SREWS MANUFACTURING CO., LTD	19	DBA GEFCO/STECO	
ASAI TEKKO CO. LTD	19	BOBCAT MANUFACTURING CO.	30
ASI DESIGN & MANUFACTURING, INC.	19	BOGNER ENGINEERING CO.	30
ASSOCIATED TOOL CO., INC.	19	BOLLHOFF & CO. GmbH & CO. KG	30
ATF INC		BOLT & NUT CO.,	30
ATLAS ENGINEERING, INC.	20	BOLT FASTENER STUD/TECHNOLOGY	30
PENN ENGINEERING COMPANY		BOLTWORKS, INC.	30
ATLAS SPECIALTY PRODUCTS	20	BOMAR ENGINEERING, INC.	30
See CURTIS PRESTON ENTERPRISES INC		BRACELENTE MANUFACTURING CO., INC.	30
AUGUST FRIEDBERG GMBH	20	BRADY MACHINE, INC.	31
AUGUST FRIEDBERG GmbH	20	BRANCH MACHINE PARTS, INC	31
AUTO BOLT AND NUT CO.	20	BRIARWOOD FASTENERS, INC	31
AUTOMATED MANUFACTURING	21	BRIDEAN MACHINE & TOOL CO., INC.	31
AUTOMATIC MACHINING AND MFG CO DBA AMMAC INC	21	BRIDGEVIEW MANUFACTURING CO.	31
AUTOMATIC MANUFACTURING COMPANY	21	ILLINOIS CORPORATION	
AUTOMATIC SCREW MACHINE PRODUCTS CO.	21	BRINTCLIFFE TURNER LTD.	31
AUTO SCREW, INC.	21	BRISTOL INDUSTRIES	31
AVDEL INTERNATIONAL (AVDEL LTD)	21	BRISTOL LOCKNUT CO.	32
AVIATION MANUFACTURING GROUP LLC	21	NUT DIVISION	
DBA FREEMAN CO., THE		BROADSTONE TOOL & DIE, INC.	32
AVIBANK MANUFACTURING, INC.	22	BROWN PRODUCTION, INC	32
PRECISION CASTPARTS CORP.		BRUNNER DRILLING & MFG. CO., INC.	32
AVK INDUSTRIES PRODUCTS INC	22	BRUNNER MFG CO. INC.	32
AZTECH ENGINEERING, INC	22	DBA BRUNNER MANUFACTURING DIVISION	
		BRYCO MACHINE, INC.	33
B		BUCK EYE FORGE, INC.	33
B & B SPECIALTIES INC	22-23	BUCKEYE MACHINING, INC.	33
DBA G S AEROSPACE DIVISION .		BUFFALO PUMPS, INC.	33
B & D THREAD ROLLING	23	SUBSIDIARY OF AMPCO-PITTSBURGH CORP.	
B & E MACHINE SHOP & SHEET METAL FAB., INC.	23	BULA FORGE INC.	33
B & E MANUFACTURING CO., INC	23	BULTEN TRADING AB	34
B & G MANUFACTURING CO., INC.	23	BURROWERS RESEARCH MACHINING, INC.	34
B & N TOOL CO.,INC.	23	BUSAN INDUSTRIAL MACHINERY CO., LTD.	34
B & R MACHINE AND TOOL CORP	23	BOLT DIVISION	
B F GOODRICH CO. RIVNUT ENGINEERED FATSENERS, THE	24	BUTECH PRESSURE SYSTEMS	34
(AERO AND DEF DIV		see BER-LOW MFG INC.	
B G ENGINEERING, INC.	24	BUTLER, INC.	34
B G M FASTENER CO., INC.	24		
B. V. FABRIEK VAN KLINKNAGELS EN SCHROEFBOUTEN V/H	24	C	
SMIT		C & D MACHINE TOLL, INC.	35
BARCO ENGINEERING COMPANY, INC.	24	C & H MFG., INC.	35
BARRRE PRECISION PRODUCTS INC	24	C. E. MACHINE CO., INC.	35
BAS AEROSPACE LIMITED	24	C.E.S. MACHINE PRODUCTS, INC	35
BAUER & SCHAURTE KARCHER GMBH	25	C.J.'S GENERAL MACHINE WORKS	35
BBC FASTENERS, INC.	25	C.R.D. MACHINING	35
BEACH MACHINE	25	CALABRESE & SONS, INC.	35
BEAVER PRODUCTS CORP.	25	CALIFORNIA SCREW PRODUCTS CORP.	36
BEC MACHINE PRODUCTS COMPANY	25	CAMBRIDGE SPECIALTY CO INC DBA POINT MACHINE	36
BEE INDUSTRIES, INC. (WISCONSIN CORPORATION)	25	COMPANY	
BEGONIA TOOL COMPANY	26		

MIL-HDBK-57C(IS)

Company Name	Page	Company Name	Page
CAMCAR DIVISION OF TEXTRON INC.	36	CSM FASTENER PRODUCTS CO.	47
AMSCO PRODUCTS	36	CURTIS PRESTON ENTERPRISES INC	47
DRILLETITE PRODUCTS	37	DBA ATLAS SPECIALTY PRODUCTS	48
RAYCARL PRODUCTS	37	CUTTING EDGE ENTERPRISE, LLC	48
ROCKFORD HEADING PRODUCTS	37	CUTTING EDGE MACHINING INC	48
SEMS PRODUCTS	38	NEVADA DIV	
SOCKET SCREW PRODUCTS	38	WESTERN SCREW MACHINE PRODUCTS, INC.	
TAPTITE PRODUCTS	38	CWR MANUFACTURING CO	48
TORX PRODUCTS	39	DIVISION OF A.J. MUPHY CO., INC.	
CAMCAR SCREW AND MFG CO DIV OF TEXTRON INC	39		
CAMLOC PRODUCTS	39	D	
CAM-TECH INDUSTRIES	39	D & D MACHINERY AND SALES	48
CANADY MANUFACTURING CO. INC	40	D & D TOOL COMPANY, INC.	48
CAPRICE ENGINEERING CO., INC.	40	D & R MACHINE COMPANY	48
CAPY MACHINE SHOP, INC.	40	D. C. MACHINING INC.	48
CARDINAL FASTENER & SPECIALTY CO., ONC.	40	D.S.O. PLASTICS, INC.	48
CARDINAL INDUSTRIAL PRODUCTS	40	DACK INDUSTRIES, INC.	49
CARR CO.	41	DANIEL CO., EDWARD W.	49
THE UNITED CARR DIV OF TRW		DAN-LOC BOLT & GASKET INC.	49
CATALINA INSTRUMENT CORPORATION	41	DARCO PRODUCTS	49
CBS FASTENERS INC.	41	DAVE ALLEN ENTERPRISES	49
CCB INDUSTRIES, INC	41	DAVIES PRECISION MACHINING, INC.	49
CCF ENTERPRISES INC	41	DAVIS AIRCRAFT PRODUCT CO., INC.	49
CEI INC	41	DECKER MANUFACTURING CORP	50
DBA COMMAND ENTERPRISES		DERE & CO	50
CELTECH ENTERPRISE	41	DEFENSE AEROSPACE	50
CENTERLINE TOOL & ENGINEERING INC	42	DEFENSE QUALITY MFG.	50
DBA MACHINE SHOP		DEFIANCE STAMPING CO., THE	51
CENTRAL OZARK MACHINE, INC.	42	DEHOUSSE (USINES)	51
CENTURY METAL PARTS CORP.	42	DELL MFG. CO., INC.	51
CER-MAC INC.	42	DELT INDUSTRIES, INC.	51
CERNY MFG. CO.	42	AEROSPACE PRODUCTS DIVISION	
CHAMPION COMMERCIAL INDUSTRIES, INC	42	DELTA MACHINE & TOOL CO., INC	51
CHAMPION RIVET DIVISION		DEL-VAL FASTENER MANUFACTURING	51
CHAMPION FASTENERS, INC.	42	DEMAT	51
CHANCE, A.B. COMPANY	42	MECAERO ALCOA FASTENING SYSTEMS TOUL	
CHANDLER PRODUCTS, INC.	43	DEPENDABLE MACHINE CO., INC.	51
CHATHAM PRECISION, INC.	43	DERBYSHIRE MACHINE & TOOL CO INC	52
CHEREK MACHINE & TOOL CO., INC.	43	DBA DERBYSHIRE MARINE PRODUCTS	
CHEROKEE TOOL & ENGINEERING CO., INC.	43	DETROIT HEADING CO.	52
CHICAGO FASTENER MANUFACTURING	43	DEUTSCH COMPANY INC	52
CHICAGO HARDWARE & FIXTURE CO.	43	DBA DEUTSCH CO THE METAL COMPONENTS	
CHIEF MFG.	43	DFCI SOLUTIONS, INC	52
CHOICE PRECISION MACHINE, INC.	43	DHL ENTERPRISES	52
CHRIS MACHINE CO.	44	DIESEL PARTS COMPANY OF CALIFORNIA	52
CHU HUA INDUSTRIAL CO., LTD.	44	DIHARD COMPANY	52
CHUN YU WORKS & CO., LTD.	44	DISC-LOCK INTERNATIONAL	52
CINCH MANUFACTURING	44	DIXON MACHINE & TOOL (see TROY D. RAY)	53
CINCH-MANADNOCK	44	DBA DIXON MACH AND FABRICATION)	
CLEVELAND HARDWARE & FORGING	44	DO MANUFACTURING COPR	53
DBA GREEN BAY DROP FORGE CO		DO-ALL PRECISION, INC.	53
CLICK BOND, INC.	44	DOMESTIC FASTENER & FORGE, INC.	53
CLYDE FASTENERS LIMITED	44	DOMESTIC FORGING, INC.	53
CM MANUFACTURING, INC.	44	DONSON MACHINE	53
CNC MACHINING INC.	45	DOUBLECO INCORPORATED	53
COAE BOLTS WORKS CO., LTD	45	DBA R & D FASTENERS	
COAST INDUSTRIAL SUPPLY CO INC	45	DOUGLASS TOOL & ENGINEERING CO., INC.	53
SUB OF SPANDCO INDUSTRIES INC		DRESSER INDUSTRIES, INC.	53
CODLING TOOL & MFG. INC.	45	DRESSER PUMP DIVISION	
COLD HEADING COMPANY, THE	45	D'SAMIC	54
COMET MFG. CO., INC	45	DTF MFG INC DIV OF FEDERAL SCREW AND SUPPLY CO	54
COMMAND ENTERPRISES	45	DUFFY ELECTRONICS & MFG. CO.	54
COMPUTA-BASE MACHINING, INC.	46	DUNCAN ELECTRONICS & MFG. CO	54
CONNECTICUT AIRCRAFT PRODUCTS	46	DUNHAM PRODUCTS, INC	54
CONQUEST MACHINE, INC	46	DUPONT, G.B. CO., INC.	54
CO-OP SCREW MANUFACTURING CORP.	46	SEE AMAX L. P.	
COOPER POWER SYSTEMS INC	46	DUSEVOIR METAL PRODUCTS, INC.	54
MCGRAW EDISON POWER SYSTEMS		DUVE GmbH & CO. KG	55
COPELAND MANUFACTURING CORPORATION DIV JAMES DIVISION	46	DYNACAST	55
COPPER STATE BOLT & NUT COMPANY INC.	46	INDUSTRIAL FASTENERS DIVISION	
CORPUS CHRISTI GASKET & FASTENER LTD	46	DYNAMIC ENGINEERING	55
CREATIVE PRECISION INC	47	DYSON CORP., THE	55
DBA CREATIVE PRECISION WEST		Formerly JOS. DYSON & SONS, INC.	
CRESCENT MANUFACTURING CO.	47	DZUS FASTENER CO., INC	55
CRS PRECISION CORP.	47	DBA DFCI SOLUTIONS, INC	
CRYSTAL METAL PRODUCTS COMPANY, INC	47		

MIL-HDBK-57C(IS)

<u>Company Name</u>	<u>Page</u>	<u>Company Name</u>	<u>Page</u>
E			
E. KOZAK PRECISION PRODUCTS CO.	55	FASTI-WERK CARL AUG. FASTENRATH GMBH & CO.GK	65
E.L.R. MACHINE AND TOOL	55	FASTRON COMPANY, THE	66
EAGAN MACHINE CORP.	56	FEDERAL EQUIPMENT COMPANY	66
EAGLE PICHER INDUSTRIES PRECISION PRODUCTS PLANT	56	FEDERAL MANUFACTURING CORP.	66
EAGLEHEAD MANUFACTURING COMPANY INC DBA DEJAK MACHINE TOOL CO. DIV DEJAK DRILLING	56	FEDERAL SCREW WORKS	66
EAST COAST METALS INC.	56	FEDERAL SCREW WORKS BIG RAPIDS DIV ROMULUS DIV	66
EASTERN SCREW CO., INC.	56	FENBAR PRECISION MACHINISTS, INC	67
EASTWOOD MFG., CO.	56	FENTON HEADING	67
EATON AEROQUIP CORPORATION AEROSPACE DIVISION	56	FERNDALE FASTENER	67
EBC INDUSTRIES FORMERLY ERIE BOLT CORP.	56	FERRIERE DI STABIO, S.A.	67
EBERHARD BRUNINGHAUS	57	FERRY CAP & SET SCREW CO., THE	67
ECENARRO S. COOP. LTDA.	57	FIBAM COMPANHIA INDUSTRIAL	67
EDS ORDNANCE	57	FILETAGE INTERNATIONAL INTERNATIONAL THREAD INC.	67
ELASTIC STOP NUT See MACLEAN-ESNA	57	FIRST AMERICAN SALES CO.	67
ELCO INDUSTRIES, INC.	57	FISCHER SPECIAL MFG. CO.	68
ELECTRO-FREETO MANUFACTURING COMPANY	58	FITZ MANUFACTURING INDUSTRIES LTD DBA FMI	68
ELITE FASTENERS	58	FLAIG & HOMMEL	68
ELLIS PRECISION INDUSTRIES DBA E P IND.	58	FLEXALLOY INC.	68
EMERALD VALLEY MFG	58	FLORES ENTERPRISES	68
EMHART CORP GRIPCO FASTENER DIV PARKER-KALON DIVISION	58	FLUIDONICS INC.	69
EMP MANUFACTURING CO	59	FLUIDYNE CORPORATION	69
EMPIRE PRECISION MACHINING, INC.	59	FOLSOM TOOL & MOLD CORP.	69
ENGEL MANUFACTURING COMPANY, INC., THE	59	FONTAL CONTROLS, INC.	69
ENGINEERED BOLTING PRODUCTS, INC.	59	FONTANA LUIGI S.p.A	69
ENGINEERING MATERIALS CO., INC FASTENER MANUFACTURING DIVISION	59 - 60	FOREMOST PRECISION INSTRUMENT CORP.	69
ENGLER MANUFACTURING COMPANY, INC., THE	60	FOREST FASTENERS	70
ENOMOTO INDUSTRIES CO., LTD. ENOMOTO FOUNDRY	60	FORMED FASTENER MANUFACTURING, INC	70
ERICO FASTENING SYSTEMS	60	FPA MANUFACTURING DBA FPA MANUFACTURING AND SUPPLY	70
ERIE BOLT CORP DBA EBC INDUSTRIES.	61	FRANROE PRECISION MACHINE COMPANY	70
ESMET INC DBA ELECTROLINE TTUFLOC SUB OF UNIMET CORP	61	FREEMAN COMPANY, THE	70
ESNA MACLEAN-FOGG COMPANY	61	FRIEDR BOESNER GMBH	70
ESP MANUFACTURING CO., INC	61	FRISBY AEROSPACE INC DE DIV TRIUMPH ACTUATION SYSTEMS -CLEMMONS	70
ESSENTIAL MACHINING	61	FRONTIER BOLT COMPANY OF TEXAS	71
ESTA PRODUCTS COMPANY	61	FUCHS SCHRAUBENWERK GmbH	71
EVERLOCK FASTENING SYSTEMS	62	G	
GREER STOP NUT (Greer-Smyrna Division)	62	G & R SCEW MACHINE PRODUCTS	71
EVERLOCK DETROIT DIVISION	62	G & S MACHINE INC	71
INTERNATIONAL SCREW DIVISION	63	G. B. MACHINE PRECISION, INC.	71
EXCEL PRECISION PRODUCTS, INC.	63	G.B. DUPONT CO., INC	71
EXPERIMENTAL MACHINE CO.	63	GAITHER PATRICIA DBA GAITHER MACHINE	72
F		GALAN PRECISION MACHINE CO.	72
FABER ENTERPRISES, INC	63	GALMAC MFG CO	72
FABSCO CORP.	63	GARCIA INDUSTRIES, INC	72
FAILING CO., GEORGE E	63	GARDINER MFG. CO.	72
FALCON MANUFACTURING CORP.	63	GATEWAY SCREW AND RIVET, INC.	72
FALL RIVER MANUFACTURING CO., INC.	63	GEN FAST MANUFACTURING COMPANY	72
FANG SHENG SCREW CO., LTD.	64	GENERAL AVIATION	72
FARIAS INDUSTRIAL MACHINING	64	GENERAL MACHINE PRODUCTS, INC	73
FARLO MACHINE & TOOL CO., INC	64	GENERAL SCREW AND SPECIALTY CO INC	73
FASSCO FASTENER & STEEL SUPPLY CO., LTD.	64	GERMAN MACHINED PRODUCTS, INC	73
FASTENAL COMPANY	64	GERTLER INDUSTRIES, INC	73
FASTENER BROKERAGE INC DBA INOFAST MANUFACTURING	65	GFD LETAGE	73
FASTENER INNOVATION TECHNOLOGY INC DBA F.I.T.	65	GILL MACHINE TOOL CO	73
FASTENER TECHNOLOGY CORP.	65	GL CNC SERVICES INC	73
FASTENING PRODUCTS CO.,INC.	65	GMJ MACHINE COMPANY, INC.	74
FASTENING PRODUCTS OF LANCASTER, INC.	65	GMP CO CORPORATION	74
FASTENRATH BEFESTUGYBGSTECGBUJ GMBH	65	GOSHO WORKS, LTD.	74
		GRACO INDUSTRIES, INC.	74
		GRADON SCREW MACHINE CORP.	74
		GRANDUER FASTENERS, INC	74
		GRAUCH ENTERPRISES	75
		GREATER MARYLAND TOOL & MFG., CORP.	75
		GREEN BAY DROP FORGE CO	75
		DIV OF CLEVELAND HARDWARE & FORGING	75
		GREENFIELD MANUFACTURING CO., INC.	75
		GREER STOP NUT, INC.	75

MIL-HDBK-57C(IS)

Company Name	Page	Company Name	Page
GRIPCO, DIVISION OF BLACK & DECKER	76	HUCK PRODUCTS	86
GROOV-PIN CORPORATION	76	HUGGINS MFG	86
GRUPO RASSINI S.A. DE C.A. RASSINI INTERNATIONAL, INC.	76	HUGO DURHOLT GMBH & CO. KG	86
GS AEROSPACE DIVISION of B & B SPECIALTIES INC	77	HUNT VALVE COMPANY INC DBA WAECO VALVE DIVISION	86
GSF FASTENING ARMSTRONG FASTENING LTD.	77	HUNTER-STEVENS CO INC	86
GUARDIAN RIVET & FASTENER GUARDIAN MFG. DIVISION	77	HUNTINGTON VALLEY INDUSTRIES, INC DBA HVI	86
GUNNISON-INTERNATIONAL INC.	77	HURON AUTOMATIC SCREW CO.	86
H		HURRICANE MACHINE COMPANY, L.L.C.	87
H C MERCHANDISERS INC DBA H C PACIFIC	77	HYDRO FITTING MANUFACTURING CORPORATION	87
H C PACIFIC	77	HYDROBOLT LIMITED	87
H. MULLINS, LTD. BADE INDUSTRIAL ESTATE	78	I	
H. PAULIN & CO. LTD. CAPITAL METAL INDUSTRIES DIVISION	78	I.G.D. MACHINE & TOOL LTD.	87
H. PRINZ GmbH FABRIK FUR VERBINDUNGSELEMENTE	78	IDEAL FASTENERS INC.	87
HABINA ENGINEERING	78	IFASTGROUPE 2004 LP see INFASCO	87
HALL INDUSTRIES INC. FORMERLY STANDARD TOOL & MACHINE COMPANY	78	see INFASCO NUT DIV	
HALLSIMS INDUSTRIAL COMPONENTS, INC.	78	see INGERSOLL FASTENERS	
HAMANAKA (THAILAND), CO., LTD HAMANAKA NUT MFG. CO., LTD	79	IMPERIAL SUPPLIES LLC	88
HANDI GADGETS CORP.	79	INDIANA AIRCRAFT HARDWARE INC	88
HANSAN SCREW CO., LTD. EXPORTING DEPARTMENT	79	INDUSTRIAL & AUTOMOTIVE FASTENERS DIVISION OF KEY MANUFACTURING GROUP, INC.	88
HARDWARE SPECIALTY CO, INC	79	INDUSTRIAL FASTENERS CORP.	89
HARRISON BOLT AND NUT CO., THE	79	INDUSTRIAL FORGE, INC.	89
HARTFORD AIRCRAFT PRODUCTS, INC.	79	INDUSTRIAL NUT CORP.	89
HARWOOD DESIGN, INC.	79	INFASCO	89
HASKELL OF HUNTINGTON, INC.	80	DIV OF IFASTGROUPE 2004 LP	
HASSALL, JOHN, INC.	80	INFASCO NUT DIV	89
HATCH INDUSTRIES	80	DIV OF IFASTGROUPE 2004 LP	
HAYDON BOLTS, INC.	80	INGERSOLL	89
HAZE SEIKO CO., LTD	80	DIV OF IFASTGROUPE LP, A HEICO COMPANY	
HEARTLAND PRECISION FASTENERS INC	81	INLAND MACHINE CO.	90
HEIM'S MACHINE AND TOOL INC.	81	INOFASST MANUFACTURING INC.	90
HEITCO MANUFACTURING, INC.	81	IN-SPECK CORP.	90
HEMCO TOOL INC	81	INSTRUMENT MACHINING SERVICE LTD.	90
HENWAY, INC.	81	INTERFLEX MFG. CORP.	90
HEPTNER MANUFACTURING COMPANY	81	INTERSTATE FITTINGS INC.	90
HESSISCHE SCHRAUBENFABRIK WELTER GmbH & CO., KG	81	IRVING MACHINE SERVICE, INC.	90
HEXAGON ENTERPRISES, INC	81	IRWIN AUTOMATION, INC.	90
HI INDUSTRIAL TECHNOLOGIES	82	ISLAND ENGINEERING DBA J SMITH MACHINE SHOP INC	91
HIGH QUALITY MACHINE SHOP INC	82	ITT HARPER AEROSPACE FASTENER OPERATIONS AEROSPACE CONTROLS DIVISION	91
HIGH TECH ENTERPRISES	82	ITW BUILDLEX	91
HIGHLAND PRODUCTS CORPORATION	82	IVACO INC	91
HIGHLAND THREADS, INC. FASTENER MANUFACTURING DIVISION	82	DBA INFASCO see IFASTGROUPE 2004 LP	
HILL AEROSPACE & DEFENSE LLC	82	J	
HILL FASTENER CORP.	82	J & M MACHINE INC	91
HILL STAMPING & MANUFACTURING INC	82	J & S PRECISION FASTENERS	91
HILTI, INC	83	J. G. FASTENERS	92
HI-SHEAR CORP. DBA FOREIGN PARENT IS LISI PARIS FRANCE	83	J. GEORG BIERBACH	92
HLC INDUSTRIES INC	83	J.M. PRECISION, INC.	92
HMS SERVICES LLC	84	J.P. PRODUCTS, INC. DBA SPECIALITES, UNLIMITED	92
HO HONG WORKS CO., LTD	84	JACO ENGINEERING, INC.	92
HOFFMANN, RICHARD GmbH HOFFMANN MACHINE COMPANY, INC. DBA HOFFMAN, RICHARD GmbH	84	JAM TECH CORP.	92
HOLLYWOOD MANUFACTURING INC.	84	JAMES JACKSON	92
HOLO-KROME CO.	84	DBA J J ENGINEERING	
HORSPOOL AND ROMINE MFG CO INC	84	JAMISON INDUSTRIES INC	93
HORST ENGINEERING & MANUFACTURING CO.	85	JAY BEE MACHINE WORKS, INC.	93
HOUSTON FASTENER	85	JAY O MACHINE CO., INC.	93
HOUSTON PRECISION FASTENERS	85	JAYCO ENGINEERING	93
HOWARD TOOL CO., INC.	85	JERGENS INC	93
HOWE MACHINE AND TOOL CORP.	85	DBA JERGENS INDUSTRIAL SUPPLY	
HOWIE MANUFACTURING CO., INC.	85	JJ ENGINEERING	93
HUCK AEROSPACE PRODUCTS	86	JAMES JACKSON	
HUCK INDUSTRIAL PRODUCTS	86	JJ SCREW PRODUCTS, INC.	93
		JMT MACHINE COMPANY	93
		JOLICO/J-B TOOL INC.	94
		JOSLYN CORP.	94
		JUPITER WASHERS, INC.	94
		JUST IN TIME INC	94
		DBA APSCO	

MIL-HDBK-57C(IS)

Company Name	Page
K	
K & K PRECISION ENTERPRISES INC	94
K.A.A. COMPANY LYNN ABADIE DBA K A A COMPANY	94
K.D.K. UPSET FORGING C.O. INC.	95
KAMAX - WERKE RUDOLF KELLERMANN GMBH	95
KAMAX L. P. FORMERLY G.B. DUPONT CO., INC.	95
KAMPWERK VIEREGGE U. PICKARDT GMBH. & CO	95
KAPCO INDUSTRIES, INC	95
KATSURAGAWA MACHINE SCREW CO., LTD.	95
KAYGOR, INC.	95
KELLER ENGINEERING CO	96
KELOC/MICRODOT PRODUCTS	96
KEN FORGING, INC.	96
KERR CHARLES W	96
KERR LAKESIDE INC.	96
KEYSTONE BOLT & NUT COMPANY KEYSTONE THREADED PRODUCTS DIVISION	96
KEYSTONE TOOL AND MACHINE CO	96
KILBOURN ENGINEERING CO.	97
KIRSTEN PIPE CO. INC.	97
KLINCHER LOCKNUT CORP.	97
KNIPPING-DORN GmbH KALTUMFORMTECHNIK	97
KNOCH MANUFACTURING CO. LTD	97
KO AMS MACHINE PRODUCTS DBA KOAM MACHINE	97
KOBE FASTENER LIMITED	97
KOLB GMBH & CO. HERSTELLER VON VERBINDUNGSELEMENTEN	97
KONDOR TECHNOLOGIES, INC.	98
KONGO BYORA CO., LTD.	98
KOREA BOLT IND. CO., LTD. FOREIGN TRADE DEPARTMENT	98
KORODY-COLYER CORP A CR INDUSTRIES CO	98
KOZAK, E. PERCISION PRODUCTS CO	98
KPF	98
KREIS TOOL & MANUFACTURING CO INC	98
KROBACH MANUFACTURING CORP.	99
KSS SOCKET SCREW, INC	99
K-TECH MFG., INC.	99
KYOEI SEISAKUSHO CO., LTD.	99
KYOKUTO MFG CO LTD	99
L	
L & C MFG CO INC	99
L & H THREADED RODS DIV OF GRAY AMERICA CORP	100
L & J FASTENERS, INC.	100
L & M ENTERPRISES INC	100
L A MARTIN COMPANY	100
L G MACHINE AND MFG INC	100
L H INDUSTRIES, INC. TIP TOP TOOL CO.	100
L N AEROSPACE, INC.	100
L P R PRECISION PARTS AND TOOL CO INC	100
L R G CORPORATION	100
LAKE ERIE PRODUCTS, INC.	101
LAMSON AND SESSIONS OF CANADA LTD. RB & W CORP. METAL FORMING DIVISION	101
LANA INDUSTRIES	102
LANARKSHIRE BOLT LTD.	102
LAND-SEA-AIR MACHINED PRODUCTS INC	102
LANIS MACHINE AND MFG CO	102
LANUM METAL PRODUCTS LLC	102
LBL PRODUCTS	102
LEBRECHT TIGGES GmbH & CO. KG	102
LELAND-POWELL FASTENERS, INC.	103
LENCH, THOMAS WILLIAM, LTD	103
LENTERN AIRCRAFT LTD.	103
LEONARD JED CO	103 - 104
MARYLAND BOLT AND NUT CO DIV	
LEVEL 1 FASTENERS	104

Company Name	Page
LEVINGSTON MACHINE COMPANY	105
LEWIS SCREW CO DIV OF MEDALIST FASTENERS INC	105
LFC INDUSTRIES	105
DIVISION RKR TECHNOLOGIES	
LINREAD NORTHBRIDGE	105
LEICESTER, UK	
LINREAD NORTHBRIDGE AIRCRAFT PRODUCT DIVISION	105
LINREAD PUBLIC LIMITED CO. AIRCRAFT PRODUCTS DIVISION	106
LIPPISCHE EISENINDUSTRIE GmbH	107
LISI AEROSPACE	107-108
A1 TECHNOLOGIES	
BLANC AERO INDUSTRIES	
BLANC AERO INDUSTRIES RUGBY	
BLANC AERO SAINT CHAMOND GRANAT	
BLANC AERO TECHNOLOGIES	
DECOLLETAGE GENERAL MODERNE	
FT BESTAS	
HI-SHEAR CORPORATION	
LISI AEROSPACE CANADA	
MONADNOCK COMPANY THE	
LITTLE WORLD MFG INC	109
LLOYD MACHINE & TOOL CO., INC.	109
LN AEROSPACE, INC	109
LOBO OFFICINE MECCANICHE SPA	109
LOBO SYSTEMS LTD	109
LONE STAR FASTENERS, LP FORMALLY LONE STAR SCREW CO OF TEXAS INC	109
LONG-LOK FASTENERS CORP.	109
LOOS & CO., INC. AEROSPACE FASTENERS DIVISION	110
LORD CORPORATION	110
AEROSPACE PRODUCTS DIVISION (PLANT) DBA MECHANICAL PRODUCTS DIVISION	
LOUGHLIN MANUFACTURING CORP	110
M	
M & M MANUFACTURING CORPORATION	110
M.A.A. CORP. MID AMERICA AEROSPACE DIVISION	110
M.L.W. MANUFACTURING CO.	110
M.S. AEROSPACE	110
MAC FASTENERS, INC.	111
MACHINE SHOP, INC. THE	111
MACHINERITE CORP.	111
MACK A W MFG COMPANY INC	111
MACKO INDUSTRIES	111
MACKSON MFG CORP	111
MACLEAN-ESNA MACLEAN-FOGG CO.	112
MACOR, INC.	113
MAGNUM MACHINE SHOP	113
MAGNUS TOOL & DIE CO., INC.	113
MAILLY MFG CO., INC.	113
MAIN MACHINE CO INC DBA MAIN MACHINE & TOOL CO	113
MANNO, RICHARD & CO., INC	113
MANUFACTURING ENGINEERING TECH.	113
MANUFACTURING SALES AND SERVICE	113
MAPECO PRODUCTS, INC.	114
MAR-BRO MFG., INC.	114
MARTIN-CHANDLER, INC	114
MARUYKO NUT CO., LTD.	114
MARVIN ENGINEERING, CO., INC.	114
MARYLAND BOLT & NUT CO., INC.	114 - 115
LEONARD JED CO	
MASTER RESEARCH & MFG., INC.	115
MASTERCRAFT TOOL COMPANY	116
MAUDLE INDUSTRIAL CO., LTD.	116
MAUI MEGA DBA KERR, CHARLES W	116
MCADAMS MACHINE AND TOOL CO INC	116
MCCULLOUGH AERO CO DBA MCCULLOUGH & ASSOCIATES	116

MIL-HDBK-57C(IS)

<u>Company Name</u>	<u>Page</u>	<u>Company Name</u>	<u>Page</u>
MCLANE MFG INC	116	NATIONAL THREADED FASTENERS CORP.	126
McMELLON BROS INC.	116	NAVPAR, INC.	126
MD3 INDUSTRIES LTD	117	NC AUTOMATED INDUSTRIES INC	126
DBA EMPIRE PRECISION MACHINING		NCMI BRUEGGEMANN INC	127
MEACO PRODUCTS CORP.	117	ND INDUSTRIES INC	127
MEC WOLF SRL	117	DBA ND WESTERN FASTENER PROCESSING DIVISION	
MECAERO PRODUCTS	117	NEDSCHROEF HALMOND B.V.	127
MECAERO CANADA INC.	117	NELSON AEROSPACE INC.	127
MECAIR AEROSPACE INDUSTRIES	117	NELSON STUD WELDING DIVISION	127
SUBSIDIARY OF SPS TECHNOLOGIES DIV		NEUMAYER, ERICH GMBH & CO.KG	127
DBA MECAIR INC		NEVADA BOLT AND MFG CO INC	127
MECHANICAL AND INDUSTRIAL FASTENERS	118	DBA SPS NON-FERROUS ENGINEERED FASTENERS	
MECHANICAL INDUSTRIES LLC	118	NEVILLE MACHINE SHOP	128
MEL-BA MANUFACTURING INC	118	NEW HORIZON MACHINE CO., INC.	128
MERCER PRODUCTS & MFG. CO., INC.	118	NICE TOOL MFG., INC.	128
MERCURY AEROSPACE FASTENERS INC	118	NIPPON MACHINE ENGINEERING, INC.	128
LISI AEROSPACE		NIPPON STEEL BOLTEN CO., LTD.	128
MERCURY TOOL & MACHINE, INC.	118	NISCO, INC.	128
METALCRAFTERS	119	NISSAN SCREW CO. LTD.	129
DIVISION OF KEYSTONE CONSOLIDATED INDUSTRIES		SALES DEPT., FOREIGN TRADE SECTION	
METAL-TECH MFG. INC.	119	NOCHIA STEELWORKS	129
METHODS AND MACHINING SERVICES INC.	119	NON-FERROUS BOLT & MANUFACTURING CO.	129
METRO TOOL AND MANUFACTURING CO.	119	NORTHBRIDGE FASTENERS	129
ALEXANDER MANUFACTURING COMPANY INC		NORTHEAST FASTENERS	130
METRIX MFG. CO.	119	NORTHEAST METAL CO., INC.	130
MI. ME. AF. S.r.l.	119	NORTHERN SCREW CO., INC.	130
MICRO SCREW MACHINE PRODUCTS, INC.	119	NORTHSTAR ENGINEERING	130
MICRODOT INC.	120	NOVA MACHINE PRODUCTS, INC.	130
MICRODOT INSERTS		A SUBSIDIARY OF CURTIS-WRIGHT FLOW CONTROL	
MICRODOT INSERTS DIVISION		SERVICE CORP.)	
KAYNAR MFG. DIVISION		NT ENGINEERING INC	130
MID CONTINENT SCREW PRODUCTS CO.	120	NUCOR FASTENER DIVISION (DIVISION OF NUCOR	130
MID-STATES SCREW CORP.	120	CORPORATION	
ILLINOIS CORPORATION		NUMERIC MACHINE PRODUCTS	131
MIDWEST ACORN NUT CO.	120	NUTS INCORPORATED	131
MILLIPART, INC.	120	DIVISION OF STANLOK	
MILLS, J. R. MACHINING, INC	121	NUTS, INC.	131
MIL-SPEC FASTENERS CORP.	121	NYLOK CORP.	131
MINEBEA CO LTD	121		
FUJISAWA MANUFACTURING UNIT		O	
MIROFINE COMPANY	121	OAKTREE FASTENERS CO.	132
MI-TECH, INC.	121	OBARS MACHINE & TOOL CO.	132
MITSUBOSHI INDUSTRIES, LTD.	121	OCM MACHINE COMPANY, INC.	132
OSAKA DIVISION		OHIO NUT & BOLT CO., THE	132
MIX TOOL CO.	122	DIV. OF FASTENERS INDUSTRIES, INC.	
MKM MACHINE TOOL CO INC	122	OHKAWA SCREW MFG. CO., LTD	132
M-MANUFACTURING	122	OKABE CO., INC.	132
MMG ENGINEERED COMPONENTS INC	122	OKABE KIKO CO., LTD.	
DBA TOOLSOURCE		OKAI IRON WORKS, INC	132
MNP CORPORATION	123	OKAWA SCREW MANUFACTURING CO., LTD	133
DBA MNP CORPORATION DIVISION 2		OMEGA THREAD ROLLING AND GRINDING INC.	133
DBA MNP CORPORATION DIVISION 4		ONEIDA TOOL & MACHINE CORP.	133
DBA MNP FASTENER DIVISION		ONO MANUFACTURER, INC.	133
MODERN METRIC MACHINE COMPANY INC	123	ONO MANUFACTURING CO., LTD	
MODFORM-ILLINOIS INC	123	ONTIC ENGINEERING & MANUFACTURING, INC.	133
MONADNOCK COMPANY THE	123	ORANGE PRECISION PARTS	133
DBA LISI AEROSPACE		ORC-O TOOL & MACHINE, INC.	134
MONOGRAM AEROSPACE FASTENERS	124	ORDNANCE PARTS & ENGINEERING CO.	134
MONROE MACHINED PRODUCTS INC	124	ORLOTRONICS CORP.	134
MONTEREY MACHINE PRODUCTS	124	OSAKA SEIKI CO., LTD.	134
MORTON FASTENERS INC.	124	OSTEEN MACHINE SHOP	134
MORTON MANUFACTURING	124	OTO MELARA S.p.A.	134
DIVISION MORTON GRINDING		FINKECCANICA COMPANY	
MOSTAR GEAR & MACHINE MFG., CO.	124	OTT BROTHERS MACHINE CO., INC.	134
MOTOR WHEEL CORP.	125	OWARI PRECISE PRODUCTS CO., LTD	134
MRL MANUFACTURING CORP	125		
		P	
N		P & I ASSOCIATES, INC.	135
N.S.S. INDUSTRIES	125	P & L ENTERPRISES	135
NAFCO INDUSTRIES, INC.	125	P.C.M., INC.	135
NAGOYA SCREW MANUFACTURING CO, LTD	125	P.S. MACHINE CO., INC.	135
NAPIER AUTO BODY	125	PABCOR, INC.	135
NARRAGANSETT SCREW MFG CO	126	PACER ALLOYS, INC.	135
NASU DENKI-TEKKO CO., LTD.	126	PACIFIC FASTENERS, INC.	135
NATIONAL BOLTS AND RIVETS LTD	126		
NATIONAL FASTENER CO., LTD.	126		

MIL-HDBK-57C(IS)





















<u>Company Name</u>	<u>Page</u>	<u>Company Name</u>	<u>Page</u>
PACIFIC SCIENTIFIC	136	R & D WELDING & MACHINE INC.	145
PACIFIC TOOL, INC.	136	R & R PRECISION	145
PADGETT MACHINE INC.	136	R B & W CORPORATION	145-146
PAINTER TOOL, INC.	136	R. BILD COMPANY, INC	146
PALNUT CO., THE	136	R.E.C. CORP.	146
UNITED CARR FASTENERS PALNUT DIV		RABOURDIN	146
PARK PRECISION CORPORATION	136	RADAX INDUSTRIES, INC.	146
PATEREX, LTD	136	RAE MANUFACTURING CO.	147
PATTERSON LAKE PRODUCTS	136	RAHMEDE SCHRAUBENFABRIK	147
SUBSIDIARY OF COLUMBIA AUTO PARTS		RAINBOW MACHINE PRODUCTS, INC.	147
PAULIN H AND CO LTD	137	RAM ENTERPRISES	147
PB FASTENERS	137	RAM PRODUCTS	147
DIVISION OF PAUL R. BRILES, INC.		RAM THREADING, INC.	147
PEERLESS SCREW PRODUCTS CORP.	137	RAMAR NUTS, INC.	147
PEINER UMFORMTECHNIK GmbH	137	RAMCO SPECIALTIES, INC.	148
PELHAM AUTO MATRIX PRECISION	137	RAMM DEFENSE PRODUCTS	148
PENN CIGAR MACHINES INC	137	RATHMANN WALTER G. SEGMENT-KLAMMERSCHRAUBEN	148
PEM INC		GMBH	
PENN ENGINEERING COMPANY	138	RA-WHITE, INC	148
ATLAS ENGINEERING INC.		RB & W CORP.	148
PENN SCREW & MACHINE WORKS, INC.	138	REED INSTRUMENT CO.	149
PEREZ MACHINE, INC.	138	REGAL AIR, INC	149
PERIGEE MANUFACTURING COMPANY, INC.	138	MICHIGAN CORPORATION	
PERKINS MACHINE CO.	138	REID PRODUCTS INC.	149
PHOENIX SPECIALTY MANUFACTURING CO., INC.	139	RELIANT FASTENER	149
PILGRIM SCREW CORPORATION	139	REPUBLIC FASTENER MANUFACTURING CORP.	149
PINE TAVERN MACHINE INC.	139	REXNORD	149
PINEY RIDGE CO.	139	SPECIALTY FASTENERS DIVISION	
PINTO PRODUCTS	139	RICHARD MFG. CO., INC.	149
PIONEER MACHINE PRODUCTS, INC.	139	RING SCREW WORKS	150
PIONEER SCREW & NUT CO.	140	RING SCREW DIVISION	
PLAINVILLE MANUFACTURING CO., INC.	140	FENTON HEADING DIV.	
PNEU-HYDRO PRODUCTS, INC.	140	FRENDALE FASTENER	
POINT MACHINE COMPANY	140	SEMCO FASTENER DIV	
PORTLAND BOLT & MANUFACTURING CO INC	140	TITAN FASTENER	
POWERPARTS, INC.	140	RIPPA PRODUCTS	150
PRD FASTENERS LTD	140	RISCO, INCORPORATED	150
PRECI-MANUFACTURING, INC.	141	RIVER VALLEY TOOL & MANUFACTURING	150
PRECISE AERO PRODUCTS	141	RIVNUT ENGINEERED PRODUCTS, INC.	151
PRECISE OF CALIFORNIA	141	RMS	151
DIV OF ADJUSTABLE BUSHING CORP		ROBBINS MANUFACTURING CO., INC.	151
PRECISION METAL PRODUCTS CO.	141	ROBERT HENRY CO., INC.	151
PRECISION PARTS & TOOL CO., INC.	141	ROCKFORD BOLT & STEEL CO.	151
PRECISION PIECE PARTS, INC	141	SUBSIDIARY OF VARLEN CORPORATION	
PRECISION SCREW & BOLT, INC.	141	ROCKFORD FASTENERS INC.	151
PRECISION TECHNOLOGIES, INC.	141	ROCKFORD PRODUCTS CORP.	152
PRECISIONMATICS CO., INC	142	ROGG MANUFACTURING COMPANY	152
PREM INDUSTRIES, INC.	142	ROMAC ELECTRONICS, INC.	152
PRICE MANUFACTURING CO.	142	RONSON MANUFACTURING, INC.	152
PRIETO MACHINE COMPANY, INC	142	ROSAN PRODUCTS	152
PRODUCT DEVELOPMENT GROUP, INC.	142	ROTAIR INDUSTRIES, INC.	153
PRODUCTION & TOOL COMPANY	142	RS MANUFACTURING, INC.	153
PRODUCTS DESIGN & MFG. CORP.	143	RUDOLPH INSTRUMENTS, INC.	153
PRO-MACHINE & TOOL COMPANY	143	RUMCO, INC.	153
PROMPTUS ELECTRONIC HARDWARE	143	RUSCOMB TOOL & MACHNE CO., INC.	153
PROTO MACHINE CO., INC.	143		
PTM INTERNATIONAL INC	143	S	
PURITAS METAL PRODUCTS, INC.	143	S & L METAL PRODUCTS CORP	153
PYE & HOGAN LLC	143	S. B. E. (ITALY CORPORATION)	154
		S.A.B.A. S.p.A. BULLONERIA E AFFINI	154
Q		S.I. STUD, INC.	154
QRP, INC.	143	SABRE MANUFACTURING, INC.	154
QSN MANUFACTURING, INC.	144	SAFETY SOCKET SCREW CORP.	154
QUALITY AIRCRAFT SCREWS, INC	144	SAGA TEKKOSHO CO., LTD	155
QUALITY FABRICATIONS, INC.	144	SAI INDUSTRIES	155
QUALITY MACHINE & MFG INC	144	SALES SYSTEM, LIMITED	155
QUALITY SCREW PRODUCTS, INC.	144	SAMUEL MARSDEN & SON	155
QUALITY SOCKET SCREW MANUFACTURING CORP.	144	SANDIK MANUFACTURING INC.	155
QUALITY THREADED PRODUCTS COMPANY	144	SANNOHASHI SEISAKUSHO CO., LTD.	155
		SANTA ANA GEAR & MACHINE	155
R		SANTA ANA SCREW PRODUCTS INC	155
R & D FASTENERS	145	SATAIR MANUFACTURING FACILITY	156
		SATURN FASTENERS, INC.	156
		SCANDIA MFG. CO., INC.	156
		SCHMICO GMBH SCHWEISSTECHNIK	156





















MIL-HDBK-57C(IS)

Company Name	Page	Company Name	Page
TRY - AZTEC COMPANY	177	WESTERN PACIFIC ENTERPRISES, W.P.E., INC.	187
TUFF FASTENERS CO.	177	WESTERN SCREW MACHINE PRODUCTS, INC	187
TURNAMICS, INC.	177	CUTTING EDGE MACHINING	
TW DESIGN AND MANUFACTURING, L.L.C.	177	WESTERN SKY INDUSTRIES, INC.	187
TWIST TITE MFG. INC.	177	DIVISION OF ATLAS CORP.	
U		WESTFIELD FASTENERS	188
U.P. MACHINE & ENGINEERING CO.	178	WESTLAND STEEL PRODUCTS, LTD.	188
U.S. BOLT MANUFACTURING, INC.	178	WESTWOOD PRECISION, INC.	188
ULTIMATE MACHINING & WELDING	178	WHAIL BOLT IND. CO., LTD	188
ULTRA SONIC MACHINE CO., INC	178	WHELAN MACHINE & TOOL CO	188
UMPCO CORP.	178	WHITNEY SCREW CORP	188
UNIFLOW CORP.	178	WHITTET-HIGGINS CO.	188
UNIMETERIC CORPORATION	179	WIGLEY MACHINE COMPANY	188
UNISTRUT CORP. (UNISTRUT PHILA)	179	WILHELM SCHUMACHER SCHRAUBEN-FABRIK GmbH	189
UNITED BOLT & SCREW CORP.	179	WILLIAM'S MACHINE & FABRICATION, INC.	189
UNITED DRILL BUSHING CORP	179	WIL-NIC	189
UNITED PRECISION PRODUCTS CO., INC.	179	E D R INDUSTRIES INC DBA WIL-NICO	
UNITED STATES DEFENSE RESEARCH & SUPPLY	179	WILSON-GARNER CO.	189
UNITED STEEL & FASTENERS INC.	180	WILT PRECISION PRODUCTS	189
UNIVERSAL MACHINE PRODUCTS	180	WINKER HERMANN GMBH & CO KG METALLWARENFABRIK	189
UPB ENGINEERING	180	WINSLOW AUTOMATICS, INC	190
URANIA ENGINEERING CO., INC.	180	WODIN, INC.	190
SPEC-NUT		WOLSTENHOLME MACHINE	190
URBAN MANUFACTURING CO.	180	DBA WM ROBOTS	
URBAN MFG. CO. INC.	180	WOLTERS GMBH	190
US TOOL & DIE	181	WOLVERINE MACHINE PRODUCTS CO.	190
UTAH TOOL & DIE, INC.	181	WOLVERINE NUT CO.	191
V		WORTHY MACHINE	191
VALCOR ENGINEERING CORP.	181	WROUGHT WASHER MANUFACTURING INC.	191
VALLEY FORGE AND BOLT MFG CO	181	WYANDOTTE INDUSTRIES, INC.	191
VALLEY-TODECO, INC.	181	WYNNSON ENTERPRISES, INC.	191
VAN PETTY MFG., INC.	181	X	
DBA J.W. MANUFACTURING INC		XCEL MFG., INC	191
V-B MACHINE CO., INC.	181	Y	
FASTENER DIVISION		Y2K MACHINE SHOP, INC.	191
VEGAS FASTENER MANUFACTURING	181	YATES TOOL, INC.	192
VENUS FASTENERS CORP.	182	YOUNG ENGINEERS INC, THE	192
VERSATECH, INC.	182	YOW MENG INDUSTRIAL CO., LTD.	192
VERTEX DISTRIBUTION	182	Z	
VICO PRODUCTS, CO.	182	Z & B GENERAL MACHINE	192
VICTOR PRODUCTS CORP.	182	ZAMON CO., INC.	192
VIP MFG. & ENGR. CORP.	182	ZENEX CORPORATION	192
VISSERIES & BOULONNERIES DE FOURMIES	182	ZERO PRODUCTS, INC.	192
VISTEK INDUSTRIES	183		
VITCO NUCLEAR PRODUCTS INC.	183		
VM MANUFACTURING CORPORATION	183		
VMC INDUSTRIES, INC.	183-184		
VOI-SHAN PRODUCTS	185		
VOSS INDUSTRIES, INC.	185		
VOSS AEROSPACE DIVISION			
VSI (AEROSPACE PRODUCTS DIVISION)	185		
VULCAN RIVET & BOLT CORP.	185		
W			
WALKER BOLT MANUFACTURING	185		
DIVISION OF LONE STAR FASTENERS, LP			
WALZ & KRENZER INC	186		
DBA MAPECO PRODUCTS DIV MAPECO PRODUCTS			
WARREN PUMPS LLC	186		
DIVISION OF COLFAX CORPORATION			
WATERBURY BUCKLE CO.	186		
WAYNE BOLT & NUT CO., INC.	186		
WEAVER MANUFACTURING, INC.	186		
WEBLUK MACHINE CORP.	186		
WELTER GMBH & CO. KG	186		
WELTON ROLLED THREAD CORP.	186		
WESLOK	187		
DIVISION OF FALL RIVER MANUFACTURING			
WEST COAST AEROSPACE, INC.	187		
WEST TENNESSEE LIONS BLIND INDUSTRIES INC	187		
DBA A P MILLS INDUSTRIES FOR THE BLIND			





















MIL-HDBK-57C(IS)











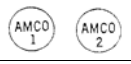

INDEX B - SYMBOL

SYMBOL	COMPANY NAME	PAGE
A		
A-1	A-1 NUT AND BOLT CO, INC	2
A-1	A-1 THREAD ROLLING CO., INC	2
	ALCO MACHINE CO.	11
A325	COAE BOLTS WORKS CO., LTD.	45
A+	ACCURATE TOOL CO., INC	4
A	AAP ACQUISITION CORP	2
A	ACCURATE PRECISION FATSENER, INC.	3
A	ACHILLES AEROSPACE PRODUCTS, INC.	4
	ACME MACHINE PRODUCT	5
   	ACME SCREW COMPANY	5
 	ADAMS, EARL M. CO.	6
A	ADVANCED CNC MANUFACTURING	6
a	ADVANCED MACHINING & FABRICATING, INC.	6
a	ADVANCED PLASTICS, INC.	6
	AEROFASST SUPPLY	8
A	AEROSPACE PRODUCTS, INC.	9
 A	AEROSTAR FASTENER CORP.	9
A*	AEROWIND CORPORATION	9
 	AFI INDUSTRIES, INC.	10
	AIR INDUSTRIES CORPORATION	10
	AIRCRAFT FUELSEAL FASTENERS, INC.	10
	ALLIED NUT & BOLT CO., INC.	12
	ALPHA MACHINING PRODUCTS & DEVELOPMENT	13
A	ALPS SEIKO CO.	14
	AMANDA BENT BOLT CO.	14
	AMERICAN ELECTRIC and THOMAS & BETTS CORPORATION	14, 173
	AMERICAN INTERNATIONAL AERO MFG INC	15
	ANDERSON FORGE & MACHINE	16
	A-ONE MACHINE COMPANY	16
A	ARNOLD UMFORMTECHNIK GMBH & CO. KG	18





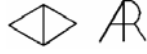





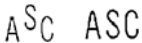







SYMBOL	COMPANY NAME	PAGE
	ARROW SCREW & MACHINE WORKS	19
A	ASAI TEKKO CO. LTD	19
	ASSOCIATED TOOL CO., INC	19
A	BELL FASTENERS	26
A	CAMCAR DIVISION OF TEXTRON INC.	36
	EATON AEROQUIP CORPORATION	56
	GARCIA INDUSTRIES, INC.	72
A	MECAERO ALCOA FASTENING SYSTEMS TOUL SE	117
AAP	AVIBANK MFG., INC.	22
AB	ABSCOA INDUSTRIES	3
AB	ADJUSTABLE BUSHING CORP	6
 	AVIBANK MFG., INC.	22
	LENCH, THOMAS WILLIAM, LTD.	103
	PRECISE OF CALIFORNIA	141
ABC	ALPHA BOLT CO.	13
ABE	ADAMS INDUSTRIES, INC.	5
ABM	AEROBOLT MANUFACTURING, INC	7
 	AUTO BOLT AND NUT CO.	20
	ACE PRECISION INDUSTRIES, INC.	4
ACI	ACI	5
 	ACIMET MFG.	5
	ACCU-TECH MANUFACTURING AND SUPPORT, INC	4
AD	ADOM ENGINEERING	6
AD	AUTOMATIC SCREW MACHINE PRODUCTS CO.	21
ADB	AVIBANK MFG., INC.	22
ADBB	AVIBANK MFG., INC.	22
	AERO DYNAMIC MACHINING, INC	7
ADP	AVIBANK MFG., INC.	22
adc 	ADC COMMUNICATIONS CORP	6
AE	A & E MACHINED PRODUCTS	1
	AASTRO ENGINEERING	2
	AERO ENGINEERING AND MANUFACTURING CO. OF CALIFORNIA	7
	ATLAS ENGINEERING, INC. and PENN ENGINEERING & MANUFACTURING CO.	20, 138
AEP 	AIRCRAFT ENGINEERING PRODUCTS, INC.	10

















MIL-HDBK-57C(IS)

SYMBOL	COMPANY NAME	PAGE
	AERO BUSHING AND COMPONENT	7
	ACCUFORM, INC.	3
	ACCURATE THREADED FASTENERS, INC	3
AF	ACUFAST AIRCRAFT PRODUCTS	5
	AEROTECH FASTENERS, INC	9
	ALLFAST FASTENING SYSTEMS, INC.	12
	ALPHA FASTENERS	13
	ATF, INC.	20
	AUGUST FRIEDBERG GMBH	20
	AFAB PRECISION MACHINING	9
	AIRFASCO, INC.	11
	AMERICAN FASTENER & SPECIALTY CO.	15
AGC	ACE GRINDING & MFG. OF TEXAS	4
AGM	ACE GRINDING & MFG. OF TEXAS	4
A/I	ARVAN, INC.	19
A-I	AVIBANK MFG., INC.	22
	AIR-COM, INC.	10
AK	ARNOLD KNIPPING GmbH	18
A-K	AVIBANK MFG., INC.	22
A.L.	S.A.B.A. S.p.A. BULLONERIA E. AFFINI	154
	ALPINE MACHINE & TOOL CORP.	14
	A & M AEROSPACE, INC.	1
AM	AEROSPACE MANUFACTURING	8
	AMACON CORP.	14
	AMERICAN FASTENER & SPECIALTY CO.	15
	AMMAC, INC.	16
	ARDOR MFG. INC.	17
	AUTOMATIC MANUFACTURING COMPANY	21
AM	AUTOMATED MANUFACTURING	21
	AUTOMATIC MACHINING AND MFG CO	21
AMATOM	AMATOM ELECTRONIC HARDWARE	14
AMB	AMERICAN METAL BEARING COMPANY	15
AMC	ALBAR MACHINE CORPORATION	11





















SYMBOL	COMPANY NAME	PAGE
	SAI INDUSTRIES CORP. EFT 2	155
	ALARD MACHINE PRODUCTS	11
	AERO MECHANICAL FASTENING SYSTEMS	7
AMS	AEROSPACE MARINE SPECIALTY FASTENERS & FITTINGS INC.	8
AMSCO	ACCURATE SCREW MACHINE CO	3
AMT - I AMT x x x x - x x x x	ALPINE MACHINE & TOOL CORP.	14
A-N	AVIBANK MFG., INC.	22
	A & N PRECISION INDUSTRIES	1
	AMERICAN QUALITY INDUSTRIES	15
AOL	ALL MANUFACTURERS INC.	12
AOL	ITT HARPER AEROSPACE FASTENER OPERATIONS	91
AP	ACCURATE AUTOMATIC PARTS CO	3
ap	ADVANCED PLASTICS, INC.	6
AP	AEROSPACE PRODUCTS CO.	8
	AIR PARTS MFG. CO.	10
	AIRDROME PARTS CO.	10
AP	ALL-POWER MFG. CO.	12
AP	ALL-PRO FASTENER & RIVET MFG. CO.	13
	ANATASE PRODUCTS	16
AP	APEX MFG. CO. INC.	17
AP	APHEONIX CORPORATION	17
A-P	AVIBANK MFG., INC.	22
	PILGRIM SCREW CORP.	139
APCO	AEROSPACE PRODUCTS	8
	APEL LTD.	16
APMI	A. P. MILLS INDUSTRIES FOR THE BLIND and WEST TENNESSEE LIONS BLIND IND. INC.	2, 187
APP	ALLIED PRECISION PRODUCTS, INC.	12
AR	A & R MFG CORP	1
	ACME RIVET & MACHINE CORP.	5
ARVAN, INC.	ARVAN, INC.	19
	AEROSTAR ENGINEERING & MANUFACTURING COMPANY	9
	ALL-STATES INC.	13











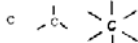





MIL-HDBK-57C(IS)

SYMBOL	COMPANY NAME	PAGE
AS	AVIBANK MFG., INC.	22
 ASC	ARCO SALES CO.	17
ASP	ATLAS SPECIALTY PRODUCTS	20
ASP	CURTIS PRESTON ENTERPRISES INC.	47
 ASTI	ARTISAN SPECIALIST TECH, INC.	19
ATBO ATLAS	ARMSTRONG ATLAS BOLT	18
 AV	AVDEL INTERNATIONAL	21
AV	AVIBANK MFG., INC.	22
AVIBANK	AVIBANK MFG., INC.	22
AVK	AVIBANK MFG., INC.	22
 AVK	AVK INDUSTRIES PRODUCTS INC.	22
AVL	AVIBANK MFG., INC.	22
A		
 AW	A & W SCREW MACHINE PRODUCTS, INC	1
 AW	AIW-ALTON INC.	
 AW	ARNOLD WRAGG (BOLTS & NUTS) LTD	19
A-W	AVIBANK MFG., INC.	22
AX	AEROMAX INDUSTRIES, INC.	8
B		
 B&E	B & E MACHINE SHOP & SHEET METAL FAB., INC.	23
 B&E	B & E MANUFACTURING CO., INC.	23
B	BELL FASTENERS	26
 B	BELL-MEMPHIS, INC.	27
 B	BERGNER, RICHARD GMBH & CO	27
 B	BETA ENGINEERING, INC.	28
 B	BLANC AIRCRAFT FASTENERS, INC.	29
 B	BOBCAT MANUFACTURING CO.	30
 B	BOLT FASTENER STUD/TECHNOLOGY	30
B B+	BRISTOL INDUSTRIES	31
B1		
 B	BROADSTONE TOOL & DIE, INC.	32
 B	BUCK EYE FORGE, INC.	33
BALL-LOCK	AVIBANK MFG., INC.	22
 B	BARRE AEROSPACE PRODUCTS INC.	24
 B		
BAF	BLANC AIRCRAFT FASTENERS, INC.	29





















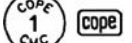

SYMBOL	COMPANY NAME	PAGE
BB	B & B SPECIALTIES, INC.	22
BB  BB	BIG BOLT CORP.	28
 BB  BB  BB		
 BB	LISI AEROSPACE	108
 BB	BETA CORP.	28
BCC	BBC FASTENERS, INC.	25
BD  BDM	SAFETY SOCKET SCREW CORP.	154
BDM	BRUNNER DRILLING & MFG. CO., INC.	32
 BE	BOGNER ENGINEERING CO.	30
 BEC	BARCO ENGINEERING COMPANY, INC.	24
BEC	BEC MACHINE PRODUCTS COMPANY	25
BEI	ANOTHER SCREW MACHINE PRODUCT	16
 BE	BOMAR ENGINEERING, INC.	30
BEK	BEK LEVEL 1 FASTENERS and LEVEL 1 FASTENERS	26, 104
 BENACO	BENACO TOOLING RESEARCH & DEV. CORP.	27
BFG+	B F GOODRICH CO. RIVNUT ENGINEERED FASTENERS, THE	24
BFI	BRIARWOOD FASTENERS, INC.	31
 BG	B G ENGINEERING, INC.	24
 BGM	B G M FASTENER CO., INC.	24
BH	BULTEN TRADING AB	34
BI	BEE INDUSTRIES, INC.	25
BI	BRISTOL INDUSTRIES	31
 BIT	BRINTCLIFFE TURNER LTD.	31
BIM	BUSAN INDUSTRIAL MACHINERY CO., LTD.	34
BL	BLAND CO., THE	29
BLC	AVIBANK MFG., INC.	22
BLSAVIBANK	AVIBANK MFG., INC.	22
 BM	BEACH MACHINE	25
BM	BERRY, JOHN DBA BERRY MANUFACTURING	28
BM	BERRY MANUFACTURING	28
BM	BRUNNER DRILLING & MFG. CO., INC.	32
BM	BRUNNER MANUFACTURING CO. DBA BRUNNER MANUFACTURING DIVISION	32
BM	BRYCO MACHINE, INC.	33
BM	BUSAN INDUSTRIAL MACHINERY CO., LTD.	34
BMC INC.	BRACELENTE MANUFACTURING CO., INC.	30
 BMC	BUCKEYE MACHINING, INC.	33















MIL-HDBK-57C(IS)

SYMBOL	COMPANY NAME	PAGE
	BRADY MACHINE, INC.	31
	BRANCH MACHINE PARTS, INC.	31
	BOLT & NUT CO.	30
	B & N TOOL CO., INC.	23
	FRIEDR BOESNER GMBH	70
BOT	BEOTOOL CORP.	27
BP	BELL PRECISION, INC.	27
BP	BUFFALO PUMPS, INC.	33
B.P.C.	BEAVER PRODUCTS CORP.	25
	FERRY CAP & SET SCREW CO., THE	67
	BROWN PRODUCTION, INC.	32
	BER-LOW MFG INC.	28
	BUTECH PRESSURE SYSTEMS	34
BR	B & R MACHINE AND TOOL CORP	23
	BRIDEAN MACHINE & TOOL CO., INC.	31
	BURROWERS RESEARCH MACHINING, INC.	34
BT	BEGONIA TOOL COMPANY	26
	BLAINE TOOL CORP.	28
	BAS AEROSPACE LIMITED	24
BUFO	BULTEN TRADING AB	34
BULA	BULA FORGE INC.	33
	BOLTWORKS, INC.	30
BVB	BRIDGEVIEW MANUFACTURING CO.	31
	ITW BUILDDEX	91
BY	BEN YUAN ENTERPRISE CO, LTD.	27
	EBERHARD BRUNINGHAUS	57
C		
C&D MACH	C & D MACHINE TOLL, INC.	35
	CAMLOC PRODUCTS	39
C	CARDINAL INDUSTRIAL PRODUCTS	40
	CHAMPION FASTENERS, INC.	42
	CHANCE, A.B. COMPANY	42
	CHIEF MFG.	43
	CINCH MANUFACTURING	44
C	CNC MACHINING INC.	45

SYMBOL	COMPANY NAME	PAGE
	COAE BOLTS WORKS CO., LTD.	45
	COAST INDUSTRIAL SUPPLY CO., INC	45
	CO-OP SCREW MANUFACTURING CORP.	46
	CSM FASTENER PRODUCTS	47
	HAZE SEIKO CO., LTD.	80
	REXNORD	149
C	SPS TECHNOLOGIES	163
	TEXTRON FASTENING SYSTEMS	172
	TOWNSEND CO.	175
CAMCAR		
	CAMCAR DIVISION OF TEXTRON INC.	36-39
CAMLOC		
	CAMLOC PRODUCTS, REXNORD	39,149
		
CAMTECH		
	CAM-TECH INDUSTRIES	39
		
	CONNECTICUT AIRCRAFT PRODUCTS	46
	BOBCAT MANUFACTURING CO.	30
CB	CLICK BOND, INC.	44
CBM	COMPUTA-BASE MACHINING, INC.	46
CBS	CBS FASTENERS INC.	41
CbS		
CCB	CCB INDUSTRIES, INC.	41
CCF	CCF ENTERPRISES INC.	41
CCS	SPS TECHNOLOGIES	163
	CAPRICE ENGINEERING CO., INC.	40
C. E. I	COMMAND ENTERPRISES	45
CES	C.E.S. MACHINE PRODUCTS, INC	35
	CHICAGO FASTENER MANUFACTURING	43
CFL	CLYDE FASTENERS LIMITED	44
CFS	CARDINAL FASTENER & SPECIALTY CO., INC.	40
CCG	CORPUS CHRISTI GASKET & FASTENER LTD.	46
	CANADY MANUFACTURING CO. INC.	40
	CHU HUA INDUSTRIAL CO., LTD.	44
	COLD HEADING CO., THE	45
CHEREK	CHEREK MACHINE & TOOL CO., INC.	43
CHF	CHICAGO HARDWARE & FIXTURE CO.	43
CI	CATALINA INSTRUMENT CORPORATION	41

MIL-HDBK-57C(IS)

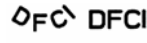
SYMBOL	COMPANY NAME	PAGE
	SPS TECHNOLOGIES	163
	C. J.'S GENERAL MACHINE WORKS	35
	CENTERLINE TOOL & ENGINEERING, INC.	42
CM	CER-MAC INC.	42
	CM MANUFACTURING, INC.	44
	CRESENT MANUFACTURING CO.	47
	CERNY MFG. CO.	42
	CHRIS MACHINE CO.	44
CMi	CONQUEST MACHINE, INC.	46
	CENTURY METAL PARTS CORP.	42
	CRYSTAL METAL PRODUCTS COMPANY, INC.	47
	CAPY MACHINE SHOP, INC.	40
	OWARI PRECISE PRODUCTS CO., LTD	134
	CENTRAL OZARK MACHINE, INC.	42
	COPELAND MFG. CORP.	46
CP	CHANDLER PRODUCTS, INC.	43
	CREATIVE PRECISION INC.	47
CPM	CHOICE PRECISION MACHINE, INC.	43
	C.R.D. MACHINING	35
	CRS PRECISION CORP.	47
CS	CALIFORNIA SCREW PRODUCTS CORP.	36
	COPPER STATE BOLT & NUT CO.	46
	CAMBRIDGE SPECIALTY COMPANY, INC.	36
C	CAMCAR DIVISION OF TEXTRON INC.	36-39
S D	CALABRESE & SONS, INC.	35
	CALABRESE & SONS, INC.	35
	CHEROKEE TOOL & ENGINEERING CO., INC.	43
	CWR MANUFACTURING CO	48
D		
D & D	D & D TOOL COMPANY, INC.	48
	B & D THREADED ROLLING	23









SYMBOL	COMPANY NAME	PAGE
d	DACK INDUSTRIES, INC.	49
	DANIEL CO., EDWARD W.	49
D	DAN-LOC BOLT & GASKET INC.	49
D	DECKER MANUFACTURING CORP	50
	DEFIANCE STAMPING COMPANY, THE	51
D	DEHOUSSE (USINES)	51
	DELL MFG. CO., INC.	51
D	DEMAT	51
	DERBYSHIRE MACHINE & TOOL CO.	52
D	DIESEL PARTS COMPANY OF CALIFORNIA	52
D	DIHARD COMPANY	52
	DO MANUFACTURING CORP.	53
	DUPONT, G.B. CO., INC. and KAMAX L. P	54, 71, 95
	DUSEVOIR METAL PRODUCTS, INC.	54
D	DUVE GmbH & CO. KG	55
	DYSON CORP THE	55
	ONTIC ENGINEERING & MANUFACTURING, INC.	133
	STEEL WAREHOUSE COMPANY, INC.	165
D A E	DAVE ALLEN ENTERPRISES	49
DAS	DEFENSE AEROSPACE	50
1		
DB	DAN-LOC BOLT & GASKET INC.	49
DC	D. C. MACHINING INC.	48
DDG	BLANC AERO INDUSTRIES and LISI	29, 108
	DYNAMIC ENGINEERING	55
	DEUTSCH COMPANY INC., THE	52
df	DTF MANUFACTURING, INC.	54
	DFCI SOLUTIONS, INC.	52
	DETROIT HEADING CO.	52
DHL	DHL ENTERPRISES	52
	DELT INDUSTRIES, INC.	51













MIL-HDBK-57C(IS)

SYMBOL	COMPANY NAME	PAGE
	DUNCAN ELECTRONICS & MFG. CO	54
	DOMESTIC FORGING, INC.	53
DL	DISC-LOCK INTERNATIONAL	52
	MILLS, J. R. MACHINING, INC.	121
DMC	DECKER MANUFACTURING CORP	50
	DEPENDABLE MACHINE CO., INC.	51
	DELTA MACHINE & TOOL CO., INC.	51
DMT	DIXON MACHINE & TOOL and TROY D. RAY	53, 176
	KNIPPING-DORN GmbH	97
	TRW	177
D P	DARCO PRODUCTS	49
DP	DUNHAM PRODUCTS, INC.	54
DPM	DAVIES PRECISION MACHINING, INC.	49
DQ	DEFENSE QUALITY MFG.	50
	DOUBLECO INCORPORATED	53
	DEMAT	51
DTE	DOUGLASS TOOL & ENGINEERING CO., INC.	53
DTE	EMERALD VALLEY MFG	58
	DTF MANUFACTURING, INC	54
	DUFFY ELECTRONICS & MFG. CO.	54
DUVE 	DUVE GmbH & CO. KG	55
DUVEX	DUVE GmbH & CO. KG	55
DV	DEL-VAL FASTENER MANUFACTURING	51
DX	DUVE GmbH & CO. KG	55
	DYNACAST	55
DZUS	DZUS FASTENER CO., INC.	55











SYMBOL	COMPANY NAME	PAGE
E		
	EAGAN MACHINE CORP.	56
E	EAST COAST METALS INC.	56
	EASTERN SCREW CO., INC.	56
E	EBC INDUSTRIES (ERIE)	56
E	ERIE BOLT CORP.	61
E	ELASTIC STOP NUT & ESNA	57, 61, 112
E	ELCO INDUSTRIES, INC.	57
e	ELLIS PRECISION INDUSTRIES	58
	ENGINEERING MATERIALS CO., INC.	59-60
	ENOMOTO INDUSTRIES CO., LTD.	60
E	ERICO FASTENING SYSTEMS	60
	ESMET, INC.	61
E	NORTHBRIDGE FASTENERS	129
	R B & W CORPORATION	145
E A	VOSS INDUSTRIES, INC.	185
	SUPERIOR TECHNOLOGY	168
EBM	EBERHARD BRUNINGHAUS	57
EBP	ENGINEERED BOLTING PRODUCTS, INC.	59
	ELCO INDUSTRIES, INC.	57
	E.L.R. MACHINE AND TOOL	55
EM	EASTWOOD MFG., CO.	56
	ENGEL MANUFACTURING COMPANY, INC., THE	59
EM	ENGLE MANUFACTURING COMPANY, INC., THE	60
	ESSENTIAL MACHINING	61
	EXPERIMENTAL MACHINE CO.	63

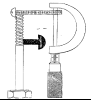







MIL-HDBK-57C(IS)

SYMBOL	COMPANY NAME	PAGE
EN	ELASTIC STOP NUT & ESNA	57, 61, 112
Ep	EAGLE PICHER INDUSTRIES	56
	EMPIRE PRECISION MACHINING and MD3 INDUSTRIES LTD.	59, 117
ERIE	EBC INDUSTRIES (ERIE)	56
ERIE	ERIE BOLT CORP.	61
ESC	ECENARRO S. COOP. LTDA	57
ESNA	ELASTIC STOP NUT & ESNA	57, 61, 112
ESTA	ESTA PRODUCTS COMPANY	61
ET	AVIBANK MFG., INC.	22
ETC	AVIBANK MFG., INC.	22
EΣΠ	ESP MANUFACTURING CO., INC	61
EWB	SPS TECHNOLOGIES	163
EWN	SPS TECHNOLOGIES	163
 EXPANDO	PRECISE OF CALIFORNIA	141
F		
F593	ENGLE MANUFACTURING COMPANY, INC., THE	60
F	AVIATION MANUFACTURING GROUP LLC (SEE DBA FREEMAN CO., THE)	21
	BLUE TEE CORP DBA GEFCO/STECO	29
	FAILING CO., GEORGE E	63
f	FALL RIVER MANUFACTURING CO., INC.	63
F F	(FASSCO) FASTENER & STEEL SUPPLY CO., LTD.	64
F	FASTENRATH BEFESTIGUNGSTECHNIK GmbH	65
F	FASTI-WERK CARL AUG. FASTENRATH GMBH & CO.KG	65
F	FASTRON COMPANY, THE	66
  F	FEDERAL SCREW WORKS	66
	FENBAR PRECISION MACHINISTS, INC.	67
	FERNDALE FASTENER	67
F	FREEMAN CO.	70
F	LISI AEROSPACE	108
F	M & M MANUFACTURING CORPORATION	110
F	VISSERIES & BOULONNERIES DE FOURMIES	182
F	FONTANA S.A.	69
2F 3F 4F 5F		











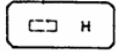







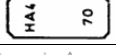

SYMBOL	COMPANY NAME	PAGE
	THIANT (BOULONNERIE DE SA)	173
FAH	FRISBY AEROSPACE INC DE and TRIUMPH GROUP OPERATIONS INC. THE	70, 176
	FRONTIER BOLT COMPANY OF TEXAS	71
FC F-C	FERRY CAP & SET SCREW CO., THE	67
	FUCHS SCHRAUBENWERK GmbH	71
FCI	FONTAL CONTROLS, INC.	69
FDC	FLUIDYNE CORPORATION	69
	FABER ENTERPRISES, INC.	63
FE	FABSCO CORP.	63
	FLORES ENTERPRISES	68
F E C	FEDERAL EQUIPMENT COMPANY	66
6 0 5 8 7		
 FF	FOREST FASTENERS	70
	FORMED FASTENER MANUFACTURING, INC.	70
F.K	VISSERIES & BOULONNERIES DE FOURMIES	182
FH	FLAIG & HOMMEL	68
	FENTON HEADING	67
	FIBAM COMPANHIA INDUSTRIAL	67
FIT	FASTENER INNOVATION TECHNOLOGY, INC.	65
	FLUIDONICS INC.	69
	FALCON MANUFACTURING CORP.	63
	FOLSOM TOOL & MOLD CORP.	69
F M C	FEDERAL MANUFACTURING CORP.	66











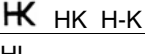







MIL-HDBK-57C(IS)

SYMBOL	COMPANY NAME	PAGE
	TRIAD PRODUCTS CORP.	176
FN	AVIBANK MFG., INC.	22
FNF	SPS TECHNOLOGIES	163
	FASTENAL COMPANY	64
FONTANA	FONTANA S.A.	69
	FASTENING PRODUCTS OF LANCASTER, INC.	65
FPA	FPA MANUFACTURING	70
	FASTENING PRODUCTS CO., INC.	65
FPIC	FOREMOST PRECISION INSTRUMENT CORP.	69
fr	FALL RIVER MANUFACTURING CO., INC.	63
F.R.	FRANROE PRECISION MACHINE COMPANY	70
FRIEDBERG	AUGUST FRIEDBERG GmbH	20
F.R.P	FRANROE PRECISION MACHINE COMPANY	70
F S	FERRIERE DI STABIO, S.A.	67
FS	FLAIG & HOMMEL	68
f t	CAMCAR DIVISION OF TEXTRON INC.	36-39
FT	FASTENER TECHNOLOGY CORP.	65
	FUCHS SCHRAUBENWERK GmbH	71
FX	FLEXALLOY INC.	68
G		
G	EVERLOCK FASTENING SYSTEMS	62
G	GALAN PRECISION MACHINE CO.	72
	GALMAC MFG CO.	72
G	GATEWAY SCREW AND RIVET, INC.	72
	GENERAL MACHINE PRODUCTS, INC	73
	GILL MACHINE & TOOL CO.	73
G	GOSHO WORKS, LTD.	74
	GRACO INDUSTRIES, INC.	74
G	GREER STOP NUT	75
	GUARDIAN RIVET & FASTENER	77
	GARDINER MFG. CO.	72

















SYMBOL	COMPANY NAME	PAGE
G.B.M	G. B. MACHINE PRECISION, INC.	71
	STERLING MARKING PRODUCTS IC.	167
	GRAUCH ENTERPRISES	75
GEBI 	J. GEORG BIERBACH	92
GF	GRANDUER FASTENERS, INC.	74
	GRIPCO, DIVISION OF BLACK & DECKER	76
GFM	GREENFIELD MANUFACTURING CO., INC.	75
G _H	EMHART CORP.	58
GII	GERTLER INDUSTRIES, INC.	73
	GL CNC SERVICE INC.	73
GMF	GAITHER PATRICIA	72
	GMJ MACHINE COMPANY, INC.	74
GMT	GREATER MARYLAND TOOL & MFG., CORP.	75
	GRIPCO, DIVISION OF BLACK & DECKER	76
Go	GOSHO WORKS, LTD.	74
Gosho	GOSHO WORKS, LTD.	74
G-P	GROOV-PIN CORPORATION	76
GPM	GALAN PRECISION MACHINE CO.	72
G & R	G & R SCREW MACHINE PRODUCTS	71
GR	RABOURDIN	146
	GERMAN MACHINED PRODUCTS, INC.	73
GS	B & B SPECIALTIES INC. and GS AEROSPACE TECHNOLOGY, INC.	22, 77
G-S	G & S MACHINE INC.	71
GS	GENERAL SCREW & SPECIALTY CO., INC.	73
GSAT	GS AEROSPACE TECHNOLOGY, INC.	77
GSF	ARMSTRONG FASTENINGS LTD.	18
GSF	GSF FASTENING	77
GSI	GS AEROSPACE TECHNOLOGY, INC.	77
	SCHRAUBENFABRIK GUSTAV STERNBERG GmbH & CO. KG	156
GTT	GUNNISON-INTERNATIONAL INC.	77
H		
H	BEK LEVEL 1 FASTENERS and LEVEL 1 FASTENERS	26, 101









MIL-HDBK-57C(IS)

SYMBOL	COMPANY NAME	PAGE
	FUCHS SCHRAUBENWERK GmbH	71
	HAMANAKA (THAILAND). CO., LTD.	79
H	HASKELL OF HUNTINGTON, INC	80
	HAYDON BOLTS, INC.	80
	HEMCO TOOL INC.	81
	HEXAGON ENTERPRISES, INC.	81
	HILL FASTENER CORP.	82
H	HILTI, INC	83
	HI-SHEAR CORP. (LISI)	83
H	HOFFMANN, RICHARD GMBH CO. KG	84
H	HOLLYWOOD MANUFACTURING INC.	84
H	HUCK PRODUCTS	86
H	HUGGINS MFG.	86
	HURON AUTOMATIC SCREW CO.	86
	MNP CORPORATION	123
	FUCHS SCHRAUBENWERK GmbH	71
	FUCHS SCHRAUBENWERK GmbH	71
	HABINA ENGINEERING	78
	HARTFORD AIRCRAFT PRODUCTS, INC.	79
	HARRISON BOLT & NUT CO., THE	79
HB	HYDROBOLT LIMITED	87
HBN	MNP CORPORATION	123
HC	H C MERCHANDISERS INC. and H C PACIFIC	77
HCP	H C MERCHANDISERS INC. and H C PACIFIC	77
	HUGO DURHOLT GMBH & CO. KG	86
HDI	HARWOOD DESIGN, INC.	79
	HORST ENGINEERING & MANUFACTURING CO.	85
	HORST ENGINEERING & MANUFACTURING CO.	85
	HILL FASTENER CORP.	82
	HYDRO FITTING MFG. CORP.	87
	HO HONG WORKS CO., LTD	84
	HI INDUSTRIAL TECHNOLOGIES	82
	HALLSIMS INDUSTRIAL COMPONENTS, INC.	78













SYMBOL	COMPANY NAME	PAGE
	HILL AEROSPACE & DEFENSE LLC.	82
HILTI	HILTI, INC	83
HI PSI	SPS TECHNOLOGIES	163
HI TI	SPS TECHNOLOGIES	163
	HOLO-KROME CO.	84
HL	HLC INDUSTRIES INC.	83
	H. MULLINS, LTD.	78
	HOWIE MANUFACTURING CO., INC.	85
	HEIM'S MACHINE & TOOL, INC.	81
HMTC	HOWE MACHINE AND TOOL CORP.	85
	CAMCAR DIVISION OF TEXTRON INC.	36-39
	H. PRINZ GmbH	78
	HENWAY, INC.	81
	HIGHLAND PRODUCTS CORPORATION	82
	MICRO SCREW MACHINE PRODUCTS, INC.	119
HPF	HOUSTON PRECISION FASTENERS	85
HPS	HILTI, INC	83
	HIGH QUALITY MACHINE SHOP	82
HR HR	HORSPOLL & ROMINE MANUFACTURING CO., INC.	84
	HARDWARE SPECIALTY CO, INC	79
HS	HILL STAMPING & MFG., INC.	82
	HI-SHEAR CORP.	83
	LISI AEROSPACE	107
HSC	HUNTER STEVENS COMPANY	86
HSLG-R	HILTI, INC	83
	HAMANAKA (THAILAND). CO., LTD.	79
	HIGHLAND THREADS, INC.	82
	HOWARD TOOL CO., INC.	85
HTC	HEITCO MANUFACTURING, INC.	81
HTE.	HIGH TECH ENTERPRISES	82
	HATCH INDUSTRIES	80
	HUNT VALVE COMPANY, INC.	86
HVI	HUNTINGTON VALLEY INDUSTRIES, INC. DBA HVI	86









MIL-HDBK-57C(IS)

SYMBOL	COMPANY NAME	PAGE
I		
 	EVERLOCK FASTENING SYSTEMS	63
I	ALPHA BOLT CO.	13
	IMPERIAL SUPPLIERS, INC.	88
I	INDUSTRIAL & AUTOMOTIVE FASTENERS	88
	INTERSTATE FITTINGS INC.	90
	PIONEER SCREW & NUT CO.	140
II	MACLEAN-FOGG CO.	112
IAH	INDIANA AIRCRAFT HARDWARE	88
IF	IDEAL FASTENERS INC.	87
IF	INDUSTRIAL FORGE, INC.	89
	I.G.D. MACHINE & TOOL LTD.	87
	STERLING MARKING PRODUCTS IC.	167
	CAMCAR DIVISION OF TEXTRON INC.	36-39
IM	INLAND MACHINE CO.	90
IM	IRVING MACHINE SERVICE, INC.	90
 IMC	INTERFLEX MFG. CORP.	90
 	INSTRUMENT MACHINING SERVICE LTD.	90
I.M.S.2		
 or INC	INDUSTRIAL NUT CORP.	89
ICHO	AIHARA SEIBYO CO LTD	10
	ISLAND ENGINEERING	91
IN	FASTENER BROKERAGE INC.	65
IN	INOFASST MANUFACTURING INC.	90
INBUS'	BAUER & SCHAURTE KARCHER GMBH	25
	IN-SPECK CORP.	90
IT	AVIBANK MFG., INC.	22
ITC	AVIBANK MFG., INC.	22
IRW	IRWIN AUTOMATION, INC.	90
J		
J	AF FASTENERS LIMITED	9
 or 	B & G MANUFACTURING CO., INC.	23
J	JJ SCREW PRODUCTS, INC.	93
J	JOSLYN CORP.	94

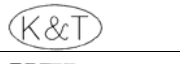
SYMBOL	COMPANY NAME	PAGE
	JUPITER WASHERS, INC.	94
J2H	B & G MANUFACTURING CO., INC.	23
J4	B & G MANUFACTURING CO., INC.	23
	JACO ENGINEERING, INC.	92
JB	BUTLER, INC.	34
B	JAY BEE MACHINE WORKS, INC.	93
JB7	B & G MANUFACTURING CO., INC.	23
JB16	B & G MANUFACTURING CO., INC.	23
	DEERE & CO.	50
	JAYCO ENGINEERING, INC.	93
	JERGENS INC.	93
JF	ELECTRO-FREETO MANUFACTURING COMPANY	58
JG	J. G. FASTENERS	92
H	HASSALL, JOHN, INC.	80
JI	JAMISON INDUSTRIES INC.	93
JIT	JUST IN TIME, INC.	94
	JAMES JACKSON DBA J J ENGINEERING	92, 93
	B & G MANUFACTURING CO., INC.	23
JP	J.M. PRECISION, INC.	92
JNC	B & G MANUFACTURING CO., INC.	23
JOLICO	JOLICO/J-B TOOL INC	94
	JAY O MACHINE CO., INC.	93
JS	B. V. FABRIEK VAN KLINKNAGELS EN SCHROEFBOUTEN V/H SMIT	24
J-S	J & S PRECISION PRODUCTS	91
JT	JAM TECH CORP.	92
K		
K	ADI MANUFACTURING, INC	6
	KAYNAR TECHNOLOGIES INC MICRODOT DIV	120
K	KATSURAGAWA MACHINE SCREW CO., LTD.	95
K	KAYGOR, INC.	95
K	KEN FORGING, INC.	96
K	KILBOURN ENGINEERING CO.	97

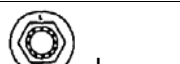
MIL-HDBK-57C(IS)

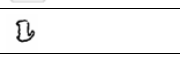
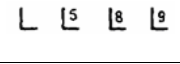
SYMBOL	COMPANY NAME	PAGE
	KEYSTONE BOLT & NUT COMPANY	96
	KEYSTONE TOOL & MACHINE CO.	96
	KNOCH MANUFACTURING CO. LTD.	97
	KOLB GMBH & CO.	97
	K	
K	KORODY COLYER CORP.	98
	KNOCH MANUFACTURING CO. LTD.	97
K	SPS TECHNOLOGIES	163
K-5673	SPS TECHNOLOGIES	163
KA	K.A.A. COMPANY	94
KAMAX	KAMAX-WERKE RUDOLF KELLERMANN GmbH & CO. KG	95
KARRO®	BAUER & SCHAURTE KARCHER GMBH	25
KDK	K.D.K. UPSET FORGING CO.	95
KE	KELLER ENGINEERING	96
k+k	K & K PRECISION ENTERPRISES	94
	KYOKUTO MFG CO LTD.	99
KL	KLINCHER LOCKNUT CORP.	97
	KERR LAKESIDE INC.	96
KO	KO AMS MACHINE PRODUCTS	97
KP	KAPCO INDUSTRIES, INC.	95
	KIRSTEN PIPE CO. INC.	97
KPP	KOZAK, E. PERCISION PRODUCTS CO.	98
	KROBACH MANUFACTURING CORP.	99
	KONGO BYORA CO., LTD.	98
KNIPPING	ARNOLD KNIPPING GmbH	18
KPP	E. KOZAK PRECISION PRODUCTS CO.	55
KS	SPS TECHNOLOGIES	163
	KSS SOCKET SCREW, INC	99















SYMBOL	COMPANY NAME	PAGE
	K-TECH MFG., INC.	99
	KT	
	TURNAMICS, INC.	177
KTI	KONDOR TECHNOLOGIES, INC.	98
KTM	KREIS TOOL & MFG., CO., INC.	98
KX	KAMAX-WERKE RUDOLF KELLERMANN GmbH & CO. KG	95
	KYOEI SEISAKUSHO CO., LTD.	99
	L	
L	CHUN YU WORKS & CO., LTD.	44
L	L & H THREADED RODS CORP.	100
	LAMSON AND SESSIONS OF CANADA LTD.	101
	LANIS MACHINE & MFG., CO.	102
L	LINREAD NORTHBRIDGE AIRCRAFT PRODUCT DIVISION	105
	LINREAD PUBLIC LIMITED CO.	106
L	LONE STAR FASTENERS, LP	109
L L1	LORD CORPORATION	110
	R B & W CORPORATION	145
LL	LINREAD PUBLIC LIMITED CO.	106
LL or LL	LONG-LOK FASTENERS CORP.	109
LAH LAH	LENTERN (AIRCRAFT) LTD.	103
LAM	L. A. MARTIN CO.	100
L B 	LANARKSHIRE BOLT LTD.	102
	<i>Raised letters</i>	
	L & C MANUFACTURING CO., INC.	99
LL	LISI AEROSPACE	107
LE	LAKE ERIE SDREW CORP.	101
LE	LIPPISCHE EISENINDUSTRIE GmbH	107
LE	WOLTERS GMBH	190
LG	L G MACHINE & MFG INC.	100
LFC	LFC INDUSTRIES INC.	105
LH	L H INDUSTRIES, INC.	100
LI	LANA INDUSTRIES	102













MIL-HDBK-57C(IS)

SYMBOL	COMPANY NAME	PAGE
	TRW	177
	L & J FASTENERS, INC.	100
L & M	L & M ENTERPRISES, INC.	100
LM	LEVINGSTON MACHINE COMPANY	105
LMC	LOUGHLIN MANUFACTURING CORP.	110
	LANUM METAL PRODUCTS, INC.	102
L.M.T.	LANUM METAL PRODUCTS, INC.	102
	LLOYD MACHINE & TOOL CO., INC.	109
LNA	L N AEROSPACE, INC.	100, 109
LOBO	LOBO OFFICINE MECCANICHE SPA	109
	LOBO SYSTEMS LTD	109
LONG LOK	LONG-LOK FASTENERS CORP.	109
L.P.R.	L P R PRECISION PARTS AND TOOL COMPANY, INC.	100
LRA	AVIBANK MFG., INC.	22
LRG	L R G CORPORATION	100
L.P.R.	PRECISION PARTS & TOOL CO., INC.	141
	R B & W CORPORATION	145
L-S-A	CEI INC.	41
L-S-A	LAND-SEA-AIR MACHINED PRODUCTS, INC.	102
L<W>M	LITTLE WORLD MANUFACTURING, INC.	109
M		
M	COOPER POWER SYSTEMS INC	46
M	DEMAT	51
	GFD LETAGE	73
M	HMS SERVICES LLC	84
	KELOX/MICRODOT PRODUCTS	96
	LISI AEROSPACE	108
M	MACKO INDUSTRIES	111
	MAGNUS TOOL & DIE CO., INC.	113
M	MEACO PRODUCTS CORP.	117
M	MECAERO PRODUCTS	117
	MERCURY AREOSPACE INC.	118
	METALCRAFTERS	119
	METRIX MFG. CO.	119









SYMBOL	COMPANY NAME	PAGE
	MI. ME. AF. S.r.1	119
	MICRODOT INC	120
	MIDWEST ACORN NUT CO.	120
	MILLIPART, INC.	120
M	MINEBEA CO. LTD	121
M	M-MANUFACTURING	122
	MNP CORPORATION	123
	MORTON MANUFACTURING	124
	MRL MANUFACTURING CORP.	125
	MACOR, INC.	113
	MIX TOOL CO.	122
	MODERN METRIC MACHINE COMPANY INC.	123
	INFASCO, NFASCO NUT and INGERSOLL FASTENERS	89
MA	M.A.A. CORP.	110
	MAC FASTENERS, INC.	111
	MCCULLOUGH AERO CO.	116
	ADAMS, EARL M. CO.	6
	MAILLY MFG CO., INC.	113
MAX	MID-STATES SCREW CORP.	120
MC	ADI MANUFACTURING, INC	6
Mc	MCADAMS MACHINE AND TOOL CO.	116
ME	MECAERO CANADA INC.	117
ME	MECAIR AEROSPACE INDUSTRIES	117
ME	METALCRAFTERS	119
	MID CONTINENT SCREW PRODUCTS CO.	120
	WROUGHT WASHER MANUFACTURING INC.	191
	MARTIN-CHANDLER, INC.	114











MIL-HDBK-57C(IS)

SYMBOL	COMPANY NAME	PAGE
MCO	MEACO PRODUCTS CORP.	117
	McMELLON BROS INC.	116
MD	LEONARD JED CO MARYLAND BOLT AND NUT CO DIV	103-104
MD	MARYLAND BOLT & NUT CO., INC.	114, 115
..MEL-BA..	MEL-BA MANUFACTURING INC.	118
METRI	METRIX MFG. CO.	119
METRIX	METRIX MFG. CO.	119
MF	MACLEAN-FOGG CO.	112
MFI	MORTON FASTENERS INC.	124
MFR06320	PYE & HOGAN MACHINE CO.	143
MFR 1L071	MIROFINE COMPANY	121
MFR 27624	PB FASTENERS	137
MFR 29839	ADVANCE PATTERN CORP	6
MFR 3L665	C. E. MACHINE CO., INC.	35
MFR - 72905	ARJAY PRECISION, INC.	17
MFR 8F781	STEVENS MFG. CO., INC.	167
	MANUFACTURING ENGINEERING TECH.	113
	MOSTAR GEAR & MACHINE MFG., CO.	124
	MECHANICAL & INDUSTRIAL FASTENERS	118
M I	MECHANICAL INDUSTRIES LLC	118
	KELOC/MICRODOT PRODUCTS	96
	MICRODOT INC.	120
	MECHANICAL & INDUSTRIAL FASTENERS	118
	MODFORM-ILLINOIS, INC.	123
MI	MONOGRAM AEROSPACE FASTENERS	124
MI-TECH, INC	MI-TECH, INC.	121
	MIX TOOL CO.	122
	LISI AEROSPACE	108
	MKM MACHINE TOOL COMPANY INC.	122
ML	LINREAD PUBLIC LIMITED CO.	106
ML	MCLANE MFG INC.	116
	M.L.W. MANUFACTURING CO.	110
	MAR-BRO MFG., INC.	114
	MACKSON MFG CORP.	111

















SYMBOL	COMPANY NAME	PAGE
MMG	MMG ENGINEERED COMPONENTS INC	122
M M M	HMS SERVICES LLC	84
	MODERN METRIC MACHINE COMPANY INC	123
	KERR, CHARLES W. and MAUI MEGA	96, 116
	MONROE MACHINED PRODUCTS, INC.	124
MMS	METHODS AND MACHINING SERVICES CO.	119
MMT	MAIN MACHINE CO INC.	113
MNP	MNP CORPORATION	123
	LISI AEROSPACE	108
MONOGRAM	MONOGRAM AEROSPACE FASTENERS	124
	MAPECO PRODUCTS, INC.	114
	MERCER PRODUCTS & MFG. CO., INC.	118
MP	MONTEREY MACHINE PRODUCTS	124
	UMPCO CORP.	178
MR	MACHINERITE CORP.	111
	MASTER RESEARCH & MFG., INC.	115
MSA	M.S. AEROSPACE	110
MSF	MIL-SPEC FASTENERS CORP.	121
	MANUFACTURING SALES AND SERVICE	113
MT	ALEXANDER MANUFACTURING COMPANY INC	12
MT	AVIBANK MFG., INC.	22
MT	METAL-TECH MFG. INC.	119
MT	METRO TOOL & MANUFACTURING CO.	119
	MASTERCRAFT TOOL COMPANY	116
	MERCURY TOOL & MACHINE, INC.	118
	TWIST TITE MFG. INC.	177
MULTI-C	CARDINAL INDUSTRIAL PRODUCTS	40
	MOTOR WHEEL CORP.	125
MW ORD		
N		
N	HANSAN SCREW CO., LTD.	79















MIL-HDBK-57C(IS)

SYMBOL	COMPANY NAME	PAGE
N	METALCRAFTERS	119
N	MITSUBOSHI INDUSTRIES, LTD.	121
N	MONOGRAM AEROSPACE FASTENERS	124
N	N.S.S. INDUSTRIES	125
N	NAFCO INDUSTRIES, INC.	125
	NAPIER'S AUTO BODY	125
N	NELSON STUD WELDING DIVISION	127
N	NEUMAYER, ERICH GMBH	127
N	NISSAN SCREW CO. LTD.	129
	NOCHIA STEELWORKS	129
	NOVA MACHINE PRODUCTS CORPORATION	130
	NUCOR CORP.	130
N	NUTS INCORPORATED	131
N	NUTS, INC.	131
	ONO MANUFACTURER, INC.	133
NA	NELSON AEROSPACE INC.	127
NAC	NC AUTOMATED INDUSTRIES INC.	126
NB	LINREAD NORTHBRIDGE	105
	NATIONAL BOLTS & RIVETS LTD.	126
NB	NORTHBRIDGE FASTENERS	129
	ND INDUSTRIES	127
	NEVILLE MACHINE SHOP	128
NEDIN	NEDSCHROEF	127
NEDLOY	NEDSCHROEF	127
NEDUR	NEDSCHROEF	127
	NORTHEAST METAL CO., INC.	130
	NORTHEAST FASTENERS	130
NF	NEVADA BOLT AND MFG CO INC.	127
NF	NON-FERROUS BOLT & MANUFACTURNG CO.	129
NFB	GREER STOP NUT	75
NH	NEDSCHROEF	127
NH	NEW HORIZON MACHINE CO., INC.	128
NI	NAVPAR, INC.	126
NK	MITSUBOSHI INDUSTRIES, LTD.	121















SYMBOL	COMPANY NAME	PAGE
NK NK	NYLOK CORP.	131
NKYM	MITSUBOSHI INDUSTRIES, LTD.	121
	METALCRAFTERS	119
NMB	MINEBEA CO. LTD	121
	NIPPON MACHINE ENGINEERING, INC.	128
NMP	NUMERIC MACHINE PRODUCTS	131
NRS	NAGOYA SCREW MANUFACTURING CO. LTD.	125
	NARRAGANSETT SCREW MFG., CO.	126
	NISCO, INC.	128
NS	NORTHERN SCREW CO., INC.	130
	NASU DENKI-TEKKO CO., LTD.	126
NT	NATIONAL THREADED FASTENERS CORP.	126
NT	NT ENGINEERING, INC.	130
NTF99	NORTHBRIDGE FASTENERS	129
	NUCOR CORP.	130
NYLOK	NYLOK CORP.	131
O		
	KERR, CHARLES W. and MAUI MEGA	96, 116
	MARUYKO NUT CO., LTD.	114
	NATIONAL FASTENER CO., LTD.	126
	OBARS MACHINE & TOOL CO.	132
	OCM MACHINE COMPANY, INC.	132
	OHIO NUT & BOLT CO., THE	132
	ORANGE PRECISION PARTS	133
	SCREWCORP.	157
	VOI-SHAN PRODUCTS	185
OAV	A. AGRATI S.P.A.	2
OB	OTT BROTHERS MACHINE CO., INC.	134
OBMC	OTT BROTHERS MACHINE CO., INC.	134
OK	OKAI IRON WORKS, INC	132
	OSTEEN MACHINE SHOP	134
	LOOS & CO., INC.	110
OP	ORANGE PRECISION PARTS	133
	ORDNANCE PARTS & ENGINEERING CO.	134

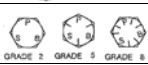













MIL-HDBK-57C(IS)

SYMBOL	COMPANY NAME	PAGE
ORC-O	ORC-O TOOL & MACHINE, INC.	134
	OHKAWA SCREW MFG. CO., LTD. and OKAWA SCREW MANUFACTURING CO., LTD	132, 133
(OTC)	ORLOTRONICS CORP	134
OTF	OAKTREE FASTENERS CO.	132
P		
P	BELL FASTENERS	26
	BLANC AERO INDUSTRIES and LISI	29, 107
P	H. PAULIN & CO. LTD.	78
	H. PRINZ GmbH	78
	LELAND-POWELL FASTENERS, INC.	103
P	LISI AEROSPACE	107
	LISI AEROSPACE	108
	OMEGA THREAD ROLLING AND GRINDING INC.	133
	PLAINVILLE MANUFACTURING CO., INC.	140
P	ORANGE PRECISION PARTS	133
	P.C.M., INC.	135
	PENN CIGAR MACHINES INC (P.C.M INC)	137
P	PATEREX, LTD.	136
P	PAULIN, H. & CO., LTD.	137
	PEINER UMFORMTECHNIK GmbH	137
	PERIGEE MANUFACTURING COMPANY, INC.	138
	PERKINS MACHINE CO.	138
	PIONEER SCREW & NUT CO.	140
	PRECISION PIECE PARTS, INC.	141
	PROTO MACHINE CO., INC.	143
	PTM INTERNATIONAL INC	143
P	PURITAS METAL PRODUCTS	143
PABCOR	PABCOR, INC.	135
PAL	PALNUT CO., THE	136
PAL	TRW	177
PAM	ABBOTT, PETER	3

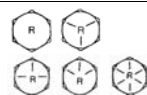

















SYMBOL	COMPANY NAME	PAGE
	PRECISE AERO PRODUCTS	141
PB	PB FASTENERS	
PB	PORTLAND BOLT & MFG., CO.	140
	UPB ENGINEERING	180
PBB	LISI AEROSPACE	108
	PB FASTENERS	
		
PBF		
PC	APHEONIX CORPORATION	17
	PRODUCT DEVELOPMENT GROUP, INC.	142
	PROMPTUS ELECTRONIC HARDWARE	143
PEINER	PEINER UMFORMTECHNIK GmbH	137
	PENN ENGINEERING & MANUFACTURING CO.	138
PHP	PNEU-HYDRO PRODUCTS, INC.	140
	P & I ASSOCIATES, INC.	135
PIP	AVIBANK MFG., INC.	22
	KAPCO INDUSTRIES, INC.	95
	P & L ENTERPRISES	135
PM	H. PAULIN & CO. LTD.	78
PM	PAULIN, H. & CO., LTD.	137
	PRICE MANUFACTURING CO.	142
PMC	BELL FASTENERS	26
	POINT MACHINE COMPANY	140
	PRECISIONMATICS CO., INC.	142
	PRIETO MACHINE COMPANY, INC.	142
PMC	VERTEX DISTRIBUTION	182
PMI	PADGETT MACHINE INC.	136
Pmi	PEREZ MACHINE, INC.	138
PMP	PIONEER MACHINE PRODUCTS, INC.	139
PMP	PURITAS METAL PRODUCTS	143
	PRO-MACHINE & TOOL COMPANY	143
	PATTERSON LAKE PRODUCTS	136

























MIL-HDBK-57C(IS)

SYMBOL	COMPANY NAME	PAGE
-PPC-	PARK PRECISION CORPORATION	136
	POWERPARTS, INC.	140
PR	PINEY RIDGE CO.	139
PRD	PRD FASTENERS LTD.	140
	PRECI-MANUFACTURING, INC.	141
	H. PRINZ GmbH	78
	P.S. MACHINE CO., INC.	135
P S	PACIFIC SCIENTIFIC	136
	PEERLESS SCREW PRODUCTS	137
	PHOENIX SPECIALTY MANUFACTURING CO., INC.	139
	PRECISION SCREW & BOLT, INC.	141
PSM PSM	PENN SCREW & MACHINE WORKS, INC.	138
	PRODUCTION & TOOL COMPANY	142
	PACIFIC TOOL, INC.	136
PTI	PAINTER TOOL, INC.	136
	PRECISION TECHNOLOGIES, INC.	141
PTM	PINE TAVERN MACHINE INC.	139
PTX	PATEREX, LTD.	136
	TRW	177
Q		
	QSN MANUFACTURING, INC.	144
Q	QUALITY SCREW PRODUCTS, INC.	144
	ALL QUALITY SPARES, INC.	12
QAS	QUALITY AIRCRAFT SCREWS, INC.	144
	CELTECH ENTERPRISE	41
	QUALITY FABRICATIONS, INC.	144



















SYMBOL	COMPANY NAME	PAGE
	QUALITY MACHINE & MFG INC.	144
	QUALITY SOCKET SCREW MANUFACTURING CORP.	144
QT	QUALITY THREADED PRODUCTS COMPANY	144
R		
R	R.E.C. CORP.	146
	RAHMEDE SCHRAUBENFABRIK	147
R	RAM THREADING, INC.	147
R	RAMAR NUTS, INC.	147
R	REPUBLIC FASTENER MANUFACTURING CORP.	149
	ROBBINS MANUFACTURING	151
	ROCKFORD BOLT & STEEL CO.	151
	ROCKFORD FASTENERS INC.	151
	ROCKFORD PRODUCTS CORP.	152
	ROGG MANUFACTURING COMPANY	152
R	RONSON MANUFACTURING, INC.	152
	RUMCO, INC.	153
	UNIFLOW CORP.	178
RAE	RAE MANUFACTURING CO.	147
RAM	RAM PRODUCTS	147
	R. BILD COMPANY, INC	146
	ROCKFORD BOLT & STEEL CO.	151
R B W	R B & W CORPORATION	145,148
	R & D FASTENERS	145
	R & D WELDING & MACHINE INC.	145
	RAMM DEFENSE PRODUCTS	148
RE	RAM ENTERPRISES	147

















MIL-HDBK-57C(IS)

SYMBOL	COMPANY NAME	PAGE
	REED INSTRUMENT CO.	149
REP	RIVNUT ENGINEERED PRODUCTS, INC.	151
	REXNORD	149
	ROBERT HENRY CO., INC.	151
	REXNORD	149
	ROSAN PRODUCTS	152
	RUDOLPH INSTRUMENTS, INC.	153
	BERGNER, RICHARD GMBH & CO.	27
	R B & W CORPORATION	145,148
R/M	MANNO, RICHARD & CO., INC.	113
	RICHARD MFG. CO., INC.	149
	RAINBOW MACHINE PRODUCTS, INC.	147
R M S	RMS	151
Rp	REID PRODUCT INC.	149
	R & R PRECISION	145
RR	GRUPO RASSINI S.A. de C.V.	76
RS 	RS MANUFACTURING, INC.	153
RT	AVIBANK MFG., INC.	22
	RUSCOMB TOOL & MACHNE CO., INC.	153
RTM		
RVT	RIVER VALLEY TOOL & MANUFACTURING	150
	RA-WHITE, INC.	148
	RADAX INDUSTRIES, INC.	146
S		
S	BELL FASTENERS	26
S	J.P. PRODUCTS, INC.	92
	MNP CORPORATION	123
	NIPPON STEEL BOLTEN CO., LTD.	128
	S.I. STUD, INC.	154
S	SABRE MANUFACTURING, INC.	154
	SAI INDUSTRIES CORP. EFT 2	155
S	SCHUHL & CO. GMBH	156
•S•	SALES SYSTEM, LIMITED	155

















SYMBOL	COMPANY NAME	PAGE
	SEMBLEX CORP.	157
	SEMCO FASTENER	157
	SENG HENG ENGINEERING PTE LTD.	157
	SONIC INDUSTRIES, INC.	160
	SESCO INDUSTRIES, INC.	157
	SHACKELFORD MACHINIG, INC.	157
	SHEFFIELD, INC.	158
	SHIGA BOLT CO., LTD.	158
	SIERRACIN/HARRISON	159
	SKYLINE INDUSTRIES	160
	SPECIALS, INC.	162
	SPECIALTY SCREW CORP.	162
	SPS TECHNOLOGIES	163
	SRI SAI INDUSTRIES CORPORATION	164
	STANDARD NUT & BOLT, INC.	165
	STELFAST FASTENERS, INC.	166
	STERLING MFG. & SUPPLY , INC.	167
	SULLIVAN BOLT CO., INC.	168
	U.S. BOLT MANUFACTURING, INC.	178
	WILHELM SCHUMACHER SCHRAUBEN-FABRIK GmbH	189
SA	BULTEN TRADING AB	34
	SPACE AGE ENGINEERING, INC.	161
	SANTA ANA GEAR & MACHINE	155
	D'SAMIC	54
	SOUTHWEST ALLIED PRODUCTS CO., INC.	161
	SOUTH BAY BOLT MANUFACTURING CO.	161
SB		
SBE	S. B. E. (ITALY CORPORATION)	154
S-C	SPS TECHNOLOGIES	163
SC	VOI-SHAN PRODUCTS	185















MIL-HDBK-57C(IS)

SYMBOL	COMPANY NAME	PAGE
	STERLING MACHINE COMPANY	167
		
SCA	SCANDIA MFG. CO., INC.	156
SCB	STEEL CITY BOLT & SCREW, INC.	165
	SCOTT CRAFT CO.	156
	SPURWAY COOKE INDUSTRIES PTE LTD.	164
	CAMCAR DIVISION OF TEXTRON INC.	36-39
SD	SIMMONDS PRODUCTS	159
	STALKER & DYSTHE, INC.	164
	TANAKA LTD.	170
SEMS	CAMCAR DIVISION OF TEXTRON INC.	36-39
SF	SOUTHERN FASTENER CORPORATION	161
	SONFARREL, INC.	160
	SHAMROCK FASTENER TECHNOLOGIES, LLC	157
	SAGA TEKKOSHO CO., LTD.	155
	SHUR-LOK CORP.	158
	SIERRA PACIFIC SUPPLY CO., INC.	159
	SOUTHWEST INDUSTRIAL SERVICES	161
SI	SUBURBAN INDUSTRIES, INC.	168
	SHUR-KUT SUPPLY CORPORATION	158
S&L	S & L METAL PRODUCTS CORP.	153
	SHUR-LOK CORP.	158
SL	ST. LOUIS SCREW & BOLT CO.	164
SG^L	GREER STOP NUT	75
SLI	SPACE-LOK, INC.	162
	STANDARD LOCKNUT, INC.	165
	SAMUEL MARSDEN & SON	155
SM	SKY MANUFACTURING	160
	STURM MACHINE CO., INC.	168
SMF	SATAIR MANUFACTURING FACILITY	156
	SANDIK MANUFACTURING, INC.	155















SYMBOL	COMPANY NAME	PAGE
SMP	SHORELINE MACHINE PRODUCTS, INC.	158
SM&M	SMITH MACHINE & MANUFACTURING	160
	SLABE MACHINE PRODUCTS	160
	FILETAGE INTERNATIONAL	67
	SKYSPARES PARTS, INC.	160
SPG	SHAW PRECISION GRINDING	4, 158
	SPARTAN PRECISION MACHINE	162
	STEEL PRODUCTS OF MASSILLION	165
SPS SPS	SPS TECHNOLOGIES	163
	SPACE SCREW, INC.	162
	MNP CORPORATION	123
	SOUTHERN FASTENING SYSTEMS	161
ST	AVIBANK MFG., INC.	22
	SWISS TECHNOLOGY, INC.	169
	SPIRAL TOOL CORP.	162
	STEADFAST CORPORATION	165
	SINN-TECH, INC.	159
	HALL INDUSTRIES INC. and STANDARD TOOL & MACHINE CO.	78, 165
STM	SPECIAL-T-METALS	162
STRUX (radial)	CAMCAR DIVISION OF TEXTRON INC.	36-39
SV	S V INDUSTRIES	169
SW	BELL FASTENERS	26
	SMITH WELDING, INC.	160
SW	STILLWATER FASTENERS, INC.	167
	SOUTHWIND INDUSTRIES, INC.	161
T		
	ARCHER SCREW PRODUCTS	17
T	BLANC AERO INDUSTRIES	29
T	ENGLE MANUFACTURING COMPANY, INC., THE	60
	LISI AEROSPACE	107













MIL-HDBK-57C(IS)

SYMBOL	COMPANY NAME	PAGE
T	MINEBEA CO. LTD	121
	OSAKA SEIKI CO., LTD.	134
	RING SCREW WORKS	150
T	SPS TECHNOLOGIES	163
	T & E MACHINE CORP.	169
	TORCO, INC.	175
	TAKENAKA SEISAKUSHO CO., LTD.	170
I	TECHNICAL FASTENERS, INC.	170
T	TELEFAST INDUSTRIES, INC.	171
T	TERRY MACHINE CO.	171
	TEXAS BOLT CO.	171
	TEXTRON FASTENING SYSTEMS	172
	TITAN FASTENER	174
	TOPURA CO., LTD.	174
T	TOWNSEND CO.	175
	TOYO STEEL WIRE CO., LTD.	175
	TRY - AZTEC COMPANY	177
TANSEY	ARVAN, INC.	19
	TEXAS BOLT CO.	171
TEXAS BOLT		
	TEBCO THREADED FASTENERS	170
	TEXAS BOLT CO.	171
	T-B & S MFG.	170
TBJ	SPS TECHNOLOGIES	163, 164
TC	TERRYCABLE, INC.	171
TCQ	T C QUALITY MACHINING INC.	169
	T & E MACHINE CORP.	169
	TEK PRECISION CO., LTD.	170
TELLEP	SPS TECHNOLOGIES-METALAC SPS INDUSTRIA	163

SYMBOL	COMPANY NAME	PAGE
TENS	TENS MACHINE CO., INC.	171
F	HI-SHEAR CORP. and TORONTO FASTENERS INDUSTRIES, INC.	83, 175
	TFI AEROSPACE CORPORATION	172
	TFP CORP.	172
F	TUFF FASTENERS CO.	177
	TFI AEROSPACE CORPORATION	172
	TFP CORP.	172
	THIANT (BOULONNERIE DE SA)	173
THOMAS	THOMAS MFG, INC.	174
	THOMAS INSTRUMENT & MACHINE CO., INC.	173
	LEBRECHT TIGGES GmbH & CO. KG and SCHMICO GMBH SCHWEISSTECHNIK	102, 156
TJB	SPS TECHNOLOGIES	163
TKS	TOKOSHA METAL WORKS LTD.	174
	TOOLEX, INC.	174
TLP	SPS TECHNOLOGIES	163
	SPS TECHNOLOGIES	163
	TERRY MACHINE CO.	171
	TRIDENT MACHINE CO.	176
TM	TRONSON MANUFACTURING	176
TM9	SPS TECHNOLOGIES	163
TMC	LISI AEROSPACE	108
	FARLO MACHINE & TOOL CO., INC.	64
TMS	MACHINE SHOP, INC., THE	111
TMTI	THOMAS MACHINING TECHNOLOGIES, INC.	173
	NICE TOOL MFG., INC.	128
	TOG MANUFACTURING CO., INC.	174
	OTO MELARA S.p.A.	134
TORX (radial)	CAMCAR DIVISION OF TEXTRON INC.	36-39

MIL-HDBK-57C(IS)

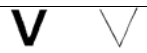
SYMBOL	COMPANY NAME	PAGE
TOPURA	TOPURA CO., LTD.	174
TP	TOPURA CO., LTD.	174
	TEXAS PRECISION MFG., INC.	171
TR	T R MACHINE INC.	169
	TOWNE ROBINSON FASTENER CO.	175
TRI	TRIUMPH MANUFACTURING CO., INC.	176
Tridair 	REXNORD	149
TRIDAIR	TRIDAIR PRODUCTS	176
	TRW	177
TTC	CAMCAR DIVISION OF TEXTRON INC.	36-39
TUZ	MAUDLE INDUSTRIAL CO., LTD.	116
	SUNDRAM FASTENERS, LTD.	168
	TFP CORP.	172
	LENCH, THOMAS WILLIAM, LTD.	103
TYE	YOUNG ENGINEERS INC, THE	192
U		
	OHKAWA SCREW MFG. CO., LTD. and OKAWA SCREW MANUFACTURING CO., LTD	132, 133
	OKABE CO., INC.	132
	R B & W CORPORATION	145
U	SPS TECHNOLOGIES UNBRACO PTY LTD	163 163
U	UNIMETERIC CORPORATION	179
	UNITED DRILL BUSHING CORP.	179
	URANIA ENGINEERING CO., INC.	180
	URBAN MANUFACTURING CO.	180
	URBAN MFG. CO. INC.	180
U130	SPS TECHNOLOGIES	163
UM	SPS TECHNOLOGIES UNBRACO PTY LTD.	163 163
UM	UNIVERSAL MACHINE PRODUCTS	180











SYMBOL	COMPANY NAME	PAGE
	ULTIMATE MACHINING & WELDING	178
UNBRAKO	SPS TECHNOLOGIES	163
	SPS TECHNOLOGIES	163
UNISTRUT 	UNISTRUT CORP.	179
UNW	SPS TECHNOLOGIES	163
	UNITED PRECISION PRODUCTS CO., INC.	179
UPME	U.P. MACHINE & ENGINEERING CO.	178
	UNITED STATES DEFENSE RESEARCH & SUPPLY	179
	UNITED STEEL & FASTENERS INC.	180
	DOMESTIC FASTENER & FORGE, INC	53
01AK	USA	
USMC	ULTRA SONIC MACHINE CO., INC	178
	US TOOL & DIE	181
V		
V	AERCO RESEARCH	7
	AERO COMPONENTS CO	7
V	CHAMPION COMMERCIAL INDUSTRIES, INC.	42
V	MNP CORPORATION	123
	PACER ALLOYS, INC.	135
	V-B MACHINE CO., INC.	181
V	VICO PRODUCTS, CO.	182
	VICTOR PRODUCTS CORP.	182
	VISTEK INDUSTRIES	183
	VITCO NUCLEAR PRODUCTS INC.	183
.V.	VMC INDUSTRIES, INC.	183
V	VOSS INDUSTRIES, INC.	185
V. V. 304 V.	VULCAN RIVET & BOLT CORP.	185
VALCOR	VALCOR ENGINEERING CORP.	180











MIL-HDBK-57C(IS)

SYMBOL	COMPANY NAME	PAGE
VERBUS'	BAUER & SCHAURTE KARCHER GMBH	25
VF	MNP CORPORATION	123
	VALLEY FORGE AND BOLT MFG CO.	181
	VENUS FASTENERS CORP.	182
V F M	VEGAS FASTENER MANUFACTURING	181
	VIP MFG. & ENGR. CORP.	182
	VM MANUFACTURING CORP.	183
VMC	VMC INDUSTRIES, INC.	183
	VOSS INDUSTRIES, INC.	185
vp	VAN PETTY MFG., INC.	181
VS	VOI-SHAN PRODUCTS	185
VS	VSI	185
	VERSATECH, INC.	182
VT	VALLEY-TODECO	181
W		
W	MEC WOLF SRL	117
	WALZ & KRENZER INC DBA MAPECO PRODUCTS	186
	WARREN PUMPS LLC	186
	WATERBURY BUCKLE CO.	186
	WAYNE BOLT & NUT CO., INC.	186
W	WELTON ROLLED THREAD CORP.	186
W	WESTLAND STEEL PRODUCTS, LTD.	188
	WHELAN MACHINE & TOOL CO.	188
	WHITNEY SCREW CORP.	188
	WIGLEY MACHINE COMPANY	188
	WILLIAM'S MACHINE & FABRICATION, INC.	189
W	WINKER HERMAN GMBH & CO. KG	189
	WODIN, INC.	190
	WOLTERS GMBH	190

SYMBOL	COMPANY NAME	PAGE
	WROUGHT WASHER MANUFACTURING INC.	191
	WYANDOTTE INDUSTRIES, INC.	191
	WYNNSON ENTERPRISES, INC.	191
	WINSLOW AUTOMATICS, INC.	190
WB	WALKER BOLT MANUFACTURING CO., INC.	185
	WEBLUK MACHINE CORP.	186
	WEST COAST AEROSPACE, INC.	187
WEDGELOCK	MONOGRAM AEROSPACE FASTENERS	124
WESLOK	WESLOK	187
	WESTFIELD FASTENERS	188
	WILSON-GARNER CO.	189
	RATHMANN WALTER G. SEGMENT- KLAMMERSCHRAUBEN GMBH	148
	WHITTET-HIGGINS CO.	188
WH	WOLTERS GMBH	190
	WOLSTENHOLME MACHINE	190
WMI	WEAVER MANUFACTURING, INC.	186
	WIL-NIC	189
	WESTERN PACIFIC ENTERPRISES, W.P.E. INC.	187
	WESTWOOD PRECISION, INC.	188
WPP	WILT PRECISION PRODUCTS	189
	CUTTING EDGE MACHINING INC. and WESTERN SCREW MACHINE PRODUCTS, INC.	48, 187
WSI	WESTERN SKY INDUSTRIES, INC.	187
WSMP	WORTHEY MACHINE	191
	KAMPWERK VIEREGGE U. PICKARDT GMBH. & CO.	95

MIL-HDBK-57C(IS)

SYMBOL	COMPANY NAME	PAGE
 WSN	WILHELM SCHUMACHER SCHRAUBEN-FABRIK GmbH	189
	TW DESIGN AND MANUFACTURING, L.L.C.	177
WWE	LINREAD PUBLIC LIMITED CO.	106
X		
	EXCEL PRECISION PRODUCTS, INC.	63
XP	R B & W CORPORATION	145
Y		
	YOW MENGI INDUSTRIAL CO., LTD.	192
Y 2 K	Y2K MACHINE SHOP	191
	FANG SHENG SCREW CO., LTD.	64
	YATES TOOL, INC.	192
Z		
Z	D.S.O. PLASTICS, INC.	48
	ZAMON CO., INC.	192
Z	ZERO PRODUCTS , INC.	192
	Z & B GENERAL MACHINE	192
ZENEX	ZENEX CORPORATION	192
	ZERO PRODUCTS , INC.	192
NUMBER		
	AERO-FAB, INC.	7
0XK38	NORTHSTAR ENGINEERING	130
01DC	RISCO, INCORPORATED	150
	MAC FASTENERS, INC.	111
01FO	ACCUTOOL	4
01FO	SUBCON TOOL/ACCUTOOL MACHINE GROUP INC. (DBA ACCUTOOL)	168
01NU	EAGLEHEAD MANUFACTURING COMPANY	56
05DT8	FITZ MANUFACTURING INDUSTRIES LTD DBA FMI	68
05141	McMELLON BROS INC.	116
09094	QRP, INC.	143
1A249	ACCURATE THREADED PRODUCTS CO.	4
1EM77	GS AEROSPACE TECHNOLOGY, INC.	77
1H423	J & M MACHINE INC.	91

SYMBOL	COMPANY NAME	PAGE
1st	FIRST AMERICAN SALES CO.	67
1Y128	D & D MACHINERY AND SALES	48
1YFG0	MAGNUM MACHINE SHOP	113
15077	NORTHBRIDGE FASTENERS	129
2	STERLING MACHINE COMPANY	167
2F 3F 4F 5F	FONTANA S.A.	69
2A832	JMT MACHINE COMPANY	93
20733	NORTHBRIDGE FASTENERS	129
	UTAH TOOL & DIE, INC.	181
	3D MACHINE COMPANY, INC	1
3D531	ALAN, JEFFREY, MFG. & ENGR	11
	MODERN METRIC MACHINE COMPANY INC.	123
30633	C & H MFG., INC.	35
32219	NORTHBRIDGE FASTENERS	129
4J 9 5 2	GENERAL AVIATION MFG., INC.	72
4J976	REGAL AIR, INC	149
4 N 1 3 3	CHATHAM PRECISION, INC.	43
4T853	D & R MACHINE COMPANY	48
5T572	NORTHBRIDGE FASTENERS	129
54878	ROTAIR INDUSTRIES, INC.	153
56878	SPS TECHNOLOGIES	163
	BISHOP ENTERPRISES, INC.	28
60529	STERLING MFG. & SUPPLY , INC.	167
61062	COMET MFG. CO., INC.	45
62206	B & B SPECIALTIES, INC.	22
7	HEPTNER MFG CO.	81
71838	SPS TECHNOLOGIES	163
8F781	STEVENS MFG. CO., INC.	167
8M938	PRODUCTS DESIGN & MFG. CORP.	143
8T968	ROMAC ELECTRONICS, INC.	152
80539	SPS TECHNOLOGIES	163
84256	AVIBANK MFG., INC.	22
	THIANT (BOULONNERIE DE SA)	173
99106	AMERICAN AIRCRAFT PARTS MANUFACTURING COMPANY	14
SYMBOL		
	3 V FASTENERS	1
	A & G ENGINEERING CO., INC	1
 	ACME RIVET & MACHINE CORP.	5
	AVDEL INTERNATIONAL	21
	ACRODYNE MFG CO.	5

MIL-HDBK-57C(IS)

SYMBOL	COMPANY NAME	PAGE
	AEROSPACE RIVET MFG CORP	9
	ALCOA FASTENING SYSTEMS	11
	ALCOA GLOBAL FASTENERS INC	12
	ALL PINS MANUFACTURING	12
	ALL-STATES INC.	13
	ANCHOR BOLT & SCREW CO.	16
	ANILLO INDUSTRIES, INC.	16
	ARMSTRONG FASTENING SYSTEMS	18
	ASI DESIGN & MANUFACTURING, INC.	19
	AUTO SCREW, INC.	21
	AMERITECH FASTNER MFG INC.	15
	ARGARWAL INDUSTRIES	17
	AVIBANK MFG., INC.	22
	AZTECH ENGINEERING, INC.	22
	BAUER & SCHAURTE KARCHER GMBH	25
	BOLLHOFF & CO. GmbH & CO. KG	30
	CARR CO.	41
	CLEVELAND HARDWARE & FORGING and GREEN BAY DROP FORGE	44, 75
	CODLING TOOL & MFG. INC.	45
	COLD HEADING CO., THE	45
	DAVIS AIRCRAFT PRODUCT CO., INC.	49
	DO-ALL PRECISION, INC.	53
	DRESSER INDUSTRIES, INC.	53
	EDS ORDNANCE	57
	ELCO INDUSTRIES, INC.	57
	GEN FAST MANUFACTURING COMPANY	72
	STELCO FASTENER & FORGING CO.	166
	EMHART CORP.	58
	FRIEDR BOESNER GMBH	70









SYMBOL	COMPANY NAME	PAGE
	INFASCO, NFASCO NUT and INGERSOLL FASTENERS	89
	FENTON HEADING	67
	FERNDALE FASTENER	67
	FISCHER SPECIAL MFG. CO.	68
	PRECISION METAL PRODUCTS CO.	141
	FOREST FASTENERS	70
	GMP CO. CORPORATION	74
	PILGRIM SCREW CORP.	139
	GRADON SCREW MACHINE CORP.	74
	GROOV-PIN CORPORATION	76
	HANDI GADETS CORP.	79
	HEARTLAND PRECISION FASTENER	81
	HESSISCHE SCHRAUBENFABRIK WELTER GmbH & CO., KG	81
	WELTER GMBH & CO. KG	186
	HOUSTON FASTENER	85
	HUCK AEROSPACE PRODUCTS	86
	HUCK INTERNATIONAL PRODUCTS	86
	HURRICANE MACHINE COMPANY, L.L.C.	87
	KOBE FASTENER LIMITED	97
	KOREA BOLT IND., CO., LTD.	98
	KPF	98
	LBL PRODUCTS	102
	LINREAD NORTHBRIDGE AIRCRAFT PRODUCT DIVISION	105
	LISI AEROSPACE	107
	MACK, A. W. MFG CO.	111
	MINEBEA CO. LTD	121



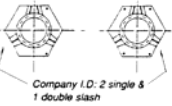



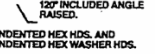

MIL-HDBK-57C(IS)

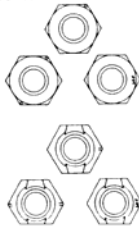
SYMBOL	COMPANY NAME	PAGE
	NAGOYA SCREW MANUFACTURING CO., LTD.	125
	NCFI BRUEGGEMANN INC.	127
	ONEIDA TOOL & MACHINE CORP.	133
	PELHAM AUTO MATRIX PRECISION	137
	PINTO PRODUCTS	139
	PREM INDUSTRIES, INC.	142
	RELIANT FASTENER	149
	REXNORD	149
	TRIDAIR PRODUCTS	176
	RING SCREW WORKS	150
	ROBBINS MANUFACTURING	151
Rubber stamped on fasteners	ROTAIR INDUSTRIES, INC.	153
	SANNOHASHI SEISAKUSHO CO., LTD.	155
	SANTA ANA SCREW PRODUCTS INC	155
	SATURN FASTENERS, INC.	156
	SHAMROCK FASTENER TECHNOLOGIES, LLC.	157
	SPS TECHNOLOGIES METALAC INDUSTRIA	163
	STELFAST FASTENERS, INC.	166
&	STILLWATER FASTENERS, INC.	167
	STRENKERT MACHINE SHOP INC.	167
	SUNRISE PRECISION MFG.	168
EARTH	SUPERIOR TECHNOLOGY	168
	SUPREME SCREW PRODUCTS, INC.	168
	TAIYO NUT MFG. CO., LTD.	169
	TECH WELDING AND MACHINE CO.	170

SYMBOL	COMPANY NAME	PAGE
	TENS MACHINE CO., INC.	171
	TFI AEROSPACE CORPORATION	172
	TOPURA CO., LTD.	174
	TOPURA CO., LTD.	174
	TOPURA CO., LTD.	174
	TRI STATE TOOL & DIE CO.	176
	UNITED BOLT & SCREW CORP.	179
	UNITED STEEL & FASTENERS INC.	180
	WHAIL BOLT IND. CO., LTD	188
	XCEL MFG., INC.	191
• (a dot)	CINCH-MONADNOCK	44
• (a dot) - (radial line)	DECKER MANUFACTURING CORP	50
• (a dot)	MONADNOCK COMPANY, THE	123
•• (2 dots)	BELL FASTENERS	26
•• (2 dots)	BRISTOL INDUSTRIES	31
	CUTTING EDGE ENENTERPRISE, LLC	48
•• (2 dots)	STILLWATER FASTENERS, INC.	167
	CSM FASTENER PRODUCTS	47
	EMP MANUFACTURING CO.	59
	ERICO FASTENING SYSTEMS	60
3 dots, centered on corner, equally spaced	WOLVERINE NUT CO.	191
•••• 4 dots inline or radial	CAMCAR DIVISION OF TEXTRON INC.	36-39
//	BRISTOL LOCKNUT CO.	32
3 radial lines	CAMCAR DIVISION OF TEXTRON INC.	36-39
	METALCRAFTERS	119
= 2 parallel lines	CAMCAR DIVISION OF TEXTRON INC.	36-39
Three parallel lines spaced insert products only	MICRODOT INC.	120

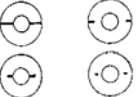
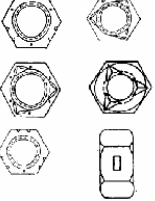
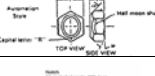
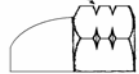
MIL-HDBK-57C(IS)

SYMBOL	COMPANY NAME	PAGE
	AMERIFAST CORP.	15
 Manufacturer identification: 2 raised ribs in (2) crimp depressions 1 raised rib in (1) crimp depression	GREER STOP NUT	75
	PENN ENGINEERING & MANUFACTURING CO.	138
Notches or Stakes cut into corners of nut	EVERLOCK FASTENING SYSTEMS	62
2, 3, or 6 dots on corner of nut 4 or 6 dots on flange of flange nuts	FEDERAL SCREW WORKS	66
 Company I.D.: 2 single & 1 double slash	INDUSTRIAL & AUTOMOTIVE FASTENERS	88
Dots, slashes, and dots with slashes 2 - 8	R B & W CORPORATION	145, 146, 148
Dots, slashes, and dots with slashes 2 - 8	STELCO FASTENER & FORGING CO.	166
 Raised or indented marks Under head, Top of head, Slotted hexhead (top of head)	INDUSTRIAL FASTENERS CORP.	89
	LAMSON AND SESSIONS OF CANADA LTD.	101
4 - 7 DOTS		
	INDUSTRIAL NUT CORP.	89
3, 4 or 6 equally spaced stakes		
 120° INCLUDED ANGLE RAISED. INDENTED HEX NDS. AND INDENTED HEX WASHER NDS.	LEWIS SREW COMPANY	105
 DASH MARKS 120° APART RAISED UNDER HEAD UPON REQUEST "HIGH-COUNTERSINK HEADS ONLY"	LEWIS SREW COMPANY	105
 Flange nuts less lock and with Uni-Torque® lock Two raised bars	MACLEAN-FOGG CO.	112
TWO RAISED BARS		
Three raised or	THIANT (BOULONNERIE DE	173



SYMBOL	COMPANY NAME	PAGE
depressed lines	SA)	
 Hex nuts and Uni-Torque® locknuts	MACLEAN-FOGG CO.	112
 Identified Lock, Head, Part	PACIFIC FASTENERS, INC.	135
	TEXTRON FASTENING SYSTEMS	172
 Two lines in three pads	VMC INDUSTRIES, INC.	183
	ELCO INDUSTRIES, INC.	57
	GRIPCO, DIVISION OF BLACK & DECKER	76
 Anodized Base, Heat treat shape, Capital letter "R", TOP and BOTTOM	RAMCO SPECIALTIES, INC.	148
 80° included angle (2) dots	RIPPA PRODUCTS	150
 2 notches for slotted heads only	SOUTHERN FASTENING SYSTEMS	161
 0.030, 0.000, 1.000, 60°	WOLVERINE MACHINE PRODUCTS CO.	190
 Straight knurls with an unknurled band adjacent to the bearing surface on socket heads. The diameter over the straight knurl does not exceed the band. There may be 2 or 3 grooves	SPS TECHNOLOGIES	163
 A raised or depressed triangle pointing from the wrenching flat toward thread on nut products.	SPS TECHNOLOGIES	163
Blue nylon insert	INDUSTRIAL NUT CORP.	89
Blue nylon locking element	NYLOK CORP.	131

MIL-HDBK-57C(IS)

SYMBOL	COMPANY NAME	PAGE
Blue - nylon® hexagon locking element 	PENN ENGINEERING & MANUFACTURING CO.	138
Green nylon insert	GREER STOP NUT	75
Green nylon insert	EVERLOCK FASTENING SYSTEMS	62
Red nylon insert	ELASTIC STOP NUT & ESNA	57, 61, 112

SYMBOL	COMPANY NAME	PAGE
Tan nylon insert	VMC INDUSTRIES, INC.	183
Yellow nylon insert	ABBOTT INTERFAST CORP.	2
Square insert in floating fasteners 	PENN ENGINEERING & MANUFACTURING CO.	138

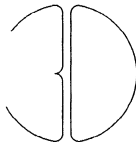

MIL-HDBK-57C(IS)

<p>3 V FASTENERS 320 REED CIRCLE CORONA, CA 92879-1349</p>  <p>CAGE code: 1ER65 <u>1/</u></p>	<p>A & M AEROSPACE, INC. 2332 SOUTH DELAWARE DENVER, CO 80223-4321</p> <p>A A & M A/M A&M M</p> <p>CAGE code: 6Z800 <u>1/</u></p>
<p>3D MACHINE COMPANY, INC. 5586 EAST LA PALMA AVENUE ANAHEIM, CA 92807-2108</p>  <p>CAGE code: 1K6P6 <u>2/</u></p>	<p>A & N PRECISION INDUSTRIES 65 FIRST STREET NEW ROCHVILLE, NY 10801-6118</p>  <p>CAGE code: 9Y423 <u>2/</u></p>
<p>A & E MACHINED PRODUCTS 93 PECK HILL ROAD JOHNSTON, RI 02919</p> <p style="text-align: center;">AE</p> <p>CAGE code: 3MAH6 <u>2/</u></p>	<p>A & R MFG CORP. 1281 JOHN FITCH BLVD. SOUTH WINDSOR, CT 06074</p> <p style="text-align: center;">AR</p> <p>CAGE code: 3X841 <u>2/</u></p>
<p>A & G ENGINEERING CO., INC 4640 EAST LAPALMA ANAHEIM, CA 92807</p>  <p>CAGE code: 4N135 <u>2/</u></p>	<p>A & W SCREW MACHINE PRODUCTS, INC. 3131 KANSAS AVE RIVERSIDE, CA 92507</p> <p style="text-align: center;">AW</p> <p>CAGE code: 63035 <u>1/</u></p>

1/ Information published in this revision was verified by direct contact with manufacturers.

2/ Information not verified to be current, no response from manufacturer. Information identical to that published in MIL-HDBK-57, Revision B.

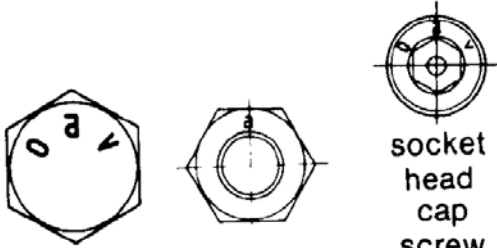
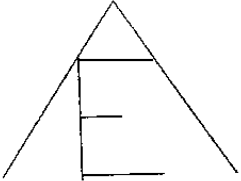

MIL-HDBK-57C(IS)

<p>A. AGRATI S.P.A. VIA PAIVE 28/30 20050 VEDUGGIO CON COLZANO MILANO, ITALY</p> <p>Plant AGRATI CORP. 925 Brewster Street Bridgeport, CT 06605</p>  <p>CAGE code: A0698 2/</p>	<p>A-1 THREAD ROLLING CO., INC. 4933 MASON ST. SOUTH GATE, CA 90280</p> <p style="text-align: center;">A-1</p> <p>CAGE code: 3N586 2/</p>
<p>A. P. MILLS INDUSTRIES FOR THE BLIND 346 ST. PAUL AVE. P.O. BOX 2175 MEMPHIS, TN 38101</p> <p>(See WEST TENNESSEE LIONS BLIND INDUSTRIES INC.)</p> <p style="text-align: center;">APMI</p> <p>CAGE code: 5L565 2/</p>	<p>AAP ACQUISITION CORP 2100 ENTERPRISE PKWY TWINSBURG, OH 44087-2212</p> <p>(SEE ACHILLES AEROSPACE PRODUCTS)</p> <p style="text-align: center;">A</p> <p>CAGE code: 0H380 2/</p>
<p>A-1 NUT AND BOLT CO, INC DIVISION OF GREEN CO. PACIFIC INC. 3433 S. MALT AVENUE COMMERCE, CA 90040</p> <p style="text-align: center;">A 1</p> <p>CAGE code: 1M493 2/</p>	<p>AASTRO ENGINEERING 1382 CORONADO AVE LONG BEACH, CA 90804</p>  <p>CAGE code: 01AL8 2/</p> <p>ABBOTT INTERFAST CORP. 190 ABBOTT DRIVE WHEELING, IL 60090</p> <p>Yellow nylon insert identifies Abbott-Interfast Corp. as manufacturer</p>  <p>CAGE code: 08928 1/</p>

1/ Information published in this revision was verified by direct contact with manufacturers.

2/ Information not verified to be current, no response from manufacturer. Information identical to that published in MIL-HDBK-57, Revision B.

MIL-HDBK-57C(IS)

<p>ABBOTT, PETER (AEROSPACE) 1982 LTD. 6 REPTON CLOSE BURNT MILLS, BASILDON, ESSEX SS13 ILE UNITED KINGDOM</p> <p style="text-align: center;">PAM PAM PAM</p> <p>CAGE code: 0WL73 <u>2/</u></p>	<p>ACCURATE AUTOMATIC PARTS CO. 2885 S. 163RD ST. NEW BERLIN, WI 53151</p> <p style="text-align: center;">AP</p> <p>CAGE code: 5S202 <u>2/</u></p>
<p>ABC TOOL AND DIE ENGINEERING & MANUFACTURING LLC 197 WALLIS STREET UNIT C EUGENE, OR 97402-5301</p> <p style="text-align: center;">No artwork for marking. Marks whatever the customer specifies.</p> <p>CAGE code: 0XJF0 <u>1/</u></p>	<p>ACCURATE PRECISION FASTENERS, INC. P.O. BOX 5239 ENGLEWOOD, NJ 07631</p> <p style="text-align: center;">Plant 20 HONECK ST. ENGLEWOOD, NJ 07631</p> <p style="text-align: center;">A</p> <p>CAGE code: 28977 <u>2/</u></p>
<p>ABSCOA INDUSTRIES 1071 WEST ARBOR VITAE ST. INGLEWOOD, CA 90301</p> <p style="text-align: center;">AB</p> <p>CAGE code: <u>2/</u></p>	<p>ACCURATE SCREW MACHINE CO. (DBA ASM) P.O. 10095 10 AUDREY PL FAIRFIELD, NJ 07004-3402</p> <p style="text-align: center;">Plant 19 Baltimore St. Nutley, NJ 07110</p> <p style="text-align: center;">AMSCO</p> <p style="text-align: center;">5/16 LONG X 1/16 HIGH X .010 DEEP</p> <p>CAGE code: 51506 <u>2/</u></p>
<p>ACCUFORM, INC. P.O. BOX 307 BUS. HWY. 36 WEST MACON, MO 63552</p> <p style="text-align: center;">AF AF</p> <p>CAGE code: <u>2/</u></p>	<p>ACCURATE THREADED FASTENERS, INC. DIVISION OF BEATRICE FOODS CO. (new company name see ATF, INC.) 3550 WEST PRATT AVE LINCOLNWOOD, IL 60645</p> <p style="text-align: center;"> </p> <p>CAGE code: 95110 <u>1/</u></p>

1/ Information published in this revision was verified by direct contact with manufacturers.

2/ Information not verified to be current, no response from manufacturer. Information identical to that published in MIL-HDBK-57, Revision B.











MIL-HDBK-57C(IS)

<p>ACCURATE THREADED PRODUCTS CO. 280 HARTFORD AVENUE NEWINGTON, CT 06111</p> <p>1A249</p> <p>CAGE code: 1A249 <u>2/</u></p>	<p>ACE GRINDING & MFG. OF TEXAS (formally ACE G & M CO. OF TEXAS) 2610 AERO DR. GRAND PAIRIE, TX 75052</p> <p>AGC</p> <p><i>Plant (plant closed)</i> <i>ACE GRINDING & MFG.</i> <i>4937 EAST SLAUSON AVENUE</i> <i>MAYWOOD, CA 90270</i> <i>CAGE code: 2N509</i></p> <p>AGM</p> <p>Plant (see SHAW PRECISION GRINDING AND THREAD ROLLING) SHAW PRECISION GRINDING 6503 W. FRYE RD. CHANDLER, AZ 85226</p> <p>SPG</p> <p>CAGE code: 5U074 <u>1/</u></p>
<p>ACCURATE TOOL CO., INC. 891 FERNHILL RD WEST CHESTER, PA 19380 - 4282</p> <p>A+</p> <p>CAGE code: 7N957 <u>1/</u></p>	<p>ACE PRECISION INDUSTRIES, INC. 925 MOE DRIVE AKRON, OH 44310-2518</p> <p>ACE</p> <p>CAGE code: 3DTZ2 <u>2/</u></p>
<p>ACCU-TECH MANUFACTURING AND SUPPORT, INC. 8875 EAST AVENUE MENTOR, OH 44060</p> <p>Accu-Tech MFG. & SUPPORT INC.</p> <p>CAGE code: 1LLG8 <u>2/</u></p>	<p>ACHILLES AEROSPACE PRODUCTS, INC. 2100 ENTERPRISE PKWY TWINSBURG, OH 44087-2212</p> <p>(SEE AAP)</p> <p>A</p> <p>CAGE code: 0H380 <u>2/</u></p>
<p>ACCUTOOL (SUBCON TOOL/ACCUTOOL MACHINE GROUP INC. DBA ACCUTOOL) SEE SUBCON TOOL 5301 IROQUOIS AVENUE ERIE, PA 16511-2529</p> <p>01FO</p> <p>CAGE code: 1UXM0 <u>1/</u></p>	

1/ Information published in this revision was verified by direct contact with manufacturers.

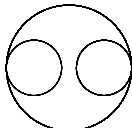
2/ Information not verified to be current, no response from manufacturer. Information identical to that published in MIL-HDBK-57, Revision B.



MIL-HDBK-57C(IS)

<p>ACI 301 W. WILSON P.O. BOX 398 OTTAWA, KS 66067</p> <p style="text-align: center;">ACI</p> <p>CAGE code: 0AV61 <u>2/</u></p>	<p>ACME SCREW COMPANY 1201 W. UNION AVE WHEATON, IL 60187-4879</p> <p>  Carbon steel  430 stainless steel </p> <p>  410 stainless steel  305 stainless steel </p> <p>CAGE code: 35EX5 <u>2/</u></p>
<p>ACIMET MFG. 1710 CLARKSTONE RD. CLEVELAND, OH 44112</p> <p style="text-align: center;">   </p> <p>CAGE code: 6V869 <u>2/</u></p>	<p>ACRODYNE MFG CO. (DIVISION OF MACK INTERNATIONAL OPERATIONS) 41 KINGSTON AVE COLUMBUS, OH 43207-2438</p> <p style="text-align: center;">  </p> <p>CAGE code: 9Y179 <u>2/</u></p>
<p>ACME MACHINE PRODUCTS 500 SOUTH VARNEY STREET BURBANK, CA 91502</p> <p style="text-align: center;">  </p> <p>CAGE code: 4M256 <u>2/</u></p>	<p>ACUFAST AIRCRAFT PRODUCTS 12424 GLADSTONE AVE. SYLMAR, CA 91342</p> <p style="text-align: center;">AF</p> <p>CAGE code: 4GP55 <u>1/</u></p>
<p>ACME RIVET & MACHINE CORP. 50 EMMETT ST. BRISTOL, CT 06010</p> <p style="text-align: center;">   </p> <p>CAGE code: 34482 <u>2/</u></p>	<p>ADAMS INDUSTRIES, INC. (A SUB OF BANNER INDUSTRIES INC.) 1160 SOUTH ST WINDSOR LOCKS, CT 06096</p> <p style="text-align: center;">ABE</p> <p>CAGE code: 33823 <u>2/</u></p>

1/ Information published in this revision was verified by direct contact with manufacturers.

2/ Information not verified to be current, no response from manufacturer. Information identical to that published in MIL-HDBK-57, Revision B.









MIL-HDBK-57C(IS)

<p>ADAMS, EARL M. CO. 100 PECK HILL RD. JOHNSTON, RI 02919</p>  <p>CAGE code: 07123 <u>2/</u></p>	<p>ADOM ENGINEERING 131 AVCO ROAD HAVERHILL, MA 01835-5956</p> <p>AD</p> <p>CAGE code: 02GZ1 <u>1/</u></p>
<p>ADC COMMUNICATIONS CORP. 17528 STUDEBAKER RD. CERRITOS, CA 90703-2637</p>  <p>CAGE code: 9X383 <u>2/</u></p>	<p>ADVANCE PATTERN CORP. 18564 FITZPATRICK DETROIT, MI 48228</p> <p>MFR 29839</p> <p>CAGE code: 29839 <u>2/</u></p>
<p>ADI MANUFACTURING, INC. 33 HAMMOND, BLDG 201 IRVINE, CA 92718</p> <p>Plant 1243 TRANSIT STREET POMONA, CA 91766</p> <p>MC</p> <p>K</p> <p>CAGE code: 0YCU4 <u>2/</u></p>	<p>ADVANCED CNC MANUFACTURING 7303 124TH AVENUE NORTH LARGO, FL 33773</p> <p>A</p> <p>CAGE code: 1YDC9 <u>1/</u></p>
<p>ADJUSTABLE BUSHING CORP. 8330 LANKERSHIM BLVD. NORTH HOLLYWOOD, CA 91605</p>  <p><i>Panel fastener</i> <i>Quick-acting pins</i></p> <p>CAGE code: 3V407 <u>2/</u></p>	<p>ADVANCED MACHINING & FABRICATING, INC. 11212 E. 112TH ST. N. OWASSO, OK 74055-5421</p> <p>a</p> <p>CAGE code: 0BD96 <u>1/</u></p>
<p>ADVANCED PLASTICS, INC. DBA ADVANCED MACHINING & FABRICATING, INC. 11212 E. 112th ST. N. OWASSA, OK 74055-5421</p> <p>ap</p> <p>a</p> <p>CAGE code: 45339 <u>1/</u></p>	<p>ADVANCED PLASTICS, INC. DBA ADVANCED MACHINING & FABRICATING, INC. 11212 E. 112th ST. N. OWASSA, OK 74055-5421</p> <p>ap</p> <p>a</p> <p>CAGE code: 45339 <u>1/</u></p>

1/ Information published in this revision was verified by direct contact with manufacturers.

2/ Information not verified to be current, no response from manufacturer. Information identical to that published in MIL-HDBK-57, Revision B.

MIL-HDBK-57C(IS)

<p>AERCO RESEARCH 295 OLD COUNTRY ROAD SUITE 10 SAN CARLOS, CA 94070-6240</p>  <p>CAGE code: 0KMN9 1/</p>	<p>AERO ENGINEERING AND MANUFACTURING CO. OF CALIFORNIA (DBA AERO ENGINEERING) 28217 AVENUE CROCKER VALENCIA, CA 91355-1249</p>  <p>CAGE code: 17772 1/</p>
<p>AERO BUSHING AND COMPONENT 15201 PIPELINE LN. HUNTINGTON BEACH, CA 92649</p>  <p>CAGE code: 2/</p>	<p>AERO MECHANICAL FASTENING SYSTEMS 15481 WEST 110TH AVE SHAWNEE MISSION, KS 66219</p>  <p>CAGE code: 1FY45 2/</p>
<p>AERO COMPONENTS CO. 5124 KALTENBRUN RD. FORT WORTH 76119 - 6400</p>  <p>CAGE code: 59213 2/</p>	<p>AEROBOLT MANUFACTURING, INC. 4736 FELSPAR STREET RIVERSIDE, CA 92509-3068</p>  <p>CAGE code: 08PH2 2/</p>
<p>AERO DYNAMIC MACHINING, INC. 11791 MONARCH STREET GARDEN GROVE, CA 92841-1818</p>  <p>CAGE code: 1KSM2 2/</p>	<p>AERO-FAB, INC. 8420 RED OAK STREET RANCHO CUCAMONGA, CA 91730</p>  <p>CAGE code: 0CAC0 2/</p>

1/ Information published in this revision was verified by direct contact with manufacturers.

2/ Information not verified to be current, no response from manufacturer. Information identical to that published in MIL-HDBK-57, Revision B.



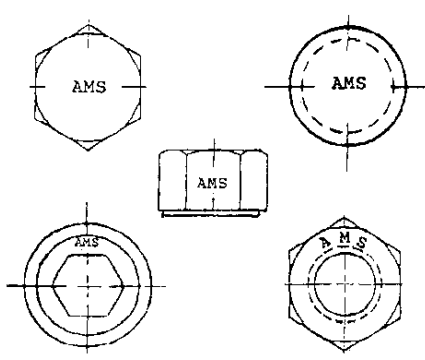



MIL-HDBK-57C(IS)

<p>AEROFAST SUPPLY 405 W 20TH ST SAN PEDRO, CA 90731</p> <p style="text-align: center;">A</p> <p>CAGE code: 2T830 <u>2/</u></p>	<p>AEROSPACE MARINE SPECIALTY FASTENERS & FITTINGS INC. DBA AMS FASTENERS 1645 WEST 135ND STREET GARDENA, CA 90249-2505</p> <p style="text-align: center;">AMS A M S</p>  <p>CAGE code: 1FGH9 <u>2/</u></p>
<p>AEROMAX INDUSTRIES, INC. DBA AEROMAX INTERNATIONAL 9546 TOPANGA CANYON BLVD. CHATSWORTH, CA 91311-4011</p> <p style="text-align: center;">AX</p> <p>CAGE code: 40581 <u>1/</u></p>	<p>AEROSPACE PRODUCTS (DIV OF APCOA FASTENERS, INC) 903 E. OHIO STREET P. O. BOX 796 INDIANAPOLIS, IN 46202</p> <p style="text-align: center;">APCO</p> <p>CAGE code: 17140 <u>2/</u></p>
<p>AEROSPACE MANUFACTURING P.O. BOX 3398 WALLINGTON, NJ 07057-1148</p> <p style="text-align: center;">Plant 80 VAN WINKLE AVE. WALLINGTON, NJ 07057-1148</p> <p style="text-align: center;">AM</p> <p>CAGE code: 0E0Z8 <u>1/</u></p>	<p>AEROSPACE PRODUCTS CO. DIV WBH (FORMERLY APCOA FASTENERS, INC.) P.O. BOX 796 INDIANAPOLIS, IN 46206-0796</p> <p style="text-align: center;">Plant 123 NORTH PINE STREET INDIANAPOLIS, IN 46202-3844</p> <p style="text-align: center;">AP</p> <p>CAGE code: 59736 <u>1/</u></p>

1/ Information published in this revision was verified by direct contact with manufacturers.

2/ Information not verified to be current, no response from manufacturer. Information identical to that published in MIL-HDBK-57, Revision B.









MIL-HDBK-57C(IS)

<p>AEROSPACE PRODUCTS, INC. 5435 PERKINS RD. BEDFORD HEIGHTS, OH 44146</p> <p style="text-align: center;">A</p> <p>CAGE code: <u>2/</u></p>	<p>AEROTECH FASTENERS, INC. ONE RIDGE ROAD PUTNAM, CT 06260</p> <p style="text-align: center;"></p> <p>CAGE code: 0TD46 <u>1/</u></p>
<p>AEROSPACE RIVET MFG CORP 8535 DICE ROAD SANTA FE SPRINGS, CA 90670</p> <p style="text-align: center;"></p> <p>CAGE code: 64728 <u>2/</u></p>	<p>AEROWIND CORPORATION 1959 JOHN TOWERS AVENUE EL CAJON, CA 92020-1117</p> <p style="text-align: center;">A </p> <p>CAGE code: 1N021 <u>1/</u></p>
<p>AEROSTAR ENGINEERING & MANUFACTURING COMPANY 25514 S. FRAMPTON AVENUE HARBOR CITY, CA 90710-2907</p> <p style="text-align: center;"></p> <p>No longer a fastener manufacturer</p> <p>CAGE code: 0MXJ2 <u>2/</u></p>	<p>AF FASTENERS LIMITED UNIT 14 & 15 GLOSSOP BROOK BUSINESS PARK, GLOSSOP, DERBYSHIRE SK13 7AJ, UNITED KINGDOM</p> <p style="text-align: center;">J</p> <p>CAGE code: <u>1/</u></p>
<p>AEROSTAR FASTENER CORP. 712 W LACY ST P.O. BOX 2201 PALESTINE, TX 75802</p> <p style="text-align: center;"></p> <p>CAGE code: 0T218 <u>2/</u></p>	<p>AFAB PRECISION MACHINING 20742 LINEAR LANE LAKE FOREST, CA 92630</p> <p style="text-align: center;"></p> <p>CAGE code: 1GSW1 <u>2/</u></p>

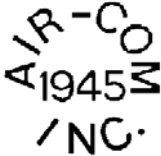
1/ Information published in this revision was verified by direct contact with manufacturers.

2/ Information not verified to be current, no response from manufacturer. Information identical to that published in MIL-HDBK-57, Revision B.





MIL-HDBK-57C(IS)

<p>AFI INDUSTRIES, INC. 475 E. KEHOE BLVD CAROL STREAM, IL 60188</p> <p> </p> <p>CAGE code: 33PQ1 <u>1/</u></p>	<p>AIR-COM, INC. 18105 S. HOBART BLVD. GARDENA, CA 90248-3617</p> <p></p> <p>CAGE code: 2Y870 <u>2/</u></p>
<p>AIHARA SEIBYO CO LTD 2084 SHIN-MACHI TANO-GUN, GUNMA, JAPAN 370-13</p> <p>ICHO</p> <p>CAGE code: <u>2/</u></p>	<p>AIRCRAFT ENGINEERING PRODUCTS, INC. 2 ACKERMAN AVENUE CLIFTON, NJ 07011</p> <p></p> <p>CAGE code: <u>2/</u></p>
<p>AIR INDUSTRIES CORPORATION 12570 KNOTT STREET GARDEN GROVE, CA 92841-3932</p> <p></p> <p>CAGE code: 06725 <u>1/</u></p>	<p>AIRCRAFT FUELSEAL FASTENERS, INC. (AEROLITE BLIND RIVET DIVISION) 5271 ARGOSY AVENUE HUNTINGTON BEACH, CA 92649</p> <p></p> <p>CAGE code: 4K209 <u>2/</u></p>
<p>AIR PARTS MFG. CO. 1117 HARRISON AVE ARLINGTON, TX 76011</p> <p></p> <p>CAGE code: 8R401 <u>2/</u></p>	<p>AIRDROME PARTS CO. 3251 SCHNIEDER ROAD S.E. P.O. BOX 1867 NORTH CANTON, OH 44720</p> <p></p> <p>CAGE code: <u>2/</u></p>

1/ Information published in this revision was verified by direct contact with manufacturers.

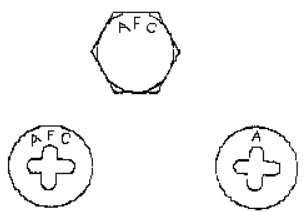
2/ Information not verified to be current, no response from manufacturer. Information identical to that published in MIL-HDBK-57, Revision B.







MIL-HDBK-57C(IS)

<p>AIRFASCO, INC. 2655 HARRISON AVE SW. CANTON, OH 44706-3047</p>  <p>CAGE code: 3Z958 <u>2/</u></p>	<p>ALBAR MACHINE CORPORATION RR3 BOX 2463 EFFORT, PA 18330-9450</p>  <p>CAGE code: 44248 <u>1/</u></p>
<p>AIW-ALTON INC. 1475 PALISADO AVE. WINDSOR, CT 06095-5140</p>  <p>CAGE code: 84027 <u>2/</u></p>	<p>ALCO MACHINE CO. 27 SEARING AVENUE HARRISON, NJ 07029</p>  <p>CAGE code: 2T918 <u>2/</u></p>
<p>ALAN, JEFFREY, MFG. & ENGR. 8625 LAPEER ROAD P.O. BOX # 8 GOODELLS, MI 48027-9766</p>  <p>CAGE code: 3D531 <u>2/</u></p>	<p>ALCOA FASTENING SYSTEMS 3016 WEST LOMITA BLVD. TORRANCE, CA 90505</p> <p>plants:</p> <p>see CAMLOC PRODUCTS</p> <p>see HUCK INDUSTRIAL PRODUCTS</p> <p>see HUCK AEROSPACE PRODUCTS</p> <p>see KELOX/MICRODOT PRODUCTS</p> <p>see MECAERO PRODUCTS</p> <p>see RAM PRODUCTS</p> <p>see ROSAN PRODUCTS</p> <p>see SIMMONDS PRODUCTS</p> <p>see TRIDAIR PRODUCTS</p> <p>see VOI-SHAN PRODUCTS</p> <p>CAGE code: 15653 <u>1/</u></p>
<p>ALARD MACHINE PRODUCTS 1629 WEST 132ND STREET GARDENA, CA 90249-2005</p>  <p>CAGE code: 1FMQ2 <u>1/</u></p>	

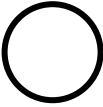
1/ Information published in this revision was verified by direct contact with manufacturers.

2/ Information not verified to be current, no response from manufacturer. Information identical to that published in MIL-HDBK-57, Revision B.

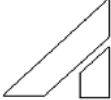
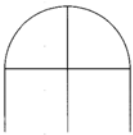
MIL-HDBK-57C(IS)

<p>ALCOA GLOBAL FASTENERS INC 13001 EAST TEMPLE AVE LA PUENTE, CA 91746-1417</p>  <p>CAGE code: 06950 <u>2/</u></p>	<p>ALL QUALITY SPARES, INC. 3 EAST BISHOP STREET WATERFORD, CT 06385</p>  <p>CAGE code: 1VGA2 <u>1/</u></p>
<p>ALEXANDER MANUFACTURING COMPANY INC. DBA METRO TOOL & MANUFACTURING CO. 2402 ARKANSAS LANE GRAND PRAIRIE, TX 75052-7203</p>  <p>CAGE code: 2M919 <u>2/</u></p>	<p>ALLFAST FASTENING SYSTEMS, INC. 15200 E DON JULLIAN RD P.O. BOX 3166 CITY OF INDUSTRY, CA 91745-1098</p>  <p>CAGE code: 53551 <u>1/</u></p>
<p>ALL MANUFACTURERS INC. DBA HARPER AEROSPACE FASTENERS 2900 PALISADES DR CORONA, CA 92880 – 9429</p>  <p>CAGE code: 57472 <u>2/</u></p>	<p>ALLIED NUT & BOLT CO., INC. 520 HERTZOG BOULEVARD P.O. BOX 670 KING OF PRUSSIA, PA 19406-2667</p>  <p>CAGE code: 4S191 <u>2/</u></p>
<p>ALL PINS MANUFACTURING P.O. BOX 137 WILSEYVILLE, CA 95257</p> <p>plant 5549 POOR MANS WAY WILSEYVILLE, CA 95257</p>  <p>CAGE code: O8CZ5</p>	<p>ALLIED PRECISION PRODUCTS, INC. 600 SAN CHRISTOPHER DRIVE DUNEDIN, FL 34698-5095</p>  <p>CAGE code: 24249 <u>1/</u></p>
<p>ALL-POWER MFG. CO. 13141 MOLETTE STREET SANTA FE SPRINGS, CA 90670-5500</p>  <p>CAGE code: 70265 <u>1/</u></p>	

1/ Information published in this revision was verified by direct contact with manufacturers.

2/ Information not verified to be current, no response from manufacturer. Information identical to that published in MIL-HDBK-57, Revision B.

MIL-HDBK-57C(IS)

ALL-PRO FASTENER & RIVET MFG. CO.
10406 ENTERPRISE ST
P.O. BOX 1525
RANCHO CUCAMONGA, CA 91730

AP

CAGE code: 1FH10 2/

ALL-STATES INC.
1801 WEST FOSTER AVE.
CHICAGO, IL 60640

ALL-STATES LOGO

=
ALL-STATES
IDENTIFICATION MARK

CAGE code: 26863 2/

ALPHA BOLT CO.
1524 EAST 14 MILE ROAD
MADISON HEIGHTS, MI 48071

ABC

I

CAGE code: 0R8B6 2/

Continued

Continued

ALPHA BOLT CO.

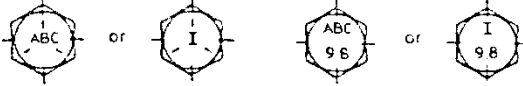

GRADE 5 BOLT PROPERTY CLASS 9.8
METRIC BOLTS

 Roman numeral "I" shown on special bolts

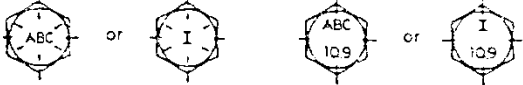

GRADE 8 BOLT PROPERTY CLASS 10.9
METRIC BOLTS

CAGE code: 0R8B6 2/

ALPHA FASTENERS
154 EAST MERRICK ROAD
FREEPORT, NY 11520

**A
F**

CAGE code: 1UJ18 1/

ALPHA MACHINING PRODUCTS &
DEVELOPMENT
8651 PRODUCTION AVENUE
SAN DIEGO, CA 92126





Plant
7929 SILVERTON AVENUE
SUITE 610
SAN DEIGO, CA 92126

α

CAGE code: 3D6Q0 2/

1/ Information published in this revision was verified by direct contact with manufacturers.
2/ Information not verified to be current, no response from manufacturer. Information identical to that published in MIL-HDBK-57, Revision B.

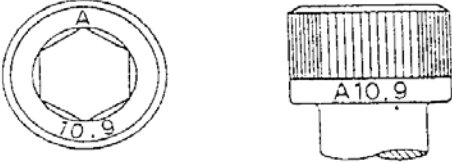
MIL-HDBK-57C(IS)

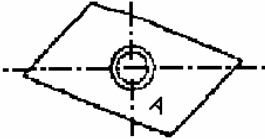
<p>ALPINE MACHINE & TOOL CORP. 42 BERGENLINE AVE. WESTWOOD, NJ 07675</p> <p>AMT - I</p> <p>AMT x x x x - x x x x</p>  <p>CAGE code: 67339 <u>2/</u></p>	<p>AMANDA BENT BOLT CO. 1120 C I C DR. LOGAN, OH 43138-9153</p>  <p>CAGE code: 22382 <u>2/</u></p>
<p>ALPS SEIKO CO. LTD. 41 HIGASHI-KANAE, KANAE IIDA-SHI, NAGANO PREF. 395-0817, JAPAN</p> <p>Plant LIDA FACTORY 524-1, SHIMOTONOHKA LIDA-SHI, NAGANO PREF. 395-0154 JAPAN</p> <p>A</p>  <p>CAGE code: <u>1/</u></p>	<p>AMATOM ELECTRONIC HARDWARE (DIVISION OF QUINCY TECHNOLOGIES, INC.) 5 PASCO HILL ROAD CROMWELL, CT 06416-1012</p> <p>A M A T O M</p> <p>AMATOM</p> <p>CAGE code: 1YGB8 <u>2/</u></p>
<p>AMACON CORP. 49 ALDER STREET WEST BABYLON, NY 11704</p>  <p>CAGE code: 54330 <u>2/</u></p>	<p>AMERICAN AIRCRAFT PARTS MANUFACTURING COMPANY 17917 MASONIC FRASER, MI 48026</p> <p>99106</p> <p>CAGE code: 99106 <u>2/</u></p> <p>AMERICAN ELECTRIC (CONSTRUCTION MATERIALS GROUP) 1555 LYNNFIELD ROAD MEMPHIS, TN 38119</p> <p>(SEE THOMAS & BETTS CORP - CAGE 56501)</p>  <p>CAGE code: <u>1/</u></p>

1/ Information published in this revision was verified by direct contact with manufacturers.

2/ Information not verified to be current, no response from manufacturer. Information identical to that published in MIL-HDBK-57, Revision B.

MIL-HDBK-57C(IS)

AMERICAN FASTENER & SPECIALTY CO.
5900 PARK AVE.
CLEVELAND, OHIO 44105



CAGE code: _____ 2/

AMERICAN INTERNATIONAL AERO MFG INC.
6973 SOUTH 300 WEST
MIDVALE, UTAH 84047



CAGE code: 0RBVB 2/

AMERICAN METAL BEARING COMPANY
7191 ACACIA AVENUE
GARDEN GROVE, CA 92841

AMB

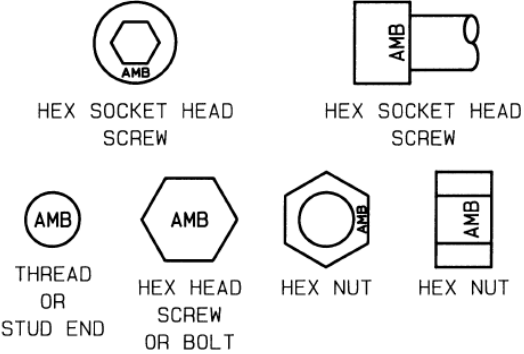

HEX SOCKET HEAD SCREW HEX SOCKET HEAD SCREW

THREAD OR STUD END HEX HEAD SCREW OR BOLT HEX NUT HEX NUT

CAGE code: 70508 1/

AMERICAN QUALITY INDUSTRIES
(FASTENER DIVISION)
411 BURNHAM STREET
EAST HARTFORD, CT 06108



GRADE 8 BOLT GRADE 5 BOLT

CAGE code: 1P581 1/

AMERIFAST CORP.
104 SYLVANNA RD.
SOUTH PLAINFIELD, NJ 07080-1448

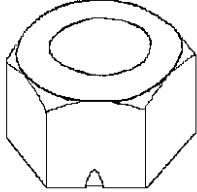

CAGE code: 0H4SO 1/

AMERITECH FASTNER MFG INC.
DIVISION OF LONE STAR FASTENERS, LP
6606 N GESSNER
HOUSTON, TX 77040

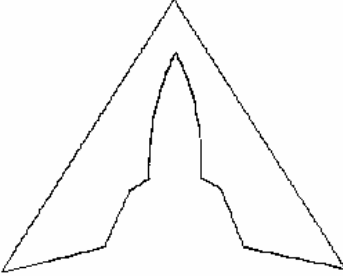









CAGE code: 0EUH2 1/

1/ Information published in this revision was verified by direct contact with manufacturers.

2/ Information not verified to be current, no response from manufacturer. Information identical to that published in MIL-HDBK-57, Revision B.



MIL-HDBK-57C(IS)

<p>AMMAC, INC. 6000 SUSQUEHANNA PLAZA YORK, PA 17406</p>  <p>CAGE code: 0NHU1 1/</p>	<p>ANILLO INDUSTRIES, INC. 2090 N. GLASSELL P.O. BOX 5586 ORANGE, CA 92865-3306</p>  <p>CAGE code: 10630 1/</p>
<p>ANATASE PRODUCTS (DIV OF HENWAY INC) 1314 GOODRICK DR TEHCHPI, CA 93561</p>  <p>CAGE code: 0MXJ8 1/</p>	<p>ANOTHER SCREW MACHINE PRODUCT EMERALD INDUSTRIAL PARK BOX 425 PONDERAY, ID 83852</p> <p style="text-align: center;">BEI</p> <p>CAGE code: 05RQ3 2/</p>
<p>ANCHOR BOLT & SCREW CO. 2001 N. CORNWELL MELROSE PARK, IL 60160-1081</p>  <p>Hex cap and indented hex screws.</p>  <p>Machine screws and Other products - 3 dots under head 120° apart</p> <p>CAGE code: 9C864 2/</p>	<p>A-ONE MACHINE COMPANY R.R.1, BOX 1660 HOP BOTTOM, PA 18824</p>  <p>CAGE code: 0AV84 1/</p>
<p>ANDERSON FORGE & MACHINE 18500 S. W. PACIFIC HWY TUALATIN, OR 97062</p>  <p>CAGE code: 7X566 2/</p>	<p>APEL LTD. COUNTRESS AVE., STANLEY GREEN TRADING ESTATE CHEADLE HULME, CHESHIRE, SK8 6QU UNITED KINGDOM</p>  <p>CAGE code: K5640 2/</p>

1/ Information published in this revision was verified by direct contact with manufacturers.

2/ Information not verified to be current, no response from manufacturer. Information identical to that published in MIL-HDBK-57, Revision B.

MIL-HDBK-57C(IS)

<p>APEX MFG. CO. INC. 11686 TUXFORD ST SUN VALLEY, CA 91352-3134</p> <p style="text-align: center;">AP</p> <p>CAGE code: 2V343 <u>1/</u></p>	<p>ARDOR MFG. INC. 400 S. 1100 W. PROVO, UT 84603</p> <p style="text-align: center;"></p> <p>CAGE code: 0CTH5 <u>2/</u></p>
<p>APHEONIX CORPORATION 101 PECK HILL ROAD JOHNSTON, RI 02919</p> <p style="text-align: center;">AP</p> <p style="text-align: center;">PC</p> <p>CAGE code: 08TF3 <u>2/</u></p>	<p>ARGARWAL INDUSTRIES 370 MARSHALL HOUSE 25 STRAND ROAD CALCUTTA, INDIA 700 001</p> <p style="text-align: center;"></p> <p>CAGE code: <u>2/</u></p>
<p>ARCHER SCREW PRODUCTS 11341 MELROSE STREET FRANKLIN PARK, IL 60131</p> <p style="text-align: center;"></p> <p>CAGE code: 1HXL9 <u>2/</u></p>	<p>ARJAY PRECISION, INC. 524 SULLIVAN AVE SUITE 15 SOUTH WINDSOR, CT 06074</p> <p style="text-align: center;">MFR - 72905</p> <p>CAGE code: 72905 <u>2/</u></p>
<p>ARCO SALES CO. 2211 WAKELING STREET P.O. BOX 23001 PHILADELPHIA, PA 19137-1214</p> <p style="text-align: center;">ASC</p> <p style="text-align: center;">ASC</p> <p>CAGE code: 5L063 <u>1/</u></p>	

1/ Information published in this revision was verified by direct contact with manufacturers.

2/ Information not verified to be current, no response from manufacturer. Information identical to that published in MIL-HDBK-57, Revision B.

MIL-HDBK-57C(IS)

ARMSTRONG ATLAS BOLT
 STATION STREET
 DARLASTON, WEST MIDLANDS, WS10 8UL
 GREAT BRITIN

CAGE code: 2/

ARMSTRONG FASTENING SYSTEMS
 FOSTER STREET STONEFERRY
 BUSINESS PARK
 HULL, GREAT BRITIAN, HU8 8BT
 UNITED KINGDOM

Symbol may be depressed or raised

CAGE code: K1012 2/
 (Continued)

(Continued)

ARMSTRONG FASTENINGS LTD.
 FOSTER STREET STONEFERRY
 BUSINESS PARK
 HULL, GREAT BRITIAN, HU8 8BT
 UNITED KINGDOM

GSF

CAGE code: K1012 2/

ARNOLD KNIPPING GmbH
 58557 KIERSPE
 POSTFACH 14 48
 GUMMERSBACH, GERMANY 5270

AK
 KNIPPING

CAGE code: C4096 2/

ARNOLD UMFORMTECHNIK
 GMBH & CO. KG
 SINDRINGEN STR. 25
 FORCHTENBERG, 74670
 GERMANY





A

CAGE code: C3705 2/

1/ Information published in this revision was verified by direct contact with manufacturers.

2/ Information not verified to be current, no response from manufacturer. Information identical to that published in MIL-HDBK-57, Revision B.

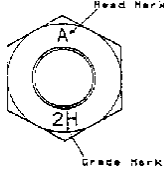

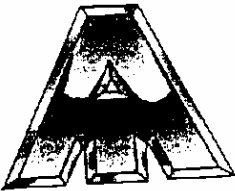

MIL-HDBK-57C(IS)

<p>ARNOLD WRAGG (BOLTS & NUTS) LTD STANNINGTON ROAD STANNINGTON, SHEFFIELD ENGLAND, UK S6 6AG</p>  <p>CAGE code: U2935 2/</p>	<p>ASAHI SREWS MANUFACTURING CO., LTD 101 KAWAMATA HIGASHIOSAKA, JAPAN</p>  <p>CAGE code: 2/</p>
<p>ARROW SCREW & MACHINE WORKS 1037 GERMANTOWN AVENUE PHILADELPHIA, PA 19123-1629</p>  <p>CAGE code: 03632 2/</p>	<p>ASAI TEKKO CO. LTD 2-14 TAJIKA SHODKAI HIRKATA-SHI OSAKA, JAPAN 573</p>  <p>CAGE code: 2/</p>
<p>ARTISAN SPECIALIST TECH, INC. 439 HIGH STREET P.O. BOX 48060 PHILADELPHIA, PA 19144</p>  <p>CAGE code: 0RJ65 1/</p>	<p>ASI DESIGN & MANUFACTURING, INC. 1070 HARDEES DRIVE P. O. BOX 957 ABERDEEN, MD 21001</p>  <p>CAGE code: 32971 2/</p>
<p>ARVAN, INC. 14083 S NORMANDIE AVE GARDENA, CA 90249</p> <p style="text-align: center;">ARVAN, INC. TANSEY A/I</p> <p>CAGE code: 29965 2/</p>	<p>ASSOCIATED TOOL CO., INC. 100 THOMAS DRIVE GADSDEN, AL 35901</p>  <p>CAGE code: 2U575 2/</p>

1/ Information published in this revision was verified by direct contact with manufacturers.

2/ Information not verified to be current, no response from manufacturer. Information identical to that published in MIL-HDBK-57, Revision B.

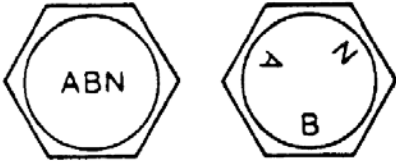
MIL-HDBK-57C(IS)

<p>ATF, INC. (formerly Accurate Threaded Fasteners, Inc.) 3550 WEST PRATT AVENUE LINCOLNWOOD, IL 60712</p>  <p>CAGE code: 95110 <u>1/</u></p>	<p>AUGUST FRIEDBERG GMBH BELFORTER STRASSE 63 P. O. BOX 10 08 43 GELSENKIRCHEN, GERMANY 45884</p>  <p>CAGE code: <u>2/</u></p>
<p>ATLAS ENGINEERING, INC. (PENN ENGINEERING AND MFG. CO.) 5190 OLD EASTON RD. DANBORO, PA 18916</p>  <p>CAGE code: 46384 <u>1/</u></p>	<p>AUGUST FRIEDBERG GmbH BELFORTER STRASSE 63 D-4650 GELSENKIRCHEN ROTTHAUSEN, GERMANY</p> <p style="text-align: center;">FRIEDBERG</p> <p>CAGE code: <u>2/</u></p>
<p>ATLAS SPECIALTY PRODUCTS (SEE CURTIS PRESTON ENTERPRISES INC.) 2299 E. WINSTON ROAD ANAHEIM, CA 92806</p> <p style="text-align: center;">ASP</p> <p>CAGE code: 0TP31 <u>1/</u></p>	<p>AUTO BOLT AND NUT CO. 4619 PERKINS AVE CLEVELAND, OH 44103</p>   <p>CAGE code: 0CUJ9 <u>1/</u></p>

1/ Information published in this revision was verified by direct contact with manufacturers.

2/ Information not verified to be current, no response from manufacturer. Information identical to that published in MIL-HDBK-57, Revision B.

MIL-HDBK-57C(IS)

AUTOMATED MANUFACTURING
8009 AUGUSTA ROAD
PIEDMONT, SC 29673-9369

A M

CAGE code: 1URY9 2/

AUTOMATIC MACHINING AND MFG CO
DBA AMMAC INC
6000 SUSQUEHANNA PLZ
YORK, PA 17406





CAGE code: 0NHU1 2/

AUTOMATIC MANUFACTURING COMPANY
300 SHADELAND AVENUE
EAST PITTSBURGH, PA 15112-1499

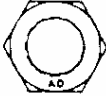

CAGE code: 18362 1/

AUTOMATIC SCREW MACHINE
PRODUCTS CO.
709 2ND AVE
P.O. BOX 1608
DECATUR, AL 35601

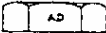
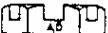
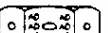
PLAIN:	SLOTTED:	DRILLED:
		
	OR	
		
AD	AD	AD

CAGE code: 92595 1/

AUTO SCREW, INC.
LYNBROCK RD. & EASTERN BLVD.
P.O. BOX 4968
BALTIMORE, MD 21220



CAGE code: 84253 2/

AVDEL INTERNATIONAL (AVDEL LTD)
HERTFORD, AL 7 1EZ
GREAT BRITIAN



CAGE code: 2/

AVIATION MANUFACTURING GROUP LLC
(SEE DBA FREEMAN CO., THE)
719 WALNUT ST
P. O. BOX 57
YANKTON, SD 57078-3542



CAGE code: 84596 1/

1/ Information published in this revision was verified by direct contact with manufacturers.

2/ Information not verified to be current, no response from manufacturer. Information identical to that published in MIL-HDBK-57, Revision B.

MIL-HDBK-57C(IS)

AVIBANK MANUFACTURING, INC.
PRECISION CASTPARTS CORP.
4650 SW MACADAM AVE. SUITE 440
PORTLAND, OR 97239-4262

Plant

AVIBANK MFG., INC.
11500 SHERMAN WAY, P.O. BOX 9909
NORTH HOLLYWOOD, CA 91609-1909

AB

ADB, ADBB, ADP,

LRA

AAP

AS

AV

AVIBANK, BALL-

LOK® , BLC, BLS,

PIP

AVL

AVK, ET, ETC, FN,

IT, ITC, MT, RT

ST

84256

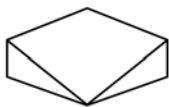

CAGE code: 84256

1/

AVK INDUSTRIES PRODUCTS INC.
25323 RYE CANYON RD
VALENCIA, CA 91355

AVK

CAGE code: 2K288

2/

AZTECH ENGINEERING, INC.
1424 CENTRE CIR.
DOWNERGROVE, IL 60515



CAGE code: 0W426

2/

B & B SPECIALTIES INC.
4321 E. LAPLMA AVE.
ANAHIEM, CA 92807

(see GS AEROSPACE)

1) PRIMARY - **BB**

2) SECONDARY - **62206**

CAGE code: 62206





1/

Continued

1/ Information published in this revision was verified by direct contact with manufacturers.

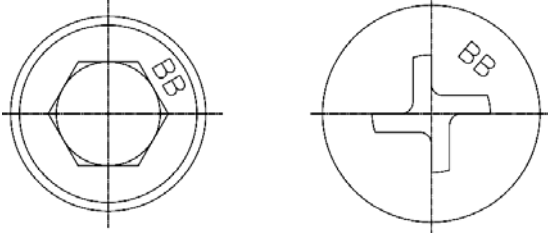
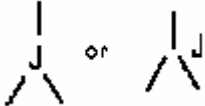
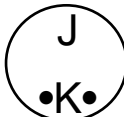
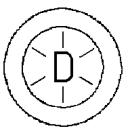
2/ Information not verified to be current, no response from manufacturer. Information identical to that published in MIL-HDBK-57, Revision B.

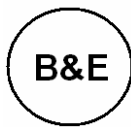



MIL-HDBK-57C(IS)

<p>Continued</p> <p>B & B SPECIALTIES INC 4321 E. LAPLMA AVE. ANAHIEM, CA 92807</p>  <p>Raised BB is for new manufactured parts. Depressed BB is for old stock.</p> <p>CAGE code: 62206 1/</p>	<p>B & G MANUFACTURING CO., INC. 3067 UNIONVILLE PIKE P.O. BOX 269 HATFIELD, PA 19440-1822</p>  <p>Grade 5</p> <p>JB7 Grade B7 JB16 Grade B16 JNC Alloy 400</p>  <p>Alloy 500</p> <p>J4 Grade 4 J2H Grade 2H</p> <p>CAGE code: 84272 2/</p>
<p>B & D THREADED ROLLING 36820 VAN BORN ROAD P.O. BOX 275 WAYNE, MI 48184</p>  <p>CAGE code: 00LR8 1/</p>	<p>B & N TOOL CO., INC. 44 ROCKWELL RD. NEWINGTON, CT 06111</p>  <p>CAGE code: 0CMJO 2/</p>
<p>B & E MACHINE SHOP & SHEET METAL FAB., INC. 3059 SE MONROE ST. STUART, FL 34997</p>  <p>CAGE code: 8W179 2/</p>	<p>B & R MACHINE AND TOOL CORP 717 MAIN STREET WESTBURY, NY 11590</p>  <p>CAGE code: 66936 1/</p>
<p>B & E MANUFACTURING CO., INC. 7562 ORANGEWOOD AVE. STANTON, CA 90680-3498</p>  <p>CAGE code: 59680 1/</p>	

1/ Information published in this revision was verified by direct contact with manufacturers.

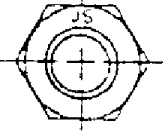
2/ Information not verified to be current, no response from manufacturer. Information identical to that published in MIL-HDBK-57, Revision B.

MIL-HDBK-57C(IS)

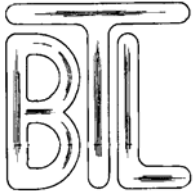
<p>B F GOODRICH CO. RIVNUT ENGINEERED FATSEENERS, THE AEROSPACE AND DEFENSE DIVISION 250 NORTH CLEVELAND-MASSILLION RD. AKRON, OH 44313</p> <p>Plant 150 SPRINGSIDE DRIVE AKRON, OH 44313-0501</p> <p>BFG+</p> <p>CAGE code: <u>2/</u></p>	<p>B. V. FABRIEK VAN KLINKNAGELS EN SCHROEFBOUTEN V/H SMIT 2980 GB RIDDERKIRK P.O. BOX 4075 THE NETHERLANDS</p>  <p>JS</p> <p>CAGE code: <u>2/</u></p>
<p>B G ENGINEERING, INC. 205 ARENA STREET EL SEGUNDA, CA 90245</p>  <p>CAGE code: 0WL62 <u>2/</u></p>	<p>BARCO ENGINEERING COMPANY, INC. 505 W MAIN ST TILTON, NH 03276</p>  <p>CAGE code: 29214 <u>2/</u></p>
<p>B G M FASTENER CO., INC. RR 5 BOX 1675 759 OLD WILLOW AVENUE HONSDALE, PA 18431</p>  <p>CAGE code: 3Y498 <u>1/</u></p>	<p>BARRE AEROSPACE PRODUCTS INC. 199 HOPRIVER ROAD RTE. 6 BOLTON, CT 06043-7443</p>  <p>CAGE code: 7R902 <u>1/</u></p>
	<p>BAS AEROSPACE LIMITED 2 CRAMPTONS ROAD SEVENOAKS, KENT N14 5EF UNITED KINGDOM</p>  <p>CAGE code: KCWE1 <u>1/</u></p>

1/ Information published in this revision was verified by direct contact with manufacturers.

2/ Information not verified to be current, no response from manufacturer. Information identical to that published in MIL-HDBK-57, Revision B.

MIL-HDBK-57C(IS)













BAUER & SCHAURTE KARCHER GMBH
FURTHER STRASSE 24-26
POSTFACH 10 01 55
D-4040 NEUSS 1
FEDERAL REPUBLIC OF GERMANY

 **INBUS[®]**

VERBUS[®] KARRO[®]

CAGE code: D2370 2/

BBC FASTENERS, INC.
4210 SHIRLEY LANE
ALSIP, IL 60658

BBC

CAGE code: 2/

BEACH MACHINE
819 WALKER LN
NEW MARKET, AL 35761



CAGE code: 0TCDO 2/

BEAVER PRODUCTS CORP.
P.O. BOX 17279
ANAHEIM, CA 92817

B.P.C.

CAGE code: 4P584 2/

BEC MACHINE PRODUCTS COMPANY
171 RUTH ROAD
HARLEYSVILLE, PA 92806

BEC

CAGE code: 0JC12 2/

BEE INDUSTRIES, INC.
(WISCONSIN CORPORATION)
W6331 BEE ROAD
WATERTOWN, WI 53098

BI

CAGE code: 7V765 2/

1/ Information published in this revision was verified by direct contact with manufacturers.

2/ Information not verified to be current, no response from manufacturer. Information identical to that published in MIL-HDBK-57, Revision B.

MIL-HDBK-57C(IS)

BEGONIA TOOL COMPANY
53 MADISON RD
HERMINIE, PA 15637

BT

CAGE code: OL3V3 2/

BEK LEVEL 1 FASTENERS
300 THIRD AVE
HUNTINGTON, WV 25701



300 Series Stainless Steel

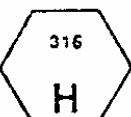

Type 316 Stainless Steel

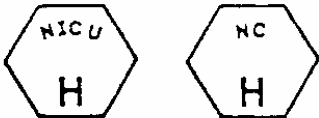

Nickel Copper (Monel)



Silicon Bronze

CAGE code: 2/

Continued

Continued

BEK LEVEL 1 FASTENERS
721 EAST COMPTON BOULEVARD
COMPTON, CA 90220

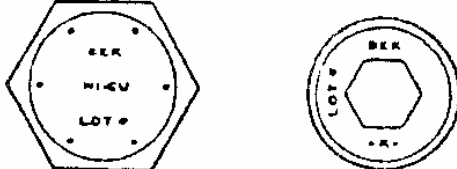

BEK

CAGE code: 2/

BELL FASTENERS (ALBANY
FASTENERS/PAWTUCKET FASTENER
DIVISION)
327 PINE STREET
PAWTUCKET, RI 02862

S

STILLWATER

B

BELL

PMC

PAWTUCKET MANUFACTURING CO.

P

PAWTUCKET

A

ALBANY

SW

ON TOP OF SCREW

••

(two dots) On the top of or bearing surface
of the screw









(SEE VERTEX)

CAGE code: 12360 2/

1/ Information published in this revision was verified by direct contact with manufacturers.

2/ Information not verified to be current, no response from manufacturer. Information identical to that published in MIL-HDBK-57, Revision B.





MIL-HDBK-57C(IS)

<p>BELL PRECISION, INC. 131 N. DILLON AVE. SAN JACINTO, CA 92383</p> <p style="text-align: center;">BP</p> <p>CAGE code: 56122 <u>2/</u></p>	<p>BEOTOOL CORP. 725 WHITNEY DR BLUE BELL, PA 19422-1205</p> <p style="text-align: center;">BOT</p> <p>CAGE code: 2N084 <u>2/</u></p>
<p>BELL-MEMPHIS, INC. 1650 CHANNEL AVE MEMPHIS, TN 38113-01871</p> <p style="text-align: center;"></p> <p>CAGE code: 22277 <u>1/</u></p>	<p>BERGNER, RICHARD GMBH & CO. BAHNHOFSTRAUSSE 8-16 P.O. BOX 1180 SCHWABACH, 91126 GERMANY</p> <p style="text-align: center;"> RIBE</p> <p>Where required and applicable, these fasteners types are also marked with the logo "RIBE" and/or capital "B" with screw in circle.</p>
<p>BEN YUAN ENTERPRISE CO, LTD. NO. 113, CHI-NAN ROAD TAI-SHIA VILLAGE, KAOHSIUNG HSIEN, TAIWAN R. O. C.</p> <p style="text-align: center;">BY</p> <p>CAGE code: <u>2/</u></p>	<p style="text-align: center;">RIBE </p> <p style="text-align: center;">RIBE </p> <p style="text-align: center;">RIBE </p> <p style="text-align: center;">RIBE </p>
<p>BENACO TOOLING RESEARCH & DEV. CORP. 9287 MERCANTILE DR MENTOR, OH 44060</p> <p style="text-align: center;"></p> <p>CAGE code: 5W644 <u>2/</u></p>	<p style="text-align: center;">RIBE </p> <p style="text-align: center;">RIBE </p> <p>CAGE code: D2282 <u>2/</u></p>

1/ Information published in this revision was verified by direct contact with manufacturers.

2/ Information not verified to be current, no response from manufacturer. Information identical to that published in MIL-HDBK-57, Revision B.

MIL-HDBK-57C(IS)

<p>BER-LOW MFG INC. DBA BUTECH PRESSURE SYSTEMS 4928 PITTSBURGH AVE ERIE, PA 16509</p>  <p>CAGE code: 62295 <u>2/</u></p>	<p>BIG BOLT CORP. 140 COVINGTON DRIVE BLOOMINGDALE, IL 60108-3105</p> <p>BB</p> <p>BB —————</p> <p>BB ————— •</p> <p>BB ————— •</p> <p>BB ————— •</p> <p>CAGE code: 3Q6H0 <u>1/</u></p>
<p>BERRY, JOHN DBA BERRY MANUFACTURING 5505 BREWSTER ST SAN ANTONIO, TX 78233</p> <p>BM</p> <p>CAGE code: 65003 <u>1/</u></p>	<p>BISHOP ENTERPRISES, INC. 10 EAST BISHOP ST. WATERFORD, CT 06385</p>  <p>CAGE code: 6Y882 <u>2/</u></p>
<p>BERRY MANUFACTURING 1090 HWY 72, BOX 336 GOLDEN, CO 80403</p> <p>BM</p> <p>CAGE code: 65003 <u>1/</u></p>	<p>BLAINE TOOL CORP. 5024 FALL CREEK RD INDIANAPOLIS, IN 46220-5344</p>  <p>CAGE code: 17027 <u>2/</u></p>
<p>BETA CORP. 2332 S DELAWARE ST DENVER, CO 80223 - 4321</p>  <p>CAGE code: 06671 <u>2/</u></p>	<p>BETA ENGINEERING, INC. P.O. BOX 80 468 DODSON LAKE DRIVE ARLINGTON, TX 76012-3441</p>  <p>CAGE code: 33436 <u>1/</u></p>

1/ Information published in this revision was verified by direct contact with manufacturers.

2/ Information not verified to be current, no response from manufacturer. Information identical to that published in MIL-HDBK-57, Revision B.







MIL-HDBK-57C(IS)

<p>BLANC AERO INDUSTRIES see LISI AEROSPACE</p> <p>BLANC AERO INDUSTRIES 193 R DE BERCY PARIS, FRANCE 75012</p> <p>BLANC AERO INDUSTRIES Saint Chamond Granat 18 20 Rue S-Hilaire Saint Ouen L'Aumone, France 95310</p> <p><u>P</u> (Sr Brieuç) B (Paris) P (Villefranche de Rouergue) ds. F</p> <p>BLANC AERO INDUSTRIES 18,20 RUE ST. HILAIRE SAINT OUEN L'AUMONE, FRANCE 95310</p> <p>T</p> <p>BLANC AERO INDUSTRIES DECOLLETAGE MODERNE 5 BIS, PLACE LEON BLUM 75020- PARIS FRANCE</p> <p>DDG</p> <p>CAGE code: F0188 <u>2/</u></p>	<p>BLANC AIRCRAFT FASTENERS, INC. 203020 PRARIE ST P.O. BOX 3819 CHATSWORTH, CA 91842</p> <p>(B)</p> <p>BAF</p> <p>CAGE code: <u>2/</u></p> <hr/> <p>BLAND CO., THE 55 BROOK ST P. O. BOX 330358 WEST HARTFORD, CT 06133</p> <p>BL</p> <p>CAGE code: 02991 <u>1/</u></p> <hr/> <p>BLUE SKY INDUSTRIES, INC. 1230 MONTEREY PASS ROAD MONTEREY PARK, CA 91754-3617</p> <p><i>No Logo Listed</i></p> <p>CAGE code: 1BRD5 <u>2/</u></p> <hr/> <p>BLUE TEE CORP DBA GEFCO/ STECO 2215 S. VAN BUREN ST. ENID, OK 73703-8218</p> <p>(F)[®]</p> <p>CAGE code: 21363 <u>2/</u></p>
---	--

1/ Information published in this revision was verified by direct contact with manufacturers.

2/ Information not verified to be current, no response from manufacturer. Information identical to that published in MIL-HDBK-57, Revision B.

MIL-HDBK-57C(IS)

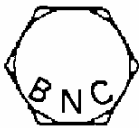
<p>BOBCAT MANUFACTURING CO. (PLANT) PECK HILL ROAD JOHNSTON, RI 02919</p>   <p>CAGE code: 8H536 <u>2/</u></p>	<p>BOLT FASTENER STUD/TECHNOLOGY 118 W NUGENT ST P.O. BOX 2569 LANCASTER, CA 93535</p> <p>Plant 210 EAST AVENUE LANCASTER, CA 93539</p>  <p>CAGE code: 31386 <u>2/</u></p>
<p>BOGNER ENGINEERING CO. 705 N. SPRINGFIELD STREET P. O. BOX 510 BERRYVILLE, AR 72616</p>  <p>CAGE code: 04BV8 <u>2/</u></p>	<p>BOLTWORKS, INC. 2150 WOODLAND WARRENDALE, PA 15086-7536</p>  <p>CAGE code: 3LYS4 <u>1/</u></p>
<p>BOLLHOFF & CO. GmbH & CO. KG ARCHIMDESTASSE 1-4 BIELEFELD, D-4800 14 GERMANY</p>  <p>CAGE code: <u>2/</u></p>	<p>BOMAR ENGINEERING, INC. 13385 PHILLIPPI AVE. SYLMAR, CA 91342</p>  <p>CAGE code: 3U494 <u>2/</u></p>
<p>BOLT & NUT CO. PARK LANE EAST TIPTON, WEST MIDLANDS, DY4 8RF GREAT BRITIAN</p>  <p>CAGE code: <u>2/</u></p>	<p>BRACELENTE MANUFACTURING CO., INC. 20 WEST CREAMERY ROAD P.O. BOX 570 TRUMBAUERSVILLE, PA 18970-0570</p> <p>BMC INC.</p> <p>CAGE code: 2Y035 <u>1/</u></p>

1/ Information published in this revision was verified by direct contact with manufacturers.

2/ Information not verified to be current, no response from manufacturer. Information identical to that published in MIL-HDBK-57, Revision B.

MIL-HDBK-57C(IS)

<p>BRADY MACHINE, INC. 6125 SKY ROAD JOSHUA, TX 76058-4048</p> <p style="text-align: center;">BMI BMI</p> <p>CAGE code: 1HLW8 1/</p>
<p>BRANCH MACHINE PARTS, INC. 2419 EMPIRE AVE BURBANK, CA 91504</p> <p style="text-align: center;">BMP</p> <p>CAGE code: 2/</p>
<p>BRIARWOOD FASTENERS, INC. 9701 OWENSMOUTH AVE UNIT 8 CHATSWORTH, CA 91311-4814</p> <p style="text-align: center;">BFI</p> <p>CAGE code: 3N278 1/</p>
<p>BRIDEAN MACHINE & TOOL CO., INC. 155 BANGOR STREET LINDENHURST, NY 11757-3632</p> <p style="text-align: center;">BRI 1</p> <p>CAGE code: 1S023 1/</p>
<p>BRIDGEVIEW MANUFACTURING CO. (ILLINOIS CORPORATION) 7320 S. FERDINAND AVENUE BRIDGEVIEW, IL 60455-1111</p> <p style="text-align: center;">BVB</p> <p>CAGE code: 0ALM2 1/</p>

<p>BRINTCLIFFE TURNER LTD. CRAMPTONS ROAD SEVENOAKS, KENT, TN14 5DS GREAT BRITAIN</p> <p style="text-align: center;">BIL B B B</p> <p>CAGE code: 2/</p>
<p>BRISTOL INDUSTRIES 630 EAST LAMBERT RD. BREA, CA 92821</p> <p>B+ CAPITAL B FOLLOWED BY PLUS SIGN RAISED OR DEPRESSED</p> <p>BI CAPITAL B FOLLOWED BY CAPITAL I USED FOR EUROPEAN PARTS ONLY RAISED OR DEPRESSED</p> <p>● ● TWO ADJACENT DOTS RAISED OR DEPRESSED</p>  <p style="text-align: center;">TWO ADJACENT DOTS RAISED OR DEPRESSED</p> <p>B - old callout no longer used on new product</p> <p>CAGE code: 27238 1/</p>

1/ Information published in this revision was verified by direct contact with manufacturers.

2/ Information not verified to be current, no response from manufacturer. Information identical to that published in MIL-HDBK-57, Revision B.

MIL-HDBK-57C(IS)

BRISTOL LOCKNUT CO. (NUT DIVISION)
 32451 N. AVIS DRIVE
 MADISON HEIGHTS, MI 48071



CAGE code: 2/

BROADSTONE TOOL & DIE, INC.
 R #1, BOX 986
 MCARTHUR, OH 45651



CAGE code: 4Z678 2/

BROWN PRODUCTION, INC.
 804 W MEEKER ST.
 KENT, WASHINGTON 98032-5702



CAGE code: 2D069 2/

BRUNNER DRILLING & MFG. CO., INC.
 405 ELROY ST.
 P.O. BOX 137
 ELROY, WI 53929

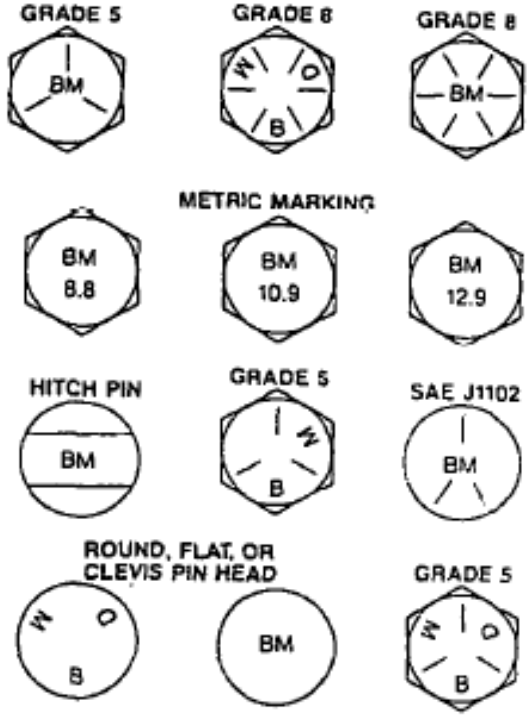

CAGE code: 24407 1/

BRUNNER MANUFACTURING CO.
 DBA BRUNNER MANUFACTURING
 DIVISION
 1025 PARKER DR
 MAUSTON, WI 53948 9381

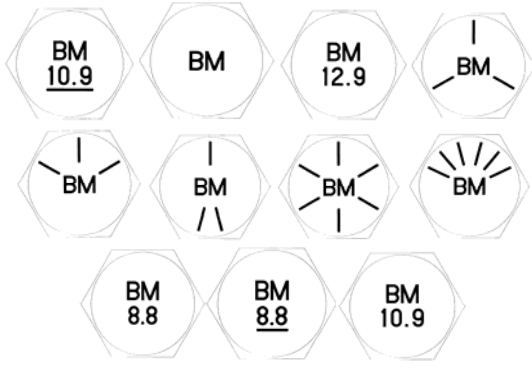



CAGE code: 3B7H2 1/

1/ Information published in this revision was verified by direct contact with manufacturers.

2/ Information not verified to be current, no response from manufacturer. Information identical to that published in MIL-HDBK-57, Revision B.

MIL-HDBK-57C(IS)

<p>BRYCO MACHINE, INC. 7800 GRAPHICS DRIVE TINLEY PARK, IL 60477</p> <p style="text-align: center;">BM</p> <p>CAGE code: 1WCD4 <u>1/</u></p>	<p>BUFFALO PUMPS, INC. (SUBSIDIARY OF AMPCO-PITTSBURGH CORP.) 874 OLIVER STREET NORTH TONAWANDA, NY 14120-3210</p> <p style="text-align: center;">BP</p> <p>CAGE code: 83130 <u>2/</u></p>
<p>BUCK EYE FORGE, INC. 11700 HARVARD AVE CLEVELAND, OH 44105</p> <p style="text-align: center;"></p> <p>CAGE code: 71177 <u>2/</u></p>	<p>BULA FORGE INC. 2987 E 87TH ST CLEVELAND, OH 44104-4</p> <p style="text-align: center;">BULA</p> <p>CAGE code: <u>2/</u></p>
<p>BUCKEYE MACHINING, INC. 25020 LAKELAND BLVD. CLEVELAND, OH 44132</p> <p style="text-align: center;"></p> <p>CAGE code: 8X808 <u>2/</u></p>	

1/ Information published in this revision was verified by direct contact with manufacturers.

2/ Information not verified to be current, no response from manufacturer. Information identical to that published in MIL-HDBK-57, Revision B.

MIL-HDBK-57C(IS)

BULTEN TRADING AB
P.O. BOX 516
734 01 HALLSTAHAMMAR
SWEDEN

Bulten Stainless AB
Ashammar Works
810 25 Ashammar
Sweden

Bulten Stainless AB
Svartå Works
710 11 Svartå
Sweden

BH

BULTEN AB

BUFO

BULTEN AB

SÅ

BULTEN STAINLESS AB

CAGE code: N8286

2/

BURROWERS RESEARCH MACHINING,
INC.
43 BRADFORD STREET
P.O. BOX 1130
CONCORD, MA 01742

BRM

CAGE code:

2/

BUSAN INDUSTRIAL MACHINERY CO.,
LTD.
BOLT DIVISION
456-9, NAE-DONG, CHANGWON
KYEONGSANGNAM-DO, KOREA

BM

BIM

CAGE code:

2/

BUTECH PRESSURE SYSTEMS
4928 PITTSBURGH AVE
ERIE, PA 16509

See BER-LOW MFG INC

BPS

CAGE code: 62295

2/

BUTLER, INC.
1600 WEST 166TH STREET
GARDENA, CA 90247

JB

CAGE code: 59053

1/

1/ Information published in this revision was verified by direct contact with manufacturers.

2/ Information not verified to be current, no response from manufacturer. Information identical to that published in MIL-HDBK-57, Revision B.

MIL-HDBK-57C(IS)

<p>C & D MACHINE TOLL, INC. 726 COURT STREET SPRINGFIELD, OH 45506</p> <p>C&D MACH</p> <p>CAGE code: 064X3 <u>1/</u></p>	<p>C. J.'S GENERAL MACHINE WORKS 15406 FOREST MIST SAN ANTONIO, TX 78232-4137</p>  <p>CAGE code: 7W334 <u>2/</u></p>
<p>C & H MFG., INC. 4280 E LOWELL ST ONTARIO, CA 91761-1529</p> <p>30633</p> <p>CAGE code: 30633 <u>2/</u></p>	<p>C.R.D. MACHINING 366 W. 131ST ST. LOS ANGELES, CA 90248</p>  <p>CAGE code: 1LA52 <u>2/</u></p>
<p>C. E. MACHINE CO., INC. 1741 SOUTH LEONINE WICHITA, KS 67209-2813</p> <p>MFR 3L665</p> <p>CAGE code: 3L665 <u>2/</u></p>	<p>CALABRESE & SONS, INC. 406 BRANDY LANE P.O. BOX 1667 MECHANICSBURG, PA 17055-2800</p>  <p>CAGE code: 07310 <u>1/</u></p>
<p>C.E.S. MACHINE PRODUCTS, INC 8880 DOUBLE DIAMOND PKWY RENO, NV 89521-5908</p> <p>CES</p> <p>CAGE code: 1WF66 <u>2/</u></p>	

1/ Information published in this revision was verified by direct contact with manufacturers.

2/ Information not verified to be current, no response from manufacturer. Information identical to that published in MIL-HDBK-57, Revision B.

MIL-HDBK-57C(IS)

CALIFORNIA SCREW PRODUCTS CORP.
 P.O. BOX 228
 PARAMOUNT, CA 90723

Plant
 14957 GWENCHRIS AVE.
 PARAMONT, CA 90723-3423

CS

C S

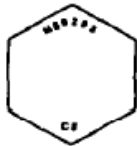

HEX. HEAD



HEX. HEAD

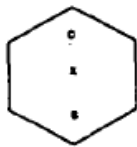

HEX. HEAD

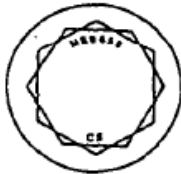

TWELVE POINTS



FLAT HEAD
PAN HEAD
ROUND HEAD
 (ALL TYPES OF HEADS)

CAGE code: 8Z507

1/

CAMBRIDGE SPECIALTY COMPANY, INC.
 DBA POINT MACHINE CO.
 588 FOUR ROD RD
 BERLIN, CT 06037-2280



CAGE code: 9E232

2/

CAMCAR DIVISION OF TEXTRON INC.
 600 18th Ave.
 Rockford, IL 61101

Plant
 AMSCO PRODUCTS
 1818 CHRISTINA ST
 ROCKFORD, IL 24382
 CAGE code: 01536

Head markings

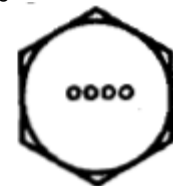

Vendor identification, "A" or four dots raised or depressed located as shown.

Under head markings



Vendor identification, four dots radially located as shown, depressed

CAGE code: 93907

2/

Continued

1/ Information published in this revision was verified by direct contact with manufacturers.

2/ Information not verified to be current, no response from manufacturer. Information identical to that published in MIL-HDBK-57, Revision B.

MIL-HDBK-57C(IS)

Continued

CAMCAR DIVISION OF TEXTRON INC.

Plant
 DRILLETITE PRODUCTS
 1304 KERR DR.
 DECORAH, IA 52101
 CAGE code: 0JMM5

Head markings



Vendor and customer
 Identification for stainless
 steel, drilled screws,
 raised or depressed

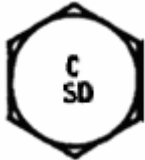

Vendor/Product
 Identification, raised or
 depressed
 Identifies "CAMCAR Self -
 Drilling Fastener."

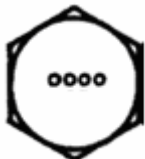

Vendor Identification,
 Four in-line dots, raised or
 depressed

Under head markings



Vendor identification, four radial dots or three equally
 spaced radial lines, depressed



CAGE code: 93907 2/

Continued

Continued

CAMCAR DIVISION OF TEXTRON INC.

Plant
 RAYCARL PRODUCTS
 600 18th Ave.
 Rockford, IL 61101
 CAGE code: 6P253

Head markings





Vendor Identification, "CAMCAR" or four in-line dots,
 raised or depressed.

Under head markings







Vendor identification, four radial dots or three equally
 spaced radial lines, depressed

Plant
 ROCKFORD HEADED PRODUCTS
 29201 TELEGRAPH RD. SUITE 611
 SOUTHFIELD, IL 48034-1331

Head markings



Product Identification,
 "HP" raised or depressed



Product Identification,
 Four in-line dots, raised or
 depressed

Under head markings

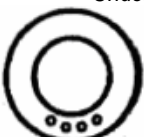

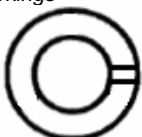

Vendor identification, four radial dots or two parallel lines,
 raised or depressed

CAGE code: 6P253 2/

Continued

1/ Information published in this revision was verified by direct contact with manufacturers.

2/ Information not verified to be current, no response from manufacturer. Information identical to that published in MIL-HDBK-57, Revision B.

MIL-HDBK-57C(IS)

Continued
CAMCAR DIVISION OF TEXTRON INC.

Plant
SEMS PRODUCTS
1818 CHRISTINA ST
ROCKFORD, IL 61104
CAGE code: 01536

Head markings

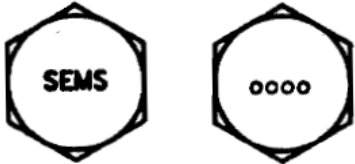

Vendor Identification, "SEMS" or four in-line dots, raised or depressed, located as shown.

Product Trademark Markings



INTERNAL TORX ® RECESS
"TORX" and two dots raised or depressed, located as shown

EXTERNAL TORX ® RECESS
"TORX" equally spaced on top of washer, raised or depressed.

TORXSTEM ®
"TORX" equally spaced on END, raised or depressed.

Plant
SOCKET SCREW PRODUCTS
1302 KERR DRIVE
DECORAH, IA 52101
CAGE code: 0JMM5

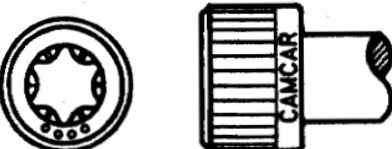

Letters "TORX" plus two dots raised or indented on recess countersink; locate as illustrated (Product Trademark)

Optional Identification, "CAMCAR", raised or indented as illustrated

Vendor Identification, Four radial dots raised or indented, located as shown

Continued 2/

Continued
CAMCAR DIVISION OF TEXTRON INC.

Plant
TAPTITE PRODUCTS
826 EAST MADISON ST
BELVIDERE, IL 61008

Head markings



Product Identification, "TTL" raised or depressed

Vendor Identification, "CTY" and three radial lines, raised or depressed



Vendor Identification, Four in-line dots raised or depressed

Vendor Identification, three radial lines and circle, raised or depressed

Under head markings

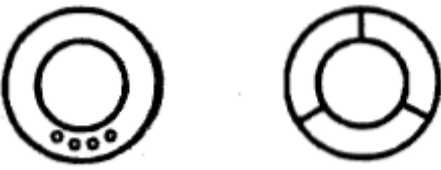

Vendor identification, four radial dots or three equally spaced radial lines, depressed

Continued 2/

1/ Information published in this revision was verified by direct contact with manufacturers.

2/ Information not verified to be current, no response from manufacturer. Information identical to that published in MIL-HDBK-57, Revision B.

MIL-HDBK-57C(IS)

Continued

CAMCAR DIVISION OF TEXTRON INC.

Plant
TORX PRODUCTS
P.O. Box 607
Rochester, IN 46975
CAGE code: 6N040

Head markings

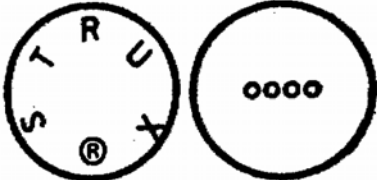

Product Identification, "STRUX ®" equally spaced raised or depressed or four in-line dots, raised or depressed.



Vendor Identification, superimposed "T" and "M" raised or depressed

Product Identification "t" and "T" located as shown, raised or depressed



Product Identification, TORX logo located as shown, raised or depressed.

Under head markings



Vendor Identification, four equally spaced radial lines, raised or depressed

Nut Markings

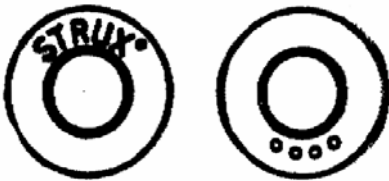

Product Identification, "STRUX ®" raised or depressed, located as shown or four radial dots, raised or depressed.

2/

CAMCAR SCREW AND MFG CO DIV OF
TEXTRON INC
29201 TELEGRAPH RD., SUITE 611
SOUTHFIELD, IL 48034 - 7649



PRODUCT IDENTIFICATION, "HP" RAISED OR DEPRESSED.

PRODUCT IDENTIFICATION, FOUR IN-LINE DOTS RAISED OR DEPRESSED.

HEAD MARKINGS



VENDOR IDENTIFICATION, FOUR RADIAL DOTS RAISED OR DEPRESSED.

VENDOR IDENTIFICATION, TWO PARALLEL LINES RAISED OR DEPRESSED.

UNDER HEAD MARKINGS

CAGE code: 6P253 2/

CAMLOC PRODUCTS
AFS TORRANCE OPERATIONS
3014 WEST LOMITA BLVD.
TORRANCE, CA 90505-5103
CAGE code: 71286

AFS KELKEIM OPERATIONS
INDUSTRIESTRASSA 6
D-65779 KELKEIM, GERMANY
CAGE code: D0680

(Corporate office see ALCOA FASTENING SYSTEMS)



CAMLOC

CAGE code: 71286, D0680 1/

CAM-TECH INDUSTRIES
95 ESTATES DR W
FAIRPORT, NY 14450-8425





CAM-TECH INDUSTRIES, INCORPORATED



CAGE code: 0GT70 2/

1/ Information published in this revision was verified by direct contact with manufacturers.

2/ Information not verified to be current, no response from manufacturer. Information identical to that published in MIL-HDBK-57, Revision B.

MIL-HDBK-57C(IS)

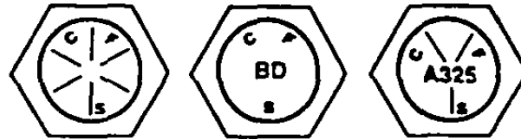





<p>CANADY MANUFACTURING CO. INC. 500 FIFTH STREET SAN FERNANDO, CA 91340-2225</p>  <p>CAGE code: 00678 2/</p>
<p>CAPRICE ENGINEERING CO., INC. 509 HINDRY AVE. INGLEWOOD, CA 90301-2017</p>  <p>CAGE code: 52916 1/</p>
<p>CAPY MACHINE SHOP, INC. 114 SPAGNOLI ROAD MELVILLE, NY 11747</p>  <p>CAGE code: 0BVP9 1/</p>

<p>CARDINAL FASTENER & SPECIALTY CO., INC. 5185 RICHMOND RD BEDFORD HEIGHTS, OH 44146-1330</p>  <p>ASTM A490 ASTM A490 TYPE III SAE J429 GR 8</p>  <p>ASTM A354 BD (1/4 in. through 1 1/2 in.) ASTM A354 BD (1 1/2 in. and over) ASTM A325</p> <p>CAGE code: 2Y089 2/</p>
<p>CARDINAL INDUSTRIAL PRODUCTS 3873 WEST OQUENDO LAS VEGAS, NV 89118-3010</p>  <p>A capital "C" to be applied to all standard ASME/ASTM bolting material.</p>  <p>The word "MULTI" followed by a capital "C" to be applied to all ASME bolts manufactured to Nuclear Standards Associates or Cardinal Industrial Products, Inc. Standards.</p> <p>CAGE code: 57454 2/</p>

1/ Information published in this revision was verified by direct contact with manufacturers.

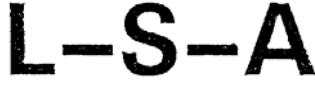
2/ Information not verified to be current, no response from manufacturer. Information identical to that published in MIL-HDBK-57, Revision B.







MIL-HDBK-57C(IS)

<p>CARR CO. (THE UNITED CARR DIV OF TRW) 31 AMES ST. CAMBRIDGE, MA 02142</p>  <p>CAGE code: 78947 <u>2/</u></p>	<p>CCF ENTERPRISES INC. 2449 N.W. DALLAS STREET GRAND PRARIE, TX 75050-4971</p>  <p>CAGE code: 08QQ4 <u>2/</u></p>
<p>CATALINA INSTRUMENT CORPORATION 44 SOUTH MALL PLAINVIEW, NY 11803-4208</p>  <p>CAGE code: 30225 <u>1/</u></p>	<p>CEI INC. DBA COMMAND ENTERPRISES 700 NORTH DELSEA DR PITMAN, NJ 08071-1244</p>  <p>CAGE code: 6U479 <u>2/</u></p>
<p>CBS FASTENERS INC. 1343 BRASHER STREET ANAHIEM, CA 92807-2046</p>  <p>CAGE code: 0F620 <u>1/</u></p>	<p>CELTECH ENTERPRISE 9774 CRESENT CTR DR SUITE 506 RANCHO CUCAMONGA, CA 91730-5745</p>  <p>CAGE code: 0EFF7 <u>2/</u></p>
<p>CCB INDUSTRIES, INC. 3200 STUART DRIVE P.O. BOX 1158 FT. WORTH, TX 76101</p>  <p>CAGE code: 60763 <u>1/</u></p>	

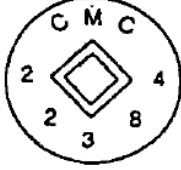
1/ Information published in this revision was verified by direct contact with manufacturers.

2/ Information not verified to be current, no response from manufacturer. Information identical to that published in MIL-HDBK-57, Revision B.



MIL-HDBK-57C(IS)

<p>CENTERLINE TOOL & ENGINEERING, INC. 3107 29TH AVENUE E BRADENTON, FL 34208-7420</p>  <p>Capital "C" and Capital "L" combined.</p> <p>CAGE code: 0B5B0 <u>2/</u></p>	<p>CERNY MFG. CO. 4057 WEST 147TH STREET LAWNDALE, CA 60260</p>  <p>CMC \diamond 22384.</p> <p>CAGE code: 22384 <u>2/</u></p>
<p>CENTRAL OZARK MACHINE, INC. HWY 19 SOUTH & HH P. O. BOX 347 ALTON, MO 65606-0347</p>  <p>CAGE code: 64896 <u>2/</u></p>	<p>CHAMPION COMMERCIAL INDUSTRIES, INC. CHAMPION RIVET DIVISION P.O. BOX 398 5137 INDIANAPOLIS BLVD EAST CHICAGO, IN 46312-0398</p>  <p><i>Rivets only</i></p> <p>CAGE code: 4B951 <u>2/</u></p>
<p>CENTURY METAL PARTS CORP. 230 SOUTH FEHRWAY BAY SHORE, NY 11706-1208</p>  <p>CAGE code: 30396 <u>1/</u></p>	<p>CHAMPION FASTENERS, INC. 707 SMITHVILLE RD LUMBERTON, NJ 08048-5302</p>  <p>CAGE code: 0NXPO <u>1/</u></p>
<p>CER-MAC INC. 971 HORSHAM RD, HORSHAM, PA 19044-1225</p>  <p>CAGE code: 53569 <u>2/</u></p>	<p>CHANCE, A.B. COMPANY 2201 LAKEVIEW RD MEXICO, MO 65265-1360</p>  <p>CAGE code: 02TP8 <u>2/</u></p>

1/ Information published in this revision was verified by direct contact with manufacturers.

2/ Information not verified to be current, no response from manufacturer. Information identical to that published in MIL-HDBK-57, Revision B.

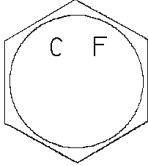

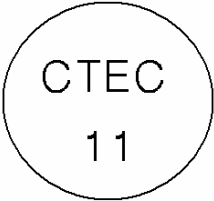

MIL-HDBK-57C(IS)

<p>CHANDLER PRODUCTS, INC. 1491 CHARDON RD CLEVELAND, OH 44117-1598</p> <p style="text-align: center;">CP</p> <p>CAGE code: 83386 <u>1/</u></p>	<p>CHICAGO FASTENER MANUFACTURING 10902 WALNUT LANE MOKENA, IL 60448-8165</p> <p style="text-align: center;"></p> <p>CAGE code: 05TL5 <u>1/</u></p>
<p>CHATHAM PRECISION, INC. COMMERCE ST. P.O. BOX 510 HINESBURG, VT 05461</p> <p style="text-align: center;">4N133</p> <p>CAGE code: 4N133 <u>2/</u></p>	<p>CHICAGO HARDWARE & FIXTURE CO. 9100 PARK LANE FRANKLIN PARK, IL 60131-3054</p> <p style="text-align: center;">CHF</p> <p>CAGE code: 71747 <u>1/</u></p>
<p>CHEREK MACHINE & TOOL CO., INC. 835 SHERMAN AVENUE HAMDEN, CT 06514-1149</p> <p style="text-align: center;">CHEREK</p> <p>CAGE code: 0YWD4 <u>2/</u></p>	<p>CHIEF MFG. 423B WEST FORK DRIVE ARLINGTON, TX 76012-3450</p> <p style="text-align: center;"></p> <p>CAGE code: 00WU0 <u>1/</u></p>
<p>CHEROKEE TOOL & ENGINEERING CO., INC. P.O. BOX 227 CANTON, GA 30114</p> <p style="text-align: center;"></p> <p>CAGE code: 30662 <u>2/</u></p>	<p>CHOICE PRECISION MACHINE, INC. 4280 COMMERCE DRIVE WHITEHALL, PA 18052</p> <p style="text-align: center;">CPM</p> <p>CAGE code: 1WAA0 <u>2/</u></p>

1/ Information published in this revision was verified by direct contact with manufacturers.

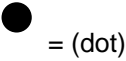
2/ Information not verified to be current, no response from manufacturer. Information identical to that published in MIL-HDBK-57, Revision B.

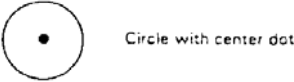

MIL-HDBK-57C(IS)



<p>CHRIS MACHINE CO. 110 DOYLE ST. DOYLESTOWN, PA 18901-1370</p>  <p>CAGE code: 2T317 <u>2/</u></p>	<p>CINCH-MONADNOCK 18301 ARENTH AVE CITY OF INDUSTRY, CA 91749</p>  <p>CAGE code: <u>2/</u></p>
<p>CHU HUA INDUSTRIAL CO., LTD. 800 FU SHING RD. LU CHU, KAOHSING, TAIWAN, 821 R.O.C.</p>  <p>CAGE code: <u>2/</u></p>	<p>CLEVELAND HARDWARE & FORGING DBA GREEN BAY DROP FORGE CO 1341 S. STATE ST P.O. BOX 11797 GREEN BAY, WI 54307-1797</p>  <p>CAGE code: 08277 <u>2/</u></p>
<p>CHUN YU WORKS & CO., LTD. 1 CIASHING KANGSHAN, TAIWAN</p>  <p>CAGE code: <u>2/</u></p>	<p>CLICK BOND, INC. 2151 LOCKHEED WAY CARSON CITY, NV 89706-0713</p> <p>CB</p> <p>CAGE code: 66530 <u>1/</u></p>
<p>CINCH MANUFACTURING 2610 S YALE ST SANTA ANA, CA 92704</p>  <p>CAGE code: <u>2/</u></p>	<p>CLYDE FASTENERS LIMITED 5 HAWBANK RD, EAST KILBRIDE, GLASGOW, SCOTLAND G74 5ET</p> <p>CFL</p> <p>CAGE code: <u>1/</u></p> <p>CM MANUFACTURING, INC. 6333 BUTLER CREEK ROAD MISSOULA, MT 59808-8861</p> <p>CM</p> <p>CAGE code: 6Z056 <u>1/</u></p>

1/ Information published in this revision was verified by direct contact with manufacturers.

2/ Information not verified to be current, no response from manufacturer. Information identical to that published in MIL-HDBK-57, Revision B.

MIL-HDBK-57C(IS)



<p>CNC MACHINING INC. 109 PANE ROAD NEWINGTON CT 06111-1552</p> <p style="text-align: center;">C</p> <p>CAGE code: 2Y832 <u>2/</u></p>	
<p>COAE BOLTS WORKS CO., LTD NO. 47 CHINAN ROAD, TASHE HSIANG KOAHSIUNG HSIEN, TAIWAN</p> <p style="text-align: center;">C -C- C -C- C -C- C -C- C</p> <p style="text-align: center;">A325</p> <p>CAGE code: <u>2/</u></p>	
<p>COAST INDUSTRIAL SUPPLY CO., INC. SUB OF SPANDCO INDUSTRIES INC. 15959 PIUMA AVENUE CERRITOS, CA 90701-1526</p> <p> On head of silicon bronze and aluminum hex head cap screws</p> <p> On head of stainless steel, monel, brass, naval bronze, chrome alloy, hex head cap screws, and the end of alloy steel studs.</p> <p>CAGE code: 9U032 <u>2/</u></p>	

<p>CODLING TOOL & MFG. INC. 665 NE 42ND STREET FORT LAUDERDALE, FL 33334</p> <p style="text-align: center;"></p> <p>CAGE code: 0P3X2 <u>2/</u></p>	
<p>COLD HEADING CO., THE 21777 HOOVER RD. WARREN, MI 48089-2544</p> <p style="text-align: center;"> . .</p> <p>CAGE code: 89657 <u>1/</u></p>	
<p>COMET MFG. CO., INC. 315 JOHN DOWNEY DRIVE NEW BRITIAN, CT 06051</p> <p style="text-align: center;">61062</p> <p>CAGE code: 61062 <u>2/</u></p>	
<p>COMMAND ENTERPRISES 700 NORTH DELSEA DR. PITMAN, NJ 08071 (see CEI, INC.)</p> <p style="text-align: center;">C. E. I</p> <p>CAGE code: <u>2/</u></p>	

1/ Information published in this revision was verified by direct contact with manufacturers.

2/ Information not verified to be current, no response from manufacturer. Information identical to that published in MIL-HDBK-57, Revision B.



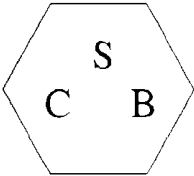

MIL-HDBK-57C(IS)

<p>COMPUTA-BASE MACHINING, INC. 411 NORTH GROVE ST P.O. BOX 340 BERLIN, NJ 08009-9704</p> <p style="text-align: center;">CBM</p> <p>CAGE code: 0A396 <u>2/</u></p>	<p>COPELAND MFG. CORP. (JAMES DIVISION) 11222 E. PINE ST. TULSA, OK 74116-1613</p> <p style="text-align: center;"></p> <p style="text-align: center;"></p> <p>CAGE code: 0CM67 <u>2/</u></p>
<p>CONNECTICUT AIRCRAFT PRODUCTS 246 SHAKER ROAD ENFIELD, CT 06082-2366</p> <p style="text-align: center;"></p> <p>CAGE code: 0KA73 <u>2/</u></p>	<p>COPPER STATE BOLT & NUT CO. 3602 N 35TH AVE. 3637 N 34TH AVE. PHOENIX, AZ 85017-4408</p> <p style="text-align: center;"></p> <p>CAGE code: 0Z0Y2 <u>2/</u></p>
<p>CONQUEST MACHINE, INC. 3655 RESEARCH DR. GENESIS A STE 106 LAS CURCES, NM 88003-1239</p> <p style="text-align: center;">CMI</p> <p>CAGE code: 0PNX2 <u>2/</u></p>	<p>CORPUS CHRISTI GASKET & FASTENER LTD. 341 WEST CHESTER RD. P.O. BOX 4074 CORPUS CHRISTI, TX 78408</p> <p style="text-align: center;">CCG</p> <p>CAGE code: 008R2 <u>1/</u></p>
<p>CO-OP SCREW MANUFACTURING CORP. 60 SINDLE AVE. LITTLE FALLS, NJ 07424-1649</p> <p style="text-align: center;">C</p> <p>CAGE code: 1FZ52 <u>2/</u></p>	
<p>COOPER POWER SYSTEMS INC (MCGRAW EDISON POWER SYSTEMS) NORTH BURSON STREET EAST STROUDSBURG, PA 18301</p> <p style="text-align: center;">M</p> <p>CAGE code: 88424 <u>2/</u></p>	

1/ Information published in this revision was verified by direct contact with manufacturers.

2/ Information not verified to be current, no response from manufacturer. Information identical to that published in MIL-HDBK-57, Revision B.

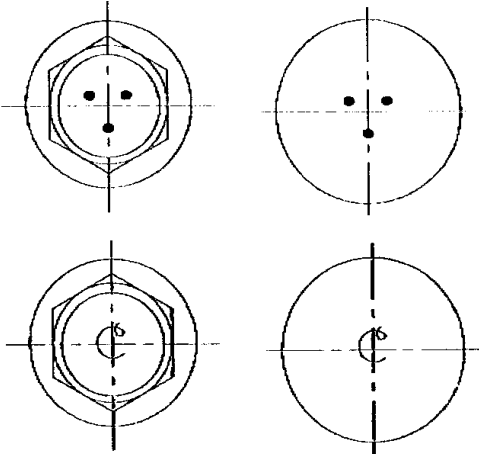

MIL-HDBK-57C(IS)

<p>CREATIVE PRECISION INC. DBA CREATIVE PRECISION WEST 2640 E. ROSE GARDEN LANE SUITE 6 PHOENIX, AZ 85050-4612</p> <p>Plant 1501 BLUEBALL AVENUE LINWOOD, PA 19061 CAGE code: 0F3N2</p> <p>CPI</p> <p>CAGE code: 1K0E5 1/</p>	<p>CRYSTAL METAL PRODUCTS COMPANY, INC. 2700 E. CASTOR AVENUE PHILADELPHIA, PA 191345</p> <p></p> <p>CAGE code: 0BPW8 2/</p>
<p>CRESENT MANUFACTURING CO. P.O. BOX 1350 BUILINGTON, CT 06013-0350</p> <p>Plant 700 GEORGE WASHINGTON TPKE BUILINGTON, CT 06013-0350</p> <p></p> <p>CAGE code: 63020 1/</p>	<p>CSM FASTENER PRODUCTS 1133 BRTN MAWR AVE. BENSENVILLE, IL 60106</p> <p></p> <p>CAGE code: 1CJW4 1/</p>
<p>CRS PRECISION CORP. 640 WEST MERRICK ROAD VALLEY STREAM, NY 11580-0482</p> <p></p> <p>CAGE code: 07QQ6 2/</p>	<p>CURTIS PRESTON ENTERPRISES INC. DBA ATLAS SPECIALTY PRODUCTS 2299 E WINSTON RD ANAHEIM, CA 92806-5538</p> <p>ASP</p> <p>CAGE code: 0TP31 1/</p>

1/ Information published in this revision was verified by direct contact with manufacturers.

2/ Information not verified to be current, no response from manufacturer. Information identical to that published in MIL-HDBK-57, Revision B.

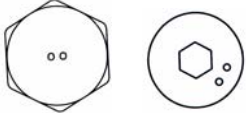

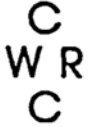
MIL-HDBK-57C(IS)

<p>CUTTING EDGE ENTERPRISE, LLC 2465 POLE LINE RD. DECORAH, IOWA 52101</p> <p>Plant 2509 172ND AVE. DECORAH, IOWA 52101</p>  <p>CAGE code: 52101 1/</p>	<p>D & D TOOL COMPANY, INC. LEWIS STREET & MAPLE AVENUE EATONTOWN, NJ 07724</p> <p style="text-align: center;">D & D</p> <p>CAGE code: 30077 2/</p>
<p>CUTTING EDGE MACHINING INC. NEVADA DIV 1625 LINDA WAY SPARKS, NV 89431</p> <p>See WESTERN SCREW MACHINE PRODUCTS, INC.</p>  <p>CAGE code: 0ZV72 2/</p>	<p>D & R MACHINE COMPANY 2310 BIG OAK ROAD LANGHORNE, PA 19047-1910</p> <p style="text-align: center;">4T853</p> <p>CAGE code: 4T853 2/</p>
<p>CWR MANUFACTURING CO (DIVISION OF A.J. MUPHY CO., INC.) P.O. BOX 2669 SYRACUSE, NY 13220</p>  <p>CAGE code: 2/</p>	<p>D. C. MACHINING INC. 1900 9TH AVE., SW WATERTOWN, SD 57201</p> <p style="text-align: center;">DC</p> <p>CAGE code: 0AUC7 2/</p>
<p>D & D MACHINERY AND SALES 2420 W. R. LARSON ROAD SAN ANTONIO, TX 78261-2200</p> <p style="text-align: center;">1Y128</p> <p>CAGE code: 1Y128 2/</p>	<p>D.S.O. PLASTICS, INC. 1220 ROCK ST. ROCKFORD, IL 61101</p> <p style="text-align: center;">Z</p> <p>CAGE code: 2/</p>

1/ Information published in this revision was verified by direct contact with manufacturers.

2/ Information not verified to be current, no response from manufacturer. Information identical to that published in MIL-HDBK-57, Revision B.

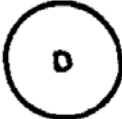
MIL-HDBK-57C(IS)

<p>DACK INDUSTRIES, INC. P.O. BOX 427 FARMINGTON, CT 06034 - 0427</p> <p style="text-align: center;">d</p> <p>CAGE code: 0CZ42 <u>2/</u></p>	<p>DARCO PRODUCTS 8406 WASHINGTON PL NE ALBUQUERQUE, NM 87113-1671</p> <p style="text-align: center;">D P</p> <p>CAGE code: 1DL79 <u>2/</u></p>
<p>DANIEL CO., EDWARD W. 11700 HARVARD AVENUE CLEVELAND, OH 441053</p> <p style="text-align: center;"></p> <p>CAGE code: 73634 <u>2/</u></p>	<p>DAVE ALLEN ENTERPRISES 10631 BLOOMFIELD AVENUE UNIT 15 LOS ALAMITOS, CA 90720</p> <p style="text-align: center;">DAE</p> <p>CAGE code: 1NWX4 <u>2/</u></p>
<p>DAN-LOC BOLT & GASKET INC. FORMALLY <i>DANIEL INDUSTRIES, INC.</i> Bolt & Gasket Division P.O. BOX 292 HOUSTON, TX 77001-0292</p> <p style="text-align: center;">Plant 725 North Drennan Houston, TX 77003</p> <p style="text-align: center;"> STUDS  HEX NUTS</p> <p>CAGE code: <u>2/</u></p>	<p>DAVIES PRECISION MACHINING, INC. 2400 COLEBROOK RD. LEBANON, PA 17042-9562</p> <p style="text-align: center;">DPM</p> <p>CAGE code: 7V760 <u>2/</u></p>
	<p>DAVIS AIRCRAFT PRODUCT CO., INC. 1150 WALNUT AVENUE BOHEMIA, NY 11716-6216</p> <p style="text-align: center;"></p> <p>CAGE code: 98313 <u>2/</u></p>

1/ Information published in this revision was verified by direct contact with manufacturers.

2/ Information not verified to be current, no response from manufacturer. Information identical to that published in MIL-HDBK-57, Revision B.

MIL-HDBK-57C(IS)

DECKER MANUFACTURING CORP
703 NORTH CLARK STREET
P.O. BOX 410
ALBION, MI 49224-1455

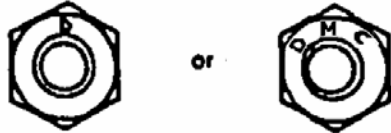

HEX WHEEL NUTS
(DEPRESSED "D" or "MDC")



AMERICAN STANDARD
SQUARE, HEX, AND ROUND WELD NUT
(SMALL RAISED DOT ON CHAMFER)



METRIC
SQUARE, HEX, AND ROUND WELD NUTS
(DEPRESSED LETTER "D" AND CLASS NO.)

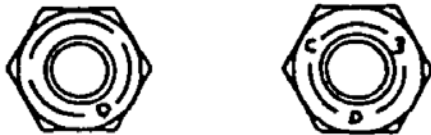

A-563
STRUCTURAL NUTS
(DEPRESSED "D" OR "DMC")

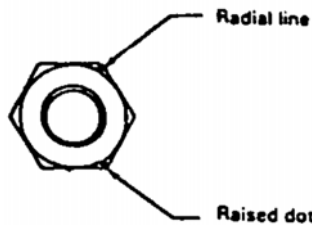

GRADE 5
HEX NUTS
(ONE RAISED RADIAL LINE 120°
COUNTERCLOCKWISE FROM ONE
RAISED DOT ON CHAMFER)

CAGE code: 12876

2/

DEERE & CO.
JOHN DEERE PLACE
MOLINE, IL 61265

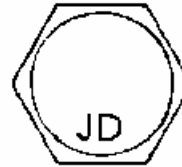

CAGE code: 75160

2/

DEFENSE AEROSPACE
MFG OF DEFENSE AEROSPACE
THREADED MACHINE PARTS
10841 NOEL ST. #104
LOS ALAMITOS, CA 90720-2527

DAS
1

CAGE code: 1W4A6

1/

DEFENSE QUALITY MFG.
40 SACCO RD.
ROYERSFORD, PA 19468-1030



DQ







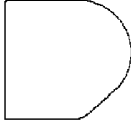

CAGE code: 0B6M7

2/

1/ Information published in this revision was verified by direct contact with manufacturers.

2/ Information not verified to be current, no response from manufacturer. Information identical to that published in MIL-HDBK-57, Revision B.



MIL-HDBK-57C(IS)

<p>DEFIANCE STAMPING COMPANY, THE P.O. BOX 506 DEFIANCE, OHIO 43512-2743</p> <p>PLANT 1090 PERRY ST DEFIANCE, OHIO 43512-2743</p>  <p>CAGE code: 6B357 <u>2/</u></p>	<p>DELTA MACHINE & TOOL CO., INC. PARKMOUNT ROAD P.O. BOX 351 GLEN RIDDLE, PA 19037</p>  <p>CAGE code: <u>2/</u></p>
<p>DEHOUSSE (USINES) 64007 PAU FRANCE</p>  <p>CAGE code: BP714 <u>2/</u></p>	<p>DEL-VAL FASTENER MANUFACTURING P.O. BOX 2901 21-D INDUSTRIAL DRIVE WARMINSTER, PA 18974</p>  <p>CAGE code: 1EE10 <u>2/</u></p>
<p>DELL MFG. CO., INC. 4 RIGHT LANE FARMINGTON, CT 06032-3195</p>  <p>CAGE code: 5A628 <u>1/</u></p>	<p>DEMAT (CANCELLED AND REPLACED BY ALCOA FASTENER SYSTEMS) BD DU GRAND CASTAING ZI BD DU GRD CASTING ROQUES, FRANCE 31120</p>  <p style="text-align: center;">DT M</p> <p style="text-align: center;">D</p> <p>CAGE code: F7411 <u>2/</u></p>
<p>DELT INDUSTRIES, INC. (AEROSPACE PRODUCTS DIVISION) 90 WEST EASY STREET, STE 2 P.O. BOX 940067 SIMI VALLEY, CA 93065-6206</p>  <p>CAGE code: 064T2 <u>1/</u></p>	<p>DEPENDABLE MACHINE CO., INC. 1846 E 30TH ST INDIANAPOLIS, IN 46218-2607</p>  <p>CAGE code: 14554 <u>2/</u></p>

1/ Information published in this revision was verified by direct contact with manufacturers.

2/ Information not verified to be current, no response from manufacturer. Information identical to that published in MIL-HDBK-57, Revision B.



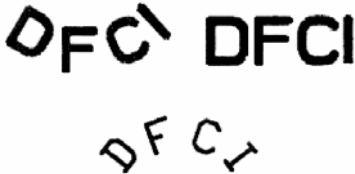

MIL-HDBK-57C(IS)

<p>DERBYSHIRE MACHINE & TOOL CO. DBA DERBYSHIRE MARINE PRODUCTS 5100 BELFIELD AVENUE PHILADELPHIA, PA 19144-1788</p>  <p>CAGE code: 71905 1/</p>	<p>DHL ENTERPRISES 1260 E. WOODLAND AVENUE #46 P. O. BOX 295 MORTON, PA 19070</p> <p style="text-align: center;">DHL</p> <p>CAGE code: 0UGD5 2/</p>
<p>DETROIT HEADING CO. 6421 LYNCH RD. DETROIT, MI 48234-4140</p>  <p>CAGE code: 0TUA2 2/</p>	<p>DIESEL PARTS COMPANY OF CALIFORNIA 1900 EAST 12TH STREET OAKLAND, CA 94606-4821</p> <p style="text-align: center;">D</p> <p>CAGE code: 24378 2/</p>
<p>DEUTSCH COMPANY INC., THE DBA DEUTSCH CO THE METAL COMPONENT 14800 S. FIGUEROA STREET GARDENA, CA 90248-1795</p>  <p>CAGE code: 14798 2/</p>	<p>DIHARD COMPANY 3161 MAJOR STREET FORT WORTH, TX 76112 - 7020</p> <p style="text-align: center;">D</p> <p>CAGE code: 0F1U4 2/</p>
<p>DFCI SOLUTIONS, INC. 425 UNION BLVD. WEST ISLIP, NY 11795-3183</p>  <p>CAGE code: 72794 1/</p>	<p>DISC-LOCK INTERNATIONAL 1924 S PACIFIC COAST HWY SUITE F REDONDO BEACH , CA 90277</p> <p style="text-align: center;">DL</p> <p>CAGE code: 72731 2/</p>

1/ Information published in this revision was verified by direct contact with manufacturers.

2/ Information not verified to be current, no response from manufacturer. Information identical to that published in MIL-HDBK-57, Revision B.

MIL-HDBK-57C(IS)

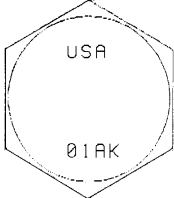
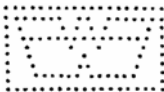
<p>DIXON MACHINE & TOOL DBA DIXON MACH AND FABRICATION 6807 CHAPMAN HWY. KNOXVILLE, TN 37920-6560</p> <p>see TROY D. RAY</p> <p>DMT</p> <p>CAGE code: 1DEP3 2/</p>	<p>DOMESTIC FORGING, INC. P.O. BOX 693 NEW HAVEN, MI 48048</p> <p></p> <p>CAGE code: 2/</p>
<p>DO MANUFACTURING CORP. P.O. BOX 2382 114 BROOKLYN ST ROCKVILLE, CT 06066</p> <p><i>PLANT</i> 114 RROOKLYN ST. ROCKVILLE, CT 06066</p> <p></p> <p>CAGE code: 1H312 2/</p>	<p>DONSON MACHINE ALSIP MACHING GROUP 12416 S. KEDVALE AVENUE ALSIP, IL 60803-1819</p> <p>DMC</p> <p>CAGE code: 0BHD5 1/</p>
<p>DO-ALL PRECISION, INC. 9 UNION AVENUE MOUNT VERNON, NY 10550</p> <p></p> <p>CAGE code: 2/</p>	<p>DOUBLECO INCORPORATED DBA R & D FASTENERS 9444 9TH STREET RANCHO CUCAMONGA, CA 91730</p> <p></p> <p>CAGE code: 1UKP3 1/</p>
<p>DOMESTIC FASTENER & FORGE, INC. P.O. BOX 14642 LENEXA, KS 66285</p> <p>Plant 15850 W. 108TH STREET LENEXA, KS 66219</p> <p></p> <p>CAGE code: 09ML9 1/</p>	<p>DOUGLASS TOOL & ENGINEERING CO., INC. 304 EAST DYER ROAD SANTA ANA, CA 92707</p> <p>DTE Marking to be indented</p> <p>CAGE code: 2/</p>
	<p>DRESSER INDUSTRIES, INC. DRESSER PUMP DIVISION 142 CLINTON ROAD FAIRFIELD, NJ 07004</p> <p></p> <p>CAGE code: 0LNV2 2/</p>

1/ Information published in this revision was verified by direct contact with manufacturers.

2/ Information not verified to be current, no response from manufacturer. Information identical to that published in MIL-HDBK-57, Revision B.

MIL-HDBK-57C(IS)

D'SAMIC
1261 HOBLITT AVE # 206
CLOVIE, CA 93612-2811



CAGE code: 2/

DTF MANUFACTURING, INC.
DIV OF FEDERAL SCREW AND SUPPLY
CO
P. O. BOX 329
146 ALBANY AVE.
LINDENHURST, NY 11757

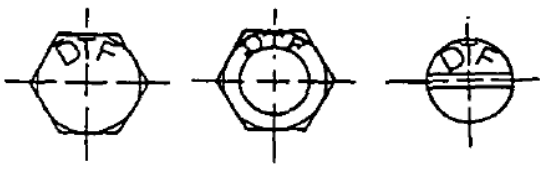

Standard: DTF
Large Dia: **DTF**
DTF
Micro Dia: **d**

CAGE code: 0H802 2/

DUFFY ELECTRONICS & MFG. CO.
50 BARNES PARK RD
WALLINGFORD, CT 06492



CAGE code: 2/

DUNCAN ELECTRONICS & MFG. CO.
701 SEVENTH AVE.
BELMAR, NJ 07719



CAGE code: 2/

DUNHAM PRODUCTS, INC.
6 INDUSTRIAL DRIVE
BEDFORD, OH 44146-4414



CAGE code: 1B4S0 2/

DUPONT, G.B. CO., INC.
(SEE KAMAX L. P.)
500 WEST LONG LAKE ROAD
TROY, MI 48098-4540



CAGE code: 1DWW1 1/

DUSEVOIR METAL PRODUCTS, INC.
1751 S TELEGRAPH RD
P.O. BOX 2158
DEARBORN, MI 41823



CAGE code: 97233 2/

1/ Information published in this revision was verified by direct contact with manufacturers.

2/ Information not verified to be current, no response from manufacturer. Information identical to that published in MIL-HDBK-57, Revision B.







MIL-HDBK-57C(IS)

<p>DUVE GmbH & CO. KG P.O. BOX 1240 NEUENRADE, GERMANY D-5982</p> <p>D - All hexagon head screws and bolts made of high tensile steel grade 8.8 up to 12.8, and sealing fasteners made of case-hardened carbon steel</p> <p>DX - Hexagon head sealing fasteners made of stainless steel</p> <p>DUVEX - Hexagon head screws and bolts made of stainless steel (A2 + A4)</p> <p>DUVE - DUVE DRIL-KWICK Self-Drilling Fastener (Screws)</p> <p><i>DUVE</i></p> <p>CAGE code: <u>2/</u></p>	<p>DYSON CORP THE formerly (JOS. DYSON & SONS, INC.) 53 FREEDOM RD PLAINSVILLE, OH 44077-1232</p>  <p>CAGE code: 22132 <u>2/</u></p>
<p>DYNACAST INDUSTRIAL FASTENERS DIVISION 1401 FRONT STREET YORKTOWN HEIGHTS, NY 10598</p>  <p>CAGE code: <u>2/</u></p>	<p>DZUS FASTENER CO., INC. see DFCI SOLUTIONS, INC. 425 UNION BLVD WEST ISLIP, NY 11795</p> <p>DZUS <i>DZUS</i></p> <p>CAGE code: 3L478 cancelled- replaced by 72794 <u>2/</u></p>
<p>DYNAMIC ENGINEERING 720 11TH AVE., S.E. P.O. BOX 697 WATERTOWN, SD 57201-0697</p>  <p>CAGE code: 9U252 <u>2/</u></p>	<p>E. KOZAK PRECISION PRODUCTS CO. 45 WOODLAND AVE. ROCKAWAY, NJ 07866</p> <p>KPP</p> <p>CAGE code: ICP43 <u>2/</u></p>
<p>DYNAMIC ENGINEERING 720 11TH AVE., S.E. P.O. BOX 697 WATERTOWN, SD 57201-0697</p>  <p>CAGE code: 9U252 <u>2/</u></p>	<p>E.L.R. MACHINE AND TOOL 48 A VINCENT CIRCLE IVYLAND, PA 18974</p>  <p>CAGE code: <u>2/</u></p>

1/ Information published in this revision was verified by direct contact with manufacturers.

2/ Information not verified to be current, no response from manufacturer. Information identical to that published in MIL-HDBK-57, Revision B.





MIL-HDBK-57C(IS)

<p>EAGAN MACHINE CORP. 135 CENTER STREET BRISTOL, CT 06010</p>  <p>CAGE code: <u>2/</u></p>	<p>EASTERN SCREW CO., INC. 15 AMFLEX DRIVE CRANSTON, RI 02921-2028</p> <p>Plant 71 MILL STREET JOHNSON, CRANSTON, RI 02921-2028</p>  <p>CAGE code: 2L684 <u>1/</u></p>
<p>EAGLE Picher INDUSTRIES (PRECISION PRODUCTS PLANT) 1927 W 4TH ST P.O. BOX 1444 JOPLIN, MO 64801-3</p>  <p>CAGE code: 9L734 <u>2/</u></p>	<p>EASTWOOD MFG., CO. P.O. BOX 231102 6825 BREEN RD HOUSTON, TX 77086-3719</p> <p>Plant 52 Lawndale Houston, TX 77023</p>  <p>CAGE code: 77903 <u>2/</u></p>
<p>EAGLEHEAD MANUFACTURING COMPANY DBA DEJAK MACHINE TOOL COMPANY DIV DEJAK DRILLING 23555 EUCLID AVE EUCLID, OH 44117-1703</p> <p>Alphanumeric Designation</p> <p>01NU</p> <p>CAGE code: 1GVE5 <u>2/</u></p>	<p>EATON AEROQUIP CORPORATION (AEROSPACE DIVISION) 300 S. EAST AVE. JACKSON, MICHIGAN 49203-1972</p>  <p>CAGE code: 00624 <u>2/</u></p>
<p>EAST COAST METALS INC. 171 RUTH ROAD HARLEYSVILLE, PA 19438</p>  <p>CAGE code: 4W058 <u>2/</u></p>	<p>EBC INDUSTRIES (FORMERLY ERIE BOLT CORP.) 1325 LIBERTY STREET ERIE, PA 16502-1641</p>  <p>CAGE code: 5G920 <u>1/</u></p>

1/ Information published in this revision was verified by direct contact with manufacturers.

2/ Information not verified to be current, no response from manufacturer. Information identical to that published in MIL-HDBK-57, Revision B.

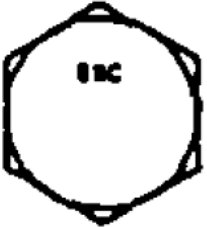
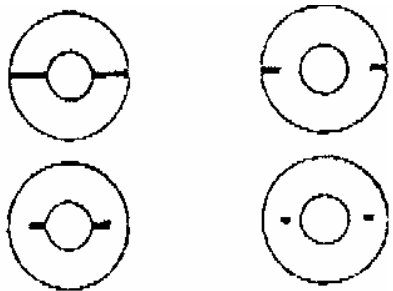

MIL-HDBK-57C(IS)



<p>EBERHARD BRUNINGHAUS POSTFAUCH 12 06 1M DUDA2 NEUENRADE, FEDERAL REPUBLIC OF GERMANY D 5982</p>  <p>EBM</p> <p>CAGE code: <u>2/</u></p>	<p>ELASTIC STOP NUT (Division of Harvard Industries, Inc.)</p> <p>See MACLEAN-ESNA</p> <p>Plant 2330 Vauxhall Road Union, NJ 07083</p> <p>2nd Plant 3200 Country Club Road P.O. Box 988 Pocahontas, AR 72455</p> <p>E, EN, or ESNA Red nylon insert in locknuts</p> <p>Red nylon insert in locknuts identifies Esna as manufacturer</p>  <p>CAGE code: <u>2/</u></p>
<p>ECENARRO S. COOP. LTDA. c/ AMILLAGA, 15. BERGARA - GUIP'UZOCA, SPAIN 20500</p>  <p>ESC</p> <p>CAGE code: <u>2/</u></p>	<p>ELCO INDUSTRIES, INC. 1111 SAMUELSON RD ROCKFORD, IL 61101</p>  <p>Underside of screw head</p>  <p>CAGE code: 83486 <u>2/</u></p>
<p>EDS ORDNANCE 644 C ANCHORS ST. FT. WALTON BEACH, FL 32548</p>  <p>CAGE code: 1CA31 <u>2/</u></p>	

1/ Information published in this revision was verified by direct contact with manufacturers.

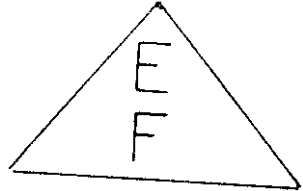
2/ Information not verified to be current, no response from manufacturer. Information identical to that published in MIL-HDBK-57, Revision B.

MIL-HDBK-57C(IS)

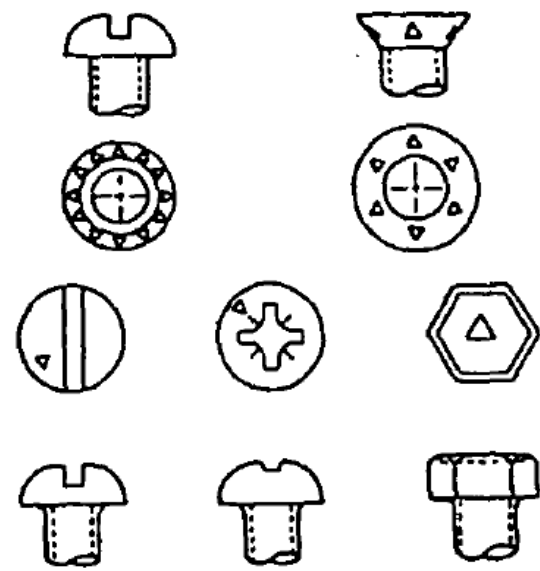

<p>ELECTRO-FREETO MANUFACTURING COMPANY 37 POPE ROAD HOLLISTON, MA 01746-2218</p> <p style="text-align: center; font-size: 2em;">JF</p> <p>CAGE code: 17401 2/</p>
<p>ELITE FASTENERS 6400 DALE STREET BUENA PARK, CA 90621</p>  <p>CAGE code: 0T3D2 2/</p>
<p>ELLIS PRECISION INDUSTRIES DBA E P IND. 3133 RAMONA DR FORT WORTH, TX 76116-5122</p> <p style="text-align: center; font-size: 1.5em;">e</p>  <p>CAGE code: 9Z199 2/</p>
<p>EMERALD VALLEY MFG 3825 W. 11TH AVE SUITE B EUGENE, OR 97402</p> <p style="text-align: center; font-size: 2.5em;">DTE</p> <p>CAGE code: 4Y352 2/</p>



<p>EMHART CORP. PARKER-KALON DIVISION 395 ROBERTS ROAD CAMPBELLSVILLE, KY 42718</p>  <p style="text-align: center;">"TRIANGLE" MARKING</p>
<p>EMHART CORP GRIPCO FASTENER DIVISION 111 EAST BROAD STREET SOUTH WHITLEY, IN 46787</p>  <p style="margin-left: 20px;">G_H raised or indented on flange or bearing surface</p> <p style="margin-left: 20px;">G_H raised on head, both inch and metric series e</p> <p style="margin-left: 20px;">G_H raised or indented on flange or bearing surface</p> <p>CAGE code: 73020 2/</p>

1/ Information published in this revision was verified by direct contact with manufacturers.

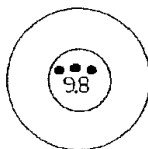
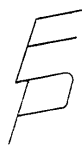
2/ Information not verified to be current, no response from manufacturer. Information identical to that published in MIL-HDBK-57, Revision B.

MIL-HDBK-57C(IS)

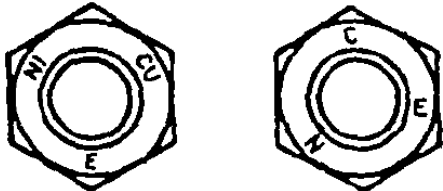
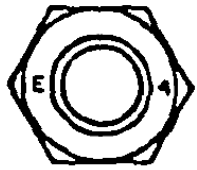
<p>EMP MANUFACTURING CO. 40935 PRODUCTION DR HARRISON TOWNSHIP, MI 48045-1351</p>  <p>CAGE code: 4G973 <u>2/</u></p>
<p>EMPIRE PRECISION MACHINING 108 W. HOLLOWAY DR. HURST, TX 76053-6807</p>  <p>CAGE code: 5V179 <u>1/</u></p>
<p>ENGEL MANUFACTURING COMPANY, INC., THE 304 W. EWING AVENUE SOUTH BEND, IN 46613-2108</p>  <p>CAGE code: 0XYS0 <u>2/</u></p>
<p>ENGINEERED BOLTING PRODUCTS, INC. P.O. BOX 7067 301 MONTGOMERY ST SHREVEPORT, LA 71137</p> <p style="text-align: center;">Plant 301 Montgomery St. Shreveport. LA 71107</p> <p style="text-align: center;">EBP</p> <p>CAGE code: 0K4X1 <u>2/</u></p>

<p>ENGINEERING MATERIALS CO., INC. FASTENER MANUFACTURING DIVISION 2055 WEST COWLES STREET LONG BEACH, CA 90813-1087</p>  <p>Mfr. Symbol/Logo embossed or intent marked. Letter "E" as shown on nut crown spaced 120 degrees from material symbol marking.</p>  <p>Mfr. Symbol/Logo letter "E" as shown, opposite material symbol marking code on nut crown at corners.</p>  <p>Mfr. Symbol/Logo letter "E", as shown on nut crown, 180 degrees opposite material symbol marking.</p>  <p>Mfr. Symbol/Logo letter "E" marked opposite material symbol code marking on nut crown at one corner location.</p> <p>CAGE code: 19968 <u>1/</u> Continued</p>

1/ Information published in this revision was verified by direct contact with manufacturers.

2/ Information not verified to be current, no response from manufacturer. Information identical to that published in MIL-HDBK-57, Revision B.

MIL-HDBK-57C(IS)

Continued

ENGINEERING MATERIALS CO., INC.



Mfr. Symbol/Logo letter "E" marked opposite material symbol code marking on nut crown at one corner location.



Mfr. Symbol/Logo letter "E" marked on crown, 180 degrees opposite thread designation letter.



Mfr. Symbol/Logo letter "E" indent marked above material symbol.



Mfr. Symbol/Logo letter "E" as shown marked above material symbol marking on stud or rod end.

CAGE code: 19968 1/

ENGLE MANUFACTURING COMPANY, INC., THE
304 W. ERVING AVE.
SOUTH BEND, IN 46613

**EM
F593
T**

CAGE code: 0XYS0 2/

ENOMOTO INDUSTRIES CO., LTD.
3-26 TAKASAGO, TAKAISHI-SHI,
OSAKA, 592
JAPAN



CAGE code: S0132 2/

ERICO FASTENING SYSTEMS
301 NEW ALBANY ROAD
MOORESTOWN, NJ 08057





CAGE code: 84483 2/

1/ Information published in this revision was verified by direct contact with manufacturers.

2/ Information not verified to be current, no response from manufacturer. Information identical to that published in MIL-HDBK-57, Revision B.

MIL-HDBK-57C(IS)

<p>ERIE BOLT CORP. 1325 LIBERTY STREET ERIE, PA 16502</p> <p>see EBC INDUSTRIES</p> <p>ERIE E</p> <p>CAGE code: 5G920 <u>2/</u></p>	<p>ESNA (MACLEAN-FOGG COMPANY) 611 COUNTRY CLUB ROAD POCAHONTAS, AR 72455-8803</p> <p>E, EN, or ESNA Red nylon insert in locknuts</p> <p>Red nylon insert in locknuts identifies Esna as manufacturer</p>  <p>CAGE code: 019L2 <u>2/</u></p>
<p>ESMET, INC.</p> <p>DBA ELECTROLINE TTUFLOC 1406 5TH ST., S.W. CANTON, OH 44702-2062 CAGE code: 79931</p>	<p>ESP MANUFACTURING CO., INC. 2331 E. INTERSTATE 20 P O BOX 871 ODESSA, TX 79766-8827</p> <p>EΣΠ</p> <p>CAGE code: 7J504 <u>1/</u></p>
<p>SUB OF UNIMET CORP 1406 5TH ST., S.W. CANTON, OH 44702-2062 CAGE code: 0EA31</p>  <p>CAGE code: 79931, 0EA31 <u>1/</u></p>	<p>ESSENTIAL MACHINING 354 HERBERTSVILLE ROAD BRICK, NJ 08724-1735</p>  <p>CAGE code: 0TR19 <u>1/</u></p>
	<p>ESTA PRODUCTS COMPANY 16 MISSOURI DRIVE WARWICK, RI 02886-8117</p> <p>ESTA</p> <p>CAGE code: 8R230 <u>2/</u></p>

1/ Information published in this revision was verified by direct contact with manufacturers.

2/ Information not verified to be current, no response from manufacturer. Information identical to that published in MIL-HDBK-57, Revision B.

MIL-HDBK-57C(IS)

EVERLOCK FASTENING SYSTEMS
 EVERLOCK DETROIT DIVISION
 6567 SOUTH STERLING DRIVE
 STERLING HEIGHTS, MI 48077

Microlock Hi-Hex Microlock



Prevailing torque surface

Flange Hi-Hex Microlock



Prevailing torque surface

Flange Toplock



Flange Nut

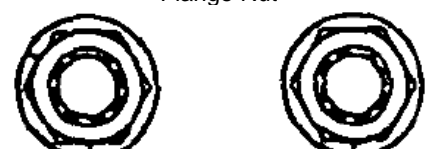

Nut and Washer Assembly



Standard Hex Nut



CAGE code: 2/
 Continued

EVERLOCK FASTENING SYSTEMS
 Continued

GREER STOP NUT
 (Greer-Smyrna Division)
 481 McNALLY DRIVE
 NASHVILLE, TN 37211

Green nylon insert identifies Greer-Smyrna as manufacturer

6 equally spaced stakes identifies Grade B

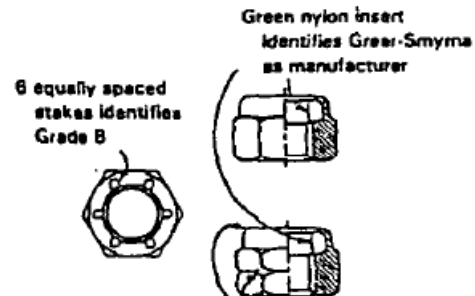

6 equally spaced stakes plug notch in corner of hex identifies Grade C

NYLON INSERT

Grade markings per IFI Standard 100 (one or two small notches cut circumferentially into each of the six corners at about mid-height)

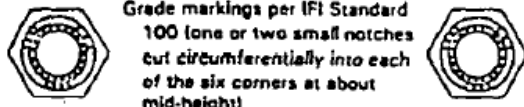

Grade B CONELOK INCH MARKINGS Grade C

Green nylon insert identifies Greer-Smyrna as manufacturer per IFI 514



Property Class 5, 9 and 10 markings per IFI 514 located on bearing surface and/or hex flats



NYLON INSERT

Manufacturer's I.D. - letter "G" stamped on one hex flat or on bearing surface









CONELOK - BEARING SURFACE
 Class 5 METRIC MARKINGS Class 10
 Class 9

CAGE code: 27687 2/
 Continued

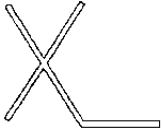
1/ Information published in this revision was verified by direct contact with manufacturers.
 2/ Information not verified to be current, no response from manufacturer. Information identical to that published in MIL-HDBK-57, Revision B.

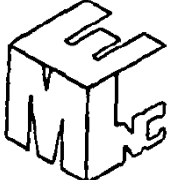
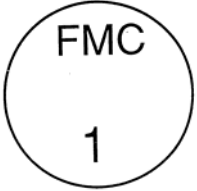

MIL-HDBK-57C(IS)

<p>Continued EVERLOCK FASTENING SYSTEMS</p> <p>INTERNATIONAL SCREW DIVISION 50631 EAST RUSSEL SCHMIDT BOULEVARD MOUNT CLEMENS, MI 48045</p> <p style="text-align: center;">  I  </p> <p style="text-align: center;">Upper case Lower case less</p> <p>CAGE code: <u>2/</u></p>	<p>FABSCO CORP. 1745 W. 124TH ST. CHICAGO, IL 60643-5345</p> <p style="text-align: center;"></p> <p>CAGE code: 4S619 <u>2/</u></p>
<p>EXCEL PRECISION PRODUCTS, INC. 2207 NW 30TH PL. POMPANO BEACH, FL 33069-1026</p> <p style="text-align: center;"></p> <p>CAGE code: 1H4K6 <u>2/</u></p>	<p>FAILING CO., GEORGE E. P.O.BOX 872 ENID, OK 73702</p> <p style="text-align: center;"></p> <p>CAGE code: <u>2/</u></p>
<p>EXPERIMENTAL MACHINE CO. 1412 SHOEMAKER RD. BALTIMORE, MD 21209</p> <p style="text-align: center;"></p> <p>CAGE code: 0NAP8 <u>2/</u></p>	<p>FALCON MANUFACTURING CORP. 10409-B OLD ATLANTA HWY. COVINGTON, GA 30014-0887</p> <p style="text-align: center;"></p> <p>CAGE code: 0HM72 <u>2/</u></p>
<p>FABER ENTERPRISES, INC. 6606 VARIEL AVE. CANOGA PARK, CA 91303-2808</p> <p style="text-align: center;"></p> <p>CAGE code: 14397 <u>1/</u></p>	<p>FALL RIVER MANUFACTURING CO., INC. 540 CURRANT ROAD FALL RIVER, MA 02720-4711</p> <p style="text-align: center;">fr f</p> <p>CAGE code: 1JWL5 <u>1/</u></p>

1/ Information published in this revision was verified by direct contact with manufacturers.

2/ Information not verified to be current, no response from manufacturer. Information identical to that published in MIL-HDBK-57, Revision B.

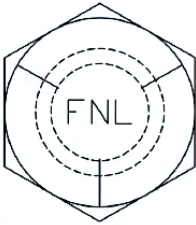
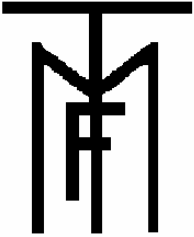

MIL-HDBK-57C(IS)

<p>FANG SHENG SCREW CO., LTD. #113 LANE 96 MINCHAUN ROAD LU CHU HSIANG, KAOHSIUNG HSIEN, 821, TAIWAN</p>  <p>CAGE code: SJ544 <u>2/</u></p>	<p>(FASSCO) FASTENER & STEEL SUPPLY CO., LTD. Quality Assurance Dept. P.O. BOX 236 HATFIELD, PA 19440</p> <p>Plant 2294 NORTH ROAD HATFIELD, PA 19440</p>  <p>Latest marking used on fasteners after August 1, 1988</p> <p>Previous marking used on fasteners</p> <p>CAGE code: <u>2/</u></p>
<p>FARIAS INDUSTRIAL MACHINING 504 BRUNKEN AVENUE, STE L SALINAS, CA 93901</p> <p>(No artwork for marking. Marks whatever the customer specifies.</p> <p>CAGE code: 3KWY7 <u>1/</u></p>	<p>FASTENAL COMPANY 2001 THEURER BLVD. WINONA, MN 55987-1500</p> <p>Plant FASTENAL COMPANY MFG DIV 1801 THEURER BLVD. WINONA, MN 55987-1500 CAGE code: 1QNZ3</p>  <p>CAGE code: 0Y3H3 <u>1/</u></p>
<p>FARLO MACHINE & TOOL CO., INC 340 CONSTANCE DR BLDG # 7 WARMINSTER, PA 18974-2815</p>  <p>CAGE code: 7S305 <u>2/</u></p>	

1/ Information published in this revision was verified by direct contact with manufacturers.

2/ Information not verified to be current, no response from manufacturer. Information identical to that published in MIL-HDBK-57, Revision B.

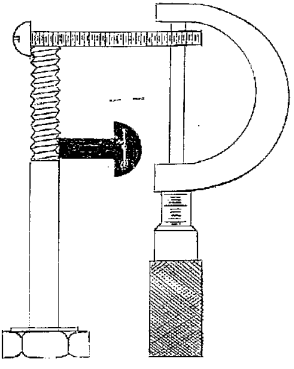
MIL-HDBK-57C(IS)





















<p>FASTENER BROKERAGE INC DBA INOFAST MANUFACTURING SUITE R 2880 BERGEY RD HATFIELD, PA 19440 - 3241</p> <p style="text-align: center;">IN</p> <p>CAGE code: 2T359 <u>2/</u></p>	<p>FASTENING PRODUCTS OF LANCASTER, INC. 1980 OLD PHILADELPHIA PIKE LANCASTER, PA 17602-3498</p>  <p>CAGE code: 4M097 <u>1/</u></p>
<p>FASTENER INNOVATION TECHNOLOGY, INC. DBA F.I.T. 14601 S. BROADWAY STREET GARDENA, CA 90248-1811</p> <p style="text-align: center;">FIT</p> <p>CAGE code: 58998 <u>1/</u></p>	<p>FASTENRATH BEFESTIGUNGSTECHNIK GmbH HERSCHEIDER STRABE 105 POSTFASH 51 42 58840 PLETTENBERG, HOLTAUSEN FEDERAL REPUBLIC OF GERMANY</p> <p style="text-align: center;">F</p> <p>CAGE code: <u>1/</u></p>
<p>FASTENER TECHNOLOGY CORP. 7415 FULTON AVE NORTH HOLLYWOOD, CA 91605-5411</p> <p style="text-align: center;">FT</p> <p>CAGE code: 58794 <u>1/</u></p>	<p>FASTI-WERK CARL AUG. FASTENRATH GMBH & CO.KG INDUSTRIEGEBIET ELBRINGHAUSEN P.O. BOX 1250 WERMELSKIRCHEM, GERMANY 42929</p> <p style="text-align: center;">F</p> <p>CAGE code: D9500 <u>2/</u></p>
<p>FASTENING PRODUCTS CO.,INC. P.O. BOX 261 CLIFTON HIGHTS, PA 19018-0334</p> <p style="text-align: center;">Plant 3 MERION TERRACE CLIFTON HEIGHTS, PA 19018-0334</p>  <p>CAGE code: 6M389 <u>1/</u></p>	

1/ Information published in this revision was verified by direct contact with manufacturers.

2/ Information not verified to be current, no response from manufacturer. Information identical to that published in MIL-HDBK-57, Revision B.

MIL-HDBK-57C(IS)



<p>FASTRON COMPANY, THE 11800 FRANKLIN AVENUE FRANKLIN PARK, IL 60131-1006</p> <p style="text-align: center; font-size: 2em; font-weight: bold; margin: 20px 0;">F</p> <p>CAGE code: 24929 2/</p>
<p>FEDERAL EQUIPMENT COMPANY 707 CARR ST CINCINNATI, OH 45203-1211</p> <p style="text-align: center; font-size: 1.5em; font-weight: bold; margin: 20px 0;">F E C</p> <p style="text-align: center; font-size: 1.5em; font-weight: bold; margin: 20px 0;">6 0 5 8 7</p> <p>CAGE code: 60587 1/</p>
<p>FEDERAL MANUFACTURING CORP. 9825 DE SOTO AVENUE CHATSWORTH, CA 91311-1441</p> <p style="text-align: center; font-size: 2em; font-weight: bold; margin: 20px 0;">F M C</p> <p>CAGE code: 17943 2/</p>

<p>FEDERAL SCREW WORKS 2400 BUHL BUILDING DETROIT, MI 48226</p> <p style="text-align: center; margin: 10px 0;">BIG RAPIDS DIVISION 400 NORTH DEKRAFT BIG RAPIDS, MI 49307</p> <div style="display: flex; justify-content: space-around;"> <div style="text-align: center;">  HEX BOLTS (INCH) (GRADE 5) </div> <div style="text-align: center;">  FLANGE BOLTS (INCH) </div> </div> <div style="display: flex; justify-content: space-around; margin-top: 10px;"> <div style="text-align: center;">  CONNECTING ROD BOLTS </div> <div style="text-align: center;">  BALL STUDS (THREADED END SHOWN) </div> </div> <p style="text-align: center; margin-top: 10px;">ROMULUS DIVISION 34846 GODDARD ROAD ROMULUS, MI 48174-3400</p> <p style="text-align: center; margin-top: 5px;">PREVAILING TORQUE NUTS</p> <div style="display: flex; justify-content: space-around; margin-top: 5px;"> <div style="text-align: center;">  HEX NUTS (INCH) (GRADE 5) </div> <div style="text-align: center;">  2 SIDE CRIMP (GRADE 5) </div> </div> <div style="display: flex; justify-content: space-around; margin-top: 10px;"> <div style="text-align: center;">  FLANGE NUTS (INCH) (CLASS 9) </div> <div style="text-align: center;">  FLANGE NUTS (INCH) (CLASS 10) </div> </div> <div style="display: flex; justify-content: space-around; margin-top: 10px;"> <div style="text-align: center;">  (OPTIONAL) </div> <div style="text-align: center;">  HEX NUTS (METRIC) </div> <div style="text-align: center;">  (OPTIONAL) </div> <div style="text-align: center;">  (OPTIONAL) </div> </div> <div style="display: flex; justify-content: space-around; margin-top: 10px;"> <div style="text-align: center;">  (OPTIONAL) </div> <div style="text-align: center;">  FLANGE NUTS (METRIC) </div> <div style="text-align: center;">  (OPTIONAL) </div> <div style="text-align: center;">  (OPTIONAL) </div> </div> <div style="display: flex; justify-content: space-around; margin-top: 10px;"> <div style="text-align: center;">  TOP LOCK 2 SIDES PERMA-TORQUE </div> <div style="text-align: center;">  </div> </div> <div style="display: flex; justify-content: space-around; margin-top: 10px;"> <div style="text-align: center;">  (METRIC) </div> <div style="text-align: center;">  (OPTIONAL) </div> <div style="text-align: center;">  (INCH) </div> </div> <p>CAGE code: 21957 2/</p>

1/ Information published in this revision was verified by direct contact with manufacturers.

2/ Information not verified to be current, no response from manufacturer. Information identical to that published in MIL-HDBK-57, Revision B.

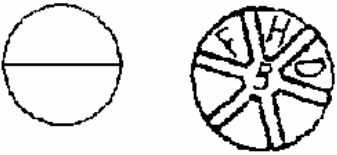
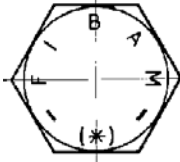
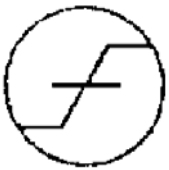
MIL-HDBK-57C(IS)

<p>FENBAR PRECISION MACHINISTS, INC 633 COMMERCE STREET THORNWOOD, NY 10594-1348</p>  <p>CAGE code: IP472 <u>1/</u></p>	<p>FERRY CAP & SET SCREW CO., THE 2151 SCRANTON RD. CLEVELAND, OH 44113-3578</p> <p>FC · F-C BPG</p> <p>CAGE code: 84513 <u>2/</u></p>
<p>FENTON HEADING 2480 OWEN RD. FENTON, MI 48430</p>  <p>CAGE code: <u>1/</u></p>	<p>FIBAM COMPANHIA INDUSTRIAL SAO BERNARDO DO CAMPO P.O. BOX 360 SAO PAULO, BRAZIL C.E.P.0 09701.907</p>  <p>CAGE code: <u>1/</u></p>
<p>FERNDAL FASTENER 31600 STEPHENSON HIGHWAY MADISON HEIGHTS, MI 48071</p>  <p>CAGE code: <u>2/</u></p>	<p>FILETAGE INTERNATIONAL (INTERNATIONAL THREAD INC.) 2225 RUE MICHLIN LAVAL, QUE, CANADA H7L9Z7</p>  <p>CAGE code: <u>2/</u></p>
<p>FERRIERE DI STABIO, S.A. VIA AL MULINO STABIO, SWITZERLAND CH-6855</p> <p>FS</p> <p>CAGE code: <u>2/</u></p>	<p>FIRST AMERICAN SALES CO. 2706 ST. LOUIS AVE. LONG BEACH, CA 90806-2026</p> <p>lst</p> <p>CAGE code: 58251 <u>2/</u></p>

1/ Information published in this revision was verified by direct contact with manufacturers.

2/ Information not verified to be current, no response from manufacturer. Information identical to that published in MIL-HDBK-57, Revision B.

MIL-HDBK-57C(IS)

FISCHER SPECIAL MFG. CO.
11 INDUSTRIAL RD.
COLD SPRING, KY 41076-9796

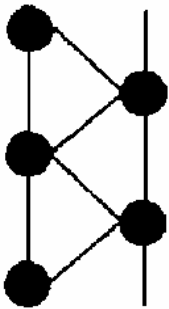

CAGE code: 73743 2/

FITZ MANUFACTURING INDUSTRIES LTD
DBA FMI
4212 MCLEAN ROAD
FORT WORTH, TX 76114-1006

05DT8

CAGE code: 05DT8 2/

FLAIG & HOMMEL
HEERSTRASSE 1
ALDINGEN, GERMANY 78554

FS Company logo to be stamped and used on all steel reusable FLAG & HOMMEL lock nuts.

FH Company logo to be stamped on all none reusable (standard) nuts.

CAGE code: C3816 2/

FLEXALLOY INC.
26000 RICHMOND ROAD
BEDFORD, OH 44146

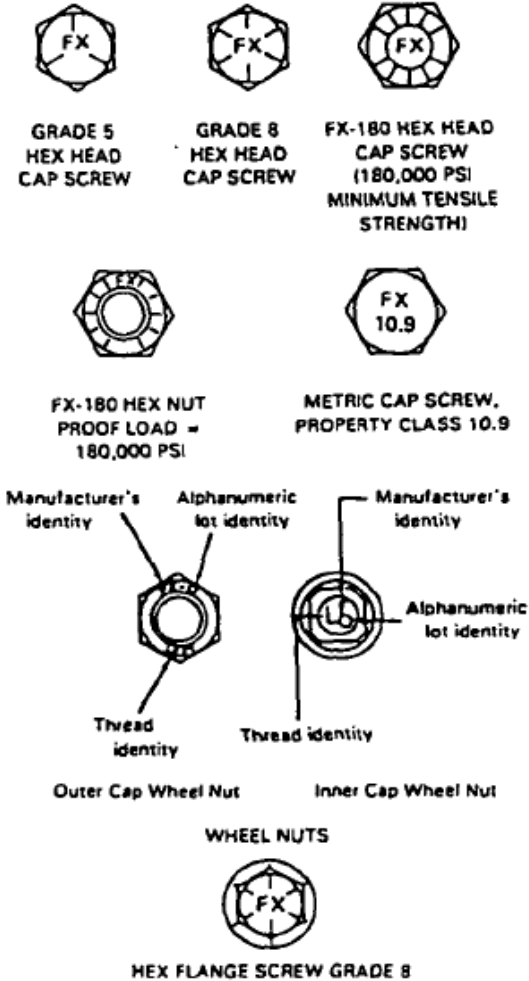

GRADE 5 HEX HEAD CAP SCREW

GRADE 8 HEX HEAD CAP SCREW

FX-180 HEX HEAD CAP SCREW (180,000 PSI MINIMUM TENSILE STRENGTH)

FX-180 HEX NUT PROOF LOAD = 180,000 PSI

METRIC CAP SCREW, PROPERTY CLASS 10.9

Outer Cap Wheel Nut

Inner Cap Wheel Nut

WHEEL NUTS

HEX FLANGE SCREW GRADE 8

CAGE code: 0C9A2 2/

FLORES ENTERPRISES
1729 E. 28TH STREET
SIGNAL HILL, CA 0806-1923









CAGE code: 0V616 1/

1/ Information published in this revision was verified by direct contact with manufacturers.

2/ Information not verified to be current, no response from manufacturer. Information identical to that published in MIL-HDBK-57, Revision B.

MIL-HDBK-57C(IS)

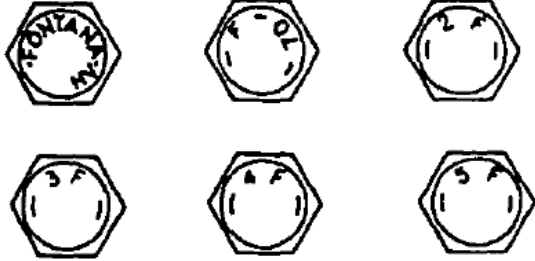
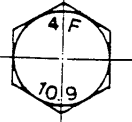
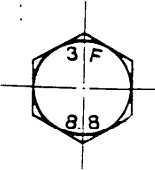
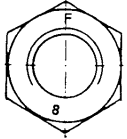
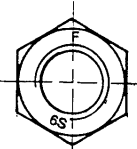
<p>FLUIDONICS INC. 205 W INDUSTRY CT P. O. BOX 9020 DEER PARK, NY 11729</p>  <p>CAGE code: 58525 2/</p>
<p>FLUIDYNE CORPORATION 9100 COLLINS AVE. PENNSAUKEN, NJ 08110</p>  <p>CAGE code: 9Y957 1/</p>
<p>FOLSOM TOOL & MOLD CORP. # 12 MOUNT PLEASANT DR. ASTON, PA 19014-4140</p>  <p>CAGE code: 6P049 2/</p>
<p>FONTAL CONTROLS, INC. 12725 ENCINITAS AVENUE SYLMAR, CA 91342-3517</p>  <p>CAGE code: 0GNC3 2/</p>

<p>FONTANA S.A. FONTANA LUIGI SPA VIA PIAVE 29 VEDUGGIO MILANO, ITALY 20050</p>   <p>Bolts and screws Hexagon Head Strength Grade 10.9 Iso Metric Thread</p>  <p>Bolts and screws Hexagon Head Strength Grade 8.8 Iso Metric Thread</p>   <p>Nut Strength Class 8 Iso Metric Thread</p> <p>CAGE code: A4733 2/</p>
<p>FOREMOST PRECISION INSTRUMENT CORP. 31 CARLETON AVE MT VERNON, NY 10550-4617</p>  <p>CAGE code: 33464 2/</p>

1/ Information published in this revision was verified by direct contact with manufacturers.

2/ Information not verified to be current, no response from manufacturer. Information identical to that published in MIL-HDBK-57, Revision B.

MIL-HDBK-57C(IS)

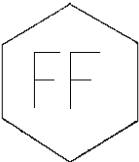
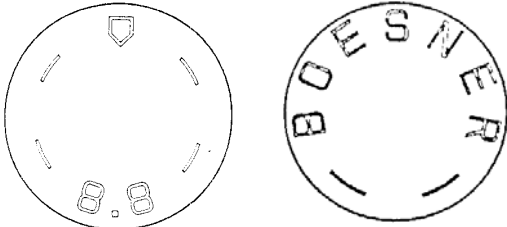
<p>FOREST FASTENERS TREForest INDUSTRIAL ESTATE PONTYPRIDD, MID. GLAMORGAN, SOUTH WALES, GREAT BRITAIN CF37 5YG</p>  <p>CAGE code: <u>2/</u></p>	<p>FREEMAN CO. P. O. BOX 57 719 WALNUT ST YANKTON, SD 57078</p> <p style="font-size: 48pt; text-align: center;">F</p> <p>CAGE code: 84596 <u>1/</u></p>
<p>FORMED FASTENER MANUFACTURING, INC. 7247 S. 78TH AVE BRIDGEVIEW, IL 60455</p>  <p>CAGE code: <u>2/</u></p>	<p>FRIEDR BOESNER GMBH AUGUSTHENALER STRABE 5450 NEUWIED 13 GERMANY</p>  <p>CAGE code: <u>2/</u></p>
<p>FPA MANUFACTURING DBA FPA MANUFACTURING AND SUPPLY 6733 S SEPULVEDA BLVD STE 245 LOS ANGELES, CA 90045-1525</p> <p style="font-size: 36pt; text-align: center;">FPA</p> <p>CAGE code: 0J6Z1 <u>2/</u></p>	<p>FRISBY AEROSPACE INC DE DIV TRIUMPH ACTUATION SYSTEMS - CLEMMONS 417 S.MAIN ST. FREEPORT, NY 11520-5144</p> <p>was FRISBY AIRBORNE HYDROLOGICS, INC</p> <p style="font-size: 48pt; text-align: center;">FAH</p> <p>CAGE code: 26437 <u>2/</u></p>
<p>FRANROE PRECISION MACHINE COMPANY 12 CHAMPION RD GLOUCESTER CITY, NJ 08030</p> <p style="font-size: 36pt; text-align: center;">F.R. F.R.P</p> <p>CAGE code: 40650 <u>2/</u></p>	

1/ Information published in this revision was verified by direct contact with manufacturers.

2/ Information not verified to be current, no response from manufacturer. Information identical to that published in MIL-HDBK-57, Revision B.

MIL-HDBK-57C(IS)

FRONTIER BOLT COMPANY OF TEXAS
555 AIRPORT DRIVE
MANSFIELD, TX 76063-2715





CAGE code: 1CE65 2/

FUCHS SCHRAUBENWERK GmbH
BISMARCKSTRASSE 24
5900 SIEGEN
GERMANY D-57076

Hex head/round head bolts, stud bolts

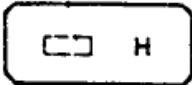
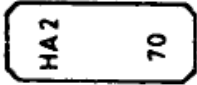

T-head bolts, hammer head/ hook head bolts





High strength structural bolts (tension controlled/ twist off)



CAGE code: 1/

G & R SCREW MACHINE PRODUCTS
21602 N. CENTRAL AVE.
SUITE 5
PHOENIX, AZ 85024



CAGE code: 7Y137 2/

G & S MACHINE INC.
2804 RENEE DRIVE
BEDFORD, TX 76021-5208



CAGE code: 62925 2/

G. B. MACHINE PRECISION, INC.
4140C AUSTIN BLVD
ISLAND PARK, NY 11558-1727

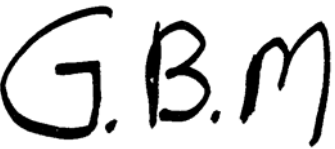

CAGE code: 03KF3 2/

G.B. DUPONT CO., INC
500 WEST LONG LAKE ROAD
TROY, MI 48098



CAGE code: 2/

1/ Information published in this revision was verified by direct contact with manufacturers.

2/ Information not verified to be current, no response from manufacturer. Information identical to that published in MIL-HDBK-57, Revision B.







MIL-HDBK-57C(IS)

<p>GAITHER PATRICIA DBA GAITHER MACHINE 201 PILGRIM LANE P. O. BOX 202 MUNFORD, AL 36268-4212</p> <p style="text-align: center;">GMF</p> <p>CAGE code: 1BTX4 2/</p>	<p>GARDINER MFG. CO. P.O. BOX 1499 OAKLAND, CA 94604</p> <p style="text-align: center;">GARCO</p> <p>CAGE code: 24042 2/</p>
<p>GALAN PRECISION MACHINE CO. 8912 LANKERSHIM BLVD. SUN VALLEY, CA 91352</p> <p style="text-align: center;">G GPM</p> <p>CAGE code: 0S1P8 2/</p>	<p>GATEWAY SCREW AND RIVET, INC. 2670 UNINTED LANE ELK GROVE VILLIAGE, IL 60007</p> <p style="text-align: center;">G</p> <p>CAGE code: 2/</p>
<p>GALMAC MFG CO. 565 COVINA BOULEVARD SAN DIMAS, CA 91773-2911</p> <p style="text-align: center;"></p> <p>CAGE code: 4V765 2/</p>	<p>GEN FAST MANUFACTURING COMPANY 225 HENRY STREET, BLDG. 5 BRANTFORD, ONTARIO CANADA N3T 6H2</p> <p style="text-align: center;"></p> <p>CAGE code: 2/</p>
<p>GARCIA INDUSTRIES, INC. 12345 FLORENCE AVENUE SANTA FE SPRING, CA 90670-3807</p> <p style="text-align: center;"></p> <p>CAGE code: 1RYN7 2/</p>	<p>GENERAL AVIATION MFG., INC. 2693 PHILMONT AVE HUNTINGDON VALLEY, PA 19006-5301</p> <p style="text-align: center;">4J952</p> <p>CAGE code: 4J952 2/</p>

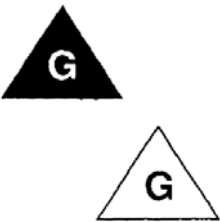
1/ Information published in this revision was verified by direct contact with manufacturers.

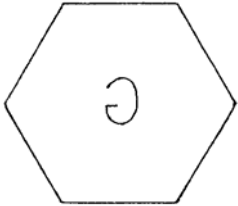
2/ Information not verified to be current, no response from manufacturer. Information identical to that published in MIL-HDBK-57, Revision B.









MIL-HDBK-57C(IS)

<p>GENERAL MACHINE PRODUCTS, INC. 3525 VICKERY BLVD FORT WORTH, TX 76105</p>  <p>CAGE code: <u>2/</u></p>	<p>GFD LETAGE ZONE INDUSTRIELLE BP 63 BOURGNE FRANCE 90140</p> <p>Plant 15. IMPASSE G. THIVOLLET P.O. BOX 26 42011 SAINT ETIENNE CEDEX 2 FRANCE</p>  <p>CAGE code: F1471 <u>2/</u></p>
<p>GENERAL SCREW & SPECIALTY CO., INC. 14 N. BLEEKER ST. MT VERNON, NY 10550</p>  <p>CAGE code: 26300 <u>2/</u></p>	<p>GILL MACHINE & TOOL CO. 200 PRAIRIE STREET ROCKFORD, IL 61107</p>  <p>CAGE code: 0H8Y5 <u>2/</u></p>
<p>GERMAN MACHINED PRODUCTS, INC. 1208 S. HOOVER ST. GARDENA, CA 90247-1771</p>  <p>CAGE code: 65813 <u>2/</u></p>	<p>GL CNC SERVICE INC. 9860 OWENSMOUTH AVE #3 CHATSWORTH, CA 91311-3852</p>  <p>CAGE code: 1DUA6 <u>1/</u></p>
<p>GERTLER INDUSTRIES, INC. 914 W. 17TH STREET COSTA MESA, CA 92627-4403</p>  <p>CAGE code: 64445 <u>2/</u></p>	

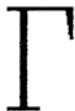
1/ Information published in this revision was verified by direct contact with manufacturers.

2/ Information not verified to be current, no response from manufacturer. Information identical to that published in MIL-HDBK-57, Revision B.



MIL-HDBK-57C(IS)

<p>GMJ MACHINE COMPANY, INC. 251 STATE LINE RD S WILMER, AL 36587-7051</p>  <p>CAGE code: 8T119 <u>2/</u></p>	<p>GRACO INDUSTRIES, INC. 44605 MACOMB INDUSTRIAL DRIVE CLINTON TOWNSHIP, MI 48096-1148</p>  <p>CAGE code: 1GT22 <u>1/</u></p>
<p>GMP CO. CORPORATION 529 8TH AVE. BETHLEHEM, PA 18018-5008</p>   <p>CAGE code: 51867 <u>2/</u></p>	<p>GRADON SCREW MACHINE CORP. P. O. BOX 1080 1411 EAST ST. NEW BRITIAN, CT 06050-1080</p>  <p>CAGE code: 69870 <u>2/</u></p>
<p>GOSHO WORKS, LTD. 3-8-1 TARU-MACHI KOHOKU, YOKOHAMA 222 JAPAN</p>    <p>CAGE code: <u>2/</u></p>	<p>GRANDUER FASTENERS, INC. 18798 E. HWY 10 DANVILLE, AR 72833-0658</p>  <p>CAGE code: 3U752 <u>1/</u></p>

1/ Information published in this revision was verified by direct contact with manufacturers.

2/ Information not verified to be current, no response from manufacturer. Information identical to that published in MIL-HDBK-57, Revision B.

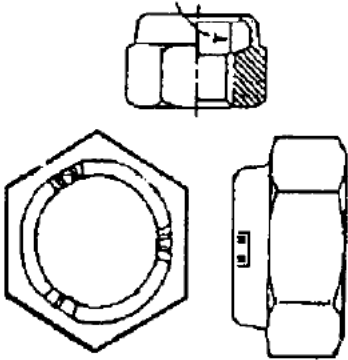
MIL-HDBK-57C(IS)

<p>GRAUCH ENTERPRISES RR 1 BOX 37 1878 PORT MATILDA HWY PHILLIPSBURG, PA 16866-3128</p>  <p>CAGE code: 1HU38 1/</p>	<p>GREENFIELD MANUFACTURING CO., INC. 920 LEVICK STREET PHILADELPHIA, PA 19111-5422</p> <p style="font-size: 2em; text-align: center;">GFM</p> <p>CAGE code: 98320 2/</p>
<p>GREATER MARYLAND TOOL & MFG., CORP. 5 RESOURCE AVE MOUNTAIN LAKE MARK, MD 21550-6362</p> <p style="font-size: 2em; text-align: center;">GMT</p> <p>CAGE code: 34549 1/</p>	<p>GREER STOP NUT 481 MCNALLY DRIVE NASHVILLE, TN 37211-3311</p> <p style="font-size: 2em; text-align: center;">G S L G L</p> <p style="text-align: center;"><i>Green nylon insert</i></p>  <p><i>Manufacturer identification: 2 raised ribs in (2) crimp depressions 1 raised rib in (1) crimp depression</i></p> <p style="font-size: 2em; text-align: center;">NFB</p> <p style="text-align: center;">for head marking on bolts and screws</p> <p>CAGE code: 27687 1/</p>
<p>GREEN BAY DROP FORGE DIV. OF CLEVELAND HARDWARE & FORGING 1341 S. STATE ST. P.O. BOX 11797 GREEN BAY, WI 54307-1797</p> <p>See CLEVELAND HARDWARE & FORGING</p>  <p style="text-align: center;"><i>Circle with center dot</i></p> <p>CAGE code: 08277 2/</p>	

1/ Information published in this revision was verified by direct contact with manufacturers.

2/ Information not verified to be current, no response from manufacturer. Information identical to that published in MIL-HDBK-57, Revision B.

MIL-HDBK-57C(IS)

GRIPCO, DIVISION OF BLACK & DECKER
111 E. BROAD ST.
SOUTH WHITLEY, IN 46787

*Raised or indented on flange or
bearing surface of bolts
Raised on head of bolts, inch or
metric
Raised or indented on flange or
bearing surface of nuts*

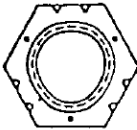

*Twin Delta
Crownlock grade
B inch locknut*

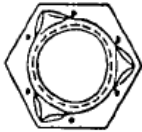

*Gripco Crown lock
Grade C inch
locknut*

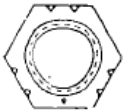

*Twin Delta
Crownlock
Class 9 metric
locknut*



*Gripco
Crownlock
Class 10
metric locknut*



*Toplock
(3-6
Indentations)*



Centerlock

CAGE code: 0KS39

2/

GROOV-PIN CORPORATION
331 FARNUM PIKE
SMITHFIELD, RI 02917-1205

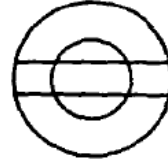

G-P

CAGE code: 73957

2/

GRUPO RASSINI S.A. de C.V.
RASSINI INTERNATIONAL, INC.
617 EAST HURON STREET
ANN HARBOR, MI 48104

Plant
TORNILLOS RASSINI S.A. de C.V.
AV. ELECTRICIDAD Y.E. PUGIBEL
CD. INDUSTRIAL, XALOSTOC
STA. CARLA, EDO DE MEXICO
APARTADO POSTAL 14-711
MEXICO D.F.

RR

Used to mark the following products:

hex cap screws
hex bolts
hex nuts
heavy hex structural bolts
heavy hex nuts
shackle bolts
hex cone nuts
wheelbolts





CAGE code:

2/

^{1/} Information published in this revision was verified by direct contact with manufacturers.

^{2/} Information not verified to be current, no response from manufacturer. Information identical to that published in MIL-HDBK-57, Revision B.



MIL-HDBK-57C(IS)

<p>GS AEROSPACE DIV. B & B SPECIALTIES INC 4321 E LA PALMA AVE. ANAHEIM , CA 92807-1805</p> <p>See B & B SPECIALTIES INC</p> <p>1) PRIMARY - GS</p> <p>2) SECONDARY - GSAT</p> <p>3) SECONDARY - 1EM77</p> <p>4) SECONDARY - GSI (OBSOLETE AS OF JAN 1, 1988)</p> <p>CAGE code: 1EM77 <u>1/</u></p>	<p>GUARDIAN RIVET & FASTENER Guardian Mfg. Division 70 AIR PARK DRIVE RONKONKOMA, NY 11779</p> <p>Plant 201 TRADE ZONE DRIVE RONKONKOMA, NY 11779</p> <p> </p> <p>CAGE code: <u>2/</u></p>
<p>GSF FASTENING (Armstrong Fastening Ltd.) MIDLAND ROAD DARLSTON WEDNESBURY, WEST MIDLANDS WS10 8JN GREAT BRITAIN</p> <p></p> <p>CAGE code: <u>2/</u></p>	<p>GUNNISON-INTERNATIONAL INC. 861 GIBBSBORO ROAD CLEMENTON, NJ 08021-1207</p> <p></p> <p>CAGE code: 4G922 <u>2/</u></p>
	<p>H C MERCHANDISERS INC. DBA H C PACIFIC 19844 QUIROZ CT WALNUT, CA 91789-2828</p> <p>HC HCP</p> <p>CAGE code: 53037 <u>2/</u></p>
	<p>H C PACIFIC 19844 QUIROZ CT WALNUT, CA 91789 - 2828</p> <p>HC HCP</p> <p>CAGE code: 53037 <u>2/</u></p>

1/ Information published in this revision was verified by direct contact with manufacturers.

2/ Information not verified to be current, no response from manufacturer. Information identical to that published in MIL-HDBK-57, Revision B.



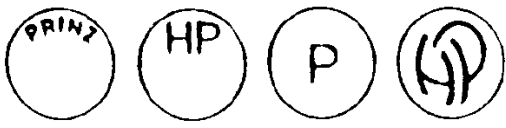



MIL-HDBK-57C(IS)

<p>H. MULLINS, LTD. (BADE INDUSTRIAL ESTATE) JARROW TYNE AND WEAR CO DURHAM, UNITED KINGDOM NE32 3EX</p> <p style="text-align: center;">HM</p> <p>CAGE code: 2/</p>	<p>HABINA ENGINEERING 4740 COTTON BELT SAN ANTONIO, TX 78219-2854</p> <p style="text-align: center;"></p> <p>CAGE code: 1SZT7 1/</p>
<p>H. PAULIN & CO. LTD. (CAPITAL METAL INDUSTRIES DIVISION) 55 MILNE AVE. SCARBOROUGH, ONTARIO CANADA MIL 4N3</p> <p style="text-align: center;"> </p> <p style="text-align: center;"><i>Hex head cap screws</i> <i>Metric standard hex head cap screws</i></p> <p>CAGE code: 95119 2/</p>	<p>HALL INDUSTRIES INC. (FORMERLY STANDARD TOOL & MACHINE COMPANY) 514 MECKLEM LANE ELLWOOD CITY, PA 16117-3028</p> <p style="text-align: center;"></p> <p>CAGE code: 29281 1/</p>
<p>H. PRINZ GmbH FABRIK FUR VERBINDUNGSELEMENTE 5970 PLETTENBERG POSTBOX 5241 GERMANY</p> <p style="text-align: center;"></p> <p>CAGE code: 2/</p>	<p>HALLSIMS INDUSTRIAL COMPONENTS, INC. 37 TERRY DR. TREVOSSE, PA 19053</p> <p style="text-align: center;">HIC</p> <p>CAGE code: 8V986 2/</p>

1/ Information published in this revision was verified by direct contact with manufacturers.

2/ Information not verified to be current, no response from manufacturer. Information identical to that published in MIL-HDBK-57, Revision B.

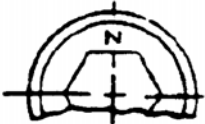







MIL-HDBK-57C(IS)

<p>HAMANAKA (THAILAND). CO., LTD. NO. 550 Moo6 TAIBAN ROAD AMPHUR MUANG, SAMUTPRAKARN, THAILAND</p>  <p>Plant HAMANAKA NUT MFG. CO., LTD KO-770 SHIRAHANA-CHO, HIMEJI-SHI HYOGO, JAPAN</p>  <p>CAGE code: 5Z615 <u>1/</u></p>	<p>HARDWARE SPECIALTY CO, INC. 48-75 36TH STREET LONG ISLAND CITY, NY 11101-1994</p>  <p>CAGE code: 07679 <u>1/</u></p>
<p>HANDI GADETS CORP. P.O. BOX 0938 LA CROSSE, WI 54603</p> <p>Plant 1230 CLINTON ST. LA CROSSE, WI 54603</p>  <p>CAGE code: 1M893 <u>1/</u></p>	<p>HARRISON BOLT & NUT CO., THE 2781 WILKENS AVE. BALTIMORE, MD 21223</p>  <p>CAGE code: 5B735 <u>2/</u></p>
<p>HANSAN SCREW CO., LTD. EXPORTING DEPARTMENT 974-7 YANG DUK-DONG MASAN 610-00 KOREA</p>  <p>CAGE code: <u>2/</u></p>	<p>HARTFORD AIRCRAFT PRODUCTS, INC. 94 OLD POQUONOCK ROAD BLOOMFIELD, CT 06002-1427</p>  <p>CAGE code: 66861 <u>2/</u></p>
<p>HARWOOD DESIGN, INC. 1507 CLYDE WAITE DRIVE BRISTOL, PA 19007-2919</p> <p>HDI</p> <p>CAGE code: 1VQQ8 <u>2/</u></p>	

1/ Information published in this revision was verified by direct contact with manufacturers.

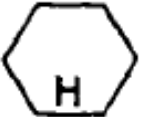
2/ Information not verified to be current, no response from manufacturer. Information identical to that published in MIL-HDBK-57, Revision B.



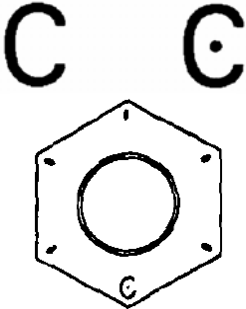





MIL-HDBK-57C(IS)

<p>HASKELL OF HUNTINGTON, INC. P.O. BOX 119 HUNTINGTON, WV 25706-0119</p> <p>Plant 300 THIRD AVENUE HUNTINGTON, WV 25701</p>  <p>300 Series Stainless Steel</p>  <p>Type 316 Stainless Steel</p>   <p>Nickel Copper (Monel)</p>  <p>Silicon Bronze</p> <p>CAGE code: <u>2/</u></p>	<p>HATCH INDUSTRIES 17000 S WSTN AVE STE 22 GARDENA, CA 90247-5262</p>  <p>CAGE code: 03AJ8 <u>2/</u></p>
<p>HASSALL, JOHN, INC. 609-1 CANTIAGUE ROCK RD WESTBURY, NY 11590-1721</p>  <p>CAGE code: 82224 <u>1/</u></p>	<p>HAYDON BOLTS, INC. 1181 UNITY ST PHILADELPHIA, PA 19124-3104</p>  <p>CAGE code: 2S013 <u>2/</u></p> <p>HAZE SEIKO CO., LTD. KO 402 SHIRAHAMA- CHO HIMEJI-SHI, HYOUGO-KEN, JAPAN 672</p>  <p>CAGE code: <u>2/</u></p>

1/ Information published in this revision was verified by direct contact with manufacturers.

2/ Information not verified to be current, no response from manufacturer. Information identical to that published in MIL-HDBK-57, Revision B.

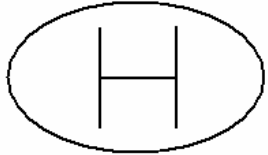





MIL-HDBK-57C(IS)

<p>HEARTLAND PRECISION FASTENER 301 PRAIRIE VILLAGE DR NEW CENTURY, KS 66031-1121</p>  <p>CAGE code: 0ZC92 1/</p>	<p>HENWAY, INC. 1314 GOODRICK DRIVE P.O. BOX 1276 TEHACHAPI, CA 93561</p>  <p>CAGE code: 0X6T3 2/</p>
<p>HEIM'S MACHINE & TOOL, INC. 36 EVERGREEN ROAD LEBANON, PA 17042</p>  <p>CAGE code: 0B117 1/</p>	<p>HEPTNER MFG CO. RIVER ROAD BLDG. PP-1 JAY-CEE INDUSTRIAL PARK BRISTOL, PA 19007 - 6103</p>  <p>CAGE code: 05BZ4 1/</p>
<p>HEITCO MANUFACTURING, INC. 60 TUTTLE ROAD MIDDLETOWN, CT 06457</p>  <p>CAGE code: 2/</p>	<p>HESSISCHE SCHRAUBENFABRIK WELTER GmbH & CO., KG STEPHAN-NIDEREHE-STR. 6 P. O. BOX 13 40 MARBURG, GERMANY 35037</p>  <p>CAGE code: D5396 2/</p>
<p>HEMCO TOOL INC. 7 SOUTH MAPLE ST. P.O. BOX 326 WESTFIELD, MA 01085-4338</p>  <p>CAGE code: 5R108 2/</p>	<p>HEXAGON ENTERPRISES, INC. 256 MINNESOTA AVENUE TROY, MI 48083</p>  <p>CAGE code: 2/</p>

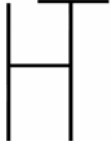
1/ Information published in this revision was verified by direct contact with manufacturers.

2/ Information not verified to be current, no response from manufacturer. Information identical to that published in MIL-HDBK-57, Revision B.

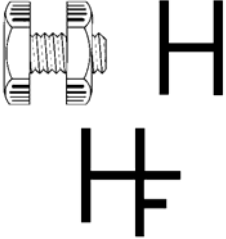
MIL-HDBK-57C(IS)

<p>HI INDUSTRIAL TECHNOLOGIES 241 WOODLAND AVE MORTON , PA 19070</p>  <p>CAGE code: 0SS65 <u>2/</u></p>	<p>HIGHLAND THREADS, INC. (FASTENER MANUFACTURING DIVISION) 708 E. TIDWELL HOUSTON, TX 77022-1822</p>  <p>CAGE code: 1DT7C <u>2/</u></p>
<p>HIGH QUALITY MACHINE SHOP 2775 WALSH ROAD SAN ANTONIO, TX 78224</p>  <p>CAGE code: 0B011 <u>2/</u></p>	<p>HILL AEROSPACE & DEFENSE LLC. 19734 DEARBORN STREET CHATSWORTH, CA 91311-6509</p>  <p>CAGE code: 55064 <u>2/</u></p>
<p>HIGH TECH ENTERPRISES 3299 SAN FERNANDO RD. UNIT 11 LOS ANGELES, CA 90065</p>  <p>CAGE code: 0TSH2 <u>2/</u></p>	<p>HILL FASTENER CORP. P.O. BOX 399 ROCK FALLS, IL 61071</p>  <p>CAGE code: 4R119 <u>1/</u></p>
<p>HIGHLAND PRODUCTS CORPORATION 9331 MERCANTILE DRIVE MENTOR, OH 44060-0452</p>  <p>CAGE code: 0AKM4 <u>2/</u></p>	<p>HILL STAMPING & MFG., INC. 3202 C STREET N.E. AUBURN, WA 98002-1789</p>  <p>CAGE code: 7M611 <u>1/</u></p>

1/ Information published in this revision was verified by direct contact with manufacturers.

2/ Information not verified to be current, no response from manufacturer. Information identical to that published in MIL-HDBK-57, Revision B.

MIL-HDBK-57C(IS)



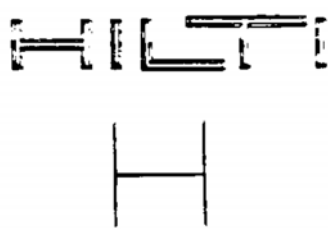

HILTI, INC.
 5400 S. 122ND E. AVE
 TULSA, OK 74121-6007

DX DIVISION

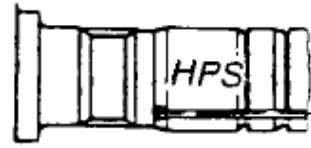

ANCHOR DIVISION

HILTI
 HEA M24 x 210
HILTI
 HEA 3/4" x 6-5/8"





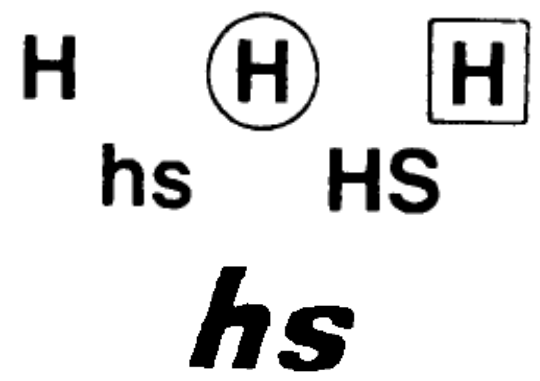

CAGE code: 11239 2/

HI-SHEAR CORP.
 DBA FOREIGN PARENT IS LISI PARIS
 FRANCE
 See listing for LISI
 2600 SKYPARK DRIVE
 TORRANCE, CA 90505



Plant
 TORONTO FASTENERS
 INDUSTRIES, INC.
 Subsidiary of Hi-Shear Corp., USA
 19 CONSTELLATION COURT
 REXDALE, ONTARIO M9W 1K4,
 CANADA



CAGE code: 73197 1/

HLC INDUSTRIES INC.
 6281 EMERALD LAKE DR
 FARMINGTON HILLS, MI 48098



CAGE code: 0SC87 2/

1/ Information published in this revision was verified by direct contact with manufacturers.

2/ Information not verified to be current, no response from manufacturer. Information identical to that published in MIL-HDBK-57, Revision B.

MIL-HDBK-57C(IS)

HMS SERVICES LLC
10039 WOLFRIVER
PLYMOUTH, MI 48170-4542

M

This is the headmarking for bolts and screws.
Headmark appears on the top of head.

M
M
M

This marking is for nuts. This mark
appears on the side of hex nuts.

CAGE code: 1UYL6 2/

HO HONG WORKS CO., LTD
10 CHUNG SHAN ROAD
LU CHU VILLAGE, KAOHSIUNG
HSIEN, TAIWAN 821

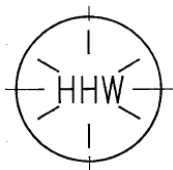

CAGE code: 1/

HOFFMANN, RICHARD GMBH CO. KG
AM KIESWASSER 8-10
D-5940 LENNESTADT-ELSPE MEISELTER
WEG
KYLLEBURG, GERMANY 5524

Plant
HOFFMANN MACHINE COMPANY,
INC.
1386 DREXEL ROAD
VALDESE, NC 28690

H

CAGE code: 0HEK2 1/

HOLLYWOOD MANUFACTURING INC.
11915 VOSE STREET
NORHT HOLLYWOOD, CA 91605-5750

H

CAGE code: 7T729 2/

HOLO-KROME CO.
31 BROOK STREET
WEST HARTFORD, CT 06110-2385

HK *On some socket
screw products*

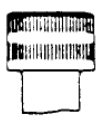

1960 series cap
screws - old
design



1960 series cap
screws - present
design



Metric socket cap



H-K



HK

CAGE code: 74445 2/

HORSPOL & ROMINE MANUFACTURING
CO., INC.
5850 MARSHALL STREET
OAKLAND, CA 94608-2696

HR **HR**

CAGE code: 95723 1/

1/ Information published in this revision was verified by direct contact with manufacturers.

2/ Information not verified to be current, no response from manufacturer. Information identical to that published in MIL-HDBK-57, Revision B.



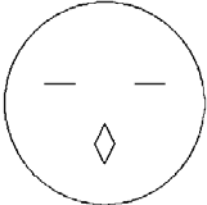
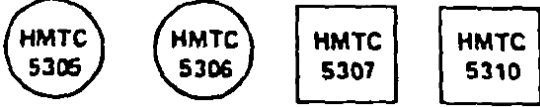





MIL-HDBK-57C(IS)

<p>HORST ENGINEERING & MANUFACTURING CO. P.O. BOX 280066 EAST HARTFORD, CT 06108-2003</p> <p>Plant 36 CEDAR ST EAST HARTFORD, CT 06108</p> <p>HEM</p> <p>HE HE</p> <p>CAGE code: 05812 1/</p>	<p>HOWARD TOOL CO., INC. 547 ODLIN ROAD BANGOR, ME 04401-6707</p> <p>HT</p> <p>CAGE code: 044B0 2/</p>
<p>HOUSTON FASTENER (DIVISION OF WESTBROOK MFG) 1202 KRESS STREET P.O. BOX 15614 HOUSTON, TX 77020</p>  <p>CAGE code: 0YN70 2/</p>	<p>HOWE MACHINE AND TOOL CORP. 236 PARK AVE. BETHPAGE, NY 11714-3709</p>  <p>CAGE code: 65777 1/</p>
<p>HOUSTON PRECISION FASTENERS 10018 TANNER ROAD HOUSTON, TX 77041</p> <p>HPF</p> <p>CAGE code: 1VSL7 1/</p>	<p>HOWIE MANUFACTURING CO., INC. P.O. BOX 426 COLLINGSWOOD, NJ 08108</p> <p>Plant 1227 MECHANIC ST. CAMDEN, NJ 08104-1221</p> <p>hmc</p> <p>CAGE code: 9V802 1/</p>

1/ Information published in this revision was verified by direct contact with manufacturers.

2/ Information not verified to be current, no response from manufacturer. Information identical to that published in MIL-HDBK-57, Revision B.



MIL-HDBK-57C(IS)

<p>HUCK AEROSPACE PRODUCTS AFS CARSON OPERATIONS 900 WATSON CENTER ROAD CARSON, CA 90745-4201 CAGE code: 17446</p> <p>AFS TUCSON OPERATIONS 3724 E. COLUMBIA ST. TUCSON, AZ 85714-3415 CAGE code: 1G6U6</p> <p>HUCK INDUSTRIAL PRODUCTS AFS WACO OPERATIONS 8001 IMPERIAL DRIVE WACO, TX 76714 CAGE code: 9K475</p>  <p>HUCK PRODUCTS AFS US OPERATIONS BP4, CLOS D'ASSEVILLE 95450 US PAR VIGNY FRANCE CAGE code: F6167</p>  <p>(Corporate office see ALCOA FASTENING SYSTEMS)</p> <p>CAGE code: 17446, 1G6U6, 9K475, F6167 1/</p>	<p>HUGO DURHOLT GMBH & CO. KG SCHRAUBENDREH-UND PREBWERK POSTFACH 16-80 D-5632 WERMELSKIRCHEN GERMANY</p>  <p>CAGE code: 1/</p>
<p>HUGGINS MFG. 4314 GARLAND DR. FORT WORTH, TX 76117</p>  <p>CAGE code: 0TCV6 2/</p>	<p>HUNT VALVE COMPANY, INC. DBA WAECO VALVE DIVISION 1913 EAST STATE STREET SALEM, OH 44460</p>  <p>CAGE code: 11859 2/</p>
	<p>HUNTER STEVENS COMPANY 4003 FLEETWOOD AVE. FRANKLIN PARK, IL 60131</p>  <p>CAGE code: 48093 2/</p>
	<p>HUNTINGTON VALLEY INDUSTRIES, INC DBA HVI 15182 TRITON LN 101 HUNTINGTON BEACH, CA 92649-1041</p>  <p>CAGE code: 9S754 2/</p>
	<p>HURON AUTOMATIC SCREW CO. P.O. BOX 610068 4914 GRATIOT RD PORT HURON, MI 48061-0068</p>  <p>CAGE code: 00905 2/</p>

1/ Information published in this revision was verified by direct contact with manufacturers.

2/ Information not verified to be current, no response from manufacturer. Information identical to that published in MIL-HDBK-57, Revision B.

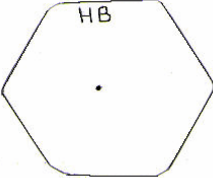
MIL-HDBK-57C(IS)

<p>HURRICANE MACHINE COMPANY, L.L.C. 2644 FREEWOOD DRIVE DALLAS, TX 75220</p> <p style="text-align: center;">9</p> <p>CAGE code: 1H7G3 <u>2/</u></p>	<p>IDEAL FASTENERS INC. 3850 E MIRALOMA AVE ANAHEIM, CA 92806</p> <p style="text-align: center;"></p> <p>CAGE code: 6F810 <u>1/</u></p>
<p>HYDRO FITTING MFG. CORP. 733 E. EDNA PLACE P.O. BOX 1558 COVINA, CA 91722-1409</p> <p style="text-align: center;">HF</p> <p>CAGE code: 13899 <u>2/</u></p>	<p>IFASTGROUPE 2004 LP CANADA</p> <p>SEE LISTINGS FOR:</p> <p style="padding-left: 40px;">INFASCO 700 OUELLETTE MARIEVILLE, QUEBEC CANADA J3M 1P6 CAGE code: 1C225</p> <p style="padding-left: 40px;">INFASCO NUT 3990 NASHUA DRIVE MISSISSAUGA, ONTARIO, CANADA L4VT IPG8 CAGE code: 06KL6</p> <p style="padding-left: 40px;">INGERSOLL FASTENERS 390 THOMAS STREET INGERSOLL, ONTARIO CANADA N5C 3K3 CAGE code: 35571</p> <p style="text-align: right;"><u>1/</u></p>
<p>HYDROBOLT LIMITED GLOBAL SERVICE CENTRE, MONMORE BUSINESS PARK, DIXON STREET WOLVERHAMPTON, WV2 2EE. U. K.</p> <p style="text-align: center;"></p> <p style="text-align: right;">HB</p> <p>CAGE code: <u>1/</u></p>	
<p>I.G.D. MACHINE & TOOL LTD. 992 HUBREY ROAD LONDON, ONTARIO, CANADA N6N 1B5</p> <p style="text-align: center;"></p> <p>CAGE code: <u>2/</u></p>	

1/ Information published in this revision was verified by direct contact with manufacturers.

2/ Information not verified to be current, no response from manufacturer. Information identical to that published in MIL-HDBK-57, Revision B.

MIL-HDBK-57C(IS)

IMPERIAL SUPPLIERS, INC.
 P.O. BOX 11008
 789 PACKER DR
 GREEN BAY, WI 54304-4527

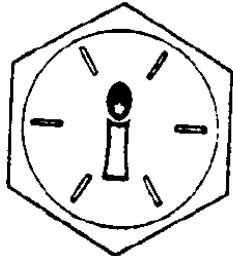

GRADE 8

CAGE code: 3A4R0

2/

INDIANA AIRCRAFT HARDWARE
 221 SOUTH MAIN STREET
 FORTVILLE, IN 46040-1514

IAH

CAGE code: 5N319

1/

INDUSTRIAL & AUTOMOTIVE FASTENERS
 (DIVISION OF KEY MANUFACTURING
 GROUP, INC.)
 3200 W. FOURTEEN MILE RD.
 ROYAL OAK, MI 48073

Inch Conelock Nuts

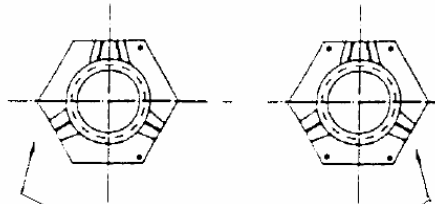

Company I.D.: 2 single & 1 double slash

Inch Wheelnut

Metric Wheelnut

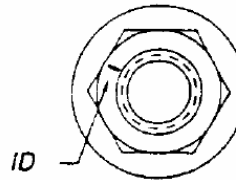

ID

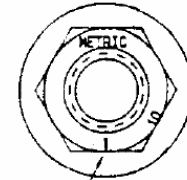

ID

Metric Flange Hex Nut
company ID: 1

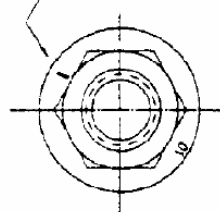

Metric Conelock Nut

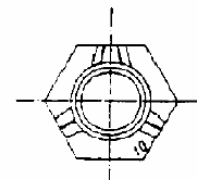

Company ID: 2 single & 1 double slash

Metric Capped Wheelnut

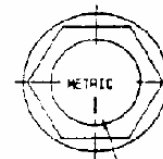

Company ID: 1

CAGE code:

2/

1/ Information published in this revision was verified by direct contact with manufacturers.

2/ Information not verified to be current, no response from manufacturer. Information identical to that published in MIL-HDBK-57, Revision B.

MIL-HDBK-57C(IS)

INDUSTRIAL FASTENERS CORP.
7 HARBOR PARK DR
PORT WASHINGTON, NY 11050

Raised or indented marks

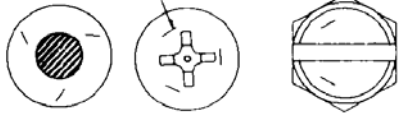

Under head Top of head Slotted hexhead (top of head)

CAGE code: 84992 2/

INDUSTRIAL FORGE, INC.
832 LANTANA RD
LAKE WORTH 33462 - 1509

IF

CAGE code: 0RY28 2/

INDUSTRIAL NUT CORP.
1425 TIFFIN AVE
SANDUSKY, OH 44870-2054

 or **INC**

Blue nylon insert identifies INC as manufacturer

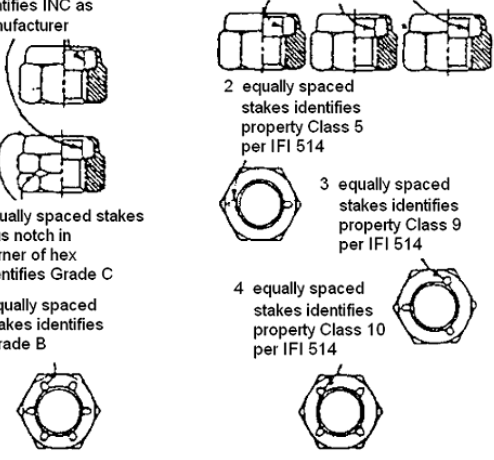

Blue nylon insert identifies INC as manufacturer per IFI 514

2 equally spaced stakes identifies property Class 5 per IFI 514

3 equally spaced stakes identifies property Class 9 per IFI 514

4 equally spaced stakes identifies property Class 10 per IFI 514

6 equally spaced stakes plus notch in corner of hex identifies Grade C

6 equally spaced stakes identifies Grade B

INCH NYLON INSERT LOCKNUTS METRIC NYLON INSERT LOCKNUTS

The blue insert is a trademark of Industrial Nut Corp. registered in the U.S. Patent & Trade Office.

CAGE code: 81198 1/

INFASCO
(see IFASTGROUPE 2004 LP)
700 OUELLETTE
MARIEVILLE, QUEBEC
CANADA
J3M 1P6

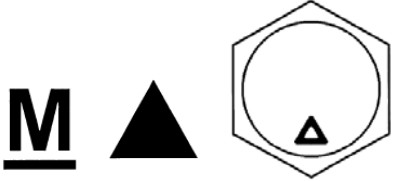

CAGE code: 1C225 1/

INFASCO NUT
(see IFASTGROUPE 2004 LP)
3990 NASHUA DRIVE
MISSISSAUGA, ONTARIO,
CANADA
L4VT 1P8

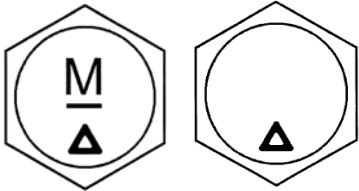

CAGE code: 06KL6 1/

INGERSOLL FASTENERS
(see IFASTGROUPE 2004 LP)
390 THOMAS STREET
INGERSOLL, ONTARIO
CANADA
N5C 3K3

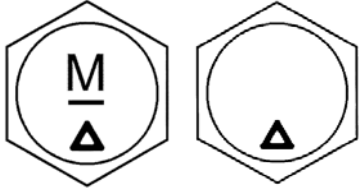



CAGE code: 35571 1/

1/ Information published in this revision was verified by direct contact with manufacturers.

2/ Information not verified to be current, no response from manufacturer. Information identical to that published in MIL-HDBK-57, Revision B.

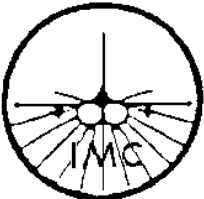

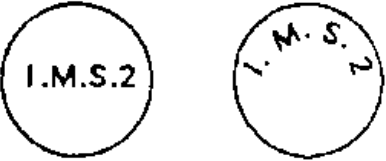

MIL-HDBK-57C(IS)

<p>INLAND MACHINE CO. 10762 EDISON CT. RANCHO CUCAMONGA, CA 91730-4845</p> <p style="text-align: center;">IM</p> <p>CAGE code: 6W617 <u>2/</u></p>	<p>INTERFLEX MFG. CORP. 144 TOLEDO ST FARMINGDALE, NY 75222-4429</p> <p style="text-align: center;"></p> <p>CAGE code: 0LD24 <u>2/</u></p>
<p>INOFAS^T MANUFACTURING INC. 1370 INDUSTRY RD. HATFIELD, PA 19440</p> <p style="text-align: center;">IN</p> <p>CAGE code: 2T359 <u>2/</u></p>	<p>INTERSTATE FITTINGS INC. 2200 SINGLETON BLVD. DALLAS, TX 75212</p> <p style="text-align: center;"></p> <p>CAGE code: 1EHF9 <u>2/</u></p>
<p>IN-SPECK CORP. 208 EAST PENN ST NORRISTOWN, PA 19401-1471</p> <p style="text-align: center;">IS</p> <p>CAGE code: 32904 <u>2/</u></p>	<p>IRVING MACHINE SERVICE, INC. 451 MAIN STREET P.O. BOX 94 IRVING, NY 14081</p> <p style="text-align: center;">IM</p> <p>CAGE code: <u>2/</u></p>
<p>INSTRUMENT MACHINING SERVICE LTD. HOWLETT WAY, THETFORD, NORFOLK IP24 IHZ UNITED KINGDOM</p> <p style="text-align: center;"></p> <p>CAGE code: <u>2/</u></p>	<p>IRWIN AUTOMATION, INC. 715 CLEVELAND STREET GREENSBURG, PA 15601-1279</p> <p style="text-align: center;">IRW</p> <p>CAGE code: 7H803 <u>1/</u></p>

1/ Information published in this revision was verified by direct contact with manufacturers.

2/ Information not verified to be current, no response from manufacturer. Information identical to that published in MIL-HDBK-57, Revision B.

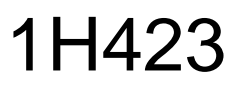

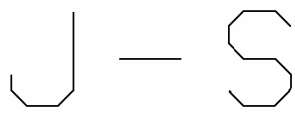
MIL-HDBK-57C(IS)

<p>ISLAND ENGINEERING DBA J SMITH MACHINE SHOP INC 153 S MAIN ST FREEPORT, NY 11520-0384</p>  <p>CAGE code: 40137 <u>2/</u></p>	<p>IVACO INC. (See IFASTGROUPE 2004 LP, CANADA)</p> <p>See listings for:</p> <p>INFASCO 700 OUELLETTE MARIEVILLE, QUEBEC CANADA J3M 1P6 CAGE code: 1C225</p> <p>INFASCO NUT 3990 NASHUA DRIVE MISSISSAUGA, ONTARIO, CANADA L4VT IPG8 CAGE code: 06KL6</p> <p>INGERSOLL FASTENERS 390 THOMAS STREET INGERSOLL, ONTARIO CANADA N5C 3K3 CAGE code: 35571</p> <p>CAGE code: 1C225 <u>1/</u></p>
<p>ITT HARPER AEROSPACE FASTENER OPERATIONS (AEROSPACE CONTROLS DIVISION) 28150 INDUSTRY DRIVE VALENCIA, CA 91355</p>  <p>CAGE code: <u>2/</u></p>	<p>J & M MACHINE INC. 1234 HIGH STREET PAINESVILLE, OH 44077</p>  <p>CAGE code: 1H423 <u>1/</u></p>
<p>ITW BUILDEX 1349 WEST BRYN MAWR AVE. ITASCA, IL 60143</p>  <p>CAGE code: <u>2/</u></p>	<p>J & S PRECISION PRODUCTS 16 EVESBORO RD. MEDFORD, NJ 08055-9592</p>  <p>CAGE code: 8B865 <u>2/</u></p>

1/ Information published in this revision was verified by direct contact with manufacturers.

2/ Information not verified to be current, no response from manufacturer. Information identical to that published in MIL-HDBK-57, Revision B.

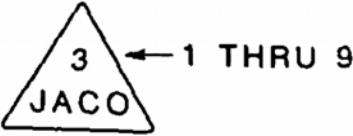



MIL-HDBK-57C(IS)

<p>J. G. FASTENERS 9720 COZYCROFT AVE CHATSWORTH, CA 91311-4423</p> <p style="text-align: center;">JG</p> <p>CAGE code: 0VWM9 <u>2/</u></p>	<p>J.P. PRODUCTS, INC. (DBA SPECIALITES, UNLIMITED) P.O. BOX 427 WILLOUGHBY, OH 44094</p> <p style="text-align: center;">S</p> <p>CAGE code: <u>2/</u></p>
<p>J. GEORG BIERBACH WERDOHLER STRASSE 23 ALTENA, GERMANY D-5990</p> <p style="text-align: center;">G E B I</p> <p style="text-align: center;"></p> <p>CAGE code: <u>2/</u></p>	<p>JACO ENGINEERING, INC. 879 SO. EAST STREET ANAHEIM, CA 92805-5356</p> <p style="text-align: center;"></p> <p>CAGE code: IH427 <u>1/</u></p>
<p>J.M. PRECISION, INC. (FASTENER DIVISION) 9722 TOPANGA CANYON BLVD CHATSWORTH, CA 913114015</p> <p style="text-align: center;">JP</p> <p>CAGE code: 0JV78 <u>1/</u></p>	<p>JAM TECH CORP. P.O. BOX 327 ESSINGTON, PA 19029</p> <p style="text-align: center;">Plant 1260 East Woodland Avenue Springfield, PA 19064</p> <p style="text-align: center;">JT</p> <p>CAGE code: IEM35 <u>2/</u></p>
<p>JAMES JACKSON DBA J J ENGINEERING 11021 VIA EL MERCADO LOS ALAMITOS, CA 90720-0281</p> <p style="text-align: center;"></p> <p>CAGE code: 0CEP4 <u>2/</u></p>	

1/ Information published in this revision was verified by direct contact with manufacturers.

2/ Information not verified to be current, no response from manufacturer. Information identical to that published in MIL-HDBK-57, Revision B.

MIL-HDBK-57C(IS)

<p>JAMISON INDUSTRIES INC. 12669 DELTA ST TAYLOR, MI 48180-6835</p> <p style="text-align: center;">JI</p> <p>CAGE code: 1Z781 <u>1/</u></p>	<p>JERGENS INC. DBA JERGENS INDUSTRIAL SUPPLY 15700 S WATERLOO RD CLEVELAND, OH 44110-3814</p> <p style="text-align: center;"></p> <p>CAGE code: 94882 <u>2/</u></p>
<p>JAY BEE MACHINE WORKS, INC. 335A CAMER DRIVE BENSALEM, PA 19020-7341</p> <p style="text-align: center;">B</p> <p>CAGE code: 74954 <u>1/</u></p>	<p>JJ ENGINEERING (See JAMES JACKSON) 11021 VIA EL MERCADO LOS ALAMITOS, CA 90720-0281</p> <p style="text-align: center;"></p> <p>CAGE code: 0CEP4 <u>2/</u></p>
<p>JAY O MACHINE CO., INC. 7685 HUB PARKWAY VALLEY VIEW, OH 44125-5706</p> <p style="text-align: center;"></p> <p>CAGE code: 5Z832 <u>2/</u></p>	<p>JJ SCREW PRODUCTS, INC. 21519 PARTHENIA STREET CANOGA PARK, CA 91304</p> <p style="text-align: center;">J</p> <p>CAGE code: 75209 <u>2/</u></p>
<p>JAYCO ENGINEERING, INC. 1660 BABCOCK AVENUE COSTA MESA, CA 92627-4330</p> <p style="text-align: center;"></p> <p>CAGE code: 7J578 <u>1/</u></p>	<p>JMT MACHINE COMPANY 9986 GANTRY ROAD PHILADELPHIA, PA 19115-1080</p> <p style="text-align: center;">2A832</p> <p>CAGE code: 2A832 <u>2/</u></p>

1/ Information published in this revision was verified by direct contact with manufacturers.

2/ Information not verified to be current, no response from manufacturer. Information identical to that published in MIL-HDBK-57, Revision B.

MIL-HDBK-57C(IS)

JOLICO/J-B TOOL INC.
4325 E. 22 MILE ROAD
UTICA, MI 48317-1507

JOLICO

CAGE code: 19549 2/

JOSLYN CORP.
MACLEAN POWER SYSTEMS
11411 ADDISON STREET
FRANKLIN, IL 60131-1130

Plant
3700 SOUTH MORGAN STREET
CHICAGO, IL 60609-1461

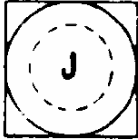

Machine bolts

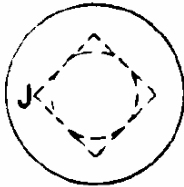

Carriage bolts

CAGE code: 74999 1/

JUPITER WASHERS, INC.
10-01 37TH AVE.
LONG ISLAND CITY, NY 11101-6014



CAGE code: 25900 2/

JUST IN TIME, INC.
DBA APSCO
2538 WEST LN., SUITE 16
STOCKTON, CA 95205

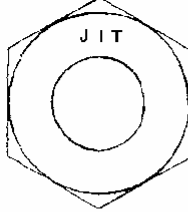
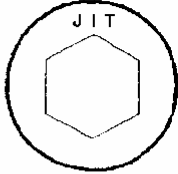
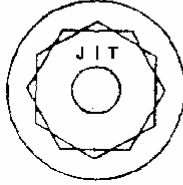
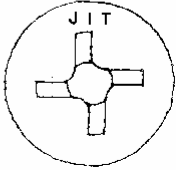
CAGE code: 0FVD5 2/

K & K PRECISION ENTERPRISES
60 STEAM WHISTLE DRIVE
WARMINSTER, PA 18974



CAGE code: 1K6D9 2/

K.A.A. COMPANY
(LYNN ABADIE DBA K A A COMPANY)
1309 MADISON STREET
WEATHERFORD, TX 76086-2144





CAGE code: 1XRQ5 2/

1/ Information published in this revision was verified by direct contact with manufacturers.

2/ Information not verified to be current, no response from manufacturer. Information identical to that published in MIL-HDBK-57, Revision B.

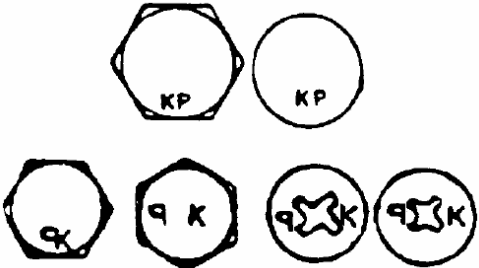
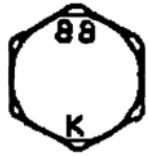
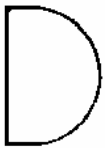



MIL-HDBK-57C(IS)

<p>K.D.K. UPSET FORGING CO. 2645 W. 139TH ST. P.O. BOX 146 BLUE ISLAND, IL 60406-0146</p> <p style="text-align: center;">KDK</p> <p>CAGE code: 8P293 <u>2/</u></p>	<p>KAPCO INDUSTRIES, INC. 5660 KNOTT AVE BUENS PARK, CA 90621</p>  <p>CAGE code: 0BMF4 <u>2/</u></p>
<p>KAMAX-WERKE RUDOLF KELLERMANN GmbH & CO. KG PETERSHUETTER ALLEE 29 OSTRODE, GERMANY 37520</p> <p style="text-align: center;">KAMAX KX</p> <p>CAGE code: C5315 <u>2/</u></p>	<p>KATSURAGAWA MACHINE SCREW CO., LTD. 3-24-1 YAGUCHI OHTA-KU TOKYO 146 JAPAN</p> <p style="text-align: center;">Plant 366-1, KOGOSYO KAKEGAWA-SHI SHIZUOKA-KEN 436 JAPAN</p>  <p>CAGE code: <u>2/</u></p>
<p>KAMAX L. P. (FORMERLY G.B. DUPONT CO., INC.) 500 WEST LONG LAKE ROAD TROY, MI 48098-4540</p>  <p>CAGE code: 1DWW1 <u>1/</u></p>	<p>KAYGOR, INC. 1243 TRANSIT STREET P.O. BOX 2950 POMONA, CA 91769-2950</p> <p style="text-align: center;">K</p> <p>CAGE code: 4H229 <u>2/</u></p>
<p>KAMPWERK VIeregge U. PICKARDT GMBH. & CO P.O. BOX 5143 PLETTENBURG 5 G-5970</p>  <p>CAGE code: <u>2/</u></p>	

1/ Information published in this revision was verified by direct contact with manufacturers.

2/ Information not verified to be current, no response from manufacturer. Information identical to that published in MIL-HDBK-57, Revision B.

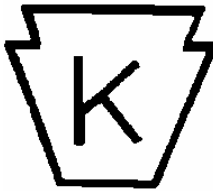
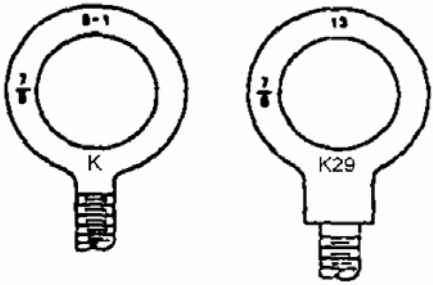
MIL-HDBK-57C(IS)

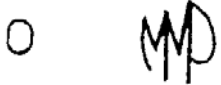
<p>KELLER ENGINEERING 136 W. 157TH STREET GARDENA, CA 90248-2226</p> <p style="text-align: center;">KE</p> <p>CAGE code: 4W941 <u>2/</u></p>	<p>KERR LAKESIDE INC. 26841 TUNGSTEN RD. P.O. BOX 32220 EUCLID, OH 44117-2680</p> <div style="text-align: center;">  </div> <p>CAGE code: 7P576 <u>1/</u></p>
<p>KELOX/MICRODOT PRODUCTS AFS TORRANCE OPERATIONS 3020 WEST LOMITA BLVD. TORRANCE, CA 90505-5103</p> <p>(Corporate office see ALCOA FASTENING SYSTEMS)</p> <div style="text-align: center;">  </div> <p>CAGE code: 75237 <u>1/</u></p>	<p>KEYSTONE BOLT & NUT COMPANY KEYSTONE THREADED PRODUCTS DIVISION P.O. BOX 31059 CLEVELAND, OH 44313-0059</p> <p style="text-align: center;">Plant 7621 OLD ROCKSIDE RD. CLEVELAND, OH 44131-0059</p> <div style="text-align: center;">  </div> <p>CAGE code: 4N487 <u>1/</u></p>
<p>KEN FORGING, INC. 1049 GRIGGS RD P.O. BOX #277 JEFFERSON, OH 44047</p> <div style="text-align: center;">  </div> <p>CAGE code: 1GMT9 <u>1/</u></p>	<p>KEYSTONE TOOL & MACHINE CO. 108 N. McDADE BLVD. DARBY, PA 19023</p> <div style="text-align: center;">  </div> <p>CAGE code: 7Y516 <u>2/</u></p>
<p>KERR, CHARLES W. RIVER RD BLDG PP-1 JAY CEE INDUSTRIAL PK BRISTOL, PA 19007</p> <p>see MAUI MEGA</p> <div style="text-align: center;">  </div> <p>CAGE code: 0M4F0 <u>2/</u></p>	

1/ Information published in this revision was verified by direct contact with manufacturers.

2/ Information not verified to be current, no response from manufacturer. Information identical to that published in MIL-HDBK-57, Revision B.

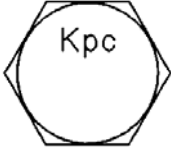
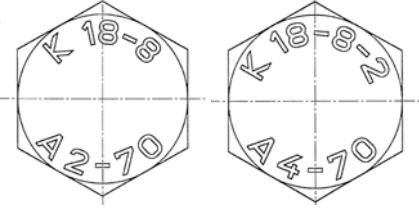

MIL-HDBK-57C(IS)

<p>KILBOURN ENGINEERING CO. 9226 WEST FLAGG AVE. MILWAUKEE, WI 53225-2718</p> <p style="text-align: center;">K</p> <p>CAGE code: 8H824 2/</p>	<p>KNOCH MANUFACTURING CO. LTD. 1054 SHAW RD DORCHESTER, CANADA N0L 1G4</p> <p style="text-align: center;"></p> <p>CAGE code: 1C763 2/</p>
<p>KIRSTEN PIPE CO. INC. 1807 NW DOCK PL P.O. BOX 70526 SEATTLE, WA 98127-0526</p> <p style="text-align: center;"></p> <p>CAGE code: 5E704 2/</p>	<p>KO AMS MACHINE PRODUCTS DBA KOAM MACHINE 915 BROOKS ST UNIT 102 ONTARIO, CA 91762-3603</p> <p style="text-align: center;">KO</p> <p>CAGE code: 0K7E0 2/</p>
<p>KLINCHER LOCKNUT CORP. 2030 N. OXFORD ST. P.O. BOX 18100 INDIANAPOLIS, IN 46218</p> <p style="text-align: center;">KL</p> <p>CAGE code: 2/</p>	<p>KOBE FASTENER LIMITED 654 HISBIE HIGASBI OSAKA, 577 JAPAN</p> <p style="text-align: center;"><i>α</i></p> <p>CAGE code: 2/</p>
<p>KNIPPING-DORN GmbH KALTUMFORMTECHNIK 4690 HERNE 1 POSTFACH 1229 GERMANY</p> <p style="text-align: center;"><i>DORN</i></p> <p style="text-align: center;">In connection with the identification mark of property class 3.6 up to and including 12.9</p> <p>CAGE code: 2/</p>	<p>KOLB GMBH & CO. HERSTELLER VON VERBINDUNGSELEMENTEN RATHENAU STRASSE 23 POSTFACH 24 02 53 WUPPERTAL GERMANY 42277</p> <p style="text-align: center;"></p> <p>CAGE code: D0472 2/</p>

1/ Information published in this revision was verified by direct contact with manufacturers.

2/ Information not verified to be current, no response from manufacturer. Information identical to that published in MIL-HDBK-57, Revision B.

MIL-HDBK-57C(IS)

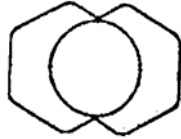
<p>KONDOR TECHNOLOGIES, INC. 206 CHRISTOPHER ST RONKONKOMA, NY 11779-6921</p> <p style="text-align: center;">KTI</p> <p>CAGE code: 06ZB0 <u>2/</u></p>	<p>KORODY COLYER CORP. A CR INDUSTRIES COMPANY 5412 MCFADDEN AVE. HUNTINGTON BEACH, CA 92649</p> <p style="text-align: center;">K</p> <p>CAGE code: 18954 <u>2/</u></p>
<p>KONGO BYORA CO., LTD. 2-1-27 SHITENNOJI TENNOJI-KU OSAKA 543 JAPAN</p> <p style="text-align: center;">Plant 3-31 NAGATA-NISHI HIGASHIOSAKA-SHI, OSAKA 577 JAPAN</p> <p style="text-align: center;"></p> <p>CAGE code: <u>2/</u></p>	<p>KOZAK, E. PERCISION PRODUCTS CO. 45 WOODLAND AVE. ROCKAWAY, NJ 07866</p> <p style="text-align: center;">KPP</p> <p>CAGE code: 1CP43 <u>2/</u></p>
<p>KOREA BOLT IND., CO., LTD. (FOREIGN TRADE DEPARTMENT) 620-34 GURO-DONG, GURO-KU SEOUL, KOREA</p> <p style="text-align: center;">Plant 732-3 WONSI-DONG, ANSAN-CITY GYUNGGI-DO, KOREA</p> <p style="text-align: center;"></p> <p>CAGE code: <u>2/</u></p>	<p>KPF 601 YOUNGTAN-DONG, CHUNGJU-CITY CHUNGCHEONGBUK-DO 380-250, KOREA</p> <p style="text-align: center;"></p> <p>CAGE code: <u>1/</u></p> <p>KREIS TOOL & MFG., CO., INC. 1615 CAMBRIDGE DR ELGIN, IL 60123 - 3114</p> <p style="text-align: center;">KTM</p> <p>CAGE code: 64592 <u>2/</u></p>

1/ Information published in this revision was verified by direct contact with manufacturers.

2/ Information not verified to be current, no response from manufacturer. Information identical to that published in MIL-HDBK-57, Revision B.

MIL-HDBK-57C(IS)

KROBACH MANUFACTURING CORP.
3504 ARDEN RD.
HAYWARD, CA 94545-5390



CAGE code: 30828 1/

KSS SOCKET SCREW, INC.
3416 S. 48TH STREET SUITE #6
PHOENIX, AZ 85040

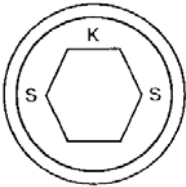

CAGE code: 0BMF5 2/

K-TECH MFG., INC.
288 HOLBROOK DRIVE
WHEELING, IL 60090

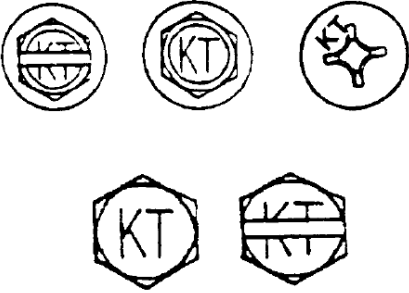

CAGE code: 2/

KYOEI SEISAKUSHO CO., LTD.
4-5-11 NUNOICHI-CHO
HIGASHIOSAKA-SHI,
OSAKA 579
JAPAN

Plant
MINAMISHINOZAKI
KAZSHI, SAILAMA-KEN
347 JAPAN



CAGE code: 2/

KYOKUTO MFG CO LTD.
3-5-29 WAKAEHONMACHI
HIGASHIOSAKA-SHI
OSAKA 578
JAPAN

Plant
1109-5 SHIBADE
KURAMOCHI-CHO,
NABARI-SHE, MIE-KEN 518-04
JAPAN



CAGE code: 2/

L & C MANUFACTURING CO., INC.
8610 S. 33RD W. AVENUE
TULSA, OK 74132-3403



CAGE code: 43813 2/

1/ Information published in this revision was verified by direct contact with manufacturers.

2/ Information not verified to be current, no response from manufacturer. Information identical to that published in MIL-HDBK-57, Revision B.

MIL-HDBK-57C(IS)

<p>L & H THREADED RODS CORP. DIV OF GRAY AMERICA CORP 3050 DRYDEN ROAD DAYTON, OH 45439</p> <p style="text-align: center;">L</p> <p>CAGE code: 0UH42 <u>2/</u></p>	<p>L H INDUSTRIES, INC. <i>TIP TOP TOOL CO.</i> 3513 NORTH 10th STREET PHILADELPHIA, PA 19140</p> <p style="text-align: center;">LH</p> <p>CAGE code: 0E7S8 <u>2/</u></p>
<p>L & J FASTENERS, INC. 3636 LACON ROAD HILLIARD, OH 43026-6122</p> <p style="text-align: center;"></p> <p>CAGE code: 1W358 <u>2/</u></p>	<p>L N AEROSPACE, INC. 6011 TENSION DRIVE FORT WORTH, TX 76112-2693</p> <p style="text-align: center;">LNA</p> <p>CAGE code: 1EB45 <u>2/</u></p>
<p>L & M ENTERPRISES, INC. 1910 NORTHERN WICHITA, KS 67216-2429</p> <p style="text-align: center;">L & M</p> <p>CAGE code: 0HDM5 <u>2/</u></p>	<p>L P R PRECISION PARTS AND TOOL COMPANY, INC. 108 ROME STREET FARMINGDALE, NY 11735-2136</p> <p style="text-align: center;">L. P. R.</p> <p>CAGE code: 31583 <u>2/</u></p>
<p>L. A. MARTIN CO. 14400 HENN STREET DEARBORN, MI 48126-1850</p> <p style="text-align: center;">LAM</p> <p>CAGE code: 9S775 <u>1/</u></p>	<p>L R G CORPORATION 210 MAGEE AVE JEANNETTE, PA 15644-2136</p> <p style="text-align: center;">LRG</p> <p>CAGE code: 75783 <u>2/</u></p>
<p>L G MACHINE & MFG INC. 1276 W. ARKANSAS LANE ARLINGTON, TX 76013-6235</p> <p style="text-align: center;">LG</p> <p>CAGE code: 0P4S2 <u>1/</u></p>	

1/ Information published in this revision was verified by direct contact with manufacturers.

2/ Information not verified to be current, no response from manufacturer. Information identical to that published in MIL-HDBK-57, Revision B.

MIL-HDBK-57C(IS)

LAKE ERIE SDREW CORP.
13001 ATHENS AVE.
LAKEWOOD, OH 44107-6201

LE



ASTM A 307



ASTM A 449



SAE J429 GR 5.1



SAE J429 GR 2



SAE J429 GR 5



ASTM F 568
CLASS 8.8

ASTM A 354 BD

SAE J429 GR 6



ASTM F 568
CLASS 9.8



ASTM F 568
CLASS 10.9



ASTM F 568
CLASS 12.9

SAE J1199
CLASS 9.8

SAE J1199
CLASS 10.9



ASTM A 325



ASTM A 325
TYPE 3
CLASS A



ASTM A 490



ASTM A 490
TYPE 3
CLASS A

CAGE code: 8B911

1/

LAMSON AND SESSIONS OF CANADA
LTD.
RB & W CORP. METAL FORMING DIVISION
8341 TYLER BOULEVARD
MENTOR, OH 44060

MANUFACTURER NUTS – Sales Office
Lamson & Sessions of Canada Ltd.
Toronto Plant – Canada
5190 Bradco Boulevard
Mississauga, Ontario L4W 1G7
CANADA

STOVER[†] PREVAILING TORQUE LOCKNUTS



Grade A



Grade B



Grade C

Hex Automation – Imperial



Grade F



Grade G

Hex Flange – Imperial



Class 9

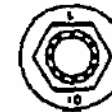

Class 10

Hex Flange – Metric



Hex Automation – Metric





CAGE code:

2/

1/ Information published in this revision was verified by direct contact with manufacturers.

2/ Information not verified to be current, no response from manufacturer. Information identical to that published in MIL-HDBK-57, Revision B.

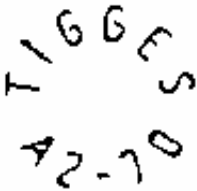







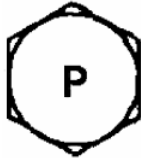

MIL-HDBK-57C(IS)

<p>LANA INDUSTRIES 4404-D MCLEAN DRIVE HALTOM CITY FORT WORTH, TX 76117</p> <p style="text-align: center;">LI</p> <p>CAGE code: <u>2/</u></p>	<p>LANUM METAL PRODUCTS, INC. 4100 N. 16TH STREET PHILADELPHIA, PA 19140-3008</p> <p style="text-align: center;"></p> <p style="text-align: center;">L.M.T.</p> <p>CAGE code: 0CY73 <u>2/</u></p>
<p>LANARKSHIRE BOLT LTD. BURNBANK HAMILTON, LANARSHIRE ML3 OQU SCOTLAND</p> <p style="text-align: center;">L B </p> <p style="text-align: center;"><i>Raised letters</i></p> <p>CAGE code: K3565 <u>2/</u></p>	<p>LBL PRODUCTS 5395 INDUSTRIAL DRIVE UNIT A HUNTINGTON BEACH, CA 92649-1516</p> <p style="text-align: center;"></p> <p>CAGE code: 1HJ06 <u>2/</u></p>
<p>LAND-SEA-AIR MACHINED PRODUCTS, INC. P.O. BOX H FLEMING PIKE WINSLOW, NJ 08095</p> <p style="text-align: center;">L-S-A</p> <p>CAGE code: 8U768 <u>2/</u></p>	<p>LEBRECHT TIGGES GmbH & CO. KG P.O. BOX 12 04 85 W 5600 WUPPERTAL 12-CRONENBERG GERMANY</p> <p style="text-align: center;"></p> <p>CAGE code: <u>2/</u></p>
<p>LANIS MACHINE & MFG., CO. 2506 S. COOPER #A-9 ARLINGTON, TX 76015-1608</p> <p style="text-align: center;"></p> <p>CAGE code: 8V177 <u>2/</u></p>	

^{1/} Information published in this revision was verified by direct contact with manufacturers.

^{2/} Information not verified to be current, no response from manufacturer. Information identical to that published in MIL-HDBK-57, Revision B.

MIL-HDBK-57C(IS)







<p>LELAND-POWELL FASTENERS, INC. P.O. BOX 260 MARTIN, TN 38237</p> <p>Plant HIGHWAY 45 EAST SOUTH MARTIN, TN 38237</p>  <p>CAGE code: <u>2/</u></p>	<p>LEONARD JED CO MARYLAND BOLT AND NUT CO DIV (REPLACES MARYLAND BOLT & NUT CO., INC. -CAGE 76213) 1104 RUSSELL ST. BALTIMORE, MD 21230 - 2622</p>  <p>SAE J429 Grade 5 ASTM A449 MIL-B-857-A Grade 5</p> <p>NOTE: Also covers round head bolts, i.e., carriage-plow and countersunk styles, etc.</p>  <p>ASTM A193 Grade 8-7 Alloy steel high temperature service bolting Tempered to 125 KSI tensile strength</p> <p>NOTE: Also covers sq. head and countersunk styles. Heavy head hex or regular configurations</p>
<p>LENCH, THOMAS WILLIAM, LTD. P.O. BOX 31 EXCELSIOR WORKS CARNEGIE ROAD, ROWLEY REGIS B65 8BZ UNITED KINGDOM</p>  <p>Raised letters</p>  <p>Indented letters</p>  <p>Raised or indented letters</p> <p>CAGE code: U0039 <u>2/</u></p>	 <p>ASTM A490 Type 1</p> <p>NOTE: Also covers round head bolts, i.e., carriage-plow and countersunk styles, etc.</p>  <p>ASTM A394 Type T-0 Tower bolts: hex head, square head Head markings also include: T-1 for medium carbon and T-3 for weathering alloy steel. Both require heat treating</p> <p>NOTE: Round head step bolts require manufacturing head identification and proper markings as above, except length size</p>
<p>LENTERN (AIRCRAFT) LTD. MAIN RD, HAWKWELL, NR. HOCKLEY ESSEX SS5 4JJ GREAT BRITIAN, UK</p>  <p>CAGE code: <u>2/</u></p>	 <p>SAE J429 Grade 8 ASTM A354 Grade 80 Also (optional) that A354 is exhibited on top of head MIL-B-857-A Grade 8</p> <p>NOTE: Also covers round head bolts, i.e., carriage-plow and countersunk styles, etc.</p> <p>CAGE code: 52373 <u>2/</u></p> <p>Continued</p>

1/ Information published in this revision was verified by direct contact with manufacturers.







2/ Information not verified to be current, no response from manufacturer. Information identical to that published in MIL-HDBK-57, Revision B.

MIL-HDBK-57C(IS)

Continued
LEONARD JED CO MARYLAND BOLT AND
NUT CO DIV

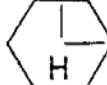
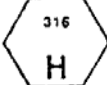
	ASTM A325 Type 1 NOTE: Also covers round head bolts, i.e., carriage-plow and countersunk styles, etc.
	ASTM A325 Type 3 NOTE: Also covers round head bolts, i.e., carriage-plow and countersunk styles, etc.
With line under A325 mark	
	SAE J429 Grade 2 ASTM A307 Grades A & B MIL-B-857-A Type 2 (ADM/5) NOTE: Also covers round head bolts, i.e., carriage-plow and countersunk styles, etc.
No Grade mark — only manufacturer's symbol	
	ASTM A490 Type 3 NOTE: Also covers round head bolts, i.e., carriage-plow and countersunk styles, etc.
With line under A490 mark	
	ASTM A193 Grade B-7-M Alloy steel high temperature service bolting Tempered to 100 ksi tensile strength NOTE: Also covers SQ head and countersunk styles Heavy head hex or regular configurations
Letters B7M on head	
	Manufacturer's symbol and the number 3 or DH3 on face For Grade C-3 three radial lines are also required Heavy hex applications for C-3 and heavy or regular for DH3 Nuts for bolt applications ASTM A325 type 3 ASTM A563 Grade C-3 Also covers square nut configurations
Heavy hex for type C-3	
Regular or heavy for DH3	
CAGE code: 52373 2/	
Continued	

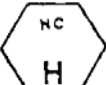





Continued
LEONARD JED CO MARYLAND BOLT AND
NUT CO DIV

	Manufacturer's symbol and the 2H or DH marking Also can be supplied in regular configurations Suitable for all Grade B and A325 or A490 bolts Nuts for bolt applications ASTM A194 Grade 2H ASTM A563 Grade DH Also covers square nut configurations
Heavy or regular	
	Manufacturer's symbol and three radial lines Heavy hex applications only Nuts for bolt applications ASTM A563 Grade C For ASTM A325 bolts Also covers square nut configurations
Heavy hex only	
CAGE code: 52373 2/	
LEVEL 1 FASTENERS 300 THIRD AVE HUNTINGTON, WV 25701	
	300 Series Stainless Steel
	Type 316 Stainless Steel
	Nickel Copper (Monel)
	
	
CAGE code: 17283 1/	

1/ Information published in this revision was verified by direct contact with manufacturers.

2/ Information not verified to be current, no response from manufacturer. Information identical to that published in MIL-HDBK-57, Revision B.

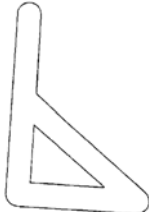
MIL-HDBK-57C(IS)

<p>LEVINGSTON MACHINE COMPANY 2428 MINNIS DR. HALTOM CITY, TX 76117-4856</p> <p style="text-align: center;">LM</p> <p>CAGE code: 46939 2/</p>	<p>LINREAD NORTHBRIDGE LEICESTER, UK VIKING ROAD WIGSTON, LEICESTER ENGLAND LE18 2BL</p> <p style="text-align: center;">NB</p> <p>CAGE code: U6683 1/</p>
<p>LEWIS SREW COMPANY (DIV OF MEDALIST FASTENERS INC.) 2550 S 27TH AVE. BROADVIEW, IL 60155 - 3851</p> <p> LEWIS SCREW COMPANY THE FASTENER SPECIALIST</p> <p> 120° INCLUDED ANGLE RAISED.</p> <p>INDENTED HEX HDS. AND INDENTED HEX WASHER HDS.</p> <p> LEWIS SCREW COMPANY THE FASTENER SPECIALIST</p> <p> 3-DASH MARKS 120° APART RAISED</p> <p>UNDER HEAD UPON REQUEST "NON-COUNTERSUNK HEADS ONLY"</p> <p>CAGE code: 1AW87 2/</p>	<p>LINREAD NORTHBRIDGE AIRCRAFT PRODUCT DIVISION CROSSGATE ROAD PARK FARM P.O. BOX 28 REDDITCH WORCESTERSHIRE B98 7TD UK</p> <p style="text-align: center;"></p> <p style="text-align: center;"></p> <p>CAGE code: K8753 2/</p>
<p>LFC INDUSTRIES INC. (DIVISION RKR TECHNOLOGIES) P. O. BOX 5982 1221 CORPORATE DRIVE WEST ARLINGTON, TX 76006-6103</p> <p style="text-align: center;">LFC</p> <p>CAGE code: 62384 1/</p>	

1/ Information published in this revision was verified by direct contact with manufacturers.

2/ Information not verified to be current, no response from manufacturer. Information identical to that published in MIL-HDBK-57, Revision B.

MIL-HDBK-57C(IS)

LINREAD PUBLIC LIMITED CO.
 (AIRCRAFT PRODUCTS DIVISION)
 P.O. BOX 28, CROSSGATE ROAD
 PARK FARM INDUSTRIAL EST. REDDITCH,
 WORCESTERSHIRE B98 7TD
 UNITED KINGDOM



Illustration No.	Notes
1, 2	<p>Y = Unified S quality</p> <p>WWE = Linread Keeley St. (was Warne Wright Engineering and which no longer trades under that name)</p> <p>M = Metric screws and bolts</p> <p>88 or 8.8 = Grade 8.8. Alternative markings such as 10.9 or 10.9 may appear as appropriate.</p>

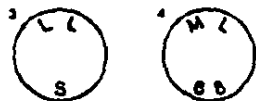

Illustration No.	Notes
3, 4	<p>LL or L = Linread Ltd</p> <p>S = Unified S quality. Alternative letters such as R and T may appear as appropriate.</p> <p>M = Metric screws and bolts</p> <p>88 or 8.8 = Grade 8.8. Alternative markings such as 10.9 or 10.9 may appear as appropriate.</p>

Illustration No.	Notes
3, 4. (Cont'd)	<p>↳ = Linread Plc</p>



CAGE code: K8753

Continued

2/

Continued

LINREAD PUBLIC LIMITED CO.
 (AIRCRAFT PRODUCTS DIVISION)
 P.O. BOX 28, CROSSGATE ROAD
 PARK FARM INDUSTRIAL EST. REDDITCH,
 WORCESTERSHIRE B98 7TD
 UNITED KINGDOM

Illustration No.	Notes
5, 6	<p>↳ = Linread Plc</p> <p>S = Unified S quality. Alternative letters such as R and T may appear as appropriate.</p> <p>M = Metric screws and bolts</p> <p>88 or 8.8 = Grade 8.8. Alternative markings such as 10.9 or 10.9 may appear as appropriate.</p>

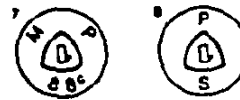

Illustration No.	Notes
7, 8	<p>↳ = Trilobular screws and bolts. Various letters may appear, viz</p> <p>M = Metric. Absence of other letters indicate Duo-Taptite or Taptite parts.</p> <p>P = Powerlok</p> <p>C = Carbon restored surface, i.e., with no decarburization permitted but not case hardened.</p> <p>N = Neutral or through hardened</p> <p>I = Induction hardened lead threads</p> <p>S = Unified S quality. Alternative letters such as R and T may appear as appropriate.</p> <p>88 or 8.8 = Grade 8.8. Alternative markings such as 10.9 or 10.9 may appear as appropriate.</p>



CAGE code: K8753

2/

1/ Information published in this revision was verified by direct contact with manufacturers.

2/ Information not verified to be current, no response from manufacturer. Information identical to that published in MIL-HDBK-57, Revision B.

MIL-HDBK-57C(IS)

<p>LIPPISCHE EISENINDUSTRIE GmbH ALTER WEG 57 D-4930 GERMANY</p> <p style="text-align: center;">LE</p> <p>CAGE code: 2/</p>	<p>Continued</p> <p>LISI AEROSPACE see BLANC AERO INDUSTRIES</p> <p><i>Plant</i> BLANC AERO INDUSTRIES VILLEFRANCHE DE ROUERGUE 18, RUE JEAN VAURS 12200 VILLEFRANCHE DE ROUERGUE FRANCE</p> <p style="text-align: center;">P </p> <p>CAGE code: F0188</p>
<p>LISI AEROSPACE LISI AEROSPACE CANADA TOUR GAMMA A 193, RUE DE BERCY 75582 PARIS CEDEX 12 FRANCE</p> <p><i>Plant</i> A1 TECHNOLOGIES 7022 ALONDRA BLVD PARAMOUNT, CA 90723 3926</p> <p>NO SYMBOL LISTED</p> <p>CAGE code:</p>	<p><i>Plant</i> BLANC AERO INDUSTRIES RUGBY RUGBY WARWICKSHIRE CV21 3 RQ ENGLAND</p> <p style="text-align: center;"><u>hs</u></p> <p>CAGE code: U6300</p>
<p><i>Plant</i> LISI AEROSPACE CANADA 2000, PLACE TRANSCANADIENNE DORVAL (QUÉBEC) H9P 2K5 CANADA</p> <p style="text-align: center;">L</p> <p>CAGE code: L4528</p> <p>Continued 1/</p>	<p><i>Plant</i> BLANC AERO INDUSTRIES SAINT OUEN L'AUMONE 95310 SAINT OUEN L'AUMONE FRANCE</p> <p style="text-align: center;">T </p> <p><u>Ɔ</u> (Sr Briouc) B (Paris) P (Villefranche de Rouergue)</p> <p>ds. F</p> <p>CAGE code: F0188 1/</p> <p>Continued</p>

1/ Information published in this revision was verified by direct contact with manufacturers.

2/ Information not verified to be current, no response from manufacturer. Information identical to that published in MIL-HDBK-57, Revision B.

MIL-HDBK-57C(IS)

Continued

LISI AEROSPACE

Plant
BLANC AERO TECHNOLOGIES
B.P. 215
22002 SAINT BRIEUC CEDEX 1
FRANCE

CAGE code: F0188

Plant closed
DECOLLETAGE GENERAL MODERNE
DECOLLETAGE MODERNE 5 BIS, PLACE
LEON BLUM

Plant
FT BESTAS
35410 GAZIEMIR-IZMIR
TURKEY

CAGE code: T0802

Plant
HI-SHEAR CORPORATION
see HI-SHEAR
260 SKYPARK DR.
TORRANCE, CA 90509-2975

CAGE code: 73197
Continued1/

Continued

LISI AEROSPACE

Plant
MONADNOCK
18301 EAST ARENTH AVE.
CITY OF INDUSTRY, CA 91748-1288

(a dot)

CAGE code: 60119

1/1/ Information published in this revision was verified by direct contact with manufacturers.2/ Information not verified to be current, no response from manufacturer. Information identical to that published in MIL-HDBK-57, Revision B.



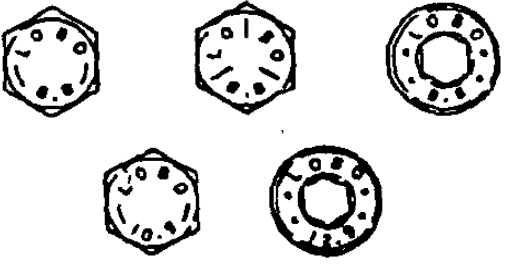



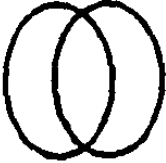

MIL-HDBK-57C(IS)

<p>LITTLE WORLD MANUFACTURING, INC. 1083 FOREST RD. WEST CHESTER, PA 19380</p> <p>Plant 525 WEST SOUTH STREET KENNETT SQUARE, PA 19348</p> <p>L<W>M</p> <p>CAGE code: 6T569 2/</p>	<p>LOBO SYSTEMS LTD 26 THE PARKER CENTRE MANSFIELD ROAD DERBY DE21 4SZ ENGLAND</p> <p>LOBO™</p> <p>CAGE code: KE018 1/</p>
<p>LLOYD MACHINE & TOOL CO., INC. 234 BROAD AVENUE WILMINGTON, CA 90744-5812</p> <p>LM</p> <p>CAGE code: 01334 2/</p>	<p>LONE STAR FASTENERS, LP (PREVIOUS LISTED AS LONE STAR SCREW CO OF TEXAS INC P.O. BOX 1149 SPRING, TX 77373</p> <p>Plant 24131 HARDY ROAD SPRING, TX 77373</p> <p>L Precedes grade marking (example: LB7)</p> <p>CAGE code: 7H174 1/</p>
<p>LN AEROSPACE, INC. 6011 TENSION DRIVE FORT WORTH, TX 76112-2693</p> <p>LNA</p> <p>CAGE code: 1EB45 2/</p>	<p>LONG-LOK FASTENERS CORP. 10630 CHESTER RD CINCINNATI, OH 45215-1206</p> <p>Plant 14119 CHADRON AVE. LOS ANGELES, CA 90250</p> <p>CAGE code: 03038</p> <p>LL or LONG LOK or LL</p> <p>CAGE code: 16941, plant 03038 1/</p>
<p>LOBO OFFICINE MECCANICHE SPA VIA T. EDISON CORANAREDO, MILANO ITALY 20010</p>  <p>CAGE code: A1208 2/</p>	

1/ Information published in this revision was verified by direct contact with manufacturers.

2/ Information not verified to be current, no response from manufacturer. Information identical to that published in MIL-HDBK-57, Revision B.





MIL-HDBK-57C(IS)

<p>LOOS & CO., INC. AEROSPACE FASTENERS DIVISION ROUTE 101 POMFRERT, CT 06258-0098</p>  <p>CAGE code: 59157 <u>1/</u></p>	<p>M & M MANUFACTURING CORPORATION 5611 KIMBALL CT CHINO , CA 91710</p>  <p>CAGE code: 0X598 <u>2/</u></p>
<p>LORD CORPORATION AEROSPACE PRODUCTS DIVISION 1635 WEST 12TH STREET P.O. BOX 3694 ERIE, PA 16508 – 0694</p> <p>CAGE code: 0PJN4</p>  <p>Plant MECHANICAL PRODUCTS DIVISION 4644 WADSWORTH RD. DAYTON, OH 45414 – 4220</p> <p>CAGE code: 30061</p>  <p>CAGE code: 0PJN4, 30061 <u>2/</u></p>	<p>M.A.A. CORP, MID AMERICA AEROSPACE DIVISION 16201 WEST 110TH STREET SHAWNEE MISSION, KS 66285</p>  <p>CAGE code: <u>2/</u></p>
<p>LOUGHLIN MANUFACTURING CORP. 1580 RAILROAD AVE HOLBROOK, N.Y. 11741-2301</p>  <p>CAGE code: 65782 <u>1/</u></p>	<p>M.L.W. MANUFACTURING CO. P.O. BOX 8445 NEW HAVEN, CT 06511</p> <p>Plant 240 SARGENT DRIVE NEW HAVEN, CT 06511</p>  <p>CAGE code: 0GH69 <u>2/</u></p> <p>M.S. AEROSPACE 3150 DAMON WAY SYLMAR, CA 91342-1005</p>  <p>CAGE code: OUCY9 <u>1/</u></p>

1/ Information published in this revision was verified by direct contact with manufacturers.

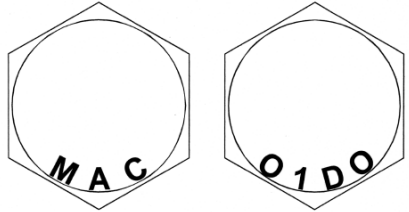
2/ Information not verified to be current, no response from manufacturer. Information identical to that published in MIL-HDBK-57, Revision B.

MIL-HDBK-57C(IS)

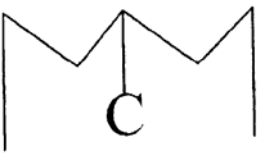
<p>MAC FASTENERS, INC. 11110 ENTERPRISE ST. OTTAWA, KS 66067-3803</p>  <p>GOTHIC LETTERS "MAC" GOTHIC LETTERS AND NUMERAL "O1DO"</p> <p>CAGE code: ORFT4 1/</p>	<p>MACK, A. W. MFG CO. 516 DUTCHESS TURNPIKE POUGHKEEPSIE, NY 12603</p>  <p>CAGE code: 32448 2/</p>
<p>MACHINE SHOP, INC., THE 470 AIR PARK RD ATWATER, CA 95301</p>  <p>CAGE code: 8T052 2/</p>	<p>MACKO INDUSTRIES HWY 39 AT FM RD. 1340 P.O. BOX 170 HUNT, TX 78024-0170</p>  <p>CAGE code: 1CN43 2/</p>
<p>MACHINERITE CORP. SYCAMORE & MILL RDS. CLIFTON HTS, PA 19018</p>  <p>CAGE code: 7J299 2/</p>	<p>MACKSON MFG CORP. 2338 SOUTHWAY DRIVE ROCK HILL, SC 29730</p>  <p>CAGE code: 093Y9 2/</p>

1/ Information published in this revision was verified by direct contact with manufacturers.

2/ Information not verified to be current, no response from manufacturer. Information identical to that published in MIL-HDBK-57, Revision B.

MIL-HDBK-57C(IS)

MACLEAN-ESNA
 (formally Elastic Stop Nut)
 611 COUNTRY CLUB RD.
 POCAHONTAS, AR 72455

E

EN

ESNA

RED NYLON INSERT INDICATES
 MACLEAN-ESNA AS
 MANUFACTURER

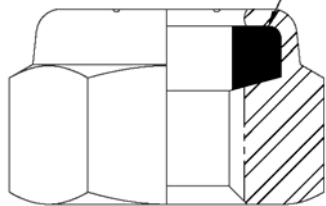

CAGE code: 019L2

1/

MACLEAN-FOGG CO.
 2551 WACKER RD.
 SAVANNA, IL 61074

*Flange nuts less lock and with
 Uni-Torque® lock
 Two raised bars*

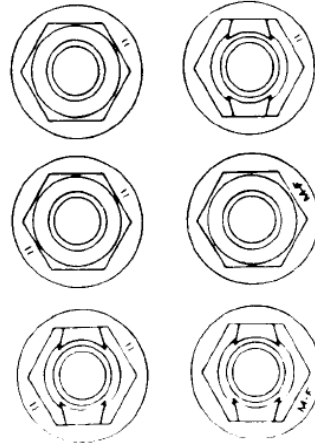

Hex and flange screws/bolts

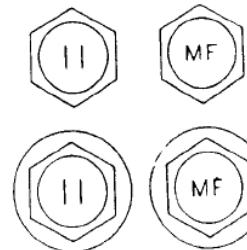

Hex nuts and Uni-Torque® locknuts

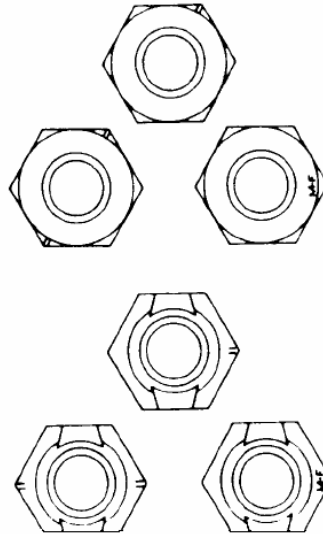





CAGE code: 0AMX8

2/

1/ Information published in this revision was verified by direct contact with manufacturers.

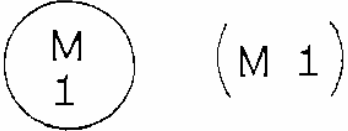
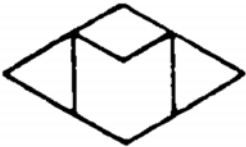
2/ Information not verified to be current, no response from manufacturer. Information identical to that published in MIL-HDBK-57, Revision B.







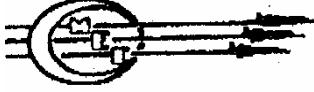

MIL-HDBK-57C(IS)

<p>MACOR, INC. 130 HOFFMAN LN CENTRAL ISLIP, NY 11722</p>  <p>CAGE code: 2A269 2/</p>	<p>MAIN MACHINE CO INC. DBA MAIN MACHINE & TOOL CO 116 MARINE STREET FARMINGDALE, NY 11735-5608</p> <p style="text-align: center;">MMT</p> <p>CAGE code: 05879 1/</p>
<p>MAGNUM MACHINE SHOP 768 HOMEWARD PL SAN JOSE, CA 95123-2906</p> <p style="text-align: center;">1YFG0</p> <p>CAGE code: 1YFG0 2/</p>	<p>MANNO, RICHARD & CO., INC. 42 LAMAR ST NORTH BABYLON, NY 11704</p> <p style="text-align: center;">R/M</p> <p>CAGE code: 0RGV4 2/</p>
<p>MAGNUS TOOL & DIE CO., INC. 256 SHEFFIELD ST. MOUNTAINSIDE, NJ 07092</p>  <p>CAGE code: 37752 2/</p>	<p>MANUFACTURING ENGINEERING TECH. 2758 AIELLO DR. SAN JOSE, CA 95111-2134</p>  <p>CAGE code: 1CC57 2/</p>
<p>MAILLY MFG CO., INC. P. O. BOX 6143 45 WAKELEE ROAD WOLCOTT, CT 06716-2620</p>  <p>CAGE code: 3L606 1/</p>	<p>MANUFACTURING SALES AND SERVICE 10631 BLOOMFIELD AVE #16 LOS ALAMITOS, CA 90720</p>  <p>CAGE code: 1S9V3 2/</p>

1/ Information published in this revision was verified by direct contact with manufacturers.

2/ Information not verified to be current, no response from manufacturer. Information identical to that published in MIL-HDBK-57, Revision B.

MIL-HDBK-57C(IS)

<p>MAPECO PRODUCTS, INC. 725 GLEN GLOVE AVE. P.O. BOX 6 GLEN HEAD, NY 11545</p>  <p>CAGE code: 4P839 2/</p>	<p>MARVIN ENGINEERING, CO., INC. 260 WEST BEACH AVENUE INGLEWOOD, CA 90302-2903</p>  <p>CAGE code: 32067 2/</p>
<p>MAR-BRO MFG., INC. 5717 W. WASHINGTON STREET PHOENIX, AZ 85043-3650</p>  <p>CAGE code: 2/</p>	<p>MARYLAND BOLT & NUT CO., INC. LEONARD JED CO 1104 RUSSELL ST. BALTIMORE, MD 21230-2622</p>  <p>SAE J429 Grade 5 ASTM A448 MIL-B-857-A Grade 5</p> <p>NOTE: Also covers round head bolts, i.e., carriage-plow and countersunk styles, etc.</p>  <p>ASTM A193 Grade B-7 Alloy steel high temperature service bolting Tempered to 125 KSI tensile strength</p> <p>NOTE: Also covers sq. head and countersunk styles. Heavy head hex or regular configurations</p>  <p>ASTM A490 Type 1</p> <p>NOTE: Also covers round head bolts, i.e., carriage-plow and countersunk styles, etc.</p>  <p>ASTM A394 Type T-0 Tower bolts: hex head, square head Head markings also include: T-1 for medium carbon and T-3 for weathering alloy steel. Both require heat treating</p> <p>NOTE: Round head step bolts require manufacturing head identification and proper markings as above, except length size</p> <p>CAGE code: 76213(canceled) Replaced by 52373 2/ Continued</p>
<p>MARTIN-CHANDLER, INC. 122 EAST ALONDRA BOULEVARD GARDENA, CA 902</p>  <p>CAGE code: 22625 2/</p>	
<p>MARUYKO NUT CO., LTD. 2-4-15 NAKANO-CHO, HIGASHI TONDABAYASHI-SHI OSAKA 584 JAPAN</p>  <p>CAGE code: 2/</p>	







1/ Information published in this revision was verified by direct contact with manufacturers.

2/ Information not verified to be current, no response from manufacturer. Information identical to that published in MIL-HDBK-57, Revision B.

MIL-HDBK-57C(IS)

Continued

MARYLAND BOLT & NUT CO., INC.



	<p>SAE J429 Grade 8 ASTM A354 Grade BD</p> <p>Also (optional) that A354 is exhibited on top of head</p> <p>MIL-B-857-A Grade 8</p> <p>NOTE: Also covers round head bolts, i.e., carriage-plow and countersunk styles, etc.</p>
	<p>ASTM A325 Type 1</p> <p>NOTE: Also covers round head bolts, i.e., carriage-plow and countersunk styles, etc.</p>
	<p>ASTM A325 Type 3</p> <p>NOTE: Also covers round head bolts, i.e., carriage-plow and countersunk styles, etc.</p>
	<p>SAE J429 Grade 2 ASTM A307 Grades A & B MIL-B-857-A Type 2 (ADM/5)</p> <p>NOTE: Also covers round head bolts, i.e., carriage-plow and countersunk styles, etc.</p>
	<p>ASTM A490 Type 3</p> <p>NOTE: Also covers round head bolts, i.e., carriage-plow and countersunk styles, etc.</p>
	<p>ASTM A193 Grade B-7-M Alloy steel high temperature service bolting Tempered to 100 ksi tensile strength</p> <p>NOTE: Also covers SQ head and countersunk styles Heavy head hex or regular configurations</p>

CAGE code: 76213(canceled)
Replaced by 52373 2/

Continued

Continued

MARYLAND BOLT & NUT CO., INC.

	<p>Manufacturer's symbol and the number 3 or DH3 on face</p> <p>For Grade C-3 three radial lines are also required</p> <p>Heavy hex applications for C-3 and heavy or regular for DH3</p> <p>Nuts for bolt applications</p> <p>ASTM A325 type 3</p> <p>ASTM A563 Grade DH3</p> <p>Also covers square nut configurations</p>
	<p>Manufacturer's symbol and the 2H or DH marking</p> <p>Also can be supplied in regular configurations</p> <p>Suitable for all Grade 8 and A325 or A490 bolts</p> <p>Nuts for bolt applications</p> <p>ASTM A194 Grade 2H</p> <p>ASTM A563 Grade DH</p> <p>Also covers square nut configurations</p>
	<p>Manufacturer's symbol and three radial lines</p> <p>Heavy hex applications only</p> <p>Nuts for bolt applications</p> <p>ASTM A563 Grade C</p> <p>For ASTM A325 bolts</p> <p>Also covers square nut configurations</p>

CAGE code: 76213(canceled)
Replaced by 52373 2/

MASTER RESEARCH & MFG., INC.
13528 PUMICE ST
NORWALK, CA 90650 - 5249









M
R
M

CAGE code: 9U245 2/

1/ Information published in this revision was verified by direct contact with manufacturers.

2/ Information not verified to be current, no response from manufacturer. Information identical to that published in MIL-HDBK-57, Revision B.

MIL-HDBK-57C(IS)

<p>MASTERCRAFT TOOL COMPANY 13743 SHORELINE CT E EARTH CITY, MO 63045 - 1202</p>  <p>CAGE code: 2M351 <u>2/</u></p>	<p>MCCULLOUGH AERO CO. DBA MCCULLOUGH & ASSOCIATES 23891 MADISON STREET TORRANCE, CA 90505-6008</p>  <p>CAGE code: 04273 <u>2/</u></p>
<p>MAUDLE INDUSTRIAL CO., LTD. 1-20 TSAO HU ROAD TALI CITY, TAIWAN 41245</p>  <p>CAGE code: SH978 <u>2/</u></p>	<p>MCLANE MFG INC. P. O. BOX 438 7210 ROSECRANS AVE. PARAMOUNT, CA 90723 - 0438</p>  <p>CAGE code: 52706 <u>2/</u></p>
<p>MAUI MEGA DBA KERR CHARLES W JAY-CEE INDUSTRIAL PARK RIVER RD. BLDG. PP-1 BRISTOL, PA 19007</p> <p>see KERR CHARLES W</p>  <p>CAGE code: 0M4F0 <u>2/</u></p>	<p>McMELLON BROS INC. 915 HONEYSPOT RD. STRATFORD, CT 06615 - 7192</p> <p>05141</p>   <p>CAGE code: 05141 <u>1/</u></p>
<p>MCADAMS MACHINE AND TOOL CO. 2853 E FLORENCE AVE HUNTINGTON PARK, CA 90255</p>  <p>CAGE code: 0UUE2 <u>2/</u></p>	

1/ Information published in this revision was verified by direct contact with manufacturers.

2/ Information not verified to be current, no response from manufacturer. Information identical to that published in MIL-HDBK-57, Revision B.

MIL-HDBK-57C(IS)

MD3 INDUSTRIES LTD
108 W HOLLOWAY DR
HURST, TX 76053 - 6807

See EMPIRE PRECISION MACHINING



CAGE code: 1/

MEACO PRODUCTS CORP.
99 PECK HILL ROAD
JOHNSTON, RI 02919-4510



CAGE code: 032Z0 2/

MEC WOLF SRL
VIA MILANO, 5
22036 ERBA (CO) ITALY



The lot identification "xy" (letter + numb.) is embossed on the ring.

The manufacturer's mark "W" is embossed on the crown.

CAGE code: 2/

MECAERO PRODUCTS
AFS TOULOUSE OPERATIONS
BD DU GRAND CASTING
ROQUES-SUR-GARONNE
31128 PORTET SUR GARONNE CEDEX
FRANCE

(Corporate office see ALCOA FASTENING SYSTEMS)



CAGE code: F7411 1/

MECAERO CANADA INC.
2250 COHEN
VILLE ST-LAURENT
QUEBEC, H4R 9Z7
CANADA



CAGE code: 2/

MECAIR AEROSPACE INDUSTRIES
SUBSIDIARY OF SPS TECHNOLOGIES DIV
DIVISION OF SPS TECHNOLOGIES
DBA MECAIR INC
225 LABROSSE
PT. CLAIRE, CANADA H9R 1A3



CAGE code: 0HL40 2/

1/ Information published in this revision was verified by direct contact with manufacturers.

2/ Information not verified to be current, no response from manufacturer. Information identical to that published in MIL-HDBK-57, Revision B.







MIL-HDBK-57C(IS)

<p>MECHANICAL & INDUSTRIAL FASTENERS 1145 JANSEN FARM DRIVE ELGIN, IL 60123</p> <p style="text-align: center;">MI</p> <p style="text-align: center;">MIF</p> <p style="text-align: center;">MIF</p> <p>CAGE code: 0P8N1 2/</p>	<p>MERCER PRODUCTS & MFG. CO., INC. 401 S. WEBSTER STREET SEATTLE, WA 98108 - 4137</p> <p style="text-align: center;">MP</p> <p>CAGE code: 30205 1/</p>
<p>MECHANICAL INDUSTRIES LLC 8900 NORTH 51ST STREET MILWAUKEE, WISCONSIN 53223-2402</p> <p style="text-align: center;">M I</p> <p>CAGE code: 1U732 2/</p>	<p>MERCURY AREOSPACE INC. 20320 PRARIE STREET CHATSWORTH, CA 91313</p> <p style="text-align: center;">M M</p> <p style="text-align: center;">M - Mercury</p> <p style="text-align: center;">- Aerospace</p> <p>CAGE code: 50945 2/</p>
<p>MEL-BA MANUFACTURING INC. 777 SUGAR LN ELYRIA , OH 44035 - 5631</p> <p style="text-align: center;">..MEL-BA..</p> <p>CAGE code: 3A092 2/</p>	<p>MERCURY TOOL & MACHINE, INC. P.O. BOX 5190 WACO, TX 76708-5190</p> <p>Plant AIRPORT DRIVE & ZOO PARK DR. WACO, TX 76708-5190</p> <p style="text-align: center;">MTM</p> <p>CAGE code: 01982 2/</p>

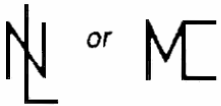
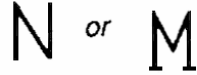
1/ Information published in this revision was verified by direct contact with manufacturers.

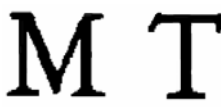
2/ Information not verified to be current, no response from manufacturer. Information identical to that published in MIL-HDBK-57, Revision B.

MIL-HDBK-57C(IS)

<p>METALCRAFTERS (DIVISION OF KEYSTONE CONSOLIDATED INDUSTRIES) 4500 KISHWAUKEE STREET P.O. BOX 7005 ROCKFORD, IL 61125-7005</p> <p> <i>Indented hex & hex washer heads</i></p> <p> <i>Hex cap screws - low carbon steel</i></p> <p> <i>Mis. markings for screws & bolts</i></p> <p>CAGE code: <u>2/</u></p>	<p>METRO TOOL & MANUFACTURING CO. ALSO SEE ALEXANDER MANUFACTURING COMPANY INC 2402 ARKANSAS LANE GRAND PRAIRIE, TX 75052-7203</p> <p></p> <p>CAGE code: 2M919 <u>1/</u></p>
<p>METAL-TECH MFG. INC. 1445 SOUTH 18TH ST. CLINTON, IA 52732-6703</p> <p></p> <p>CAGE code: 3BNL5 <u>1/</u></p>	<p>METRIX MFG. CO. 840 BRITTAN AVE. SAN CARLOS, CA 94070-4181</p> <p> METRI METRIX</p> <p>CAGE code: <u>2/</u></p>
<p>METHODS AND MACHINING SERVICES CO. 140 UXBRIDGE ST CRANSTON, RI 02920-4811</p> <p></p> <p>CAGE code: 0FYD8 <u>2/</u></p>	<p>MI. ME. AF. S.r.1. C.so EUROPA, 240 24032 CALOZIOCORTE (BG) ITALY</p> <p></p> <p>CAGE code: <u>2/</u></p>
	<p>MICRO SCREW MACHINE PRODUCTS, INC. 71 ROOSEVELT AVE CARTERET, NJ 07008</p> <p></p> <p>CAGE code: 43808 <u>2/</u></p>

1/ Information published in this revision was verified by direct contact with manufacturers.

2/ Information not verified to be current, no response from manufacturer. Information identical to that published in MIL-HDBK-57, Revision B.

MIL-HDBK-57C(IS)

MICRODOT INC.
 MICRODOT AEROSPACE FASTENING
 SYSTEMS GROUP ADVANCED PRODUCTS
 DIV
 190 W CROWTHER AVE
 PLACENTIA, CA 92670 - 5687



KAYNAR TECHNOLOGIES INC
 MICRODOT DIV
 800 SOUTH STATE COLLEGE
 BOULEVARD
 P.O. BOX 3001
 PLACENTIA, CA 92670 - 5687
 CAGE code: 1EJY4



Used on sheet metal or stamped products.



Used on forged or foreign products



Two parallel lines used on Spiralock® products only





Used on metric products



Used on miscellaneous and general Kaynar products

MICRODOT INSERTS DEVISION
 10 S. LA SALLE STREET
 SUITE 3500
 CHICAGO, IL 60603
 CAGE code: 51204

Three parallel lines spiralok insert products only

CAGE code: 0BPE9 2/

MID CONTINENT SCREW PRODUCTS CO.
 3701 WEST LUNT AVE.
 LINCOLNWOOD, IL 60712



CAGE code: 1QMD3 2/

MID-STATES SCREW CORP.
 (ILLINOIS CORPORATION)
 1817 EIGHTEENTH AVENUE
 ROCKFORD, IL 61101



CAGE code: 17264 2/

MIDWEST ACORN NUT CO.
 256 MINNESOTA AVE.
 TROY, MI 48083



CAGE code: 98960 2/

MILLIPART, INC.
 412 W. CARTER DRIVE
 GLENDORA, CA 91740-5968



CAGE code: 31095 2/

1/ Information published in this revision was verified by direct contact with manufacturers.

2/ Information not verified to be current, no response from manufacturer. Information identical to that published in MIL-HDBK-57, Revision B.

MIL-HDBK-57C(IS)

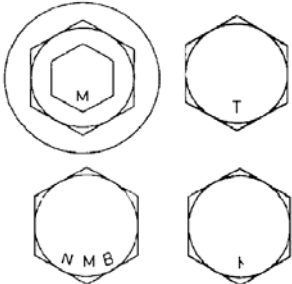

<p>MILLS, J. R. MACHINING, INC 815 McCORD HOLLOW ROAD HOHENWALD, LEWIS, TN 38462</p> <p>(0LT-22) B</p> <p>N N</p> <p>(0LT-22) N</p> <p>CAGE code: 0LT22 2/</p>	<p>MIROFINE COMPANY 1940 W. 144TH STREET GARDENA, CA 90249-2928</p> <p style="text-align: center;">MFR 1L071</p> <p>CAGE code: 1L071 2/</p>
<p>MIL-SPEC FASTENERS CORP. 314 HANOVER PIKE HAMPSTEAD, MD 21074-9999</p> <p style="text-align: center;">MSF</p> <p>CAGE code: 356S3 2/</p>	<p>MI-TECH, INC. 6685 JET PARK DRIVE N. CHARLESTON, SC 29406-4700</p> <p style="text-align: center;">MI-TECH, INC.</p> <p>CAGE code: 9J758 2/</p>
<p>MINEBEA CO. LTD FUJISAWA MANUFACTURING UNIT 1-1-1 KATASE, FUJISAWA CITY KANAGAWA 251-8531 JAPAN</p> <p style="text-align: center;">  Trademark, Takyo Rashi </p> <p style="text-align: center;">  </p> <p>CAGE code: SB962 1/</p>	<p>MITSUBOSHI INDUSTRIES, LTD. (OSAKA DIVISION) 4-16-1 CHOME, MIDORIGI SUMINOE-KU, OSAKA 559 JAPAN</p> <p style="text-align: center;">N</p> <p style="text-align: center;">NK</p> <p style="text-align: center;">NKYM</p> <p>CAGE code: 2/</p>

1/ Information published in this revision was verified by direct contact with manufacturers.

2/ Information not verified to be current, no response from manufacturer. Information identical to that published in MIL-HDBK-57, Revision B.

MIL-HDBK-57C(IS)

MIX TOOL CO.
212 E. CEDAR STREET
COMPTON, CA 90220

CAGE code: 27643 2/

MKM MACHINE TOOL COMPANY INC.
100 TECHNOLOGY WAY
JEFFERSONVILLE, IN 47130-9644

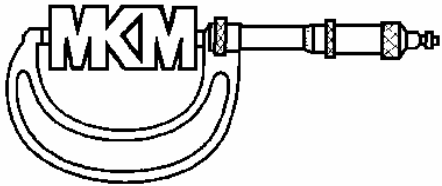

CAGE code: 8L583 2/

M-MANUFACTURING
P.O. BOX 897
ROANOKE, TX 76272

Plant
HYW. 114 & DOVE RD.
ROANOKE, TX 76262



CAGE code: 2/

MMG ENGINEERED COMPONENTS INC.
DBA TOOLSOURCE
3901 N. CARNATION
FRANKLIN PARK, IL 60131-1201

SOCKET HEAD
CAP SCREWS

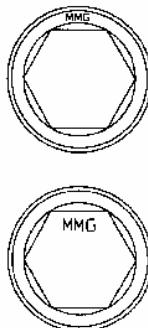
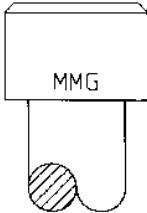
HEX HEADS
(GRADE 8)

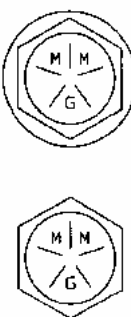

HEX HEADS
(GRADE 5)

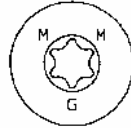

OTHER

CAGE code: 3JMF9 1/

1/ Information published in this revision was verified by direct contact with manufacturers.

2/ Information not verified to be current, no response from manufacturer. Information identical to that published in MIL-HDBK-57, Revision B.

MIL-HDBK-57C(IS)

MNP CORPORATION
 P.O. BOX 189002
 UTICA, MI 48318-9002

MNP FASTENER DIVISION
 44225 UTICA RD
 UTICA, MI 48318-9002
 CAGE code: 3R364

PLANT 2
 MNP CORPORATION DIVISION 2
 1524 E 14 MILE RD
 MADISON HEIGHTS, MI 48071-1542
 CAGE code: 064S9

PLANT 4
 MNP CORPORATION DIVISION 4
 2211 BEARD STREET
 PORT HURON, MI 48060-6424
 CAGE code: 1U3X0

MNP fasteners



Highland bolts & nut



Small screw



Viking fasteners



CAGE code: 3R364, 064S9, 1U3X0 1/

MODERN METRIC MACHINE COMPANY
 INC
 101 W. NICHOLSON ROAD
 AUDOBON, NJ 08106-1411



CAGE code: 1F6H56 2/

MODFORM-ILLINOIS, INC.
 500 36TH ST
 EAST MOLINE, IL 61244



CAGE code: 46501 2/

MONADNOCK COMPANY, THE
 DBA LISI AEROSPACE
 18301 ARENTH AVE.
 CITY OF INDUSTRY, CA 91748-1226

See LISI AEROSPACE







. (a dot)

CAGE code: 60119 1/

1/ Information published in this revision was verified by direct contact with manufacturers.

2/ Information not verified to be current, no response from manufacturer. Information identical to that published in MIL-HDBK-57, Revision B.

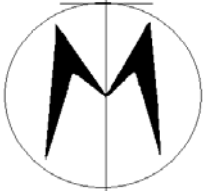



MIL-HDBK-57C(IS)

<p>MONOGRAM AEROSPACE FASTENERS 3423 SOUTH GARFIELD AVE. LOS ANGELES, CA 90040-3103</p> <p>FASTENER HEAD MARKINGS</p> <p>N  Used on Jo-Bolts and Visu-Lok® permanent blind fasteners</p> <p>MI  Used on Composi-Loks®, Double Flush Bolts, Lock Bolts and new products in the permanent fastener product line</p> <p>BODY MARKINGS</p> <p>MONOGRAM WEDGELOCK</p> <p>  Trademark "Wedgeloctite" or "Monogram", depressed. Used on temporary fasteners</p> <p>CAGE code: 98524 1/</p>	<p>MONTEREY MACHINE PRODUCTS 1504-A INDUSTRIAL PARK STREET COVINA, CA 91722-3417</p> <p style="text-align: center;">MP</p> <p>CAGE code: 1UD00 2/</p>
<p>MONROE MACHINED PRODUCTS, INC. 1422 S. 192nd ST SEATTLE, WA 98148-2314</p> <p style="text-align: center;"></p> <p>CAGE code: 7F311 2/</p>	<p>MORTON FASTENERS INC. 4544 RUNWAY DR. LANCASTER, CA 93536</p> <p style="text-align: center;">MFI</p> <p>CAGE code: 4DU57 1/</p>
	<p>MORTON MANUFACTURING (DIVISION MORTON GRINDING) 17341 W. SIERRA HIGHWAY SANTA CLARITA, CA 91351-1162</p> <p style="text-align: center;">   </p> <p>CAGE code: 2T498 1/</p>
	<p>MOSTAR GEAR & MACHINE MFG., CO. 201 E. FRANKLIN PALESTINE, IL 62451</p> <p style="text-align: center;"></p> <p>CAGE code: OHN25 2/</p>

1/ Information published in this revision was verified by direct contact with manufacturers.

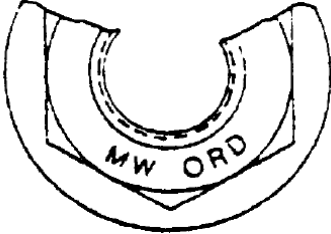
2/ Information not verified to be current, no response from manufacturer. Information identical to that published in MIL-HDBK-57, Revision B.



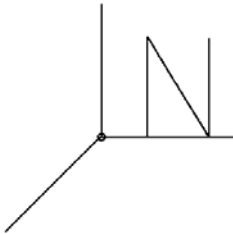



MIL-HDBK-57C(IS)

<p>MOTOR WHEEL CORP. 4000 COLLINS RD. LANSING, MI 48910</p> <p>Plant 1600 N. LARCH STREET LANSING, MI 48906</p>  <p>CAGE code: 4H871 <u>2/</u></p>	<p>NAFCO INDUSTRIES, INC. P.O. BOX 1893 CARSON CITY, NV 89702</p>  <p>CAGE code: 32387 <u>2/</u></p>
<p>MRL MANUFACTURING CORP. P.O. BOX 8440 59 LEE AVE HALEDON, NJ 07508</p> <p>Plant 525 LAFAYETTE AVENUE HAWTHORE, NJ 07506</p>  <p>CAGE code: 0GUF9 <u>1/</u></p>	<p>NAGOYA SCREW MANUFACTURING CO, LTD. 17-16 TSUBAKI-CHO I NAKAMURA-KU NAGOYA-SHI AICHI-KEN, JAPAN</p>  <p>NRS</p> <p>CAGE code: SC006 <u>2/</u></p>
<p>N.S.S. INDUSTRIES 9075 GENERAL DRIVE PLYMOUTH, MI 48170</p>  <p>CAGE code: <u>2/</u></p>	<p>NAPIER'S AUTO BODY 49879 HWY 101 STH. P. O. BOX 278 BRANDON, OR 97411-1824</p>  <p>CAGE code: 1NXQ4 <u>1/</u></p>

1/ Information published in this revision was verified by direct contact with manufacturers.

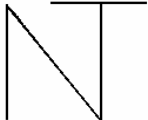
2/ Information not verified to be current, no response from manufacturer. Information identical to that published in MIL-HDBK-57, Revision B.







MIL-HDBK-57C(IS)

<p>NARRAGANSETT SCREW MFG., CO. P.O. BOX 2242 119 ROWLEY ST WINSTED, CT 06098 - 2068</p>  <p>CAGE code: OHP15 <u>2/</u></p>	<p>NATIONAL FASTENER CO., LTD. #973 YANG DUCK-DANG MASAN REPUBLIC OF KOREA</p>  <p>CAGE code: <u>2/</u></p>
<p>NASU DENKI-TEKKO CO., LTD. 1-1-14 SHINJUKU, SHINJUKU-KU TOKYO 160 JAPAN</p> <p>SUNAMACHI FACTORY 3-5-28 SHINSUNA, ETO-KU, TOKYO, JAPAN 136</p>  <p>CAGE code: <u>2/</u></p>	<p>NATIONAL THREADED FASTENERS CORP. 630 LIVELY BOULEVARD ELK GROVE VILLAGE, IL 60007</p>  <p>CAGE code: <u>2/</u></p>
<p>NATIONAL BOLTS & RIVETS LTD. P.O. BOX 5063, BOKSBURG NORTH 1461 SOUTH AFRICA</p>  <p>CAGE code: V3674 <u>2/</u></p>	<p>NAVPAR, INC. 11029 STATE ROUTE 128 BLDG C-1 HARRISON, OH 45030-9710</p>  <p>CAGE code: 0MHC4 <u>1/</u></p> <p>NC AUTOMATED INDUSTRIES INC. 90 DAYTON AVENUE BLDG. 14E PASSAIC, NJ 07055-7035</p>  <p>CAGE code: 1VPZ8 <u>1/</u></p>

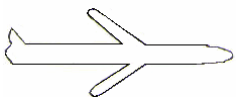
1/ Information published in this revision was verified by direct contact with manufacturers.

2/ Information not verified to be current, no response from manufacturer. Information identical to that published in MIL-HDBK-57, Revision B.







MIL-HDBK-57C(IS)

<p>NCMI BRUEGGEMANN INC. 1207 W. BROOKS STREET ONTARIO, CA 91762-3609</p>  <p>CAGE code: 0K292 <u>1/</u></p>	<p>NELSON AEROSPACE INC. 10310 NORRIS AVE PACOIMA, CA 91331-2219</p> <p style="text-align: center;">NA</p> <p>CAGE code: 52930 <u>2/</u></p>
<p>ND INDUSTRIES DBA ND WESTERN FASTENER PROCESSING DIVISION 13929 DINARD AVENUE SANTA FE SPRINGS, CA 90670</p>  <p>CAGE code: 4Y667 <u>2/</u></p>	<p>NELSON STUD WELDING DIVISION 7900 W. RIDGE RD ELYRIA, OH 44036-2019</p> <p style="text-align: center;">N</p> <p>CAGE code: 85105 <u>2/</u></p>
<p>NEDSCHROEF NEDSCHROEF HALMOND B.V. P.O. BOX 29 5700 AA HELMOND THE NETHERLANDS</p> <p>Plant KANAALDIJK NOORD WEST 71 5707 LC HELMOND THE NETHERLANDS</p>  <p>Standard hexagon high tensile bolts and screws of all property classes</p>  <p>High strength friction grip bolts for structural bolting property class 10.9</p>  <p>Socket screws</p>  <p>Nuts and all other bolts and screws</p> <p>CAGE code: HO871 <u>2/</u></p>	<p>NEUMAYER, ERICH GMBH POSTFACH 1160 WILHELM-ZANGEN-STRASSE 9 D-7613 HAUSACH GERMANY</p> <p style="text-align: center;">N</p> <p>CAGE code: C1956 <u>1/</u></p>
	<p>NEVADA BOLT AND MFG CO INC. DBA SPS NON-FERROUS ENGINEERED FASTENERS 3850 W PONDEROSA WAY LAS VEGAS, NV 89118</p> <p style="text-align: center;">NF</p> <p>CAGE code: 7U566 <u>2/</u></p>

1/ Information published in this revision was verified by direct contact with manufacturers.

2/ Information not verified to be current, no response from manufacturer. Information identical to that published in MIL-HDBK-57, Revision B.







MIL-HDBK-57C(IS)

<p>NEVILLE MACHINE SHOP P.O. BOX 22 RANGER, TX 76470-2722</p> <p>Plant 406 E. HIWAY 80 RANGER, TX 76470-2722</p>  <p>CAGE code: 8X524 <u>2/</u></p>	<p>NIPPON MACHINE ENGINEERING, INC. 1311 EAST SAINT GERTRUDE PLACE UNIT B SANTA ANA, CA 92705</p>  <p>CAGE code: 49145 <u>2/</u></p>
<p>NEW HORIZON MACHINE CO., INC. 36 LUDLOW STREET STAMFORD, CT 06902-2691</p>  <p>CAGE code: 1VVZ7 <u>2/</u></p>	<p>NIPPON STEEL BOLTEN CO., LTD. 4-3-2 NISHIZUMI, YUKUHASHI, FUKUOKA, JAPAN 824</p>  <p>CAGE code: <u>2/</u></p>
<p>NICE TOOL MFG., INC. 3280 DIANA DR. FORT WORTH, TX 76118-6237</p>  <p>CAGE code: 5K517 <u>2/</u></p>	<p>NISCO, INC. 5F SHINGA BLDG. 1-3-10 UMEBAYASHI OUTSU-SHI SHOGA-KEN 520, JAPAN</p> <p>Plant 1018-1 ROKUJO CHUZU-CHO YASU-GUM SHIGA-KEN 520-24 JAPAN</p>  <p>CAGE code: <u>2/</u></p>

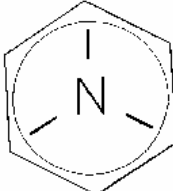
1/ Information published in this revision was verified by direct contact with manufacturers.

2/ Information not verified to be current, no response from manufacturer. Information identical to that published in MIL-HDBK-57, Revision B.







MIL-HDBK-57C(IS)

<p>NISSAN SCREW CO. LTD. SALES DEPT., FOREIGN TRADE SECTION 5-6-508 SHINKANAOKA-CHO SAKAI-SHI-OASAKA 590 JAPAN</p> <p>Plant 8-4-41 MIYAKE-NAKA MATSUBARA-SHI, OSAKA 580 JAPAN</p> <p style="font-size: 2em; text-align: center;">N</p> <p>CAGE code: <u>1/</u></p>	<p>NORTHBRIDGE FASTENERS VIKING ROAD WIGSTON, LEICESTER UNITED KINGDOM</p> <p style="font-size: 2em; text-align: center;">NB</p>  <p>E – The plain letter E is used for Rolls Royce, UK supply and Europe and will be used in the absence of any customer allocated identification.</p>
<p>NOCHIA STEELWORKS NYOGO, JAPAN</p>  <p>CAGE code: <u>2/</u></p>	 <p>32219 – Allocated by Pratt & Whitney, East Hartford for supply to Pratt & Whitney, East Hartford</p>   <p>15077 – Allocated by Pratt & Whitney, Canada for supply to Pratt & Whitney, Canada</p>
<p>NON-FERROUS BOLT & MANUFACTURING CO. 4086 NEVSO DRIVE, SUITE C LAS VEGAS, NV 89103</p> <p>Plant 3850 WEST PONDEROSA LANE LAS VEGAS, NV 89118</p> <p style="font-size: 3em; text-align: center;">NF</p> <p>CAGE code: <u>2/</u></p>	 <p>5T572 – Milsap No. for items supplied to U.S. Government</p>  <p>20733 – Allocated by Avco-Lycoming for supply to Avco-Lycoming</p>  <p>NTF99 – Allocated by General Electric for supply to Rolls Royce for joint projects with General Electric</p> <p>CAGE code: <u>2/</u></p>

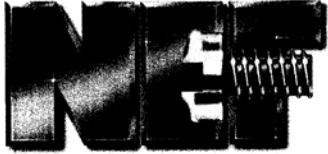
1/ Information published in this revision was verified by direct contact with manufacturers.

2/ Information not verified to be current, no response from manufacturer. Information identical to that published in MIL-HDBK-57, Revision B.

MIL-HDBK-57C(IS)







<p>NORTHEAST FASTENERS 8 TREMCO DRIVE P. O .BOX 322 TERRYVILLE, CT 06786-0322</p>  <p>CAGE code: 07ZN5 1/</p>	<p>NOVA MACHINE PRODUCTS CORPORATION A SUBSIDIARY OF CURTIS-WRIGHT FLOW CONTROL SERVICE CORP. 18685 SHELDON ROAD MIDDLEBURGE HEIGHTS, OH 44130-2465</p>  <p>CAGE code: 1EJ29 1/</p>
<p>NORTHEAST METAL CO., INC. P.O. BOX 51754 34 FRONT STREET INDIAN ORCHARD, MA 01151</p> <p>Plant AIRPORT DRIVE WESTFIELD, MA 01085</p>  <p>CAGE code: 1C4F2 2/</p>	<p>NT ENGINEERING, INC. 1050 "C" INDEPENDENCE AVE. MOUNTAIN VIEW, CA 94043</p>  <p>CAGE code: 0BEN1 2/</p>
<p>NORTHERN SCREW CO. , INC. 8121 LAKEVIEW PARKWAY PLEASANT PRAIRIE, WI 53158</p>  <p>CAGE code: 2/</p>	<p>NUCOR CORP. NUCOR FASTENER DIVISION P.O. BOX 6100, 6730 COUNTY ROAD ST. JOE, IN 46785</p>  <p style="text-align: center;">n</p> <p>CAGE code: 0BEP9 1/</p>
<p>NORTHSTAR ENGINEERING 1911 LYNX PLACE ONTARIO, CA 91761</p>  <p>CAGE code: 0XK38 2/</p>	<p>CAGE code: 0BEP9 1/</p>

1/ Information published in this revision was verified by direct contact with manufacturers.

2/ Information not verified to be current, no response from manufacturer. Information identical to that published in MIL-HDBK-57, Revision B.

MIL-HDBK-57C(IS)





<p>NUMERIC MACHINE PRODUCTS 1769 WEST AVE. K-11 LANCASTER, CA 93534</p> <p style="text-align: center;">NMP</p> <p>CAGE code: 5V524 <u>2/</u></p>
<p>NUTS INCORPORATED DIVISION OF STANLOK 1451 GRAFTON ST P.O. BOX 2735 WORCHESTER, MASSACHUSETTS 01613</p> <p style="text-align: center;">N</p> <p>CAGE code: 02972 <u>2/</u></p>
<p>NUTS, INC. ROUTE 724 & 23 PHOENIXVILLE, PA 19460-1838</p> <p style="text-align: center;">N</p> <p>CAGE code: 6N185 <u>2/</u></p>

<p>NYLOK CORP. 15260 HALLMARK DR. MACOMB, MI 48042</p> <div style="display: flex; flex-direction: column; align-items: flex-start;"> <div style="display: flex; align-items: center; margin-bottom: 5px;">  Blue nylon locking element </div> <div style="display: flex; align-items: center; margin-bottom: 5px;">  Blue nylon locking element </div> <div style="display: flex; align-items: center; margin-bottom: 5px;">  Blue nylon locking element </div> <div style="display: flex; align-items: center; margin-bottom: 5px;">  Blue nylon locking element </div> <div style="display: flex; align-items: center; margin-bottom: 5px;">  Blue nylon locking element </div> <div style="display: flex; align-items: center; margin-bottom: 5px;">  Blue nylon locking element </div> </div> <p style="text-align: center; font-size: 2em; margin-top: 20px;">NK</p> <p style="text-align: center; font-size: 3em; margin-top: 20px;">NK</p> <p style="text-align: center; font-size: 4em; margin-top: 20px;">NYLOK</p> <p>CAGE code: 59093 <u>1/</u></p>
--

1/ Information published in this revision was verified by direct contact with manufacturers.

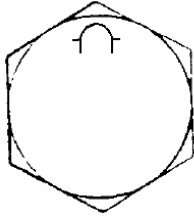
2/ Information not verified to be current, no response from manufacturer. Information identical to that published in MIL-HDBK-57, Revision B.

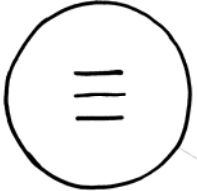
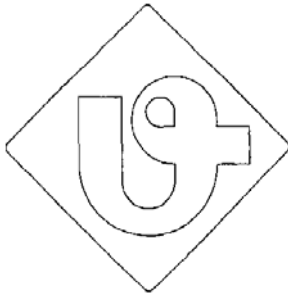

MIL-HDBK-57C(IS)

<p>OAKTREE FASTENERS CO. 12262 1/2 WOODRUFF AVE. DOWNEY, CA 90241</p> <p style="text-align: center;">OTF</p> <p>CAGE code: <u>2/</u></p>	<p>OHKAWA SCREW MFG. CO., LTD. 2-25-16 MIDORIGAOKA, MEGURO-KU, TOKYO 152 JAPAN</p> <p>Plant 6357-1 OBA, OHMIYA-MACHI, NAKA-GUN, LBARAGI-KEU 319-21 JAPAN</p> <div style="display: flex; justify-content: space-around; align-items: center;">   </div> <p>CAGE code: <u>2/</u></p>
<p>OBARS MACHINE & TOOL CO. 115-126 N. WESTWOOD AVE. TOLEDO, OH 43607</p> <div style="text-align: center;">  </div> <p>CAGE code: 0MKX0 <u>2/</u></p>	<p>OKABE CO., INC. OKABE KIKO CO., LTD. (PLANT) 4-21-15 MUKOJIMA SUMIDA-KU, JAPAN 131-8505</p> <div style="text-align: center;">  </div> <p>CAGE code: SP186 <u>2/</u></p>
<p>OCM MACHINE COMPANY, INC. 9601 HIGHWAY 80 FORT WORTH, TX 76116 - 2689</p> <div style="text-align: center;">  </div> <p>CAGE code: 06XQ6 <u>2/</u></p>	<p>OKAI IRON WORKS, INC. 12-41, 3 CHOME, TSURUHARA IZUMISANO CITY OSAKA, JAPAN 598</p> <p style="text-align: center;">OK</p> <p>CAGE code: <u>2/</u></p>
<p>OHIO NUT & BOLT CO., THE DIV. OF FASTENERS INDUSTRIES, INC. 33 LOU GROZA BLVD.. BEREA, OH 44017-1293</p> <div style="text-align: center;">  <p>Small raised mark usually on the underside of head</p> </div> <p>CAGE code: 76871 <u>1/</u></p>	

1/ Information published in this revision was verified by direct contact with manufacturers.



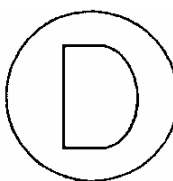
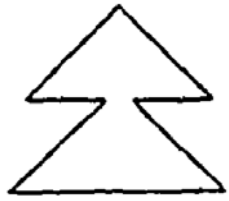

2/ Information not verified to be current, no response from manufacturer. Information identical to that published in MIL-HDBK-57, Revision B.

MIL-HDBK-57C(IS)

<p>OKAWA SCREW MANUFACTURING CO., LTD 2-20-4 HIGASHIGOTANDA SHINAGAWA-KU, 141-0022 TOKYO</p> <p style="text-align: center;">OSK</p>  <p>CAGE code: <u>1/</u></p>	<p>ONO MANUFACTURER, INC. 602 FUJITA OKAYAMA-SHI, OKAYAMA-KEN 701-0221 JAPAN</p> <p style="text-align: right;">Plant 3-800-46 TAMAHARA TAMANO- SHI, OKAYAMA-KEN 706-2555 JAPAN</p> <p style="text-align: center;"></p> <p>CAGE code: <u>1/</u></p>
<p>OMEGA THREAD ROLLING AND GRINDING INC. 54 LEWIS STREET P.O. BOX 129 PLAINVILLE, CT 06062-0129</p> <p style="text-align: center;"></p> <p>CAGE code: 06KW4 <u>2/</u></p>	<p>ONTIC ENGINEERING & MANUFACTURING, INC. 20360 PLUMMER ST. NORTH HOLLYWOOD, CA 91609-0510</p> <p style="text-align: center;"></p> <p>CAGE code: 45934 <u>2/</u></p>
<p>ONEIDA TOOL & MACHINE CORP. 837 AIR PARK RD. RHINELANDER, WI 54501-8426</p> <p style="text-align: center;"></p> <p>CAGE code: OJHAO <u>1/</u></p>	<p>ORANGE PRECISION PARTS 17632 METZLER LANE, #C HUNTINGTON BEACH, CA 92647</p> <p style="text-align: center;">P O OP</p> <p>CAGE code: 9V210 <u>2/</u></p>

1/ Information published in this revision was verified by direct contact with manufacturers.2/ Information not verified to be current, no response from manufacturer. Information identical to that published in MIL-HDBK-57, Revision B.

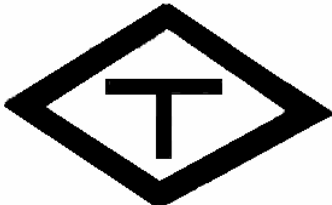





MIL-HDBK-57C(IS)

<p>ORC-O TOOL & MACHINE, INC. 75 SHAMROCK DRIVE SULLIVAN, MO 63080-2344</p> <p style="text-align: center;">ORC-O</p> <p>CAGE code: 0C1D0 2/</p>	<p>OSTEEN MACHINE SHOP RT. 1 BOX 2082 ALVARADO, TX 76009</p> <p style="text-align: center;"></p> <p>CAGE code: 8Y546 2/</p>
<p>ORDNANCE PARTS & ENGINEERING CO. P.O. BOX 8035 3152 C MAJOR ST FORT WORTH, TX 76112</p> <p style="text-align: center;"></p> <p>CAGE code: 20800 2/</p>	<p>OTO MELARA S.p.A. FINKECCANICA COMPANY VIA VALDILOCCHI 15 LA SPEZIA 19136 ITALY</p> <p style="text-align: center;"></p> <p>CAGE code: A0199 1/</p>
<p>ORLOTRONICS CORP. 401 E. FOURTH STREET BRIDGEPORT, PA 19405-1815</p> <p style="text-align: center;">(OTC)</p> <p>CAGE code: 54267 1/</p>	<p>OTT BROTHERS MACHINE CO., INC. 331 EAST 37TH STREET SOUTH WICHITA, KS 67216</p> <p style="text-align: center;">OB OBMC</p> <p>CAGE code: 09292 1/</p>
<p>OSAKA SEIKI CO., LTD. 1-19-14, MITEJIMA TOKYO 555 JAPAN</p> <p style="text-align: center;"></p> <p>CAGE code: S4247 2/</p>	<p>OWARI PRECISE PRODUCTS CO., LTD 2-148 YADA-CHO HIGASHI-KU NAGOYA- SHI AICHI-KEN, JAPAN</p> <p style="text-align: center;"></p> <p>CAGE code: SC008 2/</p>

1/ Information published in this revision was verified by direct contact with manufacturers.

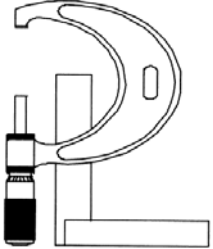
2/ Information not verified to be current, no response from manufacturer. Information identical to that published in MIL-HDBK-57, Revision B.

MIL-HDBK-57C(IS)

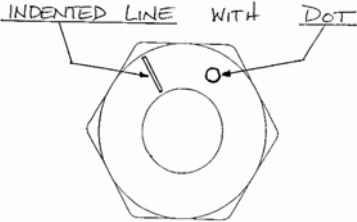
<p>P & I ASSOCIATES, INC. 26 WEST WAVERLY ROAD P.O. BOX 413 GLENSIDE, PA 19038-4012</p> <p>Plant #1 LIMEKILN PIKE GLENSIDE, PA 19038 (No mail to this address)</p>  <p>CAGE code: 0DH98 <u>2/</u></p>	<p>P.S. MACHINE CO., INC. 1505 JOHN FETCH BLVD. S. WINDSOR, CT 06074-1000</p>  <p>CAGE code: 56839 <u>1/</u></p>
<p>P & L ENTERPRISES 111 CR 4614 CASTROVILLE, TX 78009</p>  <p>CAGE code: 058B7 <u>1/</u></p>	<p>PABCOR, INC. 925 NORTH CEDAR STREET P.O. BOX 7528 NEW CASTLE, PA 16107-1323</p>  <p>CAGE code: OAGN7 <u>2/</u></p>
<p>P.C.M., INC. (BETHLEHEM PIKE INDUSTRIAL CENTER) P.O. BOX 840 60 PARRISH ST. WILKES BARRE, PA 18710</p>  <p>CAGE code: <u>2/</u></p>	<p>PACER ALLOYS, INC. 8681 SCRANTON STREET HOUSTON, TX 77075</p>  <p>CAGE code: <u>1/</u></p>
	<p>PACIFIC FASTENERS, INC. 405 UNIVERSITY AVENUE ARLINGTON HEIGHTS, IL 60004</p>  <p>CAGE code: 42918 <u>2/</u></p>

1/ Information published in this revision was verified by direct contact with manufacturers.

2/ Information not verified to be current, no response from manufacturer. Information identical to that published in MIL-HDBK-57, Revision B.

MIL-HDBK-57C(IS)

<p>PACIFIC SCIENTIFIC 22715 SAVI RANCH PARKWAY P.O. BOX 87019 YORBA LINDA, CA 92686</p> <p>PS</p> <p>CAGE code: 45402 <u>2/</u></p>	<p>PALNUT CO., THE UNITED CARR FASTENERS PALNUT DIV GLEN ROAD MOUNTAINSIDE, NJ 07092</p> <p>PAL</p> <p>CAGE code: 2G832 <u>2/</u></p>
<p>PACIFIC TOOL, INC. 15235 NE 92ND STREET REDMOND, WA 98052</p> <p>PTI</p> <p>CAGE code: 62176 <u>1/</u></p>	<p>PARK PRECISION CORPORATION 181 ELLIOT ST. UNIT 403 BEVERLY, MA 01915</p> <p>-PPC-</p> <p>CAGE code: OJWS2 <u>2/</u></p>
<p>PADGETT MACHINE INC. 1226 NORTH 143rd EAST AVENUE TULSA, OK 74116-2120</p> <p>PMI</p> <p>CAGE code: 6W037 <u>1/</u></p>	<p>PATEREX, LTD. CRAY AVE., ORPINGTON KENT BR5 3RR UNITED KINGDOM</p> <p>PPTX</p> <p>CAGE code: OBMF6 <u>2/</u></p>
<p>PAINTER TOOL, INC. 1173 IRIS DRIVE NORTH HUNTINGDON, PA 15642-4399</p> <p>PTI</p> <p>CAGE code: 34779 <u>2/</u></p>	<p>PATTERSON LAKE PRODUCTS (SUBSIDIARY OF COLUMBIA AUTO PARTS) P.O. BOX 200 PINCKNEY, MI 48169</p> <p>PP</p> <p>CAGE code: 5Y952 <u>2/</u></p>

1/ Information published in this revision was verified by direct contact with manufacturers.

2/ Information not verified to be current, no response from manufacturer. Information identical to that published in MIL-HDBK-57, Revision B.

MIL-HDBK-57C(IS)

PAULIN, H. & CO., LTD.
 CAPITAL METAL INDUSTRIES DIVISION
 55 MILNE AVENUE
 SCARBOROUGH, ONTARIO MIL 4N3
 CANADA



CAGE code: 95119 2/

PB FASTENERS
 (DIVISION OF PAUL R. BRILES, INC.)
 1700 WEST 132ND STREET
 GARDENA, CA 90249

MFR 27624



PBF
PB

CAGE code: 27624 1/

PEERLESS SCREW PRODUCTS
 286 SANDBANK RD.
 P.O. BOX 236
 CHESIRE, CT 06410-1537



CAGE code: 45950 1/

PEINER UMFORMTECHNIK GmbH
 WOLTORFER STRASSE 26
 PEINE, 31224
 GERMANY

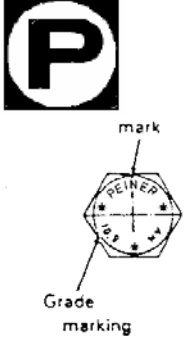
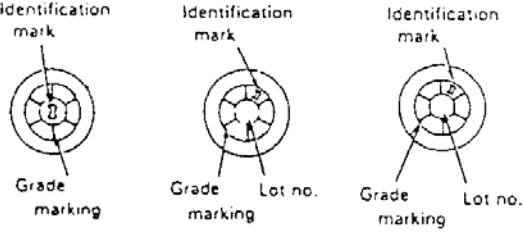
CAGE code: D2742 2/

PELHAM AUTO MATRIX PRECISION
 1 INDUSTRIAL DRIVE
 PELHAM, NH 03076



CAGE code: 1CSJ5 2/

PENN CIGAR MACHINES INC (P.C.M INC)
 P. O. BOX 1065
 60 PARRISH STREET
 WILKES BARRE, PA 18703



CAGE code: 7U218 2/

1/ Information published in this revision was verified by direct contact with manufacturers.

2/ Information not verified to be current, no response from manufacturer. Information identical to that published in MIL-HDBK-57, Revision B.

MIL-HDBK-57C(IS)

PENN ENGINEERING & MANUFACTURING CO.
 (see ATLAS ENGINEERING, INC.)
 5190 OLD EASTON RD.
 DANBORO, PA 18916

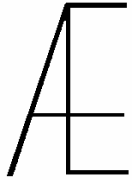

Square insert in floating fasteners

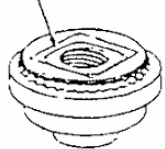

PEM trademark Blue - nylon[®] hexagon locking element

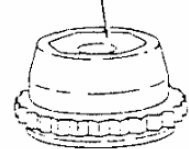

"Dimple" trademark

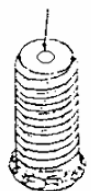

PEM 300™ identification mark

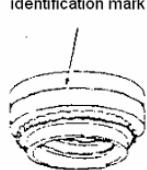

PEM - m

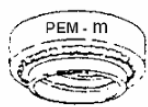

PEM

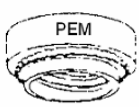

CAGE code: 46384 1/

PENN SCREW & MACHINE WORKS, INC.
 3075 ADVANCE LN.
 COLMAR, PA 18915

PSM
 PSM

CAGE code: 82926 2/

PEREZ MACHINE, INC.
 1501 W. 134TH STREET
 GARDENA, CA 90249



CAGE code: 34393 1/

PERIGEE MANUFACTURING COMPANY, INC. (MICHIGAN CORPORATION)
 7519 INTERVALE
 DETROIT, MI 48238-2401



CAGE code: 1X4X7 1/





PERKINS MACHINE CO.
 1559 PINE STREET
 OXNARD, CA 93030

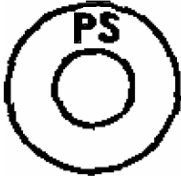

CAGE code: 84749 2/

1/ Information published in this revision was verified by direct contact with manufacturers.
 2/ Information not verified to be current, no response from manufacturer. Information identical to that published in MIL-HDBK-57, Revision B.

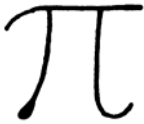





MIL-HDBK-57C(IS)

<p>PHOENIX SPECIALTY MANUFACTURING CO., INC. P.O. BOX 418 BAMBERG, SC 29003</p> <p>Plant HIGHWAY 301 SOUTH BAMBERG, SC 29003</p>  <p>CAGE code: 66920 2/</p>	<p>PINE TAVERN MACHINE INC. 7851 PINE TAVERN ROAD PERRY, NY 14530</p> <p style="text-align: center;">PTM</p> <p>CAGE code: 9J559 2/</p>
<p>PILGRIM SCREW CORP. (PROVIDENCE DIVISION) 120 SPRAGUE STREET PROVIDENCE, RI 02901</p> <p>Plant 259 DEXTER ST. PROVIDENCE, RI 02907 CAGE code: 47253</p>  <p>Plant 2 2875 WEST FRYE ROAD CHANDLER, AZ CHANDLER, AZ CAGE code: 1GP79</p>  <p>CAGE code: 47253, 1GP79 1/</p>	<p>PINEY RIDGE CO. 177 JOSHUA ROAD SALUDA, SC 29138-7770</p> <p style="text-align: center;">PR</p> <p>CAGE code: 05DT2 1/</p>
	<p>PINTO PRODUCTS P.O. BOX 83 2011 PALMER STREET KALAMAZOO, MI 49001</p>  <p>CAGE code: 0YJH8 2/</p>
	<p>PIONEER MACHINE PRODUCTS, INC. 2200 DOLMAN ST. LOUIS, MO 63104</p> <p style="text-align: center;">PMP</p> <p>CAGE code: 12829 2/</p>

1/ Information published in this revision was verified by direct contact with manufacturers.

2/ Information not verified to be current, no response from manufacturer. Information identical to that published in MIL-HDBK-57, Revision B.







MIL-HDBK-57C(IS)

<p>PIONEER SCREW & NUT CO. 2700 YORK ROAD ELK GROVE VILLAGE, IL 60007</p> <div style="display: flex; justify-content: space-around; align-items: center;">   </div> <p>Indented hex heads and Indented hex washer heads</p> <p>All other head styles slash- dot symbol to appear on bearing surface upon request</p> <p>CAGE code: 4N311 <u>2/</u></p>	<p>PORTLAND BOLT & MFG., CO. P.O. BOX 2866 1210 NW JOHNSON ST PORTLAND, OR 97208</p> <p>Plant 3441 NW GUAM ST PORTLAND, OR 97210-2688 CAGE code: 3QCS3</p> <p style="font-size: 2em; text-align: center;">PB</p> <p>CAGE code: 3S498, 3QCS3 <u>1/</u></p>
<p>PLAINVILLE MANUFACTURING CO., INC. 48 LEWIS ST. PLAINVILLE, CT 06062</p> <div style="text-align: center;">  </div> <p>CAGE code: <u>2/</u></p>	<p>POWERPARTS, INC. P.O. BOX 38557 601 MCFARLAND STREET HOUSTON, TEXAS 77011</p> <div style="text-align: center;">  </div> <p>CAGE code: 66297 <u>2/</u></p>
<p>PNEU-HYDRO PRODUCTS, INC. 353 RICHARD MINE ROAD WHARTON, NJ 07885</p> <div style="text-align: center;">  </div> <p>CAGE code: <u>2/</u></p>	<p>PRD FASTENERS LTD. UNIT 10/15 MONMER CLOSE WILLENHALL, WV12 1JR ENGLAND</p> <div style="text-align: center;">  </div> <p>CAGE code: U8651 <u>1/</u></p>
<p>POINT MACHINE COMPANY P.O. BOX 8055 33 CAMBRIDGE HEIGHTS KENSINGTON, CT 06037</p> <div style="text-align: center;">  </div> <p>CAGE code: 9N716 <u>2/</u></p>	

1/ Information published in this revision was verified by direct contact with manufacturers.

2/ Information not verified to be current, no response from manufacturer. Information identical to that published in MIL-HDBK-57, Revision B.

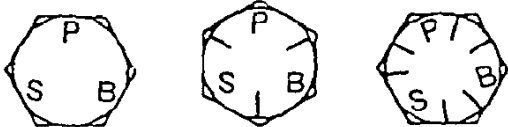

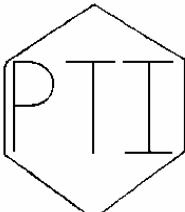

MIL-HDBK-57C(IS)

<p>PRECI-MANUFACTURING, INC. 400 WEAVER STREET WINOOSKI, VT 05404-1391</p>  <p>CAGE code: 66841 <u>1/</u></p>	<p>PRECISION PARTS & TOOL CO., INC. 108 ROME STREET FARMINGDALE, NJ 11735</p> <p style="text-align: center;">L.P.R.</p> <p>CAGE code: <u>2/</u></p>
<p>PRECISE AERO PRODUCTS 4120 INDUS WAY RIVERSIDE, CA 92503-4808</p>  <p>CAGE code: 00AE2 <u>1/</u></p>	<p>.PRECISION PIECE PARTS, INC. 712 S. LOGAN ST. MISHAWAKA, IN 46544</p>  <p>CAGE code: 98072 <u>2/</u></p>
<p>PRECISE OF CALIFORNIA DIV OF ADJUSTABLE BUSHING CORP 8330 LANKERSHIM BLVD. NORTH HOLLYWOOD, CA 91605</p>  <p><i>Panel fastener Quick-acting pins</i></p> <p>CAGE code: 62372 <u>2/</u></p>	<p>PRECISION SCREW & BOLT, INC. 1491 CHARDON ROAD CLEVELAND, OH 44117-1598</p>  <p>GRADE 2 GRADE 5 GRADE 8</p> <p>CAGE code: 02BC3 <u>1/</u></p>
<p>PRECISION METAL PRODUCTS CO. #7 CENTENNIAL DRIVE CENTENNIAL INDUSTRIAL PARK PEABODY, MA 01961-6026</p>  <p>CAGE code: 4V472 <u>2/</u></p>	<p>PRECISION TECHNOLOGIES, INC. 1538 INDUSTRIAL AVE. OTTAWA, KS 66067</p>  <p>CAGE code: <u>2/</u></p>

1/ Information published in this revision was verified by direct contact with manufacturers.

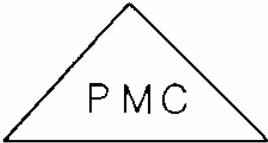
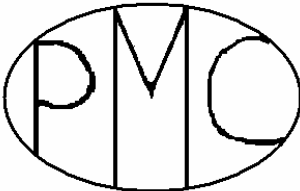
2/ Information not verified to be current, no response from manufacturer. Information identical to that published in MIL-HDBK-57, Revision B.

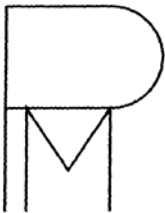



MIL-HDBK-57C(IS)

<p>PRECISIONMATICS CO., INC. HELMER AVE. WEST WINFIELD, NY 13491</p>  <p>CAGE code: <u>2/</u></p>	<p>PRIETO MACHINE COMPANY, INC. 1785 STOUT DRIVE UNIT D WARMINSTER, PA 18974</p>  <p>CAGE code: 8Y298 <u>1/</u></p>
<p>PREM INDUSTRIES, INC. P.O. BOX 907 NIAGRA FALLS, NY 14302</p> <p>Plant 574-56th ST. NIAGRA FALLS, NY 14304</p>  <p>CAGE code: 4Y327 <u>2/</u></p>	<p>PRODUCT DEVELOPMENT GROUP, INC. P.O. BOX 177 ROSE HILLS, KS 67133</p>  <p>CAGE code: OMAR7 <u>2/</u></p>
<p>PRICE MANUFACTURING CO. 372 NORTH SMITH AVENUE CORONA, CA 91720</p>  <p>CAGE code: 1K6D8 <u>1/</u></p>	<p>PRODUCTION & TOOL COMPANY 240 SARGENT DRIVE NEW HAVEN, CT 06511</p>  <p>CAGE code: 8N334 <u>2/</u></p>

1/ Information published in this revision was verified by direct contact with manufacturers.

2/ Information not verified to be current, no response from manufacturer. Information identical to that published in MIL-HDBK-57, Revision B.

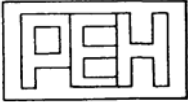





MIL-HDBK-57C(IS)

<p>PRODUCTS DESIGN & MFG. CORP. P.O. BOX 11429 NEWINGTON, CT 06111</p> <p>Plant 76 STANWELL RD. NEWINGTON, CT 06111</p> <p>8M938</p> <p>CAGE code: <u>2/</u></p>	<p>PTM INTERNATIONAL INC. 8050 NW 31ST MIAMI, FL 33122</p> <p style="text-align: center;"></p> <p>CAGE code: 0S6M6 <u>2/</u></p>
<p>PRO-MACHINE & TOOL COMPANY 792 BLAKE BOTTOM RD. HUNTSVILLE, AL 35806</p> <p style="text-align: center;"></p> <p>CAGE code: IDS66 <u>2/</u></p>	<p>PURITAS METAL PRODUCTS 7720 RACE RD NORTH RIDGEVILLE , OH 44039-3614</p> <p style="text-align: center;">PMP</p> <p style="text-align: center;">P</p> <p>CAGE code: 04368 <u>1/</u></p>
<p>PROMPTUS ELECTRONIC HARDWARE 520 HOMESTEAD AVENUE MT. VERNON, NY 10550</p> <p style="text-align: center;"></p> <p>CAGE code: 57177 <u>2/</u></p>	<p>PYE & HOGAN MACHINE CO. P. O. BOX 832 167-1 ELM ST OLD SAYBROOK, CT 06475-4134</p> <p style="text-align: center;">MFR06320</p> <p>CAGE code: 06320 <u>1/</u></p>
<p>PROTO MACHINE CO., INC. P.O. BOX 1240 1295 GOLDEN TRIANGLE BLVD. KEELER, TX 76248</p> <p style="text-align: center;"></p> <p>CAGE code: 0AWM2 <u>2/</u></p>	<p>QRP, INC. P.O. BOX 832 2307 MERCANTILE DR NE LELAND, NC 28451-4065</p> <p style="text-align: center;">09094</p> <p>CAGE code: 09094 <u>1/</u></p>

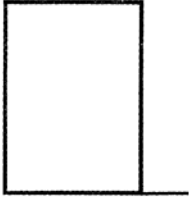
1/ Information published in this revision was verified by direct contact with manufacturers.

2/ Information not verified to be current, no response from manufacturer. Information identical to that published in MIL-HDBK-57, Revision B.

MIL-HDBK-57C(IS)

<p>QSN MANUFACTURING, INC. 201 FRONTIER WAY BENSENVILLE, IL 60106</p>  <p>CAGE code: 0MDU6 <u>2/</u></p>	<p>QUALITY SCREW PRODUCTS, INC. P.O. BOX 2355 35101 SCHOOLCRAFT ROAD LIVONIA, MI 48151</p>  <p>CAGE code: 4F051 <u>2/</u></p>
<p>QUALITY AIRCRAFT SCREWS, INC. 1030-A ORTEGE WAY PLACENTIA, CA 92670</p>  <p>CAGE code: <u>2/</u></p>	<p>QUALITY SOCKET SCREW MANUFACTURING CORP. 2790 NORTH AVE. ENGLEWOOD, IL 34224</p>  <p>Socket head cap screw head marked for I.D. QSS</p> <p>CAGE code: 5N116 <u>1/</u></p>
<p>QUALITY FABRICATIONS, INC. 3270 WROLSSEN DRIVE SAUGERTIES, NY 12477</p>  <p>CAGE code: IJB77 <u>2/</u></p>	<p>QUALITY THREADED PRODUCTS COMPANY 4734 HIGHWAY 157 N. JUDSONIA, ARKANSAS 72081</p>  <p>CAGE code: 0RXV6 <u>2/</u></p>
<p>QUALITY MACHINE & MFG INC. 1316 BLACK VALLEY ROAD LAFOLLETTE, TN 37766</p>  <p>CAGE code: 1DB71 <u>2/</u></p>	

1/ Information published in this revision was verified by direct contact with manufacturers.

2/ Information not verified to be current, no response from manufacturer. Information identical to that published in MIL-HDBK-57, Revision B.

MIL-HDBK-57C(IS)

R & D FASTENERS
 P. O. BOX 250
 9604 7TH ST
 RANCHO CUCAMONGA , CA 91730



CAGE code: 05BE3 2/

R & D WELDING & MACHINE INC.
 1200 GEORGIA AVE.
 WARNER ROBBINS, GA 31093

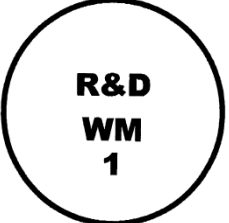

CAGE code: 1H3J7 2/

R & R PRECISION
 604 S. 9TH ST.
 GUNNISON, CO 81230



CAGE code: 0GKX6 2/

R B & W CORPORATION
 A PARK-OHIO COMPANY
 5190 BRADCO BLVD.
 TORONTO, ONTARIO
 CANADA

Plant
 DELAWARE CORPORATION
 8341 TYLER BLVD
 MENTOR, OH 44060

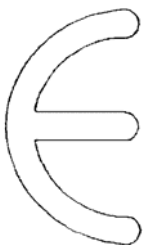

R B W or E E E
 W or E E



SAE J995
 Grade 5
 hex nuts

L S B L
 XP exposure protected
 ASTM A325 Type 3
 bolts and nuts



SAE J995
 Grade 8
 hex nuts

UNA UNA A-325 E UNA

UNA-DRIV[®]
 SYSTEM

OVALOK[®] TRI-OVAL[®]
 prevailing torque
 locknuts

Grade B Grade C



Class 9 Class 10



RAI-LOCK[®]
 SYSTEM



LAMSEAL[®]
 SYSTEM



AN 310 AN 320 RB&W Nuts



Castellated



Slotted



Not Otherwise
 Specified
 (Dots at 180°)

CAGE code: 52167

Continued 2/

1/ Information published in this revision was verified by direct contact with manufacturers.

2/ Information not verified to be current, no response from manufacturer. Information identical to that published in MIL-HDBK-57, Revision B.

MIL-HDBK-57C(IS)

Continued

R B & W CORPORATION

VIBRESIST[®] locking screws

Grade F Grade G

Grade A Grade B Grade C Grade 5 Grade 8

VIBRESIST[®] hex locknut

Class 5 Class 9 Class 10 Grade 5

VIBRESIST[®] hex locknut

Grade B Class 9 Class 10

Grade B Grade C Class 9 Class 10

Class 9 Class 10 Type "GT"

CAGE code: 52167 2/

R. BILD COMPANY, INC.
15205 STAGG STREET
VAN NUYS, CA 91405-1003

CAGE code: 04QM7 1/

R.E.C. CORP.
10 BEACH ST.
MOUNT VERNON, NY 10550

Used on all alloy and stainless steel bolts, studs, and nuts over 1/2 inch in diameter.

CAGE code: 86687 2/

RABOURDIN
ZI R DES MARAIS
P.O. BOX BP 157
ST. JUST EN CHAUSSEE,
FRANCE 60130

CAGE code: F4870 2/



RADAX INDUSTRIES, INC.
700 BASKET ROAD
WEBSTER, NY 14580

CAGE code: 6V794 2/

1/ Information published in this revision was verified by direct contact with manufacturers.

2/ Information not verified to be current, no response from manufacturer. Information identical to that published in MIL-HDBK-57, Revision B.

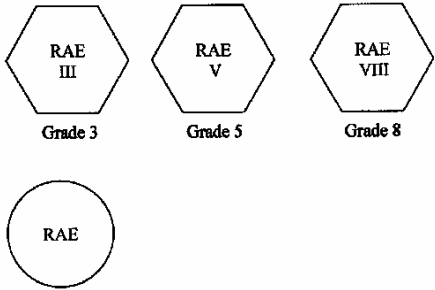
MIL-HDBK-57C(IS)

<p>RAE MANUFACTURING CO. 1327-1331 CEDAR STREET PORT HURON, MI 48060-6167</p>  <p>Grade 3 Grade 5 Grade 8</p> <p>CAGE code: 1H904 <u>1/</u></p>	<p>RAM PRODUCTS AFS TORRANCE OPERATIONS 3016 WEST LOMITA BLVD. TORRANCE, CA 90505-5103</p> <p>(Corporate office see ALCOA FASTENING SYSTEMS)</p> <h1 style="text-align: center;">RAM</h1> <p>CAGE code: 0CBU7</p>
<p>RAHMEDE SCHRAUBENFABRIK WEFELSHOHLER STR 44 D-5880 LUDENSCHIED GERMANY</p>  <p>CAGE code: D9901 <u>2/</u></p>	<p>RAM THREADING, INC. P.O. BOX 987 BEAUMONT, TEXAS 77704</p> <p style="text-align: center;">Plant 2640 CROCKETT BEAUMONT, TX 77701</p> <h1 style="text-align: center;">R</h1> <p style="text-align: center;">Centered over grade of material being stamped</p> <p>CAGE code: 1Y826 <u>2/</u></p>
<p>RAINBOW MACHINE PRODUCTS, INC. P.O. BOX 1906 226 WILLIS ROAD YORK, PA 17405</p>  <p>CAGE code: 9S535 <u>2/</u></p>	<p>RAMAR NUTS, INC. 18401 WEAVER ST. DETROIT, MI 48228</p> <h1 style="text-align: center;">R</h1> <p>CAGE code: 4L633 <u>2/</u></p>
<p>RAM ENTERPRISES 1382 CORONADO ST LONG BEACH, CA 90804</p> <h1 style="text-align: center;">RE</h1> <p>CAGE code: OU3C8 <u>2/</u></p>	

1/ Information published in this revision was verified by direct contact with manufacturers.

2/ Information not verified to be current, no response from manufacturer. Information identical to that published in MIL-HDBK-57, Revision B.

MIL-HDBK-57C(IS)

RAMCO SPECIALTIES, INC.
5369 HUDSON DRIVE
HUDSON, OH 44236

CAGE code: 6U460 1/

RAMM DEFENSE PRODUCTS
3161 D MAJOR ST
FORT WORTH, TX 76112-7270

CAGE code: 0BRC1 1/

RATHMANN WALTER G. SEGMENT-
KLAMMERSCHRAUBEN GMBH
ALTE EMSER STRASSE 32
KOBLENZ, 56077
GERMANY

CAGE code: C6486 2/

RA-WHITE, INC
967 WEST HYDE PARK BOULEVARD
INGLEWOOD, CA 90302

CAGE code: 5Y319 2/

RB & W CORP.
23001 EUCLID AVE.
CLEVELAND, OH 44117

Grade F Grade G

VIBRESIST hex locknut

Grade 8 Class 9 Class 10

Grade B Grade C Class 9 Class 10

Class 9 Class 10 Type "GT"

RAI-LOCK SYSTEM

LAMSEAL SYSTEM Stover prevailing torque locknuts

AN 310 AN 320 RB&W Nuts

Castellated Slotted











Not Otherwise Specified (Dots at 180°)

CAGE code: 0VZJ0 2/

1/ Information published in this revision was verified by direct contact with manufacturers.

2/ Information not verified to be current, no response from manufacturer. Information identical to that published in MIL-HDBK-57, Revision B.

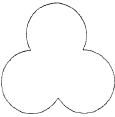
MIL-HDBK-57C(IS)

<p>REED INSTRUMENT CO. 1525 BLALOCK ROAD HOUSTON, TX 77080</p>  <p>CAGE code: 3B132 2/</p>	<p>(see ALCOA FASTENING SYSTEMS)</p> <p>REXNORD SPECIALITY FASTENERS DIVISION 3000 WEST LOMITA BLVD TORRANCE, CA 90505</p>     <p>CAMLOC PRODUCTS 601 ROUTE 46 WEST HASBROUCK HEIGHTS, NJ 07604</p>    <p>ROSAN PRODUCTS 3130 W. HARVARD ST. SANTA ANA, CA 92704</p>  <p>CAGE code: 76017 2/</p>
<p>REGAL AIR, INC. P.O. BOX 1011 108 E. ALABAMA MT. PLEASANT, TX 75455</p> <p style="text-align: center;">4J976</p> <p>CAGE code: 4J976 2/</p>	
<p>REID PRODUCT INC. 21430 WAALEW RD APPLE VALLEY, CA 92307</p> <p style="text-align: center;">Rp</p> <p>CAGE code: 59563 1/</p>	
<p>RELIANT FASTENER 201 E. 2ND STREET ROCK FALLS, IL 61071</p>  <p>CAGE code: 2/</p>	
<p>REPUBLIC FASTENER MANUFACTURING CORP. 1300 RANCHO CONEJO BOULEVARD NEWBURY PARK, CA 91320-1405</p> <p style="text-align: center;">R</p> <p>CAGE code: 52828, 71087 1/</p>	<p>RICHARD MFG. CO., INC. 250 ROCK LANE MILFORD, CT 06460-3853</p>  <p>CAGE code: 4A014 1/</p>

1/ Information published in this revision was verified by direct contact with manufacturers.

2/ Information not verified to be current, no response from manufacturer. Information identical to that published in MIL-HDBK-57, Revision B.

MIL-HDBK-57C(IS)

RING SCREW WORKS
10160 GAINEY RD
HOLLY, MI 48442 - 9331

FENTON HEADING
2480 OWEN RD.
FENTON, MI 48430-1769
CAGE code: 7M992

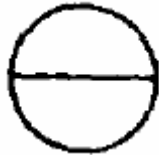

FERNDALE FASTENER
31600 STEPHENSON HIGHWAY
MADISON HEIGHTS, MI 48071



RING SCREW DEVISION
22100 SHERWOOD AVE.
WARREN, MI 48091



SEMCO FASTENER
4146 EAST BALDWIN RD.
HOLLY, MI 48442



TITAN FASTENER
10031 HOLLY RD.
HOLLY, MI 48442



CAGE code: 0B2C8

2/

RIPPA PRODUCTS
P.O. BOX 328
5 MILE POINT RD
MOHAWK, MI 49950

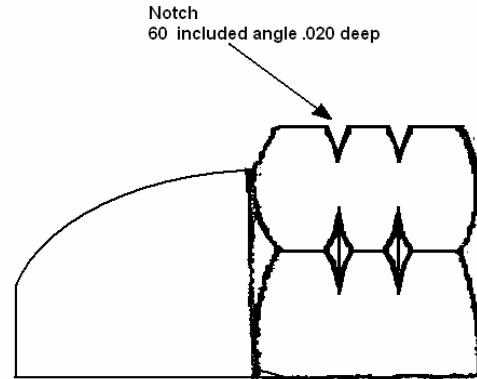

CAGE code: 0R7Z5

2/

RISCO, INCORPORATED
390 RISCO CIRCLE
BEAUMONT, CA 92223-2676

01DC

CAGE code: 6W027

2/

RIVER VALLEY TOOL & MANUFACTURING
P. O. BOX 64
260 AIRPORT INDUSTRIAL ROAD
PARIS, AR 72855

RVT



CAGE code: 3K1M6

1/

1/ Information published in this revision was verified by direct contact with manufacturers.

2/ Information not verified to be current, no response from manufacturer. Information identical to that published in MIL-HDBK-57, Revision B.







































MIL-HDBK-57C(IS)

<p>RIVNUT ENGINEERED PRODUCTS, INC. 2705 MARION DRIVE KENDALLVILLE, IN 46755</p> <p>REP</p> <p>CAGE code: 0VK23 <u>2/</u></p>	<p>ROBERT HENRY CO., INC. 87 OPAL STREET MILFORD, CT 06460</p> <p>RH</p> <p>CAGE code: 9J112 <u>2/</u></p>
<p>RMS 1125 W ACACIA AVE HEMET, CA 92543</p> <p>RMS</p> <p>CAGE code: <u>2/</u></p>	<p>ROCKFORD BOLT & STEEL CO. (SUBSIDIARY OF VARLEN CORPORATION) 126 MILL ST ROCKFORD, IL 61101-1491</p> <p></p> <p>CAGE code: 90483 <u>1/</u></p>
<p>ROBBINS MANUFACTURING P.O. BOX 704 1200 AIRPORT ROAD FALL RIVER, MA 02722</p> <p></p> <p></p> <p>CAGE code: 8T312 <u>1/</u></p>	<p>ROCKFORD FASTENERS INC. P.O. BOX 884 ROCKFORD, IL 61105</p> <p>Plant 725 SOUTH STREET ROCKFORD, IL 61102</p> <p>R</p> <p>CAGE code: 0B998 <u>2/</u></p>

1/ Information published in this revision was verified by direct contact with manufacturers.

2/ Information not verified to be current, no response from manufacturer. Information identical to that published in MIL-HDBK-57, Revision B.

MIL-HDBK-57C(IS)

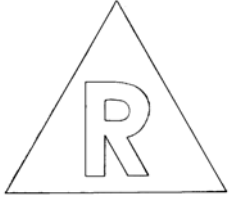
<p>ROCKFORD PRODUCTS CORP. 707 HARRISON AVE ROCKFORD, IL 61108</p>  <p>MSC. OR LOW CARBON</p>  <p>GENERAL PURPOSE</p>  <p>GRADE 3</p>  <p>GRADE 5</p>  <p>GRADE 5</p>  <p>GRADE 5.1</p>  <p>GRADE 5.2</p>  <p>GRADE 6</p>  <p>GRADE 7</p>  <p>GRADE 8</p>  <p>GRADE 8</p>  <p>GRADE 8.2</p>  <p>DURLOK</p>  <p>STAINLESS</p>  <p>SAE J-1102</p>  <p>P3T WITH APPROPRIATE GRADE</p>  <p>B7</p>  <p>METRIC GRADE 8.8</p>  <p>METRIC GRADE 9.8</p>  <p>METRIC GRADE 10.9</p>  <p>IND. HEX. HEAT TREAT & NO HEAT TREAT</p>  <p>IND. HEX. GRADE 3</p>  <p>IND. HEX. GRADE 5</p>  <p>IND. HEX. GRADE 5.1</p>  <p>IND. HEX. GRADE 6</p>  <p>IND. HEX. GRADE 7</p>  <p>IND. HEX. GRADE 8</p>  <p>IND. HEX. STAINLESS</p>  <p>OLD STYLE PLACE BOLT GRADE 3</p>  <p>OLD STYLE PLACE BOLT GRADE 5</p>  <p>NEW STYLE PLACE BOLT GRADE 3</p>  <p>NEW STYLE PLACE BOLT GRADE 5</p>  <p>METRIC NEW STYLE PLACE BOLT GRADE 9.8</p>  <p>METRIC NEW STYLE PLACE BOLT GRADE 10.9</p>  <p>HEX. NUT GRADE 5</p>  <p>HEX NUT GRADE 8</p>  <p>LOW CARBON</p>  <p>ROCKALLOY GRADE 8</p> <p>CAGE code: 77595 2/</p>	<p>ROGG MANUFACTURING COMPANY 600 DANBURY ROAD NEW MILFORD, CT 06776</p>  <p>CAGE code: 08625 2/</p> <hr/> <p>ROMAC ELECTRONICS, INC. 155 E. AMES CT. PLAINVIEW, NY 11803</p> <p style="text-align: center; font-size: 2em;">8T968</p> <p>CAGE code: 8T968 2/</p> <hr/> <p>RONSON MANUFACTURING, INC. 9933 CHILLICOCTHE ROAD KIRKLAND, OH 44094</p> <p style="text-align: center; font-size: 3em;">R</p> <p>CAGE code: 2X146 1/</p> <hr/> <p>ROSAN PRODUCTS AFS TORRANCE OPERATIONS 3018 WEST LOMITA BLVD. TORRANCE, CA 90505-5103</p> <p>(Corporate office see ALCOA FASTENING SYSTEMS)</p> <p style="text-align: center; font-size: 2em;">RI</p> <p>CAGE code: 83324 1/</p>
---	---

1/ Information published in this revision was verified by direct contact with manufacturers.

2/ Information not verified to be current, no response from manufacturer. Information identical to that published in MIL-HDBK-57, Revision B.

MIL-HDBK-57C(IS)

ROTAIR INDUSTRIES, INC.
 P.O. BOX 4098
 964 CRESCENT AVE
 BRIDGEPORT, CT 06607-1025

 Rubber stamped
 on fasteners

54878

Commercial and Government Entity
 (CAGE) number affixed or rubber

CAGE code: 54878 1/

RS MANUFACTURING, INC.
 INDUSTRIAL PARK BLVD.
 MENTOR, OH 44060

RS 

CAGE code: 0MYK3 2/

RUDOLPH INSTRUMENTS, INC.
 400 MORRIS AVE STE 120
 DENVER, NJ 07834-1362

RI

CAGE code: 23262 2/

RUMCO, INC.
 985 PAULY DR.
 ELK GROVE VILLAGE, IL 60007-1312

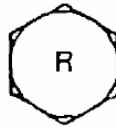
 GRADE 2

 GRADE 5

 GRADE 5.1

 GRADE 5.2

 GRADE 8

CAGE code: 6Z992 2/

RUSCOMB TOOL & MACHNE CO., INC.
 500 W. RUSCOMB STREET
 PHILADELPHIA, PA 19120

RTM

CAGE code: 07952 2/

S & L METAL PRODUCTS CORP.
 5829 57TH DR
 MASPETH, NY 11378-2232

S&L

CAGE code: 05722 2/

1/ Information published in this revision was verified by direct contact with manufacturers.

2/ Information not verified to be current, no response from manufacturer. Information identical to that published in MIL-HDBK-57, Revision B.

MIL-HDBK-57C(IS)

<p>S. B. E. (ITALY CORPORATION) VIA ENRICO DERMI 20019 SETTIMO MILANESE, ITALY</p> <p style="text-align: center;">SBE</p> <p>CAGE code: 2/</p>
<p>S.A.B.A. S.p.A. BULLONERIA E. AFFINI VIA LIGURIA 11/13, 20098 SESTO ULERIANO FRAZ. DI S. GUILLANO M.SE MILANO, ITALY</p> <p style="text-align: center;">A.L.</p> <p>CAGE code: 2/</p>
<p>S.I. STUD, INC. 1127 SILBER RD. HOUSTON, TX 77055</p> <p style="text-align: center;"></p> <p>CAGE code: 2/</p>
<p>SABRE MANUFACTURING, INC. P.O. BOX 11386 201 S. CHERRY ST. SOUTH BEND, IN 46601</p> <p style="text-align: center;">S</p> <p>CAGE code: 0GN74 2/</p>

SAFETY SOCKET SCREW CORP.
(ENGINEERING DEPARTMENT)
6501 NORTH AVONDALE AVE.
CHICAGO, IL 60631

INCH SOCKET HEAD CAP SCREWS

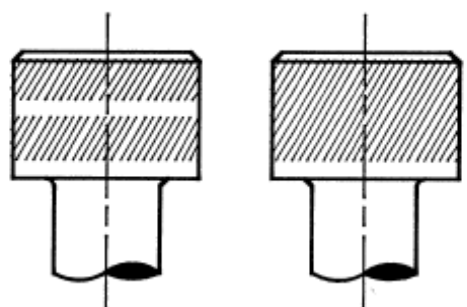

BUTTON HEAD CAP SCREWS FLAT HEAD CAP SCREWS AND SOCKET HEAD SHOULDER SCREWS

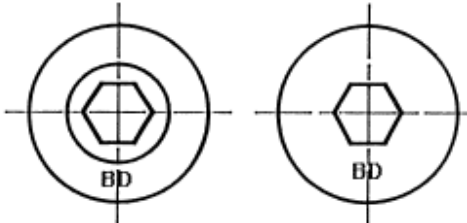

METRIC SOCKET HEAD CAP SCREWS

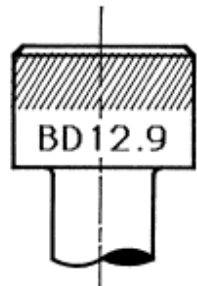

BD AND THE 60° DIAGONAL KNURL ARE REGISTERED TRADEMARKS OF SAFETY SOCKET SCREW CORPORATION FOR THE PURPOSE OF MANUFACTURERS IDENTIFICATION









BD BDM

CAGE code: 82896 2/

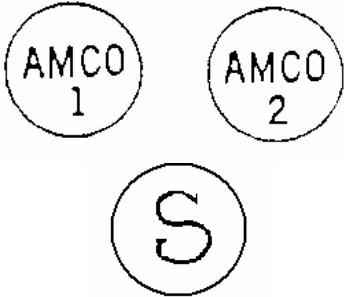
1/ Information published in this revision was verified by direct contact with manufacturers.

2/ Information not verified to be current, no response from manufacturer. Information identical to that published in MIL-HDBK-57, Revision B.

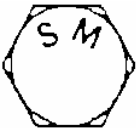
MIL-HDBK-57C(IS)

<p>SAGA TEKKOSHO CO., LTD. 129-3 TAKAYA FUJISAWA-CITY KANAGAWA PREF., JAPAN</p>  <p>CAGE code: <u>2/</u></p>	<p>SANDIK MANUFACTURING, INC. 100 8TH STREET PASSAIC, NJ 07055</p>  <p>CAGE code: 6U704 <u>2/</u></p>
<p>SAI INDUSTRIES CORP. 1207 FULTON AVENUE SAN ANTONIO, TX 78201-4501</p>  <p>CAGE code: 1KQ10, 63095 <u>2/</u></p>	<p>SANNOHASHI SEISAKUSHO CO., LTD. 2-1-18 OKINO ADACHI-KU TOKYO 123 JAPAN</p>  <p>CAGE code: <u>2/</u></p>
<p>SALES SYSTEM, LIMITED P.O. BOX 7006 700 FLORIDA AVE. PORTSMOUTH, VA 23707-1918</p>  <p>CAGE code: 8F411 <u>1/</u></p>	<p>SANTA ANA GEAR & MACHINE 15201 PIPELINE LN. HUNTINGTON BEACH, CA 92649</p>  <p>CAGE code: <u>2/</u></p>
<p>SAMUEL MARSDEN & SON WELLINGTON RD. ASHTON UNDER LYNE, LANCASHIRE OL6 7EG UNITED KINGDOM</p>  <p>CAGE code: <u>2/</u></p>	<p>SANTA ANA SCREW PRODUCTS INC. SANTA ANA, CA 92701</p>  <p>CAGE code: 33644 <u>2/</u></p>

1/ Information published in this revision was verified by direct contact with manufacturers.

2/ Information not verified to be current, no response from manufacturer. Information identical to that published in MIL-HDBK-57, Revision B.



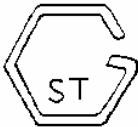
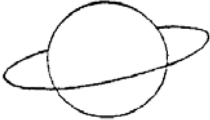
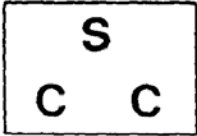
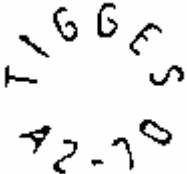



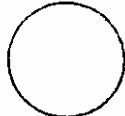

MIL-HDBK-57C(IS)

<p>SATAIR MANUFACTURING FACILITY PURDEYS WAY PURDEYS INDUSTRIAL ESTATE ROCHFORD ESSEX SS5 4JJ UK</p> <p style="text-align: center;">SMF</p> <p>CAGE code: K4975 1/</p>	<p>SCHRAUBENFABRIK GUSTAV STERNBERG GmbH & CO. KG 1000 BERLIN 27 BREITENBACHSTRASSE 11-12 GERMANY</p> <p style="text-align: center;"></p> <p style="text-align: center;">Symbol may be raised or struck in.</p> <p>CAGE code: 2/</p>
<p>SATURN FASTENERS, INC. 425 SO. VARNEY ST. BURBANK, CA 91502-2125</p> <p style="text-align: center;"></p> <p>CAGE code: 0K6Z0 1/</p>	<p>SCHUHL & CO. GMBH AUF DER HUTTE 31 WINTERBURG 59955 GERMANY</p> <p style="text-align: center;">S</p> <p>CAGE code: C3639 2/</p>
<p>SCANDIA MFG. CO., INC. 480 BRUNSWICK ST. BALTIMORE, MD 21223-2745</p> <p style="text-align: center;">SCA</p> <p>CAGE code: 00997 1/</p>	<p>SCOTT CRAFT CO. P.O. BOX 430 BELL, CA 90201</p> <p style="text-align: center;">Plant 4601 CECELIA STREET CUDAHY, CA 90201</p> <p style="text-align: center;"></p> <p>CAGE code: 28418 2/</p>
<p>SCHMICO GMBH SCHWEISSTECHNIK P. O. BOX 12 29 PETER-LINNARTZ-STRASSE JUELICH 52428, GERMANY</p> <p style="text-align: center;"></p> <p>CAGE code: C15191 2/</p>	

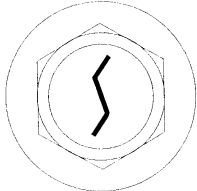
1/ Information published in this revision was verified by direct contact with manufacturers.

2/ Information not verified to be current, no response from manufacturer. Information identical to that published in MIL-HDBK-57, Revision B.





MIL-HDBK-57C(IS)

<p>SCREWCORP. (A DIVISION OF VSI) 13001 EAST TEMPLE AVE. CITY OF INDUSTRY, CA 91714</p>  <p>Indented circle on all fasteners, except machine screws.</p> <p>CAGE code: 9H901 2/</p>	<p>SESCO INDUSTRIES, INC. P. O. BOX 242 110 - 19 15TH AVENUE COLLEGE POINT, NY 11356</p>  <p>CAGE code: 0KH97 1/</p>
<p>SEMBLEX CORP. 199 W. DELEVERY AVE ELMHURST, IL 60126</p>  <p>CAGE code: 4M343 1/</p>	<p>SHACKELFORD MACHINIG, INC. 2407 LUDELLE ST. FORT WORTH, TX 76105-0755</p>  <p>CAGE code: 4K446 1/</p>
<p>SEMCO FASTENER 4146 EAST BALDWIN RD. HOLLY, MI 48442</p> <p>See RING SCREW WORKS</p>  <p>CAGE code: 0B2C8 1/</p>	<p>SHAMROCK FASTENER TECHNOLOGIES, LLC. 6125 18 MILE ROAD STERLING HEIGHTS, MI 48314</p> <p>SHAMROCK IN CIRCLE</p>  <p>SFT LDGO</p>  <p>CAGE code: 05CF6 2/</p>
<p>SENG HENG ENGINEERING PTE LTD. NO. 3 EUNOS AVE. 8A SINGAPORE 409458 REPUBLIC OF SINGAPORE</p>  <p>CAGE code: 1/</p>	

1/ Information published in this revision was verified by direct contact with manufacturers.

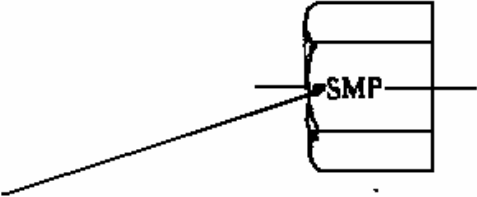
2/ Information not verified to be current, no response from manufacturer. Information identical to that published in MIL-HDBK-57, Revision B.

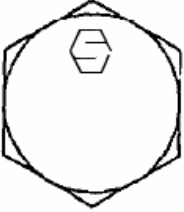
MIL-HDBK-57C(IS)

<p>SHAW PRECISION GRINDING & THREADING 6503 W. FRYE RD. SUITE 6 CHANDLER, AZ 85226</p> <p>SALES ADDRESS SEE: ACE GRINDING & MFG. OF TEXAS 2610 AERO DR. GRAND PRAIRIE, TX 75052 CAGE code: 5U074</p> <p>SPG</p> <p>CAGE code: 1KRG8 <u>1/</u></p>	<p>SHORELINE MACHINE PRODUCTS, INC. 19301 ST. CLAIR AVENUE CLEVELAND, OH 44117</p>  <p>SMP will be applied to this surface to denote Shoreline Machine Products as manufacturer.</p> <p>CAGE code: 1VN42 <u>1/</u></p>
<p>SHEFFIELD, INC. 1025 WINCHESTER AVE. KANSAS CITY, MO 64126</p> <p>S</p> <p>CAGE code: 68567 <u>2/</u></p>	<p>SHUR-KUT SUPPLY CORPORATION P.O. BOX 119 241 WOOLDAND AVENUE MORTON, PA 19070</p>  <p>CAGE code: 6R002 <u>2/</u></p>
<p>SHIGA BOLT CO., LTD. OTSU 423 MINAMI-TSUCHIYAMA TSUCHIYAMA-CHO, KOHGA-GUN SHIGA- KEN 528-02 JAPAN</p>  <p>CAGE code: <u>2/</u></p>	<p>SHUR-LOK CORP. (SPS FASTENERS DIVISION , A PCC COMPANY) 2541 WHITE ROAD IRVINE, CA 92614 - 6235</p>   <p>CAGE code: 97393 <u>1/</u></p>

1/ Information published in this revision was verified by direct contact with manufacturers.

2/ Information not verified to be current, no response from manufacturer. Information identical to that published in MIL-HDBK-57, Revision B.

MIL-HDBK-57C(IS)

SIERRA PACIFIC SUPPLY CO., INC.
 P. O. BOX 4848
 1801 W EL SEGUNDO BLVD
 COMPTON, CA 90224



CAGE code: 5G098 1/

SIMMONDS PRODUCTS
 AFS ST. COSME OPERATIONS
 9 RUE DES CRESSONNIERES
 72110 ST. COSME-EN-VAIRAIS
 FRANCE

(Corporate office see ALCOA FASTENING SYSTEMS)



CAGE code: F0224 1/

SIERRACIN/HARRISON
 3020 EMPIRE AVENUE
 BURBANK, CA 91504



CAGE code: 08199 2/

SINN-TECH, INC.
 48 GLEAM STREET
 WEST BABYLON, NY 11704







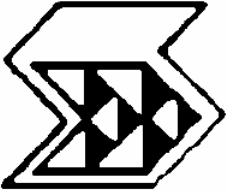

CAGE code: 9J550 1/

1/ Information published in this revision was verified by direct contact with manufacturers.

2/ Information not verified to be current, no response from manufacturer. Information identical to that published in MIL-HDBK-57, Revision B.







MIL-HDBK-57C(IS)

<p>SKY MANUFACTURING 5989 RICCKENBACKER ROAD COMMERCE, CA 90040</p> <p>SM</p> <p>CAGE code: 1CNU4 1/</p>	<p>SMITH MACHINE & MANUFACTURING RT. 4 P.O. BOX 283 CANTON, TX 75103</p> <p>SM&M</p> <p>CAGE code: 0MAJO 2/</p>
<p>SKYLINE INDUSTRIES 1201 FORUM WAY SOUTH FORT WORTH, TX 76140</p>  <p>CAGE code: 09986 2/</p>	<p>SMITH WELDING, INC. 756 PRUNNER ROAD RIDDLE, OR 97469</p>  <p>CAGE code: 1GQX1 1/</p>
<p>SKYSPARES PARTS, INC. 6660 VIEW PARK COURT RIVERSIDE, CA 92503</p>  <p>CAGE code: 6M132 2/</p>	<p>SONFARREL, INC. 3000-3010 LA JOLLA ST. ANAHEIM, CA 92806</p>  <p>CAGE code: 09036 2/</p>
<p>SLABE MACHINE PRODUCTS 4659 HAMANN PARKWAY WILLOUGHBY, OH 44094</p>  <p>CAGE code: 97139 1/</p>	<p>SONIC INDUSTRIES, INC. 20030 SO. NORMANDIE AVE. TORRANCE, CA 90502</p>  <p>CAGE code: 57928 1/</p>

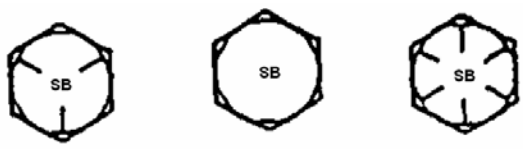
1/ Information published in this revision was verified by direct contact with manufacturers.

2/ Information not verified to be current, no response from manufacturer. Information identical to that published in MIL-HDBK-57, Revision B.

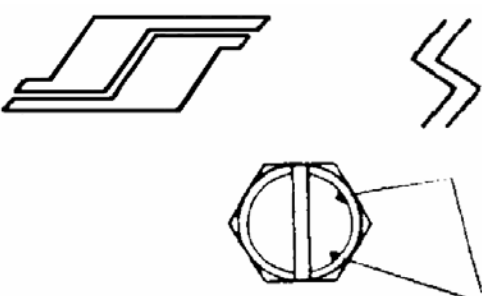

MIL-HDBK-57C(IS)

<p>SOUTH BAY BOLT MANUFACTURING CO. P.O. BOX 5805 COMPTON, CA 90224</p> <p>Plant 1775 W. El Segundo Blvd. Compton, CA 90222</p>  <p>CAGE code: 2P339 <u>2/</u></p>	<p>SOUTHWEST ALLIED PRODUCTS CO., INC. 299 HILL RD. VANLEER, TN 37181</p>  <p>CAGE code: 6P461 <u>2/</u></p>
<p>SOUTHERN FASTENER CORPORATION P. O. BOX 1387 1641 CONCEPTION STREET ROAD MOBILE, AL 36610</p>  <p>CAGE code: 1K461 <u>1/</u></p>	<p>SOUTHWEST INDUSTRIAL SERVICES P. O. BOX 9084 FT. WORTH, TX 76147</p> <p>Plant 2413 WHITMORE FT. WORTH, TX 76147</p>  <p>CAGE code: 6H920 <u>2/</u></p>
<p>SOUTHERN FASTENING SYSTEMS (DIVISION OF FARLEY METALS, INC.) P.O. BOX 1360 STATESVILLE, NC 28677</p>  <p><i>2 notches for slotted heads only</i></p> <p>CAGE code: 87308 <u>2/</u></p>	<p>SOUTHWIND INDUSTRIES, INC. P.O. BOX 98 1646 OILD BUTLER PLANK RD. PITTSBURGH, PA 15200</p>  <p>CAGE code: 0DTJ0 <u>2/</u></p>
	<p>SPACE AGE ENGINEERING, INC. 4022 E. 26TH STREET INDIANAPOLIS, IN 46218</p>  <p>CAGE code: 29953 <u>2/</u></p>

^{1/} Information published in this revision was verified by direct contact with manufacturers.

^{2/} Information not verified to be current, no response from manufacturer. Information identical to that published in MIL-HDBK-57, Revision B.

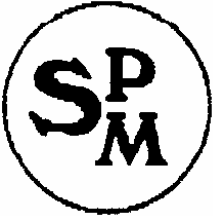
MIL-HDBK-57C(IS)

<p>SPACE SCREW, INC. 106 STANDARD ST. EL SEGUNDO, CA 90245</p> <p style="text-align: center;">SpSc</p> <p>CAGE code: 0GE51 <u>2/</u></p>	<p>SPECIAL-T-METALS P.O. BOX 14810 LENEXA, KS 66215</p> <p style="text-align: center;">Plant 14740 WEST 101 TERRACE LENEXA, KS 66215</p> <p style="text-align: center;">STM</p> <p>CAGE code: 8U495 <u>2/</u></p>
<p>SPACE-LOK, INC. 13306 HALLDALE AVE. GARDENA, CA 90249</p> <p style="text-align: center;">SLI</p> <p>CAGE code: 16258 <u>1/</u></p>	<p>SPECIALTY SCREW CORP. P.O. BOX 5003 ROCKFORD, IL 61125</p> <p style="text-align: center;">Plant 2801 HUFFMAN BLVD. ROCKFORD, IL 61103</p> <p style="text-align: center;">S</p> <p>CAGE code: 1WQE5 <u>2/</u></p>
<p>SPARTAN PRECISION MACHINE 131 ALBANY AVE FREEPORT, NY 11520</p> <p style="text-align: center;"></p> <p>CAGE code: 2M198 <u>2/</u></p>	<p>SPIRAL TOOL CORP. 761 ROUTE 6 SHOHOLA, PA 18458</p> <p style="text-align: center;"></p> <p>CAGE code: 02108 <u>1/</u></p>
<p>SPECIALS, INC. P.O. BOX 514 103 MAINLINE DRIVE WESTFIELD, MA 01086-0514</p> <p style="text-align: center;"></p> <p>CAGE code: 0WVC1 <u>1/</u></p>	

1/ Information published in this revision was verified by direct contact with manufacturers.

2/ Information not verified to be current, no response from manufacturer. Information identical to that published in MIL-HDBK-57, Revision B.

MIL-HDBK-57C(IS)

SPS TECHNOLOGIES
FASTENER DIVISION CORPORATE
HEADQUARTERS
JENKINTOWN, PA 19046-2630

SPS AREOSPACE FASTENER COPANIES

SPS TECHNOLOGIES (Cage 56878)
301 HIGHLAND AVENUE
JENKINTOWN, PA 19046-2630

The following characters (used alone or in combination with other digits/ letters which designate material, size, strength grade or part number) indicate SPS as manufacturing source:

C	K	U
CCS	K-5673	U130
EWB	KS	UNBRAKO
EWN	S	UNW
FNF	SPS	56878
HI PSI	TJB	71838
HI TI	TM9	80539

For "inch" socket head cap screws



Straight knurls with an unknurled band adjacent to the bearing surface on socket heads. The diameter over the straight knurl does not exceed the band. There may be 2 or 3 grooves near the band or a diamond knurl band at top of head.



A raised or depressed triangle pointing from the wrenching flat toward thread on nut products.



S-C used on metal nuts

SPS TECHNOLOGIES (Cage 80539)
SANTA ANA DIVISION
271 SO. HARBOR BLVD.
SANTA ANA, CA 92704-1259

SPS SPS S S

CAGE code: 56878, 80539,
Continued

1/

Continued

SPS TECHNOLOGIES (Cage K5673)
T. J. BROOKS DIVISION
191, BARKBY ROAD'
TROON INDUSTRIAL AREA
LEICESTER LE4 9HX
ENGLAND

TBJ

SPS ENGINEERED PRODUCTS GROUP

SPS TECHNOLOGIES (Cage 1C5D9)
NORTH AMERICAN FASTENERS
(AFG DIV)
4444 LEE ROAD
CLEVELAND, OH 44128-2902



UNB

SPS TECHNOLOGIES (Cage 495T1)
NORTH AMERICAN FASTENERS
DBA TERRY MACHINE
5331 DIXIE HWY
WATERFORD, MI 48329



SPS TECHNOLOGIES (Cage U3575)
P O BOX 38
BURNABY ROAD
COVENTRY CV 6 AE, ENGLAND

SPS INTERNATIONAL LTD. (Cage S3329)
UNBRACO SHANNON
BAYS 25-30 SHANNON INDUSTRIAL
ESTATE,
SHANNON, COUNTRY CLARE,
IRELAND

METALAC SPS INDUSTRIA E COMERCIO
LTDA.
AVENIDA ITAVUVU, 4690
18078-005 SOROCABA (SP),
BRAZIL

TELLEP TLP T



UNBRACO PTY LTD. AUSTRALIA
P.O. BOX 3138 NUNAWADING
VICTORIA 3131, AUSTRALIA

U UM



CAGE code: K5673, IC5D9, 495T1, U3575,
S3329

1/

^{1/} Information published in this revision was verified by direct contact with manufacturers.



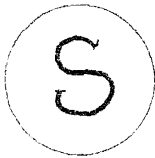
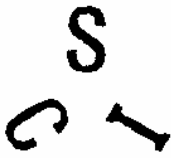



^{2/} Information not verified to be current, no response from manufacturer. Information identical to that published in MIL-HDBK-57, Revision B.

MIL-HDBK-57C(IS)

<p>SPS TECHNOLOGIES LIMITED T/A UNBRACO UK CRANFORD STREET SMETHWICK B66 2TA UNITED KINGDOM</p> <p style="text-align: center;">TBJ</p> <p>CAGE code: U3575</p> <p>SPS TECHNOLOGIES LIMITED TJ BROOKS DIVISION (UNITED KINGDOM CORPORATION) 191 BARKBY ROAD TROON INDUSTRIAL AREA LEICESTER LE4 9HX UNITED KINGDOM</p> <p style="text-align: center;">TBJ</p> <p>CAGE code: K5673 <u>2/</u></p>	<p>SRI SAI INDUSTRIES CORPORATION 1207 FULTON AVENUE SAN ANTONIO, TX 78201-5104</p> <p style="text-align: center;"></p> <p>CAGE code: 63095 <u>1/</u></p>
<p>SPURWAY COOKE INDUSTRIES PTE LTD. 2, JOO KOON ROAD JURONG SINGAPORE 628966 REPUBLIC OF SINGAPORE</p> <p style="text-align: center;"></p> <p>CAGE code: <u>1/</u></p>	<p>ST. LOUIS SCREW & BOLT CO. 6900 NORTH BROADWAY ST. LOUIS, MO 63147</p> <p style="text-align: center;"> TYPE I</p> <p style="text-align: center;"> TYPE III</p> <p>CAGE code: <u>2/</u></p> <p>STALKER & DYSTHE, INC. 5100 E. WASHINGTON BLVD. LOS ANGELES, CA 90040</p> <p style="text-align: center;">SD</p> <p>CAGE code: 6D696 <u>2/</u></p>

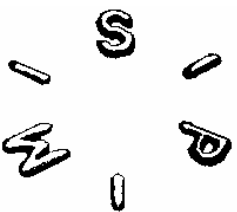
1/ Information published in this revision was verified by direct contact with manufacturers.2/ Information not verified to be current, no response from manufacturer. Information identical to that published in MIL-HDBK-57, Revision B.

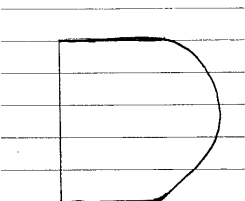
MIL-HDBK-57C(IS)

<p>STANDARD LOCKNUT, INC. P. O. BOX 780 1045 EAST 169TH STREET WESTFIELD, INDIANA 46074</p>  <p>CAGE code: 78507 <u>2/</u></p>	<p>STEEL CITY BOLT & SCREW, INC. P.O. BOX 1747 BIRMINGHAM, AL 35201</p> <p>Plant 230 WEST VALLEY AVE. BIRMINGHAM, AL 35209</p>  <p>CAGE code: 3N642 <u>2/</u></p>
<p>STANDARD NUT & BOLT, INC. 49 ABBOTT ST. CUMBERLAND, RI 02864</p>  <p>CAGE code: 758C9 <u>2/</u></p>	<p>STEEL PRODUCTS OF MASSILLION 132 WALNUT RD S.W. MASSILLION, OH 44646</p>  <p>CAGE code: 0698X <u>2/</u></p>
<p>STANDARD TOOL & MACHINE CO. 205 E. CARSON ST. PITTSBURGH, PA 15219</p> <p>Plant 208 WOODLAND RD. BIAWNOX, PA 15238</p> <p>See HALL INDUSTRIES</p>  <p>CAGE code: 0KA69 <u>2/</u></p>	<p>STEEL WAREHOUSE COMPANY, INC. 2722 WEST TUCKER DRIVE BOX 1377 SOUTH BEND, IN 46624</p>  <p>CAGE code: 0R1J8 <u>2/</u></p>
<p>STEADFAST CORPORATION 229 MARGINAL ST. CHELSEA, MA 02150</p>  <p>CAGE code: 9X854 <u>2/</u></p>	

1/ Information published in this revision was verified by direct contact with manufacturers.

2/ Information not verified to be current, no response from manufacturer. Information identical to that published in MIL-HDBK-57, Revision B.

MIL-HDBK-57C(IS)

STELCO FASTENER & FORGING CO.
1250 APPLEBY LINE
BULINGTON, ONTARIO L71 5G6
CANADA



Stelco trademark
for most
fasteners



Most other nuts
and bolts,
including metric



SAE Grade 5
hex nuts



SAE Grade 8
hex nuts

CONELOK LOCKNUTS
Inch series









Grade B



Grade C

Metric series

Class 5 Class 9 Class 10
Bearing surface

CAGE code: _____

Continued 2/

Continued

STELCO FASTENER & FORGING CO.
1250 APPLEBY LINE
BULINGTON, ONTARIO L71 5G6
CANADA

HI-HEX CONELOK LOCKNUTS
Inch series









Grade B



Grade C

Metric series









Class 5 Class 9 Class 10
Bearing surface

CAGE code: _____ 2/

STELFAST FASTENERS, INC.
(DIVISION OF STELFAST FASTENERS,
LTD.)
1710 CLARKSTONE ROAD
CLEVELAND, OH 44112

1/4 in. through 3/4 in. hex cap
screws, heavy hex bolts, square
head bolts, and specialty exter-
nally threaded fasteners, cold
headed.



3/4 in. through 2 1/4 in. reg. hex
bolts, heavy hex bolts, square
head bolts, and specialty exter-
nally threaded fasteners, hot
headed.



1/4 in. through 2 1/2 in. studs.
2 3/8 in. through 3 in. reg. hex
bolts, heavy hex bolts, square
head bolts, hot headed, and
specialty externally threaded
fasteners.

CAGE code: _____ 2/

1/ Information published in this revision was verified by direct contact with manufacturers.

2/ Information not verified to be current, no response from manufacturer. Information identical to that published in MIL-HDBK-57, Revision B.



MIL-HDBK-57C(IS)

<p>STERLING MACHINE COMPANY 23 FARRAR STREET LYNN, MA 01901-1699</p> <p style="text-align: center;">2</p> <p style="text-align: center;">SC</p> <p>CAGE code: 03983 <u>1/</u></p>	<p>STEVENS MFG. CO., INC. P.O. BOX 3041 MILFORD, CT 06460</p> <p style="text-align: center;">Plant 280 ROCK LANE MILFORD, CT 06460</p> <p style="text-align: center;">MFR 8F781</p> <p style="text-align: center;">8F781</p> <p>CAGE code: 8F781 <u>2/</u></p>
<p>STERLING MARKING PRODUCTS IC P.O. BOX 3360 STA A 349 RIDOUT ST N LONDON, ONTARIO, CANADA NGA 4K3</p> <p style="text-align: center;">GD</p> <p style="text-align: center;">IGD</p> <p>CAGE code: 37084 <u>2/</u></p>	<p>STILLWATER FASTENERS, INC. 25 GURNEY ROAD EAST FREETOWN, MA 02717-1107</p> <p style="text-align: center;">SW & ..</p> <p style="text-align: center;">Symbols are "SW", ampersand ("&") or "..."</p> <p>CAGE code: 1Y153 <u>1/</u></p>
<p>STERLING MFG. & SUPPLY, INC. P.O. BOX 8205 FORT WORTH, TEXAS 76124</p> <p style="text-align: center;">Plant 3623 E. VICKERY BLVD. FORT WORTH, TX 76105</p> <p style="text-align: center;">S or 60529</p> <p style="text-align: center;">Steel stamped or Embossed or Rubber stamped</p> <p>CAGE code: 60529 <u>2/</u></p>	<p>STRENKERT MACHINE SHOP INC. RD #2, BOX 759 INDIAN BROOK ROAD GREENE, NY 13778</p> <p style="text-align: center;"></p> <p>CAGE code: 2T174 <u>2/</u></p>

1/ Information published in this revision was verified by direct contact with manufacturers.

2/ Information not verified to be current, no response from manufacturer. Information identical to that published in MIL-HDBK-57, Revision B.

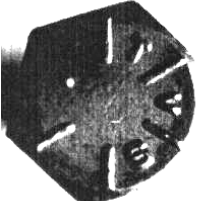
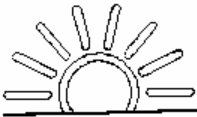

MIL-HDBK-57C(IS)

<p>STURM MACHINE CO., INC. 9846 OWENSMOUTH AVE. CHATSWORTH, PA 91311</p>  <p>CAGE code: 64733 <u>2/</u></p>	<p>SUNDRAM FASTENERS, LTD. MADRAS, INDIA</p>  <p>CAGE code: <u>2/</u></p>
<p>SUBCON TOOL/ACCUTOOL MACHINE GROUP INC. (DBA ACCUTOOL) 5301 IROQUOIS AVE ERIE, PA 16511 - 2529 See ACCUTOOL</p> <p>01FO</p> <p>CAGE code: 1UMX0 <u>1/</u></p>	<p>SUNRISE PRECISION MFG. 4406 ENTERPRISE PL, UNIT 3 FREMONT, CA 94538</p>  <p>CAGE code: 0UK47 <u>2/</u></p>
<p>SUBURBAN INDUSTRIES, INC. 11901 FRANKLIN AVE FRANKLIN PARK, IL 60131</p> <p>SII</p> <p>CAGE code: 89752 <u>2/</u></p>	<p>SUPERIOR TECHNOLOGY 11013 OLINDA STREET SUN VALLEY, CA 91352</p>  <p>EARTH</p> <p>CAGE code: <u>2/</u></p>
<p>SULLIVAN BOLT CO., INC. 3435 SOUTH MALT AVE. COMMERCE, CA 90040</p>  <p>CAGE code: 6M158 <u>2/</u></p>	<p>SUPREME SCREW PRODUCTS, INC. 1368 CROMWELL AVENUE BRONX, NY 10452</p>  <p>CAGE code: 1FMQ2 <u>2/</u></p>

1/ Information published in this revision was verified by direct contact with manufacturers.

2/ Information not verified to be current, no response from manufacturer. Information identical to that published in MIL-HDBK-57, Revision B.

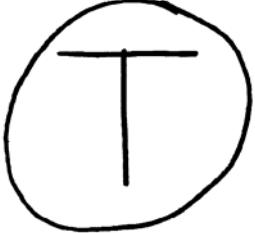
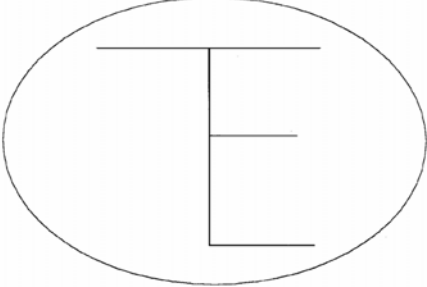
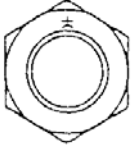





MIL-HDBK-57C(IS)

<p>S V INDUSTRIES 29280 YNEZ RD. TEMECULA, CA 92592</p> <p style="text-align: center;">SV</p> <p>CAGE code: OGVY7 <u>2/</u></p>	<p>T C QUALITY MACHINING INC. 12155 MAGNOLIA AVE STE 10D RIVERSIDE, CA 92503 - 4905</p> <p style="text-align: center;">TCQ</p> <p>CAGE code: 3H5W3 <u>1/</u></p>
<p>SWISS TECHNOLOGY, INC. 150 ST. CHARLES STREET NEWARK, NJ 07105</p> <p style="text-align: center;"></p> <p>CAGE code: 48406 <u>2/</u></p>	<p>T R MACHINE INC. 103 STATE ROUTE 75 E DAVIS, IL 61019-9586</p> <p style="text-align: center;">TR</p> <p>CAGE code: 1YJV1 <u>1/</u></p>
<p>T & E MACHINE CORP. 4519C WAYNE AVENUE PHILADELPHIA, PA 19144-3606</p> <p style="text-align: center;"> </p> <p>CAGE code: 059P5 <u>2/</u></p>	<p>TAIYO NUT MFG. CO., LTD. 2-6-12 KOUZEN, IKARUGACHO IKOMA-GUN, NARA, JAPAN</p> <p style="text-align: center;"> </p> <p>CAGE code: <u>2/</u></p>

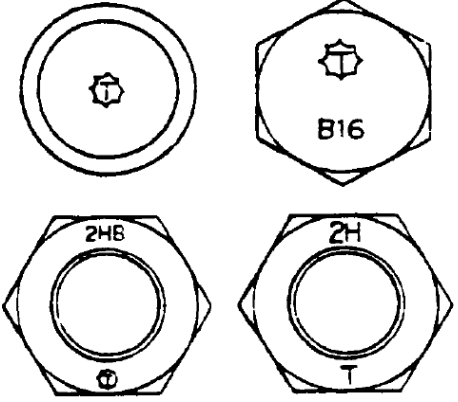
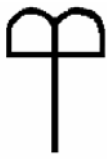
1/ Information published in this revision was verified by direct contact with manufacturers.

2/ Information not verified to be current, no response from manufacturer. Information identical to that published in MIL-HDBK-57, Revision B.

MIL-HDBK-57C(IS)

<p>TAKENAKA SEISAKUSHO CO., LTD. 178 HISHIE HIGASHI OSAKA CITY, JAPAN 578</p>  <p>CAGE code: <u>2/</u></p>	<p>TEBCO THREADED FASTENERS (DIVISION OF TENNESSEE BOLT & SCREW CO.) 2700 SUMMER AVENUE MEMPHIS, TN 38112</p> <p>Plant 665 SCOTT STREET MEMPHIS, TN 38112</p>  <p>CAGE code: 4K536 <u>2/</u></p>
<p>TANAKA LTD. 1-10-6 TEZUKAYAMA-NAKA SUMIYOSHI-KU, OSAKA, JAPAN</p>  <p>CAGE code: SP833 <u>2/</u></p>	<p>TECH WELDING AND MACHINE CO. 41 KINGSTON AVENUE COLUMBUS, OH 43207</p>  <p>CAGE code: 9Y179 <u>2/</u></p>
<p>T-B & S MFG. 4404 GARLAND DRIVE FORT WORTH, TX 76117</p>  <p>CAGE code: <u>2/</u></p>	<p>TECHNICAL FASTENERS, INC. 1129 GRIMMITT DR SHREVEPORT, LA 71107</p>  <p>CAGE code: 0GV34 <u>2/</u></p>
<p>CAGE code: <u>2/</u></p>	<p>TEK PRECISION CO., LTD. 205 WEST INDUSTRY COURT DEER PARK, NY 11729</p>  <p>CAGE code: 65780 <u>1/</u></p>

1/ Information published in this revision was verified by direct contact with manufacturers.

2/ Information not verified to be current, no response from manufacturer. Information identical to that published in MIL-HDBK-57, Revision B.

MIL-HDBK-57C(IS)

<p>TELEFAST INDUSTRIES, INC. 777 W BAGLEY RD BEREA, OH 44017-2901</p> <p style="text-align: center;">T</p>  <p>CAGE code: 3CW33 1/</p>
<p>TENS MACHINE CO., INC. 800 GRUNDY AVE. HOLBROOK, NY 11741-2606</p>  <p style="text-align: center;">TENS</p> <p>CAGE code: 8P689 1/</p>
<p>TERRY MACHINE CO. P.O. BOX 487 5331 DIXIE HWY. WATERFORD, MI 48095-1</p> <p>See SPS TECHNOLOGIES</p>  <p>CAGE code: 87880 2/</p>

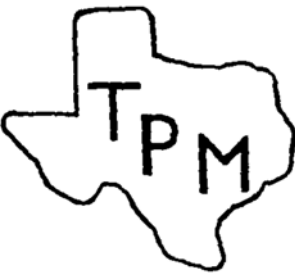
<p>TERRYCABLE, INC. 17376 EUCALYPTUS STREET HESPERIA, CA 92345</p> <p style="text-align: center;">TC</p> <p>CAGE code: 0XZ68 2/</p>
<p>TEXAS BOLT CO. P.O. BOX 1211 3235 W. 11TH ST. HOUSTON, TX 77251</p>  <p>CAGE code: 27422 2/</p>
<p>TEXAS PRECISION MFG., INC. P.O. BOX 3640 610 28TH ST LUBBOCK, TX 79452</p> <p>Plant 1204 E. 46TH STREET LUBBACK, TX 79404</p>  <p>CAGE code: ICU57 2/</p>

1/ Information published in this revision was verified by direct contact with manufacturers.

2/ Information not verified to be current, no response from manufacturer. Information identical to that published in MIL-HDBK-57, Revision B.

MIL-HDBK-57C(IS)

TEXTRON FASTENING SYSTEMS
 (AEROSPACE - SANTA ANA OPERATIONS)
 1224 E. WARNER AVENUE
 SANTA ANA, CA 92705



LOCKBOLTS
 Bold "C"

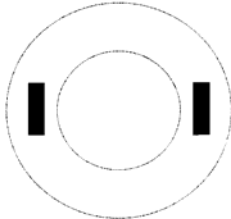

LOCKBOLT COLLARS
 Two Opposing Dashes

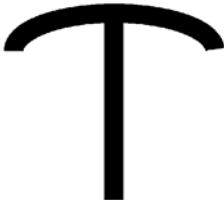

ALL PRODUCTS
 Lazy "T"

CAGE code: 11815 1/

TFI AEROSPACE CORPORATION
 19 CONSTELLATION CT.
 REXDALE, ONTARIO, CANADA



ALL NEW
 TOOLING

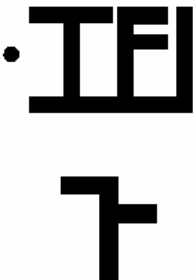

MODIFIED
 EXISTING
 TOOLING

CAGE code: L0336 2/

TFP CORP.
 (TRU-FIT PRODUCTS DIVISION)
 (SPECIAL FASTENER DIVISION)
 P. O. BOX 952
 MEDINA, OH 44258

Plant
 TRU-FIT STEEL WIRE CO.,LTD
 (TRU-WELD DIVISION)
 460 LAKE ROAD
 MEDINA, OH 44258

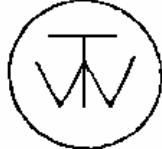
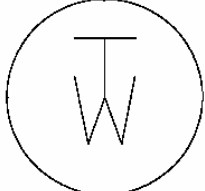
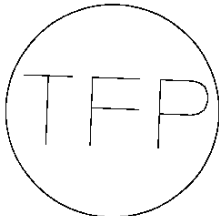
CAGE code: 31000 1/

1/ Information published in this revision was verified by direct contact with manufacturers.

2/ Information not verified to be current, no response from manufacturer. Information identical to that published in MIL-HDBK-57, Revision B.

MIL-HDBK-57C(IS)

THIANT (BOULONNERIE DE SA)
 B.P. 4
 FRANCE 59224



This marking appears on all hex nuts with or without deflection marks. The three raised lines in the corner indicate "Thiant" as manufacturer. (Clockwise system for grade.)



This marking appears on all flange nuts. The three raised lines on the flange indicate "Thiant" as manufacturer. (Clockwise system for grade.)



This marking appears on flange nuts when no mark is acceptable on the flange. Three depressed lines indicate "Thiant" as manufacturer. (Clockwise system for grade.)



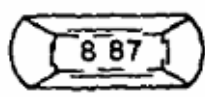

This marking appears on flange nuts when raised marks are not accepted. Three depressed lines indicate "Thiant" as manufacturer. (Clockwise system for grade.)

TRACKS FASTENERS



HIGH STRENGTH STRUCTURAL BOLT

HOT FORGED BOLTS

CAGE code: 2/

THOMAS & BETTS CORPORATION
 (FORMERLY AMERICAN ELECTRIC)
 8155 T AND B BLVD
 MEMPHIS, TN 38125 - 8888

Plant 1
 260 DENNIS STREET
 ATHENS, TN 37303

Plant 2
 8735 HAMILTON ROAD
 SOUTHAVEN, MS 38671

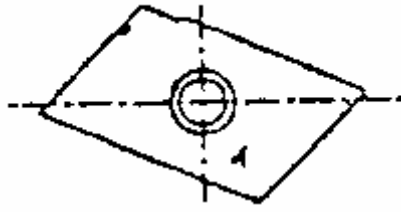

CAGE code: 56501 1/

THOMAS INSTRUMENT & MACHINE CO.,
 INC.
 3440 E FIRST ST
 BROOKSHIRE, TX 77423 - 0999



CAGE code: 5H860 2/

THOMAS MACHINING TECHNOLOGIES,
 INC.
 12 COUNT ROAD 486
 HANCEVILLE, AL 35077



CAGE code: 1VNC4 2/

1/ Information published in this revision was verified by direct contact with manufacturers.

2/ Information not verified to be current, no response from manufacturer. Information identical to that published in MIL-HDBK-57, Revision B.

MIL-HDBK-57C(IS)

THOMAS MFG, INC.
25125 W OUTER DR
MELVINDALE, MI 48122

THOMAS

CAGE code: 0NWS1 2/

TITAN FASTENER
10031 HOLLY ROAD
HOLLY, MI 48442

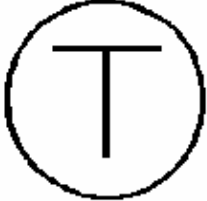

CAGE code: 2/

TOG MANUFACTURING CO., INC.
1454 SOUTH STATE STREET
NORTH ADAMS, MA 01247



CAGE code: 63649 1/

TOKOSHA METAL WORKS LTD.
NO. 7-22, 3-CHROME, NAKAGAMA-NISHI,
IKUNO-KU, OSAKA, JAPAN

TKS

CAGE code: 2/

TOOLEX, INC.
7570 MORLEY STREET
HOUSTON, TX 77061



CAGE code: 1W383 2/

TOPURA CO., LTD.
2050 YAJOI-CHO
HIGASHIOSAKA-SHI,
OSAKA, JAPAN 579

Plant
201 SOYA, HATANO,
KANAGAWA 257 JAPAN

TOPURA

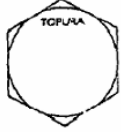

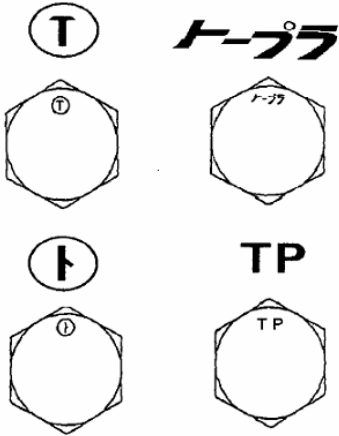





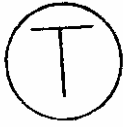
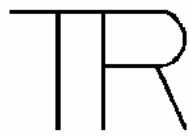

CAGE code: 2/

1/ Information published in this revision was verified by direct contact with manufacturers.

2/ Information not verified to be current, no response from manufacturer. Information identical to that published in MIL-HDBK-57, Revision B.

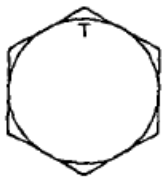



MIL-HDBK-57C(IS)

<p>TORCO, INC. P. O. BOX 4070 1330 OLD HIGHWAY 41 MARIETTA, GA 30061</p>  <p>CAGE code: 07359 <u>2/</u></p>	<p>TOWNE ROBINSON FASTENER CO. KEY MANUFACTURING GROUP, INC. P.O. BOX 232 24175 NORTHWESTERN HWY. SOUTHFIELD, MI 48037</p> <p>Plant 4401 WYOMING AVE. P.O. BOX 188 DEARBORN, MI 48121</p>  <p>CAGE code: 94678 <u>2/</u></p>
<p>TORONTO FASTENERS INDUSTRIES, INC. (SUBSIDIARY OF HI-SHEAR CORP., USA) 7475 KIMBEL ST., UNIT 8 MISSISSAUGA, ONTARIO L5S1E7</p> <p>See HI-SHEAR</p> <p>Plant 19 CONSTELLATION CT. REXDALE, ONTARIO, CANADA M9W 1K4</p>  <p>CAGE code: <u>2/</u></p>	<p>TOWNSEND CO. CERRY RIVET DIVISION 1224 E. WARNER AVE. SANATA ANA, CA 92701</p> <p> Aircraft blind rivets.  Aircraft lockbolts.</p> <p>CAGE code: 7H092 <u>2/</u></p>
<p>TORX PRODUCTS (CAMCAR DIVISION OF TEXTRON INC.) P. O. BOX 607 HWY 31 N. ROCHESTER, IN 46975</p> <p>For head markings see:</p> <p>CAMCAR Division of Textron, Inc. Plant TORX Products</p> <p>CAGE code: 6N040 <u>2/</u></p>	<p>TOYO STEEL WIRE CO., LTD. 3-9-45 TSURUHARA IZUMISANO-SHI, OSAKA, 598 JAPAN</p>   <p>CAGE code: <u>1/</u></p>

1/ Information published in this revision was verified by direct contact with manufacturers.

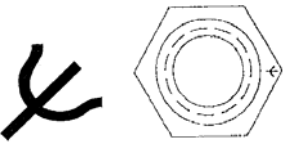
2/ Information not verified to be current, no response from manufacturer. Information identical to that published in MIL-HDBK-57, Revision B.

MIL-HDBK-57C(IS)

<p>TRI STATE TOOL & DIE CO. 1396 NORTON RD STOW, OH 44224-1333</p>  <p>BRAND AT ONE CORNER</p> <p>CAGE code: 06RM8 <u>1/</u></p>	<p>TRIUMPH GROUP OPERATIONS INC, THE (FRISBY AEROSPACE INC DE) 417 S. MAIN ST. FREEPORT, NY 11520-5144</p> <p>Ssee FRISBY AEROSPACE INC DE</p> <h1 style="text-align: center;">FAH</h1> <p>CAGE code: 26437 <u>2/</u></p>
<p>TRIAD PRODUCTS CORP. 15241 N.E. 92ND REDMOND, WA 98052</p>  <p>CAGE code: 74468 <u>2/</u></p>	<p>TRIUMPH MANUFACTURING CO., INC. P.O. BOX 380148 750 TOLLAND ST. EAST HARTFORD, CT 06138</p> <h1 style="text-align: center;">TRI</h1> <p>CAGE code: 8X098 <u>2/</u></p>
<p>TRIDAIR PRODUCTS AFS TORRANCE OPERATIONS 3000 WEST LOMITA BLVD. TORRANCE, CA 90505-5103</p> <p>(Corporate office see ALCOA FASTENING SYSTEMS)</p>  <p>CAGE code: 29372 <u>1/</u></p>	<p>TRONSON MANUFACTURING 45383 INDUSTRIAL PLACE #41 FREEMONT, CA 94538</p> <h1 style="text-align: center;">TM</h1> <p>CAGE code: 1DPK8 <u>2/</u></p>
<p>TRIDENT MACHINE CO. 3491 N. MERIDIAN ROAD ROCKFORD, IL 61101</p>  <p>CAGE code: 5N818 <u>1/</u></p>	<p>TROY D. RAY DBA DIXON MACHINE & FABRICATION 6807 CHAPMAN HWY. KNOXVILLE, TN 37920-6560</p> <h1 style="text-align: center;">DMT</h1> <p>CAGE code: 1DEP3 <u>2/</u></p>

1/ Information published in this revision was verified by direct contact with manufacturers.

2/ Information not verified to be current, no response from manufacturer. Information identical to that published in MIL-HDBK-57, Revision B.

MIL-HDBK-57C(IS)

TRW
(FASTENER DIVISION)
265 THIRD STREET
CAMBRIDGE, MA 02142

PAL

Logo Stampings Used on
Brass Snap Fastener Components

 Part No. 15100

 Part No. 16506

 Part Nos. 10412 and 10413

 Part Nos. 10224, 12206, 10412, 10413, 10414, 90307

 Part Nos. 16205 and 16206

CAGE code: 83058 2/

TRY - AZTEC COMPANY
P.O. BOX 6191
TEHACHAPI, CA 93561

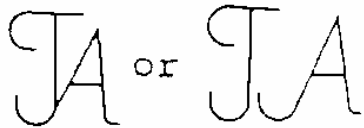

CAGE code: 2/

TUFF FASTENERS CO.
10724 GARWICK PLACE
SOUTH GATE, CA 90280-7332

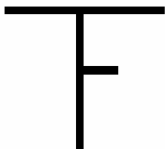

CAGE code: 5V629 2/

TURNAMICS, INC.
92 NEW LIECHESTER HWY
ASHVILLE, NC 28806



CAGE code: 1CWU8 2/

TW DESIGN AND MANUFACTURING, L.L.C.
P. O. BOX 310
33 WEST STREET
MONTELLO, WI 53949



CAGE code: 0X311 2/

TWIST TITE MFG. INC.
13649 PUMICE STREET
SANTA FE SPRINGS, CA 90670

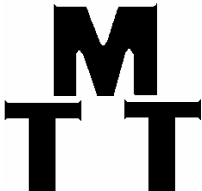







CAGE code: 007R1 1/

1/ Information published in this revision was verified by direct contact with manufacturers.

2/ Information not verified to be current, no response from manufacturer. Information identical to that published in MIL-HDBK-57, Revision B.



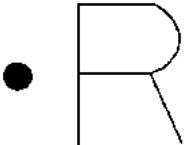

MIL-HDBK-57C(IS)

<p>U.P. MACHINE & ENGINEERING CO. P.O. BOX 400 210 NORTH THIRD STREET POWERS, MI 49874</p> <p style="text-align: center;">UPME</p> <p>CAGE code: 5H091 <u>2/</u></p>	<p>ULTRA SONIC MACHINE CO., INC. 1313 WEST 135TH STREET GARDENA, CA 90247</p> <div style="display: flex; justify-content: space-around; align-items: center;"> <div style="text-align: center;"></div> <div style="text-align: center;"></div> </div> <div style="display: flex; justify-content: space-around; align-items: center; margin-top: 20px;"> <div style="text-align: center;"></div> <div style="text-align: center;"></div> </div> <p>CAGE code: 4F713 <u>2/</u></p>
<p>U.S. BOLT MANUFACTURING, INC. 12895 SOUTH MAIN HOUSTON, TX 77035</p> <div style="text-align: center;"></div> <p>CAGE code: 0UZJ8 <u>2/</u></p>	<p>UMPCO CORP. P.O. BOX 5158 7100 LAMPSON AVE. GARDEN GROVE, CA 92841</p> <div style="text-align: center;"></div> <p>CAGE code: 18076 <u>2/</u></p>
<p>ULTIMATE MACHINING & WELDING 1003 ARGUELLO STREET REDWOOD CITY, CA 94063</p> <div style="text-align: center;"></div> <p>CAGE code: OXXP2 <u>2/</u></p>	<p>UNIFLOW CORP. P.O. BOX 705 26600 HEYN DRIVE NEW HAVEN, MI 48050</p> <div style="text-align: center;"></div> <p>CAGE code: 4S622 <u>2/</u></p>

1/ Information published in this revision was verified by direct contact with manufacturers.

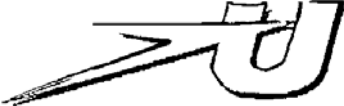
2/ Information not verified to be current, no response from manufacturer. Information identical to that published in MIL-HDBK-57, Revision B.



MIL-HDBK-57C(IS)

<p>UNIMETERIC CORPORATION P.O. BOX 4529 5 TRIPPS LANE EAST PROVIDENCE, RI 02915</p> <p style="text-align: center;">U</p> <p>CAGE code: 7U319 <u>2/</u></p>	<p>UNITED DRILL BUSHING CORP. 12200 WOODRUFF AVE DOWNEY, CA 90241</p> <p style="text-align: center;"></p> <p>CAGE code: 52369 <u>2/</u></p>
<p>UNISTRUT CORP. (UNISTRUT PHILA) 761 FIFTH AVE KING OF PRUSSIA, PA 19406</p> <p style="margin-left: 40px;">Plant UNISTRUT CORP. WAYNE MFG. DIV. 35660 CLINTON WAYNE, MI 48184</p> <p style="text-align: center;">UNISTRUT </p> <p>CAGE code: 96195 <u>2/</u></p>	<p>UNITED PRECISION PRODUCTS CO., INC. 25040 VAN BORN ROAD DEARBORN HEIGHTS, MI 48125</p> <p style="text-align: center;">UP</p> <p>CAGE code: 17328 <u>1/</u></p>
<p>UNITED BOLT & SCREW CORP. 1055 HAGGERTY AVE. DEARBORN, MI 48126</p> <p style="text-align: center;"> </p> <p>CAGE code: 8G949 <u>2/</u></p>	<p>UNITED STATES DEFENSE RESEARCH & SUPPLY 311 EASTRIDGE ROAD GRANDBURY, TX 76049</p> <p style="text-align: center;"></p> <p>CAGE code: 0XVD5 <u>2/</u></p>

1/ Information published in this revision was verified by direct contact with manufacturers.

2/ Information not verified to be current, no response from manufacturer. Information identical to that published in MIL-HDBK-57, Revision B.



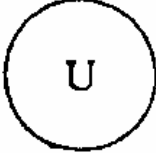
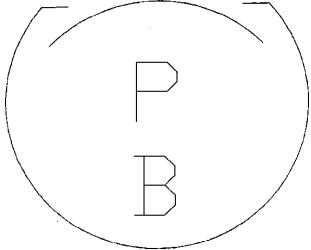
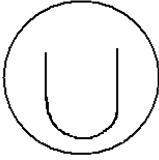





MIL-HDBK-57C(IS)

<p>UNITED STEEL & FASTENERS INC. 1500 INDUSTRIAL DRIVE ITASCA, IL 60143</p> <p style="text-align: center;">S^UF </p> <p>Identification used on all large bolts S^UF ▲</p> <p>Identification used on all small bolts and on the shoulders of nuts ▲</p> <p>CAGE code: 2R938 1/</p>	<p>URANIA ENGINEERING CO., INC. SPEC-NUT® 198 SOUTH POPLAR STREET HAZLETON, PA 18201</p> <p style="text-align: center;"></p> <p>CAGE code: 30279 2/</p>
<p>UNIVERSAL MACHINE PRODUCTS 480 SURF AVENUE STRATFORD, CT 06497</p> <p style="text-align: center;">UM</p> <p>CAGE code: 0Y156 2/</p>	<p>URBAN MANUFACTURING CO. P.O. BOX 4260 100 W. BERKLEY ST PHILADELPHIA, PA 19144</p> <p style="text-align: center;"></p> <p>CAGE code: OW5R7 2/</p>
<p>UPB ENGINEERING 13060 TOM WHITE WAY "UNIT F" NORWALK, CA 90650</p> <p style="text-align: center;"></p> <p>CAGE code: 1BER9 2/</p>	<p>URBAN MFG. CO. INC. P.O. BOX 1070 529 FORREST AVE. DREXEL HILL, PA 19026</p> <p style="text-align: center;"></p> <p>CAGE code: 9Y188 2/</p>

1/ Information published in this revision was verified by direct contact with manufacturers.

2/ Information not verified to be current, no response from manufacturer. Information identical to that published in MIL-HDBK-57, Revision B.







MIL-HDBK-57C(IS)

<p>US TOOL & DIE 23282 VERDUGO DR LAGUNA HILLS, CA 92653-1335</p>  <p>CAGE code: 3LJM2 <u>1/</u></p>	<p>VALLEY-TODECO 12975 BRADLEY AVE. SYLMAR, CA 91342</p>  <p>CAGE code: 06710 <u>1/</u></p>
<p>UTAH TOOL & DIE, INC. P.O. BOX 969 850 NO WESTERN PRECISION PARKWAY WEST JORDAN, UTAH 84084</p>  <p>CAGE code: 23509 <u>2/</u></p>	<p>VAN PETTY MFG., INC. DBA J.W. MANUFACTURING INC 2517 AZURITE CIRCLE NEWBURY PARK, CA 91320</p>  <p>CAGE code: 23899 <u>1/</u></p>
<p>VALCOR ENGINEERING CORP. 2 LAWRENCE ROAD SPRINGFIELD, NJ 07081</p>  <p>CAGE code: 96487 <u>2/</u></p>	<p>V-B MACHINE CO., INC. FASTENER DIVISION 1645 W. 135TH STREET GARDENA, CA 90249</p>  <p>CAGE code: 60682 <u>2/</u></p>
<p>VALLEY FORGE AND BOLT MFG CO. 1825 S. 27th AVENUE PHOENIX, AZ 85009-6417</p>  <p>CAGE code: 02UA5 <u>1/</u></p>	<p>VEGAS FASTENER MANUFACTURING 3873 W. OQUENDO ROAD LAS VEGAS, NV 89118</p>  <p>CAGE code: 1U1Z3 <u>2/</u></p>

1/ Information published in this revision was verified by direct contact with manufacturers.

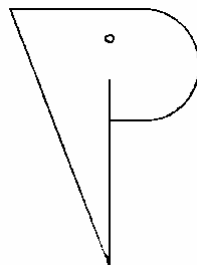
2/ Information not verified to be current, no response from manufacturer. Information identical to that published in MIL-HDBK-57, Revision B.

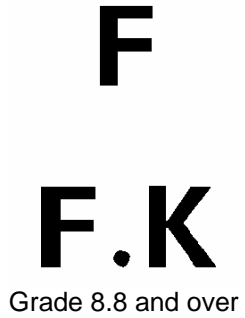
MIL-HDBK-57C(IS)



<p>VENUS FASTENERS CORP. 154 MERRICK RD FREEPORT, NY 11520</p>  <p>CAGE code: 045B2 <u>2/</u></p>	<p>VICTOR PRODUCTS CORP. 2635 WEST BELMONT CHICAGO, IL 60618</p>  <p>CAGE code: 63045 <u>2/</u></p>
<p>VERSATECH, INC. P.O. BOX 608 6012 ENTERPRISE DR., WESTMORELAND INDUSTRIAL PARK III EXPORT, PA 15632</p>  <p>CAGE code: 0CHD0 <u>2/</u></p>	<p>VIP MFG. & ENGR. CORP. 1084 MARTIN AVE. SANTA CLARA, CA 95050</p>  <p>CAGE code: 8M774 <u>1/</u></p>
<p>VERTEX DISTRIBUTION P. O. BOX 879 327 PINE STREET PAWTUCKET, R 02860</p> <p>(see BELL FASTENERS)</p>  <p>CAGE code: <u>1/</u></p>	<p>VISSERIES & BOULONNERIES DE FOURMIES 2 RUE DU CHAUFFOUR FOURMIES, FRANCE 69610</p>  <p>CAGE code: F8388 <u>2/</u></p>
<p>VICO PRODUCTS, CO. 41555 E. ANN ARBOR ROAD PLYMOUTH, MI 48170</p>  <p>The "V" is either raised or indented.</p> <p>CAGE code: 0CG15 <u>2/</u></p>	

1/ Information published in this revision was verified by direct contact with manufacturers.

2/ Information not verified to be current, no response from manufacturer. Information identical to that published in MIL-HDBK-57, Revision B.

MIL-HDBK-57C(IS)

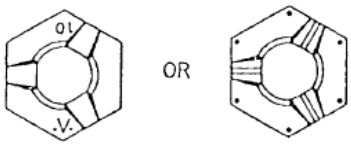
<p>VISTEK INDUSTRIES 153 RAILROAD DR IVYLAND, PA 18974-1448</p>  <p>CAGE code: 79735 2/</p>
<p>VITCO NUCLEAR PRODUCTS INC. 8171 TYLER BLVD MENTOR, OH 44060</p>  <p>CAGE code: 9L424 2/</p>
<p>VM MANUFACTURING CORP. 1536 RAILROAD AVENUE HOLBROOK, NY 11741-2301</p>  <p>CAGE code: 1NUW9 1/</p>

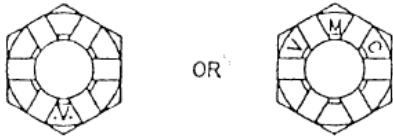
<p>VMC INDUSTRIES, INC. 20 CORPORATE DRIVE AUBURN HILLS, MI 48326</p> <p style="text-align: center;">.V. OR VMC</p> <p style="text-align: center;"><u>FEMALE FASTENERS</u></p> <p style="text-align: center;"><u>PREVAILING TORQUE NUTS</u></p> <div style="text-align: center;">  </div> <p style="text-align: center;">.V. OR TWO LINES IN THREE PADS WITH APPROPRIATE GRADE OR CLASS MARKINGS</p> <p style="text-align: center;"><u>INSERT TYPE</u></p> <p style="text-align: center;"><u>PREVAILING TORQUE NUTS</u></p> <div style="text-align: center;">  </div> <p style="text-align: center;">TAN NYLON IDENTIFIES VMC AS MANUFACTURER WITH APPROPRIATE GRADE OR CLASS MARKINGS</p> <p style="text-align: center;"><u>SLOTTED NUTS</u></p> <div style="text-align: center;">  </div> <p style="text-align: center;">.V. OR VMC WITH APPROPRIATE GRADE OR CLASS MARKINGS</p> <p>CAGE code: 0SFN8</p> <p>Continued 2/</p>
--

1/ Information published in this revision was verified by direct contact with manufacturers.

2/ Information not verified to be current, no response from manufacturer. Information identical to that published in MIL-HDBK-57, Revision B.

MIL-HDBK-57C(IS)

Continued

VMC INDUSTRIES, INC.

FEMALE FASTENERS (CONT.)

NUT & WASHER ASSEMBLY

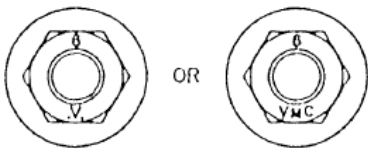

OR

“.V.” OR “VMC” WITH APPROPRIATE GRADE OR CLASS MARKINGS

FLANGE NUTS

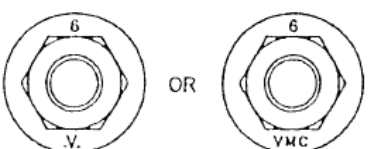

OR

“.V.” OR “VMC” WITH APPROPRIATE GRADE OR CLASS MARKINGS

HEX NUTS

ENGLISH

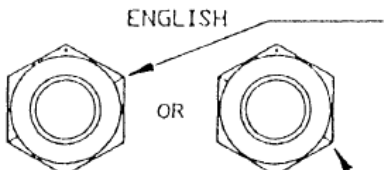

OR

GRADE 5 PER SAE J995
GRADE 8 PER SAE J995

ONE RADIAL LINE FOR MFG. ID., 180° FROM RADIAL LINE IN THE GRADE ID.

METRIC

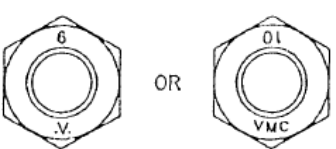

OR

CLASS 9 CLASS 10

“.V.” OR “VMC” WITH APPROPRIATE GRADE OR CLASS MARKINGS

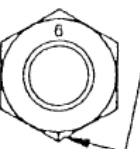

ONE RADIAL LINE 180° FROM APPROPRIATE GRADE OR CLASS MARKINGS

CAGE code: 0SFN8 2/

Continued

Continued

VMC INDUSTRIES, INC.

FEMALE FASTENERS (CONT.)

OTHER TYPE NUTS

WHEEL NUTS, HEX AND SQUARE WELD NUTS AND OTHER TYPE NUTS NOT SPECIFIED.
“.V.” OR “VMC” WITH APPROPRIATE GRADE OR CLASS MARKINGS

MALE FASTENERS

SOCKET HEADS

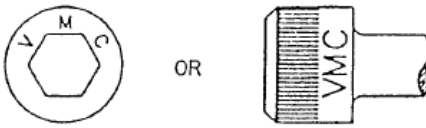

OR

HEX HEADS

INDENTED, TRIMMED, WASHER OR FLANGED.

METRIC

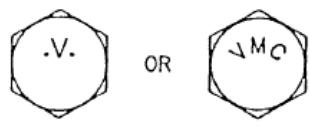

OR

ENGLISH

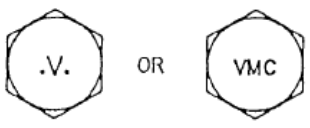

OR

“.V.” OR “VMC” WITH APPROPRIATE GRADE OR CLASS MARKINGS

CAGE code: 0SFN8 2/

1/ Information published in this revision was verified by direct contact with manufacturers.

2/ Information not verified to be current, no response from manufacturer. Information identical to that published in MIL-HDBK-57, Revision B.



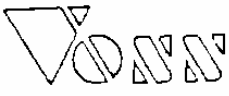





MIL-HDBK-57C(IS)

<p>VOI-SHAN PRODUCTS AFS TORRANCE OPERATIONS 3000 WEST LOMITA BLVD. TORRANCE, CA 90505-5103 CAGE code: 5M902</p> <p style="text-align: center;">VS</p> <p>AFS COI OPERATIONS 135 N. UNRUH AVE. CITY OF INDUSTRY, CA 91744 CAGE code: 06950, IRC86</p> <p style="text-align: center;">VS O SC</p> <p>AFS HILDESHEIM OPERATIONS STEVEN 3 31135 HILDESHEIM-BEVENSTEDT, GERMANY CAGE code: C4293</p> <p style="text-align: center;">VS</p> <p>(Corporate office see ALCOA FASTENING SYSTEMS)</p> <p>CAGE code: 5M902, 06950, IRC86, C4293 <u>1/</u></p>	<p>VSI AEROSPACE PRODUCTS DIVISION 557 S. DOUGLAS ST. EL SEGUNDO, CA 90245</p> <p style="text-align: center;">Plant VOI-SHAN DIVISION 4001 INGLEWOOD AVE. REDONDO BEACH, CA 90278</p> <p style="text-align: center;">VS</p> <p>CAGE code: 6A768 <u>2/</u></p>
<p>VOSS INDUSTRIES, INC. VOSS AEROSPACE DIVISION 2168 WEST 25TH STREET CLEVELAND, OH 44113</p> <p style="text-align: center;"></p> <p style="text-align: center;">E A</p> <p style="text-align: center;">V</p> <p>CAGE code: 14242 <u>1/</u></p>	<p>VULCAN RIVET & BOLT CORP. P.O. BOX 170129 BIRMINGHAM, AL 35217</p> <p style="text-align: center;">V.</p> <p style="text-align: center;"><small>All fasteners marked with the letter "V" followed by a period (.)</small></p> <p style="text-align: center;"><u>V.</u></p> <p style="text-align: center;"><small>Fasteners manufactured from special alloy steels are identified with the letter "V" followed by a period (.) and a line under the letter "V"</small></p> <p style="text-align: center;">304</p> <p style="text-align: center;">V.</p> <p style="text-align: center;"><small>Stainless steel fasteners are marked with the letter "V" followed by a period (.) with the type of stainless</small></p> <p>CAGE code: 0GEW3 <u>2/</u></p>
<p>WALKER BOLT MANUFACTURING CO., INC. DIVISION OF LONE STAR FASTENERS, LP P.O. BOX 1149 10202 AIRLINE CRIVE HOUSTON, TX 77037</p> <p style="text-align: center;">WB</p> <p>CAGE code: 39782 <u>1/</u></p>	

1/ Information published in this revision was verified by direct contact with manufacturers.

2/ Information not verified to be current, no response from manufacturer. Information identical to that published in MIL-HDBK-57, Revision B.



MIL-HDBK-57C(IS)

<p>WALZ & KRENZER INC DBA MAPECO PRODUCTS DIV MAPECO PRODUCTS 91 WILLENBROCK RD STE B4 OXFORD, CT 06478-1036</p>  <p>CAGE code: 87045 <u>2/</u></p>	<p>WEAVER MANUFACTURING, INC. 1005 E. 17TH STREET WICHITA, KS 67214</p>  <p>CAGE code: 16345 <u>2/</u></p>
<p>WARREN PUMPS LLC. (DIVISION OF COLFAX CORPORATION) P.O. BOX 969 82 BRIDGES AVENUE WARREN, MA 01083</p>  <p>CAGE code: 63857 <u>1/</u></p>	<p>WEBLUK MACHINE CORP. 4959 COMMERCE PARKWAY WARRENSVILLE HEIGHTS, OH 44128</p>  <p>CAGE code: 0C095 <u>2/</u></p>
<p>WATERBURY BUCKLE CO. 952 S. MAIN STREET WATERBURY, CT 06721</p>  <p>CAGE code: 82399 <u>2/</u></p>	<p>WELTER GMBH & CO. KG BONNER RING 49 P. O. BOX 1311 ERFTSTADT, GERMANY 50374</p>  <p>CAGE code: C3486 <u>2/</u></p>
<p>WAYNE BOLT & NUT CO., INC. 14471 LIVERNOIS AVE. DETROIT, MI 48238-2097</p>  <p>CAGE code: 5Z751 <u>1/</u></p>	<p>WELTON ROLLED THREAD CORP. 1818 GLENDALE BLVD LOS ANGELES, CA 90026</p>  <p>CAGE code: 27871 <u>2/</u></p>

1/ Information published in this revision was verified by direct contact with manufacturers.

2/ Information not verified to be current, no response from manufacturer. Information identical to that published in MIL-HDBK-57, Revision B.



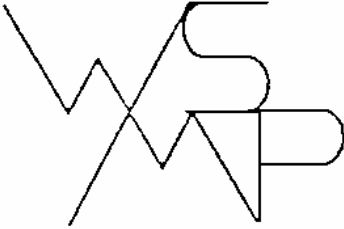





MIL-HDBK-57C(IS)

<p>WESLOK (DIVISION OF FALL RIVER MANUFACTURING) 4160 S. 13TH STREET MILWAUKEE, WI 53221</p> <p style="text-align: center;">WESLOK</p> <p>CAGE code: <u>2/</u></p>	<p>WESTERN PACIFIC ENTERPRISES, W.P.E. INC. 8110 REMMET AVE. CANOGA PARK, CA 91304</p> <p style="text-align: center;"></p> <p>CAGE code: 5N444 <u>1/</u></p>
<p>WEST COAST AEROSPACE, INC. 24224 BROAD STREET CARSON, CA 90745</p> <p style="padding-left: 40px;">Plant 220 WEST E. STREET WILMINGTON, CA 90744</p> <p style="text-align: center;"></p> <p>CAGE code: 60516 <u>1/</u></p>	<p>WESTERN SCREW MACHINE PRODUCTS, INC. (CUTTING EDGE MACHINING) 1625 LINDA WAY SPARKS, NV 89431</p> <p style="text-align: center;"></p> <p>CAGE code: OZV72 <u>2/</u></p>
<p>WEST TENNESEE LIONS BLIND IND. INC. P.O. BOX 2175 346 ST PAUL AVENUE MEMPHIS, TN 38101-2175</p> <p>(See A P MILLS INDUSTRIES FOR THE BLIND)</p> <p style="text-align: center;">APMI</p> <p>CAGE code: 6Y776 <u>2/</u></p>	<p>WESTERN SKY INDUSTRIES, INC. (DIVISION OF ATLAS CORP.) 21300 CLOUDWAY HAYWARD, CA 94545</p> <p style="text-align: center;">WSI</p> <p>CAGE code: 04169 <u>2/</u></p>

1/ Information published in this revision was verified by direct contact with manufacturers.

2/ Information not verified to be current, no response from manufacturer. Information identical to that published in MIL-HDBK-57, Revision B.





MIL-HDBK-57C(IS)

<p>WESTFIELD FASTENERS 202 UNION STREET WESTFIELD, MA 01085</p>  <p>CAGE code: <u>1/</u></p>	<p>WHELAN MACHINE & TOOL CO. 134 ROCHESTER DR LOUISVILLE, KY 40214-2681</p>  <p><small>Aerial-Bold letter "W" enclosed with a circle</small></p> <p>CAGE code: 0MB07 <u>1/</u></p>
<p>WESTLAND STEEL PRODUCTS, LTD. P. O. BOX 1052 165 CORDITE ROAD WINNIPEG, MANITOBA, CANADA R3C 2X4</p>  <p>CAGE code: 0NWX5 <u>2/</u></p>	<p>WHITNEY SCREW CORP. P.O. BOX 784 14A BROAD STREET NASHUA, NH 03061</p>  <p>CAGE code: 87181 <u>2/</u></p>
<p>WESTWOOD PRECISION, INC. 7509 HARDESON ROAD EVERETT, WA 98203</p>  <p>CAGE code: 0PL34 <u>1/</u></p>	<p>WHITTET-HIGGINS CO. 33 HIGGINSON AVE. CENTRAL FALLS, RI 02863</p>  <p>CAGE code: 79568 <u>2/</u></p>
<p>WHAIL BOLT IND. CO., LTD 779-2, WONSI-DONG, ANSAN KYUGKI-DO, KOREA</p>  <p>GRADE 5 HEX CAP SCREWS GRADE 8 HEX CAP SCREWS</p> <p>CAGE code: <u>2/</u></p>	<p>WIGLEY MACHINE COMPANY 2007 WEST 2ND AVENUE CORSICANA, TX 75110</p>  <p>CAGE code: 0UBT5 <u>2/</u></p>

1/ Information published in this revision was verified by direct contact with manufacturers.

2/ Information not verified to be current, no response from manufacturer. Information identical to that published in MIL-HDBK-57, Revision B.

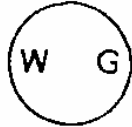
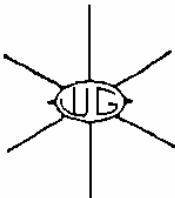
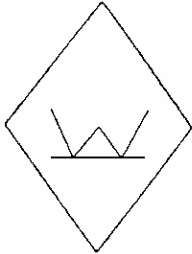

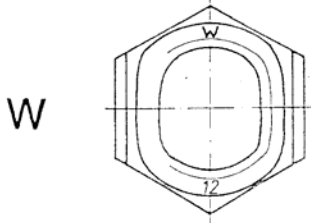

MIL-HDBK-57C(IS)

<p>WILHELM SCHUMACHER SCHRAUBEN-FABRIK GmbH POSTFACH 12 80, AM PREIST 5 D-5912 HILCHENBACH, GERMANY</p> <p> Hex head screws and bolts  Machine screws and other products</p> <p>CAGE code: _____ <u>2/</u></p>	<p>WILSON-GARNER CO. 40935 PRODUCTION DR HARRISON TOWNSHIP, MI 48045-1351</p> <p></p> <p></p> <p>CAGE code: 7E548 <u>1/</u></p>
<p>WILLIAM'S MACHINE & FABRICATION, INC. P.O. BOX 22235 700 DELAY DRIVE EUGENE, OR 97402</p> <p></p> <p>CAGE code: 0NNK2 <u>2/</u></p>	<p>WILT PRECISION PRODUCTS P.O. BOX 69 DOVER, PA 17315</p> <p></p> <p>CAGE code: 34282 <u>2/</u></p>
<p>WIL-NIC (E D R INDUSTRIES INC) DBA WIL-NICO 100 COMMERCIAL STREET FREEPORT, NY 11520-2832</p> <p></p> <p>CAGE code: 8P827 <u>2/</u></p>	<p>WINKER HERMAN GMBH & CO. KG METALLWARENFABRIK P.O. BOC 1356 DELLINGER WEG 1 SPAICHINGEN, 78549 GERMANY</p> <p></p> <p>CAGE code: D2362 <u>2/</u></p>

1/ Information published in this revision was verified by direct contact with manufacturers.

2/ Information not verified to be current, no response from manufacturer. Information identical to that published in MIL-HDBK-57, Revision B.

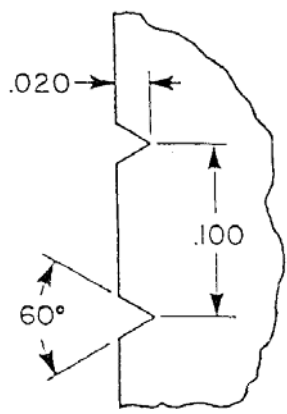

MIL-HDBK-57C(IS)

<p>WINSLOW AUTOMATICS, INC. 23 ST. CLAIR AVENUE NEW BRITAIN, CT 06051</p>  <p>CAGE code: 7W515 <u>1/</u></p>	<p>WOLTERS GMBH OTTILIENSTR 19 D-GUTERSLOH WEST GERMANY</p>  <p>WH LE</p> <p>CAGE code: <u>2/</u></p>
<p>WODIN, INC. 5441 PERKINS ROAD BEDFORD HEIGHTS, OH 44146</p>  <p>CAGE code: 5V334 <u>1/</u></p>	<p>WOLVERINE MACHINE PRODUCTS CO. P.O. BOX 209 319 COGSHALL ST. HOLLY, MI 48442</p>  <p>CAGE code: 2T549 <u>2/</u></p>
<p>WOLSTENHOLME MACHINE (DBA WM ROBOTS) 3075 ADVANCE LANE COLMAR, PA 18915-9420</p>  <p>CAGE code: 68531 <u>1/</u></p>	

1/ Information published in this revision was verified by direct contact with manufacturers.

2/ Information not verified to be current, no response from manufacturer. Information identical to that published in MIL-HDBK-57, Revision B.

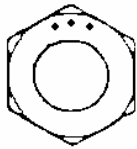
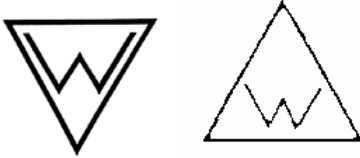

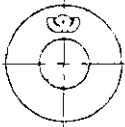
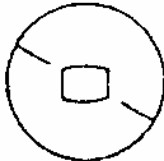



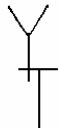

MIL-HDBK-57C(IS)

<p>WOLVERINE NUT CO. 6556 EAST McNICHOLS DETROIT, MI 48212</p>  <p>3 dots, centered on corner, equally spaced</p> <p>CAGE code: 87824 <u>2/</u></p>	<p>WYANDOTTE INDUSTRIES, INC. 4625 13TH STREET WYANDOTTE, MI 48192</p>  <p>CAGE code: 54151 <u>1/</u></p>
<p>WORTHEY MACHINE P. O. BOX 70 3000 US HWY 72 E PAINT ROCK, AL 35764-0070</p> <p>WSMP</p> <p>CAGE code: 5S740 <u>2/</u></p>	<p>WYNNSON ENTERPRISES, INC. P. O. BOX 440 12039 HWY 239-431 N. MERIDIANVILLE, AL 35759-1201</p>  <p>CAGE code: 39484 <u>1/</u></p>
<p>WROUGHT WASHER MANUFACTURING INC. 2100 SOUTH BAY STREET MILWAUKEE, WI 53207</p>  <p>Marking for medium carbon heat treated washers compatible with Grade 5 and Grade 8 bolts.</p>  <p>Marking for low carbon washers.</p> <p>CAGE code: 79807 <u>2/</u></p>	<p>XCEL MFG., INC. P.O. BOX 239 ELYRIA, OH 44036</p>  <p>CAGE code: <u>2/</u></p> <p>Y2K MACHINE SHOP 106 WALSH ROAD SAN ANTONIO, TX 78224</p> <p>Y 2 K</p> <p>CAGE code: 1TMD7 <u>1/</u></p>

1/ Information published in this revision was verified by direct contact with manufacturers.

2/ Information not verified to be current, no response from manufacturer. Information identical to that published in MIL-HDBK-57, Revision B.

MIL-HDBK-57C(IS)

<p>YATES TOOL, INC. 2425 MEDINA ROAD MEDINA, OH 44256</p>  <p>Either electroetched, steel stamped, vibropeened, or ink stamped</p> <p>CAGE code: IDV02 2/</p>	<p>ZAMON CO., INC. ENDICOTT ST., BLDG. 23 NORWOOD, MA 02062</p>  <p>CAGE code: 5Z471 2/</p>
<p>YOUNG ENGINEERS INC, THE 25841 COMMERCENTRE DRIVE LAKE FOREST, CA 92630-8812</p>  <p>CAGE code: 56958 1/</p>	<p>ZENEX CORPORATION 850 ELMHURST RD. ELK GROVE VILLAGE, IL 60007</p>  <p>CAGE code: 25723 2/</p>
<p>YOW MENG I INDUSTRIAL CO., LTD. NO. 180 WUN-AN RD., EAST SEC. MI-TUO HSIANG 82704 KAOHSIUNG HSIEN, TAIWAN, R.O.C.</p>  <p>CAGE code: 2/</p>	<p>ZERO PRODUCTS, INC. 219 BAYWOOD ST HOUSTON, TEXAS 77011</p>   <p>CAGE code: 3JC57 2/</p>
<p>Z & B GENERAL MACHINE 569 HULMEVILLE AVE. PENNDL, PA 19047</p>  <p>CAGE code: 5T735 2/</p>	

1/ Information published in this revision was verified by direct contact with manufacturers.

2/ Information not verified to be current, no response from manufacturer. Information identical to that published in MIL-HDBK-57, Revision B.

MIL-HDBK-57C(IS)

PAGE LEFT INTENTIONALLY BLANK.

1/ Information published in this revision was verified by direct contact with manufacturers.

2/ Information not verified to be current, no response from manufacturer. Information identical to that published in MIL-HDBK-57, Revision B.

MIL-HDBK-57C(1S)

MIL-HDBK-57 FASTENER IDENTIFICATION SYMBOL CONFIRMATION

Complete this form and email to emelia.altomari@dla.mil , along with a separate PDF file containing artwork of your fastener headmarking.

(Company name as it will appear in the listing) _____

(Department, Division, etc., if it is to appear in the listing)

Corporate/Mailing Address	Plant Location (if different)
_____	_____
_____	_____
_____	_____
_____	_____

Our Company is a fastener manufacturer YES () NO ()

NOTE: MIL-HDBK-57 requires the sources listed to have an inherent capability to manufacture fasteners out of raw material.

Telephone: _____ FAX Number: _____

Contact Name: _____ CAGE code: _____

Title: _____ DUNS Number: _____

Email: _____ Website URL: _____

1. Fastener headmarking artwork that is submitted electronically shall be provided in a PDF file. A resolution of 100 dpi (dots per inch) minimum shall be used for artwork that is scanned. Provide only one marking per file submitted. Include the company name and plant location in this file, along with a written description of the fastener headmarking. (For example "the script upper case letter A", or "the number 3 enclosed by a circle.")
2. If your company has plants in various locations, please provide DSCP-ITA with the symbol(s) used for each location, as well as the CAGE code, point of contact, and phone number for each point of contact.
3. All information must be supplied in the English language.
4. Submit this form and artwork to emelia.altomari@dla.mil

NOTE: We encourage you to duplicate this form and forward it to your various plants, as necessary.

SUBMITTED BY: _____

TITLE: _____

DATE (mm/dd/yyyy): _____

PLEASE SUBMIT LOGO (HEAD MARKING) ON A SEPARATE SHEET.

MIL-HDBK-57C(IS)

PAGE LEFT INTENTIONALLY BLANK

1/ Information published in this revision was verified by direct contact with manufacturers.

2/ Information not verified to be current, no response from manufacturer. Information identical to that published in MIL-HDBK-57, Revision B.

MIL-HDBK-57C(IS)

Preparing Activity:
DLA-IS

(Project No. 53GP-2007-001)

NOTE: The activities listed above were interested in this document as of the date of this document. Since organizations and responsibilities can change, you should verify the currency of the information above using the ASSIST Online database at <http://assist.daps.dla.mil>

¹/ Information published in this revision was verified by direct contact with manufacturers.

²/ Information not verified to be current, no response from manufacturer. Information identical to that published in MIL-HDBK-57, Revision B.